

# POPULAR MECHANICS

## MAGAZINE

UNDERSTAND IT

PRINTED IN U.S.A.



*Volkswagen Camp Car  
—Page 84*

What Can We Do About Smog?  
 READ WHAT OWNERS SAY ABOUT  
 THE '55 FORD

*For the Craftsman*  
 GARAGE DOOR OPENER YOU CAN BUILD

Copyrighted material

# FIRST CHOICE!

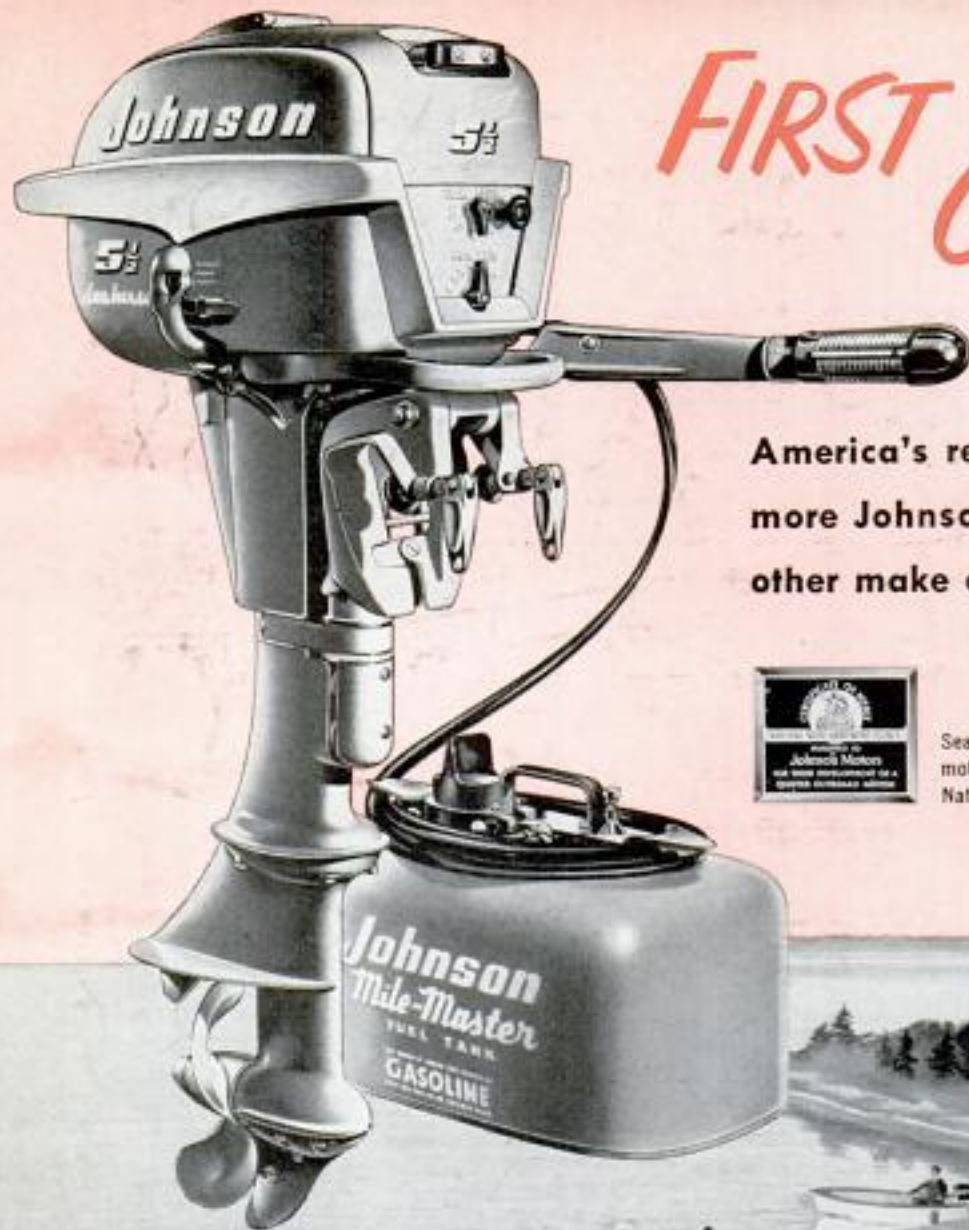

America's resort operators buy 86% more Johnson Sea-Horses than any other make of outboard motor!



Sea-Horse 5 1/2—the only outboard motor ever to win a citation from the National Noise Abatement Council.



**SEA-HORSE 3.** Another fishin' favorite! Full 3 hp. in a 32-lb. twin! Angle-matic Drive slides thru weeds, skis over under-water obstructions, keeps on driving in inches of water!

Ask the men who operate America's fishing resorts! They *know* outboards... Johnson Sea-Horses are their choice—BY 86%! On plans for future purchases, their choice is Johnson by more than 2 to 1\*. Their favorite, of course, is the Sea-Horse 5 1/2—America's leading fishing motor. This is the model that offers modern "big motor" features with small motor handling ease. Plus Johnson's revolutionary "Suspension Drive" that brings *QUIET* to outboard boating. Your Johnson Dealer will show you. Look for his name under "Outboard Motors" in your classified telephone directory.

*\*From survey by "Resort Management"*

SEA-HORSE 25	Electric Starting ... 25 hp.....	\$525.00*
SEA-HORSE 25	... 25 hp.....	430.00*
SEA-HORSE 10	... 10 hp.....	310.00*
SEA-HORSE 5 1/2	... 5 1/2 hp.....	210.00*
SEA-HORSE 3	... 3 hp.....	145.00

*\*Includes Mile-Master Fuel System, Prices f.o.b. factory, subject to change. All ratings are OBC certified brake hp. at 1000 rpm.*

**FREE!** New Sea-Horse Catalog. Complete details. Write for your copy.

**JOHNSON MOTORS**  
400 Pershing Road, Waukegan, Illinois  
A DIVISION OF OUTBOARD, MARINE & MANUFACTURING COMPANY  
In Canada: Mfd. by Johnson Motors, Peterborough

**Johnson** **SEA-HORSES**  
FOR **DEPENDABILITY**

# Compare The Cuts Of Pipe Tobacco

## See Why Edgeworth Smokes Coolest... Never Bites Your Tongue



Some brands give you shorts and bits which burn like tinder—fast and hot.



Others give you fine-cut shreds—good for cigarettes, but not so good for pipes.



Only Edgeworth gives you slow-burning "chunks" made for pipes and pipes alone.



### Edgeworth's Way with White Burley Has Never Been Equalled

Your true tobacco expert will tell you that white burleys are the world's coolest smoking tobaccos. Edgeworth is a blend of white burleys only—aged like fine wine, for years. Other tobaccos use white burley, too—but nobody else has yet found out just how to blend and process tobacco to give it the even-burning, cool-smoking character that Edgeworth "Ready-Rubbed" has maintained.

### What "Ready-Rubbed" Means to Your Smoking Pleasure

Old-time smokers knew the secret of cool, even burning. They carefully "hand-rubbed" their tobacco until it crumbled into chunks

YOU'RE SMARTER SMOKING

# Edgeworth

AMERICA'S FINEST PIPE TOBACCO FOR OVER HALF A CENTURY

## Made Right...Cut Right and Packed Right!



### Three Months in a Duck Blind

A duck hunter left an unopened Edgeworth pouch in his blind for three months. When he discovered it, the tobacco was still mellow and cool smoking!

of just the right size. Now Edgeworth does all this for you before the tobacco is packaged. An ingenious, exclusive process "ready-rubs" Edgeworth into chunks that pack right in your pipe, giving you a cool, leisurely smoke with never a touch of tongue bite.

Edgeworth tobacco leaves our plant with just the right moisture content for a cool, no-bite smoke. You can be sure every pouch will be that way when you open it, because only Edgeworth has the Seal-Pak pouch. Sealed air-and-water tight, it promises you fresher tobacco than any other type of pocket pack. No bulky corners in your pocket either.

### FOR A COOL MIXTURE TRY HOLIDAY

A blend of five tobaccos selected for mildness and aroma—in the Seal-Pak pouch.



## AT YOUR DEALER'S

Get this guaranteed "Olde London" Pipe and two full-size pouches of Edgeworth tobacco for only \$1.00. The pipe is fine, hand-rubbed imported briar... with genuine hard rubber bit... carbonized bowl for cooler smoking. If your dealer is unable to supply you, use this handy order blank.

Name \_\_\_\_\_

Address \_\_\_\_\_

City \_\_\_\_\_ State \_\_\_\_\_

Mail with \$1.00 to "Olde London," Larus & Brother Company, Inc., Richmond, Va. Offer Good Only in U. S. A. **PM-7**

JULY 1955

This One



8H81-21H-2DFE

1

Copyrighted material

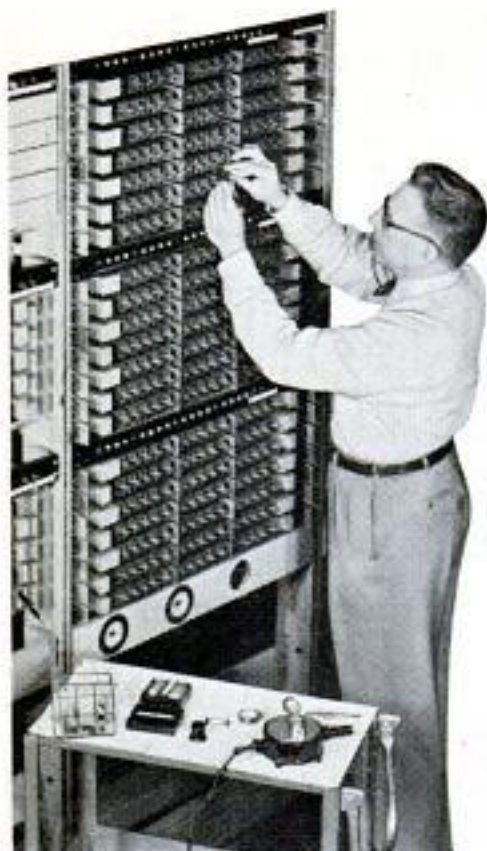

## He's "fingerprinting" a relay contact

Bell Laboratories microchemists have perfected an ingenious new technique for "fingerprinting" relay contacts, the tiny switches on which a dial telephone system critically depends.

Using a portable test set, a chemist makes a plastic print of a contact. On-the-spot examination of the print with a microscope and chemical reagents quickly reveals the effects, if any, of arcing, friction, dust or corrosive vapors. While the chemist studies the print, urgently needed contacts continue in service. The findings point the way to improve relay performance.

This is another example of how Bell Telephone Laboratories research helps to keep your telephone system the world's best.



Above, Bell Laboratories microchemist applies plastic disc in heated clamp to relay contact. Imprint reveals contours of surface and picks up contaminants, if any. Part of portable test set is shown on table. Contacts, shown in small sketches, are of precious metal fused to base metal.



Preparing disc for microscopic examination. On-the-spot examination may reveal acid, alkali, sulfur, soot or other polluting agents peculiar to an area.



A microscopic look at disc often provides lead to nature of trouble. Unlike actual contact, print can be examined with transmitted light and high magnification.



Here the plastic disc has picked up microscopic lint that insulates contact, stops current. (Picture enlarged 200 times.) Traces of contaminants are identified in microgram quantities. Inert plastic resists test chemicals that would damage contact.

### Bell Telephone Laboratories

Improving telephone service for America provides careers  
for creative men in scientific and technical fields



# Popular Mechanics Magazine

Registered in U. S. Patent Office and Canada

H. H. WINDSOR, Founder

H. H. WINDSOR, JR., Editor and Publisher



## Next Month

MAJ. ARTHUR MURRAY, climbing into the rocket plane X-1A, has been farther from the earth than any other human. He's visited the fringe of space some 17 miles out. Next month Major Murray takes you along for a ride in the X-1A. You'll suddenly drop out of a B-29 at 30,000 feet, hear the roar as the rockets ignite. You'll feel the little plane shake as it accelerates up through the speed of sound. Then quite suddenly you'll hear only the sounds inside the cockpit, for you're traveling too fast for the roar of the rockets to reach you. Up in the stratosphere you'll have the eerie feeling of weightlessness as you slowly level off and start down for a dead-stick landing. Don't miss this exciting feature

Information not listed on articles in the index, starting on page 58, frequently is listed in the WHERE-TO-FIND-IT LIST, which is available to readers without charge. A copy may be obtained by writing to the Bureau of Information, Popular Mechanics, 200 E. Ontario, Chicago 11, Ill.

Published monthly by Popular Mechanics Company, 200 E. Ontario St., Chicago 11, Ill. H. H. Windsor, Jr., president; Wm. Harrison Feltridge, exec. vice-pres.; D. F. Windsor, vice-president and secretary-treasurer; H. H. Windsor III, vice-president; Clover J. Perkins, advertising manager; Alan M. Dwyer, circulation manager. Single copy in the United States and Canada, 15 cents; subscription rates in the United States and possessions, Canada, Philippines and countries of the Pan-American Postal Union, 1 year \$3.50; 2 years, \$6.00; 3 years \$8.00. To all other countries add \$1.00 a year over United States prices for overseas postage. If you plan to move, notify us at least 30 days in advance so you will not miss an issue. Give both your old and new addresses. Entered as Second Class Matter, September 15, 1903, at the Post Office at Chicago, Illinois, under Act of March 3, 1879. Entered as Second Class Matter at Post Office Dept., Canada. Registered as Second Class Matter at the Post Office at Mexico, D. F., Mexico, June 20, 1950. Copyright 1955 by Popular Mechanics Company. Copyright under International Copyright Union. Copyright in France. All rights reserved under Pan-American Copyright Union. Printed in the United States of America.

Volume 104 JULY 1955 Number 1

Address all communications to: 200 E. Ontario St., Chicago 11, Ill.

Managing Editor.....	Roderick M. Grant
Assistant Managing Editor.....	Wayne Whittaker
Shop Notes and Crafts Editor.....	James R. Ward
Associate Editor.....	Clifford B. Hicks
Associate Editor, Automotive.....	Arthur R. Railton
Associate Editor, Shop Notes and Crafts.....	Wayne C. Lecky
Assistant Editor, Shop Notes.....	W. Clyde Lamme
Assistant Editor, Crafts.....	Frank N. Stephany
Assistant Editor, Makeup.....	John C. Dalen
Automotive Correspondent.....	Leo Donovan
Art Director.....	Frank Beatty

### Assistant Editors

Leonard F. Hiltz, Jay W. Hedden, Elliott H. McCleary, Emily Mullaney	Eastern Editor.....	Richard F. Dempewolff
Empire State Bldg., Room 2906, New York City 1		
Western Editor.....	Thomas E. Stimson, Jr.	
Suite 1010, 3460 Wilshire Blvd., Los Angeles 5, Calif.		
London Manager.....	Douglas W. Wedderspoon	
Eagle House, Jermyn St., London S. W. 1, England		
Director, Bureau of Information.....	Allan Carpenter	
	200 E. Ontario St., Chicago 11	

### Advertising Offices

Chicago: 200 E. Ontario St., Whitehall 4-0100; New York: Empire State Bldg., 350 Fifth Ave., Longacre 5-7580; Detroit: General Motors Bldg., TRinity 5-7811; Cleveland: Hanna Bldg., 1422 Euclid Ave., PRospect 1-0456; Los Angeles: Tishman Bldg., 3460 Wilshire, DUnkirk 2-8458.

## In This Issue . . .

<a href="#">What Can We Do About Smog?</a>	65
<a href="#">Earthquake by Request</a>	72
<a href="#">A Pool for Your Back Yard</a>	76
<a href="#">Detroit Listening Post</a>	82
<a href="#">Camping in a Volkswagen</a>	84
<a href="#">Owners Report on the '55 Ford</a>	86
<a href="#">An Old Town Packs up and Moves</a>	93
<a href="#">BBC Puts Inventors on TV</a>	101
<a href="#">Desert Harvest—Diamonds Under the Sand</a>	110
<a href="#">Titanium Strike in Mexico</a>	114
<a href="#">High-School Robots Learn the "Three Rs"</a>	122
<a href="#">What's New for Your Home</a>	126
<a href="#">It's Official—U. S. Weather Can Be Wild</a>	130
<a href="#">Jewels From Wood</a>	134
<a href="#">Keeping Up With the Atom</a>	139
<a href="#">Radio, TV and Electronics</a>	141

## For the Craftsman . . .

<a href="#">Load up With Color</a>	145
<a href="#">Double Vanity Desk</a>	148
<a href="#">Enclose Your Front Porch</a>	152
<a href="#">Motor-Driven Barbecue Spit</a>	159
<a href="#">Solving Home Problems</a>	162
<a href="#">Fisherman's Knot Book</a>	165
<a href="#">Boat Trailer Has Power Winch</a>	169
<a href="#">Playtime Cottage—Part I</a>	177
<a href="#">Electrify Your Garage Door</a>	185
<a href="#">Knapsack Power Unit</a>	191
<a href="#">Do-it-Yourself Safely</a>	196
<a href="#">Shopping for Tools</a>	202

Other items, and manufacturers of available products described, are listed on pages 58, 60 and 62

# Texaco Tips On Car Care



## ← How to prevent engine misfiring

When dirt and moisture accumulate on the porcelain, spark plug functioning is often impaired. They can short out, cause your engine to misfire. To prevent this from happening, simply wipe plugs regularly with a dry cloth. Keep your spark plugs clean, and they will give you better performance.

## How to enjoy smoother driving

Just treat your car to *Marfak* chassis lubrication. *Marfak* is super-sturdy . . . clings fast to vital points of wear and friction . . . seals itself in, seals out dirt, dust and road water. And *Marfak* protection is longer lasting! It gives you *cushiony* comfort for 1,000 miles or more. Get *Marfak* chassis lubrication today. See your Texaco Dealer . . . the best friend your car has ever had.



**MARFAK**  
Lubrication



**TEXACO DEALERS IN ALL 48 STATES**

*Texaco Products are also distributed in Canada and in Latin America*

THE  
TEXAS  
COMPANY

TUNE IN: TEXACO STAR THEATER starring DONALD O'CONNOR or JIMMY DURANTE, on TV Saturday nights, NBC.

# You can train with the U. S. Air Force

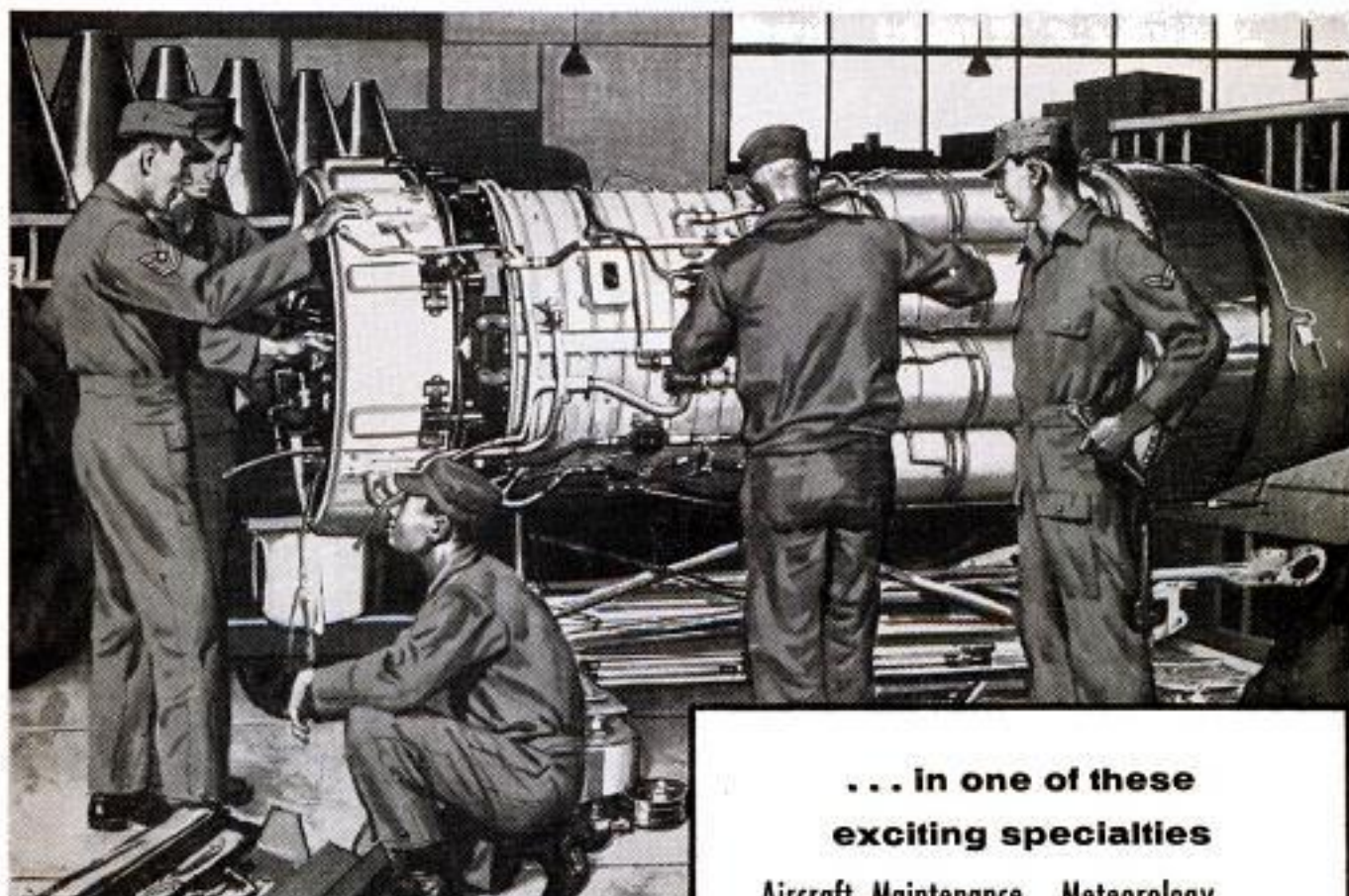

Are you interested in engines, electronics, radio, or other technical specialties? If so, you belong in the U. S. Air Force! As an Airman, you may have the opportunity to learn from the ground up, and become a specialist in anything from Turbo-jet mechanics to Radar or Electronics. You'll train with young men, men who will be quick to appreciate your skills and aptitudes.

You'll earn good pay and have unlimited opportunities for adventure and travel. What's more, you'll be assuring yourself of a good future . . . a future in which the training you may receive in the U. S. Air Force will pay you huge dividends for the rest of your life.

**You'll go places—faster  
on the young man's team**

## ... in one of these exciting specialties

Aircraft Maintenance	Meteorology
Air Traffic Control	Photography
Atomic Weapons	Photomapping
Communications	Radar
Construction	Rocket Propulsion
Guided Missiles	Supply
	Transportation



**STUDENTS! Graduate  
before you enlist**

Airman Information Branch M-6-PM-3  
Personnel Procurement Division  
Box 2202  
Wright-Patterson AFB, Dayton, Ohio

Please furnish me more information on my opportunity as an Airman in the U. S. Air Force.

Name..... Age.....

Address.....

City..... Zone..... State.....

# There's No Such Thing as a Difficult Drilling Job...

with **PROTO's**  
new



Chuck swings in 270° arc. • Handle swings in 180° arc

Both professionals and "Do-It-Yourself" handymen will find the PROTO All-Angle drill indispensable for hard-to-get-at drilling jobs in close quarters—next to floors—around obstructions.

Work it straight, or work all the angles... it's a versatile addition to any tool kit. Buy it from your PROTO dealer today! Send 10¢ for catalog of entire line to

**PLUMB TOOL COMPANY**  
2255F Santa Fe Ave., Los Angeles 54, Calif.

## ALSO NEW! PROTO GRAB-ALL Retrieving & Holding Tool

The tool of 1000 uses for every home, every shop! A push of the thumb, and four strong gripping fingers grab objects in hard-to-reach places.



5582 Eastern Factory, Jamestown, N.Y. • Canadian Factory, London, Ont.

## ACROSS THE DESK



With a deep personal sense of loss we record the death on May 4 of Frank L. Brittin, editor of the Radio, Television and Electronics Section of *Popular Mechanics*. A member of the magazine staff since January 1920, he had been a frequent contributor of radio articles even before that. His last article appeared in the June 1955 issue.

Mr. Brittin literally grew up with radio



and enjoyed a nationwide reputation as a pioneer editor in this field. He was probably instrumental in leading more young men into the world of radio (as thousands of letters in our files testify) than any other American.

Born in Springfield, Ill., Mr. Brittin built the first radio receiver in Illinois' capital city. In earlier years he was a registered pharmacist, and always maintained his contact with that profession although radio became his prime interest as "ham" and as editor. He received his ham amateur short-wave license in 1915 and was one of the early members of the American Radio Relay League. His own station was W9-DCX. Mr. Brittin was a senior member of the Institute of Radio Engineers and of the National Association of Science Writers.

(Continued to page 8)



# 5 reasons why ACCOUNTANCY



## offers you **MORE MONEY . . . and SUCCESS!**

**REASON #1.** If you were an expert accountant right now, chances are you would find yourself among the highest-paid of all professional men and women. Even back in "depression years," surveys showed that accountants earned more on the average than men in other major professions.

**REASON #2.** The demand for accountants is great—everywhere. All businesses must have trained accountants to cope with ever-growing requirements. It's a profession offering wide opportunity—always—to the man who knows.

**REASON #3.** You can fit into any business, anywhere in the country—because accounting principles are universal. Think what this means in terms of security and independence!

**REASON #4.** Accountancy is open to all. Any man or woman of good intelligence, who enjoys figure work and is willing to follow LaSalle's systematic "problem method" plan, can rapidly qualify for a highly profitable, enjoyable lifetime career . . . and he doesn't have to finish his training before beginning to "cash in."

**REASON #5.** Without losing a day from your present work, you can prepare in spare hours at home, at low cost, under LaSalle's step-by-step "Problem Method" of "learning by doing." This famous plan accounts for LaSalle's remarkable record of having trained nearly 10 per cent of all Certified Public Accountants in the U. S. . . . and of having put many thousands of others into high-paying careers.

Send today for Free Sample Lesson and "Accountancy, the Profession That Pays." Learn about the five great fields of opportunity . . . and LaSalle's time-tested plan for helping men and women to rapid advancement, higher income, greater prestige and professional standing. The coupon below will bring this information to you—without cost or obligation.

**MAIL THE COUPON—NOW**  
Member, National Home Study Council

**GET FREE SAMPLE LESSON**



**LaSalle Extension University**  
— A Correspondence Institution —  
Dept. 764H, 417 S. Dearborn St., Chicago 5, Ill.

Please send me, free of all cost or obligation, a sample lesson in Accounting . . . also, your 48-page illustrated book, "Accountancy, the Profession That Pays."

Name . . . . . Age . . . . .  
Address . . . . .  
City, Zone, State . . . . .

**LASALLE**  
417 S. Dearborn St.,  
CHICAGO 5, ILL.

JULY 1955

# Learn to Repair ELECTRIC APPLIANCES

at Home in Spare Time

**Fast Growing Field offers  
Good Pay, Interesting  
Work, Security**

Get into a field where you can do important work, have a secure future. Electrical appliance repair offers OPPORTUNITY FOR YOU. Every wired home has an average of 8 electrical appliances. Up to 10 million new appliances are being sold every year. Owners pay well to keep them in repair and enjoy the convenience they provide. That means a fast growing need for trained men.



## Learn and Earn with Tester You Build

Our training includes the parts to build a sturdy, portable appliance tester following our illustrated, easy-to-understand instructions. This multi-use tester helps you locate electrical defects quickly and easily, equips you to do professional trouble-shooting. You use it to learn electrical appliance repair techniques. Gives you the practical training of actually building the tester and a valuable piece of equipment for future use.



## Earn \$3, \$4, \$5 an Hour Spare Time

Start soon to repair electric toasters, fans, irons, mixers, vacuum cleaners, etc. for your neighbors and friends. Spare time work done at your convenience in your basement, garage, or spare room can earn you from \$3 to \$5 an hour. See how easy it is to increase your earning power—how you can pay for this training many times over with the money you'll earn in your spare time. Mail coupon.

## Train Now for Greater Security Low Price—Easy Terms

Today's automatic electric appliances need expert servicing. The man who knows this good trade has a secure future. Put your spare time to good use. Enroll now for \$2.50 down and \$5.00 a month. A small investment can assure a better future. Address Electrical Appliance Training, National Radio Institute, Dept. AG5, Washington 9, D.C.

**FREE** Lesson and Book  
MAIL this NOW



### NATIONAL RADIO INSTITUTE

DEPT. AG5, WASHINGTON 9, D. C.

Please send me lesson and book free. (No salesman will call.)

Name \_\_\_\_\_ Age \_\_\_\_\_

Address \_\_\_\_\_

City \_\_\_\_\_ Zone \_\_\_\_\_ State \_\_\_\_\_

(Continued from page 6)

## European Heliports

Almost within the shadow of Paris' famous landmark, the Eiffel Tower, a new heliport is under construction on the roof top of a new building, 117 feet off the ground.

As soon as the Bir-Hakeim Heliport is completed, helicopters will be able to land right in the heart of Paris—just a 15-minute taxi ride to the Opera.

The new airfield on the banks of the Seine will consist of a concrete platform covering a good portion of the top of the new garage now being built, and later more of the roof-top space of the adjacent Palais des Sports will stretch out to 16,800 square



yards for the small planes to land and take off.

Paris' new heliport is another link in the growing chain of helicopter service with which airline officials will soon connect up the main capitals of Europe on a commuter-like service.

At present, Sabena, Belgian Airlines, has been successfully operating Europe's only international helicopter service, but other airlines are beginning to catch on. Sabena's American-built Sikorsky S-55 doodlebugs carry only seven passengers, plus a pilot, and link Brussels with Lille, France, twice daily; Brussels-Rotterdam (via Antwerp) three times daily; Brussels-Bonn, Germany, twice daily; Brussels, Eindhoven, Holland and Duisburg-Hamborn, Germany, three times daily; and operate daily flights to Liege, Maastricht, Dortmund and Cologne, Germany.

While the copters sometimes use regular airports to land, frequently the tiny craft will sit down on the newly constructed heliports. For example, the planes come

(Continued to page 10)

# ARE YOU TOO OLD TO LEARN?

*not at all, scientists say*

New tests show that: your ability to think increases with age; your powers of deduction are greater; your judgment is better.

In the I. C. S. files are thousands of cases of men and women of every age. Their successes, their promotions, their raises prove that men and women past school age can learn!

**I.C.S. GIVES YOU EXPERT GUIDANCE FREE!** Do you have the feeling you're "stuck" in your job? Your trained I. C. S. counselor will appraise your abilities, help you plan for the future.

**IT'S NEVER TOO LATE TO GET STARTED!** You study with I. C. S. at home, in your spare time. There's no interference with business or social activity. Famous I. C. S. texts make learning easy. Don't delay. Pick your field from the coupon below. And mail it today!



## 3 FREE BOOKS

36-page, pocket-size guide to advancement, a gold mine of tips on "How to Succeed." Big catalog outlining opportunities in your field of interest. Also sample lesson (Mathematics).

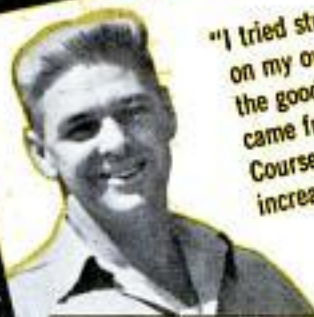

"I tried studying my work on my own, but I never got the good out of it that came from my I. C. S. Course. My salary has been increased 73.3%!"

E.L.B.  
Ohio

"I am president of a small corporation. A year ago I enrolled with I. C. S. as the most practical means available to me to learn what I needed."

W.J.A.  
Michigan



"It's been so long since I went to school, I've forgotten much. But now that I'm taking an I. C. S. Course, I have confidence in my ability again."

H.A.R.  
New Jersey



Actual statements.  
Posed by models.

For Real Job Security - Get an I. C. S. Diploma! ... Easy-pay Plan ... I. C. S., Scranton 9, Penna.

## INTERNATIONAL CORRESPONDENCE SCHOOLS

ICS

BOX 99299G, SCRANTON 9, PENNA.

(Partial list of 277 courses)

Without cost or obligation, send me "HOW TO SUCCEED" and the opportunity booklet about the field BEFORE which I have marked X (plus sample lesson):

- |  |   |  |  |  |
|--|---|--|--|--|
| <p><b>ARCHITECTURE and BUILDING CONSTRUCTION</b></p> <ul style="list-style-type: none"> <li><input type="checkbox"/> Air Conditioning-Refrig.</li> <li><input type="checkbox"/> Architecture</li> <li><input type="checkbox"/> Architectural Interior</li> <li><input type="checkbox"/> Building Contractor</li> <li><input type="checkbox"/> Building Maintenance</li> <li><input type="checkbox"/> Carpenter and Mill Work</li> <li><input type="checkbox"/> Estimating</li> <li><input type="checkbox"/> Heating</li> <li><input type="checkbox"/> Painting Contractor</li> <li><input type="checkbox"/> Plumbing</li> <li><input type="checkbox"/> Reading Arch. Blueprints</li> </ul> <p><b>ART</b></p> <ul style="list-style-type: none"> <li><input type="checkbox"/> Cartooning</li> <li><input type="checkbox"/> Commercial Art</li> <li><input type="checkbox"/> Fashion Illustrating</li> <li><input type="checkbox"/> Magazine Illustrating</li> <li><input type="checkbox"/> Show Card and Sign Lettering</li> <li><input type="checkbox"/> Sketching and Painting</li> </ul> <p><b>AUTOMOTIVE</b></p> <ul style="list-style-type: none"> <li><input type="checkbox"/> Auto Body Rebuilding</li> <li><input type="checkbox"/> Auto Elec. Technician</li> <li><input type="checkbox"/> Auto-Engine Tune Up</li> <li><input type="checkbox"/> Automobile</li> </ul> | <p><b>AVIATION</b></p> <ul style="list-style-type: none"> <li><input type="checkbox"/> Aeronautical Engineering Jr.</li> <li><input type="checkbox"/> Aircraft &amp; Engine Mechanic</li> </ul> <p><b>BUSINESS</b></p> <ul style="list-style-type: none"> <li><input type="checkbox"/> Advertising</li> <li><input type="checkbox"/> Bookkeeping and Accounting</li> <li><input type="checkbox"/> Business Administration</li> <li><input type="checkbox"/> Business Correspondence</li> <li><input type="checkbox"/> Public Accounting</li> <li><input type="checkbox"/> Creative Salesmanship</li> <li><input type="checkbox"/> Federal Tax</li> <li><input type="checkbox"/> Letter-writing Improvement</li> <li><input type="checkbox"/> Office Management</li> <li><input type="checkbox"/> Professional Secretary</li> <li><input type="checkbox"/> Retail Business Management</li> <li><input type="checkbox"/> Sales Management</li> <li><input type="checkbox"/> Stenographic-Secretarial</li> <li><input type="checkbox"/> Traffic Management</li> </ul> <p><b>CHEMISTRY</b></p> <ul style="list-style-type: none"> <li><input type="checkbox"/> Analytical Chemistry</li> <li><input type="checkbox"/> Chemical Engineering</li> <li><input type="checkbox"/> Chem. Lab. Technician</li> <li><input type="checkbox"/> General Chemistry</li> <li><input type="checkbox"/> Natural Gas Prod. &amp; Trans.</li> <li><input type="checkbox"/> Petroleum Engineering</li> <li><input type="checkbox"/> Plastics</li> <li><input type="checkbox"/> Pulp and Paper Making</li> </ul> | <p><b>CIVIL, STRUCTURAL ENGINEERING</b></p> <ul style="list-style-type: none"> <li><input type="checkbox"/> Civil Engineering</li> <li><input type="checkbox"/> Construction Engineering</li> <li><input type="checkbox"/> Highway Engineering</li> <li><input type="checkbox"/> Reading Struct. Blueprints</li> <li><input type="checkbox"/> Sanitary Engineering</li> <li><input type="checkbox"/> Structural Engineering</li> <li><input type="checkbox"/> Surveying and Mapping</li> </ul> <p><b>DRAFTING</b></p> <ul style="list-style-type: none"> <li><input type="checkbox"/> Aircraft Drafting</li> <li><input type="checkbox"/> Architectural Drafting</li> <li><input type="checkbox"/> Electrical Drafting</li> <li><input type="checkbox"/> Mechanical Drafting</li> <li><input type="checkbox"/> Mine Surveying and Mapping</li> <li><input type="checkbox"/> Plumbing Drawing and Estimating</li> <li><input type="checkbox"/> Structural Drafting</li> </ul> <p><b>ELECTRICAL</b></p> <ul style="list-style-type: none"> <li><input type="checkbox"/> Electrical Engineering</li> <li><input type="checkbox"/> Electrical Maintenance</li> <li><input type="checkbox"/> Electrician <input type="checkbox"/> Contracting</li> <li><input type="checkbox"/> Lineman</li> </ul> <p><b>HIGH SCHOOL</b></p> <ul style="list-style-type: none"> <li><input type="checkbox"/> Commercial <input type="checkbox"/> Good English</li> <li><input type="checkbox"/> High School Subjects</li> <li><input type="checkbox"/> Mathematics</li> </ul> | <p><b>LEADERSHIP</b></p> <ul style="list-style-type: none"> <li><input type="checkbox"/> Foremanship</li> <li><input type="checkbox"/> Industrial Supervision</li> <li><input type="checkbox"/> Leadership and Organization</li> <li><input type="checkbox"/> Personnel-Labor Relations</li> </ul> <p><b>MECHANICAL AND SHOP</b></p> <ul style="list-style-type: none"> <li><input type="checkbox"/> Gas-Electric Welding</li> <li><input type="checkbox"/> Heat Treatment <input type="checkbox"/> Metallurgy</li> <li><input type="checkbox"/> Industrial Engineering</li> <li><input type="checkbox"/> Industrial Instrumentation</li> <li><input type="checkbox"/> Industrial Supervision</li> <li><input type="checkbox"/> Internal Combustion Engines</li> <li><input type="checkbox"/> Machine Design-Drafting</li> <li><input type="checkbox"/> Machine Shop Inspection</li> <li><input type="checkbox"/> Machine Shop Practice</li> <li><input type="checkbox"/> Mechanical Engineering</li> <li><input type="checkbox"/> Quality Control</li> <li><input type="checkbox"/> Reading Shop Blueprints</li> <li><input type="checkbox"/> Refrigeration</li> <li><input type="checkbox"/> Sheet Metal Worker</li> <li><input type="checkbox"/> Tool Design <input type="checkbox"/> Toolmaking</li> </ul> <p><b>RADIO, TELEVISION</b></p> <ul style="list-style-type: none"> <li><input type="checkbox"/> Industrial Electronics</li> <li><input type="checkbox"/> Practical Radio TV Eng'ing</li> <li><input type="checkbox"/> Radio and TV Servicing</li> <li><input type="checkbox"/> Radio Operating</li> </ul> | <ul style="list-style-type: none"> <li><input type="checkbox"/> Television Technician</li> </ul> <p><b>RAILROAD</b></p> <ul style="list-style-type: none"> <li><input type="checkbox"/> Air Brakes <input type="checkbox"/> Car Inspector</li> <li><input type="checkbox"/> Diesel Locomotive</li> <li><input type="checkbox"/> Locomotive Engineer</li> <li><input type="checkbox"/> Section Foreman</li> </ul> <p><b>STEAM AND DIESEL POWER</b></p> <ul style="list-style-type: none"> <li><input type="checkbox"/> Combustion Engineering</li> <li><input type="checkbox"/> Diesel-Elec. <input type="checkbox"/> Diesel Eng's</li> <li><input type="checkbox"/> Electric Light and Power</li> <li><input type="checkbox"/> Stationary Fireman</li> <li><input type="checkbox"/> Stationary Steam Engineering</li> </ul> <p><b>TEXTILE</b></p> <ul style="list-style-type: none"> <li><input type="checkbox"/> Carding and Spinning</li> <li><input type="checkbox"/> Cotton, Rayon, Woolen Mfg.</li> <li><input type="checkbox"/> Finishing and Dyeing</li> <li><input type="checkbox"/> Loom Fix'g <input type="checkbox"/> Textile Des'ing</li> <li><input type="checkbox"/> Textile Eng'g's <input type="checkbox"/> Throwing</li> <li><input type="checkbox"/> Warping and Weaving</li> </ul> <p><b>MISCELLANEOUS</b></p> <ul style="list-style-type: none"> <li><input type="checkbox"/> Domestic Refrigeration</li> <li><input type="checkbox"/> Marine Engineering</li> <li><input type="checkbox"/> Ocean Navigation</li> <li><input type="checkbox"/> Professional Engineering</li> <li><input type="checkbox"/> Short Story Writing</li> <li><input type="checkbox"/> Telephony</li> </ul> |
|--|---|--|--|--|

Name \_\_\_\_\_ Age \_\_\_\_\_ Home Address \_\_\_\_\_

City \_\_\_\_\_ Zone \_\_\_\_\_ State \_\_\_\_\_ Working Hours \_\_\_\_\_ A.M. to P.M. \_\_\_\_\_

Occupation \_\_\_\_\_ Canadian residents send coupon to International Correspondence Schools, Canadian, Ltd., Montreal, Canada. . . . Special tuition rates to members of the U. S. Armed Forces.

(Continued from page 8)

into Brussels' big airport only as a transit stop to allow passengers to get off and board regular airliners bound for other points in Europe; but the main stop is at Brussels' new heliport which looks something like an auto parking lot near a skyscraper office building in downtown Brussels. The helicopter floats down like a floating leaf in the midst of heavy traffic in the business district.

Riding one of these international helicopters between Europe's cities like an international commuter is like no other air ride you've ever experienced.

Once the plane comes in for a landing, passengers get on while the whirling props overhead continue revolving. A door slides open and you climb aboard, carrying your own luggage. And then it's just a matter of minutes before the helicopter is ready to take off again, going up vertically.

Conversation becomes almost impossible due to the noise of the motor. It's possible to get in touch with the pilot, who sits in an enclosed compartment overhead, by means of a telephone receiver.

Once in the air, winds buffet the tiny craft and one gets the same swaying motion of a sky-high Ferris-wheel cabin, which the helicopter's cabin strongly resembles.

But the view is wonderful, since the

plane never flies much higher than between 300 to 400 feet off the ground, giving a good visibility of around 800 yards. You are just high enough to be able to see clearly cars moving like snails along white-ribbed highways. Passing over farm lands, you can see in miniature cows and livestock grazing in the fields. Passing over a cathedral or coming up over a great city, you get a bird's-eye view, being able to make out sharp detail which you could never really get from a commercial airliner.

Since distances between European capitals are much shorter than in other parts of the world, European businessmen particularly are beginning to see the advantages in hopping a helicopter instead of a train to travel a few hundred miles.

Arthur R. Pastore, Jr.,  
Paris 6e, France

#### Correction

Oklahoma Testing Laboratories of Oklahoma City call our attention to a statement in the article "Treasure Hunter Builds Midget Sub," in our April issue, which they state is erroneous. The article said the Laboratories reported the submarine hull "stood up under 1900 pounds' pressure during laboratory tests." Actually, say the Laboratories, samples of glass fiber

(Continued to page 14)

## New greaseless way to keep your hair neat all day



Prevents dry, unruly  
"orang-utan hair"

New Vitalis keeps hair in place and prevents dryness with V-7, the greaseless grooming discovery.

You never have an overslick, plastered-down look. Try it. You'll like it.



ANOTHER FINE PRODUCT  
OF BRISTOL-MYERS

## New VITALIS® Hair Tonic with V-7®

# I WILL TRAIN YOU AT HOME FOR GOOD PAY JOBS IN RADIO-TELEVISION

J. E. SMITH has trained more men for Radio-Television than any other man. OUR 40th YEAR.

**America's Fast Growing Industry Offers You Good Pay—Bright Future—Security**

## I TRAINED THESE MEN

"Started to repair sets six months after enrolling. Earned \$12 to \$15 a week in spare time."—Adam Kramlik, Jr., Sunnyside, Pennsylvania.

"Up to our necks in Radio-Television work. Four other NRI men work here. Am happy with my work."—Glen Peterson, Bradford, Ont., Canada.

"Am doing Radio and Television Servicing full time. Now have my own shop. I owe my success to N.R.I."—Curtis Stath, Ft. Madison, Iowa.

"Am with WCOC. NRI course can't be beat. No trouble passing 1st class Radio-phone license exam."—James W. Parker, Meridian, Mississippi.

"By the time I graduated I had paid for my course, a car and testing equipment. Can service toughest jobs."—E. J. Streitenberger, New Boston, Ohio.

Training plus opportunity is the PERFECT COMBINATION for job security, good pay, advancement. In good times, the trained man makes the BETTER PAY, GETS PROMOTED. When jobs are scarce, the trained man enjoys GREATER SECURITY. NRI training can help assure you more of the better things of life.

**Start Soon to Make \$10, \$15 a Week Extra Fixing Sets**

Keep your job while training. I start sending you special booklets the day you enroll, that show you how to fix sets. Multitester built with parts I send helps you make \$10, \$15 a week extra fixing sets while training. Many start their own Radio-Television business with spare time earnings.

### My Training Is Up-To-Date

You benefit by my 40 years' experience training men at home. Well illustrated lessons give you basic principles you need. Skillfully developed kits of parts I send (see below) "bring to life" things you learn from lessons.

**AVAILABLE TO VETERANS UNDER G. I. BILLS**

## You Learn by Practicing with Parts I Send

Nothing takes the place of PRACTICAL EXPERIENCE. That's why NRI training is based on LEARNING BY DOING. You use parts I furnish to build many circuits common to Radio and Television. As part of my Communications Course, you build many circuits, including low power transmitter shown at left. You put it "on the air," perform procedures required of broadcast operators. With my Servicing Course you build modern Radio, etc.; use Multitester you build to make money fixing sets in spare time while training. You can stay at home, keep your job, learn Radio-TV in spare time at low cost. Mail coupon for book showing other equipment you build and keep.

**The Tested Way To Better Pay!**

**2 FREE BOOKS SHOW HOW MAIL COUPON**



**Television Making Good Jobs, Prosperity**—Even without Television, Radio is bigger than ever. 115 million home and auto Radios are big market for servicing. 3000 broadcasting stations use operators, technicians. Government, Aviation, Police, Ship, Micro-wave Relay, Two-way Radio Communications for buses, taxis, trucks, R. R. are growing fields. Television is moving ahead fast.



About 200 Television stations are now on the air. Hundreds of others being built. Good TV jobs opening up for Technicians, Operators, etc.



25 million homes now have Television sets. Thousands more are being sold every week. Get a job or have your own business selling, installing, servicing.

### Radio-TV Needs Men of Action—Mail Coupon

Without obligating you in any way, I'll send an actual lesson to prove that my training is practical, thorough; 64-page book to show good job opportunities for you in Radio-TV. Terms for NRI training are as low as \$5 a month. Many graduates make more in two weeks than total cost of training. Mail coupon now. J. E. SMITH, President, National Radio Institute, Dept. 5GA, Washington 9, D. C. OUR 40TH YEAR.

### Good for Both—FREE

MR. J. E. SMITH, President, Dept. 5GA, National Radio Institute, Washington 9, D. C. Mail me Sample Lesson and 64-page Book, FREE. (No salesman will call. Please write plainly.)

Name.....Age.....

Address.....

City.....Zone.....State.....

**VETS** write in date of discharge.....

**The ABCs of SERVICING**

**How to Be a Success in RADIO-TELEVISION**

# HIGH PRESSURE FOUNTAIN BRUSH

washes cars like magic  
with **ROTARY POWER  
SPRAY**

SAVE \$3.00  
FROM FACTORY-  
TO-YOU

**\$1.98**  
COMPLETE KIT  
REG. 4.98

**No Fuss! No Mess!**

**BUILT-IN  
SUDS CHAMBER!**

**NEW 3-WAY FOUNTAIN BRUSH  
WASHES CARS, PORCHES, FLOORS,  
SCREENS, WINDOWS—QUICK, EASY!**

Now!—order your famous **AEROMAT FOUNTAIN BRUSH** direct from the factory and save \$3.00. The new, improved 1955 model is better than ever—gives you quicker, more thorough washing action. Simply attach it to your garden hose and wash your car sparkling clean in minutes! Wonderful for washing windows, screens, floors, walls, porches, outdoor furniture, too. Has built-in suds chamber . . . drop in a Magic detergent pellet supplied with your brush, turn on the water and start in! No hard scrubbing! No back straining—the hi-pressure **ROTARY SPRAY ACTION** loosens and removes all film and dirt! Easy—fast—it's fun!

## FREE TO YOU—10 CAR WASHES!

New for 1955—a 3-section fountain handle makes the new **AEROMAT** handier than ever! Each section is one foot long. Use 3 sections for washing cars, walls, windows. Use 1 or 2 sections for close work. Easy to store. Bristles made of **DUROSTYRENE**—soft, silky, won't scratch or mar surface. Yours free of extra cost—a generous trial supply of **AEROMAT** Magic suds pellets—enough for 10 car washes. Extra pkgs. available—12-wash size for 59 cents and 24-wash size for \$1. Order your **AEROMAT** brush today—use the handy coupon. Try for 5 days—if not satisfied you get immediate refund. Send only 1.98 check, cash or m.o. Or order **COD** plus 44c postage. **RUSH** the coupon **TODAY!**

No. 444 . . . . . 1.98

75,000 sportsmen gladly paid \$3.95 for this famed hunting knife from Western Germany. However, a new shipment has just arrived—too late for the past hunting season. We're sacrificing these superb knives at **HALF PRICE**—only \$1.98. It's the bargain of the year! The rugged beauty of this splendid knife has already won recognition for design in sports circles on the Continent. Its blade is actually sharp enough to shave with! Genuine leather scabbard is metal tipped. The tough Solingen Steel by Korium assures years of rugged service. Length: 10 inches. Send only 1.98 plus 12 cents postage for 5-day home trial. Check, cash or m.o. Test it—if not completely satisfactory, return it for full refund. Get yours now at **HALF PRICE!** Makes a wonderful rec room or den decoration, too. But order **TODAY!** **COD's** plus 25c fees. **Rush** the convenient coupon!

No. 80 . . . . . 1.98

## SACRIFICE!

**Black Forest  
Hunting Knife**

now  
 $\frac{1}{2}$  price  
**1.98**

Reg.  
**3.95**

**10  
INCHES  
OVER-ALL**

with  
leather  
sheath

**Solingen Steel**

**RUSH!**  
for  
**FREE  
HOME  
TRIAL**

**THORESEN'S, Dept. 6-G  
352 FOURTH AVE., NEW YORK 10, N. Y.**

Please **RUSH** me the items checked on 5-day trial. I must be satisfied in every respect with the merchandise or I will return it within 5 days for full refund.

Payment enclosed. Send postage.  Send C.O.D. plus charges.  
 No. 444. Car Washer & pellets. (1.98). (COD—2.42).  
 No. 80. Black Forest Knife (1.98 plus 12c—total 2.10). (COD—2.23).

NAME \_\_\_\_\_

ADDRESS \_\_\_\_\_

CITY \_\_\_\_\_ STATE \_\_\_\_\_

Also send \_\_\_\_\_ large pkg. (s) Magic suds pellets at \$1 each. (24 car washes).  
 Send \_\_\_\_\_ pkg. (s) at 50c ea.—enough for 12 car washes.

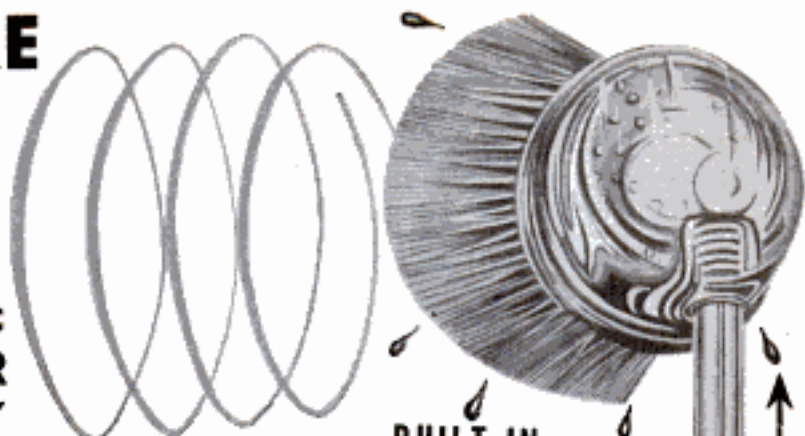

# INVENTORS

Learn how to protect your invention. The U. S. Patent Laws provide that any new and useful art, machine, article of manufacture, or composition of matter, or any new and useful improvement thereof, may be patented if the act of invention is involved. Therefore, every inventor with a valuable invention should take advantage of the Patent Laws and proceed for patent protection in order to safeguard his rights.

A patent gives the inventor the exclusive right to prevent others from making, using, or selling the invention claimed in the patent for a period of seventeen years.

The Patent Laws were enacted for the benefit of the inventor to give him protection for the features of his invention which are patentable. These features must be properly and concisely set forth and claimed in a formal application for patent, in order to comply with the requirements of the Patent Laws. For that reason, unless the inventor is familiar with patent matters, he should engage a competent registered patent attorney or agent to represent him. We are registered to practice before the U. S. Patent Office and are prepared to serve you in the handling of your patent matters.

A specially prepared booklet entitled "Patent Guide for the Inventor", containing detailed information with respect to patent protection and procedure, together with a "Record of Invention" form will be promptly forwarded to you without obligation upon request.

---

## CLARENCE A. O'BRIEN & HARVEY JACOBSON

*Registered Patent Attorneys*

51-G DISTRICT NATIONAL BUILDING  
WASHINGTON 5, D. C.

AFTER SHAVING  
**Dims Shine  
 Feels Fine  
 Doesn't Show**



Also available  
 in Canada

Finishing touch for every shave!  
 Neutral tint - crisp scent!

**MENNEN**  
 AFTER-SHAVE TALC  
**FOR MEN**

(Continued from page 10)

were given compressive-strength tests and tensile-strength tests but "we did not know, nor were we ever told, that this material would be used in the manufacture of the sub... we had nothing to do with the hull."

**To the Editor:**

I have received the book and plans for the PM Precut House and am very thankful for the fast service.

I have seen all the homes that universities have made as research for low cost and short cuts but the Precut House beats them all 95 to 1. You have come up with an answer people like myself have been dreaming of for years. Words just cannot express the feelings we had when we opened our package. Mr. Dempewolff ought to get a medal for the greatest service to "American Average Man" since television came out. Thank you, Mr. Dempewolff.

John Zilick,  
 Lackawanna, N. Y.

**To the Editor:**

I have been a constant reader of *Popular Mechanics* for more years than I like to remember! I had a copy of the July 1906 issue until about a year ago, when I foolishly loaned it to a friend and, of course, never got it back!

I send in items occasionally when I spot something original or unusual. I also have a transformer still in service that was built from an article by Frank L. Brittin that appeared in the 1923 issue for July.

I place great confidence in your articles and always accept them as authentic.

It is with this thought in mind that I would like to correct a statement in the March issue. There are thousands of people who will, or have, read this article, and will get the wrong impression from the statement.

Referring to page 141, re jails, in the second paragraph, the author states:

"They chose a tiny island a mile and a half off the California coast."

This leads one to believe that Alcatraz is out in the Pacific Ocean. Very wrong!

Alcatraz Island is in San Francisco Bay and can be seen plainly from Golden Gate bridge, not far from Angel Island, which is also in the bay. Ferry boats going from San Francisco to Sausalito pass quite close to Alcatraz.

The third bridge across the bay is now under construction, and will span the bay from Richmond to San Rafael.

Keep up the good work on *Popular Mechanics*, I sure enjoy it.

R. A. Lambert,  
 Los Angeles, Calif.



# THESE MEN ARE GETTING PRACTICAL TRAINING IN **ELECTRICITY**

—ELECTRONICS

*On Real:*



**A.C. and D.C. MOTORS  
GENERATORS  
SWITCHBOARDS  
CONTROLLERS  
WIRING JOBS  
APPLIANCES  
ELECTRONIC UNITS**

*(Shown at left—Instructor explaining operation and testing of a large Motor Generator in our A.C. Department.)*

# AND **TELEVISION-RADIO**

*On Real:*

**TELEVISION SETS  
RADIO RECEIVERS  
F.M.  
(Frequency Modulation)  
ELECTRONICS  
RECORD CHANGERS  
AUTO RADIOS  
PUBLIC ADDRESS Systems**

*(Right — Instructor helping students check the wiring and trace circuits of television receivers.)*



## Train in the great SHOPS of COYNE

**Largest, Oldest, Best Equipped School Of Its Kind In The U. S.**

Whether 17 or up to 45 years of age, prepare for your future now. Don't be satisfied with a "No Future" job. Train the Coyne way for a better job in a field that offers a world of opportunities in the years ahead.

**FINANCE PLAN** Enroll now, pay most of tuition later. Part-time employment service while training, if needed.

**WE TRAIN YOU IN CHICAGO.** At Coyne you learn on real, full-size equipment. Trained instructors show you how, then you do practical jobs yourself. No previous experience or advanced education needed.

**CLIP COUPON NOW** for big new illustrated Coyne book "Guide to Careers in ELECTRICITY and TELEVISION-RADIO". No obligation; no salesman will call. Get vital facts now!



*Mail Coupon for  
Big Free Book*

**APPROVED  
FOR  
VETERANS**

**B. W. COOKE, President  
COYNE ELECTRICAL SCHOOL**

500 S. Paulina St., Chicago 12, Ill. Dept. B5-72H

Send **BIG FREE** book and details of your training offer. This does not obligate me and no salesman will call. I am interested in:

ELECTRICITY     TELEVISION-RADIO

NAME.....

ADDRESS.....

CITY.....STATE.....

B. W. COOKE, Pres. **COYNE** FOUNDED 1899  
**ELECTRICAL SCHOOL**

A TECHNICAL TRADE INSTITUTE OPERATED NOT FOR PROFIT

500 S. PAULINA STREET CHICAGO, Dept. B5-72H

ELECTRICITY ★ RADIO ★ TELEVISION ★ REFRIGERATION ★ ELECTRONICS

JULY 1955

15

# 17 pt. Self-Cleaning Plug Alone Shows 8 hp Gain and 7 mph Greater Speed!

**Eddie Edmunds**  
CHASSIS DYNAMOMETER CHART

Make of car is..... Year.....  
Model..... No. Cyl.....  
Is engine 5..... (check, cash or money order)  
Name.....  
Address.....  
City..... State.....

**Power Test**  
At 2000 RPM - 10000 RPM

Type of Spark Plug	LIFE-TIME		Conventional	
	HP	MPH	HP	MPH
17 pt. 17	32	75	24	68
17 pt. 16	31	74	23	67
17 pt. 15	30	73	22	66

Apply for more facts on LIFE-TIME on cover and insert each page.

**Recommendations**

Sign complete name on top of spark plug box and return to LIFE-TIME Spark Plug Co. with your address label on insert for more facts.

1955-56 *Frank Williams*



**Tustin Auto Parts**

110 West Main Street, Tustin, California Phone ELectric 1-3333

Continental Mfg. Co.  
Spark Plug Division

Dear Sirs:

In December, 1954, in Orange County, Calif., the following test was conducted on a 1951 Buick Super. The test was conducted on a 1951 Buick Super. The test was conducted on a 1951 Buick Super. The test was conducted on a 1951 Buick Super.

Run at	After road plug	After LIFE-TIME
2000 RPM	24.0	32.0
3000 RPM	23.0	31.0
4000 RPM	22.0	30.0
5000 RPM	21.0	29.0

These are the results of the test. The test was conducted on a 1951 Buick Super. The test was conducted on a 1951 Buick Super. The test was conducted on a 1951 Buick Super.

The above test was conducted in an electric testing room at the rate of 100 miles per hour. The test was conducted on a 1951 Buick Super. The test was conducted on a 1951 Buick Super. The test was conducted on a 1951 Buick Super.

Yours truly,  
*Frank Williams*  
General Manager

## HOW 17 PT. FIRING WORKS

Note electrodes closely. A circular arcing area (four concave segments). Gap being the same from all points. Electricity has property of arcing from coldest point. Current also arcs more readily from apex of two planes than from the face of a flat, metallic surface.

Note that there are 16 apexes (where two planes meet) — all the same distance from the center electrode. Normal heat and spark erosion are spread around the entire 360 degrees and around the whole circumference of the center electrode.

## FULL ROTATING SPARK

allows overall cooler electrode temperature for greatly increased life. Hotter spark prevents fouling, yet the rotating and cooling effects minimize the common faults of burning, erosion, blistering and insulator failure. Compare this principle with the conventional 2-point spark plug design.

- **PLATINIUM-NICKEL ALLOY ELECTRODES**—Metallurgists' first major step beyond platinum aircraft plug electrodes. Arcing points of this material have continued to function after the equivalent of 129,000 car-miles.
- **SPECIAL SINTERED CORUNDUM INSULATOR**—Made of gem-like mineral which conducts heat 20 times better than ordinary porcelain. Special shape is designed to vaporize and exhaust wet carbon and oil.



- **INDIVIDUAL INSPECTION**—Each LIFE-TIME Spark Plug is tested for firing in oil and for resistance to 30,000 volts/CM.
- **PERMANENT GAP**—After months of use LIFE-TIME Spark Plugs make at exact factory pre-gap.
- **SELF CLEANING FOR LIFE**—Confined gases exploding in chamber formed by multiple electrodes reclean arcing surfaces with each firing stroke.



**NOW...  
ORDER REGISTERED SET  
FOR YOUR CAR AT POPULAR PRICE!**

Dealers and Distributors: The LIFE-TIME Spark Plug is now in full production. Write for full details. Distributors: Please inquire as to status of your territory.

## 50,000 CAR MILES!

Before LIFE-TIME development, the spark plug was the most often replaced part of your car. Engineers agreed that "creeping paralysis," gradual electrode disintegration, carbon buildup, widening gap, could waste one gallon in ten. The LIFE-TIME Plug has now gone far beyond the life of the average set of tires, the average battery. This plug still fired clean, hot and steady at 50,000 car miles!

Most spectacular spark plug research breakthrough in 50 years allows us to include this unique and unprecedented warranty with every set of LIFE-TIME Spark Plugs. We GUARANTEE GREATER GAS MILEAGE — GREATER ACCELERATION — A MAJOR POWER INCREASE — OR YOUR MONEY BACK.

## YOU RECEIVE BY MAIL

this registered set of LIFE-TIME Spark Plugs in proper series (heat range and gap) for the car you indicate in coupon. Now AVAILABLE FOR AMERICAN & EUROPEAN PASSENGER CARS, TRUCKS, BOATS, FARM EQUIPMENT, INDUSTRIAL ENGINES.

LIFE-TIME Spark Plug Division,  
CONTINENTAL MANUFACTURING CORP.  
Washington Blvd., at Motor Ave.  
Culver City 57, California

Destination Please mail postpaid..... 60000 (Registered) of LIFE-TIME Spark Plugs in proper heat range and gap for my car at introductory price of 50¢ per plug (out of stock \$2.98, out of stock \$7.50). 10¢ per set, balance C.O.D.

Make of my car is..... Year.....  
Model..... No. Cyl.....  
Is engine 5..... (check, cash or money order)  
Name.....  
Address.....  
City..... State.....

## 8 HORSEPOWER GAIN!

Dear Car Owner:

The real test of a spark plug is "What will it do in my own car?" Take the above dynamometer test on a 1951 Buick Super. It shows an 8 horsepower gain with Life-Time 17-point plugs. This was a 12 1/2% hp gain at 2000 RPM. You don't need a dynamometer with Life-Time plugs. You can feel the difference both in your ride and your pocketbook. Try a set and let me hear from you about them. Many thanks!

*Frank Williams*  
Inventor of the LIFE-TIME Spark Plug



# INVENTORS

If you believe that you have an invention, you should find out how to protect it. The first step is to have a search made of the prior pertinent U. S. patents. If a report on this search indicates that the invention appears patentable you can apply for a patent, and the specifications and claims should be prepared.

The firm of **McMorrow, Berman & Davidson**, with offices in Washington, D. C., is qualified to take the necessary steps for you. We can make a preliminary search on your invention, advise you whether we think it can be patented, and prepare your application for patent.

Unless you are fully familiar with the U. S. Patent Laws, we recommend that you engage the services of a Registered Patent Attorney to protect your interests. The patent laws are *your* laws. A patent gives you the right to prevent others from making, using or selling the invention claimed in your patent for a period of 17 years.

Use these patent laws for your protection. Investigate whether your invention can be patented. If you have what you believe to be an invention, we suggest that you have this firm make a search for you.

*Send for a copy of our Patent Booklet entitled "How To Protect Your Invention," containing information about patent protection and patent procedure. Along with this we will also send you an "Invention Record" form, for your use in writing down and sketching details of your invention. We will mail them promptly. No obligation. They are yours for the asking.*

## **McMORROW, BERMAN & DAVIDSON**

*Registered Patent Attorneys*

**PATENTS • COPYRIGHTS • PATENTS**

**135-G VICTOR BUILDING, WASHINGTON 1, D. C.**

## WHAT SECRET POWER DID THIS MAN POSSESS?



**BENJAMIN FRANKLIN**  
(A Rosicrucian)

**WHY** was this man great? How does anyone—man or woman—achieve greatness? Is it not by mastery of the powers within ourselves? Know the mysterious world within you! Attune yourself to the wisdom of the ages! Grasp the inner power of your mind! Learn the secrets of a full and peaceful life!

Benjamin Franklin—like many other learned and great men and women—was a Rosicrucian. The Rosicrucians (NOT a religious organization) first came to America in 1694. Today, headquarters of the Rosicrucians send over seven million pieces of mail annually to all parts of the world. Write for **YOUR FREE COPY** of "The Mastery of Life"—**TODAY**. No obligation. No salesmen. A non-profit organization. Address: Scribe N.I.Z.

**THIS BOOK FREE!**

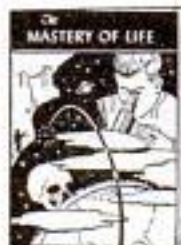

## The ROSICRUCIANS

SAN JOSE • (AMORC) • CALIFORNIA

—SEND THIS COUPON—

Scribe N.I.Z.  
The ROSICRUCIANS (AMORC)  
San Jose, California  
Please send me the free book, *The Mastery of Life*, which explains how I may learn to use my faculties and powers of mind.

Name \_\_\_\_\_

Address \_\_\_\_\_

City \_\_\_\_\_

## SEND FOR **Free Record**

START SPEAKING  
**FRENCH**  
OR  
**SPANISH** **ALMOST OVERNIGHT!**

HERE'S the easiest way to learn FRENCH, SPANISH, Russian, German, Italian, Japanese or Brazilian. Listen to FREE 2-sided non-breakable record. Let your eyes follow words in FREE sample lesson. Almost at once you'll be chatting in a new language with a perfect accent! That's all you hear! No memorizing needed. Just listen—imitate! It's that easy! Offer may end soon. Rush 25c to help cover cost of special packaging, shipping. State language you want. We'll also send free information on full Cortina course. **CORTINA ACADEMY, Dept. 647, 136 W. 52nd St., New York 19.**

**LOOK!** **A MILLION THRILLS!**



High Power  
**BINOCULARS**

**30 DAY FREE TRIAL**

Finest Precision Optics  
Money Back Guarantee  
Easy Pay Plan

Free! Catalog & Book  
"How to Select Binoculars"

Dept. M7 43 E. Green  
Pasadena, Calif.

**\$9.95 UP**  
BUSHNELL Binoculars

Send for **FREE** 112 page  
Illustrated Catalog of Farm, Home,  
and Workshop Bargains.

Write to **WELLWORTH TRADING COMPANY**

1832 S. WABASH AVE.

CHICAGO 16, ILL

## BUILD LUGGAGE AT HOME WE SELL YOUR PRODUCTS!

**ONLY NEW HOME MONEY-MAKING PLAN IN YEARS!**

Make Luggage and cases for traveling, photographers, musicians, salesmen, electronics, tools, portables, 1001 other items. Also repair Luggage. No special equipment needed. **BIG PROFITS**. We supply complete instructions, materials—everything. Write for free details and Business Plan. **ABARSI CASE-CRAFT, Dept. G-7, 805 W. Sunset Blvd., Los Angeles 12, Calif.**

**STAMP COLLECTORS**

**308 DIFFERENT STAMPS 25¢**

including scarce Trieste collection; United Nations Issues, Olympics, Latest wild animal set—in gorgeous multi-color showing the Lynx, Bear, Unicorn, Deer, etc. Stamps from riot-torn Trieste are becoming very scarce. These are only part of the big collection of 308 all different foreign stamps Catalogue \$7.98 that you get for only 25c to introduce our approvals.

**IDEAL STAMP CO., Dept. 3A, P. O. Box 64**

West Farms Station, New York 60, N. Y.



## I'll Send You This Handsome SAMPLE CASE—FREE



and Show You How to Make  
Up to \$30.00 in a Day

WRITE for this FREE Tailoring Sample Case packed with 150 beautiful, big-volume suit and overcoat fabrics. Take orders from friends, fellow-workers, others, for fine quality, made-to-measure clothes. Pocket big cash profits in advance.

Because wearing our suits and overcoats brings more orders, we make it easy for you to get your own clothes without 1c cost. No experience is needed. **SATISFACTION GUARANTEED.**

**SEND NO MONEY.** Rush your name, address, and age—today!  
**W. Z. GIBSON, INC., 500 South Throop Street**  
DEPT. D-516 CHICAGO 7, ILLINOIS

Work over  
**300** projects  
with your  
wonderful HOME  
LABORATORY



**21 INCH**  
Build and keep D.T.I.'s NEW  
2 Unit TV Set—ideal for cus-  
tom installation. (D.T.I. also  
offers home training with-  
out the TV set.)

Use and keep ALL these units to get  
all-important PRACTICAL EXPERIENCE

NOW... at home... get D.T.I.'s  
amazingly effective **NEW** training in

# TELEVISION

**RADIO-ELECTRONICS!** Nothing else like it for providing real LABORATORY-TYPE training at home. Get the kind of thorough, practical experience YOU NEED for the kind of progress YOU WANT in today's tremendous field of Television, Radio and Electronics. Qualify yourself for real money... interesting work... a wonderfully promising future. And when you finish, D.T.I.'s active Employment Service HELPS YOU GET STARTED! Or open your own profitable Television-Radio Service Business.



**NEW!**  
Build and keep  
D. T. I.'s new  
VACUUM TUBE  
VOLTMETER...  
one of the most  
useful of all test  
instruments.



ABOVE: Also build  
and keep this quality  
Oscilloscope—almost  
a "must" for Televi-  
sion servicing.



**Exclusive  
HOME  
MOVIES**

help you grasp  
important points  
**FASTER...  
EASIER...  
BETTER.**  
A tremendous  
advantage!

### THOUSANDS OF SUCCESSFUL GRADUATES

WHY has D.T.I. become one of the largest training organizations of its kind? Because it provides EVERY MAJOR HOME TRAINING AID to help make the subject EASIER to learn... EASIER to remember—the kind of training so helpful for REAL PROGRESS. Students get thorough, up-to-date, practical training that TAKES ADVANTAGE of new and improved training developments. Study the ADVANTAGES shown on this page. Think what they can mean to YOU... to YOUR FUTURE! Or come to D.T.I.'s big Training Laboratories in Chicago. MAIL COUPON TODAY for complete facts—including valuable publication, "89 Ways to Earn Money in Television-Radio-Electronics." Also, valuable information for men subject to MILITARY SERVICE.

"One of America's Foremost Television Training Centers"

**DeVRY**  
Technical Institute  
CHICAGO 41, ILLINOIS  
Formerly DeFOREST'S TRAINING, INC.

### Remarkable NEW Styrene ELECTRO-LAB\*

Insert pictorial diagram on transparent styrene base. (See insert.) Mount parts to follow pattern—using handy "snap in" fasteners. Eliminates wiring errors. Taps for speedy circuit changes... for providing maximum circuit experience in minimum time. Build and operate scores of interesting projects—such as the electronic circuit shown below.

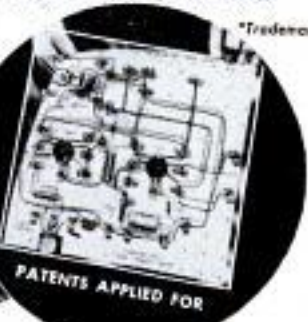

PATENTS APPLIED FOR

### MAIL COUPON TODAY

DeVRY TECHNICAL INSTITUTE Dept. PM-7-L  
4141 Belmont Ave., Chicago 41, Ill.

I would like complete facts including "89 Ways to Earn Money in Television-Radio-Electronics."

Name \_\_\_\_\_ Age \_\_\_\_\_  
Street \_\_\_\_\_ Apt. \_\_\_\_\_  
City \_\_\_\_\_ Zone \_\_\_\_\_ State \_\_\_\_\_  
1 D.T.I.'s training is available in Canada.

**89 WAYS TO  
EARN  
MONEY  
IN TELEVISION  
RADIO  
ELECTRONICS**

# NEW BODIES FOR OLD!



**I've Made New Men Out of Thousands of Other Fellows...**

**"Here's what I did for THOMAS MANFRE... and what I can do for you!"**

*-Charles Atlas*

GIVE me a skinny, second-rate body — and I'll cram it so full of handsome, bulging new muscle that your friends will grow bug-eyed! . . . I'll wake up that sleeping energy of yours and make it hum like a high-powered motor! Man, you'll feel and look different! You'll begin to LIVE!

**Let Me Make YOU a NEW MAN — IN JUST 15 MINUTES A DAY**

You wouldn't believe it, but I myself used to be a 97-lb. weakling. Fellows called me "Skinny." Girls made fun of me behind my back. THEN I discovered—"Dynamic Tension." And it turned me into such a complete specimen of MANHOOD that today I hold the title "THE WORLD'S MOST PERFECTLY DEVELOPED MAN."

**My Secret — "Dynamic Tension"**

When you look in the mirror and see a healthy, strapping fellow smiling back at you—then you'll realize how fast "Dynamic Tension" GETS RESULTS!

"Dynamic Tension" is the easy, NATURAL method you can practice in the privacy of your room—JUST 15 MINUTES EACH DAY — while your chest and shoulder muscles begin to swell, ripple . . . those arms and legs of yours bulge . . . and your whole body starts to feel full of zip and go! And you'll be using the method which many great athletes use for keeping in condition—prize fighters, wrestlers, baseball and football players, etc.

**FREE My 32-page Book—Not \$1. or 10c — But FREE**

Send NOW for my famous book, "Everlasting Health and Strength"—32 pages, crammed with photographs, valuable advice, answers to many vital questions.

This book is a real prize for any fellow who wants a better build. Yet I'll send you a copy absolutely FREE.

It may mean the turning point in your whole life! Rush the coupon to me personally: **CHARLES ATLAS, Dept. 8-U, 115 East 23rd St., New York 10, N. Y.**



**CHARLES ATLAS, Dept. 8-U  
115 East 23rd St., New York 10, N. Y.**

Send me—absolutely FREE—a copy of your famous book, "Everlasting Health and Strength"—32 pages, crammed with actual photos, advice. I understand this book is mine to keep, and sending for it does not obligate me in any way.

Name \_\_\_\_\_ Age \_\_\_\_\_  
(Please print or write plainly)

Address \_\_\_\_\_

City \_\_\_\_\_ State \_\_\_\_\_



**TUBE FREE WITH EVERY TIRE AT NO EXTRA COST**  
EXPERIENCE IS THE BEST TEACHER. OUR MANY YEARS PROVES YOU CAN'T GET MORE. WHY PAY MORE? LOW OVERHEAD—LARGE VOLUME SALES & SMALL PROFITS BRING YOU THESE "LOWEST PRICES." WHAT GOOD IS A TIRE WITHOUT A TUBE? 21 YEARS AT THIS ADDRESS. FREE TUBES.



600-16	\$4.42	820-15	\$5.42	600-20	\$7.72	32x6(8)	\$11.72
650-16	4.82	700-16	4.82	650-20	8.82	32x6(10)	12.62
700-16	5.32	670-15	4.42	700-20	9.42	900-20	15.62
650-15	4.82	710-15	4.42	750-20	10.22	1000-20	15.82
760-15	4.72	800-15	5.22	825-20	16.72	1100-20	17.82

**GOOD USED TIRES — NOT RECAPS**

**FREE** If you buy 2 or more Passenger 4-ply tires, WE GIVE ONE tire FREE, on each order, on request. Does not include W.W. or Truck Tires. This offer on 36 Mos. Tires only.

Specialists in Truck Tires—Selected for Toughest Jobs—Tops in Value

600-16	\$5.52	475-19	\$4.82	700-15(8)	\$7.52	700-20	\$9.92
600-16(8)	5.92	640-15	4.22	750-16(8)	8.72	750-20(10)	15.72
650-16	5.72	670-15	5.32	750-17	8.92	750-20(8)	11.92
650-16(8)	6.62	710-15	5.82	750-17	10.32	825-20	18.92
700-16	6.02	760-15	5.82	825-15	12.92	900-20	17.92
750-16(8)	7.82	800-15	5.92	600-20	9.02	1000-20	17.92
550-18	4.52	820-15	5.92	650-20	9.82	1100-20	19.92
550-17	3.72	670-16	5.32	32x6(8)	12.02	1100-22	18.92
650-15	5.52	760-16	7.02	32x6(10)	13.92	1000-22	20.02
700-15	4.92	700-16(8)	7.32	750-15	7.72	1100-24	23.02

**"SPECIAL OFFER" For THOSE THAT WANT THEM** all size 4 ply case. (W.W. 1.00 extra) **\$6.22**

Thousands of tires shipped all over the U.S.A. All tires shipped F.O.B. Phila. Send Check or M.O. with this ad. Dept. 2. No C.O.D.

**STANDARD 834 N. Broad St., Philadelphia 30, Pa.**

## SHORTHAND in 6 WEEKS

Famous SPEEDWRITING shorthand. 120 words per minute. No symbols; no machines; uses ABC's. Easiest to learn, write and transcribe. Lowest cost. 250,000 taught by mail. For business and Civil Service. Typing available. 32nd year. Write for FREE booklet to: **SCHOOL OF Speedwriting**  
Dept. 1507-5, 55 W. 42 St., New York 36 (R)

## Learn MECHANICAL DENTISTRY

A profession offering unlimited opportunities. Most modern and complete course embracing every branch from Plate to Porcelain Work, which prepares you to work for Dentists or start your own business. Individual instruction—practical training in day or night school. No books—no classes. Catalog upon request.  
**McARRIE SCHOOL OF MECHANICAL DENTISTRY**  
207 N. Broad Street Dept. 43 Philadelphia 7, Penna.

## Learn ACCOUNTING Business Administration

Bookkeeping, secretarial and allied subjects at home in your spare time or attend nationally approved resident school. Write for FREE Success Book giving complete details on courses, plans, rates and employment opportunities. G.I. approved.

**Hills BUSINESS UNIVERSITY AND EXTENSION SCHOOL**  
629 W. MAIN ST. OKLAHOMA CITY 2, OKLAHOMA

## MAKE EXTRA MONEY PLASTICS LEARN AT HOME

There are RICH OPPORTUNITIES for MEN and WOMEN with "know-how" in Plastics. Interstate's new Plastics course tells and shows how to make hundreds of fast selling items out of Plastics. Gives complete training in fabrication, casting, lamination, molding, internal carving, etc., in simple, easy, step-by-step language and pictures. Plastics and Fabricating Kits for 23 valuable Plastic items come with training at no extra cost. **START A PLASTICS BUSINESS OF YOUR OWN.** No other industry holds such promise for the future. You can make big money manufacturing novelties, toys, signs, etc., in your own home in spare or full time. Don't wait! Learn NOW how Interstate's Plastics Training qualifies you for success in the Plastics field.

**PLASTICS AND SUPPLIES FURNISHED FOR 23 VALUABLE PROJECTS**

**INTERSTATE TRAINING SERVICE**  
Dept. C-3-G Portland 13, Oregon



## National Schools brings you a new dimension in training for TELEVISION-RADIO-ELECTRONICS

YOU CAN LEARN BY HOME STUDY, IF—

- you are ambitious to increase your earning power.
- you want to broaden your knowledge and skill.
- you choose the school with the most complete training, service and experience.

### 50 Years of Successful Training

National Schools has been training men for success since 1905. Our graduates are located around the globe, in good-paying jobs in servicing, installation and manufacturing...in public and private industry, or in their own businesses.

### What This New Dimension in Home Study Means to You

As a National Schools student, with Shop Method Home Training, you master *all phases* of the industry—TV, Radio, Electronics—theory and practice. You learn HOW and WHY, in one complete course at one low tuition. Age and education are no barriers. Because our world headquarters are in Los Angeles—a "Capital City of Electronics"—we are in close touch with industry. Our lessons and manuals keep you up-to-the-minute on latest developments. We show you how to make spare time earnings as you learn, and give you free placement assistance upon graduation. Both our Resident and Home Study courses are approved for G. I. Training. If you are of draft age, your course helps you achieve specialized ratings and pay grades.

### Your Course Includes Valuable Units

We send you important equipment, including a commercial, professional Multitester... plus parts to build Receivers, Oscillators, Signal Generator, Continuity Checker, other units, and Short Wave and Standard Broadcast Superhet Receiver.

### Mail Coupon for Complete Information

These 2 free books explain our new dimensions in Home Training. Get illustrated fact-book and sample lesson. No obligation, mail coupon now!

## NATIONAL SCHOOLS

TECHNICAL TRADE TRAINING SINCE 1905  
 Los Angeles 37, Calif. • Chicago, 323 W. Polk St.  
 In Canada: 811 W. Hastings St., Vancouver, B. C.



### MAIL NOW TO OFFICE NEAREST YOU!

(mail in envelope or paste on postal card)

### NATIONAL SCHOOLS, Dept. RB-75

4000 S. FIGUEROA STREET LOS ANGELES 37, CALIF., OR 323 W. POLK STREET CHICAGO 7, ILL.

Rush FREE Book, "Your Future in Radio-TV-Electronics," and FREE LESSON. No obligation, no salesman will call.

NAME \_\_\_\_\_ BIRTHDAY \_\_\_\_\_ 19 \_\_\_\_\_

ADDRESS \_\_\_\_\_

CITY \_\_\_\_\_ ZONE \_\_\_\_\_ STATE \_\_\_\_\_

Check if interested ONLY in Resident Training at Los Angeles, VETERANS: Give date of discharge \_\_\_\_\_

# DRAFTSMEN



**CASH BIG  
PAY CHECKS!**

**Train Now for  
more success,  
greater security**

**LEARN AT HOME IN SPARE TIME  
(or at college in Chicago)**

Check the want ads in any newspaper—SEE the big-pay opportunities open to you as a draftsman. What's more, you can learn this well-paid, prestige profession at home—quickly, easily! No special talent needed. Get complete, step-by-step Chicago Tech lessons in the mail, spend a few pleasant hours studying each week. In a short time you'll be a well-trained draftsman, ready to take your pick of many good jobs. Act now!



**Free Information—Mail Coupon Today!**

Get **FREE TRIAL LESSON** plus information about C.T.C. practical training. Learn what successful Chicago Tech graduates say about high pay and opportunities in drafting. No charge, or obligation.

## CHICAGO TECHNICAL COLLEGE

H-253 Tech Bldg., 2000 So. Michigan Ave.  
Chicago 16, Illinois

Mail me **FREE** lesson with facts about big opportunities in **DRAFTING**.

Name \_\_\_\_\_ Age \_\_\_\_\_  
Address \_\_\_\_\_  
City \_\_\_\_\_ Zone \_\_\_\_\_ State \_\_\_\_\_

## FREE! 106 STAMPS



**ALL-DIFFERENT!**  
From **CZECHOSLOVAKIA**  
• LAOS • CAMBODIA  
• VIET-NAM • ISRAEL

**Yours FREE**—to introduce our bargain approvals—this imported collection of 106 different stamps, includes very first stamps issued by states of Laos and Viet-Nam; Temple Dancer stamp from Cambodia; Flying Stag from Israel; Roosevelt Triangle from Monaco; Lenin-Stalin stamp from Czechoslovakia—plus scores more from all over the globe! It's a regular \$1.00 value—yet yours **FREE**. (Please enclose 10¢ to cover postage and handling). "Midget Encyclopedia of Stamps" included **FREE**... plus a big selection of stamps, on approval, for free examination.

**ASK FOR LOT FO-22**

**ZENITH COMPANY**

81 Willoughby St., Brooklyn 1, N. Y.

## Shrinks Hemorrhoids New Way Without Surgery

**Science Finds Healing Substance That  
Relieves Pain—Shrinks Hemorrhoids**

For the first time science has found a new healing substance with the astonishing ability to shrink hemorrhoids and to relieve pain—without surgery.

In case after case, while gently relieving pain, actual reduction (shrinkage) took place.

Most amazing of all—results were so thorough that sufferers made astonishing statements like "Piles have ceased to be a problem!"

The secret is a new healing substance (Bio-Dyne\*)—discovery of a world-famous research institute.

This substance is now available in suppository or ointment form under the name *Preparation H.*\* Ask for it at all drug counters—money back guarantee. \*Reg. U. S. Pat. Off.

## TELEPHONES



**Desk Stand Style**  
Slightly used but in excellent condition

Many Valuable Uses  
Inter-House Phones House to Barn, etc.  
Loud Speakers Microphones  
Educational Purposes, Toys, etc.

Come complete, ready to use with wiring diagrams included. **\$2.75** Postpaid in U.S.A.  
Two complete for only **\$5.00**  
**TELEPHONE LAMP KIT**—with illustrated instructions for making Desk Telephone Lamp including all parts (harp, nipples, push switch, cord, plug, etc.)  
... \$6.50 Ppd. (Shade is not included).

**MICROPHONE**, Dept. X2802, 1760 W. Lunt Ave., Chicago 26, Ill.

## How to Make Money in PHOTOGRAPHY

**EARN WHILE YOU LEARN AT HOME!**  
If you are **OVER 17**—good pay, fascinating work await you in photography! Start making money quickly in sparetime—step into your own studio or exciting job. **LEARN-BY-DOING** method trains you at home! Write **TODAY** for **FREE** catalog. Also Resident Training. 45th Year! GE Approved.  
**NEW YORK INSTITUTE OF PHOTOGRAPHY**  
Dept. 49, 10 W. 33 St., New York 1, N.Y.



## AGENTS START BUYING SERVICE AT HOME

**GET BIG NAME MERCHANDISE**

for your clients up to 40% less than reg. price. Operate sparetime. Sales easy as you can give sizeable discounts, still make fat comm. Postcard brings free plan.

**AMERICAN BUYERS SERVICE**

HERTEL STATION, DEPT. R, BUFFALO 16, NEW YORK

**GET  
UP TO  
40%  
OFF**

## YOU can be a SUCCESS



**ACHIEVE YOUR  
LIFE'S DESIRES!**

You can have increased financial success—greater self-confidence—stronger will-power—better health—happiness. The power to possess these *and more* is within your subconscious mind! Amazing scientific discovery, formerly available only through personal consultation, puts this tremendous force to work for you! *No books or studying*

Send for free proof and details of this modern miracle.

**CAMBRIDGE  
INSTITUTE**

1157 S Robertson Blvd. Dept. A-7  
Los Angeles 35, California



# FIX TV AND RADIO SETS RIGHT AWAY



—even if you never fixed a lamp or doorbell before!

McGraw-Hill's Amazing New Low-Cost  
Instruction Manual Skips Hard-to-Understand  
"Theories" and "Formulas." Tells How-to-do-it in PLAIN ENGLISH!

WHY hasn't somebody done this BEFORE? That's what you'll exclaim the minute you start browsing through this amazing new one-volume instruction manual in TV and radio repair.

For here at last a well-known EXPERT has found a way to tell you in PLAIN ENGLISH how to fix almost ANY radio or television set. (And he even tells you where you can go to have the extra-tough jobs done FOR you . . . at reduced professional rates.) Right from the very first chapters you can start doing simple repairs . . . and before you're HALF way through the manual, you can fix HALF the television and radio sets that you encounter. In just a few weeks you can start fixing your own and friends' sets . . . get a service shop job . . . even start your own money-making business at home.

### Why It's So EASY to Understand

You get no complicated formulas, algebra, laboratory experiments. Instead you deal *only* with the parts that go wrong in sets—how to recognize the trouble—and what to do about it. "Easy as A-B-C" directions and 700 clear photos, diagrams, and drawings show you exactly WHAT and HOW to fix, step-by-step.

### Tells HOW To "Cash In" ON THE BIG DEMAND FOR RADIO-TV REPAIRMEN

Over 25 million TV sets . . . over 100 million radios! Make nice extra money just fixing sets for friends and neighbors in your spare time . . . or start your own full-time repair business. Book tells exactly how to get started; which tubes to stock; how to make a service call. Actually start fixing sets and making money before you're half-way through book.



### Save Money on Your Own Set

Save \$50 to \$100 a year just in installing, repairing, and servicing your own TV set. Book tells which controls to adjust or tubes to replace if picture is entirely dark — blurred — split — distorted — off center — tilted — wiggles — and wobbles — too pale — too black — jitters — snow — effects — drifts — etc., etc.

The author is Associate Editor of *Electronics Magazine*. He spent FOUR years making this one-volume manual practical and easy-to-understand—even for an "un-handly" beginner.

Here's everything you need to know about *where* and *how* to buy tubes and parts, where and how to get an official circuit diagram for any receiver; how to choose and use basic tools; how to test tubes WITHOUT a tube tester; how to use 58 common TV controls; how to "diagnose" and "cure" common radio and TV troubles; how to fix loudspeakers, phono pickups; how to install and check antennas; and much, much more.

### SEND NO MONEY

Examine this book for 10 days BEFORE you decide if you wish to own it. Try it out FREE on your own or a neighbor's set. See how simple and easy it makes nearly every repair job. Make it pay for itself in 10 days or don't keep it! Mail coupon to: McGraw-Hill Book Co., Inc., Dept. PM-7, 327 West 41st St., New York 36, N. Y.

TELEVISION  
AND RADIO  
REPAIRING

TRY IT  
**FREE**  
ON YOUR OWN SET  
FOR 10 DAYS

### PARTIAL CONTENTS

How to Remove and Replace Tubes  
• Testing Tubes without a Tester  
• Using a Tube Tester • Power-Supply Troubles • How to Test and Replace Resistors, Controls, Switches, Condensers, Coils, Transformers • Loudspeakers • Phono Pickups and Needles • Antennas . . . MUCH MORE.

"Written as simply and clearly as possible. A natural for the beginner."  
—Radio & TV News  
"Prepared for people who know absolutely nothing about radio or use of tools."  
—Radio Electronics  
"Unique in its ability to explain servicing in easy-to-understand terms."  
—Electrical South

### FREE 10-DAY TRIAL COUPON

McGraw-Hill Book Co., Inc., Dept. PM-7,  
327 West 41st St., New York 36, N. Y.

Please send me, for 10 days' FREE EXAMINATION, your one-volume "Television and Radio Repairing," by John Markus. If not delighted, I may return book, pay nothing. Otherwise, I will send only \$1.00 plus four cents delivery; then 3 monthly installments of \$2.00 each.

Name \_\_\_\_\_  
Address \_\_\_\_\_  
City \_\_\_\_\_ Zone \_\_\_\_\_ State \_\_\_\_\_

SAVE MONEY. Check here if enclosing full price of \$7.95 with coupon. Then WE will pay for delivery. Same 10-day return privilege. (Offer good in U.S.A. only.)



YOU  
can  
acquire

## LAW NIGHTS AT HOME! L. L. B. DEGREE

LaSalle's famous Law Library—used as reference in many Law libraries and Law offices—has enabled thousands to master Law surprisingly fast, in spare hours at home, for business and professional advancement.

These 14 remarkable volumes, compiled by leading professors and lawyers, cover the whole basic field of Law in condensed, orderly, simplified manner.

You advance rapidly with this great library, plus special lectures furnished. We guide you step-by-step with personalized Problem Method of instruction . . . you learn by doing—handling legal problems—not by memorizing rules.

Send for two FREE 48-page booklets, "Law Training for Leadership," and "Evidence," answering questions about Law and its value to you, and telling how LaSalle Law graduates are winning rapid advancement in business and public life. Mail coupon below. No obligation.

### LA SALLE EXTENSION UNIVERSITY A Correspondence Institution

417 S. Dearborn St. Dept. 764L Chicago 5, ILL.

Send me your two FREE booklets described above, without obligation.

Name.....Age.....

Street.....

City, Zone & State.....

## ENGINEERING DEGREE IN 27 MONTHS

### Big Demand for Graduates

**Aeronautical, Chemical, Civil, Electrical, Mechanical and Electronics Engineering (inc. Radio and TV)**

Hundreds of young men are earning B. S. ENGINEERING DEGREES annually in this recognized institution — year around operation. New terms start quarterly. Many students earn a major part of their college expenses in this large industrial center.

Low tuition. Competent instruction. Thorough, intense practical program. Modern, well-equipped laboratories including new physics laboratory and modern wind tunnel. Individualized instruction emphasized.

Government approved for G.I.'s. Engineering preparatory courses. Students from 48 states and 21 foreign countries. Enter September, December, March and June. Send coupon for free catalog and full information. Enroll now.

SEND COUPON TODAY

## INDIANA TECHNICAL COLLEGE

575 E. Washington Boulevard  
Fort Wayne 2, Indiana

Please send me free information on B.S. Engineering Degree in 27 months as checked.

Aeronautical  Chemical  Civil  Electrical  
 Mechanical  Electronics

Name.....

Address.....

### INSURED TIRE SERVICE POPULAR BRANDS

**FREE** INSURANCE POLICY given with each used tire sold. We guarantee the amount of service you pay for.

NOWHERE CAN SUCH QUALITY BE FOUND AT SUCH LOW PRICE!

**SPECIAL!**  
Deduct 10% on orders for Two or More used tires

**YOU CAN'T LOSE!!**

Super Quality — Rugged Performance — 15 Months Insured Service			
600x16	\$3.65	670x16	\$3.95
650x16	4.25	700x16	4.05
750x16	4.35	820x16	4.45
850x16	4.55	900x16	4.65

Supreme Quality — Nothing Finer — 30 Months Insured Service			
600x16	\$8.25	475x19	\$8.45
600x16(6)	6.75	640x15	4.95
650x16	5.75	670x15	5.35
650x16(6)	7.25	710x15	5.45
700x16	6.35	760x15	5.95
750x16(6)	8.45	800x15	6.35
850x16	4.95	820x15	5.35
850x17	4.75	880x15	5.35
650x15	5.25	670x16	5.15
700x15	5.35	700x16(6)	10.25
		32x8(10)	12.75

Whitewalls \$1.00 extra.

**MIDLAND TIRE SALES** Speedy shipments on Mail Orders. F.O.B. Chicago. Insurance policy sent with each order. Deduct 10% on orders for 2 or more used tires. Send CHECK or MONEY ORDER.—No COD's.  
3701 S. Normal, Dept. PM-36, Chicago 9, Ill.

### GIANT BALLOONS

They're really BIG—surplus U. S. Govt. (new overage) Neoprene weather, largest balloons. GREAT FUN in the backyard; at parties, picnics, dances, fairs. TERRIFIC for high school and college PROMS! They attract BIG crowds to BUSINESS openings, civic events, conventions, exhibitions, trade shows. ORDER TODAY! APPROX. inflated sizes:

3 ft. dia., 49¢ — 5 ft. dia., 99¢  
10 ft. dia., \$1.59

Postage paid on prepaid orders. Calif. residents please add sales tax.

**VOLUME SALES CO., War Assets Division**  
Dept. PM-755 3930 Sunset Blvd. Los Angeles 29, Calif.

## REAL ESTATE

**BE A BROKER**

PAYS BIG! SEND FOR FREE, BIG, ILLUSTRATED CATALOG NOW! Graduates report making substantial incomes. Start and run your own business quickly. Men, women of all ages, learn easily. Course covers Sales, Property Management, Appraising, Loans, Mortgages, and related subjects. **STUDY AT HOME** or in classrooms in leading cities. Diploma awarded. Write TODAY for free book! No obligation. Approved for World War II and Korean Veterans.

**WEAVER SCHOOL OF REAL ESTATE (Est. 1936)**  
2020R Grand Avenue Kansas City, Mo.

FREE BOOK TELLS HOW

## Secrets of VENTRILOQUISM Now Revealed!

Easy to learn in 60 to 90 days with our Home Study Course. **RESULTS GUARANTEED!** Make Money! Be Popular! Have Fun! Big Opportunity! Radio, Television, Stage Appearances! For FREE information regarding price and terms, WRITE. You must state your age. Dummy Catalog 25c.

**FRED MANER SCHOOL OF VENTRILOQUISM**  
Box 36, Studio PM-7 Kensington Station  
Detroit 24, Michigan

## SOCK-O

World's Most Powerful

### SUPER SLINGSHOT

SILENT • RIFLE FAST • POWERFUL • ACCURATE

Great for small game, targets. 45 lb. pull. BIG sturdy Stock. Lively. Raw rubber. Sweet shooting! FREE! 100 steel balls, rubber and target. FREE!!! Thrilling SURPRISE PACKAGE with Two slings at \$2.95. Hurry, get 2! Guaranteed. Approved by American Small Game Sling-shot Assoc.

**SOCK-O, PM, 4860 W. 137 St., Hawthorne, Calif.**

## RUPTURED

### BE FREE FROM TRUSS SLAVERY

NOW there is a new modern Non-Surgical treatment that permanently corrects rupture. These Non-Surgical treatments are so certain, that a Lifetime Certificate of Assurance is given. Write today for our NEW FREE Book that gives facts that may save you painful and expensive surgery, and tells how non-surgically you may again work, live, play and love and enjoy life in the manner you desire. There is no obligation.

**Excelsior Hernia Clinic Dept. 8305 Excelsior Springs, Mo.**

# HOW TO FIX

Brakes, Clutches, Transmissions, Rear Ends, Carburetors—Yes,  
**ANY PART OF ANY CAR**



QUICKLY--  
 EASILY--  
 RIGHT!

USED BY U. S.  
 ARMED  
 FORCES

**NOW—Whether You're a Beginner or an Expert Mechanic—You Can "Breeze Through" ANY AUTO REPAIR JOB! MOTOR'S BIG BRAND-NEW AUTO REPAIR MANUAL Shows You HOW—With 2900 PICTURES AND SIMPLE STEP-BY-STEP INSTRUCTIONS.**

**Free 7-DAY TRIAL**  
 Return and Pay Nothing  
 If Not Satisfied

## COVERS EVERY JOB ON EVERY CAR BUILT FROM 1940 THRU 1955

**Y**ES, it's easy as A-B-C to do any "fix-it" job on any car whether it's a simple carburetor adjustment or a complete overhaul. Just look up the job in the index of **MOTOR'S** New **AUTO REPAIR MANUAL**. Turn to pages covering job. Follow the clear, illustrated step-by-step instructions. Presto—the job is done!

No guesswork! **MOTOR'S** Manual takes nothing for granted. Tells you where to start. What tools to use. Then it leads you easily and quickly through the entire operation!

**Over 2,900 Pictures! So Complete, So Simple, You CAN'T Go Wrong!**

**BIG BRAND-NEW REVISED Edition.** Covers everything you need to know to repair over 737 chassis models—including ALL 1955 CARS. **OVER ONE THOUSAND** giant pages, 2,900 "This-Is-How" pictures, 291 "Quick-Check" charts—23,436 essential repair specifications. Over 225,000 service and repair facts. Instructions and pictures are so clear you can't go wrong!

Even a green beginner mechanic can do a good job. And if you're a topnotch mechanic, you'll find short-

cuts that will amaze you. No wonder this guide is used by the U. S. Army and Navy! No wonder hundreds of thousands of men call it the "Auto Repair Man's Bible"!

### Meat of Over 160 Official Shop Manuals

Engineers from every automobile plant in America worked out these time-saving procedures for their own motor car line. Now the editors of **MOTOR** have gathered together this wealth of "Know-How" from over 160 Official Shop Manuals, "boiled it down" into crystal-clear terms in one handy indexed book!

### Same FREE Offer On MOTOR'S Truck and Tractor Manual

Covers EVERY job on EVERY popular make gasoline truck, tractor made from 1944 thru 1954. FREE 7-Day Trial. Check proper box in coupon.

### Try Book FREE 7 Days

**SEND NO MONEY!**

Just mail coupon! When the postman brings book, pay him nothing. First, make it show you what it's got! Unless you agree this is the greatest time-saver and work-saver you've ever seen—return book in 7 days and pay nothing. Mail coupon today! Address: **MOTOR Book Dept., Desk 17, 250 West 55th St., New York 19, N. Y.**

### Covers 737 Models—All These Makes

- |           |         |            |
|-----------|---------|------------|
| Buick     | Ford    | Nash       |
| Cadillac  | Frazer  | Oldsmobile |
| Chevrolet | Henry J | Packard    |
| Chrysler  | Hudson  | Plymouth   |
| Crosley   | Raiser  | Pontiac    |
| De Soto   | Lincoln | Studebaker |
| Dodge     | Mercury | Willys     |



Many Letters of Praise from Users  
 "MOTOR'S Manual paid for itself on the first 2 jobs, and saved me valuable time by eliminating guesswork."  
 —W. SCHROP, Ohio

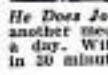

He Does Job in 20 Min.—Fixed motor another mechanic had worked on half a day. With your Manual I did it in 20 minutes."  
 —C. AUBERRY, Tenn.

## MAIL COUPON NOW FOR 7-DAY FREE TRIAL

**MOTOR BOOK DEPT.**  
 Desk 17, 250 W. 55th St., New York 19, N. Y.

Rush to me at once (check box opposite book you want):

**MOTOR'S New AUTO REPAIR MANUAL.** If O.K., I will remit \$2 in 7 days, \$2 monthly for 3 months and a final payment of \$6 (plus 35c delivery charges) one month after that. Otherwise I will return the book postpaid in 7 days. (Foreign price, remit \$9 cash with order.)

**MOTOR'S New TRUCK & TRACTOR REPAIR MANUAL.** If O.K., I will remit \$2 in 7 days, and \$2 monthly for 3 months, plus 35c delivery charges with final payment. Otherwise I will return book postpaid in 7 days. (Foreign price, remit \$10 cash with order.)

Print Name.....Age.....

Address .....

City.....State.....

Check box and save 35c shipping charge by enclosing WITH coupon entire payment of \$6.95 for Auto Repair Manual for \$8 for Truck and Tractor Repair Manual. Same 7-day return-refund privilege applies.

# ... TURN CONCRETE INTO GOLD!

**MAKE UP TO \$75 A DAY IN YOUR OWN BUSINESS**

If you want to have your own business — to start a business on your own — here's your big opportunity! New high speed, low cost General block machine produces up to 1,000 concrete blocks a day. Sell all you make to builders, supply houses, and others for homes, factories, buildings, garages. Cash in on the building boom! You can make profits of 100% to 150% — up to \$75 a day! General block machine equipped with 1/2 h.p. electric motor — or can be supplied with gasoline engine — works anywhere, in little space, indoors or out. Operates from ordinary house light socket. Simple, foolproof 3 step operation — so easy a child can do it. Makes superior 3 core blocks any size from 4" to 12". Also makes chimney, tank, corner and other types. Blocks meet any building code anywhere in the country. Materials — sand, water, cement, available anywhere. Simple illustrated operating instructions and mixing formulae for cement and cinder blocks supplied with each machine. Write for FREE folder with full information.

**MOTOR DRIVEN**

R. L. T. of New York City reports: "MY GENERAL BLOCK MACHINE PAID FOR ITSELF IN FIRST 2 WEEKS!" Hundreds now in use the world over! Write for FREE details today!

### EXTRA

Amazing Illustrated book gives floor plans for 4 sensational concrete block bungalows. Tells how to lay blocks, lay out building lines, mix concrete, build steps, porch and concrete floors all at great savings. Written by experts. Can save many times the cost of the machine! Get it now! No strings attached. Send \$1.

BOOK SENT FREE IF YOU BUY MACHINE.  
\$1 REFUNDED IF YOU BUY LATER.

**GENERAL ENGINES CO.**  
DEPT. M-75, ROUTE 130, THOROFARE, NEW JERSEY



**Easy as A-B-C**

Simple as A-B-C. Your lessons consist of real selections, instead of tiresome exercises. You read real notes—no "numbers" or trick music. Some of our 900,000 students are band LEADERS. Everything is in print and pictures. First you are told what to do. Then a picture shows you how. Then you play it yourself and hear how it sounds. Soon you are playing your favorite music. Mail coupon for our 36-page illustrated Free Book. Mention your favorite instrument. U.S. School of Music, Studio A307, Port Washington, N. Y.

# Be Your Own MUSIC Teacher

**LEARN AT HOME THIS QUICK MONEY-SAVING WAY**

Simple as A-B-C. Your lessons consist of real selections, instead of tiresome exercises. You read real notes—no "numbers" or trick music. Some of our 900,000 students are band LEADERS. Everything is in print and pictures. First you are told what to do. Then a picture shows you how. Then you play it yourself and hear how it sounds. Soon you are playing your favorite music. Mail coupon for our 36-page illustrated Free Book. Mention your favorite instrument. U.S. School of Music, Studio A307, Port Washington, N. Y.

**FREE BOOKLET**

U. S. SCHOOL OF MUSIC, Studio A307, Port Washington, N. Y.  
Please send me your 36-page illustrated Free Book. I would like to play (Name Instrument).

Instrument? ..... Have you Instrument? .....

Name ..... (Please Print)

Address .....

**Finished Photos in 2 Minutes!**  
**Great Quick Photo Invention**  
**PDQ CHAMPION PHOTOMASTER**

Takes and finishes 30 to 40 everlasting, black and white or sepia photos an hour. No dark room. Guaranteed not to fade. Photos taken on "SUPER-SPEED" direct positive paper. Picture size 2 1/2 x 3 1/2 in. Complete, easy to operate portable photo studio. **700% PROFIT.** Write quick, get details about the great PHOTOMASTER.

**P D Q CAMERA CO.**  
Chicago 10, Ill.  
1161 N. Cleveland Ave., Dept. PM-755

## SHINE WITHOUT 'POLISH'

**New Invention! • Sells Like Wild**

Replaces messy pastes, liquids. Simply glide over shoes—and PRESTO! —you have a lustrous, long-lasting shine. No mess, no fuss. Shoes gleam like mirror. For Men's, Women's, Children's Shoes. Take orders! Earn money!

**SAMPLES FOR TRIAL**

Sample offer sent to all who send name at once. Postcard will do. SEND NO MONEY—just your name. KRISTEE CO., Dept. 683, AKRON 8, OHIO

## TASOPE PHOTO-ENGRAVING PLANTS

Establish your own profitable PHOTO-ENGRAVING business. Make cuts for newspapers, printers, and advertisers. Make etched name plates, plaques etc. Instructions furnished, no experience necessary. Sold direct from factory since 1931. First five hundred cuts sold locally or by mail will pay for plant and pay you well for your time. Write for FREE catalog.

TASOPE, DEPT. PM-7, AURORA, MO.

## MAKE CRIME YOUR BUSINESS

**ON THE SIDE OF THE LAW!**

Help fight crime! ... Earn steady good pay as a Finger Print Expert or Investigator. I. A. S. trains you—by easy, low-cost home study lessons. Learn this exciting work in spare time. Write for full details now!

**OVER 800 POLICE BUREAUS...** Employ I. A. S.-trained men ... proof of what I. A. S. can do. Write today (state age) for details. No obligation. No salesmen will call.

INST. OF APPLIED SCIENCE, 1829 Sunnyside Ave., Dept. 1359 Chicago 48, Ill.

## AGENTS — SALESMEN

OPPORTUNITY TO START YOUR OWN HIGHLY PROFITABLE MAIL ORDER BUSINESS. WORK AT HOME, SPARETIME. NO MERCHANDISE TO BUY OR HANDLE. NO EXPERIENCE OR CAPITAL REQUIRED. EVERYTHING SUPPLIED. SEND POST-CARD TODAY FOR YOUR COPY OF

**DERROM COMPANY**  
21-03 WHITE, PATERSON 23, NEW JERSEY

**BUY DIRECT SAVE up to 60%**

**FREE "WHOLESALE TRADE SECRETS"**

## Free Book on Arthritis and Rheumatism

**HOW TO AVOID CRIPPLING DEFORMITIES**

Explains why drugs and medicines give only temporary relief and fail to remove the causes; tells all about a specialized non-surgical, non-medical treatment which has proven successful for the past 36 years. Write for this 44-page FREE BOOK today.

**Ball Clinic Dept. 756 Excelsior Springs, Mo.**

## Learn BAKING At Home

Baking is one of America's high industries in wages. Nearly DEPRESSION-PROOF. Thorough basic home course lays sound foundation. If you have aptitude, write for FREE Booklet, "Opportunities in Commercial Baking."

**NATIONAL BAKING SCHOOL**  
835 Diversey Parkway Dept. 1358 Chicago 14.

Get the Facts on  
**MOBILE LIVING**

Get  
**TRAILER TOPICS  
MAGAZINE**

When you subscribe to Trailer Topics Magazine, you get the latest information on Mobilehomes... Equipment... Accessories... Trailer Trips... Trailer Parks and many other interesting monthly features at only—\$3.00 for 2 years.



**TRAILER TOPICS MAGAZINE (Room 1578)**  
28 East Jackson Blvd., Chicago 4, Illinois

**BE A  
LEADER  
IN  
AVIATION**

Parks graduates are known world-wide as leaders in aviation — their education is the finest offered. Advance faster . . . earn more in less time! Become a Parksman!

B.S. degree in 3 yrs. from Saint Louis University — Aero. Eng., Aero. Adm., Maint. Eng.

Non-degree courses—A & E Mechanics, Private, Commercial, Instrument, Flight Instructor and Multi-engine Ratings . . . CAA-Approved.

All Parks schooling approved for Veterans.  
Write for full information.

**PARKS COLLEGE** ARNOLD HALL  
EAST ST. LOUIS, ILL.

**A "GOOD HAND" HELPS YOU SUCCEED!**  
**LEARN TO WRITE WELL**

Handwriting quickly improves with our easy-to-understand picture lessons! Put your spare time to good use; send today for **FREE BOOKLET**, "How to Become a Good Penman," or check volumes wanted below at \$1 each:  Business Writing  Artistic Writing  Card Writing  Bird & Design Flourishing  Engraving Alphabets, **COMPLETE SET \$4.50**. Ask for price list of penman's supplies.

**OUR 53rd YEAR**  
**TAMBLYN SCHOOL of PENMANSHIP**  
S.A. Ziller, Pres., 442 Ridge Bldg., Kansas City, Mo., USA

**MONEY in DONUTS**

Make new greaseless donuts. Start in kitchen. No smoke. Sell stores. Cash daily. No experience necessary. Free recipes. No obligation. Write! **MARTIN RAY CO., 3605 SO. 15th AVENUE, MINNEAPOLIS 7, MINN.**

**COLOR PRINTS**

FROM YOUR COLOR FILMS  
**KODACHROME • ANSCOCHROME  
EKTACHROME • ANSCO COLOR**

4x5 50¢ | 5x7 \$1 | 8x10 \$2

**25¢**  
2 1/4 x 3 1/4

Minimum order \$1  
No COD's, please

**AUTHORIZED ANSCO COLOR LABORATORY  
COLORFAX LABORATORIES**  
Dept. 775, Box 3521, Georgetown Sta., Washington 7, D. C.

**HELPFUL BOOKS**

Send post card asking for **FREE catalog**  
Popular Mechanics Press, 200 E. Ontario, Dept. 601, Chicago 11

**POWER MOWER KITS** **FREE PLANS**

Have one of the finest mowers money can buy. Write for **FREE PLANS** and **PARTS LIST** showing you how to **SAVE MONEY** by assembling Triangle's **POWER MOWERS**.

**SPECIAL FACTORY PRICES**

Kits, Parts, Engines, Wheel, etc. 18" and 20" sizes; 3 or 4-wheel models; belt or direct drive. Latest improvements, sturdy construction, money-back guarantee fully told in **FREE color folder**. Also complete **TRIANGLE MOWERS** ready to mow at low **Factory Prices**. Write today.

**▲ TRIANGLE MFG. CO., Dept. MA-7, Ft. Scott, Kan.**

**BECOME AN  
Electrical Engineer**



- Major in Electronics or Power
- Earn B. S. Degree in 36 Months

Over 50% of the nation's industrial leaders began their careers with engineering training. Prepare now for a rewarding future as an Electrical Engineer or Engineering Technician. Enroll at the Milwaukee School of Engineering.

**Plan Your Career—Seventeen Courses  
Give You Wide Range of Study**

**ENGINEERING COURSES**

Electrical Engineering—Bachelor of Science Degree  
Save a valuable year through optional year 'round study.

Electronics major .....	36 months
Power major .....	36 months

**TECHNICIAN COURSES**

Electro Technician .....	12 months
Electronic Technician .....	12 months
Radio Technician .....	12 months
Radio and Television Technician .....	18 months

**SERVICE COURSES**

Electrical Service .....	6 months
Radio and Television Service .....	12 months

**MECHANICAL TECHNOLOGY COURSES** — Also available, Service and Technician courses 6 to 18 months — Heating, Refrigeration, Welding, Air Conditioning and Mechanical — B.S. Degree in Mechanical Engineering with a major in Design, Metal Fabrication, or Plant Engineering. Also, general 3-month preparatory course.

Terms open Sept., Jan., Apr., July.

Prior Military, Practical or Academic training evaluated for advanced credit. Faculty of specialists. 50,000 former students. Annual enrollment from 48 states and 23 overseas countries. 52nd year. Non-profit.

Residence courses only. Send handy coupon today.

MS-11A



**MILWAUKEE  
SCHOOL OF ENGINEERING**

**MILWAUKEE SCHOOL OF ENGINEERING**  
Dept. PM-755, 1025 Milwaukee St., Milwaukee, Wis.

Send free illustrated career booklets  Electrical Technology  Mechanical Technology  Radio-Television.

I am interested in.....  
(name of course)

Name.....Age.....

Address.....

City.....Zone.....State.....

If veteran, indicate date of discharge.....

# INVENTORS

WE recommend that you take the following preliminary steps toward patent protection. Make a disclosure of your invention; sign, date and have your disclosure witnessed by two people who understand your invention; authorize us to conduct a preliminary search among previously granted U. S. patents for similar types of invention. We give you a report on the probable patentability of your invention and our recommendation for further course of action.

Let us send you a copy of our instructive booklet, "Patent Protection for Inventors" and our convenient "Evidence of Invention" disclosure form. No obligation.

VICTOR J. EVANS & Co. *Merlin M. Evans*

REGISTERED PATENT ATTORNEY

130-H MERLIN BUILDING, WASHINGTON 6, D. C.

## AIR CONDITIONING

is the booming new trade for smart men who want more money, more security, higher type jobs.

### START LEARNING AT HOME IN SPARE TIME

Never before in our 28 years of teaching REFRIGERATION, HEATING, AND AIR CONDITIONING has the business been greater, or the future brighter for ambitious, mechanically-minded men. In a boom of pent-up demand, exciting new equipment for homes, stores and factories is making the public buy to the tune of over \$100,000,000.00 a year—with no end in sight. Result? A critical shortage of men (age 18-55) who know the technical principles of correctly installing this new equipment and servicing the old.

### FREE BOOK!!!

Employers are having a hard time finding the men they want. Now our spare time home-study method gives you the principles and shortens your shop training. For facts, send today for our FREE BOOK.

### UTILITIES ENGINEERING INSTITUTE

2525 Sheffield Ave., Dept. C-14, Chicago 14, Ill.

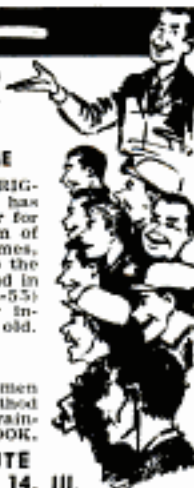

## OWN A TRIUMPH

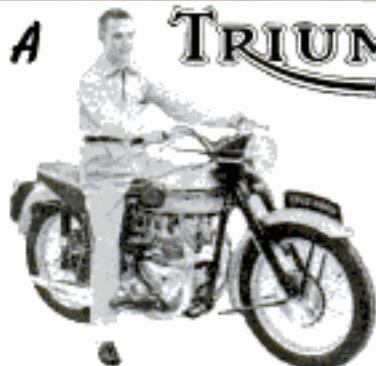

With a Triumph—you're in for some real fun at very low cost. Hours of pleasure and miles of fun filled travel are yours for only a few cents. Triumph's amazing mileage means that you save on gas without any sacrifice of speed. 4 cycle single cylinder and twin cylinder models. See your nearest Triumph dealer

for easy monthly payments, and free demonstration. He will teach you to ride.

### SEVEN NEW MODELS

FROM \$449.00

- "jet wing" double seat.
- front and rear springing
- gear position indicator
- sparkling colors with chrome
- easy to ride

Rush this coupon to nearest address below. Dept. P

The Triumph Corporation  
Towson, Baltimore 4,  
Maryland

Johnson Motors, Inc.  
247 W. Colorado St.  
Pasadena 1, Calif.

Send me absolutely FREE the 1955 Triumph MOTORCYCLE Catalogue in full color. If under 16 years of age, check square for special pictures.

NAME.....

ADDRESS.....

PHONE.....

## ★ WORK FOR UNCLE SAM ★

U. S. GOV'T. JOBS! AS HIGH AS \$4205.00 YEAR TO START. Men, women, 18-55. Grade School education often sufficient. Write immediately for FREE 36-PAGE BOOK with list of positions, salaries, sample tests and full particulars telling how to qualify for them. (Not Gov't. Controlled)

Franklin Institute, Dept. E-93, Rochester 4, N. Y.



FREE! 60 APPROVED EXERCISES, 68 PHOTOS

with FAMOUS DAN LURIE

### BARBELLS

50 lb. set \$ 8.48 • 100 lb. set \$13.98

150 lb. set \$20.48 • 200 lb. set \$25.98

SEND FOR FREE CATALOG

Order by mail—50% with order Balance

COD, Extra WTS. 13c lb. FOB Plant.

DAN LURIE BARBELL CO.

52M7 Bristol St., Dept. 559G, Brooklyn 12, N.Y.

SEE DAN ON T V "BIG TOP" SHOW

PLEASE  
SEND ME



for the  
time checked.

I am enclosing . . .

1 year \$3.50

2 years \$6.00

name

address

city

zone

state

C-75

Hand this order to your newsdealer or send it to

POPULAR MECHANICS  
200 East Ontario St. Chicago 11, Ill.

NOW-POWER YOUR MODEL PLANES, BOATS, RACE CARS!

# Real DIESEL ENGINE

Fully Assembled 1/7 HP!

Not a toy! A real Diesel Engine that runs at 7500 RPM and produces 1/7 HP! Precision-tooled as carefully as giant army engines! Cylinder honed to .0001 and hand-fitted to pistons. Yet weighs only 5 oz! Starts quickly! Rugged! Easy operating instructions. Over 100,000 sold at higher price. Now at a special, low, low price!

NOW \$1.95 Plus 5¢ Postage

2/3 ACTUAL SIZE

### SPECIAL!

196-PAGE BOOK ON MODEL ENGINES. Covers everything hobbyists should know. Only \$1 Postpaid. FREE with purchase of \$5 or more.

CHESS COMPUTER. Gives opening moves of the 16 leading chess variations. Only \$1 Postpaid. FREE with purchase of \$10 or more.

GOTHAM HOBBY CORP., Dept. M7, 107 E. 126th St., New York 35, N. Y.

You bet I'm interested in new low prices! Send me postpaid

Quan.	Item	Amount	Quan.	Item	Amount
.....	DIESEL ENGINE.....	\$2.00 \$	Also send these genuine accessories:		
.....	Prop (Free Flight).....	35¢ \$	.....	Flywheel (boat or car)	75¢ \$
.....	Shut-Off Valve.....	\$1.25 \$	.....	Tank .....	50¢ \$
.....	Test Mount .....	\$1.25 \$	.....	Spinner .....	75¢ \$
.....	Fuel Pump .....	75¢ \$	.....	Control Wire .....	75¢ \$
.....	Fuelmix (Express Collect Only).....	\$1.00 \$	.....	Control Handle .....	\$1.00 \$
.....	Model Engine Book	\$1.00 \$	.....	Electric Motor .....	\$1.95 \$
.....			.....	Chess Computer .....	\$1.00 \$

Name ..... \$  
 Address .....  
 City..... Zone..... State.....  
 TOTAL AMOUNT

## BECOME AN EXPERT IN TRAFFIC

Traffic men earn \$4,000 to \$10,000 and up. Thousands of firms need experts on rates, tariffs, regulations. We train you thoroughly in spare time at home for executive traffic jobs. Personal training under traffic authorities. Placement counsel and help. Write for free 48-page book "Traffic Management—the Fast Growing Profession."

LASALLE Extension University, 417 So. Dearborn St. A Correspondence Institution Dept. 764T Chicago 5, Ill.

## LEARN WATCH REPAIRING

AT HOME Modern, original instruction. Prepare for a position or start in business after completing our course. Write Today! WISCONSIN SCHOOL OF WATCH REPAIRING 2908 N. 44th St. Dept. M Milwaukee 10, Wis.

27 YEARS OF SINCERITY • CHECK MY GUARANTEE & PRICES! FOOLISH TO PAY MORE—DANGEROUS TO PAY LESS!

**FREE** This Pictured, Handsome Tire Ash Tray Included With 2 or More Tires!

If you buy 2 or more TIRES you get an extra tire FREE. So wise! Why buy only one! (not W.W., Truck, or "Co. Release" tires)

CHOOSE YOUR FAVORITE BRAND Family safe, partially used. Not retreads or recaps.

GOOD YEAR		Firestone	
U. S. GOODRICH & others.	36 Month Guar. & FREE TUBE		
600-16 \$4.81	640-15 \$4.81	760-15 \$4.71	820-15 \$5.31
650-16 4.71	670-15 4.71	800-15 5.11	700-15 4.51
700-16 5.21	710-15 4.71	SPECIAL WHITE WALLS \$2.00 Extra	
HEAVY DUTY TRUCK TIRES. 36 MONTH GUAR. & FREE TUBE			
600-20 \$7.91	825-20 \$16.71	600-16 (6) \$5.81	750-16 \$8.51
650-20 8.51	900-20 15.61	650-16 (6) 6.51	700-17 7.91
700-20 9.11	1000-20 15.81	700-16 (6) 7.21	750-17 9.91
750-20 9.91	1100-20 17.61	700-15 (6) 7.21	1000-22 16.81

SPECIAL TIRES RELEASED BY CO. ADJUSTERS (just used slightly) if a tire proves defective at any time, I charge you nothing. World's top value and FREE TUBE \$7.88 any car

MARVIN BLATT 6th & Spring Garden Sts. Philadelphia, Pa. MILITARY MUD-GRIP TIRES AA Guar. 20 Mos. AAA/36 Months 900-16 \$10.21 900-16 \$13.91 750-20 9.71 750-20 13.51

Send Ck. or M.O. & this ad for instant shipment. FOB Phila. I personally select your tires—as if my future depended on it. Thousands of tires shipped the world over! Read that top line again.

## MAKE YOUR NATURAL ABILITY PAY

### Train to become a Professional DIESEL & AUTO MECHANIC

• HIGH INCOME • SECURE FUTURE • LEARN AT LOW COST • STUDY UNDER EXPERTS

With U. S. Trade School training you probably can earn \$100 a week on your first job. We help you earn money in Kansas City while you learn, we help you get a job after graduation.

How many so-called mechanics do you know who can really repair a 1955 Ford-O-Matic, Power-Glide, Hydra-Matic, etc.? How many can repair Power Steering equipment for cars or trucks? How about the "12-volt system"?

### YOU'LL BE AHEAD OF THE OLDER MEN IN EVERY WAY!

You'll learn by doing, by working in shops and labs. Expert class instruction in theory and practice by career mechanics with national reputations. Ultra-modern classrooms and shops. Newest equipment. We've trained men for the U. S. Army, state rehabilitation offices, and for leading transportation corporations. Write for complete information. No obligation. Approved for veterans.

### MAIL COUPON FOR FACTS

U. S. TRADE SCHOOLS, Dt. P-1, 500 E. 11th St., Kansas City, Mo.

NAME.....

STREET.....

CITY..... ZONE..... STATE.....

KOREAN VETERAN



**what you don't know  
CAN hurt you!**

This free eye-opening booklet demonstrates clearly why you should know your gas heating system. How does a house lose heat? Why is correct venting so important to family health? What eventual damage can result from an improper installation? Learn the answers to these significant questions and many more.

Contact your nearest gas heating dealer today for your free copy of "What You Should Know About Gas Heating" or write to Dept. 00-2111

**METALBESTOS DIVISION**  
WILLIAM WALLACE CO., BELMONT, CALIF.

SAY YOU SAW IT IN  
POPULAR MECHANICS

# TERRIFIC!

USED 16 x 50  
Regularly sold at \$69.50  
**NOW \$37.60**

These are not "used" in the sense that someone else owned them, but their frames have been scratched or some of the paint rubbed off while being taken off of the shelves or when handled on our viewing range. Their cases, too, sometimes show scuff marks. OPTICALLY AND MECHANICALLY THEY ARE A-1. 7" high. Water-dust resistant. 2" wide objectives assure greater illumination and brighter sharper images. Weigh only 27 ounces!



**SALE**  
20 POWER  
Regularly \$39.95  
**NOW \$29.95**

Brand new glasses. Never in the 100 years since Carl Zeiss invented binoculars has it been possible to get a 20 POWER PRISMATIC BINOCULAR that weighed only 18 ounces! Precision made. Individual focus with removable, screw-in protective caps. Lens are color corrected. Handsome crackle finish with satin chrome trim. Increased sales have lowered production costs and we are passing on this \$10.00 savings to you!

**30 DAY NO RISK TRIAL**

If not satisfied return for full refund. Made in Japan. Leather case, straps included. Add 10% Fed. tax. Cash orders prepaid. C.O.D.'s require \$2.00 deposit. UNITED BINOCULAR CO., Dept. ARF-0308, 9043 S. Western Ave., Chicago 20. DEALERS WANTED!

## CABINETMAKING



### Low Cost Home Craft Course Now Available

Make money. Become a skilled woodworker. Interstate's new woodworking course tells and shows how to turn out hundreds of professionally constructed and finished wood projects with hand and power tools. Twenty-two profusely illustrated manuals. Over 1,000 pages. Over 75 projects. Written by expert instructors. The only complete course available today! Get full information without obligation...today.



Write for **FREE Booklet**

**INTERSTATE TRAINING SERVICE**  
SCHOOL OF WOODWORKING  
DEPT. F-3-G, PORTLAND 13, OREGON

### "I HAVE AVERAGED \$25 A DAY" APPROXIMATELY



With Science's New Midget Miracle, the Presto Fire Extinguisher, says Jack Tupper, Brooklyn.

Many others "cleaning up"—so can you! Amazing tiny new extinguisher ends fires fast as 2 seconds. Guaranteed 20 years! Sells for only \$3.98! Write for FREE Sales Kit. No obligation. (If you want a regular Presto to use as a demonstrator send \$2.00. Money back if you wish.) Merlite Industries, Dept. 57, 114 E. 32nd Street, New York 16, N.Y.

JACK TUPPER



### OWN a Business

If employed, start part time. Alert dealers can gross \$5 hourly profit on own service plus \$3 on EACH serviceman. Clean, revive, moth-proof rugs & upholstery on location. No shop needed. Services nationally advertised. Repeat customers. Easy to learn. We locally train and assist you. Quickly established. Easy terms. Send today for FREE booklet. No obligation.

**DURACLEAN CO., 5-187 Duraclean Bldg., Deerfield, Ill.**

DEUTSCHES REICH

### Free! 153 GERMANY



Giant and midget-sized Stamps; hated Hitler heads; blood-red swastikas; inflation issues with pre-war face of millions of dollars; Allied and Russian Occupation issues; birds, animals, air-mail stamps - 153 all-different, guaranteed worth \$2.46 at Catalog prices. EXTRA! Free booklet, bargain lists, and other fascinating offers for your free consideration. Send 10c for mailing expenses.

JAMESTOWN STAMP CO., Dept. 122, Jamestown N.Y.

## JEEP OWNERS

STA. WAGONS • JEEPERS • PICK-UPS!

Take full advantage of 4-wheel drive by installing a Ford V-8 engine—MORE POWER—means less shifting, better traction at lower speeds, greater safety, plenty of power in high. All this is now possible by using our F-J adaptor plate. Conversion Kit \$43.25 incl. F.E.D. TAX. Write for free details or send check or M.O. for prepaid delivery. Order now for early shipment.

**HOOSIER MACHINE PRODUCTS CO.**  
312 S.E. 6th St. Pendleton, Oregon

## WARN HUBS STOP FRONT END DRAG ON 4-WHEEL DRIVES



PAINTED Warn Hubs disengage front differential for use in 2 W.D. range, give 4 W.D. amazing pep, getaway, steering ease; save gas, tires; stop front end shimmy! Automatic models also stop front axle torque, permit high road speeds in 4 W.D. high range! Use either drive, anytime! Select drive needed—automatically with Warn Automatic Hubs, manually with Warn Locking Hubs. Willys models factory approved, sold only by Willys dealers worldwide. Dodge, other 4 W.Ds. at dealers or write—

**OVER 60,000 IN USE!** **WARN MFG. CO.** Riverton Box 6064-98 Seattle 28, Wash.



# If Ruptured

For lasting relief your rupture must  
**BE HELD BACK DAY and NIGHT.**

Consult Your Doctor.

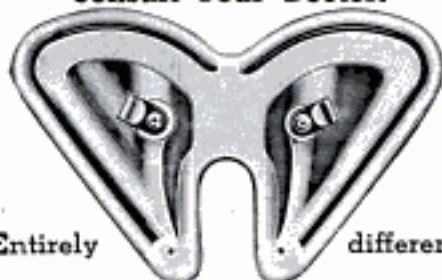

Entirely different

**SOFT, FLEXIBLE,** and fits neat as a glove. The famous Miller saves you **TIME, MONEY, DISAPPOINTMENT.**

Write for my **FREE** booklet today.

**FRED B. MILLER** Manufacturer  
Dept. PM-A, Hagerstown, Maryland

## Learn To MOUNT BIRDS

### Tan SKINS, Make Up FURS

Be a Taxidermist. Double your hunting fun. We teach you at Home. Mount Birds, Animals, Pets, Heads and Fish. Save your hunting trophies; decorate home and den. **MAKE MONEY.** Mount and Preserve for others. Big sparetime profits. **INVESTIGATE TODAY.**  
**FREE BOOK** with 100 game pictures, 48 pages. Hunters, get yours! It's Now Free. Send postal card **TODAY**—This Minute! State your AGE.  
**NORTHWESTERN SCHOOL OF TAXIDERMY, Dept. 2907, Omaha, Nebr.**



### Exclusive Double-Bearing HEAVY-DUTY PUMPS

**IRRIGATE • DRAIN • CIRCULATE • SPRAY**  
Up to 7,500 GPH, 3,000 GPH from 2 1/2" well. Use 3/4 to 1 HP motor. 1 1/4" inlet; 1" outlet. Stainless shaft. **TYPE X—2 oilless bronze bearings. \$10.95**  
Won't rust. . . . .  
**TYPE XB—Ball bearing model. \$12.95**  
Postpaid if cash with order. (West of Miss. add 50¢)  
**MONEY BACK GUARANTEE**  
Centrifugal and Gear Pumps in All Sizes  
**LABAWCO PUMPS, Belle Mead 2A, N. J.**



### MAKE TREMENDOUS PROFITS

Have fun! Earn Big Money! Cast plaster figurines, bookends, plaques, novelties at home in your spare time with N.L. rubber molds! **NO EXPERIENCE NEEDED!** Molds and rubber for 3 molds, only \$1.50 ppd. Send 25¢ (refunded with order) for 40 page catalog now!  
**PLASTIC ARTS STUDIO 3403 SO. MADISON, DEPT. PM2 MUNCIE, INDIANA**

### WATCH REPAIR

Make Sick Watches Tick Like New  
Others Can — Why Not YOU?

No previous experience needed to learn modern watch repair. Unique Sweezy System starts you making repairs right away. Learn at home or at school in Chicago. Approved for vets. **FREE** sample lesson. No obligation.

**CHICAGO SCHOOL OF WATCHMAKING**  
2330 N. Milwaukee Avenue Dept. 175 Chicago 47, Ill.



**CUT BUILDING COSTS 2/3!**  
Make Your Own Concrete  
**BLOCKS and BRICKS**  
To Use or Sell

New superior moulds make absolutely square, true, easy-to-lay blocks which will pass any building code. Production is fast . . . easy. One durable \$30 machine will make four 5"x8"x12" blocks per minute—1,000 a day. Pays for itself in one day! Sell blocks for big profit . . . or save 2/3 building cost for yourself. **POST CARD BRINGS FREE FOLDER.**

**ECONOMY MFG. CO.**  
DEPT. P STONE MOUNTAIN, GA.

# EARN BIG PAY

Industry needs skilled mechanics. **GREER**, leader for more than 50 years in the Trade School field, can train you quickly—You "learn by doing," using the finest equipment, under the supervision of expert technicians.

APPROVED FOR CIVILIANS  OR GI'S

—CHOOSE YOUR TRADE—

CHECK HERE	WEEKS
<input type="checkbox"/> DIESEL MECHANICS	20
<input type="checkbox"/> AUTO MECHANICS	20
<input type="checkbox"/> BODY & FENDER	16 2/3
<input type="checkbox"/> GAS-ARC WELDING	4 - 12
<input type="checkbox"/> REFRIGERATION	13 1/2
<input type="checkbox"/> AIR CONDITIONING	8 1/3
<input type="checkbox"/> MACHINIST TRADE	30
<input type="checkbox"/> ADVANCED MACHINIST (includes tool & die)	32 1/2
<input type="checkbox"/> PIANO TUNING & REPAIR	36

### CHOOSE YOUR ENGINEERING COURSE

These courses are intended as terminal education for men who wish to enter the Diesel-Automotive and Refrigeration-Air Conditioning fields as technicians. These courses are designed to prepare men for supervisory positions. Students with a high school education, or equivalent, will be accepted.

<input type="checkbox"/> DIESEL AUTOMOTIVE ENGINEERING	2 years
<input type="checkbox"/> REFRIGERATION & AIR COND. ENGINEERING	18 months

### HOME STUDY COURSES

Learn at Home — Approved for Civilians & G.I.s. Write for detailed information on Courses in

- PLASTICS
- REFRIGERATION & AIR-CONDITIONING
- DIESEL ENGINES

### FREE EMPLOYMENT HELP

Start your career with Greer by checking your interest above and mail coupon for complete information at no obligation.

NAME \_\_\_\_\_ AGE \_\_\_\_\_

STREET \_\_\_\_\_

TOWN \_\_\_\_\_ ZONE \_\_\_\_\_ STATE \_\_\_\_\_

Established 1902 — Over 50,000 Graduates.  
53 years of continuous trade school experience to guide your training.

## GREER SHOP TRAINING

Box G, 2236 S. Michigan Ave.  
Chicago 16, Illinois



## You Can Be a Manufacturer of BRIKCRETE



"The World's Most Modern Masonry" is produced in a chain of independently owned local plants. That's why such low prices go

along with such high quality without sacrifice of manufacturing profits. Local materials and local labor cut freight and distribution. Brikcrete brings a super-masonry down to price levels of frame. Gives owners incentive to buy.

Brikcrete has design, size, and color in keeping with the modes of today. Self-contained insulation values—12" long—8" or 4" thick—range of 14 colors. Suited to every kind of construction—residential, commercial, industrial.

Many territories are open for additional local plants. Franchise protection. Equipment available on easy terms, or basic machine can be leased to responsible operators. Write today for interesting Brikcrete Book No. 2.

**Brikcrete Associates, Inc.**  
402 W. 25th Street  
Holland, Mich.

*The World's  
Most Modern Masonry*

IN CANADA: DUNN MASONRY MACHINERY LIMITED  
800 Dundas Highway, Cooksville, Ont.



## See the Greatest Show on Earth with this GIANT ASTRONOMICAL TELESCOPE

**\$15.00**  
FULL PRICE



Delivered ready for use. Has 45X, 75X and 100 power individually mounted eyepieces with brass focusing tube plus sun projector lens for observing sun spots and solar storms. Steel telescope tube 50 in. long. Rigid 6 ft. tripod adjustable to any height. Steel forked mounting with closely machined aluminum tripod head assembly assures extra fine adjustments. This professional type instrument provides full power with clear vision at all times. See the moons of Jupiter, our own moon, planets, milky way, double stars, star clusters, etc. All for only \$13.00 FOB Mattituck. Sent express. COD orders require \$1.00 deposit. Satisfaction guaranteed. 200X and 400X eyepieces available at \$2.00 ea.

**SUFFOLK SCIENCE SERVICE**  
Dept. ATD-7  
MATTITUCK, N. Y.

## SKIN DIVER ACTION!



**Dr. Nelson E. "Doc" Mathison**  
presents his newest Skin Diving Kit  
for Pool, Lake or Ocean. World's  
newest and fastest growing sport.

*The Complete Set Includes*

- Precision made under water safety gun powered by rubber sling
- Swim mask with extra plate for pool
- Swim fins of black neoprene rubber
- Plastic Snorkel Tube.

Please state shoe size

Send cash, check  
or money order.  
(In Calif. add 5%  
Sales Tax)

Only **14.95**  
Complete  
Postpaid

**Dr. MATHISON**

2656 Fashion Ave., Dept. 7M, Long Beach 10, Calif.

## GARAGE YOUR CAR

Vinyl Plastic

ADD YEARS TO ITS LIFE!

## PORTABLE GARAGE



\$10 value

NOW ONLY **\$6.95**  
POSTPAID

Beautiful opaque-white waterproof garage covers any car, anywhere, in seconds! Protects finish from rain, sun, dust! Keeps animals, prowlers away! Strong! Durable! Folds easily to small, compact size. Also covers boats, furniture, machinery, etc. Send check or money order; no C.O.D. Great value. Immediate shipment.

**GOTHAM HOBBY CORP., Dept. M7, 107 E. 126th St., New York 35**

## \$14,839 In 1 Year SERVICING RADIATORS

—REX RYAN, Bloomfield, Iowa

Hundreds earning \$8,000-\$20,000 a year servicing auto-truck-tractor radiators! New Inland equipment makes work easy, insures finest professional workmanship. "Pays-for-itself" financing available. \$100 training course included free by world's largest radiator servicing equipment manufacturer.

WRITE for free folder "Want a business of your own?"

**INLAND MFG. COMPANY** Dept. PM-7  
1108 Jackson St., Omaha 8, Nebr.

## TERMITES IN YOUR HOUSE?

GET RID OF  
THEM YOURSELF!

DON'T PAY \$300.00 AND UP TO ERADICATE TERMITES FROM YOUR HOME OR PREVENT INFESTATION. DO IT YOURSELF IN ONE AFTERNOON. EASILY! QUICKLY! INEXPENSIVELY WITH "TERM-OUT" SEND STAMP FOR HANDBOOK.



**COMPASS RESEARCH**

90 A CLAIRTON BLVD., PITTSBURGH 36, PA.



**STAMP COLLECTORS** 327 GENUINE STAMPS 25¢

327 Different from Korea, Vatican, Laredo, Indonesia, Yemen, triangles, etc. Plus magnifying glass, stamp hinges & gauge. \$1.08 value only 25¢ with approvals.  
**NATIONAL STAMP SALES, 832-AM Eighth Ave., N.Y.C. 19**



## LEARN LOCKSMITHING

Learn this fascinating, profitable trade from experts in your spare time at home! Age or physical handicap no disadvantage. Year around, steady income. Full or part time. Practical, illustrated lessons. You can make money even while learning! All materials and special tools supplied without extra charge.  
**INSTITUTE OF LOCKSMITHING, Dept. P-68**  
15 PARK AVENUE RUTHERFORD, N. J.  
Lic. by N.J. State Board of Education  
Approved for Veterans

send  
for  
**FREE**  
**BOOKLET**

## BUILD YOUR OWN AIR CONDITIONERS

From Junked Refrigerators for a Few Dollars  
INSTRUCTION BOOKS SHOW YOU HOW... 75¢ EACH  
Special Offer  
2 or 3 books  
50¢ each  
or all 5 for \$2.00

● "HOW TO BUILD a Low Cost Air Conditioner"  
● "HOW TO BUILD an Automobile Air Conditioner"  
● "HOW TO BUILD a Low Cost Home Freezer"  
● "HOW TO BUILD an Electrostatic Precipitator"  
● "HOW TO BUILD a Low Cost Dehumidifier"

Complete "Install-It-Yourself" Air Conditioner kits for home and automobile, 2 Ton capacity, Brand New Parts—\$179.70 and up.

**FREE!**  
Instructions  
and Literature  
on kits.

**KOOL ENGINEERING CO., Dept. A-7, 3716 Belmont, Chicago 18, Ill.**

## FREE AMAZING NEW BOOK "HOW TO ANSWER ADS"



Never before have you seen anything like this. Tells you in simple language the correct way to answer ads. Gets you quicker replies—better results, and greater satisfaction. Will save you time and money and it's ABSOLUTELY FREE. No obligation whatever. Every reader of advertisement should have this booklet. Send a postcard for your copy NOW. **F. W. JOHNSON, Popular Mechanics Magazine, Room 600-A, 204 East Ontario Street, Chicago 11, Ill.**

# NEW, EXCITING SEX HORMONES MAKE FISH BITE LIKE CRAZY!

**Quick—Easy—Convenient To Use!  
Just Dab On Your Favorite Bait,  
Drop In Water And Fish As Usual!**

Are you down on your fishing luck? Have you been coming home recently with an empty creel? Have you invested hard earned cash on the latest fishing tackle, fancy lures and bait—only to be frustrated time after time? No matter how unlucky you've been, this new discovery may change all that—quickly! Now, at last, you too can use a secret that professionals have tried with astounding results—a secret that even a schoolboy can use to catch more fish, no matter what the weather, bait or tackle. Yes, you can even get big ones out of what the misinformed call "fished-out" waters. And you can do it with your present fishing methods and equipment! No need for special bait . . . whether you fish in a river, lake, pond or the open sea . . . whether you cast, spin, troll or do still-fishing . . . this new discovery will give you the thrill of your life!

## SCIENTISTS DISCOVER STRANGE HABITS OF SEA LIFE

Man has been fishing since the dawn of time. Yet during countless centuries he's never really known much about sea life. Then leading scientists from all over the world got on the job, including the U. S. Dept. of Fisheries, Ichthyologists, chemists, zoologists and sportsmen joined in the quest. Millions of dollars were spent on gigantic glass aquariums, sub-marine cameras, recording devices and lab equipment. In less than a generation man learned more about the mysteries of sea life than in the previous 10,000 years!

### EXPERIMENTS PROVE FISH ARE ALMOST BLIND

Here is the most startling discovery that the scientists unearthed: most fish—of ALL species—have very poor eyesight compared to birds and mammals. Some are almost blind! No wonder, then, that you can use the most attractive dry lures—yet go home after a day's fishing excursion with little to show for it but a sunburn!

It doesn't make much difference how good the bait is you use nor how hungry a fish may be—if he doesn't SEE it, if he can't DRAWN to it, you won't get a nibble! And test after test proved that unless you get the lure right under the fish's nose, you simply cannot attract him to your hook!

### NEW SEX-HUNGER FISH LURE DEVELOPED BY GERMAN CHEMIST

The new Lurene formula was developed by a German chemist, a graduate of the University of Tubingen in Wurtemberg, Germany. An acknowledged leader in his profession, he knew that certain lures and bait failed simply because many fish were nearly blind. But he learned that Mother Nature in her bounty provided fish with extra powerful sense-instincts that led them irresistibly to their food supply.

### FAMOUS SPORTS EDITOR PRAISES LURENE FORMULA

Millions of readers follow Walter S. Miller's sports column, "Rod, Gun & LENS," which appears in over 15 metropolitan

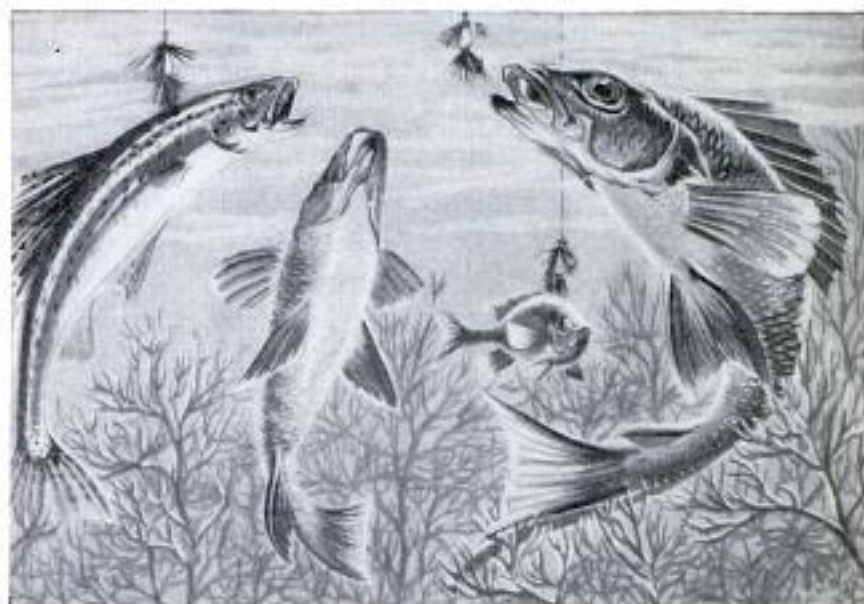

### TEST IT YOURSELF THIS EASY WAY!

No elaborate equipment required! An ordinary glass aquarium tank and ANY species of fish will prove this new method really works! Drop in 2 or 3 lines with your favorite bait. Treat only ONE with the new LURENE "triple-instinct" preparation. It's the same bait . . . the same lures . . . yet right there before your eyes you'll be witnessing a fascinating spectacle! You'll hardly believe your eyes! The fish, as if compelled by some unknown power are drawn to the Lurene-treated line. This article explains how this "triple-instinct" in fish can increase your fishing luck.

This sense-instinct for want of a better name may be called Smell-Taste. In other words, a fish both SMELLS and TASTES at one and the same time! For this purpose, the bodies of fish are covered with thousands upon thousands of tiny smell organs—without which life would be impossible. Armed with this knowledge, the eminent chemist finally developed the now famous Lurene formula.

### NOW!—SEX FACTOR ADDS EXTRA "PUNCH"

Scientists have long known that the sex factor is one of the most compelling instincts in sea life. Fish go to fantastic lengths to fertilize their eggs. They travel countless miles to fertilize them—go through incredible torture, accomplish almost impossible tasks. One of the most wondrous sights of nature is to watch male salmon struggle up river fish-ladders to fertilize the spawn. NOW—for the first time ever—natural sex hormones have been added to the new Lurene formula. This has increased production costs considerably—but you'll agree after using it that it's certainly worth it! And it's SO easy to use—just dab a little on the plug or bait, drop it in the water and fish as usual. LURENE works in lakes, streams, ponds or in the ocean. It makes no difference if you still-fish, troll, cast or spin. Lurene disperses in the water, giving

you greater penetration, longer range and far more attraction power.

### RESULTS GUARANTEED OR IT DOESN'T COST YOU 1c

Now you can try Lurene at our risk! It must help you catch more fish—faster! Lurene must prove to be the best scent lure you've ever used—or your money back! You're invited to try it without obligation. We want you to see for yourself how Lurene releases its deep, penetrating "call" into the surrounding waters. See how the mysterious instincts of the sea world help attract fish to your hook. And—of this you can be sure: Lurene really works—it positively helps draw 'em in! So we say: try it and judge for yourself. See if you don't get the big ones—even in "fished-out" waters! Use it to pull in your favorites . . . trout, pickerel, catfish, blues, weaks, pike, perch, bass, snappers, porgies. You need send no money now. Simply deposit 1.98 plus postage with your mailman when the Lurene arrives—or mail 1.98 now for immediate prepaid shipment. But please remember: you're trying—not buying! Unless you're satisfied in every way with this new, different product, it won't cost you a penny, rush the coupon now while supplies are available to:

**LURENE CO., Dept. 6-G-10**  
352 Fourth Ave., New York 10, N. Y.

### Change Your Fishing Luck—Mail Coupon Today!

**LURENE CO., Dept. 6-G-10**  
352 Fourth Ave., New York 10, N. Y.

Rush—1.98 packages of Lurene on 5-day Free Trial. It is guaranteed—the formula must help me catch more fish. It must give me thrilling results. Otherwise, you will refund my 1.98—no questions asked.

- \$1.98 enclosed—rush prepaid.  
 Send C.O.D. plus postage.

Name.....

Address.....

City..... State.....

SPECIAL OFFER: Save \$1.00 by ordering 2 packages for only \$2.98. Send check, cash or m.o. on this offer as we cannot ship C.O.D. at this low price.

"Recently a product called 'Lurene,' a prepared bait oil came into my possession with instructions to test it and pass on my opinion to you. Accordingly here are the results on several such tests.

"Using an artificial lure of the spoon type in salt water the number of casts per fish was 27. With 'Lurene' the number of casts per fish was 9. Accordingly this product is active enough to salt water fishermen since tests prove it will triple your catch regardless of type of fish. "Again using an artificial lure of the spinner type in fresh water the number of casts per fish was 58. Using 'Lurene' the number of casts per fish was reduced to the phenomenal low of 10 casts per fish. The results proved beyond doubt that in fresh water 'Lurene' quintupled the catch. I heartily endorse this product."

# BIG VALUES IN ALLIED'S

LATEST  
TV-RADIO  
SUPPLEMENT



FREE Send for it

Bargains for Experimenters,  
Builders, Amateurs, Servicemen, Hi-Fi Fans

Send for our latest Supplement packed with big values and new releases in builders' kits, High Fidelity systems and components, P.A. systems, recorders, test instruments, TV accessories, electronic parts, tubes and tools. Make your selections from the world's largest stocks at money-saving prices!

**ALLIED RADIO**  
100 N. Western Ave., Dept. S-G-5  
Chicago 80, Illinois

Send for **FREE** supplement

**ALLIED RADIO**



SAVINGS NEVER LESS THAN 35% UP TO 60% OFF REGULAR PRICES

SEND FOR YOUR FREE CATALOG!

FACTORY FRESH **BRAND NEW TIRES**  
**B.F. Goodrich • Firestone**

FIRST QUALITY 4 PLY BLACKWALL TIRES				FIRST QUALITY HEAVY DUTY TRUCK TIRES			
FULL PRICE				FULL PRICE			
670 x 15	13.97	760 x 15	16.90	700 x 15	6 ply	26.12	
710 x 15	15.42	600 x 16	12.59	600 x 16	6 ply	18.03	
SPECIAL! SPECIAL! WHITE WALL TIRES				650 x 16	6 ply	21.80	
FULL PRICE				750 x 20	10 ply	48.00	
670 x 15	16.86	710 x 15	18.62	825 x 20	10 ply	58.70	
				900 x 20	10 ply	70.32	
				1000 x 20	12 ply	89.09	

**DOUBLE LIFETIME GUARANTEE**  
All Tires Carry Mfr's Full Lifetime Guarantee plus 5 & 5 own iron-clad guarantee of quality and value!

**LATEST TUBELESS TIRES NOW AVAILABLE!**

Order by Mail—send check or M.O. All prices include excise tax, sold F.O.B. Camden, N. J. Motorists, Farmers—Truck Owners, Garage men—Gas Stations—we have the most complete stock of tires anywhere! **OPPORTUNITY FOR YOU to make REAL MONEY**—sell to your friends, neighbors, etc. Become a part time Sales representative—Sell at a discount and make profits too! Write us today for full information!

**S&S TIRE CO.** 1400 HADDON AVE.  
CAMDEN 3, N. J.

**FOR SALE!**

Over 2000 Businesses, Farms and Income Properties throughout the United States and Alaska. Many at sacrifice prices.

**FREE, 280-PAGE BOOK**, just off the press tells who the owners are, where they are, what they want to sell or trade, prices, terms, earnings, etc. Contains thousands of opportunities from \$3000 to \$3,000,000! No commission to pay us. No salesman will call. **ABSOLUTELY FREE** Write what and where you want to buy and we'll advise owners of your requirements.

Write for Book No. 76 National Business & Property Exchange, 5400 Wilshire Blvd., Los Angeles 36, Calif.



**\$2.95 OR 2 FOR \$5.00!**

Genuine Telephone Company Upright Telephones, tested and guaranteed with 50 ft. of wire and inter-communication instructions. Complete line of telephones, dial, magneto, etc. Write for free list. All shipments F.O.B. Simpson, Pa.

**TELEPHONE ENGINEERING CO.**

Dept. 7855

Simpson, Pa.

Say You Saw It in Popular Mechanics

**LAW FREE BOOK** **THE LAW TRAINED MAN**

Write today for a **FREE** copy of illustrated law book, "THE LAW TRAINED MAN," which shows how to earn the professional Bachelor of Laws (LL.B.) degree through home study of the famous Blackstone Law Course. All necessary books and lessons provided. Moderate cost; convenient monthly terms. Write for **FREE** law training book today.

**Blackstone School of Law, 225 N. Michigan Ave.**

Founded 1890

Dept. 50-B Chicago 1, Ill.

**START YOUR OWN SHARPENING BUSINESS**



**WITH THE**  
New All-In-One Ball-Bearing Sharpener. Sharpens all makes pinking shears, scissors, knives, etc. Does a perfect job unmatched by other sharpeners. Easy to operate. The machine of many uses. Order today or write for new folder J-7.

F.O.B. PASADENA

**\$69.50**

Less Motor

**TURPIN-JONES CO., Box 1109, Pasadena 1, California**

## TRAINED MEN NEEDED

**BIG PAY—GOOD FUTURE**

- TELEVISION       ELECTRONICS  
 DIESEL             AUTO

WHY WORK FOR LOW PAY or risk being out of a job??? Usually the properly trained man has a steady job... through good times or bad. Even back during DEPRESSION there was a big demand for Bailey Trained men.

In only 5½ to 6 months we can train YOU to enter one of the big pay fields!

No previous experience or special education necessary. With our method of training you do not spend years pouring over books, figures, charts and graphs. You learn by rebuilding, repairing, testing and operating the most modern equipment, under the guidance of experienced, courteous and friendly instructors. This method of training gives you the experience and confidence required to step right into the big pay jobs without spending years as a mechanic's helper.

It's **EASIER** and **COSTS LESS** than you may think to get this residence shop training... we help you find part-time jobs while in school—full-time jobs after graduation. Check subject above in which you are interested and mail for complete information.

**BAILEY Technical SCHOOLS**

Veteran Approved

1634 S. Grand St. Louis 4, Mo.

NAME.....AGE.....

STREET.....

TOWN.....ZONE.....STATE.....



Cannot channel



Easy to clean



Filters out all dirt



Traps moisture



Saves detergents



Reduces friction

# End Filter Replacement FOREVER!

with Revolutionary New Type

## Micro BRONZE OIL FILTER

1. Eliminates Engine Acids
2. Traps Damaging Moisture
3. Filters all the Dirt
4. Reduces Friction
5. Saves the Detergents

U. S. Patent App. No. 464498

**WHY GIVE YOUR ENGINE HALF-WAY PROTECTION?** The Micro Bronze permanent all-metal filter with the built-in acid neutralizer is the world's first filter that guards against all five engine enemies: Acids, abrasives, friction, moisture and sludge.

Made of solid but porous everlasting sintered bronze, the Micro Bronze Filter screens out all particles of dirt and abrasives larger than .00023 inch in size (so small you could put a thousand of them on the head of a pin!). The Micro Bronze positively cannot channel or blow up... operates efficiently at all temperatures... never wears out, never needs replacing, merely occasional cleaning.

**SAVES OIL CHANGES... SAVES DETERGENTS.** Your oil is good for at least 10,000 miles with a Micro Bronze Filter. All the valuable additives are kept in, not soaked up and wasted by the filter. You never need buy another replacement pack as long as you live! Used with modern detergent oils, Micro Bronze will add thousands of miles to engine life, help prevent loss of engine power, save costly oil changes, pack replacements and engine overhauls!

**DOES YOUR PRESENT FILTER PASS THE "ACID" TEST?** If you have a Micro Bronze Filter with the built-in Acid Neutralizer your engine is getting the full protection it needs! In a simple test you can easily make yourself, the Micro Bronze special element completely neutralizes acids in 60 seconds!

**BUILT-IN ACID NEUTRALIZER!**

### DISTRIBUTORS WANTED

We are receiving orders from all over the world for the amazing Micro Bronze Filter, and are setting up exclusive distributorships to handle our rapidly growing dealer organization. Write, wire or phone.



**THE SINTERED METALS SECRET...** Before World War II, the Germans discovered how to fuse microscopic balls of metal into solid but porous form. Following the war, this secret was made available to American industry and we've developed it for Micro Bronze Filters. This is a magnification of the filter wall.

**NO EXTRA COST FOR FULL FLOW MODELS!**

**FITS EVERY CAR & LIGHT TRUCK.** A Micro Bronze Unit costs only \$6.95, including all full-flow models. Easy to install, never needs changing. Micro Bronze Filter Housing \$9.95 for all cars with no filter equipment (does not include element). Use the easy-order coupon now.

**Micro BRONZE FILTER CORP.**  
11766 W. Pico Blvd., Los Angeles 64, Calif.  
Cable Address: MICRONZE

**FILTERS THE DIRT BUT NOT THE DETERGENTS**

Micro Bronze Filter Corp. Dept. PM-75  
11766 W. Pico Blvd., Los Angeles 64, Calif.  
Please ship the following at once

- Conversion unit \$6.95 (including all full-flow models)
- Micro Bronze Housing Unit (Needed where car does not now have filter) \$9.95 (does not include element)

Enclosed is \$\_\_\_\_\_ full price. Factory pays all shipping costs to your door.

MAKE, MODEL & YEAR CAR \_\_\_\_\_

NAME \_\_\_\_\_

ADDRESS \_\_\_\_\_

CITY \_\_\_\_\_ ZONE \_\_\_\_\_ STATE \_\_\_\_\_



Increases engine life



Never need replacing



Unaffected by pressure



Screens out abrasives



Efficient at all temperatures



Fits all cars



Eliminates acid



Train  
Animals, Pets!  
Loud Noise Like Bang of a Shot Gun!

Self Defense!  
Do Tricks!

## PLAITED LEATHER **BIG BULL WHIP**

Experts knock ashes off cigaret, gun out of hand, yank people off feet, etc. Used by trainers, ranchmen, etc. Grip lightly (pressure is on loop), then crack or coil; snake out or back; overhand, underhand, side-arm. Neat's oil finished for pliability & long life. "Cracker" or tongue on end. Solid grip handle with loop.  
6-ft. Whip \$1.98; 8-ft. Whip \$2.69; 10-ft. Whip \$3.29  
JOHNSON SMITH & CO., Dept. 153, Detroit 7, Michigan

## Catalog of **3000** Novelties **10c**

Send 10c for amazing catalog of novelties, live animals, scientific supplies, hobbies, funmakers, planes & boats, booms, magic tricks, joke articles, unusual seeds, gadget timesavers, cameras, optical goods, projectors, movies, lucky jewelry, religious novelties, disguises, musical instruments, stamps, coins, puzzles, fortune tellers, radios, auto & bike accessories, telescopes, magnifiers, compasses, banks, smokers' gadgets, artists' supplies, printing sets, any guns, motors, shockers, knives, billfolds, guns, rifles, sports, books, games, plants, etc. Send 10c (3 for 25c—get for friends!).  
JOHNSON SMITH & CO., Dept. 153, Detroit 7, Michigan

**Precision Miniature Camera**  
Less than half size of regular cigaret package! Take everywhere! Take surprise, candid & regular pictures. Weighs 2 1/2-ounces. Solid, all metal construction with leather lined body, chrome trim. Enclosed eye-level view finder. Single action, 1/250th second or time shutter. Precision ground lens. Takes 10 to 15 1/2-inch pictures per roll. Standard 16 mm. film. Fine enlargements from negatives. Low film cost. Scrolls can be used to load with 16 mm. Kodachrome color movie film. Take indoor or night pictures by use of flash or flood unit (not supplied). Beauty in looks & performance. Precision made. Camera Only... \$1.98. Camera with Pignish Leather or Ever-Ready Case & Strap \$2.99. Film 20c per roll, 6 rolls \$1.00. Case only 75c. JOHNSON SMITH CO., Dept. 153, Detroit 7, Michigan.

## INVENTORS

Send for **PATENT INFORMATION** **REGISTERED PATENT ATTORNEY**  
Book and **INVENTOR'S RECORD** **ASSOCIATE EXAMINER**  
without obligation **U.S. PAT. OFF. 1922-1929**  
**GUSTAVE MILLER** Patent Attorney & Advisor  
75-PM WARNER BUILDING U. S. NAVY DEPT. 1930-1947  
WASHINGTON 4, D. C. **PATENT LAWYER**

**RADIO CONTROL YOUR MODEL** PLANES BOATS CARS

"CUSTOM MIDGET" RADIO \$9.98  
LICENSE FREE BAND  
OPERATES SAME AS \$20.00 SETS. INCLUDES LONG RANGE TRANSMITTER RADIO, RECEIVER RADIO AND CONTROL ACTUATOR ALL 3 EASY ASSEMBLY WITH OUR PARTS AND PLANS \$9.95. PLANS ALONE \$1.  
RADIOMODELS BOX 36 DEPT. PM BALTIMORE 6, MARYLAND

DETAILED INFORMATION RE. & RADIO CATALOGUE 25c  
SPECIAL "SUPPLY SOURCE DIRECTORY" & \$7.00 SUPPLY COUPON... \$1.00  
BOOK "RADIO CONTROL OF MODEL AIRCRAFT" CONTAINS 14 PLANS \$3.98  
RADIO CONTROL GARAGE DOOR DETAILS... \$1.00

**START YOUR OWN ELECTRICAL APPLIANCE REPAIR BUSINESS**

Repair electrical appliances of friends and neighbors. Service electrical equipment in factories, stores, etc. Work full or part time. New Shop Method home-training system. Rush name today for **FREE BOOK** and special form for getting Electronic Kit. Valuable Heating Element Kits, Advisory Service and Illustrated Instructions on new easy-payment plan. Pay later from **EARNINGS WHILE LEARNING**. Rush name today and we will include **FREE** "The Secret Power of Success" book.  
**CHRISTY TRADES SCHOOL**  
4804 N. Kedzie, Dept. D-4403, Chicago 25

## INVENTORS

PROTECT YOUR INVENTION BY A U. S. PATENT. SEND FOR FREE "INVENTION RECORD" FORM AND "PATENT INFORMATION EVERY INVENTOR SHOULD HAVE".

**CARL MILLER**  
REGISTERED PATENT ATTORNEY  
"WOOLWORTH BLDG., 35th FLOOR, 75A NEW YORK CITY"

PROTECTION FOR YOUR **INVENTIONS**

**FRANK J. RENAUD** 1311 G St. N. W. WASH. 5, D. C.  
REGISTERED PATENT ATTORNEY  
FORMER ASSOCIATE EXAMINER  
U. S. PAT. OFFICE 1951-53

## PATENTS

**C.A. SNOW & CO.**  
REGISTERED PATENT ATTORNEYS  
WRITE FOR INFORMATION TO:  
428 SNOW BUILDING, WASHINGTON 1, D. C.

Say You Saw It in Popular Mechanics

## INVENTORS

Whether an invention is patentable can be substantially determined by a search of the U. S. Patent records. Without obligation, write for information explaining the steps you should take to secure a patent.

**JOHN N. RANDOLPH**  
Registered Patent Attorney  
201 Columbian Building, Washington 1, D. C.

## INVENTIONS WANTED

If you want to market, or sell, your invention for cash or royalties, write for our Free Booklet. Send no drawings. We also welcome hearing from firms, or private capital, wishing to review inventions in any field. We will be glad to send notice of our clients' inventions.

**GLOBAL MARKETING SERVICE**  
1404 Mitchell Street Dept. PD Oakland 1, Calif.

## INVENTORS

I shall be pleased to furnish you, upon request, with full information relative to patent procedure—without any obligation on your part.

**PATRICK D. BEAVERS**  
Registered Patent Attorney  
934 Columbian Building Washington 1, D. C.

**more jobs  
than graduates**

Demand for our engineering graduates exceeds supply. Effective placement service. Study in this world-famed college established 1884. New term starts quarterly. Approved for Veterans.

**Bach. Sc. degree in 27 months**

Bachelor of Science in Mechanical, Civil, Electrical, Chemical, Aeronautical, Radio (T.V., Electronics), Administrative Engineering; Business Administration and Accounting. Also 36-weeks certificate course in Drafting. Intensive program; technical fundamentals accentuated; comprehensive courses.

Small classes: personalized instruction. For earnest, mature students whose time and budget require accelerated courses and modest costs. Preparatory courses. Beautiful campus in friendly college town. Well-equipped, new and modernized buildings and labs. Enter Sept., Jan., March and June. Write Jean McCarthy, Director Admissions, for Catalog, View Book and "Your Career in Engineering or Commerce."



**TRI-STATE COLLEGE**

475 College Avenue Angola, Indiana

**ENGINEERS**  
An interesting opportunity! If you pay you to write Box D, including a complete history of your name and education.

**AUDELS Carpenters and Builders Guides 4 vols. \$6**



**Inside Trade Information** for Carpenters, Builders, Joiners, Building Mechanics and all Woodworkers. These Guides give you the sheet-out instructions that you want—including new methods, ideas, solutions, plans, systems and money saving suggestions. An easy progressive course for the apprentice and student. A practical daily helper and Quick Reference for the master worker. Carpenters everywhere are using these Guides as a Helping Hand to Easier Work, Better Work and Better Pay. To get this assistance for yourself, simply fill in and mail **FREE COUPON** below.

**Inside Trade Information On:**

How to use the steel square—How to file and set saws—How to build furniture—How to use a mitre box—How to use the chalk line—How to use rules and scales—How to make joints—Carpenters arithmetic—Solving measurement problems—Estimating strength of timbers—How to set girders and sills—How to frame houses and roofs—How to estimate costs—How to build houses, barns, garages, barnyards, etc.—How to read and draw plans—Drawing up specifications—How to excavate—How to use settings 12, 13 and 17 on the steel square—How to build hoists and scaffolds—skylights—How to build stairs—How to put on interior trim—How to hang doors—How to lath—lay floors—How to paint.



Step up your own skill with the facts and figures of your trade, Audels Mechanics Guides contain Practical Inside Trade Information in a handy form, Fully Illustrated and Easy to Understand. Highly Endorsed. Check the book you want for 7 DAYS FREE EXAMINATION. Send No Money, Nothing to pay Postman.

**MAIL ORDER**



**Check NOW!**

You Can Look Over Any Guide In Your Own Home — Start the Easy Payments If Satisfied

**MAIL THIS TODAY**



AUDEL, Publishers, 49 W. 23 St., NEW YORK 10, N. Y.

Please send me postpaid for FREE EXAMINATION books marked x below. If I decide to keep them I agree to mail \$1 in 7 Days on each book or set ordered and further mail \$1 monthly on each book or set until I have paid price, otherwise I will return them.

- AUTOMOBILE MECHANICS GUIDE, 1664 Pages. \$4
- TRUCK & TRACTOR GUIDE, 1295 Pages . . . 4
- DIESEL ENGINE MANUAL, 575 Pages . . . 2
- MACHINISTS HANDY BOOK, 1650 Pages . . . 4
- WELDERS GUIDE, 400 Pages . . . 1
- BLUE PRINT READING, 416 Pages . . . 2
- MATHEMATICS & CALCULATIONS, 700 Pages. 2
- SHEET METAL PATTERN LAYOUTS, 1100 Pages 4
- SHEET METAL WORKERS HANDY BOOK, 388 Pgs. 1
- MECHANICAL DRAWING GUIDE, 160 Pages . . 1
- MECHANICAL DRAWING & DESIGN, 480 Pages 2
- AIRCRAFT WORKER, 240 Pages . . . 1
- TELEVISION SERVICE MANUAL, 434 Pages . . 2
- RADIONANS GUIDE, 1040 Pages . . . 4
- ELECTRONIC DEVICES, 216 Pages . . . 2
- ELECTRIC MOTOR GUIDE, 1100 Pages . . . 4
- WIRING DIAGRAMS (Light & Power), 272 Pgs. 1
- ELECTRICIANS EXAMINATIONS, 250 Pages. 1
- ELECTRIC POWER CALCULATIONS, 425 Pages. 2
- HANDY BOOK OF ELECTRICITY, 1440 Pages. . 4
- ELECTRIC DICTIONARY, 9000 Terms . . . 2
- ELECTRIC LIBRARY, 7000 Pages (12 Book Set) 18
- SHIPFITTERS HANDY BOOK, 250 Pages . . . 1
- REFRIGERATION & Air Conditioning, 1280 Pgs. 4
- MILLWRIGHTS & MECHANICS GUIDE, 1200 Pgs. 4
- POWER PLANT ENGINEERS GUIDE, 1500 Pages 4
- ENGINEERS & FIREMANS EXAMS, 525 Pages . 1
- PUMPS, Hydraulics & Air Compressors, 1658 Pgs. 4
- OPERATING ENGINEERS LIBRARY (3 Books). 9
- MECHANICAL DICTIONARY, 950 Pages . . . 4
- GARDENERS & GROWERS GUIDES (4 Book Set) 6
- CARPENTERS & BUILDERS GUIDES (4 Book Set) 6
- PLUMBERS & Steamfitters Guides (4 Book Set) 6
- MASONS AND BUILDERS GUIDES (4 Book Set) 6
- PAINTERS & DECORATORS MANUAL, 450 Pgs. 2
- HOUSE HEATING GUIDE, 1000 Pages . . . 4
- OIL BURNER GUIDE, 384 Pages . . . 1
- HOME APPLIANCE SERVICE GUIDE, 800 Pages 4

**EARN EXTRA MONEY GROWING MIDGET TREES!**

AT HOME • SPARE TIME • FOR FUN AND PROFITS!

It's New! Amazing! FULL GROWN living dwarf trees—only 12 INCHES HIGH! In oranges, oak, cypress—any kind! All BLOOM and ever BEAR FRUIT! Perfect, healthy specimens, but miniature! Make costly home decorations and beautiful expensive centerpieces (sold for over \$1,500 each). It's Fun! A new fascinating hobby—a new \$55555 HOME BUSINESS! Real and sensational new growing plan details, BOTH ABSOLUTELY FREE!



**FREE!** GENUINE SEED AND PLAN

NATIONAL NURSERY GARDENS, Dept. M-7  
8462 SOUTH VAN NESS, INGLEWOOD 4, CALIFORNIA

**FREE AMAZING NEW BOOK "HOW TO ANSWER ADS"**



Never before have you seen anything like this. Tells you in simple language the correct way to answer ads. Gets you quicker replies—better results, and greater satisfaction. Will save you time and money and it's ABSOLUTELY FREE. No obligation whatever. Every reader of advertising should have this booklet. Send a postcard for your copy NOW. F. W. Johnson, Popular Mechanics Magazine, Room 600-A, 204 East Ontario Street, Chicago 11, Illinois.

**Print Your Own**

Cards, stationery, circulars, tags, labels, photo and movie titles, advertising, etc. Save money. Print for Others. Good Profit! Easy rules sent. Raised Printing like Engraving, too. Sold direct from factory only. Write for free catalog of outfits and all details. KELSEY PRESSES, M-37, Meriden, Conn.

**FREE BOOK ON RUPTURE CARE**



Contains much helpful information. Shows how thousands have been helped by the comfortable, safe WEB Truss. Write today to:

WEB TRUSS CO. Dept. M-7 HAGERSTOWN, MD;

**BUILD HELICOPTER GLIDER**



The famous new GYRO-GLIDER, world's simplest and safest aircraft, is now available to amateur builders in plans and kits. Send \$1.00 now for three-view drawings with specifications and ask about kits and detailed building and flying instructions.

BENSEN AIRCRAFT CORP., Dept. PM-7  
P.O. Box 2621 Raleigh, N. C.

ONLY \$1 Name \_\_\_\_\_ Address \_\_\_\_\_  
City \_\_\_\_\_ State \_\_\_\_\_

Greatest Thrill in Flying!

Name \_\_\_\_\_  
Address \_\_\_\_\_  
Occupation \_\_\_\_\_  
Employed by \_\_\_\_\_ P-7



**BE  
COMFORTABLE  
WEAR**  
*Tom Long*  
**HOBBIES**

**You feel so free  
and easy in the  
comfort of Tom  
Long casuals**

SLIDE into a pair of smart "hobbies" and a Tom Long sport shirt and you're set for any task, indoors or out. Hobby pants in various colors of rugged sport denim have extended waistband, adjustable side tabs for waistline comfort and deep, strong pockets. Designed and reinforced for long wear, styled for good looks and priced so you can invest in several outfits. Try out Tom Longs next time you purchase.

**ANVIL BRAND FACTORIES** HIGH POINT, N. C.

## PREPARE FOR THE BEST JOBS IN INDUSTRY

**TRAIN  
at HOME**  
IN YOUR SPARE TIME  
or at  
**ALLIED INSTITUTE**  
in Chicago

- MECH. ENGINEER
- DRAFTSMAN
- TOOL DESIGNER
- TOOL ENGINEER
- TOOL & DIE MAKER
- MASTER MACHINIST

### NO RECESSION FOR ALLIED TRAINED MEN

**MORE JOBS THAN GRADUATES** Shortages of Draftsmen, Designers, Tool Engineers, Machinists, Tool & Die Makers are so widespread that you can pick a highly paid key job and look forward to Achievement and Security.

You can begin your training in Short Courses and continue progressively to a Bachelor Degree in 26 months.

Allied is approved by Industry, Dept. of Education, Office of Public Instruction, State of Illinois, U. S. Veterans Admin., U. S. Dept. of Justice. Accredited: C. S. A.

SEND FOR  
**FREE  
BOOKS**

**ALLIED SCHOOL of MECHANICAL TRADES**  
1338-42 South Michigan Ave. P.M. 5 Chicago 5, Illinois

SEND ME WITHOUT OBLIGATION INFO. ON YOUR COURSES:

HOME STUDY  RESIDENT  VETERAN  NON VETERAN

NAME \_\_\_\_\_

ADDRESS \_\_\_\_\_

AGE \_\_\_\_\_

CITY \_\_\_\_\_

STATE \_\_\_\_\_

Now Earn \$5, \$7, \$10 per Hour

## SENSATIONAL NEW CM-7

Only in RED COMET Automatic Fire Extinguishers

Here's a new product that's already selling like wildfire! CM-7—the miracle chemical contained only in Red Comet Automatic Fire Extinguishers—has exclusive features that no other fire extinguishing fluid can offer. A simple, easy demonstration of CM-7 putting out fire clinches the sale, makes you a Big Profit. Prospects everywhere—farms, homes, businesses. No experience necessary. No investment.

**FREE use of Master DeLuxe Sales Kit**—Contains everything you need to start taking orders the first week. Write today for more information about CM-7 and how you can get the Master DeLuxe Sales Kit.

WRITE TODAY

**RED COMET, Inc.** • Littleton, Colo. Dpt. 344-Q, R. C. Bldg.

NO TANKS USED  
NEW IMPROVED METHOD  
SUCCESS IN THE  
ELECTROPLATING  
BUSINESS

## ELECTROPLATE

ANY OBJECT IN HOME, SHOP, GARAGE OR START YOUR OWN WELL PAYING ELECTROPLATING BUSINESS



NOW, using NEW plating kit.

It's easy to electroplate any object. Complete kit and instructions on plating metal and non-metal objects, with nickel, copper, chrome, gold, etc., plus full data on obtaining all the business you desire and make **NO MONEY** full or spare time. **ONLY \$5.95. SEND NO MONEY**—everything sent C.O.D. plus postage—OR

send \$5.00 now and receive it postpaid. Money back in 7 days if not satisfied. **M. Z. SALES CO., Dept. PM-16, 113 W. 42 St., New York 36, N. Y.**



## TALK - SING - PLAY OVER YOUR RADIO

with the real Radio Mikel! Attaches in a jiffy—full instructions given! Swell for "parties"—"cut in" on or "kid" regular network programs or put on your own broadcast! Amaze your friends—real fun. Beautiful Metallic Plastic 6 in. high!

**12 RADIO BROADCAST LESSONS GIVEN with each mike**  
**SEND NO MONEY** Just pay postman \$3.00 C.O.D. plus postage or send \$3.95 and we pay postage! Radio Mike is available only from us by mail—guaranteed. **Midway Co., Dept. BPM-7, Kearney, Neb.**

## ELECTRICAL BRAIN

Instructions to design and build simple electrical computers to control models, play games, and for practical applications. Parts lists and reference literature included. \$1.00 no C.O.D.

**ECO P.O. BOX 8706 PITTSBURGH 21, PA.**

EARN WHILE YOU LEARN

## UPHOLSTERY BE YOUR OWN BOSS



AT HOME, earn right off. Get a better job, be your own boss. UTS easy course teaches you professional upholstery, reupholstery, slip-covers, drapery. Included **FREE** tools, frames, materials to make beautiful upholstered furniture with slip covers.

**APPROVED FOR KOREAN VETERANS**  
Free Illustrated Book—**SAMPLE LESSON**. Write Upholstery Trades School, Dept. DL-309, 721 Broadway, New York 3, N. Y.

## How to win an Executive's JOB and PAY

Only one thing stands between you and a top executive's pay—the right kind of ability. You may be skilled in your work, yet if not trained in management you are not likely to be promoted to important executive jobs. Thousands win promotions thru LaSalle's Executive Training—and YOU too can gain tremendous advantage over others by knowing management principles. Write today for **FREE** 48-page book, "14 Steps to Executive Leadership."

**LASALLE Extension University, 417 So. Dearborn St. A Correspondence Institution Dept. 764 BM Chicago 5, Ill.**

250 POWER . . . .



Complete Telescope Lens Kit **only \$3.49** postpaid

Conquer Space, Explore the Universe, Planets, Moon Craters, New Stars, etc. Complete Lens Kit consists of 80 inch focal length ground and polished objective lens, eyepiece lenses for 50 POWER, 100 POWER, 150 POWER, 200 POWER, 250 POWER, and all necessary lens fittings. Easy to make from simple step by step instructions. (Tripod and mount not included.) Money back guarantee.

**BUSSE SALES CO., Hartford 1, Conn., Dept. PM 35**

POPULAR MECHANICS

Copyrighted material



# LEARN MEAT CUTTING AT NATIONAL

Pay After Graduation



The steady dependable trade of Meat Cutting taught easily in 8 short weeks. YOU LEARN BY DOING under actual meat market conditions in big modern school at Toledo.

For beginners or men with experience. Get a profitable store of your own. Remember, PEOPLE MUST EAT! Big pay jobs. Free employment help. Thousands of successful graduates.

Buying, cutting, percentage, pricing, advertising, selling, etc. A complete retail meat education. National School established over 30 years. Get National training NOW. Pay your tuition in easy weekly payments

after you graduate. Send coupon for FREE 52 page school catalog — TODAY. G.I. approved.

### National School of Meat Cutting, Inc., Dept. 50-T, Toledo 4, Ohio

Send me your FREE school catalog on National Training at Toledo in Meat Cutting, Meat Merchandising and Self Service Meats. No obligation. No salesman will call.

Name \_\_\_\_\_ Age \_\_\_\_\_

Address \_\_\_\_\_

City \_\_\_\_\_ State \_\_\_\_\_

Approved for training Korean Veterans

### BAZOOK HI-POWER HUNTING & TARGET SLING GUN

GUARANTEED

Patented

**\$1.50** ppd.

No C.O.D.

500 steel balls \$1.00

**order now!**

**YOU CAN SHOOT STRAIGHT**  
 Kill small game, road pests, with Arrows, steel balls, shot, etc. SAFE INDOOR with mud pellets. POWERFUL 8mm rubber sling. Hardwood barrel. Extra rubber. 50 steel balls included. For Shooting Fun, get Bazook Sling Gun!

UMACO PRODUCTS • P.O. Box 4133G • Long Beach, Cal.

### Finish HIGH SCHOOL AT HOME

Complete 4 Yrs. in 12 Months

Learn More! Earn More! Enter professional or technical schools. Advance Socially. Live a Happier, Fuller Life. Individual Courses or complete schedule. WRITE FOR SCHOOL BULLETIN.

### ACADEMY FOR ADULTS

30 W. Washington, Dept. PM-75, Chicago, Ill.

### STRENGTHEN ... TRAIN YOUR

### VOICE

### DEVELOP A HE-MAN VOICE!

Write for FREE book "How to Strengthen Your Voice for Greater Success" by Eugene Feuchtinger. No obligation. Book will be mailed at once in plain wrapper, postpaid. Just send your name and address. State age. PERFECT VOICE INSTITUTE, 210 S. Clinton St., Studio GV-2, Chicago 6, Ill.

### Home Operators Use New Rubber Stamp Machine for Big Profits!

Gives Men and Women Everywhere— Even in Small Communities—Chance to MAKE \$9.20 AN HOUR

The multi-million dollar Rubber Stamp business is now being taken over by small home operators throughout the U.S. Men and women who operate this inexpensive machine can turn out large numbers of Rubber Stamps with special wording of all kinds. Material costing only 2¢ makes a stamp that sells for \$1.80. The machine is easy for anyone to operate. It molds as many as six Rubber Stamps at a time, each with different wording such as names, addresses, notices, stock numbers, prices and other "copy" needed by offices, factories, and individuals. At full capacity, it can earn as much as \$9.20 an hour for the operator! You don't need experience to get into this big profit business at home. We supply everything, including complete instructions and eight ways to get orders for stamps coming in fast. Start making up to \$9.20 in one hour right away. We'll mail full particulars FREE and no salesman will call. Be first in your locality. Rush name, address today to Rubber Stamp Div., 1512 Jarvis Avenue, Dept. R-2-1, Chicago 26, Illinois



### MONEY in WORMS

Make thousands of dollars raising and selling fishworms and crickets—Start in backyard or basement—No odor—No experience necessary. Free literature—No obligation. Write CARTER WORM RANCH, PLAINS, GEORGIA

YOUR  
OWN  
NAME  
BRAND  
BUSINESS  
WITH  
NO  
INVESTMENT

### H. B. Davis Corp.

Dept. P • 145 W. 15th St., New York 11, N. Y.

Gentlemen:

Please send me free details on how I can get started in my own name brand business (full time or part time). Tell me how I can take orders for nationally advertised brands of appliances, cookware, silverware, housewares, tools, clocks, jewelry, watches, etc.

I understand that I do not have to make any investment, nor carry any inventory and you will ship my orders within 24 hours. Please include a FREE copy of your all-new 1955 name brands catalog.

NAME \_\_\_\_\_

ADDRESS \_\_\_\_\_

CITY \_\_\_\_\_ STATE \_\_\_\_\_

# MAKE \$15,732.00 IN ONE SUMMER \$9,504.00 WITHOUT LEAVING YOUR HOME

## DON'T READ THIS!

Unless you are near a healthy fire extinguisher or a plentiful supply of WATER. We cannot assume responsibility if this ad breaks out in ROARING FLAMES. So please do stop reading this until you have taken the necessary safety precautions. Yes, we have an item that's H O T —so H O T that we are not going to say other than the usual words of a good product for fear of setting this

good magazine on FIRE. This product is NEW! SENSATIONAL! COLOSSAL! AMAZING! and REVOLUTIONARY.—NO! No long story—All we have to say, and this is modestly, we have an ELECTRICALLY controlled bulb that is the BEST insect killer CONSOLIDATED RESEARCH has been able to produce—bar none. Not to be compared with any other unit ever sold.

Testimonials like these are pouring in by the hundreds.

"It works like a charm. I am amazed at its results."—Mrs. A. F. Willa, Atlantic City, N. J.

"Your magic bulb has at last solved my roach and fly problem."—Mrs. C. I. Thompson, Miami, Fla.

"Has given my family endless hours of comfort living."—Mr. P. V. Zane, Los Angeles.

You have heard of the 7 Wonders of the World. Now, consolidated research introduces the 8th Wonder, acclaimed a MUST in every home and establishment, being hailed by salesmen as the biggest MONEY MAKER since the opening of the U. S. MINT.

**ABSOLUTELY EVERYONE**

Now that you have taken the safety precautions, read every word in this ad, as we have said above, this item is **HOT**, so hot that to be extra safe we have ordered the publishers not to use any **RED** ink. Now, getting serious, fellows, here's the scoop. We are going to do **EVERYTHING** to make you the most welcomed salesman to ever approach a customer. We will give you **GLOSSIES, MATS, IMPRINTS**, all the material needed for an immediate mail order set up, also documented test reports of how prominent colleges and testing labs, **RATE** our product, also at your disposal is a powerful pulling pitchman sound T.V. movie on Bug Weapon. The production value of this film cost us more than \$2000.00, **PLUS BELIEVE IT OR NOT** an advertising allowance. We will **PRE-SELL** this Bug Weapon for you, by launching a tremendous advertising barrage, including almost all national magazines, radio, and T.V. The entire population of the U.S. will be put in a buying mood. Especially so since hundreds of insects will help you make every sale. They will dive bomb about him, molest his comfort, interrupt his sleep, destroy his property, and spread contagious diseases about his home, and food. Business establishments suffer enormously combating the ugly insect problem. They will greet you with arms wide open. It's a tested natural with **STAGGERING** public acceptance and mountainous profits. Yes, you will be **WELCOMED**, you will be **THANKED**, most important you will make **MONEY**.

NATIONAL VOLUME SALES CORP., Research Dept. PM-7  
1024 Cottman Ave. Phila. 11, Pa.



## DEATH

TO DISEASE-CARRYING, DESTRUCTIVE AND ANNOYING PESTS



**AMAZING NEW INVENTION**  
**KILLS ALL TYPES OF INSECTS**  
**SCIENTIFICALLY-AUTOMATICALLY**

### 10-YEAR GUARANTEE

Not a gadget — not a halfway measure. Not to be compared with flimsy, untried imitations: A finished quality appliance. Carries an ironclad 10-year guarantee and parts replacement policy. Bound by signature.



that flies and roaches are suspected carriers of 13 communicable diseases including **POLIO**. One fly can reproduce 8 million others. Flies seldom leave anything without first excreting on it. Don't take chances with your health. **YES**, you can now insect proof your home without lifting a finger. Throw out old fashioned fly swatters, and messy spray guns. A new, small, clean, decorative, little bulb enables you to destroy **HUNDREDS** of types of **INSECTS** like **MAGIC**. Only one 2 hour application keeps killing disease carrying, destructive and annoying insects around the clock for more than 2 weeks. More powerful than D.D.T. yet harmless to humans, pets and plants. Approved **SAFE**. Not a gadget, not a half way measure. Carries a **10 YEAR GUARANTEE**. It must **KILL** not **TICKLE** roaches, flies, moths, ants, and hundreds of others or your money **REFUNDED**. For your health's sake order **SEVERAL** units **NOW**. Everyone send us a check, M.O. or cash for \$2.98—C.O.D.'s accepted. Should you, after testing your unit, decide that you would like to join us in the sales of this new public servant, we will refund your \$2.98 making your unit **ABSOLUTELY FREE**.

**ODORLESS • SILENT**  
**• MYSTERIOUS**

### FREE DEMONSTRATOR COUPON

- Enclosed is \$2.98. Send me one unit for my personal use.
- Enclosed is \$2.98 in cash, check or M.O. Rush me one 20th CENTURY BUG WEAPON with sales aids, and LOWER wholesale prices. However, should I become an active salesman, you of the Volume Sales Outlet are to REFUND my \$2.98 making my demonstrator **FREE**. Furthermore, I must agree that everything you say be true or I will return everything for a refund within one week.
- Send one MONEY MAKING sales kit C.O.D.
- Lost time is lost money. Rush me \_\_\_\_\_ dozen BUG WEAPONS, at your wholesale price. Don't forget to include my FREE demonstrator and sales aids, C.O.D. (I enclose \$5.00 Deposit.)
- Together with the enclosed order don't forget to show me how to make \$4.37 on each \$2.98. \$15,732.00 in one summer. \$9,504.00 without leaving my home.

NAME \_\_\_\_\_  
ADDRESS \_\_\_\_\_  
CITY \_\_\_\_\_ STATE \_\_\_\_\_  
(Members of the Mail Order Business Bureau)

NATIONAL VOLUME SALES CORP., Research Dept. PM-7  
1024 Cottman Ave. Phila. 11, Pa.

**ABSOLUTELY EVERYONE MAIL THIS COUPON NOW!**

WORLD'S  
BEST  
WANT-AD  
MEDIUM

# CLASSIFIED ADVERTISEMENTS



Advertisements in this section \$1.00 per word, each insertion, minimum 10 words, payable in advance.

To be inserted under proper classification, copy must be in our office the

20th of the second month preceding date of issue

F. W. Johnson, Manager, Classified Advertising

Popular Mechanics Magazine, 200 East Ontario Street, Chicago 11, Illinois

## YOU'LL PROFIT

By reading and answering the classified ads in this section. Hundreds of opportunities for you to make and save money

### AUTOMOBILES, MIDGET CARS

**FIX** Any U.S.-made car, '40 through '55, quickly, easily, with Motor's Auto Repair Manual, 1000 giant pages, 225,000 fix-it facts, 2900 pictures show beginners, experts, step-by-step. Write for 7-day free trial. Then return book, or keep it for only \$6.95 plus 35c delivery, payable in 4 monthly installments. Or save 35c, send \$6.95 now; money back if not pleased. Motor Book Dept., Desk C17, 250 W. 55th, New York 19, N. Y.

**BOYS'** Power-driven auto. Build your own. Plans 25 cents. Sypher Co., Box 39, Sta. F, Toledo, Ohio.

**ANTIQUE** Automobile color slides, 2x2. Illustrated catalog free. Universal, Box 779A, Beverly Hills, Calif.

**AUTOMOBILE** Literature—New, antique and foreign; dealer books, service manuals, glossy photographs; free motor magazines—offered by non-profit organization. Write immediately; get on free mailing list. Auto Maniacs, Stockbridge, Mich.

### AUTO SUPPLIES AND EQUIPMENT

**HV Series** injector parts wanted. Bares, 7120 Carnegie, Cleveland 3, Ohio.

**CAR** Burning oil? Losing compression? Try Clifford's Compression Seal Tube, \$2 postpaid. Clifford's Engineering, 1329 Seventh, Aurora, Illinois.

**SAVE \$50-\$175** Yearly in car, truck, or any gasoline, diesel engine operation. Install yourself. New patented process prevents, eliminates carbon by cracking gasoline before combustion. Thousands satisfied users! Only \$12.95, postpaid. Money-back guarantee. Send personal check or money order. Worthwhile writing for free information to: Hydrocarbon Systems, 2805 McKinney Ave., Dallas 4, Texas.

**ELECTROPLATE** Auto parts, novelties, mirrors. Easy, inexpensive home processes. Free booklet. Tyco Metals, Box 13231-BG, Houston 19, Texas.

**AUTO** Accessory and parts catalog, 1955 edition—All new! 148 pages. Save up to 50%. Over 50,000 items, including Hollywood accessories, hi-speed equipment, rebuilt engines, all parts and accessories for all cars and trucks! Hard-to-get parts! Send 25c. Refundable. J. C. Whitney, 1919-PM Archer, Chicago 16, Illinois.

**MOTORISTS!** Truck drivers! Stop flat tire worries forever. Free details. Kaybee, Box 863, Chicago 42, Illinois.

**AUTOMOBILE** Burglar alarms. Free sample offer. Salesmen wanted. Novak, 3131W-13, Gary 17, Indiana.

**LACHAPPELLE'S** Patented treatment. A better motor for your car. \$3.00 postpaid. Write for information. Ferns Products, Box 71827-B, Los Angeles 1, Calif.

**ELECTRICALLY** Operated garage door, complete, ready to operate, only \$39.95 less motor. Write for literature. Electric Garage Door Co., P.O. Box 301A, Park Ridge, Illinois.

**LATEST** Custom accessories. Items not in stores. New low prices. Continental tire kits, push-button doors, trunks, etc. New illustrated catalog, biggest ever, 25c. Eastern Auto, 3319-A South Grand, Los Angeles 7, California.

**HARDTOP** And convertible owners. Save \$10.00 by cleaning your own leather seats. Kit includes cleaning compound and applicator for \$2.49. Oetter Products, 7894 Watson Rd., St. Louis County 19, Mo.

**BUY** Wholesale nationally advertised auto supply, thousands other products at big discount. Free "Wholesale Plan." American Buyers, Hertel Station, Buffalo 16-G, N. Y.

**SPOT** Any car trouble in a jiffy. Motor's "Trouble-Shooter," handy pocket-size illustrated manual, instantly locates 2,000 causes of trouble in engines, clutches, brakes, ignition, automatic transmissions, etc. Saves hours. Send only \$1. Money back in 7 days if not delighted. Motor Book Dept., Desk T17, 230 W. 55th, New York 19, N. Y.

**NEW** And used parts at savings. Complete guaranteed parts service for all models cars and trucks, 1924 and later. Largest in the West. Army parts specialists. No catalog, write for quotations. Fast mail order service. Pioneer Auto and Truck Parts Co., 1360 Speer Blvd., Denver 4, Colorado.

**GENUINE** Motor treatment, Lachapelle's, (patented). Only \$3.00 delivered. Increases compression, power. Saves gas, oil, repairs. Money back guarantee. You can't lose. Free circular. Write Joe Dillon, Authorized Warehouse and Agents Distributor, Box 323-10 Bridgeport, Ohio. Exclusive distributorships, agencies open.

**FISH** Pole auto top carriers. Aluminum. Rubber padded. \$1.00 pair. Barmore Mfg. Co., 1030 S. McComas, Wichita, Kansas.

**RADIOS.** Custom for 1953-3-4-5 Fords \$38.90. Free literature, Nordic Radio, Box 582, Evanston, Ill.

**BRAKE** Lining! Automotive, truck, industrial. Mobile Brake Parts, Round Lake, Illinois.

**MECHANICS** Attention. Plymouth and Dodge pistons, all sizes, \$15.84 a set. Merryman, Box 422, Ontario, Calif.

**FORD-T** parts. Most complete stock in U.S. for all old cars. Try to stump us. Wisneski, Milwaukee 7, Wisconsin.

**BUY** Wholesale! Auto supplies, 10,000 other products. Save 66%!! Free catalogs. National Buyers Service, Box 426ED, Oakland, California.

**MOTORIST** Save gasoline by vacuumating overrich mixtures. Fits all cars. For free particulars write Vacuumatic, Dept. 2113, Wauwatosa, Wis.

**CAR** And boat owners. Fabulous new carburetor gas analyzer shows 100% combustion. United States armed forces now testing carburetor. Recent city test on Ford shows 100% increase in gas mileage. Send \$1.00 for details. Money back guarantee. Gus Cioffoletti, 12 First Street, New Rochelle, New York.

**FREE** Discount catalog—Speed, power, custom equipment. Almquist Engineering, Milford 7P, Pennsylvania.

### AUTO TRAILERS

**TRAILER** Building manual, illustrated \$1.00. Circulars 20c. Craftsman Books, Box 1153, Milwaukee 1, Wis.

**EXCEPTIONAL** Expanding eight foot trailer. Accommodates family of five. Build yourself. Literature 10c. Pramur Company, Wilmington, Mass.

**BUILD** Your own trailer! Plans for all kinds. Illustrated catalog 10c. Jim Dandy, 125-M, Wausau, Wisconsin.

**"SHORT-Short"** family trailer. Simple assembly. Plans \$1.75. Welch Workshop, 645 Rochdale Circle, Lombard, Illinois.

**ASSEMBLE** Yourself kits. Slip-on cabin coach for all pick-up trucks. Trailer blueprints. Literature 10c. Comstock Trailers, 646-P, Parsons, Kansas.

### MOTORCYCLES, BICYCLES, MOTORSCOOTERS AND SUPPLIES

**RECONDITIONED** Motorcycles and motors. Chromium accessories. Complete stock Indian parts. Expert rebuilding. Fast service. Indian Motorcycle Sales, Kansas City 27, Mo.

**"BUZZZZ"** The motorcycle magazine. International coverage. Thoroughly illustrated. Yearly \$2.00. Sample 25c. 5424-A Sawyer, Chicago 25.

**AMERICAN** Motoscoot \$20; midget motorcycle \$25; Cushman \$25; midget car \$50; Whizzer engine \$5. (Mailorder only). Send 25c (35c for first class mailing) for directory catalogue Number 66, just out, listing these and hundreds of other bargains in new and used. Home builders parts, plans, etc. Midget Motors Directory, Athens, Ohio.

**HARLEY-Davidsons**—America's finest used bargains! We pay shipping on motorcycles. Genuine new, used parts, accessories for current and obsolete models. Send 25c for bulletin, catalog. Knuth's (factory dealer), 1753 Muskego, Milwaukee, Wis.

**WHIZZER** Motors \$20.00; Safticycle, completely equipped, \$30.00; motorscooter \$6.00; Cushman two-speed \$20.00. Send 25c (35c first class mail) for catalog #28 jammed with sensational bargains in wheels, motors, motorscooters, midget cars, motorbikes, construction plans, etc. Gail, 1313 Jefferson, Toledo, Ohio.

### AVIATION

**BUILD** A two-seater from proven plans using mostly standard parts: "Practical Lightplane Design and Construction for the Amateur" is your guide. \$4.75 ppd. Brochure, dime. W. J. Fike, Dept. P, Box 683, Anchorage, Alaska.

**HELICOPTER**—1 Man, experimental marvel. Build own. Instructions \$3.50. Mayberry Aircraft, Box 343, St. Clair Shores, Michigan.

**PROPELLERS**. Plans, kits for snow sleighs, air boats. Immediate delivery, satisfaction guaranteed. Catalog 25c. Banks-Maxwell, Box 3301E, Ft. Worth, Texas.

**LIGHTPLANE** Building manual, illustrated \$1.00. Circulars 30c. Craftsmann Books, Box 1153, Milwaukee 1, Wis.

**BUILD A man** carrying helicopter jet engine yourself. "Practical Ram Jet Design," \$1.00. "Practical Pulse Jet Design," \$1.00. Decker Engine Works, Plasterco, Va.

**PROPELLERS**. Plans, supplies for air boats, snow sleighs. Catalog 10c. Gano Propellers, Box 3284-A, Ft. Worth, Texas.

**FLYING Saucer!** Propelled by centrifugal force. Propulsion details, \$1.00. Decker Engine Works, Plasterco, Va.

#### BATTERIES, GENERATORS

**EDISON** Nickel storage batteries. Any voltage, any amperage. Unconditionally guaranteed. Power plants, generators, motors. Literature. Hawley Smith Co., Croton Falls 1, N. Y.

#### ELECTRICAL SUPPLIES

**LAMPS**—25c Brings bargain catalog showing all parts for repairing, building. Contains instructions for electrifying vases, oil lamps, etc. Gyro Lamps, 5402P Clark, Chicago 40.

**INTER-Com** phone system. Talk from house to garage, etc. Easy installation, \$50.00 value \$29.95. Osgoods, 1320-C, Prospect, New York City 59.

**NEW 1955 Lamp** parts catalog showing everything you need to make and repair most types of lamps. Everything at lowest wholesale prices. Send only 25c today for both catalog and wholesale price list. Gearon Co., Dept. 503-B7, 27 S. Desplaines, Chicago 6, Ill.

#### WELDING, SOLDERING, PLATING

**WELDER** Bargain. Lowest price. 300 ampere with reactor, pulley, \$89.50. Harris Machinery, Minneapolis 14, Minn.

**A.C. Welders**. 4 sizes. Lowest prices. Free literature. Holgeron's Serv., Canton, Kan.

**ACETYLENE** Welding outfits, new \$49.00; used \$29.00; arcwelders \$56.50. Eagle Welding, Dept. PM, 5083 Broadway, Chicago 40, Ill.

**ELECTROPLATING** Equipment, anodes and solutions for all types of plating. Instructions. Assemble your own plater and save. Free catalog. Ramyr, Dept. E-4, 1624 East First Street, Los Angeles 33, California.

**NEW**, Timesaving oxy-acetylene outfit welds, cuts, heats, brazes. Just change tips. Light, compact, portable. Thrifty to operate, ruggedly built. Complete outfit and instructions, only \$36.50. Special economy plan for supplying gas cylinders. Write for free literature: Dept. M, Linde Air Products Company, 30 East 42nd Street, New York 17, N. Y.

**BUILD-Your-Own** a.c. welder and a.c. power plant with a good used engine and low cost Hobart generator. Welds anywhere and supplies 5KW stand-by power for any emergency. Write Hobartweld, Box M-753, Troy, Ohio.

**WELDERS**, 110/220, Welds 1/2", \$39.50. Morris, 1070 Inner Drive, Schenectady, N. Y.

**50 NEW** 150 Amp. a.c. welders, 1 ph., from govt. surplus. \$300 value, \$75.00. DuPont Smith, 106 Verbena Road, Oak Ridge, Tennessee.

#### MACHINERY, TOOLS, SUPPLIES

**NEW** Electric drills and saws. 1/2", \$11.75 and \$15.75; 3/4", \$30.75; 6 1/4" tilting arbor \$44.50 prepaid. Wilt Surplus, 7829 Racine, Chicago 20.

**ALLEN** Two ton power bench type punch press, \$97.50. Circular, Allen, Dept. PMB, Clinton, Missouri.

**TOOL Specialties**—Drill routers, drills, saws, plastic Devil levels, Magna-Tool, professional carving tools, Screw-Drills, micrometers, Helios callipers, etc. Catalogs available. Drilsaw Co., 1561 Virginia Ave., Glendale 2, Calif.

**CONCRETE** Block machines—Standard sizes. From \$39.50. Blocks made easy. Pallets unnecessary. Mixers. Instructions. Free catalog. Francis Machinery Company, 5129 South Compton, St. Louis 11, Mo.

**DRILL** Bit sets—1/16" through 1/2" (1/32"). Finest imported German carbon steel, plastic stand, \$4.95 anywhere in U.S.A. Drill Bits, 2203 W. Barnett, Louisville, Ky.

**FAST** Boring—Wood or drill bits for soft metal. Made from nails, bolts, wire and etc. Simple, easy and no special tools needed. Diagram and instructions \$1.00. Money back guarantee. Aubrey Pearce, 328 Gulfport St., Hattiesburg, Miss.

#### ENGINES, MOTORS, DYNAMOS

**WINDING** Data, 225 motors, single and three phase, \$1.00. Data Company, Box 7631, Kansas City 28, Mo.

**REWIND** Motors yourself. Complete instructions \$1.00. Lewis Mig., Howell, Michigan.

**A.C. Generators**, 750 watt, \$38.50. Twin cylinder compressors with 1/2 horse \$22.00. Motors, 1 horse, \$37.50. Butler, 1885 Milwaukee, Chicago 47.

#### BOATS, OUTBOARD MOTORS

**RUBBER** Boat catalogue with paint and dope information. Send 10c. Box 22MP, Thomasville, Penna.

**FIBERGLASS** Your boat. Top marine grade only. Ontario Fiberglass, Ontario, N. Y.

**NEW 12V.** batteries for boats, motors, cars, etc. Include box and lid \$12.50 each. No c.o.d.'s. Leiber Supply, Selma, Calif.

**16-18-20 FOOT** Outboard powered catamaran plans \$1.00, also other plans, literature 10c. Widd Hauber, 2451 18th Ave. No., St. Petersburg 2, Fla.

**CONVERT** Fords and Jeeps to 100% marine engines with Osco's world famous Convo-Kits. Deluxe catalogue 25c (coin). Oscomotors, 3627B Lawrence, Philadelphia 40, Penna.

**OUTBOARD** Motor parts—New, used for all makes. Send stamp for price quotation, listing parts needed. Outboard Motor Mart, Inc., 229C State Street, Boston, Massachusetts.

**FULL** Size, cut-to-shape boat patterns, blueprints, 7 1/2-38 feet. New 1955 illustrated "Build a Boat" catalog of 50 naval architect-designed cruisers, runabouts, sloops, skiffs, outboard boats, sailing, racing, houseboats, 50c. Marine hardware catalog \$1.50. Bigger, better 1955 "How to Build Boats" book, \$2.50. PolyWog Houseboat Plans, 812, Cleveland Boat Blueprint Co., Dept. A-68, 9400 Steinway, Cleveland 4, Ohio.

**FIBERGLAS** Permanent boat waterproofing. Lowest wholesale prices. Guaranteed materials. Easy application. Full instructions. Complete kits, \$12.60 up. Free literature. Ajax Plastics, Dept. PM, P.O. Box 1323, Fort Worth, Texas.

**NEW**, Used, rebuilt marine motors. Marine conversions, fittings. Free catalog. Stokes Marine Supply, Dept. 24, Coldwater, Michigan.

**AIR** Boat plans, supplies, catalog 25c. Banks-Maxwell, Box 3301F, Ft. Worth, Texas.

**FREE** Instructions. Boat docks. Built, installed out of water. Dock Products Company, Box 1461, Minneapolis 6, Minn.

**MARINE** Conversion, Willys to Cadillac, engines, kits and parts. Catalogue and conversion hints free. Barr Marine, 2706 Castor Avenue, Philadelphia 34, Penna.

**PLANS**, Patterns, frame kits for modern boats 12'-22". Complete selection of modern boats especially for the amateur builder. State your requirements or send 40c for our complete catalog. Glen Designs, Box 568, Compton, Calif.

**FREE** Catalog! Boat kits, trailers, fiberglass, marine hardware. Luger Industries, Dept. M, 4452 Niccollet, Minneapolis, Minn.

**MARINE** Conversions for Ford and Jeep engines. Catalog 25c. Lehman Manufacturing Company, 972D Broad Street, Newark 2, New Jersey.

**BUY** Wholesale nationally advertised outboards, thousands other products at big discount. Free "Wholesale Plan." American Buyers', Hertel Station, Buffalo 16-N, N. Y.

**FABULOUS** Bargains on marine hardware. 35c for small boat, \$1.00 for complete catalog. Free Glasticote literature. We pay freight. Marine Associates, Box 6188-M, Long Beach 11, Calif.

**STOP** Boat leaks forever with perfected Fiberglass. Instructions free. Ev-R-Shield, 4917-P Alhambra Avenue, Baltimore 12, Maryland.

**FIBERGLAS** Boat coating. Plexiglas boat windshields—clear, blue, green tints. Wholesale-retail. Complete information catalog 15c. Gem-O-Lite, Box 8861B, North Hollywood, California.

#### ATHLETIC EQUIPMENT, BODY BUILDING COURSES

**FREE** Catalogue. 10c for postage appreciated. Dr. Thompson, 919 Fourth, Manhattan 30, Kansas.

**BARBELLS**. Exercise equipment. Courses. Free booklet. Good Barbell Co., Reading, Penna.

**DELUXE** Athletic abdominal belts for men. \$7.49. Give waist size. Stillwell's, 1209 Minn. Ave., Kansas City, Kansas.

**PUSHED** Around? Why take nonsense from bullies. Give them the surprise of their lives. Easy when you know Police Jiu Jitsu. Complete fully illustrated course in one volume same as taught police and armed forces. Send \$1 now for Police Jiu Jitsu postpaid. Satisfaction guaranteed. Books Publishing Company, Amityville 3, N. Y.

#### SPORTING GOODS, GUNS, FISHING TACKLE, ARCHERY, TRAPPING

**SWIMMERS!** Send \$3.95 for imported French mask. Catalog of skin divers' equipment and books 25c. Aquafun PM, Davenport, Iowa.

**RODS**, Reels, sporting goods wholesale prices. Free catalog. Barry Sales, Dept. P, Box 234, Gratiot Branch, Miami 50, Fla.

**180 PROFUSELY** illustrated pages antique pistols, swords, daggers, armor, etc. 50c. Robert Abels, M850 Lexington Ave., New York 21.

**TENTS**, Camping equipment. Send 10c for new 1955 100 page tent, camping equipment catalogue-handbook. Morsan, 10-21R 50th Avenue, Long Island City 1, N. Y.

**MOLDS**—For making fishermen's sinkers. Free illustrated booklet. Reading Instrument Co., Box 78, Reading, Penna.

**5000 BARGAINS**, Firearms, binoculars, war relics. Catalog 50c. Smith Firearms, Runnemed, N. J.

**MOLDS** For fisherman's sinkers, jigs, squids, casting and spinning lures. Free catalog. Sweet's Molds, Tonawanda 1, New York.

**MANY** Modern, antique guns. List 10c coin. Ed Howe, 52 Main, Coopers Mills, Maine.

**1955 SPIN** Reels at wholesale price—Mitchell #300 \$18.95, Record #400 \$18.95, Airex Larchmont \$16.75, Aristocrat \$14.50, Vagabond \$10.95, Orvis 100 \$17.95, Zebco #22 \$11.50, Johnson 80 \$10.95. Orders shipped promptly, prepaid. Lombard's, Dept. M, 3141 Bainbridge Ave., Bronx 67, N. Y.

**JAP** Rifle altering to 30-06, \$6.00. Jap-shells, \$3.75. Catalog 5c. T. P. Shop, West Branch 11, Mich.

**FISH** Crazy about amazing new fish lure. Bite like hungry walves. Works like magic on any lure. Bottle \$1.00. Results guaranteed or money back. Literature free. Smith-Parish, Rupert, Idaho.

**BUY** Wholesale nationally advertised sporting goods, thousands other products at big discount. Free "Wholesale Plan." American Buyers', Hertel Station, Buffalo 16-I, N. Y.

**RED** Wigglers: 500, \$2.50; 1000, \$4.00; 5000, \$17.50. Mixed approximately 1500, \$4.00. Capsules 1000, \$7.50. Book \$1.00 postpaid. Julius Birch X, Route 3, Muskegon, Michigan.

**FREE** Fishing catalog—132 pages. Over 3000 hard to find fishing specialties. Net-craft Company, Dept. PM7, Toledo 13, Ohio.

**SEMFINISHED** Bows and arrows. List. Jim Deeds Archery, 5151A Branciforte Drive, Santa Cruz, California.

**TEXAS** Cowboy boots, illustrated circular free. Box 5051, Beacon Hill Station, San Antonio 2, Texas.

**INTRODUCTORY Offer** — Arrowmaking kit, \$5.95 value only \$2.95 postpaid. Includes feathers, nocks, cedar shafts, target or field points with instructions. Completes dozen arrows. M. Anger, 66 West 85<sup>th</sup> St., New York 24, N. Y.

**SAVE 50%** Finest archery equipment. Revealing "How to Bow-Fish, Bow-Hunt, Make Own Tackle, Improve Accuracy" booklet plus catalog. Both free! Malibu Archery, 1036-RJU La Brea, Los Angeles 19, California.

**GUNS!** Guns! Guns! 10,000,000 bargains! Colts, Winchesters, Kentuckies, Lugers, Mausers, swords, armor. Big bargain catalog 50c. Agramonte's, 201 Warburton, Yonkers 2G, N. Y.

**20,000 GUNS**—Huge 162-page photo catalog \$2. Big frontier sixshooter catalog 50c. Hy Hunter, Burbank 51G, Calif.

**BUY Wholesale!** Guns, fishing, sporting goods. Save 65%! Free catalogs. National Buyers Service, Box 426EC, Oakland, California.

**AMMUNITION 50% Discount.** List 200 calibers 10c. Pacific Firearms, 1517 Gardner, Los Angeles 46, California.

### TAXIDERMY

**MODERN** Taxidermist magazine, Greenfield Center 2, N. Y. Devoted entirely to taxidermy, methods, photos. Trial year's subscription, \$1.00.

### BINOCULARS, TELESCOPES, MICROSCOPES, MAGNIFIERS

**SPECIALISTS!** Used microscopes and accessories. Unusual slides. Supplies. Catalog free. Research Scientific Supplies, 60 Wall St., New York City 5.

**BINOCULARS, Telescopes, microscopes,** terrific values \$3.98 up. Request free money saving catalog. Criterion, Dept. P31, Hartford, Conn.

**MICROSCOPES, Binoculars, everything** optical and photographic direct from importer. Lowest prices. Free catalog. Magnification Instrument Co., 2 East 45 Street, New York City.

**REFLECTING Telescopes, 60X,** completely assembled \$29.75. Guaranteed observatory clearness. Free information. Skyscope, 475 Fifth Avenue, New York 17.

**LOWEST Prices,** all sizes, binoculars, telescopes, microscopes. Also repaired. Free catalogue, Joe's Binocular Sales, 4827 Second Blvd., Detroit 1, Michigan.

**TELESCOPES, Microscopes, binoculars,** past quarter century. Comprehensive scientific instrument catalog \$1.00. None free. Dollar deductible from orders. Harry Ross, 70 West Broadway, New York 7, N. Y.

**400X TELESCOPE** Makers kit contains focusing tube, erector, five finished lenses and instructions, \$3.75. Giant astronomical telescope completely assembled with 6 ft. tripod, \$15.00. Free information. Suffolk Science, Mattituck 3, N. Y.

**REFLECTOR Telescope kits \$6.25 (3")** to \$175. (12"). Mirrors, cells, focusing mounts, tripods, eye-systems. Anything, everything in telescopes. Free illustrated catalog. Also ready to use telescopes from \$26 to \$175. Inquiries to Esco Products, Dept. PM-7, 1428 Willow Ave., Hoboken, N. J. Sales showroom, 166 Church St., New York City.

**DYNASCOPE**—Sensational new reflector telescope. Send for details. Criterion Co., Dept. DP9, Hartford, Conn.

**SAVE 25%!** Get interesting facts. Free 56 page binocular, telescope catalog, \$3.95 to \$250.00! United, 9043 S. Western, A-8908, Chicago 26. Dealers wanted.

**WAR** Surplus bargains! Millions of lenses, instruments, telescopes, binoculars, components and complete line of astronomical telescope items. World's greatest optical market place! Send only \$1.00 for beginner's 10-lens kit and big instruction booklet Stock 2-CH. Write for catalog CH free! Edmund Scientific Corp., Barrington, New Jersey.

**BUILD** Your own reflector telescope. Complete kits, mirrors, eyepieces, tripod, all other accessories. Request free illustrated literature. Criterion Manufacturing, Dept. KPM6, Hartford, Conn.

### PETS—DOGS, BIRDS, RABBITS, HAMSTERS, ETC.

**CHINCHILLAS**—Big profits. Send 25c for literature to Tom McGowan, 170 Horton Ave., Valley Stream, L. I., N. Y.

**WILL** Trade chinchillas for property or first mortgage. Jacobsen Chinchilla Ranch, 8320 Byrd Ave., Inglewood 4, California.

**CHINCHILLAS, Registered, Guaranteed** reproduction. Unbelievable prices. Far-West Chinchilla, 1446-A Jones, San Francisco 9, California.

**CHINCHILLAS** Top-quality registered sturdy young stock, \$75.00 per pair. Slater Chinchillas, 1535 Ruhland Ave., Manhattan Beach, California.

**START** Right by knowing facts about rabbit raising. Illustrated booklet describing all breeds, housing, feeding, breeding, marketing, 48 pages 10 cents. American Rabbit Breeders Association, 36 Arba Building, Pittsburgh, Penna.

**MAKE** Money raising chinchillas, mink, pigeons, rabbits, cavies for us. Free catalog. Keeney Brothers, New Freedom 2, Penna.

**RAISE** Moneymaking Angora, New Zealand rabbits. Particulars free. White's Rabbitry, Jackson, Mich.

**STANDARD** Rabbit Journal, Milton 3, Penna. Year \$1.00. Sample dime. Beginners manual 25c.

**GROW** Mushrooms. Cellar, shed, and outdoors. Spare, full time, year round. We pay \$3.50 lb. We paid Babbitt \$4,165.00 in few weeks. Free book. Washington Mushroom Ind., Dept. 171, 2934 Admiral Way, Seattle, Washington.

**MINK** Raising information free. Complete. Lake Superior Mink Farm, Superior, EEL, Wisconsin.

**MAKE** Big money! Raise Chinchilla rabbits. Cash markets supplied. Write today! Rockhill Ranch, Sellersville 15, Penna.

**SPORTSMEN:** World's largest kennel offers 500 Pointers, Setters, Straight Cooners, Combination Hounds, Rabbit and Squirrel Dogs, Beagles, Fox and Wolf Hounds. Trial. Prices reasonable. Catalogue free. Smokey Mountain Kennels, Cleveland, Tennessee.

**CHINCHILLAS** — Fabulous fur animals. Wholesale prices or we'll swap for things of value. What you got? Leo Hammer, Asheboro, N. C.

**MINK, Pastels, sapphires, platinum,** Aleutians, \$25.00 up. Huebl Minkery, LeSueur, Minn.

**GUINEA** Pigs. Wonderful moneymakers. Booklet free. Taylors, 426A, Hapeville, Georgia.

**OWN** Real live baby burro. Latest fad for junior cowboys. Write: Bruns, 1709 Fremont, Madison, Wis.

**HAMSTERS**—Reduced prices. Write for details. Anderson's Hamstery, 35 Oneida, Pontiac, Michigan.

**FREE** Catalog of dog and cat remedies. Norway, Hartford 3, Conn.

**HAMSTERS**—Golden: young, \$4.00 pair, fully developed, \$3.00 pair. Adirondack Hamstery, Prospect 94, New York.

**SOOPER** Dooper Pooper Scooper. To clean dog pen or yard, \$3.98. Free literature. Scooper, Box 7505, Indianapolis 22, Ind.

**BEAUTIFUL** Pure white pedigreed police puppies. Ansonia Kennels, Mose, N. Dak.

### PLANTS, SEEDS, NURSERY AND GARDEN SUPPLIES

**WORLD'S** Greatest cash crop. Free information. Write Ginseng Gardens, Asheville, N. C.

**MIRACLE** Leaf. Nature's hermaphrodite. Hang it up, put on windowsill, nail to wall. Sprouts up to twelve eight-leaf plants without soil or water! Beautiful, amazes friends. Two leaves, instructions, \$1.00. Omni-Service, P.O. Box 51, Miami, Fla.

**RAISE** Your shrubs, trees from seed. Free planting guide, price list. Woodlot Seed Co., Norway, Michigan.

### FARMS, FARM LANDS, REAL ESTATE

**HOMESITES** \$400 — Convenient payments. California's finest garden section. On Morro Bay's scenic shores. Wonderful fishing, boating, bathing. Fertile soil, softest water, temperate climate, congenial community. Free literature. Richard Otto, Department M, San Luis Obispo, Calif.

**\$5.00 MONTHLY** Buys 40 acres productive land; near town; price \$240.00; free list. Box 425-P, Carthage, Mo.

**STROUT** Catalog—Mailed free! Farms, homes, businesses, 35 states, coast-to-coast, 3036 bargains described. World's largest; 55 years' service. Strout Realty, 7-MF So. Dearborn St., Chicago 3, Ill.

**FARM** \$600. \$15 Terms. Others. Write Mr. Armstrong, Shook, Missouri.

**FLORIDA'S** Summer paradise. Enjoy your finest vacation at Green Hills near famous Panama City pleasure resort. World's most beautiful beaches. Lovely lakes, streams. Wonderful fishing, boating, water sports. Big, beautifully wooded homesites and money-making winter garden farms. Low prices, easy terms. Booklet free. Wendell Wood, Fountain, Florida.

**FLORIDA**—Beautiful retirement homesites near gulf coast. Excellent hunting, fishing in 9 fresh and salt water rivers. 11 bays and gulf. \$250 at \$10 monthly. Free literature. V. M. Mathews, Box 1406, Asheville, N. C.

**HOUSTON** Is America's fastest growing city—because increasing thousands locating here can do so much better for themselves. Get your beautiful homesite now at pre-development price—easy terms—near finest beach resorts, brochure free. Preston Wood, Box 413, Houston, Texas.

**ONLY \$5.00 Down!** Full price \$89.50 on easy terms buys big 5000 square foot homesite at Bandera, Texas, heart of "dude ranch country." Electricity, telephone. 1300 feet above sea level. Warm days and cool summer nights make vacation paradise. Hunting, fishing, golfing, swimming, horseback riding. Write for free photographs and details. Bandera Pass Ranch, Dept. 201-A, Bandera, Texas.

**VILLAGE** Home garden, busy highway, reasonable. Details. Perrys, Brier Hill, Penna.

**CALIFORNIA** Ranch and farm lands. \$15 to \$35 acre. 100% oil and uranium rights. Easy terms. Free catalog. Pacific Tax Sales, 1621-A Cahuenga, Hollywood 28, California.

### PROFITABLE OCCUPATIONS

**FOREIGN** Construction. Jobs underway and soon starting in South America, Canada, Alaska, Europe, Asia, Middle East, South Pacific. Big pay, tax exemptions. Travel, expense paid. Make your stake now. Send \$1.00 for projects, contractors, application form, etc. Prompt ppd. reply. Money-back guarantee. DCS Foreign Job News, Bridgeport 2, Ill.

**1000 JOBS** in California. All types available. Information about salary, names of companies, new industries. Highest pay in U.S. Send \$1.00 to Personnel Consultants, 736 Suite 8K Alcatraz Avenue, Oakland, California.

**FOREIGN** Employment construction work. If interested in foreign projects with high pay write Foreign Service Bureau, Dept. PM, Metuchen, N. J.

**AUCTIONEERING**—Home study course. Diploma granted. Auction School, Ft. Smith, Ark.

**ALASKA!** Last American frontier. \$1.00 brings 1953 business directory and government map. Military and civilian construction, homestead and highway facts, mining, aviation, fur-farming, grazing, timber, travel directions. Hot list of firms hiring. How-when-where to apply. Alaska Opportunists, Box 92-P, Hollywood 28, Calif.

**EARN** To \$1500 monthly — Men needed. Many types of jobs. Laborers, clerical, mechanics, truck drivers, engineers, supervisors, etc. Chance to travel, S. America, Europe, Africa, USA, etc. Many benefits. Fare paid by employers. No employment fees. Application forms. For information and quick reply. Write Dept. 760, National Employment Information, 1020 Broad, Newark, N. J.

**JOBS!** Electronics, missile engineers. Physicists, Technicians. Long current list, private and government. \$1.00. Box 1317, Las Cruces, New Mexico.

**FREE Transportation!** Travel free! Vacation California! Florida! Oregon! Texas! Many other states. Take family, friends! Over 76 nationwide sources! Send immediately for "1955 Travel-Free Directory" \$2.00. Satisfaction guaranteed. Kerrigan, 924 West 11th Place, Los Angeles 15, Calif.

**OVERSEAS,** Latin American, Alaska, Canada employment. Originator 1955 "Foreign Service Directory" up-to-minute report on military and civilian construction; oil companies; aviation; transportation; steamship; mining; government job info. How-when-where to apply. Listing firms hiring. \$1.00. Global Reports, Box 883-P, Hollywood 28, Calif.

**\$5 TO \$10 An hour.** I've did it. I'm disabled now. Real genuine offer. Complete information only \$1. Lucas, 2200 Carson St., Pittsburgh 3, Penna.

**RAISE Pheasants** on \$100 week plan. Little capital and space can make you independent. Free details. Great Central System, Columbus 1, Kansas.

**FREE Folio "Up to \$45,000; Unlimited Vacations."** No merchandise, equipment. Unknown! Work home, sparetime! Haylings, Carlsbad, Calif.

**GROW Mushrooms.** Cellar, shed, and outdoors. Spare, full time, year round. We pay \$3.50 lb. We paid Habbitt \$4,165 in few weeks. Free book. Washington Mushroom Ind., Dept. 99, 2954 Admiral Way, Seattle, Wash.

**HOME Workers needed!** Spare time, full time. Assemble luggage and cases with our complete illustrated step-by-step instructions. We sell your product—Supply everything. Manufacturing representative needed in your area immediately. Unlimited profits possible. Investigate at our risk. Free details. Cascraft, 697-G10 Sunset, Los Angeles 12, Calif.

**FREE Book "505 Odd, Successful Businesses."** Work home. Expect something odd! Pacific, Oceanside, Calif.

**MAKE New greaseless doughnuts** in kitchen. Sell stores. Free recipes. Michael Ray, 8605 South 15th Ave., Minneapolis 7, Minnesota.

**BE The Popular Mechanics representative** in your neighborhood and earn big profits in your spare time. Write Popular Mechanics Magazine, Room 408M, 200 E. Ontario St., Chicago, Ill.

**EMPLOYERS Now hiring 12,500 men** for overseas and Alaska! Construction \$830-\$1063 monthly; factory \$780; office \$650. Free transportation. Catalog, \$1. Jobservice D-16, Box 30, Billings, Montana.

**FOREIGN-U.S. employment.** If interested in stateside and foreign projects write. High pay. Stamped self-addressed envelope appreciated. Job Information, Dept. 1E, Waseca, Minn.

**WANT More money?** No matter what your present occupation or income may be—We tell you how! You can do it! Complete information. Money back guarantee. Send \$1.00 to Bruce L. Bowerman, Dept. 6A, 124 Park Avenue, Lockport, New York.

**IMMEDIATE Overseas openings,** high pay, skilled, unskilled. Write Foreign Job Surveys, 9834 Elmar Ave., Oakland 5, California for airmailed details.

**JOBS, Business opportunities galore.** Miami classified airmailed \$1.00. Classified, 540 S.W. 27th Ave., Ft. Lauderdale, Fla.

**WHOLESALE!** Musical instruments, phonographs, recorders, watches, appliances, etc. Discounts to 75%! Large catalog 50c (refundable). Strauss Music Company, 25-12, Lafayette, Paterson 23, New Jersey.

**MONEY With your 8mm camera?** Highly profitable. No overhead. Details free. Film Wizard, Hollywood 38, California.

**BUY Wholesale** thousands nationally advertised products at big discount. Free "Wholesale Plan." American Buyers', Hertel Station, Buffalo 18-B, N. Y.

**FREE!** "301 Profitable Small Businesses!" Amazing shoestring plans! Work home! Start sparetime! Deumant Surveys, Kenmore 23-PM, N. Y.

**MAILORDER Beginners instruction manual,** sources, methods, information, opportunities, 25c. Carnahan Bros., 3580 Nelson, Cypress, Calif.

**MAN Wanted.** Are you dissatisfied with your work? Would you like a business of your own? If so, write Rawleigh's, Dept. G-GG-PPM, Freeport, Ill.

**WANT A diesel job?** New opportunities to increase income. Higher pay. More money. We can help you qualify. Tools. Shop method home training. Write today! Diesel, Tractor, Heavy Equipment Division, Interstate Training Service, Dept. B-3-G, Portland 13, Oregon.

**MUSHROOMS** Grown boxes, barrels. Manureless process 50c. Spawn \$1.00. Gordon's, 553 William, Winnipeg, Manitoba.

**WHOLESALE Catalog!** 30-80% discounts! Typewriters, appliances, housewares, watches, jewelry, etc. Consolidated Distributors, 21-14 Lafayette, Paterson 13, New Jersey.

**MAGAZINE Subscriptions—Highest commissions,** bonus. Qualified Agency, 451LY Kingston, Brooklyn 25, N. Y.

**WELDING Pays big money.** Learn easily at best equipped school in country. Non-profit school with low cost training. G.I. approved. Write Hobart Trade School, Box M-752, Troy, Ohio.

**ATTENTION Construction men!** Laborers, trades, truck drivers, clerical, engineers, supervisory, many others. Latest copyrighted reports! Who to contact for highest paying jobs. To \$1500.00 monthly. Over 52 countries, including U.S., St. Lawrence project, Spain, South America, Alaska, Europe. Year registration and advisory service. Application forms. Best oil, aviation opportunities. Unconditional guarantee of satisfaction. Write or wire today! \$2.00. Airmailed \$2.25 (C.O.D.'s accepted.) International Reporter, Box 1047-PS, St. Louis 1, Missouri.

**FLORIDA'S Booming!** Employment listings \$1.00. Edwards, Box 585, Miami 33, Florida.

**LEARN Real estate business** for highly profitable lifetime career. Study at home. Low cost. Easy terms. Write for free literature. Seavy Realty Institute, 1730-B Colorado Blvd., Los Angeles 41, California.

**WASHINGTON State jobs.** Seattle classified airmailed \$1.00. Ed Murray, 224 North Mission, Wenatchee, Washington.

**MEN Wanted—Build luggage** and cases at home. We sell your products, supply complete instructions, materials, everything. No special equipment needed. Free details. Cascraft, 805-G19 Sunset, Los Angeles 12, Calif.

**\$1300.00 MONTHLY** For truck drivers, \$1400.00 monthly for carpenters, electricians, plumbers, mechanics, \$1200.00 for clerks and laborers. Full information and complete foreign listings, with current information on Spain, Korea, Australia, Alaska and Canada, \$1.00. Current information on stateside projects, \$1.00. Dept. 3-G. Opportunities Unlimited, 1110 Commerce Bldg., St. Paul, Minn.

**OPPORTUNITY California jobs.** San Francisco area. Nation's bright spot. Sunday classified airmailed \$1. Three weeks \$2. Allison, Box 4902, San Francisco, Calif.

**WEST Coast—Seattle, Portland, Spokane,** jobs, opportunities airmailed, \$1.00. Bingham, Box 740, Spokane, Wash.

**FREE Booklet "Ten Ways to Make Money in Your Own Business."** Capital, experience unnecessary. We ship orders under your name. Topval, Lindenhurst 417, New York.

**EARN To \$1200 monthly.** Foreign and domestic job openings. Full information of all contractors. Including name, address, wage rates. Both U.S.A. and foreign. Working hours, living conditions with complete information on how to apply. Truck drivers, laborers, mechanics, pipe fitters, plasterers, electricians, clerks, etc. Get application blank by return mail. All for only \$1.00; air mail \$1.25. Money back guarantee. Overseas Job Bulletin, Dept. PMS, P.O. Box 13667, Dallas, Texas.

**BUY Wholesale!** 100,000 name brand products! Save 66%!! Big profits selling others spare time! Free catalogs. National Buyers Service, Box 428EE, Oakland, Calif.

**SWITCH Plates:** Turn them into cash. Seven methods. Instructions \$1.00. Claire Creations, Dept. W-P Box 307, Plainfield, New Jersey.

**OVERSEAS And U.S. jobs.** High pay. Men, women. Skilled, unskilled. Travel paid. Write today. Eastland Co., Box 1406-A, Los Angeles 28, California.

**EARN \$7500 Profit in 3½ months.** Distribute free advertising premiums from home. Lloyd Co., Box 872, Minneapolis 1, Minn.

**MEN Wanted now!** Overseas work, all trades. High wages. Free information. For prompt reply write World Wide Survey, P.O. Box 2567, Montgomery, Alabama.

**GOOD Jobs, business opportunities,** real estate, low rent, San Francisco, Oakland, Richmond. All for \$1.00 classified sections airmailed. Box 41, Point Richmond, Richmond, California.

#### **BOOKS, PERIODICALS, PICTURES, POSTCARDS**

**BOOKHUNTERS!** All subjects. Send wants. Box 82, Newberry, Williamsport, Penna.

**SPARETIME Profits** taking subscriptions all magazines. Wholesale catalog free. Cassell Publishers, Westfield, New Jersey.

**NATIONAL Geographic Magazines, 1888-1952.** Periodical Service, Box 465-PM, Wilmington, Delaware.

**BOOKS Found!** Any author, old or new. Rush titles wanted; no obligation. International Bookfinders, Box 3003-PM, Beverly Hills, California.

**BOOKS, Government surplus, Bargain prices.** Free catalog listing 50 other free catalogs. Instructional, educational, vocational subjects. Millions of volumes, new and used. Books bought. Est. 1902. Long's College Book Co., Dept. PM, Columbus 1, Ohio.

**"SCIENCE Milestones."** Records march of science starting 400 years before Christ, right up to date. Amazing facts revealed. 312 pages packed with startling information that will thrill you. A real history of science. \$5.00. Literature free. Popular Mechanics Press, 200-8M East Ontario St., Chicago 11, Ill.

**BOOK Searchers!** Any subject, any language. Ruth Gilcreast, Books, Box 2423, San Francisco 26, California.

**PICTURE Post cards,** made from your photograph. 1000, \$11.00. Raumb's, 4154 Fifth Street, Philadelphia 40.

**BOOKFINDERS!** All subjects. Send wants! Jaher Book Service, 163 Hazelwood Drive, Westbury, N. Y.

**BOOK Catalogue, 1000 bargains,** send 10c. Books Publishers, Amityville 3, N. Y.

#### **GAMES, TOYS, NOVELTIES**

**AMAZING Electronic game.** Details 25c. Wilson, Box 86, Oakland Garden Station, Flushing 64, N. Y.

#### **MAGIC TRICKS, PUZZLES, JOKER NOVELTIES**

**MAGIC Trial lessons free.** Write today! Magic School, Sparta 9, Michigan.

**EARN Money as a magician!** fine hobby. Large professional catalog \$1.25. Holden's, 120 Boylston Street, Boston, Mass.

**BOOK Of 300 magic tricks,** \$1.00. John C. Chester, 20-B Cromwell Place, Sea Cliff, New York.

**LEARN Ventriloquism.** 3c stamp brings particulars. Smith, 801 Bigelow, Peoria 3, Ill.

**PROFESSIONAL Catalog, 175 pages,** 25c. Williams, 900 Plymouth, Ellwood City, Penna.

**WOODEN Nickel, catalog, trick,** 10c. Fun'n Magic, 423-P North St. Marys, San Antonio 5, Texas.

**500 TRICKS, Douglas famous 120-page** catalog, only 10c. Fastest service to magicians for 30 years. Send 10c today. Douglas Magicland, Dept. 1, Dallas, Texas.

**BEST Magic, Joker's novelties.** Lower prices. Catalog 10c. Top Hat, Evanston 12, Ill.

**FREE Deck trick cards** with catalog 50c. 1746-PM Market, Philadelphia 3.

**3100 NOVELTIES, Tricks, jokes, gadgets,** funmakers, hobbies, Catalog 10c. Johnson-Smith, D101, Detroit 7.

**VENTRILLO, Professional voice-throwing** instrument and catalog 25c. Box 971-PM, Philadelphia 5.

**"MAKE Magic Your Hobby."** A book of 100 knockout tricks. Easy to do. And our catalogue. Send \$1.00. Mystic Novelties, Dept. M. Box 742, Glendale, Calif.

"AMATEUR Magicians Handbook," 3 1/2 x 5", 64 pages, 10c. Franks, 3121 So. Racine, Chicago 8.

SENSATIONAL Magician's wand 25c. Vanishes handkerchief! Catalog included. Box 1352-PM, Philadelphia 5.

25% DISCOUNTS. Catalog, trick. 20c. Jakiela, 2944 North Western, Chicago 47.

LEARN Ventriloquism. Details without obligations. Harry Harmon, Box 33, Mint Spring, Va.

SET Of seven trick dice. Usual list price \$3.50 only \$1.00, postpaid. Gelazin, Box 4058, Bridgeport 7, Conn.

DOLLAR Magic set free with catalog 25c. 4462-PM Germantown, Philadelphia.

BE A magician. Large professional magic catalog of latest tricks. 35c. Ireland, C-109 North Dearborn, Chicago 2.

### COINS, TOKENS, CURRENCY

NEW Countries—First sets: Libya 5, 90c; Tahiti 4, \$1.00; Somalia 5, \$1.35; Indonesia 3, \$1.25; Pakistan 7, \$1.95. Giant catalogue 35c. Bebee's, 4514 North 30th, Omaha 11, Nebraska.

FREE! Foreign coin, banknote and coin collectors illustrated catalog to approval service applicants. Send 3c postage. Tatham Coinco, Springfield 30, Mass.

6-IN-1 Special! Magnifying glass; check list; 25 coin envelopes; giant 60 page bargain catalog; ten different Indian pennies; Mexican ten-peso; All six, \$1.00 postpaid. Ben's Coin Shop, 31 North Clark, Chicago 2, Illinois.

15 COINS From 15 countries, \$1.00. Joel Tilberg, Proctor 4, Vermont.

MORGAN Dollars; 1873, 1887, 1890, 1891, 1897 8 mint unc. \$3.00 ea. Illustrated catalogue, 25c. Shultz, Salt Lake 10, Utah.

GET Profit and pleasure in collecting old coins. Send 10c for 56-page illustrated coin catalog. You'll be delighted with it. Send for it now. B. Max Mehl, 370 Mehl Building, Fort Worth, Texas. Largest rare coin establishment in U. S. Established 53 years.

COIN Collector's Magazine. Over 1000 pages per year. Sample copy 30c; \$3.00 per year. Hewitt, 7220-J Milwaukee, Chicago 31.

INDIAN Cent with bargain lists 10c. Hutchinson, 3463 "I" Street, Philadelphia 34, Penna.

40 DIFFERENT Selected coins, \$1.00. Oddehon, Box 482, St. Louis, Mo.

OLD Money wanted. Will pay fifty dollars for nickel of 1913 with Liberty head (no buffalo). We pay cash premiums for all rare coins. Send 4c for large coin folder. May mean much profit to you. Numismatic Co., Dept. 20, Fort Worth, Texas.

EIGHT Different Liberty nickels \$1.00. Five different Canadian large cents 50c. Six different U.S. Indian cents 25c. Our price list of U.S. and foreign coins included with order. Bryson Stamp Company, 612 White, Toledo 5, Ohio.

FREE—5 Page bargain list U.S. coins. Economy Sales, 161 Dean, Mansfield, Mass.

WORLD'S Greatest magazine for coin collector's and wooden nickel 10c. Lawrence Brothers, Anamosa, Iowa.

\$1,000.00—1894-8 DIMES. Certain 1913 nickel \$2,000.00. Certain Indianhead pennies \$60.00. Others \$5.00-\$1,000.00. Complete 50c Alcon illustrated catalogue 25c. Worthycoin Corporation, K-397-A, Boston 8, Massachusetts.

### STAMP COLLECTING

FREE! Giant catalog. Offering thousands of bargains. Sent with beautiful approvals. Jamestown Stamp Co., Jamestown 613, N. Y.

FREE Animals, birds, triangles, flowers, ships, locomotives, kings, dictators, multi-colored, historical, geographical, musical, battles, giants, midjets and over 100 others. Fascinating story approvals. Send 10c handling, please. Lincoln Stamp Co., St. Catharines 318, Ontario.

FREE C34-6 used U.S. ahrs with approvals. North Andover Stamp, North Andover, Mass.

MINT U.S. at face! Send 25c for a surprise packet of all different older commemoratives. Sent with U.S. mint approvals. Western, Box 1669P, Salinas, Calif.

FLOWER Stamps. Complete mint Netherlands summer set 20c with approvals. Longhorn, Box 3068-M, Lubbock, Texas.

U.S. Mint commemoratives. 10 different 25c; 25, \$1.00. Approvals. Cooper X44, Quincy 69, Mass.

FREE! Flower triangles, others. Approvals. Delton Page, Box 201X, East Paterson, New Jersey.

50 DIFF. U. S. commemoratives 25c. Mammoth packet list free. Econopackets, Box 168, Riverside 9, Calif.

STAMPS Wanted. Mint and used, collections, accumulations. Good grades only. Buy outright if bargain. What have you? Write, give details. Vanroy Shirk, Lebanon, Penna.

FREE 105 British Colonials, pictorials, Mauritius, Tanganyika, Pakistan, Nigeria, Rhodesia, Singapore. Fascinating story approvals. Send 10c handling, please. Lincoln Stamp Co., St. Catharines 218, Ontario.

50 DIFFERENT Argentine 10c. Approvals. Reuter, 611 W. 40th Pl., Los Angeles 37.

AMAZING Offer! 200 United States stamps—including commemoratives, airmails, high denominations to \$1.00. Only 10c to approval applicants! Illustrated bargain lists free. Mystic Stamp Co., Dept. 80, Camden, New York.

100 DIFFERENT Spain 25c. Penny approvals included. Reed, Box 980, Chicago 90, Ill.

OLD Scarce U.S. seconds on approvals. Slight imperfections, lowest prices. Herfield, Clintonhill Sta., Newark 8, N. J.

SPEND Pennies! Not dollars! Thousands of fascinating stamps to choose from our 1c and 2c approvals. No premiums. Just honest value. Pat F. Knowles, Box 2247, Van Nuys, Calif.

FREE Sample! Interesting, illustrated, informative! National Stamp News, Anderson, South Carolina.

100 JAPAN 10c. All different, with approvals. Gould's Stamps, Box 631, San Francisco 1, California.

PROFITABLE Surprise: Asia, 113 diff., 20c. China, Helaz, Japan, Israel, Siam, Manchukuo. Approvals. Robert Boger, 3401 Oakmont Ave., Philadelphia 36, Penna.

SELL Stamps to our readers. Your ad in this space will be read by thousands of stamp buyers. I'll prove that to you. Write now for Folder "S." F. W. Johnson, Classified Advertising Manager, Popular Mechanics, 200 E. Ontario St., Chicago 11, Ill.

50,000 STAMP Grabbags 25c each. Anderson, Box 1, Reading, Penna.

GIANT Stamps! Valuable collection of the biggest stamps on earth! Includes mammoth diamond-shaped airmail; huge triangle; gigantic animal and ship stamps; many others. Extra: Set of 5 midjet stamps plus genuine wooden nickel. All for only 10c covering mailing expenses. Approvals included. Mystic Stamp Company, Camden 9, New York.

300 DIFF. World wide 25c. plus surprise packet. Packet list free. Econopackets, Box 168, Riverside 9, Calif.

BARGAIN Hunters attention! Free stamp magazine. 1000 interesting stamps for your approval inspection. Completely catalogued, substantially reduced. Free tongs and hinges with purchase. Niagara Stamp Co., St. Catharines 31, Ontario.

FINE Approvals. Fast, personal service. What countries do you prefer? I'll send their stamps. Skinner, 438 Locust, Long Beach 12, California.

ALBUM! Capacity over 1000 stamps! Only 10c! Stampmart, Hartford 1, Conn.

CORONATIONS. 10 Different only 10c with approvals. Seminole Stamps, Box 1138-P, Coral Gables 34, Florida.

FREE U.S. stamps. 1943 occupied nations flag, airmails, commemoratives, included in collection of 25 different U.S. plus \$5.00 stamp. Everything for 10c mailing charge. Approvals. Willett Company, Box 511-T, Port Chester, N. Y.

WORLD'S Largest stamp (7 1/2 x 14 inches). A real curiosity! Retail for 50c, only 3c to approval applicants. Tatham Stamp Co., Springfield 30, Mass.

U.S. 40 different 10c. 40 different commemoratives 25c. Both 30c. Seidenberg, Appleton, Wis.

WEIRD Diamond shape coffee stamp: Lovely flower triangle! First American big commemorative, Greenland, idol dancer, etc. Free with approvals. Capital Stamp Co., Little Rock 2, Ark.

100 OLD United States between 1861 and 1935, \$1.00. Roush Stamps, 51 Chestnut, Mansfield, Ohio.

FREE U.S. illustrated bargain catalogue. Rothberg's, 53 Bromfield, Boston 8, Mass.

TWO \$5.00 U. S. stamps plus 20 different, 10c with U. S. approvals. Irwin Stamp Co., Box 1105, Brooklyn 30, N. Y.

ECONOMICAL 1/2c-1c-2c-Approvals, 22,000 varieties available. Dresel, Box 270-n, New York 25, N. Y.

NUDES Set: Colorful approvals 10c. Atlas, 2930-M, Eisenhower, Racine, Wis.

225 STAMPS For only 10c! This mammoth value includes airmails, pictorials; stamps from strange countries cataloging up to 25c each! Also approvals. Mystic Stamp Company, Camden 30, New York.

EXCITING New book. "How to Collect Stamps, Coins, Paper Money." Packed with amazing facts; information worth dollars. Fully illustrated, 160 pages, 75c. Popular Mechanics Press, 200-ST E. Ontario St., Chicago 11, Ill.

TRIANGLES, Birds, butterflies, flowers—Big packet 10c with approvals. Southwest Stamps, Box 117, Long Beach 1, Calif.

200 DIFFERENT! Plus Macau, Rhodesia, Mauritius, etc. Only 10c to approval applicants. Evden, Box 128, Valley Stream 30, New York.

\$12.50 VALUE—Scott, only \$1.00! All different, catalog 4c up. Satisfaction guaranteed. Quality approvals accompany. Essex, 5948 Arlington Avenue, Los Angeles 43, Calif.

WILL Send you 20,000 collection, 1/2c to 3c. Many free. Cut Rate, Blue Springs 4, Missouri.

500 FINE Mixed U.S. stamps 15c. Wright, 201 Mealey, Hagerstown, Maryland.

FREE U.S. illustrated 72 page catalogue. Stone's, 192 Washington, Boston 8, Mass.

PACIFIC Packet 35c. Arsee Trading Service, P.O. Box 612, Latham, New York.

SAVE Money. We give huge discounts on our foreign approvals. Send \$1.00 and take your choice of \$1.50 from our first selection. L. Arnold, 58 Meador Ave., Baltimore 28, Md.

SUPER Grabbags, U.S. or foreign, 10c. Monjar, Fairmount, Cincinnati 14, Ohio.

DEALERS—Wholesale list, Postage 3c. Frank, 3031 Queensberry, Baltimore 15, Maryland.

BARGAIN Grabbags 30 cts. Big lots \$1. Extra special better stamps \$2. Giant assortments \$5. Literature free. No approvals. Persil, 436 New York Ave., Brooklyn 25, N. Y.

LARGEST Wholesale airmail listing. Mint, used, \$1.00; returned first order. Alex West, Scarsdale, New York.

500 MIXED 10c With approvals. Hudson's, Box 4015, Fresno 44, Calif.

ADD 30,000 Different Scott-listed stamps to your collection for only 1 1/2c each. Send \$12.50 for book of 1000 mounted by country in chronological order, as often as you wish until you have the entire collection. Stop anytime without penalty. J. Huppert, 1970 E. 18th St., Brooklyn 29, N. Y.

GIANT Stamp zoo free! Fifteen different including rhinoceros, elephant, snake, tiger, zebu, kangaroo, koalabear, emu, kookaburra, bull, horse, with approvals. Send 10c for postage and handling. Niagara Stamp Co., St. Catharines 51, Ontario.

100 CANADIAN And Newfoundland stamps including early issues, commemoratives, large size pictorials. Free for 5c postage. Empire Stamp Corp., Dept. PMM, Toronto, Canada.

115 UNUSUAL: \$1.00 U.S., \$23.00 airmail, autogiro, helicopter triangle, scarce Israel, Vatican, free banknote, 10c with approvals. Rosen, 238M 8th Ave., Paterson 4, N. J.

EISENHOWER Stamp, plus worldwide packet, free to approval buyers. Conquistador, 2627G Troy Road, Schenectady 9, N. Y.

**FREE**—Valuable U.S.A. (1) Scarce genuine stamp picturing first U.S.A., issued in 1847! (2) Big collection 30 all-different U.S.; ancient 19th century, valuable \$5 stamp, etc. (3) Packet gorgeous commemoratives. (4) Large illustrated U.S. catalog; 64-page, four-color Collectors' Guide; other unusual offers. Everything for only 10c covering mailing costs! Harrisco, 1047 Transit Bldg., Boston 17, Mass.

**GIANT** World map; complete stamp finder; encyclopedia of stamp-issuing countries plus world-wide packet 30 odd stamps and informative "How To Collect Stamps" only 10c with approvals and unusual bargain lists. Goliath Co., Bethlehem U1, New Hampshire.

**FREE**: Mint British Colonies from Brunel, Papua, New Guinea, Caymans, Gilbert Ellice, Seychelles, Sarawak, Grenada. Free with approvals. Viking, 11-Z Northern Blvd., Great Neck, N. Y.

**14,000 DIFFERENT**—Yours on our streamlined systematic club plan for only 50c weekly. Big shipment every two weeks. Details free. Sjoquist, Box 217, Valley Stream 75, New York.

**114 PAGE U.S.** illustrated price list 25c, deductible from first order. DeLisle, 69 Plaza Shopping Center, Fresno, Calif.

**FABULOUS** Collection—Large U.S. commemoratives. Only 10c. Approvals. Raymax, 39-Z Maiden Lane, New York City 38.

**TOPS!** Free book, "How to Collect Stamps." Send for your copy today! Approvals. Littleton Stamp Co., Littleton E1, N. H.

**PICTORIAL** Angola, Mozambique, Hungary, a beautiful assortment of stamps, 3 sets depicting wildlife in color, plus 100 attractive stamps. 10c to approval applicants. Modern Stamp Co., Dept. A-1, Ferrysburg, Mich.

**WHY** Pay more? Pick stamps from our large collections. 2c each. Just as purchased. Be first. Premiums given. U.S. also available. Roseland Stamp Co., Dept. A-35, Spring Lake, Mich.

**FREE** Complete set of famous Americans, flags, parks and presidentials to approval buyers. Send 5c for 15 of the above stamps plus full particulars. Triboro Stamp Company, 145 Nassau Street, Dept. 107, New York 38, N. Y.

**PAYING** High prices for approvals? Try ours at 1c and 2c in books of 1000. Special offers and U.S. available. Clark Stamp Co., Dept. A-43, Muskegon Heights, Mich.

**UNITED** States—58 different including 8 airmails, 15 commemoratives. 10c. Approvals. Sunset, Box 47, South Oate, Calif.

**FREE!** Large new profusely illustrated catalog of United States postage issues complete; 64-page, four-color Stamp Collectors' Guide; other unusual offers. Write today! Harrisco, 1039 Transit Bldg., Boston 17, Mass.

**LOOK!** Free set, worth \$1.00 every month for you! Just try our penny approvals, receive particulars free! You can't lose, all postage prepaid. Riviera, Box 971b, Santa Barbara, California.

**DIFFERENT**, 500, 50c; 1000, \$1.25; 2000, \$3.00; 5000, \$11.00. Clearing approvals wholesale. K. S. Holmes, London, Canada.

**FREE** U. S. catalogue. Contains almost 1000 illustrations; over 10,000 delightful bargains. Stone's, 192 Washington, Boston 8, Mass.

**CANADA:** 20 Commems. 10c. 100 different \$1.00; 150, \$2.00; 200, \$5.00. Baumann, 8380 DeL'Eppee, Montreal 15, Que.

**1-2c WORLDWIDE** Approvals, bargains galore! Cole, 43-A Rinewalt, Buffalo 21, N. Y.

**1887-1921 WORLD** Wide approvals. Discounts. Leelan, Box 295, Forest Hills 75, N. Y.

**SENSATIONALS** Eastcarelle 5 diff. 25c; 28 diff. \$3; Finland 99 diff. 25c; 300 diff. \$5. All order: Epalvio, Mantia, Finland.

**TEN** Complete sets all different only 25c with request for worldwide approvals. Far Stamps, 8491 Meadow, Van Dyke, Mich.

**SEVEN** Mint fascinating Pacific Islands; Papua, Tokelau, Samoa, etc. Approvals. 10c. Roy Parr, 88 Maple, Hamilton, Canada.

**MINT** Set 14 varieties, value \$2.00, free with approvals. Exotic, Box 482, Coral Gables 34, Fla.

**FREE:** Mint British Colonies from Brunel, Papua, New Guinea, Caymans, Gilbert Ellice, Seychelles, Sarawak, Grenada. Free with approvals. Viking 8, Great Neck, N. Y.

**250 DIFFERENT** Worldwide 25c with request for approvals. Name countries you collect. Herbon Stamps, 17137 Barlow Ave., Detroit 5, Mich.

**301 DIFFERENT**, Plus colorful pictorial packet 25c. Bargain approvals. Pirland Stamp Co., Box 493, Seattle 11, Wash.

**CIPEX** Souvenir sheet plus 25 different U.S., 40c. Approvals accompany. Village Stamps, 90-39P 214 St., Queens Village 28, N. Y.

**AIRMAILS**, Pictorials, foreign, 119 different, dime. Russ, 4105-57th, Woodside 77, N. Y.

**FABULOUS** United States commemorative collection, 31 different 10c. Approvals. White, 516-A Avenue L, Brooklyn 30, New York.

**FREE!** Big illustrated catalog! Send today! "Stamps By Mail," 2133 Lunt, Chicago 45.

**50 DIFFERENT** Australia 10c! Approvals. Seven Seas Stamps, Box 314-P, Jersey City 6, N. J.

**30 DIFFERENT** Australia 25c. Catalogs \$1.21! Approvals. Sound Stamps, Box 9025, Queen Anne Station, Seattle 9, Wash.

**10 COMPLETE** Foreign sets, 10c. Adults. Approvals. Farmer, 4913 Rosewood, Los Angeles 4.

**ASTONISHING** Gift, 40 U.S. with superior approvals. Send 5c for postage. Sparta, Box 1082, Rochester 3, N. Y.

**U.S.** Postal notes complete, catalogs \$1.55, 25c with approvals. Louis Golden, 6721 Eastwood, Philadelphia 49, Penna.

**INCREASE** Income. Start stamp business. Profitable. Write airmail. Smith Company, Halfwaytree 21, Jamaica, B.W.I.

**FREE** Nicaragua sport stamps, request approvals. Eagle, 6916 Roosevelt, Philadelphia 49, Penna.

**MONACO** Nudes 10c with approvals. Royal Stamp Company, Tamaqua, Penna.

#### **ANTIQUES, RELICS, INDIAN GOODS, CURIOS**

**4 FINE** Arrowheads \$1.00. Flint thunderbird \$2.00. List free. Lear's, Glenwood, Arkansas.

**4 SELECTED** Arrowheads \$1.00. List 5c. H. Talburt, Calico Rock, Ark.

#### **PRECIOUS STONES, MINERALS**

**FREE.** Big bargain list gems, jewelry, do-it-yourself projects. O'Brien's, 1116M Wilcox, Hollywood 38, Calif.

**GEMSTONES.** Mineral specimens. Every variety. Lowest prices. Free booklet. Plummer's, 4720 Point Loma Ave., San Diego 7, Calif.

**SAPPHIRE,** Topaz, tourmaline, garnet, peridot. 5 uncut gem specimens, \$1.00. O'Brien's, 1116M Wilcox, Hollywood 38, Calif.

**GEMCUTTING**—Silvercraft illustrated magazine. Tells how to cut gems, make jewelry. 150 ads illustrating equipment, gems for collectors, cutters. Free literature. Lapidary Journal, Del Mar 2, Calif.

**TEN** Beautiful highly polished genuine gems. Only \$1.00. Baroque shapes. O'Brien's, 1116-M Wilcox, Hollywood 38, Calif.

**EARTH** Science, the Rockhounds' national magazine. Subscription \$2.00, sample 25c. Box 1357, Chicago 90.

#### **HOBBIES AND COLLECTIONS**

**NAZI** Medals, ribbons, armbands, flags, daggers. Big introductory packet \$1.00. Illustrated lists. Medcrafts, 1923 34th St. S.W., Calgary 2, Canada.

**FOSSILS,** 15 Texas classified. \$1.50 plus postage. Pioneer Museum, Burnet, Texas.

**FREE!** Leathercraft catalog. Do it yourself! Tandy Leather, Box 297AH, Tulsa, Okla.

**INVENTING** Can be an interesting and profitable hobby. Write for complete particulars. Institute of American Inventors, Dept. 40-E 631-E St., N.W. Washington 4, D. C.

**UNUSUAL** Hobby: Authentic army patches, insignias, ribbons, enameled crests, navy rates, 50 assorted for \$1.00. Rex Military, Dept. C, 1186 Broadway, New York City.

**HISTORICAL** Documents (reproductions) \$1.00. Howard Sawyer, 5813 Benton Hgts., Baltimore 6, Md.

**100 MILITARY** Official shoulder patch insignia. Free album \$5.00. All different. Wolf Appleton, Inc., 566-D Broadway, New York City 12.

**NAZI** Wehrmacht, Luftwaffe medals, war books. Kingston, 3224-22 West, Seattle 99, Washington.

#### **CAMERAS, PHOTO SUPPLIES**

**BRAND** New DeJur "500" projector \$50.00. Terrific bargains. Free catalog. Economart, Box 242, Tarrytown, New York.

**BASS** Says: Quality cameras since 1910. When in Chicago visit the camera cross roads of the world, or write us for your favorite equipment, new or used. Satisfaction guaranteed. Bass Camera Co., Dept. AG, 179 W. Madison St., Chicago 2, Ill.

**CAMERA** Repairmen greatly needed! You can learn manufacturers' service methods at home, in your spare time! Free, big illustrated book tells how: Write today. National Camera Repair School, Dept. PM4, Englewood, Colorado.

**\$10,000.00** YEARLY Free lancing. 1955 Photo Market Guide lists best buyers. Tells how and where to sell your pictures. \$2. Gem Publications, P.O. Box 53, Pleasantville, New Jersey.

**PHOTO** Market Guide \$2. Studer, 113 Moonachie Avenue, Moonachie, N. J.

**8MM** Outstanding Kodachrome library. Free listings and projection sample; \$1.00. Film Wizard, Hollywood 38, California.

**FREE!** Free! Free! Central Camera Co., photographic headquarters since 1899, saves you money on all photographic equipment. Send for Central Camera Co.'s free photographic bargain list today! Central Camera Co., Dept. 7-B, 230 S. Wabash, Chicago 4, Ill.

**PHOTOGRAPHY** For pleasure or profit. Learn at home. Practical basic training. Long established school. Free booklet. American School of Photography, 633 Diversey Parkway, Dept. 3431, Chicago 14.

**OUR** Direct buying means greater savings on cameras, and photographic accessories. Write us for free quotations on your photographic needs. Camera Import Corporation, 521 Fifth Avenue, New York 17, New York.

**BUY** Wholesale nationally advertised cameras, photo supplies, thousands other products at big discount. Free "Wholesale Plan." American Buyers, Hertel Station, Buffalo 16-E, N. Y.

**ROLLEICORD** V, 3.5 Xenar, case, immaculate, \$111.47. Rolleiflexes, others. 10c brings catalogue of 1001 amazing bargains. Dealer's Mart, 34 Beverly Rd., New Rochelle, N. Y.

**WHOLESALE** Discounts to 45%. Photo equipment, typewriters, appliances. G.E. PR-1 meter \$23.75. Free catalog. Camera Shoppe, Box 601-Y6, Mt. Vernon, N. Y.

**SUPER** Balduette, f2 RP, case, spotless, \$74.00. Retina IIA, f2 RP, perfect, \$82.50. 10c brings catalogue of 1001 amazing bargains. Dealer's Mart, 34 Beverly Road, New Rochelle, N. Y.

**3-D** Color camera, matching 3-D viewer, color film, originally \$38.00, brand new, \$11.95. Spiratone, 49-M West 27th Street, New York City 1.

#### **PHOTO FINISHING**

**SPECIAL** Introductory offer, 8 jumbos 25c, 12-35c. Western Photo, PM65, Box 298, San Francisco 1, Calif.

**ROLL** Developed and 5x7 glossy prints, 8 exposure 80c; 12 exposure \$1.20. Hagner, Dept. B, 1318 West Columbia, Philadelphia 22, Penna.

**PHOTOCOPIES,** 3 5x7 or 2 8x10 enlargements from any picture. \$1.00. Original returned. Lindsey Lane Studios, Box 40, Rydal, Penna.

**12 JUMBOS** From any size roll developed 25c, with this ad only. S. Skrudland, Lake Geneva, Wis.

**FREE** Film! Write for free mailers. Vets Film, Montalvo, California.



**TRIAL Offer**—Good with ad only. One roll film developed, 8 exposures 25c, 12 exposures 35c. King sized, dated prints from roll only. Don't send negatives. Sir Walter Photo, Raleigh, N. C.

**ENLARGEMENTS!** Eight 5x7's or five 8x10's, \$1.00. Wilart Enlargers, Box 967, Little Rock, Ark.

**12 EXPOSURE** Rolls 39c, jumbo prints. Guaranteed work, one day service. Lincoln Studios, Dept. K, Box 13, Lincoln, Nebraska.

**PARTICULAR?** Custom finishing guaranteed. 8 jumbos 35c, 12—50c. Special! 35mm. 36 exposures \$1.10. Free mailer. Flash-Photo, Box 36G, Brooklyn 4, N. Y.

**GUARANTEED** Quality. Fast service. Eight jumbos in beautiful super pak plastic ring binder albums only 35c. Send for free mailers and particulars of our complete photo finishing service. Grand Fotos, G.P.O. Box 1410, New York 1, N. Y.

**TWO** Beautiful enlargements from each picture on roll—8 exposures 55c, 12 exposures 75c. Cut Rate Photos, Dept. B-4, Janesville, Wisconsin.

**TOP** Quality. Fast service. 8 jumbos 35c in beautiful super pak album. 16 contacts 40c. Reprints—Jumbos 4c; contacts 3c. Satisfaction guaranteed. Write for free mailers and circulars. Fast-X-Photo, Box A, Jersey City, N. J.

**6 OR 8** Picture roll 35c. 12 or 16 picture roll 55c. Each roll developed and printed in handy album pack. Send coin with roll. No c.o.d.'s. Mailing containers sent free. Deluxe Film Service, Box 1268-A, Shreveport, Louisiana.

**TWO** Beautiful prints from each picture on roll. 8 exposure 40c; 12 exposures 50c. Thirty four years of satisfied customers. Quick Service. Lens Photos, Dept. J-4, Janesville, Wis.

**CAMERA-Shop** quality—Prompt service. Films developed and printed—8 exposures at 50c, 12 exposures at 75c, 16 exposures at \$1. 20 exposures 35-mm. at \$1.25, 36 exposures 35-mm. at \$2. All 35-mm. fine grain developing. These prices for contact or oversize, just specify which. All reprints 5c. Bel Air Photo Service, P.O. Box 8597, Philadelphia 4, Penna.

**QUALITY** Kodak finishing. 8 exposure roll 35c; 12 exposure 50c; 16 exposure 60c. Reprints 4c. Fast service. Guaranteed quality. 40 years continuous operation. Be a satisfied customer. We do color. Send for mailers. Mail Order Photo Service, Box 297, Watertown, Wisconsin.

**TRIAL** Roll developed 16 prints 25c. Reprints 2c. Dick's Photo, Louisville 12, Ky.

**FREE** Roll of fresh film for you if you send this ad with your next roll for Delco's beautiful oversize prints, 12 hour service. Your pictures returned fast by first class mail—No extra charge. Free advice on your photo problems. No wonder thousands prefer Delco. 8 exposure roll developed, printed oversize 49c. 12-50c; 20-81. Delco Film Lab, Box 362M, Upper Darby, Penna.

**ONE** Day service—Roll 8 exposures 40c. Roll 12-50c. Reprints 3c each. High quality giant deckle edge pictures in albums. Free mailers. Sheffield Photo Service, Box K, Sheffield, Illinois.

**FREE** 5"x7" Enlargement with each roll developed! 8 picture roll—35c. 12—50c. Reprints—4c. All giant size in attractive album! Nichols Photo, Est. 1901, Tyler, Texas.

## MOTION PICTURES AND SOUND EQUIPMENT

**8-16MM.** Silent-sound films. Latest subjects. Free catalogue, sample film 10c. Garden Film, 690 Howard Ave., Brooklyn, N. Y.

**16 MM.** Sound-used projectors and films. Rental, sale, exchange, bargain prices. Free lists. National Cinema, 71 Dey Street, New York City.

**TAPE** Recorders, tapes, accessories. Unusual values. Dressner, Box 64M, Peter Stuyvesant Station, New York City 9.

**5,000** 8-16MM. Silent-sound films. International, 2120 Strauss, Brooklyn 12.

**MOVIE** Camera film: 8mm. roll \$1.50. 16mm. 100' \$3.00. Free processing. Better Films, 742 New Lots, Brooklyn, N. Y.

**SAVE** 50%! Guaranteed-fresh color, b.&w. movie film! 8mm., 16mm. Free catalog! Eco-R, 47th Holly, Kansas City 12, Missouri.

**WILD** Animal and bird movies, 8 mm. or 16 mm. beautiful color or B&W. Also 2x2 color slides. Send for free catalog. Wild Life Films, 5151-A Strohm Ave., N. Hollywood, Calif.

**TAPE** Recorders, accessories. Best buys. Boynton Studio, 10M Pennsylvania, Tuckahoe, N. Y.

**STOP** Searching! Cine adventures as you like them. 50'—8mm. \$4.00. 2 for \$7.00; 100'—16mm. \$7.00. 2 for \$13.00. Danny Davis, Box 1262, Room 663, Chicago 90, Ill.

**FREE** Sample kit. Make movie titles in color. A-to-Z Movie Accessories, Flatiron Building, New York City 10.

**MOVIE-Makers!** Save 50% on your 8-16mm. film and do-it-yourself processing equipment. Free catalog. Superior Bulk Film Co., 442 N. Wells, Chicago 10.

**8-16 SHORTS.** Features. 50%. Sale. Library. Sound, silent. Mogulls, 112 W. 48, New York City.

**40% DISCOUNT!** 8mm DeJur magazine \$1.9. List \$131.95 new \$79.15. Spiratone, 49-M West 27th Street, New York City 1.

**I** Will exchange your old 8mm. movies. Send \$1.00 with old film. W. Weaver, 108 Beauchamp, Greenville, Mississippi.

## MUSIC AND MUSICAL INSTRUMENTS

**RADIO** Song folio. (Words and music.) one dollar. King's Studio Music Publications, 4136 Peak Street, Toledo 12, Ohio.

**ELECTRONIC** Organ easy to build. 30 keys, 3 tubes. Plans \$1.00. Solotron Company, 29641 Gilchrist, Farmington, Mich.

**ACCORDIONS**—Direct from importer. Save 50% and more! Free trial. Lifetime guarantee. Trade-ins accepted. Free color catalog. Write Accordion Outlet, Dept. 75-R, 2063 Chicago, Chicago 22, Ill.

**RETIRED** Church organist composes beautiful music to sacred words. Reginald Belcher, Terrace Place, Morristown, New Jersey.

**WHOLESALE!** Musical instruments, phonographs, recorders, watches, appliances, etc. Discounts to 75%! Large catalog 50c (refundable). Strauss Music Company, 25-10, Lafayette, Paterson 23, N. J.

**SONGS.** Poems wanted! Free examination. Bengol Music, 93 Jefferson Avenue, Chelsea 50, Massachusetts.

**SONGWRITERS:** Large recording company wants new songs. Royalty basis. National sales, promotion if selected. No charge for melodies. Send songs, song poems. Music Makers, Dept. E-11, Box 2507, Hollywood, California.

**POEMS**—Urgently needed to set to music! Write clever poems, catchy rhymes. Achieve fame, money in popular music field! Send sample poems. Free evaluation. TinPan Alley, 1630 Broadway, Dept. X, New York City.

**SWISS** Musical movements, \$1.90. Helax, 218 West 72nd Street, New York 23.

**POEMS** Needed for new songs. Send poems for free examination, details. Immediate consideration. Songcrafters, 2724 Arcade Station, Nashville, Tenn.

**1955 ACCORDIONS**—Wholesale. Free catalog. American Accordion Center, PM-3, 5329 Belmont, Chicago.

**SONGWRITERS!** Send poems, songs. Music Service, 243 West 72nd St., PM, New York City 23.

**FREE** Records of your song. Your words, my melody. Free information. Johnny Mack's Melody Mart, 1094 West 39th Street, Dept. A, Los Angeles 37.

**POPULAR** Songs. How to write and sell them. Write for free booklet Successful Songwriting. Gateway Songs, Box 2470, Hollywood 28, Calif.

**WANTED!** Poems for musical settings. Write Songwriters' Service, Clifton, N. J.

**ACCORDIONS.** Wholesale to everyone. Save up to 60%. All national known brands. Free catalogue. Del Principe, 29 South Cicero, Chicago 44.

**SONGWRITERS!** Protect your ideas! Hold all songs, poems! Write for safe correct procedure first! Song Service, Dept. P. 333 W. 56th St., New York 19, N. Y.

**POEMS** Wanted for musical setting. Send poems. Free examination. Five Star Music Masters, 630 Beacon Bldg., Boston, Mass.

**WRITE** Songs. Big money and reputation. Write for information. J. Gordon Pub. Co., 4700 South California Avenue, Chicago.

**POEMS** Wanted for musical setting. Send poems. Free examination. Crown Music Company, 1476 Broadway, New York City 36, California.

**POEMS** Wanted to be set to music. Free examination. Send poems. McNeil, Master of Music, 510-PM S. Alexandria, Los Angeles, California.

**VIOLINMAKERS.** Repairers. Fine tone wood, and all violin supplies. Send for free wholesale price list. International Sales, 414-M E. Baltimore St., Baltimore 2, Md.

**PHONOGRAPH** Records 20c. Catalogue. Paramount, MA-313 East Market, Wilkes-Barre, Penna.

**ELECTRIC** Guitars, amplifiers, parts, wholesale. Free catalog. Carvin PM267, Covina, Calif.

**SONGWRITERS**—Success, fame, fortune if talented. Songs revised, composed, published, promoted by largest firm. Free appraisal. Since 1943. Postcard to Nordyke Publishing Co., 6000 Sunset Blvd., Hollywood 28, PM, Calif.

## RADIO, TELEVISION AND ELECTRONICS

**WHOLESALE** Tape recorders, radios, phonographs. Towers, 935 North 40th, Philadelphia 4.

**MAKE** Simple, tubeless, batteryless, distance-getting radio. Genuine Melomite crystal, detector, illustrated instructions. 50c postpaid. Allen, 427-PM5, Clinton, Missouri.

**TV** Trade-in sets. Philco, Emerson, G.E., Admiral, Motorola, Tele-King, others. List available. 10"-\$17, 15" to 17"-\$20 up. Washtek Service Co., 1501 Boston Rd., Bronx, N. Y. DA 3-9281.

**T.V. Repair** Secrets. Complete individual guide by experts. Send make, model and \$2.00. TV Lab, Box 185, Yuba City, California.

**ENJOY** Color television now! Non-inflammable multicolor screens for all black-white sets. Complete details free. Zingo Products, Johnstown 78, New York.

**NEW** TV catalog free. Loaded with bargains. Finest TV antennas, motors, instruments, accessories. Hundreds of items for servicemen, technicians, experimenters. Get yours now! National Electronics, 6608 Euclid, Dept. P-7, Cleveland 3, Ohio.

**BEGINNERS** "Simplicity of Radio" 62 page booklet, 10c. Franks, 3121 So. Racine, Chicago 8.

**BUILD** 15 Radio circuits at home—Progressive Radio "Edu-Kit" only \$19.95 complete. Free electric soldering iron and radio tester with "Edu-Kit." No radio background required. 30-day unconditional money back guarantee. Order direct or send for free descriptive literature, no obligation. Valuable radio and TV repair guide sent on request, no charge, no obligation. Progressive "Edu-Kits" Inc., Room 31-B, Progressive Building, 497 Union Avenue Brooklyn 11, N. Y.

**ENJOY** F-M music on your television. Tool and instructions \$1.00. Box 247M, Pasadena, California.

**REPAIR** Your own TV. Instructions compiled exclusively for your set. Simple as replacing light bulb. Send set name, chassis, model number, \$2.00. LS Engineering Company, Box 4113-PM-7, North Hollywood, Calif.

**WALKIE-Talkie.** Build wireless two-way portable radiophone for less than \$10.00. Plans 50c. Springfield Enterprises, Box 54-B7, Springfield Gardens 13, New York.

**BUILD** 2 Tube loudspeaker radio—A C operated. Complete instructions plus surprise bonus \$1.00. Amberlab, 159 Hermosilla, Santa Barbara, Calif.

**RADIO-TV** service course. New method. No theory. Learn by experience. Guaranteed results. Complete course \$7.50. Radio Service School, 3502 Mills Avenue, Austin, Texas.

**MAKE** Simple powerful distance-getting crystal radio. Works anywhere. Illustrated booklet 25c. Money back guarantee. Jay Francis, Box 5963, Cleveland, Ohio.

**BUILD** Super crystal radios, electro-magnetic crystal detector, instructions 50c. Electrotonics, Box 988, Dixon, Missouri.

**ELECTRIC** Brain plays game! Build it! Challenge your friends to beat it! No tricky parts, easy to make. Complete instructions, fifty cents. Jay Acey, Dept. P-1, Box 132, Greenwich, Conn.

**TELEVISION** Sets \$14, tubes 25c. Jones, 1115 Rambler, Pottstown, Penna.

### BUSINESS OPPORTUNITIES

**CO-Publish** "giant" magazine. Details, sample 10c. Miller, 712 Clinton Court, Findlay, Ohio.

**WHOLESALE**, Thousands items. Supply source list, 10c. Idealer, Park Ridge, Ill.

**LEARN** Sharpen scissors. Profitable, easy instructions, \$1.00. Box 85, Bronx Central P.O., New York 51, N. Y.

**LEARN** Sewing machine repair. How to make big money at home sparetime. New machines. Everything supplied. Write Taylor Service, Box 2136, San Bernardino, California.

**SECURITY** Through export business. Expect something different. Complete setup from idea to success. Hermes, 152 West 42, New York City 36.

**\$5 TO \$10** An hour. I've did it. I'm disabled now. Real genuine offer. Complete information only \$1. Lucas, 2200 Carson St., Pittsburgh 3, Penna.

**FREE** Valuable stock information to guide you in investing your money intelligently and profitably. Send 10c for postage and handling. Moss Associates, 2 East 23rd Street, New York 10, N. Y.

**IMPORT-Export** opportunity, profitable, world-wide, mail-order business from home, without capital; or travel abroad. Established world trader ships instructions for no-risk examination. Experience unnecessary. Free details. Mellinger E701, Los Angeles 24.

**REBUILD** Batteries; repair dolls; make rubber stamps; silk screen printing. Catalogue "60 Ideas" free. Universal, Box 1078-A, Peoria, Ill.

**DOLLARS** Baby record books, Kitty Kat shoes, Hollywood souvenir cards, eleven thousand new prospects daily. Sold by mail, use our literature. No-Co-Ro, Oakland 6, California.

**RECAST** Old batteries into new. Latest achievements. Battery Laboratories, Minneapolis.

**700% PROFIT** Earned with a PDQ camera. No experience needed. Simple instructions teach you how to take photos of individuals, groups, etc. and finish them on the spot in two minutes. No darkroom. Get details. PDQ Camera Co., 1161 N. Cleveland Ave., Dept. PM, Chicago 10, Ill.

**BREED** Rare tropical fish at home. Earn big money! Learn secrets! Help fill huge demand. Amazing opportunity! Free plan. Tropical Fish Breeders, Los Angeles 61, Calif.

**HOW** And where to obtain capital. Particulars free. Star Service, Wapakoneta, Ohio.

**TO \$50.00** Weekly. Sparetime, home operated mailorder business. Successful beginner's plan. Everything supplied. Lynn, 10420-M National, Los Angeles 34, Calif.

**ARE** You mechanically inclined? Amazing home business pays wonderful profits. Free book tells all. Belsaw, 34-B Field Bldg., Kansas City 11, Mo.

**BE** Appointed state notary public now. Write, Stationers, Helotes, Texas.

**MAKE** Money at home! Mail letters featuring select merchandise. 100% profit. Amazing returns! Dollars every mail. Nu-Way Enterprises, Box M747, Detroit 31, Michigan.

I want to send you proof of the wonderful pulling power of Popular Mechanics classified pages. What's your proposition? Write me today. Include literature if possible. F. W. Johnson, Manager Classified Advertising, Popular Mechanics Magazine, 200 E. Ontario St., Chicago 11, Ill.

"TIMELY Tips Magazine." Paulding 3, Ohio, publishes moneymaking ideas, plans, opportunities, formulas, each monthly issue, 30th year, \$2.00. Sample copy 25c.

**COLOR** Concrete with chemicals. Marble-glaze cement benches, pottery. Start: home, shop. Hundred beautiful designs: birdbaths to waterfalls. Your chance for fame, fortune. 10c brings sample, pictures. Hollywood Cementcraft, 8527-R Wonderland, Hollywood 46, California.

**FORTUNES** Made raising crickets and fishworms. Write for free information. Carter Farms, Plains, Ga.

**MAKE** Money growing miniature trees on your window sill. Free seed and plan. National Nursery, Dept. FC, Inglewood 4, Calif.

**FREE** Folio "Up to \$45,000; Unlimited Vacations." No merchandise, equipment. Unknown! Work home, sparetime! Haylings, Carlsbad, Calif.

**FREE** Electroplating information. Money making plans. (Formula included). Send postcard for your copy. Highly paid, interesting, uncrowded field. Plater D. Hyde, 327 West 120th Street, Los Angeles 61, California.

**MONEY** In sparetime fixit shop at home. Repeat cash business. Experience unnecessary. No selling. Free booklet explains. Victor Foley Company, Columbia Heights, Minnesota.

**WE** Love our mailman—He leaves over \$1000.00 monthly in our rural mailbox. My college professor husband drafted a scientific home mailorder method. We bought a Texas ranch, live as we always wanted. Now we sell the Ranch Mailorder Method. Operates anywhere. Inquire: Eveningshade Ranch, Helotes, Texas.

**POPCORN** And potato chip equipment. Eakins, Box 933-A5, Springfield, Ohio.

**MEN**—Income from local information. No selling. Neherco, LaVerne, California.

**RUBBER** Molds for casting plaques, figurines, novelties. Catalog illustrating over 100 fast sellers. 10c. Castcraft Studios, 568-PM Marion Street, Brooklyn 33, N. Y.

**NEWEST** Spare, full-time home business. \$5 to \$10 hour possible. Paint with suede—The finish with touch and eye-appeal. Beautiful auto dashboards, signs, radios, toys, figurines, lamps—1001 others. Complete, step-by-step instructions sent for no-risk examination. Free details. Coast, Los Angeles 61.

**START** Home manufacturing business. Make cleaners, soaps, polishes, cosmetics. Free literature. Kemix, Park Ridge, Ill.

**IMPORT-Export** mailorder opportunities! Details. Warner, Box 6, Fort Scott, Kansas.

**NATURAL** Molding rubber, extra thick. Free sample. Flock, W. Wooley, 115-A Donald, Peoria, Ill.

**BOOKKEEPERS**, Keep books, small firms spare time. Manual latest technique by C.P.A., \$3.00. Modern Business, Box 466, Youngstown 1, Ohio.

**MAKE** Money at home—Mail cards, circulars feature real merchandise. Everything furnished. Big earnings. Philip's, Box 3-P, Boston 22, Mass.

**COPUBLISH** Mail Sale Advertiser, leading mail order paper. Details, latest copy, dime. Vanroy Shirk, Lebanon, Penna.

**GROW** Mushrooms. Cellar, shed, and outdoors. Spare, full time, year round. We pay \$3.50 lb. We paid Babbit \$4,165.00 in few weeks. Free book. Washington Mushroom Ind., Dept. 172, 2954 Admiral Way, Seattle, Washington.

**PLASTERCRAFT** Molds, liquid rubber, plasters, floccs, candle supplies. Catalog and manual free. Blue Rapids Supply, Blue Rapids, Kansas.

**BUY** It wholesale! Manufacturers, distributors offer 850,000 items. Literature free. Olsen, 1231-A East Third St., Duluth 5, Minn.

**\$25 WEEKLY** Working two hours daily at home. Lycke, Box 2471-A, Cleveland 12, Ohio.

**RESILVERING** Mirrors, formula 50c; two-way lookout mirrors, (No one sees you), 50c; coppered mirrors, 50c. All \$1.00. Neiko-Mir, Box 3462-J, Chicago 54.

**OPERATE** Profitable mail order business. Write Walter Service, 4150-A East 113th, Cleveland 5, Ohio.

**COLORGLAZED** Concrete pottery made without molds. Patented method. Cemetery products, novelties, tiles. Basement leak-sealing. Money-making projects. Booklet, details free. Men only. National Potteries Company, Grand Rapids, Minnesota.

**MINK** Raising information free. Complete. Lake Superior Mink Farm. Superior, EE1, Wisconsin.

**FREE** Book "365 Odd, Successful Businesses." Work home. Expect something odd! Pacific, Oceanside, Calif.

**MONEY** In new greaseless doughnuts. Start in kitchen. No smoke. Sell stores. Free recipes. M. Ray Company, 3605 South 15th Ave., Minneapolis 7, Minn.

**VENDING** Machines—No selling. Operate a route of coin machines and earn amazing profits. 32-page catalog free. Parkway Machine Corporation, Dept. 72, 715 Esser St., Baltimore 2, Md.

**BRONZE** Baby shoes. Instructions, equipment and mountings for genuine electroplated process. Free catalog. Hollywood Bronze Supply, Dept. B-3, 1624 East First Street, Los Angeles 33, Calif.

**START** Venetian blind laundry, patented machine. Free information. Jet Company, 322 N. Rural, Indianapolis 1, Indiana.

**YOUR** Own name brand business. No investment; no inventory. Part time or full time. Sell famous brands of appliances, housewares, silverware, radios, vacuum cleaners, lamps, tools, clocks, watches, jewelry, etc., etc., over 1000 items. Join thousands of successful independent dealers. Send for free catalog and dealer price list. H. B. Davis Corp., Dept. W, 145 W. 15 St., New York City.

**BUY** Wholesale. Thousands items. Lists free. Triple J Industries, 132 Berkshire, Bridgeport 3, Conn.

**UNUSUAL** Opportunity. Spinning at home. Supplies, market, furnished. Angora House, PM, Springfield, Illinois.

**BRICK** And stone. Made of cement and sand troweled over any surface. Transform fireplace or entire home. Profits enormous! Details free. Write now! Stucco Brick, 226 S. Larch, Lansing 12, Mich.

**MAKE** Best doughnuts, yeast raised. Start in kitchen. Sell retail and wholesale. Formula and full instructions \$1.00. Another valuable pastry receipt free. Write Lyon, 1605 W. 17th St., Davenport, Iowa.

**\$3.00 TO \$5.00** Hour serrating knives. Business investment \$5.00. Free details. Serr-Edg, 9731 Lorain, Cleveland 2, Ohio.

**START** Home gift shop. Small investment. Woodcraft, 297-1, Whitehall, N. Y.

**WANTED!** Home producers, by manufacturers in our clearing house service. Become subcontractor, casting plastic products for these companies. Thousands of easy-to-make items required for consumer-industrial use. Cash in at home, without previous experience. Plastic Service Associates, Dept. 7-PM, East Boston 28, Mass.

**LIQUID** Rubber. Make flexible molds. Free sample. Chaney, 1130 E. 16th St., Jacksonville 6, Fla.

**\$40.00 DAILY** With inexpensive portable sawshop equipment. Zapart, 586 Manhattan, Brooklyn 22, N. Y.

**OPERATE** Profitable mail order business. Splendid opportunity. Write: A.C.Y. Sales Promotions, 125-PM, P.O. Box 4824, Atlanta, Ga.

**TIN**-Cans. Turn them into cash. Nine methods. Instructions 50c. Charles Company, 12-DEC, Norwood, Ohio.

**VITAMINS!** Terrific profits! Direct and mailorder sales to homes, offices, stores and get your own needs wholesale. Details free. VimVite, 2908PM Beverly, Los Angeles 57.

**WHOLESALE!** Musical instruments, phonographs, recorders, watches, appliances, etc. Discounts to 75%! Large catalog 50c (refundable). Strauss Music Company, 25-11, Lafayette, Paterson 23, N. J.

**400% PROFIT.** Machineless laminating. Details free. Box 482, Mt. Ephraim, N. J.

**STEADY** Profits, home-operated business. Simply add water to concentrates. Make waterless hand cleaner, chrome renewer, etc. Free samples. Western B Aircraft, Los Angeles 19.

**USED** And new watches. \$2 up. List free. Southern Watches? Gray, Georgia.

**GOOD** Paying business silvering mirrors, plating articles in the shop and home by late method. No tanks or shop required. Free booklet. Gunmetal Co., Ave. H, Decatur, Illinois.

**FREE** "301 Profitable Small Businesses!" Amazing shoestring plans! Work home! Start sparetime! Deumant Surveys, Kenmore 23-PM, N. Y.

**GROW** Herbs and spices at home (many rare and unusual.) Make 101 useful and salable products. Big profit orders come from neighbors, gift shops, restaurants, etc. Also mail orders. Window box supplies household needs. Successful home grower shows you how. Free, full details. Herb Center, 601-CJ So. Vermont Ave., Los Angeles 5, Calif.

**START** A buying service, buy wholesale thousands nationally advertised products. Make big profits selling at sizable discounts. Postcard brings details. American Buyers, Hertel Station, Buffalo 16-C, N. Y.

**ADVERTISING** Book matches—Cash in on big demand; sell union label matches. Cuts for all businesses and political parties. Free powerhouse selling kit, low prices, protection guaranteed on repeat orders. Cash commissions. Superior Match Co., Dept. MX-755, 7330 Greenwood, Chicago.

**START** Your own business on credit. Your own boss, 1135 of our dealers sold \$5000 to \$30,000 in 1954. We supply stocks, equipment on credit. 200 home necessities. Sales experience unnecessary. Pleasant profitable business backed by worldwide industry. Write Rawleigh's, Dept. G-U-PPM, Freeport, Ill.

**BECOME** A game warden, professional hunter! Join forestry, park, fishery services. Good pay! Opportunities open! Free revealing "Select-Job Chart," details, job-getting secrets. Write Home Study Institute JY, Los Angeles 19, California.

**WANT** To make big money at home? \$5 profit in an hour possible with invisible re-weaving. Make tears, holes disappear from clothing, fabrics. Steady year-round demand from cleaners, laundries, homes. Details free. Fabricon, 8334-S Prairie, Chicago 19, Ill.

**URANIUM** Located everywhere! Strike-it-rich! Learn prospecting secrets! New fascinating correspondence course available now! Free details and revealing map! Write Uranium League, 1036-EJ So. La Brea, Los Angeles 19, Calif.

**MONEY** Making Ideas Magazine. Write on your business letterhead for sample copy free. Franklin Publishing Company, Roanoke 1, Virginia.

**KILL** Lawn insects, ants, chiggers. Guaranteed. 5# supply \$4.69 f.o.b. Dealers wanted. Clifcraft, Juka, Illinois.

**\$1000 MONTHLY** Possible in collection agency business. Free details. Write Cole Associates, Syracuse 2, N. Y.

**WHOLESALE** Catalog! 30-80% discounts! Typewriters, appliances, housewares, watches, jewelry, etc. Consolidated Distributors, 21-11 Lafayette, Paterson 15, New Jersey.

**MAKE** Perfumes, other products. Sell mailorder. Formula catalogue free. International, 6347 Farnell PM-7, Chicago 21, Illinois.

**SELL** Popular Mechanics and all other magazine subscriptions. Free catalog, supplies. Subscription Service Company, Dept. A, P.O. Box 2070, Birmingham, Alabama.

**MAKE** Money helping others get out of debt, stop garnishments, save jobs, re-establish credit. Details. Borum 86, 411 West Walnut Street, Kalamazoo, Michigan.

**FLEXIBLE** Rubber molds for plaster and Marble figurines. Sample and large illustrated catalog 25c, refunded on first order. K-C Novelties, Dept. 175, Southampton, Mass.

**BIG** Profits with your imagination. Start national business from home promoting your own products or ideas. Details free. Banning A3, 40 South Los Robles Avenue, Pasadena 1, California.

**START** Your own business in your own home. Write Begoon Mailers, 1502 Monterey, Modesto, Calif.

**PRINT** Without a printing press! Amazing new method! Print colorful signs, banners, cards, posters, glasswear; anything at home. Big profits. Money-making opportunity! We supply everything. Beautiful sample, home-business plan free! Write Screen-Print Company, PM-7, Los Angeles 61, California.

**GROW** Expensive herbs for us! Big profit home-business of your own. Year around profitability! We supply everything necessary! Send for free rare seeds and revealing plan. National Herb Exchange, Dept. A-7, Gardena, California.

**WORK** From home in spare time. Start profitable magazine renewal service. We show you how; furnish everything free. No experience needed. Write McGregor Magazine Agency, Dept. 500-B, Mt. Morris, Illinois.

**SELL** Printing by mail! Free catalog, selling plans. Sutton Printing, Box 853-M, Waycross, Georgia.

**BECOME** Exclusive franchised distributor, agency operator. Opportunities nationwide. Information. National Franchise Reports, 333 North Michigan Avenue, Chicago 1, Illinois.

**ESTABLISH** Automatic shoe shine route. Jiffy Shine, 1630 South Second, Philadelphia 48, Penna.

**GROW** Orchids at home—Profitable, fascinating. Year round, Maine to California. No greenhouse. Gorgeous cactuses, cymbidiums, etc. Successful home grower shows you how. Full details free. Flowerland, 4622 Wilshire, Los Angeles 5.

**WANT** Up to \$100.00 weekly deposited in your mail box? Details free! Smith, 2766-P Ladera, San Bernardino, Calif.

**EARN** \$2.00 Hourly, making and selling sandals! Youngs, 1308-PM, South First, Arcadia, California.

**ADVERTISERS!** We pay good price for names! Iron River Mail Order, Box 5, Iron River, Michigan.

**ADVERTISING** Agency business—City or country. Low overhead, substantial income. Experienced advertising company offers complete setup service. Harold, 69-S Bennett, New York City 33.

**FROG** Raising! Season just starting. Get this year's eggs. New book tells how. Information 10c. Broel-A, Box 506, New Orleans 1, Louisiana.

**WINNING** Mail order plans. Merchandise, books. Details free. Mid-State, Box 214-A, Syracuse 1, N. Y.

**MAKE** Tough, attractive building plastic, easily 88½% waste. 101 uses. 800% profit. Exclusive district. Grab it. Bays Laboratory, Oklahoma City 9.

**"MAKING** Money With Mushrooms." Simplified book. \$2.00 cash. Money back guarantee. Mushroom Lab, 32 Kendrick St., Lawrence, Mass.

**MOTELS** And resorts. Mature men and couples trained for management positions. Placement service. International Motels, Millbrae, California.

**BUY** Wholesale 450,000 products. Literature free. Carter, Box 6011-H, Chicago 80.

**\$70 WEEKLY** Guaranteed—Home, spare time. Simplified mail bookkeeping. Immediate income, easy! Auditax, 34757AP, Los Angeles 34.

**FIX** Typewriters. Inexpensive home course teaches factory secrets. Free booklet. Write, Typewriter, Tarentum 1, Penna.

**YOU** Can be president of your own company without capital or experience. We ship orders under your name, supply catalogues, etc. Postcard brings booklet "Ten Ways to Make Money in Your Own Business" absolutely free. Topval, Lindenhurst 418, New York.

**BUY** Wholesale! 100,000 name brand products! Save 66½%! Big profits selling others spare time! Free catalogs. National Buyers Service, Box 426EE, Oakland, Calif.

**FULL** Time profits! Home business; machine engraving title-plates, identification tags, jewelry. Permanent lifetime demand! Details, sample 25c. Desco Distributors, 5262-M, Van Nuys, Calif.

**OUR** Mail order franchise dealers make good profits operated under own name. Easy, interesting, free details. Smith International, Mount Vernon, N. Y.

**MAKE** Tremendous profits with new imported mail and gift shop line! \$2.00 brings valuable samples, full details. Williams Co. C.P.O. Box 89, Tokyo, Japan.

**\$200 WEEKLY** Cleaning Venetian blinds. Free book. Burt, 2434A, Wichita 13, Kansas.

**\$1,000 MONTHLY**, Home, mailorder, free advertising method. Revealing information. Seidel, 6000-AG Sunset, Los Angeles 28.

**SAWDUST**, Turn it into cash. Twenty methods. Instructions 50c. Fender, Box 448-ABS, Kalamazoo, Mich.

**IMPORT** Precision 17 jewels watches from Switzerland. Profitable. Little capital. Copyrighted course \$2.00. Robert Celaya, Brownsville, Texas.

**FREE!** Your own business, work home. Start spare time. Vest, 320 Summer Ave., Newark, N. J.

**USE** Our capital to start your own business. Normalids, 653 N. Arden, Los Angeles 4, California.

**SELL** By mail, folio of valuable information and helpful suggestions, including long list of wholesale companies. \$1.00. Elroy Hein Enterprises, Route 1, Clintonville, Wis.

**TURN** Used motor oil into cash. Dollar gal. possible. Direct information 50c. R. Pyle, Dept. C, P.O. Box 85, Aspers, Penna.

**TIN**-Cans. Turn them into cash. Twenty methods. Instructions 50c. Fender, Box 448-ABR, Kalamazoo, Mich.

## MONEYMAKING OPPORTUNITIES

**SCHEMER** Magazine, Canfield 1, Ohio, monthly mailorder ideas, plans. Year \$2.00. Sample 25c.

**DO** You want your own business? For money-making opportunities. Write: Central Sales Outlet, Robbins, N. C.

**IF** You need more income. Start a home business in spare time. Make extra money. Experience not necessary. Literature free. World Sales Co., P.O. Box 179 PM, Ripley, Miss.

**WINNING** Prize contests is fabulous, confidential, home opportunity! Send stamp! National Contest Bulletin, Box 2645-F, Miami 16, Florida.

**EARN** \$50.00 Daily making mats, shoes and mud guards from old tires. S and S Patents Inc., 1307 North Clark St., Chicago 10, Ill.

**"MONEY** Getter's Bulletin." This exciting magazine prints money-making plans, ideas, spare-time tips; hobby ideas; many other types of money-making facts for men, women; young or old. Sample copy 25c. Distributors, Box 831-B, Monessen, Penna.

**EARN** \$10,000 Government bonus locating uranium ore! Handbook, "Strike It Rich With Uranium," tells how, where to prospect. You could be next uranium millionaire! Rush \$1.00 for copy! No c.o.d.'s. Warman Publishers, Frankhoover St., Uniontown, Penna.

**SELL** Religious mottoes. Send no money. We trust you. Crystalglo, Sidney, Ohio.

**\$5 TO \$10** An hour. I've did it. I'm disabled now. Real genuine offer. Complete information only \$1. Lucas, 2200 Carson St., Pittsburgh 3, Penna.

**GROW** Into the mail-order business. Experienced operator tells how. Send \$1 today! Premier, Box 8177, Chattanooga, Tenn.

**MAKE** To \$300 extra. New! Different! No selling! No mailorder! Details free. J-M Enterprises, 801½-A North Marsalis, Dallas 3, Texas.

**DOLLARS** In baby record books, baby shoe kits. Liebig Industries, Beaver Dam 2, Wisconsin.

**PRINTING** And office supplies wholesale, 20,000 items. Literature free. Royal, Box 368-A, Cleveland 27, Ohio.

**FREE** Literature describing money-making mailorder plans. Lewis Barlett, Richland, Georgia.

**BUILD** Sales by recruiting productive distributors selling direct or to retail outlets. Secure most concentrated circulation through classified columns of Salesman's Opportunity. Write for facts. Gilbert, Salesman's Opportunity, Room 1700, 850 N. Dearborn, Chicago 40.

**ACME** Saw sharpeners are the finest you can own. Don't be satisfied with less. Send for free literature. Max Mfg. Co., 138 Stockton Ave., San Jose 26, California.

**FREE** Folio "Up to \$45,000; Unlimited Vacations." No merchandise, equipment. Unknown! Work home, sparetime! Haylings, Carlbad, Calif.

**SPARETIME** Profits taking subscriptions all magazines. Wholesale catalog free. Cassell Publishers, Westfield, New Jersey.

**GENERAL Contest Bulletin.** Issued monthly. Sample, 25c. 1609½ East 5th, Duluth, Minn.

**GROW Mushrooms.** Cellar, shed, and outdoors. Spare, full time, year round. We pay \$2.50 lb. We paid Babbitt \$4,163.00 in few weeks. Free book, Washington Mushroom Ind., Dept. 173, 2954 Admiral Way, Seattle, Washington.

**50,000 ARTICLES Wholesale.** Source directory, dime. Nelko, Box 3462-DR, Chicago 34.

**READ Progressive Mailtrade,** the magazine that tells how to make money by mail. Dime brings sample and special offer. Progressive Mailtrade, Box 357, Sheboygan, Wisconsin.

**FREE Book "505 Odd, Successful Businesses."** Work home. Expect something odd! Pacific, Oceanside, Calif.

**SELL—Buy Titania gems.** More brilliant than diamonds. \$9.75 carat wholesale. Free catalogue. Diamonite, 1404-M Mitchell, Oakland 1, California.

**MONEYMAKING Opportunities** with inexpensive portable sawshop equipment. Zapart, 588-PM Manhattan, Brooklyn 22, N. Y.

**NEW Comedy, religious, general 7"x11" signs.** 7c. retail 50c. 15 samples, \$1.00. Lowy, 812 Broadway, Dept. 879, New York 3.

**300 MONEYMAKING Opportunities.** Literature 10c. M. Engel, Box 425P, New York City 36.

**LEARN Technical metaphysics** and insure your future. Easy, inexpensive correspondence course. Simplest method known. Diploma. Write: Premier College of Technical Metaphysics, 2532 McKenzie St., Vancouver, B. C., Canada.

**ATTENTION: Typewriter owners.** Make handsome profits. Write today. Groves Company, 682, Hastings 8, Nebraska.

**"HOW To Live Without Money."** Hear opportunity knocking? Open wide the door. Then money cares will vanish. Woery be no more. The aim of this book is to teach the seemingly impossible. How to end your money troubles, for ever. How to pile up a bank account. How holidays cost nothing. How to get more out of life, etc. You will never part with this book, for it will be part of your life. Must be all we claim, or money refund. Only \$1.95. Send now do not wait. Nation Wide Agent, P.O. Box 593, Jamaica 31, N. Y.

**MAILORDER.** Guaranteed imports: \$10.95 electric shaver, \$6.50. Free literature. Trader, 1 McDougal, Vallejo, Calif.

**OPERATE "Escalator" mailorder system,** selling our products or any products. Most revolutionary mailorder system known. Postcard. Selbyco, Decatur 158, Illinois.

**MEN—Women.** Proven, profitable business plans that almost anyone can operate with little or no capital required to start. Details free. Eugene Davis, 759C Tilden St., Flint 5, Michigan.

**FREE! "101 Profitable Small Businesses!"** Amazing shoestring plans! Work home! Start sparetime. Deumant Surveys, Kenmore 23-PM, N. Y.

**SELL Merchandise** by mail from your home. Everything supplied. Big profits. Stephenson's, Rattlesnake Drive, Missoula, Montana.

**START A buying service,** buy wholesale thousands nationally advertised products. Make big profits selling at sizable discounts. Postcard brings details. American Buyers, Hertel Station, Buffalo 16-D, N. Y.

**COST Of things** going up faster than your income? You can make more full or part time as a Rawleigh dealer. Write for full particulars. Rawleigh's, Dept. G-RR-PPM, Freeport, Ill.

**MINIATURE Trees.** Why pay \$2.00-\$10.00 for growing secrets? Free details. Tiny Trees, Box 3084-P, Chicago 34.

**WHOLESALE Catalog!** 30-80% discounts! Typewriters, appliances, housewares, watches, jewelry, etc. Consolidated Distributors, 21-12 Lafayette, Paterson 15, New Jersey.

**90% PROFIT Making** sparkling chipped glass signs. Easy to learn. Huge demand. Everyday a payday! Free details. Turpin Industries, 530 E. Ashby, San Antonio 1, Texas.

**LEARN Mailorder fundamentals.** Plans, Opportunities. Will Kell Company, 5253 Wishire, Beaumont, Texas.

**EARN Extra money.** Sharpen lawnmowers at home. Buy no expensive machines. Plans and instructions \$1.00. Zola, 41 Brooks, Quincy 68, Mass.

**START A profitable subscription business** in spare time! We need men and women (young or old) as representatives for all leading national magazines. Liberal commissions paid for new and renewal subscriptions. Start earning money in this pleasant work at once! Clip this ad and send with your name and address to: Agency Bureau, Dept. PM, Hearst Magazines, 250 West 53th St., New York 19, N. Y.

**MAKE Extra money** at home, sparetime! Exciting new booklet shows "how!" Dozens of proven money-making plans, ideas, for entire family! Rush 25c for yours! Mail Products, 82-46 247th Street, Bellerose 26, N. Y.

**MEXICAN Featherbird pictures.** Big profits. Sample free. Thomas, 54B-Central, North Tonawanda, New York.

**"MONEY Getter's Bulletin"** sample 25c. Miller, 712 Clinton Court, Findlay, Ohio.

**HOME Business mailing out catalogs.** Write for free sample catalog and plans. Sutton, Box 853-P, Waycross, Georgia.

**EARN Money evenings,** copying and duplicating comic cartoons for advertisers. Adservice, Argyle 1, Wisconsin.

**URANIUM Report \$1.00** tells how, where-maps. Geiger counters rented dollar monthly. Worldwide, Box 33, Sta. A, Berkeley, Calif.

**READ Idea file,** reveals sources profitable mail products. Quarter brings sample-special offer. Gordon, 19628J, Los Angeles, 19.

**\$1000 MONTHLY Possible** raising earthworms! Backyard, garage, basement. Complete illustrated booklet explains raising, feeding, packing, marketing. 25c postpaid! Ozark Worm Farm-J, Willow Springs, Missouri.

**IMPORT Direct** from Japan low-cost fast-selling merchandise for high profits. Complete, simple, home-business plan, extensive classified suppliers lists. Airmail \$1. Francis Justice Co., Akasaka P.O. Box 7, Tokyo, Japan.

**BUY Wholesale! Save 66%!** Appliances, furniture, jewelry, toys, sporting goods, tools. Free catalogues. National Buyers Service, Box 426EB, Oakland, California.

**WANT To go in business** for yourself without capital? We show you how. Postcard brings details absolutely free. Topval, Lindenhurst 420, New York.

**OPERATE Your own interesting business** from home, office, \$8 profit on \$10 order. Free details. Smith International, Mount Vernon, N. Y.

**RISKLESS Wholesale moneymaker.** Sensational discounts. Markoff, Box 4222P, Washington, D. C.

**TYPISTS! Make money** at home! Mailing. 2 Madison, Greencastle, Ind.

**MAKE Money** offering homeowners simplified landscape layout plan for shrubbery, trees, etc. Buyers delighted. Easy sales. Free details. Land-Art, 1513 Larrabee, Chicago 10.

**PROFITABLE Business plans,** cash daily, work home, literature 25c. Galen, 355 So. Marengo, Pasadena, Calif.

#### FORMULAS. PLANS. ETC.

**MAKE, Sell product** to combat battery cable corrosion. Formula, selling plan, \$2.00. John C. Chester, 20-B Cromwell Place, Sea Cliff, New York.

**MODERN Formulas** for today's fastest selling big-profit products. Literature free! Miller, Chemist, 1517-N, Tampa, Florida.

**FORMULAS 10c.** Millic-PM-Chemist, 430 South Western Ave., Los Angeles 5, Calif.

**FORMULAS: All kinds.** Latest, best. Literature free. Kemikal, Park Ridge, Ill.

**TWENTY Formulas** for pleasure or profit. Send \$2.00 to Modern Eras Enterprises, Box 35, New York 60, New York.

**REAL Manufacturing formulas.** Lists free. Cummings, Chemist, Gordon Ave., Syracuse 4, N. Y.

#### PLASTICS

**LAMINATING Supplies.** Free price list. Solomon, 46 Cornhill, Boston 8, Mass.

**PLASTIC Sheets, rods, tubes, etc.** Free list. Plastic Supply Co., 2111 Olive Street, St. Louis 3, Mo.

**PLEXIGLAS.** Cut to size. Clear. Any thickness. Colors. Rods. Tubing. McClarin Plastics, P.O. Box 168H, Hanover, Penna.

**PLASTICS Home-craft course** for men and women. Tells and shows how to make hundreds of fast selling plastics products. All plastics and materials for 23 projects included in course. No special tools needed. Course pays for itself. Write for free booklet. Interstate Training Service, Dept. D-3-G, Portland 13, Oregon.

**ACRYLIC Plastic,** water clear solution for coating brass lamps, silverware, chrome, fishing rods, tools, lampshades. 8 ounces \$2.00. A. B. Dunn, Department A, Box 5337, Chicago 80, Illinois.

**PLEXIGLAS, Lucite.** Square foot cost 1/16", \$1.10; 1/8", \$1.45; 3/16", \$1.80; 1/4", \$2.15; 3/8", \$3.28; 1/2", \$4.38. Colors add 10%. Send 15¢ for postage. Aristocrat Plastics, 55 Clarkson St., New York City.

**PLEXIGLAS, Fiberglass, polyester, acetate, vinylite.** Past service. Wholesale-retail. Catalog 15c. Gem-O-Lite, Box 6861P, North Hollywood, California.

#### CHEMISTRY

**CHEMISTRY, Biology, microscopy.** Catalog 25c. Laboratory Sales, Box 161-A, Brighton, Mass.

**NEW Idea chemical and apparatus** outfits for home experimenting, photo-scales, microscopes, chemicals, biologicals and laboratory supplies in small quantities. Catalog 25c. Established 1931 John H. Winn, 124A West 23rd St., New York, N. Y.

**CHEMICALS And apparatus** for industrial, analytical, and private laboratories. Catalog 25c. Dept. M-50, Biological Supply Co., 1176 Mt. Hope Ave., Rochester 20, N. Y.

**ILLUSTRATED Catalog:** Chemistry, mineralogy, biology 20c. Tracey Laboratories, Evanston, Illinois.

**"FUTURE Chemists of America"** teaches beginning chemistry. Systematic. Exciting. Thorough. Practical. All ages. First lesson 25c. Parkway Laboratory, R #1, McKees Rocks, Penna.

**AMAZING New book of science.** Experiments, formulas and catalogue of laboratory supplies. Only 25c. National Scientific Co., Dept. PM-7, 2204 W. North Ave., Chicago 47, Illinois.

#### HELP WANTED

**ENGINEERS Wanted.** Hundreds of openings for graduate engineers, all levels, all sections of country listed in new monthly magazine. Send 25c for copy. Engineers Placement Guide, 59 East Van Buren, Chicago 5, Ill.

#### AGENTS WANTED

**LOWEST Wholesale prices.** Thousands of name brand items. Free literature. Parker Distributors, Box 55, (Dept. C) Williamsbridge Sta., New York City 67.

**\$125 WEEKLY! 176% Profit!** New, wonder Dow-Corning car polish. Cleans, glazes, weatherproofs year 'round! Write United, 1035 East 10th St., Brooklyn 30, N. Y.

**PROVEN Money-maker.** Brand new product sells on 5 minute demonstration. Market and profit unlimited. Nationally advertised. Satisfaction guaranteed. Free details. Hoke Tool Works, Dept. B, Raeford, N. C.

**WHOLESALE Catalog!** Appliances, cameras, watches! Anelag Industries, Rochester 1, Wisconsin.

**AMAZING New whirlwind seller.** Medicated lotion. Stops itch. Insect bites, chiggers, poison ivy, sunburn. No rub off. Great repeater. Wonderful profits. Free details. Guerrieri, 2921-P N. Clark, Chicago 14.

**CLEAN, Shine autos** the easy way with \$2.00 Dustex. Chemically treated long lasting dirt removing cloth. Write for selling plan. Dustex, 2616 Harrison, Waukegan, Illinois.

**60% PROFIT** On cosmetics — Famous nationally advertised Hollywood Cosmetics pay 60%! Make \$25 day up! Hire others. For free samples, details, write Studio Girl, Glendale, Calif., Dept. PM-65.

**EARN \$150.00** Per week, giving away stainless steel tableware. Nueblings-M. Sicklerville, N. J.

**MAKING** Fast dollars easy. Attractive nameplates sell themselves. Request personalized sample. Stan Roberts, Engraving, 2118 Lee, Cleveland, Ohio.

**\$5 TO \$10** An hour. I've did it. I'm disabled now. Real genuine offer. Complete information only \$1. Lucas, 2200 Carson St., Pittsburgh 3, Penna.

**30,000,000 WOMEN** Want amazing new automatic refrigerator defroster. You sell 8 out of 10 on sure-fire free trial. \$250.00 weekly profit not uncommon. Rush postcard for guaranteed plan. D-Frost-O-Matic, Dept. H-102, 173 W. Madison St., Chicago 2, Ill.

**YOUR Own business**—Used suits \$1.30, overcoats 65c, mackinaws 35c, shoes 12½c, ladies coats 30c, dresses 15c. Enormous profits. Catalog free. Moro, 1218AA South Jefferson, Chicago 7.

**HAVE** Your own business, buy wholesale, make big profits. Free general mds. catalog. Jay Norris, Dept. P, 445 Broome St., New York.

**PRINTING.** Advertising salesmen—Excellent moneymaking sideline selling decalcomania name plates, small quantities. Automobile initials, sign letters. Free samples. Balco, XL, Boston 19, Mass.

**GOLD** Or silver letters, numbers. Windows, doors, trucks. 1" to 6". 500% profits. Free samples. Atlas-T, 544 West 79th, Chicago 20.

**MAKE** Extra money. Sell front door name plates to friends, neighbors. Retail \$1.98; you make \$1.00! Free selling kit. Modern Engraving Co., P.O. Box 194, Boston 14, Mass.

**\$1.00 PROFIT** Selling \$2.95 photo enlargement deal. Allen Studio, Riegler Bldg., Little Rock, Ark.

**AGENTS** — 300% Profit selling genuine gold window letters; stores and offices. Free samples. Metallic Sign Letter Co., 431-D North Clark, Chicago.

**INCREASE** Your income—Personal initialed buckles, belts, cap badges. Free information. Hook-Fast, Box 480 (PM), Roanoke, Va.

**CASH** In on toilet trouble—Sell plastic flush valve guide. Write for sales plan. Guide-O-Valve Co., 1616 Broadway, Redwood City, Calif.

**YOUR Ad** in this space will get some good agents for you. Yes, I'll prove it. Write for Folder "A" right now. F. W. Johnson, Classified Advertising Manager, Popular Mechanics Magazine, 200 E. Ontario St., Chicago 11, Ill.

**SELL** Sunshine cards, the name quality has made famous. No investment or experience necessary. 21 card deluxe tall slim assortment sells on sight! Imprints. Currier-Ives, religious, gift wraps, many others. Samples on approval, write: Sunshine Art Studios, Inc., Dept. PM-7, Springfield 1, Mass., Pasadena 1, Calif. (Note: East of Rockies address Springfield office.)

**CALENDARS.** Advertising novelties, matches. All styles, including religious, varnished. 12 sheet, girls. Hundreds of advertising novelties, book matches, etc. Fleming Calendar Co., Sales Division, 6539 Cottage Grove, Chicago 37, Ill.

**BUY Wholesale** thousands nationally advertised products at big discount. Free "Wholesale Plan." American Buyers, Herchel Station, Buffalo 16-A, N. Y.

**BIGGER** Profits selling greeting cards. Get list of sensational factory surplus bargains. \$1.25 boxes for 50c, \$1 boxes for 35c—while they last! Big line new 1955 Christmas cards, stationery, gifts. Assortments on approval. Personalized samples free! Midwest Cards, 1113 Washington, Dept. 557-B, St. Louis 1, Mo.

**CASH** In plenty! Exciting new-towel deal, details. Leff Distributors, Kawkawlin, Michigan.

**NEED** More money to live on? Increase your weekly income \$20 to \$25 or more in spare time. Supply Rawleigh Products to consumers. Also openings for full time dealers. Write Rawleigh's, Dept. G-DD-PPM, Freeport, Ill.

**MAKE** More money showing Elmira greeting cards this Christmas! Why more? Because Elmira offers more variety; beautiful cards for every taste, every purse. You get heart-warming, old-fashioned favorites and smartly simple ones for today's tastes. No matter who you sell, Elmira has a style to please everybody from grandmother to young Mrs. Executive. Send today for free personalized samples, catalog and sparkling assortments on approval with personalized stationery, imprinted napkins and lovely gift wrappings! Elmira Greeting Card Co., Elmira 198, N. Y.

**AGENTS-Salesmen:** Sell beautiful hand-colored plastic enlargements and sensational new personalized photo compacts, rings, bracelets, lockets, etc. Experience unnecessary. 40% advance commissions. We deliver, collect. Wonderful sideline. Better full time. Free sample outfit. Novel Portrait Co., 3343 North Ave., Chicago, Ill.

**AT Last!** Something new and sensational in latest tall Christmas cards. Make extra money fast! Show satins, velours, metallics. Gets easy orders. Pays up to 100% profit. 30 free samples. With name 50 for \$1.50. Big line, Amazing convertible pen-pencil, napkins, gifts, stationery. Several \$1.00 boxes on approval. Puro Greetings, 2801 Locust, Dept. 540-J, St. Louis, Mo.

**SELL** Christmas cards—\$1.00 and \$1.25 assortments of 21 cards. Big line, 200 items. All occasion cards, popular "slims," religious, children's cards. Gift wrappings, gifts, gadgets. Amazing profits. Bonus plan. Experience unnecessary. Free imprinted Christmas card and stationery samples, selling plan, catalog. Write today for samples on approval. Free \$1.00 gift for promptness. Hedenkamp, 361 Broadway, Dept. PM-37, New York.

**BEAUTIFUL** Feather pictures. 200% profit! Free sample. Apartado 9036, Mexico 1, D. F.

**NEW** Plastic mending tape. Just press on! Repairs clothing instantly. Lightning seller. Samples sent on trial. Kristee 72, Akron, Ohio.

**MAKE** Money introducing world's cutest children's dresses. Big selection, adorable styles. Low prices. Complete display free. Rush name. Harford, Dept. P-2341, Cincinnati 25, Ohio.

**NEW** Tall Christmas cards pay 75c profit on \$1.25 assortment. 40 exclusive name-imprints \$1.25; gift wraps by-the-yard; 30 for \$1 assortment; 250 new fast sellers. 5 assortments on approval. \$1.95 gift for promptness. Cardinal, 1400 State, Dept. 79-R, Cincinnati 14.

**150% PROFIT** Selling 500 name and address labels at \$1 retail. You keep 60c profit. Free selling kit. Bruce, Box 71-Y, Boston 1, Mass.

**CALIFORNIA** Sweet smelling beads. Sensational sellers. Particulars free. Mission, 2328 FR, W. Pico, Los Angeles 6, Calif.

**RUN** Spare-time greeting card and gift shop at home. Show friends samples of our new 1955 Christmas and all-occasion greeting cards and gifts. Take their orders and earn to 100% profit. No experience necessary. Costs nothing to try. Write today for samples on approval. Regal Greetings, Dept. 78, Ferndale, Mich.

**NEW** Bathrooms deodorizer. Hangs on wall. Banishes odors bathroom, kitchen. Lightning seller. Samples sent on trial. Kristee 73, Akron, Ohio.

**WHOLESALE** Catalog! Appliances, cameras, watches. Postcard. Selbyco, Decatur 258, Illinois.

**WHOLESALE!** Nationally advertised products. Davis, 750-K, Tilden, Flint 5, Mich.

**UNLIMITED** Market. No competition. Big profits. Authentic wood carvings imported direct from Africa. 100% profit, write today, free details. Kempo, Box 4098, San Diego 4, California.

**AGENTS** Wanted for newly invented 6 colored bulb flashlight \$1.15. Car visor carryall \$1.35. Famous electric shaver \$1.85. Terrific sellers. Make \$200 weekly. Free advertising supplied. Write, Turner Company, 1170 Broadway, New York 1, N. Y.

**ALUMINUM** Masticote liquid roofing brings big orders and big money. Madison Paint Co., Mfgs. Dept. P8557, Cleveland 2, Ohio.

**MAKE \$50, \$75, \$100** Extra money. Sell friends new tall style Christmas, all occasion greeting card assortments. Unusual gift wrappings, novelties. Profits to 100% plus cash bonus. Write for feature boxes on approval, 77 free samples personal Christmas cards, stationery. New England Art Publishers, North Abington 733-E, Mass.

**EARN \$46.80** A day! Sell Car-Olo, amazing silicone, wax treated cloth. Cleans cars with one wipe. Fantastic automotive market wide open for this sensational profit-maker! Start earning immediately! Send for free sales kit. M & M, Dept. M-3, 842 Third Ave., New York City 22.

**EARN \$200** A week and up! Amazing profits are yours selling Seal-Tite, miracle puncture-proofing discovery! \$1.98 tube stops flats forever. Sure-fire appeal to America's 50,000,000 motorists! Complete sales kit free on request. M & M, Dept. M-2, 842 Third Ave., New York City 22.

**EASY** Handwork makes fast-selling useful articles. Sample free. Sunmade Company, Brockton 64, Massachusetts.

**EARN \$30** A day! Sell Dab-It, amazing pocket-size, stick-form, "no ring" spot remover. Works like magic! Guaranteed! M & M, Dept. M-1, 842 Third Ave., New York City 22.

**CLOSEOUT.** Retractable ball pens. Assorted colors. \$14.00 hundred postpaid. Pencil type ball pens, \$4.00 hundred. Samples of four retractables and dozen pencil type \$1.00. Crescent Sales, 150-PM Broadway, New York City 38.

**AMAZING**—Dry pressing cloth. Requires no dampness. Housewives wild about it. Sells like hot cakes. Wonderful profits. Free sample with details. Dry Method Pressing, 6116 Selma Ave., Hollywood 28, Calif.

**NEW** Way to make money! Sell nothing, yet make \$132 or more weekly. Postcard brings all details free. Topval, Lindenhurst 91, N. Y.

**BUY Wholesale!** 100,000 name brand products! Save 65%!! Big profits selling others spare time! Free catalogs. National Buyers Service, Box 428EE, Oakland, Calif.

**CHRISTMAS** Card agents: Write for our samples. Wade Greetings, Box 3006, Greenville, Miss.

**WHOLESALE** Catalog! Appliances, cameras, watches! Cam Company, 6806PM 20th Ave., Brooklyn 4, N. Y.

**SENSATIONAL** Money maker. Amazing new liquid mends almost anything. Volume seller. Write for proof and particulars. Indiana Labs., Dept. PM75, Elkhart, Ind.

**EASY** Money selling the new Pro Candid 35 mm. cameras. Your area is open for anyone to cash in on these fast-selling cameras. Selling kits furnished, cash commissions guaranteed. For complete information write Beaurline Industries Inc., 500 N. Robert Street, St. Paul 1, Minn.

**IS \$250** A week worth a postcard to you? Then rush card for free details of new spray-on-window light filter needed by all factories, stores, institutions, etc. Big-profit quantity orders, re-orders. Glass-Tint, 220 S. State, Dept. G-304, Chicago.

#### BUY IT WHOLESALE

**WHOLESALE!** Musical instruments, phonographs, recorders, watches, appliances, etc. Discounts to 75%! Large catalog 50c (refundable). Strauss Music Company, 25-33 Lafayette, Paterson 23, N. J.

**BUY** Surplus wholesale. Catalogue 25c (refundable). Box 22 BW, Thomasville, Penna.

**BUY** It wholesale. Appliances, cameras, tools. Rush 50c for catalog to Edward Clemens, 318 W. Bridge St., Morrisville, Penna. (Refundable.)

**BARGAINS.** Joblots, close-outs, 2000 items. Save to 50%. Clothing, hosiery, toys, toiletries, gifts, jewelry, television, etc. Get acquainted. 25c brings wholesale catalog plus free \$1.00 merchandise certificate. Reliable Jobbing, 311-B North Desplaines, Chicago.

**WHOLESALE** Catalog! 30-80% discounts! Typewriters, appliances, housewares, watches, jewelry, etc. Consolidated Distributors, 21-20 Lafayette, Paterson 15, New Jersey.

ONE Million articles wholesale. Directory \$1.00. Johnson's, 3262-F Medina, Fort Worth, Texas.

INDIVIDUALS. Nationally advertised merchandise. Wholesale. Tremendous discounts. Kingsley, Chepachet, Rhode Island.

### SALESMEN—DISTRIBUTORS

DISTRIBUTORS—Large profits. Terrific repeat orders. Unique Italian brooms, details free. Write P.M. Peacock, 915 Bryant, San Francisco, California.

FISH Hook. New, different, fast seller. \$1.00 retail. Big profits. Details free. Kayenvee Enterprises, Box 335M, Oskaloosa, Iowa.

MAKE Easy money. Sell famous \$3 CO-2 fire extinguisher. Wholesale or direct. Past sales, liberal profits. Fire Killer Mfg. Co., Dept. E, 115 W. 17th Street, Hazleton, Penna.

NEW Jobs open in selling! Send name, address for five free issues of Opportunity Magazine's money-making guide, listing hundreds of companies who'll pay you well, full or part-time. No experience needed. Opportunity, 850 N. Dearborn, Dept. 17, Chicago 40, Ill.

\$5 TO \$10 An hour. I've did it. I'm disabled now. Real genuine offer. Complete information only \$1. Lucas, 2300 Carson St., Pittsburgh 3, Penna.

SELL World famous Goodyear liquid roof preserver for old leaky roofs. No expense necessary. Two average orders daily pay you \$211.00 weekly. Write H. V. Hulse, P.M. Consolidated Paint & Varnish Corp., Cleveland 13, Ohio.

MAKE 300% Profits! Sell Door Spy. America's new one-way door-viewer. Sample \$2.00. Profit-making details free. Unique Products, 23-53 Lafayette, Paterson, New Jersey.

AD Matches! Sell amazing designs—10, 20, 30, 40 and 240-light book matches. Bigger spot cash commissions; every business a prospect. Low prices for high quality. Repeats. Start without experience; men; women; full, part time. Buy nothing! Sales kit furnished. Match Corp., Dept. PM-67, Chicago 32, Illinois.

ADVERTISING Book matches—Cash in on big demand; sell union label matches. Cuts for all businesses and political parties. Free powerhouse selling kit, low prices, protection guaranteed on repeat orders. Cash commissions. Superior Match Co., Dept. M-755, 7530 Greenwood, Chicago.

START Your own business on credit. Your own boss. 1135 of our dealers sold \$5000 to \$30,000 in 1954. We supply stocks, equipment on credit. 200 home necessities. Sales experience unnecessary, pleasant profitable business backed by world-wide industry. Write Rawleigh's, Dept. G-U1-PPM, Freeport, Ill.

BUY Wholesale thousands nationally advertised products at big discount. Free "Wholesale Plan." American Buyers, Hertel Station, Buffalo 16-J, N. Y.

GOOD Man can make \$3,000.00 next 90 days. Every house in town wants amazing NiLite glowing curbside house numbers. Automatic selling plan pays profits everyday. Write today for details free. NiLite, 175 W. Madison, Dept. K-80, Chicago.

WILL You wear new suits and topcoats without one penny cost and agree to show them to friends? You can make up to \$30 in a day even in spare time, without canvassing. Stone-Field, 532 South Throop St., Dept. D-926, Chicago 7, Illinois.

BASKET—Earrings: Straw, bamboo, cutshell, hat-baskets with miniature fruit. Sombreros, covered wagon, guitar, saddle, fruit wagon, bird in glass cage, glass cup-saucer. Trial 3 dozen handmade pairs \$15.00. Lastufka Products, Box 10248, Tampa 9, Florida.

LIGHTNING. The fastest selling portable adding machine in the nation offers big opportunities to increase your earnings. Don't delay, write today for colored photo and full details. Lightning Adding Machine Sales Co., 234 W. 37th Pl., Los Angeles, Calif.

BIG Money-making opportunity. Exclusive line work uniforms, jackets, pants, shirts, coveralls. Advertising embroidered. Every business prospect. Outfit free. Master Div., 568 Water, Ligonier, Ind.

HOME Agency. Power mowers. Cut rate deal. Delivered. Farmco-51, Excelsior Springs, Mo.

IF You have sold or are now selling made-to-measure clothing, the Strand line, with a value-packed worsted line at \$45 retail, is a must! Even spare time men make quick sales and big profits with this fine quality line. Complete selling kit free. Strand Tailoring Company, Dept. M, Baltimore 3, Md.

EASILY Make \$30 daily. Automatic toilet bowl cleaner sells itself. Write Box 61, Belleville, N. J. No-risk sample \$2.35.

ADVERTISING Specialty directory locates sources. Eliminates jobbers \$3.50. Hofert, Utilities Bldg., Chicago 4.

SENSATIONAL Money maker. Amazing new liquid mends almost anything. Volume seller. Write for proof and particulars. Indiana Labs., Dept. PM75, Elkhart, Ind.

### EDUCATIONAL AND INSTRUCTION

EDUCATE Yourself with progressive cross word puzzles. Dictionary furnished. Calco, Drawer 988, East Chicago, Indiana.

BE A real estate broker. Study at home. Write for free book today. GI approved. Weaver School of Real Estate, 2018P Grand, Kansas City, Missouri.

UNIVERSITY Degrees by residence, correspondence. Golden State University, Box 2883, Hollywood, Calif.

PIANO Tuning pays. Big money in spare time. Learn at home in 30 days. No musical knowledge necessary. Phonograph, records, tools and instructions furnished. Information free. Capital City Tuning School, 16 Southwest 2nd, Dept. 102, Fort Lauderdale, Florida.

LOCATE Anyone: Nearly 200 professional ways outlined. \$2.00. Worthington Instructions, Box 144, Newtown Square, Penna.

BECOME A doctor of psychology or metaphysics. Learn secret of contentment, happiness. Win degree of Ps.D. or MsD. Correspondence only. Free book. College of Universal Truth, 5038-C Broadway, Chicago.

MIDLAND Linotype School. Charles City, Iowa. Civilian and Veteran Courses. Free placement. Established 1909.

INVESTIGATOR Training. Phillips Secret Service System, 1917-B North Kenneth, Chicago 39.

AUCTIONEERING. Be an auctioneer. Earn big money. Term soon. Write for catalog. Kansas City Auction School, Suite 307, Shankman Building, 3119 Troost, Kansas City, Missouri.

HIGH School diploma at home. Licensed teachers—Approved materials. Southern States Academy, Box 144-MX, Station E, Atlanta, Georgia.

SECRET Investigation. Experience unnecessary. Investigators particulars free. George Wagner, M125 West 86th, New York 24.

GROW Mushrooms. Cellar, shed, and outdoors. Spare, full time, year round. We pay \$3.50 lb. We paid Babbitt \$4,165.00 in few weeks. Free book. Washington Mushroom Ind., Dept. 174, 2954 Admiral Way, Seattle, Washington.

EARN While you learn. Auto and diesel mechanics master this top paying trade. Many graduates earn \$100 a week and up. Approved for Korean veterans. For free information write Dept. No. 256, Nashville Auto-Diesel College, Nashville 3, Tenn.

BOOKKEEPERS! Increase your earnings! Operate your own simplified "Dollar-A-Week" bookkeeping and tax service. Full or spare time. Details free. No obligation. Ellis, Box 200, Cedar Grove, North Carolina.

MEDICAL Laboratory technicians in great demand. We train you in your own home. Catalogue free. Imperial Technical Institute, Box 973-J, Austin, Texas.

USED Correspondence courses and books sold and rented. Money back guarantee. Catalog free. (Courses bought.) Lee Mountain, Pisgah, Alabama.

PIANO Tuning pays. Learn this profitable profession at home easily with patented Tonometer and mechanical aids. No knowledge music necessary. Diploma granted. Write for booklet. Niles Bryant School, 3731 Stockton Blvd., Dept. P, Sacramento 20, California.

STUDY For doctor's degree of psychology, metaphysics and divinity. Correspondence courses only. College of Divine Metaphysics, Dept. P-M, 2811 North Illinois, Indianapolis 8, Indiana.

PHYSICAL Therapy and massage. We train you at home. Earn big profits from your own private practice or work with hospitals and doctors. Free catalog. National Institute, Desk 4, 159 East Ontario, Chicago 11.

BECOME An expert real estate broker or salesman. Make money anywhere. Complete home study course. Free information. Kansas City Realty School, Suite 307, 3119 Troost, Kansas City, Missouri.

GET Fun, knowledge reading world's longest numbers. Many so long, one would reach trillion times around the earth. "World's Highest Calculator." \$1.00 manual, shows how to do, read and understand its total amount. Satisfaction guaranteed. World's Highest Calculator, 295 Clinton Street, Binghamton, N. Y.

INVESTIGATE Accidents! Many earn to \$10,000 yearly. Thousands of insurance companies, airlines, and steamship lines need claim investigators. We train you at home spare time. Placement counsel and help. Free book—Now! Universal Schools, Dept. 107, Box 8202, Dallas 5, Texas.

BLUEPRINT Reading for machine and building trades. Train at home. Learn to read blueprints with confidence in 10 easy lessons. Earn more pay. Literature free. Belton School, 1059-V North Lawndale, Chicago 51, Illinois.

HIGH School—No classes. Study at home. Spare time. Diploma awarded. Write for free catalog HF-35, Wayne School, 2527 N. Sheffield, Chicago 14, Ill.

COMPLETE Your high school at home in spare time with 58-year-old school. Texts furnished. No classes. Diploma. Information booklet free. American School, Dept. KB45, Drexel at 58th, Chicago 37, Ill.

SQUARE Peg in round hole? Dissatisfied? Restless? Unhappy? Do psychological tests at home. Uncover true abilities, aptitudes. First time available. Low cost. Details free. Write Psychologic Testing Institute, Dept. 247, 201 N. Wells, Chicago 6, Ill.

WANT A diesel job? New opportunities to increase income. Higher pay. More money. We can help you qualify. Tools. Shop method home training. Write today! Diesel, Tractor, Heavy Equipment Division, Interstate Training Service, Dept. B-3-O, Portland 13, Oregon.

IT'S Fun learning a language by Linguaphone. World's standard conversational method. At home, easily, quickly master French, Spanish, German, Japanese, Modern Greek—32 languages available. You listen to 8 to 12 outstanding native authorities speak, you understand, you speak. Save time, work, money. Gain job, school, travel, cultural advantages. Write for free book. Linguaphone Institute, 83-075 Radio City, New York 20.

HANDWRITING Character analysis self taught. Free brochure. Lucas, 2419 Sunset Boulevard, Los Angeles, California.

WELDING Training pays at Hobart Welding School, Box M-751, Troy, Ohio. VA contract. Best equipment. Catalog free.

CRIMINOLOGY Membership now available. \$5. Free details. American Association of Criminology, Box 1122, Boston 3, Massachusetts.

GUITAR Free to those who enroll. World's fastest method. Play song first lesson. Diploma awarded. National, 4 Bernard, Spokane 1, Wash.

MEDICAL Laboratory technique. Learn at home. Big demand. Good pay. Catalog free. Century College, Desk 2, 9 East Ohio, Chicago 11.

USED Correspondence courses, educational books bought, sold, rented. Catalog free. Educational Exchange, Summerville, Ga.

FREE Voice book! Shows how you can train for strong, successful voice. Sound masculine! (State age.) Prefect Voice Institute, 210 South Clinton, Studio 2GV-2, Chicago 6.

567 HOMESTUDY Courses, textbooks. Sensational bargains! Free illustrated catalog. Nelson Company, 210 South Clinton, Dept. 9GV-2, Chicago 6.

COLLEGE Degree—Home study. Keep employed. Brentwood College, Box 19-721, Los Angeles 19, California.

## PLAYS, STORIES, MANUSCRIPTS

NO Luck finding a book publisher? Write for free Booklet PM. Vantage Press, 120 W. 31, New York.

## SPECIAL SERVICES

**KETCHIKAN**—Alaska's first city! Job, housing information, your questions answered. \$1.00. Shopping service, Alaskan novelties, fur, leather, ivory goods. Free information. Dale Cook, 3512 Baranof Ave., Ketchikan, Alaska.

**CALIFORNIA** Reports big future for you in San Fernando valley! Send dollar for illustrated brochure. Progress, Box 345, Van Nuys, California.

**LAST** Names, and their origin. Send \$1.00 to: Robert Kuchenberg, 1513 Thomas Street, Marinette, Wisconsin.

## ARTISTS' SUPPLIES

IF Interested in artist frames, canvas, canvas boards, Red Sable brushes, etc., be sure to get our money saving price lists before buying. International Sales Co., 414 E. Baltimore St., Baltimore 2, Md.

## CARTOONING, COMMERCIAL ART, SHOWCARD & SIGN PAINTING, TATTOOING

**CHALK** Talks. Laugh producing program \$1.00. Catalog 10c. Balda The Cartoonist, Oshkosh, Wisconsin.

**LEARN** Sign painting at home. Test lesson free. Ben Kerns, Box 812-PM, Greenville, S. C.

**PAINT** Signs with master patterns. Set 1 1/4" to 12" high, with supplies, \$1.00. Sample free. Eyerly, B-383, Newton, Iowa.

## ADVERTISING AGENCIES, LETTER WRITERS, FOR ADVERTISERS

**BEFORE** Advertising get instructive Ad-Guide and Ratebook, 10c. Ideas developed. Advertisements prepared free. Chicago Advertising Agency (Established 1900), Chicago 4.

**NAMES:** Accurate, latest, birth lists; prospective bridegrooms; Cleveland homeowners, 100, \$1.00. Information free. Crowley's, Pearl Road, Route 3, Chardon, Ohio.

**WANT** More business? Here's an amazing opportunity to increase your sales. Talk to thousands of interested readers of "Mechanica Popular." Our Spanish Edition covers the Latin American countries like a blanket. They're real mailorder buyers. Classified rate 75c per word. Try an ad in our next issue. Classified Advertising Department, Popular Mechanics Magazine, 200 East Ontario Street, Chicago 11, Ill.

**ADVERTISING**—Display, classified. Experts since 1893. Interesting budget brochure free. Newmark's Agency, 217-7th Ave., New York.

**MAILING** Lists, most any classification, 1000 names \$5.00. 1000 your circulars mailed with ours \$4.00. 5000 your circulars printed and mailed \$12.95. Write Dixie Mailers, King, North Carolina.

**ADS** Placed in out of town newspapers and magazines. Low rates. Catalogue free. Ideas that pay. Baker Advertising Agency, Successors Ankrum Agency, 189 W. Madison, Chicago 2.

## RUBBER STAMPS AND OFFICE SUPPLIES

**CHROMETT** The self inking pocket stamp. Heavy chrome plated finish. Up to 5 lines. Only \$2.00, cash with order. Postpaid. Bailey's, Lewiston, Idaho.

**RUBBER** Stamps by professional craftsmen. 3 lines \$1.00. Price list. South Coast Press, P.O. Box 2074, San Bernardino, Calif.

**THREE** Lines \$1.00. Free stamp pad. Barber, 596 Girard, Marion, Ohio.

**SEND** For free catalogs today! Big values—Low priced rubber stamps, printing all kinds, any style, size, quantity. Delivery prepaid. Satisfaction guaranteed. Esco 175 Print, Holt, Dayton 7, Ohio.

## TYPEWRITERS, DUPLICATORS, OFFICE DEVICES

**RECONDITIONED** Typewriters, duplicating, printing devices. \$25.00 up. Supplies. Appliances. DixieGraph, King, N. C.

## PRINTING OUTFITS AND SUPPLIES

**PRESSES**, Type cabinets, supplies. List for stamp. Lincoln Press Company, 230-F Hartwell, Fall River, Mass.

**PRINTING** Presses, type, supplies. Lists 3c. Turnbaugh Service, Loysville, Penna.

**HAND** Presses; cutters; cases; type. Open Saturdays. Damon & Peets, 56 Beekman St., New York City.

**DO** Your own printing. Save money. Simple rules. We supply everything. Print for others; good profit. Raised printing like engraving too. Have home shop. Details free. Kelsey Presses, V-11, Meriden, Connecticut.

**CLOSING** Out new type—Half price. Owen Stout, Paoli, Indiana.

**USED** Presses, type, supplies. Lists free. Largay, Box 575, Lowell, Massachusetts.

**MAKE** Your own self-molding rubber stamps and printing cuts. Plexirubber. Argyle 1, Wisconsin.

## PRINTING, MULTIGRAPHING, MIMEOGRAPHING, GUMMED LABELS

**REASONABLE** Quality printing! Free pricelist. Napco, 2337-M Bath Avenue, Brooklyn 14.

**STICKERS** Printed, many styles. Want samples? Arthur Fishers, Taylorville, Ill.

**MIMEOGRAPHING**—Letters, pricelists, formulas, instructions. Lowest prices. Lem's Letter Shop, 5710 Stanton, Detroit 8.

500 3/4x2 1/4 **FOUR** Line gummed stickers 50c. Red border \$1.00. Moritz Printery, Saginaw, Mich.

**MIMEOGRAPHING**—Reasonable. Any copy. Mailers Service, Box 606-A, Chicago 90, Ill.

100 **LETTERHEADS**, \$1.00, ±6% Envelopes same, two colors, \$1.50. Broadbrook, Botsford, Conn.

**ADS** Running under this heading sell printing. Ask me for proof. I'll gladly send you amazing facts. Ask for Folder "P." F. W. Johnson, 200 E. Ontario St., Chicago 11, Ill.

1000 **ADDRESS** Labels, \$1.00. 500 note-heads or envelopes, \$3.75. 1000 business cards, \$3.50. 3x6 circulars, \$2.50 per 1000. Postpaid. Bruno, 89-44 97th St., Woodhaven 21, N. Y.

1000 8 1/2x11 **PRINTED** Letterheads, \$6.00 postpaid. Weeping Water Printing Co., Weeping Water, Nebraska.

**FREE** Printing catalog. 1000 business cards \$1.99. Leatham, Everton, Missouri.

1000 **ENGRAVED** Business cards \$2.95. Free samples. Pioneer, 210-5th Ave., New York 10.

100 8 1/2x11 **WATERMARKED** Letterheads postpaid \$1.00, envelopes same. R. Hussey Printing, Abbeville, Miss.

**OFFSET** Printing \$6.50—1000, 8 1/2x11, 16 lb. National Letter, 1463 Broadway, New York 36.

500 8 1/2x11 **LETTERHEADS** With envelopes, \$6.95 (postpaid). Sample? C. Hutchinson, 4167 Hemphill, Fort Worth 15, Texas.

**FREE** Catalog, business, personal printing, 1,000 embossed cards \$2.65 postpaid. D. M. Sales Co., Sebastopol, Calif.

**OFFSET** Printing—Letterheads, envelopes, sales letters, forms, \$3.50 thousand. London, Box 1756, New London, Conn.

**FREE** Catalog, Business printing. Reasonable. Pety Press, 16721 Prospect, Wayzata, Minnesota.

**IMPRESSIVE** Business letterheads and envelopes. 100 of each, \$2.00 postpaid. Holly-Print, Box 439, Jacksonville, N. C.

1000 **EMBOSS**ED Cards, \$2.95 postpaid. Complete business printing. Samples. Jaynar, 911-B Reed, Grinnell, Iowa.

100 **HAMMERMILL** Letterheads, 99c. Envelopes same. Samples free. Leonard, 832 Vanburen, Pueblo, Colorado.

## PATENT ATTORNEYS

**INVENTION** Record form free and "Patent Information Every Inventor Should Have." Carl Miller, Registered Patent Attorney, Woolworth Building, New York.

**REGISTERED** Patent attorney offers services. Sanders, 6430 Evans, Chicago 37, Illinois.

**PATENTS**—Irving L. McCathran, 315 McLachlen Bldg., Washington 1, D. C. Registered Patent Attorney.

**C. A. Snow & Co.**—M427, Snow Building, Washington 1, D. C. Registered Patent Attorneys. Write for information.

**INVENTORS:** When you are satisfied that you have invented something of value write me, without obligation, for information as to what steps you should take to secure a patent. Write Patrick D. Beavers, Registered Patent Atty., 933 Columbian Bldg., Washington 1, D. C.

**PATENTS**, "Proof of Invention" free. E. E. Vrooman, Registered Patent Attorney, 507 McKim Building, Washington 5, D. C.

"**INVENTOR'S** Guide" and "Record of Invention" free on request. Frank P. Ledermann, Registered Patent Attorney, 154 Nassau Street, New York City.

**INVENTORS:** Without obligation, write for information explaining the steps you should take to secure a patent. John Randolph, Registered Patent Attorney, 203 Columbian Bldg., Washington 1, D. C.

**INVENTORS:** Learn how you can protect your invention. A specially prepared booklet "Patent Guide for the Inventor" containing detailed information concerning patent protection and procedure together with "Record of Invention" form will be promptly forwarded to you upon request, without obligation. We are registered to practice before the United States patent office and are prepared to serve you in the handling of your patent matters. Clarence A. O'Brien & Harvey Jacobson, Registered Patent Attorneys, 51B-G District National Building, Washington, D. C.

**INVENTORS**—Take these preliminary steps toward patent protection. Sketch and describe your invention. Sign, date and have this disclosure witnessed by two people who understand your invention. Have us make a preliminary search among U.S. patents already granted for similar types of invention. We report on the probable patentability of your invention and recommend your further course of action. Write for our instructive booklet, "Patent Protection for Inventors" and convenient "Evidence of Invention" disclosure form. Victor J. Evans & Co., 131-H Merlin Building, Washington 6, D. C.

**INVENTORS**—If you believe you have an invention, you should find out how to protect it. The firm of McMorro, Berman & Davidson with offices in Washington, D. C., is qualified to take the necessary steps for you. Send for copy of our patent booklet "How to Protect Your Invention." We will also send you an "Invention Record" form. No obligation. They are yours for the asking. McMorro, Berman & Davidson, Registered Patent Attorneys, 134-A Victor Building, Washington 1, D. C.

## FOR INVENTORS

**INVENTORS:** If you have an invention for sale, patented or unpatented, write Institute of American Inventors, Dept. 40A, 631-E St. N.W., Washington 4, D. C.

"**INVENTOR'S** Guide" and "Record of Invention" free on request. Frank P. Ledermann, 154 Nassau Street, New York 38, N. Y.

**INVENTION** Record form free and "Patent Information Every Inventor Should Have." Carl Miller, Registered Patent Attorney, Woolworth Building, New York.

**INVENTORS:** Information on patent procedure furnished on request, without obligation. John Randolph, Registered Patent Attorney, 203 Columbian Building, Washington 1, D. C.

**SEARCHES**—Put your patent searches in the hands of a registered patent attorney or agent, as he qualifies to give a worthwhile patentability report. Record of invention form upon request and information on patent protection. Patrick D. Beavers, Registered Patent Attorney, 933 Columbian Bldg., Washington 1, D. C.

**PATENT** Searches, including copies of nearest patents, \$5.00. Reports airmailed within 48 hours. More than 100 registered patent attorneys use my service. For free invention protection forms, write Miss Ann Hastings, P.O. Box 176, Washington 4, D. C.

**INVENTORS**—If you believe you have an invention, you should find out how to protect it. The firm of McMorrow, Berman & Davidson with offices in Washington, D. C., is qualified to take the necessary steps for you. Send for copy of our patent booklet "How to Protect Your Invention." We will also send you an "Invention Record" form. No obligation. They are yours for the asking. McMorrow, Berman & Davidson, Registered Patent Attorneys, 1349 Victor Building, Washington 1, D. C.

**INVENTORS**—This firm is registered to practice before the United States Patent Office and available to assist you in the preparation and prosecution of your patent application. "Patent Protection for Inventors" booklet containing detailed information and steps to take toward patent protection sent promptly upon request. No obligation. Victor J. Evans & Co., 132-H Merlin Building, Washington 6, D. C.

**INVENTORS**: Learn how you can protect your invention. A specially prepared booklet "Patent Guide for the Inventor" containing detailed information concerning patent protection and procedure together with "Record of Invention" form will be promptly forwarded to you upon request, without obligation. We are registered to practice before the United States patent office and are prepared to serve you in the handling of your patent matters. Clarence A. O'Brien & Harvey Jacobson, Registered Patent Attorneys, 51A-G District National Building, Washington, D. C.

**EXCLUSIVE**. We help inventors to help themselves. Save hundreds. Triple your chances of success before investing in searches, patents, or promotions. "Inventor or Investor" is a free pamphlet. The Dynavit Company, 3310 Huntington, Newport News, Virginia.

**SPECIAL!** Two for one value: Washington patent search plus free Chicago marketability analysis. Protection form, list of manufacturers' requests free. Patent Sales, 208 Clinton, Oak Park, Illinois.

**MECHANICAL** Problem answered: \$3.00. Retired machinist. Don Ross, 3218 S.E. 123, Portland, Oregon.

**PATENT** Searches \$5.00. 48-hour service. Free invention protection forms. Write Raymond L. Smith, Patent Searcher, 622 Sberaton Building, Washington 5, D. C.

**INVENTORS**—Send for free patent information book and inventor's record. Registered Patent Attorney. Associate Examiner, Patent Office 1923-29. Patent Attorney & Advisor, Navy Department 1930-47. Gustave Miller, 75A Warner Building, Washington 4, D. C.

**INVENTORS**—Particulars on protection without obligation. Formerly commander, patent section, Office of Naval Research, Washington. Charles R. Werner, Registered Patent Attorney, 188 W. Randolph, Chicago 1.

**PATENT** Searches \$5.00. 48-hour airmail service. Invention protection forms free. Write Patent Engineering Service, 711 14th Street, N.W., Washington 5, D. C.

#### INVENTIONS WANTED

**PATENTED**; Unpatented. Promotion at its very best. Write for free particulars. Superior Inventions Agency, 338-344 North Rodeo, Beverly Hills, Calif.

**INVENTIONS** Wanted. Patented; unpatented. Tremendous manufacturers lists. Global Marketing Service, 1404 Mitchell, Oakland 1, California.

**FROM** Center American Industry. National Research & Development Corporation seeks patented or unpatented inventions for development or sale. Write for Letter A. Room 324, 11 West 42 Street, New York 36, N. Y.

**INVENTORS**: Hundreds of manufacturers have requested our assistance in locating marketable new products. Complete information free. Institute of American Inventors, Dept. 40-D, 631-E St., N.W., Washington 4, D. C.

**INVENTIONS** Promoted. Patented or unpatented. A-1 service for inventors since 1911. Write Adam Fisher Co., 5418 Idaho, St. Louis, Mo.

**INVENTIONS** Wanted. Patented or patent pending. 24 years experience promoting inventions. National Service Bureau, 3120 Meramec, St. Louis 18, Mo.

**INVENTORS**. Don't sell your invention patented or unpatented until you receive our offer. Write Cowgill, Box 398, Marion, Ohio.

**INVENTIONS** Wanted immediately for promoting, selling. Write for free booklet, "Marketing Your Invention." Kessler Corporation, 57X, Fremont, Ohio.

**INVENTIONS** Wanted. Patented, unpatented. Free form "S" on request. Adams, Patent Brokers, 3 Park Row, New York City.

**INVENTORS**: Suitable ideas developed. Blue prints, pilot models, manufacturing. Patents applied for in your name. National markets promoted. Complete or partial service. Sorg Co., 370 Brannan Street, Dept. M, San Francisco, California.

**INVENTIONS** Wanted by thousands of manufacturers. Our experience with inventors since 1930 brings results. Free particulars. Inventors Project Engineers, 188 West Randolph, Chicago 1.

**MANUFACTURER** With large cash reserves seeking additional products made of metal, plastics, rubber, wood, or glass, to manufacture and distribute nationally. No investment by you. Send descriptions and drawings but no models. 5% royalty agreement with minimum guarantee. Bronstone's, Inc., 10011 Cheviot Drive, Los Angeles 64.

#### PATENTS FOR SALE

**INVENTORS**: Test the commercial value of your patented or unpatented inventions, quickly and inexpensively. Write for free information. Institute of American Inventors, Dept. 40-B, 631-E St., N.W., Washington 4, D. C.

**PILL** Dispenser 2,475,738, plastic, paper or metal. Radial arm saw 2,535,908. Unusual and economic ideas. All offers considered. Leo Epplein, 10236 St. Arthur, St. Ann, Missouri.

#### MANUFACTURING

**MODELS**—Small lot manufacturing. Metals, plastics, etc. Milburn, Burlington, Kentucky.

**DESIGNING**. Manufacturing, machinery, inventions, models. Henry, Engineer, 2138 E. Monmouth, Philadelphia 34, Penna.

#### MODELS, MODEL SUPPLIES

**MODEL** Airplane engines new, used. Big discounts. Catalog 10c. Platteville Hobby Shop, Box 77, Platteville, Wisconsin.

**STEAM** Engines, boilers, castings. Catalog 35c. Anton Bohaboy, 2297 Price, Rahway, N. J.

**BALSA** Wood and model aircraft. 40-page catalog 10c. Sig Co., Montezuma, Iowa.

**SHIP** Models and yacht supplies. Complete, large 68 page catalogue 50c. Bill Wild's, 510 East 11 St., New York City 9.

**SHIP** And other scale models. Most complete line in New England. Kits, fittings, plans, books, tools, engines, motors. Illustrated catalog 25c. James Bliss & Co., Inc., Dept. SM, 342 Atlantic Ave., Boston 10, Mass.

**BUILD** Miniature passenger hauling live steam locomotive with file and drillpress. We do machine work, you bolt it together. Catalog 50c. Little Engines, Lomita, Calif.

**SHIP** And yacht model fittings; blueprints. Send 35c for illustrated catalog listing hundreds of items. A. J. Fisher, 1062-1 Etowah Ave., Royal Oak, Mich.

**MODELS**. Crafts, stamps, supplies. Western states illustrated catalog 10c. Hobbies, 15094B East 14th Street, San Leandro, Calif.

**MODEL** Boat, bobby catalogs free. Shannon's, 503 Franklin, Nutley 10, N. J.

#### HOME CRAFTSMEN

**FAST** Selling lawn furniture—6 separate selected plans, \$1.00. Summercraft Studio, Newton 53, Mass.

**BUILD** Your own furniture. We furnish wrought iron legs for all. Literature free. Hibbard's, 624 Celey, Hampton, Va.

**LEATHERCRAFT** Supplies at lowest prices. "Craftool" stamps. Catalog 10c. Crown Leather, 23 Spruce Street, New York 38.

**STYLECRAFT** Sure fire hits. "Pre-traced" leather kits. Handbags, billfolds, filigree belts, over fifty other projects. Patterns on leather. Why trace? Just carve, assemble and lace. Large assortment "precarved" kits also available. Send 25c for catalog, free folder. Refunded first order. Apache Leather Company, 2304 E. Washington St., Phoenix, Arizona.

**KNOCKDOWN** Cedar chests and lumber. Free price list. Bedford Lumber Company, Shelbyville, Tennessee.

**129 NEW** Full-size jigsaw patterns. Artist-drawn. \$1. Craftplans, 1321-A South Michigan, Chicago 5.

**FREE** Information. Money-making full size patterns. Professional designs. Furniture, gift shop items. Write Jigsaws, 117 Worth, New York 13.

**89 FULL** Size jig saw patterns of beautiful shelves, ornaments, toys, novelties. Plus "How, Where to Sell." Only \$1.00. Mastercraft 74M, 7041 Olcott, Chicago 31, Illinois.

**"BIG-T"** Portable unit! Work bench, desk, drafting table, tool chest, file cabinet, nail box, small parts cabinet. All one portable unit with 9 full drawers, yet easily carried and transported in car trunk. Plans, \$1.00. Modern Plans, 522 Packard Street, Tomah, Wisconsin.

**MAKE** A million lamps, no two alike, details 25c. Cy Products, Dept. 2-H, Lafayette, La.

**90 ALL** New, full size lawn ornament and novelty patterns, up to 20" high. Only \$1.00. Mastercraft 72M, 7041 Olcott, Chicago 31, Illinois.

**BUILD** Popular child-size park bench for lawn, porch. TV. Free plans. We supply iron legs or complete kits. Craft Sales, 500 Walker Building, Washington 5, D. C.

**BUY** Wholesale nationally advertised power, hand tools, thousands other products at big discounts. Free "Wholesale Plan." American Buyers', Hertel Station, Buffalo 16-F, N. Y.

**LEATHERCRAFT**. Everything needed by beginners, advanced hobbyists and professional leatherworkers. Largest stock of supplies in U.S. Moderate-priced tooling leathers, top quality calfskins, tools, supplies, kits. Send 10c for big catalog. J. C. Larson Co., 820 S. Tripp, Dept. 5250, Chicago 24.

**LEATHERCRAFT**. Send 10c for new 80-page catalog of tools, supplies, kits, including metalcrafts, enameling, ceramics, all other crafts. Complete stock. Reasonable. Since 1910. Sax Bros., Dept. PM7, 1111 N. 3rd, Milwaukee, Wis.

**NEW!** Largest leather and craft catalog! 1,000's of items. Send 25c (refunded with first order). Russo Handcraft Supplies, Dept. C1, 245 S. Spring, Los Angeles 12, California.

**LEATHERCRAFT**. Metal tooling, textile painting, beadcraft, shellcraft, many others. Free, big, illustrated catalog. Kit Kraft, Dept. 227, Studio City 1, California.

**WOODWORKING** Course for home craftsmen. Twenty-two manuals. Over 1000 pages. 75 training projects. Only complete home training program available today. Carefully written, profusely illustrated. Covers everything from wood selection to final finishing. Complete instruction in care and use of all hand and power tools. Prepared by expert manual training instructors. Write for free booklet. Interstate Training Service, Dept. G-3-G, Portland 13, Oregon.

**101 FULL** Size patterns. Smart, new, gifts, novelties, lawn figures, shelves, action windmills, alphabets. Plus "Make Money Jig Sawing." Only \$1.00. Mastercraft 75M, 7041 Olcott, Chicago 31, Illinois.

**HUGE** Profits from your jigsaw; send 10c for patterns and illustrated information. Woodarts, PM-6, Bridgewater, Mass.

**FREE** "Do-It-Yourself" leathercraft catalog. Tandy Leather Company, Box 791-H-10, Fort Worth, Texas.

**"FILM** Stop"—Prevents scum on paint surface after can has been opened. Send \$1.00. The New Products Co., P.O. Box 48, Traverse City, Michigan.

**FREE** Handicraft supply and project catalog. American Handicrafts, Box 1479-CQ, Fort Worth, Texas.

**JAPANESE** Fascinating, inexpensive model airplanes, trains, motorboats. Also cameras, fishing equipment, etc. Export price lists, \$1. Francis Justice Co., Akasaka P.O. Box 7, Tokyo.



16 NEW Lawn chairs, 22 picnic tables, benches, trellises, etc. All 38 plans with necessary full size patterns, \$1.00. Mastercraft T3M, 7041 Olcott, Chicago 31, Ill.

**PLASTICS** Home-craft course for men and women. Tells and shows how to make hundreds of fast selling plastics products. All plastics and materials for 23 projects included in course. No special tools needed. Course pays for itself. Write for free booklet. Interstate Training Service, Dept. D-3-G, Portland 13, Oregon.

#### DO IT YOURSELF

**SAVE** Thousands of dollars. Send for beautiful illustrated catalogs with floor plans containing two and three bedroom, 1½ story, and basementless homes at \$1.00 each. Also details on blueprints, specifications, prices and erection. Write Do It Yourself Homes Company, Box 748, Lewis-ton, Penna.

**MELT** Cast iron, brass and aluminum. Make castings for yourself and for profit. Send for literature. Ursutz Burner Co., Box 2283, Globe, Arizona.

**DRILL** Water well by hand. Use same pump and pipe for both drilling and producing. Plans \$1.00. Bennett, 2451 Lucas Drive, Beaumont, Texas.

**FURNITURE**—Wrought iron legs and frames! You assemble. Free catalogue. Phillips Furniture, East Peoria 8, Illinois.

**GEIGER** Counter and metal detector kits. Inexpensive, educational. Free literature. Electronic Applications, 3024 Lee Highway, Arlington 7, Va.

**DO It yourself.** What? Repair TV, build furniture, make barbecue, plumbing repairs, build boats, do house wiring, remodel home, lay tile, modernize kitchen, repair home, and scores of other things you can do yourself. Books covering each subject, only 25c. Send for descriptive list. It's free. Popular Mechanics Press, 200-LB East Ontario St., Chicago 11, Ill.

**DO-It-yourself** automatic lawn sprinkling system. Prints, \$1.00. Kit \$65.00 f.o.b. L. Leffler, 6146 Main St., Hollywood, Calif.

**CANDLE** Craft kit—Big profit or hobby. Materials and instructions \$2.00. Candles sell for \$10.00. 79th Street Flower Shop, 916 N.E. 79th St., Miami, Florida.

**"CEMENT, Brick Work."** 64 page booklet, 25 illustrations, 10c. Franks, 3121 Racine, Chicago 8.

**18" SOLID** Copper post lantern—Complete assemble-it-yourself kit with instructions—only \$8.95 postpaid. The St. George's, P.O. Box 143, East Hartford, Conn.

**CLOCK** Movements—Gorgeous dials, plans, kits. See ad page 233.

**AIR** Conditioners—Home, automobile. See Kool Engineering ad page 22.

#### WATCHES, OLD GOLD, JEWELRY

**MONEY** Immediately for broken jewelry, gold teeth, watches, diamonds, silverware and platinum. Highest prices. Satisfaction guaranteed. Information free. Mail today to Wilmo's, P.O. Box 6, 2547 102 St., Toledo 11, Ohio.

**10 SWISS** Watches \$18.00. Catalog 10c. Berkowitz, 1150 Castlehill, New York 62.

**HIGHEST** Cash for old gold, broken jewelry, gold teeth, watches, diamonds, silverware, spectacles, platinum. Free information. Satisfaction guaranteed. Rose Refiners, Heyworth Bldg., Chicago 2.

**AMATEUR**—Professional watchmakers' supplies; correspondence instructions; repairing. Bengale Company, Culver City, California.

**COSTUME** Jewelry supplies. Catalog and samples. 35c. Largest line in America. Milady-Fair Co., G.P.O. Box 1328, New York City 1.

**RHINESTONES.** Jewelry settings, copper enameling. Sample earring kit and catalog 25c. Catalog only, 10c. J & M Novelities, Dept. CH-3, Griffith, Indiana.

**WATCHMAKERS'** Tools, materials, supplies, watches. Catalog. Gales, Box 1000, Chicago 90, Ill.

**OUT** Of pawn. Watches—Bulova, Gruen, Elgin. Guaranteed \$10.00 plus \$1.00 tax. Sam's, 2144 Prospect, Cleveland, Ohio.

**JEWELERS** Diamond testing instrument. Tells instantly whether stone is diamond. Precision made. Guaranteed. \$4.50 postpaid. Southwest Jewelers Supply, Box 2828, Phoenix, Arizona.

**WATCH** And clock repairing books for hobbyists. Free information. North American, Dept. 15-G, 2320 N. Milwaukee, Chicago 47, Illinois.

**USED** And new watches. \$2 up. List free. Southern Watches, Gray, Georgia.

**FREE** Sample pair of earrings shows you how easy it is to make beautiful costume jewelry. Over 5000 styles listed in new catalog, 25c. Barry's, 186 Ardsley Court, Newark, N. J.

#### TOBACCO, SMOKERS' SUPPLIES

**PIPE** Smokers! Cigar smokers! Free illustrated catalog offers fabulous savings on choice imported and domestic pipes, cigars, tobaccos, supplies. Write Wally Frank, Dept. 25, 150 Nassau Street, New York 38, N. Y.

**IMPORT** Habana cigars. Ramon Delgado, 60 W. 95th Street, New York 25, New York.

**STINKY** Pipe? Send \$1.00. Two ounces pipe cleaner. Wonderful. Box 61P, Grand Rapids, Michigan.

#### RAZORS, BLADES, SHARPENING

**FREE** Double edge blades. Davies, P.O. Box 182C, Plainfield, N. J.

#### FOR THE HOME

**HAND** Carved wooden novelties imported from Italy. Very unusual. Descriptive folder. Gaines, 5105PM Mulford, Skokie, Illinois.

**AMAZING** Garden accessory. Zip hose coupler. Quick attachment to sprinklers, faucets. Solid brass, leakproof. \$1.00 postpaid, cash or money order. Conditionaire, 2000 Warrensville, Cleveland, Ohio.

**PORTRAITS**—Always wanted. Now affordable! Free illustrations. Edorsey, Ojai, California.

**FOAM** Rubber furniture cushions. Factory seconds, 50% discount. Free catalog. Perma-Foam, 429 Central Ave., East Orange, New Jersey.

#### OF INTEREST TO WOMEN

**DRESSMAKERS.** Sewers, wholesale lists. Dress suitings, formal fabrics. Box 863, Norwalk, Conn.

**BABY** Blanket, guards against suffocation \$5.95. Free details. C. E. Robinson, Lock Box 1353, Erie 8, Penna.

**GOOD** Money in weaving. Weave rugs at home for neighbors on \$69.50 Union Loom. Thousands doing it. Booklet free. Union Looms, 153 Post St., Boonville, N. Y.

**PROFITABLE** Home business. Make fast-seller chenille monkey trees, dolls, flowers. Terrific holiday demand. Information free. Velva, Bohemia 16, N. Y.

**GROW** Mushrooms. Cellar, shed, and outdoors. Spare, full time, year round. We pay \$3.50 lb. We paid Babbitt \$4,165.00 in few weeks. Free book. Washington Mushroom Ind., Dept. 178, 2954 Admiral Way, Seattle, Washington.

**MAKE** Copper enameled jewelry for pleasure or profit. Excellent results with beginners' sets. For craftsmen, 50 different copper shapes. Enamels in 30 different colors. Tools, findings, late model kilns. Send 10c for catalog. J. C. Larson Co., 820 S. Tripp, Dept. 5275, Chicago 24.

**GUATEMALAN** Cowhide leather bags, belts, skirts. Free catalog. Maplon, Box 268, Guatemala, C.A.

**EMBROIDER** Stamped linens. Buy direct from manufacturer and save. Send for free catalog. Dept. 821, Merrilbee, 22 West 21st Street, New York 10, N. Y.

**WANT** To make big money at home? \$5 profit in an hour possible with invisible reweaving. Make tears, holes disappear from clothing, fabrics. Steady year-round demand from cleaners, laundries, homes. Details free. Fabricon, 8332-S Prairie, Chicago 19, Ill.

**COLGATE'S** Lustre-Creme shampoo. 4 lbs. \$4.85. Geller, 2089 Matthews Ave., New York 62, N. Y.

**OUT-Of-way** ironing cord holder. Folds flat on board for easy storage. Has long extension cord. Satisfaction guaranteed. \$1.98. Reynolds, Box 1176, Portsmouth, Ohio.

#### FOR SALE—MISCELLANEOUS

**BUY** Direct from government at tremendous savings. Surplus power tools, machinery, truck, jeep, boat, motors, radio, photographic, printing, hunting, fishing, camping, sporting equipment, typewriters, hundreds others. List \$1.00. Box 169AST, East Hartford 8, Conn.

#### WANTED—MISCELLANEOUS

**OLD** Or used welding equipment. Get our offer. Top dollar. Klas, 6728 Warren, Detroit 10, Michigan.

**QUICKSILVER.** Sterling, silver solders, precious metals. Wholesale Terminal, Norwood, Massachusetts.

**SCRAP** Mercury (quicksilver) containers supplied—Tantalum, bismuth, tungsten. Metallurgical Products Company, Established 1909, 35th and Moore Sts., Philadelphia 45, Penna.

#### PERSONAL

**LETTERS** Remailed 25c. Write for personal mailing-receiving address rates. McLaughlin, 800 Stewart, Columbus 6, Ohio.

**MEXICAN** Law. General Practice Attorney. Apartado 79, Juárez, Chih., México.

**FOOT** Lotion for tired, aching feet. \$1.00 postpaid. Lumar Chemicals, Box 18, Rocky Hill, Conn.

**WORK** In Detroit, help wanted ads air-mailed \$1.00. Remails 25c. Slay, 4112 Joy Road, Detroit 4.

**NORFOLK** Remailing 25c. Classifieds \$1.00. Box 6162, Norfolk 8, Virginia.

**REMAILING** 25c. Replies forwarded. Ace Service, Box 186, Tampa 1, Fla.

**REMAILS** 25c. Classifieds \$1.00. Grace, Box 972, New Haven, Conn.

**BUY** Vitamins direct. Amazing savings. Catalog free. Matoska, White Bear, Minn.

**"HOW** Can I find out?" You can! Information confidentially developed. Any matter, person, problem. Worldwide. Officially licensed. Established 1923. William Herman, 170 Broadway, New York City.

**LETTERS** Remailed 25c. Personal forwarding address. Monthly rates. Hicks Service, Box 1547, Washington 13, D. C.

**HONOLULU** Help wanted columns air-mailed \$1.00. Trader Jack, Wailuku, Maui, Hawaii.

**BEAUTIFUL** Charcoal portrait (life size) done from your photo \$10.00. John Walencik, 15703 Kennicott, Harvey, Ill.

**PERMANIZED** In plastic—Pictures, newspaper clippings, valuable papers, to 5½"x7½". Only 8c square inch. Social security cards 45c. U. S. Plastics, Box 523, Shawnee, Kansas.

**NEW** Orleans letters remailed 25 cents. Brown, Box 7025, New Orleans, La.

**MILWAUKEE,** Wisconsin is booming. Complete Sunday classified \$1.00. Free map. Your line surveyed \$2.00. Letters remailed 25c. Monthly rates. Reliable. Prompt. Reid, 5001 West Oklahoma.

**SUNDAY** Classified, any metropolitan air-mailed \$1.00; New York Times 75c; Manhattan remails 20c. Theuer, 4359 Furman, Bronx 66, New York.

**PAPUAN,** Australasian stamps. 30 mixed, or remails. \$1.00. Box 107, Moresby, New Guinea.

**LETTERS** Remailed from Kansas City 25c; receiving, forwarding address available. Confidential. Sterling Services, Box 505, Kansas City 41, Mo.

**PORTRAITS**—Treasured paintings, gift-worthy, inexpensive. Details free. Edorsey, Ojai, California.

**PROFIT!** Prestige! Publish a magazine under your own name! Only \$3.25 per month! Sample, details 5c! Filmer, 910 Marion, Pharr 22, Texas.

**WASHINGTON,** D. C. want ad air-mailed, \$1.00. Modern Supply, Box 693, Alexandria, Va.

**LAST** Will and testament. Many make their own; for deposition of life's estate, for protection of one's family. Legal form, complete, \$1.00. Kincaid, Box 9141, Huntington, W. Va.

LETTERS Remailed, 25c. Rates, 2703 N. Laura Rd., Millwood 6, Wash.

**BORROWING** By mail. Loans \$50 to \$600 to employed men and women. Easy, quick. Completely confidential. No endorsers. Repay in convenient monthly payments. Details free in plain envelope. Give occupation, State Finance Co., 323 Securities Bldg., Dept. H-227, Omaha 3, Nebraska.

**UNHAPPY?** Restless? Dissatisfied? Uncover your hidden abilities, aptitudes, personality with psychological testings. Do tests at home. Receive complete analysis prepared from tests by professional psychologists. Low cost, confidential. Write Psychologic Testing Institute, Dept. 244, 201 N. Wells St., Chicago, Illinois.

**HOLLYWOOD:** Letters remailed 25c. Received-forwarded \$3.00 month. Toor-Rothchild, 6711 Sunset Blvd., Hollywood 28, Calif.

**CHICAGO Help** wanted ads \$1.00. Mail received-forwarded \$3.00 month. Eve, Box 178, West Chicago, Illinois.

**PENSIONERS.** Veterans, live in Mexico for 1/2. Complete information \$1.00. Also, remails 25c, replies forwarded. Klifford, PeñasPeña 51-11, Mexico City, Mexico.

**CHICAGO Remailing** 25c. Bohanon. Postoffice Box 701, Chicago 90, Illinois.

**SECRET** Mail address, \$3 month. Hedgpath, Box 830, Alhambra 23, California.

**URANIUM Area**—Spokane classifieds airmailed, \$1.00. Information on area, \$2.00. Bingham, Box 740, Spokane, Wash.

**REMAILS** 20c. Florida address \$3.00 monthly. Gary Marshall, 68-AG West Flagler, Miami 32.

**REMAILING**—Forwarding 25c. Confidential service for legitimate business operations. Carleton Cleveland, 864 Park, Highland Park, Illinois.

**REMAILS** 25c. Sunday classified \$1.00. Orbit, Box 3906A, Detroit 27, Michigan.

**HOW** Can I get out of debt? Stop garnishments? Save jobs? Write E. Borum, 411 West Walnut Street, Kalamazoo, Mich.

#### REMAILING SERVICE

**REMAIL:** Famous Silver Springs, Ocala, Belleview, 25c. Williamson, Box 385, Belleview, Fla.

**REMAILS** 25c. Reairmails \$1.00. Receiving, forwarding, Parker, 7644 Naldo, Jacksonville, Florida.

**CHICAGO** Letters remail 25c. Henry Bell, P.O. Box 596, Chicago 90, Ill.

**DENVER** Remails 25c, classifieds \$1.00. Ajax, Box 295, Englewood, Colo.

**CANADA:** Quebec, Montreal, Gaspeia remails 25c. Lanroy, 178 Cadillac, Quebec.

**LETTERS** Reairmailed from any Alaskan post-office 50c each. KPE, Box 148, Homer, Alaska.

#### TREASURE FINDERS

**URANIUM** Instruments, core drills, eight lines. Authorized factory repair service. Micromatic, 2322 W. Whittier Blvd., Montebello, Calif.

**GOLD** And silver indicators. Price \$30. Box 51, Plant City, Fla.

**URANIUM** Hunters! Why not buy from specialists. Largest instrument stock in Rocky Mountain area. Sales, service, write for free catalog. Mail orders shipped anywhere. The Geiger Center, 12th & Broadway, Denver 6, Colo. TAbor 5-8914.

**URANIUM** Prospectors! Billion-dollar uranium deposits lie waiting for discovery by you in Canada's great untouched Northland. Complete map set of existing ore bodies sent upon application, \$1. Postpaid. Canadian Mining-U, Lake Guindon, Quebec, Canada.

**URANIUM!** Informative booklet gives hot known and potential locations. Government map included free. \$1.00. Uranium Research, Box 1555, College Station, Tex.

**GEIGER** Counters by American Laboratories. \$19.95 up. Also Geiger parts. Literature. 471 Clifton Ave., Newark 4, N. J.

**GEIGER** Counter kit. Easily assembled. Supplied complete, only \$17.50 postpaid. Free literature. Stowers & Son, 804 Grand, Dept. 12, Kansas City, Missouri.

**QUALITY** Geiger counters at unbelievably low prices. Write for illustrated literature. Dept. 1, Electronics Division, Roberts Manufacturing Company, Cleburne, Texas.

**URANIUM** Finding made easy. Completely transistorized Geiger counters now available for the first time. Extra sensitive. Lightweight. Scientifically engineered. Unconditionally guaranteed. Also a complete line of prospecting instruments priced from \$19.95. Write today for free information. Universal Atomics Corp., Dept. PM7, 19 East 48th St., New York City.

**URANIUM,** Gold, silver treasure. New, power-packed, highly sensitive metal detectors, Geiger counters and mineralights, kits and assembled models from \$12.50. Lightest weight, guaranteed, free literature. Electronic Applications, 5024 Lee Highway, Arlington 7, Va.

**AMAZING** Triple-action Geiger counter U-238C, combines audio, neon flasher, meter. Guaranteed best available. Also metal detectors and scintillation counters from \$49.50. For radioactive uranium sample send 25c to Ooidak Company, 1541 W. Glenoaks Blvd., Glendale, California.

**TREASURE,** Metal, mineral locators M-scope type. Latest electronic design \$75.00 up. Geiger counters, scintillators, mineralights for uranium prospecting \$35.00 up. Fully guaranteed. Monthly payment plan available. Books "How to Be a Successful Uranium Prospector," "For Fun and Profit." Literature free upon request. Fisher Research Laboratory, Inc., Palo Alto, Calif.

**GOLD,** Silver, metal detectors. Geiger counters for uranium. Mineralights. Sensational new fully guaranteed models. None finer. Information free. Detector Corp., 5528 Vineland Ave., North Hollywood, California.

**URANIUM** Found easier with Universal's new miracle transistorized audio. Adapts to all Geiger counters, amplifies detection clicks ten times, replaces bulky earphones, operates 500 hours on 15c flashlight cell. \$15 f.o.b. New York City. Send \$5 for c.o.d. Universal Atomics Corp., Dept. PM70, 19 East 48th Street, New York City.

#### MISCELLANEOUS

**LABELS,** The glossy kind. Samples 10c. Fountainhead, Box 9242, San Diego 9, Calif.

**URANIUM** Seekers, rock hounds. Uranium Information Guide. Postpaid \$1.00. Bill's Uranium Research Service, Box 625, Boulder, Colorado.

**SCINTILLATION** Counters. Geiger counters. Nuclimeters. Geiger tubes \$7. Pine new scintillation crystals, from \$7. Instructions for use. Western Radiation Laboratory, 1107 W. 24th Street, Los Angeles 7, Calif.

**CLOGGED** Drains, cesspools and septic tanks cleaned by new powerful chemical. Sursolvent removes grease, soap, tree roots, etc., without expensive digging and electric rodding machines. No pumping necessary. Mix with water and pour down drain. Free details. Electric Drain Cleaning Co., Boston 34, Mass.

**GROW** Mushrooms. Cellar, shed, and outdoors. Spare, full time, year round. We pay \$3.50 lb. We paid Babbitt \$4,165.00 in few weeks. Free book. Washington Mushroom Ind., Dept. 175, 2954 Admiral Way, Seattle, Washington.

**HOW** To paint. Do it yourself. Illustrated instructive book. 25c. Catalog free. Popular Mechanics Press, 200-HP E. Ontario St., Chicago 11, Ill.

**PANNING** Gold—Free lesson; catalogue of mining, mineral books, supplies. Old Prospector, Box 729D1, Lodi, Calif.

**BE** Your own plumber. You can. Few inexpensive tools and our instructive book, "Home Plumbing Guide," shows and tells you how. Hundreds of photographs and diagrams. Easy to follow. 160 pages. \$3.50. Catalog free. Popular Mechanics Press, 200PG East Ontario St., Chicago 11, Ill.

**OUTDOOR** Toilets, cesspools, septic tanks cleaned, deodorized with amazing, safe, harmless powder. Easy, economical to use. Saves digging, pumping. 150,000 customers guarantee satisfaction. Details free. Burson Laboratories, Dept. O-36, Chicago 22, Ill.

**OUT** Of pawn suits, topcoats. Late styles. Sam's, 2144 Prospect, Cleveland, Ohio.

**LOCKS** And Lockmaking by Francis Butter is acclaimed by experts throughout the world as the finest book ever written on the subject. Order your copy today, \$4.95. McLean's, 2703 E. Third, Denver 6, Colorado.

**HEALTHFUL** Tasty old fashioned Dutch-German bread recipes. Recommended by physicians and dietary specialists. Pumpkin, whole-wheat, rye and soya bean. History and baking secrets included. Each recipe \$1.00. All for \$3.00. John Kahn Braue', P.O. Box 967, Midland, Texas.

**FREE,** Eye-opening facts about uranium! Part time prospecting. Prospecting on private owned land and how to lease minerals. Maurice Rogers, Box 1309, Odessa, Texas.

**70** BIBLE Lessons, 25c. Bulletin, Box 87, Cathedral Station, New York 25.

I Want to send you proof of the wonderful pulling power of Popular Mechanics classified pages. What's your proposition? Write me today. Include literature if possible. F. W. Johnson, Manager Classified Advertising, Popular Mechanics Magazine, 200 E. Ontario St., Chicago 11, Ill.

**STRONGEST** Glue in the world. Up to 3600 lbs. per sq. in. on wood. Famous since 1879. Always ready to use. Sticks anything stronger. Send 25c coin for trial bottle of famous, dependable Elwell's Liquid Glue, Dept. 206, Gloucester, Mass.

**SCINTILLATORS,** Geiger counters, metal locators. Mineralights. Free catalog. A. Stiebler, 125 W. Adams, Detroit 28, Michigan.

**BUY** Wholesale thousands nationally advertised products at big discount. Free "Wholesale Plan." American Buyers, Hertel Station, Buffalo 16-K, N. Y.

**RECEIVE** Magazines, samples, catalogues. Mails from everywhere. Offers, hundreds. Get listed 25c. Rorick, Box 86, Cincinnati 26, Ohio.

**HOW** To get what you want. Psychology method. Condensed 23 page, pocket-size edition \$1.00. Booklovers, 28 Cassius, New Haven 11, Conn.

**MACHINELESS** Home laminating transparent Permafilm seals by itself. Kit, 10 sheets, \$1.00. Details free. Morgans, 2829 Calumet Ave., Chicago, Ill.

**SKETCH-O-Graph;** amazing invention for sketching, designing and layout work. Craftsmen, engineers, artists, draftsmen, architects praise this 7 in 1 tool. \$2.00. Moneyback guarantee. Literature free. Sketch-O-Graph Instrument Co., Kenton, Ohio.

**ALARM** Clock turns on radio, lights, coffee pots, etc. Diagram, instructions \$1.00. Marvin Richeson, R-2, Wendell, Idaho.

**REAL** Four leaf clovers in cellophane. Unusual prize or sale item. Thirteen cents each. Lower quantity prices. S. Harper, 315 Avondale Ave., Haddonfield, N. J.

**IMPERATIVE!** Indispensable! The truth about your ability and importance. Free. Write Applied Christian Psychology, Box 1924-S, Louisville 1, Kentucky.

**WANTED!** Persons to claim \$3,000,000,000 in unclaimed securities. Information, \$1.00. American Inheritance Research, Dept. D7, Box 5340-A, Chicago 80, Illinois.

**FREE:** Exciting catalog packed with books covering most everything. Think of it—From cover to cover you will find described and illustrated hundreds of books telling how to fix and how to build almost anything. How to remodel your home; do your own decorating, plumbing, electrical work. Simplified books covering concrete work, carpentry, painting, furniture making and refinishing. How to build your own boat, home workshop tools. Best books on photography, welding, hobbies, homecraft. How to make a home freezer. Send for your free copy now. Popular Mechanics Press, 200-BC East Ontario St., Chicago 11, Ill.

**CESSPOOLS,** Outdoor toilets, septic tanks cleaned like magic. New amazing powder cleans and deodorizes in double-quick time. No digging, no pumping, no mess. Moneyback guarantee. Free literature. Chippewa Products Co., Burnt Bridge, Chippewa Falls, Wis.

**MAKE** Your vacation pay! Information and map showing gold and tantalite locations in South America \$3.00. R. M. Stone, Rt. 2, Kissimmee, Fla.

**YOURS FREE!**

**VUER-PROJECTOR & Full Color Slide Kit—Authentic \$4.95 Value!**

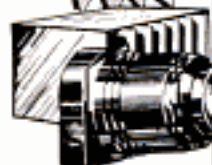

**If You're Interested In BREEDING TROPICAL FISH For Profit & Pleasure**

This handsome, precision-viewing instrument and color slides are yours FREE—just for showing your interest in Tropical Fish Breeding! See gorgeous BETTAS, colorful TETRAS, exotic ANGEL FISH, etc., in the vibrant beauty of full color! Convince yourself Tropical Fish Breeding is the profitable, easy-start home business for you! Breed them in your living room, spare-room, *anywhere*. Success is assured because we'll buy every fish you produce! No experience or costly equipment needed. Start spare-time, on a "doo-string"... build a \$10,000 home business! Investigate!

Write today for FREE details on "Profit-Proven" Success Plan & Vuer! (If under 17, ask for plan A.)

TROPICAL FISH BREEDERS OF AMERICA Dept. D-7 Los Angeles 61, Calif.



**Colorcreting Can Be Your Big Opportunity**

**Local Colorcretors are Needed Everywhere**

Colorcreting is a small investment enterprise, rich in sales potentials, high in income possibilities. Work is easy and fascinating. No experience required; we supply complete instructions.

Colorcreting is a building-beautifying process, with Colorcrete being pneumatically applied to new or old masonry surfaces such as concrete or stucco. Lasts indefinitely—25 years or more. Easily cleaned. Gleaming white, or a choice of 30 colors.

Colorcrete equipment is compact and portable. Easy to operate and practically wear-proof. Easy-payment terms when desired. Write at once for Opportunity Book.

**COLORCRETE**

Colorcrete Industries, Inc. 570 Ottawa Ave., Holland, Michigan

IN CANADA: DUNN MASONRY MACHINERY LIMITED 1020 Dundas Highway, Cooksville, Ont.

**AMAZING NEW TINY RADIO**

Really Works—Small as a Pack of Cigarettes!



GETS LOCAL RADIO STATIONS WITH CLEAR BELL-LIKE TONES—NO STATIC OR INTERFERENCE! NEEDS NO TUBES, BATTERIES OR COMPLICATED HOOKUPS! NO AC PLUG INS! Nothing to wear out. Thousands of users—many report years of service. Uses new crystal diode and HI-Q coil. SELF-CONTAINED SPEAKER PHONE. Just the tiny radio to take with you ANYWHERE YOU GO—ON TRIPS, VISITING, ETC.—for real fun and enjoyment—ANYTIME. Merely hook to anything that can act as antenna for local reception. Free DX antenna kit included. **SEND ONLY \$1.00** (bill, ch., mo.) and pay postman \$1.00 C.O.D. postage or send \$4.99 for p.d. delivery. COMPLETE READY TO LISTEN. MIDWAY CO., Dept. PPM-7, Kearney, Nebr.

**WHEELS WHEELS WHEELS**

- 7" Disc Wheel 3/4" Tire 3/4" sleeve.....45c ea.
  - 8" Disc Wheel 1 1/4" Tire 1 1/4" sleeve.....70c ea.
  - 7" Disc Wheel 1 1/4" Tire 1/2" ball bearing.....90c ea.
  - 8" Disc Wheel 1 1/4" Tire 1/2" ball bearing.....\$1.00 ea.
  - 6" Disc Wheel 1.50 semi-pneum. Tire 1/2" B.B.....\$1.35 ea.
  - 8" Disc Wheel 2" semi-pneum. T. 1/2" B.B.....\$1.50 ea.
  - 10" Disc Wheel 1.75 semi-pneum. T. 1/2" B.B.....\$1.50 ea.
  - 10" Disc Wheel 2.75 semi-pneum. Tire 3/4" B.B.....\$2.50 ea.
  - 12" Disc Wheel 1.75 semi-pneum. T. 1/2" B.B.....\$1.85 ea.
- Above wheel prices includes hub cap. Plus Postage. C.O.D.'s accepted. AXLES—Sizes 5/16 in., 3/8 in., 1/2 in.—Cut to size—End holes drilled.

UNITED WHEEL STAMPING CO. 12131 S. PEORIA STREET PM-7 CHICAGO 43, ILLINOIS

**RADIO**

Engineering. All phases radio & electronics theory & practice; television; FM; broadcasting; servicing; aviation, marine & police radio. Prepare for good pay; 18-month course. Graduates in demand by major companies. Enter Jan., March, June, Sept. Regular campus life. Write for catalog. VALPARAISO TECHNICAL INSTITUTE, Dept. D, Valparaiso, Ind.



**PROFITS UNLIMITED**

With a custom do it yourself Clock Kit

**The sale of ULTRA MODERN CLOCKS**

is booming. Custom designs sell for \$50 to \$150 to interior decorators, architects, etc. You can now build a fabulous collection of intriguing clocks for yourself and profit... and you can get the complete kit of all parts for a few dollars.

Write for FREE Catalog and Details

R. & H. PRODUCTS, Dept. P, 1343 S. 48 Ct., Cicero 50, Ill.



**GIANT 6 Ft. Balls 59c**

Great fun for Kids and Grownups. Inflates to a Giant 6 ft. across, 21 ft. around. Use at beach or playground. Made of genuine neoprene rubber for extra durability. Can be pumped to carry your message! Terrific for attracting crowds at fairs, openings, school games, gas stations, etc. Government surplus, never used, sold at a fraction of original cost. 59c each. (2 for \$1.00. 5 for \$2.00, dozen only \$5.00). Sorry no C.O.D.'s

Dealer Inquiries Invited

NOVEL MFG. 33 2ND AVE., DEPT. G-655 NEW YORK 3, N. Y.

**IF—YOUR VALVE LIFTERS CLICK YOU NEED PYROIL**

HERE'S WHY—PYROIL "B" super lubricant keeps hydraulic valve lifts free and quiet. PYROIL makes ANY oil lubricate better. It's polarized—it clings to all metals. Protects against rust and corrosion too.



PYROIL... It doesn't cost... It PAYS!

HEAT-PROOF CRANK CASE LUBRICANT

Get PYROIL "B" Today and with each oil change... Only 79c service station, garage or dealer. Or write for exciting trial offer. Pyroil, Dept. PM-75, La Crosse, Wis., U. S. A.



SUPER LUBRICANTS WORLD FAMOUS SINCE 1929

**BETTER JOB, BIGGER PAY**

**Learn How You Can Win A**

Today, choose the career you want and prepare for success during spare time at home. Or if you are in work you like best, start training at once for quick promotion and higher pay. For 58 years American School has helped many, many thousands of ambitious persons to make their dreams come true—important positions, high incomes, job security. List at right contains only a few of many big opportunities we offer.

For FREE career information, send us your name and address and tell us which opportunity subject you prefer. Do it TODAY.

- Accounting
- Architecture & Building
- Automotive Technician
- Bookkeeping
- Business Management
- Civil Engineering
- Drafting
- Electrical Engineering
- Electronics—Industrial
- High School Courses
- Mechanical Engineering
- Plumbing—Practical
- Private Secretary
- Salesmanship—Outside
- Sheet Metal Work

AMERICAN SCHOOL, Dept. 6845, Drexel & 58th, Chicago 37, Ill. Canadians: Write American School, 1610 Sherbrooke W., Montreal





**Everything You Need For UNDERWATER Sports and Adventure**  
**DIVEMASTER SKIN AND LUNG DIVING EQUIPMENT**  
 Leading nationally known and foreign made products. Inspection tested at money saving prices. Underwater Breathing Apparatus, Swimming Masks and Fins, Diving Masks, Spear Guns, Water Skis, Diving Suits, etc. Send 25c for illustrated Catalog.  
 (Dealer Inquiries Invited)  
**U. A. S. CORPORATION, Dept. PM-7**  
**5637 W. 63rd Place, Chicago 38, Ill.**

**ENGINEERING DEGREE IN 27 MONTHS**  
**INDIANA TECHNICAL COLLEGE**  
 B. S. DEGREE, Aeronautical, Chemical, Civil, Electrical, Mechanical and Electronics Engineering (inc. Radio and TV), Drafting, (y.e. G.I. Gov't. approved, Low rate, Earn board, Large industrial center, Students from 48 states, 21 countries, Demand for graduates, Enter September, December, March, June. Write for catalog, 1675 E. Washington Boulevard, Fort Wayne 2, Indiana.

**QUICK CASH PROFITS on Imports by Mail Order!**  
 Let me show you how I get up to 1,163 cash-in-advance orders in a day for imports shipped direct from abroad. ALL BY MAIL ORDER. Think! Your own business from home. I show you how to find imports for a "song". How to export too. No investment in merchandise, Big profit opportunity. FREE details. Write today! Mellinger, Importer, Dept. E257, 1717 Westwood Blvd., Los Angeles 24, California

**earn \$15 as TAX EXPERT HOUR**  
 Tax Consultants earn to \$5,000 annually in spare time preparing income tax returns and operating monthly tax service for business men. Dignified home-office business. Experience unnecessary. We train you; help you start. State approved. Write today for free prospectus.  
**UNION INSTITUTE, Lakewood 2-X, N. J.**

**STUDY INDUSTRIAL DESIGN**  
 You can train at Art Center School in California with practicing-professionals for upper-level jobs in INDUSTRIAL DESIGN. Recent graduates have been added to the staff at General Motors, Chrysler, Raymond Loewy, Henry Dreyfus, etc. Majors in transportation, general product design, structures, community development, furniture design, packaging, display, 4-year degree courses. Learn to combine imaginative design with technical proficiency, coordinate utility and beauty. Stimulating environment. Field trips. Advantages of mild Southern California climate and nearby holiday spots. Cost. Placement service. Established 24 years. New terms Feb., June, Sept. Write for catalog.  
**ART CENTER SCHOOL, Edward M. Adams, Director**  
**5353 WEST THIRD STREET, LOS ANGELES 5, CALIFORNIA**

**GROW ORCHIDS AT HOME** **BIG PROFITS SPARE OR FULL TIME**  
 World's most thrilling hobby - profitable home business. Single Orchid plant may multiply into many - each as valuable as the first. Successful home grower shows you how! Rarest gorgeous Cattleyas, Cymbidiums, Epidendrums, on living-room table. Big-profit orders come from friends, neighbors, florists, etc. - also Mail Orders. Illustrated secrets of the experts in simple "show-how" language AND blooming-size Orchid plants sent at NO RISK. Everything you need to start - for pleasure or profit. FREE - full details - SEND NO MONEY. Write today.  
**TROPICAL FLOWERLAND, Dept. 317, 4622 Wilshire, Los Angeles 5, Calif.**

**24 Carat GOLD TRIM DUTCH NAVAL DIRK**  
 AUTHENTIC and exclusive dress dirk of Officers in the Royal Netherlands Navy. Mint condition. Cross hilt and pommel are heavy 24 carat gold plate. Curious ivory-like grip, fine steel blade, both sides hand etched - intricate design and anchor emblem with other designs showing influence of ancient Spanish occupation of the Netherlands. A large dirk - 14" long. Completely rust and saltwater corrosion proof. A rare collector's item. Beautifully handmade in the tradition of finest centuries-old European workmanship and quality. In extremely limited numbers.  
**The Swordsman**  
**37 Armory Bldg. 1165 E. Colorado Street, Pasadena 1, Calif.**

**Paint STRIPES with New "PAINT PEN"!**  
**Straight, Curved or Parallel Lines**  
 Use like a fountain pen with any color paint to stripe furniture, bikes, autos, model planes, toys, linoleum, wall board. Beautiful clean, crisp results every time. Can't clog or smear. Also use with glue, tempera, textile paint or ceramic under glaze. Paints on wood, glass, plastic, metals, fabrics and paper. Tool complete with tip for 1/16" stripes only \$1.00 post-paid. Other complete tools with following tips, 1/8", 1/32", 3/64", 5/64", 3/32", 1/8" - \$1.50 each. Extra tips 15c each. Entire kit with tool and 7 tips - \$5.00. A 3/4" tip only \$1 each. COD's postage collect.  
**New! "DOUBLE-STRIPE" 5 Way Combination Model only \$2.95**  
 Double Stripes - one wide and one narrow or two wide or two narrow at the same time. **FREE** - Send postcard for complete information **\$2.95** - or **ORDER NOW...**  
**DEALERS:** Master Paint Stripping Tool in display cartons of 1 doz. FAST, Profitable seller. Write for discounts.  
**HOME CRAFTSMEN!** New Paint Stripping Tool gives "professional" results every time, simple, easy to use. Send \$1.00 now.  
**MANUFACTURERS:** Write today for information about industrial and production striping tools.  
**WENDELL MFG. CO., Dept. J7**  
**4234 Lincoln Ave., Chicago 18, Ill.**

**looks cooler - is cooler!**  
**AIR CONDITIONED VIKING**  
**\$1.95 \$2.95**  
**R. S. HERBERT CO., INC., 103 LAFAYETTE ST., N. Y. 13**

**BENJAMIN SUPER CO2 GAS CARBINE - \$16.50**  
**NEWEST TARGET RIFLE - 22**  
**IDEAL FOR SMALL GAME**  
**ECONOMICAL SAFE-NON-TOXIC ACCURATE-CONVENIENT PRACTICAL.** Easy to operate - No spring recoil - No pumping. Uses low cost Soda Cartridges Cal. 22 Benjamin H-C Pellets and Darts.  
**WRITE FOR FREE ILLUSTRATED FOLDER OF ALL MODELS BENJAMIN AIR RIFLES AND BENJAMIN AIR PISTOLS BENJAMIN AIR RIFLE CO.**  
**896 MARION ST., ST. LOUIS 4, MO. U.S.A.**

**"WE'RE LOOKING FOR PEOPLE WHO LIKE TO DRAW" . . . says Norman Rockwell, one of America's 12 Most Famous Artists. If you like to draw, you may have talent to become a successful artist, spare or full time. Find out for sure with our scientific, 8-page Free Art Talent Test. Thousands paid \$1 to take it. Get it FREE. No obligation. Send your name, address, age to: Famous Artists Schools, Dept. 6-JL, Westport, Conn.**



**\$6.95 EACH POSTPAID**  
 To order: Send check, cash or money order. Sorry, no COD. For US APO & FPO air mail, add 80c per knife. Calif. resid. add 3% state tax. Dealer inquiries invited.

# POPULAR MECHANICS

## FULL-SIZE PATTERNS

Quick • Easy  
Economical  
Beautiful Designs



Wasting time, transferring blueprint measurements? Wasting money, by making a cut in the wrong place and ruining your wood? If so, you'll want the full-size patterns listed below. All you have to do is trace the design on wood, saw and assemble.

Popular Mechanics Press has printed a new supply of these invaluable patterns. Designed by John Bergen, noted furniture designer, they give all necessary details for professional-looking work.

You can't go wrong with these patterns! If any of them doesn't please you, return it for full refund.

### Order from this listing

**No. 101. Cressette, Utility Outboard.** Length 12 feet, beam 4½ feet. Complete material list and step-by-step instructions included. Ideal for fishing, general use. Four patterns in set **\$2.00**

**No. 102. Trundle Beds.** Space-saving beds are safer for young people. 90 x 45½ inches. Top bed 40 inches high; lower bed 23 inches high. Three patterns in set **\$1.50**

**No. 103. Modern Step Table.** Handsome table, illustrated above, is designed to be companion piece to No. 104. 28 x 18 inches, upper step 24 inches high. One pattern **50 cents**

**No. 104. Modern Cocktail Table.** Matches No. 103 above. 40 x 19 inches, 15½ inches high. Beautiful original design with plank top and metal grille inserts in sides. One pattern **50 cents**

**No. 105. Toys for the Children.** "Giraffe Drawing Board" and "Bucking Bronco" riding toy. Pattern includes assembly instructions and painting suggestions. One pattern **50 cents**

**No. 106. Juvenile Chest Robe.** Has two drawers, shelf and hanging storage space. 30 inches wide, 16 inches deep, 39 inches high. Two patterns in set **\$1.00**

**No. 107. Cupola and Weathervane.** Cupola is 24 x 24 inches. 34 inches high, plus height of weathervane, which can be made of metal or tempered hardboard. One pattern **50 cents**

**No. 108. Personal Work Bench.** Top is 44 x 26 inches, 35 inches high. Provides lots of work space in small area. Drawer and sliding doors. Two patterns in set **\$1.00**

**No. 109. Valances and Trims.** For interior use around windows, cabinets, etc., and for exterior use on porches and gables. Twelve different designs are given. One pattern **50 cents**

**No. 110. Decorative Wall Shelves.** Modern shelf with metal trim is 28 x 16 x 8 inches. Traditional shelf is 29½ x 16 x 8 inches. Can be made with or without drawers. One pattern **50 cents**

**No. 111. TV Chair.** Seat 22 inches deep, 24 inches wide. Over-all, 27½ x 32½ inches, 26½ inches high. Sagless type wire springs and foam rubber. Two patterns in set **\$1.00**

**No. 112. Modern Tub Chair.** Seat 22 inches deep, 24 inches wide. Over-all, 28 x 27 x 27 inches. Foam rubber upholstery over sagless type wire springs. Two patterns in set **\$1.00**

**No. 113. Sofa Bed.** 78¾ x 29¾ inches, 33 inches high, with removable bolster. Uses standard size 4½ inch foam rubber or other mattress. Two patterns in set **\$1.00**

**No. 114. Love Seat.** Uses sagless type wire springs with foam rubber padding. 48 inches between arms, 21 inches deep. Over-all, 55½ x 29 inches. Two patterns in set **\$1.00**

**No. 115. Corner Table.** Another companion piece for Nos. 103 and 104. Table is 29½ x 29½ inches, 18 inches high. Upper diagonal step is 8 inches high. One pattern **50 cents**

### CIRCLE THE NUMBER YOU WANT AND MAIL THIS COUPON TO:

POPULAR MECHANICS PRESS, 200 E. Ontario St., Chicago 11

Send me the Full-Size Patterns whose numbers I have circled:  
101 102 103 104 105 106 107 108 109 110 111 112 113 114 115  
If not satisfied with any pattern, I will return it within 7 days for a full refund of its purchase price.

Remittance enclosed  I enclose \_\_\_\_\_  
 Send C.O.D. (\$2.00 or more)

Name \_\_\_\_\_

Address \_\_\_\_\_

City \_\_\_\_\_ Zone \_\_\_\_\_ State \_\_\_\_\_

(Continued from page 58)

Long-distance microwave pipe carries many television programs .....	128
Closed circuit TV speeds millwork .....	128
Safety door opener (National Pneumatic Co., Inc., 125 Amory St., Boston 19, Mass.) .....	129
Handle turns reflector to adjust floodlight on building (Western Railroad Supply Co., 2428 S. Ashland Ave., Chicago 8) .....	138
Vender uses powdered coffee (Deekruss Enterprises, 400 E. Beardsley Ave., Elkhart, Ind.) .....	212
Roller applies glue to seal carton (Ever-Seal Industrial Glues, Inc., 520 Fifth Ave., New York City 36) .....	222
Lawn edger buries coaxial cable .....	226
Car-key tie clasp (Maymac Co., 79 W. Grand, Dept. PM, Mount Vernon, N. Y.) .....	226
Guard for outboard motor (Victory Enterprises, Muskegon, Mich.) .....	228
Valve tap for sealed systems (Imperial Brass Mfg. Co., 1300 W. Harrison, Chicago 7) .....	228

### SCIENCE

Diamond-producing press forms genuine garnets .....	71
Drugs stunt insect growth .....	92
Chemical to combat cancer .....	97
Gauge tells ratio of fat to lean in live animals .....	97
Glass-fiber "clouds" remove radioactivity .....	97
Cancer-detection system uses sonar, radar and TV .....	105
Jupiter sends out radio waves .....	105
Miniature sounding instrument measures depths from row-boat .....	113
Blood-pressure recorder .....	125
Plants glow like fireflies .....	129

### Radio-Television, Electronics

Grooved tape recording plays for eight hours (Audio-Master Corp., 17 E. 45th St., New York City 17) .....	141
---	-----

### Craftsman and Shop Notes Index

#### FARM AND FARMING

Platted "beehive" on mailbox advertises honey products .....	158
Several waterers in pasture prevent hogs crowding .....	194
Steel-angle frames on waterer protect it against hogs .....	204
Tractor-mounted spray outfit permits one-man operation .....	204

#### HOUSE AND HOME

Cold draft through wall opening affects thermostat operation .....	164
Copper rain gutter used as hood for smoky fireplace .....	164
Sidewalk protects buried cable .....	164
Two ways of removing wrinkles when applying wallpaper .....	173
Improvised plumb bob used to set square fence posts .....	181
Shutters control air circulation .....	184
Metal weather stripping renewed by scoring with screwdriver .....	190

#### HOUSEHOLD HINTS

Pegs driven onto finishing nails quickly attached to wall .....	156
Uses for foil food containers .....	158
Solving Home Problems—	
Three-minute egg timer used when making toll calls .....	162
Discarded necktie converted into cover for umbrella .....	162
Window screens can be made waterproof .....	162
Cleaning aluminum cooking pots .....	162
Spice boxes are easily stored and identified .....	163
Plant holder for potted plants in double-hung windows .....	163
Wooden trivet placed under potted plants saves porch floor from rotting .....	163
Bowl cover over electric mixer prevents splatter .....	163
Tightening loose casters .....	163
Defrost refrigerator daily .....	164
Inexpensive toy shelves built from apple boxes .....	164
Refinishing a brass lamp .....	168
Damaged hot-water bottle used with salt as heating agent .....	173
School chair in small kitchen provides snack counter .....	173
Carbon "tet" renews rollers of washing-machine wringer .....	176

(Continued to page 62)

**IMPORTANT NOTICE**—It is the intention of this magazine to provide its readers with information regarding the latest developments in the mechanical arts. We take no responsibility as to whether the disclosures contained in our articles are covered by patents and advise readers to investigate this subject before making, using, or selling any of the products, machines, or processes described in order to avoid possible liability for patent infringements.

## PUMP FASTER with a HYDRO-JET!

Made of aircraft grade aluminum alloy, this rugged #10 centrifugal pumps up to 4500 G.P.H. ideal for irrigating, draining, filling, spraying. Uses 1.6 to 1/4 H.P. motor. Rustproof 1/2" shaft, oil-less bearing. 3/4" suction, 1/2" discharge, std. pipe threads, adapts to garden hose. **\$8.95**

Heavy-Duty HYDRO-JET #20 hits and empties ponds, ponds, etc. Extra powerful up to 8000 G.P.H. Use 1/4 to 3 H.P. motor. Rugged, rustproof 1/2" shaft, oil-less bearing. 1 1/4" suction, 1" discharge std. threads. **\$11.95**

Prepaid if cash with order. Send Check or M.O. \$2 deposit if COD. Money-back guarantee.

DEL-VAL PRODUCTS, Dept. M, Albany Ave., Westmont, N.J.



## 60 POWER TELESCOPE \$3.98

VARIABLE EYEPIECE 20x-40x-60x—BRASS BOUND

**NEW!** Three telescopes in one, 3 different magnifications. 20 power for ultra-bright images with 40 and 60 power for extra long range. Guaranteed to bring distant objects, people, sports events, ships, moon, stars, etc. 60 magnification. Closes to 1 ft. long. Contains 4 ground and polished lenses. Also used as a powerful compound microscope. Directions included. Mass production enables us to offer this instrument at amazing price of \$3.98 complete. Money back guarantee. We pay postage. Get yours now.

As A Microscope

CRITERION CO.  
DEPT. PMB 27

331 CHURCH ST.  
HARTFORD 3, CONN.

## BUILD YOUR OWN MIDGET ROADSTER \$25 BUILDS BODY & FRAME



BUILD A PONY ROADSTER or Pick-Up in few spare hours. Uses 2 hp engine, 450 lb. loads, 70 m.p.h., plenty of speed. Designed for VERY LOW-COST assembly from PARTS BOUGHT IN YOUR NEIGHBORHOOD. Use home tools. Great for kids, sturdy utility car. COMPLETE step-by-step plans, 15 large-size pages, 24 "show-how" photos, Body templates, complete material and parts list. Only \$1.05 post-paid. Satisfied or money back.

PONY PLANS, 7641-B TEXHOMA AVE., NORTHRIDGE, CALIF.



**FREE COLORED SKETCHES**  
BIG MONEY FOR YOU IN  
**ELECTRIC SIGN DESIGNING**  
COMPLETE COURSE IN ONE BOOK  
WHITEHOUSE PUBLICATIONS  
1651 EAST 233 ST., N. Y. 66, N. Y.

Say You Saw It in  
**POPULAR MECHANICS**

**SEND ME**



every month so I am sure to see each new issue. Here's

- \$3.50 for 1 year  
 \$8.00 for 3 years

name \_\_\_\_\_

address \_\_\_\_\_

city \_\_\_\_\_ zone \_\_\_\_\_ state \_\_\_\_\_ B-75

Hand this order to your newsdealer or send it to

**POPULAR MECHANICS**  
200 East Ontario St. Chicago 11, Ill.

**SAVE UP TO 50% ON FAMOUS ITALIAN ACCORDIONS**

Buy direct from America's leading distributor. Offers Students, Teachers and Professionals SPECIAL DISCOUNTS. Send NOW for FREE Literature and lowest wholesale prices. Easy Terms. Trade-ins accepted. Write today.

ACCORDION MANUFACTURERS & WHOLESALE OUTLET  
DEPT. R-75 2003 W. CHICAGO AVE., CHICAGO 22, ILL.

**5 DAY FREE TRIAL**

## STUDY AT HOME WITH AN EDUCATIONAL INSTITUTION

Courses in **ARTS AND SCIENCES**: Philosophy; Education; Letters; Public Health; Medical Jurisprudence; Psychology; Sociology; Physics; Chemistry; Geology; Pol. Science; Theology; Law; Business and Commerce; Accounting; Mathematics; Statistics; Agriculture. **ENGINEERING**: Electrical, Civil, Mechanical, Drafting, Architectural, Steam, Diesel, Aeronautical, Radio, Structural, Mining, Industrial, Petroleum, Refrigeration, Chemical. Send for free catalog. McKinley-Roosevelt Incorporated, 4610-K32, Sheridan Rd., Chicago 40, Illinois

**CURE SELF-CONSCIOUSNESS!**

How to develop a strong, positive personality—get rid of timidity, bashfulness, shyness and fear. Successful self-instruction lessons based on new principles of practical psychology. Healthy self-confidence can be yours! Complete course of 22 home-study lessons. **NOT a book.** Full price only \$6.95 postpaid, or COD plus postage. Mailed sealed in plain wrapper. Satisfaction guaranteed or refund. Order "Curing Self-Consciousness Course" today. Nelson-Hall Co., 210 S. Clinton St., Dept. 5GV-2, Chicago 6, Ill.

**HELPFUL BOOKS**  
Send post card asking for **FREE** catalog  
Popular Mechanics Press, 200 E. Ontario, Dept. 601, Chicago 11

## HIGH WAGES!

Are being paid to Operators of Bulldozers, Draglines, Back Hoes, Earthmovers and Motor Graders. Contractors want our graduates. Learn these skills **NOW**

National School of Heavy Equipment Operation  
P.O. Box 8243-D1, Charlotte, N. C.  
Please send me your School Catalog **FREE**

Name \_\_\_\_\_  
Street Address \_\_\_\_\_  
City \_\_\_\_\_ State \_\_\_\_\_

**Free! 105 BRITISH EMPIRE Stamps**

From Aden to Zanzibar—from farthest corners of the earth—comes this big valuable collection of 105 all-different British Empire including sensational new Queen Elizabeth stamps; guaranteed worth over \$2 at Standard Catalog prices. Also **FREE** booklet "How to Recognize Rare Stamps" PLUS other exciting offers. Send 10c TODAY for postage and handling.

**MAIL THIS COUPON TODAY!**

**KENMORE STAMP CO., Milford T-606, New Hampshire**  
Send my free collection of 105 all-different British Empire stamps, booklet "How to Recognize Rare Stamps," and other offers. I enclose 10c to help cover cost of mailing.

Name \_\_\_\_\_  
Street \_\_\_\_\_  
City \_\_\_\_\_ State \_\_\_\_\_

## SAVE HUNDREDS OF DOLLARS with HOME-A-MINUTE "KIT"

This is not something to fool around with. It is a hard hitting he man system of saving big money when you build or remodel



Design and build your New Home, Attic Flat, Extra Bedrooms or Remodeling—IN MINUTES—with over 100 fiber partitions, Doors, Windows, Kitchen Cabinets, made to scale same as blueprint. THEN, BELIEVE IT OR NOT, YOU, THE LAYMAN, who knows nothing about building, can estimate your own costs—IN MINUTES—after you adjust charts to local prices. Don't build anything until you get this "KIT" if you want to save money. Handbook tells you how. This information should not pass you by. Complete "KIT"

\$3.95 ppd., or COD plus postage. \$1 deposit required on COD orders. Handbook without "KIT" \$1.95 or free literature. Money back guarantee. Return in 10 days. Dealer inquiries invited.

**SPECIAL NOTICE!**—As a builder, controlling over 3 million dollars worth of home construction, we will ATTEMPT, but not promise, to obtain a special discount to you for your building materials on your new project, thru your favorite, local, Building Materials Supply Dealer. At no charge to you or your Dealer. This is a free service to our customers.

**R. K. HALL & CO.** 3824 W. ROOSEVELT DR. MILWAUKEE 18, WIS.

# WAR SURPLUS BARGAINS

\$500,000.00 INVENTORY  
for QUICK LIQUIDATION

Surplus tools—hand tools or tools for home, shop, factory, farm and outdoor use. New items, used items, reconditioned items—all at tremendous savings—all priced for quick sale.

Page After Page of Values  
This big catalog shows page after page of amazing money saving values. Write for your copy today. Send 10¢ to cover postage, handling, etc. Write today! SEND TODAY FOR YOUR COPY

## 10c

STARK'S 212 W. Madison St.  
Dept. PM-7  
CHICAGO 6, ILL.

## PROGRESSIVE RADIO "EDU-KIT"

BUILD 15 RADIO CIRCUITS—  
Learn Practical Radio Construction,  
Theory, Servicing at Home

ONLY \$19.95 COMPLETE

- Excellent background for Television
- No knowledge of radio necessary
- All parts included except solder and wire
- Build Receiver, Transmitter, Code Oscillator, Signal Tracer circuits
- Free soldering iron, Tester, TV book, Hi-Fi Guide, Quiz book, Consultation Service

MAIL TODAY—ORDER SHIPPED SAME DAY RECEIVED

30-Day Money-Back Guarantee      Include all FREE EXTRAS

Ship "Edu-Kit" postpaid. I enclose full payment of \$19.95.  
 Ship "Edu-Kit" COD. I will pay \$19.95 plus postage.  
 Outside USA: Send "Edu-Kit" postpaid. I enclose \$20.95.  
 Outside USA: Send 210-250 V. adapter. I enclose \$2.50.  
 Send more details on "Edu-Kit"—no cost, no obligation.  
 Send Free Radio-TV servicing literature—no obligation.

NAME \_\_\_\_\_

ADDRESS \_\_\_\_\_

PROGRESSIVE "EDU-KITS" INC. 497 Union Ave.  
ROOM 533B, PROGRESSIVE BUILDING Brooklyn 11, N.Y.

(Continued from page 60)

### MISCELLANEOUS

Foot of motel bed folds down forming luggage stand.....	156
Baby-shoe lamp.....	157
Canopy over toilet sand box matches house awnings.....	161
Backflow valve in sewer line keeps basement drains dry.....	168
Magnet holds eraser and pencil on typing stand or table.....	168
Weed-killer applicator made from pipe and sponge.....	176
Shield fitted on eyeglasses prevents sun fatigue and blindness.....	181
Garden-tool display rack made from nail keg.....	184
Rings with reflector "stones" locate pedestrian at night.....	184
Expansion material on post prevents cracking concrete.....	189
Joint between footing and wall sealed with metal strip.....	189
Tire-repair record kept inside hub caps.....	194
Electrified post drill with minor alterations used as power tool.....	195

### PHOTOGRAPHY

Angle bracket modifies tripod to hold camera sideways.....	158
Bell used as photo "godger".....	158
Glare in flash photos avoided by using test light.....	161
Paper holder for enlarger.....	176
Electric clock with sweep second hand modified for timer use.....	181

### TOOLS

Gauge and pliers clamped in vise cut wires to same length.....	157
Modifications increase holding capacity of drill-press vise.....	189
Tool drives small staples.....	190
Heavy spring "stretched" with hammer and chisel.....	194
Electrified post drill used as power tool.....	195
Shopping for Tools—	
Disposable saw blade (Rocco Products, Inc., 2916 Fourth Ave. S., Minneapolis 8, Minn.).....	202
Hinge butt marker (Stanley Tools, 111 Elm St., New Britain, Conn.).....	202
Hole cutter works in steel, cast iron, aluminum, other nonferrous metals (Robt. H. Clark Co., 9330 Santa Monica Blvd., Beverly Hills, Calif.).....	202
Wire stripper cuts insulation and strips it clean (Crown Industrial Products Co., 713 Amsterdam St., Woodstock, Ill.).....	202
Paint-spraying attachment (Portable Elec. Tools, Inc., 320 W. 83rd St., Chicago 20).....	202
Shaper guard for radial saw (DeWalt, Inc., Lancaster, Pa.).....	203
Air-powered hydraulic vise (Wilton Tool Mfg. Co., Inc., 925 Wrightwood Ave., Chicago 14).....	203
Paint can and brush holder (Handi-Grip Bottle Holder Co., Flint, Mich.).....	203
Flexible industrial-type drive unit (Dodge Mfg. Corp., Mishawaka, Ind.).....	203
Easily made countersink bit.....	204

### WORKSHOP HINTS

Masking tape on paint can provides brush holder.....	156
Pipe used as carport columns.....	156
Veneered furniture fretwork restored with hardboard.....	156
Oil-can spout extended.....	158
Properly installed clay tile will last indefinitely.....	168
Compass for drawing spiral made from dowel and thread.....	173
Splined joints strengthen glued-up wooden panels.....	173
Matches kept with blowtorch.....	178
Rubber-band holds nail to hammer for working in small space.....	184
Inverted funnel and can cover make safe ash tray.....	194
Plastic template used to locate center of round work.....	194
Swivel mount for table saw utilizes barber-chair base.....	195
Clamps convert lathe faceplate into oversize chuck.....	204

## Synthetic-Mica Plant

High-grade synthetic mica, enough to meet 5 to 10 percent of the nation's needs, will be produced by a plant under construction in New Jersey. Over 99 percent of high-grade mica used in this country comes from overseas—90 percent from India. In time of war, this supply might be cut off. Vital to national defense, mica is the only material that can be used in certain types of electrical insulation. The synthetic version is made from aluminum oxide, magnesium oxide, silica sand, a fluoride and potash feldspar—materials plentiful in the United States. It can be made to resist higher temperatures than natural mica can stand, and would therefore be the perfect insulating material against the extremely high temperatures encountered by supersonic aircraft and missiles.

62

POPULAR MECHANICS



## BOWHUNTERS' Outfits

SAVE 50%

Save by Mail! Complete outfits (\$16.95 up) include custom-grade LAMINATED bows, matched arrows top grade quivers, etc. Choose from one of America's largest stock of finest bamboo, glass and composite hunting and target bows. Terrific Values! Amazing FREE TRIAL plan!



FREE!

CATALOG & "How To Choose A Bow" BOOKLET, FREE. WRITE!

"HOW TO HUNT WITH BOW & ARROW" Booklet. Fascinating! Revealing! Illustrated! Also tells how to SHOOT STRAIGHT, FISH, WIN TOURNAMENTS, MAKE YOUR OWN TACKLE, ETC. Written by experts.

DEALER INQUIRIES INVITED

MALIBU ARCHERY CO., Dept. R-7, 1036 S. La Brea, Los Angeles 19, Calif.



### \$298 REVERSIBLE AUTO SEAT COVERS

Colorful SNAKE AND ZEBRA DESIGN And LEOPARD-COWHIDE DESIGN. Can Be Used On Either Side. Water and Stainproof. Tailored With Side Grip Panels For Tight Fit. Sewn With NYLON Thread For Long Wear. Simple To Install. Dress Up Your Car With A Net Of Either Of These Colorful Expensive Looking Covers!

10 DAY MONEY BACK GUARANTEE  
Choice Of SPLIT Or SOLID Front Seat Only \$2.98. Complete Set For Both Front & REAR ONLY \$3.99. When Ordering Specify Choice Of Design Wanted. Make Of Car and Seat Style. Enclose Payment And Save Postage Or Sent C.O.D.

MARDO SALES CORP., Dept. DS-969  
480 Lexington Ave., New York 17, N. Y.



### WORLD'S LOWEST PRICED ADDING MACHINE

IDEAL FOR BUSINESS AND PERSONAL USE—GUARANTEED ACCURATE. Not a toy. Operates with only a finger click. Adds, subtracts, multiplies, divides. Counts up to one billion. Pays for itself over and over. Ideal Gift—for Business, Income Tax and School use. MONEY BACK GUARANTEE. Send name and address. Pay postman only \$2.95 plus postage. (Send full cash if outside U.S.) Beautiful rich-looking Leathette Case included at no extra cost. Money back in 10 days if not delighted. AGENTS WANTED.

CALCULATOR MACHINE CO., (Mfgs.)  
Box 84 Dept. JV-55 Glenview, Illinois

## LEARN DIESEL AT HOME

Train to specialize! Run and repair these remarkable precision machines. Opportunities world-wide. Learn tricks of trade at home; finish quickly in our big Chicago training shops. Send name now for FREE BOOK.

UTILITIES ENGINEERING INSTITUTE, Est. 1927  
2521 SHEFFIELD AVE., DEPT. DC-47, CHICAGO 14, ILLINOIS

## MOTORIZED YOUR BARBECUE!

Easily rigged up by anyone. Handles whole ham or 4 small chickens. Commercial-quality thrust—2 r.p.m. gear-head motor (110V-AC)—spring-tension bronze bearing permits spit removal—

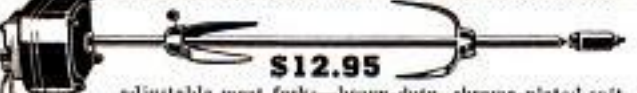

\$12.95

adjustable meat forks—heavy-duty, chrome-plated spit. Limited time. Introductory offer. Postpaid. (\$13.95 Denver and West).

B & R SALES CO. — Dept. PM755 — Muncie, Indiana

## HIGH BLOOD PRESSURE?

A home Blood Pressure Gauge now tests your pressure at home as often as you wish! That's how to avoid unexpected strokes, heart and kidney damage, insomnia, headaches, etc. Full particulars on how to test pressure and what to do for your condition are included with this dependable mercury gauge. It is simply constructed so it can be operated alone and it actually pays for itself in less than a week. Free descriptive circular sent on request.

THE STANDARD UNIT, . . . . . \$5.98 postpaid Or C.O.D. plus postage. Contains everything that is needed, including functional stethoscope.

THE DELUXE UNIT, . . . . . \$9.23 postpaid Or C.O.D. plus postage. Same outfit as standard unit, but includes genuine professional stethoscope.

JOY SPECIALTY COMPANY Scientific Instrument Dept.  
2320-A W. Hubbard Street Chicago 12, Illinois

AFTER BATH OR SHOWER —



59¢

6 OZ. ECONOMY SIZE

Say You Saw It in Popular Mechanics



## HANDS TIED?

—because you lack a HIGH SCHOOL DIPLOMA

• You can qualify for an American School Diploma in spare time at home! If you have left school, write or mail coupon for FREE booklet that tells how. No obligation of any kind.

OUR 58TH YEAR

AMERICAN SCHOOL, Dept. VB45  
Drexel at 58th, Chicago 37, Illinois

Please send FREE High School booklet.

Name .....

Address .....

City & State .....

Canadian Residents: Complete Canadian Course Available. Write American School, 1610 Sherbrooke St., West, Montreal.

To the millions of motorists who insist on

**5-RIB CHAMPION SPARK PLUGS**

for best engine performance

**HERE'S MORE PROOF OF YOUR GOOD JUDGMENT!**



**NASCAR DAYTONA BEACH GRAND NATIONAL** stock car race permits only regular stock spark plugs to be used—the kind available at neighborhood dealers. Once again, Champion scored a clean sweep! The first nine cars to finish—Chryslers, Oldsmobiles and Buicks—were all Champion-equipped!

Start of the Daytona 160-mile race. Tim Flock (R.Front) and Lee Petty (L.Front) finished 1-2 in Champion-equipped Chrysler 300's.



**THE FLORIDA INTERNATIONAL GRAND PRIX OF ENDURANCE**—Sebring's AAA-sanctioned, 12-hour race for sports cars—was won this year by Phil Walters and Mike Hawthorn in a Champion-equipped Type D Jaguar. They finished 25 seconds ahead of a Ferrari driven by Phil Hill and Carroll Shelby. The Ferrari, also running on Champions, was first on Index of Performance.

The winning Jaguar (19), owned by Briggs Cunningham and fitted with Champions, roars into an early lead from the LeMans type start.

5-RIB

**CHAMPION**

SPARK PLUGS

*Better by far for every car, regardless of make or year!*

# POPULAR MECHANICS

JULY  
1955

WRITTEN SO YOU CAN UNDERSTAND IT  
VOL. 104 NO. 1

## WHAT CAN WE DO ABOUT



Girl sealed in helmet tests smog for eye irritation

# SMOG?

By Thomas E. Stimson, Jr.

**M**OTORISTS IN SMOGGY Los Angeles are the guinea pigs in research that may produce more miles per gallon for every driver.

More than that, the research promises to reduce one of the most important causes

of air pollution in several of our busy cities.

Stanford Research Institute, seeking the causes of smog, learned that about seven percent of the fuel you feed your car is thrown away. About one gallon in every tankful goes out the exhaust pipe unused.

Mountains near Los Angeles tower above inversion layer that causes blanket of smog to smother the valleys





Area in color is often covered with a tent of smog during months from July to November. Mountain barrier restricts air flow

Projector measures ozone in the air by beaming ultraviolet rays which the gas absorbs. Ozone is one of the constituents of smog



On a national basis, this loss amounts to \$1,000,000,000 per year.

Other investigators showed that the average engine is efficient only when accelerating or cruising. It wastes up to 25 percent of its fuel when idling in traffic. During deceleration from high speed the waste amounts to 60 percent or more.

Next, Prof. A. J. Haagen-Smit of the California Institute of Technology found that the hydrocarbons in this wasted fuel combine with nitrogen dioxide (also present in the exhaust) in the presence of sunlight and form ozone. Ozone is a highly reactive pungent gas. It irritates the lungs and eyes, causes tires and other rubber products to deteriorate and combines with still other hydrocarbons to form other irritating constituents of smog.

In Los Angeles this situation is regenerative. That is, deposits of gum build up quite rapidly in automobile carburetors during smoggy weather. The so-called gum includes dust, rubber particles and oil vapor from the exhausts of other cars. The gum restricts the flow of carburetor air and enriches the mixture, thus increasing the amount of unburned fuel that goes into the atmosphere.

In extreme cases, the air-fuel ratio becomes so unbalanced that cars continually stall in traffic. One garage reported that 30 cars limped in for carburetor service during one smoggy morning alone. Another garage had 20 customers with the same complaint in a day, some with brand-new cars that had been on the streets less than a week. In each case, gum caused by atmospheric pollutants had collected around the throttle plate and upset the air-fuel ratio of the carburetor.

It is estimated that the 2,000,000-plus cars in the Los Angeles area discharge some 300,000 gallons of raw, unburned gasoline into the air every day. During an atmospheric inversion this automotive smog makes the difference between a relatively clear day and a day in which visibility is cut to a mile or less.



Smoggy atmosphere at right is creeping steadily across the city and soon will obscure the mountains at left

The problem is being attacked in several ways:

1. The Southern California Air Pollution Foundation is sponsoring road tests of a catalytic converter, a device that traps hydrocarbons in the exhaust. Six automobiles are being driven 20,000 miles each in the test. Trials show the converter is at least 80 percent efficient when first installed, but its efficiency decreases after 2000 miles. Further studies are being made. It is estimated that this type of muffler would retail at \$30 to \$50.

2. A manufacturing concern has devised an "afterburner" that is installed behind the muffler. It burns all raw hydrocarbons, delivering relatively harmless gases. The afterburner is being tested on 10 city buses. Initial reports say it is extremely effective.

3. A major oil company is marketing a detergent type of gasoline that automatically washes gum from critical areas in the carburetor. While not a cure-all, the detergent gasoline tends to keep the air-fuel mixture from the carburetor at the ratio to which it was adjusted.

4. Motorists are being advised to set the idle adjustments on their carburetors to as lean a mixture as is practical and to keep

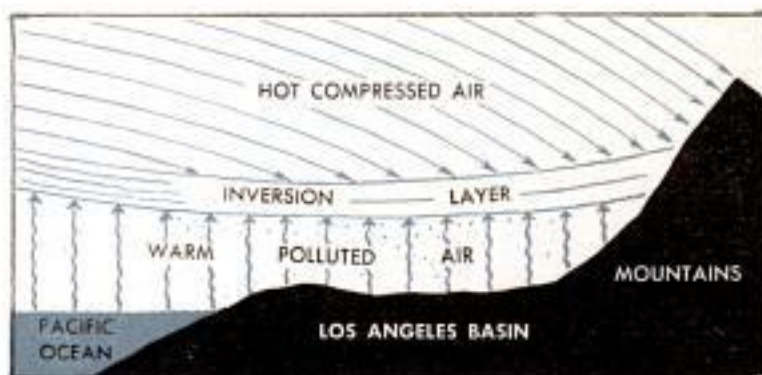

Blanket of air above the ground is hotter than the ground itself. This creates an inversion layer which the warm polluted air cannot penetrate. Mountain barrier and lack of wind clamp lid on city

Smog also damages plants. Seven hours in a smog chamber, which duplicates atmospheric smog, curled leaves of bean plants



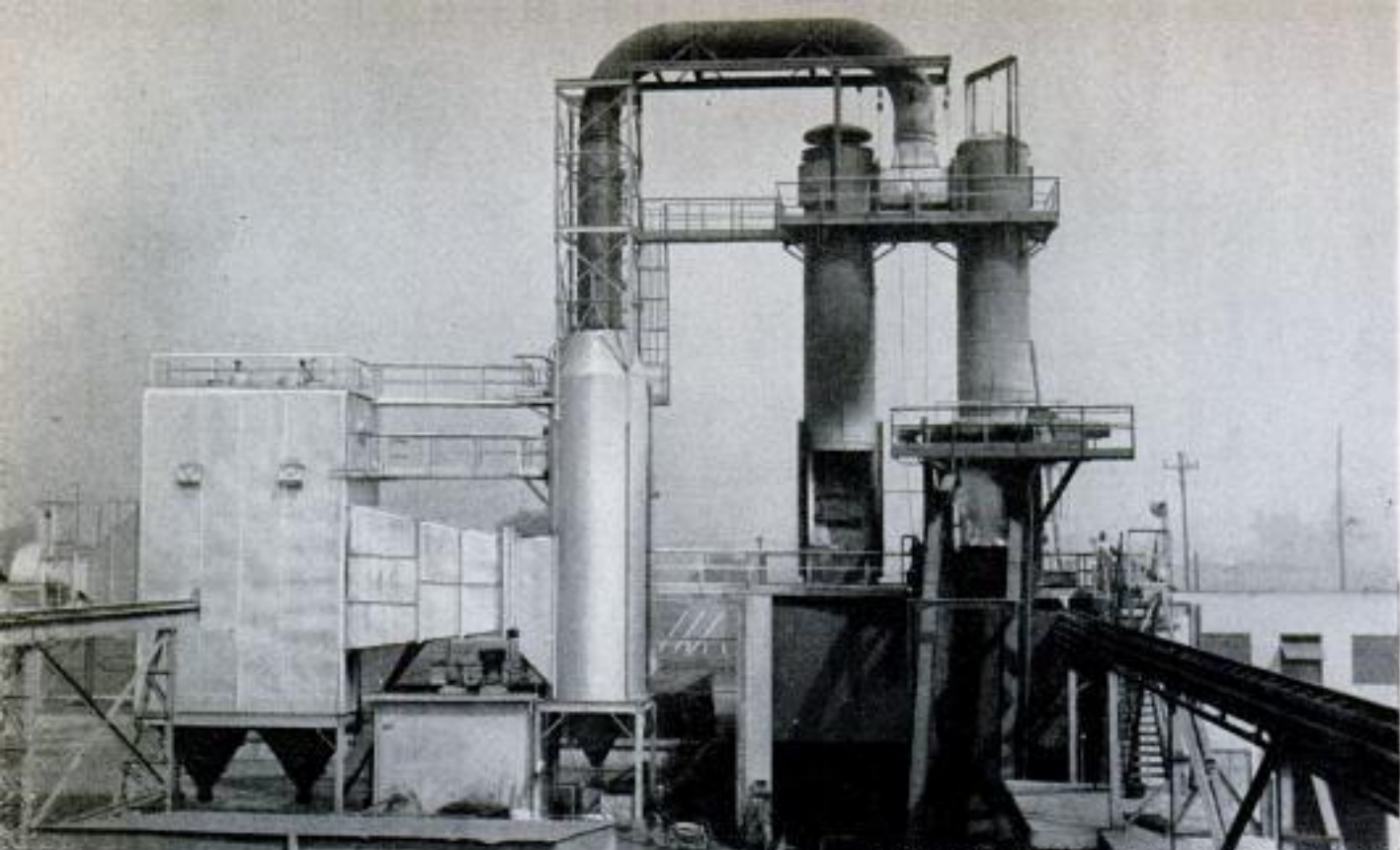

Los Angeles County Air Pollution Control District photo

As part of smog-abatement campaign, precipitator at left traps particles in smoke from an industrial furnace

their motors tuned for maximum efficiency.

5. Research departments of the major automobile factories are seeking more-efficient designs of carburetors. General Motors is said to be testing one modification that automatically restricts the flow of fuel during deceleration by as much as 90 percent, giving almost three percent greater over-all economy. Not yet in production, it might sell for \$25 or less. Chrysler is making experiments along similar lines.

Catalytic mufflers and afterburners are temporary stopgaps compared to a carbu-

retor that would meter gasoline so efficiently that all of it would be burned in the combustion chambers. The long-range program is for better carburetion so motorists will get more miles per gallon at the same time that automotive smog is materially reduced.

Los Angeles is the outstanding example of how bad smog can become, but it is not the only city in which smog is a problem. Garages in New York, Chicago, Detroit, Pittsburgh and San Francisco, among other cities, are reporting carburetor troubles due to rapid gumming, a product of smoggy conditions.

← Red spots show where gum forms in carburetor, restricting air and enriching mixture. Deposits form faster during smoggy weather. Below, muffler oxidizes unburned fuel, discharging carbon dioxide, water

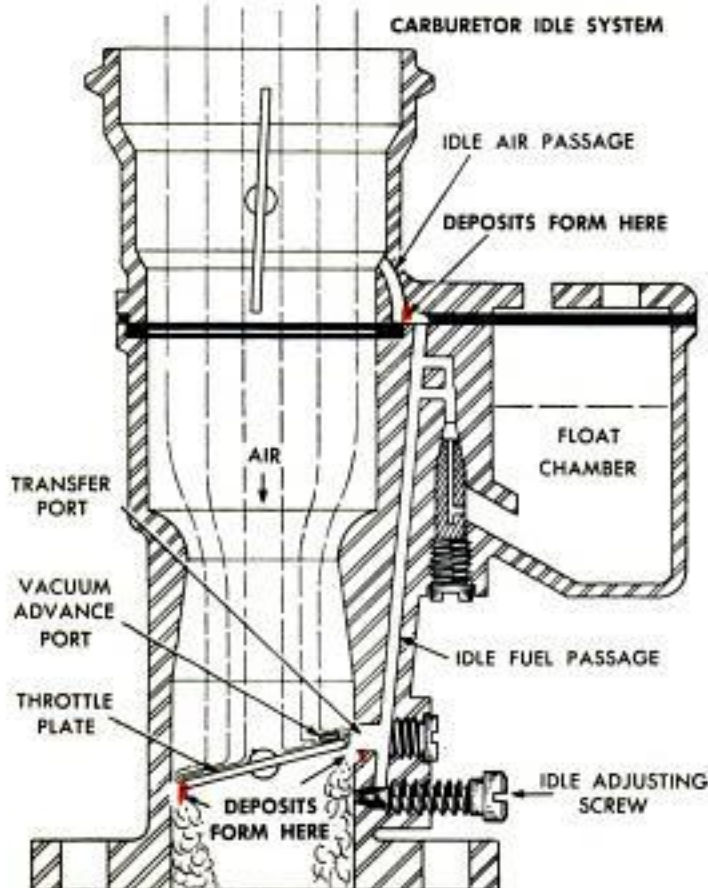

Of course smog is not caused by inefficient automobiles alone. Air pollution results principally from the various combustion processes required by civilization. Depending on local industries and fuels, the things that cause smog may vary.

It is estimated that the 5,000,000 people in the Los Angeles area burn about 58,000 tons of natural gas, fuel oil, gasoline and rubbish every day. This enormous amount of combustion plus some contaminants from industry results in the daily discharge into the atmosphere of about 3000 tons of pollutants. This is exclusive of carbon dioxide and carbon monoxide. Of this total, more than 1000 tons are produced by motor vehicles. Another 400 tons reportedly arise from gasoline refining and marketing operations. The more than 1,000,000 backyard rubbish incinerators produce another 500 tons of smoke and gases.

Normally, all products of this combustion are dispersed by the winds. Principally from July to November, however, there are times when a temperature inversion clamps a lid over Los Angeles. Then the air 500 to 4000 feet above the surface becomes hotter than at the ground. Combustion products can't rise through the hot air. The occasional lack of wind, plus the mountains to the east, makes the condition worse. Until the inversion ends or lifts to a higher altitude, Los Angeles must breathe and rebreath a limited supply of air.

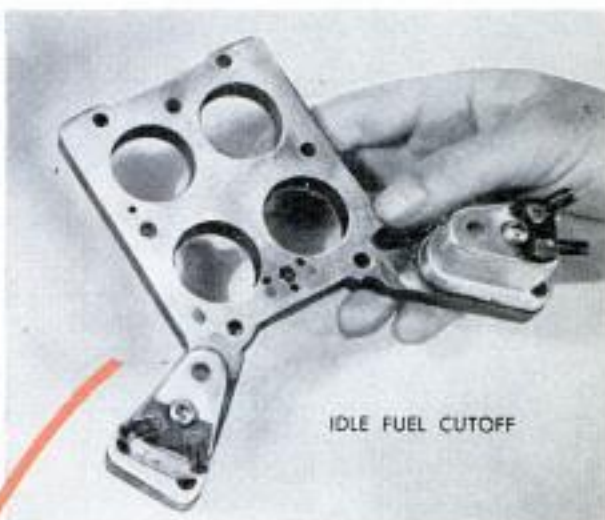
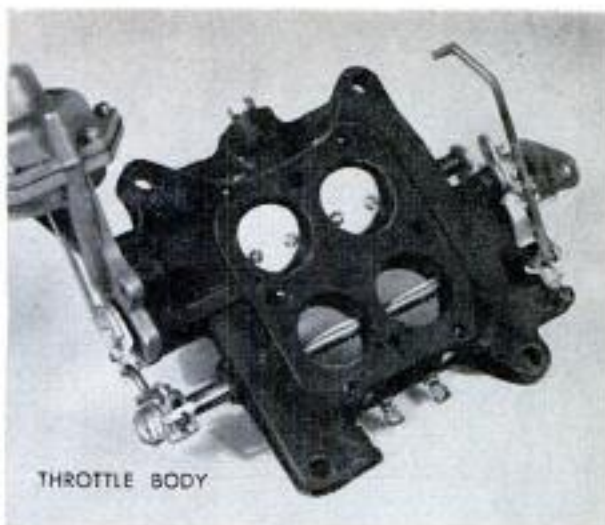

Idle fuel cutoff is installed below throttle body in experiments by Chrysler Corp. It reduces unburned carbons in exhaust gas by bleeding air into carburetor vacuum. Tests may determine whether this will cut smog

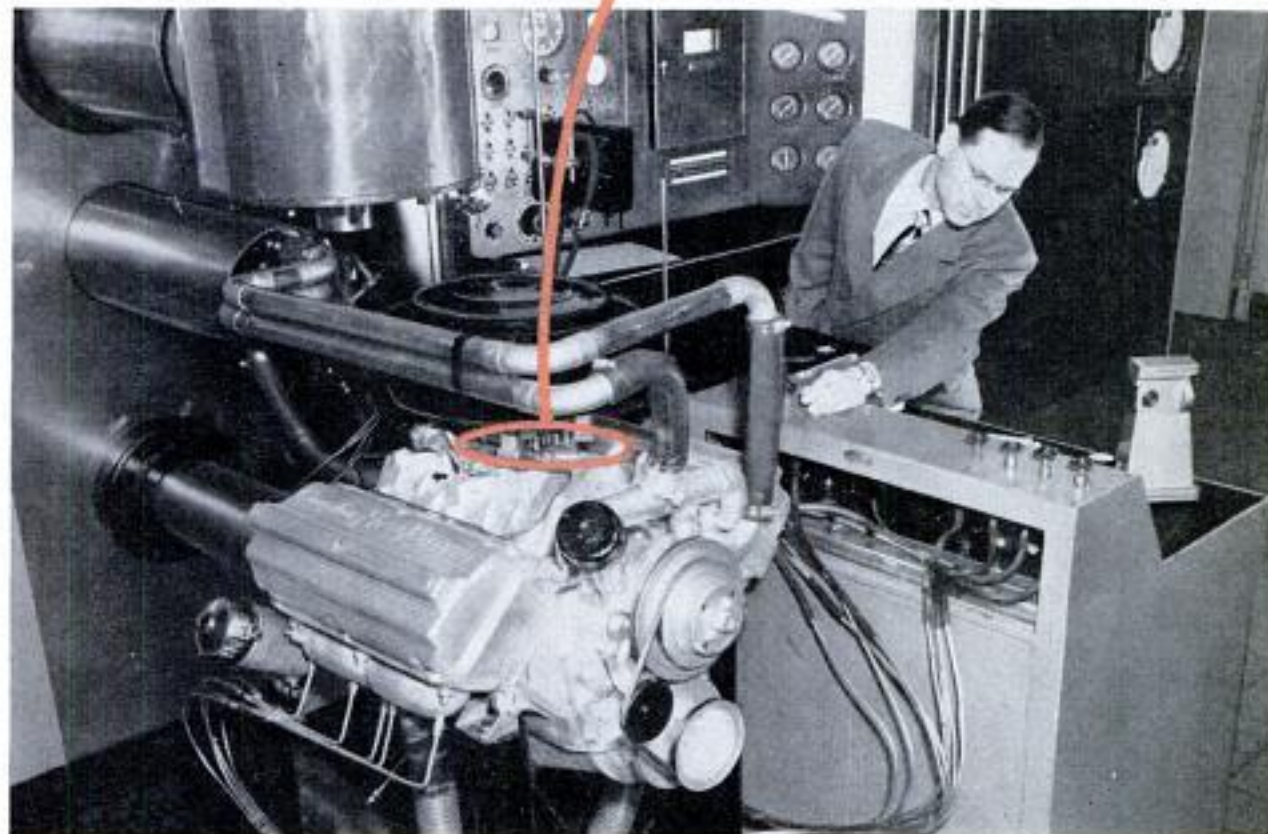

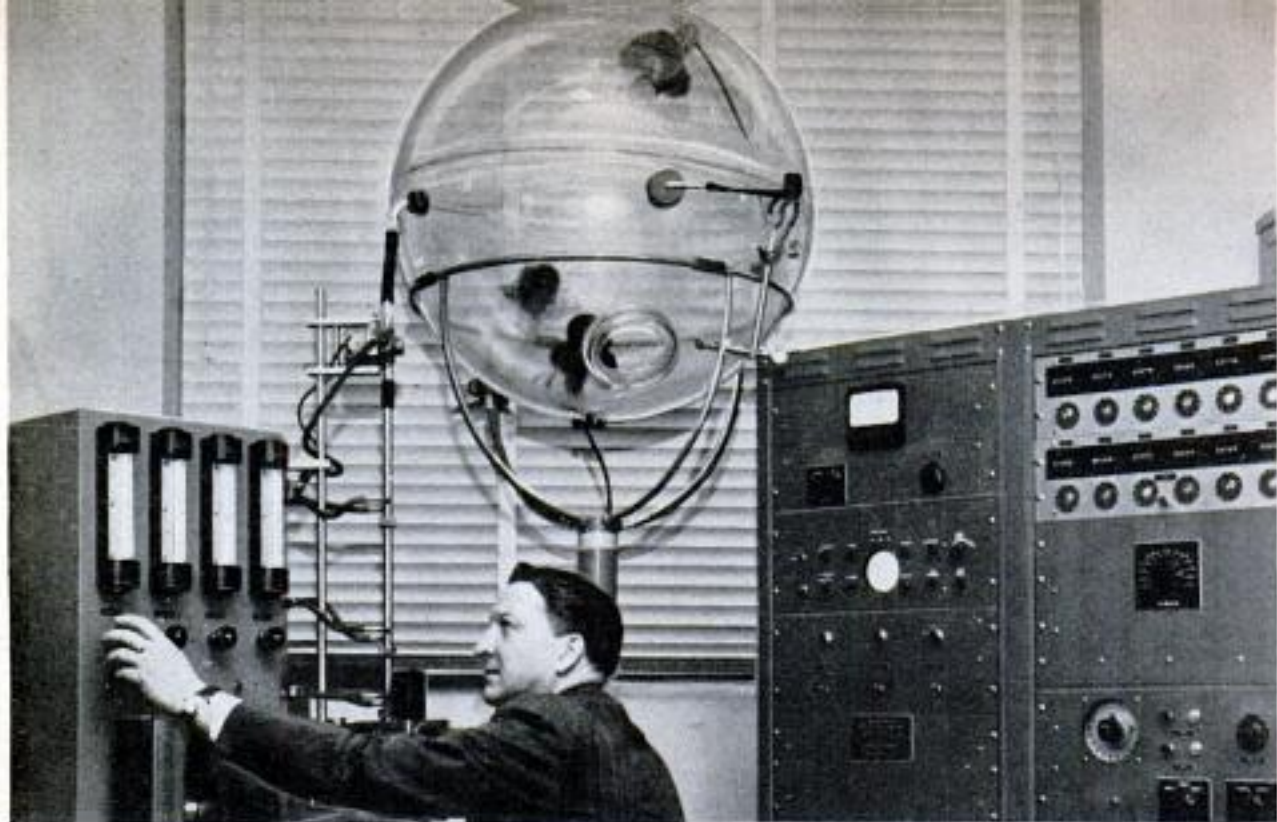

Plastic bubble with attached instruments not only can count airborne particles but also can measure their size. Below, jars filled with exhaust gases are exposed to sunlight, which changes exhaust into ozone



The inversion has been compared to an umbrella held over a person smoking a cigarette. When the umbrella is high overhead the smoker enjoys his cigarette; when the umbrella is lowered to his shoulders he suddenly finds that he is choking in the smoke. One solution is to stop smoking. Yet this is something no large city can afford to do. Cities exist on their industries.

(Continued to page 250)

Exhaust is pumped directly from car into greenhouse to determine effect of automotive smog on growing plants

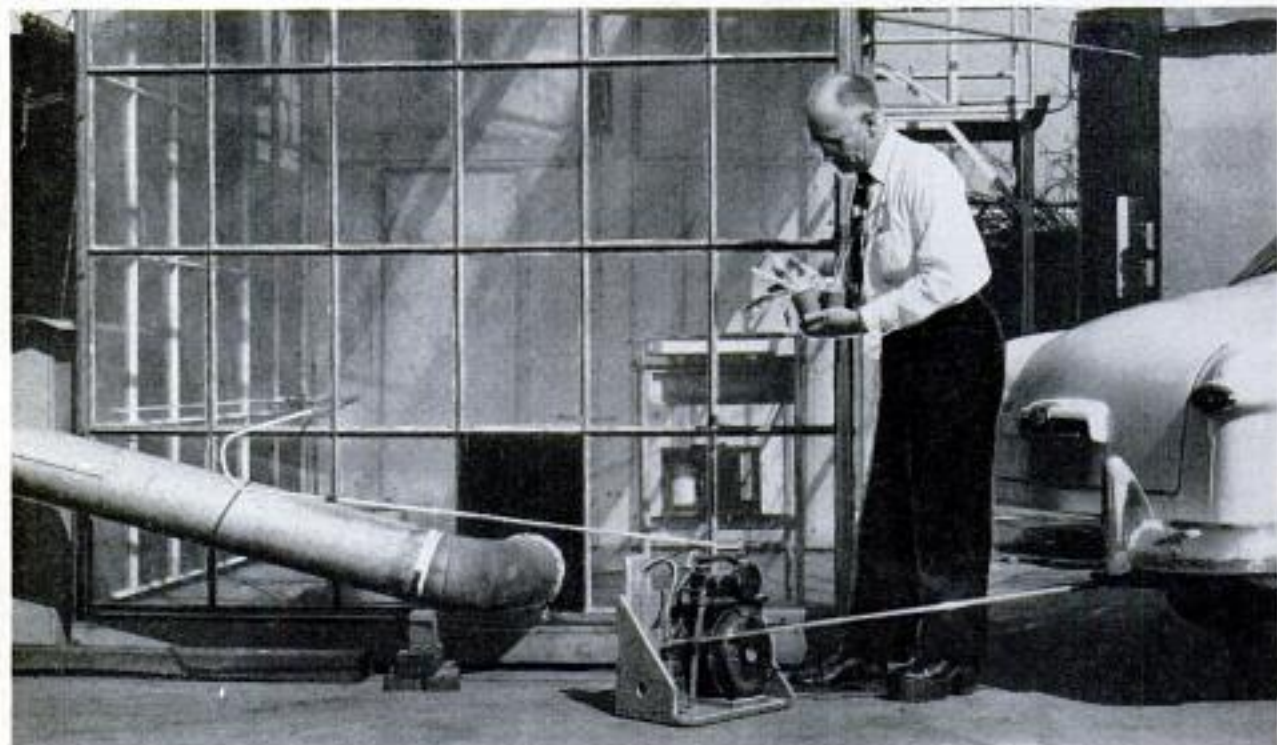



## Miniature Cabaña Shields Bathers

Sun in the eyes and sand in the hair are eliminated for bathers by a portable sunshade and headrest. A little awning adjusts to any angle to control the amount of shade on the face. The head shelf is also adjustable. Beneath it is a glovelike compartment to hold suntan lotion and other odds and ends. The sturdy metal frame of the sunshade folds up to act as a handle for the combination unit which comes in bright colors.



## Fastener For Walls Clinches Behind Plaster

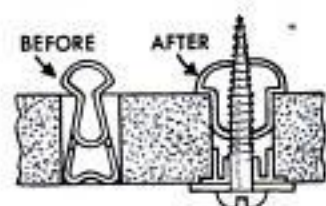

Curtain rods, pictures and other items can be anchored solidly to plaster walls with a new fastener. The fastener anchors

itself in any wall from  $\frac{3}{8}$  to  $\frac{3}{4}$  inch thick. An awl is used to punch a hole in the wall. A screwdriver with a  $\frac{1}{4}$ -inch blade is used to ream out the hole. The fastener is inserted and tapped flush. Driving home the screw causes the fastener to clinch against the back of the wall and expand to fill the hole.

## Diamond-Producing Press Forms Genuine Garnets

Garnets have been produced synthetically by the same General Electric Research press that recently formed man-made diamonds. The precious dark-red stones were made by subjecting hornblende to a temperature of about 2200 degrees Fahrenheit and pressure greater than 375,000 pounds per square inch. Garnets in the natural state are found in beds of hornblende, a green mineral. Dr. Robert Wentorf, Jr., the scientist behind the venture, found it necessary to dehydrate the hornblende by chemical means before the garnet crystals could be produced. Wentorf has also reversed the process.

## Plastic Eyeshades Without Lenses Guard Against Reflected Glare

Plastic eyeshades that do the job of sunglasses but don't contain lenses are making a hit in resort areas. The eyeshades keep out glare and give you a clear forward view. Slots in the sides and tops provide ventilation and allow side vision. Adjusting screws assure a comfortable wearing position. The shades, originally designed for salt-water fishing where ocean spray fogs standard sunglasses, are also handy for golf, shooting, sunbathing and grandstand use.



## Liner Keeps Water in Ponds

Farm ponds, swimming pools, drainage ditches and irrigation canals can be built economically with a new lining material. The liner comes in rolls and provides a waterproof, rotproof base for a stream or pond. One side is coated with mica, the other with sand, to facilitate cementing.

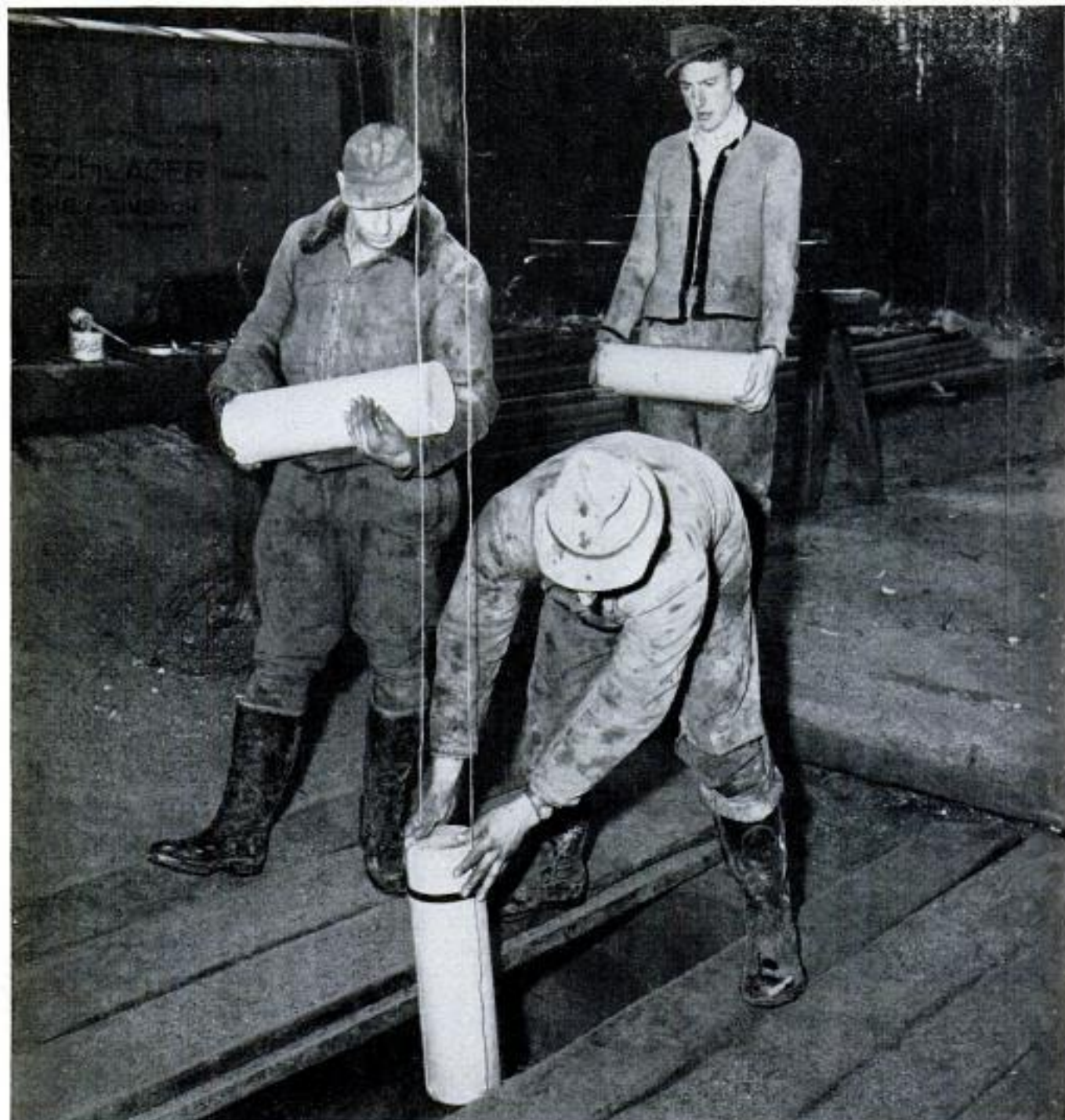

Workmen lower cylinders of powerful explosive into 1000-foot shaft where 4400-pound charge was detonated

To help German scientists prove Europe and Africa were one continent before there was a Mediterranean Sea, the U. S. Army Signal Corps staged an

## EARTHQUAKE BY REQUEST

By Pfc. Fred Weymer

**S**HORT-WAVE radio signals flashed across Western Europe one morning a few months ago. Seconds later, a massive charge of trihexogene exploded 1000 feet below the ground near Bad Tolz, Germany, sending a shock wave racing through sub-

strata rock toward the tentacles of seismographs in France, Germany and Austria.

Geophysicists from the University of Munich, assisted by the United States Army Signal Corps, set off the artificial earthquake to prove a famous and contro-

versial theory: Before the upheaval of the Alps, Europe and Africa were joined by land and there was no Mediterranean Sea.

The belief was born with the discovery of Heidelberg man, near Heidelberg, Germany, in 1907. The excavation which produced the lower jawbone of 500,000-year-old *Homo heidelbergensis* also contained the bones of tropical mammals. Elephants and rhinoceroses amazingly like modern African animals shared the half-million-year-old German grave. The animals had lived in the Pliocene period, when Europe was enveloped in a tropical climate. "It seems logical," says a Heidelberg geologist, "that as Europe cooled, the tropical animal life either migrated southward or became extinct."

Migration southward was ruled out by early geologists. To believe that the animals migrated to Africa was to suppose that the Mediterranean Sea was no barrier. And yet—why this amazing relationship between the African and European mammals? Was it pure chance, or had a passage existed between the two land masses?

The question lay dormant for years. Then, in the 1930s, scientists began to determine the age and origin of the Alps. The mountain range was young, they found, still in the process of upheaval. Its jagged peaks, not yet rounded by erosion, were still rising. The Alps' age? Five hundred thousand years, the age of Heidelberg man.

Here, perhaps, was a clue to the missing link between Africa and Europe. The rising of the Alps may have pulled a once-existent dry area of land away from Africa, creating the cavity which is today the Mediterranean Sea.

A puff of earth and rock, right, shoots 150 feet into the air as the charge explodes at the bottom of 1000-foot shaft. Map shows detonation point and seismographs that measured speeds of shock waves





Bavarian State Geologist Helmut Vidal talks by radio with one of the 49 seismograph stations. He is inside transmitter truck. Signal Corps Sergeant William Griffith operates a teletype

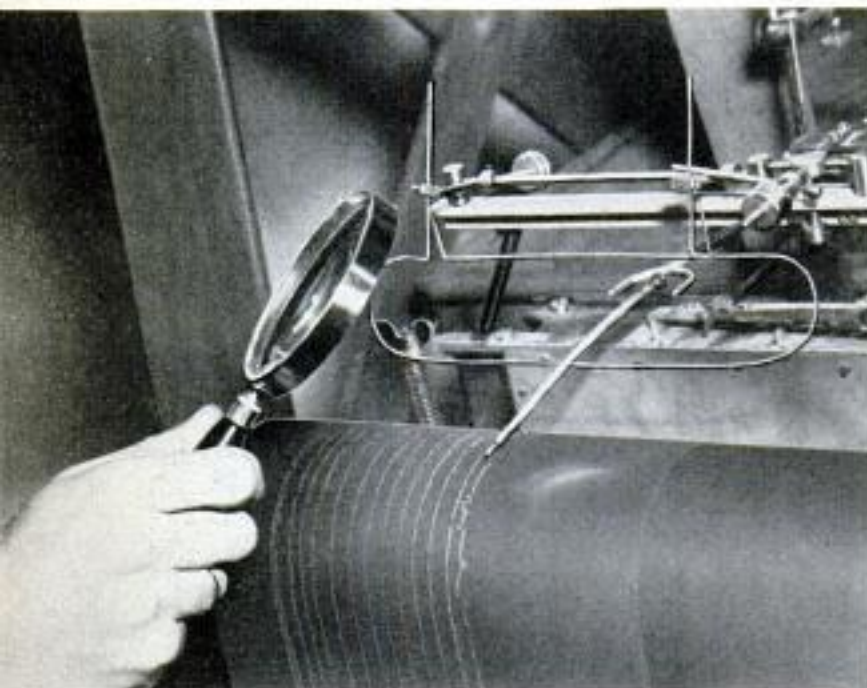

Wavy lines being traced by seismograph needle result from explosion many miles away. Length of time it takes for shock wave to reach seismograph indicates density of the substrate. Below, mobile radio transmitter was located at explosion site



Dr. Hans Reich, chairman of the University of Munich's Geophysical Institute, had planned and experimented for eight years to prove that Africa and Europe were once a single continent. With the assistance of the United States Army Signal Corps School in Ansbach, Reich and his associates staged an artificial earthquake. By metering the effects of the blast on well-dispersed seismographs, he hoped to determine the nature of the Alps' foundation. If Doctor Reich's theory was correct, the Alps' foundation would not be deeply embedded in the crust of the earth. It would be a superficial structure, of the same substance as the floor of the Mediterranean.

The Ansbach Signal School, under the direction of Col. S. P. Fink, began preparations for the test by placing 4400 pounds of trihexogene explosive 1000 feet down an abandoned oil well. Signal-school men were charged with erecting and maintaining a precision communications system between the Bad Tolz site and 49 seismographic stations within a 31-mile radius. By comparing the periods of time necessary for the explosion's impact to traverse the known distances from point zero to the various seismographs, the geophysicists would be able to determine the structure of the area's ground formation. Shock waves travel at 8000 yards per second through the hardest rock and only 3500 yards per second through the softest. Precise timing was vital.

The most important functions of the American troops were to flash a signal forewarning the receiving stations of the exact time of the explosion and to synchronize with the detonation a split-second notification to activate all seismographs. Later it was found that an accuracy within  $\frac{1}{50}$  second was obtained.

Careful analysis of seismograph records indicates that a continuity does exist between the floor of the Mediterranean Sea, the surrounding dry land in Africa and Europe, and the Alps. The German scientists believe this supports their theory that the upward thrust of the Alps pulled surrounding land, especially on the southern side, northward and upward, leaving the Mediterranean cavity. ★ ★ ★

# TRAINLOADS OF TRAILERS

EVERY NIGHT hundreds of semitrailers are rolling between New York and Chicago—on railroad tracks instead of highways. "Piggy-back" freight transportation is not new; railroads have been moving their own trailers on flatcars for some time. Now the Pennsylvania Railroad has inaugurated daily service of this type for common-carrier trucks—those that belong to independent trucking companies. The trucker's own tractor delivers the trailer to the loading dock. There it is backed aboard the train. The special 75-foot flatcars have hinged bridges which swing down to fill the gap between cars during the loading. The fully loaded train carries 100 trailers. Leaving late at night, it makes the 903-mile run on a time schedule that assures early second-morning delivery of the trailers at the other end of the line. There the trucking company picks up its own trailers for immediate delivery of the freight or for transfer to its own terminal. The railroad has built terminal facilities for parking, weighing, loading and unloading of the trailers at Chicago and Kearny, N. J., at a cost of about \$400,000.



Trailer is backed right up terminal ramp and onto the flatcar, then down length of train to its own berth on one of the special cars

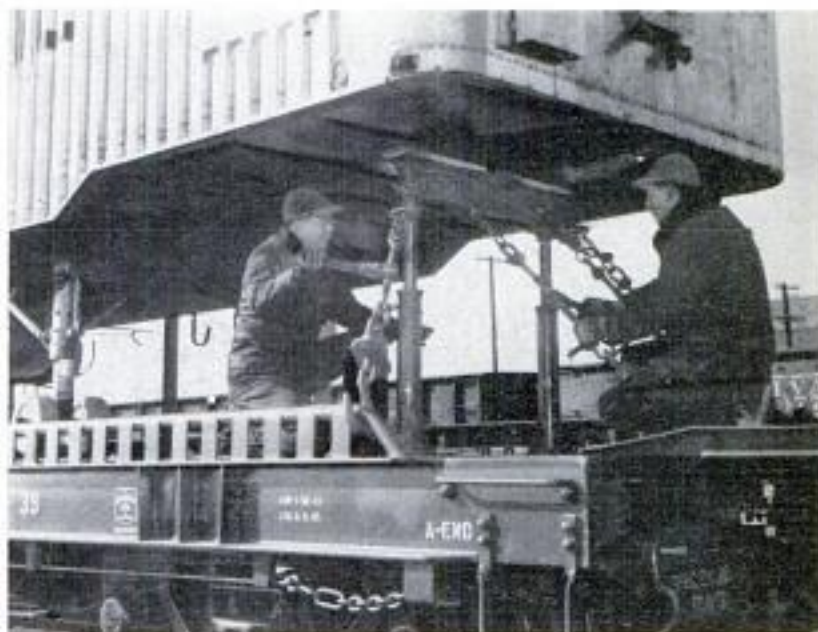

Steel jacks support the front end of each trailer. Eight chains, four in front and four in rear, anchor the trailer frame to the guard rails on the flatcar. Steel chocks immobilize the wheels. Below, solid trainload of trailers reaches destination after 903-mile run





Gunite pool fits beautifully into grounds. Back wall of the pool forms a terrace at the rear of the home

## ***A Pool for Your Back Yard***

**By Richard F. Dempewolff**

**M**Y WIFE WILL BE BACK from a trip in time for her birthday this week and I want to surprise her with a 40-foot swimming pool. Acorn shape. How about it?"

This question recently was put to Herman Silverman, president of Sylvan Pools in Doylestown, Pa. Consulting his calendar, Silverman did some fast calculating. "Sure," he replied. "Why not?"

Next morning a crew of Sylvan men arrived on the site and began digging and shaping the huge excavation. A day later

a second crew was scrambling around the hole, welding reinforcing rods into a big mesh basket. On the third day a steady stream of trucks rumbled in with "hard pack" concrete in a stiff mix that kept a 15-man mortar crew jumping. The stuff set almost as fast as it was worked into place. And on the fourth day the big, one-piece, reinforced-concrete pool—complete with waterproof-wrapped presents bobbing on crystal water—was ready for occupancy and the birthday party. The bill? Well, there are automobiles that cost more.

Sections molded of glass fiber are bolted together and lowered into an excavation to form a 30-foot pool

SCINDER-ELLA  
↓

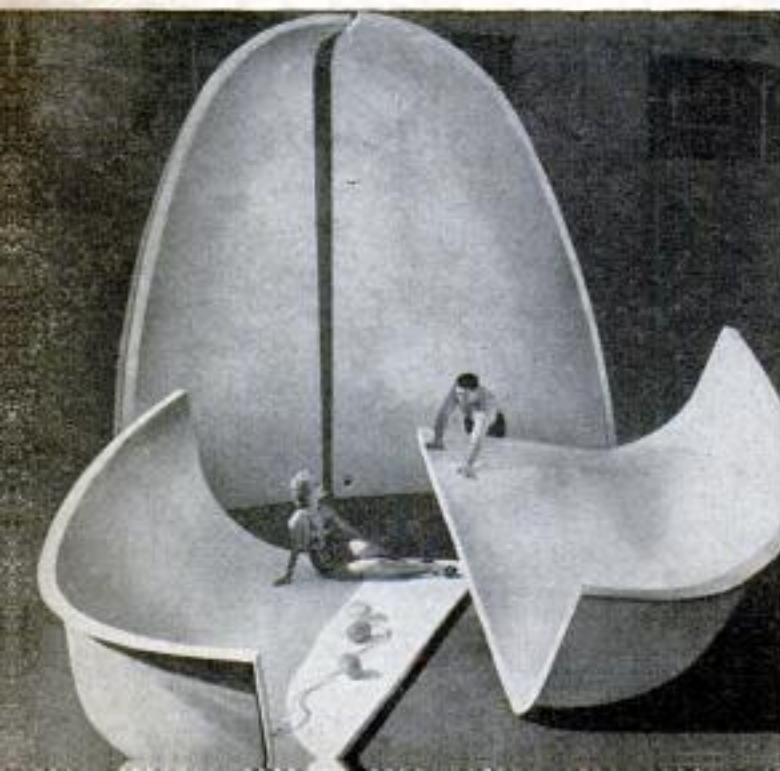

Copyrighted material

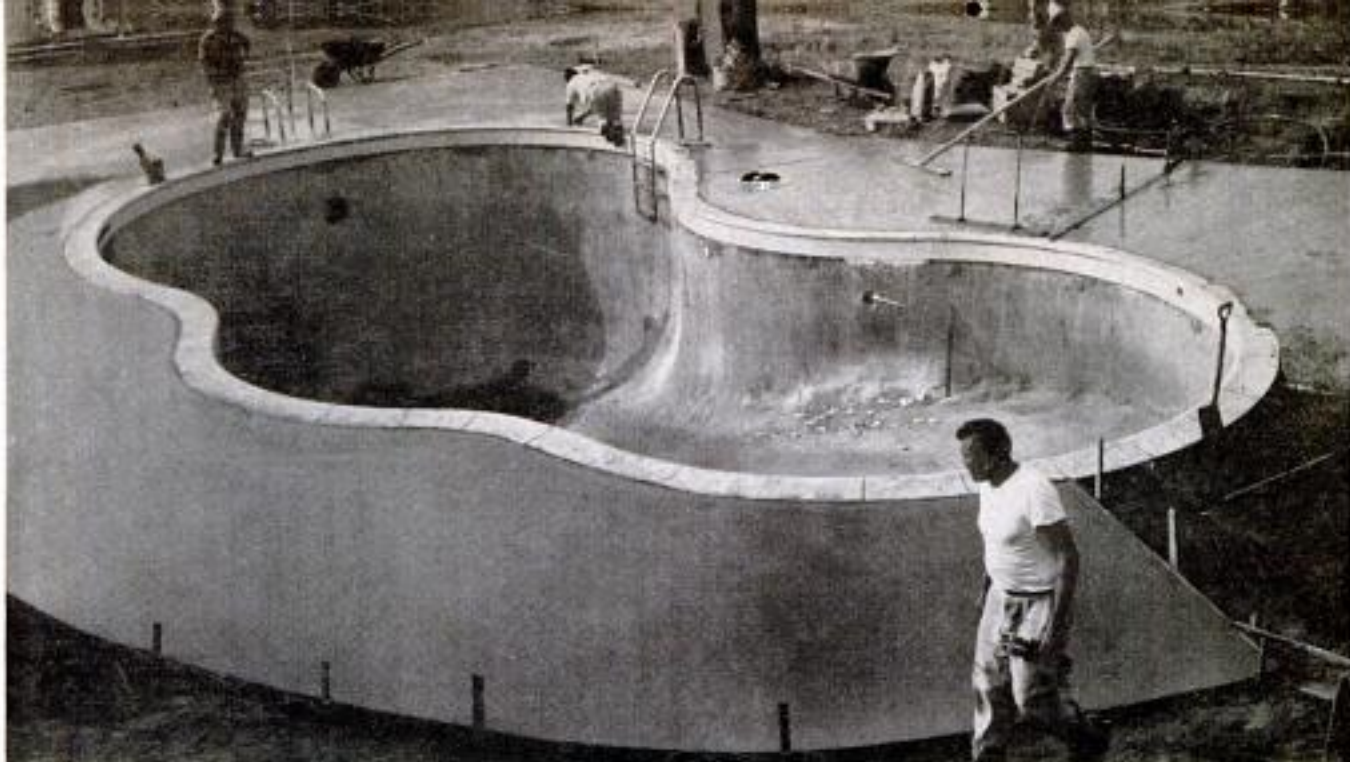

Typical low-cost, free-form Gunite pool is finished off with a coping and a broad deck around the edge

Today the luxurious private swimming pool you've dreamed of putting in the back yard may not be as much of a daydream as you think. New miracle materials and speedy techniques (many introduced this summer for the first time) have so simplified building and cut costs that residential pools are springing up across the country in a record aquatic free-for-all. Nearly 10,000 dunking enthusiasts acquired private "swimming holes" last year, according to *Beach and Pool*, the industry's publication. Silverman and some 350 of the nation's other pool builders calculate that before 1955 runs out they will have nearly doubled the 28,000 pools now existing in this coun-

try. Most will be in back yards. Most will cost about the price of the family car. A typical West Coast price list for a Gunite concrete pool installed complete with coping (rim edging), diving board, chrome ladders, filtration system, skimmer and tile trim, reads like this:

Size	Cost
15 by 30 feet	\$2900.00
18 by 36 feet	\$3250.00
20 by 40 feet	\$3400.00

Right, dry sand and cement come through hose under air pressure in Gunite system. Nozzle adds water and sprays concrete over reinforcing rods

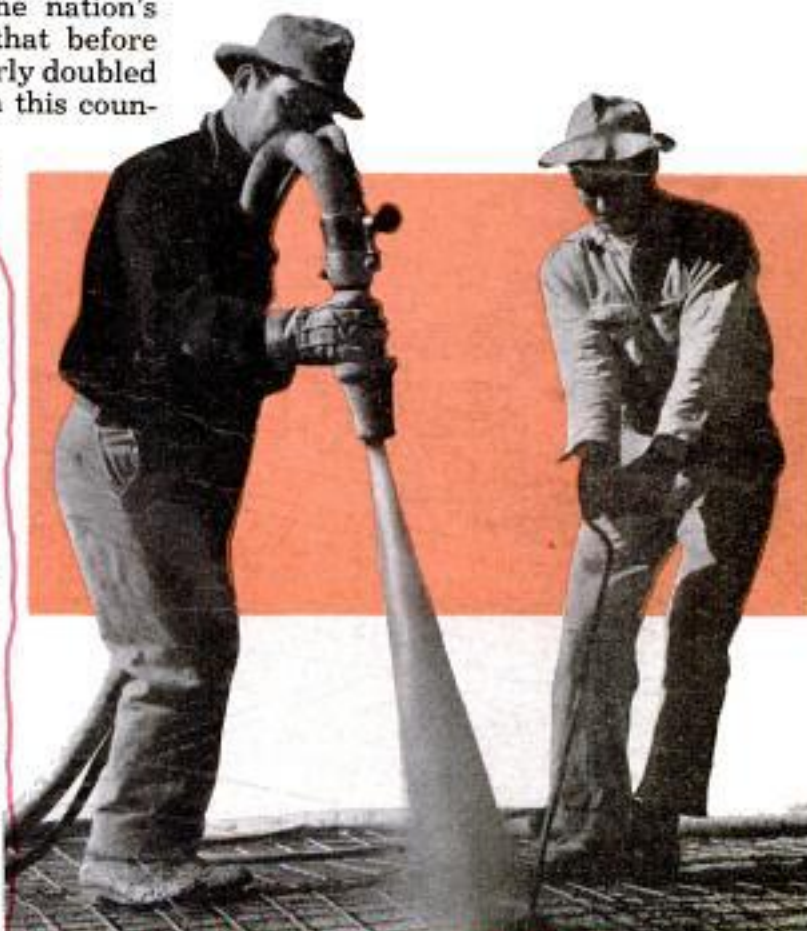

Beach + Pool + Swimming  
425 4th Ave.  
N. Y. 16, N. Y.

Copyrighted material



Prefabricated aluminum pool is delivered by truck to your back yard and lowered into place by crane. Backfilling and paving result in pool shown at left



In the East, where the pool craze is just beginning to produce the volume that brings prices down, the same pool with all the fixings would run an extra \$1000 or more.

But these figures merely hint at "what's cooking." They refer to only one type of popular pool. You can pay more or a lot less. This year's swimming-pool parade has a dizzy assortment of sizes, shapes and

Here's a typical filter and skimmer installation for a large pool. Skimmer pulls off floating objects and filter takes foreign matter out of water itself

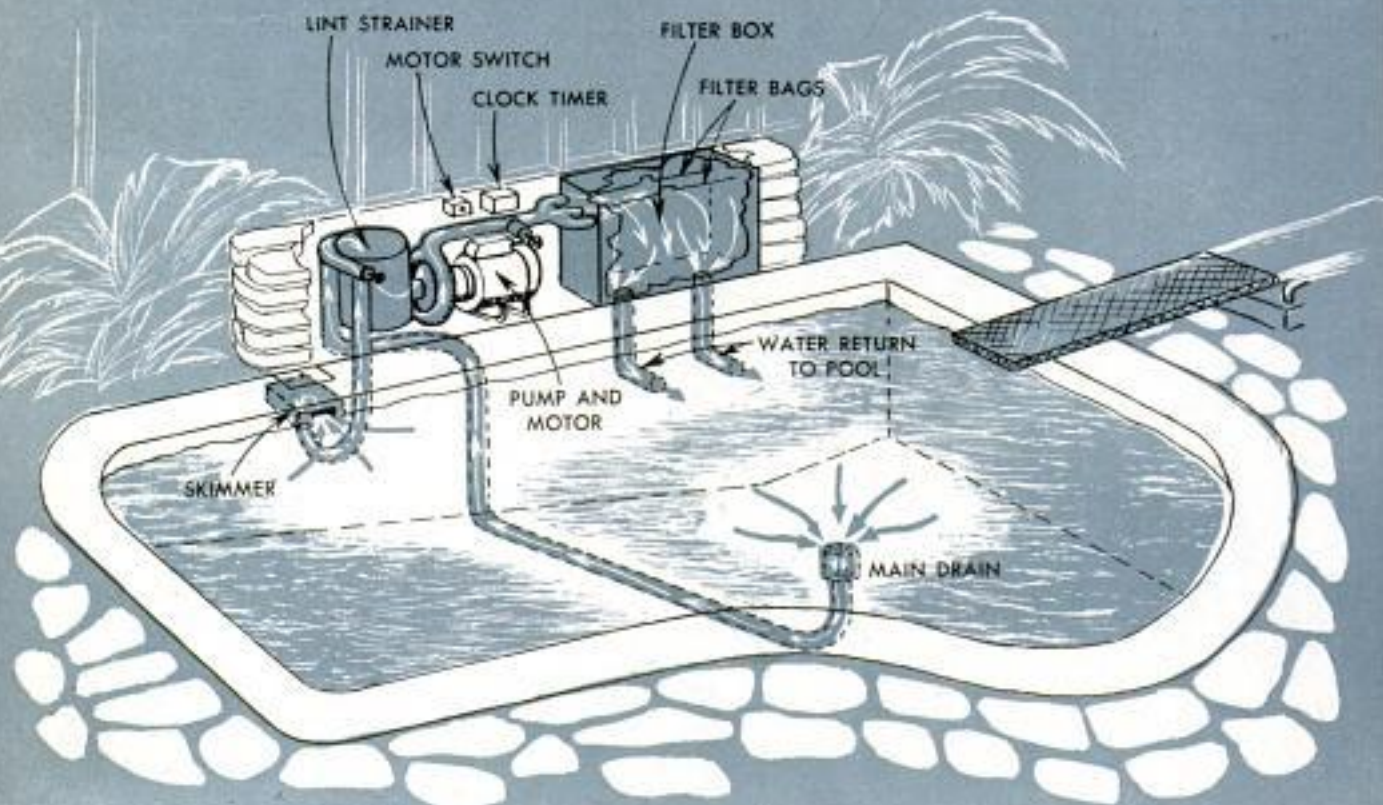



You can build this pool for less than \$1000 if you do the work yourself. The foundation, right, is built either of concrete block or wood framing. Boards are bolted to top of foundation to hold the plastic liner. Liner, below, is available in sizes up to 20 by 40 feet, with ready-made ports for underwater lights and the drainpipe. Heavy pipes slipped through the hem of the liner hold it in place. Resulting pool, bottom, costs less than most pools built by contractors—but the water feels the same!

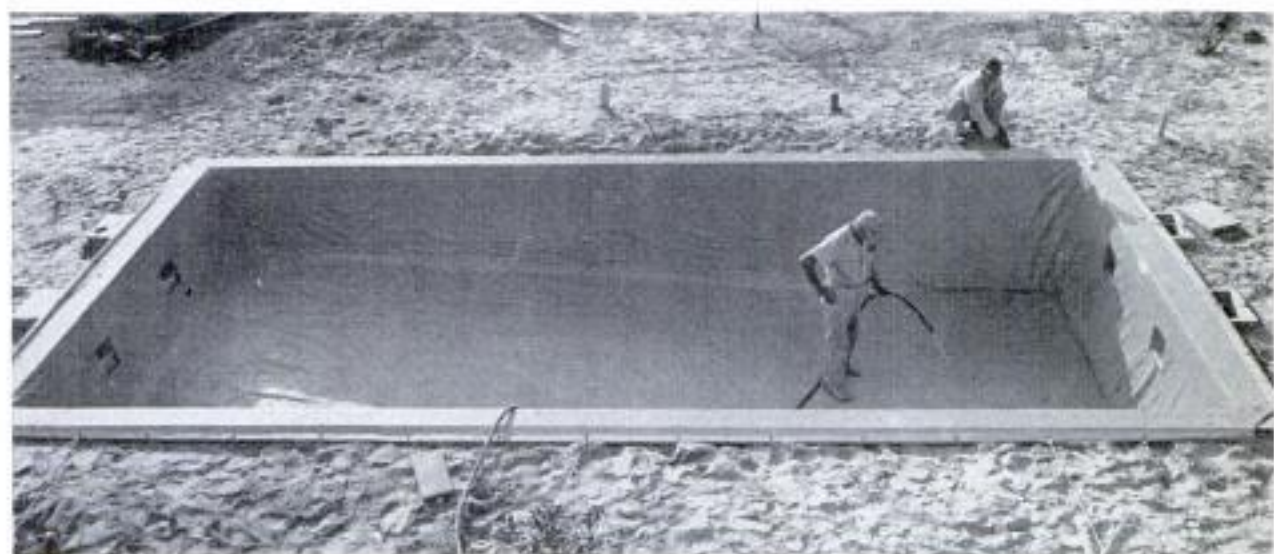
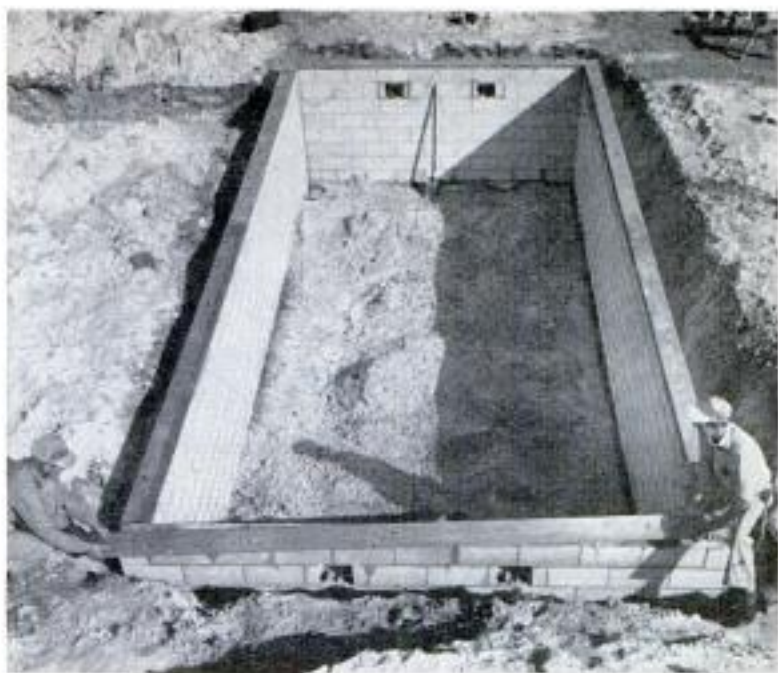

wonder materials. Some will ride piggyback to your door in one piece or several. Others may be sprayed in place, hoisted in place, punched in place, painted in place or unfolded like a blanket.

In Los Angeles, a brand-new glass-fiber pool developed by Anthony Brothers is being prefabricated in one gigantic oval chunk—34 feet long, 16 feet wide, with a 7-foot depth at the diving end. Delivered to your site on a flat-bed trailer truck, it is hoisted into a prepared hole that has been molded to pool-bottom contours. Plastic pipe connects it to the water supply, drain and filter systems. Then the hole is backfilled and you're in business. The whole process



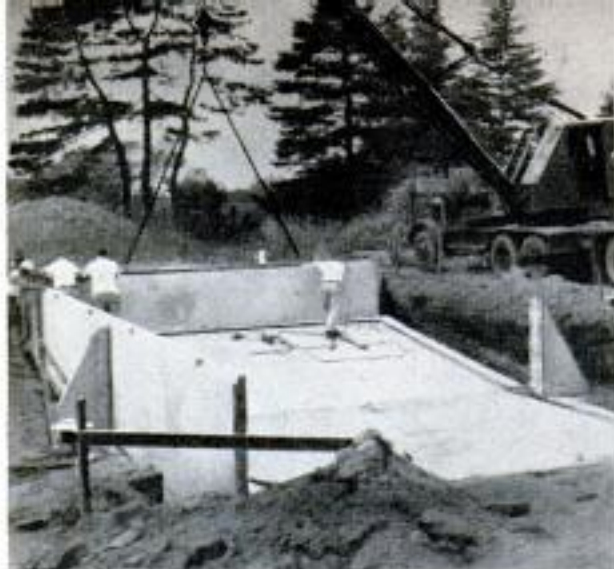

Floor of another type of pool is poured at the site, but walls are precast slabs bolted to heavy buttresses

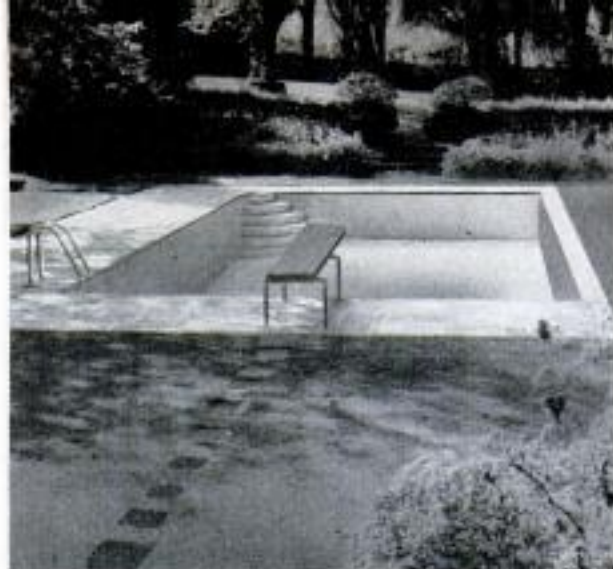

Precast steps are set in place and a deck poured. Deck of any pool has a big effect on its appearance



Plastic pool in a small size can be built for less than \$500. Liner is fastened inside a wooden frame

takes three or four days, and cost runs about a third less than a similar-size pool in concrete.

Another glass-fiber pool comes rumbling by truck up to your door in four mammoth sections, nested like a pile of giant saucers. Included in the package are a filter system, color trim for the rim, gaskets, bolts and a repair kit. Called "Cinderella," and produced for national distribution by California's Paddock, this 15 by 30-foot phenomenon is assembled on a scaffold above the hole and lowered into it after all connections are made. It, too, takes a crew of men about four days to install at a cost considerably less than concrete. The makers like to point out that it's rustproof, can't pit or chip and needs no paint. They claim it will last a lifetime if properly maintained.

These aren't the only eye openers in the

Here's the tot's wading pool grown up! Plastic tank 22 feet in diameter has sides of plastic-coated steel wire

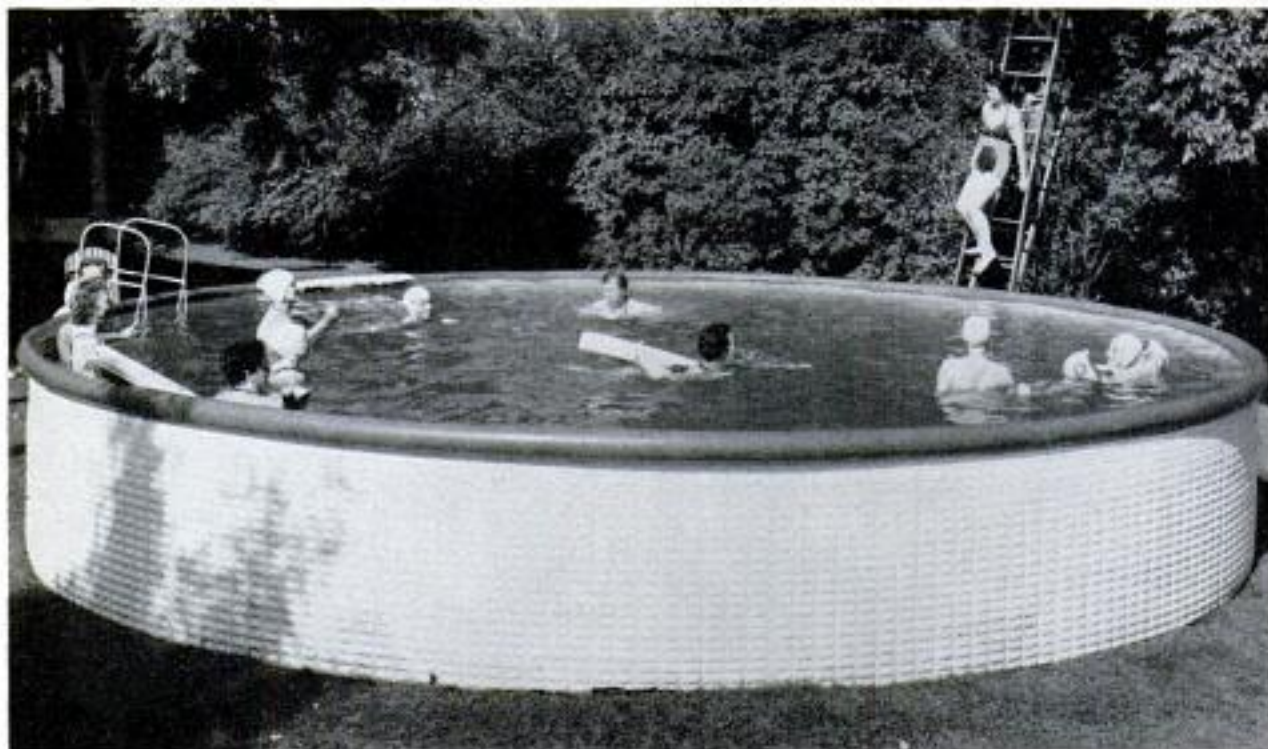



Indoor-outdoor pool is popular on the West Coast. Outdoor side of this one is covered with glass-fiber canopy

swimming-pool business. Your big 20 by 40-foot pool may come in a cardboard carton no bigger than the case in which a table-top TV set is delivered. That's the way the new Bilnor Bakelite pool lining is packaged. It fits right into a prepared hole that can be buttressed either with concrete blocks—like a house foundation—or with plain wood framing, depending on how permanent an installation you want. If you build the foundation and support work yourself, this type of pool can be installed for well under \$1000.

For the man with swimming-pool ideas and a bathtub pocketbook (\$350), Doughboy Industries has a new inflatable plastic family pool that sits in a circular cage of wire mesh to keep it rigid. Actually, it is a big version of the wading pools that have become a familiar sight in American yards.

(Continued to page 240)



Indoor side of the pool has steps that lead up into the carpeted living room. There is a boom in these elaborate pools as well as the less expensive ones

Pool with dog-leg shape was fitted into a very small area behind the home, with room left for a garden

Douglas M. Simmonds photo



# Detroit Listening Post



By Leo Donovan

**I**T MAY BE vacation time for you, but in Detroit the tool-and-die shops are working feverishly turning out the tools that will stamp out your 1956 car.

Deadlines are earlier in most cases this year because all car makers are intent on getting to market before mid-December.

Chrysler and Imperial dealers were advised to get their orders into the factory by July 1 for the cars they expect to sell through mid-October. They were told that the 1956 models will be out around November 10, a week earlier than last year. Dealer previews are expected early in October.

Because the industry spent so much on tooling for 1955 models, some observers felt that changes in 1956 would have to be so-called face-lifts only. They reasoned that 1955's new bodies and engines would have to be amortized through the 1956 models—but it's not coming out quite that way.

Tooling costs for some lines of 1956 cars will be upwards of \$100,000,000. And a considerable amount of face-lifting surgery can be had for that kind of money.

## Rumors About Studebaker

Studebaker, a brave, front-runner in styling since the end of World War II, is expected to be among the first out with its 1956 line. And the new styling is said to be markedly different from its predecessor. Some sources predict that Studebaker is dropping the graceful torpedo lines and is going to a higher hood and rear-deck lid to look more like the rest of the industry. However, these same sources promise, it will still retain some of the delicate "Italian-ish" styling that was so loudly acclaimed when it was introduced.

The rumor also is that the new hood will feature a forward-placed ventilating cowl and that the front grille will be a large oval.

If you want more gossip, the story is that Ford will make available three different types of wrap-around windshields next year and that the sweeppear chrome molding of the Fairlane line will be moved to the rear a little (more like the Dodge per-

haps?). The instrument panel is said to group all dials within a single cluster.

Chevrolet undoubtedly will have a new grille, although the company insists that the public has not objected to the simplicity of the current egg-crate Ferrari-like grille. Chevrolet will probably introduce a four-door hardtop of its own. It is also expected to put up a stronger battle with Ford for the station-wagon field.

## Four-Door Hardtops

More than Chevrolet will be introducing four-door hardtops in 1956. It looks as though everybody will have one, if tool-and-die deadlines are met. Chrysler's model will be strengthened by a huge U-shaped aluminum structural member under the front seat. It is rumored to be one of the largest aluminum pieces ever used in an American automobile.

Chrysler divisions from the Imperial down to the Plymouth are probably going to switch over to the 12-volt system for 1956. The Chrysler stylists have been working hard again this year and they promise surprises even after 1955's all-new look.

Torsion-bar suspension, reintroduced to the industry by Packard this year, may possibly be adopted by others in 1956 or 1957.

There will be marked improvements in transmissions and brakes for 1956, but for the truly big sensations there you'll have to wait until 1957 or 1958, say the experts.

At one test track recently, a car equipped with experimental brakes was stopped from 80 miles per hour within an amazingly few feet and without the customary panic-stop lurch so common to present brakes, one source reports.

Colors are not expected to be any more subdued in 1956 than this year, but some manufacturers, listening to dealers complain that they can't move certain two and three-tone combinations, may lessen the variety. Ford and some other companies have already dropped some of the more extreme hues from their offerings.

And in place of costly color-harmonized interiors, at least one manufacturer will make available neutral shades as standard upholstery material—they will go with any and all exteriors. If you wish you can get the more colorful plastic upholstery but at extra cost.

Quietly and without fanfare, the American Motors' Metropolitan seems to be selling. The company has announced that it has ordered 20,000 more of them for delivery from the British manufacturer. This will bring the total number of Metropolitans imported into this country and Canada up to 40,000. That makes it the top-selling foreign-built car in this country, outselling even the fabulous Volkswagen.



## Where Stylists Are Kings—the Turin Auto Show

With a reputation for being the show where stylists reign supreme, the 1955 Turin Show didn't disappoint anyone. Italian designers and builders, and those of 13 other nations, put their newest creations on display at this famed exposition. The emphasis was on the long, sleek look. Sloping hoods and prominent tail fins were

common. One such design was the *Streamline* (below) by Ghia of Turin. Another exhibit was a Lincoln *Indianapolis* (above) with body by Boano of Italy. It has 225 horsepower and is said to have cost \$30,000. Three huge chromed exhaust pipes seem to come straight out of the front fender. The rear fender has a scooplike opening.



## Russia's 1956 Model Automobile Even Has an Automatic Transmission



Scheduled to go into full-scale production in 1956, the new Volga automobile will be built in the Molotov Auto Works in Gorky, Soviet Russia. The car is similar in appearance to many American and European cars. It is said to have automatic lubrication, automatic transmission and a rear seat that forms a bed.



## CAMPING IN A VOLKSWAGEN

**T**HERE ARE CARS, and there are cars—and then there's the Volkswagen!

As one enthusiast described it: "The VW is not just a car, it's a disease. And a contagious one at that!"

Volkswagen sales are surprising everyone except persons who have driven the

Another Kombi model is an ambulance that will hold two stretcher cases, one sit-up case, plus attendant



homely German vehicle. In 1953, only 1200 VWs were sold in the United States. In 1954, VW sales totaled about 6000. Early figures for 1955 show VW dealers may sell 9000 in the first six months, as many as 15,000 for the year!

Everybody recognizes the beetle-shaped Volkswagen sedan, but the commercial models are less familiar. One of them is an eight-passenger station wagon-bus combination known as the Kombi or Micro Bus, depending upon the luxury you want.

An ingenious offshoot of the Micro Bus is the VW Camper—a camp on wheels. The two bench seats behind the driver are removed (it takes only a few minutes to loosen the wing nuts) and an extra-cost camping unit lifted inside. When opened the unit provides sleeping space for three adults, plus two or three children. There's a shelf for a two-burner gas stove, the tank of which tucks under the seat.

Other conveniences are a door-mounted wash cabinet and a clothing locker that sits on the rear shelf over the engine.

The beds are made up of foam-rubber mattresses and plywood panels. The same parts fit together to form a settee during the day as well as dinette benches for

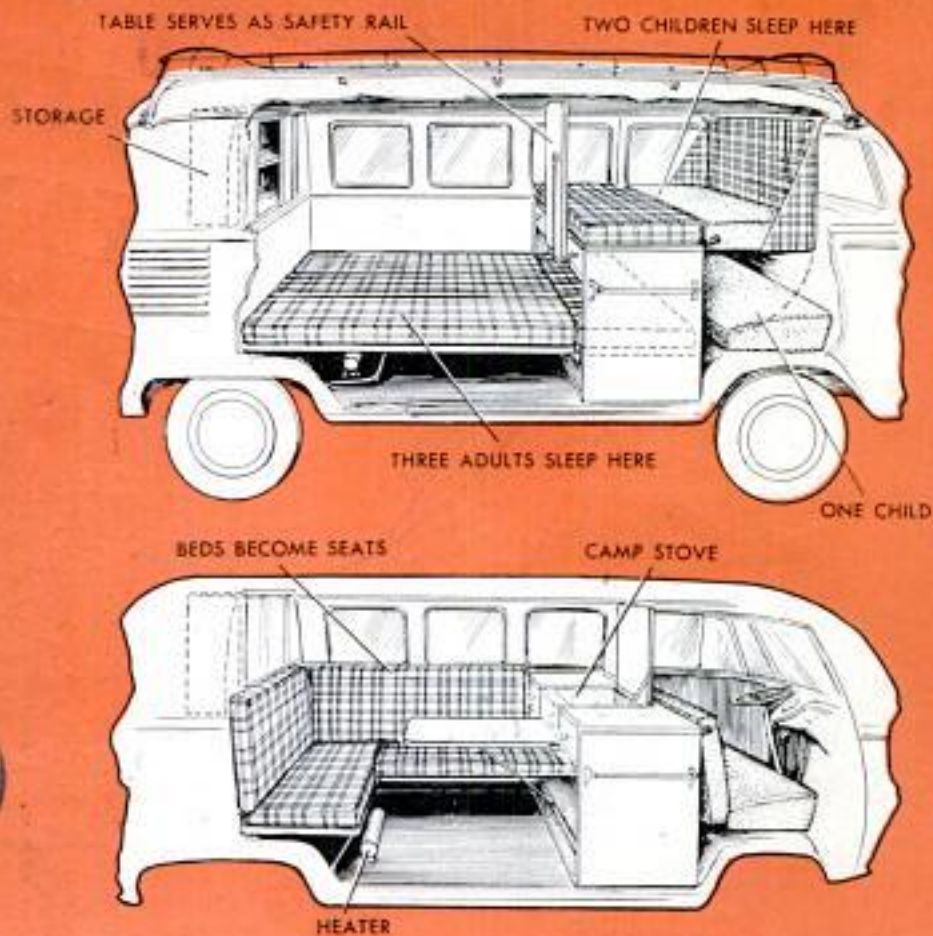

At left is Volkswagen's Camper. Cabinet on door holds washbasin. Sketches show day and night setups

meals. A colorful awning extends out from the roof, which has a big luggage rack.

What does such a setup cost? The Kombi itself sells for \$2095, delivered in Chicago (less at ports of entry), the Micro Bus for \$2195, and the Micro Bus De Luxe with a fold-back sunshine roof and other luxury features costs \$2745.

The camping unit complete with luggage rack, awning, washstand, clothes locker and other items lists for \$525. You can buy the beds and table alone for \$240, if you prefer to rough it a little.

Back cushion of the driver's seat lifts up and fits in curtain pocket to become mattress for child's bed

Power plant for the Micro Bus is the same as for the Volkswagen sedan: An air-cooled, four-cylinder, horizontal-opposed engine that hides in what Americans expect to be the trunk. Suspension is by torsion bars on all four wheels, each independently sprung. Top speed on a fully loaded Camper is around 50 miles per hour. Gas consumption is about 30 miles per gallon. What about spare parts? Take along an extra fan belt—that's all you need. VW engines normally go 100,000 miles without an overhaul! ★ ★ ★

Dining table swings up to act as a safety rail for children (top of page). Drawers hold dishes, cutlery

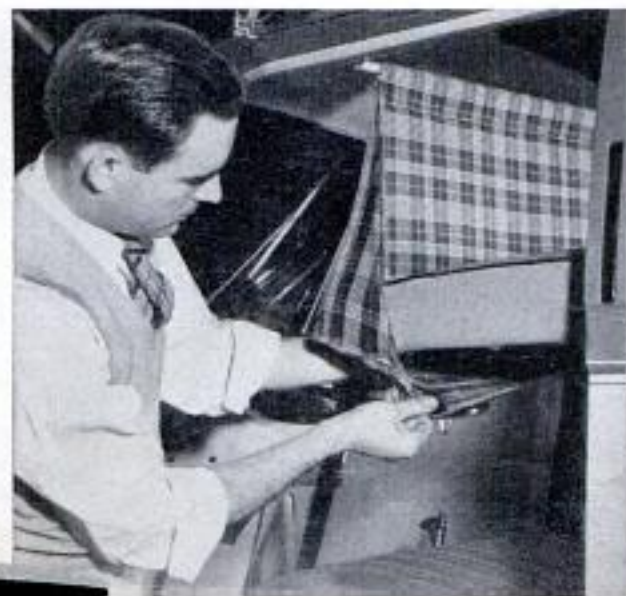

# OWNERS REPORT ON THE FORD V8



## ***They Like Its Power:***

"I like the added power -- there seems to be no end of it."

*Oregon machine operator*

## ***And Its Styling:***

"I like the two-tone paint and chrome styling. The bright colors are sensational."

*Washington, D.C. housewife*

## ***They Don't Like Rattles:***

"Body is poorly assembled which causes many rattles throughout the car."

*Georgia store manager*

## ***And Door Operation:***

"Can't get front doors to close without slamming at least twice. Rear doors close fine."

*Texas telephone worker*

Road tests alone can't tell the whole story of a new car. You've got to use it for weeks to learn its good and bad points. PM asked 1000 owners about the 1955 Ford. Here is what they told us





Best-liked feature, say the owners, is Ford V8 performance—its ability to take steep hills in stride

## OWNERS PRAISE FORD'S POWER, STYLING

*By Ford Owners*

**W**HY DO PEOPLE buy Fords? What has made it the top seller so far this year? We asked 1000 owners of the 1955 Ford these and other questions.

The most-frequently given reason why owners bought a Ford is its styling. They like the way the car looks.

"The thing that convinced me to buy a

Ford was the new design with its outstanding colors."—Arkansas millwright.

And many others agreed. In fact, 27 percent of the owners in our survey list styling as the single thing that most convinced them to buy Ford. Second most-frequently mentioned reason is past experience with Fords. The third reason is financial—the

## CLYMER TESTS THE FORD V8



**T**HE CAR TESTED was the Fairlane V8 Fordor sedan with Fordomatic transmission and power pack, which includes the 8.5:1 high-compression head, dual mufflers and four-barrel carburetor. It develops 182 horsepower. The test was from Albuquerque, N. Mex., via Taos to Denver, Colo., a

*By Floyd Clymer*

total distance of 417 miles.

The new V8 engine of 272-cubic-inch displacement is 33 inches larger than the 1954 model. The OHV engine is oversquare, with a 3.62-inch bore and 3.30-inch stroke, resulting in low piston speed and low wear.

(Continued to page 234)



Retouched photograph, above, demonstrates how Ford's rear-view mirror has a double-swivel action to adjust to fit any driver



Above, some owners report that the wrap-around windshield design causes them to bump their knees on the doorframe when getting into the front seat. Below, Clymer roughs up the Ford a little! He rates its roadability and handling above average



Ford dealer came up with the best deal or trade-in allowance.

"I bought this Ford because I drove my 1953 Ford 44,000 miles with no expense except tune-ups. Never added any oil."—Georgia owner.

"I got a wonderful deal. The Ford dealer gave me \$1495 for my 1953 Chevrolet."—Wisconsin stockbreeder.

What do the Ford owners like most about their new cars? The majority of them (59 percent) say power and performance.

"We just made a 1000-mile trip. I drove from 95 to 110 miles per hour much of the way and it never seemed to hurt it a bit. You can drive it at any speed to 110 and it handles well."—Montana carpenter.

"My average speed on the highway is around 85 to 90. I have driven this car on a fairly level road with the speedometer showing 120. I drive a car hard and this Ford will really take it."—Georgia farmer.

#### What Don't They Like?

By far the most-frequent complaint is body rattles with 29 percent of the owners listing this complaint. Incidentally, 20 percent of the Ford V8 owners made no complaints at all.

"There are more rattles in this Ford than I had in my 1952 car after driving it for 2½ years. There is an awful squeak around the steering column which the dealer hasn't been able to get out as yet. The doors have large gaps around them and rattle very much."—Minnesota accountant.

Next on the list of complaints is gasoline consumption of the V8 engine. There are 18 percent who don't like this.

"After three trips to the dealer for service, chiefly on gas consumption, there is little or no improvement. I get 10.7 miles per gallon in the city and 13.6 on trips."—Kansas owner.

Third most-frequent complaint is the poor fit and operation of the doors. Seventeen percent mention this fault.

"Can't get the front doors to close without slamming at least twice. Rear doors close all right. Not satisfied with gasoline mileage."—Texas telephone employee.



## TEST DATA

1955 FORD V8 FAIRLANE  
Four-door Sedan with Fordomatic and 182-horsepower  
optional Power Pack

### Driver's Blind Spot

Farthest point 26'10"

Nearest point 17'5"

### Acceleration Test

¼ mile from zero - - - - -	17.3 seconds
½ mile from zero - - - - -	29.9 seconds
0 to 30 miles per hour - - - - -	4.9 seconds
0 to 60 miles per hour - - - - -	13.9 seconds
Top speed by speedometer - - - - -	112 miles per hour

The 162-horsepower model was about  
6 miles per hour slower

### Economy Test

#### Constant-Speed Mileage

At constant 30 m.p.h. - - - - -	21.1 miles per gallon
At constant 50 m.p.h. - - - - -	19.2 miles per gallon
At constant 60 m.p.h. - - - - -	16.9 miles per gallon
At constant 75 m.p.h. - - - - -	13.6 miles per gallon

#### Cross-Country Mileage

Albuquerque to Taos, N. Mex. (fast driving) - - - - -	14.9 miles per gallon
Taos to Denver, Colo. (over La Veta Pass, some snow, moderate speeds) - - - - -	18.1 miles per gallon

(Premium gasoline used)

The 162-horsepower model with 2-barrel carburetor averaged about 1½ more miles per gallon, using regular gas, than the above figures.

### Comparison with 1954 Ford

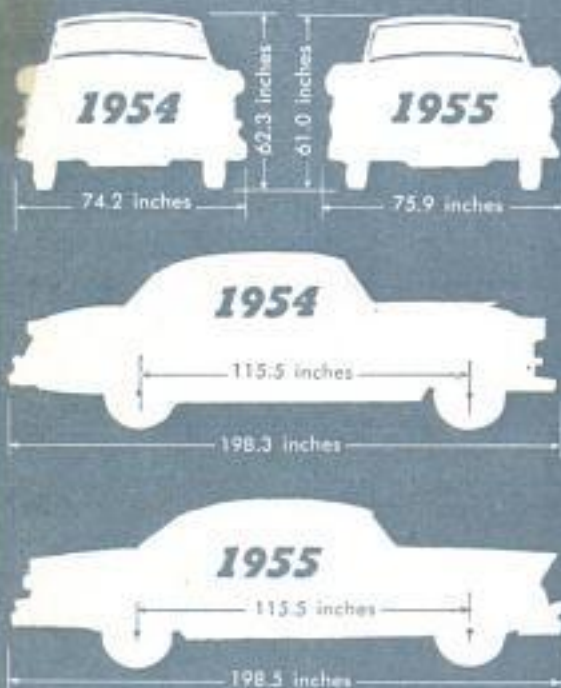

Road tests are fine, but the true test of an automobile is daily operation by the owner. That is why *Popular Mechanics* brings you two reports each month: 1. The Owners Report, a frank, uncensored resume of what the owners have learned about their cars; and, 2. a road test by the veteran test driver, Floyd Clymer

"In upper New Hampshire, our roads are not too good during the spring. Frost heaves make traveling very tough with lots of potholes, too. This Ford really irons out the bumps, makes riding a pleasure."—New Hampshire store owner.

"Holds the road at high speeds. Takes curves and mountains in marvelous fashion. Wish they could reduce the darting back and forth at slower speeds in power steering. It is not noticeable at high speed."—Oregon automobile mechanic.

The following quotations describe the other best-liked features of the 1955 Ford in order of frequency of mention:

"I like the interior styling. It relaxes a person to get into a stylish interior."—Rhode Island dairy farmer.

"Visibility is great. Can see all four corners of the car easily from driver's seat."—Illinois landscaper.

"The wrap-around windshield gives more visibility, but is blurry where it bends."—Utah engineer.

"Brakes are the best. No fading at all on panic stops."—Wisconsin truck driver.

"I like Ford's excellent dependability. Has given no trouble despite zero winter weather."—Utah farmer.

"Game wardens probably use a car harder than any other type of law-enforcement officer. We soon find faults after driving a car at high speeds on logging roads, in fields, through mud and snow. All in all, the Ford stands up well to punishment."—New Hampshire conservation officer.

"I like the very good automatic transmission. It is the smoothest."—New Hampshire Air Force member.

### Owners Like Bright Colors

There has been so much comment about the bright colors on this year's models (of all makes, not just Ford) that we asked the owners to comment on the subject. A whopping majority (87 percent) of the owners like the new color treatments. Only 10 percent dislike them and 3 percent have no opinion. Here is a selection of quotations:

"I like them. Autos should not be drab."—Maryland plant manager.

"They look ready and alive."—Virginia insulator.

"Bright colors don't show dirt."—Louisiana owner.

"It gives customers a wide variety of choices."—North Carolina secretary.

"They are for young people."—Colorado civil engineer.

"Bright colors are safer. More noticeable on the highway."—Idaho forestry worker.

"Modern colors give pride of ownership."—Indiana salesman.

(Continued to page 230)



Permanent wing-tip fuel tanks mounted on some of the new Constellations will add two hours of flying time

## Super-G Gear Adds to Range and Safety

WING-TIP FUEL TANKS, "weather eye" radar and engine analyzers are features of TWA's new Super-G Constellations.

The wing-tip fuel tanks, first to be used on civilian transports, each carry 600 gallons and add 600 miles or two hours of flight to the range of transcontinental planes. Planes thus equipped will be the longest-ranged commercial aircraft during 1955, according to TWA.

Turbulent weather up to 150 miles ahead can be seen by each pilot, thanks to the weather-eye radar. This will enable him to avoid storm centers without drastically altering his course.

Flashing pictures on the screen of the aircraft-engine analyzer give the flight en-

gineer a running account of engine operation. By twisting a dial, he can watch the performance of any one cylinder or all the cylinders in a particular engine. Green wave-form patterns produced on the screen represent ignition voltage. Faulty spark plugs, cylinders, valves and fuel injectors change the shape of the pattern. Defective parts can be spotted in the air and replaced immediately upon landing.

Flight engineer at control panel can check on the performance of any cylinder by watching analyzer

Pencil points to flashing arc made when cylinder fires. This is the screen of the engine analyzer

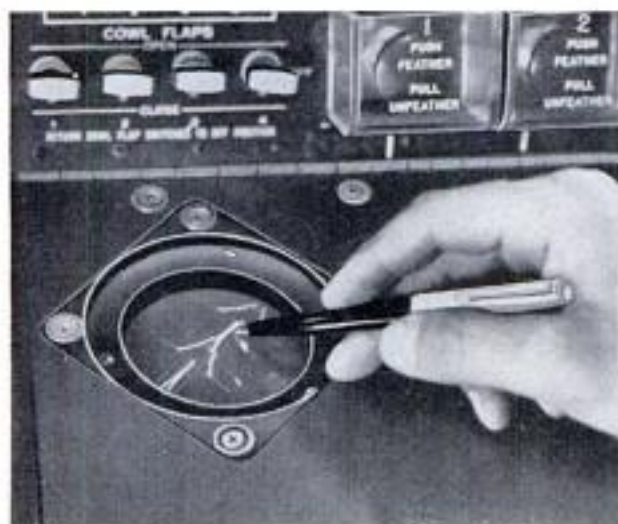



## Electric Hoe Shatters Soil With Vibrating Tines

Home gardeners now can use electricity to cultivate their flower beds and vegetable gardens. A new electric hoe (left) mulches the soil to a depth of 1½ inches. The hoe has 11 spikelike tines attached to a disk. When the disk vibrates, the tines shatter the soil into a fine mulch. In addition to cultivating, the hoe can be used to prepare areas in the lawn for reseeding, and to work peat moss, fertilizers and soil conditioners into the soil. Two sizes are available, one weighing seven pounds and having a four-inch diameter, the other nine pounds with a six-inch diameter.

## Transistor Automobile Radio Slashes Battery Drain

Car radios will be smaller and will require much less electricity in 1956, Chrysler reports. The new radio, available in the 1956 Chrysler cars, will be tubeless, the conventional electronic tubes being replaced by 11 tiny transistors each about the size of a pencil eraser. These transistors will last for the life of the car and will never need to be replaced. No vibrator, rectifier or transformer is required by the new set and, since these parts account for most car-radio failures, the new sets are said to be remarkably trouble-free. But the reduced current usage is where the big advantage comes. The new transistor set uses only one tenth as much electricity as the conventional tube set.

## Drugs Stunt Insect Growth

"Peter Pan" chemicals that prevent insects from growing up and reproducing are being tested by Department of Agriculture scientists at Beltsville, Md. Some prevent cell division. Others slow down the insects' metabolism. In one test with just piperonyl butoxide, only three percent of DDT-resistant flies reached adulthood. The growth-inhibiting chemicals are not toxic to humans and animals, the scientists report.

## Semiautomatic Gun Loads Two Shells

Sportsmen have a new shotgun available—the Browning "double" semiautomatic. The gun has the advantages of a double gun with the trim lines of a single barrel. The two shells are loaded through a port on the left side of the receiver. The first shell moves automatically into the chamber and the second remains visible in the port. The short recoil system, part of which is in the fore end and part in a tube in the stock, floats the barrel and breechblock through ejection and loading. Light loads and heavy loads can be fired without adjustments to the recoil system. The gun is available only in 12-gauge, but in a variety of barrel lengths and chokes. By pressing a single latch the sportsman can lift out one barrel and replace it with another.

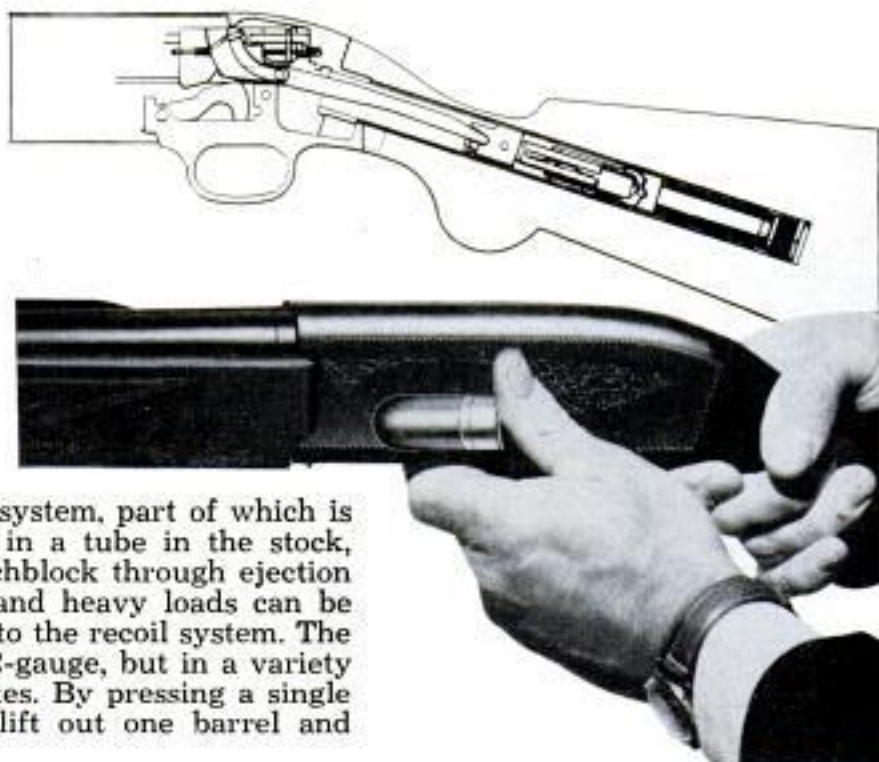



Village of Moran, in one of the most beautiful spots in the country, had its view cut off by dam in foreground

For a look at the Teton Mountains  
hidden from its view since 1916,

## *An Old Town Packs Up and Moves*

By Richard W. Emery

ONE DAY NOT long ago the old-timers at Moran, Wyo., put on their specs and read the notice from the Department of the Interior. About five paragraphs down they came to this sentence:

"As part of the project, all buildings now located in the town of Moran will be moved five miles north to Colter Bay."

The old-timers looked at each other, snorted and read the notice again. This

Moran's 110 log cabins, some of them built by homesteaders, were ordered to be moved five miles to new site





couldn't happen to the old town which got its start in the rip-roaring 1880s, when the surrounding Jackson Hole country lived with a six-shooter on its hip.

But the notice meant business. Moran's general store, restaurant, gas station, post office, photo studio and 110 log cabins were to be moved.

Moran's new location is on the shore of Jackson Lake, which stretches 15 miles along the east flank of the Teton Range. And there, for the first time since 1916, the town again will have a view.

Back in the '80s when the first white men eased into the location and set out trap lines for beaver, Moran had a wonderful view. Right in front was the shimmering lake, five miles wide. Across the lake reared the jagged Tetons. The view was still there when Frank Love homesteaded at Moran about 1895. It was still there when Benjamin Sheffield, a cattleman, started the Teton Lodge at Moran in 1903. And it was still there in June 1914 when Charles Fesler arrived as a trapper, unaware he'd still be there 40 years later as the town's storekeeper.

Two years later, in 1916, the view was gone. A towering dam across the Snake River, in Moran's front yard, had put the view out of business. Summer tourists complained.



"Fine place to build a town, under a dam," they said.

"We was here first," the old-timers replied.

Thirty-seven years passed before Moran got the official hotfoot. A \$5,000,000 development by the Grand Teton Lodge and Transportation Company got government approval and a contract was signed. Moran would be moved to a lake-shore tourist village to be carved out at Colter Bay. So, also, might buildings of Square G Ranch and Jenny Lake Lodge, both located several miles south of Moran. And up on a hilltop, a mile from the present historic site of Moran, 200 construction men swarmed in and started building a three-story, multi-winged, reinforced-concrete lodge and 22 outlying guest cottages.

Moran's old-timers visiting the construction scene learned the hilltop resort would accommodate more than 600 guests. Summertime of 1954 found the first guests there, while major construction of the central lodge continued.

Moving the old town to a new site, where visitors again would have an unobstructed view of the lake and magnificent mountain peaks, long had been considered by the Grand Teton Lodge and Transportation Company. Many of Moran's log cabins were built by the company in 1930 to match in appearance old homesteaders' cabins remaining from the town's earliest years. The five-mile haul to Colter Bay will be accomplished by truck. Buildings which cannot be hauled intact will be taken in sections or will be torn down and rebuilt.

When the moving job is done and the builders finish their work, the Colter Bay resort and the nearby hilltop Jackson Lake Lodge will accommodate many more visitors than have been able to squeeze into Moran. The multimillion-dollar Jackson





Lodge and cottages, now under construction near towering Tetons will accommodate more than 600 persons

Lake Lodge will conceal its reinforced concrete, presenting outer surfaces which will look like weathered wood.

Builders are achieving the camouflage by using etched plywood for concrete forms. When the concrete has set, its surface has the grain markings of the wood. A penetrating acid stain reacts chemically with the concrete to give a permanent finish.

Precast lightweight concrete joists manufactured in Salt Lake City were trucked in and fastened in place as floor supports in the central lodge. The central building will require 11,000 cubic yards of concrete, and the entire job will use the grand total of 370,000 square feet of plywood—enough to cover more than eight acres.

The finished building will be 500 feet long and 200 feet wide. Visitors will find a huge lounge with a wall of windows facing the Grand Tetons. Other facilities will include retail shops, a convention hall that will seat 600, a coffee shop as well as dining rooms, and 46 guest rooms on the third floor. Two central boilers in the



Etched plywood is used for the concrete forms of the lodge. Concrete takes on the wood's grain pattern. Texture is enhanced with special stain

Precast concrete joists 20 feet long support the floors of the lodge. Reinforcing bars in the concrete are welded to the steel roof trusses





For a magnificent view of the jagged Tetons, visitors will look right through a window wall in the lodge

The past still lives at Moran. Banging triangle still means chow, just as it did for cowboys during roundup



basement of the lodge will heat the entire development. The guest cottages, many of them already built, are of frame construction, with the exterior walls covered with asbestos shakes.

There are those among Moran's elder citizens who take a dim view of the whole town-moving project. Arnold Fryk, a bearded prospector who "holes up" at Moran in summertime to get away from the heat of Death Valley in California, says he and his burro will look out of place in the swanky new atmosphere.

"Too much fixin' and fussin' for me and Gert. We'll be leavin'."

Charley Fesler, staunch citizen and long-time owner of Moran's only grocery store, admits he fought the big change bitterly, but says he accepts it now.

"If they want a cement hotel up here in log-cabin country, I guess they can have it. They've paid for it, sure enough. Folks have got mighty modern, and these modern folks have got to be accommodated. We've got to give way. One thing ain't going to change, though, and I told 'em so! These mountains ain't going to change. They were here before the cement hotel came and they'll still be here when it's gone!" ★ ★ ★



## Gauge Tells Ratio of Fat to Lean in Live Animals

How much lean meat is there in a live hog? Swine breeders and packers are continually trying to answer this question. Livestock buyers can make a good guess, but it's still a guess. Now two Purdue University scientists have developed an instrument which measures the thickness of fat and lean in live animals. The same instrument can be used in packing plants to check the ratio of fat to lean in carcasses.

A delicate electrode is inserted beneath the skin of the animal. When the electrode contacts muscle, meter shows a great increase in electrical conductivity. Thus each layer of fat and lean can be checked. During research, 3000 measurements were made with the instrument without harm to the live animals. However, the instrument is expected to be especially useful in determining fat-lean ratios in carcasses.

## Glass-Fiber "Clouds" Remove Radioactivity

What appear to be clouds in a scene at the Hanford Atomic Products Operation are actually masses of fibrous-glass filter. A bed of glass fibers 7 feet deep and 56 feet long will serve to remove radioactive particles from exhaust gases at the Washington plant. General Electric, which operates the plant, will use the more efficient and less costly glass filter to replace earlier sand filters.

## Chemical to Combat Cancer

Scientists at the University of Wisconsin have isolated pure crystals of a chemical which makes cells divide and grow. The chemical is called kinetin. It is hoped that a slightly altered kinetin will block rather than promote the uncontrolled cell division which is so characteristic of all forms of cancer.

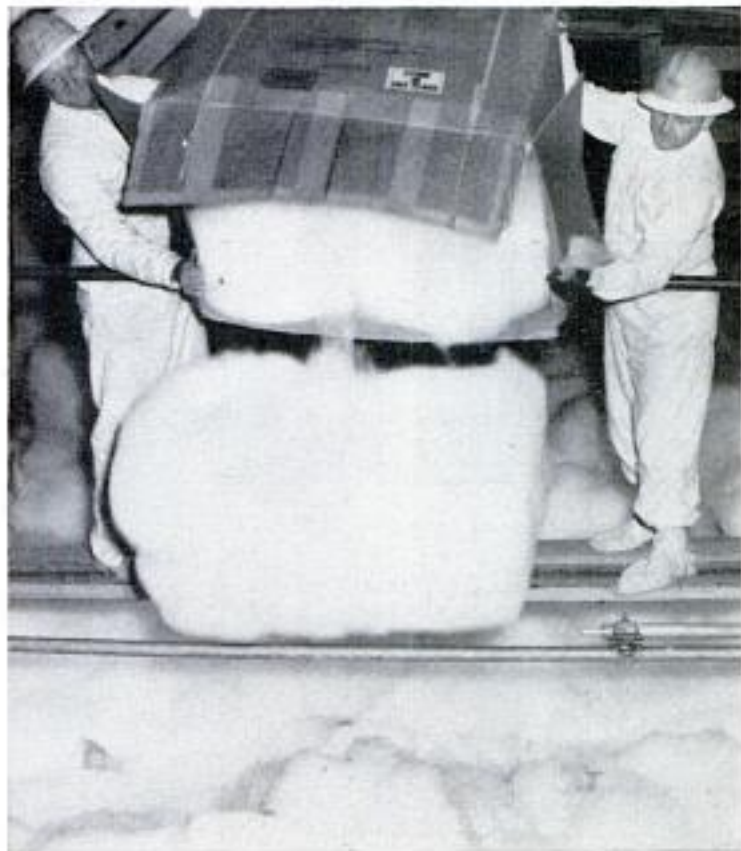

# Outdoor Billiards



A 4-3 lead for Black is marked on scoreboard. Pegs above the numbers indicate Red's score; pegs below keep count on Black

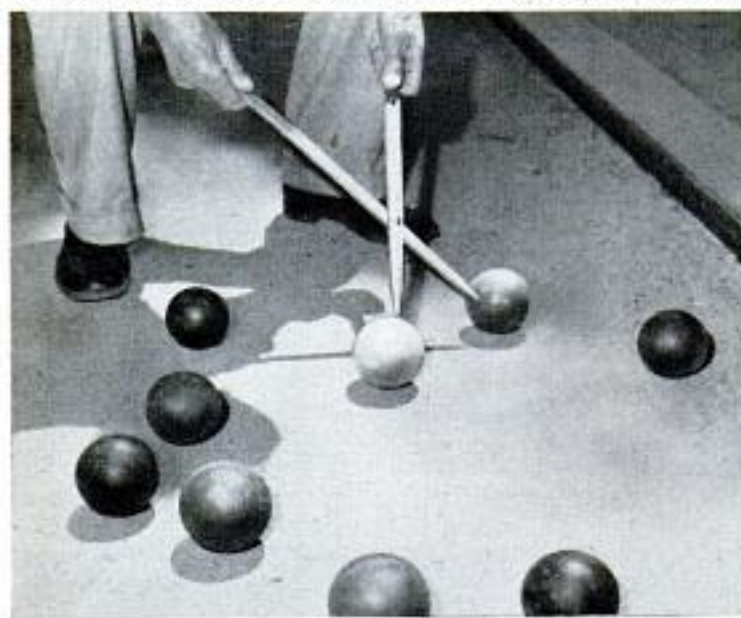

When balls are close, a scissorknife measuring device is used to determine the ball that really scores. Below, first ball thrown by A hits sideboard and rolls to within inches of cue ball. B follows with a shot that nudges A into second place



**T**ABLE BILLIARDS and lawn bowling are combined in a unique sport that's played almost every day in Oakland, Calif. Oldsters of 80 and boys of 65 meet regularly in a corner of the city's Mosswood Playground to test their skill at ground billiards.

Few tyros can best the veterans of the Mosswood league, some of whom have been playing the game ever since they were doughboys and brought it over from France after World War I. The 40-some men of the Oakland teams are all close to being champs. Competition is keen in the lively but non-strenuous matches.

Although ground billiards combines many of the skills and rules of table billiards and lawn bowling, it calls for something else—long hours of practice and expert knowledge of the particular course. Hoping for hot competition, the Mosswood players recently challenged several table-billiard and lawn-bowling champions to a match. The visitors soon learned that their special skills meant little in competition with the elderly sportsmen who play the game every day.

The game is not complicated. There are two men to a team, and partners stand at opposite ends of a 30-by-60-foot court fitted with small sideboards. Two competing players at one end start the game by rolling small wooden balls toward a cue ball at the opposite end. Each attempts to place his balls closest to the cue ball (as in lawn bowling). The sideboards are used for "cushion shots" (as in table billiards). After each of the two men has rolled his quota of four balls, play continues from the opposite side.

Before each game the court is dusted with a thin coating of sand to smooth the surface. But minute mounds and hollows remain to squash the scores of those who are not as well acquainted with the court. ★ ★ ★



Ground billiards, imported from France by World War I doughboys, requires a keen eye, skillful rolling and ears deaf to sideline kibitzing

A game starts. Player and his opponent get into position at one end of court while their respective partners wait at the other end for their turns

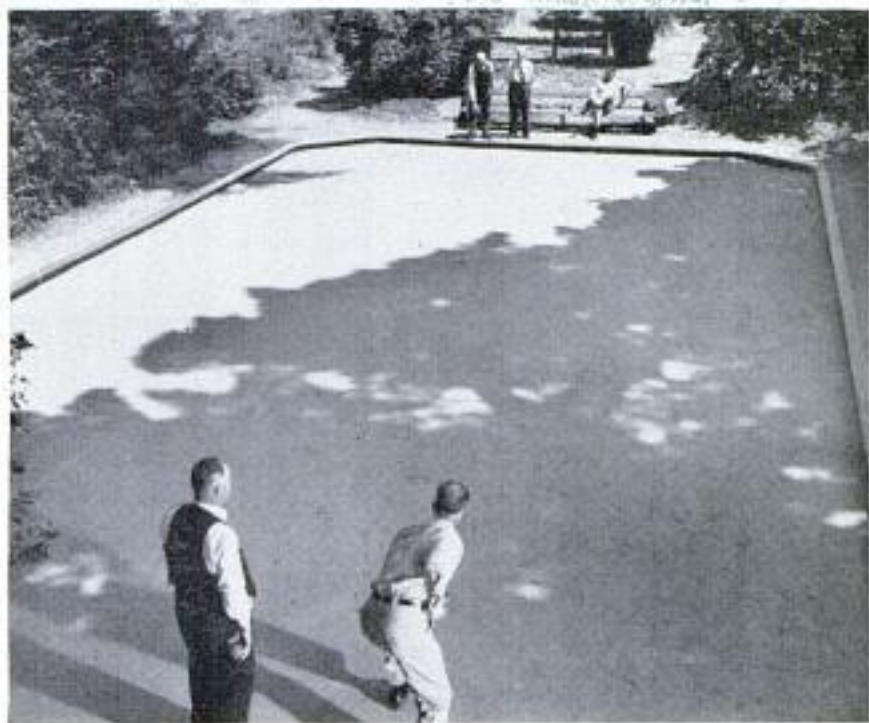

## Trailers Spread Three Fertilizers at Once



Three basic plant foods can be forced into the soil at one time by a new machine developed to spread liquid fertilizers. The Flo-Mix machine consists of two trailers that can be hauled behind a tractor. The first trailer carries tanks for potash and water concentration, liquid phosphate and compressed air, as well as steel cutting blades and tubes to feed the fertilizer to the soil back of the blades. The second

trailer carries a tank of anhydrous ammonia, which flows to the feed tubes through a hose. The compressed air forces the liquid fertilizers into the soil in the cuts made by the steel blades. A small compressor driven by the trailer wheels maintains pressure. Gauges regulate the flow of any one or all of the three elements—phosphate, potash or nitrogen—from the tractor seat.

## Rubberized-Plastic Signs Along Colorado Highways Outlast Steel 10 to 1

Colorado highways are being marked by all-plastic highway signs that are rubberized to withstand the rough treatment such signs often get. Actual tests show that the flexible signs last 10 times as long as the standard enameled-steel type. Highway engineers state that the major cause of sign damage is the thoughtless hunter who bangs away at highway signs to test his marksmanship. Bullets puncture steel signs uncovering the bare metal which

soon corrodes. With the plastic sign there is no damage other than the small holes themselves. Trucks and cars that sideswipe signs do no damage to the new type of sign as it flexes with the blow, returning to its original shape instantly. The signs have also been proven extremely weather-resistant. Although they cost 10 percent more than the standard type, the plastic signs are expected to save the state thousands of dollars because of their longer life.



*see corrected A*

# BBC Puts Inventors

on TV



Copyright by Merkuria

Designer, right, explains his unsinkable lifeboat. Either side is right side up, engine operates both ways

By David Scott

**I**NVENTIONS ARE the stars of one of the most popular television shows in Britain.

The Television Inventors' Club of the British Broadcasting Corporation has been on the air for seven years. During this time more than 7000 inventions have been submitted to the club, of which 580 have been shown on the air. A quarter of these have caught the eyes of manufacturers and many are already in production.

The inventions range from a simple shirt stud which allows for the shrinkage of the collar, to a compressible ship's fender which eases a 24,000-ton vessel against a dock.

A number of British inventors have hit the jackpot through the program. One of

them actually did it with a better mousetrap, and the world has already beaten a path to his door to the tune of over a million sales. Years of patient observation taught the inventor that a mouse twists its head when approaching the bait and nibbles from below. His trap therefore springs when the bait is lifted—not pushed down.

A tidy profit was also made by the inventor of a stair elevator for invalids. A moving step, carried on rails, is drawn up the staircase by a cable and winch. More than 500 inquiries poured into the BBC when this device was shown on TV.

The biggest problem of the organizers of the club is to select the inventions for the

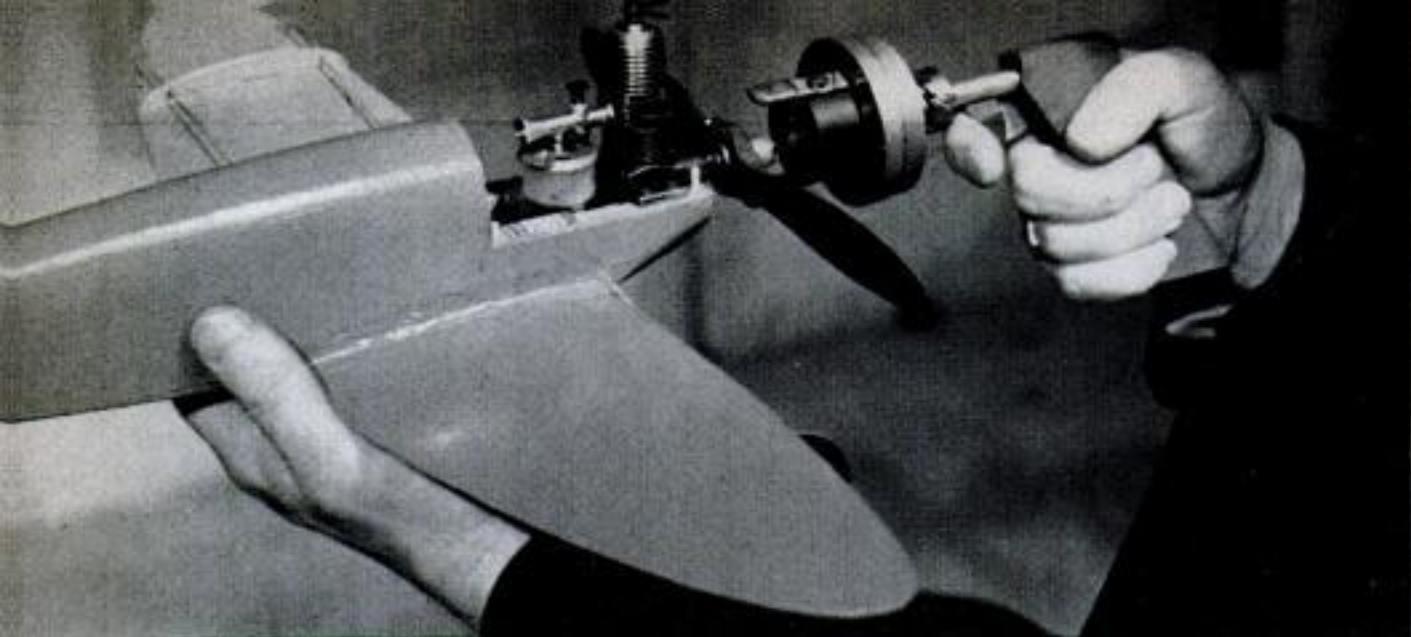

Photos by Peter H. Jones

Model-airplane-engine starter has a spring-driven flywheel, wound by hand, which is released by the trigger



Sliding jaw on a one-handed monkey wrench permits quick adjustment to correct size. A thumb-controlled ratchet tightens the jaws



Truck for a shovel makes light work of heavy loads. Shovel is cradled in a light framework which rolls along on wheels

Yarn winder is made from an egg beater. Rotating carrier for skein has adjustable arms and clamps to table



light material





Photos by Peter H. Jones

**When musician presses pedal, electromagnet attracts steel tab on the music, arm swings to turn the page**

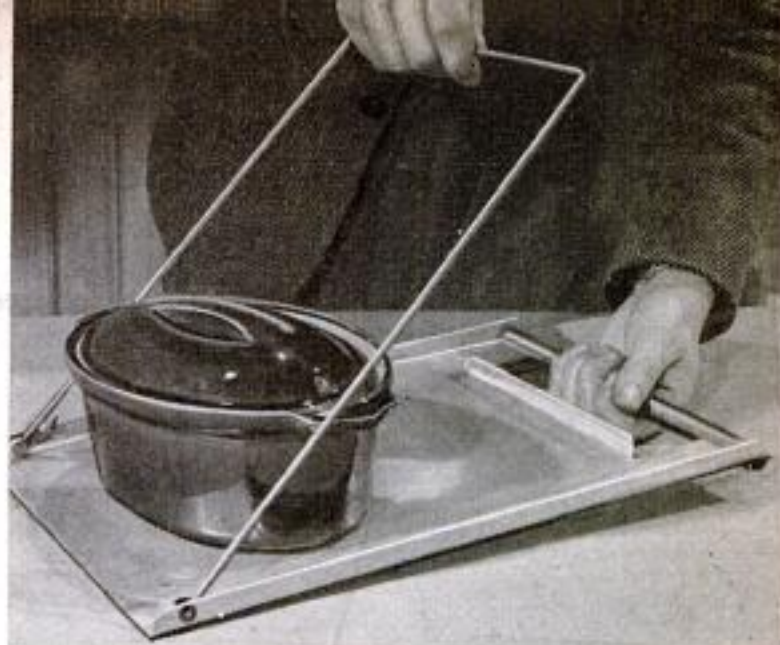

**Hot dishes and pans are easily removed from the oven on a tray. Two front handles take weight of both ends**

monthly program. Each broadcast reaps an average harvest of 200 new applications, most of which come in immediately after the show. Of these, about 40 percent are rejected outright because they are repetitions of previous contributions, obviously lack commercial prospects or are simply unsuited for television viewing.

The surviving 60 percent are submitted to technicians in various fields. A panel of specialists from industry and business is maintained. The inventions may also be shown to technical journalists who are likely to know of the existence of similar inventions.

To be approved, the idea must be patentable. A clever idea sometimes is turned down when it is apparent that any handyman could knock together the invention in half an hour at home.

Usually about 60 inventions manage to survive these hurdles each week.

**Trumpet silencer placates neighbors during practice. Mute contains a microphone which is connected through an amplifier to earphones on the musician**





Photos by Peter H. Jones

Ironing board for the tired housewife has a built-in seat. When she's through with her ironing she folds the board and seat flat. Board can be used as desk

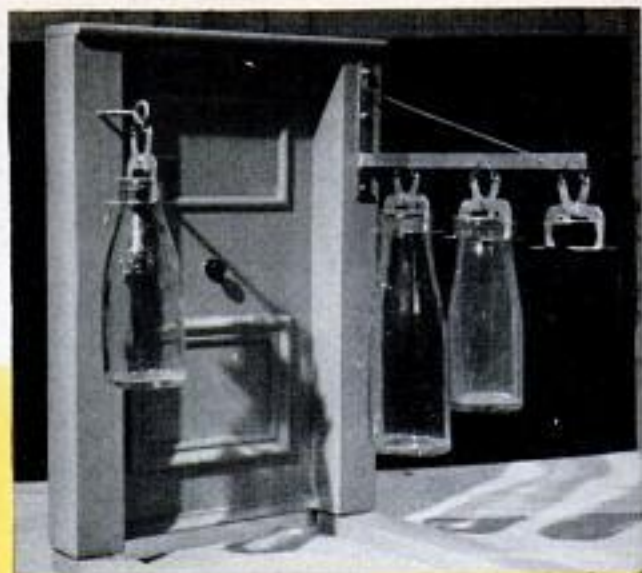

Milk-bottle holder protects bottles from animals and careless children. Hanging clips automatically grip the necks of bottles pushed up between the jaws

Clip holds a strip of wallpaper flat while paste is applied. Clip then is reversed to align the paper on the wall. Household items are especially popular when shown by Inventors' Club on television

Seat of stool is suspended on two sets of four coil springs, cushioning seat and permitting extended reach without tipping



Copyright material

They are subject to further examination which weeds out about half of them. The finalists, numbering perhaps 30, are then invited to the studio for a preview. Here the inventors demonstrate their ideas before the panel. When the last ax has fallen, 12 or 15 of them are left to appear on the next program.

Some of the inventions that fall by the wayside, of course, are screwball ideas. One budding inventor offered to demonstrate his one and only cure for fog dispersal, but this miracle was never submitted. No more was heard, either, from an inventor who claimed to have developed a chemical substitute for a parachute!

Another creative genius didn't get very far with his "door engine," which was supposed to convert the power used in opening and closing doors into useful energy. In the same class were roller skates especially designed to roll uphill.

Emphasis is on ideas with clear commercial possibilities. Sometimes an idea appears worthwhile but obviously won't pay off. No one, it was felt, would pay cash for gloves with a transparent watch panel in one wrist, or hand lights for cyclists to indicate turns at night.

One of the biggest successes on the program was a cigarette economizer which made an ordinary smoke last 35 minutes. It consisted of a slotted tube around the cigarette which retarded combustion between puffs.

Another success was an automatic dance instructor. Students stood on a raised glass panel and placed their feet on colored footprints cast on the glass by lights from below. The footprints varied in color and speed according to the dance step, and flashing arrows warned where the next would appear.

The entertainment value of the show is not neglected. Once a bull was brought into the studio to show the use of an animal gag which pried the creature's mouth open to permit easy dosing with medicine. Despite the severe misgivings of BBC officials for

### Jupiter Sends Out Radio Waves

Radio astronomers at the Carnegie Institute of Washington can hear intermittent radio waves from the planet Jupiter. It is the first recorded reception of such waves from one of the other planets in our solar system. The waves were described as having the appearance of short, random bursts of static resembling thunderstorm interference on your radio set. Although the explanation of the signals is still speculation, it is believed that they are caused by disturbances in the atmosphere of Jupiter.

JULY 1955

Mechanical hod picks up and carries stacked load of 20 bricks. A single brick beneath pile acts as a pallet



the safety of costly TV equipment, the act proceeded calmly for a time. But the beast grew restless when approached by the nervous inventor, who never before had been so close to a bull.

The program organizer, who had a farm background, took over. By now, though, the animal was so unnerved that it dragged him across the studio. The cameramen were quick to exaggerate his plight by a series of trick panning shots which increased the effect of pandemonium. Needless to say, this particular program drew a tremendous response. ★ ★ ★

### Cancer-Detection System Uses Sonar, Radar and TV

Principles of sonar, radar and television are combined in a new device used for detecting cancers and other tumors, cysts and goiters. Called the Somascope, it is an ultrasonic photographing device expected to give good pictures of internal growths in areas which cannot be seen by X ray or fluoroscope. The ultrasound beamed at a patient is reflected and the echo waves are converted into electrical signals which produce a picture on a TV screen.

105



# Inflated SPORTS BOAT Mounts OUTBOARD



**YOUR CAR TRUNK** will hold an eight-foot sports boat that inflates from a compact bundle. Minutes after arriving at your favorite lake you can be scooting across the water, pushed by an outboard motor mounted on the plywood transom of the rubberized-nylon boat.

Pulling a lanyard triggers a carbon-dioxide cylinder that inflates the craft in a few seconds. Inflation with a hand pump takes about five minutes.

The light weight of the 30-pound boat makes for easy portaging. Included with the production model is a carrying case with shoulder straps, leaving both hands free for carrying the motor and fishing equipment or guns.

Another feature of the craft, recently unveiled in Miami, will be a transparent Mylar window in the bottom of the bow section. Designed for underwater viewing, it will be handy for skin diving.

The inflated boat serves a dual purpose on land. You can turn it upside down and use it as a bunk. Raised at one end, it becomes a camper's lean-to. ★ ★ ★

Deflated boat weighs only 30 pounds. The craft has two seats, plywood transom, is made of treated nylon

Carbon-dioxide cylinder is used to inflate boat. Gauge indicates pressure. Hand pump can be used

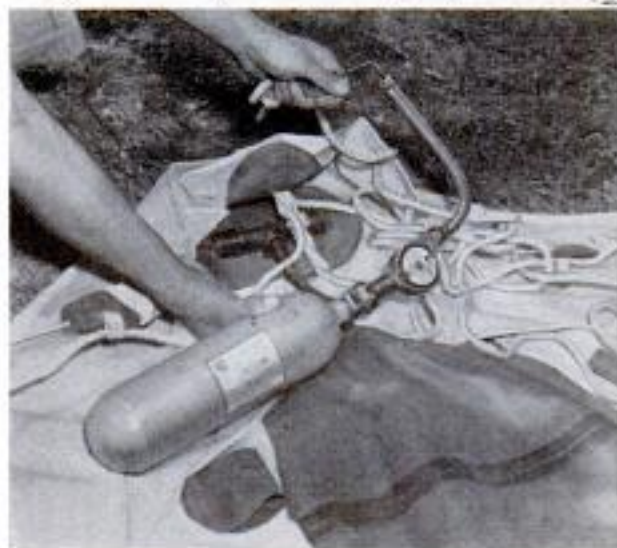



A three-horsepower outboard motor pushes the inflated boat along the surface of the water at a brisk speed



Pulling a lanyard attached to the carbon-dioxide cartridge causes the boat to inflate within seconds



Boat can be hauled out of the water, turned upside down and tilted, and used as a lean-to for camping

The boat, inverted, also serves as a hammocklike bed. It's roomy enough; dimensions are 8 feet by 38 inches

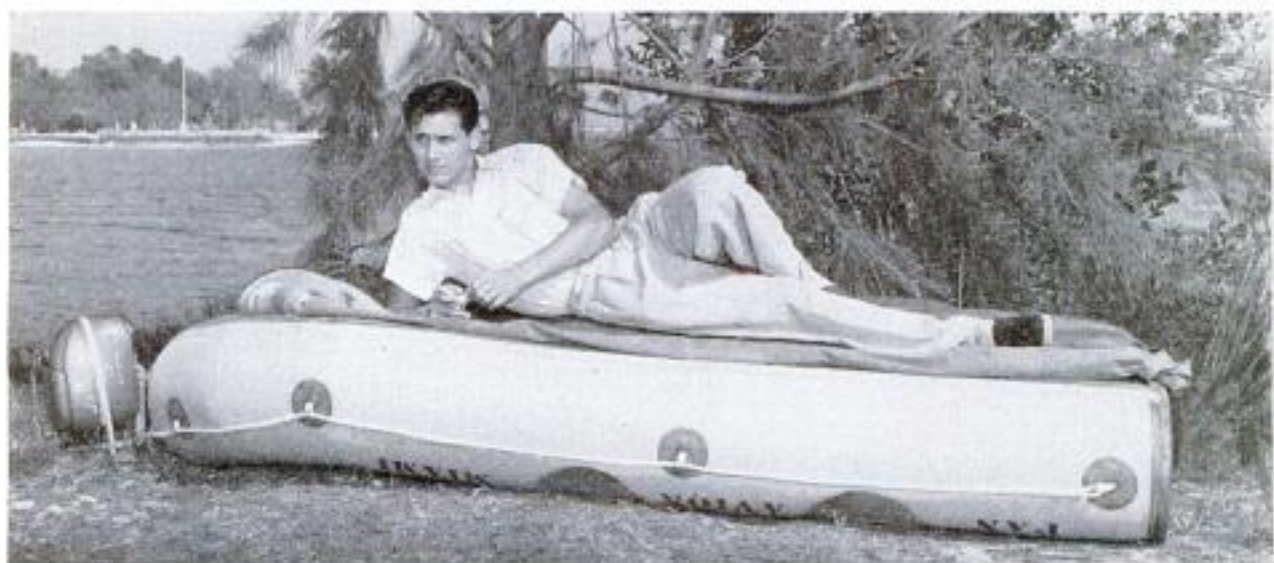



All four front wheels steer. The tractor not only pulls a load, it carries a 10,000-pound load on its back

## Semitrailer Has Four Front Wheels and Flat Diesel Engine

Powered by a pancake-type diesel engine mounted amidships under the frame, an experimental truck is undergoing tests on the West Coast. Built by the Pacific Intermountain Express truck company, the tractor has two sets of front wheels on tandem axles to reduce the weight per wheel. Both sets of front wheels turn in steering. The 235-horsepower Cummins

diesel features a combination turbocharger and exhaust system which reduces engine noise to a minimum and virtually eliminates the emission of black smog particles into the atmosphere. The tractor not only pulls a load, but it also carries one on its back. A 16½-foot box is mounted directly behind the cab. The engine is mounted under this box where it is easily accessible.

Mounted under the big box body, the pancake diesel engine has a turbocharger to reduce noise and exhaust

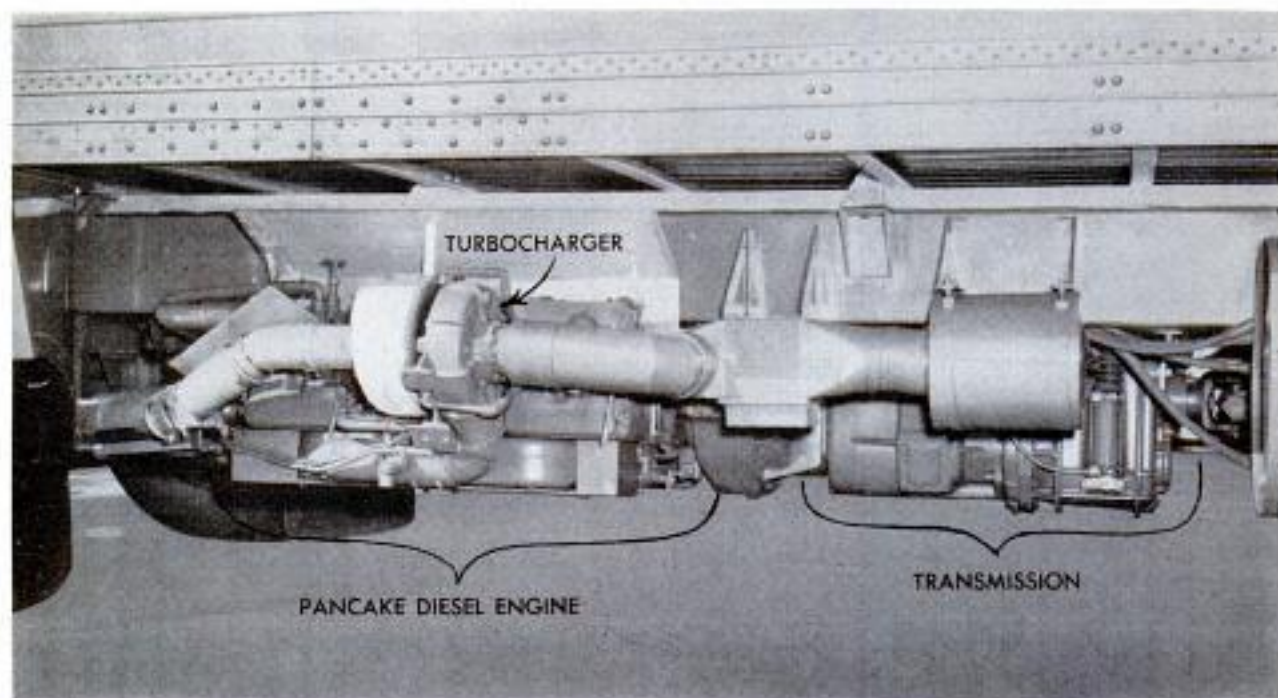

# ***Kid Stuff? Not to These Lucky Youngsters!***

## **Salvaged Bomb Makes Juvenile Space Ship**

Its central structure a discarded 500-pound aerial bomb, a juvenile "space ship" gives two-foot-power transportation to Gene Montoya of Honolulu. The space ship was built by Gene's father, D. L. Montoya, in a single week end at a cost of less than a dollar. The surplus bomb is lined with rubber padding and the wire wheels are from another juvenile vehicle.

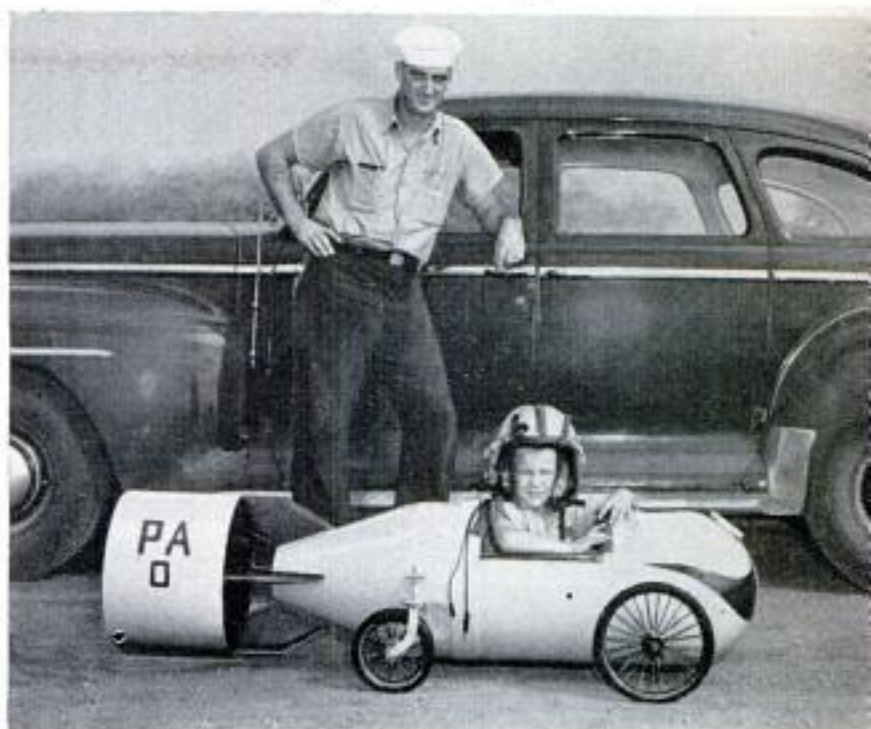

## **And Here's the Back-Yard Helicopter!**

Junior now can take a ride in his own helicopter. A new sidewalk vehicle with a frame of steel tubing is complete to a free-moving overhead rotor. The pint-size pilot sits in a bucket seat and powers his craft with foot pedals which turn a chain drive connected to the front wheels. The aircraft-type steering wheel turns both the rudder and the rear wheel to guide the craft as it "hovers" over driveway and sidewalk.

## **Last, But Not Least— The Back-Yard Handcar**

Back-yard railroading — handcar style — has come into its own with introduction of the "Yardbird," a scaled-down handcar operating on a miniature track. The Yardbird is chain and crank driven, and will hold two children. Basic diameter of the 40-foot track furnished with the handcar package is 12 feet, but additional packages of track are available for enlarging the layout.



*Desert Harvest . . .*

# DIAMONDS UNDER THE SAND

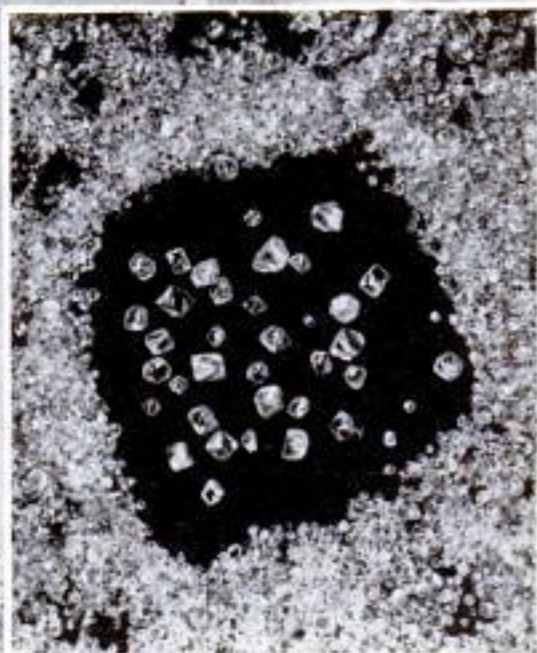
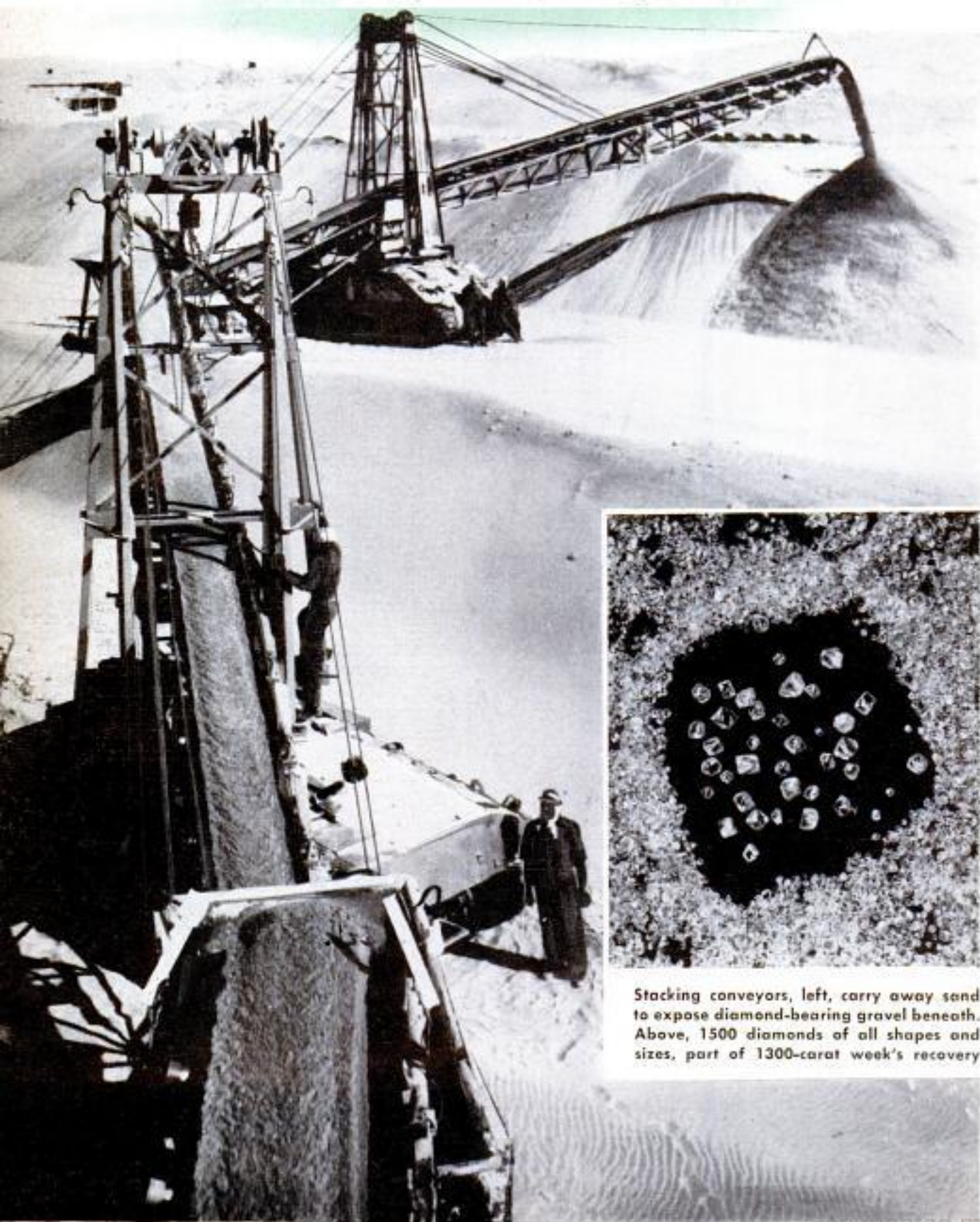

Stacking conveyors, left, carry away sand to expose diamond-bearing gravel beneath. Above, 1500 diamonds of all shapes and sizes, part of 1300-carat week's recovery





Photos by Consolidated Diamond Mines of South Africa, Ltd.

Sherman tanks pull sand-moving equipment. Tanks also provide chassis for rotary scoops, portable conveyors

**D**IAMOND HUNTING is big business along the seaboard of the Namib Desert in Southwest Africa where the Orange River empties into the Atlantic Ocean. Mobile conveyors and Sherman tanks pulling huge scoops remove sand as deep as 70 feet to uncover diamond-bearing gravel.

The diamonds were apparently released from the tops of old volcanic pipes inland and carried by the Orange River to the sea. Waves threw the diamonds onto gravel beaches which became buried in sand.

Before an area is mined, prospecting trenches are dug to determine the value of the gravel beneath the sand. The sand is removed and the "cemented" gravel bed is torn apart by drilling and blasting. The gravel is taken to the refinery, where it is crushed, washed and screened. It is then fed into a heavy liquid that causes the lighter matter to float and the heavier matter, including diamonds, to sink. The material is washed across a tilted, moving, grease belt. The diamonds stick to the grease belt and the waste washes off. The belt is continually scraped, grease added.

Another method of separation is the electrostatic process. Diamond concentrate passes through an electrical field and receives a charge. Waste, generally conductive, loses its charge to earth immediately and falls. Diamonds retain their charge long enough to be deflected. ★ ★ ★

Native worker displays a large diamond he found in the gravel. Few diamonds are collected this way



Gravel suspended in heavy liquid washes across grease belt. Diamonds sink, stick to belt. Electrostatic separator, below, relies on conductivity differences

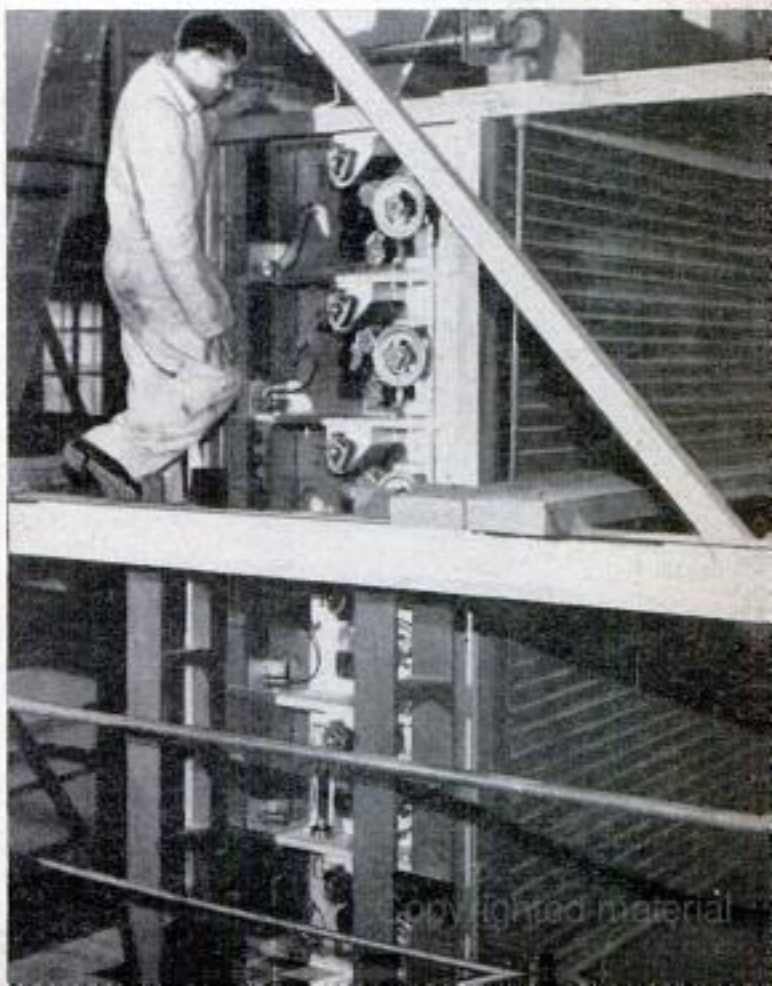



## Three-Film Camera Gives Operator Choice

Photographers who find color film in their cameras when the light requires black and white, or who want slow films and have fast, will welcome the three-film camera invented by Samuel Noble of Detroit. The 35-mm. camera can be loaded with three different films at the same time. Any one of the three can be brought into operation by revolving the back. Development took 6½ years.

## Starter for Power Mowers Operated By Foot

Rope-jerking to start a power mower is a thing of the past if you use a new electric starter. You simply press a button with the tip of your toe to start the engine. The starter, which operates on a six-volt, seven-plate battery, is similar to an automobile starter. When the button is pushed, a chain drive turns an overriding clutch on the engine crankshaft. The clutch disengages automatically. The battery produces about 400 starts.



## Round Office Building Has Service Rooms in Center

Savings of 13 to 20 percent in outer-wall construction, as well as more efficient heating and air conditioning are claimed for a round office building to be built in Holly-

wood, Calif. The 13-story, \$2,000,000 structure will have elevators and service rooms in the center, with office space around the perimeter. A model has been built.

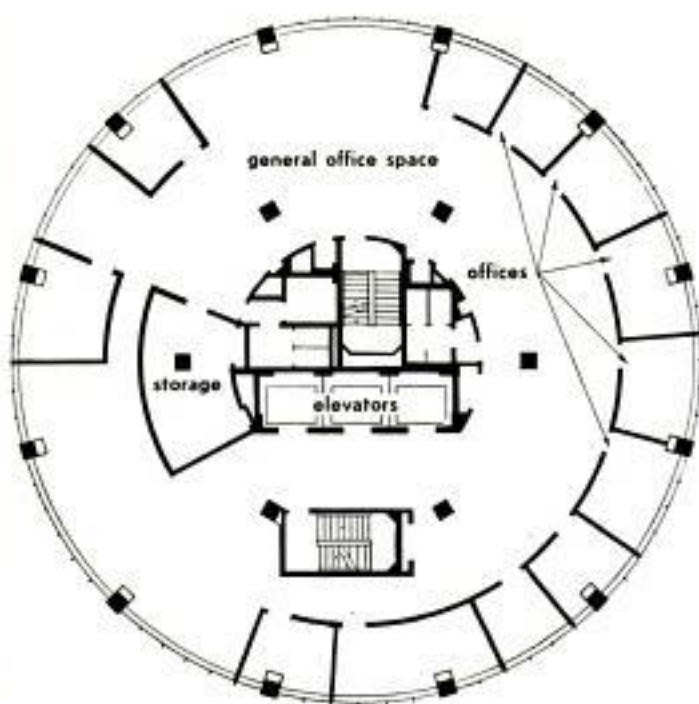

## Miniature Sounding Instrument Measures Depths From Rowboat

About the size of a small suitcase, a new electronic instrument can be used from a rowboat to chart the depths of rivers, lakes and shoal waters. The instrument is an echo depth sounder, a portable version of an instrument used by the Navy for signaling and detection. A sending-receiving unit is lowered over the side on a short pole. It sends out an ultrasonic signal which bounces off the bottom and returns. The time interval is measured by the instrument and converted into a reading in feet or fathoms. An experienced operator can even identify schools of fish with the instrument. It is designed for utilities companies and engineering firms which lay pipelines and cables.



## Soldiers Build Boat From Old Oil Drums

Three oil drums cut open lengthwise and welded together end to end form a twin-hulled boat built by A/2C Eugene Smith and A/2C Douglas Dellefield. Also used in the boat was scrap metal for the bow and stern and scrap lumber for seats. The 11-foot, 120-pound boat has two 10-gallon grease cans built under the center seat. One serves as an insulated icebox and contains a five-gallon lard can packed in glass fiber. The other 10-gallon can serves as a bait well. Needle holes piercing the bottom of the boat supply the well with four inches of fresh water at all times.

## Sturdy Paper Garbage Bags Eliminate Handling of Cans

Large paper bags chemically treated to resist moisture take the backaches out of garbage collection in Hartford, Conn. The bags fit inside conventional garbage cans, hold 40 pounds of wet garbage or 80 pounds of dry rubbish, and are removed without moving the can. Eight inches higher than a garbage can, the bags can be folded over to seal off flies and odors or grasped at the top for carrying. Use of the bags speeds garbage handling, makes it quieter and saves on maintenance of cans and collection equipment. In Hartford, use of the bags enabled 20 men to do the work of 29.

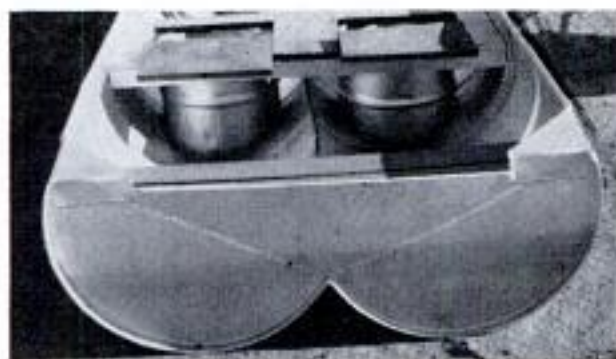

# Titanium Strike in Mexico

By Clifford B. Hicks

Exploratory tunnels carved into mountainsides have proved existence of 25,000,000 tons of rich ore. Map shows location of strike in southern Mexico. Other dots indicate smaller sources of ore



Geologist Willis Seaman, left, one of the prospectors, examines diamond drill cores with the mine superintendent





Mexican miners drive tunnel deeper into mountain. Ore will be trucked to coast for shipment to this country

**I**N SEPTEMBER 1953, three men showed up in the primitive village of Pluma Hidalgo, high in the mountains of southern Mexico.

The rugged Sierra Madre range runs like a jagged spine down the length of the country, and the mountains here, near the base of the spine, are covered with the lush vegetation of the tropics. For centuries, bearded prospectors have been exploring the reaches of these slopes.

The three men—in appearance old-time *yanqui* prospectors—excited little curiosity. Day after day they disappeared into the jagged mountains.

Then, some weeks later, the old-timers staked out claims to the biggest deposit of rutile (rich titanium ore) ever discovered in the Western Hemisphere. At least 25,000,000 tons of rich ore lie there, ready for the taking, according to estimates.

These were no ordinary prospectors.

Leader of the group was 82-year-old Donald B. Gillies, former vice-president of Republic Steel Corporation and now a mining consultant for the same firm. His associates were W. A. Seaman, a retired professor of geology, and Ward A. Broadfield.

The three experts found their bonanza of rutile in an area which had been combed over by countless other prospectors.

Republic Steel has started development of the Pluma Hidalgo lode at a time when the federal government is vitally interested in titanium for defense.

Already Republic has proved more than 25,000,000 tons of ore by carving exploratory tunnels into the mountainsides. Engineers and native miners found ore so fantastically rich that in one place it actually is 95 percent rutile.

Republic plans to build a concentrating plant near the ore bodies. It should be in



**SHEAR SCRAP**



**MACHINE CHIPS**

*Republic Steel photos*

At present, titanium is so expensive that even shear scrap and chips are saved and recharged into furnace



When titanium sponge is crushed for the furnace, a powdery residue is left. Machine above compresses powder into pellets so it too can be used. Below, first step in processing ingot is to skin off surface imperfections, assuring high-grade metal



operation within a year, turning out 2000 tons of concentrate averaging 95 percent rutile each month. But weather and terrain have a habit of fouling up the best of plans in this part of the country. Roads are impassable to anything but Jeeps, strong trucks and the sure-footed burro. Distance is measured in time instead of miles.

The discovery of a vast new source of ore won't guarantee a sudden splurge of titanium products. About four years ago titanium was cast in the role of the gee-whiz metal of the future. Its personality seemed to more than fill the role. Twice the weight of aluminum, it is four times stronger than most aluminum alloys. It resists corrosion from most acids. For many years investigators believed that titanium, because of its extremely high melting point, would stand up under elevated temperatures better than most other metals.

So what has happened? Titanium, instead of filling the role of shining hero, has taken on some of the characteristics of the villain. Its disposition in many ways is downright cantankerous.

Although titanium has a high melting point, continued exposure to high temperatures apparently tends to make it brittle. Fatigue stresses—continued vibration while under load—may cause titanium parts to snap.

Though it's one of the most abundant elements in the earth's crust, titanium wasn't extracted in any quantity until 1940, when the Kroll process was fully developed. It's a batch process, and a relatively small batch at that.

These personality quirks have had their effect. Finished shapes of titanium now are selling for



TITANIUM SPONGE



PELLETS

Sponge is a clinkerlike material which is crushed for furnace. Fine particles are squeezed into pellets

about \$20 a pound, compared with stainless-steel shapes ranging from 35 cents to \$1 a pound.

Within the past several months, some of the problems that seemed insurmountable have been solved and others are on their way to solution. New processes for the continuous production of titanium now seem possible, though they haven't been achieved to date.

Today, ingots up to 26 inches in diameter and weighing 4000 pounds are coming from the melting furnaces. Methods of heat-treating and annealing have been worked out, forgings of almost any desired shape now are possible, and the temperamental metal has succumbed to new techniques in forming, machining, grinding,

welding and other methods of fabrication.

Sponge must be crushed before it is charged into a furnace, resulting in a small amount of powder of "fines." A new machine compresses these fines into pellets which then can be charged into the furnace.

The attitude of researchers toward this mysterious metal now has come full circle. Once regarded as the child-wonder of metallurgy, it went through a phase of deep depression and now is back on top. One authority estimates that 500,000 to 2,000,000 tons of the stuff will be produced annually in the 1960s.

If this prophecy of large-scale use comes true, there'll be a big market for those mountains of ore in the Sierra Madre foothills of southern Mexico. ★ ★ ★

Ingot is removed from furnace. It next will be forged into slab. Partially forged slabs can be seen in furnace

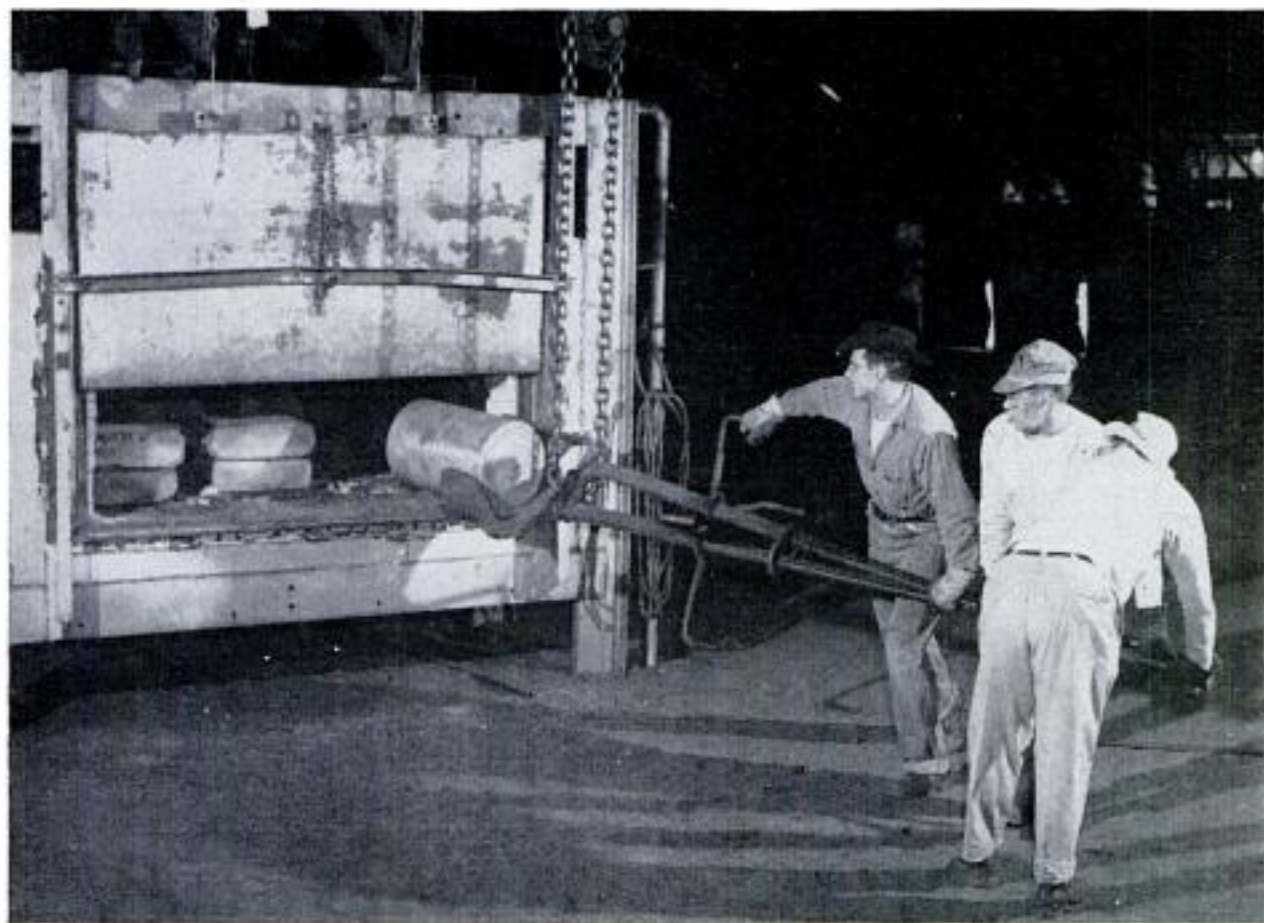



### Aluminum Harness and Holder Ease Load of Big Bass Drum

Aluminum shoulder bands are part of a new harness and holder for bass drums which is lightweight and easy to put on. A feature of the holder is a double-race ball-bearing fitting on the drum attachment that permits the instrument to be spun for a spectacular effect. The equipment was invented by Joe Waters, Jr., a student at the University of Southern California and a member of the kilted San Fernando fire-department band.

### Latch Locks Heavy Doors

Heavy sliding doors can now be latched securely with a sturdy bracket. A hook which fastens to a plate in the doorway is mounted on a tightener. The cogged tightener has a handle and is locked with a dog. The entire bracket is installed with three wood screws and three carriage bolts.

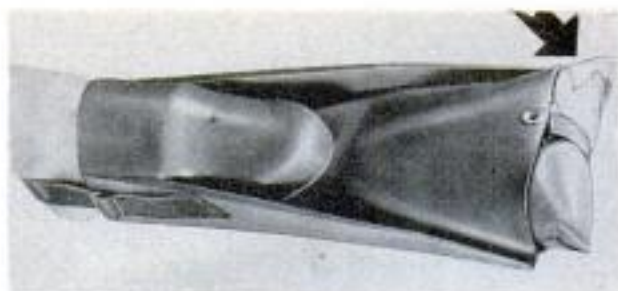

### Air Pillow Buoyo Swim Fin

Swim fins equipped with a small air-filled pillow (arrow) in each forepart don't drag on the feet of the swimmer. The pillows, seven inches wide at the front and three at the back, fit into pockets in the paddle ends of the fins. They give the fins a buoyancy which eases swimming and prevents the fins from drawing the feet downward when the swimmer is resting in the water.

### Compact Kit Plates Metal

Two miniature batteries contained in a metal case provide the electricity for a compact, economical, electroplating set. Attached to the battery case is an anode which is placed in the electroplating solution. Another wire leads from the battery case to a crocodile clip and a hooked copper wire for holding rings and other small objects in the solution. The instrument applies a silver, copper, gold, rhodium or chromelike finish.





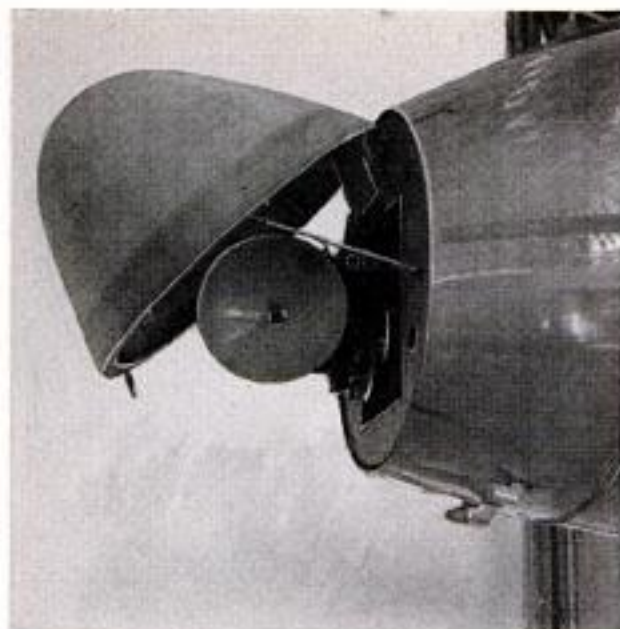

## Radar in British Transports Will Warn of Storms

Airborne weather radar, similar to that in use on some United States airlines, is planned for the Bristol Britannia transport planes on order by British Overseas Airways Corp. The radar antenna is installed in the nose of the Britannia prototype now under construction, and the hooded scope



is in the cockpit. British airborne weather radar will detect storms 50 miles away, enabling planes to alter their routes.

## GI Phone System Carries 12 Calls on One Cable

Twelve phone calls, each on a different frequency, share the same cable in a new Army telephone system. Repeaters at intervals along the cable boost weakened signals and give each unit a 200-mile range. Several systems can be linked to form a hookup of about 1000 miles. Miniaturized

parts reduce the size and weight of the rugged, weather-resistant equipment, which is housed in units like large suitcases that can be handled by one or two men. A similar four-channel terminal, also new, weighs 178 pounds and occupies 5½ cubic feet. The cable can be laid, strung or buried.

Repeater unit is used to amplify conversations, boosting range of the system to hundreds of miles

Terminal units are assembled into stacks. Combining several of the systems gives range of 1000 miles



## Scale Prints Label To Record Weight

Weight, price per pound and total price are printed on package labels by a new meat scale. The machine also prints the name of the product and a coded date. A rack above the scale holds plates which print the names of different commodities. The operator places the commodity name plates in a slot, weighs the product and presses keys to record the computed price that is registered on the scale. Other information, including the price per pound, is printed automatically. The system eliminates chances of error in reading, remembering and recording the weight, saves time and provides an attractive label. Each section of the commodity name-plate cabinet holds as many as 105 different plates.



## Pyramid-Shaped House Defeats Winter Snow and Summer Heat

"Crawl space" in a new Swiss house appears to be directly beneath the attic. The pyramid-shaped structure has no upright exterior walls, and stands on four pillars which support it high above the ground. It is designed especially for mountainous country. The elevation of the building al-

lows snow to fall clear of it, keeps it cool in summer and free of dampness and solves construction problems caused by uneven ground, according to the architects. It is also said to be warm in winter. The house cost about \$10,000 to build.





### "Orange-Peel House" for Campers Fits on Small Trailer

Developed in Germany, a portable shelter for camping or trailer travel looks like a gigantic orange—and peels apart almost like one. The parts of the shelter are shaped much like the segments of an orange peel. One person can fasten the segments together to complete the shelter in 15 minutes. The parts of the shelter including the floor are made of plywood. When the shelter is disassembled, the parts can be stacked on a small trailer for the trip to the next camping site. The collapsible house has two windows and a door. In Germany the "orange house" sells for about \$150.



Top, attractive camper stacks the parts of the portable shelter on a small trailer. There are eight of the segments and the floor, all made of plywood

Above, parts are laid out and floor assembled first. Segments are mounted on the floor and clipped to each other. In 15 minutes the home is completed

Left, finished shelter can serve as temporary home for campers and tourists. It also can be used as a beach house. A door is built right into one of the segments



Student-inventor Kenneth Freude shows control box for Castor the Great to his instructor, Alfred A. Lease

**By Jim Collison**

(Photos by Al Eisele)

Midget cannon is powered by water mixed with drops of sulphuric acid in barrel. An electrical charge changes solution to gas which ignites to shoot cork 40 feet

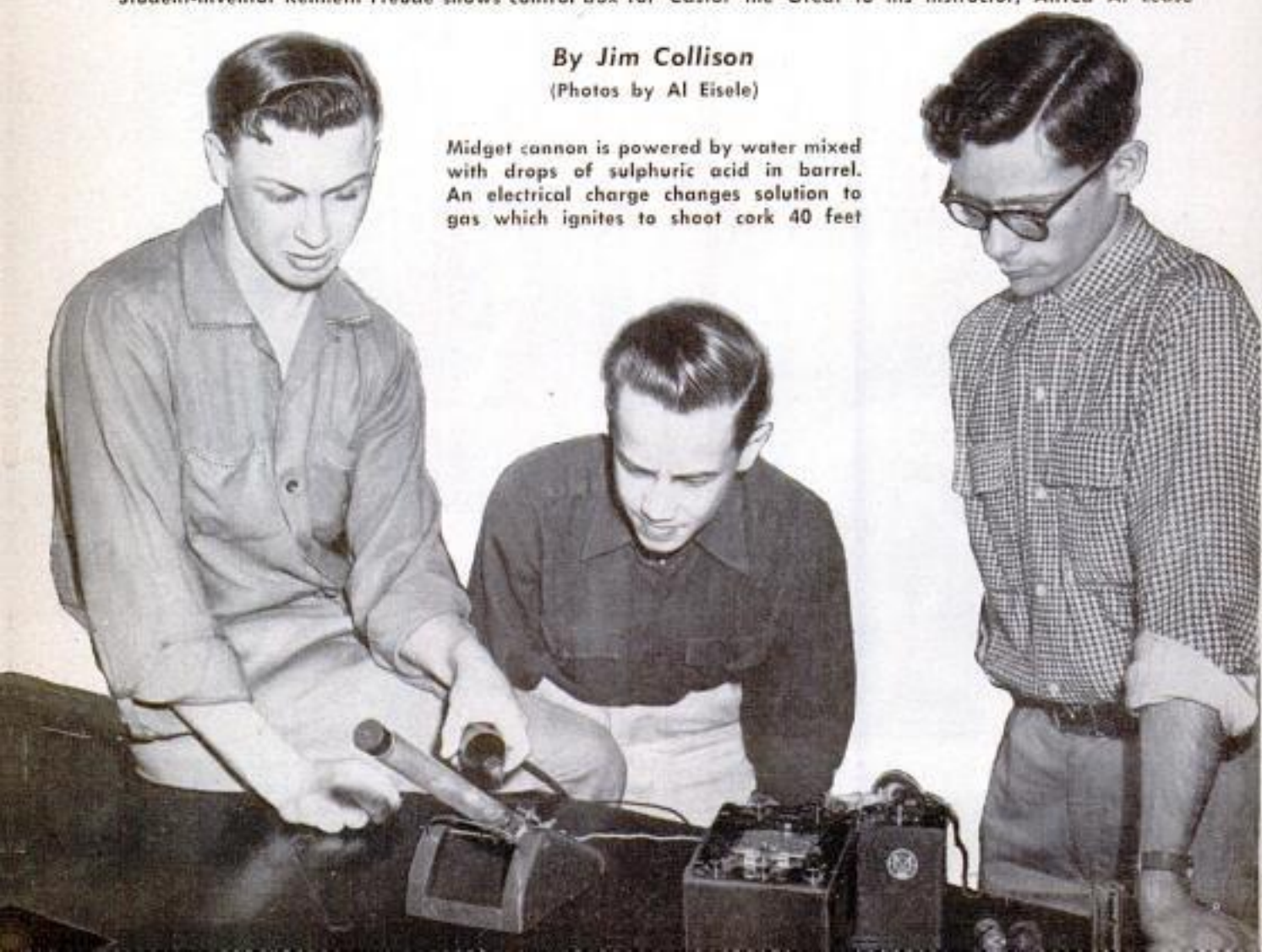

# High-School Robots Learn the "Three Rs"

**A**N ELECTRONIC THINKER—a completely mechanical robot—built by Robert Kotsmith, 16, and Michael Chmielewski, 17, high-school juniors at Foley, Minn., is passing exams of a factual nature that would stump any uneducated robot.

The machine, built during a period of 10 months at an estimated cost of only \$120, understands and answers the human voice. The Thinker answers mathematical questions, gives data on current events and history, writes and even learns new facts it does not already know.

Even to persons well versed on scientific progress, this project seems astounding. Foley science instructor Alfred A. Lease says this of his students: "Their accomplishments would make some college graduates look on with envy."

When I walked into the chemistry laboratory of Foley High School, Lease and the

two inventors were putting the Thinker through its trial performance. It had just written its first word: M-A-R-C-H. This was the month in which it was completed. As I walked in, the machine was writing L-E-A-S-E, clearly, in nearly square letters, slanted slightly left, about an inch high.

"Ask it any question you like," suggested the students.

The machine has three units: The main compartment, about six feet long, three feet wide and four feet high, contains the "brain"; the second unit holds the counting and spelling mechanisms, and the third houses the writing apparatus.

On the central brain unit are five switches and five warning lights to indicate which switch is on. These switches control the areas in which questions can be asked. Cube-root and square-root answers, each controlled from a separate switch, are

This train obeys voice signals spoken into mike. It is controlled by small black box which contains the "electric brain." Sound waves are converted to electrical waves and sent to train's directional set



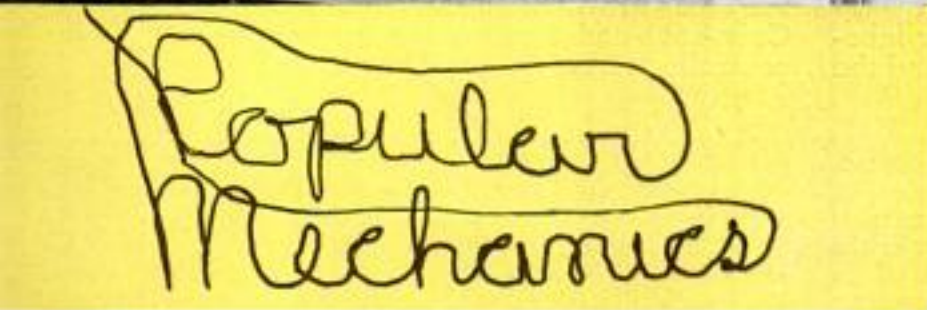

Writing unit of Thinker, above, names a president. It also told what magazine would carry its picture

Inventors of Thinker watch pointer spell out name of President Eisenhower. Number dial is just below

given on the numbered unit. There is a switch for longhand writing and one for answering current events. The fifth switch directs multiplication answers.

On the number-letter unit, one dial points to numbers 0 to 9, to a period, and to Yes and No. Another dial points to letters A to W. The mathematical answers are given through this unit along with answers that are spelled out. In the writing unit a pen, hovering over a stack of paper, is held and directed by two metal "seesaw" fingers.

I asked the machine for the square root of 98. (In asking questions through a microphone worn about the neck, each inquiry must be prefaced with "Now . . .")

"Now . . ." Lease ordered, "give me the square root of 98." As he said this he pronounced the words distinctly and counted on his fingers. Pronunciation must be clear and syllables counted since inquiries must be limited to ten syllables.

Slowly the number dial pointed out the answer. First to 9. Then to the period. Next to 8, and then back to 9. That was the correct answer, 9.89. I asked for the square root of 177. Again, the correct answer: 13.3. All

(Continued to page 218)

The Snail, a mobile wire-caged machine, follows a light beam. Inventor Versal Cross holds flashlight



Copyrighted material

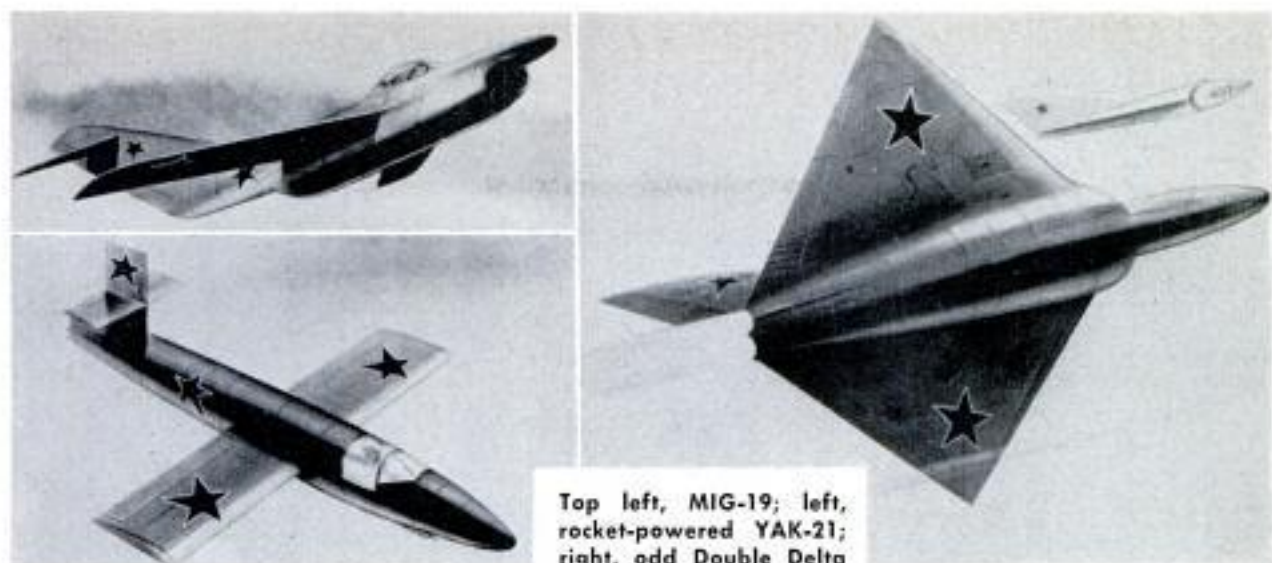

Top left, MIG-19; left, rocket-powered YAK-21; right, odd Double Delta

## Twin Jets and Rockets Power Russian Aircraft

Artists' conceptions of Russian military planes, based on known features of the aircraft, are available for American study. The sleek MIG-19 is an all-weather fighter with swept-back wing and high horizontal stabilizer. It is powered by two side-by-

side turbojet engines, as is the Double Delta, with a rhomboid wing. Resembling a guided missile, with unswept wings and tail structure, is the YAK-21, rocket-powered and capable, like the Double Delta, of extremely fast, almost vertical climb.

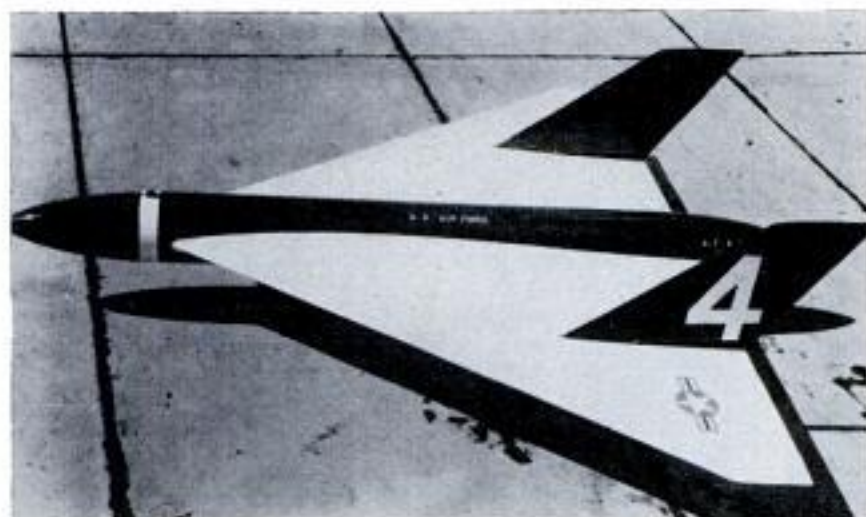

## Tow Target

With its twin vertical stabilizers and modified delta wing, the U. S. Air Force's Del Mar Delta tow target bears a resemblance to the Navy's Cutlass fighter. The Del Mar Delta can be towed at 600 miles per hour, providing high-speed target practice for Air Force pilots and gunners. Like other modern targets, the Delta not only registers hits, but records misses.

## Blood-Pressure Recorder

Blood pressure is recorded automatically at set intervals by an instrument that sounds an alarm if the patient is in danger. Used for post-surgery and cardiac cases, the unit records both diastolic and systolic pressure at selected intervals of 30 seconds to one hour. A buzzer, bell or light system connected to the machine is used to warn the nurse of a dangerous change in the patient's blood pressure.

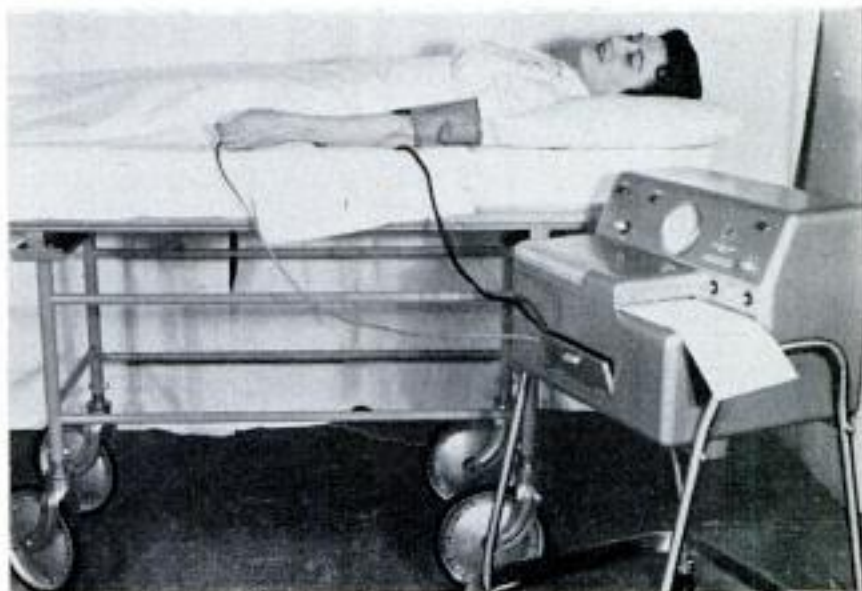

## WHAT'S NEW FOR



**ROTISSERIE** powered by electric motor fits over a roaster pan or an electric roaster oven, thus can handle a 12-pound turkey or meat 10 inches in diameter. The 1500-watt element provides ample heat to cook rotating meat plus vegetables in pan below  
Westinghouse Electric Corp., Mansfield, Ohio

**TONGS** enable you to reach shelved items without using a stool or stepladder. The wooden, cork-tipped tool can unscrew light bulbs, retrieve lost objects, aid dusting  
Gaymarth, Inc., Chilmark, Mass.



**CLOCK-RADIO-HEAT CONTROL** turns up the heat in the morning, later awakens you with music. At night, a setting on the panel will turn off the radio and the heat after you've retired. The control is part of a package heating system  
General Electric Co., 840 S. Canal St., Chicago 80







**GREASE SEPARATOR** consists of a heat-resistant-glass pitcher into which you pour roast drippings or soup stock. The grease floats on top of the liquid and stays in the pitcher as you press a release button and pour out the greaseless liquid underneath

Jepco, P.O. Box 94-E, Oakland 4, Calif.



**OUTLET STRIP** can be plugged into at any point along its length. Special outlets may be affixed anywhere along the strip by pressing a small lever. The strip ends need for bothersome extension cords

Building Electric Products Co., Electrostrip Division, 7810 Joseph Campau Ave., Detroit 32, Mich.

**CHINA RACK** holds a complete dinnerware service in a compact space. The rubber-coated rack has space for dinner plates, salad plates, saucedishes, cups and saucers. Cup hooks eliminate the need for separate hooks in the cabinet or awkward stacking of cups on shelf

Wooster Rubber Co., Wooster, Ohio



JULY 1955



**TUBE SPRAYER** holds a half gallon of solution in a plastic cylinder. Piston rod projects from its base. To pump it, you press down on the cylinder. A strong spring brings piston back after each stroke

Donaldson Co., Inc., St. Paul 14, Minn.

**FLYTRAP** lures and kills with liquid coating on platformed pylon. Pylon is dipped into container each day to apply fresh dose of poison

Pittsburgh Coke & Chemical Co., 1970 Grant Bldg., Pittsburgh 131, Pa.



127

Copyrighted material



Bell scientist checks test equipment used to bounce microwaves back and forth for 40 miles in metal tubes



The flexibility of the coiled-wire tubing permits it to be laid over long distances and rough terrain

## Long-Distance Microwave Pipe Carries Many Television Programs

Tens of thousands of cross-country telephone calls along with hundreds of television programs may someday be carried in a single two-inch metal tube. The long-distance wave guide, developed by Bell, could be buried underground and would funnel extremely short microwaves up hill, down dale and around corners. It is constructed of thin copper wire, tightly

coiled like a spring under pressure and wrapped inside a flexible outer coating which holds the wire in place. In laboratory tests, microwaves have been carried for 40 miles in a metal tube with the same loss of strength encountered when the waves travel 12 miles in a coaxial cable. The system uses microwaves shorter than any previously used in communications.

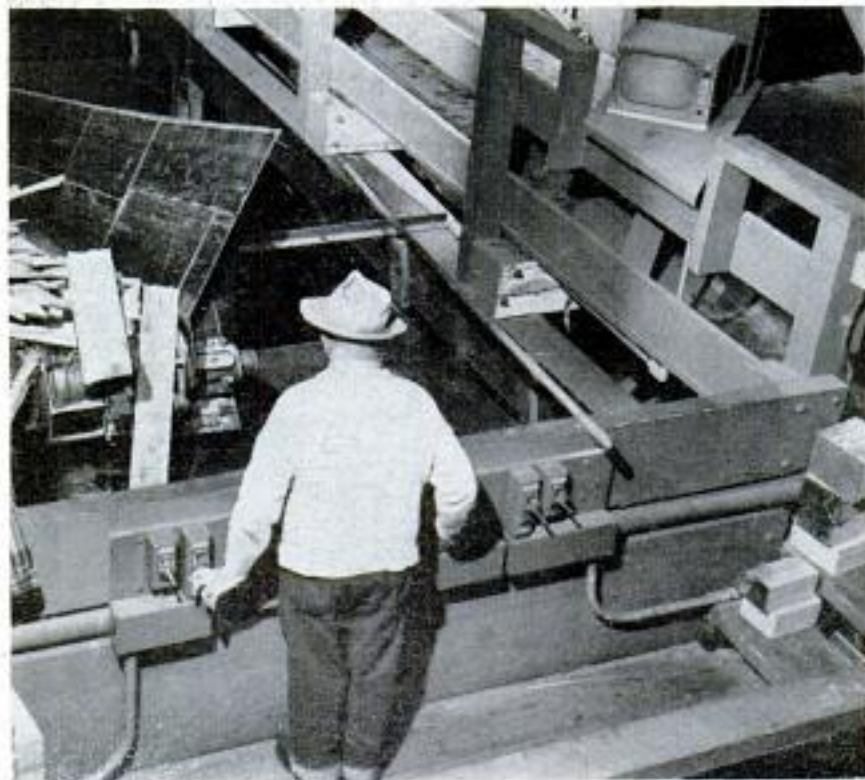

## Closed Circuit TV Speeds Mill Work

Operations in a big Longview, Wash., lumber plant are speeded by closed-circuit television that allows one man to work as if he were in two places at the same time. The controller of two conveyor belts can watch the transfer point of one belt directly from his control spot, and the other, on another floor, through a TV screen. He is able to keep a smoother flow of material from the sawmill to the pulp chippers by switching from one conveyor belt to the other. He also can sort waste materials moving on the conveyors.



## Fire-Fighting Helicopter Hovers Over Downed Aircraft

Helicopters may soon be serving as "fire trucks" of the air. The Piasecki Helicopter Corp. has proposed that fire-fighting kits be installed on the large H-21 helicopters. These airborne fire trucks would be used to fight fires resulting from aircraft accidents. Since most airports are constructed on real estate of low value, the runway approach zones are often wooded or

swampy. Such areas are difficult to reach by ground fire-fighting equipment, but could be reached by helicopter. The helicopter could hover over a downed aircraft, shooting a fire-fighting foam into the blaze. Firemen could be lowered by hoist to rescue personnel trapped in the plane. Such helicopters could also be used to fight fires in towers, in tall buildings and ships.



## Safety Door Opener

One of a series of door-control machines developed by the National Pneumatic Co., Inc., is a pneumatically operated unit. Pulling the cord operates the door-swinging mechanism (see photo at left). Use of air pressure eliminates the danger of an electrical system in risk areas.

## Plants Glow Like Fireflies

Green plants emit light much the same as fireflies. Scientists at the Oak Ridge National Laboratory have discovered that plants emit a faint red light that cannot be seen with the naked eye. They have produced the luminescent substance in the laboratory by combining the extracts of boiled green plants with a chemical from hog kidneys.



Even the Sahara Desert, Siberia and the rainiest of jungles have to look to their laurels when Uncle Sam starts talking weather. Just take that July day in Death Valley when it was 134 degrees in the shade!

# IT'S OFFICIAL . . .

## U. S. WEATHER CAN BE WILD

By Henry White Pierce

**R**ECORD HEAT SEARS MIDWEST"  
... "Snow Causes Worst Traffic Jam  
in City's History" ... "Hurricane Sweeps  
Carolina Coast" ... "18 Dead in Eastern  
Cold Wave."

These and similar headlines are splashed across thousands of front pages each year. But the most widely publicized weather stories are seldom the most severe. The New York snowstorm of Dec. 27, 1947, and the blizzard of '88 both look pretty feeble beside some of the nation's really rugged snowstorms. The heat records set in so many Midwestern cities during the summer of 1954 can't hold a candle to the all-time record for the entire country.

When it comes to rough, tough, knock-down drag-'em-out weather, the United States can give a good account of itself in any quarter of the globe. True, this country doesn't hold too many world records—the Sahara Desert and cold Siberia offer stiff competition. But with the help of its large land area, its high mountains and its extension in latitude, the nation takes top honors in some types of weather and gives the rest of the world a run for its money in others.

The United States is a part of the snowiest continent on earth. It includes the windiest point on earth where records are kept. Its heat record comes within two degrees of the record for the world. And its prairies have a range from summer heat to winter cold that is exceeded only in the vast heartland of central Asia.

Most record-breaking weather in the United States occurs in lonely mountain and desert regions and in localized sections of the Southeast. That's why the real extremes generally don't get the publicity accorded the nation's more widespread and destructive weather caprices.

Take the weather in remote Death Val-

ley, for instance. Death Valley, located in southeastern California and extending into Nevada, comprises one of the world's hottest deserts. The internationally famous explorer Roy Chapman Andrews has called it the one region of the United States which rivals the Asian deserts in heat and aridity. Rightly so, too. The heat record for Death Valley—also the record for the United States—comes within two degrees of the record for the world. On July 10, 1913, the temperature at Greenland Ranch edged its way up to 134 degrees in the shade! The world's record, held by the Libyan city of Azizia, is 136.

Death Valley also holds the nation's record for dryness. The average annual precipitation at Greenland Ranch, where records have been kept most consistently, is 1.49 inches—less than half as much as New York gets during an average single month! This puts the United States among the major contenders as far as dry weather goes. Even the most withering deserts of the Middle East can't do much better. The average annual precipitation at Cairo is two inches, and when arid Bagdad gets less than four inches it's a dry year indeed.

The United States doesn't do too badly in the heavy-rainfall field, either. The storm which brought seven inches of rain to Chicago during a single day in October 1954 made headlines at points as far apart as Tokyo and London. After all, anything more than an inch of rain in 24 hours is, by Northeastern and Midwestern standards, worthy of newspaper comment. But many southern United States cities have been drenched with more rain than hit Chicago. On June 19, 1947, Lake Charles, La., was visited by a 15.38-inch downpour in 15 hours—as much as many Great Plains cities get in an entire year! The official 24-hour rainfall record for the United States is held by Hoegess Camp, Calif. On January 22 and 23, 1943, Hoegess Camp got 26.12 inches of rain. However, a special survey at Thrall, Tex., on Sept. 9, 1921, showed 38.2

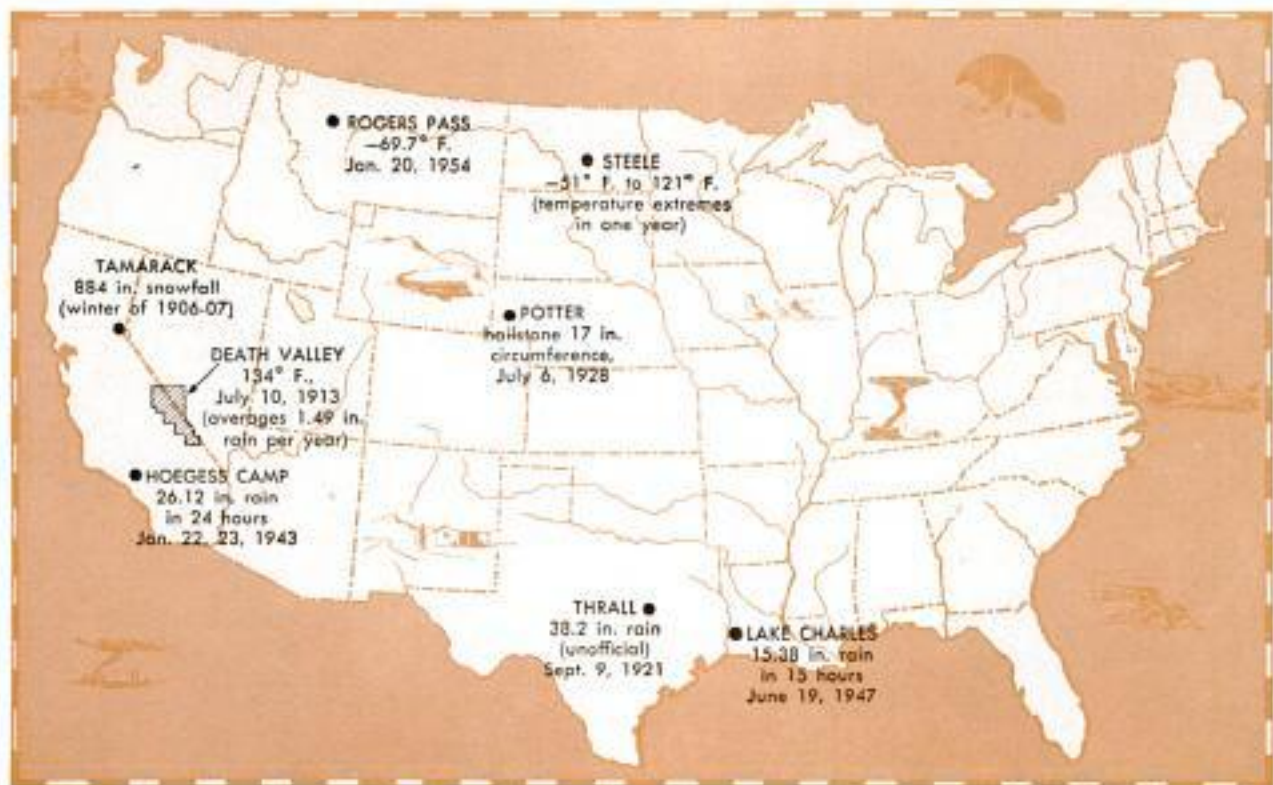

inches of rainfall in 24 hours. This was not official. The world's record: 46 inches at Baguio, Luzon, Philippine Islands, on July 14 and 15, 1911.

The coldest weather in the United States is experienced by persons living in the region of the northern Rockies. The residents of such towns as Fraser, Colo., Big Piney, Wyo. and West Yellowstone, Mont., frequently shiver under the nip of "autumn's" first frost in early August—sometimes even in July. September brings temperatures in the low 20s and January sometimes produces readings of minus 50 and 60.

The official all-time record low temperature for continental United States is a numbing 69.7 degrees below zero recorded at Rogers Pass, Mont., on Jan. 20, 1954 (until last year the record had been 66 below zero, recorded at a ranger station in Yellowstone Park). Compare this with Alaska's record of 78 below recorded at Fort Yukon on Jan. 14, 1934. Then compare it with the official record for the entire world—90 below zero at Verkhoyansk, Siberia, on Feb. 5 and 7, 1892!

The cold record for the United States falls quite a way short of the world's record low. With snow, though, it's another story. Many regions of the United States combine low winter temperatures with high winter precipitation to a degree equaled in few parts of the world. The result: Enough snow accumulates in some mountain areas to bury entire cabins.

Generally speaking, an average annual snowfall of 100 inches is considered heavy.

New York gets an average of 37 inches and Chicago gets 36 inches. Buffalo, in the snow belt of the Great Lakes, is buried under 74 inches in an average year.

The snowiest part of the United States is the mountain region of the West Coast. Large sections of the Sierra Nevada and Cascade ranges are frequently blanketed under snow 20 feet deep—and that doesn't include drifts. As might be expected, this region holds the record snowfall for a full year. During the winter of 1906-1907, Tamarack, Calif., was buried under 884 inches—over 73 feet! California also holds the record for short, hard snowstorms—60 inches in one day at Giant Forest.

Perhaps the most distinctive severe-weather feature of the United States—of north-central United States especially—is its capacity to range from extreme summer heat to extreme winter cold. It is one of the few nations on earth where temperatures lower than 50 below zero and higher than 120 have been officially recorded in the same place. Residents of the town of Steele, on the northern North Dakota prairie, have bundled up against a winter minimum of minus 51. And the same people, in this same town, have endured a record high summer temperature of 121 degrees in the shade.

Here's one record the United States probably has all to itself. The largest hailstone ever officially measured and recorded fell at Potter, Neb., on July 6, 1928. The oversize stone weighed a pound and a half and its circumference was an amazing 17 inches!

★ ★ ★

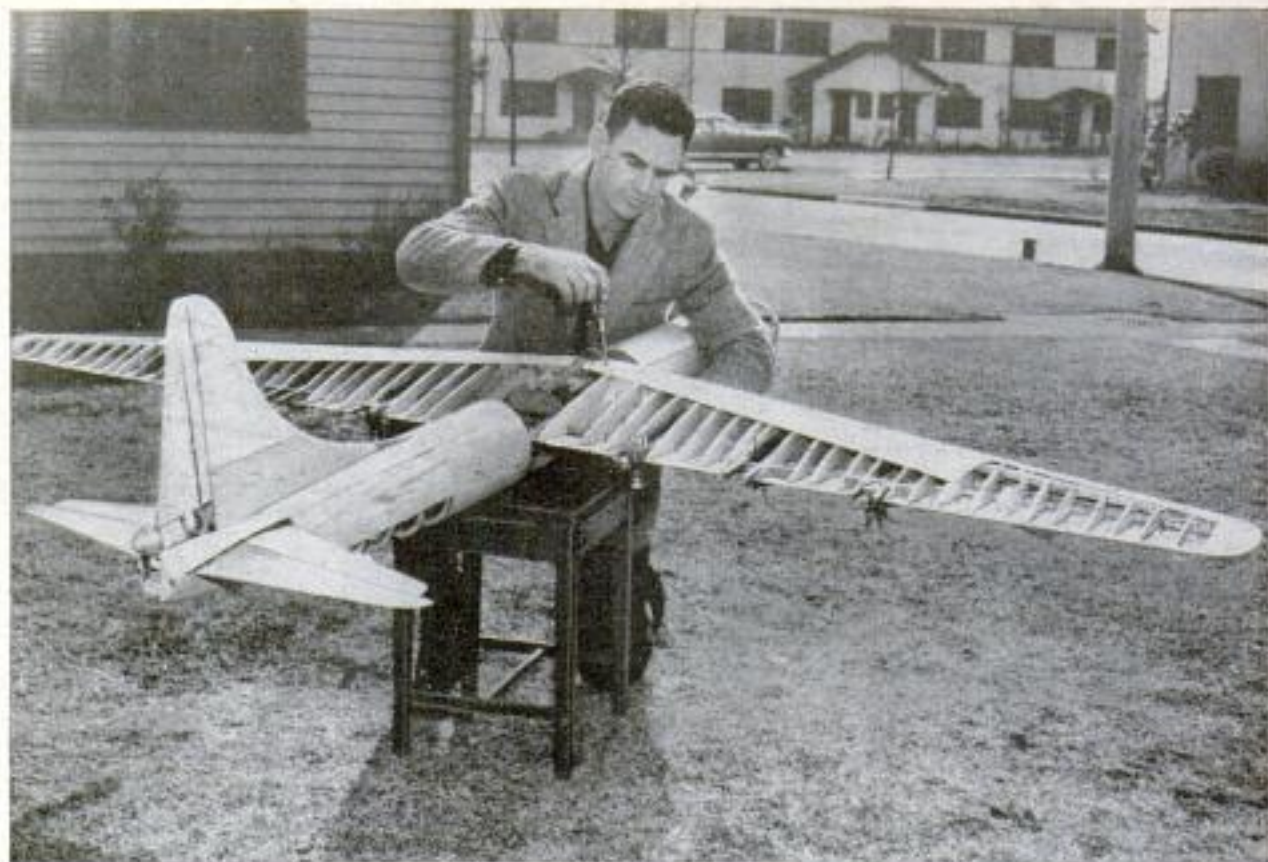

### Scale Model of B-36 Has Nine-Foot Span

With a nine-foot wingspread and six gasoline engines, Maj. John A. Vanderpoel's scale model of an intercontinental B-36 bomber is a king-size project. Vander-

poel, with the Far East Air Force in Tokyo, has spent more than \$100 on the model. Other dimensions are 77 inches, length, and 26 inches, rudder height.

### Prebuilt Dining Nook Fits Corner of Room

Amateur carpenters have no trouble installing a modern dining nook that fits into a kitchen corner. Horizontal wall strips nailed in place over the studs, together with wrought-iron legs, support the backs and seats. Fabriclike plastic covers

the upholstered cushions, which snap out for cleaning and redecorating. The upholstery wipes clean of most food and liquid stains. A plastic-topped table with wrought-iron base completes the set, which is shipped in knockdown form.

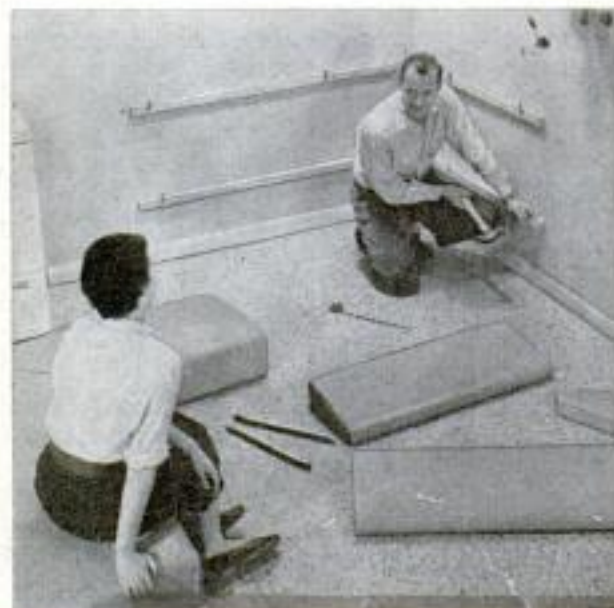

## Dodge's LaFemme Is First Automobile With a Gender—It's Female

If Dodge starts a trend with its LaFemme hardtop, license blanks will require owners to state the sex of their cars! Designed for the woman, LaFemme is truly feminine. Its interior is pink throughout. Mounted on the backs of the front seats are two matched pink leather accessory cases. One contains a pink leather handbag with matching lighter, compact, lipstick and other items. The other holds a pink rainwear outfit, including umbrella, that matches the upholstery. The car has an engine, a transmission and a differential, none of which is pink!



### Self-Winding Car Clock Mounts Inside Horn Ring

Replacing the ornament in the center of the horn ring, a self-winding automobile clock does not use any electricity. Normal rotation of the steering wheel keeps the movement fully wound, although provision for manual winding is provided, if necessary. Because the clock is fully wound all the time, it has excellent accuracy. It cannot be overwound and will run for nine days after a full wind. The dial is illuminated at night. A red arrow on the crystal can be set to keep track of elapsed driving time. The clock is available on 1955 Plymouth cars.

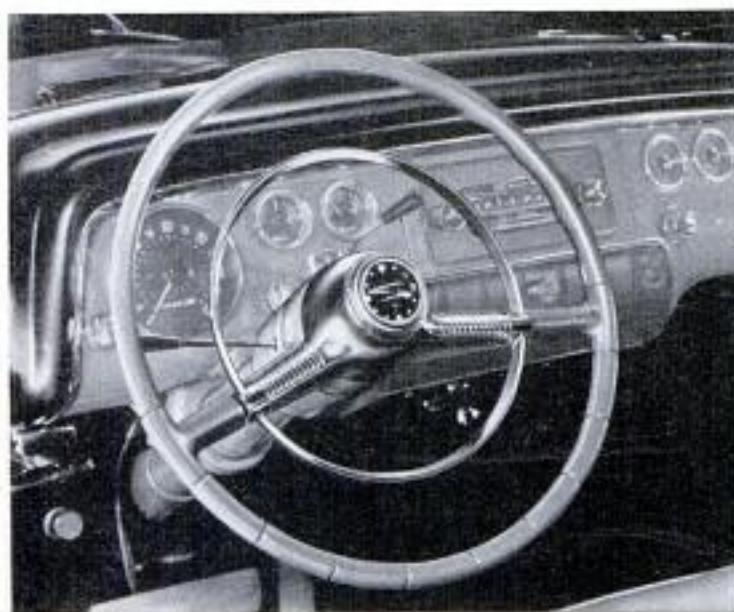

### Performance Computer For Airplanes

Designed for operation by aircraft engineers rather than computer specialists, a new Aerolog performance computer will calculate the rate of climb, speed, lift coefficients and climb angles of any airplane, according to its manufacturer, Link Aviation, Inc., of Binghamton, N. Y. The computer is of self-contained console design, so that it can be moved to engineering office or laboratory. A unique feature of its operation is that it can be changed from one problem to another and back again in a matter of minutes without "forgetting" the essentials.

☛ There are about 450 volcanoes in the world today.



# Jewels from Wood

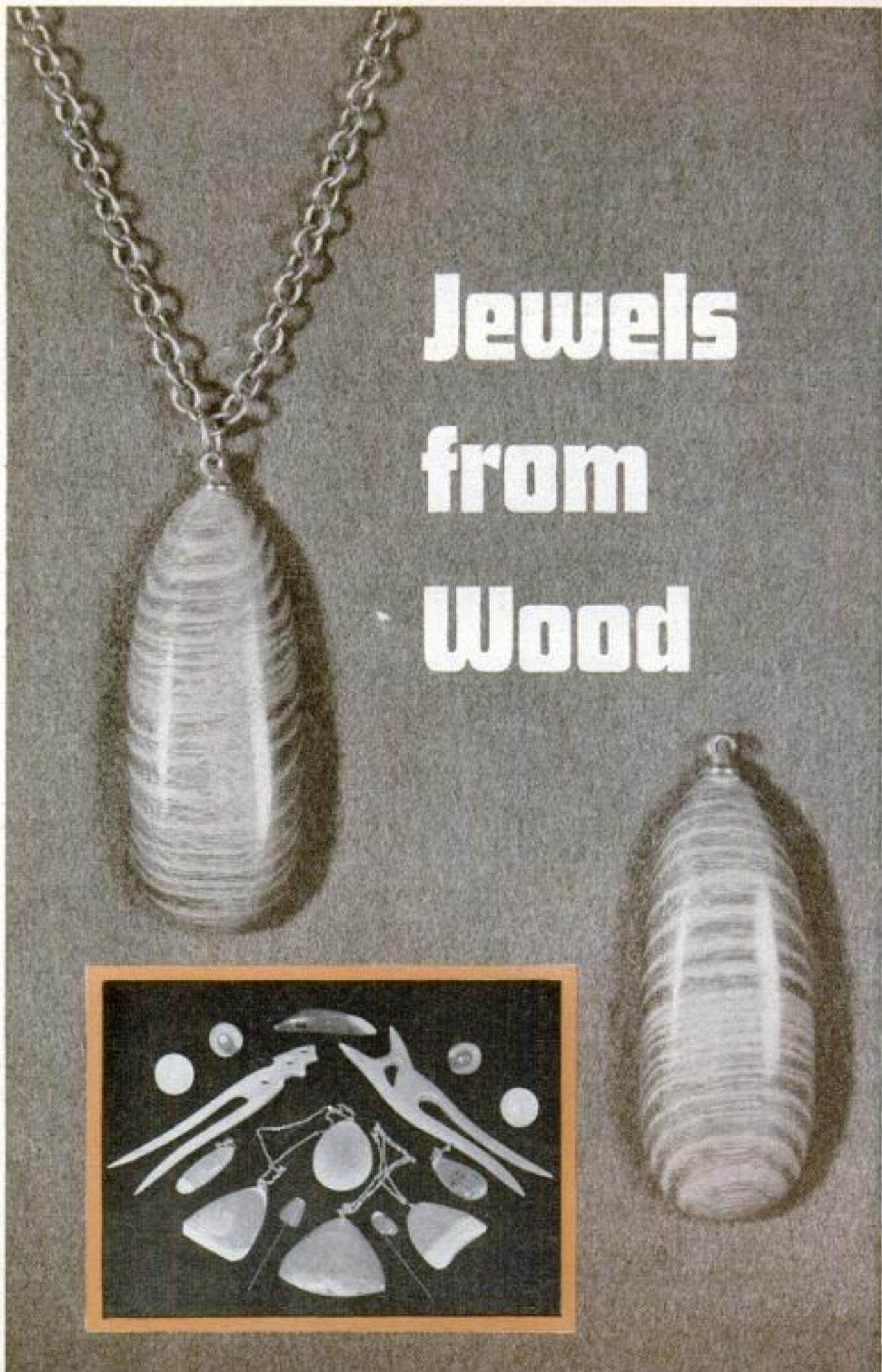



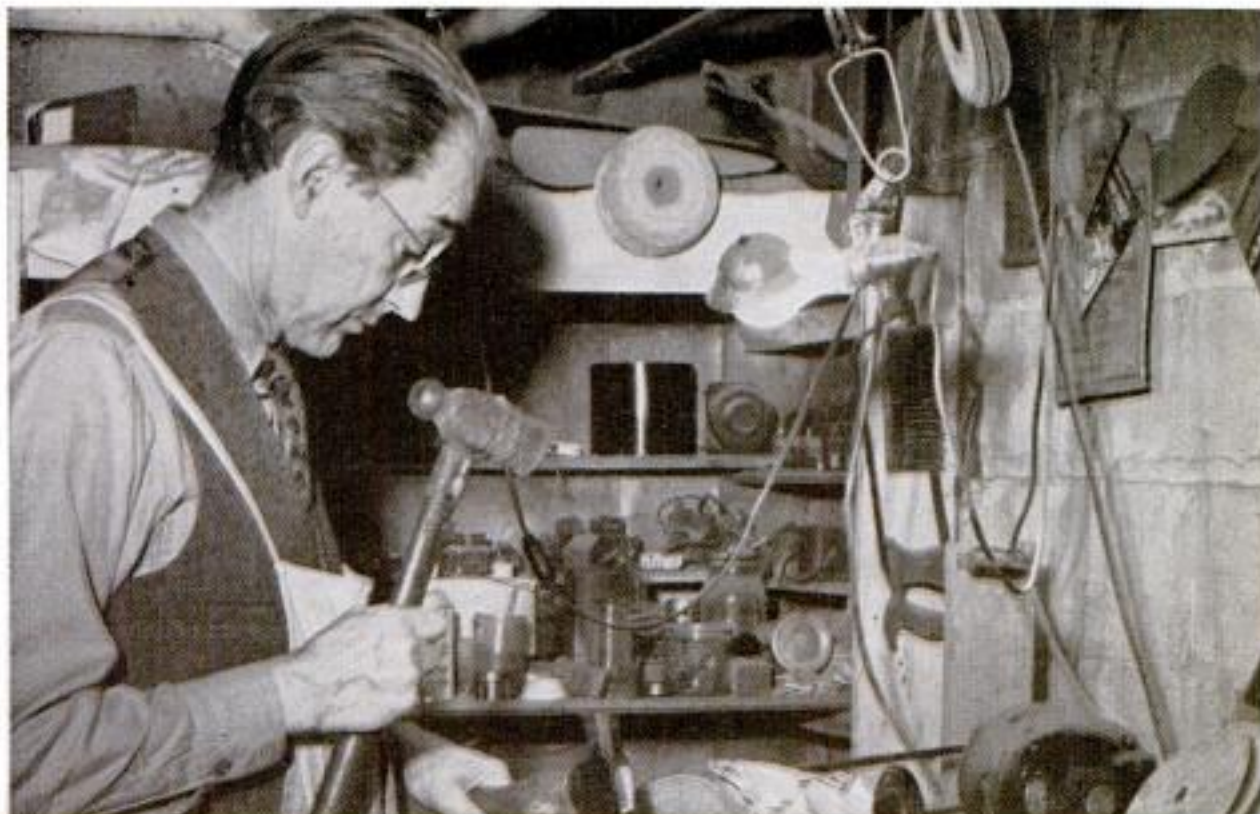

Hobbyist Arthur S. Gray at work in his basement. Samples of his wooden jewels are shown on the facing page

**WHEN CARPENTERS** By **Walter E. Burton** into unusual shapes. He tried a few ribbed or notched handles. Then he began smoothing the ribs into rounded segments to see the effect.

chopped a doorway in the wall of an old building in Ohio a few years ago, they put Arthur S. Gray on the track of a new hobby—making wooden jewels.

The whole sequence started when an Osage-orange tree stood right in front of the new entrance. So down it had to come. Gray, an inveterate hobbyist, collector and craftsman, knew that the Osage-orange wood was almost as hard, tough and flexible as tempered steel. When he saw the workmen hauling the tree away to be burned, he offered to take it off their hands. He hauled it home, cut it up and stacked the pieces away to season. Today, it is the basic raw material for his hobby of making gems of wood.

The wood is a beautiful yellow color. It is very hard, yet not so dense as some other hardwoods. It splits easily and must be worked with care. It will hold an edge or a point better than bamboo or almost any other nonmetal.

As the strips of Osage wood seasoned in Gray's basement, end cracks developed. By splitting the strips along the cracks, Gray discovered a source of graceful letter openers. He made all sizes and shapes, over 200 of them with no two alike.

At this point, he thought he had just about exhausted the uses of his cache of Osage wood. But, like any hobbyist, he decided to experiment. He began to fashion the handles of the wooden letter openers

The transformation was startling. Each of the rounded, domelike segments shimmered like a gem. The grain structure of the wood displayed an iridescence that made it look more like a semi-precious stone than wood.

Here, Gray knew, was a whole new field for his hobby activities. He would turn this beautiful wood into jewels.

He began to experiment with buttons, pendants and other forms. He had to work out much of the new art step by step, for he could find few references to guide him—no accounts of how others may have made wood jewels. He had to discover that a pendant for an earring or a necklace should be cut with the grain running crosswise in order to produce the best effect. Through trial and error, he worked out a method of producing a glasslike polish on his wood jewels. A chemist friend helped by preparing a silicone-wax mixture to produce the final luster.

Gray studies each piece carefully to determine its jewel possibilities. Often he has to rummage through hundreds of scraps before he comes across a piece suitable for the project he has in mind. Then he must determine, almost as carefully as a diamond cutter, the best way of cutting the piece into jewel blanks. To produce the

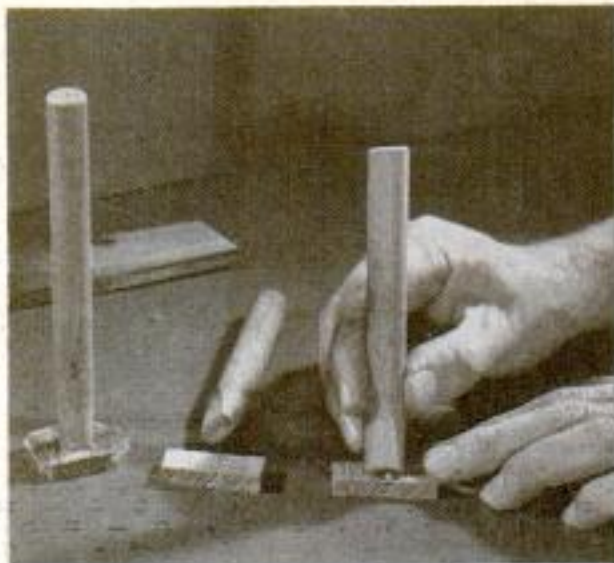

After carefully selecting the grain formation that he wants, Gray glues the wooden blanks onto handles

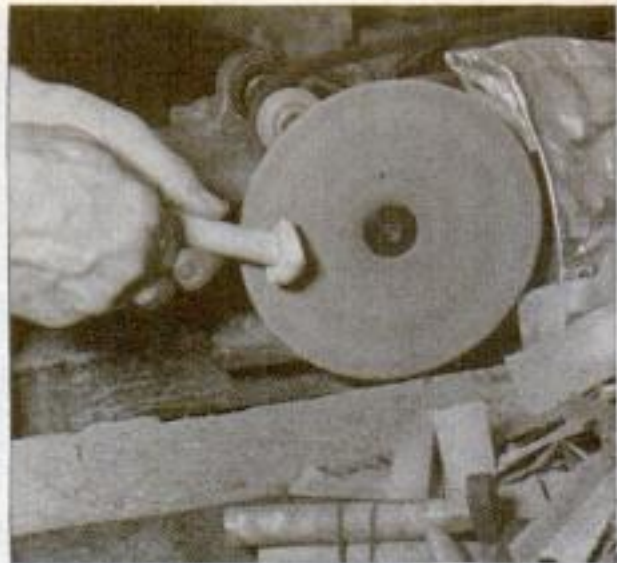

Second step is grinding the blanks roughly to shape on the disk sander. Osage-orange wood is very hard



Third, Gray clamps the handle in a vise and works the blank into the desired form with abrasive cloth



Fourth, using another piece of Osage-orange wood, he burnishes the surface until it becomes glasslike

Fifth, after burnishing, the wood is dipped in the clear lacquer, below. Later, it is polished with wax

Sixth, the final step is attaching the pin or clip. Here, Gray is inserting the tip ring in a pendant



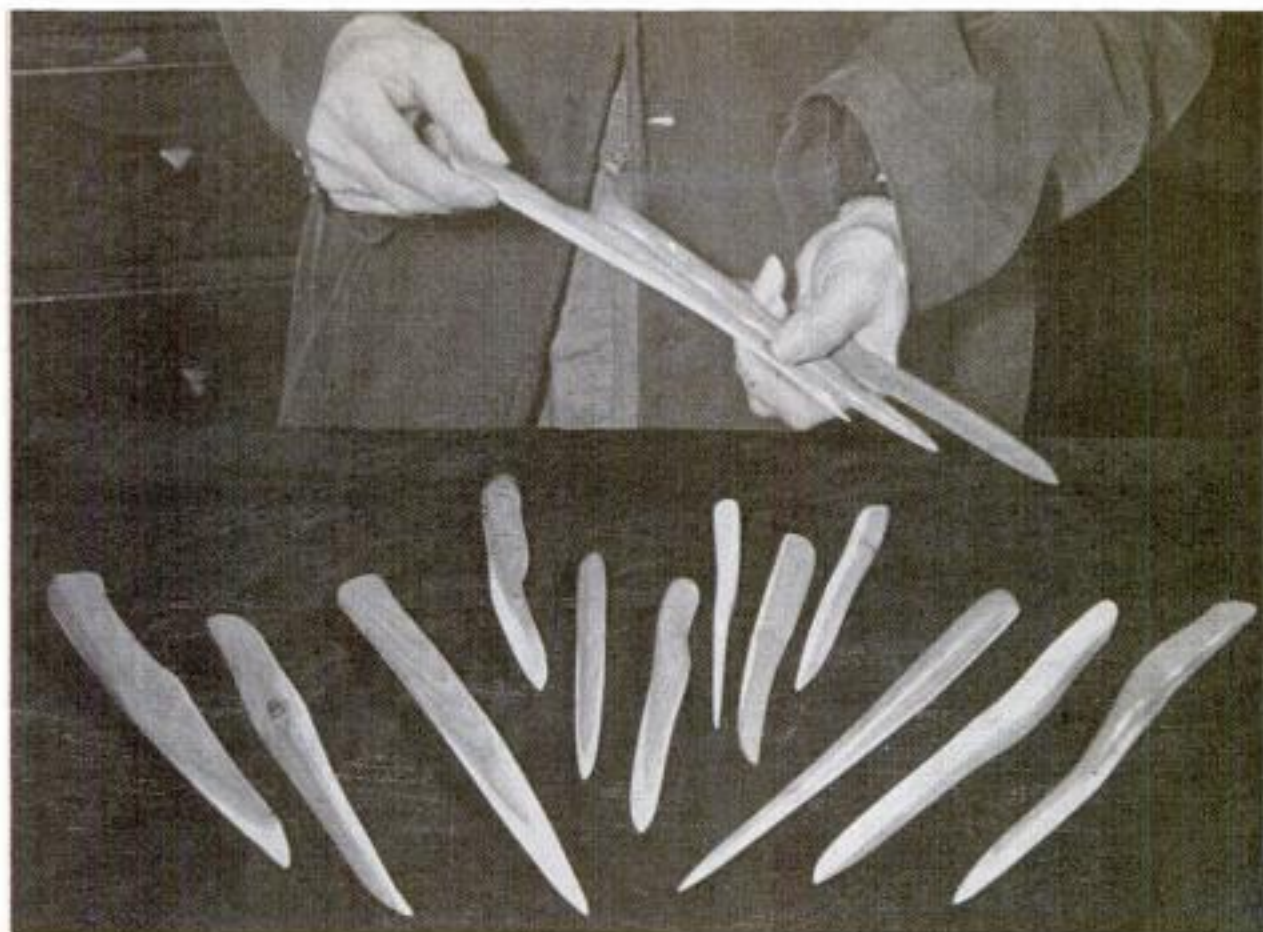

First products of Gray's work with Osage wood were scores of letter openers, such as these shown here

best effect, the grain must run in just a certain way. For instance, in two teardrop pendants, both having the grain crosswise, the laminations (annual rings) forming the pattern may slope downward in one, upward in the other and there will be a considerable difference in the brilliance of the two jewels.

Processing consists of converting the wood blank into a shape that usually is convex on the side that will be in view. The surface must be flawlessly smooth. Sometimes, the piece is worked so the end grain forms the main pattern. Round and oval buttons, teardrops and modified triangles are among the shapes Gray has found most suitable for cuff links, earrings, necklace pendants, stickpins and brooches. He has developed some interesting hair ornaments in free-form and other modern shapes.

In his basement shop he has wood, ranging from tiny blocks to sizable boards and sections of tree limbs and trunks, stored everywhere. His wood-seasoning chamber is stocked with pieces in various stages of drying. To determine whether a particular specimen has seasoned thoroughly, he simply smells it!

"When you no longer can detect the sap odor, the wood is ready to use," he explains.

Besides using Osage, Gray makes wood

jewels from such woods as buckeye, white maple, red ivory, cocobolo, ebony and ironwood. Most costly of these is the rare red ivory from Africa. It costs around \$30 a pound and because it is very dense, a pound does not contain very many cubic inches. Many softwoods produce jewels as beautiful as hard types. Some favorite cabinet woods, such as walnut, are failures as jewel material.

Gray is a purist in the making of wood jewels. He uses no stain on them. There are no glued joints. He selects the blanks so there will be no cracks or other flaws. The finish looks flawless. The making of a typical jewel, say a round button or a teardrop piece for a cuff link or earring, goes something like this:

From a piece of wood that he has carefully selected for grain pattern and freedom from cracks and other blemishes, he splits a block. With a handsaw in a miter box, he cuts it to length and usually works it further to form a blank that remotely resembles the finished jewel in shape. He flattens the surface that is to become the back of the jewel and glues to this surface the end of a handle made from a length of wooden dowel or a similar stick.

After the glue has set, Gray grinds the jewel roughly to shape on a disk sander.

(Continued to page 212)



### Custom Station Wagon Carries Tons Atop Roof

Loads of two tons or more can be hauled atop a special station wagon built by J. D. Peters of Chula Vista, Calif. The roof is only 54 inches above the road, just the right height for transferring cargo from a loading dock or highway-truck bed. Peters assembled the wagon from a Cadillac chassis, Crosley doors and side panels, Chevrolet fenders, Plymouth taillights and some additional sheet metal. The roof is heavy steel deck plate supported by strong steel box columns that

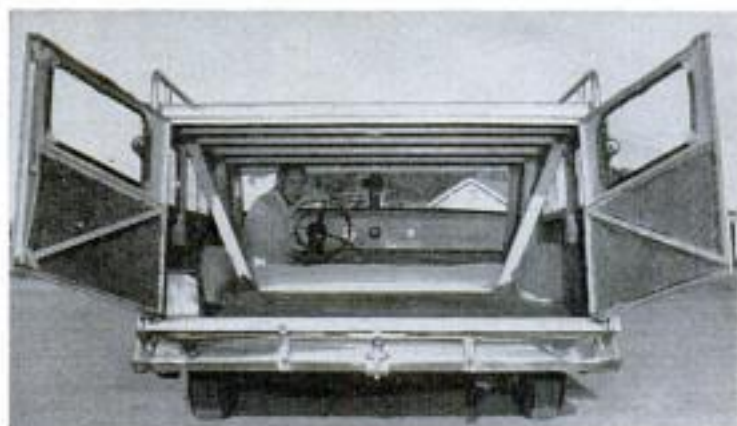

attach to the frame. The interior is 80 inches wide and the car has 120 square feet of useful floor space inside and out.

### Handle Turns Reflector to Adjust Floodlight on Building



You can direct light where you want it with an adjustable floodlight that fastens to the side of a building. A handle at the base of the eight-foot standard allows the reflector and its 200-watt bulb to be moved up, down, right or left. The floodlight is designed for use by railroads, on farms, in back yards, in camps and on construction projects.

Waste brown mud left over after the extraction of alumina from bauxite ore has been found to contain 47 percent lime, a promising new and economical source of agricultural lime.



# KEEPING UP WITH THE ATOM



**T**HE first atom smasher using the new method of "strong focusing" is now in operation at Cornell University (see photo). The electron synchrotron accelerates atomic particles by spinning them around a circular path, and strong focusing, by keeping the particles on a narrower path, produces much higher energy. The new machine has been operated at 575,000,000 electron volts and is designed to reach 1,500,000,000.

☆☆☆

Dwindling oil and gas resources will put atomic energy in a place of vital importance by the end of this century. The "squeeze" on oil and gas fuels will begin to be felt by 1975, and our primary power source will be fluid fuels from coal in the last decades of the century, according to Dr. Lawrence R. Hafstad, physicist on the staff of the Chase Manhattan Bank of New York, who was the first director of the Reactor Development Division of the Atomic Energy Commission.

Doctor Hafstad's chart shows the energy demand in the United States from 1900 to the year 2000.

"The portion that runs up to about 1953 is past history," he says. "From 1953 to about 1975 are extrapolations by the government agency which has been studying our fuel reserves. I have attempted further linear interpolation up to the year 2000." The chart shows that the amount of energy consumed in the form of coal has remained almost constant, and that power derived from water and wood have been insignificant.

"The really important increase," says Doctor Hafstad, "has been in the fluid fuels, oil and gas. But since we consume these in our oil burners, our automobiles, trucks, airplanes and so on, unfortunately it is in the fluid fuels that this nation will first run out of energy. By 1975, or sometime thereabouts, the long-awaited squeeze on fluid fuels is likely to make itself felt. At that point, it is almost certain that we will have to convert coal into a fluid fuel.

"In one pound of fissionable uranium there is as much energy as in 2,600,000 pounds of coal. There is at present at least 20 times as much energy in known reserves of uranium and thorium

(Continued to page 216)

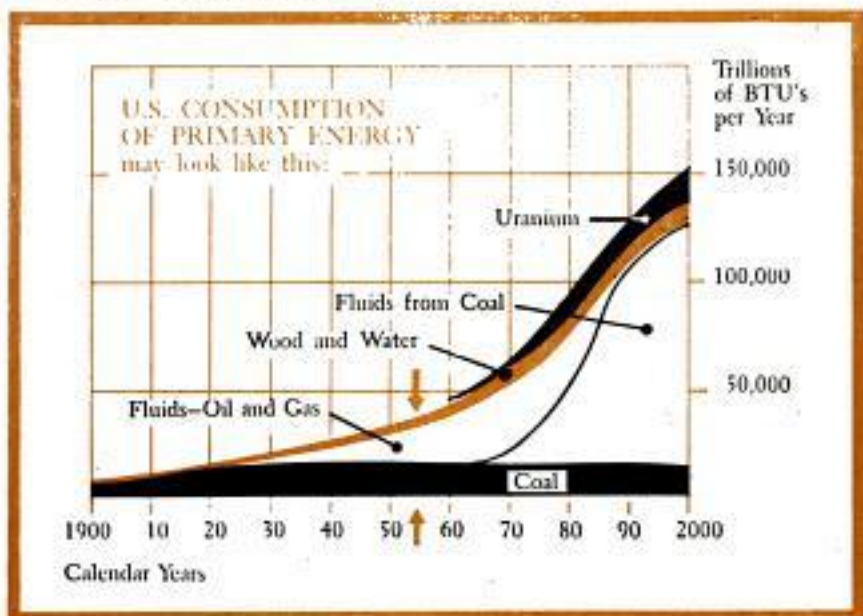
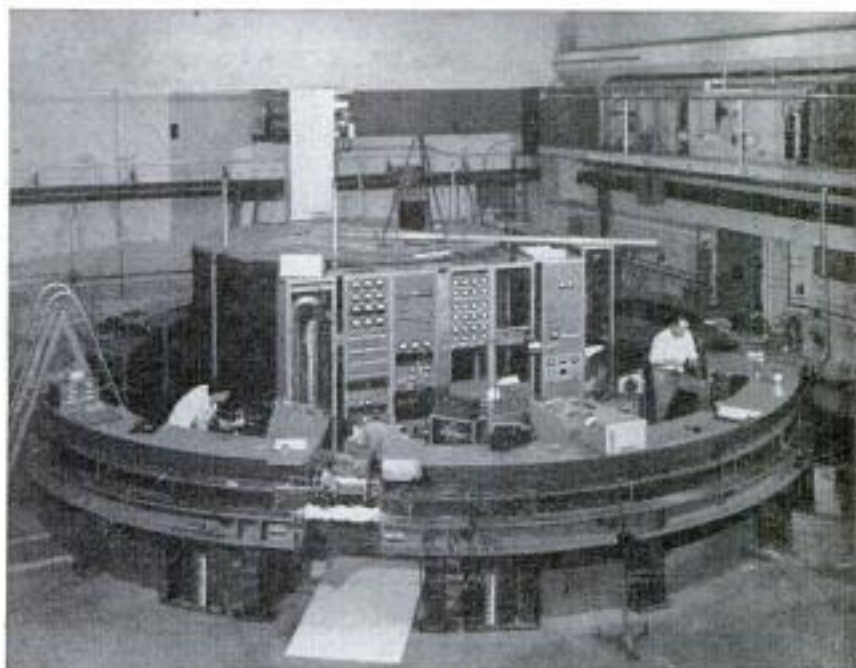



Hunting party uses several trams on Chicle Road to penetrate the heart of game-crowded Yucatan jungle



"Engineer" readies his "locomotive" for jungle run. Below, hunter rides back to Puerto Morelos after downing a pheasant



## Mule-Car Railroad Penetrates Jungle

THERE IS NO other railroad in the world quite like a 25-mile, 20-inch line in the territory of Quintana Roo, Mexico. It extends from the decaying village of Leona Vicario, deep in the Yucatan jungle, to Puerto Morelos, a cove on the Caribbean Sea. Chicle workers in the jungle village depend upon it as a link with the outside world.

The road was built nearly 50 years ago by an Englishman who hoped to cash in on the rising demand for chewing gum. He established a settlement and imported rails with which he built a line to the sea. Then he brought in several little tram cars and a dozen small Spanish mules to pull them. But his chicle-producing project collapsed, he died, and jungle choked the little right-of-way. The line was restored when the Mexican government persuaded the local chicle workers to organize a cooperative. Chicle camps were built along the railroad, and trotting mules pulled the little trams to transport chicle, men and supplies through the jungle. Now anyone can use the road, including American hunters after jaguars, lions and wild fowl.

## Grooved Tape Recording Plays for Eight Hours

**YOU CAN ENJOY** eight hours of uninterrupted music with a record player that combines features of disk and tape.

The recording itself is on vinyl tape. However, the sound is engraved in grooves as on disk records rather than magnetically.

Protected from dirt and handling inside a plastic case that looks like a fat book, the tape uses the continuous-play system. It never needs rewinding. As it unwinds from the outside of the reel, the tape winds back on the inside automatically.

The sound track is about 85 grooves high, forming a band about 1/2 inch wide. Because the sound track always goes past the pick-

up stylus in a straight line there is no tracking error.

To play the tape, you place a Sound Book, as the recording is called, over the spindle as you would a disk record. Then you pull out a short section of tape and slip it over the playing wheel or capstan. The recording is ready to play, the pickup stylus moving into the first groove automatically. A footage scale lets you select any passage you wish.

Because the tapes are pressed, they are cheaper than magnetic-tape recordings. The player sells for about \$100, the records up to \$20, depending on length.

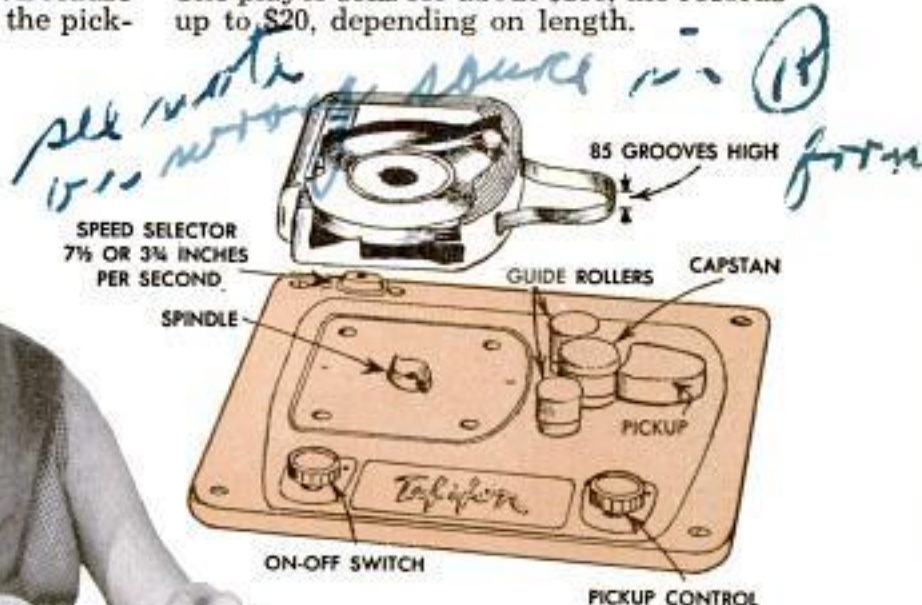

Now on sale in this country, the unusual grooved-tape record player was invented in Germany. Forty different Sound Books (like those below) are now available



# STUDENT SET NO. 2 OPERATES SPEAKER

By Jay Stanley

## MATERIAL LIST

A material list for Set No. 1 (described in *PM*, May 1955) will be mailed if you send a self-addressed and stamped envelope to Radio Department, *Popular Mechanics*, 200 East Ontario St., Chicago 11, Ill. A blueprint of Set No. 1 is available for 40 cents. No blueprint or material list is available for Set No. 2, described here. The following parts are all you need to convert Set No. 1 into Set No. 2:

- One 6AQ5 tube; one 7-pin mica tube socket
- Four 5-prong rim-type coil forms 1113B
- One 62G093 Knight standard output transformer 8000-3.5 ohm (T4)
- Two red knobs
- One 4-inch GE 400D speaker
- Two audio transformers 1:3 step-up (T2 and T3)
- One vernier-drive dial, National type K
- One 250-ohm 1-watt resistor (R10)
- One volume control .5 meg. (R11)
- One electrolytic capacitor 5 mfd., 25 v., Sprague TVA 1203 (C13)
- One tubular capacitor .01 mfd., 400 v., C-D 4S1 (C14)

IN THE MAY ISSUE we explained how to build Student Set No. 1—an excellent performer that tunes standard-broadcast stations with plenty of earphone volume.

This month we add a few parts to the May set and convert it for tuning short-wave bands down to about 15 meters with loudspeaker convenience. No drastic changes need be made in the original set.

With these additions you can receive amateurs, foreign stations, aircraft and ships, plus other short-wave broadcasts.

A high-gain transformer-coupled audio output stage is added to provide the extra power needed to operate the loudspeaker. This stage uses a 6AQ5 beam power tube. It boosts the signal so much that a volume control is added to avoid excessive volume on the broadcast-band signals and on some short-wave signals as well.

When you add the new parts, follow the layout closely. Otherwise, hum troubles may result. Transformer T3 should be lo-

Colored ink is used in the diagrams to identify the parts and data needed to convert Set No. 1 to Set No. 2

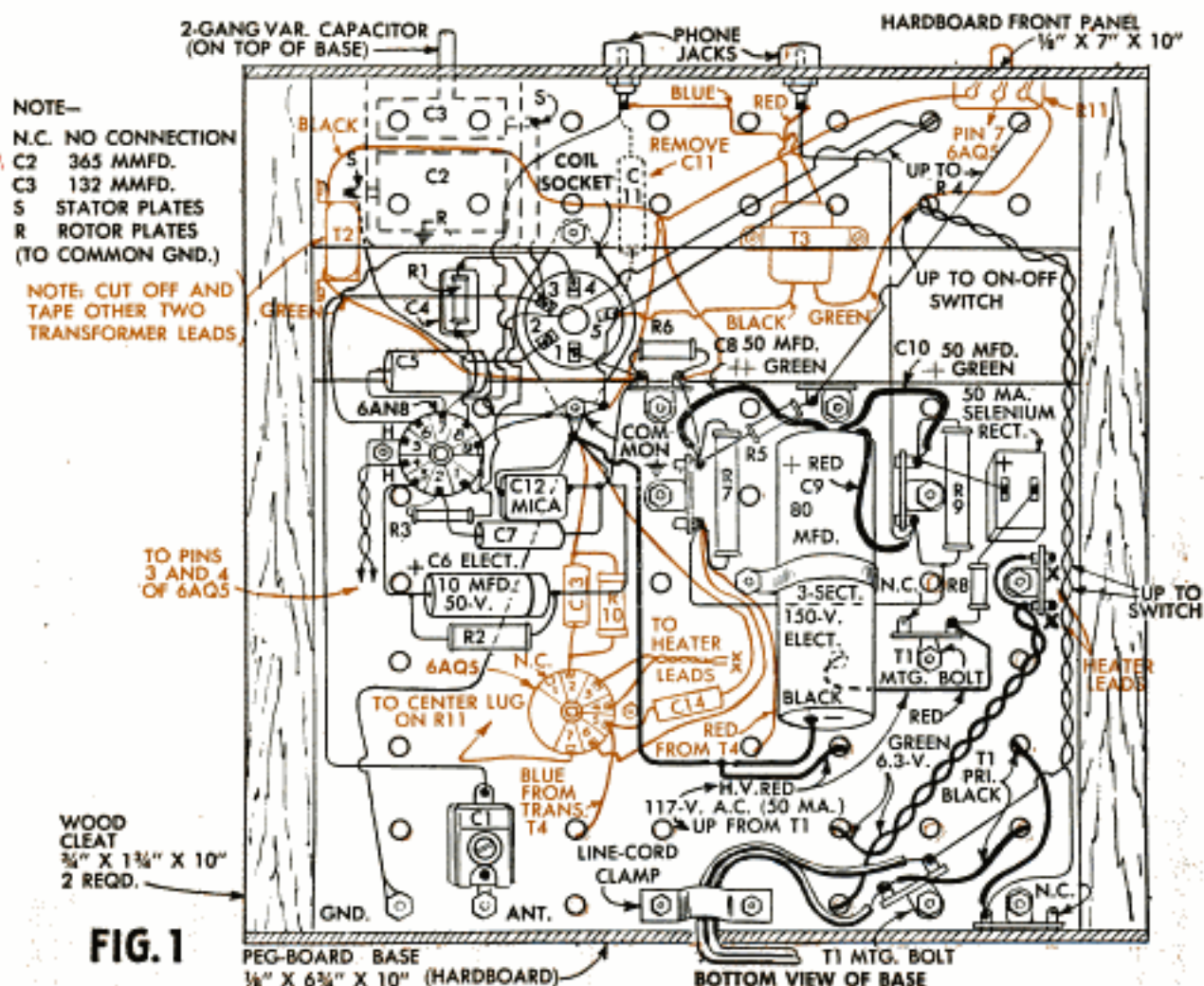



# AND TUNES SHORT-WAVE BANDS

cated as shown. If it is moved across the chassis close to the 110-volt line or the heater leads, there may be excessive hum pickup.

The speaker location is fairly critical. Don't mount it on the front panel. To do so may introduce "microphonics," caused by vibrations from the speaker reaching the detector tube.

Wiring the amplifier unit is simple and straightforward. Be careful to make correct connections at tube socket and transformers.

On the schematic (Fig. 2) and the pictorial (Fig. 1) diagrams, parts added for the second set are shown in color. Parts retained from the first set are in black.

The coil from Set No. 1 covers the broadcast band. The added short-wave coils are similar except that the jumper inside the forms is omitted.

This is done so that in short-wave tuning only the smaller section (C3) of the two-gang capacitor is connected into the circuit. The reason is that short-wave signals tune more sharply than broadcast-band

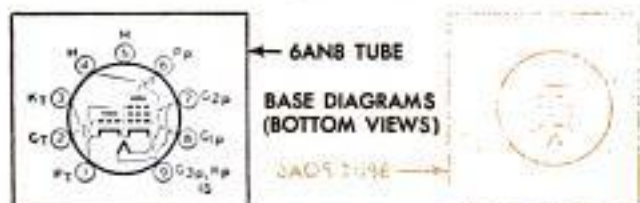
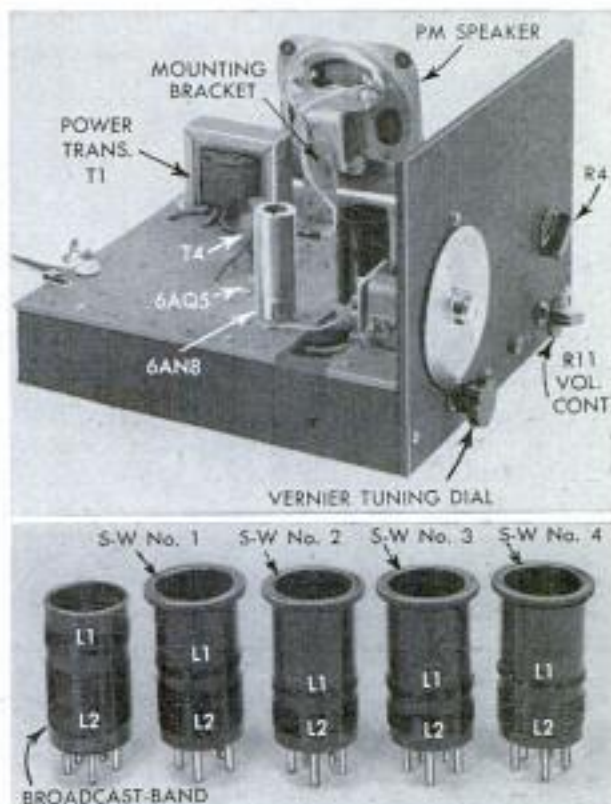

COIL CHART			
	L2	L1	Wire
Broadcast	85 turns	30 turns	#30 enameled close-wound
S-W No. 1	36½ turns	7½ turns	#26 enameled close-wound
S-W No. 2	19½ turns	5½ turns	#22 enameled close-wound
S-W No. 3	9½ turns	4 turns	#22 enameled close-wound
S-W No. 4	5½ turns	3 turns	#22 enameled spaced out

NOTE—L1 and L2 are all spaced ¼" to 1 in. on form

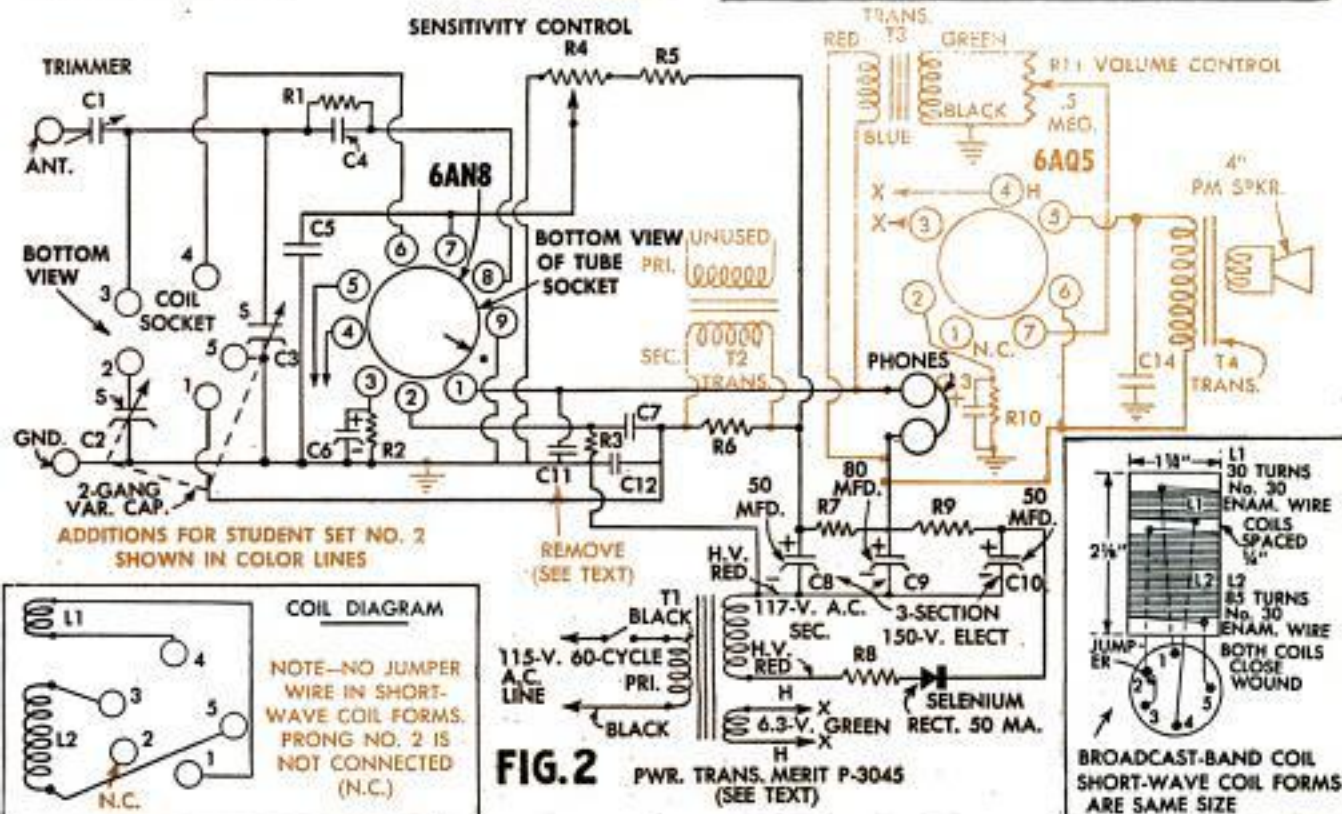

**FIG. 2** PWR. TRANS. MERIT P-3045 (SEE TEXT)

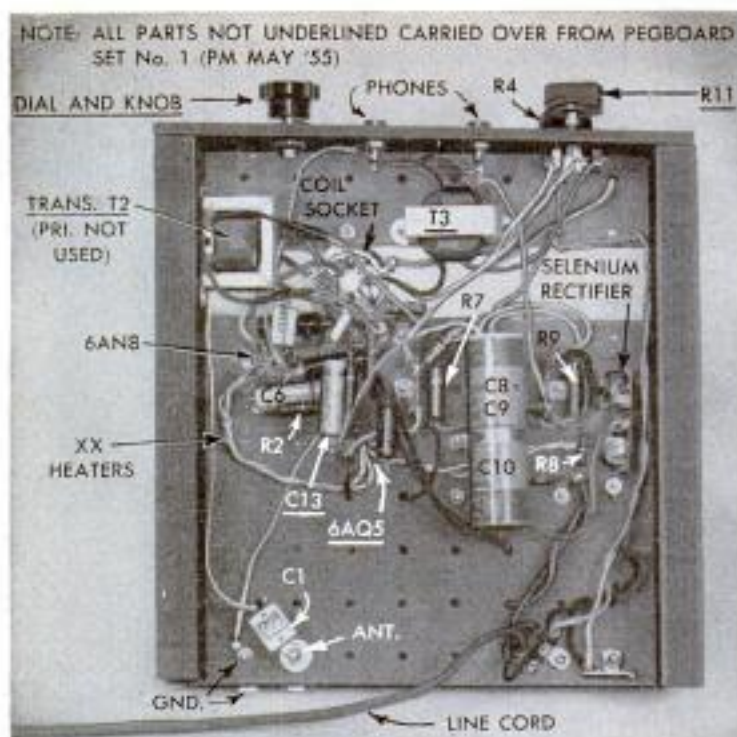

CAPACITORS	
C1	= 40-80 mmfd. trimmer (mica-type ceramic base)
C2 & C3	= 2-section superbet-type tuning capacitor. C2 = 305 mmfd.; C3 = 132 mmfd.
C4	= .0001 mfd. mica fixed capacitor
C5	= .05 mfd. 400-V. tubular paper type
C6	= 10 mfd. 50-V. electrolytic
C7	= .01 mfd. 600-V. tubular paper
C8, C9 & C10	= 3-section elect. 150-V. C8 = 50 mfd.; C9 = 80 mfd.; C10 = 50 mfd.
C11	= .01 mfd. 600-V. tubular paper
C12	= .00025 mfd. mica type
C13	= 5 mfd. 25-V. electrolytic
C14	= .01 mfd. paper fixed capacitor
RESISTORS	
R1	= 470,000-ohms, 1/2-watt carbon
R2	= 2700-ohms, 2-watt carbon
R3	= 470,000-ohms, 1/2-watt carbon
R4	= 0-25,000-ohm vol. control with switch (Mallory U29 midget linear taper)
R5	= 100,000-ohms, 1/2-watt carbon
R6	= 270,000-ohms, 1/2-watt carbon
R7 & R9	= 1000-ohms, 1-watt carbon
R8	= 22-ohms, 1-watt carbon
R10	= 250 ohms, 1-watt carbon
R11	= .5 meg. volume control

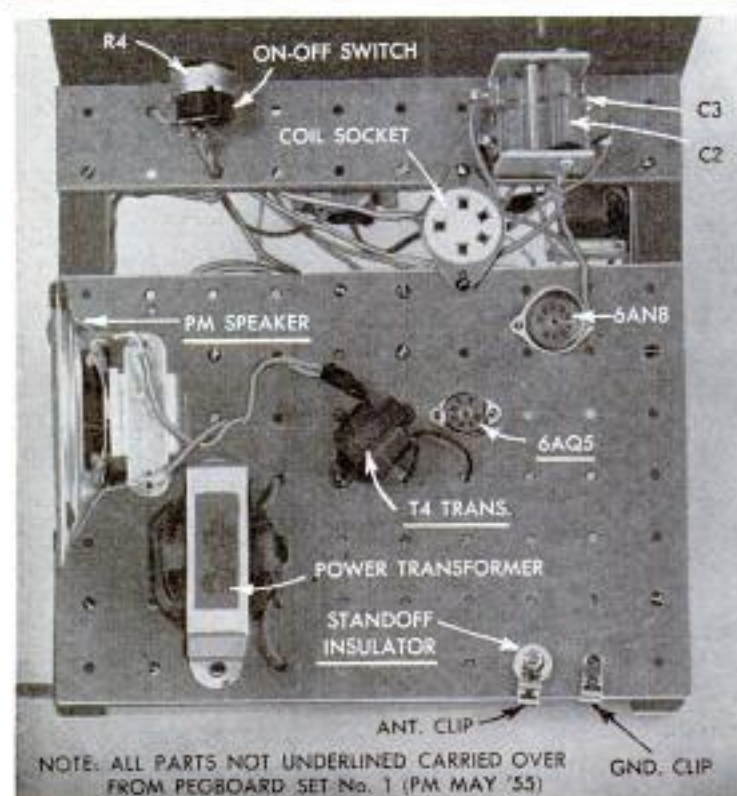

signals. Prong 2 in the short-wave coils is not connected. The top coil turnings on L2 go directly to prong 3 as shown at the lower left-hand corner of Fig. 2.

Sharp tuning of short-wave signals makes a vernier tuning dial necessary. The one in the set is a National type K, an inexpensive but good vernier dial. However, it is difficult to mount. There are two dials which are easier to mount and align although more expensive. These are the National type A (0-100 rotation) and the Millen type 10039. The beginner may prefer to use one of these.

Regeneration control is trickier on short wave, so T2 is added across the detector plate resistor. This transformer (the secondary winding of a standard audio transformer) raises the plate voltage on the detector-tube stage and provides a more favorable ratio between that and the screen voltage, increasing gain and making control smoother.

Capacitor C11 may not be needed in Set No. 2. It should be taken out if experiment shows that removing it makes no difference in reception. However, get the set working first with C11 in.

Poor insulation can cause considerable signal loss on short wave. Loss is minimized by mounting the trimmer condenser and antenna lead-in on a small standoff insulator as shown in photos on this page.

Local broadcasting stations can be picked up with a 10-foot length of wire as an antenna. A short antenna is preferred because it increases selectivity on broadcast band. For short-wave stations, an outside antenna is needed, especially for DX reception. An L-shape antenna of about 60 feet of wire works well. If you have more space, the longer the better.

If dead spots are experienced in some parts of the bands, "loosen" the antenna coupling by opening up the trimmer condenser C1. On the highest frequency bands (particularly with coil 4) some tunable hum may be apparent over part of the tuning range. This is usually caused by antenna length and its closeness to other objects. You can often eliminate it by changing the length and location of the antenna. Be certain you use a good ground. It, too, helps reduce hum. ★ ★ ★

# the POPULAR MECHANICS CRAFTSMAN



Above, bright sun on snow as shown in this shot of the Grand Canyon produces excessive light reflection and normal exposure must be varied accordingly. Below, natives in foreign countries provide good subject material when shooting with color, especially if you can get them to pose in colorful dress

## LOAD UP with COLOR

VACATION TIME means camera time. Together they mean time for color film, for there's no better way of capturing the beauty and grandeur of a scenic vacation trip than with color film.

There are no secrets to taking good vacation pictures, although few really good pictures just happen. Essentially it's a case of knowing your camera, using your imagination and planning each shot. Composition-wise, your pictures should always tell a story and the best way to do this is to include people, trees, buildings and local points of interest. These serve as important





Left, fishing boats in foreground in Monterey Harbor provide focal point and improve composition. Below, off-center vantage point always makes a more interesting picture than dead-center, as seen by this carriage shot taken at Mackinac Island



props which help to make the picture. But avoid posing people and don't let them spoil your shot by looking directly at the camera. Get yourself in the picture occasionally but here again, busy yourself by doing something, such as lighting a cigarette, talking to local citizens or buying something in the market place. Public buildings, churches, statues, memorials and parks are all good subjects of local interest that make good pictures since they carry identification. Here, composition is important and you should learn to recognize whether the subject matter indicates hor-

izontal or vertical composition. If your camera takes square pictures, it doesn't matter. In general, better composition can be obtained when shooting horizontal pictures, such as buildings, by moving the camera to an off-center position.

Don't be afraid to use film. It's actually only a fraction of the expense of a vacation trip. Try the same shot from different vantage points and vary the exposure as the professionals do. You've probably traveled a long way and you certainly don't want to return to tell your friends about the "ones that got away." ★ ★ ★

Whitecaps make a salon picture of otherwise common shot of ocean taken from Cypress Point, Carmel, Calif.



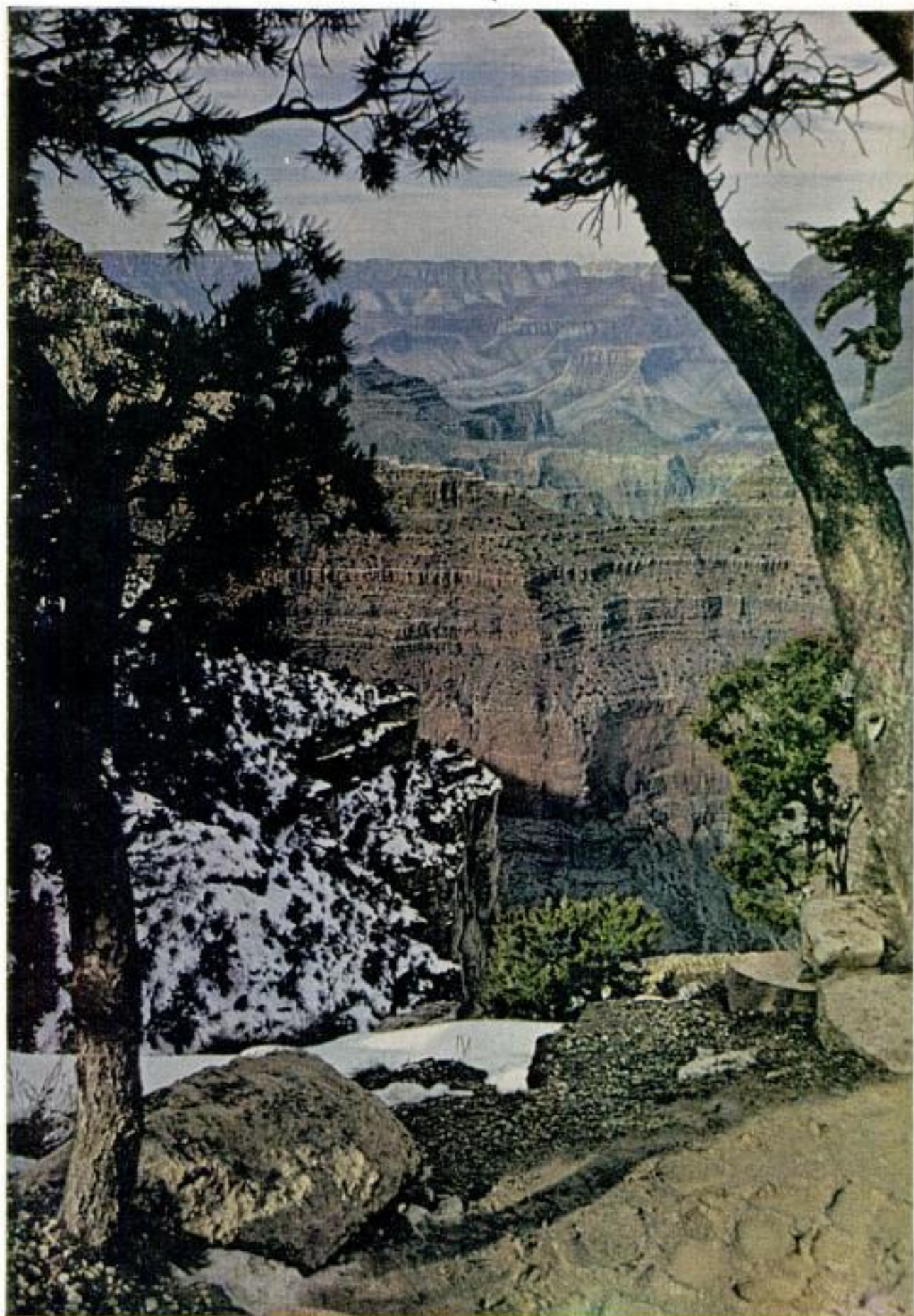

**This beautiful shot of the Grand Canyon photographed from the south rim is an excellent example of framing. The border of trees in foreground adds a dramatic effect. Generally, the frame must be large enough to register as a shape in the composition and kept out of focus. Occasionally, in the case of an arch or gateway, you can back away somewhat to keep the foreground in focus. Frame objects also can be used to identify locale**

JULY 1955

147

Copyrighted material



Original vanity was framed in inexpensive woods and finished as you see it here with plastic veneer. Matching chairs and mirrors are made in duplicate

*Modern  
Furniture*

# DOUBLE VANITY DESK

By John Bergen

**F**INE WOODS and conservative modern lines fit this double vanity desk into almost any arrangement of room furnishings. The simplest type of frame construction and drawer joinery make it easy to build, even with a small shop and limited equipment. At the start you have a choice of materials. You can use fine cabinet woods, such as cherry, birch, or primavera in solid stock or plywood faced with any of these three. The selection of wood depends on the color desired. Or you can use a less expensive wood, such as white pine or poplar, and face all exposed parts with a plastic veneer. The original vanity, pictured above, was made by the latter method.

Details of the cabinet-frame construction, also the top and drawers, are given in Figs. 1 and 2. Note first that the upper three drawers are of the flush type and are exposed, while those below in the cabinet, or pedestal, are housed behind doors. Build the lower part of the cabinet first. This unit consists of the base, bottom, side panels, back panel and drawer framing. These parts assemble into the unit pictured

in the photo in Fig. 1. All parts except the drawer framing are cut from plywood. Note that the base is inset on three sides the thickness of the plywood panels and doors. The top section, Fig. 2, consists of the top proper, a full-length back rail, end rails, and the drawer framing. Note especially in the perspective view in Fig. 2 how these parts are joined and that the top is flush at the back, ends and front. The top on the original piece was made from a  $\frac{3}{8}$ -in.-plywood panel and covered with linoleum. The edges are finished with a strip of solid stock rabbeted and mitered as in a lower right-hand detail, Fig. 2. An alternate method of finishing the top, using a plastic laminate with edgings of the same material, also is shown. The sides of the drawers in the lower cabinet are grooved before assembly. Each drawer slides on a strip attached to the inner face of the end panel and on the center guide which is attached to the center stile. The slide grooves engage the guides as in the lower left-hand detail, Fig. 1. A clearance of  $\frac{1}{8}$  in. is provided between the drawers as in the lower right-hand detail, Fig. 1.

The drawers in the top section slide on flat rails and center guides which are a part of the top-section framing. The cut-away view, Fig. 2, shows how this framing is assembled into a unit and then attached to the lower cabinet, or pedestal. Assemble the top section completely before making and fitting the drawers.

The legs which support the overhang at

Upper edge of all panels must be sanded or planed flush with the frame so top section will fit

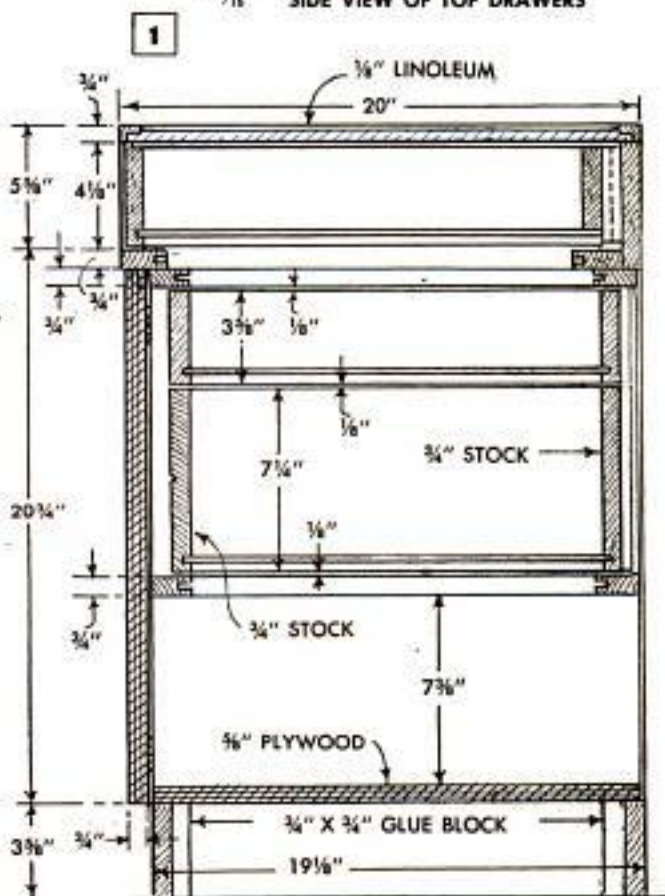
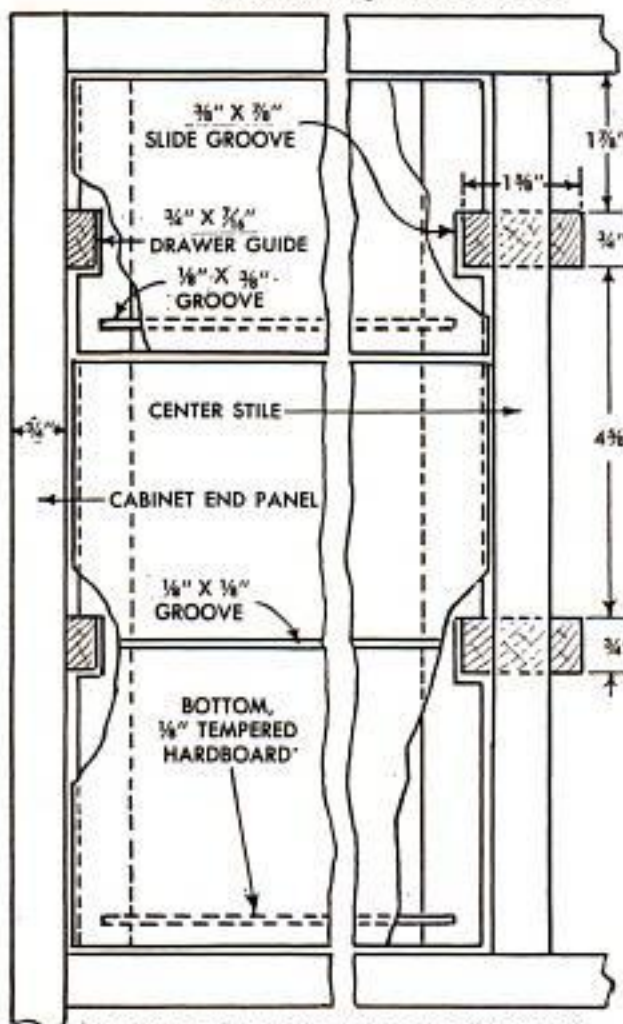
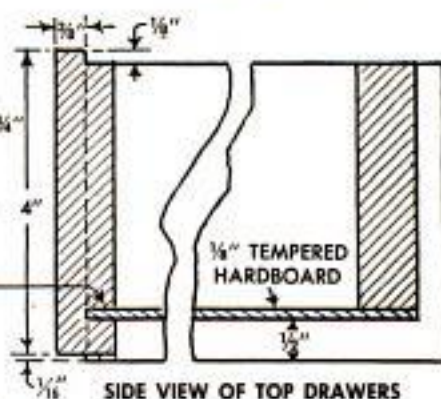
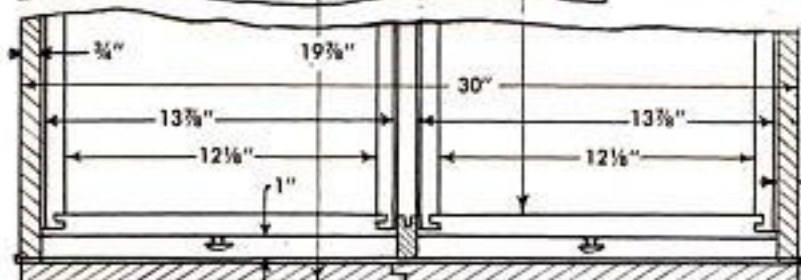
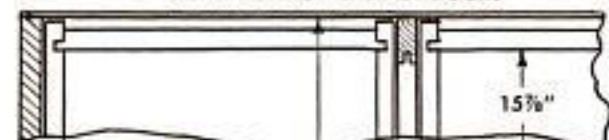
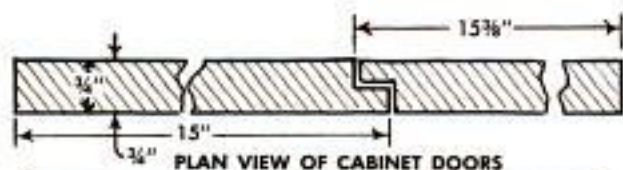





each end of the top section are 5 in. wide and  $1\frac{1}{2}$  in. thick. If solid stock has been used in the construction of the cabinet, then the legs should be cut from one piece of  $1\frac{1}{2}$ -in. material. However, if the cabinet is to be finished with plastic veneer, then each leg can be built up to the required thickness by gluing two pieces of  $\frac{3}{4}$ -in. stock face to face as indicated.

Figs. 3 and 4 detail the twin mirrors and matching chairs. These units, of course, are optional. The mirrors may be attached to the wall as pictured on page 148, or pivoted on brackets attached to the back of the top cabinet section as in Fig. 3. In either case, the mirrors should be backed with  $\frac{5}{8}$ -in. plywood. The chairs are of the swiveling type, the seat frame being mounted on a ball-bearing swivel, or fixture, as detailed in Fig. 4. The exposed legs and back braces are cut from wood that can be natural-finished to match the cabinet. All other parts of wood are covered by the upholstering materials. Upholstering consists of a simple padding and outer covering welted and tacked.

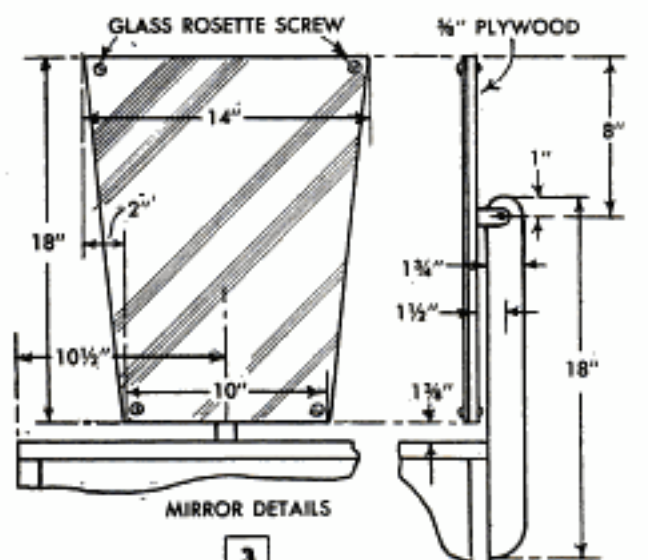

MIRROR DETAILS

3

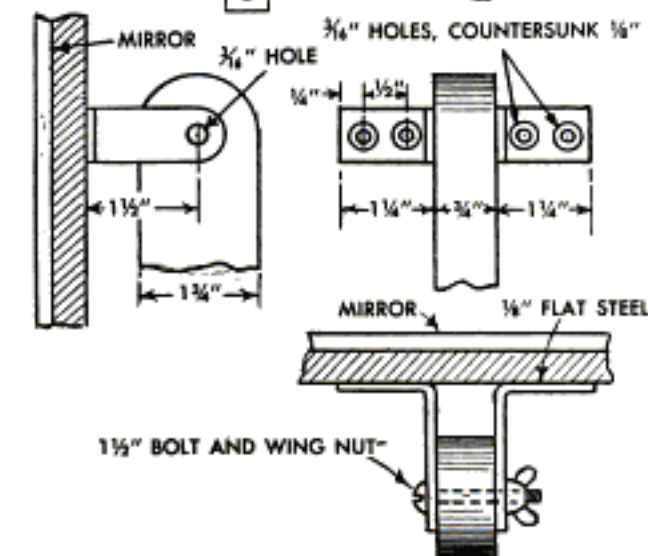

MIRROR BRACKET

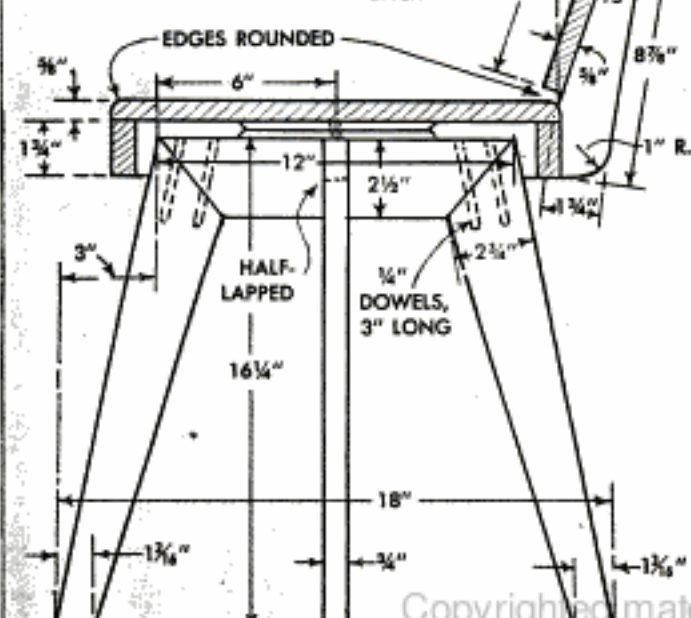
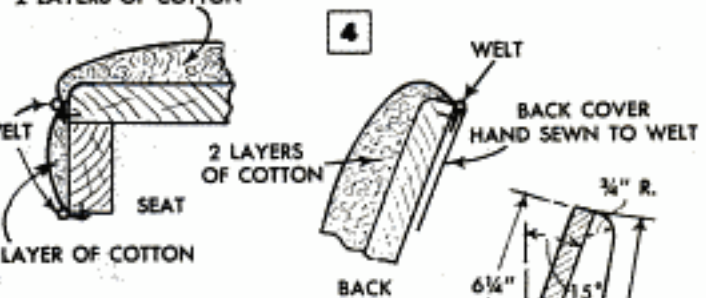
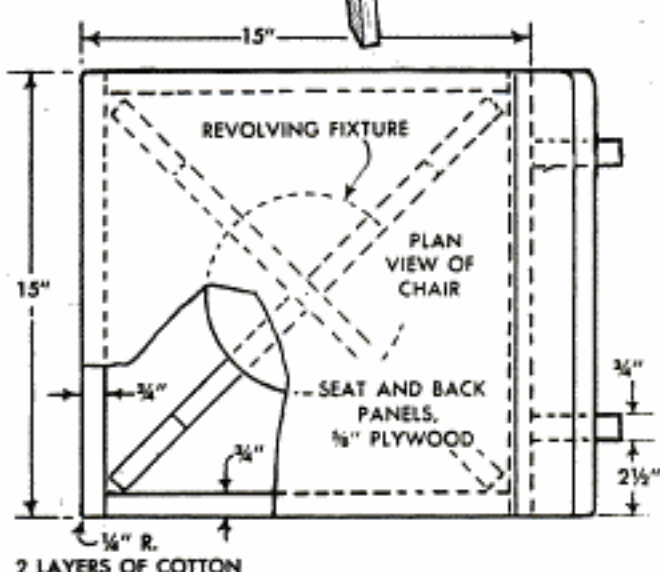
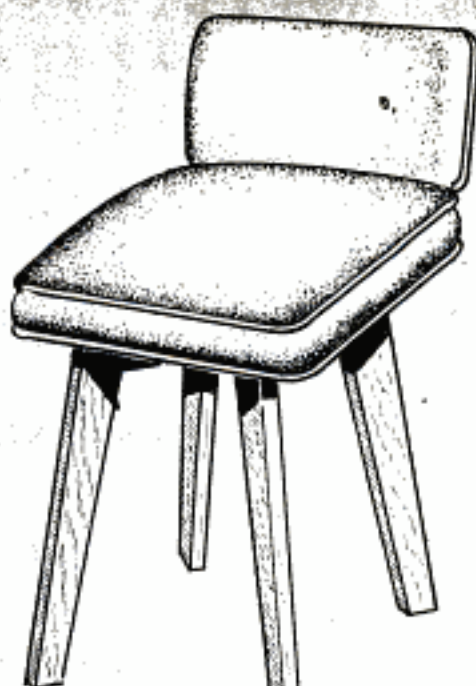

# ENCLOSE YOUR FRONT PORCH



Packages too large for the mail drop can be placed in the milk compartment. Label compartment to indicate use

**I**F YOUR HOUSE has an open front porch, enclosing it in glass will bring several distinct advantages. First, it will be an additional room—year-round, if heated, or comfortable for many extra weeks before and after the summer season, if unheated. In addition, it will serve as insulation, keeping the adjacent rooms of the house warmer in winter and cooler in summer. And, finally, it will improve the appearance and value of your property.

As every porch presents its own peculiar problems, it is impossible to give complete directions for enclosing any particular

porch. However, you will find that most of the details and general dimensions given in the story are applicable to your own porch with very little modification. In addition to these details, you also will find cabinets that facilitate the delivery of mail, newspapers, milk and packages.

The first consideration in making the enclosure is adapting the original columns for the installation of the window frames. Although the columns sometimes can be squared-up by nailing boards to them, the best procedure most often is to replace them with square posts. Make the posts



Photo above shows porch with original round columns. Note in left-hand photo how old columns have been replaced by square box-type columns to facilitate window framing. Doorway has been rough-framed with 2 x 4s. Window frames are already installed on the side



Here's how newly enclosed porch looks from the outside. Compartments flanking door make neat arrangement

from 1-in. lumber, as in the photo above Fig. 3, applying water-resistant glue to the joints and using nonrusting nails to fasten them together.

Although you can enclose your porch with almost any type of glazed unit—anything from double-hung sash to storm doors—the least expensive way is to make your own sash. Single-pane casement sash are the simplest to make, and these are hinged to close into frames made as in Figs. 1 to 3. The sash should be made of lumber at least 1 in. in actual thickness with the corner joints mortised and tenoned, as in the photo on page 154.

If the original handrail is in good condition, the window frames can be built up from it. Although the length of the



New square columns to replace round ones are made as above

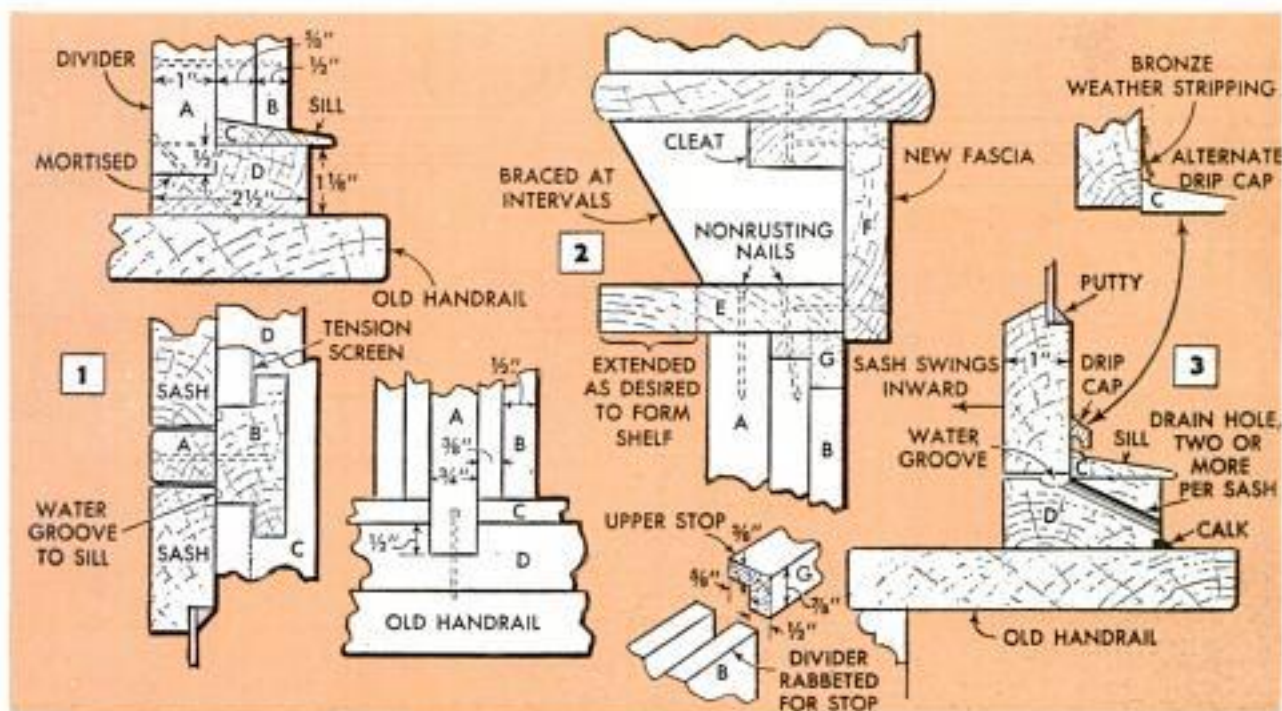

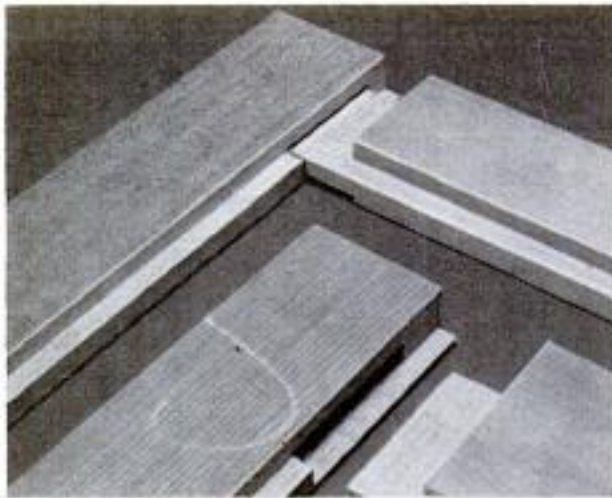

Corner joints of window sash are mortised and tenoned as above. Inside edges are rabbeted for pane

Photo below shows how sills directly above compartments are fitted with triangular-shaped blocks to drain water away from compartment door. See Fig. 7



frame members will vary according to the size of sash used, the dimensions given in Figs. 1 and 2 may be used in all cases. Note that the various parts are keyed so they may be identified in each of the drawings.

A new fascia, detail F in Fig. 2, is added, its width determined by the particular installation. Several vertical braces should be added at intervals to strengthen the framing, and the horizontal board, detail E, may be ripped to fit almost flush with the face of the sash or left wide to form a shelf.

The water grooves cut in part B, Fig. 1, together with the water groove and drain hole in part D, Fig. 2, combine with the drip cap to make the sash watertight. Apply calking compound around all fixed sash

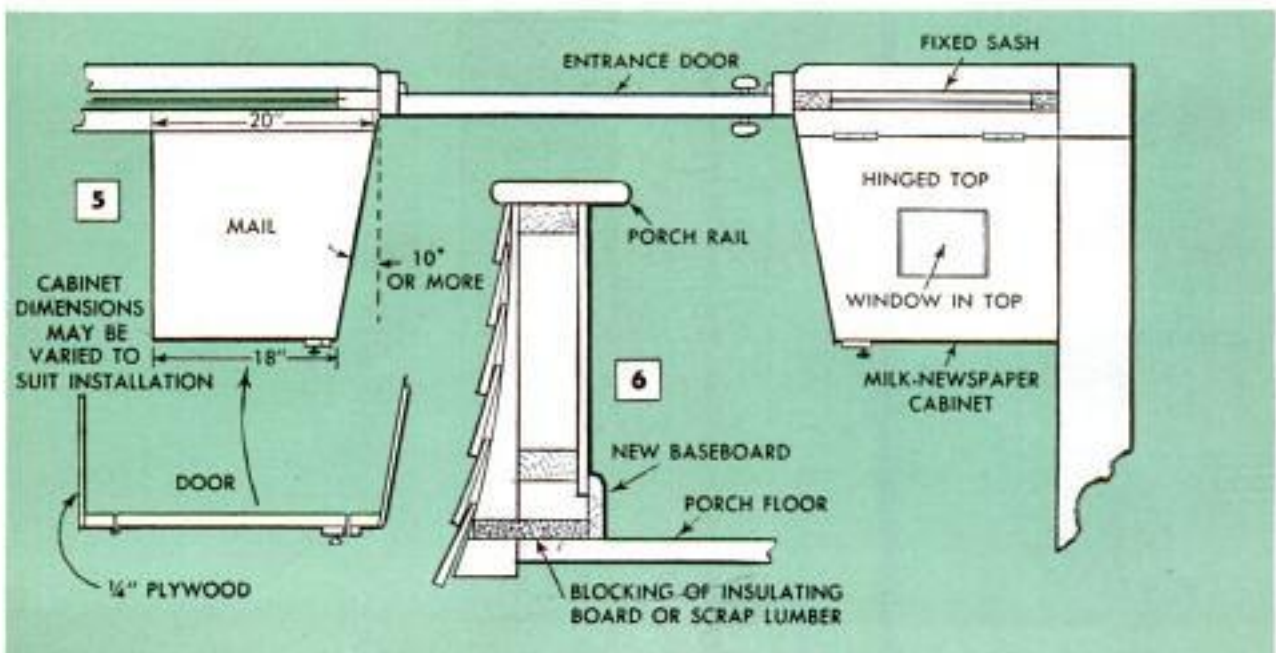
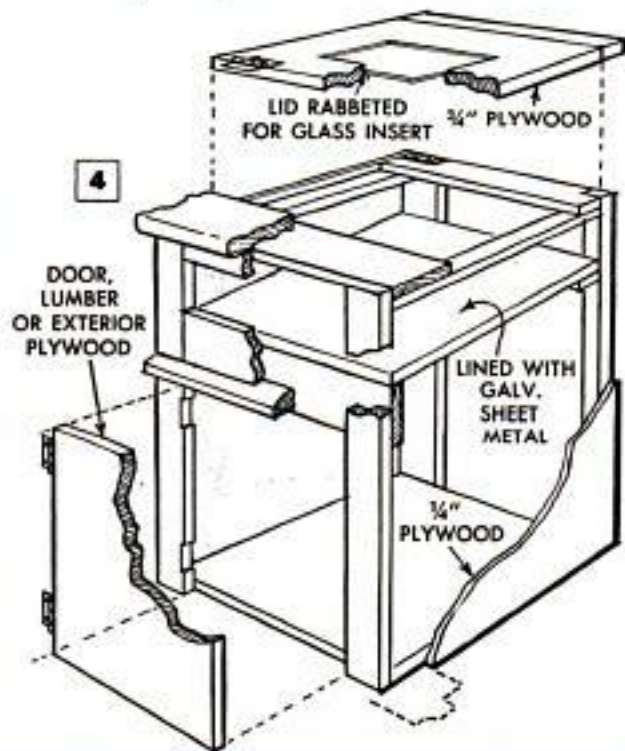

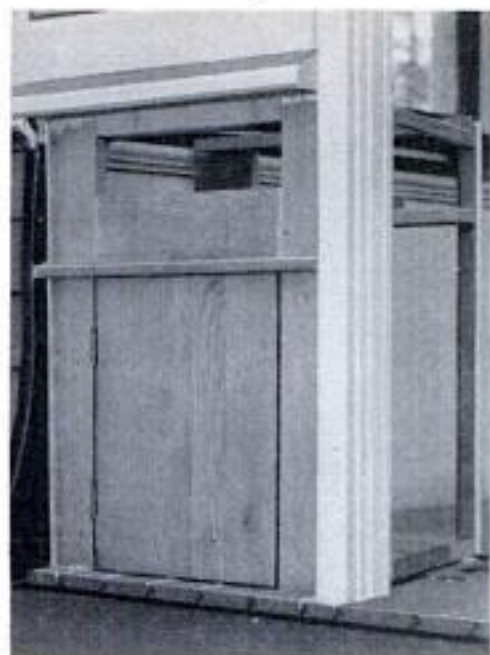

Partially finished newspaper-milk compartment is shown at left. Photo at right shows finished compartments

and at any other points where water may enter.

Figs. 4 to 8 detail the compartments which may be built on both sides of the entrance to simplify deliveries. One, detailed in Fig. 7, has a special slot for newspapers and a cabinet for milk and parcels. The other, Fig. 8, consists of a mail drop and chute. Both compartments are fitted with doors for easy access from inside the porch. Construction of the cabinets is simple, as shown in Fig. 4, although dimensions and even the design given for this particular installation may have to be varied. The mail-drop opening is  $4\frac{1}{4} \times 11\frac{1}{2}$  in., with a usable height of  $3\frac{3}{4}$  in. because of the chute.

Even though the original porch rail is covered with siding, you probably will find that it was provided with drain openings near the floor. These can be sealed with a blocking of thick insulating board or lumber, as shown in Fig. 6, and the addition of a new baseboard. ★ ★ ★



Sheet-metal mail chute is formed as above

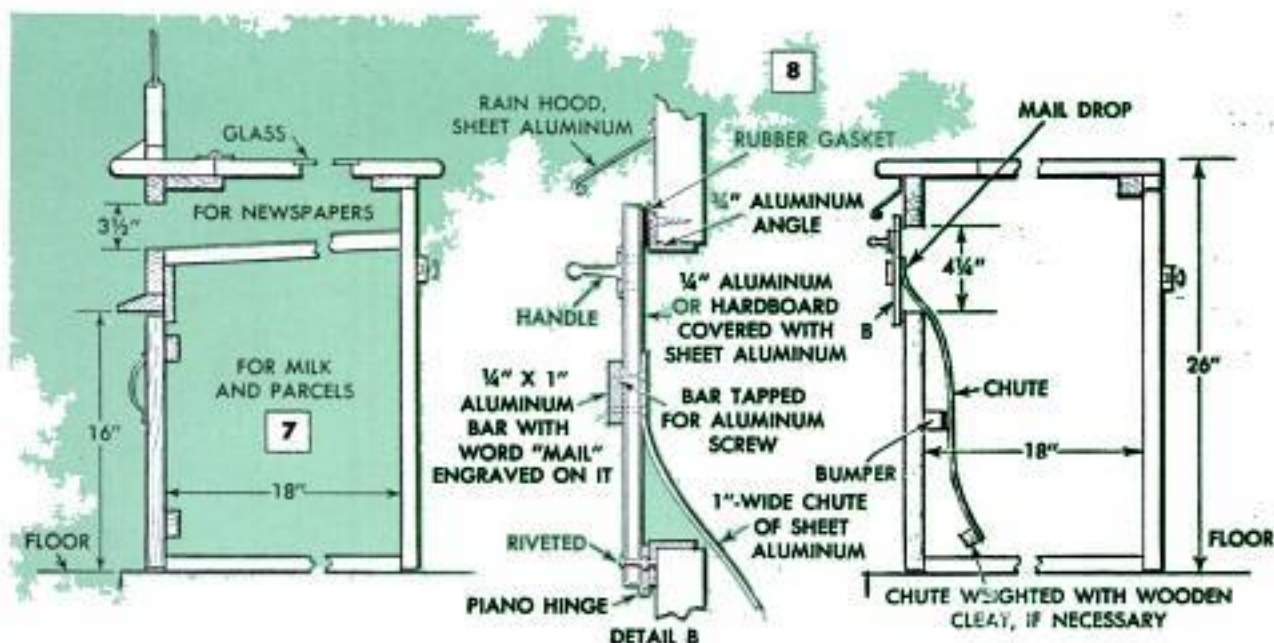

## Foot of Motel Bed Folds Down Forming Luggage Stand

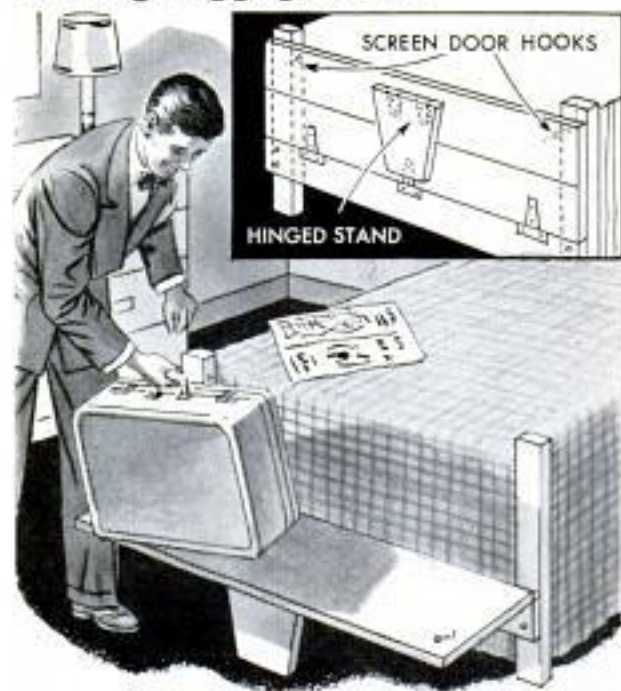

To save space in his rooms and as an added convenience for his patrons, one motel owner has provided a folding luggage stand on the end of each bed. The shelf of the stand is 1-in. pine hinged to the end of the bed, and it is supported when in the lowered position by a hinged leg. The stand is held in the raised position by screen-door hooks. If the beds are of the Hollywood type, with no posts, then 2 x 4s connected by a sturdy crosspiece should be attached to the bed to act as a support for the luggage stand.

Don Brooks, Lombard, Ill.

## Masking Tape on Paint Can Provides Brush Holder



A quickly improvised holder for a lettering or striping brush can be made by attaching a strip of masking tape across the open top of a paint can. The bristle

end of the brush is slipped under the tape, the handle rested on the can rim. When the painting job is finished, the tape is simply discarded.

G. E. Hendrickson, Argyle, Wis.

## Veneered Furniture Fretwork Restored With Hardboard

Untempered hardboard is used by the owner of one woodworking shop to restore the fretwork on antique and modern fur-

niture. Because  $\frac{1}{8}$ -in.-thick veneers of high-quality walnut, mahogany and other hardwoods are not always available,  $\frac{1}{8}$ -in. hardboard, sawed or routed to match the patterns of broken or missing panels in furniture, provides an excellent substitute. Orange shellac is used to provide a match for the darker hardwoods, while white shellac can be used to simulate pine.

## Pipe Used as Carport Columns

Steel pipe used as supporting columns for patio roofs and carports has the advantage of slender appearance as well as longer life compared to wooden posts used for the same purpose. Floor flanges are screwed to the ends of lengths of 2-in. pipe. Wood screws are used to fasten the flanges to wooden overhead beams. On concrete slabs, the flanges are fastened in place by using regular expansion sleeves in holes drilled in the concrete.



## Pegs Driven Onto Finishing Nails Quickly Attached to Wall

Decorative pegs on which pots, pans and other lightweight objects are to be hung can be attached quickly to a wall by driving them onto finishing nails. Angles are cut on the ends of  $2\frac{1}{2}$ -in. lengths of  $\frac{1}{2}$ -in. dowel and holes are drilled in the centers of the angled ends. The holes should be slightly undersize for an 8d finishing nail. The depth of each hole should be slightly less than the length of the projecting portion of the nail, so the nail will be forced into the dowel when the latter is tapped onto the nails already driven into the wall.

Bruce Porter, Clarendon Hills, Ill.

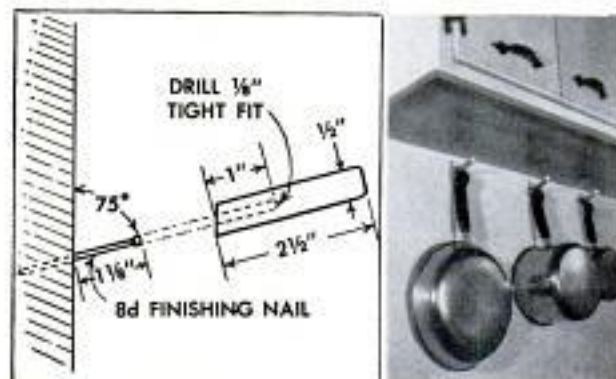



## Baby-Shoe Lamp

Baby's first shoe, a memento treasured by mother all her life, can be made into a decorative boudoir lamp, where it will be useful as well as ornamental. Such a lamp could be made as a gift that she would enjoy receiving. The base of the lamp is a 4 x 8-in. piece of  $\frac{3}{16}$ -in. brass. The ends of the base are bent to the proper shape by rolling the last  $1\frac{3}{4}$  in. of each end around a  $\frac{1}{2}$ -in. iron rod. After the base is bent, the shoe is placed on it at an angle and its position traced on the brass. Then a point is located in the center of this outline that will place the lamp socket directly over the shoe's upper, and a  $\frac{3}{8}$ -in. hole is drilled through the base at this point. With the base drilled, the parts of the lamp

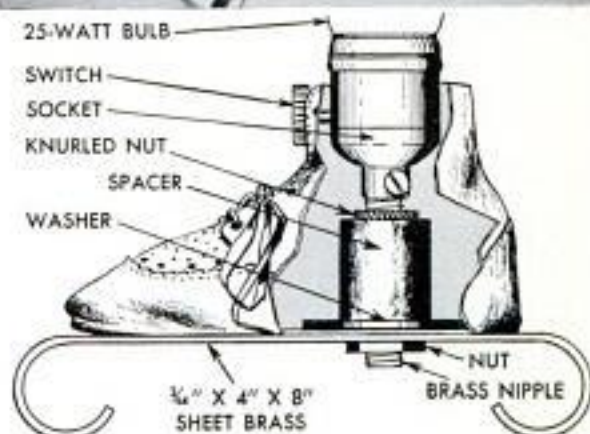

are assembled as shown in the detail. Finally, cotton is stuffed into the toe of the shoe, it is laced part way up, and then both the shoe and the brass are given a coat of clear varnish. Any small clip-on shade could be used.

J. Harley Hosack, Hartford, Conn.

## Gauge and Pliers Clamped in Vise Cut Wires to Same Length

A gauge and a pair of side-cutting pliers clamped in a vise will permit cutting a number of pieces of wire to equal lengths. The gauge is a strip of sheet metal, bent at right angles on one end to permit it to be clamped in a vise along with one jaw of the side-cutting pliers. A block of wood and a C-clamp provide an adjustable stop. The end of the wire is held against the stop and cut off with the pliers.

☞ To prevent an ice tray from sticking in the freezing unit of a refrigerator, rub the outside with salad or cooking oil.

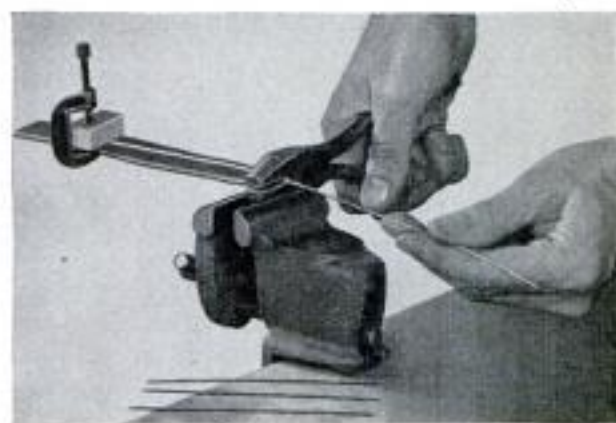

## Angle Bracket Modifies Tripod To Hold Camera Sideways

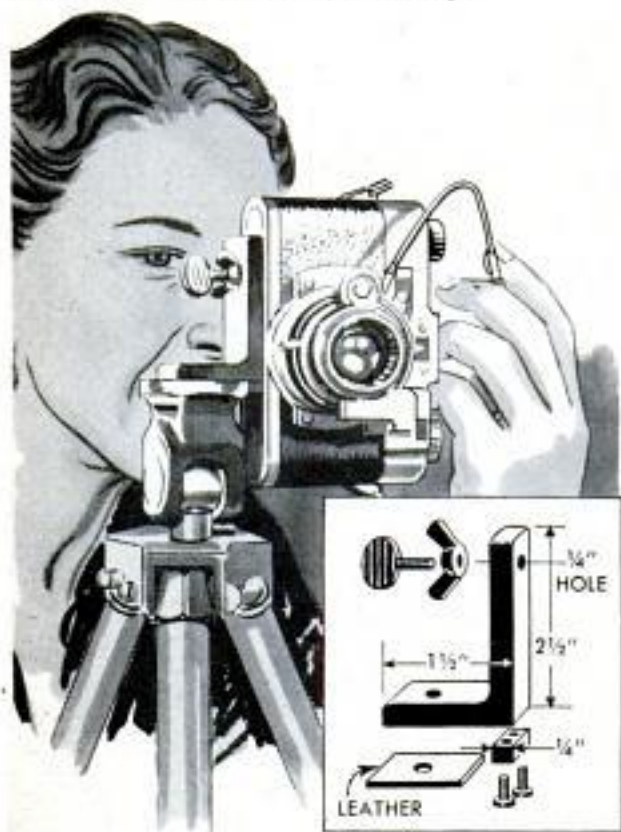

An angle bracket is used by one camera enthusiast to mount his candid-type camera on a pan-head tripod at 90 deg. from the regular position. This permits taking vertical pictures and allows the camera to be tilted up or down by the swivel handle. A 1-in. section cut from a steel angle forms the bracket. One leg of the bracket has a hole drilled and tapped in it to receive the  $\frac{1}{4}$ -20 tripod screw. The other leg has a hole drilled in it through which a  $\frac{1}{4}$ -20 thumbscrew is turned into the camera. A wing nut on the screw tightens the camera snugly against the bracket. A  $\frac{1}{4}$  x  $\frac{1}{4}$  x 1-in. block is screwed to one end of the tripod side of the bracket to prevent its turning. A leather pad between tripod and bracket prevents screw from loosening.

Edward J. Bickel, Chicago.

## Oil-Can Spout Extended

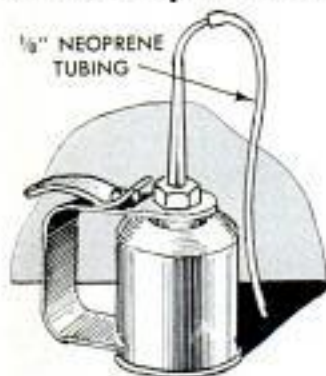

Oil cups in hard-to-reach locations, such as on the blower shaft of a forced-air furnace or behind the wheels of a lawn mower, can be lubricated by extending an oil-can spout with a length of  $\frac{1}{8}$ -in. plastic

tubing. To enlarge the end of the tubing to fit the spout, soak it in hot water to soften it. Then insert an ice pick or other pointed tool to expand it. The translucent plastic permits seeing the amount of oil being sent to the cup.

W. G. Waggoner, Sacramento, Calif.

## Ball Used as Photo "Dodger"

A small sponge-rubber ball used as a "dodger" for photo-enlarging work will eliminate the chance of getting an out-of-round shadow on a print. Fit the ball over the end of a length of wire and use in the same manner as the usual disk. Unlike a disk, the ball will cast a round shadow no matter which way it is turned.



## Uses for Foil Food Containers

Empty aluminum-foil pie and cake pans, in which many bakeries package their products, can be put to good use as containers for popcorn, candy or other delicacies. In a workshop, the foil containers make excellent disposable containers for small amounts of stain, paint and other liquids.

## Plaited "Beehive" on Mailbox Advertises Honey Products

A plaited basket made to resemble a beehive is used by one farmer as a unique roadside advertisement to acquaint motorists with the fact that he is in the honey business. The hive was plaited intact, then an opening was cut to permit it to be fitted over the mailbox.

Grover Brinkman, Okawville, Ill.





WTM '57

# Motor-Driven Barbecue Spit

IF YOU ENJOY the delights of food barbecued over an open fire but hesitate at the thought of hand-turning the spit, a motor-driven spit is the answer to your problem.

The spit, detailed in Fig. 1, is powered by a single-speed phonograph motor coupled to a war-surplus gear-reducing unit. The gearbox, in turn, is coupled to the spit rod. Two welded forks slide on the spit and can be locked in any position by means of hand-tightened wing bolts. The spit power assembly is mounted in a sheet-metal box and fitted with a convenient toggle switch.

The sheet-metal box should be made according to the dimensions in Fig. 2. Do not drill holes for mounting the motor until the motor is obtained; different makes of phonograph motors have different sizes and types of mountings. The sheet metal used in making the box does not have to be too heavy, but should be thick enough so the heat of a fire will not cause it to buckle or warp.

The gear-reducing unit for the spit is available at war-surplus stores which handle electronic and radio equipment. The

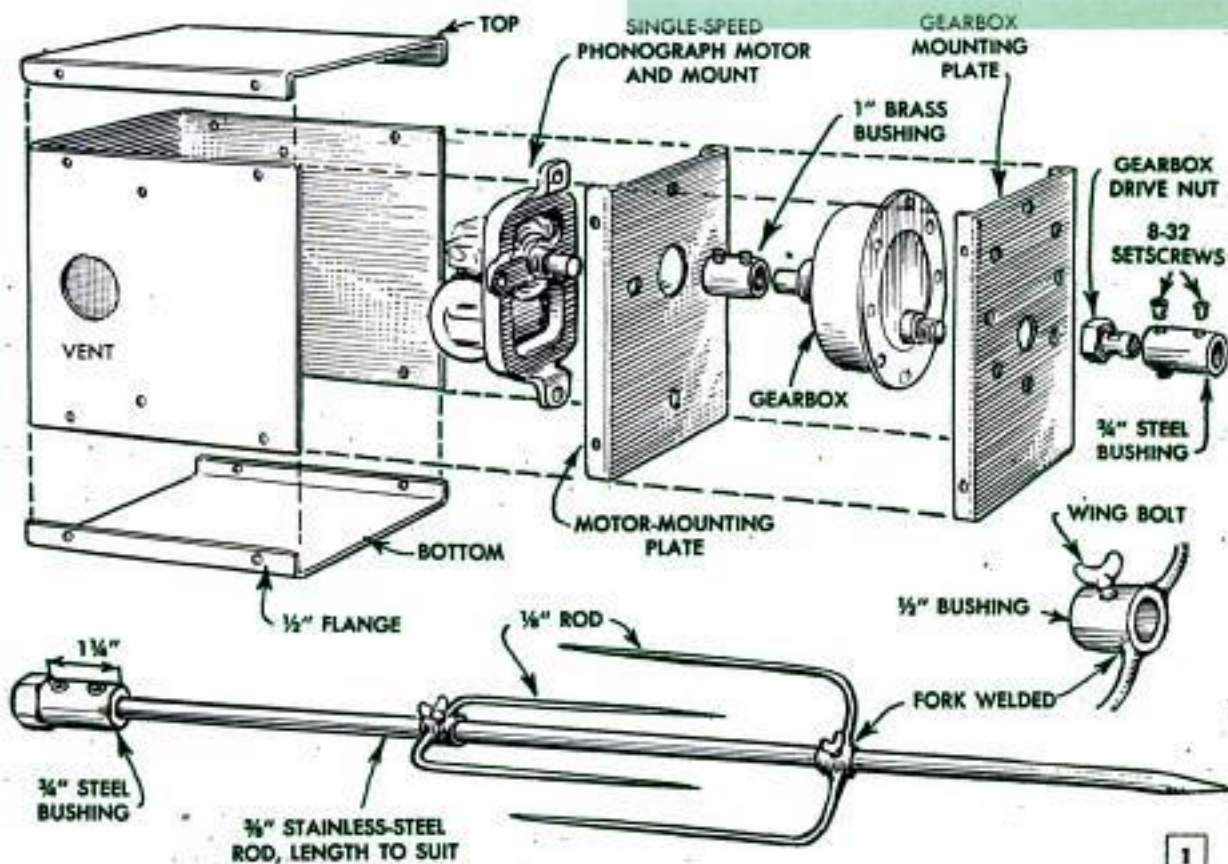

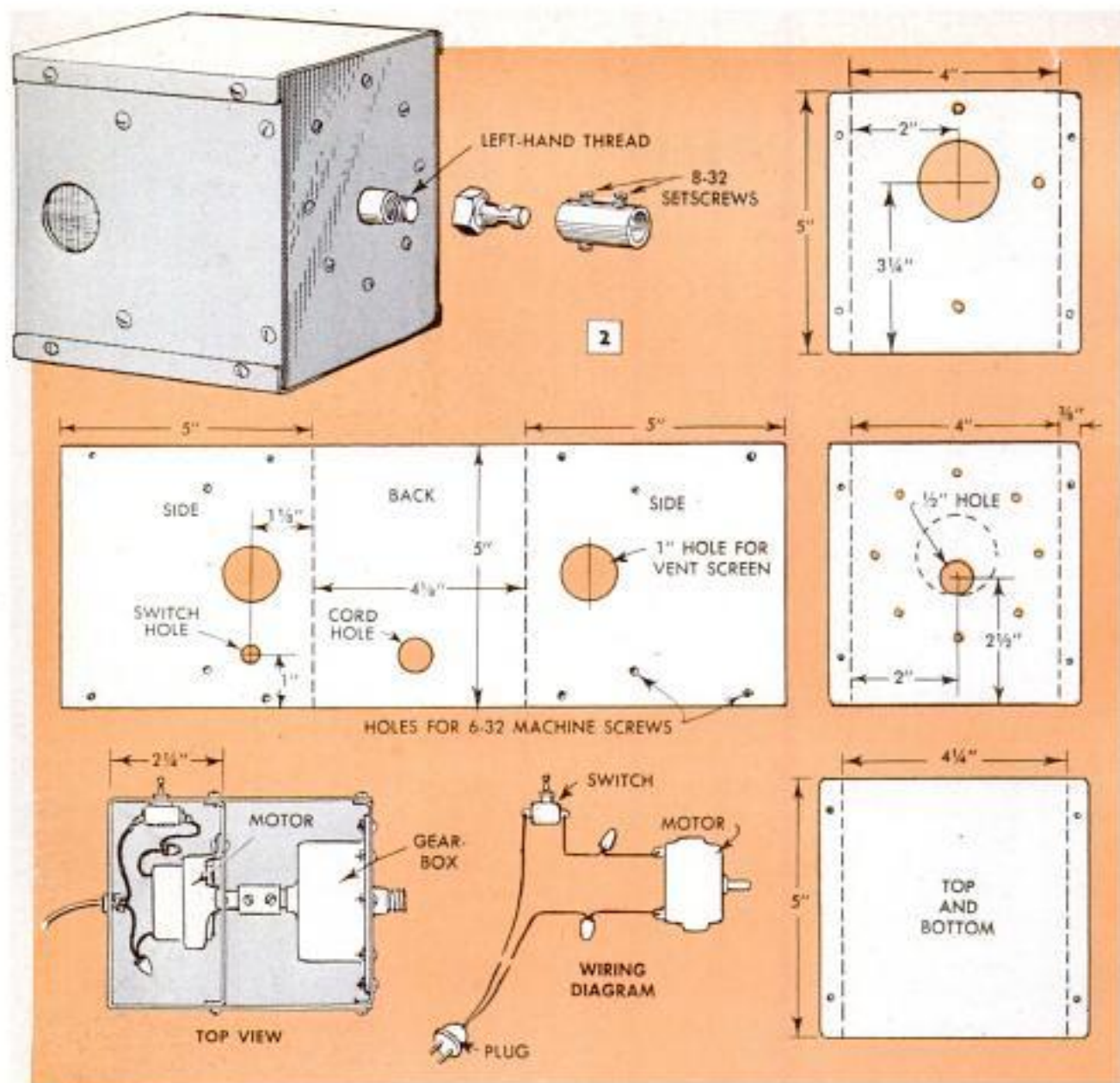

gear reducer is the type used at the rear end of a dynamotor and has the part number PE 1016. The end of the reducer driving shaft has a left-hand thread and is fitted with a specially shaped connecting nut which comes with the gearbox. Two small ears on the driven shaft of the gearbox are cut off to permit fitting a brass bushing which couples the shaft to the phonograph motor. The bushing is a 1-in. length of brass rod, drilled at one end to receive the gearbox driven shaft, and at the other end to receive the phonograph-motor shaft. The bushing is cross-drilled and tapped for 8-32 setscrews.

The electric motor for the spit power unit can be salvaged from any discarded phonograph. If none is available, a new motor can be purchased at most radio-supply houses. To assure accurate alignment between motor and gearbox, the motor is fitted on its plate and the plate is marked and drilled. After the motor is bolted in place, the gearbox is coupled to

it. The gearbox plate now is marked and drilled and both plates are bolted to the inside of the sheet-metal box.

The spit is a length of  $\frac{3}{8}$ -in. stainless-steel rod. Its length is determined by the width of the fireplace or barbecue pit over which it is to be used. The sliding forks on the spit are bent from  $\frac{1}{8}$ -in. steel rod and each tine is filed or ground to a smooth point. The forks are welded to bushings which are lengths of  $\frac{1}{2}$ -in. rod, drilled to slide freely on the spit. The bushings are cross-drilled and tapped to receive wing bolts which hold the forks in the desired position.

The bushing which couples the spit to the gearbox is a  $1\frac{1}{4}$ -in. length of  $\frac{3}{4}$ -in. steel rod. One end of the bushing is drilled to receive the spit rod. The opposite end is drilled to slip over the connecting nut on the end of the gearbox shaft. The bushing is cross-drilled and tapped to receive 8-32 setscrews. Two setscrews, one on each side of the shaft, seat on the flat surfaces of the

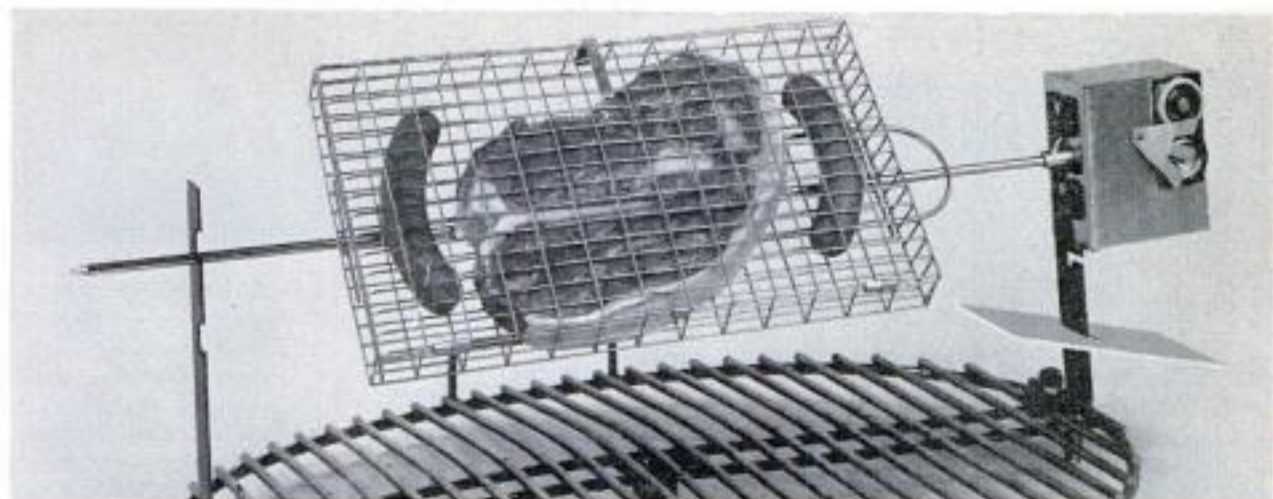

Photo courtesy U. S. Associates, Inc.

connecting nut. The spit now can be removed or replaced simply by turning the nut on or off the gearbox shaft.

A toggle switch is mounted on the side of the sheet-metal box and is wired to the motor and to a lead-in cord. For convenience, a socket or receptacle may be mounted on the box and a removable extension cord used.

A vent, covered with screen wire, is located on the side of the box to provide ventilation for the motor. It may also be necessary to line the box with some sort of insulation if the power unit is used especially close to the heat of a fire.

If you do not care to make a powered spit, there are several manufactured units

available. A spit that is especially ideal is one called "Roto-Wizard," manufactured by U. S. Associates, Inc., of Los Angeles, Calif. It is powered by two D-type flashlight batteries, which will run the spit for about 10 hours of continuous operation, longer when used intermittently. Since the inexpensive power source is self-contained, the spit can be used anywhere: around the home, in the yard or taken on picnics. The photograph at the top of this page shows the unit in action. Power unit, spit and two universal mounting brackets for attaching the unit to the grill of your barbecue are furnished as a package. Steak basket and a wheel that will hold six frankfurters are optional accessories. ★ ★ ★

2170 W. Venice Blvd.  
L. A. 6, Cal.

## Canopy Over Tots' Sand Box Matches House Awnings

Children playing in this tractor-tire sand box are protected from the sun by a canvas canopy. Uprights supporting the canopy are 4-ft. lengths of 2 x 4 bolted to the tire. Braces from tire to uprights are  $\frac{1}{8}$ -in. flat steel. The frame over which the canvas is stretched, also the braces, are 1 x 2-in. stock. Extra canvas at each end of the 48 x 52-in. frame rolls down for added protection. Tire and wood are painted to match house trim. The canopy is made of the same material as awnings used on the house.—Lewis E. Day, Canister, N. Y.



## Glare in Flash Photos Avoided By Using Test Light

The problem of "hot spots" or glares, caused by a flash bulb reflecting from a shiny object or surface, can be overcome by using a flashlight as a test light. Hold a strong flashlight in the approximate position of the flash lamp. Then, using the ground-glass or other type viewer, note where the glares occur. Adjusting the flashlight to eliminate the glares will indicate the position in which to locate the flash lamp.

When the backing on a throw rug becomes soft and the corners curl, the stiffness may be renewed by a coat or two of fresh shellac applied to the underside.



**1. PHONE BILLS** won't be so high if you time toll calls with ordinary three-minute, kitchen egg timer. After purchasing timer, check it against a clock, since many tend to run overtime. Then mount at a convenient spot near the phone. Egg timer is also handy for timing turns when playing parlor games

**2. A DISCARDED NECKTIE** can be converted into a decorative and practical cover for an umbrella. First, reinforce the stitching along inside seam, then slip the umbrella into the tie as shown. After determining how much of the tie will be required for the cover, cut off the remaining material and sew up the bottom opening



**3. WINDOW SCREENS** can be made waterproof if sprayed with one of the silicone waterproofing mixtures sold for treatment of clothing. After receiving this treatment, the screen will repel water and the mesh will remain open, even during heavy rains. Less water will splash through the screen



**4. ALUMINUM COOKING POTS** can be cleaned and scoured without leaving ugly black marks on which they are rested if an inexpensive sponge-rubber powder puff is used as a pad. This will also keep the pot from slipping during scouring



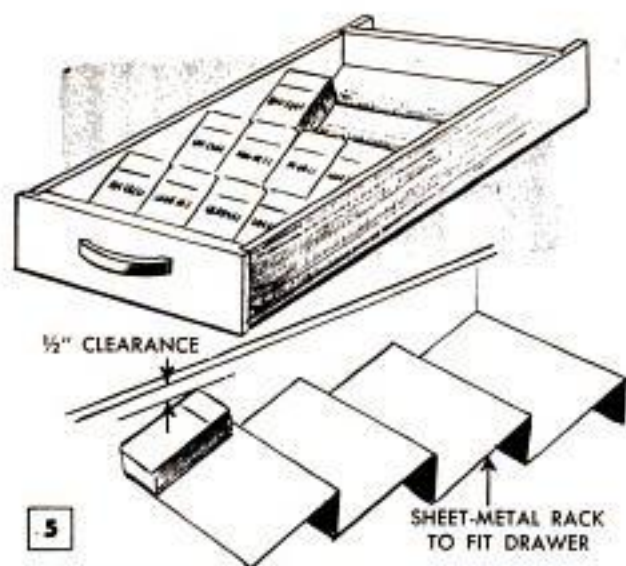

5

**5. SPICE BOXES** are easily stored and quickly identified when a drawer for them is provided with rack shown above. Bent from sheet metal, the rack is made to fit the individual drawer. The edges of the boxes should come up to  $\frac{1}{2}$  in. below drawer edge

**6. THIS PLANT HOLDER** will permit you to place potted plants in double-hung windows, for the decorative effect and so that the plant will receive more sun. The holder is cut from heavy sheet metal and bent to the shape shown. Weight of pot holds it in place

**7. A WOODEN TRIVET**, placed under potted plants used to decorate a porch, will save the porch floor from rotting due to moisture from the pot. The trivet can be of any shape, though the disk is the most attractive. Short lengths of dowel are used for trivet legs

**8. THERE WILL BE NO MORE SPLATTER** and splash from the electric mixer if you use a bowl cover such as is shown. The cover is quickly made from sheet of aluminum or plastic. Two identical pieces are cut out and hinged together with a rivet or small nut and bolt

**9. LOOSE CASTERS** that drop out of furniture when it is moved can be cured if a short slit is sawed in the end of the caster shaft. The shaft is then spread slightly with a screwdriver. Spread only enough to make the caster a tight fit when it is replaced

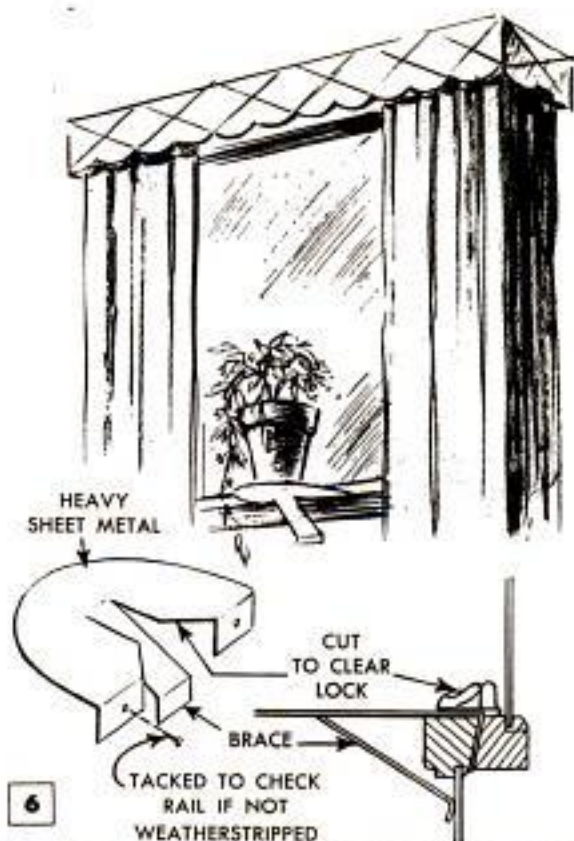

6

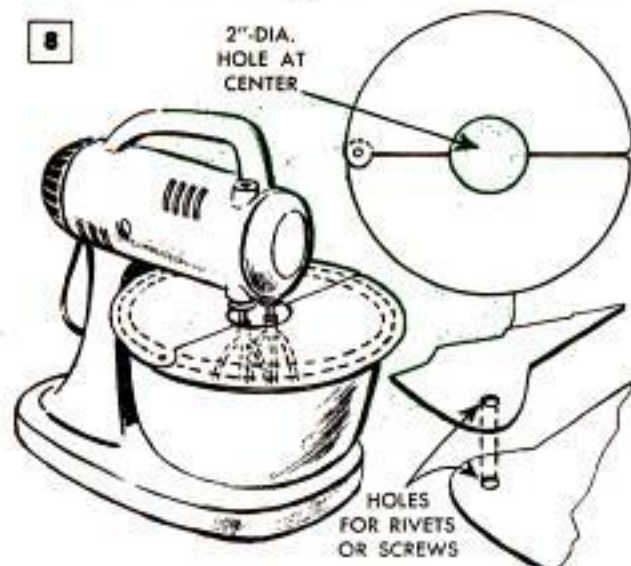

8

9

## Copper Rain Gutter Used as Hood For Smoky Fireplace



Often the only way to correct a smoky fireplace is to attach a hood to it. An inexpensive and yet good-looking hood can be made from a section of copper rain gutter, box-ended as shown in the illustration. This is fastened to the front upper edge of the fireplace opening. The top of the hood serves as a small knickknack shelf.

K. S. Anderson, Chase City, Va.

## Sidewalk Protects Buried Cable



When a buried lead or plastic-covered electric cable is used between the house and the garage, it can be protected against accidental cutting with a spade if it is laid under the edge of a sidewalk, as shown. This removes the cable to a spot where there

is no likelihood of gardening or digging. The usual precautions to avoid cutting cables are to bury them from 18 to 24 in. below grade level and to avoid crossing flower or vegetable beds.

## Defrost Refrigerator Daily

An older-model refrigerator, not equipped with an automatic defroster, can be kept fairly frost-free by shutting it off for one hour each day. To make sure that the refrigerator is not forgotten, set an alarm clock or cooking timer for one hour and shut off the refrigerator. When the

alarm rings at the end of the time, it will be discovered that a small amount of water has collected in the drip pan—the frost that has accumulated in the past 24 hours. Frozen foods and ice cubes will not thaw out during the hour, and the main compartment remains cool.

Mrs. H. Z. Hancox, Nashville, Tenn.

## Cold Draft Through Wall Opening Affects Thermostat Operation

A draft of cold air from a wall opening through which wires run to a wall-mounted furnace thermostat will affect its operation. The air cools the thermostat element, causing it to switch on the furnace, even though the room in which the thermostat is located is at the required temperature.

To eliminate the problem, plug the opening with plaster, calking compound or loose insulation.



## Inexpensive Toy Shelves Built From Apple Boxes

A space-saving combination of toy-storage shelves and child's clothes rack can be made quickly and at almost no cost. Use apple boxes or orange crates for the end shelf units and add shelves of lumber or plywood between them. Cleats nailed to the sides of the boxes support the added shelves. A wardrobe clothes pole can be mounted between the boxes and a wall. As a toddler grows, the height of the shelves and clothes pole may be gradually raised.—Emilie T. Hall, Cornell University, Ithaca, N. Y.





# FISHERMAN'S KNOT BOOK

By Walter Burton

**N**EEED A BRIEF refresher course on how to tie certain fishline knots? Then make this "vest pocket" knot book and keep it in your tackle box. It will come in handy when you are out in the middle of a lake and wonder how to join lines and leaders, tie a hook or plug to a line or make a nonslip loop knot. A glance at the condensed instructions and sequence photos will refresh your memory on the spot.

The book is practically ready-made for you. All you have to do is cut out the green-bordered illustration presented on the following two pages, paste it on a couple of pieces of stiff cardboard and hinge them

together with a strip of adhesive tape. If you wish, an actual sample of each knot may be tied from heavy cord, such as chalk line, and glued on top of the knot illustrations in the right-hand column. Brushing each sample knot, as well as the book itself, with shellac will help keep it clean and water-resistant.

The three photos across the top of the book show successive steps in tying a common fisherman's knot which is widely used to join lines or leaders. First, form a simple overhand knot near the end of one line. Then insert the end of the second line through the center of the overhand knot, loop the end around the first line and tie a second overhand knot. When this is done,



Shellac applied to sample knots, as well as the book pages, will help make them water-resistant

pull the two lines tightly to complete the knot and clip off the ends. If the same procedure is followed but each line is wrapped around three or four times before forming the overhand knots, you can make a splice for joining leaders. This particular knot is shown in the photo directly below the fisherman's knot.

To tie a nonslipping loop, or "fisherman's eye," first form a common slip knot in one end of the line. Continue with the free end of the line and tie a second knot by looping the end of the line around the standing portion of the line. Then adjust the size of the loop and finally pull the two knots together.

To attach a leader to a hook or plug, make a simple slip knot, pass the loop through the hook eye and pull enough leader through so the loop can pass over the entire hook. Note the photos captioned "Knot for Hooks and Plugs." Then draw up the slack to the point shown. Before pulling the loop tight, insert the free end of the leader through it, pull tight and trim off any excess. Many fishermen use this knot to tie nylon leaders.

To loop a leader to a dry or wet fly, proceed as in the next row of photos. Pass the leader through the hook eye

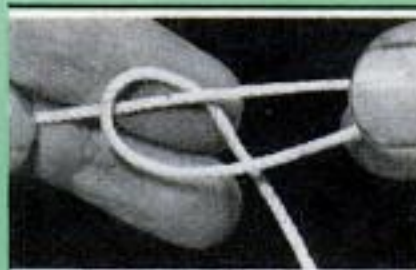

#### Joining Lines or Leaders

Loop end around line near end. Continue loop to form simple overhand knot. Form second overhand knot. Then pull both tightly and clip off ends

## Knots for Lines or Leaders

#### Nonslipping Loop Knot

First make slip knot. Then make second slip knot. Adjust first knot to regulate size of loop. Finally, pull the two slip knots together to tighten



#### Knot for Hooks and Plugs

Make slip knot and pass loop through eye of hook. Next, pass loop over entire hook. Then insert free end through loop, tighten and trim off excess leader

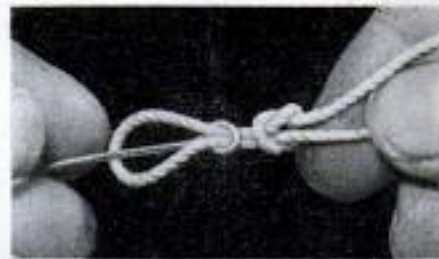

#### Knot for Looping Leader to Fly

Proceed as above but pass the leader through eye of hook before making slip knot. Extend loop so it will pass around fly and then draw leader tightly against eye



#### Tying Loops in Line or Leader

Form ring in line or leader and pass free end through it twice. Work center section of ring through twisted portion, adjust loop and pull line to tighten knot



#### Tying Line to Loop in Leader

Run line through loop to form square knot. Insert free end through square knot, pull line and leader to tighten moderately. Then pull free end of line to bring line loop inside leader loop and tighten both







If you wish, a sample of each knot can be tied, using chalk line, and glued over each illustration shown in the right-hand column at the left. Simulated fishhook eyes are formed from wire paper clips

before tying the slip knot. Then extend the loop so it will pass around the fly and draw it tightly against the eye.

Forming loops, sometimes called blood-drop loops, in a line or leader is done by making a ring in the line and passing the free end through it twice. Next, work the center of the untwisted section of the ring through the center of the twisted portion and adjust the resulting loop to the desired size. Then pull the line to tighten the knot. This knot is shown in the second row of photos from the bottom of the page.

To attach a line to a leader or to another line, run the line through a loop to form a square, or reef, knot and bring the end of the line around the remainder as in the bottom row of photos. Insert the end through the square knot, pull line and looped leader to tighten the knot moderately and then pull the free end of the line to bring its loop inside the leader loop. Finally, tighten the knot by pulling again on the line and leader. The resulting knot should look like the accompanying drawing when tied properly. ★ ★ ★

A plastic envelope, or sleeve, will keep your knot book clean while it is carried in the tackle box



## Magnet Holds Eraser and Pencil On Typing Stand or Table



Attached to the underside of a typing table or stand, a magnet of suitable strength will prevent an eraser or pencil which has been placed above it from falling off. Both the eraser and pencil should be fitted with some steel, such as a pocket clip, so that the magnet will hold them. This may be used only under thin wooden and hard-board tables. Before the magnet is attached permanently, it should be tested to determine whether or not it is strong enough to hold the articles in place in spite of the vibration caused when the machine is in use.—E. R. Haan, Evanston, Ill.

## Refinishing a Brass Lamp

When the finish on a brass lamp that has been lacquered becomes dull and marred, remove the remaining lacquer with denatured alcohol. Then wash the lamp with hot, soapy water, rinse and dry thoroughly. Finally, give it a new coat of lacquer, using only a transparent metal lacquer applied with either a high-quality paintbrush or a spray gun. A careful refinishing job will give any brass lamp the appearance of being brand new.

## Properly Installed Clay Tile Will Last Indefinitely

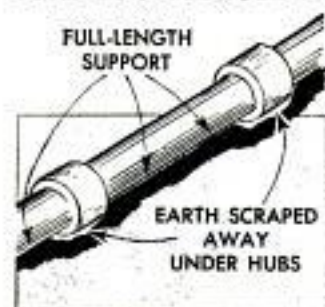

Vitrified-clay pipe, which usually will last indefinitely unless subjected to unusual strains, often breaks because of improper installation. The most common error is to

*Available larger plumbing supply houses*

lay the hubs, or bells, of the tiles on compacted earth, so the rest of the pipe is unsupported and subject to easy cracking. Dig shallow depressions to permit the hubs to be recessed so the full length of the pipe is supported. Also, remove rocks or stones from beneath the tile. A second mistake often made is to omit calking joints before filling them with mortar. The mortar enters the pipe and causes a partial obstruction even before the pipe is used. Calk each joint properly, then seal over the calking with mortar.

## Backflow Valve in Sewer Line Keeps Basement Drains Dry

One method of preventing water from backing up through basement floor drains when a sewer is temporarily overloaded is to install a backflow valve in the sewer between house and street. If the backing-up condition is occasional and mild, the valve can be installed in the line under the basement floor. It should be enclosed in a concrete pit to permit maintenance. The bottom of the pit is poured over several inches of gravel and an opening is provided so seepage from the valve will drain away. When a more severe condition exists, the backflow valve should be installed in a pit away from the house. Insulation must be provided to protect valve and line against freezing. To protect against the possibility of extreme pressure rupturing the sewer behind the backflow valve, a vertical pipe should be installed in the sewer line between the street and the valve. Excess water then will be forced to the surface where provision is made to drain it away.

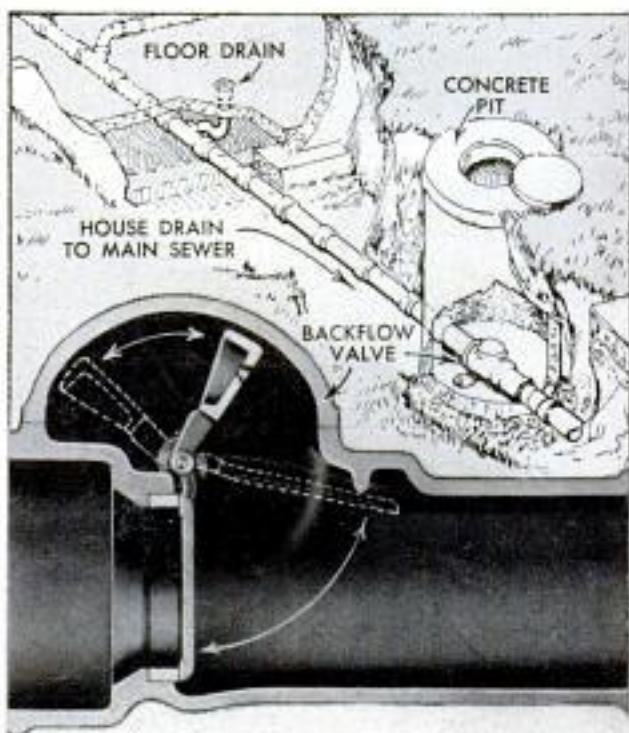



## BOAT TRAILER HAS POWER WINCH

By Joe Ott

**W**HY WORK when you don't have to? That's the theory behind this electric boat-trailer winch and the ramp-equipped trailer to go with it. You push a button, the car battery supplies the power, and the boat slides out of the water onto the trailer. The electric winch can be used on any standard boat trailer, or on the trailer built from details on the following pages. It features an extension tongue to take boats from 12 to 16 ft., torsion-bar wheel suspension and an 8-ft. ramp which leads from the rear of the trailer down to the water.

The ramp can be added to most trailers with a little modification. Its use means that you no longer have to back the trailer

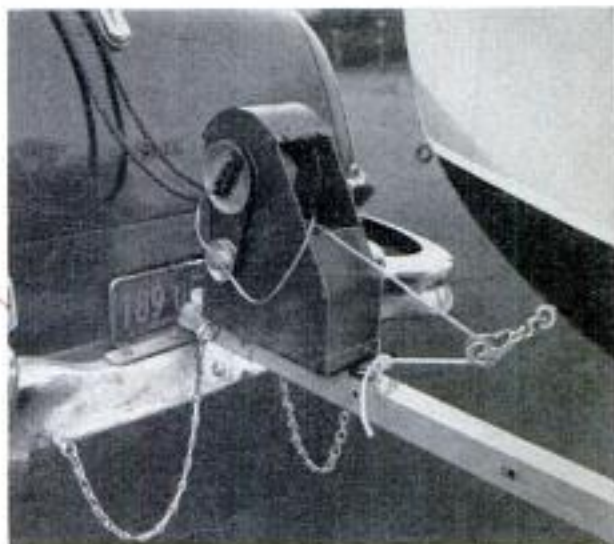

Electric winch, above, and detachable ramp, below, make launching and loading boat almost effortless job

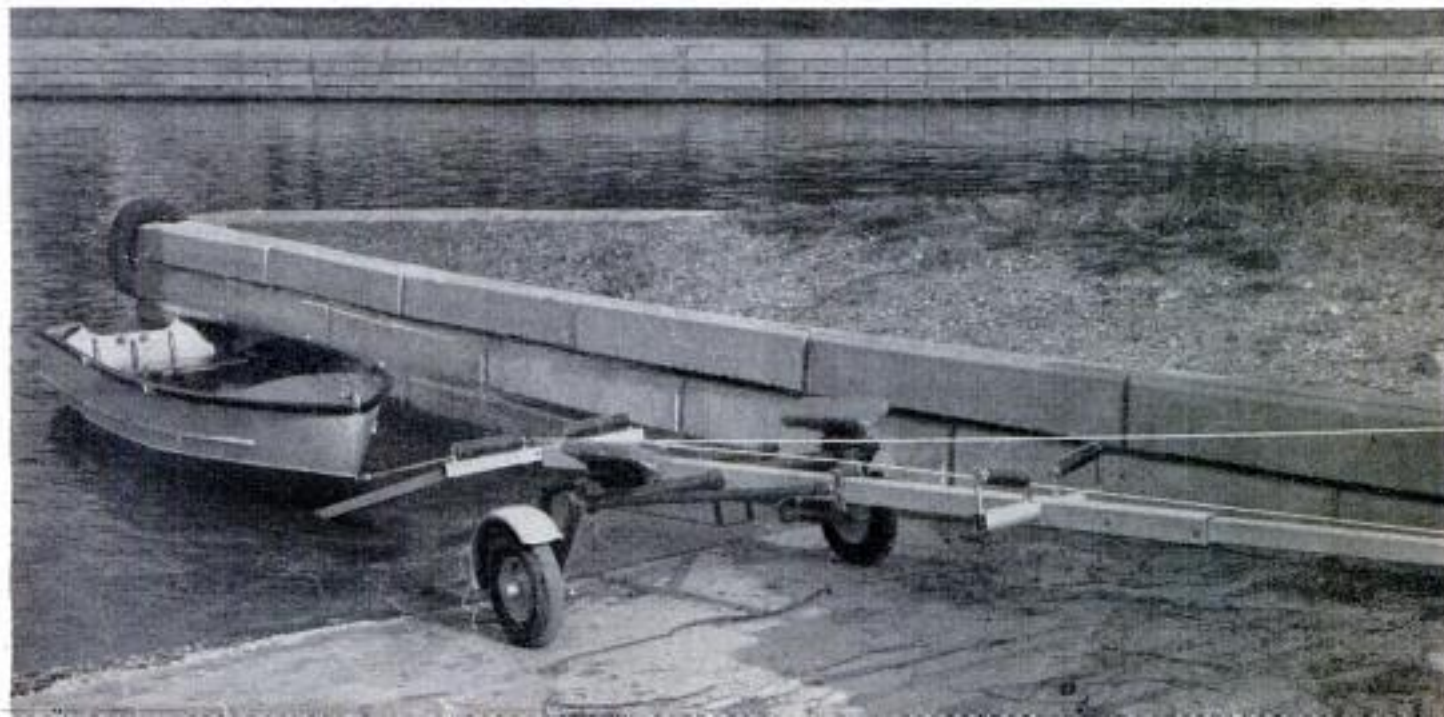

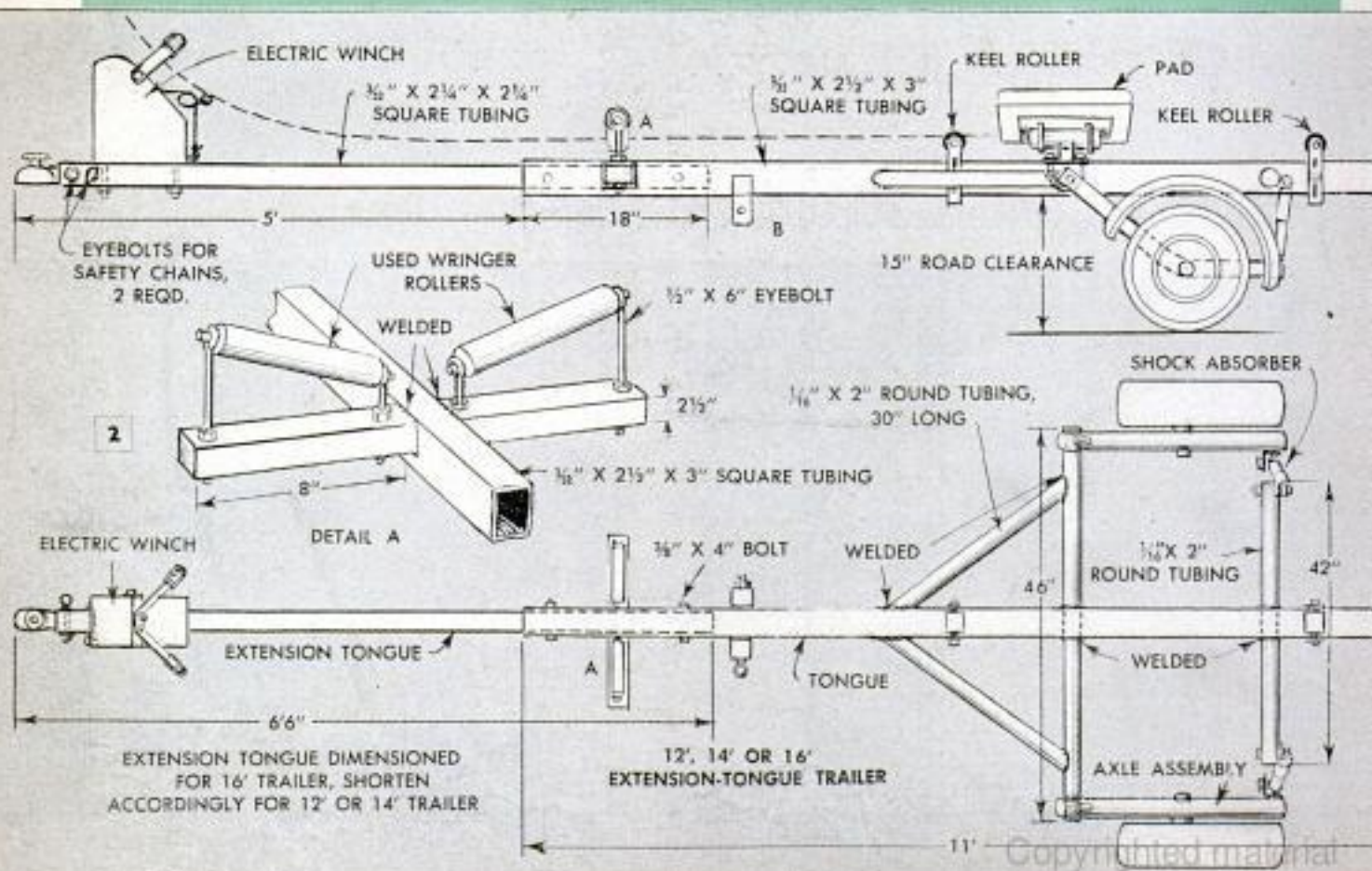
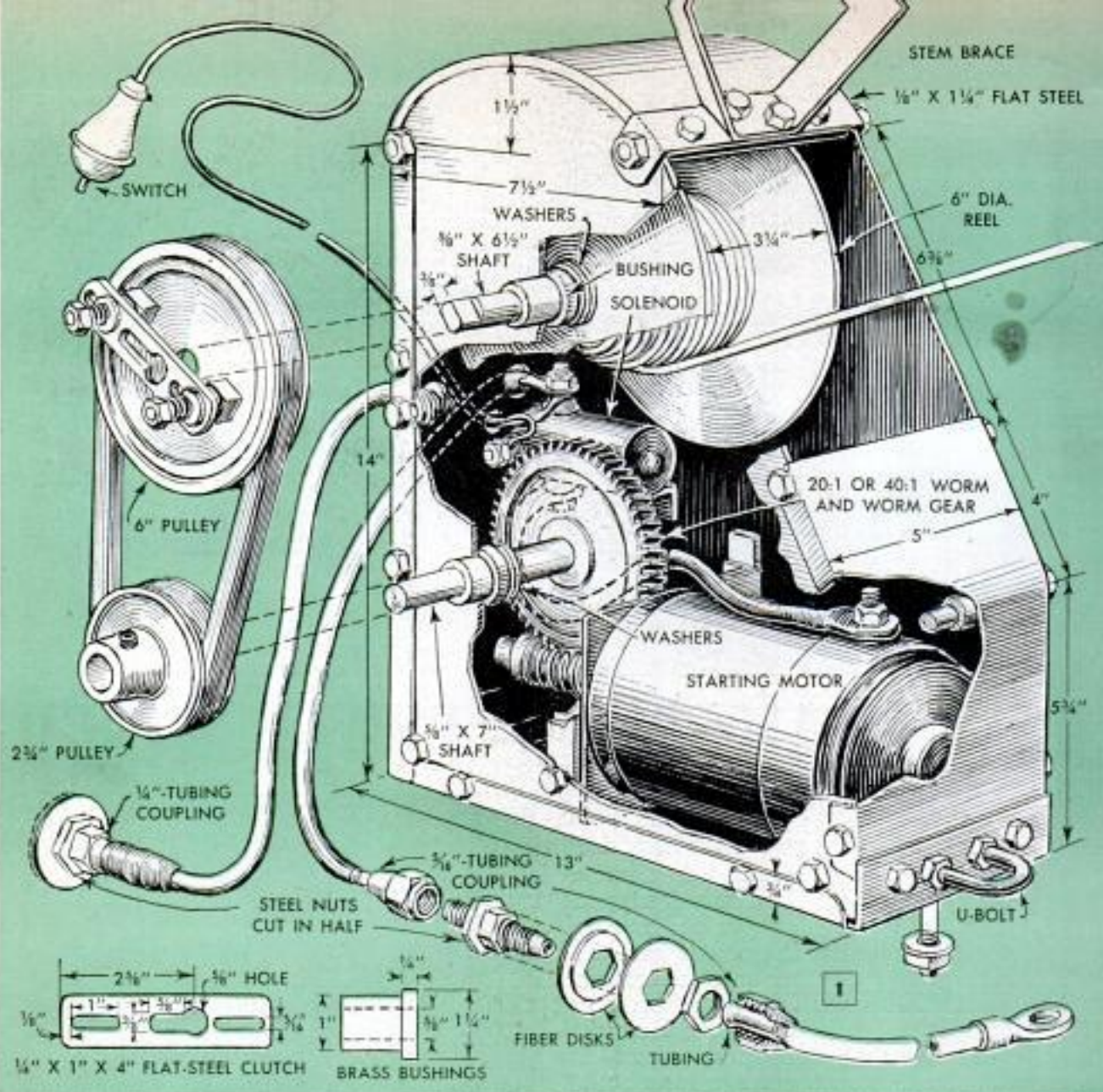

hub-deep water or maneuver the stern of a boat precariously onto rollers that are likely to be several inches above the water. The rear roller of the ramp rests on the beach bottom beneath the water, so it's easy to bring the boat into position. Then you just press the winch button and up she comes.

The winch utilizes a car starter motor to drive a 6-in. reel, as detailed in Fig. 1. The winch housing is made from  $\frac{3}{16}$ -in. sheet steel bolted together as indicated. A starter motor of the type having a long shaft (Ford, for example) is the first unit installed in the housing. A sheet-steel mounting plate is used to anchor it in place. The motor shaft is fitted with a worm, and a worm gear is located after the starter is in position, so the worm and gear can be fitted properly. The worm-gear shaft revolves in bushings set in the sides of the housing. The reel is similarly mounted above the worm gear and is V-belt-driven from a pulley mounted on the worm-gear shaft. To locate the reel-shaft bushings, mount the  $2\frac{3}{4}$ -in. worm-gear pulley on its shaft. Then slip a 22-in. V-belt over this pulley and the 6-in.-reel pulley, wedging a block of wood between the pulleys to draw the belt taut. Use this assembly as a guide for locating the reel-shaft hole in the housing.

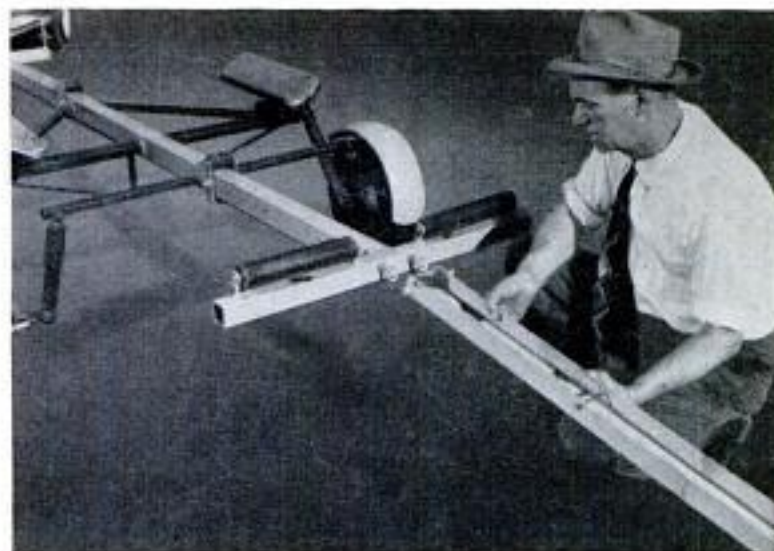

When ramp is to be used, it is slipped over two hooks in transom support. Hooks are 5-in. eyebolts opened to engage tubing in ramp

A  $\frac{1}{4}$ -in.-steel clutch bar is mounted on the reel pulley with two  $\frac{1}{4}$ -in. bolts. The center of the bar is drilled and slotted so it permits the  $\frac{5}{8}$ -in. shaft to revolve freely or engages the tenon filed on the end of the shaft. Each slotted end of the bar is held in place with a washer, spring and nut.

The "hot" lead from the car battery is connected to a solenoid mounted inside the winch housing. Solenoid, starter motor and push-button switch are wired as in Fig. 1. The switch extension cord should allow you to stand alongside the ramp.

Tubing couplings are used to connect the battery cables leading from the winch to

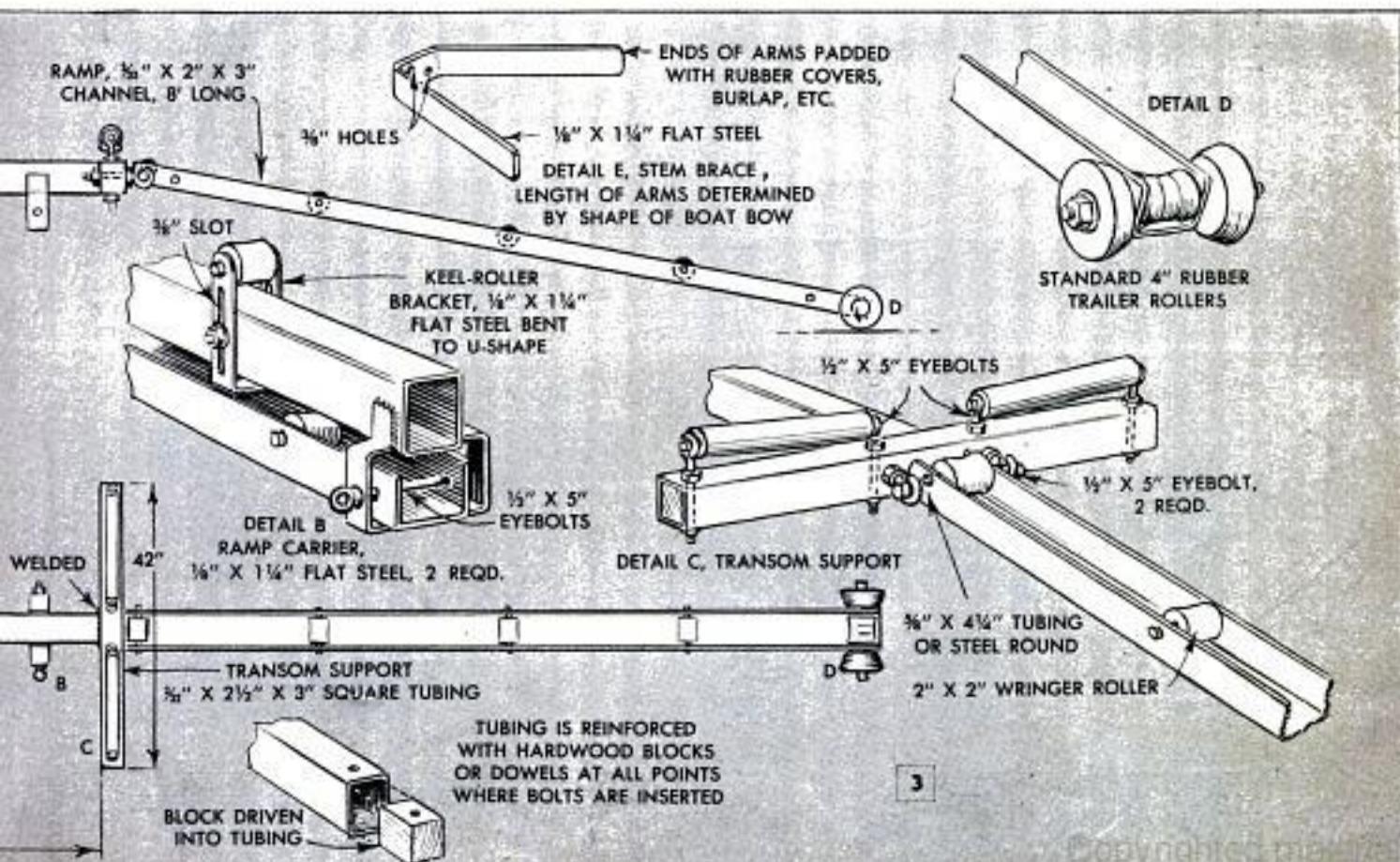



Boat is tied down on the trailer as in photo above. Note that the transom-support rollers should be raised for this particular hull

Boat is cradled in pads which are mounted on tubing welded to a pair of steel angles, as detailed below

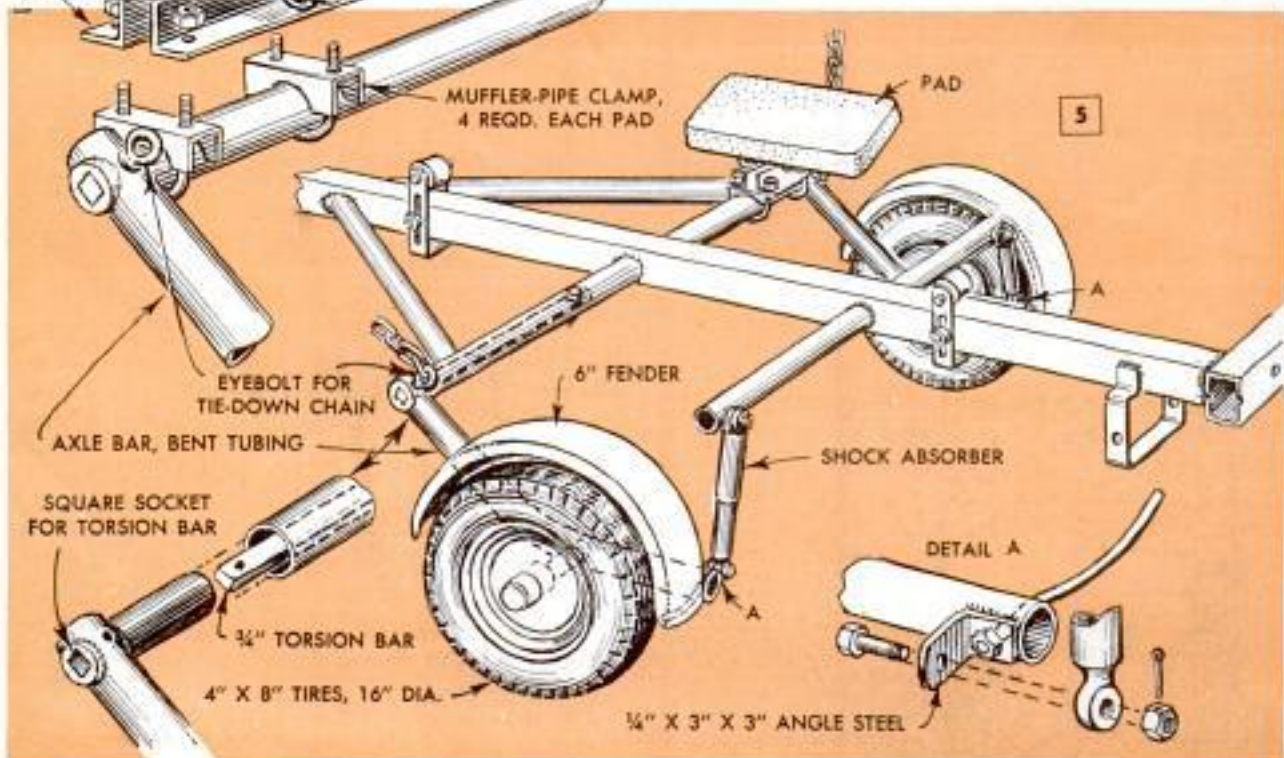
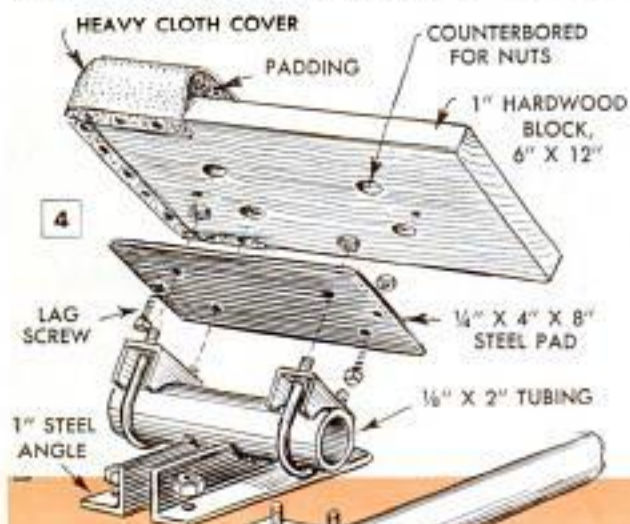

the car. A ground cable which is bolted to the car frame, and a hot cable which is connected to the starter terminal, are brought through the rear of the car body at a convenient location. The hot cable is insulated from the car body with fiber disks. Short lengths of flared tubing are welded to the ends of the cables, as shown in Fig. 1, so the coupling nuts hold the cables tightly on the male fittings. The latter are fastened permanently to the car body with steel half nuts. When the trailer is unhitched, the coupling nuts are unscrewed in a matter of seconds to disconnect the power supply.

Actual construction of the trailer is comparatively simple, as shown in Figs. 1 to 5. The extension tongue is bolted inside the main tongue and the wheel assembly is installed as in Fig. 5. The torsion bar, axle bar, wheels and fenders may be purchased as a unit and merely mounted on the main tongue. Shock absorbers are bolted between the axle bars and a length of round tubing. Both the axle bar and the shock-absorber tubes are passed through the tongue and welded in place.

All rollers are made from washing-machine-wringer rollers which are cut to the desired length. In the case of the bow support, detail A, and the transom support, detail C, the eyebolts permit adjusting the roller angles to match the hull. ★ ★ ★

## Two Ways of Removing Wrinkles When Applying Wallpaper

1st. LOOSEN PAPER FROM DOTTED LINE AND STRETCH UP



Wrinkles that appear in wallpaper being applied to irregular wall surfaces can be eliminated by one of two methods. First, when the paper pulls tight over a bulge in the wall and wrinkles in an adjacent hollow, pull the moist paper away from the wall and slightly

stretch the portion over the bulge. Smooth the paper back onto the wall. Second, if the wrinkle persists, make a cut with razor blade or pair of scissors near the edge of the wrinkle and overlap the cut edges. To be least noticeable, a horizontal cut made above eye level should have the lower edge lapped over the upper. On cuts below eye level, reverse this lap. On vertical cuts, the overlap should be on the side away from a light source.

## Compass for Drawing Spiral Made From Dowel and Thread

Drawing an accurate spiral is no problem when a dowel-and-thread "compass" is used. Drill a hole in the end of a short length of dowel and drive in a phonograph needle or a nail with head removed and filed to a point. The diameter of the dowel should be approximately one third the distance required between the lines of the spiral. Cross-drill a hole near the bottom of the dowel, run a heavy thread or light cord through and knot it. Tie a small metal eye in the opposite end of the thread to receive a pencil. To make a spiral, drive the dowel needle through the paper into a drawing board. Wind the thread around the dowel without crossing any turns. Hold the thread taut with a pencil held in the eye and circle the dowel until the desired spiral diameter is reached.

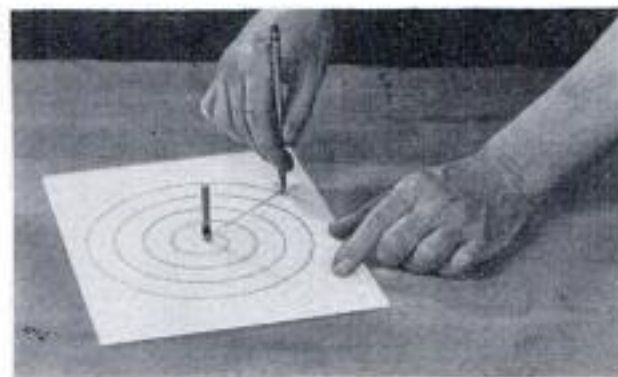

JULY 1955



## School Chair in Small Kitchen Provides Snack Counter

To conserve space in a small kitchen, one mother used a classroom chair as a snack counter for her young son. The chair requires a minimum of floor space and the wide right arm provides enough table area for a sandwich and a glass of milk. After purchasing the chair, she finished it to harmonize with the color scheme of the kitchen.—Olive Henry, Helena, Mont.

## Damaged Hot-Water Bottle Used With Salt as Heating Agent

When a hot-water bottle begins to leak, don't throw it away. Instead, heat ordinary table salt in the oven and pour it into the bottle. The salt will hold heat for a considerable length of time, and will permit continued use of the bag long after it would normally have been thrown away.

## Splined Joints Strengthen Glued-Up Wooden Panels

A wood panel, such as a table top, that consists of several boards butt-joined and glued together, will be considerably stronger if the joints are splined. Splines of  $\frac{1}{4}$ -in. plywood are used, and should be cut so the top and bottom grain is at right angles to the edges of the boards. The total depth of the two spline grooves at each joint should be at least  $\frac{1}{8}$  in. more than the width of the spline, to allow space for excess glue. Clamp the panels together firmly while the glue is drying.

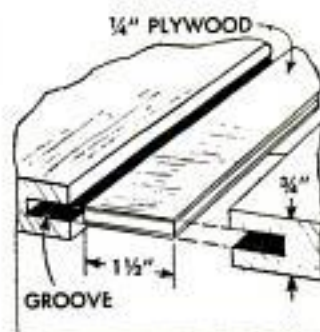

173

Copyrighted material

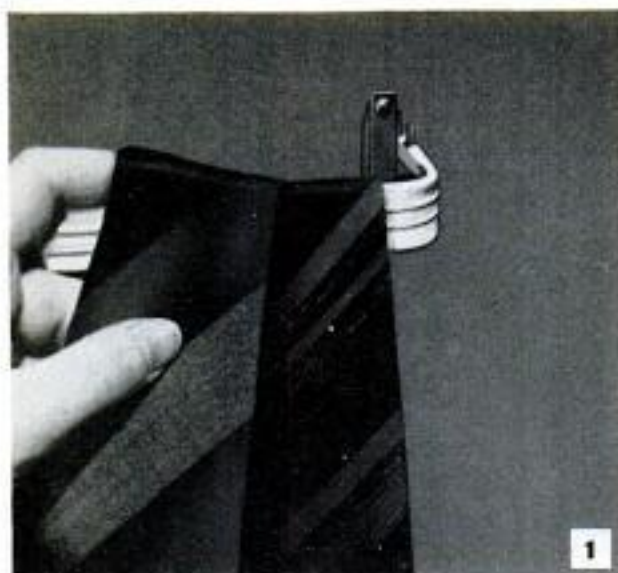

## Versatile Curtain Rods Can Be Handy

By R. F. Donovan

1. The curtain rod, either round or flat, can help around the home in many ways. For example, a tie or belt rack that is adjustable to fit the exact width of a closet door can be made by using an ordinary flat-type curtain rod. This same type of rack may be used in the kitchen for dish towels and in the laundry for conveniently hanging small articles to dry

2. If you want to install a hanging-type file in your desk, a flat curtain rod will provide inexpensive tracks. First, a wooden strip is nailed to each side of the drawer, high enough so the hanging files will clear the drawer bottom. Then a flat curtain rod is split lengthwise and half of it is tacked to each wooden strip, as shown in the photograph

3. Flat curtain rods can be used to provide spice shelves that are built quickly and yet are attractive and practical. Just mount a small plywood shelf on the inside of a kitchen-cabinet door, over the range or in some other convenient place. Then install a curtain rod as shown, to act as a fence. This will keep the containers in place, handy and visible

4. Tables, shelves, cabinet tops and other plywood panels can be given an inexpensive metal edging through the use of discarded curtain rods. First, open the folded edges of the rod enough so that it can be clamped over the edge of the plywood. Cut out V-shaped segments, as shown, to go around sharp corners. For rounded corners and longer curves, flatten the edges of the rod slightly. Attach the edging firmly in place with small screws or long escutcheon pins

5. Cabinets, file drawers and storage boxes should be labeled for convenience. Neat holders for such labels are made by cutting a flat curtain rod into short lengths and mounting as shown. Round all corners and sharp edges with a small file and bend them in to hold the label firmly. A strip of sheet plastic inserted over the label will protect it from dirt

6. An extension holder for matches proves useful in many ways: When lighting an oil-burning space heater; when trying to reach an awkwardly placed lighting port in a gas oven, when lighting overhead candles and high-set sconces. You don't have to make such an extension, but simply insert the lighted match in the eye of a standard tubular curtain rod

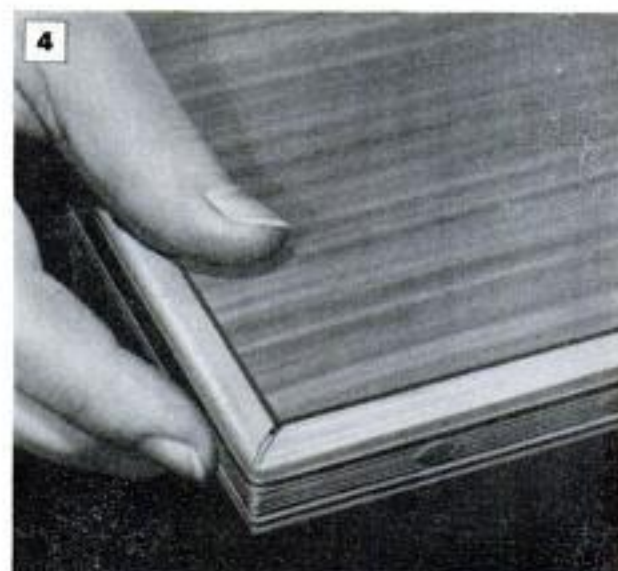



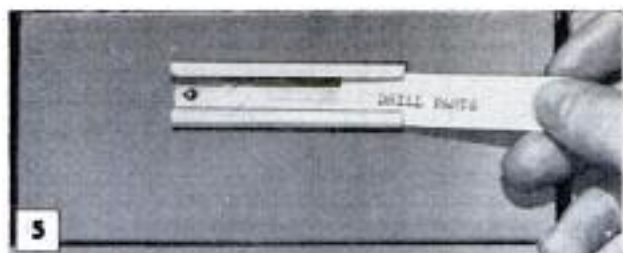

7. Flat curtain rods can provide a space-saving shoe rack on the inside of a closet door. First screw the upper bracket in place and install the rod. To space the lower rod, hang a shoe over the top rod as a guide. Women's shoes will hang nicely in this rack. For men's shoes, use wooden blocks under the bottom brackets to give the proper outward slant

8. Taking inside measurements when putting up shelves is simple if you use a tubular curtain rod as a giant "caliper." Pinch the rod slightly out of round so it does not slide too easily and will hold any set length, and then press the ends against the cabinet sides. For accuracy, make sure it is level

9. Mount the brackets of a flat curtain rod high on the back of a closet door and also on a wall or door at a spot near the ironing board. Then, when hanging space is needed in either of these places, it is a simple matter to place the rod over the brackets

10. Flowerpots on a window sill or shelf are apt to be knocked off and broken, especially if there are children around. To eliminate this danger, fit a flat curtain rod across the sill, and paint to blend with the woodwork. It is removed easily when cleaning

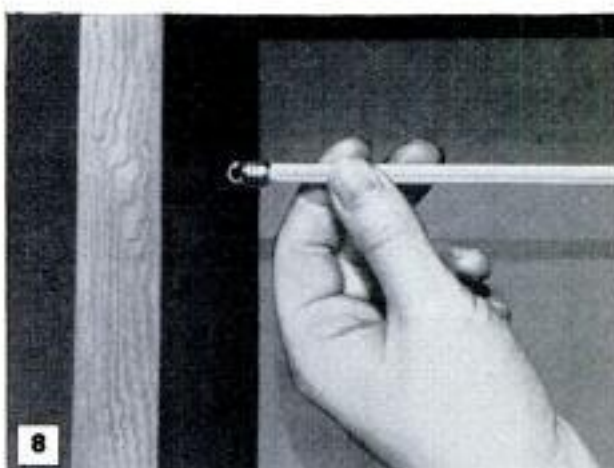
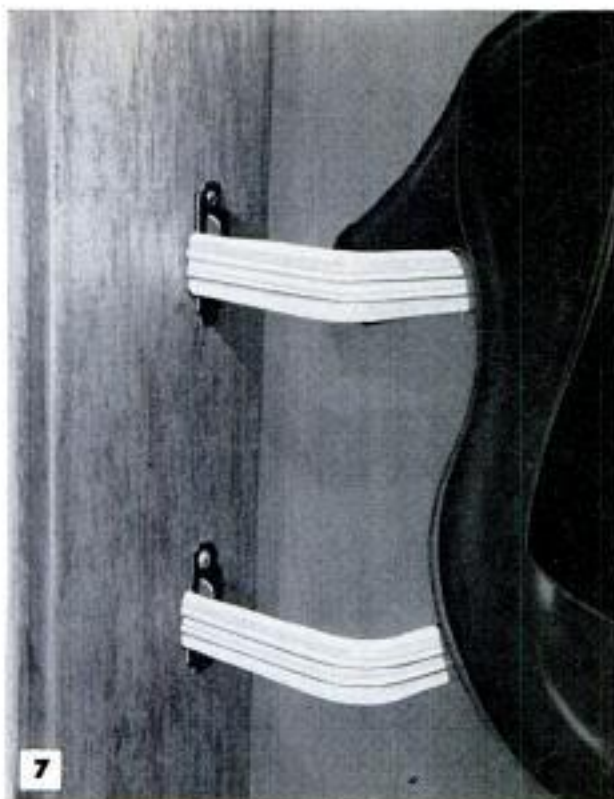

## Weed-Killer Applicator Made From Pipe and Sponge



To avoid damage to nearby grass or plants it is often necessary to apply strong weed killers to individual weeds with great care. If no special applicator is available for this purpose, one can be improvised by forcing a sponge into one end of a length of pipe. Then pour the liquid weed killer into the open end of the pipe and apply to the weed as indicated in the illustration. A slight pressure of the sponge on the weed will usually release enough of the fluid to kill the weed.

## Matches Kept With Blowtorch



Matches will always be at hand for lighting a blowtorch if a book of them is kept on the tank with a rubber band. Locate the matches as far from the torch flame as possible, and keep the book cover closed when not in use.

## Carbon "Tet" Renews Rollers Of Washing-Machine Wringer

When old washing-machine wringer rollers have become softened and unusable, they can be renewed by washing them with carbon tetrachloride. Remove the rollers from the wringer and wipe them with a clean cloth saturated with the tetrachloride. A thin layer of "dead" rubber will be removed, leaving the rollers with a tacky

surface. As soon as the tetrachloride dries, the rubber will become smooth and firm. *Caution:* Use the carbon tetrachloride in a well-ventilated space. The fumes are toxic if inhaled.

Andrew Vena, Philadelphia, Pa.

## Quick-Acting Wooden "Clamps" Hold Picture in Frame

When pictures are frequently changed in a frame, as when used for display purposes, quick-acting "clamps" to hold both picture and glass in place can be made from thin, narrow strips of hardwood. The strips are cut slightly longer than the inside width of the frame so they must be bowed to fit. The clamps hold firmly with the spring of the bow, yet can be removed in an instant. For a small picture frame, one clamp might be sufficient if it is centered.



## Paper Holder for Enlarger

A handy paper holder for making standard-size photographic enlargements can be made from an old printing frame. A piece of  $\frac{3}{4}$ -in. plywood is cut to the exact size of the paper to be used. The paper is placed on this backing, and the frame is then fitted over it. It will hold the paper smoothly in place and will provide even white margins. To keep the frame in exact position while focusing, rubber feet should be attached to each corner of the backing.

Hugh Lineback, Stillwater, Okla.

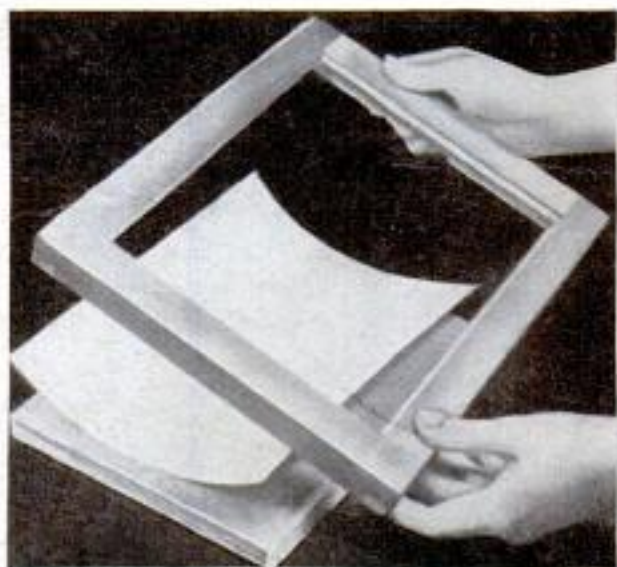

WTM 157



# PLAYTIME COTTAGE

## PART I

By Edward Mickley

YOUNGSTERS never tire of a playhouse, especially when it is equipped with electric lights and furnished with tables and chairs, bunks for overnight sleeping and even a puppet stage. And because this little house, with its front porch and picture window, looks like a real grown-up house, they'll love it even more. The materials for the basic house cost about \$75. Additional costs for finishing the interior depend on how much you do.

Start the actual construction by framing the floor, using 2 x 4s for joists. The floor is supported on concrete-block piers laid on the ground. Leave the porch unfloored until later, but lay the floor of the house proper, using 1 x 6 tongue-and-groove lumber.

Build each wall framework separately and then tip the sections into place. Brace each section temporarily until all four walls are erected and nailed together at the corners. Next, cut the roof rafters and nail them to the top wall plates. The porch-



roof framing is supported by three 2 x 4 columns which are notched at the top to lap a 2 x 4 horizontal member to which the porch-roof rafters are nailed. The porch flooring can be laid now, notching it around the supporting columns.

Windows are standard utility sash set into frames made of 1-in. pine. Buy the sash first, then build the frames around them. Fit the sill members at a slant to drain water. The door opening is framed in the same manner as the windows. All windows are hinged at the top to swing outward. The roof sheathing is applied next. Nail either 1 x 6 or 1 x 8 boards to the

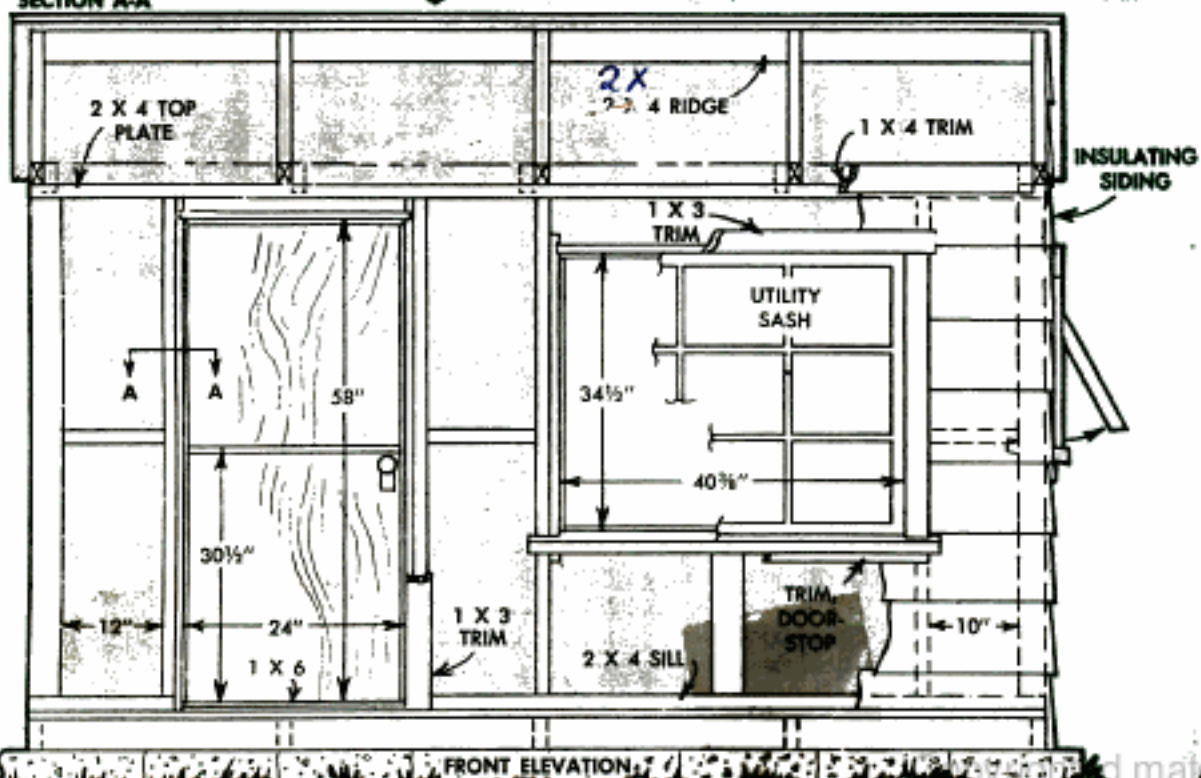
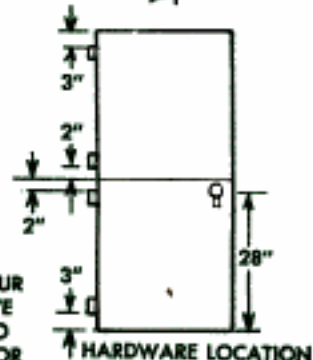
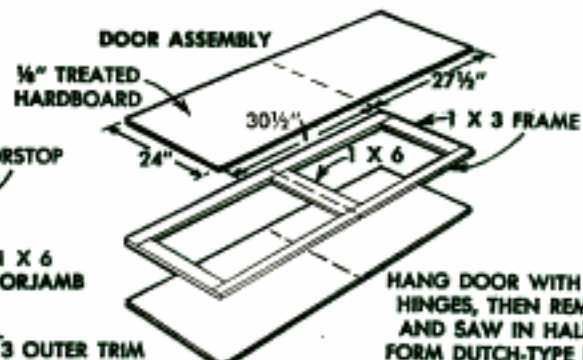
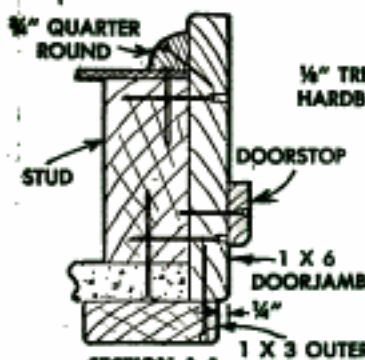
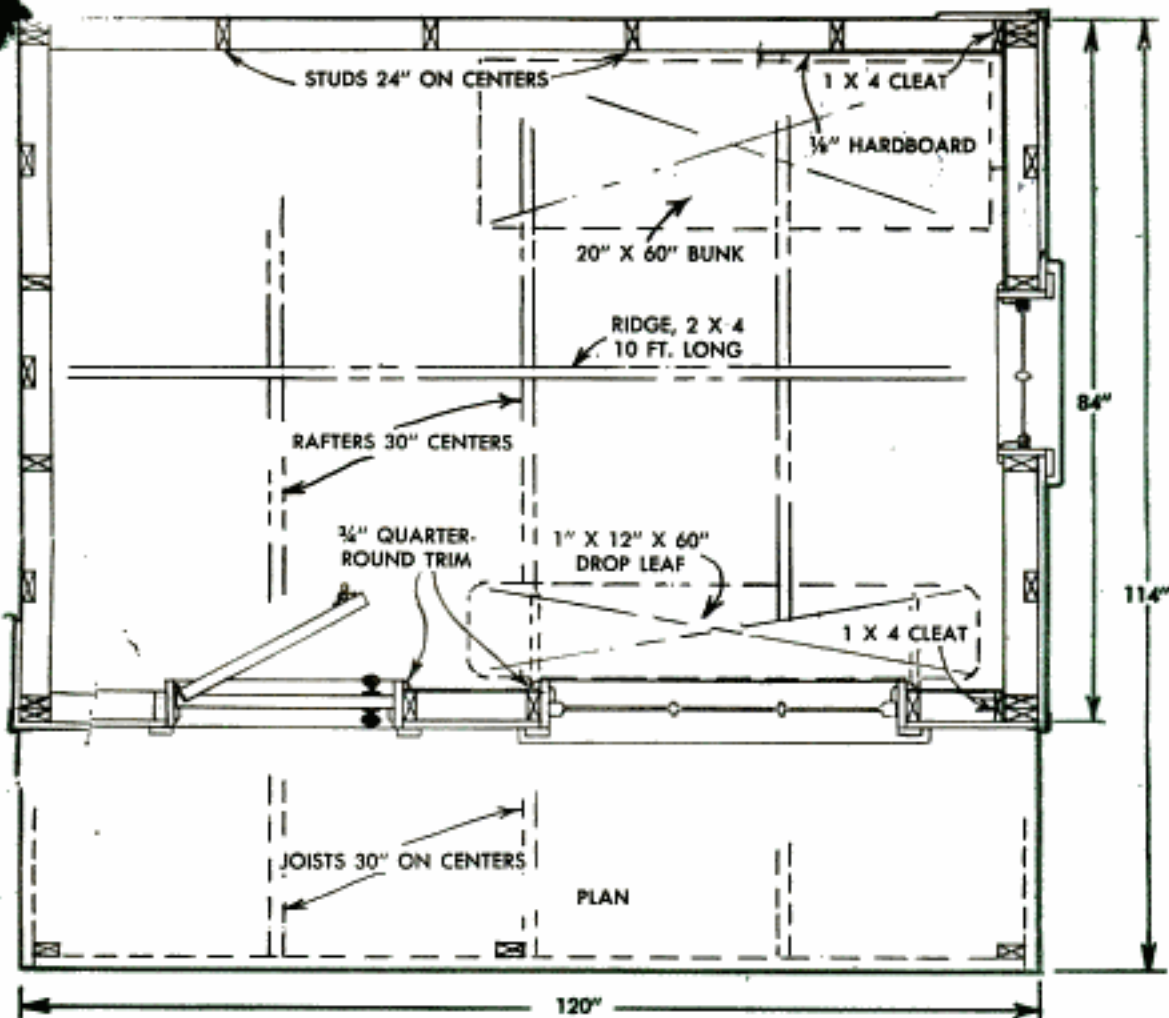

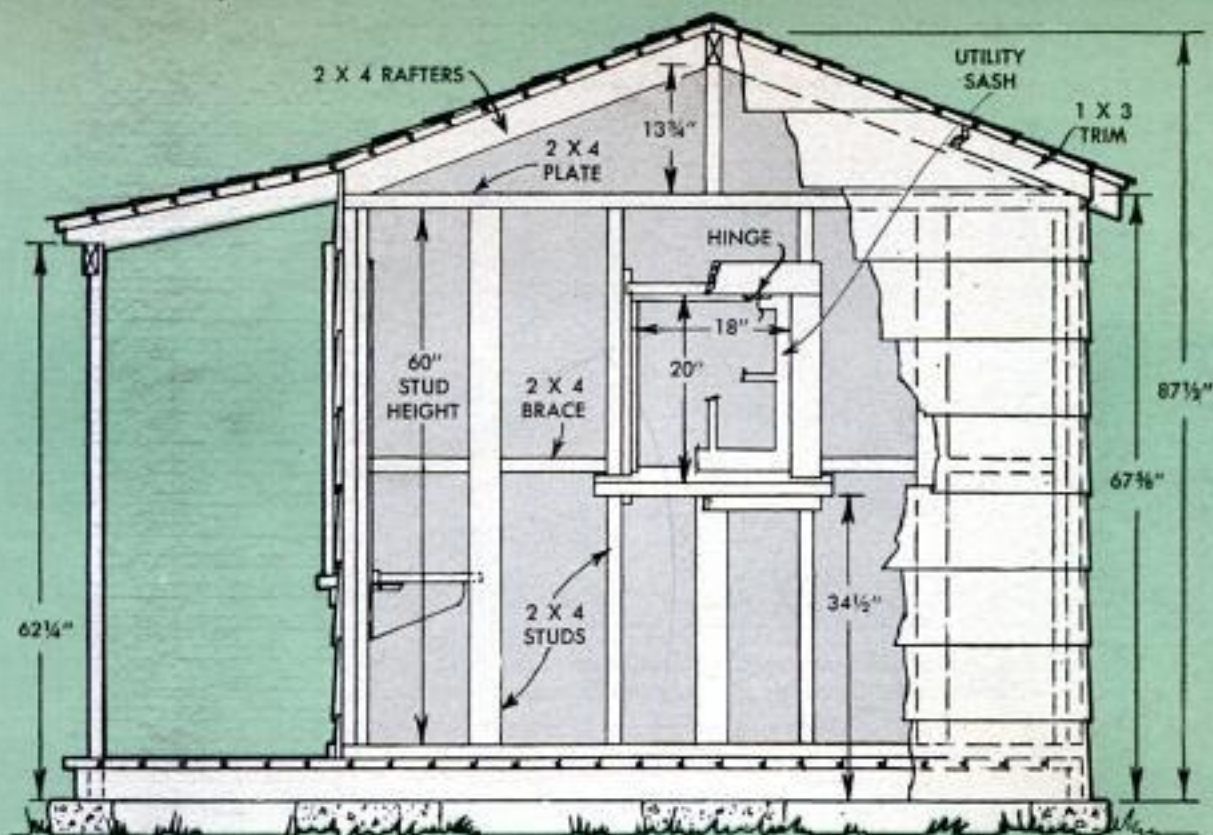

SIDE ELEVATION

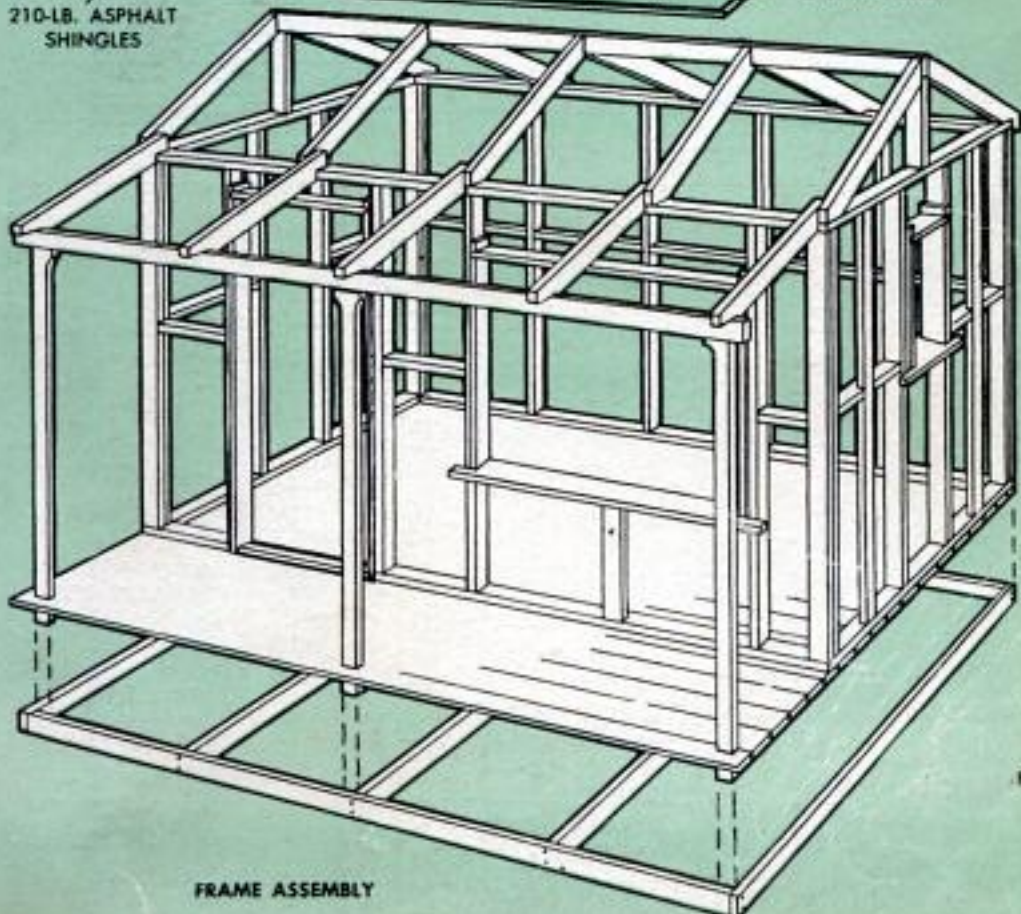
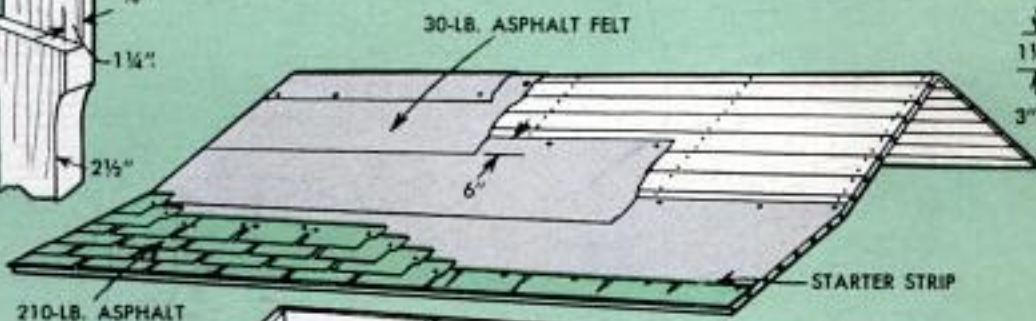
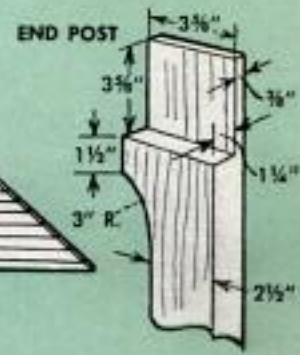
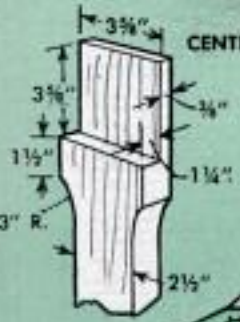



Using insulating siding saves both money and installation time because it forms the outer weather-resistant surface and the exterior wall at one time

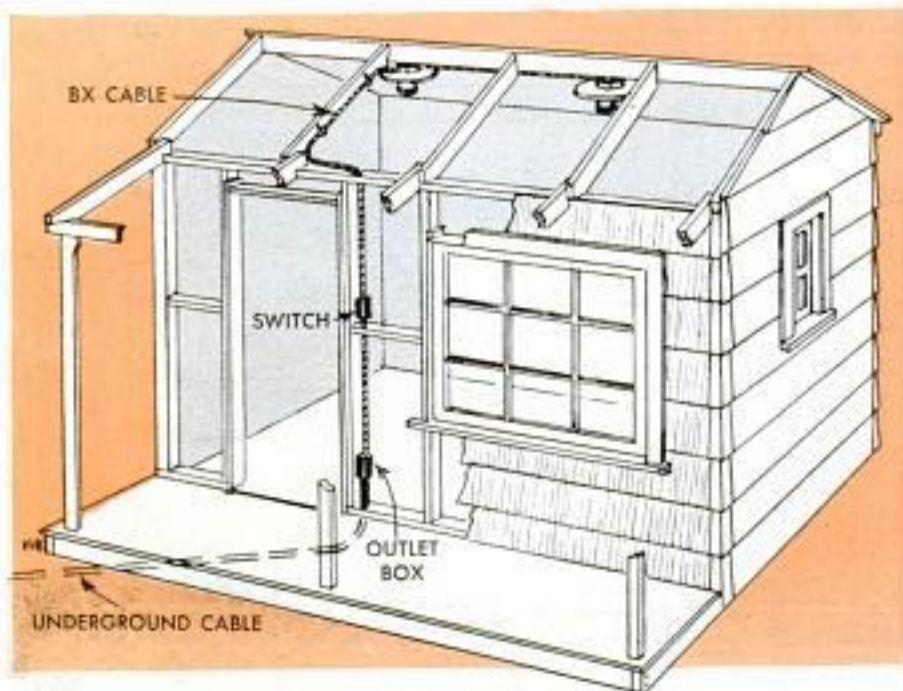

roof rafters and trim them off flush with the gable ends. Shingle the roof with regular 210-lb. asphalt shingles applied over a base of 30-lb. roofing felt. The joints of the felt should be lapped about 6 in.

A Dutch door will add endless fun possibilities. The pull-apart drawing on page 178 shows how this door is made. Construction is completed by applying insulating siding to the exterior after which 1 x 3 trim is added around the windows and the door and along the gable ends of the house. The diagram below shows how the house is wired for two lights, a switch and a duplex receptacle. The latter is convenient for plugging in a lamp to light the puppet stage or operating an electric heater on chilly days. The two light fixtures are made from 1/4-in. plywood disks, 16 in. in dia., as shown in the detail. Painted white, these disks act as reflectors, and are held in place by a standard receptacle. Two indirect lamps will provide ample light.

(To be continued)

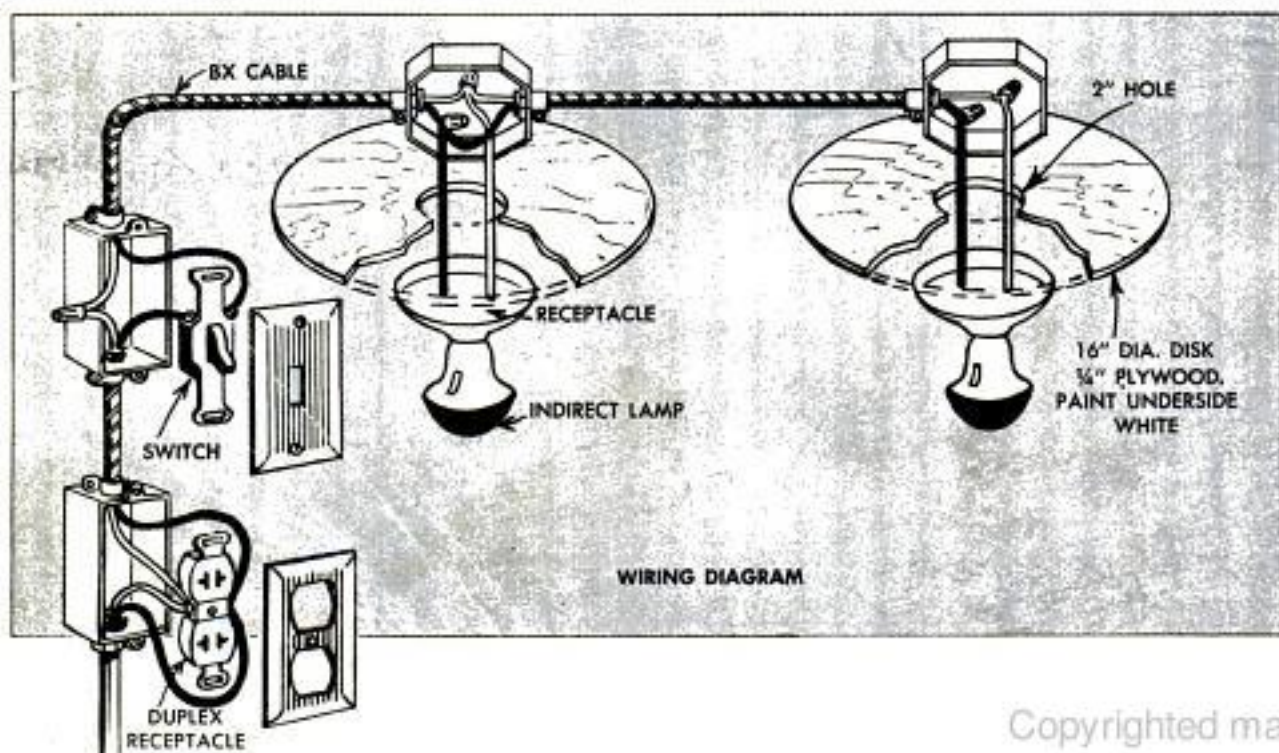

## Electric Clock With Sweep Second Hand Modified for Timer Use

An electric clock with a sweep second hand can be modified for temporary or permanent use as a darkroom timer by the addition of a timer dial. The dial is a ring cut from heavy cardboard, the inside diameter being slightly smaller than that of the clock face. After the ring is marked into 60 parts, every tenth mark is numbered, as shown in the photo. Next, a disk of clear plastic, with a hole drilled in the center, is cemented to the back of the ring. The assembly is mounted on a screw-fitted suction cup which is attached to the protective glass that covers the clock face. A grommet on the screw prevents the nut from holding the dial too tightly. In use, the

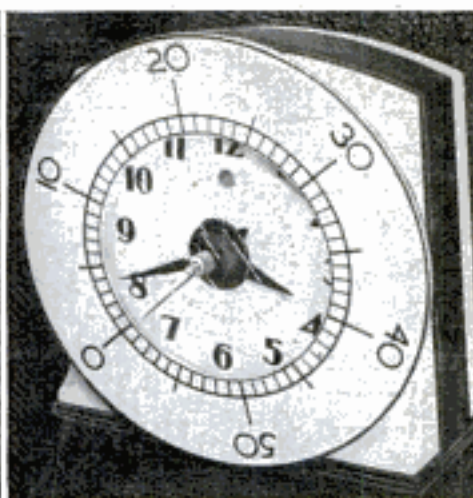
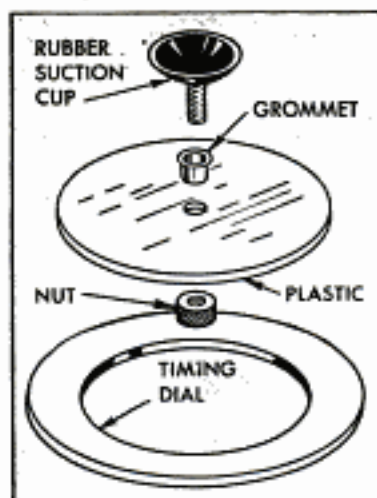

dial is rotated until the zero mark aligns with the sweep second hand, so timing always starts at zero. If the clock is self-starting, it may be plugged into the printer or enlarger so it starts when an exposure is begun.—Richard Hanscom, Elmhurst, Ill.

## Shield Fitted on Eyeglasses Prevents Sun Fatigue and Blindness

Fitted over sunglasses or regular eyeglasses, a shield that extends back along the temples will protect eyes from fatigue or snow blindness on a sunny winter day or on a bright summer day at the beach. Cut the shield from fairly heavy cardboard to the shape shown in the detail. If black cardboard is not available, paint the inside of the shield with black watercolor paint or cover with dull-finish black paper. The shield is fastened to the glasses by looping a rubber band around each temple and passing it through holes punched near the bends in the shield. The free end of each

band then is passed along the sides of the shield and looped over the end of the eyeglass temples. Hold a ruler in front of the eyes while looking into a mirror to determine the distance between pupils. Locate the vision holes accordingly. For greater horizontal field of vision, cut narrow horizontal slots instead of the holes.

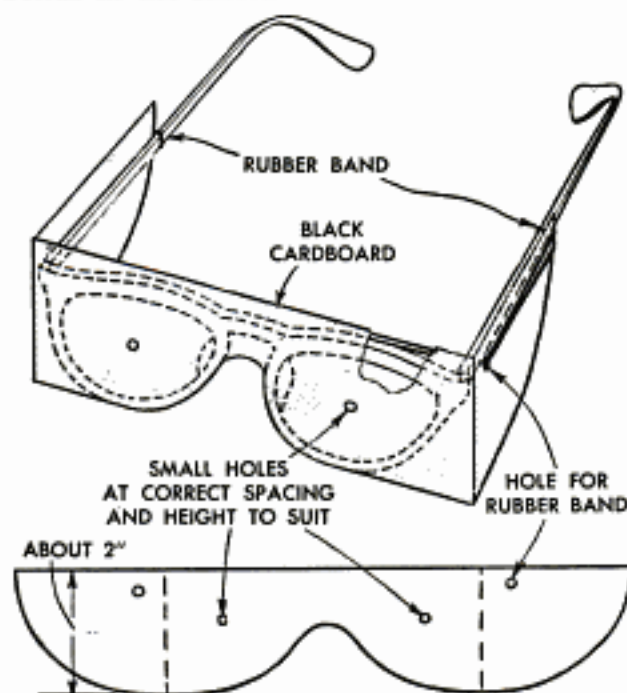

## Improved Plumb Bob Used To Set Square Fence Posts

If no level is available when setting square fence posts, they can be set plumb by using an improvised plumb bob. A short strip of wood, one end of which is notched, is nailed to the top of each post on a diagonal between corners. A string is tied to one of the nails, passed through the notch and a weight is suspended from it. When the weighted string is perfectly parallel to the corner of the post, the post is plumb. Measure the space between string and post at points near top and bottom to check the plumb in one direction. Sight between string and post corner to determine the plumb in the other direction.

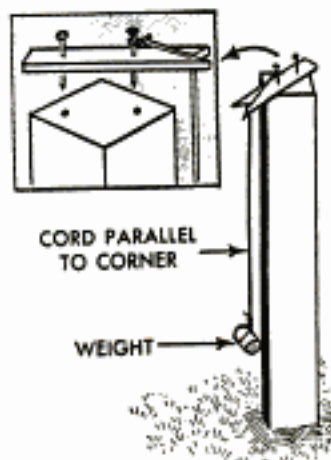

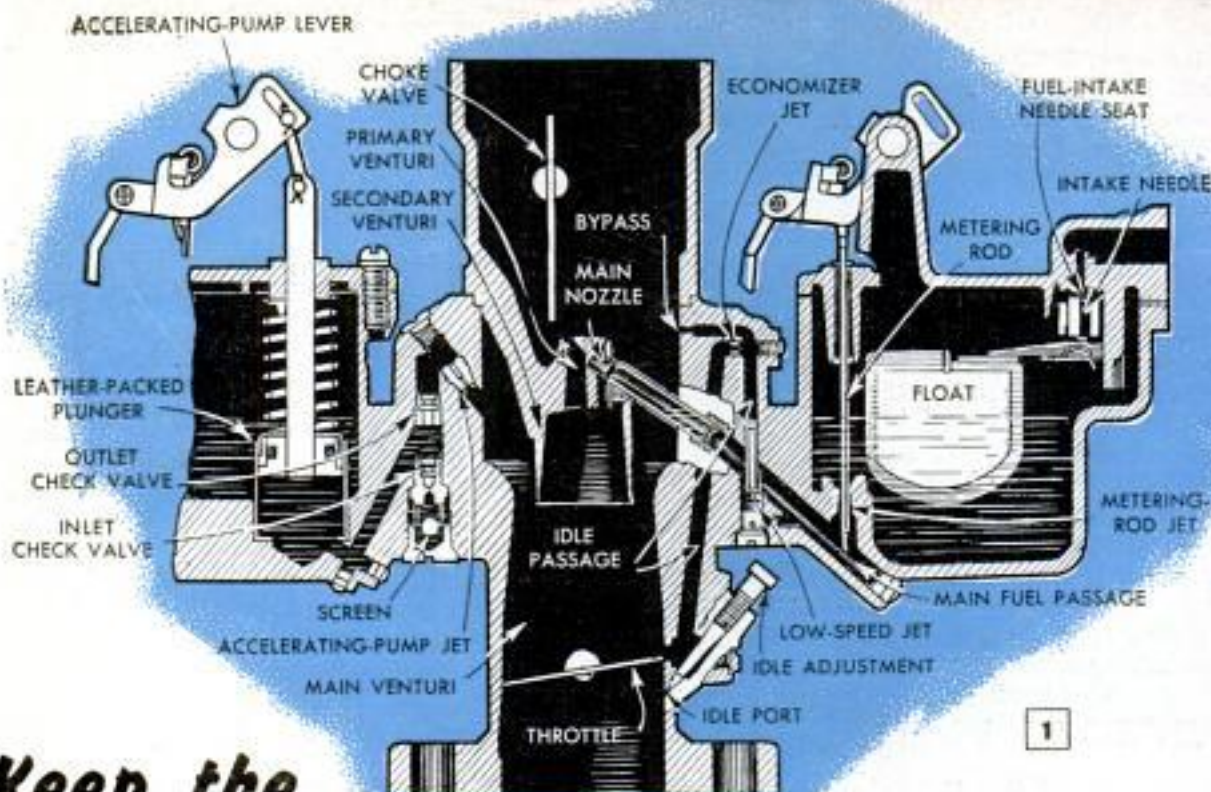

## Keep the CARBURETOR AT PEAK EFFICIENCY

**S**ERVICING a carburetor in good mechanical condition is usually a matter of cleaning with a recommended solvent made especially for the purpose. Solvents can be used in two ways, by feeding directly into the carburetor with the fuel mixture or by pouring a measured quantity of special gum-removing solvent into the fuel tank. Both methods are effective, but the former is much faster

Mechanics use a special gauge for setting the float. Check instructions to be sure of correct setting



By Ed Packer

than the latter. For a fast and thorough job of cleaning, the special solvent container is suspended above the carburetor and a flexible tube is used to conduct the solvent to the carburetor barrel. Then the engine is operated at idling speed on a half-and-half mixture of solvent and gasoline. Accelerating the engine will help to flush all passages thoroughly. Also, it's a good idea to operate it at high speed for a short interval to force solvent through the high-speed jet. Some mechanics use the palm of the hand as a choke to draw the solvent into the carburetor in quantity so that all inner surfaces are thoroughly flushed.

However, if there is any reason to believe that the accelerating pump is faulty or that the float is stuck or the throttle linkage worn, then it will be necessary to dismantle the carburetor in order to repair or re-adjust the parts. Before dismantling the unit, cover a bench with clean paper and then keep all parts in order as they are removed. Parts from carburetors that have been neglected may be badly gummed and will require soaking in a solvent for a half hour or more before blowing clean with compressed air. The parts that should be removed and examined closely for defects are the metering rods, needles and jets and the accelerating-pump plunger, Fig. 1.



All parts that show signs of wear or corrosion should be replaced. Wearing of the pivots and pins of the carburetor-float assembly causes the float level to rise. This means that the float must move farther before shutting off incoming fuel. A high level of the float can cause the engine to run rough. Hard starting and fuel waste also result. The float level should be checked with a gauge made especially for the purpose, Fig. 2. Although not always recommended as the best practice, it is possible to compensate for wear up to about  $\frac{1}{16}$  in. simply by bending the float arm to lower the level as in Fig. 3. Note that in Fig. 3 the setting is given as  $\frac{1}{4}$  in. but it should be remembered that this may not agree with the recommended setting for all makes of carburetors. Check the manufacturer's instructions before making the final adjustment.

Quick warmup is dependent not only on

the thermostat in the cooling system but also on the correct operation of the heater valve which directs heat to the intake manifold during the warm-up period. Be sure to check the operation of this valve when servicing the carburetor. Sometimes it sticks and must be loosened with light taps of a hammer as in Fig. 4.

Don't overlook the fuel pump when servicing the carburetor, as the two units are closely interrelated. Clean the fuel filter, Fig. 5, and the fuel-inlet screen, Fig. 3, while the units are disassembled. When the carburetor and pump are replaced on the engine, use all new gaskets and be sure that they are properly positioned. Set the choke controls so that the choke valve is closed with the parts cold. Check later to see that the choke valve is fully open when the engine reaches operating temperature. Adjust the idling-mixture screw, Fig. 6, until the engine idles smoothly. ★ ★ ★

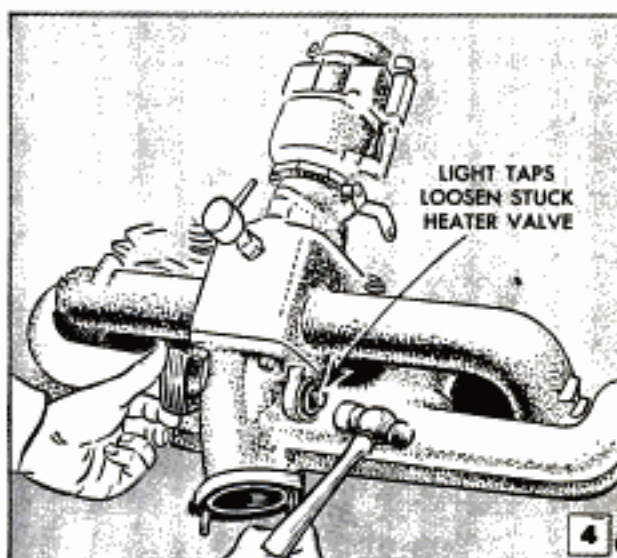
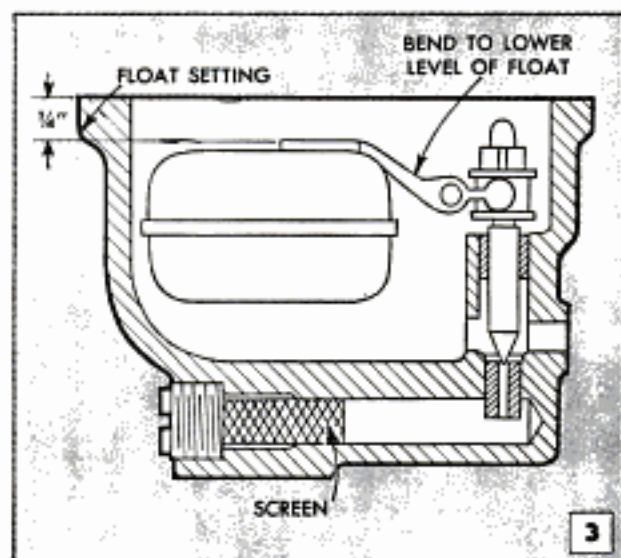

Above, within limits it is permissible to bend the float arm to compensate for wear of parts. Clean the fuel screen while parts are disassembled. Below, always clean the filter when servicing the fuel pump

Above, heater valve sometimes sticks and must be loosened. Replace it if there's any doubt about dependable operation. Below, after servicing the carburetor adjust the idling mixture for smooth operation

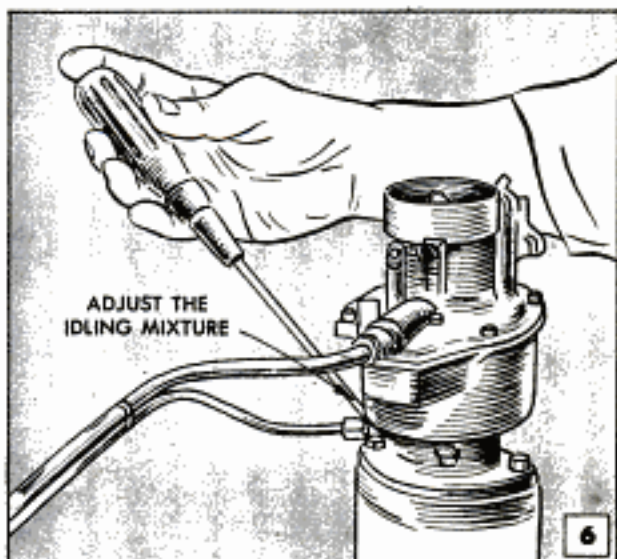
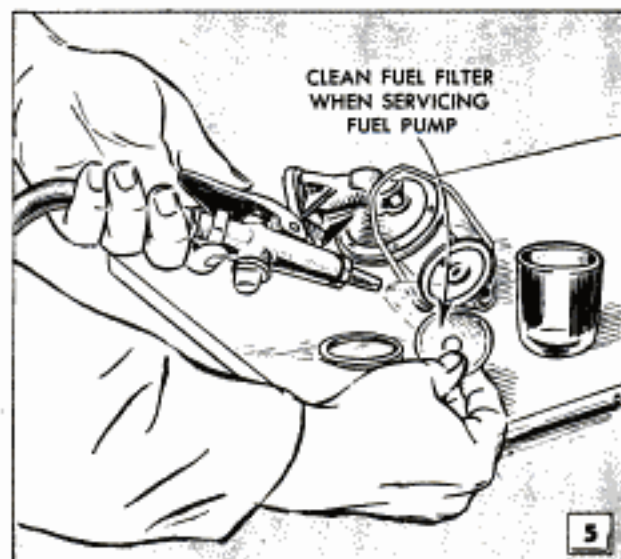

## Garden-Tool Display Rack Made From Nail Keg



Long-handled garden tools are displayed by one hardware-store owner in a portable rack made from an empty nail keg. The top hoop is removed and a piece of chicken wire stretched over the keg. Replacing the hoop and nailing it into place holds the wire tight. Garden-tool handles are slipped into the holes in the wire and held upright. In a windy location, a weight should be placed in the bottom of the keg.

## Shutters Control Air Circulation

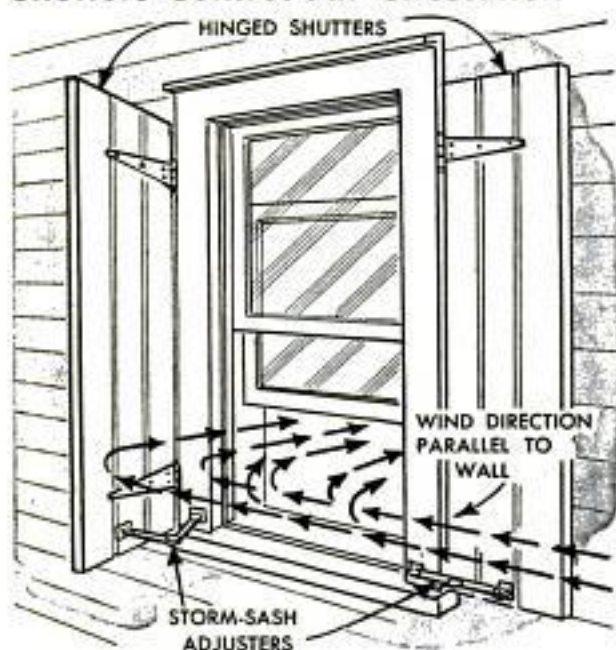

Window shutters can be used to control air circulation on hot nights so even a slight breeze moving parallel with a wall will enter a room. Shutters fastened to a house for appearance only should be taken down and hinged to the edges of the window

frame. A friction-type storm-sash adjuster then is installed between the window frame and the lower edge of each shutter. In use, one shutter is swung outward to divert the air into the window, while the other is folded flat against the wall.

## Rings With Reflector "Stones" Locate Pedestrian at Night



Slip-on finger rings with license-plate reflectors as "stones" are worn by the children of one farmer as a safety precaution when walking down a highway at night. The lights of oncoming cars reflect against the rings and locate a pedestrian, even when he is otherwise not visible because of dark clothes.

Ken Murray, Colon, Mich.

## Rubber Band Holds Nail to Hammer For Working in Small Space

When working in a small space where you cannot hold a nail for starting, a rubber band can be used to hold the head of the nail on the hammer. As shown in the photo, pass the band around the hammer handle, cross it in front of the face and draw the end of the band through and around the claws. Then slip the head of the nail under the rubber band where it crosses. Not only will this hold the nail for starting, but also will release automatically once the nail takes hold.



POPULAR MECHANICS

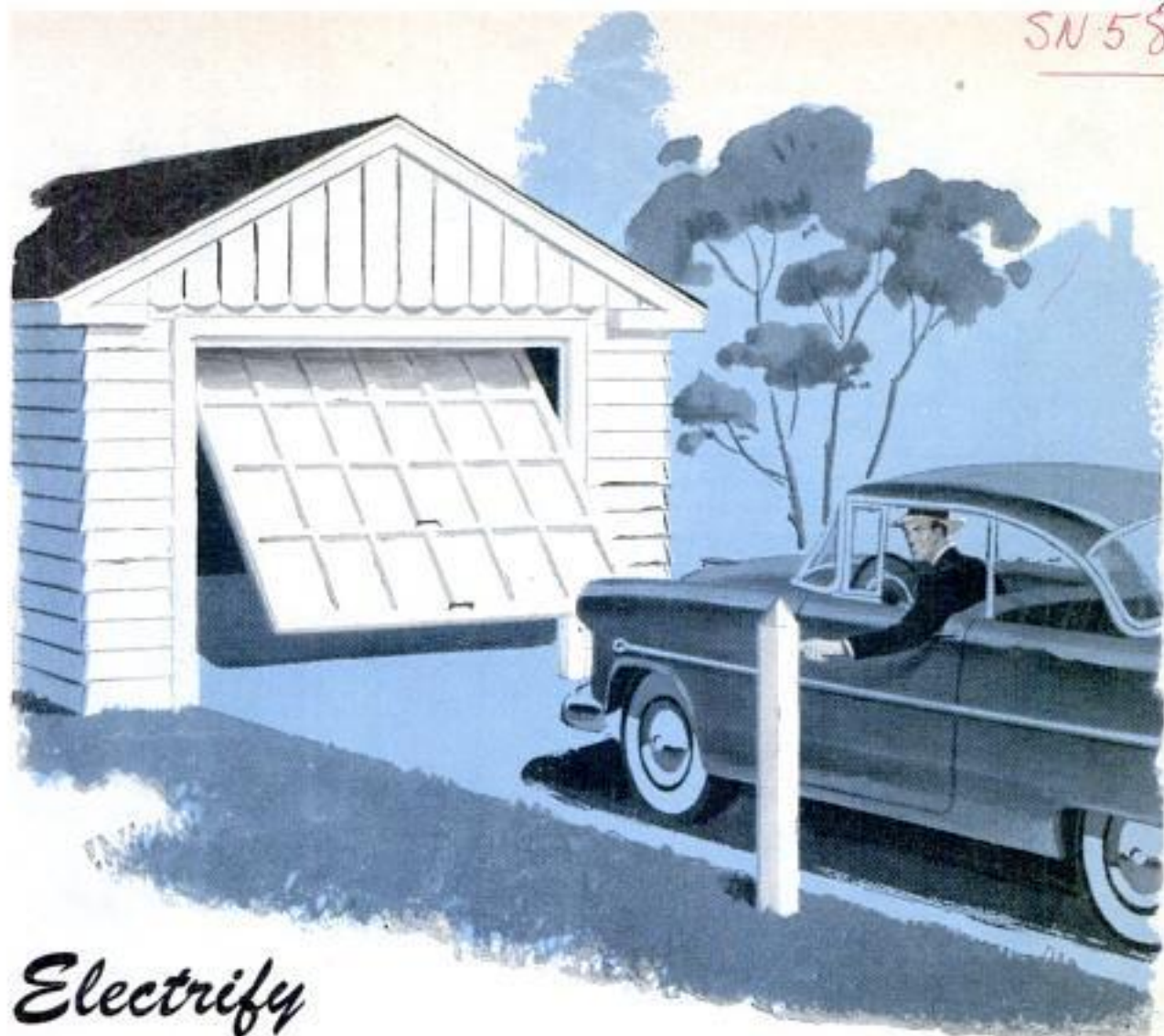

## *Electrify* YOUR GARAGE DOOR

By Tom Griberg

**POWERED BY A** washing-machine motor and gear assembly, this unit opens and closes the garage door by means of remote-control switches. When inside the garage, you press a momentary-contact switch which closes a relay and starts the motor, raising the door to the open position. As the door nears the full-open position, a stop on the lifting bar engages a rod that actuates a d.p.d.t. (double-pole, double-throw) switch, moving the sliding contact points to the opposite terminals, which stops the motor and reverses its polarity. When outside the garage you stop the car at the second momentary-contact switch, which is of the key type and is mounted on a post at a convenient height. Closing this switch starts the reverse cycle and closes the door. As the door reaches the closed position, the d.p.d.t. switch is automatically reset by means of the stop, or tripper, to

repeat the first cycle for raising the door.

The washing-machine power unit is dismantled and all gear trains removed except the worm and gear which drive the wringer shaft. On some units, the motor is directly connected through a flexible coupling; on others, the gear train is belt-driven from the motor. Either type will operate satisfactorily in the new application provided the belt is not unusually long. Unless you are thoroughly familiar with fractional-horsepower motors, have your electrician dismantle the motor and bring out the necessary reverse leads.

The next step is to assemble and mount the door-lifting mechanism on the ceiling of the garage. This consists of a length of square steel door track, 7 ft. 6 in. long, one roller-bearing hanger, three sprockets 5 in. in dia. and one 2½ in. in dia., also shafting and bearings. You will need about 20 ft.

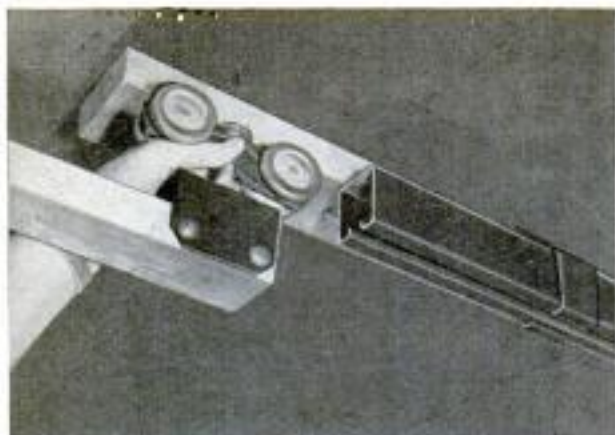

Above, sliding door hanger into square track. End of lift bar is bolted to hanger yoke. Below, drive and driven sprockets are mounted on steel base

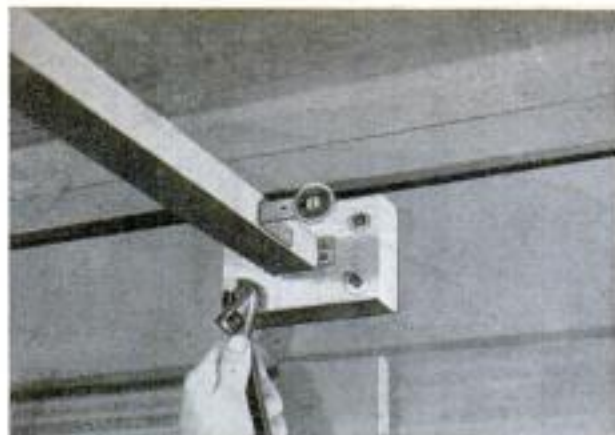

Above, end of lifting bar is hinged to upper rail of door. Below, idler sprocket is mounted at outer end of track. Lifting bar is in the closed position

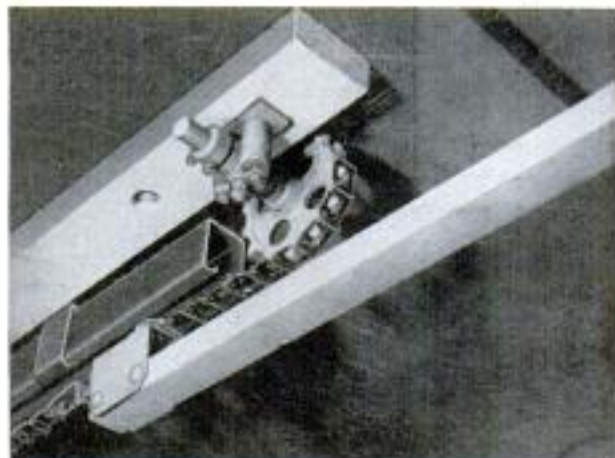
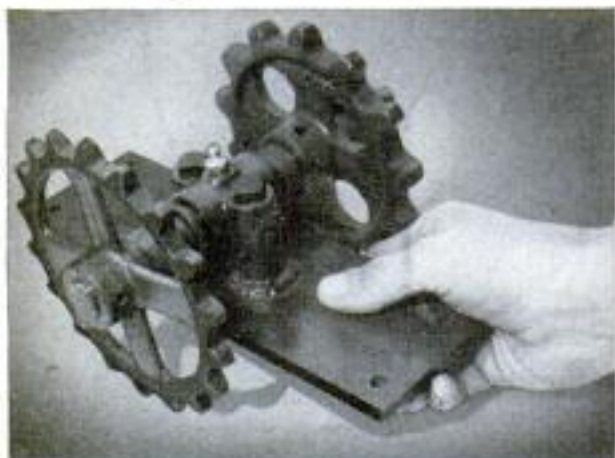

of flat-link steel chain of a size to fit the sprockets. These parts are available from farm-implement dealers. The door track is bolted to a length of 2 x 4 and the whole lag-screwed or bolted to the garage ceiling. The outer end of the track should be about 12 in. from the end of the door when the latter is in the full-open position. The track should be about 6 in. above the edge of the door, and must be located precisely on the center line of the doorframe. With the door closed, measure and cut a length of 1 1/8-in. stock and rip it to a width that will fit in-

side the yoke of the rolling hanger. Bolt one end to the hanger as in the upper left-hand photo above. Attach the other end to the top rail of the doorframe as in the right-hand photo above, using a sturdy hinge and blocking out as shown, to assure that the bar will be parallel with the floor when the door is open. Next, center and mount an idler sprocket on the 2 x 4 supporting the door track as in the lower right-hand photo above, the sprocket precisely on the center line of the track. Then assemble the drive and driven sprockets as in the center left-

Drive and driven sprockets are mounted at inner end of door track. Note provision for tightening the chain

The completed lifting unit is shown here ready for installation of the power drive. Door is nearly open

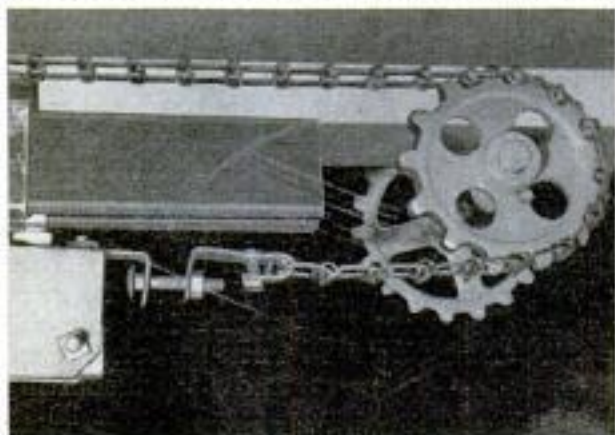

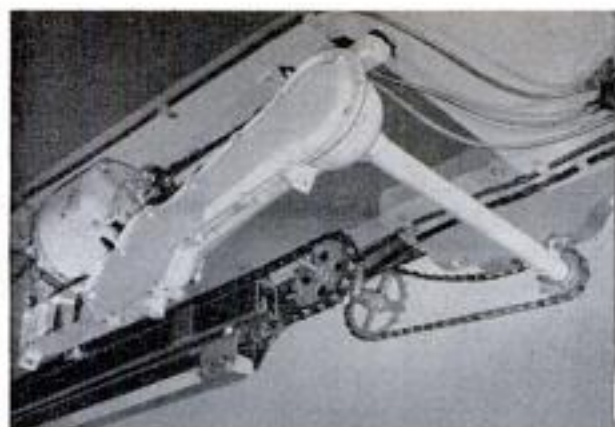

Drive unit from wringer-type washing machine provides power lift for raising and lowering the door

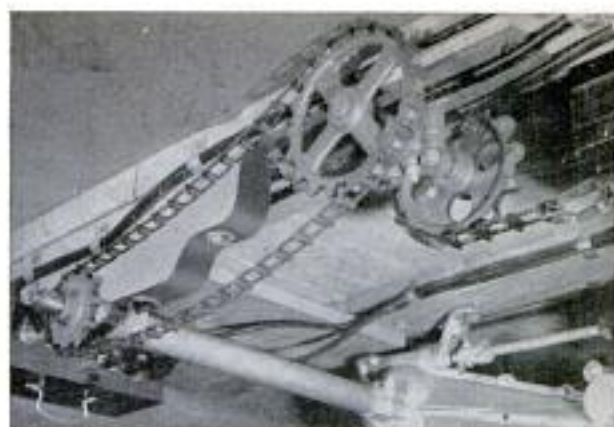

Lift is power-driven by sprocket mounted on end of wringer shaft. Note shape of wooden base blocks

hand photo, page 186, and mount at the opposite end of the door track as in the lower left-hand photo shown on the same page. When the chain has been placed on the sprockets you have the assembly shown in the lower right-hand photo on the preceding page. Note in this illustration the simple device for adjusting the tension of the chain, also in the lower left-hand photo.

Next, mount the 2½-in. sprocket on the top end of the wringer shaft of the power unit, cutting away the housing if necessary in order to mount the sprocket correctly. Then mount the drive unit as in the left-hand photo above. The mounting must, of course, be worked out to suit the power unit used, as these will vary somewhat in construction. Place the chain on the driven sprocket only, so that the door can be raised

and lowered by hand simply by pulling on the chain. Now, make the d.p.d.t. switch as in the detail and photos below, using three pieces of hardboard for each of the stationary blocks and four pieces for the sliding block. Bolt together as shown. Make spring clips and sliding contacts from 1½-in. angle brackets. Mount on rods as in the detail and test the switch for alignment of the contact points. Mount the switch in a metal box as in the upper photo on page 188.

Now the job is ready for wiring, but first some experimenting must be done in order to locate the switch correctly in relation to the lifting bar. To do this, mount the switch temporarily and then clamp stops, or trippers, near the ends of the lifting bar. These are angle-steel brackets which have a washer bolted to one end as shown in the

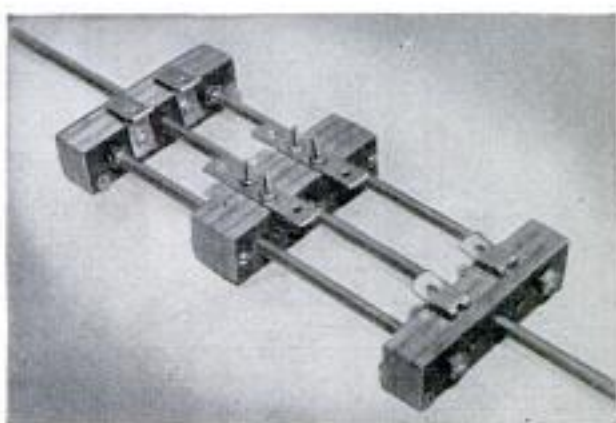
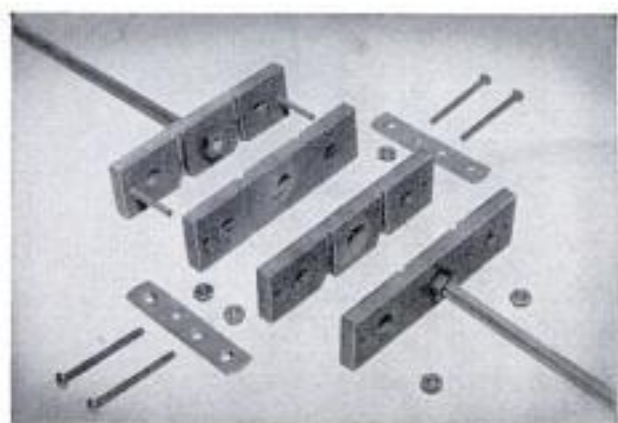
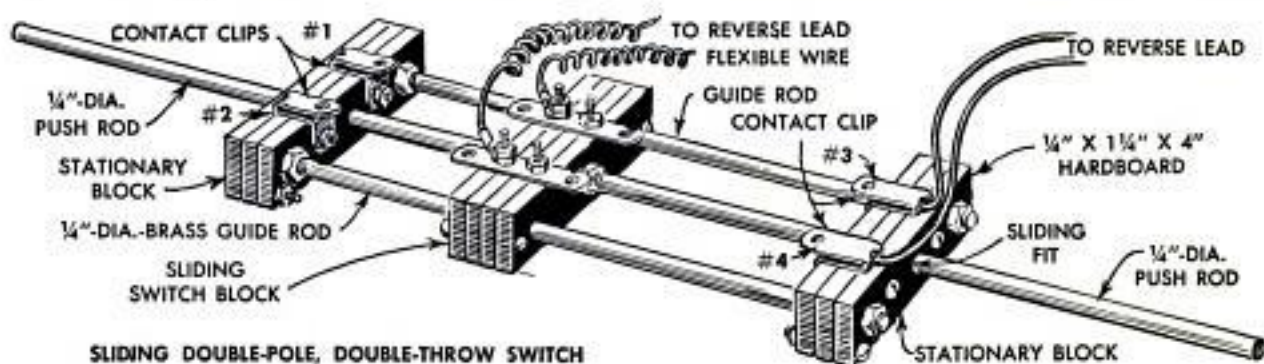

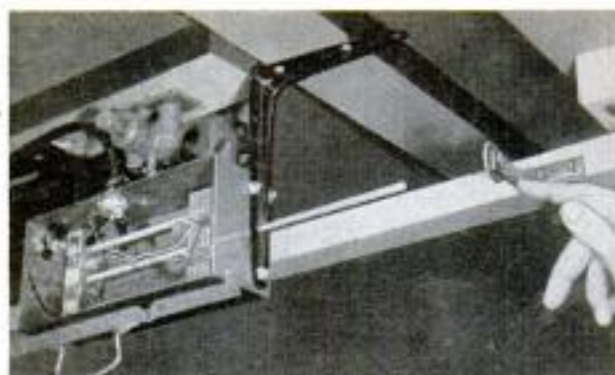

The d.p.d.t. switch is mounted at the outer end of track. Tripper is nearing end of actuating rod

upper photo on this page. Open and close the door manually, repositioning the trippers so that they engage the sliding rod carrying the switch and move it the required distance to close the contacts. Mount the switch box permanently and mark the location of the trippers. It may be necessary to relocate them later.

Complete the wiring, bringing all leads to a junction box which houses the 50-volt 90-ohm relay as in the photo below. Mount momentary-contact switches in convenient locations inside and outside the garage. When wiring the d.p.d.t. switch, connect clip No. 1 to clip No. 4, clip No. 2 to clip No. 3. Then connect wires to clips No. 1 and No. 2, the wires to be attached to one of the reverse leads on the motor. Two lengths of flexible wire lead from the contact strips on the sliding switch block to

the other pair of reverse leads on the motor. Do not solder these connections as it may be necessary to interchange them. When installing the wiring it's a good idea to wire a double-pole switch in the 115-volt power line so that current can be completely cut off from the installation.

Now test the unit, starting the cycle with the door closed. If the motor runs in the wrong direction, interchange the leads. Test again, changing the location of the trippers, if necessary, to move the sliding block of the d.p.d.t. switch the correct distance at the completion of each cycle. In this it will be necessary to take into account any tendency of the door to coast, or overrun, as it nears the full-open position. Some doors coast more than others. The distance the door moves after the tripper on the lifting bar actuates the switch, cutting off power and stopping the motor, determines the movement, or throw, of the switch. Obviously, the sliding block must move far enough to engage the contact clips at the opposite poles of the switch in order to reset the unit for the reverse cycle. This can be determined only by experimenting with each individual installation. The throw (movement of the sliding block) of the switch can be shortened if necessary by running the threads back farther on the guide rods. When correct location of the switch and trippers has been determined, solder and tape all electrical connections and screw trippers permanently in place. Be sure to oil parts and motor. ★ ★ ★

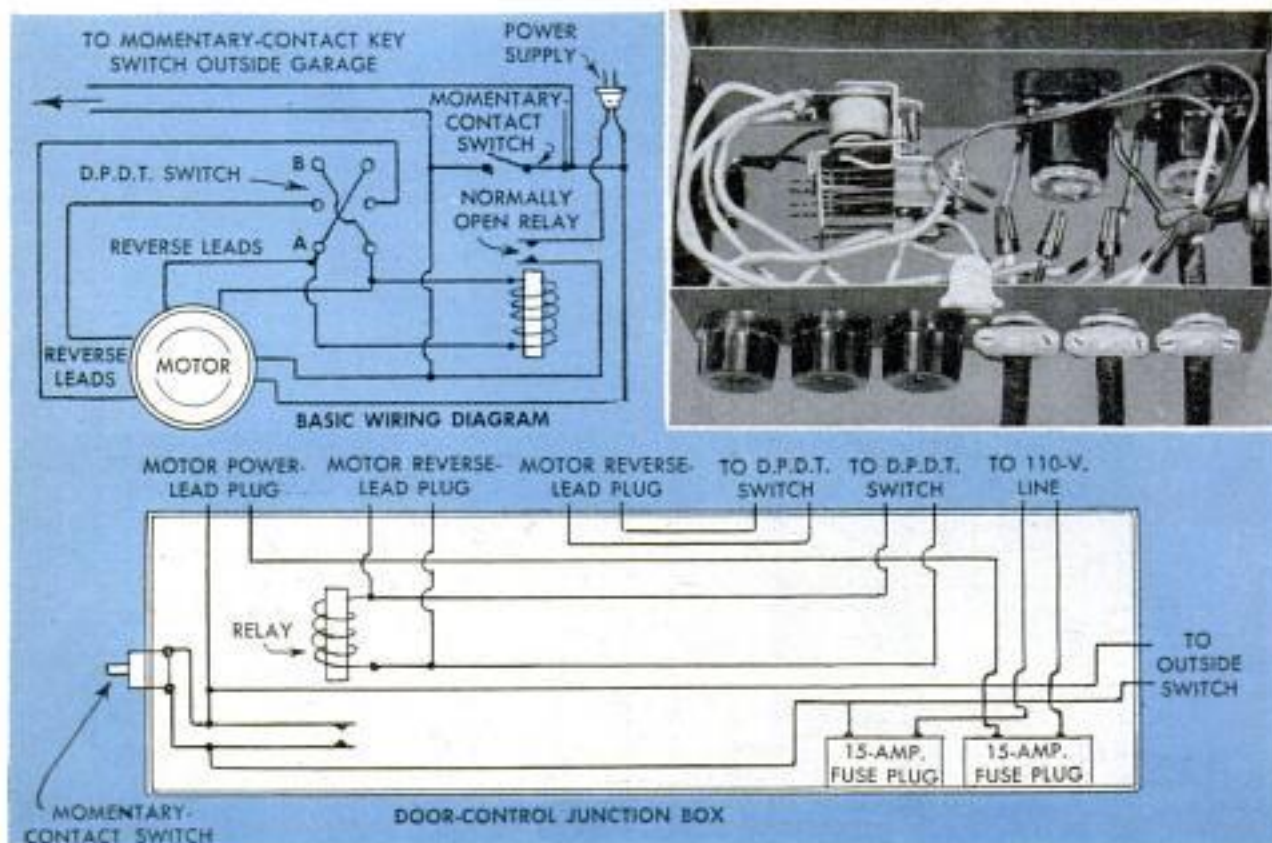

## Modifications Increase Holding Capacity of a Drill-Press Vise

The capacity of a drill-press vise of the type shown in the detail can be increased by relocating the steel jaw plate of the fixed jaw on the outside surface. When work is held in a vise so modified, a support of the same height as the fixed jaw must be placed beneath the work adjacent to the movable jaw. Further increase in holding capacity of the vise is possible by using two extension plates. The plates are pieces of steel plate with blocks screwed to opposite sides of opposite ends to form a Z-shape. The extension plates can be held solidly on the vise jaws by using blocks deep enough to permit

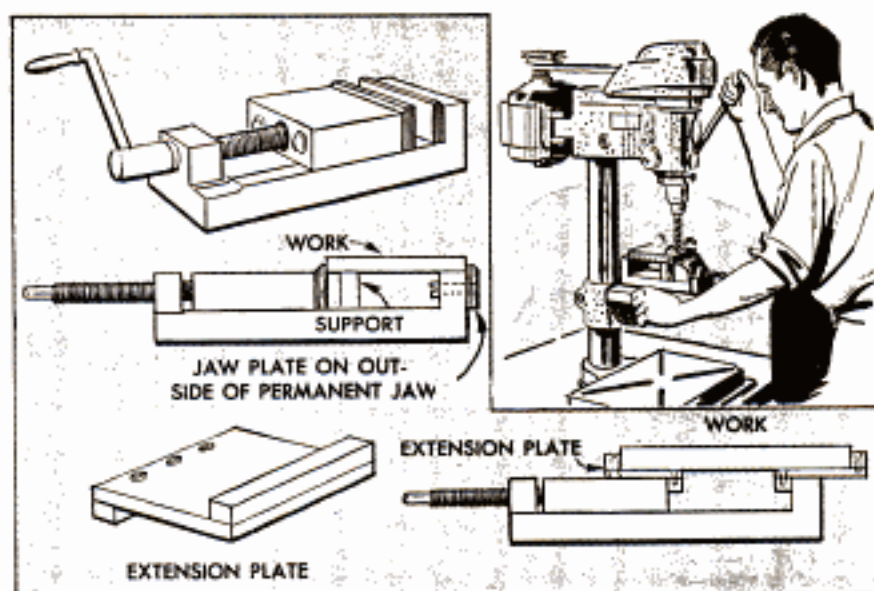

drilling holes to match the jaw-plate holes in the vise jaws. The extension plates then are screwed directly to the vise jaws.

## Expansion Material on Post Prevents Cracking Concrete

Cracking of concrete poured around a wooden post set in the ground, which results when moisture absorbed in the post freezes and expands, can be avoided by wrapping pieces of  $\frac{1}{2}$ -in. asphalt expansion-joint material around the post before pouring the concrete. After treating a post with wood preservative, pieces of the ma-

terial are wired around that portion of the post which will be enclosed in concrete, with the edges of the material overlapped. When wrapping a round post, heat the asphalt with a blow torch so it becomes pliable enough to wrap snugly around the post. The asphalt material, which is used in the construction of concrete sidewalks and driveways, is available at most building-supply yards.

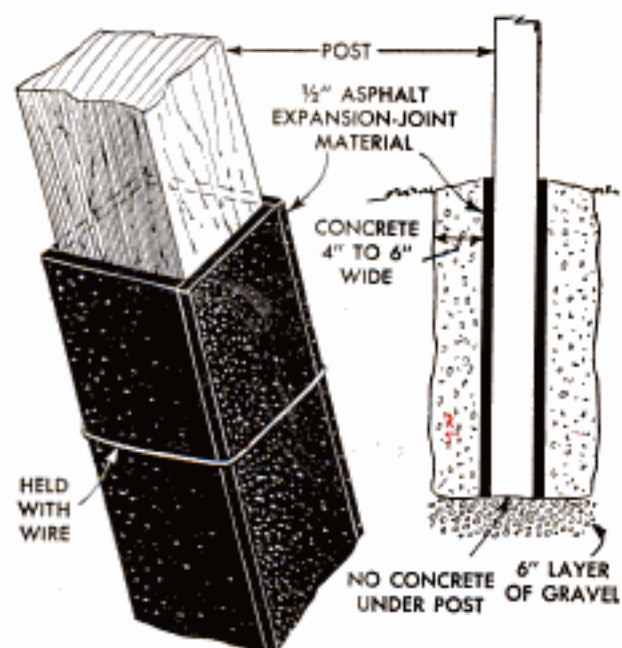

When painting the outside of a house, a much more professional-looking job can be had if the underneath edges of the clapboards are painted first. Brush several edges within arm's reach first, then coat the faces of the boards.

## Joint Between Footing and Wall Sealed With Metal Strip

In areas where ground water is likely to enter a basement through the joint between footing and concrete wall, a watertight joint may be provided when footing and wall are poured. One way of doing this is to install an 8-in.-wide strip of heavy sheet metal in the footing. Aluminum, copper or other nonrusting metal should be used. The metal is centered in the footing, with half its width projecting into the wall forms so that the wall can be poured around it. As the wall is poured, the concrete should be tamped carefully to eliminate any voids which might form around the strip.

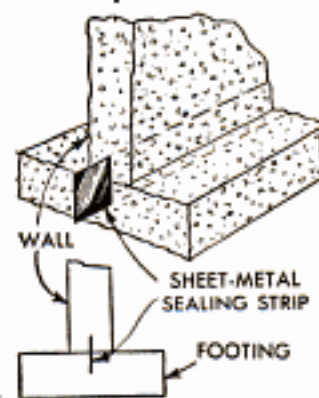

## Metal Weather Stripping Renewed By Scoring With Screwdriver



Metal weather stripping which has lost its "spring" can be renewed without being removed from the frame. Simply score the stripping with a medium-sized screwdriver along the first bend, as shown in the detail.

Apply moderate pressure on the screwdriver. At points requiring a greater bend, apply more pressure. To check the fit of the stripping, sight between door and frame at a strong light.

J. B. Mullen, Barrington, Ill.

## Tool Drives Small Staples

A tool made from a short length of flattened tubing will save both material and patience when it is necessary to drive a number of small, easily bent staples. The flattened tubing should be a loose fit over the staples. A piece of flat steel is used as a drive pin or plunger. It is cut to a length slightly longer than the tubing and the edges are rounded to prevent it from binding. In use, a staple is inserted in the end of the tool and the plunger tapped with a hammer.

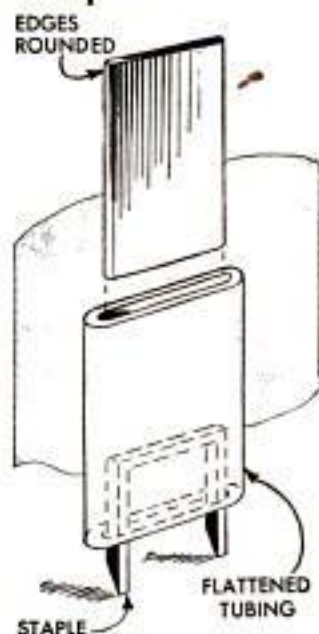

In use, a staple is inserted in the end of the tool and the plunger tapped with a hammer.

# Build This House Yourself!

## Save 65% Easily!

Two bedrooms, a spacious living room, bath, carport, compact dining room and kitchen all in a space 24 x 46 feet. You can build the Precut House in three stages, using any of numerous floor plans—all of which are designed to provide maximum comfort with minimum cost. Think of it! You can build that house you've always wanted. You can make a livable shell for only \$1800. The second stage will give you a summer home with all conveniences for only \$2800. When you add the third stage, you have a luxury home for year 'round living, in any climate, for only \$3800!



**Livable Shell—\$1800; Summer Home—\$2800; Luxury Home—\$3800; Simplified How-To-Do-It Instructions—Hundreds of Pictures—Working Blueprint Plans!**

You can build the house with the book alone. The plans make it easier. The book gives lists of materials required, all measurements and dimensions, suggestions for financing and tells in words and shows in pictures every detail of construction. Richard Dempewolf, author of the "Precut House" book, built the house in 1650 man hours for \$3731.23—complete!

Features of Expensive Homes are included: built-in furniture, unusual amount of closet space, adaptability to various interior arrangements, and materials designed especially for amateur builders. The book is \$2.50 and a complete set of 10 blueprints \$12.50 (a duplicate set is \$5.00). You can place a C.O.D. order or mail your remittance in full.

Order book and plans from

POPULAR MECHANICS BOOKSHOP

208 E. Ontario St.

Chicago 11, Ill.





# Shop Notes



## KNAPSACK POWER UNIT

*Clears land, cuts tall weeds, trims hedge, edges lawn and cultivates your garden throughout the growing season*

**I**NTERCHANGEABLE WORK HEADS fitted to this knapsack power unit give it a versatility especially suited to the needs of estate owners, farmers, highway-maintenance crews, and week-end gardeners with trimming, cultivating and lawn-edging jobs that take a lot of time when done by hand. The power unit consists of a tubular arm which houses a drive shaft, the two members being attached to an air-cooled gasoline engine of 1 to 2 hp. The unit weighs 25 to 35 lb., depending on engine size, and is carried in a handy working position by means of an adjustable shoulder strap. A special centrifugal clutch releases at engine idling speed, engages when the engine is throttled to operating speeds. The air-cooled engine is fitted with a metal shield to protect bare arms and clothing against possible burns and oil stains.

Three heavy-duty heads, or attachments, are shown at the right. The brush saw is

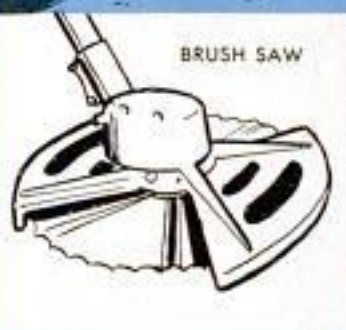

BRUSH SAW



CHAIN SAW



TALL-WEED TRIMMER





Photos courtesy Hoffer, Inc.

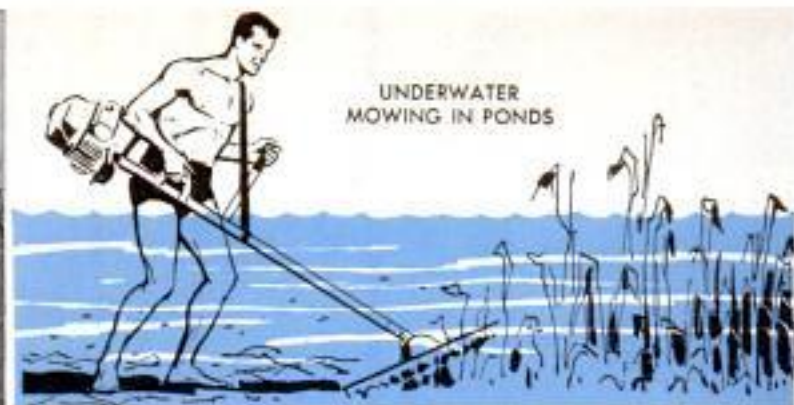

UNDERWATER  
MOWING IN PONDS

just the thing for clearing land of growth ranging from 1 to 5 in. in dia. Note especially the V-shaped openings in the blade guard. In use the guard serves a two-fold purpose, covers the blade and serves as a stop when starting the cut, either to the right or left. The chain saw fells trees up to 15 in. or more in diameter, bucks logs into cordwood lengths and trims large trees after felling much faster than the best axman. Both the brush saw and the chain saw can be operated within an inch or so of the ground level when cutting trees and brush. Two-handed control of the units is obtained by means of the handles located on the shaft extension. The tall-weed trimmer, illustrated on the preceding page, utilizes the same guard as is used with the brush saw. The circular blade is removed and replaced by the two-edged weed-cutting blade. Makes short work of mowing tall weeds on vacant lots. Farmers use the unit widely for trimming tall weeds along fence rows. It cuts small bushes and brambles close to ground level in the same manner as the brush and chain saws.

The power scythe works like a sickle-bar mower and is designed to work anywhere you can reach. It cuts saplings, weeds, grass, underwater growth in shallow ponds and along lake shores in resort areas. It's fine for hedge trimming, as the 20-in. cut reduces trimming time to a matter of minutes for a hedge of average length.

Swinging a hoe on a hot day during the vegetable-growing season is something experienced gardeners don't like to think about. But a rotary-hoe attachment for the knapsack power unit eases the labor and reduces the time required. Does a better job as it works close to the plants, pulverizes the soil to a dry-weather mulch, annihilates weeds by shredding the root systems and while all this is going on the operator simply carries the unit by the shoulder strap in a comfortable, upright position. Depth of cut is controlled by the rate of movement over the ground. Lawn edging is done in the same manner. Just change attachments and away you go as in the lower photo at the right. ★ ★ ★



SCYTHE FOR MOWING,  
WEED CUTTING AND  
HEDGE TRIMMING





ROTARY HOE



LAWN EDGER



## Variable-Speed Electric Drive For Portable Farm Elevator

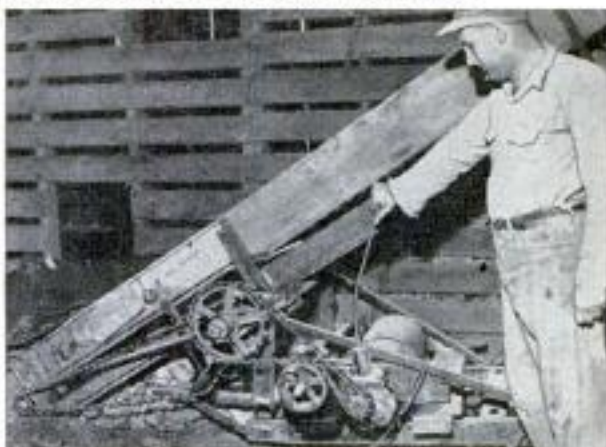

To adapt his portable elevator to various uses requiring speed changes, one farmer built a variable-speed drive employing an auto transmission direct-connected to an electric motor. The latter is connected to the input shaft of the transmission by means of a flexible coupling and the output transmission shaft carries a sprocket which drives a jackshaft. The elevator is chain-driven from the jackshaft, which is fitted with a spring-loaded friction clutch to prevent breakage should the elevator become clogged. The motor, transmission and jackshaft are mounted on the elevator trailer frame so that the gearshift lever is in a handy position for changing speeds to meet the load requirements.

## Discarded Rake Tines Utilized As Linchpins On Drawbar

After losing a number of the linchpins used to hold the ends of the drawbar of his Ford tractor in place, one farmer found that the spring ends of broken tines from a side-delivery rake worked better than the original pins. When the tine is forced into the hole, the spring tension grips the end of the bar firmly, yet permits easy removal of the tine when required.

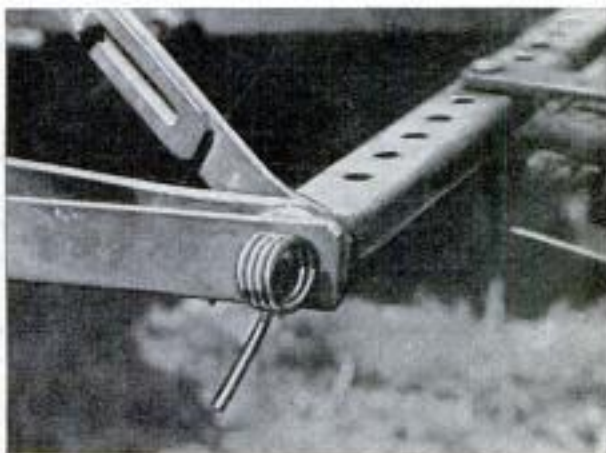



### Several Waterers in Pasture Prevent Hogs Crowding

Crowding of hogs is less likely, and fewer mud holes result, when several sled-mounted stock tanks, to which waterers are attached, are located in a large hog pasture. Sunshades and self feeders located close to each tank further minimize bunching. The stock tanks are filled from a wagon tank.

### Heavy Spring "Stretched" With Hammer and Chisel



A hammer and chisel were used by one mechanic to "stretch" a heavy spring being installed in the counterbalance mechanism of an automobile hood. The chisel is driven between the turns of the spring to force them apart, then a nail is slipped through each turn before the chisel is removed. As soon as the spring is installed,

the hood is raised so the mechanism stretches the spring and allows the nails to drop out.—R. S. Boyle, Akron, Ohio.

### Plastic Template Used to Locate Center of Round Work

To find the center of a round piece of wood or metal, use a plastic template that fits over the end of the work. On a 4-in.-sq. piece of plastic sheet about  $\frac{1}{8}$  in. thick, scribe diagonal lines from corner to corner. Drill a  $\frac{1}{16}$ -in. hole at the point where the lines cross. Place one leg of a compass in the hole and scribe circles on the plastic,

spaced  $\frac{1}{4}$  or  $\frac{1}{2}$  in. apart out from the center. To use this template, clamp the round piece vertically in a vise and hold the template against the end so that the outer edge of a circle corresponds to the circumference of the work. Then make a mark through the center hole. Even on pieces that are out of round, the center can be found by locating as many points as possible of the work on one of the scribed circles.

James I. Greene, Philadelphia, Pa.

### Inverted Funnel and Can Cover Make Safe Ash Tray

A funnel can be inverted and set in a can cover or over any dish to make a safe ash tray for use on a work bench. Such a tray will eliminate any fire risk that might arise from having an exposed ash tray on the bench, since cigarettes and matches are dropped down the spout of the funnel into the pan, where they are kept covered.



### Tire-Repair Record Kept Inside Hub Caps

To keep a handy record of when tires were repaired, crossed, balanced, etc., take off the hub caps and stick several strips of white adhesive tape to the inside of the cap. Whatever data that must be kept can then be penciled on the tape. To make sure the tape sticks properly, clean the inside of the hub cap before applying the tape.

Ivan Grosvenor, Indian Rocks, Fla.



☞ Grease packed into a blind hole before tapping it will be forced out by the tap and carry the metal chips with it.

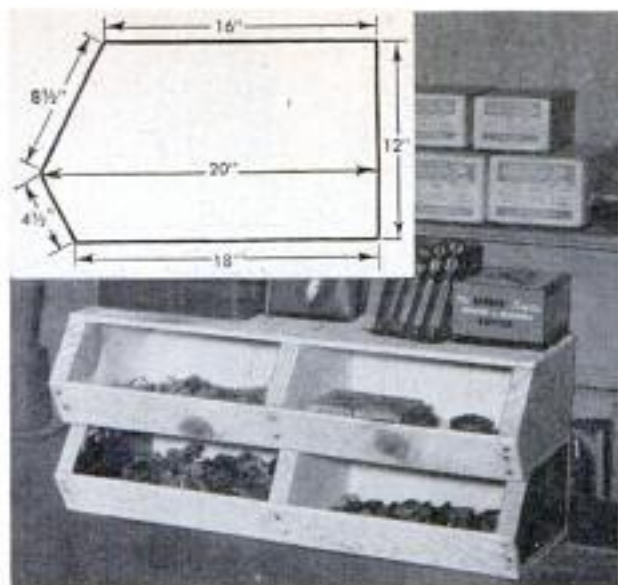

## Stacking Bins Store Parts Within Easy Reach

Open-front storage bins that stack solve the problems of storage and convenience in hardware and farm-implement stores, farm shops, tool cribs and even in the home shop—anywhere that small parts, nails, screws, bolts and washers require storage in easily accessible bins. The detail gives dimensions for the endpieces of fairly large individual bins, but by altering the dimensions in proportion the endpieces can be made larger or smaller as desired. The photo at the right pictures single-compartment bins made in duplicate, some with center dividers. A shallower, two-compartment unit is

pictured in the left-hand photo. When building either type, care must be taken to make duplicate parts precisely the same size. Only the top-row bins in the stack have cover pieces. All others have open tops as pictured in the photo at the right. Bottoms, including the slanting front piece, and the backs can be cut from plywood, hardboard or solid stock as required. Solid stock,  $\frac{3}{4}$  in. in thickness, is necessary if the bins are to hold a heavy weight such as bolts, nuts or washers. Otherwise,  $\frac{1}{4}$ -in. hardboard or  $\frac{3}{8}$ -in. plywood is suitable.

L. H. Houck, Jefferson City, Mo.

## Electrified Post Drill With Minor Alterations Used as Power Tool

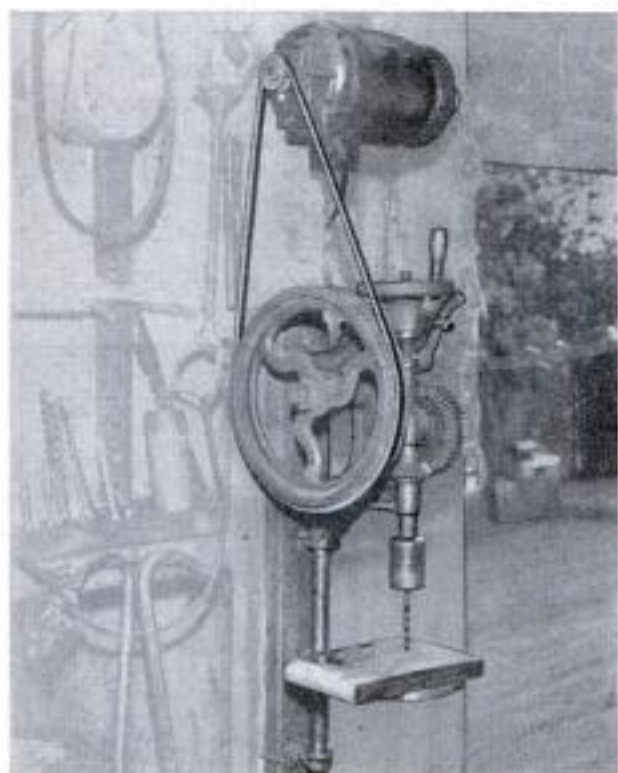

With minor modifications many hand-powered machines, such as the post drill in the photograph, can be converted to use as a power tool. In the case of the drill, an electric motor was bolted to the wall above it and a V-belt of the proper length passed around the flywheel of the drill and a pulley on the motor. The hand-powered tools, of course, are not built to run at speeds as high as regular power tools.

## Swivel Mount for Table Saw Utilizes Barber-Chair Base

One home-workshop owner solved the problem of limited space in his shop by mounting his table saw on an old barber-chair base so that it could be raised, lowered or rotated to clear adjacent tools and benches when working long pieces. The locking mechanism permits the saw to be held securely at any desired position. The base also is handy for positioning the height of the saw when more than one person uses it.—Carl Miller, Oakland, Calif.

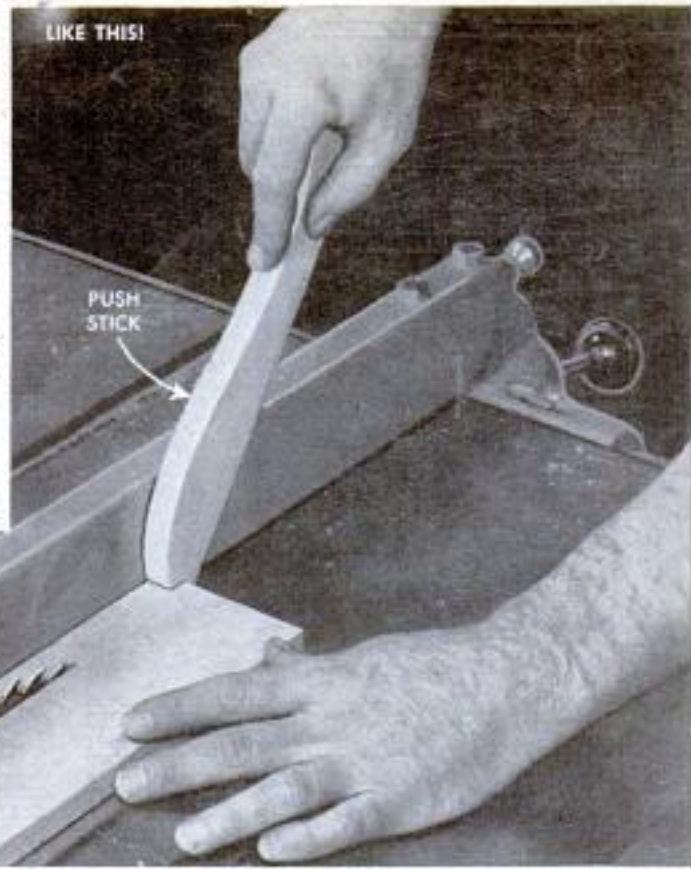

Keep all your fingers by making a notched pusher stick and use it when ripping narrow pieces. Make it a must project when you get your new saw

## Do-It-Yourself

By Wayne C. Leekey

Let's face it! Put a million or more power tools in the hands of a million week-end carpenters and you're going to have accidents due to plain carelessness. However, many painful injuries resulting from incorrect usage of power tools can be avoided

Note: Saw photos show blade unguarded only for sake of clarity. Whenever practicable, guard should be used

When less blade is exposed there's less chance of serious injury. Keep the projection  $\frac{1}{4}$  to  $\frac{1}{2}$  in.

With blade exposed this much, chance of serious cut is greater. Without guard, lower position is safer



SN 57

**I**F YOU ARE ONE of the ever increasing number of "do it yourselfers" who are walking out of hardware and lumber stores the proud owners of brand-new power tools, you are in for a lot of fun and relaxation. But don't let carelessness turn these happy hours into painful ones—do it yourself, but do it safely!

Manufacturers have made their tools as safe to operate as is practical. The truth is that many injuries result from a lack of know-how as much as from plain carelessness, whether the homeowner is sawing pickets for a fence, cleaning paintbrushes or performing some other common do-it-yourself task.

Power tools have made workshop and home repair jobs so simple and quick to do that many become careless in observing ordinary precautions. This is especially true in the case of a circular saw. While most home-workshop machines are provided with protective guards designed to cover the blade completely and include devices to prevent kickback and binding, even the best guards are inadequate for all-around use and become a hindrance. Consequently they are removed and the saw is used with the blade exposed. Best assurance against getting cut when ripping

# Safely!

Kickback, while a saw hazard, need not be feared by the operator. It generally happens when saw fence is out of alignment with blade, which causes the work to pinch and bind at completion of cut and send it flying with force. Even with saw mechanically perfect, adopt safe practice of standing to one side

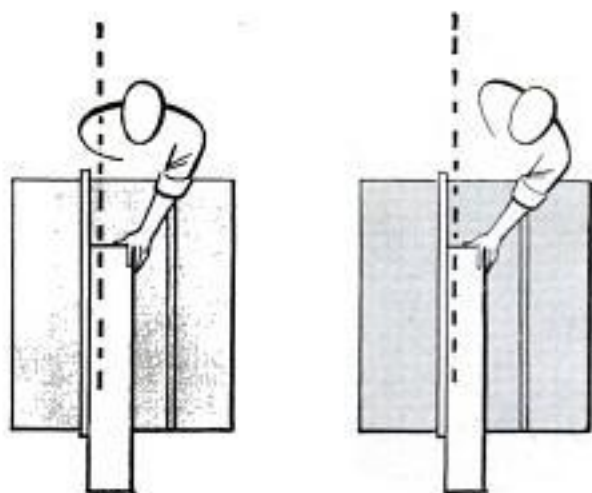

JULY 1955

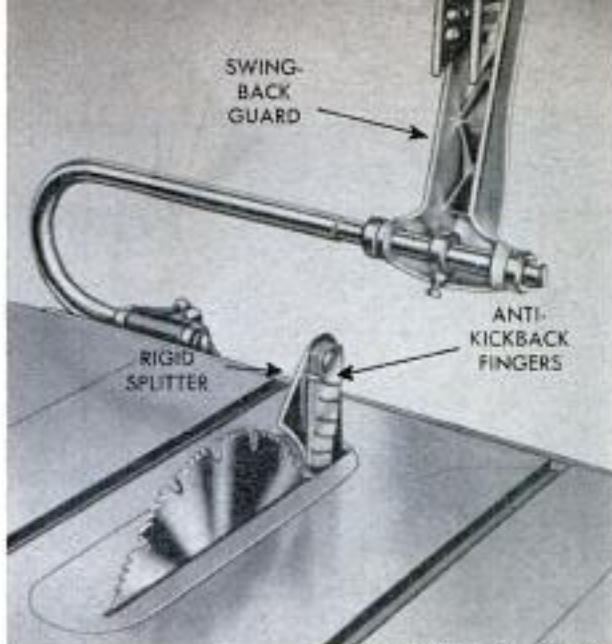

Rockwell Mfg. Co. photos

Above, typical swing-back guard, incorporating splitter and antikickback features, gives operator most protection. Below, splitter and guard is one piece

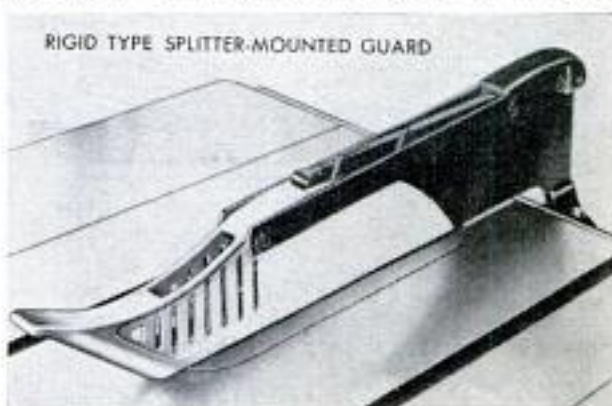

Above and below, right and wrong way of using stop rod. Wrong way invites pinching and harmful kickback



197

Copyrighted material



Here's a safer way to crosscut a wide board compared to usual way at right. Reverse miter gauge in slot, push work against it

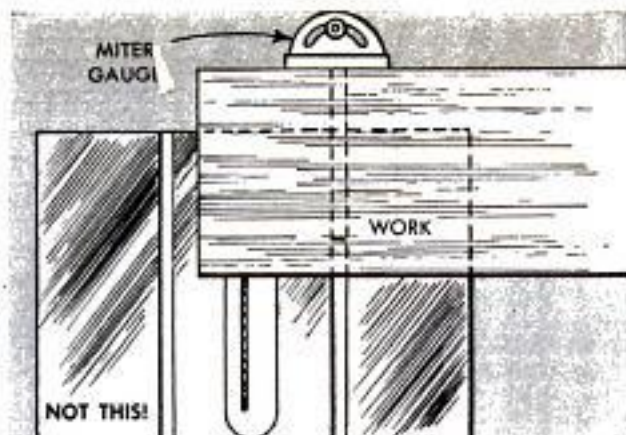

From combustion standpoint, keep oil and paint rags stored in container. Also, avoid burning off house paint with blowtorch

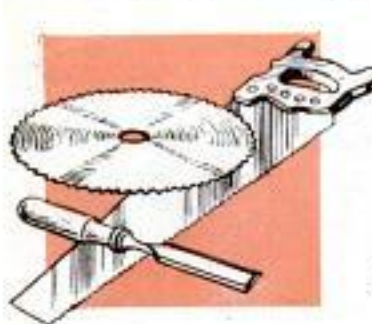

Keep cutting tools sharp—dull tools are a hazard. Smashed thumb is less likely if hammer face is polished with sandpaper



Below and at right, don't use fence as stop without first providing clearance block. Otherwise, work will jam and be thrown

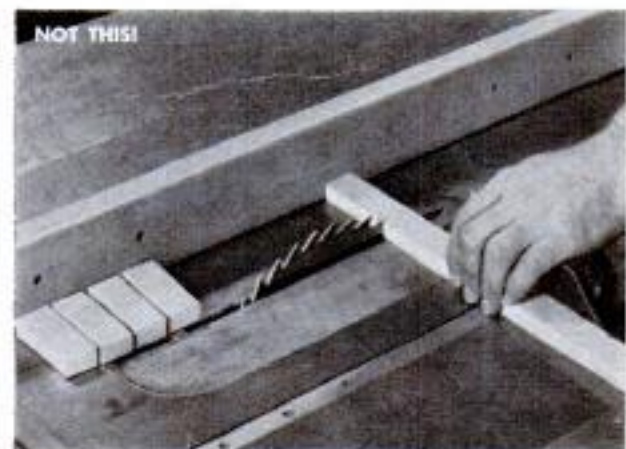
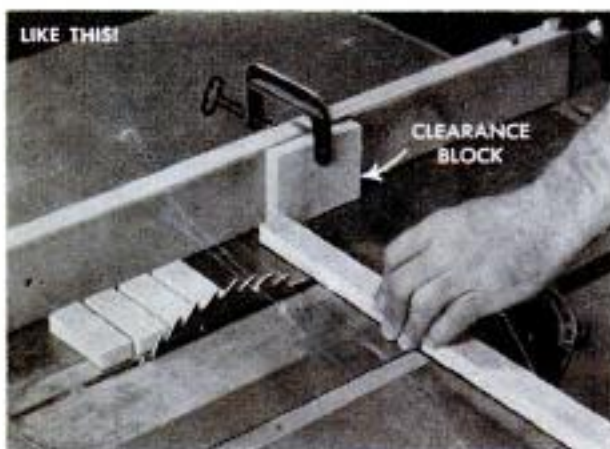

narrow work less than 2 in. wide is to make a push stick and keep it handy. It will keep your hand away from the blade. Another safe practice is to keep the saw blade  $\frac{1}{4}$  to  $\frac{1}{2}$  in. above the surface of the work. While it may require slightly more feeding pressure on some types of work, less blade is exposed and thus less chance of a serious injury should you have a mishap.

Kickback, which occurs when the work binds between the fence and the blade and is thrown with considerable force, is another saw hazard that can be charged to lack of know-how. This can happen during both rip and crosscut operations. Antikickback fingers on a splitter-type guard make ripping of narrow pieces a safe operation, although if the operator checks to see that the fence is in exact alignment with the blade, the chance of kickback is remote. In crosscutting where duplicate pieces are being mass-cut, there's a right and wrong way, the latter resulting in binding and kickback. For example, when using a stop rod on the miter gauge, always place it to the left of the blade. Placing it to the right of the blade will cause





Carelessness in leaving a chuck key in a drill press can cause a bad bruise when the machine is started

the severed piece to bind, get caught in the blade and fly. Of course, there is a more obvious reason why this shouldn't be done—the blade will strike the stop rod. Where the saw fence is used as a stop in cutting duplicate pieces to length, first clamp a clearance block to the fence as shown on opposite page. Otherwise, the work may bind between blade and fence and be thrown violently. When crosscutting a wide board on a small saw table it is safer to reverse the normal position of the miter gauge in the table slot and push the board against it as pictured at the top of the facing page. Struggling to hold a long board that is being ripped is another way of inviting trouble that could result in an accident. Always provide beforehand some means of support for the outboard end of the work. A floor-model drill press will serve as a fine support since its table can be raised or lowered to equal the height of the saw table.

Dress the part when you work in your shop. Avoid dangling shirt sleeves—either roll them all the way up or keep them buttoned. Certainly avoid wearing a tie which could become caught in a lathe or drill press. Perhaps the safest apparel is a snug-fitting sweat shirt. Arrangement of tools in your shop has a lot to do with safety. Many mishaps have been caused by long work striking other machines while being cut.

If you own a portable electric drill or handsaw, it is best to make use of the ground-connection wire that is a part of the plug. This third wire is for your protection in the event a short should develop in the switch or the tool itself. It is designed to replace the center screw that holds the



If your bench grinder is without eyeshields, protect your eyes from flying abrasive particles by always wearing goggles

Rockwell Mfg. Co. photos

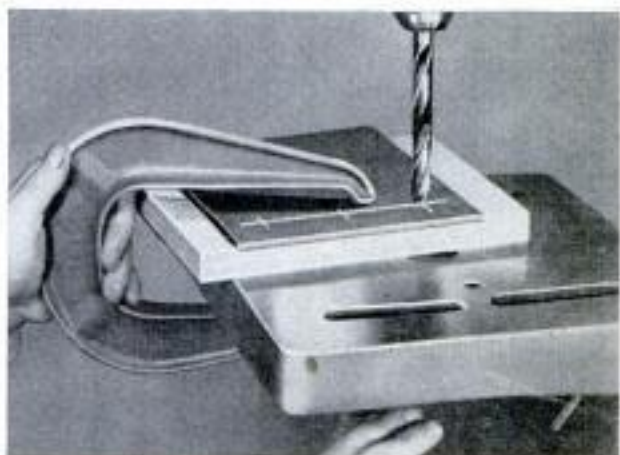

A most painful cut can be inflicted when drilling sheet metal. Always clamp the work when it is too small to hold so it can't spin when bit breaks through



WEAR RUBBER GLOVES WHEN USING PAINT REMOVER



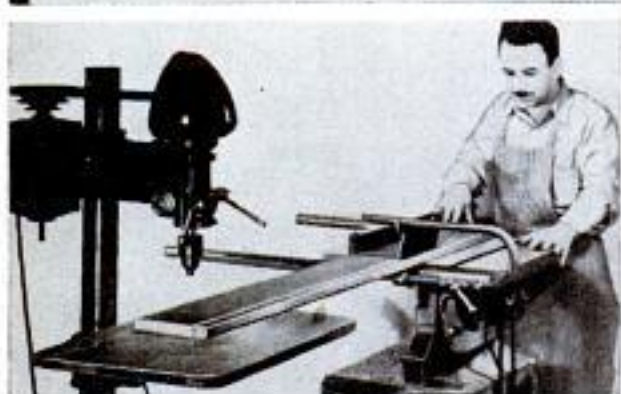
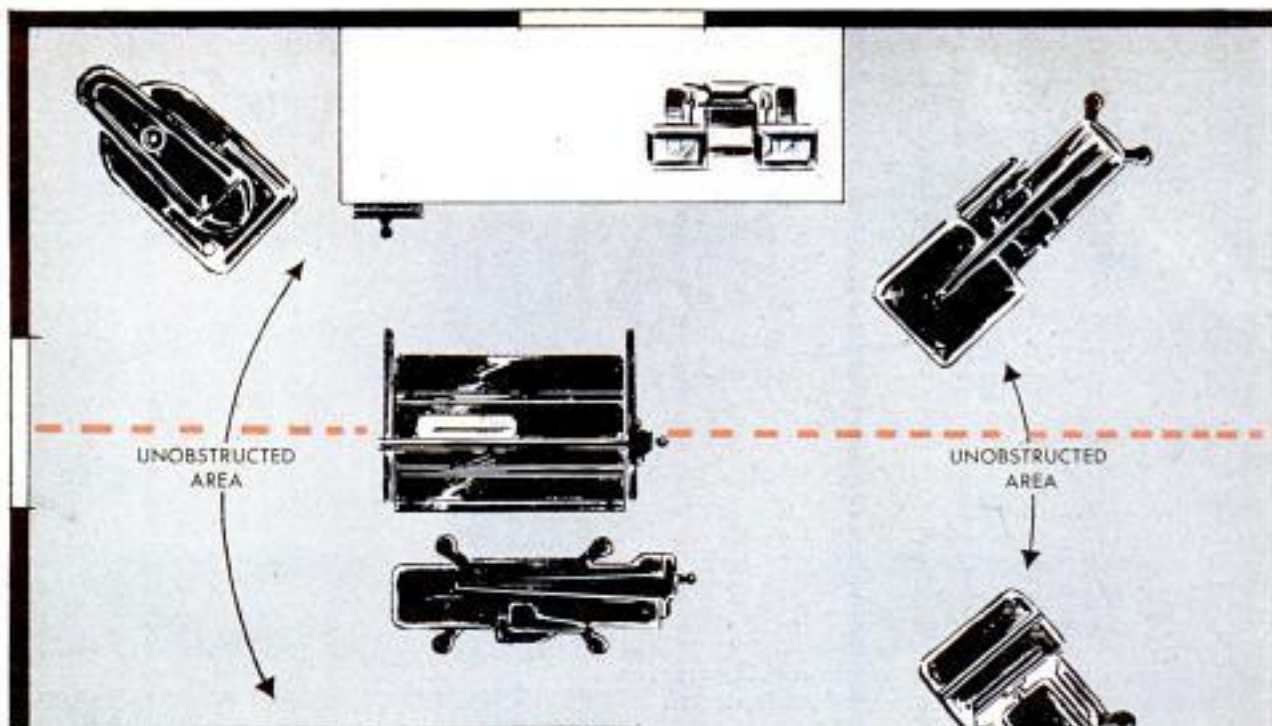

Drill press provides extra support when sawing long boards. Trying to hold such long work invites trouble

Use ground wire on your portable tools. Ground-wire receptacle is grounded to metal conduit or metal box



There's safety to be had in proper shop layout. Try to arrange tools to give unobstructed area around saw

receptacle cover. As a precaution against overloading existing circuits, you should take the time to run a separate circuit to your workshop. The diagram below shows how No. 10-ga. wires are run from the main fuse box, or circuit breaker, to a separate fuse box in the shop from which No. 14-ga. wires are run to individual plug-in receptacles.

In working with other shop tools, such as a drill press, be sure to remove the chuck key before turning on the machine, and in drilling thin work like sheet metal make it a practice to clamp the work to the table. Many a bad cut has been inflicted by the work spinning as the bit breaks

Separate circuit for workshop safeguards house wiring from overloading. Typical wiring is shown below

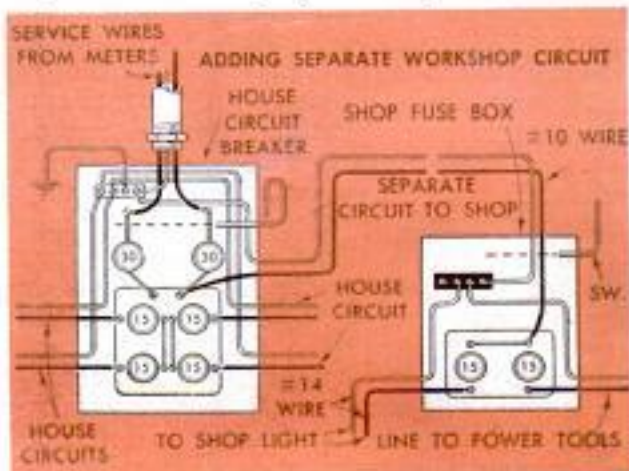



Make a hold-down pusher block and use it whenever you plane thin stock on jointer. It will save your hand

through. If your bench grinder is not fitted with eyeshields, have a pair of goggles handy to protect your eyes from flying particles. In planing thin stock on a jointer, make a hold-down pusher block, as shown, to safeguard your hand and give better support. Also, while it is perfectly safe to joint edge grain in the case of wide plywood panels, never attempt to plane edge grain of work narrower than 8 in.

Other precautions that contribute to safe do-it-yourself include keeping flammable oil or paint-soaked rags in metal containers. Special care must be used in handling quick-drying lacquers. Do spray-painting outdoors whenever possible. Cleaning of paintbrushes in solvents should likewise be done outdoors. Always wear rubber gloves when handling paint removers, thinners and other toxic finishing materials that may irritate the skin. ★ ★ ★

Never plane the end grain of work that is less than 8 in. wide. Narrower stock will catch in jointer knives

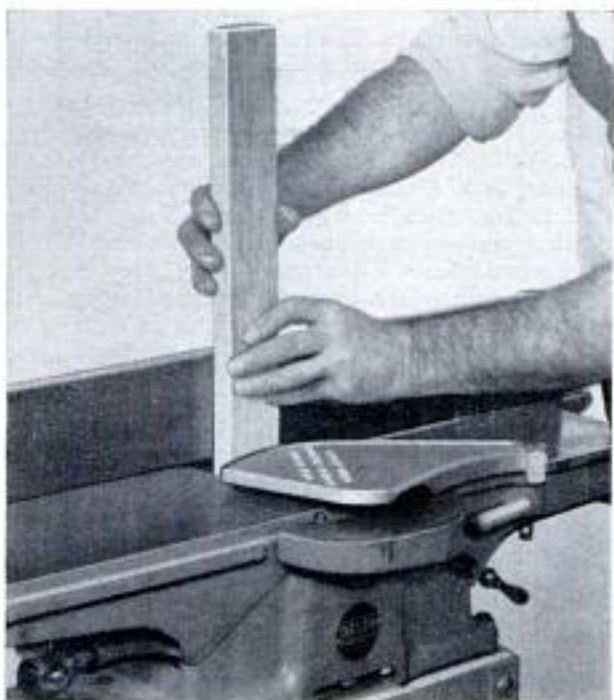

JULY 1955

## Shop Dustpan Made From Oil Can Fitted With No-Stoop Handle



No stooping and fewer trips to the trash can are the advantages of a large-capacity shop dustpan made from a 5-gal. square oil can. The top of the can is cut off at an angle and the cut edges bent over to provide stiffness. A no-stoop handle, consisting of a length of scrap wood, is screwed to the bottom of the can.

## Flatheaded Screw Used as Bit To Bore Hole in Glass

Holes can be drilled in mirrors and other plate-glass objects by using a flatheaded screw chucked in an electric drill. The screw is chucked shank first and the head is used as the boring tool by applying valve-grinding compound to the area where the hole is to be bored. A hand electric drill can be used if care is taken to hold it steady. A drill press will do a faster, more accurate job. In either case, do not permit the glass to overheat, as this will cause it to crack. The best method is to practice first on scraps of glass similar to the piece to be bored.

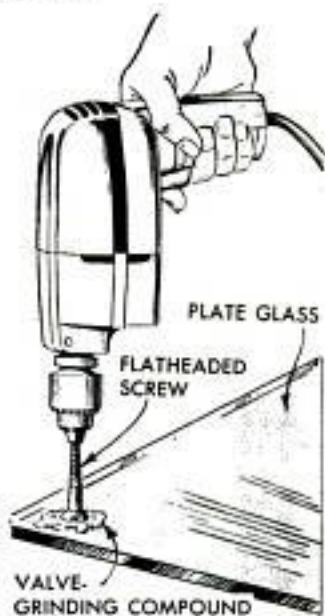

Bill Clough, Rifle, Colo.

201

# SHOPPING FOR TOOLS



**1. DISPOSABLE SAW BLADE** sells at a price that is very little above the cost of having a blade of equal size sharpened in the conventional manner. Lasts two or three times as long as ordinary circular blades. Each disposable blade is dynamically balanced, assuring true, vibrationless operation and cutting power loss to the minimum. Teeth are especially hardened to give the longest possible cutting life. Crosscuts and rips fast and clean

Rocco Products, 2019 Fourth Ave. S., Minneapolis, Minn.

**2. HINGE BUTT MARKER** cuts the three edges of a hinge mortise with several light strokes of a hammer. Waste is then removed with a chisel, using light, paring cuts. In use, edge of door and jamb are marked to locate the top of the hinge leaf. One cutting end of the butt marker is positioned on the line with the stops against the side of the door. Light hammer blows sink the cutting edges to required depth in door and jamb

Stanley Tools, 111 Elm Street, New Britain, Conn.



**3. HOLE CUTTER** works in steel, cast iron, aluminum and other nonferrous metals. Three cutting bits, 120 deg. apart, balance the cutting torque, insuring smooth cutting action and a true hole diameter. Works on flat, cylindrical or crowned shapes and can be chucked in a lathe for cleaning and rough-boring cored holes in castings. Equipped with removable pilot

bit. H. Clark Co., 9330 Santa Monica Blvd., Beverly Hills, Calif.



**4. WIRE STRIPPER** cuts insulation and strips it clean in one quick snap of the handles. Saves time for electricians and assemblers of electrical equipment where exacting workmanship is required. Takes all common wire sizes with a simple adjustment. Specially designed cutting and stripping mechanism does not nick or score wire

Crown Industrial Products Co.,  
713 Amsterdam St., Woodstock, Ill.

**5. PAINT-SPRAYING ATTACHMENT** is designed to be driven by any 1/4-in. portable electric drill. Has piston-type, twin-cylinder air compressor and pressure regulator. Spray gun is 1-qt. capacity, siphon type and is threaded to take standard Mason jar for easy color changes. Supplied in two separate kits, with or without spray gun

Portable Elec. Tools, Inc.,  
320 W. 83rd St., Chicago 26

**6. SHAPER GUARD** for radial saw provides complete coverage of motor spindle and cutters, thus protecting operator from any possible hand injury due to momentary inattention. Adjusts to within  $\frac{1}{8}$  in. of the top surface of the material being cut. Is fitted with a deflector which guides dust and chips to the rear of the machine. Unit is used with motor inverted as pictured in photo at right

DeWalt, Inc., Lancaster, Pa.

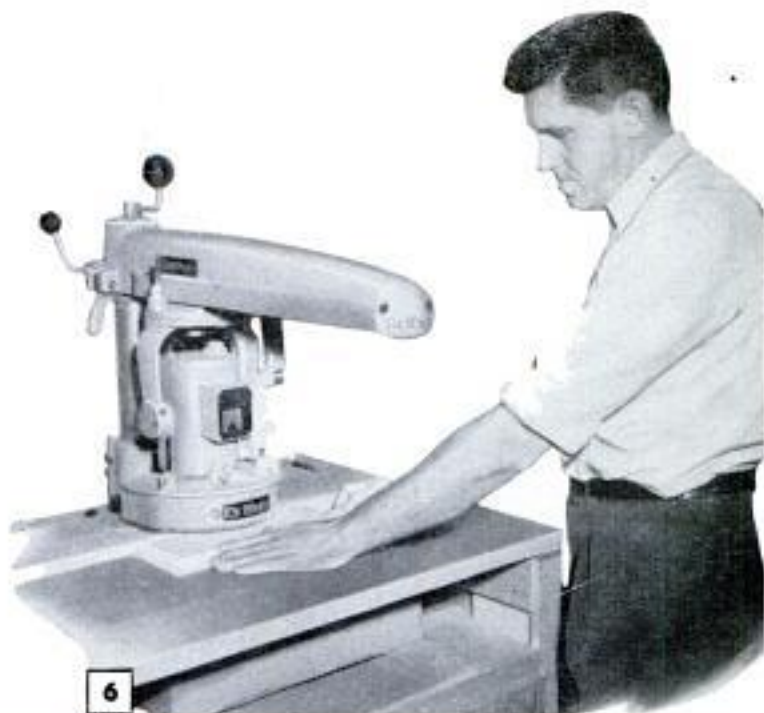

**7. AIR-POWERED HYDRAULIC VISE** utilizes compressed air and hydraulic fluid for semiautomatic actuation. Combines the speed of an air vise with the locking force of a hydraulically operated unit. Cuts loading and unloading time by as much as 50 percent on many repetitive operations. Hand crank gives fine slow-motion adjustment to the required jaw opening. Has graduated swivel base for mounting on milling machine

Wilton Tool Mfg. Co., Inc.,  
925 Wrightwood Ave., Chicago 14

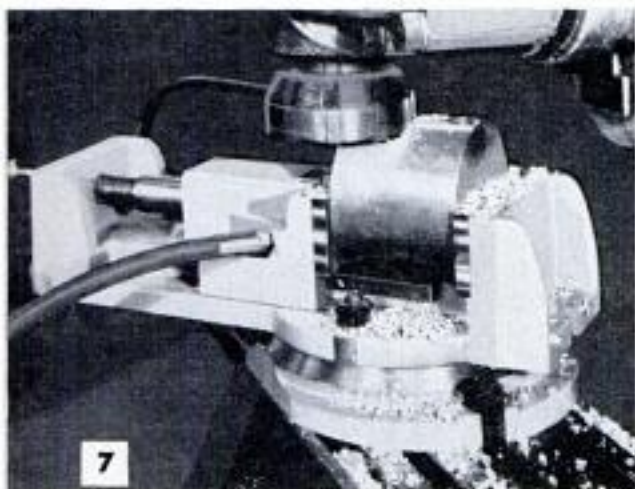

**8. PAINT CAN AND BRUSH HOLDER** provides a comfortable handle for a quart paint can and a holder for the brush as well. Enables both professional and amateur painters and decorators to work with less effort from a stepladder, chair, stool or extension plank. Unit consists of plastic handle shaped for easy gripping with one hand, an integral friction clip for holding the brush and two steel bands which grip the paint can in the manner illustrated in photo

Handi-Grip Bottle Holder Co., Flint, Mich.

**9. FLEXIBLE INDUSTRIAL-TYPE DRIVE UNIT** introduces a new principle in high-speed power transmission involving heavy inertia and shock loads on such equipment as compressors, conveyors, crushers and certain types of machines used in metal-working plants and textile mills. Unit consists of a housing inside of which is a rotor that turns concentrically as in the upper right-hand photo and the inset detail drawing which is a sectional view. The two parts are referred to as the driving housing and the driven rotor. Between these two parts are fine steel balls, or "shot," called the flow charge, which transmits power in a manner similar to a fluid. A typical application is pictured in photo. Starts smoothly and delivers constant torque

Dodge Mfg. Corp., Mishawaka, Ind.

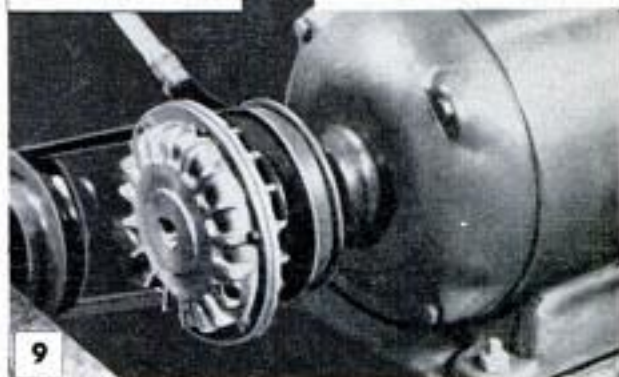
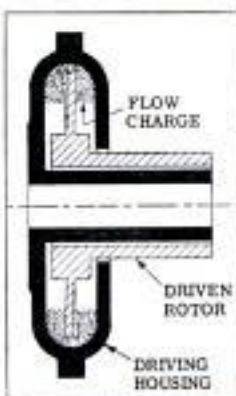



### Tractor-Mounted Spray Outfit Permits One-Man Operation

As the spray nozzle may be operated with one hand, this tractor-mounted spraying outfit makes it possible to spray weed killer while driving the tractor. The nozzle is fitted with a long hose to simplify spraying livestock and the inside of farm buildings. A rotary-type spray pump is driven by the tractor power take-off and liquid insecticide or weed killer is carried in a 50-gal. steel drum. The drum is mounted on a bracket fastened to the tractor.

### Clamps Convert Lathe Faceplate Into Oversize Chuck

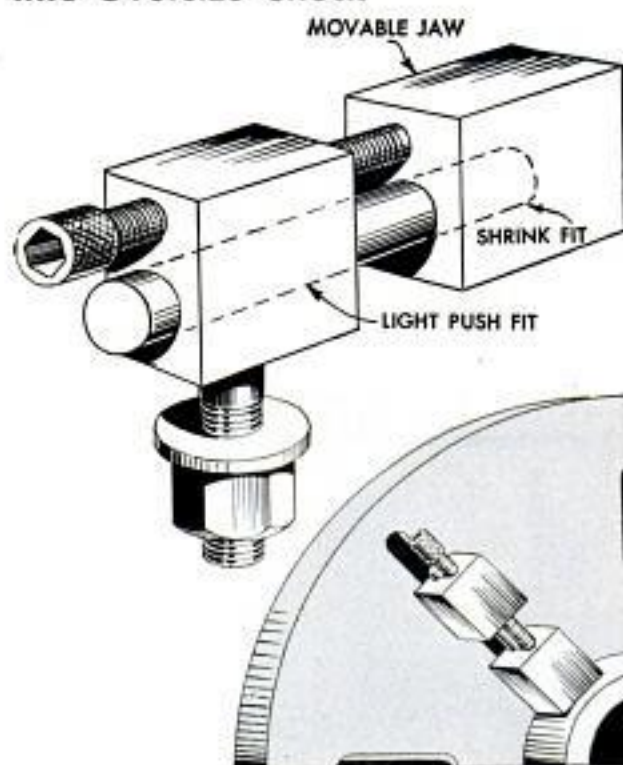

Three screw-operated clamps bolted to the large faceplate of a lathe convert it to an inexpensive, but serviceable, chuck for holding round or square work. Each clamp consists of two steel blocks. One block, which bolts through the long slot of

the faceplate, is a square shouldered down to form a stud which is threaded and fitted with a nut. A second block which forms the movable jaw, is clamped to the first and both are drilled off center for a guide rod. The hole through the fixed block is reamed to a sliding fit over the rod. The rod is a shrink fit on the movable jaw. A second hole is drilled through the stud block and tapped to receive a socket-head adjusting screw.

### Easily Made Countersink Bit

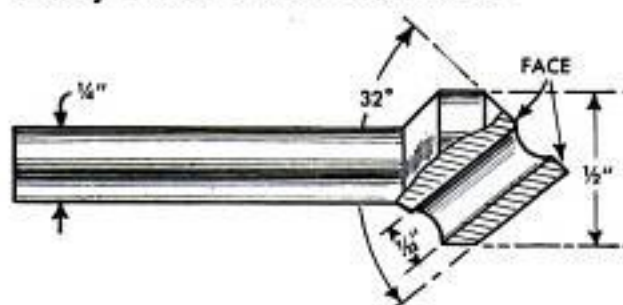

This countersink bit for woodworking requires only turning a simple blank on a metal lathe and drilling one hole. The blank is turned to the dimensions given in the detail, then the pointed face is filed smooth. A  $\frac{7}{32}$ -in. hole now is drilled in the face, being centered  $\frac{7}{16}$  in. from the point and parallel to the angle of the point. Form a cutting edge by grinding or filing away a little metal on the leading edge of the hole. Extend the relief in diminishing degree about halfway around the circumference of the hole. Temper the tool to a yellowish-brown.

Walter E. Burton, Akron, Ohio.

### Steel-Angle Frames on Waterer Protect It Against Hogs

Hogs no longer can cause this watering tank to leak by crowding against the edges of the openings and breaking the seams. Steel angles are welded together to form a frame around all four sides of each opening. Water for this particular tank is supplied from below by pipes buried in the concrete slab.

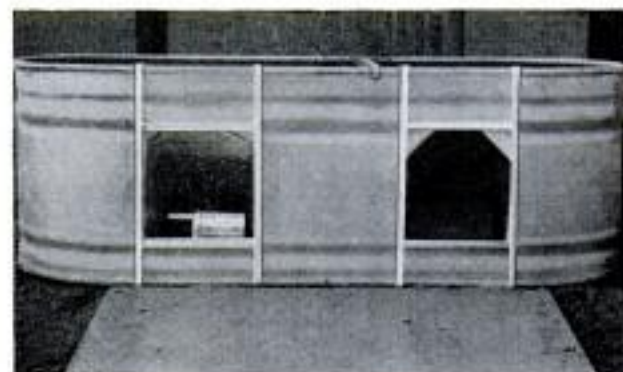



Here's how  
fresher air  
makes your  
Chevrolet strong

... says Ed Cole, Chevrolet Chief Engineer

**M**AYBE it's an odd way to put it, but it's almost literally true—the design that gave the 1955 Chevrolet its High-Level ventilation system also let us build a better body.

I'd like to explain this because it illustrates the very real benefits you get from engineering that makes one structure do the job of two.

We put the ventilation intake in the cowl, right at the base of the windshield, to pick up fresher air, above the level of road dust and fumes. This air goes into a plenum chamber, which is just an engineer's name for a reservoir or box that smooths out wind gusts to produce an even flow of air to the passenger compartment (and also drains out any stray raindrops).

We could have just hung this box inside and let it go at that. Instead, we designed a specially shaped chamber and *welded* it to the cowl and body metal to form a double-walled arch, as you see in the drawing above.

So the plenum chamber does a double job now. It delivers a *smooth* flow of outside air. And it also is a key structural member, a husky reinforcement that adds to the rigidity of the whole car. That's why the 1955 Chevrolet is so rigid and shake-free. Your dealer can show you just what this means in a demonstration drive, so why not make a date with him now? . . . Chevrolet Division of General Motors, Detroit 2, Michigan.



*motoramic*  
Chevrolet



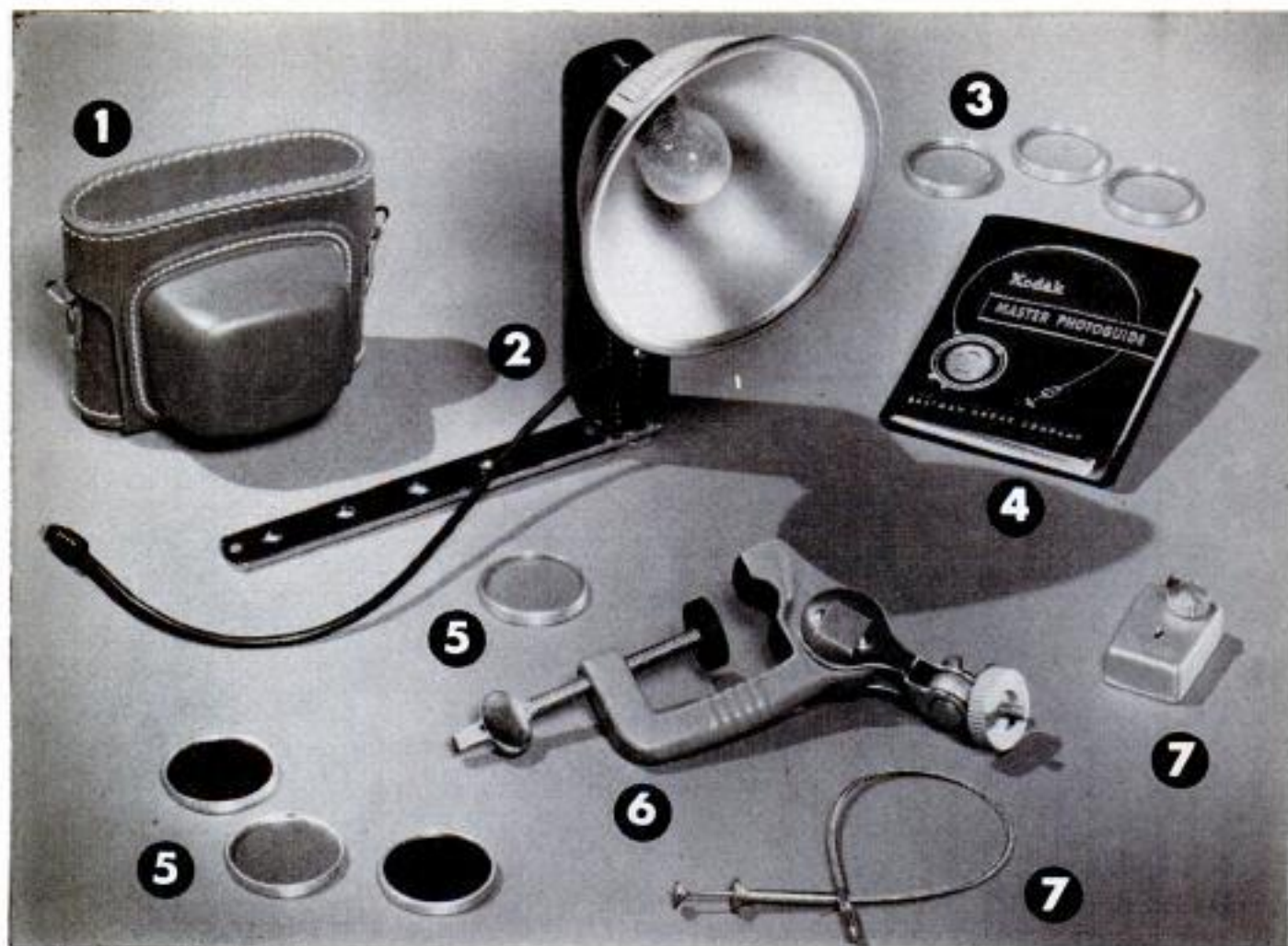

## 7 good ways to get better pictures

Good pictures generally don't "just happen." They're good because someone *planned* them to be good—and took pains to carry out that plan. Here are some suggestions on the use of picture-taking equipment you'll find at your dealer's that can help you make sure all your shots this summer are good ones. Take a few pains—get some great pictures!



### 1 Protect your camera

When you start out with your camera in search of good pictures, the fun goes out of it a little if the camera isn't protected by a carrying case. You have to be extra careful because you have a precision instrument in your hands. And this restricts your movements—particularly if you're hiking or taking off in a car. And when

you put the camera away, you have to look for a specially safe place for it. A good carrying case—at least the way Kodak makes them—is engineered not only to protect vital parts of the camera against shock but for convenience and ease of camera operation. They're of finest materials and give your camera a smart, professional look. Kodak cases, designed for Kodak cameras, begin at \$2.65.



### 2 Flash for punch

As you thumb through the current copy of your favorite illustrated weekly magazine, ask yourself what makes so many of those pictures so "snappy" and professional-looking. Chances are that—in close-ups especially—flash had something to do with the *punch* these pictures always seem to exhibit. So, do some thinking about *flash*—particularly for filling in shadows in direct daylight shooting. You



could scarcely invest less money—and reap more benefit—than in acquiring a flash unit like Kodak's Standard Flashholder, with its brilliant Lumaclad reflector and its universal bracket for attaching to any camera with a tripod socket. And, with simple adapters, it can be made to operate practically any flash shutter. It's only \$7.95 (batteries a few cents additional).

### 3 Get closer!



There are all too many snapshots in the world where the subject—someone's pet dog, or the baby, or a small, inanimate object—is "lost" somewhere in the middle of the picture with acres of space surrounding it. "Fill the picture with the subject" is a good rule to go by. And if you're shooting a relatively small subject—like the baby's face or even the fishing lure you just tied for yourself—then reach for your Kodak Portra Lenses. These are auxiliary lenses you slip over your regular lens and which *magnify* your subject, nicely filling your negative full of *subject matter* rather than *space*. Available in a choice of "magnifying powers," Kodak Portra Lenses range from \$2.65 up, in sizes and with adapters to fit almost any lens.

### 4 Photographic Professor



We'll admit that not even the most experienced and proficient photographer could store in his memory *all* the film and picture-taking data and calculations one might ever need. This is why the Kodak Master Photoguide was devised. It's like having an expert at your elbow to provide you with exactly the right shutter and lens aperture setting to use, regardless of light conditions and for any of the several films you might be using. You will profit greatly by getting one of these vest-pocket guides (only \$1.75) and keeping it with you. There is scarcely a question about a given picture with a given film under a given light condition which it can't answer—right on the spot!

### 5 Filters for realism



When placed over your camera lens, a filter can improve the realism of almost any black-and-white picture you take. Kodak Pictorial Filters, available in yellow, green and red, are easy to use and inexpensive (from \$1.50). A yellow Pictorial Filter emphasizes clouds and

contrasts a light object or figure against the sky. A green Pictorial Filter is used for natural reproduction of blossoms and foliage and for outdoor portraits against the sky. A red Pictorial Filter provides highly dramatic blue sky-white cloud contrast.

There are some useful filters for Kodak color film, too. One is the Skylight Filter (from \$1.75) which reduces bluish haze found on overcast days or in the shade. Others are filters which permit you to use certain outdoor types of Kodak color film indoors and indoor types outdoors—a great convenience when you want to buy one roll of color film and use it both indoors and outdoors. The exact filter to use and the exposure data are found in the instruction sheet packed with your color film.

### 6 Steady, brother!



With today's fast film and fast shutters, the usefulness of the good old tripod is sometimes forgotten. Well, if a tripod is just too much to carry around, give a thought to the Kodak Flexiclamp—which you can slip into a coat pocket! It is basically a tripod screw swivel-mounted on a padded "C" clamp which will open as wide as 2 inches to clamp on anything from the back of a chair to a garden gate! Use it for time exposures of any kind, of course. But use it, too, for *any* picture which takes careful composition—from landscapes to table-top shots. Costs only \$5.95.

### 7 Get into the picture!



It is often pointed out that the least-photographed member of any given family is the one who takes most of the family pictures. Seems logical. Well, if that means *you*, and your camera shutter can be operated by a cable release, you can change all this by utilizing a Kodak Auto-Release (\$3.86). It's merely a delayed action "trigger" which takes your place at the camera while *you* get into the picture. Simply attach the Auto-Release to your camera using an ordinary cable release (a 7-incher costs only \$1.25). You press the button and walk into the scene. The Auto-Release waits about 10 seconds—and then snaps the picture!

*Prices are list, include Federal Tax where applicable, and are subject to change without notice.*

**Kodak**  
TRADE-MARK

Eastman Kodak Company, Rochester, 4, N. Y.

# Care and Feeding of Engines



BY  
S. P. CORP

## WORN BEARINGS WASTE OIL

Even a brand new Sealed Power KromeX Ring Set can't keep worn or cracked bearings from wasting oil. A main bearing clearance of .0015" will allow enough oil to discharge through the side of the bearing for lubrication. If clearance wears to .003", five times as much oil is discharged. If clearance wears to .006", discharge is 25 times as much as that of a normal bearing. Pistons and rings can't control such a flood of oil.

Worn connecting rod bearings will discharge a large amount of oil directly onto the cylinder wall, flooding rings designed to take care of a normal oil flow.

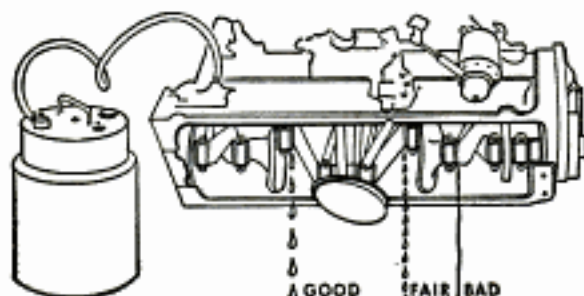

## BEARING LEAK TEST

To test for bearing leaks, remove oil pan and attach an oil pressure tank to the oil gallery between oil pump and bearings. Use an SAE 20 oil, under 20 to 25 lbs. pressure, and check oil drip from each bearing. 15 to 20 drops per minute is desirable. 30 to 120 drops per minute is serviceable. 120 to a stream is excessive and corrections must be made to bearings or shaft.

Turning the crankshaft during this test will indicate an out-of-round condition of the shaft if the oil drip varies.

## WRITE FOR FREE MANUAL

Thousands of car owners already have their free copies of Sealed Power's new illustrated handbook, "Care and Feeding of Engines." It's crammed with useful, easy-to-understand, money-saving helps on car care. Send a postal card request for your copy today! And when you re-ring, be sure to use Sealed Power KromeX Ring Sets—for quick seating, fast break-in, immediate oil control, and long, long service. Sealed Power, Dept. G-7, Muskegon, Michigan.



# Sealed Power

## PISTON RINGS

# Clinic for Homemakers



As a service to our readers in solving the hundreds of problems pertaining to a home—inside or out—the editors of *Popular Mechanics* invite you to present your problems to The Clinic Editor for help and advice. Address your questions to The Clinic Editor, *Popular Mechanics Magazine*, 200 East Ontario Street, Chicago 11, Ill.



## Sidewalk Repair

**Q**—The sidewalk leading to my back door is laid next to the house wall. It has tipped inward toward the building wall and is broken in several places along the entire length. I have thought of pouring a new walk right over the old, using the latter as a foundation or fill. Can I do this successfully? If not, what do you suggest?

—N.W., Va.

**A**—We do not advise the procedure you suggest. It seems to us that it would only aggravate the condition already existing. Obviously, the original walk has settled and broken up due to a lack of adequate support. Quite likely it was laid over freshly graded earth without allowing sufficient time for settling. We would suggest that you consider breaking up the old walk and removing it entirely. Then excavate for a gravel fill about 5 in. deep. This should be tamped firmly. Pour a new walk in wooden forms, striking off the concrete to a depth of at least 3 in. As soon as the mixture sets, cover with burlap or earth and wet with a hose at intervals for a week or more. This procedure will cure the concrete slowly.

## Leaf Disposal

**Q**—I have always made it a practice to use leaves from my wooded lot as a mulch for shrubs, rather than raking and burning each autumn. Now I'm told that a leaf mulch should not be used for this purpose as prolonged use "sours" the soil and provides a haven for insects. What about it, is this right or wrong? I want to know beforehand so that I can plan the best procedure for this coming fall. I have a deep lot with a number of large trees.

—O.R., Okla.



**A**—Are the shrubs you have been mulching with leaves slowly withering, or are they still growing vigorously after several seasons? Their condition should be the answer to your question. We'll guess

(Continued to page 210)



# The **SPARK** for today's high compression and higher horsepower was **pioneered**



## 1 An Exclusive Fused Copper-Ceramic Seal —What it is and what it does!

Among many important spark plug design features pioneered by AC—the unique Fused Copper-Ceramic Seal stands out as a particularly brilliant technological achievement. The problem was to provide both electrical and thermal conductivity while maintaining the gas-tight seal between the center electrode of the plug and its insulator.

AC engineers came up with a metal-ceramic formula that is the perfect answer. This is a mixture of copper and ceramic material which is fused at high temperatures during plug assembly, and bonds with both the metal of the electrode and the ceramic of the insulator. Naturally, the copper insures high electrical and thermal conductivity.

## 2 AC Exclusive THIN Insulator Tip Difficult to Form—but worth doing!

If you will examine the firing end of an AC Spark Plug closely, you will observe that, unlike any other spark plug, its insulator tip is made thin by recessing it all around the center electrode wire. At the right is a cut-away to show you how this insulator tip is made.

AC, and only AC, does this—a difficult engineering accomplishment, but worthwhile because it enables the plug to work more efficiently. The thin tip heats faster than a thick tip can—and burns away combustion residues which would otherwise deposit. Briefly—that's why AC Spark Plugs stay clean longer, come to top operating efficiency faster. They boost power and insure quick starting.



AC SPARK PLUG DIVISION  
GENERAL MOTORS CORPORATION  
FLINT, MICHIGAN

## TEST YOUR WOOD RASP I.Q.



- Q.** What fine wood rasps are most useful to the home craftsman?
- A.** According to surveys by Nicholson File Co., the most useful rasps are: Flat, Half Round, Cabinet, Last Maker's and 4-in-Hand. (The 4-in-Hand is actually a versatile combination tool: half round and flat, file and rasp.)
- Q.** What brand of rasp does the home craftsman prefer?
- A.** Nicholson by 7 to 1 over the next leading brand, according to sales records and polls of brand preference.
- Q.** Why does the home craftsman prefer this brand?
- A.** Because he is sure of a *perfect rasp every time*. Durable, uniformly excellent Nicholson rasps are the product of 91 years of rasp-making leadership.
- Q.** What other Nicholson wood files or rasps are available?
- A.** Special purpose rasps include Round and Round Cabinet, Round Staggered Tooth. Nicholson also makes Flat and Half Round Wood files and Half Round Cabinet files, with teeth especially cut for smooth filing action on wood.

Send for Free 50-page Book, "File Philosophy," to learn more about the proper choice, care and use of files and rasps.

**NICHOLSON U.S.A.** **NICHOLSON FILE COMPANY** **MADE IN U.S.A.**  
 22 Acorn St., Providence 1, R. I.  
 (In Canada: Nicholson File Company of Canada Ltd., Port Hope, Ontario)

**NICHOLSON**  
**FILES** FOR EVERY PURPOSE

(Continued from page 208)

they are doing very well under the mulching procedure you are using. There is little justification for burning leaves or any other organic matter which can be made available as plant food by mulching or composting. Leaves that cover lawns should be raked and composted, or used as a mulch around shrubs and trees. If leaves are left on a lawn the larger ones tend to settle, flatten and overlap and may smother the new growth of grass in the spring. A thin coating of the smaller leaves from trees and shrubs will do no harm. A valid reason for burning leaves is to destroy those from diseased trees or shrubs to prevent spreading of the disease to plants not yet infected. The leaves from certain oaks tend to acidify soils after prolonged use as a mulch. They should be used as a mulch around plants that thrive in soils of high acid content.

### Pruning Fruit Trees

**Q.**—I want to set out several fruit trees either this fall or the coming spring and I want to know how to prune them correctly to obtain the best shape for fruit bearing. The first question that comes up is whether to plant one-year or two-year trees and then how to prune the trees to form what I have heard is called "a fruit-bearing frame." What does this mean? Does it refer to the shape of the tree, or to the limbs individually?—S.R., Md.

**A.**—You did not say what kind of trees you are referring to—apple, pear, peach or what. For this reason our answer can only be general. Also, we are assuming you refer to nursery stock when you say "one-year or two-year" trees. Although it is not a recommended procedure in all cases, we would suggest that you consider the purchase of one-year whips for spring planting. These whips usually come branchless, which generally permits one to train the tree by controlling to some extent the development of branches where desired by simply pinching off new growth during the first spring and summer. During this period it's a common practice to keep growth to three or five branches. In this procedure it should be kept in mind that the purpose of pruning is not to change the natural growth habits of the tree. Pruning is designed only to correct faults and maintain natural form consistent with good structure. A general aim of experienced orchardists is to obtain what they call a low heading of branches before the tree reaches bearing age. To accomplish this desired tree shape, they begin early, remembering that growth from terminal, or end, buds such as those at the top of a whip, usually grow straight, while those from branch, or lateral, buds, tend to grow at an angle. Thus they take advantage of this natural sequence of growth development to shape the tree so as to obtain the low-headed growth structure in detail A.

Before whips are planted, shorten all roots (if this has not already been done by the nursery) which have developed to the size of a lead pencil. Cut back any injured roots to sound wood, being careful to make clean cuts with a sharp knife. Plant according to approved practices. Then keep a close watch on the first-year shoots that develop along the trunk, permitting only three or four to develop in a full season's growth. Do not cut off the leader, or main stem. Detail B shows two to three-year growth after thinning and heading back for correct structural development.

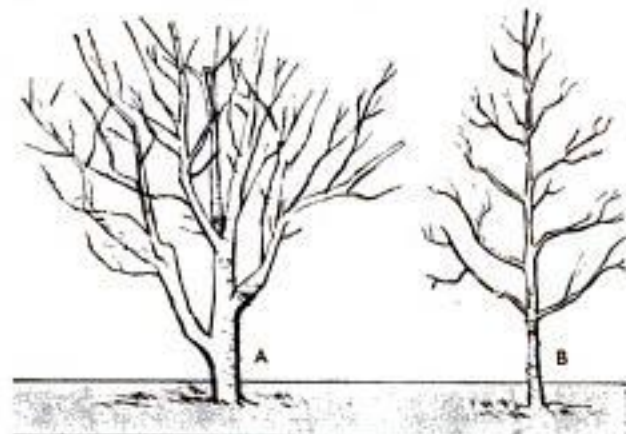

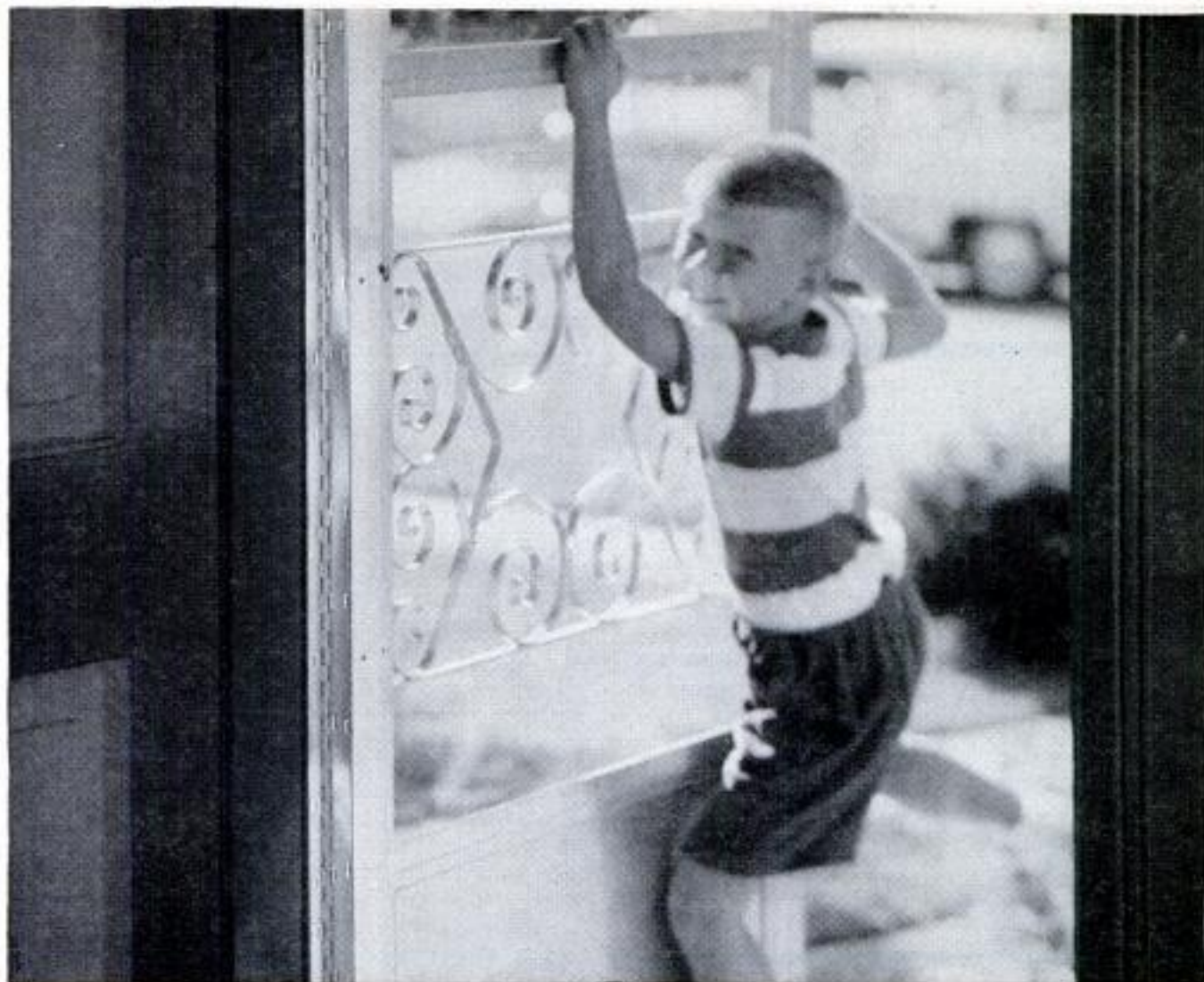

**STAPLING SAVES 66%, STOPS SAG!** You're looking at a big-selling feature of a well-known storm-and-screen door. It's the strong, continuous hinge secured by *staples* to aluminum frames. Until recently, self-tapping screws held three 8-inch hinges. In time, screws worked loose. Doors sagged.

A Bostitch Economy Man saw a way to improve this method—using metal-piercing, rust-proofed staples and longer, stronger hinges. Now, Bostitch Metal Stitching saves manufacturer *two-thirds* in fastening costs, offsets extra cost of better hinge. The improved doors work better, sell faster, last longer.

## How much can you save by swinging over to Bostitch stapling?

Your Bostitch Economy Man can tell you—objectively and honestly. He's one of 350 trained fastening specialists working out of 123 cities in the U. S. and Canada. There are over 800 kinds of Bostitch staplers in his cost-cutting repertoire. Look up "Bostitch" in your telephone directory or check the coupon.

*Fasten it better and faster with*

**BOSTITCH, Inc., 547 Mechanic St., Westerly, R. I.**

I'd like to know exactly how stapling can cut costs in our fastening operations. I'm particularly interested in the applications checked below:

### HI-SPEED PRODUCTION FASTENING

- stapling vs. riveting
- stapling vs. spot welding
- stapling vs. screws or bolts
- stapling vs. glue or cement
- stapling vs. tape
- stapling vs. tacks or nails
- stapling vs. solder
- stapling vs. wire or string

### PACKAGING and CARDING

- sealing bags (cloth, paper or plastic)
- mounting products on display cards
- fastening items to individual cards

### SHIPPING ROOM ECONOMIES

- preparing cartons for filling
- sealing filled cartons
- lining or padding crates
- applying shipping bills or tags

### BUILDING APPLICATIONS

- applying asphalt roofing
- laying underfelt
- installing ceiling tile
- applying insulation
- installing low-voltage wiring
- applying shake shingle siding

### OFFICE EFFICIENCIES

- filing
- routing
- posting
- binding folders and reports
- preparing advertising dummies

**BOSTITCH®**  
STAPLERS AND STAPLES

Name \_\_\_\_\_ Position \_\_\_\_\_

Company \_\_\_\_\_

Address \_\_\_\_\_

City \_\_\_\_\_ Zone \_\_\_\_\_ State \_\_\_\_\_

# upson panels

for a  
beautiful job  
the easy way



### beautiful walls

Be your own professional decorator. Remodel with stunning, modern Upson Striated Panels. Use Striated as a fourth wall and for cabinet doors. *Upson Striated won't crack or splinter.* Has unbroken embossed surface. Easy to apply. Paint two-tone for glamorous effect. FREE details, mail coupon.



### garage workshop

Made warm and comfortable with Upson All Weather Sheathing used as interior walls. Just nail rugged, super-strong Upson All Weather direct to studs. Easy to paint. Easy to work, saws clean. Every fiber waterproofed. Available many sizes. See lumber dealer. Insist on Upson.



### zoo cut-outs

For the kids' room. Animal cut-outs of Upson  $\frac{1}{8}$  Panels. A cinch to do with coping or jig saw. Fun to paint. Nail or glue up. Upson Strong-Bilt Panels make wonderful walls, too. They are crackproof, add lasting beauty to your home. FREE details yours, mail coupon today!

Every Upson Panel type paints beautifully, is easy to work, saws clean, neat. Upson Panels are available in many sizes and thicknesses. See your lumber dealer. Insist on the name "Upson" for highest quality.

45th

FREE DETAILS, MAIL COUPON



PROVEN QUALITY YOU CAN TRUST UPSON

The Upson Company  
5117 Upson Point, Lockport, New York

Year

Please rush FREE details on \_\_\_\_\_  
(TYPE OF PANEL)

Name \_\_\_\_\_

Address \_\_\_\_\_

City \_\_\_\_\_ State \_\_\_\_\_

## Jewels from Wood

(Continued from page 137)

Then he clamps the handle in a vise and, with a strip of abrasive cloth, further smooths the surface and works the piece to final shape. With an Osage-orange stick, he burnishes the surface of the wood until it takes on a glasslike appearance. Other kinds of wood can be used for such friction polishing, but the Osage stick, being very hard and strong, seems to work better than any. Immediately after the burnishing operation, he dips the piece into clear lacquer, drains off the excess and stands the handle in an empty bottle until the lacquer has dried. Next he applies the silicone-wax compound and polishes the surface to its final sheen.

Then he removes the wood jewel from the handle to which it had been glued and smooths the back surface before he glues on the proper jewelry finding—ear wire, cuff-link part, or pin. In the case of a pendant, he inserts the pin of a tip ring in a drilled hole. ★ ★ ★

## Vender Uses Powdered Coffee

Fresh coffee is available 24 hours a day in a small vending machine. The vender has a built-in automatic water heater and uses powdered instant coffee. Despite its small size—only 12 inches in diameter and 22 inches high—it holds enough coffee, cream, sugar and cups for 250 servings.



# CRESCENT AVIATION SNIPS

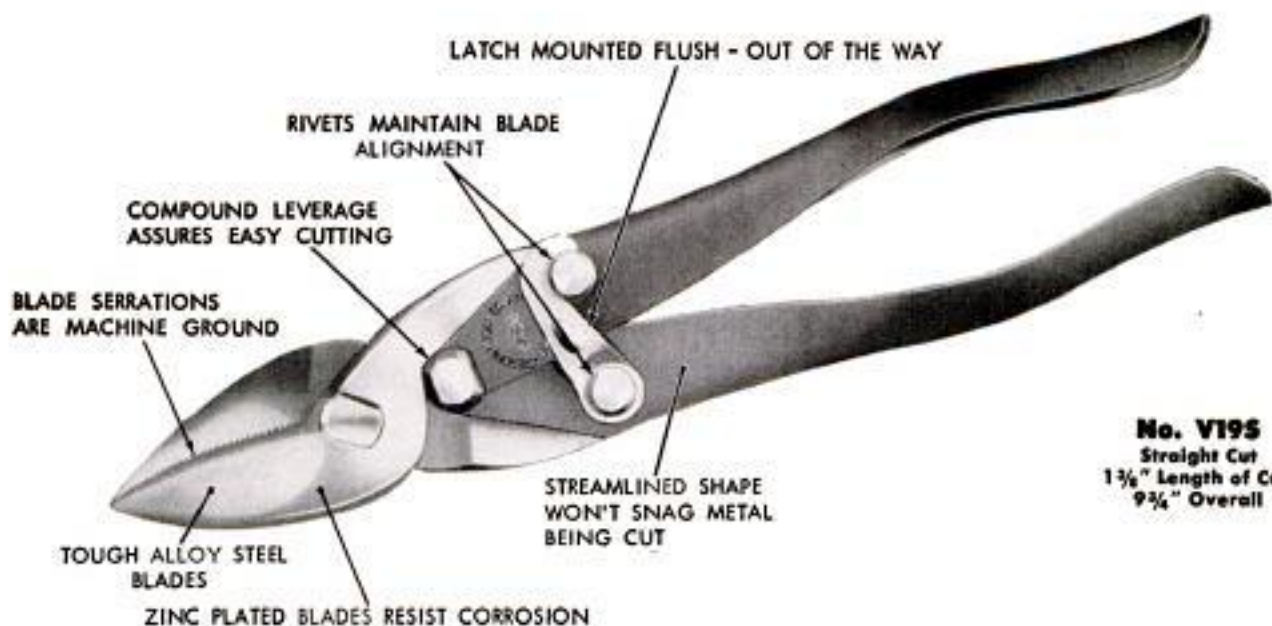

**No. V19S**  
Straight Cut  
1 3/8" Length of Cut,  
9 3/4" Overall

Distinguished by CRESCENT'S exclusive streamlined design, these new Snips have many outstanding features. Alloy steel blades have extraordinary hardness and toughness and keen edges with machine ground serrations which can be factory reground. Compound leverage produces tremendous blade power with ordinary handle pressure.

Made in three patterns: V19S, straight cut, V19L, left hand which cuts to the right, and V19R, right hand which cuts to the left. All have zinc plated blades and parkerized handles. Neoprene Insulating Sleeves are available separately or installed.

*Sold by Hardware Dealers  
and Industrial Distributors Everywhere.*

## New CRESCENT SCRATCH AWL WITH TENITE HANDLE

Four inch fine steel blade hardened full length — can be easily and repeatedly re-sharpened.

**No. 74**  
Tough, Blue  
Tenite Handle

**CRESCENT TOOLS**  
*Give Wings to Work*

*Sign of the Artisan  
Symbol of Excellence*



Crescent is our trade-mark, registered in the United States and abroad, for wrenches and other tools. Sold by leading distributors and retailers everywhere and made only by  
**CRESCENT TOOL COMPANY, JAMESTOWN, NEW YORK**



**Guaranteed to fire in oil.** Aldor Spark Plugs have bi-metallic thermostat control that keeps spark plug always at peak efficiency. Adjusts to any heat range requirement automatically. Special non-burning electrodes. In sets (AR1388-2) ..... **95c ea.**



**Add new beauty and style** to your car's interior, and protect your floor mat from wear with these handy rubber Utility Mats. Also has many uses around the house. Choice of 5 colors, 17"x17" (2N1105-9) ..... **Ea. 95c**  
17"x 20" (2N1110-14) ..... **Ea. \$1.25**



**Car Top Carriers** — complete, ready to install. Mount on any car top quickly, easily. Adjustable. Heavy web straps anchor to rain guard — Vacuum cups support and cushion any load. Strong steel 40" (CS332) Pr. **\$8.55**  
Hardwood — 48" (CS229) Pr. **\$6.50**



## New Power... New Beauty...

Over 40 Years... Headquarters



**Guaranteed leakproof Wizard Muffler** protects against deadly carbon monoxide gas fumes. Engineered to conform to original equipment specifications. Heavy, long-lasting steel construction. Gives your old engine "new car" silence! (71144-1386) ..... **\$4.40 up.**



**Don't be stranded** by a worn-out fan belt. Replace now with a Wizard extra-quality Fan Belt. Inner core of endless rubber impregnated rayon cords. Tough rubber cushion reduces heat, assures long life. Can't slip, stretch. Guaranteed fit. (71105-9209) **69c up.**



**Get more miles per gallon** with Pyroil "A". Gives heatproof lubrication. Reduces carbon, gum deposits. Lubricates upper part of motor. Pyroil "B" Crankcase Oil gives a cleaner engine—more power. Removes gum, sludge. Pyroil "A" or "B" (AR1336-7) Pt. **98c**





**Wizard De-Sludge-Er** oil filter cartridge has new 100% cellulose filter agent. Out-filters paper or cotton. Removes sludge-forming elements from oil. Won't clog, channel or by-pass. For all cars, trucks, tractors with full-flow or by-pass systems. From..\$1.25 up

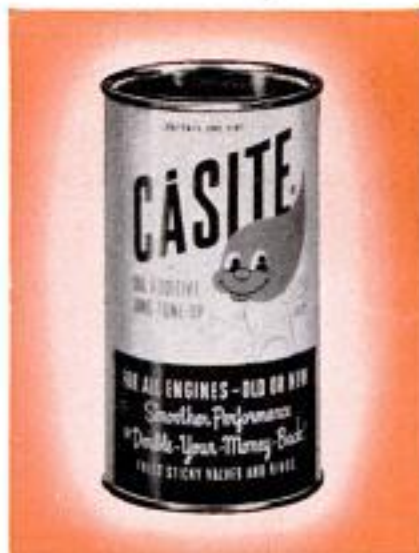

**Like a "tune-up"!** For better engine performance the year around, add Casite to your motor oil with every oil change. Keeps engine clean. Gives you easier, faster starting . . . quiet, smooth power. Ideal for breaking in new cars. Pint, only (A122P).....\$1.00

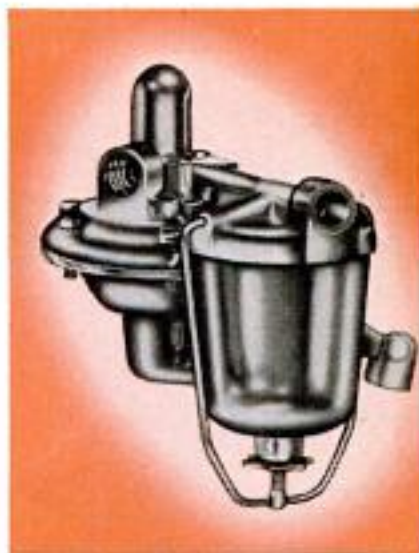

**Wizard Fuel Pumps**, guaranteed for long, dependable service. Original equipment replacement. Diecast body; precision machined surfaces and parts; fully tested. Extra high quality diaphragm for longer life, top performance. All popular cars. From. \$2.45 up

## New Safety For Your Car At **Western Auto**

For Top Quality Auto Supplies.

**Western Auto**  
STORES AND ASSOCIATE STORES

NOTE: Western Auto Associate Dealers own their stores and set their own prices, terms and conditions. Prices may vary due to differences in local conditions. (D51-75)



**Chrome Exhaust Deflectors** and Extensions add beauty to your car. Keep exhaust off bumper. Easy to attach . . . fit most cars. Western's Exhaust Deflector; simple, flared design (C8286) **53c** Exhaust Extension (8" x 2 1/2"); straight-tube type. (C8287) **\$1.19**

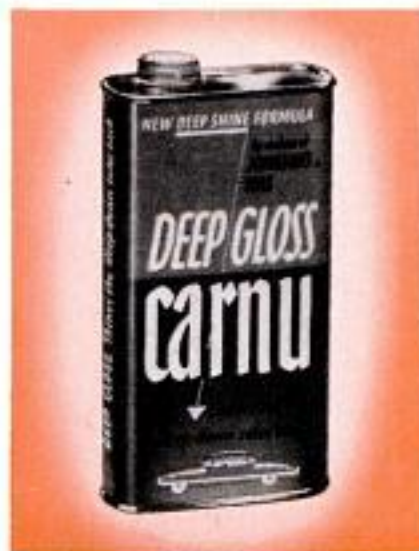

**It cleans! It polishes!** Johnson's Deep Gloss Carnu cleans as you put it on . . . shines to a hard, long-lasting mirror finish when you wipe it off. No tiresome buffing or rubbing. Restores deep down color. Won't harm finish 20-oz. can (D7719).....\$1.65



**Drednaut Hydraulic Jack** takes work and danger out of tire changing. Easy wrist-action lifts any car. Twist—it's down, safely and smoothly. Precision built for most severe transport service requirements. 7" high, raises to 14 1/4". With handle. (A6188).....\$10.25



## Get Good Performance the Way Big Fleets Do...

### All States Freight, Inc., Akron, Ohio, Uses Federal- Mogul Engine Bearings

With headquarters in Akron, a natural "hub" city, All States Freight provides fast, dependable common carrier service throughout the midwest and east.

All States' rigid schedule of maintenance keeps its hundreds of trucks ready to solve the problems of time and distance. They use Federal-Mogul engine bearings for always-dependable heavy-duty service.

Federal-Mogul oil-control bearings have led in the replacement field for more than 30 years—because of *quality!* Get this quality, next time your car, truck or tractor engine is overhauled. It costs no more to get the best—ask your mechanic!

for New Power . . .

**FEDERAL-MOGUL**  
Oil-Control Bearings



RESEARCH • DESIGN • METALLURGY •  
PRECISION MANUFACTURING • SERVICE

## Keeping Up With the Atom

(Continued from page 139)

in this country as in the known and estimated reserves of coal, petroleum, oil and natural gas combined."

With the energy demand constantly growing in industrial United States, Doctor Hafstad's chart shows uranium beginning to supplement other fuels as a power source in the '60s and, although not displacing other fuels, arriving "just in time to be very helpful in meeting this country's increased energy demands."

"But our fossil fuels will not last forever," Doctor Hafstad says, "and oil and natural gas particularly may be depleted to a very large extent before the end of this century. With such tremendous reserves as those contained in uranium and thorium, the implications are that this new source of energy will become increasingly vital as time progresses."

☆ ☆ ☆

Army engineers have demonstrated that water and sewage can be sterilized by exposure to gamma rays available in waste products of atomic power plants.

☆ ☆ ☆

Although many deaths from lung cancer have been reported among miners working in European uranium mines, five years of study in the Colorado plateau uranium mines produced no proof that radiation in the mines has caused lung cancer.

☆ ☆ ☆

Deep-seated cancer is being treated at Cedars of Lebanon Hospital in Los Angeles by exposure to a radioactive cobalt "bomb." The cobalt is encased in 2000 pounds of lead shielding and housed in a room with armor-plate door and concrete walls three feet thick. For further protection of the operator, a fluoroscope is focused on the patient's "target area" and a TV camera transmits the picture to the remote control room.

☆ ☆ ☆

Yugoslavia is the first Balkan country to announce plans for the production of nuclear energy for nonmilitary purposes.

☆ ☆ ☆

The British have disposed of 1500 tons of radioactive waste by dumping it into a deep spot of the Atlantic Ocean. The dangerous atomic garbage was placed in tanks calculated to remain sealed under water for 30 years or more.

Now is the perfect time to take

# CHRYSLER'S

# "100-MILLION-DOLLAR RIDE!"



**GREATEST V-8 POWER** on the road . . . Performance as you've *never* known it before. Thrilling response. The biggest margin of safety-reserve in any car!

**FULLY-AUTOMATIC** no-clutch driving . . . with famous Chrysler Power-Flite! Incredibly smooth and silent, it multiplies engine power over 400%!

**EASIEST STEERING** is yours with Chrysler Full-time Power Steering. Absorbs road-shock and wheel-fight, gives you safest maneuverability!

**SMOOTHEST GOING** over even the roughest roads . . . with Oriflow shock absorbers' double-strength cushioning power! Plus Antiroll suspension.



**HERE'S THE SLEEK** new "100-Million-Dollar Look" . . . the trend-setting new automotive fashion that's got motorists swinging to Chrysler in record numbers! And here's today's greatest new car *value!* All of Chrysler's eye-filling new beauty . . . plus Chrysler's traditionally famous size, comfort, and matchless performance . . . *at an easy-to-buy price that's much less*

*than you might think!* We invite you to see Chrysler and learn the **BIG** difference in big cars today . . . by taking the thrilling "100-Million-Dollar Ride!" Your Chrysler Dealer will be happy to see you at any time it suits your convenience (but make it *soon!*) . . . to show you how easily he can fit this great new Chrysler Windsor DeLuxe V-8 to *your* budget!

**COME SEE AND DRIVE AMERICA'S MOST SMARTLY DIFFERENT CAR!**

# TRUE TEMPER®

## Tool News

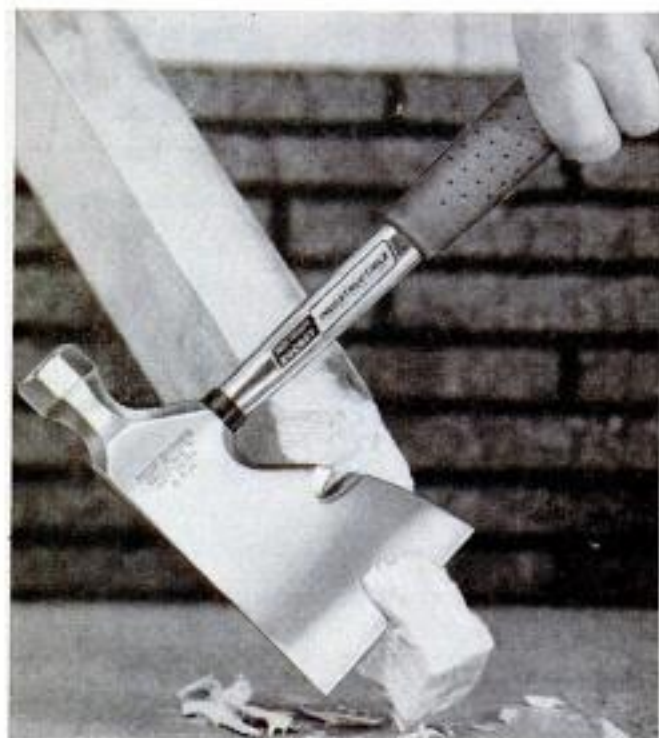

### NEW: HANDLE WON'T BREAK Cushion grip absorbs shock

Now you can get a True Temper **ROCKET hatchet**. The tubular steel handle won't bend or break. The cushion grip absorbs shock. Thin blade is forged from finest steel, full polished. The **ROCKET hatchet** is built like the **ROCKET hammer**—indestructible in all normal use!

Less than a year old, the **ROCKET hammer** is already the craftsman's favorite. Ask any carpenter! They like the nonslip grip, perfect balance, head that can't loosen. No other tools in the world are like the **ROCKETS**. Made by True Temper Corporation, Cleveland 15, Ohio.

### NOW: A family of **ROCKET** tools at your hardware store



**TRUE TEMPER®**

Finest quality in hammers, hatchets and axes • Lawn, garden and farm tools • Shovels • Shears • Fishing tackle • Golf-club shafts

## High-School Robots Learn the "Three Rs"

(Continued from page 124)

these answers were "pumped" into the Thinker in a briefing session before I started my "interview."

I turned to current events. "Now . . . president after Harry Truman." Slowly it spelled out **E-I-S-E-N-H-O-W-E-R**. I asked for the governor of Minnesota. It paused a few seconds—about 10 seconds are needed between the answers—and wrote in those peculiar "drawn" letters, **F-R-E-E-M-A-N**. Correct.

That's remarkable for current events, I thought, but how would it do on history? I led off with, "Now . . . who won the world's series last year?" That was too easy. It quickly answered, **G-I-A-N-T-S**. I decided to go back a few years and asked the robot, "Now . . . who was president after Monroe?" The machine wrote in distinct letters, **A-D-A-M-S**.

Can the machine reason? A simple test showed that it will not. I asked, "Now . . . will Red China attack Formosa?" There was no answer.

The final question during this first 20-minute "run" surprised me. As a special treat for me the boys had "briefed" it. "Now . . ." they asked proudly, "name the represented magazine." Placing one word over the other, it wrote, **P-O-P-U-L-A-R M-A-C-H-A-N-I-C-S**.

They immediately noticed the error, and looked embarrassed. "Mechanics" was spelled wrong.

So the machine could make a mistake, I thought. But no, it was a mistake in briefing the Thinker, not the Thinker's error. The machine spells phonetically. After they told it to spell "mEchanics" the spelling was correct.

Neither Lease nor the boys will tell exactly how the Thinker functions. The "magic brain" is still under wraps because of possibilities of patents. This much of an explanation is given:

First, the Thinker is a facsimile type of machine. It reproduces answers given to it, but can't think for itself.

An audible word, signal or sentence is spoken into the mike and is carried to the central "nervous system" or "brain." Here the question is acted upon and answered by relaying electrical impulses over wires to a receiving apparatus which changes the impulses back into intelligible answers.

It does not involve anything basically original. Lease, who advised the boys, stressed that "we make absolutely no

(Continued to page 220)

## NOW! Apply Three Finishing Coats a Day!

Wonderful Satinlac® dries so quickly, you're ready for the next coat in 3 or 4 hours. Thus, 3 coats a day is a reality! But time-saving isn't Satinlac's only advantage . . . not by a long shot!



It gives you the most beautiful natural finish you've ever seen. A handsome satiny effect which not only wears well but is easy to maintain. This Wizard with Wood works like magic with hard or soft woods! Never darkens or turns yellow.

## New Adhesive with 1001 Uses Discovered!

It's the most revolutionary adhesive in years! It bonds instantly, permanently, on contact . . . without clamps, presses or nails! It's Weldwood® Contact Cement! Bonds any combination of wood, glass, leather, paper, cloth, rubber and metal (including do-it-yourself aluminum). Makes it easy . . . even for amateurs . . . to apply Micarta or other plastic surfacing materials to table tops, kitchen counters, etc. Enables you to put up plywood paneling without nails! A real Wizard around home, shop or garage.



## Get Weldwood Glues and Finishes at Hardware, Paint and Lumber Dealers!

You can always get Weldwood Glues, as well as Firzite® and Satinlac, at your local hardware, paint or lumber dealers. Weldwood Products come in a variety of convenient sizes, suited

to your individual needs. Weldwood Contact Cement comes in 25¢, 35¢ and 60¢ and larger sizes. Weldwood Presto-Set® Glue comes in 25¢, 45¢ and larger sizes. Weldwood Plastic Resin Glue comes in 15¢, 35¢, 65¢ and larger sizes. Firzite and Satinlac are available in pints, quarts, gallons and 5 gallon cans. Keep a supply of these Wizards with Wood on hand in your shop — you'll use them all the time.

## First Ready-to-Use Glue worthy of the Weldwood Name!

We experimented for years to find a white glue worthy of Weldwood's reputation. Now we have it—Weldwood's new Presto-Set Glue. It's ready to use! Sets fast! Bonds like magic! Bonds wood to wood, wood to cloth, cloth to paper, upholstery fabrics to wood, etc. Saves you time, too, because you can often machine jobs just 30 minutes after using Presto-Set! Now available in handy "squeeze" bottle.



## Best Undercoater for Plywood Stain Jobs . . . Clear Firzite!



Yes, there is a way to tame unsightly wild fir plywood grain! There is a way to make it take on the appearance of costlier woods. Start with a coat of Clear Firzite on stain jobs. This Wizard with Wood soaks into the pores and subdues the wavy grain; practically eliminates grain raise and surface checking. To produce oak, walnut and mahogany stains, simply add colors-in-oil.

## Weldwood Plastic Resin Glue is "Old Reliable" of Professionals!

Professional cabinetmakers, men whose reputations are at stake on every job, call Weldwood Plastic Resin Glue, "Old Reliable" . . . and with good reason. It makes glued joints stronger than the wood itself. The joints actually grow stronger with age. It's highly water-resistant, too! More and more hobbyists have discovered that when the job has to be right . . . it's best to rely on the "Old Reliable" . . . Weldwood Plastic Resin Glue.



## Best Undercoater for Paint Jobs . . . White Firzite!

Hobbyists use White Firzite to solve 2 distinct problems. They use it as an undercoater on fir plywood paint jobs, to seal the pores; help prevent grain raise and checking. And they use it to get a "woody" blond or pickled or wiped effect so popular today. White Firzite can easily be tinted with colors-in-oil to obtain any light pastel tone you want.



\*Trade Mark

### UNITED STATES PLYWOOD CORPORATION

Dept. 38, 55 West 44th St.  
New York 36, N. Y.

Send me leaflets on:

- Weldwood Plastic Resin Glue     Satinlac  
 Weldwood Presto-Set Glue     Firzite  
 Weldwood Contact Cement

NAME \_\_\_\_\_

ADDRESS \_\_\_\_\_

CITY \_\_\_\_\_ ZONE \_\_\_\_\_ STATE \_\_\_\_\_



***If your car's dip stick repeatedly shows you need to add oil, your power is fading... and it's time to replace your Piston Rings!***

Having to buy too much oil and gas, and slow pickup reveal POWER FADE! Your rings are badly worn—you're wasting money on lost power.

Top performance is gone. And despite the extra oil used, vital engine parts remain starved for oil. This is not only costly and wasteful, but is a warning of expensive repairs to come later.

See your motor specialist for a ring check-up. If he recommends a ring change, it will pay you to install Hastings replacement rings. They're engineered exclusively for worn engines to quickly stop power fade, oil-pumping and gasoline waste.

All the safety and driving enjoyment of full-powered performance are yours again with Hastings Rings... it's the best money you can spend on your car.

HASTINGS MANUFACTURING CO., HASTINGS, MICHIGAN  
HASTINGS LTD., TORONTO

*Piston Rings, Casite, Oil Filters, Spark Plugs*

**\* TOUGH but oh so gentle**



**HASTINGS**

STEEL-VENT PISTON RINGS

*Regular or Chrome-Faced*

**\* TOUGH on oil-pumping • GENTLE on cylinder Walls**

claims of discovering any new scientific phenomena."

It is unique because it applies old principles in a completely new and different way, according to Lease. He explained it this way:

"A professor once told me the only difference between an engineer and anyone else is that what takes others 100 hours to do, an engineer can do in one hour. About the same thing is the case here."

The machine's parts—mostly scraps—are worth about \$120. The boys estimate their actual labor at 560 hours each. At a dollar an hour the total cost would run a little over \$1000. It's powered by regular household current, and uses about 200 watts.

The Thinker is built largely around the molecular theory of magnetism, the electromagnetic theory and the theory of electromagnetic induction. In other words, it is as simple as the common bar magnet, the electric motor, the electric generator and the transformer. It deals with inductance and inductive reactance, as applied in pulsating direct-current and alternating-current circuits.

The inventors emphasize that it is a completely "closed circuit" device, using no form of radio-type transmitter or receiver. The machine was originally designed to be a communications device rather than a question-and-answer-type machine. Its biggest value would be as a communicator, the boys believe.

As a novelty—leaving the Thinker in the back room for a moment—Castor the Great steals the show. He's a handsome, romantic and "dangerous" robot who roams the halls of Foley High School. Directing Castor on his jaunts is his creator, Kenneth Freude, 17, a junior.

After working for two months assembling various pinball-machine parts and other pieces of "junk," Kenneth was able to make Castor walk, defend himself with a water gun, pick up paper, wink at girls, talk and react with fright by raising his hair! Total value of this project—about \$200.

There is also a little robot. Versal Cross, 17, the senior student who built it calls it a Doodlebug or Snail. The Snail follows a beam of light and, having lost it, searches until it finds the light again. It is not controlled by radio or by other remote controls. Assembled, it looks like a giant bug with feelers guiding it as it searches for the beam of light.

Armies of the future might use cannons like the one Edward Heintze constructed as his science project. Loaded with water and a few drops of sulphuric acid, the

(Continued to page 222)

HOW TO

# Keep Cool

This Summer

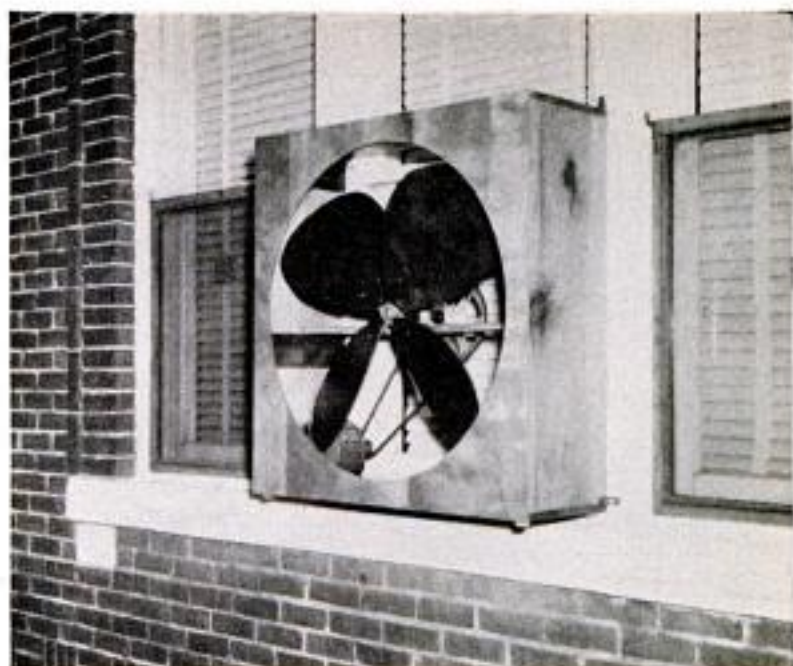
## Few Dollars Builds Breeze with Easy-to-Assemble FAN KITS • SAVE UP TO 75%

### NEW IMPROVED FAN KITS CAN BE INSTALLED THREE WAYS!

Cooling, refreshing outside breezes can now bring relief from summer heat at the lowest cost ever in your choice of installations! Window and Standard Attic fans have been assembled by thousands—NOW, with the new All-Purpose Fan Kit you can also make a dependable HORIZONTAL installation in your attic. Efficient operation is guaranteed!

### NO SPECIAL TOOLS OR SKILL REQUIRED FAN READY TO PLUG-IN IN FEW HOURS

Step-by-step instructions, included in every complete kit of parts, shows exactly how to assemble and install your own low-cost cooling system. Even the most inexperienced householder can do it. All Necessary parts are included in the kit. The only additional requirements are a few pieces of lumber for fan housing and a new or used  $\frac{1}{4}$  or  $\frac{1}{2}$  HP 1750 RPM motor, usually available at appliance dealers at small cost.

Sizes for every need are available for immediate shipment. Installations now in use include Homes, Apartments, Farm Buildings, Laundries, Shops, Offices and many more.

30" Fan cools average 5-room home, 6000 CFM.....	\$14.95
36" Fan cools larger homes, 8000 CFM.....	17.95
24" Fan cools smaller homes, 4500 CFM.....	13.95
20" Fan cools apts., offices, etc. 2800 CFM.....	12.95

Shipped direct by manufacturer postpaid on orders accompanied by check or money order. Deposit of \$3.00 required on C.O.D. orders.

**Satisfaction Guaranteed — Circular Free.**

## FAN KIT Company

154-P, No. Belvedere

MEMPHIS, TENN.

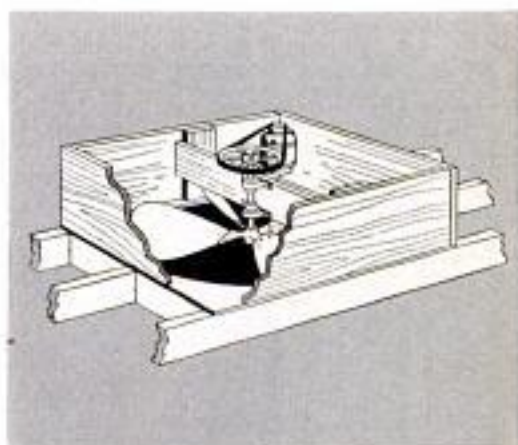

Typical HORIZONTAL ATTIC INSTALLATION with new All-Purpose Fan Kits. No extra parts needed.



PARTS included in all kits: Aluminum fan spider, Masonite blades, shaft, oilite bronze bearings, collars, pulleys, belt and bolts. Everything you need with complete instructions.

# FAIRCHILD

A Famous Name in Industry

## MAKES THE FIRST AND ONLY TWO MOTION ELECTRIC SANDER

Perfect for every  
**"DO-IT-YOURSELF"**  
Enthusiast !!



DUALINE . . . the only sander with both Orbital and Strate Line motion, using separate, instantly interchangeable plates. Orbital motion provides for very rapid stock removal while Strate Line delivers a whisper smooth finish cut. Designed to reach corners, ceilings and other hard to reach spots, the DUALINE is light, powerful, quiet and smooth . . . ball bearing throughout. \$44<sup>95</sup>  
5500 OPM from the 1/2 HP universal motor . . . Push-button paper removal is fast and easy.

Fairchild makes a complete line of drills, drill kits, bench grinders and other tools . . . plus the new single action Orbital sander. Low priced, fully guaranteed, thousands of uses. Send for Free catalog and prices of these rugged, industrial type Fairchild electric tools.

AT YOUR DEALER, OR WRITE DIRECT.

**FAIRCHILD INDUSTRIES**  
110 MAIN STREET BURLINGTON, 2, VT.



### HOW TO GET A NEW GARAGE DOOR AT LESS THAN HALF PRICE!

Yes, you can have a swing-up garage door like the one shown here — complete with Stanley Swing-Up Hardware for less than half what you'd normally pay!

How? Build it yourself from Easi-Bild's\* Pattern No. 86. It's easy! No special tools — no special skill! Just follow the clear, "can't-go-wrong" directions of the pattern. Tells you everything — including what materials to buy,

where and when to use them. Stanley Garage Door Set is simplicity itself to install. You'll be amazed how quickly you can do the job — and mighty proud of your results.

Ask your dealer for Simplified Directions for Installing Stanley Garage Hardware and Easi-Bild Pattern. Or use coupon below. \*Trade Mark Reg. U.S. Pat. Off. — Easi-Bild Pattern Co.

EASI-BILD PATTERN CO., Dept. 627, Pleasantville, N.Y.  
Enclosed is 50¢ in coin, money order, check for  
Garage Door Pattern No. 86

Please send Simplified Directions for installing  
( ) Single ( ) Double Garage Door Hardware.

NAME \_\_\_\_\_

ADDRESS \_\_\_\_\_

CITY \_\_\_\_\_ ZONE \_\_\_\_\_ STATE \_\_\_\_\_

cannon breaks the solution into gases. The gases are ignited by an electrical charge. With a loud "crack," the cork is sent sailing across the 40-foot classroom.

For a more recreational project, seniors Thomas Wildman and Gordon Viste, both 17, connected an "electronic brain" to an electric train. A spoken command causes the train to stop, go forward or back up. The brain changes the sound waves of the voice into electrical currents. These are sent to the controls of a regular electric-train set. One "shot" of electricity stops the train, two shots make it back up and three shots cause it to move forward. When a series of syllables is said—either one, two or three—the same number of electrical shots enter the controls and move the train.

The train works just like an old Iron Horse, too. Using "whoa" for the one-syllable command, the train stops. "Get-up" will make it lunge forward. "Back boy" starts the train on a backward run. The more ordinary commands are "stop," "go forward" and "back up."

In every corner of this Foley classroom are student-built machines that perform a variety of tasks. Each student must work on one project a year.

Lease, who taught shop classes for two years before becoming science instructor last year, says, "I will feel lucky if my efforts help produce only a handful of scientists, for even this handful may be responsible in the end for keeping our country in the scientific lead." ★ ★ ★

### Roller Applies Glue to Seal Carton

Gummed tape or staples are not needed to seal a paperboard carton when a new roller is used. The hand roller carries a quart of glue. Rolling the machine across the surface applies an even coat of glue and the paperboard flaps then are pressed into place. Ungummed labels also can be applied to the carton with the aid of the roller.





# MOLLY

WHERE NAILS AND SCREWS WON'T HOLD ... MOLLY WILL

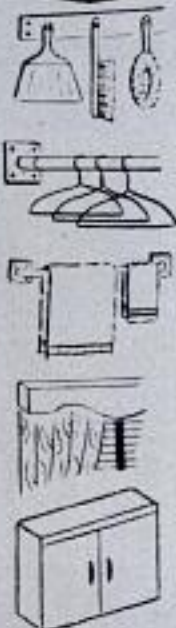

**PUTS  
THE FIX IN  
FIXTURES**

★  
REPLACEMENT OR A REFUND OF MONEY  
Guaranteed by  
Good Housekeeping  
IF NOT AS ADVERTISED THEREON

OVER  
85,000,000  
MOLLYS  
IN USE!

Molly Screw Anchors hold any fixture securely in any hollow wall construction. Molly puts an end to loose fixtures and allows you to install new ones exactly where you want them—not where the studs are. Molly puts an end to broken wall surfaces and crumbled plaster!

Molly will not pull through. It forms its own backing and actually reinforces the area in which it is used. Once installed, anchorage is permanent. Fixtures can be removed for cleaning and be replaced in the same anchor! Mollys are inexpensive and easy to install!

**ASK YOUR HARDWARE DEALER  
Write For FREE Folder!**



**EASY TO INSTALL  
NO SPECIAL TOOLS NEEDED**

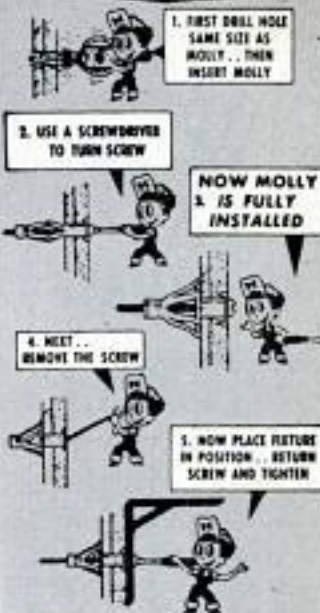

WHERE SCREWS WON'T HOLD  
USE  
**MOLLY**  
SCREW ANCHORS  
MOLLY CORPORATION • DEPT. G7 • READING, PA.

## FIND URANIUM!!!

Prospecting made easy with Goldak's new U-238C triple-action geiger counter! Also famous line of metal locators, from \$49.50. Send 25c for radioactive uranium sample! FREE DETAILS, Dealer Inquiries Welcome.



**GOLDAK COMPANY** 1542 W. Glenside Blvd., Glendale, Calif.

## NEW, IMPROVED CALCULATOR FOR WOODWORKERS only 25c

Instantly gives information on lumber, nails, concrete mixes, painting materials, etc. Convenient, simple to read. Just set dial for nail specifications, to convert linear to board feet, find bit sizes for screws, compare characteristics of woods. 6" diameter heavily varnished cardboard. Send 25c, no stamps, please to Greenlee Tool Co., 2107 Columbia Avenue, Rockford, Illinois.



## Need an extra \$1,000, \$2,000, or more? Make it with an IDEAL LAWNMOWER SHARPENER

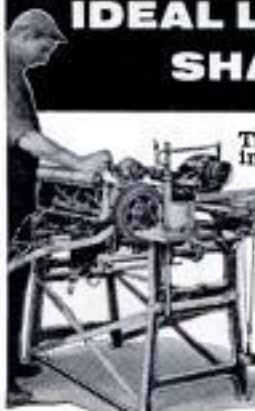

There are thousands of lawnmowers in your locality: Average \$1,000 profit per 250 mowers with customer satisfaction and repeat business assured. Provide this essential service with an Ideal Lawnmower Sharpener, the only machine that grinds the reel to "fit" the bed knife. Compare by any standard. The Ideal, backed by 53 years of experience, costs no more. Write today for complete, free catalog.

**THE FATE-ROOT-HEATH COMPANY**  
Dept. PM-7 Plymouth, Ohio



## Prevents Vapor Lock IN YOUR CAR OR TRUCK

Vapor lock is not only annoying, but can burn out exhaust valves and result in expensive repair bills. The Bendix Electric Fuel Pump positively prevents vapor lock. Simple to install. Get your Bendix Electric Fuel Pump at any independent garage or service station.



\*REG. U. S. PAT. OFF.

**FREE:** A complete descriptive folder is yours for the asking. Write us today.



## ELECTRIC FUEL PUMP

Grand Prix Winner  
ECLIPSE MACHINE DIVISION, BENDIX AVIATION CORP.,  
ELMIRA, N. Y.

# New central heating system has a thermostat in every room

Steam turbine operated fan in each room heater circulates filtered warm air. Thermostats are non-electric

*Why didn't someone think of this long ago?* Once in many years a new idea is born; one so simple, so logical, and so practical that it wins immediate and wide acceptance. People constantly tell us that the SelecTemp heating system is just such an idea.

**Home comfort beyond anything you've ever known.** SelecTemp is the ultimate in modern heating—every room a zone, with its own thermostat. Every member of the family has just-right warmth, from 65° or so in mother's busy kitchen to tropical warmth for grandmother. Each room has a separate steam-fed heating unit, which constantly circulates filtered warm air. There is no wiring; fans and thermostats are non-electric. (See diagram at right.)

**Economically installed. Fuel cost low.** SelecTemp heating is very economically installed in new or old homes or buildings, since small flexible copper tubing carries steam to room units. SelecTemp eliminates *overheating* and *unnecessary* heating. Rooms not in use can be kept cool and quickly reheated when wanted. SelecTemp boiler with immersion coils will provide plenty of hot water, winter and summer, at low cost.

**Continuous, modulated heat.** The speed of the fan and the amount of steam supplied are constantly and automatically adjusted to room needs. No more heat than is needed, and no less. No pop-on, pop-off. Just steady heat, accurately metered.

**Learn more about this revolutionary heating system.** Mail the coupon. You will receive a 32-page booklet "12 Plans for Home Heating," describing SelecTemp heating, as well as accurate information on all principal types of modern heating.

### CLIP AND MAIL

IRON FIREMAN MANUFACTURING COMPANY  
3014 West 106th Street, Cleveland 11, Ohio.  
In Canada: 80 Ward Street, Toronto, Ontario.  
Please send me your free booklet "12 Plans for Home Heating."

Name \_\_\_\_\_

Address \_\_\_\_\_

City \_\_\_\_\_ Zone \_\_\_\_\_ State \_\_\_\_\_

224



SelecTemp room units, only 18 inches high, are recessed into wall and can be painted to match color scheme. Three sizes: 6,000, 12,000, and 18,000 Btu output.

Air circulating fan continuously draws room air through SelecTemp unit, quietly filters and re-circulates it.

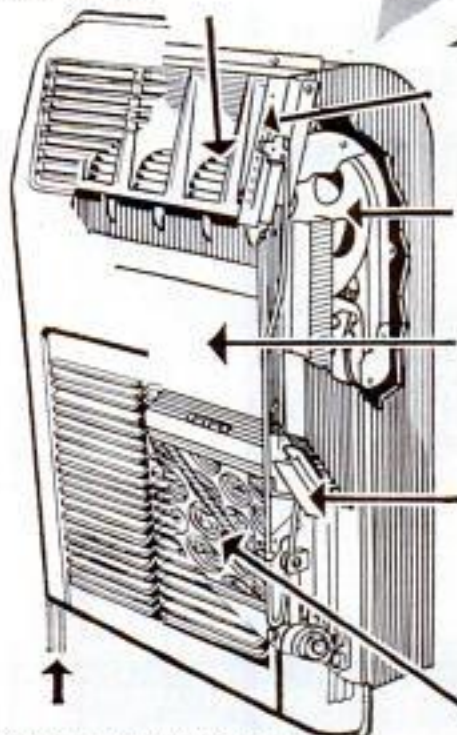

Thermostat control lets you choose desired room temperature; any warmth level from 40° to 90°.

Small steam turbine operates air circulating fan faster or slower, as thermostat calls for more or less heat.

Heat transfer core. Efficient copper core heat exchanger converts steam heat to warm air heat.

Air sampling chimney constantly samples temperature of room air.

Spun glass filter cleans circulating air; prevents smudged walls and draperies.

Supply and return lines are of flexible copper tubing, only 1/4 and 1/2 inch, I.D.

## IRON FIREMAN®



# SelectTemp

MODULATING ZONE HEATING  
POPULAR MECHANICS

Copyrighted material

# 5 do-it-yourself ideas for week-end carpenters

Save money—have fun with Easi-Bild® patterns and Weldwood Fir Plywood. Here's a happy combination that makes do-it-yourself easy, quick and satisfying!

With Weldwood Fir Plywood you can build any of these projects. Make things for the house— even *make* a house!

Most patterns are full size—all contain famous Easi-Bild step-by-step directions and pictures plus detailed list of materials. Your lumber dealer can furnish the exact amount of superior Weldwood Fir Plywood you'll need. And chances are he'll have all the other materials, too.

Get started today—send the coupon now!



**Garden chaise on wheels.** Comfortable, relaxing; comes apart for easy storage. #325—35¢

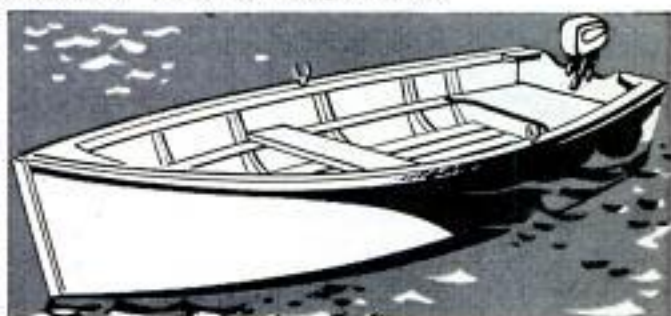

**Utility boat.** 11½-footer handles well with oars, is perfect for 2 to 10 hp. outboard. #85—\$1.00

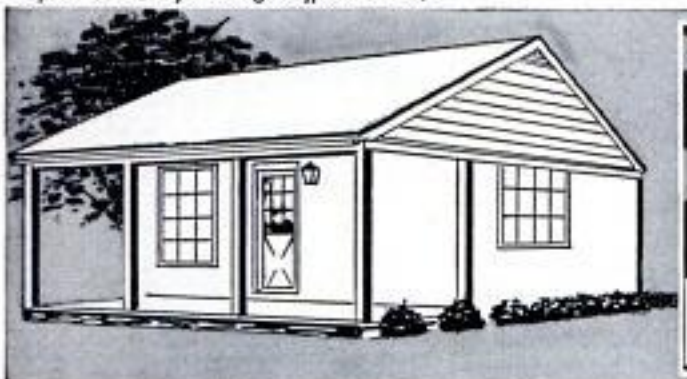

**Vacation cabin.** Compact yet roomy, contains living room, kitchen, bedroom, bath on entry floor; lower floor has recreation room or second bedroom, laundry and utility rooms. Plus 300 sq. ft. of attic storage! #432—\$3.00



**Storage wall on wheels.** Divides bedroom or sleeping area in den or spare room. #263—50¢



**Swimming float.** Ride with the waves! "Seascope" window can be fitted to view marine life. #247—50¢

\*Trade-Mark Easi-Bild Pattern Company

United States Plywood Corp. Pattern Dept.  
P. O. Box 215, Pleasantville, New York



PM-7-55

I am enclosing \$\_\_\_\_\_ for the following Easi-Bild patterns.

#324—35¢                       #432—\$3.00                       #247—50¢

#85—\$1.00                       #263—50¢

Easi-Bild catalog listing over 200 projects—35¢

NAME \_\_\_\_\_

ADDRESS \_\_\_\_\_

CITY \_\_\_\_\_ STATE \_\_\_\_\_



Ask your lumber dealer for

**Weldwood®**

**DOUGLAS FIR PLYWOOD**

Made by UNITED STATES PLYWOOD CORPORATION

World's Largest Plywood Organization

 **NO MORE  
BLOWN OUT FUSES!**

**Here's Mini-Breaker® . . . the lifetime replacement for old-fashioned fuses**



- Fits like a fuse in any standard fuse socket.
- Just press the shockproof Mini-Breaker button to restore service.
- Built-in timelag handles starting loads of major appliances.
- Protects against all overloads and short circuits.
- Lifetime protection against electrical fire hazards.

In 10, 15, 20, 30 amps. AC only, 125 volts max. Listed by Underwriters' Laboratories, Inc.

**MINI-BREAKER®**

Ask for it at your favorite store or write Mechanical Products, Inc., Jackson, Michigan

*Say You Saw It in Popular Mechanics*

CLIP THIS TO GET

**NEW! DELCO  
LOW PRICE  
WATER**

WELLMASTER JUNIOR JET

SHALLOW WELL PUMP



Precision-Engineered and Quality-Built By . . .

**GENERAL MOTORS  
DELCO**

Only **\$89.95** f.a.b. Rochester (Suggested List Price Model 53372 as Illustrated)

- No other pump can match this new Delco Jet for PRICE . . . and QUALITY . . . in 1/2 HP class!
- New simplicity . . . only ONE moving part . . . New compactness . . . Self-adjusting capacity . . . New durability . . . All at new LOW PRICE!

**WRITE! for Full Information or Call Your Delco Water Pump Dealer Today!**

**DELCO APPLIANCE DIVISION**

GENERAL MOTORS CORPORATION  
Dept. PM3, Rochester 1, New York



**Lawn Edger Buries Coaxial Cable**

In some areas television viewers now have the option of connecting directly to a coaxial cable, eliminating the need for a towering antenna. One TV dealer in Florida who operates such a service has found a power-driven lawn edger an ideal tool to dig a trench for the cable. Previously the trench had been dug by hand, which required resodding that part of the lawn. The edge-cutter blade was removed and replaced with a 10-inch carbide-tipped steel blade. After the edger is run across the lawn, a spade is forced into the cut and moved back and forth to widen the trench slightly. The coaxial cable fits easily into this space, dirt is tamped down over it, and the grass shows no sign of disturbance.

**Car-Key Tie Clasp**



Useful as well as ornamental is a tie clasp that serves as an emergency car key. The key, which bears a crest of the owner's automobile, swivels away from the tie bar when it is to be used. It is made to fit the locks of the owner's car as well as does the original key.

# SAVE UP TO \$8 WHEN YOU BUY **SILENTONE** WORLD'S BEST MUFFLER

26 gauge inner shell—22 gauge outer shell.

Double shell lasts longer.

Non-clogging extruded holes—  
no whistling, no restriction.

16 gauge, spun-locked,  
blowout-proof steel heads.

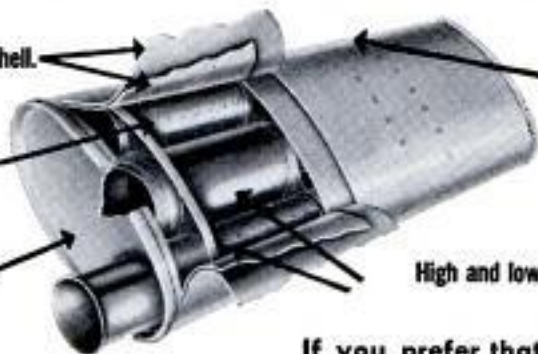

Crimped seams  
eliminate  
weak points.

High and low frequency tuning chambers.

Ordinary mufflers silence your engine by throttling its power. Remember, every pound of muffler back pressure wastes 2 hp of engine output. Silentones are scientifically designed to keep back pressure at a minimum, give you the performance you want, the mileage you expect. Leaktight 1/3 heavier steel construction makes Silentones safe and last thousands of miles longer. They're individually engineered for your car. Install Silentone® yourself—save up to \$8.

If you prefer that deep mellow tone—hear how Dynatone Mufflers sound on your car. Your store has a recording. Dynatones are engineered, not packed. Cost far less than Hollywood types. Dynatone duals and headers available for use with any type muffler.

Write for your free copy of the interesting booklet "Carbon Monoxide, Your Car and You."

## SILENTONE MUFFLERS

Dept. 2G, Toledo 1, Ohio

Sold only by America's Leading Automotive Chain Stores

**FREE BOAT KIT CATALOG** Write: **LUGER INDUSTRIES**

**8' to 14' Models from \$39.95 incl. freight**

- Assemble your own boat
- No experience necessary
- Save 1/2 "factory prices"

Marine Hardware, Fiberglass, & Trailers

12 ft. Runabout Pictured.

DEPT. B 4452 NICOLLET AVE MINNEAPOLIS 9, MINN.

### STOP WATER WASTE AUTOMATICALLY

Use HECO Flex-tip, the nozzle that shuts off the water FOR YOU. FLEX to use—RELEASE, it's off. No running back and forth to faucet. Stop puddles, save water and mess when washing cars, mixing cement, transplanting flowers and shrubs, etc. Made from solid brass bar stock and grease resistant Neoprene. Nothing to clog or break. Thousands in daily use. Get yours! \$1.75 each, 2 for \$3.00 postpaid. Satisfaction guaranteed. If dealer can't supply, send check or money order to: Customer Service, Dept. M, HECO, Littleton, Colorado. Colorado residents add 2% sales tax.



**SEND FOR FREE CATALOG**



### Money-Making Tools!

It's easy to own the same "pay-off" tools used and endorsed by America's top-earning mechanics! You can start building your own kit with basic Snap-on sets—add others any time. Never sold in stores—direct to users only. Send today for free catalog!

Snap-on Tools Corporation  
8062-G 28th Ave., Kenosha, Wis.



A perfect paint job with half the trouble. Get your money's worth. Paint shaken on a Red Devil Paint Conditioner is ready to use right out of the can. Paint is perfectly mixed factory-fresh—needs no stirring. Ask your dealer to mix your paint on a

## Red Devil PAINT CONDITIONER



**FREE**

How to Prepare Surfaces for Finishing. Illustrated instructions on preparing masonry, wood and metal surfaces for painting.

**Red Devil Tools.** Dept. 146  
130 Colt Street, Irvington, N. J.

Please send FREE copy of "HOW TO PREPARE SURFACES FOR FINISHING."

NAME \_\_\_\_\_  
ADDRESS \_\_\_\_\_  
CITY \_\_\_\_\_ ZONE \_\_\_\_\_ STATE \_\_\_\_\_

JULY 1955

227

## STOP SAGGING REARS!



with  
LOW-COST

### AIR LIFT PNEUMATIC SPRING BOOSTERS

Car got that "middle age spread" look? Even new cars need help for overloads of luggage, equipment or extra passengers. AIR LIFTS fit between leaf springs and frame — inflate with air to support overloads up to 1000 lbs! Perfect for vacation trips, and so easy to install. See your dealer or write for his name.

Most  
Models  
\$20



**FREE!** . . . tip-packed literature on Air Lift remedies for sagging rears. Write Dept. 47.

**AIR LIFT**

**AIR LIFT COMPANY,**  
LANSING, MICHIGAN

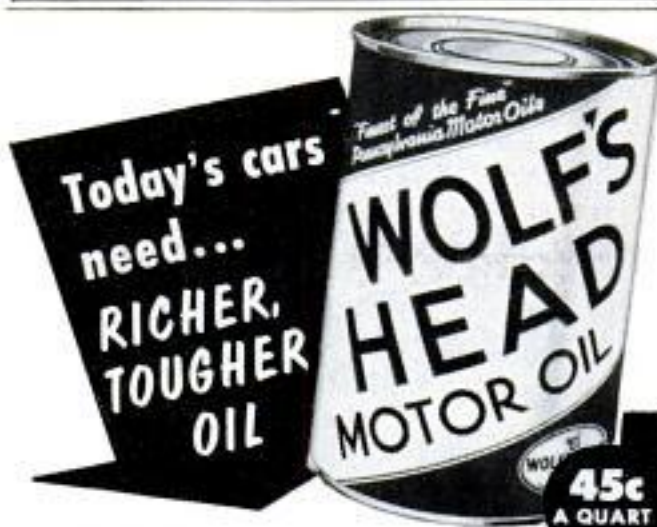

## INSIST ON WOLF'S HEAD!

- 100% Pure Pennsylvania.
- Refined three steps further than ordinary oils.
- Scientifically fortified . . . cleans as it lubricates.

Insist on WOLF'S HEAD for better engine protection, more power, better oil mileage!

**WOLF'S HEAD OIL REFINING CO., INC.**  
OIL CITY, PA.

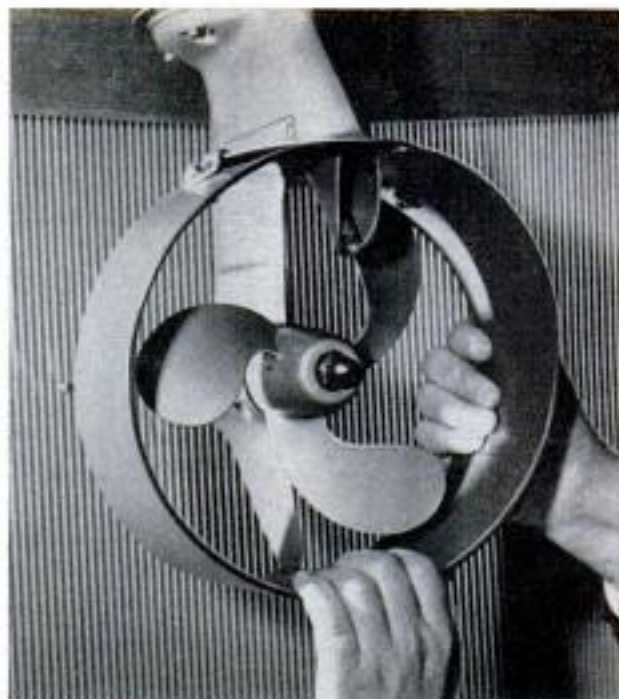

### Guard for Outboard Motor

Most outboard motors can be fitted with a new aluminum guard which fits around the propeller and prevents swimmers from being injured by the blades. The guard helps to prevent weeds from fouling the propeller and is said to increase the maneuverability of the boat. The manufacturer claims that its use will also increase the speed of a boat up to 25 percent.

### Clamp-On Valve Tap Drains Sealed Systems



It takes only a moment to tap and drain tubing at any point along the line with a clamp-on valve unit. The valve pierces a hole in the line and serves as a conventional valve for draining the fluid. One size of valve fits three sizes of tubing from 1/4-inch to 3/8-inch. A Neoprene gasket

seals the valve in position so there are no leaks. It can be left in position for future use or, if desired, removed and the tiny hole closed by soldering.

From chick to three-pound broiler in 10 weeks is the rate of growth of a new chicken, a Silver Cornish-New Hampshire cross, developed at the Department of Agriculture's Beltsville, Md., research center.

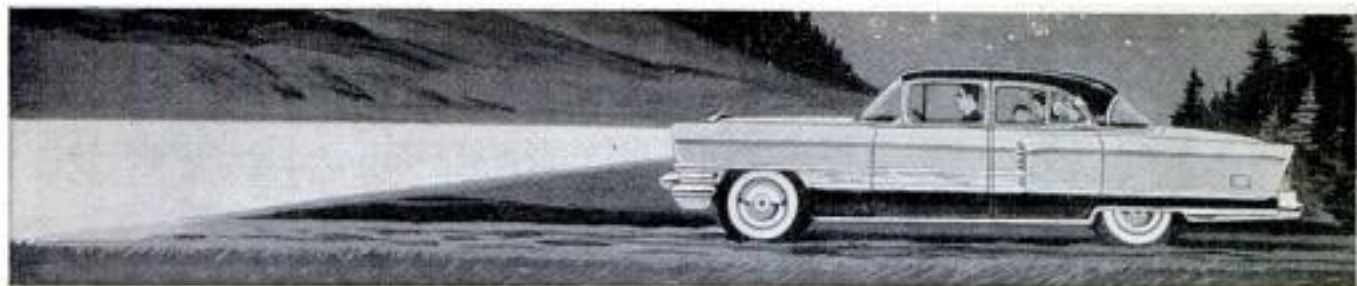

**Headlight Beams Stay on the Road!**

Packard Torsion-Level Suspension keeps headlights steady and properly aimed for best visibility regardless of passenger or luggage load — an important safety factor in night driving.



**Takes Sweeping Curves, Sharp Corners in Stride!**  
Front and rear wheels are interconnected to give equal load on both outside wheels. You get a secure sensation of positive control on sweeping curves, tight corners with added stability and safety.



**Takes Off at Ideal Ride Level!**  
There's no rear-end "squat" to snap the neck or jar the spine when the new Packard takes off! The car drives forward evenly balanced and seat backs nestle more closely to passengers.

## New PACKARD TORSION-LEVEL Ride

### ELIMINATES CONVENTIONAL COIL AND LEAF SPRINGS

Smooths the Road... Levels the Load — *Automatically*

Long famed for creative engineering leadership, Packard has developed new Torsion-Level Suspension... hailed as the greatest ride development in automotive history... and here's why! In other cars, twisting forces due to vertical wheel movement are transmitted to the frame.

Passengers are pitched and bounced, car body and frame are wracked.

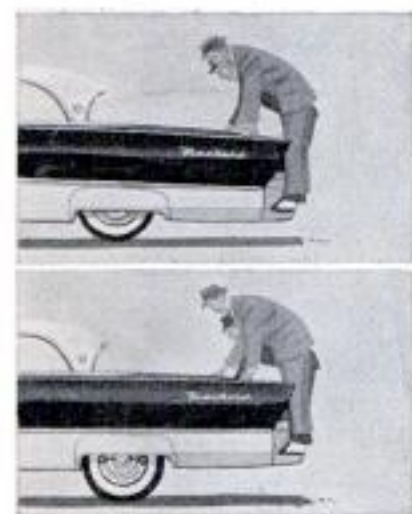

Just 7 seconds after load change, the unique levelizer automatically brings Packard back to ideal ride level.

With the new Packard, these same twisting forces are transmitted along the new Torsion Bar system, and absorbed before they can reach either frame or passengers. A power-controlled levelizer automatically compensates for changes in passenger or luggage load... keeps the new Packard always at ideal ride level.

But to fully appreciate this new kind of ride, see your Packard dealer — Take The Key And See... Let The Ride Decide!

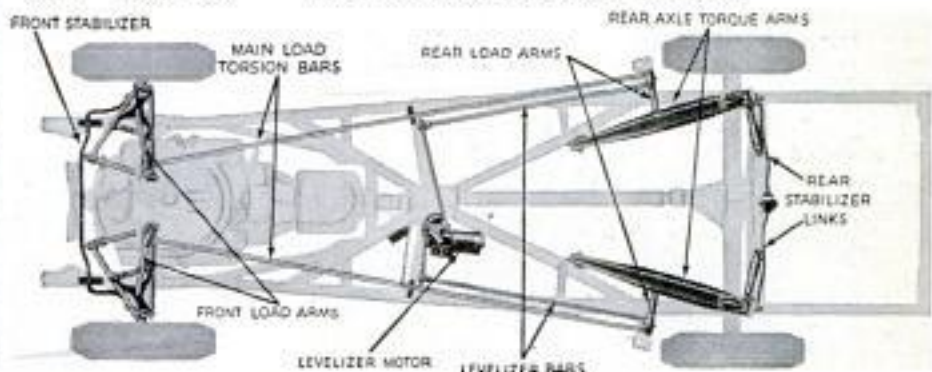

Torsion Suspension is made up of two full-length torsion bars, four pivot arms and links. Driving torque arms connect rear axle housing to frame. The levelizer has two shorter bars connected by links and levers to a two-way motor.

**PACKARD DIVISION • Studebaker-Packard Corporation**

JULY 1955

229



## The Oil Filter that Guards the *Life* of your car engine

Grime doesn't pay in your engine. It robs you of oil life and trouble-free engine service. That's why it's smart to rely on WIX to police your oil and stop costly engine repairs.

**wix**  
ENGINEERED FILTRATION

WIX HEVI-DUTY Oil Filter Cartridges more than meet automotive engineers' specifications for filtering efficiency — and do not disturb additives in today's heavy-duty oils. Ask your Serviceman for a WIX Cartridge the next time he changes your oil. There's one designed especially for your car—to keep your oil *clean* and your engine sweet-running—to protect your engine *and* your pocketbook.

**POROSITE**—the modern, pleated paper WIX Cartridge for Full Flow Filtration Systems.



WIX CARTRIDGES  
are priced \$1.50  
as low as

**WIXITE**—the outstanding depth-type WIX Cartridge for Partial Flow Systems.

**OIL FILTERS wix CARTRIDGES**  
AUTOMOTIVE • INDUSTRIAL • RAILROAD  
WIX CORPORATION • GASTONIA, N. C.  
IN CANADA: WIX ACCESSORIES CORP. LTD., TORONTO

## Owners Praise Ford's Power, Styling

(Continued from page 90)

"I prefer black. My wife wanted two-tone white and buckskin. That's what we got. Hard to keep clean."—Delaware chemical engineer.

"Some of them are too loud."—South Dakota blacksmith.

"They look awful."—New York welder.

"They won't be beautiful too long due to fading."—New Hampshire clerk.

### 1955 FORD V8 SPECIFICATIONS

#### ENGINE

Bore and stroke	3.62 x 3.30 in.
Piston displacement	272 cu. in.
Brake horsepower	162 at 4400 r.p.m.
Compression ratio	7.6 to 1
(Optional high-compression V8 in Fairlane and station wagons equipped with Fordomatic: 182 hp. at 4000 r.p.m.; 8.5:1 compression; 4-barrel carburetor. Dual exhaust standard on Fairlane and station wagons)	
Transmissions	3-speed conventional, Overdrive, Torque converter with planetary gears.

#### GENERAL

Steering ratio (over-all)	25.3:1
Steering wheel turns, (lock to lock)	4.5
Turning diameter (curb to curb)	41.2 ft.
Shipping weight (unladen)	3236 lb.
Wheelbase	115.5 in.
Tread, front	58 in.
Tread, rear	56 in.
Height over-all	61.0 in.
Width over-all	75.9 in.
Length over-all	198.5 in.
Road clearance	6.5 in.

#### CAPACITIES

Oil (less filter)	5 qt.
Water (less heater)	19 qt.
Gasoline	17.5 gal.

#### INTERIOR DIMENSIONS

Front-seat width	60.5 in.
Rear-seat width	60.3 in.
Headroom, front	35.1 in.
Headroom, rear	34.2 in.
Legroom, front	44.3 in.
Legroom, rear	41.9 in.

### Here Are More Complaints

"When parked on an incline in the rain, water will run into the interior when the door is opened."—South Carolina overseer.

"We have lots of rain here. The doors just can't be stopped from leaking. The curve of the windshield causes the water to come around and in the vent window when driving."—Oregon store manager.

"I expected more than I got in a new car. Body is very poorly assembled. Attention to detail terrible. I have three type-written pages of deficiencies."—Delaware engineer.

"Chrome seems to be a very weak point

(Continued to page 232)



Here's what



found out about Car-Plate —

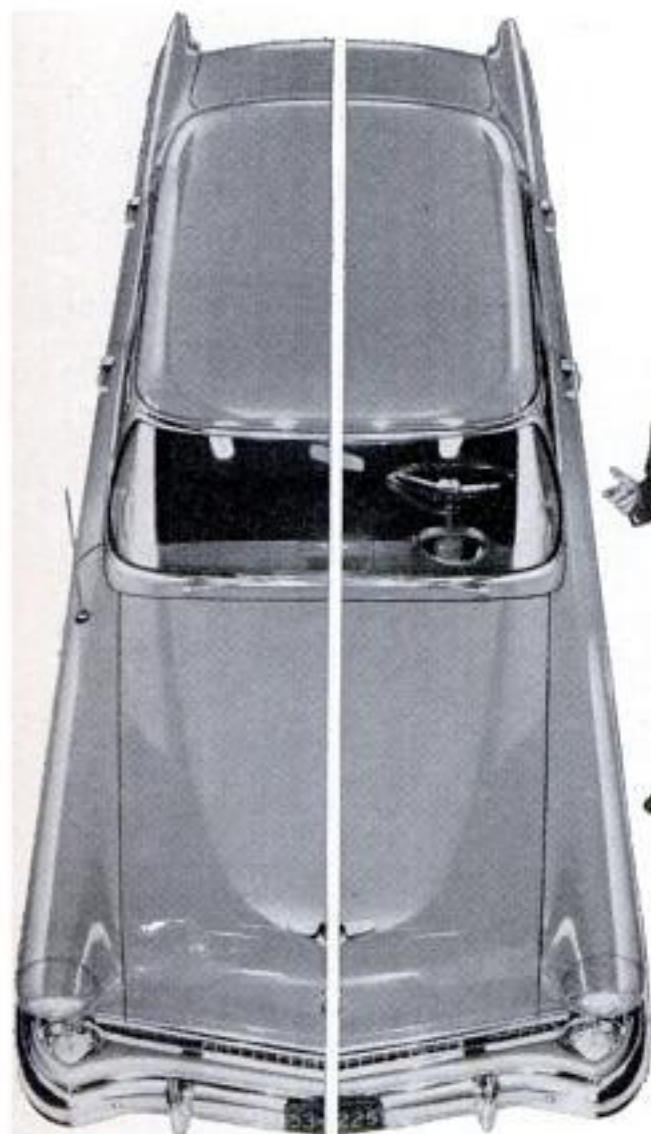

# Easiest way to put on the toughest kind of wax

*EVEN AFTER 3 MONTHS—  
CAN YOU PICK THE CAR-PLATE  
WAX SIDE FROM THE HARD-RUB  
AUTO WAX JOB?*

**HERTZ** picked 20 of its rental cars in cities across the U.S. One side of each was waxed with liquid Car-Plate, the other with one of three well-known paste waxes.

**HERTZ FOUND:** *Car-Plate is far faster, easier to apply than any paste auto wax.*

After months on the road, the sides were compared for wear and shine.

**HERTZ FOUND:** *Car-Plate lasts as long as the most durable paste auto wax.*

The reason: all the Car-Plate Wax stays on your car—you don't rub wax off as when polishing paste wax. The Hertz test car shown here was driven 3 months, then simply washed and photographed. If you can't tell the Car-Plate side (right) from the paste side, why waste hours rubbing? Next time wax with Car-Plate!



*Before waxing use Car-Plate Cleaner. Wax will bond perfectly in a brilliant, long-lasting finish.*



## JOHNSON'S

# CAR-PLATE WAX

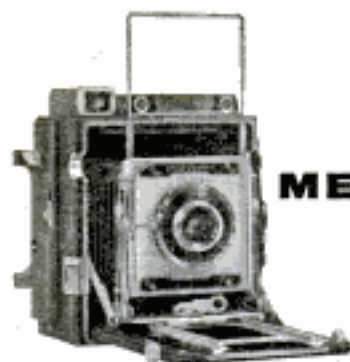

## WHY 3 METHODS OF

# Focusing

WITH

## THE GRAPHIC® 45?

Three focusing methods are featured in the Pacemaker Graphic 45—one of many reasons why it is the most popular, most used all-purpose hand camera on the market. Let's examine these methods one by one.

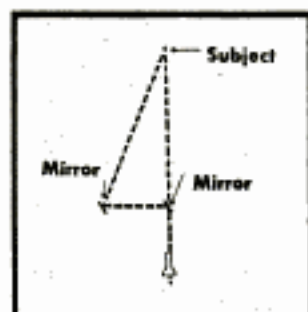

### 1. Coupled Rangefinder

**Focusing** with the new Graphic Rangefinder for normal eye level shooting—fastest method for all-around use. Interchangeable cams couple it to wide angle, normal or telephoto lenses. As you turn the focusing knobs on the camera

bed, the two images seen through the Graphic Rangefinder window gradually merge until at the point of accurate focus of the lens, both images are superimposed, clear and bright. Built-in Rangefinder for night focusing.

### 2. Ground Glass

**Focusing** is the original and basic method of determining sharpest focus and subject matter to be included in the finished picture. It enables you to see: a) your picture exactly as it will appear in the print; b) what parts of your picture are in or out of focus; c) how you can improve framing or composition. Ground glass focusing is a "must" for the serious photographer.

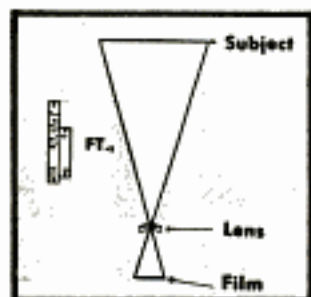
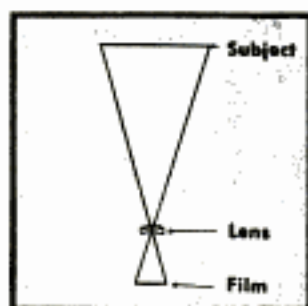

### 3. Scale or "Guess"

**Focusing** for quick "off the cuff" shooting—convenient for sports, action or ordinary snap shooting. You simply focus the lens with the focusing knobs on the front of the camera bed until the focusing scales on the bed indicate the estimated distance from the subject to the camera.

For the full story on Pacemaker Graphic 45's, write Dept. PM-75, Graflex, Inc., Rochester 8, N. Y.

# GRAFLEX®

*Price-Winning Camera*

for the 1955 Ford. The bumpers have not begun to corrode, but screws holding the parking-light lenses and rear lights have corroded. Trim around windows showed corrosion within two months. Inside, the parking-light housing was particularly bad."—Alabama chemist.

"Had to have it repainted due to sand in paint on first job. Side chrome on crooked."—Virginia telephone worker.

"Overhead valves rattle terribly from 40 to 50 miles per hour."—Georgia machine operator.

"Wrap-around windshield protrudes too far into the path of a person entering the front doors. Ash tray is located in an awkward position."—Nevada salesman.

"Bump knees every time I enter it because of wrap-around windshield."—Washington, D.C., hotel supplier.

"Tires should be inspected more carefully. I find that two of mine are about 1/2 inch out of round."—Washington soldier.

"Rear-spring suspension had to be beefed up. I had two leaves added so I could carry three persons, their luggage and a full gas tank."—Indiana sales engineer.

"Wheels are out of alignment at the slightest touch of a curb."—New Jersey merchant seaman.

"Turn-indicator lights on dash are blinding at night. Oil filter in such an out-of-the-way place."—Ohio brakeman.

"Ford policy as regards furnishing a wiring diagram and service manual is intolerable. Other manufacturers make a slight charge for such information. I am still waiting (almost five months) to get mine from Ford. It's impossible to trace a wire and if an emergency arises you're just out of luck."—New York electrical engineer.

"Headlights stick out in front too far to give enough clearance when parking. Or else the bumper does not extend far enough."—Washington, D.C., credit manager.

"Speedometer noisy this year, too."—Minnesota salesman.

"Buttons on the seat upholstery are an awful nuisance."—Arizona student.

### How Is the V8 Engine?

Ford has made more V8 engines than any other manufacturer. Has this experience helped? We asked the owners if they had had any trouble with their engines and 73 percent said they had none at all, 21 percent said they had some trouble, and 3 percent said they had considerable (the other 3 percent did not answer the question). With the 24 percent that said they

(Continued to page 234)

# If you have a hammer



You'll do a more professional job with Plastic Wood. Fills nail holes, covers hammer marks. Handles like putty, hardens into real wood.

You need **"PLASTIC WOOD"**

Stronger—resists weather—sands to a smooth finish.

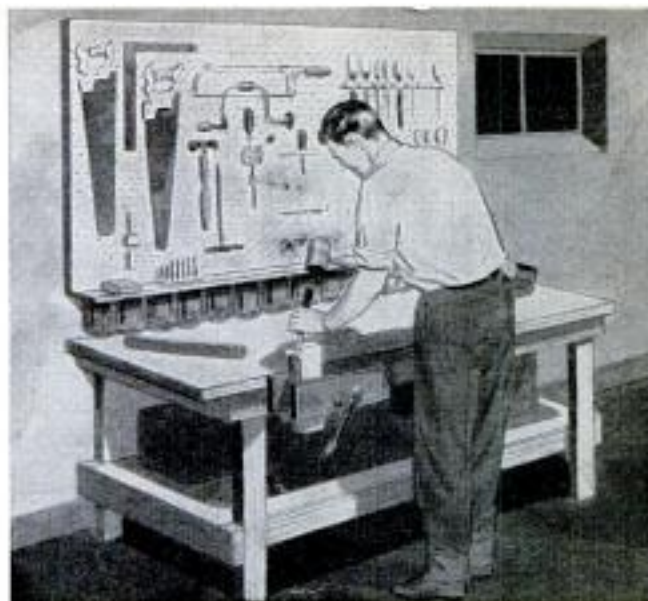

## SEND FOR FREE PLAN!

### Presdwood work bench and Peg-Board tool rack

New, easy-to-follow plans show how to build this sturdy Masonite Presdwood® work bench...how to hang this handy tool rack made of Masonite Peg-Board\* paneling.

With smooth, sturdy Tempered Presdwood for work surfaces, you don't have to worry about splinters or slivers. This dense, knotless and grainless material will withstand a tremendous amount of bumps, dents, scrapes, yet won't harm work. Lasts for years.

Famous Peg-Board panel is readily fastened to any wall. Wide choice of hangers keeps tools within easy reach.

Send the coupon today. And see your lumber and building materials dealer for the many types and thicknesses of Presdwood.

Choose this Man—He  makes the difference  
**MASONITE PRESWOOD**  
 PANEL PRODUCT OF MASONITE® CORPORATION

MASONITE CORPORATION  
 Dept. PM-7, Box 777, Chicago 90, Ill.

Please send me your free plan, No. AE-312, and Masonite Presdwood "Idea Book."

Name.....

Address.....

Town.....Zone.....

County.....State.....

\*T.M. REG. U.S. PAT. OFF., B. B. BUTLER MFG. CO., INC.

## MAGNETS 225# PULL

GENUINE ALNICO—NEVER WEAKENS

AMAZING, PERMANENT MAGNETS—WILL NOT WEAKEN! NON-ELECTRIC. Retrieve guns, tackle, tools and other steel items from lake, river, plating tanks, drains or other hard-to-reach spots. Recover drills, taps, etc. from sweepings. Clear alley of harmful tacks, nails. Many other uses. Pays for itself quickly. GUARANTEED. Try any magnet one week. Money refunded if you are not well pleased.

No. M-725 (Weights 54 oz.) Has pull of 225 lbs. on steel block. \$15.00  
 No. M-825 (Weights 70 oz.) Has pull of 125 lbs. on steel block. \$ 8.50  
 No. M-575 (Weights 18 oz.) Has pull of 75 lbs. on steel block. \$ 6.00  
 No. M-500 (Weights 13 oz.) Has pull of 50 lbs. on steel block. \$ 4.00  
 No. M-101 U-shaped Magnet (Wt. 2 1/4 oz.) Pull of 6 1/2 lbs. 2 for \$ 1.50  
 No. M-291 Pocket Magnet (Wt. 1 1/2 oz.) Pull of 4 lbs. 2 for \$ 1.15  
 No. M-35 Hobbyist assortment of eight small magnets. . . . \$ 1.50  
 No. M-48 Powerful Hot Pad Magnets. 8 for \$1.00. 30 for \$ 3.00

Send Money Order or Check. We pay postage. No C.O.D.'s.  
 MIAMI MAGNET COMPANY, 3240 N. W. 27th Ave., Miami 42, Fla.

**BUILD FINE GRANDFATHER CLOCK NOW**  
 The simple sensible Red-i-Kut way as thousands have—  
 SAVE HALF. SHOP TESTED PLANS "SPIRIT OF THE CENTURY" Narrow waist 20" tall or stately straight side "SPIRIT OF AMERICA." EASY-TO-FOLLOW step-by-step PLANS tell all—plus BROCHURE of heavy brass weight Westminster, tube chime, movements, gorgeous dials, 2 1/2" solid mahogany case kits. Send \$1.00 today — Both plans \$1.50 NOW.  
 KUEMPEL CHIME CLOCK CO., #7 Kuempel Bldg., Minneapolis 16, Minn.



Mechanics call them "America's finest."

Sockets and attachments  
 Open end and box wrenches  
 Combination wrenches  
 Complete tool sets

BONNEY FORGE & TOOL WORKS • ALLENTOWN, PA.

It's the BOUNCE THAT COUNTS!

**Lumiclad**  
 ROOF COATING

The amazing insulation quality of Lumiclad provides low-cost temperature control. Keeps buildings cooler in summer; Warmer in winter. Apply Lumiclad yourself...goes on quickly, easily.

WRITE FOR FREE TEST KIT!  
 Dept. 75J

Abesto MANUFACTURING CORP.  
 MICHIGAN CITY, INDIANA

had trouble with the engine, the valve system was the most frequently mentioned troublemaker. After this come the carburetor, then the ignition system and oil leaks and finally oil consumption.

"I threw a valve. Factory failed to put two valve keepers on No. 2 intake."—California traffic manager.

"Have changed to smaller jets in carburetor. From No. 59 to No. 51."—Kansas clerk.

"Carburetor leaks."—North Carolina hosiery worker.

"Tappets keep working loose or tight. Had to have new exhaust-heat riser."—Oregon truck driver.

"New rings installed at 1400 miles. Still uses oil."—Kentucky federal officer.

### Changes They Would Like

Here are some miscellaneous quotations by owners describing the one change they would like to have made in their Ford:

"Put starter switch on the right of the steering post."—Maine truck driver.

"Take off the Fairlane streak."—An owner who prefers to remain anonymous.

"Have all dull finish in front of the driver. Too much chrome to reflect in his eyes."—Washington, D.C., retired owner.

"Be able to open trunk without using the key."—Utah civil engineer.

"Put glove compartment in middle of dash."—Colorado clerk.

"Improve front seat. It squeaks every time someone moves on it."—Oregon machine operator.

"Have ventilators in rear door open."—Georgia district manager.

Well, there you have it, the good and the bad of the 1955 Ford V8. For a detailed listing of percentages in these and other categories, turn to the percentage table on page 89. ★ ★ ★

Turn back to page 86 to begin Floyd Clymer's report on his road test of the 1955 Ford V8.

### Clymer Tests the Ford V8

(Continued from page 87)

Ford's spark plugs this year have no gasket. A gas-tight seal is accomplished by a taper just above the threads, which insures better heat dissipation than plugs using gaskets. Servicing is inconvenient as the spark plugs must be removed from the underside of the engine, as must the oil filter. Extra-long dipsticks for checking crankcase or Fordomatic oil levels are easy to reach and read.

The test car's speedometer on long, open stretches would show 112 miles per hour.

(Continued to page 236)

## GIVE YOUR CAR THE SAME MIRACLE POWER TUNE-UP AUTO ENGINEERS DO!

Modern engines need more lubrication than even premium oils can give. Auto engineers themselves tune up their engines with Miracle Power.

Even new cars can develop sticky valves, noisy hydraulic valve lifters, and sluggishness. That's because engines get as hot as 1400°F, oils burn at about 550°F, and oil can't lubricate after it's burned.

But Miracle Power *always* provides lubrication. You pour it in your gas and oil, and the colloidal synthetic graphite it contains is carried to every part of your engine. The graphite forms a breath-like protective lubricating film on all metal surfaces. The film impregnates metal as butter does bread. It won't burn or drain off, and it doesn't build up on itself. It protects even in those vital five minutes after

you start your car... when oil is still being pumped from your crankcase.

### Here's how you can use Miracle Power



Ford dealers' package

Prove Miracle Power for yourself. Add an 85c-can to your oil and gas every 1000 miles; use the 39c-size in gas between treatments. Your valve troubles will disappear, you'll burn less oil, your car will start like a breeze even on cold mornings, and your engine will deliver everything it's got. Follow the lead of auto engineers. Get Miracle Power at car dealers, garages, service stations. Miracle Power is available at Ford, Studebaker,

800 to 1400

300 to 550

300 to 550

300 to 800

Oil burns at 550°F, but engine heat rises to 1400°F. You need more than oil to lubricate your engine. You need Miracle Power—which always lubricates and won't burn away!

International Harvester, Kaiser, Willys dealers in their own Miracle Power containers. It treats the engine, not the oil.



Miracle Power Division  
**THE AP PARTS CORPORATION**  
E-7 AP Building Toledo 1, Ohio  
Mufflers • Pipes • Miracle Power • dgf 123

POPULAR MECHANICS

**MODERN****LAWN MOWER SHARPENER****COMPARE  
BEFORE YOU BUY**

Write for  
free  
booklet  
10E

Start your own  
business—increase  
your income

Sharpens any mower in  
ten to twenty minutes.  
Handles complete assem-  
bly of all reel types in-  
cluding 36 in. power  
mowers. Handle, wheels,  
roller, and engine are  
not removed.

Oil remains in engine  
while sharpening. Bed  
knife sharpened in same  
centers — no attachments  
needed.

**\$263.00****MODERN MFG. CO.**

F.O.B. PASADENA

160 N. FAIR OAKS, PASADENA, CALIF.

### POWER TOOL PROJECTS YOU CAN MAKE

This book shows you how to turn out professional-quality built-ins, furniture and toys. 30 easy-to-build projects. Drawings and step-by-step photos by the hundreds. Shop hints and short cuts. At most newsstands (Fawcett How-To Book 251) or at your SHOPSMITH dealer's! Get your copy today!

**THE BEST  
IN PLIERS?****CHAN NEL LOCK**

CHAMPION DeARMENT TOOL CO., MEADVILLE, PA.

*Air Condition* **YOUR ENTIRE HOME****FOR THE COST of a SINGLE WINDOW UNIT**

If you have your own well or cold city water  
WRITE FOR **FREE** ILLUSTRATED LITERATURE

**HASTINGS AIR CONTROL, INC.** DEPT. P-7  
OMAHA 5, NEBR.

**WONDER DRILL****SAW BIT****DRILLS and SAWS****DRILLS OWN STARTING HOLE**

Combination bit for electric drills. Use as a drill, saw or reamer. Use for circles, ovals, squares, inside, hard-to-reach work. Works equally well in metal, pipe, wood, plastic, etc. Easy to use. Every carpenter, mechanic, electrician, plumber, hobbyist needs one. Made of abrasive resistant, hi-speed steel. Stands severe, continuous use without breaking. Resharpens free. Use with electric drill, slow drill press, lathe or milling machine. 1" diameter, 2" cutting section, total length 3 1/2". 3 types—wood, metal or all purpose. Set of 3, \$5.75. Details on request. Dealer inquiries invited. Money Back Guarantee. Shipped same day. Send check or money order to

**WONDER DRILL COMPANY**

Box 8321, Dept. PM 5

Kansas City 5, Mo.

**NOW**  
**only**  
**\$1.95**

## How to choose a paintbrush that does faster, streak-free work



Here's why it pays you to use a brush  
with Du Pont **TYNEX** nylon bristles



**1. No break-in!** You don't have to soak or flex a new brush . . . if it has "Tynex" nylon bristles.



**2. Full paint pickup!** Specially tipped and flagged "Tynex" bristles hold a full load of paint.



**3. Smooth, even flow!** Anyone can do streak-free work, because each tapered "Tynex" bristle provides better, more even flow.



**4. Easier to clean!** They're the easiest-to-clean bristles there are! Paint loosens quickly in any commercial cleaner, rinses out thoroughly.

**FREE!** 8-page booklet full of helpful painting tips. Write Du Pont Company, Polychemicals Dept. PM-7, Wilmington 98, Del.

**DU PONT**  
POLYMER DIV.

"Tynex" is the registered trade-mark for Du Pont nylon bristles.

BETTER THINGS FOR BETTER LIVING . . . THROUGH CHEMISTRY

Even though the speedometer is fast by about 7 percent, this model is definitely a sensational performer that handles and performs like a car in the high-price range. It really "scats" away from traffic signals and up hills.

Roadability and handling are better than any other Ford I have ever driven and compare favorably with any car I have tested, regardless of price.

The ball-joint front suspension, coupled with the tilted front springs, is a revelation. It makes for easier steering and, even over the hardest bumps at high speeds, there was very little bounce. The shock absorbers do an excellent job of controlling the rebound. Suspension design is good. There is very little "roll" on the corners and the stability of the car under almost any road condition is excellent. I ran into some snow with icy roads over LaVeta Pass (altitude 9382 feet) in the Colorado Rockies and even there I had a feeling of safety in driving this new Ford.

The brake drums are 11 inches in diameter this year (as against 10 in 1954) and have 192 square inches of braking surface. I experienced very little fading, even on winding mountain curves or when slowing down from high speeds. The suspended brake pedal operates with little pressure, even without a power assist. The left-hand-

operated parking brake is effective and easily applied or released.

The gasoline economy is average. With the 8.5:1-compression-ratio engine I found premium gasoline to be most desirable.

The Fordomatic transmission is smooth in operation and with careful use of the throttle upshifting is hardly noticeable. With wide-open throttle, high gear engages at about 56 miles per hour. Depressing the throttle causes instant downshift below 56 miles per hour, but above this speed no downshift is possible, except by pulling the shift lever into Low. Low can be engaged at high speeds, which gives the effect of a dual-range transmission. Low gear is excellent for emergency braking.

The hood is wide, long and high, giving the impression of a very large car. Bumpers are large and afford good protection.

The instruments are well located. I can't go for the left-hand-controlled ignition-key starter. Most people are right-handed, but perhaps the styling engineer is a "south-paw" and likes it that way—I don't.

The heating and ventilating system is very efficient, simple to operate and the levers are well located in a compact unit within easy reach of the driver's right hand.

Speedometer location is excellent and its

(Continued to page 238)

**BURGESS**  
*flashlight*  
**BATTERIES**

A QUALITY DRY BATTERY FOR EVERY PURPOSE

SEALING IN STEEL AND PLASTIC

ASK FOR THEM AT YOUR FAVORITE STORE

"BURGESS BATTERIES SHO' RUIN'D DE' SPOOKIN' BIZ'NESS"!!!

The advertisement features a large illustration of a Burgess flashlight battery in the foreground. The battery is cylindrical with a black and white striped pattern and the word 'BURGESS' printed vertically. Above the battery, the text 'BURGESS flashlight BATTERIES' is written in a stylized font. To the left of the battery, a speech bubble contains the text 'A QUALITY DRY BATTERY FOR EVERY PURPOSE'. Below the battery, the text 'SEALING IN STEEL AND PLASTIC' is written. To the right of the battery, a cartoon scene depicts a boy in a hat and boots fishing with a flashlight. A bear is visible in the background, and a signpost reads 'ASK FOR THEM AT YOUR FAVORITE STORE'. At the bottom of the scene, a speech bubble from the bear says 'BURGESS BATTERIES SHO' RUIN'D DE' SPOOKIN' BIZ'NESS'!!!'. The background shows a forest with trees and a crescent moon in the sky.

# Popular Mechanics Precut House

Build a Livable Shell from a Precut Kit for Only \$1800

Build a Summer Home With All Conveniences for Only \$2800

Build a Luxury Home for Year 'Round Living for Only \$3800



Designed  
by  
Wilson  
and Christie,  
Architects,  
Towson, Md.

## Build This House Yourself!

Save 65% Easily!

New Popular Mechanics Book and Plans—New Precut Materials Kit—Packaged Plumbing, Heating, Chimney, Etc.—Make Amateur Carpenter's Job Easy

Here is the newest Popular Mechanics "Build-It-Yourself" house. You can build it in three stages, with or without an available kit of materials pre-cut to actual size and shape, for the amazing low price of only \$1800. The first stage will give you the start of a grand home that you can live in while you progress with building. The second stage will give you a fine summer home, with all wanted conveniences, for a total of only \$2800 for both stages. When you add the third stage you have a real luxury home for year 'round living in any climate for only \$3800 total cost. Richard Dempewolf, author of the "Precut House" book and a Popular Mechanics editor built the test house pictured above for even less. Today, the appraised value, including the land is \$12,000.00.

Simplified How-To-Do-It Instructions—Hundreds of Pictures—Working Blueprint Plans!

You can build the house with the book alone. The plans make it easier. The book gives lists of materials required, all measurements and dimensions, suggestions for financing, and tells in words and shows in pictures every detail of construction. Like thousands of others who have built their homes themselves, you can do it too and save up to 70% of the cost. The dream home that seemed impossible is here. This fabulous, economical house, designed by famous architects, especially for amateur builders, is your answer to the home you always wanted.

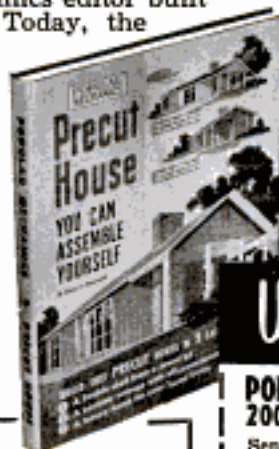

Build It to Your Own Plan in The Same Shell—2 Bedrooms or 3 With or Without Fireplace—Install Windows Where You Want Them!

Overall size 24 x 46 feet. Note the two typical floor plans shown. Above: Two bedrooms, bath, kitchen, dining room, living room, car port or porch. Below: Three bedrooms, bath, utility room, kitchen, dining area, living room, porch. The "Precut House" book shows many other variations.

### Features of Expensive Homes

The unusual features of the Precut House are: adaptability to various interior arrangements; use of materials designed especially for amateur builders; easy construction; unusual amount of closet and storage space; built-in furniture; house that is suitable for city, country and resort; low maintenance cost; complete insulation. All this at a cost so low no other house of similar size can compare with it.

### Money Back Offer

The coupon will bring you the "Precut House" book and plans. Mail it Today. If you do not like what you get or decide not to build this fine house, return either or both within 10 days for full refund of purchase price. Mail coupon today.

### Building the Test House

The test house pictured above was built in eastern Pennsylvania by the author and his wife, neither of whom had any previous building experience. It is a year 'round home, insulated, modern heating and plumbing, fireplace, redwood interior finish, dozens of built-in features and floor-to-ceiling, 9-foot wide picture window. Total man hours required to build—1650. Total cost not including ground and inexpensive foundation—\$3731.23

Use This Coupon To Get Book and Plans

POPULAR MECHANICS PRESS, DEPT. PCH  
200 E. ONTARIO ST., CHICAGO 11

Send at once:

- Popular Mechanics Precut House book \$2.50
- Complete set of ten blueprints \$12.50
- Sets duplicate blueprints @ \$5.00 per set
- I enclose remittance for \$\_\_\_\_\_ Send postpaid.
- Send COD, I will pay postman plus charges. I understand I may return either book or plans, or both, within 10 days if not satisfactory and you will refund full purchase price.

Name \_\_\_\_\_

Address \_\_\_\_\_

City \_\_\_\_\_ State \_\_\_\_\_

# INSTALL YOUR OWN 1200-SQ. FT. **RAIN JET**<sup>®</sup> Sprinkler System

## SPRINKLER SYSTEM IN A FEW HOURS

KIT FOR 50' x 24'  
LAWN... \$29<sup>95</sup>  
only



**2 RAIN JETS  
EQUAL TO 10  
SPRINKLERS**

Install a complete underground system for less than the ordinary cost of pipe and fittings alone. Kit contains 2 Rain Jet heads, 60' flexible polyethylene tubing, gate valve and metal fittings, wrench, instructions. No cementing, no clamps, no threading—uses patented slip-on couplers. Great for slopes, hill-sides, old lawns, newly seeded areas. So fast and easy you can make system-installing a profitable part-time business!

**RAIN JET HEAD** available separately only **3<sup>95</sup> ea.**

Rotating, pop-up stem shown in operating position. Mounts flush with lawn.

Uniformly covers area 34-ft. in diameter. Rain-size drops and low angle of discharge give deep penetration. No puddling or runoff. No water-wasting mist. Top performance even at low pressures (3-30 lbs.). Solid brass... made to last. Fits 1/2" metal, plastic or rubber pipe.

**FOR LARGER LAWNS!** Order extra 1-Head Kit for each added 24' x 24' area. **\$15.95**

**IDEAL FOR TRIAL!** Order portable Stand for hose use. **\$6.95**



**10 DAY MONEY  
BACK GUARANTEE**

**SEND  
PLOT-PLAN with  
ORDER**

Sketch lawn plot showing  
ingress and obstacles.  
Give water line size  
and pressure. We'll  
show best layout.  
See your dealer, or  
enclose payment. We  
pay freight (add  
C.O.D.)

**RAIN JET CORP.** 3087 N. California St.  
Burbank, California 91503

transparent hood makes for easier daylight reading. The dial is directly in front of the driver and vision is perfect because there is no upper half of the horn ring to interfere. Fuel and temperature gauges use needle indicators, but red warning lights for oil and generator signals leave me cold. I like to see those indicator needles move. The directional-signal indicating lights are located on each side at the bottom of the speedometer panel. These flashing lights are brilliant, certainly no driver can fail to heed their warning.

The Fordomatic lever operation is simple, easy to shift, plainly marked and illuminated for night driving. The quadrant is now enclosed in a panel mounted on the dash. It is easily visible, but I'd prefer it located near the top of the steering column, which requires less movement of the eyes to determine location.

The body has a solid feeling when the doors are closed and there is but little body rumble at high road speeds. Factory assembly and inspection seem to be better than in past years. During heavy rain a little water seeped in, but there was no evidence of dust coming in during the tests. The arm-rests, door handles and window cranks are well located, but the cranks could turn more easily. Seat springs and upholstery are of top quality. Seating position and leg-room are both excellent.

The interior finish and appointments are certainly the finest ever offered by Ford and are the equal of or better than some medium-priced cars.

The wrap-around windshield affords excellent front vision, and the wide rear window gives plenty of rear vision.

One feature I like about the Ford front doors is that locking positions hold them stationary in half or full-open positions. There is an exceptional amount of trunk space. The lid doesn't open as wide as on some other makes.

I also tested the Fordor Town Sedan. The handling qualities and general characteristics are the same as the more powerful Fairlane model, but I found that top speed is about 6 miles per hour less. However, mileage was approximately 1 1/2 miles per gallon better with the less-powerful unit—which has 162 horsepower, a two-barrel carburetor, single muffler and the standard head. The Ford Fairlane models develop 182 horsepower. ★ ★ ★

## Compare Your Ceiling with Your Floor

With parquetry, rugs, tile—the floor is part of your decorative scheme. The ceiling was once decorative, too. Then, the old materials became too expensive.

Today we have new materials—easy to handle—and the ceiling comes back into its own. An attractively paneled ceiling is something you can build for yourself—in a new home or right over the old plaster.

Take advantage of Homasote's Big Sheets—up to 8' x 14'—with their great strength, their insulation and sound-deadening properties. Homasote saws, nails, works easier than wood. Cut the Homasote to your own design. Have a recessed center panel; bevel the edges; cover the joints with molding.

Three well-illustrated folders with 18 valuable make-it-at-home ideas are yours for only 10¢—ideas for furniture, attics, basements, pools, etc. Mail the coupon today.

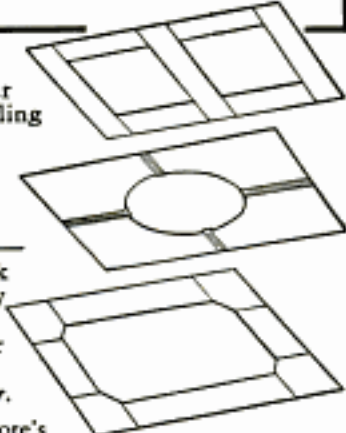

### MAKE IT AT HOME—WITH HOMASOTE

**HOMASOTE COMPANY**  
Department G-2, Trenton 3, N. J.

I enclose 10¢ for 3 Make-It-At-Home Folders.

NAME.....  
ADDRESS.....  
CITY.....ZONE.....STATE.....  
My lumber dealer is:.....

Sources of available products described in this issue are listed on pages 12, 14 and 16. Sources of further information on other articles are listed in our free WHERE-TO-FIND-IT LIST. For your copy just write to the Bureau of Information, Popular Mechanics, 200 East Ontario Street, Chicago 11





## Cuts Cement Finishing Time in Half!

### PONY TROWEL

Finishes complete to wall. One-man operation. Blades self-adjusting. Sturdily built. Quick, easy to assemble. Successfully used nationwide with 1/2" or 5/8" drills. Handle and trowel complete less drill **\$49.50**

f. o. b. Muncie, Ind.  
Extra blades only \$3.50  
See Your Dealer or Order Direct  
**ELMO MFG. CO.**  
Dept. C, 324 W. Howard St.  
Parker, Indiana (Pat. Pend.)

## SHEET METAL BRAKES

Forms angles, locks, pans, etc. New eccentric clamps. All steel construction. Size 15"—16 gauge steel, \$21.50; 36"—22 ga., \$33.00; 48"—24 ga. \$48.00. Floor Stand, \$7.00.



**FOOT POWER PRESS BRAKE.** Open ends, any length, 12" from edge, \$42.00  
**SHEARS**—7"—16 ga. Angle stop gauges, \$16.50, 36"—24 ga. floor shear, \$36.00  
**FOLDERS**—15"—1/2" to 1", 24 ga., \$16.50, 36"—28 ga., \$36.00  
**IRON BENDER.** Forms braces, eyelets, angles up to 1/2" x 3". \$9.50  
ORDER DIRECT OR SEND FOR CATALOG  
**VYKE MFG. CO., 2435 15th St., Denver 2, Colo.**



You go finer when you go **FORD!**

## 18 OUTDOOR FURNITURE PROJECTS

Clearly illustrated plans by outstanding designers. Step-by-step plans make it easy to build practical, attractive porch and lawn furniture at low cost. See your dealer or order direct. **ONLY 50c** (65c outside U.S.A.)

**ATLAS PRESS COMPANY**  
724 N. Pitcher St., Kalamazoo, Mich.

## EARN GOOD MONEY IN SPARE OR FULL TIME.

With a **Universal Lawn Mower Grinder** Have a business of your own in your garage or basement, sharpening lawn mowers. Be your own boss. Small investment. We furnish everything you need to start. Write **FREE** Dept. M-75 today for complete details

**ROGERS MANUFACTURING CO.**  
LINDSEY, OHIO

## NOW YOU CAN BUY A PROFESSIONAL TYPE GEIGER COUNTER

with transistor-amplified, loud speaker

Not a toy—not a gadget. Vic-Tic is a full size professional Geiger Counter with a transistor-amplified, loud speaker, adjustable in tone pitch. The ideal instrument for uranium exploration. Weighs only 3 pounds and has 4 sensitivity ranges: 1000, 10,000 and 100,000 c/p.m. plus extra sensitive background range. Furnished with an aluminum-wall, counter tube, batteries, shoulder-strap, instruction manual

Write for Bulletin VT-27.  
and Radio Active Sample, complete for \$225.00. Additional accessories available include **SIX PACK** of high sensitivity Blomath Geiger Tubes (15 times more sensitive than standard tube), hand probe, and deep-hole probe can readily be plugged into built-in jack. Vic-Tic was designed by the same staff of engineers who developed the first instrumentation for Atomic Science. Fully Guaranteed. Order now for immediate shipment.

**VICTOREEN INSTRUMENT CO. 8806 HOUGH AVENUE CLEVELAND 3, OHIO**

## WAR SURPLUS AND OTHER BARGAINS SAVE UP TO 90%

### SENSATIONAL GENERATOR BUY!!

**Famous Navy NEA-5 Generator.** Combination AC-DC Type. AC voltage—115 V. DC voltage—24 V. 200 Amp. 2 complete generators in 1... 2 separate fields and 2 separate armatures on same shaft yet no larger than regular aircraft generator. Ideal for home, farm and shop lighting plants by hooking wires to AC side. DC side can be used for welding and operating various low voltage hobby motors and equipment. Weight 54 lbs. NEW. Approx. GOVT. COST \$350. NEW \$27.50 used perfect \$18.00

### SPECIAL CARBON PILE TYPE VOLTAGE REGULATOR

to go with above generator. Incl. mounting base and completely enclosed in steel mesh box. Helms maintain constant current and prevents nuisance. Ideal for installation with above generator for lighting plant. Wt. 5 lbs. Complete NEW. Approx. GOVT. COST \$90. Now only \$7.95

BUY 'EM BOTH - SAVE \$5.45! Generator & Regulator together \$30

### P1 GENERATORS

Electric Auto-Lite, 200 Amps, 24 Volt, 4400 RPM. Dandy arc welder. Wt. 53 lbs. Approx. GOVT cost \$450. Like NEW. \$12.50 incl. easy diagram.

### CAMPER'S STOVE

Terrific for hunters, ranch, home, farm, civilian defense, boat, camp, trailer, barbecue, etc. Burns any type gasoline. Burner 10 3/4" dia. Unit approx. 23" x 21" x 10". Has 2 tanks (2 1/4" x 5 3/4") with welded seams, 3 brass valves, 3 air filters, air gauge to 80 lbs. Can use as air tank for compressor or fill with liquid for spraying. NEW Korean war surplus. Wt. 95 lbs., boxed. Approx. GOVT cost \$150. Complete with 2 spare energizers and orifice cleaner (compare this price) — \$10.50

### NEW PUMP AND MOTOR

Pump has 1" connections, built-in relief valve, adjustable up to 1500 lbs. Max capacity 6 GPM, 1 1/2 H.P., 24-volt motor, 4000 RPM. Can be used on 12 or 36 volts. Govt. cost approx. \$350 — our price — NEW — \$9.95.

### SENSITIVE ALTIMETER

in 10 Ft. increments. Famous Pioneer! 0 to 35,000 ft. (inches of Mercury). Tested and inspected in our own instrument lab. Guaranteed perfect. Approx. Govt. Cost \$150. NOW ONLY \$13.95 Ppd. U.S.A.

### MICROMETER DEPTH GAUGE

With 3 rods to measure all depths from 0 to .3 inches by thousandths. Hardened tool steel lead screw has full 1 inch run. Base is 2 1/4" long, hardened ground and hand lapped. Accuracy guaranteed. Mfd. by Millers Falls Co. GOVT COST approx. \$30. NEW—\$10.95 ppd. USA. In velvet case.

### MICROMETERS

Chrome plated, precision engineered, carefully tooling to give long life. All new 0-1" cap. \$2.25 ea., 1-2" cap. \$3.50.

### NEW 1955 CATALOG

Biggest ever... new low prices... Send 25c for your copy today. Prices F.O.B. Culver City unless otherwise stated. Check, money order or cash. 25c deposit for C.O.D.

**AIRBORNE SALES CO., INC. DEPT. PM 755**  
8501 Stellar Drive, Culver City, Calif.

### STARRETT "Tools and Rules" BOOK

Describes and illustrates the precision methods skilled mechanics use. Only one dime. Write Dept. AP.  
The L. S. STARRETT CO., Athol, Mass., U. S. A.

## SPORTSMAN'S REPAIR TIP No. 4

### SEAL PUNCTURES or tears in plastic or rubber waders quickly with tough, waterproof "SCOTCH" 33 Plastic Tape.

Stretchy tape sticks tight, resists sunlight, oil, abrasions. Get "SCOTCH" 33 Plastic Tape for hundreds of handy uses at home and outdoors—39¢ and 79¢ at your favorite store. Minnesota Mining and Mfg. Co., St. Paul 6, Minn.

## Building this table's a picnic . . .



Full-Size EASI-BILD\* Pattern # 323. Only 35¢. Just trace, saw, assemble. Send 35¢ in cash or stamps to Elmer's Pattern Dept., PM-75, P.O. Box 215, Pleasantville, N. Y.



. . . with

## ELMER'S WATERPROOF GLUE

There's still lots of time to enjoy this easy-to-build picnic table this summer. Just be sure to make it strong with ELMER'S WATERPROOF GLUE, the first completely waterproof cold-setting wood glue. Elmer's is resistant to alkali, acids, fungus and rot—makes a strong durable bond. Used by boat-building experts . . . ideal for any outdoor project. Get ELMER'S WATERPROOF GLUE today. Product of The Borden Company, Chemical Division, Dept. PM-75, 350 Madison Ave., New York 17, N. Y.



Available at better hardware, lumber, and marine supply dealers.

## TURN YOUR SPARE TIME INTO \$5 an HOUR EXTRA CASH

Earn Big Money in Your Own Home with the BELSAW SHARP SMITH



Thousands of Belsaw users have proved that sharpening circular saws, grinding planer and jointer knives is profitable. Many have given up regular jobs to devote their entire time to their own money-making business.

The initial investment is only \$15 down payment. The space required is small . . . 15 square feet in your home or garage.

No experience is necessary. A beginner can produce expert work the day his Belsaw arrives.

The demand is in your own neighborhood . . . constantly expanding. More and more circular saws are used by professionals, carpenters, contractors . . . plus the thousands with basement workshops. All these circular saws need dependable sharpening . . . the kind you can give them with a Belsaw.

You do the jobs in your own home in your own spare time. No punching the time clock. If you want to take the day off to go fishing, it's yours for the taking. Every man has dreamed of being his own boss. With your Belsaw you can make it possible.

Write today for actual experiences of Belsaw owners . . . and Free Book, "Lifetime Security with Your Own Business."

FREE Book



**BELSAW MACHINERY CO**

3707 Field Bldg., 315 Westport Rd., Kansas City 11, Mo.

## A Pool for Your Back Yard

(Continued from page 81)

The new one, however, is 22 feet in diameter, 3 feet deep and will hold the entire family and a few neighbors. It comes in a small cardboard box with all the necessary parts.

Bulkier and heavier by many tons, but designed to last indefinitely, are the precast slabs of concrete that make up Jack Robineau's Amcrete pools in Briarcliff, N. Y. These massive prefab walls are as



Water pressure of garden hose operates vacuum cleaner for pool. Suction behind nozzle draws refuse

solid and smooth as buffed granite. "We make them to order for any given pool dimensions," explains Robineau. "In giant flat-bed forms at Marietta Company plants, the wet mix is juggled until nearly all the air is out—producing a remarkably dense concrete slab five inches thick. It is then hand-troweled to a high finish that resists chipping, honeycombing and pitting in the roughest climate." Hauled to location on trucks, the 20-foot sections are slid by crane into slots in the previously poured floor of the pool. Sections are joined and bolted firmly to precast concrete buttresses. The result is a pool that is cheaper than concrete poured conventionally, but so solidly constructed that if lifted from the ground it would stand by itself.

If you don't like plastic or concrete, how about metal? The Chester Products Company in Hamilton, Ohio, will be glad to

(Continued to page 242)

## FIRM FOUNDATION for HOME-MADE TRAILERS

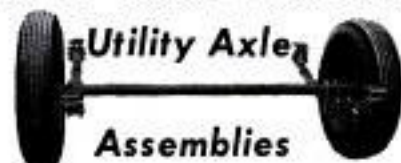

Model 1-UCO, shown, features 1 1/4" solid steel axle, loads 2500 lbs. Comes completely equipped, except for tires. \$65.29 postpaid (when paid in advance). Many other models. We manufacture a complete line of trailer axles, couplers and jacks . . . tell us what you need!

**HAMMER BLOW TOOL CO.**  
WAUSAU 13-G, WISCONSIN

SAVE TIME - SAVE MONEY  
HAVE MORE FUN TRAVELING

## DINSMORE AUTO COMPASS

Travelite \$5.49  
Illuminated \$6.49  
Goldway \$4.49



Your best friend in strange places. Shows you the right way—the short cuts. Compact—attractive. Fits all cars. Send for FREE folder "Pants Knives and Compasses".

Dinsmore Instrument Co.  
1802-33 Kelsey St., Flint 1, Mich.

## FREE! SOUTH BEND CATALOGS

- 9" to 16" SWING LATHES
- 14" DRILL PRESSES
- 7" BENCH SHAPER
- ATTACHMENTS

Write today—check catalog wanted



**SOUTH BEND LATHE WORKS**  
425 E. Madison St., South Bend 22, Ind.

## BRONZE FOUNDRY Schools and Home Workshops

Make your own castings of aluminum, copper, bronze, silver. Foundry sets are available in three sizes including 2400 Deg. F. blast furnaces. See advertisements in March or Apr. Issues, free Circular.

**KANSAS CITY SPECIALTIES CO.**  
P.O. Box 6022 Dept. P-7 Marysville, Kan.

## AGENTS — SELL

Buy tools, photo equipment, sporting goods, jewelry and thousand other nationally advertised products at big discounts. Big profits selling to others. Postcard brings free plan.

**AMERICAN BUYERS SERVICE** HERTEL STATION, DEPT. 15  
BUFFALO 16, NEW YORK



## FREE CATALOG BUY DIRECT—SAVE UP TO 2/3

**NEW CHRYSLER BOAT KITS**



**FACTORY TO YOU!**  
No Dealers! You SAVE the BIG PROFIT!

12 MODELS—8 to 14 ft. —\$39 up  
Finest quality Boat Kits at the lowest prices in history! Mahogany decks. Easy to build. Also: FIBERGLAS—ACCESSORIES—TRAILERS

CHRYSLER-CRAFT (DEPT. 20) TONAWANDA, N.Y.

# \$35,000 REWARD FOR URANIUM



Here's your chance to "cash in!" Over \$3,750,000 in Government Bonuses have been paid for URANIUM discoveries in the past 2 years. Currently \$175,000 a month is paid to people like you.

Precision Geiger Counters and Scintillators are the finest instruments made for URANIUM prospecting. These highly sensitive instruments are compact, lightweight and ruggedly built for field use. Prices start at \$29.95.

### CONTACT YOUR NEAREST DEALER

or write direct to factory for FREE 12-PAGE CATALOG and our 24-PAGE BOOKLET with "64 QUESTIONS AND ANSWERS ON GEIGER COUNTERS AND SCINTILLATORS."



PROSPECTORS RELY ON . . .



### MAIL TODAY FOR FREE INFORMATION

Name \_\_\_\_\_ Title \_\_\_\_\_  
Company \_\_\_\_\_  
Address \_\_\_\_\_ City \_\_\_\_\_ State \_\_\_\_\_

**PRECISION RADIATION INSTRUMENTS, INC.**  
4223 PMW. Jefferson Blvd., Los Angeles 16, Calif.  
World's Largest Manufacturer of Radiation Instruments



## REMOVE PAINT varnish, enamel, EASILY

Just spread Wonder-Paste over the surface with a paint brush. Softens finish so you can remove it easily—not coat by coat, but all in one scraping. Will not run on upright surfaces. At paint and hardware stores.

Write for leaflet—and advice on your removing problem.

Wilson-Imperial Co., 119 Chestnut St., Newark 5, N. J.

**WONDER-PASTE 5 MILLION CANS SOLD**

**Amazing  
CAR POLISH  
Discovery!**  
*FAST as a car wash!*



Now! MAC'S new Resin Coat. A long-lasting polish that's quick and easy to apply. Fast-acting Solvent Action does it...loosens surface film harmlessly while special resins produce a hard, high gloss that lasts up to 6 months. Just rub on, wipe off. Do a perfect job in minutes—not hours. Nothing like it.

**"DON'T WAX IT—MAC'S-IT!"**  
...with MAC'S RESIN COAT!

AT  
YOUR  
SERVICE  
STATION

**MAC'S SUPER GLOSS CO., INC.**  
Los Angeles 42, California

**FREE PLAN**  
tells how to start your own business  
**FILING SAWS**

Here is a steady repeat CASH business you can start in your own basement or garage in your spare time and make up to \$3 or \$5 an hour. You can file hand, band and cross-cut circular saws on the Foley Saw Filer. No eyestrain—no experience needed. "The first



saw I sharpened with my Foley Filer came out 100%"—writes Clarence E. Parsons.

Every saw you sharpen with the Foley Saw Filer brings you more customers. "I rented a two-car garage and have all the work I can do"—Charles H. Smith.

**FREE BOOK**  
Shows How To Start  
Send coupon today.  
No salesman will call.

**SEND COUPON FOR FREE BOOK**

FOLEY MFG. CO., 716-S Foley Bldg.  
Minneapolis 18, Minn.

Send me free book "Money Making Facts"

Name \_\_\_\_\_

Address \_\_\_\_\_



send out a truck loaded with one of their brand-new aluminum pools prefabricated in one piece. A crane on the truck hefts its burden into the prepared hole in your back yard, and in three days the finish-welded pool is ready for water.

So far this manmade pond comes only in rectangular shapes. If you'd prefer a metal pool with curves, there are new steel pools designed to ramble all over your lot. Off the drawing boards of Koven Pools in Jersey City have come a wide assortment of curving steel sections, ready to weld on any pool site. Kidneys, pears, acorns, eggs, ovals, free forms and wiggly curlicues that encompass "satellite" wading pools off the big main pool are all possible. The curved steel sections, in various combinations, will make up a pool in almost any form the human mind can conjure. U. S. Steel's American Bridge division also has announced a family-size prefab steel pool this year.

The new "wonder pools" are a far cry from those of a few years ago, when a private pool was something you saw only in pictures of movie stars' homes. It was right after World War II that two revolutionary methods of applying concrete suddenly put the average American "in the swim." Gunite and hard pack eliminated expensive forms and cut building time from weeks to days. What's more, using either system a man could design his pool in any conceivable shape at no extra cost.

How do they work? In both systems the hole itself is the form against which the concrete is applied. Roughly dug by skip loader or clam bucket, it is then carefully finish-shaped by a shovel crew. Welded steel mesh is then laid in the hole like a basket, held away from the earth by small blocks so it will be thoroughly embedded in the concrete. In the hard-pack method, described at the outset of this article, the concrete arrives in a stiff, quick-setting mix that is quickly thumped and troweled in place by a scrambling crew of 12 to 20 men. In the Gunite system, dry cement and sand in proper proportions are shot through a hose under air pressure and mixed with water at the nozzle. The Gunite man, holding a stance like a fireman at a big blaze, simply sprays the concrete in place. His crewmates do the finish troweling on the final coat of silica plaster by hand. The whole job of digging and "pouring" takes about two days.

Actually, Gunite and hard pack still are far and away the most-popular methods of low-cost permanent pool construction. "They put the swimming-pool business in business," says one builder. Thousands

(Continued to page 244)

## Put Up This APPROVED Fireplace and Chimney YOURSELF in 4 Hours NO MORTAR.. NO MASONRY



For 1, 1 1/2 or 2-story houses

Save more than half! Full-sized wood-burning fireplace and chimney. Safety clearances built in. Labeled by Underwriters Laboratories Inc. Sets right against wood floors, walls, studs, joists. Fully engineered, tested, proved — won't smoke. Triple-wall chimney of stainless steel and aluminum. Realistic brick-finish aluminum top. Write for



Add any mantel design

FREE details!

### Majestic THULMAN FIREPLACE

The Majestic Co., Inc., 456 Erie St., Huntington, Ind.

**WELD BRAZE**  
**SOLDER CUT**



**4WAY**  
**ONLY \$14.75**  
f.o.b. factory

**WELDER**  
Complete with Twin Carbon Arc Torch and accessories... to handle all metal-craft work.

Acclaimed by thousands of Homeowners, Mechanics and Hobbyists as the welder of 1001 uses. Easily operated from properly wired 110 volt AC or DC line. The ideal gift with a life-long use... Order today on 10 day money back guarantee.

**FOUR-WAY WELDER CO., Dept. F2-G**  
1810 S. Federal St. • Chicago 16, Ill.

## Porter-Cable

*Quality Electric Tools*

### SAVE MONEY on SURPLUS PARTS for MILITARY TYPE TRUCKS & JEEPS

4 & 6 wheel drive. FREE catalog. State make of truck or Jeep. (New Jeep Tops, steel or canvas for all models). **AMERICAN AUTO PARTS CO., Inc., 1830 Locust, Kansas City, Mo.**

Say You Saw It in Popular Mechanics

**make your own Gems 29.50**  
F.O.B.

The Gem Maker comes complete with all necessary equipment, including a super-charged diamond blade for sawing, and all wheels for grinding, shaping and polishing; also complete instructions. The complete equipment as shown, less motor and belt, for only \$29.50, f.o.b., Burlington, Wisconsin. Write today for information and literature.

**B&I MANUFACTURING CO.**  
Dept. 5 Burlington, Wis.

**AMAZING DEVICE**

Operates on principle that water seeks its own level. Use this most versatile level when measuring for home repairs or building. Check points of level around corners, behind walls or anywhere. By applying the "WATER LEVEL" to combined lengths of garden hose the level of distant points can be determined.

**WATER LEVEL**

Economical—faster than elaborate expensive instruments—Makes straightedges obsolete. Ideal for carpentering, surveying, bricklaying, home-craft, plastering, landscaping and plumbing.

**HOOPS MFG. CO., 126 S. Marengo, Pasadena, Calif.**

**\$4.65** POSTPAID GUARANTEED

Every turn is the RIGHT turn

WITH AN

## Airguide AUTO COMPASS

- Saves you miles and minutes... points the right way all the way
- Neatly styled for today's smart car interiors... choice of case colors, soft gray or brown. Double ball and socket mounting permits positioning for most convenient reading. Fits all cars. Easy to install and adjust.
- Super power alnico V magnet and aircraft type compensators assure steady, dependable performance under all types of driving conditions. Three models to choose from...
- NO. 84 NON-ILLUMINATED.....\$5.95
- NO. 85 ILLUMINATED by car power.... 6.95
- AND NOW

**THE NEW NO. 86**

**SELF-ILLUMINATED**

PRESS BUTTON — LIGHT'S ON

RELEASE BUTTON — LIGHT'S OFF

Dome lights up with a soft green glow. No wires to attach. Operates on long-life self-contained flash cell. **\$6.95**

Made and guaranteed by **AIRGUIDE INSTRUMENT CO., CHICAGO 47**

**FREE CATALOG**

Choose your genuine Gerstner Chest from our Free Catalog.

**GERSTNER TOOL CHESTS**  
455 Columbia St., Dayton 7, Ohio

## GET THESE U-CAN-DO-IT WOODWORKING PLANS ... TODAY

Making furniture, toys, household articles is simple with a set of Rogers Project Plans... and a bottle of Rogers Glue. Simple illustrations with easy-to-follow directions are given in these Plans as well as directions for setting up a simple workshop. With "gorilla grip" Rogers Glue, you'll discover that joints are really firm and solid... only the finest materials obtainable go into the making of Rogers Glue. Use it for mending broken furniture, too. Send 15c today for this Special Offer: a full bottle of Rogers Glue with a new set of 3 Project Plans. Rogers Isinglass & Glue Co., Gloucester, Mass. Ask for Rogers Glue At Your Local Hardware Store.

"A Ton of Strength in Every Drop"

**ROGERS**

the best LIQUID FISH GLUE

GLoucester, MASS.

**FIND URANIUM REWARDS EASIER with**  
**The Only COMPLETELY**  
**TRANSISTORIZED**  
**MIRACLE GEIGER COUNTERS\***

- Sensitivity: Indicates full scale on background count
- Completely transistorized power supply\*
- NO VIBRATORS
- NO TUBES
- NO REPAIRS
- FEATHERWEIGHT
- ALMOST INDESTRUCTIBLE
- WEATHERPROOF



**MIRACLE TRANSISTORIZED AUDIO**

—available separately at \$15.  
 —adapts to ALL geiger counters  
 Amplifies detection clicks 10 times.  
 Single 15c flashlight cell. 12 ounces.  
 Size of cigarette pack cubed. Replaces bulky, irritating earphones. No drain on expensive geiger batteries—pays for itself in short time!

**Walking Stick —UAC 402—\$99.50**

(with scabbard). 46" x 2" overall. Weighs less than 3 lbs. Over 1,000 hours continuous use on 2-15c flashlight cells! Includes Universal's Transistorized Audio\* & flashing neon light. Aluminum shield for beta discrimination.

**Gun Type —UAC 411—\$149.50**

(with holster). Weighs less than 4 lbs. Over 500 hours of continuous use on 2-15c flashlight cells! Includes Universal's Transistorized Audio\* built-in, and newly designed full view, free swing ratemeter with 3 ranges. Aluminum shield for beta particle discrimination.

**UNCONDITIONALLY GUARANTEED**

All instruments sold by UAC are tested and approved by our scientific laboratory. Send your check or money order (we pay shipping) or send 25% (we ship COD, FOB N.Y.C.). Specify single or double jack if ordering audio separately. Write for free information on uranium prospecting and instruments from \$19.95 to \$4995.

\*pat. applied for

**UNIVERSAL ATOMICS CORPORATION**

Dept. M7 19 East 48th St. New York 17, N. Y.

**NEW! Giant AUTOMOTIVE CATALOG**

1955 Edition! Everything for car, truck, custom-styled car, hot rod ... at **LOWEST PRICES!** Save up to 50% on all parts, accessories! Only complete automotive buying guide...50,000 items...148 pages! Thousands of **hard-to-find parts**; equipment, parts for 1920 to 1955 models; **Hollywood accessories** never before offered; **hi-speed parts**. Send your name and address and 25c (refundable with first \$5.00 order) to:

J. C. Whitney & Co., 1917 Archer, Dept. P-7, Chicago 16, Ill.



**WROUGHT IRON LEGS**  
 for "Do It Yourself" Hobbyists

**5 HANDY SIZES 5**

PRICE PER SET OF FOUR	
6 Inch	.....\$3.75
12 Inch	..... 3.95
16 Inch	..... 4.50
22 Inch	..... 4.95
28 Inch	..... 5.75

FOR coffee tables, record players, TV sets, book cases, chairs, couches—WITH SCREWS.

**ADD 50c Postage and Handling.**  
 V-Shape, rust-resistant legs, made of 7/16" cold rolled dull matte finish wrought iron. Ebony painted! Chip and rustproof!

COMPLETE WITH SCREWS

ENGMAN MFG. CO., 1317-19 LOCUST, DES MOINES, IA.

built by such companies as Paddock, Anthony and Baker on the West Coast, and Welding Engineering, Sylvan, East Coast and E. L. Wagner in the East already have made them familiar.

Principal appeal, besides cost, is the versatility they offer in shape and size. People with odd-shaped lots and small yards still can have real pools. Builder Wagner has sprayed a Gunitite installation in a tiny private yard squeezed in among a square block of New York skyscrapers. "We had some fun removing the earth with scoops hung on skyhooks—booms perched on neighboring roof tops and setbacks," he says. "But the pool went in, and it met all the rigid city health codes."

Probably nowhere have these pools taken as many varied and unique forms as in southern California, where half of all the new pools are being built, and where one new home in every 40 boasts its private pond. Free-form pools cling to tiny ledges on precipitous hillsides, kidney shapes slip snugly away in triangular back yards, dog-legs sneak around corners and under the shade of plastic-roofed lanais. One trick, easily effected in Gunitite and hard pack, is to leave an island somewhere in the middle of the pool. One owner uses his for a diving platform, another as a planter for trees and ferns. A smart swimming enthusiast, whose back yard dropped away over an abrupt cliff a short distance from the house, used an island to support one whole corner of the building. The pool swoops in from the edge of the cliff and curls around the island to provide a swimming area under the patio roof.

Some California ideas are even more elaborate. One fellow built a pool that starts outdoors, goes right under the glass wall of his house and into his living room. The built-in steps at the end bring the swimmer up to a nice soft carpet. Many Western pools have rock gardens built along their picturesque edges, and some folks have arranged to pipe the water returning from the filter over a tiny rock cascade so it gurgles back into the pool as pleasantly as a woodland brook. This year one company has introduced a design whereby water is returned by a perforated pipe running along the eave of a lanai that projects over the pool rim. It provides a curtain of water that produces a melodious drizzle, cools the breezes wafting through it, and purifies the water by aeration as it rains down.

Which of the new pools is best? Each has advantages, depending on the use expected of it, terrain features, available space and individual preference.

(Continued to page 246)

# MAIL SURPLUS SALE OF HOME, FARM AND FACTORY EQUIPMENT

## PESCO GEAR TYPE HYDRAULIC PUMP

Compact — Powerful — Reliable



**ITEM #160**—Especially designed for belt drive from fan belt, power take-off, drive pulley, electric motor or small gas engine. Equally suitable for direct coupling.

Pedestal type mounting with two bolt holes for 3/4" hold-down bolts. Standard 1/2" pipe thread inlet and outlet ports. Delivers 4.5 GPM at 1000 PSI at 2800 RPM with 3 HP. Hardened steel gears turn in dense oilite bronze bearings. Rotation—clockwise facing shaft. Guaranteed trouble-free service. Ship. wt. 6 lbs. F.O.B. Chicago **22.50**

## GROBAN HYDRAULIC SPEED REDUCER with FINGERTIP CONTROL

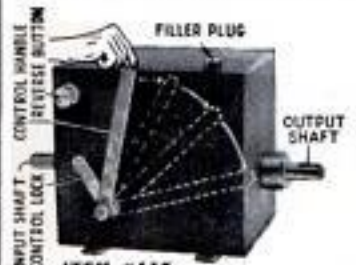

**ITEM #115**  
FOR: Reamer Drives • Midget Cars • Feed Mills • Canning Machines • Conveyors • Lathes • Milling Machines • Motor Boats • Cream Separators • Garden Tractors • Pumps.  
Variable output speeds from 0 to input speed available by moving control handle. Locking handle maintains setting. Use input power of 1 1/2 H.P. Shafts 3/8" diam. Input rotation counter-clockwise facing shaft. Input speed 750 R.P.M. 7/8" x 7 1/2" x 11 1/2". Gov't acquisition cost \$428.00. Ship. wt. 31 lbs. Complete with 2 qts. of oil and full instructions. **54.50**  
F.O.B. Chicago

### FREE — SUMMER CATALOG

1955 EDITION, 52 PAGES, chock-full of unsurpassed War Surplus Equipment Bargains for farm, home, factory, workshop. Write letter today.

## FACTORY-TO-YOU-VALUE PORTABLE ELECTRIC LIGHT PLANT



**BRAND NEW 1955**

**ITEM #1008**

### COMPACT — FITS IN THE TRUNK OF YOUR CAR

**1000 WATTS OUTPUT**, continuous duty. 115 Volts A.C. 60 cycles. 9 amps. Powered by husky, easy starting Clinton engine. Engine and generator operate at 3600 R.P.M. for maximum efficiency at minimum weight. Both units are mounted on welded base, with heavy sheet metal belt guard. Generator is self regulating, and is equipped with outlet box containing fuse and 2 A.C. convenience receptacles. Cost only 5c an hour to operate. Dimensions: Length 20 1/2", Width 12", Height 16". Shipping wt. 100 lbs. F.O.B. Chicago. **149.50**

**700 WATT-GENERATOR SET**—same as above, slightly smaller—with Briggs-Stratton Engine—Model 708—F.O.B. Chicago. **129.50**

**1500 WATT-GENERATOR SET**—50% more capacity—with husky Clinton 3.8 H.P. Engine. \$100 below usual price—Model 1508—F.O.B. Chicago. **199.50**

## SAVE \$1,100.00 ON THIS SURPLUS HALE CENTRIFUGAL PUMPING UNIT

• FOR IRRIGATION • FIRE FIGHTING

Pump has standard 4" inlet (for hydrants), and two 2 1/2" outlets. Rated—500 gal. per min., at 175 P.S.I. Powered by Chrysler 6 cylinder Industrial Engine, Model T-118B; electric start, direct coupled. Instrument panel contains engine instruments and pump pressure gauges. Unit is equipped with exhaust priming system. Available with heat exchanger cooling, as illustrated, or radiator cooled, at the same price. Underwriters Approved Fire Fighting Unit. Gov't acquisition cost 1,995.00. Dimensions: L—72" X W—27" X H—40 5/8". Ship. Wt. 1646 lbs. **895.00**  
F.O.B. CHICAGO



**ITEM #401**

To place phone orders call WEBster 9-3793

**GROBAN SUPPLY CO.** Dept. PM-7  
1139 S. WABASH AVE., CHICAGO 5, ILL.

## U.S. NAVY ALL BRONZE CENTRIFUGAL PUMP



These all bronze Centrifugal Pumps are ideal for use as marine bilge pumps, circulating pumps, fire protection or irrigation, car-washers, dewatering, basement sump pumping, lawn sprinkling. Will pump water, oil, brine, gasoline, DDT and sulphur compounds. Equipped with 6" adjustable 'V' pulley, 2" dia. inlet and outlet, 180 GPM capacity. Inlet and outlet take hose with 2 1/4" inside diameter. Dimensions: 11" x 8" x 11". **ITEM #384**

Total head-feet	Speed	H.P.	GPM
25	3600 RPM	3	180
35	3000 RPM	1 1/2	90
20	2400 RPM	5/8	75

Back plate may be rotated for most convenient inlet position. Gov't acquisition cost \$96.00. Shipping weight 31 lbs. F.O.B. Chicago. **29.50**

## SAVE \$30.30 ON THIS PESCO HYDRAULIC CONTROL VALVE

FOR SAFE POSITIVE CONTROL OF HYDRAULIC CYLINDERS AND MOTORS **ITEM #371V**

— • BUILT-IN RELIEF VALVE — face 50% set at 1200 P.S.I. • FOUR-WAY VALVE — to operate one double acting cylinder • OPEN CENTER — with valve in neutral, cylinder is locked in position and pump is unloaded. • SPRING RETURN TO NEUTRAL. • FULLY BALANCED PLUNGER • EASILY STACKED INTO 2, 3, or 4 valve combinations for multiple cylinder operation. • 8 gal. per min. capacity, at 1500 P.S.I.—3/4" pipe ports • CONNECT PUSH RODS TO HANDLE FOR REMOTE CONTROL. • EASY MOUNTING. • LIST PRICE — \$46.80. • YOU SAVE \$10.30. • DIMENSIONS — 9" x 4 1/2" x 2 1/2" — Ship. Wt. 8 lbs. F.O.B. Chicago. **16.50**

ORDER DIRECT FROM AD SATISFACTION GUARANTEED  
Send Payment Or Purchase Order Today

## URANIUM AND METALS

Easily located with the new M-Scope Detector. Superior Performance. Prices \$35.00 up. Monthly payment plan. Booklets "How to be a Successful Uranium Prospector" — "For Fun and Profit" free upon request.

**FISHER RESEARCH LABORATORY, INC.**  
PALO ALTO CALIF.

## "FEATHER-LIGHT" LEVEL MAGNIFIES!

### NEW EMPIRE ACRA-LITE NO. 1521

ONE THIRD LIGHTER than aluminum, ACRA-LITE Magnesium levels handle like a breeze! Easier to read, too, with "Full-View" magnifying vial cover plates. You'll want yours now! Order from your dealer, or direct.

**EMPIRE LEVEL MFG. CO.**  
10930 W. Puffer Rd., Dept. PM,  
Milwaukee 13, Wis.

**EMPIRE ACRA-LITE Level**  
No. 1521, 24", Only \$6.70  
28", \$7.60, 48", \$13.50

Also Adult Eshelman 2 Passenger Sport Cars

**1/5 Price** of any other Auto

70 Miles Per Gal. Free Catalog.

**ESHELMAN**

MAKES FLOWS CULTIVATES HARROWS HAULS SPRAYS SAWS DOZER MOWS CUTS ROLLS TILLS SNOW PLOW

Rollery Tillers Riding Mowers Tractors Low As **\$69**

FOR Better LAWNS And GARDENS

Women can operate it. 1 to 8 H.P.

Shipping Points: **BALTIMORE, CHICAGO, RENO**

Free Catalog Write: **ESHELMAN CO., Dept. R-57**  
109 Light St., Balto. 2, Md.

## ENJOY EACH MILE MORE THIS SUMMER

Take along a HULL AUTO COMPASS. Leave driving strain, confusion at home.

THE FAMOUS QUALITY NAME IN AUTO COMPASSES  
At Better Dealers Everywhere.  
Write for literature

**HULL MFG. CO.**  
P. O. Box 246, D-7 WARREN, OHIO

## Opportunity for Men with Automotive Background and Executive Ability

Manufacturer and marketer of nationally-advertised line of automobile products now expanding operation here and abroad. Distributors needed to warehouse and administrate to growing dealer network. If you have organizational ability and are financially responsible, write for details.

Your inquiry held in confidence; Write: Box P.M.-7, 10418 Venice Blvd., Culver City, Calif.

**NOW! It's EASY To REMOVE STUMPS** With "MAGIC" STUMP REMOVER

All you do is pour "Magic" Stump Remover—a new, quick-acting chemical compound—into hole drilled in center of stump. Wood fibres soon decompose all way to root tips, making removal easy—even for women and youngsters!

**SPECIAL TRIAL OFFER:** 8-oz. Can (enough for one stump)—\$1.50; 16-oz.—\$2.50; 3 lbs.—\$5.00. Send no money! Pay postman, plus postage. (Or send full amount with order for prepaid delivery.)

**FREE!** Generous sample of "GRO-GREEN," new liquid lawn fertilizer, with each Stump Remover order.

**H. D. CAMPBELL CO. Rochelle 6, Ill.**

**No Digging! No Chopping! No Blasting!**

**EASY TO USE! Saves Time, Money!**



Also ADULT 2 Passenger "Eshelman" SPORT CAR

1/5 the cost of any other auto

70 Miles per Gal. Free Catalog

**ESHELMAN RIDING MOWER**

Better, Faster, Easier! Just ride along on this deluxe Rotary Lawn Mower.

ROYALTY TRACTORS from \$69

Shipping Points: BALTIMORE, CHICAGO, RENO

Free Catalog Write: ESHELMAN, Dept. M-57, 109 Light St., Balto. 2, Md.



1955 CATALOG—Send 35c

70 Models for '55! See the world's finest line before you buy. Rated tops in design, styling, performance by the experts. '55 catalog plus booklet "Boat Selection, Operation, Maintenance" \$1.00

**Custom-Craft THE ORIGINAL "PACKAGED" BOAT KITS**

**BOAT PLANS AND FULL-SIZE PATTERNS**

Over 100 Modern plans and full size patterns. Racing classes, cruisers, inboards, outboards, sail boats. By famous designers. 6' to 30' DESIGN CATALOG only 35c. For Design Catalog plus boat building handbook send \$1.00.

**CUSTOM-CRAFT (DEPT. A) BUFFALO 7, N. Y.**

**FREE for URANIUM PROSPECTORS**

**GEIGER COMPANATOR CHART**

NCA's Geiger Comparator Chart, "How to Select a Geiger Counter," tells you all you have to know about the different types of geiger counters presently available. Enables you to select the counter best suited to your needs. Send for your copy today.

**Nucleonic Company of America**  
Dept. PM-57  
196 DeGraw St., Bklyn. 31, N.Y.



For the do-it-yourselfer, a plastic pool liner hung over a homemade concrete block or wood frame in a hand-dug hole provides a big tank at remarkably low cost. When these pool liners first appeared, word got around that squirrels found the plastic good eating and spent the winter fattening up on chunks of swimming pool. "Since then we've changed the plasticizer that appealed to them," the fabricators reveal, "and they hate the stuff now."

New do-it-yourself pool ideas already are in the cards. Celanese is working with a prototype in which glass cloth is laid over a homemade wood form, and bonded in place with layers of polyester resin that anyone can apply with paintbrush.

In the more permanent pools, most of the bugs already have been worked out. Steel tanks once had a reputation for floating out of the hole like a boat, if heavy rain or flood raised the water table sufficiently. "We fixed that," explains a Koven engineer, "by using extra-heavy structural girders under the pool bottom."

Sufficient ground pressure can even hoist a concrete pool out of its hole. Recently a 20 by 35-foot kidney-shaped structure weighing 52 tons floated out of its hole when a nearby brook flooded the area. Engineers had to float it back where it belonged. That pool, incidentally, was good old-fashioned poured concrete, made by a new method that brings its cost right in line with other new types. The secret is a system of flexible steel forms invented by Arnold Sheldon of Clinton, N. J. Unlike wood, they can be used over and over indefinitely and can be made to assume any desired shape.

"One of our franchised contractors in Omaha is building a 20 by 30-foot pool with 10-inch-thick walls in any shape, complete with filter system, diving board and ladder, for \$2990," Sheldon says.

What about filter systems and other accessories? Are they necessary? Most reputable pool builders will not make an installation without at least including proper openings for installation of such equipment. Some won't build a pool without them. And if they're not included in the price of the pool, you can expect to add another \$600 to \$1000 to get them. But any experienced pool man will tell you they're well worth the cost in reducing maintenance troubles and in keeping a pool swimmable.

John Kurtz, president of Superior Swimming Pools in Miami, Fla., makes typical comments on the subject. "Some folks," he explains, "are inclined to think of a home pool as an enlarged bathtub. There's no comparison. After each bath you drain

(Continued to page 248)



## DO IT YOURSELF!

### Save Time and Money with the "NEW HOME SERVICE TESTER"

No more waiting for TV and Radio service... eliminate electrical and other repair bills... Now you can test all radio and TV tubes... Now you can check home appliance shorts and broken wires... Now you can test light bulbs and fuses. You do all this yourself with the "NEW HOME SERVICE TESTER." Complete with easy instructions - SAVE MONEY - AND have fun, too. ORDER TODAY! SATISFACTION GUARANTEED or your money back.

**\$4.95**  
EA.  
POSTPAID



Lindaily Products 2626 W. 103rd Pl., Dept. MP-7  
Chicago 43, Ill.

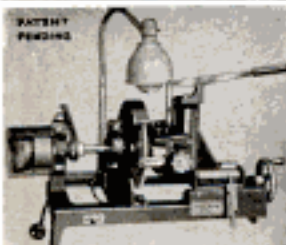

### Start a NEW BUSINESS!

or Add to your present Repair Business  
**SHARPEN DULL PIPE WRENCHES**  
PIPE TAPS & DIES  
"GUM" CIRCULAR SAWS  
Also MOTOR DRIVEN ROTARY HONE  
Write for Information

J. C. MOORE INDUSTRIES  
BOX M 276 FREDONIA, PA.



### Get New 148 Page Catalog of WOOD AND WOODWORKING MATERIALS

**WORLD'S LARGEST SELECTION - Lowest Prices**  
Your buying guide for finest kiln dried domestic and rare imported woods, inlays, bendings, matched plywood, moldings, ornaments, etc. Biggest selection of tools and hard-to-find hardware. Packed with scroll saw patterns, projects, wood facts and money making ideas. Enclose 25c (refunded on first order) to help pay mailing and handling costs. Write today to CRAFTSMAN WOOD SERVICE CO., 2729 S. Mary St., Dept. A-7, Chicago 8, Ill.



### PUNCH PRESS

2 Ton Power Bench Type  
Make Your Shop Complete  
Powerful - Dependable - Economical  
Easily make your own dies for light stampings, forming, riveting etc. Ideal for production or experimental work. Replaces more expensive presses. Requires only 1/2 H.P. motor. Weight 105 lbs. Fully guaranteed. Only \$97.50 less motor. Write for free circular. Dealer inquiry invited.  
ALVA F. ALLEN, Dept. PM, Clinton, Missouri



### BUILD YOUR OWN ARC-WELDER

WE SHOW YOU HOW to build this powerful welder without re-winding. Uses most any surplus aircraft generator. Produces 7-350 amps. Easy to build. **PLANS \$36**, includes NEW booklet "How to Weld," and FREE war surplus and electrical catalog.  
LEJAY MFG. CO., 1247 LEJAY BLDG., MINNEAPOLIS 8, MINN.



### DRAINS cellars, cisterns, wash tubs; \$6.95

IRRIGATES - CIRCULATES - SPRAYS  
Type P Pump has 1,001 uses. Up to 3000 GPH; 450 GPH 80' high; or 1800 GPH from 25' well. Use 1/2 to 3/4 HP motor. Coupling included free. 1" inlet; 3/4" outlet. Stainless shaft. Won't rust or clog! Postpaid if cash with order. (Foot of Miss. add 50¢)  
**MONEY BACK GUARANTEE**  
Centrifugal and Gear Pumps in All Sizes  
LABAWCO PUMPS, Belle Meade 7A, N. J.

## HELPFUL BOOKS

Send post card asking for FREE catalog  
Popular Mechanics Press, 200 E. Ontario, Dept. 601, Chicago 11

## MAGNETS

ASSORTED MAGNETS with big list of handy uses... 5 for \$1  
POWERFUL POCKET MAGNET ideal for testing metals... \$1  
RETRIEVING MAGNET pulls tools, etc., from tank or lake... \$4  
HOT PAD MAGNETS to insert in your own hot pads... 8 for \$1  
BULLETIN BOARD MAGNETS to "pin-up" memos, etc... 8 for \$1  
SLENDER MAGNETS remove chips from drill holes... 2 for \$1  
Write for free booklet including heavy retrieving magnets. 100% satisfaction guaranteed... POSTPAID  
PARK MAGNETS, 257, 1557 GREENBAY RD., HIGHLAND PARK, ILL.

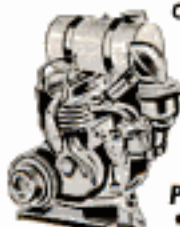

Convert Lawn Mowers into Power Units with this  
**Briggs & Stratton**  
**2-H.P., 4-Cycle GAS ENGINE**  
AIR COOLED FULLY GUARANTEED  
Reg. Price \$48.00  
**SAVE! SPECIAL OFFER \$37.50**  
while they last... fab

**Powers Farm, Home & Industrial Tools**  
• Garden Equipment • Pumps • Compressors

### GOV'T SURPLUS

Briggs & Stratton leads the world in dependable, trouble-free performance. A precision-built 2-horsepower, 4-cycle engine with advance styling and economical operation. Easy rope start—sure fire ignition in all weather. Positive, automatic splash-lubrication system. 2 Qt. gas tank. Float feed carburetor with adjustable idle speed and automatic governor. Oil bath air cleaner. Complete with muffler. 3 Piston rings for added compression. 2000-3800 RPM adjustable speed range.  
**SUPPLY LIMITED! IMMEDIATE DELIVERY! ORDER FROM AD FREE CATALOG of Compressors, Generating Plants, Motors**  
ROBERTS ELECTRIC CO., Dept. P-300, 849 W. Grand, Chicago 22, Ill.



### DIVING EQUIPMENT

Build Your Own Equipment. By using parts we can supply, you can build a professional diving set at a fraction of what you would pay for one on the market. These parts are not from surplus high altitude breathing apparatus.  
**Lungs, Self-Contained Equipment, Masks, Fins, Spear Guns, Snorkels, Frogman suits, Commercial Diving Equipment, Both U.S. and Foreign, Helmets, Navy Surplus, Commercial, and Foreign Diving Dresses, Air Hose, Hand Air Pumps, Tanks, Valves and Fittings, Telephone Equipment, Underwater Cutting Equipment, Shallow Water Diving Equipment.**  
**SEND \$1.00 FOR LARGE CATALOG**  
**WEST COAST DIVERS EXCHANGE**  
P.O. BOX 442 WILMINGTON, CALIF.

### THE NEW DALTON Model D-500 ELECTRIC PORTABLE JIG SAW



**7 SAWS IN ONE!**  
Does the work of a RIP...  
**CROSS CUT... COPING...  
JIG... SCROLL... BAND  
and KEYHOLE SAW**  
**'CUTS ANY MATERIAL'**  
**'SAWS ANY SHAPE'**  
**RIPS and CROSS CUTS 2x4's**  
Makes fast, smooth cuts  
no jumping or chattering. Has  
the capacity to rip and cross  
cut 2 x 4's. The only other similar  
type device on the market that can  
match this amazing performance costs  
almost three times as much!  
Specially built Dayton motor assures  
smooth, steady cutting. A built-in compressor  
blows sawdust away from guide  
line.

**SPECIFICATIONS**  
• 4 to 1 gear reduction. • All gears hardened steel.  
• Motor exposed for cool running. • Oilite bronze bearings.  
• Air is pumped from top down through the center section, cooling unit as well as blowing sawdust from line.  
Complete with 5 different blower composition boards - hard rubber and \$48.00 others.

IT CUTS wood - plastics - metals -  
IT SAWS circles - curves - straight lines - intricate designs.  
**SHIPPED ON APPROVAL**  
**NO MONEY WITH ORDER - NO C.O.D.**

Try it ten days before you buy. If completely satisfied then send \$15.00 and pay balance at rate of \$11.00 per month for 3 months - No Interest or Finance Charges Added. If not completely satisfied, return to us, no explanation necessary.

**KAPNER HARDWARE, INC.**  
Dept. A-140, 3248 Second Ave., N. Y. 29, N. Y.  
Please rush one D-500 Jig Saw. I agree to pay \$15.00 within 10 days after receipt and \$11 per month thereafter.

Name \_\_\_\_\_  
Address \_\_\_\_\_  
City \_\_\_\_\_ Zone \_\_\_\_\_ State \_\_\_\_\_

## MACHINED PARTS READY TO ASSEMBLE

Do it Yourself **MODEL 120 FANKIT** Do it Yourself

- For home—farm—shop!
- 20" assembled and balanced aluminum fan blade with steel hub
- 4840 cubic ft. of air per minute
- Rubber mounted bearings
- Complete V belt drive
- Steel fan shaft & collars
- All hardware to assemble
- All you need is any 1/4 to 1/2 hp 1725 RPM Motor, a Screw Driver and 20 minutes time to assemble this wonderful home or shop fan kit. Quality at low cost!

Parcel Post Prepaid. Send check or M. O.

DEALER INQUIRIES INVITED

**A. E. Bogg Machine & Tool Company**  
Dept. PM-7, 811 Jefferson St., Jefferson City, Mo.



**FANKIT**  
ONLY  
**\$16.95**

RETAIL PRICE \$125.00

FACTORY TO YOU **\$79.95**

**SUPERSHOP** includes precision-built 8" tilting table saw, vertical and horizontal drill press, 30" lathe, sander, grinder. 100% BALL BEARING. Write for FREE catalog, full details, trial plan. Easy Pay Plan.

**POWER TOOLS, INC.**

173 YATES AVENUE  
SELOIT, WIS.



### AIR-VACUUM

— Chapin Multi-Purpose Model 22 air compressor, air engine, vacuum pump, vacuum motor, etc. 2 cu. ft. displ. at 1725 rpm. With coupling to direct connect to any 1/4 or 1/2 h.p. motor with 1/2" shaft. 2 cyl. reversible. 35 psi. working pressure \$34.50.

Model 44—4 cyl.—4 cu. ft. displ. at 1725 rpm. Use also as torque motor, speed control, remote control, automatic devices, etc. With pulley and mount \$59.75.

Oilite bearings. Rotary ports. Bore 1 1/4"—Stroke 1". Prepaid with cash or send \$5.00 bal. C.O.D. and postage. Order today. Patent applied for. Mfg. & dist. by Bryan W. Chapin, Tully, N. Y.

### PORTABLE JIG SAW

CUTS AS FAST AS SAWS  
COSTING \$50 AND UP!

Does work of Jig, Keyhole, Coping, Band, Rip, Backsaw. Has built-in air blower, fits any 1/2" drill, cuts wood, plastics, metals. At your dealer or try it on our 10-day trial. Send check, M.O. (Postpaid), C.O.D.—postage extra.

**ARROW METAL PRODUCTS CO.**

Dept. PM-7, 140 W. 87th St., N.Y. 13, N.Y.



At Better Hardware Stores Everywhere  
"Arrow Jig-Saw"  
ONLY **\$8.95**



### ELECTRIC WELDER

AC or DC  
110 Volts

The "Little Marvel" all-metal welder, 5-year written guarantee. Welds 1/8" metal or money back. Repairs tanks, tools, fenders, machine parts, etc. Complete with everything—rods, unit, eye shield, directions; \$6.45

plus 50c postage. Flame torch accessory for soldering, cutting, brazing \$3.95 complete with carbons, brass rods, flux. \$2.00 Deposit on C.O.D. 1/4 inch Transformer Welder \$19.95 F.O.B.

**ESSAY MFG. CO.,** Dept. 51, Quincy 69, Mass.

**\$6.45**  
Com-  
plete

### Earn Big Money! DRY CLEAN RUGS

**New Easy Way!** Dry clean rugs on location in homes, stores—fast and easy—machine does hard work for you! Amazing ALM-13 machine with Float-Action Brush whirls cleaning material into rug fibers—gets out grime, dirt like magic! Use rug at once. Also, use same machine with no-tool attachments to clean, wax, polish any floor—make extra profits! Write for details.

**AMERICAN Floor Surfacing Machine Co.**  
535 So. St. Clair St., Toledo 3, Ohio



#62  
**VIZI-DOME**  
**KNIFE SET**  
**\$2.50**  
**X-ACTO, INC.**

48-45 Van Dam St.  
Long Island City, N.Y.

Send 25c for 28-page Catalog

your tub, but you don't drain a 30,000-gallon pool after each swim. Yet a swimming pool is not fit to bathe in after the first swimming party if the water isn't chemically treated or filtered. Insects, dust and vegetation join the other ingredients. The water clouds. Spores of algae begin to establish their beachhead of green slime in the first day. In a week you are forced to drain, scrub and refill your tank."

Actually, pool owners "never had it so good" as far as worksaving gadgets go. Filters do most of the dirty work. They come in a variety of sizes to suit many pocketbooks and pool sizes—from portable affairs on dollies that can be wheeled up to the pool edge to buried tanks for large pools. Actually the filter is nothing more than a tank filled with diatomaceous earth, or with layers of gravel and sand going from coarse to fine. Water pulled from the pool by a pump swishes through and all dirt is sifted out. After filtering, a valve is turned, the pump reversed, and water backs up through the filter and washes the dirt out to a drain or dry well.

What about silt and stones on the bottom? Water vacuum cleaners, with hoses that float on tiny buoys, pick this off the bottom and wash it out through the filter. Leaves and twigs floating on the surface? Automatic "skimmers," or openings in the pool side at surface level, suck in surface water and anything on it, and pass it out to the dry well or through the filter. All these contraptions, plus a few chemicals (and even water heaters if you can stand the tariff), make the job of maintaining a modern pool an easy one for the harried fellow with a nine-to-five job. And the cost of operation? It is estimated at about \$20 a month the year 'round. ★ ★ ★

Portable filtering unit mounts electric pump, strains pool water through diatomaceous earth to purify it





# SAVE MONEY *with these New* DO-IT-YOURSELF BOOKS

**1. HOW TO PAINT INSIDE AND OUT:** Step-by-step instructions in POPULAR MECHANICS' famous, easy-to-follow style. Detailed diagrams.

**2. HOW TO LAY LINOLEUM AND TILE:** This book simplifies a usually difficult job by giving illustrated know-how. Photos, drawings, diagrams.

**3. HOW TO REMODEL YOUR BASEMENT AND ATTIC:** Easy-to-follow guide, including planning ideas, on how to make full use of basement or attic.

**4. HOW TO TAKE CARE OF YOUR LAWN:** Details for a perfect lawn and healthy shrubs. Make a new lawn, give new life to an old one. Illustrated.

**5. HOUSE WIRING AND ELECTRICAL REPAIRS:** Ideas and instructions for the homemaker on how to improve lighting. Full details.

**6. SMALL BOATS YOU CAN BUILD:** Plywood dinghy, 15-ft. sailing knockabout, 8-ft. duckboat—all included in this booklet. Complete instructions.

**7. PLUMBING REPAIRS MADE SIMPLE:** How to fix faucet noises, water hammer, leaky faucets, backflow, clogged pipes and drains, etc.

**8. FENCES, GATES, TRELLISES AND WALKS:** Wagon-wheel, rock-garden, rail, brick fences; formal, fan-type, portable trellises; wagon-wheel gates.

**9. BUILT-IN FURNITURE FOR YOUR HOME:** How to build wall cabinet, combination wardrobe and linen closet, foldaway crib, picture windows, etc.

**10. BUILD YOUR OWN BARBECUE:** Stone or rubble fireplaces, grills, barbecue pits for all occasions. Easy for the handyman. Photographs, diagrams.

**11. LAWN AND GARDEN PROJECTS:** Picnic furniture, folding chairs, garden pool, bent-tube furniture, etc. Easy to make, money-saving projects.

**12. THREE LOW-COST HOMES YOU CAN BUILD YOURSELF:** More than 100,000 families have built their own homes in the past few years. You can build yours, too.

**13. 125 SIMPLE HOME REPAIRS:** Stop faucet leaks, change a fuse, replace sash cords, make a plaster patch, etc. All easy-to-follow instructions, with diagrams.

**14. SIMPLE TELEVISION REPAIRS:** Only a screwdriver, pliers and soldering iron are needed for the repairs discussed in this booklet.

**15. MODERNIZE YOUR KITCHEN:** Planning for convenience and economy; illumination valances; drop ceilings; ventilation; built-ins; relocating windows, doors, etc.

**16. SIMPLE AUTO REPAIRS:** A treasury of trouble-shooting tips for motorists, covering engine, ignition, transmission, running gear, frame, body and interior, etc.

**17. HOW TO WINTERIZE YOUR HOME:** Prepare for bad weather by tuning up your own heating system. Learn to do your own insulating. Make storm windows, etc. Fix plumbing.

**18. HOW TO SET UP YOUR HOME WORKSHOP:** Detailed layout plans for model workshops in basement, attic, garage or spare room. Wiring, lighting, tool panels, cabinets, etc.

**ONLY  
25¢  
EACH**

6 FOR  
**\$1.25**

18 FOR  
**\$3.25**

*Order on this Handy Coupon*

POPULAR MECHANICS PRESS, 200 E. Ontario, Chicago 11

Gentlemen: Please send copies of books Nos.: 1: 2: 3: 4: 5: 6: 7: 8: 9: 10: 11: 12: 13: 14: 15: 16: 17: 18: (circle numbers desired)

Remittance enclosed

Send C.O.D. (\$2.00 or more)

I enclose \$ \_\_\_\_\_

Name \_\_\_\_\_

Address \_\_\_\_\_

City \_\_\_\_\_ Zone \_\_\_\_\_ State \_\_\_\_\_

# READ THIS

This sounds unbelievable—but if you will spend \$1.00 and 30 minutes of your time, you will be able to repair over 40 common television troubles. The SIMPLIFIED TV SERVICING manual brings you thousands of man-hours of experience in a condensed form. If you can follow simple step-by-step instructions, YOU CAN REPAIR TV SETS FOR PROFIT. YOU NEED NOT HAVE ANY PREVIOUS KNOWLEDGE OF TELEVISION. Get your copy of this valuable manual today. Read and use it for seven days and if it isn't entirely satisfactory, return it for a full refund.

Send only \$1.00 for your copy to

**TV PUBLISHING CO.**

Dept. A-75

Escanaba, Michigan

**IT'S WHAT YOU HAVE  
BEEN LOOKING FOR!**

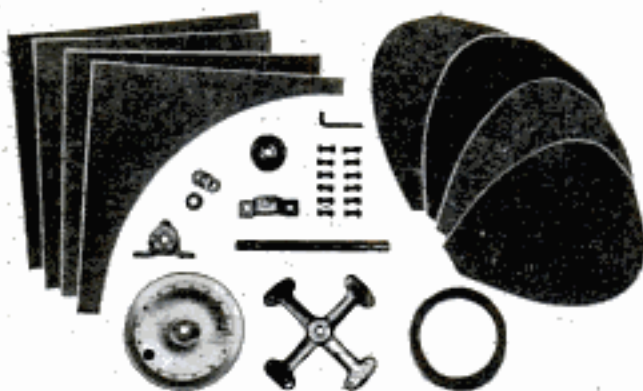

HUGE SAVINGS! ASSEMBLE YOUR OWN FANS!

## 30" Window Fan \$15

We supply all precision parts shown (includes baffle cut in 4 sections for easy packaging), along with easy-to-follow instructions. Anyone including women can assemble these fans. You save up to 75%. A great idea especially if you need several fans. Also you can assemble in your spare time and earn extra income selling them. S. J. STEWART [ELECTRIC], in business for over 56 years, guarantees every precision part to be of fine quality, giving you a fan of long silent, trouble-free operation. Ap. 7500 CFM.

Sold with money-back guarantee. Free circular.

**30" BLADE SIZE \$15**

(24" \$14.25) delivered—Transportation prepaid in Continental U.S. if cash accompanies order.

**S. J. STEWART [ELECTRIC]**  
527 St. Joseph Street New Orleans, La.

## What Can We Do About Smog?

(Continued from page 70)

Smog not only is irritating to the eyes and respiratory tract, but there is a hint that the increase in cancer may be associated with the increase in air pollution in large cities. Medical authorities have warned that a material increase in smog in Los Angeles may have a grave effect on public health.

From the standpoint of agriculture, smog does about \$3,000,000 worth of damage to leafy crops in the Los Angeles region every year. Some growers have moved their operations to outlying, smog-free areas. Realizing that smog will continue for some time to come, experts at the Riverside Experiment Station of the University of California are now trying to develop smog-resistant strains of plants and are seeking chemical sprays that might afford some protection to crops. Some fungicides normally used for blight control seem to have value. The experts suggest that irrigation be held to a minimum during smoggy periods.

About 1000 tons of pollutants that formerly were discharged into the air every day in Los Angeles are now being collected at their sources. As reported by the Los Angeles County Air Pollution Control District, these contaminants include 350 tons of sulphur dioxide now being reclaimed at petroleum refineries, 400 tons of gasoline vapor now being trapped at refineries and storage areas, 60 tons of dusts and fumes from metals industries and 65 tons of particles from unimproved industrial furnaces. The exasperating thing is that smog has become worse at the same time that these pollutants were removed; this is ascribed to a boost in population (with more automobiles and incinerators) during the same period.

Smog appeared to be an easy thing to control when Los Angeles first became concerned about it, but now the many agencies that are fighting it find that air pollution and its control are complicated subjects. Millions of dollars have been spent so far and the estimate is that the total bill will run into the hundreds of millions.

Lauren B. Hitchcock, president of the Southern California Air Pollution Foundation, points out that Los Angeles spent \$750,000,000 in bringing water to the city and distributing it. Now it is faced with the problem of providing itself with tolerable air, an even more important basic need. Mr. Hitchcock expects that the diagnosis and remedies being sought for this one city will be of value in other cities.

(Continued to page 252)

# General SURPLUS SALE!

## BUILD YOUR OWN ARC WELDER OR LIGHT PLANT D-C GENERATOR

Instructions Incl.	TYPE AMPS VOLTS	PRICE
(Westinghouse) D1	200 24	\$17.40
(G. & Heintz) H1	300 24	\$23.50
(Austelite) G1	160-250 30	\$12.95 (New 15.50)

2511 AC-DC Gen. 200 Amps, 30 V. D.C. & 1250 Watts, 800 cy. A.C. Instruction for A.C. Light Plant & D.C. Battery Charger incl. Good Cond. \$19.50. New \$29.50.

**RHEOSTAT = 27 or CARBON PILE VOLTAGE REGULATOR**, regulates voltage & pulsation on D.C. Generators. Instructions, \$6.95 ea.

**REVERSE CURRENT RELAY**, Curtis Aircraft type, for control of 24V. D.C. Generators and motors. Instructions incl. \$6.95.

**ECLIPSE MOTOR & GEAR UNIT**. Makes Ideal GARAGE DOOR OPENER, Lawn Mower Drive, etc. Gear ratio 28:1. 12 to 32 Volt D.C. motor. For Belt or direct drive. O. Cost over \$200.00. Wt. 20 lbs. Instruction = \$21 \$9.95

**FIRE EXTINGUISHER**, 1 quart size, brass finish, \$6.95 postpaid, 4 Gallon size, F. Extinguisher & insect sprayer pump with hose & nozzle, Wt. 15 lbs. \$2.95 (add postage). Used, good condition.

**SENSATIONAL SELSYNS**. Two or more connected together work on 110 V. A. C. For controlling distance, operation, etc. (Fig. 5). Instructions incl. \$9.95 per pair postpaid.

**HYDRAULIC SOLENOID CONTROL VALVES**. Bendix = B1550. For remote control & hydraulic cylinders. For 24 V. D. C. & applicable for 110 V. A. C. Cap. 1500 P.S.I. \$35.00 value. (Fig. 6). Instruction \$3.95 ea. \$7.50 per pair.

**BEAM ROTATOR MOTOR**. #101. Reversible. Geared for 7V. Ham. P.M., etc. 2 R.P.M. For 110 V. A.C. or 24 V. D.C. Gov't cost over \$200.00 (Fig. 7). Instructions \$9.95.

**SOLENOID = 804**. Gives 1/2" or 1 1/4" travel. Powerful for locks, switches, toys, etc. For 24 V. D.C. & applicable for 110 V. A.C. (Fig. 8). Instructions \$2.95 ea. \$4.95 postpaid.

**CUNO OIL FILTER**. Aircraft Type Filters without cartridge replacements. Std. 3/4" ports \$4.95 Postpaid.

**PUROLATOR FILTER = 255**. For trucks or tractors 1 1/2" I.P. ports \$4.95 Postpaid.

Send CHECK OR M. ORDER. PRICES F.O.B. KCMO EXCEPT when marked POSTPAID U.S.A.

GENERAL SALVAGE CO., 2922 E. 27 St., Dept. 775 Kansas City, Mo.

## MAKES IDEAL WINCH HOIST

Aircraft starting motor for 12 to 32 Volts. Gives high torque & power, slow speed. Applicable for moving heavy loads. Belt or direct drive. O. cost \$300.00. \$9.95

**PUMPS, GEAR, SPEED REDUCERS, Etc.**  
**BLACK & DECKER MOTOR & PUMP UNIT**. For equipping fluid metering coolant, etc. 1730 R.P.M. 1200 I.P.M. 2 G.P.H. 1/2" ports. For 24 V. D.C. & applicable for 110 V. A.C. (Fig. 1). Instructions \$8.95.

**CHANDLER EVANS LARGE WATER PUMP** for oil, insecticides, etc. 400 G.P.H. 1 1/2" Drive spline shaft. 1" ports. (Fig. 2). \$7.50

**THOMPSON CENTRIFUGAL PUMP & MOTOR**. For fuel, hot water heating circulator, etc. 300 G.P.H. For 24 V. D.C. & applicable for 110 V. A.C. (Fig. 3). Instructions \$7.50.

**ROTARY GEAR PUMP**, (Fig. 4) for Hydraulic, water, or Vacuum. Rated 180 G.P.H. 200 P.S.I. 20" Vacuum size 4"x4"x8". Instructions incl. \$7.95 Postpaid.

**SPEED REDUCER**. 5:1 or 10:1 ratio. 20 degree angle. Rated 2 H.P. \$6.45 Postpaid.

**RIGHT ANGLE DRIVE**, 1:1 ratio through 90 degree bevel gears. Drive & take off shafts are 3/4" dia. size 1 1/2"x2 1/2"x1 1/2". (Fig. 4). \$3.50 Postpaid.

**GEAR UNIT**. Angle drive type. 1 input, 2 output shafts, 1:1 ratio. Rated 10 H.P. Size 10"x8"x4". (Fig. 5). \$5.95.

**GLIDER TOW BAR**. Will hold 100-1000 lbs. & release load when release lever is pulled. Ideal for quick release tow bars, winch lines, etc. 1 1/2" x 3 1/2" Wt. 10 lbs. Gov't cost \$100.00. \$7.50

**ELECTRIC ACTUATOR**. For lifting, lowering, etc. 3/4" H.P. Motor with 5" travel actuator. For 24 V. D.C. & applicable for 110 V. A.C. Rated 2800 lbs. (Fig. 6). Instructions \$7.50.

**VOLTMETER D.C.** 30 Volt with zero center. 300 Ohms. Easy to calibrate. (Fig. 1). \$4.95 Postpaid.

**D. C. AMMETER**. Range 0 to 300 Amps. (Fig. 1). \$4.95 Postpaid.

**TACHOMETER INDICATOR**. Aircraft type. Kollsman = 0508-03. Range 0 to 1000 R.P.M. New. (Fig. 2). \$7.95

**HYDRAULIC PRESSURE GAUGE**. 0 to 2000 P.S.I. 1/4" Ports. (Fig. 3). \$3.50 postpaid.

**G.E. MINIATURE MOTOR**. 27V. D.C. 5 Amps. 200 R.P.M. 8 oz. torque. \$4.95 Postpaid.

## NEW HYDRAULIC CYLINDERS

Stock #	For AIR or HYDRAULIC	all double Action	Price
# 11	1 1/2"	6"	\$7.95
# 512	2 1/2"	4"	\$8.50
# 70	(2 1/2" incl. built in relief)	10"	\$19.50
# 111	3"	24"	\$27.50
# 511	3 1/2"	21"	\$29.50

**WEAVER HYDRAULIC HAND PUMP**. With built in relief. 2000 P.S.I. (Fig. 6). \$8.95.

**STRATOPUMP CONSTANT DISPLACEMENT PUMP**. 400 G.P.H. 3750 R.P.M. 1250-1500 P.S.I. with built in relief. \$150.00 value. \$17.50.

**VICKERS CONSTANT DISPLACEMENT PUMP**. New = PP-28-2715-25-2E. 400 G.P.H. 3750 R.P.M. 1500 P.S.I. .507 Cu. In. rev. (Fig. 8). \$17.50.

**PESCO GEAR TYPE HYD. PUMP**. .227 Cu. In. Rev. 198 G.P.H. 1500 R.P.M. 1500 P.S.I. = 340. (Fig. 8).

**PESCO GEAR TYPE HYD. PUMP** = 382. Rated 360 G.P.H. 4300 R.P.M. 1500 P.S.I. .375 Cu. In. Rev. Std. 3/4" ports. \$12.95

(Fig. 1). **HYDRAULIC or AIR ACCUMULATORS**. 2000 P.S.I. 5 1/2" dia. \$5.50. 7 1/4" dia. \$7.95. **SIMMONDS ACC.** (Fig. 2). 3000 P.S.I. 60 cu. in. 1/2" ports. New \$10.95. **CYLINDER TYPE ACC.** 4 1/2"x3 1/2" 2000 P.S.I. Wt. 23 lbs. (Fig. 3) \$12.95

**FOUR WAY HYD. CONTROL VALVES**. **ADEL = 227**. Poppet type 3/4" ports to operate 1 D.A. cylinder (Fig. 4). \$7.95.

**= 620 Valve** to operate 2 D.A. cylinders. Off at neutral with built in relief & 3 position raise, lower & hold. 3/4" ports. (Fig. 5). \$12.50

**Adel = 1000G**. Poppet type open center to control 1 to 4 double action cylinders, including built in relief and metering. 3/4" ports. O. Cost \$160.00. (Fig. 6). \$14.50.

(Fig. 7) **FOUR WAY SOLENOID VALVES**. For 24 V. D.C. & Appl. for 110V. A.C. Off in neutral. 3/4" ports. = 1215 \$12.50 = 324 with 1/4" ports \$9.95. Instructions incl.

**ROMEC PUMP & MOTOR UNIT**. Positive displacement. Rotary type. 24 V. D.C. 28 H.P. 2500 I.P.M. 900 G.P.H. 3/4" Ports. O. Cost over \$150.00. New \$19.95

**PESCO = 397-D HYDRAULIC FLOW EQUALIZER**. For 2 systems or 2 cylinders. 1500 P.S.I. \$50.00 value. \$9.95.

**WINCH HOIST PORTABLE**. Rated 1500 lbs.; has 21:1 gear ratio, 40" arm extension, 3" pulley, 12 ft. of 3/16" steel cable incl. operating handle with ratchet brake \$19.50

## MONEY FOR MEN ALL DATA FREE

THE PLASTEX Industry needs manufacturers on small scale and for big production of Lamp and Clock Stands, Art Goods and Novelties in Plastex and Marble imitation. Experience unnecessary. 1 1/2 material makes regular 10c store sellers. Rubber moulds furnished for speed production. Small investment brings good returns. We are now placing big Chain Store Orders with manufacturers. Ambitious men have chance for real prosperity. Our Free booklet will interest and benefit you.

**PLASTEX INDUSTRIES, Dept. A**  
 3400 Third Ave. New York 56, N. Y.

## WORLD'S BEST SMALL TRENCHERS

Portable **DITCH-WITCH** digs 2" to 6" deep, even ditches to 36" depth in all types of soil. Complete unit—self propelled—outdigs 8 men. Four rugged models.

Write for illustrated literature.  
**THE CHARLES MACHINE WORKS**  
 620 B Street Perry, Oklahoma

## 2 GREAT AUTO BARGAINS

**KING MIDGET** for 1955. Lower priced. Improved performance. Drive it for 75c per week. Rider agents wanted—earn your own car. Also just out. **KING MIDGET JUNIOR**, finely engineered, less than one-third cost of any comparable car, one twelfth cost of large cars. Agents wanted. **GET THE FACTS**—send 25c for literature and agents propositions on both cars, or \$1 (refunded first order) for this plus actual assembly book and service manual.

**MIDGET MOTORS MFG. CO.**  
 ATHENS 1, OHIO

## HOBBY FUN for EVERYONE!

### AMAZING FOOT-A-MINUTE (7,200 Strokes Per Min.) CUTTING SPEED!

**DREMEL ELECTRIC COPING SAW ONLY \$6.85** with 3 saw blades

**FREE PROJECT PLANS** Make your own saw table. Complete plans and six project patterns, included FREE.

Here is a high speed, electric power tool with hundreds of household and workshop uses! It's so easy to handle women and children love it, yet so rugged it is used by craftsmen, tile layers and carpenters. Has amazing capacity—easily cuts asphalt and rubber tile, masonite and formica, wood up to 3/4" thick! Perfect for coping and jig saw work, making knick-knacks, toys, other hobby projects. Has high speed reciprocating motor, only two moving parts, never needs oiling. Proved on the job and in thousands of homes.

**SEE YOUR DEALER.** If he cannot supply, order direct on 5-day trial, money-back guarantee. Remit in full for postpaid shipment; or send \$2, pay postman balance plus postage and COD.

**DREMEL MFG. CO. Dept. 115-G, Racine, Wis.**

## KEEP ALL SAWS SHARP



**SO EASY!** With this new filing jig and jointer anyone can now sharpen any handsaw like new! When file hits hardened steel rollers teeth are finished and EXACTLY SAME HEIGHT. All teeth cut and saw runs true and smooth. Jig and instructions \$2.95 postpaid. Free literature.

**SAVE TIME AND \$\$\$**

### JOINT & SHARPEN CIRCULAR SAWS

Sensational new Super Filer No. 11 joints and sharpens both hand and circular saws 6" to 10" with all teeth the correct height, depth, pitch and bevel. Easy to use—when file hits hardened steel rollers, teeth are finished. Saw runs true and smooth with no side pull. Complete with special 8" file \$9.95 ppd. "TRU-CIRCLE" saw set automatically sets teeth at 10° or more \$2.95.



Guaranteed.

### SUPER SAW FILER NO. 6

Automatically controls

**DEPTH ANGLE PITCH**  
Automatic DEPTH CONTROL Rollers



IT'S NEW!

Perfect bevel and angle maintained, and fool-proof depth control for all Rip, Crosscut and Handsaws. Precision made and calibrated for instant setting at desired angle. Can be used in any vise or clamp. Complete with file only \$6.50 ppd. SEND FOR FREE CATALOG

### SUPER DRILL GRINDER

Sharpens round shank drills from 3/32" to 1/2" in diameter, up to 6" long. Grinds odd drills like new in 4 different point angles, using hand or power grinding wheels... \$2.95

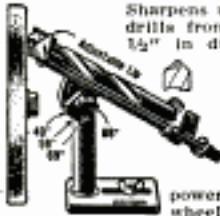

A. D. McBURNEY, 5908 Hollywood Blvd., Hollywood 28, Cal., Dept. A-75

## VARIABLE SPEED

HYDRAULIC POWER TRANSMISSION



It has Infinite Speeds 0 to 550, Reverse, Automatic Overload Protection; Adjustable Torque up to 180 inch pounds. 5/8" input and Output Shafts. It will handle 1/2" to 1 1/2" H.P. Motor. Case measures 7 1/2" long, 7" high, 6 1/2" wide. VALUE OVER \$300. Shipping Wt. 25#. On C.O.D. orders we require a 10% only \$54.50 Deposit. Fab. Chicago

DIRZIUS MACHINE SHOP "D" 1423-25 So. 52nd Ave., Cicero 50, Ill.

## FREE FOLDER "HOW TO SAND"

ADDRESS "Handy" SANDY CARBORUNDUM® Niagara Falls, New York



### 10" TILT/ARBOR SAW

BUILD-IT-YOURSELF from GIL-BILT KITS-PLANS

Sturdy wood, steel, and aluminum construction, NEW DEPARTURE ball bearings. Capacity and performance of floor saws selling for \$150.00 and up. Plans, all metal parts in kit with 10" comb. blade \$25.90, 1000 blade \$22.95. F.O.B. St. Louis. Detail PLANS-PATTERNS only \$1.00 postpaid. Build-it-yourself 12" and 18" Bandsaws, Belt Sander, Shaper. Simplified plans, build easily with hand tools only. Advertised and sold for 7 years, over 30,000 units in use. Money back guarantee. FREE CATALOG.

GILLIOM POWER TOOLS, Dept. 80-G, Lambert Field, St. Louis 21, Mo.

## NEW, EXCLUSIVE LOK-BLOK®

LOCKS BLADE IN HANDLE

Now TWIST & IMPACT PROOF!

Plus many other great features and unsurpassed quality... yet cost no more than ordinary drivers!

At All Leading Dealers  
UPSON BROS., INC., Rochester 14, N. Y.



**HOLD-E-ZEE**  
The Original Automatic Grip SCREWDRIVERS

To find out more about the constituents of smog, radioactive tracer elements are being introduced into fuels, then studied for chemical changes after combustion. To find the areas in which smog appears to generate most rapidly, aerometric sampling stations have been set up in the area. In addition, radar beams that are absorbed by some compounds suspected as constituents of smog are to be directed across the Los Angeles basin. Wind movements in the area are being studied with the use of fluorescent aerosols that serve as tracers.

It may be that ozone and nitrogen dioxide occur in greater-than-normal amounts in the air along parts of the Pacific coast. To find out, improved types of measuring devices are being installed in and away from Los Angeles. If it turns out that there are "ozone clouds" drifting in from the sea, a proposal has been made to detect the clouds by microwave radio or even to disperse them while still offshore.

One of the things that is under study is some way of replacing home incinerators. Municipal incinerators aren't a satisfactory answer, and burying the refuse of a large city is costly. One suggestion is to grind up all rubbish and refuse at home and flush it down the drain, similar to the way garbage grinders dispose of food scraps. Objections to this include the waste of precious water and the fact that sewage systems could hardly handle so large an additional load.

This isn't the first time that Los Angeles has had an air-pollution problem. Up to 15 or 20 years ago the city occasionally was blanketed by black smoke from the thousands of smudge pots set out in the citrus groves to prevent frost. Today all the old-fashioned pots have been replaced by modern "return stack" orchard heaters that produce more heat and no smoke. These, plus wind machines, solved one air-pollution problem.

Smog will be vanquished, too, though the campaign will take longer and cost more money. ★ ★ ★

## Stroboscopic Lights on Plane

Flashing stroboscopic lights clearly indicate the presence and direction of a DC-6 air coach flown by United Air Lines. Three are mounted under the fuselage, four on top (two on either side of the dorsal fin). The photographic-type lights are flashed in pairs (one above and one below) 60 times per minute, moving forward from the tail. The flashing lights give the illusion of bright horizontal lines which leap ahead in the direction of the plane's course.

# BE YOUR OWN BOSS

Make Hundreds of \$ Spare or Full Time Work

## NO EXPERIENCE NEEDED

Here is the ideal business with no previous experience or large investment required and no high-priced equipment to buy. A business that will return dollars for the pennies you invest.

## YOU CAN CAST ANYTHING

With Flexible Mold Making and Ornamental Casting, an amazing fact-packed book, you learn how you can cast practically any article in concrete, plaster, imitation marble or any other casting material using a marvelous new process. You can make ash trays, novelties, garden and lawn ornaments and hundreds of other highly profitable items that cost you but a few cents and sell for as much as \$5.00 and more. Why you can even make true-to-life full-sized busts of your neighbors and friends.

## NO EXPENSIVE MOLDS TO BUY

Why buy high-priced molds from others? Learn how you can make your own molds quickly, easily and inexpensively with materials that can be used over and over. You get copyrighted formulas, complete instructions and detailed how-to-do-it photographs as well as complete sources of supply for the few inexpensive materials you need. This is the only book printed in America today that contains instructions for making profitable papier-mache casts.

## MONEY BACK GUARANTEE

Start on your road to extra income and independence today. Send only \$1.98 for your copy of Flexible Mold Making and Ornamental Casting. Complete satisfaction guaranteed or your money refunded within seven days.

POPULAR MECHANICS PRESS, Dept. 46

200 E. ONTARIO ST., CHICAGO 11, ILL.

You can make simply and cheaply



BUSTS



GARDEN URNS



NOVELTIES



TILE



STATUARY



## AIR CONDITION

ONE TO THREE ROOMS

FOR ONLY \$34.50

NOW DELIVERED COMPLETELY ASSEMBLED, evaporative air conditioner easily installed in minutes in window opening; sliding side panels assure snug fit. Beautiful hammertone finish.

WEATHER MERCHANTS  
2913-M Gaston Ave. Dallas 4, Texas  
Balanced fan and powerful 1/25-hp, 115-v AC shaded pole motor deliver 1500 cu. ft. cool, filtered air per minute through adjustable directional louvers. Pure aspen filters; clog-free drip trough; brass metering valve; toggle switch; pipe connection; 25' tubing. Send \$5.00 m.o. or check; balance C.O.D. plus shipping. Full price only \$34.50 f.o.b. Dallas. Supply limited—ACT NOW!

MOTOR GUARANTEED FOR ONE YEAR



## MAKE EXTRA MONEY

### Start Your Own Business

Sell tools part time, full time. Save money for your industrial and institutional use. A MILLION DOLLAR INVENTORY AT YOUR FINGERTIPS. Buy NATIONALLY ADVERTISED hand tools, hardware, fans, motors, power tools, paints, etc., NO INVESTMENT REQUIRED. Buy as you need it. Up to 50% DEALERS DISCOUNT.

Send \$1 Deposit for Dealers Card and monthly dealers catalog. \$1 refunded on first purchase or returned if you are not 100% satisfied. SILVO HARDWARE CO., Dept. PM-7, 108 Market St., Phila. 6, Pa.

## SAY YOU SAW IT IN POPULAR MECHANICS



BUY FROM MANUFACTURER  
**ATTIC EXHAUST FANS** \$6.66 F.O.B. N. Y.

20" Kit includes: Steel blade 2 self-aligning bearings 2 pulleys, shaft, collars, instructions. Easy to install and assemble.

VISIT US OR SEND FOR FAN PARTS & MOTOR BOOK  
**Albin Machine Co., Inc.**

New York, 423 Broome St. | Detroit, Mich., 425 W. Jefferson Ave. | Cincinnati, Ohio, 1529 Vine St. | Louisville, Ky., 225 E. Market St.

**NEW PORTABLE Kitchen-like STOVE**

Cooks • Boils • Fries • Melts Solids fast —without fuss

- Fits your pocket
- weighs only 7 oz.
- Simple to operate
- no valves — pumps
- Thousands of satisfied users
- Get one today!

Only \$1.98 postpaid

checks, cash or money order Dealer inquiries invited. Send to: 1929 Opdyke Rd., Clay Mfg. Co., Pontiac, Mich.

**SOLAR BATTERIES**

now available, \$2.00 each. Electric energy direct from the sun. Power for transistor radios, microphones, photo cells, exposure meters, hearing aids and the like, direct from the sun. No batteries needed. Light from a 60 watt lamp will furnish enough power to operate our famous MYSTERY BUTTON as a telephone. A KIT of one solar battery, one mystery button, and one hearing aid type ear phone, A.L.S. for only \$4.95. Also 5000 word booklet on mystery button and an 8 page booklet on transistors included with order.

**ELECTRONIC PRODUCTS CO., St. Charles 1, Ill.**

**TEST CIRCUITS, Fuses, Outlets easily, quickly, safely. Shockproof. Pull fuses 10 to 100 Amp.**

**STAR TEST-PLIERS**

Test 110-600 Volts

\$2.75 \$1.50 add'l for 2 ft. leads. At dealers... or order direct from us. Mailed POSTPAID

**STAR FUSE CO., 233 Canal St., New York 13, N. Y.**

**PUMP WATER FAST!**

Drains Wash Tubs, Cellars, Cisterns. Famous #7 pumps 2800 gph. 420 gph. at 75' high or 1600 gph. from 25' well. Sturdy rustproof alloy metal. Six blade impeller. 3/4" inlet, 1/2" outlet. Standard pipe threaded. Uses any 1/2 to 1/2 H.P. Motor. Will not leak or clog. Iron clad guarantee. Send check, M.O., or sent C.O.D. \$8.95

Irrigate, Fill Tanks, Draw Well Water. Heavy duty #8 pumps 7000 gph. —1000 gph. 75' high 3000 gph. from 25' well. Rustproof alloy metal. 8 blade impeller. 1" inlet, 1" outlet. Standard pipe threaded. Will not leak or clog. Iron clad guarantee. Send check, M.O., or sent C.O.D. \$11.95

Free Catalogue—Gear Pumps, Large Centrifugal Pumps, Deep and Shallow Well Pumps, Sump Pumps.

**MOORE MANUFACTURING CO. SWEDSBORO 1, NEW JERSEY**

**Earn Big Money arc Welding**

Air Cooled Engine Drive "Husky Boy"  
 AC Power or AC Welding  
 AC Transformer Welder  
 DC "Bantam Champ"

Check the machine you're interested in—tear out ad and mail it today!

Cash is on "big pay" emergency repair work. Light, rugged "Husky Boy" easily handles general shop and outside repairs.

Weld where power is unavailable, or furnish emergency power for power tools, electric lights, 200 or 300 amp., plus 5 or 8 KW AC power.

Transformer will improve your AC welding. Operates on single phase power lines. "Bantam Champ" for small shops or building your own 200 amp. welder.

**HOBART BROTHERS CO., BOX M-75, TROY, OHIO, PHONE 21223**

# AMMUNITION

for a fraction of  
regular cost



Reload a whole carton for the cost of a few rounds of factory ammunition. Shotgun shells, rifle and pistol cartridges can be reloaded safely and easily with an inexpensive set of famous IDEAL Reloading Tools. Send for free literature.

**THE LYMAN GUN SIGHT CORP.**  
Middlefield, Conn.

## YOU BUILD **EICO** KITS

in one evening. SAVE 50% & LEARN

Easy Instructions | Vacuum Tube Voltmeter  
38 Instruments | **KIT \$25.95** Wired \$39.95

Write now for FREE Catalog . . . **PM-7**



Electronic Instrument Co., Inc. • 84 Withers St. • Brooklyn 11, N.Y.

ALSO  
"ESHelman"  
CHILD'S  
2 Passenger  
MOTOR CAR  
Eshelman Cars  
Commended  
by Parents'  
Magazine  
Free Catalog.

### ESHelman ADULT SPORT CAR Model 6 HP

**1 THE MOST OF ANY OTHER AUTO**  
70 Miles Per Gal. Gas.  
35 Miles Per Hour

Shipping Points:  
BALTIMORE,  
CHICAGO, RENO  
Free Catalog Write:  
**ESHelman CO.**  
DEPT. MC-57, 109 Light St., Balto. 2, Md. Pat. Pend.



"I SAVED \$68 on RECONDITIONING MY WATER SOFTENER INTERNALLY" writes H. J. of Pittsburgh. You, too, can renew the efficiency of your softener, have much more soft water, longer, with this nationally industry tested chemical . . . ZEO-TREET . . . a brine additive that super cleans, reactivates your present minerals faster, thoroughly, and at a very low cost. Saves labor and cost of replacement of expensive minerals. Used nationally by industry, municipalities, hospitals. Available to home owners for only \$2 (postpaid). No equipment to buy, no extra work. Satisfaction guaranteed or money refunded. Agents wanted for home or industrial sales. Craft Products Co. (Water Chemists since 1921), 1500 Spring Garden Ave., Pittsburgh 12, Pa.

"DO IT YOURSELF"  
IT'S EASY WITH  
**KESTER SOLDER**



Soldering's really a "cinch" . . . when you use time-tested, reliable KESTER . . . available everywhere.

FREE! "Soldering Simplified" . . . 16-page how-to-solder booklet. At your dealer or write direct.

**KESTER SOLDER COMPANY**  
4251 Wrightwood Avenue Chicago 39, Illinois

## FREE - BIG CATALOG

HOBBY - PROFESSIONAL

### MICROSCOPES

100 to 2000 POWER-\$6.95 to \$319. 40 pages of fascinating information on microscopes, micro-hobby materials, telescopes and binoculars  
**SEND POSTCARD**

PRECISION OPTICAL CO.

18 Precision Bldg., 4379 Sunset Blvd.  
Los Angeles 27, Calif.



## MILLIONS IN URANIUM!

**Strike it rich!** New pocket size book by noted geologist with 29 years experience tells where to look, what to look for, use of Geiger counter, staking your claim, where to send samples, government bonuses, etc. Uranium has been found in nearly every state. Many have become fabulously rich. Why not you? **Order your copy today. \$1.95**  
*Money refunded if not satisfied*

**GEOLOGISTS RESEARCH, 166 Crescent Pl., Ithaca, N. Y.**

24-Page Illustrated

### DO-IT-YOURSELF PROJECTS BOOK

Describes attic finishing, built-in cabinets, add-a-room, recreation room, kitchen remodeling, summer cottage and farm projects. Contains helpful information on how to get started, planning, cost estimating, materials purchasing, and proper procedures, also nail charts, moulding designs, etc. Send only 25c and also receive **FREE 52-PAGE POWER TOOL CATALOG.**

**BOICE-CRANE COMPANY, 943 Central Avenue, Toledo 6, Ohio**

## HELPFUL BOOKS

Send post card asking for **FREE catalog**

Popular Mechanics Press, 200 E. Ontario, Dept. 601, Chicago 11

## YES! SEND



directly  
to my door  
every month

I am enclosing

- \$3.50 for 1 year  
 \$8.00 for 3 years

name \_\_\_\_\_

address \_\_\_\_\_

city \_\_\_\_\_

zone \_\_\_\_\_

state \_\_\_\_\_

A-75

Hand this order to your newsdealer or send it to

**POPULAR MECHANICS**

200 East Ontario St.

Chicago 11, Ill.



GIGANTIC  
SAVE-TO-70%

# MAIL SALE

WAR SURPLUS  
EXCESS INVENTORY  
BANKRUPT STOCK

## LINEAR ACTUATOR MOTOR UNIT

Brand new, Amazing hi-speed series motor operates worm jack to give tremendous straight-stroke push or pull power up to 3 1/2". Use to operate boat throttles, clutches, door openers, hundreds uses.

Operates on AC or DC voltages as low as 6 volts. Govt. cost over \$100.  
**SUPER SPECIAL \$11.95**

## AIR COMPRESSORS — TANKS, Etc.

Save to 70% on air fittings, tanks, compressors, etc. See our catalog.

- Piston Air Compressor, 150 lb. . . . \$18.91
- Air Corp 300-lb. Pressure Tank . . . \$6.79
- Auto Pressure Switch for Motor . . . \$4.95
- Professional Paint Spray Gun . . . \$9.95
- Deluxe Air Kit complete . . . \$45.49

## NAVY STEEL LETTER STAMPS

Finest steel stamps. Letter size 3/8". Mark on brass, copper, steel, wood, leather. Identify tools and equip. Reduce that loss. Box size 3 1/2" x 2 1/2" x 1 1/2". Complete alphabet. Std. list, \$15.25.

**SALE, Prepaid \$6.91**

## SUMMER SUPER BARGAIN LISTINGS

Typical surplus bargains offered to stimulate summer buying. Limited lots. Order promptly. Fraction original cost. Write for more details if necessary.

- Marine Control, 3-lever unit . . . \$7.91
- Pressure Gauge, 1000-lb. . . . \$4.71
- Finest 4-Drawer Oak Card Cabinet . . . \$9.17
- Army Wool Sleeping Bag (\$12.50) . . . \$4.29
- Photo Paper, Film, fraction of cost.
- G.E. Laby Amplifier, 110-v, 60-c . . . \$6.97
- Step Down Trans, 3.5 KW 250/115-v . . . \$3.90
- Powerful Air Corp Spot Lite . . . \$5.61
- S112 Plane Propeller 7 1/2" FOB Lincoln \$5.29
- CarWood 12,000 lb. Power Winch \$189.50
- Hydraulic Pump, 1000 lb. 12 gpm. \$45.50
- Hydraulic Servo Cylinder (SRT.50) . . . \$3.89
- Hydraulic Hand Pump 1000-lb. . . . \$10.95

## ARMY POWER PLANTS

Wonderful buys. Lowest prices in USA. Write for complete listings. We pay freight.

- 1000-w, 115-v, 60-c . . . \$189
- 2000-w, 115-v, 60-c . . . \$289
- 3000-w, 115-v, 60-c . . . \$349
- 7500-w, 115-v, 60-c . . . \$590

## SPECIAL OF THE MONTH!

### NAVY IRRIGATION PUMP

2 1/2" size, 16,500 gph  
● Brand new Marine Products Co. all bronze ball bearing hi capacity centrifugal. Wonderful small farm and truck irrigation, many industrial uses.  
● Capacity to 280 gpm. Pressure to 65". Speed 2100-2700. Clock-wise rotation. Complete with 6" galley, Wt. 40 lbs. Size 10"x11"x8". Inlet 2 1/2", outlet 2".  
● Note—2 of these units driven by single engine. Will deliver almost 600 gpm or 35,000 gph. Natl. Adv. List. \$98.  
**SALE, Prepaid \$44.37**  
We have many other marvelous buys in leading make war surplus pumps. Get our catalog.

## SPECIALS FROM PREVIOUS ADS

- Army Tool and Parts Cabinet, FOB KY. \$7.95
- Hydraulic Pump, 2500-lb. 6-v. FOB \$45.49
- Precision Surveyors Tripod Level. \$27.50
- Attic Fan Kit, 30" size . . . \$15.95
- Desk Telephone, make antique lamp \$1.99
- Police Mobile Radio Trans-Recv . . . \$70.21

We pay transportation except where FOB. Write for large FREE Catalog. 100s items.

**BURDEN SALES COMPANY**  
809 O ST., LINCOLN, NEBR.

## Save Hundreds of Dollars Yearly With Guide to Home Repairs

### Home Repairs, Modernizing Jobs Made Easy for Home Owners

Beat the high cost of home upkeep. Stop staggering labor costs. Save hundreds of dollars every year on carpentry, electrical, painting, plumbing and other jobs around the house with Popular Mechanics GUIDE TO HOME REPAIRS. Simplified how-to-do-it instructions and 646 pictures make all jobs, inside and out, easy. Covers construction, remodeling, modernizing, repairing that you can do yourself at small cost. Repair leaky faucets for pennies; save \$10 to \$15 on new electrical outlets; save hundreds of dollars on new floors, porch repairs, tuck pointing, gutter replacements and other improvements. 192 page cloth bound book only \$2.50 postpaid. Get GUIDE TO HOME REPAIRS today under our money back guarantee.

POPULAR MECHANICS PRESS, Dept. PM1, 200 E. Ontario St., Chicago 11



CARPENTRY



ELECTRICAL WORK



INSULATION



PLUMBING

## Do a Real Professional-Like Job Yourself and SAVE

# HOW to PAINT

With Brush and Spray

### Covers All Painting Methods and Materials

You can do professional-like painting and finishing jobs yourself and save about two-thirds of the cost. Sam Brown, noted craft authority, makes it so easy for you in his book HOW TO PAINT WITH BRUSH AND SPRAY. Order your copy now and enjoy this tremendous saving. It covers exterior painting, wall and interior decorating, furniture finishing, concrete painting — every type of painting with brush, spray gun, roller and other methods. Tells what finish is best; what materials to use, etc. No previous experience needed. Fully illustrated. Order by mail. Only \$2.00. Money back if not pleased.

POPULAR MECHANICS PRESS, Dept. PM18  
200 E. ONTARIO ST., CHICAGO 11, ILL.



## Save on a New GARAGE - Complete Popular Mechanics Plans Only \$2

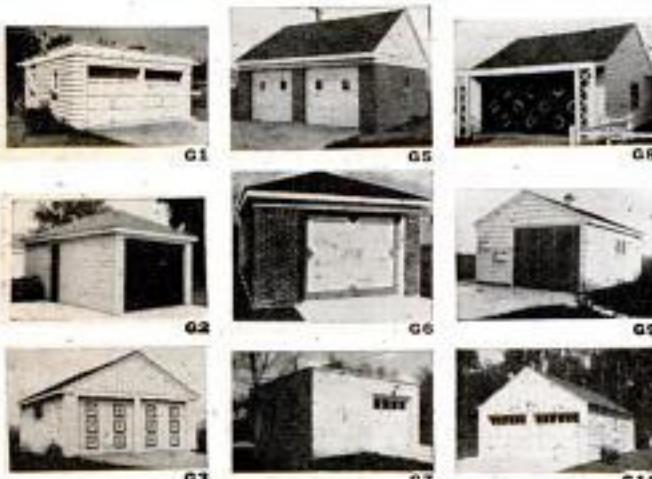

One, One and One-Half and Two-Car, Modern Stylish Garages — Frame, Brick and Block Construction. Specially Prepared for "Weekend Carpenters." Material List Included.

Use a set of these Popular Mechanics plans and build a garage yourself. Or get a set for your contractor or builder to follow. Made from famous architect's drawings in Popular Mechanics easy-to-understand style. 10 different garages—10 sets of plans—only \$2 each. Plans consist of two full size working blueprints with all details and dimensions and a fully itemized material list. All plans adaptable to frame, brick or block construction with slight modification.

### Super-Detailed and Simplified Plans

Anyone without previous experience can follow these plans and build a good, stylish, up-to-date garage at a big saving. Order plans you want by number below. Clip and mail the coupon today.

## How to Build Your Own GARAGE

Complete build-a-garage instruction from excavation to final finish, step by step. 25 designs and many usable ideas. Cuts garage costs in half. Cloth binding, 128 large size pages. 529 pictures. Postpaid \$3.50.



## Select and Check Plans Wanted - Mail this Handy Coupon

- TWO CAR**
- G1 Frame 20x20
  - G3 Frame 20x20
  - G5 Brick 20x21
  - G8 Frame 20x20
  - G10 Frame 20x26
- ONE AND ONE-HALF CAR**
- G4 Frame 14x20
  - G7 Brick 14x20
  - G9 Frame 15x20
- ONE CAR**
- G2 Frame 12x20
  - G6 Block 20x20

POPULAR MECHANICS PRESS  
200 East Ontario Street, Chicago 11

I enclose remittance for \$\_\_\_\_\_ Send me Popular Mechanics Garage Plans as indicated.  Check here if you want book 'How to Build Your Own Garage' (Remit \$3.50 additional).

Name \_\_\_\_\_

Address \_\_\_\_\_

City \_\_\_\_\_ State \_\_\_\_\_

**• New BUILD-IT-YOURSELF Window Fan Kit**  
20, 24 & 30" Blade Fan Part Kits, less frame

These FAN KITS provide low cost, high efficiency belt driven fans, for COOLING nature's way. Dynamically balanced, highly polished, completely assembled Aluminum Blade, Rubber Mounted Bearings, 3/8" Shaft, Collars, Motor and Fan Pulleys & Belt. Instructions included in factory packed carton. Complete less motor. (Special Price on 1/2 H.P. Motor below).

FK-301-6000 CFM 20" Blade & Complete Kit..... **\$13.95**

• 1 YEAR GUARANTEE • ORDERS SHIPPED SAME DAY

FK-304-8000 CFM 24" Blade & Complete Kit..... **\$15.95** Easily Assembled

FK-307-10000 CFM 30" Blade & Complete Kit..... **\$19.95**

(for vertical installation add \$7.50 for ball bearing assembly)

• SPECIAL PRICE Limit to AUG. 15th •  
W-1 Westinghouse 1/2 H.P. 110V—60 cy. Motor 1 speed. Rubber Mounted. 1725 RPM... only **\$10.00**

Send for U-Build-It Literature, Water Pumps, Sump Pumps, Shallow-Well Pumps, Lawn Sprinklers, ETC.

F.O.B. CHGO.

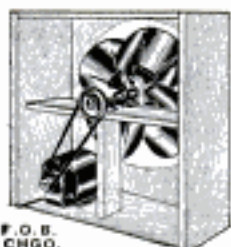

C. MARSHALL SALES, 3546 W. Fullerton Av., Dept. P-7, CHICAGO 47

**A USEFUL GAGE THAT IS NEW AND DIFFERENT**



MADE OF BRASS Jay Dee Tool Co., 9102 E. Valley Blvd. PRICE \$1.00 Postpaid, No C.O.D. Rosemead 4, Calif.

**DO MORE PLANING JOBS WITH LOW COST BELSAW**

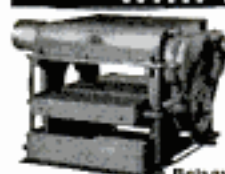

Exclusive MONEY-MAKING Features: • Full 12 3/4" x 6" capacity • Power feeds at 24" a minute • Provides for Grinding Knives in the Cutterhead • Attachments for Jointing, Rabbling, Tongue, Groove, Matching. Convert low cost rough lumber into high priced cabinet finished stock... Easy to make flooring and popular patterns. Send today for free literature and prices.

Belshaw Machinery Co., 1012 Field Bldg., Kansas City II, Mo

**TRAIN IN THE SOUTH**

AIR CONDITIONING—REFRIGERATION—ELECTRICITY—MAJOR APPLIANCES—ELECTRONICS—TELEVISION  
**COMMERCIAL TRADES INSTITUTE**  
200 So. 20th St. Birmingham, Ala.

SAY YOU SAW IT IN POPULAR MECHANICS



**READY FOR ALL HOME DO-IT-YOURSELF JOBS**

The amazing SYNCRO 208 gives you all this! cuts 1 3/4" wood—cuts to center of 30" circle—is safe—motor guaranteed against burnout! Remember: More Syncro-made jig saws have been sold than any other self-powered make. Send for Catalog, low price!

SYNCRO CORP., Dept. 1-BS, Oxford, Michigan, U.S.A.



**NEW! ALLEN WRENCH INDEX CASE**

First time offered! Durable draw steel. Holds standard set of 11 wrenches from 3/8" across flats to .050". Fly stands upright for easy selection. Each wrench individually plated, will not fall out. Quality and service GUARANTEED. Send cash, check or money order today! \$1.25 for case only... \$2.50 for case and 11 wrenches. Postpaid.

WAT-NOK SALES CO. 1515 2ND. AVE. SO., DEPT. PM-55 MINNEAPOLIS 3, MINN.

*Special*  
**BLUEPRINT SALE**  
**10 for \$1.00**

A plan for every project—no matter what it is... modern home furniture, workshop bench, model ship, toy, ice yacht. We have a limited number of blueprints available at 10 for \$1.00, regularly 40c each! You can save dollars by buying now!

**Easy to Follow**



Beginner or craftsman, you will know exactly how to give your project that professional touch if you follow our plans. There will be no waste of materials—no extra cost. You choose from more than 70 different designs, including:

- 638 Flat Roof Arbor
- 764 12 Point Star Lamp
- 795 Two Cedar Chests
- 821 Entrance Unit
- 912 Folding Card Table and chairs
- 918 Martha Washington Sewing Cabinet
- 981 Colonial Coffee Table



- 985 Bent Metal Flower Stand
- 989 Speedy Motor Scooter
- 993 Twin Deck Beds
- 994 Console Table
- 996 Modern Table Lamps
- 997 Speedy Bobsled
- 1005 Six Towel Racks
- 1027 Hostess Tray



- 1030 Workshop Electro-magnet
- 1043 Cricket Chair
- 1044 Chairside Magazine Case
- 1045 "Whizz" Fast Class E Ice Yacht
- 1049 Swedish Supper Cart

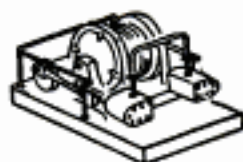

The biggest blueprint bargain in years. Any one of 70 designs may be yours. Don't miss this opportunity to buy your plans. BUY NOW from:

**POPULAR MECHANICS PRESS**

200 E. Ontario, Chicago 11, Illinois

Send 3c stamp for complete listing

## SAVE ON PALLEY SPECIAL VALUES

### GENTRIFUGAL PUMP AND MOTOR



**9.95**  
20%<sup>00</sup> VALUE

DELIVERS UP TO 700 GAL. PER HOUR

For draining cellars, fish ponds, sungees, water circulators, etc. Powered by the famous G.E. 110 volt, 60 cycle motor. Has 1" standard pipe inlet, 3/4" I.D. hose outlet. A Gov't Surplus Bargain. Completely Reconditioned. Motor is re-wound and checked for serviceability. Ready to Run! Your satisfaction fully guaranteed. Order Today!

### PRESSURE TANKS



G-1 Type - Stainless Steel, shatterproof & rustless. Has reinforcing ribs and its pressure tested up to 400 PSI. Has high safety factor. Both ends have 1/4" pipe ports.

Ideal for use as buoy, for drinking water supply, underwater fishing, diving, painting, cooking or spraying.  
G-1 - 12 1/2" x 24" ONLY **10.95**  
D-2 Tank - 500 cu. in. cap. . . . **3.95**  
A-4 Tank - 104 cu. in. cap. . . . **1.95**

### IN STOCK AGAIN VICKERS HYD. TRANSMISSION



Self-contained, constant torque at all speeds with a variable volume, reversible piston pump which supplies piston hydraulic motor. Has 2 H.P. Automatic pressure dash pot for smooth control. Power output RPM is -0 to 1/2 input RPM in both directions. Input RPM is 1800 PSI continuous, 4000 intermittent. Ideal for Lathes, Duplicators on Mills, Conveyors, Small Cars, Drives, etc.

4" SPLINE SHAFTS for power input and take-off on above. . . . per pair \$2.50  
INPUT & TAKE-OFF PLATE ASSEM. To adapt above transmission to pulley drive. Has self-lubricating, high speed bearings. 1/2" keyway shaft. . . . Per SET **20.00**

### 180° OFFSET DRIVE

For use where tremendous power at low take-off RPM is desired. 6 gears rotate on self-lubricating, hi-speed roller bearings. 85 to 1 gear ratio. Shafts are 1-1/4" x 3/8" diam. All NEW! **12.95 NEW**

### NEW FROGMAN SUITS

Of finest quality seamless Latex rubbers. Two piece type. Factory seconds with minor imperfections, but guaranteed. With either long or short arms and legs. Please specify. \$54.95 val. **24.95**

### BUILD YOUR OWN DIVING LUNG

As seen in Popular Science. Save up to \$100. Our fully illustrated instructions show how. Kit includes 2 Air Bottles (1 hour air supply), pressure regulator, Hase, Shoulder Harness, Safety Belt, Clamps, Mouth Piece, Valves, etc. **45.95**

FREE CATALOG Fully ILLUSTRATED! Complete with the latest information on Diving Equipment. Also an illustrated and described article "How to Build Your Own Diving Lung". See the latest in Diving Equipment NOW! Send for Your Copy Today!

### AIR CORPS RUBBER BOATS

Ideal for Fishing and Hunting. Made to top Gov't Spec. Reconditioned & ready to use. Order Today!  
1 MAN **22.50** 7 MAN **69.50** 10 MAN **115.00**  
COLLAPSIBLE OARS **1.25 EA.**



SAVE UP TO 50% BUY FROM IMPORTER

### Genuine Select PHILLIPINE MAHOGANY LUAN PLYWOOD

Ideal For Fine CABINET WORK, FURNITURE, Paneling DENS, OFFICES, HOTELS, etc.

Our prices are LESS THAN DOMESTIC PLYWOOD at WHOLESALE. This selected LUAN MAHOGANY meets the most rigid specifications. It is WEATHER and WATER RESISTANT. You'll be amazed at the beauty of this fine wood. Its rich golden elegance will thrill you. Rotary cut for beauty of grain. Both sides sanded and ready to use. Bonded with finest resin adhesive. Face side unjointed.

Available in three thicknesses - 3mm (approx. 1/8"), 4mm (approx. 3/16") and 1/4". All orders shipped by Special Truck for lowest rates. No order accepted for less than 100 lbs. - equal to (8) 3mm sheets, (6) 4mm sheets or (4) 1/4" sheets. . . .

See for YOURSELF FREE SAMPLE on request!

3mm (1/8") x 3ft. x 6ft. \$5.00 VALUE <b>1.79 PER SHEET</b> Minimum order 8 sheets	4mm x 4ft. x 8 ft. \$7.50 VALUE <b>3.89 PER SHEET</b> Min. order 6 sheets	1/4" x 4ft. x 8 ft. \$9.50 VALUE <b>4.99 PER SHEET</b> Min. order 4 sheets
--	---	--

TRANSLUCENT FIBERGLASS PANELS Special purchase of 500,000 sq. ft. SAVE 40% - Fleet Quality. In all lengths and widths. Full range of colors. As described in Oct., '54 issue of Popular Mechanics. Write for FREE Booklet and Sample. 85¢ sq. ft. value. **49¢**

### 3400 RPM 1/2 HP POWER SAW

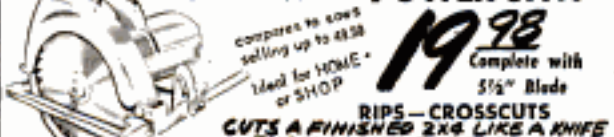

Compares to saws selling up to \$8.50. Ideal for HOME or SHOP. **19.98** Complete with 5 1/2" Blade. RIPS - CROSSCUTS CUTS A FINISHED 2x4 LIKE A KNIFE THROUGH HOT BUTTER!

A rugged, professional type, adjustable saw. Cut any angle, 0 to 45°. Has adjustable (0 to 6") rip fence. Safety trigger switch on handle. Full 1/2 HP Universal AC-DC, 110-120 Volt, 60 cycle motor. Weighs 6 1/2 lbs.

EXTRA SAW BLADES - Available in Rip, Crosscut or Combination. Please specify . . . price per each **2.95**

### SPORTSMAN'S 12 Pc. IMPORTED COMBINATION KNIFE



Eliminates 12 individual items from your Pack or Tool Kit! (A \$12.95 VALUE) **4.95** COMPLETE CAMPKIT

Here is the Perfect, Combination Knife-Tool for every Outdoor Sportsman, Hunter, Camper, Fisherman, Boy Scout, Ranger, Rancher, etc. Think of it! 11, Fine quality Steel Tools, precision made to fold easily into the heavy bone covered body. In one neat, compact unit you have: (1) a regular knife, (2) a fork, (3) a spoon, (4) a draw knife, (5) a bone-saw and fish-scaler, (6) scissors, (7) a can and bottle opener, (8) a cork-screw, (9) awl punch, (10) a screwdriver and (11) a metal file. All this PLUS a genuine leather, belt holster.

ORDER NOW While We Can Guarantee Delivery of this Special Low Price.

ORDER FROM THIS AD - Pay by Money Order or Check. Purchase Orders accepted from D&B firms. 50% dep. with C.O.D.s. Prices F.O.B. our store!!

## PALLEY SUPPLY CO

2263 E. VERNON AVE., DEPT. PM47 LOS ANGELES 33, CALIF.

## 10 New DELTA Hard Cover Books

"How To Get The Most Out Of" your Power Tools. Clearly written, illustrated. New projects, ideas. Write for FREE descriptive folder: Delta Power Tool Div., Rockwell Mfg. Co., 502-GN, Lexington Ave., Pgh. 8, Pa.

### NEW! Lightweight, compact ELECTRIC PLANTS

2,500-watt model—only 154 pounds!  
New AJ and AK models from 500 to 2,500 watts. High output, small size, low-cost. Powered by new Onan short-stroke engines.  
WRITE FOR FOLDER.  
D. W. ONAN & SONS INC. 3307 Univ. Ave. S.E. Minneapolis 14, Minnesota

## Say You Saw It in Popular Mechanics

### URANIUM HUNTERS!

Free Prospecting Information! Latest News and Data on Equipment and Methods.

MINERALIGHT locates uranium, tungsten, zinc, mercury, zirconium, and other valuable minerals. Shows traces other responses miss. FREE information packet on ultra-violet MINERALIGHT plus latest data on Geiger counters and scintillation counters. Write Department PM, Ultra-Violet Products, Inc., San Gabriel, California.

**MAKE MORE THAN  
\$20<sup>00</sup>  
PER HOUR**

**SERRATING &  
SHARPENING**



**TABLE AND  
KITCHEN KNIVES**



## SAW-KEEN

**PORTABLE ELECTRIC, EASY-TO-OPERATE, KNIFE  
SERRATOR AND SHARPENER**

Be Your Own Boss! Every restaurant, cafeteria, drive-in, hotel, hospital are repeat customers. Serrated (saw-edged) table knives are in big demand. Your investment of \$98.50 returns the first day. Guaranteed! Write today for proven method of getting profit making jobs daily.

**CUTTER-CRAFT DEPT. H, 58 S. RAYMOND  
PASADENA 1, CALIFORNIA**



best hardware . .  
for hard wear

## GRIFFIN HINGES

at your hardware or  
building supply store

GRIFFIN MFG. CO., ERIE, PA.

Say You Saw It in Popular Mechanics

**SHAW  
DU-ALL  
TRACTORS**

**rake - bulldoze - plow  
cut trees - cultivate  
saw wood - mow**

**You just steer!**

1½ to 5 H.P. walking tractors breeze through work. Variable speeds, run between or astride rows. Powerful 5, 8, 12 H.P. Riding Tractors. All wanted tools. Send for FREE CATALOG, low prices.

**SHAW Manufacturing Co.**

4507 Front Street, Galesburg, Kansas  
668-G North 4th Street, Columbus, Ohio



**AUTOMOTIVE  
Gears—3 speeds  
and reverse**

**SAVE MONEY! SAVE SERVICE CALLS!  
CHECK ALL TV, RADIO & PICTURE TUBES  
with this VISULITE TV TUBE CHECKER**



Only  
**\$3.95**  
Complete

**NO TECHNICAL KNOWLEDGE REQUIRED**  
Simple Instructions Furnished  
**SAFE — QUICK — FOOLPROOF**

Most Radio set failures are due to burned out tubes. Just plug tube into socket provided and Neon Lamp indicates this condition instantly. Operates on 110 Volt AC or DC.

**PERFORMS 1001 ELECTRICAL CHECKS!**

Checks continuity of resistors, appliances, motors or any Electrical device. Sturdily built for long life of trouble shooting. Test Leads included—Nothing else to buy. **SOLD ON 10 DAY MONEY BACK GUARANTEE.** See it at your distributor today. If he can't supply, order direct from factory. \$3.95 Postpaid anywhere in the U. S.

**VISULITE CO., Dept. PM-7 423 Broome St., New York 13, N.Y.**



**WHAT! ANOTHER "GIMMICK"?**

**No Sir!... It's a practical and mighty useful tool — the new PROTO ALL-ANGLE DRILL — a "must" for mechanics and hobbyists.**

Not only one of the best straight drills on the market—the new PROTO ALL-ANGLE DRILL is a real "must" for your tough drilling problems. ¼" chuck capacity with long storage space in handle for your high speed drills. **DON'T MISS THIS!**

Order No. 370 ALL-ANGLE DRILL at \$4.95

Chuck is adjustable over 370° etc.

Handle moves in 180° arc at right angle to chuck.

For prompt PREPAID (in USA) delivery, send check or M.O. to **JAY-DEE SALES CO., 3304 North San Fernando Blvd., Burbank, Calif.** Send 10¢ for 68-page PROTO TOOL Catalog — or no charge on request with your order.



## OVERLOAD SPRINGS

**\$9.95** Per Pair  
postpaid  
**2000 LB. SIZE**  
\$11.95

For cars and trucks. Front and rear. Gives 2000 lbs. extra capacity for all ½, ¾, and 1 ton trucks; 500 or 1000 lbs. extra for all cars. Easily installed. Guaranteed. State make, model. Dealers wanted.

**BRINKMAN MANUFACTURING CO.**  
2315 Clay Dept. 15-Y Topeka, Kansas



**POSITIVELY STOPS VAPOR LOCK!  
New KLEMM VAPOR-LIMINATOR**

Exclusive SNORKEL TUBE prevents vapor lock while filtering gas thru "Chemistone" element. Satisfaction guaranteed or money back. Send make of car with \$2.95 postpaid (or C.O.D.)

**FENTON-CHASE COMPANY Dept. P**  
2000 St. Paul Avenue • Chicago 47, Illinois

## MACHINE TOOL RECONDITIONING

**& THE ART OF HAND SCRAPING**  
—USEFUL FOR DESIGN, SHOP & INSPECTION WORK—  
SEND FOR FOLDER DESCRIBING ILLUSTRATED BOOK  
MACHINE TOOL PUBLICATIONS, 382 Holly Ave., St. Paul 2, Minn.

**\$1. SCRIBER of CARBIDE**

Will scribe on hardened steel, ceramics, glass, etc. Designed for close work for TOOL and DIE workers.

**SIEG KONRAD MANUFACTURING CO.**  
1636 W. 7th St., St. Paul 2, Minn. \$1.

## URANIUM PROSPECTORS

**NATIONALLY FAMOUS SCINTILLATORS  
or GEIGER COUNTERS • SALES-SERVICE**

**ALL MODELS** Orders Shipped Anywhere  
\$29.95 to \$2,995. Write for FREE

Instrument Catalog

**THE GEIGER CENTER**

12th & Broadway, Denver 6, Colorado  
TAbor 5-8914

## 'WRAP-ON' STOPS DRIPPING PIPES INSTANTLY

**Low cost • do-it-yourself  
Fiberglass Insulation**

**QUICK . . . EASY TO USE**

Stop rust and ruined floors caused by dripping pipes. Protect basement or "rec" room with 'WRAP-ON' fiberglass insulation and vapor seal tape. 1 Pkg. covers 17' of ½ pipe. Smooth surface takes paint.

**no dirt or mess, no tools**  
**super-tough, long lasting**  
**\$1 at Dept. & Hdw. stores**  
**beware of imitations**  
**insist on 'WRAP-ON'** Wrap-On Co., Chicago 10, Ill. Dept 60A

## PORTABLE LIGHT PLANTS

GIANT 2000-2500 WATT PLANT

110-120 v. 60 cyc. AC. absolutely the best made—exclusive dynamically balanced armature; heavy windings develop up to 5000 watt overload for motor starting. Skid mounted—portable. Powered by an easy starting Briggs & Stratton 6 HP engine—complete with all accessories; engine easily disconnected for other uses. Big outlet box, voltmeter, no wiring necessary. Ample current for all purposes. Factory warranty. (Item 31) Wt. 210 lb. Reg. price \$585. Special at... **\$299.50**

Same plant with electric self starter (Item 31a)... **\$359.50**  
Generator only and control box... **\$169.50**  
**DUAL VOLTAGE** 110-220 available on any of these models for \$28.00 additional.

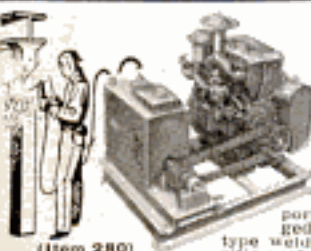

## MASTER DC ARC WELDERS

Now! a portable, rugged, industrial type welder with terrific performance, yet at a price hundreds of dollars less than you'd expect. Senior model made for years of trouble-free, continuous service. High capacity DC welding unit enables you to tackle any job with confidence—easily welds anything up to 2" plate using from 1/16" to 5/8" rods. Built-in stabilizer and cooling system makes arc easy to strike and hold. Dual control rheostat provides low heat soldering, brazing and welding from 30 to 300 amps. Complete with instructions, guarantee and triple V-belt or flat pulley. You can pay more, but you can't buy a better welder.

**WELDER ONLY—DUAL CONTROL MODEL.** Same as above, but drive with your tractor, jet or gas engine of 14 HP or more. (Item 32a) Wt. 120 lbs. \$450 value... **\$119.50**

**WELDER ONLY—STANDARD MODEL.** Same as above but with single rheostat for heavy metal welding only. (Item 32b) Wt. 110 lbs. \$400 value... **\$99.75**

**COMPLETE POWER MASTER** (Illustrated above) powered by a 14.6 hp., air cooled Wisconsin engine. Wt. 480 lbs. (Item 280) Complete with welder costing \$1200. **\$449.50** Factory Special.

**WELDING KIT.** Two 10 ft. leads, welding helmet, electrode holder, ground clamp. Sold only with welder at... **\$10.50**

## CONDITIONAIRE VENTILATING FANS

Save big money installing your own exhaust fan. Efficient propeller type blade moves huge volume of air quietly and efficiently. Heavy welded frame—pre-drilled for easy installation. Just cut opening and bolt in place. Continuous duty motors. Ideal for attics, restaurants, garages, barns, chicken houses, etc. Control manually or with thermostat.



Blade Opening CFM	Wt.	Item	Price
16" 1814"	2925 19 lb.	165A	\$27.95
18" 1914"	3600 27 lb.	165B	\$31.95
20" 2114"	4100 30 lb.	165C	\$39.95

## FLASH-WELD SOLDER GUN

High powered double transformer soldering gun that converts ordinary 115 v. current to instant heat for big soldering jobs! Installs or removes copper pipe fittings in two seconds! Applies solder joints, heats tools for hardening, provides heat for continuous sheet metal soldering. Saves at least 50% labor time. Includes complete heating unit transformer, heavy cables and grip type soldering pliers. Wt. 38 lbs. (Item 777) Reg. \$79.50. Close-out **\$39.50**

## 52 pc. SOCKET SET

Highest quality, guaranteed non-breakable sockets made by Husky. Beautifully finished chrome trim, wall alloy absolutely the best. Contains a complete set of 28 sockets in 1/2" drive, 3/4" drive and 1" drive, plus all necessary extensions, handles, speeders, reversible ratchets, etc., all unexcelled, guaranteed against breakage. A beautiful set of tools that will handle any job! In a big double steel box. Wt. 17 lbs. (Item 205) Reg. \$29.95. Last price \$22.90. Factory special... **\$27.95**

Send check or M.O. Prices f.o.b. Factory. 10 day Money back guarantee. SEND 10c for... **MASTER MECHANIC MFG. CO.,** DEPT. ZAK Burlington, Wis.

## SAVE middleman profits BUY DIRECT from MASTER MECHANIC factory

(Item 24)

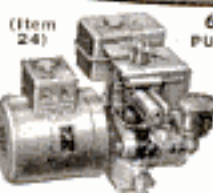

## 600-700 WATTS PUSH BUTTON START

115 v. 60 cyc. AC Powered by a rugged 2 HP easy starting Briggs engine. No wiring necessary! Just plug in and operate. Plenty of current for any oil burner, freezer, brooder, emergency lights, etc., which require radios. Complete with Voltmeter and built-in winding to charge 6 v. auto batteries. (Item 24.) Wt. 75 lbs. Easily fits in car trunk. Be prepared if storm knocks out power lines. Reg. \$275 Value... **\$143.50**  
**1000-1200 Watt Plant** (Item 45) same as Item 24 but larger generator and engine with 50% greater output... **\$199.50**

## 1300-1500 WATT PLANT

115v. 60 cyc. AC Push Button Start. Powered by a 3 1/2 HP. Clinton engine. Combines big output with easy portability. Provides emergency power for operating any oil burner, sump pump, freezer, television, lights, communications, etc. Which require up to 1300 watts. (Item 22.) Wt. 110 lbs. Reg. \$475 value. Factory price... **\$239.50**

**1750 Watt Plant** Powered by 4.5 Briggs engine. Electric starting & battery charging built-in. Factory price... **\$279.50**

**2500 WATT PLANT—Push Button Start** (Item 21) 110/120 60 cyc. A.C. A rugged powerful plant. Reg. \$645. Spec... **\$329.50**

**3500 Watt Plant Push Button Start** (Item 23) 115 v. 60 cyc. AC. Similar to above, but larger and 35% more capacity. Wt. 270 lbs. Reg. \$720. Factory price... **\$379.50**  
Dual Voltage 110/220 available for above plants for \$30.00 additional.

## JET STEAM MASTER



Now, a super efficient portable steam generator that produces live steam at 100 lbs. pressure in 60 seconds from a cold start! Produces large volume of high pressure steam on 2 pints of fuel oil. Instantly cleans sticky grease, dirt, rust, old paint, etc. off implements and road machinery. Says for itself in a few weeks. Sterilizes soil. Sterilizes as it cleans—milk equipment, etc.

Fully automatic—oil fired with new, built-in lifetime bronze water circulating pump. Draws water from faucet or bucket. Simple and safe—no one can use it! Built-in safety valve. Complete with 12 ft. of high-pressure steam hose and new triple efficiency steam gun that automatically mixes in soap solution if desired. Wt. 250 lbs. Item 463. **\$329.50** Special factory price.

## HI-FLO Centrifugal PUMP



Completely self-priming! No foot valve required. Tremendous capacity—300 gal. per min. 1" Special impeller enables pump to handle muddy or sandy water. Simple to operate—simply start engine and watch the water go. Powered by a rugged, easy-starting 2 HP Briggs engine. Pre-lubricated sealed bearings for years of heavy low-cost service. Big 1 1/2" Model. Item 582. Wt. 10 lbs. **\$134.50** Factory price.

## BIG JOE Portable Pump

A powerful pump that handles up to 15,000 gal. per hour. Easy to operate. Self-priming (after initial prime), no foot valve needed—resulting in 25% more capacity. Exclusive impeller design provides maximum rate of water per horsepower, yet handles water containing a large percentage of stone, gravel and mud. 2 in. suction and discharge. Powered by an easy starting 6 hp. Wisconsin engine and mounted on big rubber tired wheels. Wt. 280 lbs. (Item 280). Special Factory price... **\$299.50**  
Same pumps mounted on steel skids. Wt. 250 lbs. (Item 503). Factory price... **\$275.00**



## SELF-PROPELLED MASTER GARDENER

It's a power sickle It's a rotary tiller  
It's a lawn mower It's a blower  
New! with Power reverse!  
Improved Master Gardener with new extra power and a full gear transmission—providing forward, neutral and POWER REVERSE! Works for you the year 'round. Does terrific job of cutting weeds, tall grass, etc. or prepares mellowed deep seed beds without labor. So well balanced that any woman can easily handle it. Has two built-in clutches controlling motion and implement drive. New gear tread tires assure nonslip drive. Performs better—does more than tractors costing twice as much. Converts in minutes to Tiller, Power Lawn Mower, Snow Blower, etc. Basic self-propelled tractor with famous 2 1/2 hp Briggs engine, complete with rewired starter. **\$129.50**  
Wt. 110 lbs. Factory Special... **\$129.50**

Tractor shown with Sickle Bar Attachment  
Cultivator... **\$18.75** Rotary Tiller... **\$49.50**  
Furrowing Plow **\$9.75** Disc Harrow... **15.75**  
Snow Blow... **\$39.50** Damp wheel barrow **49.50**  
Rear Lawn Mower... **39.50**  
Sickle Bar Mower... **49.50**  
Lawn Mower Hitch... **4.75**  
Easy payment plan available. Freight paid east of Rockies—half paid elsewhere.

## HEATING & VENTILATING FAN

(Item 10) Easily installed in furnace pipes. Forces even heat to all rooms. Over range removes kitchen smoke and odors. Powerful, continuous duty motor. 110-120v. AC. Mount in wall or ceiling to ventilate any area. Quiet, super-efficient fan moves huge volume of air. (400 to 600 CFM).

8" Pipe, wt. 5 lb.	36.85
9" Pipe, wt. 6 lb.	37.85
10" Pipe, wt. 7 lb.	38.85
12" Pipe, wt. 8 lb.	59.85

**HEAVY DUTY FAN.** Semi-enclosed motor, suitable for spray booths, restaurant exhausts, poultry houses, etc. 10" Fan, wt. 9 lbs. (Item 10E)... **\$11.95**  
12" Fan, wt. 10 lbs. (Item 10D)... **\$12.95**



## 9 TON HYDRAULIC PRESS

A tremendously powerful hydraulic press, capable of exerting 18,000 lbs. pressure. Pays for itself many times over—straightening bent connecting rods, king pins, crankshafts, axles, link pins and bars—or pushing out from bearings and bushings. Developed pressure under precise control and visible at all times on accurate gauge. Complete with both large and small anvils and jigs to straighten any kind of curve or bend. (Item 444) Wt. 110 lb. Actual list price \$365. Our special list price close-out price... **\$69.50**



## EXTENSION CORD

Heavy duty and very flexible. Neoprene 14-2cable. 20 year quality. Wt. 12 lbs. (Item 185) 100 ft. Complete with rubber plug and outlet. A terrific buy at only **\$8.95**

**NO. 12-2 POWER CABLE.** Very flexible rubber covered, special outside shield for grounding power tools, etc. 50 ft. (Item 109) Wt. 8 lbs. \$4.95. 100 ft. (Item 200)... **\$12.95**

## Variable Speed Selector

Heavy duty, made by R. F. GOODRICH for industrial use. Provides instant speed changes for any drive. For machine tools, dryers, printing, conveyors, production lines, hoists—any operation requiring variable speed. Employs reliable "torque free" planetary system. No hydraulic power losses. Infinite range, smooth operation, easy installation. 3 sizes: 1 1/2 hp., 36 lbs.; 1-2 hp., wt. 35 lbs.; 2-3 hp., wt. 105 lbs.; Reg. list \$228, \$252 and \$322. Our prices... **\$79.50, \$89.50 and \$114.50**



## JET FLOW BLOWER

Tremendous air movement (1800 CFM) and quiet operation make this double inlet 10" turbine blower unbeatable for heating, cooling, drying and air conditioning. Ideal for attic or barn ventilation, converting gravity heating to forced air; spray booth exhausts, etc. Operates with any 1/2, 1 1/2 or 3 HP motor. Overized, long life bearings. Includes variable speed motor pulley and belt. Dimensions 10" h x 18" x 10 1/2". Outlet opening 10" x 11 1/2". Wt. 45 lbs. Item 245. Reg. \$54.50. **\$27.50** Factory Special.  
**HEAVY DUTY 1/2 HP motor** for above **\$16.95**  
**12" TURBINE BLOWER** Similar to above, but larger with 2400 CFM capacity. Wt. 65 lbs. (Item 245a) Reg. \$70.00. Factory Spec. **\$34.50**



Send check or M.O. Prices f.o.b. Factory. 10 day Money back guarantee. SEND 10c for... **MASTER MECHANIC MFG. CO.,** DEPT. ZAK Burlington, Wis.

FREE WORLD FACES  
ENGINEERING SHORTAGE

35,000 ENGINEERING  
POSTS STILL UNFILLED

REDS LEAD FREE WORLD  
IN ENGINEERING RACE

INDUSTRY'S DOOR IS  
WIDE OPEN TO  
NEW ENGINEERS

# HERE'S NEW OPPORTUNITY FOR YOU IN THE BIG RACE FOR ENGINEERS!

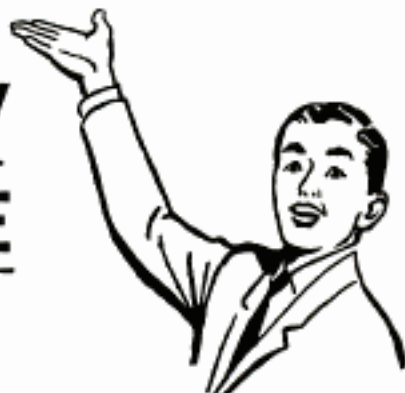

Read between the news headlines. You'll see a whole new field of opportunity opening up in the race for Engineers. Here's your one big chance to help the Free World and win a professional rating.

As an Engineer you'll do interesting, rewarding work. You'll have a real chance for advancement. Half our industrial leaders have come up through Engineering. You'll enjoy high professional standing; economic, cultural and social prestige. You'll get true job security. And soon after you start your course you'll be ready for a job in an engineering department as an aide.

### I. C. S. can help YOU!

Almost every phase of Engineering is represented in the 277 I. C. S. courses. You study in your spare time, at your own pace. No interference with job or social life. Instruction is personalized, direct, job-related. Bedrock facts and theory plus practical application. Low cost. Easy-pay plan. Diploma to graduates.

### Coupon brings 3 free books!

(1) "How to Succeed"—36-page guide to advancement. (2) Career Catalog of opportunities in field of your choice. (3) Sample I. C. S. lesson in basic mathematics. Just mark and mail the coupon below.

"I obtained a professional rating one year short of the time required to complete a college engineering course," reports A. P. A., Wyomissing, Pa.

This statement helps demonstrate the thoroughness of I. C. S. instruction. Take the Engineering courses, for example. You go step-by-step from simple Arithmetic to advanced subjects: Thermodynamics, Drafting, Hydrostatics, Strength of Materials, Report Writing, Commercial Law, etc. There's no scrimping. You cover as many as 176 subjects in all—as rapidly as your time and ability permit.

For Real Job Security—Get an I. C. S. Diploma! . . . Easy-Pay Plan . . . I. C. S., Scranton 9, Penna.

## INTERNATIONAL CORRESPONDENCE SCHOOLS

ICS

BOX 35299G, SCRANTON 9, PENNA.

Without cost or obligation, send me "HOW TO SUCCEED" and the opportunity booklet about the field BEFORE which I have marked X (plus sample lesson):

- |   |   |  |   |  |
|---|---|--|---|--|
| <p><b>ARCHITECTURE and BUILDING CONSTRUCTION</b></p> <ul style="list-style-type: none"> <li><input type="checkbox"/> Air Conditioning—Refrig.</li> <li><input type="checkbox"/> Architecture</li> <li><input type="checkbox"/> Architectural Interior</li> <li><input type="checkbox"/> Building Contractor</li> <li><input type="checkbox"/> Building Maintenance</li> <li><input type="checkbox"/> Carpenter and Mill Work</li> <li><input type="checkbox"/> Estimating</li> <li><input type="checkbox"/> Heating</li> <li><input type="checkbox"/> Painting Contractor</li> <li><input type="checkbox"/> Plumbing</li> <li><input type="checkbox"/> Reading Arch. Blueprints</li> </ul> <p><b>ART</b></p> <ul style="list-style-type: none"> <li><input type="checkbox"/> Cartooning</li> <li><input type="checkbox"/> Commercial Art</li> <li><input type="checkbox"/> Fashion Illustrating</li> <li><input type="checkbox"/> Magazine Illustrating</li> <li><input type="checkbox"/> Show Card and Sign Lettering</li> <li><input type="checkbox"/> Sketching and Painting</li> </ul> <p><b>AUTOMOTIVE</b></p> <ul style="list-style-type: none"> <li><input type="checkbox"/> Auto Body Rebuilding</li> <li><input type="checkbox"/> Auto Elec. Technicians</li> <li><input type="checkbox"/> Auto-Engine Tune Up</li> <li><input type="checkbox"/> Automobile</li> </ul> | <p><b>AVIATION</b></p> <ul style="list-style-type: none"> <li><input type="checkbox"/> Aeronautical Engineering Jr.</li> <li><input type="checkbox"/> Aircraft &amp; Engine Mechanic</li> </ul> <p><b>BUSINESS</b></p> <ul style="list-style-type: none"> <li><input type="checkbox"/> Advertising</li> <li><input type="checkbox"/> Bookkeeping and Accounting</li> <li><input type="checkbox"/> Business Administration</li> <li><input type="checkbox"/> Business Correspondence</li> <li><input type="checkbox"/> Public Accounting</li> <li><input type="checkbox"/> Creative Salesmanship</li> <li><input type="checkbox"/> Federal Tax</li> <li><input type="checkbox"/> Letter-writing Improvement</li> <li><input type="checkbox"/> Office Management</li> <li><input type="checkbox"/> Professional Secretary</li> <li><input type="checkbox"/> Retail Business Management</li> <li><input type="checkbox"/> Sales Management</li> <li><input type="checkbox"/> Stenographic-Secretarial</li> <li><input type="checkbox"/> Traffic Management</li> </ul> <p><b>CHEMISTRY</b></p> <ul style="list-style-type: none"> <li><input type="checkbox"/> Analytical Chemistry</li> <li><input type="checkbox"/> Chemical Engineering</li> <li><input type="checkbox"/> Chem. Lab. Technician</li> <li><input type="checkbox"/> General Chemistry</li> <li><input type="checkbox"/> Natural Gas Prod. &amp; Trans.</li> <li><input type="checkbox"/> Petroleum Engineering</li> <li><input type="checkbox"/> Plastics</li> <li><input type="checkbox"/> Pulp and Paper Making</li> </ul> | <p><b>CIVIL, STRUCTURAL ENGINEERING</b></p> <ul style="list-style-type: none"> <li><input type="checkbox"/> Civil Engineering</li> <li><input type="checkbox"/> Construction Engineering</li> <li><input type="checkbox"/> Highway Engineering</li> <li><input type="checkbox"/> Reading Struct. Blueprints</li> <li><input type="checkbox"/> Sanitary Engineering</li> <li><input type="checkbox"/> Structural Engineering</li> <li><input type="checkbox"/> Surveying and Mapping</li> </ul> <p><b>DRAFTING</b></p> <ul style="list-style-type: none"> <li><input type="checkbox"/> Aircraft Drafting</li> <li><input type="checkbox"/> Architectural Drafting</li> <li><input type="checkbox"/> Electrical Drafting</li> <li><input type="checkbox"/> Mechanical Drafting</li> <li><input type="checkbox"/> Mine Surveying and Mapping</li> <li><input type="checkbox"/> Plumbing Drawing and Estimating</li> <li><input type="checkbox"/> Structural Drafting</li> </ul> <p><b>ELECTRICAL</b></p> <ul style="list-style-type: none"> <li><input type="checkbox"/> Electrical Engineering</li> <li><input type="checkbox"/> Electrical Maintenance</li> <li><input type="checkbox"/> Electrician <input type="checkbox"/> Contracting</li> <li><input type="checkbox"/> Lineman</li> </ul> <p><b>HIGH SCHOOL</b></p> <ul style="list-style-type: none"> <li><input type="checkbox"/> Commercial <input type="checkbox"/> Good English</li> <li><input type="checkbox"/> High School Subjects</li> <li><input type="checkbox"/> Mathematics</li> </ul> | <p><b>LEADERSHIP</b></p> <ul style="list-style-type: none"> <li><input type="checkbox"/> Foremanship</li> <li><input type="checkbox"/> Industrial Supervision</li> <li><input type="checkbox"/> Leadership and Organization</li> <li><input type="checkbox"/> Personnel-Labor Relations</li> </ul> <p><b>MECHANICAL AND SHOP</b></p> <ul style="list-style-type: none"> <li><input type="checkbox"/> Gas—Electric Welding</li> <li><input type="checkbox"/> Heat Treatment <input type="checkbox"/> Metallurgy</li> <li><input type="checkbox"/> Industrial Engineering</li> <li><input type="checkbox"/> Industrial Instrumentation</li> <li><input type="checkbox"/> Industrial Supervision</li> <li><input type="checkbox"/> Internal Combustion Engines</li> <li><input type="checkbox"/> Machine Design-Drafting</li> <li><input type="checkbox"/> Machine Shop Inspection</li> <li><input type="checkbox"/> Machine Shop Practice</li> <li><input type="checkbox"/> Mechanical Engineering</li> <li><input type="checkbox"/> Quality Control</li> <li><input type="checkbox"/> Reading Shop Blueprints</li> <li><input type="checkbox"/> Refrigeration</li> <li><input type="checkbox"/> Sheet Metal Worker</li> <li><input type="checkbox"/> Tool Design <input type="checkbox"/> Toolmaking</li> </ul> <p><b>RADIO, TELEVISION</b></p> <ul style="list-style-type: none"> <li><input type="checkbox"/> Industrial Electronics</li> <li><input type="checkbox"/> Practical Radio TV Eng'ng</li> <li><input type="checkbox"/> Radio and TV Servicing</li> <li><input type="checkbox"/> Radio Operating</li> </ul> | <p><input type="checkbox"/> Television Technician</p> <p><b>RAILROAD</b></p> <ul style="list-style-type: none"> <li><input type="checkbox"/> Air Brakes <input type="checkbox"/> Car Inspector</li> <li><input type="checkbox"/> Diesel Locomotive</li> <li><input type="checkbox"/> Locomotive Engineer</li> <li><input type="checkbox"/> Section Foreman</li> </ul> <p><b>STEAM AND DIESEL POWER</b></p> <ul style="list-style-type: none"> <li><input type="checkbox"/> Combustion Engineering</li> <li><input type="checkbox"/> Diesel—Elec. <input type="checkbox"/> Diesel Eng'g</li> <li><input type="checkbox"/> Electric Light and Power</li> <li><input type="checkbox"/> Stationary Fireman</li> <li><input type="checkbox"/> Stationary Steam Engineering</li> </ul> <p><b>TEXTILE</b></p> <ul style="list-style-type: none"> <li><input type="checkbox"/> Carding and Spinning</li> <li><input type="checkbox"/> Cotton, Rayon, Woolen Mfg.</li> <li><input type="checkbox"/> Finishing and Dyeing</li> <li><input type="checkbox"/> Loom Fix'g <input type="checkbox"/> Textile Des'g'ng</li> <li><input type="checkbox"/> Textile Eng'g <input type="checkbox"/> Throwing</li> <li><input type="checkbox"/> Warping and Weaving</li> </ul> <p><b>MISCELLANEOUS</b></p> <ul style="list-style-type: none"> <li><input type="checkbox"/> Domestic Refrigeration</li> <li><input type="checkbox"/> Marine Engineering</li> <li><input type="checkbox"/> Ocean Navigation</li> <li><input type="checkbox"/> Professional Engineering</li> <li><input type="checkbox"/> Short Story Writing</li> <li><input type="checkbox"/> Telephony</li> </ul> |
|---|---|--|---|--|

Name \_\_\_\_\_ Age \_\_\_\_\_ Home Address \_\_\_\_\_

City \_\_\_\_\_ Zone \_\_\_\_\_ State \_\_\_\_\_ Working Hours \_\_\_\_\_ A.M. to P.M. \_\_\_\_\_

Occupation \_\_\_\_\_

Canadian residents send coupon to International Correspondence Schools, Canadian, Ltd., Montreal, Canada. . . . Special tuition rates to members of the U. S. Armed Forces.

Learn how homeowners everywhere  
save money by installing their own

# MATICO TILE FLOORING



*MATICO's New Improved  
Install-It-Yourself System  
Makes It Easy!*



Yes, you can enjoy colorful, durable MATICO Asphalt Tile Flooring in your home at amazing low cost by installing MATICO yourself. You can't buy a more economical type of luxury flooring than MATICO. It lasts for years . . . is easy to keep sparkling clean and comes in 32 striking decorator colors that can't wear off because colors and marbleization go clear through the tile.

It's a cinch to install, too, with MATICO's tested install-it-yourself instruction booklet . . . tile calculator . . . and special

tool kit. Why, you can finish a room in just a few hours.

Why put up with a dingy, worn-out floor when it costs so little to install a MATICO tile floor yourself.

See your classified telephone directory for the name of your MATICO dealer.

1—Mark straight lines through the center of the room in both directions, using a chalk and line.

2—With a notched trowel, spread adhesive evenly over floor and allow to "set."



3—Press tiles into position. You can walk on MATICO as soon as floor is in place.



## MASTIC TILE CORPORATION OF AMERICA

Joliet, Ill. • Long Beach, Calif. • Newburgh, N. Y.

Manufacturers of:

Aristaflex • Confetti • Parquetry • Maticork • Asphalt Tile • Cork Tile • Plastic Wall Tile

MASTIC TILE CORPORATION OF AMERICA  
Dep't. M2-7, P.O. Box 986, Newburgh, N. Y.

Please send me MATICO's money-saving install-it-yourself instruction kit and complete color chart.

Name .....

Address .....

City..... Zone..... State.....

4 C. 173

For more  
pure pleasure,  
have a  
**Camel!**



R. J. Reynolds Tobacco Co., Winston-Salem, N. C.

No other cigarette is so **rich-tasting**  
yet **so mild** as **Camel**

● Certainly one of the comforts and pleasures of a smoker's life is: Camel cigarettes! No other cigarette is so rich-tasting, yet so mild! For more pure pleasure, Camels agree with more people than any other brand!

**Make your own 30-day Camel Mildness Test.** Smoke only Camels for 30 days. We think you'll agree — no other cigarette is so rich-tasting, yet so mild as Camel, year after year America's most popular cigarette!

Copyrighted material