

JUNE 1955

35 CENTS

# POPULAR MECHANICS

## MAGAZINE

WRITTEN SO YOU CAN UNDERSTAND IT

U.S. TRADE MARK GREAT BRITAIN No. 40428

U.S. PAT. OFF.



**HOMEMADE FLYCYCLE**  
—Page 115

Owners Report on the  
**'55 DODGE V8**

Does the Sun Cause Stormy Weather?

**TOP MAN OF 100,000 RADIO HAMS**

How to Select a Boat Trailer



FOR THE  
*Lift*  
OF YOUR  
LIFE!

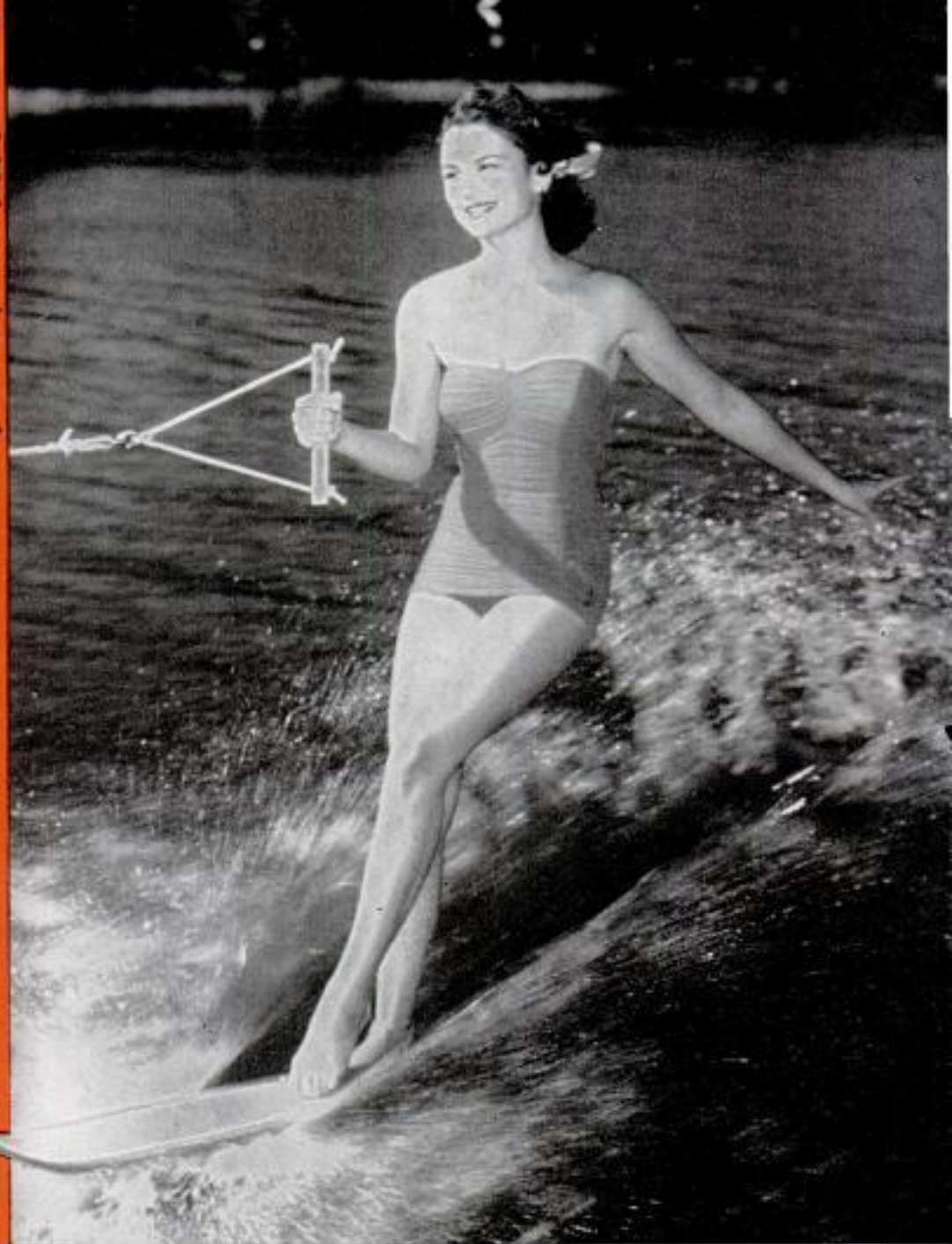

Electric Starting  
Sea-Horse 25

Where there's a Sea-Horse, there's FUN! These tireless motors work while their owners play. The lift they give boating with their power, speed and **DEPENDability** make them **THE** favorite in all water sports. More fishermen use Johnsons than any other outboard motor! More outboard cruiser owners, too! More water skiers! And fishing-resort owners buy 86% more Sea-Horses than any other make!

This year there is further reason for Johnson popularity. The 1955 Sea-Horses are **QUIET**, thanks to Johnson's wonderful Suspension Drive. *There is no longer any excuse for noisy outboard motoring!* See your Johnson Dealer. Look for his name under "Outboard Motors" in your classified telephone directory.

**FREE!** Write for catalog which illustrates and describes the 5 great Sea-Horses for 1955. A model for every outboard need.

**JOHNSON MOTORS, 400 Pershing Road, Waukegan, Ill.**  
A DIVISION OF OUTBOARD, MARINE & MANUFACTURING COMPANY  
In Canada: Manufactured by Johnson Motors, Peterborough

**1955 SEA-HORSES**

- SEA-HORSE 25  
Electric Starting ... 25 hp ... \$525.00\*
- SEA-HORSE 25 ... 25 hp ... 430.00\*
- SEA-HORSE 10 ... 10 hp ... 310.00\*
- SEA-HORSE 5½ ... 5½ hp ... 210.00\*
- SEA-HORSE 3 ... 3 hp ... 145.00

\*Includes Mile-Master Fuel System.



Prices f.o.b. factory, subject to change. All ratings are OBC certified brake hp. at 1600 rpm.

**Johnson** **SEA-HORSES**  
FOR **DEPENDABILITY**

Copyrighted material



Jimmy Bryan, named America's champion driver for 1954 by the American Automobile Association, poses with his new Buick Century.

**"Get Quick Action  
From Your Car In  
Any Situation With  
5-Rib Champion  
Spark Plugs...I DO!"**

says

*Jim Bryan*

1954



DRIVING CHAMPION

"I have learned through experience in the Air Corps and big-time racing that no engine is better than its spark plugs. That's why I use Champions in everything I drive—on the track or in everyday traffic. I know that even under the toughest conditions Champion's full-firing, sharp, hot spark can be depended on to get the most out of modern gasoline in any make engine. I'm sure you, too, will feel safer with Champion Spark Plugs under the hood for instant engine response in any emergency."

Remember, only Champion has the patented 5-RIB insulator that discourages flash-over and keeps *all* the spark inside the cylinder for *full* power.

CHAMPION SPARK PLUG COMPANY  
TOLEDO 1, OHIO



During 1954, Bryan's racing skill won him 2630 points, highest total in modern big-time racing.

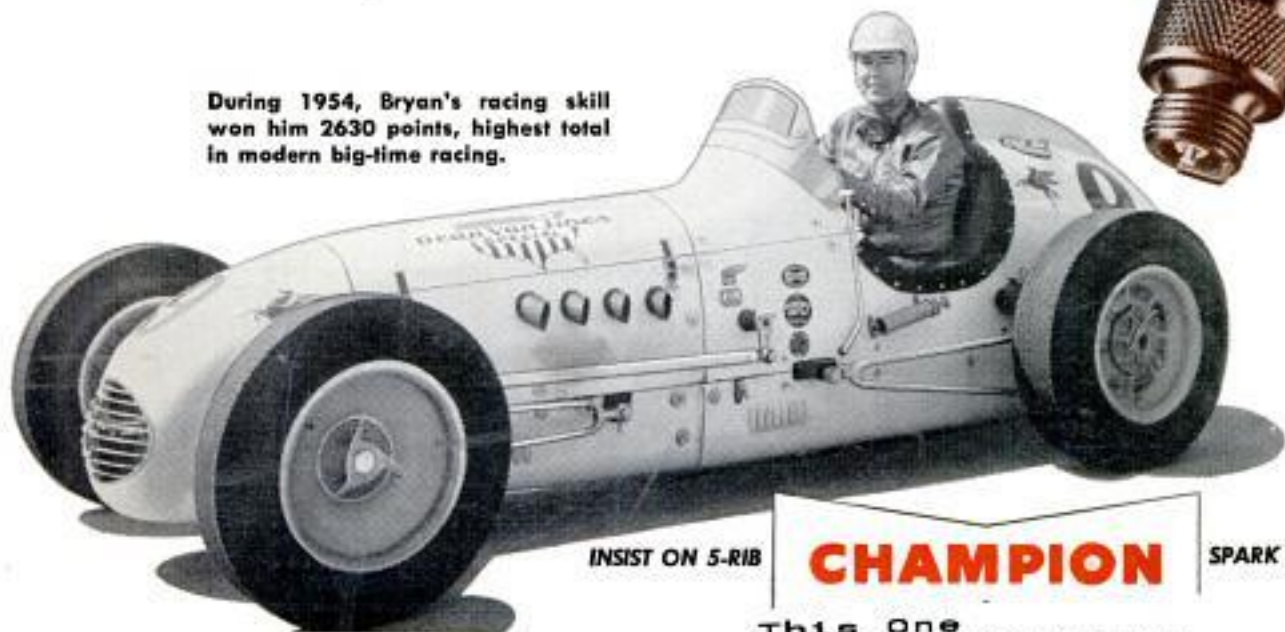

INSIST ON 5-RIB

**CHAMPION**

SPARK PLUGS

This One



75C2-1SR-ZCQK

# Young Men With Mechanical Skills



## Can Train With The U.S. Air Force

The U. S. Air Force needs ground personnel...young men who may be trained in technical specialties...men to keep our giant Air Force bombers and jet fighters in the air. Start planning your future today...as an Airman in the U. S. Air Force. You'll earn good pay and learn a skill that may benefit you the rest of your life. Get the facts right now about the opportunities offered by your U. S. Air Force.

**You Go Places—Faster  
in the U.S. Air Force**

## ...In One Of These Exciting, Interesting Specialties

AIRCRAFT MAINTENANCE	GUIDED MISSILES
ATOMIC WEAPONS	ROCKET PROPULSION
COMMUNICATIONS	SUPPLY
CONSTRUCTION	TRANSPORTATION



*STUDENTS—Graduate before  
you enlist*

**Personnel Procurement Division**  
**AFPTR-P-4 U. S. Air Force**  
**Washington 25, D. C.**

M-6-PM2

Please send me more information on my opportunity as an Airman in the U.S. Air Force.

Name..... Age....

Address .....

City.....Zone.....State.....

# Popular Mechanics Magazine

Registered in U. S. Patent Office and Canada

H. H. WINDSOR, *Founder*

H. H. WINDSOR, JR., *Editor and Publisher*



## Next Month

TRAPPED IN those bottles is smog—the ghostly stuff that smothers Los Angeles and plagues half a dozen other cities. Actually the bottles hold metals, tars and acids that can touch off more sneezes than a flu epidemic. When weather conditions clamp a lid on Los Angeles, residents breathe and rebreathe the same air while they gasp out curses at their enviable mountains and climate. Science has been called into the battle and the research may have some startling sideline results. For example, tests show that one gallon in every tankful of gas flows unused through your car. A feature next month shows smog sleuths at work, and tells how their research may benefit you, wherever you live

Information not listed on articles in the index, starting on page 58, frequently is listed in the WHERE-TO-FIND-IT LIST, which is available to readers without charge. A copy may be obtained by writing to the Bureau of Information, *Popular Mechanics*, 200 E. Ontario, Chicago 11, Ill.

Published monthly by Popular Mechanics Company, 200 E. Ontario St., Chicago 11, Ill. H. H. Windsor, Jr., president; Wm. Harrison Ferguson, exec. vice-pres.; D. F. Windsor, vice-president and secretary-treasurer; H. H. Windsor III, vice-president; Clover L. Perkins, advertising manager; Alan M. Dejno, circulation manager. Single copy in the United States and Canada, 35 cents; subscription rates in the United States and possessions, Canada, Philippines and countries of the Pan-American Postal Union, 1 year \$3.50; 2 years, \$6.00; 3 years \$8.00. To all other countries add \$1.00 a year over United States prices for overseas postage. If you plan to move, notify us at least 30 days in advance so you will not miss an issue. Give both your old and new addresses. Entered as Second Class Matter, September 15, 1903, at the Post Office at Chicago, Illinois, under Act of March 3, 1879. Entered as Second Class Matter at Post Office Dept., Canada, Registered as Second Class Matter at the Post Office at Mexico, D. F., Mexico, June 20, 1950. Copyright 1955 by Popular Mechanics Company. Copyright under International Copyright Union. Copyright in France. All rights reserved under Pan-American Copyright Union. Printed in the United States of America.

Volume 103 JUNE 1955 Number 6

Address all communications to: 200 E. Ontario St., Chicago 11, Ill.

Managing Editor.....Roderick M. Grant  
 Assistant Managing Editor.....Wayne Whittaker  
 Shop Notes and Crafts Editor.....James R. Ward  
 Radio-Television, Electronics Editor.....Frank L. Brittin  
 Associate Editor.....Clifford B. Hicks  
 Associate Editor, Automotive.....Arthur R. Railton  
 Associate Editor, Shop Notes and Crafts.....Wayne C. Lecky  
 Assistant Editor, Shop Notes.....W. Clyde Lamney  
 Assistant Editor, Crafts.....Frank N. Stephany  
 Assistant Editor, Makeup.....John C. Dalen  
 Automotive Correspondent.....Leo Donovan  
 Art Director.....Frank Beatty

### Assistant Editors

Leonard F. Hilts, Jay W. Hedden, Elliott H. McCleary, Emily Mullaney  
 Eastern Editor.....Richard F. Dempewolf  
 Empire State Bldg., Room 2906, New York City 1  
 Western Editor.....Thomas E. Stimson, Jr.  
 Suite 1010, 3460 Wilshire Blvd., Los Angeles 5, Calif.  
 London Manager.....Douglas W. Wedderspoon  
 Eagle House, Jermyn St., London S. W. 1, England  
 Director, Bureau of Information.....Allan Carpenter  
 200 E. Ontario St., Chicago 11

## In This Issue . . .

Can We Blame the Sun for Stormy Weather?	65
Hit-Run Rocket Launcher	72
The "Hams" Have a Man of the Year	75
TV Crosses the Horizon	84
Keeping up With the Atom	88
"Paul Revere" Ships Join the Lookout	89
Detroit Listening Post	92
What to Do When Lightning Strikes	94
Whaler to Double as Supertanker	97
Prestressed Tile Bends Without Breaking	102
The Owners Report on the '55 Dodge V8	106
They Build Their Own Planes	115
What's New for Your Home	120
Skin Divers . . . Play it Safe	125
Sculpture in Copper	134
Mr. Ladybug	140
Radio, TV and Electronics	145

## For the Craftsman . . .

Wrought-Iron Dinette Set	149
Solving Home Problems	154
Completing the PM Precut House	158
Patterncraft—Lamps and Planter	166
Tow-Tow-Tow Your Boat	170
Keep Warm in Winter, Cool in Summer—Conclusion	175
All-Weather Tent Has Tubular-Steel Frame	182
Rebuilding Old Auto Engines	187
Make Your Own T-Bolts and Clamps	191
High-Speed Sanding on Your Drill Press	194
Shopping for Tools	202
Clinic for Homemakers	208

Other items, and manufacturers of available products described, are listed on pages 58, 60 and 62

# For greater driving safety, one control now operates MoPar windshield washers and wipers



**MOPAR ISN'T JUST THE NAME OF A WINDSHIELD WASHER.** It identifies thousands of parts and accessories especially designed for your Plymouth, Dodge, De Soto, or Chrysler car or Dodge truck. Drive in where you see the MoPar sign for the finest in parts and accessories.

## MOPAR

**PARTS DIVISION • CHRYSLER CORPORATION  
DETROIT 31, MICHIGAN**



**YOU CAN KEEP YOUR HANDS ON THE WHEEL . . .** forget about fumbling for a wiper knob when you want a clean windshield. Just touch your toe on the foot button of the new MoPar "Jiffy Jet" windshield washer. Twin nozzles start to spray . . . wipers start to clean . . . *simultaneously, automatically.* Wipers will keep cleaning after spray stops until you release foot button.



**STRONG SPRAY EVEN ON HILLS** or when passing. That's because "Jiffy Jet" does not depend on engine vacuum like most windshield washers . . . won't dribble or stop when you accelerate. Spray pressure at the nozzles is *3 times* stronger than with most washers, too . . . blows out dirt that might clog nozzle openings otherwise.



**GET THE NEW "JIFFY JET"** from your nearest Plymouth, Dodge, De Soto, Chrysler dealer or wherever you see the MoPar sign. And look for the MoPar label whenever you want the *official* Chrysler Corporation parts and accessories. They are all factory engineered and inspected to *fit right, work right, last longer.*

Only \$59<sup>50</sup>!

## New 3" belt sander MAKES TOUGH JOBS EASY!

*You'll breeze through* hundreds of sanding tasks with Porter-Cable's new Model 136 Homemaster Belt Sander!

Build and finish your own furniture and cabinetwork, or refinish antiques . . . remove paint and varnish, fit windows and doors . . . finish new or old wood, metals, plastics, ceramics . . . *get professional results every time!*

Full 3" belt width and powerful universal motor make short work of anything from rough sanding to velvet-smooth final finishing.

Model 136 is Porter-Cable built for exceptional value and years of faithful service. See and try it soon.

### MODEL 136... ONLY \$59.50 COMPLETE

With locking trigger switch, quick-change belt tensioner, instant belt tracking control. Ballbearing construction, precision spur gear drive. Stand available for accurate bench sanding.



VISIT YOUR PORTER-CABLE DEALER OR MAIL COUPON TODAY

PORTER-CABLE MACHINE CO.  
5146 N. Salina St., Syracuse 8, N. Y.

Please send complete information on the Model 136 Homemaster Belt Sander.

Name.....

Address.....

City.....Zone.....State.....

**Porter-Cable**

*Homemaster Tools*

# Step Up Your Pay LEARN TO FIX APPLIANCES

*at Home in Spare Time*  
**Fast Growing Field for  
men who know this  
Profitable Trade.**

Get into a field where you can do important work, have a secure future. Electrical appliance repair offers OPPORTUNITY FOR YOU. Every wired home has an average of 8 electrical appliances. Up to 10 million new appliances are being sold every year. Owners pay well to keep them in repair and enjoy the convenience they provide. That means a fast growing need for trained men.



## Learn and Earn with Tester You Build

Our training includes the parts to build a sturdy, portable appliance tester following our illustrated, easy-to-understand instructions. This multi-use tester helps you locate electrical defects quickly and easily, equips you to do professional trouble-shooting. You use it to learn electrical appliance repair techniques. Gives you the practical training of actually building the tester and a valuable piece of equipment for future use.



## Earn \$3, \$4, \$5 an Hour Spare Time

Start soon to repair electric toasters, fans, irons, mixers, vacuum cleaners, etc. for your neighbors and friends. Spare time work done at your convenience in your basement, garage, or spare room can earn you from \$3 to \$5 an hour. See how easy it is to increase your earning power—how you can pay for this training many times over with the money you'll earn in your spare time. Mail coupon.

## Train Now for Greater Security Low Price—Easy Terms

Today's automatic electric appliances need expert servicing. The man who knows this good trade has a secure future. Put your spare time to good use. Enroll now for \$2.50 down and \$5.00 a month. A small investment can assure a better future. Address Electrical Appliance Training, National Radio Institute, Dept. AFS, Washington 9, D.C.

**FREE Lesson and Book**  
**MAIL this NOW**

**NATIONAL RADIO INSTITUTE**  
DEPT. AFS, WASHINGTON 9, D. C.  
Please send me lesson and book free. (No salesman will call.)

Name \_\_\_\_\_ Age \_\_\_\_\_

Address \_\_\_\_\_

City \_\_\_\_\_ Zone \_\_\_\_\_ State \_\_\_\_\_

# ACROSS THE DESK



## To the Editor:

When a man does a particularly good piece of work his effort deserves to be appreciated and commended. Your article "What Does It Cost to Own a Car" is the best I've read on the subject. The illustrations and graphs summarize the subject in a manner easily remembered.

I was especially interested in what car owners are willing to forego to lower costs—top speed, style changes, deluxe trim, etc. I agree with that 100 percent, but every time I mention it to a car dealer he insists emphatically that these things are continually boosted because the buyer demands them and is willing to pay the extra costs. That certainly is not true of the car owners I have questioned. They would jump at the chance to trade in their cars for more functional vehicles unencumbered by excessive top speed, annual style changes, deluxe trim, etc., but at a lower price. Give us an article on "What Does the Car Owner Really Want" and we'll be your friends for life.

Joseph Wiznuk,  
Stonewall, Manitoba, Can.

## To the Editor:

On page 106 of the March issue there is a picture with this description: "Chevrolet's instruments are easy to read, but horn ring interferes with driver's view of speedometer."

Cut off the upper part of the horn ring. I did.

It is easy to do and it makes the instruments readily visible.

Joseph R. Younglove,  
Johnstown, N. Y.

☆☆☆

The K.L.M. Royal Dutch Airlines' Freight Manual states that during an air trip monkeys aboard the plane must be spoken to from time to time to keep them from quarreling with one another.

## To the Editor:

Strangest of the winds of the world occurs in the northwestern United States. During the coldest days of winter it originates in the Pacific Ocean off the coast of Washington, blows eastward, inland, over Washington, Idaho and western Montana,

(Continued to page 8)



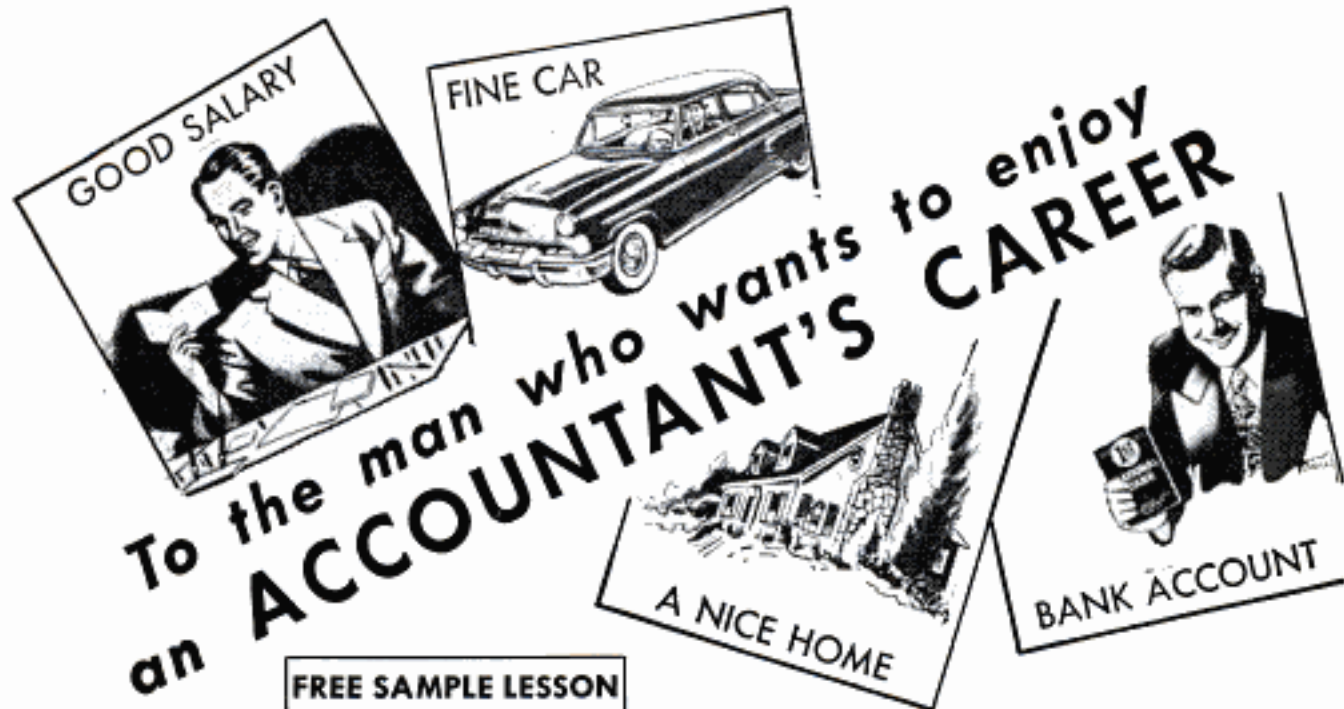

**FREE SAMPLE LESSON**

**IF** you're that man, here's something that will interest you.

Not a magic formula—not a get-rich-quick scheme—but something more substantial, more practical.

Of course, you need something more than just the desire to be an accountant. You've got to pay the price—be willing to study earnestly, thoroughly.

Still, wouldn't it be worth your while to sacrifice some of your leisure in favor of interesting home study—over a comparatively brief period? Always provided that the rewards were good—a salary of \$4,000 to \$10,000?

An accountant's duties are interesting, varied and of real worth to his employers. He has *standing!*

Do you feel that such things aren't for you? Well, don't be too sure. Very possibly they *can* be!

Why not, like so many before you, investigate LaSalle's modern Problem Method of training for an accountancy position?

Just suppose you were permitted to work in a large accounting house under the personal supervision of an expert accountant. Suppose, with his aid, you studied accounting principles and solved problems day by day—easy ones at first—then more difficult ones. If you could do this—and could turn to him for advice as the problems became complex—soon you'd master them all.

That's the training you follow in principle under the LaSalle Problem Method.

You cover accountancy from the basic Principles right up through Accountancy Systems and Income Tax Procedure. Then you add C. P. A. Training and prepare for the C. P. A. examinations.

As you go along, you absorb the principles of Auditing, Cost Accounting, Business Law, Statistical Control, Organization, Management and Finance.

Your progress is as speedy as you care to make it—depending on your own eagerness to learn and the time you spend in study.

Will recognition come? The only answer, as you know, is that success *does* come to the man who is really *trained*. It's possible your employers will notice your improvement in a very few weeks or months. Indeed, many LaSalle graduates have paid for their training—with increased earnings—before they have completed it! For accountants, who are trained in organization and management, are the executives of the future.

**Get Free Sample Lesson—Also "Accountancy, The Profession That Pays"**

For your own good get all the facts. Write for Free Sample Lesson—also 48-page book "Accountancy, The Profession That Pays." They will prove that Accountancy offers brilliant futures to those who aren't afraid of serious home study, and will show the wide range of opportunities that exist today. No cost or obligation. If you want a position of higher income, greater prestige and professional standing... **MAIL THE COUPON NOW!**

**Over 4,000 Certified Public Accountants among LaSalle alumni**

Member, National Home Study Council

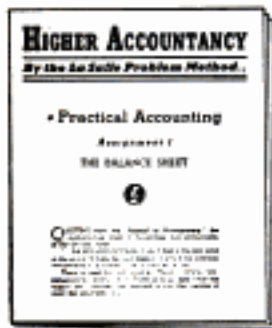

**LASALLE EXTENSION UNIVERSITY**  
A CORRESPONDENCE INSTITUTION

417 S. Dearborn St. Dept. 664H Chicago 5, Ill.

I want to be an accountant. Send me without obligation, Free Sample Lesson—also "Accountancy, The Profession that Pays."

Name.....Age.....  
Address.....  
City, Zone & State.....





## Pin Point Focus

### EVEN IN THE DARK with the PACEMAKER GRAPHIC'S RANGEFINDER AND BUILT-IN RANGELITE

Two beams of light projected onto your subject from the Graphic Rangelite let you see when your subject is in accurate, pin point focus.

Here's the way it works. Referring to the illustration above, the push-button switch (1) connects batteries (2) to lamp (3). Beam of light is reflected by mirror (4) through lens (5) onto beam-splitting mirror (6). Part of light is deflected at right angle onto subject, rest passes through glass to movable mirror (7) which is connected to camera focusing mechanism. As camera is focused, this mirror moves, directing a second beam of light onto the subject.

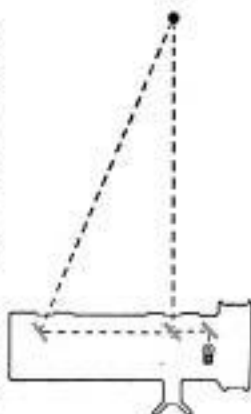

When camera is exactly focused, both beams of light are superimposed. Simultaneously, parallax is automatically corrected on the optical viewfinder (8) through linkage (9).



For further information regarding the Pacemaker Graphic 45 and the features which make it the press photographers choice, write Dept. PM-65, Graflex, Inc., Rochester 8, N. Y.



# GRAFLEX®

(Continued from page 6)

and blows out on the great plains of eastern Montana.

Called the "Chinook," it develops intense heat in eastern Washington, Idaho and western Montana. The country may lie frozen during January in 40 degrees below



Picture taken at start of the Chinook — 12 noon



The Chinook almost blown out—4 p.m. same day

zero; the Chinook stirs, and in the space of an hour the temperature may jump to 40 above zero and water begins to run. The name comes from a tribe of Indians at one time inhabiting the coast of Washington. At no other place upon earth does this type of wind occur except in a very limited manner in Greenland and Switzerland.

In pioneer times, people waited for the Chinook, and even today the cattlemen and lumbermen watch anxiously, during spells of intensely frigid weather, for the Chinook. It develops and blows during the

(Continued to page 10)

POPULAR MECHANICS

Copyrighted material

Cast your ballot for a successful future!

# 277 I.C.S. COURSES



Whether you stand at a machine or sit at a desk . . . whether you're making \$75 a week or \$75 hundred a year . . . whether your interest is Power Plants or Paper Pulp, Advertising or Electronics . . . chances are I.C.S. has exactly the course you need to get ahead.

I.C.S. is not only the oldest and largest correspondence school. It also offers the most courses. 277 in all. Each one success-proved by graduates who rose to top technical and administrative positions. Chief engineers. Superintendents. Foremen. Managers. Executive assistants.

I.C.S. Courses cover bedrock facts and theory plus practical, on-the-job applications. No skimping. Texts

are prepared by leading business and industrial authorities working with I.C.S. editors and educators. They are constantly being reviewed and revised in line with current developments.

As an I.C.S. student, you study in your spare time, set your own pace. No time lost getting to class or waiting for slower students to catch up. If you wish, I.C.S. will make progress reports to your employer. You win recognition as a "comer," one who is ready to move ahead. Thousands of students report pay increases and promotions within a few months of enrollment. All graduates win the coveted, approved I.C.S. diploma.

**3 FREE BOOKS!** Check the subject that interests you in the coupon below. I.C.S. will rush you (1) a special book outlining your opportunities in this field, (2) the 32-page gold mine of career tips, "How to Succeed," (3) a sample I.C.S. lesson (Math) demonstrating the famous "I.C.S. Method." "X" MARKS OPPORTUNITY.

For Real Job Security—Get an I.C.S. Diploma! . . . Easy-pay Plan . . . I.C.S., Scranton 9, Penna.

## INTERNATIONAL CORRESPONDENCE SCHOOLS

ICS

BOX 23299F, SCRANTON 9, PENNA.

(Partial list of 277 courses)

Without cost or obligation, send me "HOW TO SUCCEED" and the opportunity booklet about the field BEFORE which I have marked X (plus sample lesson):

- |  |   |  |  |  |
|--|---|--|--|--|
| <p><b>ARCHITECTURE AND BUILDING CONSTRUCTION</b></p> <ul style="list-style-type: none"> <li><input type="checkbox"/> Air Conditioning—Refrig.</li> <li><input type="checkbox"/> Architecture</li> <li><input type="checkbox"/> Architectural Interior</li> <li><input type="checkbox"/> Building Contractor</li> <li><input type="checkbox"/> Building Maintenance</li> <li><input type="checkbox"/> Carpenter and Mill Work</li> <li><input type="checkbox"/> Estimating</li> <li><input type="checkbox"/> Heating</li> <li><input type="checkbox"/> Painting Contractor</li> <li><input type="checkbox"/> Plumbing</li> <li><input type="checkbox"/> Reading Arch. Blueprints</li> </ul> <p><b>ART</b></p> <ul style="list-style-type: none"> <li><input type="checkbox"/> Cartooning</li> <li><input type="checkbox"/> Commercial Art</li> <li><input type="checkbox"/> Fashion Illustrating</li> <li><input type="checkbox"/> Magazine Illustrating</li> <li><input type="checkbox"/> Show Card and Sign Lettering</li> <li><input type="checkbox"/> Sketching and Painting</li> </ul> <p><b>AUTOMOTIVE</b></p> <ul style="list-style-type: none"> <li><input type="checkbox"/> Auto Body Rebuilding</li> <li><input type="checkbox"/> Auto Elec. Technician</li> <li><input type="checkbox"/> Auto-Engine Tune Up</li> <li><input type="checkbox"/> Automobile</li> </ul> | <p><b>AVIATION</b></p> <ul style="list-style-type: none"> <li><input type="checkbox"/> Aeronautical Engineering Jr.</li> <li><input type="checkbox"/> Aircraft &amp; Engine Mechanic</li> </ul> <p><b>BUSINESS</b></p> <ul style="list-style-type: none"> <li><input type="checkbox"/> Advertising</li> <li><input type="checkbox"/> Bookkeeping and Accounting</li> <li><input type="checkbox"/> Business Administration</li> <li><input type="checkbox"/> Business Correspondence</li> <li><input type="checkbox"/> Public Accounting</li> <li><input type="checkbox"/> Creative Salesmanship</li> <li><input type="checkbox"/> Federal Tax</li> <li><input type="checkbox"/> Letter-writing Improvement</li> <li><input type="checkbox"/> Office Management</li> <li><input type="checkbox"/> Professional Secretary</li> <li><input type="checkbox"/> Retail Business Management</li> <li><input type="checkbox"/> Sales Management</li> <li><input type="checkbox"/> Stenographic-Secretarial</li> <li><input type="checkbox"/> Traffic Management</li> </ul> <p><b>CHEMISTRY</b></p> <ul style="list-style-type: none"> <li><input type="checkbox"/> Analytical Chemistry</li> <li><input type="checkbox"/> Chemical Engineering</li> <li><input type="checkbox"/> Chem. Lab. Technician</li> <li><input type="checkbox"/> General Chemistry</li> <li><input type="checkbox"/> Natural Gas Prod. &amp; Trans.</li> <li><input type="checkbox"/> Petroleum Engineering</li> <li><input type="checkbox"/> Plastics</li> <li><input type="checkbox"/> Pulp and Paper Making</li> </ul> | <p><b>CIVIL, STRUCTURAL ENGINEERING</b></p> <ul style="list-style-type: none"> <li><input type="checkbox"/> Civil Engineering</li> <li><input type="checkbox"/> Construction Engineering</li> <li><input type="checkbox"/> Highway Engineering</li> <li><input type="checkbox"/> Reading Struct. Blueprints</li> <li><input type="checkbox"/> Sanitary Engineering</li> <li><input type="checkbox"/> Structural Engineering</li> <li><input type="checkbox"/> Surveying and Mapping</li> </ul> <p><b>DRAFTING</b></p> <ul style="list-style-type: none"> <li><input type="checkbox"/> Aircraft Drafting</li> <li><input type="checkbox"/> Architectural Drafting</li> <li><input type="checkbox"/> Electrical Drafting</li> <li><input type="checkbox"/> Mechanical Drafting</li> <li><input type="checkbox"/> Mine Surveying and Mapping</li> <li><input type="checkbox"/> Plumbing Drawing and Estimating</li> <li><input type="checkbox"/> Structural Drafting</li> </ul> <p><b>ELECTRICAL</b></p> <ul style="list-style-type: none"> <li><input type="checkbox"/> Electrical Engineering</li> <li><input type="checkbox"/> Electrical Maintenance</li> <li><input type="checkbox"/> Electrician <input type="checkbox"/> Contracting</li> <li><input type="checkbox"/> Lineman</li> </ul> <p><b>HIGH SCHOOL</b></p> <ul style="list-style-type: none"> <li><input type="checkbox"/> Commercial <input type="checkbox"/> Good English</li> <li><input type="checkbox"/> High School Subjects</li> <li><input type="checkbox"/> Mathematics</li> </ul> | <p><b>LEADERSHIP</b></p> <ul style="list-style-type: none"> <li><input type="checkbox"/> Foremanship</li> <li><input type="checkbox"/> Industrial Supervision</li> <li><input type="checkbox"/> Leadership and Organization</li> <li><input type="checkbox"/> Personnel-Labor Relations</li> </ul> <p><b>MECHANICAL AND SHOP</b></p> <ul style="list-style-type: none"> <li><input type="checkbox"/> Gas—Electric Welding</li> <li><input type="checkbox"/> Heat Treatment <input type="checkbox"/> Metallurgy</li> <li><input type="checkbox"/> Industrial Engineering</li> <li><input type="checkbox"/> Industrial Instrumentation</li> <li><input type="checkbox"/> Industrial Supervision</li> <li><input type="checkbox"/> Internal Combustion Engines</li> <li><input type="checkbox"/> Machine Design-Drafting</li> <li><input type="checkbox"/> Machine Shop Inspection</li> <li><input type="checkbox"/> Machine Shop Practice</li> <li><input type="checkbox"/> Mechanical Engineering</li> <li><input type="checkbox"/> Quality Control</li> <li><input type="checkbox"/> Reading Shop Blueprints</li> <li><input type="checkbox"/> Refrigeration</li> <li><input type="checkbox"/> Sheet Metal Worker</li> <li><input type="checkbox"/> Tool Design <input type="checkbox"/> Toolmaking</li> </ul> <p><b>RADIO, TELEVISION</b></p> <ul style="list-style-type: none"> <li><input type="checkbox"/> Industrial Electronics</li> <li><input type="checkbox"/> Practical Radio TV Eng'ing</li> <li><input type="checkbox"/> Radio and TV Servicing</li> <li><input type="checkbox"/> Radio Operating</li> </ul> | <ul style="list-style-type: none"> <li><input type="checkbox"/> Television Technician</li> </ul> <p><b>RAILROAD</b></p> <ul style="list-style-type: none"> <li><input type="checkbox"/> Air Brakes <input type="checkbox"/> Car Inspector</li> <li><input type="checkbox"/> Diesel Locomotive</li> <li><input type="checkbox"/> Locomotive Engineer</li> <li><input type="checkbox"/> Section Foreman</li> </ul> <p><b>STEAM AND DIESEL POWER</b></p> <ul style="list-style-type: none"> <li><input type="checkbox"/> Combustion Engineering</li> <li><input type="checkbox"/> Diesel—Elec. <input type="checkbox"/> Diesel Eng's</li> <li><input type="checkbox"/> Electric Light and Power</li> <li><input type="checkbox"/> Stationary Fireman</li> <li><input type="checkbox"/> Stationary Steam Engineering</li> </ul> <p><b>TEXTILE</b></p> <ul style="list-style-type: none"> <li><input type="checkbox"/> Carding and Spinning</li> <li><input type="checkbox"/> Cotton, Rayon, Woolen Mfg.</li> <li><input type="checkbox"/> Finishing and Dyeing</li> <li><input type="checkbox"/> Loom Fix'g <input type="checkbox"/> Textile Des'ing</li> <li><input type="checkbox"/> Textile Eng'g <input type="checkbox"/> Throwing</li> <li><input type="checkbox"/> Warping and Weaving</li> </ul> <p><b>MISCELLANEOUS</b></p> <ul style="list-style-type: none"> <li><input type="checkbox"/> Domestic Refrigeration</li> <li><input type="checkbox"/> Marine Engineering</li> <li><input type="checkbox"/> Ocean Navigation</li> <li><input type="checkbox"/> Professional Engineering</li> <li><input type="checkbox"/> Short Story Writing</li> <li><input type="checkbox"/> Telephony</li> </ul> |
|--|---|--|--|--|

Name \_\_\_\_\_ Age \_\_\_\_\_ Home Address \_\_\_\_\_

City \_\_\_\_\_ Zone \_\_\_\_\_ State \_\_\_\_\_ Working Hours \_\_\_\_\_ A.M. to P.M. \_\_\_\_\_

Occupation \_\_\_\_\_

Canadian residents send coupon to International Correspondence Schools, Canadian, Ltd., Montreal, Canada. . . . Special tuition rates to members of the U. S. Armed Forces.

## USING TOO MUCH GAS



Clean your  
carburetor with  
**GUMOUT**

One big cause of high gas consumption is a dirty, gummed-up carburetor. When tiny gas and air passages become clogged, the fuel-air ratio is upset. The carburetor can't function right. And there is no adjustment you can make to compensate for dirt and gum! The carburetor must be cleaned!

**But—the carburetor doesn't have to be taken apart to clean it!**

GUMOUT does the job for you—while you drive. Just add GUMOUT to your gas tank every two or three months, and you'll keep your carburetor sparkling clean. There's nothing like GUMOUT.

Send for FREE 46-page Carburetor Handbook. Gives you all the answers. Good to have.



POWER MOWERS and OUTBOARDS need GUMOUT, too. Winter storage and infrequent use are sure to cause gum formation in the carburetor and fuel system. Hard starting, stalling, and rough idling results. GUMOUT dissolves the gum, cleans out the fuel system . . . fast.

GUMOUT is sold by service stations, garages, auto supply dealers, and hardware stores everywhere.



GUMOUT DIVISION

Pennsylvania Refining Company  
2671 Lisbon Road, Cleveland 4, Ohio

(Continued from page 8)

months of January and February and sometimes early March.

Eric Thane,  
Helena, Mont.

### To the Editor:

Enclosed is a picture of my model D8 Caterpillar. The approximate size is 14 inches long, 9½ inches wide and 8 inches high. It is built entirely out of balsa wood. It is powered by two six-volt motors. The

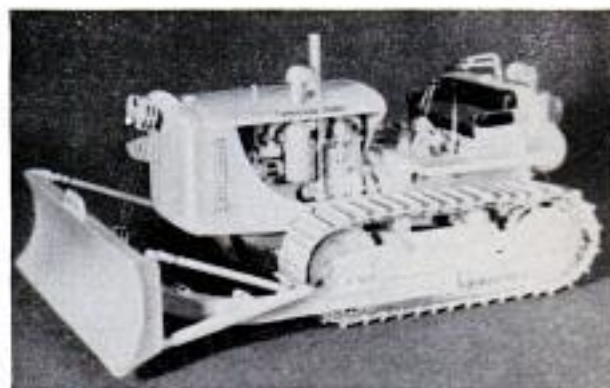

blade works off two more six-volt motors.

There are two separate electrical systems to run and operate my Cat. I used no plans or blueprints, only photographs of a full-size Caterpillar. Batteries used are six-volt electric-fence type.

Robert N. Jensen,  
Las Vegas, Nev.

### To the Editor:

We were not too surprised at the criticism of windshield reflections from instruments during night driving by owners of early models of the 1955 Plymouth ["Owners Report on the Plymouth", *PM*, April 1955]. We have, however, developed a very satisfactory solution for this problem which has now been in production for a considerable length of time. It involves the use of dull-black paint on the portion of the bezels which face the instrument dials plus a stripe of dull-black paint properly located in the lower half of the instrument housings. The maximum light intensity in the speedometer was further reduced by omitting one of the two bulbs originally used. We thought your article on the Plymouth car gave a rather complete coverage.

R. W. Steere,  
Assistant Chief Engineer,  
Plymouth Division,  
Detroit, Mich.

☆☆☆

☐ Meteorologists of the U.S. Weather Bureau believe that the highest wind ever measured reliably—close to 300 miles an hour—swept over Philadelphia at 20,000 feet last Jan. 23.



**J. E. SMITH**  
President, National Radio Institute. 40 years' experience training men at home for Radio-TV

I Will Send You A  
**SAMPLE LESSON FREE**  
to show you how easy, practical it is to  
**Train at Home for Good Radio-Television Jobs**



**America's Fast Growing Industry Offers You Good Pay Plus a Bright Future**

TRAINING plus OPPORTUNITY is the PERFECT combination for ambitious men. Let me send you a sample lesson from my course to prove you can keep your job while TRAINING at home in your spare time for better pay and a brighter future. I will also send my 64-page book to show you that Radio-Television is today's field of OPPORTUNITY for properly trained men.

**Make \$10, \$15 a Week Extra**  
Many men I train fix neighbors' Radios, make extra money, soon after they enroll. Actual equipment you build gives you practical experience.



**Television's Growth is Making More Jobs, Prosperity**

Radio is bigger than ever and television is growing fast. Government, Aviation, Police, Ship, Micro-wave Relay, Two Way Communications for buses, taxis, railroads are other growing fields for Radio-Television trained men.

**Mail Coupon—Find Out About This Tested Way to Better Pay**

Take NRI training for as little as \$5 a month. Many NRI graduates make more in two weeks than the total cost of my training. Mail coupon today for Actual Lesson and 64-page Book—Both FREE. J. E. SMITH, National Radio Institute, Dept. 5FA, Washington 9, D.C. Our 40th Year.



**I Trained These Men**



"I am a police captain and also have a good spare time Radio and Television service business. Just opened my new showrooms and shop."  
C. W. LEWIS, Pensacola, Florida.

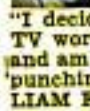

"I decided to quit my job and do TV work full time. I love my work and am doing all right. I'm not just 'punching a time clock.'"  
—WILLIAM P. KLINE, Cincinnati, Ohio.



"Thanks to NRI, I operated a successful Radio repair shop. Then I got a job with WPAQ, later WBOB and now am an engineer for WHPE."  
—VAN W. WORKMAN, High Point, N. Carolina.

**You Learn by Practicing with Equipment I Send**



Nothing takes the place of practical experience. That's why NRI training is based on LEARNING BY DOING. My training includes kits of parts which you use to build equipment and get practical experience on circuits common to both Radio and Television. Shown at left is the low-power Broadcasting Transmitter you build as part of my Communications Course.



AVAILABLE TO **VETERANS** UNDER G.I. BILLS

**Good for Both—FREE**

Mr. J. E. Smith, President, Dept. 5FA  
National Radio Institute, Washington 9, D.C.  
Mail me Sample Lesson and 64-page Book, FREE. (No salesman will call. Please write plainly.)

Name \_\_\_\_\_ Age \_\_\_\_\_  
Address \_\_\_\_\_  
City \_\_\_\_\_ Zone \_\_\_\_\_ State \_\_\_\_\_

**VETS** write in date of discharge \_\_\_\_\_  
Approved Member, National Home Study Council

# STURDY, LONG-LIFE AUTO SEAT COVERS MADE WITH HEAVY-DUTY UPHOLSTERY FABRICS

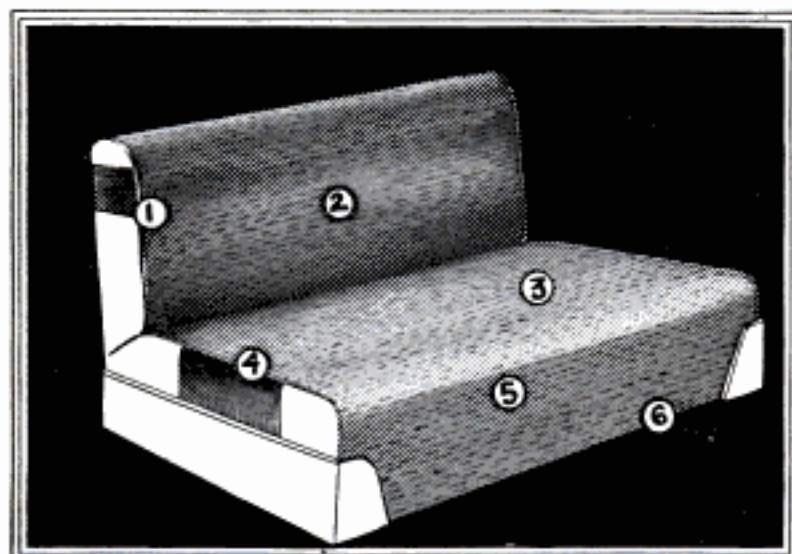

## 6 QUALITY FEATURES

1. Flex-O-Snap fits any car!
2. Tight-Weave, Sturdy Fabric! Never Tears! Lasts Years!
3. Tuck Flap Holds Seat Down!
4. Your Choice of 3 Colors
5. Lockstitch Nylon Thread
6. Snap-Flex Feature

Because we purchased thousands of yards of genuine upholstery fabrics far below wholesale cost . . . because we produce our own seat covers in our own factory . . . because we use no middlemen but sell direct from factory to you . . . that is why this amazing value is possible. Yes! Only 3.99 each for these smart, durable covers!

### Generous Tailoring!

We use 3 full yards for each seat!

There's nothing skimpy about these superb auto seat covers! We use 3 full yards of heavy duty upholstery fabric—the kind you'd expect to pay up to 4.00 a yard! The cloth is durably tailored for good fit plus long life! MOTO-MATIC Seat Covers can really take lots of punishment day after day. You'll love the rich looking upholstery fabric that gives old worn interiors that new, neat look. Wonderful, too, for protecting new upholstery against wear, dust, stains, etc.

### Snap on . . . Snap off. Quick and Easy With Snap-Flex Feature

Install in a jiffy—remove in a jiffy! Ingenious design—one style fits All cars from Chevrolet to Cadillac—1936 to 1955. Special "SNAP-FLEX" feature adapts to any type seat, front or back. Result: You get a smooth contour-shaped cover that will not ride up or lose shape. The tough, durably tailored upholstery material won't tear or crack like certain thin plastics. Won't stretch out of shape and—most important of all—they're SANFORIZED and will not shrink more than 1/2 of 1% after washing or dry-cleaning.

### Your Choice! 3 Distinctive Colors

Choose any of these 3 smart colors: Dappled Blue, Forest Green or Duotone Grey. You'll love any one of these luxurious shades, with that rich tweedy feel. No matter which color you choose you'll add new distinction and greater resale value to your car. NOTE: Front seats come in 2 styles: A—for SOLID back seats in 4-door models, B—for SPLIT back seats in 2-door cars. Either type front seat, one price—3.99 each. Mark your choice in coupon.

You'd expect to pay  
up to \$12.00  
for the luxury  
fabric alone!

Now **3.99**

(2 for 6.98)

**DIRECT FROM  
FACTORY TO YOU**

### Try a Set in Your Car Without Obligation

We want to send you a set of these LONG-LIFE covers on approval. Then you can see and feel the attractive, durable cloth. Install them in your car. Enjoy them for 5 days—without risking any money! Send only 3.99 each—or \$6.98 for front AND rear, and they will be sent postage prepaid. Or you can order C.O.D. plus postage. But in either case, remember: You're TRYING—not BUYING! You must be delighted in every way or your money back at once!

### Rush Order Now to avoid disappointment

We made a lucky buy on the material—because we purchased in huge quantities! WE'RE PASSING THE SAVINGS ON TO YOU—but there's a catch: this big bargain can't last forever. You'll have to act fast to avoid disappointment! Orders received after supplies are ended will be promptly returned. Try a set now on FREE trial! Mail coupon today to famous:

## MOTO-MATIC COMPANY

Dept. 6-F-151

352 Fourth Avenue, New York 10, N. Y.

### CHECK TYPE BELOW

(For Front Seat Only)



STYLE "A"  
(Solid Back)



STYLE "B"  
(Split Back)

### RUSH TODAY FOR FREE TRIAL!

MOTO-MATIC COMPANY, Dept. 6-F-151  
352 Fourth Avenue, New York 10, N. Y.

RUSH your "Long Life" Seat Covers made with sturdy upholstery cloth on approval for 5 days. If I am not delighted in every way, you will return 3.00 each at once—no questions asked.

- Send only Front Seat at 3.99
- Send Front & Back Seats at 6.98 for BOTH, plus FREE offer.
- Payment enclosed, RUSH prepaid.
- Send C.O.D. plus 49c postage each.

Check color desired.  BLUE  GRAY  GREEN

Name \_\_\_\_\_

Address \_\_\_\_\_

City \_\_\_\_\_ State \_\_\_\_\_

## FREE!

To those ordering more than one seat cover (i.e., a front and a back), we are GIVING a brand-new POLY-SHEEN auto cleaning cloth. POLY-SHEEN adds a magic-like lustre and polish to your car—enables you to DRY WASH it in less than 10 minutes! Makes your home sparkle, too, when you use it on furniture, glassware, woodwork, mirrors, windows and walls. New and used car dealers swear by it! POLY-SHEEN retails for \$1.98, but it's yours—FREE of EXTRA CHARGE—when you order TWO seat covers at the special price of \$6.98.



# INVENTORS

Learn how to protect your invention. The U. S. Patent Laws provide that any new and useful art, machine, article of manufacture, or composition of matter, or any new and useful improvement thereof, may be patented if the act of invention is involved. Therefore, every inventor with a valuable invention should take advantage of the Patent Laws and proceed for patent protection in order to safeguard his rights.

A patent gives the inventor the exclusive right to prevent others from making, using, or selling the invention claimed in the patent for a period of seventeen years.

The Patent Laws were enacted for the benefit of the inventor to give him protection for the features of his invention which are patentable. These features must be properly and concisely set forth and claimed in a formal application for patent, in order to comply with the requirements of the Patent Laws. For that reason, unless the inventor is familiar with patent matters, he should engage a competent registered patent attorney or agent to represent him. We are registered to practice before the U. S. Patent Office and are prepared to serve you in the handling of your patent matters.

A specially prepared booklet entitled "Patent Guide for the Inventor", containing detailed information with respect to patent protection and procedure, together with a "Record of Invention" form will be promptly forwarded to you without obligation upon request.

**CLARENCE A. O'BRIEN & HARVEY JACOBSON**

*Registered Patent Attorneys*

51-F DISTRICT NATIONAL BUILDING

WASHINGTON 5, D. C.

# 17 pt. Self-Cleaning Plug Alone Shows 8 hp Gain and 7 mph Greater Speed!

**Eddie Edmunds**  
CHASSIS DYNAMOMETER CHART

Model No. \_\_\_\_\_  
Year \_\_\_\_\_  
Make \_\_\_\_\_  
Model \_\_\_\_\_  
Year \_\_\_\_\_

**Power Test**

PLUG TYPE	HP	MPH	0-30 SEC.	0-50 SEC.
17 pt. LIFE-TIME	12.5	72	11.5	18.5
16 pt. Standard	10.0	65	13.5	21.5

**Recommendations**

Special plug for this car is recommended for best performance.



**Tustin Auto Parts**  
110 West Main Street, Tustin, California, Phone BR 6-6321

Dear Sir:

We have just received your order for 17-point LIFE-TIME Spark Plugs. We are pleased to serve you and will ship your order as soon as possible. We will also include a coupon for your next order.

PLUG TYPE	QUANTITY	PRICE
17 pt. LIFE-TIME	12	\$12.00
16 pt. Standard	12	\$12.00

Yours truly,  
E. Edmunds

## HOW 17 PT. FIRING WORKS

Note electrodes closely. A circular arcing area (four concave segments). Gap being the same from all points. Electricity has property of arcing from coldest point. Current also arcs more readily from apex of two planes than from the face of a flat, metallic surface. Note that there are 16 apexes (where two planes meet) — all the same distance from the center electrode. Normal heat and spark erosion are spread around the entire 360 degrees and around the whole circumference of the center electrode.



## FULL ROTATING SPARK

allows overall cooler electrode temperature for greatly increased life. Hotter spark prevents fouling, yet the rotating and cooling effects minimize the common faults of burning, erosion, blistering and insulator failure. Compare this principle with the conventional 2-point spark plug design.

- **PLATINUM-NICKEL ALLOY ELECTRODES**— Metallurgists' first major step beyond platinum aircraft plug electrodes. Arcing points of this material have continued to function after the equivalent of 120,000 car-miles.
- **SPECIAL SINTERED CORUNDUM INSULATOR**— Made of gem-like mineral which conducts heat 20 times better than ordinary porcelain. Special shape is designed to vaporize and exhaust wet carbon and oil.

- **INDIVIDUAL INSPECTION**— Each LIFE-TIME Spark Plug is tested for firing in oil and for resistance to 30,000 volts C.M.
- **PERMANENT GAP**— After months of use LIFE-TIME Spark Plugs make at exact factory pre-gap.
- **SELF CLEANING FOR LIFE**— Confined gases exploding in chamber formed by multiple electrodes reclean arcing surfaces with each firing stroke.



**NOW...  
ORDER REGISTERED SET  
FOR YOUR CAR AT POPULAR PRICE!**

Dealers and Distributors: The LIFE-TIME Spark Plug is now in full production. Write for full details. Distributors: Please inquire as to status of your territory.

## 50,000 CAR MILES!

Before LIFE-TIME development, the spark plug was the most often replaced part of your car. Engineers agreed that "creeping paralysis," gradual electrode disintegration, carbon buildup, widening gap, could waste one gallon in ten. The LIFE-TIME Plug has now gone far beyond the life of the average set of tires, the average battery. This plug still fired clean, hot and steady at 50,000 car miles!

Most spectacular spark plug research breakthrough in 50 years allows us to include this unique and unprecedented warranty with every set of LIFE-TIME Spark Plugs. We GUARANTEE GREATER GAS MILEAGE — GREATER ACCELERATION — A MAJOR POWER INCREASE — OR YOUR MONEY BACK.

## YOU RECEIVE BY MAIL

this registered set of LIFE-TIME Spark Plugs in proper series (heat range and gap) for the car you indicate in coupon. Now AVAILABLE FOR AMERICAN & EUROPEAN PASSENGER CARS, TRUCKS, BOATS, FARM EQUIPMENT, INDUSTRIAL ENGINES.

LIFE-TIME Spark Plug Division,  
CONTINENTAL MANUFACTURING CORP.  
Washington Blvd., at Motor Ave.  
Culver City 47, California

Gentlemen: Please mail postpaid. . . . . 50001 Registered set of LIFE-TIME Spark Plugs in proper heat range and gap for my car at introductory price of 50¢ per plug (set of six, \$2.50, set of eight, \$7.00) 10¢ each \$1 per set, balance C.O.D.)

Make of my car is \_\_\_\_\_ Year \_\_\_\_\_  
Model \_\_\_\_\_ No. Cyl. \_\_\_\_\_  
I enclose \$ \_\_\_\_\_ (check, cash or money order)  
Name \_\_\_\_\_  
Address \_\_\_\_\_  
City \_\_\_\_\_ Zone \_\_\_\_\_ State \_\_\_\_\_

## 8 HORSEPOWER GAIN!

Dear Car Owner:

The real test of a spark plug is "What will it do in my own car?" Take the above dynamometer test on a 1951 Buick Super. It shows an 8 horsepower gain with Life-Time 17-point plugs. This was a 12 1/2% hp gain at 2000 RPM. You don't need a dynamometer with Life-Time plugs. You can feel the difference both in your ride and your pocketbook. Try a set and let me hear from you about them. Many thanks!

*Frank Williams*  
Inventor of the LIFE-TIME Spark Plug





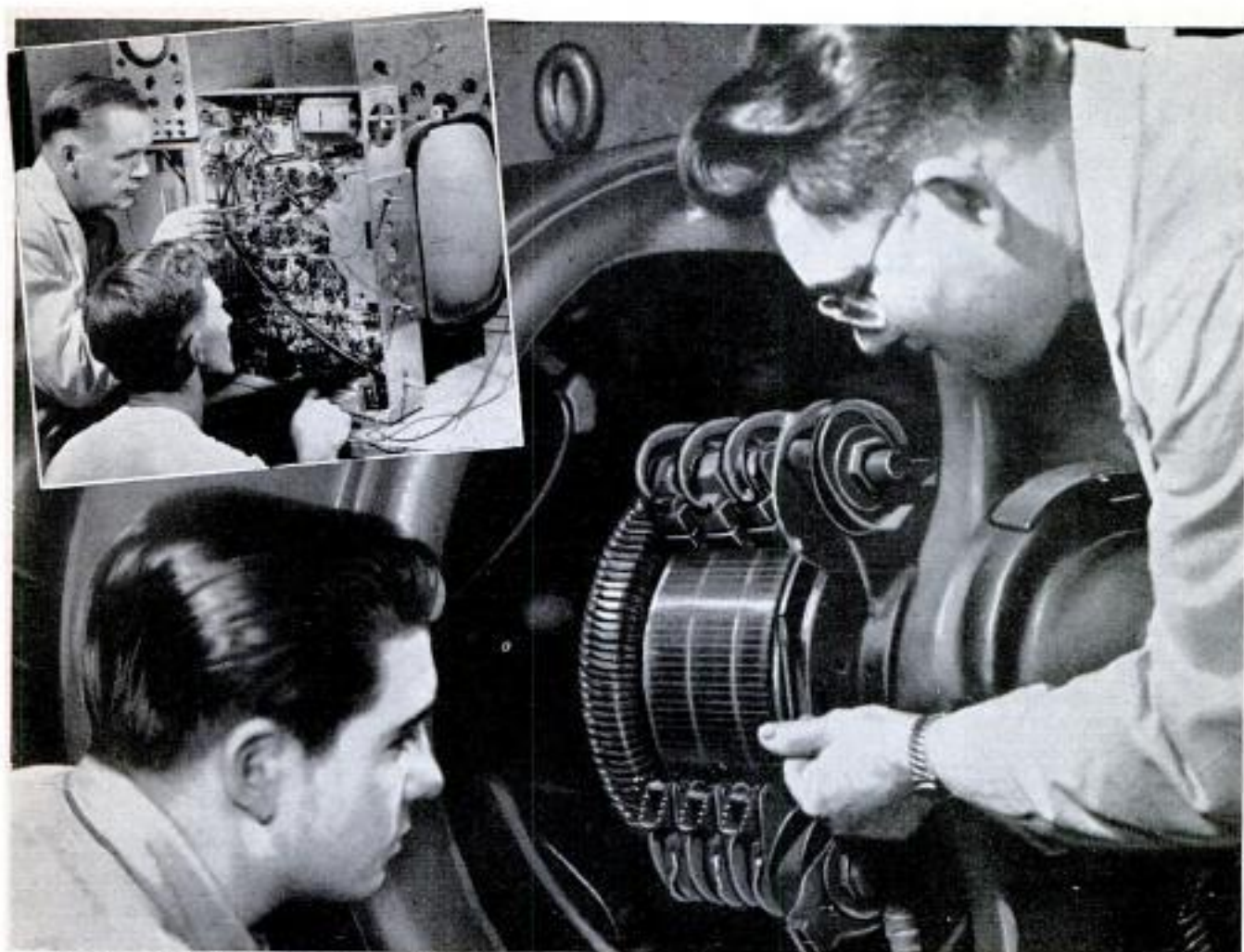

# TRAIN FOR A FUTURE IN Electricity or Television-Radio

**IN GREAT SHOPS OF COYNE—  
Largest, Oldest, Best Equipped  
School Of Its Kind In The U. S.**

Prepare quickly at Coyne for a career with a future! Whether 17 or up to 45 years of age, prepare for your future now. Don't be satisfied with a "No Future" job. Train the Coyne way for a better job in a field that offers a world of opportunities in the years ahead.

### WE TRAIN YOU IN CHICAGO

Learn the easier, practical way at Coyne, on real, full size equipment. No advanced education or previous experience needed. You learn better the Coyne way.

Train in the shops of Coyne—where thousands of successful men have trained for over 56 years—Coyne is the largest, oldest, best equipped school of its kind—established in Chicago in 1899.

**FINANCE PLAN** Enroll now. You may pay most of tuition later. We have a special plan for men of draft age.

**CLIP COUPON NOW** for big new illustrated Coyne book. No obligation; no salesman will call. Get vital facts now!

B. W. COOKE, Pres. **COYNE** FOUNDED 1899

**ELECTRICAL SCHOOL**

A TECHNICAL TRADE INSTITUTE OPERATED NOT FOR PROFIT  
500 S. PAULINA ST., CHICAGO, DEPT. A5-72H  
ELECTRICITY ★ RADIO ★ TELEVISION ★ REFRIGERATION ★ ELECTRONICS

**APPROVED  
FOR  
VETERANS**

Mail Coupon  
Today for  
**BIG FREE  
BOOK**

"Guide to Careers  
in ELECTRICITY and  
TELEVISION-RADIO"



B. W. COOKE, President  
COYNE ELECTRICAL SCHOOL  
500 S. Paulina St., Chicago 12, Ill., Dept. A5-72H

Send BIG FREE book and details of your training offer. This does not obligate me and no salesman will call. I am interested in:

ELECTRICITY  TELEVISION-RADIO

Name.....

Address.....

City..... State.....

# HOW TO FIX ANY PART OF ANY CAR

**QUICKLY--EASILY--RIGHT!**



**FREE 7-DAY TRIAL**

Whether you're a beginner or an expert mechanic—now you can "breeze through" any "fix-it" job from simple carburetor adjustment to complete overhaul. Just look up job in index of MOTOR'S Brand-New 1955 Auto Repair Manual. Follow simple step-by-step directions, clear pictures. Presto—the job is done!

No guesswork! MOTOR'S MANUAL takes you from "scratch"—shows WHERE to start, WHAT tools to use. Covers EVERY job on EVERY car built from 1940 thru 1955!

**Everything You Need to Know "Boiled Down" from 160 Official Shop Manuals**

NEW, REVISED, ENLARGED, 1955 Edition contains the "meat" from over 160 OFFICIAL shop manuals—simplified for YOU. 23,430 essential repair specifications on 737 chassis models. Over 1,000 big pages. More than 3,900 "this-is-how" pictures, 225,000 service and repair facts. Leads beginners every step of the way. Time-saving factory repair procedures for experts. Instructions and pictures so clear you CAN'T go wrong. Used by U. S. Army and Navy.

**Try Book FREE 7 Days**

SEND NO MONEY! Pay postman nothing. Make Manual show you what it's got. Unless you agree this is the greatest time and work saver you've ever seen—return book in 7 days and pay nothing. Mail coupon today to MOTOR—Book Dept., Desk 16, 250 W. 55th St., New York 10, N. Y.

**MOTOR'S AUTO REPAIR MANUAL**

Covers 737 Models All These Makes

- Buick
- Cadillac
- Chevrolet
- Chrysler
- Crosley
- De Soto
- Dodge
- Ford
- Frazer
- Henry
- Hudson
- Kaiser
- Lincoln
- Mercury
- Nash
- Oldsmobile
- Packard
- Plymouth
- Pontiac
- Studebaker
- Willis

2,000,000 Copies Sold!

**Same FREE Offer On MOTOR'S Truck and Tractor Manual**

Covers EVERY job on EVERY popular make gasoline truck, tractor made from 1940 thru 1954. FREE 7-Day Trial. Check proper box in coupon.



**MAIL COUPON NOW FOR 7-DAY FREE TRIAL**

**MOTOR BOOK DEPT.**  
Desk 16, 250 W. 55th St., New York 19, N. Y.

Rush to me at once (check box opposite book you want):

MOTOR'S New AUTO REPAIR MANUAL. If O.K., I will remit \$2 in 7 days, \$2 monthly for 2 months and a final payment of \$6 (plus 35c delivery charge) one month after that. Otherwise I will return the book postpaid in 7 days. (Foreign price, remit \$9 cash with order.)

MOTOR'S New TRUCK & TRACTOR REPAIR MANUAL. If O.K., I will remit \$2 in 7 days, and \$2 monthly for 3 months, plus 35c delivery charge with final payment. Otherwise I will return book postpaid in 7 days. (Foreign price, remit \$10 cash with order.)

Print Name..... Age.....

Address.....

City..... State.....

Check box and save 35c delivery charge by enclosing WITH coupon entire payment of \$6.95 for Auto Repair Manual (or \$8 for Truck & Tractor Repair Manual.) Same return-refund privilege.



**GIVE THE GIFT OF LANGUAGE**

IT'S FUN TO LEARN

by **LINGUAPHONE**

World's Standard Conversational Method

**FRENCH SPANISH GERMAN JAPANESE**  
**RUSSIAN ITALIAN MODERN GREEK**

32 languages available

A Linguaphone Language Set is a lasting gift—an invaluable asset in business, travel, school, armed services and social life. With LINGUAPHONE'S life-like recordings, you LISTEN and LEARN another language the same easy, natural way you learned your mother tongue long before you went to school. AT HOME you hear 8 to 12 outstanding native authorities, both men and women, make everyday conversation—you Understand—YOU SPEAK! It's like living in another land. Over a million home-study students of all ages. There's nothing like "The Gift of Language." Write TODAY for FREE Book, "Passport to a New World of Opportunity." Linguaphone Institute, 143-065 Radio City, New York 20, N. Y.

**I'll Send You This Handsome SAMPLE CASE—FREE**



and Show You How to Make Up to \$30.00 in a Day

WRITE for this FREE Tailoring Sample Case packed with 160 beautiful, big-value suit and overcoat fabrics. Take orders from friends, fellow-workers, others, for fine quality, made-to-measure clothes. Pocket big cash profits in advance.

Because wearing our suits and overcoats brings more orders, we make it easy for you to get your own clothes without 1c cost. No experience is needed. SATISFACTION GUARANTEED. SEND NO MONEY. Rush your name, address, and age—today!

J. C. FIELD & SON, INC., Harrison & Throsp Sts. DEPT. C-1716 CHICAGO 7, ILLINOIS



**MECHANICAL DENTISTRY**

To make Crowns, Plates, Bridgework, etc., for Dentists. Easy practical way to learn mechanical dentistry at home in spare time. FULL EQUIPMENT OF TOOLS AND MATERIALS INCLUDED WITH COURSE. Low tuition. Easy terms. Write for FREE BOOK about this money making profession that is not affected by machine age.

MCCARRIE SCHOOL OF MECHANICAL DENTISTRY  
207 N. Broad St., Dept. 42, Philadelphia 7, Pa.



**'How to MAKE MONEY with Simple CARTOONS'**

A book everyone who likes to draw should have. It is free; no obligation. Simply address **FREE BOOK**

**CARTOONISTS' EXCHANGE**  
Dept. 96D Pleasant Hill, Ohio

MAKE EXTRA MONEY

**PLASTICS**

LEARN AT HOME

LEARN HOW TO MAKE fast-selling PLASTIC NOVELTIES FURNITURE JEWELRY



There are RICH OPPORTUNITIES for MEN and WOMEN with "know-how" in Plastics. Interstate's new Plastics course tells and shows how to make hundreds of fast selling items out of Plastics. Gives complete training in fabricate a casting, lamination, molding, internal carving, etc., in six steps, easy, step-by-step language and pictures. Plastics and Fabricating Kits for 23 valuable Plastic items come with training at no extra cost. START A PLASTICS BUSINESS OF YOUR OWN. No other industry holds such promise for the future. You can make big money manufacturing novelties, toys, signs, etc., in your own home in spare or full time. Don't wait! Learn NOW how Interstate's Plastics Training qualifies you for success in the Plastics field.

PLASTICS AND SUPPLIES FURNISHED FOR 23 VALUABLE PROJECTS

**INTERSTATE TRAINING SERVICE**  
Dept. C-3-F Portland 13, Oregon

# INVENTORS

If you believe that you have an invention, you should find out how to protect it. The first step is to have a search made of the prior pertinent U. S. patents. If a report on this search indicates that the invention appears patentable you can apply for a patent, and the specifications and claims should be prepared.

The firm of McMorrow, Berman & Davidson, with offices in Washington, D. C., is qualified to take the necessary steps for you. We can make a preliminary search on your invention, advise you whether we think it can be patented, and prepare your application for patent.

Unless you are fully familiar with the U. S. Patent Laws, we recommend that you engage the services of a Registered Patent Attorney to protect your interests. The patent laws are *your* laws. A patent gives you the right to prevent others from making, using or selling the invention claimed in your patent for a period of 17 years.

Use these patent laws for your protection. Investigate whether your invention can be patented. If you have what you believe to be an invention, we suggest that you have this firm make a search for you.

*Send for a copy of our Patent Booklet entitled "How To Protect Your Invention," containing information about patent protection and patent procedure. Along with this we will also send you an "Invention Record" form, for your use in writing down and sketching details of your invention. We will mail them promptly. No obligation. They are yours for the asking.*

**McMORROW, BERMAN & DAVIDSON**

*Registered Patent Attorneys*

**PATENTS • COPYRIGHTS • PATENTS**

**135-F VICTOR BUILDING, WASHINGTON 1, D. C.**

These great minds were Rosicrucians . . .



Francis Bacon Benjamin Franklin Isaac Newton

## WHAT SECRET POWER DID THEY POSSESS?

### Why were these men great?

How does anyone—man or woman—achieve greatness? Is it not by mastery of the powers within ourselves?

Know the mysterious world within you! Attune yourself to the wisdom of the ages! Grasp the inner power of your mind! Learn the secrets of a full and peaceful life!

Benjamin Franklin, statesman and inventor . . . Isaac Newton, discoverer of the Law of Gravitation . . . Francis Bacon, philosopher and scientist . . . like many other learned and great men and women . . . were Rosicrucians. The Rosicrucians (NOT a religious organization) have been in existence for centuries. Today, headquarters of the Rosicrucians send over seven million pieces of mail annually to all parts of the world. Address: Scribe M.V.Z.

THIS BOOK FREE



## The ROSICRUCIANS

San Jose (AMORC) California, U.S.A.

SEND THIS COUPON

Scribe M.V.Z.  
The ROSICRUCIANS  
(AMORC)  
San Jose, California, U.S.A.

Please send me the free book, *The Mastery of Life*, which explains how I may learn to use my faculties and powers of mind.

Name \_\_\_\_\_  
Address \_\_\_\_\_  
City \_\_\_\_\_  
State \_\_\_\_\_

**INSURED TIRE SERVICE**  
**POPULAR BRANDS**

**FREE** INSURANCE POLICY given with each used tire sold. We guarantee the amount of service you pay for.  
NOWHERE CAN SUCH QUALITY BE FOUND AT SUCH LOW PRICE!

SPECIAL! Deduct 10% on orders for two or more used tires. **YOU CAN'T LOSE!!**

Super Quality — Rugged Performance — 15 Months Insured Service	
600x16 \$3.65 670x15 \$3.95 700x16 \$4.45 760x16 \$4.75	
650x15 3.85 670x16 4.05 710x15 4.35 820x15 4.95	
650x16 4.25 700x15 3.95 760x15 4.45 550x17 4.65	
Supreme Quality — Nothing Finer — 30 Months Insured Service	
600x16 \$5.25 475x19 \$5.45 700x15(6) \$10.45 700x20 \$12.50	
600x16(6) 6.75 640x15 4.95 780x16(8) 15.95 750x20(8) 15.50	
650x16 5.75 670x15 5.35 700x17 11.95 750x20(10) 17.50	
650x16(6) 7.25 710x15 5.45 750x17 11.45 820x20 21.50	
700x16 6.35 760x15 5.95 750x15 10.95 900x20 19.95	
750x16(6) 8.45 800x15 6.35 30x5 11.25 1000x20 20.45	
850x18 4.95 820x15 6.35 600x20 10.95 1100x20 21.25	
550x17 4.75 550x15 5.35 650x20 11.75 1000x22 21.95	
650x15 5.25 670x16 5.15 32x6(8) 11.95 1100x22 22.75	
700x15 5.35 700x16(6) 10.25 32x6(10) 12.75 1100x24 25.95	
Whitewalls \$1.00 extra.	

**MIDLAND TIRE SALES** 3701 S. Normal, Dept. PM-35, Chicago 9, Ill.

## TELEPHONES

**Desk Stand Style**  
Slightly used but in excellent condition

Many Valuable Uses  
Inter-House Phones House to Barn, etc.  
Loud Speakers Microphones  
Educational Purposes, Toys, etc.

Come complete, ready to use with wiring diagrams included. Two complete for only \$5.00 **\$2.75 Postpaid in U.S.A.**

**TELEPHONE LAMP KIT** — with illustrated instructions for making Desk Telephone Lamp including all parts (sharp, nipples, push switch, cord, plug, etc.) . . . \$6.50 Ppd. (Shade is not included).

**MICROPHONE**, Dept. X2702, 1760 W. Lunt Ave., Chicago 26, Ill.

*Secrets of* **VENTRILOQUISM**  
*Now Revealed!*

Easy to learn in 60 to 90 days with our Home Study Course. **RESULTS GUARANTEED.** Make Money! Be Popular! Have Fun! Big Opportunity! Radio, Television, Stage Appearances! For FREE Information regarding price and terms, WRITE. You must state your age, Dummy Catalog 25c.

**FRED MAHER SCHOOL OF VENTRILOQUISM**  
Box 36, Studio PM-6 Kensington Station  
Detroit 24, Michigan

## MONEY in DONUTS

Make new greaseless donuts. Start in kitchen. No smoke. Sell stores. Cash daily. No experience necessary. Free recipes. No obligation. Write: **MARTIN RAY CO., 3605 SO. 15th AVENUE, MINNEAPOLIS 7, MINN.**

**AGENTS START BUYING SERVICE AT HOME**

**GET BIG NAME MERCHANDISE**

for your clients up to 40% less than reg. price. Operate sparetime. Sales easy as you can give sizeable discounts, still make fat comm. Postcard brings free plan.

**AMERICAN BUYERS SERVICE**  
631-R LINDEN AVE., BUFFALO 16, NEW YORK

**GET UP TO 40% OFF**

## Worry of FALSE TEETH Slipping or Irritating?

Don't be embarrassed by loose false teeth slipping, dropping or wobbling when you eat, talk or laugh. Just sprinkle a little **FASTEETH** on your plates. This pleasant powder gives a remarkable sense of added comfort and security by holding plates more firmly. No gummy, gooey, pasty taste or feeling. It's **alkaline** (non-acid). Get **FASTEETH** at any drug counter.

Work with and keep all of this practical, commercial type equipment

"YOU LEARN BY DOING! THAT'S WHY D.T.I. GETS REAL RESULTS!"



**21 INCH**

Build and keep D.T.I.'s NEW 21 Unit TV Set—ideal for custom installation. (D.T.I. also offers home training without the TV set.)



Television, Radio, Electronics, has created thousands of good jobs; jobs with money, respect, position; jobs you may choose among—if you only had training. DeVRY Training is modern, thorough, practical—followed by a real Employment Service. Thousands have stepped into good pay—why not you? No need to leave home; no need to quit your present job; no special preliminary training required. Fill out coupon below and get the full story. Men 17 to 45 preferred.

# Amazingly effective NEW home training in TELEVISION RADIO ELECTRONICS

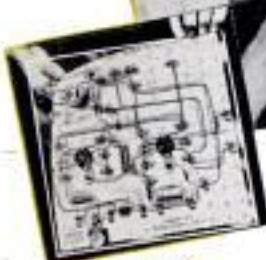

## NEW STYRENE ELECTRO-LAB<sup>®</sup> SPEEDS LEARNING

Simply place a pictorial diagram under transparent Styrene base. Follow the diagram. Wiring is tremendously simplified. Work a total of over 300 learn-by-doing projects—a wonderful way to get practical experience.

\*Trade-mark

One of America's Foremost Television Training Centers



You build and keep a quality Oscilloscope—almost a necessity for Television servicing. Helps you earn while you learn. You also build and keep a Vacuum Tube Voltmeter—a highly versatile test unit you can use when you are ready to make real money! IF PREFERRED, you may get all your preparation in D.T.I.'s big Chicago training laboratories—among the finest. (See building pictured below.) Valuable information for men subject to military service.

## YOUR OWN HOME MOVIES

Movies are a remarkable feature of the D.T.I. System. You use a movie projector and many reels of film. Run off each film as often and as slowly as you want. A wonderful aid to help make important points crystal-clear. Get the full story! Send in that coupon.



**DEVRY TECHNICAL INSTITUTE**  
FORMERLY  
**DEFOREST'S TRAINING, INC.**  
CHICAGO 41, ILLINOIS

Mail Coupon Today

**DEVRY TECHNICAL INSTITUTE**

4141 Belmont Ave., Chicago 41, Ill. Dept. PM-6-L

I would like complete facts including "89 Ways to EARN MONEY in Television-Radio-Electronics."

Name \_\_\_\_\_ Age \_\_\_\_\_

Street \_\_\_\_\_ Apt \_\_\_\_\_

City \_\_\_\_\_ Zone \_\_\_\_\_ State \_\_\_\_\_

2 D.T.I.'s training is available in Canada.

**89 WAYS TO EARN MONEY IN TELEVISION RADIO ELECTRONICS**

# Will You Let Me PROVE I Can Make YOU a New Man?

LET ME START SHOWING RESULTS FOR YOU



I COULD fill this whole magazine with enthusiastic reports from OTHERS. But what you want to know is—"What can Atlas do for ME?"

### 15 MINUTES A DAY

Just give me 15 minutes of your spare time daily. That's all I ask. And even in that short time I'll start giving RESULTS. And it will be the kind of RESULTS that you (and anyone else) can SEE, FEEL, MEASURE with a tape.

I myself was once a 97-pound weakling—sickly, half-alive. Then I discovered "Dyssasie Tension." And I won the title, "The World's Most Perfectly Developed Man!"

"Dyssasie Tension" has done so much for other fellows that I simply ask you to let me prove that it can make a New Man of YOU—that it can start new inches of power pushing out your chest—build up your shoulders to champion bulkiness—put new, hard, firm muscles on your biceps—make those stomach muscles of yours hard-ridged!

**FREE** My 32-Page Illustrated Book is Yours **FREE**—Not for \$1.00 or 10c—But **FREE**

Send for my book, "Everlasting Health and Strength"—32 pages, packed with actual photos, valuable advice. A real prize for any fellow who wants a better build... But yours **FREE!** Rush coupon to me personally:

CHARLES ATLAS, Dept. 8T,  
115 East 23rd St., New York 10, N. Y.

**CHARLES ATLAS, Dept. 8T,  
115 East 23rd St., New York 10, N. Y.**

Send me—absolutely **FREE**—your famous book, "Everlasting Health and Strength"—32 pages, crammed with photos, answers to vital questions, valuable advice. I understand book is mine to keep, and sending for it does not obligate me in any way.

Name \_\_\_\_\_ Age \_\_\_\_\_  
 (Please print or write plainly)  
 Address \_\_\_\_\_  
 City \_\_\_\_\_ State \_\_\_\_\_



## See the Greatest Show on Earth with this GIANT ASTRONOMICAL TELESCOPE

\$15.00 FULL PRICE



Delivered ready for use. Has 45X, 75X and 100 power individually mounted eyepieces with brass focusing tube plus sun projector lens for observing sun spots and solar storms. Steel telescope tube 50 in. long, rigid 6 ft. tripod adjustable to any height. Steel forked mounting with closely machined aluminum tripod head assembly assures extra fine adjustments. This professional type instrument provides full power with clear vision at all times. See the moons of Jupiter, our own moon, planets, milky way, double stars, star clusters, etc. All for only \$15.00 F.O.B. Mattituck. Sent express. C.O.D. orders require \$5.00 deposit. Satisfaction guaranteed. 200X and 400X eyepieces available at \$2.00 ea.

SUFFOLK SCIENCE SERVICE  
Dept. ATD-6 MATTITUCK, N. Y.

## A "GOOD HAND" HELPS YOU SUCCEED! LEARN TO WRITE WELL

Handwriting quickly improves with our easy-to-understand picture lessons! Put your spare time to good use; send today for **FREE BOOKLET**, "How to Become a Good Penman," or check volumes wanted below at \$1 each:  Business Writing  Artistic Writing  Card Writing  Bird & Design Flourishing  Engraving Alphabets. **COMPLETE SET \$4.50.** Ask for price list of penman's supplies.

TAMBLYN SCHOOL of PENMANSHIP  
S.A. Ziller, Pres., 442 Ridge Bldg., Kansas City, Mo., USA

## Learn To MOUNT BIRDS

**TAN SKINS, MAKE UP FURS**  
Be a Taxidermist. We teach you at Home. Mount Birds, Animals, Pets, common specimens. Have your hunting trophies decorate home and den. Make genuine **KROME LEATHER**, tan and make up furs for sparetime profit. **INVESTIGATE TODAY.**

**FREE BOOK** 48 pages—tells all about it. Hunters, get your copy. State your AGE. It's Now Free. Send post card. **N. W. SCHOOL OF TAXIDERMISTRY, DEPT. 2506, Omaha, Nebr.**

## LEARN WATCH REPAIRING

**AT HOME** Modern, original instruction. Prepare for a position or start in business after completing our course. **Write Today!**  
**WISCONSIN SCHOOL OF WATCH REPAIRING**  
 2908 N. 44th St. Dept. M Milwaukee 10, Wis.

## Send for FREE 112 page Illustrated Catalog of Farm, Home, and Workshop Bargains.

Write to **WELLWORTH TRADING COMPANY**  
 Dept. E-6  
 1832 S. WABASH AVE. CHICAGO 16, ILL

## TASOPE PHOTO-ENGRAVING PLANTS

Establish your own profitable **PHOTO-ENGRAVING** business. Make cuts for newspapers, printers, and advertisers. Make etched name plates, plaques etc. Instructions furnished, no experience necessary. Sold direct from factory since 1931. First five hundred cuts sold locally or by mail will pay for plant and pay you well for your time. Write for **FREE** catalog.  
**TASOPE, DEPT. PM-6, AURORA, MO.**

## SOCK-O

World's Most Powerful **SUPER SLINGSHOT**  
**SILENT • RIFLE FAST • POWERFUL • ACCURATE**  
 Great for small game, targets. 45 lb. pull. **BIG sturdy Stock**. Lively. Raw rubber. Sweet shooting! **FREE!** 100 steel balls, rubber and target. **FREE!!!** Thrilling **SURPRISE PACKAGE** with Two slings at \$1.99. Hurry, get 2! Guaranteed. Approved by American Small Game Sling-shot Assoc.  
**SOCK-O, PM, 4860 W. 137 St., Hawthorne, Calif.**

## Learn BAKING At Home

Baking is one of America's high industries in wages. Nearly **DEPRESSION-PROOF**. Thorough basic home course lays sound foundation. If you have aptitude, write for **FREE** Booklet, "Opportunities in Commercial Baking."  
**NATIONAL BAKING SCHOOL**  
 835 Diversey Parkway Dept. 135A Chicago 14, Ill.



## National Schools brings you a new dimension in training for **TELEVISION-RADIO-ELECTRONICS**

YOU CAN LEARN BY HOME STUDY, IF—

- you are ambitious to increase your earning power.
- you want to broaden your knowledge and skill.
- you choose the school with the most complete training, service and experience.

### 50 Years of Successful Training

National Schools has been training men for success since 1905. Our graduates are located around the globe, in good-paying jobs in servicing, installation and manufacturing...in public and private industry, or in their own businesses.

### What This New Dimension in Home Study Means to You

As a National Schools student, with Shop Method Home Training, you master *all phases* of the industry—TV, Radio, Electronics—theory and practice. You learn **HOW** and **WHY**, in one complete course at one low tuition. Age and education are no barriers. Because our world headquarters are in Los Angeles—a “Capital City of Electronics”—we are in close touch with industry. Our lessons and manuals keep you up-to-the-minute on latest developments. We show you how to make spare time earnings as you learn, and give you free placement assistance upon graduation. Both our Resident and Home Study courses are approved for G. I. Training. If you are of draft age, your course helps you achieve specialized ratings and pay grades.

### Your Course Includes Valuable Units

We send you important equipment, including a commercial, professional Multitester... plus parts to build Receivers, Oscillators, Signal Generator, Continuity Checker, other units, and Short Wave and Standard Broadcast Superhet Receiver.

### Mail Coupon for Complete Information

These 2 free books explain our new dimensions in Home Training. Get illustrated fact-book and sample lesson. No obligation, mail coupon now!

## NATIONAL SCHOOLS

TECHNICAL TRADE TRAINING SINCE 1905  
Los Angeles 37, Calif. • Chicago 323 W. Polk St.  
In Canada: 811 W. Hastings St., Vancouver, B.C.



### MAIL NOW TO OFFICE NEAREST YOU!

(mail in envelope or paste on postal card)

### NATIONAL SCHOOLS, Dept. RB-65

4000 S. FIGUEROA STREET OR 323 W. POLK STREET  
LOS ANGELES 37, CALIF., OR CHICAGO 7, ILL.

Rush FREE Book, "Your Future in Radio-TV-Electronics," and FREE LESSON. No obligation, no salesman will call.

NAME \_\_\_\_\_ BIRTHDAY \_\_\_\_\_ 19\_\_

ADDRESS \_\_\_\_\_

CITY \_\_\_\_\_ ZONE \_\_\_\_\_ STATE \_\_\_\_\_

Check if interested ONLY in Resident Training at Los Angeles.  
VETERANS: Give date of discharge \_\_\_\_\_

# EARN BIG PAY

Industry needs skilled mechanics. GREER, leader for more than 50 years in the Trade School field, can train you quickly—You "learn by doing," using the finest equipment, under the supervision of expert technicians.

APPROVED FOR CIVILIANS  OR GI'S

## —CHOOSE YOUR TRADE—

CHECK HERE	WEEKS
<input type="checkbox"/> DIESEL MECHANICS	20
<input type="checkbox"/> AUTO MECHANICS	20
<input type="checkbox"/> BODY & FENDER	16 2/3
<input type="checkbox"/> GAS-ARC WELDING	4 - 12
<input type="checkbox"/> REFRIGERATION	13 1/2
<input type="checkbox"/> AIR CONDITIONING	8 1/3
<input type="checkbox"/> MACHINIST TRADE	30
<input type="checkbox"/> ADVANCED MACHINIST (includes tool & die)	32 1/2
<input type="checkbox"/> PIANO TUNING & REPAIR	36

## CHOOSE YOUR ENGINEERING COURSE

These courses are intended as terminal education for men who wish to enter the Diesel-Automotive and Refrigeration-Air Conditioning fields as technicians. These courses are designed to prepare men for supervisory positions. Students with a high school education, or equivalent, will be accepted.

<input type="checkbox"/> DIESEL AUTOMOTIVE ENGINEERING	2 years
<input type="checkbox"/> REFRIGERATION & AIR COND. ENGINEERING	18 months

## HOME STUDY COURSES

Learn at Home — Approved for Civilians & G.I.s. Write for detailed information on Courses in

- PLASTICS
- REFRIGERATION & AIR-CONDITIONING
- DIESEL ENGINES

## FREE EMPLOYMENT HELP

Start your career with Greer by checking your interest above and mail coupon for complete information at no obligation.

NAME \_\_\_\_\_ AGE \_\_\_\_\_

STREET \_\_\_\_\_

TOWN \_\_\_\_\_ ZONE \_\_\_\_\_ STATE \_\_\_\_\_

Established 1902 — Over 50,000 Graduates.  
53 years of continuous trade school experience to guide your training.

## GREER SHOP TRAINING

Box F, 2236 S. Michigan Ave.  
Chicago 16, Illinois



## FULLY GUARANTEED TIRES COST LESS!

Nationally famous FIRESTONE, GOOD-RICH, U. S. ROYAL, GOODYEAR, and other makes. Every tire selected and inspected for your safety.

BUY WITH CONFIDENCE FROM PYRAMID TIRE WHITE WALL TIRES \$1 EXTRA

STOCK	AAA PREMIUM GRADE GUARANTEED 18 MONTHS
600x16 4.14	700x16 5.14
650x16 4.94	670x16 4.74
680x16 4.34	650x20 7.84
700x16 4.64	700x20(R) 8.94

STOCK	AAA PREMIUM GRADE GUARANTEED 18 MONTHS
550x15 5.48	700x15 5.98
600x16 5.28	700x16 6.78
600x16(G) 5.58	700x16(G) 7.98
640x15 5.68	750x16(G) 8.98
650x16 5.78	800x15 6.88
650x16(G) 6.98	820x15 7.48
680x15 5.98	710x15 6.09
670x16 6.18	550x18 5.98

Largest stock of used tires in the East. Thousands of satisfied customers. Write for Free Catalog. MONEY ORDER OR CHECK WITH ORDER. NO C.O.D.'s

NEW TREAD GUAR. 24 MOS.  
600x16 8.98  
600x16(G) 9.98  
700x16(G) 15.95  
750x20(R) 24.98

## POWER MOWERS & KITS

Build your own quality mower with our LOW COST KITS, Parts, Engines. Free Plans guide you. 3 and 4 Wheel Kits, complete. Parts precision finished, ready to use. Write TODAY for Free Plans, Low Prices, Parts List and Guarantee.



▲ TRIANGLE MANUFACTURING CO., Dept. M-6, Fort Scott, Kansas

## TRADE MAGAZINES

Business, Vocational, Professional, Hobbies, Agricultural, Educational, Sports. Single current copies. Special get acquainted service. Choose from 5347 publications—all fields. Current 1st FREE. COMMERCIAL ENGRAVING PUBLISHING CO. 348 North Ritter Indianapolis 19, Ind.

## "YOU ARE UNDER ARREST!"

Help Bring Crooks to Justice Through Scientific CRIME DETECTION! We have taught thousands this exciting, profitable, pleasant profession. Let us teach you in your own home. Learn Fingerprinting, Firearms Identification, Police Photography, Secret Service Methods thoroughly, quickly, at small cost. Over 800 of all American Bureaus of Identification employ I.A.S. students or graduates. Write stating age, for "Blue Book of Crime," (A Correspondence School Since 1916)

INSTITUTE OF APPLIED SCIENCE, 1920 Sunnyside Ave., Dept. 135-A, Chicago 40, Ill.

## BECOME AN EXPERT IN

# TRAFFIC

Traffic men earn \$4,000 to \$10,000 and up. Thousands of firms need experts on rates, tariffs, regulations. We train you thereby in spare time at home for executive traffic jobs. Personal training under traffic authorities. Placement counsel and help. Write for free 48-page book "Traffic Management—the Fast Growing Profession."

LASALLE Extension University, 417 So. Dearborn St. A Correspondence Institution Dept. 6647 Chicago 5, Ill.

## RUPTURED

### BE FREE FROM TRUSS SLAVERY

NOW there is a new modern Non-Surgical treatment that permanently corrects rupture. These Non-Surgical treatments are so certain, that a Lifetime Certificate of Assurance is given. Write today for our New FREE Book that gives facts that may save you painful and expensive surgery, and tells how non-surgically you may again work, live, play and love and enjoy life in the manner you desire. There is no obligation. Excelsior Hernia Clinic Dept. 8305 Excelsior Springs, Mo.



# NEW INVENTION **REPLATES** by **ELECTROPLATING** RESTORES HOME, AUTO METALS **CHROME-SILVER-GOLD!**

NEW BRILLIANCE WITH SAME PROCESS AS PROFESSIONAL PLATERS  
**SILVER-CHROME-GOLD, ETC.**



**REPLATED. Quickly. Easily.** Now—with an amazing new invention, **APPL-I-COTER**, you plate hundreds of items, using the mild, safe current of 2 flashlight batteries in its handle. All you do is simply hold disk on applicator to metal, dip brush into solution—and plate as you brush. It's Easy. Quick. Genuine plating.

**RESTORES METALS LIKE NEW** Replates Silver, Chrome, Nickel, Steel, Gold and Brass—all worn Spots, Stains, "Blisters," Silverware, Trays, Teapots, Rims of Holloware and other items can look like new again with this exclusive Electroplating process. Restore all your valuable Gold jewelry with amazing **APPL-I-COTER**. The plating you apply becomes an indestructible part of the metal itself!

**QUICKLY BUILDS-UP A THICK NEW PLATING WITH EACH APPLICATION.**



**COMPLETE PLATING KITS:**  
**MET-L-COTE:** For Chrome & other white metals... **\$3.95**  
**SILV-R-COTE:** For Silver-plating with pure Silver... **\$3.95**  
**GOLD-COTE:** Gold Plate with 24 K. Gold... **\$6.25**  
**Copper** \$3.95; **Rhodium** \$7.95  
**ALL 5 METALS... \$19.95** (You Save \$6.10)



**BRILLIANT AUTO TRIM** — You'll be mighty proud of the Dazzling new finish on your car's bumpers and trim after replating with **MET-L-COTE**... and remember, each time you electroplate worn areas you build up a lasting layer of coating that tremendously lengthens the life of original trim.

**MET-L-COTE** is constantly used in leading hospitals, and in doctors and dentists offices to Replate surgical instruments—Also in hotels and restaurants to RESTORE cutlery.

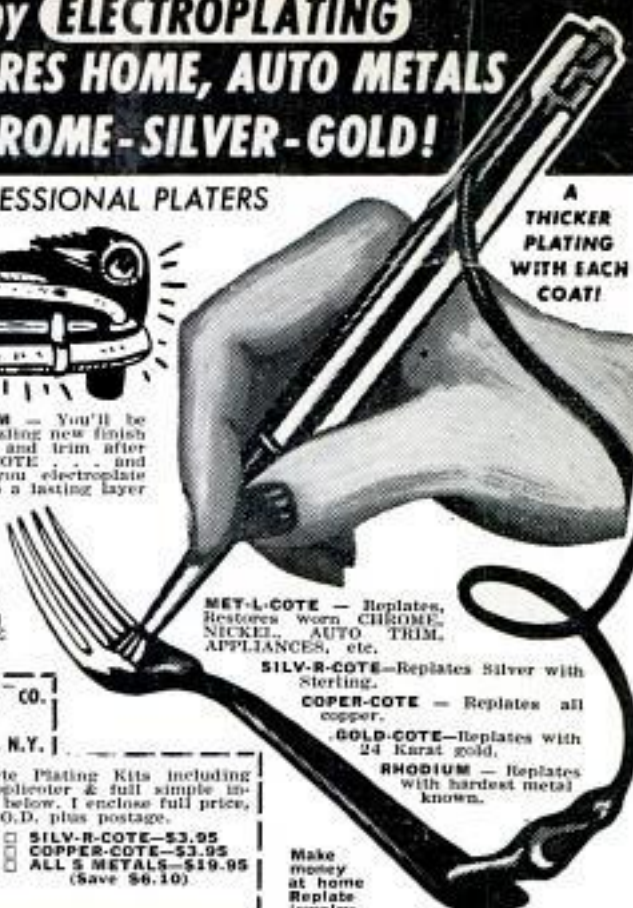

**A THICKER PLATING WITH EACH COAT!**

**MET-L-COTE** — Replates, Restores worn **CHROME, NICKEL, AUTO TRIM, APPLIANCES**, etc.  
**SILV-R-COTE**—Replates Silver with Sterling.  
**COPER-COTE** — Replates all copper.  
**GOLD-COTE**—Replates with 24 Karat gold.  
**RHODIUM** — Replates with hardest metal known.

Make money at home Replate jewelry, silver, chrome. Earn up to \$10 per hour.

**EMPIRE MERCHANDISING CO.**  
 Dept. J-61  
 28 E. First St., Mt. Vernon, N.Y.

Please rush the Complete Plating Kits including Solution, New Pocket Applicator & full simple instructions I have checked below. I enclose full price, sent postpaid, or send C.O.D. plus postage.

- MET-L-COTE—\$3.95**
- GOLD-COTE—\$6.25**
- RHODIUM—\$7.95**
- SILV-R-COTE—\$3.95**
- COPER-COTE—\$3.95**
- ALL 5 METALS—\$19.95** (Save \$6.10)

NAME \_\_\_\_\_  
 ADDRESS \_\_\_\_\_  
 CITY \_\_\_\_\_ STATE \_\_\_\_\_

**RESTORE YOUR TREASURES—MAKE THEM VALUABLE AGAIN**

Empire Mfg. Co., 28 E. First St., Mt. Vernon, N.Y.

## \$1150 BUILDS GARAGE APT.



**EXTRA INCOME!** Build your own 22'x24' concrete block garage apartment complete for \$1150. Modular designed, no blocks to cut, steel windows, wall furnace, rock wool insulated. Contains two car garage, 10'x12' living room, 7'x11' kitchenette dining area, 5'x5' bath, 8'x10' and 10'x11' bedrooms, four closets, genuine 1/4" birch trim, step by step instructions and material cost list \$1.00 ppd. Money back guarantee.—Also \$1200 block duplex, 24'x36', liv. room, kit, bedroom, bath, each side, plans \$2.00.

**BAILEY BUILDERS, 915 Pyramid Bldg., Little Rock, Ark.**

**RADIO** Engineering. All phases radio & electronics theory & practice; television; FM; broadcasting; servicing; aviation, marine & police radio. Prepare for good pay; 18-month course. Graduates in demand by major companies. Enter Jan., March, June, Sept. Regular campus life. Write for catalog.  
**VALPARAISO TECHNICAL INSTITUTE, Dept. D, Valparaiso, Ind.**

## High School at Home

**MANY FINISH IN 2 YEARS**  
 No classes. No time wasted going to and from school. Progress as fast as your time and abilities permit. Standard H. S. texts supplied. Thousands enroll each year in this 58-year-old school. Send for **FREE** descriptive booklet.

**AMERICAN SCHOOL, Dept. HA45**  
 Drexel at 58th St., Chicago 37, Ill.  
 Without obligation, please send **FREE** descriptive booklet.

Name \_\_\_\_\_  
 Address \_\_\_\_\_  
 Canadian Residents: Complete Canadian Course Available. Write American School, 1610 Sherbrooke St., West, Montreal.

**IT'S AS EASY AS...**  
**LIGHTING A CIGARETTE**  
**TO MAKE OVER \$50 A DAY WITH CIG-O-MAT**

**The AMAZING Automatic Dashboard Cigarette Lighter**  
**10-SECOND DEMONSTRATION MAKES THE SALE**  
 Insert — Push Button — Cigarette Is Lit

Rich enamel finish. Precision made. Guaranteed for two years. Fits lighter socket on all cars. No installation necessary. Cig-O-Mat means safer driving. Motorists can now keep eyes on road while lighting a cigarette.

**SALESMEN:** Sell individually boxed Cig-O-Mats direct to car owners.  
**DISTRIBUTORS:** Sell Cig-O-Mats on display cards to filling stations, garages, hardware stores, taverns and many other retail stores.  
**FREE Display Counter Card with 9 CIG-O-MATS**  
 Retail Price \$1.65 each  
**BIG PROFITS — FULL OR SPARE TIME**

**TRIANGLE PRODUCTS, INC., Dept. PM-6**  
 1226 Fourth Ave., Milwaukee, Wis.

PLEASE RUSH:

- 12 Cig-O-Mats individually boxed for \$10.00
- 9 Cig-O-Mats on Display Easel for \$7.38
- 1 Sample and Details for \$1.00

I enclose \$ \_\_\_\_\_  
 NAME \_\_\_\_\_  
 ADDRESS \_\_\_\_\_  
 CITY \_\_\_\_\_ ZONE \_\_\_\_\_ STATE \_\_\_\_\_

# DRAFTSMEN



**CASH BIG  
PAY CHECKS!**

**Train Now for  
more success,  
greater security**

**LEARN AT HOME IN SPARE TIME  
(or at college in Chicago)**

Check the want ads in any newspaper—SEE the big-pay opportunities open to you as a draftsman. What's more, you can learn this well-paid, prestige profession at home—quickly, easily! No special talent needed. Get complete, step-by-step Chicago Tech lessons in the mail, spend a few pleasant hours studying each week. In a short time you'll be a well-trained draftsman, ready to take your pick of many good jobs. Act now!



**Free Information—Mail Coupon Today!**

Get **FREE TRIAL LESSON** plus information about C.T.C. practical training. Learn what successful Chicago Tech graduates say about high pay and opportunities in drafting. No charge, or obligation.

## CHICAGO TECHNICAL COLLEGE

G-253 Tech Bldg., 2000 So. Michigan Ave.  
Chicago 16, Illinois

Mail me **FREE** lesson with facts about big opportunities in **DRAFTING**.

Name \_\_\_\_\_ Age \_\_\_\_\_

Address \_\_\_\_\_

City \_\_\_\_\_ Zone \_\_\_\_\_ State \_\_\_\_\_

**BIG PAY JOBS**  
for men who qualify in  
**DIESEL**



**TRAIN NOW FOR A DIESEL FUTURE.** Steady, high-pay jobs await men qualified in Diesel, Tractor, and Heavy Equipment. Are you qualified for job and advancement opportunities in this fast-growing field? You can qualify!

**COMPLETE DIESEL COURSE NOW AVAILABLE.** If you are ambitious and want to get ahead in this big money field, you'll want to know about the complete Diesel home training course now offered by Interstate Training Service. Covers all phases of operation, repair, service. Easy to master in spare time. No interference with present job. Up-to-the-minute. Regularly revised to cover new developments. We invite comparison of material offered. Advisory placement service for our students.

**YOU OWE IT TO YOURSELF** to investigate Interstate Training Service Diesel Training. Thousands agree it has helped them to better jobs...better pay. It can do the same for you!

**WRITE FOR FREE INFORMATION TODAY**

INTERSTATE TRAINING SERVICE, Portland 13, Ore.  
Please see that I receive **FREE** 24-page book,  
"Getting Ahead in Diesel." (A-3-F)

NAME \_\_\_\_\_ AGE \_\_\_\_\_  
ADDRESS \_\_\_\_\_  
CITY \_\_\_\_\_ ZONE \_\_\_\_\_ STATE \_\_\_\_\_

## Shrinks Hemorrhoids New Way Without Surgery

**Science Finds Healing Substance That  
Relieves Pain—Shrinks Hemorrhoids**

For the first time science has found a new healing substance with the astonishing ability to shrink hemorrhoids and to relieve pain—without surgery.

In case after case, while gently relieving pain, actual reduction (shrinkage) took place.

Most amazing of all—results were so thorough that sufferers made astonishing statements like "Piles have ceased to be a problem!"

The secret is a new healing substance (Bio-Dyne\*)—discovery of a world-famous research institute.

Now this new healing substance is offered in ointment form under the name of **Preparation H.\*** Ask for it at all drug stores—money back guarantee. \*Reg. U. S. Pat. Off.

**BE A  
LEADER  
IN  
AVIATION**

Parks graduates are known worldwide as leaders in aviation—their education is the finest offered. Advance faster...earn more in less time! Become a Parkman!

B.S. degree in 3 yrs. from Saint Louis University—Aero. Eng., Aero. Adm., Maint. Eng.

Non-degree courses—A & E Mechanics, Private, Commercial, Instrument, Flight Instructor and Multi-engine Ratings...CAA-Approved.

All Parks schooling approved for Veterans.  
Write for full information.

**PARKS COLLEGE** ARNOLD HALL  
EAST ST. LOUIS, ILL.

## MAKE TREMENDOUS PROFITS

Have fun! Earn Big Money! Cast plaster figurines, bookends, plaques, novelties at home in your spare time with X.L. rubber molds! NO EXPERIENCE NEEDED! Models and rubber for 3 molds, only \$1.50 ppd. Send 25c (refunded with order) for 40 page catalog now!

**PLASTIC ARTS STUDIO** 3403 SO. MADISON, DEPT. PM2  
MUNCIE, INDIANA

**LEARN LOCKSMITHING**

Learn this fascinating, profitable trade from experts in your spare time at home! Age or physical handicap no disadvantage. Year around, steady income. Full or part time. Practical, illustrated lessons. You can make money even while learning! All materials and special tools supplied without extra charge.

**INSTITUTE OF LOCKSMITHING, Dept. P-67**  
15 PARK AVENUE RUTHERFORD, N. J.  
Lic. by N.J. State Board of Education  
Approved for Veterans

send for **FREE BOOKLET**

## LAW FREE BOOK THE LAW TRAINED MAN

Write today for a **FREE** copy of illustrated law book, "THE LAW TRAINED MAN," which shows how to earn the professional Bachelor of Laws (LL.B.) degree through home study of the famous Blackstone Law Course. All necessary books and lessons provided. Moderate cost; convenient monthly terms. Write for **FREE** law training book today.

**Blackstone School of Law, 225 N. Michigan Ave.**  
Founded 1890 Dept. 50-A Chicago 1, Ill.

## BUILD LUGGAGE AT HOME WE SELL YOUR PRODUCTS!

**ONLY NEW HOME MONEY-MAKING PLAN IN YEARS!**

Make Luggage and cases for traveling, photographers, musicians, salesmen, electronics, tools, portables, 1001 other items. Also repair Luggage. No special equipment needed. **BIG PROFITS.** We supply complete instructions, materials—everything. Write for free details and Business Plan. **ABARSI CASE-CRAFT, Dept. G-6, 805 W. Sunset Blvd., Los Angeles 12, Calif.**

# HIGH PRESSURE FOUNTAIN BRUSH WASHES CARS LIKE MAGIC WITH ROTARY POWER SPRAY

SAVE \$3.00  
FROM FACTORY-  
TO-YOU

**\$1.98**  
COMPLETE KIT

Reg. 4.98

**A SPARKLING CLEAN CAR  
YOURS . . . IN 7 TO 10 MINUTES  
NO HARD LABOR! NO FUSS!  
NO MESS!**

**NEW 3 WAY FOUNTAIN BRUSH  
WASHES CARS, PORCHES, FLOORS,  
SCREENS, WINDOWS - QUICK, EASY!**

Now . . . Order your famous **AEROMAT FOUNTAIN BRUSH** direct from the factory and save \$3.00. Thousands sold last year at much higher prices. The new, improved 1955 model is better than ever—gives you quicker, more thorough washing action. Simply attach it to your garden hose and wash your car sparkling clean in 7 to 10 minutes! Wonderful for household chores also! Washes screens, windows, venetian blinds, floors, walls, tile, awnings, porches, outdoor furniture. So thorough—so quick—so easy!

**ROTARY HIGH PRESSURE ACTION WORKS FOR YOU!**

The **AEROMAT** has a built-in suds chamber. Drop in a "Magic" Detergent Pellet supplied with your brush, turn on the water and glide it along your car! No hard scrubbing. No back straining. You take it easy while the high pressure **ROTARY SPRAY ACTION** loosens and removes all road film and dirt. It's easy . . . it's fast . . . it's fun!

**3 SECTION TELESCOPE HANDLE LIKE 3 BRUSHES IN ONE!**

**NEW for 1955**—a 3 section fountain handle—makes the new model **AEROMAT** handler than ever. Each section is one foot long. Use 3 sections for washing cars, walls, windows. Use one or two sections for other work. Easy to store away or take along when you travel! **STAR FEATURE:** Bristles are made with the new miracle product—**DUROSTYRENE**—soft as silk, cannot scratch or mar paint—yet it lasts for years and years!

**COMPLETE KIT—ONLY 1.98**

Includes Brush, Handle, Suds Chamber, Magic Pellets and Carrying Case

You get everything you need, ready for **INSTANT** use—nothing else to buy. Try an **AEROMAT** kit now—without risk. Send only **1.98** m.o., check or cash for immediate delivery. Or order COD plus 44 cents postage. **RUSH COUPON AT ONCE!** Quantities limited. First come, first served. Get yours direct from the manufacturer and save over half! Your money back if not 100% satisfied!

**SEE IT IN ACTION!  
TRY—BEFORE YOU BUY!**

**FREE TO YOU  
10 CAR WASHES!**

Use, try, test an **AEROMAT** any way you like for 5 days. See the **ROTARY SUDS ACTION** thru the **VISIBLE HEAD**. See how it dissolves road sludge and dirt with practically no work! Then, if you're not thrilled in every way, return to our factory for immediate refund of your 1.98—no questions asked! Rush coupon now for free trial—no obligation. It's not a sale until you've tried it and agree it's simply amazing.

**USE FOR ALL HOUSE WASH JOBS!**



**FLOORS SCREENS WALLS WINDOWS**

Yours free of extra cost—a generous trial supply of **AEROMAT "MAGIC" SUDS PELLETS**—enough for 10 car washes. Place in built-in chamber. As water flows through, pellets foam into suds. Road film dissolves and slides off. Leaves no streaks! Never more finish. Free package contains enough pellets for 10 car washes. If you paid only \$1 per wash you would save \$10. Extra packages available: Regular Size for 12 washes: 29 cents. Large size washes 24 cars, costs only \$1.

**MOTO-MATIC  
COMPANY**

352 Fourth Ave.,  
Dept. 6-F-444  
New York 10, N. Y.

**RUSH!**  
for  
**COMPLETE  
KIT**

**... ON 5 DAY APPROVAL ...**

**MOTO-MATIC COMPANY,  
352 Fourth Ave., Dept. 6-F-444, New York 10, N. Y.**

**RUSH** Aeromat Washer Kits, Complete with Carrying Case, Brush, Head, Suds Chamber, 3 handles with all fittings, complete for 1.98 each—on 5 DAY TRIAL—**MONEY BACK GUARANTEE.** I'm not buying—I'm trying. If I am not delighted, you will refund my 1.98 at once.

1.98 enclosed—RUSH all postage paid.  Send COD plus 44c postage.

Name \_\_\_\_\_  
Address \_\_\_\_\_ Town \_\_\_\_\_ State \_\_\_\_\_  
 ALSO send \_\_\_\_\_ Large Size package of magic pellets at \$1. each—enough for 24 car washes.  
 Send \_\_\_\_\_ pgs. reg. size at 59c each for 12 washes.

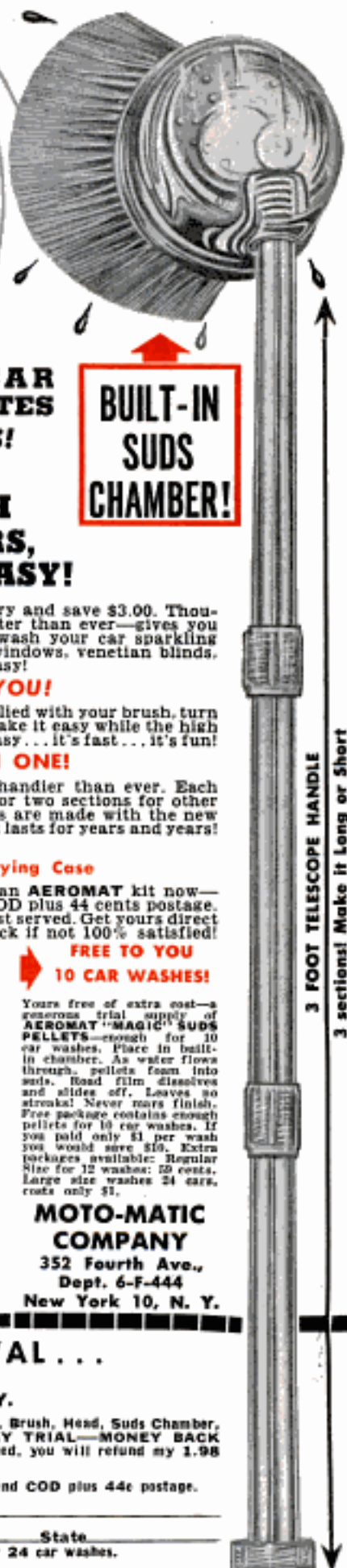



YOU  
can  
acquire

## LAW NIGHTS AT HOME! L. L. B. DEGREE

LaSalle's famous Law Library—used as reference in many Law libraries and Law offices—has enabled thousands to master Law surprisingly fast, in spare hours at home, for business and professional advancement.

These 14 remarkable volumes, compiled by leading professors and lawyers, cover the whole basic field of Law in condensed, orderly, simplified manner.

You advance rapidly with this great library, plus special lectures furnished. We guide you step-by-step with personalized Problem Method of instruction . . . you learn by doing—handling legal problems—not by memorizing rules.

Send for two FREE 48-page booklets, "Law Training for Leadership," and "Evidence," answering questions about Law and its value to you, and telling how LaSalle Law graduates are winning rapid advancement in business and public life. Mail coupon below. No obligation.

### LA SALLE EXTENSION UNIVERSITY A Correspondence Institution

417 S. Dearborn St. Dept. 664L Chicago 5, ILL.

Send me your two FREE booklets described above, without obligation.

Name..... Age.....

Street.....

City, Zone & State.....

## FINE WORK CLOTHES AT LESS THAN

# 1/3 COST!

STERILIZED, CLEAN-AS-NEW

Surplus Stock. Terrific Values!



**PANTS** Worth \$3.95 new!

You get 4 used pairs for less than the price of 1 new pair! Navy or green. Send waist and inside leg measurements.

**99c**  
4 for \$3.75

**SHIRTS to Match.** (Made to sell for \$2.99). 4 for the price of 1! Sturdy fabrics for long tough wear. Send neck size.

**79c**  
4 for \$2.99

**COVERALLS.** Made to sell for \$5.95. Yours for less than 1/3! Send chest measurement.

**\$1.95**  
3 for \$5.45

**MONEY BACK GUARANTEE** If you're not convinced these are terrific bargains, return 'em within 10 days for full refund. Order today. C.O.D., or send money and we'll pay postage.

\$1.00 Deposit Required on C.O.D. Orders.

**TRU VALU SALES CO.** Dept. PM-17 1294 E. 9th St. Cleveland 14, Ohio



Send for these valuable booklets—TODAY!

- **SELF-CONTAINED DIVING**—Fact-packed guide, covers many kinds of equipment. Explains effects of underwater pressure. Decompression table shows time you may safely swim at different depths. 95c VALUE . . . SEND COIN NOW, ONLY 25c.
- **DIVING GEAR**—Catalog richly illustrated, latest foreign & domestic equipment (masks, swimfins, snorkle tubes, frogmen suits, spearguns, "Aqua-Lungs") 24-PAGE CATALOG . . . SEND COIN NOW, ONLY 15c.

Dept. PM-3, U. S. DIVERS COMPANY  
1045 Buxton Ave. W. Los Angeles 24, Calif.

## OWN a Business

If employed, start part time. Alert dealers can gross \$5 hourly profit on own service plus \$3 on EACH serviceman. Clean, revive, moth-proof rugs & upholstery on location. No shop needed. Services nationally advertised. Repeat customers. Easy to learn. We locally train and assist you. Quickly established. Easy terms. Send today for FREE booklet. No obligation.

**DURACLEAN CO.,** 5-168 Duraclean Bldg., Deerfield, Ill.

**FREE!** 60 APPROVED EXERCISES, 68 PHOTOS with **FAMOUS DAN LURIE BARBELLS**

50 lb. set \$ 8.48 • 100 lb. set \$13.98  
150 lb. set \$20.48 • 200 lb. set \$25.98

**SEND FOR FREE CATALOG**  
Order by mail—50% with order Balance C.O.D. Extra WTS. 13c lb. FOB Plant.

**DAN LURIE BARBELL CO.**  
52M6 Bristol St., Dept. 559F, Brooklyn 12, N.Y.  
SEE DAN ON T V "BIG TOP" SHOW

## TERMITES

### Kill Termites Yourself with ARAB U-DO-IT TERMITE CONTROL

Costs \$19.95 to protect 5-room house for 5 years. Harmless to flowers and shrubs. FREE FOLDER and prices. Write **FEDERAL CHEMICAL CO., INC.**, 2701 Winthrop Avenue, Indianapolis, Dept. PM 655.

## MECHANICAL ADDRESSER COMPLETE

30 DAY TRIAL OFFER \$10<sup>95</sup>

Addresses anything mailable—easily, quickly, professionally. Thousands in use. Complete with supplies for 250 names. Money-back guarantee. Send check or money order to: **THE HEYER CORP. Dept. 655** 1856 S. Kostner, Chicago 23, Illinois

## WARN HUBS STOP FRONT END DRAG ON 4-WHEEL DRIVES

**PATENTED** Warn Hubs disengage front differential for use in 2 W.D. range, give 4 W.D.s. amazing pep, getaway, steering ease; save gas, tires; stop front end shimmy! Automatic models also stop front axle torque, permit high road speeds in 4 W.D. high range! Use either drive, anytime! Select drive needed—automatically with Warn Automatic Hubs, manually with Warn Locking Hubs. Willys models factory approved, sold only by Willys dealers worldwide. Dodge, other 4 W.D.s. at dealers or write—

**OVER 60,000 IN USE!** **WARN MFG. CO.** Riverton Box 6664-A7 Seattle 28, Wash.



# INVENTORS

WE recommend that you take the following preliminary steps toward patent protection. Make a disclosure of your invention; sign, date and have your disclosure witnessed by two people who understand your invention; authorize us to conduct a preliminary search among previously granted U. S. patents for similar types of invention. We give you a report on the probable patentability of your invention and our recommendation for further course of action.

Let us send you a copy of our instructive booklet, "Patent Protection for Inventors" and our convenient "Evidence of Invention" disclosure form. No obligation.

VICTOR J. EVANS & Co. *Merlin M. Evans*  
REGISTERED PATENT ATTORNEY

130-G MERLIN BUILDING, WASHINGTON 6, D. C.

## Free! 75 ORIENTALS



Brought to you from the farthest ends of the earth—these exotic valuable genuine Stamps of the Orient! 75 all-different from Borneo, Siam, China, Japan, Hong Kong, Malaya, Sarawak, Singapore,—and other exciting mysterious lands of the Far East. EXTRA! Free booklet, bargain lists, fascinating offers for your free examination. Send 10c for mailing expenses. Supplies limited. Act NOW!

### USE THIS HANDY COUPON

JAMESTOWN STAMP CO. D-191 Jamestown, N.Y.  
RUSH my FREE Collection of 75 Orientals & other offers. I enclose 10c for cost of mailing.

Name .....  
Street .....  
City ..... State .....

## EVEN IF YOU DON'T KNOW A NOTE OF MUSIC NOW...

YOU CAN LEARN YOUR FAVORITE INSTRUMENT THIS EASY A-B-C WAY

No special "talent," no previous training needed. This U.S. School home-study method is so successful because you learn to play by playing real tunes by note, right from the start. And just think, you can learn your favorite instrument for only a few cents a day!

If interested, mail coupon for FREE 36-page Book showing how easy it is to learn any instrument, right at home, in spare time, without a private teacher. No obligation; no salesman will call on you. U.S. SCHOOL OF MUSIC, Dept. A306, Port Washington, New York. (57th Year)



U. S. SCHOOL OF MUSIC,  
Dept. A306, Port Washington, N. Y.

Please send me your 36-page illustrated Free Book. I would like to play (Name Instrument).

Instrument..... Have you Instrument?.....

Name..... (Please Print)

Address.....

## Learn ACCOUNTING Business Administration

Bookkeeping, secretarial and allied subjects at home in your spare time or attend nationally approved resident school. Write for FREE Success Book giving complete details on courses, plans, rates and employment opportunities. G.I. approved.

Hills BUSINESS UNIVERSITY AND EXTENSION SCHOOL  
619 W. MAIN ST. OKLAHOMA CITY 2, OKLAHOMA

## REAL ESTATE BE A BROKER

PAYS BIG! SEND FOR FREE, BIG, ILLUSTRATED CATALOG NOW! Graduates report making substantial incomes. Start and run your own business quickly. Men, women of all ages, learn easily. Course covers Sales, Property Management, Appraising, Loans, Mortgages and related subjects. STUDY AT HOME or in classrooms in leading cities. Diploma awarded. Write TODAY for free book! No obligation.

Approved for World War II and Korean Veterans  
WEAVER SCHOOL OF REAL ESTATE (Est. 1936)  
2020R Grand Avenue Dept. PH Kansas City, Mo.

FREE BOOK TELLS HOW

## YES! SEND



directly to my door every month

I am enclosing

- \$3.50 for 1 year  
 \$8.00 for 3 years

name.....  
address.....  
city..... zone..... state..... A-65

Hand this order to your newsdealer or send it to  
POPULAR MECHANICS  
200 East Ontario St. Chicago 11, Ill.

# Draw me!

**TRY FOR A FREE 2-YEAR  
ART SCHOLARSHIP WORTH \$335.00**

Imagine, free training for a profitable career in advertising art or illustrating!

\$335.00 Scholarship is offered by a school famous among artists—world's largest home study art school. Graduates include many earning big money today.

You're trained by professional artists. You get individual coaching—plus a complete Drawing Outfit—and an Art Library of illustrated textbooks to which over 40 leading artists have contributed.

Draw this girl's head 5 inches high. Use pencil only. All drawings must be received by July 31, 1955. None returned. Winner notified. Amateurs only. Our students not eligible. Mail your drawing today!



*Art Instruction, Inc.* STUDIO 6135

500 S. 4th St., Minneapolis 15, Minn.

Please enter my drawing in your July contest.  
(PLEASE PRINT)

Name \_\_\_\_\_ Age \_\_\_\_\_  
Address \_\_\_\_\_ Apt. \_\_\_\_\_  
City \_\_\_\_\_ Zone \_\_\_\_\_ State \_\_\_\_\_  
Occupation \_\_\_\_\_ Phone \_\_\_\_\_

## ENGINEERING DEGREE IN 27 MONTHS

**INDIANA  
TECHNICAL  
COLLEGE**

B. S. DEGREE, Aeronautical, Chemical, Civil, Electrical, Mechanical and Radio Engineering (Inc. TV and Electronics), Drafting, I-377, G.I. Gov't. approved. Low rate. Earn board. Large industrial center. Students from 48 states, 21 countries. Demand for graduates. Enter June, September, December, March. Write for catalog, 1665 E. Washington Boulevard, Fort Wayne 2, Indiana.

## WATCH REPAIR

Make Sick Watches Tick Like New Others Can — Why Not YOU?

No previous experience needed to learn modern watch repair. Unique Swezey System starts you making repairs right away. Learn at home or at school in Chicago. Approved for vets. FREE sample lesson. No obligation.

**CHICAGO SCHOOL OF WATCHMAKING**  
2330 N. Milwaukee Avenue Dept. 165 Chicago 47, Ill.

**OVER 700%  
PROFIT!**  
WITH THE  
**PDQ CHAMPION  
PHOTOMASTER**

Makes finished pictures in 2 minutes.

Takes and finishes 30 to 40 everlasting, black and white or sepia photos an hour. No dark room. Guaranteed not to fade. Photos taken on "SUPER-SPEED" direct positive paper. Picture size 2 1/4 x 3 1/2 in. Complete, easy-to-operate portable photo studio. Size 4 1/2 x 5 x 10. Wt. 8 lbs. 700% PROFIT. Write quick, get details about the great PDQ CHAMPION PHOTOMASTER.

**P D Q CAMERA CO.**

1161 N. CLEVELAND AVE. Dept. PM-655 CHICAGO 10, ILL.

## GROW Living MIDGET TREES!

**EARN BIG MONEY!**

- AT HOME
- IN SPARE TIME
- NO EXPERIENCE NEEDED



It's new! Amazing! At last, the secret of growing miniature (MING) trees can be yours. FULL GROWN, dwarf trees—only a few inches high. Beautiful miniature fir, orange, oak, Chinese elm, peach, pine, cypress—any kind! ALL BLOOM and even BEAR FRUIT. All perfect healthy specimens—but miniature in size! Make costly home decorations and expensive centerpieces. (SOLD FOR OVER \$1,500 EACH) Big demand. Costs only pennies—takes only minutes per week. IT'S EASY! Fun! A new fascinating hobby—a new fabulous \$\$\$\$ business. Send for free secret plan details and real seed.

**HELP US FILL HUGE DEMAND!**

These trees are being demanded by STORES CLUBS • HOTELS • FLORISTS • HOUSEWIVES • INTERIOR DECORATORS • COLLECTORS • HOBBYISTS—A Big Money Opportunity FOR YOU.

**FREE!** GENUINE SEED AND PLAN!

NATIONAL NURSERY GARDENS, Dept. M-6  
8463 South Van Ness  
Inglewood 4, Calif.

Rush me FREE plan and seed IMMEDIATELY!

Name \_\_\_\_\_  
Address \_\_\_\_\_ Zone \_\_\_\_\_  
City \_\_\_\_\_ State \_\_\_\_\_





**what you don't know  
CAN hurt you!**

This free eye-opening booklet demonstrates clearly why you should know your gas heating system. How does a house lose heat? Why is correct venting so important to family health? What eventual damage can result from an improper installation? Learn the answers to these significant questions and many more.

Contact your nearest gas heating dealer today for your free copy of "What You Should Know About Gas Heating" or write to Dept. 00-2111

**METALBESTOS DIVISION**  
WILLIAM WALLACE CO., BELMONT, CALIF.

**TRAINED MEN NEEDED**

**BIG PAY—GOOD FUTURE**

- |                                     |                                      |
|-------------------------------------|--------------------------------------|
| <input type="checkbox"/> TELEVISION | <input type="checkbox"/> ELECTRONICS |
| <input type="checkbox"/> DIESEL     | <input type="checkbox"/> AUTO        |

WHY WORK FOR LOW PAY or risk being out of a job??? Usually the properly trained man has a steady job... through good times or bad. Even back during DEPRESSION there was a big demand for Bailey Trained men.

In only 5½ to 6 months we can train YOU to enter one of the big pay fields!

No previous experience or special education necessary. With our method of training you do not spend years pouring over books, figures, charts and graphs. You learn by rebuilding, repairing, testing and operating the most modern equipment, under the guidance of experienced, courteous and friendly instructors. This method of training gives you the experience and confidence required to step right into the big pay jobs without spending years as a mechanic's helper.

It's EASIER and COSTS LESS than you may think to get this residence shop training... we help you find part-time jobs while in school—full-time jobs after graduation. Check subject above in which you are interested and mail for complete information.

**BAILEY Technical SCHOOLS**

Veteran Approved

1634 S. Grand St. Louis 4, Mo.

NAME.....AGE.....  
STREET.....  
TOWN.....ZONE.....STATE.....



**GIANT BALLOONS**

They're really BIG—surplus U. S. Govt. (new coverage) Neoprene weather, target balloons. GREAT FUN in the backyard; at parties, picnics, dances, fairs. PERFECT for high school and college PROMS. They attract BIG crowds to BUSINESS openings, civic events, conventions, exhibitions, trade shows. ORDER TODAY! Approx. inflated sizes:

3 ft. dia., 49c — 6 ft. dia., 99c  
13 ft. dia., \$1.59 — 20 ft. dia., \$1.95

Postage paid on prepaid orders.  
Calif. residents please add sales tax.

**VOLUME SALES CO., War Assets Division**  
Dept. PM-655 3930 Sunset Blvd. Los Angeles 29, Calif.

**"I HAVE EARNED \$15.20 AN HOUR"**



with Science's New Midget Miracle, the Presto Fire Extinguisher, says W. F. Wydallis, Ohio



Many others "cleaning up"—so can you! Amazing tiny new extinguisher ends fires fast as 2 seconds. Guaranteed 20 years! Sells for only \$3.98! Write for FREE Sales Kit. No obligation. If you want a regular Presto to use as a demonstrator send \$2.50. Money back if you wish. Merritt Industries, Dept. 56, 114 East 32 Street, New York 16, N. Y.

**COLOR PRINTS**

FROM YOUR COLOR FILMS  
**KODACHROME • ANSCOCHROME**  
**EKTACHROME • ANSCO COLOR**  
4x5 50¢ | 5x7 \$1 | 8x10 \$2 Satisfaction or money back  
AUTHORIZED ANSCO COLOR LABORATORY  
**COLORFAX LABORATORIES**  
Dept. J65, Box 3521, Georgetown Sta., Washington 7, D. C.

**25¢**  
2 ¼ x 3 ¼  
Minimum order \$1  
No COD's, please



**UPHOLSTERY**  
**BE YOUR OWN BOSS**

AT HOME, earn right off. Get a better job, be your own boss. UTS easy course teaches you professional upholstery, reupholstery, slip-covers, drapery. FREE tools, frames, materials to make beautiful upholstered furniture and slip covers.

APPROVED FOR KOREAN VETERANS  
Free Illustrated Book—SAMPLE LESSON. Write Upholstery Trades School, Dept. DH-309, 721 Broadway, New York 3, N. Y.

**FREE AMAZING NEW BOOK**  
**"HOW TO ANSWER ADS"**



Never before have you seen anything like this. Tells you in simple language the correct way to answer ads. Gets you quicker replies—better results, and greater satisfaction. Will save you time and money and it's ABSOLUTELY FREE. No obligation whatever. Every reader of advertising should have this booklet. Send a postcard for your copy NOW. F. W. JOHNSON, Popular Mechanics Magazine, Room 600-A, 204 East Ontario Street, Chicago 11, Ill.

**A USEFUL GAGE THAT IS NEW AND DIFFERENT**



MADE OF BRASS Jay Dee Tool Co., 9102 E. Valley Blvd. PRICE \$1.00 Postpaid, No C.O.D. Rosemead 3, Calif.

Say You Saw It in Popular Mechanics

**BUILD HELICOPTER GLIDER**

The famous new GYRO-GLIDER, world's simplest and safest aircraft, is now available to amateur builders in plans and kits. Send \$1.00 now for three-view drawings with specifications and ask about kits and detailed building and flying instructions.

**SENSEN AIRCRAFT CORP., Dept. PM-6**  
P.O. Box 2621 Raleigh, N. C.

ONLY \$1 Name \_\_\_\_\_ Address \_\_\_\_\_  
Greatest Thrill in Flying! City \_\_\_\_\_ State \_\_\_\_\_





**MENDS  
MOST ANYTHING**

*"HOLDS LIKE IRON"*

Used by fine furniture makers. Ideal for home and office. In ¼ oz. or 2½ oz. sizes.

**STAMP COLLECTORS**

**312 STAMPS Only 25c**

Collection of 312 all different foreign stamps including group of sport sets from Nicaragua, Marino, Hungary, MUSICIANS of Intl. Western Sahara, Guinea, Czechoslovakia. PLUS hundreds of interesting issues from the four corners of the world. This collection catalogs \$6.50 and comes to you for only 25c with our approvals. **APEX STAMP CO., Dept. 1J, P.O. Box 457, Port Ewen, N. Y.**



**WELDING may aid your SUCCESS**

Are and Acetylene; welding metallurgy; Heliarc, etc. This is home, spare-time training for men who appreciate the importance of welding and want to advance in the art, get promotion, enlarge own shop, etc. Send for FREE BOOK. Utilities Engineering, 2523 Sheffield, Dept. WC-10, Chicago 14

**SHORTHAND IN**

Famous SPEEDWRITING shorthand. 120 words per minute. No symbols; no machines; uses ABC's. Easiest to learn, write and transcribe. Low cost. 250,000 taught by mail. For business and Civil Service. Typing available. 32nd Year. Schools in over 400 cities. Write for FREE booklet to:

**Speedwriting**  
Dept. 1506-S  
85 W. 42 St., N.Y. 36, N.Y.

**6  
WEEKS**

**... TURN CONCRETE INTO GOLD!**

**MAKE UP TO \$75 A DAY IN YOUR OWN BUSINESS**

If you want to have your own business — to start a business on your own — here's your big opportunity! New high speed, low cost General block machine produces up to 1,000 concrete blocks a day. Sell all you make to builders, supply houses, and others for homes, factories, buildings, garages. Cash in on the building boom! You can make profits of 100% to 150% — up to \$75. a day! General block machine equipped with ½ h.p. electric motor — or can be supplied with gasoline engine — works anywhere, in little space, indoors or out. Operates from ordinary house light socket. Simple, foolproof 3 step operation — so easy a child can do it. Makes superior 3 core blocks any size from 4" to 12". Also makes chimney, ash, corner and other types. Blocks meet any building code anywhere in the country. Materials — sand, water, cement, available anywhere. Simple illustrated operating instructions and mixing formulae for cement and cinder blocks supplied with each machine. Write for FREE folder with full information.

**MOTOR DRIVEN**

R. L. T. of New York City reports: "MY GENERAL BLOCK MACHINE PAID FOR ITSELF IN FIRST 2 WEEKS!" Hundreds now in use the world over! Write for FREE details today!

**EXTRA** Amazing illustrated book gives floor plans for 6 sensational concrete block buildings. Tells how to lay blocks, lay out building lines, mix concrete, build steps, porch and concrete floors all at great savings. Written by experts. Can save many times the cost of the material! Get it now! No strings attached. Send \$1.



BOOK SENT FREE IF YOU BUY MACHINE.  
\$1 REFUNDED IF YOU BUY LATER.

**GENERAL ENGINES CO.**  
DEPT. M-65, 307 HUNTER STREET, GLOUCESTER, N. J.

**YOU BUILD EICO KITS**

in one evening. SAVE 50% & LEARN

Easy Instructions | Vacuum Tube Voltmeter  
38 Instruments | KIT \$25.95 Wired \$39.95

Write now for FREE Catalog . . . PM-6

Electronic Instrument Co., Inc. • 84 Withers St. • Brooklyn 11, N.Y.

**LEARN MEAT CUTTING AT NATIONAL** Pay After Graduation



The steady dependable trade of Meat Cutting taught easily in 8 short weeks. YOU LEARN BY DOING under actual meat market conditions in big modern school at Toledo.

For beginners or men with experience. Get a profitable store of your own. Remember, PEOPLE MUST EAT! Big pay jobs. Free employment help. Thousands of successful graduates.

Buying, cutting, percentage, pricing, advertising, selling, etc. A complete retail meat education. National School established over 30 years. Get National training NOW. Pay your tuition in easy weekly payments

after you graduate. Send coupon for FREE 52 page school catalog — TODAY. G.I. approved.

**National School of Meat Cutting, Inc., Dept. 50-S, Toledo 4, Ohio**

Send me your FREE school catalog on National Training at Toledo in Meat Cutting, Meat Merchandising and Self Service Meats. No obligation. No salesman will call.

Name \_\_\_\_\_ Age \_\_\_\_\_

Address \_\_\_\_\_

City \_\_\_\_\_ State \_\_\_\_\_

Approved for training Korean Veterans

# How to get into the **BIG PROFIT**, fast-growing **MAIL ORDER PLASTICS BUSINESS**

**FREE!** MAIL THIS  
COUPON

**WARNER ELECTRIC CO., 1512 Jarvis Ave.  
Dept. L-10-H, Chicago 26, Ill.**

Please rush me free and without obligation complete information, postage paid.

NAME.....

ADDRESS.....

CITY.....ZONE.....STATE.....

**on a shoe string!**

Write today for free facts about the newest and most fascinating of all home operated businesses. For the first time, a simplified machine brings the fabulous profits of Plastic Sealing and Plastic Laminating within reach of the small operator. Anyone can operate the machine with a few minutes practice. Then — with our **MAGIC MAIL PLAN** — can get mail orders pouring in daily with cash in every envelope.

**No Canvassing or Selling**

Fill orders at home in spare time to start. Then expand to full-time business. We even supply circulars to bring back cash and orders. Rush coupon for all the facts you need to start or a card will do. No charge. Write today.

**WARNER ELECTRIC CO.**  
1512 Jarvis Ave., Dept. L-10-H, Chicago 26, Ill.



**SEND NAME TODAY!**

# TERRIFIC!

**USED 16 x 50**  
Regularly sold at \$69.50  
**NOW \$37.60**



These are not "used" in the sense that someone else owned them, but their frames have been scratched or some of the paint rubbed off while being taken off of the shelves or when handled on our viewing range. Their cases, too, sometimes show scuff marks. **OPTICALLY AND MECHANICALLY THEY ARE A-1.** 7" high. Water-dust resistant. 2" wide objectives assure greater illumination and brighter sharper images. Weigh only 27 ounces!

**30 DAY NO RISK TRIAL**

If not satisfied return for full refund. Made in Japan. Leather case, straps included. Add 10% Fed. tax. Cash orders prepaid. C.O.D.'s require \$2.00 deposit. **UNITED BINOCULAR CO., Dept. ARF-9208, 1043 S. Western, Chicago 20. DEALERS WANTED.**

## ENGINEERING DEGREE IN 27 MONTHS

**Big Demand for Graduates**

**Aeronautical, Chemical, Civil, Electrical, Mechanical and Radio Engineering (inc. TV and Electronics)**

Hundreds of young men are earning B. S. **ENGINEERING DEGREES** annually in this recognized institution — year around operation. New terms start quarterly. Many students earn a major part of their college expenses in this large industrial center.

Low tuition. Competent instruction. Thorough, intense, practical program. Modern, well-equipped laboratories including new physics laboratory and modern wind tunnel. Individualized instruction emphasized.

Government approved for G.I.'s. Engineering preparatory courses. Students from 48 states and 21 foreign countries. Enter June, September, December and March. Send coupon for free catalog and full information. Enroll now.

**SEND COUPON TODAY**

### INDIANA TECHNICAL COLLEGE

565 E. Washington Boulevard  
Fort Wayne 2, Indiana

Please send me free information on B.S. Engineering Degree in 27 months as checked.

Aeronautical,  Chemical,  Civil,  Electrical,  
 Mechanical,  Radio-Television

Name.....

Address.....

**\$14,839 In 1 Year**  
**SERVICING RADIATORS**

—**REX RYAN, Bloomfield, Iowa**

Hundreds earning \$8,000-\$20,000 a year servicing auto-truck-tractor radiators! New Inland equipment makes work easy, insures finest professional workmanship. "Pays-for-itself" financing available. \$100 training course included free by world's largest radiator servicing equipment manufacturer.

**WRITE** for free folder "Want a business of your own?"

**INLAND MFG. COMPANY** Dept. PM-6  
1108 Jackson St., Omaha 8, Nebr.

*Write Like This*

YOUR penmanship can be improved in 3 hours or corrected to your satisfaction in 10 hours' practice with my **DEFINITE HAND CONTROLS**. New way!

**WRITE OZMENT** BOX 665  
34-N, ST. LOUIS, MISSOURI

**Complete OUTLINE FREE!**

**TERMITES**  
**IN YOUR HOUSE?**

**GET RID OF THEM YOURSELF!**

DON'T PAY \$300.00 AND UP TO ERADICATE TERMITES FROM YOUR HOME OR PREVENT INFESTATION. DO IT YOURSELF IN ONE AFTER-NOON. EASILY! QUICKLY! INEXPENSIVELY! WITH "TEAM-OUT"! SEND STAMP FOR HANDBOOK.

**COMPASS RESEARCH**  
4135A BROWNSVILLE RD., PITTSBURGH 27, PA.



**SAY YOU SAW IT IN POPULAR MECHANICS**

**Do a Real Professional-Like Job Yourself and SAVE**

**HOW to PAINT**  
With Brush and Spray

Covers All Painting Methods and Materials

You can do professional-like painting and finishing jobs yourself and save about two-thirds of the cost. Sam Brown, noted craft authority, makes it so easy for you in his book, **HOW TO PAINT WITH BRUSH AND SPRAY**. Order your copy now and enjoy this tremendous saving. It covers exterior painting, wall and interior decorating, furniture finishing, concrete painting — every type of painting with brush, spray gun, roller and other methods. Tells what finish is best; what materials to use, etc. No previous experience needed. Fully illustrated. Order by mail. Only \$2.50. Money back if not pleased.

**POPULAR MECHANICS PRESS, Dept. PM18**  
200 E. ONTARIO ST., CHICAGO 11, ILL.



# GOING OUT OF BUSINESS

**\$5,000  
Cash Security**

IS DEPOSITED IN THE  
**FIRST NATIONAL BANK  
& TRUST CO.**  
OF NEW HAVEN, CONN.

\$5,000 to honor any exchange or refund for any reason whatsoever. \$5,000 deposit of guarantee shall be maintained for the duration of the corporation's liquidation plus 45 ADDITIONAL days.

## HERE ARE THE FACTS

The brand of the illustrated watches bearing a century old name may not be revealed in print. However, a 15-day non-obligational free trial offer carries an assurance of recognition to the most discriminating buyer.

These modern designed time-pieces are Grade A quality high caliber watches—bearing a nationally-advertised name established since 1835. Authorized agency to this watch is nationally distributed to a select group of fine jewelers. Every watch is 17-jewel equipped with interchangeable parts—serviceable in any part of the world. The manufacturer is not going out of business. Every watch carries the standard 1-year guarantee backed by the New York City head-quarter branch.

The Henry Spere Corporation has ordered to liquidate its entire stock. To expedite a COMPLETE and QUICK sell-out, these distinguished watches are offered at certified-below-wholesale-cost. The much abused term, "below wholesale cost" is a true claim subject to confirmation by a certified public accountant; it is hereby guaranteed to be an authentic statement backed by the \$5,000 pledge-deposit in The First National Bank & Trust Co. of New Haven, Conn.

Order one or more watches at once. Wear it—test it—appraise it—try it for 15 days. Should an outside appraisal not confirm its retail value to be at least 3 times its present price—should you not be entirely pleased for any reason whatsoever—kindly return your purchase. It will not cost you A SINGLE CENT.

Attention! Persons with A-1 credit rating! 15-DAY CHARGE ACCOUNTS INVITED! No deposit required, remit payment (plus postage) after 15-day trial period or return purchase at no obligation. Charge account privilege limited to persons living 10 years at same address with one or more bank reference required.

*55 Year Old Watch Firm Retiring From Business!*

Nationally Advertised **WATCHES** Distinguished Quality

**UNCONDITIONAL BELOW WHOLESALE SACRIFICE**

*Wear It! Test It! Appraise It! For 15 Days Without Obligation*



PHOTO 3/5th ACTUAL SIZE



PHOTO 3/5th ACTUAL SIZE

A. Established retail price \$35.75. Gent's. Incuboo-shock and water-resistant. Unbreakable crystal, luminous dial, stainless steel back. **\$9.80**

B. Established retail price \$65.00. Gent's. Automatic self-winder. Equipped with 2 Incuboo-shock-protectors. Fully waterproof. 100% stainless steel case. Unbreakable crystal. Non-magnetic. **\$18.90**

*Every Watch Carries A Standard 1-Year Guarantee*



PHOTO 3/5th ACTUAL SIZE



PHOTO 3/5th ACTUAL SIZE

C. Established retail price \$71.50. Gent's. Automatic self-winder. Equipped with 2 Incuboo-shock-protectors. Fully waterproof. 100 stainless steel case. Unbreakable crystal. Non-magnetic. **\$19.90**

C-1. Established retail price \$82.50. (not illustrated) same as C, except case is 14K yellow gold filled made by America's foremost watch case manufacturer, The Wadsworth Watch Case Co. **\$23.70**

C-2. Established retail price \$95.00. (not illustrated) same as C, except case is 14K yellow gold top with stainless steel back. **\$27.90**

*Every Watch Has 17 Ruby Jewels And Interchangeable Parts*



PHOTO 3/5th ACTUAL SIZE



PHOTO 3/5th ACTUAL SIZE

D. Established retail price \$67.50. Gent's. dress watch with 2 Incuboo-shock-protectors. Entire case 10K yellow gold filled. **\$19.35**

E. Established retail price \$85.00. Gent's. dress watch. All 14K yellow gold case. Dial of 14K gold numerals and figures. Rock crystal. Dust-proof crown. **\$23.90**

F. Established retail price \$71.50. Gent's. calendar watch. 2 Incuboo-shock-protectors. Dust-proof case. 100% stainless steel case. Non-magnetic. **\$17.50**

*Every Watch May Be Serviced In Any Part Of The World*



PHOTO 3/5th ACTUAL SIZE



LADY'S WATCH SHOWN IN ACTUAL SIZE

G. Established retail price \$67.50. Gent's. dress watch, 10K yellow gold filled case. Dial of 14K gold numerals and figures. Durable, masculine design. Rock crystal. **\$18.90**

H. Established retail price \$95.00. Ladies' dress watch. Supremely crafted all 14K gold case in natural color. Dial of 14K gold raised numerals and figures. Incomparable value. **\$25.70**

Add 10% federal excise tax to each purchase. Represented waterproof watches are fully waterproof in conformance to U. S. Government Standards. Guaranteed to remain fine if not tampered with, and if serviced by reputable jewelers.

FINE QUALITY

*Diamonds*

traditional in keeping with 55 years of ethical practice.

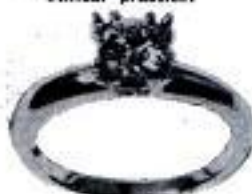

**OUTSIDE APPRAISALS INVITED**

**WEAR IT—TEST IT—APPRAISE IT—**

If not entirely pleased, kindly return it at no obligation. 40% saving unconditionally guaranteed.

Your purchase shall be protected with a money-back CERTIFICATE OF GUARANTEE and a 10-power enlarged photograph of the registered diamond.

1/2 carat diamond in 14K gold solitaire ring. Guaranteed established value \$325.00. **\$195.00**

1/4 carat diamond in 14K gold solitaire ring. Guaranteed established value \$175.00. **\$95.00**

PLUS 10% FEDERAL EXCISE TAX

(due to restricted space, kindly copy this order form in enlarged size)

**HENRY SPERE, INC.**  
280 Main Street, Ansonia, Conn.

Gentlemen! With the understanding that my purchase shall be honored with a full refund, if desired, after a 15-day trial period, please send:

1/4 carat diamond ring  1/2 carat diamond ring.

Finger size: \_\_\_\_\_  
Watch model:  
 A,  B,  C,  C-1,  C-2,  D,  E,  F,  G,  H.

Send postage prepaid; an enclosing check or money-order in full.

Send C.O.D. an enclosing \$5.00 deposit, Balance plus C.O.D. & postage to be paid upon delivery to mail-man.

Please charge to my account, I shall remit payment plus postage 15 days after delivery. You may check my credit with following bank \_\_\_\_\_

Name \_\_\_\_\_ Address \_\_\_\_\_ City \_\_\_\_\_

**PROFESSIONAL-TYPE ELECTRIC  
HAIR CLIPPER**

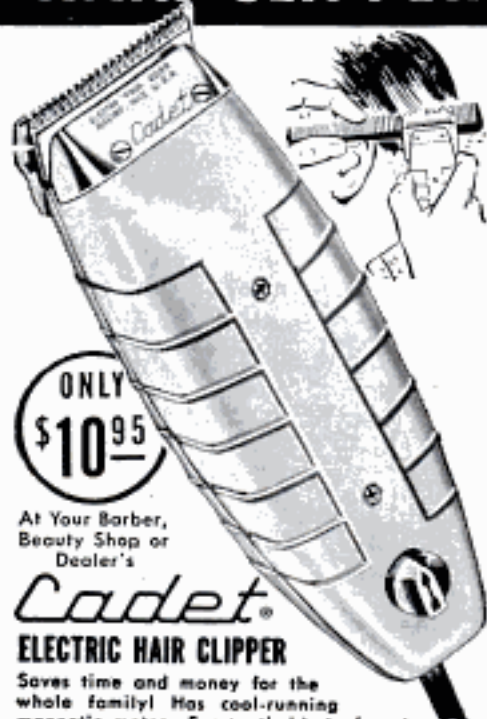

ONLY  
**\$10<sup>95</sup>**

At Your Barber,  
Beauty Shop or  
Dealer's

**Cadet**  
ELECTRIC HAIR CLIPPER

Saves time and money for the whole family! Has cool-running magnetic motor; fine-tooth blade for close cutting; streamlined plastic case. 110v 60 cycle AC; fully tested by UL. If your barber, beauty shop or dealer cannot supply you, order direct on 10-day money-back guarantee.

**ELECTRO TOOL CORPORATION**  
DEPT. C525-F • RACINE, WISCONSIN

For Racing at its Thrilling Exciting Best . . .

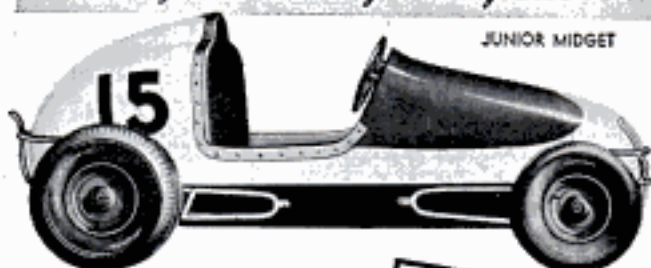

JUNIOR MIDGET

Get in on Micro-Midget racing, America's newest, most exciting, and fastest growing sport. Speeds up to 30 M.P.H. on a 1/10 mile track. Can be purchased in kit form or complete ready-to-run. Send 25 cents for completely illustrated literature describing all details.

Now available, the **HANDBOOK** for **SMALL RACING CARS**. The handbook is the most complete of its type ever printed and has angles, plans, specifications, engine information, track and racing data, all rules and regulations, etc. for 1/4 Midgets, Micro-Midgets, and 1/8 Midgets, only \$1.00

**COMET MANUFACTURING CO.**

DEPT. 14, P.O. BOX 1882

SACRAMENTO 9, CALIF.

**RADIO & TV TUBES**

**BIG SAVINGS ON THESE TUBE SPECIALS**

1B3GT .55 6A6S .48 6BQ6GT .74 6SN7GT .52 12SA7 .39 35L6GT .38  
1U4 .38 6AU6 .37 6CD6G .74 6W4GT .38 12SK7 .39 50L6GT .45  
5U4G .39 6BE6 .39 6S4 .38 12AT7 .65 12SQ7 .35

Send check, cash or money order. No C.O.D.'s please. No minimum order. Postage prepaid. Send for full complete tube listing.

**TELTRON ELECTRIC COMPANY**

Dept. PM-G

428 Harrison Ave.

Harrison, N. J.

**BE YOUR OWN BOSS  
AS A MAIL ORDER OPERATOR**

One of America's most distinguished Mail Order experts is now offering a remarkable home-study correspondence course, teaching you how to run a profitable Mail Order business of your own, and will forward free facts to those interested. Send name and address to **The L. W. Survey, Dept. 16, 805 Larrabee, Los Angeles 46, California.**

**STRENGTHEN  
...TRAIN YOUR  
VOICE**

**DEVELOP A HE-MAN VOICE!**

Write for FREE book "How to Strengthen Your Voice for Greater Success" by Eugene Feuchtinger. No obligation. Book will be mailed at once in plain wrapper, postpaid. Just send your name and address. State age. **PREFECT VOICE INSTITUTE, 210 S. Clinton St., Studio FV-2, Chicago 6, Ill.**

**BUILD YOUR OWN  
AIR CONDITIONERS**

From Junked Refrigerators for a Few Dollars **INSTRUCTION BOOKS SHOW YOU HOW... 75c EACH**

"HOW TO BUILD a Low Cost Air Conditioner"  
"HOW TO BUILD an Automobile Air Conditioner"  
"HOW TO BUILD a Low Cost Home Freezer"  
"HOW TO BUILD an Electrostatic Precipitator"  
"HOW TO BUILD a Low Cost Dehumidifier"

Complete "Install-it-Yourself" Air Conditioner kits for home and automobile, 2 Ton capacity, Brand New Parts—\$179.70 and up.

**KOOL ENGINEERING CO., Dept. A-6, 3716 Belmont, Chicago 18, Ill.**

**FREE!**  
Instructions  
and Literature  
on kits.

**The Chief**

**Steel 5-Shelf Unit**

**75 Inches High**

**36" Wide—12" Deep**



- ... Hundreds of Uses
- Offices • Churches
  - Schools • Garages
  - Stores • Homes
  - Shops • Greenhouses
  - Hobby Shops

Adjustable shelves, back brace...green metallic finish Shipped K. D.

**10<sup>88</sup>**  
F.O.B. Detroit

15" depth 12.38

18" depth 13.88

**MOHAWK LUMBER & SUPPLY COMPANY**

14525 W. Chicago Blvd., Detroit 28 Mich.

Ship \_\_\_\_\_ Shelf Units as follows \_\_\_\_\_ 12" deep \_\_\_\_\_ 15" deep \_\_\_\_\_ 18" deep

F.O.B. Detroit. Enclosed  Check  M.O. for \$ \_\_\_\_\_

\$3 deposit with C.O.D. NAME \_\_\_\_\_

orders ADDRESS \_\_\_\_\_

FREIGHT  EXPRESS CITY \_\_\_\_\_ STATE \_\_\_\_\_



**OPPORTUNITIES AHEAD!  
TRAIN FOR A FUTURE IN**

**DIESEL**

Prepare for the big earning power of Diesel Trained Men. Start learning at home, in spare time. UEI's easy, practical training covers all phases of DIESEL engine operation, fuel systems, auxiliary equipment, repairs and maintenance. Also new Scientific Auto Motor Tune-up. After home course, you come to Chicago for actual practice in UEI's modern shop under experienced instructors. **GET ALL THE FACTS FREE. WRITE TODAY!**

**DIESEL DIVISION UTILITIES ENGINEERING INSTITUTE**  
2521 Sheffield Avenue, Dept. DC-46 Chicago 14, Illinois

**The HARDEST HITTING CO<sub>2</sub> GAS RIFLE  
at the LOWEST PRICE on the MARKET!**

Pioneers **BENJAMIN** Leaders  
AIR RIFLES GAS AIR PISTOLS GAS  
You can Depend on **BENJAMIN**

Single Shot — Cal. .22  
Up to 1 inch Penetration



MODEL No. 352

**\$16.50**

including 1  
CO<sub>2</sub> Cartridge  
& Sample Supply  
Cal. .22  
Benjamin H-C  
Pellets.

**New BENJAMIN  
SUPER CARBINE CO<sub>2</sub> GAS RIFLE**

The **FINEST** Short Light Rifle for **TARGET and GAME.**

**Famous BENJAMIN AIR RIFLES**

For Target  
and Game



**HAND PUMP  
BREECH LOADING  
BOLT ACTION—HAMMER FIRE  
HAIR TRIGGER—ADJUSTABLE POWER**

With  
Safety  
Lock

**DYNAMIC COMPRESSED AIR SHOOTING FORCE.** Easy to pump when standing or sitting. No heavy springs to cock. Always ready to use—ideal for Target Shooting, Hunting, Camping, Fishing—Adjustable Shooting Force—amazingly Powerful and Accurate. Hair trigger firing without forward lunge or recoil. Other quality features include Front Blade Sight—Adjustable Rear Sight, Walnut finish turned stock and pump handle.  
No. 310—BENJAMIN SUPER SINGLE SHOT AIR RIFLE—Smooth Bore—for shooting lead or steel air rifle shot. **\$18.00**  
No. 312—BENJAMIN SUPER SINGLE SHOT AIR RIFLE—rifled—for shooting Caliber .22 BENJAMIN H-C PELLETS. **\$20.00**  
No. 317—BENJAMIN SUPER SINGLE SHOT AIR RIFLE—rifled—for shooting Caliber .177 BENJAMIN H-C PELLETS. **\$20.00**

Sample Supply  
BENJAMIN H-C PELLETS included with each Gun.

**BIGGEST VALUE** on the market—at a sensation-ally **LOW PRICE.** Excels all other guns in its class for **Power—Accuracy—Convenience—Economy—Safety—Operation and Performance.** It is **SAFE INDOORS—NON TOXIC—NO FUMES OR ODORS.** Gives you up to 15 very hard shots from **LOW COST POPULAR STANDARD SIZE CO<sub>2</sub> Cartridges.** No Cocking or Pumping. No Recoil or Flinching. It sports a walnut turned stock with trigger guard, takedown steel barrel with Rifled Bronze Liner. It has a **Safety Lock.** Front Blade Sight; Adjustable Rear Sight, and brings you such really important features as **BREECH LOADING—BOLT ACTION—HAMMER FIRE—Very Fine Hair Trigger Action.**

Benjamin makes the Largest Selection of Air and Gas Guns in America. Each Gun is Equipped with Positive Safety Lock.

**FREE FOLDER**  
All Models Benjamin Air and Gas Rifles and Pistols.

New Benjamin CO<sub>2</sub> Rocket Gas Pistol \$18.00

SEE YOUR HARDWARE OR SPORTING GOODS DEALER. If he cannot supply, write to factory for full details and include name of dealer.

**BENJAMIN AIR RIFLE CO.**  
895 MARION ST. ST. LOUIS 4, MO.



No. 1401C  
AXE-  
KNIFE  
SET

Most useful combination for any camping or hunting trip. Knife blade 4". Stag handle, sheath with compass. Axe has correctly shaped blade and handle, sheath with lanyard hole. Sheaths are detachable. Set weighs only 2 3/4 lbs. **\$10.95**



No. 1456  
No. 1456G—Heavy all purpose, 5" blade, corkscrew and can opener fold into Stag handle. With sheath. **\$6.50**



No. 1454  
No. 1454C—Narrow Sabre ground blade with long blood groove. Sticking shape, Stag handle. With sheath. 3 3/4" blade. **\$3.05**  
No. 1454F—4 3/4" blade. **\$3.50**

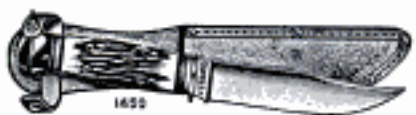

No. 1460D  
BAIT  
KNIFE  
No. 1450E—All purpose. Standard blade, Stag handle. With sheath. 4 1/2" blade. **\$3.20**. No. 1450G—5" blade. **\$3.55**. No. 1450H—6" blade. **\$3.90**. No. 1450S—5" blade, saw back. **\$4.00**

**SEE YOUR DEALER.** If he can't supply, ORDER DIRECT! Send Money Order for prepaid delivery, and include name of dealer. No C.O.D.'s. Money back if not delighted.

**Fishermen! Hunters! Campers! Trappers!**

**Greatest Sportsman's  
Knife Values IN AMERICA!**

Made in SOLINGEN, W. Germany, of Finest Quality Hi-Carbon Cutlery Steel. They have ALL the Features Outdoorsmen Want, yet are Realistically **LOW PRICED!** Tough, Rugged, Beautifully Balanced—they TAKE AN EDGE and STAY SHARP! CUT CLEAN!

**PYRAMID  
HUNTING &  
FISHING  
KNIVES**



No. 1456G—Heavy all purpose, 5" blade, corkscrew and can opener fold into Stag handle. With sheath. **\$6.50**



No. 1454C—Narrow Sabre ground blade with long blood groove. Sticking shape, Stag handle. With sheath. 3 3/4" blade. **\$3.05**  
No. 1454F—4 3/4" blade. **\$3.50**



No. 1460D  
BAIT  
KNIFE  
No. 1450E—All purpose. Standard blade, Stag handle. With sheath. 4 1/2" blade. **\$3.20**. No. 1450G—5" blade. **\$3.55**. No. 1450H—6" blade. **\$3.90**. No. 1450S—5" blade, saw back. **\$4.00**



No. 1450 1/2  
All purpose. Light weight. Sturdy. 3 3/4" blade. Cherry wood handle. Sheath with compass. Excellent for Boy Scouts and Fishermen. **\$1.95**

**SPORTSMAN'S PAL**

**12-IN-1 TOOL** OF A 1001 PRACTICAL USES IN HOME, SHOP, CAMP... FISHERMEN, HUNTERS—Any & All Outdoorsmen.

The most versatile tool made. Belongs in every tackle box and tool kit. Can be worn on belt, in sheath, or on lanyard. Made in Solingen, W. Germany, of finest quality Rust Resistant materials. 7 1/2" overall length, 2" Jaws. Top grain leather sheath with snap button fastener and belt loop. Fully guaranteed. Includes in one handy tool: 1. Scaler; 2. Disgorger; 3. Can Opener; 4. Knife; 5. Slicer; 6. Cutters; 7. Pinners; 8. Splitters; 9. Hogs; 10. Screw Driver; 11. Bottle Opener; 12. Corkscrew (or Awl).  
No. 1402-1—Sportsman's Pal with Corkscrew. **\$5.95**  
No. 1402-2—Sportsman's Pal with Awl. **\$5.95**

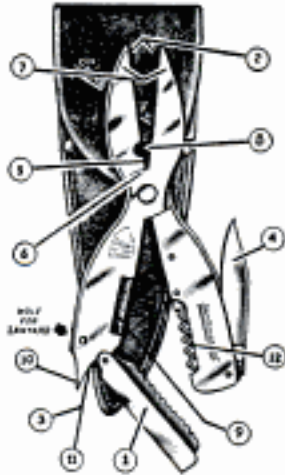

**SCOUT KNIFE. 4**  
Blades—Cut, Pencil, Open Cans, Lift Bottle Caps. **\$1.15.**



No. 1455D—FLOATING FISH KNIFE  
Floats with Red Top of Handle on surface. 3 3/4" Stainless steel blade. Serrated back edge. Finest cork handle. With sheath. **\$1.40**

**FREE Folder**  
of Hunting and Pocket Knives, Pliers, Steak Knife Sets. Dealers wanted.

**PYRAMID SALES CO.** 812 BARRY ST., ST. LOUIS 4, MO.

## DIVEMASTER MK-III DIVING LUNG

Complete  
Only  
**\$24.50**

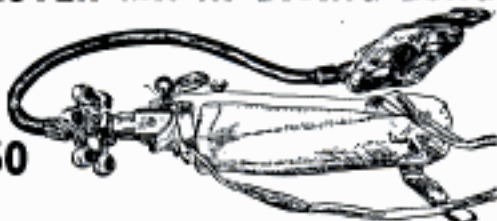

Ready for use. Gives you 10 minutes underwater time. Amazing low price—thoroughly tested. Wonderful fun for the beginner or use as spare unit safety device.

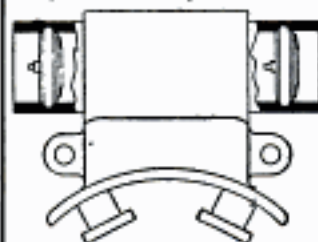

### DIVEMASTER PURE RUBBER MOUTHPIECE

Precision unit, comes completely assembled, can be quickly installed on diving lung. Incorporates two check valves—one for exhaust, one for intake. Designed to allow minimum amount of water to enter the air lines. Provides for constant air supply when in use. Porehole sizes: 1 1/2" O.D. . . . . **\$8.50**

Illustrated Catalog of everything you need for Underwater Sports Adventure, 25c.

DIVEMASTER U. A. S. CORPORATION, DEPT. PM-6  
5643 W. 63RD PLACE, CHICAGO 38, ILL.

## GLASS SPINNING ROD and SPIN REEL *Outfit*

**\$9.95** AMERICAN MADE!  
A complete Spin Fishing Outfit—everything you need at an amazing low price. Only UNITED'S tremendous buying power makes this exceptional offer possible. Regular \$13.95 seller! The superb, precision made SPIN REEL positively will not backlash! Beautifully styled and finished. Made of rugged, featherweight aluminum. Synchron-meshed for smoothest performance. 3.44 gear ratio! Fully automatic bail pickup. Sensitive brake with anti-reverse click. 250 yd. capacity unbreakable spool; simplified, trouble-free construction permits taking reel apart for cleaning and re-assembling in 30 seconds time! 6 1/2 foot, 2 piece SPINNING ROD of precision, taper-ground, laminated glass fibre. Featherweight and flexible with all the whip and zing usually associated with only the most expensive of rods. SPINNING LURES, a complete assortment, pre-tied to "strike" waiting fish no matter what their mood. 300 feet monofilament SPIN LINE chemically treated for long life and for landing Mr. PRIZE FISH safely, surely. Complete SPIN FISHING instruction Book included if order is rushed right away. **MONEY BACK GUARANTEE! USE 10 DAYS.** If not satisfied return for refund. Cash orders prepaid. C.O.D.'s require \$2.00 deposit. UNITED PRODUCTS CO., 9043 S. Western Ave., Dept. YA-408, Chicago 20.



Get a NEW HE-MAN BODY For Your OLD SKELETON FRAME!  
**I GAINED 60 LBS.**  
of SHAPELY MIGHTY MUSCLES  
in 10 EASY MINUTES OF FUN a day

"Hey YOU SKINNY You look like SOMETHING the CAT DRAGGED IN!"  
the boys yelled as I dragged myself into the gym, says another pupil, Gleason R. Cleveland. Then I gained 70 lbs. and made the football team.  
◀ BEFORE—70 lb. Skeleton AFTER JOWETT TRAINING ▶ 160 lbs. of Muscle

Do as I did! Mail the all-FREE Coupon Get the "Amazing Secret" PHOTO BOOK plus ALL 5 Picture-packed Courses. Millions sold for \$1. Yours FREE!



I was @ 125 lb. Skinny Weakling Look at me NOW!

**LAST CHANCE COUPON — 5 COURSES FREE!**

JOWETT INSTITUTE, 220 Fifth Avenue, New York 1, N. Y. Dept. PM-56

Dear George: Please mail to me prepaid FREE Jowett's Photo Book of Sports Men, a Plastic Medal plus all 5 Muscle Building Courses, "How to Become a Mighty He-Man." ENCLOSED FIND 10c for postage and handling (no C.O.D.'s)

NAME \_\_\_\_\_ AGE \_\_\_\_\_  
(Please print plainly, include Date Number)

ADDRESS \_\_\_\_\_

CITY \_\_\_\_\_ ZONE & STATE \_\_\_\_\_

# INVENTORS

PROTECT YOUR INVENTION BY A U. S. PATENT. SEND FOR FREE "INVENTION RECORD" FORM AND "PATENT INFORMATION EVERY INVENTOR SHOULD HAVE".

**CARL MILLER**  
REGISTERED PATENT ATTORNEY

WOOLWORTH BLDG., 35th FLOOR, 65A  
NEW YORK CITY

## PROTECTION FOR YOUR INVENTIONS

**FRANK J. RENAUD** 1311 G St. N. W.  
WASH. 5, D. C.

REGISTERED PATENT ATTORNEY  
FORMER ASSOCIATE EXAMINER  
U. S. PAT. OFFICE 1951-53



# PATENTS

## C. A. SNOW & CO.

REGISTERED PATENT ATTORNEYS  
WRITE FOR INFORMATION TO  
428 SNOW BUILDING, WASHINGTON 1, D. C.

Say You Saw It in Popular Mechanics

# INVENTORS

Whether an invention is patentable can be substantially determined by a search of the U. S. Patent records. Without obligation, write for information explaining the steps you should take to secure a patent.

**JOHN N. RANDOLPH**  
Registered Patent Attorney  
201 Columbian Building, Washington 1, D. C.

# INVENTORS

Send for PATENT INFORMATION Book and INVENTOR'S RECORD without obligation  
**GUSTAVE MILLER**  
55-PM WARNER BUILDING WASHINGTON 4, D. C.

REGISTERED PATENT ATTORNEY  
ASSOCIATE EXAMINER  
U. S. PAT. OFF. 1922-1929  
Patent Attorney & Advisor  
U. S. NAVY DEPT. 1930-1947  
PATENT LAWYER

# INVENTORS

I shall be pleased to furnish you, upon request, with full information relative to patent procedure—without any obligation on your part.

**PATRICK D. BEAVERS**  
Registered Patent Attorney  
934 Columbian Building Washington 1, D. C.

**WAR SURPLUS BARGAINS**

**WAR SURPLUS BARGAINS**

**\$500,000.00 INVENTORY for QUICK LIQUIDATION**

Surplus items—hundreds of them for home, shop, factory, farm and outdoor use. New items, used items, reconditioned items—all at tremendous savings—all priced for quick sale.

Page After Page of Values

This big catalog shows page after page of amazing money saving values. Write for your copy today. Send 10c to cover postage, handling, etc. Write today! **SEND TODAY FOR YOUR COPY**

**10c**

**STARK'S** 212 W. Madison St. Dept. PM-6 CHICAGO 6, ILL.

**INCREASE FARM INCOME**

Level land, layout structures, roads, irrigation, water lines—No guesswork! Professional Transit at farm budget price! \$205.00. Earn money from your neighbors too. Bulldog rugged, brilliant optics, lifetime service.

**PROVE AT OUR RISK!** If you're not 100% happy, return undamaged in 5 days—full refund. If your dealer's out-of-stock, we pay freight. Start it earning now! FREE Literature.

**MIKRON INSTRUMENTS, INC.**  
Dept. PM-65, 1966 E. Walnut St., Pasadena 8, Calif.

**STUDY INDUSTRIAL DESIGN**

You can train at Art Center School in California with practicing-professionals for upper-level jobs in INDUSTRIAL DESIGN. Recent graduates have been added to the staff at General Motors, Chrysler, Raymond Loewy, Henry Dreyfus, etc. Majors in transportation, general product design, structures, community development, furniture design, packaging, display. 4-year degree courses. Learn to combine imaginative design with technical proficiency, coordinate utility and beauty. Stimulating environment. Field trips. Advantages of mild Southern California climate and nearby holiday spots. Coed. Placement service. Established 24 years. New terms Feb., June, Sept. Write for catalog.

**ART CENTER SCHOOL, Edward M. Adams, Director**  
5353 WEST THIRD STREET, LOS ANGELES 5, CALIFORNIA

**Watch Repairing Pays Big Money** Learn at home

Watch repairers in great demand. Train step-by-step in 10 easy lessons. We furnish all tools and 15 jewel watch and practice movement. Turn spare time into cash. A licensed school. Low cost. Send for FREE book today.

**ILLINOIS SCHOOL OF WATCH REPAIRING**  
2870 Elston Ave., Dept. PM65, Chicago 18, Ill.

**WHEELS WHEELS WHEELS**

7" Disc Wheel 3/4" Tire 3/4" sleeve	45c ea.
8" Disc Wheel 1 1/4" Tire 1 1/4" sleeve	70c ea.
7" Disc Wheel 1" Tire 1 1/2" ball bearing	80c ea.
8" Disc Wheel 1 1/4" Tire 1 1/2" ball bearing	\$1.00 ea.
6" Disc Wheel 1.50 semi-pneum. Tire 1/2" B.B.	\$1.35 ea.
8" Disc Wheel 2" semi-pneum. T. 1/2" B.B.	\$1.50 ea.
10" Disc Wheel 1.75 semi-pneum. T. 1/2" B.B.	\$1.50 ea.
10" Disc Wheel 2.75 semi-pneum. Tire 5/8" B.B.	\$2.50 ea.
12" Disc Wheel 1.75 semi-pneum. T. 1/2" B.B.	\$1.85 ea.

Above wheel prices includes hub cap. Plus Postage. C.O.D.'s accepted.  
AXLES—Sizes 5/16 in., 3/8 in., 1/2 in.—Cut to size—End holes drilled.

**UNITED WHEEL STAMPING CO.**  
12131 S. PEORIA STREET PM-6 CHICAGO 43, ILLINOIS

**ATHLETE'S FOOT**  
**CUTICURA Relieves Faster**

Clinical tests prove new, sensational CUTICURA MEDICATED LIQUID relieves 9 out of 10 cases—in just 4 to 14 days! It stops itching instantly—checks most cases of infection—usually kills pathogenic fungi—and soothes as it helps heal raw, open cracks. 60c at druggists. If your druggist hasn't it, don't waste money on substitutes but send us 10c for generous trial size.

**CUTICURA, Dept. 16FY, Malden 48, Mass.**

**AUDELS Carpenters and Builders Guides 4 vols. \$6**



**Inside Trade Information** for Carpenters, Builders, Joiners, Building Mechanics and all Woodworkers. These Guides give you the short-cut instructions that you want—including new methods, ideas, solutions, plans, systems and money saving suggestions. An easy progressive course for the apprentice and student. A practical daily helper and Quick Reference for the master worker. Carpenters everywhere are using these Guides as a Bridging Hand to Better Work, Better Work and Better Pay. To get this assistance for yourself, simply fill in and mail FREE COUPON below.

**Inside Trade Information On:**

How to use the steel square—How to file and set saws—How to build furniture—How to use a mitre box—How to use the chalk line—How to use rules and scales—How to make joints—Carpenters arithmetic—Solving measurement problems—Estimating strength of timbers—How to set girders and sills—How to frame houses and roofs—How to estimate costs—How to build houses, barns, garages, bungalows, etc.—How to read and draw plans—Drawing up specifications—How to excavate—How to use settings 12, 13 and 17 on the steel square—How to build hoists and scaffolds—skylights—How to build stairs—How to put on interior trim—How to hang doors—How to lath—lay floors—How to paint.

Step up your own skill with the facts and figures of your trade. Audels Mechanics Guides contain Practical Inside Trade Information in a handy form. Fully illustrated and Easy to Understand. Highly Endorsed. Check the book you want for 7 DAYS FREE EXAMINATION. Send No Money, Nothing to pay Postman.

**MAIL ORDER**

**AUDEL, Publishers, 49 W. 23 St., NEW YORK 10, N. Y.**

Please send me postpaid for FREE EXAMINATION books marked (X) below. If I decide to keep them I agree to mail \$1 in 7 days on each book or set ordered and further mail \$1 monthly on each book or set until I have paid price, otherwise I will return them.

- AUTOMOBILE MECHANICS GUIDE, 1664 Pages. \$4
- TRUCK & TRACTOR GUIDE, 1299 Pages . . . 4
- DIESEL ENGINE MANUAL, 575 Pages . . . 2
- MACHINISTS HANDY BOOK, 1650 Pages . . . 4
- WELDERS GUIDE, 400 Pages . . . 1
- BLUE PRINT READING, 416 Pages . . . 2
- MATHEMATICS & CALCULATIONS, 700 Pages. . . 2
- SHEET METAL PATTERN LAYOUTS, 1100 Pages. . . 4
- SHEET METAL WORKERS HANDY BOOK, 388 Pgs. 1
- MECHANICAL DRAWING GUIDE, 160 Pages . . . 1
- MECHANICAL DRAWING & DESIGN, 480 Pages. . . 2
- AIRCRAFT WORKER, 240 Pages . . . 1
- TELEVISION SERVICE MANUAL, 434 Pages. . . 2
- RADIOAMANS GUIDE, 1040 Pages . . . 4
- ELECTRONIC DEVICES, 216 Pages . . . 2
- ELECTRIC MOTOR GUIDE, 1000 Pages . . . 4
- WIRING DIAGRAMS (Light & Power), 272 Pgs. 1
- ELECTRICIANS EXAMINATIONS, 250 Pages. . . 1
- ELECTRIC POWER CALCULATIONS, 475 Pages. . . 2
- HANDY BOOK OF ELECTRICITY, 1440 Pages. . . 4
- ELECTRIC DICTIONARY, 9000 Terms . . . 2
- ELECTRIC LIBRARY, 7000 Pages (12 Book Set) 18
- SHIPFITTERS HANDY BOOK, 250 Pages . . . 1
- REFRIGERATION & Air Conditioning, 1280 Pgs. 4
- MILLWRIGHTS & MECHANICS GUIDE, 1200 Pgs. 4
- POWER PLANT ENGINEERS GUIDE, 1500 Pages 4
- ENGINEERS & FIREMANS EXAMS, 525 Pages. . . 1
- PUMPS, Hydraulics & Air Compressors, 1658 Pgs. 4
- OPERATING ENGINEERS LIBRARY (3 Books) . . . 9
- MECHANICAL DICTIONARY, 950 Pages . . . 4
- GARDENERS & GROWERS GUIDES (4 Book Set) 6
- CARPENTERS & BUILDERS GUIDES (4 Book Set) 6
- PLUMBERS & Steamfitters Guides (4 Book Set) 6
- MASONS AND BUILDERS GUIDES (4 Book Set) 6
- PAINTERS & DECORATORS MANUAL, 450 Pgs. 2
- HOUSE HEATING GUIDE, 1000 Pages . . . 4
- OIL BURNER GUIDE, 384 Pages . . . 1
- HOME APPLIANCE SERVICE GUIDE, 800 Pages . . . 4

**Check NOW!**

You Can Look Over Any Guide In Your Own Home — Start the Easy Payments If Satisfied

**MAIL THIS TODAY**



Name \_\_\_\_\_

Address \_\_\_\_\_

Occupation \_\_\_\_\_

Employed by \_\_\_\_\_ P-6

## Make Money Manufacturing Concrete Drain Tile



Manufacturers of concrete drain tile are in the driver's seat. Why? Because their basic costs are not burdened by freight, distribution and breakage costs—items which the clay tile people have to pass along. Net results: concrete tile can sell for less, yet show a generous profit.

The market is big—and getting bigger. Not only because of increased farm drainage, but also because drain tile are needed in home building, reclamation projects, highway construction, and many other purposes.

Tile made on the Champion are outstanding in quality—dense, strong, uniform and truly round. All sizes up to 12" diameter. Easy to make, because the Champion Machine is simple, compact, and requires no skilled labor. Business is a low-investment opportunity, with equipment available on terms. Write for catalog.



**W. E. DUNN MFG. CO.**  
522 W. 24th Street, Holland, Mich.



**IN CANADA: DUNN MASONRY MACHINERY LIMITED**  
970 Dundas Highway, Cooksville, Ont.

27 YEARS OF SINCERITY • CHECK MY GUARANTEE & PRICES!  
FOOLISH TO PAY MORE—DANGEROUS TO PAY LESS!  
Tiny Overhead—Tiny Profits—Terrific Sales.



**FREE** This Pictured, Handsome  
Tire Ash Tray Included  
With 2 or More Tires!  
If you buy **TIRES** you get an extra tire **FREE**.  
2 or more **TIRES** Be wise! Why buy only one!  
(not W.V., Truck, or "Co. Release" tires)

**CHOOSE YOUR FAVORITE BRAND** Family safe, partially used.  
Not retreads or recaps.

GOOD YEAR		Firestone	
U. S.	GOODRICH & others.	36 Month Guar. & FREE TIRE	
600-16	\$4.81 640-15	\$4.81 760-15	\$4.71 820-15 \$5.31
650-16	4.71 670-15	4.71 800-15	5.11 700-15 4.51
700-16	5.21 710-15	4.71	SPECIAL WHITE WALLS \$2.00 Extra
<b>HEAVY DUTY TRUCK TIRES, 36 MONTH GUAR. &amp; FREE TIRE</b>			
600-20	\$7.91 825-20	\$16.71 600-18 (0)	\$5.81 750-16 \$8.51
650-20	8.51 900-20	15.81 650-18 (0)	6.51 700-17 7.91
700-20	9.11 1000-20	18.81 700-18 (0)	7.21 750-17 9.91
750-20	9.91 1100-20	17.91 700-15 (0)	7.21 1000-22 16.81

**SPECIAL! TIRES RELEASED BY CO. ADJUSTERS (just used slightly)**  
if a tire proves defective at World's top value **\$7.86**  
any time, I charge you nothing—and **FREE TUBE** any car

**MARVIN** 6th & Spring Garden Sts. Philadelphia, Pa.  
**BLATT** 750-20 9.71 750-20 13.51

**MILITARY MUD-GRIP TIRES**  
AA Guar. 20 Mos. AAA 36 Months  
900-18 \$10.21 900-15 \$11.91  
750-20 9.71 750-20 13.51

Send CK. or M.O. & this ad for instant shipment. FOR Phila.  
I personally select your tires—as if my future depended on it.  
Thousands of tires shipped the world over! Read that top line again.

**ELECTROPLATE**  
ANY OBJECT IN HOME, SHOP, GARAGE OR STAIR  
TOUR OWN WILL PAYING ELECTROPLATING BUSINESS!

NO TANKS USED  
NEW UNIMPLIFIED METHOD  
SUCCESS IN THE  
ELECTROPLATING  
BUSINESS

NOW, using NEW plating kit.  
It's easy to electroplate any object. Complete kit and instructions on plating metal and non-metal objects, with nickel, copper, chrome, gold, etc., plus full data on obtaining all the business you desire and make **BIG MONEY** full or spare time. **ONLY \$5.95. SEND NO MONEY**—everything sent C.O.D. plus postage—OR send \$5.95 now and receive it postpaid. Money back in 7 days if not satisfied.  
**M. Z. SALES CO., Dept. PM-15, 113 W. 42 St., New York 36, N. Y.**

**LOCKSMITHING & Key Making**  
**PRACTICAL UP-TO-DATE COURSE—ONLY \$4.95**  
Easy-to-learn modern information for self-instruction. How to work on locks, de-code, make master-keys, repair, install, service, etc. For every handyman, home owner, carpenter, mechanic, service station operator, fix-it shop, hardware dealer, etc. Illustrated in plain illustrations.  
**FULL PRICE ONLY \$4.95. SEND NO MONEY.**  
Just pay postman plus C.O.D. postage. Or send \$4.95 with order, we'll ship postpaid. Satisfaction guaranteed or refund.  
**NELSON-HALL CO., 210 S. Clinton St., Dept. FV-2, Chicago 6, Ill.**

**WITH RO-TA-TOR**  
**AMAZING NEW WINDSHIELD STREAK ELIMINATOR**  
A new device that fits on wiper post. Shifts back automatically. Overlays and removes streaks. Prevents accidents. Makes driving a pleasure in any nasty weather. Works like magic. \$3.00 per set.

**DISTRIBUTORS WANTED**  
Agents! Salesmen! Dealers! Here is your Big Opportunity! Cash in on the greatest of all minute money makers! Write TODAY for free literature telling you how to get started in BIG PROFITS!  
**RO-TA-TOR, Dept. A-65 6034 S. Mesard, Chicago 38, Ill.**

**AGENTS — SALESMEN**  
OPPORTUNITY TO START YOUR OWN HIGHLY PROFITABLE MAIL ORDER BUSINESS. WORK AT HOME, SPARETIME. NO MERCHANDISE TO BUY OR HANDLE. NO EXPERIENCE OR CAPITAL REQUIRED. EVERYTHING SUPPLIED. SEND POST-CARD TODAY FOR YOUR COPY OF  
**DERROM COMPANY**  
21-03 WHITE, PATERSON 23, NEW JERSEY

**BUY DIRECT SAVE UP TO 60%**  
**FREE WHOLESALE TRADE SECRETS**

**New Low Cost Electric Water Heater Gives You HOT WATER AUTOMATICALLY FROM YOUR PRESENT TANK!**  
Lektromatic changes your water heater into automatic unit. Install in 10 min without draining. Screw-in, plug-in and save \$75 to \$150. Clean, safe as electric light. Temp. adjust 30 thru 180 degrees. Thread is 1" pipe size. UL approved switch-thermostat. 1250 w 110 v \$19.95 (2000 w 220 v \$21.95) Send payment and save ship. or order C.O.D. 10 day free trial. 1 yr full guarantee.  
**Lektromatic Mfg. Co., Dept. PM-6 852 Rogers Ave., Brooklyn 26, N. Y.**

Here it is—a new **UNDERWATER CAMERA BOX** that's tops in quality, yet low in price.  
All parts are corrosion resistant.  
Brownie Holiday Camera included.

**ALL FOR ONLY \$17.95**  
C.O.D., or send check

Send 35c for a complete catalog of professional and amateur diving gear.

**DIVERS SUPPLY**  
6906 COAST HIGHWAY, NEWPORT BEACH, CALIFORNIA

**BUILD 15 RADIO CIRCUITS AT HOME WITH THE NEW IMPROVED 1955 PROGRESSIVE RADIO "EDU-KIT"**  
**ONLY \$19.95 COMPLETE**

• Excellent Background for Television  
• No Knowledge of Radio Necessary  
• No Additional Parts Needed, except Solder & Wire  
• Learn Radio Construction, Theory, Servicing  
• Build Receiver, Transmitter, Code Oscillator, Signal Tracer Circuits  
• Free Soldering Iron, Tester, TV Book, III-Fi Guide, Quiz Book  
• Send No Money With Order—"Edu-Kit" sent on Approval  
• Free Consultation Service

Mail Today — Order Shipped Same Day Received

Send "Edu-Kit" on approval. If satisfied, I will remit \$19.95 plus postage within 30 days. Otherwise, I will return "Edu-Kit," and will owe you nothing.

Send more details on "Edu-Kit" FREE—no obligation.

Send FREE Radio-TV Servicing Literature—no obligation.

NAME \_\_\_\_\_  
ADDRESS \_\_\_\_\_  
CITY \_\_\_\_\_ ZONE \_\_\_\_\_ STATE \_\_\_\_\_

**PROGRESSIVE "EDU-KITS" INC.** 497 Union Ave. Room 5308, PROGRESSIVE BUILDING Brooklyn 11, N.Y.



# Bass Fishermen will Say I'm Crazy . . . until they try my method!



**But, after an honest trial, if you're at all like the other men to whom I've told my strange plan, you'll guard it with your last breath.**

Don't jump at conclusions. I'm not a manufacturer of any fancy new lure. I have no rods or lines to sell. I'm a professional man and make a good living in my profession. But my all-absorbing hobby is fishing. And, quite by accident, I've discovered how to go to waters that everyone else says are fished out and come in with a limit catch of the biggest bass that you ever saw. The savage old bass that got so big, because they were "wise" to every ordinary way of fishing.

This METHOD is NOT spinning, trolling, casting, fly fishing, trot line fishing, set line fishing, hand line fishing, live bait fishing, jugging, netting, trapping, seining, and does not even faintly resemble any of these standard methods of fishing. No live bait or prepared bait is used. You can carry all of the equipment you need in one hand.

The whole method can be learned in twenty minutes—twenty minutes of fascinating reading. All the extra equipment you need, you can buy locally at a cost of less than a dollar. Yet with it, you can come in after an hour or two of the greatest excitement of your life, with a stringer full. Not one or two miserable 12 or 14 inch over-sized keepers—but five or six real beauties with real poundage behind them. The kind that don't need a word of explanation of the professional skill of the man who caught them. Absolutely legal, too—in every state.

This amazing method was developed by a little group of professional fishermen. Though they are public guides, they rarely divulge their method to their patrons. They use it only when fishing for their own tables. It is probable that no man on your waters has ever seen it, ever heard of it, or ever used it. And when you have given it the first trial, you will be as closed-mouthed as a man who has suddenly discovered

a gold mine. Because with this method you can fish within a hundred feet of the best fishermen in the county and pull in ferocious big ones while they come home empty handed. No special skill is required. The method is just as deadly in the hands of a novice as in the hands of an old timer. My method will be disclosed only to those few men in each area who will give me their word of honor not to give the method to anyone else.

Send me your name. Let me tell you how you can try out this deadly method of bringing in big bass from your "fished out" waters. Let me tell you why I let you try out my unusual method without risking a penny of your money on instructions or lures. There is no charge for this information, now or at any other time. Just your name is all I need. But I guarantee that the information I send you will make you a complete skeptic—until once you try it! And then, your own catches will fill you with disbelief. Send your name, today. This will be fun.

**ERIK T. FARE, Libertyville 24, Illinois**

**Erik T. Fare, Libertyville 24, Illinois**

Dear Mr. Fare: Send me complete information without any charge and without the slightest obligation. Tell me how I can learn your method of catching big bass from "fished out" waters, even when the old timers are reporting "No Luck."

Name.....  
Address.....  
City..... Zone..... State.....

## QUICK CASH PROFITS on Imports by Mail Order!

Let me show you how I get up to 1,163 cash-in-advance orders in a day for imports shipped direct from abroad. ALL BY MAIL ORDER. Think! Your own business from home. I show you how to find imports for a "song". How to export too. No investment in merchandise. Big profit opportunity. FREE details. Write today! Mellinger, Importer, Dept. E256, 1717 Westwood Blvd., Los Angeles 24, California

## BIG MONEY FOR YOU IN MONOGRAMMED WORK UNIFORMS

**EARN UP TO \$50.00 A DAY PICKING UP ORDERS**

Hundreds of firms are ready to switch to our new ACRILAN and ORLON Miracle Fabrics that require no dry-cleaning, rarely need pressing, wear like iron! We need men to call and pick up their orders. **NO EXPERIENCE NEEDED** We send you complete Order Kit and Instructions FREE! Build your own fast-growing, repeat business right from your home. If not delighted with earnings after 10 days, return Kit and forget the matter. Write TODAY to Del Bergstrom, Pres.

The Geo. MASTER GARMENT DIV., Dept. 564, LIGONER, INDIANA (Est. 1928)



## BETTER JOB, BIGGER PAY

### Learn How You Can Win A

• Today, choose the career you want and prepare for success during spare time at home. Or if you are in work you like best, start training at once for quick promotion and higher pay. For 58 years American School has helped many, many thousands of ambitious persons to make their dreams come true—important positions, high incomes, job security. List at right contains only a few of many big opportunities we offer.

For FREE career information, send us your name and address and tell us which opportunity subject you prefer. Do it TODAY.

- Accounting
- Architecture & Building
- Automotive Technician
- Bookkeeping
- Business Management
- Civil Engineering
- Drafting
- Electrical Engineering
- Electronics—Industrial
- High School Courses
- Mechanical Engineering
- Plumbing—Practical
- Private Secretary
- Salesmanship—Outside
- Sheet Metal Work

**AMERICAN SCHOOL, Dept. 6A45, Drexel & 58th, Chicago 37, Ill.**  
Canadians: Write American School, 1610 Sherbrooke W., Montreal

# MAKE \$15,732.00 IN ONE SUMMER \$9,504.00 WITHOUT LEAVING YOUR HOME

# DON'T READ THIS!

Unless you are near a healthy fire extinguisher or a plentiful supply of WATER. We cannot assume responsibility if this ad breaks out in ROARING FLAMES. So please do stop reading this until you have taken the necessary safety precautions. Yes, we have an item that's H O T —so H O T that we are not going to say other than the usual words of a good product for fear of setting this

good magazine on FIRE. This product is NEW! SENSATIONAL! COLOSSAL! AMAZING! and REVOLUTIONARY.—NO! No long story—All we have to say, and this is modestly, we have an ELECTRICALLY controlled bulb that is the BEST insect killer CONSOLIDATED RESEARCH has been able to produce—bar none. Not to be compared with any other unit ever sold.

Testimonials like these are pouring in by the hundreds.

"It works like a charm. I am amazed at its results."—Mrs. A. F. Willa, Atlantic City, N. J.

"Your magic bulb has at last solved my roach and fly problem."—Mrs. C. I. Thompson, Miami, Fla.

"Has given my family endless hours of comfort living."—Mr. P. V. Zane, Los Angeles.

You have heard of the 7 Wonders of the World. Now, consolidated research introduces the 8th Wonder, acclaimed a MUST in every home and establishment. Being hailed by salesmen as the biggest MONEY MAKER since the opening of the U.S. MINT.

**ABSOLUTELY EVERYONE**

Now that you have taken the safety precautions, read every word in this ad, as we have said above, this item is **HOT**, so hot that to be extra safe we have ordered the publishers not to use any **RED** ink. Now, getting serious, fellows, here's the scoop. We are going to do **EVERYTHING** to make you the most welcomed salesman to ever approach a customer. We will give you **GLOSSIES, MATS, IMPRINTS**, all the material needed for an immediate mail order set up, also documented test reports of how prominent colleges and testing labs, **RATE** our product, also at your disposal is a powerful pulling pitchman sound T.V. movie on Bug Weapon. The production value of this film cost us more than \$2000.00, **PLUS BELIEVE IT OR NOT** an advertising allowance. We will **PRE-SELL** this Bug Weapon for you, by launching a tremendous advertising barrage, including almost all national magazines, radio, and T.V. The entire population of the U.S. will be put in a buying mood. Especially so since hundreds of insects will help you make every sale. They will dive bomb about him, molest his comfort, interrupt his sleep, destroy his property, and spread contagious diseases about his home, and food. Business establishments suffer enormously combating the ugly insect problem. They will greet you with arms wide open. It's a tested natural with **STAGGERING** public acceptance and mountainous profits. Yes, you will be **WELCOMED**, you will be **THANKED**, most important you will make **MONEY**.

NATIONAL VOLUME SALES CORP., Research Dept. PM-6  
1024 Cottman St. Phila. 11, Pa.

MOSQUITOES SILVER FISH  
MOTHS TERMITES



**New!** 20th CENTURY BUG WEAPON **FREE READ HOW!**

## DEATH

TO DISEASE-CARRYING, DESTRUCTIVE AND ANNOYING PESTS

LICE GNATS  
FLIES ROACHES  
SPIDERS ANTS

## AMAZING NEW INVENTION

### KILLS ALL TYPES OF INSECTS SCIENTIFICALLY-AUTOMATICALLY

### 10-YEAR GUARANTEE

Not a gadget — not a halfway measure. Not to be compared with flimsy, untried imitations: A finished quality appliance. Carries an irrevocable 10-year guarantee and parts replacement policy. Bound by signature.

COST ONLY PENNIES A MONTH TO OPERATE



**STOP**  
FLIES  
ROACHES

**DID YOU KNOW?**

that flies and roaches are suspected carriers of 13 communicable diseases including **POLIO**. One fly can reproduce 8 million others. Flies seldom leave anything without first excreting on it. Don't take chances with your health. **YES**, you can now insect proof your home without lifting a finger. Throw out old fashioned fly swatters, and messy spray guns. A new, small, clean, decorative, little bulb enables you to destroy **HUNDREDS** of types of **INSECTS** like **MAGIC**. Only one 2 hour application keeps killing disease carrying, destructive and annoying insects around the clock for more than 2 weeks. More powerful than D.D.T. yet harmless to humans, pets and plants. Approved **SAFE**. Not a gadget, not a half way measure. Carries a **10 YEAR GUARANTEE**. It must **KILL** not **TICKLE** roaches, flies, moths, ants, and hundreds of others or your money **REFUNDED**. For your health's sake order **SEVERAL** units **NOW**. Everyone send us a check, M.O. or cash for \$2.98—C.O.D.'s accepted. Should you, after testing your unit, decide that you would like to join us in the sales of this new public servant, we will refund your \$2.98 making your unit **ABSOLUTELY FREE**.

**ODORLESS • SILENT**  
**• MYSTERIOUS**

### FREE DEMONSTRATOR COUPON

- Enclosed is \$2.98. Send me one unit for my personal use.
- Enclosed is \$2.98 in cash, check or M.O. Rush me one 20th CENTURY BUG WEAPON with sales aids, and **LOWER** wholesale prices. However, should I become an active salesman, you of the Volume Sales Outlet are to **REFUND** my \$2.98 making my demonstrator **FREE**. Furthermore, I must agree that everything you say be true or I will return everything for a refund.
- Send me **MONEY MAKING** sales kit C.O.D.
- Lost time is lost money. Rush me \_\_\_\_\_ dozen **BUG WEAPONS**, at your wholesale price. Don't forget to include my **FREE** demonstrator and sales aids, C.O.D. (I enclose \$5.00 Deposit.)
- Together with the enclosed order don't forget to show me how to make \$4.37 on each \$2.98. \$15,732.00 in one summer. \$9,504.00 without leaving my home.

NAME \_\_\_\_\_

ADDRESS \_\_\_\_\_

CITY \_\_\_\_\_ STATE \_\_\_\_\_

(Members of the Mail Order Business Bureau)

NATIONAL VOLUME SALES CORP., Research Dept. PM-6  
1024 Cottman St. Phila. 11, Pa.

**ABSOLUTELY EVERYONE MAIL THIS COUPON NOW!**



# CLASSIFIED ADVERTISEMENTS



Advertisements in this section \$1.00 per word, each insertion, minimum 10 words, payable in advance.

To be inserted under proper classification, copy must be in our office the

20th of the second month preceding date of issue

F. W. Johnson, Manager, Classified Advertising

Popular Mechanics Magazine, 200 East Ontario Street, Chicago 11, Illinois

## YOU'LL PROFIT

By reading and answering the classified ads in this section. Hundreds of opportunities for you to make and save money

### AUTOMOBILES, MIDGET CARS

**HOT** Rod cams, equipment catalog, money maker, Rush 25c. Weber Tool, Los Angeles 63.

**\$25.00 REWARD** For discoveries of old-time automobiles, if I purchase same. Condition unimportant. F. Edwards, 839 Marsh Road, Menlo Park, California.

**ANTIQU** Automobile color slides. 2x2. Illustrated catalog free. Universal, Box 779A, Beverly Hills, Calif.

**ENGINES**, Wheels and equipment for midget cars \$10.00 up. Cauffiel Motors, Temperance, Michigan.

**BOYS'** Power-driven auto. Build your own. Complete plans 25 cents. Sypher Co., Box 39, Sta. F, Toledo, Ohio.

### AUTO SUPPLIES AND EQUIPMENT

**AUTOMOBILE** Deodorizer. Guaranteed. \$1.00 postpaid. Satisfiservice, 108 Bishop, Watertown, N. Y.

**PERSONALIZE** Automobiles; Reflecting letters, nickel apiece. Minimum order accepted; 20 letters, one dollar. Iowa residents add two percent tax. Tapelite, Box 802, Sioux City, Iowa.

**AUTOMOBILE** Burglar alarms. Free sample offer. Novak, 3131 W. 13, Gary 16, Indiana.

**TIRES**, First quality. Guaranteed. Unbelievable discounts. Write for quotation stating size. American Tire Co., 155 Truman Street, New Haven, Conn.

**GYPSEY** Sleeper, car top bed, save motel expenses, leaflet furnished. Simonson's, 401 Second S.W., Albuquerque, N. M.

**DUAL** Points in ten minutes with Du-L-Spark. Don't remove distributor. Ford-Mercury \$1.50. Chevrolet six \$2.00. Hove, 5666 Clinton, Minneapolis 19, Minn.

**DO** You park your car and forget to turn off the lights? For less than two dollars you can build a warning device to prevent this. Send fifty cents for plans. Hanson Sales Company, P.O. Box 350, Tacoma, Washington.

**BUY** Wholesale nationally advertised auto supply, thousands other products at big discount. Free "Wholesale Plan," American Buyers, 629-DD Linden, Buffalo 16, New York.

**LACHAPPELLE'S** 100,000 Miles treatment. Makes any car better, for longer. \$3.00 postpaid. Ferns, Box 71827-B, Los Angeles 1, Calif. Free data.

**COMPACT** Auto care kit contains brush, cloth, sewing kit, window scraper, flashlight, screwdriver, bottle opener, pencil and pad. \$2.95 no c.o.d.'s. Lienhardt, 65 Hillside Avenue, New York 40, New York.

**HV** Series injector parts wanted. Bares, 7120 Carnegie, Cleveland 3, Ohio.

**UNIVERSAL** Truck drivers signal book. \$1. Driver to driver communication. Groeclose, Box 1662, Texarkana, Texas.

**SAVE 15%** On 1965 cars. 35% on gas; oil, 50%; tires, 50%; insurance, 30%. Free details. Clifton, Ephrata T-A, Wash.

**GENUINE** Motor treatment, Lachapelle's, (patented). Only \$3.00 delivered. Increases compression, power. Saves gas, oil, repairs. Money back guarantee. You can't lose. Free circular. Write Joe Dillon, Authorized Warehouse and Agents Distributor, Box 323-9 Bridgeport, Ohio. Exclusive distributorships, agencies open.

**CAR** Burning oil? Losing compression? Try Clifford's Compression Seal Tube. \$2 postpaid. Clifford's Engineering, 1329 Seventh, Aurora, Illinois.

**BOSCH** (Germany) sparkplugs—6 cyl. \$5.10; 8 cyl. \$6.80 postpaid. Howard Werts, LaSalle, Ill.

**60,000 VOLTS**. JSMC universal ignition coil. Terrific spark, perfect for super sports, track, truck, farm, marine engines. Enthusiastic users report quicker starting, substantially increased r.p.m. and gas mileage. Cuts oil consumption, allows use of cooler plugs. Only \$15.00, includes condenser, instructions. Specify 6 or 12 volts, 15 day money-back guarantee. Check with order postpaid. Wilson Auto Specialties, 68 Sylvan Drive, Morris Plains, New Jersey.

**HARDTOP** And convertible owners. Save \$10.00 by cleaning your own leather seats. Kit includes cleaning compound and applicator for \$2.49. Oetter Products, 7894 Watson Rd., St. Louis County 19, Mo.

**CHROME** Guard keeps chrome new all year. Brush, cleaner and preservative stop rust! Save money. Year's supply, \$3.50. Regular size, \$2.00. Speed-O-Plast Co., 5721 19th Avenue South, Minneapolis, Minnesota.

**SAVE** Gas with "jetflow" carburetor device. \$4.00 postpaid. Valley, 705 Sixth Street, Clarksdale, Miss.

**WHY** Die? Free auto safety belt literature. Lifesaving Products Co., Box 8076 Northgate Station, Seattle, Wash.

**FREE** Discount catalog. Speed, power, custom equipment. Almquist Engineering, Milford 2, Pennsylvania.

**ALIGN-A-Matic** outperforms all drive over alignment devices. \$22.50. Align-A-Matic, 62 Gaston St., W. Orange, N. J.

**BIG** All-new 1965 speed-sport-chrome and custom hot-rod catalog. Entirely new and different. Illustrating thousands nationally known products at tremendous discounts! Send 25c (refundable). Gotham, 1155 Broadway, New York 1, N. Y.

**SAVE** \$50-\$175 Yearly in car, truck, or any gasoline, diesel engine operation. Install yourself. New patented process prevents, eliminates carbon by cracking gasoline before combustion. Thousands satisfied users! Only \$12.95, postpaid. Money-back guarantee. Send personal check or money order. Worthwhile writing for free information to: Hydrocarbon Systems, 2808 McKinney Ave., Dallas 4, Texas.

**COMBINATION** Magnetic sun visor and memorandum clip. \$1 pair. Sunblotter, Lakeville, Michigan.

**FORD-T** parts. Most complete stock in U. S. for all old cars. Try to stump us. B. S. Wisneski, Milwaukee 7, Wisconsin.

**TAPPET** Noises in Fords, Chevrolets and Mercurys stopped with Kaye Tappet Silencers. Free literature. Kaye Products, 2087E S. Layton Blvd., Milwaukee 15, Wis.

**ELECTROPLATE** Auto parts, novelties, mirrors. Easy, inexpensive home processes. Free booklet. Tyco Metals, Box 13231-BG, Houston 19, Texas.

**AUTO** Accessory and parts catalog. 1955 edition—All new! 148 pages. Save up to 50%. Over 50,000 items, including Hollywood accessories, hi-speed equipment, rebuilt engines, all parts and accessories for all cars and trucks! Hard-to-get parts! Send 25c. Refundable. J. C. Whitney, 1919-PM Archer, Chicago 16, Illinois.

**NEW** And used parts at savings. Complete guaranteed parts service for all models cars and trucks, 1924 and later. Largest in the West. Army parts specialists. No catalog, write for quotations. Fast mail order service. Pioneer Auto and Truck Parts Co., 734 W. 13th Avenue, Denver, Colorado.

**MOTORISTS!** Truck drivers! Stop flat tire worries forever. Free details. Kaybee, Box 863, Chicago 42, Illinois.

**LATEST** Custom accessories. Items not in stores. New low prices. Push button doors, trunks, windows, etc. New illustrated catalog, biggest ever. 25c. Eastern Auto, 3319-A, South Grand, Los Angeles 7, California.

### AUTO TRAILERS

**TRAILER** Parts catalog. Largest in mid-west. Send 25c. Refundable. Hanna Trailer Supply, 615 West Layton, Milwaukee, Wis.

**ASSEMBLE** Yourself kits. Slip-on cabin coach for all pick-up trucks. Trailer blueprints. Boat trailers. Literature 10c. Comstock Trailers, 646-M, Parsons, Kansas.

**DUO-Therm** refrigerated air conditioners for trailers. Installed easily on roof. No water used, operate on a.c. current. Cool-Aire, Box 26181, Los Angeles.

**"SHORT-Short"** family trailer. Simple assembly. Literature 10c. Welch Workshop, 645 Rochdale Circle, Lombard, Illinois.

**TRAILER** Building manual, illustrated \$1.00. Circulars 20c. Craftsmann Books, Box 1153, Milwaukee 1, Wis.

**EXCEPTIONAL** Expanding eight foot trailer. Accommodates family of five. Build yourself. Literature 10c. Framar Company, Wilmington, Mass.

**BUILD** Your own trailer! Plans for all kinds. Illustrated catalog 10c. Jim Dandy, 125-M, Wausau, Wisconsin.













ROUGH Turquoise for cutting. \$1.00 ounce. Santa Fe Gem Co., Santa Fe 1, N. M.

TEN Beautiful highly polished genuine gems. Only \$1.00. Baroque shapes. O'Brien's, 1116-M Wilcox, Hollywood 38, Calif.

GEMSTONES, Mineral specimens. Every variety. Lowest prices. Free booklet. Plummer's, 4720 Point Loma Ave., San Diego 7, Calif.

SAPPHIRE, Topaz, tourmaline, garnet, peridot. 5 uncut gem specimens, \$1.00. O'Brien's, 1116M Wilcox, Hollywood 38, Calif.

GEMCUTTING—Silvercraft illustrated magazine. Tells how to cut gems, make jewelry. 150 ads illustrating equipment, gems for collectors, cutters. Free literature. Lapidary Journal, Del Mar 2, Calif.

### HOBBIES AND COLLECTIONS

50 ARMY Insignia \$1.00. Insignia Mart, 703A Broadway, New York 3, N. Y.

WANTED Old cigarette cards. Write Charles Bray, East Bangor, Penna.

CYLINDER Phonographs, records, parts, sold. Pollard, 4109 Soquel Dr., Santa Cruz, Calif.

NAZI Medals, war books. Illustrated listing. Kingston, 3224-22 W., Seattle 99, Washington.

FASCINATING Color process—Hobby or business. Directions \$1.00. P.O. Box 466, Quincy 69, Mass.

LEARN Fascinating hobbies. 3 issues of club magazine, 25c. Hobbies, Box 83, Redwood City, California.

FREE! Leathercraft catalog. Do it yourself! Tandy Leather, Box 397AH, Tulsa, Okla.

UNUSED Matchbook covers, 100 different \$1.00. 35 page catalog 25c. Match-cover album \$3.00. Charles Edelman, 1311C East 84, Cleveland 3, Ohio.

INVENTING Can be an interesting and profitable hobby. Write for complete particulars. Institute of American Inventors, Dept. 40-E 631-E St., N.W. Washington 4, D. C.

UNUSUAL Hobby: Authentic army patches, insignias, ribbons, enameled crests, navy rates, 50 assorted for \$1.00. Rex Military, Dept. C, 1188 Broadway, New York City.

NAZI Medals, ribbons, armbands, flags, daggers. Big packet, \$1.00. Illustrated lists. Medcrafts, 1923 34th St. S.W., Calgary 2, Canada.

### CAMERAS. PHOTO SUPPLIES

PHOTOGRAPHY For pleasure or profit. Learn at home. Practical basic training. Long established school. Free booklet. American School of Photography, 835 Diversey Parkway, Dept. 3431, Chicago 14.

BUY Wholesale nationally advertised cameras, photo supplies, thousands other products at big discount. Free "Wholesale Plan." American Buyers, 629-RR Linden, Buffalo 16, N. Y.

FREE! Free! Free! Central Camera Co., photographic headquarters since 1899, saves you money on all photographic equipment. Send for Central Camera Co.'s free photographic bargain list today! Central Camera Co., Dept. 6-B, 230 S. Wabash, Chicago 4, Ill.

NEW Argus C-4 camera, flash, case \$73.75. Ronson electric shaver 40% off. Big savings photo equipment, appliances, typewriters. Free catalog. Camera Shoppe, Box 691-Y3, Mt. Vernon, New York.

BRAND New DeJure "300" projector \$50.00. Terrific bargains. Free catalog. Economart, Box 242, Tarrytown, New York.

POLAROID Highlander outfit, factory boxed, \$97.00. Includes camera, flash, meter, carryall case, 6 films. 10c brings catalogue of 1001 amazing values. Dealer's Mart, 54 Beverly Road, New Rochelle, N. Y.

BASS Says: Quality cameras since 1910. When in Chicago visit the camera cross roads of the world, or write us for your favorite equipment, new or used. Satisfaction guaranteed. Bass Camera Co., Dept. AG, 179 W. Madison St., Chicago 2, Ill.

CAMERA Repairmen greatly needed! You can learn manufacturers' service methods at home. In your spare time! Free, big illustrated book tells how: Write today. National Camera Repair School, Dept. PM4, Englewood, Colorado.

20 TO 50% Discount everything photographic, giftware. Catalogue 10c. Dart, 3812 E. Atlantic Avenue, Brooklyn 24, New York.

### PHOTO FINISHING

TRIAL Offer—Special with ad only. Roll developed and 8 jumbo prints 35c. Complete with memory folder. Best quality. Very fast service. Send for free mailers. Crown Photo Service, Box 392, Augusta 1, Georgia.

EIGHT Exposures 40c. Send coin. Holliday Photo Service, 2810 Cleveland Ave., Steubenville, Ohio.

SPECIAL Introductory offer. 8 jumbos 25c. 12—35c. Western Photo, PM85, Box 298, San Francisco 1, Calif.

FAST, Dependable service. Deckled jumbos 8-exp. roll, 35c; 12-exp. roll, 50c; reprints 4c. Postpaid. Whale Film Service, Box 965, Spokane 10, Wash.

ROLL Developed and 5x7 glossy prints, 8 exposure 40c; 12 exposure \$1.20, Hagner, Dept. B, 1318 West Columbia, Philadelphia 22, Penna.

GET All 3! Only Delco gives you same day return, first class mail, fine grain developing at regular prices. Mail any 12 exposure roll with 50c and this ad, or 8 for 49. Delco, Box 362M, Upper Darby, Penna.

SPECIAL. 10 Reprints 25c. 50, \$1.00. Dick's Photo, Louisville 12, Ky.

PHOTOCOPIES. 3 5x7 or 2 8x10 enlargements from any picture. \$1.00. Original returned. Lindsey Lane Studios, Box 40, Rydal, Penna.

12 OR 16 Exposure jumbo in booklet 50c. Free mailer. Jet Photo, Box 11, Dept. PM, Brooklyn 12, N. Y.

12 JUMBOS From any size roll developed 25c, with this ad only. S. Skrudland, Lake Geneva, Wis.

FREE Film! Write for free mailers. Vets Film, Montalvo, California.

GIANT Photos 30x40 \$4.50. PhotoRama Studios, 129 1st St., Bethpage, N. Y.

TRIAL Offer—Good with ad only. One roll film developed, 8 exposures 25c, 12 exposures 35c. King sized, dated prints from roll only. Don't send negatives. Sir Walter Photo, Raleigh, N. C.

ENLARGEMENTS! Eight 5x7's or five 8x10's, \$1.00. Wilart Enlargers, Box 957, Little Rock, Ark.

12 EXPOSURE Rolls 39c, jumbo prints. Guaranteed work, one day service. Lincoln Studios, Dept. K, Box 13, Lincoln, Nebraska.

PARTICULAR? Custom finishing guaranteed. 8 jumbos 35c, 12—50c. Special! 35mm. 38 exposures \$1.10. Free mailer. Flash-Photo, Box 36G, Brooklyn 4, N. Y.

GUARANTEED Quality. Fast service. Eight jumbos in beautiful super pak plastic ring binder albums only 35c. Send for free mailers and particulars of our complete photo finishing service. Grand Fotos, G.P.O. Box 1410, New York 1, N. Y.

TWO Beautiful enlargements from each picture on roll—8 exposures 55c, 12 exposures 75c. Cut Rate Photos, Dept. B-4, Janesville, Wisconsin.

TOP Quality. Fast service. 8 jumbos 35c in beautiful super pak album. 16 contacts 40c. Reprints—Jumbos 4c; contacts 3c. Satisfaction guaranteed. Write for free mailers and circulars. Fast-X-Photo, Box A, Jersey City, N. J.

6 OR 8 Picture roll 35c. 12 or 16 picture roll 55c. Each roll developed and printed in handy album pack. Send coin with roll. No c.o.d.'s. Mailing containers sent free. Deluxe Film Service, Box 1268-A, Shreveport, Louisiana.

CAMERA-Shop quality—Prompt service. Films developed and printed—8 exposures at 50c, 12 exposures at 75c, 16 exposures at \$1. 20 exposures 35-mm. at \$1.25, 36 exposures 35-mm. at \$2. All 35-mm. fine grain developing. These prices for contact or oversize, just specify which. All reprints 5c. Bel Air C Photo Service, P.O. Box 8597, Philadelphia 4, Penna.

JUMBO Prints, 8-exposure roll 30c; 12 exposure, 45c; 16 exposure 55c. Reprints, oversize 4c. Guaranteed quality. We do color. Mail Order Photo Service, Box 297, Watertown, Wisconsin.

ROLLS Developed and 2 prints each, 30c with this ad. Capital Photo Co., Raleigh, N. C.

TWO Beautiful prints from each picture on roll. 8 exposure 40c; 12 exposures 50c. Thirty four years of satisfied customers. Quick Service. Lens Photos, Dept. J-4, Janesville, Wis.

### MOTION PICTURES AND SOUND EQUIPMENT

FREE Catalog, 8 and 16 mm. films available. Best Rate Sales Co., P.O. Box 357, Times Square Station, New York 36, N. Y.

EARN Up to \$15.00 daily with your movie projector! Metcalf, 16806 Glenroy, Chicago.

1 1/2" REVERE Fx 5 foc. telephoto lens, fits all 8mm. cameras, (Reg. \$57.75). Our price \$39.00. 1 1/2" fl. 4 foc. (Reg. \$92.50) \$52.50. Factory boxed, 10c brings catalogue of 1001 amazing values. Dealer's Mart, 54 Beverly Road, New Rochelle, New York.

8-16MM. Silent-sound films. Latest subjects. Free catalogue, sample film 10c. Garden Film, 690 Howard Ave., Brooklyn, N. Y.

8 AND 16MM. professional national parks movies in Kodachrome. List free. Ideal Service Supply, 4644-PM Geary, San Francisco 18, Calif.

16 MM. Sound-used projectors and films. Rental, sale, exchange, bargain prices. Free lists. National Cinema, 71 Dey Street, New York City.

TAPE Recorders, tapes, accessories. Unusual values. Dressner, Box 66M, Peter Stuyvesant Station, New York City 9.

5,000 8-16MM. Silent-sound films. International, 2120 Strauss, Brooklyn-12.

MOVIE Camera film: 8mm. roll \$1.50, 16mm. 100' \$3.00. Free processing. Better Films, 742 New Lots, Brooklyn, N. Y.

SAVE 50%! Guaranteed-fresh color, b.&w. movie film! 8mm., 16mm. Free catalog! Eso-R, 47th Holly, Kansas City 12, Missouri.

WILD Animal and bird movies, 8 mm. or 16 mm. beautiful color or B&W. Also 2x2 color slides. Send for free catalog. Wild Life Films, 5151-A Strohm Ave., N. Hollywood, Calif.

TAPE Recorders, accessories. Best buys. Boynton Studio, 10M Pennsylvania, Tuckahoe, N. Y.

### MUSIC AND MUSICAL INSTRUMENTS

SWISS Musical movements, \$1.90. Helax, 218 West 72nd Street, New York 23.

ACCORDIONS. Buy direct from importer. Save 50% and more. Five days free trial; lifetime guarantee. Trade-ins accepted. Big color catalog free. Write today. Accordion Manufacturers & Wholesalers Outlet, Dept. 65-R, 2003 West Chicago Ave., Chicago 22, Illinois.

SONGWRITERS: Large recording company may record your song. National sales and promotion if selected. No charge for melodies. Send song material to Music Makers, Dept. E-10, Box 2507, Hollywood, Calif.

SONGWRITERS—Success, fame, fortune if talented. Songs revised, composed, published, promoted by largest firm. Free appraisal. Since 1943. Postcard to Nurdyke Publishing Co., 7970 Hollywood Blvd., Hollywood 28, PM, Calif.

PHONOGRAPH Records 20c. Catalogue. Paramount, MA-313 East Market, Wilkes-Barre, Penna.

SONGWRITERS. A combination offer of a piano arrangement and a recording of your song. For particulars write: Angelo Musolino (Ascap), 29 Fifth Ave., New York 3, N. Y.

RADIO Song folio, words and music, one dollar. King's Studio Music Publications, 4136 Peak Street, Toledo 13, Ohio.

RETIRED Church organist composes beautiful music to sacred words. Reginald Belcher, Terrace Place, Morristown, New Jersey.

GUITAR Free to those who enroll. Play first day. World's fastest method. Diploma awarded. National, N4 Bernard, Spokane, Wash.

POEMS Needed for new songs. Send poems for free examination, details. Immediate consideration. Songcrafters, 2724 Arcade Station, Nashville, Tenn.

1955 ACCORDIONS — Wholesale. Free catalog. American Accord. Center, PM-3, 5329 Belmont, Chicago.

**SONGWRITERS!** Send poems, songs. Music Service, 243 West 72nd St., PM, New York City 23.

**FREE** Records of your song. Your words, my melody. Free information. Johnny Mack's Melody Mart, 1094 West 39th Street, Dept. A, Los Angeles 37.

**POPULAR** Songs. How to write and sell them. Write for free booklet Successful Songwriting. Gateway Songs, Box 2470, Hollywood 28, Calif.

**WANTED!** Poems for musical settings. Write Songwriters' Service, Clifton, N. J.

**ACCORDIONS**, Wholesale to everyone. Save up to 60%. All national known brands. Free catalogue. Del Principe, 29 South Cicero, Chicago 44.

**SONGWRITERS!** Protect your ideas! Hold all songs, poems! Write for safe correct procedure first! Song Service, Dept. P, 333 W. 56th St., New York 19, N. Y.

**POEMS** Wanted for musical setting. Send poems. Free examination. Five Star Music Masters, 630 Beacon Bldg., Boston, Mass.

**WRITE** Songs. Big money and reputation. Write for information. J. Gordon Pub. Co., 4760 South California Avenue, Chicago.

**POEMS** Wanted for musical setting. Send poems. Free examination. Crown Music Company, 1476 Broadway, New York City 36.

**POEMS** Wanted to be set to music. Free examination. Send poems. McNeil, Master of Music, 510-PM S. Alexandria, Los Angeles, California.

**VIOLINMAKERS**, Repairers. Fine tone wood, and all violin supplies. Send for free wholesale price list. International Sales, 414-M E. Baltimore St., Baltimore 2, Md.

**WHOLESALE!** Complete line musical instruments, phonographs, tape recorders, typewriters, watches, diamond rings, appliances, etc. Discounts to 75%! Send 25c (refundable) for large catalog. Strauss Music Company, 25-10 Lafayette, Paterson 23, New Jersey.

**PLAY** Piano the first day! Copyrighted secret. Details free. Miracle Method, Box 5203P, Phoenix, Arizona.

### RADIO, TELEVISION AND ELECTRONICS

**BUILD** 15 Radio circuits at home—Progressive Radio "Edu-Kit" only \$19.95 complete. Free electric soldering iron and radio tester with "Edu-Kit." No radio background required. 30-day unconditional money back guarantee. Order direct or send for free descriptive literature, no obligation. Valuable radio and TV repair guide sent on request, no charge, no obligation. Progressive "Edu-Kits" Inc., Room 30-B, Progressive Building, 497 Union Avenue, Brooklyn 11, N. Y.

**PERFECT** TV pictures, UHF-VHF, all channels, all directions, without motors. Send for free catalog on motorless Directronic antenna, other radio-TV bargains. National Electronics, Dept. P-6, 6666 Euclid, Cleveland 3, Ohio.

**WHOLESALE** Tape recorders, radios, phonographs. Towers, 935 North 40th, Philadelphia 4.

**CRYSTAL** Set hobby book. 132 illustrations, charts, circuits. Over 18,000 words. Refund guarantee. \$1.00. Kott, 5626 St. Clair, Detroit 13, Michigan.

**CRYSTAL** Radio experimenters. Write Leslie Hulet, 305 Hope, Lakewood, N. J.

**REPAIR** Your own TV. Instructions compiled exclusively for your set. Simple as replacing light bulb. Send set name, chassis, model number. \$3.00. L&S Engineering Company, Box 4113-PM-6, North Hollywood, Calif.

**CRYSTAL** Radio. Wired, sensitive, loud-est, guaranteed, 80c. Cozzo, 1080 Ovington, Brooklyn 19, N. Y.

**TELEVISION** Manual \$1.00. Explanations by steps throughout receiver. Bursha, 918 Bath, Ann Arbor, Michigan.

**DUOSCOPE** TV antenna. Shipped anywhere \$4.50. Box 333, Lodi, N. J.

**SUN** Battery powers transistors. Free details. Strong, 601D E. Centre, South Pasadena, California.

**HANDBOOK** Plans "20 Long Distance Crystal Sets" 50c, including "Radiobuilder" magazine. Laboratories, 328-C Fuller, Redwood City, California.

**WALKIE-TALKIE**. Build a real wireless two-way portable radiophone for less than \$10.00. Plans 50c. Springfield Enterprises, Box 54-B6, Springfield Gardens 13, New York.

**"TELEVISION — How It Works"** and "Simplicity of Radio." Both books 35c. Franks Book Service, 3121 So. Racine, Chicago 8, Illinois.

**GOVT.** Surplus electronics: Radar, walky-talkies, receivers, transmitters, components priced from 35c. List 3c. Meshna, 580 Lynn, Malden 48, Mass.

**MAKE** Simple, tubeless, batteryless, distance-getting radio. Genuine Melomite crystal, detector, illustrated instructions. 50c postpaid. Allen, 427-PM5, Clinton, Missouri.

**TV** Trade-in sets. Philco, Emerson, G.E., Admiral, Motorola, Tele-King, others. List available. 10"—\$17, 13" to 17"—\$20 up. Washtek Service Co., 1501 Boston Rd., Bronx, N. Y. DA 3-9281.

**ENJOY** Color television now! Non-inflammable multicolor screens for all black-white sets. Complete details free. Zingo Products, Johnstown 78, New York.

**BUILD** Super crystal radios. Electrotonic crystals, detector, instructions, 50c. Electrotonics, Box 98M, Dixon, Missouri.

### BUSINESS OPPORTUNITIES

**BECOME** A game warden, professional hunter! Join forestry, park, fishery services. Good pay! Opportunities open! Free revealing "Select-Job Chart," details, job-getting secrets. Write Home Study Institute JE, Los Angeles 19, California.

**BUYING** Ginseng roots has been our specialty for 50 years. Write for free price list and shipping tags. Snowiss Fur Company, Williamsport, Penna.

**START** Your own business on credit. Your own boss. 1135 of our dealers sold \$5000 to \$30,000 in 1954. We supply stocks, equipment on credit, 200 home necessities. Sales experience unnecessary. Pleasant profitable business backed by worldwide industry. Write Rawleigh's, Dept. F-U-PPM, Freeport, Ill.

**ADVERTISING** Book matches—Cash in on big demand; sell union label matches. Cuts for all businesses and political parties. Free powerhouse selling kit, low prices, protection guaranteed on repeat orders. Cash commissions. Superior Match Co., Dept. MX-655, 7530 Greenwood, Chicago.

**WHOLESALE**, Thousands items. Supply source list, 10c. Idealer, Park Ridge, Ill.

**BIG** Profits weaving rugs. Send 10c for our catalog, sample card, and low prices on carpet warp, rug filler, looms, parts, inexpensive beam counter. If you have loom, give make, weaving width please. Or. Rug Company, Dept. 6538, Lima, Ohio.

**SELL** To stores newly invented flashlight, has six colored bulbs. Thousands of uses, millions of customers, sells itself. Make money up to \$500 weekly. Dealers wanted immediately. Write Turner Company, 1170 Broadway, New York 1, N. Y.

**DOLLARS** Every day! Amazing new mail order business. Anyone can operate. I furnish complete plan and practically everything needed. MB, 405-P Gorham Bldg., Minneapolis 3, Minn.

**\$1000** MONTHLY Possible in collection agency business. Free details. Write Cole Associates, Syracuse 2, N. Y.

**GROW** Herbs and spices at home (many rare and unusual). Make 101 useful and salable products. Big profit orders come from neighbors, gift shops, restaurants, etc. Also mail orders. Window box supplies household needs. Successful home grower shows you how. Free, full details. Herb Center, 601-CH So. Vermont Ave., Los Angeles 5, Calif.

**GROW** Orchids at home—Profitable, fascinating. Year 'round, Maine to California. No greenhouse. Gorgeous cactleyas, cymbidiums, etc. Successful home grower shows you how. Full details free. Flowerland, 4623-PR Wilshire, Los Angeles 5.

**FREE** "301 Profitable Small Businesses!" Amazing shoeing plans! Work home! Start sparetime! Deumant Surveys, Kenmore 23-R, N. Y.

**EXPORT**. Career/profitable hobby. Wade, 8/119 Hamilton Terrace, London N.W.8, England.

**RUN** Cafe, diner. Free booklet reveals opportunities open, how to get started. Restaurant School BU16, Fremont, Ohio.

**OPERATE** Profitable magazine subscription service. New telephone plan. Handle renewals for all magazines. No experience or investment needed. Rush name; send no money. McGregor Agency, Dept. 500-B, Mt. Morris, Illinois.

**BE** Your own boss. Start profitable home business. Minimum investment. Details free. L. O. Lewis, Fremont, Michigan.

**EXTRA** Dollars for you. No investment. Get paid for information. Details free. Howell, 1320 St. Andrew, New Orleans 13, La.

**\$1000** EXTRA This year selling famous Iroquois red wigglers to fellow fishermen? We put you in business. Free information. Earthworms, 1521-D Colonial, Macon, Ga.

**MEN** Wanted—Build luggage and cases at home. We sell your products, supply complete instructions, materials, everything. No special equipment needed. Free details. Cascraft, 805-G18 Sunset, Los Angeles 12, Calif.

**START** A buying service, buy wholesale thousands nationally advertised products. Make big profits selling at sizable discounts. Postcard brings details. American Buyers, 627-R Linden, Buffalo, N. Y.

**LIQUID** Marble—Brushed, sprayed! Mold novelties, tile. Particulars free. Marbleizing Service, Edwardsville, Illinois.

**CO-Publish** "giant" magazine. Details, sample 10c. Miller, 712 Clinton Court, Findlay, Ohio.

**FABULOUS** Southern California offers jobs, homes galore. Giant employment or real estate classifieds airmailed, \$1.00 each. Order both and receive free map. Westguide, Box 3044-C, Santa Ana, Calif.

**LEARN** Sharpen scissors. Profitable, easy instructions, \$1.00. Box 85, Bronx Central P.O., New York 51, N. Y.

**WANTED!** Home producers, by manufacturers in our clearing house service. Become subcontractor, casting plastic products for these companies. Thousands of easy-to-make items required for consumer-industrial use. Cash in at home, without previous experience. Plastic Service Associates, Dept. 6-PM, East Boston 23, Mass.

**FREE** Details. Buy direct from mfrs., jobbers, thousands agents, dealers items. Local, mail selling plans included. Cottage Industries, 2804-A Hanover, Omaha 12, Nebr.

**OPPORTUNITY** Seekers names 60 days old. All seeking ways to make money at home. 1,000, \$8.00, typed on gummed labels; two copies \$10.50. Ken-West Distributors, 7-KB South Harlem Street, Worcester 4, Mass.

**PRINT** Without a printing press! Amazing new method! Print colorful signs, banners, cards, posters, glasswear; anything at home. Big profits. Money-making opportunity! We supply everything. Beautiful sample, home-business plan free! Write Screen-Print Company, PM-6, Los Angeles 61, California.

**WINNING** Mail order plans. Merchandise, books. Details free. Mid-State, Box 214-A Syracuse 1, N. Y.

**MILLIONS** Will be made in mail-order this year! Free success information. McCairns, Box 432-P, Detroit 31, Michigan.

**FRANCHISES** Make profits! Exclusive distributorships, agencies available nationwide. Information rushed. National Franchise Reports, 333 North Michigan Avenue, Chicago 1, Illinois.

**\$70** WEEKLY Guaranteed, home, spare time. Simplified mail bookkeeping. Immediate income—easy! Auditax, 34757AL, Los Angeles 34.

**MAKE** Durable building plastic, easily. Beautiful, tough—101 uses. Exclusive district. Unlimited demand. 800% profit. Bays Laboratory, Oklahoma City 9.

**TWO** Giant wholesale catalogues, \$1.00. Refundable. Seiler's, 119 Ave. D, S.E., Winter Haven, Fla.

**WHOLESALE**. Name brand merchandise. Sell on terms. Sample display and catalog supply furnished free. Encore Industries, Box 247, Midland, Michigan.

**MONEYMAKING** Mailorder business plan, free! Write, George Lenhoff, Lincoln 8, Nebraska.

**MAKE** Mystery color changing plaques, souvenirs. Simple, profitable. Hoffmans, 225 Republic Bldg., Miami 32, Florida.

**TRADE-Business magazines help you get ahead.** Late single copies. More than 5,300 publications—all fields. Current list free. Commercial Engraving Publishing Company, 34C North Ritter, Indianapolis 19, Indiana.

**VITAMINS!** Terrific profits! Direct and mail sales to homes, offices, stores and get your own needs wholesale. Details free. VimVite, 2908PM Beverly, Los Angeles 37.

**BUY Wholesale famous brand products.** Sell friends at discount. Catalog \$1.00 (refundable). Davis, 759-K Tilden, Flint 5, Mich.

**NEWSPAPERS.** Turn them into cash. Eighteen methods. Instructions 50c. Charles Company, 12-DEB, Norwood, Ohio.

**EARN \$2.00 Hour!** I do—Making sandals. Youngs, 1308-PM, South First, Arcadia, California.

**NEW 1955 Catalog** nationally advertised merchandise. Rush 50c for catalog to Edward Clemens, 318 W. Bridge St., Morrisville, Penna. (Refundable.)

**THOUSANDS Items** wholesale catalog \$1, refunded first order. Opportunity, Box 142, Basking Ridge, N. J.

**MINIATURE Trees.** Why pay \$2.00-\$10.00 for growing secrets? Free details. Tiny Trees, 5038 N. Winthrop, Chicago 40.

**MAKE Perfumes, other products.** Sell mailorder. Formula catalogue free. International, 6347 Parnell PM-6, Chicago 21, Illinois.

**BIG Profits** with your imagination. Start national business from home promoting your own products or ideas. Details free. Banning A2, 40 South Los Robles Avenue, Pasadena 1, California.

**WHOLESALE!** 12,000 Nationally famous products! 30-80% discounts! Sensational plans, small catalog free. Derron Company, 21-11 White, Paterson 20, N. J.

**MAKE Big money at home!** Invisible re-weaving pays up to \$10.00 profit in an hour. Make tears, holes disappear from fabrics. Constant demand from laundries, cleaners, homes brings steady earnings. Details free. Fabricon, Dept. AE, 6342 S. Prairie, Chicago 19, Illinois.

**LEARN Sewing machine repair.** How to make big money at home sparetime. New machines. Everything supplied. Write Taylor Service, Box 2126, San Bernardino, California.

**HIDDEN Mailorder markets**—Puerto Rico, Alaska, U.S.A. possessions. Everything furnished for sizable income. Harold, 69 Bennett, New York City 33.

**SELL Popular Mechanics** and all other magazine subscriptions. Free catalog, supplies. Subscription Service Company, Dept. A., P.O. Box 2070, Birmingham, Alabama.

**\$26,500 SALES** in two weeks! Amazing radio-mail order method. Free details. Broadcast Service, 1412-Q Great Northern Building, Chicago 4, Illinois.

**LIFETIME Business** at home. Operate Venetian blind renovating service. Manual \$1.00. Heam, Box 8892, Richmond 25, Va.

**"MAKING Money With Mushrooms."** Simplified book. \$2.00 cash. Money back guarantee. Mushroom Lab., 32 Kendrick St., Lawrence, Mass.

**MAKE Money** helping others get out of debt, stop garnishments, save jobs, re-establish credit. Details. Borum R6, 411 West Walnut Street, Kalamazoo, Michigan.

**\$80.00 WEEKLY.** Operate our selective mailorder business in your area, sparetime. House of Plastics, Mailorder Division, Paramus 19, New Jersey.

**ROACHES.** Raise for profit. Complete instructions \$1.00. Fisher Enterprises, Brighton, Tenn.

**SECURITY** Through export business. Expect something different. Complete setup from idea to success. Hermes, 152 West 42, New York City 36.

**WANT Up to \$100.00 weekly** deposited in your mail box? Mail order! Details free! Aldensmith, 2708-P Ladera, San Bernardino, Calif.

**PHOTOGRAPHY Hobbyists!** Start profitable full or sparetime business from home on shoestring. Free details. Sandi Sales, 2150 Sylvan Circle S.W. B-3, Atlanta, Ga.

**GLASS Bottles.** Turn them into cash. Nine methods. Instructions 50c. Fender, Box 448-ABM, Kalamazoo, Mich.

**PRODUCT Manufacturer**—Large, metal manufacturing plant equipped to expand, develop new products, inventions or supplement production. 43 years industrial experience. Arlington Corporation, 344 Hamm Building, St. Paul, Minnesota.

**PROFITS! Opportunities!** Illustrated catalog \$2.00. C. Smith, 843 East 95, Cleveland 8, Ohio.

**\$1000 CONSIGNMENT.** Automotive and industrial lubricants, if you qualify. Other products available. Dealerships and distributorships. Full or part time. \$1 deposit to: Delray Industries, Box 6271, Tulsa, Oklahoma.

**READ "Mailorder Laws and Regulations."** Discusses federal, state, and local licenses, permits, taxes, legal requirements, etc. governing mailorder businesses. Play safe. Order today. Only \$1.00. Tasker, 105 East Custis Avenue, Alexandria, Virginia.

**SAWDUST.** Turn it into cash. Twenty methods. Instructions 50c. Fender, Box 448-ABF, Kalamazoo, Mich.

**YOU Can be president** of your own company without capital or experience. We ship orders under your name, supply catalogues, etc. Postcard brings booklet "Ten Ways to Make Money in Your Own Business" absolutely free. Topval, Lindenhurst 318, New York.

**\$1 PAYS \$16.00.** Enclose \$1 bill, receive charges prepaid materials for making \$16 worth sensational new tire cleaning discovery. Lifetime opportunity. Money-back guarantee. Waldrop-Southard Mfg. Co., P.O. Box 3755 W.E., Birmingham, Ala.

**TIN Cans.** Turn them into cash. Twenty methods. Instructions 50c. Fender, Box 448-ABA, Kalamazoo, Mich.

**BUY Wholesale!** 100,000 name brand products! Save 66 $\frac{2}{3}$ %! Big profits selling others spare time! Free details. National Buyers Service, Box 426EE, Oakland, Calif.

**OWN Business** with post cards and drop shipment. Folio tells all. 50c. Tom Cox, Box 209, Clinton, Tenn.

**THIS Is it.** Sell by mail or direct. Korkit, tire fluid, puncture seals inner tubes. Formula \$1.00. Manufacture Korkit, or sell formulas for us. Wholesale price 100 Korkit formulas \$10. Get started today. Otto Wandrie Printing Co., Frazee, Minn.

**LIVE As you want to.** Be independent. No boss. Samples, details, \$1.00. Fender, Box 448-ABN, Kalamazoo, Mich.

**HANDY Men** in small towns! Assemble and sell the finest three channel aluminum combination storm window. Work full or part time. Your cost,  $\frac{1}{3}$  of retail price. \$100 starts you in business. All-Time Mfg. Co., Dept. M2, New Britain, Conn.

**\$5 TO \$10 An Hour.** I've did it. I'm disabled now. Real genuine offer. Complete information only \$1. Lucas, 2200 Carson St., Pittsburgh 3, Penna.

**IMMEDIATE Income** in your own business selling packaged products for Illinois Screw & Nut Company, 2857 N. Halsted Street, Chicago 14, Illinois. Literature free.

**MAKE \$10,000 Year** and more with 2 great wholesale catalogs (64 and 300 pages). Appliances, homewares, jewelry, furniture, sporting goods, toys! Free catalog plans! General Wholesalers, Box 3058EH, San Francisco.

**WE'VE Got a highly unusual deal** for you on a new line of fire extinguishers. This is a new company, but you'll recognize the men behind it, who have had more than 20 years' experience in this field, when you write us, and it might pay you well to airmail us today. The Fire King Company, Inc., Dept. 12, Littleton, Colo.

**FREE Valuable stock information** to guide you in investing your money intelligently and profitably. Send 10c for postage and handling. Moss Associates, 2 East 23rd Street, New York 10, N. Y.

**IMPORT-Export opportunity,** profitable, world-wide, mail-order business from home, without capital; or travel abroad. Established world trader ships instructions for no-risk examination. Experience unnecessary. Free details, Mellinger E701, Los Angeles 24.

**GET More orders** with our imprinted circulars. Flinson, 708G East 19th, Kansas City 8, Mo.

**START Home gift shop.** Investment about \$40.00. Woodcraft, Box 207-1, Whitehall, N. Y.

**WHAT'S New** in mailorder? Let "Mail-order World," published monthly, keep you informed. Sample, 25c. Wayte, 1233 Elden, Los Angeles 6, Calif.

**REBUILD Batteries;** repair dolls; make rubber stamps; silk screen printing. Catalogue "60 Ideas" free. Universal, Box 1076-A, Peoria, Ill.

**DOLLARS!** Baby record books, Kitty Kat shoes, Hollywood souvenir cards, eleven thousand new prospects daily. Sold by mail, use our literature. No-Co-Ro, Oakland 6, California.

**RECAST Old batteries** into new. Latest achievements. Battery Laboratories, Minneapolis.

**100% PROFIT Earned** with a PDQ camera. No experience needed. Simple instructions teach you how to take photos of individuals, groups, etc. and finish them on the spot in two minutes. No darkroom. Get details. PDQ Camera Co., 1161 N. Cleveland Ave., Dept. PM, Chicago 10, Ill.

**BREED Rare tropical fish** at home. Earn big money! Learn secrets! Help fill huge demand. Amazing opportunity! Free plan. Tropical Fish Breeders, Los Angeles 61, Calif.

**HOW And where** to obtain capital. Particulars free. Star Service, Wapakoneta, Ohio.

**TO \$50.00 Weekly.** Sparetime, home operated mailorder business. Successful beginner's plan. Everything supplied. Lynn, 10420-M National, Los Angeles 34, Calif.

**ARE You mechanically inclined?** Amazing home business pays wonderful profits. Free book tells all. Belsaw, 34-B Field Bldg., Kansas City 11, Mo.

**BE Appointed state notary public now.** Write. Stationers, Helotes, Texas.

**FOR Proof** of what you can do in specialty manufacturing, get our literature. It's free! Miller, Chemist, 1517-H, Tampa, Florida.

**MAKE Money at home!** Mail letters featuring select merchandise. 100% profit. Amazing returns! Dollars every mail. Nu-Way Enterprises, Box M747, Detroit 31, Michigan.

**I Want to send you proof** of the wonderful pulling power of Popular Mechanics classified pages. What's your proposition? Write me today. Include literature if possible. F. W. Johnson, Manager Classified Advertising, Popular Mechanics Magazine, 200 E. Ontario St., Chicago 11, Ill.

**"TIMELY Tips Magazine,"** Paulding 3, Ohio, publishes moneymaking ideas, plans, opportunities, formulas, each monthly issue, 30th year, \$2.00. Sample copy 25c.

**BRUSH Plating outfits** connect to a battery, no tanks necessary. Your opportunity to make good income silvering mirrors, plating articles in the shop and home at low cost. Free particulars. Gummetal Co., Ave. H, Decatur, Illinois.

**COLOR Concrete** with chemicals. Marble-glass cement benches, pottery. Start: home, shop. Hundred beautiful designs: birdbaths to waterfalls. Your chance for fame, fortune. 10c brings sample, pictures. Hollywood Cementcraft, 8527-R Wonderland, Hollywood 46, California.

**FORTUNES Made** raising crickets and fishworms. Write for free information. Carter Farms, Plains, Ga.

**MAKE Money** growing miniature trees on your window sill. Free seed and plan. National Nursery, Dept. FC, Inglewood 4, Calif.

**FREE Folio "Up to \$45,000; Unlimited Vacations."** No merchandise, equipment. Unknown! Work home, sparetime! Haylings, Carlsbad, Calif.

**FREE Electroplating information.** Money making plans. (Formula included). Send postcard for your copy. Highly paid, interesting, uncrowded field. Plater D. Hyde, 327 West 120th Street, Los Angeles 61, California.

**MONEY** in sparetime fixit shop at home. Repeat cash business. Experience unnecessary. No selling. Free booklet explains. Victor Foley Company, Columbia Heights, Minnesota.

**BOOKKEEPERS,** Increase earnings operating sensational bookkeeping service. Kern, 5632 Lankershim, North Hollywood, California.

**WE Love our mailman—He leaves over \$1000.00 monthly in our rural mailbox. My college professor husband drafted a scientific home mailorder method. We bought a Texas ranch, live as we always wanted. Now we sell the Ranch Mailorder Method. Operates anywhere. Inquire: Eveningshade Ranch, Helotes, Texas.**

**POPCORN** And potato chip equipment. Ekins, Box 933-A5, Springfield, Ohio.

**LIQUID Rubber.** Make flexible molds. Free sample. Chaney, 1130 E. 16th St., Jacksonville 6, Fla.

**MEN—Income** from local information. No selling. Neberco, LaVerne, California.

**RUBBER Molds** for casting plaques, figurines, novelties. Catalog illustrating over 100 fast sellers, 10c. Castcraft Studios, 308-PM Marion Street, Brooklyn 33, N. Y.

**NEWEST Spare, full-time home business.** \$5 to \$10 hour possible. Paint with suede—The finish with touch and eye-appeal. Beautifully auto dashboards, signs, radios, toys, figurines, lamps—1001 others. Complete, step-by-step instructions sent for no-risk examination. Free details. Coast, Los Angeles 61.

**START Home manufacturing business.** Make cleaners, soaps, polishes, cosmetics. Free literature. Kemix, Park Ridge, Ill.

**IMPORT-Export mailorder opportunities!** Details. Warner, Box 6, Fort Scott, Kansas.

**NATURAL Molding rubber, extra thick.** Free sample. Flock, W. Wooley, 115-A Donald, Peoria, Ill.

**ELECTROPLATE** Auto parts, novelties, mirrors, baby shoes. Easy, inexpensive home processes. Free booklet. Tyco Metals, Box 13231-MM, Houston 19, Texas.

**BOOKKEEPERS.** Keep books, small firms spare time. Manual latest technique by C.P.A., \$3.00. Modern Business, Box 406, Youngstown 1, Ohio.

**MAKE Money at home—Mail cards, circulars feature real merchandise.** Everything furnished. Big earnings. Philip's, Box 3-P, Boston 22, Mass.

**COPUBLISH Mail Sale Advertiser,** leading mail order paper. Details, latest copy, dime. Vanroy Shirk, Lebanon, Penna.

**GROW Mushrooms.** Cellar, shed, and outdoors. Spare, full time, year round. We pay \$3.50 lb. We paid Habbitt \$4,165.00 in few weeks. Free book. Washington Mushroom Ind., Dept. 172, 2954 Admiral Way, Seattle, Washington.

**PLASTERCRAFT Molds.** Liquid rubber, plasters, floccs, candle supplies. Catalog and manual free. Blue Rapids Supply, Blue Rapids, Kansas.

**BUY It wholesale!** Manufacturers, distributors offer 850,000 items. Literature free. Olsen, 1231-A East Third St., Duluth 5, Minn.

**\$25 WEEKLY** Working two hours daily at home. Lycke, Box 2471-A, Cleveland 12, Ohio.

**RESILVERING Mirrors,** formula 50c; two-way lookout mirrors. (No one sees you). 50c; coppered mirrors. 50c. All \$1.00. Nelko-Mir. Box 3462-J, Chicago 54.

**OPERATE Profitable mail order business.** Write Walter Service, 4159-A East 112th, Cleveland 5, Ohio.

**MINK Raising information free.** Complete. Lake Superior Mink Farm. Superior, EEL, Wisconsin.

**COLORGLAZED Concrete** pottery made without molds. Patented method. Cemetery products, novelties, tiles. Basement leak-sealing. Money-making projects. Booklet, details free. Men only. National Potteries Company, Grand Rapids, Minnesota.

**FREE Book "505 Odd, Successful Businesses,"** Work home. Expect something odd! Pacific, Oceanside, Calif.

**FIX Typewriters.** Free booklet describes our modern, inexpensive home-study course. Factory methods taught. Write Typewriter, Building 1, Tarentum, Penna.

**MONEY** In new greaseless doughnuts. Start in kitchen. No smoke. Sell stores. Free recipes. M. Ray Company, 3605 South 15th Ave., Minneapolis 7, Minn.

**VENDING Machines—No selling.** Operate a route of coin machines and earn amazing profits. 32-page catalog free. Parkway Machine Corporation, Dept. T2, 715 Ensor St., Baltimore 2, Md.

**BRONZE Baby shoes.** Instructions, equipment and mountings for genuine electroplated process. Free catalog. Hollywood Bronze Supply, Dept. B-3, 1624 East First Street, Los Angeles 33, Calif.

**START Venetian blind laundry,** patented machine. Free information. Jet Company, 522 N. Rural, Indianapolis 1, Indiana.

**BE A real estate broker.** Study at home. Write for free book today. GI approved. Weaver School of Real Estate, 2016D Grand, Kansas City, Missouri.

**\$40.00 DAILY.** Write: Zapart Saw Filer, 585 Manhattan, Brooklyn 22, N. Y.

**WHOLESALE: 1000 Items** nationally advertised appliances, jewelry, watches. Catalog 50c. International Sales Co., 173 Fifth Ave., New York 10, N. Y.

**YOUR Own name brand business.** No investment; no inventory. Part time or full time. Sell famous brands of appliances, housewares, silverware, radios, vacuum cleaners, lamps, tools, clocks, watches, jewelry, etc., etc., over 1000 items. Join thousands of successful independent dealers. Send for free catalog and dealer price list. H. B. Davis Corp., Dept. W, 145 W. 15 St., New York City.

**REVEALING Booklet "How To Sell By Mail"** 25c. Bud E. Hine, Box 93, Battle Creek, Michigan.

**DIRECT Factory distributors** wanted for well known automotive product. \$1000 inventory turns over fast with 50% profit. Exclusive sales rights. Write Sales Manager, 6329 Wilson Ave., St. Louis 10, Mo.

**BUY Wholesale.** Thousands items. Lists free. Triple J Industries, 132 Berkshire, Bridgeport 8, Conn.

**\$46 FROM Square foot plywood;** Saws necessary. Write: Woodarts, Bridgewater, Mass.

**"FROG Raising!"** Season just starting! Get this year's eggs. New book tells how. Free folder. Broel-A, Box 506, New Orleans 1, Louisiana.

**FLEXIBLE Rubber molds** for plaster and Marble figurines. Sample and large illustrated catalog 25c, refunded on first order. K-C Novelties, Dept. 155, Southampton, Mass.

**WHOLESALE!** Complete line musical instruments, phonographs, tape recorders, typewriters, watches, diamond rings, appliances, etc. Discounts to 75%! Send 25c (refundable) for large catalog. Strauss Music Company, 25-11 Lafayette, Paterson 23, New Jersey.

**UNUSUAL Opportunity.** Spinning at home. Supplies, market, furnished. Angora House, PM, Springfield, Illinois.

**START Your own business at home.** Sell subscriptions for popular magazines. Liberal commissions. Send for supplies, etc. DeSales Magazine Service, 60 East 42nd St., New York 17, N. Y.

#### MONEYMAKING OPPORTUNITIES

**COST** Of things going up faster than your income? You can make more full or part time as a Rawleigh dealer. Write for full particulars. Rawleigh's, Dept. P-RR-PPM, Freeport, Ill.

**FREE!** "301 Profitable Small Businesses!" Amazing shoeing plans! Work home! Start sparetime. Deumant Surveys, Kenmore 23-R, N. Y.

**LEARN Mailorder fundamentals.** Plans, Opportunities. Will Kell Company, 5255 Wilshire, Beaumont, Texas.

**WHOLESALE!** 12,000 Nationally famous products! 30-80% discounts! Sensational plans, small catalog free. Derron Company, 21-13 White, Paterson 23, N. J.

**GROW Earthworms.** Sell breeding stock. Soil culture, fishbait. Home business opportunity. Write Earthworms, 597, Corona, California.

**EXTRA Income** serrating and sharpening knives. Service welcomed. Free details. Serr-Edg, 9731 Lorain, Cleveland 2, Ohio.

**SCHEMER Magazine,** Canfield 1, Ohio. monthly mailorder ideas, plans. Year \$2.00. Sample 25c.

**LEARN Swimming** the easy way. Teach children, others. Complete easy to understand lessons. Four lessons, practiced without pool, \$1.00. Swimming, Del Mar 1, Calif.

**DO You want your own business?** For moneymaking opportunities. Write: Central Sales Outlet, Robbins, N. C.

**IF You need more income.** Start a home business in spare time. Make extra money. Experience not necessary. Literature free. World Sales Co., P.O. Box 179 PM, Ripley, Miss.

**START A buying service,** buy wholesale thousands nationally advertised products. Make big profits selling at sizable discounts. Postcard brings details. American Buyers, 830-R Linden, Buffalo, N. Y.

**TYPISTS! Make money at home!** Mailing, 2 Madison, Greencastle, Indiana.

**LEARN Technical Metaphysics** and insure your future. Easy, inexpensive correspondence course. Simplest method known. Diploma. Write: Premier College of Technical Metaphysics, 2532 McKenzie St., Vancouver, B. C., Canada.

**100 TESTED Ways to make money, \$1.00.** Roger Frink, Whittemore, Iowa.

**MAKE Extra money at home, sparetime!** Exciting new booklet shows "how!" Dozens of proven money-making plans, ideas for entire family! Rush 25c for yours! Mail Products, 62-46-247th Street, Bellerose 26, N. Y.

**WHOLESALE Brand named products** catalog \$1.00. D. Kabel, 870 Lafayette, Buffalo, N. Y.

**SAVE To 80% on famous brand products!** Appliances, tools, jewelry, etc. Receive large fully illustrated catalog every year! Costs you nothing! \$1.00 deposit (refundable) brings 1955 catalog. Satisfaction guaranteed! R. Broderick, 383 Park, Glencoe, Illinois.

**RAISE, Sell earthworms.** Instructions free. Johnny K's Hatcheries, 965 Selby, St. Paul 4, Minn.

**WINNING Prize contests** is fabulous, confidential, home opportunity! Send stamp! National Contest Bulletin, Box 2685-P, Miami 16, Florida.

**EARN \$50.00 Daily** making mats, shoes and mud guards from old tires. S and S Patents Inc., 1307 North Clark St., Chicago 10, Ill.

**"MONEY Getter's Bulletin"** This exciting magazine prints money-making plans, ideas, spare-time tips; hobby ideas; many other types of money-making facts for men, women; young or old. Sample copy 25c. Distributors, Box 831-B, Monessen, Penna.

**ALUMINUM Awnings.** Sell yourself. Sell neighbors. Factory prices. Write Groff Awnings, Box 10254, Tampa, Florida.

**EARN Money evenings,** copying and duplicating comic cartoons for advertisers. Adservice, Argyle 1, Wisconsin.

**\$9.00 RETURNS \$160.00.** Repeats. Make us prove it. Ezee, Bayport 7, Mich.

**NEW 7"x11" Ultra-blue signs.** To retail 50c. Sample free! Lowy, 812 Broadway, Dept. 872, New York City 3.

**\$1000 MONTHLY Possible** raising earthworms! Backyard, garage, basement. Complete illustrated booklet explains raising, feeding, packing, marketing. 25c postpaid! Ozark Worm Farm-J, Willow Springs, Mo.

**TYPISTS! Make money at home!** Mailing, 2 Madison, Greencastle, Indiana.

**MAKE Jewelry!** Pleasure, profit. Tremendous demand. Complete instructions. Material sources. Send \$1.00. Haase, 2719 East Washington, Madison 4, Wisconsin. Priceless or refund.

**BINGO Markers,** greeting cards, books. 300% profit. Freemans, Cornwall, Ontario.

**ORGANIZATIONS.** Individuals make good profits selling \$1.00 gift items. 3 samples \$2.00. W & J Wholesale, 222 E. Third, Dayton 2, Ohio.

**MAILORDER Operators,** many unused 100% profit items, sample \$1.00 refunded. Trader, 1 McDougal, Vallejo, California.

**EARN \$10,000 Government bonus** locating uranium ore! Handbook, "Strike It Rich With Uranium," tells how, where to prospect. You could be next uranium millionaire! Rush \$1.00 for copy! No c.o.d.'s. Warman Publishers, Frank Hoover St., Uniontown, Penna.

**WANT To go in business for yourself** without capital? We show you how. Postcard brings details absolutely free. Topval, Lindenhurst 320, New York.

**BUY Wholesale 100,000 advertised products!** Profit selling others! Free details! National Buyers Service, Box 426EF, Oakland, California.

**SELL Religious mottoes.** Send no money. We trust you. Crystalglo, Sidney, Ohio.

\$5 TO \$10 An hour. I've did it, I'm disabled now. Real genuine offer. Complete information only \$1. Lucas, 2200 Carson St., Pittsburgh 3, Penna.

GROW Into the mail-order business. Experienced operator tells how. Send \$1 today! Premier, Box 8177, Chattanooga, Tenn.

CASH Profits. Supply prospects for stupendous silverware deal. We do selling. Raymond Lindblom, 216 West Jackson, Chicago 6.

MAKE To \$300 extra. New! Different! No selling! No mailorder! Details free. J-M Enterprises, 801 1/2-A North Marsalis, Dallas 3, Texas.

BUY, Sell and swap for profit. Amazing new method. Inquire Box 621G, Culver City, Calif.

DOLLARS In baby record books, baby shoe kits. Liebig Industries, Beaver Dam 2, Wisconsin.

PROFIT! Prestige! Publish a magazine under your own name! Only \$3 per month! Sample, details 5c! Filmer, 910 Marion, Pharr 22, Texas.

PRINTING And office supplies wholesale, 20,000 items. Literature free. Royal, Box 248-A, Cleveland 27, Ohio.

FREE Literature describing moneymaking mailorder plans. Lewis Bartlett, Richmond, Georgia.

BUILD Sales by recruiting productive distributors selling direct or to retail outlets. Secure most concentrated circulation through classified columns of Salesman's Opportunity. Write for facts. Gilbert, Salesman's Opportunity, Room 1709, 850 N. Dearborn, Chicago 49.

FREE Booklet "Money Making Facts" tells mechanically inclined men how to start sparetime business at home. V. Foley Company, Columbia Heights, Minnesota.

ACME Saw sharpeners are the finest you can own. Don't be satisfied with less. Send for free literature. Max Mig. Co., 138 Stockton Ave., San Jose 26, California.

FREE Folio "Up to \$45,000; Unlimited Vacations." No merchandise, equipment! Unknown! Work home, sparetime! Haylings, Carlsbad, Calif.

SPARETIME Profits taking subscriptions all magazines. Wholesale catalog free. Cassell Publishers, Westfield, New Jersey.

MAKE To \$4.50 hour doing common pen lettering. National Artists, 801 1/2-A North Marsalis, Dallas 3, Texas.

ATTENTION: Typewriter owners. Make handsome profits. Write today. Groves Company, 682, Hastings 8, Nebraska.

GENERAL Contest Bulletin. Issued monthly. Sample, 25c. 1609 1/2 East 5th, Duluth, Minn.

GROW Mushrooms. Cellar, shed, and outdoors. Spare, full time, year round. We pay \$3.50 lb. We paid Babbitt \$4,165.00 in few weeks. Free book. Washington Mushroom Ind., Dept. 173, 2934 Admiral Way, Seattle, Washington.

50,000 ARTICLES Wholesale. Source directory, dime. Nelko, Box 3462-DR, Chicago 34.

READ Progressive Mailtrade, the magazine that tells how to make money by mail. Dime brings sample and special offer. Progressive Mailtrade, Box 357, Sheboygan, Wisconsin.

FREE Book "505 Odd, Successful Businesses." Work home. Expect something odd! Pacific, Oceanside, Calif.

SELL—Buy Titania gems. More brilliant than diamonds. 89.75 carat wholesale. Free catalogue. Diamonite, 1404-M Mitchell, Oakland 1, California.

#### FORMULAS, PLANS, ETC.

FORMULAS 10c. A. Millic, Chemist, 430 South Western Ave., Los Angeles 5, Calif.

MAKE. Sell product to combat battery cable corrosion. Formula, selling plan, \$2.00. John C. Chester, 20-B Cromwell Place, Sea Cliff, New York.

75 MONEY Making formulas. Complete instructions \$1.00. Midwest, Box 359, De Soto, Mo.

53 MONEY Making formulas 25c. Ralph Bastiens, LaMolle, Nevada.

ANY Formula \$5.00. Satisfaction guaranteed. Jack, Chemist, 5138 Gainer, Philadelphia 31.

FREE Formula catalog. Anything analyzed \$35.00. Western Chemical, Salem, Oregon.

FORMULAS: All kinds. Latest, best. Literature free. Keminax, Park Ridge, Ill.

FOR Proof of what you can do in specialty manufacturing get our literature. It's free! Miller, Chemist, 1517-P, Tampa, Florida.

REAL Manufacturing formulas. Lists free. Cummings, Chemist, Gordon Ave., Syracuse 4, N. Y.

PRODUCT Analysis, manufacturing formulas, processes developed. Moderate fees. Plastics, Box 1574, Boston 4, Mass.

FREE Formula list. Anything analyzed. Northwestern Laboratories, 2316 Brown, Evanston, Illinois.

THE Best mfg. formulas at any price. A. F. Hanlon, Malvern, Penna.

#### PLASTICS

PLASTICS Home-craft course for men and women. Tells and shows how to make hundreds of fast selling plastics products. All plastics and materials for 23 projects included in course. No special tools needed. Course pays for itself. Write for free booklet. Interstate Training Service, Dept. D-3-P, Portland 13, Oregon.

NEW Liquid casting plastic. Clear, colors. Embed flowers, insects, coins. Saw, drill, carve. Send 25c for "How to Cast With Liquid Plastic" and proved success plan showing how to make money at home. Castolite, Dept. G-101, Woodstock, Illinois.

PLEXIGLAS, Lucite. Square foot cost 1/16", \$1.10; 1/8", \$1.45; 3/16", \$1.80; 1/4", \$2.15; 5/16", \$3.28; 3/8", \$4.38. Colors add 10%. Send 15¢ for postage. Aristocrat Plastics, Inc., 35 Clarkson Street, New York City.

PLEXIGLAS, Fiberglass, polyester, acetate, vinylite. Fast service. Wholesale-retail. Catalog 15c. Gem-O-Lite, Box 686P, North Hollywood, California.

PLEXIGLAS Sheets—Cut to size. Clear. All thicknesses. Standard outdoor translucent colors. McClarin Plastics, P.O. Box 168H, Hanover, Penna.

LAMINATING Supplies. Free price list. Solomson, 48 Cornhill, Boston 8, Mass.

PLASTIC. Sheets, rods, tubes, etc. Free list. Plastic Supply Co., 2111 Olive Street, St. Louis 3, Mo.

#### CHEMISTRY

"CHEMISTRY For Beginners" and "Chemistry of Familiar Things." Both books 30c. Franks Book Service, 3121 So. Racine, Chicago 8, Illinois.

CHEMISTRY, Biology, microscopy. Catalog 25c. Laboratory Sales, Box 161-A, Brighton, Mass.

NEW Idea chemical and apparatus outfits for home experimenting, photo-scales, microscopes, chemicals, biologicals and laboratory supplies in small quantities. Catalog 25c. Established 1931. John H. Winn, 1244 West 23rd St., New York, N. Y.

CHEMICALS And apparatus for industrial, analytical, and private laboratories. Catalog 25c. Dept. M-50, Biological Supply Co., 1176 Mt. Hope Ave., Rochester 26, N. Y.

ILLUSTRATED Catalog: Chemistry, mineralogy, biology 20c. Tracey Laboratories, Evanston, Illinois.

#### AGENTS WANTED

MEN, Women, make money spare time plus new car as bonus for encouragement. Amazing hosiery guaranteed to wear without holes, snags, and runs, or replaced free. For example, lovely 60 gauge nylons guaranteed for as long as 1 1/4 years, or replaced free. Write Wilkint, 1756 Washington, Greenfield, Ohio.

MAKE Money selling ties! Buy from manufacturer. Pleated, feather, bows, tie kerchief set. Knitted slims, regulars. Money back guarantee. We pay postage. Special offer—3 sample ties only \$1.00. Free catalog. Phillip's Neckwear, 29 W. 22nd, Dept. 415, New York 10.

LOWEST Wholesale prices. Thousands of name brand items. Free literature. Parker Distributors, Box 55, (Dept. C) Williamsbridge Sta., New York City 67.

NEED More money to live on? Increase your weekly income \$20 to \$25 or more in spare time. Supply Rawleigh Products to consumers. Also openings for full time dealers. Write Rawleigh's, Dept. P-DD-PPM, Freeport, Ill.

BEAUTIFUL Feather pictures, 200% profit! Free sample, Apartado 9636, Mexico 1, D. F.

\$125 WEEKLY! 176% Profit! New, wonder Dow-Corning car polish. Cleans, glazes, weatherproofs year 'round! Write United, 1035 East 10th St., Brooklyn 30, N. Y.

MAKE Money introducing world's cutest children's dresses. Big selection, adorable styles. Low prices. Complete display free. Rush name. Harford, Dept. N-8341, Cincinnati 25, Ohio.

BUY Wholesale thousands nationally advertised products at big discount. Free "Wholesale Plan." American Buyers, 629-R Linden, Buffalo, N. Y.

FAR East and European firms seeking agents for exclusive and general lines. International survey \$1.00. Rachalske, 1902 South 93rd, West Allis 14, Wisconsin.

SELL 8x10 Enlargements \$2.95. \$1.00 commission plus bonus. Acme Enlargers, Levy Sta., No. Little Rock, Ark.

WHOLESALE. Only name brand catalog with S&H green stamps. Send \$1, refunded. Pollack, 12 Cedar, Akron, N. Y.

POWER Mowers. Free demonstrator. Prepaid. Home agents. Dealers. Cut rate deal. Farmco-PM, Excelsior Springs, Mo.

WHOLESALE! 12,000 Nationally famous products! 30-80% discounts! Sensational plans, small catalog free. Derrom Company, 21-10 White, Paterson 20, N. J.

EARN \$200 Weekly! "Seal-Tite," sensational \$1.98 puncture-proofer guaranteed to stop flats. Big sales, profits. Free sales kit. M & M, Dept. M-2, 842 Third Ave., New York City 22.

AMAZING Unbreakable plastic housewares, tablecloths, drapes, utility covers. Fast sales, big profits, large selection. Free catalog. Acclaim Plastics, Box 4, New York 49, N. Y.

PROVEN Money-maker. Brand new product sells on 5 minute demonstration. Market and profit unlimited. Nationally advertised. Satisfaction guaranteed. Free details. Hoke Tool Works, Dept. B, Raeford, N. C.

WHOLESALE Catalogue! Appliances, cameras, watches! Anelag Industries, Rochester 1, Wisconsin.

AMAZING New whirlwind seller. Medicated lotion. Stops itch, insect bites, chiggers, poison ivy, sunburn. No rub off. Great repeater. Wonderful profits. Free details. Guerrieri, 2921-P N. Clark, Chicago 14.

CLEAN. Shine autos the easy way with \$2.00 Dustex. Chemically treated long lasting dirt removing cloth. Write for selling plan. Dustex, 2818 Harrison, Waukegan, Illinois.

60% PROFIT On cosmetics — Famous nationally advertised Hollywood Cosmetics pay 60%! Make \$25 day up! Hire others. For free samples, details, write Studio Girl, Glendale, Calif., Dept. PM-65.

EARN \$30.00 Daily with "Dab-it," sensational spot-remover stick. Like magic! Buyers everywhere! Big sales, profits. Free details. M & M, Dept. M-1, 842 Third Ave., New York City 22.

MAGAZINE Subscriptions, advertising. Big commissions, bonuses. Supplies 50c. Jaggard Publishers, 132 N. Wyoming, Ventnor City, N. J.

EASY Handwork makes fast-selling useful articles. Sample free. Sunmade Company, Brockton 64, Massachusetts.

EARN \$150.00 Per week, giving away stainless steel tableware. Nueblings-M, Sicklerville, N. J.

WHOLESALE Catalog! Appliances, cameras, watches. Postcard. Selbyco, Decatur 157, Illinois.

MAKING Fast dollars easy. Attractive nameplates sell themselves. Request personalized sample. Stan Roberts, Engraving, 2118 Lee, Cleveland, Ohio.

HIGHLY Profitable magnetic pencils for everyone! Samples \$1.00. Nicholson Products, 3401 Cahuzanga, Los Angeles 28, Calif.

MAKE Money giving away free hosiery! Introduce amazing nylon stockings (guaranteed against runs and snags) and men's-children's hosiery (guaranteed one year) by giving away free trial pairs regardless whether or not final purchase is made! Earn up to \$3 hour spare time. Mail postcard today for free samples men's and women's hosiery with complete moneymaking outfits. Nothing to pay now or later. Absolutely no obligation. Kendex, Babylon 63, N. Y.

**FABULOUS Offer!** Mailorder made easy, local selling just fun. No investment. Free advertising literature, salesplans, namelists, we fill orders for \$1.00. Amazing home-haircutter (like nationally advertised at \$3.00) saves average family \$50.00 yearly. Rush \$1.50 for sample, territory assignment, etc. Lisco, 525 Glenview, Philadelphia 11.

**NEW Way to make money!** Sell nothing, yet make \$132 or more weekly. Postcard brings all details free. Topval, Lindenhurst 81, N. Y.

**ONCE** in a lifetime deal never before offered. Want representatives each city, town, village also foreign countries. Nothing to sell. Tremendous opportunity. Kleckner, Box 2, Far Hills Branch, Dayton, Ohio.

**EASILY** Make \$30 daily. Automatic toilet bowl cleaner sells itself. Write Box 61, Belleville, N. J. Sample, only \$2.35.

**BIG** Profits yours—Sell revolutionary room climatizers also fire alarm and extinguisher kits. Write for literature and sample prices. Micro-Moisture Controls, Inc., Mineola 60, N. Y.

**FREE!** Wholesale catalogs appliances, homewares, sporting goods, furniture. United Distributors, 23A Grant, San Francisco.

**EARN \$45.80 Daily!** One application Silicone, wax-treated "Car-Glo" cloth cleans car beautifully. Big sales, profits. Free details. M & M, Dept. M-3, 842 Third Ave., New York City 22.

**\$5 TO \$10 An hour.** I've did it. I'm disabled now. Real genuine offer. Complete information only \$1. Lucas, 2200 Carson St., Pittsburgh 3, Penna.

**"MIRACLE Mitt."** Simonizes, polishes autos like magic. No messy rags, no dirty hands. Works on furniture. Big profits. Whirlwind seller. Miracle Mitt, Box 276-P, New York City 18.

**30,000,000 WOMEN** Want amazing new automatic refrigerator defroster. You sell 8 out of 10 on sure-fire free trial. \$250.00 weekly profit not uncommon. Rush postcard for guaranteed plan. D-Frost-O-Matic, Dept. H-102, 173 W. Madison St., Chicago 2, Ill.

**YOUR Own business—Used suits \$1.50, overcoats 85c, mackinaws 35c, shoes 12½c, ladies coats 30c, dresses 15c. Enormous profits. Catalog free. Moro, 1213AA South Jefferson, Chicago 7.**

**CHROME** Plating. New profitable method! Complete outfit \$2.00. Good House-keeping guarantee. Agents wanted. Dutch, 51, Monkham Lane, Woodford, Essex, England.

**HAVE** Your own business, buy wholesale, make big profits. Free general mdse. catalog. Jay Norris, Dept. P, 445 Broome St., New York.

**WEDDING** Invitations, personalized napkins. Wholesale prices. Sperry-Print, Williamsport 45, Penna.

**PRINTING.** Advertising salesmen—Excellent moneymaking sideline selling decalcomania name plates, small quantities. Automobile initials, sign letters. Free samples. Balco, XL, Boston 18, Mass.

**GOLD** Or silver letters, numbers. Windows, doors, trucks. 1" to 8". 500% profits. Free samples. Atlas-T, 544 West 79th, Chicago 20.

**MAKE** Extra money. Sell front door name plates to friends, neighbors. Retail \$1.98; you make \$1.00! Free selling kit. Modern Engraving Co., P.O. Box 194, Boston 14, Mass.

**\$1.00 PROFIT** Selling \$2.95 photo enlargement deal. Allen Studio, Riegler Bldg., Little Rock, Ark.

**AGENTS—300%** Profit selling genuine gold window letters; stores and offices. Free samples. Metallic Sign Letter Co., 431-D North Clark, Chicago.

**INCREASE** Your income—Personal initialed buckles, belts, cap badges. Free information. Hook-Fast, Box 480 (PM), Roanoke, Va.

**BARGAINS,** Joblots, close-outs. 2000 items. Save to 50%. Clothing, hosiery, toys, toiletries, gifts, jewelry, television, etc. Get acquainted. 25c brings wholesale catalog plus free \$1.00 merchandise certificate. Reliable Jobbing, 311-B North Desplains, Chicago.

**CASH** in on toilet trouble—Sell plastic flush valve guide. Write for sales plan. Guide-O-Valve Co., 1616 Broadway, Redwood City, Calif.

**WHOLESALE Catalogue!** Appliances, cameras, watches! Cam Company, 6806 20th Ave., Brooklyn 4, N. Y.

**YOUR Ad** in this space will get some good agents for you. Yes, I'll prove it. Write for Folder "A" right now. F. W. Johnson, Classified Advertising Manager, Popular Mechanics Magazine, 300 E. Ontario St., Chicago 11, Ill.

### SALEMEN—DISTRIBUTORS

**PROVEN** Profits. Specialty salesman. Part or full time. Selling dazzling diamond and square reflectorized road signs to motels, auto repairmen, truck stops, every line business. Make \$50 up daily. Write for dealer application form. Hi-Way National Sign Co., 1944 Park Ave., New York 37, N. Y.

**SELL** Fishermen's items. Make 30% profit on investment. The season's here. Make big profits on 4 fast-selling patented sports items. Write Con-Mar Sales Co., P.O. Box 9531 C, Oklahoma City, Okla., for details and literature.

**MAKE \$75-\$200 Weekly.** Dealers, farmers, agents demonstrate, take orders, new proven nationally advertised Gro-Green Liquid Fertilizer and Nitrogen Nutrients. Full, part time. Prospects everywhere. Campbell Co., Rochelle 51, Illinois.

**JEWELRY.** Watches (rebuilt) wholesale. Star Enterprise, 109 Washington, Providence 3, R. I.

**UNUSUAL** Mail order plan pays \$100.00 per car commission. No investment required. Take orders only. Brand new 1955 automobiles equipped with windshield washers, outside Rearr mirror, turn indicators, tutone paint, oil filter, undercoating, federal taxes, Michigan sales tax, license and title. Prices start at Nash \$1673.00, Ford \$1733.00, Plymouth \$1730.25, Chevrolet \$1795.65, Studebaker \$1858.96, Dodge \$2085.00, Pontiac \$2107.74, Mercury \$2233.60, Buick \$2341.15, Oldsmobile \$2415.17. Other equipment additional. Also Lincoln, DeSoto, Chrysler, Packard, Hudson, etc. Send \$1.00 for complete details. Harry Harwoods, 20058 Renfrew Rd., Detroit 21, Michigan.

**\$5 TO \$10 An hour.** I've did it. I'm disabled now. Real genuine offer. Complete information only \$1. Lucas, 2200 Carson St., Pittsburgh 3, Penna.

**AGENTS,** Salesmen, buy standard brand merchandise at rockbottom wholesale prices: \$49.50 watches at \$22.95. \$49.50 dinner sets at \$15.60. \$1.00 ladies' first quality nylon hose at \$6.50 per dozen. Ladies closeout \$8-\$10 fall and winter dresses at \$1.50. Other sensational values in clothing, silverware, jewelry and appliances. Minimum order \$10.00. Send \$1.00 for catalog with confidential price list. Refundable first order. Merchandise Dept. P-6, P.O. Box 66, Bronx 59, New York.

**ANYONE** Can sell famous Hoover uniforms for beauty shops, waitresses, nurses, doctors, others. All popular miracle fabrics, nylon, dacron, orlon. Exclusive styles, top quality. Big cash income now, real future. Equipment free. Hoover, Dept. R-100, New York 11, N. Y.

**START** Your own business on credit. Your own boss. 1135 of our dealers sold \$5000 to \$30,000 in 1954. We supply stocks, equipment on credit. 200 home necessities. Sales experience unnecessary, pleasant profitable business backed by world-wide industry. Write Rawleigh's, Dept. F-U1-PPM, Freeport, Ill.

**ADVERTISING** Book matches—Cash in on big demand; sell union label matches. Cuts for all businesses and political parties. Free powerhouse selling kit, low prices, protection guaranteed on repeat orders. Cash commissions. Superior Match Co., Dept. M-855, 7530 Greenwood, Chicago.

**SALESMAN—Immediate opening.** Large national organization. \$7,500 to \$10,000. Write, wire, Utility, 330 South Dearborn, Dept. PM-6, Chicago.

**\$800 PROFIT A year—From just one sale a day!** Keep safe, only full-size personal safe sold direct, lets you offer low-cost fire and theft protection that all homeowners, farmers and businessmen need—and less than 5% have! \$73.95 sale means \$26.45 profit, plus big bonus. No competition. Exclusive territory. Full details from Manufacturer, John D. Brush & Co., 578 West Ave., Rochester, N. Y.

**WILL** You wear new suits and topcoats without one penny costs and agree to show them to friends? You can make up to \$20.00 in a day even in spare time, without canvassing. J. C. Field, Harrison and Throop Sts., Dept. D-1826, Chicago 7, Ill.

**DISTRIBUTORS—Large profits.** Terrific repeat orders. Unique Italian brooms, details free. Write P.M. Peacock, 915 Bryant, San Francisco, California.

**BIG Money-making opportunity.** Exclusive line work uniforms. Jackets, pants, shirts, coveralls. Advertising embroidered. Every business prospect. Outfit free. Master Div., 316 Water, Ligonier, Ind.

**AD Matches!** Sell amazing designs—10, 20, 30, 40 and 240-light book matches. Bigger spot cash commissions; every business a prospect. Low prices for high quality. Repeats. Start without experience; men, women; full, part time. Buy nothing! Sales kit furnished. Match Corp., Dept. PM-66, Chicago 32, Illinois.

**GOOD** Man can make \$3,000.00 next 90 days. Every house in town wants amazing Nilite glowing curbside house numbers. Automatic selling plan pays profits everyday. Write today for details free. Nilite, 173 W. Madison, Dept. J-80, Chicago.

**BUY** Wholesale thousands nationally advertised products at big discount. Free "Wholesale Plan." American Buyers, 630-DD Linden, Buffalo, N. Y.

**35 MILLION** TV owners welcome new, exclusive, remote volume control. Eliminate undesired commercials, converse, phone, adjust volume up or down from easy chair. Editorially featured leading magazines. Portable radio demonstration or free trial practically assures sale. Retail \$6.95. Money-back guarantee. Send \$3.50 for sample and deal. Control-Tone Company, 111 No. Tacoma Ave., Tacoma, Wash.

**A Salesman's dream!** Thousands items nationally advertised! Wholesale! Tremendous discounts! Premiums! Share profits with us! A.I.M. Co., Box 2002-Q, Paterson, N. J.

**MAKE \$75-\$200 Weekly.** Dealers, farmers, agents demonstrate, take orders, new proven nationally advertised Gro-Green Liquid Fertilizer and nitrogen nutrients. Full, part-time. Prospects everywhere. Campbell Co., Rochelle 51, Illinois.

**FISH** Hook. New, different, fast seller. \$1.00 retail. Big profits. Details free. Kayvenee Enterprises, Box 335M, Oskaloosa, Iowa.

**MAKE** Easy money. Sell famous \$3 CO-2 fire extinguisher. Wholesale or direct. Fast sales, liberal profits. Fire Killer Mfg. Co., Dept. E, 115 W. 17th Street, Hazleton, Penna.

**NEW** Jobs open in selling! Send name, address for five free issues of Opportunity Magazine's money-making guide, listing hundreds of companies who'll pay you well, full or part-time. No experience needed. Opportunity, 850 N. Dearborn, Dept. 17, Chicago 40, Ill.

**MAKE** Good profits with oriental incense, perfumes, deodorants. Eastern Trading, 3974 Vincennes, Chicago 15, Ill.

### EDUCATIONAL AND INSTRUCTION

**IT'S** Fun learning a language by Linguaphone, world's standard conversational method. At home, easily master French, Spanish, German, Japanese—32 languages available. It's like living in another land. You listen, you hear native men and women speak, you understand, you speak. Save time, work, money. Gain job, school, travel, cultural opportunities. Write for free book. Linguaphone Institute, 83-065 Radio City, New York 20.

**WANT** A diesel job? New opportunities to increase income. Higher pay. More money. We can help you qualify. Tools. Shop method home training. Write today! Diesel, Tractor, Heavy Equipment Division, Interstate Training Service, Dept. B-3-P, Portland 13, Oregon.

**MAKE** Big money as newspaper correspondent. Learn by doing in your own home. No experience necessary. Individual instruction. Free details. Premar School, 227-90th, Brooklyn 9, N. Y.

**WELDING** Training pays at Hobart Welding School, Box M-651, Troy, Ohio. VA contract. Best equipment. Catalog free.

**HIGH** School—No classes. Study at home. Spare time. Diploma awarded. Write for free catalog HP-54, Wayne School, 2627 N. Sheffield, Chicago 14, Ill.

**FREE** Home study course in basic economics offered as a public service. Recommended by many leaders. Send postcard for complete information. Henry George School, Dept. PM, 50 E. 69th St., New York 21, New York.

**EDUCATE** Yourself with progressive cross word puzzles. Dictionary furnished. Ca'co, Drawer 988, East Chicago, Indiana.

**CAN A man my age become a hotel executive even though he has no previous hotel experience? Would you like to step into a well-paid position as hotel or club manager, purchasing agent, social director or assistant manager, etc.?** The success of Lewis graduates from 30 to 50 proves you can—though you have no experience in hotel work. Melvin I. Dalrymple says: "Every person wanting success in the hotel field should enroll for the Lewis Course. What it taught me about all 'round departmental operations qualified me for the position of assistant manager. Anyone can do what I have done with the Lewis Training." Our free book explains how you can qualify for a well-paid position at home or through resident classes in Washington; how you are registered free in Lewis National Placement Service. Write today. Course approved for veteran training. Lewis Hotel Training School, Desk AH-324, Washington T, D. C.

**BE A real estate broker. Study at home. Write for free book today. GI approved. Weaver School of Real Estate, 2018 P Grand, Kansas City, Missouri.**

**INVESTIGATORS Trained, men-women. Learn fascinating, profitable profession, spare time study. Big pay. Important details on how to open your own agency in any state. Free booklet. Investigator, Box 490, Times Square Station, New York 36, N. Y.**

**COMPLETE Your high school at home in spare time with 58 year old school. Texts furnished. No classes. Diploma. Information booklet free. American School, Dept. XA45, Drexel at 58th, Chicago 37, Illinois.**

**UNHAPPY? Restless? Dissatisfied? Uncover your hidden abilities, aptitudes, personality with psychological testings. Do tests at home. Receive complete analysis prepared from tests by professional psychologists. Low cost, confidential. Write Psychologic Testing Institute, Dept. 246, 201 N. Wells, Chicago, Illinois.**

**UNIVERSITY Degrees by residence, correspondence. Golden State University, Box 2883, Hollywood, Calif.**

**PIANO Tuning pays. Big money in spare time. Learn at home in 30 days. No musical knowledge necessary. Phonograph, records, tools and instructions furnished. Information free. Capitol City Tuning School, 16 Southwest 2nd, Dept. 102, Fort Lauderdale, Florida.**

**BLUEPRINT Reading for machine and building trades. Train at home. Learn to read blueprints with confidence in 10 easy lessons. Earn more pay. Literature free. Belton School, 1659-U North Lawn-dale, Chicago 51, Illinois.**

**CORRESPONDENCE Courses, educational books bought, sold, rented. Catalog free. Willard Bayles, 211 Essex, Hackensack, New Jersey.**

**ENGINEERS. End area to cubic yards table 50c. Shepard, 5242 Browncroft, Houston 21, Texas.**

**"HOW To Overcome Self-Consciousness" and "Hints on Developing Personality." Both books 20c. Franks Book Service, 3121 So. Racine, Chicago 8, Illinois.**

**567 HOMESTUDY Courses, textbooks. Sensational bargains! Free illustrated catalog. Nelson Company, 210 South Clinton, Dept. 9FV-2, Chicago 6.**

**FREE Sample lesson for piano or piano-accompaniment! Prove you can teach yourself to read and play in 30 days with new Klavay method. 409,000 have learned. Send today. State Instrument. No obligation. Klavay Institute, 836 Altgeld Street, Chicago 14, Illinois.**

**INVESTIGATE Accidents! Many earn to \$10,000 yearly. Thousands of fire losses, auto accidents, burglaries, collisions must be investigated for insurance companies, airlines, steamship lines. Excellent openings for trained men as company investigators. Also big opportunities in your own independent business. Train home, spare time. Placement counsel and help. Free book, now! Universal Schools, Dept. 106, Box 8202, Dallas 5, Texas.**

**LOCATE Anyone: Nearly 200 professional ways outlined. \$2.00. Worthington Instructions, Box 144, Newtown Square, Penna.**

**WORK For U. S. Gov't! Men-women, 18-55. Start high as \$80.00 week. Qualify now! 23,000 jobs open. Experience often unnecessary. Get free 36-page book showing jobs, salaries, requirements, sample tests. Write: Franklin Institute, Dept. E-24, Rochester, N. Y.**

**\$200 WEEKLY Reported! No selling. Free booklet. T. J. Surface, Roanoke 4, Virginia.**

**BECOME A doctor of psychology or metaphysics. Learn secret of contentment, happiness. Win degree of Ph.D. or M.S.D. Correspondence only. Free book. College of Universal Truth, 5038-C Broadway, Chicago.**

**MEDICAL Laboratory technique. Learn at home. Big demand. Good pay. Catalog free. Century College, Desk 4, 9 East Ohio, Chicago 11.**

**MIDLAND Linotype School. Charles City, Iowa. Civilian and Veteran Courses. Free placement. Established 1909.**

**EARN College degree, remain employed. Write: Brentwood College, Box 19-721, Los Angeles 19, California.**

**INVESTIGATOR Training. Phillips Secret Service System, 1917-B North Kenneth, Chicago 39.**

**AUCTIONEERING. Be an auctioneer. Earn big money. Term soon. Write for catalog. Kansas City Auction School, Suite 307, Shankman Building, 3119 Troost, Kansas City, Missouri.**

**HIGH School diploma at home. Licensed teachers—Approved materials. Southern States Academy, Box 144-MX, Station E, Atlanta, Georgia.**

**SECRET Investigation. Experience unnecessary. Investigators particulars free. George Wagner, M125 West 86th, New York 24.**

**GROW Mushrooms. Cellar, shed, and outdoors. Spare, full time, year round. We pay \$3.50 lb. We paid Babbitt \$4,165.00 in few weeks. Free book. Washington Mushroom Ind., Dept. 174, 2954 Admiral Way, Seattle, Washington.**

**EARN While you learn. Auto and diesel mechanics master this top paying trade. Many graduates earn \$100 a week and up. Approved for Korean veterans. For free information write Dept. No. 256, Nashville Auto-Diesel College, Nashville 3, Tenn.**

**BOOKKEEPERS! Increase your earnings! Operate your own simplified "Dollar-A-Week" bookkeeping and tax service. Full or spare time. Details free. No obligation. Ellis, Box 200, Cedar Grove, North Carolina.**

**MEDICAL Laboratory technicians in great demand. We train you in your own home. Catalogue free. Imperial Technical Institute, Box 973-J, Austin, Texas.**

**USED Correspondence courses and books sold and rented. Money back guarantee. Catalog free. (Courses bought.) Lee Mountain, Pisgah, Alabama.**

**PIANO Tuning pays. Learn this profitable profession at home easily with patented Tonometer and mechanical aids. No knowledge music necessary. Diploma granted. Write for booklet. Niles Bryant School, 3731 Stockton Blvd., Dept. P, Sacramento 20, California.**

**STUDY For doctor's degree of psychology, metaphysics and divinity. Correspondence courses only. College of Divine Metaphysics, Dept. P-M, 2811 North Illinois, Indianapolis 8, Indiana.**

**PHYSICAL Therapy and massage. We train you at home. Earn big profits from your own private practice or work with hospitals and doctors. Free catalog. National Institute, Desk 4, 159 East Ontario, Chicago 11.**

**BECOME An expert real estate broker or salesman. Make money anywhere. Complete home study course. Free information. Kansas City Realty School, Suite 307, 3119 Troost, Kansas City, Missouri.**

**PLAYS, STORIES, MANUSCRIPTS**

**NO Luck finding a book publisher? Write for free Booklet PM. Vantage Press, 120 W. 31, New York.**

#### SPECIAL SERVICES

**TECHNICAL Questions answered by engineers. \$1.00 each. Box 31, Westbury, N. Y.**

**CANADA: Quebec, Montreal, Gaspeia reminds 25c. Lanroy, 178 Cadillac, Quebec.**

**INFORMATION On anything. Ferguson Research Specialists, 116-14 141 St., So. Ozone Park 36, N. Y.**

#### ARTISTS' SUPPLIES

**IF Interested in artist frames, canvas, canvas boards, Red Sable brushes, etc., be sure to get our money saving price lists before buying. International Sales Co., 414 E. Baltimore St., Baltimore 2, Md.**

#### CARTOONING, COMMERCIAL ART, SHOWCARD & SIGN PAINTING, TATTOOING

**CARTOON Your way to success! Internationally known instructor, Raye Burns, will personally teach you to create original, salable cartoons at home. Course of 26 lessons only \$2.85. Write for free details. Raye Burns School, Box 3583-P, Cleveland 18, Ohio.**

**"HOW To Make Money With Simple Cartoons"—A book everyone who likes to draw should have. It is free; no obligation. Simply address Cartoonists' Exchange, Dept. 96C, Pleasant Hill, Ohio.**

**BARGAINS, Quick landscape painting, poster art, lettering, cartooning. Literature free. Art Book Shop, Arnold 8, Missouri.**

**PERFORATED Sign patterns, designed to your copy. Samples 10c. Vande Linde Signs, Madison, W. Va.**

**"CARTOONING Made Easy." Simple method. Big profits. Send \$1.00 for complete booklet to A. L. Baggett, Box 162, Freehold, New Jersey.**

**CARTOONISTS: Amateur, professional. Prepare for animation with Max Fleischer's plan. Write Vera Coleman, Lincoln Building, New York, N. Y.**

**CHALK Talks. Laugh producing program \$1.00. Catalog 10c. Balda The Cartoonist, Oshkosh, Wisconsin.**

**TATTOOING Course, supply brochures 25c. Zeiss, 728 Lesley, Rockford, Illinois.**

**LEARN Sign painting at home. Test lesson free. Ben Kerns, Box 813-PM, Greenville, S. C.**

**PAINT Signs with Master patterns. Set 1 1/4" to 12" high, with supplies, \$2.00; sample 3c. Everly, B-583, Newton, Iowa.**

**"FEMALE Figure Drawing." Illustrations galore. Step-by-step instructions. \$2.00. Southern Book Co., Box 426, Edgefield, S. C.**

#### ADVERTISING AGENCIES, LETTER WRITERS, FOR ADVERTISERS

**BEFORE Advertising get instructive Ad-Guide and Ratebook, 10c. Ideas developed. Advertisements prepared free. Chicago Advertising Agency (Established 1900), Chicago 4.**

**NAMES: Accurate, latest, birth lists; prospective bridegrooms; Cleveland homeowners. 100, \$1.00. Information free. Crowley's, Pearl Road, Route 3, Chardon, Ohio.**

**WANT More business? Here's an amazing opportunity to increase your sales. Talk to thousands of interested readers of "Mechanics Popular." Our Spanish Edition covers the Latin American countries like a blanket. They're real mailorder buyers. Classified rate 75c per word. Try an ad in our next issue. Classified Advertising Department, Popular Mechanics Magazine, 200 East Ontario Street, Chicago 11, Ill.**

**ADVERTISING—Display, classified. Experts since 1893. Interesting budget brochure free. Newmark's Agency, 217-7th Ave., New York.**

**MAILING Lists, most any classification. 1000 names \$5.00. 1000 your circulars mailed with ours \$4.00. 5000 your circulars printed and mailed \$12.95. Write Dixie Mailers, King, North Carolina.**

**ADS Placed in out of town newspapers and magazines. Low rates. Catalogue free. Ideas that pay. Baker Advertising Agency, Successors Ankrum Agency, 189 W. Madison, Chicago 2.**

#### RUBBER STAMPS AND OFFICE SUPPLIES

**1, 2 OR 3 Line rubber stamp with self-inking stamp pad included. \$1.00 postpaid. Mishak, Waseca 2H, Minn.**

**NOBODY Gives bigger values or lower prices. Here's one. 3 lines, 2" long, 3/4" wide, cushion mounted, knob handle, indexed rubber stamp \$1.00. Big catalog, 10c refundable. Money back guarantee. Esco 165 Print, 8 Holt, Dayton 7, Ohio.**

**OFFICE Supplies and equipment catalogue 25c. Refundable. Box 1165, Washington, D. C.**

**CHROMETT The self inking pocket stamp. Heavy chrome plated finish. Up to 5 lines. Only \$2.00, cash with order. Postpaid. Bailey's, Lewiston, Idaho.**

4 LINES \$2. Includes business slogan and emblem, container. Opportunity, Box 142, Basking Ridge, N. J.

3 LINES. Pocket or cushion \$1.00. Hansen, 4908-F Ohio, Chicago 44.

RUBBER Stamps by professional craftsmen. 3 lines \$1.00. Price list. South Coast Press, P.O. Box 2074, San Bernardino, Calif.

#### TYPEWRITERS, DUPLICATORS, OFFICE DEVICES

TYPEWRITER Ribbons, two \$1.00. Black, red-black. Give typewriter name. Franklin Specialties, 613 18th St., Altoona, Penna.

RECONDITIONED Typewriters, duplicating, printing devices. \$25.00 up. Supplies. Appliances, DixieGraph, King, N. C.

#### PRINTING, MULTIGRAPHING, MIMEOGRAPHING GUMMED LABELS

OFFSET Printing \$6.50-10.00, 8 1/2 x 11, 16 lb. National Letter, 1463 Broadway, New York City 36.

FREE Printing catalog. 1000 business cards \$1.99. Leatham, Everton, Missouri.

REASONABLE Quality printing! Free pricelist. Napco, 2337-M Bath Avenue, Brooklyn 14.

FREE Catalog, business, personal printing. 1000 Thermographed cards \$2.65 postpaid. D & M Sales, Sebastopol, Calif.

5000 3 x 6 CIRCULARS Printed—\$4.98 postpaid. Print-Rite Service, 50 East 2nd Street, Pottstown, Penna.

ILLUSTRATED Printing catalog. Proofs. Klifford, 545 North Oakland, Pasadena 4, California.

100 DISTINCTIVE Business letterheads and envelopes \$2.00 postpaid. Holly-Print, P.O. Box 459, Jacksonville, N. C.

1000 EMBOSSED Cards, \$2.95 postpaid. Complete business printing. Samples. Jaynar, 911 Reed, Grinnell, Iowa.

MIMEOGRAPHING—High quality, reasonable prices. Free samples, pricelists. Mail-Me-Mimeo, 920 Vanburen, Milwaukee 2.

100 8 1/2 x 11 LETTERHEADS. Carefully printed \$1.00 postpaid. Envelopes same. Race Printers, Hudson, New York.

\$1.00 EACH Specials. 1000 name-address labels, 200 noteholds, pocket stamp. Allen, 216 W. Jackson, Chicago 6.

STICKERS Printed, many styles. Want samples? Arthur Fishers, Taylorville, Ill.

1000 EMBOSSED Business cards, one color \$3.95, two color \$4.50. Samples free. L. Watson, Box 182, St. Charles, Illinois.

OFFSET Printing \$6.50, 1000, 8 1/2 x 11, 20 lb. Albert Oden, Devils Glen Road, Bettendorf, Iowa.

MIMEOGRAPHING—Letters, pricelists, formulas, instructions. Lowest prices. Lem's Letter Shop, 5710 Stanton, Detroit 8.

500 3 1/2 x 2 1/4 FOUR Line gummed stickers 50c. Red border \$1.00. Moritz Printery, Saginaw, Mich.

QUALITY Printing. Booklets, publication, catalogs, stationery. Free catalog. Adams Printers, 30 W. Washington, Chicago 2, Illinois.

MIMEOGRAPHING—Reasonable. Any copy. Mailers Service, Box 806-A, Chicago 90, Ill.

100 LETTERHEADS, \$1.00. #6 1/2 Envelopes same, two colors, \$1.50. Broadbrook, Botsford, Conn.

ADS Running under this heading sell printing. Ask me for proof. I'll gladly send you amazing facts. Ask for Folder "P." P. W. Johnson, 200 E. Ontario St., Chicago 11, Ill.

#### PRINTING OUTFITS AND SUPPLIES

MAKE Your own self-molding rubber stamps and printing cuts. Plexirubber, Arvyle 1, Wisconsin.

PRESSES, Type cabinets, supplies. List for stamp. Lincoln Press Company, 220-F Hartwell, Fall River, Mass.

MAKE Your own cuts. Free literature. Piastarubber, Box 4308-M, Mobile, Ala.

PRINTING Presses, type, supplies. Lists 2c. Turnbaugh Service, Loysville, Penna.

DO Your own printing. Save money. Simple rules. We supply everything. Print for others; good profit. Raised printing like engraving too. Have home shop. Details free. Kelsey Presses, V-11, Meriden, Connecticut.

HAND Presses; cutters; cases; type. Open Saturdays. Damon & Peets, 56 Beekman St., New York City.

#### PATENT ATTORNEYS

INVENTORS—If you believe you have an invention, you should find out how to protect it. The firm of McMorrow, Berman & Davidson with offices in Washington, D. C., is qualified to take the necessary steps for you. Send for copy of our patent booklet "How to Protect Your Invention." We will also send you an "Invention Record" form. No obligation. They are yours for the asking. McMorrow, Berman & Davidson, Registered Patent Attorneys, 1348 Victor Building, Washington 1, D. C.

INVENTORS—Take these preliminary steps toward patent protection. Sketch and describe your invention. Sign, date and have this disclosure witnessed by two people who understand your invention. Have us make a preliminary search among U.S. patents already granted for similar types of invention. We report on the probable patentability of your invention and recommend your further course of action. Write for our instructive booklet, "Patent Protection for Inventors" and convenient "Evidence of Invention" disclosure form. Victor J. Evans & Co., 131-G Merlin Building, Washington 6, D. C.

INVENTION Record form free and "Patent Information Every Inventor Should Have." Carl Miller, Registered Patent Attorney, Woolworth Building, New York.

REGISTERED Patent attorney offers services. Sanders, 6430 Evans, Chicago 37, Illinois.

PATENTS—Irving L. McCathran, 315 McLachlen Bldg., Washington 1, D. C. Registered Patent Attorney.

C. A. Snow & Co.—M427, Snow Building, Washington 1, D. C. Registered Patent Attorneys. Write for information.

INVENTORS: Learn how you can protect your invention. A specially prepared booklet "Patent Guide for the Inventor" containing detailed information concerning patent protection and procedure together with "Record of Invention" form will be promptly forwarded to you upon request, without obligation. We are registered to practice before the United States Patent Office and are prepared to serve you in the handling of your patent matters. Clarence A. O'Brien & Harvey Jacobson, Registered Patent Attorneys, 51B-D District National Building, Washington, D. C.

INVENTORS: When you are satisfied that you have invented something of value write me, without obligation, for information as to what steps you should take to secure a patent. Write Patrick D. Beavers, Registered Patent Atty., 835 Columbian Bldg., Washington 1, D. C.

PATENTS. "Proof of Invention" free. E. E. Vrooman, Registered Patent Attorney, 507 McKim Building, Washington 5, D. C.

"INVENTOR'S Guide" and "Record of Invention" free on request. Frank P. Ledermann, Registered Patent Attorney, 154 Nassau Street, New York City.

INVENTORS: Without obligation, write for information explaining the steps you should take to secure a patent. John Randolph, Registered Patent Attorney, 203 Columbian Bldg., Washington 1, D. C.

#### FOR INVENTORS

INVENTORS—This firm is registered to practice before the United States Patent Office and available to assist you in the preparation and prosecution of your patent application. "Patent Protection for Inventors" booklet containing detailed information and steps to take toward patent protection sent promptly upon request. No obligation. Victor J. Evans & Co., 132-G Merlin Building, Washington 6, D. C.

INVENTORS—If you believe you have an invention, you should find out how to protect it. The firm of McMorrow, Berman & Davidson with offices in Washington, D. C., is qualified to take the necessary steps for you. Send for copy of our patent booklet "How to Protect Your Invention." We will also send you an "Invention Record" form. No obligation. They are yours for the asking. McMorrow Berman & Davidson, Registered Patent Attorneys, 1347 Victor Building, Washington 1, D. C.

INVENTORS: Profit from copyrighted "One Inventor's Experience" or money back. Send \$1: R. E. McLean, 5703 South Benton, Kansas City 30, Missouri.

INVENTORS—Send for free patent information book and inventor's record. Registered Patent Attorney, Associate Examiner, Patent Office 1923-29, Patent Attorney & Advisor, Navy Department 1930-47. Gustave Miller, 65A Warner Building, Washington 4, D. C.

PATENTS Wanted for publication. Room 302, Box 2052, Austin, Texas.

FREE List of inventions manufacturers have requested. Tell us whether yours is patented, unpatented. Invention Bureau, 208-M Clinton, Oak Park, Illinois.

INVENTORS: If you have an invention for sale, patented or unpatented, write Institute of American Inventors, Dept. 40A, 631-E St. N.W., Washington 4, D. C.

"INVENTOR'S Guide" and "Record of Invention" free on request. Frank P. Ledermann, 154 Nassau Street, New York 38, N. Y.

INVENTION Record form free and "Patent Information Every Inventor Should Have." Carl Miller, Registered Patent Attorney, Woolworth Building, New York.

INVENTORS: Information on patent procedure furnished on request, without obligation. John Randolph, Registered Patent Attorney, 203 Columbian Building, Washington 1, D. C.

SEARCHES—Put your patent searches in the hands of a registered patent attorney or agent, as he qualifies to give a worthwhile patentability report. Record of invention form upon request and information on patent protection. Patrick D. Beavers, Registered Patent Attorney, 936 Columbian Bldg., Washington 1, D. C.

PATENT Searches \$5.00. 48-hour service. Free invention protection forms. Write Raymond L. Smith, Patent Searcher, 822 Sheraton Building, Washington 5, D. C.

PATENT Searches \$5.00. 48-hour airmail service. Invention protection forms free. Write Patent Engineering Service, 711 14th Street N.W., Washington 5, D. C.

PATENT Searches, including copies of nearest patents, \$5.00. Reports airmailed within 48 hours. More than 100 registered patent attorneys use my service. For free invention protection forms, write Miss Ann Hastings, P.O. Box 175, Washington 4, D. C.

INVENTORS: Learn how you can protect your invention. A specially prepared booklet "Patent Guide for the Inventor" containing detailed information concerning patent protection and procedure together with "Record of Invention" form will be promptly forwarded to you upon request—without obligation. We are registered to practice before the United States Patent Office and are prepared to serve you in the handling of your patent matters. Clarence A. O'Brien & Harvey Jacobson, Registered Patent Attorneys, 51A-D District National Building, Washington, D. C.

#### INVENTIONS WANTED

NEW Products, ideas wanted by large manufacturer. Up to \$10,000 or more prizes, royalties in big contest. For entry blank write Dept. P.M. All-Aluminum Products, 36th and Reed Streets, Philadelphia, Penna.

INVENTORS. We sell, promote inventions. Write immediately if you have marketable invention. Details free. Kessler Corporation, 56X, Fremont, Ohio.

INVENTIONS Wanted. Patented, unpatented. Free form "S" and literature. Gilbert Adams, Patent Broker, 3 Park Row, New York City.

WORLDWIDE Associates produce results for inventors, manufacturers, investors. Consultants on development, patenting, financing, sales; patented, unpatented inventions. Information free. Inventors Project Engineers, 188 West Randolph, Chicago 1, Illinois.

PATENTED; Unpatented. Promotion at its very best. Write for free particulars. Superior Inventions Agency, 338-344 North Rodeo, Beverly Hills, Calif.

CASH Buyers for ideas and inventions. Write National Inventors Institute, 457 Munsey Building, Washington 4, D. C., or 4097 East 131st St., Cleveland 5, Ohio.

INVENTIONS Wanted. Patented; unpatented. Tremendous manufacturers lists. Global Marketing Service, 1404 Mitchell, Oakland 1, California.



FROM Center American industry. National Research & Development Corporation seeks patented or unpatented inventions for development or sale. Write for Letter A, Room 324, 11 West 42 Street, New York 36, N. Y.

**INVENTORS:** Hundreds of manufacturers have requested our assistance in locating marketable new products. Complete information free, Institute of American Inventors, Dept. 40-D, 631-E St. N.W., Washington 4, D. C.

**INVENTIONS Promoted.** Patented or unpatented. A-1 service for inventors since 1911. Write Adam Fisher Co., 5418 Idaho, St. Louis, Mo.

**INVENTIONS Wanted.** Patented or patent pending, 24 years experience promoting inventions. National Service Bureau, 3120 Meramec, St. Louis 18, Mo.

**INVENTORS,** Don't sell your invention patented or unpatented until you receive our offer. Write Cowgill, Box 298, Marion, Ohio.

#### PATENTS FOR SALE

**SIX** Patents for lease, market ready. Douglass, 1480 51st Street, Sacramento, Calif.

**HARMONICA** Playing instructor (2 patents). Slidingly adjustable on any harmonica. Automatic note-picking. Double-action reed attachment with special systematic one, two, three note selectors. Learn note by note, step by step. Money needed to manufacture 100,000. Can retail for \$1.00. With harmonica \$2.00. Partnership etc. A. Balint, 426 E. 67th Street, New York 21, N. Y.

**INVENTORS:** Test the commercial value of your patented or unpatented inventions, quickly and inexpensively. Write for free information. Institute of American Inventors, Dept. 40-B, 631-E St. N.W., Washington 4, D. C.

#### MANUFACTURING

**DESIGNING.** Manufacturing, Machinery, parts, models. Henry, Engineer, 2136 E. Monmouth, Philadelphia 34, Penna.

**MODELS**—Small lot manufacturing. Metals, plastics, etc. Milburn, Burlington, Kentucky.

#### MODELS, MODEL SUPPLIES

**1955 CAR** Models, 1/25 scale, all metal, chrome trim. Send for catalog! Cars & Hobbies, Dept. PM-27, 2333 Haddon, Chicago.

**MODEL** Airplane engines new, used. Big discounts. Catalog 10c. Platteville Hobby Shop, Box 77, Platteville, Wisconsin.

**BOATS**—Scale models, outboard, inboard motors. Bob's Model Railroad Shop, 5815 Webster, Kansas City 4, Kansas.

**NEW Model** railroad book! Ideas. Save money. Do yourself. \$1.00. Trains, 1196 Portland, St. Paul, Minnesota.

**AUTHENTIC** Outboard boat model, ready to float. 17-inch aluminum reproduction of Arkansas Traveler 12-ft. Sportsman. Sealed to run with miniature outboard motors. \$5.95 postpaid, if remittance with order. For c.o.d. shipment, send \$1.00 deposit. Arkansas Traveler Boats, Box 2339, Little Rock, Ark.

**MINIATURE** Circus wagon kits. Catalog 35c. Hobbycraft Cyclopedic, Catalog \$1. Walters Hobby Shop, 207 French, Utica 4, New York.

**STEAM** Engines, boilers, castings. Catalog 35c. Anton Bohaboy, 2297 Price, Rahway, N. J.

**BALSA** Wood and model aircraft. 40-page catalog 10c. Sig Co., Montezuma, Iowa.

**POWER** Models. Unusual steam, gasoline and traction engines, fittings, metals. Anniversary catalog 50c. Chas. Cole, Ventura, Calif.

**SHIP** Models and yacht supplies. Complete, large 68 page catalogue 50c. Bill Wild's, 510 East 11 St., New York City 9.

**SHIP** And other scale models. Most complete line in New England. Kits, fittings, plans, books, tools, engines, motors. Illustrated catalog 25c. James Bliss & Co., Inc., Dept. SM, 342 Atlantic Ave., Boston 10, Mass.

**BUILD** Miniature passenger hauling live steam locomotive with file and drillpress. We do machine work, you bolt it together. Catalog 50c. Little Engines, Lomita, Calif.

**SHIP** And yacht model fittings: blueprints. Send 35c for illustrated catalog listing hundreds of items. A. J. Fisher, 1002-1 Etowah Ave., Royal Oak, Mich.

#### HOME CRAFTSMEN

**NEW!** Largest leather and craft catalog! 1,000's of items. Send 25c (refunded with first order). Russo Handicraft Supplies, Dept. C, 245 S. Spring, Los Angeles 12, California.

**101 FULL** Size patterns. Smart, new, gifts, novelties, lawn figures, shelves, action windmills, alphabets. Plus "Make Money Jig Sawing." Only \$1.00. Mastercraft 65M, 7041 Olcott, Chicago 31, Illinois.

**PLASTICS** Home-craft course for men and women. Tells and shows how to make hundreds of fast selling plastics products. All plastics and materials for 23 projects included in course. No special tools needed. Course pays for itself. Write for free booklet. Interstate Training Service, Dept. D-3-F, Portland 13, Oregon.

**90 ALL** New, full size lawn ornament and novelty patterns, up to 20" high. Only \$1.00. Mastercraft 62M, 7041 Olcott, Chicago 31, Illinois.

**FAST** Selling lawn furniture—6 separate selected plans, \$1.00. Summercraft Studio, Newton 58, Mass.

**BUY** Wholesale nationally advertised power, hand tools, thousands other products at big discounts. Free "Wholesale Plan." American Buyers', 628-RR Linden, Buffalo 16, N. Y.

**89 FULL** Size jig saw patterns of beautiful shelves, ornaments, toys, novelties. Plus "How, Where to Sell." Only \$1.00. Mastercraft 64M, 7041 Olcott, Chicago 31, Illinois.

**LEATHERCRAFT.** Send 10c for new 60-page catalog of tools, supplies, kits, including metalcrafts, enameling, ceramics, all other crafts. Complete stock. Reasonable. Since 1910. Sax Bros., Dept. PM6, 1111 N. 3rd, Milwaukee, Wis.

**WOODWORKING** Course for home craftsmen. Twenty-two manuals. Over 1000 pages. 75 training projects. Only complete home training program available today. Carefully written, profusely illustrated. Covers everything from wood selection to final finishing. Complete instruction in care and use of all hand and power tools. Prepared by expert manual training instructors. Write for free booklet. Interstate Training Service, Dept. G-3-F, Portland 13, Oregon.

**LEATHERCRAFT** For pleasure or profit. Make easy-to-assemble purses, belts, gloves, woolskin toys. 100 other items for gifts or to sell. Send 10c today for big catalog. Largest leathercraft stock in U.S. J. C. Larson Co., 420 S. Tripp, Dept. 5150, Chicago 24.

**MAKE** Latest novelties, toys. Write Ace, Copley St., Auburn, N. Y.

**16 NEW** Lawn chairs, 22 picnic tables, benches, trellises, etc. All 38 plans with necessary full size patterns, \$1.00. Mastercraft 63M, 7041 Olcott, Chicago 31, Illinois.

**SHOP** Chart containing 20 tables, 10,000 bits of information on drilling, spinning, turning, screw and nail sizes, compound angle cutting, wood and metal properties, etc. Printed on 12x18 inch chart, mailed flat. Send \$1.00. Craftchart, P.O. Box 446, Roslyn Heights, N. Y.

**ALUMINUM.** Heavy gauge 1"-1 1/2" strip. 101 shop and home uses. 30 ft. roll \$1.00 postpaid. Satisfaction guaranteed. Filbrun-Ploey Enterprise, R.4 Box 111C, Anderson, Indiana.

**FREE** Plans, trade secrets for the shop and home. \$1.00 brings complete list. Aviron Enterprises, P.O.B. #71, Bay Station, Brooklyn 35, N. Y.

**LEATHERCRAFT.** Metal tooling, textile painting, beadcraft, shellcraft, many others. Free, big, illustrated catalog. Kit Kraft, Dept. 226, Studio City 1, California.

**BUILD** Your own furniture. We furnish wrought iron legs for all. Literature free. Hibbard's, 624 Celey, Hampton, Va.

**LEATHERCRAFT** Supplies at lowest prices. "Craftool" stamps. Catalog 10c. Crown Leather, 22 Spruce Street, New York 38.

**STYLECRAFT** Sure fire hits. "Pre-traced" leather kits. Handbags, billfolds, filigree belts, over fifty other projects. Patterns on leather. Why trace? Just carve, assemble and lace. Large assortment "precarved" kits also available. Send 25c for catalog, free folder. Refunded first order. Apache Leather Company, 2804 E. Washington St., Phoenix, Arizona.

**KNOCKDOWN** Cedar chests and lumber. Free price list. Bedford Lumber Company, Shelbyville, Tennessee.

**129 NEW** Full-size jigsaw patterns. Artist-drawn. \$1. Craftplans, 1321-A South Michigan, Chicago 5.

**MAKE.** Sell. Toy power shovel. Sturdy Mfg. Co., Clarkston, Wash.

**FREE** Information. Money-making full size patterns. Professional designs. Furniture, gift shop items. Write Jigsawers, 117 Worth, New York 13.

**FREE** "Do-It-Yourself" leathercraft catalog. Tandy Leather Company, Box 791-UP, Fort Worth, Texas.

**KNOCKDOWN** Cedar chests. Lumber and veneers. Free price list. Giles & Kendall Company, Huntsville, Ala.

**FREE** Make-it-yourself craft catalog, low-cost kits and supplies. American Handicrafts, Box 1479-BQ, Fort Worth, Texas.

#### DO IT YOURSELF

**DRILL** Water well by hand. Use same pump and pipe for both drilling and producing. Plans \$1.00. Bennett, 2461 Lucas Drive, Beaumont, Texas.

**BUILD** Inexpensive concrete blockmaker. Motor-hand. Also mixer. (Both for less than \$10.) Then make blocks for 3 room house for \$93. Write. C. Lee, Mountain View, Oklahoma.

**MAKE** Your own cut off saw. Complete plans and pictures \$1.00. Clarence Emhouser, Kankakee, Illinois.

**IMITATION** Brick and stone. Create out of cement and sand troweled over any surface. Undetectable imitations. Instructions \$1.00. George Petchnik, 226 S. Larch, Lansing 12, Mich.

**UNFINISHED** Cherry shadow box kit. Assemble in minutes. \$2.50 prepaid. Free literature. Lester Werblin, 71 Middlesex, Waltham 54, Mass.

**WINDOW** Fan kits 20" \$12.95, 30" \$13.95. Free literature. Mesco, 3835 Banks, New Orleans 19, La.

**CLOCK** Movements—Gorgeous dials, plans, kits. See ad page 219.

**AIR** Conditioners—Home, automobile. See Kool Engineering ad page 34.

**HOW** To make a duplicator that costs a dollar and make big money with it. 25c. Oakwood-PM, Philadelphia 26.

**BUY** Aluminum storm windows at wholesale! 3 minute assembly on frame—and windows are ready to install. Finest quality three channel window. All-Time Mfg. Co., Dept. PM, New Britain, Conn.

**\$2,500.00 BUILDS** \$10,000.00 Home. Complete plans, details \$1.98. S. J. Savage, Builder, 103 Riverside Drive, Scranton 9, Penna.

**GUARANTEED** Satisfaction disposal system cleaner. Vandot, Box 666P, Council Bluffs, Iowa.

**BUILD** An add-on house. Drawings and information. \$1. P.O. Box 572, Yakima, Washington.

**FURNITURE**—Wrought iron legs and frames! You assemble. Free catalogue. Phillips Furniture, East Peoria 3, Illinois.

**GEIGER** Counter and metal detector kits. Inexpensive, educational. Free literature. Electronic Applications, 5024 Lee Highway, Arlington 7, Va.

**DO** It yourself. What? Repair TV, build furniture, make barbecue, plumbing repairs, build boats, do house wiring, remodel home, lay tile, modernize kitchen, repair home, and scores of other things you can do yourself. Books covering each subject, only 25c. Send for descriptive list. It's free. Popular Mechanics Press, 200-LB East Ontario St., Chicago 11, Ill.

#### WATCHES, OLD GOLD, JEWELRY

**IMITATION** Diamond ring \$5 details stamp. Bluegrass, 1417-36th, Louisville 11, Ky.

**WATCH** And clock repairing books for hobbyists. Free information. North American, Dept. 15-F, 2320 N. Milwaukee, Chicago 47, Illinois.

**RHINESTONES.** Jewelry settings, copper enameling. Sample earring kit and catalog 25c. Catalog only, 10c. J & M Novelties, Dept. CG-3, Griffith, Indiana.

**USED** And new watches \$2.50 up. List 10c. Southern Watches, Gray, Georgia.

**MONEY** Immediately for broken jewelry, gold teeth, watches, diamonds, silverware and platinum. Highest prices. Satisfaction guaranteed. Information free. Mail today to Wilmot's, P.O. Box 8, 2647 102 St., Toledo 11, Ohio.

**TITANIA** Gems, unset. Lowest prices anywhere. \$7.95 carat. Satisfaction or refund. Rogers Jewelers, 291 Grant, Buffalo, N. Y.

**WATCHES, Clocks, Jewelry, typewriters, appliances.** Tremendous discounts. Kingsley, Chepachet, Rhode Island.

10 **SWISS** Watches \$18.00. Catalog 10c. Berkowitz, 1150 Castlehill, New York 62.

**HIGHEST** Cash for old gold, broken jewelry, gold teeth, watches, diamonds, silverware, spectacles, platinum. Free information. Satisfaction guaranteed. Rose Refiners, Heyworth Bldg., Chicago 2.

**AMATEUR** - Professional watchmakers' supplies; correspondence instructions; repairing. Bengale Company, Culver City, California.

**COSTUME** Jewelry supplies. Catalog and samples. 35c. Largest line in America. Milady-Fair Co., G.P.O. Box 1328, New York City 1.

#### TOBACCO, SMOKERS' SUPPLIES

**TOBACCO,** 4 Lbs. fine pipe smoking \$2.00 postpaid. L. Pulliam, Patesville, Ky.

**PIPE** Smokers! Cigar smokers! Free illustrated catalog offers fabulous savings on choice imported and domestic pipes, cigars, tobaccos, supplies. Write Wally Frank, Dept. 25, 150 Nassau Street, New York 38, N. Y.

#### RAZORS, BLADES, SHARPENING

**PERFECT** Shaves guaranteed. 100 hollow ground blades \$1.75 postpaid. Write for free samples. Davies, P.O. Box 182B, Plainfield, N. J.

100 **BLADES** \$1.00. (Single-double.) Rapco, 113 Oregon, Fall River, Mass.

#### OF INTEREST TO WOMEN

**MAKE** Copper enameled jewelry for pleasure or profit. Excellent results with beginners' sets. Easy to make ash trays, bracelets, earrings, pins, cuff links as gifts or to sell. For craftsmen, 30 different copper shapes. Enamels in 30 different colors. Tools, findings, late model professional kilns. Free booklet. Write J. C. Larson Co., 830 S. Tripp, Dept. 5175, Chicago 24.

**DRESSMAKERS.** Sewers, wholesale lists. Dress suitings, formal fabrics. Box 863, Norwalk, Conn.

**ATTRACTIVE,** All-occasion gift merchandise. Free catalog. Gifts, Layton, Utah.

**PORTRAITS**—3x10 Oils. Personal art treasures. Satisfaction guaranteed. Send color snapshot, \$10. E. Dorsey, Ojai, Calif.

**BABY** Blanket, guards against suffocation \$5.95. Free details. C. E. Robinson, Lock Box 1553, Erie 8, Penna.

**GOOD** Money in weaving. Weave rugs at home for neighbors on \$89.50 Union Loom. Thousands doing it. Booklet free. Union Looms, 153 Post St., Boonville, N. Y.

**MAKE** Big money at home! Invisible reweaving pays up to \$10.00 profit in an hour. Make tears, holes disappear from fabrics. Constant demand from laundries, cleaners, homes, brings steady earnings. Details free. Fabriccon, Dept. C, 8342 S. Prairie, Chicago 19, Illinois.

**PROFITABLE** Home business. Make fast-seller chenille monkey trees, dolls, flowers. Terrific holiday demand. Information free. Velva, Bohemia 16, N. Y.

**GROW** Mushrooms. Cellar, shed, and outdoors. Spare, full time, year round. We pay \$3.50 lb. We paid Babbitt \$4,165.00 in few weeks. Free book. Washington Mushroom Ind., Dept. 178, 2954 Admiral Way, Seattle, Washington.

#### FOR SALE—MISCELLANEOUS

**ELECTRONIC** Eye. Automatically activates by light change from day to night. \$15.95. Teeple Co., 715 Rim Rd., Pasadena, Calif.

**COVERALLS.** \$1.19. (Sizes 36-42). Used quality uniforms. Reconditioned. Shirts, 49c; pants, 70c. Postage 30c each coverall or shirt-pants set. Arrow Overall, 5544 Vine St., Philadelphia 39, Penna.

**SAVE,** Buy direct from government; hundreds of surplus items. Radio, photographic projectors, sound equipment, binoculars, printing, hunting, fishing, camping, sporting equipment, hundreds others. List \$1.00. Box 169FN, East Hartford 8, Conn.

#### WANTED—MISCELLANEOUS

**OLD** Or used welding equipment. Get our offer. Top dollar. Klas, 6728 Warren, Detroit 10, Michigan.

**HIGHEST** Prices for gold, silver, platinum, diamonds, watches, gold teeth. Satisfaction assured. Goods returned if offer unsatisfactory. United Smelting Works (Old Reliable), 6-B East Monroe, Chicago 3.

**QUICKSILVER,** Sterling, silver solders, precious metals. Wholesale Terminal, Norwood, Massachusetts.

**SCRAP** Mercury (quicksilver) containers supplied—Tantalum, bismuth, tungsten. Metallurgical Products Company, Established 1909, 35th and Moore Sts., Philadelphia 45, Penna.

#### PERSONAL

**BORROWING** By mail. Loans \$50 to \$800 to employed men and women. Easy, quick. Completely confidential. No endorsers. Repay in convenient monthly payments. Details free in plain envelope. Olive occupation. State Finance Co., 323 Securities Bldg., Dept. G-227, Omaha 2, Nebraska.

**LETTERS** Remailed 35c. Beautiful postcards 5 for \$1.00. Queens, Box 1017, Honolulu, T.H.

**MAIL** Received, forwarded. \$3 month. Hedgpeh, Box 850, Alhambra 23, Calif.

**MEXICAN** Law. General Practice Attorney. Apartado 79, Juárez, Chih., México.

**FOOT** Lotion for tired, aching feet. \$1.00 postpaid. Lumar Chemicals, Box 18, Rocky Hill, Conn.

**N.Y.C.** Remails 25c, company volume rates. Sunday classifieds any section U.S. \$1.00. Employment, property, businesses. Mailing Service, Box 448, Grand Central Station, New York 17, N. Y.

**LETTERS** Remailed 25c. Write for personal mailing-receiving address rates. McLaughlin, 800 Stewart, Columbus 6, Ohio.

**DENVER** Remails 25c, classifieds \$1.00. Ajax, 3080 Cornell Circle, Englewood, Colo.

**WORK** In Detroit, help wanted ads airmailed \$1.00. Remails 25c. Slay, 4112 Joy Road, Detroit 4.

**SQUARE** Peg in round hole? Dissatisfied? Restless? Unhappy? Do psychological tests at home. Uncover true abilities, aptitudes. First time available. Low cost. Details free. Write Psychologic Testing Institute, Dept. 243, 201 N. Wells, Chicago 6, Ill.

**MIAMI,** Miami Beach — Jobs, business opportunities, over 30 columns 50c. Letters remailed 25c. Kelleo, P.O. Box 798, Hialeah, Florida.

**LETTERS** Remailed from Los Angeles or Hollywood 25 cents each. Los Angeles classifieds \$1.00. Hollywood Mail Service, 1723 1/2 Sichel St., Los Angeles 31, Calif.

**URANIUM** Area — Spokane classifieds airmailed, \$1.00. Specify section. Personal information, \$2.00. Bingham, Box 740, Spokane, Wash.

**BOSTON,** Mass., remail 25c. P.O. Box 196, Cochrane, Mass.

**REMAILS** — Famous roundup city, 25c. Jode, 508 N.W. 4th St., Pendleton, Oregon.

**IMPROVE** Yourself at low cost and have happier, richer life. A big book of vital information for your success. Free information. Write at once. Varna House, Box 3096, Burbank, Calif.

**LETTERS** Remailed from Hartford 25c; Sunday classifieds Hartford, Boston, New York airmailed \$1 each. Harold Sattin, 60 Westbourne Parkway, Hartford 12, Conn.

**REMAIL** Letters 25c. 5 Cornwall views \$1.00. Receiving, forwarding \$2.00 monthly. Freemans, Cornwall, Ont.

**HOW** Can I get out of debt? Stop garnishments? Save jobs? Write E. Borum, 411 West Walnut Street, Kalamazoo, Mich.

**UNITED** Nations remails 25c. Richard Edmonds, 116 Union Avenue, New Rochelle, New York.

**SAVE!** 10%-25%. Watches, cameras, furnishings. Catalog 50c. Osgood, 1320-B Prospect, New York 59, N. Y.

**NORFOLK** Remailing 25c. Classifieds \$1.00. Box 6162, Norfolk 8, Virginia.

25 **INSPIRING** Mealtime prayers \$1.00. Meekers, 3822 Fairmount, Canton 5, Ohio.

**COLORADO** Springs remails 25c. Violet Turner, 1325 North Wahsatch, Colorado Springs, Colo.

**REMAILING** 25c. Replies forwarded. Ace Service, Box 186, Tampa 1, Fla.

**REMAILS** 25c, Classifieds \$1.00. Grace, Box 972, New Haven, Conn.

**BLACK** Eye kit makes blemishes, discolorations unnoticeable. \$1.00. Ross, 641 S. 19 St., Newark, N. J.

**BUY** Vitamins direct. Amazing savings. Catalog free. Matoeska, White Bear, Minn.

**LETTERS** Remailed from Kansas City 25c; receiving, forwarding address. \$3 monthly. Confidential. Sterling Services, P.O. Box 505, Kansas City 41, Mo.

"**HOW** Can I find out?" You can! Information confidentially developed. Any matter, person, problem. Worldwide. Officially licensed. Established 1922. William Herman, 170 Broadway, New York City.

**LETTERS** Remailed 25c. Personal forwarding address. Monthly rates. Hicks Service, Box 1547, Washington 13, D. C.

**HAVE** Your letters mailed from glamorous California for 20c. \$3.00 monthly address charge. Ideal, 4644-a Geary, San Francisco 18, Calif.

#### REMAILING SERVICE

**LETTERS** Remailed 25c. Henry Bell, Box 596, Chicago 90, Ill.

**REMAIL:** Famous Silver Springs, Ocala, Belleview, 25c. Williamson, Box 385, Belleview, Fla.

#### TREASURE FINDERS

**TREASURE.** Metal, mineral locators M-scope type. Latest electronic design \$75.00 up. Geiger counters, scintillators, mineralights for uranium prospecting \$35.00 up. Fully guaranteed. Monthly payment plan available. Books "How to Be a Successful Uranium Prospector," "For Fun and Profit." Literature free upon request. Fisher Research Laboratory, Inc., Palo Alto, Calif.

**URANIUM.** Gold, silver treasure. New, power-packed, highly sensitive metal detectors, Geiger counters and mineralights, kits and assembled models from \$12.50. Lightest weight, guaranteed, free literature. Electronic Applications, 5024 Lee Highway, Arlington 7, Va.

**AMAZING** Triple-action Geiger counter U-238C, combines audio, neon flasher, meter. Guaranteed best available. Also metal detectors and scintillation counters from \$49.50. For radioactive uranium sample send 25c to Goldak Company, 1541 W. Glencoe Blvd., Glendale, California.

**GEIGERSCOPES** (For detecting uranium) \$3 postpaid. Larry Lee, Mountain View 1, Oklahoma.

300 **TREASURES**—26x42" U.S. map 50c. R. Grumman, 3336 Boudinot, Cincinnati 11, Ohio.

**SCINTILLATORS,** Geiger counters, metal locators, mineralights. Catalog 10c. Int'l. Stamp Bureau, 125 W. Adams, Detroit 26, Michigan.

**TREASURE** Map! Just released! Gold, silver, treasure. Shows approximate locations of best-known buried treasures and lost mines of U. S. Mail \$3.00 to Professional Publications, Box 1078-M, Sweetwater, Texas.

**URANIUM** Found easier with Universal's new miracle transistorized audio. Adapts to all Geiger counters, amplifies detection clicks ten times, replaces bulky earphones, operates 500 hours on 15c flashlight cell. \$15 f.o.b. New York City. Send \$5 for c.o.d. Universal Atomic Corp., Dept. PM80, 19 East 48th Street, New York City.

**GEIGER** Counters \$29.95 to \$95.00. Free literature. Geiger counter tubes, vibrator step-up, probes, etc. Catalog. Amerlabs, 471 Clifton Ave., Newark 4, N. J.

**GOLD,** Silver, metal detectors. Geiger counters for uranium. Mineralights. Sensational new fully guaranteed models. None finer. Information free. Detector Corp., 5528 Vineland Ave., North Hollywood, California.

**MAKE** Millions! Priceless booklet tells where to find uranium. Rush \$1.00 to Uranium Research, Box 1555, College Station Texas.

**RECOGNIZE Uranium**—Quickly, easily! \$2 rushes fact-filled, illustrated book, "How to Find Uranium—With or Without a Geiger Counter." Satisfaction guaranteed. Uran-Co Publishing, 114 S. 38th Ave., Omaha 3, Nebraska.

**METAL Detectors**, Free details. Engineering, 620 S. Ingleswood, Ingleswood 1, Calif.

**URANIUM Finding** made easy. Completely transistorized Geiger counters now available for the first time. Extra sensitive. Lightweight. Scientifically engineered. Unconditionally guaranteed. Also a complete line of prospecting instruments priced from \$19.95. Write today for free information. Universal Atomics Corp., Dept. PM6, 19 East 48th St., New York City.

**MISCELLANEOUS**

**BUY Wholesale** thousands nationally advertised products at big discount. Free "Wholesale Plan." American Buyers, 631-DD Linden, Buffalo, N. Y.

**GERMAN Address lists**. Anything manufactured—\$1.00. Manufacturers' Index, Box 262, Woburn, Massachusetts.

**SENSATIONAL Pocket size knife grinder**. Sharpens knives quickly, easily \$1.00. Guaranteed. Charles Willard, Canastota, N. Y.

**WHOLESALE!** Plastic pipe; prefabricated swimming pools; septic tanks; pbg. supplies; cabinets, sinks. Send 10c. Stamps for catalog. Russell Wholesalers, Shortsville, N. Y.

**MAKE Your own signs** with Master stencil disk. 3/4 inch characters \$1.00 post-paid guaranteed. Stencil Shop, 47 Pearl, Laconia, N. H.

**COMBINATION Sharpener-glass cutter**. \$1.00. Arkay, Dept. S-9, 3733 Marburg, Cincinnati 9, Ohio.

**FORGETFUL?** Reminds any date 25c. five for \$1. Arnold's, 11 E. Thomson, Springfield, Penna.

**WHOLESALE!** 12,000 Nationally famous products! 30-80% discounts! Sensational plans, small catalog free. Derron Company, 21-13 White, Paterson 23, N. J.

**MATHEMATICS Made easy** with Wolfe's New Slide Rule. Literature available. Wolfe & Wolfe, 432 N. Walnut St., Danville, Ill.

**WESTERN Summer resort jobs**, Wyoming and Yellowstone Park. Complete information \$1.00. Frontiers, 429 Majestic Building, Dept. 1, Cheyenne, Wyoming.

**LABELS**. The glossy kind. Samples 10c. Fountainhead, Box 9342, San Diego 9, Calif.

**SCINTILLATION Counter blueprints**, instructions, \$4.95. John Glaze, 6908D Creger Ave., Chicago 49, Illinois.

**URANIUM Seekers**, rock hounds. Uranium Information Guide. Postpaid \$1.00. Bill's Uranium Research Service, Box 625, Boulder, Colorado.

**BUY Wholesale!** Save 80%! Catalog, \$1.00. Satisfaction guaranteed. Lee Clemmons, Silverpoint, Tenn.

**100 BALLOONS \$1.00**. Inflates to 17 inches. W & J, 222 East Third, Dayton 2, Ohio.

**BIG Money** selling individualized landscape blueprint planting plans to homeowners. Details \$1.00. Landart, 1513 Larabee St., Chicago 10.

**URANIUM Instruments**, eight complete lines. Large stock for immediate delivery, catalogues. Dealerships open, tremendous profits. Micromatic Associates, 2322 W. Whittier Blvd., Montebello, Calif.

**SCINTILLATION Counters**, Geiger counters. Naclometers. Geiger tubes \$7. Fine new scintillation crystals, from \$7. Instructions for use. Western Radiation Laboratory, 1107 W. 24th Street, Los Angeles 7, Calif.

**MILLIONS Earthworms** urgently needed! Raise indoors, backyard! Men, women, elderly! 800% profit! Instructions, markets, 25c. Oakhaven-M, Cedar Hill, Texas.

**300 BIG Mails** guaranteed. Samples, plans, offers, propositions, 12 months listing, \$1.00 refundable. Wright Publications, 2270 Hubbard, Memphis 8, Tenn.

**RECEIVE Magazines**, samples, catalogues. Mails from everywhere. Offers, hundreds. Get listed 25c. Rorick, Box 66, Cincinnati 26, Ohio.

**CLOGGED Drains**, cesspools and septic tanks cleaned by new powerful chemical. Sursolvent removes grease, soap, tree roots, etc., without expensive digging and electric rodding machines. No pumping necessary. Mix with water and pour down drain. Free details. Electric Drain Cleaning Co., Boston 34, Mass.

**GROW Mushrooms**. Cellar, shed, and outdoors. Spare, full time, year round. We pay \$3.50 lb. We paid Babbitt \$4,165.00 in few weeks. Free book. Washington Mushroom Ind., Dept. 175, 2954 Admiral Way, Seattle, Washington.

**HOW To paint**. Do it yourself. Illustrated instructive book. 25c. Catalog free. Popular Mechanics Press, 200-HP E. Ontario St., Chicago 11, Ill.

**PANNING Gold**—Free lesson; catalogue of mining, mineral books, supplies. Old Prospector, Box 729D1, Lodi, Calif.

**SNOOPER Geiger counter**. Only \$29.95 complete. Super-sensitive. Pocket size. Find a fortune in uranium. Order now. Send \$5.00, balance C.O.D. Money back guarantee. Free catalog, scintillator and larger uranium and metal detectors. Precision Radiation Instruments, 2235 CPM So. LaBrea, Los Angeles 16, Calif.

**BE Your own plumber**. You can. Few inexpensive tools and our instructive book, "Home Plumbing Guide," shows and tells you how. Hundreds of photographs and diagrams. Easy to follow. 160 pages. \$3.50. Catalog free. Popular Mechanics Press, 200PG East Ontario St., Chicago 11, Ill.

**OUTDOOR Toilets**, cesspools, septic tanks cleaned, deodorized with amazing, safe, harmless powder. Easy, economical to use. Saves digging, pumping. 150,000 customers guarantee satisfaction. Details free. Burson Laboratories, Dept. O-36, Chicago 22, Ill.

I want to send you proof of the wonderful pulling power of Popular Mechanics classified pages. What's your proposition? Write me today. Include literature if possible. F. W. Johnson, Manager Classified Advertising, Popular Mechanics Magazine, 200 E. Ontario St., Chicago 11, Ill.

**GROW HERBS & SPICES AT HOME**  
**MEN! WOMEN! Earn Spare Time \$\$**

Successful home grower tells you how he started growing Herbs as hobby in SMALL APARTMENT and developed a fine, nationwide business. Learn how to make 101 profitable items at home. **BIG-PROFIT** orders come from neighbors, stores, gift shops, many business firms—**ALSO MAIL ORDERS**. Millions of \$8 worth used yearly in foods, drinks, cosmetics, perfumes, medicines, etc. **EASY TO GROW** indoors or out. Few plants in kitchen window supply household needs. **HERBS MULTIPLY RAPIDLY**—half-dozen plants soon become hundreds. No big overhead. **SEND NO MONEY**. Instructions including **PLANS FOR 25 WAYS TO MAKE MONEY AT HOME** with Herbs **AND LIVING HERB PLANTS** sent for no-risk examination. **FREE**—full details. **WRITE NOW! WORLD OF HERBS**, Dept. 66, 601 S. Vermont, Los Angeles 5, Calif.

**If Ruptured**  
**For lasting relief your rupture must BE HELD BACK DAY and NIGHT.**  
**Consult Your Doctor.**

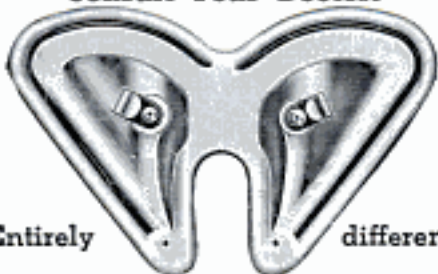

Entirely different  
**SOFT, FLEXIBLE**, and fits neat as a glove. The famous Miller saves you **TIME, MONEY, DISAPPOINTMENT**. Write for my **FREE** booklet today.  
**FRED B. MILLER** Manufacturer  
 Dept. PM-A, Hagerstown, Maryland

**PREPARE FOR THE BEST JOBS IN INDUSTRY**

**TRAIN at HOME**  
 IN YOUR SPARE TIME  
 or at **ALLIED INSTITUTE**  
 in Chicago

- MECH. ENGINEER
- DRAFTSMAN
- TOOL DESIGNER
- TOOL ENGINEER
- TOOL & DIE MAKER
- MASTER MACHINIST

**NO RECESSION FOR ALLIED TRAINED MEN**  
**MORE JOBS THAN GRADUATES** Shortages of Draftsmen, Designers, Tool Engineers, Machinists, Tool & Die Makers are so widespread that you can pick a highly paid key job and look forward to Achievement and Security.

You can begin your training in Short Courses and continue progressively to a Bachelor Degree in 26 months.

Allied is approved by Industry, Dept. of Education, Office of Public Instruction, State of Illinois, U.S. Veterans Admin., U. S. Dept. of Justice. Accredited C. S. A.

**SEND FOR FREE BOOKS**

**ALLIED SCHOOL OF MECHANICAL TRADES**  
 1338-42 South Michigan Ave. Dept. PM-6 Chicago 5, Illinois

SEND ME WITHOUT OBLIGATION INFO ON YOUR COURSES:  
 HOME STUDY  RESIDENT  VETERAN  NON VETERAN

NAME \_\_\_\_\_  
 ADDRESS \_\_\_\_\_ AGE \_\_\_\_\_  
 CITY \_\_\_\_\_ STATE \_\_\_\_\_

# Paint STRIPES with New "PAINT PEN"!

## Straight, Curved or Parallel Lines

Use like a fountain pen with any color paint to stripe furniture, bikes, autos, model planes, toys, linoleum, wall board. Beautiful clean, crisp results every time. Can't clog or smear. Also use with glue, tempera, textile paint or ceramic under glaze. Paints on wood, glass, plastic, metals, fabrics and paper. Tool complete with tip for 1/16" stripes only \$1.50 post-paid. Other complete tools with following tips, 1/64", 1/32", 3/64", 5/64", 3/32", 1/4" — \$1.50 each. Extra tips 75¢ each. Entire kit with tool and 7 tips — \$5.00. A 1/4" tip only \$1 each. COD's postage collect.

### New! "DOUBLE-STRIP" 5 Way Combination Model only \$2.95

Double Stripes — one wide and one narrow or two wide or two narrow at the same time.

FREE — Send postcard for complete information  
— or ORDER NOW... \$2.95



**DEALERS:** Master Paint Stripping Tool in display cartons of 1 doz. FAST, Profitable seller. Write for discounts.

**HOME CRAFTSMEN!** New Paint Stripping Tool gives "professional" results every time, simple, easy to use. Send \$1.00 now.

**MANUFACTURERS:** Write today for information about industrial and production stripping tools.

**WENDELL MFG. CO., Dept. 36**  
4234 Lincoln Ave., Chicago 18, Ill.



## START YOUR OWN ELECTRICAL APPLIANCE REPAIR BUSINESS

Repair electrical appliances of friends and neighbors. Service electrical equipment in factories, stores, etc. Work full or part time. New Shop Method home-training system. Rush name today for **FREE BOOK** and special form for getting Electronic Kit, Valuable Heating Element Kits, Advisory Service and Illustrated Instructions on new easy-payment plan. Pay later from **EARNINGS WHILE LEARNING**. Rush name today and we will include **FREE "The Secret Power of Success"** book.

**CHRISTY TRADES SCHOOL**  
4804 N. Kedzie, Dept. D-4303, Chicago 25

IF — YOUR CAR VALVES STICK AND BURN

## YOU NEED PYROIL

HERE'S WHY — PYROIL "A" clings to valves and stems so carbon can't form and keep them from closing. PYROIL keeps your engine clean. Plugs fire every time. Compression stays high. You save gas... and repairs.



HEAT-PROOF UPPER ENGINE LUBRICANT

PYROIL... It doesn't cost... It PAYS!

Get PYROIL "A" Today service station, garage or Only 25¢ dealer. Or write for exciting trial offer. Pyroil, Dept. PM-65, La Crosse, Wis., U.S.A.



**SUPER LUBRICANTS**  
WORLD FAMOUS SINCE 1929

## IF YOU "EAT, SLEEP & LIVE" CARS — LEARN HIGH-PAY AUTO MECHANICS & Diesel!



**DON'T LOSE OUT — FIND OUT!** At Home in Spare Time prepare for profitable Mechanic work, or OWN Business! Easy to learn by our Shop-Method Training. Low tuition. TOOL SET included. Earn as you Learn. Age and education no barrier!

Rush coupon for **FREE BOOK AND LESSON!**

OK FOR VETS

**MAIL NOW TO OFFICE NEAREST YOU!**

(mail in envelope or paste on postal card)

**NATIONAL SCHOOLS, Dept. DB-65**

4000 SO. FIGUEROA STREET OR 323 WEST POLK STREET  
LOS ANGELES 37, CALIF. OR CHICAGO 7, ILL.

Rush free Auto Mechanics Book & Lesson! No obligation!

NAME \_\_\_\_\_ BIRTHDAY 19\_\_

ADDRESS \_\_\_\_\_

CITY \_\_\_\_\_ ZONE \_\_\_\_\_ STATE \_\_\_\_\_

## WHERE-TO-BUY-IT INDEX

Source of supply appears after items commercially available

### AUTOMOTIVE

Ford's 1955 tractors offer tricycle design.....	71
Chevrolet pickup truck has plastic body panels.....	81
Tongue hitch for Jeep converts it to trailer.....	111
Army can take complete theater to forward areas in Showmobile.....	122
Side wings on bus unfold for crowds.....	131
Detachable truck-trailer body speeds freight delivery (Clark Equipment Co., Battle Creek, Mich.).....	132
Fisherman's truck mounts boat.....	137
\$850 sports car.....	138
Two-cylinder car.....	144

### AVIATION

10,000 feet in 56 seconds set fighter record.....	70
Submarines refuel Navy's big long-range seaplanes on open sea.....	70
Navy sub hunter.....	81
Air-to-air rocket searches out enemy plane.....	93
Assembly-line crane lifts Constellation in its "first flight" (Lockheed Aircraft Corp., Burbank, Calif.).....	111
Plane tethered to post takes off in circle.....	112
Accurate airdrops with rotor chute (Kaman Aircraft Corp., Bloomfield, Conn.).....	119
Helicopter tilted on special ramp for testing at various angles (Bell Aircraft Corp., P.O. Box 482, Fort Worth, Tex.).....	123
Air Force's Matador missile launched from special semitrailer (Martin Aircraft, Baltimore 3, Md.).....	129
Electronic target tests aim of strafing pilot.....	130
Twin-rotor convertiplane successfully test flown at 3000 feet (Transcendental Aircraft Corp., Glen Riddle Road, Glen Riddle, Pa.).....	131
Scorpion twin-jet interceptor carries 104 rockets (Northrop Aircraft, Inc., Hawthorne, Calif.).....	133

### HOUSE AND HOME

What's New for Your Home—	
Vacuum cleaner-polisher combines two appliances into one (Pillery Home Appliances, Inc., 38 Pearl St., New York City).....	120
Grater has a rotating handle that prevents skinned knuckles (Hoffritz for Cutlery, 49 E. 34th St., New York City 16).....	120
Shower head molded from plastic can't corrode (Warren-Magnuson Co., 612 E. Alcesta Ave., Glendora, Calif.).....	120
Step and handle screwed onto closet doorframe provide easy access to upper shelves (Narva Products, Inc., 70 E. 45th St., New York City 17).....	120
Bracket for food grinder prevents damage to counter tops and edges (Robert B. Haynes, 2005 Laskey Rd., Toledo 13, Ohio).....	121
Hose caddy eliminates dragging of heavy hose across lawn (H & W Products Co., P.O. Box 792, Peoria, Ill.).....	121
Clothes catcher fastens to bottom of laundry chute (Fornell Manufacturing Co., Minneapolis 19, Minn.).....	121
Toaster turns out hot buttered toast at the table (Munsey Products, Inc., Little Rock, Ark.).....	121
Paint roller ends splatter (No-Spray Foam Rubber Co., 17-19 W. Second St., Fond du Lac, Wis.).....	127

### MISCELLANEOUS

Flashlight batteries recharged overnight.....	62
Egg-shaped dome on church has unique panels of light.....	71
Golf bag becomes chair for player's relaxation (Moreland Golf Bag Co., Box 1441, Houston, Tex.).....	93
Light submachine gun.....	93
Giant testing machine will measure strength of full-size girders.....	119
550-mile "dingo" fence.....	122
TV finds parking spots to speed lot operation (Radio Corporation of America, Camden, N. J.).....	122
Homemade pile driver pounds stumps into soil.....	124
Electric reel brings in odd fish caught at great depths (Alex Mihalco, 3505 Stern St., San Diego, Calif.).....	124
Forage cutter tractor-mounted.....	129
Pencil with liquid graphite writes like ball-point pen (Parker Pen Co., Janesville, Wis.).....	129
Floating inspectors check tank wall.....	130
Lubricant loosens locks (Gebauer Chemical Co., 9410 St. Catherine, Cleveland, Ohio).....	132
Sleeping bags made of paper (E. B. Tunstead, 4412 W. Lake Harriet Blvd., Minneapolis 10, Minn.).....	132
Mower has overlapping blades (Henderson Mfg. Co., Fisher, Ill.).....	133
Pavement pounder records road test.....	137
Camera splits seconds into 15,000,000 parts.....	138
Saxophone keyboard simplified by inventor (Frank Martorano, San Jose, Calif.).....	138
Adhesive-coated wood strip covers edges of plywood (Ellisott Bay Lumber Co., 600 W. Spokane St., Seattle 4, Wash.).....	143
Electric-powered caddy hauls clubs for golfers (Power-Caddy, Inc., Littleton, Colo.).....	143

(Continued to page 60)

★★★  
**SHRINK SPACE**  
**105 POWER SUPER SCOPE**



There's No Better Value

**\$11.95** Post Paid

**FREE with your order**  
 Star Explorer Map enables you to find any star automatically  
 108-page book, "Discover the Stars" Carrying Case for Telescope

Reaching for the moon? You can bring it 105 times closer with CRITERION Super-Scope. Same goes for ships, people, animals, planets, stars. Space literally shrinks away. All images erect. Telescope can also be used as powerful compound microscope. Set comes ready for use: Brilliant variable 33X-65X-105X power adjustable eyepiece. 3 foot telescope, brass bound, closes to 16 inches. 4 precision lenses. Shipped complete with sturdy 5 foot hardwood folding Tripod equipped with universal mount that has 360° horizontal range, 180° vertical range. Locks in any position. The price has been shrunk, too—only \$11.95. Satisfaction guaranteed or money refunded. We pay all delivery charges. Send check or money order to DEPT. MPS2.

**CRITERION CO. 331 CHURCH ST. HARTFORD 1, CONN.**

**BIG MONEY FOR YOUR TV IDEAS**

TV Producers are "crying" for your new story ideas. "CASH IN" on your hidden talent in your spare time. Let the "know how" of leading TV writers and directors turn your untapped talent into dollars. Write for free information and sample script actually used on recent TV show. **TELECRAFTERS, INC.**, 6087-A Sunset Blvd., Columbia Square, Hollywood 28, Calif.

**Learn CORRESPONDENCE SCHOOL OPERATION & MANAGEMENT**

Many opportunities in the Home Study field. Learn how course is prepared, how to obtain student enrollments and how they should be serviced, then put your own ideas across. Send for **FREE Folder P-6**. Write today to Director, P.O. Box 652, Encino, California.

**Interested in Money?**

Our distributors are making it hand over fist, handling our nationally advertised automotive products in their own protected territories. Some areas still open. No charge for exclusive franchises. For details, write Room 1010, 3460 Wilshire Blvd., Los Angeles 5, California.

**The SKIN DIVER**  
 (Monthly Magazine)

Write to **Box 128-P Lynwood, California**

4th year of publication. Complete national and world-wide coverage on all spearfishing and underwater diving activities.

**SEND 25c** For introductory copy

**Subscription Rates**  
 \$3.00 1 yr. — \$5.00 2 yr. — Foreign \$4.00 1 yr.

**THE FIRST AND ONLY NATIONAL MAGAZINE OF ITS KIND!**



**AFTER BATH OR SHOWER—**

**DRY OFF!**

**Cool Off!**



**Say You Saw It in Popular Mechanics**

**more jobs than graduates**

**ENGINEERS**  
 Enging opportunity! If you are interested work in these fields pay you to write Box D 2 or, including a complete history of the profession and education.

Demand for our engineering graduates exceeds supply. Effective placement service. Study in this world-famed college established 1884. New term starts quarterly. Approved for Veterans.

**Bach. Sc. degree in 27 months**  
 Bachelor of Science in Mechanical, Civil, Electrical, Chemical, Aeronautical, Radio (T.V., Electronics), Administrative Engineering; Business Administration and Accounting. Also 36-weeks certificate course in Drafting. Intensive program: technical fundamentals accentuated: comprehensive courses. Small classes: personalized instruction. For earnest, mature students whose time and budget require accelerated courses and moderate costs. Preparatory courses. Beautiful campus in friendly college town. Well-equipped, new and modernized buildings and labs. Enter June, Sept., Jan., March. Write Jean McCarthy, Director Admissions, for Catalog, View Book and "Your Career in Engineering or Commerce."



465 College Avenue Angola, Indiana

# FREE 1955 ALLIED TV & RADIO CATALOG

THE COMPLETE ELECTRONIC SUPPLY GUIDE



**308  
VALUE-  
PACKED  
PAGES**

Save on  
Everything  
in  
Electronics

WORLD'S  
LARGEST  
STOCKS

Everything for Experimenters,  
Builders, Amateurs,  
Servicemen, Engineers and  
Hi-Fi Specialists

Send for ALLIED's big 308-page value-packed buying guide to everything in TV, Radio and Electronics! Largest selections of custom TV chassis, antennas and accessories; FM and AM tuners; High Fidelity systems and components; recorders and phono equipment; Amateur supplies; test instruments; builders' kits; industrial electronic supplies — plus the world's largest stocks of electronic parts, tubes, tools and books. Save on everything in Electronics — send today for your FREE 1955 ALLIED Catalog.

ultra-modern facilities to SERVE YOU BEST



Send for  
FREE  
Catalog

**ALLIED RADIO**

ALLIED RADIO CORP., Dept. 5-F-5  
100 N. Western Ave., Chicago 80, Ill.

Rush FREE 1955 ALLIED 308-Page Catalog

Name \_\_\_\_\_

Address \_\_\_\_\_

City \_\_\_\_\_ Zone \_\_\_\_\_ State \_\_\_\_\_

(Continued from page 58)

Synthetic paper (E. I. du Pont de Nemours & Co., Wilmington 98, Del.).....	143
Helicopter trawl fishes humans.....	144
Jets push boat.....	144

## SCIENCE

Glaciers are growing.....	70
The President announces an atomic freighter.....	80
Automatic distress machine.....	81
Balloons inflated under water to raise sunken ships.....	112
Electric-heating thermostat measures radiant effects (White-Rodgers Electric Co., 1209 Cass Ave., St. Louis 8, Mo.).....	112
Radar reveals locust hordes.....	119
Radar traces projectiles, locates mortar.....	123
Tiny radio transmitter.....	123
Air saves fish.....	131
Radar guides Swiss rocket.....	137
Fish preserved alive in ice.....	216
Supersonic paint for jets.....	216
Separator for viruses uses electrical process.....	224
Winds blow balloon to a distance record of 6250 miles.....	240

## Radio-Television, Electronics

"8-Transistor" portable radio (Raytheon Mfg. Co., 5921 W. Dickens Ave., Chicago 39).....	145
Battery-operated pocket tape recorder (Mohawk Business Machines Corp., 944 Halsey St., Brooklyn 33, N. Y.).....	145
Lightweight portable TV set (Zenith Radio Corp., 6061 W. Dickens Ave., Chicago 39).....	146
Broad-band flat-gain TV antenna for color (American Phenolic Corp., 1830 S. 54th Ave., Chicago 50).....	148

## Craftsman and Shop Notes Index

### BOATS

How to select a used outboard.....	157
Transom drag brakes boat to trolling speed.....	169
Piggyback boat trailer.....	201

### FARM AND FARMING

Pipe and stove poker used to make ratchet-type hog holder.....	193
Portable chicken feeder.....	193
Modified tractor scoop used as wagon jack.....	200
Weather shield on hoist pulley.....	200
Transmission on manure spreader increases speed variations.....	204

### HOUSE AND HOME

Outdoor window boxes supported by storm-sash hangers.....	151
Chimney efficiency improved by metal draft deflector.....	153
Solving Home Problems—	
Recipe books kept clean when slipped into transparent plastic bag.....	154
Leaves and other debris easily removed from eaves trough.....	154
Cutting a window shade straight to fit a narrower roller.....	154
Plywood disk attached to feet of dressmaker's dummy.....	154
Garbage can locked on a concrete base won't tip over.....	155
When sink drain is stopped up.....	155
Poultry wire stapled to trellis keeps youngsters away.....	155
Pouring ground coffee from a newly opened can without spilling.....	155
Display holder for collector's miniature cup-and-saucer set.....	157
Antispash box prevents damage by water from dormer downspout.....	164
Plastic tape on easters prevents black streaks.....	164
Trellis for potted plants.....	168
Important to use proper adhesive spreader when applying tile.....	169
Bar between clothesline posts to air garments on hangers.....	174
Inexpensive basement shower utilizes laundry tubs.....	179
Rope rings stop rolling of washing machine.....	180

### MISCELLANEOUS

Blotter strips around cot legs bar crawling insects.....	151
Comfortable kneeling assured with pad pockets on overalls.....	151
Letter knives of hammered copper.....	152
Dinner-table stunt with spoon.....	153
Tumblers and embroidery hoops provide party game.....	153
Loose woodpile ends fastened with old auto chains.....	156
Small insecticide sprayer.....	157
Preserving natural-wood color.....	168
Suet "cupcake" is bird treat.....	168
Quick-starting a barbecue fire.....	174
Flashing electric flare protects stalled car.....	179
Window attachment in auto supports clothes hangers.....	180
Resistance in air-duct turns reduced by increasing radius.....	186
"Stakes" for ring-toss game are inflated balloons.....	186

(Continued to page 62)

**IMPORTANT NOTICE**—It is the intention of this magazine to provide its readers with information regarding the latest developments in the mechanical arts. We take no responsibility as to whether the disclosures contained in our articles are covered by patents and advise readers to investigate this subject before making, using, or selling any of the products, machines, or processes described in order to avoid possible liability for patent infringements.

MAKE \$5 PER HOUR WITHOUT A PRINTING PRESS

# PRINTING

REVOLUTIONARY NEW SCREEN METHOD

FREE complete "BIG MONEY" Plan and SAMPLE!

PRINT colorful signs, posters, banners, fabrics, wall paper, show cards—ANYTHING! Print on any surface. NO printing press or special equipment is needed with this amazing "approved" new printing secret. 300% profit on nearly every job. Easy to learn—NO EXPERIENCE or art ability necessary. Exceptional opportunity. Complete illustrated detailed plan and colorful sample FREE—Write:

SCREEN-PRINT COMPANY, Dept. 26  
15127 S. Broadway, Los Angeles 61, Calif.



## Finish HIGH SCHOOL AT HOME

Complete 4 Yrs. in 12 Months

Learn More! Earn More! Enter professional or technical schools. Advance Socially. Live a Happier, Fuller Life. Individual Courses or complete schedule. WRITE FOR SCHOOL BULLETIN.

### ACADEMY FOR ADULTS

30 W. Washington, Dept. PM-65, Chicago, Ill.



## TALK - SING - PLAY OVER YOUR RADIO

with the real Radio Mike! Attaches in a jiffy—full instructions given! Swell for "parties"—"out in" on or "kid" regular network programs or put on your own broadcasts! Amaze your friends—real fun. Beautiful Metallic Plastic 6 in. high.

12 RADIO BROADCAST LESSONS GIVEN with each mike

SEND NO MONEY Just pay postman \$2.99 COD plus postage or send \$3.99 and we pay postage! Radio Mike is available only from us by mail—guaranteed. Midway Co., Dept. MPM-6, Kearney, Nebr.

## FREE - Amazing Book on RHEUMATISM, ARTHRITIS

If you suffer the aches, pains and discomforts of Rheumatism, as manifested in ARTHRITIS, NEURITIS, SCIATICA or LUMBAGO, send today for the FREE Book. It reveals important facts about why drugs and medicine give only temporary relief without removing cause. Explains fully a proven, specialized system of treatment that may save you years of distress. No obligation. Write for this FREE Book today!

BALL CLINIC, Dept. 756, Excelsior Springs, Mo.

## 250 POWER . . . .



Complete Telescope Lens Kit only \$3.49 postpaid

Conquer Space. Explore the Universe. Planets, Moon Craters, New Stars, etc. Complete Lens Kit consists of 80 inch focal length ground and polished objective lens, eyepiece lenses for 50 POWER, 100 POWER, 150 POWER, 200 POWER, 250 POWER, and all necessary lens fittings. Easy to make from simple step by step instructions. (Tripod and mount not included.) Money back guarantee.

BUSSE SALES CO., Hartford 1, Conn., Dept. PM 34



## SAVE UP TO 50% ON FAMOUS ITALIAN ACCORDIONS

Buy direct from America's leading distributor. Offers Students, Teachers and Professionals SPECIAL DISCOUNTS. Send NOW for FREE Literature and lowest wholesale prices. Easy Terms. Trade-ins accepted. Write today. ACCORDION MANUFACTURERS & WHOLESALE OUTLET DEPT. R-65 2003 W. CHICAGO AVE., CHICAGO 22, ILL.

5 DAY FREE TRIAL



The World's Most Modern Masonry

## Opportunities Open for Local Manufacturing

From local plants dotting the country has come the Brikrete used to erect many thousands of buildings—homes, apartments, motels, stores, shopping centers—practically every type of residential, commercial and industrial construction. Why?

Because Brikrete has more quality features than any other fine masonry—design, size, light weight, insulation properties, range of 14 colors. And a price competitive to lumber! It's an outstanding business opportunity.

### High Income Potentials

Freight and distribution costs are by-passed in the manufacture of Brikrete. By using local aggregates and local labor it's a "direct to user" business. Production economies enable low prices to consumers and generous profit margins to manufacturers.

More plants are needed to operate in protected territories under franchise privileges. Basic machine available on lease or purchase. Write for Brikrete Book No. 2.

Brikrete Associates, Inc. **BRIKRETE**  
402 West 25th Street  
Holland, Mich.

IN CANADA: DUNN MASONRY MACHINERY LIMITED  
800 Dundas Highway, Cooksville, Ont.



Genuine Western 4-Ply Hand Plaited Leather

Train Animals, Pets' Self Defense! Do Tricks! Loud Noise Like Bang of a Shot Gun!

## PLAITED LEATHER BIG BULL WHIP

Experts knock ashes off cigaret, gun out of hand, yank people off feet, etc. Used by trainers, ranchmen, etc. Grip lightly (pressure is on loop), then crack or coil; snake out or back; overhand, underhand, side-arm. Neat's cut finished for pliability & long life. "Cracker" or tongue on end. Solid grip handle with loop. 6-ft. Whip \$1.98; 8-ft. Whip \$2.69; 10-ft. Whip \$3.29 JOHNSON SMITH & CO., Dept. 987, Detroit 7, Michigan

## Catalog of 3000 Novelties 10c

Send 10c for amazing catalog of novelties, live animals, scientific supplies, hobbies, funmakers, planes & boats, toms, magic tricks, joke articles, unusual seed, get timesavers, cameras, optical goods, projectors, movies, lucky jewelry, religious novelties, disguises, musical instruments, stamps, coins, puzzles, fortune tellers, radios, auto & bike accessories, telescopes, magnifiers, compasses, banks, smokers' gadgets, artists' supplies, printing sets, ety gines, motors, shockers, knives, billfolds, guns, rifles, sports, books, games, plants, etc. Send 10c (3 for 25c—get for friends!) JOHNSON SMITH & CO. Dept. 987 Detroit 7, Michigan

## LEARN SUBMARINE DIVING

Here's a thrilling business that pays amazing profits. My 23 years experience under water will help make you an experienced skin diver in quick time. Complete, guaranteed booklet sent to you for only \$1.00. "DIVER" DELPS, Granite City, Illinois.

## HUNTERS!

## Confiscated Russian Rifles!



THIS is the Russian Late Model 7.62 MM Mosin Rifle, 28 3/4" barrel. (Dates 1935-67). Mechanically perfect. Outside: good. Bore: fair. Ballistics: 2820 F.P.S. with 150 grain bullet. Ammunition available everywhere in U.S., an excellent hunting cartridge. Hinged floor plate. Russian ordnance marks on receiver include hammer and sickle. The Russians won the International Meet in Venezuela (1954) with this model rifle. These guns were confiscated from Communist revolutionaries and placed on the free world market. They are of the type used by Red Chinese in Korea. The sale of these guns in no way aids any country behind the iron curtain. A Once-in-A-Lifetime collector's item. This is the lowest price we have ever seen which would allow a man to equip himself for big game hunting. Send check, cash or money order. All guns shipped F.O.B. Pasadena, Calif. 25% deposit on C.O.D. GOLDEN STATE ARMS CORPORATION 32 Armory Bldg., 1165 East Colorado St., Pasadena 1, Calif.

\$14.50

# It's easy to Panel a Room ...or a Wall



## to Match Your Beautiful HARDWOOD Doors

Why not? The work is simple. The cost is low when you do it yourself. The result—elegant, beautiful, and so professional looking. It's easy to finish...easy to maintain...and it lasts and lasts.

See your local lumber dealer for how-to-do-it suggestions and panels in these species. Write HPI for helpful folder on paneling Rooms with Doors to match.



Mahogany



Oak



Maple



Gum



Birch

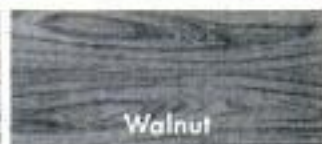

Walnut



### Hardwood Plywood... Natural Wood Fabricated in America

The HPI trademark identifies American mills operating under a rigid 5-point quality control program. It's your assurance of quality.

**HARDWOOD PLYWOOD INSTITUTE**  
600 South Michigan Avenue • Chicago 5, Ill.

(Continued from page 60)

Litmus paper held with tweezers.....	190
Blade of rotary-type lawn mower turns on auto-wheel spindle.....	193
Improvised fence-post puller.....	199
Countersunk screws covered with turned wooden buttons.....	201
Detecting, eliminating chiggers.....	204

#### PHOTOGRAPHY

Telescoping camera tripod used as sketching easel.....	168
Improvised photo timer.....	174
Photo chemicals filtered through medical cotton.....	185
Modified cords on floodlamps permit easier storage.....	186

#### TOOLS

Gauge-tool holds bevel siding to permit one-man operation.....	180
Worn brass fitting turned by "shim grip" wrench.....	180
Adjustable bar clamp made from auto bumper jack.....	193
Shaper-mounted grinder smooths flat work.....	200
Shopping for Tools—	
Jigsaw attachment for circular saw uses standard jigsaw blades (Versa-Tool Co., Lake Ave., at 4th St., Racine, Wis.).....	202
Protractor guide for portable electric handsaws (Boden Sales, 274 Busher Ave., Valley Stream, N. Y.).....	202
Electric brake for small radial saws (DeWalt, Inc., Lancaster, Pa.).....	202
Chain-saw sharpener will precision-sharpen any saw chain (Forester Mfg. Co., 10 McCue Ave., Locksport, N. Y.).....	202
Laboratory "jack" provides a working platform (Central Scientific Co., 1700 Irving Park Rd., Chicago 13).....	203
100-amp. welder (Lincoln Electric Co., 22801 St. Clair Ave., Cleveland 17, Ohio).....	203
Panel saw cuts mild steel (Kett Tool Co., 5 E. Third St., Cincinnati 2, Ohio).....	203
Precision-balanced jigsaw provides unmatched smoothness (Atlas Press Co., 2643 N. Pitcher St., Kalamazoo, Mich.).....	203
Rolling rule enables draftsman to rule lines without using a T-square (Stationer's Guild of America, 1421 Chestnut St., Philadelphia 2, Pa.).....	203

#### WORKSHOP HINTS

Pencil and tape hold nut in difficult-to-reach location.....	152
Adjustable cardboard pointers assure uniform line spacing.....	153
Emergency methods of boring holes in confined places.....	156
Finger grip on case aids winding long measuring tape.....	156
Rusted bolt loosened quickly.....	156
Sheet-metal support for ladle.....	156
Wide footrest on shovel prevents foot soreness.....	163
Wires locked in electric plug.....	174
Glass-cutting pattern.....	180
Turns computed easily when coils are wound on metal lathe.....	181
Dowel ends vented in vise.....	185
Sanding disks will not tear if reinforced with tape.....	186
Shelf above drawing board swings on strap hinge.....	190
Small parts dropped from vise caught in cloth "net".....	200
Tapped-hole threads counted with wooden "thread gauge".....	200
Extend life of electrode by filing to chisel edge.....	204
"Locking" flatheaded screws in metal with center punch.....	204
Sandpaper-wrapped cotter pin provides small sanding drum.....	204

## Flashlight Batteries Recharged Overnight

You can recharge the batteries in a new flashlight up to 200 times. Recharged, they have approximately the life of an ordinary dry cell. The special batteries are sealed into the flashlight. They are recharged overnight with a small charger about twice the size of a pack of cigarettes.

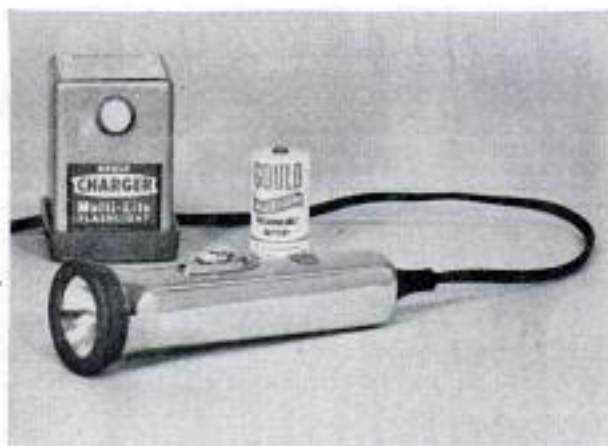



Reading time: 3 minutes to learn how to

- cut engine wear up to 38%
- prevent loss of power, compression
- save 15%-25% on oil . . . without ever changing your oil filter

# This Gadget is Worth \$320,000,000

...and I Discovered it by Accident!

by Albert Wells

IT ALL STARTED the day I got the bill: \$214.36 for an engine overhaul—and I had only 28,000 miles on the car!

I told my troubles to a neighbor—a lubrication engineer—told him how I'd always changed oil every 1500 miles, changed filters every 5,000 miles. His answer floored me.

"You've been wasting your money," he said. "We've spent millions developing oil additives that keep carbon, gum and abrasives from damaging your engine. Your oil costs about 15c more a quart because of those additives. Yet, some of the filter packs you've been buying actually remove oil additives. And the more often you change filter packs, the more money it costs you."

"But don't I need a filter to take the impurities out of the oil?" I asked.

He took a deep breath. "This will really shock you. Engine damage is done by abrasives 10 to 40 microns in size (a micron is .000039"). Your oil filter can't take them all out because cloth or paper can't be packed tight enough without stopping oil flow when the fibers soak up oil and expand."

"What kind of oil filter do you recommend, then?"

He laughed. "Well, there's a porous bronze filter they're using in supersonic aircraft that does a perfect job. But you can't get one like that for your car."

I asked myself: "Why not?" Next day, I tracked down the outfit that was making the filters for aircraft, and got the answer. These porous bronze filters were made by fusing together millions of tiny bronze balls. Non-absorbent, they didn't remove additives, yet they removed abrasives in the 10-to-40 micron danger zone. Could they be made for automobiles? Again, the answer floored me.

## OPPORTUNITY FOR DEALERS AND DISTRIBUTORS

A dealer and distributor network is now being formed to handle demand generated by advertising and editorial features in national magazines. If you can qualify, you can be first with the most exciting automotive product of this decade, to win new customers and build a substantial business. These valued franchises are not being sold; they are awarded on the basis of ability to grow with us. For complete details, write or wire: Continental Manufacturing Corporation, Dept. FPM-6, Washington Blvd. & Motor Avenue, Culver City, Calif.

©1954



## LIFETIME FILTER TESTED IN CARS, TRUCKS, BOATS

Test models had already been used in cars and trucks for millions of miles, proving the porous bronze filter: 1. Never needs replacing. 2. Saves the quart of oil thrown away with ordinary filter packs. 3. Increases engine life.

Trouble was, almost the entire production was being absorbed by military and industrial users.

That day I went to work on the biggest job of my life: setting up production of the Lifetime porous bronze permanent filters for cars and trucks (an estimated \$320,000,000 replacement industry).

## HOW TO GET A LIFETIME FILTER FOR YOUR CAR

Try the Lifetime filter on your car for 2 weeks: if it isn't all I say, you get your money back; if you keep it, you're through buying filter packs—the Lifetime filter is guaranteed for 10 years, actually will last many times that long.

For complete unit, including case and fittings (install on any car in 10 minutes), send make, year and model of your car and \$12.95 (we pay shipping).

For conversion kit, which replaces your present filter pack with Lifetime bronze, send make and number of filter and \$6.95 (we pay shipping).

Or send only \$2 deposit, pay C.O.D. charges on arrival. But do it today—don't waste another cent on filter pack replacements!



Complete Lifetime Filter; fits any car.



Lifetime Conversion Kit; replaces ordinary packs with permanent bronze element.

Permanent Filter Division, Dept. FPM-6  
CONTINENTAL MANUFACTURING CORP.  
Washington Blvd. at Motor Ave., Culver City, Calif.

Ship  complete unit  conversion kit

Make, model, year of car: \_\_\_\_\_

Present filter make (if known) \_\_\_\_\_

I enclose  \$12.95 for complete unit (\$18.95—chrome)  
 \$6.95 for conversion kit  
 \$2.00 deposit; send C.O.D.

Name \_\_\_\_\_

Address \_\_\_\_\_

City \_\_\_\_\_ Zone \_\_\_\_\_ State \_\_\_\_\_

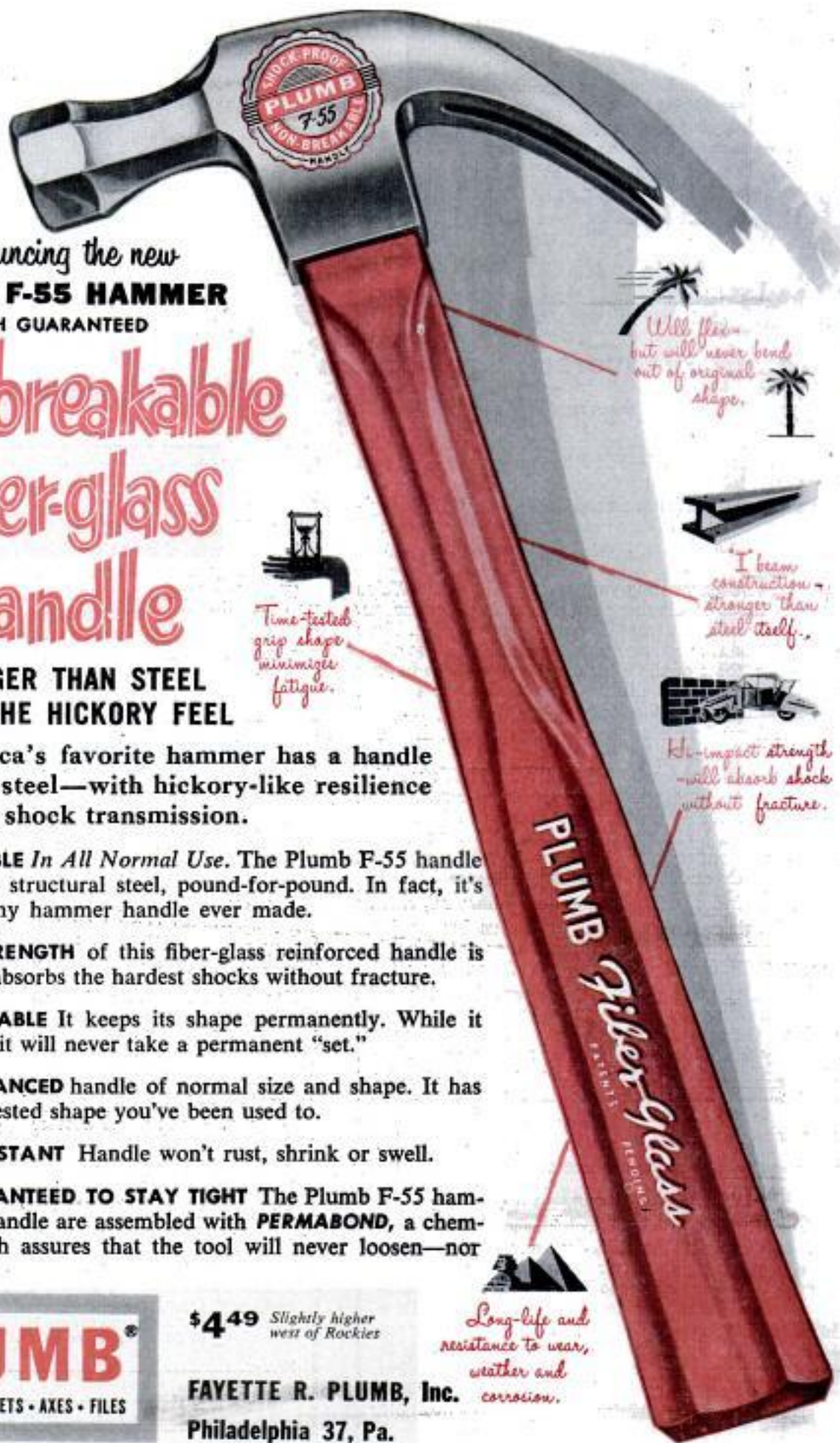

announcing the new  
**PLUMB F-55 HAMMER**  
WITH GUARANTEED

# non-breakable fiber-glass handle

**STRONGER THAN STEEL**  
**— WITH THE HICKORY FEEL**

Now, America's favorite hammer has a handle tougher than steel—with hickory-like resilience for minimum shock transmission.

**NON-BREAKABLE** In All Normal Use. The Plumb F-55 handle is stronger than structural steel, pound-for-pound. In fact, it's stronger than any hammer handle ever made.

**HI-IMPACT STRENGTH** of this fiber-glass reinforced handle is so great that it absorbs the hardest shocks without fracture.

**NON-DEFORMABLE** It keeps its shape permanently. While it will flex in use, it will never take a permanent "set."

**PERFECTLY BALANCED** handle of normal size and shape. It has the same time-tested shape you've been used to.

**WEATHER-RESISTANT** Handle won't rust, shrink or swell.

**HANDLE GUARANTEED TO STAY TIGHT** The Plumb F-55 hammer head and handle are assembled with **PERMABOND**, a chemical weld, which assures that the tool will never loosen—nor lose its head.

*Will flex—but will never bend out of original shape.*



*Time-tested grip shape minimizes fatigue.*



*"I-beam construction—stronger than steel itself."*



*Hi-impact strength—will absorb shock without fracture.*



*Long-life and resistance to wear, weather and corrosion.*



**\$4.49** *Slightly higher west of Rockies*

**FAYETTE R. PLUMB, Inc.**  
Philadelphia 37, Pa.

# Can We Blame the Sun for Stormy Weather?

By Dr. Walter Orr Roberts

*(Doctor Roberts, an internationally known solar scientist, is director of the High Altitude Observatory at Boulder, Colo.)*



**E**ACH MORNING, winter and summer, a young man arises before dawn and shuffles sleepily out into the thin air of a high mountain pass near Climax, Colo. He walks a few hundred yards to a small building, rolls back a section of the roof and aims a relatively small telescope at the sun as it climbs over the surrounding peaks. With a camera attached to the

Author examines occulting disk of new coronagraph. Disk will blot out sun to its rim, producing artificial eclipse

Observer uses a photometer for a quick measurement of the brightness of the atmospheric halo of the sun. The small circle on the end of the spar serves as artificial moon for eclipsing sun

High Altitude Observatory photos





U. S. Navy photo

Coronagraph photo shows sun's halo. Streamers may flow all the way to earth (exaggerated size in drawing)



telescope he takes half a dozen pictures.

It seems quite possible that research based on these pictures, and others taken at a few places scattered across the face of the earth, will have as far-reaching effects as any scientific program ever undertaken in the history of astronomy. It is a program that may well touch the life of every person on earth.

Through these pictures, scientists are discovering that storms raging on the sun's surface may have a profound effect on the earth's climate; that long-sustained cycles of these storms may explain the droughts and deluges of history; that streams of energy from the sun play havoc with radio broadcasts, intensify the beams of cosmic rays playing on the earth, and may even affect the weather from Kansas City to Kyoto.

Mounting system of new coronagraph will keep spar aimed at sun. It is so delicately mounted that a teacup-size motor will move the 26-foot tube. Diagram shows optics of new coronagraph

It even seems possible that some day we will be able to make long-range weather forecasts here on earth by studying the storms that rage across the sun's surface.

Few people outside the field of astronomy know of the daily sun-watch of Richard T. Hansen and his assistant, David Dodgen, in the thin air of the mountain pass. They send their photos of the sun 120 miles northeast to the research laboratories of the High Altitude Observatory at the University of Colorado in Boulder. There Dr. Donald E. Billings and the rest of our staff analyze the photos.

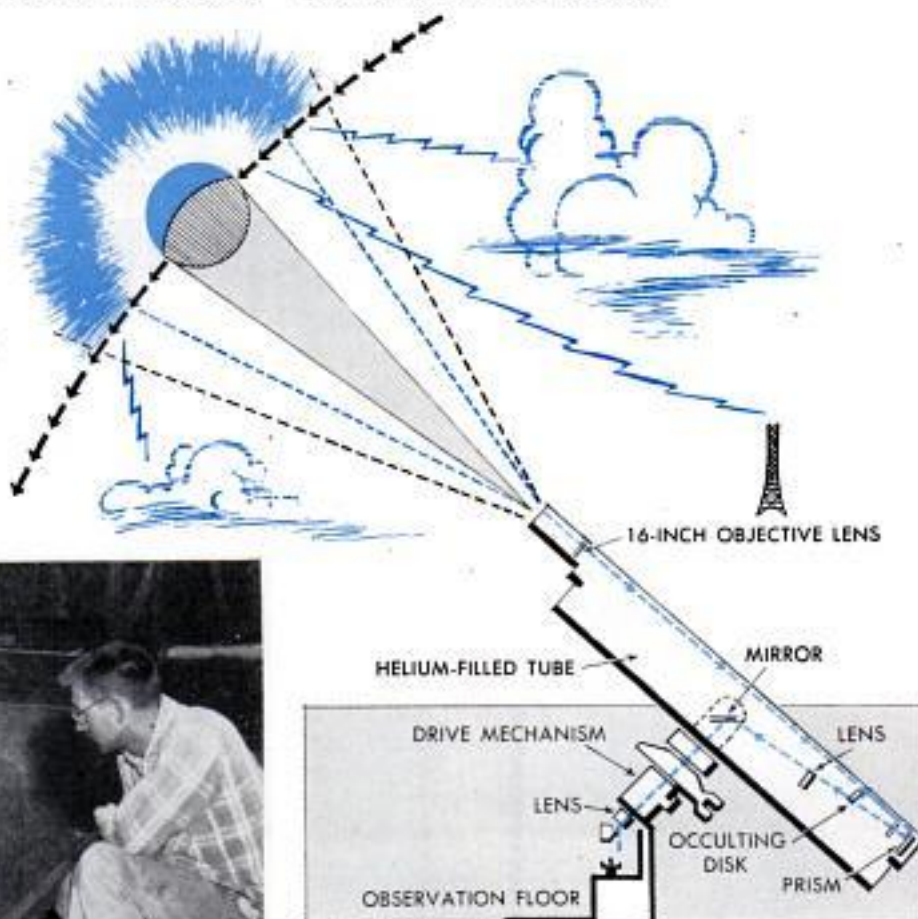

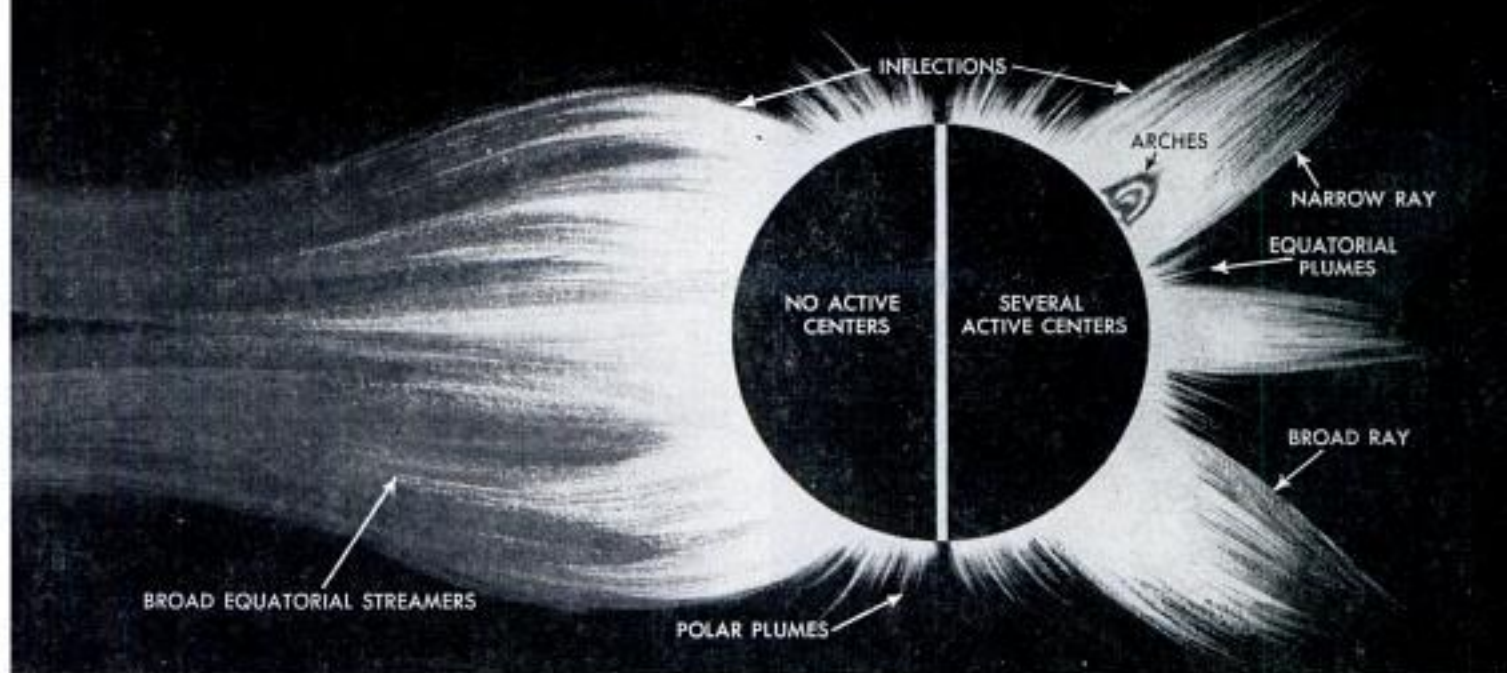

Sun's magnetic field focuses rays into streamers. Earth's magnetic field causes them to shower down near poles

Much of our information about solar storms has been obtained through the single eye of that mountain telescope—a special kind of telescope designed not for looking at the sun's face but into the tenuous atmosphere that lies beyond. In this atmosphere are hidden the clues to many of the important secrets of the sun's effects on earth—secrets that centuries of looking at the sun's face through telescopes have failed to reveal.

Scientists long have tried to peer into the swirling atmosphere of the sun. That is why, for many decades, scientific expeditions have carried solar telescopes to remote corners of the earth for observations during eclipses. At the moment of eclipse, the shadow of the moon falls upon a narrow strip of the earth's surface, and for a selected few of the earth's inhabitants, blocks out the brilliant rays of the sun. At such moments, even an untrained observer without a telescope can see the gleaming, pearly white halo around our parent star. This halo, called the corona, was recognized as far back as 2000 B.C. Recently it has cast light on many of the age-old mysteries of the sun. During the less than eight minutes of total eclipse, scientists work with practiced speed to photograph the corona and the vast clouds of incandescent gas that surge out from the rim of the sun.

But eclipses are infrequent. As early as 1868 scientists asked: Why not build an eclipse into a telescope by blotting out the brilliant circle of the sun with a disk? The corona then could be observed at any time. Many famous astronomers wrestled with the problem of building such an eclipse into a telescope, and failed. Reflected and scattered light always penetrated their telescopes to overpower the dim light of the corona.

Flare patrol is an instrument used to detect sudden, bright prominences that interfere with radio reception

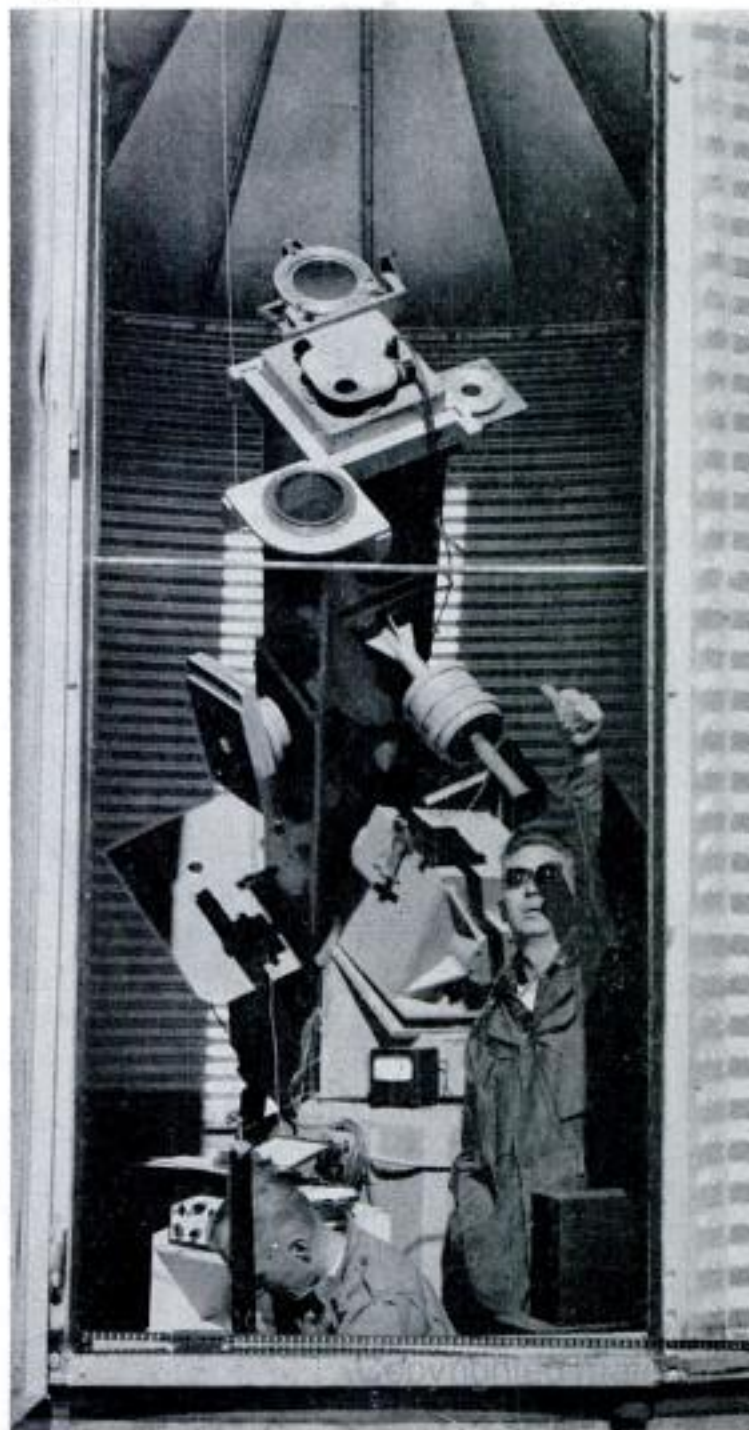

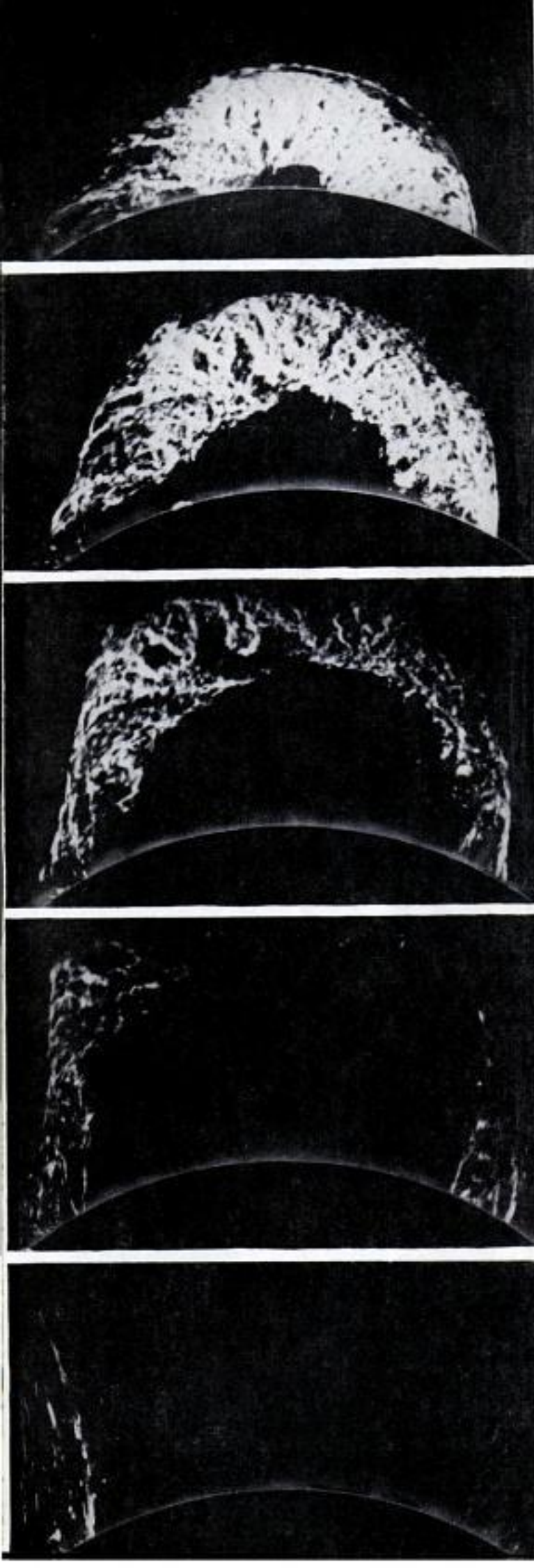

By 1929 the problem looked quite hopeless. That year two distinguished astronomers concluded that it was impossible to build a coronagraph. Just one year later, B. Lyot, a young French astronomer, hauled a small instrument on skis to the top of a mountain in the Pyrenees. There for the first time, on July 25, 1930, he cast a manmade "moon shadow" on the earth. He used a simple but ingenious optical system to mask out unwanted light from the sun's face.

Other coronagraphs soon appeared. But even today there are only an estimated 15 such instruments throughout the world. In 1939, Dr. Donald H. Menzel of Harvard University was well on the way to building the first coronagraph in the Western Hemisphere. In that year, as a graduate student working under Doctor Menzel's supervision, I took over the completion and installation of the coronagraph as a thesis project for my doctorate in astronomy. In 1940 we moved the new telescope to its permanent home on Fremont Pass in Colorado. I remained at Climax operating the coronagraph for seven years and then moved to Boulder to take over the development of the High Altitude Observatory research station on the campus of the University of Colorado, where we now guide the operation of the Climax coronagraph.

A few months ago, our observatory passed a great milestone in its history. We dedicated a large new solar laboratory and coronagraph at Climax. Sometime this year we hope to start spying on the sun with this new telescope. It will be the largest coronagraph ever built. The new instrument will have a 16-inch objective lens, contrasting to the five-inch lens of the present coronagraph, and will produce much larger and clearer images of the sun's rim and corona. Instead of a tube, the new coronagraph is simply a rectangular metal box 26 feet long. The optical system will be fastened to the outside of the box. At the lower end of the box we will bounce the sun's rays inside the box and down to a special light-tight camera room directly below the main mounting of the telescope. Photoelectric cells will keep the huge spar unerringly aimed at the sun as the earth whirls on its axis and swoops through space. Though the spar weighs over nine tons, it is so delicately balanced that it is driven by a  $\frac{1}{4000}$ -horsepower motor small enough to fit into a teacup. The basic telescope was provided for us by the Office of Naval Research, and the funds for the

Successive photos taken through coronagraph show, top to bottom, stages in development and disappearance of solar prominence. This immense cloud of hydrogen rose to height of over 1,000,000 miles

High Altitude Observatory photos



Old observatory, foreground, and new building are located in the thin, clean air of a Colorado mountain pass

associated laboratory were provided by private donors. We are now raising funds to complete the expensive and precise optical systems that will take full advantage of the powers of the new instrument. A twin of this big coronagraph is under construction at Sacramento Peak, N. Mex. It will be used for basic research on the sun at the Upper Air Research Observatory of the United States Air Force.

We believe that these two new coronagraphs will help solve some of the riddles of the sun's atmosphere. The sun is a revolving ball of gas some 864,000 miles in diameter. At the center the temperature is probably around 25,000,000 degrees C. and the pressures are so great that the gas is compressed until it is 10 times the density of a bar of iron. It is here in the center that nuclear fusion gives the sun its heat.

Near the surface is an unstable layer of unknown depth called the convective zone. It has been variously estimated to be from

a few thousand to over 100,000 miles in thickness. Above this layer is the photosphere, which you might call the real surface of the sun for it is here that the gas changes from opaque to transparent, giving the sun a sharp rim when viewed from the earth. The temperature here is about 6000 degrees C. Just above lies the chromosphere, a radiant layer of gas. Near the bottom of it lies the coolest region generally found anywhere near the sun—called the reversing layer and possessing a temperature of a mere 4500 degrees. Above this point the temperature rises, reaching millions of degrees in the corona. The sun, paradoxically, is much hotter at some distance above its surface than it is right at the surface.

One complete rotation of the sun on its own axis, as viewed from the earth, takes about 27.3 earth-days. One of the surprising mysteries concerning the sun is that its

(Continued to page 234)

Diagram shows what has been learned—and surmised—about our parent star, its corona and prominences

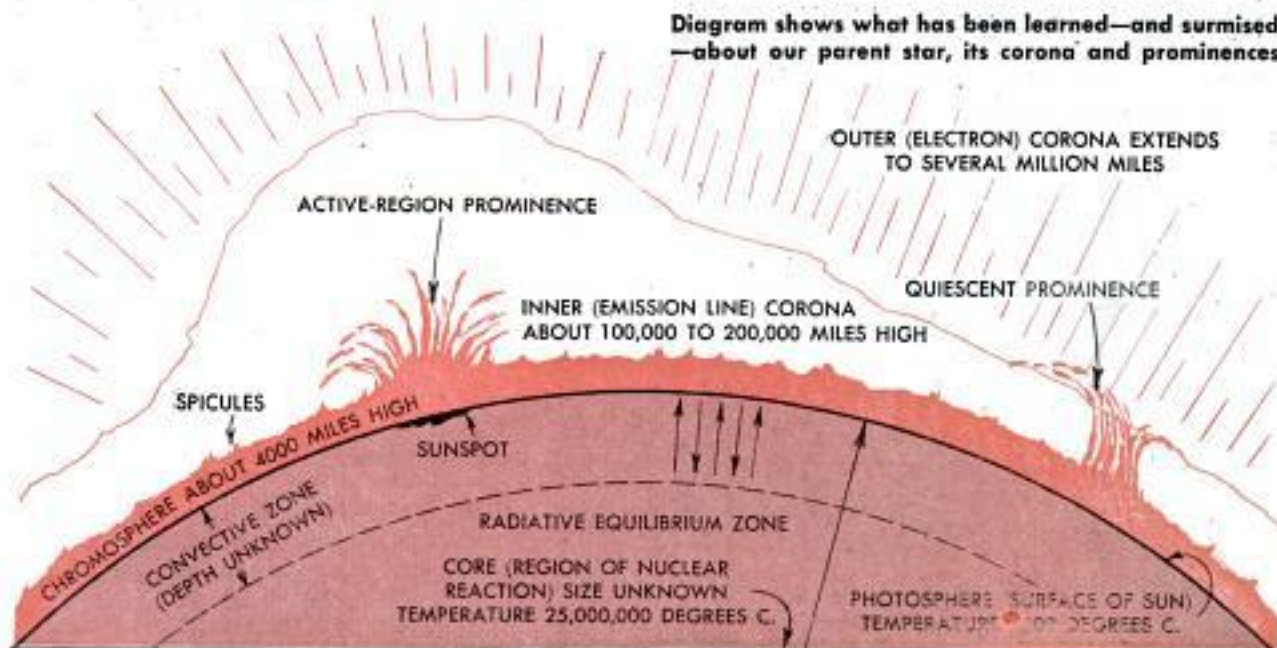



## Submarines Refuel Navy's Big Long-Range Seaplanes on Open Sea

Refueling of long-range seaplanes by submarines surfacing on the open sea has greatly increased the striking power of the Navy's giant seaplanes. The refueling system was worked out in the Caribbean in a two-week operation involving the submarine-oiler *Guavina* and a twin-engine

P5M Martin Marlin patrol seaplane. A long-range striking force of high-speed, submarine-refueled seaplanes is important in the Navy's plans to retain mobility of action in the event of war. The Navy expects to use submarine tankers to refuel its new 600-mile-per-hour jet flying boats.

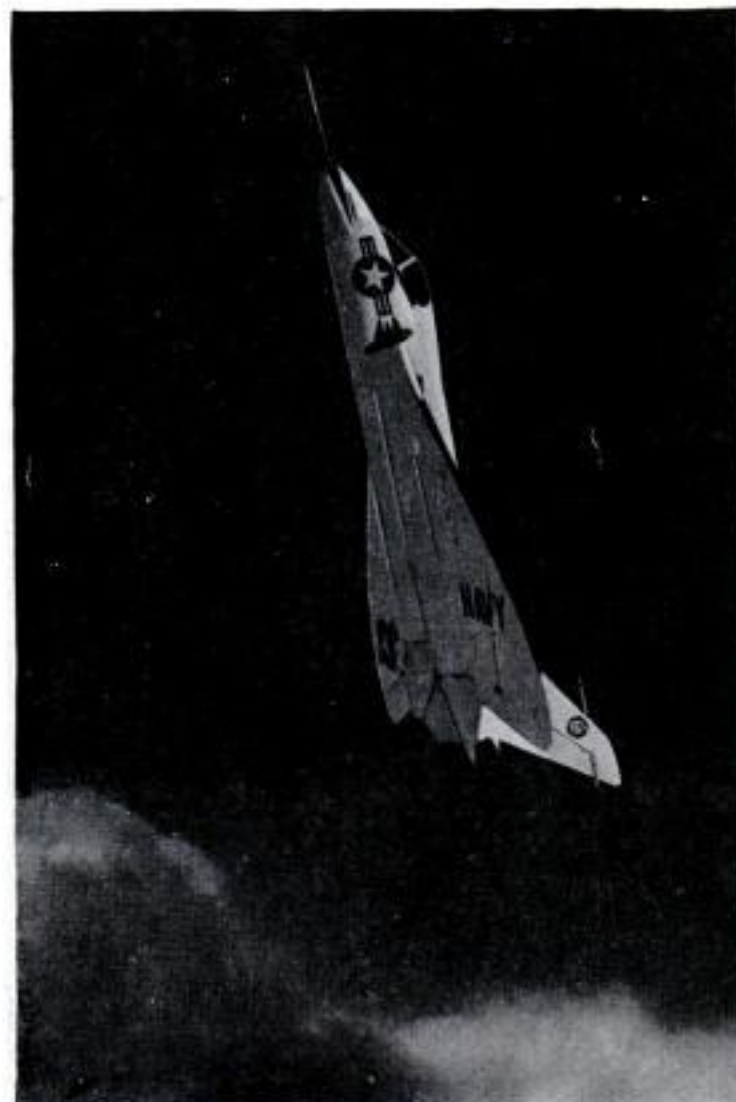

## 10,000 Feet in 56 Seconds Sets Fighter Climb Record

A United States Navy F4D Douglas Skyray has climbed to a height of 10,000 feet in 56 seconds for a new unofficial climb record. The production-model Skyray is powered by a Pratt & Whitney J57 jet engine, equipped with afterburner. Earlier models, with less powerful engines, were supersonic and hung up two new world speed records. The F4D is a carrier-based fighter. Today's rate of climb appears even more amazing when compared with that of World War I fighter aircraft, which required an hour to reach an altitude of only 6000 feet.

## Glaciers Are Growing

Glaciers in western United States are growing, not receding, according to Dr. A. E. Harrison of the University of Washington. Data secured with photogrammetry, a precise form of three-dimensional photography applied to surveying, shows that the trend is evident throughout the western states. The "most spectacular growth," Harrison says, has occurred in the Cascade Range of Washington.



## Ford's 1955 Tractors Offer Tricycle Design

Ford tractors have always been identified with the four-wheel design. Now for 1955, Ford is introducing three new lines of tricycle tractors to increase its tractor line to eight models. The tricycle tractors have two small front wheels mounted on a slight angle directly under the radiator, giving the effect of a single wheel, hence the name tricycle. Directly above the double wheel is a rack in which as much as 450 pounds of additional weight can be placed in easily handled segments to help balance when necessary. The rear wheels can be spread apart by a power unit and adjust in one-inch increments from 56 to 76 inches, or from 64 to 84 inches with disks reversed. Front-mounted equipment designed for use with the new tractors includes two and four-row cultivators with planter, fertilizer and side-dresser attachments.



## Egg-Shaped Dome on Church Has Unique Panels of Light

In Düsseldorf, Germany, the new St. Rochus Church is dominated by a dome shaped like an egg. The dome is 84 feet high. Covered with copper plates, it has no conventional windows. Running up

three sides of the dome are panels of glassed-in openings. The panels meet in a circle at the top, and form a unique pattern of light when viewed from inside the church, replacing stained-glass windows.

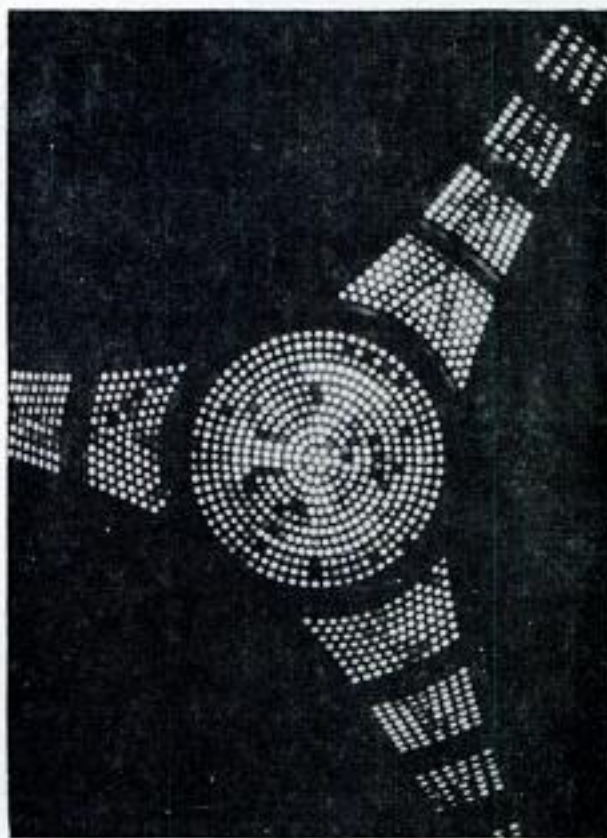

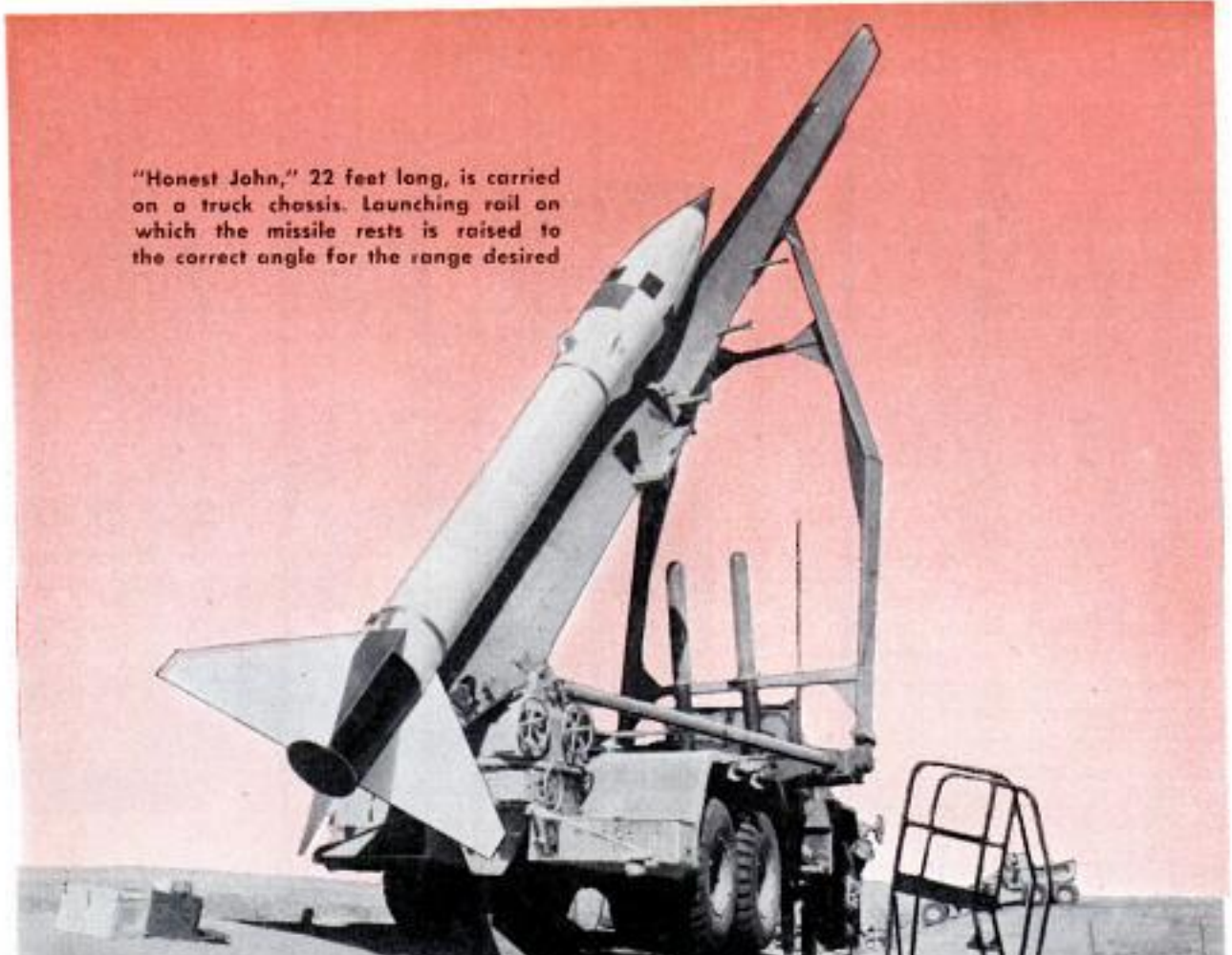

"Honest John," 22 feet long, is carried on a truck chassis. Launching rail on which the missile rests is raised to the correct angle for the range desired

## Hit-Run Rocket Launchers

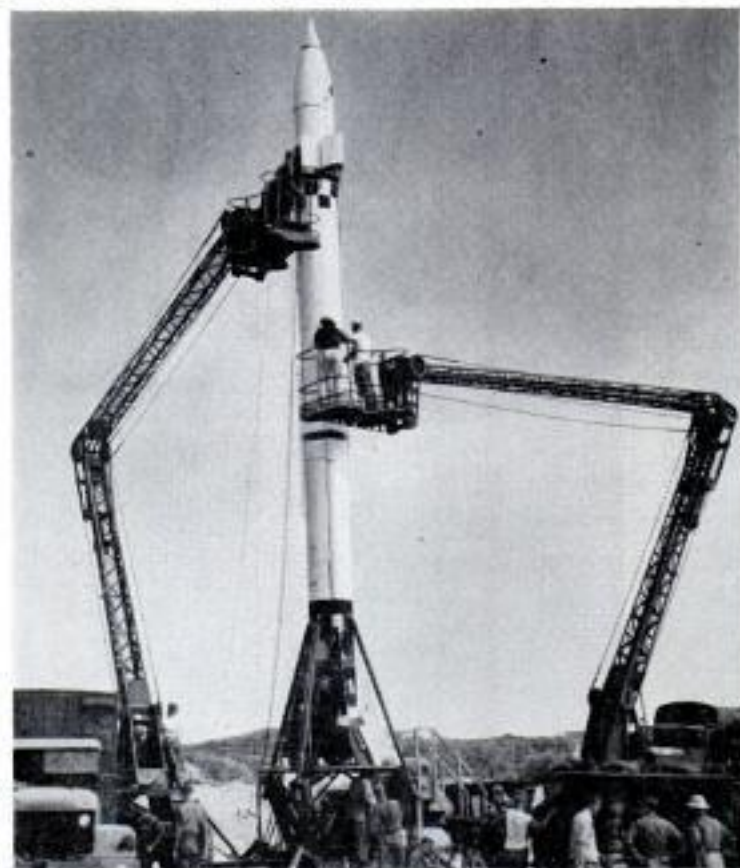

UNDER TEST by the Army are "hit and run" transporters which serve as launchers for huge rockets. The purpose of the transporters is to avoid launching missiles from fixed positions that could be located and destroyed by an enemy. One type of transporter carries a 22-foot "Honest John" artillery rocket designed for close support of front-line troops. Built on the chassis of a standard Army truck, it is equipped with leveling pads and launching rail. A free-flight rocket, Honest John is aimed by elevating one end of the launching rail to the desired angle. For the longer range, liquid-fueled "Corporal" guided missile, the Army is testing a truck convoy. It includes the transporter, fuel trucks and maintenance trucks fitted with aerial platforms for servicing the 45-foot rocket. ★ ★ ★

After "Corporal" is placed on its launching platform, aerial platforms are raised from service trucks and men adjust the big rocket

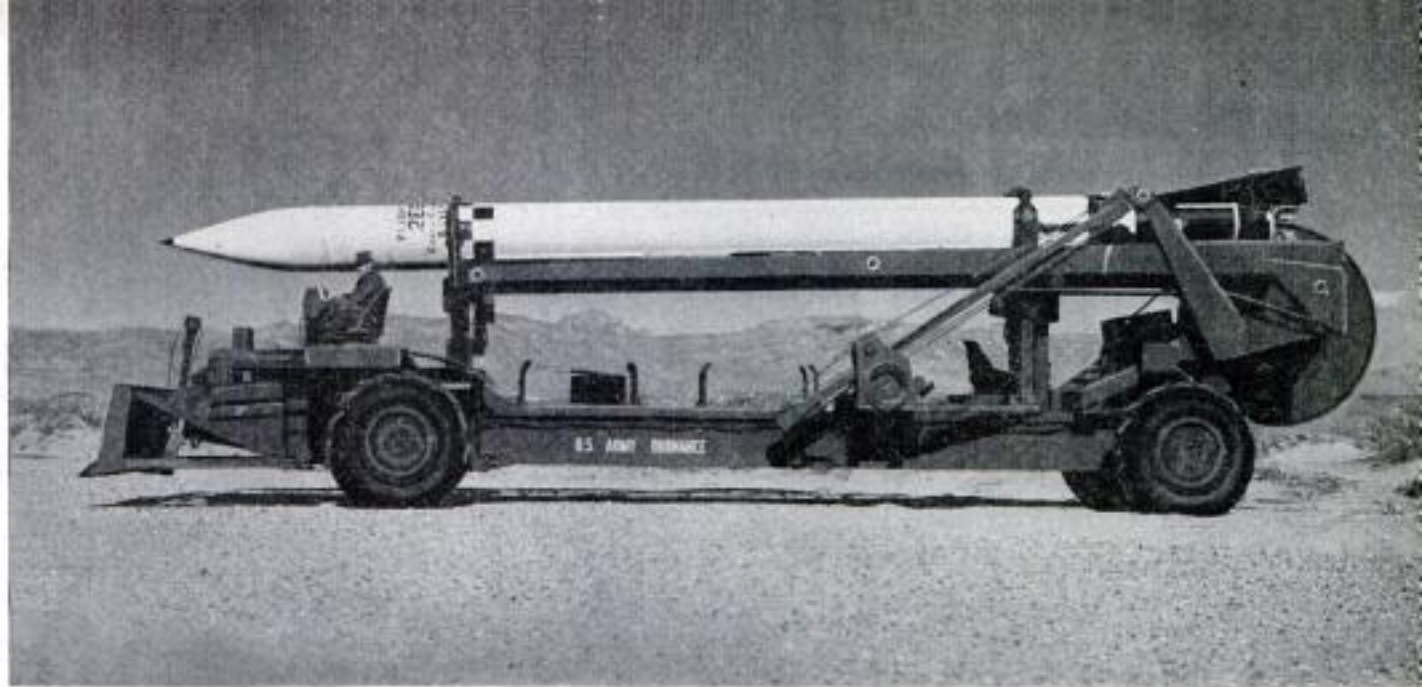

Corporal rides on a long transporter that has its own bulldozer blade for leveling an uneven firing site

An Honest John roars up from its launching truck. In this test, balloons spaced along line of flight were used to compile research data



Truck has an erecting mechanism which pivots the 45-foot Corporal into position and then lowers it to the launching platform





When the unit is used as a swimming and diving raft, cots unfold to provide a comfortable canvas sun deck



Motor mounted astern, craft becomes fishing boat



At end of day, unit is beached. Tent converts it into a camp. Below, the trailer has capacity of 750 pounds

## Four-In-One Trailer Becomes Boat, Raft and Camp

SPORTSMEN CAN HITCH a new trailer unit to the car and head for their favorite camping or fishing spot. There they push the trailer right into the water and retract its single wheel. The trailer then is afloat, converted into a boat. Actually it is a catamaran-type craft, with a hull supported by two steel pontoons. Each pontoon is divided into three watertight sections, making the unit virtually unsinkable. Even when the hull is full of water the craft won't sink. Turn it upside down and there's as much of the boat out of the water as when it is right side up. If rough weather brings water into the hull, the craft can be drained by removing a plug. The boat can be fitted with an outboard motor up to 15 horsepower or with a sail. When the day is over, the sportsman pulls the unit up on the beach and mounts a tent over it. The unit then becomes a camp with four built-in cots more than seven feet long. No tent pegs are required, and no drainage ditches need to be dug, as the cots are more than two feet off the ground. In the water, the unit can also be used as a swimming and diving raft. The canvas deck measures seven feet by eight feet. On the road the trailer has a load capacity of 750 pounds.

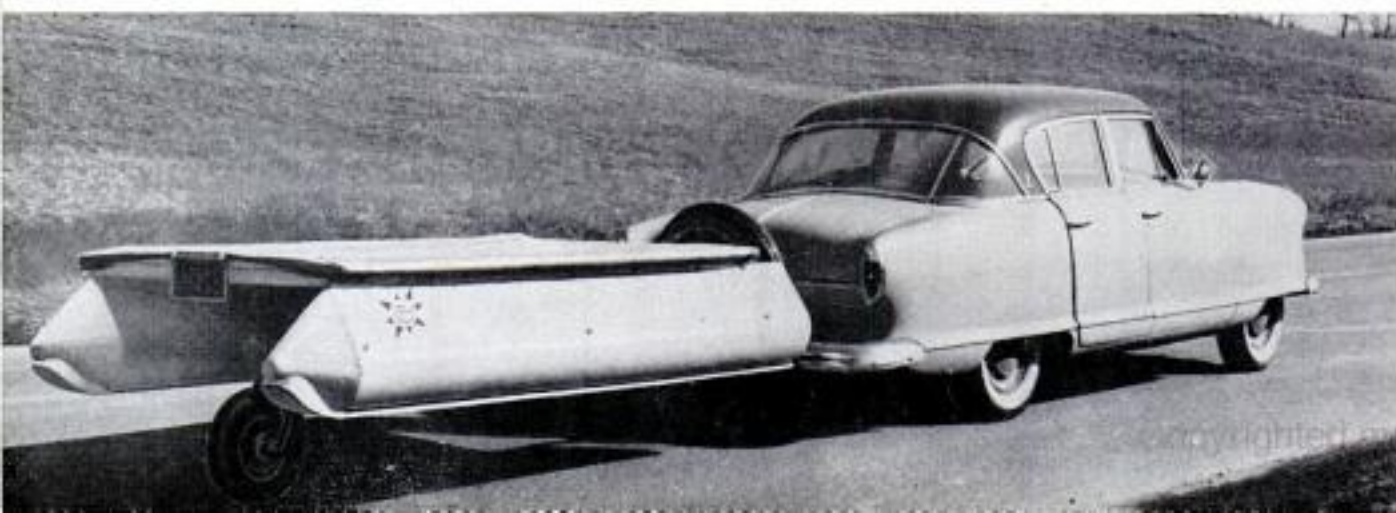

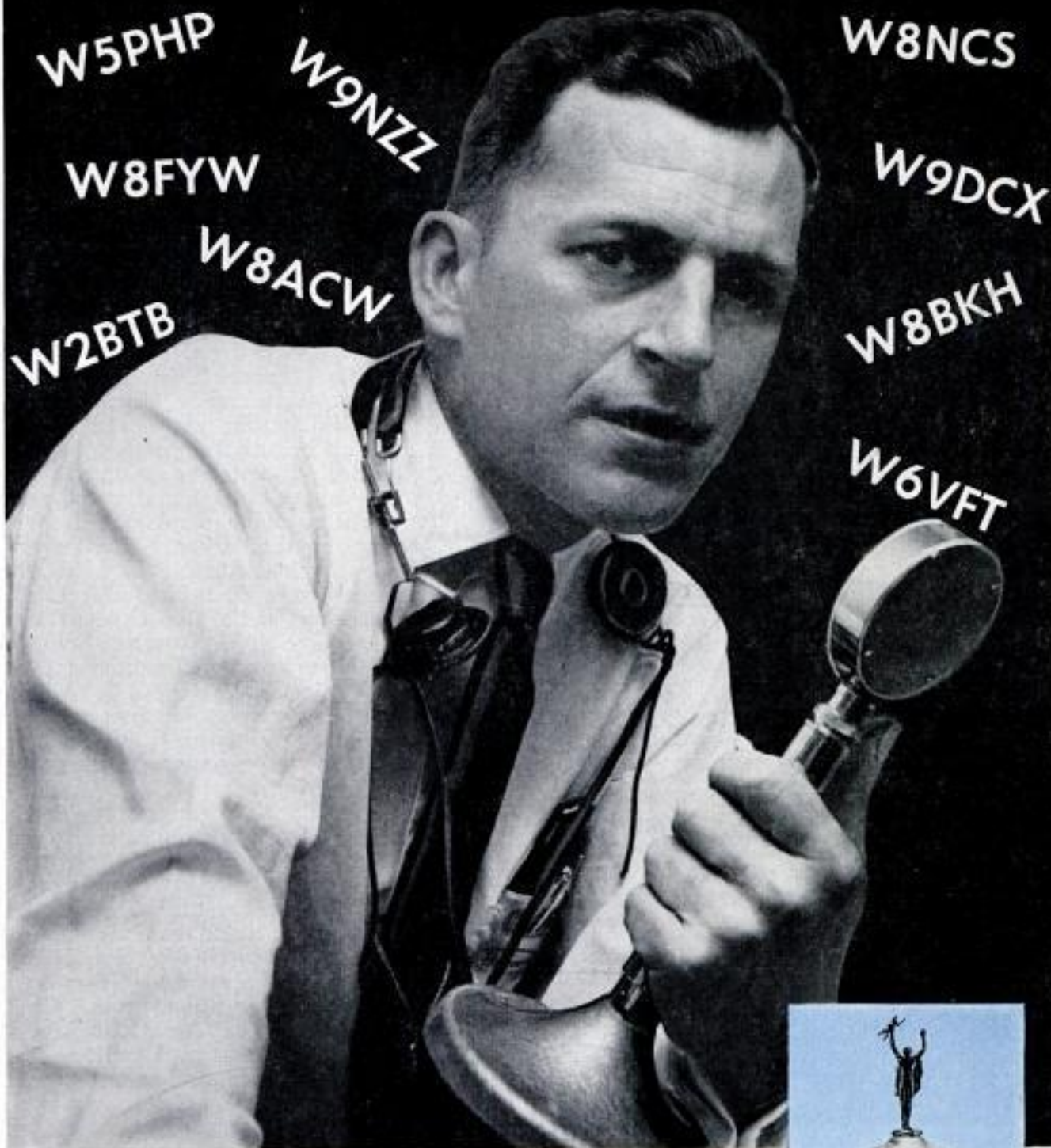

Benjamin S. Hamilton, winner of award as outstanding "ham" of the year, organized a Civil Defense radio network of 35 stations for San Diego County

## **The "Hams" Have a Man of the Year**

**By Wayne Whittaker**

**I**N WASHINGTON, D. C., the other day a group of distinguished men gathered to pay tribute to a radio "ham," a young man with a look on his face that said: "This must be happening to somebody else."

Those who came to honor him included Congressmen, a former governor and director of Federal Civil Defense, high brass

of the Army, Navy and National Guard, American Red Cross executives, directors of MARS (Military Affiliate Radio Systems), a vice-president of a large business concern, representatives of the press, television and radio.

The man singled out from the nation's 100,000 amateur radio operators, better known as hams, to receive the Edison Amateur Radio Award is Benjamin S.





Hamilton instructs a class of radio students at Civil Defense headquarters in San Diego. He has trained over 200 amateurs



Hamilton's radio network embraces an area the size of Connecticut and could serve 750,000 persons in time of disaster. Below, Hamilton directs drill at Civil Defense headquarters



Hamilton (W6VFT), a school-teacher of La Mesa, Calif., who has been working 20 hours a week to organize and equip an outstanding 200-man radio-communication system to care for his 750,000 neighbors in San Diego County. This county is about the size of Connecticut. To serve it he has organized a 10-transmitter control station and 35 subsidiary stations.

Each year the award, sponsored by the General Electric Tube Department, is made "for the outstanding public service of the year which brings the greatest benefit to an individual or group and for the amount of ingenuity and personal sacrifice displayed in performing the service." The judges who picked 1955's "ham of the year" were E. Roland Harriman, president of the Red Cross; Commissioner E. M. Webster, Federal Communications Commission; G. L. Dosland, president of the American Radio Relay League; and Val Peterson, Federal Civil Defense administrator and former governor of Nebraska.

Hamilton, a veteran of both World War II and the Korean War, found one of his biggest jobs was training operators. He was well equipped for this because he makes his living teaching industrial electronics at San Diego Junior College and Vocational School. In addition to the Civil Defense system for which he received the award, Hamilton has set up a communication system for his local Red Cross chapter.

The Edison awards were started by GE three years ago and have done more to raise the morale and prestige of hams than anything since the beginning of "time." Time for the hams goes back to 1914 when the group that was to become the American Radio Relay League, to which nearly all hams belong, boasted 23 members. Before GE got busy, all that the hams received for their valiant efforts to keep communication lines open in times of flood, tornado, fire and other disasters was a big "thank you" from government officials and neighbors. The hams, who are licensed as amateurs by the Federal Communications Commission, are prevented by law from receiving payment of any kind for their services.



**J. Stan Surber, last year's top ham, sends 1000 messages a month to men at Arctic weather stations**



**Spread before Surber are some of the hundreds of letters he receives with messages for the Arctic**

Every year hundreds of letters are received by GE nominating hams for the coveted Edison award. The job of selecting a winner, however, isn't quite as Herculean as you might imagine because each year a half dozen hams stand out far above the others. Some of these finalists are given special citations.

Last year, so many nominations were received for hams along the East Coast who

performed communication miracles during the hurricanes (remember Carol, Edna and Hazel?) that the judges gave a special citation to 1245 hams in that area. Operators of mobiles as well as fixed stations received high praise for maintaining emergency communication. Their work included routing traffic to guard against fallen trees and live wires, conducting fire patrols in cities where telephone and fire-alarm circuits

**Ben Hamilton, left, instructs a Civil Defense field worker on hill overlooking valley near La Mesa, Calif.**





Boy at Columbus (Ohio) State School for the Blind was one of class trained by ham operator Bill Jenney

were out, cooperating with the Red Cross and Civil Defense and in one case (Norfolk, Mass.) helping the police set up road blocks to capture escaped convicts. When Hurricane Edna was lashing her way up the coast, a special hurricane network was organized. At one time 131 hams were reporting to the network.

The year before, an amateur radio club in Genesee County, Mich., W8ACW re-

At Red Cross headquarters in San Diego, Hamilton showed workers how to make use of the ham network should need arise



Don Mullican, first Edison award winner, used makeshift telephone to contact station during tornado

ceived a citation for the members' work during the tornado that struck Flint.

Civil Defense leaders, such as Val Peterson, consider ham radio the most important hobby in the United States. Peterson says that if an all-out war comes to our shores the hams will be called upon to perform a supreme task in keeping communications flowing and preventing panic. When power plants and lines are destroyed, the ham can get his CQ (seek you) or QRRR (the SOS of ham radio) out on the short waves with batteries or generators.

During the 40 years of amateur radio's development, hundreds of articles have been written depicting the valor of the ham operators. The Edison award citations for this year prove that the hams are still running true to form. Carter Rogers (W8NCS) of Richwood, W. Va., operated a mobile transmitter for 16 hours continuously when a flash flood severed his town's communications with the rest of the world. Carl J. Theis (W8BKH) of Cleveland, Ohio, was credited with saving three lives. Theis was cited for his work in designing, converting and constructing radio equipment for missionaries overseas.

The top award winner before Hamilton was J. Stan Surber





Hamilton calls the roll for his class of mobile-equipped hams who are part of the Civil Defense network

(W9NZZ) of Peru, Ind. The judges were almost bowled over with nominations for Surber—112 letters from 28 states and 5 foreign countries.

Surber is known as the "Arctic mailman" and for the last five years has served as the link between government weathermen stationed at lonely outposts near the North Pole and their homes. His work has been called the greatest morale builder in the Arctic. "Send a message through Stan" is a byword in the icy regions where mail is received only once or twice a year.

Surber's regular job is that of railroad dispatcher and his hours are from four p.m. to midnight. This leaves his days free to contact such stations as Mould Bay, Eureka, Alert, Resolute Bay, Fletcher's Ice Island (known as T-3) and other places where even the Eskimos refuse to live. Surber works seven hours a day contacting the various stations on a regular schedule and averages 1000 messages a month. He handles all the work in Morse code, which is much harder than phone.

Surber's messages cover the entire gamut of human relations including birth, death, sickness, love, despair and all the trivia that bind men to their homes and families. There was the case of a young man who lay near death on Ellef Ringnes Island and no plane available to fly him out for medical attention. His buddies sent a QRRR to Surber who immediately wired the sick man's father. The father made arrangements to

(Continued to page 232)

## "Q" SIGNALS

### LANGUAGE OF THE HAMS

- CQ—Seek you, general call
- QRG—Will you tell me my exact frequency?
- QRK—What is the readability of my signals?
- QRL—Are you busy?
- QRN—Are you troubled by static?
- QRQ—Shall I send faster?
- QRS—Shall I send more slowly?
- QRX—When will you call again?
- QRZ—Who is calling?
- QSB—Are my signals fading?
- QSL—Can you acknowledge receipt?
- QSY—Shall I change to transmission on another frequency?
- QTH—What is my location?
- QTR—What is the exact time?
- QST—General call preceding a message
- QRRR—the "land SOS," distress call for emergencies only

*(Q abbreviations take the form of questions only when each is followed by a question mark)*

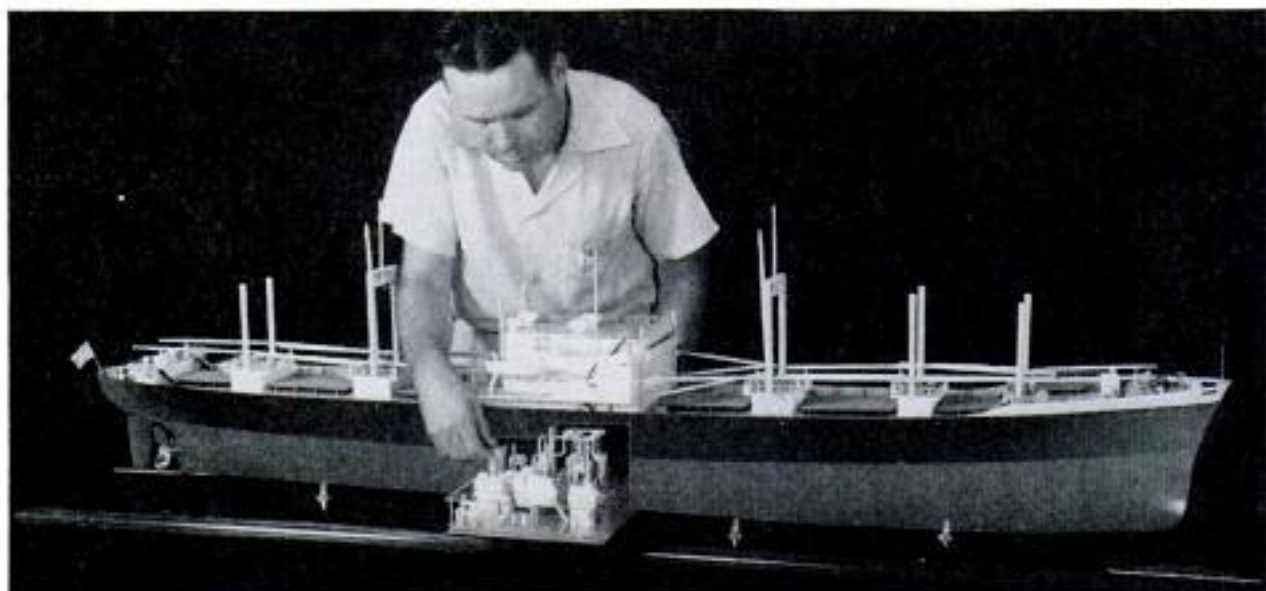

## The President Announces an Atomic Freighter

WHEN President Eisenhower, late in April, announced his plan for the construction of a nuclear-powered cargo ship, engineering studies of such a ship had already been made. A model of an atomic-powered ship has been built by the Newport News Shipbuilding and Dry Dock Co. The company, along with Bethlehem Steel Corp., is under contract to the Atomic Energy Commission to study the application of nuclear power to cargo vessels. The ship, according to Mr. Eisenhower, would be able to sail "scores of thousands of miles" without refueling and will "demonstrate to people everywhere this peacetime use of atomic energy, harnessed for the improvement of human living." The President gave no estimate of the cost, but one spokesman for the Maritime Administration said it would

be "terrifically high." He said it would be built and owned by the government, even though it might be leased to a private operator. The model which had been built at the time of the President's announcement represents a 650-foot 20-knot cargo vessel of the Mariner class. The power plant is a pressurized-water reactor which will use uranium as a fuel. Experts have estimated that the propulsion plant on an atomic ship developing 10,000 shaft horsepower would require only 30 pounds of uranium a year. A two-pound lump of uranium, about the size of a golf ball, is the equivalent of about 460,000 gallons of fuel oil or 3000 tons of coal. Engine and boiler rooms on the atomic-powered ship would occupy about the same space as those of a conventional vessel, but additional cargo space would be created by the elimination of fuel-oil tanks. Two great problems confront designers of atomic-powered ships: Economy and speed. Costly reactors can be built today to achieve the comparatively low speeds satisfactory for a submarine, but a plant is yet to be built that can provide the speeds required for passenger liners, destroyers and carriers. The cargo-ship power plant would achieve a speed greater than that of the submarine but lower than that required for other naval vessels. Some marine designers anticipate that it will be easier to sail a nuclear-powered ship because there will be no great changes in the weight of the fuel. A conventional ship must frequently take on sea-water ballast as the fuel is drained from the tanks. The atomic-powered vessel would also eliminate some of the maintenance problems which normally result from the use of both sea water and fuel in the same tanks.

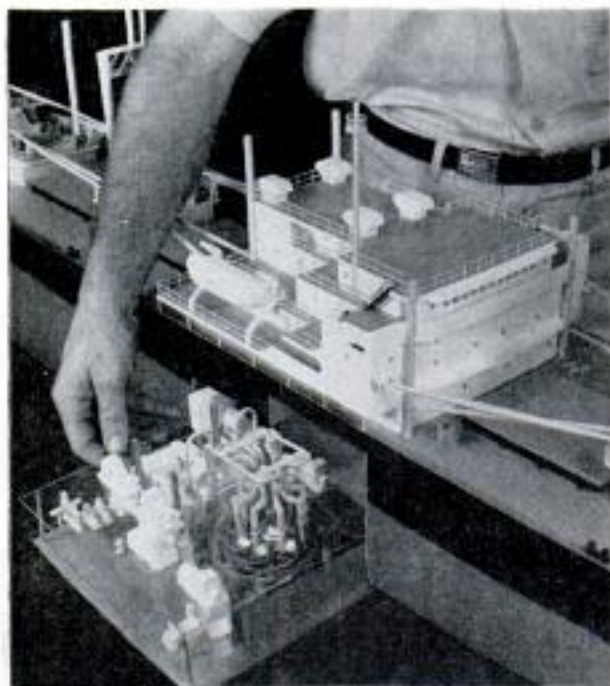



Plastic body panels carry out the front-fender line to make Chevrolet's Cameo Carrier appear low and long

## Chevrolet Pickup Truck Has Plastic Body Panels

It may be just a truck, but the 1955 Chevrolet Cameo Carrier is as stylish as a new car. It has plastic body panels that bulge out flush with the cab and wrap-around glass front and rear. Spring-loaded cables replace clumsy chains in the end-gate, the handles of which are recessed. The interior of the cab is red and beige.

Also new in Chevrolet trucks is a pump-up cushion. Driver and passenger inflate sections individually



## Navy Sub Hunter

Submarines have a tough time avoiding detection by the Navy's Grumman S2F, a two-engine plane that spots the underwater craft whether afloat or submerged. A plastic radar dome extends from the belly of the plane to detect and track surfaced subs. Extending from the tail is a long boom which houses the magnetic detection device that spots submerged subs.

## Automatic Distress Machine

Firing a signal flare every eight minutes for about 12 hours, an automatic distress machine requires no attention once it has been set in operation. Demonstrated on a Dutch vessel, the machine is a turntable containing 96 flare shells. It is powered by the movement of the ship.

Customers in a Long Island shopping center can watch their children at play in a supervised kiddie park by glancing at large-screen television receivers, a TV camera in the park bringing the picture over a closed circuit.





### Hose Unit Mixes Fertilizer

You can fertilize and water your lawn or garden at the same time with a mixing unit that connects to a garden hose. Weed killers, insecticides and even grass seed can also be applied with the unit. Up to 10 pounds of dry material or 2¼ gallons of liquid are placed in the aluminum mixing chamber. Water rushing through the chamber picks up the mix and deposits it uniformly on the area to be covered. The mixer, which has no moving parts, can be used with a hose and nozzle, with an automatic lawn sprinkler or with soaking hose. Hydrated lime, wettable sulphur and gypsum are among the materials the unit distributes.

### Glassless Sunglasses



Protection for the eyes from both direct and reflected sun glare is offered by double visors, called "See Shells," designed to replace sunglasses. An upper visor guards against overhead rays, and translucent lower visors filter any reflected sunlight.

# Flying Platform

**S**OMEDAY SOON you may be able to ride a column of air to work. You would step out of the house after a leisurely breakfast, jump into the family "flying saucer" parked on the lawn and be wafted away to your plant or office in a few minutes.

Glimpses of this dream flashed through the minds of observers watching test flights of the Navy's revolutionary "flying platform." Not a plane or a helicopter, but a new type of flying machine that looks like nothing else on earth, the circular craft literally rests on a column of air when in flight.

Two contrarotating ducted propellers, or fans, are located beneath the platform on which the pilot stands. Enclosed in a circular casing, they pull air from the top of the open platform and thrust it out the bottom with great force. This accomplishes two things: Air pressure on top of the curved lip, or "wing," is lowered, and a lifting force is created; air rushes up around the outside of the platform to exert an upward thrust on bottom of lip.

Two small engines, one for each propeller, spin the fans in opposite directions to eliminate torque. If a V-belt should snap, or one of the four-cylinder air-cooled engines should fail, the craft would careen to earth. This is one of the many safety

Pilot of the simple craft operates only two controls. The two engines develop less than 100 horsepower



POPULAR MECHANICS

# Rides Air Column

problems that still bother the designers. But the craft may be designed to fly on one motor alone if necessary, and a quick-opening parachute could conceivably save the pilot in case of total power failure.

Flying the platform is so simple that, as one spokesman suggested, "a trained bear could do it." To go forward, backward or sidewise, you simply lean in the desired direction. The shift of weight tilts the platform, changes the direction of the air stream and the machine moves horizontally. A built-in safety feature prevents the machine from tipping over should you lean too far. There are only two controls—one for the throttle, one for an undisclosed purpose.

The circular platform is about six feet across and lands on four metal legs that give it a height of 30 inches. The unit is so lightweight that two men can carry it, so simple in design that production-line models for civilian use could be turned out for well under \$1000.

But Hiller Helicopters, which developed the craft with the aid of studies made by the National Advisory Committee for Aeronautics, emphasizes that the first model is only a crude prototype. It has flown only a few hours, and in most of these flights the craft has been tethered to an overhead line for safety. Future models big enough to hold several people and lift huge weights would probably incorporate several fan units. In any case, according to Hiller, the dream of a "flying saucer in every garage" will depend upon the military success of the flying platform. Granted that, safe, dependable, low-cost family saucers may come within a decade. ★ ★ ★



JUNE 1955



The platform goes straight up, down or sidewise. Pilot changes direction just by shifting his weight. Below, safety tether used in test flight saves pilot and craft from sudden letdown if trouble develops



83

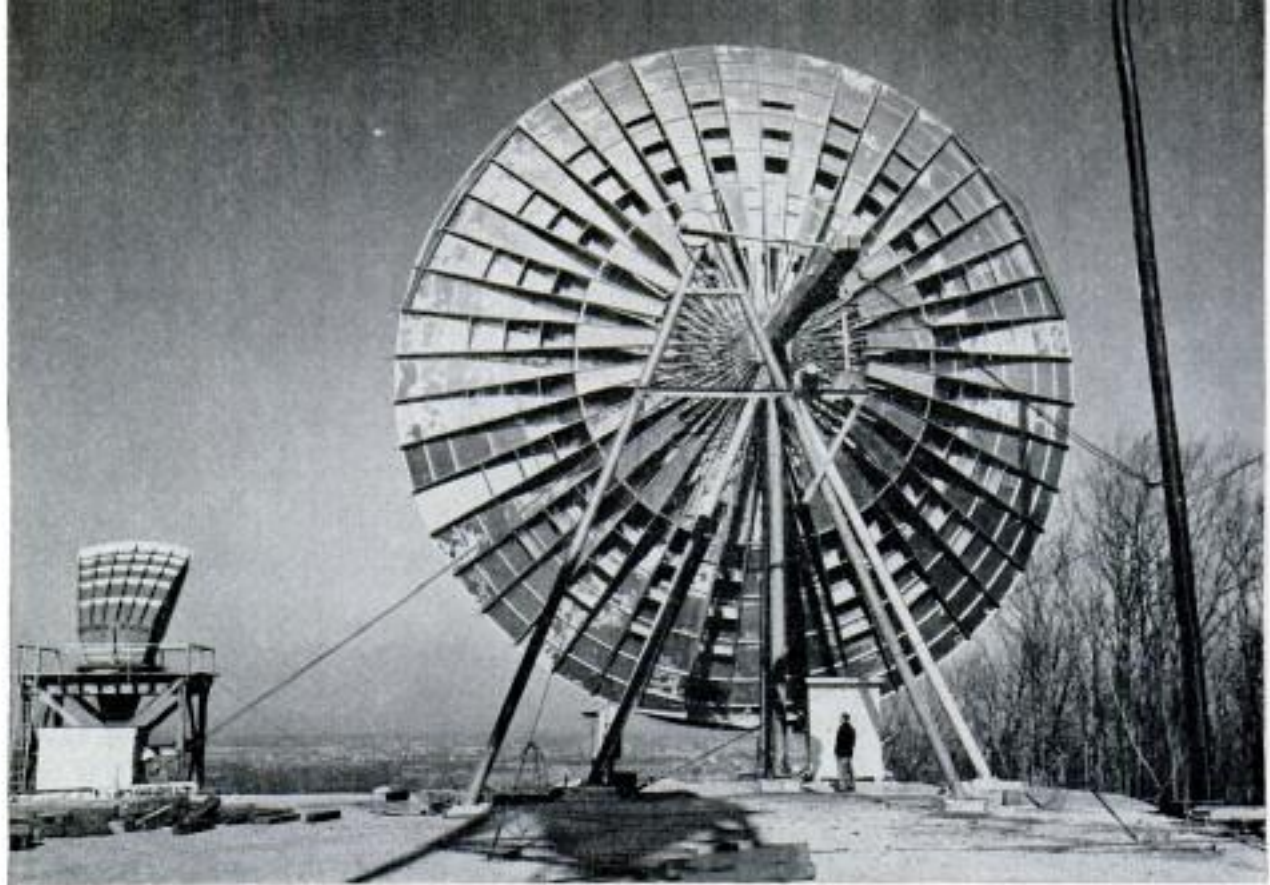

Dish-shaped antenna 60 feet in diameter is the type that will beam TV over the horizon from Florida to Cuba

# TV CROSSES THE HORIZON

By Richard F. Dempewolf

**I**N A TAR-PAPER SHACK squatting on a coral pile in Florida's endless Everglades, a peculiar clock with a circle of pegs under its face hangs on a bare stud. It announces the arrival of each quarter hour with a honk as nerve-shattering as the cry of a wounded swamp bird. The racket doesn't subside until Gene Womble unfolds

his lanky frame, reaches across the crude counter and punches the peg for that particular 15-minute period. Then Womble turns to an electronic nightmare of wavering dials, humming tubes and gleaming red-button lights. He lifts a telephone from a hook, mumbles a cryptic message into the mouthpiece and hangs up.

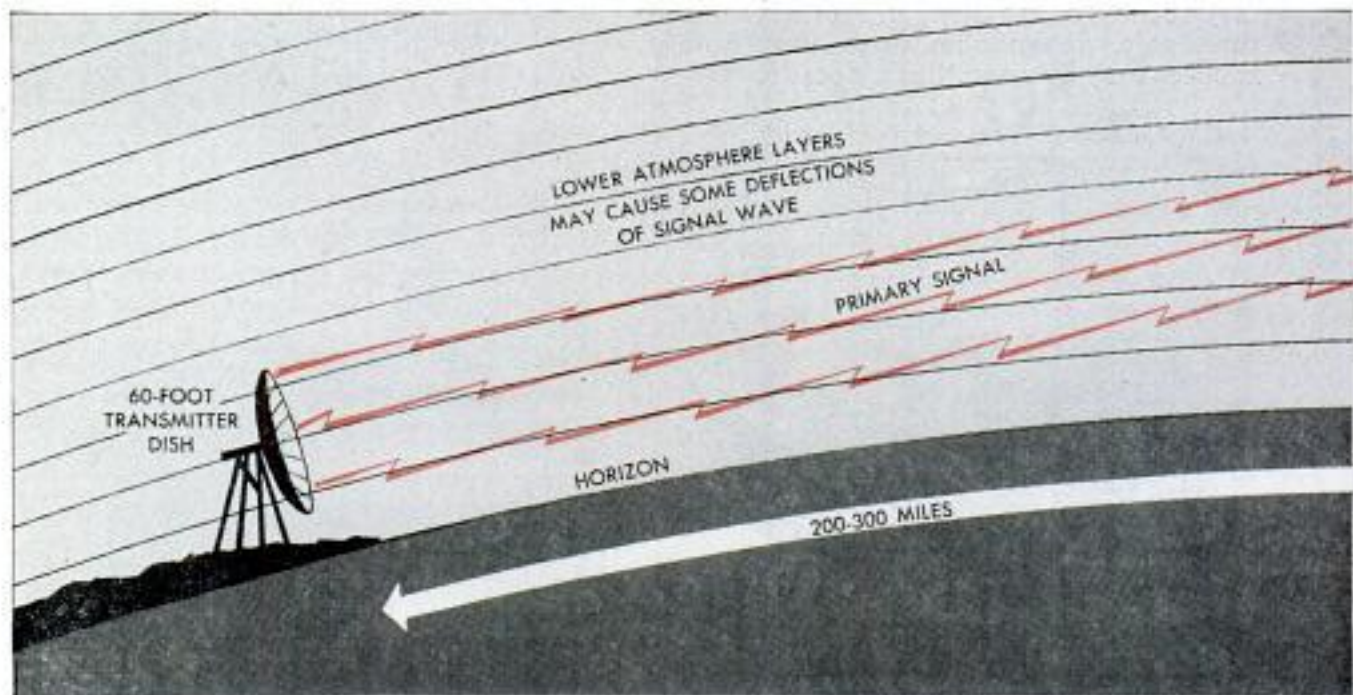

Womble and two other electronics experts for the Long Lines Department of American Telephone and Telegraph Company have been following the same dreary routine for the past several months. Every 15 minutes, 24 hours a day, they have been spelling each other off in 8-hour shifts.

There's little about their hermitlike existence and the monotonous round of chores out there in the snake and 'gator-ridden swamp to indicate that anything unusual is going on. And, except for the 10-foot dish antenna atop a 50-foot aluminum tower on the highest point of the coral pile, few people roaring down the nearby highway to Key West would guess that the shack out in the morass was anything but a fisherman's hut.

No other Everglades hut ever held a secret like this one, however. The \$20,000 worth of gleaming equipment under its tarpaper siding is providing the test run on a radically new radio-relay system. It can blast TV or multichannel radiotelephone signals 200 miles across wilderness and water in a single mighty leap to Cuba. In the hills behind Havana, a similar antenna, manned by a crew of Cuban-American Tel and Tel technicians, is snatching Gene Womble's signals out of the ether and measuring them for strength and stability. Cuban-American is owned jointly by A.T. & T. and the International Telephone and Telegraph Corporation.

But all this is just a forerunner of more fantastic things to come. Right now, tough engineering crews are splashing through the Florida Everglades and the jungles on Cuba's coast. They are exploring permanent sites for the king-size dish antennas (60 feet in diameter) and the big transmit-

ters which, sometime early in 1956, will start blasting 40 or 50 telephone circuits over the ocean. If these work, hundreds more circuits will be added. Then TV shows may break their tight relay leashes and leap the chasms of water that have hemmed them in until now.

Since it first went to work transmitting TV and multichannel telephone circuits, the handy microwave has had one bad characteristic: It refuses to follow the curvature of the earth. When a microwave passes the horizon, it continues dead ahead and spears off into space. "Most radio waves do the same thing," Womble will tell you, "but those in the lower frequencies can be bounced off the ionosphere and, by this means, can be used for communications over hundreds and thousands of miles. Not the microwave, though. It goes right on through and keeps going forever, for all we know."

That's why microwaves must be relayed from stations spaced about 30 miles apart—even on 300 to 400-foot towers across mid-western prairies. These towers have square or dish-shaped antennas at the pinnacle. Each catches the signal from the previous tower, boosts it, focuses it in its own reflector and shoots it along to the next.

It is because of this microwave behavior that large bodies of water have provided a barrier against transmission. Relay stations would have to be hung from skyhooks or planted on manmade islands—and that gets expensive.

The new system, based on nearly 10 years of research at Bell Laboratories, Massachusetts Institute of Technology, A.T. & T. and other electronics centers, lets the stubborn signals go ahead and shoot

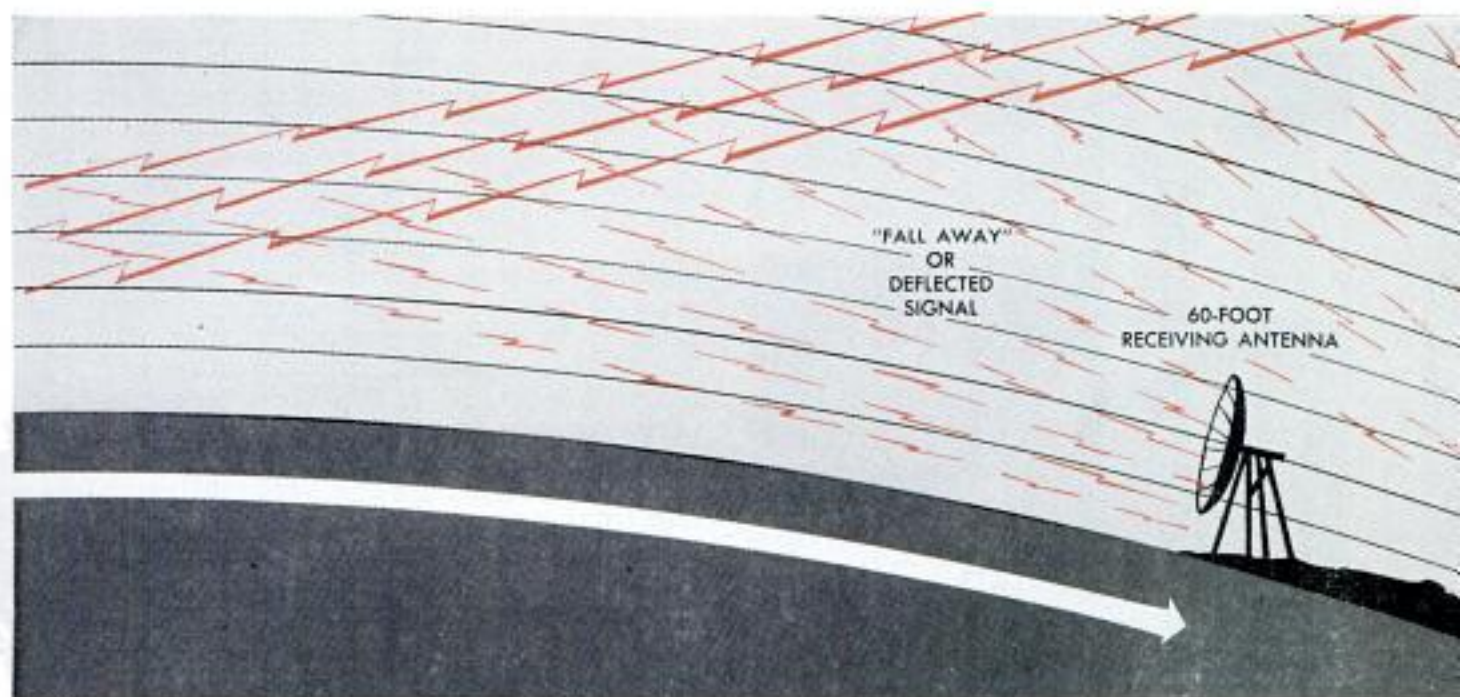



A.T. & T. photo

Small antenna is raised to the top of its tower for the first test broadcasts between Florida and Cuba. Huge antennas for commercial broadcasts may follow

Tar-paper shack in the Everglades contains more than \$20,000 worth of electronics gear. Every 15 minutes a technician broadcasts a message picked up in Cuba



themselves out of this world with a tremendous blast of power, then picks up a few of the leavings at the other end with an equally powerful receiving setup.

Oddly enough, none of the experts will tell just what makes it work. Reason: They don't know. "Back in 1946," says G. W. Gilman of Bell Laboratories, "our engineers observed some unusual behavior of FM radio waves and did some measuring. Waves didn't always do what mathematics said they should. Sometimes they propagated themselves to great distances across the earth when they should have been gone forever. One cause was what we call 'ducting,' due to unusual weather effects. The other was something else—nobody knows what."

Whatever it was, Bell engineers set up equipment in Whippany, N. J., and tried something. During 1950 and 1951 they blasted the ether with something which the men have dubbed super-high frequency, or "SHF." Broadcast from two transmitters—500 megacycles and 3700 megacycles at a peak power about 300,000 watts (the usual microwave signals for TV go out at  $\frac{1}{2}$  watt), the Whippany signals got quite a send-off. A mobile unit with a 57-inch antenna on top roared away to see how far it could still pick up signals. It was out several months, roving at great distances, and never lost the beam. Actually, the racket was picked up on Mount Washington, N. H.—285 miles away, where optical line of sight from the transmitter would have been eight miles in the sky above the receiving antenna!

Were the waves bounced off layers in the lower atmosphere? Some electronics men think so. Others think the signals picked up may be stray emanations from the main beam, like the trailing sparks from a July 4th rocket. This idea has given the phenomenon the name "fall away," now used by some engineers to describe it.

Probably the most graphic description is Gilman's: "If you've ever driven down a highway at night toward a big city, you've noticed the glow in the sky from the city's lights long before you ever saw an actual light. That's propagation of light. It's quite possible that these radio waves are propagated in a similar way, and that it's the 'glow' that our receivers are picking up."

Jim Rae of A.T. & T.'s Long Lines Department, who supervised logistics for the test equipment in Florida and Cuba, listened to all the stories of snakes and 'gators told by the men, and worried about what to do when the crew in Havana discovered they'd forgotten the "feed horns" for their antennas, is pretty realistic about the whole thing. "We're simply shooting out tons of signals at the transmitter and pick-



ing up an ounce or two at the other end," he says.

For this reason the long-leaping super-high-frequency waves are not likely to replace the microwave-relay networks already in existence. The vast power and tremendous nine-story dish antennas needed to do the job cost considerably more than standard 30-mile relay stations set up over a 200-mile route. But across gaps of water separating us from many neighbors, and where cable or short-range relay is impractical, the new system may soon carry telephone and TV service to places it never went before.

It will find many other uses. Guided missiles are governed in their flight by microwaves that follow them out into space, move their control surfaces to steer and stabilize them and fire their warheads. Microwaves from the missile to men stationed in blockhouses back on earth, relay all kinds of information about what's going on up there in space. It works nicely on vertical or near-vertical flights, where the missile always remains in a theoretical line of sight from the launching point. But until now, low-level horizontal flights have been tough to handle. On horizontal paths, the missile soon is out of "sight" over the earth's horizon, and contact with "home

base" is lost. Using ultra-high-frequency (super-high-frequency) signals with the new powerful equipment may give missile men control over their charges at much greater distances than they have had before.

The galloping waves may also come in handy to flash scope pictures from the outposts of our Arctic radar network back across the inaccessible lakes and wilds of the Canadian North to headquarter filter stations nearer civilization. In fact, rumor has it that this system of mighty "forward pass" relays already is under construction.

Meantime, down in the Everglades, Gene Womble and his companions continue to punch that noisy clock every 15 minutes. And from their "baby" 10-foot dish, a faithful message beams across waste and water to Cuba on a single narrow band, kicked off by their 800-megacycle transmitter, blasting at 500 watts' output. That's just a trickle compared with the job the permanent equipment will do. Signals from the huge 60-foot antennas will get a 10,000-watt boost. There won't be just one of the giant dishes at each end, but two—to offset rapid fading. Both can be used to receive signals. "If the signal fades on one, the other will tap in," explains Jim Rae.

(Continued to page 244)

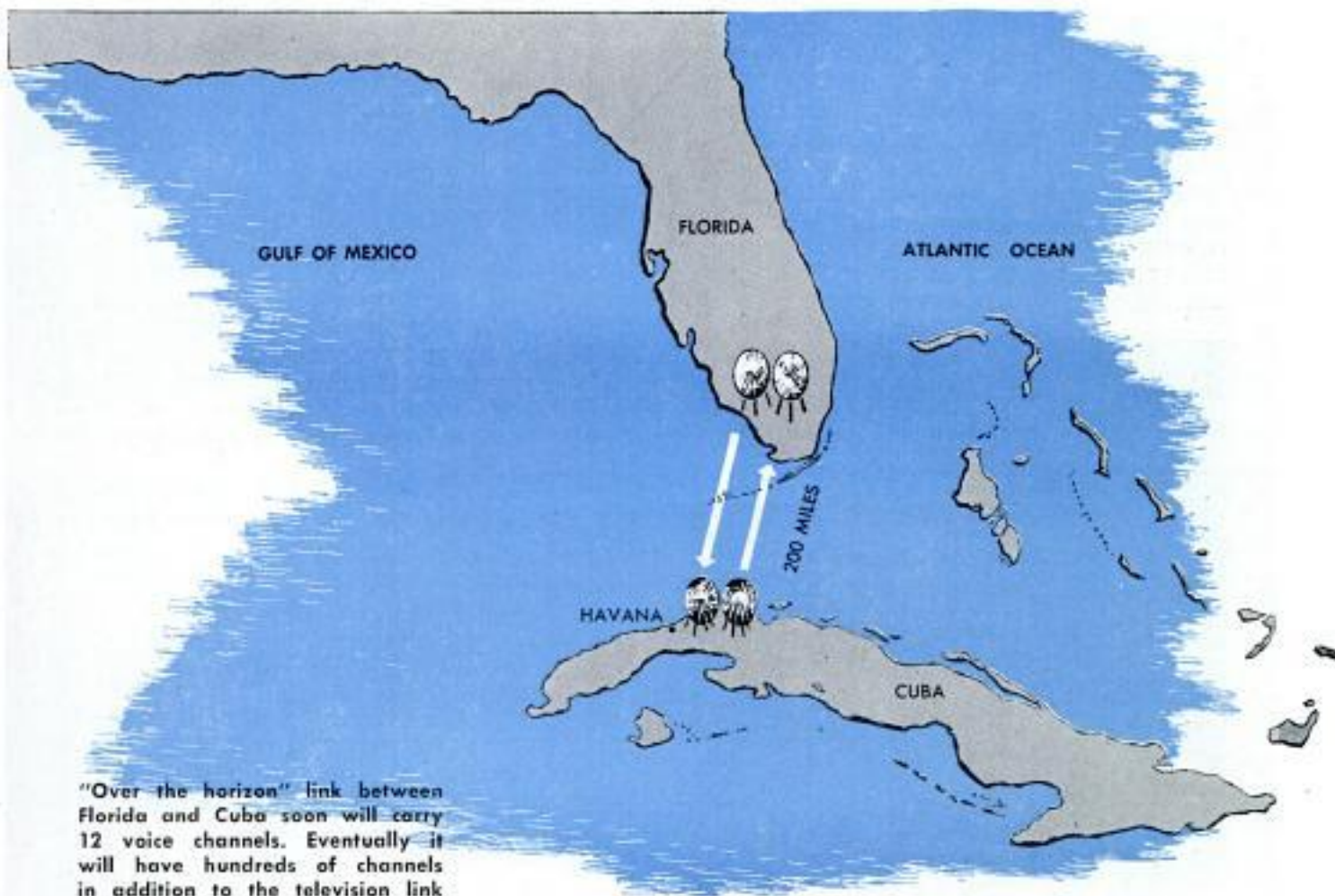



# KEEPING UP WITH THE ATOM



HOW GOES OUR uranium supply for weapons and power? Three or four years ago there were fears that our military program might be restricted by a shortage of the strategic mineral, but not today. In a recent address, Jesse C. Johnson, Director of the Division of Raw Materials of the Atomic Energy Commission, gave assurance that "uranium rapidly is becoming just another strategic material and we can look forward to adequate supplies to meet foreseeable military and industrial requirements." Prior to 1942, when uranium suddenly became a vital war material, there was little interest in it, and up to 1948 no new source had been discovered. The Belgian Congo was then almost our sole supplier. "Today," said Mr. Johnson, "private uranium activities in the United States have a value of about \$100,000,000 per year. In the past two years, private financing totaling \$70,000,000 has been arranged for three Canadian uranium projects alone. In addition, there are the extensive Canadian government operations and many private projects. The investment in South African uranium mills is approaching \$150,000,000," besides other projects in the Congo, Australia and Portugal. Most domestic uranium comes from the Colorado plateau, with other production being developed in Texas, Wyoming and the Dakotas. While most of the presently worked deposits may be mined out within 10 years, Mr. Johnson said continued exploration may discover even greater ore reserves than known to-

day. Phosphate and shale also provide a large low-grade uranium reserve.

☆☆☆

X-ray photographs can be taken anywhere with a portable atomic X-ray machine that weighs less than 20 pounds (see photo below). The X-ray source is a radioactive isotope shielded so that the machine requires no special precautions. The little unit, which is small enough to fit into a woman's hatbox, requires no electricity, and can be used in ambulances, at accident scenes, in industry or combat zones.

☆☆☆

The rate of wear of machine-tool bits has been measured accurately by another new application of radioisotopes. The bits were first irradiated at Oak Ridge laboratory, and the amount of radioactivity transferred to the chips was used as the basis for determining relative tool life.

☆☆☆

Atomic scientists can see and photograph radioactive specimens in three dimensions with a specially designed periscopic, stereoscopic telescope already in use in Knolls Atomic Power Laboratory.

☆☆☆

The site for Australia's first research reactor has been chosen a few miles south of Sydney where its coastal location will permit dumping radioactive wastes into the sea.

☆☆☆

Doctors at the University of Michigan have found a way to sterilize bone tissue by exposing it to radioactive cobalt; the irradiated bone afterward was transplanted into dogs without harmful effect.

☆☆☆

Radioactive gold has been used to treat more than 200 cancer patients at the Ohio State University Medical Center. In some, all evidence of cancer has been eliminated, but the evidence is not yet conclusive since the cancer may already have spread to other parts of the body; some of the patients have since died of the malignant disease. The method used in the center's experiments is to embed the radioactive gold in nylon thread which is then sewn throughout cancers that cannot be removed by surgery.



The USS Haverfield, first of a new class of radar picket ships, is crammed with electronic gear from the topmast to keel

U.S. Navy photo



# "Paul Revere" Ships Join the Lookout

By Comdr. W. D. Brinckloe, USN

(Head of Battleship-Cruiser-Destroyer Branch, Bureau of Ships)

ON THE SLEEK AIRLINER speeding across the Atlantic from England, scarcely anyone noticed that the pilot, departing from his straight flight path, was gently turning the big plane in a wide circle. This maneuver completed, he returned to course and continued on toward New York. One passenger asked the pretty hostess to explain the odd evolution.

"A Navy picket ship has challenged us," she explained. "That's our recognition signal for this flight."

The passenger pondered her reply. "And what would happen if we didn't give the right signal?"

The pretty hostess' smile faded a bit. "I've often wondered," she said.

Down below, across the horizon from the big plane, the men aboard the little picket ship tossing in the oily swells didn't wonder what would happen. They knew. That's why they were out there. One word from them, and jet interceptors poised at coastal

airfields hundreds of miles away would streak seaward to strike down the suspicious plane that hadn't known the password.

Day and night these rugged radar picket ships keep their lonely vigil, in the hardy tradition of Paul Revere, ready to spread the alarm of an approaching enemy.

Like her human counterpart on an isolated sentry post, the picket ship's lot is a lonely one. Consigned to a desolate stretch of sea, separated from her sisters by the very nature of her vigil, she lives in the constant realization that she stands her watch at the enemy's border. In today's uneasy peace, her station is no man's land—hers the outpost that would be overrun in the first strike. In an age where every stranger must be considered hostile, she lives by the border guard's stern rule of shooting first and asking questions later.

The first improvised radar pickets were born of necessity in the Pacific fighting, to guard the outlying flanks of World War II's



Incoming raids are plotted and evaluated in the busy Combat Information Center, heart of the picket ship's watch system

Diagram below shows the radar picket ships' position in the four bands of defense of the Continental Air Defense System. Planes, ships, towers and ground stations are on constant alert

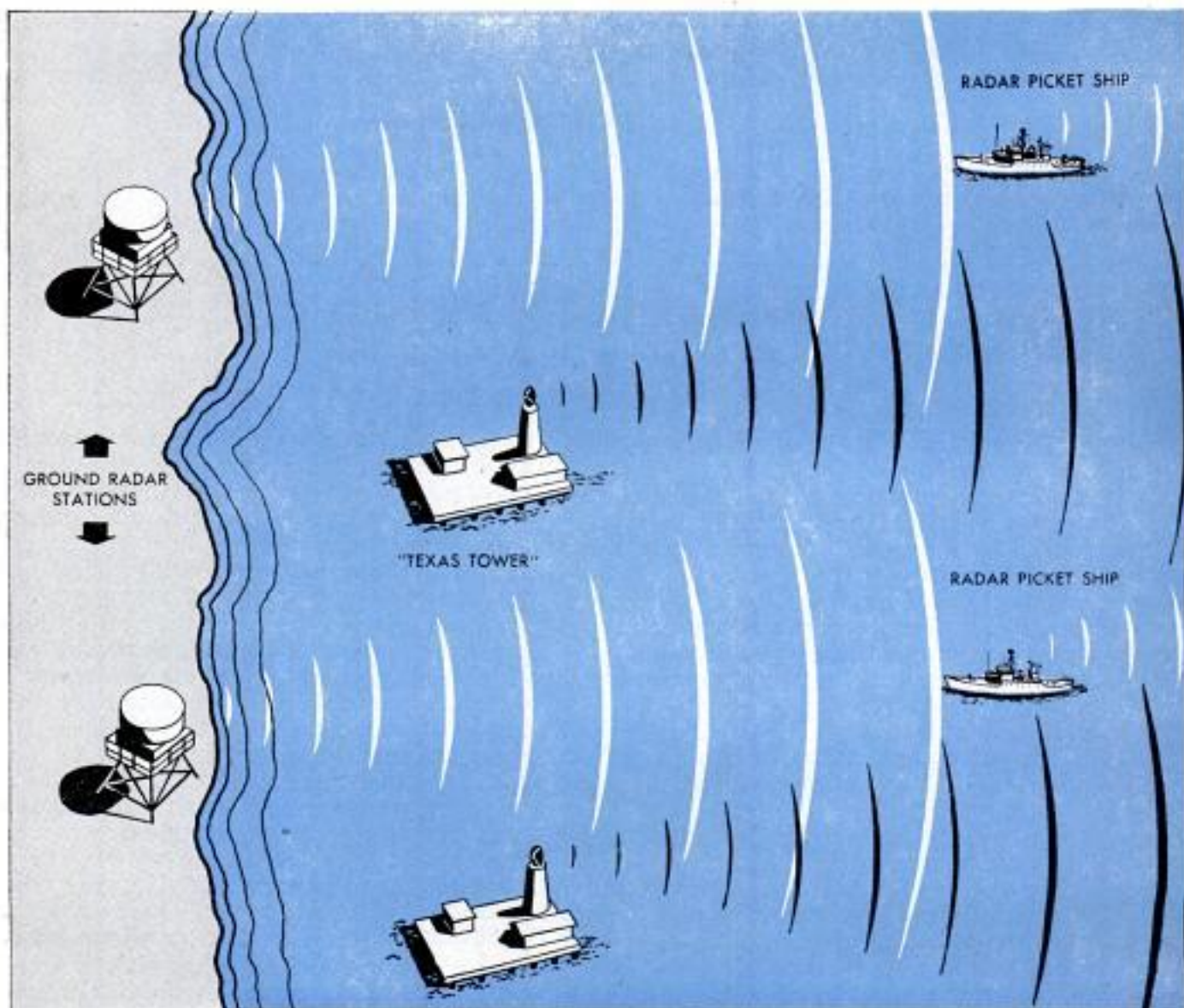

mighty task forces. Patrolling just over the horizon from the main body, they caught the first warning of attacking planes and vectored carrier fighters to intercept them. Later, with the increasing need for air defense, radar picket groups took station off Okinawa during the 1945 campaign.

Okinawa's most remote picket stations were 40 to 70 miles out from the transport area. But the speed of modern planes has so shrunk the oceans that today's pickets must roam hundreds of miles out at sea, keeping watch over an entire nation.

When war ended, the bulk of our Navy was moth-balled against the day of need. Among these hibernating ships was the destroyer escort *Haverfield*, winner of the Presidential Unit Citation for extraordinary heroism in action against the Nazis. While she slept,

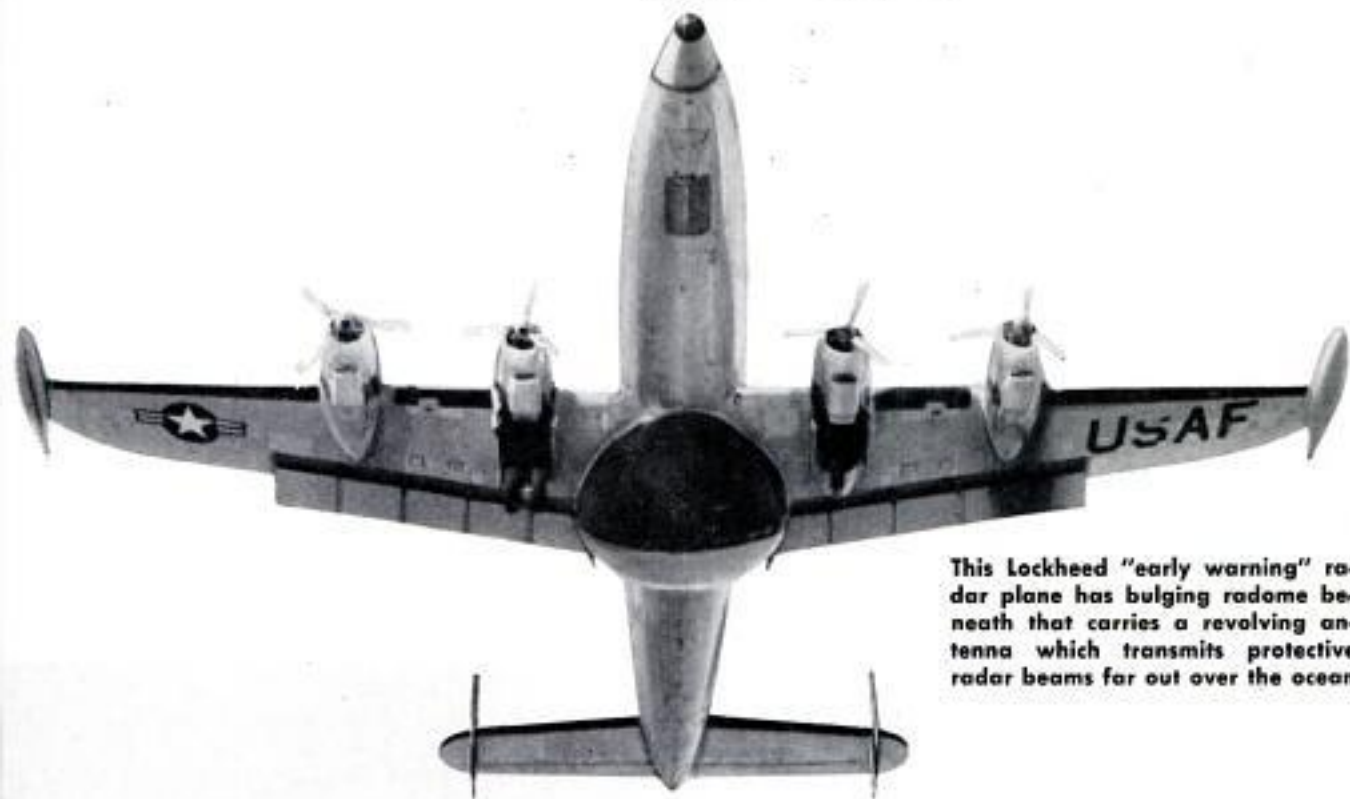

This Lockheed "early warning" radar plane has bulging radome beneath that carries a revolving antenna which transmits protective radar beams far out over the ocean

six destroyer escorts—merely a token force—were given a trial conversion to radar pickets to provide a nucleus force and keep the techniques alive. There the matter stood until the international cauldron began to seethe again.

The nation manned its ramparts swiftly. SAC was formed—the massive retaliatory weapon that stands poised to strike at a moment's notice. The Continental Air Defense System was set up—a vast network of defense lookouts, laced with hornets' nests of ready interceptors. And *Haverfield* and her sisters, roused from their slumber, were ripped open in a multimillion-dollar conversion into modern radar picket ships for the Barrier Patrol.

Lead ship of this crash program, *Haverfield* is just now taking her place in the line, with her sister pickets coming close behind. A maze of electronics gear, probably pound for pound more than in any other ship afloat, *Haverfield* is a virtual floating radar set tuned to spot aircraft, submarines and surface vessels headed for our coastline.

"Most of the electronic gear is highly classified," says Lt. Comdr. B. G. Westfield, USN, *Haverfield's* skipper. "But I can tell you that the heart of our detecting system—where all contacts are first spotted, evaluated and tracked—contains more equipment than the average cruiser or battleship!"

*Haverfield* is comfortable. She has to be, to make those lonely patrols tolerable. She's completely air-conditioned—the smallest ship in the fleet to rate this luxury. She is fluorescent-lighted throughout, and her mess hall's aluminum tables are small

(Continued to page 242)

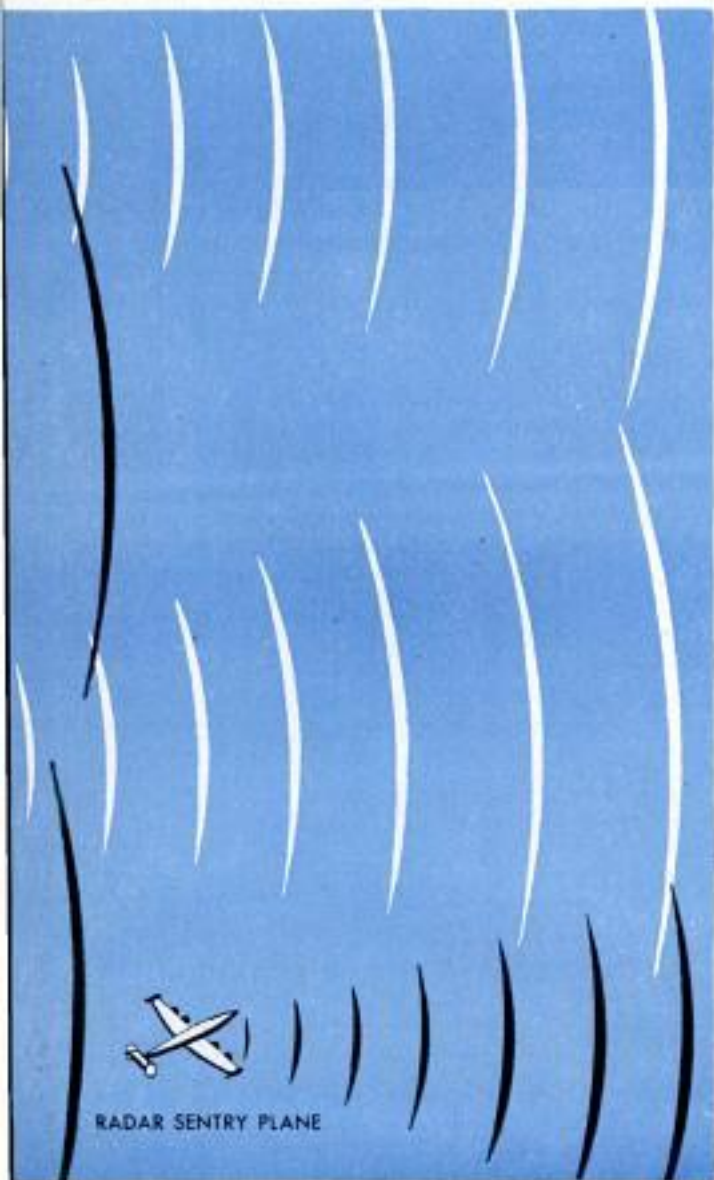

# Detroit Listening Post



By Leo Donovan

**T**TALK ABOUT THE TAIL wagging the dog! It may come to that at American Motors if the Rambler continues to grow. One out of every two cars built by the Nash-Hudson combine is a Rambler—an impressive success story for a car that started out as a mere sideline.

When the Rambler debuted, it was a deluxe, compact convertible on a 100-inch wheelbase. Today it comes in a full line except there is no convertible—the model that started it all. Half of all Ramblers sold are four-door station wagons on a 108-inch wheelbase. Another 25 percent or so are four-door sedans on the same wheelbase. The original 100-inch wheelbase seems destined to be dropped. Those extra eight inches are the difference between smallness and spaciousness, say designers.

And the 1956 Rambler will be even more spacious, rumor reports. It will be wider and longer. This just proves once again that you can't sell America on a small car. The rule seems to be that at any given price level, the bigger the car the more you'll sell.

You'll be able to buy a V8 Rambler in 1956 and perhaps even in 1955, reports our underground. It will be an American Motors V8, not one bought from some other manufacturer, and it will be sold through the A/M line in varying horsepowers.

## Can You Sell Safety?

You're likely to hear more talk about safety in 1956. Chrysler now offers optional seat belts for \$80. Nash offered seat belts a few years ago and the dealers were kept busy tearing them out of the cars that came through with belts installed. It will be interesting to see what Chrysler's experience is. Most of the industry still seems to feel that you can't sell safety—it's a negative approach.

John O. Moore of the Cornell University College of Medicine told the Society of Mechanical Engineers that in any serious accident the occupants of the newer cars (1950 to 1954) are more likely to be killed

than those in older cars (1940 to 1949). Why? The newer cars are usually traveling faster. And speed plus impact means death. In 15 years, Moore said, there have been no advances in "crash worthiness" of automobiles.

Any increase in safety emphasis, however, is not expected to retard the trend toward higher horsepower. Compressions on 1956 models will be up, with 10.1:1 being a definite possibility. There will be more than just Chrysler bragging about 300 horsepower!

## Rocket-Ship Tail Fins

It's beginning to look as though 1956 will bring the rocket-ship motif to automobiles—especially in the tail-fin department. The 1956 Chrysler is said to have huge fins that run straight back, rising at a slight angle in the style of a space ship. The Cadillac Eldorado Brougham, the car that GM plans to compete with the forthcoming Lincoln Continental, also has an exaggerated tail structure. The 1955 Cadillac Eldorado started the whole business. Whether Cadillac itself will abandon its turned-up tail is still a secret. That design has been worked and reworked so many times that a change seems likely. After all, you can't just keep making the same thing bigger and bigger—or can you?

The top three of GM—Cadillac, Buick and Oldsmobile—are expected to make more than minor styling changes in 1956, but Chevrolet and Pontiac will get only face lifts.

Ford Motor Company's reorganization leaves the way open for a new line of cars priced between Mercury and Lincoln. This would compete with upper-middle-price cars like Buick, DeSoto and the Clipper.

The Continental, incidentally, will probably offer a removable hardtop for use with convertible models—a la Thunderbird.

Lincoln, at this writing the only make that has built fewer cars in 1955 than in 1954, will be completely restyled for 1956. Longer, lower and more lush in appointments, it will be aimed less at the performance market, more at the elegance market—the one so successfully dominated by Cadillac. The 1956 Lincoln may be out sooner than you think.

In fact, as the season approaches, more and more rumors are heard that all cars will be out in the late fall.

By the way, we have been getting letters from readers asking if our crystal ball was clouded when we predicted power windows, top and other comfort features on the new Corvettes. No, the ball wasn't clouded. It saw very clearly. It was just that we didn't realize how far ahead it sees. Watch the 1956 Corvette for further details.



## Air-to-Air Rocket Searches Out Enemy Plane

Capable of knocking down any bomber in the world is a new air-to-air rocket designed to be fired from United States interceptor aircraft. Trevor Gardner, assistant Air Force secretary, said the rocket, called the Falcon, can destroy enemy bombers carrying hydrogen bombs long before they reach their targets. The Falcon carries its own power plant and automati-

cally "locks on" its target bomber, no matter what its speed or evasive action. Two other new weapons are the Atlas, an intercontinental ballistic missile capable of flying several thousand miles per hour, and the Rascal, an air-to-ground weapon with a nuclear warhead capable of hitting targets far removed from the United States bomber that launches it.

## Light Submachine Gun

London Sea Scout, Barrie Spraggon, recently demonstrated the new lightweight Sterling submachine gun, a replacement for Britain's famed wartime Sten gun. The new weapon weighs but 6½ pounds, and can fire 575 rounds per minute. It is said to be accurate at 200 yards and lethal at 500.

## Golf Bag Becomes Chair For Player's Relaxation

Golfers who have waited long periods for slow foursomes will appreciate a combination golf-bag seat that weighs little more than an ordinary bag. The bag is actually a lightweight folding chair with a hollow back that holds clubs. When there is a delay in the game, the golfer unfolds it and sits down. With wheels attached it becomes a golf cart.



# What to Do When **LIGHTNING STRIKES**

A FEW PRECAUTIONS can save you from possible injury or death the next time you're out in an electrical storm. The suggestions on these pages, advanced by the National Safety Council, point up the importance of seeking shelter in low spots, avoiding electrical conductors and seeking shelter only in protected enclosures. Even an open window or a fireplace can be dangerous when lightning follows air currents. ★ ★ ★

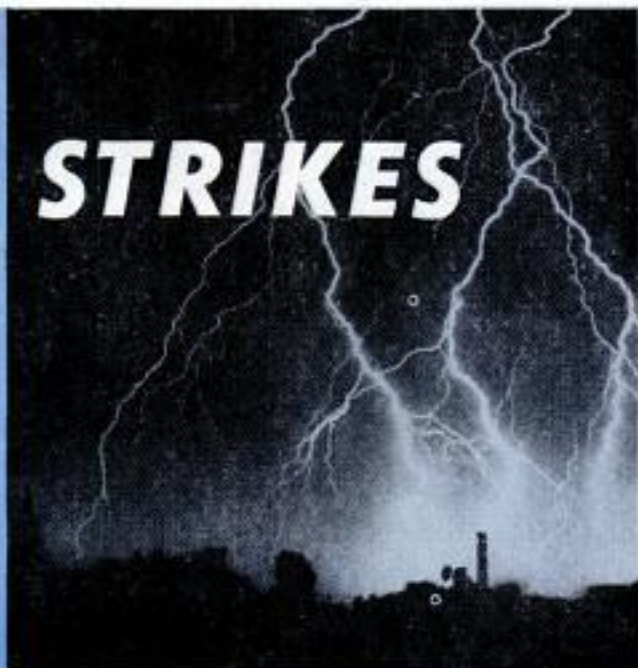

## **AVOID . . .**



**. . . exposed shelters**



**. . . boats**



**. . . swimming**



**. . . beaches**



**. . . hills**



**. . . lone trees**

## **YOU'RE SAFER . . .**



**. . . in a ravine**



**. . . in thick timber**



**. . . flat on the ground**



**. . . in a ditch**



**. . . under a cliff**



**YOU'RE IN DANGER . . .**

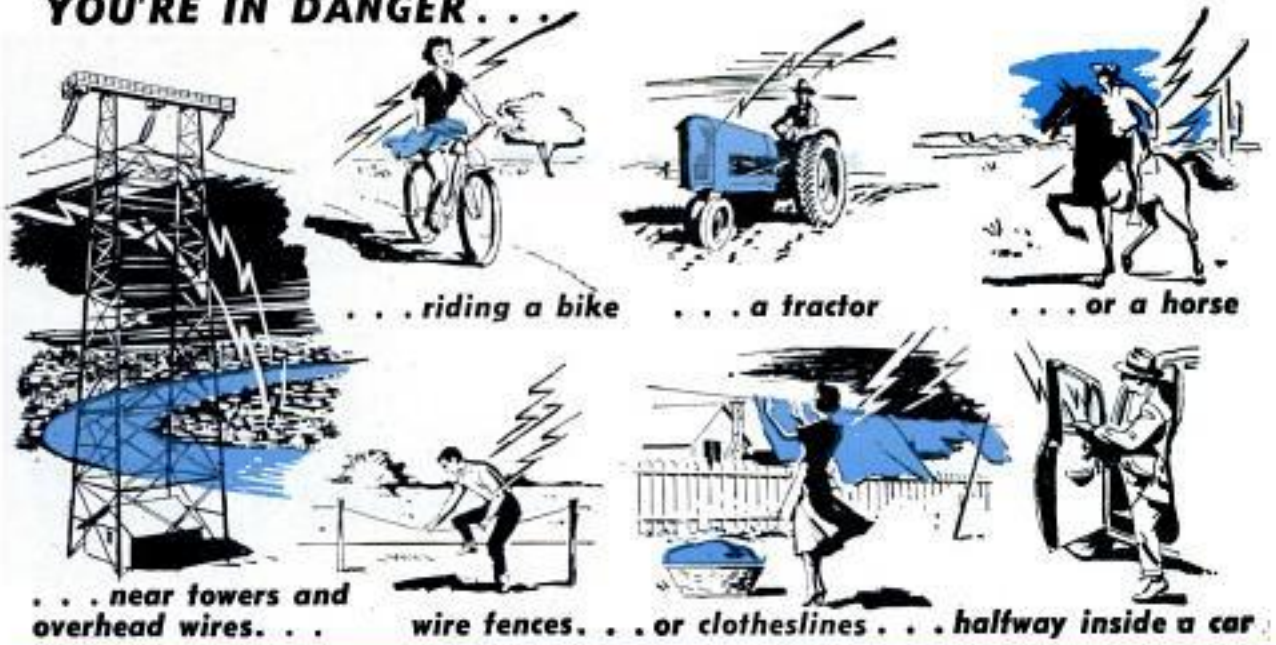

**CHOOSE SHELTER IN . . .**

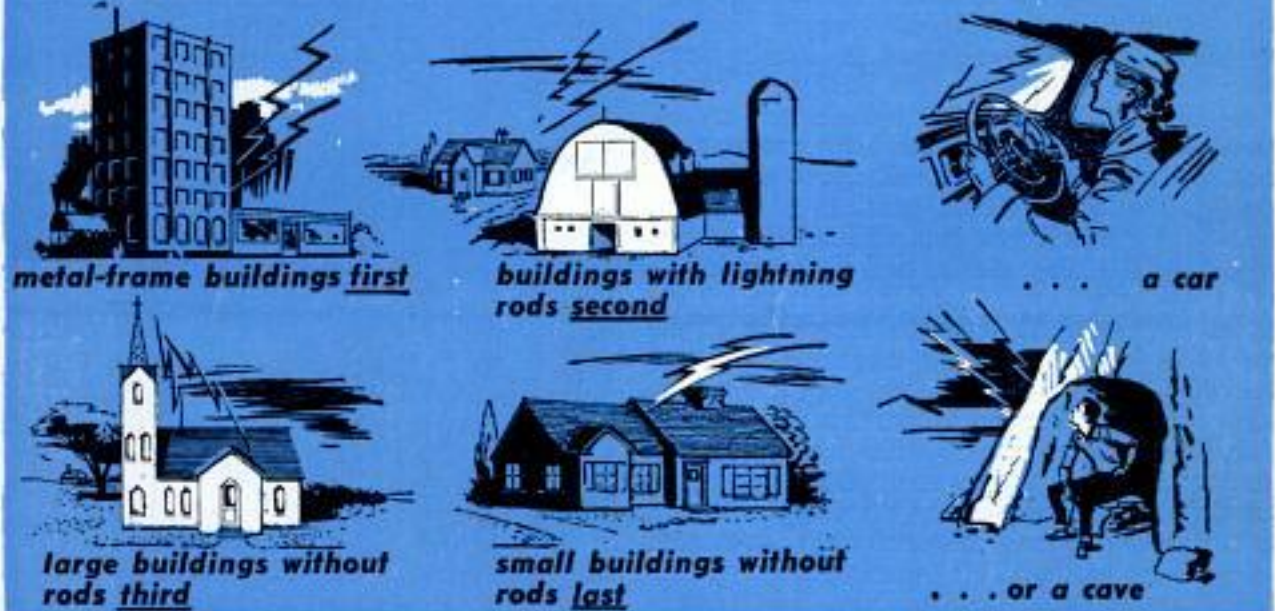

**AT HOME . . . Keep Away From:**

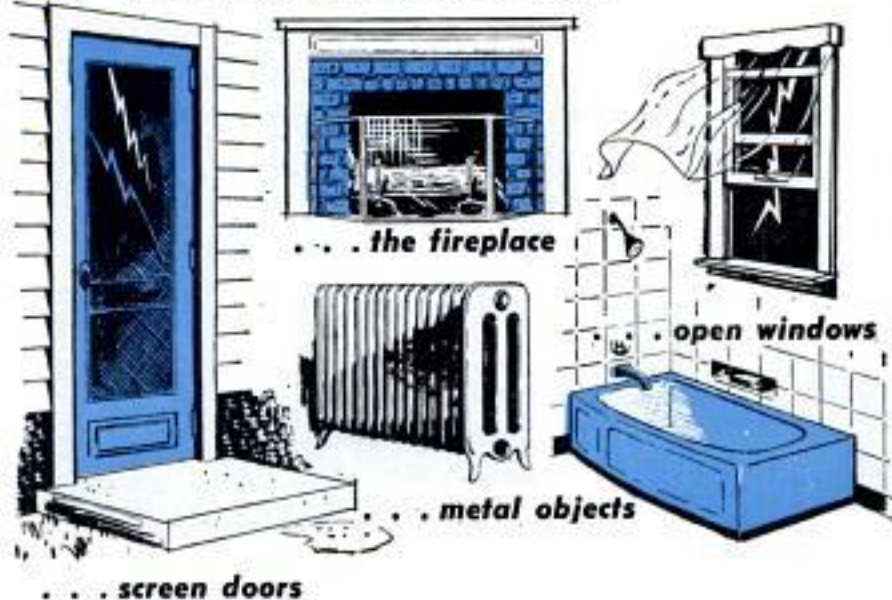

**Safest Spot:**



## Italy's Answer to the VW



**POWERED** by a four-cylinder, water-cooled rear engine, the Fiat 600 has a striking resemblance to a snub-nosed Volkswagen. The four-seater is Fiat's first excursion into rear-engine design. Wheelbase is 78 $\frac{3}{4}$  inches. All wheels are independently sprung, the front by transverse leaf spring, the rear by coil springs. Compact power unit in rear consists of engine, clutch, transmission and differential. Top speed of the tiny car is said to be around 60 miles per hour. Gasoline consumption is an estimated 50 miles to the gallon. The radiator for the engine's cooling system is mounted on the side of the engine and is supplied by a shrouded fan that draws air through louvers on the rear deck. In winter, air that has passed through the radiator is piped into the passenger compartment for heating. Spare tire and fuel tank are located under the hood, leaving some space for luggage and small parcels. Additional luggage room is available behind the rear seat. The car sells for \$980 in Italy. It is not available in the United States.

Described as a four-passenger car, the Fiat 600 is large enough for a family with three young children



Above, with its four-cylinder engine in the rear, the 600 has spare tire, fuel tank and some luggage space under the hood. Below, cross-section shows the efficient use of space inside the integral body

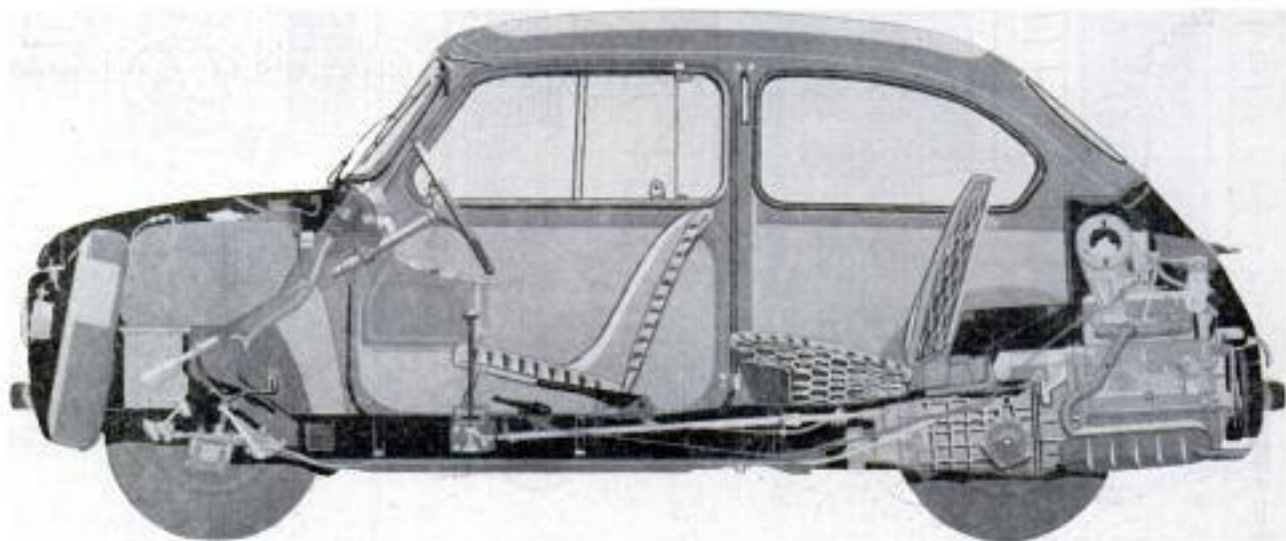



GUNNER AND HARPOON GUN ON THE FORECASTLE OF A CATCHER



A Dutch "corvette" catcher approaches its target, a spouting blue whale. Gun on forecastle fires a harpoon that explodes and snaps open in whale

## Whaler TO DOUBLE AS Supertanker

**I**CEBERGS and Antarctic gales hold little terror for the whaling fleets that yearly hunt their prey at the bottom of the world. Modern, radar-equipped "floating factories," each accompanied by a brood of smaller vessels, harvest the seas with systematic and determined thoroughness.

Most modern and biggest of the floating factories will soon be the Dutch vessel, *Willem Barendsz II*, scheduled for action in 1956. Carrying a crew of 500 officers and men, the 635-foot vessel will have

(Continued to page 101)

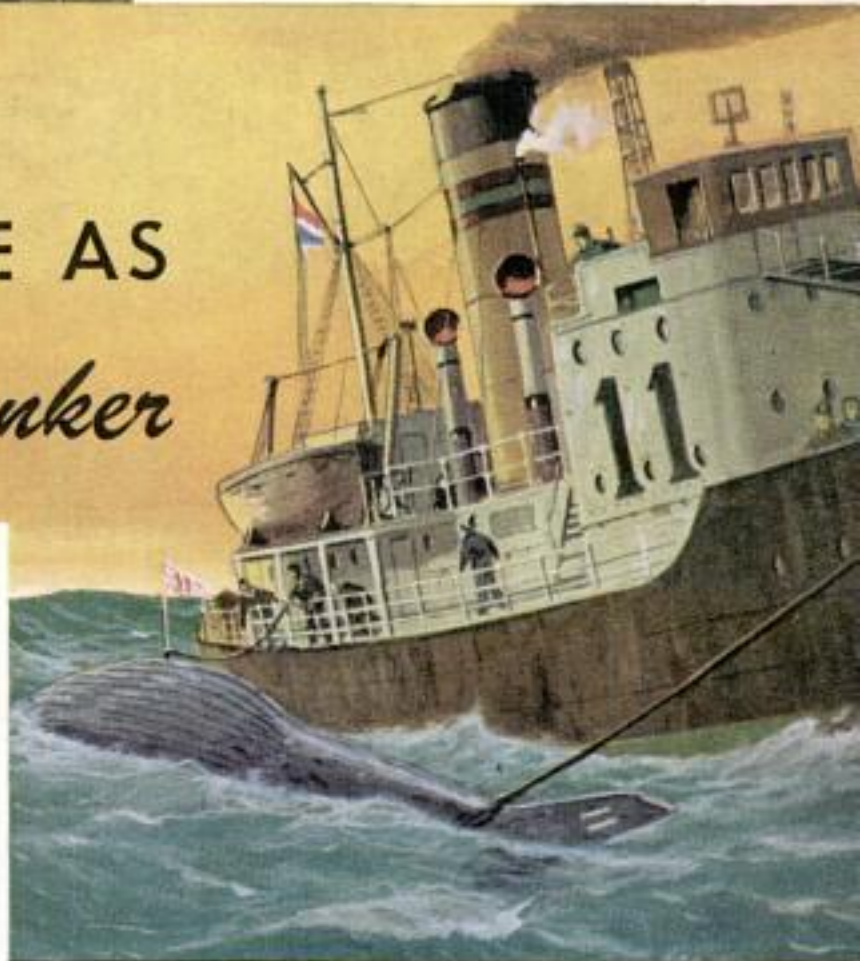

Dutch trawler-type catcher prepares to cast loose whale it has killed. Inflated to keep it afloat, marked with a flag and a number cut into flukes, whale will be retrieved by another boat

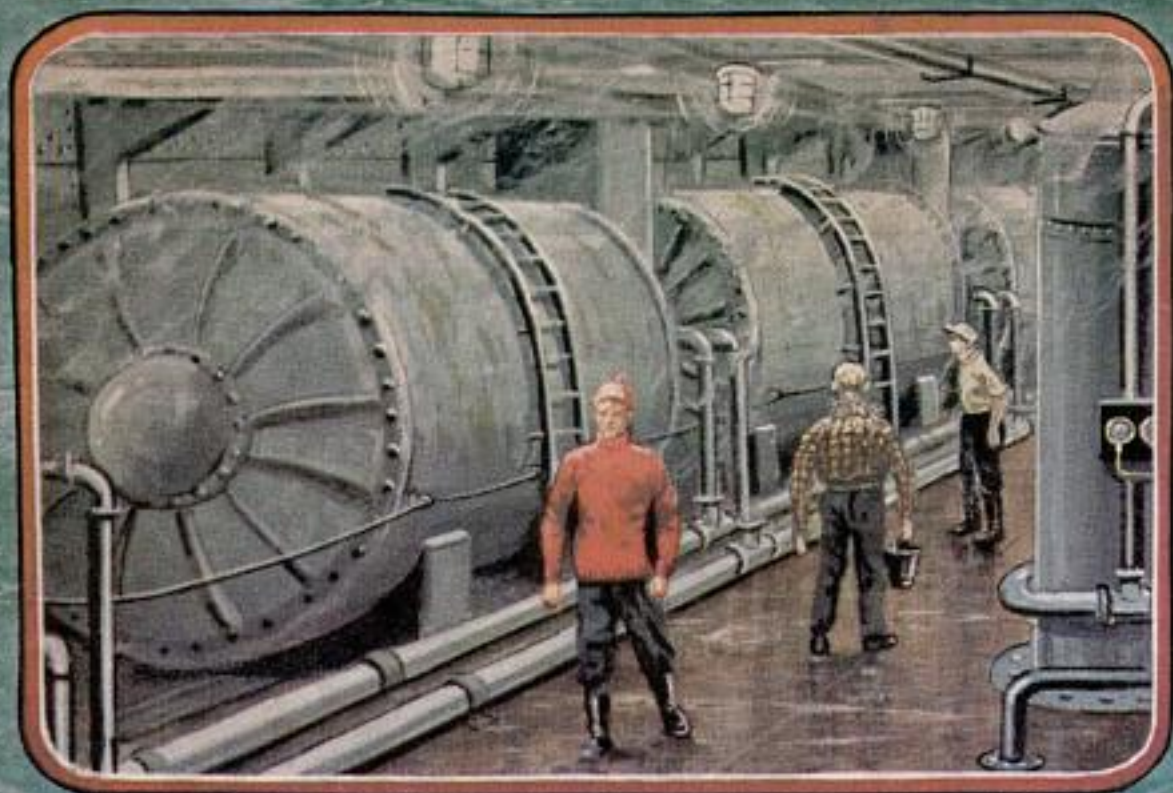

A CORNER OF THE FACTORY DECK

**"WILLEM BARENDZ II"**

Dead weight — 26,400 tons  
Over-all length — 635 feet  
Beam — 86 feet  
Depth — 58 feet  
Crew — 500 officers and men  
Speed — 14 knots



G. HAVIS  
1954

Copyrighted material



- |   |                                       |
|---|---------------------------------------|
| 1. Whale skidway                                      | 15. Meat-and-bone boilers             |
| 2. Whale-towing bollards                              | 16. Final-separation plant            |
| 3. Capstans   | 17. Whale-oil tanks                   |
| 4. Spare propellers                                   | 18. Whale-hauling winches             |
| 5. Sleeping quarters                                  | 19. Derrick post                      |
| 6. Factory steam boilers                              | 20. Mixture tank                      |
| 7. Diesel propulsion engines                          | 21. "Coast guard" tank                |
| 8. Fuel bunkers                                       | 22. Drier of meat-treatment plant     |
| 9. Blue whale on flensing deck                        | 23. Bone-meal plant                   |
| 10. Factory control room                              | 24. Radar scanners, direction finders |
| 11. Separator tanks                                   | 25. Crow's nest                       |
| 12. Settling tanks                                    | 26. Radio cabins and wheelhouse       |
| 13. Chute hole  | 27. Bridge                            |
| 14. Blubber boilers                                   | 28. Anchor winch                      |
| 30. Officers quarters, administrative offices, galley | 29. Bow lookout                       |

THE "WILLEM BARENDZ II" AS SHE WILL APPEAR WHEN COMPLETED



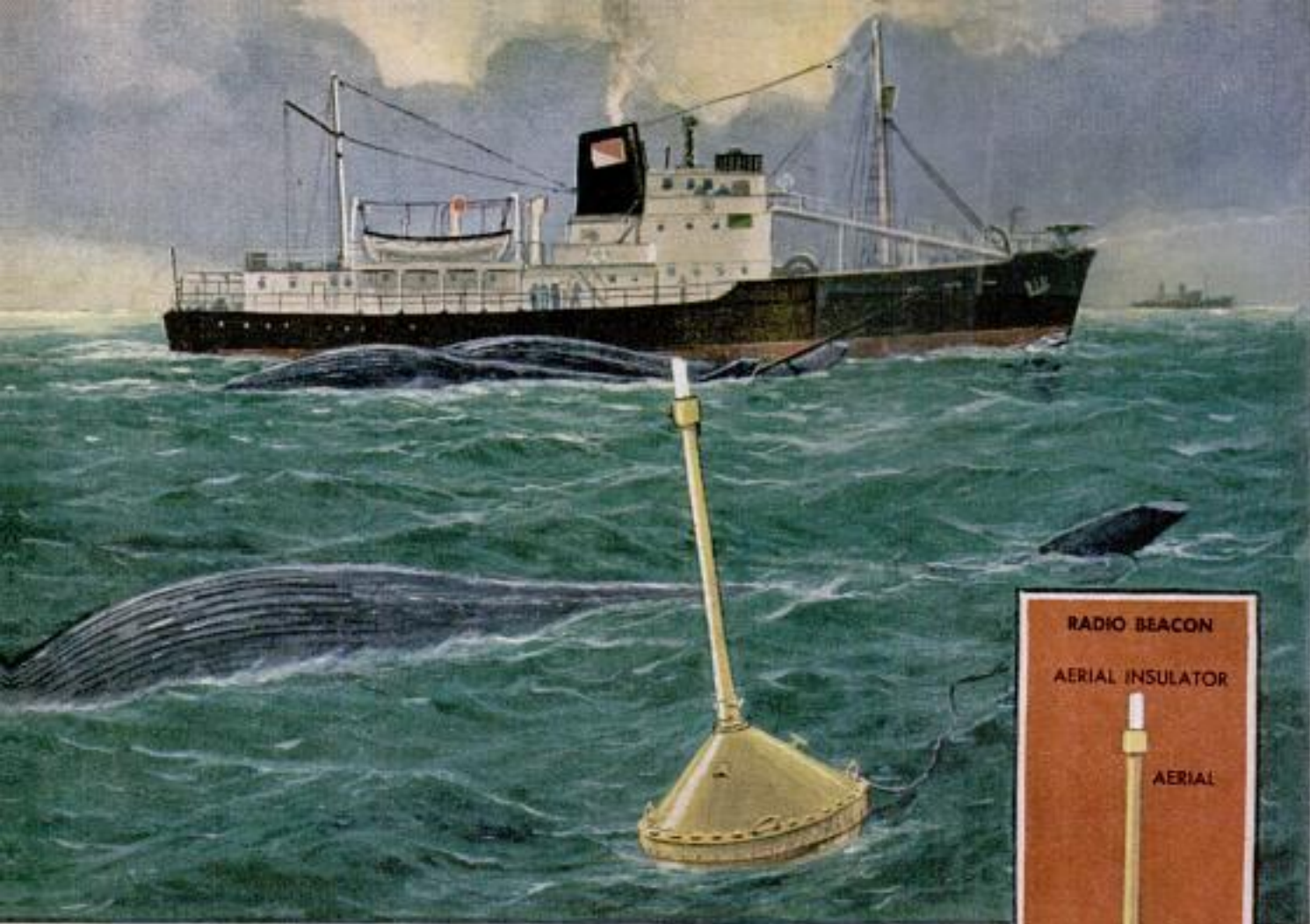

Radio beacon in buoy transmits a distinctive signal that helps a retrieving vessel locate a floating whale carcass. Dead whales may drift for miles after killer vessels cast them loose. In background is one of the latest Norwegian catcher ships. Below, a blue whale just after it has been pulled from sea up slanting skidway to ship's deck



RADIO BEACON  
 AERIAL INSULATOR  
 AERIAL  
 FLOAT  
 COUNTERWEIGHT

a speed of 14 knots and a dead weight of 26,400 tons. The latest processing equipment will enable it to slice up a whale in an hour, and advanced navigational equipment will insure its safety.

Its huge whale-oil tanks, stretching almost the length of the vessel, have a capacity of 30,000 cubic meters. Its owners plan to use these huge tanks for carrying mineral oil during the six months of the year when the vessel would normally be idle.

The golden days of Nantucket and New Bedford are gone, when America alone sent forth a thousand wooden sailing ships to do battle with the largest creature ever to appear on earth. But today, during a hunting season that may last only 10 weeks, the world's whaling fleets gather five times the yield of a record year in the 19th century.

Each year, an international commission sets a quota that may reach 16,000 units, with the large blue whale equaling one unit. Two fin whales, 2½ humpback whales or six sei whales equal one blue. Once the season opens, in January, a furious race begins between the 16 or more expeditions from various countries. Each tries to capture as many whales as it can, before the quota is filled, for the only limitation is upon the total catch of all the fleets.

At the core of each expedition is the factory ship, a great departure from the old wooden whaler whose only equipment was a primitive tryworks on deck for boiling oil out of the blubber, a hold full of wooden casks for oil and small harpooning boats.

The factory ship, which carries several hundred men, contains a maze of specialized equipment for reducing a 125-ton whale to oil and valuable by-products like vitamins, adrenal extracts and animal feed.

Operating with the factory ship are a dozen or more catchers, ships from 130 to 180 feet long, that do the actual hunting and shooting. Fueled and provisioned by the main ship, they cover vast areas and may search several hundred miles from the factory ship. The catcher ships carry a crew of 16 to 21 men.

Supporting the main ship are tankers and buoy boats—catcher ships with their harpoons removed that collect the buoyed carcasses of the whales and take them to the mother ship.

The sighting of a whale marks the beginning of furious activity on board a tossing catcher ship. First to sight the animal is the lookout, stationed on a cold, gyrating crow's nest high on the foremast. From the ice-laden bridge the skipper (who usually doubles as gunner) scrambles across the gangway to the bow and mans his swivel-mounted harpoon gun.

The catcher surges forward, rolling and

pitching with the waves, until the whale looms close. The gunner fires his harpoon, which arcs a trailing rope across the 150 to 180 feet separating whale and ship, and buries itself deep within the huge body. An instant later, a charge in the harpoon's nose explodes and heavy barbs snap open to anchor the hook.

The dying whale may plunge and thrash, but the killer ship has it well under control. Maneuvering with rudder and engines to maintain constant pressure on the whale, the catcher slowly reels in the six-inch Manila line until the inert whale floats alongside the vessel.

Spikes attached to compressed-air lines are driven into the carcass, and the whale is inflated until it floats like a balloon. Otherwise, if it is a baleen whale, it would soon sink. The catcher marks the whale with a distinctive flag, casts the dead monster loose and resumes its hunt.

The floating whale may drift for miles before a buoy boat, alerted by radio from the catcher ship, is able to reach it. To hasten the discovery of the carcass, a buoy containing a radio transmitter may be attached to the dead whale. For 22 hours, every 10 minutes, the buoy transmits a radio signal of 2 minutes' duration. The buoy boats track down the signals and secure the catch despite fog or darkness.

The buoy boat lashes onto the floating whale and heads for the factory ship. Sometimes, as many as five whales will be towed at one time by a retriever boat. The tow lines are secured to bollards on the stern of the factory ship and the whales are towed behind the vessel until they are one by one drawn up into the ship for processing. As each whale's turn comes, it is grasped around the flukes and pulled by winches up a slanting skidway that starts at the water line and terminates on the flensing deck.

The flensing crew, armed with knives on long poles, attacks the thick hide of the whale, cutting through the flesh, and tying winch ropes through holes in the blubber. The winches strain, and peel huge slabs of blubber from the carcass. These are cut up and thrown into holes that lead to the boilers below. When the blubber is removed, and the tons of bone plate from the whale's mouth thrown overboard, the remainder of the whale is pulled forward to another deck, where the bones and flesh are cut up and chuted to the processing plant below.

Cookers below decks extract from the flesh the oil, which is piped to huge storage tanks and later sold for use in margarine. The residue is dried and ground into meal for use as animal feed. Oil from the liver has a high vitamin content, and glands yield other therapeutic products. ★ ★ ★



Tile roof slab is eased into position. Made of ordinary clay, it has resiliency of spring steel

## ***Prestressed Tile***



Strands of strong wire protrude at left. Under high tension, they give slab its amazing strength



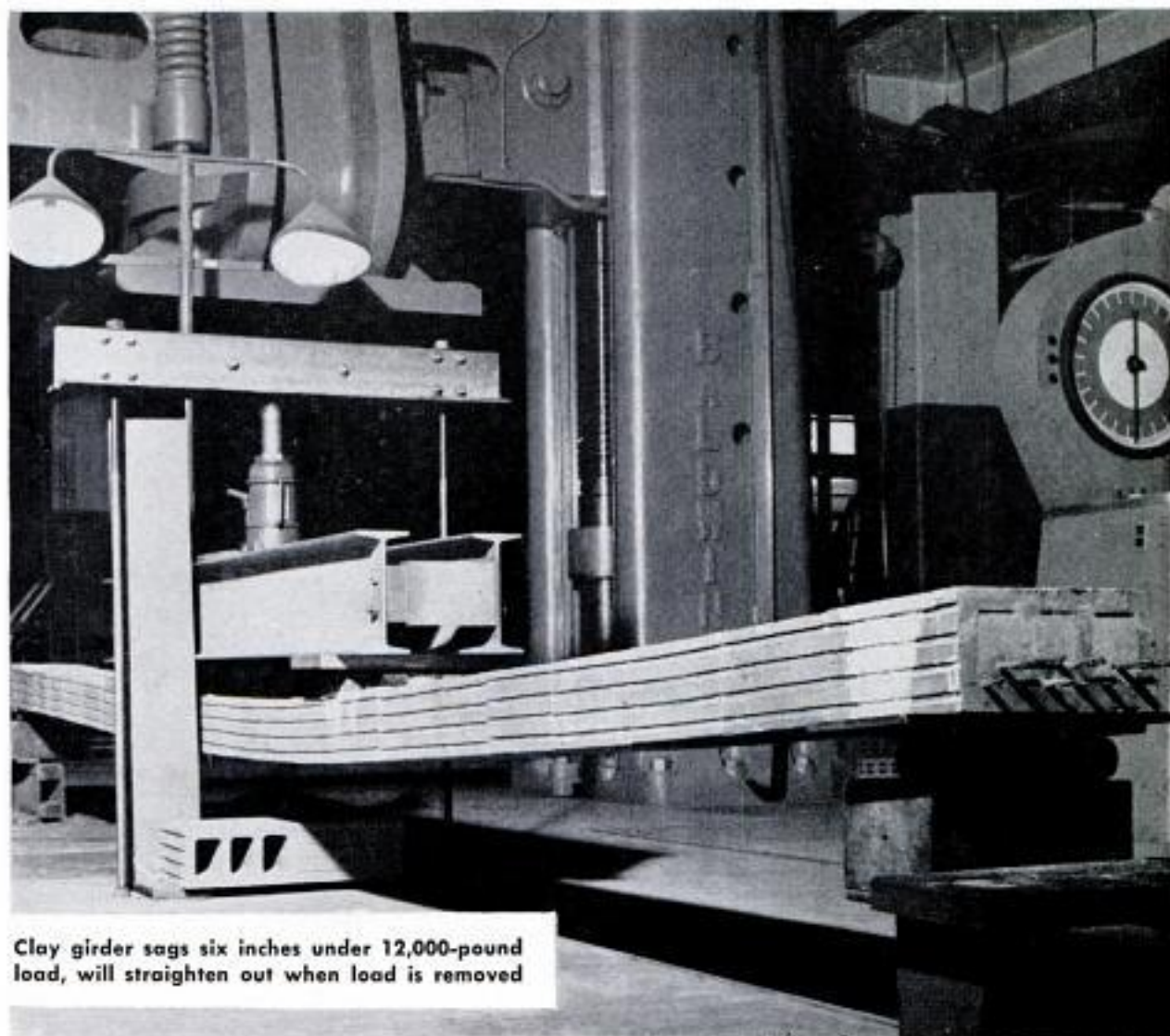

Clay girder sags six inches under 12,000-pound load, will straighten out when load is removed

## ***Bends Without Breaking***

**H**AVE YOU ever heard of clay that behaves like steel?

Clay-tile beams that bend instead of shattering under tremendous loads have been developed in the Pacific Northwest.

The secret of making brittle, baked clay behave like spring steel lies in the use of a special kind of "high compression." These girders, fabricated out of ordinary hollow tile, are subjected to a continuous end-to-end squeeze by tension bars which run through cells in the tile.

This steady squeeze is anything but gentle. In 50-foot beams the total longitudinal compression is maintained at a whopping 99,000 pounds. Compression makes the beams capable of supporting great weight and imparts elastic ruggedness to the clay.

Harry R. Powell, a Seattle consulting engineer who introduced prestressed concrete to the Pacific Northwest construction industry in the immediate postwar period, began experiments with prestressed tile

By Robert Hertzler in 1953. His aim was to create a structural material which would be more fire resistant than wood or steel and lighter than concrete.

He has succeeded in developing not only practical fireproof-tile girders, but roof and wall slabs as well. To prove these new materials, he designed a unique all-ceramic structure. The building has four 50-foot prestressed-tile beams supporting a roof made up of 30 prestressed-tile slabs, each of which is 20 feet long and 5 feet wide.

The 50-foot girders are formed from seven courses of common 12 by 12 by 6-inch load-bearing tile. When the units were fabricated, the tremendous squeeze exerted by the tension bars was sufficient to bow each girder  $\frac{3}{8}$  inch. This bow disappeared when the slabs were laid.

An interesting characteristic of prestressed-tile beams is that their exposed surfaces are tough and highly resistant to chipping and cracking under impact. When

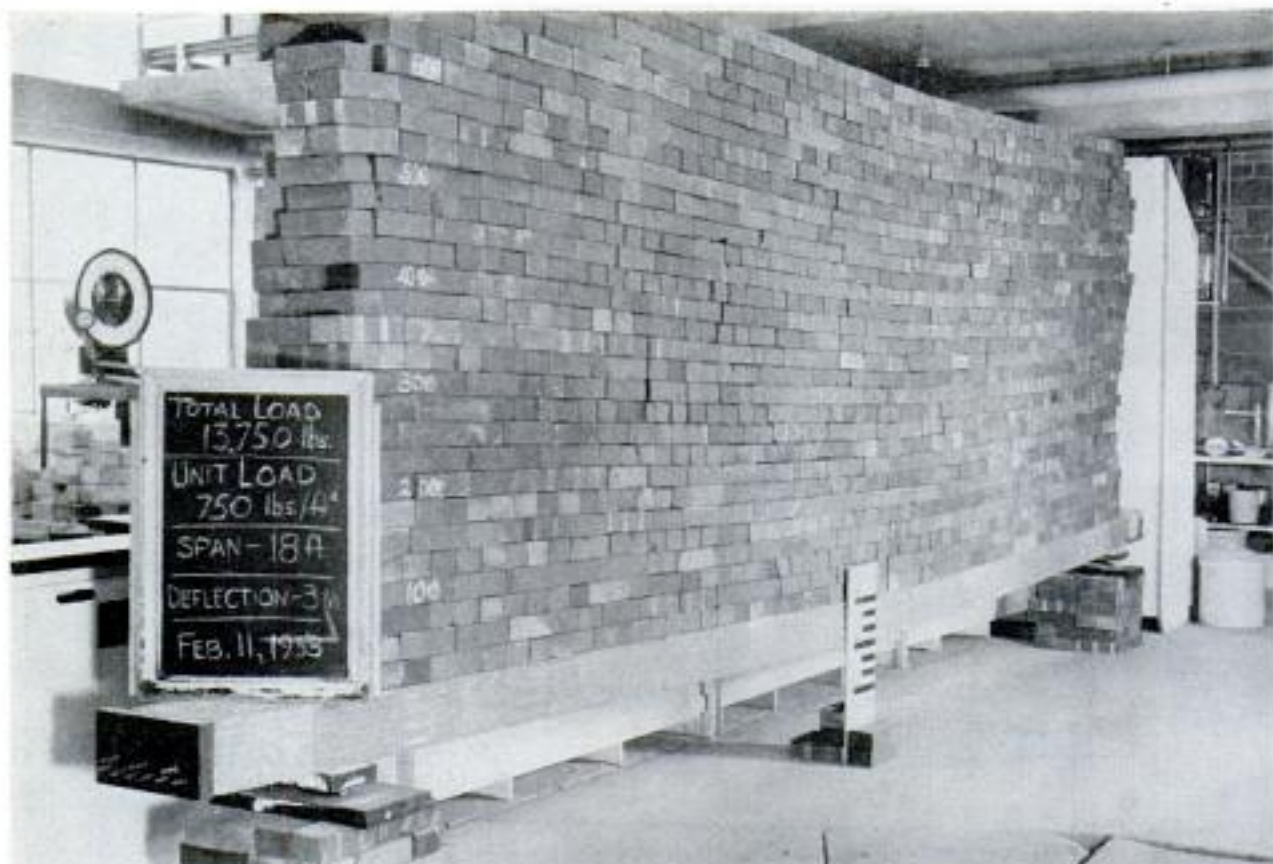

Stack of bricks weighing almost 14,000 pounds gives a stressed-tile beam the bends but fails to break it

Tile beam drops into place atop a reinforced tile column. The stress exerted by the tension bars is distributed evenly throughout the beam



a heavily loaded tile beam is struck with a hammer, it gives back a metallic, bell-like tone.

The most amazing characteristic of stressed-tile beams is their ability to bend under great weight and then spring back when the load is removed.

The 3000-square-foot demonstration structure, sections of which were assembled beforehand, was erected in half a day by six men using a crane.

In addition to reducing on-the-job labor costs, Powell maintains that tile can be fabricated into girders for about one-third the cost of prestressed-concrete beams.

Powell believes the day is not far distant when stressed ceramic beams capable of spanning 100 feet under load will be designed. In the meantime, he predicts increasing interest in squeezed-tile beams and slabs for roof girders, tilt-up walls and "lift on" roofs. ★ ★ ★

## PRESS EXERTS BIG SQUEEZE TO TURN OUT PLANE PARTS

WHEN THIS new forging press goes into action, it puts a 35,000-ton squeeze on metals to produce aircraft parts. The press is said to be the largest of its type now in production, although another rated at 50,000 tons is being assembled in the same plant. The existing press stands 45 feet above the operating floor of the shop and extends 62 feet below it. The press weighs 7180 tons and the accessories for it weigh at least that much. It is turning out aluminum-alloy wing spars for the F102, a delta-wing, supersonic, all-weather interceptor for the U. S. Air Force. Each spar is 12 feet long, 18 inches wide at its widest point, and only  $\frac{3}{16}$  inch thick in some areas. It takes only three squeezes of the mighty press with three different sets of dies to produce one of the spars. The metal for each spar is heated to a temperature of 800 degrees F. for each pressing. In the aircraft, four of the spars will replace 272 parts and save 3200 rivets. Three 1500-horsepower pumps develop the pressure for the hydraulic press. The press will be used for civilian and armed forces' work.

Top, press dwarfs men working around it. The machine weighs 7180 tons, extends 45 feet above the floor and 62 feet below

Right, operation of press is directed from panel of instruments. One man can control the press, contact rest of crew by phone

Below, 12-foot plane spar made of light-weight alloy was turned out by press in three squeezes. It requires little machining

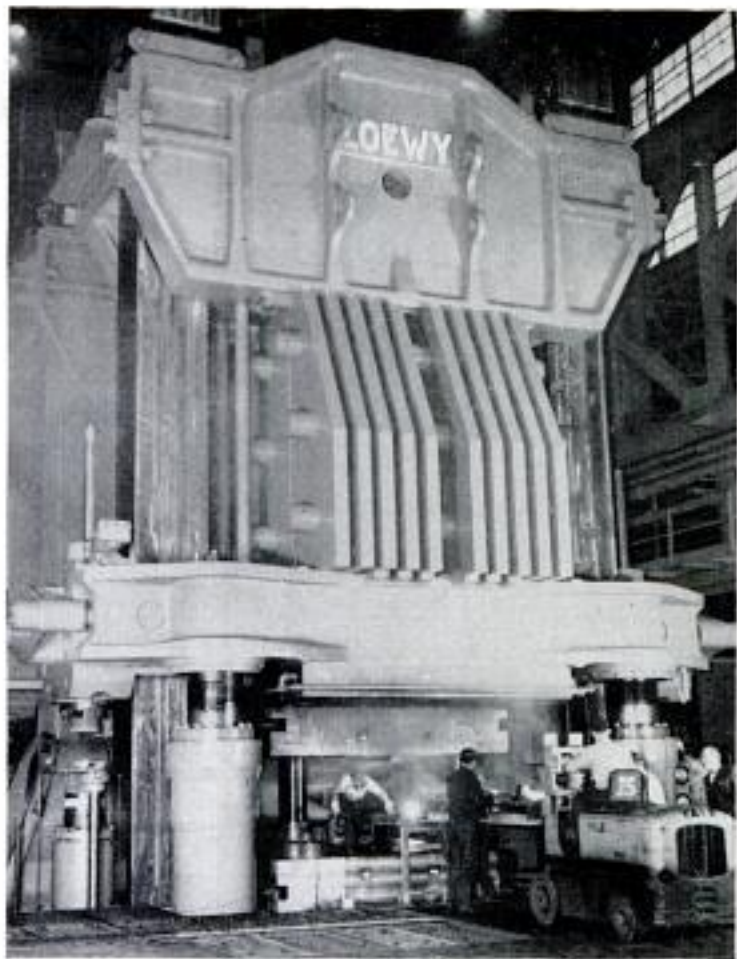

# Dodge Owners Rate Handling As The Best-Liked Feature

**By Dodge Owners**

**T**HERE'S VERY LITTLE disagreement among owners of the 1955 Dodge V8 about its good points. Nearly half (47 percent) of them list Dodge's fine handling as the best-liked feature. This big chunk of agreement is especially surprising in view of Dodge's emphasis on its new styling this year.

"Handling is excellent. Power steering is very precise. I like it this way."—New Jersey manufacturer.

"The day after I bought my new Dodge with power steering I drove 874 miles (from 8 p.m. until 4 p.m. the following day). Prior to that I was not interested in power steering. Now I would not own a car without it—Dodge power steering, that is."—New Jersey fire chief.

"A good woman's car. Easy to handle and easily parked."—Virginia housewife.

Topping the list of complaints by a wide margin was poor gas economy (22 percent of the owners listed it).



## CLYMER ROAD TEST

**By Floyd Clymer**

**T**HE TEST WAS MADE over the route from Los Angeles to Phoenix, Ariz., returning via San Diego, a distance of 849 miles which included some tests on back trails of the desert.

The test car was the Royal Custom four-door sedan, powered by the Super Red Ram V8 engine of 7.6:1 compression ratio. This over-square engine has hemispheric combustion chambers. Displacement is 270

cubic inches as against 241 for 1954 and horsepower has been increased to 183 from last year's 140.

Dodge for 1955 offers two V8 engines. The more expensive is the Super Red Ram described above. It features the double-rocker-arm-shaft design with hemispheric combustion chambers. The second Dodge V8 is the 175-horsepower Red Ram. It has a

(Continued to page 226)

# OWNERS REPORT: 1955 DODGE V8

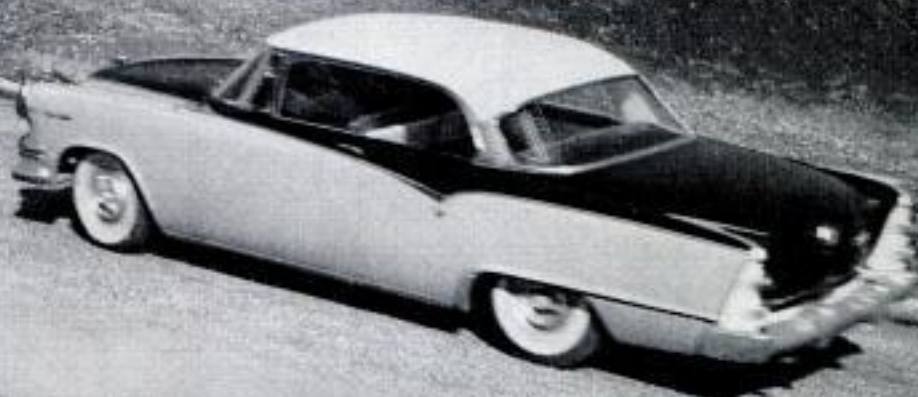

"So far my gasoline mileage is not what I was led to expect. It is 12.8 miles per gallon for over-all average for 1000 miles. Hope to have this situation improved by the 3000-mile check."—Texas guard.

### Other Best-Liked Features

Dodge owners rate power and performance second on the list of best-liked features and the much-publicized "flair fashioned" styling is third.

"I like its ready response when I want to go. All trips seem too short. It is indeed a pleasure to drive."—Nebraska farmer.

"The 193-horsepower engine has plenty of get-up-and-go. It takes hills like a charm. I make an average of 35 stops a day calling on customers, and I am amazed at the mileage I get with such a big car."—New Jersey salesman.

"Even after I have owned the car for three months, people still stop, stare and admire it and ask questions about it."—Pennsylvania store owner.

"I like the styling best. Chrysler Corporation has finally caught up with the rest of the industry in this aspect."—Pennsylvania insurance man.

Most attractive model in the Dodge line is the three-tone Royal Lancer hardtop shown above in a fast corner.

### Best-Liked Features:

"Holds curves nicely. Handles just as well at 100 miles per hour as at 40 miles per hour." *Oregon minister*

"Has smooth flow of power when needed. I have gone 95 miles per hour with no motor labor. That's fast enough for any emergency."

*Texas guard*

### Most-Wanted Changes:

"Disappointed with gas mileage. Had trouble with automatic choke. Car has never done better than 14 miles per gallon."

*Mississippi mill operator*

"Would like glove compartment to be larger and in center of dash."

*Papa Clark*

Dodge's glove compartment is too small, owners say, and too far from driver. It is less than six inches deep





Dodge's unusual two-toning lets you put a dark color on top of the hood of a light-colored car to reduce glare

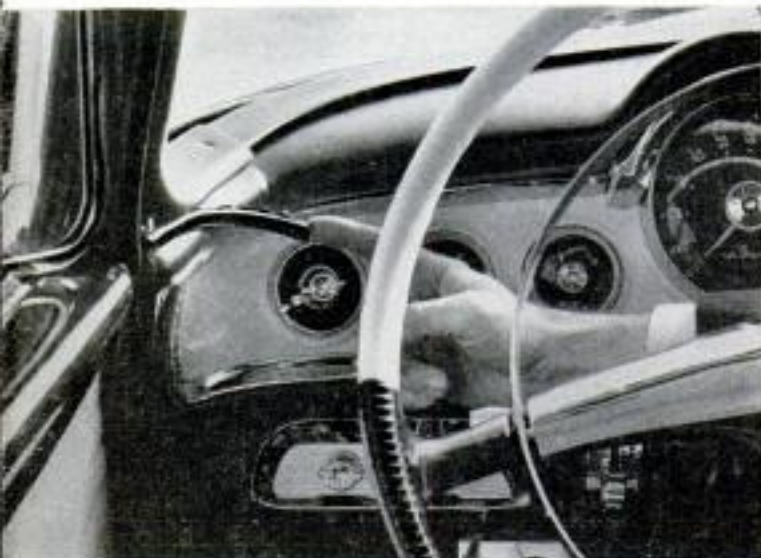

Owners say body assembly is careless, especially on details like this improperly fitted plastic piping

Driver's position and dash are fine, says Clymer, but he still objects to horn ring blocking view of panel



"Over-all beauty gives the car snob appeal. Colors harmonize beautifully. Incidentally, in a demonstration drive with PowerFlite, I was told by the salesman it was safe to reverse the car at speeds under 40. I tried it at 30 miles per hour repeatedly. No damage done. It's a nice feeling, while driving with children in front, to know they will not cause harm to the transmission by an accidental bump of the shift."  
—Pennsylvania printer.

#### And Other Complaints

Second and third on the list of most-frequent complaints are body noises (squeaks and rattles) and the operation of PowerFlite transmission.

"There are too many rattles in doors and instrument panel."—Virginia factory superintendent.

"PowerFlite is not smooth operating. It is noisy and jerks when dropping into low gear at stops. Has not had final adjustment, however."—Nebraska Army employee.

"PowerFlite thumps when car is put into motion."—Florida nurseryman.

Owners of the Dodge V8 are unbothered by engine trouble, the survey shows. Three out of four say they had no engine trouble at all (77 percent). Another 20 percent say they had some trouble and only a tiny 3 percent report considerable trouble.

Although Dodge offers a brand-new V8 this year (the 175-horsepower Red Ram with a single rocker-arm shaft), in addition to the double-rocker-arm-shaft Super Red Ram (183 horsepower), there apparently is no oil-consumption problem among the engines. Only 7 percent of the owners report using some oil and none reports that the engines use considerable amounts of oil.

Most of the owners who report some engine trouble list the automatic choke as the



Dodge owners in 30 states took part in this Owners Report. Tabulation of their opinions is given below

## Percentages from PM Poll of Dodge V8 Owners

**Miles per gallon**  
 City driving.....13.4 m.p.g.  
 On trips.....17.3 m.p.g.

**Oil consumption**  
 None .....93%  
 Some ..... 7%  
 Considerable ..... 0%

**Acceleration from zero**  
 Excellent .....78%  
 Good .....21%  
 Poor ..... 1%

**Acceleration from 50 m.p.h.**  
 Excellent .....75%  
 Good .....24%  
 Poor ..... 1%

**Had trouble with V8 engine?**  
 None .....77%  
 Some .....20%  
 Considerable ..... 3%

**What was engine trouble?**  
 Automatic choke.....11%  
 Hard starting in cold..... 3%  
 Rough idle.....2%  
 Ignition .....2%  
 Trouble not described..... 3%

**Dashboard shift-lever location**  
 Like .....84%  
 Dislike ..... 6%  
 No difference.....10%

OVER-ALL RATING OF DODGE V8	
Excellent .....	76%
Average .....	22%
Poor .....	2%

**Exterior styling**  
 Like bright colors.....94%  
 Dislike ..... 4%  
 No opinion ..... 2%

Like chrome treatment.....88%  
 Dislike ..... 4%  
 No opinion ..... 8%

Like longer body.....92%  
 Dislike ..... 5%  
 No opinion ..... 3%

Like windshield.....85%  
 Dislike ..... 5%  
 No difference.....10%

**What did you trade in?**  
 Dodge .....61%  
 Other Chrysler make.....14%  
 Non-Chrysler make.....19%  
 No trade ..... 6%

**Trade-in allowance**  
**Dodge traders**  
 Excellent .....42%  
 Average .....52%  
 Poor ..... 6%  
**Other Big Three traders**  
 Excellent .....43%  
 Average .....51%  
 Poor ..... 6%  
**Independent traders**  
 Excellent .....40%  
 Average .....50%  
 Poor .....10%

**What Should Be Changed?**  
 Needs no changes.....43%  
 Glove compartment..... 5%  
 Better gas economy..... 5%  
 Tighter body..... 5%  
 Better assembly..... 4%  
 Add Park to PowerFlite... 3%

**Most-Frequent Complaints**  
 Poor gas economy.....22%  
 Squeaks, rattles.....14%  
 PowerFlite ..... 7%  
 Water leaks..... 5%  
 Tubeless tires..... 5%  
 Road noises..... 5%  
 Poor assembly..... 5%  
 27% of the owners made no complaints at all

**Best-Liked Features**  
 Handling ease.....47%  
 Power, performance.....35%  
 Styling .....32%  
 Riding comfort.....29%  
 Visibility.....16%  
 Roadability ..... 8%  
 Interior styling..... 8%

offender. A few more say the engine is hard to start in cold weather.

"Automatic choke flooded frequently until it was adjusted properly."—Kansas executive.

"Carburetor kept flooding. Dealer installed a new one. It's okay now."—Florida dragline operator.

"On cold mornings the car has been very hard to start due to the choke."—Mississippi mill operator.

Another complaint is that the engine has a rough idle.

"Engine should idle more smoothly. It rocks all the time."—Pennsylvania laborer.

### What Should Be Changed?

Asked to name one change they would make in their Dodge, 43 percent of the owners say no change is needed. The other 57 percent offer various suggestions, but no more than 5 percent agree on any specific change. Five percent want the glove compartment larger or moved closer to the driver. The same percentage (5 percent)

want gasoline economy improved. Another 5 percent say the body should be tighter. Here are some typical quotations by owners asking for specific changes (in order of frequency of mention):

"I would like the glove compartment to be larger and in center of dash. Also two ash trays in front."—Texas clerk.

(Quotations about better fuel economy have already been given.)

"Factory or dealer should take more care to tighten body. I found I had to replace several bolts and tighten others under the car and inside."—Arizona contractor.

"Add parking dog to PowerFlite."—Ohio insurance agent.

"Make the steering wheel clear the lap more."—Kansas fireman.

"Get rid of push-button door latches. Hard to open with groceries in hands."—Oregon minister.

"Eliminate cowl ventilator."—Texas clerk.

"Put ram's head back on hood."—Tennessee machine operator.

## TEST DATA

1955 DODGE V8  
Four-Door Sedan with PowerFlite

### Driver's Blind Spot

Farthest point 19½ feet

Nearest point 12½ feet



The combination of a high seat and a low hood gives Dodge drivers excellent forward vision

### Acceleration Test

¼ mile from zero	20.3 seconds
½ mile from zero	32.4 seconds
0 to 30 miles per hour	5.3 seconds
0 to 60 miles per hour	15.6 seconds
Top speed by speedometer	108 miles per hour
True top speed about	103 miles per hour

### Economy Test

#### Constant-Speed Mileage

At constant 30 miles per hour	21.7 miles per gallon
At constant 50 miles per hour	19.8 miles per gallon
At constant 60 miles per hour	16.7 miles per gallon
At constant 75 miles per hour	13.9 miles per gallon

#### Cross-Country Mileage

Los Angeles, Calif., to Phoenix, Ariz.	16.7 miles per gallon
Phoenix to San Diego, Calif.	17.2 miles per gallon
San Diego to Los Angeles	14.5 miles per gallon

(Both premium and regular gasoline used)

### Comparison with 1954 DODGE

Dodge for 1955 is a longer, lower and wider automobile as these comparative figures show

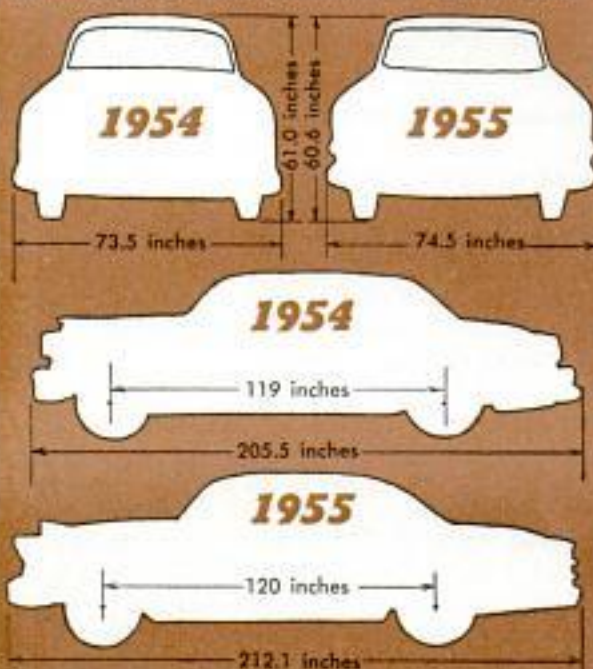

To bring its readers a full report on new cars, *Popular Mechanics* combines two tests: 1. A road test by Floyd Clymer (the results of which are given above); and 2. An actual use test by owners themselves. Opinions of owners all over the country are studied and summarized in the monthly *PM Owners Report*

### Other Best-Liked Features

The following typical quotations were made by owners in stating what they like best about their 1955 Dodges:

"Excellent riding comfort. Do not get jarred on bad roads."—Pennsylvania sales manager.

"It has the best visibility of any car on the market."—North Carolina farmer.

"Sloping hood and raised fenders offer good vision."—Iowa railroad fireman.

"Windshield design makes it easy to get in and out plus giving a nice view to front and right side."—Washington service-station attendant.

"Roadability excellent. You feel safe at all times."—Iowa auto mechanic.

"Interior styling is excellent, especially the plastic upholstery that eliminates the previous dissatisfaction of buying good-looking upholstery and then having to cover it for protection."—Florida owner.

"Doesn't use any oil to speak of and is so easy on gas. Always ready to go when others won't even start."—Missouri owner.

"I drive to work every day. With six in the car we are not crowded."—Pennsylvania crane operator.

"I like the way I get traction on ice and snow with PowerFlite."—Washington petroleum wholesaler.

"I like the new bright colors. They are cheerful and can be seen quicker on the highway."—Arizona shovel operator.

"Large trunk area and convenient map light on instrument panel."—Oklahoma housewife.

### Additional Complaints

"Water leaked in around top of the windshield."—Washington foreman.

"Body leaks. Floor mats are always wet on underside."—Pennsylvania engineer.

"Tubeless tires are not satisfactory. Ride very hard, out of round, give the car vibrations. I removed all four tires and substituted tires and wheels from a 1949 Chrysler which I own and the difference was amazing. Vibration was cut down at least 40 percent."—New York machine operator.

"Had trouble with tires being out of round. Three were replaced in 1300 miles and I still get vibration."—Illinois machinist.

"Steering post is very noisy over rough roads."—New Jersey mason.

"Had several bad chrome sections when delivered, but were taken care of to my satisfaction by my Dodge dealer."—Pennsylvania businessman.

"Defroster clears windshield unevenly."—Washington farmer.

"Defroster very poor on driver's side."—Connecticut rubber worker.

(Continued to page 222)





### Assembly-Line Crane Lifts Constellation in Its "First Flight"

Ten-ton, 110-foot fuselages for Super Constellations become "airborne" for the first time when a specially designed crane balances them carefully and then lifts them at the Lockheed Aircraft Corporation's

final assembly line, Burbank, Calif. The crane moves the immense fuselages from one point on the final line to the next. Small wheels are attached temporarily to the fuselage for ground movement.

### Tongue Hitch for Jeep Converts It to Trailer

Often used as a tractor, a Jeep becomes a trailer when equipped with the tongue hitch made by an Indiana farmer. With the hitch, the Jeep can be towed behind self-powered equipment to the job, and then driven home, leaving the equipment at the job site. The tongue folds up out of the way when not in use. It is attached by steel pins to brackets welded to the Jeep bumper.



Information not listed on articles in the index frequently is listed in the WHERE-TO-FIND-IT LIST, which is available to readers without charge from Bureau of Information, Popular Mechanics, 200 East Ontario Street, Chicago 11

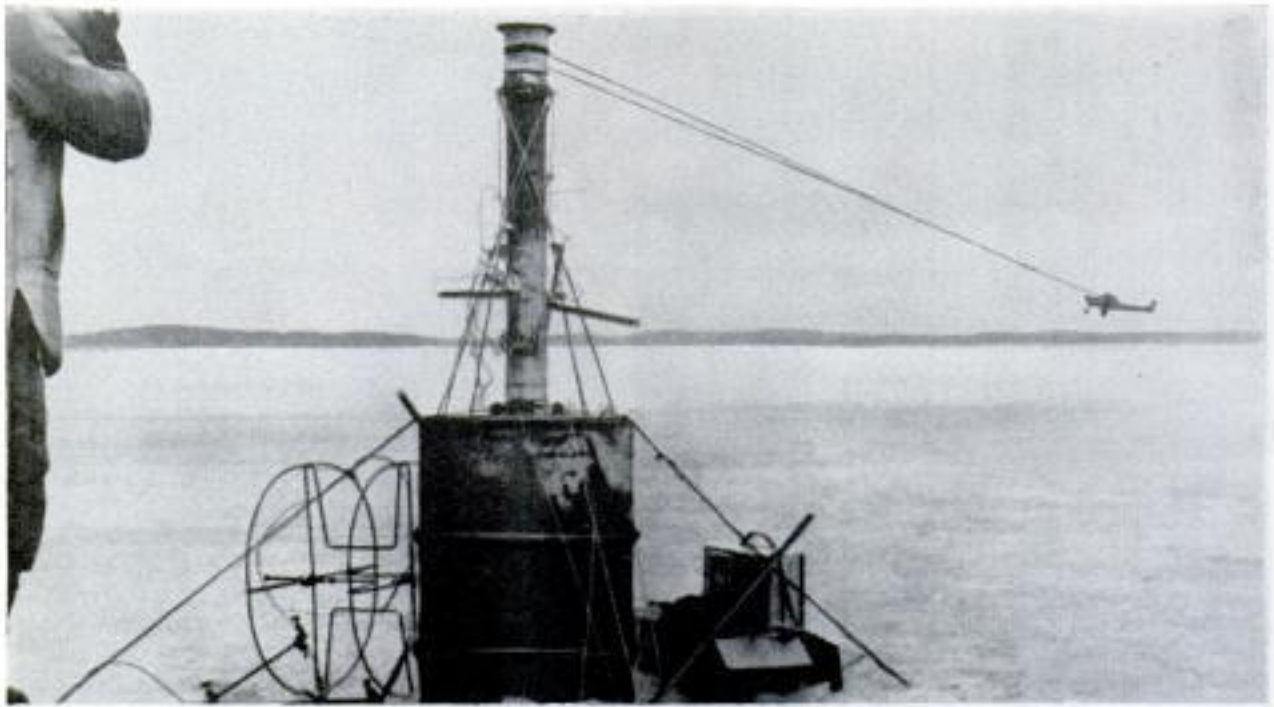

### Plane Tethered to Post Takes Off in Circle

Comparatively small circular landing fields could replace excessively long runways with a tethered take-off system for aircraft devised by Prof. J. G. Winans of the University of Wisconsin. A plane using the system would be attached by a cable to a central pivot while it gained flying speed traveling in a circle whose radius is

determined by the length of the tether. When flying speed is reached, the cable is dropped. Winans himself made several successful take-offs with a light plane tied to a central post on a frozen Wisconsin lake. In his experiments he used a 400-foot nylon cord. The central post pivoted in an oil drum fastened to the ice.



### Balloons Inflated Under Water To Raise Sunken Ships

Nylon balloons designed to aid in raising sunken ships were tested in the Baltic Sea off Kiel recently when they brought a one-man submarine to the surface. The balloons were attached to the submarine, which had been submerged for the test, and then inflated. Greater numbers of balloons would be used for larger vessels.

### Electric-Heating Thermostat Measures Radiant Effects

Both radiant heat and air temperature are measured by a room thermostat designed for use with electric heating systems. It contains a new type of sensitive element directly exposed to air and radiant effects. The result is said to be constant comfort combined with economical operation. The unit, which fits into a standard outlet box, contains the complete switching system and operates silently without clicks, chatter or arc flash. It can be set for any temperature in the normal heating range, and is made for such systems as radiant-cable heat, radiant-glass panels, radiant electric baseboards and rubber panels.



Six-pronged pick artistically smooths out the fins of a fish. These two ice statues will become banquet centerpieces. Right, mouth of fish gets last-minute touches. Slip of hand would ruin an evening's work



## Here's a Chilly Hobby: ICE CARVING

FOR 22 YEARS John F. Krich has chosen to spend his evenings and week ends seated in front of 350-pound chunks of ice in a warehouse kept at a chilly 22 degrees above zero. While others seek the warmth of the fireplace in winter, Krich pursues his hobby—carving detailed figures from commercial ice blocks—in an atmosphere that only a polar bear could appreciate. Come summer, he likes his hobby even better.

Krich, of Cleveland, Ohio, carves a variety of subjects ranging from simple alphabet letters to his masterpiece, a 20-foot frozen miniature of a locomotive,

Chips fly as Krich forms a basket from a 350-pound chunk of ice. Smaller basket is ready for the table

tender, oil car, freight car and a caboose.

Tools of the ice carver's trade are pronged ice picks. His "uniform" is a pair of arctic boots, two woolen shirts, a hat or a cap with earflaps, a canvas glove for his "carving" hand and a rubber glove for his "chip-brushing" hand.

One of his toughest projects was carving an ice ball, hollowing it out and placing a plastic dollhouse, trees and fence inside. He added snowflakes to the scene and then drilled a hole in the back of the globe and inserted a thin hose. The hose piped in compressed air, which blew the snow about to create a novel winter scene.

Sculptor works winter and summer surrounded by big blocks of ice in the freezing climate of a warehouse



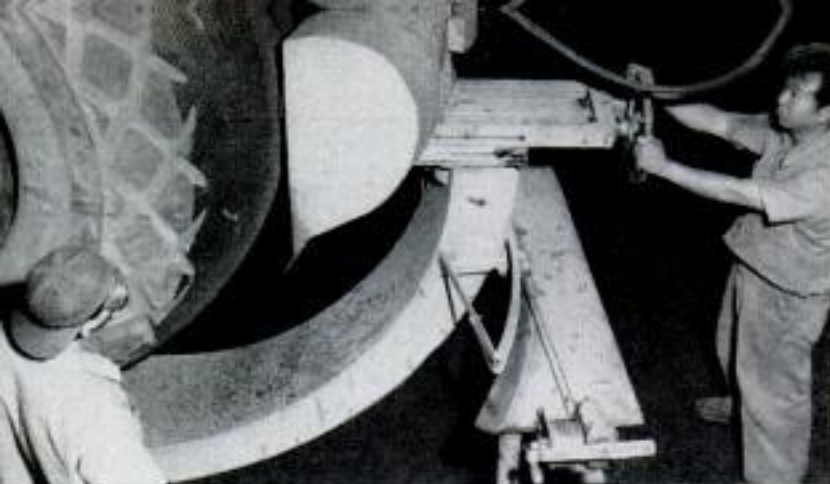

Major problem was getting a buffer big enough to handle the huge tires. Parts of this one are from an old B-29 bomb bay

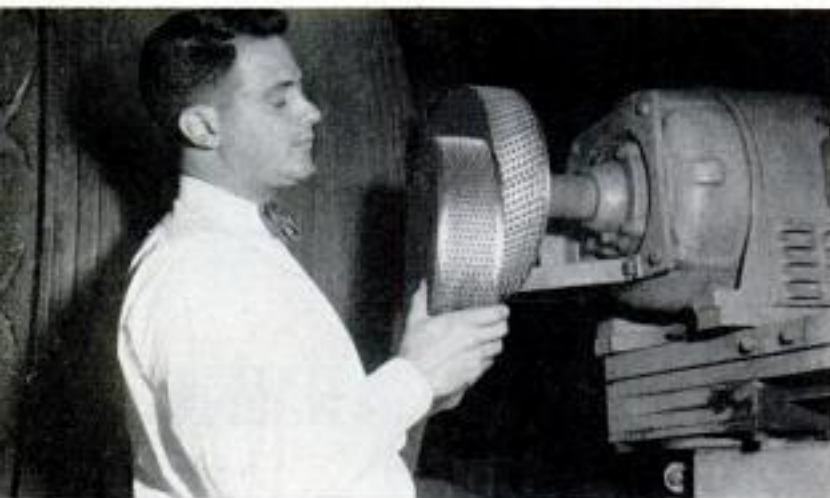

Two grades of buffing wheels are needed to chew off the old tread—one coarse, one fine. Note the tremendous tread size



New tread is formed in a big mold, shown under man's right foot. Below, the mold is pulled upward, exposing "new" tire



## \$3000 Tire Gets Recap

WHEN A NEW TIRE has a price tag of \$3000, you don't throw the old one away just because the tread is bald. You don't, that is, if you can get the giant doughnut recapped at half the price.

Cliff Melim, head of a tire servicing company in Hawaii, was confronted with the big recapping problem when his customers began using mammoth LeTourneau haulers instead of steam locomotives on their plantations. The customers couldn't see shelling out \$3000 when a recap job would do.

So Melim and Walter Woodside, a local welding expert, put together some electric motors, a 1942 Dodge transmission, parts of a B-29 bomber, plus a set of commercial cutters and buffers, to make one of the largest tire-preparing machines in use today.

Once the worn tread has been peeled and buffed off, recapping is done in a standard mold, differing only in size from the usual mold used by recap companies.

As a result, Melim's customers save about \$1500 a tire and he has a new branch to his business.

Ready to go back to work on the Hawaiian plantation, the tire wears a \$1500 recap





Lawrence Farnham wanted to combine the best points of a plane, horse and motorcycle. The Flycycle resulted

## THEY BUILD THEIR OWN PLANES

**I**F A THREE-WHEELED motorcycle whizzes by you 50 feet off the ground, and adds insult to injury by blowing dust in your face, it is not a nightmare and you are not going crazy—it is just Lawrence Farnham's Flycycle.

Farnham, of Fort Collins, Colo., designed and built the Flycycle for his own special purposes. He wanted a short-hop aircraft that combined the best qualities of a crop-dusting plane, a motorcycle and a saddle horse. No manufacturer built such an aircraft, so Farnham, a member of the Experimental Aircraft Association and an experienced builder of light planes, made the craft for himself.

The Flycycle is a one-man light plane, powered by a 75-horsepower Continental engine, that the pilot rides like a motorcycle. He sits astride the fuselage and controls it with handlebars, rather than a conventional stick or wheel. The motorcycle likeness is also in the throttle control which is a twisting handlebar grip.

Farnham is one of several thousand Americans who have built or rebuilt their own airplanes. He built his aircraft to fit a special purpose. Other back-yard plane makers, who prefer to call themselves "homebuilders," have other reasons.

Typical of these is Howard Myers of Chicago, flying counterpart of the postman who goes for a walk on his day off. Myers

Although protection from the weather is at a minimum, visibility could not be improved in the Flycycle. Handlebar replaces normal control stick



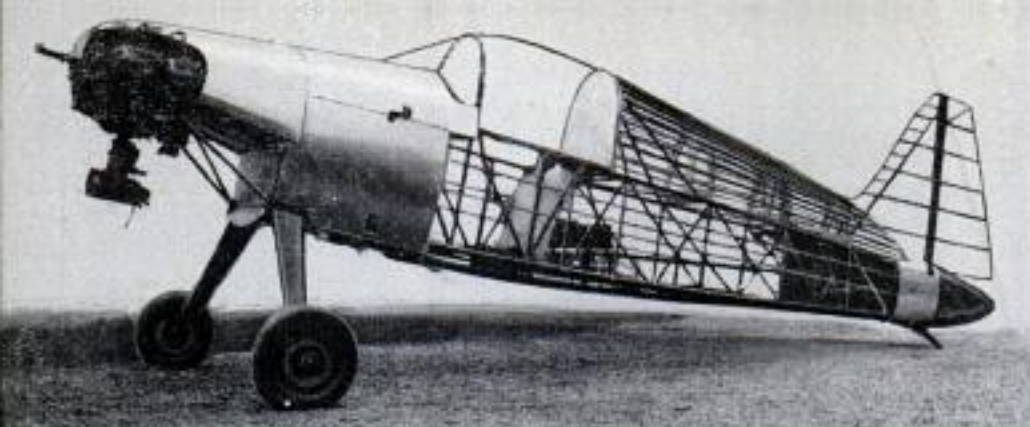

Without wings, propeller or fabric covering, steel-tube construction of single place *Little Audrey* is evident. Ready to fly (below, left) Paul Poberezny's homebuilt looks trimmer and smaller



Many homebuilders seek more speed than that built into ordinary light planes and turn out slick racing jobs like the 180-mile-per-hour *Pitts Special*, below. Engine turns up only 85 horsepower



flies TWA Super Constellations and Martin 404s for a living and, for relaxation, he flies his own high-performance clipped-wing Cub.

"I wanted something pretty good," Myers said, "something better than I could afford as a complete plane."

He has it. By completely rebuilding and repowering a 1946 Cub, he has a light plane that cruises at 110 miles per hour, as compared to the original 75, and will climb 1500 feet per minute, pretty good for any light aircraft.

Farnham and Myers are good examples of aircraft homebuilders. They had different reasons for their projects and they went at them in different ways, but each now has a homebuilt plane that suits his purposes. One is a completely new design

and the other is a modification of an existing airplane.

Although some pilot-built aircraft are radically different, most follow conventional lines but incorporate the ideas of the builder, ideas that differ from those of the designers in the large airplane plants.

Each homebuilder believes, of course, that his design changes are improvements, and the belief is encouraged by the Experimental Aircraft Association, the pilot-builders' own organization.

"In encouraging homebuilding," says Paul Poberezny of Milwaukee, president of EAA, "we hope that perhaps some of our members will have an idea that can be incorporated into a design that may revolutionize private flying."

That would be a big, and profitable, or-



J. H. C. Palen, Jr., of Poughkeepsie, N. Y., built this flying replica of the famous 1909 Bleriot monoplane

der. Latest Aircraft Owners and Pilots Association figures show almost 65,000 privately owned aircraft in the United States.

Poberenzy himself has built at least three airplanes, and is working right now on an adaptation of a prewar light plane he hopes can be made available to EAA members in kit form.

As maintenance officer for a Wisconsin National Guard outfit, Poberenzy finds it

necessary to make official trips to various parts of the country. And there are few airports at which he stops that are not within easy telephone distance of at least one enthusiastic homebuilder who wants to know the latest experimental-aircraft news.

The EAA has about 1000 members in chapters scattered from coast to coast. Those who can, attend the annual "fly in," or meeting, to talk shop, exchange views and

Some homebuilts are so small pilots must lie prone. In others, odd wings combine with normal fuselages





Builder Ray Stits claims 200-mile speed for this tiny biplane, one of several midgets he has designed

examine other members' ideas as incorporated in their planes.

Some members experiment in fields far removed from the conventional. Queries in the *Experimenter*, official EAA publication, indicate that ambitious amateur builders are working on or planning such widely diverse projects as a ramjet helicopter and a water-ski seaplane.

Others, like Ray Stits of Riverside, Calif., build more or less conventional airplanes to make available in kit form, and then let their imaginations roam on truly experimental aircraft. Stits has produced two flyable airplanes with wings so short they look incapable of lifting good-sized models.

The homebuilders are lineal descendants of the thousands who, a couple of generations back, built their own improvements into Model-T Fords. But they have more material to draw from. Instead of one automobile, they have any number of light aircraft with which to start. Sometimes they wind up with interesting hybrids.

Poberenzy, for instance, built a one-place sport plane, the *Little Audrey*, using the basic fuselage of Benny Howard's famous prewar racer, *Pete*. Before the aircraft flew it included wings from a Luscombe, wing struts from a Cessna and the Continental A-75 engine from a Rearwin.

Typical of pilot-builders who use few salvaged parts is Tom Cassutt of Deer Park, N. Y., another TWA pilot. He flies Super Constellations between New York and Paris. Cassutt started with little more than his own design for a miniature racing plane, a supply of steel tubing and the ability to weld.

The *Cassutt Special* cruises at about 185 miles per hour, which is pretty fast for a light plane, but it also takes more runway to get off the ground than its slower cousins. Low stalling speed and high top speed seldom go together, and Myers, Cassutt's fellow transport pilot-homebuilder, declares:

(Continued to page 218)

Even with its modern, in-line, air-cooled engine, this aircraft is recognized easily as a World War I Jenny





## Accurate Airdrops With Rotor Chute

Pinpoint accuracy in airdrops to confined combat areas is claimed for the rotochute, a device using a rotor rather than a parachute to slow descent of falling bodies. The rotochute, developed by the Kaman Aircraft Corp., consists of two rotor blades mounted on a hub attached to a standard airborne supply container. The blades fold 90 degrees to form the tail of the container when it is carried on bomb racks. Released, the blades automatically spread to rotor position.

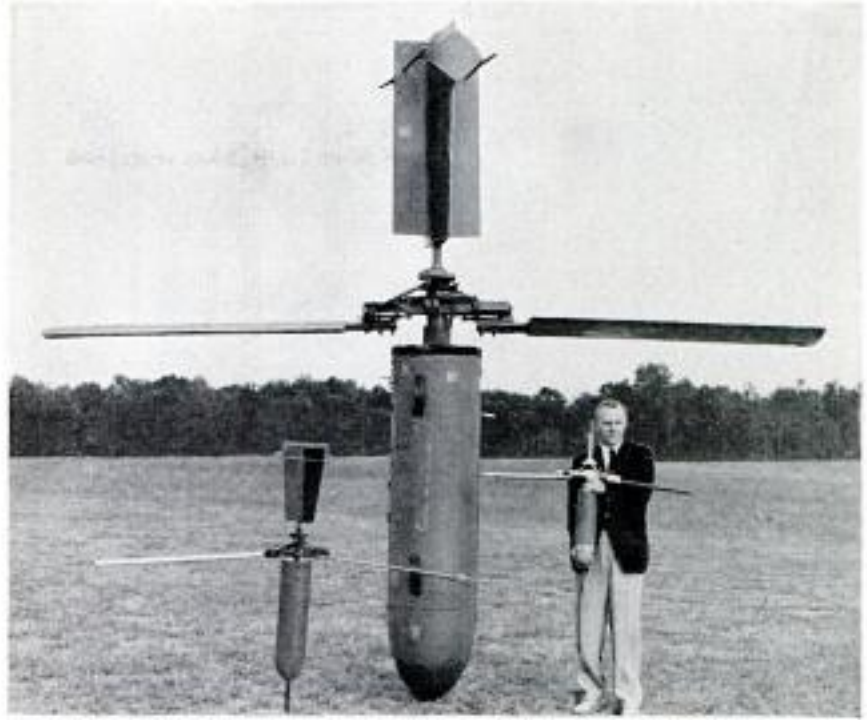

## Giant Testing Machine Will Measure Strength of Full-Size Girders

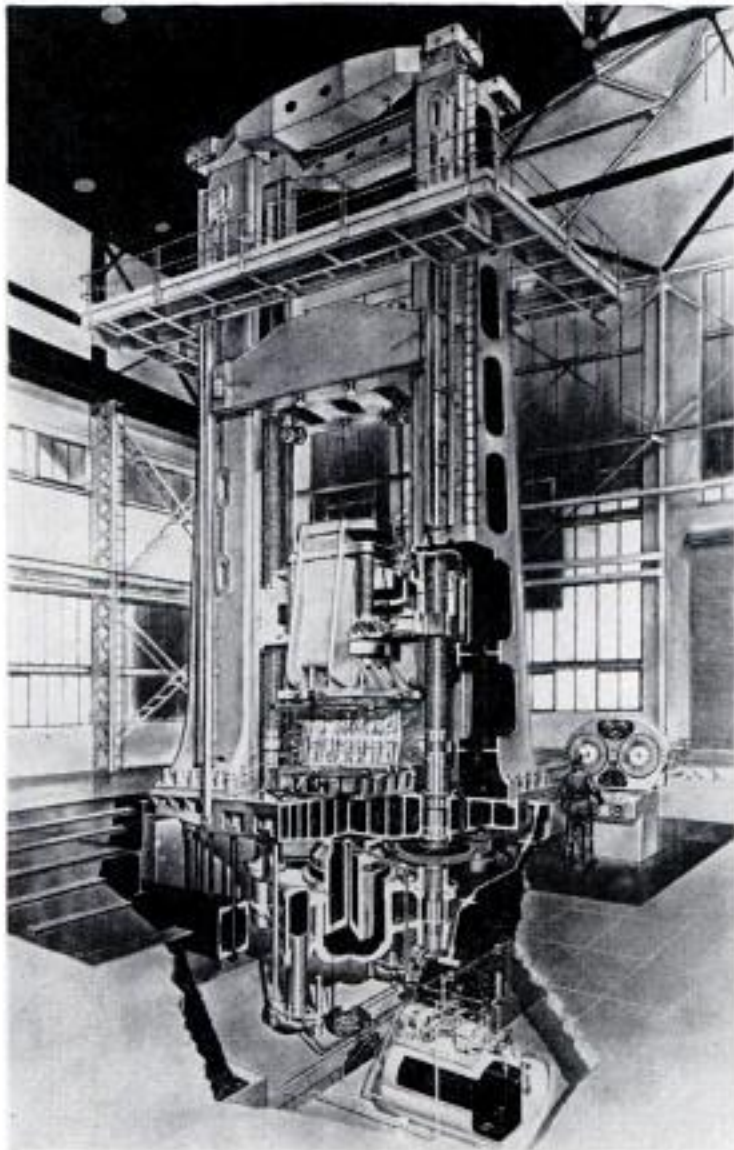

Steel girders will crumple like soda straws in a giant universal testing machine nearing completion at Lehigh University in Bethlehem, Pa. Its designers believe it to be the largest in the world. Able to exert forces up to 5,000,000 pounds, the machine will make it possible to test full-size structural members in designing the skyscrapers and bridges of tomorrow. Previously, effects of actual tension and compression could only be figured on paper. A 30 by 100-foot working platform will make possible the testing of plate girders with a span of 100 feet, and the machine's 53-foot height will permit the testing of building columns and cross sections up to 36 feet high.

## Radar Reveals Locust Hordes

Radar, long established as an early warning system for detecting approaching hostile aircraft, is now employed to warn of a different kind of airborne enemy—hordes of locusts. British scientists report that radar has successfully spotted locust swarms in the Persian Gulf area. Advance warning will enable aircraft to take off and intercept them with clouds of insecticide. One application of 300 gallons of aerial spray can kill 3,000,000 locusts.

# WHAT'S NEW FOR Your Home



1

**1. VACUUM CLEANER-POLISHER** combines two appliances into one. As a vacuum cleaner it adjusts to three positions depending upon depth of pile. Flip of a switch brings polishing brushes down against floor. Sponge can be attached to brushes to apply detergent  
Fillery Home Appliances, Inc., 38 Pearl St., New York City 4

**2. GRATER** has a rotating handle that prevents skinned knuckles and permits cheese to be grated directly onto the food. Pressure on the movable handle feeds cheese into the hopper. The grater can also be used on chocolate, nuts, bread, other foods  
Hoffritz for Cutlery, 49 East 34th St., New York City 16



2

**3. SHOWER HEAD** molded from plastic can't corrode and will not attract lime deposits. Shower stream can be shut off at the head itself if desired. The head is milky-white in color but can be dyed to match bathroom color scheme with household dyes  
Warren-Magnuson Co., 612 E. Alhambra Ave., Glendora, Calif.

**4. STEP AND HANDLE** can be screwed onto a closet doorframe, permitting easy access to upper shelves or to second clothes pole. Unit is available in two models, one with a permanent step and the other with a step that flips out of way when not in use  
Narva Products, Inc., 70 E. 45th St., New York City 17



3



4

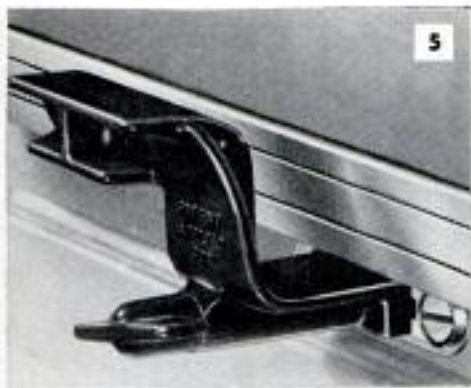
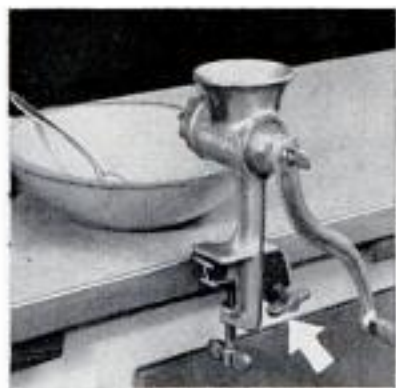

**5. BRACKET** for food grinder prevents damage to kitchen counter tops and edges. Slotted plate is attached permanently just beneath edging at point where grinder will be used. The bracket itself slides into the plate and the grinder is clamped to it. After use, bracket can be stored

Robert B. Haynes, 2005 Laskey Rd., Toledo 13, Ohio

**6. HOSE CADDY**, similar to golf cart, eliminates dragging of heavy hose across a lawn. It holds up to 200 feet of garden hose. Flat-tread rubber wheels prevent damage to a wet lawn. A clamp on caddy, adjustable with a wing nut, holds hose nozzle in any desired position for sprinkling lawn

H & W Products Co., P.O. Box 792, Peoria, Ill.

**7. CLOTHES CATCHER** fastens to the bottom of the laundry chute. An aluminum zipper across the bottom permits easy unloading. Made in a variety of fabrics, the clothes catcher is easily installed with four hooks attached to the basement ceiling. It holds up to four bushels of laundry

Fornell Manufacturing Co., Minneapolis 19, Minn.

**8. TOASTER** turns out hot buttered toast at the table. In most toasters, butter can't be applied to bread before toasting. New appliance is an aluminum box with a heating element in the top. In upper position, drawer turns out buttered toast; in lower, it heats rolls or coffee cake

Munsey Products, Inc., Little Rock, Ark.





## TV Finds Parking Spots To Speed Lot Operation

Mounted atop a light standard in an Oakland, Calif., parking lot, a closed-circuit TV camera serves as an extra attendant, spotting open spaces. The camera constantly scans the lot, and its picture is reproduced on a 21-inch screen in the entrance booth. The attendant merely sends incoming cars to the vacant parking spaces he sees on his screen.

## 550-Mile "Dingo" Fence

All Australian wildlife except the dingo, a medium-sized wild dog, has been brought under control, but dingoes are still a serious menace to sheep. To protect the continent's 17,000,000 sheep, a 550-mile dingo-proof fence is being erected. It will stretch north through Queensland from the New South Wales border.

## Army Can Take Complete Theater to Forward Areas in Showmobile

First Army vehicle built specifically for entertainment purposes, the Showmobile, an \$18,000 theater on wheels, has been delivered to Fifth Army headquarters in Chicago. The Showmobile, mounted on a truck chassis powered with a V8 engine,

includes a 14-foot roll-out stage, two fully equipped dressing rooms, storage space and a 10,000-watt generator for extensive theatrical lighting. It will be used to take stage shows to maneuver or combat areas in which auditorium space is nonexistent.



## Radar Traces Projectiles, Locates Mortar

Infantrymen who have exhausted their vocabularies on mortar fire that pinned them down will welcome a new Army radar that spots enemy mortars by tracing the trajectory of projectiles. In Army terminology, the device is known as counter-mortar radar AN/MPQ-10. Developed by the Signal Corps and Sperry Gyroscope Co., the mortar spotter was first used in the late stages of the Korean war. It consists of a dish-shaped radar antenna, automatic tracker, remote-control console with radarscopes, a gasoline-powered motor-generator and a trailer mount. Backtracking projectiles, the radar pinpoints the enemy mortar.



## Tiny Radio Transmitter

Housed in the war head of a speeding 20-millimeter projectile, a thimble-size Navy radio transmitter broadcasts signals that are recorded by an oscilloscope on the ground. The transistor-equipped unit is used to trace the rotation of projectiles.

## Helicopter Tilted on Special Ramp for Testing at Various Angles

Looking as if it were about to nose over, a Bell HSL-1 antisubmarine helicopter is tilted to a 45-degree angle for testing. The tests are conducted on a specially built

ramp at Bell's Fort Worth, Tex., plant. It was necessary to build the ramp on a downhill slope so that the forward rotor would not strike the ground.

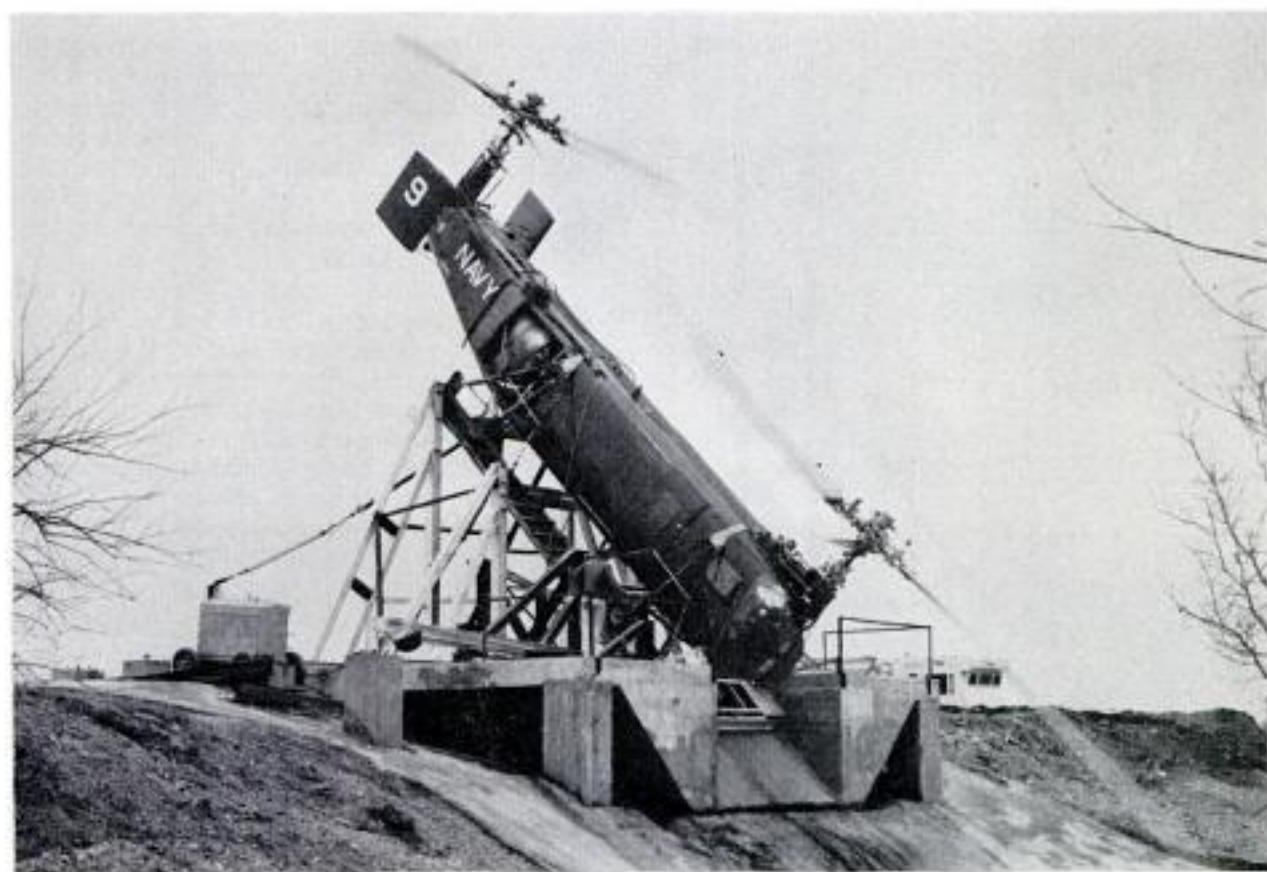



## Electric Reel Brings in Odd Fish Caught at Great Depths

Odd species of ocean fish that live half a mile or so below the surface can be caught with a new electric fishing reel that takes the hard work out of angling at great depths. As much as 3500 feet of thin Ni-chrome wire with a breaking point of 70 pounds can be carried on the reel. Tested in the Pacific off San Diego, the reel has brought up rare sable fish from 3200 feet,

rock cod and halibut from 1200 feet, 10-foot sharks and a 115-pound black sea bass. The reel has a drag to regulate speed and is used with a short, stiff boat rod having a roller tip. A 12-volt automobile storage battery will power two reels for a full day's fishing at depths not practical for angling with ordinary equipment. Nibbles a half mile down are detected immediately.



## Homemade Pile Driver Pounds Stumps Into Soil

Instead of dynamiting the stumps on their land, two Arkansas farmers have built a machine like a pile driver to pound them into the ground. A 2000-pound weight is hoisted to the top of an 18-foot frame and dropped on the stump. Repeated blows are necessary to bury the stump the required depth of 16 inches in the soft earth, well below the reach of a plow. Between 15 and 25 blows are required to sink the toughest oak stumps, which were cut flush with the ground many years ago when the land was first cleared. The homemade machine, built at a cost of \$1500 by Ebb and Leo Sellmeyer of Knobel, Ark., is powered by a V8 automobile engine, rides on three huge wheels from junked B-17 bombers, and has a chassis made from scrap.

☞ Texas Longhorn cattle, almost extinct 25 years ago, now number over 500 because of federal efforts to preserve the breed.



Can you spot errors of these divers? They're careless with weapons, diving near boats, seaweed, swimmers.

## *Skin Divers . . . Play it Safe*

By Richard W. Emery



**S**KIN DIVING — the fascinating pastime that takes you into a new world beneath the surface of lake or ocean—is fast becoming one of the most popular water sports. It's loaded with excitement and fun. It's also loaded with danger.

Each year several skin divers go down but fail to come up because they didn't follow simple rules of underwater safety. The skin diver who is reckless with his own life may also endanger the lives of others. On the other hand, skin diving can be safe if the diver obeys the rules.

Off the California coast, five teen-age boys equipped with aqualungs were diving and surfacing near beds of seaweed. It was a lot of fun—until one of the older boys

suddenly noticed that a 15-year-old was entangled beneath the surface in heavy kelp. He dived immediately, cut loose the kelp and the aqualung equipment and brought the drowning lad to the surface. Lifeguards worked four hours in an unsuccessful attempt to revive the boy.

Only five days before, kelp beds nearby had claimed the life of an 18-year-old who was skin diving from a boat.

Even shallow water claims its victims. In Fort Worth, Tex., a 14-year-old boy suffocated in his rubber-and-glass swimming mask. Vacuum, created as he tried



**DON'T** dive in areas that are known to be dangerous. **DON'T** take chances with strange, untested equipment

to breathe, sucked the mask so tight over his nose and mouth it had to be cut from his face. The lad had drowned in only three feet of water in a swimming pool.

Attempts to set underwater records can lead to tragedy. In Elkhart, Ind., a teenager was experimenting with a "rebreathing" mask, designed for use in aircraft at high altitudes. The mask filters air so it can be breathed again. The lad weighted

**DO** use only basic equipment if you're a novice. Beginner has only face plate, fins, float, bag, spear



**DON'T** enter deep water if you can't swim. Inflated rubber floats can be punctured and let you down

his body and went down to a depth of 30 feet. He managed to stay down a full hour before he resurfaced. The following day he returned to the lake, determined to break his own record. His body was recovered an hour and 15 minutes later.

There may be even more such accidents this summer because there'll be more skin divers. And these tragedies need never happen if divers use their heads and obey

**DON'T** overburden yourself. This diver carries pack full of fishing gear, hand fins, knives and weights







**DON'T** carry a cocked weapon until you're ready to fire it. It may go off accidentally, injuring someone

a few common-sense rules of water safety.

The rash of preventable accidents along the coast of California prompted a recent demonstration of right and wrong diving practices. In the demonstration, members of the Council of Southern California Diving Clubs and the American Red Cross illustrated the rules for skin-diving safety.

The most important rule of all, of course, is to learn to swim well before you ever

**DON'T** venture into kelp beds. Kelp may tie itself in knots around equipment you carry on your back



**DO** try artificial respiration on a float in an emergency. Alternately compress and release diaphragm

try skin diving. The good swimmer is less likely to panic and better able to take care of himself if he ever does get in any trouble. Inflated inner tubes, for example, can be punctured and let the novice swimmer down in deep water.

Experienced divers agree that too many beginners weight themselves down with too much equipment. Gear that loads down a diver may also foul him up under water.

**DO** swim on your back if you get tired. Tank-type breathing equipment will help support you in water





**DO** use this type of fastening if you hang weights on your body. One pull will release the entire belt



**DON'T** show off by inviting nonswimmers into deep water to watch you dive. Their floats may fail them



**DO** save your strength by resting part of your weight on float while looking around for underwater game

Try the recommended minimum—face plate, fins, float, bag and spear—before you try any other equipment. And use only tested and approved breathing devices. Don't take chances with poor equipment.

Converted aluminum breathing devices designed for high-altitude flying may corrode in salt water and become dangerous.

Weights that are hung on the body, of course, should never be secured in such a way that you can't get rid of them instantly.

**DO** learn to swim well before using equipment in deep water. This is the most important rule of all



**DO** team up for artificial respiration. One man applies pressure while another tows two men ashore

Weapons are dangerous. Anything that can kill a fish can also kill a human. Treat underwater weapons with the same respect you treat their surface counterparts.

Skin divers never should swim alone.

And one of the most important rules of all is to swim only in water that has no hazards. Seaweed, jagged stones and boats are all dangerous to the skin diver.

The underwater world can be oceans of fun—if you keep it safe. ★ ★ ★

**DO** use the buddy system. Never swim alone. Here a buddy comes to the rescue of a diver fouled in kelp



## Air Force's Matador Missile Launched From Special Semitrailer

No runway is needed by the U. S. Air Force's B-61 Matador missile, which is launched from a specially constructed semitrailer, 39 feet long and weighing 35,000 pounds. Complete launching equipment, in addition to the tandem-axle semitrailer, consists of a launcher tractor, a 15,000-pound transport semitrailer and a 20-ton truck-mounted crane. Before launching, the missile is mounted on the launcher at three points. When power is applied, a bolt in the rear support shears and the two forward supports pivot away.



### Pencil With Liquid Graphite Writes Like Ball-Point Pen

Pencils using liquid rather than solid graphite have been developed separately and simultaneously by two companies, one a major maker of fountain pens and the other a mechanical-pencil producer. The liquid-graphite writing instruments are designed to multiply many times the life of ordinary pencils, and it is claimed that one could write a straight line three miles long. Liquid graphite flows around a ball, as in a ball-point pen. Marks made by the liquid graphite can be erased just as easily as those of ordinary pencils.

### Forage Cutter Tractor-Mounted

By mounting an ensilage cutter on a 25-year-old tractor, Chan Smith of Cuttingsville, Vt., has created a self-propelled forage harvester that speeds work by going backward. Smith reversed the gears of his tractor, mounted a 30-horsepower engine on the tractor to drive the cutter and offset the new seat and steering wheel. A belt-and-pulley rigging connects the steering wheel to the main steering shaft. A pickup was added to the cutter, which was hinged to the tractor's drawbar and suspended from springs. The entire operation is with-

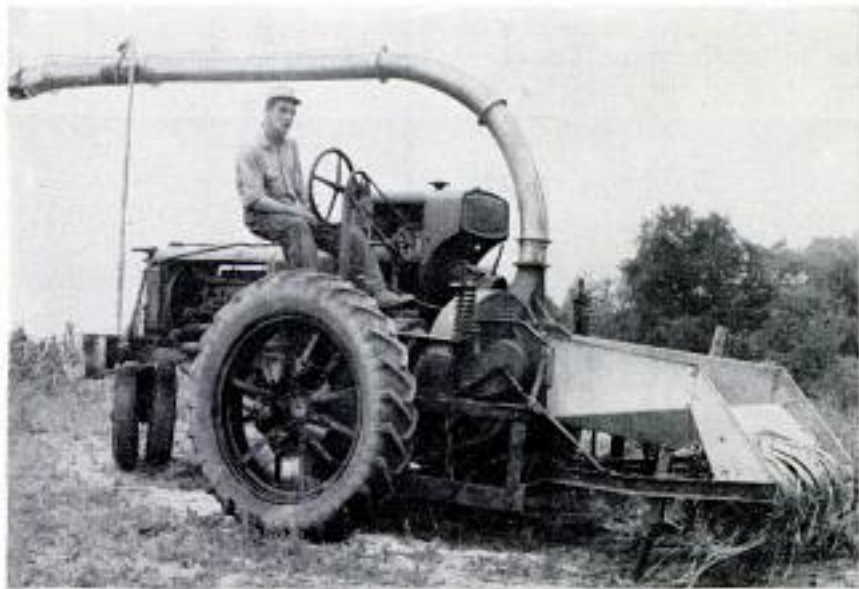

in view of the operator and maneuvering is easy. Chopped corn or hay is blown into a towed trailer.



Navy photos

Above left, in tests of the target, men count each hit to make sure the instrument is tallying pilot's score correctly

Above, officer on tower observes pilot's run while instrument records hits. Cable runs between the recorder and the target



Left, pilot aims at 12-foot-square target made of rubber panels. Hit is registered whenever electric circuit is disrupted

## Electronic Target Tests Aim of Strafing Pilot

Pilots who make strafing attacks on a new electronic target can't boast of hits they never made. On the other hand, the practice target gives them credit for every hit. The new target is made of six sheets of rubber, each measuring four by six feet, mounted on a wooden framework. The rubber sheets are impregnated with minute particles of carbon. The sheets then are en-

ergized with an electric current. A cable carries the current to a recording instrument on an observation tower. The instrument gives a steady reading until the circuit is disrupted by the impact of a bullet registering a hit. As many as 300 hits per second have been accurately recorded by the instrument. A unique feature of the target is that it is self-sealing.



## Floating Inspectors Check Tank Wall

"Routine inspection" of an oil tank in the Saudi Arabian desert calls for two engineers and one rubber life raft. Before inspection of the Arabian American tank, the oil is removed, the gases purged by steam and water admitted. Water level is raised in eight-foot steps until the inspection is finished. During the check, the men paddle along the steel wall of the bubble-shaped tank, looking for signs of corrosion.



### **Twin-Rotor Convertiplane Successfully Test Flown at 3000 Feet**

Test flights to altitudes of 3000 feet have been made with a convertiplane designed and built by Transcendental Aircraft Corp. (*PM*, June 1954, page 119). The aircraft is lifted by twin rotors, one at each wing tip,

and is expected to attain full forward speed when the rotors are turned forward 90 degrees to act as propellers. In tests so far, the rotors have been turned forward about 30 degrees.

### **Side Wings on Bus Unfold for Crowds**

Not many people can travel aboard a new Italian bus, but when it reaches its destination it unfolds to accommodate 100. The bus is designed for agricultural agencies, manufacturers and others who want to hold traveling schools or demonstrations. Wings unfold from the sides of the chassis, converting the bus into a large room.

### **Air Saves Fish**

Winter ice kills fish by preventing sunlight from reaching green plants, which produce oxygen. Jack Hemphill of the Arizona Game and Fish Commission keeps fish alive by laying a perforated plastic pipe on the lake bottom. Compressed air escaping through the holes forces the warm water at the bottom of the lake up to the surface, where it melts the ice.

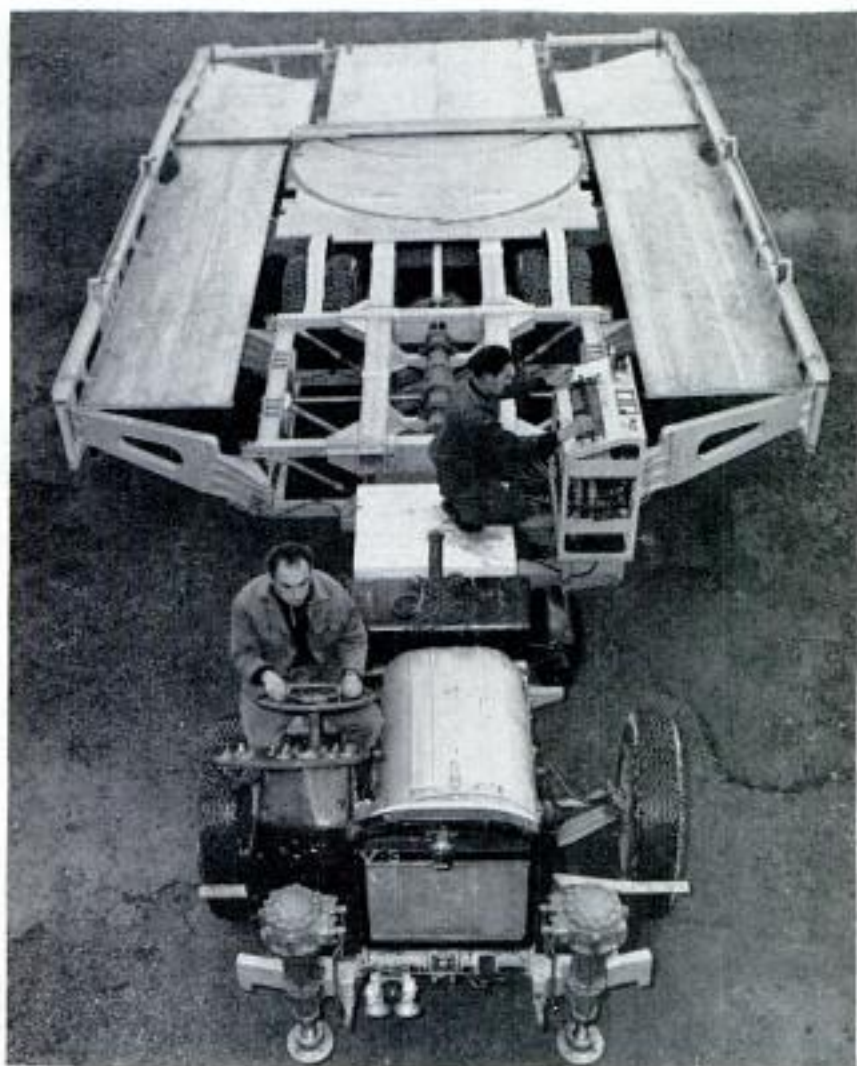



## Detachable Truck-Trailer Body Speeds Freight Delivery

Freight carried in a shipping container that is 17 feet long, 8 feet wide and 8 feet high can be shifted quickly from truck to rail transport. The 3000-pound box, which holds 20,000 pounds of freight, is handled by fork-lift or straddle carriers and is fastened with automatic locking devices to

the bed of a freight car or a truck. One can be carried on a city delivery truck, two on the conventional 35-foot highway truck trailer, or three on a standard railroad flatcar. After the box reaches its destination, it can serve as a temporary warehouse for the freight.

## Sleeping Bags Made of Paper

Disposable paper sleeping bags are proving their worth in tests by the U. S. Forest Service. Because they are lightweight, pack into a small space, and cost so little they can be thrown away after use, the paper bags are being used by forest-fire fighters, especially those who parachute into isolated areas. The bags are water-repellent, roomy and sturdy. They are made of quarter-inch cellulose paper with two layers of crinkled paper and one layer of dry, waxed, kraft paper on top. A draft curtain of flannel which is wrapped around the



U. S. Forest Service

shoulders is sewed into the mouth of the sleeping bag. If more warmth is needed, a regular woolen blanket or a disposable paper blanket can be used.



## Lubricant Loosens Locks

Designed to clear frozen or rusted locks, hinges and other gummed moving parts is a new lubricant whose principal ingredient is graphite. The lubricant is supplied in a convenient applicator bottle. Special grease-cutting fluid in the lubricant gives it penetrating power.

Use of a nylon tube as a permanent replacement for a damaged or diseased artery has proved successful in a human being.

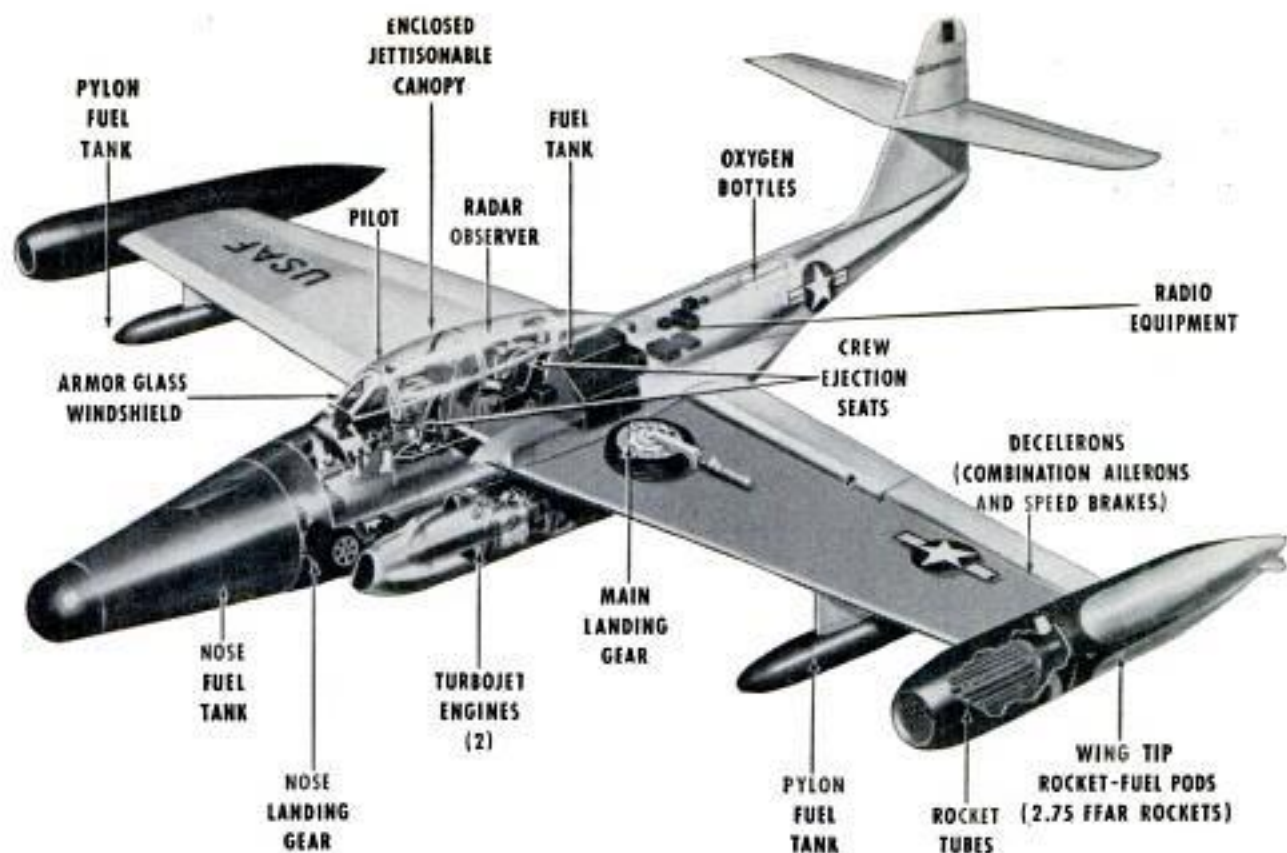

## Scorpion Twin-Jet Interceptor Carries 104 Rockets

Internal details of the Air Force's Scorpion F-89D, twin-jet all-weather interceptor, are revealed in a phantom view released by its builder, Northrop Aircraft. The plane, now guarding approaches to vital industrial areas, is said to be America's most heavily armed fighter. It carries 104 big folding-fin rockets, each capable of downing the largest enemy bomber, in the forward part of the wing-tip pods. Fuel

is carried in the aft portion. Additional fuel tanks slung beneath the wing supplement a fuel tank in the nose to give extended range. The 600-mile-per-hour F-89D is powered by two turbojets with afterburners, flies at altitudes in excess of 45,000 feet, and mounts electronic aiming and triggering equipment that enables its two-man crew to seek out aircraft despite darkness or fog.



## Mower Has Overlapping Blades

On a new power mower, dozens of short, overlapping blades cut the grass by high-speed impact. The blades, mounted on a shaft between rubber spacers, revolve away from the operator. A safety hood over the shaft traps flying objects and expels them without damage. The mower mulches as it cuts, and mows high grass and weeds, wet or dry. It is available in two sizes, 16 and 20-inch.

☐ In 1954 the nation's home handymen invested about \$6,000,000,000 in workshop tools and do-it-yourself materials.



600 15th St.  
Miami Beach, Fla.

# SCULPTURE **IN COPPER**

By Ed Dickson and Max Hunn

THE 33 YEARS which Alexander Lapkoff spent in the prosaic work of an expert auto-body repairman gave no hint of his artistic talents. But in the three years since a heart attack forced him to give up regular work he has developed the hobby of sculpture in copper to the point where it may rate recognition as a new art medium.

When the doctors gave him orders to slow down, the Russian-born metalworker decided to occupy himself by working with copper. It is a craft often taught in hobby courses, but he made it an outlet for his heretofore hidden artistic talents. With characteristic intensity, he copied and created all sorts of pictures in the medium he was developing—portraits, maritime scenes, Western sketches, animal life, Oriental characters and abstractions.

The work in copper is given its dramatic effect by "stretching" the metal to project figures and lines from the background. This elevation creates perspective.

Lapkoff started his hobby in Washington, D. C., where he had operated his automobile-body shop. To take things easy, he moved to Miami Beach, Fla., where he

hopes to interest art circles in his work.

Most of Lapkoff's works are left in the natural copper color. This can be varied in shading by steel-wool polishing and by use of acids. On some pictures he uses

Tracing of design to be sculptured on back of soft-copper sheet is necessary before shaping can start

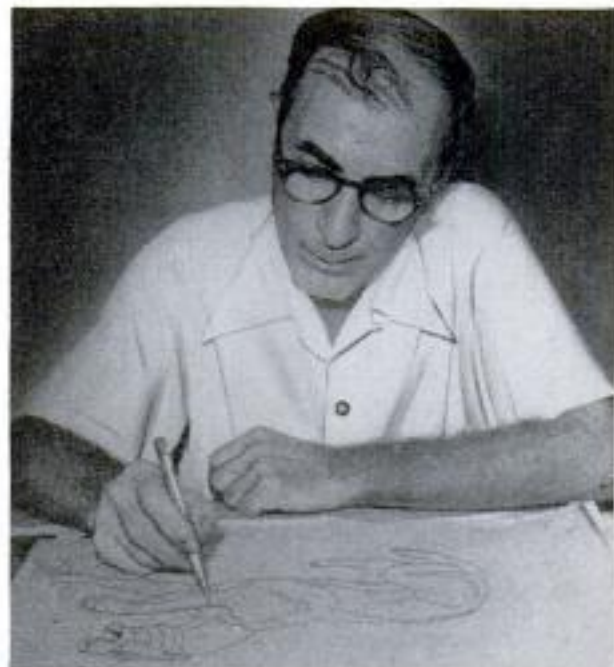





**Strong, vigorous line lends itself effectively to copper sculpture. This scene is one of Lapkoff's largest**

vivid colors. These are of fingernail polish, made especially for him in a dozen colors by a nail-polish manufacturer. Nail polish was selected because it leaves no brush marks. He covers the finished pictures with linoleum lacquer as a protective coat.

Lapkoff has spent hour after hour sketching the pictures he wants to work in relief in copper. He has learned that detail some-

times cannot be followed minutely—a single line may be more telling than several lines. On the other hand, he will spend tedious hours working an intricate pattern when detail is impressive.

Lapkoff does most of his work in 36-gauge copper. It can be obtained in rolls of 12, 14 or 18-inch widths. For larger pictures he uses the heavier 32-gauge.

**Impressions are worked into copper from back (left). Final finishing and smoothing are done on front (right)**





Lapkoff made impression of his heart attack (above) and worked intricate detail into mandarin (below)



Sculptor works in copper on wide range of subjects. This bulldogging scene shows variety of interest



To prepare the sheet of copper for working, Lapkoff lays it on about eight thicknesses of newspaper and attaches the sketch of the drawing to be transferred. Masking tape is used to hold the sketch firmly to the copper. Then, he traces the lines of the drawing, the copper easily taking the impression from the overlay.

From now on Lapkoff works with the sheet of copper lying on a pane of glass to provide a smooth surface. He slides a section of the copper off the edge of the working surface so he can reach the back with his sculpturing tools.

The tools are adapted leatherworking and clay-working tools, all with blunt or ball-shaped ends. With the proper tool, he gently massages, thus stretching, the metal from the back of the sheet of copper. This produces the elevation in the picture to give perspective. As he gently works the elevations into the picture, he watches from the front side of the picture to get the effect he wants.

When all the various elevations are achieved, Lapkoff works on the front side of the picture, smoothing out any irregularities in the background and in sections which are not elevated.

One of the lessons Lapkoff learned was to protect the finished picture by pouring melted paraffin in the larger depressions on the back side of the sheet of copper. This prevents the depressions—which are elevations when viewed from the front—from collapsing. ★ ★ ★

## Pavement Pounder Records Road Test

Capable not only of simulating the pounding roads take from traffic, but also of recording the effects of the pounding, is a new road tester perfected by the Shell Oil Company. The testing equipment, mounted on a two-wheel trailer, uses a base plate and vertical shaft to impart to the pavement simulated traffic impact. Recording equipment mounted on trailer electronically measures pavement movements as small as  $\frac{1}{10,000}$  in.



## Radar Guides Swiss Rocket

Guided by radar is a Swiss ground-to-air rocket designed for vertical take-off. Twenty-five of the experimental anti-aircraft missiles have been sold to the United States by the Oerlikon Machine Tool Works. The rocket is undergoing tests in the Alps.

## Paint Roller Ends Splatter

You don't need to cover rugs and furniture when you paint a room with a roller designed not to drip or splatter. The foam-rubber roller can be used only with water-soluble paints because it would be damaged if cleaned with turpentine. It is said to hold more paint than most rollers.

## Fisherman's Truck Mounts Boat

Like a snail carrying its shell, a bantam-size two-cylinder Italian truck chugs along with a boat on its back. It's owned by an Italian fisherman who takes his boat and his family with him as he transfers from the Adriatic Sea to the Mediterranean.

Sources of available products described in this issue are listed on pages 58, 60 and 62. Sources of further information on other articles are given in the WHERE-TO-FIND-IT LIST, available from Bureau of Information, Popular Mechanics, 200 East Ontario Street, Chicago 11





## Saxophone Keyboard Simplified by Inventor

It takes only 15 minutes for a musician to replace the felt pads and clean his saxophone when it is equipped with a simplified keyboard invented by a California man. There are 27 fewer key-holding posts on the new keyboard than on a conventional model which is so complicated that the instruments have to be turned over to a repairman for cleaning. Another advantage is claimed in addition to the ease of maintenance: The saxophone has a deeper tone with more volume because of the absence of the 27 key-holding posts.

## Camera Splits Second Into 15,000,000 Parts

Motion pictures at the rate of 15,000,000 frames per second are taken by a camera that shoots up to 96 consecutive pictures of a single event. Developed at Los Alamos, the camera is used to record explosive phenomena and other high-speed actions. Light enters the camera through a long tube and is reflected to one face of a three-sided mirror that revolves 23,000 times per second. As the mirror turns, it flashes the image through a series of lenses that are arranged in an arc. Behind the lens is the film, on which separate pictures are recorded. Before the mirror makes another turn, an electric detonator shatters a glass block in the light path, the shattered block

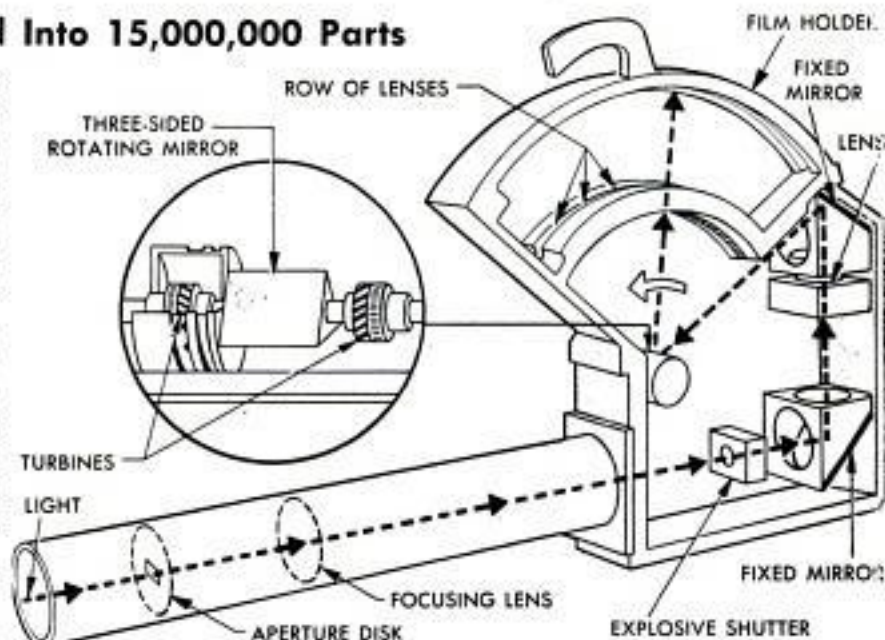

being opaque enough to bar the light until a mechanical shutter can close. The revolving mirror is made of high-strength, highly polished steel.



## \$850 Sports Car

If you can't afford to buy a speedy competition car, you can always build one. At least, that's what Don James found out. This San Mateo car enthusiast built a 155-mile-per-hour speedster for only \$850—plus, of course, 18 months of spare-time activity on his part. The body is glass fiber. The power plant is a 1949 Ford V8 engine.



"Restless" dormitory starts across bridge. Two tractors in photo push in reverse while two others pull

## Hotel Takes a Ride

RANCHERS near Glacier National Park rubbed their eyes in amazement one morning when they sighted a two-story frame building moving down U.S. 2 toward the tall steel-and-concrete bridge spanning the Two Medicine River Gorge. For weeks the 179-ton building had been moving across the rugged country, in easy stages, on a 25-mile trip to its new location in Glacier Park. Half of a former dormitory for railroad men at Blackfoot, Mont., it will serve as housing for park employees. Most of the time the structure was carried on trailers pulled by two crawler tractors and a truck tractor. But at Two Medicine bridge, it was necessary to reload the hotel on other trailers. Two truck tractors pulled at the front while two at the rear followed in reverse gear. The cost of moving the 32-by-80-foot structure was around \$15,000. Difficulties included the crossing of 10 rural electric lines and five telephone lines.

Too wide for the bridge, the big building had to be raised six feet to clear the guard rails. Dormitory weighs 179 tons

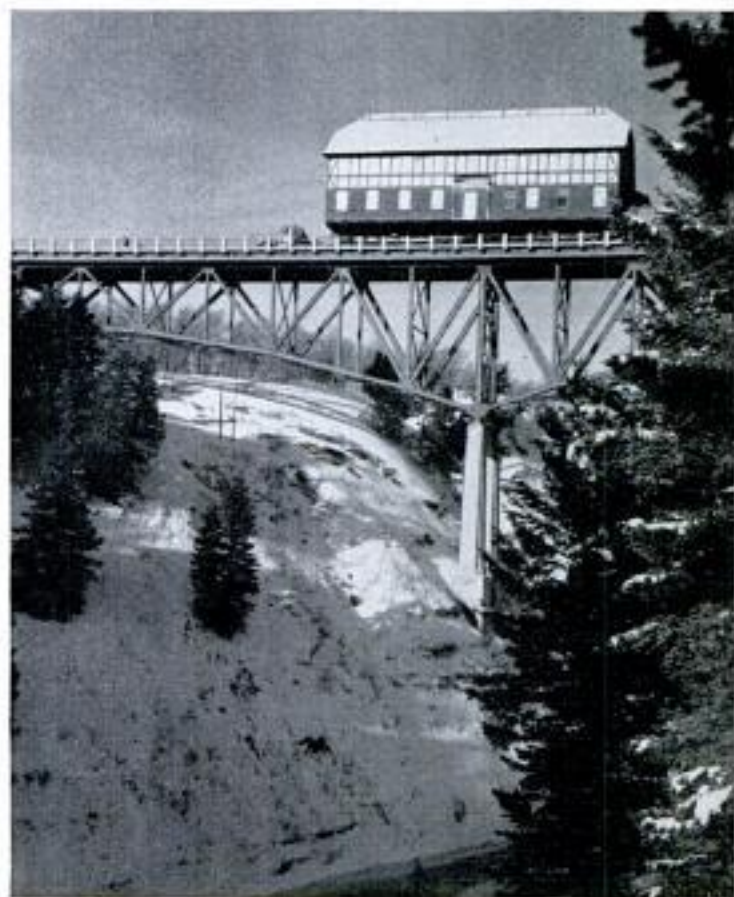

# MR. LADYBUG

He'll probably sell over a billion this year to garden lovers—a man-sized mail-order business

By James Joseph

About 500,000 "ladies" — killers of garden pests — crawl in this bucket



Gatherer harvests a crop of ladybugs by scooping them into a container while they hibernate in mountains

**I**N ATLANTA, neighbors were astonished to see a young man sowing ladybugs by the handful over a small garden.

His explanation left them even more incredulous.

"Sure," he said, "we've got 20,000 of the critters stashed in our refrigerator. Every week we scatter a few thousand ladybugs among our roses and petunias. Within 24

hours they've devoured every aphid, red spider and mealy bug—all the soft-bellied, sapsucking insects that were ravishing our plants."

He neglected to mention that he'd latched onto his 20,000 unladylike ladybugs for just \$3.50. Moreover, his "garden packet"—a screened, fiberboard box—had arrived via the postman.



Bugs, dazed in the cool mountain temperatures, cling to a sheet of burlap which is shaken into a tub. They are sold to gardeners for release during summer

Colonies are scooped into plastic mesh bags by the gatherers. They are dumped into a container through a sieve, which separates the ladybugs from the trash

And where had it come from? Greenbug Control Company, Oroville, Calif.

Greenbug's originator is lanky Paul Harris, a former woodcutter and truck driver who has made a big thing of nature's own little ladybug. In 1954—his fourth year as a full-time "lady's" man—Harris grossed about \$80,000 selling ladybugs mail-order to thousands of homeowners. How many of the critters did he ship during the year? About 10,000 gallons—1,350,000,000 insect-hungry little ladies.

Coast to coast, back-yard gardeners are taking a tip from their greener-thumbed cousin, the farmer. Agriculturists have long employed ladybugs to rid crops of leaf worm, onion thrip, apple mite, red spider, lygusbug, aphid and a score of other pests, their eggs and larvae.

If Harris guesses correctly, more and more gardeners will be reaching for ladybugs instead of insecticides. Some chemicals indiscriminately slaughter good insects and bad. Ladybugs have appetite for harmful insects only.

Harris, plunging into the mail-order bug business without capital, customers or formal education, has proved that big-money ideas can lurk anywhere. He found his jackpot between 2000 and 5000 feet on the western slope of the Sierra Nevada.

One day in the mid-'30s he laid aside his woodcutter's ax and stooped to examine a huge colony of swarming red insects. Ladybugs.

But what were they doing at 3000 feet, especially since it was February and the



mountains were blanketed with snow? Curiosity led him to other ladybug clusters. Millions of the insects, he discovered, were congregated across the Sierra Nevada's snow belt.

Harris scribbled postcards to a half-dozen county farm agents.

"Is there," he asked, "any commercial use for ladybugs in quantity?"

Sacked ladybugs are temporarily stored in a walk-in refrigerator to keep them from getting too lively





Bugs are measured into boxes for shipment to gardeners. There are about 135,000 ladybugs to a gallon

His own county agent replied yes, emphatically. Enough ladybugs scattered around prune orchards could rid them of the fruit-destroying aphid.

The agent's appraisal neither surprised nor elated Harris. Having been reared on a California citrus ranch, he remembered his father's praise for ladybugs and the work they did. Though he now had prospects of a market, Harris knew nothing about gathering ladybugs and even less about shipping and handling them. Nor had he any capital.

During the next few years he swung his

Harris, left, and assistant load screened boxes of insects for shipment



ax by day and thought about ladybugs in his spare time. Whenever he came across a cluster in the mountains he hawked them to prune growers for 25 cents a pound. That way he managed to pick up an additional \$500 to \$700 a year.

Meantime he did some research. Ladybugs, he learned, were creatures of habit, especially the *Hippodamia convergens*. These bugs, true to their name, congregate during hibernation. It's this penchant for colonizing which makes the species commercially harvestable.

From mid-May through September, millions of ladybugs swarm up from the cultivated valleys. Often they fly 100 miles to reach their annual hibernation area. Clustering, they sleep out the winter, dazed to inactivity by the cold. A dozing colony can be brushed, scooped or shaken into containers with little difficulty. About February, revitalized by a week or two of sunshine, they fly back to the valleys. Now hungry, they gobble up every soft-bellied, leaf-eating insect in sight.

Eventually the females (ladybugs are ladies in name only) lay about 700 eggs. The eggs hatch in about seven days, producing ugly, six-legged larvae which look like miniature alligators. Larvae have even greater appetites than their parents for leaf-eating insects.

In another 10 to 20 days the larva spins a cocoon and emerges in a week or so as a ladybug. That's when the Sierra migrations begin. Last year's ladybugs—loath to compete with their offspring for food—head for the highlands, often to die. Before many weeks, the youngsters have gone through the cycle. Then they migrate.

Figuring an average of 135,000 ladies to a gallon and 200 gallons to a colony, Harris often stumbled upon 27,000,000 ladybugs all ready for gathering.

First, however, Harris had to overcome a formidable problem. Summertime was the most profitable season for gathering. Yet customers—cotton growers in Texas, milo raisers in Louisiana and Arkansas, Midwestern gardeners—needed ladybugs in the spring as the first green shoots poked through the soil. For it was then that leaf-eaters—especially aphids—swarmed to the kill. How could

(Continued to page 212)





Paper backing is peeled off wood strip to expose the adhesive. Tape then is applied to the plywood edges

Household iron, set at medium heat, permanently bonds edging. The tape is available in various woods

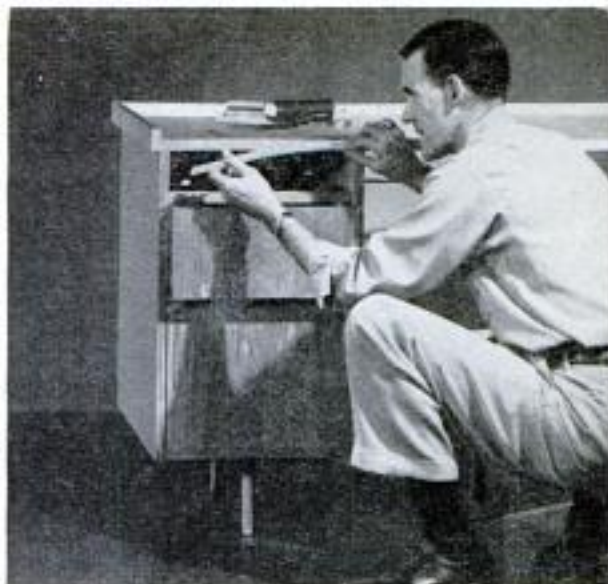

### Adhesive-Coated Wood Strip Covers Edges of Plywood

Finishing the edges of plywood is easy with a new tape. The tape is a thin strip of wood which can be stained or painted to match the plywood. One side is coated with an adhesive which is covered with a strip of paper. The home craftsman peels off the paper and applies the wood tape to the edge of the plywood. He then runs an ordinary household iron, set at medium heat, along the tape to bond it to the edge permanently. A special tool is also available for this purpose. The tape comes in  $\frac{3}{4}$ -inch strips four feet long, two strips to a package. It is available in six different woods, red mahogany, white mahogany, birch, fir, walnut and oak.



### Electric-Powered Caddy Hauls Clubs for Golfers

Newest step in removing the drudgery from sport is found in a powered golf-bag cart. The cart, called a Power Caddy, will propel two golf bags for 18 holes or one bag for 36 holes on one charge of its two 12-volt storage batteries. A speed selector paces the unit to the player's walking speed.

### Synthetic Paper

Paper three to ten times stronger than average has been produced from synthetic fibers. Instead of pulp or rags, the product is made of nylon, Dacron and Orlon. Highly resistant to chemicals, it also resists the action of molds, bacteria, light and moisture.





## Helicopter Trawl Fishes Up Humans

Helicopter pilots can literally scoop up human beings as a fisherman hauls in fish with a rescue device perfected by Britain's Royal Navy. The apparatus consists of a scoop made of netting and held open by a light tubular-steel frame. It is lowered from the helicopter winch on a single cable and trawled through the water just under the surface so that it can pick up the person to be rescued. The net is designed primarily for the aid of injured or unconscious persons, unable to strap themselves to the harness already widely used in helicopter rescue service.

## Two-Cylinder Car

Two cylinders and 14 horsepower give a small German automobile a top speed of 50 miles per hour and a fuel economy of about 70 miles per gallon. Inside, there is room for four persons plus luggage. The rear engine is air-cooled. The car weighs 1320 pounds and costs \$690 in Germany. Its four-speed gearbox and differential are combined with the engine in a unit at the rear.



## Jets Push Boat

There's no propeller or rudder on a Russian hydrojet cutter that sucks in water at the bow and pumps it out the stern. Two forward-facing side jets amidships permit reversing. A control valve directs the flow to stern or central pipes, and to port or starboard for steering. Elimination of the propeller and rudder allows navigation with high maneuverability in shallow water.



## ELECTRONICS TODAY

EIGHT tiny Raytheon transistors, on the card held by the young lady in photo A, replace the usual vacuum radio tubes in the "8 Transistor" portable radio that she is demonstrating. Now available for \$79.95, it comes in a choice of four bright colored leather coverings with a short carrying handle. A long leather shoulder strap is available as an accessory. This small portable receiver is only  $2\frac{5}{8}$  in. thick,  $6\frac{3}{16}$  in. high, and  $9\frac{3}{16}$  in. wide at the bottom. It is claimed to operate for 500 hours solely on the power from four standard flashlight batteries. With batteries, it weighs only 5 pounds. Volume, sensitivity and selectivity are claimed to be equivalent to that obtained from present-day radios using vacuum tubes.

The parts used in fabricating the "rate grown" transistors made by General Electric are so small that the 40-power microscope shown in photo B must be used to attach the base-lead wire to the transistor bar. GE engineers are designing special automatic tools to perform the operation.

One of the smallest magnetic-tape recorders is illustrated in photos C and D. This tiny tape recorder is small enough to fit into a pocket and operates anywhere. It measures  $8\frac{1}{2}$  by  $3\frac{7}{8}$  by  $1\frac{7}{8}$  inches, weighs  $3\frac{1}{4}$  pounds. The tape, good for one hour's recording on its double track, is continuous and comes in an easy-loading cartridge. It is designed to operate for 45 hours on a set of batteries.



A



B



C

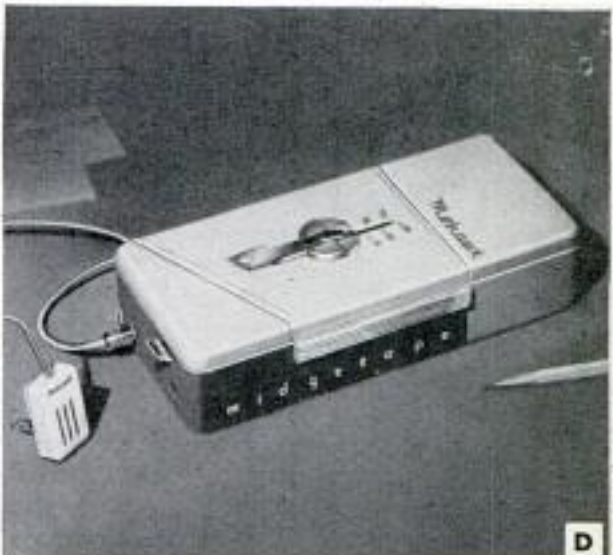

D

## ★ ★ ★ Television Operating Hints

By Frank L. Brittin

**B**UILT-IN television arrangements where the unit must be custom installed in a specially built wall are usually expensive and require an inflexible furniture arrangement. However, many of today's homemakers would like to fit TV receivers into some sort of inexpensive, good-looking, space-saving wall unit. This idea has been made possible with the introduction of stock cabinet units; they come in all price ranges, finishes and even in unfinished versions.

Many TV viewers prefer the operating convenience and flexibility of the table-top or portable TV set as they can take advantage of an available or easily constructed wall-alcove cabinet located in a good viewing position such as the one in photo A. Efficient ventilation is a must in all TV and radio installations. For this reason, the wall alcove with sliding door in photo C must be provided with several large vent-holes cut in the sides and rear. The sliding-door idea was prompted by the desire to prevent children from tuning the sets without supervision. One of the new "pick up and carry" lightweight portables is the 17-in. Zenith model T1816L illustrated in photo B. Balanced handholds on the sides of the set make it convenient for moving whenever and wherever the family prefers; this type of TV set solves a lot of temporary present-day home installation problems.

The homemade plywood stop shown in photo D is a simple installation hint for protecting the picture-tube neck that usually



## and Planned Home Installations

projects from the back of the console set under a rather fragile fiber cover. The stop should extend about 1 in. beyond the tube cover.

Helpful demonstrations of modern planned TV installations for the homemaker have been worked out by the Motorola, Inc., research stylists and several interior decorators and furniture manufacturers. These are shown in photos, A, E, F and G. The room divider, photo E, is used in this recreation room to separate the bar from the entertainment area. An interesting installation is illustrated in photo F. This is a wall assembly made from readily available units called "Space-Span." This series can be assembled along any wall, even in a tiny room, to incorporate storage, a desk, TV set and shelf space. If your TV set does not line up exactly as this Motorola console 21K26 does, you can use furniture glides under the cabinets to raise them. Photo G shows how you can achieve a built-in look with standard equipment. Shelves of bleached oak extend across the room and over the louvered closet door. The recessed lighting is ideally suited for TV viewing. ★ ★ ★

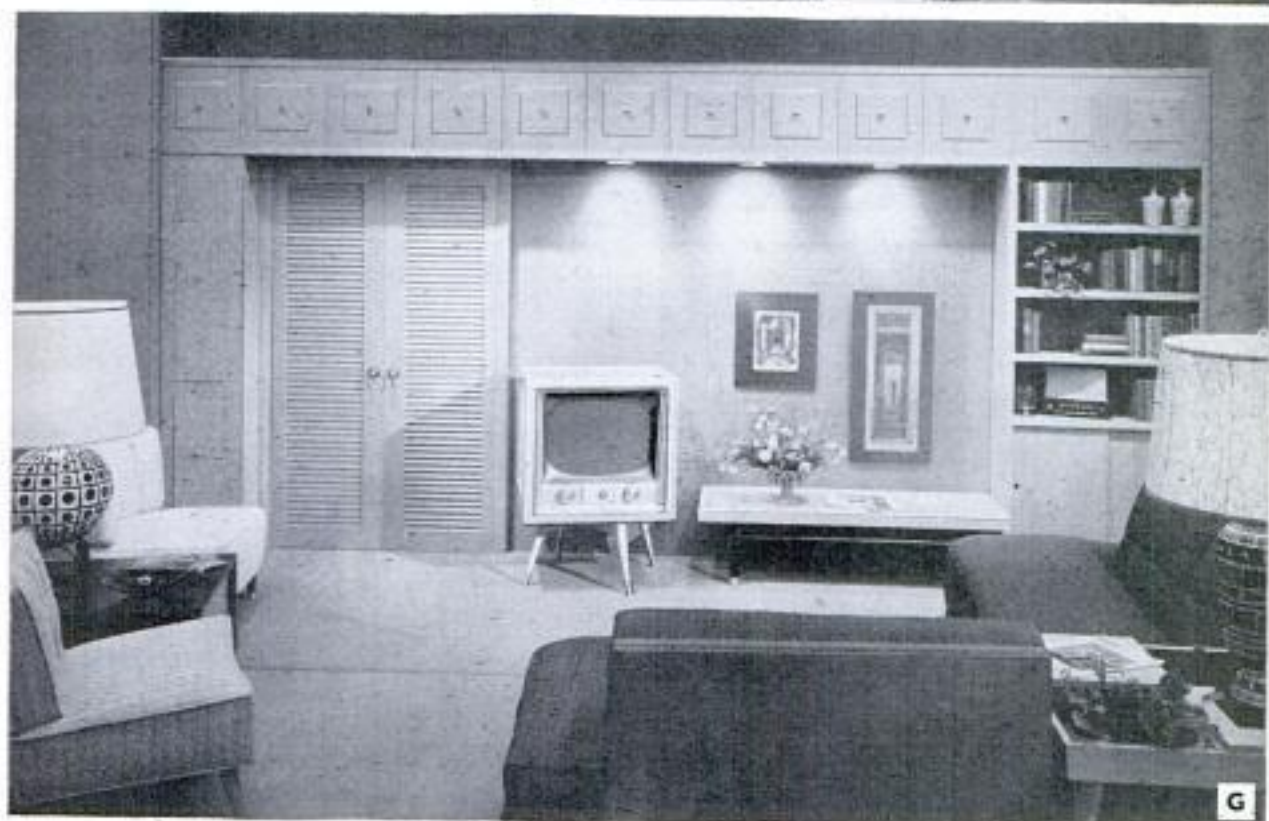

## BROAD-BAND FLAT-GAIN TV ANTENNA FOR COLOR

OUTDOOR TV antennas will invariably give a better over-all color picture on all channels than an indoor type, although some of the portable indoor types do perform fairly well in strong-signal areas. A color signal, as received from the transmitter, contains a number of additional signals which must reach the receiver for good color reproduction.

For fidelity color reception the antenna must have these characteristics: It must be an all-channel VHF type, unless you are located in a UHF area. In that case, all of the following specifications apply, with extra care required for the more critical special UHF-antenna setup. The color-TV antenna gain must be flat; no gain or loss greater than 1.50 db within 1.5 megacycles below, and 0.6 megacycles above the color sub-carrier. The antenna gain must be held down across the FM frequencies, 88 mc. to 108 mc. These specifications also hold good for the regular black-and-white TV broadcasts, and some of the VHF-TV-antenna systems that have been in use for several years are able to meet these color specifications perfectly. One of these commonly used types is the Amphenol "Inline" illustrated in the photos. The color advantages of this system are also good in fringe areas with 2 or 4-bay stacked arrays.

Available in knockdown kit form for assembly on the job as shown in photo A, it is installed on the roof and oriented for maximum-signal pickup before the clamp brackets are tightened, as illustrated in photos B and D. Extension mast sections are used where greater height is necessary, and these are guyed below the array as indicated in photo C.

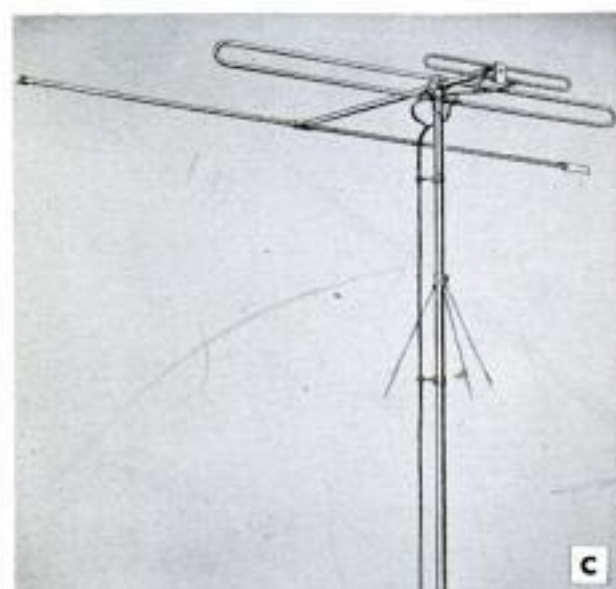
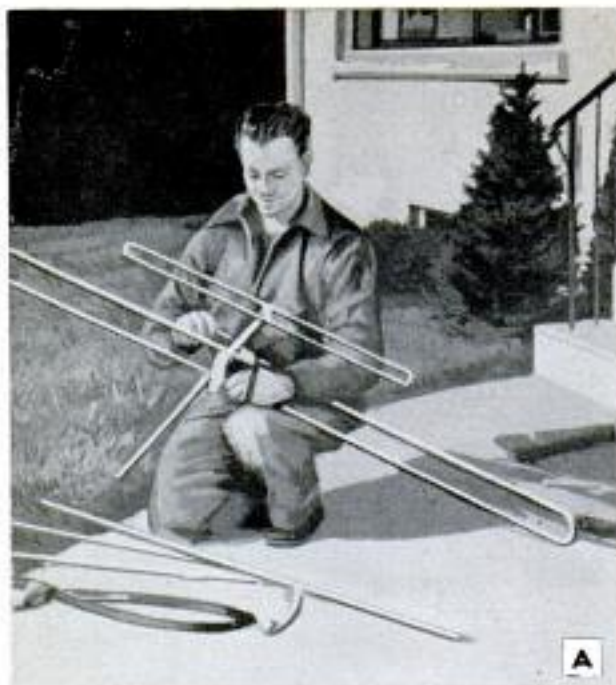

X810

Modern Furniture

the

POPULAR  
MECHANICS

## CRAFTSMAN

*Wrought iron legs + backs for this set were suggested by:*

*Rosemary Design Co.  
1904 Sullivan St.  
Greensboro, N. C.*



## WROUGHT-IRON DINETTE SET

FURNITURE IN WROUGHT iron is high fashion and dinette sets are no exception. Most popular are the sets featuring chairs upholstered with a plastic fabric and tables finished in a plastic laminate. Such sets are not only decorative, but will wear well and are wonderfully easy to keep clean. But even more important, a wrought-iron dinette set is so simple to build that any handyman can do it. It makes a pleasant week-end project and, with a little care, the average craftsman can produce at a considerable saving a set equal in quality

and appearance to one that he could buy.

The wrought-iron table legs and chair frames are available in individual units. The dimensions of the table can be varied to suit your family needs. On page 151, the detail shows how a 31 x 42-in. table and four chairs can be cut from a 4 x 6-ft. sheet of  $\frac{3}{4}$ -in. plywood with very little waste.

Both seats and backs are padded with three layers of roll cotton, or equivalent of foam rubber, cut to the same size as the plywood. The covering material is cut 2 in. larger all around than the plywood, which



Above, three layers of roll cotton, or the equivalent in foam rubber, are used as padding. Below, the material covering the backs of the chairs is held in place by large-headed, decorative furniture nails

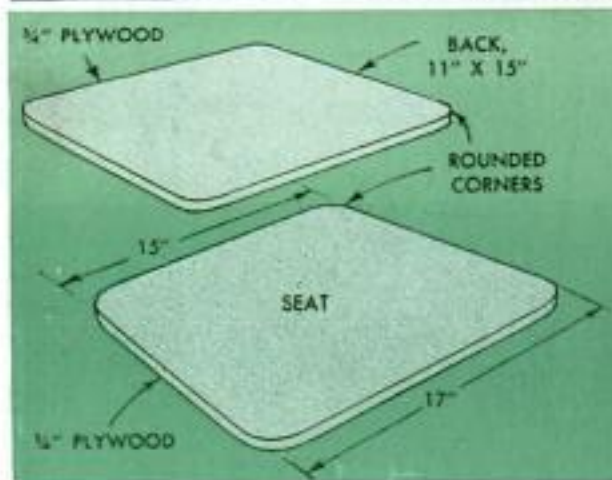
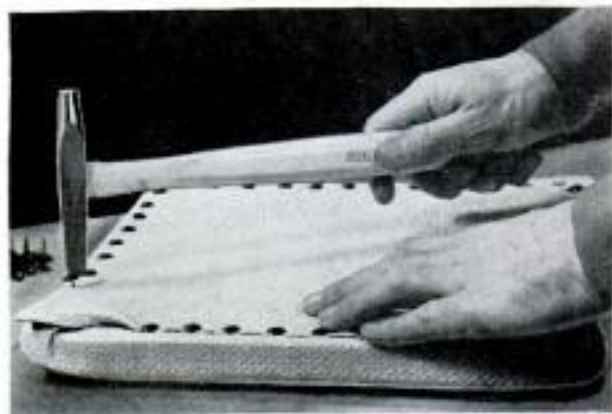

Below, the right amount of mastic is applied to the laminate and plywood with a notched applicator



Final assembly is completed by attaching the seat and back of the chair to the metal frame with screws

leaves plenty of material for tacking. Tack one side first, spacing  $\frac{1}{2}$ -in. carpet tacks about 2 in. apart. Then tack the opposite side, pulling the material as tight as possible. At the corners make two neat folds to follow the radius. The backs are done in the same manner, except that an additional piece of material covers the back side.

The plastic laminate is applied to the table top according to the directions given with the type of mastic you are using. Normally, the mastic is spread on both the plywood and the laminate, and allowed to dry 30 to 40 min. The laminate then must be positioned on the wood carefully, since as soon as the coated surfaces make contact, they cannot be separated. ★ ★ ★

Firm pressure should be applied to the entire surface of the plastic-laminate top with a rolling pin







It is best to cut the laminate slightly larger than the table top and then file it back flush before attaching the metal molding. Below, table legs are screwed to top, setting them in 1 in. from corners. Several types of wrought-iron legs are available

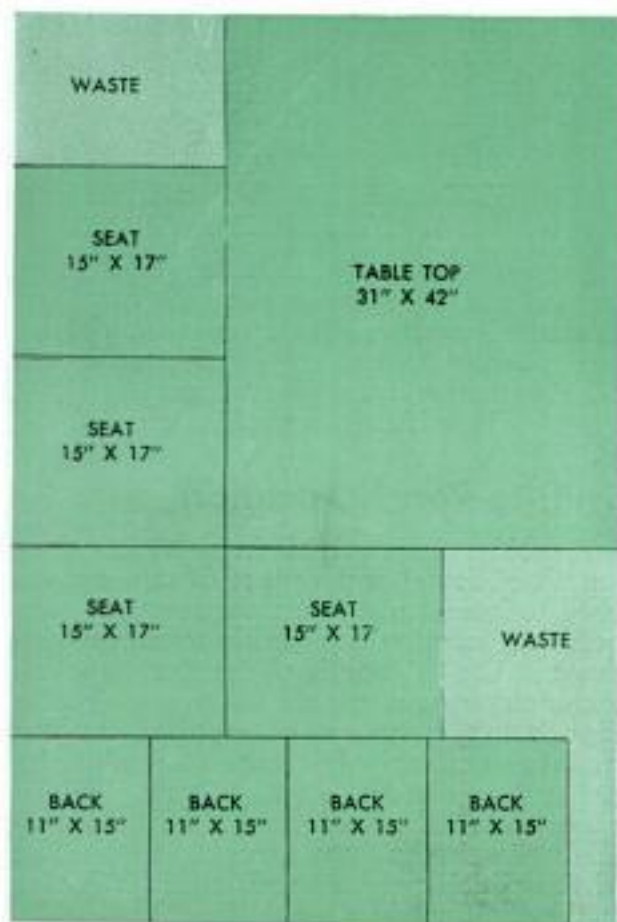
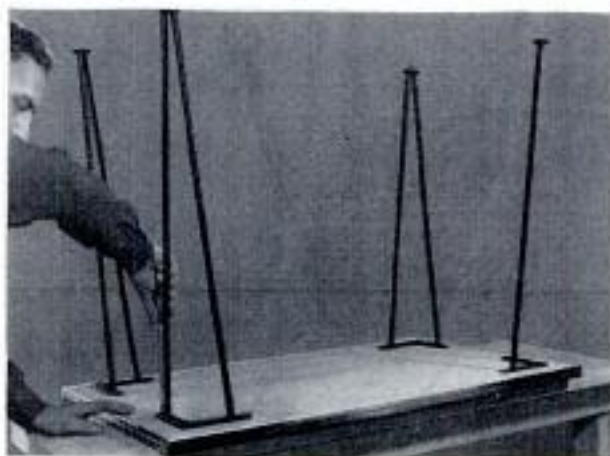

JUNE 1955

## Blotter Strips Around Cot Legs Bar Crawling Insects

When it is necessary to keep crawling insects from getting onto camp cots and bedding, one preventive measure consists of putting an insecticide barrier on each leg. Pieces of blotting paper are taped around each leg, saturated with DDT or other insecticide solution.

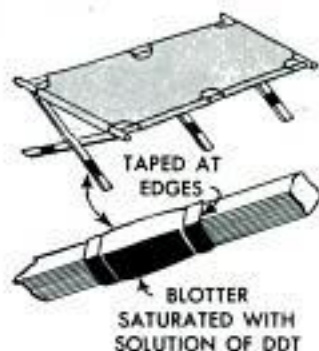

Keep the cot and bedding from touching a tent or cabin wall which would nullify the effectiveness of the barriers. Tables used for food can be protected in the same manner.

## Comfortable Kneeling Assured With Pad Pockets on Overalls

Comfortable sponge-rubber kneepads are always in place when and where needed if they are kept in pockets sewed to the outside of the knees of overalls. The "pocketed pads" are regular kneepads cut in half with all corners trimmed round.



When the overalls are to be washed, the pads are simply removed. The pockets can be made of overall material, but for longer wear light canvas should be used.

## Outdoor Window Boxes Supported By Storm-Sash Hangers

Storm-sash hangers can be used to provide inconspicuous supports for small outdoor window boxes that are stored for the winter. The hooks of the hangers are screwed to the siding of the house or screw-anchored to concrete or masonry and the eyes are screwed to the backs of the window boxes.



When it is time to store the boxes, they are lifted off the hooks.

151

Copyrighted material

# Letter Knives of Hammered Copper

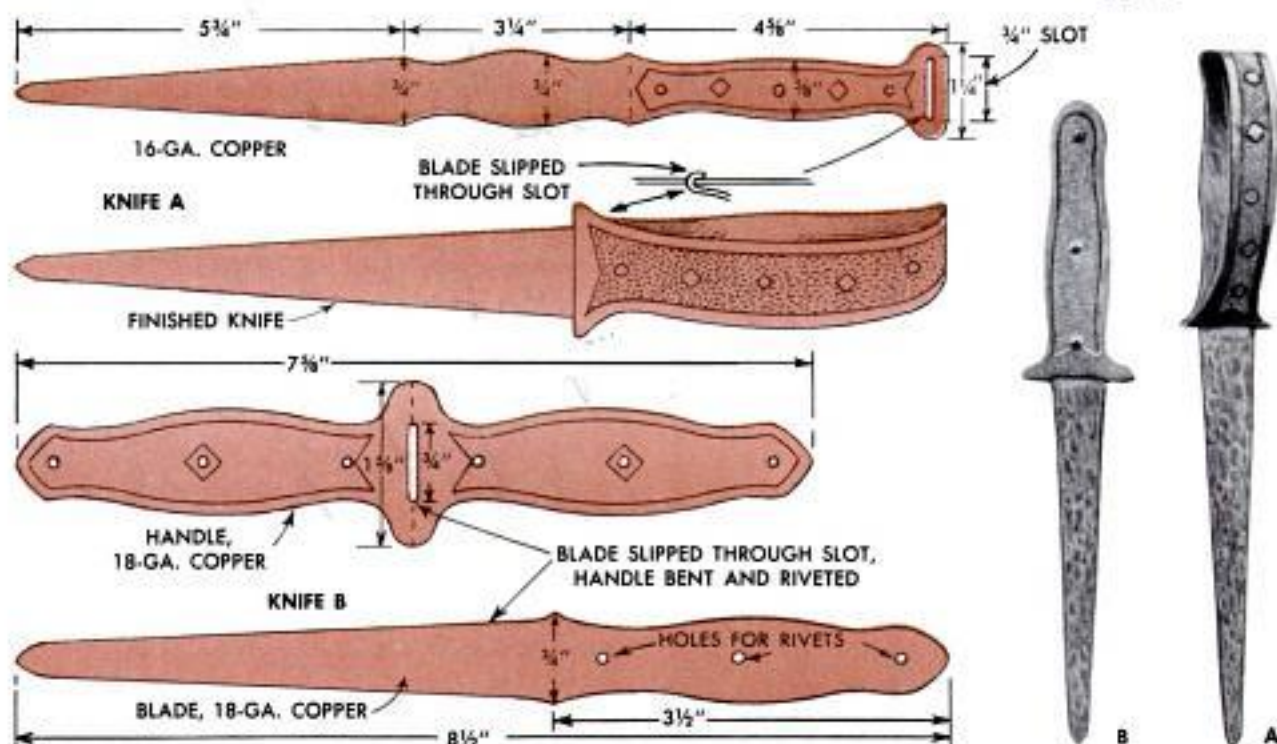

Either of these two copper letter knives makes an interesting addition to your desk or an attractive gift. Knife A is made from 16-ga. copper, the blade and handle being formed from one piece. The blank is cut out first, as in the upper detail, and then the handle portion is hammered with a ball-peen hammer. The center pattern of the handle is outlined and the diamond-shaped reliefs made with a blunt cold chisel. The small round reliefs are formed with a rivet set, and the decorative background is completed with a paneling tool, or with a nail set, center punch or any other tool that will make small indentations. Then the blank is bent and the blade slipped through the slot cut in the end of the handle portion. To hammer the blade to a knife edge, place the blade on an anvil or steel block and hammer one edge and then the opposite edge on the same face of the blade. Although the blade

will curve somewhat when the first edge is hammered, it will straighten when the second edge is hammered, provided the work is done carefully. Finally, file down both edges evenly. Knife B is made from 18-ga. copper in much the same way, except that the handle is cut out separately and riveted to the knife blank. After both blade and handle blanks are hammered and decorated, the blade is slipped through the slot in the handle blank and the handle is bent double. Then the handle section of the knife is drilled, as indicated, and the handle is riveted to the blade. To finish the knives, coat them with copper-nitrate solution, applying it with a cotton swab and being careful not to get the acid on the hands or clothing. Next, heat the knives with a blowtorch to a dark-brown color. Then brush off the residue, burnish and wax.

Dick Hutchinson, Alhambra, Calif.

## Pencil and Tape Hold Nut in Difficult-to-Reach Location



A holder improvised from a pencil or length of dowel and a piece of tape can be used to hold a nut when threading it on a bolt in a location impossible to reach with fingers. Cut a length of friction tape no wider than the nut is thick—to prevent the tape being caught between the nut and surface—and tape the nut to the end of the holder, as shown in the illustration. In cases where the holder must be held parallel with the bolt, tape the nut to the side of the pencil near its end, at right angles to the position shown.

## Adjustable Cardboard Pointers Assure Uniform Line Spacing



Held securely on a T-square or ruler by means of masking tape, the cardboard spacing guides shown in the illustration will enable you to rule equally spaced lines rapidly. In use, the guide points are aligned with the last line drawn in

order to position the ruler for the next line. Guides can be made in a number of lengths and kept handy on the drawing board, for use when different spacing is required.

## Dinner-Table Stunt With Spoon

A dinner-table diversion—of which your hostess should be informed beforehand—is apparently to bend the handle of a teaspoon in your hands. The secret of the stunt lies in the fact that the spoon handle actually pivots between the small fingers of your hands, the top end of the handle sliding down between the palms. When doing the trick, place the bowl of the spoon on a napkin, then hold the hands cupped as shown. Do not clasp the fingers, merely cup one hand over the other. Avoid altering the position of the hands and tense hand and arm muscles as though using considerable force. Realistic presentation of the spoon trick, as with any illusion, requires practice beforehand.

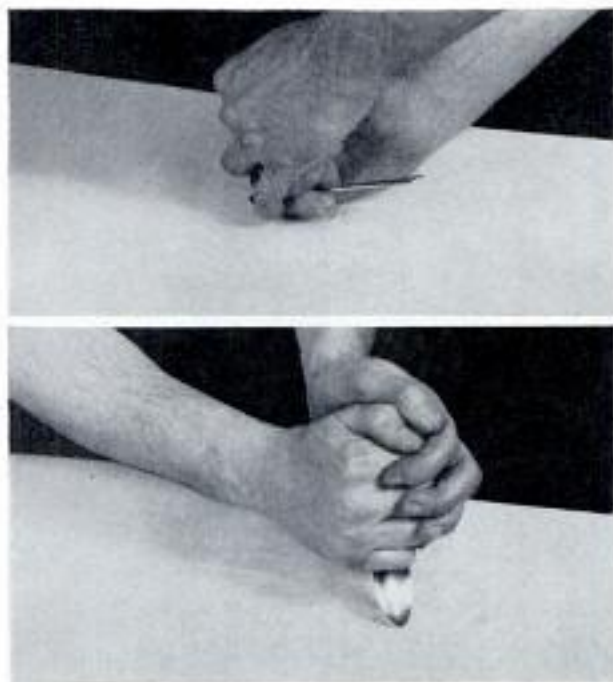

JUNE 1955



## Tumblers and Embroidery Hoops Provide Party Game

An interesting party game for youngsters, in which the prizes are visible to the contestants, requires only a few water tumblers and a couple of embroidery hoops. The prizes are placed under the tumblers which are inverted on the floor in a geometric design, such as the triangle shown. Each child then is given two or more embroidery hoops which he attempts to toss over the tumbler containing his choice of prize.

## Chimney Efficiency Improved By Metal Draft Deflector

A chimney which is adversely affected by horizontal air currents from any direction can be improved by installing a draft deflector made from a 5-gal. can. A hole is cut in the bottom of the can and the top is completely removed. The top edge of the can then is slit at each

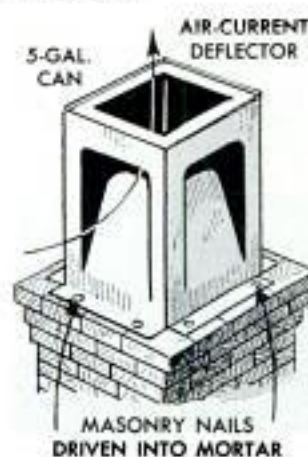

corner and the edges bent down at right angles to form flanges for fastening the inverted can on the chimney top. All four sides of the can are cut and bent in, as shown in the illustration. Masonry nails are driven through the flanges on the can and into the mortar of the chimney. The draft deflector also could be fabricated.

153

Copyrighted material

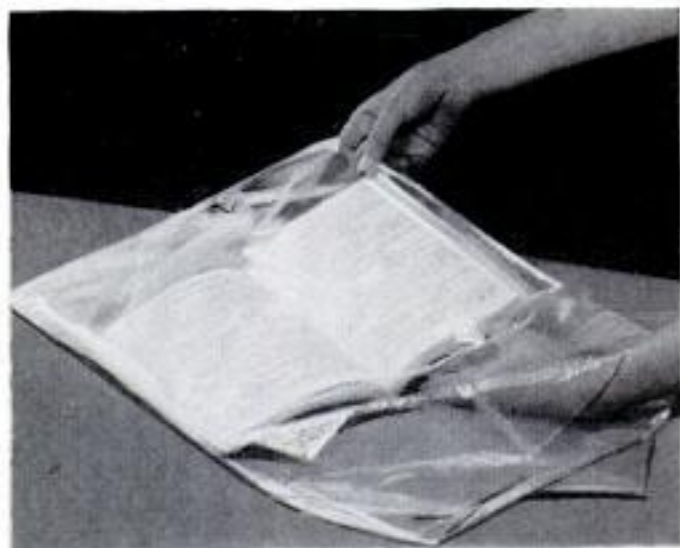

**RECIPE BOOKS** are kept clean and free of grease spots when used on the kitchen counter if the open book is slipped into a transparent plastic bag. The print is visible through the plastic, the bag will keep the book open at the right page, and the bag is easily washed

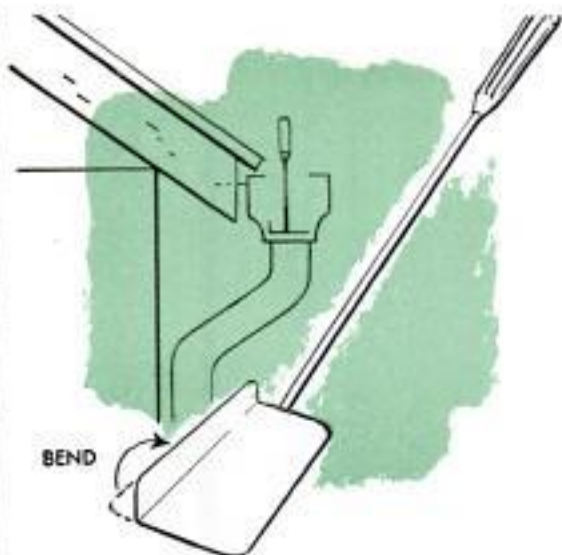

**LEAVES AND OTHER DEBRIS** which accumulate in eaves trough can be removed easily with the help of a pancake turner that has been altered as shown. The blade is bent in a vise so that it fits into the bottom of the trough

Solving

# HOME PROBLEMS

**WHEN CUTTING WINDOW SHADE** to fit narrower roller, the edge to be cut can be kept straight if it is marked by inserting a pin through the material. Roll the shade evenly, then pass the pin through all layers. With the shade unrolled, pin holes will mark line to be cut. For greater accuracy, draw line along holes before cutting.

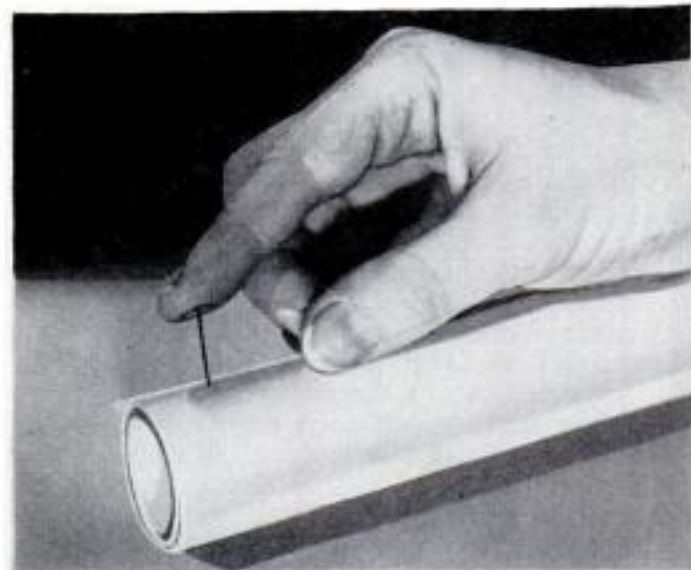

**A DRESSMAKER'S DUMMY** is less likely to tip if a plywood disk is attached to the feet as shown. The disk should be cut from  $\frac{3}{4}$ -in. plywood and the diameter should be slightly larger than the spread of the feet. Drill each leg for wood screws for attaching the disk

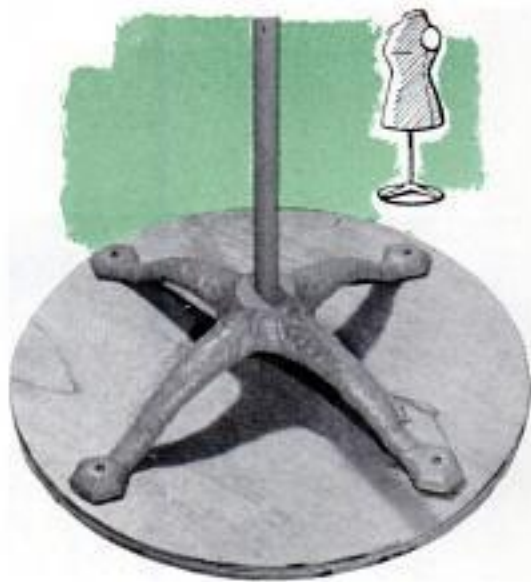

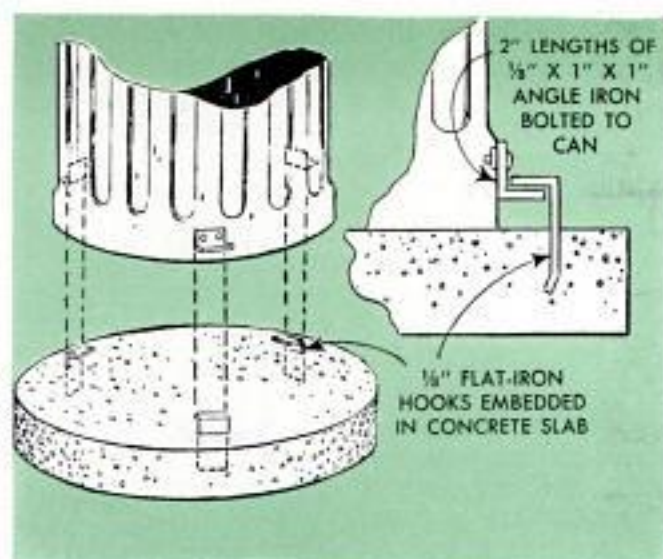

**DOGS WON'T BE ABLE TO TIP** over a garbage can if the can is locked on a concrete base. A 4-in.-thick concrete base is poured for the can and three brackets are set equidistantly in the wet concrete. Then three similar brackets are bolted to the can. To lock in position, set can on base and turn until the brackets engage as shown

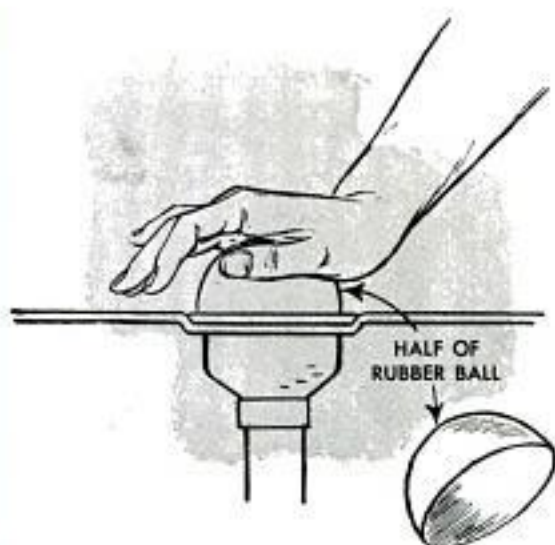

**IF SINK DRAIN IS STOPPED UP** and no plumber's force cup is available, half of a child's hollow-rubber ball can be used as a substitute. Rapid pressing on the ball with the hand produces suction. The rubber walls of the ball must be thick enough to provide good spring action

**YOUNGSTERS WON'T BE** tempted to climb a trellis to which a length of poultry wire has been stapled. The wire will prevent them from getting a foothold on the trellis but is not dangerous to them, nor will it prevent vines or rosebushes from climbing. Use the wire to a height of at least 5 ft. or more

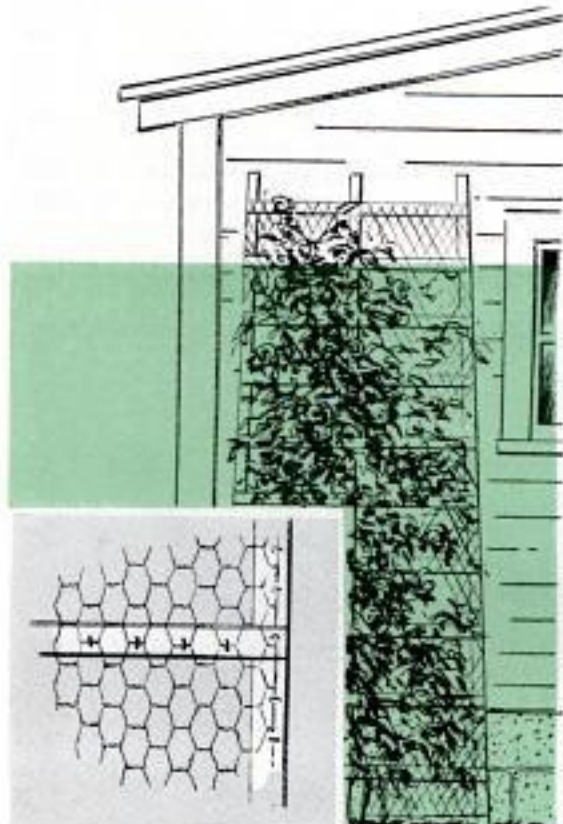

**GROUND COFFEE CAN BE POURED** from an opened can into a storage container without spilling if a two-piece photographic funnel, which can be purchased at any photo-supply store, is used. The larger section of the funnel will just fit over the top of the can snugly. Smaller half of funnel, pictured at the left in the photo below, can be used if the coffee is to be poured into a narrow-mouthed container



## Loose Woodpile Ends Fastened With Old Auto Chains



Since they are dangerous to children who might be tempted to play on them, loose woodpiles should be fastened securely in place when first stacked. One way of doing this is to set straight saplings vertically against the end of the pile as it is stacked, as shown, and then secure them with chains which extend into the woodpile and are held by the weight of the wood.

## Emergency Methods of Boring Holes In Confined Places



The next time it is necessary to bore a small-diameter hole with a wood bit in such small quarters that a brace cannot be used, use a door-knob as shown. Slip the knob on the shank of the bit and tighten the setscrew so that the bit can be turned by hand.

Another emergency method of turning a bit is to use a ratchet wrench that has a square hole of the proper size to receive the shank of the bit.

## Rusted Bolt Loosened Quickly

When it becomes necessary to loosen a rusted nut or bolt, form a dam of putty around it, and then pour in a small quantity of any carbonated beverage. This will

loosen the rusted part quicker than most penetrating oils commonly used for the same purpose. If the nut is in a position where the putty dam is impossible, good results can be obtained by applying the fluid with a saturated cloth or sponge.

## Sheet-Metal Support for Ladle

A supporting stand for holding a lead-melting ladle over a gas-stove burner can be cut in one piece from heavy sheet metal. The pattern for the stand is shown in the detail. The cutout for the ladle must permit it to sit deeply enough so it is held firmly against tipping. Three

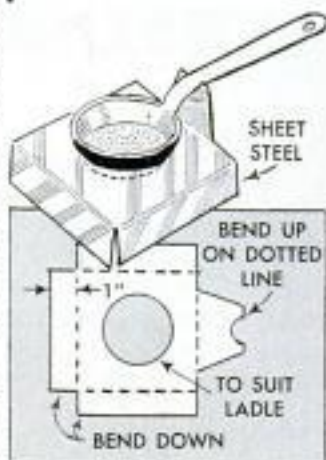

sides are bent down to serve as legs and the extending tab on the fourth side is bent up as a support for the ladle handle. Adjust it to support the ladle in a level position over the burner. If the stand becomes overheated, it may be necessary to drill a number of holes in the bent-down sides to permit a circulation of cooling air.

## Finger Grip on Case Aids Winding Long Measuring Tape

A small, wooden finger grip cemented to the case of a long measuring tape will make it easier to hold when winding the tape. The grip, which can be a portion of a thread spool or a special turning, is located on the side of the case opposite the crank. If the case is disassembled easily, small nails or screws can be driven from inside the case into the grip.

H. Hanscom, Elmhurst, Ill.



# How to Select a Used Outboard

Even though the cost of a new outboard motor is more than the budget can stand, you still may be able to join in the outboard-boating fun this summer by buying a used motor. As, in most cases, a good used outboard can be purchased for only a fraction of the cost of a similar new model, you probably can buy one that is well within your price range. When you have found a motor you want, a good idea of its condition can be had by checking the following points.

**1. Compression:** Pull the starter rope and note the "pull" and "bounce" as the motor turns over. Before you do this, be sure it is not possible for the motor to start.

**2. Crankcase bushing:** Check for excessive accumulation of dirty oil on the armature plate. Its presence indicates a faulty upper-bearing assembly.

**3. Condition of cylinders:** Remove the spark plugs and check the inside of the cylinder head with the aid of a pencil flashlight. Excessive carbon deposits here mean poor motor performance immediately.

**4. Propeller bushing:** Exert up-and-down pressure on the propeller shaft and look for seepage around the propeller-shaft bushing. Excessive up-and-down play or seepage indicates a worn bushing.

**5. Needle-valve response:** Insist that the motor be run in a test tank and check both slow-speed and high-speed carburetor adjustments. In this way you can tell whether

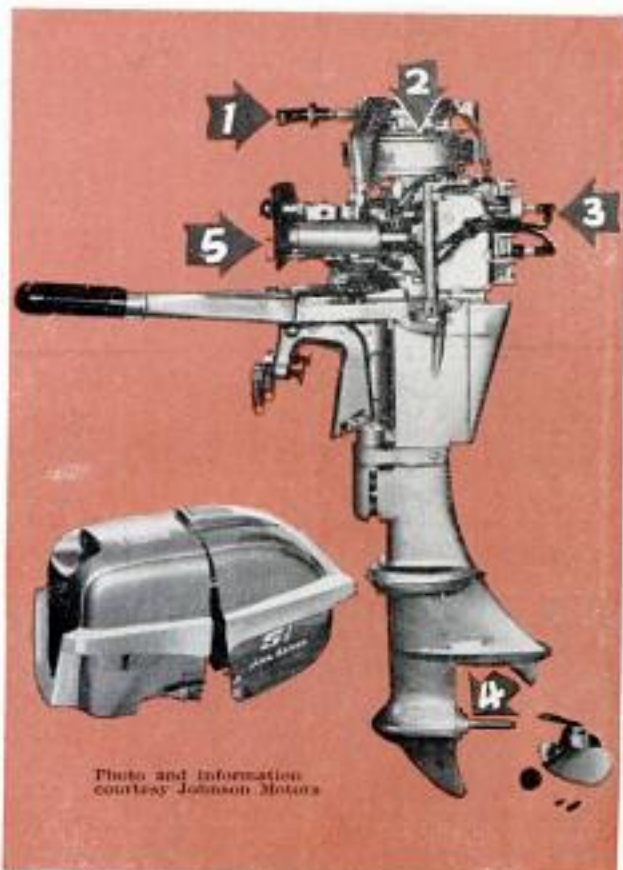

or not the needle valves respond readily. While the motor is running, note particularly if it idles smoothly. At this time, you also can check the condition of the wiring, fuel connections and fuel line.

## Display Holder for Collector's Miniature-Cup-and-Saucer Set



Cup-and-saucer collectors who have difficulty finding display holders for miniature-size sets can build their own inexpensively from  $\frac{1}{4}$ -in. hardwood stock. The stock is cut and shaped to the dimensions shown in the detail. A slot for the saucer and well for the cup are routed to a depth of  $\frac{1}{8}$  in. The diameter of the well is determined by the size of the base of the cup for which the holder is designed. The holder detailed is for a cup of approximately 1-in. top diameter. The holder could be made to accommodate various sizes.

Jane Whitman, Chicago.

## Small Insecticide Sprayer

An insecticide sprayer for use in an automobile can be made by utilizing a plastic spray bottle in which cosmetics are packaged. Small and leakproof, the emptied bottle, when filled with insecticide, is carried easily in the glove compartment. The sprayer also is handy on picnics.

Gene L. Henderson, Philadelphia, Pa.

# COMPLETING THE PM PRECUT HOUSE

By Richard F. Dempewolff

**H**OW WOULD YOU LIKE your new PM House? With two or three bedrooms? Take your choice. The difference in cost of materials wouldn't buy the week's groceries. If you want four bedrooms and two baths, with attached two-car garage, that can be arranged too. There are plans for an added wing that will cost about \$1500 more for materials.

Once the precut shell is erected, there is almost no limit to what you can do with it. Maybe you prefer wood siding. If so, put it on. The Homasote in the kit makes an ideal sheathing with high insulation value. Is a hardwood floor important to you? Put it right on top of the flooring that came in the kit. This single floor was designed to serve as a finished floor as long as needed, but makes a good subfloor for any surface.

In the test house, we allowed ourselves \$1000 to develop the shell first into a summer cabin, with partitions finished on one side, and with plumbing, wiring and fireplace chimney complete. A final \$1000 was budgeted to produce the fully winterized "stage 3," including insulation, finished ceilings, walls and trim, heating system and built-ins. To achieve this, we had to be careful of our "extras." The siding looked perfect the way it was, and we knew it would last as long as we would. So, it is

Finished storage wall on bedroom side has a built-in chest, luggage bin, cedar wardrobe and cabinets

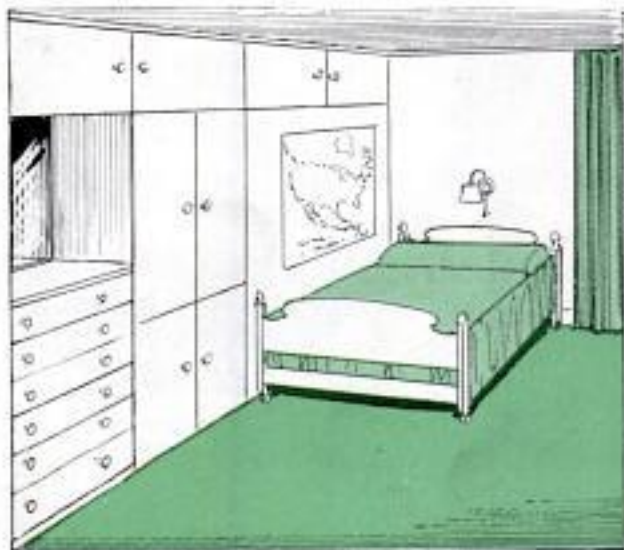

Partition walls with single top and bottom plates are assembled on deck, then tipped up into place



Short blocking between partition studs provides nailers for wooden wall panels. Insulation is reflective type, applied with a rented stapler, below





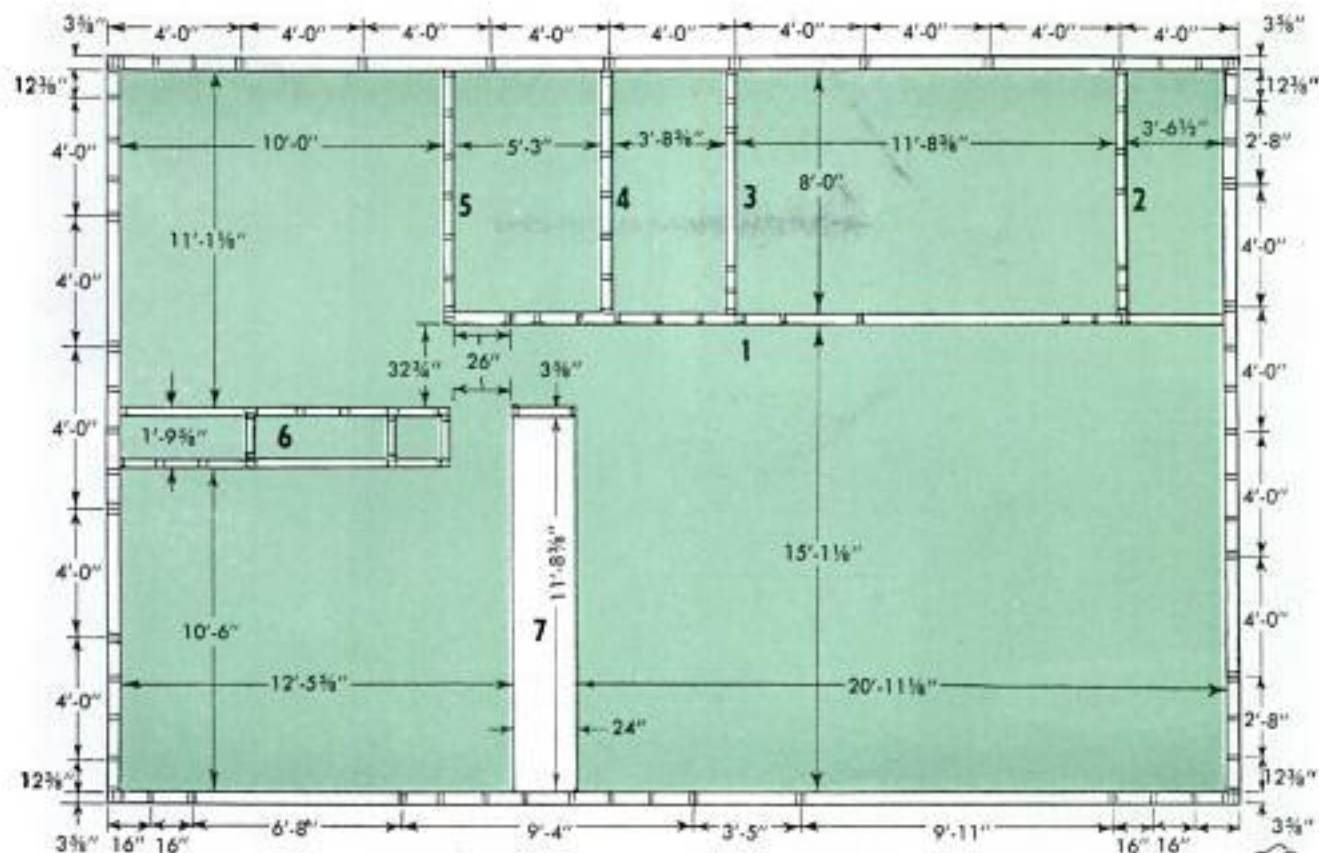

**WALL FRAMING AND PARTITION PLAN**

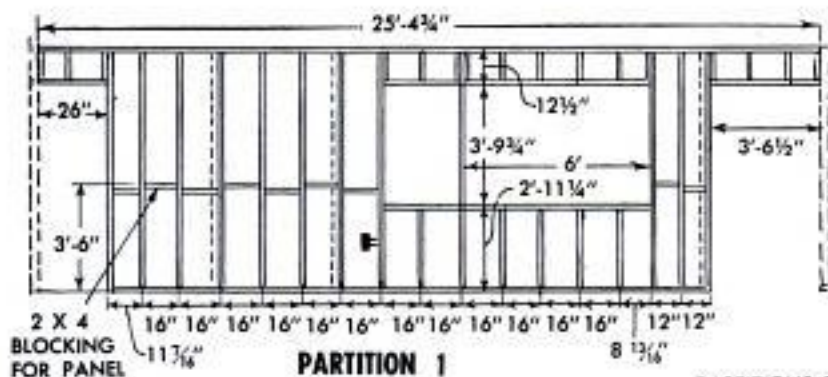

STRIP OF WASTE FLOORING NAILED TO BACK OF END STUD ON ANY WALL AT RIGHT ANGLES TO PARTITION NO. 1 PROVIDES CORNER NAILER FOR SIDING

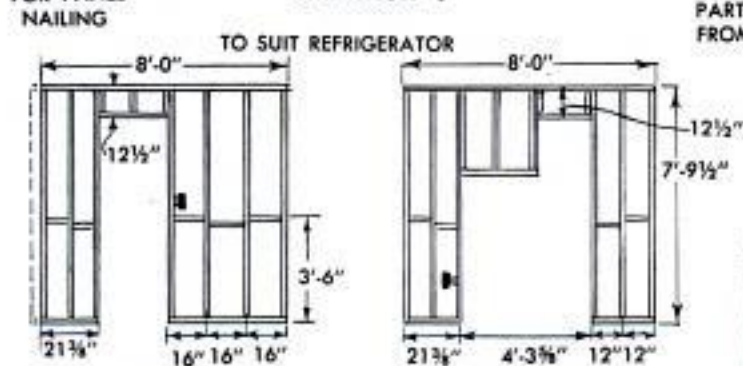
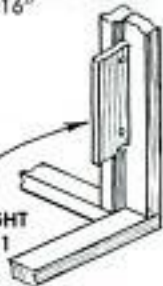

PARTITIONS 2, 3, 4 AND 5 VIEWED FROM PORCH END OF HOUSE

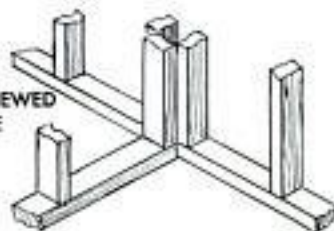

Partition framing is designed for simple assembly. Plates are laid out first, as below

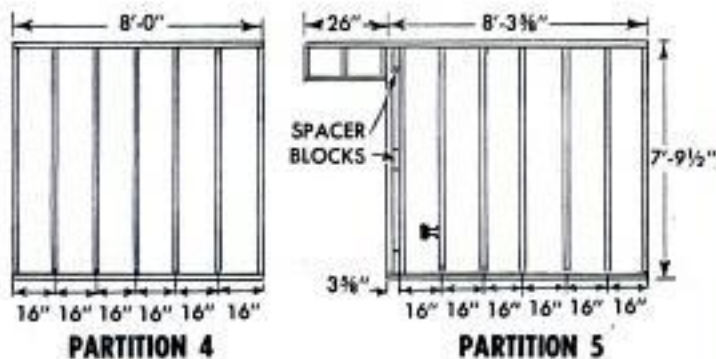

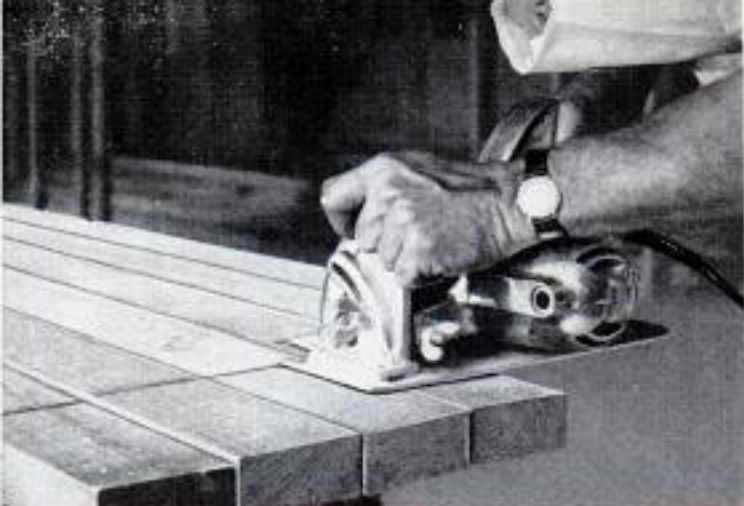

Partition studs are clipped off up to 12 at a time by using a simple jig and a portable electric saw



Furring strips nailed to roof trusses support fasteners that clinch big ceiling panels from behind

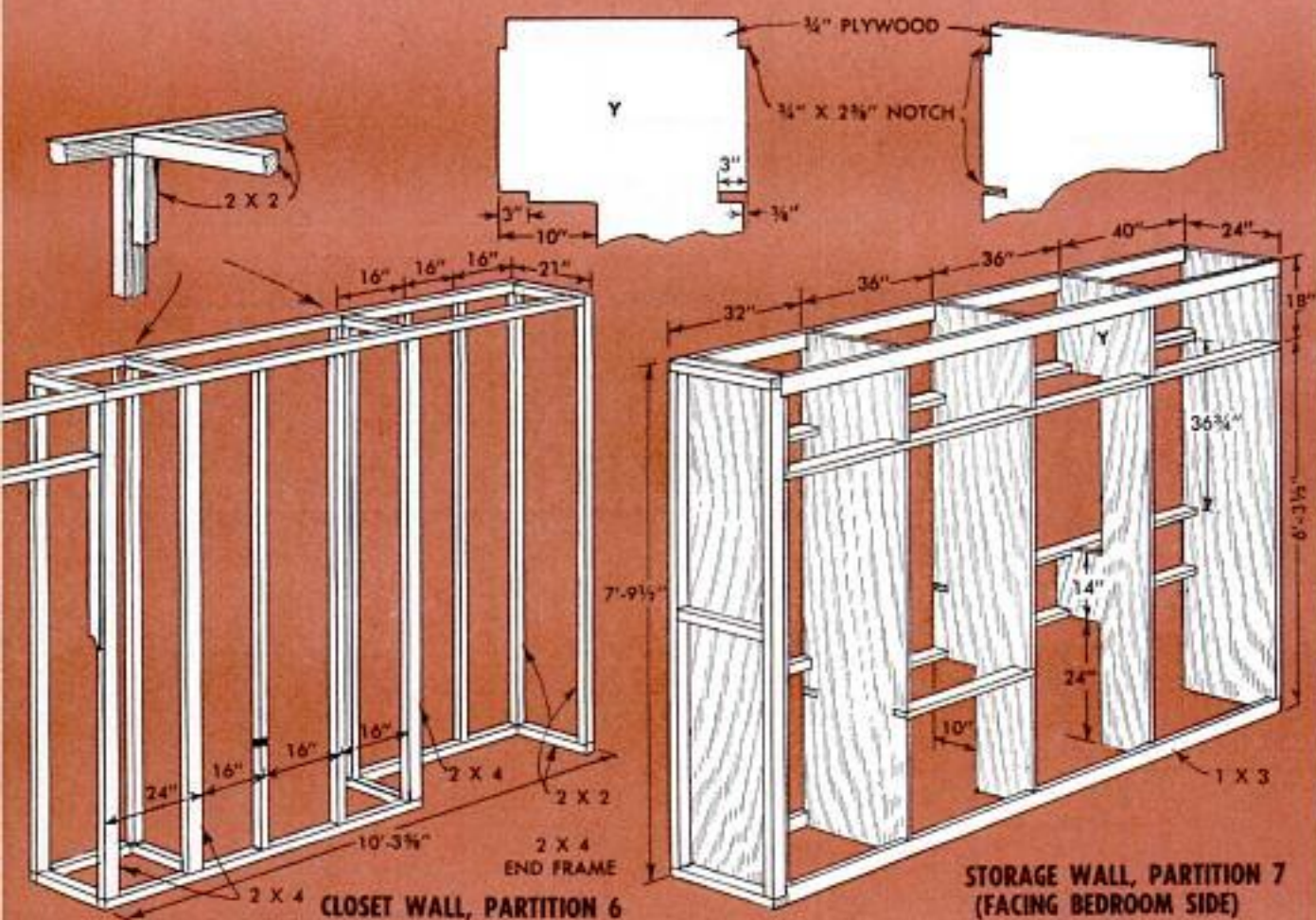

Huge Upson wallboard panels, up to 8 x 20 ft., pass through any standard door if bowed with black slings

Ceiling fasteners are clinched in rear side of wallboard panels with hammer and padded block

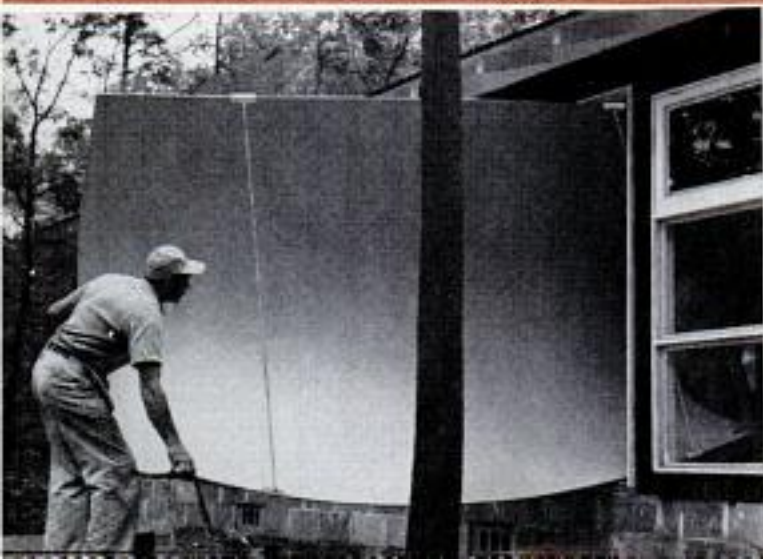



King-size panel covers entire wall with no nails showing. Secret is a claw that grips panel from behind. Studs are marked, and fasteners nailed to them, above. Same interval-marked stick used on studs now locates fasteners. Each is clinched, right

our permanent exterior. The single fir flooring is our finished floor, except for kitchen and bath which are tiled in linoleum and vinyl asbestos respectively. Actually, we like it as is and it may stay that way.

The fact is that completion of this house is entirely up to you. The pictures and sketches on these pages merely show one way in which the shell may be completed under cost limits mentioned.

Our two-bedroom floor plan cost about \$20 less than the three-bedroom plan described in the book and blueprints on this house. But two bedrooms or three, partitions are constructed in the manner shown on page 159. Because the trusses make a self-supporting roof, partition walls bear no weight. Single top and bottom plates do the job that requires double plates in conventional houses. All studs are 16 in. on centers, as shown, except where walls are too long or short to take this "module." Then, spacer studs are set closer, to make the others come out even—as was done on the right end of partition 1.

Closet wall, partition 6, designed to go between two adjacent bedrooms, is framed largely of 2 x 2 material to save lumber and space. And the storage wall—which



is designed to go between living room and bedroom—is a simple frame of plywood and 1 x 3s. By using plywood dividers instead of vertical framing members you kill two birds with one stone. The dividers become the interior walls of the cabinets.

Closet and storage walls are best framed in place. Flat partitions can be assembled on the floor and raised in place as shown.

Before insulating the house or covering

Combination tool, such as this Shopsmith, earns its way in cutting, shaping and jointing finish trim



### *Detailed Book Shows How*

In addition to a 128-page instruction book which shows you step by step how to build the precut house, there is a complete set of blueprints available. Write: Blueprint Department, Popular Mechanics Magazine, 200 East Ontario St., Chicago 11



Fuse box to handle all circuits is a four-fuse service located in entry closet right behind meter



Counters are designed to make standard-size plastic top easy for amateurs to apply, like this Formica



Fixtures in plumbing kit for this house are designed for amateur assembly. Kitchen sink, above, is fastened to the counter top with simple ring and clamps. Lavatory legs, below, are adjustable



Water for the test house is pumped from private well by a Myers jet pump that is easily primed and drained for seasonal use. Below, closet and pass-through closures are Novafold sliding bamboo doors



any walls, wiring and plumbing are installed. Electrical circuits for this house are the simplest possible, so that an amateur can install them himself where codes permit. The entire plumbing—including all units and fixtures for complete bath and kitchen, plus rigid copper tubing, and all necessary drainpipe cut to size and threaded—is available in a do-it-yourself kit made up especially for this house. The copper tubing is sleeve-jointed and soldered. Other units are designed for rapid assembly by an amateur craftsman as illustrated on page 162.

Though the *PM Precut House* shell is designed to take any type interior finish, including plaster, "dry wall" construction was used in the test house due to its ease and speed of application.

Floating fasteners nailed to the studs, as shown in the photos on page 161, grab the Upson panels from behind, so no nailheads show on any wall or ceiling. The huge 8 x 20-ft. panels cover entire wall and ceiling areas without a seam in evidence. Genuine 3/4-in. redwood used in living areas (and to make the beams for all ceiling seams) is easy to work and remarkably cheap. Cabinet, interior doors and trim are all made of this material.

Installation of a heating system is a mat-

**Prefab Van-Packer chimney hangs on ceiling joists, will flue any furnace, can be erected in 3 hours**



JUNE 1955



**Open-face modular closets in kitchen frame pass-through opening. Cabinet doors are cleated redwood panels hung with wrought-iron strap hinges**

ter of choice. In the test house, the LP gas space heater required three hours to install. It keeps the house at 70° in zero weather. The packaged utility chimney (below, left) went up in one morning. Its three sections of cement asbestos with tile lining, sit in brackets between ceiling joists and will flue any furnace you care to put in the house.

If you do the important things first, you can satisfy a lot of whims with what's left of your budget. Plans and directions for some of those whims—such as a bed with gliding drawers for Junior's treasures, and a roll-away closet for sports and recreation gear—are fully detailed in the blueprints and book. ★ ★ ★

**Luxury items left until last include cedar lining for storage-wall wardrobe and blanket cabinets**



163

## Antisplash Box Prevents Damage By Water From Dormer Downspout

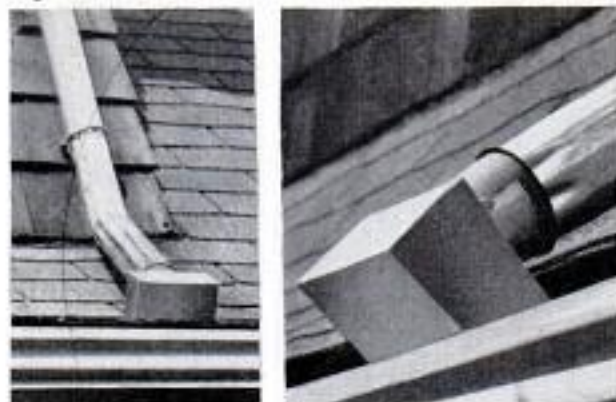

Running the downspout from a dormer roof into an antisplash box fitted over the eaves trough on the main roof was the method used by one homeowner to eliminate two problems caused by rainwater draining from the dormer. The first problem was damage to the roofing resulting from the rush of water across it as water drained from the dormer downspout. The second problem was damage to the side of the house and dampness in the basement, caused by water running across the roof so rapidly it overshot the eaves trough and ran down the wall. The antisplash box is made from 26-ga. sheet metal. It is 5 $\frac{3}{8}$  in. long, 3 $\frac{1}{4}$  in. high, and the cross section tapers from 2 $\frac{3}{4}$  in. at the top to 2 $\frac{3}{8}$  in. at the bottom where it fits between the top edges of the eaves trough. The upper side of the box is fitted with a standard slip fitting into which the downspout is pressed.

L. H. Georger, Buffalo, N. Y.

## Plastic Tape on Casters Prevents Black Streaks

Black streaks on hardwood and tile floors caused by rubber furniture casters can be prevented by covering the casters with a strip of electrician's plastic tape. The durable plastic tape will last from 6 months to a year under steady usage. It then can be replaced easily.

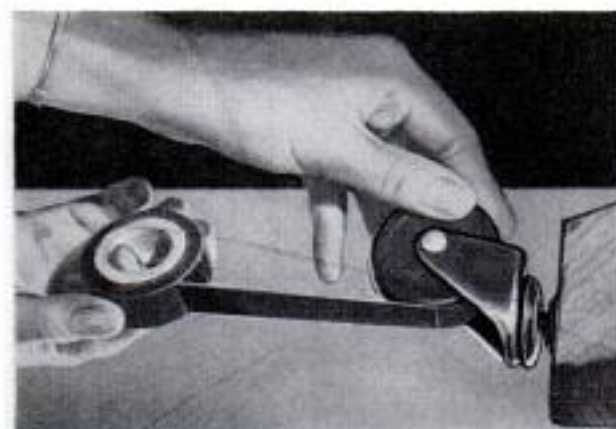

# AUTOMATIC

**R**ELYING ON MEMORY to turn a dehumidifier off when not needed usually results in unnecessary operation. But with this humidity-sensitive control you can practically forget about your dehumidifier so far as watchful operation is concerned, for it will turn it on and off automatically with rise and fall of humidity in the room.

The heart of the control is a humidity-sensitive element which is made by cementing a strip of blotting paper to a strip of very thin copper. In use, the blotting paper absorbs moisture in proportion to the atmospheric humidity and in so doing, expands, causing the copper element to curl as the humidity increases and make electrical contact. The element is made from a strip of .003-in. sheet copper,  $\frac{1}{2}$  in. wide and 5 $\frac{3}{8}$  in. long. It is important that the blotting paper be dried in an oven at 225°F. for 15 min. just before it is cemented to the copper strip.

A small silver or tungsten contact is soldered to the copper side of the element  $\frac{3}{16}$  in. from one end, and a  $\frac{5}{16}$ -in. hole is drilled at the other end for mounting the element. The support bracket for the element is cut and bent from thin brass,  $\frac{3}{8}$  in. wide. Then a 6-32 brass machine screw is soldered to the bracket as shown and flats are filed on the end of the screw so it can be turned with pliers to adjust the element. A  $\frac{1}{2}$ -in. 6-32 brass machine screw is used to mount the element on the bracket, placing the copper side of the element against the bracket and a  $\frac{1}{2}$  x  $\frac{3}{8}$ -in. brass "washer" between the blotter side and the nut. A fixed bracket, fitted with a silver or tungsten contact, also is cut from thin brass.

The case for the control is made of 18-ga. sheet aluminum and fitted with screen-wire sides to allow air to pass through to the element. Both the element and the fixed contact are fastened to the top of the case which is a piece of  $\frac{1}{8}$ -in. hardboard or Bakelite. A receptacle is mounted in the back panel of the case, and a single-pole, double-throw, center-off toggle switch (equivalent to a 3-position rotary switch) is mounted in the front panel. A 6.3-volt, 3-amp. transformer, such as a filament radio transformer, and a 6-volt, single-pole, single throw, normally open relay are mounted on the base of the case. The various parts are wired according to the diagram given.

The element will move approximately  $\frac{1}{8}$  in. during a 10-percent change in humidity. Position the element so it will be

# DEHUMIDIFIER CONTROL

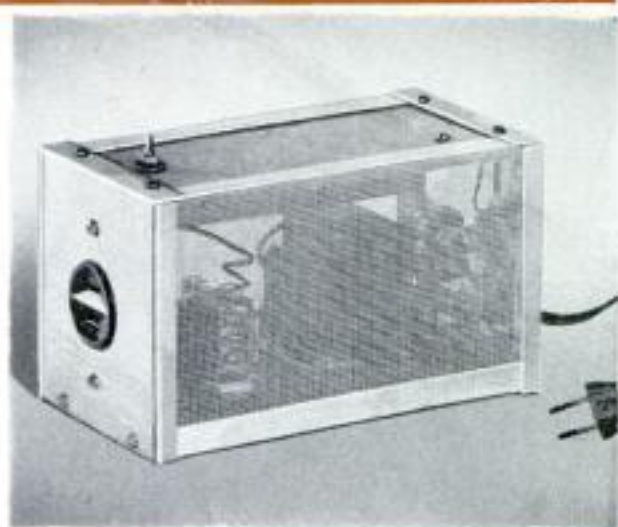
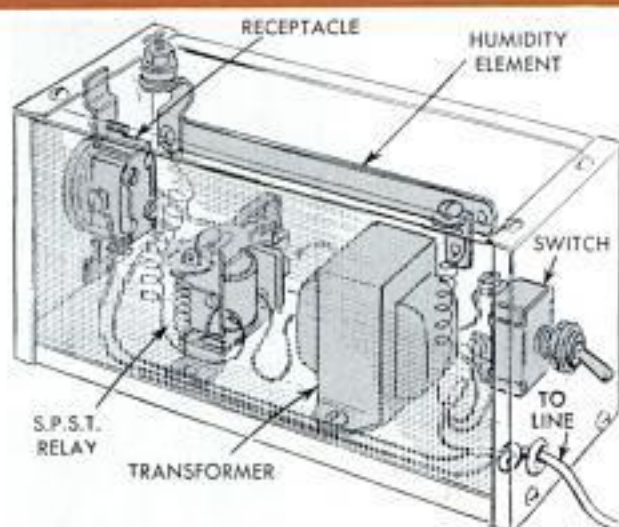

parallel with the side of the case. With the element in this position, the control will usually operate at about 50-percent relative humidity, which is a satisfactory level for most purposes. By turning the flat-sided adjusting screw with pliers, the humidity turn-off point can be regulated (raised or lowered) as desired. The dehumidifier switch should be left in the "on" position and the control switch in the "automatic" position. The dehumidifier will operate as long as the humidity element contacts are closed and will shut off when the humidity drops sufficiently to open the contacts. ★★★

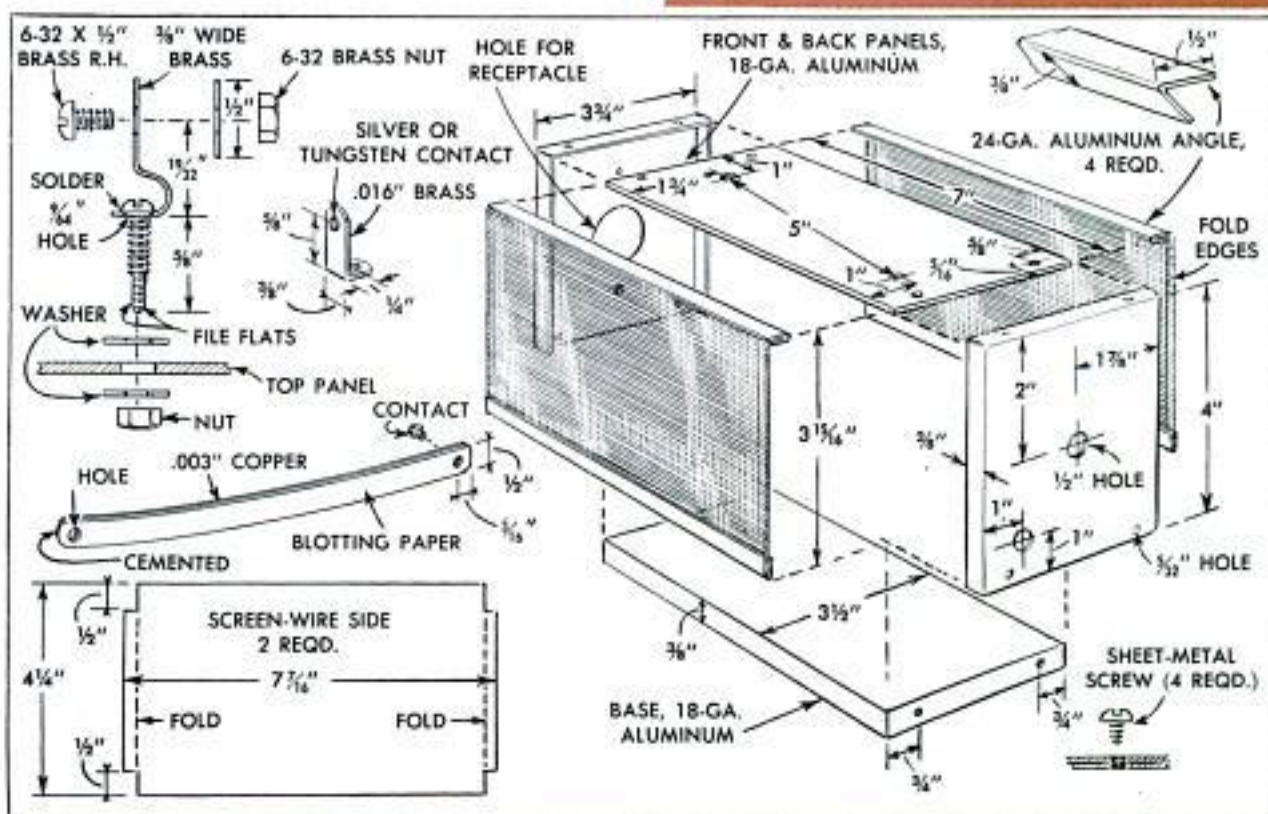
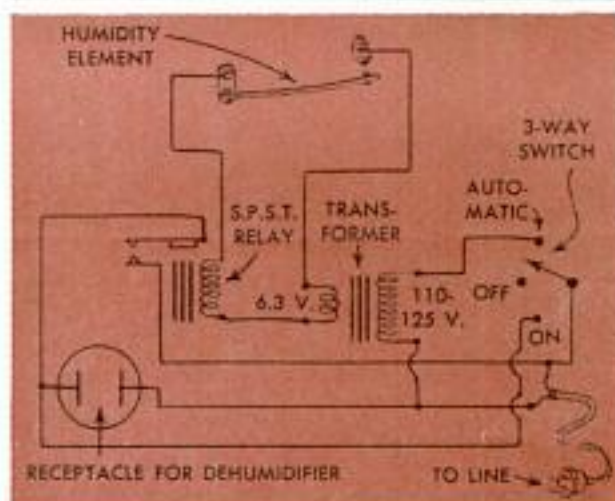

# PATTERN CRAFT LAMPS

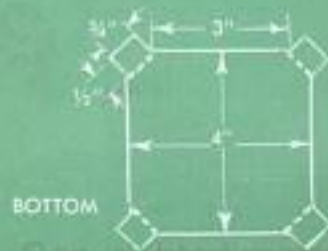
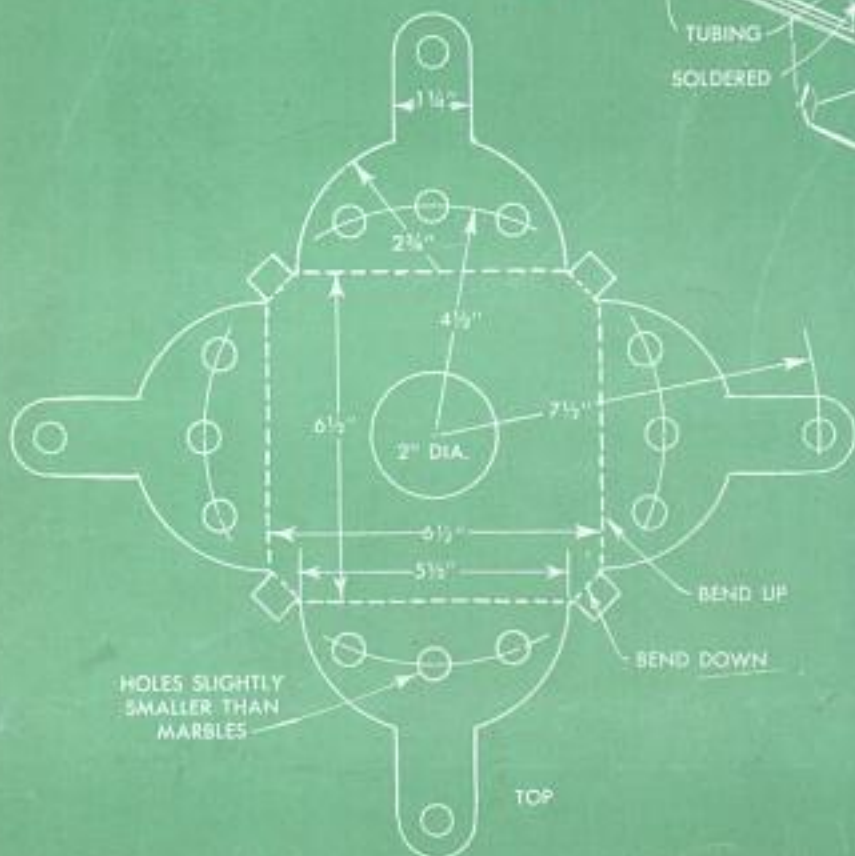
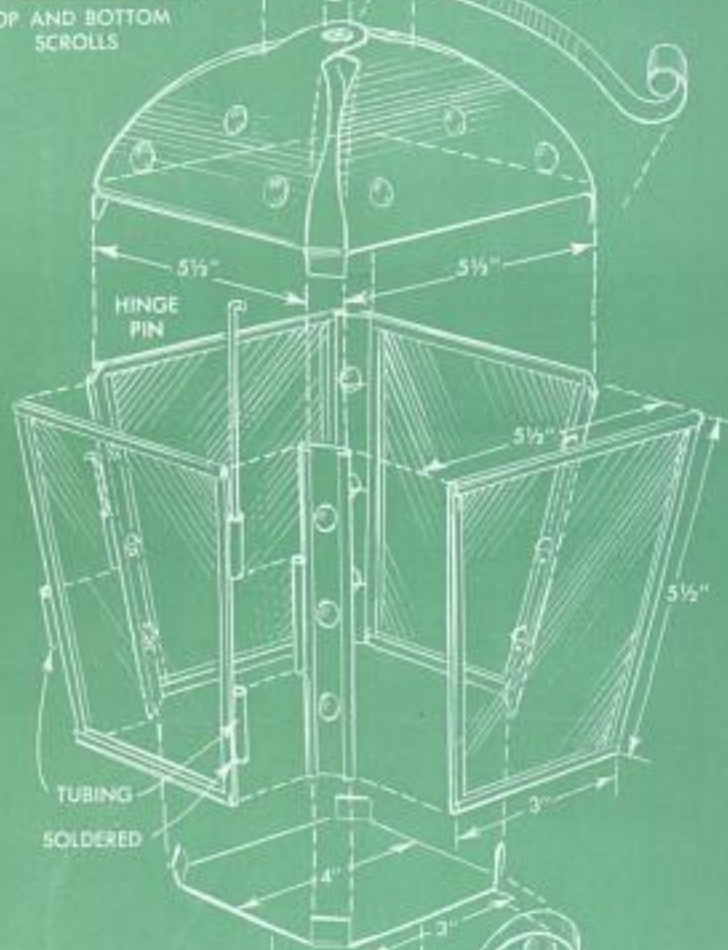
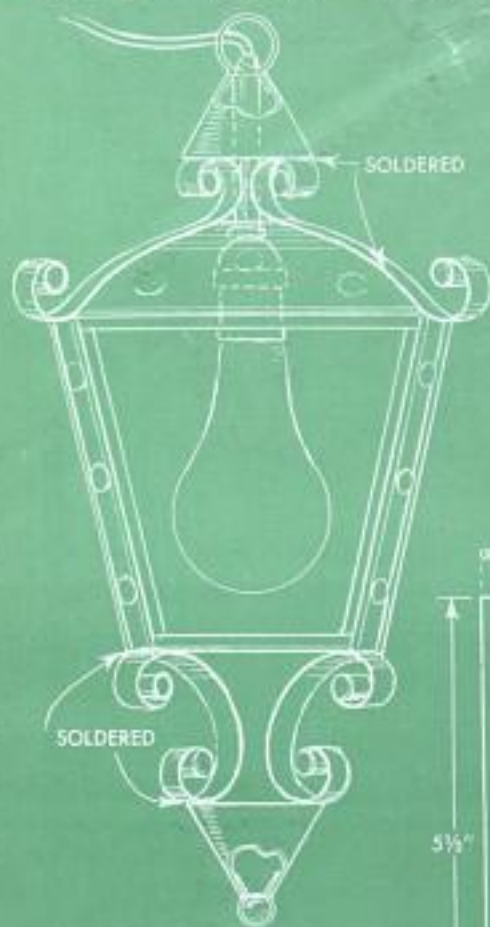



# and PLANTER

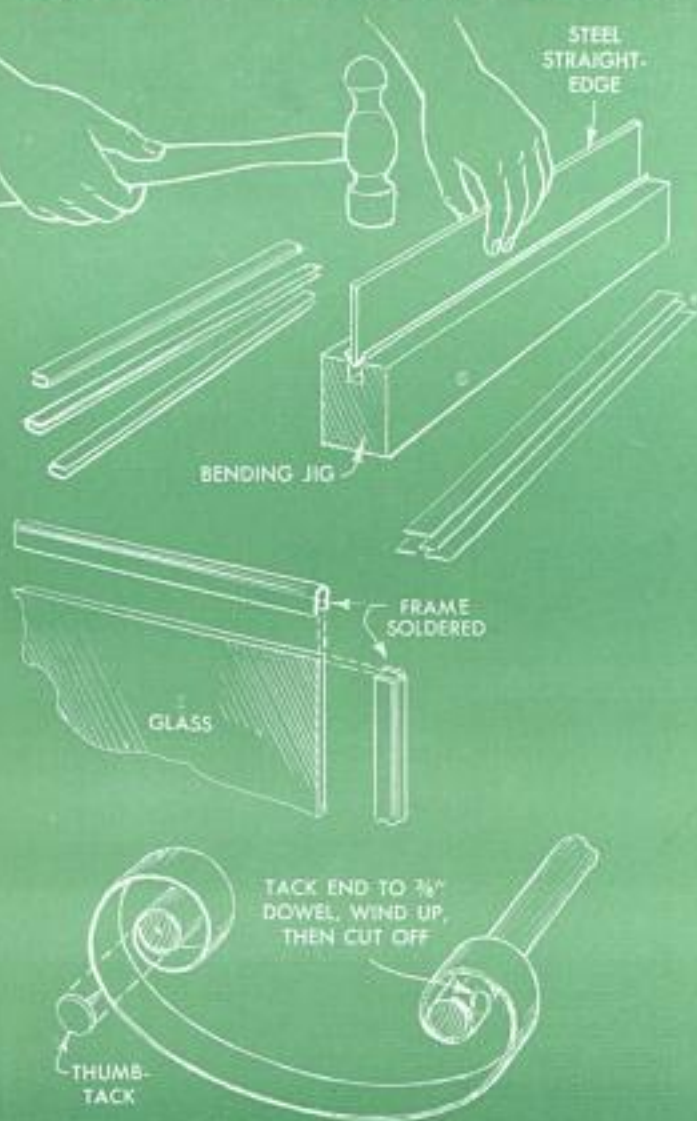

## FULL-SIZE PATTERNS

Actual-size patterns which can be traced directly on your metal save you the trouble of making a full-size pattern from the magazine plan. If you prefer to make the jewel lamp detailed here from a pattern already drawn full size, you can purchase this pattern by writing to ~~Pottercraft, Popular Mechanics Magazine, 200 E. Ontario St., Chicago 11, and asking for plan No. 118.~~ This plan also includes full-size trace-and-cut patterns, plus instructions, for making the hanging planter and the coach lamp pictured at the right. All three items are basically tin-snip-and-solder projects. The fairylike jewel lamp from Old Mexico makes use of colored glass marbles for the jewels. Holes for the marbles are stamped out with a homemade punch which is made by grinding one end of a piece of pipe to provide a cutting edge. The holes are punched with the metal placed on a hardwood block. Wire bands hold the marbles in the holes

WTM '57



*Jewel Lamp*



*Hanging Planter*



*Coach Lamp*

## Telescoping Camera Tripod Used as Sketching Easel



A small telescoping camera tripod does an excellent job as a sketching easel when light weight and compactness are required. Some tripods can be folded and telescoped down to a 10-in. length. The telescoping feature also is useful for adjusting the height of the easel. A sketch pad or drawing board is placed against two of the tripod legs and supported on spring clips. The clips can be the flat-spring type or clipboard clamps which have a circular cross section that fits the tubular legs of the tripod can be used.

## Wide Footrest on Shovel Prevents Foot Soreness

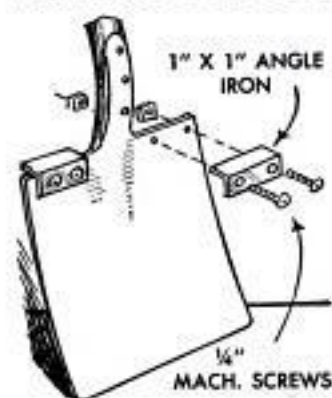

When it is necessary to use a spade or a shovel for any length of time, sore arches can be avoided if a wide footrest is attached to it as shown. The rest is made by bolting lengths of 1-in. angle iron to the shovel with  $\frac{1}{4}$ -in. machine screws.

The wider contact area that is provided distributes strain over the foot and prevents soreness.

## Suet "Cupcake" Is Bird Treat

A real treat can be provided for the birds at your feeding station by serving them bird "cupcakes." The cakes are made

by mixing a handful of sunflower seeds, grain or commercial birdseed into some melted suet and pouring the mixture into paper drinking or baking cups. After the suet has cooled and hardened, place the cups on the feeding stations.

R. M. Woodbury, Natick, Mass.

## Preserving Natural-Wood Color

To preserve the natural color of white birch, bird's-eye maple, hickory or any smooth-grained, light-colored wood without darkening, brush on two coats of clear lacquer. If the lacquer is sprayed, use three coats instead of two. Sand lightly between the coats and, finally, apply one or more coats of white wax.

Thomas Bishop, Sr., Seattle, Wash.

## Trellis for Potted Plants

This attractive trellis for climbing house plants requires only a few lengths of small-diameter wooden dowel and some stiff wire for its construction. Cut the dowels into 6-in. lengths and drill holes about 1 in. from the ends. The holes should be a fairly snug fit for the wire. Bend the wire in the desired arch to determine the length, then straighten out both lengths and place on a flat surface. String the dowels on the wires, using household cement if they are loose. When the cement is thoroughly dry, rebend into an arch and force the ends of the wire into the earth in the plant holder. If the trellis is painted, be sure to use paint that does not contain lead or other materials toxic to plants.

A. O. Aldrich, Oakland, Calif.



# Transom Drag Brakes Boat to Trolling Speed



In the raised position, this transom drag has no effect on the speed or performance of an outboard motorboat. However, when lowered, it greatly reduces the idling speed of the boat, making it an ideal accessory for slow trolling and leisurely plug casting along the shore line. From the standpoint of convenience, the drag can be raised or lowered from inside the boat in a matter of seconds. It is cut from  $\frac{1}{2}$ -in. exterior-grade plywood, as in the upper right-hand detail, and held in position on the transom with a pair of  $\frac{3}{8}$ -in. carriage bolts and wing nuts. Before drilling the bolt holes through the transom, it is important to locate the drag so it will clear the propeller regardless of the direction in which the motor is turned. To do this, hold or clamp the drag in the lowered position and check for clearance by swinging the motor. Then move the drag to the raised position so that its lower edge is  $\frac{1}{2}$  in. above the bottom of the boat and locate the bolt holes at the bottoms of the two slots. Use galvanized bolts and wing nuts and give the drag

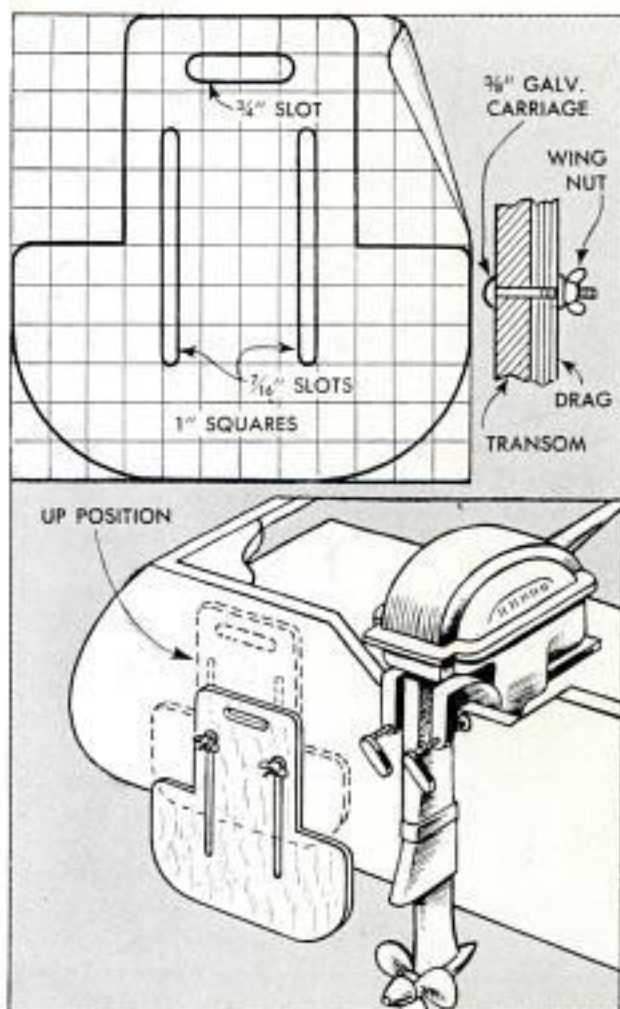

several coats of marine paint or varnish before installing. If you use a large outboard motor, it may be necessary to install a second drag on the opposite side of the transom for satisfactory braking action.

Tom Riley, Portland, Ore.

## Important to Use Proper Adhesive Spreader When Applying Tile

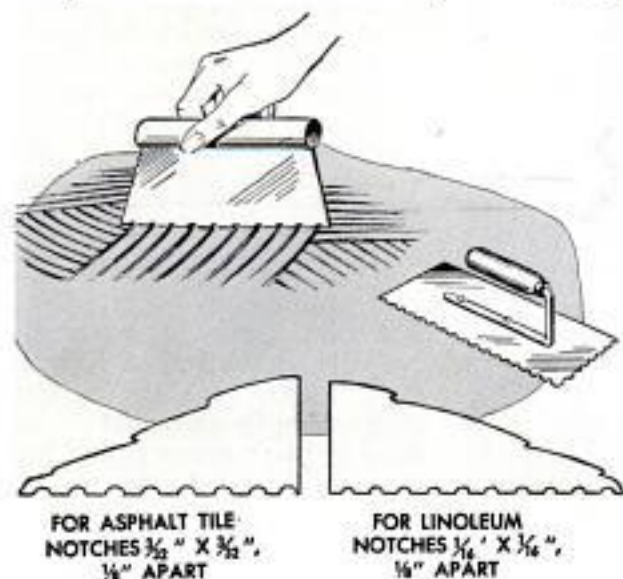

JUNE 1955

When applying wall or floor tile, countertop coverings or linoleum, it is important to use the correct cement-spreading tool since there is a definite difference in the amount of cement each type will apply. First, check the manufacturer's recommendations as to the type of cement to use. Then, use either the larger-notched tool for asphalt-tile cement or the finer-toothed spreader for linoleum cement.

## Hook Rings for Clothesline

Single side links taken from a tire chain make excellent hook rings for clotheslines. Tied onto the end of the line, the links are dropped over the hooks between which the clothesline usually is strung, thus eliminating the need for tying and untying.

169

# Tow-Tow-Tow-



By Edward S. Spanke and Frank N. Stephany

**Y**OU WILL SEE more boats and trailers than ever before at resorts and fishing areas this summer, and a closer look likely will disclose that the cars have out-of-state license plates and big-city windshield stickers.

Yes, you've guessed it. Folks are bringing their boats hundreds of miles to the waters they want to fish, explore and enjoy. And they're not all country people or suburbanites who might be expected to have a boat-trailer rig and plenty of room to store it during the off season. Many of these boat owners live right in the hearts of the large cities.

The boat trailer did it. Now, no matter where you live, or how far it might be from the water, you can own an outboard boat. All you need is garage or yard space in which to store the outfit. As far as size is concerned, you can go from a small utility boat all the way up to a cabin cruiser that will sleep four to six people.

Everything is set for this family to enjoy a pleasant day of boating



When buying a boat trailer, size and weight capacity are the first things to consider. There is no hard-and-fast rule. The trailer should handle your present boat and even be able to carry a somewhat larger one that you may purchase in the future. Several factors determine the weight-carrying capacity required—weight of the outboard motor if it remains on the transom while towing, and weight of extra fuel, luggage and camping gear that may be stowed in the boat. So estimate the total weight of everything to be carried in the boat and select a trailer accordingly. If the weight comes within 100 lb. of the rated capacity, better get a trailer of the next largest size. If you intend to carry the motor on the boat, the trailer should be designed to support the boat transom.

As the hitch is the most important trailer accessory, don't attempt to improvise at this point. Use a standard ball-and-socket car hitch, preferably one with a latch that keeps the coupling from working loose. Safety chains are required in some states, but they are well worth their small cost regardless of where you live.

A taillight is necessary for night-time driving, and can be anything from a flashlight clamped to the boat transom to a combination stop light and taillight. The latter operates on the car battery and plugs into an extension cord kept in the trunk.

Before driving off with the boat and trailer, be sure that the boat is tied down securely, that the hitch is locked tightly and that the safety chains are in place. It's also wise to stick some reflective tape on the boat transom or the rear of the trailer in case the taillight should burn out.

Hauling the trailer over

# YOUR BOAT

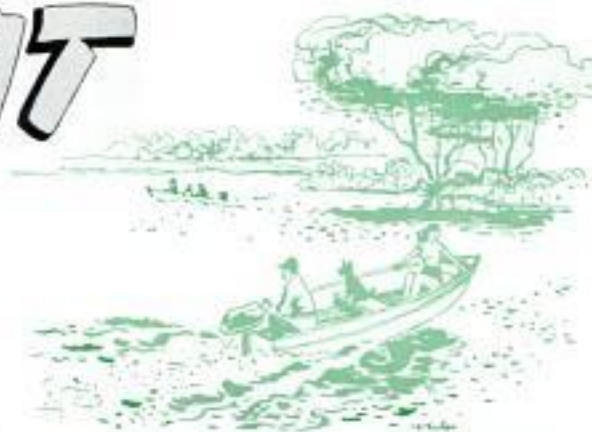

For night trailering, a combination stop light and taillight either on boat or trailer is ideal. Light is plugged into extension cord kept in trunk of the car



Treat your trailer tires just as you would those of the car. Check air pressure before traveling, especially if you haven't used trailer for a while

Being sure that hitch is clamped tightly is tops in importance. Most couplers have a safety latch to keep the socket from working loose while under way

Safety chains are as inexpensive a form of insurance as you can get. Should the trailer hitch fail, chains keep boat and trailer from taking off cross-country





To start trailer into its turn, cut steering wheel hard left. All procedures shown are reversed for backing into the turn from opposite direction

With trailer well into turn, watch your "target"—driveway in this case. Proceed slowly and steadily, making slight corrections with steering wheel



As trailer enters turn, bring steering wheel from left to right, but not too hard—just enough to even out turn. Now, you begin to get "feel" of turn

Turn begins to straighten out here. This is done by bringing steering wheel a little harder to right. To sharpen turn, bring the wheel to left



As boat starts to line up with driveway, bring steering wheel to the left to come out of turn



If boat bow points either right or left, cut steering wheel in the opposite direction to straighten it

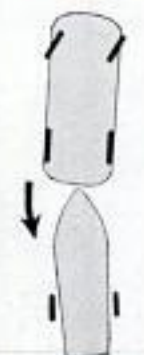

the road is no problem as long as you remember that it's there when driving in traffic or passing. In fact, it's a good idea to have something in the boat that will rattle and serve as a reminder. The only troublesome maneuver in trailering is backing up, and this is explained by the photos and diagrams on the opposite page. You will find that all trailers built by reputable manufacturers are designed to be towed at high speeds—but it's wise to stay somewhat under the posted speed limits. With a trailer in tow, it is going to take more distance to brake the car.

Trailer maintenance is simplicity itself. Your trailer wheels most likely will have high-speed bearings, so be sure they are lubricated with wheel-bearing grease and nothing else. Keep the tires at recommended air pressure and occasionally oil the moving parts, such as rollers and winch. If rust appears, remove it and repaint. ★ ★ ★



Launching boat is easy. Back trailer so end of boom is at water, release winch lock and push boat into water



To bring boat out of water, fasten winch rope to bow, line up boat with the trailer boom and reel in the boat

Transom support is shown on trailer at left. Rollers under transom prevent its being weakened by motor weight

Modern trailers are truly one-man, or one-woman, operated. Hefty boat, below, is handled easily by one person





### Bar Between Clothesline Posts To Air Garments on Hangers

When installing pipe standards for clotheslines, the standards being two uprights with a crossbar between, one homeowner included an auxiliary crossbar for airing clothes that must remain on hangers. The auxiliary crossbar is a length of  $\frac{3}{4}$ -in. pipe suspended below the main crossbar and spaced with short lengths of  $\frac{3}{4}$ -in. pipe. Long bolts run through both crossbars and spacer pipes.

Roman Smits, Green Bay, Wis.

### Quick-Starting a Barbecue Fire

For efficient cooking, a barbecue fire made of wood should start quickly and burn down to a bed of glowing charcoal; or when starting with charcoal, the fire should ignite rapidly to furnish cooking heat. Here are a number of ways of hastening the process:

A stub of a candle can be used as an igniter, with a teepee of twigs built against it. As the fire grows, the candle will melt and the wax burn away.

Wood alcohol or kerosene poured directly on wood or charcoal will provide a quick blaze, but kerosene has the disadvantage of producing black smoke and an objectionable odor. Do not, of course, pour flammable liquids onto a fire that is already burning.

Wax fire starters can be purchased, or you can make them yourself by dipping lengths of tightly rolled newspaper in melted wax.

Homemade tapers, slivers of wood dipped

in melted wax, work in much the same way as the wax-and-paper starters, but provide a wood fire immediately.

A fire brick soaked in kerosene or alcohol will provide a giant lighter; use a shovel to move it around after it is ignited.

Finally, if a fire is made on a flat surface, such as a pan filled with sand, or in a shallow, portable barbecue pit, fit a 5-gal. can, its top and bottom removed, over the fire to provide a chimney for draft. When the fire is well started, the chimney is removed.

Max Alth, Port Chester, N. Y.

### Improvised Photo Timer

A timer for use when developing photographs can be improvised from an alarm clock, a small vacuum cup and a sheet-metal pointer. The pointer is attached to the vacuum cup with a small nut and bolt, and the cup is then pressed against the face of the alarm clock over the hub of the hands. In use, the pointer is turned ahead of the clock's minute hand the number of minutes the developing operation will require. When the minute hand appears under the pointer, the time is up and the operation can be stopped.

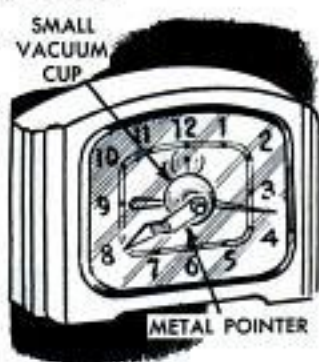

### Wires Locked in Electric Plug

Loosening of terminal screws or shorting of bare wires inside a male electric plug can be avoided by filling the plug with sealing wax. The wax will insulate the wires from each other and absorb the strain if the cord instead of the plug is pulled when it is removed from a wall receptacle.





Part III—  
Conclusion



## *Keep Warm in Winter and Cool in Summer*

**I**N THIS ARTICLE, the final one of three articles on installing a heating and air-conditioning plant in your home, you are ready to wire the units, adjust them correctly and then relax and enjoy with your family the comforts of modern living.

For an installation of this type, two electrical circuits are required, a 220-volt circuit for the air conditioner and a 110-volt circuit for the furnace. Since electrical consumption varies in different homes, check with your local utility company as to the size of service necessary for your particular requirements. In this installation, electrical consumption in the home made it necessary to install 100-amp. service at 220 volts.

Since certain electrical codes must be met in wiring, this work should be done by a licensed electrician. However, if you have an experienced person available to guide you, you may do the work yourself. In this case, the entire wiring job should be inspected by your utility company.

The furnace-blower motor and oil burner, if the furnace is oil fired, require 110-volt current. This should be fed to a fused switch box located near the furnace. Since wiring diagrams will vary from the one

used for this installation, which was a warm-air furnace and air conditioner made by the Lennox Furnace Company of Marshalltown, Iowa, no diagrams are given. Just follow the wiring diagram provided by the manufacturer of your equipment for wiring from the switch box to the furnace. On an oil-fired furnace there is a control in the smoke pipe and one in the warm-air plenum. The former controls the oil burner and the latter the blower.

After the furnace has been wired, connect the oil line to the oil burner, lower right photo, page 176. Be sure to install a filter in the oil line, preferably near the oil tank. Follow the manufacturer's instructions for putting the furnace into operation. When the furnace is operating satisfactorily you are ready to wire the air conditioner. Again, follow manufacturer's instructions.

Wire size for the 220-volt circuit will be determined by the load it must carry. For this installation, which was a 2-ton air conditioner having a 2-hp. motor, a 3-wire conduit was run from the electrical service box to a Square-D switch box near the conditioner as shown in upper-left photo on page 177. Notice that the control panel for the conditioner is mounted directly



Combination limit control and blower control is located in warm-air plenum as shown in photo above. Below, an automatic humidifier installed in the plenum maintains the correct humidity in your home



Above, use flexible conduit to the blower motor as it rests on flexible mountings which would fracture rigid conduit. Below, if the furnace is oil fired, an oil filter should be installed in the oil line

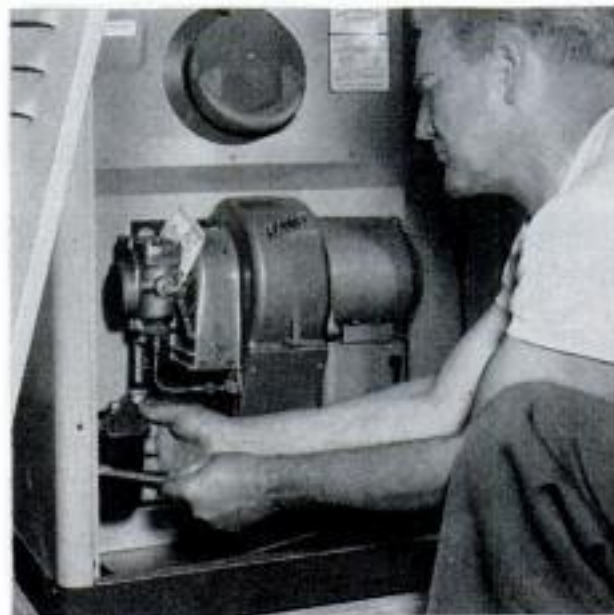
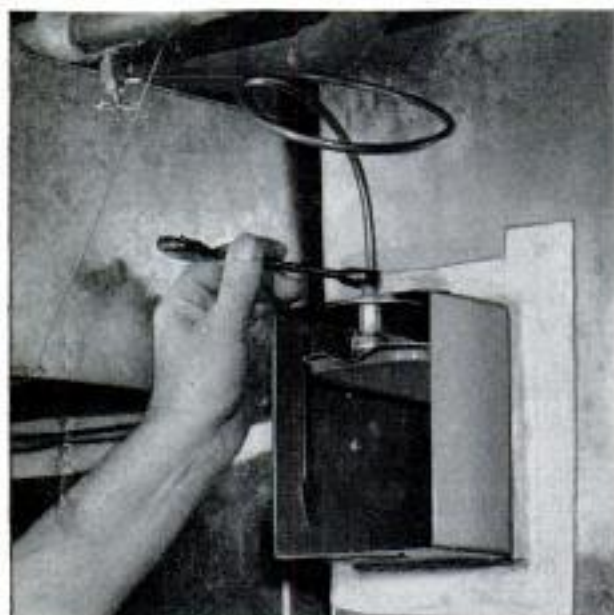

Water towers are of two general types. The natural-draft type shown at left below, and the forced-draft type shown at the right below

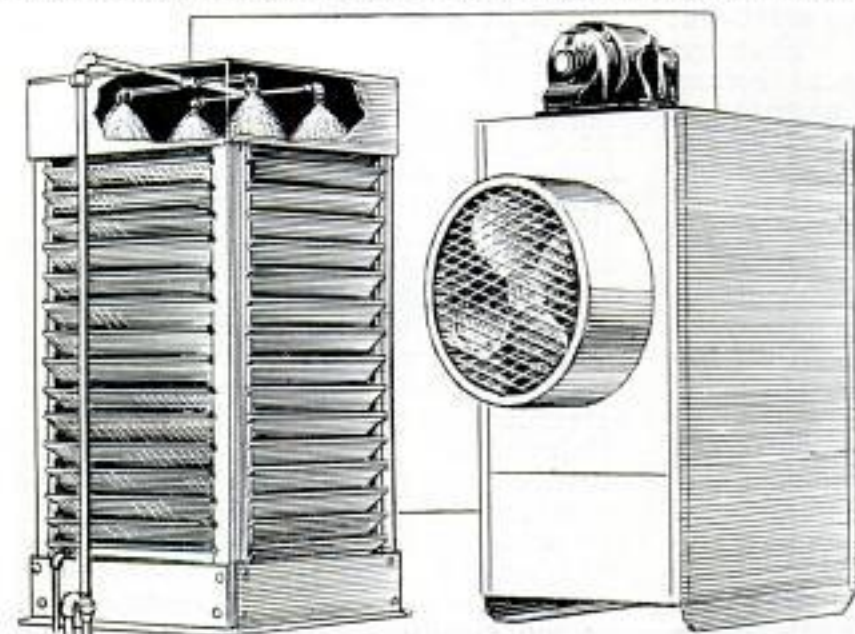

above the switch. From this panel a 2-wire conduit goes to the air-conditioner junction box, the conditioner having been shipped already wired to this point.

The control panel contains starting relays for the air-conditioner motor, the furnace blower, which is used in conjunction with the air conditioner, and for the motors on a water tower if used. It will be necessary to run a 2-wire conduit from the control panel to the furnace-blower control in the plenum. This provides current for the blower independent of the furnace when the air conditioner is in use. The

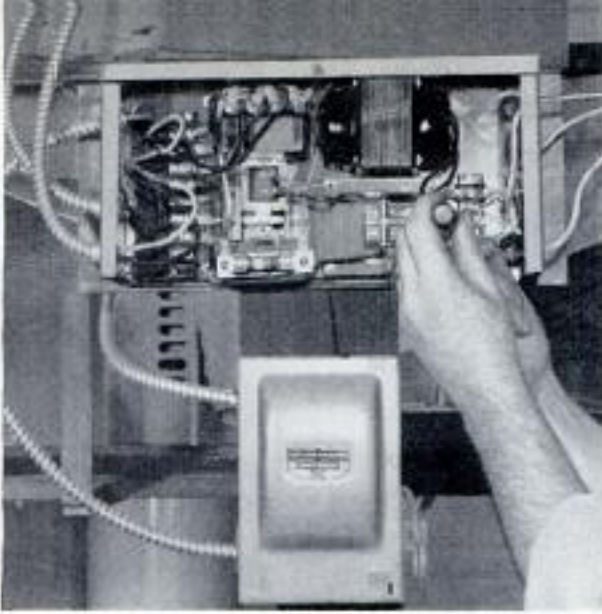

A fused switch box should be installed in the air-conditioner electrical circuit as pictured above. Below, connecting the 220-volt circuit into the service box. This should be done by a licensed electrician



Above, a 2-wire conduit from the control panel is connected to the air conditioner at a junction box. Below, delivery water line to conditioner should have a valve to control the flow of water as desired

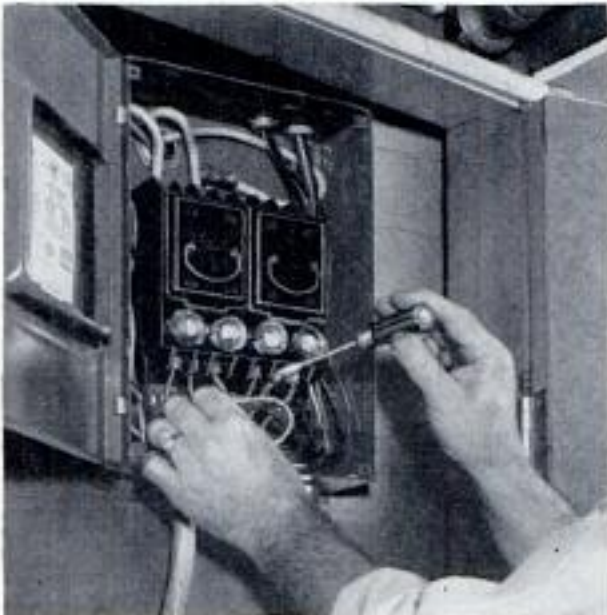

control panel also contains a 24-volt transformer which provides current for the low-voltage circuit to the room thermostat.

In locating the room thermostat, place it where cool or warm drafts cannot affect it. On some installations, two separate room thermostats are used—one for heating and one for cooling—while other installations use a combination thermostat for both of these operations.

After the air conditioner has been wired, the circuit is connected into the electrical service box, lower-left photo, this page. Since many air conditioners of this size or larger are water cooled, the water supply and its cost will determine whether or not a water tower is to be used. If the water supply and its cost permit, the discharged cooling water is run into a sewer or through a hose to a lawn sprinkler. No definite figure for the amount of water required can be given as several factors determine this, some of which are outside temperature,

temperature of water entering the air conditioner, etc. An average, however, would likely be between 2 and 3 gal. per min. when the conditioner is in operation. A water-cooling tower would save most of the water as it receives discharge water from the conditioner, cools it and then recirculates it through the conditioner. Water towers are of two general types. One depends on natural air circulation over the water baffles for cooling, left detail of diagram, page 176. The other uses a fan to move the air over the baffles, right detail. The detail at the top of page 178 is representative of an air conditioner-water tower hookup.

Flow of water through the conditioner should be adjusted so that the temperature of the discharge water does not exceed 95° F. A thermometer connected to the discharge pipe as in the lower-right detail on page 178 will enable you to correctly adjust the flow of water.

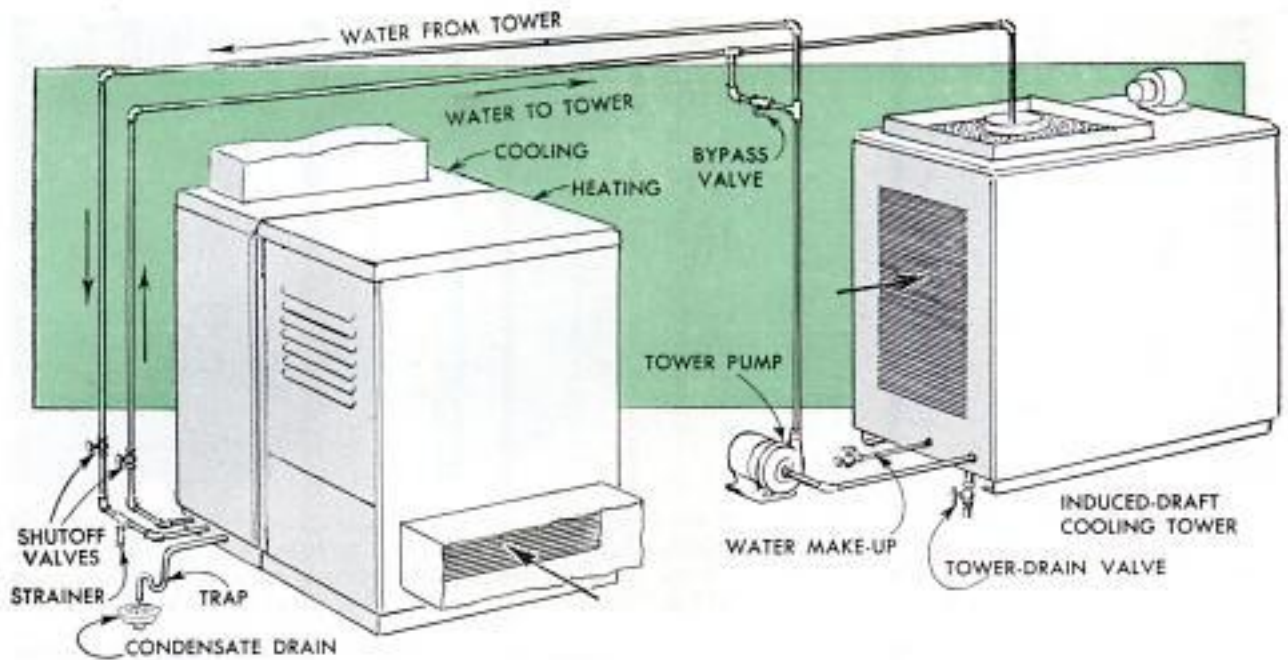

Once the furnace and air conditioner are operating, the final step is to balance the air flow into the rooms to get uniform heating and cooling. For heating, a temperature rise of 100 deg. as the air flows through the furnace is desirable. To check this, install a thermometer in the return-air plenum and another in the warm-air delivery duct adjacent to the furnace. If a ceiling-mounted air conditioner is used, the thermometer should be installed in the duct on the delivery side of the conditioner. Allow the furnace to operate continuously until all parts of the system are thoroughly heated. Then reduce or increase the blower speed to get a difference of 100 deg. reading between the two thermometers. Reduce the blower speed to increase the temperature and increase the blower speed to lower the temperature of the air.

For cooling, one method is to use the same thermometer setup and adjust the blower so the temperature of the air is lowered 18 to 20 deg. as it passes through

the conditioner. A more accurate method is the use of a draft gauge with which you can determine the air-pressure drop through the coil and then adjust the blower speed to maintain the drop recommended by the manufacturer. Depending on the house, cooling and heating requirements may not be the same. Cooling coils are designed for a certain air volume for maximum efficiency. This sometimes requires changing blower speeds twice each year. The Lennox Furnace Co., as well as other manufacturers, also make equipment with self-contained blowers which make changing unnecessary.

This completes the installation except for adjusting the air valves in the diffusers, lower-left photo this page to get uniform heating or cooling in each room. If you desire some rooms cooler than others, just reduce the flow of air through the diffuser in these rooms. Or in cooling, increase the flow of air. Use thermometers in the rooms while making the adjustments. ★ ★ ★

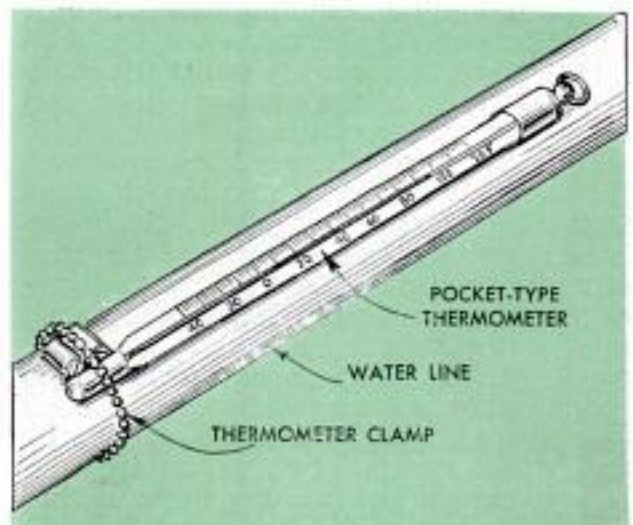
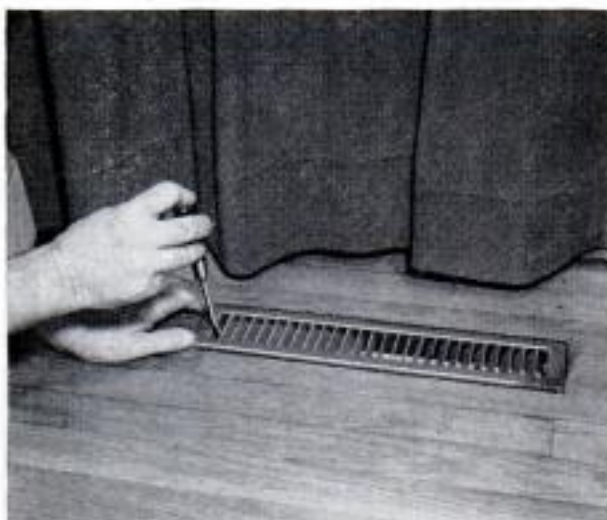

## Flashing Electric Flare Protects Stalled Car

When a flat tire forces a stop on a highway at night, this flashing electric flare will warn oncoming cars. The flare consists of a truck-type, directional-signal lamp and a flasher of the type used on emergency vehicles. On the original flare the flasher is a Tungsol 129D. The flare support is a junction-box cover welded to a flat-steel upright. Two holes are drilled and tapped in the upright, the lower hole used to attach the flasher and the upper for clamping the wires. The lead-in wire is a length of two-wire lamp cord fitted with two battery clips or a cigarette-lighter plug at one end. One wire of the opposite end is connected to terminal "X" on the flasher and the other to the lamp. The lamp is wired to "L" terminal on the flasher. The terminal "P" may be used to connect a second flashing lamp. A removable base supports the flare upright. A trouble light can be wired directly from the lead-in wire, by-passing the flasher unit, as shown in the illustration.

John M. Avery, Dexter, N. Y.

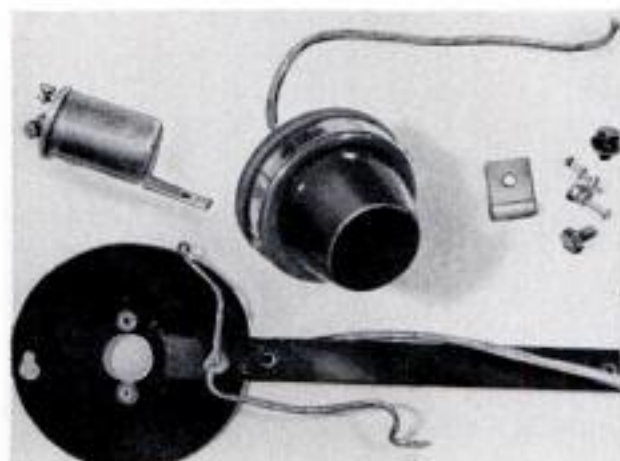
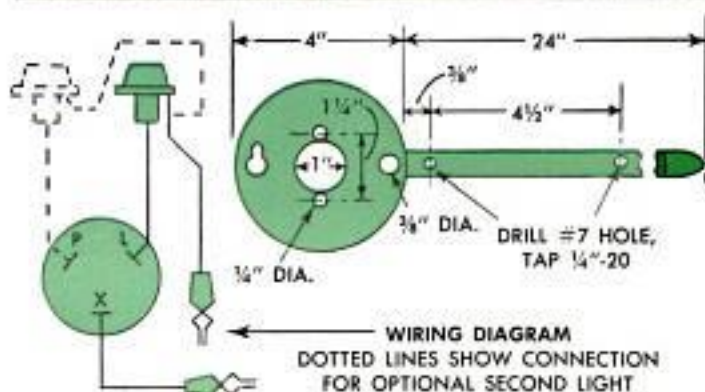
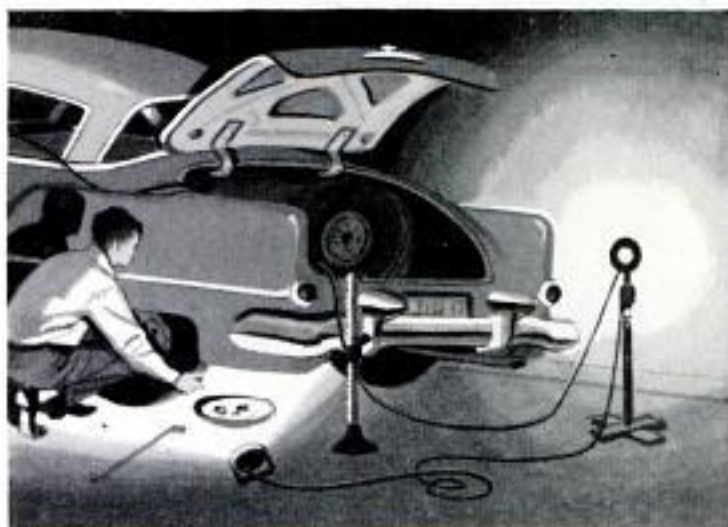

## Inexpensive Basement Shower Utilizes Laundry Tubs

A simple and inexpensive shower can be installed in any basement equipped with laundry tubs and a floor drain. Locate the shower head—it can be purchased at most hardware stores—over the floor drain and couple it to a length of  $\frac{1}{2}$ -in. pipe clamped to the floor joists. The pipe is run to a point over the laundry tubs and fitted with a pipe-to-garden-hose adapter. A length of hose with a female coupling at each end is used to connect the pipe to the faucet of the laundry tub. In use, the water temperature is controlled by adjusting the mix-

ing faucet in the tubs. The hose is simply unscrewed from the faucet when the laundry tubs are to be used for washing. For greater comfort and safety, a wooden-slat floor grating can be made for the shower.

☐ To provide a smooth surface on woodwork before it is repainted or refinished, fill all cracks, gouges, nail holes, etc., with wood putty. Apply the putty so it is slightly higher than the surface, permit it to dry completely, then sand flush.

## Gauge-Tool Holds Bevel Siding To Permit One-Man Operation

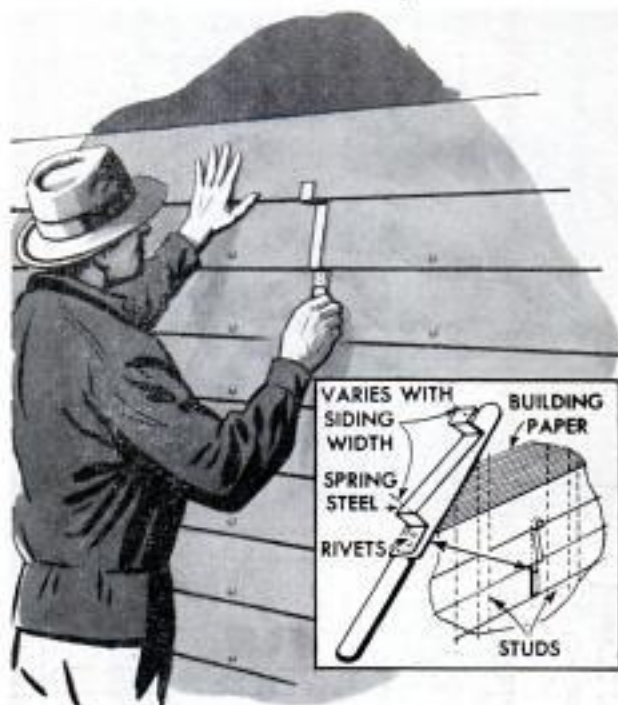

A handy gauge-tool that will both space bevel siding and hold it in place for nailing can be made from a kitchen knife to which is riveted a length of flat spring steel. The knife blade slips under the last strip of siding installed. The end of the strip to be installed then is set on the hook end of the steel spring. Cutting and nailing are done at the opposite end, making a one-man job of an operation ordinarily requiring two men. Dimensions of the tool will vary according to the width of the siding used.

## Glass-Cutting Pattern

One method of overcoming the difficulty of cutting glass to exact size is to draw a pattern on a large piece of paper, cardboard or plywood and lay the sheet of glass directly over the pattern. The pencil lines will show through the glass for perfectly aligning a straightedge.—J. R. E. Cameron, Buccaneer Bay, B.C., Can.

## Rope Rings Stop Rolling Of Washing Machine

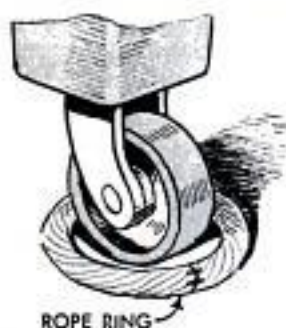

A washing machine that rolls around the basement during operation can be kept in one place by means of rope rings laid on the floor around the casters. The rings can be made by joining the ends of 1-ft. lengths of clothesline. When

these rings are placed around the casters, as shown, the wheels wedge against the rope and further rolling is prevented. Two rings usually are enough to keep the machine stationary, though more can be used if necessary.

Bruce W. Porter, Clarendon Hills, Ill.

## Window Attachment in Auto Supports Clothes Hangers

A simple window attachment to support clothes hangers when traveling by car can be made with only a short length of string or wire and a pencil, as shown in the illustration. Then, with a rear window rolled partially down, the pencil is

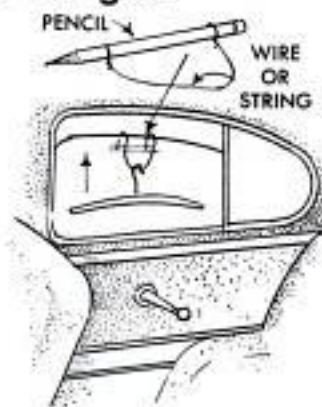

placed outside the window and the loop of the wire kept on the inside. The window is then closed and a clothes hanger suspended from the loop of wire. Several of these hangers can be used on each window.

Robert B. Forbes, Fort Custer, Mich.

## Worn Brass Fitting Turned By "Shim Grip" Wrench

When a brass fitting, such as a tubing connector on an automobile oil filter, has become so rounded that a wrench merely slips around it, an L-shaped shim bent from sheet metal will restore a positive grip for the wrench. First, choose a box-end wrench that most nearly fits the brass shape, then drive the shim between the wrench and an angle of the brass fitting. If possible, screw another fitting inside the first to prevent it from collapsing. When the wrench is firmly locked on, simply turn out the fitting.—C. E. Packer, Oak Park, Ill.



## Play Yard Has Adjustable All-Day Awning



Photo above and the detail below show attachment of swing. Awning frame pivots at center. Right, standard playpen fits inside uprights

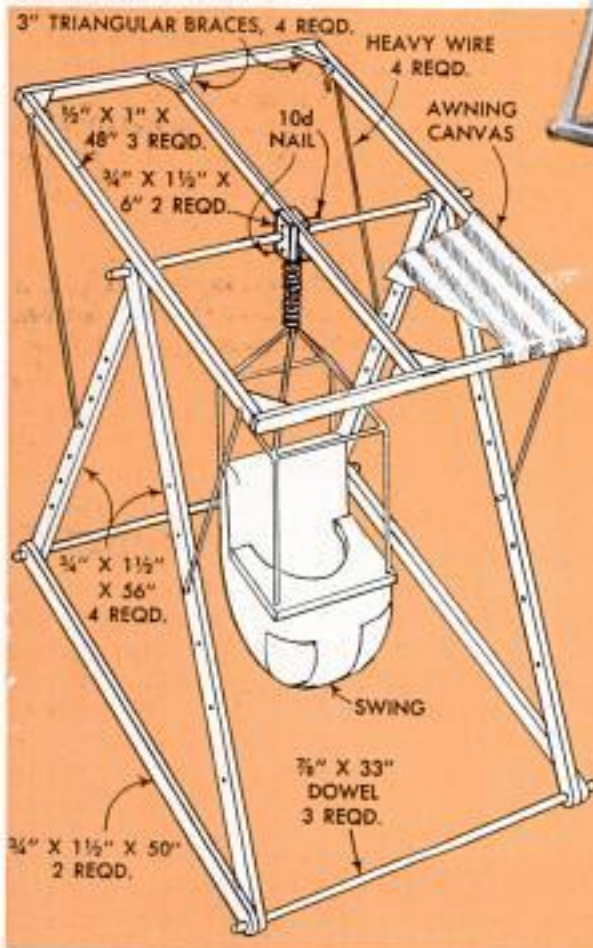

This novel play yard will keep a toddler happy and safe out of doors for hours at a time. The adjustable awning provides an all-day shade from the sun and there's room within the span of the supports for a standard playpen as in the photo above. When desired, the playpen can be removed and a swing substituted as in the upper left-hand photo and the detail. Note in the detail that the awning frame is held in place at the center by a 10d nail, which makes it easily removable. Adjustment is provided by four lengths of heavy wire, the upper ends being bent in a U-shape after insertion in holes drilled in the awning frame. The lower ends are bent at a right angle and inserted in spaced holes drilled in the slanting uprights. The length of the wires must be determined after assembly of the framing. Use hardwood and finish in the natural color with spar varnish.

M. L. Foster, Barrie, Ont., Can.

## Turns Computed Easily When Coils Are Wound on Metal Lathe

One craftsman has found that a handy method of counting turns when winding several coils is to use the thread gears on a lathe and to measure off the distance on the bed for carriage travel. For example, when several coils with 1760 turns each are required, he sets the thread gears for 176 threads per in., and then moves the

carriage to the end of the lathe bed and marks off 10 in. A toggle switch is clamped on so it will ring a bell when the carriage has traveled about 9 7/8 in. When winding is started, the coil is set at the first mark. When the bell rings, the carriage is stopped and turned by hand until it reaches the second mark. This will give 1760 turns.

# ALL-WEATHER TENT

## Has Tubular-Steel Frame

By Jim Kendall



1 The tent folds into small units ready for transport. The screened sides and canvas top are intact

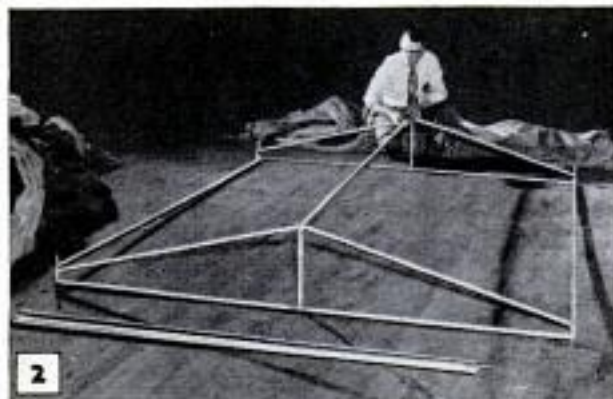

2 Tubular-steel frame is quickly assembled. Gable ends are single units of all-welded construction



3 Above, second step in setting up is placing canvas roof and screen sides over frame. Below, setting corner posts after roof and sides are in place



4

**S**PECIAL FEATURES of this tent will appeal to hunters, fishermen and campers on trips where protection from insects and inclement weather is the first requirement of camping equipment. It is just as good on week-end trips, too, as it's a screened breezeway and a storm tent in one. The basic unit consists of a tubular-steel frame and a canvas roof having walls of 16-mesh plastic screen sewed to the eaves all the way around. The ends of the screen are closed insect-tight at the front when the unit is set up and staked. Setting up the tent is accomplished in three steps as in Figs. 2 to 4 inclusive. Fig. 5 shows the unit set up as a screened enclosure, and in Fig. 6 the storm sides have been attached to serve as protection against wind, rain or snow.

For transporting, the canvas top and screen and the storm sides are placed in a sack, or duffel bag, and the roof frame dismantled as in Fig. 1. To set up the unit, the tubular frame is assembled as in Fig. 2. This is easily and quickly accomplished as the gable ends are welded units. The ridgepole and side members, or "plates," slip over pins welded to the gable ends. Next, the roof with its plastic-screen walls is stretched over the tubular frame as in Fig. 3. One end is then raised and the corner posts placed in position. Then the other end is raised for placement of the two remaining corner posts as in Fig. 4. This three-step procedure ends with the structure set up as in Fig. 5. Double ropes staked at all four corners hold the unit securely.

Build the tubular frame first, as all measurements to determine the size of the canvas and screen covering must be made with the tubular frame assembled. Note in Fig. 8 that all principal parts of the frame are keyed to the material list, which gives the sizes and kinds of materials used. The ridgepole and the two side members, part F, Fig. 8, each consist of two sections, one 72 in. long, the other 30 in. long. These join by means of a  $\frac{5}{8}$ -in. threaded rod 7 in. long, center detail, Fig. 8. The rod is pinned to the longer tube as in the cutaway view. The other end of the threaded rod is inserted in the open end of the short tube, forming an expansion joint adjustable by means of a nut. The nut on each assembled member provides a means of stretching the canvas roof after setting up the tent and also of slackening the tension on the canvas





when disassembling the tent. The gable ends, which consist of the parts A, B, C, D, E and H, are assembled by welding into a rigid unit. The ends of the tubes (the term "tubes" refers to both pipe and tubing used in the assembly) are shaped by filing to fit the rounded contours of the parts to which they are joined. Care must be taken when cutting to make allowance for filing the ends to fit before welding. All dimensions given are only close approximations. Note that the pins, parts H in Fig. 8, are shown in two locations on the frame. Six pins in all are required. They are cut approximately 2 in. long; one end is rounded and the other filed convex to fit the contour of the tubing. They are surface welded in the positions indicated. Some filing likely will be necessary on both the pins and open ends of the tubes in order to obtain an easy, sliding fit. The same is true of the expansion joints in the ridgepole and the two side

members, F in Fig. 8. Care must be taken to form sound welds on all joints in the frame assembly as the parts are subjected to considerable stress in normal use. The vertical pins, E in Fig. 8, may have to be shimmed into the ends of the short tubes, B, in order to obtain a tight fit as there are allowable variations in the inside diameter of the pipe from which these are cut. The projecting ends of the rods pinned into the upper ends of the corner posts, part G, Fig. 8, may also have to be filed or turned down to an easy fit in the lower ends of the corner tubes, B. The projecting rods, or tenons, are pinned into the ends of the posts in the same manner as are the threaded rods which form the expansion joints in the parts F, Fig. 8. Ends of the pins are peened over so that they hold securely.

The 16-mesh screen which encloses the area under the roof consists of strips of screening of standard width sewed together

**All set for use as a comfortable screened enclosure. Zipper at front closes screen, keeps out insects**

**Attachment of storm sides protects interior against wind and rain. Storm sides are closed from interior**



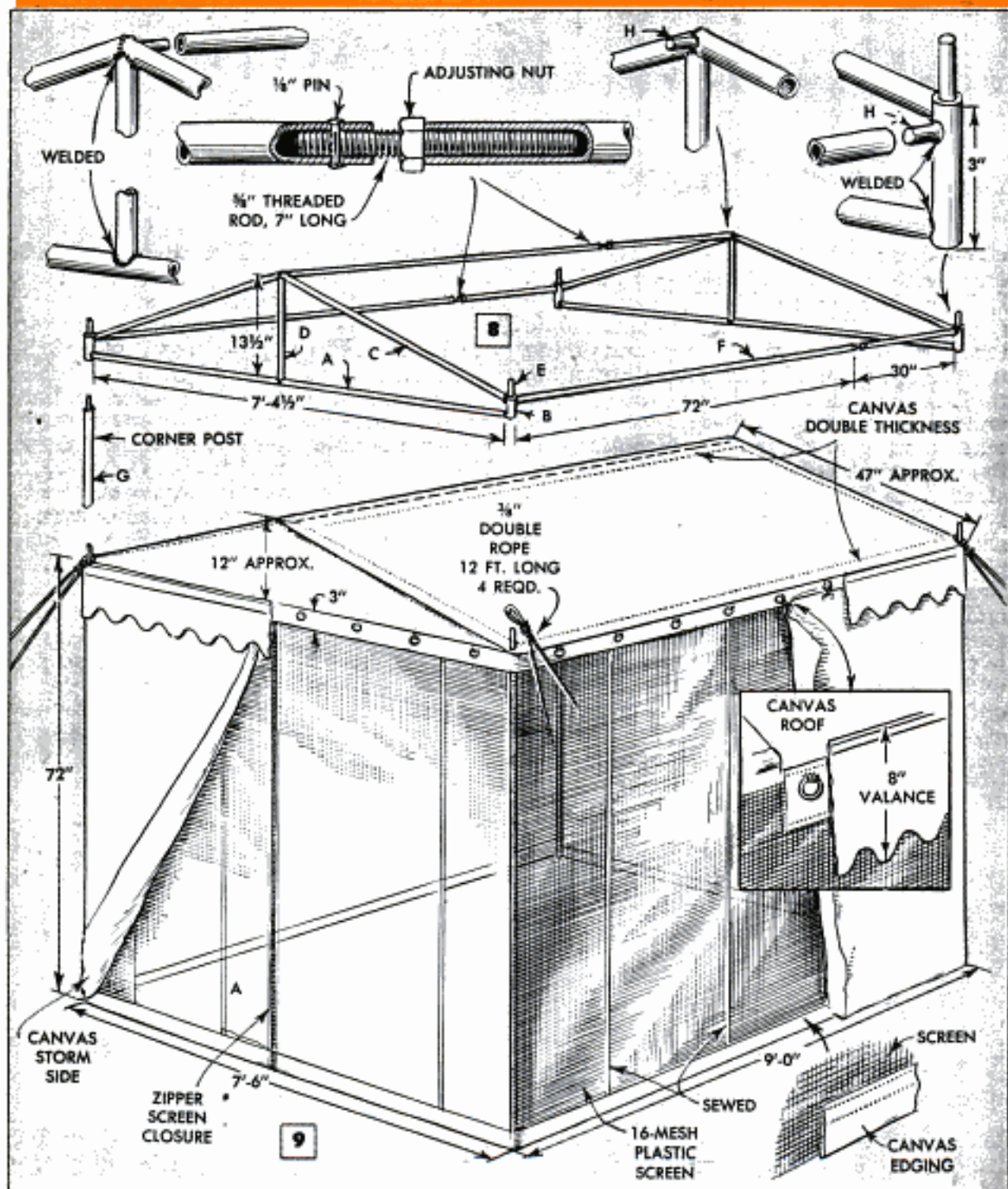
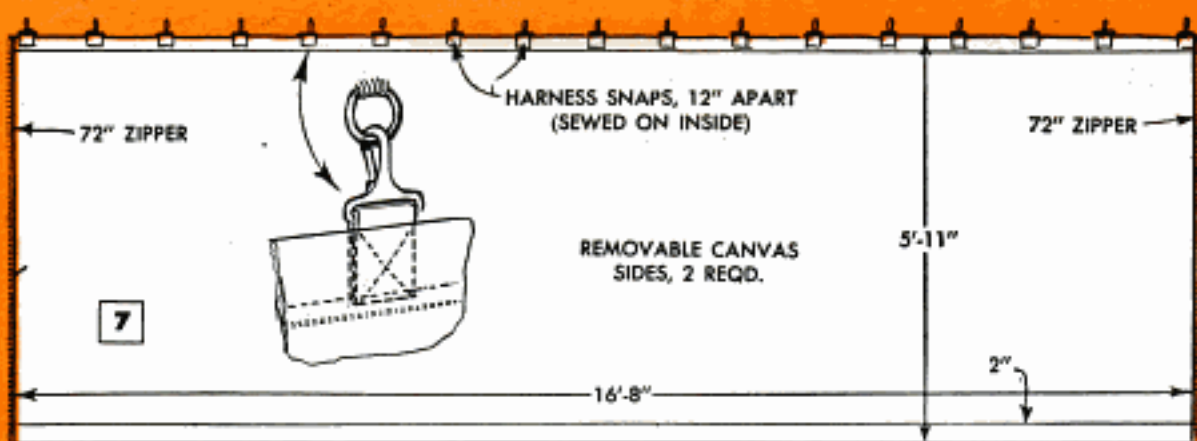

## MATERIAL LIST—TENT FRAME

- \*(A) 2 pcs.  $\frac{1}{2}$ " Thin-wall conduit, 7'-4" long
- (B) 4 pcs.  $\frac{1}{2}$ " Steel pipe, each 3" long
- (C) 4 pcs.  $\frac{1}{2}$ " Steel pipe, each 46 $\frac{1}{4}$ " long
- (D) 2 pcs.  $\frac{1}{2}$ " Thin-wall conduit, each 13 $\frac{1}{2}$ " long
- (E) 4 pcs.  $\frac{3}{8}$ " Steel rod, each approximately 4 in. long
- (F) 3 pcs.  $\frac{1}{2}$ " Steel pipe, each 72" long  
3 pcs.  $\frac{1}{2}$ " Steel pipe, each 30" long
- (G) 4 pcs.  $\frac{1}{2}$ " Thin-wall conduit, each 72" long
- (H) 6 pcs.  $\frac{3}{8}$ " Steel rod, each 2" long  
1 pc.  $\frac{5}{8}$ " Threaded steel rod (for expansion joints)

\*Parts are shown letter-keyed in Fig. 8

to form a continuous strip with a single zipper closure at the front. A screen flap, extends 12 in. beyond the zipper, part A in Fig. 9, the edge being clothbound. The canvas roof is made first, the measurements being taken over the tubular frame assembled on a flat surface. Expand the joints in the ridgepole and side members about 1 $\frac{1}{2}$  in., this allowance being necessary for possible shrinkage of the canvas. Be sure when measuring to make allowance for seams and the 3-in. drop at the eaves, Fig. 9. After the parts of the roof have been stitched together the screen is sewed into the 3-in. drop. The unit is completed with a scalloped flap, or valance, fastened to the eaves as in the detail, Fig. 9. Steel rings are sewed under the valance all the way around as in Fig. 9. The rings are spaced 12 in. apart.

The canvas storm sides, Fig. 7, consist of two identical units, each 16 ft. 8 in. long and having a zipper closure at the front and back of the tent when in position. Each unit is attached to the tent over the screen by means of harness snaps which are spaced 12 in. apart as in Fig. 7. These snap

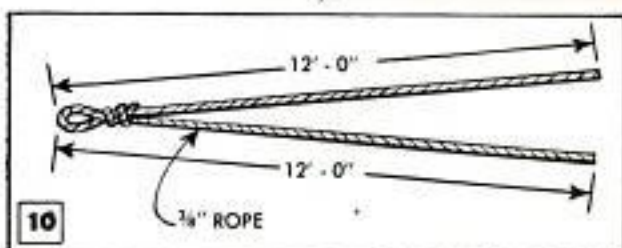

into the rings sewed to the roof under the valance, forming a watertight closure. In use, the zipper at the front of the tent is closed from the inside. Where possible, all canvas parts should be made up by a dealer in awnings having the necessary equipment for the heavy seam work required. Use a heavy grade of waterproof canvas of the type used in making tents. Provide four tie ropes made as in Fig. 10, also suitable stakes. ★★★

## Photo Chemicals Filtered Through Medical Cotton

Medical cotton of the type packaged in the form of balls, provides efficient, disposable filters for photographic chemicals and other solutions. A ball of cotton is dropped into a funnel, as shown, so that liquid poured into the funnel must pass through the cotton. Packages of cotton balls are available at drugstores and drug counters of department stores.

Frank A. Javor, North Bergen, N. J.

## Dowel Ends Vented in Vise

Instead of shaving one side of dowel ends to vent them for driving and gluing, the same purpose can be accomplished by crushing the ends slightly in a bench vise. Moisture from the glue will cause the ends to expand again after they have been inserted in the holes, thus providing firmer anchoring than ordinarily possible.



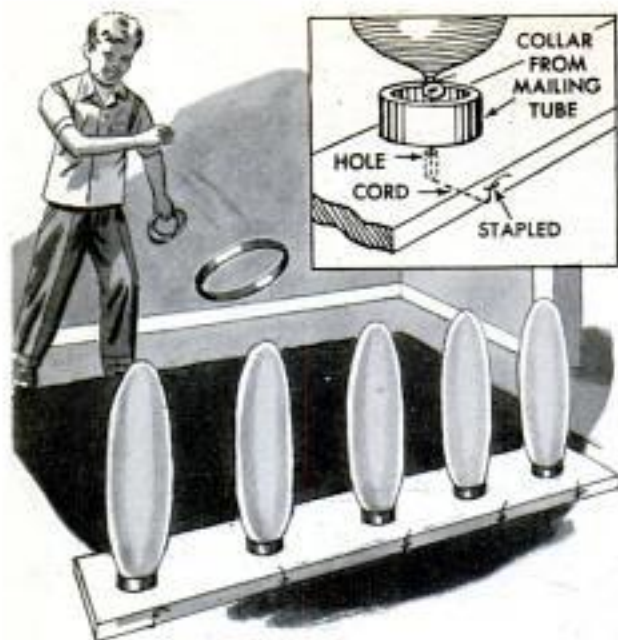

### "Stakes" for Ring-Toss Game Are Inflated Balloons

Novel "stakes" for a ring-toss game can be made by using a few balloons fitted in cardboard collars on a strip of smooth wood. The balloons, which should be the elongated sausage type rather than spherical, are inflated to a diameter of about  $3\frac{1}{2}$  or 4 in. and tied shut with lengths of string. They then are placed over collars cut from a cardboard mailing tube and the strings passed through holes drilled 6 in. apart on the wooden strip. The ends of the strings are stapled to the edge of the strip after the balloons are pulled to a vertical position. Embroidery hoops about 6 in. in diameter are used as rings for the game.

### Resistance in Air-Duct Turns Reduced by Increasing Radius

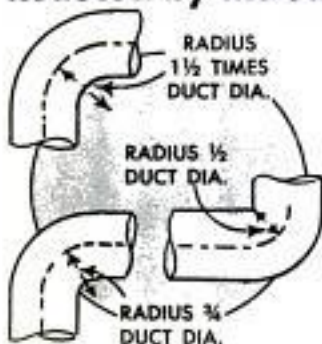

Right-angle turns in air ducts used for warm-air heating and air conditioning should, if possible, have a radius equal to  $1\frac{1}{2}$  times the duct diameter, upper detail. A turn in which

### *A playtime cottage . . .*

is something that children will never tire of, especially when it boasts such features as its own table and chairs, bunks for overnight sleeping, electric lights and even a puppet stage. It looks like a real house in miniature, complete even to the front porch. Completely detailed plans for it will be featured in next month's issue

radius is equal to three fourths the pipe diameter presents twice as much resistance, while a turn equal to one half the radius of a duct offers four times as much resistance. Lines which conduct fluids are similarly influenced by the radii of the turns.

### Sanding Disks Will Not Tear If Reinforced With Tape

Sanding disks won't tear out at the center washer if the slots around the center hole are reinforced with masking tape. The tape is applied to the back of the disk before it is mounted on the rubber plate. Thus reinforced, the disk will stay on until it is worn out and needs to be replaced.



L. D. McNamara, Columbus, Ohio.

### Modified Cords on Floodlamps Permit Easier Storage

Replacing the extension cords of photo floodlamps with short leads and male plugs will permit easier storage and portability of the lamps. Also, the nuisance of cords dangling from the lamps when they are being located is eliminated. The removed extension cords are fitted with female plugs and, when the lamps have been approximately located for the picture, the cords are run to the lamps and connected. Another method is to use a single, rather long, extension cord to which a number of sockets have been wired. The single extension then is run from lamp to lamp and each one plugged in.

Hugh Lineback, Stillwater, Okla.



# REBUILDING OLD AUTO ENGINES

By Ed Packer

**F**OR STATIONARY POWER applications beyond convenient reach of electric power lines, an old auto engine is hard to beat. On heavy beltwork and as a power source for certain types of portable farm equipment, such as shellers, grinders, sawmills and pumps, a reconditioned six or eight-cylinder engine can turn up the speed and horsepower required.

An old engine, long neglected, can look pretty hopeless either in or out of the chassis. But it's the useful life left in the wear parts that counts. Old engines often are in better condition than they appear to be. Usually the first step in reconditioning is to clean and space plugs and breaker points, replace damaged wiring, add oil, water, fuel and a battery to turn the engine over. At the time the plugs are removed for cleaning, pour a small quantity of crankcase oil in each cylinder, about two tablespoonfuls. Turn the engine over several times with the ignition off. This will distribute the oil over the cylinder walls. Start



the engine and adjust the carburetor to give a slow idle. Let the engine run for 10 min., then shut off the ignition without acceleration. Remove the cylinder head and drop the oil pan, or sump. At slow idle the high vacuum will pull oil past the pistons if the rings are stuck or the cylinder walls in poor condition. This will show as a wetness on the tops of the pistons, also on the valves and spark plugs. On the other hand,

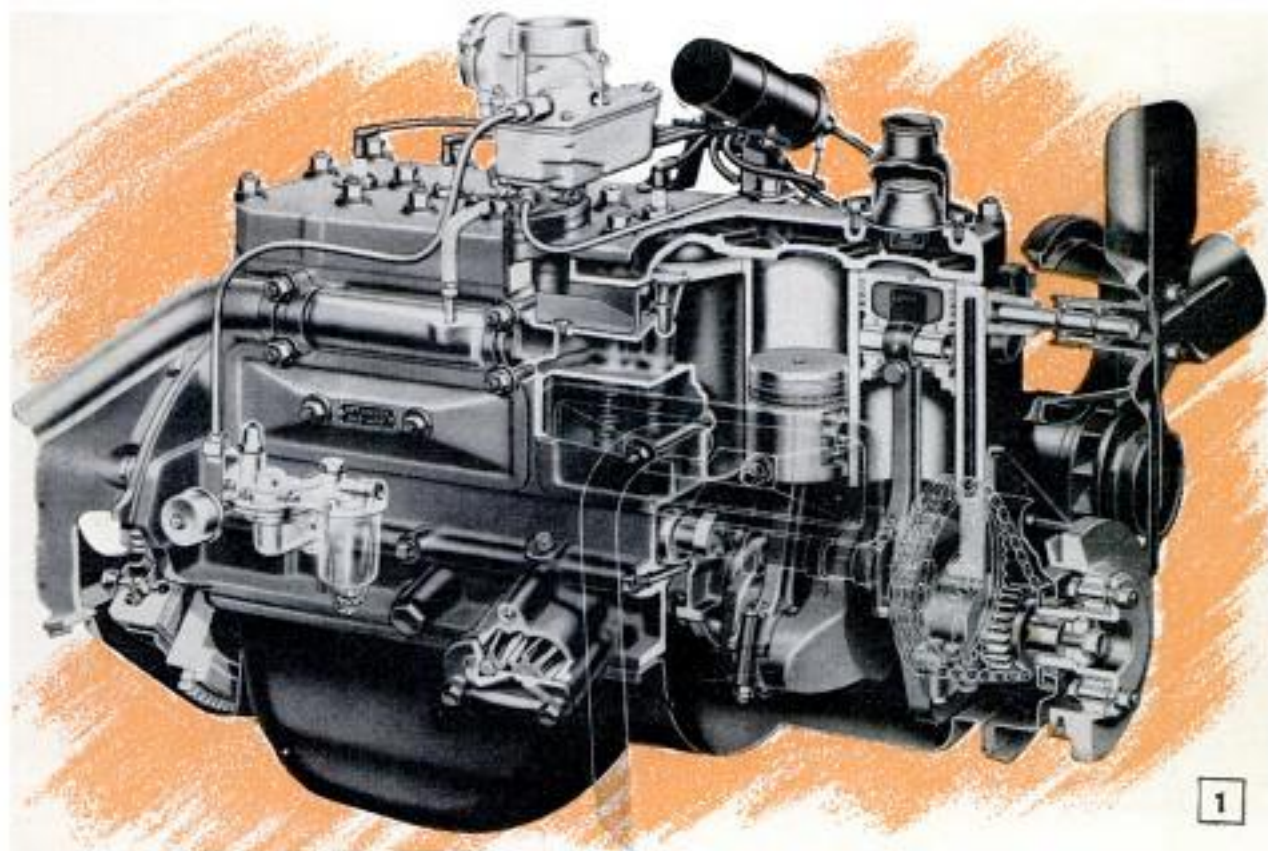

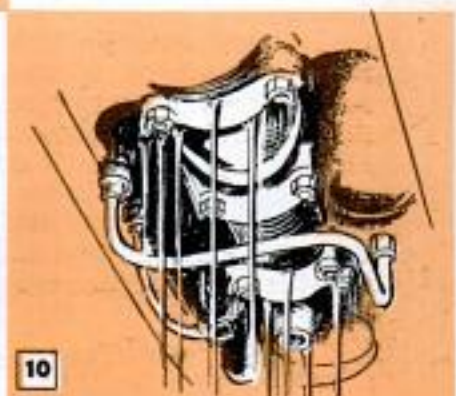
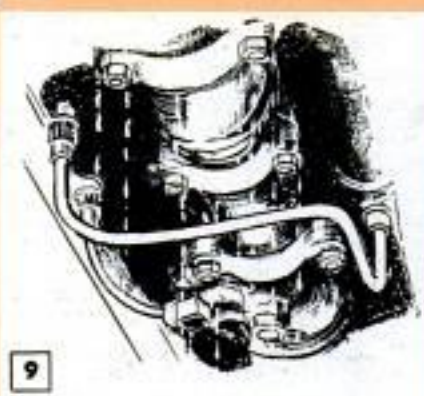
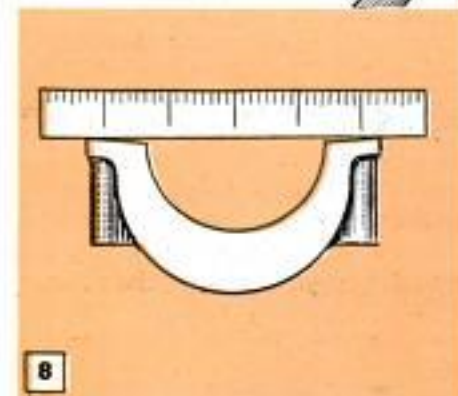
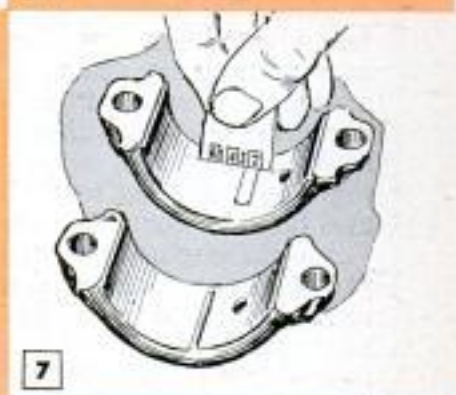
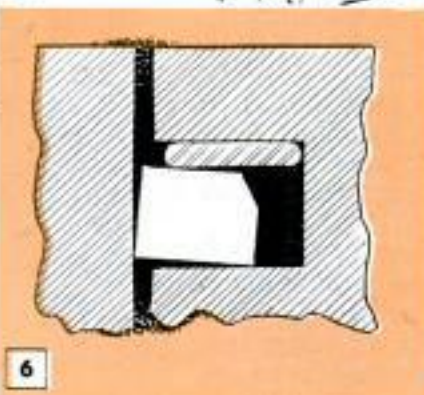
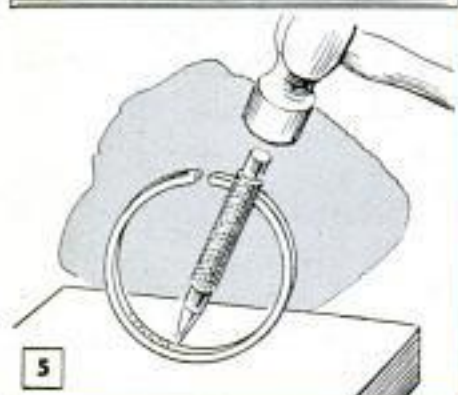

if these parts are still in good condition, the surfaces will be dry. In this case, removing carbon deposits and grinding the valves generally will be sufficient to put internal parts in good operating order. However, nearly all old engines of four, six and eight-cylinder types, Fig. 1, will have cylinders worn out-of-round, ridges at the top ends and possibly light scoring of the cylinder walls. These will require either reboring and the installation of oversize pistons, or removing the ridges at the top ends of the cylinders, honing and the installation of special rings and piston expanders. Methods of removing the ridges and honing the cylinder walls are shown in Figs. 2 and 3. However, before removing the pistons for reconditioning, test the condition of the main and connecting-rod bearings, also camshaft bearings, using a pressurized tank containing No. 20 lubricating oil. This is connected to the engine oil line and the pressure raised to about 30 lb. Drops of oil forced out of the bearings, Fig. 9, indicate that they still are in reasonably good con-

dition. Streams of oil, Fig. 10, usually indicate the need for bearing replacement.

When removing connecting-rod bearing caps always check each one with a straightedge, Fig. 8. When necessary, true the cap as in Fig. 13. Bearing clearances are easily checked by using a precision plastic strip especially made for the purpose, Fig. 7. This is placed in the cap, which is tightened. The strip flattens and its width is measured with a special scale as in the upper detail, Fig. 7. This gives the bearing clearance sufficiently accurate for all practical purposes. Another thing to be sure about when reassembling the bearing caps after reconditioning is the location of the oil holes, or "squirt" holes, as they are often called. Make certain that the caps are replaced with these holes in register with those in the crankpin, Fig. 11.

Older-type piston rings in serviceable condition can be expanded, or tensioned, with a row of punch marks as in Fig. 5. Usually, however, it is advisable to install new rings in accordance with the manufacturer's in-

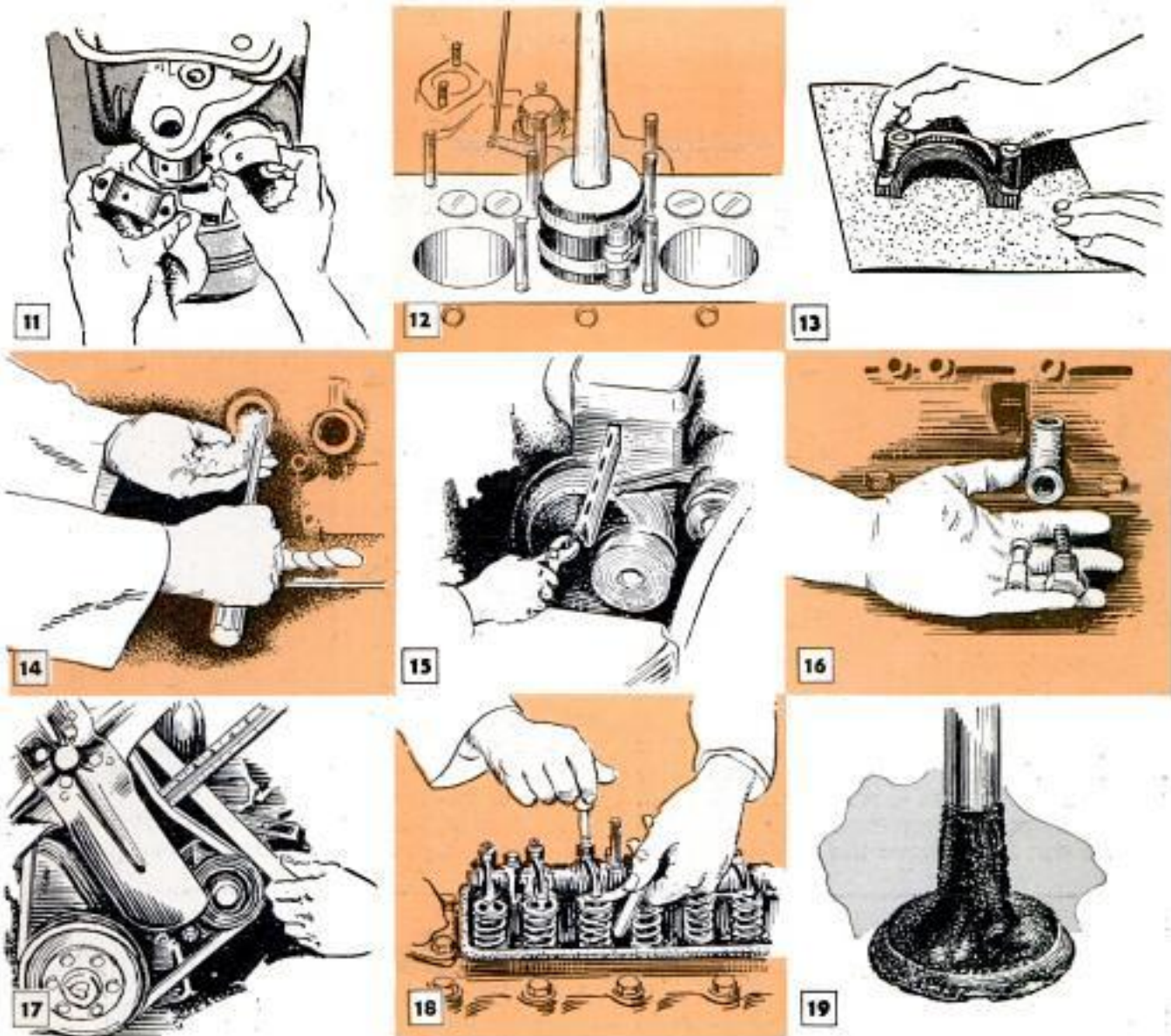

structions. In some cases, ring fillers will serve the purpose, Fig. 6. After installing a filler be sure that the ring is free as in the exaggerated view, Fig. 6. When installing pistons, use a ring guide as in Fig. 12.

While the engine is dismantled give the valves a thorough going over. Valves badly pitted and carboned like that in Fig. 19 are seldom worth the attempt at reconditioning. If the valves are in generally poor condition, it's good economy to replace them all. New guides also may be needed, as they are likely to be badly worn. Check for correct valve clearance and adjust as in Fig. 18. Refer to the manufacturer's instructions for the correct clearance. When reassembling the engine be sure to use all new gaskets, cotter pins, lock washers and nuts if the latter have been damaged in any way. It will pay to borrow or rent a tension wrench so that nuts and cap screws can be drawn to a uniform tension, especially on the oil pan, cylinder head, water-pump and timing-gear housings.

A lot of sediment collects in the water

jackets of an older engine. This will not ordinarily be removed by regular cleaning procedure. The only sure way to get at it effectively is to remove the expansion plugs in the sides of the block, Fig. 14, and loosen the deposits with a screwdriver, or similar tool. Some engines are fitted with a water-distributing tube which should be replaced as a rule, Fig. 15. With the expansion plugs and the water tube removed, hose out the block with water under pressure. Then replace the plugs (new ones generally are required) and the water tube. Replace the thermostat while the cooling system is open. Final checks on the engine itself include the oil-pressure-regulator spring, Fig. 16, and the slack in the fan belt, Fig. 17. In most cases, it will be advisable to replace the regulator spring and readjust or replace the fan belt. When auto engines are used for stationary work it usually is necessary to increase the capacity of the cooling system. This usually is done by substituting a radiator of greater capacity than that originally supplied. ★ ★ ★

## Shelf Above Drawing Board Swings on Strap Hinge

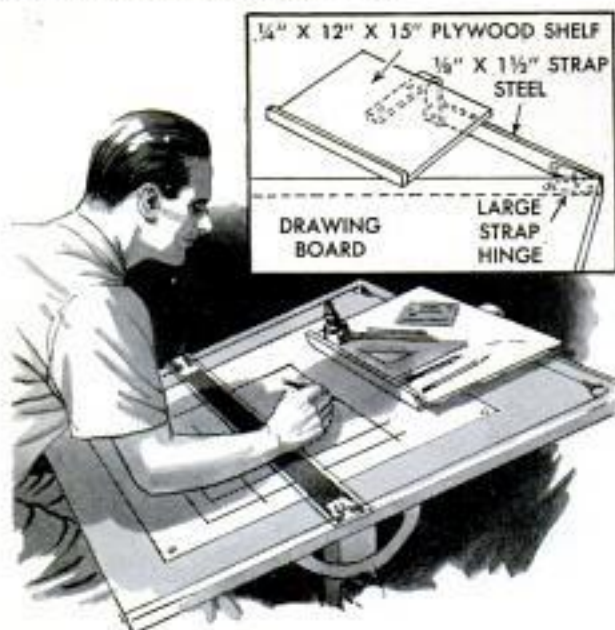

Especially useful where a parallel straightedge is used on a drawing board, a swinging shelf keeps tools and supplies handy yet off the board. The shelf is a 12 x 15-in. sheet of  $\frac{1}{4}$ -in. plywood screwed to an L-shaped piece of  $\frac{1}{8}$  x  $1\frac{1}{4}$ -in. steel strap. The L-shape is long enough to hold the shelf about 2 in. above the drawing board

when it is bolted to another length of strap steel. The latter strap is bolted to a strap hinge screwed to the back edge of the drawing board at the right side. The hinge pin is upset so the hinge will stay in whatever position it is placed when the shelf is swung back.

Leonard W. Mitchell, Carrsville, Ky.

## Litmus Paper Held With Tweezers

To prevent false or confusing reactions on litmus paper, which might be caused by perspiration stains from his fingers, one chemist handles the sensitive paper with small tweezers. Less paper is wasted when the tweezers are used, because there is no stained portion that must be cut off before the paper is used.



A pair of tweezers is kept in the litmus-paper containers so they are always at hand when needed.

## Popular Mechanics Bookshop

### Information Every Craftsman Should Have at His Fingertips

Save your time, temper and money with a new book written by the craft editors of *Popular Mechanics Magazine*. *How to Use Hand Tools* will enable you to do your work more quickly, with less fuss and bother and with fewer mistakes.

Good tools are worth their weight in gold to the craftsman—and this book tells in words and pictures how you can get the most out of them.

If you want clear, precise information on using such tools as handsaws, pliers, clamps, hacksaws, planes, scrapers and soldering equipment, you'll want a copy of this handsome, clothbound and profusely illustrated book.

Also included are money-saving articles on tool maintenance, such as: Sharpening planes, saw setting and filing, blowtorch cleaning and file care.



In addition, you'll want its detailed charts on lumber and molding sizes, nails, wood screws, nuts and bolts always on hand for quick reference.

Get *How to Use Hand Tools* for your shop today! For your copy of this indispensable book, mail only \$2.50 to

## POPULAR MECHANICS PRESS

200 E. ONTARIO STREET

CHICAGO 11, ILLINOIS





# SHOP NOTES

## Make Your Own T-BOLTS AND CLAMPS

By C. W. Woodson

ACCURATE MACHINING of work mounted on the drill press, milling machine or metal shaper requires that the work piece be securely clamped to the machine table so that it cannot shift under cutting stresses. Ordinary C-clamps and machine vises do not always meet this exacting requirement. Machinists use T-bolts and clamp bars, or hold-downs of various types and sizes, many of which are made in the shop. Most of the smaller sizes are easily made from stock materials.

Fig. 1 shows a typical setup on a drill-press table using two flat clamps, two T-bolts, two parallels and two packing blocks. On some types of light work the L-clamp, Fig. 1, can be substituted in the setup. The L-clamp eliminates the need for packing blocks, thus speeding up setups on repetitive work. Parallels (not to be confused with machinist's precision parallels), or shims, are cut from mild-steel bar stock of various widths and thicknesses to suit the purpose, Fig. 2. A conventional V-block with clamp, Fig. 2, usually is included in the kit of clamping accessories. T-bolts, so-called because of the special shape of the head, usually are made in the shop. They also may be purchased in conventional types. Details A, B, C, D and E in Fig. 3

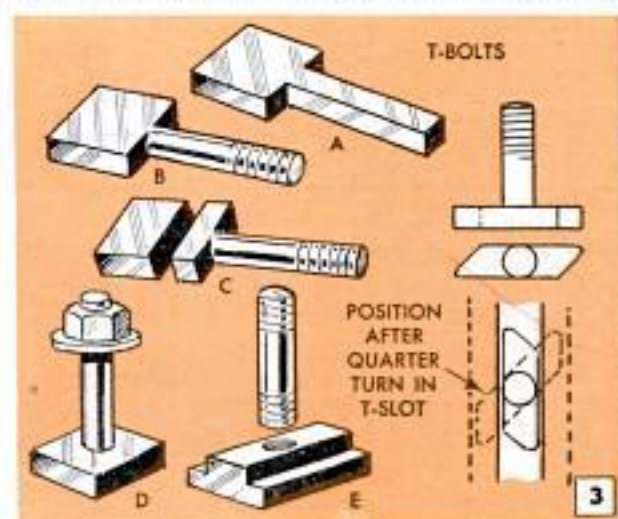
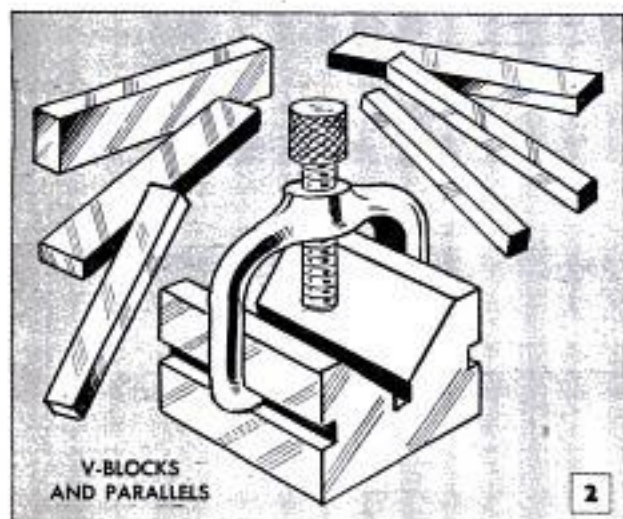
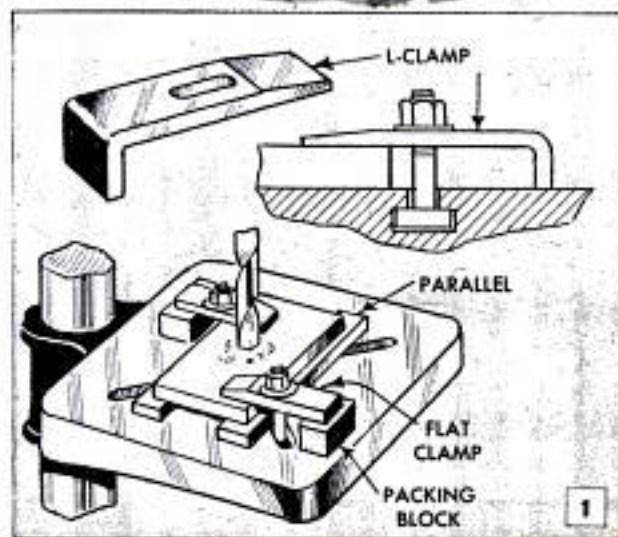

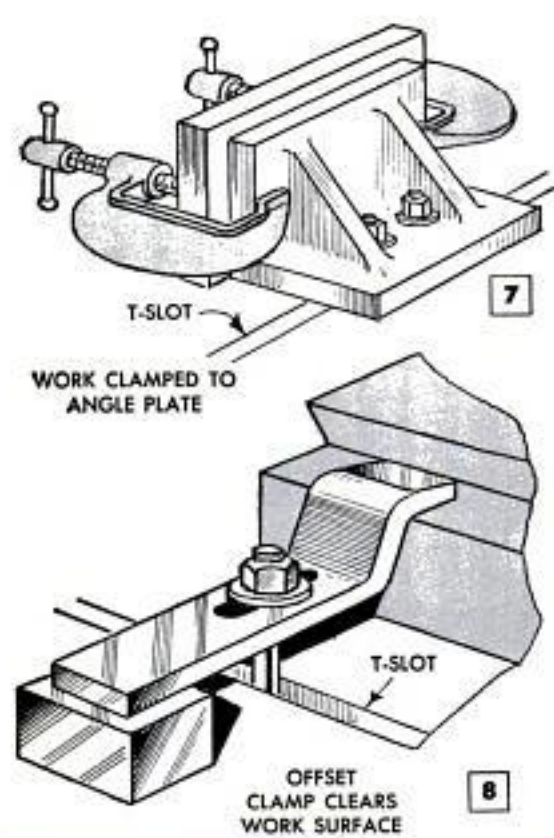
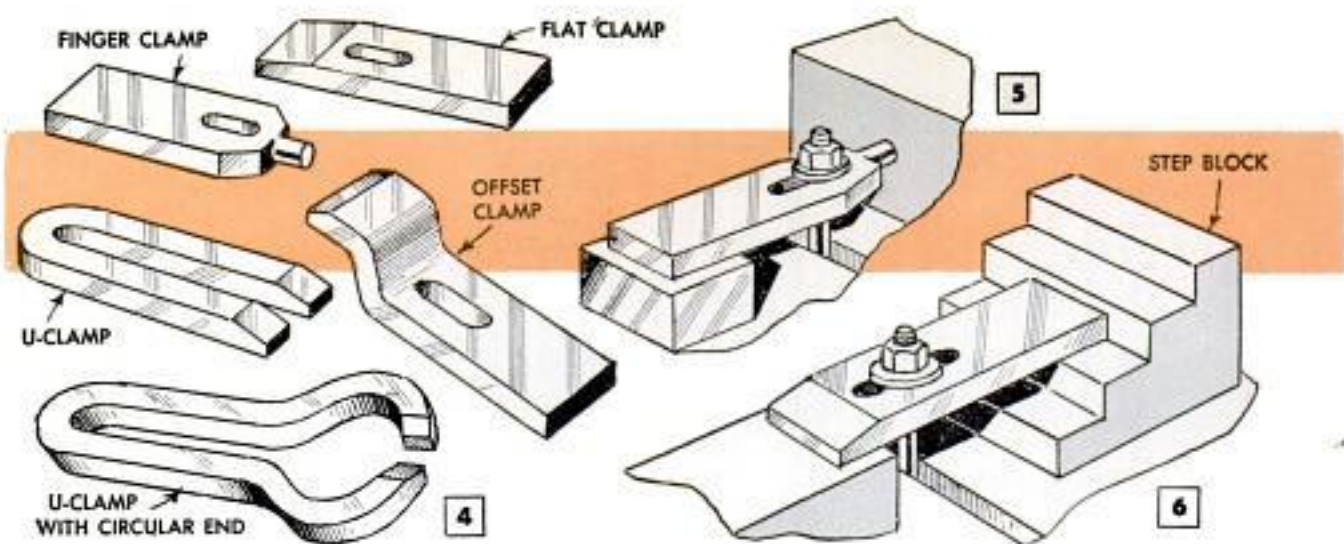

show several types commonly used. Details A, B and C show the development of the quarter-turn bolt which is especially designed to be dropped into the T-slots in machine tables and locked by a quarter turn as in the details at the right in Fig. 3. This bolt is easily turned in a lathe from flat stock. The square-head bolt, detail D, will withstand the greatest clamping pressure, but the shape of the head makes it necessary to insert it in the end of the slot in the machine table. Machinists generally use the squarehead bolt and the quarter-turn bolt in combination, as the latter can be inserted in the slots in the table at any point and tightened on the clamp bar. The T-head slide, detail E, Fig. 3, is tapped for a stud as shown and is designed for use where the clamp must be assembled after the work is placed in position on the machine table. The accessory kit generally includes assorted sizes of all the common types of bolts.

Four different shapes of clamps, or clamping bars, are shown in Fig. 4. Unusual setups using the finger clamp and the straight, or flat, clamp are detailed in Figs. 5 and 6. The finger clamp, Fig. 4, is especially useful where the nature of the work makes it necessary to

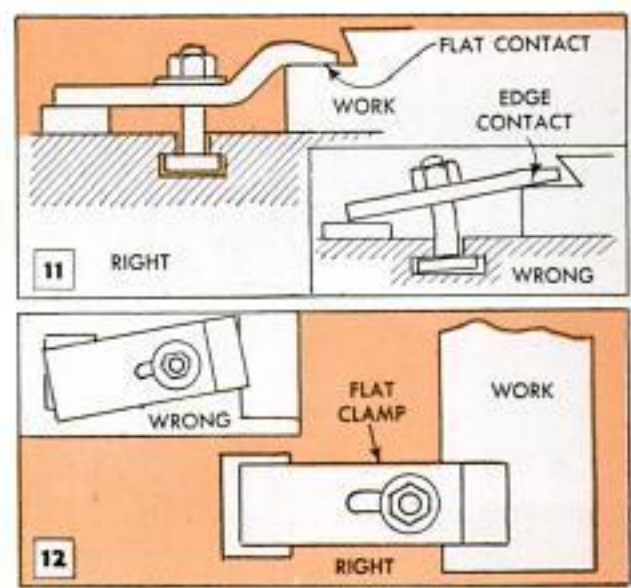
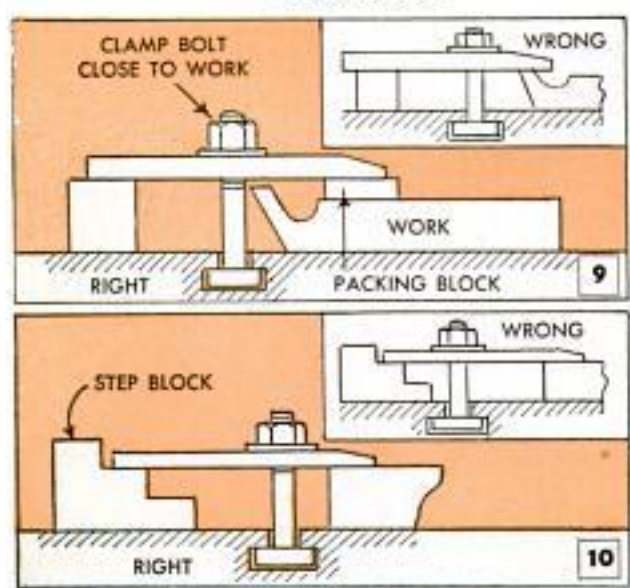

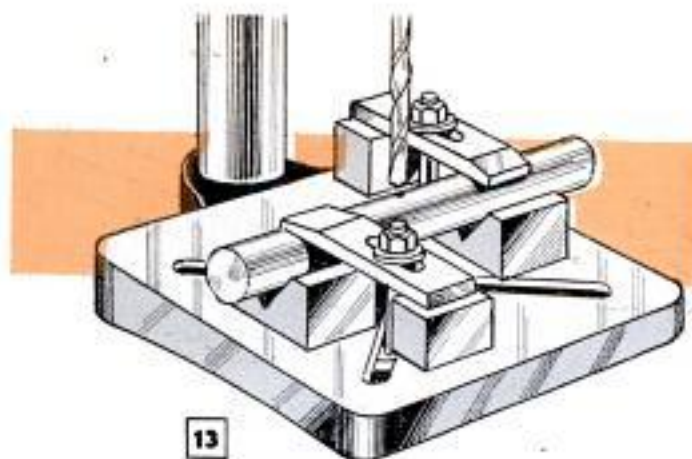

13

V-BLOCKS AND FLAT CLAMPS  
HOLD ROUND WORK

place the clamp so as to leave a clearance for machining the surface of the work. In this case the finger of the clamp is inserted in a hole or slot in the side of the work piece in such a manner that the clamp, packing block and clamp nut are below the surface to be machined. In the setup in Fig. 6 the unusual feature is the use of a step-type packing block. A similar step-block setup is illustrated in Fig. 10. Special short T-bolts are handy for angle-plate setups as in Figs. 7 and 14. In Fig. 7 the work piece is clamped to the vertical face of the angle plate with machinist's C-clamps, while in Fig. 14 the work is attached to the vertical face with bolts. In some cases the offset clamp can be used as in Fig. 8 where it is necessary to provide machining clearance. Right and wrong methods of making setups with clamps and T-bolts are detailed in Figs. 9 to 12 inclusive. Note especially the correct placement of the T-bolts in relation to the edge of the work. Flat clamps, V-blocks and packing blocks also can be combined in an accurate setup for drilling round work in the manner shown in Fig. 13. ★ ★ ★

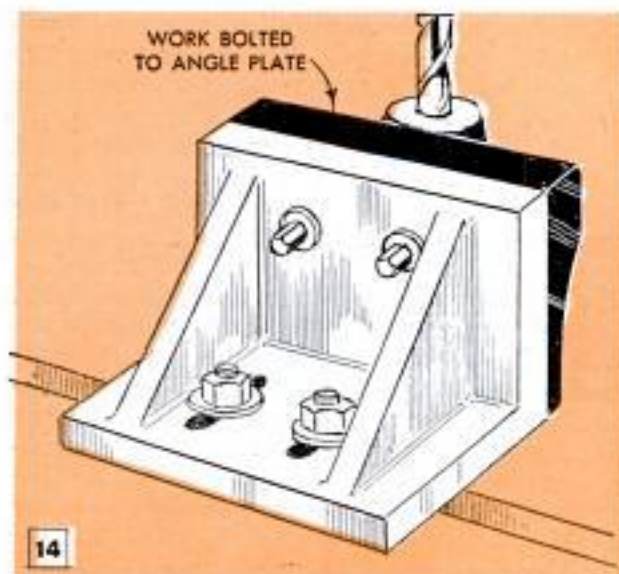

14

## Blade of Rotary-Type Lawn Mower Turns on Auto-Wheel Spindle



Parts from an automobile front-axle assembly are combined with metal scraps from a farm machine shop to build this rotary-type lawn mower, which is powered by a ½-hp. electric motor. An 18-in. blade is mounted on a cut-down front-wheel spindle from a car. Bevel gears on the spindle and motor shaft provide direct drive to the mower blade. The wheel hub, with bearings and spindle stub, was removed from the brake drum and bolted directly to a semicircular steel plate that forms the top of the mower. Two rubber-tired wheels are fitted at the back of the mower, while a single wheel at the front is pivoted to permit easier steering.

A. M. Wettach, Mt. Pleasant, Iowa.

## Portable Chicken Feeder

A large, portable chicken feeder can be made easily by supporting a 5-gal. paint or grease pail above the bottom of a wide, shallow pan. Remove the bottom of the pail and punch four holes, equally spaced, near its lower edge. Two ¼-in. steel rods span the pan, passing through the holes in the pail and corresponding holes in the pan. The rods support the pail above the bottom of the pan and also permit picking up the feeder as a unit by the bail.





1 For best results, drum-sanding should be done with an auxiliary table bolted to the drill-press table



2 In some cases where work is small size, drum can be worked off edge of machine table in manner pictured. Lower end of drum should be below surface of table



3 Above, purpose of auxiliary table is to permit running drum with its lower end below surface. Below, table with raising cleats allows drum to be adjusted up or down to equalize wear on the abrasive sleeve

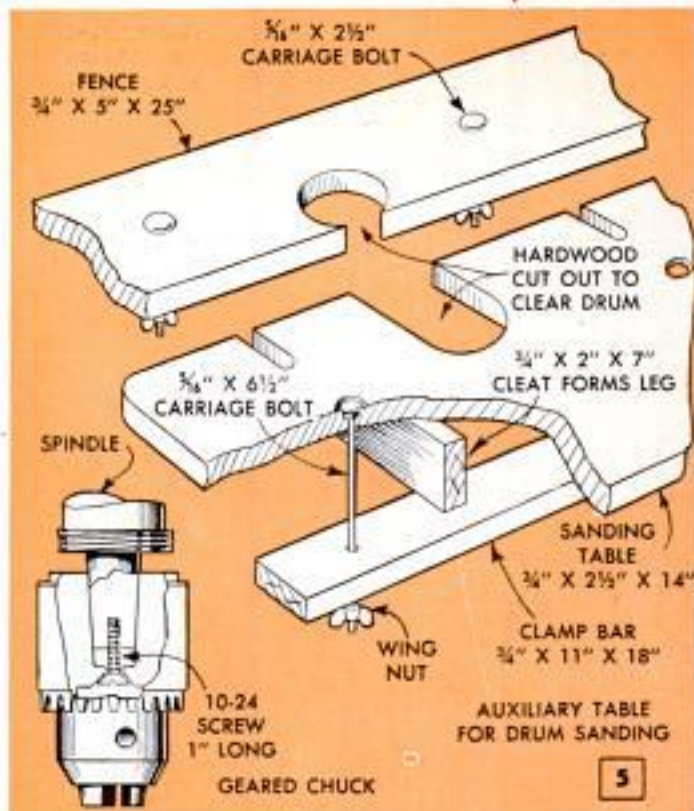

# High-Speed

By Sam Brown

**Y**OUR DRILL PRESS can take the hard work out of sanding both edges and flat surfaces. Edge-sanding by hand is a tedious, unsatisfactory job at best, especially if the nature of the work demands that you produce a perfectly square edge without rounded corners. Due to the slow speed of the abrasive in hand-sanding it is difficult to eliminate scratches, even though different grades of sandpaper are used. Also the abrasive grains in the coarser grades tend to "track" on the surface, leaving comparatively deep scratches due to the tendency of each individual grain to load with wood fibers.

In machine-sanding the relatively high surface speed of the abrasive produces remarkably smooth work even with the coarser grades of abrasive. Due to the movement of the work and the abrasive, the individual abrasive grains do not track. Smooth work and faster cutting result on both hardwoods and softwoods, on both surface sanding with a disk and edge sanding with a drum. Abrasives of different grades cut fast and clean with only moderate pressure.

**Drum-sanding setups:** Small sanding drums suitable for use with a home-shop drill press come in a wide range of sizes,

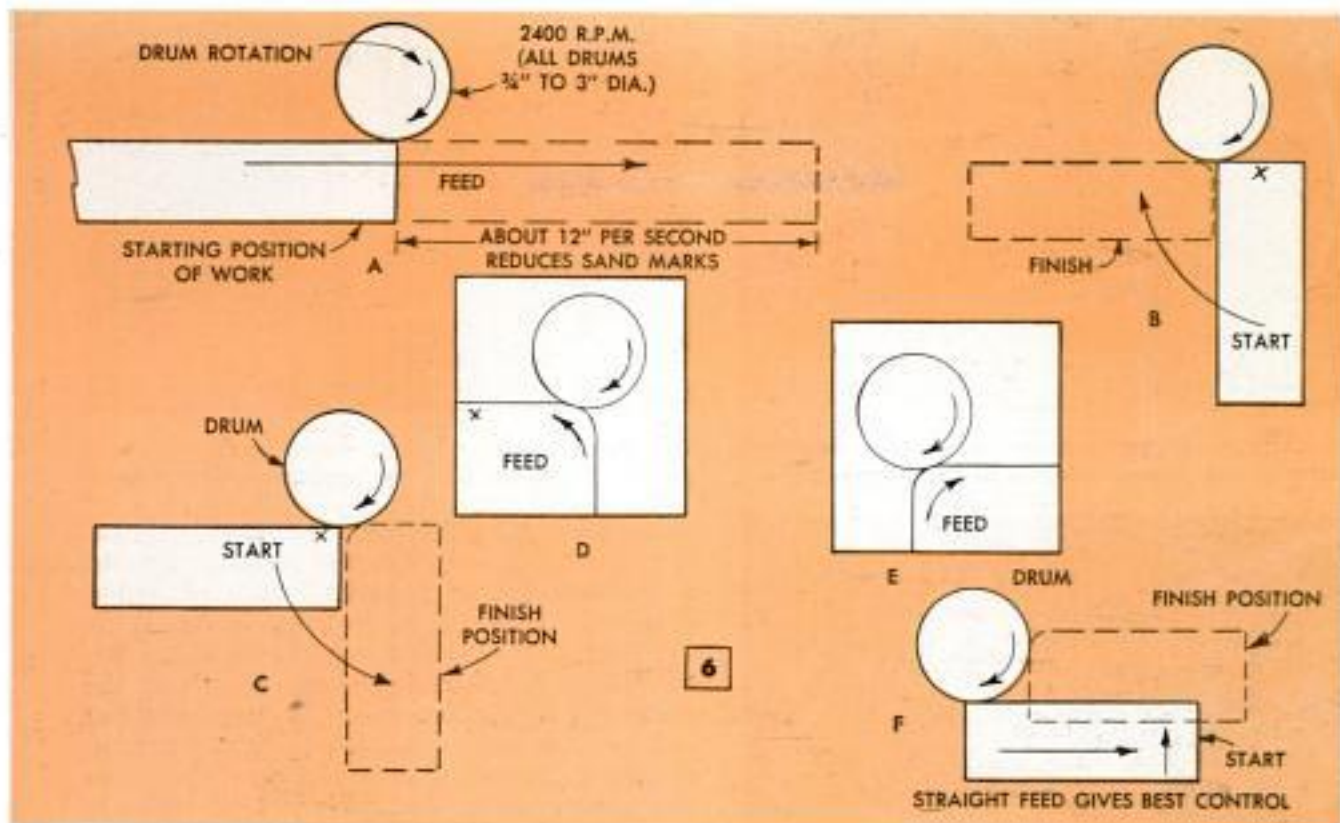

# Sanding on Your Drill Press

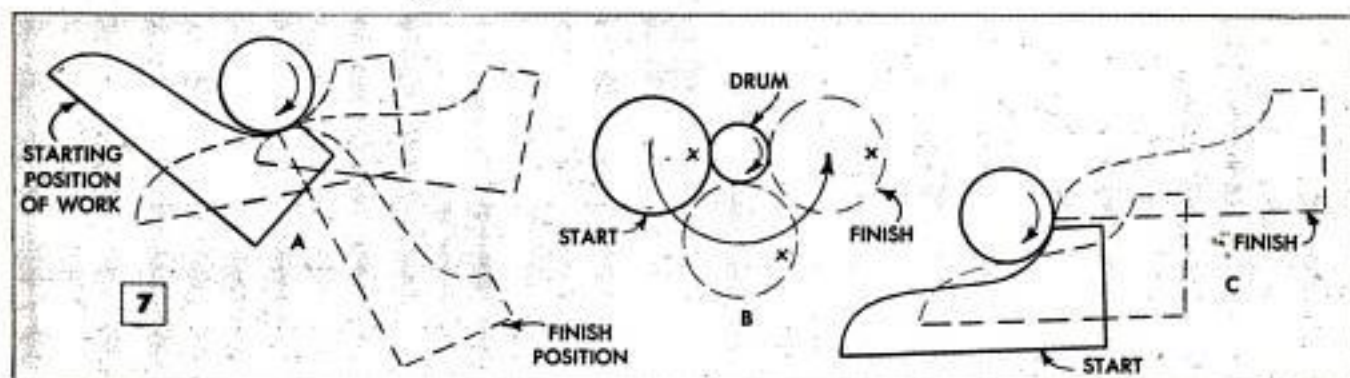

from about  $1\frac{1}{16}$  to 3 in. dia. Both the drums and the abrasive sleeves are inexpensive and very efficient for edge-sanding curved work. Figs. 1 to 5 inclusive show typical drum-sanding setups on a drill press. On curved work of the type pictured it is necessary to provide an auxiliary table of plywood with a hole at the center through which the drum can be worked as in Figs. 1, 3 and 4. In some cases the drum can be worked off the edge of the drill-press table as in Fig. 2. However, only short pieces of work can be adequately supported in this setup. The method of mounting the sanding drum varies. For light work where only light side pressure is required, the spindle of the drum can be held in the geared chuck which is regularly supplied with the machine, Fig. 2. On drums having

sleeves, a  $\frac{1}{2}$ -in. adapter spindle is used. Accessory adapters or interchangeable spindles are supplied for nearly all small drill presses. The mounting point on these accessories is closer to the spindle bearing, thus reducing the overhang as in Figs. 1, 3 and 4. On some drill presses the geared chuck is mounted on a tapered spindle. Side pressure sometimes loosens the chuck. This can be prevented by drilling and tapping the end of the spindle for a machine screw as in Fig. 5, the lower left-hand detail. Drill the spindle as in Fig. 12. Although manufacturers do not ordinarily recommend this procedure it is permissible where possible slight impairment of chuck accuracy is not important.

**Drum-sanding procedures:** Fig. 5, the upper detail, shows a convenient sanding



8 Coating the soft-rubber drum with commercial talcum powder will prevent sticking of the abrasive sleeve



9 Wire-brushing the abrasive sleeve occasionally will prolong its useful life and produce smoother work



table which is designed to clamp onto the drill-press table. A similar auxiliary table is pictured in Fig. 4. When sanding the edges of straight work where the width dimension is not extremely important, the work is moved past the drum from left to right as in Fig. 6, detail A. When a certain amount of stock must be removed by sanding and the width must be uniformly close, use a guide fence as in Fig. 11. When sanding uniform curves and especially when rounding corners with a drum, details B and F show what is generally considered the best procedure when very smooth sanding is required. Other methods, details C, D and E, produce fairly good results where finish is not so important. Although 2400 r.p.m. is a recommended speed, any speed between 2000 and 3000 r.p.m. will give good results, provided feeding of the stock is properly handled. When drum-sanding curved work, the procedures A and C de-

tailed in Fig. 7 often are used, that in detail C giving uniformly the best results. Truing a bandsawed or jigsawed disk of wood generally is done as in Fig. 7, detail B. Ordinarily this is done freehand when the accuracy of a turning is not required. In some cases it is necessary to spot-sand the high areas before finish-sanding for true contour. Before applying a new sleeve to the drum, dust the surface with talcum powder as in Fig. 8. This will prevent the sleeve from sticking. Wire-brushing the sleeve occasionally, Fig. 9, will prolong its useful life. Ordinarily, this is most effective if done while the machine is running.

**Guided sanding:** Although nearly all drum-sanding on a small drill press is done freehand, straight work usually requires a guide fence made to suit the purpose. Examples are shown in Figs. 13, 14 and 15. In order to produce a true edge on the work and at the same time prevent undue wear on the lower edge of the sanding sleeve, it is necessary to lower the drum below the surface of the sanding table. This requires an auxiliary table of plywood and a separate guide, or fence, set up as in Fig. 13. A hole is drilled or sawed through the guide, the diameter slightly greater than that of the drum, Fig. 11. Then the edge of the guide is planed with a  $\frac{1}{16}$ -in. offset between the infeed and outfeed edges as in Fig. 11. The fence and auxiliary table are then bolted to the machine table. Adjust to the correct position before tightening the bolts. If you're working to close dimensions, test

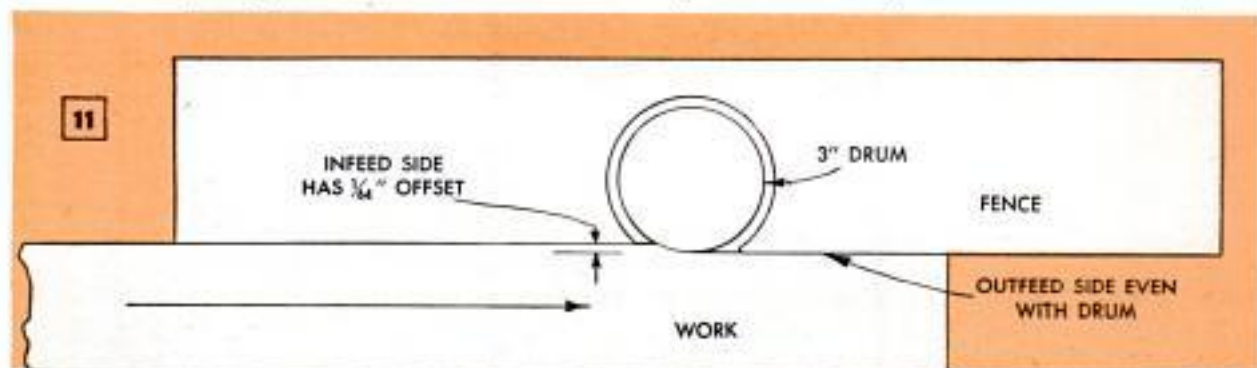



When drilling spindle, place drill bit in vise and lower spindle onto it slowly. Use very light feed

the setup on a piece of waste stock and readjust if necessary to give the desired results. In sanding straight work the rate of feed is not so important as uniformity. The work must be kept moving at a uniform rate past the drum. If the work is stopped at any point along its length while in contact with the rotating drum, it may be scored or burned at the stop point. An uneven feed can produce scoring at intervals along the length of the stock. On short work, such as that pictured in Fig. 13, it is possible to make the sanding stroke with one sweep of the arms without removing either hand from the work. On longer stock it will be necessary to shift the hands alternately. Here the trick is to maintain uniform pressure and rate of feed with the one hand while the other is being shifted. In some cases an overhand movement gives satisfactory results.

**Disk sanding:** When you do not have a belt sander available, the disk sander, power-driven in the drill press, is the next best thing. The rubber-cushioned disk, supplied for use in the drill press, does a good job of surfacing when driven at speeds above 2000 r.p.m. Ordinarily, the depth of cut is set by chucking the disk and bringing it down lightly on the work. Then lock the drill-press spindle. As a rule it's best to use a fairly coarse abrasive on a disk, especially when the disk is run flat on the work surface. Only minor swirl marks will be left on the work if the feed is uniform. These are easily sanded out by hand if

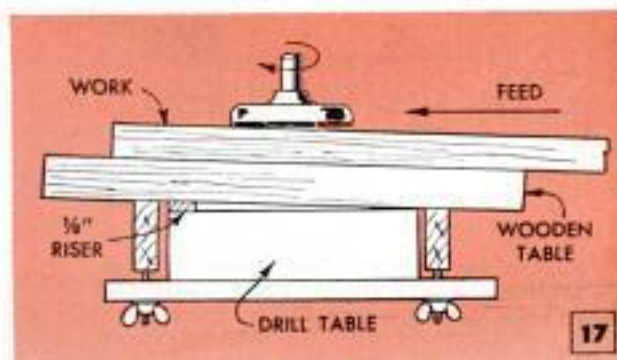

JUNE 1955

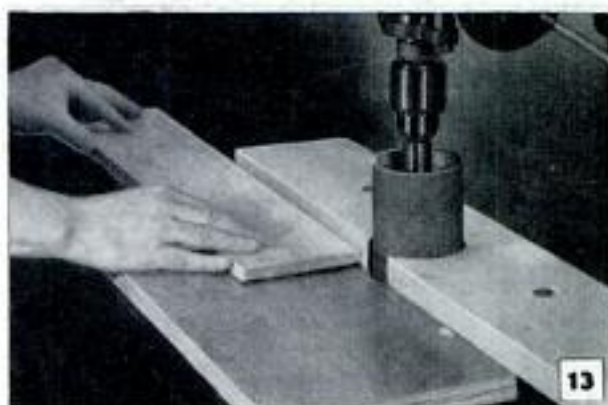

Straight sanding requires a fence with infeed and outfeed edges offset 1/64 in. as shown in Fig. 11



When squaring the end of a narrow strip use a follow block to guide end of strip past fence opening. This precaution assures a square end on the stock



Above, a shaper fence can be used with drums 2 in. or less in dia. Fence is adjustable to proper offset. Below, disk sander is efficient unit for surfacing either hardwood or softwood to a uniform thickness



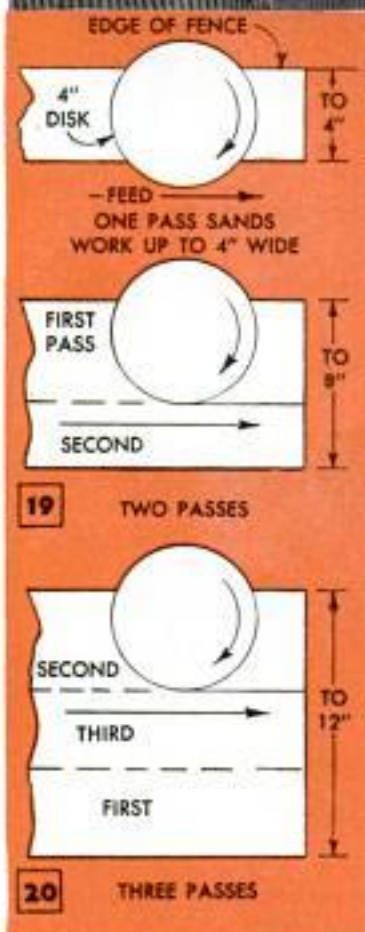
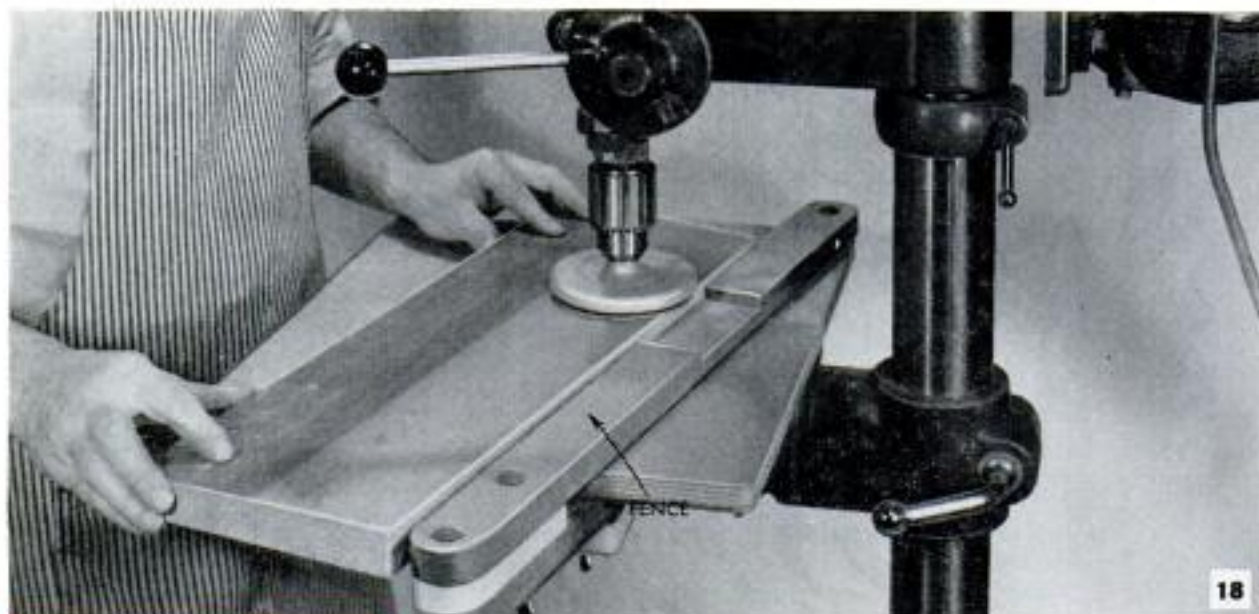

necessary for a fine finish. The work will require a guide as in Figs. 10, 16, 18 and 21. In some cases a hold-down is an advantage, Fig. 16. When it is necessary to remove considerable waste as quickly as possible by sanding, the work table can be tilted slightly by means of a riser as in Fig. 17. The slight angle of the work causes the disk to cut much faster. This position of the work produces some swirl marks and a slight concavity of the surface, but these imperfections are easily removed by hand-sanding or by flat-sanding with the disk.

Boards up to 12 in. wide can be flat-sanded with a 4-in. disk by using overlapping passes as in Figs. 18, 19 and 20. If care is used in feeding the stock at a uniform rate, very smooth sanding can be done by using this procedure. For best results all three passes should be made without shifting the stock end for end. A pivoted fence like that in Fig. 18 makes it easy to pass the stock under the disk in one direction from left to right.

Another job on which the disk sander is especially effective is finishing the beveled edges of a raised panel. This is difficult to do by any hand-sanding method, but the setup shown in Figs. 21 and 22 does the trick in a professional manner. Care must be taken in locating the disk in relation to the bevel. The fence, Fig. 22, must clear the disk and must be so placed that the abrasive covers the entire face of the bevel in one pass. Be sure that the abrasive is correctly centered on the disk. If it overhangs it may damage the smooth contour of the work. ★★★

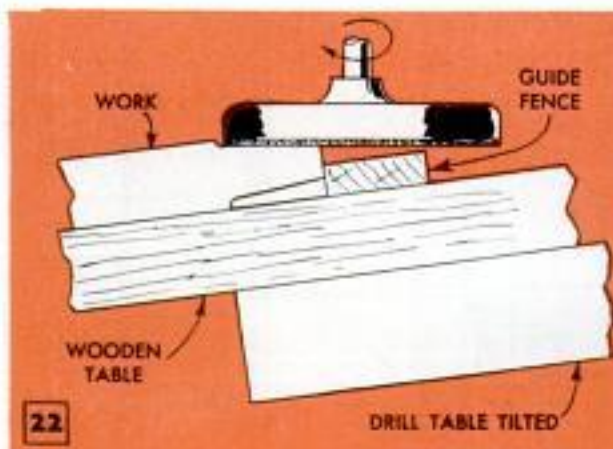



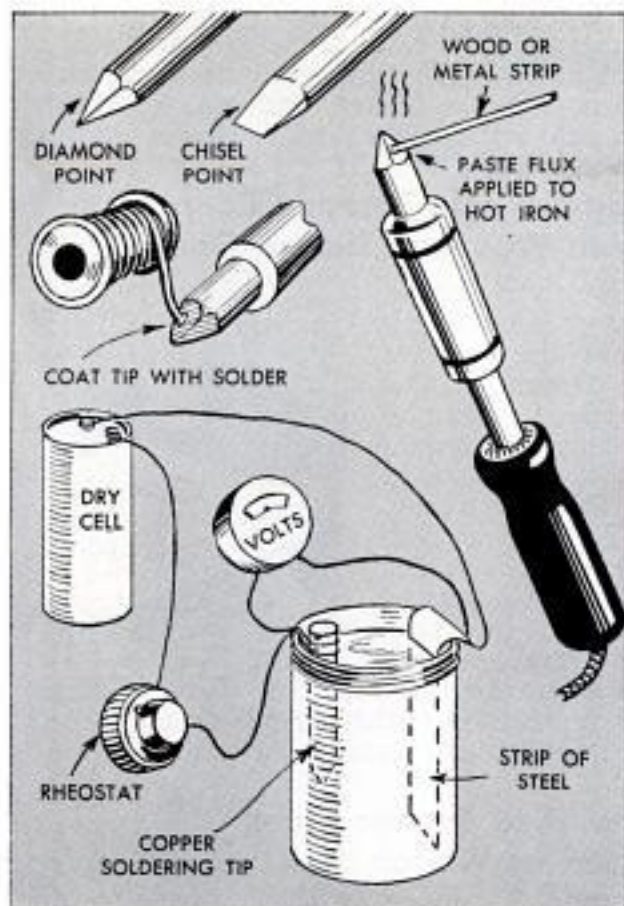

## New Life for Soldering-Iron Tips

Worn and pitted soldering-iron tips can be restored to new and greater efficiency by first filing the point to the preferred shape, either diamond or chisel point, and then electroplating with an iron-plating solution. The iron plating prevents burning and pitting of the tip and at the same time does not impair the high-heat conductivity of the copper.

The iron-plating solution is prepared by dissolving ferrous (iron) chloride, 8 oz., and potassium chloride, 6 oz., in 1 qt. of water in a glass container. To this solution add  $\frac{1}{2}$  fl. oz. of hydrochloric acid and stir in clean iron filings. Continue stirring until the solution is a bright-green color. Then make the electroplating hookup shown in the details above, using a large dry cell, a rheostat and a voltmeter. Although the latter is not essential, its use gives a somewhat more positive control of plating conditions. Wire-brush the copper soldering tip to remove any loose particles, then dip for a few seconds in nitric acid which has been diluted with an equal volume of water. Rinse the tip in hot water and place in the plating bath without drying. Hang a strip of sheet steel in the plating bath as shown and connect to the positive terminal of the battery. Connect the soldering tip to the negative terminal. Adjust the rheostat

to give a smooth, uniform deposit on the tip, between  $\frac{1}{2}$  and 1 volt on the voltmeter. Turn the tip once or twice during the plating period, which should be about 45 min. When the time is up, remove the tip from the solution and wash thoroughly in clean, hot water.

Replace the tip in the heating head, heat to working temperature and coat with paste flux. Then tin with solder as in the details above, using care to assure a uniform coating. The iron-plated tip will last indefinitely. Do not remove the plating by filing the tip. Simply brush lightly to clean.

*Caution:* Handle concentrated acids with extreme care. Wear rubber gloves and take every precaution to protect the eyes from spatters.

J. B. Mullen, Barrington, Ill.

### Improved Fence-Post Puller

An automobile bumper jack can be used as an effective fence-post puller. Attach a chain to the post at ground level and to the lifting pad of the jack. On large posts use two jacks, one on either side of the post. The latter method provides greater pulling force, and if both jacks are raised at the same time, will lift a steel post without bending it.

## Shaper-Mounted Grinder Smooths Flat Work



Mounted on a shaper ram, a tool-post grinder can be used to accurately grind small flat work. Run the shaper at slow speed and fine feed for best results. The shaper cross rails and vertical slides of the table must be protected against grinding-wheel dust and grit. Heavy paper or light canvas can be used for the latter purpose. For purposes of illustration, the protective covering is not shown in the drawing but should always be used to prevent accidents.

C. W. Woodson, Chicago.

## Weather Shield on Hoist Pulley

A section of auto tire will provide a convenient weather shield that can be fitted easily over a hay-hoist pulley that must be left outdoors. Punch a hole in the casing and slip it over the hoist before it is mounted in place.

## Small Parts Dropped From Vise Caught in Cloth "Net"

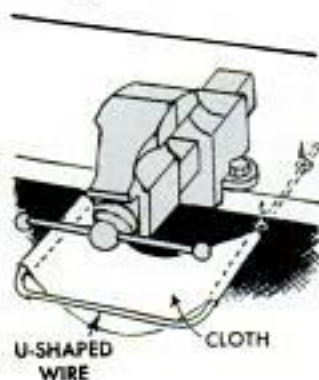

Supported on a wire frame from the underside of the bench top, this simple cloth "net" catches small parts dropped while working in a vise. The supporting frame is heavy wire bent into a U-shape. The ends of this frame slide

in screw eyes so the net can be removed and stored under the bench top when it is not needed. The edges of the cloth may be hemmed to fit over the wire, or it can be held with safety pins.

## Tapped-Hole Threads Counted With Wooden "Thread Gauge"

When a thread gauge is not available, the number of threads in a tapped hole can be determined quickly by using a wooden plug. Whittle the plug so that one end is slightly larger than the hole size, yet small enough to be turned into the hole. This produces an impression of the threads on the wood, where they are counted easily.

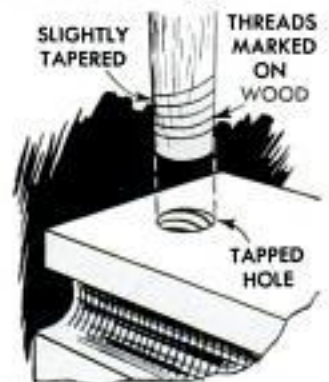

## Modified Tractor Scoop Used as Wagon Jack

When a wagon jack was unavailable, one farmer modified his tractor scoop to permit dumping wagon loads of ear corn at the elevator. A heavy steel bar is bolted across the teeth at the front of the scoop. When it is being used to raise the front of a wagon, the scoop is positioned so the bar fits behind the front cleat on the bottom of the wagon box. This prevents the box from slipping off the scoop.

A. M. Wettach, Mt. Pleasant, Iowa.

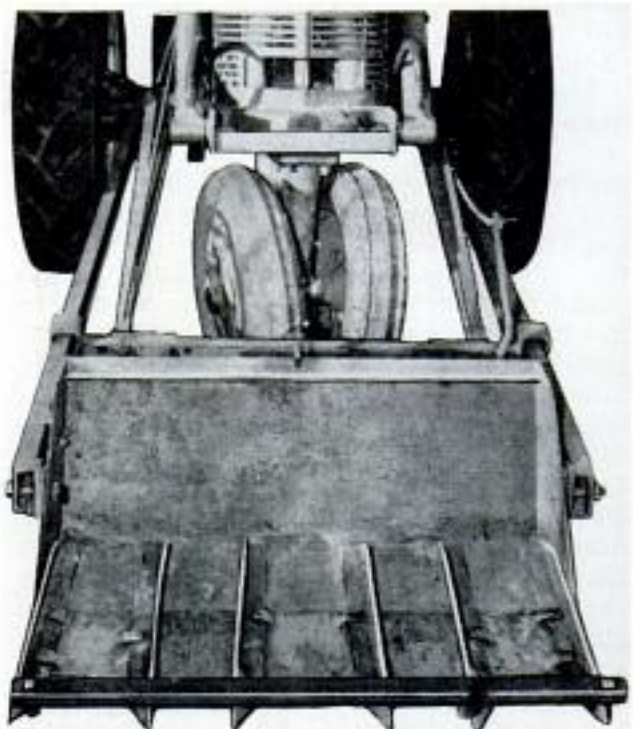

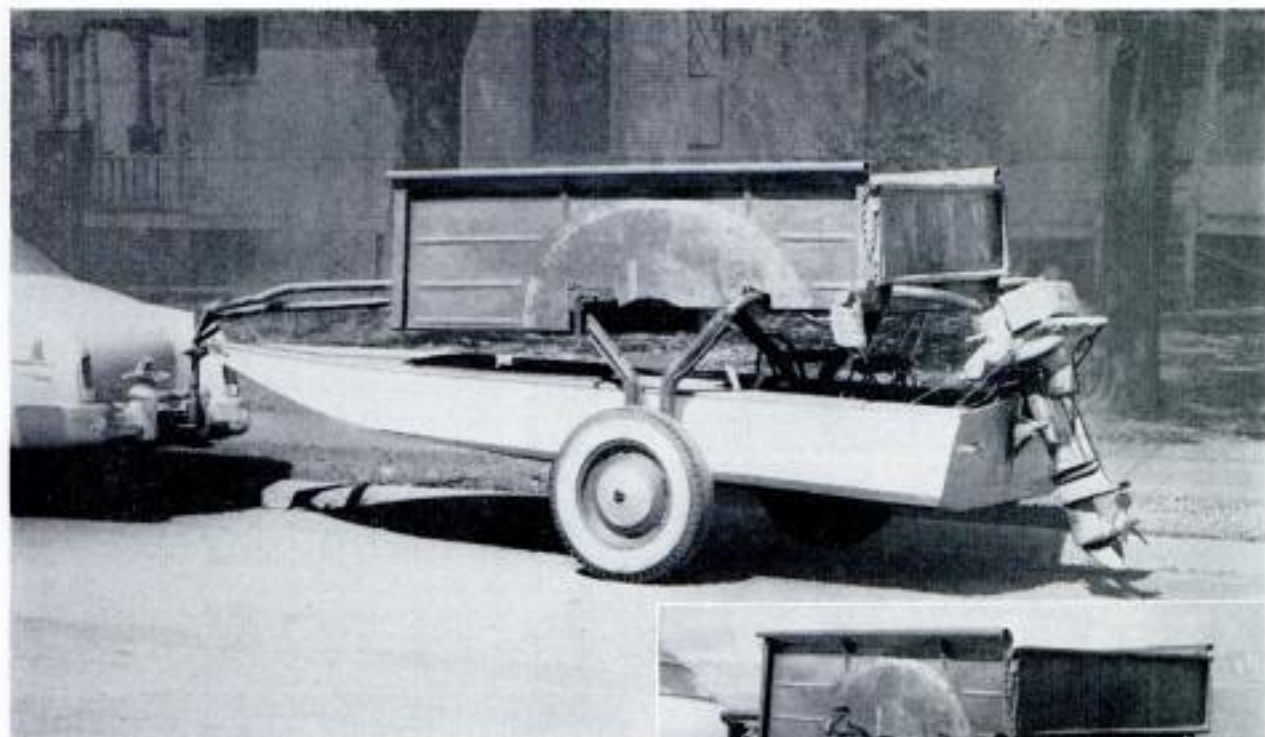

## PIGGYBACK BOAT TRAILER

This dual-purpose trailer carries the boat and sufficient camping gear for a full week end of fun. The unit consists of a standard boat trailer of the underslung type with a pickup-truck bed mounted on the axle arch as pictured. The fenders were removed from the pickup bed and U-shaped cuts were made in the sheet-metal skirt on both sides to permit the bed to fit down snugly on the axle arch. U-bolts passing around the arches and through holes drilled in the bottom of the bed hold it securely in place. This placement of the pickup bed does not in any way interfere



with operation of the winch which raises and lowers the boat. In some cases it may be necessary to use wooden cleats between the arches and the bottom of the bed in order to raise it to the correct height to clear the winch drums. In some states fenders are required on trailers used on the highways. Attach fenders to the axle arches, either by welding or by means of U-bolts.—Grover Brinkman, Okawville, Ill.

## Countersunk Screws Covered With Turned Wooden Buttons

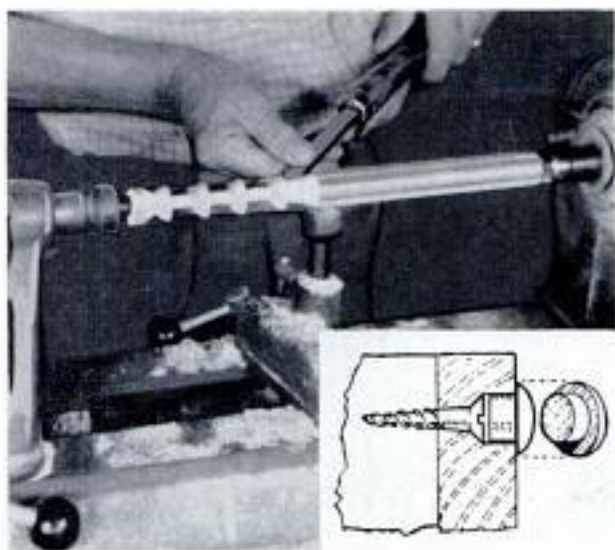

When assembling furniture, the use of turned wooden buttons will simplify the job of covering the heads of countersunk screws. The buttons are turned with stems the same diameter as the screwheads and glued in counterbored holes into which the screws are driven. As shown in the detail, the heads of the buttons are slightly larger in diameter than the stems. Turning all the buttons from a single length of stock will assure that all will be of the same grain and color. All screw holes should be aligned, spaced evenly or located to form a pattern. The wood used for the buttons can be the same as is used in the furniture, or of a grain and color to present a pleasing contrast.

Dick Hutchinson, San Gabriel, Calif.



# SHOPPING FOR TOOLS

**PROTRACTOR GUIDE** for portable electric handsaws permits cuts to be made with the accuracy and speed of a table saw. Works like a draftsman's T-square, except that the blade is adjustable either right or left to any common angle from 90 deg. This permits angle cuts to be made in either direction. Guide is placed on top of the work, the arm being adjusted to the angle desired. Then saw is placed with the edge of the shoe against the edge of the guide arm. Protractor is calibrated in deg. for accurate setting

Boden Sales, 274 Busher Ave., Valley Stream, N. Y.

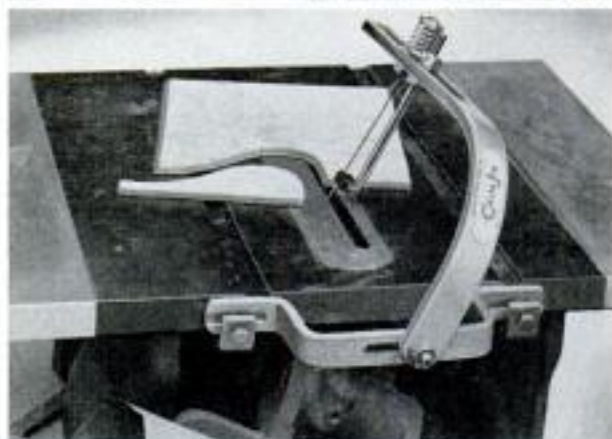

**JIGSAW ATTACHMENT** for circular saw uses standard jigsaw blades, cuts work up to 2 3/4-in. thickness and works to the center of a 16-in. circle. Jigsaw arm can be tilted for angle cuts as pictured in lower photo above. Unit comes complete, ready for attachment to any small circular saw. Jigsaw blade is driven from circular-saw arbor at arbor speeds. Tension of the blade is adjustable to prevent breakage

Verso-Tool Co., Lake Ave., at 4th St., Racine, Wis.



**ELECTRIC BRAKE** for small radial saws brings saw blade to a dead stop within a few seconds after motor switch is opened. Normally, saw blade spins from 2 to 4 min. after shutting off motor. From this the saving in time when making certain repetitive cuts or changing cutting tools will be apparent. Unit is supplied as a kit which can be installed easily. Brake is fitted with switch and is entirely automatic

DeWalt, Inc., Lancaster, Pa.

**CHAIN-SAW SHARPENER** will precision-sharpen any saw chain that normally is sharpened with a round file. Adjustments are easily made for any horizontal and vertical angles ordinarily required and also for all common sizes and lengths of teeth. Sharpening is done by a carbide burr driven at 20,000 r.p.m. High speed of burr prevents any tendency to overheating and produces smooth, sharp edge. Bolts to bench top

Forester Mfg. Co., 10 McCue Ave., Lockport, N. Y.





**LABORATORY "JACK"** provides a working platform on which experimental apparatus or work projects can be mounted and raised and lowered as desired while assembly or tests are carried out. Elevation range is 7 in. Lowers to 3 in. in height

Central Scientific Co.,  
1700 Irving Park Rd., Chicago 13



**100-AMP. WELDER** works on 115-230-volt current and is designed for conventional welding processes, also revolutionary new "Self-weld" process. Selfweld simplifies ordinary arc welding by means of a special matchhead electrode which is placed on the work to be welded. Starting switch is then pressed and arc forms automatically. Adjustable leg holds rod at correct angle

Lincoln Electric Co., 22801 St. Clair Ave., Cleveland 17, Ohio

**PANEL SAW** cuts mild steel up to 16-ga., aluminum, hardboard, metal and plastic laminates. Circular saw blade is 2 in. in dia., cuts  $\frac{3}{8}$  in. deep. A "gun sight" guide, similar to that on electric hand-saws, makes it easy to follow a line scribed on the stock. Will cut straight and also in long, sweeping contours without binding

Kett Tool Co.,  
5 E. Third St., Cincinnati 2, Ohio



**PRECISION-BALANCED JIGSAW** provides unmatched smoothness of operation due to an entirely new blade-driving mechanism in which each part is individually balanced. Table is 14 x 14 in., tilts 45 deg. to right, 15 deg. to left and swivels 90 deg. to handle angular cutting of long stock. Full 24-in. capacity

Atlas Press Co.,  
2643 N. Pitcher St., Kalamazoo, Mich.

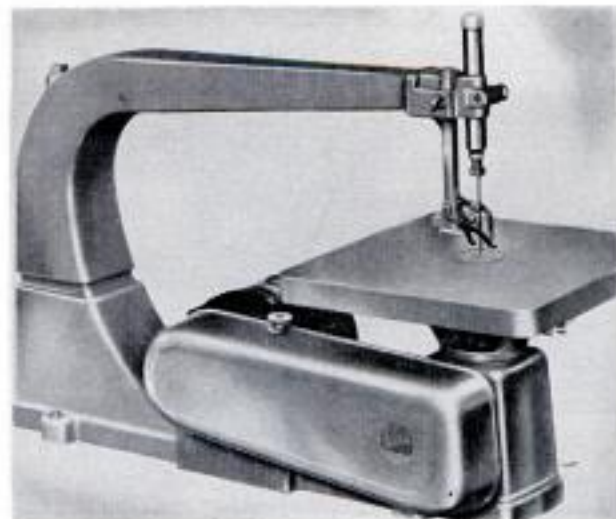

**ROLLING RULE** enables the draftsman to rule lines either vertically or horizontally without using a T-square. Spiral index measures distance between horizontal parallel lines. To draw vertical lines, insert pencil in hole in straightedge and move the unit up or down. Spiral index gives length of line

Stationer's Guild of America,  
1421 Chestnut St., Philadelphia 2, Pa.

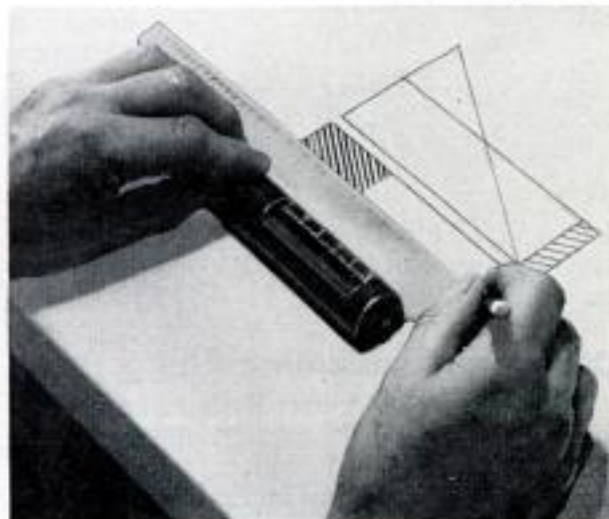

## Sandpaper-Wrapped Cotter Pin Provides Small Sanding Drum



A variable-diameter sanding drum for finish-honing small-diameter holes can be improvised from an ordinary cotter pin. Slip the end of a sandpaper strip through the legs of the cotter pin and twist the pin clockwise, wrapping the paper until the desired diameter is reached. Additional strips can be added by slipping about 2 in. of the new strip under the free end of the strip already on the key and winding it on in the same manner as the first. To prevent slipping the sandpaper can be glued to itself. The finished hone can be chucked in either a drill press or hand drill.

Sidney V. Worth, Philadelphia, Pa.

## "Locking" Flatheaded Screws In Metal With Centerpunch

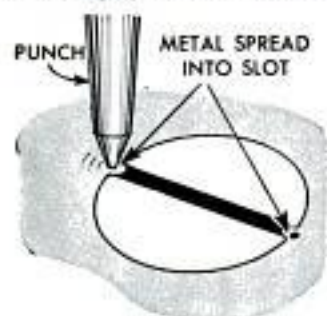

Centerpunching a mark at each end of the screwdriver slot will more effectively anchor a flatheaded screw in metal than will centerpunching of the screwhead perimeter. The former method

forces a small amount of metal into the slot, thus providing a "key" to prevent the screw from turning.

## Detecting, Eliminating Chiggers

In areas of the United States where chiggers are prevalent, the entomologists of the U. S. Department of Agriculture suggest a simple method of detecting an infested

location. Place a square of black cardboard edgewise in the ground at the suspected spot and carefully observe it for a few minutes. If small yellowish or pinkish mites are seen moving rapidly across the cardboard and collecting on the top edge, a chigger-infested spot has been located. The area should be dusted or sprayed with a suitable insecticide. The Department of Agriculture suggests chlordane, toxaphene or lindane. The suggested amounts to be applied per acre are: Chlordane, 1 to 2 lb.; toxaphene, 1 to 2 lb.; lindane,  $\frac{1}{4}$  to  $\frac{1}{2}$  lb. As with any toxic material, the operator should be careful when applying. Keep clear of gardens and fish ponds.

## Extend Life of Electrode By Filing to Chisel Edge

When doing delicate jobs of arc-soldering on small work, file the carbon electrode to a chisel shape, rather than a point. The chisel shape has most of the advantages of a point, yet will last much longer.



## Transmission on Manure Spreader Increases Speed Variations

Desiring greater variation of apron speeds than is possible with the regular controls on a manure spreader, one farmer mounted an automobile transmission on the side of the spreader frame and belt-drives the apron from it. The transmission, in turn, is driven from the power take-off shaft through a system of belts and pulleys. A pulley on the side of the frame opposite the transmission is coupled to a sprocket and chain that drive the beater. Shifting gears in the auto transmission provides lower or higher speeds as required.



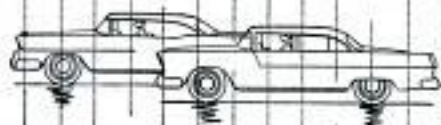

**Just in passing...**

**...Mr. Vacuum can help you to safer driving!**

You need power—lots of power—to keep today's king-size windshields clear.

If your car is like the vast majority of cars on the road, wiper action depends on vacuum power. But, each time you step on the gas to pass another car on the road you need *extra* vacuum power . . . and with an AC Combination Fuel and Vacuum Pump you get it!

AC supplies a vacuum boost to keep wiper action steady, keep your windshield clear. And, you drive on through rain, storm, snow or sleet with greater visibility and greater safety—thanks to AC!

If you *don't* have an AC Combination Pump in your car, you need one. See your nearby AC dealer, won't you?

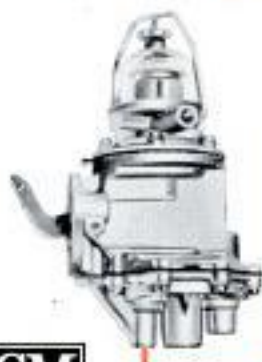

With an AC Combination Pump you can depend on steady fuel flow to your engine—and on stronger wiper action to give you clearer, safer vision.

AC SPARK PLUG DIVISION • GENERAL MOTORS CORPORATION

**AC FUEL PUMPS ARE STANDARD FACTORY EQUIPMENT ON 9 OUT OF 10 CARS AND TRUCKS ON THE ROAD TODAY!**

# How to choose a camera

The best camera for you is the one that gets the pictures *you* want. So, start off by analyzing your needs. Do you want to take snapshots (black-and-white or color), color slides, or stereo pictures? Are you interested in slow-moving or fast-action subjects? Do you want to be able to take close-ups? Are the pictures for album use or for enlarge-

ment? And what about flash shots?

Deciding upon points such as these will help provide the basis for an intelligent, satisfying choice. Then from the comments below, plus the additional details your Kodak dealer will supply, you will be able to select a camera whose type, features, and capabilities are fitted precisely to your needs.

## Box and simple Reflex-type Cameras

These cameras are inexpensive, easy to use, need little, if any, adjusting. They have simple lenses, capable of taking sharp, clear snapshots. All shown here take black-and-white or color pictures. They're suitable for snapshots, in good daylight, of non-moving or slow-moving subjects, and for flood and

flash shots. The reflex camera is similar to the box type except for a large hooded viewfinder at the top, which shows the subject big and clear just as it looks in the finished snapshot.



### MOST POPULAR CAMERA . . .

Over 5,000,000 Brownie Hawkeye Cameras now in use. The ultimate in simplicity. Large viewfinder. Fixed-focus lens—no adjustments to make. 12 pictures on #620 films. Standard enlarged prints,  $3\frac{1}{2}$ " x  $3\frac{1}{2}$ ".

**Brownie Hawkeye Camera, \$6<sup>95</sup>**  
Flashholder, \$4.



### UNIQUE DISTANCE-DIAL

on Brownie Bull's-Eye Camera focuses quickly for "Scenes," "Groups," or "Close-ups" down to 4 feet. *Lumenized* lens for sharp detail, color purity. Double-exposure preventer. 8 pictures on #620 films. Standard enlarged prints,  $3\frac{1}{2}$ " x 5". Flashholder takes new, low-cost M-2 bulbs.

**Brownie Bull's-Eye Camera, \$12<sup>85</sup>**  
Midget Flashholder, \$3.20



### ADVANCED SNAPSHOT CAMERA

The Kodak Duaflex III, Kodar model, is reflex-type camera with 3-element, coated lens for sharp detail, color purity. "Faster"  $f/8$  lens lets in more light for snaps on dull days. Focuses to  $3\frac{1}{2}$  feet for close-ups. Extra-large hooded viewfinder; handy exposure selector; double-exposure prevention. Standard enlarged prints,  $3\frac{1}{2}$ " x  $3\frac{1}{2}$ ".

**Kodak Duaflex III Camera, \$22<sup>50</sup>**  
Kodar  $f/8$  lens  
Flashholder, \$4.



## Miniature Cameras

Small and compact, these cameras feature fast lenses ( $f/4.5$  and faster), fast shutters, and often other picture-taking refinements such as rangefinder, automatic film stop, exposure counter, etc.

They make crisp color slides (black-and-white or color snapshots, too), using economical 35mm or Bantam-sized films. Their picture-taking scope extends beyond that of snapshot cameras to cover fast-action subjects and subjects under poor lighting con-

ditions. Added controls make picture-taking more precise and thus more satisfying.

Lifelike, 3-dimension color slides are also made with a special type of miniature camera. Known as a stereo camera, it has two lenses spaced about the same distance as your eyes and takes two pictures at the same time. The resulting pictures, when seen in a viewer, appear as a single picture with depth. This added dimension gives them a realistic, true-to-life appearance.



### BUDGET-PRICED MINIATURE

The Kodak Pony Camera has Anaston  $f/4.5$  Lumenized lens,  $1/200$  shutter, automatic film stop and counter, no-thread loading. Takes 20- or 36-exposure #135 films.

**Kodak Pony 135 Camera, \$29<sup>75</sup>**  
Model B  
Flashholder, \$7.95

### RANGEFINDER MINIATURE

The Kodak Bantam Camera has an Ektanon  $f/3.9$  Lumenized lens, super-imposed image rangefinder, automatic film stop, double-exposure prevention. Takes 8 pictures on #828 film.

**Kodak Bantam RF Camera, \$56<sup>75</sup>**  
Flashholder, \$7.95

### KODAK'S FINEST LENS

The Kodak Signet Camera features Kodak's famous  $f/3.5$  Ektar lens, unsurpassed for quality.  $1/300$  shutter. Coupled rangefinder combined with viewfinder. Automatic film stop and counter.

**Kodak Signet 35 Camera, \$75**  
Flashholder, \$7.95



**SIMPLIFIED STEREO** — Kodak Stereo Camera offers top-quality, precision stereo photography at low cost. New easy distance-selector dials for "Scenes," "Groups," "Close-ups." New easy exposure selector adjusts for "Bright," "Hazy," or "Cloudy Bright" conditions. Matched Anaston  $f/3.5$  Lumenized lenses,  $1/200$  shutter. Scopesight viewfinder, automatic film stop and counter, double-exposure prevention.

**Kodak Stereo Camera, \$84<sup>50</sup>**  
Flashholder, \$7.95

Prices inc. Fed. Tax where applicable; subject to change without notice.

Most Kodak dealers offer convenient terms

**Eastman Kodak Company**

Rochester 4, N. Y.

**Kodak**  
TRADE-MARK

# Care and Feeding of Engines



BY  
S. P. CORP

## AIR CLEANER CARE

Servicing the air cleaner is as important as chassis lubrication or changing engine oil. In the oil bath type of air cleaner, air enters through opening A, passing down through B to the oil at C, which picks up dust and dirt. Air carries some oil into the filter element, where the air gets more cleaning. The oil drips back into the sump, E, as clean air is drawn into the carburetor at F.

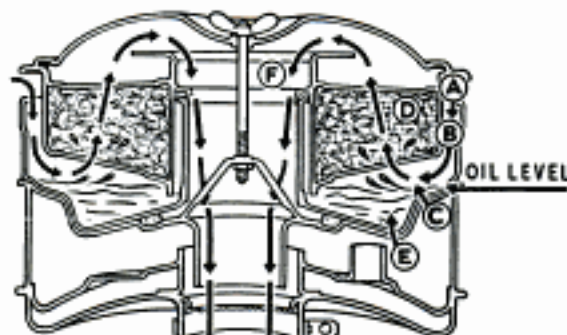

OIL BATH AIR CLEANER

Clean the filter often to reduce engine wear. (1) Remove wing nut and cover and lift out filter. (2) Plunge filter up and down in a pail of kerosene; then drain and blow out with air until dry. (3) Clean out oil sump and fill to correct level with same grade of oil used in engine. **CAUTION: DON'T OIL THE FELT IN THE COVER. KEEP THIS DRY.** (4) Re-assemble and install on carburetor, but don't over-tighten the clamp, as this would affect the operation of the automatic choke valve.

## ENGINE VENTILATION

Air which circulates through the crankcase is drawn in through the oil filler cap, where a copper mesh air filter screens out dust. Always keep the oil filler cap clean, as a dirty cap will allow dust and grit to get into the crankcase, circulate through the oil, and cause premature wear on bearings and thrust surfaces.

## FREE ILLUSTRATED HANDBOOK

Be sure to write for your free copy of Sealed Power's new illustrated booklet, "Care and Feeding of Engines." You'll find a world of carefully indexed hints about car care, which may save you a lot of money. And be sure to use Sealed Power KromeX Ring Sets when you re-ring. These sets have chrome where it counts, to fight heat, friction, abrasion, and corrosion in modern engines. Sealed Power, Dept. G-6, Muskegon, Michigan.



# Sealed Power

## PISTON RINGS

# Clinic for Homemakers



As a service to our readers in solving the hundreds of problems pertaining to a home—inside or out—the editors of *Popular Mechanics* invite you to present your problems to The Clinic Editor for help and advice. Address your questions to The Clinic Editor, *Popular Mechanics Magazine*, 200 East Ontario Street, Chicago 11, Ill.

## Painting Screens



**Q**—A year ago I installed aluminum screens. I was told at the time not to finish them. They remained bright for only a short time, then the fly screen became coated with a powdery white substance, the aluminum frames turned a grayish color. Is there a remedy for this?

H. L., Me.

**A**—The grayish-white coating on the metal frames and wire screening results from a slow oxidation of the metal on exposure to the air. The condition is merely unsightly, however, as it does not impair the screens in any way. In time the metal will appear to darken, the discoloration shading almost to black in some instances. The discoloration is not inherent in the coating, but is due to the accumulation of dust which finds lodgment in the tiny pits which indent the surface of the metal. After several seasons of exposure this coating is difficult to remove by any ordinary means. In your case, however, it may still be practicable to smooth the screen and frames with fine steel wool and in the process remove most of the discoloration. A clear metal lacquer sprayed on the metal forms a coating that will prevent oxidation for a season or two, after which it must be renewed. The next best thing is the clear-plastic spray material supplied in pressurized containers. When spraying be careful to apply a uniform coating to both the screen and frames.

## Attic Louvers



**Q**—How does one calculate the required size of attic louvers? Must they be installed in the gables, or can they be installed along the ridge?—L. S., Ill.

**A**—The recommended practice is to allow 1 sq. ft. of free louver area for each 100 sq. ft. of attic floor space. This specification is intended to serve as a guide when installing louvers in the gable ends or in the roof. On a long, low-pitched roof there probably is some advantage in installing louvers, or ventilators, in the roof rather than in the gable ends. Roof ventilators are quite easy to install on a roof where the shingles are already laid. Simply remove shingles to expose the roof boards at the points where the ventilators are to be located. If care is used, the shingles can be removed and replaced without damage. Bore a hole through the roof boards large enough to admit the

(Continued to page 210)



Some brands give you shorts and bits which burn like tinder—fast and hot.



Others give you fine-cut shreds—good for cigarettes, but not so good for pipes.



Only Edgeworth gives you slow-burning "chunks" made for pipes and pipes alone.

PIPE SMOKERS: COMPARE THE CUTS OF TOBACCO AND SEE

# Why Edgeworth Smokes Coolest



## Edgeworth's Way with White Burley Has Never Been Equalled

Your true tobacco expert will tell you that white burleys are the world's coolest smoking tobaccos. Edgeworth is a blend of white burleys only—aged like fine wine, for years. Of course, other tobaccos use white burley, too—but nobody else has yet found out just how to blend and process tobacco to give it the even-burning, cool-smoking character that Edgeworth "Ready-Rubbed" has maintained.

### What "Ready-Rubbed" Means to Your Smoking Pleasure

Old-time smokers knew the secret of cool, even burning. They carefully "hand-rubbed" their tobacco

**This Amazing Pouch Means Cooler Smoking!**



Edgeworth tobacco leaves our plant with just the right moisture content for a cool, no-bite smoke. You can be sure every pouch will be that way when you open it, because only Edgeworth has the Seal-Pak pouch. Sealed air-and-water tight, it promises you fresher tobacco than any other type of pocket pack. No bulky corners in your pocket either.

**Two Weeks On a Radiator**

One friend of ours left an unopened Edgeworth pouch on a hot radiator. When discovered two weeks later, the tobacco was still moist and cool smoking.

co until it crumbled into chunks of just the right size. Now Edgeworth does all this for you *before* the tobacco is packaged. An ingenious, exclusive process "ready-rubs" Edgeworth into chunks that pack *right* in your pipe, giving you a cool, leisurely smoke with never a touch of tongue bite.

### FOR A COOL MIXTURE TRY HOLIDAY

A blend of five tobaccos selected for mildness and aroma—in the Seal-Pak pouch.



### SPECIAL OFFER \$1.50



Get this new polished aluminum stem "Park Lane" pipe with interchangeable imported briar bowl and exclusive "dri-dome" moisture trap—along with 2 full-sized pouches of EDGEWORTH tobacco. If your dealer cannot supply you, use this handy order blank.

Name \_\_\_\_\_

Address \_\_\_\_\_

City \_\_\_\_\_ State \_\_\_\_\_

Mail with \$1.50 to Park Lane, Larus & Brother Company, Inc., Richmond, Virginia. Offer good only in the U.S.A. **PM-6**

YOU'RE SMARTER SMOKING

# Edgeworth

AMERICA'S FINEST PIPE TOBACCO FOR OVER HALF A CENTURY

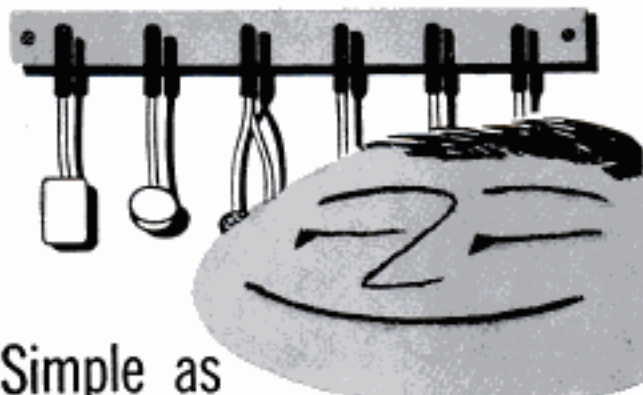

Simple as  
**ABC**  
to fasten fixtures  
with



*Rocket*  
**WALLGRIPS**  
HOLLOW WALL SCREW ANCHORS



Securely fasten mirrors, pictures, cabinets, curtain and shelf brackets to plaster, wallboard, gypsum, cinder block, marble, hollow tile . . . with perfect ease and safety. Quick "Knee-Action" permits tightening with practically no effort. Ribbed wings assure a "Positive Stop" — tell you when WALLGRIP is set . . . guarantee a vise-like fastening everytime. Yet fixtures can be quickly removed and replaced when redecorating — without disturbing the WALLGRIP.

**FREE PAMPHLET!** "Don't be a WALLFOULER." Write Dept. PM-6

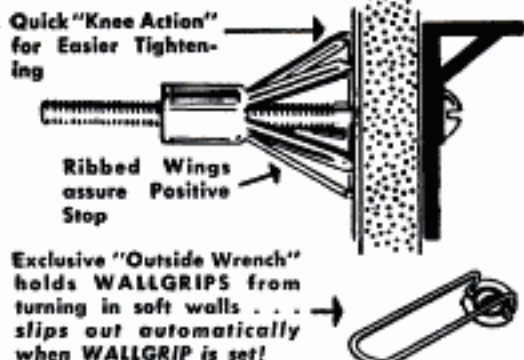

WHEREVER HARDWARE IS SOLD  
**ROCKET DEVICES CORPORATION**  
142 Liberty Street • New York 6, N. Y.

(Continued from page 208)

blade of a keyhole saw. Then mark off and saw an opening into which the ventilator will fit snugly. Then replace the shingles, cutting them so that the edges cover the flange of the ventilator. Usually, instructions are furnished with the units covering the recommended method of installation. Ready-made louvers are just as easily installed in the gable ends by cutting an opening of a size to take the unit in a snug fit. In some cases, when installing large louvers it may be necessary to cut one of the studs when sawing the opening. In this case it is advisable to install headers.

**Air Conditioning**

**Q**—I am going to build a home in which an air-conditioning unit will be installed. I'm told that in planning the design something can be gained by extending the cornices to fully shade the windows in the summer from the direct rays of the sun, and still get full exposure of the windows during the winter months. How is this done?—N. H., Tex.

**A**—You did not say which way the house faces. Neither did you describe the window arrangement on the southern exposure. However, assuming as an example that the admission of solar heat in winter and the exclusion of the direct rays of the sun in summer is a consideration in planning window size and placement, it's the usual practice to shield windows on the southern exposure with a cornice overhang of 2 ft. This applies only to windows with stools 3 ft. from the floor, in homes

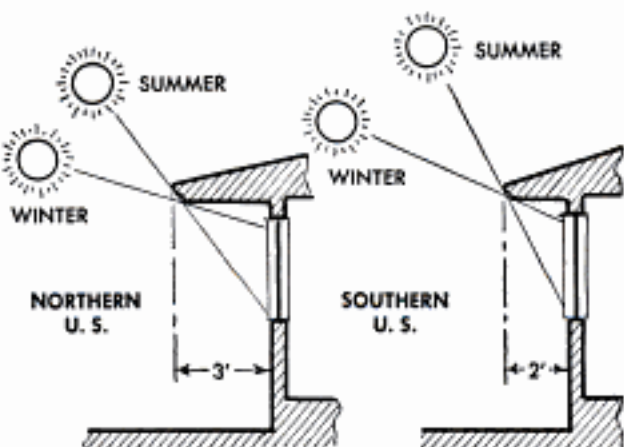

built in the southern United States. In northern United States, the cornice overhang must be at least 3 ft. as will be seen from the sketches. If the window extends to the floor, the overhang must be at least 1½ to 2 ft. wider. Whether or not these overhangs are practical must be determined by the builder. In some cases it may be more practical to consider the construction of a louvered structure with adjustable slats or a trellis with climbing vines. Louvers, of course, can be adjusted to admit direct sunlight in winter and shade the windows in summer. In general, the same installations should be considered for the east and west exposures also, unless, of course, trees or shrubs provide shade.

**Repairing Field-Stone Masonry**

**Q**—The walls of my home are of field stone and the mortar is beginning to loosen in some of the joints near the top of the walls on the north side of the house. Small pieces of mortar have fallen out, leaving unsightly openings. How do I go about repairing the wall?—A. T., Pa.

**A**—Ordinarily this job is for an experienced stonemason. The cost should be quite nominal, unless, of course, a major repair job is necessary. However, if you wish to attempt the work yourself, then the first step is to remove all loose mortar from the defective joints, brushing away dust and fine particles. Large openings should be undercut slightly with a chisel where possible. Prepare a fairly stiff mortar. Dampen the wall and sides of the openings where new mortar is to be applied. Then trowel the fresh mortar into the openings, pressing it in with some force to assure that the depressions are completely filled. Then, finish the surface of the mortar by brushing lightly with a whisk broom.

# Add an extra room to your home —easily, economically



- 1. Do it yourself** with Armstrong Temlok® Tile and Plank. Finish off unused space in the attic, basement, garage, or enclosed porch quickly with these attractive wood fiber building materials. Start by nailing up 1" x 3" wood furring strips at right angles to all framing members.



- 2. The Lok-Bevel® joint** on both Tile and Plank has an extra wide nailing flange for quick installation. This special joint hides all nails or staples, assures neat joint lines, helps you do a really professional looking job. With Temlok Tile, you can choose a smooth or a noise-absorbing perforated surface.



- 3. Temlok goes up fast** by either nailing or stapling. Use staples with ½" legs or 1¼" 3d box nails. Four nails or staples should be used for each 12" x 12" or 16" x 16" Temlok Tile. Finish the walls with Temlok Plank. Both Tile and Plank build, insulate, and decorate in one application.



- 4. No painting needed.** Temlok is handsomely finished at the factory. There's practically no mess or waste—once Temlok is installed, the job is done. Add a few decorative touches and you've got that extra living space in the form of a game room, workshop, or bedroom . . . and at low cost.

See your lumber dealer now for price, size, and color details on Temlok Tile and Plank and information on other Armstrong building products.

Send for free booklet, "New Ways to Remodel Your Home." Write Armstrong Cork Company, 3706 Watch Avenue, Lancaster, Pennsylvania.

\* Trade-Mark

## Armstrong TEMLOK

Cushiontone® • M-67® Monowall® • Hardboards • Insulating Wool • Counter-top Cement



# Looking for Something?



PAVING  
CONTRACTORS



FROM CEMENT TO LINOLEUM  
WHATEVER YOU NEED

Find It Fast  
In The  
'Yellow Pages'



## Mr. Ladybug

(Continued from page 142)

he keep ladybugs alive and healthy through the winter and have them ready in the spring?

Harris found the answer in his own refrigerator. Ladybugs sleep just as soundly in cold storage as on some frigid slope.

Currently Greenbug Control Company employs 10 gatherers, three of them the year-round. Armed with meshed sacks (capacity, 1½ gallons), they trek the highlands, each collecting an average 45 gallons a day — about 6,000,000 ladybugs. Gatherers are paid \$2.00 a gallon for bugs retailing at \$10. Ladies are also sold by the pound. Four pounds usually, but not always, equal one gallon. As ladybugs age they lose weight. Typically, nine-month-old bugs, nearing the end of their life span, weigh but 2½ pounds to a gallon.

Although gathering depletes colonies, at least half are left to hibernate and return to the valleys. This conservation is motivated more by economics than altruism. Though a colony's top layers are composed almost entirely of insects, lower levels contain a high percentage of trash—sticks, stones and humus. Customers want ladybugs, not forest litter, so only the upper or "clean" insects are taken.

Once, hoping to mechanize the gathering, Harris rigged a modified tank-type vacuum cleaner to a 1½-horsepower gasoline generator mounted on one of his pickups.

"The vacuum did a roaring good job," Harris concedes, "but the impact killed a million ladies in five minutes. We tried using every kind of nozzle imaginable—but it was mass murder from start to finish."

If Greenbug Control Company has a secret, it's constant chilling, which keeps ladies dazed and inactive. Let a colony warm up and you have a flying, crawling horde on your hands.

"Like handling mercury," Harris says, recalling the unsealed container a gatherer once left in his kitchen. The Harris family moved outdoors as a million ladybugs commandeered the house.

Ladybugs, gathered between sunup and 10 a.m. (during the heat of the day they're too active), are trucked to a refrigerator in Oroville. It's a walk-in box, thermostatically monitored to 36 degrees Fahrenheit. Colder, the bugs freeze to death. Much warmer (say 24 hours at 50 degrees), they revive.

Harris shudders at the thought of a prolonged power failure.

"I'd hate to be around when maybe

(Continued to page 214)

# 9

## DO-IT-YOURSELF IDEAS for home, garden and vacation!

### REYNOLDS *DO-IT-YOURSELF*\* ALUMINUM You work it with woodworking tools

the  
home..



Junior can't ram holes through the screen door when you make a good looking screen guard with Reynolds Do-It-Yourself Aluminum perforated sheet. Make a kickplate, too.



Children "might" actually hang clothes up if you provide a handy rod arrangement like this—of Reynolds Do-It-Yourself Aluminum tube—of course. Easy to put up.



Summer rains and messy summer mud go together. Keep the mud outdoors with an aluminum scraper. Ask the hardware man for Reynolds Do-It-Yourself Aluminum bar.

the  
garden..



Don't have miniature canyons under your downspouts. A trough of Do-It-Yourself Aluminum sheet will carry the water away. Easy to remove.



Make pruning and trimming faster—easier. Equip your pruning saw with a lightweight extension handle of Do-It-Yourself Aluminum tube.



This trellis of Do-It-Yourself Aluminum tube and rod can't rust or rot—never needs painting. You keep the beauty of aluminum's soft sheen.

your  
vacation..



It's a lucky fisherman who has a minnow and fish box of Do-It-Yourself Aluminum sheet—sturdy, rust-proof, lightweight—and easy to make.



The most prized rod can be carried in perfect safety in this rod case of Do-It-Yourself Aluminum tube. Non-rusting and light, good looking.



Make a croquet set of Reynolds Do-It-Yourself Aluminum rod and tube. It'll be unusual and handsome looking, non-rusting—no trick at all to make

This Reynolds Do-It-Yourself Aluminum rack in your hardware or building supply dealer's contains:

tube • rod • bar • a wide variety of sheet designs • angles • fasteners  
screen and storm sash sections • window hardware • trim strip  
Reynolds plastic film • Do-It-Yourself plans and Easi-Bild\*\* Patterns

ASK YOUR DEALER FOR FREE "IDEA SHEET"  
CONTAINING THESE IDEAS AND SIX OTHERS.

REYNOLDS METALS COMPANY, 2494 S. THIRD ST., LOUISVILLE, KY.



AVAILABLE  
IN CANADA

\*\*T. M. EASI-BILD  
PATTERN COMPANY  
\*T. M. REYNOLDS  
METALS COMPANY



**"Put in Quaker State!  
I want my new car  
to stay new!"**



Super-refined from 100% Pure Pennsylvania Grade Crude Oil, world's finest. Famous for performance, protection, economy! Try it!

**QUAKER STATE OIL REFINING CORP., OIL CITY, PA.**  
Member Pennsylvania Grade Crude Oil Association

10,000,000 ladies thawed out. They'd overrun a couple of counties.

When gatherers accumulate a truckload (about 1000 gallons), Harris hauls the critters 26 miles to the big cold-storage room he rents in Yuba City. The room doubles as a packaging and mailing plant. Ladybugs are held at 36 degrees right up to shipping time. Air-expressed or hauled in refrigerated trucks, they usually arrive in peaceful bug-slumber.

Customers—back-yard gardeners, park superintendents, farmers and flower growers—stash cartoned ladies in their refrigerators or cold rooms until ready to sow. Scattered before sunup or after dark, they slowly revive and within 24 hours start hunting down crop destroyers.

How many ladies does it take to do the job? That depends on their assignment.

"On the average," says Harris, "an ordinary-size yard or garden needs 20,000 to 30,000 ladybugs during the summer. A few thousand—a couple of handfuls—sowed every other week seems satisfactory."

Harris advises farmers to use 2000 ladies per acre on small plants, lightly infested. Where trees or large plants are heavily infested, as many as 120,000 ladies may be required per acre.

When ladybugs are packaged, they're weighed directly from cold storage into fiberboard cartons. The ends of the cartons are ventilated with fly screen. Greenbug markets 1 and 1½-gallon batches (135,000 and 200,000 bugs, respectively) for agriculture. The gallon size retails for \$12; the larger for \$18. Both prices include shipping charges.

The garden pack, retailing for \$3.50, contains about 15,000 to 30,000 ladies. The carton is designed to fit beneath the bottom shelf of a standard refrigerator. Kept chilled, bugs destined for periodic back-yard sowing should live three months—through the summer.

"I discovered right off," admits Harris, "that simply scooping a quarter-million ladies into a carton and air-expressing them invites disaster. Once I lost 300,000 bugs and two customers. Ladies can't be crowded. They 'pack' during shipment and smother to death."

Thus, into each carton goes excelsior, some pine cones or perhaps bits of shredded cardboard—anything to give the ladies a footing.

Potential bug merchants must square their operations with the U. S. Department of Agriculture and often with state agriculture agencies. Even though ladies are beneficial and welcomed across state lines, permits are required.

(Continued to page 216)



*How it feels  
to take off with a Super Silent*  
KIEKHAEFER  
**MERCURY**

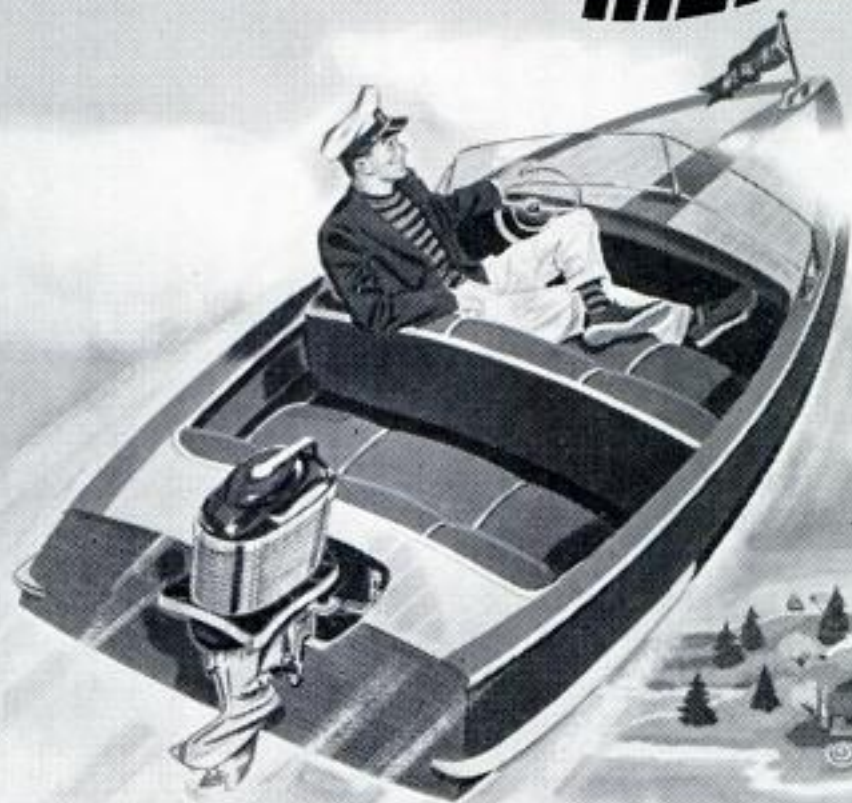

**DYNA-FLOAT SUSPENSION  
GIVES YOU A  
VIBRATION-FREE RIDE!**

So smooth, so quiet, so exhilarating you'll feel airborne! See your Mercury dealer for a demonstration. Ten models for 1955 for every purpose and every purse... 5 to 40 h.p. — all with Full Jeweled Power®.

**Mark 55E MercElectric** — World's Only 4 Cylinder in Line Outboard — 40 plus h.p. Alternate Firing Thunderbolt Engine. Reverse Gear and Neutral — Exclusive 12-volt Electric Starter and Generator

**Mark 25E** — 18 h.p. Alternate Twin Hurricane Engine — Reverse Gear and Neutral

**COMPLETE ENGINE SILENCING** — quietness without power loss!

**DYNA-FLOAT SUSPENSION** — floats the engine on rubber, mounted in shear, to keep vibration away from your boat!

**MERCHROMATIC 2-TONE COLOR COMBINATIONS** — another Mercury "first"!

Write for **FREE** illustrated catalog!

© 1955 KIEKHAEFER CORPORATION,  
Fond du Lac, Wisconsin

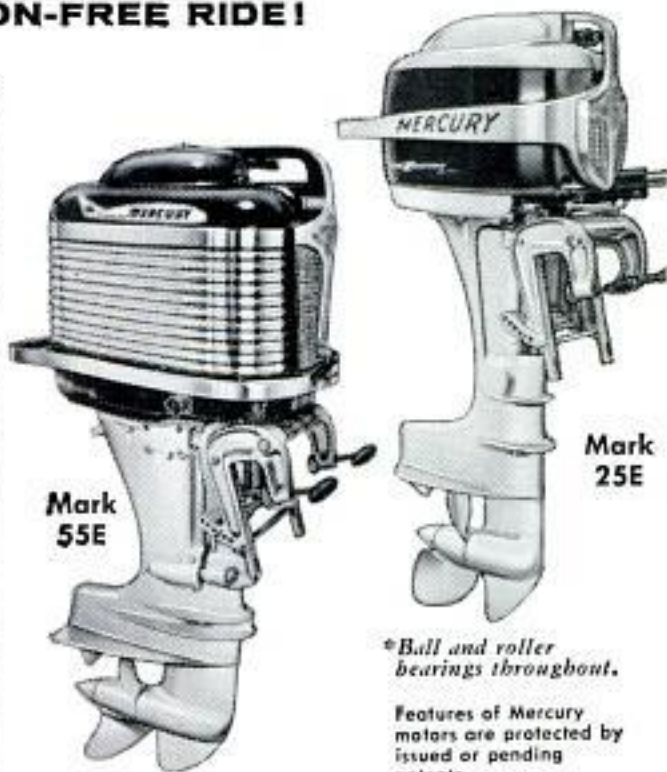

**Mark  
55E**

**Mark  
25E**

\*Ball and roller bearings throughout.

Features of Mercury motors are protected by issued or pending patents.

Harris chuckles when he thinks of mink ranchers and chinchilla breeders who spend hundreds of dollars for feed.

"My ladies eat nothing at all during hibernation. My feed bill last year? Zero dollars and no cents."

Repeat business—thanks to ladybugs' foraging habits—is Greenbug's sustainer. Once ladies are sowed, they're on their way. When near-at-hand food has been devoured, they turn to neighboring fields. They circle the sower's own crops or flowers with a wide, bug-free isolation belt. But having left your field or yard, they seldom return.

Some ladybird eggs hatch, of course, and their larvae keep up the good work. But they'll need reinforcements.

Greenbug's four or five competitors operate in a half-dozen western states, although the congregating species of ladybug has been found as far east as Connecticut. All this indicates that the market has hardly been sampled yet. It's estimated that not more than 30,000 gallons are marketed annually by all dealers, big and small.

Most-frequent complaint comes from back-yard farmers who hanker to sow ladies—but don't want to pass their benefits on to the neighbors. Typical query: "How can I keep the ladybugs in my yard? Can I train them to stay at home?"

Harris remains strictly aloof from such urban squabbles. ★ ★ ★

### Fish Preserved Alive in Ice

Fish can be preserved alive in blocks of ice. The method, developed by Arne Joker of Esbjerg, Denmark, may result in the shipment of live fish to market. In his experiments, Joker anesthetizes live fish and then freezes water around them. Fish that are frozen solid cannot be revived, but they remain unfrozen and alive at temperatures slightly below the freezing point of water. The fish have been left in a torpid state in a block of ice for 29 days and then revived. Joker now is attempting to cut down the loss, which in experiments has run 38 percent. If he is successful, living fish will be exported in Danish refrigerator ships.

### Supersonic Paint for Jets

Aircraft paint that won't peel off at supersonic speeds and resists temperatures up to 400 degrees Fahrenheit is being tested by the British Royal Air Force. The finish sticks to the fuselage despite air friction, rain or hail. Friction generated by air rushing past the fuselage heats the metal, softening conventional paints.

## FIX SLUGGISH ENGINES AS AUTO ENGINEERS DO — GET PEAK POWER ALWAYS WITH MIRACLE POWER

Auto engineers are bothered by the lubrication problems of modern motors...and faulty lubrication is a major cause of sluggishness. Even the best motor oils burn at 550°F—but temperatures in combustion chambers reach as high as 1400°F. And burned-off oil can't lubricate. What's more, it takes up to 5 minutes after you start your car for your pump to get oil to all moving parts. Meanwhile, dry metal is clashing against dry metal—and wearing out your engine fast.

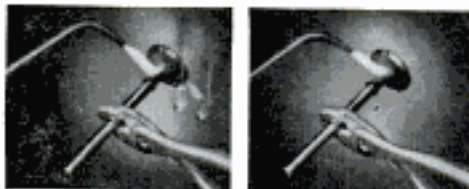

An acetylene torch instantly burns motor oil (left). But engine heat is often greater than that of the torch! Use Miracle Power—it always lubricates, never burns off.

### How MIRACLE POWER prevents sluggish performance

Miracle Power is a pure petroleum product containing colloidal synthetic graphite in suspension. The graphite forms a lubricating film that impregnates metal as butter does bread. This coating won't burn off and it doesn't build up. It provides lubrication under *all* circumstances—keeps your engine tuned and free from sluggishness, lubricates in the top cylinder area, prevents dry starting damage, frees sticky valves, quiets hydraulic lifters, cuts oil consumption.

Miracle Power is not a chemical. It's *all* lubricant. Follow the lead of auto engineers

and try it yourself. Add an 85c can to your oil and gas every 1000 miles; use the 39c size in gas between treatments.

Get Miracle Power at car dealers, garages, service stations. It is available at Ford, Studebaker, International Harvester, Kaiser and Willys dealers in their own Miracle Power containers. Miracle Power treats the *engine*, not the oil.



Ford dealers' package

**THE AP PARTS CORPORATION**  
E6 AP Building Toledo 1, Ohio

Miracle Power Division

Mufflers • Pipes  
Miracle Power  
dgf 123

# Real DIESEL ENGINE FULLY ASSEMBLED 1/7 H.P.

A perfect power plant for planes, boats, race cars.

ACTUAL SIZE

over 100,000 sold at a higher price

YOURS AT A NEW LOW, LOW PRICE

**NOW \$195**

Plus 5¢ Postage



Enjoy hours of fun pursuing your hobby with DEEZIL... the real diesel engine that runs at 7500 RPM and produces 1/7 HP. It weighs only 5 oz., is compact, rugged, streamlined. Starts quickly. Simple to install. Factory tested. Easy-to-follow operating instructions.

## SPECIAL!

### 196-PAGE BOOK ON MODEL ENGINES!

18 easy-to-read chapters on model engines covering everything hobbyists should know. Tells you how to operate, "hop-up," improve, assemble and disassemble the engine. Special chapters also devoted to carburetion, engine performance, trouble-shooting and many other pages chock-full of interesting information.

**ONLY \$1.00 POSTPAID**



### AUTO SEAT COVER (any car)

Long-lasting first-quality fabric. Installed in minutes. In grey, green, blue. FOR SOLID OR SPLIT BACK SEATS. Be sure to specify type and color. Value-priced at only \$3.95 postpaid



### Vinyl Plastic PORTABLE GARAGE

Cover any car, anywhere, in seconds. Protects finish; keeps rain, dirt and sun away. Durable construction. Elasticized bottom. \$10 value... NOW only \$6.95 postpaid



**GENUINE "DEEZIL" ACCESSORIES**—For perfect performance order genuine DEEZIL accessories listed in order coupon (below):

DEEZIL ENGINE & ACCESSORIES AVAILABLE FROM GOTHAM ONLY. ORDER TODAY

GOTHAM HOBBY CORP., Dept. P, 107 E. 126th St., New York 35, N. Y. Please send me the following postpaid:

Quan.	Item	Amount	Quan.	Item	Amount
	DIESEL ENGINE .. \$2.00	\$.....		196-Page book on MODEL ENGINES	\$1.00
	Portable Garage .. \$6.95	\$.....		Auto Seat Cover	
	Chess Computer .. \$1.00	\$.....		Color, Type	\$3.95
<b>GENUINE DEEZIL ACCESSORIES</b>					
	Prop (Free Flight)	35¢		Flywheel (boat or car)	75¢
	Shut-Off Valve ..	\$1.25		Tank ..	50¢
	Test Mount ..	\$1.25		Spinner ..	75¢
	Fuel Pump ..	75¢		Control Wire ..	75¢
	Fuelmix (sent by Express)			Control Handle ..	\$1.00
	Collect. No C.O.D.)	\$1.00		Electric Motor ..	\$1.95
<b>ADD TOTAL</b>			<b>ADD TOTAL</b>		



### CHESS COMPUTER

A handy reference calculator for experts and beginners gives the opening moves of the 16 leading chess variations. No easier way to become a chess winner! only \$1.00 postpaid

GOTHAM HOBBY CORP.

Dept. P, 107 E. 126th St.

New York 35, N. Y.

Serving the hobbyist for over 20 years.

Name .....

Address .....

City..... Zone..... State.....

**FREE** 196-page book on model engines with every purchase of \$5 or more.

## SHEET METAL BRAKES

Forms angles, locks, pans, etc. New eccentric clamps. All steel construction. Size 15"—16 gauge steel, \$21.50; 36"—22 ga., \$33.00; 48"—24 ga. \$48.00. Floor Stand, \$7.00.



HAND PRESS BRAKE. Forms any length up to 12" from edge. \$38.00  
FOLDER, 15"—14" to 1"—24 ga. \$16.50. 36"—28 ga. \$36.00  
12" REACH, 12" wide Bending Tongs, 36" long. \$ 9.50  
bench, or portable shear, 7"—16 Ga. steel. \$12.50  
(Immediate delivery. Order cash or C.O.D., or send for folder)

VYKE MFG. CO., 2435 15th St., Denver 2, Colo.

Say You Saw It in Popular Mechanics

**FREE CATALOG**  
NEW CHRYSLER  
**BOAT KITS**

BUY DIRECT—SAVE UP TO 2/3



FACTORY TO YOU!  
No Dealers!  
You SAVE the BIG PROFIT!

12 MODELS—8 to 14 ft.—\$39 up  
Finest quality Boat Kits at the lowest prices in history! Mahogany decks. Easy to build.  
Also: FIBERGLAS—ACCESSORIES—TRAILERS

CHRYSLER—CRAFT (DEPT. 20) TONAWANDA, N. Y.

## 18 OUTDOOR FURNITURE PROJECTS



Clearly illustrated plans by outstanding designers. Step-by-step plans make it easy to build practical, attractive porch and lawn furniture at low cost. See your dealer or order direct. **ONLY 50¢** (65¢ outside U.S.A.)

ATLAS PRESS COMPANY  
624 N. Picher St., Kalamazoo, Mich.



The Modern PLASTIC for lasting Home Repairs

PERMANENTLY mends cracks or holes in wood, tile, stone or plaster. Sticks and stays put—Does not chip, shrink or fall out. Easy to use. Economical. Mold it, chisel it, polish or paint it. The big 4-lb. can is obtainable from your lumber, paint or hardware dealer at \$1.25; or will be shipped direct postpaid (in U. S.) for \$1.50. Complete satisfaction guaranteed or your money refunded.

DONALD DURHAM CO.  
Box 804-T Des Moines, Iowa



## solves woodworking problems in seconds!

Speed your jobs, get answers to countless building and woodworking questions immediately! Improved GREENLEE Woodworking Calculator converts linear to board feet, gives nail specifications, tool sharpening tips. Compares woods, gives bit sizes for screws, concrete mixes, painting information, etc. Convenient . . . simple to read. 6" diameter . . . heavily varnished cardboard. Special offer by the makers of famous GREENLEE TOOLS . . . **Only 25c**

(no stamps please)

TOOLS FOR CRAFTSMEN

# GREENLEE

The GREENLEE line of fine tools includes auger bits, electric drill bits, chisels, gouges, spiral screw drivers, drawknives, and many more. At leading hardware and building supply dealers.

**GREENLEE TOOL CO.,**  
2106 Columbia Ave., Rockford, Ill.

## They Build Their Own Planes

(Continued from page 118)

"The only fellow who gets them both is Steve Wittman."

He is almost right. S. J. "Steve" Wittman of Oshkosh, Wis., is practically a living legend in the homebuilt and racing field. An active member of EAA and of the Professional Race Pilots' Association, Steve has been designing, building and racing his own aircraft since many of today's pilots were in knee pants.

As far back as two decades ago Wittman's low-cost racing ships in both limited and open classifications were the despair of pilots and owners who spent several times Steve's investment, only to "eat" his exhaust around the pylons.

One of Wittman's latest accomplishments inspires every homebuilder. His two-place *Tailwind* is the first pilot-designed-and-built aircraft to receive a Civil Aeronautics Administration certificate permitting transportation of nonrevenue passengers.

In an effort to assist and encourage pilot-builders, the CAA has worked out regulations (CAR 174-3) providing for inspection and licensing of individually made aircraft. All ships are made under CAA regulations and have experimental licenses but, until the *Tailwind* came along, none was certificated to carry passengers.

The *Tailwind* is truly an outstanding example of what can be done in the field, and its performance and economy set a mark the commercial builders can shoot at.

Powered by an 85-horsepower Continental, the *Tailwind* will carry two persons and their luggage comfortably at a cruising speed of 150 and a top of 175. Even with this top speed it will land at 50 miles per hour with flaps and at 60 without them. And it has the Wittman landing gear, another inspiration to homebuilders. Wittman worked out his gear for racing aircraft before World War II. It is extremely simple and light—basically nothing more than a strip of high-quality spring steel upon which the wheels and brakes are mounted.

One piece of spring steel has little surface to streamline and no hydraulic mechanism to maintain. The gear is so efficient that it has been adopted by one of the largest light-plane makers for all fixed-gear aircraft.

This commercial use of a pilot-built gear inspires other garage aircraft builders. If they can work out something like Wittman's gear and sell it to a commercial builder, they will have funds to make a lot of homebuilt aircraft.

(Continued to page 220)



## \$35,000 REWARD FOR URANIUM

Here's your chance to "cash in!" Over \$2,500,000 in Government Bonuses have been paid for URANIUM discoveries in the past 2 years. Currently \$150,000 a month is paid to people just like you.

Precision Geiger Counters and Scintillators are the finest instruments made for URANIUM prospecting. These highly sensitive instruments are compact, lightweight and ruggedly built for field use. Prices start at \$29.95.

CONTACT YOUR NEAREST DEALER or write direct to factory for FREE 12-PAGE CATALOG, describing URANIUM and Metal detectors.



**P**RECISION RADIATION INSTRUMENTS, INC.  
2235PM S. La Brea, Los Angeles 16, California

WORLD'S LARGEST MANUFACTURER OF PORTABLE RADIATION INSTRUMENTS

## More people use

For more than 50 years 3-IN-ONE has been America's most popular household oil. If it works better with oil, it will work best with 3-IN-ONE.



## "3-IN-ONE" OIL



### BUILD FINE GRANDFATHER CLOCK NOW

The simple, reliable Red-I-Kut way as thousands have — SAVE HALF. SHOP TESTED PLANS "SPIRIT OF THE CENTURY" Narrow waist 80" tall or stately straight side "SPIRIT OF AMERICA." EASY-TO-FOLLOW photograph PLANS tell all—plus BROCHURE of heavy brass weight Westminster, tube chime, movements, gorgeous dials, 3/4" solid mahogany case kits. Send \$1.00 today — Both plans \$1.50 NOW.

KUENZEL CHIME CLOCK CO., 27 Kuempel Bldg., Minneapolis 16, Minn.

### WORLD'S BEST SMALL TRENCHERS



Portable DITCH-WITCH digs 2" to 6" clean, even ditches to 36" depth in all types of soil. Complete unit—self propelled—outdigs 8 men. Four rugged models.

Write for illustrated literature.  
THE CHARLES MACHINE WORKS  
620 B Street Perry, Oklahoma



**INTERNATIONAL**  
SPEED COP SAW DRILL BIT

*Insist on the genuine original*

DRILL, SAW, REAM . . . metal, pipe, wood, plastic, Transite, etc. Use with electric drill, slow drill press, lathe, milling machine. Drill own starting hole, upper part of bit is used to cut, saw, ream circles, oval, square, swirls. Easy to use. Ideal for carpenters, mechanics, electricians, plumbers, hobbyists, etc. Abrasive resistant, high speed steel. Flutes ground from solid. Withstands severe continuous use without breaking. Resharpens free. Takes place of up to \$50 in tools. 2" diameter, 2" cutting sections, total length 31". Three types—All Purpose, Wood, Heavy Metal. Specify type needed. Set of three \$11.50. Details on request. Shipped same day. Money-back guarantee. Dealer inquiries invited. Order Now Send Cash, Check or Money Order to

**INTERNATIONAL TWIST DRILL CORP.**  
618 Wyandotte, Rm. 634, KANSAS CITY, MO.

Only  
**\$3.95**  
POST  
PAID



## Motorists prefer **FRAM** more than 2 to 1

Surveys prove it . . . and in many cases the preference for FRAM Oil Filters more than equals the preference for the next two most popular brands combined!

Here's why: FRAM is engineered for extra-high filter efficiency . . . keeps oil clean, cuts wear, saves power and reduces repair bills.

There's a FRAM Cartridge engineered for your car. See your FRAM Dealer today!

Send FRAM boxtop or 25c for big, colorful, 68 page Vacationland America Book describing motor trips throughout America!



FRAM CORPORATION, Providence 16, R. I.  
Fram Canada Ltd., Stratford, Ont.

You need fewer tools  
when you use ...



**CHAN NEL LOCK** pliers  
TRADE MARK REG. U. S. PATENT OFFICE



here's why

Look for the Channellock line when you're shopping for hand tools. Channellock pliers offer features that you can't get with other makes. And when you buy a Channellock plier, ask to see the full line—you'll find a style and model to do any job better.



THE PLIER DESIGN THAT OBSOLETE ALL OTHERS

CHAMPION D•ARMENT TOOL CO. • MEADVILLE, PA.

Not all homebuilders attempt racing or sport craft. Some reconstruct or duplicate antique airplanes, much as antique automobile fans labor long hours over their Stutzes and Pierce-Arrows. One antique builder has reconstructed a 1909 Bleriot monoplane, and there is more than one rebuilt Jenny—famed World War I training plane—still flying.

William Chana and Ken Coward, who worked in the Convair plant at San Diego, set out to see how small a plane they could build that would carry a man. They developed the *Wee-Bee*, powered by a 20-horsepower two-cycle engine designed for a drone target plane. So small the pilot must lie on his stomach and fly from the prone position, the *Wee-Bee* weighs in at 210 pounds and is said to be the only heavier-than-air craft that can carry or be carried by the pilot.

Homebuilding of aircraft is in the American tradition of "do it yourself," and brings aviation and its fascination to many a man who could not afford to buy a new airplane and would rather rebuild an old one than let someone else do it.

The homebuilder must be careful, however, and he must know what he is doing. The CAA asks that plans be submitted before construction is started and that inspectors be allowed periodic checks. The Experimental Aircraft Association heartily endorses this practice. It insists that its members exceed commercial builders' safety standards, and also makes every effort to lend a hand to the novice.

EAA members have no desire to see unsafe, unflyable aircraft built by amateurs. They urge would-be homebuilders to come to them for aid and advice. They feel that the potential airplane builder should know such basic facts as the necessity for high-strength steel tubing in fuselage construction. Gas pipe is not a suitable substitute, as one aspiring builder found after he had completed his airframe. ★ ★ ★

## Echo From World War II

Remember the supersecret Norden bombsight, considered the nation's biggest military secret early in World War II? Downed pilots were ordered to destroy the bombsight at all costs. A patent finally has been issued for the sight, 32 years after it was conceived. Carl L. Norden invented the sight in 1923, but military security kept it under wraps until 1945, when application was made for a patent. Now, 10 years later, it has been issued. For just 25 cents you now can purchase plans for the once top-secret sight from the United States Patent Office!

## NEW POWERFUL ELECTRIC MOTOR for HOBBY • RESEARCH • INDUSTRY

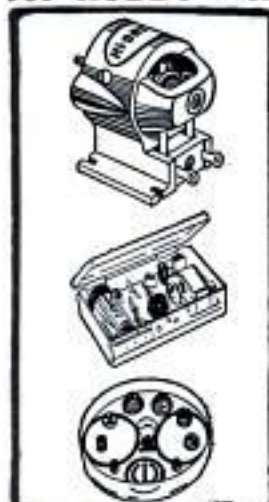

Meet Wilson's NEW Hi-Drive motors—tiny yet powerful enough to motorize hobby items, toys, recording equipment, research devices, industrial models. Long motor and battery life. Other high-quality, low-cost items listed may help solve your motorizing problems.

- \*No. 7-100—Hi-Drive Motor 1 1/2-3V \$2.00
- \*No. 8-100—Same for 3-6V \$2.50
- \*No. 9-100—Same for 6-12V \$3.00
- No. 3-100—Tiny Atom Motor, 1 1/2-3V \$2.00
- For higher voltages \$2.50
- No. 5002—2-speed metal motor \$3.00
- No. 95—Steel frame motor with gear, pinions, pulley, worm \$4.00
- \*No. 3113—Tiny Atom motor assembly kit with many acc. \$3.00
- No. 1300—Small accessories kit \$1.00
- No. 3700—Large accessories kit \$3.00
- No. 4000—DeLuxe acc. kit with motor \$5.00
- No. 700—Super-Power kit with motor, speed reducer, all accessories \$10.00
- \*No. 88—Kit of 8 pulleys—2 belts \$2.00
- No. 3000—Vari-speed gear unit \$4.00

\* Item illustrated. Ask for FREE Cat.

All Wilson's motors have Permanent Alnico V Magnets.

Result with order and we pay postage in U.S.A. No C.O.D. Add 3% Sales Tax for delivery in Ohio. Write Dept. PM.

For quick delivery see your local dealer — or order direct



**WILSON'S OF CLEVELAND**

425 Lakeside Ave., N.W. • Cleveland 13, Ohio

## Carpenters' NAILPULLER Pocket size!

Powerful, Easy to Use, Handy as a Hammer!

Satisfaction guaranteed up to tenpenny nails.

POSTPAID  
U.S. ONLY

**\$174**

No C.O.D.  
No Stamps.



Only 12" long.

Carpenters' favorite. Convenient in tight places, carries in pocket. Tool steel counteracting jaws driven into wood under nailhead. Double leverage with hammer. All steel, rustproofed.

K-D Mfg. Co., 526 N. Plum St., Lancaster, Pa.

## Exclusive Double-Bearing HEAVY-DUTY PUMPS

IRRIGATE • DRAIN • CIRCULATE • SPRAY  
Up to 7,500 GPH, 3,000 GPH from 25' well. Use 1/2 to 1 HP motor. 1 1/2" inlet; 1" outlet. Stainless shaft. TYPE X—2 oilless bronze bearings. \$10.95

Won't rust. . . . . \$12.95

TYPE XB—Ball bearing model. . . . . \$12.95

Postpaid if cash with order. (West of Miss. add 10%)

— MONEY BACK GUARANTEE

Centrifugal and Gear Pumps in All Sizes

LABAWCO PUMPS, Belle Mead 2A, N. J.



Also ADULT  
2 Passenger  
"ESHELMAN"  
SPORT CAR

1/5 The Price of any other Auto  
70 Miles per Gal.  
Free Catalog

**ESHELMAN 70 MILES PER GAL. GAS CHILD'S AUTO WITH MOTOR**

STURDY, SAFE FOR KIDS  
Commended by "Parent's Mag." Write for Free Catalog.

SHIPPING POINTS:  
BALTO. CHICAGO, ILL.  
CHICAGO, ILL.  
For Free Catalog Write  
Eshelman, Dept. MC-55  
109 Light St.,  
Balto., Md.



## TOP SPEED For RACING or FUN

These famous AQUA-JET propellers won twice as many times in the "National Stock Outboard Championship" as all other wheels, custom built included. Inexpensive stock propellers, requiring no alteration of lower unit, each specifically engineered for motor used 5HP to 50 HP. Write for FREE 1955 catalog—the Outboarder's Bible. Shows how to get better performance from any boat and motor combination—for pleasure or racing—also fine line of boat trim. Michigan Wheel Company, Dept. P-76, Grand Rapids 3, Mich.

## NEW! BEAUTIFUL PRE-FINISHED HARDWOOD PANELING YOU PUT UP WITHOUT NAILS!



New pre-finished Weldwood paneling comes in figured walnut or light oak, 32" x 96" or 48" x 96", both 1/4" thick.



Brush Weldwood Contact Cement on studs and panel backs at points of contact. Let dry 1/2 hour and repeat. When dry, position panel, tap with hammer and wood block—job's done!

Here's real wood paneling that needs no staining or waxing—and you install it with a brush! New Weldwood panels come already pre-finished and waxed by expert wood craftsmen. You can put them up with new Weldwood Contact Cement—no nails, no hard-to-cover-up nail holes.

Panel a wall in your living room, dinette or den—Weldwood gives a lift and sparkle to the whole room. An 8' x 12' wall in pre-finished walnut costs about

\$78—other unfinished decorative paneling from \$23 for 8' x 12' area. See your lumber dealer for pre-finished and regular Weldwood paneling and superior Douglas Fir Weldwood, or visit any of the 82 United States Plywood showrooms in principal cities.

Ask your lumber dealer for



# Weldwood®

Pre-finished Hardwood Paneling  
UNITED STATES PLYWOOD CORPORATION  
World's Largest Plywood Organization  
55 West 44th Street, New York 36, New York

"Handy" SANDY offers



more work-saving  
**GOOD  
SHORT-CUTS**  
you can use

Sharpen the cutting wheel on your wife's wall-type can opener quickly and easily by running a strip of CARBORUNDUM® Brand Fine Emery Cloth through it a few times. Saves taking the wheel out . . . puts a keen new edge on it.

Ever take a clock apart and lose a few small parts? Next time you're working with a number of tiny screws, springs, bolts and other elusive parts, lay a long strip of FLEXBAC® Masking Tape by CARBORUNDUM on your bench or table, sticky side up. Simply place your parts on the tape as you remove them, and they can't fall or roll away. Keeps them in order, too!

Safe way to clean your No. 109 Combination Stone or other sharpening stones by CARBORUNDUM: dissolve any household detergent in lukewarm water and scrub into the pores of the stone with a stiff brush. Lifts out the dirt, grit and grease—doesn't leave a residue.

Here's a brand new sanding block developed by the folks at CARBORUNDUM—now on sale by your hardware or building supply dealer. It's called RED-I-RUB, and it's the handiest little block you can use for sanding wood, metal, paint. It's made from two layers of thick, flexible rubber . . . sandpaper wraps around and is held tight between them. Because it's so flexible,

it's perfect for sanding irregular surfaces like moldings and such. Get two or three RED-I-RUB blocks (they're very moderate in cost) so you'll have one handy in the house, garage and workshop. I think they're terrific . . . once you've tried one you'll think so too!



Send me your ideas on how my line of CARBORUNDUM® Brand products can save time or work around the house or workshop. Put each Short-Cut idea on a separate postcard, and for each one I can use in later columns, I'll pay you \$5.00 right away. If I can't use 'em (because of duplicates, etc.), I'll send you a worth-while little gift anyway.

A free folder called "How to Sand", giving lots of useful information, is yours for the asking, too. Address all your postcards to me . . .



"Handy" SANDY  
**CARBORUNDUM**

REGISTERED TRADE MARK

Niagara Falls, New York

90-124

## Dodge Owners Rate Handling As the Best-Liked Feature

(Continued from page 110)

"Steering wheel too low. When I get in and out my legs hit it."—Kansas farmer.

"Ash tray hard for front-seat passenger to reach."—Texas refinery worker.

"I am still waiting for the heater that I paid for when I bought the car."—Florida electrician.

"Trunk lid closes too hard for women."—Wisconsin mechanic.

"Slight distortion where windshield curves."—Texas cafe owner.

### SPECIFICATIONS 1955 DODGE

#### ENGINE

	SIX	V8
Type	In-line, L-head 6	OHV V8
Bore and stroke	3.25 x 4.63 in.	3.63 x 3.256 in.
Displacement	230 cu. in.	270 cu. in.
Horsepower	123 at 3600	175 at 4400 (Red Ram) 183 at 4400 (Super Red Ram) 193 at 4400 (Super Red Ram with Power Pack)
Compression ratio	7.4	7.6
Transmissions	Three-speed; overdrive; PowerFlite (torque converter with gears)	

#### GENERAL

Steering wheel, lock-to-lock	4 turns (3.5 turns with power steering)	5 turns 42 ft., 3 in.
Turn circle	42 ft., 3 in.	3395 lb. (Coronet) 3425 lb. (Royal) 3485 lb. (Custom Royal)
Shipping weight	3295 lb.	
Wheelbase	120 in.	120 in.
Tread, front	58.9 in.	58.9 in.
Tread, rear	59.1 in.	59.1 in.
Height over-all	60.3 in.	60.6 in.
Width over-all	74.5 in.	74.5 in.
Length over-all	212.1 in.	212.1 in.
Road clearance	5.0 in.	5.0 in.

#### INTERIOR DIMENSIONS

Front (four-door sedan)	62.5 in.	62.5 in.
Rear hiproom	62.8 in.	62.8 in.
Front headroom	35.5 in.	35.5 in.
Rear headroom	34.9 in.	34.9 in.
Front legroom	44.5 in.	44.5 in.
Rear legroom	45.0 in.	45.0 in.

#### CAPACITIES

Oil	5 qt.	5 qt.
Water	13 qt. (without heater)	19 qt. (without heater)
Gasoline	17 gal.	17 gal.

"Horn ring positively dangerous. Answers to pressure on bottom third of wheel only. In a curve, driver has to hunt for pressure spot to sound horn."—Missouri lawyer.

"Chrome inside and out is not put on the right way. It works loose and causes squeaks and noises."—New Jersey baker.

"Driver cannot see right front fender clearly."—Pennsylvania salesman.

(Continued to page 224)



What home job do YOU want to do?



**NEW!**

**Black & Decker  
1/4 inch Drill  
does 'em ALL better!**

The Black & Decker 1/4-inch Utility Drill made even better! It's 44% more powerful ... smoother and quieter in operation ... and easier than ever to handle! Does hundreds of home jobs! See it at your dealer's. For "Handy Tips" booklet, send 25c to: THE BLACK & DECKER MFG. Co., Dept. M065, Towson 4, Maryland.

See "Tools-Electric" in phone directory for



**Black & Decker®**  
PORTABLE ELECTRIC TOOLS



44% MORE POWER!  
TWICE THE TORQUE!  
CONTOURED HANDLE!  
HELICAL GEARS!  
SMOOTHER OPERATION!

Still only  
**\$24.95**  
with geared  
chuck \$26.95

**STOP WATER WASTE AUTOMATICALLY**

Use HECO Flex-tip, the nozzle that shuts off the water FOR YOU. FLEX to use—RELEASE, it's off. No running back and forth to faucet. Stop puddles, save water and mess when washing cars, mixing cement, transplanting flowers and shrubs, etc. Made from solid brass bar stock and grease resistant Neoprene. Nothing to clog or break. Thousands in daily use. Get yours! \$1.75 each, 2 for \$3.00 postpaid. Satisfaction guaranteed. If dealer can't supply, send check or money order to: Customer Service, Dept. M, HECO, Littleton, Colorado. Colorado residents add 2% sales tax.



**FIND \$\$\$\$**

NEW U-238 geiger counter—world's smallest, most sensitive uranium locator. Ideal for prospecting even on hunting, fishing trips! (Full line of mineral and metal locators, too.)



FREE booklets on request. (Dealer inquiries welcome.)

GOLDAK COMPANY 1542 W. Glenoaks Blvd., Glendale, Calif.

Protect your home against power interruptions with an ...

**ONAN Emergency ELECTRIC PLANT**



Provides dependable stand-by electricity for heating system, pumps, freezer, lights, appliances. Keeps home safe, livable. Automatic start and stop. Find out how little it costs!

Write for Folder!

**D. W. ONAN & SONS, INC.**  
3305 University Ave. S. E. • Minneapolis 14, Minnesota

JUNE 1955

A SIZE FOR EVERY NEED  
400 to 75,000 watts.  
Compact, quiet-running,  
easy to install. Gasoline engine powered.

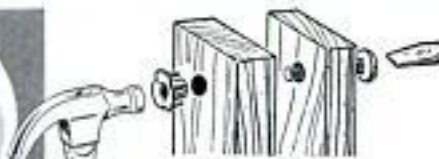

**TEENUTS**

steel threads in wood

TEENUTS mount flush without counter-boring. Excellent for new work or repairs ... wood to wood, wood to metal ... and where old screw holes have worn out. Simply drill hole for TEENUT barrel, hammer home TEENUT and its steel prongs provide rigid, permanent anchorage. Same size hole for bolt. Sizes to fit standard bolts: 6-32, 8-32, 10-24, 10-32 (4 per card), 1/4-20 (3 per card), 5/16-18, 3/8-16 (2 per card).

AT HARDWARE COUNTERS EVERYWHERE 15¢ per card



3229 South Ashland Ave., Chicago 8, Illinois

THE DOT LINE



### Dash-Mounted Shift Lever

One of the most talked-about features of the entire Chrysler Corporation line is the location of the PowerFlite selector lever on the dashboard. Only 6 percent of the owners polled dislike the new location. Another 10 percent say it makes no difference to them and 84 percent like the idea. Here are some opinions:

"Selector lever on dashboard is the hardest thing to get used to. It is handier under the steering wheel, but must admit it is out of the way of coat sleeves on the dash and you don't use it much anymore."—Washington prison officer.

"Dash-mounted lever is just as convenient (but no more so) as when on steering column."—New Jersey salesman.

"Dashboard location is wonderful. Seems the natural place for it."—West Virginia salesman.

"New position is very good. I cut the lever off flush with the dash."—California electronics engineer.

Well, there you have it—the good and the bad about the 1955 Dodge V8. A brief summary of the owners' opinions would state that the Dodge is excellent in handling, power and performance. Its two V8 engines are reliable and very miserly with oil. The major complaint is that the car

uses too much gasoline, especially with PowerFlite. For a more detailed summary of the survey, study the percentages listed on page 109. ★ ★ ★

Turn back to page 106 to begin Floyd Clymer's road test of the Dodge V8.

### Separator for Viruses Uses Electrical Process

Low-cost separation of proteins, viruses, bacteria and similar compounds can be achieved with a new electrical process developed by Alexander Kolin of the University of Chicago. Hitherto, separation of viruses of different kinds and the separation of them from their host cells was difficult and expensive. The Kolin apparatus, most efficient yet developed, can be set up for less than \$20. The process is based on placing a solution containing the mixtures to be separated in a vessel containing fluids that are different from each other by reason of weight or other qualities. When an electric current is passed through the fluids, the particles in solution move toward a point at which their electrical charge is zero—their isoelectric point. Different particles have different points, and tend to collect in the container with the fluid having their same isoelectric point.

*Under the Beauty...*

**Steel for strength...**

**Leather for comfort!**

You'll like the skillful way that Estwing craftsmen combine leather and steel in making the world's only one piece hammers and hatchets.

Perfectly balanced and beautifully finished, Estwing is the choice of skilled tradesmen the world over.

Available at your favorite hardware store. \$3.95

FREE Catalog on request

Estwing Mfg. Co., Dept. 4M, Rockford, Illinois



## Fold-over edges continue grain design on this coffee table



get complete detail drawings and easy-to-follow directions in

### FREE PATTERN KIT 407

along with the picture-packed booklet, "Friendly Home Ideas in Western Pine." Write for it to Western Pine Association, Dept. 407-N, Yeon Bldg., Portland 4, Ore.

You'll enjoy making this coffee table with the handsomely grained woods of the Western Pines\*. Mitered fold-over edges on sides and ends continue grain design all around—give you a table without end grain. Tapered legs complete this unusual contemporary design.

Smooth-surfaced, even-textured Western Pine woods are easy to work and economical for all do-it-yourself projects. They cut clean and accurately without grain raising. See these carefully selected, well-seasoned woods at your local lumber dealer—ask him to give you an estimate!

## the Western Pines

- \* IDAHO WHITE PINE
- \* PONDEROSA PINE
- \* SUGAR PINE

TODAY'S WESTERN PINE TREE FARMING GUARANTEES LUMBER TOMORROW

### MONEY MEN ALL DATA FREE

THE PLASTEX Industry needs manufacturers on small scale and for big production of Lamp and Clock Stands, Art Goods and Novelties in Plastex and Marble-imitation. Experience unnecessary. 1/2¢ material makes regular 10¢ store sellers. Rubber moulds furnished for speed production. Small investment brings good returns. We are now placing big Chain Store Orders with manufacturers. Ambitious men have chance for real prosperity. Our Free booklet will interest and benefit you.

**PLASTEX INDUSTRIES, Dept. A**  
3400 Third Ave. New York 56, N. Y.

only \$95 freight incl. Write For FREE FOLDER

### 12 ft. SPORTBOAT KIT



Includes ready-cut parts and hardware. Models low as \$39.00 freight incl.

**TAFT MARINE WOODCRAFT**  
Dept. PM-6, 636 39th Ave. N.E., Minneapolis 21, Minn.

### 2 GREAT AUTO BARGAINS



**NEW KING MIDGET** for 1955. lower priced, improved performance. Drive it for 75¢ per week. Rider agents wanted. earn your own car. Also just out **KING MIDGET JUNIOR** chassis, finely engineered.



ready to run, and priced at less than the retail cost of parts. Agents wanted. Get all the facts—send 25¢ for literature, special prices and proposition on both cars, or \$1 (refunded first order) for this plus actual assembly book and service manual.

**MIDGET MOTORS MFG. CO.**  
ATHENS 1, OHIO

## How to PROTECT hobby equipment from MOISTURE DAMAGE





**Just plug in the amazing FRIGIDAIRE electric DEHUMIDIFIER**

Positively controls moisture in workshops, basements, or any closed area up to 10,000 cu. ft. where moisture is a problem.

18 1/4" high; 20 1/2" long; 11 3/4" wide.

See your Frigidaire Dealer for details. Or for free folder write to Frigidaire, Dept. 2354, Dayton 1, O. In Canada, Toronto 13, Ont.



**Built and backed by General Motors**



**Fast, Safe**  
**No Wash**  
**Non-inflammable**

**Peels Off Paint**

**How you can get perfect paint jobs every time!**

Klean-Strip is totally unlike ordinary paint removers that dissolve the finish and are so messy to use. Klean-Strip actually breaks the bond between finish and surface . . . removes many coats with one application. It's clean, fast-acting and easy to use . . . leaves the surface smooth and dry, ready to paint without neutralizing or afterwash.

Use Klean-Strip on furniture, woodwork, walls, metal. Klean-Strip peels off any finish. Buy it when and where you buy paint.

**KLEAN-STRIP**  
**Paint Remover**

**THE KLEAN-STRIP CO., INC.**  
2340 S. Lauderdale, Memphis 6, Tenn.

Super-honed wheel and special axle, perfect design and workmanship guaranteed. Long life and perfect, easy cuts. Factory-sealed packaging for your protection.

**Red Devil**  
**GLASS CUTTERS**

**FREE** How To Cut Glass. Illustrated instructions on tools and methods of cutting glass.

**Red Devil Tools.** Dept. 145  
130 Coit Street, Irvington, N. J.  
Please send FREE copy of "HOW TO CUT GLASS."

NAME \_\_\_\_\_  
ADDRESS \_\_\_\_\_  
CITY \_\_\_\_\_ ZONE \_\_\_\_\_ STATE \_\_\_\_\_

1963

## Clymer Road Test

(Continued from page 106)

single-rocker-arm shaft with modified hemispheric chambers. All specifications except horsepower are the same on both engines. The single-rocker-arm-shaft design is also used in the Plymouth and Chrysler Windsor V8 engines.

Dodge has terrific performance. It eats up average hills as if they were level ground and loafs along at 95 miles per hour. The speedometer showed 108 top speed, but it is fast by about 5 percent.

At high speeds there is more road noise than I believe is necessary. It is magnified some, perhaps, because there is no sound-deadening material on the underside of the hood.

The ride is comfortable and well controlled. Weight distribution is good with 56 percent on the front and 44 percent on the rear. There is considerable roll when sharp corners are taken at high speed. However, there is a feeling of safety in operating the car and fast road speeds can be maintained mile after mile. It was hard to make the frame hit bottom on the worst bumps, even at high speed with two persons in the car.

Chrysler's full-time power steering requires 3½ turns from lock to lock; without power it is five turns. This is an excellent ratio, but because of the very easy steering, one is inclined to over-steer until he has driven a few miles. After rounding a corner the wheel returns without assistance to normal straight position—an improvement over the first full-time power steering on Chrysler-built cars.

The hydraulic brakes are excellent. The power brakes on the test car are the best I have ever found on a stock production car. There was no fading and the pedal seemed less sensitive than on most power units.

PowerFlite transmission is not as smooth in the changing of speeds as some automatic transmissions. However, the operation of the foot throttle has much to do with the smoothness of PowerFlite operation. With some practice, the changes can be as smooth as silk, but they can also be jerky if the throttle is manipulated carelessly. If the throttle is held wide open, top speed engages at about 58 miles per hour. By depressing the throttle pedal, step-down below 58 miles per hour is quick and increased speed takes place instantly with a surge. It is a positive-operating transmission with no evidence of slippage.

The gas economy was not good and not bad—just average for a car with Dodge's

(Continued to page 228)

they keep your tools handy  
... and cost nothing extra

## UTILITY HOLDERS

included with Indestro Socket and Wrench Sets

Here's the handiest thing ever, for your home work shop, hobby bench, garage, etc. and you don't pay a penny extra for it. Simply buy super-value Indestro Socket or Wrench Sets at your Indestro dealer's and he will include without any extra charge these convenient Utility Holders that keep your tools in easy reach.

### Double Duty Wall-Klip Yours with Socket Sets

The eleven or nineteen piece Indestro Socket Set comes in a metal holder that you will want to use as a handy wall hanger.

### Klip-Tite Holder Yours with Wrench Sets

Box End or Combination Wrenches; popular assortment of sizes, packaged in exclusive Indestro Klip-Tite Wall-Bracket Holder that opens into hanger, as shown.

See the hardware, implement, auto supply or variety store that sells Indestro Tools, or write us for name and address of your nearest Indestro dealer.

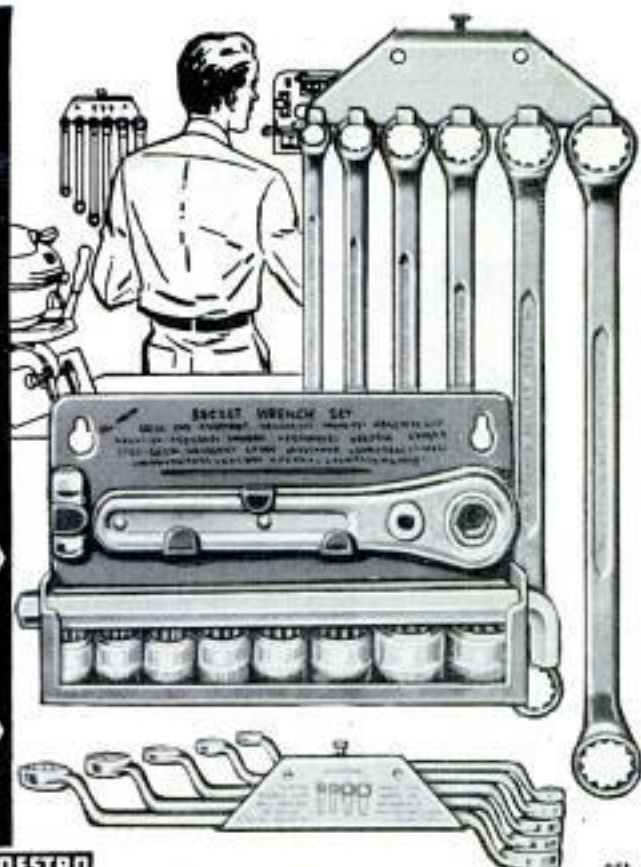

**INDESTRO MFG. CO.**

NORTH KILDARE at SCHUBERT • CHICAGO 39, ILLINOIS

**YIPEE - A SAWHORSE IN A Jiffy**

Jiffy Brackets and 2x4s are all you need. Set-up and knocked down in a jiffy—no nails, screws, or bolts required. Easy to move or store. Sold by hardware and building supply stores everywhere, or order direct.

GRAND HAVEN STAMPED PRODUCTS CO., Grand Haven, Mich.

**\$1. SCRIBER of CARBIDE**  
Will scribe on hardened steel, ceramics, glass, etc.  
Designed for close work for TOOL and DIE workers.

**SIEG KONRAD MANUFACTURING CO.**  
1636 W. 7th St., St. Paul 2, Minn.

**\$1.**

**GOSH! what a boat!**



In independent tests, Cadillac aluminum boats outperformed 12 leading makes in six ways with different loads and horsepower. They're roomy, light... built to last a lifetime. Car top models take up to 16 h.p. Cadillac exclusive: you can add front and center decks, steering wheel, windshield... by yourself! Write for literature on Cadillac's complete line of aluminum, molded plywood and cedar strip boats.

**CADILLAC MARINE & BOAT CO.**  
168 Seventh Avenue • Cadillac, Michigan

**Cadillac SWEETEST BOAT AFLOAT**

**FREE**

**SANDING HANDBOOK**  
**For DO-IT-YOURSELFERS!**

Free new 20-page handbook explains sanding technique on wood, metal, glass, plastic; shows correct methods, names the proper tools for removing surfaces of different types of woodwork. Lists sandpaper grades, uses; tells how to sand hard-to-reach places, etc. Helps you save time, money on home projects—invaluable to beginners, experts. Authoritative, informative! Fully illustrated. Includes Syncro Catalog of Sanders and Jig Saws!

Saws! Send coupon for your free copy now.

**SYNCR**  
**Tools**

**NEW HEAVY-DUTY SYNCR SANDER**  
Removes paint, varnish—outsands all others per dollar cost. Has sight-saving lamp—world's most powerful reciprocating sander motor (patented). Priced **LOW**.

**SYNCR CORP.**  
Dept. A-15, OXFORD, MICHIGAN

Send me **FREE** Sanding Handbook, Syncro Sander Catalog, Low Prices.

Name \_\_\_\_\_  
St. & No. \_\_\_\_\_  
City \_\_\_\_\_ State \_\_\_\_\_

Approved

**AMAZING ADHESIVE DISCOVERED!**

## Glues without presses, clamps, nails!

New Weldwood® Wizard  
Bonds Instantly...  
Permanently on Contact!



**Use it to modernize kitchen  
counters, table tops, etc. with  
Micarta and other plastics  
quicker, easier than ever before!**

Weldwood Contact Cement works like magic! No need for clamps or presses. Just apply...let dry...then bring laminate and surface together! Instantly you get a permanent bond!

**PUT UP PLYWOOD WITHOUT NAILS!** Do it yourself with Weldwood Contact Cement. Revolutionary new method—faster, easier. No nail holes to spoil finished surfaces!

**1001 JOBS MADE EASIER** around home, shop, garage. Weldwood Contact Cement bonds any combination of wood, glass, leather, paper, cloth, fiberglas, metal (including do-it-yourself aluminum).

In tubes, bottles, cans. 25¢, 35¢, 60¢ and larger sizes at hardware, paint and lumber dealers, and variety stores. Mail coupon for leaflet!

®Trademark

### United States Plywood Corporation

Dept. 104, 55 W. 44th St., N. Y. 36

Please send me information on Weldwood Contact Cement.

Name \_\_\_\_\_

Address \_\_\_\_\_

City \_\_\_\_\_ Zone \_\_\_\_\_ State \_\_\_\_\_

horsepower and weight. (See Economy Test, page 110.)

I found no squeaks or rattles and the body, which is extremely roomy, developed no water or dust leaks. The body has a tight feeling; the doors open and close easily. I like the short  $2\frac{1}{2}$  turns of the crank to lower or raise the windows.

Interiors are very attractive. The seat springs, front and rear, are excellent. Adjustment of the front seat is controlled by pulling up on a lever operated by the driver's left hand and this arrangement is awkward. Movement of the seat could be easier if this seat adjustment were redesigned.

The instrument panel is very attractive. I like the indicator needles that are used on all instruments, instead of red warning lights used by many other makes.

The heating system, although somewhat slow to warm up, is efficient and controlled by one lever. The ventilating system is good and the cowl ventilator, of which I approve, is now operated by a slide-movement lever below the center of the instrument panel.

The speedometer, directly in front of the driver, has an easy-to-read dial, but the top of the horn ring is annoying in that it is directly between the driver's eyes and the speedometer dial.

Dodge's brake pedal (now suspended from the firewall) is seven inches wide, easily operated by either foot. Incidentally, more and more drivers operating cars with automatic transmissions are learning to use the left foot for braking. This is as it should be; it makes for faster and safer braking. The brake-pedal location, in relation to the throttle, is good. As on all Chrysler models, the parking brake operates on the propeller shaft, a design I have never liked.

The starter is operated by the ignition key. The more accustomed I become to Chrysler's new shift-lever position on the dash, the better I like it. Windshield wipers are electric with slow, fast or varying speeds of operation.

There is some slight distortion at the extreme sides of the windshield, such as I have noticed on all cars using the wrap-around design. The vision directly in front of the hood is above average, due to the slope of the hood toward the front. Rear vision is also good.

The bumpers are massive, with good front and side protection. There is an exceptional amount of trunk space, the 1955 Dodge being almost seven inches longer than the equivalent model was in 1954 (see chart on page 110). ★ ★ ★

Now that you've read what Floyd Clymer thinks about the Dodge, turn to page 106 for the Owners Report.



Launch a day of fun...most anywhere!

—quiet fun, with an Evinrude



Outdoor America's most exciting discovery . . . TRAILER BOATING! Thousands will tell you there's nothing like it! You can explore famed vacation waters, or whisk your boat to lovely shores in easy reach. From highway driving to waterway cruising is a matter of *minutes*. Each launching starts a holiday of fresh adventure, new family fun.

Your boat? Your choice is wide—able fisherman, smart runabout, snug cruiser. Your motor? An Evinrude with *Whispering Power* . . . smooth as sailing! *And nothing less!* For this is the new *kind* of motor . . . so incredibly different from ordinary outboards . . . so amazingly *quiet* . . . so *smooth* . . . you have to ride with one to believe it. SEE YOUR EVINRUDE DEALER. Look for his name under "Outboard Motors" in your phone book. He knows boats, motors, trailers, and will gladly help you choose the right outfit for your needs. Time payments if you like, **FREE!** Write today for full-color catalog of the complete Evinrude line. EVINRUDE MOTORS, 4582 N. 27th St., Milwaukee 16, Wisconsin.

*A Division of Outboard, Marine & Mfg. Company*  
In Canada: Mfd. by Evinrude Motors, Peterborough



**Evinrude**  
Pioneers in quiet Outboard Motors

*all are quiet!*

**ELECTRIC BIG TWIN Aquazonic**—25 h.p.\* The *proved* electric starting outboard. \$525!  
**BIG TWIN Aquazonic**—25 h.p. Brilliant power for big runabouts, cruisers, water skiing. \$430  
**FASTWIN Aquazonic**—15 h.p.—speed to 30 m.p.h. America's "middleweight" favorite. \$347  
**FLEETWIN Aquazonic**—7½ h.p.—only 49 lbs. Top value in the light motor field. \$235  
**LIGHTWIN with famed Fisherman Drive**—3 h.p., 32 lbs. It "goes anywhere, stows anywhere." \$145  
\*All ratings are OBC certified at 4000 RPM tested in conformity with SAE test code. Weights are approximate. †Prices f.o.b. factory subject to change without notice.

# Popular Mechanics Precut House

Build a Livable Shell from a Precut Kit for Only \$1800

Build a Summer Home With All Conveniences for Only \$2800

Build a Luxury Home for Year 'Round Living for Only \$3800



Designed by  
Wilson  
and Christie,  
Architects,  
Towson, Md.

## Build This House Yourself!

Save 65% Easily!

New Popular Mechanics Book and Plans—New Precut Materials Kit—Packaged Plumbing, Heating, Chimney, Etc.—Make Amateur Carpenter's Job Easy

Here is the newest Popular Mechanics "Build-It-Yourself" house. You can build it in three stages, with or without an available kit of materials precut to actual size and shape, for the amazing low price of only \$1800. The first stage will give you the start of a grand home that you can live in while you progress with building. The second stage will give you a fine summer home, with all wanted conveniences, for a total of only \$2800 for both stages. When you add the third stage you have a real luxury home for year 'round living in any climate for only \$3800 total cost. Richard Dempewolf, author of the "Precut House" book and a Popular Mechanics editor built the test house pictured above for even less. Today, the appraised value, including the land is \$12,000.00.

Simplified How-To-Do-It Instructions—Hundreds of Pictures—Working Blueprint Plans!

You can build the house with the book alone. The plans make it easier. The book gives lists of materials required, all measurements and dimensions, suggestions for financing, and tells in words and shows in pictures every detail of construction. Like thousands of others who have built their homes themselves, you can do it too and save up to 70% of the cost. The dream home that seemed impossible is here. This fabulous, economical house, designed by famous architects, especially for amateur builders, is your answer to the home you always wanted.

### Features of Expensive Homes

The unusual features of the Precut House are: adaptability to various interior arrangements; use of materials designed especially for amateur builders; easy construction; unusual amount of closet and storage space; built-in furniture; house that is suitable for city, country and resort; low maintenance cost; complete insulation. All this at a cost so low no other house of similar size can compare with it.

### Money Back Offer

The coupon will bring you the "Precut House" book and plans. Mail it Today. If you do not like what you get or decide not to build this fine house, return either or both within 10 days for full refund of purchase price. Mail coupon today.

### Building the Test House

The test house pictured above was built in eastern Pennsylvania by the author and his wife, neither of whom had any previous building experience. It is a year 'round home, insulated, modern heating and plumbing, fireplace, redwood interior finish, dozens of built-in features and floor-to-ceiling, 9-foot wide picture window. Total man hours required to build—1650. Total cost not including ground and inexpensive foundation—\$3731.23



Build It to Your Own Plan in The Same Shell—2 Bedrooms or 3 With or Without Fireplace—Install Windows Where You Want Them!

Overall size 24 x 46 feet. Note the two typical floor plans shown. Above: Two bedrooms, bath, kitchen, dining room, living room, car port or porch. Below: Three bedrooms, bath, utility room, kitchen, dining area, living room, porch. The "Precut House" book shows many other variations.

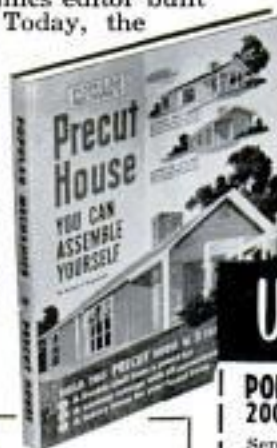

Use This Coupon To Get Book and Plans

POPULAR MECHANICS PRESS, DEPT. PCH  
200 E. ONTARIO ST., CHICAGO 11

Send at once:

- Popular Mechanics Precut House book \$2.50
- Complete set of ten blueprints \$12.50
- Sets duplicate blueprints @ \$5.00 per set
- I enclose remittance for \$\_\_\_\_\_ Send postpaid.
- Send COD. I will pay postman plus charges. I understand I may return either book or plans, or both, within 10 days if not satisfactory and you will refund full purchase price.

Name \_\_\_\_\_

Address \_\_\_\_\_

City \_\_\_\_\_ State \_\_\_\_\_



## KNOW WHEN YOUR BRAKES NEED FLUID!

### **EVER SAFE**

#### BRAKE FLUID LEVEL INDICATOR

You never have to worry about brake failure due to insufficient fluid with Ever Safe, the automatic indicator which warns you the instant your brakes need more fluid. Ever Safe consists of a red warning light attached to the dashboard of your car and connected through the ignition switch to a float in master brake cylinder. When your brake fluid drops below the safety level, the warning light flashes on instantly. Ever Safe operates continuously... automatically. You can install Ever Safe in your own car in only 30 minutes. Just pin three one dollar bills to this ad and send with your name and address and the make and year of your car for complete Ever Safe kit and instructions.



ONLY  
**\$300**

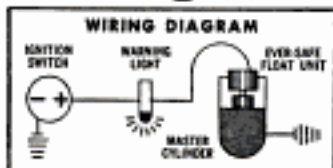

WAGNER ELECTRIC CORPORATION  
Dept. 5PD, 6400 PLYMOUTH AVE., SAINT LOUIS 14, MO., U.S.A.

## Give your family FREEDOM FROM FEAR OF FIRE



When fire strikes, the Edwards Home Fire Alarm can save *your life... and your family's!* Stands guard over your loved ones every minute of every day and night—permanently. It's automatic, electric, foolproof—easy to install. Run low cost bell wire to detectors (usually in furnace room and storage area)... screw detectors onto ceiling... and mount 5" x 7" signal unit onto wall. Connect detectors and plug in. That's all. Two UL listed detectors give you 400 sq. ft. safe coverage each (for protection in *every* room, use additional detectors at \$3.50 each). At 140°, detectors set off loud alarm that gives your family fair warning—*fire warning.* Guaranteed by Edwards, maker of fire alarm systems for you and your family in schools, hospitals, industrial and office buildings... since 1872. For freedom from fear of fire for *your* family, buy it today from your electrical or hardware dealer, or mail coupon for literature and name of nearest distributor.



So sensitive  
a lighted match  
sets off alarm.



# EDWARDS

## HOME FIRE ALARM...\$1995

EDWARDS CO., INC., Dept. PM-6, Norwalk, Conn.  
(In Canada: Address Owen Sound, Ontario)

Please send literature and name of nearest distributor.

Name \_\_\_\_\_

Address \_\_\_\_\_

City \_\_\_\_\_ State \_\_\_\_\_

**SHAW**  
DU-ALL  
TRACTORS

**rake - bulldoze - plow  
cut trees-cultivate  
saw wood-mow**

### You just steer!

1½ to 5 H.P. walking tractors breeze through work. Variable speeds, run between or astride rows. Powerful 5, 8, 12 H.P. Riding Tractors. All wanted tools. Send for FREE CATALOG, low prices.

**SHAW Manufacturing Co.**  
4506 Front Street, Galesburg, Kansas  
668-G North 4th Street, Columbus, Ohio

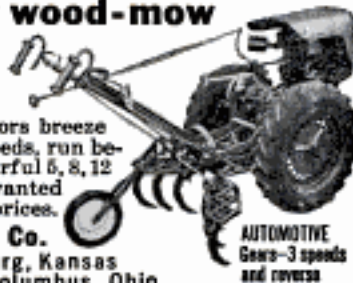

AUTOMOTIVE  
Gears-3 speeds  
and reverse

## HOW TO FIND URANIUM

FORTUNES ARE BEING MADE. In the last few months "V.P." found a claim worth 10 million! "C.S." found one worth 150 million and "J.C." found one worth many millions (names on request). Get this completely new prospector's handbook, based on latest geological discoveries and scientific findings. For the first time in one handy Manual, the vital information you need. Tells you what minerals contain Uranium. Where to look: How to make simple tests in the field; How to prospect with Radiation Detection Instruments; How to evaluate deposits; How to make a claim. Uranium Ore containing only 10% brings \$1694 per ton.

SEND \$1. FOR PROSPECTOR'S HANDBOOK  
MINERALS RESEARCH LABORATORY, STURTEVANT, WISCONSIN

Say You Saw It in Popular Mechanics

Need an extra \$1,000, \$2,000, or more? Make it with an  
**IDEAL LAWNMOWER  
SHARPENER**



There are thousands of lawnmowers in your locality: Average \$1,000 profit per 250 mowers with customer satisfaction and repeat business assured. Provide this essential service with an Ideal Lawnmower Sharpener, the only machine that grinds the reel to "fit" the bed knife. Compare by any standard. The Ideal, backed by 53 years of experience, costs no more. Write today for complete, free catalog.

**THE FATE-ROOT-HEATH COMPANY**  
Dept. PM-6 Plymouth, Ohio

Take a note  
from  
sticking  
trumpet  
valves!

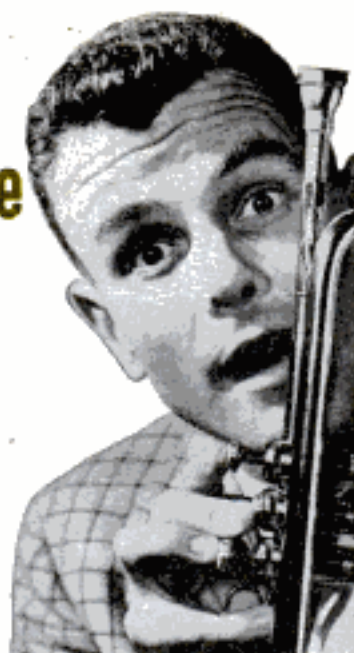

**Free your car's engine from harmful deposits to UNLOCK HORSEPOWER**

Trumpet or engine, deposits can cause valves and other vital parts to stick. Then rhythm is gone and the *tune* goes sour. In your engine it means lost power, wasted gasoline, excessive wear.

Pennzoil with Z-7 disperses all harmful contaminants, lets the *Tough-Film*® lubricate completely—*unlocking* engine horsepower for instant response, better gasoline economy.

Next time, change to Pennzoil with Z-7 and *feel* the difference!

Sound your  for the  
**LONG QUART**

NOW with  
**Z-7**  
the POWER  
INGREDIENT



Switch now at this sign

BETTER DEALERS  
IN EVERY STATE FEATURE PENNZOIL® PRODUCTS

© 1955, The Pennzoil Co., Oil City, Pa., Member Penn. Grade Crude Oil Assn., Permit No. 2

**The "Hams" Have a Man of the Year**

(Continued from page 79)

have his son flown to a hospital at Thule, Greenland, where his life was saved.

Another case was that of a young radio operator on T-3, which is only 270 miles from the North Pole. He was stricken with appendicitis. There was no doctor available and the man had to be flown out under near-impossible weather conditions at 40 below zero. En route to Thule, the rescue plane was forced down at Alert, in Northwest Territory, Canada. The newspapers were playing the story for all it was worth and the stricken operator's parents were almost frantic until they heard from Surber. He contacted an operator at Alert who checked on the youth's condition. Through this cooperating ham, Surber kept the parents in constant touch with their son, reporting his condition through attempted and finally successful take-off for Thule, arrival at the hospital and successful operation.

Comedy, too, has a part in the hams' communication with the Arctic stations. Once an operator, also at T-3, reported that the station cook was getting "mighty tired of using a flattened tin can as a pancake turner." This message was picked by a ham in Pennsylvania. When the next package of mail was dropped, the cook was surprised with a brand-new pancake turner.

The first Edison award winner was Don L. Mullican (W5PHP), a college student of Searcy, Ark. He stuck to his radio for five days and nights to direct emergency aid to tornado victims in two nearby towns.

Among those who have won citations in the past is William C. Jenney (W8FYW) of Columbus, Ohio. Jenney was cited for spending many of his evenings teaching the boys at the Columbus State School for the Blind how to become hams. He helped them beg, borrow and buy equipment and taught them how to take down communications in Braille. The reports of his work have inspired blind boys all over the world.

Another special citation winner, Philip S. Rand (W1DBM) of Redding Ridge, Conn., has penetrated the Iron Curtain with his broadcasts. In recent months other hams have reported contacts with operators in Russia and satellite countries.

The big thrill to the hams as they eye the Edison awards is the fact that every man knows he has as good a chance as the next guy to become the ham of the year. National leaders in many fields salute the awards as an important incentive to a group of people who work without pay and are an important factor in civil-defense plans. ★ ★ ★

# GREATEST RIDE DEVELOPMENT IN AUTOMOTIVE HISTORY

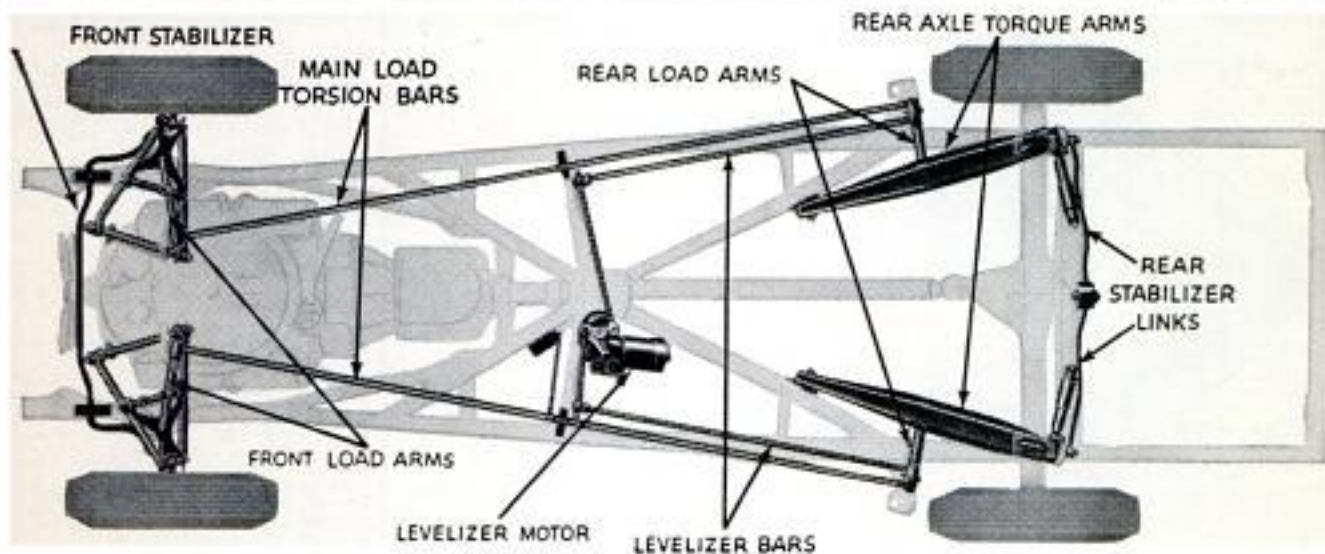

**Torsion Suspension** has two long, torsionally flexible bars, four pivoting arms (called "load arms"), and four links. These support the frame and body.

**The Levelizer (Compensator)** has two short "levelizer" bars connected at one end by links and levers to a two-way motor with reduction gearing and at the

other end to the rear of the main torsion bar load arms.

**Rear Axle Mounting**—Driving torque arms connect the rear axle housing to the frame. Side movement of the rear axle is controlled with two transverse stabilizer bars, allowing only true vertical axle movement.

## NEW PACKARD TORSION-LEVEL RIDE A Sensational New System of Suspension Eliminates Conventional Coil and Leaf Springs

### Smooths the Road . . . Levels the Load Automatically

**H**ERE'S WHY the new Packard Torsion-Level suspension gives you comfort unequalled by any car on any road . . . whether super-smooth or rugged and rutted.

In other cars, twisting forces due to wheel shock are transmitted to the frame. You submit to resulting pitch and bounce, the car is subjected to wracking of frame and body. In the new Packard, these same twisting forces are transmitted along the new torsion bar system and absorbed *before* they can reach either frame or passengers.

Torsion suspension has two "main load" torsion bars running the full length of the frame on each side connecting a front and rear wheel and making them work as a team. Each "team"

acts as a longitudinal stabilizer, reducing "pitch" and "dip" much as a transverse sway bar stops side roll. As the wheels move up or down, four pivoting arms (called "load arms") transmit twisting force to the main torsion bars, which, in turn, tell the wheels how to react to bumps and ruts.

A new type of front and rear stabilizer control helps give better handling on sweeping curves and tight corners. And an ingenious power-controlled levelizer compensates for changes in passenger and luggage load, and automatically keeps the car always at "flight-level."

But to fully appreciate this new kind of ride, visit your Packard dealer . . . take the key and see . . . let the ride decide.

"Ask the Man Who Owns One."

PACKARD DIVISION • STUDEBAKER-PACKARD CORP.

# How to choose a paintbrush that does faster, streak-free work



Here's why it pays you to use a brush with Du Pont TYNEX nylon bristles



**1. No break-in!** You don't have to soak or flex a new brush . . . if it has "Tynex" nylon bristles.

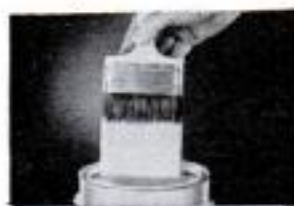

**2. Full paint pickup!** Specially tipped and flagged "Tynex" bristles hold a full load of paint.



**3. Smooth, even flow!** Anyone can do streak-free work, because each tapered "Tynex" bristle provides better, more even flow.



**4. Easier to clean!** They're the easiest-to-clean bristles there are! Paint loosens quickly in any commercial cleaner, rinses out thoroughly.

FREE! 8-page booklet full of helpful painting tips. Write Du Pont Company, Polychemicals Dept. PM-6, Wilmington 98, Del.



"Tynex" is the registered trade-mark for Du Pont nylon bristles.

BETTER THINGS FOR BETTER LIVING . . . THROUGH CHEMISTRY

## Can We Blame the Sun for Stormy Weather?

(Continued from page 69)

equatorial regions revolve considerably faster than its higher latitudes.

Inside the coronagraph, an artificial eclipse produced by the "occluding disk" blots out the sun to its rim, so that the observatory staff sees only the portions of the sun that extend beyond the luminous surface—a sort of cross section from the rim out through the sun's atmosphere. The two extremities of the rim are called limbs. Because the sun takes roughly 28 days to make one revolution, anything observed on the east limb will directly face the earth about seven days later, and the west limb shows the area which passed by the earth some seven days before. By recording our observation on the east limb and then studying the west limb some 14 days later, Miss Dorothy Trotter, who maps the solar activity daily at our Boulder research center, is able to interpret what was happening in a particular area on the sun at the moment it faced the earth.

These studies are important because the sun releases a great deal of energy in addition to sunlight. It emits this energy in two ways:

1. If you looked at the surface of the sun through a high-quality telescope of substantial size, equipped with filters to protect your eyes, you'd see that it has a mottled or granular appearance. Astronomers now believe that the tremendous energy born in the center of the sun greatly disturbs the layers just below the sun's surface as it seethes outward, producing violent agitation. This agitation shows up as bubblelike bright granules all over the solar surface. A typical granule lasts about three minutes. We believe that these granules are actually jets which shoot incandescent gas through the solar surface. Some of the largest of these show up as tiny spikes projecting from the rim of the sun. We have given the name "spicules" to these, and in the coronagraph they are fascinating objects for study. A spicule shows first as a tiny bump on the solar limb, which then thrusts upwards perhaps 10,000 miles at a speed of about 20 miles per second, releasing an accelerating jet of protons and electrons out into space. These protons and electrons form a part of the sun's corona and also, we believe, have effects on the earth.

2. Huge clouds of rosy-lavender, gaseous material lash out from the sun to tremendous heights. For example, one of these fiery clouds, photographed on June 4, 1946,

(Continued to page 236)



# B.F. Goodrich ASPHALT FLOOR TILE



**EASY** TO INSTALL  
TO CLEAN



Save by installing this low-cost tile yourself! The precision-cut edges and true corners help you do a fast, neat job.

A new electronically controlled process now gives B. F. Goodrich Asphalt Floor Tile a superior finish . . . extra smooth . . . easier to clean. It also provides uniform marbleization . . . brilliant colors . . . that make any room look new!

Send for **FREE** folder ▶



B. F. GOODRICH CO.  
Flooring Division, Dept. PM6,  
Watertown 72, Massachusetts

Name.....  
Street.....  
City..... Zone..... State.....

surged out to a height of 1,000,000 miles, more than one percent of the distance from the sun to the earth. Such "prominences" grow and fade in irregular fashion on the surface of the sun. Usually they arch and fall back into the solar surface. Many more are seen dropping towards the sun than can be seen shooting upwards. Some astronomers believe that at least a substantial number of prominences come to the sun from elsewhere in space, and fall into it. Prominences may last from a few minutes to several months. One extremely bright and abrupt type of prominence is called a "solar flare." Flares release powerful ultraviolet and X-ray radiations that find their way to earth.

Certain areas of the sun often become cooler than the rest of the solar surface, though no one yet knows exactly why. These are the famous sunspots, huge irregular areas that fluctuate in number and size in an 11-year cycle. They have been blamed for everything from depressions in our economic system to cycles in the frequency of twins. It seems likely that they have many profound though indirect effects on the earth. Flares are most likely to occur close to sunspots, and there are indications that the energy they release can very well alter the earth's climate and weather.

Astronomers have recently concluded that the sun has a gigantic magnetic field surrounding it, and speculate that this field can focus the proton-electron beams that shoot into the solar atmosphere. The sun's magnetism, most likely, focuses these beams into a broad band around the sun's equator. In addition, areas of intense solar activity where there are flares and sunspots create localized magnetic fields which can bend and distort the beams.

These electron-proton beams presumably flow the 93,000,000 miles through space from sun to earth in something between 6 and 80 hours. When they enter the earth's magnetic field they swerve to one side or the other, veer through space in a gigantic S-curve and shower down upon our planet in areas near both poles. What we see as the northern and southern lights are concentrations of these corpuscles. We are viewing the spectacular halo of the sun as it strikes the earth.

A violent outburst of flare activity on the sun sometimes produces a sudden surge in this shower of corpuscles. Impinging on the earth, this causes sudden and violent changes in the earth's magnetic field. Delicate compass needles, particularly in polar areas, develop irregular tremors. Brilliant auroral lights show up in the night. The

(Continued to page 238)

# GREAT SURPLUS SALE OF HOME, FARM AND FACTORY EQUIPMENT

**DOUBLE ACTION HYDRAULIC CYLINDER**  
**ITEM #310**—3 1/2" bore, 11" stroke. Alloy steel cylinder wall. Micro-honed and all steel 1 1/4" diameter piston rod. 19 1/2" overall length closed. Clevis mounting at base and shaft. Will lift 8625 lbs. with 1000 P.S.I. Pump Pressure. Uses 3/4" tubular fittings. Fittings to pipe thread: two 3/4" MPT @ 35c. A \$102.00 value. Shipping weight 11 lbs. FOB Chicago. . . . **25.00**



**GROBAN FOUR-WAY OPEN CENTER HYDRAULIC CONTROL VALVE**  
**ITEM #126**—Four-way open center control valve, with built-in adjustable relief valve factory set at 1000 P.S.I. Spring loaded neutral position. For use with one double acting cylinder. In neutral position cylinder is locked and pump unloaded. Can be used as single unit or mounted in series. Has 3/4" pipe thread inlet and outlet, 1/2" pipe thread cylinder ports. Finger grip handle. Ship. wt. 10 1/2 lbs.  
**AN OUTSTANDING BUY!**  
 F.O.B. Chicago **21.50**



**New . . . ALL PURPOSE 5-TON HAND WINCHES**  
**IDEAL FOR:**  
 • Tow Trucks • Bricklayers  
 • Loggers • Roofers  
 • Construction uses  
 Manufactured by:  
 Seattle Chain and Mfg. Co. — Div. of Republic Steel. 5-ton capacity, single drum, 2 speed, compound gear, locable cam and lever type, with hand grip steel shoe brake and spring actuated steel safety dog. The drum has a 5" core, is 9" long, and has a capacity of 265 feet of 1/2" rope. Adjustable hand crank allows greater cranking speed.  
**ITEM #737**  
 DIMENSIONS:  
 22"x24"x16". Packed in wooden box—Ship. Wt. 200 Lbs. Regular Value \$161.50. Now Only **79.00**



ORDER DIRECT FROM AD SATISFACTION GUARANTEED  
 Send Payment Or Purchase Order Today

## BRAND NEW 1955! FACTORY-TO-YOU-VALUE PORTABLE ELECTRIC LIGHT PLANT

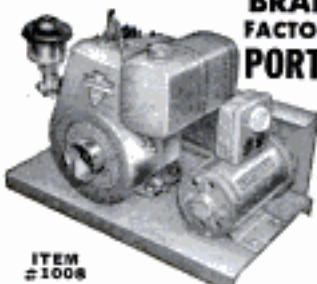

**POWER TO OPERATE:**  
 • Electric Saw, Electric Drills, Pipe Bender.  
 • Refrigerator, Deep Freezer, Incubator.  
 • Water Pump, Radio, Lights, Air-conditioner.  
**COMPACT — FITS IN THE TRUNK OF YOUR CAR**  
 1000 watts output, continuous duty. 115 Volts A.C. 60 cycles. 9 amps. Powered by husky, easy starting Clinton engine. Engine and generator operate at 3600 R.P.M. for maximum efficiency at minimum weight. Both units are mounted on welded base, with heavy sheet metal belt guard. Generator is self regulating, and is equipped with outlet box containing fuse and 2 A.C. convenience receptacles. Cost only 5c an hour to operate. Dimensions: Length 20 1/2", Width 12", Height 16". Shipping wt. 100 lbs. F.O.B. Chicago. . . . **149.50**

## GROBAN HYDRAULIC SPEED REDUCER



**with FINGERTIP CONTROL**  
**USE FOR:** • Reamer Drives • Midget Cars • Feed Mills • Canning Machines • Conveyors • Lathes • Milling Machines • Motor Boats • Cream Separators • Garden Tractors • Pumps.  
 Variable output speeds from 0 to input speed available by moving control handle. Locking handle maintains setting. Use input power of 1/4 to 1 1/2 H.P. Shafts 3/8" diam. Input rotation counter-clockwise facing shaft. Input speed 750 R.P.M. 7 1/2" x 3 1/2" x 1 1/2". Gov't acquisition cost \$428.00. Ship. wt. 31 lbs. Complete with 2 qts. of oil and full instructions. F.O.B. Chicago. . . . **54.50**

## Brand New! 5-TON BLACKHAWK HYDRAULIC LIFT KIT

**The Complete Kit** Now Only **38.95** Complete  
 For — • Dumping farm wagons • Adjusting depth of plows • Hydraulic press • Hydraulic jack • Snow plows.  
**KIT CONSISTS OF:**  
 1—Brand new Blackhawk Model P-153—Hydraulic hand pump with built-in oil tank and release valve. Rated from 1200 P.S.I.—to 5400 P.S.I. 20" handle. Dim. 8" x 6" x 6" Item #82 . . . . . **22.50**  
 1—4 Ft. length double wire braid rubber covered hydraulic hose—tested to 20,000 lbs. Item #2784 . . . . . **3.95**  
 1—Hydraulic cylinder, 2" bore, 9" stroke, bushy 1" solid steel shaft, will lift 10,000 lbs., using pump pressure. Standard clevis mounting. May be used for double action service. Item #4131C . . . . . **12.50**  
 2—Qts. non-foaming hydraulic fluid. . . . . **1.00**  
 All necessary hydraulic fittings.  
 Total ship. wt.—46 lbs.  
**COMPLETE KIT PRICE 38.95**  
 ALL OF ABOVE INCLUDED F.O.B. Chicago



To place phone orders call WEBster 9-3793  
**GROBAN SUPPLY CO.** Dept. PM-6  
 1139 S. WABASH AVE., CHICAGO 5, ILL.

## MULTI PURPOSE HYDRAULIC PUMP OR MOTOR

**ITEM #255** Silent, high efficiency. Helical Gear Type Ball Bearing. Hydraulic Pump or Motor. Rated 8 Gal. Per Min. At 1500 R.P.M.—Delivers 1000 P. S. I. Using 6 H.P.—Reversible Rotation—3/4" Pipe Thread Inlet and Outlet Ports—1/2" Drain Port—3/4" shaft with keyway and flat for either direct or pulley drive. Dimensions—5 3/4" high, 7 1/2" long, 5 1/4" wide. Shipping weight 18 lbs. F.O.B. Chicago. . . . . **45.50**



## SELF-PRIMING ALL BRONZE & MONEL GEAR PUMP

**ITEM #383—USE FOR:**  
 • Sprinkling • Irrigation • Insecticide Spraying • Sump Pump • Fuel Transfer • Home Water Systems • Dewatering • Salt Water, Chemical, Acid Pumping.



**FEATURES:** • Needle Bearing Construction • 1 1/2" Pipe Thread Inlet, 1 1/4" Hose Outlet • Standard 3/4" Keyed Shaft • All Bronze Body & gears. Monel Shaft • Equipped with Drain Cocks, Grease Cup, Steel Internal Drive Gears for long, trouble free service.  
**CAPACITY:** From 10 to 80 Gal. Per Min. At Speeds from 550 to 2400 Rev. Per Min. Using from 1/2 to 6 Horse Power. For Pressures to 60 lbs. Ship. wt. 58 lbs. U. S. Navy Cost \$168.00. F.O.B. Chicago **39.50** Ea. Two for **75.00**

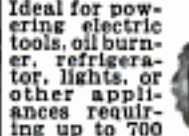

## BELT DRIVEN A. C. GENERATOR

**ITEM #700**  
 Ideal for powering electric tools, oil burner, refrigerator, lights, or other appliances requiring up to 700 watts of power. 700 watts, 115 Volts, 60 cycles A.C. 3600 R.P.M. Compact, self-regulating generator with V Belt pulley and double outlet receptacle. Rotation counter-clockwise. May be driven by tractor or auxiliary gasoline engine. Requires 2 HP minimum. Dimensions: 10" long x 8" high x 6" wide. Shipping wt. 27 lbs. F.O.B. Chicago. . . . . **59.50**



**FREE CATALOG**  
 52 PAGES, chockfull of unsurpassed War Surplus Equipment Bargains for farm, home, factory, workshop. Write letter today.

**Auxiliary Accelerator.. LEFT FOOT PEDAL**  
 Step on the gas with either foot with equal ease. Drive relaxed. Guaranteed for the life of the car— which originally installed on, FITS ALL CARS.  
 PRICE \$6.95 Per Pair ORDER FROM  
 Delivered to You **R. V. LEHNER**, Ness City, Kansas

Also ADULT 2 Passenger "Eshelman" **SPORT CAR** 1/5 the cost of any other auto 70 Miles per Gal. Free Catalog

**ESHELMAN RIDING MOWER**  
 Better, Faster, Easier! Just ride along on this deluxe Rotary Lawn Mower. Write for Free Catalog.  
**ROTARY TRACTORS \$69** TILLER from  
 Shipping Points: BALTO., CHICAGO, RENO  
 Free Catalog Write: ESHELMAN, Dept. M-55 109 Light St., Balto. 2, Md.



# Build your own FIREPLACE INDOOR - OUTDOOR

FREE Booklet shows how



Booklet gives  
Complete  
instructions.

- Foundation
- Steel heat-circulating form
- Cold and warm air ducts
- Mantel or decorative front

Fireplace form set on foundation includes firebox, damper, down draft shelf and smoke dome.



Brick, stone or cement block can be used around the form.



Save time, money and materials with PRICE steel fireplace forms.

## Build this outdoor fireplace in **ONE DAY!**

- Use inexpensive concrete blocks with the Fyro-Grill steel form and complete the job in a day. Includes grill, grate, draft control.

Removable for winter storage.

\$21.95

at Buffalo.

Slightly higher at distant points.

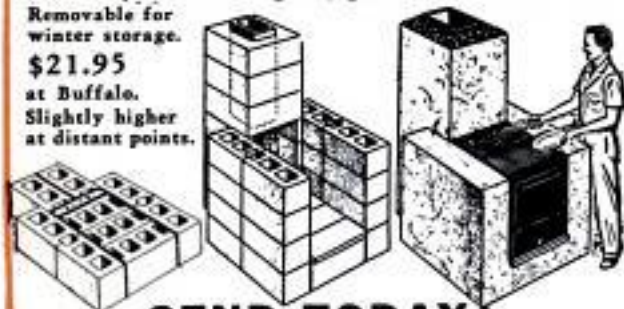

**SEND TODAY!**

Please send —

- Directions for building heat-circulating fireplace, free.
- Book "100 Fireplace Ideas". Pocket size book, free.
- Larger book, 8½ x 11, beautifully illustrated, 25c.
- Build outdoor fireplace in 1 day. Also, 10 beautiful designs, free.

Name.....

Street.....

City.....

PRICE FORMS AVAILABLE FROM YOUR DEALER

**PRICE** FIREPLACE HEATER & TANK CORP.  
277 W. Austin Street, Buffalo 7, New York

corpuseular energy also affects the ionosphere, upon which we depend for long-distance radio broadcasts; stormy weather on the sun can completely black out radio reception on the earth. Some years ago, at a time when Easter messages were being sent by telegraph, Western Union instruments in many parts of the country suddenly started clicking gibberish. A great flare on the sun had sent out a tremendous surge of energy which induced currents in the telegraph lines.

Radiation from spicules, prominences and the corona can be analyzed by spectroscope. The presence of certain elements produces lines of particular colors. Two isotopes of iron give the two strongest spectrum lines of the sun's corona, one representing red radiation and the other line green. There is also a yellow line, rarely seen, which indicates violent activity and high temperatures on the sun.

In recent years, many astronomers and meteorologists have sought a relationship between the mysterious red and green lines and weather on the earth. It is too soon to be at all certain that real effects exist, but there are some clues that suggest to us that periods of very weak solar activity correspond to the development of dust-bowl conditions in this country.

Our measurements of the corona, in the hands of E. D. Farthing, a meteorologist with Trans World Airlines, have yielded even more specific results. Farthing has made an intensive three-year study of weather records in the Kansas City area, and the spectrum lines of the corona. This showed a definite relationship between the coronal lines and the rainfall at Kansas City. The greatest rainfall for the period 1951 through 1954 came when strong regions of green coronal emission covered areas of the sun facing the earth. Farthing also found that as the minimum of solar activity approached in mid-1954, the red emission line grew stronger compared to the green, and drought conditions prevailed at Kansas City. Then in August and in October, solar activity increased with strong green coronal emission. With this, heavy rains came again.

In some yet-unexplained way, it seems that the behavior of cold fronts in the Kansas City area also is controlled, at least partially, by these mysterious solar radiations. The position and timing of cold fronts, with attendant rainfall and temperature effects, appears to be synchronized with the green line of the corona. The TWA meteorologist found that on 81 percent of the days in the three-year period, the day following green coronal activity was colder

(Continued to page 240)



**H**ERE'S famous Harley-Davidson quality at a new low cost. You can own the Hummer for only \$17 per month!\* And you ride for pennies . . . up to 100 miles per gallon of fuel. You'll save time too. No traffic jams . . . no parking problems for the man with a Hummer. Join the smart, thrifty thousands who are getting more miles for their money. See your Harley-Davidson dealer today, or write for free, illustrated literature. The Harley-Davidson Motor Co., Dept. P, Milwaukee 1, Wisconsin.

\*Average after minimum down payment includes Federal tax; fire, theft and collision insurance; freight and carrying charges.



the New HARLEY-DAVIDSON

# HUMMER

Averages up to 100 miles per gallon

thriftiest  
transportation  
you can own!

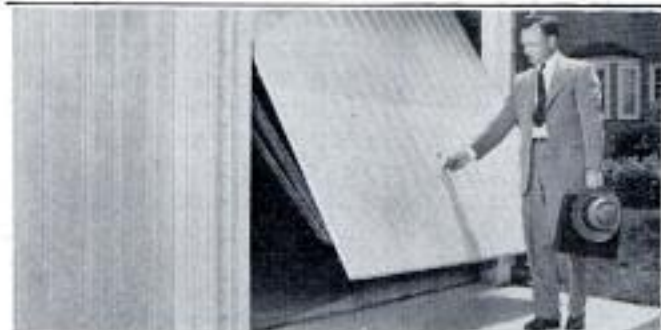

## HOW TO GET A NEW GARAGE DOOR AT LESS THAN HALF PRICE!

Yes, you can have a swing-up garage door like the one shown here — complete with Stanley Swing-Up Hardware for less than half what you'd normally pay!

How? Build it yourself from Easi-Bild's\* Pattern No. 86. It's easy! No special tools — no special skill! Just follow the clear, "can't-go-wrong" directions of the pattern. Tells you everything — including what materials to buy,

where and when to use them. Stanley Garage Door Set is simplicity itself to install. You'll be amazed how quickly you can do the job — and mighty proud of your results.

Ask your dealer for Simplified Directions for Installing Stanley Garage Hardware and Easi-Bild Pattern. Or use coupon below. \*Trade Mark Reg. U.S. Pat. Off. — Easi-Bild Pattern Co.

EASI-BILD PATTERN CO., Dept. 626, Pleasantville, N.Y.

Enclosed is 50¢ in coin, money order, check for Garage Door Pattern No. 86

Please send Simplified Directions for Installing ( ) Single ( ) Double Garage Door Hardware.

NAME \_\_\_\_\_

ADDRESS \_\_\_\_\_

CITY \_\_\_\_\_ ZONE \_\_\_\_\_ STATE \_\_\_\_\_

JUNE 1955

Made

**\$900**

**IN SPARE TIME**

"I did very well last year with my Foley equipment, about 950 saws in my spare time. About \$900 for me."—Leo H. Mix.

You can make up to \$3 or \$5 an hour in Spare Time. With a Foley Automatic Saw Filer you can file hand, band and circular saws better than the most expert hand filer. Cash business—no canvassing. No eyestrain, no experience needed.

### FREE BOOK "MONEY MAKING FACTS"

shows just how you can start at home in spare time, with small investment, no overhead — and develop into a full-time repair shop. Send coupon today for this practical plan. No salesman will call.



Send Coupon for **FREE BOOK**

**FOLEY MFG. CO.** 616-S FOLEY BLDG. MINNEAPOLIS 18, MINN.

Send **FREE BOOK** — "Money Making Facts".

Name \_\_\_\_\_

Address \_\_\_\_\_

## INSTALL TRUSCON SERIES 138 DOUBLE-HUNG WINDOWS YOURSELF!



### THIS FREE BOOK SHOWS HOW

Step-by-step guide and clear pictures show you exactly how to install Truscon Double-Hung Steel Windows in frame, brick veneer, masonry or concrete-block construction. Hammer, screwdriver and level are the only tools you need.

You buy Truscon Series 138 Windows from your dealer *ready to install*. All hardware is factory-attached. Stainless steel weatherstripping and tape balances are built in. These steel windows won't rot, warp, swell or shrink. Won't rattle or stick. Will last a lifetime. Types and sizes for every home style. Storms and screens available, too.

*Send coupon today. No obligation.*

**TRUSCON STEEL DIVISION  
REPUBLIC STEEL  
YOUNGSTOWN 1, OHIO**



**TRUSCON STEEL DIVISION,  
REPUBLIC STEEL**

1126 Albert Street • Youngstown 1, Ohio  
Please rush free book showing how to install  
Truscon Double-Hung Steel Windows, Series 138.

Name .....

Address .....

City ..... Zone ..... State .....

K-8461

than its predecessor. These cold temperatures tended to continue for about five days as the front passed beyond Kansas City. These effects are of great importance to the airlines, as these fronts produce low ceilings and poor visibility.

The emissions also appear to have an effect on the jet stream and the large-scale circulation of the earth's wind systems. For example, during the test period examined by Farthing, TWA's San Francisco to New York flights averaged over 14 minutes faster during periods of strong green coronal emission than at other times. A word of caution, however, is in order, as Farthing is careful to point out. All of these sun-weather effects are difficult to isolate and even more difficult to explain. In a new field of research it is very easy to be fooled. The only answer will be more years of painstaking scientific study.

Nobody should pretend, at this stage, that accurate local weather forecasts are possible by studying the sun's activity. We don't even know the answers to the basic questions about how the sun's variable energy is generated. We have no even remotely satisfactory explanation of how the green coronal emission can affect frontal activity at Kansas City. We don't know what causes sunspots. The sun's corpuscular streams appear to have insignificantly small energy to modify the course of the jet streams. Nor do we fully understand what the high temperatures and violent activity of the rare yellow line indicate.

But there are many fascinating questions for the future. When we know more, will we be able to predict the drought years and seasons with accuracy? Will we be able to forecast the flow of the mysterious storm-generated jet stream? Can we use the new knowledge that we will most surely gain about sun-weather effects to produce significant modifications of the distribution of the earth's rainfall?

The answers to these and to many other questions lie hidden in the swirling atmosphere of our mother star. ★ ★ ★

### Winds Blow Balloon to a Distance Record of 6250 Miles

Launched at Vernalis, Calif., a research balloon traveled 6250 miles to Spain in 52½ hours to set a new distance record in the high-altitude program being sponsored by the U. S. Air Force. Unusually strong winds at high altitudes carried the big balloon across the United States, the Atlantic Ocean and to a landing near the town of Badajaz, Spain, near the Portuguese border. Data from the flights gives scientists added information on winds at high altitudes.

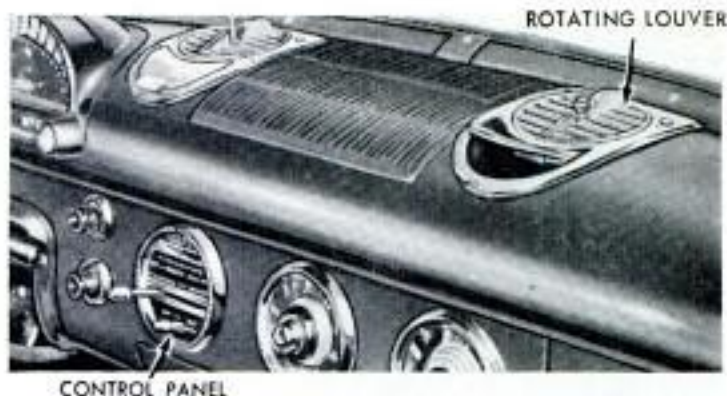

**NOW...a single system for cooling, heating, ventilating, defrosting provides desired "climate" in your car under all weather conditions**

Another great Ford engineering achievement . . . so simply designed that one sliding lever adjusts for maximum cooling or for average heating. Air circulation is controlled by a two-position blower, while two rotating louvers atop instrument panel distribute air in any direction for passenger comfort and defrosting. Entire unit is installed forward in engine compartment and under control panel!

### HERE'S HOW IT WORKS

Cooling takes place in the Evaporator (1) located under the control panel. Liquid Freon-12 expands, turns into gas, absorbing heat from inside the car. Gas then goes to the belt-driven compressor (2). High pressure gas goes next to the Condenser (3) which is located in front of Ford's radiator. Here, heat is absorbed by the car's airstream and the gas turns back into liquid Freon-12. From here the liquid goes to the Receiver (4) a reservoir where it waits to pass through cycle again. The heater core (5), operating on engine coolant, is located in front of the Evaporator. Also included in the system is a by-pass valve, a two-speed blower, thermostatic switches for cooling and heating units plus the necessary ducts and wiring.

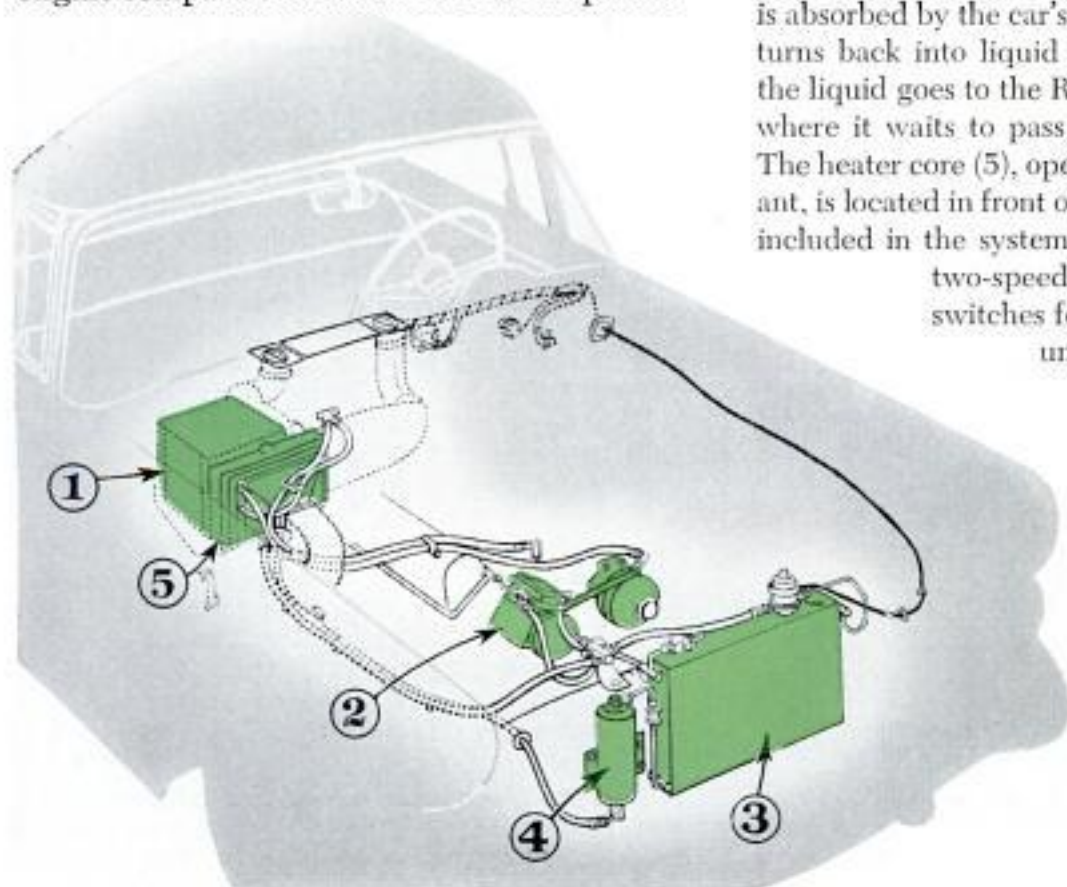

*Nothing takes up passenger or luggage space*



ask for  
**IRWIN** auger bits  
 World's finest wood-boring tools

Irwin Auger Bits make any boring job easier. They're precision made of special bit steel—heat-treated, tempered, hardened full length for longer life. Cutting heads stay sharp job after job. Original solid center design adds extra strength for steadier, cleaner, more accurate cuts. No binding, no clogging. Ask for Irwin at your independent hardware dealer—the auger bit that bores true... clean through.

**IRWIN 62T Solid Center Auger Bit**— sizes  $\frac{1}{4}$ " to  $1\frac{1}{2}$ ". Double cutter head. Open throat for quick chip clearance. No binding, no chewed edges.

**IRWIN All-Purpose Expansive Bits**— two types, small and large sizes. Boring range  $\frac{1}{8}$ " to 3". Accurate, easily adjusted. Two cutters with each bit. Individually packaged.

**IRWIN Bit Sets**— in hardwood box or plastic rolls. 6, 10 or 13 bit assortments. Sizes  $\frac{1}{4}$ " to 1". Ideal gift for handyman or professional.



**FREE!** Useful booklet tells, How to Select, Use, Care for Auger Bits. Send name and address to IRWIN, Dept. 3B, Wilmington, Ohio.

**IRWIN**

the original solid center auger bit  
 screw drivers  
 screw driver bits



**"Paul Revere" Ships  
 Join the Lookout**

(Continued from page 91)

individual units, topped with decorative laminate and laid out breakfast-nook fashion. When not in use, they fold back and the seats reverse to make a compact theater.

The officers' wardroom suggests a club-room with its blue carpeting and smart leather-covered furniture. But the mailed fist can be felt beneath the velvet glove, for the glossy dining table doubles as operating table and the trim lampstand opens to disclose sterilizer, anesthesia equipment, retractors and suture trays.

What's it like out there on the picket line?

"The toughest thing to combat is monotony," says one executive officer. "The crew try all sorts of things to beat it, but probably the most successful is our disk-jockey program—Station DER, broadcast over an internal circuit."

On a picket ship, rolling lazily out there on the ocean, the sea seems very close. Shark fishing is commonplace, and stranger specimens have been reeled in from the depths. The sea seems close, too, when typhoons rage. The Air Force liaison officers who go along on occasional patrols are overwhelmed by the relative sizes of the waves and the small ship.

But on the whole, Air and Navy have a mutual respect for each other's roles on the integrated team. The airmen are impressed by the compact machinery and the intricate air-control setup, while the seamen are awed by the vast communication and command network that can spew forth coastal fighters on an instant's notice.

The present picket line is a little like a patchwork quilt. It includes big shore-based radars at promontories along the coast, "Texas Towers" in shallow ocean areas offshore, converted Liberty ships with radar installed and the rapidly multiplying DERs. But the time isn't far off when the nation's outer defense perimeter will be a uniform radar net, as nearly airtight as modern science can make it.

The picketeers are a hardy breed and few hardships or dangers disturb them. But ask them if there's any phase of their lonely work that's really tough to take—and they answer soberly that, yes, there is one thing that nearly stops them.

It's those blasted mile-long patrol reports they have to write up when they come in!

★ ★ ★

*The opinions and assertions expressed herein are those of the author, and do not necessarily represent the views of the Navy Department or the naval service at large.*

## 1/4" ELECTRIC DRILL

One of the first and best home power tool investments. Full powered, permanently lubricated, drill in metal, wood, concrete. Complete Drill Tool set includes horizontal stand and accessories for polishing, sanding, sharpening, cleaning, buffing.



*You'll Always Be Glad  
You Bought a*



## FLAT SANDER

Fast, powerful, light, dependable—orbital action. At 4,000 cycles per second produces fine finish on all woods, metals, fibres, etc., wherever hand sanding is usually employed.



The SIoux name needs no introduction to the skilled mechanic who makes his living working with power tools. In the aircraft and automotive fields and in industry they're the tools the professionals have used for over 40 years!

WRITE FOR  
FREE  
CATALOG!



ALBERTSON & CO., INC. • SIOUX CITY, IOWA

## POWER SAW

This modern SIOUX hand saw is really rugged with a world of surplus power. Available in 8 1/4", 7 1/2" and a 6 1/2" Model that will saw through 2 x 4's at a 45° angle with plenty of blade to spare.



**Mitre Cuts**—Adjustable base for bevel cuts from 0 to 45°, to 1 1/4" depth. Spring lift with nut adjustment is quick, accurate.



**Cross Cutting**—Edge of base follows line. High speed makes it many times faster than hand sawing.



**Rip Sawing**—Adjustable rip scale guide is plainly graduated in fractions of an inch. Blower keeps line of cut free of saw dust.



For Fast, Accurate  
Long Measurements

buy

**LUFKIN**

WHITE CLAD  
**BANNER**  
LONG STEEL TAPE



ONLY  
**\$3.50**  
25 FT. LENGTH



IN 25, 50, 75  
AND 100 FOOT  
LENGTHS

Ideal for room measurements, construction work, lawn and garden planning, home maintenance.

Durable snow white 3/8" line made of bonderized tempered steel for long wear . . . graduated feet, inches and 8ths . . . rugged welded steel case covered in durable vinyl . . . Choice of plain or folding hook ring.



**FREE**  
Reusable plastic box with each Banner tape.

365

BUY **LUFKIN** TAPES • RULES • PRECISION TOOLS  
AT HARDWARE AND LUMBER DEALERS  
**THE LUFKIN RULE CO., Saginaw, Michigan**

JUNE 1955

Lawn Beauty's a Breeze  
with a **BOLENS**



SELF-PROPELLED

**ROTARY MOWER**

No pushing . . . you just guide the BOLENS self-propelled power mower over your lawn. 6 easy-starting, sturdy, safe BOLENS rotary power mowers are available in cutting widths from 18" to 21"—front, or side-trimmer models that eliminate hand trimming. Also 3 powerful BOLENS reel type power mowers.

Bolens has a mower for every need and budget. You invest in quality, style and easy lawn care when you BUY BOLENS.

**GRIND-A-LEAF** attachment for Bolens gasoline rotary power mowers pulverizes leaves and eliminates raking.

**AMERICA'S FINEST OUTDOOR POWER EQUIPMENT**

**MAIL COUPON TODAY!**

BOLENS PRODUCTS DIVISION  
Food Machinery and Chemical Corporation  
265-6 South Park St., Port Washington, Wisconsin

Send me literature on:

POWER MOWERS  TRACTORS  ROTARY TILLERS  CHAIN SAWS

Name \_\_\_\_\_

Address \_\_\_\_\_

City \_\_\_\_\_ Zone \_\_\_\_\_ State \_\_\_\_\_

# IN INDUSTRY...

The grip, accuracy and durability of the Jacobs Plain Bearing Chuck have made it standard equipment all over the world. This model, especially designed for drill presses, features a Jacobs-engineered PLUS—the threaded locking collar for extra safety and more versatile use of the tool.



AND  
IN THE  
**HOME  
SHOP**

The Jacobs Plain Bearing Chuck equipped with threaded locking collar makes any drill press a safer, surer, more versatile tool.

**Safer** because the threaded collar keeps chuck locked on tapered spindle regardless of speeds or type of thrust.

**Surer** because it's a Jacobs, the most accurate, holdingest, longest lasting chuck of its kind—anywhere.

**More versatile** because it eliminates the necessity of using special collet chucks or similar adapters for holding routing, carving or dovetailing bits.

When you work with a drill press or portable electric tool you'll hold your drill or bit best when you use a Jacobs Chuck. There is none better for accuracy, grip and durability. The Jacobs Manufacturing Company, West Hartford 10, Connecticut.



**Jacobs**  
C H U C K S

If it's a Jacobs—it holds

## TV Crosses the Horizon

(Continued from page 87)

You get a pretty good idea of what those dishes will look like when you see the experimental 60-footer announced recently by Bell Laboratory engineers at Holmdel, N. J. The 13,000-pound reflector, which A.T. & T. engineers say their production models will resemble, was so vast that new techniques were used to erect it.

"First we set up the tripod, with a vertical bearing post in the center," says one of the Bell engineers who helped construct it. "Then we installed the hub of the dish—horizontally—and fastened it with pivot pins to the top of the bearing post. Then we stuck the 'inpole' or feed horn, on top of that."

Usually, a feed horn, which actually puts out the signal, is a rod about the diameter of your finger sticking out of the center of a dish antenna. On this monster, however, the feed horn was stout enough to become the mast of an improvised derrick, which was used to raise prefabricated dish sections, shaped like orange-peel sectors, into place. When the entire assembly was completed, the 60-foot reflector sat atop its tripod with bowl pointing skyward. Then it was swung into vertical position on its pivot pins and rotated to proper direction on the hub bearing.

What happens if a hurricane should blow into the center of that massive cup? "She's built to stand a 100-mile-per-hour wind head-on," explains a Bell engineer, "which is about the most we ever get up this way. But the ones for that hurricane country in Florida and Cuba will have to take 150-mile-per-hour winds. Guys and other supports will probably have to be used. They can do it for billboards, so why not for big dishes, too?"

And for all anyone knows, the big antennas may one day be relaying radar warning pictures across the Caribbean of hurricanes they will have to buck. ★ ★ ★

## Nylon Balls Travel 15,000 Miles Per Hour

Rifles are firing nylon balls at a speed equivalent to 15,000 miles per hour at the Naval Ordnance Laboratory, White Oak, Md. The balls travel so fast they get hotter than the surface of the sun and light up the room in which they are fired. The purpose of the experiments is to study what happens to gases around a high-speed missile. The nylon balls, fired from a rifle with a 30-caliber cartridge, reach speeds far greater than the largest artillery shells.

# Most Complete House "Package"

**Panelized and Ready for Fastest "Do-It-Yourself" Erection**

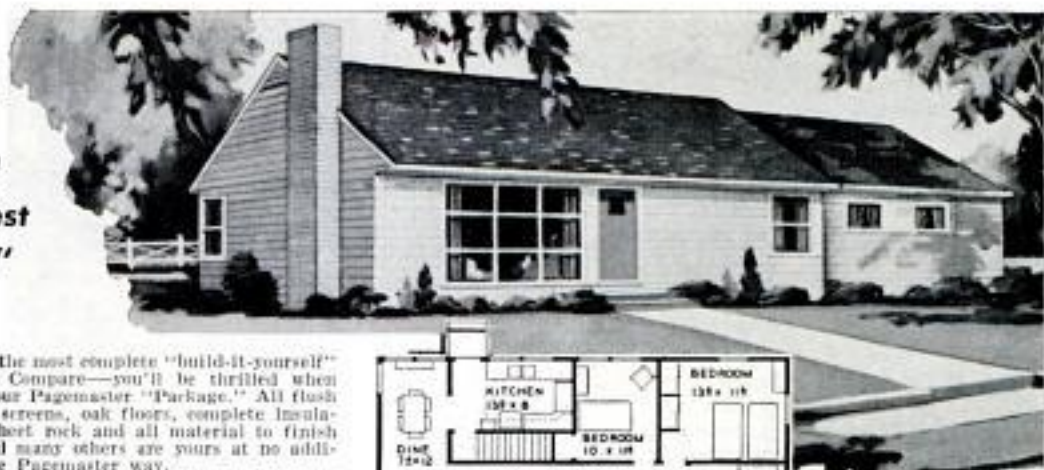

PAGEMASTER Homes are the most complete "build-it-yourself" houses on the market today. Compare—you'll be thrilled when you find the many extras in your Pagemaster "Package." All flush modern doors, all storms and screens, oak floors, complete insulation for ceilings and walls, sheet rock and all material to finish your interior walls—these and many others are yours at no additional cost when you build the Pagemaster way.

No other house can save you so much construction time—or help you to avoid on-the-job mistakes. All exterior walls are panelized—all openings are accurately cut in; windows and doors are hung in frames ready to insert into the prepared openings. Roof trusses are manufactured in two sections ready to be nailed together and raised into position. Precut partitions and foundation capping materials are included in your Pagemaster "Package." You can sheet-rock your entire ceiling, inside walls and lay all flooring before partitions are in—no cutting around partitions.

**YOU PLAN IT . . .** Submit your own plan or revise any of ours to suit your family needs. Build a home truly yours. Write TODAY. Send 25c in coin for full-color catalog with many excitingly new models to choose from. Let our expert architectural service department help plan your Pagemaster Home Now!

All Pagemaster Homes meet and exceed FHA and VA financing requirements.

# Pagemaster HOMES

302 PIERCE ST., SHAKOPEE, MINNESOTA

Exclusive Northwest Producer "the PM Precut House"



No. 542 JAMES—  
3 Bedrooms, Study,  
Dining Room,

1241 Sq. Ft. Only \$5,057

### PAGEMASTER HOMES, Shakopee, Minnesota

Gentlemen: Send your full-color catalog of beautiful Pagemaster Homes. 25c in coin is enclosed.

NAME \_\_\_\_\_

ADDRESS \_\_\_\_\_

CITY \_\_\_\_\_ STATE \_\_\_\_\_

6-55

**NOW!  
GO RIDING  
WITH YOUR SMALL  
POWER LAWN MOWER**

**\$39.50**  
List Price

**MOWER-CYCLE**

Shown attached to a popular brand 18" mower



**CONVERTS ANY REEL TYPE MOWER SIZE 18" to 30" TO A "RIDING MODEL"**

# Mower-Cycle

Pat Pending

Now you can enjoy the small size riding lawn mower you want! MOWER-CYCLE comes complete, ready to convert your power lawn mower to a rugged, efficient "rider." Especially designed to work with low h.p. engines. Weight of rider bears down on wheels, gives extra traction, improved performance! Fun to ride, a real wizard for work! To hook on MOWER-CYCLE, just remove old mower handle. Drill 8 holes in motor mounting plate. Fasten with nuts and bolts. Drive it away! Whether you buy a new mower, or already have one, MOWER-CYCLE converts it to a "rider." Weighs only 37 lbs. If your dealer doesn't handle, write us for free details, Dept. PM today!

**E. F. BREWER CO., Butler, Wis.**

## The New Model 70 UTILITY TESTER FOR REPAIRING ALL ELECTRICAL APPLIANCES MOTORS • AUTOMOBILES • TV TUBES

As an electrical trouble shooter the Model 70:



- Measures A.C. and D.C. Voltages, A.C. and D.C. Current, Resistances, Leakage, etc.
- Will measure current consumption while the appliance under test is in operation.
- Incorporates a sensitive direct-reading resistance range which will measure all resistances commonly used in electrical appliances, motors, etc.
- Leakage detecting circuit will indicate continuity from zero ohms to 5 megohms (5,000,000 ohms).
- Will test toasters, irons, Broilers, Heating Pads, Clocks, Fans, Vacuum Cleaners, Refrigerators, Lamps, Fluorescents, Fans, Switches, Thermostats, etc.
- Will test all TV tubes for open filaments, inter-element shorts, burned out tubes, etc.

As an Automotive Tester the Model 70 will test:

- Both 6 Volt and 12 Volt Storage Batteries • Generators • Starters • Distributors • Ignition Coils • Regulators • Relays • Circuit Breakers • Cigarette Lighters • Stop Lights • Condensers • Directional Signal Systems • All Lamps and Bulbs • Fuses • Heating Systems • Horns • Also will locate poor grounds, breaks in wiring, poor connections, etc.

Woodcase round-covered molded bakelite case, 3 1/2" x 3 1/2" x 3 1/2". Complete with all test leads. Also included is a 64 page book giving detailed instructions for testing all electrical appliances, automotive equipment, TV tubes, etc. Only **15.85**

**SHIPPED ON APPROVAL  
NO MONEY WITH ORDER — NO C. O. D.**

Try it for 15 days before you buy. If completely satisfied then send \$2.85 and pay balance at rate of \$4.00 per month for 3 months — No Interest or Finance Charge Added! If not completely satisfied, return to us, no explanation necessary.

MOSS ELECTRONIC DIST. CO., Inc.  
Dept. D-135, 3849 Tenth Ave., N. Y. 34, N. Y.

Please rush 1 Model 70. I agree to pay \$2.85 within 15 days after receipt and \$4.00 per month thereafter.

Name \_\_\_\_\_  
Address \_\_\_\_\_  
City \_\_\_\_\_ Zone \_\_\_\_\_ State \_\_\_\_\_

Every turn is the RIGHT turn

WITH AN

# Airguide

## AUTO COMPASS

- Saves you miles and minutes... points the right way all the way
- Neatly styled for today's smart car interiors... choice of case colors, soft gray or brown. Double ball and socket mounting permits positioning for most convenient reading. Fits all cars. Easy to install and adjust.
- Super power alnico V magnet and aircraft type compensators assure steady, dependable performance under all types of driving conditions. Three models to choose from...

- NO. 84 NON-ILLUMINATED.....\$5.95
- NO. 85 ILLUMINATED by car power.... 6.95
- AND NOW

### THE NEW NO. 86

SELF-ILLUMINATED



PRESS BUTTON LIGHT'S ON

RELEASE BUTTON LIGHT'S OFF

Come lights up with a soft green glow. No wires to attach. Operates on long-life self-contained flash cell. \$6.95

Made and guaranteed by  
AIRGUIDE INSTRUMENT CO., CHICAGO 47

## BUILD YOUR OWN POWER TOOLS - WITH GIL-BILT PARTS KITS



- ### TILT/ARBOR SAW
- 27x28 in. table. 13 1/2 in. capacity in front of blade
  - 10 in. blade cuts 3 1/4 in. deep, tilts full 45 degrees
  - Floor model 34" high, table always stays level
  - New Departure ball bearing arbor, 3/4" precision shaft turned down for 3/8" core blades, alum. housing, shipped ready to run
  - Jackscrew and 4 1/2 in. dia. handwheel lowers and raises blade
  - Cast aluminum miter gauge and self-aligning rip fence guide
- GIL-BILT Metal Parts Kit includes Plans, ball bearing arbor, miter gauge and bar, rip fence guide, dado insert, lock knobs, jackscrew mechanism and handwheel, and all other metal parts (less blades).....\$22.95  
Same Kit with 10" Combination Blade...\$25.90  
Same Kit with 8" Combination Blade...\$24.90

### GIL-BILT 12-INCH BAND SAW

Ball bearing drive, rigid cast aluminum wheels, rubber tires. Handles stock up to 6 inches thick. Cuts to center of 24" circle. 18 x 18 inch tilt table. Capacity and performance of hand saws selling for \$80 and up. Plans and all metal parts in kit with 1/4" blade \$23.95  
Return Kits in 10 days for refund if not satisfied.  
For shipments up to 600 miles, add 5%; over 600 add 10%. Amount in excess of postal postage will be refunded.  
Order Kit now, or order Plans at \$1.00 each and Kit later less cost of plans.

PLANS ONLY \$1.00 EACH POSTPAID

Write for FREE Catalog.  
Also Available: Plans & Parts Kits for 18" Band Saw, Belt Sander, Spindle Shaper, 8" Tilt-Table Saw

GILLIOM POWER TOOLS

Dept. 80-F, Lambert Field St. Louis 21, Missouri

# Swif

New 50/50 Solder and Flux in paste form

Easier to apply, works faster and cleaner. Do small jobs with heat of a match. One tube makes hundreds of joints.

At Hardware counters ..... **59¢**

HERCULES CHEMICAL CO.  
332 Canal St., N. Y. 13, N. Y.

## Get New 148 Page Catalog of WOOD AND WOODWORKING MATERIALS

WORLD'S LARGEST SELECTION - Lowest Prices

Your buying guide for finest kiln dried domestic and rare imported woods; inlays, bendings, matched plywood, moldings, ornaments, etc. Largest selection of tools and hard-to-find hardware. Packed with serial saw patterns, projects, wood facts and money making ideas. Enclose \$2.00 (refunded on first order) to help pay mailing and handling costs. Write today to

CRAFTSMAN WOOD SERVICE CO.  
2729 S. Mary St., Dept. A-6, Chicago 8, Ill.

## FREE BOAT KIT CATALOG

8' to 14' Models from \$39.95 incl. freight

- Assemble your own boat
- No experience necessary
- Save 1/2 to 2/3 "factory built" prices

Write: Marine Hardware, Fiberglass, & Trailers

12 ft. Runabout Pictured.

DEPT. B 4452 NICOLET AVE. MINNEAPOLIS 9, MINN.

## AGENTS - SELL TOOLS! GUNS! CAMERAS!

Buy tools, photo equipment, sporting goods, jewelry and thousand other nationally advertised products at big discounts. Big profits selling to others. Postcard brings free plan.

Get up to 40% off

AMERICAN BUYERS SERVICE 631 LINDEN AVE., DEPT. 15 BUFFALO 16, NEW YORK

## Find URANIUM!!

GEIGER COUNTERS for uranium detection. All models and sizes - from low-cost, portable to super-sensitive airborne units. Prices start at \$37.50. Also TREASURE DETECTORS and MINERALITES. FREE INFORMATION

Detection Corp.  
5528 Vineland, North Hollywood, Calif.

## Say You Saw It in Popular Mechanics

WELD BRAZE SOLDER CUT

4WAY ONLY \$14.75 f.o.b. factory

WELDER

Complete with Twin Carbon Arc Torch and accessories... to handle all metal-craft work.

Acclaimed by thousands of Homeowners, Mechanics and Hobbyists as the welder of 1001 uses. Easily operated from properly wired 110 volt AC or DC line. The ideal gift with a life-long use... Order today on 10 day money back guarantee.

FOUR-WAY WELDER CO., Dept. F2-F 1810 S. Federal St. • Chicago 16, Ill.



**MODERN****LAWN MOWER SHARPENER****COMPARE  
BEFORE YOU BUY**

Write for  
free  
booklet  
10E

Oil remains in engine while sharpening. Bed knife sharpened in same centers — no attachments needed.

Start your own  
business—**increase  
your income**

Sharpens any mower in ten to twenty minutes. Handles complete assembly of all reel types including 36 in. power mowers. Handle, wheels, roller, and engine are not removed.

**\$26300****MODERN MFG. CO.**

F.O.B. PASADENA

160 N. FAIR OAKS, PASADENA, CALIF.

**MAGNETS****225<sup>lb.</sup>  
PULL**

GENUINE ALNICO—NEVER WEAKENS

**AMAZING, PERMANENT MAGNETS—WILL NOT WEAKEN! NON-ELECTRIC**

Retrieve guns, tackle, tools and other steel items from lake, river, plating tanks, drains or other hard-to-reach spots, recover drills, taps, etc. from sweepings. Clear alley of harmful tacks, nails. Many other uses. Pays for itself quickly. **GUARANTEED.** Try any magnet one week. Money refunded if you are not well pleased.

No. M-725 (Weights 54 oz.) Has pull of 225 lbs. on steel block. **\$15.00**  
 No. M-625 (Weights 70 oz.) Has pull of 125 lbs. on steel block. **\$ 8.50**  
 No. M-575 (Weights 18 oz.) Has pull of 75 lbs. on steel block. **\$ 6.00**  
 No. M-500 (Weights 13 oz.) Has pull of 50 lbs. on steel block. **\$ 4.00**  
 No. M-101 U-shaped Magnet (Wt. 2 1/4 oz.) Pull of 6 1/2 lbs. 2 for **\$ 1.50**  
 No. M-291 Pocket Magnet (Wt. 1 1/2 oz.) Pull of 4 lbs. 2 for **\$ 1.15**  
 No. M-35 Hobbyist assortment of eight small magnets. . . . **\$ 1.50**  
 No. M-48 Powerful Hot Pad Magnets. 8 for \$1.00. 30 for **\$ 3.00**

Send Money Order or Check. We pay postage. No C.O.D.'s.

MIAMI MAGNET COMPANY, 3240 N. W. 27th Ave., Miami 42, Fla.

**BRONZE FOUNDRY** Schools and Home Workshops

Make your own castings of aluminum, copper, bronze, silver. Foundry sets are available in three sizes including 2400 Deg. F. blast furnaces. See advertisements in March or Apr. issues, free Circular.

KANSAS CITY SPECIALTIES CO.

P.O. Box 6022 Dept. P-6 Marysville, Kan.

**SOUTH BEND Light Ten  
Lathe**

Highly accurate and versatile for better than average work. 10" swing. Send for free catalog.

**SOUTH BEND LATHE**  
South Bend 22, Ind.

**"HANDY DANDY" Wall Unit**

Includes 6  
Reg. & Phillips  
Screw Driver

Only **\$1.75 Ppd.**  
**COMPLETE**

You get: 6 screw drivers with unbreakable shockproof plastic handles and hardened, tempered steel blades, 2 unbreakable jars with caps permanently welded to rack, a supply of assorted screws in each jar plus — the wall rack ready to mount over your work bench. **ALL FOR LESS THAN THE COST OF 6 SCREW DRIVERS ALONE!**

**MONEY BACK GUARANTEE**  
**RIGHTON TOOL COMPANY**  
520 N. 13th Street, Newark 7, New Jersey

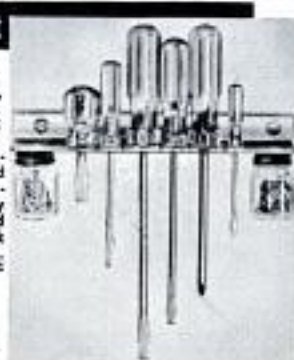

# Now you can have clean motor oil from filter change to filter change\*

## When you replace Hastings Cartridges as normally recommended

## The reason is DENSITE!



Densite—an amazing new type of filtering material—is made of millions of selected raw cotton fibres, pressure packed so oil must flow through countless tiny openings, pass many surfaces of fibres. The most microscopic abrasives cling to these fibres—and stay there!

Next time you change oil—change your filter cartridge. Ask for Hastings and have clean motor oil *all the time!*

\* As proven by tests conducted in accordance with U. S. Bureau of Standards procedure.

**HASTINGS MANUFACTURING CO.**  
HASTINGS, MICHIGAN

**HASTINGS**

**OIL FILTER  
CARTRIDGES  
with DENSITE**

# Get Power Brakes

## ON YOUR PRESENT CAR!

FOR QUICKER, EASIER, SMOOTHER STOPS!

AVAILABLE AT ALL CAR DEALERS,  
GARAGES AND SERVICE STATIONS  
OR WHEREVER CARS ARE SERVICED.

SPECIFY **Bendix**

AMERICA'S NO. 1 POWER BRAKE  
Bendix Products, South Bend, Indiana

**NEW 12-FT. POCKET TAPE  
MAKES L-O-N-G MEASUREMENTS EASY**  
made only by **EVANS**

Only  
**\$1.89**

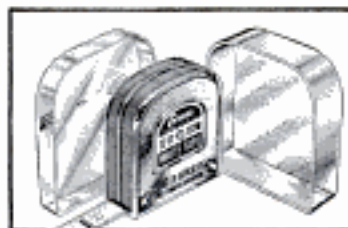

No longer need you make two measurements for 12-ft. jobs as you must do with shorter tapes. Chrome-plated case is no larger. Each EVANS Tape packed in FREE transparent Tenite utility case.

Marked So You Don't Have To Figure

No Other Tape Is Marked This EVANS Way

Work in feet and inches?  
Read here



Work in inches?  
Read here

King-Size 10-Ft. White-Tape

**STANDS UP STRAIGHT**

For Upright Measurements!

Wider (3/4") heavy-duty blade makes those long upright measurements easy and accurate. Exclusive EVANS double markings, same as 12-ft. pocket tape. FREE belt clip and Tenite utility case with every EVANS King-Size.



Only  
**\$2.39**

At hardware stores everywhere in the U.S.A.

2642

**Evans & CO., Elizabeth, N. J.**

Makers Of Evans "Long Tapes"—25-50-75-100 Ft.

# OWN A... FORD?

## FIX IT YOURSELF!

Popular Mechanics Magazine has published an Owners Manual covering all 1941 to 1952 models of Ford cars . . . So accurate mechanics use it . . . so simple a woman can understand it.



Save money on your Ford car repairs. Prevent trouble. Enjoy care-free driving. Increase trade-in value. Avoid major repairs by fixing minor troubles before they get serious. Get sparkling performance at all times. Has 272 pages, more than 350 photos, diagrams, tables, charts, breakdown drawings, plus clear, non-technical directions that make all repairs simple as A B C. Written by Ed Packer with the assistance of the Ford Motor Company. Shows you how to diagnose all Ford troubles by feel, sound, sight, smell and performance. Simple trouble shooting. Permanent repairs. Emergency repairs. Plus, "How to get value from garages."

## MONEY BACK IF IT DOESN'T SAVE MORE THAN IT COSTS!

One minor repair will save the cost ten times over. Read it. Then you decide. If you don't see that you'll save more than the cost, send it back for refund. SEND NO MONEY. Send postcard. Ask for the Ford Manual. Postman will deliver C.O.D. for \$3.50 plus postage. Or, save postage by sending \$3.50 with order. Send today. Save its cost on your next repair.

**POPULAR MECHANICS PRESS**

200 E. Ontario, Dept. 90, Chicago 11, Illinois

## Build This Beautiful Corner Table

Full-Size Pattern  
Now Available



To make this attractive table, you merely trace the design on wood, saw, smooth the edges and assemble. It's so easy it takes all the guesswork out of furniture building. Designed as a companion piece for the step and cocktail tables detailed in Full-Size Patterns Nos. 103 and 104, this table can be used alone or with any grouping of contemporary furniture.

**Other Patterns In This Series**

There are 14 other full-size patterns in stock. These include a 12-foot boat, a work bench and toys for the children. For details, send coupon.

**Guaranteed to Please**

Designed by John Bergen, noted furniture designer, this table will be a handsome addition to your home. If, however, you are not thoroughly pleased with the pattern, you may return it within 7 days for a full refund. The price is only 50c.

### Order on this Handy Coupon

**POPULAR MECHANICS PRESS, 200 E. Ontario St., Chicago 11**

Please send postpaid the Full-Size Corner Table Pattern. If not satisfied, I will return it within 7 days for a full refund of the purchase price.

- Send the Corner Table Pattern (I enclose 50c)  
 Send information on other full-size patterns

Name \_\_\_\_\_

Address \_\_\_\_\_

City \_\_\_\_\_ State \_\_\_\_\_



Convert Lawn Mowers into Power Units with this  
**Briggs & Stratton**  
**2-H.P., 4-Cycle GAS ENGINE**  
 AIR COOLED FULLY GUARANTEED  
 Reg. Price \$68.00  
**SAVE! SPECIAL OFFER \$37.50**  
 while they last . . .  
**Powers Farm, Home & Industrial Tools**  
 • Garden Equipment • Pumps • Compressors

### GOV'T SURPLUS

Briggs & Stratton leads the world in dependable, trouble-free performance. A precision-built 2-horsepower, 4-cycle engine with advance styling and economical operation. Kick or rope start—sure fire ignition in all weather. Positive, automatic splash-lubrication system. 2 Qt. gas tank. Float feed carburetor with adjustable idle speed and automatic governor. Oil bath air cleaner. Complete with muffler. 3 Piston rings for added compression. 2000-3600 RPM adjustable speed range.  
**SUPPLY LIMITED! IMMEDIATE DELIVERY! ORDER FROM AD FREE CATALOG of Compressors, Generating Plants, Motors**  
**ROBERTS ELECTRIC CO., Dept. P-291, 849 W. Grand, Chicago 22, Ill.**



### URANIUM AND METALS

Easily located with the new M-Scope Detector. Superior Performance. Prices \$35.00 up. Monthly payment plan. Booklets "How to be a Successful Uranium Prospector"—"For Fun and Profit" free upon request.

**FISHER RESEARCH LABORATORY, INC.**  
 PALO ALTO CALIF.



#53  
**RAZOR SAW**  
 BLADE SET  
**\$1.75**

**X-ACTO, INC.**  
 48-45 Van Dam St.  
 Long Island City, N. Y.  
 Send 25c for 28-page Catalog

### BUILD YOUR OWN ARC-WELDER

WE SHOW YOU HOW to build this powerful welder without re-winding. Uses most any surplus aircraft generator. Produces 75-350 amps. Easy to build. **PLANS 35c**. Includes NEW booklet "How to Weld," and FREE war surplus and electrical catalog.



**LEJAY MFG. CO., 1247 LEJAY BLDG., MINNEAPOLIS 8, MINN.**

### YOU MAKE \$5 CASH AN HOUR

sharpening circular saws, planer and jointer knives...in 15 square feet of your home or garage you can earn up to \$5 an hour spare time. No experience needed...beginners turn out expert work. Only \$15 down brings you this money-maker. Hundreds of jobs in your neighborhood. The cash you take in is 90% clear profit. Write today for FREE book, "Lifetime Security with Your Own Business."

**BELSAW MACHINERY CO 3707 Field Bldg., Kansas City 11, Mo.**

### BUILD-IT-YOURSELF 24 INCH WINDOW FAN KIT

Only fan kit with all these features:  
 • TORINGTON all-steel 4-blade FAN  
 • New Departure lifetime BALL BEARINGS  
 • Cast ALUMINUM PEDestal mount  
 • Simplified plans, FULL SIZE PATTERNS  
 Over 30,000 build-it-yourself units in use. Advertised and sold for 7 years. Money-back guarantee. FREE fan catalog.



**GILLIOM POWER TOOLS Dept. 30-F, Lambert Field, St. Louis 21, Mo. ONLY \$17.95 F.O.B. St. Louis**

### DEVELOP INVINCIBLE FAITH!

● Think Yourself Into Health and Happiness  
 The subconscious belief that you have sinned is at the bottom of all problems. Ontology shows you how to "forgive" yourself and dissolve self-condemnation. Gives step-by-step directions how to acquire "FAITH that can remove mountains" as the Bible says. Send for FREE Trial Lesson today. No obligation.

**ONTOLOGY FOUNDATION, Box 9-A, Homewood, Ill.**

**\$3995**  
 New  
**WALL-SHOP**  
 Drill and  
 Saw Kit  
**Model 1440-4**



Features a super-duty geared-chuck 1/4" drill with power-saw attachment. Woodgrain-finish tool panel holds all accessories for grinding, sanding, polishing, paint mixing. A place for everything—everything in its place!

# MORE DO-IT PER DOLLAR! FOR DAD!

Remember **FATHER'S DAY, June 19**

Do-It-Yourself has become what amounts to a national pastime. And the "Do-It" in Do-It-Yourself is less work and more fun with good power tools.

There are many such tools on the market. But none offer the outstanding performance of PET tools at such low prices. Check around. Price all leading, nationally advertised brands. Do that and you'll insist on PET Power Tools.

**\$4995**  
 New Ball-Bearing Saw  
 (Mirror Finish)

Cuts a full 2 1/4" at 90°. Cuts a dressed 2 x 4 at 45°. Ball bearings give smooth operation, long life. Has adjustable rip guide. Rotating, telescoping guard keeps blade covered for safety.

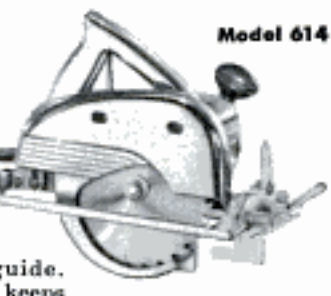

Model 614

**\$3750**  
 New Oscillating Sander  
 (Mirror Finish)  
**Model 200**

With oscillating motion for smooth finish. Knurled rollers hold sandpaper vise-tight. Adjustable swivel handle—especially easy on vertical work. Direct drive—no belts, no pulleys. Heavy duty. Extra-large ball-bearing construction.



**FREE! Write for new PET Power Tool Catalog**



**PORTABLE ELECTRIC TOOLS, INC.**  
 320 W. 83rd St., Dept. PM  
 Chicago 20, Ill.  
 In Canada: Portable Electric Tools, Ltd.,  
 425 Birchmount Rd., Toronto 13, Ont.

it's  
**"The Life of Riley"**  
 with  
**UTICA TOOLS®**

says Wm. Bendix  
 Star of NBC-TV Show  
 "The Life of Riley"



Mighty amusing fellow, Riley, on your TV screen. Lots of chuckles Friday nights.

But, make no mistake about it, as William Bendix he's mighty serious in his choice of hand tools for his DO-IT-YOURSELF hobby.

"In my home workshop I find wonderful relaxation after a tough day at the studio. And in my workshop you'll find a complete variety of UTICA® Pliers and Adjustable Wrenches. They're tops," says Bendix.



THE HALLMARK OF QUALITY  
 UTICA DROP FORGE & TOOL CORP.  
 UTICA 4, N. Y.

In Canada: Adlam Tool & Supply Co., Ltd., Montreal

# READ THIS

This sounds unbelievable—but if you will spend \$1.00 and 30 minutes of your time, you will be able to repair 45 common television troubles. The SIMPLIFIED TV SERVICING manual brings you thousands of man-hours of experience in a condensed form. If you can follow simple step-by-step instructions, YOU CAN REPAIR TV SETS FOR PROFIT. YOU NEED NOT HAVE ANY KNOWLEDGE OF TELEVISION. Get your copy of this valuable manual today. Read and use it for seven days and if it isn't entirely satisfactory, return it for a full refund.

Send only \$1.00 for your copy to  
**TV PUBLISHING CO.**

Dept. A-655

Esconaba, Michigan

**IT'S WHAT YOU HAVE  
 BEEN LOOKING FOR!**

**\$35,000 BONUS OFFERED BY THE U. S. GOVERNMENT FOR URANIUM\* FOUND ANYWHERE!**

**FREE BOOKLET!**  
**"HOW TO MAKE MONEY PROSPECTING FOR URANIUM"**

Tells where to look for Uranium, how to stake claims, equipment needed. Where to sell—plus many other authoritative facts to help you cash-in on rich Uranium rewards. Please send 20c to cover cost of handling & postage.

\*Atomic Energy Commission offer due to national defense need of Uranium

**U. S. GEIGER CO.**  
 195 SACKETT ST. DEPT. PM6 B'KLYN 31, N. Y.

**POSITIVELY STOPS VAPOR LOCK!**  
**New KLEMM VAPOR-LIMINATOR**

Chrome Plated  
 Exclusive SNORKEL TUBE prevents vapor lock while filtering gas thru "Chemistone" element. Satisfaction guaranteed or money back. Send make of car with \$2.95 postpaid (or C.O.D.)

**FENTON-CHASE COMPANY** Dept. P  
 2000 St. Paul Avenue • Chicago 47, Illinois

**Build Your Own Walks, Driveway, Outdoor Fireplace, Steps, Etc.**

**What to Make With CONCRETE**

The terrific high costs of even little concrete jobs are mostly for labor. Get Popular Mechanics **WHAT TO MAKE WITH CONCRETE** and save all the labor costs while making your home or farm ship-shape. You can lay foundations, sidewalks and driveways; build steps, outdoor fireplaces, sandboxes, tennis courts, garden and swimming pools and other installations at very little cost. Book shows all — tells all — how to make the right mixture, plan, apply and gives 50 professional short cuts. Hundreds of pictures. Only \$2.00 postpaid. Order today. Money back if not pleased.

**POPULAR MECHANICS PRESS**  
 Dept. PM17, 200 E. Ontario  
 Chicago 11, Ill.

**NEW HORIZONTAL DOUBLE REDUCTION 1/8 H.P. SPEED REDUCER**

Complete your work bench with this sturdy, efficient, Ohio Gear double reduction unit. Especially adaptable to Home Work shops, Farm equipment, and light industrial applications, such as — mixers, pump drives, animated displays, barbecues, conveyors. Available in ratios of 4:1 to 1600:1.

Torque capacities 25 to 150 inch pounds.

**\$32.50**  
 POST PAID

**PROMPT DELIVERIES**

**OHIO GEAR CO. • 1401 EAST 179th STREET CLEVELAND 10, OHIO**



**5 BIG POWER TOOLS**  
in ONE

8" TILTING  
TABLE SAW

HORIZONTAL  
DRILL PRESS

GRINDER

30" LATHE

SANDER

RETAIL PRICE \$125.00

**FACTORY TO YOU \$79.95**

**SUPERSHOP** is a PRECISION-BUILT WORKSHOP. 100% ball bearings. All running parts precision ground. Big capacity. Extra rugged. Amazing value. Write for FREE catalog.

BUY ON EASY PAYMENTS

**POWER TOOLS, INC.** 172 YATES AVENUE  
BELDIT, WISCONSIN



VERTICAL  
DRILL PRESS

## RANCH LIFE IN YOUR HOME

Bring authentic western ranch life right into your own home with a finely detailed miniature Chuck Wagon Kit. Includes an interesting book on Western Life by a leading author. Money back guarantee. Send \$1.95 to **ALLBRAND**, 612 No. Paulina Ave., Redondo Beach, Calif.

**CRESCENT TOOLS**

*Give Wings to Work*

ASK YOUR  
HARDWARE  
DEALER



## YOU CAN BUILD A VIOLIN FOR PLEASURE OR PROFIT

Now you can build a rich toned mellow violin modeled after a famous "Strad." YOU CAN MAKE A STRADIVARIUS VIOLIN contains 8 full scale plans plus complete instructions. You work directly from the plans with no confusing scale of dimensions to translate. Detailed instructions for each step including varnishing and stringing—even shows how to build your own tools. Cloth bound. Order today from

**POPULAR MECHANICS PRESS . . . \$3.50**  
200 EAST ONTARIO STREET, CHICAGO 11, ILLINOIS

## PUMP WATER FAST!

Drains Wash Tubs, Cellars, Cisterns. Famous #7 pumps 2800 gph. 420 gph. at 75' high or 1600 gph. from 25' well. Sturdy rustproof alloy metal. Six blade impeller. 3/4" inlet, 1/2" outlet. Standard pipe threaded. Uses any 1/4 to 1/2 H.P. Motor. Will not leak or clog. Iron clad guarantee. Send check, M.O., or sent C.O.D. **\$8.95** M.S.R.

Irrigate, Fill Tanks, Draw Well Water. Heavy duty #8 pumps 7000 gph. 3000 gph. 75' high 3000 gph. from 25' well. Rustproof alloy metal. 8 blade impeller. 1" inlet, 1" outlet. Standard pipe threaded. Will not leak or clog. Iron clad guarantee. Send check, M.O., or sent C.O.D. **\$11.95** M.S.R.

Free Catalogue—Gear Pumps, Large Centrifugal Pumps, Deep and Shallow Well Pumps, Sump Pumps.

**MOORE MANUFACTURING CO.**  
SWEDSBORO 1, NEW JERSEY

**WAR SURPLUS** AND OTHER **SAVE UP TO 90%**  
BARGAINS

### CAMPER'S STOVE

Terrific for hunters, ranch, home, farm, civilian defense, boat, camp, trailer, bar, booze, etc. Burns any type gasoline. Burner 100 1/4" dia. Unit approx. 23" x 21" x 10". Has 2 tanks (21 1/4" x 5 1/2") with welded seams, 3 brass valves, 3 air filters, air gauge to 80 lbs. Can use as air tank for compressor or fill with liquid for spraying. NEW Korean war surplus. Wt. 95 lbs., boxed. Approx. GOVT cost \$150. Complete with 2 spare emitters and orifice cleaner (compare this price) — **\$10.50**



### AUXILIARY POWER UNIT GOVT. COST \$4770



Ideal for your shop, camp, cottage, farm, trailer, home, boat or mines. Makes a terrific welder for any sized job. 2-cylinder horizontally opposed 15 HP. air cooled engine. Complete with G.E. DC generator, 200 Amp. Will serve peak load requirements up to 7 1/2 KW. Economical operation, runs on cheap gasoline. Batteries will power generator as self-starter. Dual Scintilla Magnets. Mfd. by Lawrence. Comes complete in fire-proof enclosure which cuts motor noise to a minimum. Shpg. wt. cased 380 lbs. Net wt. 213 lbs. Like new. Complete, guaranteed perfect. Special now. Model 30C-2 complete with new dry-charged aircraft batteries, spark plugs, magneto switch, voltage regulator—all this for **\$177.50**.

**SENSITIVE ALTIMETER** in 10 Ft. Increments. Famous Pioneer! 0 to 35,000 ft. inches of Mercury. Tested and inspected in our own instrument lab. Guaranteed perfect. Approx. Govt. Cost \$150. NOW ONLY **\$13.95** Ppd. U.S.A.



### MICROMETER DEPTH GAUGE

With 3 rods to measure all depths from 0 to 3 inches by thousandths. Hardened tool steel lead screw has full 1 inch run. Base is 2 1/2" long, hardened ground and hand-lapped. Accuracy guaranteed. Mfd. by Millers Falls Co. GOVT COST approx. \$30. NEW—**\$10.95** Ppd. USA. In velvet case.

**MICROMETERS** Chrome plated, precision engineered, carefully tool to give long life. All new 0-1" cap. **\$2.25** ea., 1-2" cap. **\$3.50**.



### PI GENERATORS

Electric Auto-Lite. 200 Amps, 24 Volt, 4400 RPM. Dandy arc welder. Wt. 53 lbs. Approx. GOVT cost \$450. Like NEW, **\$12.50** incl. easy diagram.

**NEW 1955 CATALOG** Biggest ever . . . new low prices . . . Send 25c for your copy today. Prices F.O.B. Culver City unless otherwise stated. Check, money order or cash. 25% deposit for C.O.D.

**AIRBORNE SALES CO., INC. DEPT. PM 655**  
8501 Stellar Drive, Culver City, Calif.

**LONG LASTING**



Let a better-built Gerstner Chest give your tools the care they deserve. Free Catalog. **GERSTNER TOOL CHESTS**  
455 Columbia St., Dayton 7, Ohio



Surplus! **\$110.00 VALUE**  
**STEEL TRAILER**  
With **PNEUMATIC TIRES**  
(Timken Taper Roller Bearings)  
**BRAND NEW! \$42.50**

Carries 2500 lbs. Unused—ready to GO! Attach to car, jeep, tractor—or easily pulled by its tow-bar. Can be utilized as a boat carrier or an all-purpose trailer. A natural for moving heavy, concentrated weights such as: Generating plants; Compressors; Welders; Power tools; Farm and industrial equipment. Buzzed steel construction—two standard 400x18 pneumatic tires—tubes! Bed dimensions are 25"x16" . . . wheel span can easily be increased to hold very large, wide items. Shipped job from San Francisco or Chicago. Fully guaranteed. Order direct from AD!

**ROBERTS ELECTRIC CO., Dept. P-293, 849 W. Grand, Chicago 22, Ill.**



## Simplified ARC WELDING pays big profits

"Build Your Own." Set up your own welding business at low cost. This 200 or 300 amp. Hobart generator plus your hook-up will earn hundreds of extra dollars for you.

AC Transformer Type. Here's a real production and repair welder for you who want improved AC welding performance. Operates on single phase 220 volt power lines.

**HOBART Bros. Co., Box 'M-65, Troy, Ohio**



AC Transformer Type Welder

## Check and Mail today!

. . . with your name and address for complete data

- Build Your Own
- Transformer Type
- Trade School G. I. approved
- FREE Welder's Vest Pocket Guide

America's favorite...



sold and serviced nationally

CUSHMAN MOTOR WORKS, inc.

960 No. 21 Lincoln, Nebraska

## Cushman EAGLE

THE TOP TRANSPORTATION BUY

- Up to 75 miles per gallon
- $\frac{3}{4}$ c per mile total operating cost
- Endurance proved

Own a Cushman Eagle for as little as \$5.00 a week.

See your nearest dealer for FREE demonstration or write for illustrated literature.



## HOME REPAIR TIP No. 15



WRAP TOOL HANDLES with tight-sticking "SCOTCH" 33 Plastic Tape. Makes smooth non-slip grip—resists water, oil, perspiration. Fine for shock-proofing frayed electric cords, mending rainwear, too.

"SCOTCH" 33 Plastic Tape—39¢ or 79¢—on sale at stores everywhere. Minnesota Mining and Mfg. Co., St. Paul 6, Minn.

## MOTORIZE YOUR BARBECUE!

Easily rigged up by anyone. Handles whole ham or 4 small chickens. Commercial-quality thrust—2 r.p.m. rear-head motor (110V-AC)—spring-tension bronze bearing permits spit removal—

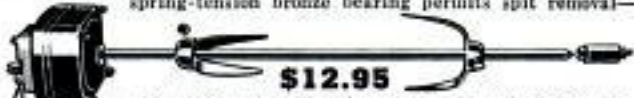

adjustable meat forks—heavy-duty, chrome-plated spit. Limited time. Introductory offer. Postpaid. (\$13.95 Denver and West).

B & R SALES CO. — Dept. PM655 — Muncie, Indiana

## OVERLOAD SPRINGS



\$9.95 Per Pair  
postpaid  
2000 LB. SIZE  
\$11.95

For cars and trucks. Front and rear. Gives 2000 lbs. extra capacity for all  $\frac{1}{2}$ ,  $\frac{3}{4}$ , and 1 ton trucks; 500 or 1000 lbs. extra for all cars. Easily installed. Guaranteed. State make, model. Dealers wanted.

BRINKMAN MANUFACTURING CO.  
2315 Clay Dept. 15-E Topeka, Kansas

## SAVE MONEY on SURPLUS PARTS for MILITARY TYPE TRUCKS & JEEPS

4 & 6 wheel drive. FREE catalog. State make of truck or Jeep. (New Jeep Tops, steel or canvas for all models). AMERICAN AUTO PARTS CO., Inc., 1830 Locust, Kansas City, Mo.

## DRAINS collars, cisterns, wash tubs; \$6.95 IRRIGATES - CIRCULATES - SPRAYS



Type P Pump has 1,001 uses. Up to 3000 GPH; 450 GPH 80" high; or 1800 GPH from 25" well. Use 1/8 to 3/8 HP motor. Couplings included from 1" inlet; 3/4" outlet. Stainless shaft. Won't rust or clog! Postpaid if cash with order. (West of Miss. add 50¢)

MONEY BACK GUARANTEE

Centrifugal and Gear Pumps in All Sizes

LABAWCO PUMPS, Belle Meade 7A, N. J.

## VARIABLE SPEED HYDRAULIC POWER TRANSMISSION



It has Infinite Speeds 0 to 550. Reverse, Automatic Overload Protection. Adjustable Torque up to 180 inch pounds. 3/4" input and Output Shafts. It will handle 1/2 to 1 1/2 H.P. Motor. Case measures 7 1/2" long, 7" high, 6 1/2" wide. VALUE OVER \$300. Shipping Wt. 25#. On C.O.D. orders we require a 10% deposit. **\$54.50** only Fab. Chicago

DIRZIUS MACHINE SHOP "C" 1423-25 So. 52nd Ave., Cicero 50, Ill.

## SPECIAL INTRODUCTORY OFFER



Genuine Aqua Lung (Cousteau-Gagnon process). Get the latest model Aqua Lung Regulator complete with hoses and mouthpiece plus a 38 cu. ft. cap. I.C.C. approved tank with an automatic positive 5 minute reserve air supply valve. Thousands of skin divers have used the Aqua Lung for the past ten years with not one mechanical failure. **\$77.00** PPD.

Order today—send check or money order. \$10.00 deposit on C.O.D. \$8.95 extra

MEL'S AQUA SHOP, Dept. M6

1911 S. CATALINA AVE. REDONDO BEACH, CALIF.

The easy way to paint!

Speedy Sprayer



ONLY \$36.50 LESS MOTOR

Favorite of home owners and craftsmen for 20 years! SPEEDY SPRAYER gives your work that professional paint finish everyone admires. Sprays paint, enamel, varnish, lacquer, etc. . . . 4 to 7 times faster than hand brushing! Lightweight, portable, uses any 1/4 H.P. motor. Improved diaphragm principle assures clean, oil-free air. You'll find dozens of time and money saving uses for SPEEDY SPRAYER, including spraying insecticides 2-4-D and DDT. Complete outfit, without motor, only \$36.50.

At leading hardware, lumber, and auto supply dealers. FREE—write for handy booklet "How to Spray."

W. R. BROWN CORPORATION  
2635 N. Normandy • Chicago 35, Ill.

SEND FOR  
**FREE  
CATALOG**



## Money-Making Tools!

It's easy to own the same "pay-off" tools used and endorsed by America's top-earning mechanics! You can start building your own kit with basic Snap-on sets—add others any time. Never sold in stores—direct to users only. Send today for free catalog!

Snap-on Tools Corporation  
8062-F 28th Ave., Kenosha, Wis.



**Snap-on Tools**  
THE CHOICE OF BETTER MECHANICS



BUY FROM MANUFACTURER  
**ATTIC EXHAUST  
FANS** \$666  
F.O.B.  
N. Y.

**20"** Kit includes: Steel blade  
2 self-aligning bearings  
2 pulleys, shaft, collars,  
instructions. Easy to in-  
stall and assemble.

VISIT US OR SEND FOR FAN PARTS & MOTOR BOOK  
**Albin Machine Co., Inc.**

New York, 423 Broome St. | Detroit, Mich., 425 W. Jefferson Ave.  
Cinn. Ohio, 1529 Vine St. | Louisville, Ky., 225 E. Market St.

## EARN GOOD MONEY IN SPARE OR FULL TIME.

With a Universal Lawn Mower Grinder

Have a business of your own in your garage or basement, sharpening lawn mowers. Be your own boss. Small investment. We furnish everything you need to start. Write **FREE** Dept. M-63 today for complete details



**ROGERS MANUFACTURING CO.**  
LINDSEY, OHIO



## STARRETT "Tools and Rules" BOOK

Describes and illustrates the precision methods skilled mechanics use. Only one dime. Write Dept. AP.

The L. S. STARRETT CO., Athol, Mass., U. S. A.



## ELECTRIC WELDER AC or DC 110 Volts

The "Little Marvel" all-metal welder, 5-year written guarantee. Welds 1/8" metal or money back. Repairs tanks, tools, fenders, machine parts, etc. Complete with everything—rods, unit, eye shield, directions. \$6.45 plus 50c postage. Flame torch accessory for soldering, cutting, brazing \$3.95 complete with carbons, brass rods, flux. \$2.00 Deposit on C.O.D. 1/4 Inch Transformer Welder \$19.95 F.O.B.

**\$645**  
Com-  
plete

ESSAY MFG. CO., Dept. 51, Quincy 69, Mass.



## HULL HAS PERFECTED THE VACUUM CUP AUTO COMPASS MOUNT

Self-aligning, has its own adhesive, guaranteed not to come loose. Permits mounting where best for accuracy and visibility . . . away from magnetic interference of dash, from obstruction of sun visors and rear-view mirror.

THE QUALITY NAME IN AUTO COMPASSES  
At Better Dealers Everywhere - Write for Literature

Beaconlite  
\$6.95  
-STRENGTH  
\$4.95

**HULL MFG. CO.** P.O. Box 246, D-6  
WARREN OHIO

## "ARCO JIG-SAW"



**NOW  
REDUCED TO  
only \$8<sup>95</sup>**

First to fit 1/4" drills, this rugged portable jig-saw attachment has same capacity & precision as \$55 saws. Does work of jig, keyhole, coping, crosscut, rip, band & hacksaw! Built-in "Air-Jet" blows away sawdust. Guaranteed to cut intricate patterns—however large—in plywood, plastics, metals—even cuts 2x4's! Starts inside holes. Includes blade. Converts to Table Model with "ARCO STAND" Sturdy Casting \$2.75 6 Extra Blades \$1.95

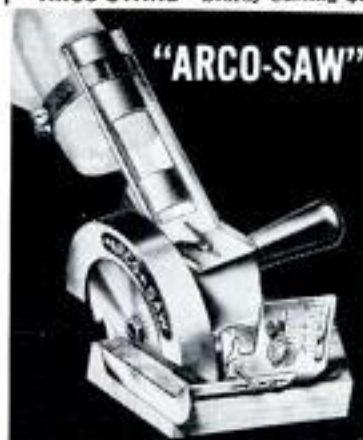

## "ARCO-SAW"

## CUTS 2x4's!

Fits any 1/4" drill. Has same features as high priced Portable Saws. Over 1/4 million in use! Complete with **Depth-Bevel-Rip Gages** for accurate cuts. **Right Angle Steel Gear Drive & Safety-Yoke** for safe one-hand operation and quick-cutting 5" Safe-cut blade. . . . **\$12.50**

**BLADES—5" Comb., Rip, Crosscut. \$1.75**

**SOLD AT BETTER HDWE STORES.** If

not available, try these amazing tools on our **UNCONDITIONAL 10-DAY MONEY BACK GUARANTEE.** Send check or M.O. (ppd.). C.O.D.'s—plus post.

## ARROW METAL PRODUCTS CO.

Dept. PM-6, 140 West Broadway, New York 13, N. Y.

## TRANSISTORIZED GEIGERS = URANIUM \$\$\$

**NOW!** FOR THE FIRST TIME SINCE  
THE DISCOVERY OF URANIUM

## COMPLETELY TRANSISTORIZED MIRACLE GEIGER COUNTERS

- Extra sensitive
- Featherweight (Less than 3 lbs.)
- Scientifically engineered power supply
- **OVER 500 hours of battery life** (And battery replacements cost only 30c)
- Includes Miracle Transistorized Audio (Usually sells for \$15.00)

## UNCONDITIONALLY GUARANTEED

- No Vibrators • No Tubes • Almost Indestructible

All instruments sold or distributed through or by UAC are checked IN and OUT by qualified Ph.D.'s in our complete scientific laboratory. Prices from \$19.95 to \$4995. Write today for free information:

Walking Stick  
UAC 402:  
\$99.50  
(with carrying scabbard)

Gun Type  
UAC 411:  
\$149.50  
(with holster)

## UNIVERSAL ATOMICS CORPORATION

Dept. M6 19 East 48th St. New York 17, N. Y.

# DEGREASER!

engine shampoo

QT. SIZE CONCENTRATE  
MAKES 2 GALLONS



Takes clog out of oil and grease . . . emulsifies it . . . so that all dirt may be hosed off as easily as you rinse hands under water faucet.

Launders engines faster, more completely, and safer than steam cleaning (warm the engine). Self scouring action brings out factory new appearance . . . provides accurate visual inspection . . . Gunked engines run cooler.

Get Genuine Gunk in quart and larger sizes at better wholesale auto suppliers throughout the country . . . Flatly refuse imitations.

The **CURRAN CORPORATION**, Lawrence, Mass.

## RADIO CONTROL YOUR MODEL

"CUSTOM ONLY  
MIDGET" RADIO \$9.98

LICENSE FREE BAND  
OPERATES SAME AS \$50.00  
SETS. INCLUDES LONG RANGE  
TRANSMITTER RADIO, RECEIVER RADIO AND CONTROL ACTUATOR ALL 3  
EASY ASSEMBLY WITH OUR PARTS AND PLANS \$9.98. PLANS ALONE \$1.  
RADIOMODELS BOX 36 DEPT. PM BALTIMORE 6, MARYLAND

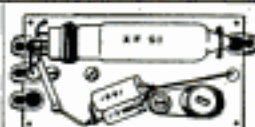

PLANE BOATS CARS  
DETAILED INFORMATION & RADIO CATALOGUE 25c  
SPECIAL "SUPPLY SOURCE DIRECTORY" & \$7.00 SUPPLY COUPON... \$1.00  
BOOK "RAVING CONTROL OF MODEL AIRCRAFT" CONTAINS 14 PLANS \$3.98  
RADIO CONTROL GARAGE DOOR DETAILS... \$1.00

## Need Cash Quick? BORROW by MAIL

If you need \$50-\$600 now and are regularly employed, rush the coupon!

We are State Licensed and make quick cash loans anywhere in the U.S. ENTIRELY BY MAIL. No agents will call.

Repay in small monthly installments to fit your income. No endorsers. Your employer, relatives, tradespeople, friends, never know you are applying for a loan. RUSH COUPON for free information and Money Request sent in plain envelope. **POSTAL FINANCE CO., 200 Keeline Bldg., Dept. 7K4, Omaha, Nebraska . . . Serving America Since 1905.**



### \$50-\$600 EASY-CONFIDENTIAL!

**POSTAL FINANCE CO., Dept. 7K4**  
200 Keeline Bldg., Omaha, Nebraska

Please rush FREE information and Money Request Form.

NAME .....

ADDRESS .....

TOWN..... STATE.....

OCCUPATION.....

AGE..... AMOUNT YOU WANT TO BORROW \$ .....

# OUTDOOR KITCHEN



### Written Step-by-Step For You!

Now you can have a beautiful outdoor kitchen to enjoy all summer long. Tom Riley, well-known building authority, tells and shows you how you can build your own outdoor fireplace, Chinese oven, barbecue pit or grill. There are complete building instructions included.

### A Standard Piece of Equipment

Once the almost exclusive luxury of Western ranches, the outdoor barbecue now is a coast-to-coast American institution. Every year more families take to this pleasant and gracious way of outdoor dining and entertaining. Now with this book, you can join in with a minimum of expense and the utmost in results. Mr. Riley, an old hand around the barbecue ovens of Oregon, has prepared this complete book, in order that you may find the ideal outdoor fireplace for your particular back yard. He not only gives you many fireplaces from which to choose, but he also gives you money-saving short cuts in construction, hints on firing up and cooking and for extra good measure a collection of fire-tested recipes ranging from tasty frankfurters to filet of sole a la fresco.

### No Experience or Special Tools Needed

Complete step-by-step building instructions with diagrams, photos and drawings make construction a cinch. There are designs for brick, field country stone, cement, concrete block and poured concrete, and many examples of each. With the know-how gained from this book, yours can be the most popular back yard in town and, besides you'll have lots of fun.

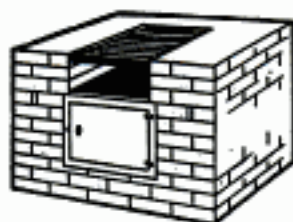

### Special Section of 40 Tested Recipes!

Here are some secrets of successful barbecuing — the best fuels to use, ways to maintain proper draft, and hints on firing up and cooking that will enable you to capture the authentic barbecue flavor in the foods you serve to family and friends. So that your fare won't be confined to wieners and hamburgers, Tom Riley also tells you how to prepare and serve such barbecued delicacies as ribs, roasts, fowl, fish, special sauces, and various vegetables.

### Partial Contents

Which Barbecue for you? Barbecue Fireplaces, Portable Grill, Masonry Grill, Barbecue Pits, Chinese Ovens, Infra Red Roasters, Combination Barbecues, Construction plans, Basic Fireplace Foundation, Barbecue Fireplace of poured concrete, stone construction, Firing Up! Types of Charcoal, Hardwood, Softwood, Compressed Sawdust, Cooking Temperature, Flame Tested Recipes, Charcoal Broiled Steaks, Barbecued Spare ribs, special section of cooking methods employing various vegetables not usually associated with outdoor cooking, and much more.

### 7-Day Money Back Guarantee

Send for your copy of **OUTDOOR KITCHEN**, today. Read and use it for 7 days. If it isn't entirely satisfactory, return it for a full refund. We know once you have looked your copy over, and found the fireplace for your backyard, you won't part with this book under any conditions.



## Use This Handy Order Coupon

**POPULAR MECHANICS PRESS**  
200 E. Ontario St., Chicago 11, Illinois

Gentlemen:

Please send my copy of **HOW TO BUILD AND USE YOUR OWN OUTDOOR KITCHEN**, now. Enclosed is my remittance of \$2.00. If I am not completely satisfied with the book I will return it for a full refund after 7 days.

Name.....

Address.....

City..... Zone..... State.....

Send C.O.D. I will pay postman

POPULAR MECHANICS

Copyrighted material





## BALL BEARING ATTIC FAN KIT

COOLS ENTIRE HOME OR BARN  
MOVE HOT AIR OUT EASY TO INSTALL  
EASY TO ASSEMBLE



### HERE IS WHAT YOU GET IN THE KIT

"TORRINGTON" 4 bladed fan (Deep pitched), one ALL-METAL STURDY STEEL STAND, 2 rubber cushioned "Sealed-for-life" ball bearing pillow blocks, 1 belt, 1 motor pulley, 1 fan pulley, a 3/4" shaft.

This sturdy, silent running fan is the finest you can buy. It can be mounted horizontally or vertically. **DRAWNS MORE AIR** per minute than any other fan on the market. Why suffer with summer heat and sleepless nights? **GET RELIEF AT VERY LOW COST.**

Reg. Value **\$49.50**  
OUR PRICE **\$23.95**

SIZE	DIMENSIONS L W H	APPROX. CFM OF AIR	MOTOR NEEDED	REG. VALUE	OUR PRICE
24"	24 x 20 x 32	6250	1/4 HP	49.50	\$23.95
30"	24 x 21 x 38	8800	1/2	55.00	25.95
36"	24 x 22 x 44	13750	3/4 or 1	65.00	27.50

Shipping weight approx. 30 lbs. Complete instructions included

Decide the size you need and order at once at these low prices. Send check or M.O. No C.O.D.'s. Prices FOB Phila. Money refunded less freight if not satisfied if returned within 3 days of receipt.

**MARTIN ELECTRIC T & S CO., 604 ARCH ST., PHILA. 6, PA.**

## SAVE GAS! I'LL SEND YOU THIS FREE!



**10 DAY FREE TRIAL! SEND NO MONEY! PAY POSTMAN NOTHING!**  
Users Report 4, 5, 6 Extra Miles per Gallon with New Miracle Gas Air-Flow Needle. (\$1.50 Value)  
Up to 25% MORE MILEAGE, FASTER PICK-UP, QUICKER STARTING reported. Phenomenal money-saving results coming from 1/2 MILLION USERS. Carburetor Engineering Co. reports **SAVING OF 72¢ PER DAY, YELLOW CAR CO., FLEET OWNERS, POLICE, EMERGENCY** vehicle users. Outstanding performance "approved". **FITS ALL CARS AND TRUCKS. INSTALL YOURSELF IN 2 MINUTES** with simple twist-of-the-wrist. (Replaces present idle adjustment screw in your carburetor.) **AMAZINGLY EASY TO DO!**

**also FREE!** Receive valuable revealing booklet if you **WRITE TODAY** without delay.  
**HOW TO OBTAIN OVER 47 MILES PER GALLON**  
● **TRY IT FREE! JUST SEND NAME AND ADDRESS!** ●  
**PAY NOTHING!** Test this revolutionary new automotive discovery in your car **AT OUR EXPENSE!** Check mileage. (Some users report no improvement—so **TRY BEFORE YOU BUY!**) If amazed at increased mileage—**SEND ONLY \$1.50 EA.** Otherwise, just return the "little stinkers" and you owe us nothing. Fair enough? Specify make of car, # cyl., and year (8 cyl. cars use 2.). Rush, Free Trial **SUPPLY LIMITED,**

**NEWHOUSE AUTOMOTIVE INDUSTRIES**  
Dept. 340 5805 E. Beverly Blvd. Los Angeles 22, Calif.

## POWERFUL CENTRIFUGAL PUMP

For CELLARS, WASHTUBS, CESSPOOLS  
Home, garden, farm — two sizes

CAN'T RUST Die-cast ALUMINUM 1/2" Shaft	Head Intake Discharge Gal. Per Hr. Value	No. 12	No. 14
		22" 1 1/4" 1" 3000 \$16.50	30" 1 1/2" 1 1/2" 5000 \$22.00

OUR PRICE P.P. PREP. **\$8.95 \$12.95**

## SURPLUS 1/4" ELECTRIC DRILL BALL BEARINGS THRUOUT

New in Orig. Carton. Val. \$49.50.  
1 Yr. Guar. OUR PRICE **\$23.95** POST-PAID  
Jacobs gear key chuck. Industrial Type. Powerful, rugged 110 V. AC-DC 2000 RPM. Fits all Accessories. Mfg. by U. S. Elect. Tool Co. Send Check or M.O. Money refunded less ship. chgs. if returned within 5 days of receipt.

**MARTIN ELECT. T & S CO., 604 Arch St., Phila. 6, Pa.**

## 100 BEST Woodworking Projects

SELECTED FOR YOU BY POPULAR MECHANICS EDITORS  
Enjoy the fun — the pride — of making things. Get 100 BEST WOODWORKING PROJECTS, complete with simplified instruction, plans, diagrams and more than 400 how-to-do-it pictures. Make all kinds of furniture, baby carriages, clocks, lamps, book shelves, fireplaces and other useful articles at little or no cost. Send only \$2.00 with name and address. Money back if not pleased.

POPULAR MECHANICS PRESS, Dept. PM6, 200 E. Ontario St., Chicago 11

## SKIN DIVER ACTION!



**Dr. Nelson E. "Doc" Mathison** presents his newest Skin Diving Kit for Pool, Lake or Ocean. World's newest and fastest growing sport.

The Complete Set Includes

- Precision made under water safety gun powered by rubber sling
- Swim mask with extra plate for pool
- Swim fins of black neoprene rubber
- Plastic Snorkel Tube.

Please state shoe size  
Send cash, check or money order. (In Calif. add 3% Sales tax)  
Only **14.95** Complete Postpaid

**Dr. MATHISON**

2656 Fashion Ave., Dept. 6M, Long Beach 10, Calif.

## BOAT KITS

OVER 70 MODELS: 8 to 21 ft.



INTRODUCING THE NEW  
19 and 21 ft. **VICTORY CRUISER SERIES**

Sensationally new from stem to stern! Featuring new bulkhead construction with longitudinal stressing... 50% stronger... easier to assemble! 20% lighter and faster than conventional designs. "Pay-as-you-build" kits available... hull prices start at \$295! Three cabin styles: Express, Sedan and revolutionary "Twin-Trunk" (shown above). Advanced features include wrap-around windshield, Flying transom, etc.

SEND 10c for VICTORY CRUISER CATALOG ONLY.

**COMPLETE 1955 KIT CATALOG: SEND 35c**  
Includes over 70 models from 8 to 21 ft. Inboard and outboard, dinghies to cruisers. Also hardware, paint, fittings, trailers and Armor-Glass. **SPECIAL OFFER:** Send \$1.00 for both kit catalogs plus valuable book "Boat Selection, Operation & Maintenance."

DEALER-AGENT INQUIRIES INVITED

## BOAT PLANS

OVER 150 MODERN PLANS with FULL-SIZE PAPER PATTERNS  
Build your boat the modern way—the easy way, with Custom-Craft patterns. Save time-money. Material lists, building procedure included. Racing classes—cruisers—Inboards—outboards—sailboats, etc. 6-36"—plywood or planked. **SEND 35c for DESIGN CATALOG** or send \$1.00 for design catalog plus boat building handbook.

**CUSTOM-CRAFT • DEPT. 7 • BUFFALO 7, N. Y.**

# Holt's WORLD FAMOUS "Do-It-Yourself" PRODUCTS

## HOLT'S ORIGINAL Piston Seal



does help in  
**6**  
important ways

- 1—reduces oil consumption
- 2—restores compression
- 3—stops piston slap
- 4—increases miles per gallon
- 5—improves performance
- 6—makes engine quieter

Good for 10,000 miles of carefree driving. Next best thing to a complete motor overhaul... at 1/20 the cost. Today's biggest seller. Millions of tubes have been sold throughout the World during the past 18 years. Undeniably safe for even the finest engines. Endorsed by leading technical automotive experts. Easy to use. \$4.95 a tube POSTPAID for most cars.

\$1.69  
CAN

## Holt's GUN-GUM

Mends leaky mufflers—  
seals pipes and joints

## MUFFLER SEAL

Sets like a weld in  
a few minutes.  
Apply by hand

At Every Auto and Accessory Store  
**TREGLOWN CO., Inc.**  
Fanwood 33, N. J.  
CANADA: 1366 Greene Ave., Montreal 6

Write  
for full  
details

Prices slightly higher in Canada

## FAMOUS FAN KIT SAVES UP TO 75% ON HOME COOLING

IMPROVED MODEL FOR WINDOW, ATTIC OR HORIZONTAL ATTIC INSTALLATIONS

The new all-purpose Fan Kits are adapted to any type installation. No extra parts needed. New Low Price!



30" FAN  
**\$14.95**  
Cools average home

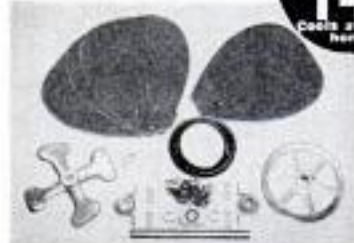

Kit of parts, with step-by-step instructions includes: Aluminum fan spider, Masonite blades, Shaft, Oilite bronze bearings, Collars, Pulleys, belt and bolts.

ANYONE can assemble a quiet, efficient fan from the original FAN KITS. Everything you need except a little lumber for fan housing and a new or used 1/4 HP motor, is included. Money-back Guarantee.

- 30" Fan cools average home, \$14.95
- 36" Fan cools larger homes, \$17.95
- 24" Fan cools smaller homes, \$13.95
- 20" Fan cools apts., offices, etc., \$12.95

Money order or check with order shipped postpaid. \$3.00 deposit on C.O.D. orders. Circular Free.

### FAN KIT COMPANY

154-N, NO. BELVEDERE

MEMPHIS, TENN.

## END FUSE TROUBLES FOREVER!

Guaranteed by  
Good Housekeeping

with a push on this button



• Fits like a fuse in any standard fuse socket!

• Just press the Mini-Breaker button to restore service.

• Safe protection against overloads, and short circuits.

• Lifetime protection against electrical fire hazards.

In 10, 15, 20, 30 amps. AC only, 125 volts max.

Listed by Underwriters' Laboratories

## MINI-BREAKER®

Ask for it at your favorite store or write  
Mechanical Products, Inc., Jackson, Michigan.



Save 50%! Assemble Your Own  
**DIVING LUNG**

FREE BOOK SHOWS HOW

We furnish the parts and instructions. Complete outfits \$49.95 and \$59.95. Write for our descriptive literature today!

**UNDERWATER SPORTS, INC.**  
Dept. E, 302 W. Adams  
O'Fallon, Ill., P.O. Box 65

## Guaranteed Auto Parts at Western Auto

### 695 HEAVY OIL-PH-BALL BEARINGS PUMPS MILLIONS OF GALS.



For wells, spray, irrigate, drain, circulate. Heavy aluminum alloy, patented seal. Will not leak, clog, nor rust.

2800 gph 6.95 Heavier 8.95  
7500 gph 9.95 Heavier 11.95

Write for FREE Literature—Comparison Charts  
Check, 100 or C.O.D.—Money Back Guarantee  
**U. A. T. ENG. & MFG. CO. HICKSVILLE 273, NEW YORK**



## Cuts Cement Finishing Time in Half!

### PONY TROWEL

Finishes complete to wall. One-man operation. Blades self-adjusting. Sturdily built. Quick, easy to assemble. Successfully used nationwide with 1/2" or 5/8" drills.

Handle and trowel complete less drill **\$49.50**  
f. o. b. Muncie, Ind.

Extra blades only \$3.50  
See Your Dealer or Order Direct

### ELMO MFG. CO.

Dept. C, 324 W. Howard St.  
Parker, Indiana (Pat. Pend.)

**new—different**  
**Uranium Radioactivity**  
**Detector**  
**GEIGERSCOPE**

INDICATES RADIOACTIVE CONTENT WITH SPARKLES OF LIGHT. MORE SENSITIVE FOR USE ON SAMPLES THAN A GEIGER COUNTER. WILL DETECT CONTAMINATION OF FOOD, WATER, CLOTHING, AND UTENSILS. CAUSED BY RADIOACTIVE FALL OUT.

30 POWER



PROFESSIONAL MODEL

Check mineral specimens for uranium with this amazingly sensitive, inexpensive optical radioactivity detector. FOR PROSPECTORS, ENGINEERS, CIVIL DEFENSE, HOBBYISTS, everyone interested in atomic energy. Thousands used in field, labs, and mills. Durable, portable as pocket watch; needs no power source. Complete with uranium ore sample. Radium standard. Weather-proof holster. Complete instructions.

UNCONDITIONALLY GUARANTEED.....\$5

ATOMIC PROSPECTOR'S HANDBOOK.....\$1

Valuable data on radioactive ores, field, lab and mill methods, and map. Everything you need know about this vital new field! Send for Handbook or Geiger scope separately... better yet, order both today!

We Pay Postage

**KEN RESEARCH**

Sales Dept.

681 MAIN STREET • HACKENSACK 15, N. J.

**make your own Gems 29.50 F.O.B.**

The Gem Maker comes complete with all necessary equipment, including a super-charged diamond blade for sawing, and all wheels for grinding, shaping and polishing; also complete instructions. The complete equipment as shown, less motor and belt, for only \$29.50, f.o.b., Burlington, Wisconsin. Write today for information and literature.

**B&I MANUFACTURING CO.**  
 Dept. 5 Burlington, Wis.



**GIANT MAGNETS**



POWERFUL ALNICO - HORSESHOE TYPE

For industry, electronics, hobby, practical use. Amazing pulling power. Mounting brackets and aluminum shielded. 54 oz. Only \$6.00 ppd. guaranteed. (No C.O.D.'s).

LaBash, 422 S. Palm, Alhambra, Calif.

**Automatic Saw Set...**

**MAKE EXTRA PROFITS!**

Set 400 teeth per minute on hand or band saws, 4 to 16 point, with the BeMaCo Automatic Saw Set. Fast, accurate, true hammer-anvil action sets teeth uniformly, eliminates tooth breakage. Used profitably by saw shops and manufacturers everywhere. Every machine positively guaranteed!

Write for details—today!



Saw Machine Division 16-C

**BEAVER MFG. CO.**

800 ISIS AVENUE • INGLEWOOD, CALIF.

**Powerful? IT'S**  
**DYNO-MITE**  
REGISTERED U.S. PATENT OFFICE

The most Use-Full power tool you can own!



Start with this

rugged 1/3 h.p. No. 888

**Dyno-Mite Power Unit**

fully equipped as a 3/8" Drill

with Jacobs Geared Key Chuck, 6"

Portable Disc Sander, and 6" Polisher

\$39.95

Then add these inexpensive attachments to build up a complete Dyno-Mite Workshop



#881 Horizontal Bench Stand, \$2.95

#882 Orbital Sanding Attachment, \$15.50

#883 6 1/4" Bench Saw Attachment, \$22.95



#886 Portable Jig Saw Attachment, \$9.95

#887 Jig Saw Table, \$1.75

#889 Bench Sander Attachment, \$7.95



#8810 Bench Grinder Attachment, \$5.95

#8811 Portable Saw Attachment, \$15.95

#8816 Drill Press Vise, \$5.25

**JUST ANNOUNCED!**

#8814 Drill Press Stand, \$19.95

**Millers Falls**  
**Dyno-Mite Power Tools**



FREE FOLDERS on Millers Falls wide line of Dyno-Mite Electric Tools and accessories. Ask for them at your hardware dealer's or write:

**MILLERS FALLS COMPANY**  
 Dept. PM-8  
 Greenfield, Mass.

For easier work, better results—  
use these high quality



## D-P COMPOUNDS!

D-P Glazing Compound



D-P Caulking Cartridge

- For glazing all sash—wood or metal.
- Perfect for dozens of additional home repair jobs—filling nail holes, cracks, etc.
- It's white—easy to handle—seals permanently!
- Finest caulking compound made—packed in handy 1/10 gallon cartridge with applicator tip.
- Designed for use in standard or half-barrel caulking guns.

At hardware, paint and building supplies stores, D-P means Dicks-Pontius—and that means high quality!



THE DICKS-PONTIUS COMPANY • Dayton, Ohio  
Alexandria, Va. • Decatur, Ga. • Dallas, Tex.

HERE'S THE MONEY-SAVING WAY TO BUILD A

*Mall*

**POWER TOOL  
WORKSHOP**

*Custom-built to your own requirements.*

Start with the basic shop tool—MALL Model 149B 1/4" electric drill (\$23.95 with geared chuck). Then add low cost attachments that do the kind of work you do in your shop. The drill makes every attachment a power tool . . . at a small fraction of the cost of buying special power tools for every job. There are MALL attachments for sanding . . . sawing . . . coping and scroll work . . . grinding . . . and dozens of other shop jobs.



See Your Mall Dealer for the best buys in Power Tools. He knows tools, and is waiting to help you.

**FREE**

**MALL TOOL CO.** PORTABLE POWER TOOLS  
GASOLINE • ELECTRIC • AIR

7805 South Chicago Avenue, Chicago 19, Illinois  
Send me your valuable FREE Do-It-Yourself Booklet.

Name \_\_\_\_\_

Address \_\_\_\_\_

HU-178

make it with 60¢ worth of sand & cement  
SELL IT FOR \$2000

every home a prospect for  
these patented "LIFETIME"  
**CONCRETE INCINERATORS**

Make big profits manufacturing rust proof, fire proof, almost indestructible concrete incinerators in your own backyard or garage . . . full or part time. Sell to home-owners, hardware, department and garden supply stores. Phila. manufacturer doing big volume with Sears, Roebuck; large department stores. Easy to follow instructions and all needed equipment supplied. Exclusive protected franchise—No competition! Territories going fast. Write immediately for full details. Dept. PM-65, T. C. TOR, 2113 Bellevue St., Phila. 40, Pa.



## SKIN DIVERS

BUILD YOUR OWN  
DIVING LUNG



Write for illustrated instructions on "HOW TO BUILD AND USE YOUR DIVING LUNG." We carry a complete line of supplies, replacement parts and Skin Diver accessories at savings up to 85%.

Please enclose 25¢ for handling and mailing.

**C & H SALES COMPANY**

2174 East Colorado Street • Pasadena 6, Calif.

**AIR COMPRESSORS and  
PAINT SPRAY UNITS ON WHEELS.**

FACTORY PRICES. FREE FOLDER.  
ILL. MFG. & SUPPLY CO., 1831 S. State, Chicago 18, Ill.

BUILD YOUR OWN **MIDGET ROADSTER \$25** BUILDS BODY & FRAME



BUILD A PONY ROADSTER or Pick-Up in low spare hours. Uses 2 hp engine, 450 lb. loads, 70 m.p.h., plenty of speed. Designed for VERY LOW-COST assembly from PARTS BOUGHT IN YOUR NEIGHBORHOOD. Use home tools. Great for kids, sturdy utility car, COM-PLYE step-by-step plans, 15 large-size pages, 24 "show-how" photos, Body templates, complete material and parts list. Only \$1.95 post-paid. Satisfied or money back.

PONY PLANS, 7641 TEXHOMA, NORTHRIDGE, CALIF.

**AIR CONDITION  
ONE TO THREE ROOMS  
FOR ONLY \$34.50**

NOW DELIVERED COMPLETELY ASSEMBLED, evaporative air conditioner easily installed in minutes in window opening; sliding side panels assure snug fit. Beautiful hammertone finish. WEATHER MERCHANTS 2913-M Gaston Ave. Dallas 4, Texas. Balanced fan and powerful 1/25-hp, 115-v AC shaded pole motor deliver 1500 cu. ft. cool, filtered air per minute through adjustable directional louvers. Pure aspen filters; clog-free drip trough; brass metering valve; toggle switch; pipe connection; 25' tubing. Send \$5.00 m.o. or check; balance C.O.D. plus shipping. Full price only \$34.50 f.o.b. Dallas. Supply limited—ACT NOW!

**MOTOR GUARANTEED FOR ONE YEAR**

**NOW!** put locking, folding legs on any table with **BOSTROM**

**folding leg hinge**

easy to install  
holds up to 500 lbs.  
fits any type leg



Mount folding legs on any table. New one-piece Bostrom folding leg hinge holds up to 500 lbs. without swaying. Fits round, square or tapered legs. Folds and unfolds instantly. Locks leg securely in place. Instructions, plus materials for installation, included.

Available at Most Hardware Dealers  
If your dealer has not received his Bostrom Folding Leg Hinges write

**BOSTROM MANUFACTURING CO.**  
133 W. Oregon St., Milwaukee 4, Wisconsin

## FIRELARM AT LAST NO NEED TO BE TRAPPED BY FIRE

**PRECIOUS SECONDS** with "FIRELARM"—mean tremendous Savings of Lives and Property—**FIRELARM** will warn of Excessive, Poisonous "HEAT" (the real killer)



- automatic — on duty 24 hours a day
- simple installation (hook on—plug in)
- uses no electricity until needed
- completely portable (use when traveling)
- for homes, offices, cottages, stores, etc.
- won important National Safety Award
- America's lowest priced system at \$12.95 each

DISTRIBUTOR INQUIRIES INVITED

**HEBEL ENTERPRISE CORPORATION**

1257 18th Street Detroit 16, Michigan TA 6-9555

### SPECIAL GET ACQUAINTED OFFER WITH COUPON

Please send \_\_\_\_\_ Firelarm units at special price of \$9.95 each. Check or Money Order, no C.O.D.'s. 10 day money back guarantee.

Name \_\_\_\_\_

Address \_\_\_\_\_

City \_\_\_\_\_

State \_\_\_\_\_

# BAD CHECK?

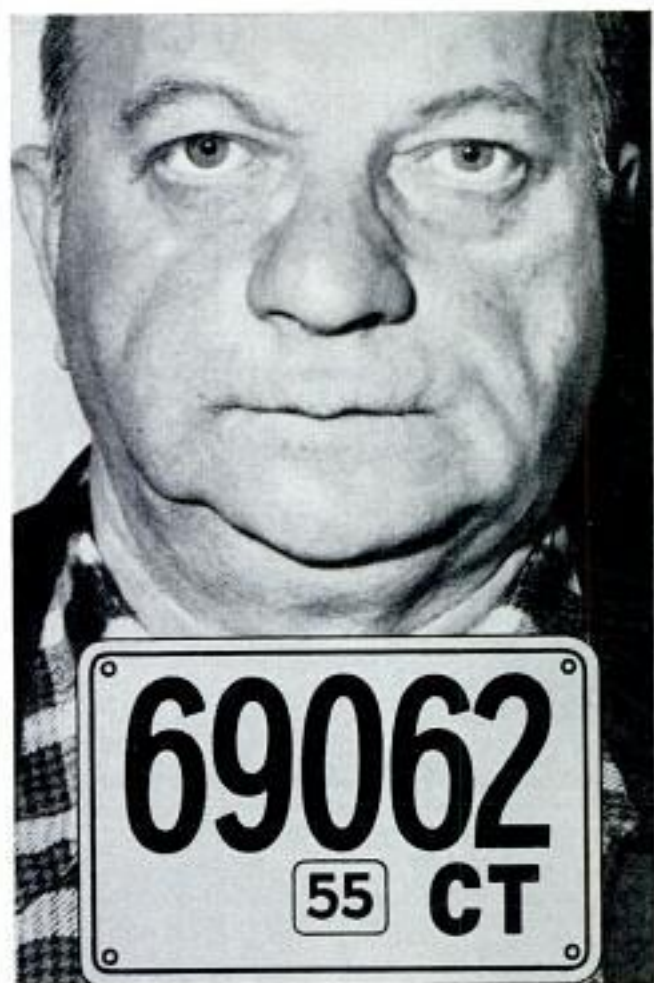

This motorist failed to have his service man check his oil filter every time he changed his oil. Now he's paying for it -- costly engine repair bills. A clogged oil filter lets road dust, hard carbon and sludge grind away at delicate engine parts. Keep out of trouble! Ask your service man to check your filter when changing oil. Insist on PurOlator -- toughest, most efficient filter made. There's one engineered for every make of car. Refills cost as little as \$1.60.

# PurOlator

**America's No.1 OIL FILTER**

"PurOlator" Reg. U. S. Pat. Off.  
PurOlator Products, Inc., Rahway, N. J.; Toronto, Canada

## GIGANTIC MAIL SALE

**WAR SURPLUS EXCESS INVENTORY BANKRUPT STOCK**

### IRRIGATION PUMP

• Genuine Deming new Navy surplus high head centrifugal heavy duty pump. Useful for farm sprinkler or ditch systems.

• Head pressure 220' (approx. 100 gpm) at 150 gpm. Heavy double ball bearings, finest seal, dynamically balanced impeller, etc. 2" x 3/8", 1 1/2" dia. 1" shaft. 181 g. 16"x15"x21".

Natl. Adv. List #170. SPECIAL. \$79.50 F.O.B.

### AIR COMPRESSOR-TANKS

• Powerful Piston Air Compressor.....\$18.91

• Air Corp 300 lb. Pressure Tank.....\$6.79

• Automatic Motor Pressure Switch.....\$4.95

• Professional Paint Spray Gun.....\$9.95

• Closeouts in fittings, hose, etc. Save 70%.

### HYDRAULIC BARGAINS

• Control Valves, 1 or 2 way.....\$18.00

• Cylinder Special (farm type).....\$14.95

• Cylinder for Boat Control, etc.....\$3.89

• Hydraulic Pump, 1000 PSI, 1 1/2 gpm.....\$44.90

• Hydraulic Pressure Gauges (0-1500).....\$3.49

• Hydraulic Hand Pump (1000 lb.).....\$10.50

• Dozens hydraulic items, save to 70%.

### POLICE MOBILE RADIO TRANS-REC. UNITS

• Surplus Army outfit. Genuine Motorola compact unit. Mount in car trunk. Work off 6-v car battery. 30-w output. 30 to 40 megacycle freq. Use point to point, amateur, etc.

Govt. Cost. \$235. PREPAID. \$79.21.

### ARMY POWER PLANTS

Amazing prepaid bargains, write for free catalog.

- 2000-w, 115-v, 60-c.....\$289
- 3000-4000-w, 115-v, 60-c.....\$349
- 7500-9400-w, 115/230-v, 60-c.....\$681

### SPECIALS FROM PREVIOUS ADS

- Army Wool Sleeping Bags (\$12.50) \$4.29
- Surveyors Tripod Precision Level \$42.00
- Army Motor Driven Sirens (6-12-v) \$11.87
- Giant Electro-Magnet (2 1/2"x3 1/2").....\$3.61
- Portable DC-Power Plant.....\$69.50
- Attic Fan Kit, 30".....\$15.95
- Air Power Tree Trimmer.....\$19.51

## SPECIAL OF THE MONTH!

### Truck or Tractor Hydraulic Unit—6-V Motor-Pump

• Motor driven 2500 lb. Hydraulic pump. Operates from any 6-v battery. Mount anywhere. Install in 5 min.

• Use to operate lift or push cylinders for plows, dump bodies, graders, hoists, etc. Pressure to 2500 PSI and up to 1 gal. per min. Wt. 48 lb. New surplus. List \$121.50. SALE, \$45.50 F.O.B.



### ARMY TOOL AND PARTS CABINET

• Marvelous 28"x21"x20" cabinet with 22 compartments, drawers, etc. Fine for home or shop. Govt. Cost \$78. SALE, F.O.B. Ky., \$7.99



WE PAY all freight, express, parcel post—except where shown "F.O.B."

**FREE CATALOG**, 100's items in our surplus center warehouse. Mail card today.

**BURDEN SALES COMPANY**  
 808 "O" ST., LINCOLN, NEBR.

## get into the URANIUM BOOM!

They're discovering URANIUM everywhere—and thousands of people just like YOU are making fortunes finding it! Get your share of big Govt. payoffs—by finding URANIUM all you need is a good uranium detector. Radiac Co., the largest supplier of Strategic Metal & Mineral Detectors in the U. S. features a complete line of URANIUM prospecting equipment from \$25 to \$500! Radiac instruments are GUARANTEED to indicate presence of any uranium within detection range!



**THE SOURDOUGH**

ONLY \$35 F.O.B. N. Y.

**NOW A LOW-PRICED GENUINE GEIGER COUNTER!**

Write today for FREE descriptive brochures. We ship via the U.S. Airmail Express Company, and now you can have your prospecting equipment from the same source. **THE RADIAC CO., Inc.** Dept. PM-2, 489 Fifth Ave., New York 17, N. Y.

## AMAZING NEW TINY RADIO

Really Works—Small as a Pack of Cigarettes!



GETS LOCAL RADIO STATIONS WITH CLEAR BELL-LIKE TONE—NO STATIC OR INTERFERENCE! NEEDS NO TUBES, BATTERIES OR COMPLICATED HOODS! NO AC PLUG! INS! NOTHING TO WEAR OUT. Thousands of users—many report years of service. Uses new crystal diode and HI-Q coil. SELF-CONTAINED SPEAKER PHONE. Just the tiny radio to take with you ANYWHERE YOU GO—ON TRIPS, VISITING, ETC.—for real fun and enjoyment—ANYTIME. Merely hook to anything that can get an antenna for local reception. Free 1X antenna kit included. **SEND ONLY \$1.00** (bill, ck., mo.) and pay postman \$3.00 C.O.D. Postage of send \$4.00 for a.p.d. delivery. COMPLETE READY TO LISTEN. **MIDWAY CO., Dept. PPM-6, Kearney, Nebr.**

### No Leak Lamp

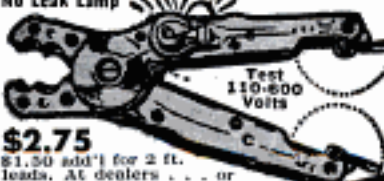

Test 110-600 Volts

**\$2.75**  
\$1.50 add'l for 2 ft. leads. At dealers... or order direct from us. Mailed POSTPAID

**STAR TEST-PLIERS**

**STAR FUSE CO., 233 Canal St., New York 13, N. Y.**

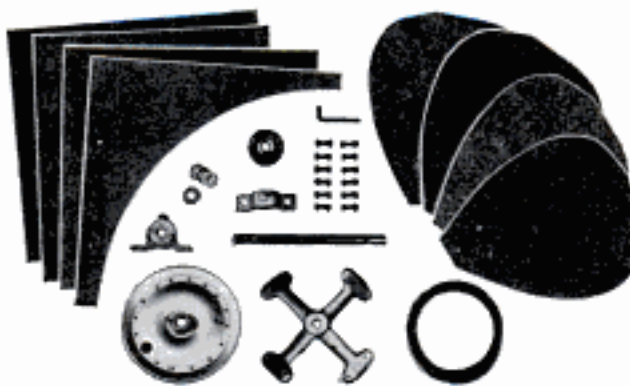

**HUGE SAVINGS! ASSEMBLE YOUR OWN FANS!**

## 30" Window Fan \$15

We supply all precision parts shown (includes baffle cut in 4 sections for easy packaging), along with easy-to-follow instructions. Anyone including women can assemble these fans. You save up to 75%. A great idea especially if you need several fans. Also you can assemble in your spare time and earn extra income selling them. S. J. STEWART [ELECTRIC], in business for over 56 years, guarantees every precision part to be of fine quality, giving you a fan of long, silent, trouble-free operation.

Sold with money-back guarantee. Free circular.

**30" BLADE SIZE \$15**  
(24" \$14.25) delivered—Transportation prepaid if cash accompanies order.

**S. J. STEWART [ELECTRIC]**  
527 St. Joseph Street New Orleans, La.

## START YOUR OWN SHARPENING BUSINESS

WITH THE New All-In-One Ball-Bearing Sharpener.



Sharpens all makes pinking shears, scissors, knives, etc. Does a perfect job unmatched by other sharpeners. Easy to operate. The machine of many uses. Order today or write for full details.

**\$69.50**  
Less Motor

F.O.B. PASADENA

**TURPIN-JONES CO., Box 1109, Pasadena 1, California**

## For Greater ENGINE PERFORMANCE USE Colgra Superfilm



**COLGRA** (since 1909) gives plated lubrication, and frees sticking valves, reduces engine wear and unlocks added power, performance and gas mileage. Use this additive in crankcase and gas tank and thrill to a new motoring performance. If your service station cannot supply you, send \$1.50 for an 18 oz. trial can.

**DISTRIBUTORS WANTED:** Many choice territories available. Write for information about this splendid business opportunity.

**COLGRA OIL CO.**  
3814 Willet Ave., Culver City, Calif.

USE **LUBRIPLATE**  
 MAKES BIKES RUN DANDY  
 STOPS SQUEAKS—STOPS RUST  
 IT'S CLEAN AND HANDY



**TRY LUBRIPLATE!** It's a new, white and clean, semi-fluid lubricant that stays put. Tops for sprockets and bearings. Rain won't wash it away.

• In handy 35¢ and 95¢ tubes at hardware, sporting goods and auto supply stores.

• Dealers write to LUBRIPLATE DIVISION, Fiske Bros. Refining Co., Newark 5, N.J.

**LUBRIPLATE**  
 THE MODERN LUBRICANT

looks cooler—  
 is cooler!



AIR CONDITIONED  
**VIKING**

R. S. HERBERT CO., INC., 103 LAFAYETTE ST., N. Y. 13

Say You Saw It in Popular Mechanics

**DIAL YOUR JOB**  
 WITH NEW



Exclusive new Speed Dial automatically selects the right speed for any job. Infinitely variable settings from 700 to 5200 rpm. SHOPSMITH® comes complete—\$289.50. Write for free catalog. MAGNA ENGINEERING CORP., Dept. 282-B, 12819 Colt Rd., Cleveland 8, Ohio, or Menlo Park, Calif. \*T.M. Reg.

*Attention* **HEAVY DUTY MECHANICS**  
 Improve Your Tool Chests



Includes: One 1 1/4" by 1 1/2" open end wrench—One 7" heavy duty screwdriver to fit Phillips Screws. One Carbon Scraper for cylinder heads and blocks, and one surprise tool. All for \$3.95 postage paid. All are Army surplus items—they are the best brand named tools. It is a bargain if you can use them. **\$3.95**

A \$7.00 value—All for...  
 Delivered to your door anywhere in the U. S.  
**TERRA CO., 311 W. First St., Cle Elum, Washington**

JUNE 1955

Step into the **BOOM**  
 of Building, Remodeling!

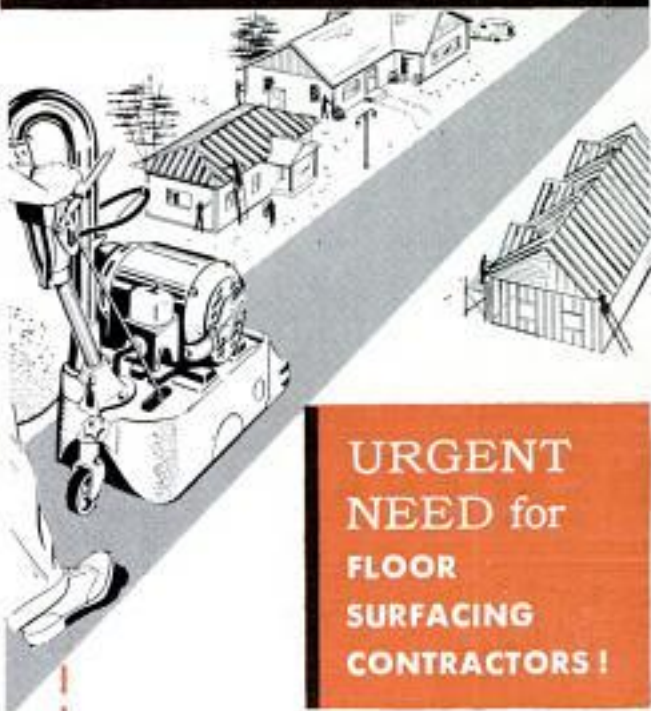

**URGENT**  
 NEED for  
 FLOOR  
 SURFACING  
 CONTRACTORS!

Be Own Boss—BIG Earnings!

Look down any street at all the new homes going up, remodeling and construction of all kinds being done! All around you are new floors to be finished; old worn floors to be re-surfaced! Never before was the opportunity so great for you to quickly establish yourself in a fine business that pays you well . . . sanding floors with an easy-to-run American machine. Many earn \$50 a day and more. Age no barrier—men from 18 to 80, even with physical handicaps, enjoy this pleasant year 'round work. No schooling, no special talent or skills required. Only small investment in sander gets you started in a business that has brought financial security and happiness to thousands! Send today for "money-making booklet".

SEND FOR . . .



THE **AMERICAN**  
 FLOOR SURFACING MACHINE CO.

The American Floor Surfacing Machine Co.  
 535 So. St. Clair St., Toledo 3, Ohio

Here is 25c in stamps or coin for booklet "Opportunities in Floor Surfacing", telling me how I can start my own floor sanding business.

Name.....

Street.....

City..... State.....

## BUILD YOUR OWN AUTOMATIC PORTABLE SPRAYER AND SAVE

1/2 or 1 H.P. Quincy 3 CFM Compressor & pulley . . . \$20.50  
 1/4 or 1 H.P. Quincy 9 CFM Twin Cylinder Comp. . . \$52.00  
 Tank 6 x 20 Wheels Platform handle Welded . . . \$12.00  
 Tank 12 x 24 Stainless on Wheels 500- tested . . . \$27.00  
 Tank 15 x 30 Wheels Platform handle Welded . . . \$34.50  
 1/2 H.P. A.C. Motor 110 V. Cap. 1725 R.P.M. . . . \$24.50  
 1 H.P. A.C. Motor 110/220 Cap. 1725 R.P.M. . . . \$45.00  
 Automatic Adjustable Pressure Switch . . . \$ 6.50  
 Adjustable Pressure Regulator and Gauge . . . \$ 6.00  
 Hose and Tire Chuck . . . \$ 2.50  
 Safety Valve . . . \$ 1.50  
 Check Valve . . . \$ 3.75

• ORDER FROM THIS AD • All Prices F.O.S. Chicago

•K-3 Paint Sprayer 1/2 H.P. AC Motor, 6x20 Tank on Wheels—Quincy 3 CFM Compressor, Hose & Gun . . . \$57.50  
 ONLY  
 •K-55 Complete Automatic Spray Unit, Knocked Down 1/2 H.P. A.C. Motor, Quincy Compressor, 12 x 24 Stainless Steel Tank on Wheels, All Accessories, FREE Qt. Spray Gun, SPECIAL . . . \$97.00  
 •SK-100 1 H.P. A.C. Motor, 15 x 30 Tank Twin Cylinder, 9 CFM, Quincy Compressor, All Accessories, You Assemble, FREE Qt. Spray Gun . . . \$169.50  
 ONLY



ALL ORDERS SHIPPED PROMPTLY  
 Write For FREE Catalog: Listing Motors, Compressors: ALL SIZES.

C. MARSHALL SALES, 3546 W. Fullerton Av., Dept. P-6, CHICAGO 47

## • New BUILD-IT-YOURSELF Window Fan Kit 20, 24 & 30" Blade Fan Part Kits, less frame

These FAN KITS provide low cost, high efficiency belt driven fans, for COOLING nature's way. Dynamically balanced, highly polished, completely assembled Aluminum Blade, Rubber Mounted Bearings, 5/8" Shaft Collars, Motor & Fan Pulleys & Belt. Instructions included in factory packed carton. Choice of 1 speed 1/2 H.P. Westinghouse 1725 RPM rubber mounted Motor, Cord & Plug or 1/4 H.P. Westinghouse 2 speed 1725/1140 RPM rubber mounted Motor & two speed Switch, Cord & Plug.

•FK-301-6000 CFM 20" Blade & Complete Kit . . . \$13.95

•FK-304-8000 CFM 24" Blade & Complete Kit . . . \$15.95

•FK-307-10000 CFM 30" Blade & Complete Kit . . . \$19.95

Easily Assembled

•W-1 Westinghouse 1/2 H.P. 110V-60 cy. Motor 1 speed, Rubber Mounted, 1725 RPM . . . \$15.95

•W-2 Westinghouse 1/4 H.P. 110V-60 cy. Motor 2 speed, 1725/1140 RPM & 2 speed Switch . . . \$25.75

FOR Chgo., 1 YEAR FACTORY GUARANTEE  
 Send for U-BUILD-IT LITERATURE, WATER PUMPS, SUMP PUMPS, SHALLOW-WELL PUMPS, LAWN SPRINKLERS, ETC.



## HELPFUL BOOKS

Send post card asking for FREE catalog

Popular Mechanics Press, 200 E. Ontario, Dept. 601, Chicago 11



### Safe . . . Practical . . . Economical! CATAMARANS

A boat the whole family will enjoy! Double pontoons . . . almost impossible to sink. 8, 10 or 12 ft. sailboats—plus runabouts for the outboard fan! Prices start at \$139.50. Larger models to \$449.50. Custom built up to 80 ft. Write for FREE literature and complete price list.

DOLPHIN MARINE CO.  
 P.O. BOX 66, DAYTONA BEACH, FLA.

## FREE AMAZING NEW BOOK "HOW TO ANSWER ADS"



Never before have you seen anything like this. Tells you in simple language the correct way to answer ads. Gets you quicker replies—better results, and greater satisfaction. Will save you time and money and it's ABSOLUTELY FREE. No obligation whatever. Every reader of advertising should have this booklet. Send a postcard for your copy NOW. F. W. Johnson, Popular Mechanics Magazine, Room 600-A, 204 East Ontario Street, Chicago 11, Illinois.

## BUILD Your Own GARAGE



### Save Up to 50% of Usual Cost!

Build your own garage and save! Wayne Leckey, Popular Mechanics Assistant Shop Notes Editor, tells and shows how in his new book *How to Build Your Own Garage*.

### No Previous Building Experience Required

If you can use a hammer and a saw you can build your own garage. Leckey tells how in simple step-by-step instructions and shows how in big, clear photos, drawings and diagrams. Everything is covered from the laying of the foundation right up to and including applying the final trim.

### 25 Designs—Brick, Frame and Concrete Block Construction. Complete Building Data

There are 25 different designs from which you may choose. Brick, frame and concrete block construction is fully covered. Leckey tells and shows how to pour the foundation, erect the framework, erect the roof, apply insulation and shingles, lay the driveway, install trim, flower boxes, etc. It's all there for you to read and see.

### 7-Day Money Back Guarantee

Get your copy of this valuable book today. Read and use it for seven days and if it isn't entirely satisfactory return it for a full refund. Send only \$3.50 for your copy to Dept. 90 POPULAR MECHANICS PRESS 200 E. Ontario, Chicago 11, Ill.

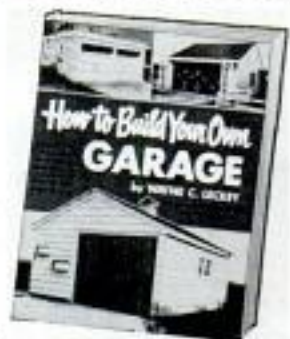

## For Father's Day, GIVE the Perfect Gift for Perfect Finishes—a

### DREMEL STRAIGHT-LINE-ACTION SANDER



MODEL "53" New heavy-duty sander with powerful ROTARY MOTOR. Weighs only 5 1/4 lbs., has 24 sq. in. pad. Can be used for rough and finish sanding. Complete with 2 detachable pads, 6 abrasive sheets. . . . \$34.85

Write for FREE catalog

Finishing experts agree—and tests prove—only straight-line-action sanding is free of orbital swirls and gouges. Be sure of perfect finishes! Insist on DREMEL with-the-grain sanders. Choose from three unbeatable models.



MODEL "2000" Perfect for small shop and home use. High speed motor produces 14,400 strokes per minute; Wt. 5 lbs.; 21 sq. in. sanding surface. Price including steel carrying case, polishing pad, 6 abrasives. . . . \$24.50



SEE YOUR DEALER. If he cannot supply, order direct on 7-day trial, money-back guarantee. Remit in full for postpaid shipment. Or send \$2. pay postman balance plus C.O.D. fee.



MODEL "A" Wt. 2 1/2 lbs.; 12 sq. in. sanding surface, 14,400 strokes per min. Complete with polishing pad, massage pad, 6 abrasives. . . . \$14.85

DREMEL MFG. CO., Dept. 115-F, Racine, Wisconsin



500

**POWER!** 50 — 100 — 300 — 500X

Our new quad turret microscope is the most powerful ever placed on the market at this low price. Brilliant optics, four precision optically-ground glass objective lenses, plus optically-ground glass ocular lens (eyepiece). An amazingly versatile, precision-built instrument. It is already a popular favorite in schools and colleges throughout the country. Covered by a money-back guarantee, it is shipped to you postpaid with slides, fitted hardwood cabinet and manual...

**\$14.95**  
postpaid

**FREE**

Just published! The new '55 catalog of the most outstanding microscopes and accessories ever offered anywhere at such low factory-to-you prices. Included with your order or — write for your free copy today!

10-Day Money-Back Guarantee. Send check or money order. 1/3 deposit on C.O.D. California resident add 3% state tax.

**PRECISION OPTICAL CO.**

14 Precision Bldg., 4379 Sunset Blvd., Los Angeles 29, Calif.



Whenever you're painting, you need **SAVOGRAN** PRODUCTS ... at better paint & hardware stores

Write for free helpful literature

SAVOGRAN CO., Dept. 75, 25 Huntington Ave., Boston, Mass.

**WIN up to \$1,000 worth of DELTA Tools in Delta Users' "Finest Home Workshop" Contest!**

Write today for entry blank to: Contest, Delta Power Tool Div., Rockwell Manufacturing Co., 503-F N. Lexington Ave., Pittsburgh 8, Pa. Contest closes July 15, 1955.

**SAVE MONEY ON U.S. GOV'T SURPLUS**

Save money. Buy surplus from government. These are a sample of the savings that can be made. Life boat \$13.10, Machine Grinder \$4.89, Shaper \$15.00, Drafting \$10.00, Dump truck \$76.77, Semi trailer \$60.00, Tractor \$75.00, Typewriter \$7.51, Freezer \$50.00, Spray painter \$15.25, Motor \$4.05. Hundreds of other items put up for sale by US Government each month and may be purchased at tremendous savings through our Bulletin "Surplus Sales." Price \$1.00.

THE ABACUS PRESS, Box 169DDD, Dept. 5, East Htfd. 8, Conn.

**DO IT YOURSELF!**

Save Time and Money with the "NEW HOME SERVICE TESTER"

No more waiting for TV and Radio service... eliminate electrical and other repair bills... Now you can test all radio and TV tubes... Now you can check home appliance shorts and broken wires... Now you can test light bulbs and fuses.

You do all this yourself with the "NEW HOME SERVICE TESTER." Complete with easy instructions — SAVE MONEY — AND, have fun, too. ORDER TODAY!

**\$4.95**

E.A.

POSTPAID



Lindaily Products 2626 W. 103rd Pl., Dept. MP-6  
Chicago 43, Ill.

**YOU SAVE FIVE WAYS WITH THIS GREAT ALL-ALUMINUM SWING-UP GARAGE DOOR**

1. assemble & install yourself
2. buy factory-direct
3. needs no paint
4. no maintenance cost
5. lasting strength



**BACK VIEW:** note heavy V-brace which prevents twist, warp or sag.



**INSTALLED:** dent-resistant "Monocoque" face gives durable strength.

DO-IT-DOR will beautify your garage and home. Designed by aircraft engineers. Only 7 parts to assemble. Aircraft speed nuts make rigid strength equal to riveting. Illustrated instructions for easy assembly & installation. Fool-proof color system for matching parts. No holes to drill. Anyone can do it with ordinary tools.

Protect children against falling heavy doors. Light weight DO-IT-DOR has floating action—cushioned stop. When open it STAYS UP! Occasional wash with garden hose keeps rust proof aluminum shiny new.

**CHOICE OF EITHER TRACK OR JAMB PRECISION-ENGINEERED HARDWARE**



**JAMB:** provides canopy when open. Hardware fastens to door jamb. Saves space. Tension and leverage adjustable for smooth, easy operation. No slam.



**TRACK:** recedes door fully into garage. Four-point suspension. Self-adjusting rollers never stick. Weatherstripped. Keyed, center locking handle.

DOOR SIZES TO FIT THESE STANDARD OPENINGS*		MINIMUM OVERHEAD CLEARANCE REQUIRED		COMPLETE PRICE INCLUDE HARDWARE & PREPAID FREIGHT TO ANY CITY IN U.S.A.	
WIDTH	HEIGHT	JAMB	TRACK	JAMB	TRACK
8'	7'	1"	4"	\$62.90	\$67.90
9' JUMBO SINGLE	7'	1"	4"	\$69.90	\$74.90
16' 1-PIECE DOUBLE	7'	1"	4"	\$110.30	\$117.30

\*you can easily saw face panels before assembly to fit non-standard opening widths

**MONEY BACK SATISFACTION GUARANTEED**

**PURCHASE ORDER TO:** Stevens-Thuet Company  
40 Atlantic Ave., Long Beach 2, California

Ship immediately one DO-IT-DOR as follows:  
garage opening size:  8' x 7'  9' x 7'  16' x 7';  
hardware type:  jamb  track  
Enclosed is my  check  money order for \$ \_\_\_\_\_  
covering full cost including freight. (No C.O.D.)

NAME \_\_\_\_\_

ADDRESS \_\_\_\_\_

CITY \_\_\_\_\_

STATE \_\_\_\_\_

THE STEVENS-THUET "ALUMI-DOOR" IS SPECIFIED FOR ARMY, NAVY AND GOVT. AGENCIES. SPANS OPENINGS TO 60' WIDE WITHOUT POSTS. ECONOMICAL FOR BARN, COMMERCIAL OR INDUSTRIAL DOORS. WRITE FOR LITERATURE OR ESTIMATE.



**BETTER PERFORMANCE  
IN ALL KINDS OF WEATHER**

Whether it is 100 in the shade or 30 below zero, your car will start quicker and run better with a Bendix\* Electric Fuel Pump. It's easy to install and costs less per mile of operation than any electric fuel pump on the market. Sold by independent garages and service stations.



**FREE:** A descriptive folder is yours for the asking. Write today.

**Bendix**

**ELECTRIC FUEL PUMP**

Grand Prix Winner

ECLIPSE MACHINE DIVISION, BENDIX AVIATION CORP.,  
ELMIRA, N. Y.

now! make your own  
**ALUMINUM  
SCREENS**  
IN **5**  
simple  
steps

Save Money and Work with  
**HOMESHIELD®**  
Easy-to-Make **SCREEN KITS**

- ★ Anyone can make these screens in minutes—No special tools! Saves money—adds beauty!
  - ★ ALUMINUM full-frames never need painting!
  - ★ Rustfree & Light—Saves back-breaking work!
  - ★ Easy-to-handle FIBERGLAS\* screening can't rust, corrode or stain!
  - ★ Kits for full & half-screens—complete with installation hardware & a handy miter box!
- See your hardware or building materials dealer today or write Dept. KF-4 for FREE literature.



**AMERICAN SCREEN PRODUCTS CO.**

GENERAL OFFICES: 807 N.W. 20th St., Miami, Fla.  
Factories: California, Texas, Illinois, Indiana, Florida

**FILE SAWS THE RIGHT WAY**

**SUPER SAW FILER NO. 6**

**IT'S NEW!** and so simple you can file a saw blindfolded!

**Automatically controls  
DEPTH—ANGLE—PITCH**

Perfect bevel and angle maintained, and fool-proof depth control for all Rip, Crosscut, and Handsaws. Precision made and calibrated for instant setting at desired angle. Can be used in any vise or clamp. Complete with file, only **\$6.50ppd.**



**Automatic  
DEPTH CONTROL  
Rollers**

**SAVE TIME  
AND \$\$\$**



**JOINT & SHARPEN CIRCULAR SAWS**

Sensational new Super Filer No. 11 joints and sharpens both hand and circular saws 6" to 10" with all teeth the correct height, depth, pitch and bevel. Easy to use—when file hits hardened steel roller, teeth are finished. Saw runs true and smooth with no side pull. Complete with special 8" file \$9.95 ppd. "TRU-CIRCLE" saw set automatically sets teeth at 10° or more \$2.95.

**AT DEALERS  
OR POSTPAID**

SEND FOR FREE CATALOG

Guaranteed

A. D. McBURNEY, 5908 Hollywood Blvd., Hollywood 28, Cal., Dept. A-65

**PUMP FASTER with a HYDRO-JET!**

Made of aircraft grade aluminum alloy, this rugged #10 centrifugal pumps up to 4500 G.P.H. Ideal for irrigating, draining, filling, spraying. Uses 1 1/2 to 3 H.P. motor. Rustproof 1/2" shaft, oil-less bearing. 1/2" suction, 1/2" discharge, std. pipe threads, adaptable to garden hose **\$8.95**

Heavy-Duty HYDRO-JET #20 fills and empties pools, ponds, etc. Extra powerful up to 8000 G.P.H. Use 1/2 to 3 H.P. motor. Rugged, rustproof 1/2" shaft, oil-less bearing. 1 1/4" suction, 1" discharge, std. threads **\$11.95**

Prepaid if cash with order. Send Check or M. O. \$2 deposit if C.O.D. Money-back guarantee

DEL-VAL PRODUCTS, Dept. M, Albany Ave., Westmont, N.J.



**MAGNETS**

ASSORTED MAGNETS with big list of handy uses.....5 for \$1  
POWERFUL POCKET MAGNET ideal for testing metals.....\$1  
RETRIEVING MAGNET pulls tools, etc., from tank or lake.....\$4  
HOT PAD MAGNETS to insert in your own hot pads.....8 for \$1  
BULLETIN BOARD MAGNETS to "pin-up" memos, etc.....8 for \$1  
SLENDER MAGNETS remove chips from drill holes.....2 for \$1  
Write for free booklet including heavy retrieving magnets. 100% satisfaction guaranteed.....POSTPAID  
PARK MAGNETS, 256, 1557 GREENBAY RD., HIGHLAND PARK, ILL.

Also Adult  
Eshelman  
2 Passenger  
Sport Cars  
**1/5** The  
Price  
of any  
other Auto  
70 Miles  
Per Gal.  
Free Catalog.

**ESHELMAN**

RAKES  
PLOWS  
CULTIVATES  
HARROWS  
HAULS  
SPRAYS  
SAWS  
DOZERS  
MOWS  
CUTS  
ROLLS  
TILLS  
SNOW  
FLOW

Rotary  
Tillers  
Riding Mowers  
Tractors  
Low As **\$69**

FOR **LAWNS  
And GARDENS**

Women can operate it.  
1 to 8 H.P.

Shipping Points:  
**BALTO.,  
CHICAGO, RENO**

Free Catalog Write:  
**ESHELMAN CO., Dept. R-58**  
109 Light St.,  
Balto., Md.

**NEW** Magnetic Holder Keeps  
Tools in Place

World's handiest way to hold tools neatly in place, within easy reach. Natural hardwood finish with permanently magnetized steel bars. Get one for your workshop, tool shed, paneled kitchen, rampus room. Comes in three convenient lengths. (Can be cut with hacksaw to fit exact space, if desired.)

24-in. Magnabar only \$5.25;  
18-inch, \$4.25; 12-inch, \$3.25.

If your regular hardware or housewares store does not carry them, send check or money order direct to



**MAGNABAR®**

71 Maple Street  
East Longmeadow, Mass.

POPULAR MECHANICS

**HURRY!**  
While they last!



Brand New Government Surplus  
**SLEEPING BAGS**

100% VIRGIN WOOL ZIPPER LINER

ONLY **\$5<sup>95</sup>** POSTPAID

SAVE \$15.55! But act now! At the low price of only \$5.95 — actually less than 1/3 the Gov't's original cost of \$21.50 — these top-quality sleeping bags are bargains that are bound to sell fast!

Made to U.S. Government design and rigid specifications. Will last a lifetime. Water repellent cover. Heavy duty zipper. Wool-lined hood keeps head and ears warm. Plenty of room for the huskiest 6-footer-plus. Don't risk disappointment.

Send check or Money Order  
**TODAY!**  
SATISFACTION GUARANTEED  
Or Money Back!

**K & F TRADING  
COMPANY**  
3249 E. McDowell Rd.  
Phoenix, Arizona



AMAZING NEW FORMULA  
**SPRAY-O-NAMEL**  
THE ORIGINAL  
BRUSHLESS PAINT!

**EASIEST WAY TO PAINT  
LIKE A PROFESSIONAL!**

Here's the handiest paint a handyman can use for re-finishing or re-touching . . . indoors or out! No fuss, no mess, no brush — just press a lever and spray. **SPRAY-O-NAMEL**, the proven brushless paint, is foolproof. Won't run, won't bubble. Dries to a smooth, durable finish in 5 minutes. "Not an ounce of work in a 12-oz can!"

**LARGEST SELECTION OF COLORS**

Including: Chrome Aluminum, Golden Lustre, Coppertone, Battleship Grey, Garden Green, Canary Yellow, Medium Blue, Ivory, Pink, Chartreuse, Orchid, Sky Blue, Orange, Chinese Red, Wrought Iron Black, Dove or Maytag Grey, Dearborn Blue, Hollywood Tan, Burgundy Maroon, Ridge Green, Gloss White, Gloss Black, Appliance White, Flat White, Clear Plastic Zinc Chromate — and matched farm implement colors.

**Special Introductory Offer** to Popular Mechanics readers. Regular \$1.69 price at your dealer now only \$1.25 if you order from this ad. Limit: 1 per customer. Specify color. Order today from Dept. PM.

Send Check or M.O.



ILLINOIS BRONZE POWDER CO., Inc.  
2023 S. Clark St., Chicago 16, Ill.

*Just Off  
the Press!*

**TOOL CATALOG**



YOUR NAME

**Mammoth  
1955 Wholesale  
Tool Catalog**

The opportunity now awaits you to own and operate your own business on a part time or full time basis in the lucrative field of **HARDWARE, HAND TOOLS, FANS, POWER TOOLS, MOTORS, PAINTS, etc.,** or **BUY TOOLS FOR YOUR INDUSTRIAL OR INSTITUTIONAL USES.**



Buy Nationally Advertised Tools for Resale or Industrial or Institutional Use  
**NO INVESTMENT REQUIRED, BUY AS YOU NEED IT. A MILLION DOLLAR INVENTORY AT YOUR FINGER TIPS.**

*Discount*  
**UP TO 50%**

\$1.00 refund on first purchase or refund if you are not 100% satisfied.



Every one needs tools. Meet the demands of the growing "Do-it Yourself" markets. Sell direct from the jumbo buying guide—your cost is known only to you.

**JUST FILL OUT  
COUPON**

ENCLOSE \$1.00 FOR DEALERS CARD & 1955 MAMMOTH TOOL CATALOG.

**SILVO HARDWARE COMPANY**

Dept. PM-6, 108 Market St., Philadelphia 6, Pa.

I am enclosing \$1.00. Rush me your dealer's card and big Catalog Today. If I am not completely satisfied with your plan, I understand that I can return the Dealer's Card and Catalog for refund, and if I decide to order, my \$1.00 will be deductible from my first order.

NAME .....

ADDRESS .....

CITY ..... ZONE ..... STATE .....

**"I'm set up"**

says the Hollingshead Service Center



Drive in where you see this display stand set up! It identifies service stations best equipped to solve car-care problems like radiator leaks.



INSTANT SEALER 75¢

**Hollingshead**  
CAMDEN 2, NEW JERSEY



**AMAZING NEW TRIP CONTROL\* LETS YOU ADJUST LAWN SPRAY FOR FULL OR PART CIRCLE COVERAGE!**

**RAIN BIRD Full or Part-Circle Sprinkler**

KEEPS HOUSE, WALKS, PATIO DRY ...while covering every area of lawn or garden!

Now, with the flick of a finger, you can limit spray coverage to any fraction of full circular rotation. Simple adjustment lets you sprinkle everywhere you wish, only where you wish! Eliminates unwatered "dry spots." Can be adjusted while sprinkling, without wetting you. Here's the same thorough rainlike spray that's made RAIN BIRD famous for over 20 years.



Only \$8.95 complete ... \$6.45 without base. Now at your nursery or hardware store.

\*New RAIN BIRD Trip Control adjusts to cover all or only a part—any part—of usual full spray rotation. Easy to adjust.

Write for Free Illustrated Catalog FP to:  
**RAINY SPRINKLER SALES** 609 W. Lake Street, Peoria 5, Illinois  
**NATIONAL RAIN BIRD SALES & ENGINEERING CORP.**  
P. O. Box 547 • Azusa, Calif.

**MAKE WATER HEATERS LAST YEARS LONGER**

WITH THE AMAZING NEW

**McRAY ZINC ANODE**

Made of zinc and copper on stainless steel core. Anode actually "zinc plates" inner surface of tank and adds years to life.

**NOW ADOPTED BY MANY WATER HEATER MFGRS.**

ASK YOUR PLUMBER OR ORDER DIRECT

For Gas,	20-30 gal. tank No. PD30.	\$4.85 ea.
Oil,	To 40 gal. tank No. PD40.	5.80 ea.
Electric LP Gas	To 60 gal. tank No. PD60.	7.15 ea.

POSTAGE PAID



Easily Installed Insert in hot water outlet nipple. DO IT YOURSELF or ask your plumber. Send for literature.

**SATISFACTION GUARANTEED OR MONEY BACK**

Also McRay Protecto Rods for Auto Radiators \$2 ea.

**McRAY PRODUCTS OF CALIFORNIA**

6806 MELROSE AV., LOS ANGELES 38, CAL.

**MAKE UP TO \$5 AN HOUR WITH**

**EASISHARP**



Big profits in your spare time sharpening scissors. We show you how to start making money immediately. This is your chance now to have your own business and a steady income. Sharpen a pair of scissors in less than two minutes. A child can operate it. Weighs only 10 lbs. Every home, barber, tailor, dressmaker—everybody uses scissors and all need sharpening two to four times a year. Don't let some one else beat you to this opportunity. Write immediately to:

**MONEY MAKING SALES PLAN FREE**

**SERR-EDGE MACHINE CO., 9731 Lorain Ave., Cleveland, Ohio**

**Say You Saw It in Popular Mechanics**

**NON-MAGNETIC DRIV-RITE**

**AMAZING NEW SCREWDRIVER**



2 Magic-Discs Non-magnetic Rustproof

8" long Can't Roll Hexagon handle

Revolutionary Magic-Discs make any job incredibly easy—grip screw head firmly, apply pressure to head of screw, not the slot—hold until operation is completed. Handles No. 4 to No. 14 screws. Fully insulated plastic handle. Magic Discs are hard steel, permanently sharp. Adjustable sleeve spring operated.

**\$2.50** (Sold on money-back basis.)

**A O & S PRODUCTS CO.**

Dept. PM-655, 4424 W. ARMITAGE AVE. CHICAGO 39, ILLINOIS

**WHAT! ANOTHER "GIMMICK"?**

No Sir!...It's a practical and mighty useful tool — the new **PROTO ALL-ANGLE DRILL** — a "must" for mechanics and hobbyists.



Check is adjustable over 270° arc.

Handle moves in 180° arc of right angle to chuck.

Not only one of the best straight drills on the market—the new **PROTO ALL-ANGLE DRILL** is a real "must" for your tough drilling problems. 1/2" chuck capacity with long storage space in handle for your high speed drills. **DON'T MISS THIS!**

Order No. 370 ALL-ANGLE DRILL at \$4.95

For prompt **PREPAID** delivery, send check or money order to **JAY-BEE SALES CO., 3304 North San Fernando Blvd., Burbank, Calif.** Send 10¢ for 68-page **PROTO TOOL CATALOG** — or no charge on request with your order.

# SAVE ON PALLEY SPECIAL VALUES

## CENTRIFUGAL PUMP AND MOTOR



**9.95**  
200¢ VALUE  
DELIVERS up to  
700 G.P.H.

For draining cellars, fish ponds, sumps, water circulators, etc. Powered by the famous G.E. 110 volt, 60 cycle motor. Has 3" standard pipe inlet, 3/4 inch I.D. hose outlet, A Gov't Surplus Bargain. Completely Reconditioned. Motor is re-wound and checked for serviceability. Ready to run. Your satisfaction fully guaranteed.

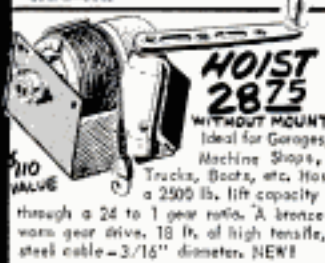

**HOIST 28.75**  
WITHOUT MOUNT  
Ideal for Garages,  
Machine Shops,  
Trucks, Boats, etc. Has  
a 2500 lb. lift capacity  
through a 24 to 1 gear ratio. A bronze  
worm gear drive, 18 ft. of high tensile,  
steel cable - 3/16" diameter. NEW!

**WINCH HOIST** - Same as above  
with a free-spool, pull-out clutch. **29.75**

**HOIST MOUNTING FRAME**  
Specially designed for above  
winches. Allows easy universal  
mounting. Price of Frame Only **4.50**

## ARMY PORTABLE WINCH HOIST



**LIFTS 1500 POUNDS**  
Made for U.S. Army Bureau  
of Ordnance as a Bomb  
Hoist. Has a 21 to 1 gear ratio, 40"  
tubular arm extension with a 3" pulley  
at the end. Drum has 12 ft. of 3/16",  
high tensile strength steel cable. The  
operating handle has a ratchet brake  
ideal for "swing about",  
truck or platform loading. **22.50**  
A \$125.00 Surplus Value.



**PESCO HYDRAULIC PUMP**  
Only **14.95**

A gear type pump. Will  
deliver 2 gal. per min. at  
1500 RPM with 1500 PSI. Delivers 6 gal.  
per min. at 4300 RPM with 1500 PSI.  
Has .375 cu. in. displacement per rev.  
3/4" standard pipe ports. 3/8" valve  
spline drive shaft. 4" pulley mount.



**AIR ASSOC. TEST70MI HYDRAULIC TEST STAND**  
COST GOVT. APPROX. \$6000

Electric motor driven type. Has 2500 PSI  
Hydro Pump which delivers up to 10GPM.  
Powered by 15 HP, 3 phase motor which  
operates on 220-440 V, 60 cycle current.  
Unit has selector valves, pressure gauges,  
flow meter, reservoir, heat exchanger and  
filter pressure regulator. Mounted on steel  
frame. Has work bench, fluorescent lights  
and hand operated, high pressure TEST70  
pump for high pressure testing. **\$1495**

**TEST70MI TEST STAND** - Same as  
above with a Reeves, variable speed re-  
ducer to control pump output. **\$1895**

NOTE: Send for Catalog of our entire stock  
of Hydraulic Cylinders, Valves, Pumps,  
Motors, Tubing, Fittings, etc. Save NOW!



## ARMY RIFLESCOPE AND SPECIAL MOUNT

A top quality Rifle Scope, built to rigid  
Gov't specifications - plus our own spe-  
cially designed Mount. The Rifle Scope  
contains the finest, precision achromatic  
optics. Five double element lenses -  
fully corrected for spherical aberration  
and color. Has full 3-power magnification.  
Dot reticle. The newly developed Palley  
Scope Mount may be used with any type  
rifle. Has adjustments for windage and  
elevation. Will allow you to remove scope  
from mount for carrying or storage, and in  
addition you can remove the scope with-  
out disturbing your pre-set windage &  
elevation settings. Made of  
hardened alloy steel. **9.95**  
Price for Scope alone ONLY

**MOUNT ALONE (without scope) 15.00**  
Scope and Mount, BOTH **24.50**



**180° OFFSET DRIVE**  
For use where  
tremendous power at  
low take-off RPM is desired.  
6 gears rotate on self-lubri-  
cating, hi-speed roller bearings.  
85 to 1 gear ratio. Shafts are  
1 1/2" & 3/8" dia. All NEW **12.95**  
NEW

## IN STOCK AGAIN VICKERS HYD. TRANSMISSION

ball-contained, con-  
stant torque at all  
speeds with variable  
volume, reversible piston pump which  
supplies piston hydraulic motor. Has  
2 H.P. Automatic pressure dash pot  
for smooth control. Power output RPM  
= 0 to 1/3 input RPM in both directions.  
Input RPM 1500 continuous, 4000 inter-  
mittent. Ideal for Lathes, Dup-  
licator setup on mills, Convey-  
ors, Small Cars, Drives, etc. **NOW 44.50**

**4" SPLINE SHAFTS** for input and  
power take-off on above. Pair \$2.50

**INPUT & TAKE-OFF PLATE ASSEM.**  
To adapt Trans. to pulley drive. Has  
1/2" keyway shaft. **20.00 SET**  
High speed bearings.

## SAVE 50% ON NEW PALLEY HYDRAULIC CYLINDERS



Announcing our own line of HYDRAULIC  
CYLINDERS. Designed to meet the most rigid  
requirements. ALL STEEL with 'O' rings.  
1500 and 3000 PSI. Full stock of replacement  
parts available. We also Custom Build in any  
size to your specs. Write for full details of  
our entire line or see examples below . . .

BORE	STROKE	SHAFT	PSI	PRICE
3"	4"	1-1/8"	1500	\$32.50
4"	5"	1-1/8"	1500	\$37.50
4"	5"	1-1/2"	3000	\$52.50
5"	18"	2"	3000	\$85.00
5"	30"	2"	3000	\$130.00



**4-WAY OPEN CENTER CONTROL VALVE \$21.50**  
Has built-in adjustable relief valve, set at  
1000 PSI. Spring loaded neutral position.  
For use with one double action cylinder as  
shown above. May be mounted in series. Has  
3/4" pipe, inlet & outlet, 1/2" pipe threaded  
cylinder ports. Shipping weight 10 1/2 lbs.

## SURPLUS BARGAIN

No. 29 HYDRAULIC CYLINDER - will  
give 20,000 lbs. thrust using 1500 PSI  
line pressure as delivered from our  
hydraulic pumps. Gives up to 40,000  
lbs. thrust with 3000 PSI. Has 4" bore;  
18" stroke; 30-1/2" long. . . . .  
**USED 29.95 NEW 43.95**



SAVE  
UP TO 50%  
BUY FROM  
IMPORTER

## Genuine Select PHILLIPINE MAHOGANY LUAN PLYWOOD

Ideal For Fine CABINET WORK, FURNITURE,  
Panelling DENS, OFFICES, HOTELS, etc.

Our prices are LESS THAN DOMESTIC PLYWOOD at WHOLE-  
SALE. This selected LUAN MAHOGANY meets the most rigid  
specifications. It is WEATHER and WATER RESISTANT. You'll

be amazed at the beauty of this fine wood. Its rich golden elegance will thrill  
you. Rotary cut for beauty of grain. Both sides sanded and ready to use. Bonded  
with finest resin adhesive. Face side unjointed.

Available in three thicknesses - 3mm (approx. 1/8"),  
4mm and 1/4". ALL orders shipped by Special Truck for  
lowest rates. No order accepted for less than 100 lbs. -  
equal to (2) 3mm sheets, (5) 4mm sheets or (4) 1/4" sheets.

3mm (1/8") x 3 ft. x 8 ft. <b>\$5.90 VALUE</b> <b>1.79 PER SHEET</b> Minimum order 8 sheets	4mm x 4 ft. x 8 ft. <b>\$7.50 VALUE</b> <b>3.89 PER SHEET</b> Min. order 6 sheets	1/4" x 4 ft. x 8 ft. <b>\$9.50 VALUE</b> <b>4.99 PER SHEET</b> Min. order 4 sheets
--	--	---

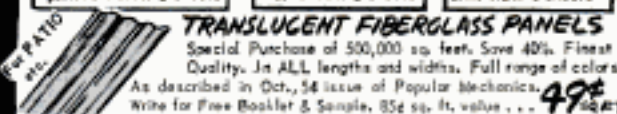

## TRANSLUCENT FIBERGLASS PANELS

Special Purchase of 500,000 sq. feet. Save 40%. Finest  
Quality. In ALL lengths and widths. Full range of colors.  
As described in Oct., 54 issue of Popular Mechanics. **49¢**  
Write for Free Booklet & Sample. 85¢ sq. ft. value . . .

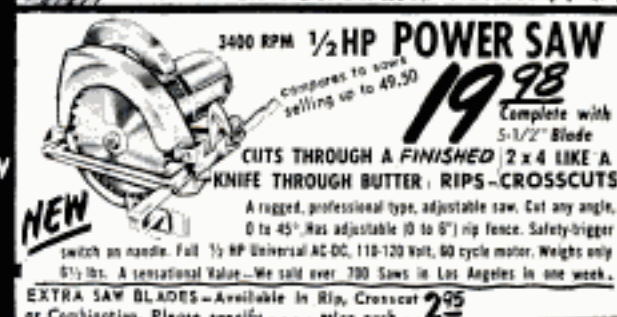

## 3400 RPM 1/2 HP POWER SAW

Compares to saws  
selling up to 49.50  
**19.98**  
Complete with  
5-1/2" Blade

**CUTS THROUGH A FINISHED 2 x 4 LIKE A  
KNIFE THROUGH BUTTER; RIPS - CROSS CUTS**

A rugged, professional type, adjustable saw. Cut any angle,  
0 to 45°. Has adjustable (0 to 6") rip fence. Safety-trigger  
switch on handle. Full 1/2 HP Universal AC DC, 110-120 Volt, 60 cycle motor. Weighs only  
8 1/2 lbs. A sensational Value. We sold over 700 Saws in Los Angeles in one week.

**EXTRA SAW BLADES** - Available in Rip, Crosscut or Combination. Please specify . . . price each . . . **2.95**



## SPORTSMAN'S 12 Pc. IMPORTED COMBINATION KNIFE

Eliminates 12 individual items from  
your Pack or Tool Kit!  
(A \$12.95 VALUE) **4.95**  
**COMPLETE CAMPKIT**

Here is the Perfect, Combination Knife-Tool for  
every Outdoor Sportsman, Hunter, Camper, Fisherman,  
Boy Scout, Ranger, Rancher, etc. Think of it! 11, fine  
quality Steel Tools, precision made to hold easily into  
the heavy bone covered body. In one neat, compact  
unit you have (1) a regular knife, (2) a fork, (3) a spoon,  
(4) a draw-knife, (5) a bone saw and fish scaler,  
(6) a screwdriver and (11) a metal file. All this PLUS a  
genuine leather, belt holster.  
ORDER NOW While We Can Guarantee Delivery at this Special Low Price

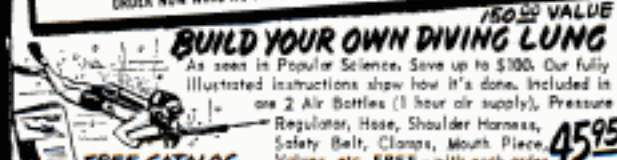

## BUILD YOUR OWN DIVING LUNG

As seen in Popular Science. Save up to \$100. Our fully  
illustrated instructions show how it's done. Included in  
one 2 Air Bottles (1 hour air supply), Pressure  
Regulator, Hose, Shoulder Harness,  
Safety Belt, Clamps, Mouth Piece, **45.95**  
Valves, etc. FREE - with each order



## NEW MEDUSA DIVING MASK

Has two built-in, snorkle  
type breathing tubes. Fully  
covers both the mouth and the nose.  
Made of finest quality rubber with  
quality safety glass eye  
lens. Formerly \$10.95 . . . **8.95**



## NEW GRESSI PINOCCHIO DIVING MASK

Specially designed to bring the lens  
close to eyes. The mask's Pinocchio  
nose allows you to grasp it between  
the fingers & blow out to relieve  
pressure on the ears. Special lens is  
3/16" tempered safety glass.  
Be the first to own this fine **5.95**  
Italian import. Guaranteed!

ORDER FROM THIS AD - Pay by Money Order or Check. Purchase orders  
accepted from D.B. firms. 50% deposit with C.O.D.s. Prices F.O.B. here.

**PALLEY SUPPLY CO**  
2263 E. VERNON AVE., DEPT. PM-6  
LOS ANGELES 58, CALIF.

# INSTALL YOUR OWN 1200-SQ. FT. **RAIN JET**<sup>®</sup> Sprinkler System



2 RAIN JETS  
EQUAL TO 10  
SPRINKLERS

Install a complete underground system for less than the ordinary cost of pipe and fittings alone. Kit contains 2 Rain Jet heads, 60' flexible polyethylene tubing, gate valve and metal fittings, wrench, instructions. No cementing, no clamps, no threading—uses patented slip-on couplers. Great for slopes, hill-sides, old lawns, newly seeded areas. So fast and easy you can make system-installing a profitable part-time business!

**RAIN JET HEAD** available separately only \$3.95 ea. →

Rotating, pop-up stem shows in operating position. Mounts flush with lawn.

Uniformly covers area 34-ft. in diameter. Rain-size drops and low angle of discharge give deep penetration. No puddling or runoff. No water-wasting mist. Top performance even at low pressures (5-30 lbs.). Solid brass... made to last. Fits 1/2" metal, plastic or rubber pipe.

**FOR LARGER LAWNS!** Order extra 1-Head Kit for each added 24' x 24' area. \$15.95

**IDEAL FOR TRIAL!** Order portable Stand for hose use. \$5.95

**RAIN JET CORP.** 3087 N. California St., Burbank, California 91505

## SPRINKLER SYSTEM IN A FEW HOURS

KIT FOR 50' x 24'  
LAWN... \$29.95  
only



10 DAY MONEY  
BACK GUARANTEE



**SEND PLOT-PLAN with ORDER**  
Sketch lawn plot, showing trees and obstacles. Give water line size and pressure. We'll show best layout. See your dealer, or enclose payment. We prepay freight (add tax in Calif.) Or order C.O.D.

# Screwdrivers

with Comfort Grip  
feel right  
in your  
hands!

**WORK FASTER AND EASIER  
WITH PRECISION FORGED BITS**

Forged from special alloy steel, extra hard P&C bits are precision ground and oil tempered. Fluted, plastic amber handles take the toughest twists, are kinder to your hands. Shock, hammer, acid and grease-proof. Knurled tips for fast finger twirling.

There's a big difference in screwdrivers. Be sure you buy P&C... guaranteed... the best tools money can buy. Look for P&C tool displays—in over 10,000 stores across the nation. Send 10c TODAY for catalog of 500 tools.

## P&C Hand Forged Tool Company

DEPT. H-4 • BOX 5926 • PORTLAND 22, OREGON

# MAKE MORE THAN \$20.00 PER HOUR

SERRATING &  
SHARPENING

TABLE AND  
KITCHEN KNIVES



## SAW-KEEN

PORTABLE ELECTRIC, EASY-TO-OPERATE, KNIFE  
SERRATOR AND SHARPENER

Be Your Own Boss! Every restaurant, cafeteria, drive-in, hotel, hospital are repeat customers. Serrated (saw-edged) table knives are in big demand. Your investment of \$98.50 returns the first day. Guaranteed! Write today for proven method of getting profit making jobs daily.

**CUTTER-CRAFT** DEPT. F, 58 S. RAYMOND  
PASADENA 1, CALIFORNIA

## WRAP-ON

**STOPS DRIPPING  
PIPES INSTANTLY**

Low cost • do-it-yourself  
Fiberglass Insulation

**QUICK... EASY TO USE**

Stop rust and ruined floors caused by dripping pipes. Protect basement or "rec" room with 'WRAP-ON' fiberglass insulation and vapor seal tape. 1 Pkg. covers 17' of 1/2" pipe. Smooth surface takes paint.

- no dirt or muss, no tools
- super-tough, long lasting
- \$1 at Dept. & Hdw. stores

**beware of imitations**  
insist on 'WRAP-ON' Wrap-On Co., Chicago 10, Ill. Dept 606

## Swanky New Lounge Chair

**SAVE 50%—NOTHING LIKE IT**

Big do-it-yourself kit only \$11.95. Ultra-modern design. For your lawn, den, TV room. Unique, no other like it. 3 position, full reclining with footrest. Ventilated seat and back curved to fit. Rubber tired wheels. Folds! Extra strong solid oak bent to shape. Easily assembled and painted. Strength and comfort guaranteed. Save half—order yours now! \$11.95 ready to assemble. (Assembled, ready to use, costed green, \$24.95 each). Send check or money order to:

**LAWN LO-BUY, LEWISTOWN, ILLINOIS**

## Print Your Own

Cards, Stationery, Advertising, labels, circulars, photo and movie titles, church work, tags, etc. Save money. Sold direct from factory only. Raised printing like engraving, too. **Print for Others, Good Profit.** Have a home print shop. Easy rules supplied. Pays for itself in a short time. Write for free catalog of outfits and a list of details.

**KELSEY PRESSES**  
KELSEY PRESSES, N-37 MERIDEN, CONN.

**DO IT YOURSELF**

It's Easy With...

**KESTER**  
FLUX CORE  
**SOLDER**

Soldering's really a "cinch" . . . when you use time-tested, reliable KESTER . . . available everywhere.

**FREE! "Soldering Simplified"**  
. . . 16-page how-to-solder booklet. At your dealer or write direct.

**KESTER SOLDER COMPANY**  
4251 Wrightwood Avenue Chicago 39, Illinois

## NEW! MASTER Tiller-Mower

It's a rotary mower! It's a rotary tiller. Amazing new gardener combination that works for you the year around. Switches in seconds without tools from gear driven tiller to big 90° rotary lawn mower. Powered by an easy starting 2 HP Briggs & Stratton engine. Has exclusive built-in automatic clutch which smoothly engages power as throttle is opened. Tiller transmission sealed in grease for years of smooth operation. Non clogging steel tines till or cultivate soil down to 8" depth. Perfect for cultivating—ends backbreaking hoeing and weeding. Tiller propels itself forward—no pushing necessary. 20" mower attaches in less than 1 minute. Does a perfect job on any grass, short or tall, velvet smooth! Matches as it cuts—eliminates raking. Years ahead of other mowers and tillers. Basic power unit, factory price... **\$69.50**



Gardener shown with tiller attachment

### ROTARY MOWER ATTACHMENT



Attaches in less than 1 minute. Does a perfect job on any grass, short or tall, velvet smooth! Matches as it cuts—eliminates raking. Years ahead of other mowers and tillers. Basic power unit, factory price... **\$69.50**

### TILLER ATTACHMENT COMPLETE... \$40.00

### 30" ROTARY MOWER ATTACHMENT (Item 737a) ... \$49.50

Easy payment plan available. Freight paid east of Rockies—half paid elsewhere.

### FLASH-WELD SOLDER GUN

High powered double transformer soldering gun that converts ordinary 115 v. current to instant heat for big soldering jobs. Install or remove copper pipe fittings in two seconds! Applies solder bugs, heats tools for hardening, provides heat for continuous sheet metal soldering. Saves at least 50% labor time. Includes complete heating unit transformer, heavy cables and grip type soldering pliers. Wt. 38 lbs. (Item 777) Reg. \$79.50, Close-out **\$39.50**



### EXTENSION CORD

Heavy duty and very flexible. Neoprene 14-2 cable, 20 year quality. Wt. 12 lbs. (Item 185) 100 ft. Complete with rubber plug and outlet. A terrific buy at only **\$8.95**

NO. 12-2 POWER CABLE. Very flexible rubber covered, special outside shield for grounding power tools, etc. 50 ft. (Item 109) wt. 8 lbs. **\$6.95**. 100 ft. (Item 200) wt. **\$12.95**

### 9 TON HYDRAULIC PRESS

A tremendously powerful hydraulic press, capable of exerting 18,000 lbs. pressure. Pays for itself in many ways overstraining bent connecting rods, king pins, crankshafts, axles, link pins and nuts—or pushing out frozen bearings and bushings. Developed pressure under precise control and visible at all times on accurate gauges. Complete with both large and small anvils and jigs to straighten any kind of curve or bend. (Item 464) Wt. 110 lb. Actual list price \$365. Our special close-out price... **\$69.50**



### MASTER DC ARC WELDERS

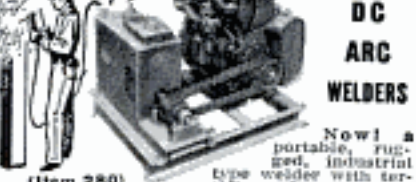

Now! a portable, rugged, industrial type welder with terrific performance, yet at a price hundreds of dollars less than you'd expect. Senior model made for years of trouble-free, continuous service. High capacity DC welding unit enables you to tackle any job with confidence—easily welds anything up to 2" plate using from 1/16" to 1/4" rods. Built-in stabilizer and cooling system makes arc easy to strike and hold. Dual control rheostat provides low heat soldering, brazing and welding from 30 to 300 amps. Complete with instructions—guarantee and triple V-belt of flat pulley. You can pay more, but you can't buy a better welder. **WELDER ONLY—DUAL CONTROL MODEL.** Same as above, but drive with your tractor, jeep or gas engine of 14 HP or more. (Item **\$119.50**) Wt. 110 lbs. \$450 value. **WELDER ONLY—STANDARD MODEL.** Same as above but with single rheostat for heavy metal welding only. (Item 38.) Wt. 110 lbs. \$400 value. Special... **\$99.75** **COMPLETE POWER MASTER** (Illustrated above) powered by a 14.6 hp., air cooled Wisconsin engine. Wt. 480 lbs. (Item 280) Compare with welder costing \$1200. Factory Special... **\$449.50** **WELDING KIT** Two 10 ft. leads, welding helmet, electrode holder, ground clamp. Sold only with welder at... **\$10.50**

### get BEDROCK factory prices from MASTER MECHANIC

### 600-700 WATTS PUSH BUTTON START

115 v. 60 cyc. AC Powered by a rugged 2 HP easy starting Briggs engine. No wiring necessary! Just plug in and operate. Plenty of current for any oil burner, freezer, brooder, emergency lights, etc. which require up to 700 watts. Ideal for television and radios. Complete with Voltmeter and built-in winding to charge 6 v. auto batteries. (Item 24.) Wt. 75 lbs. Easily fits in car trunk. He prepared if storm knocks out power lines. Reg. \$275 value... **\$143.50** **1000-1200 Watt Plant (Item 45)** same as Item 24 but larger generator and engine... **\$199.50**



### 1300-1500 WATT PLANT

115v. 60 cyc. AC Push Button Start. Powered by a 3 1/2 HP. Clinton engine. Combines big output with easy portability. Provides emergency power for operating any oil burner, sump pump, freezer, television, lights, communications systems, etc. which require up to 1500 watts. (Item 22.) Wt. 110 lbs. Reg. \$475 value. Factory price... **\$239.50** **2500 WATT PLANT—Push Button Start (Item 21)** 110/120 60 cyc. A.C. A rugged powerful plant. Reg. \$645. Spec... **\$329.50** **3500 Watt Plant Push Button Start (Item 23)** 115 v. 60 cyc. AC. Similar to above, but larger and 33% more capacity. Wt. 270 lbs. Reg. \$760. Factory Price... **\$379.50** **Dual Voltage 110/220** available for above plants for \$30.00 additional.



We make every type and size of light plants—Write, giving us your requirements!

### HEATING & VENTILATING FAN

(Item 10) Easily installed in furnace pipes. Forces even heat to all rooms. Over range removes kitchen smoke and odors. Powerful, continuous duty motor 110-120v. AC. Mount in wall or ceiling to ventilate any area. Quiet, super-efficient fan moves huge volume of air. (400 to 600 CFM). 8" Pipe, wt. 5 lb. .... **\$6.95** 9" Pipe, wt. 6 lb. .... **\$7.85** 10" Pipe, wt. 7 lb. .... **\$8.85** 12" Pipe, wt. 8 lb. .... **\$9.85** **HEAVY DUTY FAN.** Semi-enclosed motor, suitable for spray booths, restaurant exhausts, poultry houses, etc. 10" Fan, wt. 8 lbs. (Item 102) .... **\$11.95** 12" Fan, wt. 10 lbs. (Item 103) .... **\$12.95**



### JET FLOW BLOWER

Tremendous air movement (1800 CFM) and quiet operation make this double inlet 10" turbine blower unbeatable for heating, cooling, drying and air conditioning. Ideal for attic or barn ventilation, converting gravity heating to forced air; spray booth exhausts, etc. Operates with any 1/4, 1/2 or 1/2 HP motor. Oversized, long life bearings. Includes variable speed motor pulley and belt. Dimensions 19" hi x 18" x 16 1/2". Outlet opening 13" x 11 1/4". Wt. 45 lbs. (Item 245). Reg. \$54.50. Factory Special... **\$27.50** **HEAVY DUTY 1/2 HP motor** for above **\$16.95** **12" TURBINE BLOWER** Similar to above, but larger with 2400 CFM capacity. Wt. 65 lbs. (Item 245a) Reg. \$70.00. Factory Spec. **\$34.50**

### JET STEAM MASTER

Now, a super efficient portable steam generator that produces live steam at 150 lbs. pressure in 60 seconds from a cold start! Produces large volume of high pressure steam on 2 pints of fuel oil. Instantly cleans sticky grease, dirt, rust, old paint, etc. off implements, tools, machinery. Pays for itself in a few weeks. Sterilizes soil. Sterilizes as it cleans—milk equipment, etc. Fully automatic—oil fired with new, built-in lifetime bronze water circulating pump. Draws water from faucet or bucket. Simple and safe—anyone can use it! Built-in safety valve. Complete with 12 ft. of hi-pressure steam hose and new triple efficiency steam gun that automatically mixes in soap solution if desired. Wt. 250 lbs. Item 463. Special factory price... **\$329.50**



### PORTABLE LIGHT PLANTS

#### GIANT 2000-2500 WATT PLANT

110-120 v. 60 cyc. AC. Absolutely the best made exclusive dynamically balanced armature; heavy windings develop up to 5000 watt overload for motor starting. Skid mounted—portable. Powered by an easy starting Briggs or Wisconsin 6 HP engine—complete with all accessories; engine easily disconnected for other uses. Oil outlet box, voltmeter, no wiring necessary. Ample current for all purposes. Factory warranty. (Item 31) Wt. 210 lb. Reg. price \$585. Special at... **\$299.50** Same plant with electric self starter (Item 31a) ... **\$359.50** Generator only and control box... **\$109.50** **DUAL VOLTAGE 110-220** available on any of above models for \$28.00 additional.

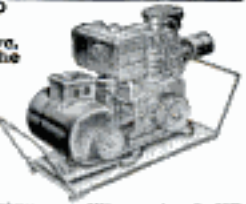

### CONDITIONAIRE VENTILATING FANS

Save big money installing your own exhaust fan. Efficient propeller type blade. Moves huge volume of air quietly and effortlessly. Heavy welded frame—pre-drilled for easy installation. Just cut opening and bolt in place. Continuous duty motors. Ideal for attics, restaurants, garages, barns, chicken houses, etc. Control manually or with thermostat.



Blade Opening CFM	Wt.	Item	Price
14" 18 1/4"	2025	19 lb.	\$65a \$27.95
18" 18 1/4"	3600	27 lb.	\$65b \$31.95
20" 21 1/4"	4100	30 lb.	\$65c \$39.95

### HI-FLO Centrifugal PUMP

Completely self-priming! No foot valve required. Tremendous capacity—100 gal. per min. Special impeller enables pump to handle muddy or sandy water. Simple to operate—simply start engine and watch the water go. Powered by a rugged, easy-starting 2 HP Briggs engine. Pre-lubricated sealed bearings for years of heavy low-cost service. Big 1 1/2" Model. Item 507. Wt. 70 lbs. Factory price... **\$134.50** 2" Model (150 gal. per min.) with 2 1/2 HP engine. Item 502a. 90 lbs. Fact. Spec. **\$154.50**

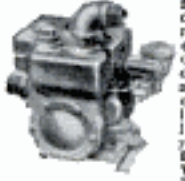

### BIG JOE Portable Pump

A powerful pump that handles up to 15,000 gal. per hour. Easy to operate. Self-priming (after initial prime), no foot valve needed—resulting in 2 1/2" surge capacity. Exclusive impeller design provides maximum rate of water per horsepower, yet handles water containing mud, 2 1/2" suction and discharge. Powered by an easy starting 6 hp. Wisconsin engine and mounted on big rubber tired wheels. Wt. 280 lbs. (Item 280). Special factory price... **\$299.50** Same pump mounted on steel skids. Wt. 270 lbs. (Item 503). Factory price... **\$275.00**



### 52 pc. SOCKET SET

Highest quality, guaranteed non-breakable sockets made by Husky. Beautifully matched chrome trim wall alloy absolutely the best. Contains a complete set of 28 sockets in 1/2" drive, 3/4" drive and 1 1/2" drive, plus all necessary extensions, handles, speeders, reversible ratchets, etc.; all uncond. guaranteed against breakage. A beautiful set of tools that will handle any job on a big doghouse steel box. Wt. 17 lbs. (Item 205). List price \$62.90. Factory special... **\$27.95**



### Variable Speed Selector

Heavy duty, made by B. F. GOODRICH for industrial use. Provides instant speed changes for any drive. For machine tools, dryers, printing, conveyors, production lines, hoists—any operation requiring variable speed. Employs reliable "trouble free" planetary system. No hydraulic power losses. Infinite range, smooth operation. Easy installation. 3 sizes: 1 1/2 hp. 30 lbs.; 1-2 hp. wt. 55 lbs.; 2-3 hp. wt. 105 lbs.; Reg. list \$228, \$252 and \$352. Our prices **\$79.50, \$89.50 and \$114.50**



Send check or M.O. Prices f.o.b. Factory. 10 day Money back guarantee. SEND 10c for... **BIG 1955 Catalog** **MASTER MECHANIC MFG. CO., DEPT. CEM Burlington, Wis.**

We will invest these

# 3 FREE BOOKS

in your future

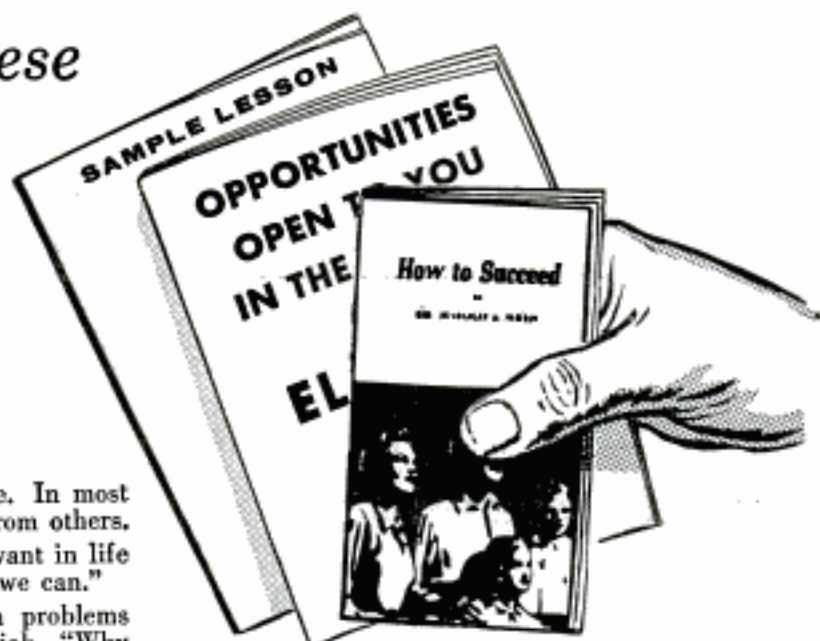

Life's problems are never simple to solve. In most cases they require help and inspiration from others.

It was Emerson who said—"Our chief want in life is somebody who shall make us do what we can."

Perhaps one of today's most common problems has something to do with an individual's job. "Why can't I make more money?" . . . "Will I be the next to be fired?" . . . "Why are others promoted over me?" are some of the questions that plague most of us at some time or another.

If you wonder about your job security, about your future, here's help that is yours for the asking. Three FREE BOOKS—any one of which could change the course of your entire life.

Don't put it off. If you are really interested in succeeding, send for these three free books today. Remember, hesitation is one of the greatest causes of failure.

**Book No. 1, "How to Succeed,"** is a gold mine of tips on how a hundred little things about you, your personality, your outlook on life can affect your future. It will help you discover hidden talents in yourself, it will show you how others—less educated,

less intelligent than you, perhaps—have overcome all sorts of obstacles and have gone on to success.

**Book No. 2** is a complete catalog that outlines opportunities in the field in which you are most interested. It gives you the facts on just what your chances are of succeeding in a given field.

**Book No. 3** is a sample I.C.S. lesson text. Literally thousands and thousands of men and women of all ages have won promotions, pay raises, the respect of friends and community through I.C.S. training.

I.C.S. is the oldest and largest correspondence school. 277 courses. Business, industrial, engineering, academic, high school. One for you. Direct, job-related. Bedrock facts and theory plus practical application. Complete lesson and answer service. No skimping. Diploma to graduates.

For Real Job Security—Get an I. C. S. Diploma! . . . Easy-pay Plan . . . I. C. S., Scranton 9, Penna.

## INTERNATIONAL CORRESPONDENCE SCHOOLS



BOX 25299F, SCRANTON 9, PENNA.

(Partial list of 277 courses)

Without cost or obligation, send me "HOW TO SUCCEED" and the opportunity booklet about the field BEFORE which I have marked X (plus sample lesson):

- |  |   |  |  |  |
|--|---|--|--|--|
| <p><b>ARCHITECTURE and BUILDING CONSTRUCTION</b></p> <ul style="list-style-type: none"> <li><input type="checkbox"/> Air Conditioning—Refrig.</li> <li><input type="checkbox"/> Architecture</li> <li><input type="checkbox"/> Architectural Interior</li> <li><input type="checkbox"/> Building Contractor</li> <li><input type="checkbox"/> Building Maintenance</li> <li><input type="checkbox"/> Carpenter and Mill Work</li> <li><input type="checkbox"/> Estimating</li> <li><input type="checkbox"/> Heating</li> <li><input type="checkbox"/> Painting Contractor</li> <li><input type="checkbox"/> Plumbing</li> <li><input type="checkbox"/> Reading Arch. Blueprints</li> </ul> <p><b>ART</b></p> <ul style="list-style-type: none"> <li><input type="checkbox"/> Cartooning</li> <li><input type="checkbox"/> Commercial Art</li> <li><input type="checkbox"/> Fashion Illustrating</li> <li><input type="checkbox"/> Magazine Illustrating</li> <li><input type="checkbox"/> Show Card and Sign Lettering</li> <li><input type="checkbox"/> Sketching and Painting</li> </ul> <p><b>AUTOMOTIVE</b></p> <ul style="list-style-type: none"> <li><input type="checkbox"/> Auto Body Rebuilding</li> <li><input type="checkbox"/> Auto Elec. Technician</li> <li><input type="checkbox"/> Auto-Engine Tune Up</li> <li><input type="checkbox"/> Automobile</li> </ul> | <p><b>AVIATION</b></p> <ul style="list-style-type: none"> <li><input type="checkbox"/> Aeronautical Engineering Jr.</li> <li><input type="checkbox"/> Aircraft &amp; Engine Mechanic</li> </ul> <p><b>BUSINESS</b></p> <ul style="list-style-type: none"> <li><input type="checkbox"/> Advertising</li> <li><input type="checkbox"/> Bookkeeping and Accounting</li> <li><input type="checkbox"/> Business Administration</li> <li><input type="checkbox"/> Business Correspondence</li> <li><input type="checkbox"/> Public Accounting</li> <li><input type="checkbox"/> Creative Salesmanship</li> <li><input type="checkbox"/> Federal Tax</li> <li><input type="checkbox"/> Letter-writing Improvement</li> <li><input type="checkbox"/> Office Management</li> <li><input type="checkbox"/> Professional Secretary</li> <li><input type="checkbox"/> Retail Business Management</li> <li><input type="checkbox"/> Sales Management</li> <li><input type="checkbox"/> Stenographic-Secretarial</li> <li><input type="checkbox"/> Traffic Management</li> </ul> <p><b>CHEMISTRY</b></p> <ul style="list-style-type: none"> <li><input type="checkbox"/> Analytical Chemistry</li> <li><input type="checkbox"/> Chemical Engineering</li> <li><input type="checkbox"/> Chem. Lab. Technician</li> <li><input type="checkbox"/> General Chemistry</li> <li><input type="checkbox"/> Natural Gas Prod. &amp; Trans.</li> <li><input type="checkbox"/> Petroleum Engineering</li> <li><input type="checkbox"/> Plastics</li> <li><input type="checkbox"/> Pulp and Paper Making</li> </ul> | <p><b>CIVIL, STRUCTURAL ENGINEERING</b></p> <ul style="list-style-type: none"> <li><input type="checkbox"/> Civil Engineering</li> <li><input type="checkbox"/> Construction Engineering</li> <li><input type="checkbox"/> Highway Engineering</li> <li><input type="checkbox"/> Reading Struct. Blueprints</li> <li><input type="checkbox"/> Sanitary Engineering</li> <li><input type="checkbox"/> Structural Engineering</li> <li><input type="checkbox"/> Surveying and Mapping</li> </ul> <p><b>DRAFTING</b></p> <ul style="list-style-type: none"> <li><input type="checkbox"/> Aircraft Drafting</li> <li><input type="checkbox"/> Architectural Drafting</li> <li><input type="checkbox"/> Electrical Drafting</li> <li><input type="checkbox"/> Mechanical Drafting</li> <li><input type="checkbox"/> Mine Surveying and Mapping</li> <li><input type="checkbox"/> Plumbing Drawing and Estimating</li> <li><input type="checkbox"/> Structural Drafting</li> </ul> <p><b>ELECTRICAL</b></p> <ul style="list-style-type: none"> <li><input type="checkbox"/> Electrical Engineering</li> <li><input type="checkbox"/> Electrical Maintenance</li> <li><input type="checkbox"/> Electrician <input type="checkbox"/> Contracting</li> <li><input type="checkbox"/> Lineman</li> </ul> <p><b>HIGH SCHOOL</b></p> <ul style="list-style-type: none"> <li><input type="checkbox"/> Commercial <input type="checkbox"/> Good English</li> <li><input type="checkbox"/> High School Subjects</li> <li><input type="checkbox"/> Mathematics</li> </ul> | <p><b>LEADERSHIP</b></p> <ul style="list-style-type: none"> <li><input type="checkbox"/> Foremanship</li> <li><input type="checkbox"/> Industrial Supervision</li> <li><input type="checkbox"/> Leadership and Organization</li> <li><input type="checkbox"/> Personnel-Labor Relations</li> </ul> <p><b>MECHANICAL AND SHOP</b></p> <ul style="list-style-type: none"> <li><input type="checkbox"/> Gas—Electric Welding</li> <li><input type="checkbox"/> Heat Treatment <input type="checkbox"/> Metallurgy</li> <li><input type="checkbox"/> Industrial Engineering</li> <li><input type="checkbox"/> Industrial Instrumentation</li> <li><input type="checkbox"/> Industrial Supervision</li> <li><input type="checkbox"/> Internal Combustion Engines</li> <li><input type="checkbox"/> Machine Design-Drafting</li> <li><input type="checkbox"/> Machine Shop Inspection</li> <li><input type="checkbox"/> Machine Shop Practice</li> <li><input type="checkbox"/> Mechanical Engineering</li> <li><input type="checkbox"/> Quality Control</li> <li><input type="checkbox"/> Reading Shop Blueprints</li> <li><input type="checkbox"/> Refrigeration</li> <li><input type="checkbox"/> Sheet Metal Worker</li> <li><input type="checkbox"/> Tool Design <input type="checkbox"/> Toolmaking</li> </ul> <p><b>RADIO, TELEVISION</b></p> <ul style="list-style-type: none"> <li><input type="checkbox"/> Industrial Electronics</li> <li><input type="checkbox"/> Practical Radio TV Eng'ing</li> <li><input type="checkbox"/> Radio and TV Servicing</li> <li><input type="checkbox"/> Radio Operating</li> </ul> | <ul style="list-style-type: none"> <li><input type="checkbox"/> Television Technician</li> </ul> <p><b>RAILROAD</b></p> <ul style="list-style-type: none"> <li><input type="checkbox"/> Air Brakes <input type="checkbox"/> Car Inspector</li> <li><input type="checkbox"/> Diesel Locomotive</li> <li><input type="checkbox"/> Locomotive Engineer</li> <li><input type="checkbox"/> Section Foreman</li> </ul> <p><b>STEAM AND DIESEL POWER</b></p> <ul style="list-style-type: none"> <li><input type="checkbox"/> Combustion Engineering</li> <li><input type="checkbox"/> Diesel—Elec. <input type="checkbox"/> Diesel Eng's</li> <li><input type="checkbox"/> Electric Light and Power</li> <li><input type="checkbox"/> Stationary Fireman</li> <li><input type="checkbox"/> Stationary Steam Engineering</li> </ul> <p><b>TEXTILE</b></p> <ul style="list-style-type: none"> <li><input type="checkbox"/> Carding and Spinning</li> <li><input type="checkbox"/> Cotton, Rayon, Woolen Mfg.</li> <li><input type="checkbox"/> Finishing and Dyeing</li> <li><input type="checkbox"/> Loom Fix'g <input type="checkbox"/> Textile Des'ing</li> <li><input type="checkbox"/> Textile Eng'g <input type="checkbox"/> Throwing</li> <li><input type="checkbox"/> Warping and Weaving</li> </ul> <p><b>MISCELLANEOUS</b></p> <ul style="list-style-type: none"> <li><input type="checkbox"/> Domestic Refrigeration</li> <li><input type="checkbox"/> Marine Engineering</li> <li><input type="checkbox"/> Ocean Navigation</li> <li><input type="checkbox"/> Professional Engineering</li> <li><input type="checkbox"/> Short Story Writing</li> <li><input type="checkbox"/> Telephony</li> </ul> |
|--|---|--|--|--|

Name \_\_\_\_\_ Age \_\_\_\_\_ Home Address \_\_\_\_\_

City \_\_\_\_\_ Zone \_\_\_\_\_ State \_\_\_\_\_ Working Hours \_\_\_\_\_ A.M. to P.M. \_\_\_\_\_

Occupation \_\_\_\_\_

Canadian residents send coupon to International Correspondence Schools, Canadian, Ltd., Montreal, Canada. . . . Special tuition rates to members of the U. S. Armed Forces.



No wonder it's called  
"Miracle Vinyl-Flooring"!

# MATICO ARISTOFLEX

RESISTS GREASE, ACID, ALKALI AND GRIME!



You'll call it "miracle flooring," too, when you see for yourself how rugged, durable MATICO Aristoflex shrugs off household acid, alkali and grease... stays new and sparkling looking with easy damp moppings. Biggest miracle of all is the price! Produced especially to meet the needs of homeowners everywhere, MATICO

Aristoflex is low in cost... gives you more for your money. And you can install economical Aristoflex in every room in your home... from basement to attic. See Aristoflex in 13 rich, clear colors at your MATICO dealer soon. You'll find him listed in your classified telephone directory.



## MASTIC TILE CORPORATION OF AMERICA

Joliet, Ill. • Long Beach, Calif. • Newburgh, N. Y.

Manufacturers of:

Aristoflex • Confetti • Parquetry • Maticerck • Asphalt Tile • Cork Tile • Plastic Wall Tile

### INSTALL IT YOURSELF AND SAVE!



It's easy! Just mark a straight line through the center of your room in both directions, using a chalk and line. Be careful not to cover up your guide lines.



With a notched trowel, spread adhesive over one-half of your room at a time. Leave only a thin coat of adhesive on the floor.



After adhesive becomes tacky, snap the tiles into place. Do not slide tiles or adhesive will push up between the tiles.



Here's the best part! Show your wife your handiwork. (Don't tell her what a cinch it is with MATICO's easy-to-follow instructions).



# extra miles

For thousands of  
of peak-performance, re-ring with Perfect Circle...

Doctors of Motors *everywhere* know from experience that Perfect Circle's 2-in-1 Chrome piston rings assure sustained power and positive oil control.

In Perfect Circle's 2-in-1 Chrome piston ring set, *both* the TOP ring *and* the OIL ring are plated with thick, solid chrome giving complete wear protection throughout the

THE BRAND MOST PEOPLE PREFER!

entire area of ring travel. Life of cylinders, pistons and rings is *more than doubled!*

Enjoy thousands of *extra* miles of carefree, economical driving by installing Perfect Circle's 2-in-1 Chrome piston rings. Perfect Circle Corporation, Hagerstown, Indiana; the Perfect Circle Co., Ltd., Toronto, Ontario.



## Perfect Circle

**2 in 1 chrome piston rings**

*The Standard of Comparison*

Copyrighted material