

MARCH 1955

REPORT ON THE CHEVROLET V8

35 CENTS

# POPULAR MECHANICS MAGAZINE

YOU CAN UNDERSTAND IT

REG. U.S. PAT. OFF. MAR. 1955. MAIL PERMIT NO. 4047

REG. U.S. PAT. OFF.

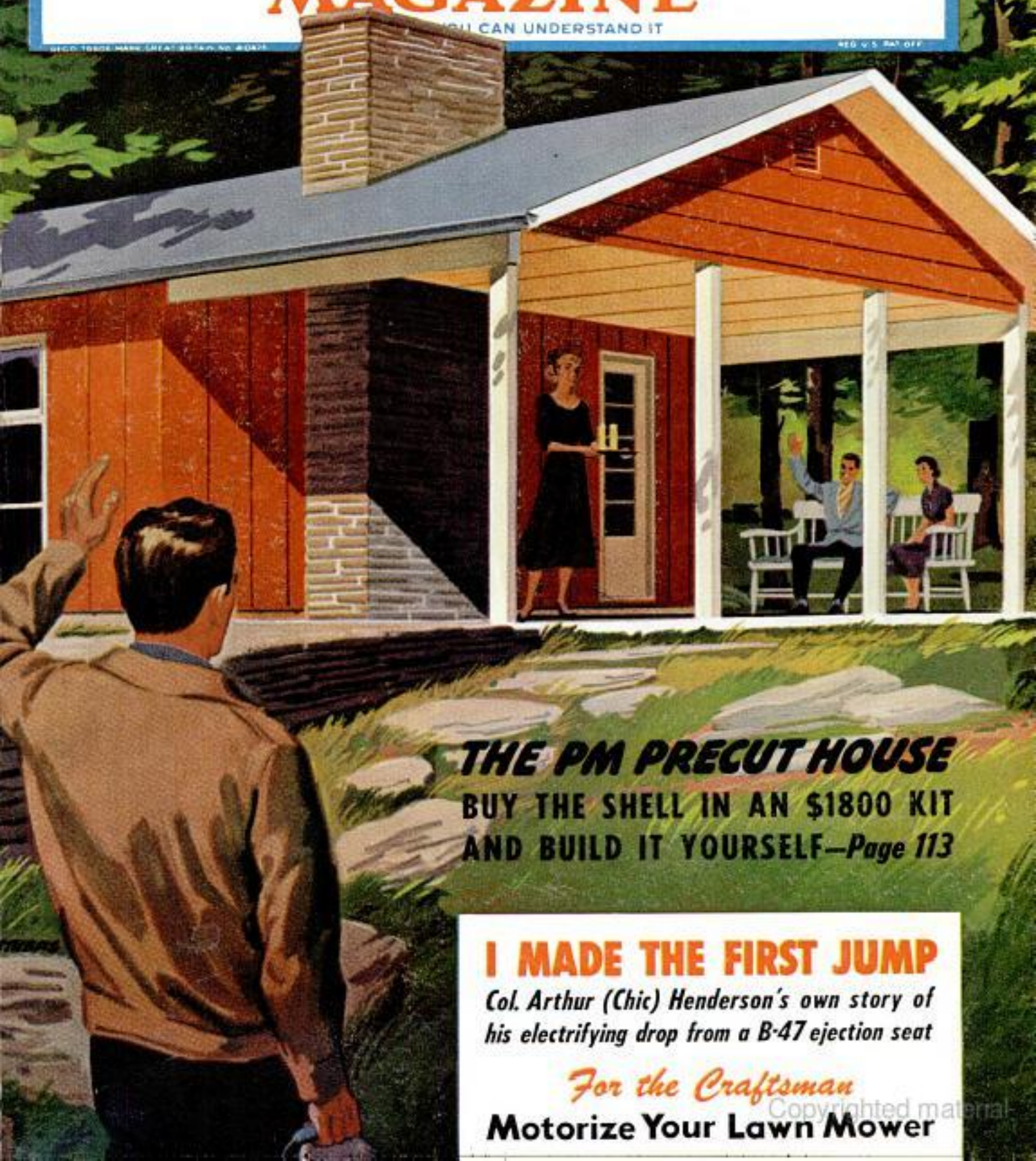

**THE PM PRECUT HOUSE**  
BUY THE SHELL IN AN \$1800 KIT  
AND BUILD IT YOURSELF—Page 113

## I MADE THE FIRST JUMP

Col. Arthur (Chic) Henderson's own story of  
his electrifying drop from a B-47 ejection seat

*For the Craftsman*

Motorize Your Lawn Mower

Copyrighted material





# "Nothing Else Like It!"

**SAYS TED WILLIAMS**

Red Sox star, Marine pilot,  
Expert angler



Ted Williams, one of the greatest hitters of all time, is also one of the world's great fishermen. Naturally he knows outboard motors. He has driven all kinds. Listen to what *he* says:

"I've learned from experience that nothing is more important to an outboard owner than the dependability of his engine. That's where Johnson excels. I've owned lots of outboards, including several Sea-Horses. I've just got myself the best one of all—the new Sea-Horse 10 with Suspension Drive. The smoothness and quiet of this motor are unbelievable. There's nothing else like it!"

**FREE!** Write for the new Johnson Catalog describing the 5 great motors of the 1955 line. Four Suspension Drive models—Sea-Horse 5½, 10, 25 and Electric Starting 25. **THEY'RE QUIET!** Also the famous Sea-Horse 3, 32 pound twin with 3 solid hp! (OBC certified brake hp. at 4000 rpm.)

**JOHNSON MOTORS, 400 Pershing Road, Waukegan, Illinois**

*In Canada: Manufactured by Johnson Motors, Peterborough*

**Johnson**  
  
**SEA-HORSES**  
**FOR DEPENDABILITY**



# How your telephone call asks directions... and gets quick answers

*Perforated steel cards, which give directions to the Long Distance dial telephone system, are easy to keep up to date. New information is clipped (1) and punched (2) by hand on a cardboard template. This guides the punch-press that perforates a steel card (3), and the two are checked (4). The new card is put into service in the card translator (5).*



When the Bell System's latest dial equipment receives orders to connect your telephone with another in a distant city, it must find—quickly and automatically—the best route.

Route information is supplied in code—as holes punched on steel cards. When a call comes in, the dial system selects the appropriate card, then reads it by means of light beams and phototransistors. Should the preferred route be in use the system looks up an alternate route.

It is a simple matter to keep thousands of cards up to date when new switching points are added or routing patterns are changed to improve service. New cards are quickly and easily punched with the latest information to replace out-of-date cards.

This efficient, flexible way of keeping your dial system up to the minute was devised by switching engineers of Bell Telephone Laboratories, who are continually searching for ways to improve service and to lower costs. Right now most of the Long Distance dialing is done by operators, but research is hastening the day when you will be able to dial directly to other telephones all over the nation.



## BELL TELEPHONE LABORATORIES

Improving telephone service for America provides careers for creative men in scientific and technical fields.



# Popular Mechanics Magazine

Registered in U. S. Patent Office and Canada

H. H. WINDSOR, Founder

H. H. WINDSOR, JR., Editor and Publisher



## Next Month

"ANYONE CAN BE a Frogman," almost literally, and that is the title of an aptly named article in next month's *Popular Mechanics* that takes you into the fascinating new world beneath the surface of the sea. Diving with aqualungs is becoming increasingly popular in this country and abroad and can be as safe as wading in a back-yard pool. Men, women and children are donning face masks and aluminum air tanks to explore the bottom, to fish with spears or just for the sheer pleasure of floating, weightless movement through water, described as "the closest thing to flying." "Anyone Can Be a Frogman" initiates you into the rapidly growing fraternity of fin-footed skin divers

Information not listed on articles in the index, starting on page 74, frequently is listed in the WHERE-TO-FIND-IT LIST, which is available to readers without charge. A copy may be obtained by writing to the Bureau of Information, *Popular Mechanics*, 200 E. Ontario, Chicago 11, Ill.

Published monthly by Popular Mechanics Company, 200 E. Ontario St., Chicago 11, Ill. H. H. Windsor, Jr., president; Wm. Harrison Fetridge, exec. vice-pres.; D. F. Windsor, vice-president and secretary-treasurer; H. H. Windsor III, vice-president; Clover L. Perkins, advertising manager; Alan M. Deyoe, circulation manager. Single copy in the United States and Canada, 35 cents; subscription rates in the United States and possessions, Canada, Philippines and countries of the Pan-American Postal Union, 1 year \$3.50; 2 years, \$6.00; 3 years \$8.00. To all other countries add \$1.00 a year over United States prices for overseas postage. If you plan to move, notify us at least 30 days in advance so you will not miss an issue. Give both your old and new addresses. Entered as Second Class Matter, September 15, 1903, at the Post Office at Chicago, Illinois, under Act of March 3, 1879. Entered as Second Class Matter at Post Office Dept., Canada. Registered as Second Class Matter at the Post Office at Mexico, D. F., Mexico, June 20, 1950. Copyright 1955 by Popular Mechanics Company. Copyright under International Copyright Union. Copyright in France. All rights reserved under Pan-American Copyright Union. Printed in the United States of America.

Volume 103

MARCH 1955

Number 3

Address all communications to: 200 E. Ontario St., Chicago 11, Ill.

Managing Editor.....	Roderick M. Grant
Assistant Managing Editor.....	Wayne Whittaker
Shop Notes and Crafts Editor.....	James R. Ward
Radio-Television, Electronics Editor.....	Frank L. Brittin
Associate Editor.....	Clifford B. Hicks
Associate Editor, Automotive.....	Arthur R. Railton
Associate Editor.....	George E. Moise
Associate Editor, Shop Notes and Crafts.....	Wayne C. Leckey
Assistant Editor, Shop Notes.....	W. Clyde Lamney
Assistant Editor, Crafts.....	Frank N. Stephany
Assistant Editor, Makeup.....	John C. Dalen
Automotive Correspondent.....	Leo Donovan
Art Director.....	Frank Beatty

### Assistant Editors

Leonard F. Hiltz, Jay W. Hedden, Elliott H. McCleary, Emily Mullaney	
Eastern Editor.....	Richard F. Dempewolf
Empire State Bldg., Room 2906, New York City 1	
Western Editor.....	Thomas E. Stimson, Jr.
Suite 1010, 3460 Wilshire Blvd., Los Angeles 5, Calif.	
London Manager.....	Douglas W. Wedderspoon
Eagle House, Jermyn St., London S. W. 1, England	
Director, Bureau of Information.....	Allan Carpenter
<a href="#">200 E. Ontario St., Chicago 11</a>	

## In This Issue . . .

Bobwhite King - - - - -	81
I Made the First Jump - - - - -	88
The Owners Report on the '55 Chevrolet -	102
Detroit Listening Post - - - - -	107
The PM Precut House - - - - -	113
The Store With Nothing to Sell - - - - -	122
What's New for Your Home - - - - -	130
Seat Belts vs. Traffic Deaths - - - - -	137
Big Boom in Jails - - - - -	141
Wade Deep for Better Fishing - - - - -	151
Radio, TV and Electronics - - - - -	161

## For the Craftsman . . .

Drafting Desk for Your Home - - - - -	165
Shoot 'Em Caged - - - - -	173
Solving Home Problems - - - - -	181
Motorize Your Lawn Mower - - - - -	193
Taking Guesswork Out of Painting - - - - -	198
12-Volt Ignition Systems - - - - -	205
Figuring Concrete Jobs - - - - -	209
Know Your Saw Blades - - - - -	213
Shopping for Tools - - - - -	219

Other items, and manufacturers of available products described, are listed on pages 74, 76 and 78



Learn how homeowners everywhere save money by installing their own

# MATICO TILE FLOORING



*MATICO's New Improved  
Install-It-Yourself System  
Makes It Easy!*



1—Mark straight lines through the center of the room in both directions, using a chalk and line.

2—With a notched trowel, spread adhesive evenly over floor and allow to "set."



3—Press tiles into position. You can walk on MATICO as soon as floor is in place.



Yes, you can enjoy colorful, durable MATICO Asphalt Tile Flooring in your home at amazing low cost by installing MATICO yourself. You can't buy a more economical type of luxury flooring than MATICO. It lasts for years . . . is easy to keep sparkling clean and comes in 32 striking decorator colors that can't wear off because colors and marbleization go clear through the tile.

It's a cinch to install, too, with MATICO's tested install-it-yourself instruction booklet . . . tile calculator . . . and special tool kit. Why, you can finish a room in just a few hours.

Why put up with a dingy, worn-out floor when it costs so little to install a MATICO tile floor yourself.

See your classified telephone directory for the name of your MATICO dealer.



## MASTIC TILE CORPORATION OF AMERICA

Joliet, Ill. • Long Beach, Calif. • Newburgh, N. Y.

Manufacturers of:

Aristoflex • Confetti • Parquetry • Asphalt Tile • Cork Tile • Plastic Wall Tile

MASTIC TILE CORPORATION OF AMERICA  
Dep't. M2-3, P. O. Box 986, Newburgh, N. Y.  
Please send me MATICO's money-saving install-it-yourself instruction kit and complete color chart.

Name .....

Address .....

City..... Zone..... State.....

This One



AH8F-W9Z-OKFY



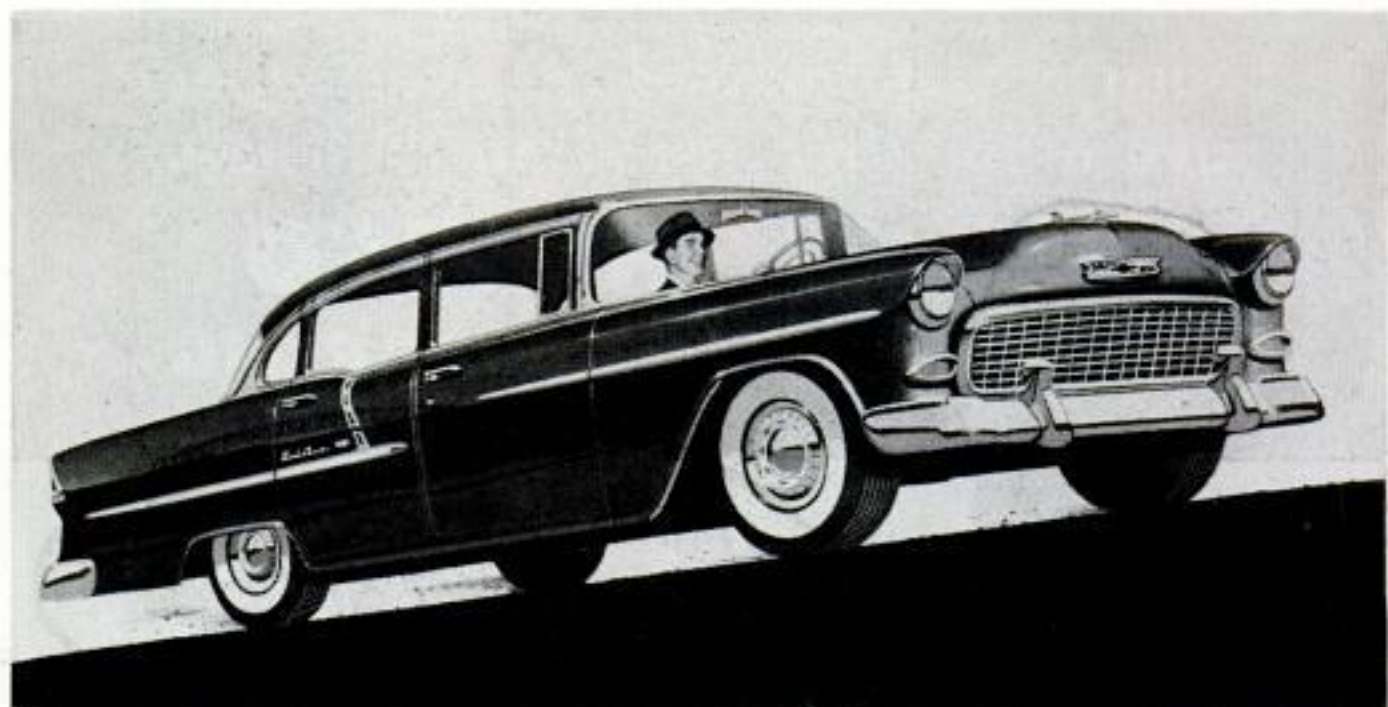

## "The Performance of Chevrolet's Three New Engines Is Only Half the Story"

—Ed Cole, Chevrolet Chief Engineer

Your shoulders and your ears will tell you about the *performance* of the new Chevrolet "Turbo-Fire V8" . . . for you'll feel the skyrocket acceleration as 162 h.p. shoves you back into the seat . . . and you'll strain to hear the hush of eight balanced power impulses.

But I wish it were as easy to explain the even more important *design* features that give this ultra-compact power plant its long life and economical running—how, for example, we planned for low heat-rejection, so the cooling system could be smaller; how we cut the stroke to three inches to pare down power-wasting friction (and how this let us use a four-quart oil capacity instead of five); how the shorter, lighter connecting rods put less strain on the bearings; and how the high-turbulence cylinder head permitted the super-efficient 8 to 1 compression ratio.

I'd like to take you "inside" the two new "Blue-Flame" 6's to show you the

high-capacity water pumps, the one-third reduction in fan speed (which means much quieter running), the floating intakes that pick up cleaner oil, the four-point engine suspensions that smother power vibrations, the 12-volt electrical systems that give faster winter starting and better firing at high speed—all the things that make these overhead-valve sixes the world's yardstick for engine dependability.

But I can't even list all the *major* engineering advances on this page. All I can say is: Once you've driven a 1955 Chevrolet you'll know why we're so proud of these three new engines. . . . Chevrolet Division of General Motors, Detroit 2, Michigan.

*motoramic*



More than a new car...a new CONCEPT of low-cost motoring!



# 99 International and American Performance Records Set with Full-Firing **CHAMPION SPARK PLUGS!**

*(Subject to official confirmation)*

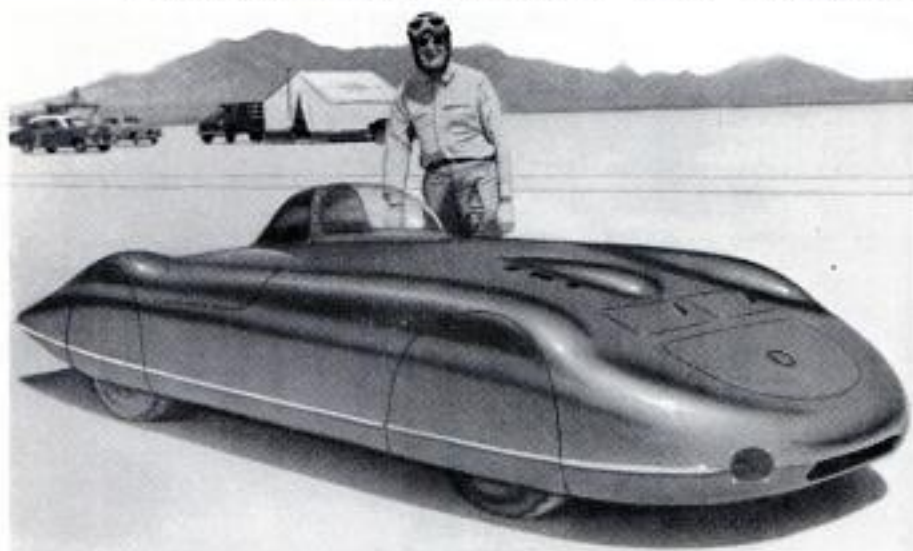

THE M. G. SPECIAL with famed racing driver Capt. G.E.T. Eyston assisted by Ken Miles set 37 International and American Class F records, including top speed of 153.6 m.p.h. and 129.8 average for 12 hours—with CHAMPIONS!



THE AUSTIN-HEALEY 100 S on the Utah Salt Flats set 53 International and American Class D records, including a 24-hour, 3174-mile endurance run at average speed of 132.29 m.p.h.—with CHAMPIONS!

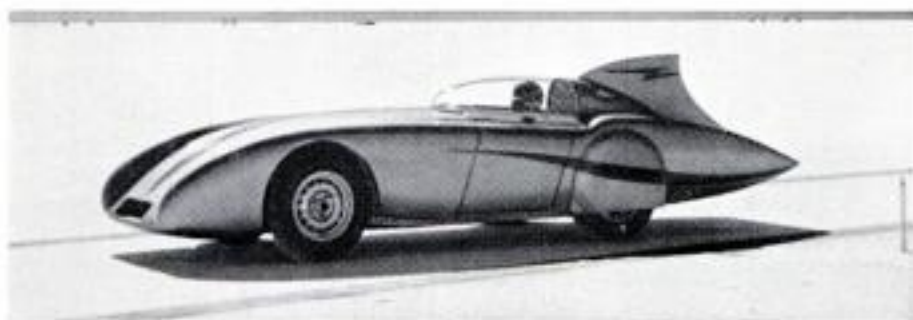

THE AUSTIN-HEALEY 100 broke 9 International and American Class D marks, and established itself as perhaps the world's fastest, modified production sports car with a mean speed of 192.62 m.p.h. over the flying mile—with CHAMPIONS!



**SEE FOR YOURSELF!**

Replace Ordinary  
Spark Plugs with  
**5-RIB CHAMPIONS**

Engineered to use  
all the Power of  
**Modern Gasoline**

Find out what your  
engine can really do!

Insist on—



CHAMPION SPARK PLUG COMPANY, TOLEDO



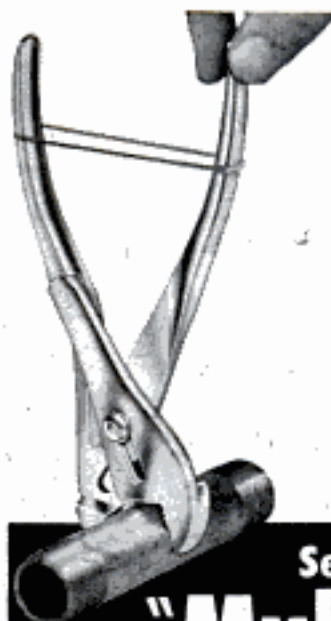

## Try the Novel Rubber Band Test

Place a rubber band around the handles of a No. 234 "Multi-Plier," and grip a hard-to-hold object, like a piece of pipe. Suspend the plier by one handle only, and note how the jaws hold the weight securely without further pressure. Now try the same test with an ordinary two-piece plier — see what happens.

## Sensational "Multi-Plier"

**Increases Your Gripping Power 10 Times!**

### Unique 3-Piece, Compound Leverage Design Is Greatest Plier Development in 19 Years

Everyone should own PROTO'S new "Multi-Plier" — a multi-purpose, multi-pressure plier that is really a "chest of tools in one." By using a patented 3-piece design to compound the leverage, pressure applied to the handles is increased *ten times* at the jaws. That means you can hold square, round and even tapered objects securely with just a slight grip. The plier gets into hard-to-reach places, works safely at any angle, and holds small or large objects, having four different jaw opening positions. First try this revolutionary plier — No. 234 — at your PROTO dealer's, and then buy one! Send 10¢ for 68-page catalog of entire PROTO line to

**PLOMB TOOL COMPANY**

2255Q Santa Fe Ave., Los Angeles 54, California



### BENDIX BRAKE PLIER

Actually three tools in one, the new No. 216 plier handles three big jobs on Bendix brakes. Special jaws remove the hold-down cup. One handle releases anchor pin springs. The other handle replaces these springs. Get this plier now and save precious time on Bendix brake work.

**Also  
NEW!**

5486



Eastern Factory—Jamestown, N.Y.  
Canadian Factory—London, Ont.

## ACROSS THE DESK



Col. Arthur (Chic) Henderson, author of "I Made the First Jump" on page 88, is in charge of test jumping at the Aero Medical Laboratory, Wright Air Development Center. When any new equipment is tested, such as the downward-ejection seat, he always makes the first jump while staff members stand by holding their breath.



He has made 108 jumps and holds the rank of "master parachutist," one of the few in the Air Force. Although he entered the service in 1924, he did not start jumping until 1943 when he attended the parachute school at Fort Benning, Ga. Later he commanded the 542d Parachute Infantry Battalion and served with the 11th Airborne Division in the Philippines and Japan. On the personal side: Colonel Henderson weighs only 135 pounds,

is 47 years old and a grandfather. Off duty, his informal and loyal staff address him with such titles as Grandpa, The Old Man, Father and The Old Eagle (the latter in reference to a tattoo on his chest). Another title no one would challenge is that of the world's No. 1 authority on parachute jumping.

### To the Editor:

Having noted with interest the article appearing on page 83 of the January issue of your magazine and being a minor employee of Norfolk & Western Railway Company, appreciate very much the story.

Naturally, I have followed the progress of the coal-fired, steam-turbine locomotive, which so far has been dubbed "The Jawn Henry" in shop parlance, and as always during my 26 years' association with the road been very proud of their own shop-constructed locomotives, etc.

(Continued to page 8)



**GOOD SALARY**

**FINE CAR**

**To the man who wants to enjoy  
an ACCOUNTANT'S CAREER**

**A NICE HOME**

**BANK ACCOUNT**

**FREE SAMPLE LESSON**

**IF** you're that man, here's something that will interest you.

Not a magic formula—not a get-rich-quick scheme—but something more substantial, more practical.

Of course, you need something more than just the desire to be an accountant. You've got to pay the price—be willing to study earnestly, thoroughly.

Still, wouldn't it be worth your while to sacrifice some of your leisure in favor of interesting home study—over a comparatively brief period? Always provided that the rewards were good—a salary of \$4,000 to \$10,000?

An accountant's duties are interesting, varied and of real worth to his employers. He has *standing!*

Do you feel that such things aren't for you? Well, don't be too sure. Very possibly they *can* be!

Why not, like so many before you, investigate LaSalle's modern Problem Method of training for an accountancy position?

Just suppose you were permitted to work in a large accounting house under the personal supervision of an expert accountant. Suppose, with his aid, you studied accounting principles and solved problems day by day—easy ones at first—then more difficult ones. If you could do this—and could turn to him for advice as the problems became complex—soon you'd master them all.

That's the training you follow in principle under the LaSalle Problem Method.

You cover accountancy from the basic Principles right up through Accountancy Systems and Income Tax Procedure. Then you add C. P. A. Training and prepare for the C. P. A. examinations.

As you go along, you absorb the principles of Auditing, Cost Accounting, Business Law, Statistical Control, Organization, Management and Finance.

Your progress is as speedy as you care to make it—depending on your own eagerness to learn and the time you spend in study.

Will recognition come? The only answer, as you know, is that success *does* come to the man who is really *trained*. It's possible your employers will notice your improvement in a very few weeks or months. Indeed, many LaSalle graduates have paid for their training—with increased earnings—before they have completed it! For accountants, who are trained in organization and management, are the executives of the future.

**Get Free Sample Lesson—Also  
"Accountancy, The Profession That Pays"**

For your own good get all the facts. Write for Free Sample Lesson—also 48-page book "Accountancy, The Profession That Pays." They will prove that Accountancy offers brilliant futures to those who aren't afraid of serious home study, and will show the wide range of opportunities that exist today. No cost or obligation. If you want a position of higher income, greater prestige and professional standing... MAIL THE COUPON NOW!

**Over 4,000 Certified  
Public Accountants among  
LaSalle alumni**

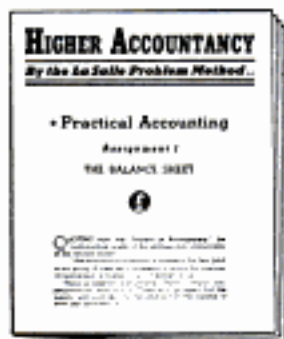

**LASALLE EXTENSION UNIVERSITY  
A CORRESPONDENCE INSTITUTION**

417 S. Dearborn St. Dept. 364H Chicago 5, Ill.

I want to be an accountant. Send me without obligation, Free Sample Lesson—also "Accountancy, The Profession that Pays."

Name.....Age.....  
Address.....  
City, Zone & State.....





(Continued from page 6)

My position with the road is Leading Lumber Inspector and necessitates considerable traveling into nine states, which of course gives me quite an extensive observation of other railroads' equipment, none of which surpasses N&W.

Best wishes for the continued progress and success of a very valuable and interesting publication.

H. C. Allen,  
Eastman, Ga.

**To the Editor:**

I have just finished reading the interesting article on the new lightweight carving



material in the January issue of *Popular Mechanics*. I am enclosing a sample of one of nature's lightweight carving materials available here in Missouri. This is a form of Cotton Rock and is fairly plentiful here in the Ozarks. Hope this will be of interest to you.

F. Ray Pickell,  
El Dorado Springs, Mo.

**To the Editor:**

Read your wonderful article on TV reception (*PM*, November 1954). We here in London, Ont., have also received KFEL, Denver, Colo.; KRLD, Dallas, Tex.; KGNC, Amarillo, Tex.; WTVJ, Miami, Fla.; KFBC, Cheyenne, Wyo.; KPRC, Houston, Tex.; WKY, Oklahoma City, Okla.; WJDX, Jackson, Miss., and WMBR, Jacksonville, Fla.

Ken Day,  
London, Ont., Can.

**To the Editor:**

Until the advent of the U.S. Air Force, motor traffic was forbidden in Bermuda, and the "surrey with the fringe on top" was almost a trademark of the islands. Taxis have now taken the place of the horse-drawn surrey, but the fringed top remains—on the taxis. It's possible because speed laws permit a maximum speed of 25 miles

(Continued to page 10)

## NEW GREASELESS WAY TO KEEP YOUR HAIR NEAT ALL DAY



**New Vitalis with V-7 makes even dry, unruly hair easy to manage**

V-7, the *greaseless* grooming discovery now in Vitalis, outdates messy oils. Keeps your hair neat, yet you never have an over-slick, plastered-down look.

What's more, Vitalis gives you wonderful protection from dry, brittle hair and parched scalp—even after a shampoo. Try it—you'll like it!

**VITALIS<sup>®</sup>**  
**HAIR TONIC**  
**WITH V-7<sup>®</sup>**

PRODUCT OF BRISTOL-MYERS







# What's your boss saying about you?

The door is usually open. Today it's closed. They're talking about you . . . about your future. You don't have to hear to know what they're saying. Because there's nobody who knows more about you and your present job than *you*.  
O.K. . . . So you have "experience," Five years on the same job.

Have you *mastered* the job . . . learned everything there is to know about it? If your answer is "yes," success is right around the corner. But if the answer is "no," then your experience doesn't amount to much. And chances are these things are true about you: you just "coast" along with things . . . you do nothing and go

home all tired out. **BEWARE!** Those are danger signals. Unless you take a fresh look at things, you'll be doing the same job at the same salary for the next five years. And the *next* five.

### What you can do about your future

If you want to succeed . . . make more money, earn the respect of your family and community . . . you have to take the bull by the horns. Success doesn't just come along. You have to meet it halfway. So act **NOW** and make your experience mean something. Add I. C. S. *training* to your record and start going places. Do it at home, in your spare time, for a few cents a day.

*Does it work? These facts answer that.* A recent survey shows that in a single 120-day period, 1973 I. C. S. students were promoted to better jobs. If you had acted a year ago, one of them could have been you. So mail the coupon below today.

### Pick your favorite subject

277 I. C. S. courses to choose from. 203 expert I. C. S. instructors to give you personal help. No time or expense going to and from classes. No interference with business and social life.

### Your first step

Sit down *right now* and fill out the coupon below. Check your favorite subject. I. C. S. will send you **FREE** and without obligation of any sort, two books. One, "How to Succeed," tells you how to start climbing to the top. Second book outlines the opportunities in the field of your choice. Also, free sample lesson. Mail this coupon today.



For Real Job Security—Get an I. C. S. Diploma! . . . Easy-pay Plan . . . I. C. S., Scranton 9, Penna.

## INTERNATIONAL CORRESPONDENCE SCHOOLS

ICS

BOX 45299C, SCRANTON 9, PENNA.

(Partial list of 277 courses)

Without cost or obligation, send me "HOW TO SUCCEED" and the opportunity booklet about the field BEFORE which I have marked X (plus sample lesson):

- |  |   |  |   |  |
|--|---|--|---|--|
| <p><b>ARCHITECTURE and BUILDING CONSTRUCTION</b></p> <ul style="list-style-type: none"> <li><input type="checkbox"/> Air Conditioning—Refrig.</li> <li><input type="checkbox"/> Architecture</li> <li><input type="checkbox"/> Architectural Interior</li> <li><input type="checkbox"/> Building Contractor</li> <li><input type="checkbox"/> Building Maintenance</li> <li><input type="checkbox"/> Carpenter and Mill Work</li> <li><input type="checkbox"/> Estimating</li> <li><input type="checkbox"/> Heating</li> <li><input type="checkbox"/> Painting Contractor</li> <li><input type="checkbox"/> Plumbing</li> <li><input type="checkbox"/> Reading Arch. Blueprints</li> </ul> <p><b>ART</b></p> <ul style="list-style-type: none"> <li><input type="checkbox"/> Cartooning</li> <li><input type="checkbox"/> Commercial Art</li> <li><input type="checkbox"/> Fashion Illustrating</li> <li><input type="checkbox"/> Magazine Illustrating</li> <li><input type="checkbox"/> Show Card and Sign Lettering</li> <li><input type="checkbox"/> Sketching and Painting</li> </ul> <p><b>AUTOMOTIVE</b></p> <ul style="list-style-type: none"> <li><input type="checkbox"/> Auto Body Rebuilding</li> <li><input type="checkbox"/> Auto Elec. Technician</li> <li><input type="checkbox"/> Auto-Engine Tune Up</li> <li><input type="checkbox"/> Automobile</li> </ul> | <p><b>AVIATION</b></p> <ul style="list-style-type: none"> <li><input type="checkbox"/> Aeronautical Engineering Jr.</li> <li><input type="checkbox"/> Aircraft &amp; Engine Mechanic</li> </ul> <p><b>BUSINESS</b></p> <ul style="list-style-type: none"> <li><input type="checkbox"/> Advertising</li> <li><input type="checkbox"/> Bookkeeping and Accounting</li> <li><input type="checkbox"/> Business Administration</li> <li><input type="checkbox"/> Business Correspondence</li> <li><input type="checkbox"/> Public Accounting</li> <li><input type="checkbox"/> Creative Salesmanship</li> <li><input type="checkbox"/> Federal Tax</li> <li><input type="checkbox"/> Letter-writing Improvement</li> <li><input type="checkbox"/> Office Management</li> <li><input type="checkbox"/> Professional Secretary</li> <li><input type="checkbox"/> Retail Business Management</li> <li><input type="checkbox"/> Sales Management</li> <li><input type="checkbox"/> Stenographic-Secretarial</li> <li><input type="checkbox"/> Traffic Management</li> </ul> <p><b>CHEMISTRY</b></p> <ul style="list-style-type: none"> <li><input type="checkbox"/> Analytical Chemistry</li> <li><input type="checkbox"/> Chemical Engineering</li> <li><input type="checkbox"/> Chem. Lab. Technician</li> <li><input type="checkbox"/> General Chemistry</li> <li><input type="checkbox"/> Natural Gas Prod. &amp; Trans.</li> <li><input type="checkbox"/> Petroleum Engineering</li> <li><input type="checkbox"/> Plastics</li> <li><input type="checkbox"/> Pulp and Paper Making</li> </ul> | <p><b>CIVIL, STRUCTURAL ENGINEERING</b></p> <ul style="list-style-type: none"> <li><input type="checkbox"/> Civil Engineering</li> <li><input type="checkbox"/> Construction Engineering</li> <li><input type="checkbox"/> Highway Engineering</li> <li><input type="checkbox"/> Reading Struct. Blueprints</li> <li><input type="checkbox"/> Sanitary Engineering</li> <li><input type="checkbox"/> Structural Engineering</li> <li><input type="checkbox"/> Surveying and Mapping</li> </ul> <p><b>DRAFTING</b></p> <ul style="list-style-type: none"> <li><input type="checkbox"/> Aircraft Drafting</li> <li><input type="checkbox"/> Architectural Drafting</li> <li><input type="checkbox"/> Electrical Drafting</li> <li><input type="checkbox"/> Mechanical Drafting</li> <li><input type="checkbox"/> Mine Surveying and Mapping</li> <li><input type="checkbox"/> Plumbing Drawing and Estimating</li> <li><input type="checkbox"/> Structural Drafting</li> </ul> <p><b>ELECTRICAL</b></p> <ul style="list-style-type: none"> <li><input type="checkbox"/> Electrical Engineering</li> <li><input type="checkbox"/> Electrical Maintenance</li> <li><input type="checkbox"/> Electrician <input type="checkbox"/> Contracting</li> <li><input type="checkbox"/> Lineman</li> </ul> <p><b>HIGH SCHOOL</b></p> <ul style="list-style-type: none"> <li><input type="checkbox"/> Commercial <input type="checkbox"/> Good English</li> <li><input type="checkbox"/> High School Subjects</li> <li><input type="checkbox"/> Mathematics</li> </ul> | <p><b>LEADERSHIP</b></p> <ul style="list-style-type: none"> <li><input type="checkbox"/> Foremanship</li> <li><input type="checkbox"/> Industrial Supervision</li> <li><input type="checkbox"/> Leadership and Organization</li> <li><input type="checkbox"/> Personnel-Labor Relations</li> </ul> <p><b>MECHANICAL AND SHOP</b></p> <ul style="list-style-type: none"> <li><input type="checkbox"/> Gas—Electric Welding</li> <li><input type="checkbox"/> Heat Treatment <input type="checkbox"/> Metallurgy</li> <li><input type="checkbox"/> Industrial Engineering</li> <li><input type="checkbox"/> Industrial Instrumentation</li> <li><input type="checkbox"/> Industrial Supervision</li> <li><input type="checkbox"/> Internal Combustion Engines</li> <li><input type="checkbox"/> Machine Design-Drafting</li> <li><input type="checkbox"/> Machine Shop Inspection</li> <li><input type="checkbox"/> Machine Shop Practice</li> <li><input type="checkbox"/> Mechanical Engineering</li> <li><input type="checkbox"/> Quality Control</li> <li><input type="checkbox"/> Reading Shop Blueprints</li> <li><input type="checkbox"/> Refrigeration</li> <li><input type="checkbox"/> Sheet Metal Worker</li> <li><input type="checkbox"/> Tool Design <input type="checkbox"/> Toolmaking</li> </ul> <p><b>RADIO, TELEVISION</b></p> <ul style="list-style-type: none"> <li><input type="checkbox"/> Industrial Electronics</li> <li><input type="checkbox"/> Practical Radio TV Eng'ng</li> <li><input type="checkbox"/> Radio and TV Servicing</li> <li><input type="checkbox"/> Radio Operating</li> </ul> | <ul style="list-style-type: none"> <li><input type="checkbox"/> Television Technician</li> </ul> <p><b>RAILROAD</b></p> <ul style="list-style-type: none"> <li><input type="checkbox"/> Air Brakes <input type="checkbox"/> Car Inspector</li> <li><input type="checkbox"/> Diesel Locomotive</li> <li><input type="checkbox"/> Locomotive Engineer</li> <li><input type="checkbox"/> Section Foreman</li> </ul> <p><b>STEAM AND DIESEL POWER</b></p> <ul style="list-style-type: none"> <li><input type="checkbox"/> Combustion Engineering</li> <li><input type="checkbox"/> Diesel—Elec. <input type="checkbox"/> Diesel Eng's</li> <li><input type="checkbox"/> Electric Light and Power</li> <li><input type="checkbox"/> Stationary Fireman</li> <li><input type="checkbox"/> Stationary Steam Engineering</li> </ul> <p><b>TEXTILE</b></p> <ul style="list-style-type: none"> <li><input type="checkbox"/> Carding and Spinning</li> <li><input type="checkbox"/> Cotton, Rayon, Woolen Mfg.</li> <li><input type="checkbox"/> Finishing and Dyeing</li> <li><input type="checkbox"/> Loom Fix'g <input type="checkbox"/> Textile Des'ing</li> <li><input type="checkbox"/> Textile Eng'g <input type="checkbox"/> Throwing</li> <li><input type="checkbox"/> Warping and Weaving</li> </ul> <p><b>MISCELLANEOUS</b></p> <ul style="list-style-type: none"> <li><input type="checkbox"/> Domestic Refrigeration</li> <li><input type="checkbox"/> Marine Engineering</li> <li><input type="checkbox"/> Ocean Navigation</li> <li><input type="checkbox"/> Professional Engineering</li> <li><input type="checkbox"/> Short Story Writing</li> <li><input type="checkbox"/> Telephony</li> </ul> |
|--|---|--|---|--|

Name \_\_\_\_\_ Age \_\_\_\_\_ Home Address \_\_\_\_\_  
 City \_\_\_\_\_ Zone \_\_\_\_\_ State \_\_\_\_\_ Working Hours \_\_\_\_\_ A.M. to P.M. \_\_\_\_\_  
 Occupation \_\_\_\_\_

Canadian residents send coupon to International Correspondence Schools, Canadian, Ltd., Montreal, Canada. . . . Special tuition rates to members of the U. S. Armed Forces.



## WHAT SECRET POWER DID THIS MAN POSSESS?



**BENJAMIN FRANKLIN**  
(A Rosicrucian)

**WHY** was this man great? How does anyone—man or woman—achieve greatness? Is it not by mastery of the powers within ourselves? Know the mysterious world within you! Attune yourself to the wisdom of the ages! Grasp the inner power of your mind! Learn the secrets of a full and peaceful life!

Benjamin Franklin—like many other learned and great men and women—was a Rosicrucian. The Rosicrucians (NOT a religious organization) first came to America in 1694. Today, headquarters of the Rosicrucians send over seven million pieces of mail annually to all parts of the world. Write for YOUR FREE COPY of "The Mastery of Life"—TODAY. No obligation. No salesmen. A non-profit organization. Address: Scribe L.W.C.

**THIS BOOK  
FREE!**



## The ROSICRUCIANS

SAN JOSE • (AMORC) • CALIFORNIA

—SEND THIS COUPON—

Scribe L.W.C.  
The ROSICRUCIANS (AMORC)  
San Jose, California  
Please send me the free book, *The Mastery of Life*, which explains how I may learn to use my faculties and powers of mind.

Name \_\_\_\_\_  
Address \_\_\_\_\_  
City \_\_\_\_\_

(Continued from page 8)



per hour on the open road, and only 15 in towns.

K. S. Anderson,  
Chase City, Va.

### Largest Water Wheel?

Reputed to be the largest water wheel in the world, the "Lady Isabella," as it is known locally, has just celebrated its hundredth birthday.

It was built by Robert Casement, a young Manx engineer at Laxey, Isle of

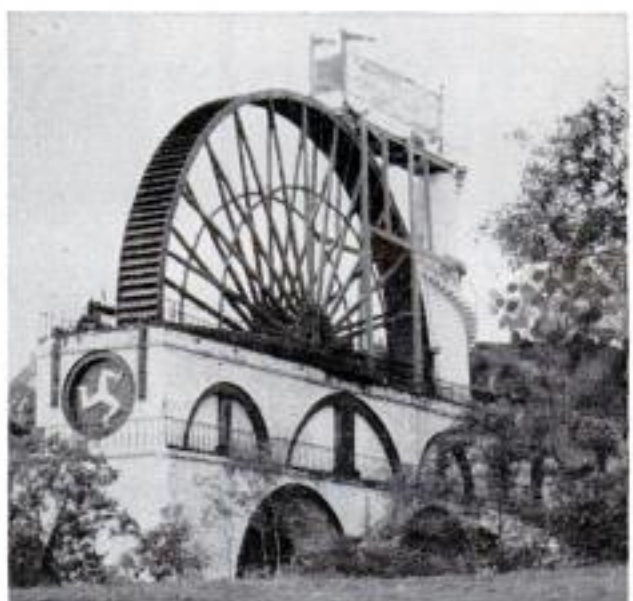

Man, to keep the lead mines free from water. Having a circumference of 228 feet and a breadth of 6 feet, the effective power of the wheel is 200 horsepower. Water rises through the hollow stone tower and overflows into the overshot lade from where it discharges into the buckets around the circumference of the wheel. The crank, on the opposite side, actuates a connecting rod some 1200 feet long, carried on wheels on an arched stone viaduct, to the pump shaft.

The mine is now unused, but the wheel still turns for the entertainment and interest of visitors.

James Vose,  
Isle of Man,  
Britain.



# I WILL TRAIN YOU AT HOME FOR GOOD PAY JOBS IN RADIO-TELEVISION

J. E. SMITH has trained more men for Radio-Television than any other man. OUR 40th YEAR.



**America's Fast Growing Industry Offers You Good Pay—Bright Future—Security**

## I TRAINED THESE MEN

 "Started to repair sets six months after enrolling. Earned \$12 to \$15 a week in spare time."—Adam Kramlik, Jr., Sunnyside, Pennsylvania.

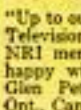
 "Up to our necks in Radio-Television work. Four other NRI men work here. Am happy with my work."—Glen Peterson, Bradford, Ont., Canada.

 "Am doing Radio and Television Servicing full time. Now have my own shop. I owe my success to N.R.I."—Curtis Stath, Ft. Madison, Iowa.

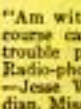
 "Am with WCOC. NRI course can't be beat. No trouble passing 1st class Radio-phonelicense exam."—Jesse W. Parker, Meridian, Mississippi.

 "By the time I graduated I had paid for my course, a car and testing equipment. Can service toughest jobs."—E. J. Streitenberger, Now Boston, Ohio.

**AVAILABLE TO VETERANS UNDER G.I. BILLS**

## You Learn by Practicing with Parts I Send

Nothing takes the place of PRACTICAL EXPERIENCE. That's why NRI training is based on LEARNING BY DOING. You use parts I furnish to build many circuits common to Radio and Television. As part of my Communications Course, you build many circuits, including low power transmitter shown at left. You put it "on the air," perform procedures required of broadcast operators. With my Servicing Course you build modern Radio, etc.; use Multitester you build to make money fixing sets in spare time while training. You can stay at home, keep your job, learn Radio-TV in spare time at low cost. Mail coupon for book showing other equipment you build and keep.

**The Tested Way To Better Pay!**

Training plus opportunity is the PERFECT COMBINATION for job security, good pay, advancement. In good times, the trained man makes the BETTER PAY, GETS PROMOTED. When jobs are scarce, the trained man enjoys GREATER SECURITY. NRI training can help assure you more of the better things of life.

**Start Soon to Make \$10, \$15 a Week Extra Fixing Sets**

Keep your job while training. I start sending you special booklets the day you enroll, that show you how to fix sets. Multitester built with parts I send helps you make \$10, \$15 a week extra fixing sets while training. Many start their own Radio-Television business with spare time earnings.

### My Training Is Up-To-Date

You benefit by my 40 years' experience training men at home. Well illustrated lessons give you basic principles you need. Skillfully developed kits of parts I send (see below) "bring to life" things you learn from lessons.

**2 FREE BOOKS SHOW HOW MAIL COUPON**



**Television Making Good Jobs, Prosperity**—Even without Television, Radio is bigger than ever. 115 million home and auto Radios are big market for servicing. 3000 broadcasting stations use operators, technicians. Government, Aviation, Police, Ship, Micro-wave Relay, Two-way Radio Communications for buses, taxis, trucks, R. R. are growing fields. Television is moving ahead fast.



About 200 Television stations are now on the air. Hundreds of others being built. Good TV jobs opening up for Technicians, Operators, etc. 25 million homes now have Television sets. Thousands more are being sold every week. Get a job or have your own business selling, installing, servicing.

### Radio-TV Needs Men of Action—Mail Coupon

Without obligating you in any way, I'll send an actual lesson to prove that my training is practical, thorough; 64-page book to show good job opportunities for you in Radio-TV. Terms for NRI training are as low as \$5 a month. Many graduates make more in two weeks than total cost of training. Mail coupon now. J. E. SMITH, President, National Radio Institute, Dept. 5CA, Washington 9, D. C. OUR 40TH YEAR.

**Good for Both—FREE**

MR. J. E. SMITH, President, Dept. 5CA  
National Radio Institute, Washington 9, D. C.  
Mail me Sample Lesson and 64-page Book, FREE.  
(No salesman will call. Please write plainly.)

Name..... Age.....  
Address.....  
City..... Zone... State.....

**VETS** write in date of discharge.....

**The ABCs of SERVICING**  
**How to Be a Success in RADIO-TELEVISION**



**NOW**

**SAVE!** BUY DIRECT FROM THE IMPORTER!



**FAMOUS KORIMUM STEEL "BLACK FOREST" HUNTING KNIFE**



Made of superfine KORIMUM steel in Solingen, West Germany. Blade is actually sharp enough to shave with! Rugged beauty of this knife has made it a prime favorite with sportsmen on 2 continents. Length: 10 inches. Genuine leather scabbard is metal tipped. SOLINGEN Steel assures years of dependable service. Sleek, graceful lines also make it ideal wall decoration. Order by No. 80.....\$3.95

**Tiny MICROSCOPE MAGNIFIES 50 TIMES!**



Measures but 2 1/2" — GIVES GIANT POWER & PERFORMANCE! Metal design—optically ground precision lenses. West German make. Gives 2,500 times area Magnification! Easy eyepiece focusing. With 2 special slides. See Nature's wonders — examine liquids, textiles, insects, cells, tissue, etc. CLEAR, SHARP IMAGES—no distortion! Ideal for students, hobbyists, technicians. Order by No. 12 . . . Now!.....Only \$1.98

Order by No. 12 . . . Now!.....Only \$1.98

**FREE!**

Yours FREE of extra cost—with any article ordered from this ad—a sparkling new pair of **SPECTOSCOPES**—the binoculars you wear like eyeglasses! They give you close-up viewing all day — without fatigue! More thrills from TV, sports, movies, theatre are yours with **SPECTOSCOPES**. Nationally advertised at 1.98. Order with confidence! Every item guaranteed! Money back if not delighted in 5-day trial! **RUSH!** Offer limited!

**POWERHOUSE Binoculars \$4.95 F.T.I.**

These West German binoculars give you 16 TIMES AREA MAGNIFICATION! You get clear, sharp images UP TO 20 MILES AWAY! COATED, precision lenses made by skilled optics craftsmen. Latest hinge model—adjusts for width between YOUR eyes. Genuine leather case at no extra cost. Center focusing. Former price \$11.95. Special to readers of this magazine: only 4.95 incl. tax, case & delivery. Order by No. 60.



**SWISS ARMY TYPE KNIFE**

10 TOOLS IN ONE—the famed Swiss Army Knife is recognized by sportsmen & hobbyists as the most compact multi-purpose tool ever devised. This is LOWEST PRICE ever sold for! Made of finest Solingen steel! Can be worn on belt. Length: 3 1/2". Has scissors, saw, file, jackknife, screwdriver, awl, can opener, bottle opener, corkscrew & small knife. Solid Vidal handle. Order by No. 88.....\$3.95



**10 - IN - 1 All-Purpose OPTICAL GLASS**

IMAGINE! 10 separate optical instruments in ONE compact unit—magnifying glass, reading glass, telescope, compass, binoculars, mirror, solar watch, campfire lighter, magnifying mirror and textile tester. Folds into small space—carry it in your pocket. One of the most amazing gadgets in years! Imported from West Germany.



No. 93.....only \$1.98

**SAVE MONEY WITH THIS COUPON!**

**THORESEN'S, Dept. 6-C**  
352 Fourth Avenue, New York 10, N. Y.

**RUSH** the items checked on 5-Day Free Trial . . . Money Back Guarantee. Include with each item ordered one pair of Spectoscopes at no extra cost—mine to keep in any case.

- Payment enclosed. Send tax & postpaid.
- Send COD plus postal charges.

- No. 60—Powerhouse Binoculars . . . \$4.95
- No. 88—Swiss Army Knife . . . \$3.95
- No. 80—Korium Hunting Knife . . . \$3.95
- No. 12—Tiny Microscope . . . \$1.98
- No. 93—10-IN-1 Optical Glass . . . \$1.98

NAME \_\_\_\_\_  
ADDRESS \_\_\_\_\_  
CITY \_\_\_\_\_ STATE \_\_\_\_\_

CANADIANS: Save Tariff! Send orders direct to: THORESEN CO., Dept. 6-C, 45 St. James St. West, Montreal 1, P. Q.



# INVENTORS

Learn how to protect your invention. The U. S. Patent Laws provide that any new and useful art, machine, article of manufacture, or composition of matter, or any new and useful improvement thereof, may be patented if the act of invention is involved. Therefore, every inventor with a valuable invention should take advantage of the Patent Laws and proceed for patent protection in order to safeguard his rights.

A patent gives the inventor the exclusive right to prevent others from making, using, or selling the invention claimed in the patent for a period of seventeen years.

The Patent Laws were enacted for the benefit of the inventor to give him protection for the features of his invention which are patentable. These features must be properly and concisely set forth and claimed in a formal application for patent, in order to comply with the requirements of the Patent Laws. For that reason, unless the inventor is familiar with patent matters, he should engage a competent registered patent attorney or agent to represent him. We are registered to practice before the U. S. Patent Office and are prepared to serve you in the handling of your patent matters.

A specially prepared booklet entitled "Patent Guide for the Inventor", containing detailed information with respect to patent protection and procedure, together with a "Record of Invention" form will be promptly forwarded to you without obligation upon request.

---

**CLARENCE A. O'BRIEN & HARVEY JACOBSON**

*Registered Patent Attorneys*

**51-C DISTRICT NATIONAL BUILDING  
WASHINGTON 5, D. C.**



# NEW BUSINESS PLAN FOR INVENTORS

We are undertaking further product diversification as a part of our current expansion program.

If you have a patented product and would like to go into business with us, we have worked out a plan for the development and marketing of new inventions which you should investigate immediately. Our success has been built on engineering ingenuity, distribution skill and sound management. Preliminary discussions arranged at your convenience.

Contact:

Robert F. Dick, Vice President

**ILLINOIS TOOL WORKS**

2507 North Keeler Avenue, Chicago 39, Illinois

Manufacturers of Gear Cutting Tools, SHAKEPROOF Fastenings, Plastic Products and Special Machines



## BE YOUR OWN MUSIC TEACHER

Send for Free Book Telling How Easily You Can Learn Piano, Guitar, Accordion, ANY Instrument This EASY A-B-C Way

NOW IT'S EASY to learn music at home. No tiresome "exercises." No teacher, just START RIGHT OUT playing simple pieces. Thousands now play who never thought they could. Our pictured lessons make it easy as A-B-C to learn to play popular music, hymns, classical and any other music. Only a few cents a lesson. Over 900,000 students! (Our 57th successful year.)

Mail Coupon for FREE BOOK

Find out why our method can teach you quickly, easily, inexpensively. Write for 36-page illustrated Book. No obligation. Mention your favorite instrument. Just mail coupon below.

**U. S. SCHOOL OF MUSIC**  
Studio A303  
Port Washington, N. Y.

**FREE BOOK**

U. S. SCHOOL OF MUSIC, Studio A303, Port Washington, N. Y.

Please send me Free 36-page illustrated Book. I would like to play (Name instrument).

Instrument \_\_\_\_\_ Have you \_\_\_\_\_ Instrument?

Name \_\_\_\_\_ (Please Print)

Address \_\_\_\_\_

## 'How to Make Money with Simple Cartoons'



A book everyone who likes to draw should have. It is free; no obligation. Simply address

FREE BOOK

**CARTOONISTS' EXCHANGE**  
Dept. 93D Pleasant Hill, Ohio

## Finish HIGH SCHOOL AT HOME

Complete 4 Yrs. in 12 Months

Learn More! Earn More! Enter professional or technical schools. Advance Socially. Live a Happier, Fuller Life. Individual Courses or complete schedule. WRITE FOR SCHOOL BULLETIN.

**ACADEMY FOR ADULTS**

30 W. Washington, Dept. PW-35, Chicago, Ill.

MAKE EXTRA MONEY

## PLASTICS

LEARN AT HOME

LEARN HOW TO MAKE Fast-selling PLASTIC NOVELTIES FURNITURE JEWELRY



There are RICH OPPORTUNITIES for MEN and WOMEN with "know-how" in Plastics. Interstate's new Plastics course tells and shows how to make hundreds of fast selling items out of Plastics. Gives complete training in fabrication, casting, lamination, molding, internal carving, etc., in simple, easy, step-by-step language and pictures. Plastics and Fabricating Kits for 23 valuable Plastic items come with training at no extra cost. START A PLASTICS BUSINESS OF YOUR OWN. No other industry holds such promise for the future. You can make big money manufacturing novelties, toys, signs, etc., in your own home in spare or full time. Don't wait! Learn NOW how Interstate's Plastics Training qualifies you for success in the Plastics field.

PLASTICS AND SUPPLIES FURNISHED FOR 23 VALUABLE PROJECTS

**INTERSTATE TRAINING SERVICE**  
Dept. C-3-C Portland 13, Oregon



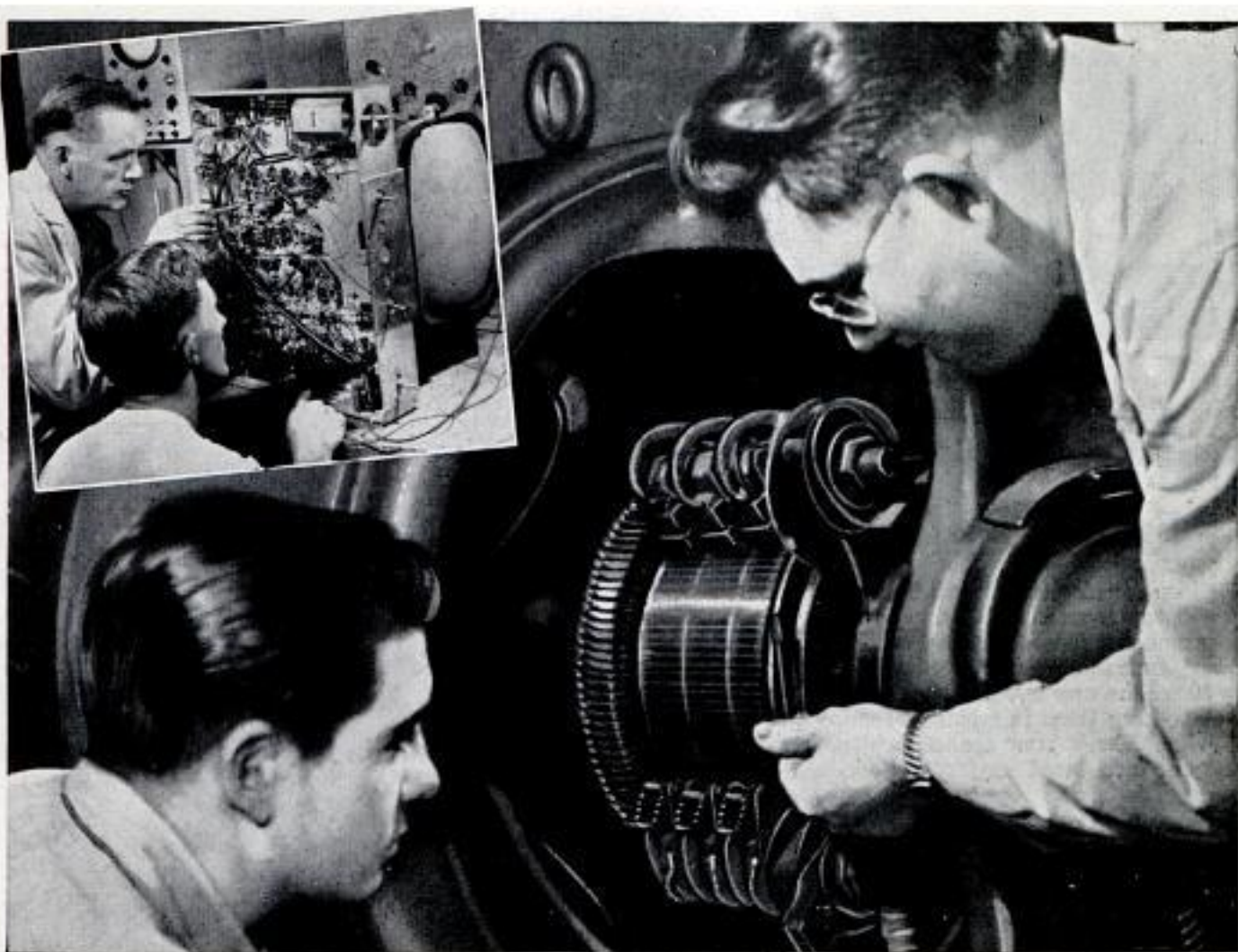

**TRAIN FOR A FUTURE IN**

# Electricity or Television-Radio

**IN GREAT SHOPS OF COYNE—  
Largest, Oldest, Best Equipped  
School Of Its Kind In The U. S.**

**Prepare quickly at Coyne for a career with a future!**

Whether 17 or up to 45 years of age, prepare for your future now. Don't be satisfied with a "No Future" job. Train the Coyne way for a better job in a field that offers a world of opportunities in the years ahead.

**WE TRAIN YOU IN CHICAGO**

Learn the easier, practical way at Coyne, on real, full size equipment. No advanced education or previous experience needed. You learn *better* the Coyne way.

**Train in the shops of Coyne**—where thousands of successful men have trained for over 56 years—*Coyne is the largest, oldest, best equipped school of its kind*—established in Chicago in 1899.

**FINANCE PLAN** Enroll now. You may pay most of tuition later. We have a *special plan for men of draft age*.

**CLIP COUPON NOW** for big new illustrated Coyne book. No obligation; *no salesman will call*. Get vital facts now!

**APPROVED  
FOR  
VETERANS**

*Mail Coupon  
Today for*  
**BIG FREE  
BOOK**

"Guide to Careers  
in ELECTRICITY and  
TELEVISION-RADIO"



B. W. COOKE, President  
COYNE ELECTRICAL SCHOOL  
500 S. Paulina St., Chicago 12, Ill., Dept. 35-72H

Send **BIG FREE** book and details of your training offer. This does not obligate me and no salesman will call. I am interested in:

ELECTRICITY     TELEVISION-RADIO

Name.....

Address.....

City.....State.....

B. W. COOKE, Pres. **COYNE** FOUNDED 1899  
**ELECTRICAL SCHOOL**

A TECHNICAL TRADE INSTITUTE OPERATED NOT FOR PROFIT  
500 S. PAULINA ST., CHICAGO, Dept. 35-72H  
ELECTRICITY ★ RADIO ★ TELEVISION ★ REFRIGERATION ★ ELECTRONICS



# STEP UP YOUR PAY Learn to Fix Appliances

**AT HOME IN SPARE TIME**

## Fast Growing Field for Men Who Know This Profitable Trade

Get into a field where there is important work and the security that comes from knowing a good trade. The electrical appliance repair business offers OPPORTUNITY FOR YOU. Every wired home today has an average of 8 electrical appliances. Up to 10 million new appliances are sold every year. Owners pay well to keep them in repair and enjoy the convenience they provide. Here's your chance to qualify for a better job or be your own boss!

## You Learn and Earn With Appliance Tester You Get

This course includes the parts to build a portable, sturdy Appliance Tester that helps you locate electrical defects quickly and easily. You use it to learn and do actual electrical and appliance repair jobs. It helps put you in the professional technician's class. Use it to start making money doing repairs soon after beginning the course.

## Pick Up \$3, \$4, \$5 an Hour in Spare Time Starting Soon

Start soon to fix electric toasters, clocks, fans, vacuum cleaners, etc., for neighbors and friends. Work in your basement, garage, or spare room. Earn \$3 to \$5 an hour in your spare time. See how easy it is to increase your earning power—how you can pay for this training many times over with your spare time earnings.

## Train Now for Greater Security Low Price—Easy Terms

The day when the tinkerer could do the job is past. Today's automatic electrical appliances need expert servicing. Start now to learn a good trade like appliance repairing. No need to give up your present job while you train. Only \$2.50 starts you, and you pay only \$5.00 a month. A small price to pay for increased earnings, a more secure future. Mail coupon now.



## Find Out about Your Opportunities in Electric Appliance Servicing

Actual lesson we send to prove home training is practical. Book tells more about Electric Appliance industry, gives details of our training. Address: Electrical Appliance Training, National Radio Institute, Dept. AC5, Washington 9, D.C.



**FREE LESSON and  
BOOK**  
—MAIL THIS NOW

### NATIONAL RADIO INSTITUTE

Dept. AC5, Washington 9, D. C.

Please send me Electric Appliance Training lesson and book free. (No salesman will call.)

Name \_\_\_\_\_ Age \_\_\_\_\_

Address \_\_\_\_\_

City \_\_\_\_\_ Zone \_\_\_\_\_ State \_\_\_\_\_



# INVENTORS

If you believe that you have an invention, you should find out how to protect it. The first step is to have a search made of the prior pertinent U. S. patents. If a report on this search indicates that the invention appears patentable you can apply for a patent, and the specifications and claims should be prepared.

The firm of McMorrow, Berman & Davidson, with offices in Washington, D. C., is qualified to take the necessary steps for you. We can make a preliminary search on your invention, advise you whether we think it can be patented, and prepare your application for patent.

Unless you are fully familiar with the U. S. Patent Laws, we recommend that you engage the services of a Registered Patent Attorney to protect your interests. The patent laws are *your* laws. A patent gives you the right to prevent others from making, using or selling the invention claimed in your patent for a period of 17 years.

Use these patent laws for your protection. Investigate whether your invention can be patented. If you have what you believe to be an invention, we suggest that you have this firm make a search for you.

*Send for a copy of our Patent Booklet entitled "How To Protect Your Invention," containing information about patent protection and patent procedure. Along with this we will also send you an "Invention Record" form, for your use in writing down and sketching details of your invention. We will mail them promptly. No obligation. They are yours for the asking.*

**McMORROW, BERMAN & DAVIDSON**

*Registered Patent Attorneys*

**PATENTS**

• **COPYRIGHTS**

• **PATENTS**

135-C VICTOR BUILDING, WASHINGTON 1, D. C.



Smokes 35° Cooler!

THE NEW

# MEDICO

TRADE MARK

## Double-Dri

Best looking pipe!  
Best smoking pipe!



- ① **CONDENSATION:** No Goo! Double-Dri condenses it out.
- ② **RADIATION:** Radiates heat away! Cool to hold.
- ③ **FILTRATION:** Throw away nicotine trapped by filter.



**\$250**

incl. box of 10 filters

Bowls of imported briar. Nylon bits. Bowls, bits and shanks in contrasting colors! Simply beautiful. Extra bowls, \$1.00 each.

WRITE FOR FOLDER E MEDICO, N. Y. 22

## WORK FOR THE



## GOVERNMENT

START AS HIGH AS \$4,209.00 YEAR  
Any Appointments To Be Made. Experience Usually Not Required. MEN-WOM-EN. Mail Coupon Today—Sure.

FRANKLIN INSTITUTE, Dept. A-83, Rochester 4, N.Y.  
(Not Government Controlled) **Send FREE:**  
(1) 32-page book with list of U.S. Gov't Jobs.  
(2) Tell me how to get one of these jobs.

Name \_\_\_\_\_ Age \_\_\_\_\_  
Address \_\_\_\_\_

## LOOK BETTER! FEEL BETTER!

USE A  
**Vibrosage**  
ELECTRIC MASSAGER

- Professional-Type
- 4 Scientifically Designed Applicators
- Sanitary

A few minutes daily use of VIBROSAGE gives that stimulating, healthful aid to circulation . . . relief from aches and pains. Four applicators assure maximum effectiveness for scalp, face and body. Operates on 110 volt, 60 cycle A.C. Five day trial—money-back guarantee! If your dealer cannot supply you, send \$8.95 check or money order, for pre-paid shipment. Or, send \$2; pay postman balance plus postage and C.O.D. charges.



BEAUTY APPLIANCE CORP., Dept. V525-C, RACINE, WIS.

### How to Make Money in PHOTOGRAPHY

EARN WHILE YOU LEARN AT HOME

If you are OVER 17—good pay, fascinating work await you in photography! Start making money quickly in sparetime — step into your own studio or exciting job. LEARN-BY-DOING method trains you at home! Write TODAY for FREE catalog. Also Resident Training. 45th Year! GI Approved.

**NEW YORK INSTITUTE OF PHOTOGRAPHY**  
Dept. 49, 10 W. 33 St., New York 1, N.Y.

Send for FREE BOOK

### FREE BOOKLET

### HOW I MAKE OVER \$125 WEEKLY

### SELLING BOOKS BY MAIL!

YES, I AVERAGE \$125.00 WEEKLY, SELLING BOOKS BY MAIL. YOU CAN SELL THE SAME BOOKS I DO! YOU CAN START IN YOUR SPARE TIME. NO STOCK TO CARRY. ONLY SMALL INVESTMENT NEEDED.

WRITE NOW TO PAUL COOPER  
245-PM TAUNTON, BUFFALO, NEW YORK

## STOP MAKING MISTAKES IN ENGLISH!

Is your English holding you back? You can gain greater confidence, win new friends, make more money—through BETTER ENGLISH. Free 32-page booklet tells how you can become a more effective speaker, writer, and conversationalist without going back to school. New, easy method takes only 15 minutes a day. Costs little. For your FREE booklet, send a card or letter. No obligation—no salesman will call.

CAREER INSTITUTE DEPT. E-113, 25 E. JACKSON, CHICAGO 4, ILLINOIS

### Better Than Your Own SHOE STORE AT HOME

No investment, no experience needed. Just show magic cushion comfort to friends, neighbors, co-workers. Advance commissions to \$4.00 a pair, plus Cash Bonus, Paid Vacation, \$25.00 Reward Offer. Outstanding values for men, women, children. Money back guarantee. Shoe samples supplied without cost. Write TODAY for FREE new 76 page catalog and full details.



Two-Eyelet Hit With Cushioned Comfort

TANNERS SHOE CO., 548 BROCKTON, MASS.



All Electronic Parts  
YOURS TO KEEP!

# NOW! WORK OVER 300 PRACTICAL PROJECTS with THESE PARTS AT HOME

to help You learn

# TELEVISION RADIO-ELECTRONICS

Now . . . at home in spare time you can get BOTH the very training and subsequent Employment Service you need to help you start earning real money in America's thrilling, multi-billion dollar opportunity field of Television-Radio-Electronics. Now that Television is coming to almost every community, here is a chance of a lifetime to prepare to cash in on one of Television's great expansions.

D.T.I.'s amazingly practical home method enables you to set up your own HOME LABORATORY. You get many Electronic parts which you mount on individual bases with spring clip connectors. Tops for experimenting! Add or remove parts in a jiffy. No wasted hours of soldering and unsoldering for each project. You spend minimum time to get maximum knowledge of important circuits that really work. In fact, you get exactly the same type of basic training equipment used in our Chicago training laboratory—one of the nation's finest.

### Build and KEEP This VALUABLE TEST EQUIPMENT

Your home laboratory projects also include building and keeping a versatile 5-inch Oscilloscope and precision Jewel Bearing Multi-Meter. These quality commercial test instruments help you EARN WHILE YOU LEARN and will prove mighty valuable, should you later decide to start your own full time TV-Radio service business. You also build and keep a quality 21-inch TV SET.

### D. T. I. Provides EVERYTHING YOU NEED to master TELEVISION

In addition to your home laboratory and easy-to-read lessons, you even use HOME MOVIES—a wonderfully effective and exclusive D.T.I. training advantage. You watch hidden actions . . . see electrons on the march. Important fundamentals become "movie clear," helping you learn faster . . . easier . . . better.

### LABORATORY TRAINING

Full time Residential training in D.T.I.'s great Chicago laboratories also available. MAIL COUPON TODAY for all facts. (If subject to MILITARY SERVICE you'll especially welcome the information we have for you.)

HOME MOVIES



Get This Information-  
Packed Publication  
**FREE!**

**89 WAYS  
TO  
EARN  
MONEY  
IN TELEVISION  
RADIO  
ELECTRONICS**



MULTIMETER

OSCILLOSCOPE

# 21 INCH

Build and keep this BIG DTI Engineered TV set—easily converted to U.H.F. (DTI offers another home training, but without the TV set.)

## MAIL COUPON TODAY!

### DeVRY TECHNICAL INSTITUTE

4141 BELMONT AVE., CHICAGO 41, ILL., Dept. PM-3-L

I would like your valuable information-packed publication showing how I can get started toward a good job or my own business in Television-Radio-Electronics.

Name \_\_\_\_\_ Age \_\_\_\_\_

Street \_\_\_\_\_ Apt. \_\_\_\_\_

City \_\_\_\_\_ Zone \_\_\_\_\_ State \_\_\_\_\_

D. T. I.'s Training is Available in Canada



"ONE OF AMERICA'S  
FOREMOST TELEVISION  
TRAINING CENTERS"

## DeVRY TECHNICAL INSTITUTE

AFFILIATED WITH  
**DeFOREST'S TRAINING, INC.**  
CHICAGO 41, ILLINOIS



# DRAFTSMEN



**CASH BIG  
PAY CHECKS!**

**Train Now for  
more success,  
greater security**

**LEARN AT HOME IN SPARE TIME  
(or at college in Chicago)**

Check the want ads in any newspaper—SEE the big-pay opportunities open to you as a draftsman. What's more, you can learn this well-paid, prestige profession at home—quickly, easily! No special talent needed. Get complete, step-by-step Chicago Tech lessons in the mail, spend a few pleasant hours studying each week. In a short time you'll be a well-trained draftsman, ready to take your pick of many good jobs. Act now!



**Free Information—Mail Coupon Today!**

Get **FREE TRIAL LESSON** plus information about C.T.C. practical training. Learn what successful Chicago Tech graduates say about high pay and opportunities in drafting. No charge, or obligation.

## CHICAGO TECHNICAL COLLEGE

C-253 Tech Bldg., 2000 So. Michigan Ave.  
Chicago 16, Illinois

Mail me **FREE** lesson with facts about big opportunities in **DRAFTING**.

Name \_\_\_\_\_ Age \_\_\_\_\_  
Address \_\_\_\_\_  
City \_\_\_\_\_ Zone \_\_\_\_\_ State \_\_\_\_\_

## BECOME AN EXPERT IN TRAFFIC

The Traffic Executive today is one of the most important and well paid positions in industry and transportation. Thousands of firms need experts on rates, tariffs, regulations, etc.

We train you thoroly at home in spare time thru the famous LaSalle Problem Method under the guidance of expert traffic authorities.

For nearly 50 years LaSalle has been helping ambitious men get ahead in this interesting and profitable field. Course compiled and reviewed by 175 of the country's leading traffic executives.

Get the facts. Mail coupon today for **FREE** 48-page book, "Traffic Management—the Fast Growing Profession" and learn of the opportunities in Traffic, and how you can become expert in this field.

**LASALLE EXTENSION UNIVERSITY**  
*A Correspondence Institution*

417 S. Dearborn St., Dept. 364T, Chicago 5, Ill.

Name \_\_\_\_\_  
Address \_\_\_\_\_  
City \_\_\_\_\_ Zone \_\_\_\_\_ State \_\_\_\_\_



## "SPRING-STEP" SHOES CAN DOUBLE YOUR INCOME

Earn \$100, \$200, \$300 per week and more selling Ortho-Vent "Spring-Step" cushion shoes full-time or part-time. Over 160 different styles make this world famous, direct-to-consumer, shoe line a proven money-maker for you! No experience or investment needed! We supply everything you need to start earning money from the very first day. Build lifetime security by selling the world's most comfortable, flexible, lightest weight cushion shoe... Ortho-Vent "Spring-Step."  
**WRITE TODAY!**

**ORTHO-VENT  
SHOE CO., Inc.**

Salem, Virginia  
Dept. PM-355

## SHORTHAND in

**6  
WEEKS**

Famous **SPEEDWRITING** shorthand, 120 words per minute. No symbols; no machines; uses ABC's. Easiest to learn, write and transcribe. Lowest cost. 250,000 taught by mail. For business and Civil Service. Typing available. 32nd year. Write for **FREE** booklet to: **SCHOOL OF**

**Speedwriting**  
Dept. 1503-5, 55 W. 42 St., New York 36 (R)

## TASOPE PHOTO-ENGRAVING PLANTS



Material Cost  
Of This Cut 3/40  
Selling Price  
\$1.00 And Up

Establish your own profitable **PHOTO-ENGRAVING** business. Make cuts for newspapers, printers, and advertisers. Make etched name plates, plaques etc. Instructions furnished, no experience necessary. Sold direct from factory since 1931. First five hundred cuts sold locally or by mail will pay for plant and pay you well for your time. Write for **FREE** catalog.

**TASOPE, DEPT. PM-3, AURORA, MO.**

*Write Like This* **Complete OUTLINE FREE!**

YOUR penmanship can be improved in 3 hours or corrected to your satisfaction in 10 hours' practice with my **DEFINITE HAND CONTROLS**. New way!

**WRITE OZMENT BOX 605 34-N, ST. LOUIS, MISSOURI**

## REAL ESTATE BE A BROKER

**PAYS BIG! SEND FOR FREE, BIG, ILLUSTRATED CATALOG NOW!** Graduates report making substantial incomes. Start and run your own business quickly. Men, women of all ages, learn easily. Course covers Sales, Property Management, Appraising, Loans, Mortgages, and related subjects. **STUDY AT HOME** or in classrooms in leading cities. Diploma awarded. Write **TODAY** for free book! No obligation.



Approved for World War II and Korean Veterans  
**WEAVER SCHOOL OF REAL ESTATE (Est. 1916)**  
2020 Grand Dept. PM Kansas City, Mo.

## FALSE TEETH That Loosen Need Not Embarrass

Many wearers of false teeth have suffered real embarrassment because their plate dropped, slipped or wobbled at just the wrong time. Do not live in fear of this happening to you. Just sprinkle a little **FASTEETH**, the **alkaline** (non-acid) powder, on your plates. Holds false teeth more firmly, so they feel more comfortable. Does not sour. Checks "plate odor" (denture breath). Get **FASTEETH** at any drug counter.



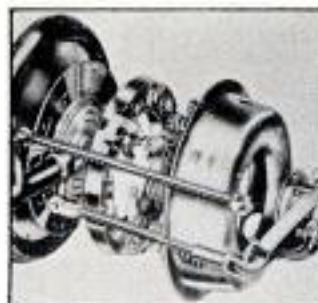

2950 photos and diagrams, plus crystal-clear directions, make every operation easy as A-B-C.

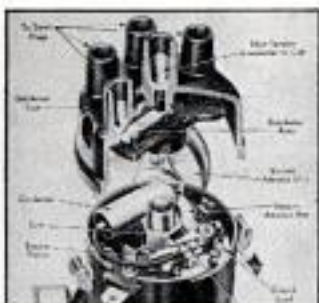

Diagrams, tables and text take the "mystery" out of all ignition systems.

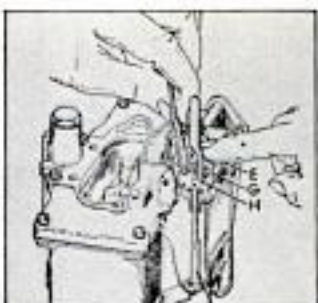

You get illustrated repair procedures for all types of carburetors.

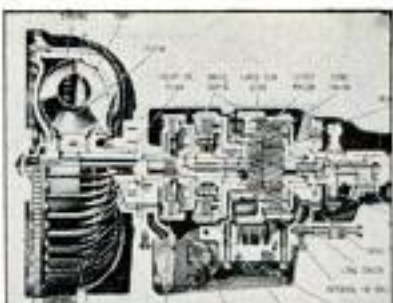

ALL AUTOMATIC TRANSMISSIONS are fully covered in special big section. (NOTE: All pictures shown here are greatly reduced in size. Actually, this giant book is almost a foot high!)

# Here's the EASY Step-by-Step Way to FIX ANY CAR IN A JIFFY!

Now—Whether You're a Beginner or Expert Mechanic—You Can "Lick" Any Repair Job On Any Car Built From 1940 Thru 1954

Now you can tackle any repair job, and do it quickly, easily, right—the first time! MOTOR'S BRAND-NEW AUTO REPAIR MANUAL shows you how—with crystal-clear pictures and step-by-step directions you can easily follow.

No guesswork. This giant guide tells you where to start; what tools to use. Leads you easily and quickly through the entire operation. Covers everything from a simple carburetor adjustment to a complete overhaul.

### Everything You Need to Know

BIG, NEW REVISED Edition has MORE REPAIR INFORMATION THAN EVER! ONE THOUSAND giant pages, 2,950 "This-Is-How" pictures—clear drawings, diagrams, cut-away photos—make every step EASY; Over 290 "Quick Check" charts—more than 22,598 essential repair specifications. Over 225,000 service and repair facts. Instructions and pictures so COMPLETE, so CLEAR—so CAN'T go wrong!

Even a green beginner can do a good job. If you're a top mechanic, you'll be amazed at the time-saving procedures.

### The "Meat" of Over 140 Official Shop Manuals

The editors have put together the "Know-How" from over 140 Official Shop Manuals; "balled it down" into one handy indexed book.

Includes ALL Automatic Transmissions (including new PowerFlite). Covers the newest Carburetors, Engines (including new Buick & Ford V-8s) Chokes Oil Filters Fuel Pumps Starting Motors Generators Distributors Clutches Universals

... Axles ... Brakes ... Power Steering ... Shock Absorbers, etc.

Factory Specifications and Adjustment Tables. Tune-up Charts. Tables of Measurements and Clearances. Overhauling and Replacement Facts—AND MUCH MORE.

Used by Armed Forces, hundreds of thousands of auto service men! YOU'LL want to try it, too—on the following UNCONDITIONAL GUARANTEE:

### Try Book for a Week FREE

SEND NO MONEY. Pay nothing to postman. Test book in your own garage or shop. It's GUARANTEED to pay for itself in 7 days. If it doesn't just return the book, and owe nothing. Rush coupon for your free-trial copy of this great money-saving Manual. MOTOR Book Dept., Desk 13, 250 West 55th St., New York 19, N. Y.

USED BY  
U.S. ARMY  
NAVY  
MARINES



Fuel pumps can cause trouble. Pictures show exactly how to take them apart, fix them.

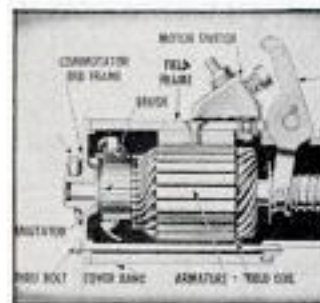

No guesswork. Clear pictures show how to fix starting motor, generator, brakes, chokes, etc.

**Just 2 of the Many Letters of Praise**  
Does Every Job. "My MOTOR Manual is a wonderful help. It has put me in a position to do every job." — S. L. Sharpless, Los Angeles, Calif.  
Amazed Self and Friends. "I amazed myself and my friends, too. Now do jobs that stumped me before." — Michael Ballesky, Newark, N. J.

Some FREE 7-Day Offer on MOTOR'S TRUCK and TRACTOR REPAIR MANUAL  
Covers EVERY job on EVERY gasoline-powered truck and farm tractor made from 1946 thru 1954. 2,200 pictures, 850 big 8 1/2 x 11 inch pages, 300,000 facts. Check proper box in coupon for free trial.

### COVERS 685 MODELS— ALL THESE MAKES

Buick	Ford	Nash
Cadillac	Frazer	Oldsmobile
Chevrolet	Henry J	Packard
Chrysler	Hudson	Plymouth
Crosley	Kaiser	Pontiac
De Soto	Lincoln	Studebaker
Dodge	Mercury	Willys

1,886,000 COPIES SOLD!

### MAIL COUPON NOW FOR 7-DAY FREE TRIAL

MOTOR Book Dept., Desk 13, 250 West 55th Street, New York 19, N. Y.

Rush to me at once! (Check box opposite book you want).

MOTOR'S New AUTO REPAIR MANUAL. If okay, I'll remit just \$2.00 in seven days, then \$2.00 monthly for two months and a final payment of 95c (plus 35c delivery charge) one month after that. Otherwise, I'll return the book postpaid in seven days. (Foreign price: Remit \$9.00 cash with order.)

MOTOR'S New TRUCK AND TRACTOR REPAIR MANUAL. (Described at left.) If okay I will remit \$2.00 in seven days, and \$2.00 monthly for three months, plus 35c delivery charge with final payment. Otherwise, I will return book promptly. (Foreign price: Remit \$10.00 cash with order.)

Print Name.....Age.....

Print Address.....

City & Zone No..... State.....

SAVE 35c delivery charge by enclosing WITH COUPON check or money order for full payment of \$6.95 for Auto Repair Manual (or \$8.00 for Truck and Tractor Manual.) Same 7-day return-for-refund privilege applies.



# Inventors

If you consider your invention valuable, take these necessary preliminary steps promptly to protect it by applying for a United States patent.

Sketch and describe your invention. (For convenience in starting action on your invention, use "Evidence of Invention" form offered below.)

Sign, date and have this invention disclosure witnessed by two people capable of understanding your invention.

Have us make a preliminary search among U. S. patents already granted for similar types of invention.

We then prepare a report for you on the probable patentability of your invention and recommend your further course of action.

This firm is registered to practice before the U. S. Patent Office. We are available to assist you in the preparation and prosecution of your application for patent.

We shall be glad to send you promptly and without obligation, an instructive booklet—"Patent Protection for Inventors"—and our convenient "Evidence of Invention" form.

**VICTOR J. EVANS & Co.** *Merlin M. Evans*  
REGISTERED PATENT ATTORNEY  
130-C MERLIN BUILDING, WASHINGTON 6, D. C.

## Shrinks Hemorrhoids New Way Without Surgery

Science Finds Healing Substance That Relieves Pain—Shrinks Hemorrhoids

For the first time science has found a new healing substance with the astonishing ability to shrink hemorrhoids and to relieve pain—without surgery.

In case after case, while gently relieving pain, actual reduction (shrinkage) took place.

Most amazing of all—results were so thorough that sufferers made astonishing statements like "Piles have ceased to be a problem!"

The secret is a new healing substance (Bio-Dyne\*)—discovery of a world-famous research institute.

Now this new healing substance is offered in ointment form under the name of Preparation H.\* Ask for it at all drug stores—money back guarantee. \*Reg. U. S. Pat. Off.

## SHINE WITHOUT 'POLISH'



**Cars Gleam Like Mirror**

**MEN! WOMEN!** So easy a child can do it! Amazing "Dry" Polisher puts mirror-like shine on car WITHOUT 'POLISH'. No messy pastes, liquids, sprays. Simply glide over car. PRESTO! Leaves hard, lustrous, long-lasting protective Wax Coating. Take orders! Earn money!

**SAMPLES FOR TRIAL**

Sample offer sent immediately to all who send name at once. Just a postcard will do. SEND NO MONEY—just your name.

KRISTEE CO., Dept. 681, Akron 8, Ohio

### Secrets of VENTRILOQUISM Now Revealed!

Easy to learn in 60 to 90 days with our Home Study Course. RESULTS GUARANTEED. Make Money! Be Popular! Have Fun! Big Opportunity! Radio, Television, Stage Appearances! For FREE information regarding price and terms, WRITE. You must state your age. Dummy Catalog 25c.  
FRED MAHER SCHOOL OF VENTRILOQUISM  
Box 36, Studio PM-3 Kensington Station  
Detroit 24, Michigan

## WE PAY FOR NAMES OF MEN WHO WEIGH 200 LBS. OR MORE

If you know any BIG MEN—sizes 44 to 72—just send us their names and addresses. We'll send them our new Spring Catalog of large-size, high-quality, low-priced clothing. And we'll send you a list of wonderful items from which you choose a free gift when Mr. Big orders from us. Act now!

**BURNS MARTIN** Dept. 729, 121 Summer St.,  
Boston 10, Mass.

## MAKE CRIME YOUR BUSINESS

### ON THE SIDE OF THE LAW!

Help fight crime! . . . Earn steady good pay as a Finger Print Expert or Investigator. I.A.S. trains you—by easy, low-cost home study lessons. Learn this exciting work in spare time. Write for full details now!

### OVER 800 POLICE BUREAUS...

Employ I.A.S.-trained men . . . proof of what I.A.S. can do. Write today (state age) for details. No obligation. No salesmen will call.

## INSTITUTE OF APPLIED SCIENCE

(A Correspondence School Since 1916)

1920 Sunnyside Ave., Dept. 1353, Chicago 40, Illinois



# GET INTO AUTOMOTIVE DIESEL AND ALLIED MECHANICS

*by Shop Method Home Training*

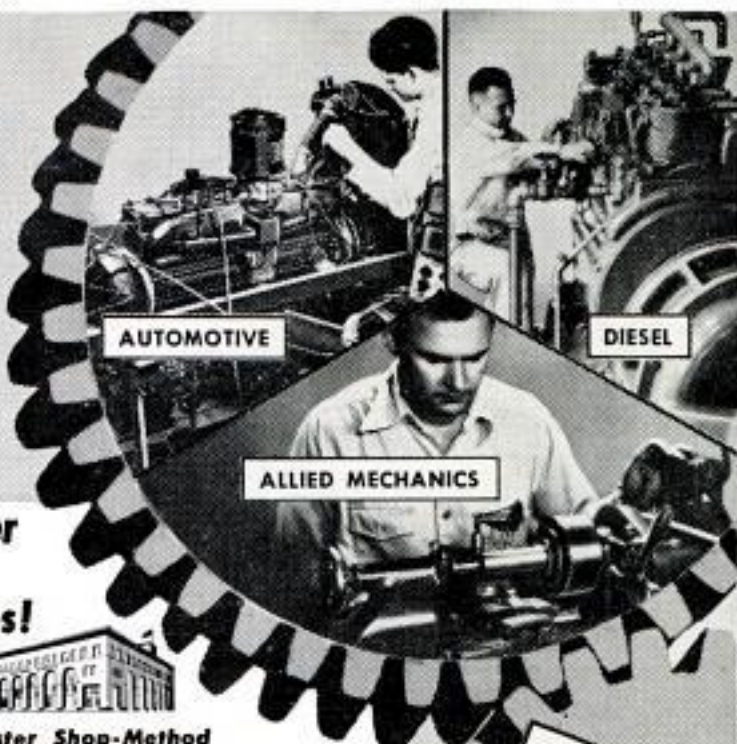

**JOBS LIKE THESE ARE OPEN TO YOU AS A TRAINED ENGINE MECHANIC... CHOOSE THE FIELD YOU LIKE BEST!**

**Get complete training**

- Diesel Fuel Injection
- Automotive Motor Tune-up
- Diesel Engine Maintenance
- General Garage Mechanics
- Agricultural Implements

- Auto Engine Rebuilding • Auto Elec. Service
- Public Utilities • Parts Dealers
- Bus & Truck Lines • Industrial Maintenance
- Contracting & Excavating
- Business of Your Own

AND MANY other similar openings

**EARN WHILE YOU LEARN**

With our practical Master Shop-Method Home Training, you study at home in your spare time. You receive Spare Time Work Lessons, which show you how to earn while you learn...for extra money and experience. You Learn by DOING.

**YOU RECEIVE AND KEEP ALL THIS MATERIAL:**

- |   |                             |
|---|-----------------------------|
| Basic Lesson Texts                        | Engine Service Manuals      |
| Diesel Installation Operation—Maintenance | Engine Repair Drive Systems |
| Diesel Chart Manual                       | Diesel Electric Power       |
| Spare Time Lessons                        | Thermodynamics              |

**TOOLS AND EQUIPMENT**

**INVESTIGATE!  
SECURE FULL  
INFORMATION**

**WE GIVE  
YOU TOOLS  
OF YOUR  
TRADE**



**Master All Phases!**



Get Master Shop-Method Home Training from an Established Resident School with its own Training Shops and Laboratories—and almost 50 years of Successful Experience in Training Men.

**We Bring National Schools To You**

National Schools trains you for all opportunities in the dynamic, fast-growing Automotive-Diesel and Allied Industries. You get complete training for this great industry.

Thousands upon thousands of autos, trucks, tractors, ships, trains, farms and factories are dependent upon engine power! Trained engine mechanics are needed in the Armed Forces as well as in civilian production. This huge field needs trained men for servicing, repairing, installing, operating and manufacturing equipment. The pay is good, the future excellent! National Schools offers you a practical, all-embracing Automotive-Diesel Mechanics Course that qualifies you for your choice of many good jobs.

Your National Course covers Gasoline and Special Fuel Engines; Diesels, High Speed and Heavy Duty; Semi-Diesels; Allied Mechanics.

**APPROVED FOR  
VETERANS AND  
NON-VETERANS**

**BOTH  
RESIDENT AND  
HOME STUDY  
COURSES  
OFFERED**

**NATIONAL SCHOOLS** LOS ANGELES 37 CALIFORNIA  
IN CANADA: 811 WEST HASTINGS STREET, VANCOUVER, B. C.  
**TECHNICAL TRAINING SINCE 1905**

**GET FACTS FASTEST! MAIL TO OFFICE NEAREST YOU!**

(mail in envelope or paste on postal card)  
**NATIONAL SCHOOLS, Dept. DB-35**  
4000 S. FIGUEROA STREET LOS ANGELES 37, CALIF. or 323 WEST POLK STREET CHICAGO 7, ILLINOIS  
Send FREE Auto-Mechanics Book & FREE sample lesson. No obligation, no salesman will call.

NAME \_\_\_\_\_ BIRTHDAY \_\_\_\_\_ 19\_\_\_\_  
ADDRESS \_\_\_\_\_  
CITY \_\_\_\_\_ ZONE \_\_\_\_\_ STATE \_\_\_\_\_

Check if interested ONLY in Resident School Training at Los Angeles.  
VETERANS: Give Date of Discharge \_\_\_\_\_



**Free Book and Sample Lesson Show You How**

Send today for National Schools' new, illustrated Book of Opportunity in Automotive, Diesel and Allied Mechanics, and an actual sample lesson. No cost — no obligation. Use the coupon now — we'll answer by return airmail.





**YOU  
can  
acquire**

**LAW NIGHTS AT HOME!  
L. L. B. DEGREE**

LaSalle's famous Law Library—used as reference in many Law libraries and Law offices—has enabled thousands to master Law surprisingly fast, in spare hours at home, for business and professional advancement.

These 14 remarkable volumes, compiled by leading professors and lawyers, cover the whole basic field of Law in condensed, orderly, simplified manner.

You advance rapidly with this great library, plus special lectures furnished. We guide you step-by-step with personalized Problem Method of instruction . . . you learn by doing—handling legal problems—not by memorizing rules.

Send for two FREE 48-page booklets, "Law Training for Leadership," and "Evidence," answering questions about Law and its value to you, and telling how LaSalle Law graduates are winning rapid advancement in business and public life. Mail coupon below. No obligation.

**LA SALLE EXTENSION UNIVERSITY  
A Correspondence Institution**

417 S. Dearborn St. Dept. 364L Chicago 5, ILL.

Send me your two FREE booklets described above, without obligation.

Name..... Age.....  
Street.....  
City, Zone & State.....



**OWN YOUR OWN BUSINESS**

Free folder tells how! Build and operate this profitable roadside stand—seasonal or year 'round. Mail coupon now.



**RICHARDSON CORPORATION**  
Dept. PM-3, P.O. Box 790, Rochester 3, N. Y.

Please send me FREE folder on your tested, franchised refreshment stand.

Name.....  
Address.....  
Place.....

**Ball-Bearing SPEED WHEELS**

JUVENILE WHEELS (No bearing, solid tires)	
5" .....	45c
6" .....	65c
7" .....	75c
(Semi-pneumatic tire, ball bearing)	
8x1.25 .....	\$1.85
8x1.75 .....	1.95
8x2 .....	2.20
10x1.25 .....	\$2.20
10x1.75 .....	2.30
10x2 .....	2.65
12x1.75 .....	3.45
INDUSTRIAL WHEELS	
(Lug Base, Semi-Pneumatic tire)	
6x2 SW .....	\$3.45
6x2.00 .....	4.00
8x2.00 .....	5.20
8x2.50 .....	5.40
10x4.00 .....	15.15
(Smooth Base, Pneumatic tire and tube)	
8x3 2 ply .....	\$10.00
10x3.50 2 ply .....	10.55
12x4 2 ply .....	14.41
4.00x8 2 ply .....	13.10
14x4.50 2 ply .....	15.96

CASTERS—Now Available. Write for circulars on all wheels. No c.o.d. orders. Prices F.O.B. our plant.  
**JIM BROWN TOY COMPANY**  
1095 HOME AVENUE PM-355 AKRON 10, OHIO

**LEARN TO MOUNT BIRDS**

**ANIMALS, FISH, PETS**

Be a Taxidermist. Save your hunting TROPHIES. Have a fine home-museum. Hunters, save and MOUNT your beautiful DUCKS, QUAIL, DEER, TAN skins, FURB. Great Fun. Spare-time PROFITS.

**FREE BOOK** Tells ALL about it. 100 fine wild-game pictures, 48 pages. SEND TODAY, don't delay. Get this WONDERFUL FREE BOOK, MEN AND BOYS. Learn Taxidermy. Double your hunting pleasure. Rush letter or POSTAL today. STATE YOUR AGE.

**N. W. SCHOOL OF TAXIDERMISTRY, Dept. 2503, Omaha, Neb.**

**LEARN LOCKSMITHING**

Learn this fascinating, profitable trade from experts in your spare time at home! Age or physical handicap no disadvantage. Year around, steady income. Full or part time. Practical, illustrated lessons. You can make money even while learning! All materials and special tools supplied without extra charge.

**INSTITUTE OF LOCKSMITHING, Dept. P-64**  
15 PARK AVENUE RUTHERFORD, N. J.  
Lic. by N.J. State Board of Education  
Approved for Veterans

send for **FREE BOOKLET**

**Learn CARTOONING**

at home in spare time . . . the quick easy Landon Picture Chart way. Teaches how to originate—today's big need. Scores of successes. Send 1/c for Picture Chart (to test ability) and full details. Please state age.

**Landon School of Cartooning, 5503 CTS Bldg., Cleveland 14, O.**

**Make BIG MONEY!**

**RAISE CHINCHILLA RABBITS!**

Cash Markets Supplied for Your Production

**FREE - Illustrated Booklet - WRITE TODAY!**  
**ROCK HILL RANCH, SELLERSVILLE 36, PA.**

World's Largest Breeder of Chinchilla Rabbits

**RUPTURE**

RELIEF...OR YOUR MONEY BACK

Original, patented Web, copied but never matched. Users say it's best ever. Relief or no cost to you. Write:

**WEB TRUSS CO., Dept. M-3, Hagerstown, Md.**

**250 POWER . . . .**

**Complete Telescope Lens Kit** only **\$3.49** postpaid

Conquer Space. Explore the Universe, Planets, Moon Craters, New Stars, etc. Complete Lens Kit consists of 80 inch focal length ground and polished objective lens, eyepiece lenses for 50 POWER, 100 POWER, 150 POWER, 200 POWER, 250 POWER, and all necessary lens fittings. Easy to make from simple step by step instructions. (Tripod and mount not included.) Money back guarantee.

**BUSSE SALES CO., Hartford 1, Conn., Dept. PM 31**



**It's New! 3 Years in Development  
-NOW READY FOR YOU!**



This is the new Sprayberry Training Television Receiver.

You build the new Sprayberry Tester... 18-range Volt-Ohm-Milliammeter readings.

**17" to 24"  
PICTURE TUBE**

**New Equipment! New Lessons! Enlarged Course!**  
**SPRAYBERRY PRACTICAL TRAINING IN**  
**RADIO-TELEVISION**  
**3 NO OBLIGATION TRAINING PLANS**



F. L. SPRAYBERRY  
Pres.

You have **NO MONTHLY PAYMENT CONTRACT** to sign... pay for this outstanding training as you learn!

Mail the coupon at once for my big all-new 56 page **FREE CATALOG** and **FREE Sample Lesson**. Get the full story of this remarkable new Training Plan. Read about my 3 **NO OBLIGATION PLANS** of "packaged unit" instruction. I can prepare you in as little as 10 MONTHS to take your place as a **Trained Radio-Television Technician**. You take no risk in enrolling for my Training because you **DO NOT SIGN A BINDING TIME PAYMENT CONTRACT**. I have been training successful Radio-TV technicians for 22 years...I can prepare you, too, to get into your own profitable Service Shop or a good paying job. Full information **FREE** and without any obligation. No salesman will call.



You will build this powerful short wave and broadcast superhet radio receiver.

**NEWEST DEVELOPMENTS**

Your training covers U H F, Color Television, F.M., Oscilloscope Servicing, High Fidelity Sound and Transistors.

**PRACTICE AND TRAIN AT HOME WITH 25 NEW KITS of EQUIPMENT**

You get valuable practical experience in construction, testing and shop practice. You build a powerful 2 band superhet radio, the all-new 18 range Sprayberry multimeter, the new Sprayberry Training Television receiver, signal tracer and many other projects. All equipment is yours to use and keep. All your training is **IN YOUR HOME** in spare hours. I help you earn extra spare time money while you learn. Rush coupon below for all the facts—**FREE!**

**SPRAYBERRY ACADEMY OF RADIO**

**111 NORTH CANAL STREET, DEPT. 10-W  
CHICAGO 6, ILLINOIS**

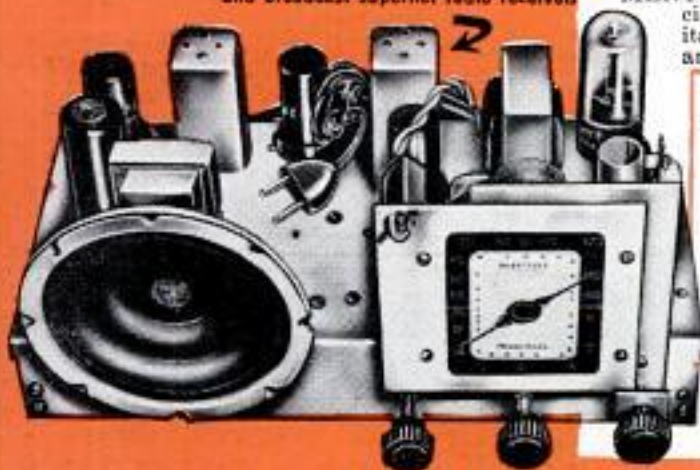

**FREE CATALOG AND SAMPLE LESSON**

Rush coupon for my catalog "How to Make Money in Radio-Television". **PLUS** an actual sample Sprayberry Lesson without obligation—**ALL FREE**. Mail coupon **NOW!**



**SPRAYBERRY ACADEMY OF RADIO** MAIL THIS COUPON FOR **FREE** Dept. 10-W, 111 N. Canal St., Chicago 6, Ill. **FACTS AND SAMPLE LESSON**

Please rush New Catalog and Sample Lesson **FREE**. I understand that no salesman will call.

Name \_\_\_\_\_ Age \_\_\_\_\_

Address \_\_\_\_\_

City \_\_\_\_\_ Zone \_\_\_\_\_ State \_\_\_\_\_



# ... TURN CONCRETE INTO GOLD!



## MAKE UP TO \$75 A DAY IN YOUR OWN BUSINESS

If you want to have your own business — to start a business on your own — here's your big opportunity! New high speed, low cost General block machine produces up to 1,000 concrete blocks a day. Sell all you make to builders, supply houses, and others for homes, factories, buildings, garages. Cash in on the building boom! You can make profits of 100% to 150% — up to \$75. a day! General block machine equipped with 1/2 h.p. electric motor — or can be supplied with gasoline engine — works anywhere, in little space, indoors or out. Operates from ordinary house light socket. Simple, foolproof 3 step operation — so easy a child can do it. Makes superior 3 core blocks any size from 4" to 12". Also makes chimney, sash, corner and other types. Blocks meet any building code anywhere in the country. Materials — sand, water, cement, available anywhere. Simple illustrated operating instructions and mixing formulae for cement and cinder blocks supplied with each machine. Write for FREE folder with full information.

**MOTOR DRIVEN**

R. L. T. of New York City reports: "MY GENERAL BLOCK MACHINE PAID FOR ITSELF IN FIRST 2 WEEKS!" Hundreds now in use the world over! Write for FREE details today!

**EXTRA**

Amazing illustrated book gives floor plans for 6 sensational concrete block bungalows. Tells how to lay blocks, lay out building lines, mix concrete, build steps, porch and concrete floors all at great savings. Written by experts. Can save many times the cost of the machine! Get it now! No strings attached. Send \$1.

BOOK SENT FREE IF YOU BUY MACHINE. \$1 REFUNDED IF YOU BUY LATER.



## GENERAL ENGINES CO.

DEPT. M-35, 307 HUNTER STREET, GLOUCESTER, N. J.



## MEN! TRAIN NOW FOR A BIG PAY FUTURE IN DIESEL & SCIENTIFIC MOTOR TUNE-UP



- Diesel Construction
- Diesel Engine Repairman
- Diesel Operator
- Industrial Maintenance
- Auto Engine Rebuilding
- Bus & Truck Maintenance

### Be a Trained Diesel Man

Go places with DIESEL! Farms, factories and power plants, trains, ships, trucks, buses all use DIESEL POWER... all need DIESEL-trained men! You can start your DIESEL training at home, in spare time, with tested, proved U E I training. Course includes practical work on Diesel engines under skilled instructors. You learn the operation, maintenance, servicing of all types of Diesel engines, PLUS Scientific Motor Tune-up.

**ACT NOW!** if you have mechanical ability, you'll like Diesel! High School diploma not necessary. Write now for FREE book, "EARNING POWER IN DIESEL." Act Today!

**MAIL NOW FOR FREE BOOK!**

UTILITIES ENGINEERING INSTITUTE, Dept. DC-44, 2521 Sheffield Ave., Chicago 14, Ill. (Founded 1887) O. K.! Rush, without obligation, FREE Book on DIESEL.

NAME \_\_\_\_\_

ADDRESS \_\_\_\_\_

CITY \_\_\_\_\_ ZONE \_\_\_\_\_ STATE \_\_\_\_\_

Check here for information if under 17.

## more jobs than graduates

**ENGINEERS**  
 exciting opportunity! If you are interested in these 11, pay you to write Box D 1, including a complete history of science and education.

Demand for our engineering graduates exceeds supply. Effective placement! Study in this world-famed college... established 1884. New term starts quarterly. Approved for Korean Vets.

### Bach. Sc. degree in 27 months

Bachelor of Science in Mechanical, Civil, Electrical, Chemical, Aeronautical, Radio (Television), Administrative Engineering; Business Administration and Accounting. Also 36-week certificate course in Drafting. Intensive program; technical fundamentals accented; comprehensive courses. Small classes; personalized instruction. For earnest, mature students whose time and budget require accelerated courses and modest costs. Preparatory courses.

Beautiful campus in friendly college town. Well-equipped, new and modernized buildings and labs. Enter March, June, Sept., Jan. Write Jean McCarthy, Director Admissions, for Catalog and View Book.



## A "GOOD HAND" HELPS YOU SUCCEED! LEARN TO WRITE WELL

Handwriting quickly improves with our easy-to-understand picture lessons! Put your spare time to good use; send today for  FREE BOOKLET, "How to Become a Good Penman," or check volumes wanted below at \$1 each:  Business Writing  Artistic Writing  Card Writing  Bird & Design Flourishing  Engraving Alphabets, COMPLETE SET \$4.50. Ask for price list of penman's supplies.

Beautifully written, plus special pen-point for shaded writing. **OUR 53rd YEAR**

**TAMBLYN SCHOOL OF PENMANSHIP**  
 S.A. Ziller, Pres., 442 Ridge Bldg., Kansas City, Mo., USA

## \$2100 and MORE YOURS! IN A WEEK YOURS!

**New Refrigerator Defroster Sells Itself on Sure-Fire FREE TRIAL!**  
 NOTHING ELSE LIKE IT! 8 out of ten housewives buy amazing D-Frost-O-Matic after daring FREE TRIAL. Pocket \$15.00, \$20.00 and more in few hours full or spare time, up to \$210.00 in a week!  
**FREE!** RUSH POSTCARD now for big-profit facts, sure-fire FREE TRIAL Plan. Everything free, no obligation. Write TODAY!  
**D-FROST-O-MATIC, 173 W. Madison, Dept. F-6, Chicago 2, Ill.**

**BREED New Plant Varieties** Win up to \$10,000

THOUSANDS are paid every year by growers, seedsmen, etc. for new varieties. Learn Luther Burbank's secrets, also latest methods. Pave the way to a fascinating, profitable hobby. No experience or costly equipment needed. Let us show you in concise, non-technical form, how to produce "sports", giant forms, doubling, etc., without poisons, in a fraction of former time required.

**FREE!** Write now for FREE Folder and Facts. The Ascher Co., Dept. M-3, 200 Detroit Ave., Concord, Calif.

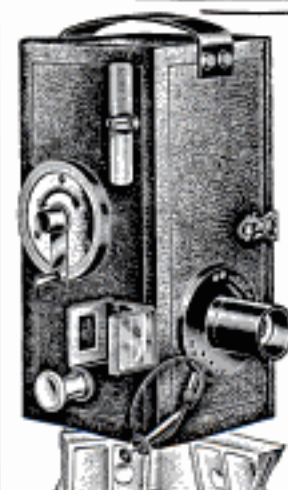

## Finished Photos in 2 Minutes! Great Quick Photo Invention PDQ CHAMPION PHOTOMASTER

Takes and finishes 30 to 40 everlasting, black and white or sepia photos an hour. No dark room. Guaranteed not to fade. Photos taken on "SUPER-SPEED" direct positive paper. Picture size 2 1/2 x 3 1/2 in. Complete, easy to operate portable photo studio. **700% PROFIT.** Write quick, get details about the great PHOTOMASTER.

**P D Q CAMERA CO.**  
 Chicago 10, Ill.  
 1181 N. Cleveland Ave., Dept. PM-355



# 1000 GOLDEN OPPORTUNITIES

For years we have been teaching and guiding ambitious people how to acquire profitable and fascinating occupations, starting at home or shop with only a few dollars investment, and how to make more money than ever before! We now offer **YOU** the same unlimited opportunities! On this page are briefly described only 4 out of **HUNDREDS** of similar products and processes waiting for you in Catalogs Nos. 19 and 20. Wonderful ideas for turning your **TIME** into **MONEY!**

## The Wonders of Liquid Plastics

### Manufacture Without Tools or Machinery

No previous experience or special ability required! **NO TOOLS OR MACHINERY** required - the entire process is about as easy as pouring water out of a glass! The **WONDERS OF LIQUID PLASTICS** make all this possible! Many of the products made with our liquid plastics serve so many diverse and useful functions, many can so easily be converted into beautiful and attractive products that thousands of our customers are now actively engaged in a wide variety of proud and profitable businesses established with the aid of our products and instructions!

### UNLIMITED OPPORTUNITIES

Work with **LIQUID IVORY, LIQUID GLASS, LIQUID MARBLE, LIQUID EBONY, LIQUID PORCELAIN, LIQUID WOOD, LIQUID GEMSTONE,** and many other **LIQUID PLASTICS** and in a matter of minutes turn them into an endless and valuable procession of beautiful imbedded jewelry, novelties, ornaments, statuettes, bookends, lamps, pensets, lighters, ashtrays, keychains, figurines, curios, **SOUVENIRS,** art and gift products, fishing lures, **BOATS, GADGETS** galore, exquisite **GEMS!** Make gears, tools, dies, forms, handles, dials, knobs, **MACHINE PARTS,** models of inventions, pistol grips - the list is endless! The only **LIMITATION** is your **IMAGINATION!** Liquid Plastics are the blessing of every creative and ambitious person - with these materials **ANYONE** can create and manufacture by the **THOUSANDS** and at a tiny fraction of what it would cost by any other method! Just send 25c and we will send you our big combination Instruction-Catalog No. 19, describing all of the products mentioned above and the methods of use! You'll readily admit it's the most fascinating book of its kind as for as opening new worlds of activity and opportunities for you!

**FREE** Catalog #19 is devoted exclusively (64 pages) to the art of manufacturing **EVERYTHING** without tools or machinery! Send for it today! We will include valuable book, **THE WONDERS OF LIQUID PLASTICS** absolutely free! Catalog No. 19, 25c



## PLASTIC LAMINATING

We manufacture new-process Laminating Machines from \$35.00 and up! Here is a wonderful business you can operate right from home! Make \$10.00 an hour easily! Laminate photos, cards of all kinds (identification, Social Security, business, credit, membership, etc.), newspaper clippings, etc. Send us any card or photo (not over 2" x 3") and 50c and we will laminate it for you to demonstrate the fine quality of work performed by our laminating machines! For more details, see Catalog No. 20.



## FREE KIT!

CATALOG #20 is filled with fascinating occupations that can be turned into extremely **PROFITABLE** home and shop businesses! **UNLIMITED POSSIBILITIES! UNLIMITED PROFITS!** No previous skill required. Learn Jewelrycraft, Wirecraft, Photocraft, Woodcraft, Machine Shop Practice, Metalizing, Ceramic Craft, Bolt Making, Mold Making, Model Making, Metalcraft, Metal Enameling, Gemcraft, Plastic Laminating, Basket Weaving, Leathercraft, Embossing, Lampcraft, Feathercraft, Internal Coring, Extruding, Etching, Plating and dozens of other unique and fascinating occupations that can lead to riches! Send only 25c for CATALOG #20 and receive one outfit mentioned above (our choice) **ABSOLUTELY FREE!**



## THE UNIMAT 8 PRECISION TOOLS IN ONE

A high precision, powerful variable speed **LATHE** for metal, wood, plastics, etc. Sturdily built, compact micro-controls! Ideal for machinists, model and tool makers, jewelers, hobbyists. Attachments quickly convert the **UNIMAT** into a **TABLE SAW** in less than a minute. Also, **DRILL PRESS** (with Jacobs-like chuck), **SURFACE GRINDER, MILL, SANDER, SCREW CUTTER** and **PORTABLE HAND DRILL** can be set up with the **UNIMAT** in a matter of minutes and each conversion is a precision tool with variable speed adjustment. Comes in handsome wood chest. **UNIMAT** is a terrific tool at a very low price. Easy terms. Literature and valuable **MACHINIST'S GUIDE** free. Be sure to mention **UNIMAT**.

**FREE!**

Valuable set of 5 **CARVING TOOLS** (Value \$2.98) and remarkable \$2 book **"THE JOB FOR YOU AND HOW TO GET IT!"** Also, all Plastic **RAINCOAT**. All these valuable items are **FREE**. See Catalog #19 for details.

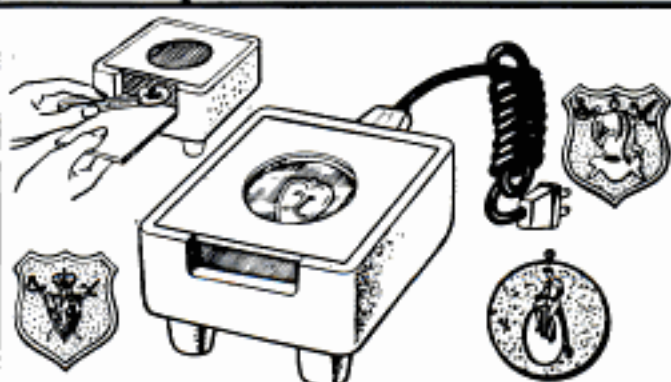

## VITRO-NAMEL

Here is a wonderful opportunity to manufacture **LIFETIME ENAMELED JEWELRY** at home with our complete **VITRO-NAMEL OUTFIT!** High-temperature Kiln, glazes and all accessories (ready to operate) included at this unbelievably low price of only \$8.50 postpaid! Over 60 exquisite pre-stamped designs to choose from resulting in magnificent work with a minimum of labor or skill! Nothing else like **VITRO-NAMEL** anywhere... only \$8.50 complete and postpaid. See Catalog No. 20 above.

P. O. BOX 6737  
CHICAGO 80, ILL.

**PLASTICAST CO.,** Dept. C-102  
(Write to either address)

P. O. BOX 987  
PALO ALTO, CALIF.



Sworn statement from Charles Lemming reads:

"After starting my own business,  
I've averaged

**\$100 A DAY**

—most of it clear profit!"

Not everyone does as well...  
Mr. Lemming owns 2 machines

• In small city, Mr. Lemming started his own business, averaged \$100 a day during first year. Many have succeeded. For example, George Held grossed \$350 in single week.

• How much you earn depends largely on you. No special skill, no large investment. Can start spare time until full time available.

No shop necessary. Operate from home. Clean upholstered furniture on customers' premises—homes, hotels, motels, etc. Auto upholstery, too. Profits high.

• To be free of bosses, layoffs, start your own successful business. Mail coupon today.

**SEND COUPON TODAY FOR FREE BOOK**

• VON SCHRADER MFG. CO.

• 310 "D" Pl., Racine, Wisconsin

• Please rush your FREE booklet telling how I can start my own profitable, year-round electric Upholstery-Cleaning business. Request incurs no obligation.

• Name \_\_\_\_\_

• Address \_\_\_\_\_

• City \_\_\_\_\_ Zone \_\_\_\_\_ State \_\_\_\_\_



## Can A Man My Age Become A Hotel Executive Even Though He Has No Previous Hotel Experience?

Would you like to step into a well-paid position in a Hotel, Motel, Club, Institution, School, Apartment House Project? Would you like to look forward happily to the future? The success of Lewis graduates from 20 to 50 PROVES you can!



Harold L. Beals Becomes Resident Manager  
Although Without Hotel Experience

"I worked at many occupations—none offered a future—until the Lewis Course. I have been employed by a catering company as Accountant and Assistant Manager. I have accepted a Resident Manager's position with an excellent salary plus a bonus of 10% on the profit."

Step Into a Well-Paid Hotel Position  
FREE Book Gives Fascinating Facts

Our FREE Book, "Your Big Opportunity," explains how you can qualify for a well-paid position at home, in leisure time or through resident classes in Washington; tells how you are registered FREE in the Lewis National Placement Service. Most important, it shows how you can be a Lewis Certified Employee—certified to "make good" when placed in a position. Mail the coupon NOW!

Course Approved by ALL Veteran Training

LEWIS HOTEL TRAINING SCHOOL  
Room AC-324, Washington 7, D. C.

**39** TH SUCCESSFUL  
YEAR

Send me the Free Book, "Your Big Opportunity," without obligation. I wish to know how to qualify for a well-paid position.

Home Study       Resident Training

Name \_\_\_\_\_  
(Please Print Name & Address)

Address \_\_\_\_\_

City \_\_\_\_\_ Zone \_\_\_\_\_ State \_\_\_\_\_

Check here if eligible for Veteran Training.

## REPAIR ANY WATCH



... Swiss or American

No previous experience needed to learn modern watch repair. An enjoyable hobby or profitable career. Unique Sweezy System starts you making repairs right away. Develops your skill step by step. Teaches you modern shop methods... professional short cuts... mistakes to avoid. Learn by personal attendance or spare time home study. Individual training. Start any time. Free sample lesson. No obligation. Write today!

CHICAGO SCHOOL OF WATCHMAKING

2330 N. Milwaukee, Dept. 135, Chicago 47, Illinois

Founded 1908 • Approved for veterans

## TELEPHONES



Desk Stand Style

Slightly used but in excellent condition

Many Valuable Uses

Inter-House Phones    House to Barn, etc.  
Loud Speakers        Microphones

Educational Purposes, Toys, etc.

Come complete, ready to use with wiring diagrams included. Two complete for only \$5.00

**\$2.75** Postpaid  
in U.S.A.

TELEPHONE LAMP KIT— with illustrated instructions for making Desk Telephone Lamp including all parts (harp, nipples, push switch, cord, plug, etc.)

... \$6.50 Ppd. (Shade is not included).

MICROPHONE, Dept. X-2402, 1760 W. Lunt Ave., Chicago 26, Ill.

## HULA POPPER • GETS BIG BASS

Surface popping lure. Ideal combination of noise, action, casting and hooking qualities. Pops, plunks, jerks, twitches — obeys your slightest wrist command. Rubber Hula Skirt imitates live bug. At your dealer 5/8 oz. or 1/4 oz., \$1.25. Fly rod size, 75c.



FRED ARBOGAST CO. INC., 2253 W. North St., Akron 3, Ohio

**FREE** WRITE TODAY FOR YOUR BIG FREE ARBOGAST COLOR CATALOG— FULL OF PICTURES OF CATCHES

## BE A DETECTIVE

WORK HOME or TRAVEL. Experience unnecessary. DETECTIVE Particulars FREE. Write to GEO. P. M. WAGNER, 125 W. 86th St., N. Y.

*Learn* **ACCOUNTING** Business Administration

Bookkeeping, secretarial and allied subjects at home in your spare time or attend nationally approved resident school. Write for FREE Success Book giving complete details on courses, plans, rates and employment opportunities. G.I. approved.

*Hills* **BUSINESS UNIVERSITY AND EXTENSION SCHOOL**  
619 W. MAIN ST. OKLAHOMA CITY 2, OKLAHOMA

**BUILD LUGGAGE AT HOME**  
**WE SELL YOUR PRODUCTS!**

ONLY NEW HOME MONEY-MAKING PLAN IN YEARS!

Make Luggage and cases for traveling, photographers, musicians, salesmen, electronics, tools, portables, 1001 other items. Also repair Luggage. No special equipment needed. BIG Profits. We supply complete instructions, materials—everything. Write for free details and Business Plan. ABARSI CASE-CRAFT, Dept. G-3, 805 W. Sunset Blvd., Los Angeles 12, Calif.

*Learn* **BAKING At Home**

Baking is one of America's high industries in wages. Nearly DEPRESSION-PROOF. Thorough basic home course lays sound foundation. If you have aptitude, write for FREE Booklet, "Opportunities in Commercial Baking."

**NATIONAL BAKING SCHOOL**  
835 Diversey Pkwy. Dept. 1353 Chicago 14



# AUDELS Carpenters and Builders Guides

4 vols. \$6



**Inside Trade Information** for Carpenters, Builders, Joiners, Building Mechanics and all Woodworkers. These Guides give you the short-cut instructions that you want—including new methods, ideas, solutions, plans, systems and money saving suggestions. An easy progressive course for the apprentice and student. A practical daily helper and Quick Reference for the master worker. Carpenters everywhere are using these Guides as a Helping Hand to Easier Work, Better Work and Better Pay. To get this assistance for yourself, simply fill in and mail FREE COUPON below.

## Inside Trade Information On:

How to use the steel square—How to file and set saws—How to build furniture—How to use a mitre box—How to use the chalk line—How to use rules and scales—How to make joints—Carpenters arithmetic—Solving measurement problems—Estimating strength of timbers—How to set girders and sills—How to frame houses and roofs—How to estimate costs—How to build houses, barns, garages, bungalows, etc.—How to read and draw plans—Drawing up specifications—How to excavate—How to use settings 12, 13 and 17 on the steel square—How to build hoists and scaffolds—skylights—How to build stairs—How to put on interior trim—How to hang doors—How to lath—lay floors—How to paint.



**AUDEL, Publishers, 49 W. 23rd St., New York 10, N. Y.** Mail Audels Carpenters and Builders Guides, 4 vols., on 7 days' free trial. If OK I will remit \$1 in 7 days and \$1 monthly until \$6 is paid. —Otherwise I will return them. No obligation unless I am satisfied.

Name \_\_\_\_\_  
 Address \_\_\_\_\_  
 Occupation \_\_\_\_\_  
 Employed by \_\_\_\_\_ P-3

# AUDELS HOME APPLIANCE SERVICE GUIDE

This HANDY, Practical "How to Do It" book for Electric & Gas Home Appliance Servicemen, Mechanics & Dealers covers Basic Principles, Servicing, Operation & Repairs of Home Appliances, Tells How to Locate Troubles, How to take Appliances Apart, How to Make Repairs, How to Assemble and Connect. Gives up to date testing methods, wiring diagrams and complete data on each appliance.



## IT PAYS TO KNOW HOW TO FIX

Toasters—Pressing Irons—Waffle Bakers—Casseroles—Roasters—Broilers—Coffee Makers—Space Heaters—Water Heaters—Ranges—Home Wiring—Shop Work—Appliance Testing—Fundamental Electricity—Fractional H.P. Motors—Food Mixers—Fans & Blowers—Vacuum Cleaners—Washing Machines—Clothes Dryers

—Ironers—Dishwashers—Garbage Disposers—Refrigeration—Window Air Conditioners—Oil Burners—Drainage Pumps—Gas Ranges, Furnaces & Water Heaters—Bottled Gas Appliances. A SHOP COMPANION THAT ANSWERS YOUR QUESTIONS. Easy to read and understand—over 800 pages fully illustrated—with 500 photos and diagrams—1001 Facts. A ready reference.

**\$4 COMPLETE • PAY \$1 A MONTH** TO GET THIS SERVICE INFORMATION FOR YOURSELF—FILL IN AND MAIL 7 DAY TRIAL COUPON TODAY.



**AUDEL, Publishers, 49 W. 23rd St., New York 10, N. Y.** Mail AUDELS HOME APPLIANCE SERVICE GUIDE (\$4) for free examination. If O.K. I will send you \$1 in 7 days; then remit \$1 monthly until \$4 is paid. Otherwise, I will return book promptly.

Name \_\_\_\_\_  
 Address \_\_\_\_\_  
 Occupation \_\_\_\_\_  
 Employed by \_\_\_\_\_ P-3

# WHAT ALL AUTO MECHANICS WANT TO KNOW

1664 PAGES



This Big Practical Book gives full information with working diagrams covering the principles, construction, ignition, service and repair of modern cars, trucks and buses.

## Diesel Engines, Hydrumatic & Fluid Drives Fully Explained.

A complete Guide of 1664 pages, with over 1500 illustrations showing inside views of working parts, with instructions for service jobs.

## IT PAYS TO KNOW

How to fit pistons—How to locate engine knocks, How to fit connecting rod bearings—How to service main bearings—How to recondition valves—How to time valves—How to adjust fan belts—How to adjust carburetors and chokes, How to rebuild a clutch—How to service automatic transmissions—How to service brakes—How to adjust steering gear—How to cope with ignition troubles—How to service distributors—How to time ignition—How to "tune up" an engine.



**\$4 COMPLETE • PAY \$1 A MO.** TO GET THIS ASSISTANCE FOR YOURSELF SIMPLY FILL IN AND MAIL COUPON TODAY.

Step up your own skill with the facts and figures of your trade. Audels Mechanics Guides contain Practical Inside Trade Information in a Handy Form. Fully Illustrated and Easy to Understand. Highly Endorsed. Check the book you want for 7 DAYS FREE EXAMINATION. Send No Money. Nothing to pay postman.

# MAIL ORDER



**AUDEL, Publishers, 49 W. 23 St., NEW YORK 10, N. Y.**

Please send me postpaid for FREE EXAMINATION books marked as below. If I decide to keep them I agree to mail \$1 in 7 Days on each book or set ordered and further mail \$1 monthly on each book or set until I have paid price, otherwise I will return them.

- AUTOMOBILE MECHANICS GUIDE, 1664 Pages. \$4
- TRUCK & TRACTOR GUIDE, 1299 Pages . . . . . 4
- DIESEL ENGINE MANUAL, 575 Pages . . . . . 2
- MACHINISTS HANDY BOOK, 1650 Pages . . . . . 4
- WELDERS GUIDE, 400 Pages . . . . . 1
- BLUE PRINT READING, 416 Pages . . . . . 2
- MATHEMATICS & CALCULATIONS, 700 Pages. . . . . 2
- SHEET METAL PATTERN LAYOUTS, 1100 Pages . . . . . 4
- SHEET METAL WORKERS HANDY BOOK, 388 Pgs. . . . . 1
- MECHANICAL DRAWING GUIDE, 160 Pages . . . . . 1
- MECHANICAL DRAWING & DESIGN, 480 Pages . . . . . 2
- AIRCRAFT WORKER, 240 Pages . . . . . 1
- TELEVISION SERVICE MANUAL, 434 Pages. . . . . 2
- RADIO MANS GUIDE, 1040 Pages . . . . . 4
- ELECTRONIC DEVICES, 216 Pages . . . . . 2
- ELECTRIC MOTOR GUIDE, 1000 Pages . . . . . 4
- WIRING DIAGRAMS (Light & Power), 272 Pgs. . . . . 1
- ELECTRICIANS EXAMINATIONS, 250 Pages. . . . . 1
- ELECTRIC POWER CALCULATIONS, 425 Pages. . . . . 2
- HANDY BOOK OF ELECTRICITY, 1440 Pages. . . . . 4
- ELECTRIC DICTIONARY, 9000 Terms . . . . . 2
- ELECTRIC LIBRARY, 7000 Pages (12 Book Set) 18
- SHIPFITTERS HANDY BOOK, 250 Pages . . . . . 1
- REFRIGERATION & Air Conditioning, 1280 Pgs. . . . . 4
- MILLWRIGHTS & MECHANICS GUIDE, 1200 Pgs. . . . . 4
- POWER PLANT ENGINEERS GUIDE, 1500 Pages . . . . . 4
- ENGINEERS & FIREMANS EXAMS, 525 Pages . . . . . 1
- PUMPS, Hydraulics & Air Compressors, 1658 Pgs. . . . . 4
- OPERATING ENGINEERS LIBRARY (3 Books) . . . . . 9
- MECHANICAL DICTIONARY, 950 Pages . . . . . 4
- GARDENERS & GROWERS GUIDES (4 Book Set) 6
- CARPENTERS & BUILDERS GUIDES (4 Book Set) 6
- PLUMBERS & Steamfitters Guides (4 Book Set) 6
- MASONS AND BUILDERS GUIDES (4 Book Set) 6
- PAINTERS & DECORATORS MANUAL, 450 Pgs. . . . . 2
- HOUSE HEATING GUIDE, 1000 Pages . . . . . 4
- OIL BURNER GUIDE, 384 Pages . . . . . 1
- HOME APPLIANCE SERVICE GUIDE, 800 Pages . . . . . 4

## Check NOW!

You Can Look Over Any Guide In Your Own Home — Start the Easy Payments If Satisfied

## MAIL THIS TODAY

Name \_\_\_\_\_  
 Address \_\_\_\_\_  
 Occupation \_\_\_\_\_  
 Employed by \_\_\_\_\_ P-3



# 105 POWER SUPER TELESCOPE



Everything for the Astronomer, Hobbyist, Student, and Scout in this complete astronomical super value telescope combination. Set comes ready for immediate use, consists of brilliant 33x-85x-105x telescope, 5 foot hardwood Tripod, carrying case for scope, Star Explorer map and 108 page book "Discover the Stars." The 3 foot telescope (closes to 16 inches) is brass bound, has 4 precision lenses that will bring distant objects, people, moon, stars, ships, etc., 105 times closer. All images erect. The sturdily built tripod is equipped with universal mount that has a 360 degree horizontal range and 180 degree vertical range. It locks in any position with one simple adjustment. The Star Explorer map enables you to find any star automatically. This marvelous all purpose instrument is proclaimed by Scientists as a most unusual development. Everyone that has used it is amazed at its performance and value. It will fascinate the entire family. Shipped to you complete, nothing else to buy, at the amazing low price of.....

**\$11.95**  
POST PAID

Satisfaction guaranteed or money refunded. We pay all delivery charges. Send check or money order to DEPT. PMS7

CRITERION CO. 331 CHURCH ST., HARTFORD 1, CONN.

## PRINTS POST CARDS

Learn how both large and small businesses are boosting sales with new advertising machine. Write today for FREE illustrated BOOK of unique advertising plans, money-making ideas for your business. **Cardmaster, 1920 Sunnyside, Dept. 12-c, Chicago 40, Ill.**



## Colorcreting Can Be Your Big Opportunity

Local Colorcretors are Needed Everywhere

Colorcreting is a small investment enterprise, rich in sales potentials, high in income possibilities. Work is easy and fascinating. No experience required; we supply complete instructions.

Colorcreting is a building-beautifying process, with Colorcrete being pneumatically applied to new or old masonry surfaces such as concrete or stucco. Lasts indefinitely — 25 years or more. Easily cleaned. Gleaming white, or a choice of 30 colors.

Colorcrete equipment is compact and portable. Easy to operate and practically wear-proof. Easy-payment terms when desired. Write at once for Opportunity Book.

**COLORCRETE** Colorcrete Industries, Inc. 570 Ottawa Ave., Holland, Michigan

IN CANADA: DUNN MASONRY MACHINERY LIMITED 1020 Dundas Highway, Cooksville, Ont.

Get the facts on Mobile Living



When you subscribe to Trailer Topics Magazine, you get the latest information on Mobilhomes... Equipment... Accessories... Trailer Trips... Trailer Parks and many other interesting monthly features at only—\$3.00 for 2 years.

6-Month Trial Subscription \$1

TRAILER TOPICS MAGAZINE (Room 1577)  
28 East Jackson Blvd., Chicago 4, Illinois

## CASTING SECRETS REVEALED

Big money! Cast 1000's of plaques, figurines, etc. with N.L. rubber molds. No exper., little capital req. N.L. rubber pts. \$2.50, qty. \$4 (postage extra). Models, rubber for 3 molds, \$1.50 ppd. U. S. only. Send 20c (refundable) for 40 pp fact catalog.

HUGE PROFITS!  
MORE MONEY!

PLASTIC ARTS STUDIO, Dept. PM2, 3403 S. Madison St., Muncie, Ind.



## FREE OPPORTUNITY BOOK

- Have a business of your own! Make \$100.00 a week with no investment, no stock to carry.
- Thousands now earning lifetime incomes!
- Send for FREE Opportunity Book at no obligation.

HARRY COHON & SONS, Inc. 1067A Utica Ave., Brooklyn, N. Y.

"TRADE WITH THE HOUSE THAT HELPS YOU SUCCEED"

## LAW FREE BOOK

Write today for FREE book. "THE LAW-TRAINED MAN," which shows how to learn law in spare time through the famous Blackstone home-study course in business and professional law. All instruction material furnished including big 16-vol. law library. Bachelor of Laws (LL.B.) degree awarded. Moderate cost; easy terms. Write today.

Blackstone School of Law, 225 North Michigan Ave. Dept. 53, Chicago 1, Ill. Founded 1890

## 500 TRICKS MAGIC TRICKS

IT'S FUN TO DO MAGIC

Be popular! Amaze—mystify—entertain! For 30 years Douglas has satisfied customers all over the world. Now, you can enjoy this fascinating hobby. Only 10c brings our Catalog 500 Tricks, containing brand new tricks for pocket, parlor, stage. Join in the fun—send 10c today!

Douglas Magicland, Dept. A, Dallas, Texas

## Make Big Money At Home



PAYS UP TO \$10.00 IN AN HOUR!

Here's your chance for lifetime financial security! Be THE expert INVISIBLE REWEAVER in your own community. Make caps, berms, cloth boxes, tears in dresses, suits, all fabrics DISAPPEAR! Do it at home—in spare time. Constant demand from tailors, cleaners, dept. stores, laundries, individuals—and reweavers are scarce! Profits up to \$10.00 for a single hour's work! Quick, easy to learn with complete, professional home-study course—first in the field! Write for FREE details TODAY! FABRICON CO., 8342 S. Prairie Ave., Dept. 323, Chicago 19, Ill.



# HIGH-FIDELITY MUSIC-APPRECIATION RECORDS

TO HELP YOU UNDERSTAND MUSIC BETTER AND ENJOY IT MORE



**ON ONE SIDE** there is a full performance of a great musical work, just as on the ordinary records you buy. The records will feature orchestras and soloists of recognized distinction in this country and abroad. You listen to the performance first, or afterward, and then . . .



**ON THE OTHER SIDE** is an illuminating analysis of the music, with the various themes and other main features of the work played separately with running explanatory comment, so that you can learn *what to listen for* in order to appreciate the work fully.

## A NEW IDEA OF THE BOOK-OF-THE-MONTH CLUB

**ALL TOO FREQUENTLY**, most of us are aware, we do not listen to good music with due understanding and appreciation. Our minds wander, and we realize afterward that we have missed most of the beauties of the work. There is no doubt about the reason: we are not primed about *what to listen for*. Music-Appreciation Records meet this need—for a fuller understanding of music—better than any means ever devised. They do it, sensibly, by *auditory demonstration*.

**YOU HEAR MUSIC AS THE GREAT CONDUCTORS HEAR IT . . .** On the podium they have in mind at every moment the various themes of the work, their interplay and development, and the main architectural features of the composition. This combined aesthetic and intellectual pleasure is what every music-lover can now acquire through Music-Appreciation Records. After hearing several of these records, all the music you listen to is transformed, because you learn in general what to listen for.

This enjoyable form of self-education can be as thorough as the Music-Appreciation courses that are given in many universities.

**YOU SUBSCRIBE BUT TAKE ONLY THE RECORDS YOU WANT . . .** A new Music-Appreciation Record will be issued—for subscribers only—every month. Ultimately all the great masterpieces of music will be included. The announcement about each forthcoming record will be written by Deems Taylor. After reading this descriptive essay you may take the record or not, as you decide at the time. *You are not obligated as a subscriber to take any specified number of records.* And, of course, you may stop the subscription at your pleasure—at the end of one month, three months, any time!

**TWO TYPES OF RECORDS AT A RELATIVELY LOW COST . . .** All Music-Appreciation Records will be high-fidelity long-playing records of the highest quality—33 $\frac{1}{3}$  R.P.M. on Vinyl-

ite. They will be of two kinds: first, a so-called Standard Record—a *twelve-inch* disc—which will present the performance on one side, the analysis on the other. This will be sold at \$3.60, to subscribers only. The other will be an Analysis-Only Record—a *ten-inch* disc—priced at \$2.40. The latter will be made available each month for any subscriber who may already have a satisfactory long-playing record of the work being presented. (A small charge will be added to the prices above to cover postage and handling.)

**TRY A ONE-MONTH SUBSCRIPTION—NO OBLIGATION TO CONTINUE . . .** Why not make a simple trial, to see if these records are as pleasurable and as enlightening as you may anticipate? The first record, **BEETHOVEN'S FIFTH SYMPHONY**, will be sent to you at once—at *no charge*. You may end the subscription immediately after hearing this record—and keep it with our compliments—or you may cancel at any time thereafter.

As a demonstration  
WILL YOU ACCEPT  
WITHOUT CHARGE



## Beethoven's Fifth Symphony

A NEW HIGH-FIDELITY RECORDING BY THE LONDON SYMPHONY ORCHESTRA

Norman Del Mar, Conductor  
Analysis by Thomas Scherman

**YOU HAVE HEARD** this great work countless times—what have you heard in it? And what may you have failed to hear? This demonstration will show you what you may have been missing in listening to great music.

PLEASE RETURN ONLY IF YOU HAVE A RECORD PLAYER WHICH CAN PLAY 33 $\frac{1}{3}$  R.P.M. LONG-PLAYING RECORDS

MUSIC-APPRECIATION RECORDS R71-3  
c/o Book-of-the-Month Club, Inc.  
345 Hudson Street, New York 14, N. Y.

Please send me at once the first Music-Appreciation Record, *Beethoven's Fifth Symphony*, without charge, and enter my name in a Trial Subscription to Music-Appreciation Records, under the conditions stated above. It is understood that, as a subscriber, I am not obligated to buy any specified number of records, but may take only those I want. Also, I may cancel this subscription after hearing the first record, or any time thereafter at my pleasure, but the introductory record is free in any case.

Mr. }  
Mrs. } \_\_\_\_\_ (Please Print)  
Miss }  
Address \_\_\_\_\_

City \_\_\_\_\_ Zone \_\_\_\_\_ State \_\_\_\_\_ MAR 1



I SHOW YOU HOW TO  
**① MAKE MONEY AT ONCE**  
**② START YOUR OWN BUSINESS**  
**IN 2 WEEKS— AT HOME IN SPARE TIME**



**METALIZE BABY SHOES**

IF YOU ACT NOW, I will show you how to start earning extra money immediately—in spare time or full time. AND I SHOW YOU HOW to start your own profitable business. With my complete course and easy-to-understand illustrated instructions containing trade secrets of ALL metalizing processes PLUS beautifully processed sample metalized baby shoe AND all my tested and proved methods of operating a successful metalizing business. I show you how to start YOUR OWN profitable, fascinating business right in YOUR OWN HOME. Absolutely no experience needed. For PROOF send coupon today for FREE details of my MONEY MAKING PLAN for you and be convinced.

**FREE!**  
**MONEY MAKING PLAN**  
 Full Details Without Obligation  
**MAIL COUPON TODAY!**

KIKTAVI CO., Dept. PM-553  
 11029 So. Vermont, Los Angeles 44, Calif.  
 Send me FREE details of your MONEY MAKING PLAN, without obligation.  
 NAME \_\_\_\_\_  
 STREET \_\_\_\_\_  
 CITY \_\_\_\_\_ ZONE \_\_\_\_\_ STATE \_\_\_\_\_

**MANUFACTURE THIS BEAUTIFUL CONCRETE OUTDOOR FIREPLACE**

Right In Your Own Backyard

**\$4.00 Worth of Sand & Cement produces this Attractive Fireplace.**



Sells on Sight from \$60. to \$80. Easy to start your own Profitable Business.

The General Fireplace Molds and Process are the most amazing and foolproof ever invented. Simple to operate. Two men can produce five fireplaces a day.

**BIG DEMAND!!**

Sell all you produce to Department Stores, Homeowners, Parks, Nurseries and Picnic Groves. Fireplaces sell on sight. No experience necessary. We supply full operating instructions and equipment plus the know-how that spells BIG PROFITS. This is an outstanding opportunity for men of vision and small capital to get into a busy rich paying field. Don't delay, be the only exclusive manufacturer in your own home town. Mail coupon at once for full details as to how you can reserve your territory. Molds sold only on exclusive franchise.

**GENERAL ENGINES CO., Inc., Dept. MF-35**  
 307 HUNTER ST. • GLOUCESTER CITY, N. J.

Mr. Tor of Philadelphia writes: Sold 250 in first 4 months. Selling to Sears Roebuck, John Wanamaker, and Gimbel Bros. in Philadelphia area.

Name \_\_\_\_\_  
 Address \_\_\_\_\_  
 City \_\_\_\_\_ Zone \_\_\_\_\_  
 State \_\_\_\_\_

**INSURED TIRE SERVICE POPULAR BRANDS**

**FREE INSURANCE POLICY** given with each used tire sold. We guarantee the amount of service you pay for.  
 Tube Given Free with Each Used Passenger Tire Upon Request

**SPECIAL!** Deduct 10% on orders for 2 or more used tires

**YOU CAN'T LOSE!!**

Super Quality — Rugged Performance — 15 Months Insured Service		
600x16 \$3.85 670x15	\$3.95 700x16	\$4.45 760x16
650x15 3.85 670x16	4.05 710x15	4.35 820x15
650x16 4.25 700x15	3.95 760x15	4.45 950x17
Supreme Quality — Nothing Finer — 30 Months Insured Service		
600x16 \$5.25 475x19	\$5.45 700x15 (H)	\$10.45 700x20
600x16 (G) 6.75 640x15	4.95 750x16 (H)	15.95 750x20 (H)
650x16 5.75 670x15	5.35 700x17	11.95 750x20 (L)
650x16 (H) 7.25 710x15	5.45 780x17	16.45 825x20
700x16 6.35 760x15	5.95 750x15	10.95 900x20
750x16 (H) 8.45 800x15	6.35 30x5	11.25 1000x20
550x18 4.95 820x15	6.35 600x20	10.95 1100x20
550x17 4.75 550x15	5.35 650x20	11.75 1000x22
650x15 5.25 670x16	5.15 32x8 (S)	11.95 1100x22
700x15 5.35 700x16 (H)	10.25 32x8 (10)	12.75 1100x24

Whitewalls \$1.00 extra.

Speedy shipments on Mail Orders. F.O.B. Chicago. Insurance policy sent with each order. Deduct 10% on orders for 2 or more used tires. Send CHECK or MONEY ORDER—No COD's.  
**MIDLAND TIRE SALES** 3701 S. Normal, Dept. PM-32, Chicago 9, Ill.

**Own Your Own Business... SERVICING RADIATORS**

Earn \$6.75 per hour—\$8,000-\$12,000 a year—servicing auto-truck-tractor radiators! New modern equipment makes work easy, fascinating, insures finest professional workmanship. "Pays-for-itself" financing available. \$100 training course included free by world's largest radiator servicing equipment mfr.

**WRITE for free folder, "Want a business of your own?"**

**INLAND MFG. COMPANY** Dept. PM-3  
 1108 Jackson St., Omaha 8, Nebr.  
 P.S.—Training alone also available—ask for school literature

**STUDY AT HOME WITH AN EDUCATIONAL INSTITUTION**

Courses in ARTS AND SCIENCES: Philosophy; Education; Letters; Public Health; Medical Jurisprudence; Psychology; Sociology; Physics; Chemistry; Geology; Pol. Science; Theology; Law; Business and Commerce; Accounting; Mathematics; Statistics; Agriculture. **ENGINEERING:** Electrical, Civil, Mechanical, Drafting, Architectural, Steam, Diesel, Aeronautical, Radio, Structural, Mining, Industrial, Petroleum, Refrigeration, Chemical. Send for free catalog.

McKinley-Roosevelt Incorporated, 4610-K32, Sheridan Rd., Chicago 40, Illinois

**MECHANICAL DENTISTRY**

Learn A profession offering unlimited opportunities. Most modern and complete course embracing every branch from Plate to Porcelain Work, which prepares you to work for Dentists or start your own business. Individual instruction—practical training in day or night school. No books—no classes. Catalog upon request.

**MCCARRIE SCHOOL OF MECHANICAL DENTISTRY**  
 207 N. Broad Street Dept. 39 Philadelphia 7, Penna.

**SOCK-O** World's Most Powerful

**SUPER SLINGSHOT**  
 SILENT • RIFLE FAST • POWERFUL • ACCURATE  
 Great for small game, targets, 45 lb. pull. BIG sturdy Stock. Lively. Raw rubber. Sweet shooting! FREE! 100 steel balls, rubber and target. FREE!!! Thrilling SURPRISE PACKAGE with Two slings at \$2.95. Hurry, get 2! Guaranteed. Approved by American Small Game Sling-shot Assoc.

**SOCK-O, 4860 W. 137 St., Hawthorne, Calif.**

**I'll Send You This Handsome SAMPLE CASE - FREE**



and Show You How to Make Up to \$30.00 in a Day

WRITE for this FREE Tailoring Sample Case packed with 100 beautiful, big-value suit and overcoat fabrics. Take orders from friends, fellow-workers, others, for fine quality, made-to-measure clothes. Pocket big cash profits in advance. Because wearing our suits and overcoats brings more orders, we make it easy for you to get your own clothes without cost. No experience is needed. **SATISFACTION GUARANTEED!** SEND NO MONEY. Rush your name, address, and size—today!

**PIONEER TAILORING CO., Congress & Throop Sts. DEPT. Y-1116 CHICAGO 7, ILLINOIS**



**Tired of Being Ashamed of Your Build?**

# LET ME GIVE YOU A NEW HE-MAN BODY!

*Charles Atlas*

Awarded the title of "The World's Most Perfectly Developed Man" in an international contest.

**My Secret Method Has Worked for Thousands No Matter How Skinny or Flabby They Were — Now, Why Not Let It Work For You?**

**HERE'S WHAT I'LL PROVE  
15 MINUTES A DAY CAN DO FOR YOU**

I don't care how old or young you are, or how ashamed of your present physical condition you may be. If you can simply raise your arm and flex it I can add **SOLID MUSCLE** to your biceps—yes, on each arm—in double-quick time! Only 15 minutes a day—right in your own home—is all the time I ask of you! And there's no cost if I fail.

I can broaden your shoulders, strengthen your back, develop your whole muscular system **INSIDE** and **OUTSIDE**! I can add inches to your chest, give you a vise-like grip, make those legs of yours lithe and powerful. I can shoot new strength into your old backbone, exercise those inner organs, help you cram your body so full of pep, vigor and red-blooded vitality that you won't feel there's even "standing room" left for weakness and that lazy feeling! Before I get through with you I'll have your whole frame "measured" to a nice, new beautiful suit of muscles!

**WHAT'S MY SECRET?**

"**DYNAMIC TENSION!**" That's the ticket! The identical natural method that I myself developed to change my body from the scrawny skinny chested weakling I was at 17 to my present superman physique! Thousands of other fellows are becoming marvelous physical specimens—my way. I give you no gadgets or contraptions to fool with. When you have learned to develop your strength through "Dynamic Tension" you can laugh at artificial muscle-makers. You simply utilize the **DORMANT** muscle-power in your own God-given body—watch it increase and multiply double-quick into real solid **LIVE MUSCLE**.

utilize the **DORMANT** muscle-power in your own God-given body—watch it increase and multiply double-quick into real solid **LIVE MUSCLE**.

**FREE** Illustrated 32-page Book. Just Mail the Coupon.

SEND NOW for my famous book, "Everlasting Health and Strength." Packed with actual photographs, Page by page, it shows what "Dynamic Tension" can do for YOU.

This book is a real prize for any fellow who wants a better build. Yet I'll send you a copy absolutely **FREE**. Rush coupon to me personally. **CHARLES ATLAS**, Dept. 8Q, 115 East 23rd St., New York 10, N.Y.



"I gained 11 lbs. and 4 1/4 inches on my chest, 3 inches on my arms. I am never constipated."  
—Henry Neven, Canada

"I gained 34 lbs. and increased my chest 6 inches!"  
—Stanley Lynn, Calif.

"What a difference! Have put 3 1/2 inches on my chest (normal) and 2 1/2 inches expanded."  
—F. S., New York

"Gained 20 pounds. When I started your course I weighed only 141. Now I weigh 170."  
—T. K., New York

**CHARLES ATLAS, Dept. 8Q, 115 East 23rd St., New York 10, N. Y.**

Send me—absolutely **FREE**—a copy of your famous book, "Everlasting Health and Strength"—32 pages, crammed with photographs, answers to vital health questions, and valuable advice. I understand this book is mine to keep and sending for it does not obligate me in any way.

Name.....Age.....  
(Please print or write plainly)

Address.....

City.....State.....



**SILVER CUP GIVEN AWAY**

This handsome cup, over a foot high, will be given to the pupil who makes the greatest physical improvement in the next 3 months.

**ARE YOU**  
Skinny, weak, and run down?  
Always tired?  
Nervous?  
Lacking in confidence?  
Constipated?  
Suffering from bad breath?  
Fat and flabby?  
Do you want to lose or gain weight?  
**WHAT TO DO ABOUT IT** is told in my **FREE BOOK**.





**Fabulous Collection of FREE! NORTH AMERICA**

**MOST EXCITING OFFER WE'VE EVER MADE!**

You get this big valuable collection of all-different, all-genuine stamps—including Greenland (North Pole!), Alaska, Confederate States commemorative, St. Pierre, Newfoundland, Sensational Canadian issues picturing Royal Canadian Mounted Police, Indians, moose, walrus, beaver, AND scarce 1851 train stamp. PLUS! United States—ancient 19th century issues, beautiful War & Peace, Army & Navy, bird and animal stamps. Fascinating Commemoratives picturing bucking broncos, Red Cross, Gutenberg & first Holy Bible. Many, many others. EXTRA! Scarce U. S. Telegraph stamp PLUS bargain lists and other interesting offers for your consideration. Send only 10c to help defray cost of mailing.

**Kenmore Stamp Company, Milford, E-568, N. H.**

**GIANT BALLOONS**

They're really BIG—surplus U. S. Govt. (new coverage) Neoprene weather, target balloons. GREAT FUN in the backyard! at parties, picnics, dances, fairs. TERRIFIC for high school and college PROMS. They attract BIG crowds to BUSINESS openings, civic events, conventions, exhibitions, trade shows. ORDER TODAY! Approx. inflated sizes:

3 ft. dia., 49c — 6 ft. dia., 99c  
13 ft. dia., \$1.59 — 20 ft. dia., \$1.95

Postage paid on prepaid orders. Calif. residents please add sales tax.

**VOLUME SALES CO., War Assets Division**  
Dept. M-355 3930 Sunset Blvd. Los Angeles 29, Calif.

**HANDS TIED?**

—because you lack a **HIGH SCHOOL DIPLOMA**

• You can qualify for an American School Diploma *in spare time at home!* If you have left school, write or mail coupon for FREE booklet that tells how. No obligation of any kind.

----- OUR 58TH YEAR -----

**AMERICAN SCHOOL, Dept. V345**  
Drexel at 58th, Chicago 37, Illinois

Please send FREE High School booklet.

Name.....

Address.....

City & State.....

Canadian Residents: Complete Canadian Course Available.  
Write American School, 1810 Sherbrooke, St. West, Montreal.

**EARN \$25 TO \$75 A WEEK IN SPARE TIME ... No Selling To Do!**

**With Guaranteed JETMATIC Venetian Blind Laundry**

No Experience Necessary. Start your own business part time in basement or garage. In a short time, when your profits exceed your job salary, you will make it your FULL-TIME business, as hundreds of others have done. Tremendous demand from homes, offices, factories, for this low-cost service. JETMATIC, made by world's largest manufacturer of professional Venetian blind laundries, guarantees perfect results without taking blinds apart, without hand rubbing. WRITE TODAY for complete details.

**L. C. ROBINSON MANUFACTURING CO.**  
522 North Rural St. DEPT. M9 Indianapolis 1, Ind.

**FALSE TEETH**

**KLUTCH holds them tighter**

KLUTCH forms a comfort cushion; holds dental plates so much firmer and snugger that one can eat and talk with greater comfort and security; in many cases almost as well as with natural teeth. Klutch lessens the constant fear of a dropping, rocking, chafing plate. 35c and 60c at druggists . . . If your druggist hasn't it, don't waste money on substitutes, but send us 10c and we will mail you a generous trial box.

**KLUTCH CO. Box 5593-C ELMIRA, N. Y.**

**PROTECT YOUR EYES! NEW GOGGLES**

Now, for new low price, shield precious eyes against flying particles from lathes, grinders, etc. This fine one-piece, full-view goggle—beautifully moulded of plastic—yours for only \$1.95 postpaid. Provides complete visibility & perfect protection in workshop, machine shop, on farm. Adjustable headband holds form-fitting goggles snugly comfortably for hours. In clear plastic for shop wear, green-tinted for outdoors (lathers, cyclers, etc.). State which. Order today! Moneyback guarantee. Free folder on this, other unusual items.

**CRAFTLINE, P.O. Box 9197-M, Richmond 27, Va.**

**ONLY \$1.95 Ppd.**

**TRADE MAGAZINES**

Business, Vocational, Professional, Hobbies, Agricultural, Educational, Sports. Single current copies. Special get acquainted service. Choose from more than 5,000—all fields. Current List FREE.

**COMMERCIAL ENGRAVING PUBLISHING CO.**  
344B North Ritter Indianapolis 19, Ind.

**New Low Cost Electric Water Heater Gives You HOT WATER AUTOMATICALLY from Your Present Tank!**

LEKTROMATIC changes your water heater into automatic unit. Install in 10 min. without draining. Screw-in, plug-in & save \$75 to \$150. Clean, safe as electric light. Temp. adjusts 30 thru 180 degrees. UL Approved switch-thermostat. 125 w. 110 v. \$19.95 (2000 w. 220 v. \$21.95). Send payment & save shipping. For COD, shipping added. 10 day Free Trial! 1 year guarantee. LEKTROMATIC MFG. CO., Dept. PM-3, 852 Rogers Ave., Brooklyn 26, N. Y.

**Say You Saw It in Popular Mechanics**

**Wanted New Writers**

of Stories, Mysteries, Articles Plays

Would you be willing to spend a few hours a week learning to write so you may earn \$300-\$1200 a year part-time? Or many thousands full-time? FREE book, "Art of Writing Salable Stories," tells how to get started writing short stories, radio-TV scripts, articles, business items. Many students earn while learning (Graham Doar sold one story to Post, CBS Radio and NBC-TV). Endorsed by famous authors, scores of successful graduates; approved for veterans. Send today for FREE book (no salesman will call).

**PALMER INSTITUTE OF AUTHORSHIP, Since 1917**  
1680 N. Sycamore Hollywood 28, Calif. Desk T-35



# GET INTO RADIO-TELEVISION ELECTRONICS by Shop-Method Home Training

## GOOD JOBS AWAIT THE TRAINED RADIO-TV TECHNICIAN

There is a place for you in the great Radio-Television-Electronics industry when you are trained as National Schools will train you at home!

Trained technicians are in growing demand at good pay—in manufacturing, broadcasting, television, communications, radar, research laboratories, home Radio-TV service, and other branches of the field. National Schools Master Shop-Method Home Training, with newly added lessons and equipment, trains you in your spare time, right in your own home, for these fascinating opportunities. OUR METHOD IS PROVED BY THE SUCCESS OF NATIONAL SCHOOLS TRAINED MEN, ALL OVER THE WORLD, SINCE 1905.

## EARN WHILE YOU LEARN

Many National students pay for all or part of their training with spare time earnings. We'll show you how you can do the same! Early in your training, you receive "Spare-time Work" Lessons which will enable you to earn extra money servicing neighbors' and friends' Radio and Television receivers, appliances, etc.



Signal Generator

Audio Oscillator

T. R. F. Receiver

## MASTER ALL PHASES!

Get Master Shop-Method Home Training from an Established Practical Resident School with its own Training Shops, Laboratories, Studios—almost 50 Years of Successful Experience in Training Ambitious Men. We Bring National Schools To You!



Superheterodyne Receiver

## LEARN BY DOING

You receive and keep all the modern equipment shown above, including tubes and valuable, professional quality Multitester. No extra charges.

## FREE! RADIO-TV BOOK AND SAMPLE LESSON!

Send today for National Schools' new, illustrated Book of Opportunity in Radio-Television-Electronics, and an actual Sample Lesson. No cost—no obligation. Use the coupon now—we'll answer by return airmail.

APPROVED FOR VETERANS AND NON-VETERANS Check coupon below

Both Resident and Home Study Courses Offered!

## NATIONAL SCHOOLS

Dept. RB-35  
Los Angeles 37, California • Chicago: 323 W. Polk Street  
In Canada: 811 West Hastings Street, Vancouver, B. C.

## GET FACTS FASTEST! MAIL TO OFFICE NEAREST YOU!

(mail in envelope or paste on postal card)  
NATIONAL SCHOOLS, Dept. RB-35  
4000 S. Figueroa Street or 323 West Polk Street  
Los Angeles 37, Calif. Chicago 7, Ill.  
Send FREE Radio-TV Electronics book and FREE sample lesson. No obligation, no salesman will call.

NAME \_\_\_\_\_ BIRTHDAY \_\_\_\_\_ 19\_\_\_\_  
ADDRESS \_\_\_\_\_  
CITY \_\_\_\_\_ ZONE \_\_\_\_\_ STATE \_\_\_\_\_  
 Check here if interested in Resident School Training at Los Angeles.  
VETERANS: Give Date of Discharge \_\_\_\_\_

## National Schools Training is All-Embracing

National Schools prepares you for your choice of many job opportunities. Thousands of home, portable, and auto radios are being sold daily—more than ever before. Television is sweeping the country, too. Co-axial cables are now bringing Television to more cities, towns, and farms every day! National Schools' complete training program qualifies you in all fields. Read this partial list of opportunities for trained technicians:

- Business of Your Own • Broadcasting
- Radio Manufacturing, Sales, Service • Telecasting
- Television Manufacturing, Sales, Service
- Laboratories: Installation, Maintenance of Electronic Equipment
- Electrolysis, Call Systems
- Garages: Auto Radio Sales, Service
- Sound Systems and Telephone Companies, Engineering Firms
- Theatre Sound Systems, Police Radio
- And scores of other good jobs in many related fields.

## TELEVISION TRAINING

You get a complete series of up-to-the-minute lessons covering all phases of repairing, servicing and construction. The same lesson texts used by resident students in our modern and complete Television broadcast studios, laboratories and classrooms!





**USE THIS  
FREE KIT**



**MAKE UP TO**

**\$1000<sup>00</sup> a Month!**

Everything You Need to Make Big Money with New "Midget Miracle" PRESTO Over 2 MILLION Already Sold!

**FREE**—everything you need to cash in on this amazing new kind of fire extinguisher. Tiny "Presto" (about the size of a flashlight) does job of bulky extinguishers, that cost 4 times as much and are 3 times as heavy. Ends fires fast as 2 seconds. Fits in palm of hand. Never corrodes. Guaranteed for 20 years! A tremendous money-making bargain—sells for only \$3.98!



Advertised in National Magazines

On this offer you get complete Sales Kit FREE. Everything you need to "wrap up" sales to civil defense workers, owners of homes, cars, boats, farms, etc. and to stores for re-sale—make big income. C. S. Meltona made \$175 in just 5 days. M. R. Stanley \$100 a day. C. Kama \$1,000 a month. Write for your FREE Sales Kit. No risk. No obligation. (If you want a regular Presto to use as a demonstrator, send only \$2.50. Money back if you wish.) MERLITE INDUSTRIES, Dept. 53, 114 East 32nd St., New York 16, N. Y.

IN CANADA: Nepe Co., Ltd., 371 Dand St., Montreal 1, P. Q.

OVER \$1,000  
A MONTH



Charles Kama

"I'm making more than \$1,000.00 a month—and I haven't touched bottom yet."

**BUILD HELICOPTER GLIDER**



The famous new GYRO-GLIDER, world's simplest and safest aircraft, is now available to amateur builders in plans and kits. Send \$1.00 now for three-view drawings with specifications and ask about kits and detailed building and flying instructions.

BENSEN AIRCRAFT CORP., Dept. PM-3 P.O. Box 2621 Raleigh, N. C.

ONLY \$1 Name \_\_\_\_\_ Address \_\_\_\_\_  
City \_\_\_\_\_ State \_\_\_\_\_

Greatest Thrill in Flying!

**ENGINEERING DEGREE IN 27 MONTHS**

**Big Demand for Graduates**

Aeronautical, Chemical, Civil, Electrical, Mechanical and Radio Engineering (Inc. TV and Electronics)

Hundreds of young men are earning B. S. ENGINEERING DEGREES annually in this recognized institution — year around operation. New terms start quarterly. Many students earn a major part of their college expenses in this large industrial center.

Low tuition. Competent instruction. Thorough, intense, practical program. Modern, well-equipped laboratories including new physics laboratory and modern wind tunnel. Individualized instruction emphasized.

Government approved for G.I.'s. Engineering preparatory courses. Students from 48 states and 21 foreign countries. Enter March, June, September and December. Send coupon for free catalog and full information. Enroll now.

SEND COUPON TODAY

**INDIANA TECHNICAL COLLEGE**

535 E. Washington Boulevard  
Fort Wayne 2, Indiana

Please send me free information on B.S. Engineering Degree in 27 months as checked.  
 Aeronautical,  Chemical,  Civil,  Electrical,  
 Mechanical,  Radio-Television

Name \_\_\_\_\_

Address \_\_\_\_\_

**INVENTORS**

PROTECT YOUR INVENTION BY A U. S. PATENT. SEND FOR FREE "INVENTION RECORD" FORM AND "PATENT INFORMATION EVERY INVENTOR SHOULD HAVE".

**CARL MILLER**  
REGISTERED PATENT ATTORNEY

WOOLWORTH BLDG., 35th FLOOR, 35A  
NEW YORK CITY

**PATENTS**  
**C. A. SNOW & CO.**  
REGISTERED PATENT ATTORNEYS  
WRITE FOR INFORMATION TO  
428 SNOW BUILDING, WASHINGTON 1, D. C.

**INVENTORS**

Send for PATENT INFORMATION Book and INVENTOR'S RECORD without obligation  
**GUSTAVE MILLER**  
35-PM WARNER BUILDING WASHINGTON 4, D. C.

REGISTERED PATENT ATTORNEY  
ASSOCIATE EXAMINER  
U. S. PAT. OFF. 1922-1929  
Patent Attorney & Advisor  
U. S. NAVY DEPT. 1930-1947  
PATENT LAWYER

**FREE AMAZING NEW BOOK "HOW TO ANSWER ADS"**



Never before have you seen anything like this. Tells you in simple language the correct way to answer ads. Gets you quicker replies—better results, and greater satisfaction. Will save you time and money and it's ABSOLUTELY FREE. No obligation whatever. Every reader of advertising should have this booklet. Send a postcard for your copy NOW. F. W. JOHNSON, Popular Mechanics Magazine, Room 600-A, 204 East Ontario Street, Chicago 11, Ill.

**HELPFUL BOOKS**

Send post card asking for FREE catalog  
Popular Mechanics Press, 200 E. Ontario, Dept. 601, Chicago 11

**INVENTORS**

Whether an invention is patentable can be substantially determined by a search of the U. S. Patent records. Without obligation, write for information explaining the steps you should take to secure a patent.

**JOHN N. RANDOLPH**

Registered Patent Attorney  
201 Columbian Building, Washington 1, D. C.

**INVENTORS**

I shall be pleased to furnish you, upon request, with full information relative to patent procedure—without any obligation on your part.

**PATRICK D. BEAVERS**

Registered Patent Attorney  
934 Columbian Building Washington 1, D. C.



**Super Powerful All Channel TV RECEPTION IN ALL DIRECTIONS**

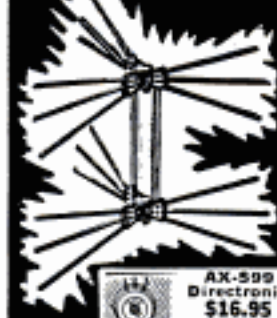

**Rocket DIRECTRONIC MOTORLESS TV ANTENNA**

- 360° Electronically Switched Beam
- No Motors
- No Roof Orientation
- No Electric Power
- No Ghosts
- Flick of Switch Clears Picture Instantly

In the city or in an ultra-fringe area, the Directronic will outperform ordinary antennas. Only the Motorless 360° Directronic TV Antenna offers "around the compass" reception WITHOUT Rotors. Clarity of picture will amaze, it's so bright, so sharply defined. AX-509 "Serviceman's Array" contains Hi-Pac molded insulator of extremely high tensile strength, 18 hi-tensile aluminum alloy elements, 1 set of connecting stubs (3), Universal U-Clamps for masts to 1 1/2", Directronic Beam Selector, 75 feet of Tri-X Cable.

AX-509 Directronic \$16.95 You pay postage

Do not remit more than complete purchase price, 25% deposit on C.O.D. orders, please. Money-back guarantee. NATIONAL ELECTRONICS OF CLEVELAND 6608 EUCLID AVENUE Dept. P-3 CLEVELAND, OHIO

**DAN LURIE**  
"America's Most Muscular Man"  
—on television's "Big Top."

**FAMOUS DAN LURIE**

**BARBELLS**

with 4 courses—low factory prices  
50 lb. set...\$ 8.48 | 150 lb. set...\$20.48  
100 lb. set... 13.98 | 200 lb. set... 25.98

Write for Order by Mail; 50% with order, bal. C.O.D. Free Catalog Extra wts. 13c per lb., F.O.B. plant

**DAN LURIE BARBELL CO.**

52-M-3 Bristol St. Dept. 559C Brooklyn, N. Y.

**Do You Make These Mistakes in English?**

MANY persons say "between you and I"—use "who" for "whom"—don't know whether to use one or two "e's" or "m's" or "a's." Every time you speak or write you show what you are. A command of effective English brings you added advantages, better opportunities.

You can improve your English through Sherwin Cody's 100% self-correcting invention. If you are ever embarrassed by mistakes in grammar, spelling, punctuation, or pronunciation, write for FREE book "How You Can Master Good English in 15 Minutes a Day." No obligation. SHERWIN CODY COURSE IN ENGLISH, 583 Central Drive, Fort Washington, N. Y.

**FREE-U.S. STAMPS**



U. S. 1943 Bi-Colored Flag of Occupied Nations (as illustrated) Airmails, Commemoratives. Regular issues, included in this collection of 25 selected, all different, genuine U. S. Stamps.

PLUS VALUABLE U. S. \$5.00 STAMP. Everything for 10c to cover mailing expenses. Approvals included. Act at once.

WILLETT CO. P. O. BOX 511, Dept. 707: Port Chester, N. Y.



**Blast off with DUAL vacuum AIR HORNS!**

ONLY \$9.95 \*POSTPAID Money-back Guarantee

The voice of authority and commanding warning for safer highway driving. One BLAST and those "Road Hogs" really move over. Installed under the hood or on the front fender. Beautiful lacquer finish. Operates from intake manifold. No tank needed. Only \$9.95 complete with cylinder head bracket, steering column lever, hose, fittings, etc. Send check or money order today. We pay postage. \$1.00 deposit required on all C.O.D. orders.

THE PROTECTUROOD CO.

Dept. 404, 716 N. E. 17th Rd., Fort Lauderdale, Florida

**POWER MOWERS & KITS**

**FREE PLANS**



Build your own quality mower with our LOW COST KITS, Parts, Engines. Free Plans guide you. 3 and 4 Wheel Kits, complete. Parts precision finished, ready to use. Write TODAY for Free Plans, Low Prices, Parts List and Guarantee.

3-WHEEL KIT NO. T-800



America's Finest Power Mowers completely assembled in 3 and 4 wheel models. Belt or direct drive. 18" and 20" sizes. Nationally known make engine. Latest improved features, sturdy construction and money back guarantee fully described in color folder. Write today.

▲TRIANGLE MANUFACTURING CO., Dept. M-3, Fort Scott, Kansas

**Fix Cars!**

**EASIER...TWICE AS FAST**

any make, model, part

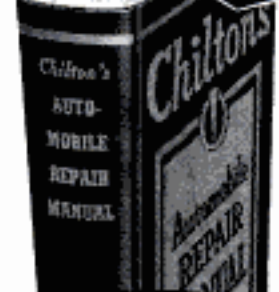

Fix cars easier than you may have thought possible... even if you never have tackled a car repair job before!

Just look up the make, model and part you want to fix. This giant, 4 1/4 pound, 864-page Chilton "ALL CARS" Service Manual shows you what to do... tells you exactly how to do it. Gives step-by-step details in a way you can hardly fail to understand.

**BY THE WORLD'S LARGEST AUTOMOTIVE PUBLISHERS**

Using your Chilton Manual is like having the 10 Chilton experts who prepared it standing by your side, telling you just what to do... even to what tools to use! "Minor" details, often so puzzling to beginners are fully explained.

Largest book of its kind. First choice of garages, schools. Used for U.S. Army-Navy training. Published and fully revised EVERY year by Chilton... home of Motor Age and Automotive Industries magazines, the Flat Rate Book, etc.

No guesswork! From simple tune-ups to the most complicated over-drive or automatic transmission jobs, Chilton makes every step perfectly clear in both text and almost 3,000 clear pictures. 58 Quick Check Trouble Charts and 353 Quick Check Data Tables help you work faster... better. Use coupon. Practice from it for 10 days AT OUR RISK.



**The Giant Manual That REALLY SHOWS YOU HOW!**

**OVER 14 YEARS OF CAR SERVICE DATA!**

Covers every model of these makes from 1940—over 600 models!...

- |           |            |
|-----------|------------|
| BUICK     | KAISER     |
| CADILLAC  | LINCOLN    |
| CHEVROLET | MERCURY    |
| CHRYSLER  | NASH       |
| DE SOTO   | OLDSMOBILE |
| DODGE     | PACKARD    |
| FORD      | PLYMOUTH   |
| FRAZER    | PONTIAC    |
| HENRY J.  | STUDEBAKER |
| HUDSON    | WILLYS     |

Manual is fully revised EVERY year. LATEST edition will be sent.

**PRACTICE 10 DAYS FREE!**

Dept. PM-35, The Chilton Company  
5605 Chestnut St., Philadelphia 39, Pa.  
Send latest edition of giant, Chilton "ALL CARS" Service Manual (Price \$6.95) for 10-DAY FREE EXAMINATION. If I like Manual, I will then promptly remit \$1.95 (Plus 35c postage); then send \$2.50 monthly for 2 months. Otherwise, I will return Manual postpaid in 10 days and owe you nothing. (OUTSIDE U.S.A. ... Price \$7.95, cash with order. Same 10-day return privilege with money refunded.)

Name .....

Address .....

City, Zone, State .....



## NEW WAY TO MAKE MONEY!



**75c PROFIT on each dollar!** Luxurious stainless steel tableware, guaranteed 50 years. Can't rust, tarnish or stain. Looks like sterling silver. 30, 50 and 75 piece sets and open stock. Offer women set free for every two sets they sell to friends. Have agents, others sell for you. Write orders on commission or go in business for yourself. Use our catalogue with **ONLY** your name. Many other money-making plans. We can also ship under your label.

**FREE OUTFIT AND MONEY-MAKING PLANS!** No obligation. Send postcard with your name and address for free catalogue, all money-making plans and everything you need to start making money spare or full time.

**TOPVAL CORP. • LINDENHURST 22, NEW YORK**

## MECHANICAL ADDRESSER COMPLETE

**30 DAY TRIAL OFFER \$10<sup>95</sup>**



Addresses anything mailable—easily, quickly, professionally. Thousands in use. Complete with supplies for 250 names. Money-back guarantee. Send check or money order to: **THE HEYER CORP. Dept. 355** 1856 S. Kostner, Chicago 23, Illinois

## FREE—A BUSINESS OF YOUR OWN

- No Store to Equip
- No Training Period
- No Investment
- No Stock to Buy

### SUBSTANTIAL MONEY-MAKING OPPORTUNITY

**Your Total Cost — a 3-cent stamp**



All I ask of you is that you like to sell. If you can make a fair living selling anything else, I'll show you how to make tremendous profits as a **MASTER Work Garment Salesman**, and I'll furnish everything you need, free of charge.

**MASTER Work Garment** salesmen are cashing a harvest of dollars in hundreds of communities all over America. Men who—a year ago—didn't know what a work garment was, are now buying homes and cars with the profits from a **MASTER Dealer** franchise. Your sales are volume sales, repeat sales, steady-income-to-you sales. Every business in the country is a prospect for uniforms and work clothes with name-and-advertising embroidery. Stores can't compete. **MASTER** brings you the world's finest, most complete quality lines in all new styles and fabrics. I supply everything you need—samples, sales material and guidance. Thousands making big money easily. Your territory may be open. Write me today for full details; a postcard will do.—**Del. V. Bergstrom, Pres.**

**GEO. MASTER GARMENT DIV.**  
309 WATER STREET, LIGONIER, INDIANA

# SEND FOR Free Record

## START SPEAKING FRENCH OR SPANISH ALMOST OVERNIGHT!



**HERE'S** the easiest way to learn **FRENCH, SPANISH, Russian, German, Italian, Japanese or Brazilian.** Listen to **FREE** 2-sided non-breakable record. Let your eyes follow words in **FREE** sample lesson. Almost at once you'll be chatting in a new language with a perfect accent! That's all you hear! No memorizing needed. Just listen—imitate! It's that easy! Offer may end soon. Rush 25c to help cover cost of special packaging, shipping. State language you want. We'll also send free information on full Cortina course. **CORTINA ACADEMY, Dept. 643, 136 W. 52nd St., New York 19.**

## BE A LEADER IN AVIATION

Parks graduates are known world-wide as leaders in aviation—their education is the finest offered. Advance faster . . . earn more in less time! Become a Parksmen!

B.S. degree in 3 yrs. from Saint Louis University—Aero. Eng., Aero. Adm., Maint. Eng.

Non-degree courses—A & E Mechanics, Private, Commercial, Instrument, Flight Instructor and Multi-engine Ratings . . . CAA-Approved.

*All Parks schooling approved for Veterans. Write for full information.*

**PARKS COLLEGE** ARNOLD HALL  
EAST ST. LOUIS, ILL.

## Be a CARBURETOR and IGNITION EXPERT

### SPECIALIZE—EARN BIG MONEY!



Learn how all these things work by actually doing it. In our school you get the know-how plus the experience. Learn how to overhaul Carburetors, Generators, Starters, Distributors, How to rewire and check for shorts. How to read testing equipment and Diagnose. Write for particulars.

**GEO. R. WILLY'S SCHOOL OF CARBURETOR AND AUTOMOTIVE ELECTRICITY**  
12158 Western Av. Blue Island, Ill. Dept. P-3

# MONEY in DONUTS

Make new grainless donuts. Start in kitchen. No smoke. Sell stores. Cash daily. No experience necessary. Free recipes. No obligation. Write! **MARTIN RAY CO., 3605 SO. 15th AVENUE, MINNEAPOLIS 7, MINN.**

## Bar Bells



Buy Direct From Factory **\$8<sup>95</sup>** up

Write for free booklet and price list.

**INDEPENDENT IRON WORKS**  
2416 East 23rd Street, Dept. B  
Los Angeles 58, Calif.

## CUT BUILDING COSTS 25% Make Your Own Concrete BLOCKS and BRICKS To Use or Sell



New superior moulds make absolutely square, true, easy-to-lay blocks which will pass any building code. Production is fast . . . easy. One durable \$30 machine will make four 8"x8"x12" blocks per minute—1,000 a day. Pays for itself in one day! Sell blocks for big profit . . . or save 25 building cost for yourself. **POST CARD BRINGS FREE FOLDER.**

**ECONOMY MFG. CO.**  
DEPT. P STONE MOUNTAIN, GA.



**MILLIONS OF APPLIANCES NEED REPAIR!**

# EARN BIG MONEY.. WORK PART OR FULL TIME IN ELECTRIC APPLIANCE REPAIRING!

**ELECTRIC REFRIGERATORS**  
**WASHING MACHINES**  
**VACUUM CLEANERS**  
**ELECTRIC RANGES**  
**MOTORS**  
**SEWING MACHINES**  
**TOASTERS**  
**WAFFLE IRONS**  
**MANGLES**  
**HEATING PADS**  
**FREEZERS**  
**ELECTRIC FANS**  
**ELECTRIC IRONS**  
**LAMPS**  
**ETC., ETC.**



**ELECTRONIC KIT TROUBLE DETECTOR**  
 (Checks shorts, wattage, continuity, etc.)  
 is sent to all students

**MAIL COUPON FOR FREE BOOK**

Learn this fascinating big money paying profession at home in your spare time. Learn by doing, by working with your hands building, testing, repairing electrical appliances of all kinds. Electrical appliance repairmen are needed everywhere — wherever electricity is used. You need no special previous training or experience. Age is no handicap. CHRISTY has trained over 33,000 men in all parts of the world. Men who today command big wages or own profitable businesses of their own.

**PAY LATER FROM EARNINGS WHILE LEARNING**  
 CHRISTY shows you how to make money while still learning, what to charge, how to set up your own shop, how to build power tools from spare parts, etc. It will pay you to write today.

CHRISTY TRADES SCHOOL, Dept. D-4003  
 4804 N. Kedzie Ave., Chicago 25, Ill.

Send me your FREE book on Electrical Appliance Repairing and special form for "paying later from earnings made while learning."

NAME \_\_\_\_\_ AGE \_\_\_\_\_  
 ADDRESS \_\_\_\_\_  
 CITY \_\_\_\_\_ STATE \_\_\_\_\_

**LOOK!** **A MILLION THRILLS!**  
**High Power BINOCULARS**  
**30 DAY FREE TRIAL**  
 Finest Precision Optics  
 Money Back Guarantee  
 Easy Pay Plan  
 33 Models  
**\$9.95 UP**  
**BUSHNELL Binoculars**  
 Free! Catalog & Book "How to Select Binoculars"  
 Dept. M3 43 E. Green Pasadena, Calif.

## LEARN WATCH REPAIRING

**AT HOME** Modern, original instruction. Prepare for a position or start in business after completing our course. Write Today!  
**WISCONSIN SCHOOL OF WATCH REPAIRING**  
 2908 N. 44th St. Dept. M Milwaukee 10, Wis.

**SAY YOU SAW IT IN POPULAR MECHANICS**

**WRITE: BREVITYPE INSTITUTE, SAN DIEGO, CALIF., DEPT 1815**  
**LEARN THE WORLD'S SIMPLEST, SPEEDIEST SHORTHAND NOW**

**FREE**—please send me typical lessons, details on Brevitype—world's simplest, speediest shorthand—first machine shorthand to eliminate coding. Tell me how I learn Brevitype in 1/2 the time through your personally guided home-study course. Show me how switching to Brevitype, as hundreds have, prepares me for security as a stenographer, secretary, court or hearing reporter here, and abroad, in business or Civil Service—helps me increase my salary 50% to 100%. Include costs and budget plans.

# BREVITYPE SHORTHAND

THE EASY-TO-LEARN MACHINE

**Guaranteed by Good Housekeeping**  
**MODERN: TYPEWRITER KEYBOARD! NO CODING! FAST ABC!**  
**THE BREVITYPE MACHINE, WHICH CARRIES THIS SEAL, COMES WITH THIS COURSE**

## GROW Living MIDGET TREES! EARN \$10.00 PER HOUR!



- AT HOME
- IN SPARE TIME
- NO EXPERIENCE NEEDED

It's new! Amazing! At last, the secret of growing miniature (MING) trees can be yours. FULL GROWN, dwarf trees—only a few inches high. Beautiful miniature fir, orange, oak, Chinese elm, peach, pine, cypress—any kind! ALL BLOOM and even BEAR FRUIT. All perfect healthy specimens—but miniature in size! Make costly home decorations and expensive centerpieces. (SOLD FOR OVER \$1,500 EACH) Big demand. Costs only pennies—takes only minutes per week. IT'S EASY! Fun! A new fascinating hobby—a new fabulous \$\$\$\$ business. Send for free secret plan details and real seed.

**HELP US FILL HUGE DEMAND!**  
 These trees are being demanded by STORES CLUBS • HOTELS • FLORISTS • HOUSEWIVES • INTERIOR DECORATORS • COLLECTORS • HOBBYISTS — A Big Money Opportunity FOR YOU.

**FREE! GENUINE SEED AND PLAN!**

**NATIONAL NURSERY GARDENS, Dept. M-3**  
 8463 South Van Ness  
 Inglewood 4, Calif.  
 Rush me FREE plan and seed IMMEDIATELY!

Name \_\_\_\_\_  
 Address \_\_\_\_\_ Zone \_\_\_\_\_  
 City \_\_\_\_\_ State \_\_\_\_\_





# Be Independent!

"The World's Best Motorcycle"

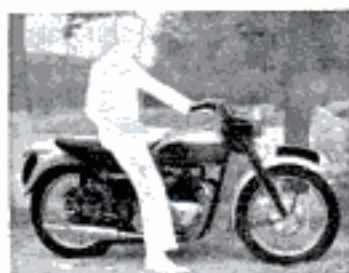

WRITE for FREE catalog and name of Triumph dealer nearest you. Dept. P.

**NEW!** Unlike clumsy, heavy types. Has no "junk" or useless accessories. Is functional and all motorcycle from head to foot. Beautifully engineered. Triumphs are leading America's trend to two-wheeled transportation. Used by air line pilots, sportsmen, policemen, farmers, business men, service men, etc. Solves traffic problems—easy to ride, safe, maneuverable.

TWELVE MODELS from  
**\$449.00**

West  
JOHNSON MOTORS,  
INC.  
267 W. Colorado St.  
Pasadena 1, Calif.

# TRIUMPH

- "jet wing" double seat
- sparkling colors, with chrome finish
- front and rear springing
- gear position indicator

East  
THE TRIUMPH  
CORPORATION  
1727 E. Joppa Rd.  
Towson, Baltimore 4, Md.

## WOODWORKING Low Cost Home Craft Courses Now Available

**LEARN  
The Easy  
Way!**

Make money. Become a skilled woodworker. Interstate's new woodworking course tells and shows how to turn out hundreds of professionally constructed and finished wood projects with hand and power tools. Twenty-two profusely illustrated manuals. Over 1,000 pages. Over 75 projects. Written by expert instructors. The only complete course available today! Get full information without obligation...today.

HOW TO  
BE A  
SKILLED  
WOOD  
WORKER

Write for **FREE** Booklet  
**INTERSTATE TRAINING SERVICE**  
SCHOOL OF WOODWORKING  
DEPT. F-3-C, PORTLAND 13, OREGON

## MAKE MONEY WRITING .. short paragraphs!

You don't have to be a trained author to make money writing. Hundreds now making money every day on short paragraphs. I tell you what to write, where and how to sell; and supply big list of editors who buy from beginners. Lots of small checks in a hurry bring cash that adds up quickly. No tedious study. Write to sell, right away. Send for free facts. **BENSON BARRETT, 1751 Morse Ave., Dept. 27-C, Chicago 26, Ill.**

### INVENTORY CLEARANCE 25% OFF!

**500X FOUR-TURRET MICROSCOPE KIT WITH PROFESSIONAL LIGHT**  
Only 800 on hand. Contains our famous new four-turret microscope allowing 75, 150, 300 and 500 power! First with these features under \$75. Contents: 1 model 500 microscope, 3 prepared slides, 9 blank slides, 1 professional light, 1 magnifying glass, 1 surgical steel dissecting scalpel, 1 dissecting tweezers, 1 dissecting needle, 1 fitted hardwood cabinet.  
**REGULARLY \$19.95 LIMITED INVENTORY \$14.75 OFFER**  
FREE — NEW 1955 CATALOG — Microscopes from \$7.95 to research models at \$319.  
TO ORDER — Send check, cash or money order, 1/3 dep. for C.O.D. Unconditional money-back guarantee.



**PRECISION OPTICAL CO.**

4 Precision Bldg.  
4379 Sunset Blvd.  
Los Angeles 29, Calif.

## FREE! 105 BRITISH COLONY STAMPS

Standard Catalogue Value over \$2.25. Attractive, colorful, from the earth's four corners, every one different. Fascinating story approvals. Send 10¢ handling please.

Write today!

**CANADA STAMP CO.**

1907 Main, Dept. 418, Niagara Falls, N.Y.



## OIL FILTER REFILLS . . . 10¢

Here's News! Ordinary toilet paper makes an ideal oil filter. Laboratory tests prove it cleans oil faster and better than popular makes of filter elements. All you need is a simple set of Retlif Adapter Plates . . . and you can start using toilet paper rolls (costing about 10¢) in your present oil filter. For proof and descriptive literature, send name and address to:

**RETLIF CORP., Dept. 144, 915 No. Highland Ave., Los Angeles 38, Calif.**

## YES! SEND



directly  
to my door  
every month

I am enclosing

- \$3.50 for 1 year  
 \$8.00 for 3 years

name

address

city

zone

state

Hand this order to your newsdealer or send it to

**POPULAR MECHANICS**  
200 East Ontario St. Chicago 11, Ill.



# GET A JET BOOST TO BIG-PAY PROMOTIONS WITH AN I.C.S. DIPLOMA!



Here's how you can turn "normal advancement" into a sudden, tremendous spurt that will put you years ahead in your job!

Most men are content to rise slowly, letting seniority and experience carry them to bigger, better jobs. A few, however, have what it takes to skyrocket upward, passing older, more experienced men along the way.

You can be one of the few. If you have ambition and determination, ICS can supply the rest—modern training, especially developed for "accelerated advancement" in business and industry. In a single three-month period, 1973 ICS students reported pay increases and promotions!

"My ICS training is paying off

with an extra \$120 a month—and more to come," writes J.R.T., Crane, Texas.

### New, exciting opportunities!

If you want to move up fast—get higher pay, do more interesting work, leave money worries far behind—take advantage of today's new, exciting opportunities—NOW!

The aircraft industry, for example, is suddenly booming with new billions in defense orders. Color television, microwave transmission, industrial electronics are wide-open fields. Trained men are in demand in industry after industry!

### A few cents a day, the ICS way!

For only a few cents a day, you can prepare yourself for advancement. 277 ICS courses to choose from. Direct, job-related. Personalized, expert instruction. Lesson and answer service. Diploma to graduates.

You study at home. No conflict with business or social life. You set your own pace—progressing as rapidly as your abilities permit.

### 3 FREE BOOKS

Free ICS career kit consisting of: (1) "How to Succeed," a 36-page gold mine of valuable success tips; (2) Career Catalog outlining new opportunities in your field of interest; (3) sample ICS lesson (Mathematics) demonstrating the famous ICS method.

For Real Job Security—Get an I. C. S. Diploma! ... Easy-pay Plan ... I. C. S., Scranton 9, Penna.

## INTERNATIONAL CORRESPONDENCE SCHOOLS

ICS

BOX 07299C, SCRANTON 9, PENNA.

(Partial list of 277 courses)

Without cost or obligation, send me "HOW TO SUCCEED" and the opportunity booklet about the field BEFORE which I have marked X (plus sample lesson):

- |  |   |  |  |  |
|--|---|--|--|--|
| <p><b>ARCHITECTURE and BUILDING CONSTRUCTION</b></p> <ul style="list-style-type: none"> <li><input type="checkbox"/> Air Conditioning—Refrig.</li> <li><input type="checkbox"/> Architecture</li> <li><input type="checkbox"/> Architectural Interior</li> <li><input type="checkbox"/> Building Contractor</li> <li><input type="checkbox"/> Building Maintenance</li> <li><input type="checkbox"/> Carpenter and Mill Work</li> <li><input type="checkbox"/> Estimating</li> <li><input type="checkbox"/> Heating</li> <li><input type="checkbox"/> Painting Contractor</li> <li><input type="checkbox"/> Plumbing</li> <li><input type="checkbox"/> Reading Arch. Blueprints</li> </ul> <p><b>ART</b></p> <ul style="list-style-type: none"> <li><input type="checkbox"/> Cartooning</li> <li><input type="checkbox"/> Commercial Art</li> <li><input type="checkbox"/> Fashion Illustrating</li> <li><input type="checkbox"/> Magazine Illustrating</li> <li><input type="checkbox"/> Show Card and Sign Lettering</li> <li><input type="checkbox"/> Sketching and Painting</li> </ul> <p><b>AUTOMOTIVE</b></p> <ul style="list-style-type: none"> <li><input type="checkbox"/> Auto Body Rebuilding</li> <li><input type="checkbox"/> Auto Elec. Technician</li> <li><input type="checkbox"/> Auto-Engine Tune Up</li> <li><input type="checkbox"/> Automobile</li> </ul> | <p><b>AVIATION</b></p> <ul style="list-style-type: none"> <li><input type="checkbox"/> Aeronautical Engineering Jr.</li> <li><input type="checkbox"/> Aircraft &amp; Engine Mechanic</li> </ul> <p><b>BUSINESS</b></p> <ul style="list-style-type: none"> <li><input type="checkbox"/> Advertising</li> <li><input type="checkbox"/> Bookkeeping and Accounting</li> <li><input type="checkbox"/> Business Administration</li> <li><input type="checkbox"/> Business Correspondence</li> <li><input type="checkbox"/> Public Accounting</li> <li><input type="checkbox"/> Creative Salesmanship</li> <li><input type="checkbox"/> Federal Tax</li> <li><input type="checkbox"/> Letter-writing Improvement</li> <li><input type="checkbox"/> Office Management</li> <li><input type="checkbox"/> Professional Secretary</li> <li><input type="checkbox"/> Retail Business Management</li> <li><input type="checkbox"/> Sales Management</li> <li><input type="checkbox"/> Stenographic-Secretarial</li> <li><input type="checkbox"/> Traffic Management</li> </ul> <p><b>CHEMISTRY</b></p> <ul style="list-style-type: none"> <li><input type="checkbox"/> Analytical Chemistry</li> <li><input type="checkbox"/> Chemical Engineering</li> <li><input type="checkbox"/> Chem. Lab. Technician</li> <li><input type="checkbox"/> General Chemistry</li> <li><input type="checkbox"/> Natural Gas Prod. &amp; Trans.</li> <li><input type="checkbox"/> Petroleum Engineering</li> <li><input type="checkbox"/> Plastics</li> <li><input type="checkbox"/> Pulp and Paper Making</li> </ul> | <p><b>CIVIL, STRUCTURAL ENGINEERING</b></p> <ul style="list-style-type: none"> <li><input type="checkbox"/> Civil Engineering</li> <li><input type="checkbox"/> Construction Engineering</li> <li><input type="checkbox"/> Highway Engineering</li> <li><input type="checkbox"/> Reading Struct. Blueprints</li> <li><input type="checkbox"/> Sanitary Engineering</li> <li><input type="checkbox"/> Structural Engineering</li> <li><input type="checkbox"/> Surveying and Mapping</li> </ul> <p><b>DRAFTING</b></p> <ul style="list-style-type: none"> <li><input type="checkbox"/> Aircraft Drafting</li> <li><input type="checkbox"/> Architectural Drafting</li> <li><input type="checkbox"/> Electrical Drafting</li> <li><input type="checkbox"/> Mechanical Drafting</li> <li><input type="checkbox"/> Mine Surveying and Mapping</li> <li><input type="checkbox"/> Plumbing Drawing and Estimating</li> <li><input type="checkbox"/> Structural Drafting</li> </ul> <p><b>ELECTRICAL</b></p> <ul style="list-style-type: none"> <li><input type="checkbox"/> Electrical Engineering</li> <li><input type="checkbox"/> Electrical Maintenance</li> <li><input type="checkbox"/> Electrician <input type="checkbox"/> Contracting</li> <li><input type="checkbox"/> Lineman</li> </ul> <p><b>HIGH SCHOOL</b></p> <ul style="list-style-type: none"> <li><input type="checkbox"/> Commercial <input type="checkbox"/> Good English</li> <li><input type="checkbox"/> High School Subjects</li> <li><input type="checkbox"/> Mathematics</li> </ul> | <p><b>LEADERSHIP</b></p> <ul style="list-style-type: none"> <li><input type="checkbox"/> Foremanship</li> <li><input type="checkbox"/> Industrial Supervision</li> <li><input type="checkbox"/> Leadership and Organization</li> <li><input type="checkbox"/> Personnel-Labor Relations</li> </ul> <p><b>MECHANICAL AND SHOP</b></p> <ul style="list-style-type: none"> <li><input type="checkbox"/> Gas—Electric Welding</li> <li><input type="checkbox"/> Heat Treatment <input type="checkbox"/> Metallurgy</li> <li><input type="checkbox"/> Industrial Engineering</li> <li><input type="checkbox"/> Industrial Instrumentation</li> <li><input type="checkbox"/> Industrial Supervision</li> <li><input type="checkbox"/> Internal Combustion Engines</li> <li><input type="checkbox"/> Machine Design-Drafting</li> <li><input type="checkbox"/> Machine Shop Inspection</li> <li><input type="checkbox"/> Machine Shop Practice</li> <li><input type="checkbox"/> Mechanical Engineering</li> <li><input type="checkbox"/> Quality Control</li> <li><input type="checkbox"/> Reading Shop Blueprints</li> <li><input type="checkbox"/> Refrigeration</li> <li><input type="checkbox"/> Sheet Metal Worker</li> <li><input type="checkbox"/> Tool Design <input type="checkbox"/> Toolmaking</li> </ul> <p><b>RADIO, TELEVISION</b></p> <ul style="list-style-type: none"> <li><input type="checkbox"/> Industrial Electronics</li> <li><input type="checkbox"/> Practical Radio TV Eng'g</li> <li><input type="checkbox"/> Radio and TV Servicing</li> <li><input type="checkbox"/> Radio Operating</li> </ul> | <ul style="list-style-type: none"> <li><input type="checkbox"/> Television Technician</li> </ul> <p><b>RAILROAD</b></p> <ul style="list-style-type: none"> <li><input type="checkbox"/> Air Brakes <input type="checkbox"/> Car Inspector</li> <li><input type="checkbox"/> Diesel Locomotive</li> <li><input type="checkbox"/> Locomotive Engineer</li> <li><input type="checkbox"/> Section Foreman</li> </ul> <p><b>STEAM AND DIESEL POWER</b></p> <ul style="list-style-type: none"> <li><input type="checkbox"/> Combustion Engineering</li> <li><input type="checkbox"/> Diesel—Elec. <input type="checkbox"/> Diesel Eng's</li> <li><input type="checkbox"/> Electric Light and Power</li> <li><input type="checkbox"/> Stationary Fireman</li> <li><input type="checkbox"/> Stationary Steam Engineering</li> </ul> <p><b>TEXTILE</b></p> <ul style="list-style-type: none"> <li><input type="checkbox"/> Carding and Spinning</li> <li><input type="checkbox"/> Cotton, Rayon, Woolen Mfg.</li> <li><input type="checkbox"/> Finishing and Dyeing</li> <li><input type="checkbox"/> Loom Fix'g <input type="checkbox"/> Textile Des'ing</li> <li><input type="checkbox"/> Textile Eng'g <input type="checkbox"/> Throwing</li> <li><input type="checkbox"/> Warping and Weaving</li> </ul> <p><b>MISCELLANEOUS</b></p> <ul style="list-style-type: none"> <li><input type="checkbox"/> Domestic Refrigeration</li> <li><input type="checkbox"/> Marine Engineering</li> <li><input type="checkbox"/> Ocean Navigation</li> <li><input type="checkbox"/> Professional Engineering</li> <li><input type="checkbox"/> Short Story Writing</li> <li><input type="checkbox"/> Telephony</li> </ul> |
|--|---|--|--|--|

Name \_\_\_\_\_ Age \_\_\_\_\_ Home Address \_\_\_\_\_

City \_\_\_\_\_ Zone \_\_\_\_\_ State \_\_\_\_\_ Working Hours \_\_\_\_\_ A.M. to P.M. \_\_\_\_\_

Occupation \_\_\_\_\_

Canadian residents send coupon to International Correspondence Schools, Canadian, Ltd., Montreal, Canada. . . . Special tuition rates to members of the U. S. Armed Forces.



## You Can Be a Manufacturer of Gardencrete

Set of 18 Flagstones (below). Sells for \$8.25; Costs to make, \$3.00. Your markup, \$5.25.

Your spare-time manufacture of Gardencrete can lead to a full-time business, with broad sales potentials and generous income possibilities. A small investment buys the Colorglazing machine and a few molds. Add more molds as your business continues to expand.

Gardencrete has wide sales appeal wherever people have pride of lawn and garden. Colors are fused on under air pressure. Stay put for years and years. Choice of 30 colors.

Your mark-up on basic costs is 200%—300%. Products easily made in shed or garage. We supply full instructions. Write for literature and information on costs and selling prices on complete line.

**Colorcrete Industries, Inc.**  
710 Ottawa Ave., Holland, Mich.



Bird Baths  
Jars and Vases  
Flower Boxes  
Flagstones  
Lawn Seats

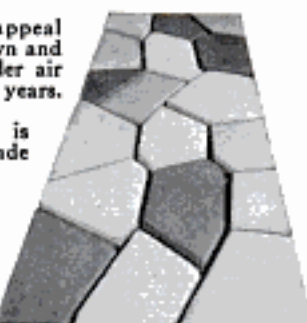

## NEW TV PICTURE TUBES

Wholesale Prices—Guaranteed 1 Year—Order Now!

10BP4A	\$14.00	16RP4	\$21.00	20HP4A	\$31.00
12LP4A	16.50	17BP4A	22.50	21AP4	35.00
14CP4	18.50	17CP4	27.00	21EP4A	32.00
16AP4A	23.50	17HP4	23.00	21FP4A	33.50
16DP4A	22.00	19AP4A	31.00	21MP4	36.00
16GP4A	23.50	20CP4	30.00	27GP4	73.00

GLASS ALUMINIZED TUBES ADD \$5.00  
F.O.B. LOS ANGELES—20% DEPOSIT ON ALL ORDERS

COMPLETE STOCK OF ALL RADIO-TV PARTS

**WESTERN STATES ELECTRONICS**

1509 N. WESTERN AVE., HOLLYWOOD 27, CALIF.



## HAWAIIAN WIGGLER #1

Deep runner. No snag-up in pads and brush. Easy to cast. Rubber Hula Skirt acts alive. At your dealer 5/8 oz. or 1/4 oz., \$1.15 each.



WORLD-FAMOUS  
FISH-GETTER

FRED ARBOGAST CO. INC.  
2213 W. North St., Akron 3, Ohio

**FREE** WRITE TODAY FOR YOUR BIG FREE ARBOGAST COLOR CATALOG—FULL OF PICTURES OF CATCHES

Say You Saw It in Popular Mechanics

## AN OUTSTANDING BUY

### PORTABLE COMPRESSOR UNIT WITH 22 GALLON TANK

Heavy duty, 1/2 h.p. capacitor AC motor, 125 lbs. capacity. Complete with rubber tired wheels, all valves, gauges, cord, plug, air hose, tire chuck, paint spray gun. NOTHING ELSE TO BUY. Ship wt. 90 lbs. FOB CHICAGO

UNASSEMBLED... \$82.95 ASSEMBLED... \$92.95



Send for **FREE** 112 page  
Illustrated Catalog of Many More  
Farm — Home — Workshop — Buys

Write to **WELLWORTH TRADING COMPANY**  
Dept. E-3  
1832 S. WABASH AVE. CHICAGO 16, ILL.

# OWN A... FORD?

## FIX IT YOURSELF!

Popular Mechanics Magazine has published an Owners Manual covering all 1941 to 1952 models of Ford cars . . . So accurate mechanics use it . . . so simple a woman can understand it.



Save money on your Ford car repairs. Prevent trouble. Enjoy care-free driving. Increase trade-in value. Avoid major repairs by fixing minor troubles before they get serious. Get sparkling performance at all times. Has 272 pages, more than 850 photos, diagrams, tables, charts, breakdown drawings, plus clear, non-technical directions that make all repairs simple as A B C. Written by Ed Packer with the assistance of the Ford Motor Company. Shows you how to diagnose all Ford troubles by feel, sound, sight, smell and performance. Simple trouble shooting. Permanent repairs. Emergency repairs. Plus, "How to get value from garages."

## MONEY BACK IF IT DOESN'T SAVE MORE THAN IT COSTS!

One minor repair will save the cost ten times over. Read it. Then you decide. If you don't see that you'll save more than the cost, send it back for refund. SEND NO MONEY. Send postcard. Ask for the Ford Manual. Postman will deliver C.O.D. for \$3.50 plus postage. Or, save postage by sending \$3.50 with order. Send today. Save its cost on your next repair.

**POPULAR MECHANICS PRESS**

200 E. Ontario, Dept. 90, Chicago 11, Illinois

## 200 ONE-EVENING PROJECTS

### Start and Finish Any One of These Projects in One Evening!

The editors of Popular Mechanics have assembled 200 projects, any one of which you can start and complete in a single evening. In a few hours' time, using only simple hand tools, you can build a coffee table, magazine rack, end table or scores of other useful projects. There are projects for the entire family. Best of all, any one may be built in just a few hours. No special skills are needed. Even if you have never built anything before, you can build the 200 projects in this big new book!

#### Step-by-Step Instructions, Show-How Photos, Drawings

First you read how to do it in famous Popular Mechanics step-by-step instructions and then actual photos, drawings and diagrams show you how it is done.

#### Each Project Costs Just 1c

Just imagine! Each project costs you only 1c. Where else today can you get so much for so little? Fill out and mail the coupon now. Full money-back guarantee, of course.



**POPULAR MECHANICS PRESS, Dept. EP-1**

200 E. Ontario St., Chicago 11, Ill.

Gentlemen:  
Remittance for \$2.00 enclosed. Rush postpaid my copy of 200 ONE-EVENING PROJECTS. Unless it is entirely satisfactory I may return it in seven days for a full refund.

NAME \_\_\_\_\_

ADDRESS \_\_\_\_\_

CITY \_\_\_\_\_ ZONE \_\_\_\_\_ STATE \_\_\_\_\_

Send C.O.D. (U.S.A. only). Postage extra.



# LEARN MEAT CUTTING AT NATIONAL

Pay After Graduation



The steady dependable trade of Meat Cutting taught easily in 8 short weeks. YOU LEARN BY DOING under actual meat market conditions in big modern school at Toledo.

For beginners or men with experience. Get a profitable store of your own. Remember, PEOPLE MUST EAT! Big pay jobs. Free employment help. Thousands of successful graduates.

Buying, cutting, percentage, pricing, advertising, selling, etc. A complete retail meat education. National School established over 30 years. Get National training NOW. Pay your tuition in easy weekly payments

after you graduate. Send coupon for FREE 52 page school catalog — TODAY. G.I. approved.

**National School of Meat Cutting, Inc., Dept. 50-P, Toledo 4, Ohio**

Send me your FREE school catalog on National Training at Toledo in Meat Cutting, Meat Merchandising and Self Service Meats. No obligation. No salesman will call.

Name \_\_\_\_\_ Age \_\_\_\_\_

Address \_\_\_\_\_

City \_\_\_\_\_ State \_\_\_\_\_

Approved for training Korean Veterans



## HAVE A BIGGER — MORE EFFICIENT HOME WORKSHOP

Popular Mechanics **PLANNING YOUR HOME WORKSHOP** shows you how to make use of every inch of space in your workshop; detailed floor plans, wiring layouts and power tool hookups plus actual photographs of famous home workshops you can use as models. Save money by building your own shop furniture. Special Where-to-Buy-It Guide, 450 Illustrations, Cloth Bound, Working Diagrams. Order your copy today from

**\$2.50**

POPULAR MECHANICS PRESS  
200 E. Ontario Street Chicago 11

## STUDY INDUSTRIAL DESIGN

You can train at Art Center School in California with practicing professionals for upper-level jobs in INDUSTRIAL DESIGN. Recent graduates have been added to the staff at General Motors, Chrysler, Raymond Loewy, Henry Dreyfuss, etc. Majors in transportation, general product design, structures, community development, furniture design, packaging, display, 4-year degree courses. Learn to combine imaginative design with technical proficiency, coordinate utility and beauty. Stimulating environment. Field trips. Advantages of mild Southern California climate and nearby holiday spots. Coed. Placement service. Established 24 years. New term begins June 8. Write for catalog.

ART CENTER SCHOOL, Edward M. Adams, Director  
5352 WEST THIRD STREET, LOS ANGELES 5, CALIFORNIA

# Fix Electrical Appliances!

... handle ANY job on ANY make, model or part



**ONLY \$5.00**  
No lessons to wait for!

A complete repair guide to practically every appliance used in the modern home.

**FIX IT YOURSELF!**  
It's Easy!

### SAVE MONEY!

By showing you how to do the work yourself, **ELECTRICAL APPLIANCE SERVICE MANUAL** helps you save appliance service charges of as high as \$5 to \$10 an hour!

### MAKE MONEY!

Fix appliances for friends or neighbors... Build a good-pay full or part-time business!



**Don't throw that broken appliance away!**

Let this big, how-to-fix-it manual show you how to make it good as new. Includes complete service details on **IRONS, ELECTRIC RAZORS, CLOCKS, MIXERS, HOT PLATES, HOT PADS, BLANKETS, ROASTERS, COFFEE MAKERS, JUICE EXTRACTORS, TOASTERS, RANGES, CLEANERS, WAFFLE IRONS, FANS, GRILLS, WASHERS, IRONERS, DRYERS, CHIMES, WATER HEATERS, FLUORESCENT LIGHTS**, etc.

IN ADDITION, you learn to service appliance motors... and you learn appliance refinishing methods!

You don't even need previous experience!

This big, how-to-fix-it book shows how to do the toughest electrical appliance repair jobs as well as the easy ones. Step-by-step instructions plus more than 180 clear pictures and charts guide you all the way.

Just look up the appliance you want to repair!

From complicated thermostat control and timing assemblies to appliances that get too hot, not hot enough or won't heat at all....

From electric range, automatic washer or dryer problems to stopping radio-TV interference caused by an appliance....

From troubles on electric

clocks, cleaners or razors to fluorescent lamps or any other appliance used around the house. **ELECTRICAL APPLIANCE SERVICE MANUAL** makes every job easy... even if you've never fixed an appliance before.

Troubleshooting charts help you locate troubles fast... show how to make tests... then tell exactly how to make the needed repairs. Basic electrical principles are explained. Simple test instruments, tools and wiring problems are described. Above all, you learn to work SAFELY... what mistakes to avoid.

Practice from **ELECTRICAL APPLIANCE SERVICE MANUAL** for 10 full days AT OUR RISK.

## PRACTICE 10 DAYS FREE!

Dept. PM-35, RINEHART & CO., INC.  
232 Madison Ave., New York 16, N. Y.

Send Electrical Appliance Service Manual for 10 DAY FREE EXAMINATION. If I like book, I will then send you the full price of only \$5.00 (plus a few cents postage). Otherwise, I will return book postpaid and owe you nothing.

Name \_\_\_\_\_

Address \_\_\_\_\_

City, Zone, State \_\_\_\_\_

OUTSIDE U.S.A.—Price \$1.50, cash only. Some 10 day return privilege with money refunded.



## WHAT TREASURES WILL YOU FIND?



**Exciting Treasure Hunt!** This big cloth bag contains over 1,000 genuine foreign postage stamps from more than 30 countries in far-away Africa, Asia, Europe, Australia, the South Seas, etc. Stamps are mostly still on paper, unpicked, unsorted, weighed out in bulk, just as received from foreign missionaries, banks, etc. Nobody knows what's inside! Worth \$10.00 or more at Standard Catalog prices. Money-back guarantee.

Only \$1.00 Post-paid

**FREE** Write for our Big New United States Stamp Catalog. Valuable guide and checklist. Hundreds of illustrations.

H. E. HARRIS & CO., 1598 Transit Bldg., Boston 17, Mass.

## FREE OUTFIT STARTS YOU IN BIG MONEY SHOE BUSINESS!

We furnish everything **FREE** to set you up in your own profitable full or spare-time shoe business. Just 3 easy sales a day brings up to \$84 a week **EXTRA!** Repeat orders mean big, steady profits. No experience or investment needed. You feature over 150 fast-selling styles in dress, sport, work shoes for men, women, including beautiful Nylon mesh shoes with Air Cushion innersoles. Also special kinds of shoes for different occupations. Amazing range of sizes, widths. Fit customers stores are unable to take care of. Start now by selling to friends, neighbors and relatives. **EVERYONE** is your prospect. Just send your name on postcard **TODAY** for **FREE SELLING OUTFIT!** Mason Shoe Mfg. Co., Dept. MA-539, Chippewa Falls, Wis.



Write TODAY!

**LIFE-TIME SECURITY**  
with YOUR OWN BUSINESS

## FREE BOOK

**TELLS HOW YOU CAN MAKE \$5.00 AN HOUR IN YOUR SPARE TIME!** You can easily make up to \$5.00 an hour at home in your own spare time repair service. No expensive equipment to buy. No experience needed. You can quickly build up your own steady repeat cash business. Find out about this spare time hobby that gives you extra Cash Income. Send postcard today for **FREE** book! BELSAW MACHINERY CO SS1 Field Bldg., Kansas City 11, Mo.

## WELDING may aid your SUCCESS

Arc and Acetylene; welding metallurgy; Hellarc, etc. This is home, spare-time training for men who appreciate the importance of welding and want to advance in the art, get promotion, enlarge own shop, etc. Send for **FREE** Book, Utilities Engineering, 2523 Sheffield, Dept. WC-9, Chicago 14

## LEARN TV in KC

**UNIVERSAL TV FAMOUS FOR 24 YEARS**  
**1,000's OF SUCCESSFUL GRADS COAST TO COAST**



Easy, quick, fascinating. Learn TELEVISION in 36 short weeks of enjoyable companionship in shop training. Wonderful job opportunities. Graduates have choice of many jobs or can establish their own TV repair shop. **YOU CAN START EARNING AS MUCH AS \$150 PER WEEK.** NO limit as time goes on. U.T.S. is an old established school (TV exclusive for 24 years) staffed by expert instructors, headed by one of America's first TV broadcasters. Costs so little to prepare yourself for life. No previous experience needed. Fully approved for Korean Veterans. Also fully approved course in color TV (1st in US). Send coupon now for **FREE** book on TV Electronic opportunities.

**WRITE FOR FREE CATALOG**

FILL OUT COUPON

**UNIVERSAL TV SCHOOL**  
1228M Admiral Boulevard, Kansas City, Missouri

PLEASE SEND ME INFORMATION FREE

Name \_\_\_\_\_ Age \_\_\_\_\_

Address \_\_\_\_\_

City \_\_\_\_\_ State \_\_\_\_\_

Check here if Korean Veteran



## 2 GREAT AUTO BARGAINS

**NEW KING MIDGET** for 1955, lower priced, improved performance. Drive it for 75c per week. Rider agents wanted, earn your own car. Also just out **KING MIDGET**

**JUNIOR** chassis, finely engineered, ready to run, and priced at less than the retail cost of parts. Agents wanted. Get all the facts—send 25c for literature, special prices and proposition on both cars, or \$1 (re-funded first order) for this plus actual assembly book and service manual.

**MIDGET MOTORS MFG. CO.**  
ATHENS 1, OHIO



## OVERLOAD SPRINGS



\$9.95 Per Pair postpaid  
2000 LB. SIZE \$11.95

For cars and trucks. Front and rear. Gives 2000 lbs. extra capacity for all 1/2, 3/4, and 1 ton trucks; 500 to 1000 lbs. extra for all cars except Olds prior to '52, and Buicks. Easily installed. Guaranteed. State make, model. **BRINKMAN MANUFACTURING CO.** 2315 Clay Dept. 15-M Topeka, Kansas



## UPHOLSTERY BE YOUR OWN BOSS

**AT HOME, earn right off.** Get a better job, be your own boss. UTS easy course teaches you professional upholstery, reupholstery, slip-covers, drapery. **FREE** tools, frames, materials to make beautiful upholstered furniture and slip covers.

**APPROVED FOR VETERANS**

Free Illustrated Book—**SAMPLE LESSON.** Write Upholstery Trades School, Dept. DC-309, 721 Broadway, New York 3, N.Y.

## STAMMER?

Get your copy of the new 18th edition of my book, "Stammering, Its Cause and Correction," which describes the Bogue Unit Method for scientific correction of stammering and stuttering. Ask, also, for free **SPEECH CHART!** 54th year. Benjamin N. Bogue, Dept. 553, Circle Tower, Indianapolis 4, Indiana.

GET THIS FREE BOOK!



## Guide to HOME REPAIRS

## Pays for Itself 100 Times Over

Beat the high cost of home upkeep. Save hundreds of dollars every year on carpentry, electrical, painting, plumbing and other jobs around the house with **Popular Mechanics GUIDE TO HOME REPAIRS.** Simplified how-to-do-it instructions and 648 pictures make all jobs, inside and out, easy. Covers construction, remodeling, modernizing, repairing that you can do yourself at small cost. 192 page cloth bound book only \$2.50 postpaid. Order today under our money back guarantee.

**POPULAR MECHANICS PRESS, Dept. PM16**  
200 EAST ONTARIO STREET CHICAGO 11, ILLINOIS

## BENJAMIN SUPER CO2 GAS CARBINE-\$16.50

**NEWEST TARGET RIFLE-22**  
**IDEAL FOR SMALL GAME**



**ECONOMICAL SAFE-NON-TOXIC ACCURATE-CONVENIENT**

**PRACTICAL** Easy to operate—No spring recoil—No pumping. Uses low cost Soda Cartridges Cal. 22 Benjamin H-C Pellets and Darts.

New Benjamin CO2 ROCKET Gas Pistol \$15.00

**WRITE FOR FREE ILLUSTRATED FOLDER OF ALL MODELS BENJAMIN AIR RIFLES AND BENJAMIN AIR PISTOLS BENJAMIN AIR RIFLE CO.**

896 MARION ST., ST. LOUIS 4, MO. U.S.A.

## RUPTURED

### BE FREE FROM TRUSS SLAVERY

**NOW** there is a new modern Non-Surgical treatment that permanently corrects rupture. These Non-Surgical treatments are so certain, that a Lifetime Certificate of Assurance is given. Write today for our **FREE** Book that gives facts that may save you painful and expensive surgery, and tells how **non-surgically** you may again work, live, play and love and enjoy life in the manner you desire. There is no obligation. **Excelsior Hernia Clinic Dept. 8305 Excelsior Springs, Mo.**



New **PROFIT-PROVEN\*** Home-Business!

**"I make \$400<sup>00</sup> a week!"**



**SCREEN PRINT**  
TRADE MARK REG

**SCREEN PRINT CO.**  
Dept. 23  
15127 S. Broadway, Los Angeles 61, Calif.  
Gentlemen: Please mail me Free Revealing Details, samples, Opportunity Plan, etc.—All this is sent absolutely Free and sent to me by return mail. I am under no obligation now or ever.

NAME \_\_\_\_\_  
ADDRESS \_\_\_\_\_  
CITY \_\_\_\_\_ ZONE \_\_\_\_\_ STATE \_\_\_\_\_

**free!**

Complete REVEALING DETAILS, Authentic SAMPLES, Proven Big-Money OPPORTUNITY PLAN, "HOW-TO" BOOKLET. Learn the secrets. Rush this coupon TODAY!

\*Proves **MR. J. T. ANDERSON**, Inglewood, Calif.  
(Notorized statement on file in our office and open to inspection)

Big Money?—sure it is—because Huge Profits are waiting to be "tapped" with this **MIRACLE NEW PRINTING METHOD**. Now, you may share the exciting secrets and build a big-paying **FULL OR SPARE TIME** Screen Printing Business right in **YOUR OWN HOME**. Yes, we'll teach you, too, how to turn pennies into dollars in this newest, most sensational printing method ever invented. **WHAT IS SCREEN-PRINT?** It's an exciting new printing technique—amazingly simple and fascinating. (It may soon revolutionize the entire printing industry) **NO EXPENSIVE EQUIPMENT**, no printing press, no "cuts," no art ability, no experience is necessary—yet you can print beautiful professional jobs on **PAPER, GLASS, LEATHER, CLOTH—ANYTHING!** You print in all colors—even new "glowing" **FLUORESCENT**

**COLORS**. It's amazing—but true! **EARN PROFITS IMMEDIATELY—IN YOUR OWN HOME!** Start in your garage, basement, kitchen, spare room—anywhere! It's much easier than you think. Then expand as this new printing industry grows. **300% PROFIT** on some jobs—earn up to \$12.50 per hr. **HELP FILL THE HUGE GROWING DEMAND**. No selling because every business in your area needs Screen-Printing. You can save them up to 50% on printing, too. **WE SUPPLY EVERYTHING YOU NEED**. Never before has such a profitability been offered to anyone wishing to start a full-time or spare-time "business of his own." Don't Hesitate! All the **CONFIDENTIAL FACTS** are yours if you **MAIL COUPON TODAY**—before it's too late.

**READ WHAT OTHERS ARE SAYING**—Investigate! "Would not take \$1000.00 for secret...just what I have been searching the world over for," C.S., Nev.; "Making 75% of living expenses already in spare time," E.L., Ontario; "Made \$80 first week—terrific opportunity"—W.S., Iowa.

Mail Coupon and Learn Secrets Tool

Print colorful **ADVERTISING DISPLAYS, SIGNS, BANNERS, POSTERS, LABELS, WALLPAPER, NOVELTIES, INSTRUMENTS, ETC. ETC.**

**Watch Repairing Pays Big Money Learn at home**



Watch repairers in great demand. Train step-by-step in 10 easy lessons. We furnish all tools and 15 jewel watch and practice movement. Turn spare time into cash. A licensed school. Low cost. Send for **FREE** book today.

**ILLINOIS SCHOOL OF WATCH REPAIRING**  
2870 Elston Ave., Dept. PM35, Chicago 18, Ill.

**GROW WITHOUT SOIL**



YOU can grow vegetables, flowers or rare plants without soil (**HYDROPONICS**) every day of the year. Start this fast, clean **EASY** way to grow any plant for fun or **PROFIT** now. Big returns from small space. Send postcard today for **FREE** picture book showing how others from every state are succeeding in this new wide open field.

**GILBERT CO., Box 22-W, San Diego 6, Calif.**

**SEWS LEATHER**

**AND TOUGH TEXTILES LIKE A MACHINE**

With **SPEEDY STITCHER** Automatic Sewing Awl, anyone can quickly and skillfully sew or repair anything made of **LEATHER, CANVAS, NYLON, PLASTIC**, or other heavy materials. Sews firm, even lock-stitches like a machine. Gets into hard-to-reach places. Specially made for heavy duty sewing on **LUGGAGE, FOOTWEAR, RUBS, AWNINGS, SAILS, SADDLERY, UPHOLSTERY, OVERALLS, AUTO-TOPS, SPORTS GEAR**, and other tough sewing jobs. Here's the handiest tool you'll ever own. Will save you many times its small cost. Comes ready for instant use... complete with bobbin of waxed thread and 3 different types of diamond-pointed needles. Easy-to-follow directions will make you an expert in minutes. Extra needles and waxed-thread always available. Save money, send \$1.98 for postpaid delivery. If C.O.D., \$1.98 plus postage. **MONEY BACK GUARANTEE.**

**SPORTSMAN'S POST**  
366 Madison Ave., Dept. A-340, New York 17



**198**  
ONLY

**Learn ELECTRIC APPLIANCE REPAIR AND SERVICE**

**FREE! PLAN FOR YOUR SUCCESS**

**BIG PROFITS—BIG DEMAND** for qualified men in field of Home Freezers, Washing Machines, Dishwashers, House wiring, Auto electricity, etc. Learn at home—start your own business. **NO PREVIOUS EXPERIENCE NEEDED**. Special tools & equipment furnished. Earn while learning. Write for **YOUR FREE SUCCESS PLAN—ACT NOW!**

**PACIFIC TRAINING SCHOOL Dept. P-553**  
11029 S. Vermont • Los Angeles 44, California

**FREE BOOK**

**Paint STRIPES with New "PAINT PEN"!**

**Makes Straight, Curved or Parallel Lines!**

Just fill glass vial with any color paint. Use like a fountain pen to stripe furniture, bikes, autos, model planes, toys, linoleum, wall board. Beautiful, clean, crisp results every time, like professional painters. No experience needed to draw straight, curved, circular or evenly spaced parallel lines. Can't clog or smear. May also be used with glue, tempera, textile paint, or ceramic underglazes. Paints on wood, glass, plastics, metal, fabrics and paper. Lasts a lifetime. Only \$1 postpaid, complete with tip for 1/16 inch stripe. C.O.D.'s plus postage. Used by industry. Order your **Paint Striping Tool TODAY!**

**New! "DOUBLE-STRIPE" MODEL Only \$2.95**

Newest paint striping invention. Makes **DOUBLE STRIPES**—one wide and one narrow or two wide or two narrow **at the same time**. Or adapt quickly for wide or narrow single stripes. Makes 5 combinations. **FREE**—Send postcard for complete information... or order now... \$2.95.



**\$1.00 DEALERS**

Master Paint Striping Tool packed in Display Cartons of 1 dozen. Fast, profitable seller. Write for discounts.

**Attention All Home Craftsmen!** New Paint Striping Tool gives "professional" results every time, yet simple, easy to use. Send \$1 now.

**ATTENTION—MANUFACTURERS!** Write today for information about our industrial and production striping tools.

**WENDELL MFG. CO., Dept. 33**  
4234 Lincoln Ave., Chicago 18, Illinois

**6 Other Complete Tools**  
Complete tools for 1/64, 1/32, 3/64, 5/64, 3/32 or 1/8 inch stripes, \$1.50 each. Extra tips 75c ea. **COMPLETE KIT with ALL 7 TIPS, \$5.00.** (Also 1/4" tip, only \$1.00). All tips interchangeable.



# Become an Electrical Engineer



## Major in Electronics or Power BS Degree in 36 months

Prepare now for a career as an electrical engineer or engineering technician—and take advantage of the many opportunities in these expanding fields.

You can save a year by optional year 'round study. At MSOE previous military, academic, or practical training may be evaluated for advanced credit.

## Enter Radio and Television — courses 12 to 18 months

You can be a radio technician in 12 months. In an additional 6-months you can become a radio-television technician with Associate in Applied Science degree. Color television instruction is included in this program.

These technician courses may form the first third of the program leading to a degree in Electrical Engineering. Twenty-one subjects in electronics, electronic engineering and electronic design are included in these courses.

Courses also offered: radio-television service (12 mos.); electrical service (6 mos.); general preparatory (3 mos.).

## Terms — April, July, Sept., January

Faculty of specialists. 50,000 former students — annual enrollment from 48 states, 23 foreign countries. Non-profit institution. 52nd year. Courses approved for veterans. Residence courses only.

MS-68



## MILWAUKEE SCHOOL OF ENGINEERING

MILWAUKEE SCHOOL OF ENGINEERING  
Dept. PM-355, 1025 N. Milwaukee Street  
Milwaukee 1, Wisconsin

Send FREE illustrated booklets  
 Career in Electrical Engineering,  
 Career in Radio-Television.

I am interested in.....  
(name of course)

Name.....Age.....

Address.....

City.....Zone.....State.....

If veteran, indicate date of discharge.....

## GROW HERBS & SPICES AT HOME

MEN! WOMEN! Earn Spare Time \$\$



YEAR 'ROUND  
ANY CLIMATE

Successful home grower tells you how he started growing Herbs as hobby in SMALL APARTMENT and developed a fine, nationwide business. Learn how to make 101 profitable items at home. BIG-PROFIT orders come from neighbors, stores, gift shops, many business firms—ALSO MAIL ORDERS. Millions of \$\$ worth used yearly in foods, drinks, cosmetics, perfumes, medicines, etc. EASY TO GROW indoors or out. Few plants in kitchen window supply household needs. HERBS MULTIPLY RAPIDLY—half-dozen plants soon become hundreds. No big overhead. SEND NO MONEY. Instructions including PLANS FOR 25 WAYS TO MAKE MONEY AT HOME with Herbs AND LIVING HERB PLANTS sent for no-risk examination. FREE—full details. WRITE NOW! WORLD OF HERBS, Dept. 63, 601 S. Vermont, Los Angeles 5, Calif.

only  
\$95  
freight incl.  
Write For  
FREE  
FOLDER

## 12 ft. SPORTBOAT KIT

Includes ready-cut parts and hardware. Models low as \$39.00 freight incl.



TAFT MARINE WOODCRAFT

Dept. PM-3, 636 39th Ave. N.E., Minneapolis 21, Minn.

## RAISE GIANT FROGS

BIG DEMAND

Nuford  
Giants



MILLIONS USED YEARLY!

Nation-wide markets waiting for all you can ship. Good prices year round. Breeder lays up to 20,000 eggs yearly. Season just starting! Men and women get ready now for this year's crop. Small pond starts you. New book tells how! Send for my illustrated FREE folder today. Write now!

ALBERT BROEL-7

P.O. Box 506 New Orleans 1, La.

## PROTECT YOUR EXPENSIVE MACHINERY!



You can save money on costly repairs and maintenance. Add your own power take-offs to tractors and other equipment. Keep your buildings and other improvements in top shape. 1955 edition of POPULAR MECHANICS FARM MANUAL shows you how in 192 pages of easy-to-follow, fully-illustrated kinks and ideas.

Get your copy now—before fieldwork begins. Your choice of another valuable book, PLANNING YOUR HOME WORKSHOP or 60 POWER TOOLS YOU CAN MAKE, in addition to FARM MANUAL, a \$1.50 value for just \$1. Send \$1 bill at our risk to:

**POPULAR MECHANICS**

200A E. ONTARIO ST., CHICAGO 11, ILLINOIS



**TUBE FREE WITH EVERY TIRE AT NO EXTRA COST**

EXPERIENCE IS THE BEST TEACHER. OUR MANY YEARS PROVES YOU CAN'T GET MORE. WHY PAY MORE? LOW OVERHEAD—LARGE VOLUME SALES & SMALL PROFITS BRING YOU THESE "LOWEST PRICES." WHAT GOOD IS A TIRE WITHOUT A TUBE? 21 YEARS AT THIS ADDRESS. FREE TUBES.

AN ESTABLISHED POLICY OF CAREFUL SELECTION ASSURES YOU MANY HAPPY MILES. BE WISE — TRY ONE — YOU'LL BUY MORE! WE WELCOME COMPETITION. NO ONE CAN TOUCH OUR QUALITY & PRICE!

**GOOD USED TIRES — NOT RECAPS**

**FREE** If you buy 2 or 3 PASS, 4 FLY, 32 mos. guarantee tires, We GIVE ONE tire FREE. **FREE**

Specialists in Truck Tires—Selected for Toughest Jobs—Tops in Value 32 MOS. WRITTEN GUARANTEE 34 MOS. WRITTEN GUARANTEE

600-16	\$4.42	475-16	\$4.82	700-15(6)	\$7.22	700-20	\$9.42
600-16(8)	5.92	640-15	4.22	750-16(8)	8.72	750-20(10)	15.72
650-16	4.82	670-15	4.52	700-17	7.92	750-20(8)	10.22
650-16(8)	6.62	710-15	4.52	750-17	10.92	825-20	16.72
700-16	5.32	780-15	4.82	825-15	10.82	900-20	15.82
750-16(6)	7.22	800-15	5.22	800-20	8.02	1000-20	15.82
850-16	3.72	820-15	5.42	650-20	8.82	1100-20	17.62
550-17	3.72	870-16	5.02	32x6(8)	11.72	1100-22	20.02
650-15	4.52	760-16	7.02	32x8(10)	12.92	1000-22	16.82
700-15	4.62	700-16(6)	7.22	750-15	10.72	1100-24	23.02

DeLuxe WHITE WALLS \$1.00 extra

Thousands of tires shipped all over the U.S.A. All tires shipped F.O.B. Phila. Send Check or M.O. with this ad. Dept. 2, No C.O.D.

**STANDARD 834 N. Broad St., Philadelphia 30, Pa.**

**Both FREE!** **BE**

Write For "ADVANCE YOU" BOOKLET Plus Outline of a **SUCCESS PLAN** by a Well-Known **MANAGEMENT CONSULTANT**.

**PERSONAL PROGRESS PLAN**  
McIntyre Bldg. Asheville, N. C.

**MORE SUCCESS-FULL**

**\$750 BUILDS 4 ROOMS & BATH!**  
**WHY PAY RENT?**

For Seven Hundred Fifty Dollars and 30 days of your spare time, you can build yourself this Beautiful Home. Living Room 11x15, Front bedroom 9x11, Back bedroom 10x12, Kitchen 9x11, Bath 5x8, Hall 3x4. Wind out steel casement windows. Concrete block, stuccoed. Step-by-step illustrated instructions, blueprint and material list \$1.00 ppd. No C.O.D. Moneyback guarantee. Economy Home, Dept. C Box 645 Columbus 16, Ohio



Ask Dealers for "Stemmler's"

**FINE BOWS and ARROWS**  
SELECTED RAW MATERIALS

**Catalog 5c; HAND BOOK**  
— Illustrated on Making and Shooting Archery—75c

**L. E. STEMMLER CO.**  
Manorville (Box 1) L. I. N. Y.



**AMAZING NEW PRECISION BINOCULARS**  
LEAVE HANDS FREE *worn like eyeglasses*

THE feather-light DeLuxe TEMPLESCOPE gives you clear, enlarged close-ups at track, fights, ball games, plays and concerts. Has many features of instruments selling for \$22.50 and more. Optically-ground COATED lenses that give WIDE FIELD and admit up to 50% more light. Easy individual eye focusing for exact, fine adjustment. You wear them like spectacles without eye or arm fatigue. Contoured nose-rests and shaped ear-pieces assure all-day comfort. Do not confuse these sensational German-made binoculars with inferior toy-like imitations. Heat-sealed soft case included at no extra cost. Try the remarkable TEMPLESCOPE for 10 days. You must be delighted; otherwise full refund. ONLY \$3.95 prepaid, Federal Tax included. Sorry, no C.O.D.'s at this low price. Rush your order today!

**SHERWOOD HOUSE DEPT. A, 7308 SHERWOOD ROAD PHILADELPHIA 31, PA.**



**NOW! SAVE MONEY ON YOUR OWN CUSTOM HI-FI MUSIC SYSTEM**

**free!**



**ALLIED'S 64-PAGE HI-FI BOOK SHOWS YOU HOW**

Send for "This is High Fidelity" the FREE book that tells you everything you'd like to know about Hi-Fi

**DO IT YOURSELF**



Here's your guide to an easy understanding of Hi-Fi—the new electronic way to bring lifelike music into your home. Shows you how to select a custom Hi-Fi music system for your home at no more than the cost of an ordinary phonograph. Tells you what to look for and how to save money on each unit. Shows many handsome, practical do-it-yourself installation ideas. Offers you the world's largest selection of complete systems as well as individual amplifiers, tuners, changers, speakers and accessories from which to make your money-saving choice. If you love your music you'll want this helpful ALLIED Hi-Fi book. Write for it today—it's FREE.

**FREE HI-FI BOOK**

**ALLIED RADIO**  
America's Hi-Fi Center

ALLIED RADIO CORP., Dept. A-35  
100 N. Western Ave., Chicago 80, Ill.

Send FREE 64-Page Hi-Fi Book

Name .....

Address .....

City ..... Zone ..... State .....







# FREE PROOF!

## Amazing New Liquid Rubber Waterproofs, Repairs, Patches!

69¢ Bottle yours FREE with quart or gallon! Must amaze you, or all your money refunded!

HERE IT IS... The brand new "MIRACLE" MATERIAL that will rubberize everything from a pair of pants to an entire roof! Actually gives you a natural liquid rubber right out of a can! Brush it on like paint—spray it on—dip it! Just "apply and let dry!" Can be applied to almost anything: paper, wood, fabric, etc.

### YOU RISK NOTHING

With every quart or gallon you get a regular 69¢ bottle absolutely free! Try the small bottle. See for yourself how Rub-R-ize works—keep it—it's yours free. If the small bottle isn't everything we say—return the unopened large size and get your full price. You risk nothing!



**WATERPROOFS!  
INSULATES!  
SHOCKPROOFS!**

MAIL ORDERS FILLED! DEALER INQUIRIES INVITED!

RUBBER MAGIC INC., DEPT. H

4312 Third Ave., Brooklyn 32, N. Y.

Send me size and color checked below, plus 69¢ free bottle.

QUART \$3.75     GALLON \$8.95

Red     Green     Black

Grey     Transparent

Send C.O.D. I'll pay postage & charges.

Money enclosed. You pay postage.

Name .....  
Street .....  
City .....  
Zone ..... State .....

**MONEY-BACK GUARANTEE**



Roofs, gutters, leaders

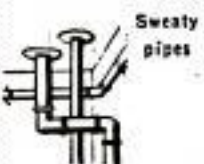

Sweaty pipes



Auto ignition wires

### WHICH OF THESE ITEMS NEEDS FIXING?

- Lamp-Statue-Ash Tray Bases
- Waterproofs Hunting Equipment
- Weatherstrips
- Seals Leaky Windshields
- Protects Bathroom Baseboards
- Renews Convertible Car Tops
- Rubber Caulking for Boats
- Makes Gaskets, Washers
- Insulates Wire Couplings
- Rustproofs Car Exhausts

### WHAM-O SPORTSMAN

\$1.50 35-LB. PULL!

HITS LIKE A RIFLE—KILLS RABBITS, SQUIRRELS. Powerful, silent, accurate.

For hunting, target, routing pests.

Sportsman's choice and world over!



### HUNTING SLINGSHOT

Heavy duty 7" ash stock.

40 steel balls, extra rubber, target.

GUARANTEED. \*Professional model of Nat'l Slingshot Assn.

If your sporting goods dealer can't supply you, send \$1.50 to

Wham-O Mfg. Co., Box 612, Alhambra, Calif.

World's Largest Selection of Home-Study Books, Courses, Texts... all at low money-saving prices! Train at home for locksmithing, radio, shoe repairing, watch repairing, real estate, mail order business, piano tuning, criminology, management, hundreds of other money-making subjects. Write today for FREE "Success" Catalog. No obligation. NELSON-HALL CO., 210 S. Clinton St., Dept. 8CV-2, Chicago 6, Ill.

Get This FREE CATALOG

## 205 GERMANY only 25¢



This fabulous collection contains **Scarc Stamps** nearly 100 years old; giant and midget stamps; Hitler & blood-red swastikas; battle scenes; inflation issues with pre-war face of millions of dollars; Peace, Music & Religious stamps; birds, animals, sports, airmails—205 all-different, worth \$4.22 at Catalog prices! PLUS free booklet, bargain lists and other offers for your free consideration. All for only 25¢. Send TODAY!

FALCON STAMP CO., Dept. 164, Falconer, N.Y.

## PREPARE FOR BETTER JOB, BIGGER PAY IN SPARE TIME AT HOME

Today, choose the job you want—and prepare for it in time you might otherwise waste. Or if you are already in the work you like best, start training now for quicker promotion and increased pay. During more than 50 years AMERICAN SCHOOL has helped ambitious people to reach higher goals. Check subject that interests you and mail coupon for full information.

AMERICAN SCHOOL, Dept. G345, Drexel at 58th, Chicago 37, Ill.

Without obligation, please send FREE and postpaid, full particulars about the subject checked below.

- |  |   |   |
|--|---|---|
| <input type="checkbox"/> Accounting              | <input type="checkbox"/> Diesel Technician        | <input type="checkbox"/> Mechanical Engineering |
| <input type="checkbox"/> Apprenticeship Courses  | <input type="checkbox"/> Drafting—Building Trades | <input type="checkbox"/> Plastics Engineering   |
| <input type="checkbox"/> Architecture & Building | <input type="checkbox"/> Drafting—Machine Trades  | <input type="checkbox"/> Plumbing Engineering   |
| <input type="checkbox"/> Automotive Technician   | <input type="checkbox"/> Electrical Engineering   | <input type="checkbox"/> Plumbing—Practical     |
| <input type="checkbox"/> Better Farmmanship      | <input type="checkbox"/> Electricity—Practical    | <input type="checkbox"/> Private Secretary      |
| <input type="checkbox"/> Bookkeeping             | <input type="checkbox"/> Electronics—Industrial   | <input type="checkbox"/> Retail Merchandising   |
| <input type="checkbox"/> Business Management     | <input type="checkbox"/> High School Courses      | <input type="checkbox"/> Salesmanship—Outside   |
| <input type="checkbox"/> Civil Engineering       | <input type="checkbox"/> Machine Shop Operations  | <input type="checkbox"/> Sheet Metal Work       |
| <input type="checkbox"/> Contracting             | <input type="checkbox"/> Mathematics & Slide Rule | <input type="checkbox"/> Tool Making            |

NAME \_\_\_\_\_ OCCUPATION \_\_\_\_\_ AGE \_\_\_\_\_  
HOME ADDRESS \_\_\_\_\_ STATE \_\_\_\_\_ CITY \_\_\_\_\_

Canadian Residents: Write American School, 1610 Sherbrooke St. West, Montreal

MAIL COUPON NOW





**FREE!**  
U. S.  
AIRMAIL  
STAMPS



**FREE! 3 OTHER OFFERS FREE!**

Rush coupon today for one of the most exciting offers we've ever made! Imagine... this scarce collection of beautiful, hard-to-get U. S. Airmail stamps all yours absolutely FREE! — all genuine, all different. And that's not all! Also yours FREE — handsome souvenir of the World's Rarest Stamp in color. PLUS! helpful "Stamp Collector's Guide". PLUS! valuable 1/2 penny Falkland Island Stamp and details on how to get 8 more. Other offers for your free inspection. Don't wait — it's a rare offer for a limited time only! If coupon has been clipped, send 10c for postage and handling direct to GARCELON STAMP CO., Dept. PM3A, Calais, Maine.

GARCELON STAMP CO., Dept. PM3A, Calais, Maine

Rush FREE U. S. Airmail Stamps and other offers. Enclosed is 10c for postage and handling. (PLEASE PRINT)

NAME \_\_\_\_\_

ADDRESS \_\_\_\_\_

CITY \_\_\_\_\_

STATE \_\_\_\_\_

**PREPARE FOR THE  
BEST JOBS**

**TRAIN  
at HOME**  
IN YOUR SPARE TIME  
or at  
**ALLIED INSTITUTE**  
in Chicago

- MECH. ENGINEER
- DRAFTSMAN
- TOOL DESIGNER
- TOOL ENGINEER
- TOOL & DIE MAKER
- MASTER MACHINIST

**NO RECESSION FOR ALLIED TRAINED MEN**

**MORE JOBS THAN GRADUATES** Shortages of Draftsmen, Designers, Tool Engineers, Machinists, Tool & Die Makers are so widespread that you can pick a highly paid key job and look forward to Achievement and Security.

You can begin your training in Short Courses and continue progressively to a Bachelor Degree in 26 months.

Allied is approved by Industry, Dept. of Education, Office of Public Instruction, State of Illinois, U. S. Veterans Admin., U. S. Dept. of Justice. Accredited: C. S. A.

SEND FOR  
**FREE**  
BOOKS

**ALLIED SCHOOL OF MECHANICAL TRADES**  
1338-42 South Michigan Ave. Dept. PM-3 Chicago 5, Illinois

SEND ME WITHOUT OBLIGATION INFO. ON YOUR COURSES:

HOME STUDY  RESIDENT  VETERAN  NON VETERAN

NAME \_\_\_\_\_

ADDRESS \_\_\_\_\_

AGE \_\_\_\_\_

CITY \_\_\_\_\_

STATE \_\_\_\_\_

## AMMUNITION

for a fraction of  
regular cost



Reload a whole carton for the cost of a few rounds of factory ammunition. Shotgun shells, rifle and pistol cartridges can be reloaded safely and easily with an inexpensive set of famous IDEAL Reloading Tools. Send for free literature.

**THE LYMAN GUN SIGHT CORP.**

Middlefield, Conn.

## WHEELS WHEELS WHEELS

7" Disc Wheel 3/4" Tire 3/4" sleeve	45c ea.
8" Disc Wheel 1 1/4" Tire 1 1/2" sleeve	70c ea.
7" Disc Wheel 1" Tire 1 1/2" ball bearing	80c ea.
8" Disc Wheel 1 1/4" Tire 1 1/2" ball bearing	\$1.00 ea.
6" Disc Wheel 1.50 semi-pneum. Tire 1 1/2" S.B.	\$1.35 ea.
8" Disc Wheel 2" semi-pneum. T. 1 1/2" S.B.	\$1.50 ea.
10" Disc Wheel 1.75 semi-pneum. T. 1 1/2" S.B.	\$1.50 ea.
10" Disc Wheel 2.75 semi-pneum. T. 1 1/2" S.B.	\$3.50 ea.
12" Disc Wheel 1.75 semi-pneum. T. 1 1/2" S.B.	\$1.85 ea.

Above wheel prices include hub cap. Plus Postage, C.O.D.'s accepted. AXLES—Sizes 5/16 in., 3/8 in., 1/2 in.—Cut to size—End holes drilled.

UNITED WHEEL STAMPING CO.

12131 S. PEORIA STREET. PM-3 CHICAGO 43, ILLINOIS



Foreign Coin, Banknote and large illustrated coin list FREE to approval service applicants for 3c postage. HARGAINS! Indianhead cent, 10c; Wood-nickel, 10c; Chinese Dollar, 53c.

TATHAM COIN CO., SPRINGFIELD 5, MASS.

**PLEASE  
SEND ME**



for the  
time checked.

I am enclosing . . .

- 1 year \$3.50  
 2 years \$6.00

name \_\_\_\_\_

address \_\_\_\_\_

city \_\_\_\_\_

zone \_\_\_\_\_

state \_\_\_\_\_

A-35

Hand this order to your newsdealer or send it to

**POPULAR MECHANICS**  
200 East Ontario St. Chicago 11, Ill.



# NOW.. Start Fixing TV and Radio Sets RIGHT AWAY

TRY IT  
**FREE**

FOR 10 DAYS IN  
YOUR OWN HOME

JOHN  
MARKUS

## TELEVISION AND RADIO REPAIRING

McGraw-Hill's Amazing New Low-Cost Instruction Manual Skips "Theories" and "Formulas", Tells How-to-do-it in PLAIN ENGLISH!



### Prove It on Your Own Set

Save up to \$20 a year just by installing, repairing, and servicing your own TV set. Book tells which controls to adjust or tubes to replace if picture is entirely dark — blurred — split — distorted — off center — tilted — wiggles and weaves — too pale — too black — jitters — snows — drifts — etc., etc.

### PARTIAL CONTENTS

Tools Needed • How TV and Radio Sets Work • How to Remove and Replace Tubes • Testing Tubes without a Tester • Using a Tube Tester • Power-Supply Troubles • How to Test and Replace Resistors • How to Switches, Condensers, Coils, Transformers • Tuning Devices • Loudspeakers • Phono Pickups and Needle Trinnas • . . . and MUCH MORE

### TELLS HOW TO "Cash In" ON THE BIG DEMAND FOR RADIO-TV REPAIRMEN

Over 25 million TV sets . . . over 100 million radios in this country! Shortage of skilled repairmen! You can make nice extra money and fix for friends and neighbors in your spare time . . . or start your own full-time repair business, with steady profits. Book tells exactly how to get started; how to plan your workshop; information to stock; where to get information; how to make a service call. You can start fixing sets and making money before you're halfway through book. Author tells how tough jobs can be done so you STILL make money.



. . . even if you have never fixed a LAMP or DOOR BELL before!

"Why hasn't somebody done this BEFORE?" That's what you'll say when you start browsing through this new and complete one-volume instruction-manual in radio and TV repairs.

For here at last a well-known EXPERT has found a way to tell you in PLAIN ENGLISH how to fix almost ANY radio or television set. (And he even tells you where you can go to have the extra-tough jobs done FOR you . . . at professional rates.) Right from the very first chapters you can start doing simple repairs . . . and before you're HALF way through the book, you can fix HALF the television and radio sets that you encounter. Surprisingly quickly you can fix your own and friends' sets . . . get a service shop job . . . even start your own money-making business right in your own home.

### Why It's So EASY to Understand

No electronic formulas . . . no algebra . . . no laboratory experiments. Instead you deal only with the things that go wrong in sets—how to recognize and spot the trouble—and what to do about it. "Easy as A-B-C" directions and 700 clear photos, diagrams, and drawings show you exactly WHAT and HOW to fix, step-by-step.

The author is Associate Editor of *Electronics Magazine*. He's a long-recognized expert—not only on radio and TV—but also on making technical subjects easily understood by the average reader. He has spent FOUR years making this one-volume instruction manual so practical and easy-to-understand that even a man who never fixed a door bell before will have no trouble.

Here's everything you need to know about where and how to buy tubes and parts, where and how to get a circuit diagram for any receiver; how to choose and use basic tools; how to test tubes WITHOUT a tube tester; how to adjust 58 common TV controls; how to "diagnose" and "cure" common radio and TV troubles; how to fix or replace loudspeakers, phono pickups; how to install and check antennas; and much, much more.

### SEND NO MONEY

Examine this big 556-page book for 10 days BEFORE you decide if you wish to own it. Try it out FREE on your own set. See how easy it makes your handling of repairs. Take 10 days to prove it PAYS FOR ITSELF, or don't keep it. Just mail coupon to: McGraw-Hill Book Co., Inc., Dept. PM-3, 327 West 41st St., New York 36, N. Y.

### FREE 10-DAY TRIAL COUPON

McGraw-Hill Book Co., Inc., Dept. PM-3  
327 West 41st St., New York 36, N. Y.

Please send me, for 10 days' FREE EXAMINATION, your one-volume "Television and Radio Repairing," by John Markus. If not delighted with it, I may return book, pay nothing. Otherwise, I will keep book and send only \$1.95 plus postage; followed by 3 monthly installments of \$2.00 each.

Name \_\_\_\_\_

Address \_\_\_\_\_

City \_\_\_\_\_ Zone \_\_\_\_\_ State \_\_\_\_\_

SAVE MONEY. Check here if enclosing full price of \$7.95 WITH this coupon. Then WE will pay delivery. Same 10-day return privilege—full refund guaranteed.

### Trouble-Shooting Chart Tells Where to Look for Bad Tube If:

No picture; no raster; no sound.  
No picture; raster OK; no sound.  
No picture; no raster; sound OK.  
No picture; raster OK; sound OK.  
Picture wiggles and weaves, lacks blacks, or is very black; raster OK; sound OK.  
Picture jittery, double image; raster OK; sound OK.  
Snow on all channels; raster OK; sound weak.

Snow on all channels, raster OK; sound OK.  
Picture and raster do not fill screen; sound OK.  
Picture drifts up and down but not sideways; raster OK; sound OK.  
Picture muddy and gray; raster OK; sound OK.  
PLUS 29 OTHER COMMON TV TROUBLES.



## SEND FOR FREE WELDING GUIDE

# "Linwelder 100" makes metalworking as easy as woodworking

Weld at home with "Linwelder 100" . . . no previous experience or training necessary. With this new "weld-it-yourself" method, you simply touch electrode to the work, press a switch . . . "Linwelder 100" does the rest.



Complete "Selfweld" kit includes "Linwelder 100" machine, welding shield, cable, electrode holder and supply of special "Selfweld" electrodes.

**PRICE...\$99**

F. O. B. Cleveland, Ohio

Welding guide teaches you how to build wrought iron furniture, farm tools, home equipment . . . also make repairs, solder, torch heat, cut metal.

**THE LINCOLN ELECTRIC COMPANY**  
Dept. 2901, Cleveland 17, Ohio

Name \_\_\_\_\_  
Address \_\_\_\_\_  
City \_\_\_\_\_ State \_\_\_\_\_  
 Send free "Selfweld" Guide giving more information on do-it-yourself welding.  
 Send me complete "Selfweld" kit. Enclosed is check \_\_\_\_\_ money order \_\_\_\_\_ for \$99.00.

## DON'T BE FROZEN OUT THIS WINTER!

GET UNĒK'S  
3 way  
protection  
kit  
only \$3.49



includes three amazing new products

### 1 NEW KEY-HOLE Anti-Freeze

A new chemical formula that ends the danger of tiny droplets of moisture freezing in your car door or trunk locks. A quarter tube-full squeezed into the key opening will protect you against lockouts all winter! Will not stain finish or fabrics. Ideal for protecting exposed padlocks, garage door and mail box locks!

protects  
locks  
all  
winter

### 2 prolong your motor's "heart-beat" the ignition system



### NEW! ELEK-TRIC SHIELD

gives instant starts in cold damp air  
Now! you can prevent annoying motor stalling in traffic on damp, rainy days, and hard starting in cold weather. Applied to ignition wire connections at the spark plugs and distributor cap, Elek-trik Seal dries in minutes to form a perfect non-cracking sealant—assuring your motor a full hot spark for easy starting, and smooth going in cold, damp days! Makes a perfect sealant for your outboard motor's ignition in summer too! NOT A VARNISH!

### STOP BATTERY FAILURE

caused from short circuiting corrosion . . .

with NEW BATTERY SHIELD  
Anouncing new, felt battery post washers . . . impregnated with a corrosion killing ingredient that prevents short circuiting, corrosion "accus" from forming for the life of your battery. Actually helps your battery to longer life by preventing short circuit drains. No motorist should be without Battery-Shield!

**DON'T DELAY! Get this 3 way protection against DAMP DAYS TODAY!**

10 DAY MONEY BACK GUARANTEE

JUST send \$3.49 for kit (post paid)



**UnĒk Products Co.**  
Oconomowoc,  
Box 184 Wisconsin

**WAR SURPLUS BARGAINS!**

**WAR SURPLUS BARGAINS**

**\$500,000.00 INVENTORY for QUICK LIQUIDATION**

Surplus Items—hundreds of them for home, shop, factory, farms and outdoor use. New items, used items, reconditioned items—all at tremendous savings—all priced for quick sale.

Page After Page of Values

This big catalog shows page after page of amazing money saving values. Write for your copy today. Send 10c to cover postage, mailing, etc. Write today! **SEND TODAY FOR YOUR COPY**

10c

**STARK'S** 212 W. Madison St.  
Dept. PM-3  
CHICAGO 6, ILL.

**GROW ORCHIDS AT HOME**

BIG PROFITS SPARE OF FULL TIME

COST: 1 YEAR ROUND ANY CLIMATE NO EQUIPMENT

World's most thrilling hobby—profitable home business. Single Orchid plant may multiply into many—each as valuable as the first. Successful home grower shows you how! Raise gorgeous Cattleyas, Cymbidiums, Epidendrums, on living-room table. Big-profit orders come from friends, neighbors, florists, etc.—also Mail Orders. Illustrated secrets of the experts in simple "show-how" language AND blooming-size Orchid plants sent at NO RISK. Everything you need to start—for pleasure or profit FREE—full details—SEND NO MONEY. Write today. TROPICAL FLOWERLAND, Dept. 313, 4622 Wilshire, Los Angeles 5, Calif.

**A-D-E THE WORLD'S GREATEST NAME IN DIVING EQUIPMENT**

everything under water

FLASH—New "ADE Seokelung" \$19.50  
Uninflator Frog Suits \$19.95 "S-38" lung \$39.00  
20 Lung Models—\$20.00 and up

Write for FREE literature to:  
**AMERICAN DIVING EQUIPMENT CO.**  
MAX GENE NOHL, Pres. Box 171 Milwaukee, Wis.

**DEVELOP A HE-MAN VOICE!**

Write for FREE book "How to Strengthen Your Voice for Greater Success" by Eugene Feuchtinger. No obligation. Book will be mailed at once in plain wrapper, postpaid. Just send your name and address. State age.

**PREFECT VOICE INSTITUTE, 210 S. Clinton St., Studio CV-2, Chicago 6, Ill.**

**ENGINEERING DEGREE IN 27 MONTHS**

**INDIANA TECHNICAL COLLEGE**

B. S. DEGREE, Aeronautical, Chemical, Civil, Electrical, Mechanical and Radio Engineering (inc. TV and Electronics). Drafting, 1-yr. G.I. Gov't. approved. Low rate. Each board. Large industrial center. Students from 48 states, 21 countries. Demand for graduates. Enter March, June, September, December. Write for catalog, 1635 E. Washington Boulevard, Fort Wayne 2, Indiana.

**What Every Farmer Should Know About Taking Care of Farm Animals**

**The Most Popular Veterinary Guide Ever Printed**

This practical and helpful VETERINARY GUIDE FOR FARMERS prepares the farmer to perform many routine veterinary tasks—provides quick information that can often save the life of an animal—prevents disease in herds—saves money on the farm in a hundred different ways.

Written in plain understandable language. It covers symptoms, causes of disease and prevention, and treatment of cattle, swine, sheep, horses and poultry and warns when to call in the professional veterinarian. Names, terms and phrases made clear in a separate section. Over 100,000 copies of this book are in use on American farms. 375 pages. Fully illustrated. Only \$3.95. Order today under money-back guarantee.

**POPULAR MECHANICS PRESS, Dept. PM13**  
200 E. Ontario St. Chicago 11, Ill.



**More Enjoyment from TV,  
Radio or Phonograph with Your Own  
PERSONAL SPEAKER and  
Dual Volume Control**

**2-VOLUME  
CONTROLS,**  
full on to off,  
one for main  
set sound, one  
for this unit.  
**25-ft. Cord.**



Puts sound anywhere you want it, by easy chair, at bedside, in shop, playroom, on patio. Carry about or pass to guests. Silence unwanted parts of program without getting up. Boon to hard-of-hearing; avoids blaring. Lets you listen late without disturbing others' sleep or study. Stereophonic sound effects; auxiliary "tweeter" for Hi-Fi fans. Satisfaction guaranteed. Clips on any set. Complete, \$12.95 (Canada \$13.95). Check or m.o. (no COD) to:

**Winoko Corp., 1719 Wyandotte, Kansas City 8, Mo.**

**AMAZING NEW TINY RADIO**

Really Works—Small as a Pack of Cigarettes!



GETS LOCAL RADIO STATIONS WITH CLEAR BELL-LIKE TONE—NO STATIC OR INTERFERENCE NEEDS NO TUBES, BATTERIES OR COMPLICATED HOOKUPS! NO AC PLUG INS! Nothing to wear out. Thousands of users—many report years of service. Uses new crystal diode and III-Q coil. SELF-CONTAINED SPEAKER PHONE. Just the tiny radio to take with you ANYWHERE YOU GO—ON TRIPS, VISITING, ETC.—for real fun and enjoyment—ANYTIME. Merely hook to anything that can act as antenna for local reception. Free DX antenna kit included. **SEND ONLY \$1.00** (bill, ck., mo.) and pay postman \$3.99 C.O.D. postage or send \$4.99 for p.p. delivery. COMPLETE READY TO LISTEN. MIDWAY CO., Dept. PPM-3, Kearney, Nebr.

**SAY YOU SAW IT IN  
POPULAR MECHANICS**

**Print Your Own**



Cards, stationery, circulars, tags, labels, photo and movie titles, advertising, etc. Save money. **Print for Others.** Good Profit! Easy rules sent. Raised Printing like Engraving, too. Sold direct from factory only. Write for free catalog of outfits and all details. **KELSEY PRESSES, M-37, Meriden, Conn.**

**AGENTS START BUYING  
SERVICE AT HOME**

**GET BIG NAME MERCHANDISE**

for your clients up to 40% less than reg. price. Operate sparetime. Sales easy as you can give sizeable discounts, still make fat comm. Postcard brings free plan.

**AMERICAN BUYERS SERVICE**  
631-R LINDEN AVE., BUFFALO 16, NEW YORK

**GET  
UP TO  
40%  
OFF**

**Success Requires Training! LEARN  
AIR CONDITIONING  
and REFRIGERATION**

This great, modern industry is alive with opportunities for trained men. Installation, maintenance and servicing of home and industrial equipment is a well-established, paying trade and business. Now mechanically inclined men can get practical instruction in spare time at home, plus quick shop practice at U.E.I. (founded 1927).

**IMPORTANT FACTS FREE — Write today**

Find out all about these interesting opportunities without obligation. Send a postcard or short note right now.

**UTILITIES ENGINEERING INSTITUTE, Dept. C12**  
2525 SHEFFIELD AVENUE CHICAGO 14, ILLINOIS

**BUY DIRECT and  
SAVE UP TO 1/2  
on ITALIAN ACCORDIONS  
EASY TERMS**



Accordions of famous makes and breath-taking beauty now can be yours! Mail coupon for FREE Color Catalog and amazing Wholesale Prices.

**TRY BEFORE YOU BUY**

World's largest selection direct from Importer to you! 30 models to choose from. **SATISFACTION GUARANTEED** or your money back. Trade-ins accepted. Terms as low as \$10 monthly. Write today!

**5 DAYS  
FREE  
TRIAL  
•  
MONEY  
BACK  
GUARANTEE  
•  
MAIL  
COUPON  
NOW**

**Big  
Color  
Catalog  
FREE!**

Send me Free Color Catalog—full details.

Name \_\_\_\_\_

Address \_\_\_\_\_

City \_\_\_\_\_ State \_\_\_\_\_

**ACCORDION MANUFACTURERS & WHOLESALE OUTLET**

2003 West Chicago Ave., Dept. R-35 Chicago 22, Ill.

**HELPFUL BOOKS**

Send post card asking for FREE catalog  
Popular Mechanics Press, 200 E. Ontario, Dept. 601, Chicago 11



**SELL JUST ONE  
SENTRY SAFE A DAY  
AND YOU CAN EARN  
\$8,000 A YEAR!**

Only 5% of the people own a personal safe to protect their valuables from fire, theft and loss! Cash in on this untapped market with **SENTRY**—the world's finest small safe. New mahogany cabinet model makes everyone a prospect—householders, professional men, farmers, small businessmen. Set your own price, take a big mark-up, and still under-sell all competition. Just one **SENTRY** sale a day can bring you \$8,000 a year. Choice, exclusive territory. Drop shipment if desired. Send for full details, giving address including county.



**BRUSH-PUNNETT CO. 575 West Ave., Rochester 11, N.Y.**



# TRAINED MEN NEEDED

## BIG PAY—GOOD FUTURE

- TELEVISION       ELECTRONICS  
 DIESEL             AUTO

WHY WORK FOR LOW PAY or risk being out of a job??? Usually the properly trained man has a steady job... through good times or bad. Even back during DEPRESSION there was a big demand for Bailey Trained men.

In only 5½ to 6 months we can train YOU to enter one of the big pay fields!

No previous experience or special education necessary. With our method of training you do not spend years pouring over books, figures, charts and graphs. You learn by rebuilding, repairing, testing and operating the most modern equipment, under the guidance of experienced, courteous and friendly instructors. This method of training gives you the experience and confidence required to step right into the big pay jobs without spending years as a mechanic's helper.

It's EASIER and COSTS LESS than you may think to get this residence shop training... we help you find part-time jobs while in school—full-time jobs after graduation. Check subject above in which you are interested and mail for complete information.

### BAILEY Technical SCHOOLS

Veteran Approved

1634 S. Grand      St. Louis 4, Mo.

NAME.....AGE.....  
 STREET.....  
 TOWN.....ZONE.....STATE.....



## FAST—Old Town Lapstrake Boat

SMOOTH lines of this lapstrake outboard boat help you start in a hurry—and get there fast! She's roomy, too, with wide cross seats (folding backs) and long seats on both sides at the stern. Handles easily, with deep bow to fight stormy waves! Built of handsome woods for strength and service. Upkeep is easy.

FREE CATALOG shows just the model you need. Write for one today! Also rowboats, sailing dinghies, sailboats, canoes.

## OLD TOWN BOATS

Old Town Canoe Co., 243 Middle St., Old Town, Maine  
PLEASE SEND ME FREE CATALOG

Name.....

Address.....

City.....State.....

## VALUABLE FREE TOOL



### 7 WAY HAMMER-WRENCH

FOR AUTO MECHANICS, RADIO & TV REPAIRMEN, MACHINISTS, HOME APPLIANCE REPAIRS, ETC.

101 USES, 2 SETTINGS, THUMB SLIDE FOR INSTANT GRIP & FINE SCREW FOR TIGHTENING. GUARANTEED UNBREAKABLE. GIVEN FREE with order for amazing 21 PIECE SOCKET SET.

## 21 PIECE SOCKET SET

Regular \$16.00

INCLUDES... 8-12 point sockets 7/16, 1/2, 9/16, 5/8, 11/16, 3/4, 7/8, 15/16, plus 1/4" extension, L handle, reversible ratchet, reversible screwdriver bit, plus 6-1/4" drive sockets with L handle, extra large extension with shock-proof handle made of finest steel with bright sheen finish, plus handy carrying tray.



Complete 21 piece set, with free gift NOW at the very low price of ONLY \$9.95. SEND NO MONEY. We'll ship everything C.O.D. or send \$9.95 now and receive set postpaid. Keep set 10 days free, if you are not completely satisfied we will immediately refund your money. THE 7 WAY HAMMER-WRENCH IS YOURS TO KEEP FREE EVEN IF YOU RETURN SOCKET SET.

M & Z SALES CO., 230 Division St., Dept. PM11, New York 2, N.Y.



## TALK—SING—PLAY OVER YOUR RADIO

with the real Radio Mike! Attaches in a jiffy—full instructions given! Swell for "parties"—"cut in" on or "kid" regular network programs or put on your own broadcast! Amaze your friends—real fun. Beautiful Metallic Plastic 6 in. high!

12 RADIO BROADCAST LESSONS GIVEN with each mike

SEND NO MONEY Just pay postman \$5.00 COD plus postage or send \$5.00 and we pay postage! Radio Mike is available only from us by mail—guaranteed. Midway Co., Dept. MPM-3, Kearney, Nebr.

**WHOLESALE Electric Guitars - Parts - Build Your Own**  
 Accordions, amplifiers, double-necks, triple-necks, pickup mikes, mandolins, non-electric instruments, etc. 1955 Models wholesale. Free Catalog. Free home study course with instruments. Parts and plans available to build your own 4 or 8 string or multi-neck electric guitar. Martin and Fender available at list price.  
**CARVIN CO., Box 28 PM3, Baldwin Park, Calif.**

## SEND ME



every month so I am sure to see each new issue. Here's

- \$3.50 for 1 year  
 \$8.00 for 3 years

name

address

city

zone

state

Hand this order to your newsdealer or send it to

**POPULAR MECHANICS**  
 200 East Ontario St. Chicago 11, Ill.



## Lt. Wt. Aluminum PIANO HINGE

Length 72  
inches,  
thickness  
.040—width  
1 1/4"—Operating  
radius 275  
degrees. Made of  
aluminum alloy,  
sold in 6 foot  
lengths only—  
per length... **\$1.15**

## HEAVY DUTY STEEL PIANO HINGE

Length 56"—Thickness 3/32"—  
Width (open) 3-5/16"—Operating  
radius 330 degrees—Made  
of heavy duty steel—Drilled  
ready for use. Ideal for drop  
tables, heavy tool boxes, heavy  
doors, and many other uses  
where heavy hinges are re-  
quired. Sold in 56" lengths only.  
Ship. Wt. 7 lbs. At a  
fraction of original cost **\$1.45**

## LIVE RUBBER SHOCK CORD



Made in accordance with rigid army  
specifications. Clean fresh stock. 1/2"  
contains approx. 40 strands of live  
rubber. 3/4" approx. 100 strands. 1"  
approx. 500 strands, etc. Sold in 25  
ft. lengths or more. At about 20% of  
original cost. Excellent for marine  
and boat supplies, for trampolines,  
for tying down tarpaulins, etc.

DIA.	PRICE (per 25')	SHIP. WT.
1/4"	\$2.00	2 lbs.
3/8"	\$2.75	3 lbs.
1/2"	\$3.25	4 lbs.
5/8"	\$4.50	5 lbs.
3/4"	\$5.75	6 lbs.

Quantity price on application.

Prices F.O.B. Chicago. Include approx. postage on orders paid for  
in advance. C.O.D. orders enclose 25%, balance sent C.O.D.

**U. A. S. Corp.** Dept. PM-3 5637 W. 63rd Pl.  
Chicago, Ill.

## MOTORIZED YOUR BARBECUE!

Easily rigged up by anyone. Handles whole ham or 4 small chickens.  
Commercial-quality throat—2 r.p.m. gear-head motor (110V-AC)—  
spring-tension bronze bearing permits spit removal—

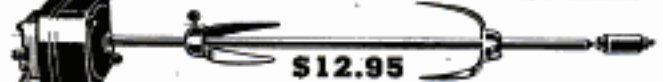

**\$12.95**

adjustable meat forks—heavy-duty, chrome-plated spit.  
Limited time, introductory offer. Postpaid. (\$13.95 Denver and West).

**B & R SALES CO. — Dept. PM355 — Muncie, Indiana**

## RUPTURED?

Something different. Light. Cool. No leg straps. No elastic. No  
pressure on hips or spine. Inexpensive. Worn by Mechanics, Farmers,  
Doctors, etc., everywhere. Guaranteed. Write

**HAND-LOCK PRODUCTS** EST. 1893  
DEPT. PM, PRESTON, ONT., CAN.



## STOP Radio and TV Noises with NEW, IMPROVED FILTER PLUG

BALANCED CIRCUIT eliminates power line inter-  
ference from household appliances, fluorescent  
lights, motors, oil burners, autos, etc. Simple to  
use. Don't despair if you've tried other filters  
without success. THIS ONE  
WORKS. 3 day trial period.  
Money back guarantee. No  
Ppd. COD's please.

**SCOPE MFG. CO.** Dept. PM-1, Box 23,  
128 E. Broadway, NYC 2, N.Y.

## Say You Saw It in Popular Mechanics

**Buy WHOLESALE**  
Save up to 50% on  
**BIG NAME MERCHANDISE!**

Send 50c Coin or Stamps for Catalog.  
Same Refunded with First Order.  
Sold for premium, business gifts or sales incentive prizes only.  
**GALENTINE COMPANY**  
DEPT. P 519 E. JEFFERSON BLVD. SOUTH BEND, IND.



## WORLD'S LOWEST PRICED ADDING MACHINE

**Vest Pocket  
Size  
FREE TRIAL  
\$2.95**

IDEAL FOR BUSINESS AND PERSONAL  
USE—GUARANTEED ACCURATE.  
Not a toy. Operates with only a finger  
click. Adds, subtracts, multiplies, di-  
vides. Counts up to one billion. Pays  
for itself over and over. Ideal Gift—for  
Business, Income Tax and School use.  
**MONEY BACK GUARANTEE.** Send  
name and address. Pay postman only \$2.95 plus  
postage. (Send full cash if outside U.S.) Beautiful  
Rich-looking Leatherette Case included at no extra  
cost. Money back in 10 days if not delighted.  
**AGENTS WANTED.**

**CALCULATOR MACHINE CO. (Mfrs.)**  
Box 84 Glenview, Illinois

# 50X POCKET MICROSCOPE

so it magnifies the total surface area of what  
you view **2500 times!** Yet, it's only 2 1/2" x  
3 3/4" in size including its upright, adjustable  
stand. Made in **Germany** by master optical craft-  
men. Weighs less than 3 ounces—carry in your  
pocket! Now beginners, students and adults can

**\$3.95**

thrillingly explore  
the microbe world,  
study plant life, the  
mysteries of inor-  
ganic matter, etc.  
See the wonders of a single drop of  
water. Opens new worlds for you.  
Two laboratory slides for inter-  
changeable viewing included. Low  
cost labor enables us to offer it with  
easy-to-follow instructions for only  
**\$3.95! 10 DAY NO RISK TRIAL.**  
Return for full refund if not satisfied.



### SEND NO MONEY

Simply pay postman plus C.O.D. charges on delivery. Cash order  
shipped postpaid. AIRMAIL SHIPMENT, same day add \$1.00.  
UNITED IMPORTING CO., Dept. POM-102, 9043 S. Western,  
Chicago 20.

## SPINNING REEL

**SALE! Reduced from \$7.95!**

Guaranteed top performance at bottom  
price. Featherweight aluminum. Posi-  
tively no backlash. Hard brass syn-  
chromesh gears. Full ball pickup, finger-  
tip drag control. 3.22 gear ratio. Un-  
breakable spool (250 yd. capacity).

**USE 10 DAYS AT OUR RISK**  
If not satisfied return for refund. Add  
\$1.00 for postage and handling. Im-  
mediate delivery. **UNITED PRODUCTS**  
CO., 9043 S. Western Ave., Dept.  
SPR-202, Chicago 20. Mail Orders Only!



**\$4.99**

## SALE

**INSIST ON UNITED**  
"Seal of Quality." ALL  
UNITED glasses are  
Achromatic, Color cor-  
rected for Sharper,  
Clearer, Crisper im-  
ages. Prices include  
leather case and straps.

**7 POWER \$14.95**

Pocket Size. All chrome. Sturdy.  
Precision made. Reg. \$19.95.

**6x30 4x6 in. 15 oz. 390 ft. field. All purpose. Reg. \$34.50. \$24.95**

**7x35 5x8 in. 20 oz. 375 ft. field. Very popular. Reg. \$45.50. \$34.50**

**7x50 7x7 in. 32 oz. 375 ft. field. Day & Nite glass. Reg. \$49.50. \$29.95**

**8x30 4x5 in. 18 oz. 390 ft. field. Concentrated power. Reg. \$39.50. \$26.95**



## SALE!

**AIRMAIL SERVICE**  
For same day ship-  
ment by AIR add  
Pocket models—\$1.00;  
6x, 7x35, 8x—\$2.00;  
7x50, 12x, 16x, 20x  
—\$3.00; 15x—\$4.00.

**10 POWER \$19.95**

8 1/2 oz. Perfectly balanced. Reg. \$24.95.

**12x50 5 1/2 x 7 in. 27 oz. 260 ft. field. Center focus. Reg. \$67.50. \$47.50**

**15x65 8 1/2 x 9 in. 51 oz. Center focus. Just Received. \$59.50**

**16x50 5 1/2 x 7 in. 27 ounces. Terrific! Reg. \$69.50. \$49.50**

**20 Power Falcon 12 ounces! Exclusive with UNITED. \$39.95**

Use 30 Days at Our Risk. If not satisfied return for full refund. Made  
in Japan. Add Federal tax. Cash order ppd. C.O.D. include \$2.00 de-  
posit. **UNITED BINOCULAR CO., Dept. ARS-8908, 9043 S. Western,**  
Chicago 20. DEALERS WANTED.

## HELPFUL BOOKS

Send post card asking for **FREE** catalog  
Popular Mechanics Press, 200 E. Ontario, Dept. 601, Chicago 11

## NOW! It's EASY To REMOVE STUMPS With "MAGIC" STUMP REMOVER

All you do is pour "Magic" Stump Remover—a  
new, quick-acting chemical compound—into hole  
drilled in center of stump. Wood fibres soon de-  
compose all way to root tips, making removal  
easy... even for women and youngsters!

**SPECIAL TRIAL OFFER: 8-oz. Can (enough for  
one stump—  
\$1.50) 16-oz.  
— \$2.50; 3  
lbs. \$5.00.**

Send no money—  
pay post-  
man, plus  
postage. (Or send full amount with order for  
postpaid delivery.)

**FREE!** Generous sample of "GRO-GREEN," new liquid  
lawn fertilizer, with each Stump Remover order.  
**H. D. CAMPBELL CO.**



**No Digging! No Chopping!  
No Blasting!**

**EASY TO USE!  
Saves Time, Money!**  
Rochelle 3, Ill.



\$5 hourly profit in . . .

# Your OWN Business

... Even if NOW Employed

We'll personally train and help you get established . . . starting full or part time.

If reliable and diligent, you can become financially independent in a growing lifetime business of your own. Alert dealers can average \$5 hourly gross profit on service they render plus \$3 on EACH serviceman. Nationally Advertised services rendered IN homes, offices, clubs, institutions, etc.

**DURACLEAN** (illustrated above) cleans by absorption. Eliminates scrubbing . . . soaking . . . shrinkage. Dirt, grease and many unsightly spots vanish as if by magic. Wool fibers come to life . . . matted pile rises . . . colors revive. Upholstery and floor coverings last longer.

**DURAPROOF** (not illustrated) is another year 'round service. Kills moths and carpet beetles. Makes material resistant to both. Protects furnishings, clothing, and auto interiors. Only such service backed by international money-back, 6-year warranty.

Easy to learn. A Duraclean dealer will train you right in your town. He'll reveal his successful methods and sales plan. He'll work with you. Our entire program of continuous help will impress you. Your service dealership becomes part of a world-wide organization built upon repeat orders and recommendations from satisfied customers. You have the freedom, prestige and profits of YOUR OWN business.

- No Overhead Expense
- No Shop Necessary
- No Experience Needed
- You Learn Quickly, Easily
- Nationally Advertised
- World-wide Services

Operate from your own home, a shop or office as you prefer. We furnish enough materials to return your TOTAL INVESTMENT. We help finance reliable men. Start part or full time. Write TODAY for FREE booklet and full details while territory is available.

DURACLEAN CO., 5-163 Duraclean Bldg., Deerfield, Illinois



Write For FREE Booklet

Our 25th year

I Personally Select Your Tires As If My Future Depended On It  
**FOOLISH TO PAY MORE. DANGEROUS TO PAY LESS!**

**FREE** This Pictured, Handsome Tire Ash Tray Included With 2 or More Tires!

If you buy a PAIR, you get a SPARE **FREE**  
 If you buy THREE, you get a 4th tire **FREE**  
*Does not include W.V. Mud-Grips or truck tires*

**GOODYEAR, GOODRICH, FIRESTONE, U.S., and others.**  
 Partially used tires, "family-safe", not recaps, not retreads.

**STANDARD 34 MOS. GUAR. BOND AGAINST DEFECTS**

600-16	\$4.52	670-15	\$4.52	650-15	\$4.62	800-15	\$5.22
650-16	5.02	710-15	4.52	700-15	4.72	820-15	5.42
700-16	5.42	760-15	4.82	650-17	3.92	850-16	4.52
640-15	4.32	<b>WHITEWALL TIRES \$1 EXTRA</b>		890-15	4.52		

**FLEETOWNERS**—get the RIGHT tire for the RIGHT job. Heavy-Duty and Dependable. They're WORTH the slight difference.

**GOLDEN RULE 35 MOS. GUAR. BOND**

600-16 (B)	\$6.42	700-17	\$ 8.42	750-20	\$10.92
650-16 (B)	6.92	750-17	10.92	825-20	17.92
700-16 (B)	7.72	800-20	7.92	900-20	17.92
700-15 (B)	7.92	650-20	9.32	1000-20	17.92
750-16 (B)	8.92	700-20	10.22	1100-20	18.42

**FLASH! A SPECIAL LOT OF EXTRA FINE TIRES RELEASED BY COMPANY ADJUSTERS.**

**24 MOS. "REPLACE" FREE GUAR. BOND \$6.87 ANY CAR**  
 YES, I CHARGE YOU NOTHING. If a Tire Fails for ANY REASON Golden Rule Unconditional Warranty — Whitewalls \$2 EXTRA

**MARVIN MILITARY MUD-GRIP TIRES**  
**BLATT** 6th & Spring Garden Sts. AA Guar. 20 Mos. AAA 36 Months  
 Philadelphia, Pa. 900-16 \$10.22 900-16 \$13.92  
 750-20 9.72 750-20 13.52

Send Ck. or M.O. and this Ad for Instant Shipment the world over.  
 "Sincerity born 27 years ago"—The Name to TRUST in TIRES

**For Best Results! Use**  
 a white glue — invisible when dry  
**WILHOLD GLUE** Finest Quality  
 with Colored PLASTIC APPLICATORS  
 Always Dependable  
 DAMP-PROOF HARMLESS

49¢  
 15¢

WILHOLD PRODUCTS CO., Los Angeles 31 • Chicago 44

**FURNITURE FOR YOUR BEDROOM**

YOU'LL BE THE ENVY of your neighbors with this beautiful bedroom suite in honey maple, oak or walnut! Here's a bed with storage space . . . a three-piece vanity with cosmetic compartment and makeup mirror . . . a Mr. and Mrs. dresser . . . twin night stands with drawers!



**YOU MAKE IT YOURSELF!** Only two power tools, a saw and a jointer, are needed to turn out this modern bedroom furniture. No other project of Popular Mechanics Magazine in recent years has captured the fancy of home craftsmen as has this easy-to-build suite. Letters demanding detailed plans poured in after the suite was pictured in Popular Mechanics. And now the plans are ready! They're detailed scaled drawings—a complete set of 4. Send for them today!

POPULAR MECHANICS PRESS, Dept. 26  
 200 East Ontario Street, Chicago 11, Illinois

I enclose \_\_\_\_\_ for a complete set of plans for making the modern bedroom suite illustrated above.

Name \_\_\_\_\_  
 Address \_\_\_\_\_  
 City \_\_\_\_\_ Zone \_\_\_\_\_ State \_\_\_\_\_

## Free! 75 ORIENTALS



Brought to you from the farthest ends of the earth—these exotic valuable genuine **Stamps of the Orient!** 75 all-different from Borneo, Siam, China, Japan, Hong Kong, Malaya, Sarawak, Singapore,—and other exciting mysterious lands of the Far East. **EXTRA!** Free booklet, bargain lists, fascinating offers for your free examination. Send 10c for mailing expenses. Supplies limited. **Act Now!**

**MAIL THIS COUPON TODAY!**

**JAMESTOWN STAMP CO., Dept. 162, Jamestown, N. Y.**  
 RUSH my FREE Collection of 75 Orientals & other offers. I enclose 10c for cost of mailing.

Name \_\_\_\_\_  
 Street \_\_\_\_\_  
 City \_\_\_\_\_ State \_\_\_\_\_



start a big profit business  
with a small investment  
**EARN UP TO  
\$200 a DAY**

Manufacturing Exciting New

## RAINBOW ROCK

Concrete Slump Brick  
in your back yard

Earn big building boom profits with Rainbow Rock, the colorful new building brick that's taking the country by storm. Sell all you can make to contractors, builders, building supply houses. **RAINBOW ROCK CUTS LABOR COSTS BY 1/3!** Amazing low cost machine makes modern slump brick 24" long (3 times the length of ordinary brick) in a variety of widths and pastel colors . . . up to 1500 bricks a day! **NEEDS NO SPECIAL SKILL.** Operates indoors or out. Full instructions and valuable mixing formulae supplied. **YOU CAN START EARNING BIG MONEY NOW. PAY AS YOU PROFIT!** A limited number of machines available on easy payment terms. NOW is the time to start. Write today for free literature and full information.

**GENERAL ENGINES CO., INC.**  
Dept. MR-35—307 Hunter Street  
Gloucester, N.J. • Gloucester 6-1337



**STEEL PIER SENSATION**  
Luxurious RAINBOW ROCK fireplace wall in living room of the "Home of the Century" in Atlantic City, N. J.'s Steel Pier . . . acclaimed by over 500,000 Summer, 1952 visitors as the most beautiful they'd ever seen! Endorsed by the Pier's famous architect, William F. S. Koelle.



Makes beautiful, decorative fences, garden walls, garages, outside walls, room separators, etc.

# BUILD 15 RADIOS

AT HOME

ONLY

With the New Improved 1955  
Progressive Radio "EDU-KIT"

**\$19.95**

NOW INCLUDES

**HIGH FIDELITY, SIGNAL  
TRACER, CODE OSCILLATOR**

Complete

- Attractively Gift Packed
- Free Soldering Iron
- Absolutely No Knowledge of Radio Necessary
- No Additional Parts Needed
- Excellent Background For Television
- 10-Day Money-Back Guarantee
- School Inquiries Invited
- Sold in 79 Countries



## WHAT THE PROGRESSIVE RADIO "EDU-KIT" OFFERS YOU

The "Edu-Kit" offers you a Home Radio Technician Course at a rock-bottom price. You will learn how to identify Radio Symbols and Diagrams; how to build radios, using regular radio schematics; how to wire and solder in a professional manner. You will learn how to operate Receivers, Transmitters, and Audio Amplifiers. You will learn how to service and trouble-shoot radios. You will learn code. You will receive training for F.C.C. license. In brief, you will receive a practical basic education in Radio, worth many times the small price you pay.

### THE KIT FOR EVERYONE

It is not necessary that you have even the slightest background in science or radio. The "Edu-Kit" is used by young and old; by radio schools and clubs; by Armed Forces personnel and Veterans for training and rehabilitation. No instructor is required. Instructions are complete, simple and clear. You cannot make a mistake.

### PROGRESSIVE TEACHING METHOD

The "Edu-Kit" uses the principle of "Learn by Doing." Therefore you will build radios, perform jobs, and conduct experiments to illustrate the principles which you learn. You begin by learning the function and theory of each of the radio parts. Then you build a simple radio. Gradually, in a progressive manner, you will find yourself constructing more advanced multi-tube radio sets, and doing work like a professional Radio Technician. The "Edu-Kit" Instruction Books are exceedingly clear in their explanations, photographs and diagrams. These sets operate on 105-125 V. AC/DC. Adapter for 210-250 V. AC/DC available.

### The Progressive Radio "EDU-KIT" is Complete

You will receive every part necessary to build fifteen different radio sets. Our kits contain tubes, tube sockets, chassis, variable condensers, electrolytic condensers, mica condensers, paper condensers, resistors, line cords, selenium rectifiers, tie strips, coils, hardware, tubing, Instruction Manuals, etc. A soldering iron is included, as well as an Electrical and Radio Tester. Complete, easy-to-follow instructions are provided. In addition, the "Edu-Kit" now contains lessons for servicing with the Progressive Signal Tracer, F.C.C. instructions, quizzes, High Fidelity. The "Edu-Kit" is a complete radio course, down to the smallest detail.

### TROUBLE-SHOOTING LESSONS

Trouble-shooting and servicing are included. You will be taught to recognize and repair troubles. You will build and learn to operate a professional Signal Tracer. You receive an Electrical and Radio Tester, and learn to use it for radio repairs. While you are learning in this practical way, you will be able to do many a repair job for your neighbors and friends and charge fees which will far exceed the cost of the "Edu-Kit." Our Consultation Service will help you with any technical problems which you may have.

### FREE EXTRAS

- Electrical & Radio Tester • Electric Soldering Iron • TV Book
  - Radio Trouble-Shooting Guide • Consultation Service • Quizzes
  - F.C.C. Training
- PROGRESSIVE "EDU-KITS" INC., 497 Union Ave., Brooklyn 11, N.Y.**  
MAIL TODAY—Order shipped same day received.  
10-Day Money-Back Guarantee. **INCLUDE ALL FREE EXTRAS.**

- RUSH ME the Following—Include all Free Extras:
- "EDU-KIT" Postpaid. I enclose full payment of \$19.95
  - "EDU-KIT" COD—I will pay \$19.95 plus postage
  - Outside USA: "Edu-Kit" Postpaid. Enclose full payment \$20.95
  - Outside USA: 210-250V. AC/DC Adapter. Enclose \$2.50
  - More details on "EDU-KIT" Free—No Obligation
  - FREE Radio-TV Servicing Literature. No Obligation

NAME \_\_\_\_\_  
ADDRESS \_\_\_\_\_

### PROGRESSIVE "EDU-KITS" INC.

Room 527B, Progressive Bldg., 497 Union Ave., Bklyn. 11, N.Y.

## LEARN Modern Appliance and Electrical Servicing

Revolutionary New Method shows you how—at home—in YOUR SPARE TIME! We send you complete Home Training Kits and Latest Engineered Test Equipment. You can actually earn BIG MONEY WHILE LEARNING! Many men are making \$2.50—\$3.00 and more PER HOUR! RUSH name and address for big FREE book and full details—WRITE TODAY!

**ADVANCE TRADES INSTITUTE, Dept. 153**  
5944 NO. NEWARK AVE. CHICAGO 31, ILL.

## \$2.95 OR 2 FOR \$5.00!

Genuine Telephone Company Upright Telephones, tested and guaranteed with 50 ft. of wire and inter-communication instructions. Complete line of telephones, dial, magneto, etc. Write for free list. All shipments F.O.B.

**TELEPHONE ENGINEERING CO.**  
Dept. 38-55 Simpson, Pa.

## HELPFUL BOOKS

Send post card asking for FREE catalog  
Popular Mechanics Press, 200 E. Ontario, Dept. 601, Chicago 11

## FREE BOAT KIT CATALOG

8' to 14' Models from \$39.95 incl. freight

- Assemble your own boat
- No experience necessary
- Save 1/2 to 2/3 "factory" prices



Write: **LUGER INDUSTRIES** Marine Hardware, Fiberglass, & Trailers  
DEPT. B 4452 NICOLLET AVE. MINNEAPOLIS 9, MINN.

## CARBURETOR SAVES GAS VACUMATING OVERRICH MIXTURES



Car owners who are getting poor gas mileage, and wasting money due to overrich mixtures, will be pleased to learn how to save gas. Easily installed Vacu-matic invention is **Automatic** and operates on the supercharge principle. For cars, trucks, tractors

**SALESMEN WANTED! Big Profits!**  
FOR FREE PARTICULARS, HOW YOU CAN GET ONE ON YOUR OWN CAR FOR INTRODUCING, just send your name and address on a post card to—

**VACU-MATIC, 7617- 2107W. State St., Wauwatosa, Wis.**



MAKE up to \$10 AN HOUR  
AT HOME with 50¢ worth of...  
**MICRO-FLUFF**



**HIGH COST OF LIVING GETTING YOU DOWN?** Want an extra \$100 or more added to your monthly pay check in a few SPARE TIME hours AT HOME? That's what I wanted a few years ago when I ran across an Old-World formula for applying short cotton fibers to practically any surface, so that it looked and felt just like costly velvet or velour.

I was amazed. I spent several years experimenting until I developed what I now call the FLOK-KRAFT MICRO-FLUFF method. This NEW METHOD is far removed from the Old-World way of applying these short fibers. Also it permits the use of tiny fibers of RAYON and other modern materials in MANY COLORS in addition to cotton.

**NO OVERHEAD. NO EXPENSIVE EQUIPMENT.** Start in your basement, garage, attic, service porch, or even on a card table in your bedroom. With an hour's practice you can apply a few pennies worth of FLOK-KRAFT MICRO-FLUFF to a yard or two of butcher paper, and make it look like \$15-a-yard velvet for window displays in the finest jewelry, gift, or department stores, etc. Takes only a few minutes and practically no effort.

**MICRO-FLUFF IS BEAUTIFUL—LONG WEARING,** the most amazing material you ever saw. It comes in every rainbow color, is long lasting, has the TOUCH appeal of luxurious velvet or suede, and goes on practically any surface—paper, metal, wood, glass, plastic, plaster, rubber, etc. Wonderful to line silverware or hushery drawers, cover and line jewelry boxes, decorate lamps and lamp shades, finish the inside of auto trunks or glove compartments (to protect luggage and accessories from scratching), re-cover women's party shoes, photograph turntables, etc. Apply to toys, figurines, wall plaques, signs, store displays—a thousand-and-one other items, new or old. MICRO-FLUFF makes old objects beautiful and salable—increases value of many new products by 500%. Big-profit orders come from neighbors, gift shops, stores of all kinds. Every household has one or more items that can be saved from discard by a FLOK-KRAFT job. Decorate store display cases and windows (jewelers love this) and also supply them with fast-selling FLOK-KRAFTED gift items and other merchandise. Manufacturers are prospects for contracts to apply FLOK-KRAFT to furniture, instrument cases, luggage, and hundreds of other products. Every neighborhood needs a FLOK-KRAFTER. HELP US FILL HUGE DEMAND.

Since succeeding beyond my wildest dreams in my own FLOK-KRAFT business, I have concentrated on helping ambitious men get started the same way toward a successful future, free of time clocks and nagging bosses. My plan is designed to help you start at home in spare time, and build gradually toward a full-time business with employees working for you. And you can start RIGHT NOW. Just send me your name and address on a postcard, and I'll rush you a FREE SAMPLE OF FLOK-KRAFT MICRO-FLUFF and full FREE details. I'll also arrange to send you the complete FLOK-KRAFT MICRO-FLUFF outfit to try out right in your own home without risk. The outfit includes detailed instructions with hundreds of show-how photographs and drawings that make everything simple, right from the start. Also included is our specially designed, high-velocity Applicator and a generous supply of FLOK-KRAFT MICRO-FLUFF—everything you need to get going right away. You owe it to yourself to investigate. Rush me your name and address today by Airmail, and I'll show you how to start making money at once!

**NELS IRWIN, Coast Industries, Dept. 23**  
Los Angeles 61, California

**PAPER COVER BOOKS**

- Large volume & paper bindings mean big value at low cost. Authoritative pocket sized books, well written and beautifully illustrated. Prices postpaid.
- Dictionary of Science. 240 p. B990 55¢
  - Thousands of Science Projects. 46p. B821 25¢
  - Understanding Science. Conant 144p. B940 40¢
  - Universe & Dr. Einstein. Barnett B929 40¢
  - Einstein's Theory of Relativity B136 52.00
  - College Physics. Bennett. 208p. B421 \$1.10
  - College Chemistry. B405 \$1.60
  - Chemical Elements Chart 38x50" F804 \$2.00
  - The Chemical Industry. (Penguin) C114 55¢
  - Mineralogy Handbook. Eckert 24p B826 55¢
  - Minerals in Industry. Jones 224p. C122 40¢
  - Hunting with a Microscope. 132p. C229 80¢
  - Beyond the Microscope. Smith 152p C134 55¢
  - Dictionary of Biology. B993 55¢
  - General Biology. Alexander 224p B404 \$1.35
  - General Botany. Fuller 190p. B433 \$1.10
  - How to Predict the Weather. Fisher B937 40¢
  - New Handbook of the Heavens illus B920 55¢
  - Discover the Stars. illus. 136p. C226 80¢
  - Plans for 100 Power Telescope 24p B835 20¢
  - Stars. Full Color Guide. 150 illus. C270 \$1.05
  - Birds. Full Color Guide. 112 illus. C276 \$1.05

- Flowers. Color Guide. 134 illus. C277 \$1.05
- Insects. Color Guide. 225 illus. C278 \$1.05
- Trees. Color Guide. 130 illus. C280 \$1.05
- Reptiles. Color Guide. 212 ill. C281 \$1.05
- How to Care for Animal Pets 32p. B833 20¢
- How to Paint. (Pop Mech.) C250 30¢
- Laying Limestone & Tile Pop. Mech. C251 30¢
- Wiring & Appliance Repairing C254 30¢
- Working With Tools. 128p. C218 65¢
- The Inventor & His World. 256p. C118 40¢
- All About Money. 24p. B156 25¢
- How to Relax. 32p. B152 25¢
- Your Way to Popularity & Power B908 30¢
- Consumers Guide to Better Buying C901 40¢
- How to Afford a College Education B707 52.05
- Directory of 4,387 Magazines B287 52.10
- Dictionary of Psychology. 320p. B992 70¢
- Self Mastery Through Psychoanalysis B341 30¢
- Human Physiology. Walker 170p. C158 55¢
- Atlas of Human Anatomy. 86p. B470 52.10
- Skin Allergies. Hirschfeld 24p. C375 30¢
- Headaches. Cause & Relief. 16p. C401 15¢
- Spanish Conversation. 124p. B105 55¢
- College Algebra. Moore. 230p. B438 \$1.10
- Writing Better Examinations B436 60¢
- Speech & Voice Training 270p. B489 \$1.85
- How to Sell What You Write C224 65¢
- Story of Human Birth. Hillebee B817 30¢

- Psychology of Sex. Schwarz 286p. C141 70¢
- Sex Habits of American Women B340 40¢
- Analysis of Kinsey's Sex Repts. B946 55¢
- How to Get a Job & Keep It. B508 55¢
- Travel & Get Paid For It. 72p. B700 \$1.10
- Where to Retire on a Small Income B704 \$1.05
- Travel Routes Around the World B701 \$1.05
- Complete U. S. Road Maps F120 \$1.60
- Duncan Hines Vacation Guide. B807 \$1.60
- American Combat Judo 128p. C212 65¢
- Tumbling & Gymnastics Handbook B801 35¢
- Directory of Hobby Products. ill. B813 52.15
- Photography for Fun. C220 65¢
- Camera Handbook for Travelers B723 \$1.05
- How to Throw Knives 32p. B831 20¢
- 125 Card Tricks, etc. 64p. B834 35¢
- Book of Games 32p. B162 25¢
- Life of the Party. 128p. C206 65¢
- Chess in an Hour. Marshall C203 65¢
- Everyday Law in Plain Language B153 25¢
- Protecting Your Invention 112p. C223 65¢
- Dictionary of Musical Terms. B600 80¢
- How to Play the Harmonica C202 65¢
- 1,200 Science & Adventure Items, Kits, Specimens, Charts, Records, etc. Catalog 10¢

**WORLD OF ADVENTURE**  
Dept. 152 Ann Arbor, Michigan

**Wheel-Horse garden tractors**

Reg. U. S. Pat. Off.

2½ or 3½ h.p.  
pulls 8"  
plow



Ride-Away Jr.

only  
\$275

You can't beat a Wheel-Horse for trouble-free performance... mighty pulling power... amazing low price! Pulls 8" plow. Big "traction-master" wheels. Smooth-running 2½ or 3½ h.p. engine. Five speeds. Reverses. Fifteen attachments. Guaranteed!

**Wheel-Horse Products Co.**

Dept. P-2, 2643 Dixieway North, South Bend, Indiana



**FIND THE WOOD STUD IN YOUR WALL WITH A FORD DOWSER BALL**

Indispensable when hanging pictures, mirrors, fixtures, shelves and when making alterations. YOU MAY NEED ONE TOMORROW! The ORIGINAL STUD FINDER. The roll of the ball finds the actual STUD in the wall, not just a nail in the baseboard. Only \$2.00 ppd. Money-back guarantee. No C.O.D.'s. Usual trade discounts to dealers.



\$2.00  
POST PAID

**FORD PRODUCTS** Dept. P-4  
PORT CHESTER, N. Y.

**RADIO**

Engineering. All phases radio & electronics theory & practice; television; FM; broadcasting; servicing; aviation, marine & police radio. Prepare for good pay; 18-month course. Graduates in demand by major companies. Enter Jan., March, June, Sept. Regular campus life. Write for catalog. VALPARAISO TECHNICAL INSTITUTE, Dept. D, Valparaiso, Ind.

**AMAZING NEW DOOR KNOBS**

Installed in seconds No screws needed!

Replace old, loose doorknobs with these beautiful modern plastic knobs. Install them in 30 seconds. No tools needed. Won't ever work loose. Choice of Ivory or Marbleized Gray. Order direct from the manufacturer. MONEY BACK GUARANTEE. Sent Postpaid. Send Check, Cash or Money Order—No C.O.D.'s



**MURPHY MACHINE PRODUCTS, 14320 E. Jefferson, Detroit 15, Mich.**

**Enjoy the Fascinating Story of the Horseless Carriage in**

It's thrilling, fascinating, informative. From the very first gasoline-propelled buggy to the cars of today and the atomic auto of the future. The first cars—the men who made them—the scrambled start and development of the fabulous auto industry—the story of auto racing. 166 thrilling action pictures—old-time cars—racing cars—early auto advertising—automotive oddities. Listing of 2000 U. S. autos included. Ideal gift book. Cloth bound, only \$3.00 by mail. Money back if not pleased.



**POPULAR MECHANICS PRESS, Dept. PM15, 200 E. Ontario St., Chicago 11**





# NEW TYPE BATTERY makes 100,000 STARTS per MONTH month after month!

PATENT PENDING  
#408439

## "TORTURE TESTS"

by authorized member of American Council of Commercial Laboratories demonstrate amazing performance\* of Life-Long—the only battery in the world with a TEN-YEAR BONDED GUARANTEE featuring free replacement or money back. These independent laboratory reports prove what you yourself will soon discover in your own car... that your Life-Long Battery gives you faster starts, a hotter spark, brighter lights, sure starts in any weather, ample power for extra electrical equipment.

\*Let us send you details of these independent laboratory tests

**OVERCHARGE TEST**... Life-Long exceeds SAE requirements by 400%, eliminating all possibility of burn-outs through overcharge.

**R.P.M. TEST**... Life-Long spins your engine 20% faster.

**COLD TEST**... Life-Long operates efficiently at 70 degrees below zero

**HIGH TEMPERATURE TEST**... Life-Long operates efficiently at blistering temperature.

# 10 YEAR Bonded Guarantee

BACKED BY GREAT WESTERN  
ESCROW COMPANY  
BOND



## \$1,000 REWARD OFFER



*I will pay you  
\$1,000 if you can  
disprove this claim!*

*J. M. Watt  
PRESIDENT  
LIFE-LONG BATTERY MFG. CORP.*

### TRY IT!

With your ignition switch off and your headlights on, step on your starter until the battery won't start the engine or light the lights. Now wait one minute with headlights off—then step on the starter. The LIFE-LONG BATTERY will start your car instantly with a surge of power that it has regained during that brief 60-second interval! Make this test as many times as you like! One LIFE-LONG dealer has demonstrated this amazing recuperative ability of LIFE-LONG BATTERIES over 500 times with the same battery, with no sign of weakening, yet!

# Tremendous RESERVE POWER

## Insures You a TROUBLE-FREE BATTERY!

You insist on "reserve" horsepower in your motor. You need extra emergency power in your battery, too, as insurance against costly, embarrassing battery failure. You get that reserve power with Life-Long—the only battery backed by a 10-year Bonded Guarantee.

# LIFE LONG

Large corporations, Fire Departments, Police Departments, Taxicab Companies in every part of the country, as well as the U. S. Government and many foreign countries are now buying LIFE-LONG BATTERIES. • LIFE-LONG manufactures a complete line of Industrial, Commercial, Marine and Motorcycle batteries. Prices on request.

**END YOUR BATTERY  
TROUBLES!**

More than 50,000 satisfied Life-Long customers have put an end to annoying battery troubles. \$1,500,000 worth of Life-Long Batteries sold to date—not one failure reported yet!

IF NO DEALER NEAR YOU, USE COUPON

## BUY NOW! UNDER MONEY-BACK GUARANTEE

### DISTRIBUTOR TERRITORY OPEN

Life-Long Batteries, sold all over U. S. and abroad, are protected by exclusive patents. Some territories are still open for men who recognize this big profit opportunity. Write for details.

### COSTS NO MORE

You Can Now Buy a LIFE-LONG TEN-YEAR BATTERY for less than the cost of an ordinary lead acid battery. Look at the money you save!

All 6-volt

LIFE-LONG AUTO BATTERIES—\$29.95

All 12-volt

LIFE-LONG AUTO BATTERIES—\$34.95

A so-called "First Quality" three-year battery costs you \$10.00 a year.

A LIFE-LONG TEN-YEAR BATTERY

costs you only

\$3.00 a year.

LIFE-LONG BATTERY MFG. CORP., DEPT. PM-35

11766 W. Pico Blvd., Los Angeles 64, California

Please ship Life-Long Battery, 10-year guarantee:

6 volt automotive battery (\$29.95 including tax)

12 volt automotive battery (\$34.95 including tax)

for \_\_\_\_\_

Make & Model, Year of Car

Cash, check or money order enclosed. Life-Long pays all delivery costs to your door.

Name \_\_\_\_\_

Address \_\_\_\_\_

City \_\_\_\_\_ Zone \_\_\_\_\_ State \_\_\_\_\_

Copyrighted material





## "HOW TO COVER YOUR BOAT WITH FIBERGLAS"

I estimate there are over 200,000 boats of many kinds, big and little, covered with Fiberglas\*. You know, Tomahawk and Thompson strip plank boats are covered right at the factory.

I have written a little book on how you can do-it-yourself—how you can cover your own boat. Use the coupon to get your copy.

\*T. M. Reg. Owens-Corning Fiberglas Corp.



CHARLIE M.  
Essex, Connecticut

Please rush my copy of *How to Cover Your Boat with Fiberglas*, at no obligation to me.

Name .....

Address .....

City ..... Zone ..... State .....

# LOOK

**POWER SICKLE  
CONVERTS TO  
ROTARY TILLER**



Powerful self-propelled Jari with Rotary Tiller attachment tills 5' seed bed, safely cultivates right next to plants, mulches perfectly. Sturdy self-propelled Jari with sickle bar attachment cuts 36" swath thru weeds, brush, tall grass, work of six men! Other attachments: self-propelled reel mower, self-propelled snow thrower. Write for information and dealer. All products guaranteed.



**jari**

**jari PRODUCTS, INC.**

2940-D Pillsbury Avenue, Minneapolis 8, Minn.

Save Hundreds of Dollars Yearly With  
**Guide to Home Repairs**

**Home Repairs, Modernizing Jobs Made Easy for Home Owners**

Beat the high cost of home upkeep. Stop staggering labor costs. Save hundreds of dollars every year on carpentry, electrical, painting, plumbing and other jobs around the house with Popular Mechanics **GUIDE TO HOME REPAIRS**. Simplified how-to-do-it instructions and 646 pictures make all jobs, inside and out, easy. Covers construction, remodeling, modernizing, repairing, that you can do yourself at small cost. Repair leaky faucets for pennies; save \$10 to \$15 on new electrical outlets; save hundreds of dollars on new floors, porch repairs, tuck pointing, gutter replacements and other improvements. 192 page cloth bound book only \$2.50 postpaid. Get **GUIDE TO HOME REPAIRS** today under our money back guarantee.



CARPENTRY



ELECTRICAL WORK



INSULATION



PLUMBING

POPULAR MECHANICS PRESS, Dept. PMI, 200 E. Ontario St., Chicago 11

MAKE A "Stradivarius"  
**VIOLIN**  
—For Pleasure  
—For Profit  
—For Your Own Use

**BOOK AND PLANS ALL YOU NEED**

**You Can Do It at Little Cost!  
It's Easy! It's Fun!**

Here is the "top" of all home crafts projects. Make a violin—a replica of a famous "Strad"—the original of which sold for \$80,000.00. Joe Reid who has made hundreds of fine violins makes the job so easy—so inexpensive—in his new book "You Can Make a 'Stradivarius' Violin." You don't need any tools. Reid shows you how to make all the tools you need from old table knives, worn out files, sheet metal, etc. Eight full-size plans, 18x23 inches, folded into the book give you every detail in actual size.

**Violins Bring High Prices**

Make a violin and you probably will never want to sell it. But good tone modern violins bring terrific prices, yet the materials cost comparatively little. With Reid's plans and step-by-step instructions you can make such a violin for yourself. 15 chapters guide you in selection of wood, fashioning the belly, back, sides, mold, lining, neck, scroll, purfling. Other chapters cover varnishing, finishing, stringing. Others show how to make tools and clamps at little or no cost.

**Order Book Today.  
Money Back if Not Satisfied.**

Make your own violin for pleasure or profit. Get book and plans now. Clip this ad and mail with check, money order or cash for only \$3.50 or we will ship C.O.D. Money back in 7 days if not satisfied.

**FULL SCALE PLANS INCLUDED**  
Working plans, drawn to full scale, are included in a special pocket inside the book where they may be withdrawn for quick and easy reference.

**POPULAR MECHANICS PRESS** Dept. 30  
200 E. Ontario St., Chicago



Complete  
Instructions

**8 Actual Size Plans  
How to Make the  
Tools You Need  
Where to Get the  
Materials**

You trace or work direct from actual size plans. No measurements to translate or confuse you. You see the entire violin in the plans. You read the how-to-do-it instructions in the book.

\$3.50 Cloth Bound



**SENSATIONAL LOW-PRICED  
IMPROVED DOCK**  
30-FT. PIER  
**INSTALLS IN 2 HOURS**  
*After Easy Assembly*



**FOSTER  
PORTABLE  
PIER**

**Install Without Boats—No Standing in Water**



For Camps,  
Lodges,  
Resort Homes

Written up in LIFE. Fast pivot assembly swings sections into position from the shore or dock, easily taken-out each winter. Readily portable. Complete with rust-proofed Tubular Steel Frame, Wood Decking, and Jack, for all sizes and plans.

At Your Dealers—Write for Bulletin M-3 Dealer Inquiries invited

**L.B. FOSTER** CO. 231 S. LaSALLE ST. CHICAGO 4, ILL.



**1000 NAME AND  
ADDRESS LABELS \$1**

Your name and address (choice of 3 lines) on 1000 fine quality gummed labels, WITH PLASTIC BOX, only \$1 postpaid. Six orders for \$5. THIS IS A SPECIAL OFFER. Use on stationery, checks, books, greeting cards, records, etc. Satisfaction guaranteed. Handy Labels, 342 Jasperson Bldg., Culver City, California.

IT'S AS EASY AS...  
**LIGHTING A CIGARETTE**

TO MAKE OVER  
**\$50 A DAY WITH**

**CIG-O-MAT**



**The AMAZING Automatic  
Dashboard Cigarette Lighter**  
10-SECOND DEMONSTRATION MAKES THE SALE  
*Insert — Push Button — Cigarette Is Lit*

Rich enamel finish. Precision made. Guaranteed for two years. Fits lighter socket on all cars. No installation necessary. Cig-O-Mat means safer driving. Motorists can now keep eyes on road while lighting a cigarette.

**SALESMEN:** Sell individually boxed Cig-O-Mats direct to car owners.  
**DISTRIBUTORS:** Sell Cig-O-Mats on display cards to filling stations, garages, hardware stores, taverns and many other retail stores.

**FREE** Display Counter Card with 9 CIG-O-MATS  
Retail Price \$1.69 each

**BIG PROFITS — FULL OR SPARE TIME**

TRIANGLE PRODUCTS, INC., Dept. PM-3  
1226 Fourth Ave., Milwaukee, Wis.

PLEASE RUSH:

- 12 Cig-O-Mats individually boxed for \$10.00  
 9 Cig-O-Mats on Display Easel for \$7.38  
 1 Sample and Details for \$1.00

I enclose \$\_\_\_\_\_

NAME \_\_\_\_\_

ADDRESS \_\_\_\_\_

CITY \_\_\_\_\_ ZONE \_\_\_\_\_ STATE \_\_\_\_\_

*Just Off  
the Press!*

**Mammoth  
1955 Wholesale  
Tool Catalog**

**TOOL CATALOG**



The opportunity now awaits you to own and operate your own business on a part time or full time basis in the lucrative field of HARDWARE, HAND TOOLS, FANS, POWER TOOLS, MOTORS, PAINTS, etc., or BUY TOOLS FOR YOUR INDUSTRIAL OR INSTITUTIONAL USES.



Buy Nationally Advertised Tools for Resale or Industrial or Institutional Use  
**NO INVESTMENT REQUIRED, BUY AS YOU NEED IT. A MILLION DOLLAR INVENTORY AT YOUR FINGER TIPS.**

*Discount*  
**UP TO 50%**

\$1.00 refund on first purchase or refund if you are not 100% satisfied.



Every one needs tools. Meet the demands of the growing "Do-it Yourself" markets. Sell direct from the jumbo buying guide—your cost is known only to you.

**JUST FILL OUT  
COUPON**

ENCLOSE \$1.00 FOR DEALERS CARD & 1955 MAMMOTH TOOL CATALOG.

**SILVO HARDWARE COMPANY**

Dept. PM-3, 108 Market St., Philadelphia 6, Pa.

I am enclosing \$1.00. Rush me your dealer's card and big Catalog Today. If I am not completely satisfied with your plan, I understand that I can return the Dealer's Card and Catalog for refund, and if I decide to order, my \$1.00 will be deductible from my first order.

NAME \_\_\_\_\_

ADDRESS \_\_\_\_\_

CITY \_\_\_\_\_ ZONE \_\_\_\_\_ STATE \_\_\_\_\_



# Start a profitable manufacturing business in spare time

with your own home as your headquarters



**R**IGHT at this moment there is a tremendous demand for new business enterprises in a branch of the plastics industry. Fortunately, this is a type of manufacturing business that does not require heavy or expensive machinery, rented space for storage, production or sales. A portable hand machine does the work wherever electric current is available, and the working area can be in almost any part of your home.

The opportunity that is open to you today, is to meet this growing demand in a new industry by establishing yourself as the manufacturing agent in your own trading area. Several hundred of our machines are already in use in both large and small communities. Some are even being operated successfully by women whose family duties make it necessary for them to be at home during the day, but whose family income is not enough to meet rising expenses. Most are being operated by men. Many started in spare time just to pick up an extra five or ten dollars for an evening's work. They found the work so profitable that some have now given up former jobs to devote full time to a business of their own.

One of our manufacturers gets all of his business by mail. Orders and money come to him in envelopes and he sends his products out the same way. Another delivers his entire output to stores in the vicinity. An-

other does a wholesale business supplying other manufacturers who do the selling. Still another works with advertisers in the manufacture of plastic advertising novelties and specialties.

The operation of the machine is simple and easy for anyone to learn. It does not require any knowledge of chemistry, mechanics, or electricity. And what some say is best of all, a manufacturing business like this enables a person to make good money without any house to house canvassing. The machine turns out from \$5.00 to \$15.00 worth of work per hour and it can be operated for as short or long a time as you wish.

We have prepared a simple step by step instruction manual that not only tells how to operate the machine, but also tells how to get the business coming in at a profitable clip right from the start. We will lend a copy of this book to any serious minded man or woman with the

understanding that a copy will be given them free if and when they purchase a machine—or the copy we lend can be returned if you decide not to go into the business. Reading it will not cost you anything.

If you are interested in a nice little home business that can bring in an extra \$60 or more for ten or twelve hours work in spare time, send your name. All information on the book and machine will be sent free, postage prepaid and no salesman will call to bother you. You read about it in the privacy of your own home without outside pressure and then decide whether you'd like to take the next step. Address your envelope to me in person. Send me the coupon below. Or, if you prefer send your name on a post card and ask for "Free information on starting a manufacturing business at home." Either way, send your name today and find out about this wonderful new fast growing money-making business.

RAYMOND E. BRANDELL

1512 Jarvis Ave., Dept. L-10-C, Chicago 26, Ill.

Raymond E. Brandell, 1512 Jarvis Ave., Dept. L-10-C, Chicago 26, Ill.

Dear Mr. Brandell: Please send information showing how I can start a profitable manufacturing business in my home in spare time. All the information you send will be mailed to me free of charge and no salesman is to call on me. I am not under any obligation to go ahead with the business and there is no charge for this information now or any other time.

Name \_\_\_\_\_

Address \_\_\_\_\_

City \_\_\_\_\_ Zone \_\_\_\_\_ State \_\_\_\_\_



**WORLD'S  
BEST  
WANT-AD  
MEDIUM**

# CLASSIFIED ADVERTISEMENTS



Advertisements in this section \$1.00 per word, each insertion, minimum 10 words, payable in advance.

To be inserted under proper classification, copy must be in our office the

20th of the second month preceding date of issue

F. W. Johnson, Manager, Classified Advertising

Popular Mechanics Magazine, 200 East Ontario Street, Chicago 11, Illinois

## YOU'LL PROFIT

By reading and answering the classified ads in this section. Hundreds of opportunities for you to make and save money

### AUTOMOBILES, MIDGET CARS

**BUILD** Your own race car. Two 17x23 detailed blue prints, \$2.50. Suitable for TQ Midget and the young man. Wriff Mfg., 2344-A Dudley, Pasadena 7, Calif.

**BOY'S** Power-driven auto. Build your own. Complete plans 25 cents. Sypher Co., 170 Cherry, Toledo, Ohio.

**ANTIQU** Automobile color slides, 2x2. Illustrated catalog free. Universal, Box 779A, Beverly Hills, Calif.

**FREE** Motor magazines; automobile literature, old, new and foreign; glossy photos, dealer books; shop manuals, offered with non-profit organization. Write today; get on free mailing list. Auto Maniacs, Stockbridge, Mich.

**HOT** Rod cams, equipment catalog, money maker, Rush 25c. Weber Tool, Los Angeles 63.

**FIBERGLAS** Automobile materials. Wholesale-retail. Complete information catalog 15c. Gem-O-Lite, Box 686A, North Hollywood, California.

### AUTO SUPPLIES AND EQUIPMENT

**CROSLY** Parts. New, Used. Rebuild transmissions. Shift covers. No list, tell me your needs. Gene's, 1915 So. H, Fort Smith, Arkansas.

**"HAN-D-Wipe"** cleans hands with or without water. \$3.75 gallon, prepaid. Colonywax, Davenport, Iowa.

**AMAZING** "Tops" radiator cleaner cleans and copper plates. \$1.98 post paid. Wasco, Post Office Box 1231, Sandusky, Ohio.

**LACHAPELLE'S** Motor treatment. For a better car for \$3.00. Ferns, Box 71827-B, Los Angeles 1, Calif. Free information.

**STEEL** Emergency tire chains. Four for \$3.98. Easiest to put on available. Guaranteed. Kon-Veen-Yunt Chains, 1405 Cherokee Road, Richmond 23, Va.

**DON'T** Drive half blind. Increase road illumination up to 50%. Precision, fully automatic device ensures 100% headlight efficiency. \$6.00 postpaid, insured. Money back guarantee. Details free. Please print name, make, year, voltage. Graham Muir, 321 M Street, West Palm Beach, Florida.

**BUY** Wholesale nationally advertised auto supply, thousands other products at big discount. Free "Wholesale Plan." American Buyers, 629-D Linden, Buffalo 16, New York.

**CRANKSHAFT** Grinder, hand operated. Makes bearings fit without taking engine apart. \$3.75. Literature. L. D. McGee, 719 Cascade St., Wenatchee, Wash.

**HOME** Solution in windshield washer. Cleans off road grease. 25c in coin for information to Box 236, Yamhill, Oregon.

**UPHOLSTERY** Repair kit, auto and furniture. Sewing instructions. Curved needles, leather cleaner and conditioner, upholstery glue. \$2.95 pp. No c.o.d.s. Money back guarantee. Also all purpose utility needle kit 59c. Piewood Top Shop, 11008 West Pico Blvd., Los Angeles 64, Calif.

**DOOR** Edge protector, stainless steel, fits any car, stays on. \$2.50 per 2-door kit. Send money order to Protectors, P.O. Box 1235, Jacksonville 1, Florida.

**REAR** Seat speaker kit. Complete with instructions, speaker, wiring, switch, and handsome grill. \$7.95. Brown's, 1237 7th St., San Pedro, Calif.

**FREE** Discount catalog. Speed, power, custom equipment. Almqvist Engineering, Milford 3P, Pennsylvania.

**MECHANICS**, Gas stations. Make extra money. Fast chargers converted to 6 and 12 volts. We show you how! Repair all makes. Agents wanted. A. Allen Co., 3353 Irving Park, Chicago 18, Illinois.

**STOP** Acid engine wear. Install Noxacid kit. Fits any car. \$1.00. Noxacid, Elliott City 3, Md.

**GENUINE** Motor treatment, Lachapelle's, (patented). Only \$3.00 delivered. Increases compression, power. Saves gas, oil, repairs. Money back guarantee. You can't lose. Free circular. Write Joe Dillon, Authorized Warehouse and Agents Distributor, Box 323-6 Bridgeport, Ohio. Exclusive distributorships, agencies open.

**THIEF** Chaser. Stops tire, gasoline and auto thieves. Sample offer. Salesmen wanted. Novak Company, 3131-W13, Gary 13, Indiana.

**MOTOROLA** Auto radios. Get our prices, literature. State make and model car. Cherry Radio, 1438 Belfield Ave., Philadelphia 40, Penna.

**LATEST** Custom accessories. Items not in stores. New low prices. Push button doors, trunks, windows, etc. New illustrated catalog, biggest ever, 25c. Eastern Auto, 3319-A, South Grand, Los Angeles 7, California.

**FREE!** Exciting catalog of sensational free trial cut-price bargains in famous automotive instruments and accessories! Write today! New England Surplus Sales, Dept. PM-3, Newburyport, Mass.

**FORD-T** parts. Most complete stock in U. S. for all old cars. Try to stump us. B. S. Wisneski, Milwaukee 7, Wisconsin.

**CAR** Burning oil? Losing compression? Try Clifford's Compression Seal. \$2 postpaid. Clifford's Engineering, 1329 Seventh, Aurora, Illinois.

**NEW** And used parts at savings. Complete guaranteed parts service for all models cars and trucks—1924 and later. Largest in the West. Army parts specialists. No catalog, write for quotations. Fast mail order service. Pioneer Auto and Truck Parts Co., 734 W. 13th Avenue, Denver, Colorado.

**TAPPET** Noises in Fords, Chevrolets and Mercurys stopped with Kage Tappet Silencers. Free literature. Kaye Products, 2067B S. Layton Blvd., Milwaukee 15, Wis.

**AUTO** Accessory and parts catalog. 1955 edition—all new! 148 pages. Save up to 50% over 50,000 items, including Hollywood accessories, hi-speed equipment, rebuilt engines, all parts and accessories for all cars and trucks! Hard-to-get parts! Send 25c (refundable). J. C. Whitney, 1919-PM Archer, Chicago 16, Illinois.

**ELECTROPLATE** Auto parts, novelties, mirrors. Easy, inexpensive home processes. Free booklet. Tyco Metals, Box 13231-BG, Houston 19, Texas.

### AUTO TRAILERS

**ASSEMBLE** Yourself kits. Slip-on cabin coach for all pick-up trucks. Boat trailers. Trailer blueprints. Literature 10c. Comstock Trailers, 585-P, Parsons, Kansas.

**TRAILER** Manual. Over 200 pages, 250 pictures. Tells how to: buy, tow, travel, build, live-in, repair. \$1.98. Trail-R-Club of America, Dept. PM-3, Box 1376, Beverly Hills, California.

**"SHORT-Short"** family trailer. Simple assembly. Literature 10c. Welch Workshop, 645 Rochdale Circle, Lombard, Illinois.

**ALUMINUM** Camp trailer kit. Vacationists, hunters, fisherman, folding, 560 lbs., sleeps five. Literature. Sample materials 20c. Master Camper, West Sayville, N. Y.

**EXCEPTIONAL** Expanding eight foot trailer. Accommodates family of five. Build yourself. Literature 10c. Framar Company, Wilmington, Mass.

**BUILD** Your own trailer! Plans for all kinds. Illustrated catalog 10c. Jim Dandy, 125-M, Wausau, Wisconsin.

### MOTORCYCLES, BICYCLES, MOTORSCOOTERS AND SUPPLIES

**HARLEY-Davidsons** — America's best used buys! We pay shipping on motorcycles. Genuine new, used, parts, accessories for current and obsolete models. Send 25c for bulletin, catalog. Knuth's (Harley-Davidson factory dealer), 1753 So. Muskego Ave., Milwaukee, Wis.

**WHIZZER** Motor \$8. Maytag \$5, midget car less wheels \$15. Bantam chassis \$20. (mailorder only). Send 25c (35c for first class mailing) for directory catalogue Number 64 just out, listing these and hundreds of other bargains in motorcycles, midget cars, parts, plans, etc. Midget Motors Directory, Athens, Ohio.

**NSU** And BMW motorcycles, 1 1/2 to 35 hp., singles and twins, chaindrive and shaftdrive. Butler & Smith, 160 West 83rd Street, New York 24, N. Y.

**MONEY** Back guarantee, parts and accessories, engines, remanufactured units, all makes and models, speed equipment, chrome plating, free bulletins. Factory dealer, South's largest. Wichita Motorcycle Supply Service, Since 1921, 813 Ohio Avenue, Wichita Falls, Texas.

**WHIZZER** Motors \$20.00; midget car \$15.00; motorscooter \$6.00; Cushman two-speed \$20.00. Send 25c (35c first class mail) for catalog #28 jammed with sensational bargains in wheels, motors, motorscooters, midget cars, motorbikes, construction plans, etc. Gail, 1313 Jefferson, Toledo, Ohio.

**REBUILT** Bicycle or motorscooter engines. \$17.00 up. Gausfield Motors, Temperance, Michigan.



**RECONDITIONED** Motorcycles and motors. Chromium accessories. Complete stock Indian parts. Expert rebuilding. Fast service. Indian Motorcycle Sales, Kansas City 27, Mo.

**"BUZZZZ"** The motorcycle magazine. International coverage. Thoroughly illustrated. Yearly \$2.00. Sample 25c. 3424-A Sawyer, Chicago 25.

#### AVIATION

**BUILD A man** carrying helicopter jet engine yourself. "Practical Ram Jet Design," \$1.00. "Practical Pulse Jet Design," \$1.00. Decker Engine Works, Plasterco, Va.

**FREE:** Monthly aircraft, electronic, gadget list. Dick Rose, Everett, Wash.

**PROPELLERS.** Plans, supplies for air boats, snow sleighs. Catalog 10c. Gano Propellers, Box 3284-A, Ft. Worth, Texas.

**FLYING Saucer!** Propelled by centrifugal force. Propulsion details, \$1.00. Decker Engine Works, Plasterco, Va.

**BUILD Pulse jet** helicopter. Plans \$6.00. Rovin Engineering, 800j University Ave., Ithaca, N. Y.

**PROPELLERS.** Plans, kits for snow sleighs, air boats. Immediate delivery, satisfaction guaranteed. Catalog 25c. Banks-Maxwell, Box 3301E, Ft. Worth, Texas.

#### BATTERIES, GENERATORS

**LONG Life battery**—Make your own. Details free. Marbill Products, Ellicott City 3, Md.

**EDISON Nickel** storage batteries. Any voltage, any amperage. Unconditionally guaranteed. Power plants, generators, motors. Literature. Hawley Smith Co., Croton Falls 1, N. Y.

#### ELECTRICAL SUPPLIES

**SAVE \$50.00-\$100.00.** Make your garage as modern as your home. Open and close your garage door right from your car with an amazing Door-O-Matic electric garage door operator. New 1955 models for as little as \$129.50. Attaches to any overhead door, pre-assembled at factory for easy installation, complete with full size motor. Write for details. Special discounts to contractors, dealers and suppliers. Door-O-Matic Co., Dept. 2B, Russia, Ohio.

**RECTIFIERS.** One twenty-five watt selenium dry type sixty cycle; One ten volt a.c. input; one ten volt d.c. output mounted in steel cases 3 x 10 1/4 x 3 1/2 inches complete with input output cord and fuse holder, rebuilt \$5.50 each postpaid. L. S. Tarshis & Sons, 219 Front Street, East, Toronto, Canada.

**FREE Catalog** welders, welder-kits, motors, generators, hydraulic-kits, pumps, tools, winches, surplus items, etc. Dunbar Mfg., 6602 Sylvan Road, Houston 23, Tex.

**ELECTRIC Pencil:** Engraves all metals \$1.50. Beyer Mfg., 10511-H Springfield, Chicago 43.

**LAMPS—25c** Brings bargain catalog showing all parts for repairing, building. Contains instructions for electrifying vases, oil lamps, etc. Gyro Lamps, 5402P Clark, Chicago 40.

**LAMP Supplies**—Wholesale. Any amounts. All parts for repairing and building lamps. Catalogue 15c. Brown Lamp Co., Box 501-Wellston Sta., St. Louis 12, Mo.

#### WELDING, SOLDERING, PLATING

**TIN-Quik**—Perfect soldering now possible. New amazing tinning compound does wonders. Failureproof. For steel, cast iron, copper, lead, etc. Smooth jobs guaranteed. 4 oz. tin \$1.00. 1 lb. \$2.50. Canadian Powdered Metals, R. #1, Hamilton, Ontario, Canada.

**"BUILD-UR-OWN"** a.c. welder and a.c. power plant with a good used engine and low cost Hobart generator. Welds anywhere and supplies 5KW stand-by power for any emergency. Write Hobartweld, Box M-353, Troy, Ohio.

**ELECTROPLATE** Articles new again. Earn extra money. Complete outfits \$3.95. Easy instructions. LeJay 77, Minneapolis, Minnesota.

**AMAZING** New battery welder repairs anything. No experience needed. Complete outfit \$3.95. LeJay 37, Minneapolis, Minn.

**ATOMIZED** Powdered solder. The new wonder. 50-50 pure fine powdered solder for all soldering jobs. Saves money. Stops waste. 1 lb. tin \$1.50. Canadian Powdered Metals, R.R. #1, Hamilton, Ontario, Canada.

**ACETYLENE** Welding outfits new \$49.00; used \$29.00; arcwelders \$49.50. Eagle Welding, Dept. P.M., 5085 Broadway, Chicago 40, Ill.

**A.C. Welders.** 4 sizes. Lowest prices. Free literature. Holgeron's Serv., Canton, Kan.

**ELECTROPLATING** Equipment, anodes and solutions for all types of plating. Instructions. Assemble your own plater and save. Free catalog. Ramyr, Dept. E-4, 1624 East First Street, Los Angeles 33, California.

**SELF-Training** System. Radiator repairing, cleaning, reeoring. How to equip small shop at low cost. Supply sources, trade secrets. Instructions. Radiator Service, East Jordan, Mich.

#### MACHINERY, TOOLS, SUPPLIES

**HAND Bellows**—Compressed air to clean tools, motors, workbench. Outdoor grill, fireplace. Top grain cowhide. 25/32 basswood. 10" diameter, 18" length, \$6.30 postpaid. Kit, \$4.95. Free literature. Cincinnati Bellows, 4233 Cooper Rd., Cincinnati 36, Ohio. Makers of fine bellows since 1883.

**CONCRETE** Block machines. Standard sizes. Free catalog. Concrete Machine Company, 5129 South Compton, St. Louis 11, Missouri.

**DESIGNING,** Manufacturing. Machinery, inventions, models. Henry, Engineer, 2136 E. Monmouth, Philadelphia, Penna.

**TOOL Catalog.** Send \$1.00, refundable. Yuhas, 3350 Theodore, Detroit 11, Mich.

**FREE!** Three tool racks. Save on seven piece Oxwall all-purpose tools. Thousands used. Includes forged steel adjustable wrench, 7" linesman pliers with wire cutter. Four snap-in blades include 8" recess head driver, 9" mechanic screw driver, \$7 45" V-claw, 7" cabinet screw driver, insulated amber handle with flanged aluminum screw chuck. Excellent gift, ideal for glove compartment. Order now, only \$3.99! Guaranteed. David Brown, Box 33, Bronx 51, N. Y.

**LOOK.** Imported German high-speed twist drill sets. Precision made finest chrome-vanadium steel. Save, buy direct! Set 60 sizes, 1-60, \$11.95 ppd. (\$24.50 value!) Drill-case included. Set 29 sizes, 1/16-1/2" (64ths), \$14.95 ppd. (Reg. \$37.60!) Drill-stand included. Special! Both sets \$24.95 ppd.! Satisfaction guaranteed! Supply limited, order now! Precision Tool Supply, 111-F Reno, Santa Cruz, Calif.

**BUY** Surplus machinery, power tools, boats, jeeps, trucks, etc., from government. List \$1.00. Box US169, East Hartford 8, Conn.

**FREE Catalogue.** 60 unusual tools. Benrich, Box 64, Jamaica 35, N. Y.

**POWER,** Hand tools, motors, hardwares, paint. 2000 items, catalog 50c, refundable. Reid, 125-B, Audubon Station, New York City 32.

**BIG Factory** catalog! Buy direct—Save middleman's profits; hundreds of labor saving tools and equipment; tremendous savings. Send 10c. Master Mechanic Mfg., Dept. CL-86, Burlington, Wis.

**BODY Jack,** one ton. Works 3 inch space, around corners. Free literature. Spertjack, Ellicott City 3, Md.

**BE Smart.** Why pay retail prices? Buy everything wholesale. Illustrated catalog \$1.00, refundable. New York Distributors, 1431 Canterbury, Dearborn, Michigan.

**\$16.50 PRECISION** 2" Diameter, three jaw Universal chuck with #2 Morse taper arbor, key \$8.95 prepaid. Chuck alone \$5.95. Holds over two inches. Use in headstock or tailstock. Guaranteed. Prehler, 1625 Milwaukee, Chicago 47.

**MICROMETER.** One inch \$3.00, two inch \$4.00. Semi-steel frame. Accurate to .0005. Money back guarantee. Postpaid. Lewis Machine Tool Co., Los Nietos, Calif.

**NEW Electric** drills and saws. 1/4", \$11.75 and \$15.75; 1/2", \$30.75; 6 1/2" tilting arbor \$44.50 prepaid. Wilt Surplus, 7629 Racine, Chicago 20.

**"TREE Farmer"** chain saws, new, direct drive, 21 lb., \$139.50, wholesale. M-G Saw, Coatesville, Penna.

**ALLEN** Two ton power bench type punch press. \$97.50. Circular. Allen, Dept. PMB, Clinton, Missouri.

**SNOWTRACTORS!** Army Weasel parts. World's largest supplier. Symington of Seattle, Union Bay Place, Seattle 5, Wash.

**SHEBEL** Saw filer files all saws. Circular. A. P. Shebel, 730 So. 2nd St., Milwaukee 4, Wis.

#### ENGINES, MOTORS, DYNAMOS

**REBUILT** 1 1/2 to 3 h.p. engines \$17.00 to \$37.00. Cauffiel Motors, Temperance, Michigan.

**WINDING** Data, 225 motors, single and three phase, \$1.00. Data Company, Box 7631, Kansas City 28, Mo.

**REWIND** Motors yourself. Complete instructions \$1.00. Lewis Mfg., Howell, Michigan.

**HV Series** injector parts wanted. Bares, 7120 Carnegie, Cleveland 3, Ohio.

**ENGINES—Marine, industrial.** Helwege Co., 741 S. Ocean, Freeport, N. Y.

**A.C. Generators,** 750 watt, \$38.50. Twin cylinder compressors with 1/2 horse \$22.50. Motors, 1 horse, \$37.50. Butler, 1885, Milwaukee, Chicago 47.

#### BOATS, OUTBOARD MOTORS

**OUTBOARD** Motor parts—New, used for all makes. Send stamp for price quotation, listing parts needed. Outboard Motor Mart, Inc., 229C State Street, Boston, Massachusetts.

**USED** Outboard motors, many sizes and makes. Write for listings. Murray's Boat Shop, Traverse City, Mich.

**SUBMARINE** Glider, adjustable carlocks, anchor controls. Full information free. Boat Supply Co., Marshall, Michigan.

**AIRPLANE** Floats, pontoons. Catalogue 10c. Ort, Box 22X, Thomasville, Penna.

**SAVE** Money. Boat accessories catalog. 25 cents in coin. Garland Frasher Marine Sales, 2626-C Fifth Avenue, Huntington, W. Va.

**BUY** Wholesale nationally advertised outboards, thousands other products at big discount. Free "Wholesale Plan." American Buyers', 628-D Linden, Buffalo 26, New York.

**SEA** Legs boat kits, prices from \$39.00. Complete kits, including brass wood screws, precut parts, pre-assembled frames, foolproof illustrated instructions, write for free literature. Penney Woodcraft Industries, Dept. C-35, Defiance, Ohio.

**WE** defy competition. 12 ft. boat kit \$47.95. Precut mahogany and marine plywood. Free folder. AFPO, Box 113, Belding, Mich.

**BUY** Surplus boats, engines, gear from government. List \$1.00. Box ST169, East Hartford 8, Conn.

**SAVE** Money! Bargain used inboard, outboard motor list free. Masters, 212 W. Chicago Ave., Chicago.

**70 DESIGNS,** Kits, hardware. Advance literature. Marinecraft, 55-M Sorrento, Allston, Mass.

**FIBERGLASS** top marine grade. Yard or kit. Ontario Fiberglass Co., Ontario, N. Y.

**SIMPLIFIED,** Modern plans and patterns. Inboards and outboards 12'-22'. Please state type. Glen Designs, Box 568, Compton, Calif.

**FIBERGLAS** Boat coating. Wholesale-retail. Complete information catalog 13c. Gem-O-Lite, Box 686B, North Hollywood, California.

**REDUCE** Breakage. Plexiglas windshields, side panels. Clear or colored. Cut to size. Send 25c for complete catalogue and prices. Direct factory distributor. Delta Products, 1400 Henderson, Fort Worth, Texas.

**FULL** Size, cut-to-shape boat patterns, blueprints, 7 1/2-38 feet. New 1955 illustrated "Build a Boat" catalog of 50 naval architect-designed cruisers, runabouts, sloops, skiffs, outboard boats, sailing, racing, houseboats, 50c. Marine hardware catalog, \$1.50. Bigger, better 1955 "How to Build Boats" book, \$2.50. PolyWog Houseboat Plans, \$12. Cleveland Boat Blueprint Co., Dept. A-66, 9400 Steinway, Cleveland 4, Ohio.

**FIBERGLAS** Permanent boat waterproofing. Lowest wholesale prices. Guaranteed materials. Easy application. Full instructions. Complete kits, \$12.50 up. Free literature. Ajax Plastics, Dept. PM, P.O. Box 1323, Fort Worth, Texas.



**FREE Catalog!** Boat kits, trailers, fiberglass, marine hardware. Luger Industries, Dept. M, 4452 Nicollet, Minneapolis, Minn.

**MARINE Conversions** for Ford and Jeep engines. Catalog 10c. Lehman Manufacturing Company, 972D Broad Street, Newark 2, New Jersey.

**NEW, Used, rebuilt marine motors.** Marine conversions, fittings. Free catalog. Stokes Marine Supply, Dept. 24, Coldwater, Michigan.

**AIR Boat plans, supplies, catalog 25c.** Banks-Maxwell, Box 3301F, Ft. Worth, Texas.

### ATHLETIC EQUIPMENT, BODY BUILDING COURSES

**FREE Catalogue.** 10c for postage appreciated. Dr. Thompson, 919 Fourth, Manhattan 30, Kansas.

**BARBELLS.** Exercise equipment. Courses. Free booklet. Good Barbell Co., Reading, Penna.

### SPORTING GOODS, GUNS, FISHING TACKLE, ARCHERY, TRAPPING

**PORT-A-Camp.** Self-contained, portable kitchen provides quick, economical meals for campers, vacationists. Sturdy metal cabinet holds burning units, all necessary gear, utensils to serve four. Only \$34.95. Free details. Port-A-Camp, Dept. PM-3, 442 N. Seneca, Wichita, Kansas.

**FLY Makers!** 1955 free catalogue. D. H. Thompson, 335 Walnut Ave., Elgin, Illinois.

**BUILD Your own tackle box.** Four sizes. Write. Longhorn Trading Post, 227 E. Cowan Drive, Houston, Texas.

**FREE Catalog** on tents, sleeping bags, binoculars, knives, gov't surplus, etc. General Mdse Co., P.O. Box 144, Rahway 2, New Jersey.

**FREE Fishing catalog—132 pages.** Over 3000 hard to find fishing specialties. Network Company, Dept. PM3, Toledo 13, Ohio.

**GUNS.** Buy, sell, trade, repair. Modern, antique. Catalog 25c. Barlow's, 5363 So. Howell Ave., Milwaukee 7, Wis.

**NOW!** Your choice of six rare Colt replicas for your den, lodge, or office. Information free. Woolslair, 645 30th, Hermosa Beach, Calif.

**180 PROFUSELY Illustrated pages** antique pistols, swords, daggers, armor, etc. 50c. Robert Abels, M360 Lexington Ave., New York 21.

**BUY Wholesale** nationally advertised sporting goods, thousands other products at big discount. Free "Wholesale Plan." American Buyers', 627-D Linden, Buffalo 16, N. Y.

**TENTS, Camping equipment.** Send 10c for new 1955 100 page tent, camping equipment catalogue-handbook. Morsan, 10-21R 50th Avenue, Long Island City 1, N. Y.

**FISHERMEN:** Catch more fish. Do-it-yourself. Illuminate your plugs with luminous paint. Glows under water. Yellow, blue, green, orange. Two 1/2 oz. bottles \$1.00. Specify colors. Luminous Products, Div. B, 195 Garrison Road, Williamsville, 21, N. Y.

**GUN Parts** for obsolete firearms. Mausers, Lagers, Walthers, firing pins, springs, extractors, barrels, magazines. Order today No. 10 illustrated parts list 25c. Western Gun Exchange, Box 619, Whittier, Calif.

**BUY Wholesale** famous spinning, casting reels. Tremendous savings. Mail card for prices. Tubular Products, Box 4541-PM, Atlanta, Ga.

**1000 USES Plastic matchbox, waterproof, unbreakable, 25c.** Appleton's, 705 Broadway, New York City 3.

**WE Trade guns, scopes, reloading equipment, binoculars.** Catalog 25c. Firearms, 1517 Gardner, Los Angeles 46, Calif.

**GUNS!** Free catalog. Owens Sporting Goods, Box 4145-A, Long Beach, Calif.

**LEARN Gun** repairing at home. Profitable business. Details 10c. Modern Gun Repair School, Box 430-P, Marshfield, Wis.

**TUBULAR Glass rod kits—Casting, spinning and boat, fresh and saltwater.** Build custom rods at home for profit. Free listing of blanks, guides, handles and accessories. Fisherman's novelty key chain 25c. Rodman, Box 41 Wauwatosa Wisconsin

**HOLLOWGLASS Fishing rod kits.** Assemble yourself. Save over half. Casting, spinning, fly and boat, \$4.95 up. Full instructions. Free literature. Makit Rod Co., 429 1/2 Fulton, Fort Worth, Texas.

**SWIMMERS!** Send \$3.95 for imported French mask. Catalog of skin divers' equipment and books 25c. Aquafun PM, Davenport, Iowa.

**MOLDS—For making fishermen's sinkers.** Free illustrated booklet. Reading Instrument Co., Box 78, Reading, Penna.

**OLD Guns.** Current prices. Free catalog. Pioneer Books, Harriman, Tennessee.

**5000 BARGAINS, Firearms, binoculars, war relics.** Catalog 50c. Smith Firearms, Runnemed, N. J.

**MANY Modern antique guns.** List 10c coin. Ed Howe, 52 Main, Coopers Mills, Maine.

**JAP Rifle** altering to 30-06, \$6.00. Japshells, \$3.75. Catalog 5c. T. P. Shop, West Branch 11, Mich.

**IMPORTED, Daggers, stilettos, throwing, pocket, hunting knives, etc.** Free catalog. J. D. Clinton, Mt. Clemens 2, Mich.

**MOLDS For fisherman's sinkers, jigs, squids, casting and spinning lures.** Free catalog Sweet's Molds, Tonawanda 1, New York.

**MONOFILAMENT—Fishing line.** Genuine soft Dupont Tynex at lowest prices. All popular sizes. 1000 feet, 3 pound; 600 feet, 6 pound; or 300 feet, 12 pound test. Your choice \$1.00 postpaid and guaranteed. Spin-Line, Box 145, Muskegon, Mich.

**KITKAST.** The pocket rod that really casts. Ideal for women, children, campers, hunters, trappers and traveling men. Fits in brief case, car glove compartment or knapsack. \$3.00. Unconditionally guaranteed. Dealers invited. Request c.o.d. or send check to Raynal, 330 W. 41st St., Hialeah, Florida.

**2000 COLTS, Winchester, western guns.** Fantastic collection antique-modern guns, swords, daggers, armor, ammunition, accessories. Deluxe catalog 50c. Agramonte's, 201 Warburton, Yonkers 2G, N. Y.

**WORMS Without digging.** Amazing discovery. Free details. Eds, Box 287, Holland Patent, N. Y.

**1955 SPIN Reels** at wholesale price—Mitchell #300 \$18.95, Record #400 \$18.95, Airex Larchmont \$16.75, Aristocrat \$14.50, Vagabond \$10.95, Orvis 100 \$17.95, Zebco #22 \$11.50, Johnson 80 \$10.95. Orders shipped promptly, prepaid. Lombard's, Dept. M, 3141 Bainbridge Ave., Bronx 67, N. Y.

### BINOCULARS, TELESCOPES, MICROSCOPES, MAGNIFIERS

**BUILD Your own reflector telescope.** Complete kits, mirrors, eyepieces, tripods, all other accessories. Request free, complete illustrated literature. Criterion Manufacturing, Dept. KPM-3, Hartford, Conn.

**REFLECTOR Telescope kits** from \$6.25. Mirrors and mirror cells, diagonals, focusing mounts, tripods, tubing, oculars. Fully guaranteed. Free illustrated catalog. Visit our store 166 Church St., New York, N. Y. Send orders and inquiries to Esco Products, Dept. PM-3, 1428 Willow Avenue, Hoboken, N. J.

**MAKE 6" Telescope reflector.** Glass, abrasives, instructions, \$10.50. P. Cameron, Box 65, Inwood 96, N. Y.

**DYNASCOPE—New, sensational reflector telescope.** 65X-130X-167X. 4 power finder, fully achromatic. Hardwood folding tripod. Complete ready for use. Send for details. Criterion Manufacturing, Dept. DP-10, Hartford, Conn.

**WAR Surplus bargains:** millions of lenses, instruments, telescopes, binoculars, components and complete line of astronomical telescope items. World's greatest optical market place! Send only \$1.00 for beginner's 10-lens kit and big instruction booklet Stock CH. Write for catalog CH free! Edmund Scientific Corp., Barrington, New Jersey.

**ULTRA Powerful telescopes and telescope makers lens kits.** Trifling cost. A. Jamer, Manorville, N. Y.

**BINOCULARS, Telescopes, microscopes.** Terrific values, \$3.98 up. Request free money saving catalog. Criterion, Dept. P27, Hartford, Conn.

**TELESCOPES, Microscopes, binoculars,** past quarter century. Comprehensive scientific instrument catalog \$1.00. None free. Dollar deductible from orders. Harry Ross, 70 West Broadway, New York 7, N. Y.

**MAKE 6" Telescope reflector.** Glass, abrasives, instructions—\$10.50. P. Cameron, Box 65, Inwood 96, N. Y.

**SPECIALISTS! Used microscopes and accessories.** Unusual prepared slides. Supplies. Biological kits. Scientific oddities. Fossilized insects in amber. Minerals, sea-shells. 1955 catalog free. Research Scientific, 60 Wall St., New York City 5.

**SALE! Save 40%! Free 52 page, 3 color, informative binocular-telescope catalog.** \$3.95 to \$250.00! United Binoculars, 9043 S. Western, A-8608, Chicago 20. Dealers wanted.

**400X TELESCOPE Makers kit** contains focusing tube, erector, 5 lenses and instructions. \$3.75. Giant 100X astronomical telescope complete with tripod, \$15.00. Free information, Suffolk Science, Mattituck 3, N. Y.

**IMPORTERS' Amazing prices, precision binoculars, 22 models.** Free trial. Folder, "Binocular Selecting," catalog free. Dealers wanted. Prentiss Importers, Mercury Bldg., West Los Angeles 25, Calif.

**MICROSCOPES.** Prepared slides, biological stains, oculars, illuminators, mechanical stages, objectives, mounting media, parts, specialized equipment. Premium quality merchandise, lowest prices anywhere. Write for free illustrated microscope catalog and price list. Benjamin Miller, 134 W. 32nd St., Rm. 204-A, New York 1, N. Y.

**REFLECTING Telescopes, 60X,** completely assembled \$29.75. Guaranteed observatory clearness. Free information. Skyscope, 475 Fifth Avenue, New York 17.

### TAXIDERMISTRY

**MODERN Taxidermist magazine,** Greenfield Center 2, N. Y. Devoted entirely to taxidermy, methods, photos. Trial year's subscription, \$1.00.

### PETS—DOGS, BIRDS, RABBITS, HAMSTERS, ETC.

**MONEYMAKING Squabs!** Practical, illustrated book explains raising, feeding, marketing. Absolutely dependable. \$1.00 while supply lasts. Pigeonier, 4442 Woodman, Sherman Oaks, California.

**CHINCHILLAS.** Selling out, \$150.00 to \$250.00 pair. Brights' Chinchillas, 2312 N. 38th Street, Kansas City, Kansas.

**ANY Dry place used.** Raise white mice 50c each. Also colors, spotted and fancy mice. Information 10c. Shaw, 830 E. Paterson, Flint, Michigan.

**RAISE Rabbits.** Quick profits. Booklet free. Tayco Rabbitry, Hapeville, Georgia.

**BEAUTIFUL Pure white pedigreed police puppies.** Ansonia Kennels, Mose, N. Dak.

**HAMSTERS—Golden:** young, \$4.00 pair, fully developed, \$5.00 pair. Adirondack Hamstery, Prospect 70, New York.

**CHINCHILLAS.** Registered. Guaranteed reproduction. Unbelievable prices. Far-West Chinchilla, 1446-A Jones, San Francisco 9, California.

**GUINEA Pigs.** Markets guaranteed. Booklet free. Taylors, 426A, Hapeville, Ga.

**CHINCHILLAS.** Big profits. Send for free literature to Tom McGowan, 170 Horton Ave., Valley Stream, L. I., N. Y.

**WHITE German Shepherd puppies.** Theatrical dog tricks. Knoff, Nashotah, Wisconsin.

**UNUSUAL Pets:** baby monkeys, ocelots, kinkajous, skunks, etc. Send 10c for complete price list. Eric O. Sonntag, 4001 W. Pico, Los Angeles, Calif.

**PET Monkeys.** Illustrated listing 25c. Bronson Birds, 140 Fort George, New York 40, N. Y.

**HAMSTERS.** Special sale. Write for details. Anderson's Hamstery, 35 Oneida, Pontiac, Michigan.

**CHINCHILLAS—Fabulous fur animals.** Wholesale prices. Leo Hammer, Asheboro, N. C.

**RAISE Rabbits.** Let me show you how to succeed. Market information and prices of rabbits sent free. A. Johnson, Box 694, Kansas City 41, Mo.

**CHINCHILLAS (No rabbit.)** Easily raised anywhere. Profitable. Big future. Terms. Hibner Chinchillas, Ithaca, Mich.

**CHINCHILLAS Top-quality registered sturdy young stock, \$75.00 per pair.** Slater Chinchillas, 1535 Ruhland Ave., Manhattan Beach, California.



**HUNTERS!** Raccoon Mountain and Short Creek Kennels now combined. Large number of coonhounds, foxhounds, rabbit-hounds, beaglehounds, bird-dogs, puppies. Free literature and pictures. Trial. Dures Thomas, Owner, Box 464, Boaz, Alabama.

**START** Right by knowing facts about rabbit raising. Illustrated booklet describing all breeds, housing, feeding, breeding, marketing. 48 pages 10 cents. American Rabbit Breeders Association, 36 Arba Building, Pittsburgh, Penna.

**MAKE** Money raising chinchillas, mink, pigeons, rabbits, cavies for us. Free catalog. Keeney Brothers, New Freedom 2, Penna.

**RAISE** Moneymaking Angora, New Zealand rabbits. Particulars free. White's Rabbitry, Jackson, Mich.

**STANDARD** Rabbit Journal, Milton 3, Penna. Year \$1.00. Sample dime. Beginners manual 25c.

**GROW** Mushrooms. Cellar, shed, and outdoors. Spare, full time, year round. We pay \$3.50 lb. We paid Babbitt \$4,165.00 in few weeks. Free book. Washington Mushroom Ind., Dept. 171, 2954 Admiral Way, Seattle, Washington.

**MINK** Raising information free. Complete. Lake Superior Mink Farm, Superior, E.E.I. Wisconsin.

**MAKE** Big money! Raise Chinchilla rabbits. Cash markets supplied. Write today! Rockhill Ranch, Sellersville 15, Penna.

### FARMS, FARM LANDS, REAL ESTATE

**STROUT** Catalog—Mailed free! Farms, homes, businesses, 35 states, coast-to-coast, 3,357 bargains described. World's largest; 55 years service. Strout Realty, 7-M So. Dearborn St., Chicago 3, Ill.

**FLORIDA** Lakefront homesites near Ocala Forest and Saint John's River. Excellent fishing-hunting. \$10.00 monthly without interest. \$295.00-3895.00. Literature. Write, Parker, Paisley, Florida.

**MAKE** Money in Texas. Get yourself a fine tract now near Houston for only \$345. Pay \$15 cash and \$15 monthly. Fastest growing city and second largest seaport in the U.S. Huge \$100 million steel plant. World's greatest oil producing, refining, chemical, manufacturing and shipping center. Many are making phenomenal profits here and you can too. These beautiful tracts located in Houston's desirable southside suburbs with all-weather streets, electricity, schools, bus service, etc. Insured title. Write today for maps, pictures, full information free. Bailey Wood, Owner, Box 6804, Houston 5, Texas.

**FOR** Fishing, vacationing, living. 5 acre baby farms about 60 miles from St. Petersburg. Fine for homesites, farm or camp; close to finest hunting, bathing, boating, deep sea fishing. Only \$345.00. \$10.00 down, \$10.00 month. Information write G. B. Potterfield, Owner, Union Building, Dept. C, Charleston, W. Va.

**RELIABILITY** Guaranteed. Farms \$95. 35 terms. Descriptions mailed free. Write Mr. Armstrong, Shook, Missouri.

**RETIREMENT** Homes, gardens, nothing down. List free. Perrys, Brier Hill, Penna.

**GOVERNMENT** Land where and how to buy. 25c. National Tax Service Bureau, 2520A, David Stott Bldg., Detroit, Mich.

**CALIFORNIA** Ranch and farm lands. \$15 to \$35 acre. 100% oil and uranium rights. Easy terms. Free catalog. Pacific Tax Sales, 1621-A Cahuenga, Hollywood 28, California.

**\$5.00 MONTHLY** Buys 40 acres productive land; near town; price \$240.00; free list. Box 425-P, Carthage, Mo.

**CANADIAN** Tax sale lands for three dollars an acre and up. Small monthly payments. Farms, timber, hunting and fishing camps, minerals. Limited number of properties. Write at once for free catalogue. Tax Sale Service, Room 105, 120 Bloor St., West, Toronto 5, Canada.

**FLORIDA**—Nice homesites near Ocala national forest in Lake county. Best fishing, hunting. Low prices, easy payments. Folder free. Howard Vernor, DeLand, Florida.

**HOMESITES** \$400—Convenient payments. California's finest garden section. On Morro Bay's scenic shores. Wonderful fishing, boating, bathing. Fertile soil, softest water, temperate climate, congenial community. Free literature. Richard Otto, Department M, San Luis Obispo, Calif.

**FLORIDA**—Beautiful retirement homesites near gulf coast. Excellent hunting, fishing in 9 fresh and salt water rivers. 11 bays and gulf. \$250 at \$10 monthly. Free literature. V. M. Mathews, Box 1406, Asheville, N. C.

### PLANTS, SEEDS, NURSERY AND GARDEN SUPPLIES

**GINSENG**, Goldenseal roots bring \$1.50, \$12.00 pound. Full information. F. M. Collins, Viola, Iowa.

**TREES** And shrubs. Raise your own from seed for shade, windbreak, snow fence, ornament, erosion control, etc. For free planting guide, price list, write Woodlot Seed Company, Norway 9, Michigan.

**VITA-Rooter**. New garden tool waters plants, shrubs, flower beds underground at root level. Reduces water costs 50%. Eliminates muddying top soil. Prevents erosion. Protects petals from sprayed water. Allows watering during hot sun. Attaches to any garden hose. \$5.00. Cemco, 1292 Commonwealth Ave., Allston 34, Mass.

### FARM MACHINERY AND SUPPLIES

**AMERICA'S** Finest weedcutting electric fence controller. Send for free literature. Bandelin Products Co., 213-14th Avenue Northeast, Minneapolis 13, Minnesota.

### POULTRY, FARM SUPPLIES

**CAPONIZE** Cockerels chemically. 100 pellets, implanter included, \$2.00. Success guaranteed. Circular free. Majors Produce, Manhattan 5, Kansas.

**GUINEAS**, eggs and keets. Ducks, ducklings, eggs. Geese, goslings, eggs. Low prices. Gorgeous catalog free. Berry's Farm, Route 12, Clarinda, Iowa.

**RAISE** Turkeys the new way. Write for free information explaining how to make up to \$3000 in your own backyard. Address—National Turkey Institute, Dept. 3, Columbus, Kansas.

### PROFITABLE OCCUPATIONS

**MAKE** Money writing short paragraphs! No tedious study. I tell you what to write, where and how to sell; and supply list of editors buying from beginners. Many small checks add up quickly. Write to sell, right away. Send for free facts. Benson Barrett, 1791 Morse, Dept. C-27-C, Chicago 26.

**EARN** \$600.00 Month raising earthworms. Illustrated instructions dime. Wiggler Farms, Burt, Michigan.

**CINCINNATI**, Cleveland jobs, business opportunities, airmailed \$1.00. York, Plymouth, Ohio.

**WELDING** Pays big money. Learn easily at best equipped school in country. Non-profit school with low cost training. G.I. approved. Write Hobart Trade School, Box M-352, Troy, Ohio.

**ANNOUNCING** Home study course in commercial baking. Practical basic training. Good field for those with aptitude. Free booklet. "Opportunities in the Baking Industry." National Baking School, 835 Diversey Pkwy., Dept. 3433, Chicago 14.

**CALIFORNIA** Jobs and opportunities. San Francisco classified airmailed \$1.00. Hubbard, Box 1442, Palo Alto, California.

**DETROIT** And Flint, Michigan, help wanted ads airmailed \$1.00. Remails 25c. Press, 4725 N. Dort, Flint, Michigan.

**WHOLESALE!** Huge selection, famous brand products. Sensational discounts! Large catalog. Unusual business plans included. Consolidated Distributors, 21-20, Lafayette, Paterson 15, New Jersey.

**MUSHROOMS** Grown boxes, barrels. Manureless process 50c. Spawn \$1.00. Gordons, 553 William, Winnipeg, Manitoba.

**BOOM TOWN**—1955. Houston help wanted ads, \$1.00. National Notice Co., 710 Grenfell Lane, Houston 22, Texas.

**WANT** A diesel job? New opportunities to increase income. Higher pay. More money. We can help you qualify. Tools. Shop method home training. Write today! Diesel, Tractor, Heavy Equipment Division, Interstate Training Service, Dept. B-3-C, Portland 13, Oregon.

**"HOW** To Make Money With Simple Cartoons"—A book everyone who likes to draw should have. It is free; no obligation. Simply address Cartoonists' Exchange, Dept. 93CP, Pleasant Hill, Ohio.

**FREE!** "301 Profitable Small Businesses!" Amazing shoestring plans! Work home! Start sparetime! Deumant Surveys, Kenmore 23-PM, N. Y.

**I Average** \$125 weekly selling books by mail! So can you! Start sparetime! Work home! Cooper, 247-R Taunton, Buffalo, N. Y.

**BUY** Wholesale thousands nationally advertised products at big discount. Free "Wholesale Plan." American Buyers', 628-P Linden, Buffalo, N. Y.

**MAN** Wanted. Are you dissatisfied with your work? Would you like a business of your own? If so, write Rawleigh's, Dept. C-QG-PPM, Freeport, Ill.

**CERAMIC**, Copper enameling, supplies. Fabulous glazes, colors, kilns, findings, everything! Catalogues 25c. Sunkroft's, Panama City, Florida.

**1000 JOBS** In California! Mechanics, carpenters, drivers, draftsmen, clerks, engineers, executives. Highest pay in U.S.! Names of companies, addresses and salaries. Booklet \$1.00. Personnel Consultants, Box 356-E, Oakland, Calif.

**ATTENTION** Construction men! Laborers, trades, truck drivers, clerical, engineers, supervisory, many others. Latest copyrighted reports! Who to contact for highest paying jobs. To \$1500.00 monthly. Over 52 countries, including U.S., St. Lawrence project, Spain, South America, Alaska, Europe. Year registration and advisory service. Application forms. Best oil, aviation opportunities. Unconditional guarantee of satisfaction. Write or wire today! \$2.00. Airmailed \$2.25. (C.O.D.'s accepted.) International Reporter, Box 1047-PM, St. Louis 1, Missouri.

**FOREIGN** U.S. jobs to \$18,000. Many overseas countries, fare paid. Skilled-unskilled trades, office. Stamped self-addressed env. brings reply. Job Opportunities, Waseca, 1M Minn.

**\$1390.00 MONTHLY** For truck drivers, \$1400.00 monthly for carpenters, electricians, plumbers, mechanics, \$1200.00 for clerks and laborers. Full information and complete foreign listings, with current information on Spain, Korea, Australia, Alaska and Canada, \$1.00. Current information on stateside projects, \$1.00. Dept. 3-C. Opportunities Unlimited, 1110 Commerce Bldg., St. Paul, Minn.

**RAISE** Pheasants on \$100 week plan. Little capital and space can make you independent. Free details. Great Central System, Columbus 1, Kansas.

**GOLD** Stamping machine. Biggest profit personalizing greeting cards, matches, napkins, pencils, leathersgoods, etc. \$39.50. Free literature. Abalton's Machinery, 131 West 42nd, New York City 36.

**AUCTIONEERING**. Home study course. Diploma granted. Auction School, Ft. Smith, Ark.

**PREPARE** Now for big opportunities in metallurgy. Write Fran Council, Box 150, Wildwood, New Jersey.

**ATTENTION**. Construction workers! St. Lawrence Seaway started. Latest information \$1.00. Trans-Canada construction opportunities \$1.00 cash or money order. Both airmailed with application forms \$2.25. Allied Opportunities, Dept. PM3, Box 10, Station B, Hamilton, Ontario, Canada.

**\$150 DAILY** In mail possible. Amazing facts free. Clifton's, 105 F. Northeast, Ephrata 20-A, Washington.

**PROFITS** Up to \$15,000 annually. Your own mailorder business. No investment. Details free. Mail-O-Mart, Box 861, White Plains, N. Y.

**BUY** Wholesale 450,000 products. Literature free. Carter, Box 6011-A, Chicago 80.

**MEN**, Boys! Handy with tools? Do house repairing and maintenance. Complete folio \$2. Or for further free information write: Crusader Enterprises, Fremont, N. H.

**MOST** Complete list of U.S. construction jobs coast to coast. Top pay berths. No phonies. Latest dope tells who, what, where, when. Send \$1.00. Money-back guarantee. Dempster's Construction News, Bridgeport 22, Ill.

**FOREIGN** Construction. Jobs underway and soon starting in South America, Europe, Canada, Asia, Alaska, Middle East, South Pacific. Big pay, tax exemptions. Travel, expense paid. Make your stake now. Send \$1.00 for projects, contractors, application forms, etc. Prompt ppd. reply. Money-back guarantee. DCS Foreign Job News, Bridgeport 2, Ill.

**\$10,800 PROFITS!** Your own mailorder business! No risk! Success plan free! Treasury, 709 Webster, New Rochelle L-28, N. Y.



FREE Folio "Up to \$45,000; Unlimited Vacations." No merchandise, equipment. Unknown! Work home, sparetime! Haylings, Carlsbad, Calif.

**MAILORDER** Beginners instruction manual, sources, methods, opportunities, 25c. Carnahan Bros., 5580 Nelson, Cypress, Calif.

IF You are interested in high pay, worldwide corporations need workers. Write Servoc, Box 1217, New Orleans 4, La.

**FOREIGN** Employment construction work. If interested in foreign projects with high pay write. Foreign Service Bureau, (Dept. PM), Metuchen, New Jersey.

**TYPISTS** - Profitable home business. Complete copyrighted information, \$1. Gaunt, 827-B Irving, Chicago 13.

**ALASKA!** Last American frontier. \$1.00 brings 1935 business directory and government map. Military and civilian construction, homestead and highway facts, mining, aviation, fur-farming, grazing, timber, travel directions. Hot list of firms hiring. How-when-where to apply. Alaska Opportunists, Box 92-P, Hollywood 28, Calif.

**OVERSEAS**, Latin American, Alaska, Canada employment. Originator 1955 "Foreign Service Directory" up-to-minute report on military and civilian construction; oil companies; aviation; transportation; steamship; mining; government job info. How-when-where to apply. Listing firms hiring. \$1.00. Global Reports, Box 883-P, Hollywood 28, Calif.

**EVERYBODY** Likes candy. Learn to make professionally. Our 44th year. Ragdale Candies, D6, East Orange, New Jersey.

**SECRET** Investigation. Experience unnecessary. Investigators particulars free. George Wagoner, 125 M West 86th, New York 24.

**HOME** Workers needed! Spare time, full time. Assemble luggage and cases with our complete illustrated step-by-step instructions. We sell your product—Supply everything. Manufacturing representative needed in your area immediately. Unlimited profits possible. Investigate at our risk. Free details. Cascraft, 807-G10 Sunset, Los Angeles 12, Calif.

**MAKE** Flexible molds. Cast figurines, plaques. Free sample. Tooker, 630-M Chestnut, Hamilton, Ohio.

**GROW** Mushrooms. Cellar, shed, and outdoors. Spare, full time, year round. We pay \$3.50 lb. We paid Babbitt \$4,165 in few weeks. Free book. Washington Mushroom Ind., Dept. 99, 2954 Admiral Way, Seattle, Wash.

**FREE** Book "505 Odd, Successful Businesses." Work home. Expect something odd! Pacific, Oceanside, Calif.

**MAKE** New greaseless doughnuts in kitchen. Sell stores. Free recipes. Michael Ray, 3605 South 15th Ave., Minneapolis 7, Minnesota.

**BE** The Popular Mechanics representative in your neighborhood and earn big profits in your spare time. Write Popular Mechanics Magazine, Room 408M, 200 E. Ontario St., Chicago, Ill.

### BOOKS, PERIODICALS, PICTURES, POSTCARDS

**POSITIVE** Bargains! Brand new 25c and 35c pocketbooks just 11c! All kinds! Rush 25c (refunded!) for unique illustrated catalogue and pick 'em yourself. Breezy, snappy, thrilling and save too! Keystone Book, 8882 Forrest Avenue, Philadelphia 38, Penna.

**FREE** Psychological books catalogue. Write: Powers, 1324 Wilshire, Hollywood 17, California.

**PICTURE** Bible. 320 pages. 1000 illustrations; \$5.95. Free literature. Fleisher Enterprises, 343 South, Garwood, N. J.

**PICTURE** Post cards, made from your photograph. 1000, \$11.00. Raum's, 4154 Fifth Street, Philadelphia 40.

**BOOK** Catalogue, 1000 bargains. Send 10c. Books Publishers, Amityville 3, N. Y.

**BOOKS**, Out-of-print. Any subject. Bay Books, Box 2423, San Francisco 26, California.

**SELF-Help** publications by famed physician-psychologist-author C. Franklin Leavitt. Revealing way of mastering fears, self, problems, life. Free literature. The Leavitt Science, Clinton 5, Illinois.

**FREE** Information. Falk's sensational handbook gives instant solutions to 100,000 practical problems. Columbia Graphs, Columbia, Conn.

**SPARETIME** Profits taking subscriptions all magazines. Wholesale catalog free. Cassell Publishers, Westfield, New Jersey.

**BOOKHUNTERS!** All subjects. Send wants! Jaher Book Service, 620-P East 178 Street, New York 57.

"**SCIENCE** Milestones." Records march of science starting 400 years before Christ, right up to date. Amazing facts revealed. 312 pages packed with startling information that will thrill you. A real history of science. \$5.00. Literature free. Popular Mechanics Press, 200-8M East Ontario St., Chicago 11, Ill.

**NATIONAL Geographic** Magazines, 1888-1952. Periodical Service, Box 463-PM, Wilmington, Delaware.

**BOOKS** Found! Any author, old or new. Rush titles wanted; no obligation. International Bookfinders, Box 3003-PM, Beverly Hills, California.

**BOOKHUNTERS!** All subjects. Send wants! College Book Service, 52 W. Kingsbridge Rd., New York 68, N. Y.

**REMODEL** Your own home. Save hundreds of dollars. New, amazing book shows you how. Written so you can understand it. Step by step instructions make it easy. Fully illustrated, 400 photographs, hundreds of diagrams, 160 pages. \$2.95. Literature free. Popular Mechanics Press, 200-8M East Ontario St., Chicago 11, Ill.

### MAGIC TRICKS, PUZZLES, JOKER NOVELTIES

**40 LAUGH**-Provoking anecdotes, \$1.00. Forrest Miller, 522 Raub, Easton, Penna.

**FREE** Details. Or send \$1.00. Magic surprise packages. Melone, 604 Montrose, Charlottesville, Virginia.

**THRILLING** 224 Page catalog, magician's tricks, sensational Houdini escapes, handcuffs, amusement goods together with "Mystery Review Book" prepaid. Send one dollar. Magician Heaney Co., Oshkosh, Wisconsin.

**LEARN** Ventriloquism. 3c stamp brings particulars. Smith, 801 Bigelow, Peoria 5, Ill.

**BE** A magician, earn money; excellent hobby. Get free \$1 trick when you order our large professional catalog for \$1.25. Holden's, 120 Boylston Street, Boston, Mass.

**\$3.00 VALUE** Professional routine of tricks—Instructive bulletins, secrets, offers, mailed frequently 25c. Southeast Magic Studio, Box 15-W, Eutawville, S. C.

**BE** A magician. Large professional magic catalog of latest tricks. 35c. Ireland, C-109 North Dearborn, Chicago 2.

**VENTRILLO**. Professional voice-throwing instrument and amazing catalog 25c. B-971, Philadelphia 5.

**FIFTY** Samples, tricks, jokes, novelties \$1.00! Manufacturers, 1746-PM Market, Philadelphia.

**DOLLAR** Magic set free with catalog 25c. 4462-PM Germantown, Philadelphia.

**3100 NOVELTIES**, Tricks, jokes, gadgets, funmakers, hobbies. Catalog 10c. Johnson-Smith, D853, Detroit 7.

**PROFESSIONAL** Catalog, 175 pages, 25c. Williams, 900 Plymouth, Ellwood City, Penna.

**SENSATIONAL** Magician's wand 25c. (Vanishes handkerchief!) Catalog included. Box 1352-PM, Philadelphia 5.

**WOODEN** Nickel, catalog, trick, 10c. Fun'n Magic, 423-P North St. Marys, San Antonio 5, Texas.

**500 TRICKS**, Douglas famous 120-page catalog, only 10c. Fastest service to magicians for 30 years. Send 10c today. Douglas Magicians, Dept. 1, Dallas, Texas.

**2500 TRICK** Catalogue (512-pages), pocket, parlor, stage. World's finest magic. Catalogue \$2.00 (dollar trick included free). Kanter's, M-1311 Walnut, Philadelphia 7.

**BEST** Magic, Joker's novelties. Lower prices. Catalog 10c. Top Hat, Evanston 12, Ill.

### COINS, TOKENS, CURRENCY

**OLD** Money wanted. Will pay \$100.00 for 1894 dime, S. mint, \$50.00 for 1913 Liberty head nickel (not buffalo). Big premiums paid for all rare coins. Send 4c for large coin folder. May mean much profit to you. Numismatic Co., Dept. 20, Fort Worth, Texas.

**FIFTY** Indian cents \$2.00, twenty different dates \$1.00. Sayers, 1000 East Unaka, Johnson City, Tennessee.

**40 DIFFERENT** Selected coins \$1.00. Oddehon, Box 482, St. Louis, Mo.

**FOREIGN** Coins, 25 different \$1.00. Webb, 2200 Quintara, San Francisco 16, Calif.

**NEW** Sets. Irish animal (8) \$3.00; Vatican holy year (4) \$1.45; Tahiti (4) \$1.00; Siam porcelain (4) \$1.45. 64 page bargain catalogue 35c. Beber's, 4514 North 30th, Omaha 11, Nebraska.

**MORGAN** Dollars; 1878, 1887, 1890, 1891, 1897 S mint unc. \$2.00 ea. Illustrated catalogue, 25c. Shultz, Salt Lake 10, Utah.

**50,000 COINS**, Medals, bills. Lists free. Collectors magazine 10c. Nagy, 8-F South 18th, Philadelphia 3, Penna.

**FIVE** Page bargain list, Indianhead cent 10c. Economy Sales, 156-A Dean, Mansfield, Mass.

**36 DIFFERENT** Foreign coins \$1.10. Valley Coinco, Box 66, McAllen, Texas.

**COINS** On approval. Catalogue 3c. Chelsea, 26 W. 18th St., New York City 11.

**ANCIENT** Chinese coins, now rare and precious, make good collectors' items and lucky pocket pieces, \$1, six assorted \$5. Box 199, GCS, New York City.

**WANTED** Old and recent coins, Canadian, Newfoundland and United States. Good premiums. Send 25c for 3 latest buying lists. William Marley, 98 Barton Ave., Toronto, Canada.

**GIANT** Price list of coins, catalogues, albums, supplies, 10c. Canada Coin Co., Box 35, Toronto A, Canada.

**WRITE** For prices of complete 1954-5 coinage. Oliver James, P.O. Box 299, San Francisco, California.

**SAVE!** Bargains—Coins, stamps. Hubers, 210 South Sixth Street, Minneapolis.

**APPRAISALS**, Certified by expert. Minimum \$1.00. Special collection fees arranged. Numismatic Appraisal Service, Box 456-P, Encino, California.

**GET** Profit and pleasure in collecting old coins. Send 10c for 56-page illustrated coin catalog. You'll be delighted with it. Send for it now. B. Max Mehl, 370 Mehl Building, Fort Worth, Texas. Largest rare coin establishment in U. S. Established 55 years.

**COIN** Collector's Magazine. Over 1000 pages per year. Sample copy 30c; \$3.00 per year. Hewitt, 7320-J Milwaukee, Chicago 31.

**20 FOREIGN** Bills 25c. Lists included. Dwight Musser, Dunbar, West Virginia.

**FREE!** Foreign coin, banknote and coin collectors illustrated catalog to approval service applicants. Send 3c postage. Tatham Coinco, Springfield 30, Mass.

**INDIAN** Cent with bargain lists 10c. Hutchinson, 3463 "I" Street, Philadelphia 34, Penna.

**CONFEDERATE** And Southern bank notes, 3 different, \$2.00. 50 mixed Indian pennies, \$2.00. Ben's Coin Shop, 31 N. Clark, Chicago 2.

**WORLD'S** Greatest magazine for coin collector's and wooden nickel 10c. Lawrence Brothers, Anamosa, Iowa.

### STAMP COLLECTING

**PICTORIAL** Angola, Mozambique, Hungary, a beautiful assortment of stamps, 3 sets depicting wildlife in color, plus 100 attractive stamps. 10c to approval applicants. Modern Stamp Co., Dept. A-1, Ferrysburg, Mich.

**FREE** Belgium collection 50 different pictorials and commemoratives. Send 10c for postage and handling. With approvals. P. Harrison, 181 Clarkson Ave., Brooklyn 26, New York.

**FREE** Mint British Colonies from Brunel, Papua, New Guinea, Caymans, Gilbert Ellice, Seychelles, Sarawak, Dominica. Free with approvals. Viking, 11-Z Northern Blvd., Great Neck, N. Y.

**OLD** Stamps wanted. I will pay \$100.00 each for 1924 1c green Franklin stamps, rotary perforated eleven (up to \$1000.00 each unused). Send 10c for large illustrated folders showing amazing prices paid for old stamps and coins. Baker-Stamps, (PM-53), Elyria, Ohio.

**101 DIFFERENT** Worldwide; triangles, commemoratives, pictorials, 10c. Free \$5.00 U.S. stamp. Approvals. V-Ann, G.P.O. 671M, Brooklyn 1, New York.

**50,000 STAMP** Grabbags 25c each. Anderson, Box 1, Reading, Penna.



**FREE!** 50 Different British Colonies, no Great Britain, with Gold Star approval selection. Cyrus, P.O. Box 8423, South Charleston, West Virginia.

**DEALERS**—Wholesale list. Postage 3c. Frank, 5031 Queensberry, Baltimore 15, Maryland.

**WHY Pay more?** Pick stamps from our large collections. 2c each. Just as purchased. Be first. Premiums given. U.S. also available. Roseland Stamp Co., Dept. A-35, Spring Lake, Mich.

**FABULOUS Collection**—Large U.S. commemoratives. Only 10c. Approvals. Raymax, 39-Z Maiden Lane, New York City 38.

**PAYING High prices for approvals?** Try ours at 1c and 2c in books of 1000. Special offers and U.S. available. Clark Stamp Co., Dept. A-45, Muskegon Heights, Mich.

**SEND \$1 Bill for 175 Swedish stamps.** Nylin, Box 372, Livermore, California.

**FIRST U.N. set.** Among world's prettiest. Only 10c. Approvals. Welles, Box 1246-R, New York City 8.

**S. Africa**—Wild animals \$2, compl. \$6, airmailed. Exchanged if not delighted. Walker, 10 Springbok Flats, Bloemfontein, South Africa.

**25 DIFFERENT Luxembourg 10 cents.** Approvals. Waha Company, 178 No. 17th Street, East Orange, N. J.

**PENNY Approvals that satisfy.** Robert Moed, 245 Kosciuszko St., Brooklyn 21, N. Y.

**100 JAPAN 10c.** All different, with approvals. Gould's Stamps, Box 631, San Francisco 1, California.

**135 DIFFERENT U.S. commemoratives \$1.** Request approvals. Harold Holub, 18 East 198th Street, New York 68, N. Y.

**FIRST Complete German airport set.** 10 cents. Approvals. Boger, 3401 Oakmont, Philadelphia 36, Penna.

**FREE Complete set of famous Americans, flags, parks and presidentials to approval buyers.** Send 5c for 15 of the above stamps plus full particulars. Triboro Stamp Company, 145 Nassau Street, Dept. 103, New York 38, N. Y.

**SUPERIOR Worldwide mission mixture.** Amazing variety! Bulging sample \$1.00. Baye Nielsen, 1834B Bayle, Montreal 25, Canada.

**100 CANADIAN AND Newfoundland stamps** including early issues, commemoratives, large size pictorials. Free for 5c postage. Empire Stamp Company, Dept. PMM, Toronto, Canada.

**BARGAINS Galore.** Low priced approvals. Schur, Box 117, Williamsville 21, N. Y.

**1953 U.S. Commemoratives (13) 10c.** Approvals. S. Penniston, Norborne, Mo.

**300 DIFFERENT British Colonies \$1.00.** John Lyons, Box 17, Inwood Station, New York 34, N. Y.

**MOZAMBIQUE Animals!** 5c, world approvals. Pegram, Box 785, Huntington Park, Calif.

**114 PAGE U.S. illustrated price list 25c,** deductible from first order. DeLisle, 69 Plaza Shopping Center, Fresno, Calif.

**FREE! Prized set of 4 United Nations stamps, sample stamp newspaper.** Send 10c to cover handling costs. Approvals. Littleton Stamp Co., Littleton 01, N. H.

**FREE New Zealand health camp set.** Approvals. Greentree Stamp, Allendale, New Jersey.

**FREE! Fascinating, valuable special lists, collector's supplies, U.S. and foreign stamps, mixtures, packets, sets, singles, coins and paper money.** Approvals. Littleton Stamp Co., Littleton 01, N. H.

**500 FINE Mixed U.S. stamps 15c.** Wright, 201 Mealey, Hagerstown, Maryland.

**SWITZERLAND Prize package.** 50 different. Trains, bridges, castles, commemoratives, bi-colors, pictorials. Unusual cancellations too! Only 10c with approvals. Molzan, 720 Pomona, El Cerrito 8, California.

**EISENHOWER, Syngman Rhee Korean stamp, plus worldwide packet, free to approval buyers.** Conquistador, 2627D Troy Road, Schenectady 9, N. Y.

**FREE Stamp collection.** 100 different all world to new applicants for our super value approvals. Send 3c postage. Palmland Stamp Co., 1624 N.E. 12th Ter., Ft. Lauderdale, Florida.

**INTERESTING "Pentagon Canceled" 3c stamp.** Latest philatelic oddity, 50c. Description free. Tasker, 105 East Custis, Alexandria, Virginia.

**FREE Triangles with helicopters, flowers, birds, ugly bug, 26 others for 3c postage.** Approvals. Deival, Alloway, N. J.

**FREE—World's only double triangle.** Singapore, 1mi, 27 others. Postage 3c. Approvals. Decker, 35 St. James, Buffalo 25, N. Y.

**U.S., Canada price list over 100 pages,** hundreds of illustrations, stamp identification 15c. Thom, 4808 15th Ave., Minneapolis 17, Minn.

**FREE! Nicaragua sports stamps, Cape triangle, Monaco Roosevelt triangle, Nauru ship, Timor Saint stamp, premium coupon, to new approval applicants.** Moulmow, 304N Lynn, East Northport, New York.

**AIRMAILS 25 Different South and Central American 25c.** Hugh Watchorn, Box 310, Middlebury, Vermont.

**1000 DIFFERENT 95c.** John Hourigan, 1500 Archer Road, New York 62, New York.

**21 AMERICAN Republics—5c with approvals.** Howard Stamps, Box 164, Crawfordsville, Indiana.

**CIPEX Souvenir sheet plus 25 different U.S., 10c.** Approvals accompany. Village Stamps, 90-39P 214 St., Queens Village 28, N. Y.

**FREE Stamps your choice for year.** Monthly membership \$1.00 yearly. Superiorex, Grafton, Ohio.

**TRIPLE Value! Worldwide grab bags 10c.** Monjar, Fairmount, Cincinnati 14, Ohio.

**MOZAMBIQUE Company set free.** Approvals. Weits, Box 83F, Orange, N. J.

**ITALY—5 Complete sets.** High value only 5c with approvals. DeRespinis, G.P.O. Box 711W, New York City 1.

**FREE United States illustrated catalog.** Bailey, 44 Bromfield, Boston, Mass.

**GIANT Stamps! Valuable collection of the biggest stamps on earth!** Includes mammoth diamond-shaped airmail; huge triangle; gigantic animal and ship stamps; many others. Extra: Set of 5 midget stamps plus genuine wooden nickel. All for only 10c covering mailing expenses. Approvals included. Mystic Stamp Company, Camden 9, New York.

**TEN Queen Elizabeths, 25 others, \$1.60 value, approvals, 10c.** Bluebonnet, Box 3084, Waco, Texas.

**50 DIFFERENT Australia, 3c.** Approvals. Boulder, Box 578-M, La Mesa, California.

**OVER 200 Different better stamps.** Beautiful triangle set, pictorials, etc. Greene, 4301 46 St., Long Island City 4, N. Y.

**WORLD-Wide used assortment.** Amazing stamp collection. Catalog value \$7.50, only \$1.00. Henry Trenka, 48 Cedar Lake West, Denville, N. J.

**FREE 105 British Colonials, pictorials.** Mauritius, Tanganyika, Pakistan, Nigeria, Rhodesia, Singapore. Fascinating story approvals. Send 10c handling, please. Canada Stamp Co., 19218 Main St., Niagara Falls, N. Y.

**325 DIFFERENT Worldwide collection;** includes everything; airmails; complete sets; triangles; bi-colors; birds; flowers; animals. Everything (catalogs over \$6.00) 25c to approval applicants. Century Stamps, Box 7-PM, Cathedral Station, New York City 25.

**NORTH Borneo, Nise, Cook, Turks and Paikland Islands, 50 exciting British Colonies, 5c with approvals.** Fortune Stamps, Washington 11, D. C.

**202 DIFFERENT, including Elizabeth coronations, only 10c.** Popular pictorial approvals accompany. Firland Stamp Co., Box 403, Seattle 11, Washington.

**AUSTRALIA: 47 All different, only 10c.** Anderson, 68C, Seaside Heights, N. J.

**65 DIFFERENT U.S. and Canada only 6c with bargain lists.** Hudson's, Box 4015, Fresno, Calif.

**1000 DIFFERENT Worldwide stamps \$1.00.** Universal, P.O. Box 6, Kenosha, Wisconsin.

**GIANT Stamp zoo free!** Fifteen different including rhinoceros, elephant, snake, tiger, zebu, kangaroo, koalabear, emu, koozaburra, bull, horse, with approvals. Send 10c for postage and handling. Niagara Stamp Co., St. Catharines 51, Ontario.

**OLD U.S. approvals. Low prices.** MacG., 3835 Ault Park Ave., Cincinnati 8, Ohio.

**ASTONISHING Gift, 40 U.S. with superior approvals.** Send 5c for postage. Sparta, Box 1082, Rochester 3, N. Y.

**EIGHT Triangles plus 100 different stamps, 10c.** Approval applicants. Bennett, Candor 1, N. Y.

**MONACO Nudes—10c with approvals.** Royal Stamp Company, Tamaqua, Penna.

**FREE Animals, birds, triangles, flowers, ships, locomotives, kings, dictators, multi-colored, historical, geographical, musical, battles, giants, midgets and over 100 others.** Fascinating story approvals. Send 10c handling, please. Canada Stamp Co., 19318 Main St., Niagara Falls, N. Y.

**SUPER-Bargain lot! 25 triangles, plus 100 U.S., plus 350 foreign, plus 10 complete sets.** Every stamp different, \$1. Approvals. Farmer, 4913 Rosewood, Los Angeles 4, Calif.

**513 DIFFERENT Worldwide 25c.** Jumbo approvals. Streff, 1419 American St., Philadelphia 22, Penna.

**U.S. Illustrated price list free.** Lush, 6422A Ellsworth, Detroit 28, Mich.

**ZEPPELIN Set free, with approvals.** Variety Stamps, 57-P Circuit, Newton Highlands 61, Mass.

**CIVIL War revenues, 10 different 25c.** Approvals. Anzac's, 53 Bromfield, Boston 8, Mass.

**MINT U.S. approvals.** Russell Patrick, 5550 East 42nd, Indianapolis 26, Indiana.

**BRITISH Colonies, 100 different only 50c.** Thompson, 906-22 Ave. N.E., Minneapolis, Minn.

**BEAUTIFUL Bi-colored and African sets, 10c.** Great Lakes Stamp Mart, R-2, Muskegon, Michigan.

**OLD United States—25 different before 1933, 10c, approvals.** Ladue Stamp Co., 9815 Clayton, St. Louis 17, Mo.

**300 DIFF. World wide 25c, plus surprise packet.** Packet list free. Econopackets, Box 168, Riverside 9, Calif.

**200 DIFFERENT Germany and Hungary; 10c.** Beginner approval applicants. Discounts! Char-Min, 7 Crombie, Burlington 1, Vt.

**BARGAIN Hunters attention! Free stamp magazine, 1000 interesting stamps for your approval inspection.** Completely catalogued, substantially reduced. Free tongs and hinges with purchase. Niagara Stamp Co., St. Catharines 31, Ontario.

**BUCK Buster bargain approvals for stamp sorters and savers.** Wm. Kuehl, 3125 East K. Tacoma 4, Wash.

**ROMAN States set free.** Approvals. WBM, P.O. Box 758, Wilkes-Barre, Penna.

**SAVE \$1.50.** Five complete sets, retailing \$1.75 just 25c with exciting approvals. Satisfaction guaranteed. 50c gift. Write today. Kingsway Stamps, 2638H Kingshighway, Brooklyn, N. Y.

**UNITED States, superb mint complete sets of famous Americans, authors 60c, poets 90c, educators 75c, scientists 50c, composers 90c, artists 60c, inventors \$1.95.** Fine mint U.S. approvals accompany, references required. Merritt Brundige, Cambridge, New York.

**GIVEN! Octagonal stamp; giant triangle; diamond; mammoth and midget stamps, to foreign approval buyers.** Gifts with purchases including \$7.00 album. Plymouth, Dept. A-9, Bell, California.

**TERRIFIC, Five continents, bicolors, triangles, flowers, animals, commemoratives, 10c approvals.** Richardson Stamp Co., Niagara-on-the-Lake 1, Canada.

**FINE Approvals, Past, personal service.** What countries do you prefer? I'll send their stamps. Skinner, 438 Locust, Long Beach 12, California.

**FREE U.S. 72 page catalogue.** Contains almost 1000 illustrations; over 10,000 delightful bargains, plus "How to Collect." Stone's, 192 Washington, Boston 8, Mass.

**UNMATCHED Offer: 100 different world stamps—20c; 500, 75c; 1000, \$1.50, 25 nudes, \$1.00; 50 birds, \$1.00; 100 pictorials, 75c; 25 triangles, \$1.00; 100 ships, \$1.00; limited supply.** Thompson, 906-22 Ave. N.E., Minneapolis, Minn.

**ALBUM! Capacity over 1000 stamps!** Only 10c! Stampmart, Hartford 1, Conn.

**LOOKING For better U.S. approvals?** Write. New-Way Stamp, Lawrence, Mass.

**CORONATIONS, 10 Different only 10c with approvals.** Seminole Stamps, Box 1138-P, Coral Gables 34, Florida.

**25 U.S. Commemoratives 13c.** Segal, 984 Bronx Park South, New York City 60.

**SENSATIONAL! Over 100 different worldwide.** Catalog to 25c each. Everything 10c with approvals. Beeman, Box 181, Ingram, Texas.

**50 DIFF. Finland, 10c with approvals.** Carroll's, W310-A Sprague, Spokane, Wash.



U.S. Mint specials! Flag set, \$1.00; Tixex-Cixex souvenir sheets, 60c. Free price list. Brooks, 2352A East 23rd Street, Brooklyn 29, New York.

**TURKEY**—50 Different (worth 50c). Only 10c with approvals! Saxon, Vista, California.

**FREE U.S. stamps, 1943 occupied nations flag, airmails, commemoratives, included in collection of 25 different U.S. plus \$5.00 stamp. Everything for 10c mailing charge. Approvals. Willett Company, Box 511-T, Port Chester, N. Y.**

**AMAZING Savings:** Picture stamps by the thousands. Choose choice ones for pennies. Approvals postpaid both ways. Costs nothing to try us. The Elders, El Venado Dr., Puente, Calif.

**14,000 DIFFERENT**—Yours on our streamlined systematic club plan for only 50c weekly. Big shipment every two weeks. Details free. Sjoquist, Box 217, Valley Stream 75, New York.

**WORLD'S Largest stamp (7½ x 14 inches).** A real curiosity! Retail for 50c, only 3c to approval applicants. Tatham Stamp Co., Springfield 30, Mass.

**WEIRD Diamond shape coffee stamp!** Lovely flower triangle! First American big commemorative. Greenland, idol dancer, etc. Free with approvals. Capital Stamp Co., Little Rock 2, Ark.

**UNITED States—58 different including 8 airmails, 15 commemoratives, 10c. Approvals. Sunset, Box 47, South Gate, Calif.**

**126 DIFFERENT. Includes triangle, diamond, airmails, old United States, British Colonies, animals, others; 10c with approvals. Cactus Stamps, Desert Springs 2, Calif.**

**U.S. 40 different 10c. 40 different commemoratives 25c. Both 30c. Seidenberg, Appleton, Wis.**

**100 OLD United States between 1861 and 1935, \$1.00. Roush Stamps, 51 Chestnut, Mansfield, Ohio.**

**1500 MIXED Foreign stamps \$1.00. No approvals. Aaron, 789 Valencia, San Francisco 10, Calif.**

**FREE! Big United States catalog. Valuable guide and check list. Hundreds of illustrations. Approvals. Harrisco, 1010 Transit Building, Boston 17, Mass.**

**100 PICTORIALS, Giant and triangle stamps, 15c with approvals. Bilislands, Box 1101P, Spokane 10, Wash.**

**12,000 PENNY Approvals waiting for you. Many from exotic countries, pictorials, airmails, new issues. Tilbury, Box 862, Newark 1, New Jersey.**

**125 UNITED States different commemoratives, etc., 25c. C. P. Steger, Steger, Ill.**

**U.S. commemoratives, 33 different 10c. Approvals. White, 516A Avenue L, Brooklyn 30, N. Y.**

**TRIANGLES, Bi-colors and large pictorials. Worldwide, on approval! Cole, 43-A Rinewalt, Buffalo 21, N. Y.**

**EXCITING New book, "How to Collect Stamps, Coins, Paper Money." Packed with amazing facts; information worth dollars. Fully illustrated, 160 pages. 75c. Popular Mechanics Press, 200-ST E. Ontario St., Chicago 10, Ill.**

**DIFFERENT, 500, 10c; 1000, \$1.25; 2000, \$2.75; 5000, \$11.00. Approvals. K. S. Holmes, London, Canada.**

**WONDERFUL Offer. 7 complete mint sets only 10c with approvals. Reich (M26), 1033 Lawrence, Chicago 40.**

**UNITED Nations cover free to applicants of U.S. or British Colonial approvals. A. Taylor, Skyland, N. C.**

**FREE U.S. illustrated bargain catalogue. Rothberg's, 53 Bromfield, Boston 8, Mass.**

**TWO \$5.00 U. S. stamps plus 20 different, 10c with U. S. approvals. Irwin Stamp Co., Box 1105, Brooklyn 30, N. Y.**

**ECONOMICAL ½c-1c-2c-Approvals, 22,000 varieties available. Dresel, Box 370-n, New York 25, N. Y.**

**50 DIFFERENT Bulgaria 10c! Approvals. Ensign Stamp Company, Dept. M, Berdan Avenue, Paterson 2, New Jersey.**

**NUDES Set: Colorful approvals 10c. Atlas, 2830-M, Eisenhower, Racine, Wis.**

**225 STAMPS For only 10c! This mammoth value includes airmails, pictorials; stamps from strange countries cataloguing up to 25c each! Also approvals. Mystic Stamp Company, Camden 80, New York.**

**WOW! 153 All different Germany, 10c. Zeppelins, semi-postals, airmails, high values, big bargain lists and approvals included. Jamestown Stamp, Jamestown 512, New York.**

**50 DIFF. U. S. commemoratives 25c. Mammoth packet list free. Econopackets, Box 168, Riverside 9, Calif.**

**STAMPS Wanted. Mine and used, collections, accumulations. Good grades only. Buy outright if bargain. What have you? Write, give details. Vanroy Shirk, Lebanon, Penna.**

**300 DIFFERENT. Triangle, airmail, pictorials, etc. 25c. 500 mixed U. S. 25c. Carlton's, Tujunga, Calif.**

**200 DIFFERENT, including Roosevelt triangle, 10c to approval applicants. M. Avalon Stamp Company, Springfield, Mass.**

**50 DIFFERENT Argentine 10c. Approvals. Reuter, 611 W. 40th Pl., Los Angeles 37.**

**AMAZING Offer! 200 United States stamps—including commemoratives, airmails, high denominations to \$1.00. Only 10c to approval applicants! Illustrated bargain lists free. Mystic Stamp Co., Dept. 80, Camden, New York.**

**100 DIFFERENT Spain 25c. Penny approvals included. Reed, Box 980, Chicago 90, Ill.**

**OLD Scarce U.S. seconds on approvals. Slight imperfections, lowest prices. Herfield, Clintonhill Sta., Newark 8, N. J.**

**SPEND Pennies! Not dollars! Thousands of fascinating stamps to choose from our 1c and 2c approvals. No premiums. Just honest value. Pat F. Knowles, Box 2247, Van Nuys, Calif.**

**50 DIFFERENT United States 5c with bargain approvals, lists. Bookman, Manatee 1, Florida.**

**200 DIFFERENT! Plus Macau, Rhodesia, Mauritius, etc. Only 10c to approval applicants. Erden, Box 128, Valley Stream 50, New York.**

**GIANT Approvals, thousands different, one cent each. Wahl's Stamp Exchange, 7008P Farragut, Chicago 31, Ill.**

**FREE Sample! Interesting, illustrated, informative! National Stamp News, Anderson, South Carolina.**

**ESTONIA Carrier pigeon set free. Approvals. Canyon Stamps, Box 808, San Fernando, California.**

**FREE—British, Spanish, French Colonial collection. Approvals. Pleasure Stamps, 1665P—52nd, Brooklyn 4, New York.**

**FREE French West Africa pictorials, approvals. Eagle, 6916 Roosevelt Boulevard, Philadelphia 49, Penna.**

#### **ANTIQUES, RELICS, INDIAN GOODS, CURIOS**

**4 FINE Arrowheads \$1.00. Flint thunderblu \$2.00. List free. Lear's, Glenwood, Arkansas.**

**UNITED States silver dollars \$1.75 each postpaid. Fred Birch, Box 634, Deer Lodge, Montana.**

**4 SELECTED Arrowheads \$1.00. List 5c. H. Talburt, Calico Rock, Ark.**

#### **PRECIOUS STONES, MINERALS**

**28 ORE Specimens, including 2 uranium, mounted on heavy display card all named, \$1.75 to \$2.50 postpaid in U.S.A. Postcard will bring description. Mineral Specimen Supply, 226 Walsen, Walsenburg, Colorado.**

**SPECIMEN Native copper from Michigan copper country, 25c postpaid. Goodman's, Houghton, Michigan.**

**EARTH Science, the Rockhounds' National magazine. Subscription \$2.00, sample 25c. Box 1357, Chicago 90.**

**GEMCUTTING, Silvercraft authority. Illustrated magazine tells how. Cut rocks, make jewelry. 150 ads illustrating equipment, offering gems for collectors, cutters. Postal brings literature. Lapidary Journal, Del Mar 2, Calif.**

**GENUINE Quartz crystal stars, 60 sparkling facets. Drilled for earrings, pendants. ¾" \$12.00 doz., sample \$1.75. Wholesale jewelry catalog 30c. Diagem Jewels, Hampton Bays 11, New York.**

**MINERAL Specimens, mineralight, books, Geiger counters. Write, Minerals, Winston, New Mexico.**

**TEN Beautiful highly polished genuine gems. Only \$1.00. Baroque shapes. O'Brien's, 1116-M Wilcox, Hollywood 38, Calif.**

**GEMSTONES, Mineral specimens. Every variety. Lowest prices. Free booklet. Plummer's, 4720 Point Loma Ave., San Diego 7, Calif.**

**SAPPHIRE, Topaz, tourmaline, garnet, peridot, 5 uncut gem specimens, \$1.00. O'Brien's, 1116M Wilcox, Hollywood 38, Calif.**

#### **HOBBIES AND COLLECTIONS**

**NEW 15 Different match covers 15c. Eugene Bevins, Abingdon, Md.**

**NAZI Wehrmacht, Panzer, Luftwaffe medals sources! Kingston, 3224-22, Seattle 99, Washington.**

**100 DIFFERENT Military patches. Colorful, authentic. Free album, \$5.00. Wolf Appleton, Inc., 566-D Broadway, New York City 12.**

**UNUSUAL Hobby; authentic army patches, insignias, ribbons, enameled crests, 50 assorted for \$1.00. Rex Military, 1188 Broadway, New York City.**

**RECORDISTS! Exchange talking and musical tapes internationally! Box 1404-AH, San Francisco 1.**

**COLLECTING Chinese art made easy. Our 48-page illustrated guide book reveals amazing opportunity. Only \$1.00. Box 199, GCS, New York City.**

**NEW, 15 Different match covers 10c. Box 202, Rochester 1, N. Y.**

**EXOTIC Birds, 1½", realistically carved, beautifully colored. \$1, six assorted \$5. Box 199, GCS, New York City.**

**RECORDING Fans! Swap tapes everywhere! Details free. Box 1404-AH, San Francisco 1.**

**FREE! Leathercraft catalog. Do it yourself! Tandy Leather, Box 397AH, Tulsa, Okla.**

**NAZI Medals, ribbons, souvenirs. Big packet \$1.00. Illustrated lists. Medcrafts, 1923 34th St. S.W., Calgary, Canada.**

**UNUSED Matchbook covers. 100 different \$1.00. 36 page catalog 25c. Match-cover album \$3.00. Charles Edelman, 1311C East 84, Cleveland 3, Ohio.**

**INVENTING Can be an interesting and profitable hobby. Write for complete particulars. Institute of American Inventors, Dept. 40-E 631-E St., N.W. Washington 4, D. C.**

#### **CAMERAS, PHOTO SUPPLIES**

**KINE Exakta VX, f2.8 CZT preset, immaculate, \$209.90. Contax IIIa, f1.5 etd, case, \$261.00, spotless. Free catalogue. 1001 bargains. Dealer's Mart, 54 Beverly Rd., New Rochelle, N. Y.**

**BUY Wholesale nationally advertised cameras, photo supplies, thousands other products at big discount. Free "Wholesale Plan." American Buyers, 629-PP Linden, Buffalo 16, N. Y.**

**ARGUS C-3, case, flash, spotless, \$48.98. Argus C-4, case, flash, never used, \$73.81. Free catalogue. 1001 bargains. Dealer's Mart, 54 Beverly Rd., New Rochelle, N. Y.**

**GE Flashbulbs. Save ½ in case lots. 120 #5, \$10.40; 120 #M2, \$8.00; 120 #11, \$13.60, prepaid. Calvert Studio, Box 53, Westview Station, Binghamton, N. Y.**

**BUY Wholesale photo equipment, appliances. Discounts to 45%. New Bolex B-2 threesome \$47.95. Royal quiet deluxe typewriter \$84.95. Free catalog. Camera Shoppe, Box 601-Y2, Mt. Vernon, New York.**

**CAMERA Repairmen greatly needed! You can learn manufacturers' service methods at home, in your spare time! Free, big illustrated book tells how. Write today. National Camera Repair School, Dept. PM3, Englewood, Colorado.**

**PHOTOGRAPHY For pleasure or profit. Learn at home. Practical basic training. Long established school. Free booklet. American School of Photography, 835 Diversey Parkway, Dept. 3431, Chicago 14.**

**BARGAIN Prices on new and used photo supplies. Send 10c for latest catalog. Fotoshop, 132A West 32nd St., New York City 1.**

**20 TO 50% Discount everything photographic, giftware. Free catalogue. Dart, 3812 E. Atlantic Avenue, Brooklyn 24, New York.**

**BASS Says: Quality cameras since 1910. When in Chicago visit the camera cross roads of the world, or write us for your favorite equipment, new or used. Satisfaction guaranteed. Bass Camera Co., Dept. AG, 179 W. Madison St., Chicago 2, Ill.**



## PHOTO FINISHING

**WALLET Photos**, double weight silk finish, for gifts, applications, made from any picture of you, your baby, wedding, etc., 20 for \$1. Money back guarantee. Send picture (returned unharmed) and \$1. Delco, Box 362M, Upper Darby, Penna.

**TWO Beautiful prints** from each picture on roll. 8 exposure 35c, 12 exposure 45c. Thirty-three years of satisfied customers. Quick service. Lens Photos, Dept. J-4, Janesville, Wis.

**BEAUTIFUL Enlargement** from each picture on roll. 8 exposure 35c; 12 exposure 45c. Cut Rate Photos, Dept. B-4, Janesville, Wis.

**FREE Roll of film plus money back** if not delighted with Delco's oversize prints in albums. Special! 8 or 12 exposure roll 39c with this ad. Delco Film Lab., Box 362M, Upper Darby, Penna.

**24 JUMBOS** From 12 exposure rolls developed 35c. With this ad only. S. Skrudland, Lake Geneva, Wis.

**PHOTOS**, Cent each, of yourself, children, pets. Samples 10c. Rapco, 113 Oregon, Fall River, Mass.

**PHOTOS Copied**, 20 wallet-size deluxe prints \$1.00. Original picture returned. Send any size photo or negative. Federal Wallet-Size Photo Co., Dept. PM-5, P.O. Box 2448, Kansas City 6, Mo. (No c.o.d.'s please.)

**JUMBO Prints**, 8-exposure roll 30c; 12 exposure, 45c; 16 exposure 55c. Reprints, oversize 4c. Guaranteed quality. Mail Order Photo Service, Box 297, Watertown, Wisconsin.

**CANADIANS:** Photos copied, 16 wallet-size prints \$1.00. Original picture returned. Send any size picture or negative. Order from Canadian firm, save duty. Columbia Wallet-Size Photo Company, P.O. Box 248, New Westminster, B. C. (No c.o.d.'s please.)

**SPECIAL Introductory offer**, 8 jumbos 25c, 12-35c. Western Photo, PM25, Box 298, San Francisco 1, Calif.

**TRIAL Offer**—Good with ad only. One roll film developed, 8 exposures 25c, 12 exposures 35c. King sized, dated prints from roll only. Don't send negatives. Sir Walter Photo, Raleigh, N. C.

**ENLARGEMENTS!** Eight 5x7's or five 8x10's, \$1.00. Wilart Enlargers, Box 967, Little Rock, Ark.

**12 EXPOSURE Rolls** 39c. Jumbo prints. Guaranteed work, one day service. Lincoln Studios, Dept. K, Box 13, Lincoln, Nebraska.

**PARTICULAR?** Custom finishing guaranteed. 8 jumbos 35c, 12-50c. Special! 15mm, 36 exposures \$1.10. Free mailer. Flash-Photo, Box 36G, Brooklyn 4, N. Y.

**GUARANTEED Quality**. Fast service. Eight jumbos in beautiful super pak plastic ring binder albums only 35c. Send for free mailers and particulars of our complete photo finishing service. Grand Fotos, G.P.O. Box 1410, New York 1, N. Y.

**TOP Quality**. Fast service. 8 jumbos 35c in beautiful super pak album, 16 contacts 40c. Reprints—Jumbos 4c; contacts 3c. Satisfaction guaranteed. Write for free mailers and circulars. Fast-X-Photo, Box A, Jersey City, N. J.

**8 OR 8 Picture roll** 35c. 12 or 16 picture roll 55c. Each roll developed and printed in handy album pack. Send coin with roll. No c.o.d.'s. Mailing containers sent free. Deluxe Film Service, Box 1268-A, Shreveport, Louisiana.

## MOTION PICTURES AND SOUND EQUIPMENT

**8-16MM.** Silent-sound films. Latest subjects. Free catalogue. Sample film 10c. Garden Film, 1365 East New York Ave., Brooklyn 12, N. Y.

**8 AND 16MM.** professional national parks movies in Kodachrome. List free. Ideal Service Supply, 4644 W. Geary, San Francisco 18, Calif.

**WORLD'S Largest selection** of films. Free bulletins. Specify 8mm., 16mm., silent or sound. Dept. F3, Peerless Camera, 415 Lexington Ave., New York City 17.

**FREE!** Blackhawk's spring sale catalog new and used 16mm., 8mm. films, used 16mm. sound projectors, new 2"x3" color slides. Blackhawk Films, 1153 Eastin, Davenport, Iowa.

**SAVE Half** on good used sound movie projectors, films, cameras. Send \$1.00 for latest listings. Empire Services, Box 1235, Santa Rosa, California.

**SOUND Films** sale. 16 mm. features, comedies, serial, soundies. Free list. Lewis Film Service, 1425 E. Central, Wichita 2, Kansas.

**KODACHROME Professional 8mm.** movies. Widest selection. Free listings, outstanding projection sample: \$1.00. Classics, Box 36441-J, Hollywood 38, California.

**TAPE Recorders**, accessories. Best buys. Boynton Studio, 10 Pennsylvania, Tuckahoe, New York.

**16 MM.** Sound-used projectors and films. Rental, sale, exchange, bargain prices. Free lists. National Cinema, 71 Dey Street, New York City.

**TAPE Recorders**, tapes, accessories. Unusual values. Dressner, Box 66M, Peter Stuyvesant Station, New York City 9.

**5,000 8-16MM.** Silent-sound films. International, 2120 Strauss, Brooklyn 12.

**MOVIE Camera film:** 8mm. roll \$1.50, 16mm. 100' \$3.00. Free processing. Better Films, 742 New Lots, Brooklyn, N. Y.

**SAVE 50%!** Guaranteed-fresh color, b.&w. movie film! 8mm., 16mm. Free catalog! Eso-R, 47th Holly, Kansas City 12, Missouri.

**WILD Animal** and bird movies, 8 mm. or 16 mm. beautiful color or B&W. Also 2x2 color slides. Send for free catalog. Wild Life Films, 5151-A Strohman Ave., N. Hollywood, Calif.

## MUSIC AND MUSICAL INSTRUMENTS

**1955 ACCORDIONS**—Wholesale. Free catalog. American Accordion Center, PM-3, 5329 Belmont, Chicago.

**POEMS Urgently** needed to set to music! Write clever poems, catchy rhymes. Achieve fame, money in popular music field! Send sample poems. Free evaluation. TinPan Alley, 1650 Broadway, Dept. K, New York City 19.

**POEMS Wanted** for musical setting. Send poem for immediate examination and free rhyming dictionary. Richard Brothers, 24 Woods Building, Chicago.

**ACCORDIONS:** Buy direct from importer, save 50% and more. Five days free trial; lifetime guarantee. Trade-ins accepted. Big color catalog free. Write today. Accordion Manufacturers & Wholesalers Outlet, Dept. 35-M, 2003 West Chicago Ave., Chicago 22, Illinois.

**SONGWRITERS!** Send poems, songs. Music Service, 243 West 72nd St., PM, New York City 23.

**SONGWRITERS:** Large recording company may record your song. National sales and promotion if selected. No charge for melodies. Send song material to Music Makers, Dept. E-7, Box 2507, Hollywood, California.

**SWISS Musical movements**, \$1.90. Helax, 218 West 72nd Street, New York 23.

**SEND \$1.00** For set finest guitar strings. Free wholesale catalog of guitars, harmonicas, musical instruments, supplies. Musicians Service, Box 711, Wilkes-Barre, Penna.

**SONGS, Poems, offer.** Newark Publications, GPO Box 1226, Syracuse, New York.

**GUITAR Students**. Let this new copyrighted chart give sight to your fingers. Send \$1.00. E.K.P. Publishing Co., Box 68, Coral Gables, Fla.

**PHONOGRAPH Records** cheap. Catalogue. Paramount, M-313 East Market, Wilkes-Barre, Penna.

**FREE Records** of your song. Your words, my melody. Free information. Johnny Mack's Melody Mart, 1094 West 39th Street, Dept. A, Los Angeles 37.

**POEMS Needed** for new songs. Send poems for free examination, details. Immediate consideration. Songcrafters, 2724 Arcade Station, Nashville, Tenn.

**PLAY Piano** the first day! Copyrighted secret. Details free. Miracle Method, Box 520P, Phoenix, Arizona.

**POPULAR Songs**. How to write and sell them. Write for free booklet Successful Songwriting. Gateway Songs, Box 2470, Hollywood 28, Calif.

**WANTED!** Poems for musical settings. Write Songwriters' Service, Clifton, N. J.

**ACCORDIONS**, Wholesale to everyone. Save up to 60%. All national known brands. Free catalogue. Del Principe, 29 South Cicero, Chicago 44.

**SONGWRITERS!** Protect your ideas! Hold all songs, poems! Write for safe correct procedure first! Song Service, Dept. P, 333 W. 36th St., New York 19, N. Y.

**POEMS Wanted** for musical setting. Send poems. Free examination. Five Star Music Masters, 630 Beacon Bldg., Boston, Mass.

**WRITE SONGS**. Big money and reputation. Write for information. J. Gordon Pub. Co., 4700 South California Avenue, Chicago.

**POEMS Wanted** for musical setting. Send poems. Free examination. Crown Music Company, 1476 Broadway, New York City 36.

**SONGWRITERS**—Success, fame, fortune if talented. Songs revised, composed, published, promoted by largest firm. Free appraisal. Since 1943. Postcard to Nordyke Publishing Co., 7070 Hollywood Blvd., Hollywood 28, PM, Calif.

## RADIO, TELEVISION AND ELECTRONICS

**TUBELESS Voice transmitter?** Fifteen dollar tape recorder? Razor blade receiver? "Smelser Electronix Monthly" detailed construction, television repair. Subscription \$1.50 yearly. Free microphone. 140 Ellis Ave., Troy, Missouri.

**TELEVISION Repair book**, illustrated. Make your own adjustments and repairs. Postpaid only \$2.00. George Guy, P.O. Box 931, Rochester 3, N. Y.

**PICTURE Tubes**, brand new RCA licensed. Year guarantee. 12LP4, \$18.95; 16GP4, \$29.95; 17BP4, \$23.50; 21EP4, \$28.50. Write for complete list. Mail-O-Mart Co., Box 861, White Plains, N. Y.

**B.Sc. in E.E.** Major electronics degrees earned through extension division. American College of Engineering, Box 27724(B), Hollywood 27, Calif.

**FREE Radio tester**, soldering iron. Build and keep 15 high quality radios. Only \$19.95 complete. No experience required. Enclose 25c for valuable Radio-TV Repair Guide and kit catalog. Progressive Edu-Kits Inc., 497 Union Ave., Dept. PM27, Brooklyn 11, N. Y.

**TV Trouble?** Fix it yourself. Revolutionary new guide shows how. No experience necessary. Satisfaction guaranteed. Only \$1.00. Sentinel Electric Company, Box 2693-C, Kansas City 42, Missouri.

**CRYSTAL Set book**. 132 illustrations, charts, circuits. Over 18,000 words. Refund guarantee, \$1.00. Kott, 5024 St. Clair, Detroit 13, Michigan.

**REPAIR Your TV**. Prepared exclusively for you. Plus additional service. Make, model, \$2.00. Personal TV, Box 66A, Little Neck, N. Y.

**AMAZING Flat 100 degree rotation** indoor TV antenna. Makes excellent rotator for outside antenna \$5.00 p.p. Television and tools wholesale list 25 cents, 16 record hits \$3.00 postpaid. Ridgway Television, 4500 East 31st, Kansas City, Mo.

**WORLD'S Smallest**, most economical Geiger counter. Transistor circuit. Rush postal for amazing details. Trans-Mite Labs., Manteo, North Carolina.

**SURPRISE Kit** consisting five pounds new radio-TV parts. Amazing value only \$2.95 prepaid. Write for catalog of electronic parts. Capitol Commodities Co., 1229 W. Washington Blvd., Chicago 7, Ill. Dept. P.

**HIGH Powered T.V. antennas** for less than \$2.00. For plans, plus tips to improve reception, send \$1.00. T.V., Box 217, Longview, Wash.

**CONTROL Volume** or cut commercials on television from your easy chair. Remote control only \$2.00 postpaid. Radiolab, 32 Arnold Road, N. Attleboro, Mass.

**TUBES**—TV, radio, transmitting, special purpose types. Bought, sold, exchanged. Send details to B. N. Gensler W2LNI, 512 Broadway, New York 12, N. Y.

**REPAIR Your own TV**. Instructions compiled exclusively for your set. Simple as replacing light bulb. Send set name, chassis, model number, \$2.00. LS Engineering Company, Box 4113-PM-3, North Hollywood, Calif.

**MAKE Simple**, tubeless, batteryless, distance-getting radio. Genuine Melomite crystal, detector, illustrated instructions. 50c postpaid. Allen, 427-PM5, Clinton, Missouri.

**COLOR Television!** Enjoy 3 color screen now. Easily attached. Details free. Zingo Products, Johnstown 77, New York.



## BUSINESS OPPORTUNITIES

**700% PROFIT** Earned with a PDQ camera. No experience needed. Simple instructions teach you how to take photos of individuals, groups, etc. and finish them on the spot in two minutes. No darkroom. Get details. PDQ Camera Co., 1161 N. Cleveland Ave., Dept. PM, Chicago 10, Ill.

**CLEAN Up** with Autobroom. Newest trade stimulator. Sample and particulars \$1.00. Autobroom Company, Columbia City, Indiana.

**SOME Day** I'll start my own business. Stop dreaming. Challenge our profitable home operated import opportunity. Free keepsake, details. Frontier Imports, 2909 Pershing, El Paso, Texas.

**WHOLESALE!** Huge selection, famous brand products. Sensational discounts! Large catalog. Unusual business plans included. Consolidated Distributors, 21-11, Lafayette, Paterson 15, New Jersey.

**OPPORTUNITY** Mails three months 25c. Donovan, 791 Greenbelt, Levittown, N. Y.

**\$1000 MONTHLY** Possible in collection agency business. Free details. Write Cole Associates, Syracuse 2, N. Y.

**MINIATURE Trees.** Why pay \$2.00-\$10.00 for growing secrets? Free details. Tiny Trees, 5038 N. Winthrop, Chicago 40.

**\$80.00 WEEKLY.** Operate our selective mailorder business in your area, sparetime. Write House of Plastics, Paramus 2, N. J.

**MAKE Perfumes,** other products. Sell mailorder. Formula catalogue free. International, 6347 Parnell PM-3, Chicago 21, Illinois.

**"MAKING Money With Mushrooms."** Simplified book. \$2.00 cash. Money back guarantee. Mushroom Lab, 32 Kendrick St., Lawrence, Mass.

**\$200 WEEKLY Reported!** No selling. Free booklet. T. J. Surface, Roanoke 4, Virginia.

**FREE!** Private labels! Exclusive sales! Own a business! Sell radio PI, stores, mailorder. We supply product, plan, literature; you furnish executive management and employ salesmen. Vitamins, 2908PMA Beverly, Los Angeles 57.

**MINK Raising** is profitable. Complete information free. Voight Farms, Lomira 1, Wis. or Atlanta, Texas.

**BECOME A sewing machine mechanic.** Instructions are given on domestic and industrial sewing machines. Address Marek, 17 Lafayette Pl., Irvington, N. J.

**NEW Plastic mending tape.** Just press on! Repairs clothing instantly. Lightning seller. Samples sent on trial. Kristee 110, Akron, Ohio.

**GROW Orchids** at home—Profitable, fascinating. Year 'round, Maine to California. No greenhouse. Gorgeous cattleyas, cymbidiums, etc. Successful home grower shows you how. Full details free. Flowerland, 4622-PM Wilshire, Los Angeles 5.

**MAKE 70c Profit** on \$1 sales. You will not be an agent or salesman but an independent dealer buying at wholesale and selling at retail. Details free. "Husk" O'Hare, 5732 North Kenmore, Chicago 40, Illinois.

**BECOME A game warden,** or join forestry, park, lookout, wildlife conservation services. Enjoy outdoor work, good pay, real security. Complete information free! Write Home-Study Institute, Los Angeles 19, California.

**BREED Rare tropical fish** at home. Earn big money! Learn secrets! Help fill huge demand. Amazing opportunity! Free plan. Tropical Fish Breeders, Los Angeles 61, Calif.

**CO-Publish "Progressive Mail Trade."** Sample and details 25c. Bud E. Hine, Box 93, Battle Creek, Michigan.

**PROFITABLE!** Bronzing baby shoes. Instructions, \$1.00. Foster, 1520 Ardmore, Chicago 26.

**CHINCHILLAS:** Top-quality N.C.B.A. registered breeders. Mature, guaranteed bred pairs or sturdy, young stock. Terms. C & B Chinchillas, Wyoconia, Wis.

**NEW 1955 Catalog.** Nationally advertised merchandise. Rush 50 cents for catalog to Edward Clemens, 318 W. Bridge St., Morrisville, Penna.

**TRADE, Business, vocational, diversion magazines.** Late copies. Get-acquainted service. More than 5,000 publications, all fields. Current list free. Commercial Engraving Publishing Company, 34C North Ritter, Indianapolis 19, Indiana.

**START Your own business on credit.** Your own boss. 1661 of our dealers sold \$5,000 to \$28,500 in 1953. We supply stocks, equipment on credit. 200 home necessities. Sales experience unnecessary. Pleasant profitable business backed by world-wide industry. Write Rawleigh's, Dept. C-U-PPM, Freeport, Ill.

**BUY Wholesale** thousands items. Free details. Triple J Industries, 132 Berkshire, Bridgeport 8, Conn.

**OWN A business** without investment! Write for free display. America's finest work uniforms embroidered to advertise. Prospects, profits unlimited. Topps, Dept. 533, Rochester, Indiana.

**LEARN Sewing machine repair,** electrify, trade, sell. How to make big money at home sparetime. New zigzag machines, parts, etc., wholesale. Free details. Taylor Service, Hamilton PM-3, Ohio.

**BUY Wholesale.** Nationally advertised merchandise. Unlimited wealth of opportunities on credit. Sell on easy terms. Encore Industries, Dept. 112, Box 247, Midland, Mich.

**ADVERTISING Book matches—Cash** in on big demand; sell union label matches. Cuts for all businesses and political parties. Free powerhouse selling kit, low prices, protection guaranteed on repeat orders. Cash commissions. Superior Match Co., Dept. MX-355, 7530 Greenwood, Chicago.

**MEN Wanted—Build luggage** and cases at home. We sell your products, supply complete instructions, materials, everything. No special equipment needed. Free details. Cascraft, 805-G15 Sunset, Los Angeles 12, Calif.

**OPERATE Profitable home mail order business.** Details free. Bud E. Hine, Box 93, Battle Creek, Michigan.

**GROW Herbs** and spices at home (many rare and unusual). Make 101 useful and salable products. Big profit orders come from neighbors, gift shops, restaurants, etc. Also mail orders. Window box supplies household needs. Successful home grower shows you how. Free, full details. Herb Center, 601-R, So. Vermont Ave., Los Angeles 5, Calif.

**START Home business—Make gold plated costume jewelry.** Beginners kit \$1.00. Completed sells for \$3.00. Catalog 25c. Don-Bar Novelty, Dept. E-83, 3511 Armitage, Chicago 47.

**FREE!** "301 Profitable Small Businesses!" Amazing shoestring plans! Work home! Start sparetime! Deumant Surveys, Kenmore 23-PM, N. Y.

**I Average \$125 weekly** selling books by mail! So can you! Start sparetime! Work home! Cooper, 246-R Taunton, Buffalo, N. Y.

**GROW Expensive herbs** for us! Big profit home-business of your own. Year around profitability! We supply everything necessary! Send for free rare seeds and revealing plan. National Herb Exchange, Box 304-BH, Gardena, California.

**COMMISSION Circulars—Offering** real merchandise. Send 10c for samples and details. Products, Box 23, Boston 17, Mass.

**IMPORT-Export opportunity,** profitable, world-wide, mail-order business from home, without capital; or travel abroad. Established world trader ships instructions for no-risk examination. Experience unnecessary. Free details. Mellinger E703, Los Angeles 24.

**HOW And where** to obtain capital. Particulars free. Star Service, Wapakoneta, Ohio.

**START A buying service,** buy wholesale thousands nationally advertised products. Make big profits selling at sizable discounts. Postcard brings details. American Buyers, 627-P Linden, Buffalo, N. Y.

**TO \$50.00 Weekly.** Sparetime, home operated mailorder business. Successful beginner's plan. Everything supplied. Lynn, 10420-M National, Los Angeles 34, Calif.

**ARE You mechanically inclined?** Amazing home business pays wonderful profits. Free book tells all. Belsaw, 34-B Field Bldg., Kansas City 11, Mo.

**PRINT Without a printing press!** Amazing new method! Print colorful signs, banners, cards, posters, glasswear; anything at home. Big profits. Moneymaking opportunity! We supply everything. Beautiful sample, home-business plan free! Write Screen-Print Company, PM-3, Los Angeles 61, California.

**PLASTIC Furniture.** New. Profitable. Instructions, plans, sample, \$1.00. Taylor Plastic Co., 75 Ferguson, Tallmadge, Ohio.

**TIN Cans.** Turn them into cash. Nine methods. Instructions 50c. Charles Company, 12-DCV, Norwood, Ohio.

**WINNING Mail order plans.** Merchandise, books. Details free. Mid-State, Box 214, Syracuse 1, N. Y.

**NEW Product,** mailorder or direct. Write, Smith Products, R.F.D. 4, Mocksville, N. C.

**\$70 WEEKLY Guaranteed—Home,** spare time. Simplified mail bookkeeping. Immediate income, easy! Auditax, 34651AH, Los Angeles 34.

**EXCLUSIVE Your area** selling revolutionary plastic adhesive. Details and sample. Box 71, Troy, Ohio.

**MAILORDER—Operate profitable home business** using free advertising method. Revealing information. Seidel, 6000-HP Sunset, Los Angeles 28.

**\$200 WEEKLY Cleaning Venetian blinds.** Free book. Burt, 2434A, Wichita 13, Kansas.

**NEWSPAPERS.** Turn them into cash. Eighteen methods. Instructions 50c. Charles Company, 12-DCV, Norwood, Ohio.

**WHOLESALE Appliances,** watches, toys. Details 50c, refundable. Goncarova, Scripps Center, N. Y.

**BUY 550,000 Articles** direct wholesale. Write Publishers, Box 1486, Detroit 31.

**BE Appointed state notary public** now. Write, Stationers, Helotes, Texas.

**SELL Popular Mechanics** and all other magazine subscriptions. Free catalog, supplies. Subscription Service Company, Dept. A, P.O. Box 2070, Birmingham, Alabama.

**GERMAN Address lists!** Anything manufactured. 50c. Burke Associates, Manchester 1, Mass.

**WHY Risk capital?** Use free advertising method. The Barn, Box 167, Hales Corners, Wisconsin.

**MONEYMAKING Mailorder business plan, free!** Write, George Lenhoff, Lincoln 8, Nebraska.

**SAWDUST.** Turn it into cash. Twenty methods. Instructions 50c. Charles Company, 12-DCT, Norwood, Ohio.

**SELL Religious items,** jewelry, automotive items by mail. We furnish everything, fill orders. Eastern, Box 142A, Rochester 24, Mass.

**MAIL Circulars.** 100% commission. Free details. Fisher's, Dept. M3, 4750 So. Central, Los Angeles 11, California.

**BECOME Businessman.** Little capital needed. Indispensable "Policeman's bible." Hurry! Craft, Box 235, Pittsburgh, Penna.

**STAY Home.** Sell books, merchandise by mail. Circulars, names furnished, orders filled. National, Box 88A, Dorchester 22, Mass.

**START Your own business** at home. Sell subscriptions for popular magazines. Liberal commissions. Send for supplies, etc. DeSales Magazine Service, 60 East 42nd St., New York 17, N. Y.

**CHINCHILLA Dealership** available for local representation of large western ranch. Huge profits made from fascinating business operated from home. Andes Chinchillas, Paramus, N. J.

**OPERATE "Escalator" mailorder system,** selling our products or any products. Most revolutionary mailorder system known. Write: Selbyco, Decatur 154, Ill.

**LEARN To sell** by mail. Inexpensive course reveals how. Ranso, Box 1719-B, Richmond 14, Virginia.

**WANT To sell,** distribute or manufacture petroleum products, line of modern furniture, effective fire extinguisher, helicopter, yard novelty or toy? Car or airplane useful. Send \$1 deposit. Delray Industries, Box 6271, Tulsa, Oklahoma.

**TUNE Pianos.** Earn up to \$6.00 hour. Learn quickly at home. Musical knowledge unnecessary. Literature free. Piano Technician, 708P Rawlings, Carbondale, Ill.

**\$3.00 To \$5.00 Per hour.** Spare or full time. Electrical appliance repairing. Learn at home. Tremendous opportunity for mechanically inclined men. Details sent free. ATI, 5944 N. Newark, Dept. C21, Chicago 31, Ill.

**"137 SUCCESSFUL Home Business Money-making Plans,"** \$2.98 postpaid. Satisfaction guaranteed. Refund five days. Descriptive folder free addressed stamped envelope. Ferpubco, 324 West Maple Road, Indianapolis 8, Indiana.



FOR Proof of what you can do in specialty manufacturing, get our literature. It's free! Miller, Chemist, 1517-H, Tampa, Florida.

PERFUME Concentrates, cosmetic materials, goldcote bottles, fillers. Farrand Chemical, Tyrone, Penna.

STAINLESS Steel flatware at wholesale prices. Hudson Steel, Box 4015, Fresno, Calif.

MAKE Money at home! Mail letters featuring select merchandise. 100% profit. Amazing returns! Dollars every mail. Nu-Way Enterprises, Box M747, Detroit 31, Michigan.

EARN \$2.00 Hour! I do—Making sandals. Youngs, 1308-PM, South First, Arcadia, California.

TYPEWRITERS—Adders, Reconditioned, Bargains. Pricelist. Equipment, 2710 Tracy, Kansas City 9, Missouri.

MONEY Sharpening shears. Details free. W. Zell, Summitville, PM-2, Indiana.

"MAKING—Money for Millions" can help you. Sterling, Great Neck 50, New York.

FISHWORM Breeder's book—\$1.00 postpaid. Literature free. Dixdok, Kent, Ohio.

MAKE Strange new plastic, easily. Durable, attractive. 101 uses. 800% profit. Exclusive territory. Bays Laboratories, Oklahoma City 9.

FRANCHISE Opportunities nationwide! Secure profitable distributorship, dealership, agency. Information rushed. National Franchise Reports, 920 North Michigan Avenue, Chicago 11, Illinois.

SAVE 20% To 50%. Buy wholesale nationally advertised merchandise. Free details! Beecher Sales, Box 2161-B, Cincinnati 1, Ohio.

FREE Bargain list, catalog. Costume jewelry supplies. Send \$2.25 for five gross rhinestones. Value \$5.00. Ebert, Box P183, East Orange, New Jersey.

INEXPENSIVE Mailorder home instruction manual. Particulars free. Bureau, Box 396-A, Toronto 1, Canada.

I Want to send you proof of the wonderful pulling power of Popular Mechanics classified pages. What's your proposition? Write me today. Include literature if possible. F. W. Johnson, Manager Classified Advertising, Popular Mechanics Magazine, 200 E. Ontario St., Chicago 11, Ill.

PRODUCTS In monthly digest featuring new products and patents for sale, license or franchise. Subscription (\$10 annually) billed upon approval of first copy. Syndreco, Inc., P.O. Box 2052, Austin 11, Texas.

OPERATE Cafe, diner. Big profits. Independence can be yours. Begin easily, quickly. My guides explain every step. Experience unnecessary. Learn at home. Amazing details free. Restaurant Arts, BUI3, Fremont, Ohio.

BIG Profits in your own wholesale merchandising business. No investment! No inventory! America's greatest wholesale appliance, homewares, jewelry, sporting goods catalog in color. Space for your own name. We drop ship! Send \$1.00 for catalog and sales plan. Refundable. General Wholesalers, Box 2054EC, San Francisco.

NOTARY Public! Be appointed in your state. No experience needed, requirements are easy. Complete manual covers everything you'll need know. \$2.00. Fisher-PM, 3213 Mission, San Francisco, Calif.

IT'S Here! 1200% profit! Machineless laminating photos, documents, licenses, etc. in clear, self-sealing, plastic. Lifetime protection. No equipment needed! Also, sell through agents, homeworkers, etc., or cash in selling home laminating kits, local, by mail. Everybody a prospect. \$1 brings complete laminating kit (seals 10 articles) wholesale prices, all details, postpaid. Satisfaction guaranteed. Garen Sales, 1321-M4 Stanberry, Zanesville, Ohio.

AMBITIOUS? Practical business-success correspondence course dynamically explains how. Limited offer \$5. Box 388, Killeen, Texas.

\$150 DAILY In mail possible. Amazing facts free. Clifton's, 105 F. Northeast, Ephrata 20-B, Washington.

PHOTOGRAPHS. Yours can bring cash. Instructions 50c. Photo Profits, 817 Park S.W., Canton, Ohio.

MAILORDER Success by following our suggestions. Informative treatise 25c. Griffe Enterprises, Box 91, Station D., Toledo 8, Ohio.

WANT Up to \$100.00 weekly deposited in your mail box? Details free! Inquire Aldensmith, Dept. PM 2708 Ladera, San Bernardino, Calif.

BUY Wholesale direct! Save up to 66% on nationally advertised appliances, homewares, watches, cameras, sporting goods, giftwares. Big profits selling others. Catalog \$1.00. Refundable. Wholesalers Mart, Box 6125ED, Houston, Texas.

"TIMELY Tips Magazine," Paulding 3, Ohio, publishes moneymaking ideas, plans, opportunities, formulas, each monthly issue. 30th year. \$2.00. Sample copy 25c.

\$26,500 SALES In two weeks! Amazing radio-mail order method. Free details. Broadcast Service, 1413-A Great Northern Building, Chicago 4, Illinois.

\$2.00 HOUR Guaranteed. Your business. Investment under \$25. Details \$1.00. Olson, 2945 Henderson, Cheyenne, Wyoming.

WANTED—Men and women. Help fill huge demand. Raise live bearing tropical fish in your home. Send \$1.00 for instructions to: Fish, 609 N. 19th, Humboldt, Tennessee.

MAIL Order plan, proved winner, practical, workable, profitable. Send now for copyrighted fact-packed booklet and complete plan, both for only 25c postpaid. Satisfaction guaranteed. Maine Industries, 22 Dartmouth, Bangor, Maine.

BRUSH Plating outfits connect to a battery, no tanks necessary. Your opportunity to make good income silvering mirrors, plating articles in the shop and home at low cost. Free particulars. Gunmetal Co., Ave. H, Decatur, Illinois.

COLOR Concrete with chemicals. Marble-glaze cement benches, pottery. Start: home, shop. Hundred beautiful designs: birdbaths to waterfalls. Your chance for fame, fortune. 10c brings sample pictures. Hollywood Cementcraft, 8527-R Wonderland, Hollywood 46, California.

FLEXIBLE Rubber molds for plaster and Marble figurines. Sample and large illustrated catalog 25c, refunded on first order. K-C Novelities, Dept. 125, Easthampton, Mass.

FORTUNES Made raising crickets and fishworms. Write for free information. Carter Farms, Plains, Ga.

MAKE Money growing miniature trees on your window sill. Free seed and plan. National Nursery, Dept. FC, Inglewood 4, Calif.

FREE Folio "Up to \$45,000; Unlimited Vacations." No merchandise, equipment. Unknown! Work home, sparetime! Haylings, Carlsbad, Calif.

WANTED! Home producers, by manufacturers in our clearing house service. Become subcontractor, casting plastic products for these companies. Thousands of easy-to-make items required for consumer-industrial use. Cash in at home, without previous experience. Plastic Service Associates, Dept. 2-PM, East Boston 28, Mass.

PART Time or full time. Your own business, selling name brands. No inventory required. H. B. Davis Corp., 145-W, W. 15 St., New York City.

\$46 FROM Square foot plywood; jigsaw necessary. Details free. Woodarts, X-38, Bridgewater, Mass.

PIANO Tuning learned quickly at home. Tremendous field! Be independent. Information free. G. I. approved. Empire School of Piano Tuning, Champaign, Ill.

FREE Electroplating information. Money making plans. (Formula included). Send postcard for your copy. Highly paid, interesting, uncrowded field. Plater D. Hyde, 327 West 120th Street, Los Angeles 61, California.

OWN, Operate, route Wishing Wells. Place these new \$3.50 skill games on counters in cafes, luncheonettes, clubs, etc. Collect coins weekly. Write, Legalsarr, Box 929, Long Beach 1, California.

BUDGET Your wholesale costs. 1000s of personal and household items. Tremendous discounts. Catalog and budget club plan. Send \$1.00 no risk deposit, refundable on 1st order. Join today. Cooperative, Box 1296, Eustis, Florida.

MAKE Big money at home! Invisible reweaving pays up to \$10.00 profit in an hour. Make tears, holes disappear from fabrics. Constant demand from laundries, cleaners, homes, brings steady earnings. Details free. Fabricon, Dept. AE, 8342 S. Prairie, Chicago 19, Illinois.

DOLLARS In personalized baby record books. Sell by mail. Eleven thousand new prospects daily. Use same literature we do. No-Co-Ro, Oakland 6, California.

MONEY In sparetime fixit shop at home. Repeat cash business. Experience unnecessary. No selling. Free booklet explains. Victor Foley Company, Columbia Heights, Minnesota.

MAIL Cards, circulars for advertisers. Siegel, Box 183, Knick., New York City 2.

BOOKKEEPERS, Increase earnings operating sensational bookkeeping service. Kern, 5632 Lankershim, North Hollywood, California.

MAKE Money at home as renewal headquarters for all magazines. Liberal commissions. No experience—no capital needed. Supplies furnished. Write for free catalog. McGregor Magazine Agency, Dept. 300B, Mount Morris, Ill.

WE Love our mailman—He leaves over \$1000.00 monthly in our rural mailbox. My college professor husband drafted a scientific home mailorder method. We bought a Texas ranch, live as we always wanted. Now we sell the Ranch Mailorder Method. Operates anywhere. Inquire: Eveningshade Ranch, Helotes, Texas.

EXPORT Business made easy! Substantial income, home operated, low overhead, no merchandise buying. Complete setup service. Hermes Exports, 152 West 42, New York 18.

INVESTIGATE Earthworm breeding! Pleasant, profitable home industry! Part; full time! Free revealing facts, information! Write Earthmaster System, 45D, El Monte, Calif.

UNUSUAL Home mailorder business. Fascinating, clean, profitable. Ready to operate. Angora House, PM2, Springfield, Illinois.

POPCORN And potato chip equipment. Eakins, Box 933-A5, Springfield, Ohio.

EXTRA Income. Do leathercraft easy way. Free information. Tandy Leather Company, Box 791-Q8, Fort Worth, Texas.

LIQUID Rubber. Make flexible molds. Free sample. Chaney, 1130 E. 16th St., Jacksonville 6, Fla.

MEN—Income from local information. No selling. Neherco, LaVerne, California.

RUBBER Molds for casting plaques, figurines, novelties. Catalog illustrating over 100 fast sellers. 10c. Castcraft Studios, 508-PM Marion Street, Brooklyn 33, N. Y.

NEWEST Spare, full-time home business. \$5 to \$10 hour possible. Paint with suede—The finish with touch and eye-appeal. Beautify auto dashboards, signs, radios, toys, figurines, lamps—1001 others. Complete, step-by-step instructions sent for no-risk examination. Free details. Coast, Los Angeles 61.

START Home manufacturing business. Make cleaners, soaps, polishes, cosmetics. Free literature. Kemix, Park Ridge, Ill.

IMPORT-Export mailorder opportunities! Details. Warner, Box 6, Fort Scott, Kansas.

MAKE Flexible molds. Cast figurines, plaques. Free sample. Tooker, 630-R Chestnut, Hamilton, Ohio.

METALIZE Baby shoes, jewelry, gifts. Bronze, gold, silver. Free bulletin. Kiktavi, 7217-PY South Broadway, Los Angeles 3.

NATURAL Molding rubber, extra thick. Free sample. Flock, W. Woolley, 115-A Donald, Peoria, Ill.

ELECTROPLATE Auto parts, novelties, mirrors, baby shoes. Easy, inexpensive home processes. Free booklet. Tyco Metals, Box 13231-MM, Houston 19, Texas.

BOOKKEEPERS. Keep books, small firms spare time. Manual latest technique by C.P.A., \$3.00. Modern Business, Box 405, Youngstown 1, Ohio.

MAKE Money at home—Mail cards, circulars feature real merchandise. Everything furnished. Big earnings. Phillip's, Box 3-P, Boston 22, Mass.

RECAST Old batteries into new. Latest achievements. Battery Laboratories, Minneapolis.

MAKE Rubber stamps, repair dolls; learn silk screen printing. Catalogue (60 ideas) free. Universal, Box 1076-A, Peoria, Ill.

COPUBLISH Mail Sale Advertiser, leading mail order paper. Details, latest copy, dime. Vanroy Shirk, Lebanon, Penna.

SCHEMER Magazine, Canfield 1, Ohio, monthly mailorder ideas, plans. Year \$1.00. Sample 20c.

GROW Mushrooms, Cellar, shed, and outdoors. Spare, full time, year round. We pay \$3.50 lb. We paid Babbitt \$4,165.00 in few weeks. Free book. Washington Mushroom Ind., Dept. 172, 2954 Admiral Way, Seattle, Washington.



**PLASTERCRAFT** Molds, liquid rubber, plasters, blocks, candle supplies. Catalog and manual free. Blue Rapids Supply, Blue Rapids, Kansas.

**BUY** It wholesale! Manufacturers, distributors offer 850,000 items. Literature free. Olsen, 1231-A East Third St., Duluth 5, Minn.

**\$25 WEEKLY** Working two hours daily at home. Lycke, Box 3471-A, Cleveland 12, Ohio.

**RESILVERING** Mirrors, formula 50c; two-way lookout mirrors, (No one sees you), 50c; coppered mirrors, 50c. All \$1.00. Nelko-Mir, Box 3462-J, Chicago 54.

**MAKE** Money spare or full time, casting metal toys and novelties. Big wholesale and chain store demand for autos, soldiers, ashtrays, banks, etc. Keeps manufacturers busy. Production moulds furnished for up to 100 and more castings per hour. No experience or special place necessary. Write for information and illustrations of patterns needed. Metal Cast Products Co., Dept. A, 1696 Boston Road, New York 60, N. Y.

**OPERATE** Profitable mail order business. Write Walter Service, 4159-A East 112th, Cleveland 5, Ohio.

**MINK** Raising information free. Complete. Lake Superior Mink Farm, Superior, EEL, Wisconsin.

**COLORGLAZED** Concrete pottery made without molds. Patented method. Cemetery products, novelties, tiles. Basement leak-sealing. Money-making projects. Booklet, details free. Men only. National Pottery Company, Grand Rapids, Minnesota.

**FREE** Book "505 Odd, Successful Businesses" Work home. Expect something odd! Pacific, Oceanide, Calif.

**FIX** Typewriters. Free booklet describes our modern, inexpensive home-study course. Factory methods taught. Write Typewriter, Building 1, Tarentum, Penna.

**MONEY** In new greaseless doughnuts. Start in kitchen. No smoke. Sell stores. Free recipes. M. Ray Company, 3605 South 15th Ave., Minneapolis 7, Minn.

**BRONZED** Baby shoe supplies, instructions, mountings. Metal bookends, \$1.50 pair. Free catalog. National Bronze Supply, Box 56, Los Angeles 32, Calif.

**VENDING** Machines—No selling. Operate a route of coin machines and earn amazing profits. 32-page catalog free. Parkway Machine Corporation, Dept. 72, 715 Ensor St., Baltimore 2, Md.

**BRONZE** Baby shoes. Instructions, equipment and mountings for genuine electroplated process. Free catalog. Hollywood Bronze Supply, Dept. B-3, 1624 East First Street, Los Angeles 33, Calif.

**NEW** Exceptionally profitable plans. Ideas for home operated mail business. Rush name. Miller, 1861-P Roxbury Road, East Cleveland 12, Ohio.

**START** Venetian blind laundry, patented machine. Free information. Jet Company, 522 N. Rural, Indianapolis 1, Indiana.

**INFORMATION** Worth dollars. Free details. Wolfe, 8106 So. Park Ave., Chicago 19.

#### **MONEYMAKING OPPORTUNITIES**

**EARTHWORMS** Profitable home business. Complete instructions book plus folders \$1.00. Hand selected breeders, spring special, 1000, \$4.00 postpaid. Starr Earthworm Farms, Orland, Calif. America's most publicized grower.

**BIG** Profits in spare time! I'll send assortment full-size samples fine foods, household necessities to ambitious men, women who need money. Friends, neighbors buy eagerly. Send no money. Just write Blair, Dept. 31NC-2, Lynchburg, Va.

**MAKE** Money at home as renewal headquarters for all magazines. Liberal commissions. No experience—no capital needed. Supplies furnished. Write for free catalog. McGregor Magazine Agency, Dept. 500C, Mount Morris, Ill.

**COST** Of things going up faster than your income? You can make more full or part time as a Rawleigh dealer. Write for full particulars. Rawleigh's, Dept. C-RR-PPM, Freeport, Ill.

**MAKE** Profitable fast moving automotive accessory. Drawings \$1.00. Veale Mfg., Box 5, Columbus, Ind.

**BUY** Anything wholesale, big savings. Also chinchillas, wholesale. 1600B West Goodhope, Milwaukee 9, Wisconsin.

**FREE!** "301 Profitable Small Businesses!" Amazing shoestring plans! Work home! Start sparetime. Deumant Surveys, Kenmore 23-PM, N. Y.

**INCREASE** Your income, turn your spare time into cash—Making quick-selling, highly profitable lamps and fiber glass shades. Every home a prospect for one or more. Hundreds already doing it, so can you. No experience needed. No special tools required. Gearon's big, new 72 page 1955 illustrated Catalog No. 8 will show you how, quickly. One special 8-page section shows 6 beautiful lamps in kit form, ready for you to assemble. Another 12-page section shows you how to make stunning, ultra-modern fiber glass shades. Page after page filled with wide variety of other attractive shades, shade frames, figurines, and lamp bases. Also oil lamp converters, boring compound, and all kinds of cords, sockets, pipes, harps, finials, bases, and hundreds of other parts. Everything you need. And you can buy everything wholesale, sell at retail, make big profits, fast. Send only 25c right now for Gearon's big 1955 catalog and wholesale price list. Like hundreds of others, you'll be glad you did. Gearon Co., Dept. 503-B3, 27 S. Desplaines, Chicago 6, Ill.

**"HOW** To Make Money With Simple Cartoons"—A book everyone who likes to draw should have. It is free; no obligation. Simply address Cartoonists' Exchange, Dept. 93-CM, Pleasant Hill, Ohio.

**NEW** "X11" Ultra-blue signs. 7c, retail 50c. Sample free! Lowy, 812 Broadway, Dept. 847, New York 3.

**REFRIGERATION** Made childishly simple. Non-technical basic theory book. Quickly start own business. Write Ray Adcox Enterprises, Box 171, Saint Louis 3, Missouri.

**AMATEUR** Artists, cartoonists. Turn your art ability into money. Hamilton, Box 4-PM, Astoria 5, N. Y.

**EARN** Extra cash. Fifty tested plans. 25c. Wayte, 1233 Elden, Los Angeles 6, Calif.

**START** A buying service, buy wholesale thousands nationally advertised products. Make big profits selling at sizable discounts. Postcard brings details. American Buyers, 620-P Linden, Buffalo, N. Y.

**BIG** Money repairing jewelry at home. Details free. Colford, 1610 Rucker, Everett, Washington.

**LEARN** Professional candy making, profitable home business. Details free. Pate, Kissimmee, Florida.

**I** Make \$25.00 weekly, sparetime, selling used typewriters, without leaving home. So can you! Plan \$1.00. Money back if not satisfied. Typewriter Exchange, 827 Emmett Street, Schenectady, New York.

**SELL** Merchandise, books by mail. Orders filled for you. Unlimited earnings. Experience unnecessary. Free folder. Thomas, 276 Weaver Street, Rochester 21, New York.

**WHOLESALE!** Huge selection, famous brand products. Sensational discounts! Large catalog. Unusual business plans included. Consolidated Distributors, 21-12, Lafayette, Paterson 15, New Jersey.

**100% PROFIT.** Personalized gifts. Details 25c. Weigand, 3914 Carondelet, New Orleans 15.

**LEARN** Technical Metaphysics and insure your future. Easy, inexpensive correspondence course. Simplest method known. Diploma. Write: Premier College of Technical Metaphysics, 2532 McKenzie St., Vancouver, B.C., Canada.

**HOMEWORKERS** Profitability packet 10c. O'Dell's, 3340 I So. 8th St. Road, Springfield, Illinois.

**BREED** Earthworms at home. Small investment. Part; full time. Every farmer, gardener, fisherman your market. Free information. Write Global Earthworm Farms, R.R. 1, Pickering, Ontario.

**FISHWORMS.** Live delivery guaranteed. 1,000, \$4.00. 100,000, \$300.00. Our sales show tremendous yearly increase. Lakeshore Ranch, Route 3, Yukon, Oklahoma.

**MEXICAN** Featherbird pictures. Enormous profits. Samples 25c. Mexican Importing, Northern Pacific 1190, Albany, Oregon.

**MEN, Women,** make extra money. 121 home methods, "Shoestrings to Fortunes." Completely new, \$1.00. Brockway Plan, 1145 High, Topeka 1, Kansas.

**MAGAZINE** Subscriptions. Largest commissions, bonus. Qualified Magazine Agency, 451CM Kingston, Brooklyn 25, N. Y.

**START** Mail order business spare time. Book "Doing Business by Mail" tells how. Every business scheme fully explained \$1.00. Ken-West Distributors, 7-K South Harlem St., Worcester 4, Mass.

**SELL** Merchandise by mail. Everything supplied. Big profits. Details free. Stall's Buying Service, Box 425, Scranton, Penna.

**PRINTING** And office supplies wholesale, 20,000 items. Literature free. Royal, Box 368-A, Cleveland 27, Ohio.

**ATTENTION** Construction men! Laborers, trades, truck drivers, clerical, engineers, supervisory, many others. Latest copyrighted reports! Who to contact for highest paying jobs. To \$1500.00 monthly. Over 52 countries, including U.S., St. Lawrence project, Spain, South America, Alaska, Europe. Year registration and advisory service. Application forms. Best oil, aviation opportunities. Unconditional guarantee of satisfaction. Write or wire today! \$2.00. Airmailed \$2.25. (C.O.D.'s accepted.) International Reporter, Box 1047-TM, St. Louis 1, Missouri.

**HIGHLY** Profitable imports, sell mail order or direct. Importer: William Spear, 536 So. 19th St., Richmond 3, Calif.

**FREE** Literature describing moneymaking mailorder plans. Lewis Barlett, Richmond, Georgia.

**MAIL** Cards at home! We supply everything. Start you with little cost. Mednis, 10 Port Norfolk, Boston 22A, Mass.

**LEARN** Directing money-raising campaigns for churches, institutions. Earned \$3085 in six weeks on my first campaign on \$50 investment. Unlimited field. Two months low cost course. 35 years experience. William Arbogast, 229 East Mason Avenue, Alexandria, Virginia.

**EARN** Quick cash! Enjoy steady, growing income, full, sparetime! Most unusual, easy, money-making plan requires little effort! Expect something different, worthwhile! Get details now! Havaway Company, Suite 211-A, 628 Montgomery Street, San Francisco, California.

**CORNICES**—Reversible window valances. Add beauty to every room. Details 25 cents. Specialty Products Co., 302 New Market Ave., South Plainfield, N. J.

**\$200** MONTHLY Possible raising earthworms! Backyard, garage, basement. Complete illustrated booklet explains raising, feeding, packing, marketing. 25c postpaid! Ozark Worm Farm-J, Willow Springs, Missouri.

**MAKE** And sell new fishing rig. For blueprints, instructions and 3 rigs, send \$2.00. Ethers, Box 34, Roosevelt Station, Dayton, Ohio.

**ONE** Million articles wholesale. Directory \$1.00. Johnson's, 3262-K Medina, Fort Worth, Texas.

**\$100** WEEKLY. Sell glamorous jewelry, silverplate, gift items. Wholesale prices. Linwood, 93 Linwood, New Britain, Conn.

**HOME** Business. Mail letters. Get \$10.00 merchandise orders. 100% profit. Genmerco, Box 142, Dorchester 24J, Mass.

**HOW** To earn more money through novel ideas. Literature free. Fishers Projects, Fishers, N. Y.

**\$10.00** DAILY Part time selling magic dustcloths. Details. Smith, 654 E. Baseline, San Bernardino, Calif.

**BUY** Wholesale! Anything, everything! Save 35%-75%! Free miracle plan. Clifton Service, Ephrata 25, Washington.

**MAKE** \$15,732.00 Fast—\$9,504.00 without leaving your home. \$4.37 profit on every \$2.98 sale. Free new invention with staggering public acceptance. Everyone write "Research," Dept. PM2, 1024 Cottman Ave., Philadelphia 11, Penna.

**BUILD** Sales by recruiting productive distributors selling direct or to retail outlets. Secure most concentrated circulation through classified columns of Salesman's Opportunity. Write for facts, Gilbert, Salesman's Opportunity, Room 1700, 850 N. Dearborn, Chicago 40.

**BIG** Profits repairing automatic washing machines. Manuals covering repairs of leading washers \$5.00 complete. Musart, 152 W. 42nd St., New York City.

**FANTASTIC** Profits! Shoestring investment! Write Independence, 819 Dufferin, London, Ont., Canada.

**PIANO** Tuning pays. Big money in spare time. Learn at home in 30 days. Phonograph records, tools and instructions furnished. Information free. Capitol City Tuning School, 16 S.W. 2nd St., Fort Lauderdale, Fla.

**FREE** Booklet "Money Making Facts" tells mechanically inclined men how to start sparetime business at home. V. Foley Company, Columbia Heights, Minnesota.



**START** Own mail business. Limited offer. Write, Rockaway-Hall, Rockaway 4, Oregon.

**LITERATURE** Explaining scores of profitable opportunities, 25c. Rebill, Manitowoc, Wisconsin.

**FREE** Particulars. Many profitable money-making opportunities. Kossol's, 3545 Maryland Gary, Indiana.

**ACME** Saw sharpeners are the finest you can own. Don't be satisfied with less. Send for free literature. Max Mfg. Co., 138 Stockton Ave., San Jose 26, California.

**FREE** Folio "Up to \$45,000; Unlimited Vacations." No merchandise, equipment. Unknown! Work home, sparetime! Haylings, Carlsbad, Calif.

**SELL** Religious mottoes. Send no money. We trust you. Crystalgio, Sidney, Ohio.

**MONEY** By mail, selling real merchandise. Cooperative plan, details free. Atlantic Publications, Box 1103, Riverdale, Md.

**SPARETIME** Profits taking subscriptions all magazines. Wholesale catalog free. Cassell Publishers, Westfield, New Jersey.

**EARTHWORMS:** Raise for profit, bait. El Sobrante Earthworm Farm, 749 Rincon, El Sobrante 11, California.

**MAKE** To \$4.50 hour doing common pen lettering. National Artists, 801 1/2-A North Marsalis, Dallas 3, Texas.

**EARN** \$50.00 Daily making mats, shoes and mud guards from old tires. S and S Patents Inc., 1307 North Clark St., Chicago 10, Ill.

**PROFIT!** Prestige! Publish a magazine under your own name! Only \$3 per month! Sample, details 3c! Filmer, 910 Marion, Pharr 22, Texas.

**ATTENTION:** Typewriter owners. Make handsome profits. Write today. Groves Company, 682, Hastings 8, Nebraska.

**GENERAL** Contest Bulletin. Issued monthly. Sample, 25c. 1609 1/2 East 5th, Duluth, Minn.

**GROW** Mushrooms. Cellar, shed, and outdoors. Spare, full time, year round. We pay \$3.50 lb. We paid Babbitt \$4,163.00 in few weeks. Free book. Washington Mushroom Ind., Dept. 173, 2954 Admiral Way, Seattle, Washington.

**50,000** ARTICLES Wholesale. Source directory, dime. Nelko, Box 3462-DR, Chicago 54.

**READ** Progressive Mailtrade, the magazine that tells how to make money by mail. Dime brings sample and special offer. Progressive Mailtrade, Box 357, Sheboygan, Wisconsin.

**WINNING** Prize contests is fabulous, confidential, home opportunity! Send stamp! National Contest Bulletin, Box 2685-P, Miami 16, Florida.

**FREE** Book "505 Odd, Successful Businesses." Work home. Expect something odd! Pacific, Oceanside, Calif.

**SELL**—Buy Titania gems. More brilliant than diamonds. \$9.75 carat wholesale. Free catalogue. Diamondite, 1404-M Mitchell, Oakland 1, California.

**SCHOOL** Seniors—Sell classmates America's most beautiful graduation name cards. Largest selection. Highest commission. Outsell all others. Free sample kit. Printcraft, Dept. M, 1509 Maple Street, Scranton 5, Penna.

#### FORMULAS, PLANS, ETC.

**SCENTED** Bead necklaces. In demand year round. Simple to make. Large profit. Formula and instructions 25c. J. L., 419 St. Joseph St., Fremont, Ohio.

**TESTED** Formulas. Catalog free. Pont Laboratories, 2625 South Eighth, Terre Haute, Indiana.

**FREE** Formula catalog. Anything analyzed \$35.00. Western Chemical, Salem, Oregon.

**FOR** Proof of what you can do in specialty manufacturing get our literature. It's free! Miller, Chemist, 1517-P, Tampa, Florida.

**FORMULAS;** All kinds. Latest, best. Literature free. Kemixal, Park Ridge, Ill.

**REAL** Manufacturing formulas. Lists free. Cummings, Chemist, Gordon Ave., Syracuse 4, N. Y.

**PRODUCT** Analysis, manufacturing formulas, processes developed. Moderate fees. Plastics, Box 1574, Boston 4, Mass.

#### PLASTICS

**LAMINATING** Supplies. Price list free. Solomonson, 46 Cornhill, Boston 8, Mass.

**PLASTICS** Home-craft course for men and women. Tells and shows how to make hundreds of fast selling plastics products. All plastics and materials for 23 projects included in course. No special tools needed. Course pays for itself. Write for free booklet. Interstate Training Service, Dept. D-3-C, Portland 13, Oregon.

**NEW** Liquid casting plastic. Clear colors. Emb'd flowers, insects, coins. Saw, drill, carve. Send 25c for "How to Cast With Liquid Plastic" and proved success plan showing how to make money at home. Castolite, Dept. C-101, Woodstock, Illinois.

**PLEXIGLAS,** Lucite. Square foot cost 1/16", \$1.10; 1/8", \$1.45; 3/16", \$1.75; 1/4", \$2.15; 3/8", \$3.28; 1/2", \$4.38. Colors add 10%. Send 15% for postage. Aristocrat Plastics, Inc., 55 Clarkson St., New York City.

**LEARN** Plastics at home. Complete kit—\$5.98 postpaid. Dime brings sample plastic, three experiments, full details. Plastic Projects, Box 5151, Detroit 35, Mich.

**PLEXIGLAS,** Fiberglass, polyester, acetate, vinylite. Fast service. Wholesale-retail. Catalog 15c. Gem-O-Lite, Box 686P, North Hollywood, California.

**PLASTICS,** All types. Plexiglas, vinyl, acetate, teflon, nylon, polyethylene. Rods, sheets, tubing, film. Send 25c for complete catalogue and prices. Direct factory distributor. Delta Products, 1400 Henderson, Fort Worth, Texas.

**PLASTIC,** Sheets, rods, tubes, etc. Free list. Plastic Supply Co., 2901 N. Grand Blvd., St. Louis 7, Mo.

**PLEXIGLAS,** Lucite sq. ft. (12"x12") cost 1/16" \$1.14, 1/8" \$1.50, 3/16" \$1.85, 1/4" \$2.20. Add 10% for postage. Almac Plastics, 600 Broadway, New York 12, N. Y.

**PLEXIGLAS** Sheets—Cut to size. Clear. All thicknesses. Standard outdoor translucent colors. McClarin Plastics, P.O. Box 168H, Hanover, Penna.

**MONEYMAKING** Liquid casting plastic. Complete kit \$3.00. Handbook only 50c. Kennits Corporation, 2755 N. 5, Milwaukee 12, Wisconsin.

#### CHEMISTRY

**NEW** Idea chemical and apparatus outfits for home experimenting, photo-scales, microscopes, chemicals, biologicals and laboratory supplies in small quantities. Catalog 25c. Established 1931. John H. Winn, 124A West 23rd St., New York, N. Y.

**AMAZING** New book of science. Experiments, formulas and catalogue of laboratory supplies. Only 25c. National Scientific Co., Dept. PM-3, 2204 W. North Ave., Chicago 47, Illinois.

**CHEMICALS** And apparatus for industrial, analytical, and private laboratories. Catalog 25c. Dept. M-50, Biological Supply Co., 1178 Mt. Hope Ave., Rochester 20, N. Y.

**ILLUSTRATED** Catalog: Chemistry, mineralogy, biology 20c. Tracey Laboratories, Evanston, Illinois.

**SPECTROSCOPE** For quick chemical analysis, \$3.00. Kutting Sons, Los Altos, Calif.

**SEND** Secret messages. Invisible ink 25c. Chemlab, 800 Delaware, Berkeley, Calif.

**CHEMICALS,** Supplies. Catalog 20c. Laboratory Sales, Box 161-A, Brighton, Mass.

#### AGENTS WANTED

**FREE** Box of all occasion greeting cards just for sending your name and address. Permit us to tell how you too can make big money during your spare time showing friends, neighbors Elmira's sparkling line of all occasion greeting cards. No obligation to buy. To receive your gift box with details and samples on approval, send post card today to Elmira Greeting Card Co., Dept. 199, Elmira, N. Y.

**CHAMOIS.** Best quality. Low cost direct imports. Sample \$1.00. Babrok, PM3, Hudson Falls, N. Y.

**SHINE** Cars without "polish." New invention. Lightning seller. Cars gleam like mirror. Samples sent on trial. Kristee 69, Akron, Ohio.

**HAVE** Your own business, buy wholesale, make big profits. Free general mdse. catalog. Jay Norris, Dept. P, 443 Broome St., New York.

**RUN** A spare-time greeting card and gift shop at home. Show friends samples of our new 1955 all-occasion greeting cards and gifts. Take their orders and earn up to 100% profit. No experience necessary. Costs nothing to try. Write today for samples on approval. Regal Greetings, Dept. 189, Ferndale, Michigan.

**BEAUTIFUL** Feather pictures. 200% profit! Free sample. Apartado 9036, Mexico 1, D. F.

**WHOLESALE!** Huge selection, famous brand products. Sensational discounts! Large catalog. Unusual business plans included. Consolidated Distributors, 21-10, Lafayette, Paterson 15, New Jersey.

**GET** These important details, and get a fresh start with a modern line. Here is an established, nationally-known, nationally advertised product that right now has openings in many parts of the country for capable agents and sales people. Both men and women. This highest quality, yet extremely moderately priced product is needed, and is already being used, by thousands of men, women and children; and the possibilities for continuous growth are absolutely unlimited. Repeat sales come naturally, with a minimum of effort. This is a highly profitable business, up to \$1,000 a month earnings. The best part of it all is, you need no large investment to start. We have the product, the proved-successful plans and guidance that make big earnings possible. We are not giving details here for a good reason. This is not the kind of story that can be glossed over in a few words. It is well worth reading and studying at your leisure, and then make up your own mind. It costs us about a dollar to prepare the material and mail you this information, but we'll gladly send it postpaid without any obligation whatsoever. Inquire immediately for complete free information. Address Sales Opportunity, Dept. PM, Box 470, Glendale, California.

**MEN,** Women, make money spare time plus new car as bonus for encouragement. Amazing hosiery guaranteed to wear without holes, snags, and runs, or replaced free. For example, lovely 60 gauge nylons guaranteed for as long as 1 1/2 years, or replaced free. Write Wilkmit, 1753 Washington, Greenfield, Ohio.

**MAKE** Money introducing world's cutest children's dresses. Big selection, adorable styles. Low prices. Complete display free. Rush name. Harford, Dept. N-4341, Cincinnati 25, Ohio.

**CASH** in on tremendous demand for new low priced burglar alarm for cars, homes, stores. Nothing like it. Everybody wants one. 286% profit. Unique sample offer. Northwest Electric Co., 132-C Main, Mitchell, S. Dak.

**OPPORTUNITIES** Now open for initial agents in all states to sell new line on all-purpose signs. Ad-O-Plastic, Woodbridge, N. J.

**YOUR** Own business—Used suits \$1.50, overcoats 85c, mackinaws 35c, shoes 12 1/2c, ladies coats 30c, dresses 15c. Enormous profits. Catalog free. National, 1218AA South Jefferson, Chicago 7.

**STRANGE** Dry window cleaner. Sells like wild. Replaces messy rags, liquids. Simply glide over glass. Samples sent on trial. Kristee 66, Akron, Ohio.

**NEED** More money to live on? Increase your weekly income \$20 to \$25 or more in spare time. Supply Rawleigh products to consumers. Also openings for full time dealers. Write Rawleigh's, Dept. C-DD-PPM, Freeport, Ill.

**AT** Last! Something new and sensational in everyday cards. 21 for \$1. Make extra money fast! Show satin, velvet, metallic cards. Get orders easy. Big line \$1 assortments scented stationery, personalized napkins, gift items. Imprints free. Several \$1 boxes on approval. Puro Co., 2801 Locust, Dept. 540-C, St. Louis 3, Mo.

**AGENTS-Salesmen:** Sell beautiful hand-colored plastic enlargements and sensational new personalized photo compacts, rings, bracelets, lockets, etc. Experience unnecessary. 40% advance commissions. We deliver, collect. Wonderful sideline. Better full time. Free sample outfit. Novel Portrait Co., 3343 North Ave., Chicago, Ill.

**BUY** Wholesale thousands nationally advertised products at big discount. Free "Wholesale Plan." American Buyers, 629-P Linden, Buffalo, N. Y.

**I** Average \$125 weekly selling books by mail! So can you! Start sparetime! Work home! Cooper, 245-R Taunton, Buffalo, N. Y.



**BUY Wholesale** — 25,000 items. Catalog 25c. Matthews, 1472-B6 Broadway, New York City 36.

**SEND Postcard** for free money-making kit guaranteed direct-from-mills nylons, lingerie, blouses, men's and children's wear. American Mills, Dept. 455, Indianapolis.

**EXTRA Money** every week. I'll send you full-size Blair household products. Show them to friends and neighbors. You can make big extra profits. Write Blair, Dept. 31NC-1, Lynchburg, Va.

**HIGH Profits** in amazing unbreakable plastic housewares, tablecloths, drapes, utility covers. Free catalog PM53. Acclaim Plastics, Box 4, New York 40, N. Y.

**EASILY Make \$30 daily.** New automatic toilet cleaner sells itself! Write Box 61, Belleville, N. J.

**MAKE \$35.00 Weekly,** sparetime, selling Necco nameplates, and desk signs to homes, schools, banks, and other institutions. Free selling kit, Northeast Engraving Co., P.O. Box 469, Cohoes, N. Y.

**FREE Jewelry catalog** for agents, distributors. Pickeraft Factory, Attleboro, Mass.

**10 GOLD Letters,** \$1.00. Signs painted. Frank Watkins Signs, 1241 Overton Park, Memphis, Tennessee.

**EASY Handwork** makes fast-selling useful articles. Sample free. Sunmade Company, Brockton 64, Massachusetts.

**WANT Real business?** Represent long time manufacturer, full or part time. Have subagents helping sell reproductions of customers' snapshots on lamp shades, tiles, brooches, plaques, compacts, bracelets, fobs. Unique processes and appearance, no competition. Highly profitable, interesting, dignified. Wells Studio, 14040 Euclid Ave., Cleveland, Ohio.

**POWER Mowers \$42.** Riding rotary. Chain saws. Terms. Sales kit free. Farmco-51, Excelsior Springs, Mo.

**WHOLESALE; Buy,** sell nationally advertised guaranteed merchandise. Free literature. Central Wholesalers, 1139 South Sixth, Terre Haute, Indiana.

**CLEANER, Porcelain,** chrome, metal and glass. Removes dirt, rust and tarnish. Guaranteed results. Sample 10c. Dealers wanted. For-Met, 18891 Detroit Ave., Cleveland 7, Ohio.

**JAPAN Trade directory!** Leading firms Japan! Hoffman, Box 662P, Passaic, N. J.

**HAND Beaded monograms,** our Puerto Rican factory assures amazingly low prices. Sew on to any garment. Every lady of any age a sure customer. Send for catalogue. Rupert Weidner, Inc., 131 West 45th Street, New York City, Dept. A.

**SELL New automatic floor waxer.** Trigger on handle. Retail \$2.95. Your profit 125%. Write Smith, Inc., Greenfield 15, Mass.

**MAKE Money** giving away free hosiery! Introduce amazing nylon stockings (guaranteed against runs and snags) and men's children's hosiery (guaranteed one year) by giving away free trial pairs regardless whether or not final purchase is made! Earn up to \$3 hour spare time. Mail postcard today for free samples men's and women's hosiery with complete money-making outfits. Nothing to pay now or later. Absolutely no obligation. Kendex, Babylon 33, N. Y.

**BUY Wholesale** for yourself or profit. Most complete instructions and list of best name brand wholesale catalogs. \$1.00. Sherwood Enterprises, 428 Hall S.E., Grand Rapids 7, Michigan.

**PROFITS Unlimited** in your own wholesale buying service. Buy 65% less than retail famous appliances, homewares, jewelry, sporting goods, furniture. Big profits selling others at discount. Free details. National Buyers Service, Box 426EA, Oakland, California.

**BIG Profits** in your own wholesale merchandising business. No investment! No inventory! America's greatest wholesale appliance, homewares, jewelry, sporting goods catalog in color. Space for your own name. We drop ship! Send \$1.00 for catalog and sales plan. Refundable. General Wholesalers, Box 3058EC, San Francisco.

**WHOLESALE To you!** 40%-80% off! Waxes, polishes, cleaners, brushes, mops, cosmetics, plastics, cutlery. Write: Mail Order Supply, Box 2022 Uptown Station, San Bernardino, Calif.

**WHOLESALE!** All standard brands, personal use or profitable resale. Catalog \$1.00, refunded. Metropolitan, 2212 Division, Chicago.

**MEN'S "Stretch" socks** bring profits! Details, prices free. Frank Thomas, Box 2206-PM, Ft. Pierce, Florida.

**WHOLESALE Catalog** — Confidential price list free. Invest no money for merchandise. Sell friends, business associates nationally advertised watches, jewelry, appliances. Earn extra money daily. Louis Perloff, Dept. PM, 733 Walnut St., Philadelphia, Penna.

**WEDDING Invitations,** personalized napkins. Wholesale prices. Sperry-Print, Williamsport 45, Penna.

**PROFITABLE Deal** selling magnetic pencils to waitresses, nurses. Sample \$1.00. Nicholson, Universal City 2, Calif.

**BUY Wholesale.** Catalog 35c (refundable). Carlton, 3007 Wharton, Philadelphia 46, Penna.

**60% PROFIT** on cosmetics — Famous nationally advertised Hollywood Cosmetics pay 60%! Make \$25 day up! Hire others. For free samples, details, write Studio Girl, Glendale, Calif., Dept. PM-25.

**BARGAINS, Job lots,** close-outs! Save up to 50% on clothing, hosiery, notions, drugs, toiletries, gifts, jewelry, television, etc. 2000 items. 25c brings wholesale bargain catalog with special get acquainted offer which includes free \$1.00 merchandise certificate. Reliable Jobbers, 311-B North Desplaines, Chicago.

**APPLIANCES, Cameras,** watches! Large wholesale catalogue! Cam Company, 6806PM—20th Ave., Brooklyn 4, N. Y.

**THOUSANDS Articles** wholesale. Supply source directory 10c. Idealer, Park Ridge, Illinois.

**CALIFORNIA Sweet** smelling beads. Sensational sellers. Particulars free. Mission, 2323 FR, W. Pico, Los Angeles 6, Calif.

**PROFITS To 150%!** selling finest everyday greeting cards. New 21-card \$1.00 assortments, unusual gifts, 100 fast-sellers. Valuable gift bonuses. Assortments on approval, stationery samples free. \$1.00 gift free for prompt action! Creative Cards, 4401 Cermak, Dept. 525-A, Chicago 23.

**MAKE Easy money.** Sell famous \$3 CO-2 fire extinguisher. Wholesale or direct. Fast sales, liberal profits. Fire Killer Mfg. Co., Dept. E, 115 W. 17th Street, Hazleton, Penna.

**TREMENDOUSLY Profitable.** Sell religious articles. Different. New. Write J. Cross Company, North Attleboro, Mass.

**FREE Wholesale kit** guarantees you 33% to 60% profit on cameras, appliances, typewriters, etc. Arrow Distributing, 154G Nassau St., New York 38.

**PRINTING, Advertising** salesmen—Excellent moneymaking sideline selling decalcomania name plates, small quantities. Automobile initials, sign letters. Free samples. Raleco, XL, Boston 19, Mass.

**GOLD Or silver letters,** numbers. Windows, doors, trucks. 1" to 6". 500% profits. Free samples. Atlas-T, 544 West 79th, Chicago 20.

**MAKE Extra money.** Sell front door name plates to friends, neighbors. Retail \$1.98; you make \$1.00! Free selling kit. Modern Engraving Co., P.O. Box 194, Boston 14, Mass.

**SCHOOL Seniors—Be** popular with classmates. Have spending money galore. Details free. Craftcards, Box 235-L, Pittsburgh 19, Pennsylvania.

**\$1.00 PROFIT** Selling \$2.95 photo enlargement deal. Allen Studio, Riegler Bldg., Little Rock, Ark.

**AGENTS — 300%** Profit selling genuine gold window letters; stores and offices. Free samples. Metallic Sign Letter Co., 431-D North Clark, Chicago.

**INCREASE Your income—Personal** installed buckles, belts, cap badges. Free information. Hook-Fast, Box 480 (PM), Roanoke, Va.

#### SALESMEN—DISTRIBUTORS

**POSTCARD** Can put you in a fine business! Complete line of air cushion shoes. Big steady commissions. No experience or investment needed. Send postcard for free outfit. Mason Shoe, Dept. MC61, Chippewa Falls, Wisconsin.

**AD Matches!** Sell amazing designs—10, 20, 30, 40 and 240-light book matches. Bigger spot cash commissions; every business a prospect. Low prices for high quality. Repeats. Start without experience; men, women; full, part time. Buy nothing! Sales kit furnished. Match Corp., Dept. PM-63, Chicago 32, Illinois.

**75c PROFIT** On each dollar! Luxurious stainless steel tableware, guaranteed 50 years. Can't rust, tarnish or stain. Looks like sterling silver. 30, 50 and 75 piece sets, open stock, attractive chests. Write orders on commission or go in business for yourself. Use our catalogues with only your name. Have agents, others sell for you. Offer women set free for every two sets they sell to friends. Many other money-making plans. We can also ship under your label. Rush postcard for free catalogue, plans, etc. No obligation. Topval Corp., Lindenhurst 61, New York.

**CALENDARS, Advertising** novelties, matches. All styles, including religious, varnished, 12 sheet, girls. Hundreds of advertising novelties, book matches, etc. Fleming Calendar Co., Sales Division, 6539 Cottage Grove, Chicago 37, Ill.

**BIG Money-making** opportunity. Exclusive line work uniforms. Jackets, pants, shirts, coveralls. Advertising embroidered. Every business prospect. Outfit free. Master Div., 313 Water, Ligonier, Ind.

**WILL You** wear new suits and topcoats without one penny cost and agree to show them to friends? You can make up to \$30.00 in a day even in spare time, without canvassing. Progress Tailoring Co., 500 South Throop St., Dept. Y-326, Chicago 7, Illinois.

**MY Free outfit** puts you in a fine business! Just 2 sales a day brings you up to \$217 extra a month in big money shoe business! Complete line of air cushion shoes for men, women. Just rush postcard for your powerful free selling outfit! Mason Shoe, Dept. MC 61, Chippewa Falls, Wisconsin.

**ADVERTISING Specialty** salesmen—Show America's newest, sensational low-priced imprinted advertising specialties. Buyers everywhere. Big commissions advanced. Samples furnished. Charms & Cain, 37 West VanBuren, Dept. PM-35, Chicago 5.

**GET New shirt** outfit free; make \$90.00 weekly on 5 average orders a day. Famous quality made-to-measure dress and sport shirts at \$3.95 up sell fast to all men. No experience needed. Full or part time. Write Packard Shirt Co., Dept. 871, Terre Haute, Ind.

**ANYONE** Can sell famous Hoover uniforms for beauty shops, waitresses, nurses, doctors, others. All popular miracle fabrics, nylon, dacron, orlon. Exclusive styles, top quality. Big cash income now, real future. Equipment free. Hoover, Dept. M-100, New York 11, N. Y.

**AIM Your sales** high in '55 — Earn \$10,000 a year selling a repeat, volume product. Write Hi-Lite Corp., 400 Warner Street, Dept. PM, Cincinnati 19, Ohio.

**BE Independent.** Sell Rawleigh products. Good nearby locality open. Write today. Rawleigh's, Dept. C-D-PPM, Freeport, Ill.

**ADVERTISING Book** matches—Cash in on big demand; sell union label matches. Cuts for all businesses and political parties. Free powerhouse selling kit, low prices, protection guaranteed on repeat orders. Cash commissions. Superior Match Co., Dept. M-355, 7530 Greenwood, Chicago.

**SELL "Dandy"**—Fast moving automotive accessory. Dandy, Box 5, Columbus, Ind.

**BUY Wholesale** thousands nationally advertised products at big discount. Free "Wholesale Pinn." American Buyers, 630-D Linden, Buffalo, N. Y.

**SALESMEN: Over \$50.00 daily.** New colossal industrial and store deal. Samples furnished. Durawear, 53 West Jackson, PM-3, Chicago 4.

**AMAZING Discovery.** Master Glaze, puts brilliant glasslike surface on cars. Free sample, information. Big commission. Master Glaze, Dept. 822, 7720 Harwood, Milwaukee, Wis.

**EARN \$30 A day** showing our famous boots. Part or full time. No experience necessary. Write for free sales outfit. No obligation. Jim Richards Shoe Co., Dept. M, Wellesley Hills, Mass.

**SELL Every business** and profession unique printed and advertising specialties, envelopes, collection helps. Big profits. Tremendous repeat business. We start you without cost. M. P. Brown, Inc., 436 N. Third St., Burlington, Iowa.

**QUICK Profits,** up to 90%, selling "Heat-Gard" to garages and stations. Send \$1.50 (refundable) for demonstrator and sales details. Rodman Mfg. Co., Inc., Box 349, Jackson, Mich.



**PATEST** Selling line out! Today every merchant needs our sensational low-priced business boosting advertising specialties. Average \$20 per sale. Calendars, printed necessities triple your earnings. 25% cash commissions. Experience unnecessary. Free sample outfit. Willens, 2130 Gladys, Dept. 501, Chicago 12, Ill.

**DISTRIBUTORS**—Salesmen wanted. Very good profits. Steady repeat business. Write Favorite Records Company, Box 841, Chicago 90, Illinois.

**GLASSRITE** Window cleaning cloth. Single 59c, kit \$1.19 retail. Now sold Jordan Marsh. Particulars, sample free. Sampson Co., Melrose 78, Mass.

**QUALITY** Ties. Your profit, 189%. Catalog free. Loren Specialties, 4351-A3 Flournoy, Chicago 24.

**SALESMEN:** \$40.00 Daily possible. Sell new popular lumber product. Details free. Love Lumber Products, 306 E. College St., Whiteville, North Carolina.

**DESK** Signs, nameplates. Free samples. Biggest profits. Whitney Signs, West Springfield, Mass.

**NEW** Jobs open in selling! Send name, address for five free issues of Opportunity Magazine's money-making guide, listing hundreds of companies who'll pay you well, full or part-time. No experience needed. Opportunity, 850 N. Dearborn, Dept. 17, Chicago 40, Ill.

**100% PROFIT.** Fast money for you! Take orders for Sweet Georgia Brown cosmetics. Colored people buy it quick. Free sample. Write Valmor, 2451-PN Michigan, Chicago 16.

**SELL "Dandy"**—Fast moving automotive accessory. Dandy, Box 5, Columbus, Ind.

**NEW** Chemical discovery. Pro Auto Wax, easy way to car beauty. Free sample, information. Amazing profits. Burford Auto Finishes, 1680-20th Street, Santa Monica, Calif.

**30,000,000 WOMEN** Want amazing new automatic refrigerator defroster. You sell 8 out of 10 on sure-fire free trial. \$230.00 weekly profit not uncommon. Rush postcard for guaranteed plan. D-Frost-O-Matic, Dept. D-102, 173 W. Madison St., Chicago 3, Illinois.

## EDUCATIONAL AND INSTRUCTION

**A Better job—More money.** Learn accountancy at home. Send for free sample lesson, we'll include catalog describing opportunities in the well paying field. Low cost, easy terms. LaSalle Extension University, A Correspondence Institution, Dept. H 843, 417 So. Dearborn, Chicago 5.

**HIGH** School—No classes. Study at home. Spare time. Diploma awarded. Write for free catalog HF-52, Wayne School, 2527 N. Sheffield, Chicago 14, Ill.

**WELDING** Training pays at Hobart Welding School, Box M-351, Troy, Ohio. VA contract. Best equipment. Catalog free.

**IT'S** Easy to learn a language by Linguaphone, world's standard conversational method. At home, learn to speak French, Spanish, modern Greek; 32 languages available. You learn by listening. Save time, work, money. Over a million home-study students. Send for free book. Linguaphone Institute, 33035 Radio City, New York City 20.

**COMPLETE** Your high school at home in spare time with 58 year old school. Texts furnished. No classes. Diploma. Information booklet free. American School, Dept. X345, Drexel at 58th, Chicago 37, Illinois.

**WANT** A diesel job? New opportunities to increase income. Higher pay. More money. We can help you qualify. Tools. Shop method home training. Write today! Diesel, Tractor, Heavy Equipment Division, Interstate Training Service, Dept. B-3-C, Portland 13, Oregon.

**X-Ray** technicians in great demand. Fascinating work. Good pay. Free catalog. National Institute, Desk 7, 4868½ Sheridan, Chicago 40.

**FINGERPRINTING** Course \$12.00—Diplomas awarded. Details free. Alabama School of Fingerprinting, Box 185, Fairfield, Alabama.

**BLUEPRINT** Reading for machine and building trades. Train at home. Learn to read blueprints with confidence in 10 easy lessons. Literature free. Belton School, 1059P North Lawndale, Chicago 51, Ill.

**SQUARE** Peg in round hole? Dissatisfied? Restless? Unhappy? Do psychological tests at home. Uncover true abilities, aptitudes. First time available. Low cost. Details free. Write Psychologic Testing Institute, Dept. 237, 201 N. Wells, Chicago 6, Ill.

**HOW** To write short stories, mysteries, articles. Learn at home for career or extra part-time income. (A. Aretz sold first 2 stories for \$255.) Professional writers show you how. Send today for free book and lesson material which explain opportunities. Clip this reminder ad. Palmer Institute of Authorship, Desk TM-35, 1680 N. Sycamore, Hollywood 28, Calif.

**BOOKS**—Government surplus. Free catalog listing fifty other free catalogs on instructional, text and vocational subjects. Three million volumes, new and used. Bargain prices. Long's College Book Co., Dept. PM, Columbus 1, Ohio.

**HANDWRITING** Character analysis self taught. Free brochure. Lucas, 2419 Sunset Boulevard, Los Angeles, California.

**INVESTIGATE** Accidents! Many earn to \$10,000 yearly. Claim investigators needed by airlines, insurance companies, railroads, government offices. Also excellent opportunities for your own business. Allan earned over \$2000.00 in ten weeks without prior experience. Free book. No obligation. Placement counsel and help. Write today! Universal Schools, Dept. 103, Box 8202, Dallas 5, Texas.

**DOCTOR** Psychology degree by correspondence. College Cosmic Sciences, 7645 North Sheridan, Chicago 26.

**UNIVERSITY** Degrees by residence and correspondence. Golden State University, Hollywood, Calif.

**HIGH** School, commercial, civil service, correspondence courses. Auras, 156 West 73rd Street, New York City.

**567 HOME-Study** courses, textbooks. Sensational bargains! Free illustrated catalog. Nelson Company, 210 South Clinton, Dept. 9CV-2, Chicago 6.

**OVERCOME** Self-consciousness. Rise above fear and handicaps. Learn to direct your powers creatively. Personal, confidential help. Free information. Leavitt Science, Clinton 5, Illinois.

**FREE** Voice book! Shows you how you can train for strong, confident voice. Sound masculine! State age. Prefect Voice Institute, 210 South Clinton, Studio 2CV-2, Chicago 6.

**SUPER** Memory overnight! Revolutionary method! Bijou, Box 1727-MU, Hollywood 28, California.

**LEARN** Lettering at home. Fascinating, high-paying profession. Clarence Donigan Associates, 2712 N. Vermont, Royal Oak, Michigan.

**WANT** U.S. gov't job? Men-women, 18-55. Start high as \$350.00 month. Qualify now! 23,000 jobs open. Experience often unnecessary. Get free 36-page book showing jobs, salaries, requirements, sample tests. Write: Franklin Institute, Dept. B-24, Rochester, N. Y.

**BECOME** A doctor of psychology or metaphysics. Learn secret of contentment, happiness. Win degree of Ps.D. or MsD. Solve mental worries. Free book. College of Universal Truth, 5038-C Broadway, Chicago.

**CORRESPONDENCE** Courses, books, rented, sold, bought. World wide service. Lists free. Lohmer, Box 1272-P3, Burbank, Calif.

**MIDLAND** Linotype School. Charles City, Iowa. Civilian and Veteran Courses. Free placement. Established 1909.

**OPERATE** Cafe, diner. Study at home for business of your own. Complete cafe training. Big booklet free. Restaurant Arts, E113, Fremont, Ohio.

**MEDICAL** Laboratory technique. Learn at home. Catalog free. Century College, Desk 4, 9 East Ohio, Chicago 11, Illinois.

**12 STEPS** To success. New self-analysis technique shows you how to become successful by selling your strong points and overcoming your weak points. Send \$1.00 to Reeves-North, Personal Consultants, S. 1129 Buena Vista Drive, Spokane 44, Washington.

**AVOID** Failure! Six lessons small business management. Auditor-business advisor established 1929. Text distributed nationally. Write! Wm. Grosnick, 115 State, Springfield 3, Mass.

**DRAFTSMEN**—Urgent demand. Train now. Pay later. Free details. Industrial Training, 1704-A Frederick, Fort Worth 7, Texas.

**EARN** College degree, remain employed. Write: Brentwood College, Box 19-721, Los Angeles 19, California.

**POSITIVE** Success. Secrets free! Write today. Success School, Sparta 7, Michigan.

**INVESTIGATOR** Training. Phillips Secret Service System, 1917-B North Kenneth, Chicago 39.

**AUCTIONEERING.** Be an auctioneer. Earn big money. Term soon. Write for catalog. Kansas City Auction School, Suite 307, Shankman Building, 3119 Troost, Kansas City, Missouri.

**BE** A real estate broker. Study at home. Write for free book today. GI approved. Weaver School of Real Estate, 2020C Grand, Kansas City, Missouri.

**STUDY** By correspondence for Doctor's degree in Psychology, Metaphysics and Divinity. College of Divine Metaphysics, Dept. P-M, 2811 North Illinois St., Indianapolis 8, Indiana.

**HIGH** School diploma at home. Licensed teachers—Approved materials. Southern States Academy, Box 144-MX, Station E, Atlanta, Georgia.

**SECRET** Investigation. Experience unnecessary. Investigators particulars free. George Wagner, M125 West 86th, New York 24.

**PHYSICAL** Therapy and massage. We train you at home. Earn big profits from your own private practice or work with hospitals and doctors. Free catalog. National Institute, Desk 4, 4868½ Sheridan Road, Chicago 40, Illinois.

**GROW** Mushrooms. Cellar, shed, and outdoors. Spare, full time, year round. We pay \$3.50 lb. We paid Babbitt \$4,165.00 in few weeks. Free book. Washington Mushroom Ind., Dept. 174, 2954 Admiral Way, Seattle, Washington.

**EARN** While you learn. Auto and diesel mechanics master this top paying trade. Many graduates earn \$100 a week and up. Approved for Korean veterans. For free information write Dept. No. 256, Nashville Auto-Diesel College, Nashville 3, Tenn.

**BOOKKEEPERS!** Increase your earnings! Operate your own simplified "Dollar-A-Week" bookkeeping and tax service. Full or spare time. Details free. No obligation. Ellis, Box 200, Cedar Grove, North Carolina.

**MEDICAL** Laboratory technicians in great demand. We train you in your own home. Catalogue free. Imperial Technical Institute, Box 973-J, Austin, Texas.

**USED** Correspondence courses and books sold and rented. Money back guarantee. Catalog free. (Courses bought.) Lee Mountain, Pisgah, Alabama.

**PIANO** Tuning pays. Learn this profitable profession at home easily with patented Tomometer and mechanical aids. No knowledge music necessary. Diploma granted. Write for booklet. Niles Bryant School, 3731 Stockton Blvd., Dept. P, Sacramento 20, California.

## PLAYS, STORIES, MANUSCRIPTS

**NO** Luck finding a book publisher? Write for free Booklet PM. Vantage Press, 120 W. 31, New York.

## SPECIAL SERVICES

**MIAMI**, Florida, remains 25c. Reply address \$1.00. Classified \$1. Thompson's, 8425 N.W. 32nd Ave., Miami, Florida.

**INFORMATION** On anything. Ferguson Research Specialists, 116-14 141 St., South Ozone Park 36, N. Y.

## CARTOONING, COMMERCIAL ART, SHOWCARD & SIGN PAINTING, TATTOOING

**CARTOONISTS:** Amateur, professional. Prepare for animation with Max Fleischer's plan. Write Vera Coleman, Lincoln Building, New York, N. Y.

**CHALK** Talks. Laugh producing program \$1.00. Catalog 10c. Balda The Cartoonist, Oshkosh, Wisconsin.

**TATTOOING** Course, supply brochures 25c. Zeiss, 738 Lesley, Rockford, Illinois.

**LEARN** Sign painting at home. Test lesson free. Ben Kerns, Box 812-PM, Greenville, S. C.

**PAINT** Signs with master patterns. Set 11½" to 12" high \$1.00; sample 3c. Eyerly, B-583, Newton, Iowa.

**9 ALPHABET**, 3 Numeral pattern sets and raised wood letter catalog, \$1.00. Sign Letter Distributors, P.O. Box 101, Mineola, N. Y.



"HOW To Make Money With Simple Cartoons"—A book everyone who likes to draw should have. It is free; no obligation. Simply address Cartoonists' Exchange, Dept. 93C, Pleasant Hill, Ohio.

PAINT Signs with perforated patterns. Vande Linde Signs, Madison, W. Va.

FREE Cartooning lesson. No obligation. Write Stephenson's, Rattlesnake Drive, Missoula 7, Mont.

CARTOONISTS: Join the Universal Cartoonists Club, 173 Bay 28th Street, Brooklyn 14, New York. Information free.

FREE Cartooning lesson. No obligation. V. Vande Linde, Madison, W. Va.

#### ARTISTS' SUPPLIES

WHOLESALE Prices — Drafting equipment, artists' supplies. Catalogue. Gordon's, 219-M Madison, Chicago 6.

#### ADVERTISING AGENCIES. LETTER WRITERS. FOR ADVERTISERS

ADVERTISE: 24 Words, 100 Canadian newspapers \$5.50. Lists free. Advertising Bureau, 10511-C Springfield, Chicago 43.

CANADIAN Lists. Direct-selling agents. Details: Elliott's, 252 Gainsborough, Toronto 8.

MILWAUKEE Monthly birth list average 1300 names \$5.00. Small community lists 1000 names \$5.00. The Barn, Box 167, Hales Corners, Wisconsin.

24K GOLD Embossed leather key cases, with your 3 or 4 line ad. 1 post \$14 per 100, 2 post style \$18 per 100. Samples 50c. Arizadco, Box 1456, Minneapolis 6, Minn.

ADVERTISING—Display, classified. Experts since 1893. Interesting budget brochure free. Newmark's Agency, 217—7th Ave., New York.

FREE Copy, layout service. Mailorder ad. 1,600,000 nationwide circulation. \$28.70 inch. 24-word classified. 20 big Sunday newspapers. \$30. Advertising ratebook free. Chicago Advertising Agency (Established 1900). Chicago 4.

FREE! 1955 Advertisers Rate and Data Directory. 52 pages! E. H. Brown Advertising Agency, 20 N. Wacker, Chicago 6.

MAILING Lists, most any classification. 1000 names \$5.00. 1000 your circulars mailed with ours \$4.00. 5000 your circulars printed and mailed \$12.95. Write Dixie Mailers, King, North Carolina.

ADS Placed in out of town newspapers and magazines. Low rates. Catalogue free. Ideas that pay. Baker Advertising Agency, Successors Ankrum Agency, 189 W. Madison, Chicago 2.

#### RUBBER STAMPS AND OFFICE SUPPLIES

THREE Lines \$1.00. Free stamp pad. Barber, 596 Girard, Marion, Ohio.

3 LINES Pocket or cushion, \$1.00. Free catalog. Hansen, 4908-p Ohio, Chicago 44.

RUBBER Stamps by professional craftsmen. 3 lines \$1.00. Price list. South Coast Press, P.O. Box 2074, San Bernardino, Calif.

#### TYPEWRITERS, DUPLICATORS, OFFICE DEVICES

TYPEWRITERS. Government surplus from \$23.00. Free picture list. Meshna, 580 Lynn, Malden 48, Mass.

RECONDITIONED Typewriters, duplicating, printing devices. \$25.00 up. Supplies. Appliances. DixieGraph, King, N. C.

#### PRINTING, MULTIGRAPHING, MIMEOGRAPHING GUMMED LABELS

OFFSET Printing, highest quality, reasonable prices; samples, quotations free. Modern Press, Box 24, Crescent Hill Station, Louisville 6, Ky.

BUSINESS Letterheads, job printing, circulars. Press, Box 591, Bristol, Conn.

BUSINESS Letterheads. Catalog; illustrated design book 10c. Howprint, 723-G Eunice, Webster Groves 19, Missouri.

JUMBO Surprise package, usable printing, 25c. Merchants Press, Taylor, Texas.

BUSINESS Cards, 500, \$1.50, other printing cheap. Scott, 3211 N. McKinley, Oklahoma City.

PRINTING. Rubber stamps. Business cards. Samples. Lites, 5352-PM Princeton, Chicago 9.

CAREFUL Composition, superior stock, particular presswork, postpaid prices. Dollar-saving combinations. Mageeprint, Durham 2, Connecticut.

OFFSET Printing, stationery, forms. Free samples, prices. Mimeo, Madison, Tennessee.

1000 EMBOSSED Cards, \$3.95. 4-line stamp, choice of 800 emblems, \$2.00 postpaid! Accuracy guaranteed. Samples. Parr, 426-M Ontario, Burbank, Calif.

MODERN Mimeographing. Anything 250, 8 1/2 x 11, \$2.25. Free 24 page catalog. Samples. Pennway, 439 Adams, Scranton, Penna.

PERSONAL Postcards, 100 for \$1.00, postage paid. Name-address printed on fine vellum card. Loyt Publishers, Box 34802, Los Angeles 34, Calif.

OFFSET Printing, \$6.50-1000. 8 1/2 x 11, 16 lb. National Letter, 1463 Broadway, New York 36.

100 Envelopes or letterheads \$1.00. Two colors \$1.50. Broadbrook, Botsford, Conn.

DON'T Underrate our quality! Rubber stamps 30c up. Beautifully printed 8 1/2 x 11" Hammermill letterheads 250, \$3.50. Envelopes to match 250, \$4.25. Fully guaranteed. Big catalog 10c refundable. None free. Esco 135-Print, 8 Holt, Dayton 7, Ohio.

100 ENVELOPES. Printed 2-colors \$1.25. Box 523, Rochester 2, N. Y.

1000 THERMOGRAPHED Business cards, \$4.44 postpaid. Type chart, sample free. Luis Embossed Cards, Box 423, Lansing 2, Michigan.

FREE Catalog, business, personal printing. 1000 embossed cards \$2.50 postpaid. D & M Sales, Sebastopol, Calif.

THOUSAND Quality business cards \$3.95. Stickers \$2.95. Postpaid. Trowbridge, 312-A West 75th, Chicago 21.

MIMEOGRAPHING — Letters, pricelists, formulas, instructions. Lowest prices. Lem's Letter Shop, 5710 Stanton, Detroit 8.

500 3/4 x 2 1/4 FOUR Line gummed stickers \$6c. Red border \$1.00. Moritz Printery, Saginaw, Mich.

PRINTING By Ace. Samples, catalog free. P.O. Box 262, Lyndhurst, N. J.

QUALITY Printing. Booklets, publication, catalogs, stationery. Free catalog. Adams Printers, 30 W. Washington, Chicago 2, Illinois.

MIMEOGRAPHING — Reasonable. Any copy. Mailers Service, Box 606-A, Chicago 90, Ill.

BUSINESS Stationery. Letterheads, envelopes, cards, invoices, statements, office forms. Samples free. Oren, Printer, Valiant, Okla.

#### PRINTING OUTFITS AND SUPPLIES

MAKE Your own cuts. Free literature. Piastarubber, Box 4308-M, Mobile, Ala.

MAKE Your own self-molding rubber stamps and printing cuts. Plexirubber, Argyle 1, Wisconsin.

PRINT Your own. Free details. Devine, 3594 Los Flores, Lynwood, Calif.

DO Your own printing. Save money. Simple rules. We supply everything. Print for others; good profit. Raised printing like engraving too. Have home shop. Details free. Kelsey Presses, V-11, Meriden, Connecticut.

PRINTING Presses, type, supplies. Lists 3c. Turnbaugh Service, Laysville, Penna.

FREE Lists: Used printing and office equipment. Sperry's, Williamsport 34, Penna.

PRESSES, Type cabinets, supplies. List for stamp. Lincoln Press Company, 220-C Hartwell, Fall River, Mass.

#### PATENT ATTORNEYS

HERMAN Lewis Gordon, registered patent attorney. Patent investigations and opinions. Warner Building, Washington 4, D. C.

INVENTORS—If you believe you have an invention, you should find out how to protect it. The firm of McMorro, Berman & Davidson with offices in Washington, D. C., is qualified to take the necessary steps for you. Send for copy of our patent booklet "How to Protect Your Invention." We will also send you an "Invention Record" form. No obligation. They are yours for the asking. McMorro, Berman & Davidson, Registered Patent Attorneys, 1342 Victor Building, Washington 1, D. C.

INVENTORS — Take these preliminary steps toward patent protection. Sketch and describe your invention. Sign, date and have this disclosure witnessed by two people who understand your invention. Have us make a preliminary search among U.S. patents already granted for similar types of invention. We report on the probable patentability of your invention and recommend your further course of action. Write for our instructive booklet, "Patent Protection for Inventors" and convenient "Evidence of Invention" disclosure form. Victor J. Evans & Co., 131-C Merlin Building, Washington 6, D. C.

INVENTION Record form free and "Patent Information Every Inventor Should Have." Carl Miller, Registered Patent Attorney, Woolworth Building, New York.

REGISTERED Patent attorney offers services. Sanders, 6430 Evans, Chicago 37, Illinois.

PATENTS — Irving L. McCathran, 315 McLachlen Bldg., Washington 1, D. C. Registered Patent Attorney.

C. A. Snow & Co.—M427, Snow Building, Washington 1, D. C. Registered Patent Attorneys. Write for information.

INVENTORS: When you are satisfied that you have invented something of value write me, without obligation, for information as to what steps you should take to secure a patent. Write Patrick D. Beavers, Registered Patent Att'y., 935 Columbian Bldg., Washington 1, D. C.

PATENTS. "Proof of Invention" free. E. E. Vrooman, Registered Patent Attorney, 507 McKim Building, Washington 5, D. C.

"INVENTOR'S Guide" and "Record of Invention" free on request. Frank P. Ledermann, Registered Patent Attorney, 154 Nassau Street, New York City.

INVENTORS: Without obligation, write for information explaining the steps you should take to secure a patent. John Randolph, Registered Patent Attorney, 203 Columbian Bldg., Washington 1, D. C.

INVENTORS. Learn how to protect your invention. Unless the inventor is familiar with patent matters, he should engage a competent registered patent attorney or agent to represent him. We are registered to practice before the U.S. Patent Office and prepared to serve you in handling your patent matters. "Patent Guide for the Inventor" containing detailed information concerning patent protection and procedure with "Record of Invention" form will be forwarded to you upon request—without obligation. Clarence A. O'Brien & Harvey Jacobson, Registered Patent Attorneys, 31B-A District National Building, Washington, D. C.

#### FOR INVENTORS

INVENTORS—This firm is registered to practice before the United States Patent Office and available to assist you in the preparation and prosecution of your patent application. "Patent Protection for Inventors" booklet containing detailed information and steps to take toward patent protection sent promptly upon request. No obligation. Victor J. Evans & Co., 132-C Merlin Building, Washington 6, D. C.

NEW Information! How to study patents to make your own new products to sell. Rush name on postcard. Houston Maupin, Tipp City 54, Ohio.

INVENTORS—If you believe you have an invention, you should find out how to protect it. The firm of McMorro, Berman & Davidson with offices in Washington, D. C., is qualified to take the necessary steps for you. Send for copy of our patent booklet "How to Protect Your Invention." We will also send you an "Invention Record" form. No obligation. They are yours for the asking. McMorro, Berman & Davidson, Registered Patent Attorneys, 1341 Victor Building, Washington 1, D. C.

INVENTORS—Send for free patent information book and inventor's record. Registered Patent Attorney. Associate Examiner, Patent Office 1922-29; Patent Attorney & Advisor, Navy Department 1930-47. Gustave Miller, 25A Warner Building, Washington 4, D. C.

FREE List of inventions manufacturers have requested. Tell us whether yours is patented, unpatented. Invention Bureau, 268-M Clinton, Oak Park, Illinois.

INVENTIONS Developed or marketed. Industrial Engineering Research Institute, Monsey, New York.



**COMPLETE** Services for inventors. "Record of Invention" form free. Write National Inventors Institute, 457 Munsey Building, Washington 4, D. C., or 4097 East 131st St., Cleveland 5, Ohio.

WE Promote new inventions on a royalty basis. Patented, unpatented. Automotive devices only. O. W. Automotive Devices Co., 4413 Underwood St., Hyattsville, Md.

**INVENTORS** Don't sell your invention, patented or unpatented, until you receive our offer. Write Cowgill, Box 298, Marion, Ohio.

**CANADIAN** Patent Enterprises. Active Canadian, U.S. sales. 31 Leighton East, Burlington, Ontario, Canada.

**EXPERIMENTAL** And patent development of wood projects. Models designed and built. Details free. Telesis Company, 2206-38 Street, Des Moines 10, Iowa.

**WHO** Will cash in on your idea? Every inventor should read "How to Manufacture and Promote Your Own Invention." Gives planning, procedures, actual costs of patents, parts, materials, assembly, distribution of product successfully promoted by inventor. \$1. Bryn, 422 Washington Bldg., Washington 5, D. C.

**PATENT** Searches, including copies of nearest patents, \$5.00. Reports airmailed within 48 hours. More than 100 registered patent attorneys use my service. For free invention protection forms, write Miss Ann Hastings, P.O. Box 176, Washington 4, D. C.

**PATENT** Searches \$5.00. 48-hour service. Free invention protection forms. Write Raymond L. Smith, Patent Searcher, 622 Sheraton Building, Washington 5, D. C.

**PATENT** Searches \$5.00. 48-hour airmail service. Invention protection forms free. Write Patent Engineering Service, 711 14th Street, N. W., Washington 5, D. C.

**INVENTORS**, A booklet telling you how and where to find out what I have learned in 11 years as an inventor, \$1.00. Mark Smith, Box 29, Glen Ridge, N. J. Money refunded if returned within 10 days.

**INVENTORS**. Learn how to protect your invention. Unless the inventor is familiar with patent matters, he should engage a competent registered patent attorney or agent to represent him. We are registered to practice before the U.S. Patent Office and prepared to serve you in handling your patent matters. "Patent Guide for the Inventor" containing detailed information concerning patent protection and procedure with "Record of Invention" form will be forwarded to you upon request—without obligation. Clarence A. O'Brien & Harvey Jacobson, Registered Patent Attorneys, 51A-A District National Building, Washington, D. C.

**INVENTORS**: If you have an invention for sale, patented or unpatented, write Institute of American Inventors, Dept. 40A, 631-E St. N.W., Washington 4, D. C.

"**INVENTOR'S** Guide" and "Record of Invention" free on request. Frank P. Ledermann, 154 Nassau Street, New York 38, N. Y.

**INVENTION** Record form free and "Patent Information Every Inventor Should Have." Carl Miller, Registered Patent Attorney, Woolworth Building, New York.

**INVENTORS**: Information on patent procedure furnished on request, without obligation. John Randolph, Registered Patent Attorney, 202 Columbian Building, Washington 1, D. C.

**SEARCHES**—Put your patent searches in the hands of a registered patent attorney or agent, as he qualifies to give a worthwhile patentability report. Record of invention form upon request and information on patent protection. Patrick D. Beavers, Registered Patent Attorney, 936 Columbian Bldg., Washington 1, D. C.

#### INVENTIONS WANTED

**INVENTORS**: If your invention is adaptable to our business we will contract on cash or royalty. If not, we will try to place. Free booklet. Kessler Corporation, 53X, Fremont, Ohio.

**INVENTIONS** Wanted. Patented, unpatented. Send for free form "S." Gilbert Adamec, Patent Broker, 3 Park Row, New York City.

**NEW** Products wanted: Patented or unpatented, royalty or purchase; reliable manufacturer, not an agency. Send general description only; details required after acceptance. Box 176, Roslyn, New York.

**INVENTIONS**. New ideas wanted by manufacturers. Otto Grube, Egg Harbor, N. J.

**PATENTED**; Unpatented. Write for our inventions wanted list and particulars of foremost promotion service. Superior Inventions Agency, 338-344 North Rodeo, Beverly Hills, Calif.

**CASH** Buyers for ideas and inventions. Write National Inventors Institute, 457 Munsey Building, Washington 4, D. C., or 4097 East 131st St., Cleveland 5, Ohio.

**ATTENTION** Inventors! Sell your invention to manufacturers, investors, through the pages of: "Gadgets Patents & Invention News." Write Inventors' Service Bureau, 847 W. Roscoe, Chicago 13, Illinois.

**INVENTIONS** Wanted. Patented, pending only. Inventors Patent Exchange, Hartford 1, Conn.

**INVENTIONS** Wanted. Patented; unpatented. Tremendous manufacturers lists. Global Marketing Service, 1404 Mitchell, Oakland 1, California.

**INVENTORS**: Hundreds of manufacturers have requested our assistance in locating marketable new products. Complete information free. Institute of American Inventors, Dept. 40-D, 631-E St. N.W., Washington 4, D. C.

**FROM** Center American Industry, National Research & Development Corporation seeks patented or unpatented inventions for development or sale. Write for booklet A. Room 324, 11 West 43 Street, New York, N. Y.

**INVENTIONS** Promoted. Patented or unpatented. A-1 service for inventors since 1911. Write Adam Fisher Co., 5418 Idaho, St. Louis, Mo.

**INVENTIONS** Wanted. Patented or patent pending. 24 years experience promoting inventions. National Service Bureau, 3120 Fremont, St. Louis 18, Mo.

#### PATENTS FOR SALE

**ALUMINUM** Noiseless fishing boat motor. 18 lbs. B. Nadolinski, 2412 W. Becher, Milwaukee 15, Wis.

**PATENTED** Combination automotive cigarette lighter and dashlight. Edward Hiscar, 2064 Lucina, Pittsburgh 10, Penna.

**INVENTORS**: Test the commercial value of your patented or unpatented inventions, quickly and inexpensively. Write for free information. Institute of American Inventors, Dept. 40-B, 631-E St. N.W., Washington 4, D. C.

#### MODELS, MODEL SUPPLIES

**BALSA** Wood and model aircraft. 40-page catalog 10c. Sig Co., Montezuma, Iowa.

**POWER** Models. Unusual steam, gasoline and traction engines, fittings, metals. Anniversary catalog 50c. Chas. Cole, Ventura, Calif.

**SHIP** Models and yacht supplies. Complete, large 68 page catalogue 50c. Bill Wild's, 510 East 11 St., New York City 9.

**SHIP** And other scale models. Most complete line in New England. Kits, fittings, plans, books, tools, engines, motors. Illustrated catalog 25c. James Bliss & Co., Inc., Dept. SM, 342 Atlantic Ave., Boston 10, Mass.

**1955** CAR Models, 1/25 scale, all metal, chrome trim. Send for catalog! Cars & Hobbies, Dept. PM-24, 2333 Haddon, Chicago.

**ATTENTION**; R. R. and supply mfg's. Have superior grip one piece rail spike, model, photo, notarized. Also have valuable interior shoe gauge, confidential. E. O. Kroells, 647 Bailey, Los Altos, California.

**BUILD** Miniature passenger hauling live steam locomotive with file and drillpress. We do machine work, you bolt it together. Catalog 50c. Little Engines, Lomita, Calif.

**SHIP** And yacht model fittings; blueprints. Send 35c for illustrated catalog listing hundreds of items. A. J. Fisher, 1002-1 Etowah Ave., Royal Oak, Mich.

#### HOME CRAFTSMEN

**VIOLINMAKERS**, Repairers, amateurs, professionals. Pine tone European wood. Materials, tools, patterns, instructions. Illustrated catalogue 10c. Premier Violin Supplies, Division PVM, 430 South Broadway, Los Angeles 13, California.

**LEATHERCRAFT** Supplies at lowest prices. "Craftool" stamps. Catalog 10c. Crown Leather, 22 Spruce Street, New York 38.

**35** FULL-Size lawn and animated weathervane patterns \$1.00 postpaid. Lincoln Studio, Columbia, Conn.

**FREE** "Do-it-yourself" leathercraft catalog. Tandy Leather Company, Box 791-HB, Fort Worth, Texas.

**STYLECRAFT** Sure fire hits. "Pre-traced" leather kits. Handbags, billfolds, filigree belts, over fifty other projects. Patterns on leather. Why trace? Just carve, assemble and lace. Large assortment "precarved" kits also available. Send 25c for catalog, free folder. Refunded first order. Apache Leather Company, 2804 E. Washington St., Phoenix, Arizona.

**KNOCKDOWN** Cedar chests. Lumber and veneers. Free price list. Giles & Kendall Company, Huntsville, Ala.

**FREE** Information. Money-making full size patterns. Professional designs. Furniture, gift shop items. Write Jigsawers, 117 Worth, New York 13.

**KNOCKDOWN** Cedar chests and lumber. Free price list. Bedford Lumber Company, Shelbyville, Tennessee.

**FIGURINE** Catalog, 1955 edition, 800 illustrated items including Mrs. Helm's paints, enamels; Helen's water color paints, etc., only 35c. Klosterman, Dept. K, 954 Arcade, St. Paul 6, Minnesota.

**15** NEW Patterns animated weather-vanes; bull chasing farmer, bucking bronco, drummer, locomotive with moving piston, etc. \$1. Craftplans, 1321-T South Michigan, Chicago 5.

**AWNINGS**, Ventilated, aluminum, wood frame. Materials \$3.50. Plans \$1.00. Coolshade Awnings, 125 Broad, Pawtucket, Rhode Island.

**101** FULL Size patterns. Smart, new, gifts, novelties, lawn figures, shelves, action windmills, alphabets. Plus "Make Money Jig Sawing." Only \$1.00. Mastercraft 35M, 7041 Olcott, Chicago 31, Illinois.

**MONEY** in plastics; new inexpensive molding press. Paragon, Lewistown, Ohio.

**16** NEW Lawn chairs, 22 picnic tables, benches, trellises, etc. All 38 plans with necessary full size patterns. \$1.00. Mastercraft 33M, 7041 Olcott, Chicago 31, Ill.

**MAKE**, Sell. Toy power shovel. Sturdy Mfg. Co., Clarston, Wash.

**90** ALL New, full size lawn ornament and novelty patterns, up to 20" high. Only \$1.00. Mastercraft 32M, 7041 Olcott, Chicago 31, Illinois.

**PATTERNS**, For woodworkers, 800 projects. 1955 catalog 25c. Walters Hobby Shop, 207 French, Utica 4M, New York.

**129** NEW Full-size jig saw patterns. Artist-drawn. \$1. Craftplans, 1321-A South Michigan, Chicago 5.

**89** FULL Size jig saw patterns of beautiful shelves, ornaments, toys, novelties. Plus "How, Where to Sell." Only \$1.00. Mastercraft 34M, 7041 Olcott, Chicago 31, Illinois.

**LEATHERCRAFT**—The quick, easy way to make extra money. No tools or experience needed with Larson easy-to-assemble beginners kits. Free illustrated instructions included. In minutes, you'll be making belts, billfolds, handbags, gloves, moccasins, woolskin animals, etc. Amaze yourself and friends with your new skill as a leather craftsman! Send 10c today for big new illustrated catalog of ideas, kits, materials and supplies. Act now! J. C. Larson Co., 820 S. Tripp, Dept. 4950A, Chicago 24.

**WOODWORKING** Course for home craftsmen. Twenty-two manuals. Over 1,000 pages. 75 training projects. Only complete home training program available today. Carefully written, profusely illustrated. Covers everything from wood selection to final finishing. Complete instruction in care and use of all hand and power tools. Prepared by expert manual training instructors. Write for free booklet. Interstate Training Service, Dept. G-3-C, Portland 13, Oregon.

**LEATHERCRAFT**. Metal tooling, textile painting, beadcraft, shellcraft, many other crafts. Fun, easy, profitable! Free, big, illustrated catalog. Write today. Kit Kraft, Dept. 223, Box 1086, Studio City 1, Calif.

**PLASTICS** Home-craft course for men and women. Tells and shows how to make hundreds of fast selling plastics products. All plastics and materials for 23 projects included in course. No special tools needed. Course pays for itself. Write for free booklet. Interstate Training Service, Dept. D-3-C, Portland 13, Oregon.

**SHOPMASTER**. Sensational combination power tool. Saws, drills, sands, routs. Used machinery taken in trade. Free literature. Barr Co., 811 W. Lake, Chicago 7.



**LEATHERCRAFT.** Tremendous stock of leather, tools, supplies, and kits. In leather business over forty years. Send 10c for big catalog. Sax Bros., 1111 No. 3rd, Dept. PM-3, Milwaukee 3, Wisconsin.

**BUY Wholesale** nationally advertised power, hand tools, thousands other products at big discounts. Free "Wholesale Plan." American Buyers, 628-PP Linden, Buffalo 16, N. Y.

**JIGSAW.** Bandsaw owners, let your machine bring extra profits, fun. Free details. Nu-Art, Box 2235, Boston, Mass.

**BIG Savings leather**—Now, for first time, you can buy full sides of top grain cowhide at our special, amazingly low "tannery-to-you" prices. For details, write Dept. 1, W. D. Byron & Sons, Williamsport, Md. Fine cowhide tanners since 1832.

**MODERN Furniture do-it-yourself plans.** Free literature. McAleer Hardwood Products, Box 645, Bensenville, Ill.

**REDWOOD**—Myrtle wood burl samples. List free. Artwood, Santa Rosa, Calif.

**MAKE Your own bookcases, beds, tables, desks.** We furnish wrought iron legs for all. Literature free. Hibbard's, 624 Celey Ave., Hampton, Va.

**LAWN-Garden furniture patterns with instructions, \$1.00.** Bell Plans RD10, 362 East 59th St., Brooklyn 3, New York.

**PLYWOOD.** Random lengths, widths and thickness, thirty square feet prepaid \$2.50. Mebane Novelty, Mebane, N. C.

**DOWEL Locator centers, 3 sizes 1/4, 3/8, and 1/2.** Set of 12 in toolboard pkg. Check, money order. Ken Griffin, Dept. M, 225 N. Lucas St., Iowa City, Iowa.

**BUZZMASTER.** Portable electric bench saw. Cuts rapidly. Wonderful for home workers, carpenters, tilers, etc. Literature free. Steeligrip, 336 N. Central, Chicago 44.

**VENEERS.** Inlay strips. Price list, "veneering tips," 10c. Fourteen exotic veneer samples \$1. Southern Craftsmen, Box 1644-D, Louisville 1, Ky.

**LEATHER.** Tools, lacings, supplies. Free catalog. National Handicraft, 199 William St., New York City 38.

**HEATING.** Do it yourself. Heat loss, installation plan, specifications, furnace provided. Save 50%. Tomco, 3415 McClain Dr., Cedar Falls, Iowa.

## MANUFACTURING

**MODELS**—Small lot manufacturing. Metals, plastics, etc. Milburn, Burlington, Kentucky.

## DO IT YOURSELF

**MAKE Profitable fast moving automotive accessory.** Drawings \$1.00. Veale Mfg., Box 5, Columbus, Ind.

**BUILD Streamlined plywood kitchen cabinets.** Plans, photos, instructions, \$1.00. Playnecabinets, 4617 Johnson, Western Springs, Illinois.

**CONSTRUCT Home swimming pool; trampoline for \$50.** Both plans, \$1.00. Paragon Engineering, Box 116, Athol, Massachusetts.

**BUILD An add-on house.** Drawings and information. \$1. P.O. Box 572, Yakima, Washington.

**BUILD Inexpensive concrete blockmaker.** Motor-hand. Also mixer. (Both for less than \$10.) Then make blocks for 5 room house for \$95. Write C. Lee, Mountain View, Oklahoma.

**SHELLCRAFT Catalogue 25c.** Refundable first order. World, 26 W. 18th St., New York City 11.

**BUILD 10 Amazing machinist tools that can't be bought anywhere!** Save \$100! Free literature. Progressive Tool Designers, 2161A So. 76th St., Milwaukee 14, Wis.

**PLASTER Your unfinished basement or attic rooms.** Detailed instruction manual specially prepared for the home handyman. Send \$1.00. Box 2705, Asheville, N. C.

**CLOCK Movements**—Gorgeous dials, plans, kits. See ad page 257.

**EASILY Apply sheetrock ceilings alone.** Plan 25c. Gilchrist, 440 North Seward Ave., Auburn, N. Y.

**DO It yourself.** What? Repair TV, build furniture, make barbecue, plumbing repairs, build boats, do house wiring, remodel home, lay tile, modernize kitchen, repair home, and scores of other things you can do yourself. Books covering each subject, only 25c. Send for descriptive list. It's free. Popular Mechanics Press, 200-LB East Ontario St., Chicago 11, Ill.

**CESSPOOL.** Septic-tank cleaner formula, dollar bill. Stenseth, Box 231, Regina, Canada.

**BEGINNER'S Shellcraft kit with catalog \$1.** Fairway Company, Rye, N. Y.

**MAKE Your own beautiful awnings for a fraction of regular cost.** Plan \$1.00. Henkemeyer, Box 36, St. Cloud, Minn.

**SAVE 50-75%.** Build it yourself, tools, household appliances. Wholesale catalog. Nueblings-M, Sicklerville, N. J.

**FURNITURE**—Wrought iron legs and frames! You assemble. Free catalogue. Phillips Furniture, East Peoria 8, Illinois.

**GEIGER Counter and metal detector kits.** Inexpensive, educational. Free literature. Electronic Applications, 5024 Lee Highway, Arlington 7, Va.

**DO It yourself.** What? Repair TV, build furniture, make barbecue, plumbing repairs, build boats, do house wiring, remodel home, lay tile, modernize kitchen, repair home, and scores of other things you can do yourself. Books covering each subject, only 25c. Send for descriptive list. It's free. Popular Mechanics Press, 200-LB East Ontario St., Chicago 11, Ill.

## WATCHES, OLD GOLD, JEWELRY

**UNREDEEMED Diamond, 1-carat, \$295.** 30-day refund. Free catalog. Broff's Diamond Loan Association, 411 Smithfield, Pittsburgh, Penna.

**HIGHEST Cash for old gold, broken jewelry, gold teeth, watches, diamonds, silverware, spectacles, platinum.** Free information. Satisfaction guaranteed. Rose Refiners, Heyworth Bldg., Chicago 2.

**AMATEUR**—Professional watchmakers' supplies; correspondence instructions; repairing. Bengale Company, Culver City, California.

**COSTUME Jewelry supplies.** Catalog and samples. 35c. Largest line in America. Milady-Pair Co., G.P.O. Box 1328, New York City 1.

**FREE Sample pair of earrings shows you how easy it is to make beautiful costume jewelry.** Over 5000 styles listed in new catalog, 25c. Barry's, 188 Ardsley Court, Newark, N. J.

**HIGHEST Prices for gold, silver, platinum, diamonds, watches, gold teeth.** Satisfaction assured. Goods returned if offer unsatisfactory. United Smelting Works, (Old Reliable), 6-B East Monroe, Chicago 3.

**WATCHMAKERS' Tools, materials, supplies, watches.** Catalog. Gales, Box 1000, Chicago 90, Ill.

**WATCH And clock repairing books for hobbyists.** Free information. North American, Dept. 15-C, 2320 N. Milwaukee, Chicago 47, Illinois.

**RHINESTONES.** Jewelry settings, cameos, sequins, beads, hobby kits. Catalog free. J & M Novelties, Dept. CC-3, Griffith, Indiana.

**YOUR Watch reconditioned \$4.** Year guarantee. Edwin Burke, Fairfax, Vt.

**WATCHES Overhauled \$4.50.** One year's guarantee. Berkowitz, 1130 Castlehill, New York 62.

**USED And new watches, \$2 up.** Free list. Southern Watches, Gray, Georgia.

**DIAMONDS, \$1.00 Per point.** Old gold accepted in trade. B. Lowe, Holland Bldg., St. Louis 1, Mo.

**MAKE Costume jewelry for fun and profit.** Catalog 25c. Bergen Arts, 128M Main, Hackensack, N. J.

## TOBACCO, SMOKERS' SUPPLIES

**PIPE Smokers! Cigar smokers!** Free illustrated catalog offers fabulous savings on choice imported and domestic pipes, cigars, tobaccos, supplies. Write Wally Frank, Dept. 25, 150 Nassau Street, New York 38, N. Y.

**FREE Pipe tobacco.** Advise favorite brand. Sidney Ram, 220 North Clark, Chicago 1, Ill.

## RAZORS, BLADES, SHARPENING

**100 FINEST Quality double edge blades \$1.00.** Free sample. Park Sales, 58 Central Avenue, Rochelle Park, N. J.

**FREE Sample.** Mystery blades save on shaves. allenCrafts, 1061-A Myrtle St., Grand Rapids 4, Mich.

## FOR THE HOME

**EAGLE 6'** Folding rule 65c prepaid. Free catalog tools, plumbing supplies. Sands Supply Co., 348 Third Ave., New York City 10, N. Y.

**FOAM Rubber furniture cushions.** Factory seconds, 30% discount. Free catalog. Perma-Foam, 140-C Main Street, East Orange, New Jersey.

## OF INTEREST TO WOMEN

**GOOD Money in weaving.** Weave rugs at home for neighbors on \$69.50 Union Loom. Thousands doing it. Booklet free. Union Looms, 153 Post St., Boonville, N. Y.

**MAIL Order magazine, sample copy, 25c.** Clark, Box 3602, Miami 23, Florida.

**COLGATE'S Lustre-Creme shampoo, 4 lbs. \$4.85.** Geller, 2089 Matthews Ave., New York City.

**MAKE Big money at home!** Invisible reweaving pays up to \$10.00 profit in an hour. Make tears, holes disappear from fabrics. Constant demand from laundries, cleaners, homes, brings steady earnings. Details free. Fabricon, Dept. C, 8342 S. Prairie, Chicago 19, Illinois.

**DRESSES 24c; Shoes 39c; men's suits \$4.95; trousers \$1.20.** Better used clothing, free cat. Transworld, 164-AH Christopher, Brooklyn 12, N. Y.

**PROFITABLE Home business.** Make fast-seller chenille monkey trees, dolls, flowers. Terrific holiday demand. Information free. Valva, Bohemia 16, N. Y.

**GROW Mushrooms.** Cellar, shed, and outdoors. Spare, full time, year round. We pay \$3.50 lb. We paid Babbitt \$4,165.00 in few weeks. Free book. Washington Mushroom Ind., Dept. 176, 2954 Admiral Way, Seattle, Washington.

**KILL Chimney creosote, down draft and fire risk at once, forever.** Mailable metal product. Money back guarantee. Write Boston Machine Works Company, Manufacturers, Dept. M, 7 Willow Street, Lynn, Mass.

**LADIES Electric razor (a.c.) scientifically designed.** Makes underarms and legs beautifully smooth without irritation! Guaranteed. \$3.95 postpaid. Afco Sales, Box 123, Jersey City, N. J.

**DRESSMAKERS.** Sewers, wholesale lists. Dress, suitings, formal fabrics. Box 863, Norwalk, Conn.

**A Dress shop in your home.** No investment. Liberal sales commissions. Write Bellecraft Fashions, 111 YS Eighth Ave., New York City.

**GETTING Married?** Outstanding samples announcements, napkins, book-matches, everything 10c (refund order). One day service. Engraversprint, 1223 Springarden, Pittsburgh 12, Penna.

## FOR SALE—MISCELLANEOUS

**AMAZING Bargains! Amplifiers—Save 50%.** Tremendous savings: Accordions, pianos, organs, typewriters, movie equipment, binoculars, recorders, hi-fi systems. Abelmart, 466 Belmont, Paterson, New Jersey.

**HEARING Aid batteries, wholesale.** Free list. Habs, Box 51, York, Penna.

**OLD Wall telephones.** Working order, oak cabinets, hand crank for ringing. \$5.00 each. Telephone Co., Turtle Lake, Wis.

**PATENTED Adjustable bed table with light.** Unpainted \$24.95, express collect. Crescent Line Furniture, Morgantown, W. Va.

**NAZI Wehrmacht war merit cross \$3.95.** Kingston, 3224-22, Seattle 99, Washington.

**VERMONT'S Best known product: Maple syrup, cakes, soft sugar, cream.** "To be sure buy the pure." List. Marshall Maples, Poulney 5, Vt.

**BUY Surplus boats, jeeps, trucks, airplanes, machinery, tools, photographic, radio, electrical, plumbing equipment, office machines, typewriters, etc., direct from U.S. Government.** List \$1.00. Box 88169, East Hartford 8, Conn.

**"SCIENCE Milestones":** New, thrilling history of science, and the men who made it. More fascinating than fiction. 300 pages, 8 1/2 x 11. Packed with pictures. \$5.00. Descriptive literature free. Windsor Press, Book Dept., 200 E. Ontario St., Chicago 11, Ill.



**WANTED—MISCELLANEOUS**

**SCRAP** Copper, brass, etc. Any amount. Ralph Bowman, 327 State St., Wadsworth, Ohio.

**QUICKSILVER**, Sterling, silver solders, precious metals. Wholesale Terminal, Norwood, Massachusetts.

**SCRAP** Mercury (quicksilver) containers supplied—Tantalum, bismuth, tungsten Metallurgical Products Company. Established 1909, 35th and Moore Sts., Philadelphia 45, Penna.

**PERSONAL**

**LETTERS** Remailed - forwarded 20c. Carleton Cleveland, 864 Park, Highland Park, Illinois.

**INTRODUCTORY** Offer. Your social security card sealed in plastic. 25c. Johnson, 1171 Smith, Birmingham, Michigan.

**HOLLYWOOD** Or Los Angeles remails 25c Confidential receiving-forwarding. Monthly rates. Los Angeles classifieds \$1.00. Lowell Enterprises, Box 608, Hollywood, Calif.

**LETTERS** Remailed 25c—Six \$1.00. J. Love, 1419 E. 83rd, Los Angeles, Calif.

**REMAILING**, Receiving-forwarding address available to you. Write for rates. McLaughlin, 800 Stewart, Columbus 6, Ohio.

**HOLLYWOOD**, Los Angeles, California. Letters remailed 20c. Sunday classifieds airmailed \$1.00. Private address service \$3.00 monthly. Your projects performed, \$2.00 up. Evans Service Bureau, 7101 Apperson, Tujunga, California.

**SWEDEN**—Letters reairmailed \$1. Lofgren, Kapellgatan 6, Katrineholm, Sweden.

**OHIO** Remailing 25c each stamped letter. Box 146, Dayton 1, Ohio.

**BORROWING** By mail. Loans \$50 to \$600 to employed men and women. Easy, quick. Completely confidential. No endorsers. Repay in convenient monthly payments. Details free in plain envelope. Give occupation, State Finance Co., 323 Securities Bldg., Dept. D-227, Omaha 2, Nebraska.

**REMAILS**—Southern California. You receive three scenic cards for 25c. Return for remailing direct from Hollywood. Letters remailed 25c each. Vanderveide, P.O. 245, Hawthorne, California.

**INDIANAPOLIS** Help wanted column, airmailed \$1.00. P.O. Box 2, Carmel, Ind.

**FINANCIAL** Independence. Operate profitable home mailorder business. Meder, 550-PM Fifth Avenue, New York City 36.

**PHILADELPHIA**, Atlantic City, letters remailed 25c. Sunday classified \$1.00. Receiving and forwarding address \$3.50 monthly. Folette, 1738 E. Washington Lane, Philadelphia, Penna.

**CALIFORNIA** Employment and business opportunity ads, air-mailed \$1.00. Mac, 745 E. Willow, Long Beach 6, California.

**DETROIT** Classifieds airmailed \$1.00. Specify sections desired. Distributor, 4515 So. Jackson Rd., Jackson, Michigan.

**REMAIL** Letter 25c. San Francisco address \$2 monthly. Mailite, 1358 6th Ave.

**DETROIT** Sunday help wanted ads airmailed dollar, letters remailed quarter, information developed. John P. Daniels, 13309 Alien Road, Wyandotte, Mich.

**AIRMAILS** Remailed one dollar, 5 views Papua one dollar. Vale, Careoff Post Office, Moresby, New Guinea.

**BOSTON**, Mass., remail 25c. P.O. Box 196, Cochituate, Mass.

**REMAILS** From historic Springfield, Illinois, home and tomb of Abraham Lincoln 25c. 8 Lincoln post cards \$1.00, remailed, free. Springfield newspaper \$1.00. Lincoln Remail Service, Box 413-A, Springfield, Illinois.

**BUY** Vitamins direct. Amazing savings. Catalog free. Matoska, White Bear, Minn.

**HANDWRITING** Analyzed! Character reading 40c. Expert guaranteed service. N. Hildebrandt, 4906-S "N" St., Southeast, Washington 27, D. C.

**DENTURES** Refinished better than new. We remove tobacco, tartar stains, recare and give them diamond finish. 24 hour service. Satisfaction guaranteed. \$4.95 postpaid. Perreca, 601 W. 139 St., New York City.

**SHUT-Ins**—Cheerful travel letters, three, \$1.00. McDowell, Box 925, Palm Springs, Calif.

**IQ?** Your intelligence rating revealed. Fast, confidential testing service. Send age, occupation, \$2.00. VTS, Box 872-A, Minneapolis, Minn.

**FOR** Mail-order business information. send 25c. J. Andrews, 17311 Victory Blvd., Van Nuys, Calif.

**REMAILS** 25c. Foot of Blue Ridge Mts. Atlanta, Ga. Help wanted column airmailed \$1.00. Box 341, Seneca, S. C.

**BIG** Mail! Attractive offers! Magazines, etc. 6c! Filmer, 9101 Marion, Pharr, Texas.

**REMAILS** 25c. Classifieds \$1.00. Highco Service, Box 3782, Birmingham 11, Ala.

**GOMEZ** Trevina, Mexican law. Bank references. P.O. Box 263, El Paso, Texas.

**ENTERTAINERS:** Win popularity! Spark your speech with fresh, amusing anecdotes. Folio of forty, \$1.00. Forrest Miller, 522 Raub, Easton, Penna.

**LETTERS** Remailed from Kansas City 25c; receiving, forwarding address, \$5 monthly. Confidential Sterling Services, P.O. Box 565, Kansas City 41, Mo.

**MEXICAN** Law. General Practice Attorney, 1263 Arizona St., El Paso, Texas.

"**HOW** Can I find out?" You can! Information confidentially developed. Any matter, person, problem. Worldwide. Officially licensed. Established 1922. William Herman, 170 Broadway, New York City.

**LETTERS** Remailed 25c. Personal forwarding address. Monthly rates. Hicks Service, Box 1547, Washington 13, D. C.

**MISCELLANEOUS**

**SPEED**—Sparkle diamond and jewelry cleaner. Diamonds need cleaning often to restore brilliance. Do professional job at home. \$1.00 postpaid. Money back guarantee. Send remittance with order to Wright Products Company, Dept. B, Mt. Orab, Ohio.

**TREASURE**, Metal, mineral locators M-seco type. Latest electronic design \$75.00 up. Geiger counters, scintillators, mineralights for uranium prospecting \$35.00 up. Fully guaranteed. Monthly payment plan available. Books "How to Be a Successful Uranium Prospector," "For Fun and Profit." Literature free upon request. Fisher Research Laboratory, Inc., Palo Alto, Calif.

**DIRECTORY** Of government surplus disposal agencies. Send \$2.00. Directories Diversified, P.O. Box 2545, Minneapolis 14, Minnesota.

**THE** Automatic tie-presser \$3.95. (Patented.) Bentley Manufacturing Co., Hobart, Ind.

**CIGARETTES**—Roll 200 guaranteed to please for 75c. Particulars free. Pete Moberly, Box 782, Owensboro, Ky.

**GEIGER** Counters, kits and assembled models. All include radioactive sample. Send for details. Geiger Counters, Box 111, Sta. A., Hartford 6, Conn.

**CLOGGED** Drains opened by new powerful chemical called Sursolvent. Removes grease, soap, tree roots, etc., without expensive digging and electric rodding machines. Simple to use. Mix with water and pour down sink. Postal brings free details. Electric Sewer Cleaning Co., Allston 34, Mass.

**300** BIG Mails guaranteed. Samples, plans, offers, propositions, 12 months listing. \$1.00 refundable. Wright Publications, 2270 Hubbard, Memphis 8, Tenn.

**RECEIVE** Magazines, samples, catalogues. Mails from everywhere. Offers, hundreds. Get listed 25c. Rorick, Box 88, Cincinnati 26, Ohio.

**TREASURE** Finders for gold, silver and minerals. Money back guarantee, best available. Also Geiger counters for uranium prospectors, free information. Write Goldak Company, 1541 West Glencaks, Glendale 1, Calif.

**GROW** Mushrooms. Cellar, shed, and outdoors. Spare, full time, year round. We pay \$3.50 lb. We paid Babbitt \$4,165.00 in few weeks. Free book. Washington Mushroom Ind., Dept. 175, 2954 Admiral Way, Seattle, Washington.

**URANIUM**, Gold, silver, treasure. New power-packed, highly sensitive metal detectors and Geiger counters. Kit and factory assembled models from \$34.50. Lightest weight, guaranteed. Free literature. Electronic Applications, 5024 Lee Highway, Arlington 7, Va.

**PANNING** Gold—Free lesson; catalogue of mining, mineral books, supplies. Old Prospector, Box 729D1, Lodi, Calif.

**SNOOPER** Geiger counter. Only \$29.95 complete. Super-sensitive. Pocket size. Find a fortune in uranium. Order now. Send \$5.00, balance C.O.D. Money back guarantee. Free catalog, scintillator and larger uranium and metal detectors. Precision Radiation Instruments, 2235 CPM So. LaBrea, Los Angeles 16, Calif.

**PHOTOS**, Wallet cards, etc. Pressure sealed in clear plastic. Free sample. Box 32, Paris, Illinois.

**PRESERVE** Your snapshots, newspaper clippings, etc. in sparkling plastic. Free sample, literature. Write The Lamco Co., Box 14-B, Woodside, Penna.

**LEATHERCRAFT** For pleasure or profit. Make easy-to-assemble purses, belts, gloves, woolskin toys, 100 other items for gifts or to sell. Send 10c today for big catalog. Largest leathercraft stock in U.S. J. C. Larson Co., 820 S. Tripp, Dept. 4551, Chicago 34.

**LEARN** While asleep! Illustrated booklet shows how. Easily, inexpensively. Results guaranteed. \$2.00. Sleeplearning Research Association (C-2), 114 S. 38th Ave., Omaha, Nebraska.

**NEWSBOYS:** Rubber bands, one pound up at wholesale. Old Fashion Bands, Anthony, Kans.

**EARN** Money evenings, copying and duplicating comic cartoons for advertisers. Adservice, Argyle 1-A, Wisconsin.

**BUY** Wholesale thousands nationally advertised products at big discount. Free "Wholesale Plan." American Buyers, 631-D Linden, Buffalo, N. Y.

**I** Average \$125 weekly selling books by mail! So can you! Start sparetime! Work home! Cooper, 248-R Taunton, Buffalo, N. Y.

**MICHIGAN** Packet. Free samples, magazines, offers. Send quarter. Mail Center of Detroit, 17587 Hull, Detroit, Michigan.

**GOLD**, Silver, metal detectors. Geiger counters for uranium. Mineralights. Sensational new fully guaranteed models. None finer. Information free. Detectron Corp., 5528 Vineland Ave., North Hollywood, California.

**70** BIBLE Lessons, 25c. Bulletin, Box 87, Cathedral Station, New York 25.

**WHOLESALE!** Huge selection, famous brand products. Sensational discounts! Large catalog. Unusual business plans included. Consolidated Distributors, 21-13, Lafayette, Paterson 15, New Jersey.

**GENUINE** Bull-whips, hickory cattle canes, cowboy boots, cow-bells. Write for free list. Stock Yards Market, 6001 Benore Road, Toledo 12, Ohio.

**RECORDS**, Hillbilly, jazz. Issued 1930 to present. Katherine Smith, 3110 W. 5th, Ft. Worth, Texas.

**50** CALIBER Shell cigarette lighter. Stands 5½ inches high. Makes practical gift, souvenir, or decoration. Send \$1.00 check or m.o. to Estanix, 1924 South Fairfield Ave., Chicago 8, Illinois.

**WONDERFUL** Uplifting poem "Christ Chose Men." 2 copies 25c. Beulah Lunan, 2419 Eoff St., Wheeling, W. Va.

**GERMAN** Address lists! Anything manufactured, 50c. Burke Associates, Manchester 1, Mass.

**BUY** Wholesale through our club membership. Save up to 50%. No catalogs to buy. Details free. Consumers Buyers Service, 1117-36 St., Sacramento 16, California.

**VIGOROUS** Health. Amazing method. Solar Health, 8214-V7 Jeffery Blvd., Chicago 17, Ill.

**EXCEPTIONAL** Information. Successful human management, shop, office. P. Stine, 8576 Florence, Downey, California.

**STOP** Flooded basements. Modern engineering data on preventive devices with illustrations, how to install, what kind to use. What happens when sewerage backs up, how surface waters can do costly damage. How and what preventive steps to take with low cost "do it yourself" methods. Send \$1.00. W. Coulson, 9942 Strathmore Ave., Detroit 27, Mich.

**FREE** Diagram. Amazingly inexpensive Geiger counter. Kits available. Columbia Distributors, Box 599B, Camas, Wash.

**HAND** Beaded monograms, our Puerto Rican factory assures amazingly low prices. Adorn your sweater, blouse, etc. Easily attached to any garment. Send for catalogue. Rupert Weidner, Inc., 131 West 45 Street, New York City, Dept. M.



**NEW** Invention attached to vacuum cleaner removes loose dandruff from hair and scalp in minutes. \$3.00 postpaid, no c.o.d. Nelco Mfg. Co., 6542 37th Ave. S.W., Seattle 6.

**GEIGER** Counter, scintillation counters, neulometers. Geiger tubes, crystals, calibrating sources. Mineralights. Guaranteed, established brands. Western Radiation Laboratory, 1107 W. 24th Street, Los Angeles 7, Calif.

**PHOTO** Lampshades. Use your negatives or pictures. For information write Conaways, Box 7261, San Antonio 10, Tex.

**GEIGERS** Copes. For uranium detection. \$3 postpaid. Larry Lee, Mountain View 1, Okla.

**SELL!** Buy! Trade! Anything. In. "Trading Post Magazine." Details free! Thorne's, 525 Dewey, Jackson 40, Mich.

**BE** Somebody! Get somewhere! Request free positive thought motivation plan. Easy, quick results. Write Applied Christian Psychology, Inc., Box 1924-P, Louisville 1, Ky.

**VITAMINS** For health, energy. 10 vitamins, 12 minerals. 21 days' supply \$1.00. Hirsch, 320 Webster, New Rochelle, N. Y.

**FLYING** Saucer book list, and magazine. 10c. New Era System, 320 Melrose Building, Houston, Texas.

**ATTENTION** Vitamin users! World's best vitamin values! High quality. Low prices! Scientifically prepared and unconditionally guaranteed! Buy direct, save! Free folder. Write today. Vimtons Products, P.O. Box 2587, Montgomery, Alabama.

**BE** Your own plumber. You can. Few inexpensive tools and our instructive book, "Home Plumbing Guide," shows and tells you how. Hundreds of photographs and diagrams. Easy to follow. 160 pages. \$3.50. Catalog free. Popular Mechanics Press, 200PG East Ontario St., Chicago 11, Ill.

**HOW** To paint. Do it yourself. Illustrated instructive book, 25c. Catalog free. Popular Mechanics Press, 200-HP E. Ontario St., Chicago 11, Ill.

**SUPER** Memory overnight! Revolutionary method! Bijou, Box 1727-MU, Hollywood 28, California.

**SUGGESTION** Handbook helps you win suggestion awards. \$1.00. Almar, Box 141, Miamisburg, Ohio.

**BUY** Wholesale! Anything, everything! Save 35%-75%! Free miracle plan. Clifton Service, Ephrata 25-A, Washington.

**NEED** Mining equipment? Interesting monthly publication, Sample free! Mining Equipment News, PM-81, Middlesboro, Ky.

**SEPTIC** Tanks. \$5 saves you \$75. Easy treatment. Guaranteed corrective, saves pumping, digging and inconvenience. Write for free pamphlet "Care and Treatment of Septic Tanks." Chippewa Products Co., Burnt Bridge, Chippewa Falls, Wis.

I want to send you proof of the wonderful pulling power of Popular Mechanics classified pages. What's your proposition? Write me today. Include literature if possible. P. W. Johnson, Manager Classified Advertising, Popular Mechanics Magazine, 200 E. Ontario St., Chicago 11, Ill.

## EXPERIMENTERS

New System Invention



**HOW TO STUDY PATENTS TO MAKE YOUR OWN NEW PRODUCTS TO SELL.** Make electric hammers, Jet engines, Helicopter bicycles, Blow bicycle, Toys, Tools, Gift goods, Sell by mail. New advanced service for serious experimenters. Small cost. Nowhere near what it's worth to you if you can make money. Find out now. Get quick action. Rush name on postcard.

J. HOUSTON MAUPIN, Dept. 56, Tipp City, Ohio

## \$1300 BUILDS INCOME DUPLEX

FINANCIAL SECURITY!



Build your own 24' x 36' concrete block duplex, complete for \$1300. Slab floor, steel windows, wall furnaces, Rock wool insulated. Each side contains 11' x 13' Living Room and Kitchenette, 10' x 11' bedroom, 6' x 9' bath and four closets. Genuine 1/4" x 1" scale blueprint, step by step instructions, and material cost list—\$1.00 ppd. Money back guarantee.

BAILEY BUILDERS, 915 Pyramid Bldg., Little Rock, Ark.

## It's EASY to play The MUSICAL SAW



the Glass-O-Phone the Jazz-O-Nette, Musical-Pitchfork, Flute-O-Phone

If you can whistle or hum a tune, you can play these remarkable Novelty Instruments. They are played entirely by ear. Low priced. Write for FREE literature. MUSSEHL & WESTPHAL, Est. 1921, 10 FORT ST., FORT ATKINSON, WISCONSIN

## ARTHRITIS—RHEUMATISM VITAL FACTS EXPLAINED

FREE DESCRIPTIVE BOOK

How crippling deformities may be avoided. This amazing FREE BOOK explains why ordinary methods give only temporary relief—if that. Describes a drugless method of treatment successfully applied in thousands of cases. Write for this 44-page FREE BOOK today. No obligation. BALL CLINIC, DEPT. 756, EXCELSIOR SPRINGS, MO.



**New**  
**1955 Issue**  
MARCH 1955

# Catalog of 3200 Novelties, Gadgets, Jokes & Tricks

Send 10c for amazing catalog of novelties, joke articles, funmakers, tricks, gadgets, live animals, scientific supplies, hobbies, planes & boats, unusual seeds, time-savers, cameras, optical goods, projectors, movies, lucky jewelry, religious goods, disguises, masks, musical instruments, stamps, coins, puzzles, fortune tellers, radios, auto & bike accessories, telescopes, magnifiers, compasses, banks, smokers' items, artist supplies, printing sets, engines, motors, shockers, knives, billfolds, guns, rifles, sports, books, games, plants, pennants, emblems, etc. Send name, address and 10c to:

JOHNSON SMITH & CO.  
Dept. 942 Detroit 7, Mich.

**THIS ONE ALL-PURPOSE HOUSEHOLD CEMENT**  
"BONDS ANYTHING TO ANYTHING"

**GOOD YEAR ADHESIVE**

**Plibond**

Amazing quick-setting plastic adhesive makes you an expert "Mr. Fixit". Mends leather, metal, wood, glass, rubber, china, fabric, plaster, paper, plastic. Easy to use. Makes strong permanent flexible bond that won't get brittle. Waterproof. Resists oil, chemicals, etc. Bottle 25c. Handy tube 35c.

\*T.M. Reg. The Goodyear T. & R. Co.  
W. J. RUSCOE CO., AKRON 13, OHIO

AT DIME AND HARDWARE STORES EVERYWHERE

**Why Buy Expensive Equipment?**

MAKE THESE CONCRETE BLOCKS AT LOW COST FOR YOUR OWN USE OR FOR SALE WITH EQUIPMENT YOU CAN MAKE FOR LESS THAN \$3.00 AND A FEW HOURS TIME.

REQUIRES NO PALLETES

A PROFITABLE PART-TIME OR FULL-TIME BUSINESS

SEND FOR THIS COPYRIGHTED, LITHOGRAPHED BOOKLET "SIMPLIFIED CONCRETE BLOCK MAKING"

THIS BOOKLET CONTAINS SIMPLIFIED BLUEPRINTS, INSTRUCTIONS AND PHOTO-ILLUSTRATIONS FOR THE "PLANS SYSTEM" OF MAKING CONCRETE BLOCKS WITH A MINIMUM OF EFFORT AND EQUIPMENT.

**PLANS**  
PM1 VIRGINIA, MINNESOTA

PRICE ONLY \$1.00  
Post Paid U. S. & Canada

Here's 10c. Rush me New Catalog!

Johnson Smith & Co., Dept. 942, Detroit 7, Mich.

Name \_\_\_\_\_

Address \_\_\_\_\_



# EARN BIG PAY

Industry needs skilled mechanics. GREER, leader for more than 50 years in the Trade School field, can train you quickly—You "learn by doing," using the finest equipment, under the supervision of expert technicians.

APPROVED FOR CIVILIANS  OR GI'S

— CHOOSE YOUR TRADE —

CHECK HERE	WEEKS
<input type="checkbox"/> DIESEL MECHANICS	20
<input type="checkbox"/> AUTO MECHANICS	20
<input type="checkbox"/> BODY & FENDER	16½
<input type="checkbox"/> GAS-ARC WELDING	4-12
<input type="checkbox"/> REFRIGERATION	13½
<input type="checkbox"/> AIR CONDITIONING	8½
<input type="checkbox"/> MACHINIST TRADE	30
<input type="checkbox"/> ADVANCED MACHINIST (includes tool & die)	32½
<input type="checkbox"/> PIANO TUNING & REPAIR	36

## CHOOSE YOUR ENGINEERING COURSE

These courses are intended as terminal education for men who wish to enter the Diesel-Automotive and Refrigeration-Air Conditioning fields as technicians. These courses are designed to prepare men for supervisory positions. Students with a high school education, or equivalent, will be accepted.

<input type="checkbox"/> DIESEL AUTOMOTIVE ENGINEERING	2 years
<input type="checkbox"/> REFRIGERATION & AIR COND. ENGINEERING	18 months

## HOME STUDY COURSES

Learn at Home—Approved for Civilians & G.I.s. Write for detailed information on Courses in

- PLASTICS  
 REFRIGERATION & AIR-CONDITIONING  
 DIESEL ENGINES

## FREE EMPLOYMENT HELP

Start your career with Greer by checking your interest above and mail coupon for complete information at no obligation.

NAME \_\_\_\_\_ AGE \_\_\_\_\_

STREET \_\_\_\_\_

TOWN \_\_\_\_\_ ZONE \_\_\_\_\_ STATE \_\_\_\_\_

Established 1902 — Over 50,000 Graduates.

53 years of continuous trade school experience to guide your training.

## GREER SHOP TRAINING

2236 S. Michigan Ave.  
Chicago 16, Illinois



## WHERE-TO-BUY-IT INDEX

Source of supply appears after items commercially available

### AUTOMOTIVE

Jeep and trailer equipped for travel almost anywhere.....	86
Service-station air hose powers vacuum cleaner (Knitter Co., 1637 S. Broadway, Denver 10, Colo.).....	86
Dream truck has front-wheel drive, inboard front brakes (GMC Truck & Coach Div., General Motors Corp., 660 S. Bend, E., Pontiac 11, Mich.).....	87
Jensen 541 opens up for engine inspection.....	87
Lincoln shows its idea automobile.....	95
Miniature crawler-type tractor designed for truck gardening (Lincoln Steel Works, 315 W. O St., Lincoln, Neb.).....	95
Lancia PF 200 shown in Paris.....	96
Chrysler introduces a hardtop sports coupe with 300 horsepower.....	97
Police car rides narrow-gauge track "catwalk" in tunnel.....	100
Car-straightening jack pulls parts together (Snap-on Tools Corp., Kenosha, Wis.).....	127
Catalytic purifier destroys dangerous fumes from lift truck (Oxy-Catalyst, Inc., Wayne, Pa.).....	127
"Otter" totes cargo.....	145
Streamlined cycle.....	145
You wouldn't know it—but there's a trailer inside this house.....	146
Tubeless-tire repair clamp holds hot patch under pressure.....	146
Miniature British auto carries five.....	148
German version of Jeep passes field tests.....	149
Miniature semitrailer duplicates full-size over-the-road rig.....	150
Low-slung locomotive speeds through potash mine.....	158
Carriage unloader (Guns, 4110 Fannin, Houston 4, Tex.).....	254
Trailer-hitch lock (A. M. Lavin Machine Mfg. Works, Hatboro, Pa.).....	254
Key-operated brake lock (Auto-Safe, 80 Upper Church St., Albany, Ill.).....	272

### AVIATION

Wind blows two ways at air-meet site.....	85
British two-seat fighter attains the speed of sound.....	97
High-temperature alloy (General Motors Corp., General Motors Bldg., Detroit 2, Mich.).....	100
Windshield TV screen to aid blind flying.....	101
Fighter plane launched like missile from truck platform.....	108
Multijet seaplane has three-story tail.....	112
SAC refuels every 3½ minutes.....	112
Magnetic detector spots submarines.....	133
Heavy transport planes get boost from lightweight turbojet.....	136
Chromium protects cylinders.....	148
Radiotelephone "rings" pilots.....	148

### BOATS

British passenger liner has funnel and engines at rear.....	120
"Envelope" for boats (Union Bag and Paper Corp., 233 Broadway, New York City).....	133
Salt water cools deck.....	135
Cruiser mounts motors on outrigger brackets (Southwest Mfg. Co., 2008 E. 14th St., Little Rock, Ark.).....	140
Jet-propelled fire boat.....	140

### FARM

Automatic feeder doles out ration (Hobart Mfg. Co., 211 E. Third St., Hobart, Okla.).....	108
---	-----

### HOUSE AND HOME

Colonial-style cabinet latch closed on small magnet (American Cabinet Hardware Corp., Rockford, Ill.).....	86
Garage "doornaments" give individual touch (Barber-Colman Co., Clifford Ave., Love Park, Rockford, Ill.).....	94
Blanket wakens sleeper (Sears, Roebuck & Co., 925 S. Homan, Chicago).....	96
What's New for Your Home—	
Adhesive tile simplifies floor laying (Robbins Floor Products, Inc., Tusculumbia, Ala.).....	130
Combination tool uncaps and recaps bottles (Great Lakes Sales, 95 E. 15th St., Holland, Mich.).....	130
Convertible air conditioner cools or heats (Electriglas Corp., Bergenfield, N. J.).....	130
Egg rack times boiling (Jetfoam Corp., Ambassador Bldg., St. Louis 1, Mo.).....	131
Steam-driven spit (Buck Mfg. Co., Elizabethtown, Pa.).....	131
Glowing switch easy to find in dark (General Electric, Bridgeport 2, Conn.).....	131
Turkey lifter provides sure grip (Krohme Industries, Walnut Creek, Calif.).....	131
Range has removable broiler (Kelvinator Div., American Motors Corp., Detroit, Mich.).....	131
Blower ducts carry ashes from basement—no baskets needed.....	132
Cedar-shingle panels save application time.....	132
Vacuum cleaner flushes dirt down sewer (Simplon Corp., 23589 Van Born Rd., Dearborn, Mich.).....	134

### MISCELLANEOUS

One-man speed clock spots fast drivers (Traffic House, Inc., 202 National Bank Bldg., Decatur, Ill.).....	85
Shock treatment gives burned-out fluorescent bulbs new life.....	85
Spring-wound bike "engine" energized by part-time pedaling.....	94
Barrel diving exercise for West Berlin police.....	96
Rifle-bullet magazine clips to hunter's belt (Durden-Fraleigh Co., 1043 Peachtree St. N. E., Atlanta, Ga.).....	96

(Continued to page 76)



# Clean both sides INDOORS!

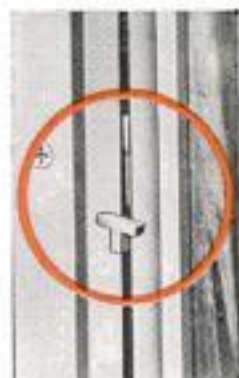

## Something new has been added - **LIFTLOX**

The most important window improvement in 50 years!

- Finger pressure raises or lowers sash!
- Sash lift out entirely! No tapes to unhook! Nothing to adjust!
- Self-contained Liftlox Window Balance "locks" automatically when sash is removed!

R.O.W. SALES CO., 1346 ACADEMY AVENUE • FERNDALE 20, MICHIGAN

R.O.W. is the registered trade-mark of the R.O.W. Sales Co.

**make your own Gems** **29.50**  
F.O.B.

The Gem Maker comes complete with all necessary equipment, including a super-charged diamond blade for sawing, and all wheels for grinding, shaping and polishing; also complete instructions. The complete equipment as shown, less motor and belt, for only \$29.50, f.o.b., Burlington, Wisconsin. Write today for information and literature.

**B&I MANUFACTURING CO.**  
Dept. 5 Burlington, Wis.

**SECRET CAR GUARD**

stops auto theft even if keys left in. Only those knowing secret can start car. Complete, easy-to-install electronic theft protector fits all cars. Money-back guarantee. \$3.00 postpaid.

**ELECTRO-PROTECTO** 910 Ave. E. Council Bluffs, Ia.

**BRONZE FOUNDRY**

Schools and Home Workshops

Make your own castings of aluminum, copper, bronze, silver. Foundry sets are available in three sizes including 2400 Deg. F. blast Furnaces. \$22.50; \$29.50; and \$42.00. f.o.b. Kansas City. Free Circular.

**KANSAS CITY SPECIALTIES CO.** P. O. Box 6022, Dept. P-3  
KANSAS CITY, MO.

**A MICHIGAN PROPELLER**  
MATCHED TO YOUR OUTBOARD  
MOTOR, BOAT AND LOAD

WILL PROVIDE BETTER  
PERFORMANCE  
FOR RACING OR PLEASURE

Write for FREE 1955 catalog. Contains much helpful boating data and carefully engineered propeller recommendations.

**MICHIGAN WHEEL CO., Dept. P-83**  
GRAND RAPIDS 3, MICHIGAN

## Say You Saw It in Popular Mechanic **NOW** — A Real "Do-It-Yourself" OPEN FIREPLACE and CHIMNEY

**Without Mortar or Masonry**

For old or new homes, cottages, cabins, shelters.

**SAVE MORE THAN HALF!**  
Eliminate masonry materials and save labor costs with this complete, full-sized, full-service wood-burning fireplace and chimney!

**FIRE-SAFETY CLEARANCES BUILT IN!**  
Butts right against wood flooring, walls, studs, joists and beams with complete safety. Labeled by Underwriters' Laboratories, Inc.

**EASY ONE-MAN INSTALLATION!**  
No mortaring! Flue is of strong, permanent, stainless steel. Realistic brick-finish aluminum chimney top.

Scientifically proportioned—WON'T SMOKE!  
Write today for free details!

For 1-story, 1 1/2-story and 2-story houses

**Majestic THULMAN FIREPLACE**

**THE MAJESTIC CO., INC., 456 ERIE ST., HUNTINGTON, IND.**



# FREE 1955 ALLIED TV & RADIO CATALOG

THE COMPLETE ELECTRONIC SUPPLY GUIDE



**308  
VALUE-  
PACKED  
PAGES**

**Save on  
Everything  
in  
Electronics**

**WORLD'S  
LARGEST  
STOCKS**

**Everything for Experimenters,  
Builders, Amateurs,  
Servicemen, Engineers and  
Hi-Fi Specialists**

Send for ALLIED's big 308-page value-packed buying guide to everything in TV, Radio and Electronics! Largest selections of custom TV chassis, antennas and accessories; FM and AM tuners; High Fidelity systems and components; recorders and phono equipment; Amateur supplies; test instruments; builders' kits; industrial electronic supplies — plus the world's largest stocks of electronic parts, tubes, tools and books. Save on everything in Electronics — send today for your FREE 1955 ALLIED Catalog.

**ultra-modern facilities to SERVE YOU BEST**



**ALLIED RADIO**

**Send for  
FREE  
Catalog**

**ALLIED RADIO CORP., Dept. 5-C-5  
100 N. Western Ave., Chicago 80, Ill.**

Rush FREE 1955 ALLIED 308-Page Catalog

Name \_\_\_\_\_

Address \_\_\_\_\_

City \_\_\_\_\_ Zone \_\_\_\_\_ State \_\_\_\_\_

(Continued from page 74)

Heavy machinery moved on casters (Stokvis-Edera & Co., Inc., 18 Secatong Ave., Port Washington, N. Y.).....	97
Children watched through special mirror.....	100
Two box cameras coupled on platform to make low-price stereo.....	112
Heated blade aids plastic sculpture (Merritt Engr. Co., 674 23rd St., Oakland 12, Calif.).....	121
Toy rolls along belt curved in any pattern.....	127
Milk-o-magnes-a coating cures mechanical headache.....	128
Flattened plastic strip tells bearing clearance (Perfect Circle Corp., Hagerstown, Ind.).....	128
Rotating tines of ditcher-terracer throw dirt to one side.....	132
Glass-fiber repair kit (Fybrglass Div., Schramm Fiberglass Prod., Inc., Higgins Rd., Chicago 30).....	134
Stepladder levels itself.....	134
Stairs on work tower end ladder climbing (Safway Steel Products, Inc., 6234 W. State St., Milwaukee 13, Wis.).....	135
Vertical passenger-conveyor belts take the place of elevators.....	135
Lift truck hoists nine drums at once (Yale & Towne Mfg. Co., 11000 Roosevelt Blvd., Philadelphia 15, Pa.).....	140
Antitank rifle mounted on Jeep.....	147
Electronic brain slows cars in making up trains in freight yard.....	147
Rubber sandwiches for rail crossing (Goodyear Tire & Rubber Co., Akron, Ohio).....	149
Full-dimensional home movies photographed with lens adapter.....	150
Portable charcoal stove heats cabins or cooks meals (Specialty Engr. Co., 391 Topping at Western, St. Paul 3, Minn.).....	155
Double-edged weeder (Ames Power Count Co., Ames, Iowa).....	155
Stump splitter attached to bulldozer blades speeds removal.....	155
Repeating stereo viewer (Stereo 50 Viewer Corp., 946 N. Ca-huenga Blvd., Hollywood, Calif.).....	236
Newsman makes own aerial camera.....	272
Holder for fishing rod (Alto Mfg. Co., 1647 Wolfram St., Chicago 13).....	274
Light bulb has two "lives" (Solar Electric Corp., Warren, Pa.).....	274

## SCIENCE

Biggest star dwarfs sun.....	87
The cars talk, too.....	96
Special air conditioning beats Arizona summer sun.....	120
Visitors' portable radios pick up museum lectures.....	120
Lightweight electronic piano replaces strings with metal reeds (Rudolph Wurlitzer Co., 105 W. Adams St., Chicago).....	128
Museum superfly defies swatters.....	133
Offspring of aluminum.....	135
Kit analyzes uranium ore (Sherwin Instrument Co., 2875 Broadway, New York City).....	136
Portable plastic heat sealer (Sealing Mfg. Corp., 4716 W. Lake St., Chicago 44).....	136
Reflective aluminum insulation makes suits for fire fighters.....	145
Power glove for paralytics.....	146
100-power baby telescope (John B. Norman, 1118 S. Wall St., Tyler, Tex.).....	148

## Radio-Television, Electronics

Solar energy powers midget radio transmitter.....	161
Assembling transistors in "dry boxes".....	161
Car radios keyed to civil-defense emergency.....	161
Magnetic disk recorder (The U. S. Time Corp., 500 Fifth Ave., New York City).....	164
Simplified sound system control (ClaroStat Mfg. Co., Inc., Dover, N. H.).....	164
Midget radio-phonograph streamlined to save space (Webster-Chicago Corp., 3610 W. Bloomingdale, Chicago 39).....	164
Telephone intercom system (Connecticut Telephone & Electric Corp., Meriden, Conn.).....	164

## Craftsman and Shop Notes Index

### AUTOMOTIVE

Automobile engine on trailer powers portable elevator.....	212
Portable gasoline tank used on stationary auto engine.....	260

### FARM AND FARMING

Rain from roofs of hog sheds used for livestock.....	208
Single fence-line tank supplies two feed lots.....	208
Farm dam doubles as roadway.....	212
Straw stacked near feed barn minimizes handling.....	256
Tractor seat folds back when driver stands up.....	256
Modified corn planter.....	258

### HOUSE AND HOME

Storm-sash carrying handle.....	172
Too-frequent house painting results in poor protection.....	172
Felt strips stop light leakage between fixture and ceiling.....	179
Cabinets on laundry equipment add appearance and storage.....	179
Solving Home Problems—	
Fixing slide fastener when teeth have separated.....	180
Sandpaper provides nonskid surface on ladder.....	180
Wrench for removing tight screw caps.....	180
White shellac for book covers.....	180
Nail-polish bottles prevented from upsetting.....	181
Gas supply shut off by wrench tied to pipe.....	181
Small decorative touches utilize plastic coasters.....	181
Removing lipstick stains from napkins.....	181

(Continued to page 78)



# BE YOUR OWN BOSS

# EARN \$10,000 and up THE FIRST YEAR

Start Your Own Year 'round Business with a fast-digging

## Jeep-A-Trench

### GEAR-DRAULIC Trenching Machine

EASY TO BUY! ECONOMICALLY OPERATED!

There'll be a year 'round demand for your services in town and country when you own and operate a Jeep-A-Trench, the trenching machine with more advance design-engineering FIRSTS than any other in the industry.

#### MANY YEAR 'ROUND USES!

- Gas and Water Mains • Sewer Lines • Tiling
- Septic Tank Laterals • Farm Water Systems
- Sprinkling Systems • Irrigation • Foundation Footings
- Underground Conduit • Many others

Complete Jeep-A-Trench unit may be bought with a small down payment — pay the balance as you earn! Easy terms. Financing arranged.

FITS ANY JEEP • Streamlined Design  
• Hydraulic Controls • Gear Driven

DIGS TRENCHES 6" TO 14" WIDE  
AND TO DEPTHS UP TO 6 FT.  
ONE-MAN OPERATION



Custom operators "Digging for Profit" on many jobs, large and small, enjoy earnings of \$10,000 to \$25,000 per year.

Designed, Engineered and Built by the World's Largest Producer of Trenching Attachments.

**AUBURN MACHINE WORKS, INC.**  
AUBURN, NEBRASKA

**FREE** Send Today for Complete Information — No Obligation

**JEEP-A-TRENCH**  
Auburn Machine Works, Auburn, Nebraska

Please send me the FREE Jeep-A-Trench folder and additional information.

Name \_\_\_\_\_

Address \_\_\_\_\_

City \_\_\_\_\_ State \_\_\_\_\_



## SHOOT TELEVISION FILMS

FOR YOUR LOCAL TV STATION... make Extra Profits with the "Cine-Voice" Sound-On-Film 16mm Camera. \$695! Write for free information.

**BERNDT-BACH, Inc.**

6952 Romaine St., Hollywood 38, Calif.

SOUND-ON-FILM SINCE 1931

**LUBRIPLATE**  
KEEPS TOOLS LIKE NEW  
PREVENTS RUST  
AND LUBRICATES TOO!



**TRY LUBRIPLATE!** Not an old-fashioned oil that runs off or gets gummy. LUBRIPLATE is a new, white and clean, semi-fluid lubricant that stays put.

• In handy 20¢, 35¢ and 95¢ tubes at Sporting Goods, Hardware, Marine and Auto Supply Stores.

• Dealers write to LUBRIPLATE DIVISION, Fiske Bros. Refining Co., Newark 5, N.J.

**LUBRIPLATE**  
THE MODERN LUBRICANT

JUST for YOU ...



**BROCHURE**

Save money... get economical and faster car operation, guard against leaks and anti-freeze seepage. Know your car's cooling system. Write today for your copy of "Truths... Consequences" booklet. IT'S FREE



**GET YOURS NOW Hurry!**

"Truths... Consequences" was written by automotive engineers for car owners, fleet operators, garage mechanics, farmers, service station men and car dealers. Send a postcard for your copy today.

**BAR'S LEAKS**

BAR'S PRODUCTS SUPPLY, Inc.  
Dept. PM, 5871 S. Telegraph Rd., Dearborn, Mich.



# FREEZES ACTION

AT 1/1400 OF A SECOND



## GRAFLEX-MADE STROBOFLASH I

FOR THE CAMERA HOBBYIST AND PROFESSIONAL

Now, almost any camera with built-in synchronization can stop action at 1/1400 of a second, with Strobflash I, a feature that makes this portable electronic flash welcome equipment for your photographic hobby or profession. In addition: capable of thousands of economical flashes without changing bulbs. Soft light captures highlight detail. Equally good for color or black and white.

Duration of flash: 1/1400 second. Capacitor recharging rate: 3-5 seconds. Guide numbers for color: 28 to 35. Power pack, enclosed in a scratch-proof Royalite case, small enough to fit into coat pocket.

See your local Graflex dealer today. You'll find his name in the Classified Telephone Directory.

ONLY \$104<sup>90</sup> WITH BATTERIES AND BRACKETS

Available in Larger Models  
Strobflash II and III

For further information write: Dept. PM-35  
GRAFLEX, INC., ROCHESTER 8, N. Y.

**GRAFLEX**® *Price-Winning  
Camera*

(Continued from page 76)

Interlocking cabinet.....	183
Efficient oil-drum incinerator has improved draft door.....	184
Electrical-outlet guard protects crawling baby.....	189
Eliminate vent-pipe freezing by using insulation.....	204

### HOUSEHOLD HINTS

Store electric extension cord without knots or kinks.....	177
Glass blocks light dark closet.....	183
Color of paint when dry shown by blotter test.....	183
Caster cups protect cabinet against ant invasion.....	184
Envelope made "lightproof" with newspaper lining.....	184
Card tables "locked" together by tin cans under legs.....	188
Weights inside steel posts keep clothesline taut.....	188
Raising dents in furniture.....	196
Bullet-type cabinet catch silences rattling door.....	196
Circles painted on drawer knobs add decorative touch.....	208
Varnish applied to old woodwork.....	212
Bottle stopper kept handy with rubber band.....	218

### LAWN AND GARDEN

Marking location of water valve when lawn is regraded.....	203
--	-----

### MISCELLANEOUS

Trussed strip of plywood provides "bridge" over pool.....	170
Small garden toos easily located.....	177
Fish bag hung over side of boat eliminates need for stringer.....	177
Roller-skate whitewall wheels provide safety feature.....	178
Wide-sweeping tether gives dog freedom.....	178
Surface water kept out of well.....	182
Rubber bumper on children's swing prevents accidental injury.....	188
Paint auto instrument panel to improve appearance.....	192
Suet "stick" feeds birds.....	192
Stocking protects furled flag.....	196
Eraser aids pinpoint removal.....	203
Fishline dried on clothespins clamped to rod.....	203
Clip on auto instrument panel holds notes and papers.....	204
Fishhook utilized as line guide.....	204
Grow greens in poultry yard under hardware-cloth screen.....	218
Scouring pad provides strainer.....	260

### PHOTOGRAPHY

Film-developing tank agitated by motor and flexible shaft.....	170
Towel bar provides shelf rail.....	184
Prevent sticking of prints.....	188
Guides speed photo cropping.....	196
Replacement knobs for kettle lids prevent damaged bottle corks.....	203
Prints held flat on cutter by sheet of clear plastic.....	208

### WORKSHOP HINTS

Nail holder extends arm reach when installing wallboard.....	170
Worn bench stop held in place.....	170
Neutralize concrete floor before painting.....	170
Rubber tubing holds screw on driver blade.....	172
Thumbtack prevents slipping of steel measuring tape.....	172
Rack for wooden dowels improvised with discarded sanding belts.....	172
Dowel stops on sawhorse hold work when planing.....	177
Spring provides drawer stop.....	179
Building fence is one-man job when pair of legs is used.....	179
Cutting glass with tin snips.....	182
Prevent knot from untying by dipping in shellac.....	182
Tubular rivets utilized as bearings for toys.....	182
Using chain for top rung improves ladder safety.....	182
Foil helps amateur painter.....	184
Plywood magazine rack is one-evening project.....	189
Ball bearing in thimble holds end of twine.....	192
Stopper for screw-top can.....	192
End-grain splitting.....	192
Fence on sanding block assures straight edges.....	196
Dowel provides screw anchor in end grain of wood.....	204
Twin-blade hacksaw cuts thin-wall tubing.....	204
C-clamp prevents splitting when nailing thin wood.....	208
Ends of dowel pins flattened for use in oversized holes.....	212
Yardstick used as gauge for fuel-oil tank.....	218
Rivets set in steel block provide "branding iron".....	218
Shrinking valve-seat inserts.....	218
Tray on heavy-duty wheelbarrow is section cut from boiler.....	258

### TOOLS

Salvaging chipped end mills.....	212
Shopping for Tools—	
Lathe cutoff tool (H. W. Herder Tool Specialties, 2723 E. Michigan Ave., Kalamazoo, Mich.).....	219
Micrometer (L. S. Starrett Co., Athol, Mass.).....	219
Tilting bandsaw (Toolcraft Corp., Springfield, Mass.).....	219
Plastic cutter (Wodack Elec. Tool Corp., 4627 W. Huron St., Chicago 44).....	220
Wrecking bar (Unique Products, Inc., Box 2263, Reno, Nev.).....	220
Plane-type handle (The Circo Co., 1257 King's Highway East, Bridgeport 5, Conn.).....	220
Self-feed soldering iron (Scotco Products Co., Beverly, Mass.).....	220
Pencil-size soldering iron (Telvac, Box 6001, Arlington 6, Va.).....	220
Tiny circular saw (Steelgrip Plastics, 336 N. Central Ave., Chicago 44).....	220

**IMPORTANT NOTICE**—It is the intention of this magazine to provide its readers with information regarding the latest developments in the mechanical arts. We take no responsibility as to whether the disclosures contained in our articles are covered by patents and advise readers to investigate this subject before making, using, or selling any of the products, machines, or processes described in order to avoid possible liability for patent infringements.



Courtesy Maxwell Offset



**“WE’RE LOOKING FOR PEOPLE WHO LIKE TO DRAW”... say America’s 12 Most Famous Artists. Many men and women have hidden art talent they never dreamed of. They could be trained for success and security in the field of art if they only knew their own ability. We artists will help you discover your art talent free! Send for our **FREE ART TALENT TEST.****



Thousands paid \$1 to take this revealing 8-page test. It's yours **FREE** if you act at once. Mail the coupon **NOW!**

**America's 12 Most Famous Artists**

- NORMAN ROCKWELL
- JON WHITCOMB
- AL PARKER
- STEVAN DOBANOS
- HAROLD VON SCHMIDT
- PETER HELCK
- FRED LUDEKENS
- BEN STAHL
- ROBERT FAWCETT
- AUSTIN BRIGGS
- DONG KINGMAN
- ALBERT DORNE

**FAMOUS ARTISTS SCHOOLS**

Studio 6-MA, Westport, Conn.

Send me without obligation your Famous Artists Talent Test.

Mr. \_\_\_\_\_ Age \_\_\_\_\_  
 Mrs. \_\_\_\_\_  
(PLEASE PRINT)

Address \_\_\_\_\_

City \_\_\_\_\_ Zone \_\_\_\_\_ State \_\_\_\_\_

**Free IMPORTS**

from faraway lands, to new members...

Important world changes now make it possible for you to become prosperous taking orders for unique and appealing imports in... **YOUR OWN BIG MAIL ORDER BUSINESS.**

See ads of Mellinger trained importers in national magazines offering fantastic bargains to U. S. Mail order buyers at fine profits.

**START QUICKLY WITHOUT CAPITAL.** Foreign nations want U. S. dollars and offer terrific bargains. With my training you may now take big profit, cash-in-advance mail orders for imports shipped direct from abroad like other men and women I've taught. Many other plans, too.

**FREE MEMBERSHIP TO SPEED YOUR SUCCESS.** With my course in import-export, you get a year's membership in International Traders Guild - 4000 members in 42 countries. Includes eight free imports (see examples) and monthly bulletins of trade opportunities. Also, I'll give you unlimited consultation and assistance for a full year.

**NO PREVIOUS EXPERIENCE NEEDED.** My method is complete-gives you all the information you need to start quickly and successfully, full or part time from your home. Opportunities for travel abroad.

**FREE DETAILS--ACT NOW!** Write me today for full information and success stories of others. No obligation. Air mail reaches us overnight.

B. L. MELLINGER, THE MELLINGER CO., Dept. E253  
 1717 Westwood Blvd., Los Angeles 24, California

**NEW!**



**... A VOLT-OHMMETER THAT FITS IN YOUR SHIRT POCKET**

**Simpson MIDGETESTER**

**SELF SHIELDED!** The world's first and smallest instrument of its type. Ideal for appliance maintenance, radio-TV service, and electrical experimenters. Sensitivity of 10,000 ohms per volt AC and DC. *Fourteen* **MODEL 355**  
*ranges: five for AC voltages, five for DC voltages, and four for DC resistances.* **\$29.95**

See your Electronics Parts Distributor, or write **SIMPSON ELECTRIC COMPANY**  
 5226 W. Kinzie St., Chicago 44, Ill. • EStbrook 9-1121



Doctors of Motors everywhere use

**Perfect Circle's**

# **power** **service**

for low-cost, dependable  
engine overhauls!

When an engine needs an overhaul, here is the safe, sure and profitable way to stretch dollars and miles! Perfect Circle *low cost* Power Service will assure satisfaction and give thousands of *extra* miles of *sustained* power and *positive* oil control! See your Doctor of Motors. Perfect Circle Corporation, Hagerstown, Indiana; The Perfect Circle Co., Ltd., Toronto, Ontario.



**Performance assured with:**

**1. 2-in-1 CHROME PISTON RINGS.** Both top ring and oil ring are plated with thick, solid chrome, giving complete wear protection where heat is highest, pressure greatest, lubrication poorest!

**2. NURLIZING.** Restores worn pistons to correct fit quickly, accurately and permanently, for only a fraction of the cost of new pistons.

**3. STEEL TOP RING GROOVE SPACER.** Precision-made to compensate for increased groove width and to retard top ring and ring groove side wear.

**4. MANULATHE.** Accurately and quickly regrooves worn top ring grooves. Gives new top rings a break . . . not breakage!

**5. PLASTIGAGE.** Bearing clearances are quickly and accurately checked, in as little as one third the time required by older methods!

**6. TAPER SHIM BEARING ADJUSTERS.** Custom-made to correct excessive clearance in main and connecting rod bearings.

# **Perfect Circle** **PISTON RINGS**

*The Standard of Comparison*



# POPULAR MECHANICS

MARCH  
1955

WRITTEN SO YOU CAN UNDERSTAND IT  
VOL. 103 NO. 3



Halston Purina photo

Five years ago Lowrance decided to help bring back the bobwhite. Last year his birds produced 57,000 tiny eggs

## Bobwhite King

By Clifford B. Hicks

**A** GENERATION AGO, most hunters knew exactly where they could flush a covey of quail within walking distance. Hunting was fine. An hour in the corn rows and wood lots, the sudden whistle of wings as the covey shattered into flight, the pleasant little kick of excitement a split second before the kick of the gun—these were the elements of a fine day in the field.

Today a good many sportsmen drive 100 to 500 miles, then wander wearily back from the timber lots and hedgerows without even seeing one of the wily little birds. The bobwhite quail is a vanishing American.

Five years ago, a big friendly man named Carl Lowrance decided to do something to insure good quail hunting for his teen-age sons. He bought some quail eggs, incubated them, and suddenly found that he had







Halston Purina photo

Dawny day-old birds already are able to scamper all over the electric brooder unit which houses 300 of them

Incubator holds 3200 eggs, not much bigger than your thumbnail, under carefully controlled conditions



hatched himself a new hobby. Today that hobby has grown into a \$100,000 investment, and Lowrance has become the biggest commercial quail farmer in the world. Last year on his 40-acre farm near Joplin, Mo., he raised some 42,000 of the intriguing little bobwhites and sold 15,000 of their eggs.

Lowrance is a modest, sincere and vastly enthusiastic man. He is proud of his quail-raising business, but even prouder that he is, in a small way, accomplishing the goal he set out for himself: he is helping bring back the bobwhite quail as a game bird.

To generations of sportsmen the bobwhite has been one of the most fascinating of all birds. Man's own institutions are reflected, to some degree, in the family life and community relations of the quail. When the female chooses her mate, she does it very carefully, for she'll stick by her husband for life. Motherhood is her forte—she may lay as many as 140 eggs each year. She guards her nest jealously, and her young are her pride and joy. If a dog or cat finds her chicks, she may feign a broken wing or other injury to draw attention to herself and away from her children.

Her mate is an ideal family man. He sits on the nest himself while she takes a daily flight for exercise or forages for food. Nature has given him no weapons with which to fight, but he will flutter courageously at any predator which threatens his family. Families band themselves into organized communities called coveys. A covey usually numbers from 8 to 20 full-





Farm superintendent Eldon Corn designed and built a six-chute feeder to haul feeds around 40-acre farm

grown birds. If it grows beyond this size, a few birds will split off to form a new covey. As darkness falls, members of the covey gather and huddle together for warmth and mutual protection from nocturnal predators.

As long as there are food and water nearby, the covey will travel no more than a quarter mile. Thus a covey may exist for generations on the same small plot of ground.

If the judicious hunter is careful not to shoot up the entire covey, he can have good hunting year after year. Quail hunters, in general, are a breed apart. With few exceptions, they are conservationists right down to their trigger fingers, and they give a covey plenty of time to rebuild before hunting it again.

Lowrance points out two things that have upset this balance in the past 20 years:

"One is simply the fact that there are more hunters today. Where two hunters formerly shot up a covey, today there are four or five sighting in on the same birds. But an even more important factor is intensive farming. In the old days the farmer never bothered to plow right up to the edge of the wood lot. In some areas he used thorny hedgerows instead of fences. And his hand-

harvesting methods left grain as feed for the birds, and corn shocks and other cover for their safety. Today the same farmer cultivates right up to his fence lines and wood lots, and mechanical harvesters leave his land as clean as a new-plowed field. If the bobwhite doesn't starve, he has nowhere to hide from the hawks, cats, foxes

Electric instrument painlessly snips off chick's beak. Dull beaks help prevent birds from killing each other later in life, as quail will peck to death any birds which have been injured

Lederle photo

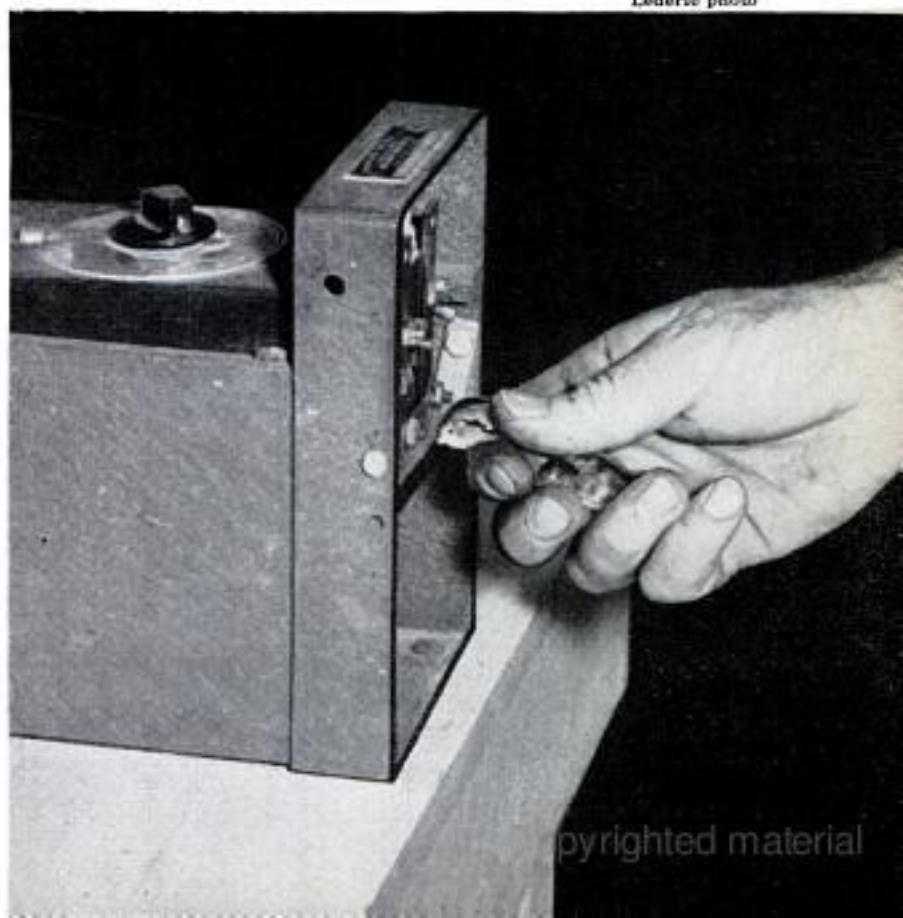



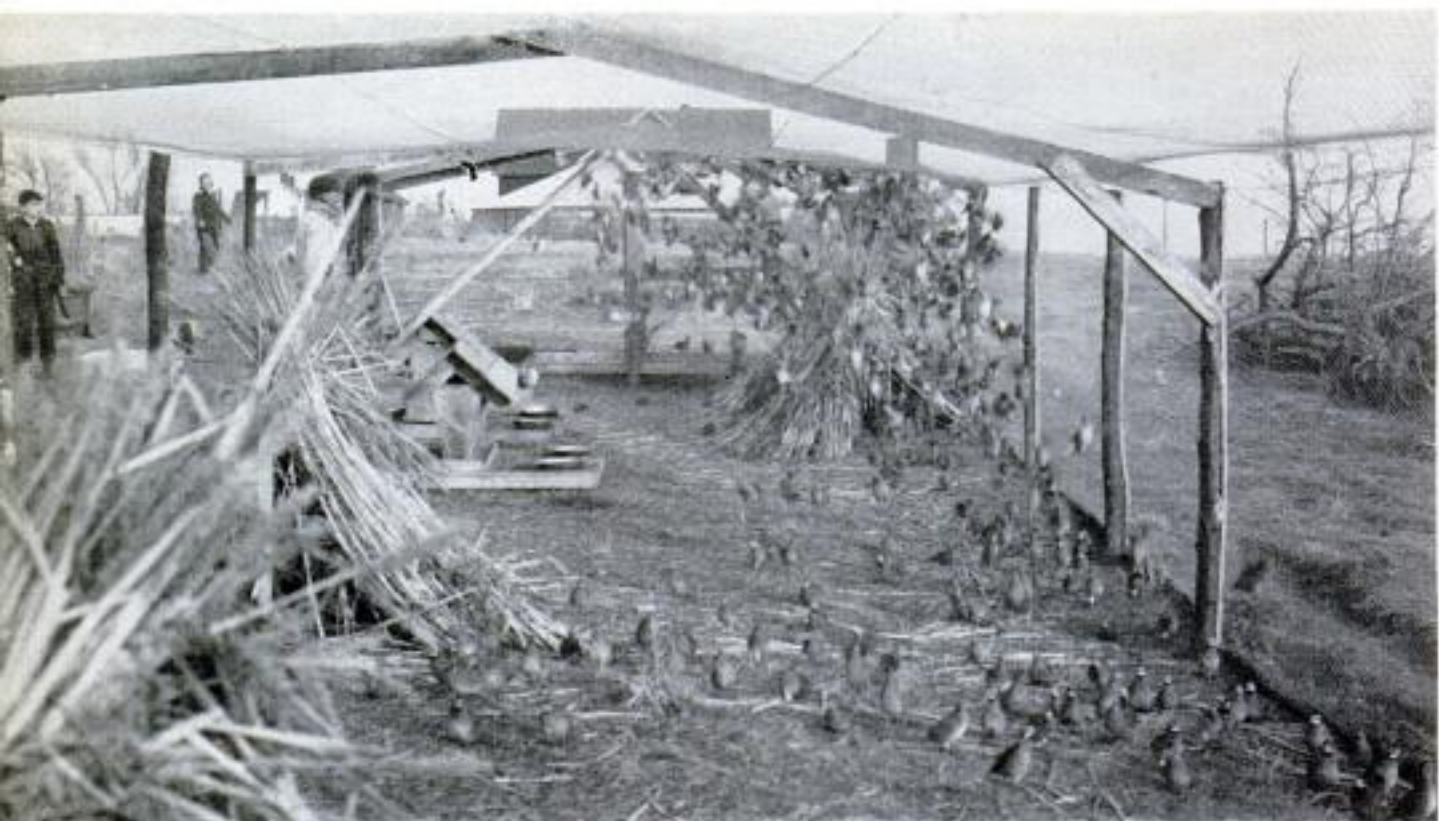

You can see only a small part of the 400 birds in conditioning pen, where they learn to hide and hunt food

Chicks develop amazing strength and aggressiveness within a few days. Here one battles a blade of grass



and other predators who are his enemies."

Lowrance is firmly convinced that he has hit upon a way to bring back the quail. He probably knows as much about the bobwhite as any man alive. He learned it by raising hundreds of thousands of birds.

After his experience with his first few quail, Lowrance bought 10,000 eggs from breeders scattered across the country. Only a few of these batches had a high rate of incubation, and most of those eggs yielded weak, scrawny chicks with little resistance to disease. Only two breeders provided eggs of high quality. That was enough to convince Lowrance there were a good many secrets to be learned. He hopped into his personal plane and visited every one of the breeders. When he returned to Joplin he thought he had the answer to some of his questions.

Sanitation was one of them. Quail are highly susceptible to disease. In nature, they never "covey up" in the same spot two nights in a row. This not only protects them from predators, but assures them of sterile ground for the night. Lowrance keeps his pens meticulously clean and gives the birds fresh water and feed each day.

Selective breeding not only has increased the egg yield, but has assured hatches of 90 to 95 percent.

The breeder pens measure four by six feet, split into compartments for three pairs of quail. Lowrance uses artificial light to encourage his breeders to lay early. About

(Continued to page 246)



## One-Man Speed Clock Spots Fast Drivers

Compact enough to fit in a large suitcase, a battery-operated timing device enables one policeman to clock and stop traffic violators. Two rubber hoses spaced 132 feet apart start and stop the stop watch, which is read directly in miles per hour. The timer itself can be located 250 feet farther down the road than the second hose, giving the traffic officer ample time to check an automobile's speed and flag down violators.

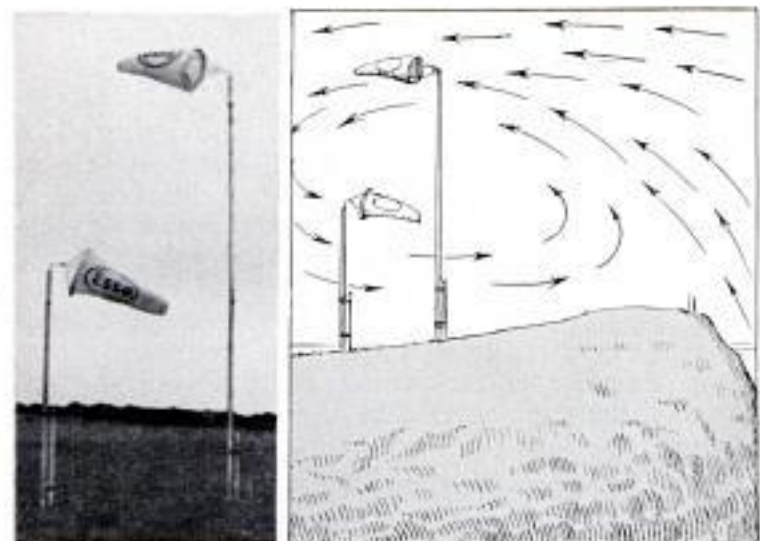

## Wind Blows Two Ways At Air-Meet Site

A pilot attempting to put his airplane or glider down with the assistance of wind socks on one field in England might be somewhat confused. Opposite surface winds were recorded within a few feet at Camp Hill, Derbyshire, England, scene of the World Gliding Championship meet of 1954. The extreme surface turbulence was attributed to a break in air flow, caused when the wind came over the top of a steep bluff, making a partial vacuum on the ground.

## Shock Treatment Gives Burned-Out Fluorescent Bulbs New Life

That burned-out fluorescent tube can probably be made to shine again. A new machine will find out by giving it two quick tests: One to see if the filament is still intact, another to make sure the gas is still sealed in. If both tests are positive, failure is probably caused by oxidation on the fila-

ment. The machine knocks this off with a high-voltage-pattern current and the tube can be returned to service. The entire operation, including the tests, takes 15 seconds. Roughly 50 percent of all tubes can be rejuvenated with the machine, according to the manufacturer.

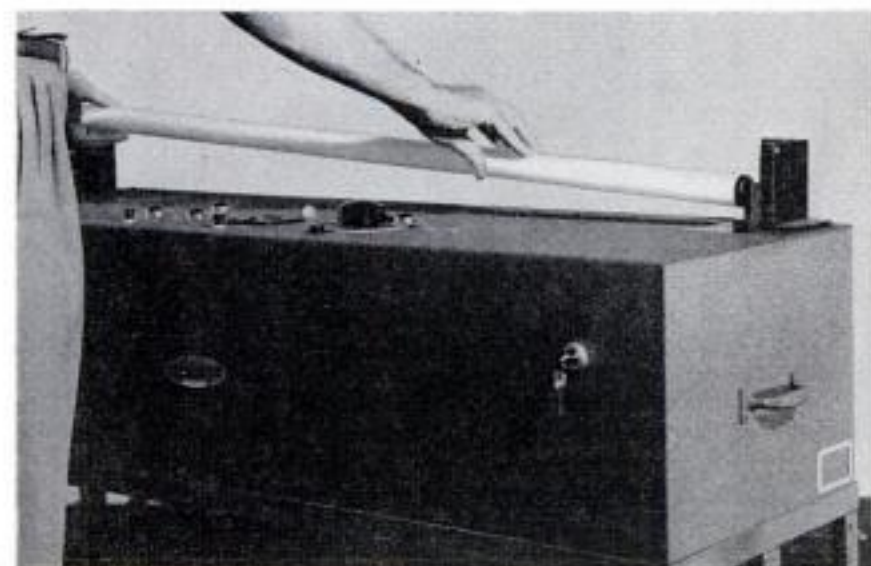





## Jeep and Trailer Equipped for Travel Almost Anywhere

Hard service in remote places poses no problems for a modified Jeep and a special trailer designed by Jack Coultas, Montana sportsman. Large gasoline and water tanks on the Jeep give a wide range of operations and a 14-foot boat is carried on top. Two outboard motors can also be carried. A combination 6-volt d.c. and 115-volt a.c. generator supplies current for the Jeep battery, lights, projector, public-address

system and repair tools. The lightweight trailer has a folding top to cut down clearance and reduce sway on rough roads. A few strokes of an air pump actuate cylinders which raise the top three feet. Inside are a double bed, table for two, refrigerator, sink, cupboards, gasoline stove and a variety of photographic and communication equipment. Awnings and fishing equipment are carried in aluminum tubes.

## Colonial-Style Cabinet Latch Closes on Small Magnet

Cabinet latches which hold doors shut by magnetic attraction are now available in the colonial style. The powerful little magnet pulls the door shut and holds it firmly until enough pressure is put on the door handle to overcome the magnetic attraction. The latches are available in black, antique or Swedish iron and are made to fit both flush and offset doors.

## Service-Station Air Hose Powers Vacuum Cleaner

Attached to the regular air-hose system, a small vacuum cleaner provides the filling-station attendant with a fast method of cleaning car interiors. The cleaner reverses the air pressure of the system, converting it into a strong suction that will pull cigarette butts and ashes out of ash trays. It weighs only five pounds and is trouble-free, having no moving parts.

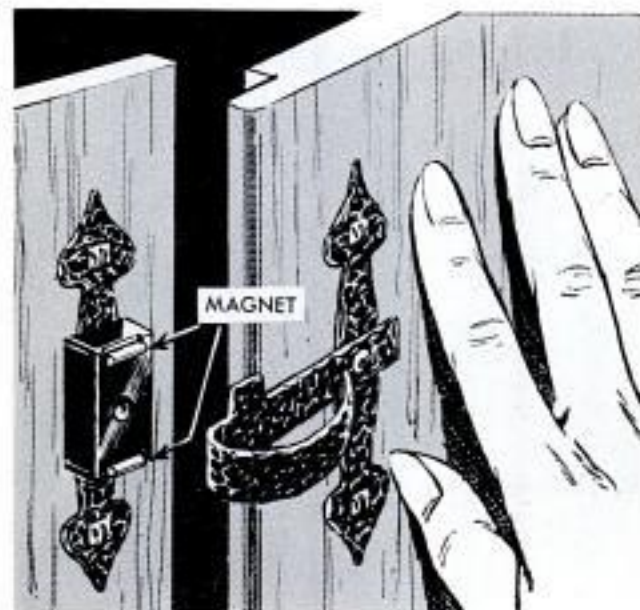



## Jensen 541 Opens Up For Engine Inspection ➔

Getting at the engine is no trouble in a Jensen 541 recently shown in London. Hood, headlights and grille lift up in one piece to give easy access to the six-cylinder engine. It's a mechanic's dream.

## Biggest Star Dwarfs Sun

Alpha Herculis, the biggest known star in the universe, is 200,000 times the diameter of our sun, according to Dr. Armin J. Deutsch of Mount Wilson and Palomar observatories. Visible to the naked eye, it is 1200 light-years from the earth and is surrounded by an immense cloud of gas.



## Dream Truck Has Front-Wheel Drive, Inboard Front Brakes

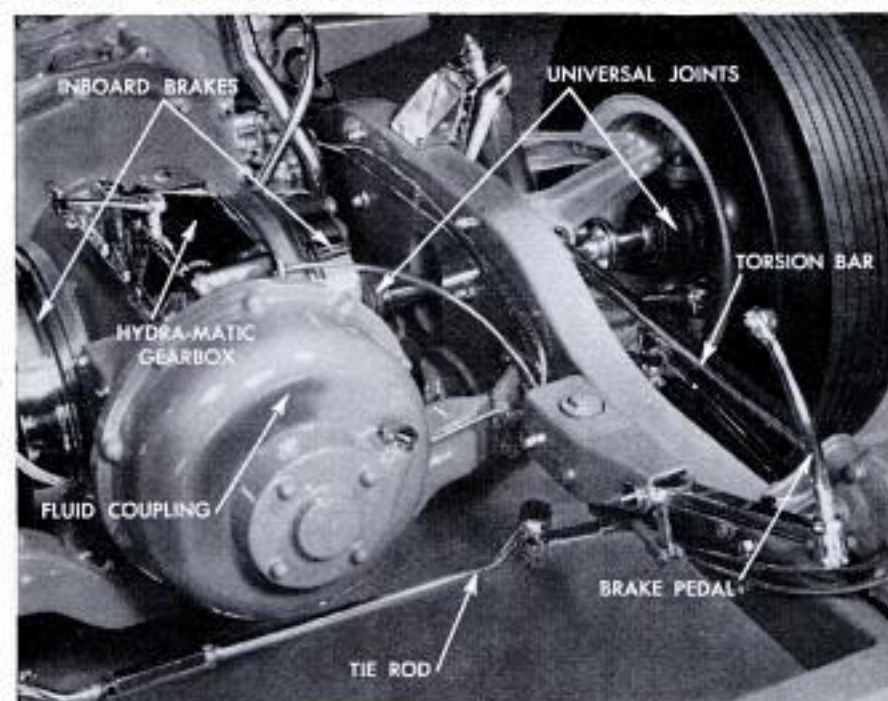

Originally called the Expedier, General Motors' dream truck has been renamed L'Universelle so it can be billed an all-purpose vehicle. It has an unusual power train with its V8 engine driving the front wheels through an inverted Hydra-Matic transmission. The front drive eliminates the driveshaft tunnel to the rear axle and gives a smooth flat bed for the pay load.



Above, close-up of the front-wheel drive. Below, radiator is mounted on an angle behind engine so air from roof vent will flow through the core

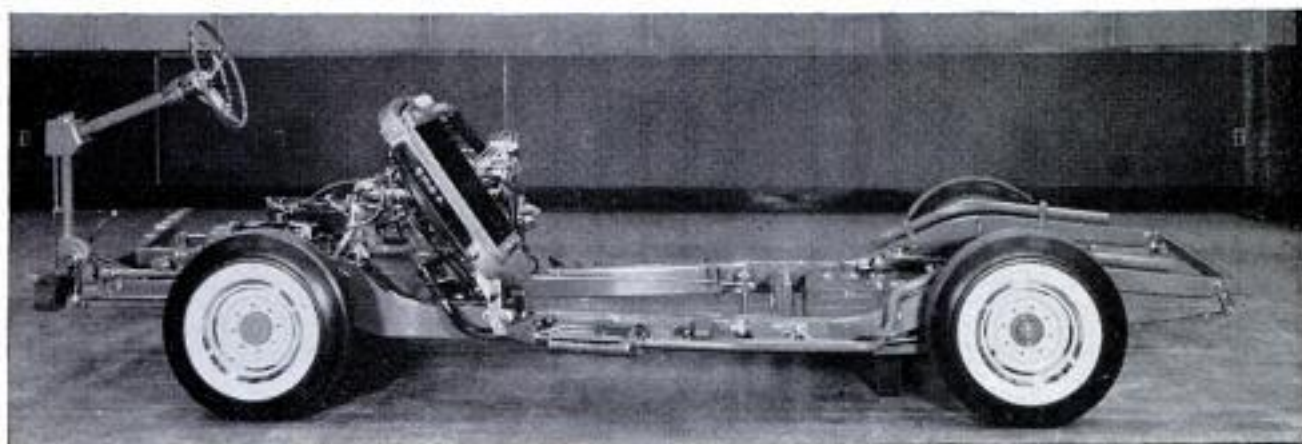



# I Made the First Jump

When the colonel made his historic downward ejection from a B-47 jet nobody knew for sure what would happen—but the lives of countless future jet pilots were at stake

By Col. Arthur M. (Chic) Henderson, USAF (MSC)

(Assistant Director, Aero Medical Laboratory, Wright-Patterson Air Force Base)

**S**WISH is the easiest way of describing the sensation of downward ejection from a jet plane. There is no jolt, nor is there the sickening feeling one experiences in rapidly descending elevators. With the downward-ejection seat, everything is automatic. You're sitting there relaxed and then, instantly, when you fire the seat you're gone. A kaleidoscopic scene of color unfolds before your eyes. There is no blackout or redout, but merely a few moments

of confusion. By the time you can move your head to look at the belt, the seat is gone—you are free-falling through emptiness. . . . But I am getting ahead of my story.

The day of our history-making test at Eglin Air Force Base, Fla., dawned with hardly a cloud in the sky. The temperature was in the 80s, and surface winds were 10 to 12 knots. There was a noticeable air of tenseness and excitement in our operations shack during the preflight briefing. This

Pulled aboard rescue boat after parachuting into bay, Colonel Henderson holds on while gear is stripped off







Sequence of downward-ejection test shows seat leaving B-47, separation from seat and opening of parachute—all automatic

test was the result of many months of planning, working and testing (with dummies) at Wright Air Development Center in Ohio.



As I waited in the shack, the voices in the background were an unintelligible drone. I stared out the window. There on the strip, poised like some violent beast ready to strike, was our test ship, B-47 052. I thought to myself, "What will the first human test be like? Is there something we could have slipped up on?" A voice calling, "Let's get ready, colonel," snapped me out of my reverie and I started to dress.

Take-off time was 9 a.m. I was ready. The usual squeamish feeling was with me and my mind was racing with varying thoughts. At last I was in the test seat and by this time anxious to get going. Then it was discovered that the leg-retaining device could not be locked into place. Mission aborted! Two more hours of impatient sweating were required before I could again climb into the navigator's position and get under way.

Finally, B-47 052 gracefully left the runway on this special mission which, if successful, would give our aircrew men a more positive method of escape.

Air Force photo Courtesy Boeing Airplane Company

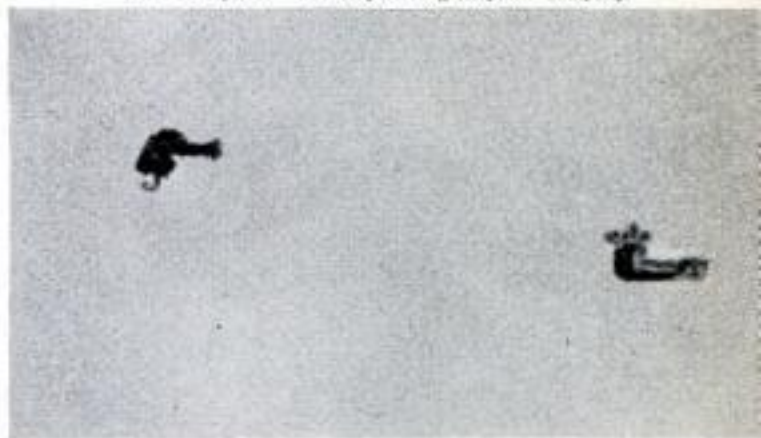



Capt. Bill Campbell, pilot, and Capt. Ralph Lusk, copilot of Flight and All-Weather Test, were as busy as ants on a hot rock guiding 052 into position above Choctawhatchee Bay. On a prescribed course at 10,000 feet, they prepared for a dry run. Tests are done at this altitude for safety purposes.

I was wearing a T-1 altitude suit, K-1 pressure helmet, light flying suit of bright red primarily for camera-tracking purposes, underarm life preserver, leather gloves, jump boots, B-5 standard back-style parachute, seat-type parachute as a reserve, and a knife strapped to my leg. The H-2 oxygen bottle was located in a pocket on the right flap of the back chute. Although there was a complete check list within view, Sergeant Donnelson, a fourth man in the aircraft, was there for a final equipment check 15 minutes prior to ejection. Having been fixed in the seat with shoulder harness and automatic lap belt prior to take-off, I could do nothing for

about 30 minutes but sit over the open hatch and be with God and my thoughts.

Procedures for all tests are the same. The copilot notifies the subject several minutes prior to actual ejection. On the 30-second count, the subject inflates his partial-pressure suit by pulling the activating knob of the bail-out bottle. The D ring is grasped with both hands, head firmly placed against the headrest, and, come what may, the subject is ready to go.

Lusk to Henderson: "We are on the final run."

The man who is going to jump does not have return vocal communication. We do have a red light, which I flicked, to indicate message received.

Lusk to Henderson: "203 knots . . . seconds FIVE, FOUR, THREE, TWO, ONE. FIRE!"

I could have sworn that Lusk said, "There goes Grandpa!" (He denies it.) [Editor's note: See biographical sketch on page 6.]

Now I can return to the first paragraph where I was free-falling through space

Special suit for downward ejection provides underarm life preservers for coming down in water. Bail-out bottle holds a six-minute oxygen supply





after the seat was gone. The parachute was automatically released and opened above me in a glorious and, indeed, welcome swirl of white. I found myself swaying in the breeze and sighed with relief. I then began a gentle descent to the water where eager rescue personnel were waiting.

Here is what happens in the seven seconds of the ejection procedure: When the seat D ring is pulled the hatch blows off and the ejection seat is fired. As the seat leaves the aircraft it activates a cartridge which, in turn, initiates the gas-operated lap-belt mechanism. Two seconds later, the belt fires, opening the belt and allowing the shoulder harness and lap-belt tie-down strap to slide off. The occupant leaves the seat by the combined forces of gravity and drag. The greater the speed, the more forceful the separation from the seat. During ejection, the lap-belt key remains firmly attached to the belt and by means of a lanyard is attached to the automatic parachute device. As the seat leaves the subject, it pulls this device and the parachute timer is armed. The parachute timer also has a two-second delay, so that in six to seven seconds following ejection you are dangling under an open canopy.

The automatic parachute device has two settings, one barometric and the other set on time. This is to provide for a longer free fall at high altitudes. For example, if you bail out at 30,000 feet the barometric device is set for 15,000 feet. At that level the timer is



Timer is started as the ejection seat moves down the rails



Belt, shoulder harness and leg-strap release automatically two seconds after ejection. As man leaves seat, parachute is armed



Parachute is opened two seconds later—all in seven seconds





Loaded with paraphernalia, Colonel Henderson sighs with relief at end of first downward-ejection test

activated and the parachute opens two seconds later. The obvious reason for this is that the H-2 bottle has only a six-minute oxygen supply. To open your parachute at high altitudes and expect to survive is out of the question.

There were seven downward ejections made during our first series of tests. The No. 2 jump was made by M/Sgt. George



As the parachuting colonel approaches water, helicopter hovers around in case rescue work is needed

Post. Others were made by Lt. Hank Nielsen and Capt. Ed Sperry. Four of the ejections were perfect. Post proved in his jump that a man can hold himself in the seat at low speeds despite opening of the lap belt. At a speed of 390 knots (449.1 miles per hour) Nielsen discovered you could not hold on to the D ring. Immediately upon entry into the air stream his hands came

After plunging into the water, the colonel's head and feet bobbed to surface due to antiexposure suit





off the ring and his arms flailed, causing a dislocated right elbow and a chip fracture in the upper right arm. Sperry had the same experience at the same speed and suffered a chip fracture in his upper right arm.

The first tests were made on Oct. 7, 1953. It was July 1954 before we were again ready to go. Meanwhile, we developed a shock-absorbing spring which was attached to the D ring and successfully tested with dummies.

The first ejection of the second series was scheduled for July 8 and again I was to make the first try. The night before I felt restless and jittery. At dinner my appetite was lacking. All kinds of thoughts kept racing through my mind and to top it off the evening paper carried a headline: **MARINE FLYER KILLED — PARACHUTE FAILS TO OPEN.** Later on in the evening I went over to the officers' club and while I was meditating over the things that could go wrong, someone sat down beside me. It was Lt. Ira Barash, our "team" doctor. He advised me to get some sleep. I went to bed and tried with small success. I arose at dawn, had breakfast (which I promptly lost) and then went over to the operations building.

For this second series we had the Beast (our B-47 jet bomber), two helicopters, three 63-foot rescue boats and three jet fighters that would carry the photographers aloft. These aircraft could be spaced in line to get sequence

(Continued to page 252)

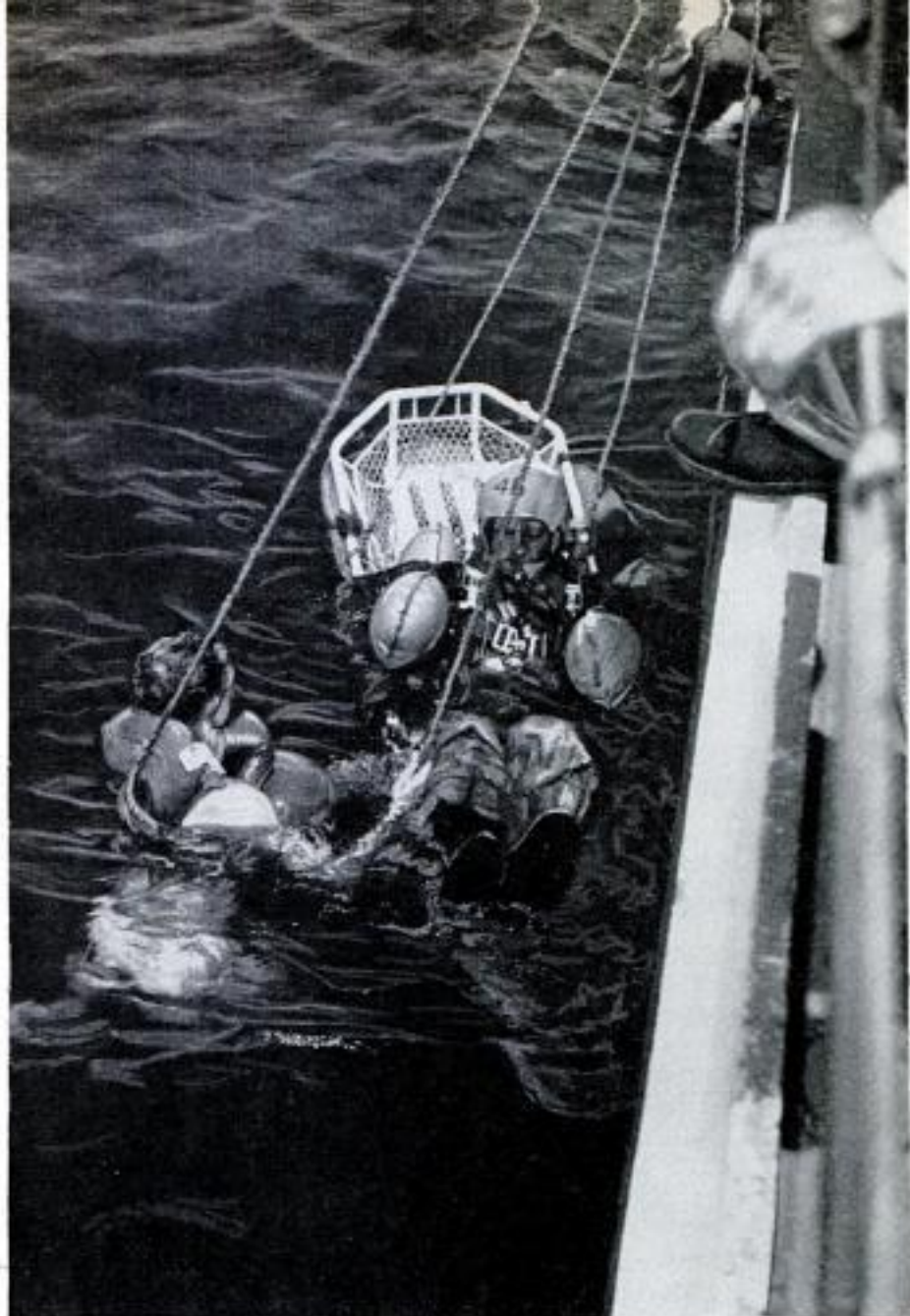

With a helper floating nearby, Colonel Henderson is eased into a basket beside rescue boat. Antiexposure suit keeps water out and the underarm life preservers keep him afloat. Below, experiences during test jumps are recorded on tape as soon as the parachutist comes aboard the rescue boat





## Spring-Wound Bike "Engine" Energized by Part-Time Pedaling



You have to pedal only one mile out of five when your bicycle is equipped with a "spring engine" developed in the Netherlands. A spring about 60 feet long is wound up during one kilometer ( $\frac{1}{2}$  mile) of pedaling. During the next four kilometers the bike cruises under its own power at 15 miles per hour. Pedaling a spring-wound bike is no more demanding than ordinary pedaling, according to the inventor, who has announced no plans for manufacturing the bike.

## Garage "Doornaments" Give Individual Touch

Ornamental pieces designed for mounting on garage doors are available in many sizes and shapes. These include concentric circles, squares, diamonds, fleurs-de-lis and others. With different types of molding, a homeowner can use the "doornaments" to create an individual and attractive design. The decorative pieces are made of molded aluminum or wood, and small brass screws and nuts are supplied for easy attachment.

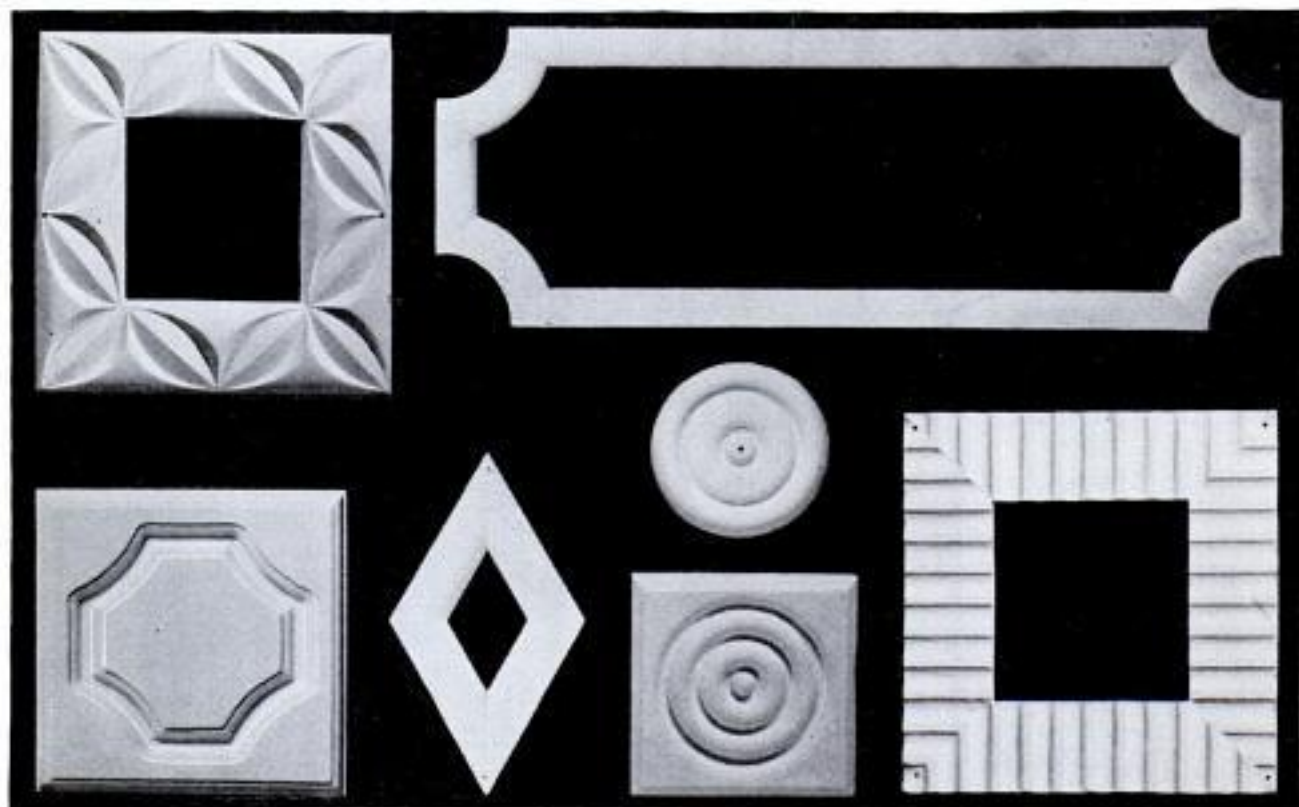
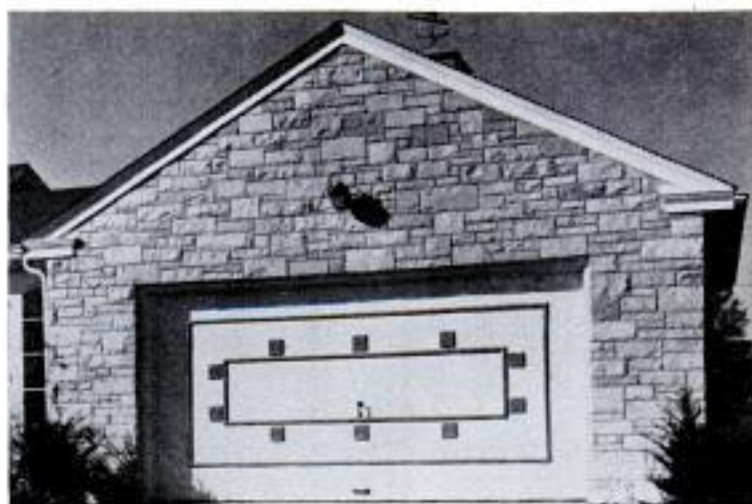





## Lincoln Shows Its Idea Automobile

With a plastic bubble for a roof, Lincoln's idea car, the Futura, needs no windows—it's all window! The roof lifts automatically as the door opens so you enter without stooping. Huge taillights, shaped like boomerangs, are set in the rear fins (right). The car is not slated for production, according to Lincoln.

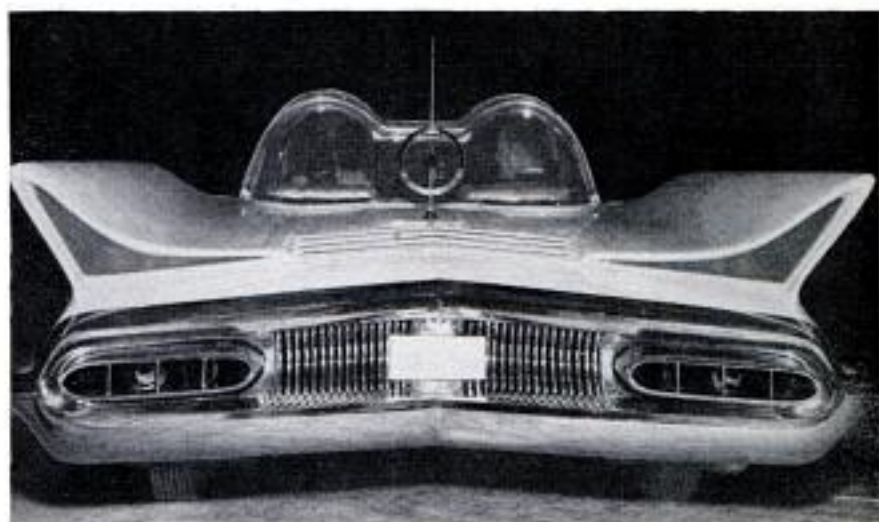

## Miniature Crawler-Type Tractor Designed for Truck Gardening



Truck gardeners and orchardists now have a miniature crawler-type tractor designed for their needs. It measures 6 feet long and 3½ feet high. It is especially useful on hilly land or in wet soils. The tractor is powered by an 8.3-horsepower engine and has three speeds forward and one in reverse. The steering brakes and the implements are operated through hydraulic controls. Implements include a 4-foot dozer blade, a ¼-yard scoop and a 40-inch rotary mower.

☐ The world's airlines flew about 30,000,000,000 passenger miles last year.





## Rifle-Bullet Magazine Clips to Hunter's Belt

Hunters can keep rifle bullets instantly available in a transparent-plastic dispenser that clips to the belt. A twist of a dial at the bottom of the container releases one cartridge at a time. The dispenser, which holds a full box of .22 bullets, can be adapted to carry shorts, longs or long rifles. The container protects cartridges from dirt and, at the same time, prevents bullets from soiling pockets. The transparency of the case keeps the hunter informed of his bullet supply.

## Lancia PF 200 Shown in Paris

On exhibit at the Paris Motor Show was the new bulletlike Lancia PF 200. The custom body of the sports car was designed by Pinin of Turin, Italy. It has a top speed of 115 miles per hour.



## Blanket Wakens Sleeper

You're almost forced to get up in the morning when you use an electric blanket that sounds a warning buzzer and then shuts off the heat at a preset time. A 10-minute warning is given.

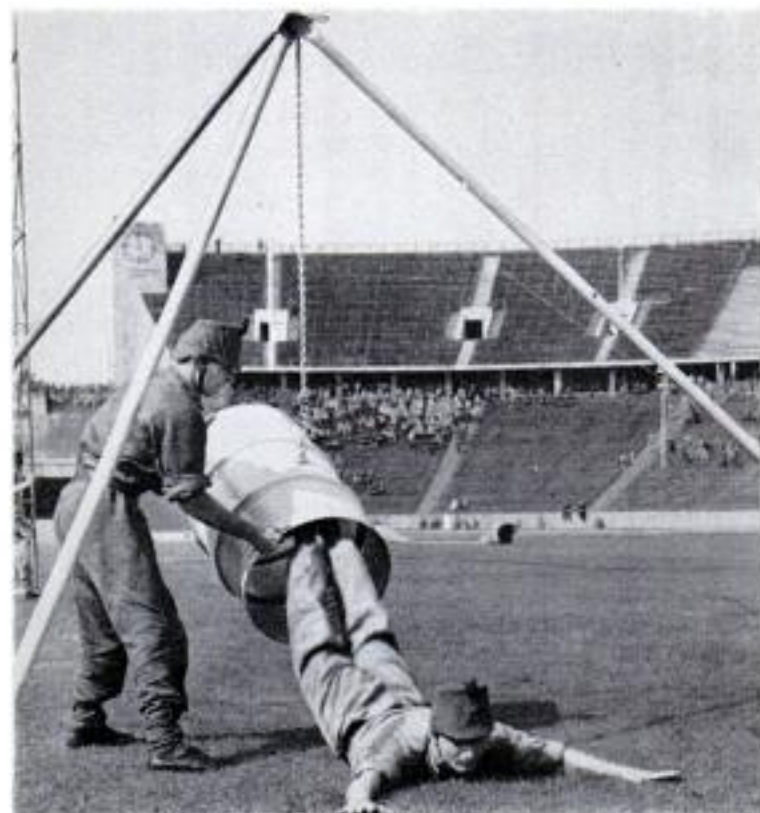

## Barrel Diving Exercise For West Berlin Police

Suspended from a metal tripod, an old oil drum with the ends knocked out is being used by West Berlin police for training in diving through small openings without receiving injury.

## The Ears Talk, Too

Ohio State University's Speech and Hearing Clinic is conducting experiments to learn how humans talk through their ears as well as their mouths. Dr. Henry M. Moser of the clinic says it is definitely established that speech is emitted through the ears, but the exact nature of the process is still unknown. If ear sounds can be separated from mouth sounds, ear microphones might be used for communication where mouth microphones are not convenient.





## British Two-Seat Fighter Attains the Speed of Sound

Britain's first two-seat operational fighter plane to achieve supersonic speed, the De Havilland 110 has been checked out by the Royal Navy for carrier operation. Also newly operational are angled landing

strips on flattops and the mirror system for bringing in aircraft. With this system, mirrors and lights guide the incoming pilot, replacing the officer who guided in planes by paddles or bats.

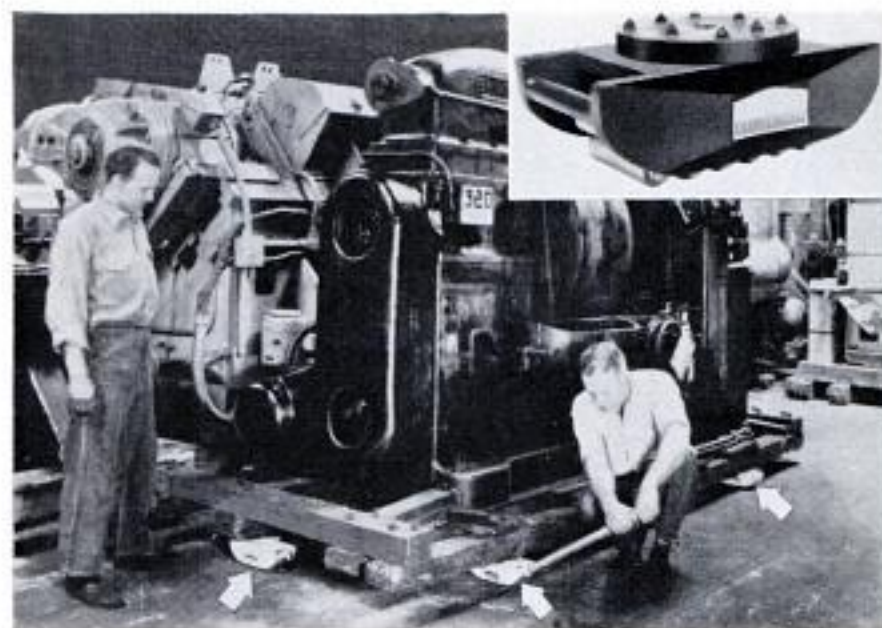

## Heavy Machinery Moved on "Casters"

Heavy machinery can be moved without roller bars when special "casters" (see arrows) are used. Each, although light enough to be carried in one hand, can support up to 50 tons, according to the manufacturer. A caster rolls on an endless chain composed of heavy steel rollers joined by links. A turntable on top contains gripping teeth that embed themselves in the wooden frame underneath the load.

## Chrysler Introduces a Hardtop Sports Coupe With 300 Horsepower

Unadorned almost to the point of austerity, a powerful, low-slung Chrysler hardtop coupe is being offered to the sports-car set. With two four-barrel carburetors and a full-race camshaft, the modified Chrysler V8 develops 300 horsepower. The front grille is like the Imperial's, the rest of its styling being standard Chrysler minus chrome. Special spring suspension makes it two inches lower than other Chryslers.







Screen on which movies are projected is half a hemisphere. Larger screens are used for audience presentation

**M**ILLIONS who have taken *Cinerama's* famous roller-coaster ride have thrilled to the movie's realism. But its complicated system requires three cameras, three films and three specially con-

structed projectors in separate projection booths, all of which must be synchronized by elaborate electronic equipment. Now a Detroit firm has introduced a system that produces a similar effect on smaller scale

A Naval trainee "fires" his mockup machine gun at enemy plane as it appears to swoop down at him from curved motion-picture screen

with one camera, one film and a standard projector. Not just another wide-screen movie, it "wraps the picture around the onlooker," relying on his peripheral vision to make him feel he is at the scene.



The system depends upon a 142-degree hemispherical lens used on both camera and projector. It was produced by the Jam Handy Company to perfect an aerial-gunnery trainer developed for the Navy. So complex are the optics of the system that a team of engineers and mathematicians spent four years designing and perfecting the new lens. With a front element approximately seven inches in diameter, funneling down to a rear element of about one inch, the lens is rated at f:2.2 and has





Observer "inside" screen gets the feeling that he is cruising down street. Audience must be close to screen

a focal length of  $\frac{1}{10}$  inch. The lens unit weighs 35 pounds. When mounted in a standard motion-picture camera, the lens squeezes a wide-angle picture onto regular 35-mm. film. If projected normally, the picture would be distorted like an image on a reflecting sphere.

Instead, the screen is half a hemisphere and the standard 35-mm. projector is fitted with the lens used on the camera. When the audience is seated just inside the quarter sphere the picture is undistorted and uniformly bright. On the horizontal plane, the audience is surrounded with 180 degrees of picture (Cinerama's screen, which curves in a horizontal direction only, covers 146 degrees laterally). In the vertical plane the picture ascends 90 degrees to a point above the observer.

At present, the system will be used primarily to train Navy crewmen in shooting down enemy aircraft. It may also be used to train pilots and navigators. ★ ★ ★

John Campbell and optics engineer Alfred Davock prepare to project a film. The same 35-pound, 142-degree lens unit used on camera is mounted on front of projector. Unit tapers from a front element seven inches wide to a one-inch rear element

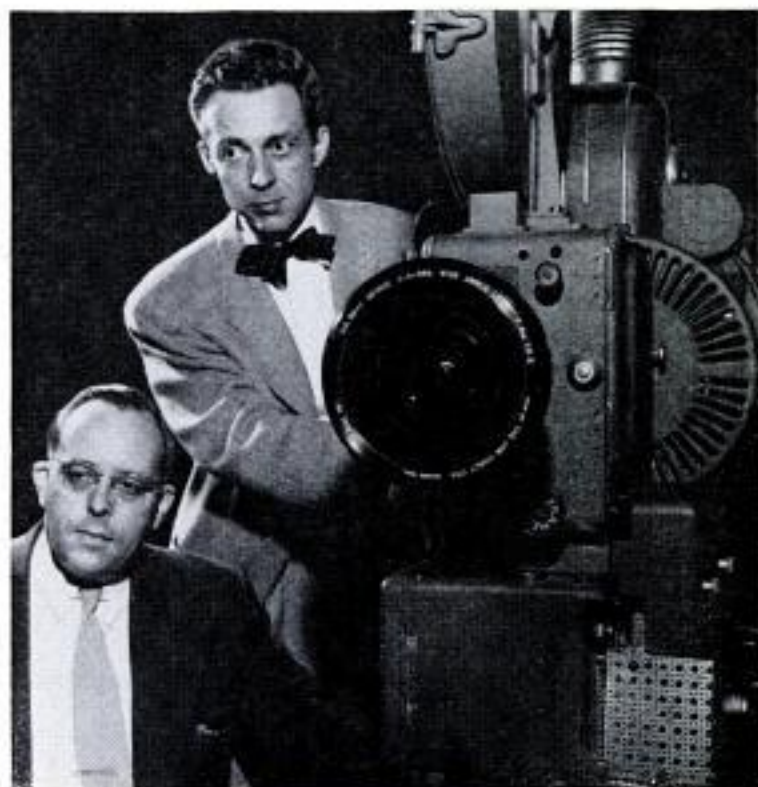





## Police Car Rides Narrow-Gauge-Track "Catwalk" in Tunnel

Patrolmen who regulate the flow of traffic through the Holland Tunnel recently tested a miniature electric car that rolls along the tunnel's "catwalk." The car is designed to give the officers greater control over traffic by permitting them to cover tunnel posts faster. It was tested on a 2200-

foot run of miniature railroad track. Only two feet wide, the 1300-pound car can be driven in either direction from a swivel seat inside the glass-enclosed cab. Push buttons control the speed at six or twelve miles per hour. A 240-volt, three-horsepower motor powers the car.

## Children Watched Through Special Mirror



Children in the Oxford, Miss., grammar school can be seen without seeing, thanks to a one-way mirror installed in a classroom wall. Parents and teachers can observe children through the mirror, unseen, from a lounge adjoining the classroom. A window to the parents, it is a mirror to the children, who are not told they are being watched.

## High-Temperature Alloy

New entrant in the high-temperature-alloy race is a General Motors development called GMR-235. A nickel-base alloy, it also contains carbon, manganese, silicon, chromium, iron, molybdenum, aluminum, titanium and boron. GM says it will withstand jet-engine temperatures.



# Windshield TV Screen To Aid Blind Flying

FUTURE NAVY PILOTS may sit behind a thick glass windshield on which a picture of the ground appears whenever fog or darkness obscures vision. The windshield is actually a flat, transparent television tube whose scanner, or antenna, picks up an image of the terrain ahead.

When landing in fog the pilot will hardly be aware of the moment when he sees the strip rather than its identical TV image.

One experimental tube is three inches thick, about the size and shape of a big telephone book. The picture is created inside it by means of electronic beams which are deflected onto a transparent phosphor screen, causing selected areas on the screen to glow. Standard TV-broadcast programs are reproduced on the screen.

Eventually the Office of Naval Research and Development expects that the tube will be so perfected that "a relatively untrained pilot will be able to fly a high-speed jet down the winding Grand Canyon in zero-zero weather and in perfect safety."

The tube is part of a cockpit simplification program by which the Navy hopes air-

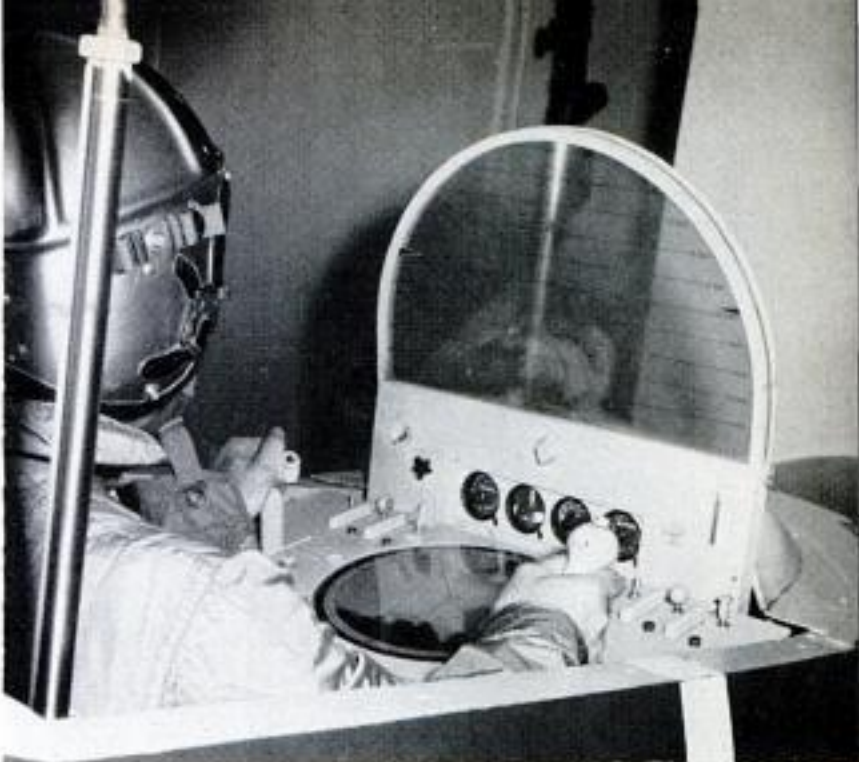

In bad weather view ahead would show in TV-screen windshield. Picture of ground below plane appears on round screen on desk

craft instrumentation will become less complicated. Ultimate goal is a "dream" cockpit containing little more than a throttle, control stick and two TV pictures. One of the TV pictures would be on the vertical windshield screen, and the other would be on a round horizontal screen on the pilot's desk, showing position and course in relation to a radar-type image of the ground.

Research is being performed by the West Coast electronics laboratory of Willys Motors in cooperation with Douglas Aircraft Co.

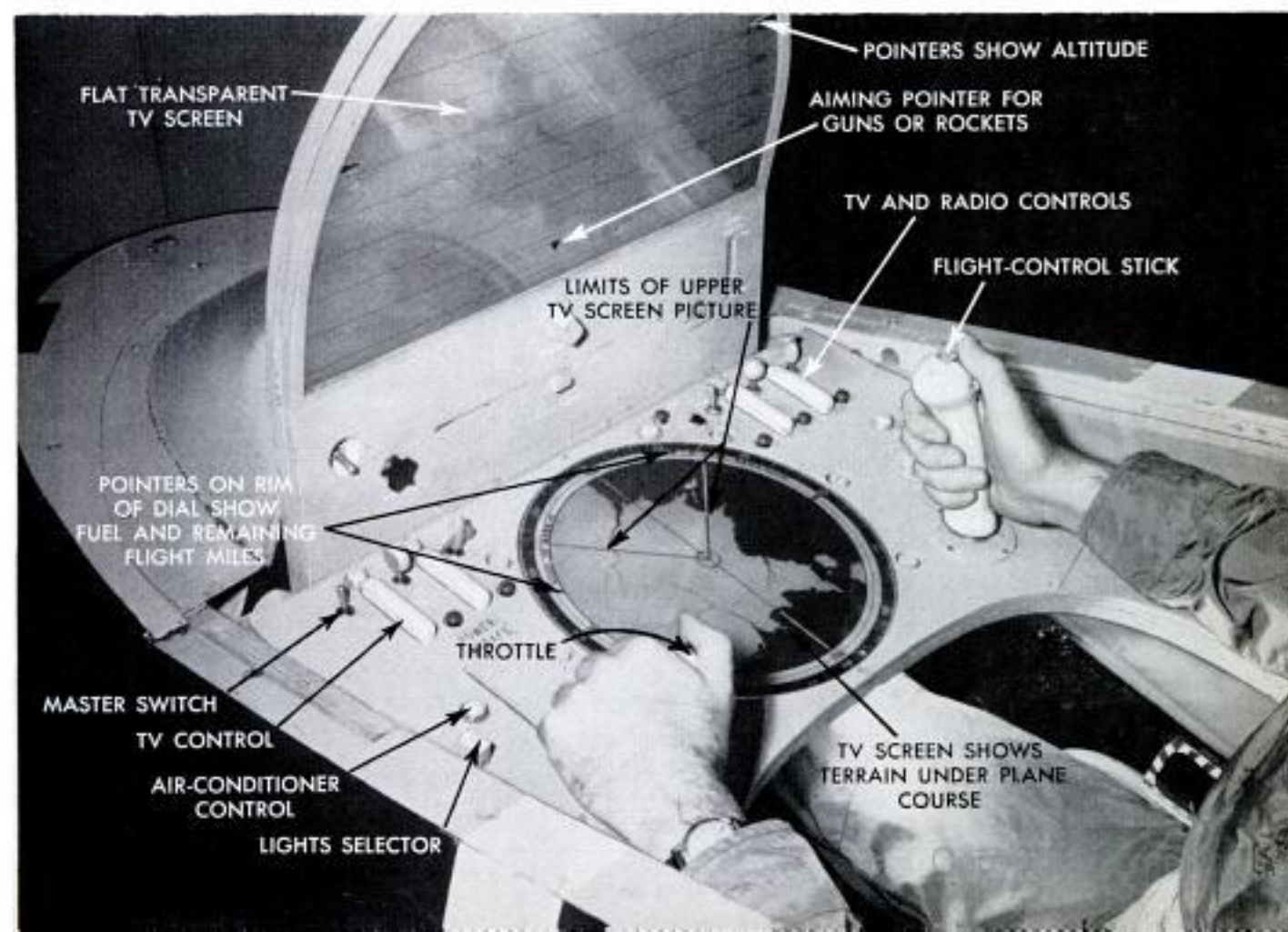



## OWNERS REPORT:

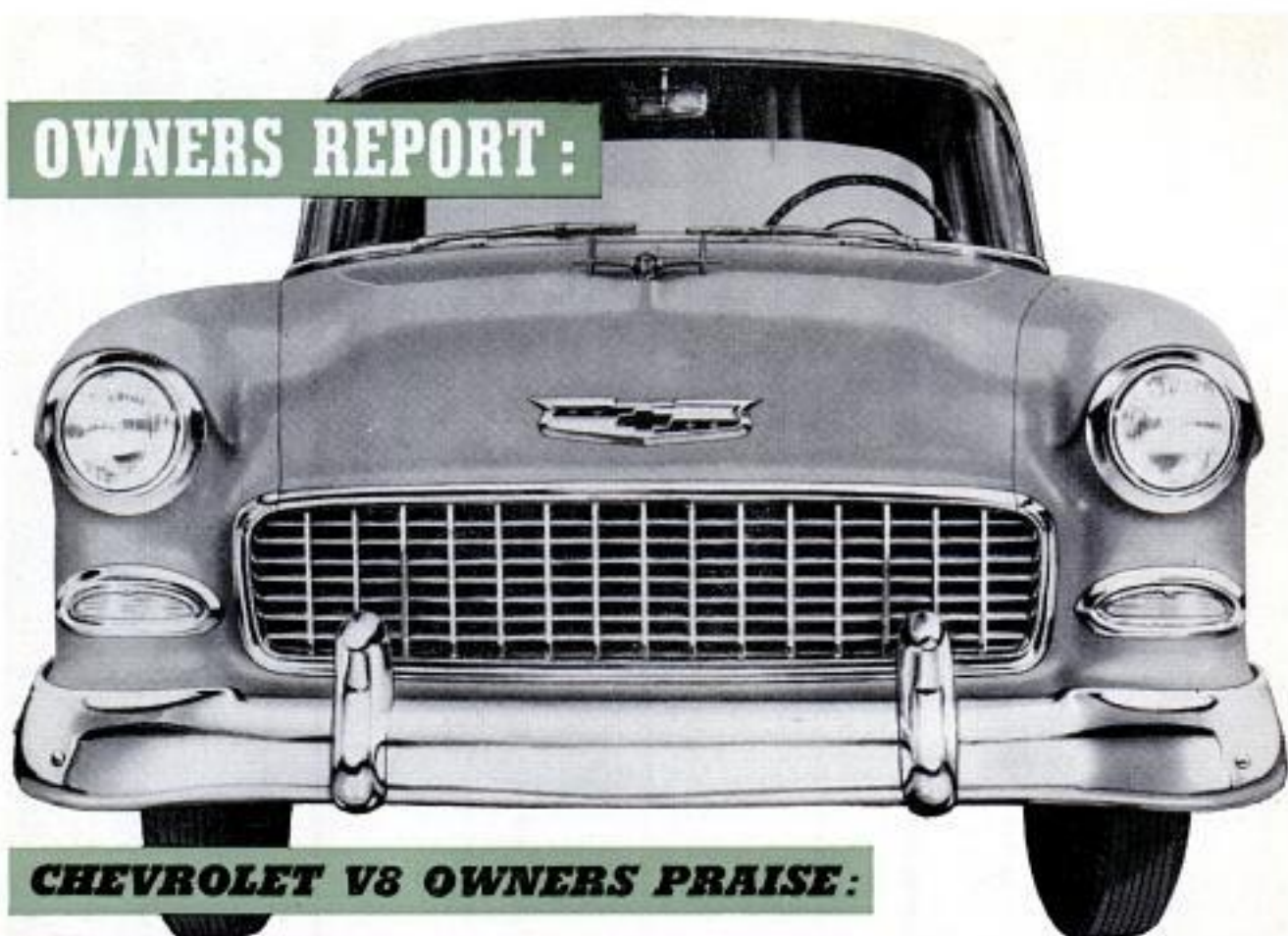

## CHEVROLET V8 OWNERS PRAISE:

### **Its performance**

"It gets away fast. Has reserve power to pass when out on the road. Cruises smoothly and quietly at all speeds."

*Colorado letter carrier*

### **Its body styling**

"Can see all four fenders. It has a big-car appearance for less money."

*Michigan truck driver*

### **Its handling**

"It steers easily, almost like power steering. Really holds the road, no sway or front-end nosing down."

*Ohio auto mechanic*

## BUT SOME OF THEM COMPLAIN ABOUT:

### **Its oil consumption**

"To begin with, it used about three quarts of oil every 10 days, but after 1000 miles it dropped to two quarts. Now it's only one quart."

*Ohio shipping clerk*

### **Its body noises**

"Has a lot of squeaks and whistles we can't find. Horn button won't stay on. Flaws in the paint job."

*Tennessee foreman*

### **Its gasoline mileage**

"Not enough miles per gallon. Should be getting at least 17 or 17½."

*Utah salesman*



# OWNERS PRAISE CHEVROLET V8's PERFORMANCE AND BIG-CAR FEEL

By Chevrolet Owners

**L**IKE A BIG BROTHER who suddenly discovers his kid sister is a big girl now, owners of the 1955 Chevrolet boast that their car has just about everything a big car has!

"It rides and steers great. It has zip. All in all, it really handles itself like a big car, which of course is really what it is!"—Illinois farmer.

"I like its excellent acceleration and the big-car feel."—Montana farmer.

Strangely enough this reaction has little basis in fact because, as you will see by looking at the diagrams on page 106, the 1955 Chevrolet is smaller than the 1954 model! But it definitely feels bigger, our survey of 1500 Chevrolet owners reveals.

Biggest news at Chevrolet, of course, is the new 162-horsepower V8 engine. As you might expect, the V8 owners rate power and performance as the best-liked feature.

"I like its ability to accelerate fast."—wrote one V8 owner who prefers to remain unidentified.

"Acceleration best of any car I've driven in its field. Response is wonderful."—Michigan salesman.

"Fast acceleration at low speeds but poor at high speeds."—Colorado zone manager.

But all is not perfect with the new V8 engine, report the owners. The most frequent complaint of the owners is that the V8 engine uses too much oil. Twenty-two percent of the V8 owners gave this as their chief complaint. Apparently oil consumption declines as the engine is broken in because some owners reported the trouble cleared up after they had driven their cars a thousand miles or so.

"Used oil for the first 1000 miles then it quit."—Kansas banker.

"Burned oil for the first 1200 miles then quit. It's a motor that has to be driven for 2000 miles before you like it."—Michigan salesman.

"To begin with, it used about three quarts of oil every ten days, but after the

(Continued to page 104)



## CLYMER ROAD TESTS THE CHEVROLET V8

By Floyd Clymer

**T**HE TEST CAR was a 1955 Chevrolet Bel Air four-door sedan with Powerglide and the 162-horsepower V8 engine. I drove it from Los Angeles to Phoenix, Ariz., returning via Las Vegas, Nev., and the Lake Arrowhead route for a total of 992 miles, including some off-highway driving.

It is the best-handling Chevrolet I have ever driven and it feels like a large car. It has good stability on corners with its

improved front suspension. The ball bearings used in the steering gear make steering without power assistance much easier.

The longer rear springs are located outside the frame, as in the Corvette, and undoubtedly add to stability and road-holding quality. Chevrolet has changed to an open propeller shaft (Hotchkiss drive), which is unquestionably better than the former torque-tube drive as there is less

(Continued to page 268)



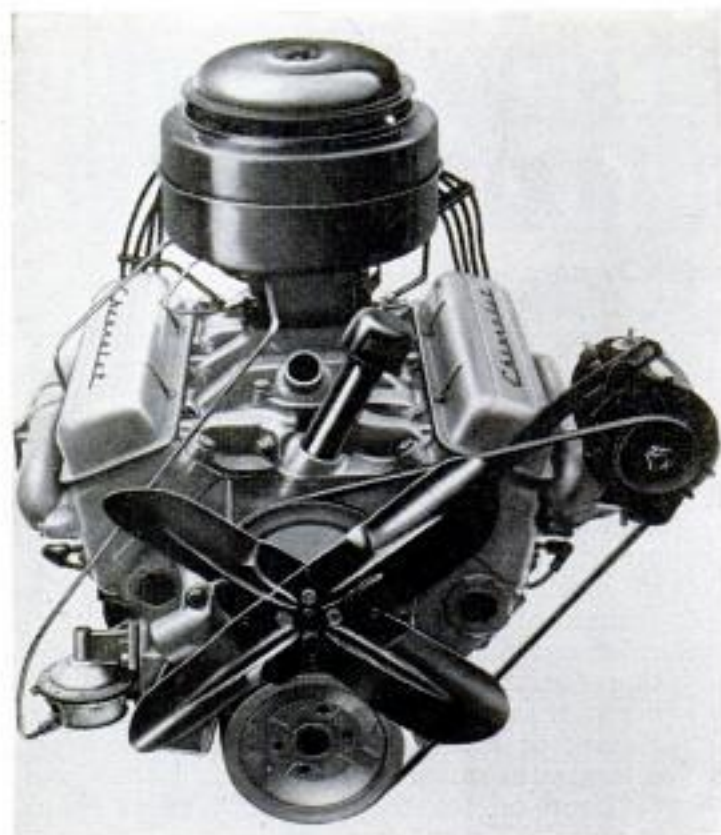

Chevrolet's new V8 engine develops 162 horsepower in this version. With power pack added, it puts out 180 horsepower



Above, heater intake is on cowl. Below, Clymer likes driving position. Note the slight distortion of wrap-around windshield



first 1000 miles it dropped to two quarts and now it is only one quart."—Ohio shipping clerk.

"It used 5 quarts of oil the first 500 miles, 4 quarts the second 500. I've had it in the shop about three times a week."—Tennessee contractor.

"Is leaking oil. Have put on a new pan gasket and it still leaks. Had to put on another carburetor."—Michigan railroad man.

"They are putting a new motor in today. An oil plug leaked. They tore it down three times and couldn't stop the leaking. I have been without the use of the car 11 days in eight weeks."—Indiana housewife.

### Chevrolet's Explanation

There were so many oil-consumption complaints that we asked Chevrolet for a statement on the subject. Here it is, in part:

"The figure of 22 percent of owners complaining that the V8 uses too much oil is very unrealistic at this time. It is true that we have experienced some problem with the oil consumption on the very first engines.

This was due in part to the chrome-oil-ring installation which was slow to break in and in part to a greater oil supply to the valve-operating mechanism than was planned. Both of these conditions were corrected very early and the 22-percent figure becomes less realistic every day. Only the first, relatively few, engines gave trouble.

"With the new ring we are showing oil economies so good that I hesitate to quote them here. We are well satisfied that this problem is well in hand and our service department, working through the dealers, will take care of any owner's problem by first installing the new oil deflector, then if this is not effective, the new rings—on the early engines, of course, that did not have the rings.

"The slow seating of the chrome rings has its good returns, generally speaking, in long life and outstanding oil economy after they are properly seated."—W. R. MacKenzie, liaison engineer, Chevrolet Division.

That, then, is the official explanation of the oil-consumption problem by Chevrolet. Apparently dealers are correcting the early engines, as the following quotations from owners indicate:







following favorable quotations are typical of those made by the owners in the survey:

"The new body style makes my car look much more expensive than it is."—Ohio contractor.

"It steers easily, almost like power steering. It really holds the road. No sway or front end nosing down."—Ohio mechanic.

"Holds the road on curves."—Illinois factory worker.

"I like its riding quality. Sometimes I think it rides too easy."—Kansas farmer.

"I can see all four fenders."—Michigan truck driver.

"Takes the curves faster with very little tilting and no tire squealing."—Illinois carpenter.

"Simplified and well-arranged dashboard."—Michigan punch-press operator.

### Other Complaints of V8 Owners

While the oil consumption was by far the most frequent complaint, there were others. Here are some representative complaints in order of frequency of mention by the owners:

"It has lots of squeaks and whistles that we can't find as yet. Horn button won't stay on. Flaws in paint job. Rear window leaks."—Tennessee foreman.

"For a car with such a nice body styling, I think it should have a better-looking front grille."—Michigan guard.

"Grille should be restyled. Cowl vent should have better method of flowing air into heater."—Indiana student.

"Not enough miles per gallon. Should be at least 17 or 17.5."—Utah salesman.

"Dealer said regular gas was okay for the V8, but the ping is terrific when I use it. Ethyl stopped most of the ping. Engine unusually noisy. Maybe it's just tappets and the 5000-mile check will correct."—Washington Army officer.

(Continued to page 262)

Chevrolet's instruments are easy to read, but horn ring interferes with driver's view of speedometer



## Driver's Blind Spot

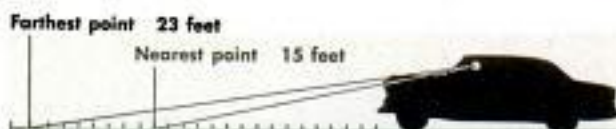

Driver of average height has a blind spot ranging from 15 to 23 feet in front of car

## Acceleration Test

1955 CHEVROLET V8

Bel Air Four-Door Sedan with Powerglide

¼ mile from zero	- - - - -	19.2 seconds
½ mile from zero	- - - - -	30.3 seconds
0 to 30 miles per hour	- - - - -	4.2 seconds
0 to 60 miles per hour	- - - - -	12.9 seconds
Top speed by speedometer	- - - - -	108 miles per hour
Actual top speed about	- - - - -	101 miles per hour

## Economy Test

At constant 30 miles per hour	-	21.6 miles per gallon
At constant 50 miles per hour	-	19.4 miles per gallon
At constant 60 miles per hour	-	16.1 miles per gallon
At constant 75 miles per hour	-	13.8 miles per gallon

Cross-Country Mileage

Los Angeles to Phoenix, Ariz.	-	16.9 miles per gallon
Phoenix to Las Vegas, Nev.	-	17.3 miles per gallon
Las Vegas to Los Angeles	-	15.9 miles per gallon

(Premium gasoline used)

## Comparison with 1954 Chevrolet

Below, measurements show the 1955 Chevrolet is slightly smaller than the 1954 Chevrolet

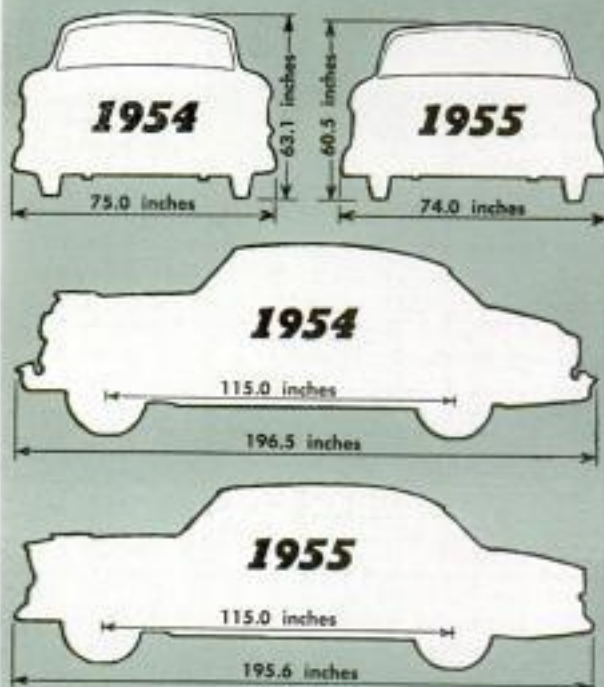

To give its readers a thorough, impartial coverage of automobiles, *Popular Mechanics* each month combines two reports: First, the owners themselves describe frankly the good and bad points of their cars in the Owners Report (names of owners are chosen for us at random from state registration lists by an independent organization); and second, a road test in which Floyd Clymer details performance data and his driving impressions



# Detroit Listening Post



By Leo Donovan

**Y**OU PROBABLY WON'T believe it, but some experts in the auto industry say the next step is economy!

Right now it is difficult to detect, but they say it's on the way. Some predict smaller, lighter and more economical cars within 10 years. That is one reason for the interest in the LaSalle dream cars at General Motors' Motorama. These two cars were supposedly powered by fuel-injection V6 engines, but they were surrounded by so much secrecy that nobody except GM is sure what is under the hood. Despite requests, the hoods were never raised so the LaSalle engines could be examined.

Chevrolet is interested in the V6 even though some other divisions keep repeating the claim that the V6 is "inherently out of balance" and therefore will never be an important engine. Chevrolet is interested because about 20 percent of its customers are penny-conscious buyers who use vehicles not for pleasure but to make money—taxicab owners, truckers, fleet buyers and even the government.

As compressions go up (and 10:1 is not far distant), the in-line six will have to be dropped. Its crankshaft is not rigid enough unless it is supported by seven bearings. Making the six in a vee increases rigidity so compressions can be boosted as gasoline quality improves.

One fleet owner in Manhattan reportedly saves 25,000 gallons of gasoline a month with six-cylinder taxicabs over his previous eight-cylinder cars. Of course, the six-cylinder cabs are lighter, so all the economy is not in the engine design.

Countering such enthusiasm for the V6, one top official recalls that his personal car in 1948 and 1949 was powered by an experimental V6, but that the engine was shelved when the trend to the high-performance V8 took over.

## Production Problems

The V6 has lighter weight, smaller size and fewer parts, but it can't be built on the same line as the V8. The V6 banks are

angled at either 60 or 120 degrees while the V8 is at 90 degrees. The massive, costly transfer machines that turn out V8s "untouched by human hands" can't make V6s—they bore at the wrong angle. You just don't eliminate two cylinders and use the same equipment. So the V6 is a long time off, if it comes at all, say its critics.

At the same time, L. D. Crusoe, general manager for the Ford Division, predicts that the six has only five years to go. Last year about 30 percent of the Fords sold were sixes. This year the percentage has dropped to 15, he says. If this continues, it won't be long before the six is gone. However, the popularity of the six as a truck engine will keep it around for a while.

Where are the big cars going from here? How much bigger can a V8 be made? Not much, says one engineer who won't permit his name to be used. Once you get above 40 cubic inches per cylinder (320 for a V8), you begin to develop stress problems, he claims, although he admits there are successful engines in the bracket right now. But, he says, it is better to go to smaller and more frequent explosions. So you can expect V12 or V16 engines with horsepowers of around 400 and compression ratios of better than 10:1.

## Some Predictions

Hydra-Matic will be an all-new transmission in 1956. Details are still secret.

Lincoln will bring out its 1956 models this summer. The Futura (page 95) may give a tiny clue as to some of its style tricks. The way the hood curves sharply upward at the base of the windshield (Lincoln calls it the "race boat" cowl) is a styling feature the 1956 model may have as is the protective chrome-covered bulge that runs along the body from front to rear.

The Corvette will have 195 horsepower in its V8 models (now in production). This 1955 model will be a bold answer to the competition of the Thunderbird. It will have power windows, power-operated top and other comfort features aimed at overcoming the sales resistance to the "rugged" sports-car character of previous Corvettes. It's to be more sporty and less sports car. With 195 horsepower, performance will be terrific. For those who want a "bomb," a 225-horsepower engine may be available later. The plastic body will look the same as in 1954.

Apparently plastic is not going to take over the industry. After more than a year of experience with plastic-body production, President Harlow H. Curtice of General Motors said: "If time permits we will always tool for steel rather than plastic." There may or may not be significance to the word "always."





## Fighter Plane Launched Like Missile From Truck Platform

Blasted into the air like guided missiles, piloted jet-fighter aircraft have taken off successfully from rocket launchers mounted on trucks. The zero-length launching platforms are the same ones developed by the Glenn L. Martin Company for the Martin Matador guided missile. Planes used on the launching tests at Edwards Air Force Base, Calif., were Republic F-84-G Thunderjets. In zero-length launching the

turbojet engine of the plane is run at full speed and added thrust is provided by a detachable booster bottle that gives a rocketlike push. Martin test pilot Bob Turner said the shock of platform take-off was no greater than that felt when a plane is catapulted into the air. Officials of both Martin and the Air Force said that development of the launchers might do away with the need for front-line fighter strips.

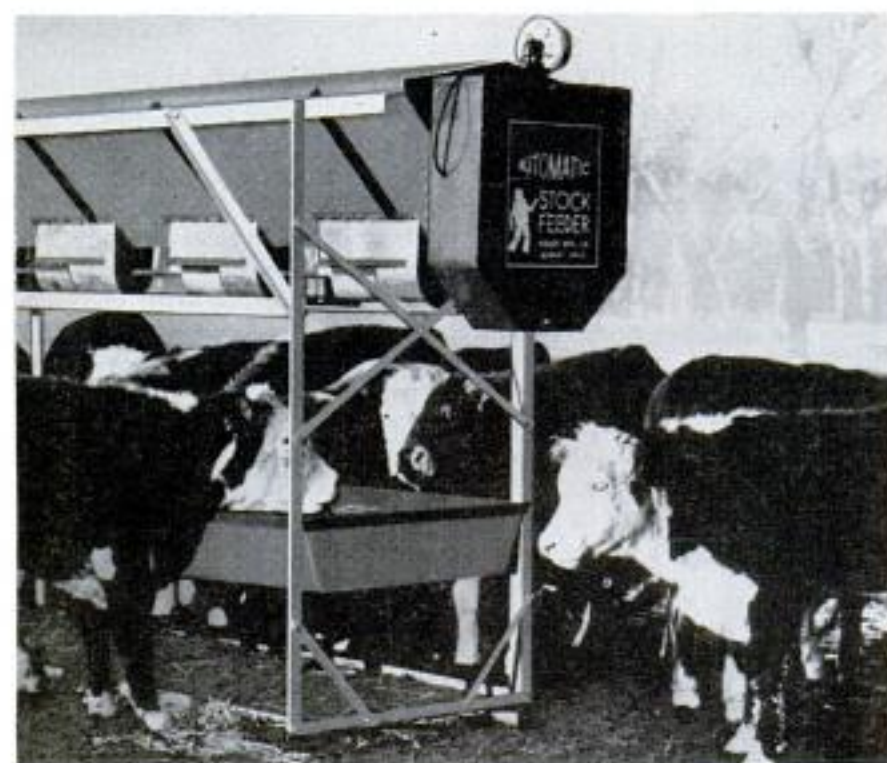

## Automatic Feeder Doles Out Ration

Automatic farming gets another boost from a robot cattle feeder invented by two Oklahomans. At a preset time, the robot sounds an automobile horn to call the cattle in from the pasture. Minutes later, it augers out a measured ration. Essential parts of the feeder are a standard electric timer and an electric motor which revolves an auger to drop feed from an overhead supply trough.

Ⓞ During 1953 more than 80,000,000 tons of commodities were moved on the Mississippi River.



## Huge Generator Moves on Planks

EVERY FOOT of nine miles of highway was successively covered with thick plank when a 217-ton generator was moved from a railroad siding to its new site. The three-inch-thick planks protected the pavement from the crushing weight of the generator, which was carried by an 82-wheel tractor-trailer 89 feet long and 17½ feet wide. Cargo and carrier together weighed 275 tons. The trip was the last leg of a 3100-mile journey for the 150,000-kilowatt electric-generator stator, built in New York State by General Electric and installed in a power station under construction at Morro Bay, Calif. A crew of 59 men with crane trucks and lumber carriers took eight 24-hour days to move the generator the last nine miles.



Moving the huge generator the last nine miles was a round-the-clock operation. A total of 550 planks, each 20 feet long, 12 inches wide and 3 inches thick, was used to protect the pavement from the load





# SOME PEOPLE THRIVE

It's all a matter of balance. German strong man Milo Barus keeps his footing while climbing a flight of stairs carrying a live and kicking 300-pound pony on his back, while Carl Carson, an Austrian acrobat, literally takes his life in his right hand by balancing himself on a cane atop a 100-foot Las Vegas, Nev., electric sign



He is not alone. At least motorcycle jumper Ken Butler will have company in the hospital if this stunt fails





# ON THRILLS

**Y**OU DON'T have to be crazy, but it helps." That is a hackneyed phrase, but stunt people such as parachute jumpers, motorcycle riders and others apply it to themselves. It fits the performers in these pictures, who cannot content themselves with the normal hazards of traffic, cellar stairs and slippery bathtubs, but go out of their way to tempt fate. But none of them goes through with these stunts until he has had long and careful training. They know what they are doing, and are probably better insurance risks than clerks and housewives. Betty Fox, for instance, may consider herself safer on her 18-inch platform 13 floors above Chicago's Michigan Avenue than she would be dodging its traffic. Most pedestrians would disagree. ★ ★ ★

Flying under bridges is tricky business right side up, but this Swiss daredevil risks life (and license) the hard way



Not content merely to dare danger, Betty Fox flouts superstition by suspending her tiny rope-skipping platform from a 13th-floor window. Others prefer their danger hot, and crash through flaming walls

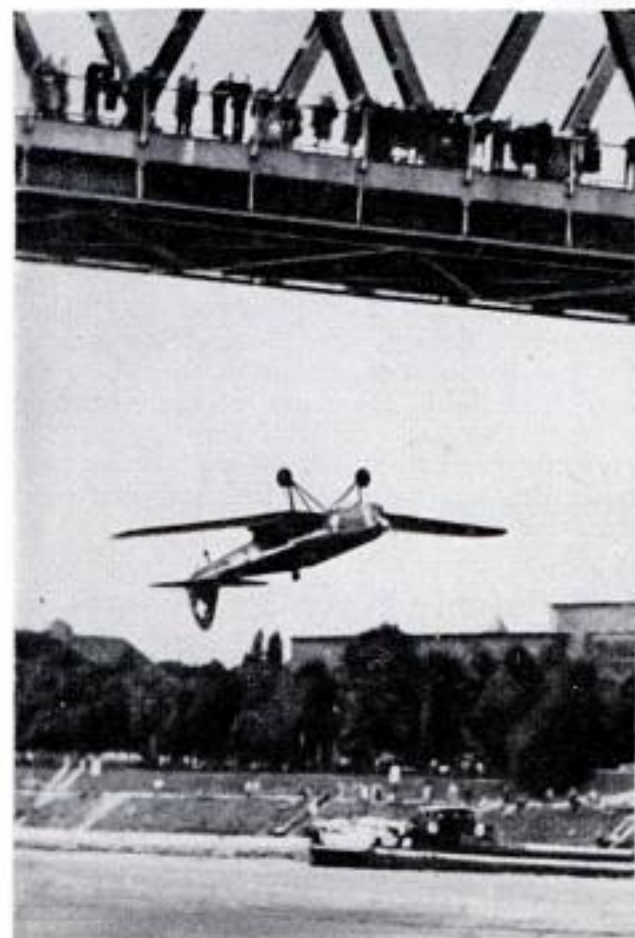



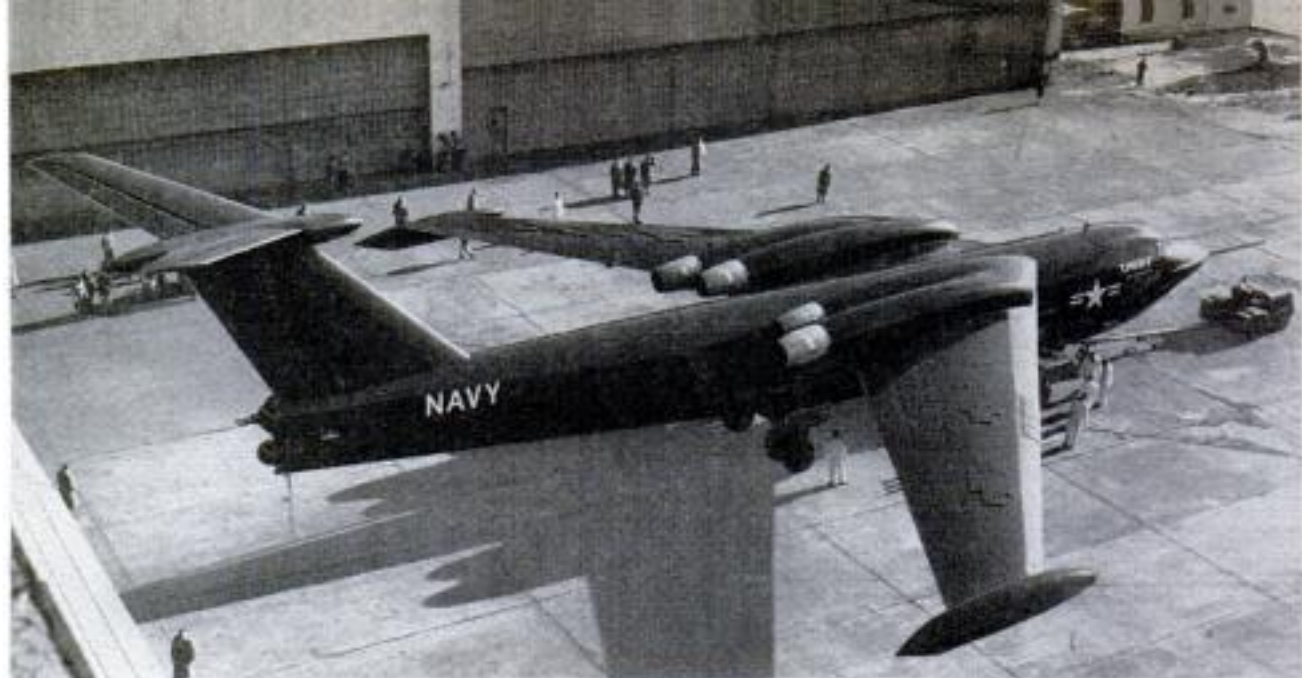

## Multijet Seaplane Has Three-Story Tail

Designed primarily for mine-laying and photo reconnaissance, the Navy's Martin XP6M-1 Seamaster is the world's first multijet attack seaplane. The gigantic aircraft is powered by four Allison J-71 turbojet engines mounted in nacelles atop the sweptback wings. The immense T-shaped tail stands three stories high. Fuel tanks are sealed within the wings and the wing tips have permanent plastic floats for buoyancy when the plane is at rest on the water. When the Seamaster was first rolled out of the plant, her wings still carried checkerboardlike pressure pads for maximum-load testing. They were removed before flight.

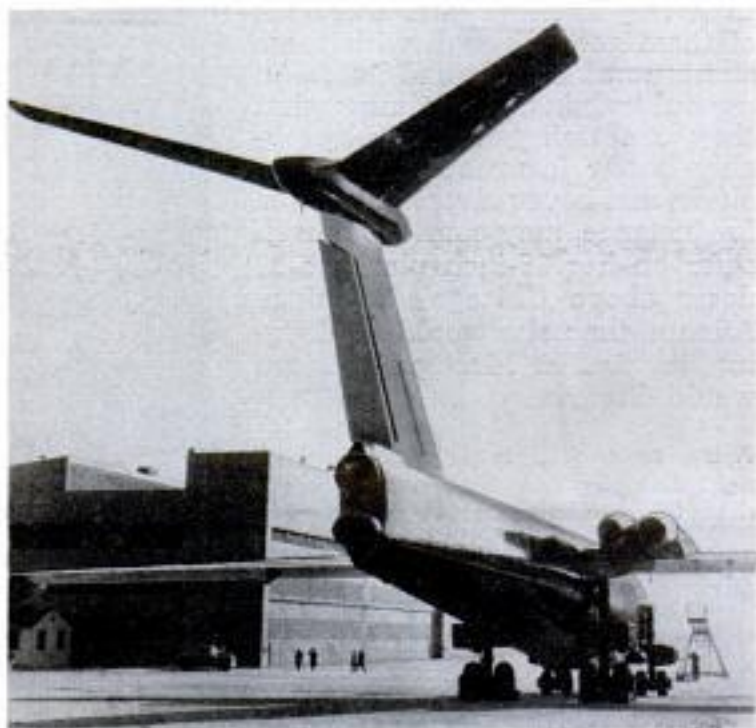

## Two Box Cameras Coupled on Platform to Make Low-Priced Stereo



By mounting two identical small box cameras side by side, Sears, Roebuck & Co. has brought stereo photography to the low-price field. The cameras are placed on a mounting bar so that they achieve a stereoscopic effect. A stereo viewer and mounting equipment for finished prints are included with the camera.

## SAC Refuels Every 3½ Minutes

Operating around the clock in all weather conditions, the Strategic Air Command completed 142,000 aerial refuelings in 1954. Fast B-47 bombers and F-84 fighters coupled to the refueling tubes of KC-97 flying tankers on the average of once every 3½ minutes. Aerial refueling has extended the range of these jet planes to the physical limit of crew endurance.





Introducing—

## THE PM PRECUT HOUSE:

A LOW-COST BASIC HOME OR SUMMER COTTAGE

*I built this attractive home in the Pocono Mountains. Now you can buy its shell for \$1800 in precut kits and build your own house or vacation cottage*

Part I

By Richard F. Dempewolff

**H**OW WOULD YOU LIKE this trim, ground-hugging two or three-bedroom house on your favorite mountain, seashore or lake site? Better still, how would you like the winterized version of the same shell on the plot you've picked in town?

It looks like—and is—a lot of house. It was specially planned to serve two purposes: A basic, low-cost year-round home, or a summer cabin in the woods.

Looks expensive, too, doesn't it? Well, it isn't.



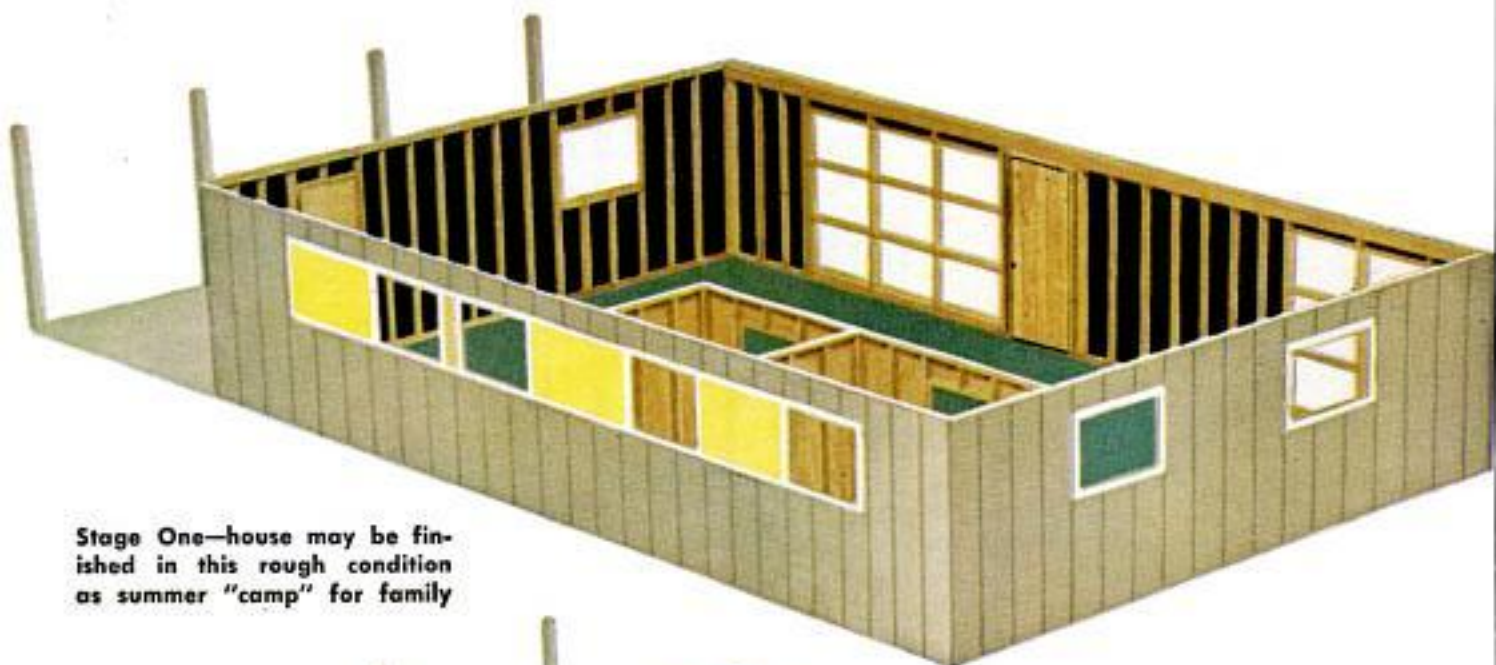

**Stage One**—house may be finished in this rough condition as summer "camp" for family



**Stage Two**—interior of living room is paneled, partitions added for use as ideal summer cottage



**Stage Three**—this is how Dempewolff finished house as a year-round home complete with built-ins and fireplace





View from dining area shows how the big picture window dominates the living room with spacious effect

I know how inexpensive it is because I have just finished building all three stages of the prototype house pictured here.

The shell for this spacious 24 by 46-foot home (including porch) was test-built to create what will now become *Popular Mechanics'* Precut Home Kit. It's a packaged and labeled bundle of pieces, all cut to proper lengths and angles, ready for any hammer-wielding amateur to nail together on a building site. Prepared by carefully selected fabricators to *Popular Mechanics'* own design and specifications, the F.O.B. price of the shell kit is less than the cost of a new automobile — \$1800. Naturally, there's nothing to prevent you from taking the material list to your local lumberyard

and cutting the pieces yourself from the standard-size lumber they supply. Depending on where you live, shell materials might cost slightly less if you do this. But the kit is designed to save you all lumber waste and days of cutting time. Although the kit includes the shell only, possibilities for finishing it off are endless. Its "open design" gives a choice of scores of floor plans and interior finishes that depend only on your desires and pocketbook. A few of the many alternate possibilities are shown on these pages.

For another \$1000, for instance, you can buy material to develop the shell, as I did, into a two or three-bedroom summer cottage — complete with bath and kitchen

Bunk beds in child's room, which is 10 by 11 feet, save space and provide extra overnight facilities



Corner sofa of living room is made of two Hollywood beds that pull out to sleep guest couple in comfort







Top, dining area with kitchen beyond. Bamboo curtain above separates rooms. Below, Rita helps



plumbing, wiring and partitions finished on one side. Though I completed this stage in a few weeks, you can do it over several years, if you wish, since the big shell lends itself admirably to "camping out" while you're busy finishing the house to your taste.

Finally, for one more \$1000 worth of material, I took the last leap to "stage three," making my prototype house the handsome all-year-round dwelling you see pictured on these pages. The dry-panel ceilings are spanned by rich redwood beams in every room but the kitchen. Knotty redwood panels line all living-area walls. New, easy-to-apply reflective insulation blankets the whole house. Gas space heat will keep the house at a toasty 70 degrees on zero days. The built-in storage walls and roll-away closets are luxury features you'd hardly expect to find in a house with a total cost for materials (including all three stages) of only \$3800. That price was *Popular Mechanics'* goal, in a high-priced eastern building area. When the last nail was hammered home in the last piece of baseboard molding, I had squeezed in right under the wire. And I own a house that would have cost about three times that amount had it been built for me in the usual way.



How long does it take to build this home? Let's not kid about it. If you think you can finish the complete winterized house all by yourself in one summer of week ends and a two-week vacation, you'll be sorely disappointed. But, with the help of friends on heavy and tedious jobs such as raising walls or trusses, and laying floor, you certainly should get the shell up yourself during free time in one summer. No use trying to overdo it.

With the assistance of a carpenter friend, Lewis Bush, who helped me through a large part of the major structure and partitioning so these articles would be ready in time, I had erected a crawl-space foundation and the whole shell (complete with paint) between April 17 and June 15. The entire winterized version, down to the last built-in cabinet-door clip, was wrapped up October 17, six months to a day from start of construction. Most of that time (except for three months of five-day weeks that Lew put in) was week-end, vacation and holiday time.

For years my wife, Rita, and I had wanted a summer cabin for family vacations and to entertain friends. We had our spot picked out—on the brink of a wooded ridge overlooking a spectacular view in the heart of eastern Pennsylvania's Pocono Mountains. Like most people, we could



afford dreams, but not much more. The cabin we wanted had to have space, and lots of it. We didn't want to settle for a one-room shack if we could help it. It had to be modern, for easy, convenient living. But we wanted a rustic atmosphere in spite of that. It had to be so designed that it could be completed in stages, starting with some kind of big, open shelter, like a boys' camp mess hall that we could camp in, as a starter. We could have it finished, we thought, in easy jumps over a period of five or ten years.

But even in the mountains, the cost of labor for anything like the size house we wanted was sky-high. The hundreds of plans and catalogues that we thumbed dog-eared turned up a few "shells" that looked possible. But by the time things like the "de luxe" windows and doors in the pictures were substituted for the standard ones that came with the house, the price

Rear of house shows window arrangement for the kitchen, bath and the small bedroom in corner at right







The Dempewolffs raided a stone pile to make this fireplace. Its total cost, including Heatilator, was \$325

was out of reach again. Most of the readymades in our economic range, though many were well conceived, were far smaller than the house we'd set our hearts on.

"Maybe you should build one yourself," Rita finally suggested. "We could buy a tent and camp out while the thing was going up. The fresh air might do us good and you could write a book about it by campfire light."

The suggestion was supposed to be funny. But the more we thought about it, the better we liked it. There must be others, we figured, who'd prefer roominess to fanciness—and who'd give an eyetooth for a house they could build themselves, and live in while they finished it at leisure.

Though I'm one of *Popular Mechanics'* editors, my general-article work rarely collides with crafts editor Jim Ward's "do it yourself" section. My hammer wielding has been confined to amateur projects, a pine-paneled wall being my most ambitious project. But I knew from housing stories I'd covered that it doesn't take an expert craftsman to build a house. Last year, the Federal Housing Administration broke out figures to prove that in 1952 more than 200,000 people in this country built their own homes entirely, or partly. I remembered that Tom Riley, a self-confessed greenhorn with a hammer, built the famous *Popular Mechanics* Ranch House in Port-

land, Ore., without the help of a single professional except a chimney mason. "If I can do it, anyone can," he had said. I felt pretty sure that if I could erect and complete the three stages of the house in six months with minimum help, any *Popular Mechanics* reader could do the same. It was worth trying. Rita, who loves to paint, agreed to take on this and other light work. So did our 10-year-old daughter, Judy.

Before long, a hundred random thoughts had congealed into a firm plan for *Popular Mechanics'* kit home. My plan was to line up fabricators to precut a basic-shell kit, and work with one of them nearest the building site, cutting and testing each piece of material for size, quality and practicality as I built the shell myself. Then, working from professionally designed plans, I would show one way in which the shell could be optionally developed into a semifinished summer cottage or a winterized home.

Was it tough? Sure it was—physically. "Building a house is 90 percent pure physical labor," Tom Riley maintained. I throw in my vote with his. I'd been sitting on my swivel chair for most of the past 15 years, and there were late nights when I fell into bed wondering if I'd ever get the stiff old carcass back into painful motion again. The carpentry problems were minor, and those that did give us trouble we eliminated by changing the plans.



But there were plenty of chores to complete before a hammer could even be lifted. First, from a list of interested bidders, three nationally known fabricators were selected to pre-cut, label and package the shell kit.

How do you get one? Write to *Popular Mechanics*. The order will be processed through the proper fabricator. If you live in the South, your kit will come from Crawford Homes in Baton Rouge, La. In the North and Northwest, it will go out from Pagemaster Homes in Shakopee, Minn. Kits for Pennsylvania, New England and the Northeastern Seaboard will come to you from the R. C. Cramer Lumber Co. in Stroudsburg, Pa.

Rough plans for the shell were drawn up. Wilson and Christie, outstanding young modern architects in Towson, Md., just outside Baltimore, agreed to take on the job of making the kit house workable from my rough plans. Specialists in new ideas, these men have produced hundreds of eye-catching modern homes on the East Coast. Last year they completed recently featured plans for Baltimore County's ultramodern \$1,000,000 fire-department center — including training school, central telegraph alarm center and six other facilities. Unafraid of new ideas and materials, they plunged into the *Popular Mechanics'* kit house with a keen eye for good lines and economy.

It wasn't easy. The shell had to be versatile enough to take any of a hundred different floor plans. It had to be economical, but sturdy, too. That meant trusses for the roof, so there'd be no need for immovable posts or bearing walls to clutter the inside of the shell. It also meant some kind of tricky windows that could be moved around to conform with any floor plan a person might want. It wouldn't do to have a partition tie into an outside wall right smack in the center of a window.

This problem set everyone's teeth on edge. Nothing inexpensive seemed to work. Then, at lunch one day, Pete Christie threw his hands in the air. "Forget the house," he said. "Let's build a sensible summer cabin. Then you'll have no window problem. We'll just eliminate windows."

Amused with his own idea, he scribbled a sketch on the tablecloth—a sort of summer-camp dormitory, with wooden side flaps raised by ropes over pulleys. When all the flaps were up, the thing looked like the barbecue tent at a country fair—the upper half of each wall completely raised to the eaves. When they were down, it



Paneled kitchen has plenty of work space and sunshine. The refrigerator protrudes into utility room with door in kitchen

looked like a barn. "Sure! And if you want a window effect," Dave Wilson chimed in, "you just lower some flaps—where your partitions would come — and leave others up. How's that for versatility?"

It got a laugh. But, out of that fruitstand trick came the answer that makes the *Popular Mechanics* shell one of the most—if not the most—versatile house enclosures in the world. For the flap idea grew into the long narrow panel enclosing the string of windows on the bathroom side of the house. Into that 28-foot "picture frame" goes a row of simple awning-type windows and fixed panels that can be swapped around in any imaginable combination. If you're a sun worshipper, you can even throw away any two or three units and put in solid plate glass, since the rugged wall headers are designed to span openings up to nine feet. The wide variety of tricks you can play with this wall, and how, will be detailed for you in Part III of this series.

"Switchable" windows are only one of the features that modern thinking and materials provided to make this house so much home for such modest cost. The base structure of the shell is designed to sit on any kind of foundation you choose—crawl space, full cellar, slab or just simple piers. Since everyone wants his own kind of underpinning, foundation materials are not included in the kit. But plans show you how to construct each type in preparation for arrival of kit, or shell materials.

Half-a-dozen architects and engineers

(Continued to page 232)





## British Passenger Liner Has Funnel and Engines at Rear

There will be little danger of smoke to choke passengers on deck or oily fumes to ruin clothes on the new British liner, the *Southern Cross*. Engines and funnel are placed aft, giving the 600-foot-long ship an unusual appearance. The aft position of boiler and engine rooms leaves more of the hull free of obstruction and permits better

passenger accommodation. The ship will carry no cargo and the absence of cargo holds provides additional space in the 20,000-ton vessel. Cabins for 1200 passengers are spread over five decks and all the cabins are air-conditioned. The ship is equipped with antiroll stabilizers to prevent seasickness.

## Visitors' Portable Radios Pick Up Museum Lectures

Visitors carrying portable radios get a tape-recorded lecture tour as they pass through the American Museum of Natural History in New York. Five tape recorders in a central sound-control room continuously feed the recorded lectures into the broadcasting system. At intervals during each lecture, a bell rings to advise the visitor to move on to the next display. The compact, self-contained aluminum radios pick up the broadcasts from antenna wires hidden around the exhibits. Earphones are of either the headset or lorgnette type.



## Special Air Conditioning Beats Arizona Summer Sun

Arizona's summer sun no longer slows pilot training at Luke Air Force Base by baking officers in a mobile control tower set up close to landing strips. The tower, like most similar structures, is almost entirely of glass, and the sun in summer made it unbearably hot—170 degrees or more—before it was air-conditioned. The air-conditioning unit is built into the tower base, and is powered by the portable generator that provides current for radio communication. It was necessary to build the unit around a three-horsepower motor when room units were ineffective.



## Heated Blade Aids Plastic Sculpture

Accidentally discovered when an electric cutting tool was left too long in contact with plastic tile, heat-sculpture of plastic has developed into a hobby called polymodeling. Since a regular cutting tool was too large, Charles Garland, Oakland, Calif., manufacturer, designed and built a small, electrically heated, tile-modeling tool specifically for sculpture. The cutter has an insulated handle, a beryllium-copper blade and a 35-watt wire heating element that raises blade temperature to 1000 degrees. The term polymodeling was adopted because polystyrene plastics were found best for sculpture. Costume jewelry and small ornaments are easily carved with the heated blade.



It is no trick at all to turn out plastic flowers for costume jewelry with the polymodeling cutting tool. Most common modeling material is polystyrene

The special sculpturing tool is smaller than the standard plastic tile cutter. Its beryllium-copper blade is electrically heated by a 35-watt element

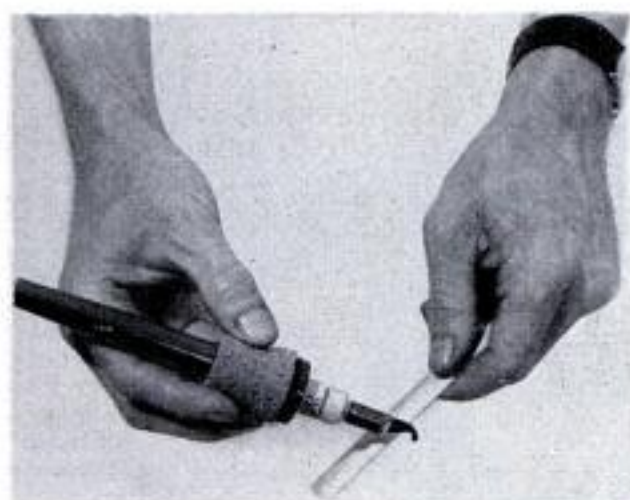

Given a supply of plastic and a modeling tool, an art student produced these poodles. The contrasting eyes and noses are of different colored plastic



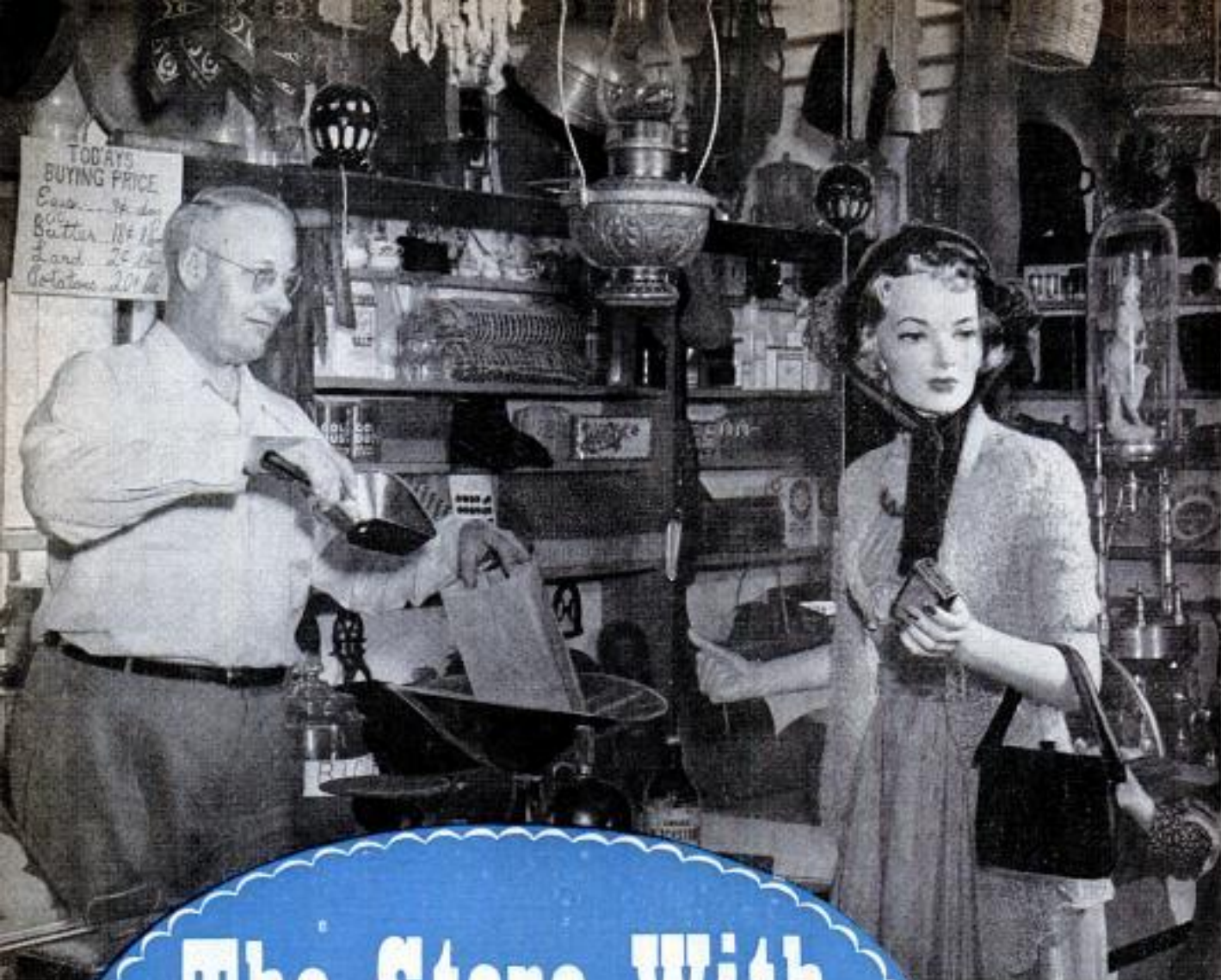

## The Store With Nothing to Sell

Willis weighs an order for Blondie, one of the mannikins that serve as customers in the general store. Two other dummies represent her children

By  
Walter E. Burton

FOR A JOURNEY into the past, follow U.S. Route 42 as it angles down across Ohio on its way to Louisville. On the northeastern edge of Ashland, Ohio, you'll come to the home that houses the Possum Run General Store. Inside is an authentic replica of a crossroads shopping center that has been transplanted, merchandise and all, from the late 19th century.

A thousand products of the 1875-1900 period fill the room. Cans of Rising Sun Stove Polish share shelf space with Oelerich Flapjack Syrup, Grandpa's Wonder Pine Tar Soap and Copenhagen Snuff, some of them still familiar brands. But, although there's plenty of merchandise to choose from, none is for sale. In this establishment, customers are urged to look but not buy.

In one corner is a well-preserved cobbler's bench complete with tools and an assortment of hickory shoe pegs. There's a silver-plated 1874-model soda fountain, a post office with envelopes and post cards of the era, three permanent mannikin "customers" and unbelievably low price tags.

Owner of Possum Run is Ted Willis, a lieutenant on the local police force and an ardent collector of old merchandise.

Willis, who as a youngster spent many an after-school hour







Front of the Possum Run General Store, plastered with signs and curios, is actually a partition inside the house

turning a coffee grinder, mixing milk shakes and doing other chores in a general store, likes to imagine himself back in the period when such crossroads stores were the nerve centers of their communities.

"The general store," he'll tell you, "was easy to identify, for signs advertising plug tobacco and scores of other necessities of the times covered much of its outside, and often the tin patches helped make the sid-

ing reasonably weatherproof. If you wanted to find the community's stray dogs, pigs or chickens, you simply looked underneath the store's front porch, where the shade was plentiful and cool.

"Inside was the supply depot for the countryside—plus the local post office; and there were facilities that enabled the store to function as a public forum. At the general store our homespun forefathers won

Willis home, which houses the Possum Run General Store, is on Route 42 at the northeastern edge of Ashland, Ohio. A wooden horse will soon be hitched to the sleigh in front







Ted Willis slips a wax cylinder on one of his latest Edison cylinder-type phonographs, a two-speed model made in 1896

Possum Run, like most general stores, includes a post office in one corner. Stamps and envelopes are of 1875-1900 period



and lost many an election, fought important battles over and over again and analyzed to the smallest detail such important matters as crops, cattle and the newfangled machinery that was just getting a foothold."

Willis opened the model store in a room of his home in 1951, filling it with merchandise collected over a 15-year period. There is no admission charge, although it helps attract customers to a store in another room opened in 1954, where Mr. and Mrs. Willis and their son Robert retail antiques and art novelties to pausing tourists.

Willis says that the best returns from the model store are "the compliments I receive and the fun of watching the reactions of the young visitors who have never seen such a place, and the older ones in whom the store arouses long-buried memories."

The store's signs, listing prices of goods and produce, recall the days when a few cents would buy a great deal. Sodas and sundaes sold for a nickel. Dill pickles were a penny each. Buying prices, those the store paid the farmer, were nine cents a dozen for eggs, 18 cents a pound for butter, two cents a pound for lard and 20 cents a bushel for potatoes.

In one corner of the store is a workbench where Willis pursues the hobby that started his collection of antiques—renovating old talking machines. Today he has 58 ancient phonographs, 47 of which are in playing order. They date back to a tiny Columbia phonograph made in 1886, nine years after Edison's first machine. All of them are of the cylinder type.

Whenever Willis adds another talking machine to his collection, he first takes it completely apart and cleans it. More than half a century has converted the old oil into a sort of varnish. This he removes with carbon tetrachloride, aided by some scraping and rubbing when required. He cleans and smooths each rusty piece. When a part is missing, he makes a new one in his shop, where he has a metal lathe and other equipment.

It takes an average of 30 hours to put one of the old talking machines in good condition—to clean it, restore the finish, repaint the morning-glory horn if it has one and



adjust the mechanism. Only when he has a duplicate of some item in his collection will Willis sell one of his cylinder machines.

Willis has more than 3000 cylinder records in his permanent collection, plus a sizable stock of others which kindred talking-machine collectors could probably persuade him to sell. His records include the earlier two-minute kind, which are yellow and jet black, and later three and four-minute records, which are blue. Most records of this color are the four-minute variety. These have the best sound reproduction, he says. A record was made by casting the wax cylinder, shaving it smooth, cutting a spiral groove in the shaved surface and then making the recording with a vibrating needle riding the pre-cut groove. Thus each cylinder was individually recorded, not made by a molding process as are present-day "platters."

Willis' hobbies took another turn when he decided, years ago, to collect old lamps of the kind used in pre-electric days. He has more than 50 specimens in his collection.

Because the lamp and phonograph collections take up so much space, they are stored in other parts of the house, and are exhibited only when Willis lectures on them at a nearby club or county fair. But his knowledge of phonographs and lamps often helps to answer a question posed by a visitor to the model store.

Space in the Possum Run store has become a problem as gifts from friends, purchases and chance finds have increased the stock. Willis therefore plans an annex so that he can enlarge both the general store and the art, craft and antique store. He has acquired an old sleigh and has a wooden horse to go with it. He plans to hitch the horse and sleigh to a post in front of his property, to serve as a landmark for the travelers who wish to spend an hour in a preatomic age. ★ ★ ★



Silver-plated soda fountain was made in 1874. Syrup and other soda ingredients were kept in kegs and forced to spigots by air pressure

Another prized item of the store is an old cobbler's bench, complete with tools, specimens of work and a box of assorted wooden pegs





## Paper-Coated Lumber

**TOUGH**, waterproofed paper is now being used in tests to cover the defects of cheap, low-grade lumber. The paper covering, treated with synthetic resin for water resistance, hides knots, splits and other faults of the wood, reduces swelling and provides a smooth surface.

Scientists at the U.S. Forest Products Laboratory at Madison, Wis., are conducting the long-term tests. Paper-overlaid house siding has been installed on a test building for weathering in Wisconsin's tough climate. Boards one inch thick and over two feet wide are being tested for built-in furniture. Overlaid seat planking has been installed in the university football stadium to compare its durability with high-quality planks. House paint has stayed in good condition on paper-overlaid bevel siding exposed for three years.

If successful, the paper coating will be valuable in "upgrading" knotty lumber of small second-growth timber.



Two-inch plank made up of knotty narrow pieces edge-glued together is spread with synthetic resin. Paper overlay, below, is laid in place on top of glue. The overlay contains waterproofing resin



Press, below, puts uniform pressure on planks while glue cures at room temperature. Wood preservative, below right, is squirted into bolt holes to protect wood from decay in tests of stadium planking

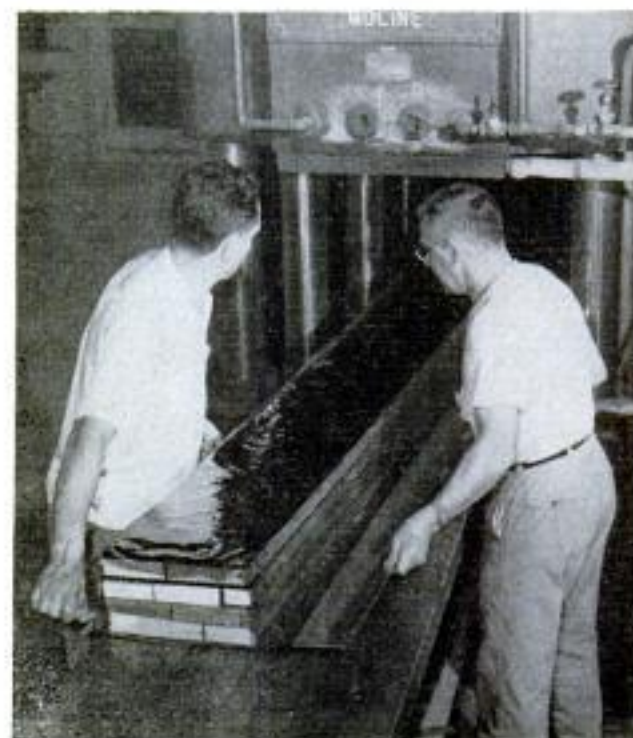



## Catalytic Purifier Destroys Dangerous Fumes From Lift Truck

Harmful exhaust fumes are said to be purified by a catalytic unit that replaces the muffler on the gasoline motor of a lift truck. The unit contains porcelain rods coated with catalytic alumina and platinum alloy. As exhaust gases pass over the rods, the catalyst reportedly oxidizes the carbon monoxide and hydrocarbons to produce harmless carbon dioxide and water vapors. Elimination of dangerous fumes makes possible the safe use of gasoline lift trucks in enclosed areas. The unit can be used to purify the exhaust of any mobile or stationary engine powered with nonleaded fuels. The catalytic purifier is similar to systems used to purify stack gases.

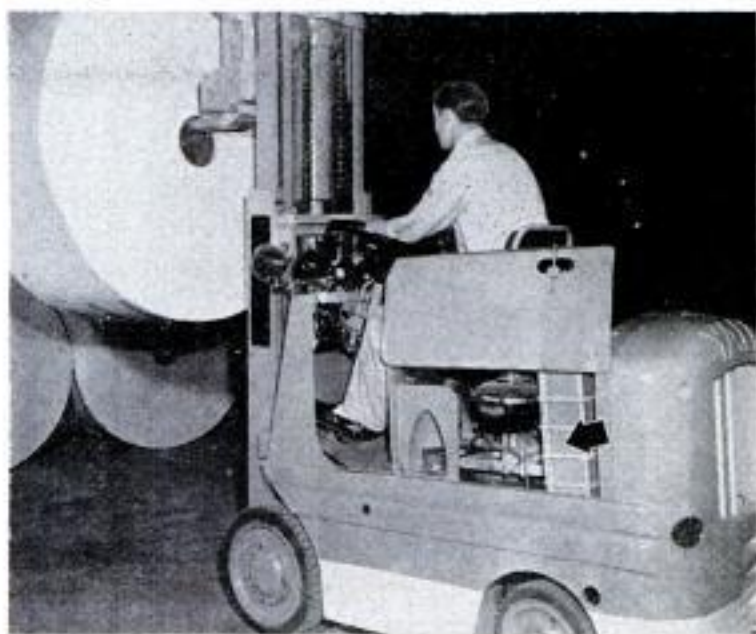

## Car-Straightening Jack Pulls Parts Together

Wrecked cars are pulled back into shape with a compact and lightweight jack equipped with chain and attachment hooks. The jack, which exerts a powerful pull from several inches to seven feet, can be used in body work to straighten damaged parts. Since it takes up little space, it can be used in tight spots when a ratchet box wrench is employed. The chain makes it possible to pull around corners. The pull is exerted by turning a nut. This draws the chain into the hollow yoke of the jack. The jack pulls 12 inches before a new "bite" must be taken.



## Toy Rolls Along Belt Curved in Any Pattern

Made in Japan, a toy car rolls along on a track made of a round rubber belt. The belt can be curved in any pattern on the floor. The two front wheels of the toy are placed astride the belt and the motor is wound up. When the car is released it careens around even the sharpest curves of the rubber track.



Information not listed on articles in the index frequently is listed in the WHERE-TO-FIND-IT LIST, which is available to readers without charge from Bureau of Information, Popular Mechanics, 200 East Ontario Street, Chicago 11





## Lightweight Electronic Piano Replaces Strings With Metal Reeds

You can carry a new electronic piano about like a suitcase. The 75-pound instrument, now in production, was developed by Benjamin Miessner, holder of many patents in the electronic-instrument field. According to Miessner, it surpasses the conventional piano in purity and richness of tone. Instead of strings, the low-cost instrument uses small spring-steel reeds, struck by key-actuated hammers and

stopped by simple dampers. The vibration is picked up electrostatically, translated into tone currents by an FM-type-preamplifier and reproduced through a loudspeaker by means of a power amplifier. The units which pick up the sounds from the reeds are interconnected to create suitable overtones each time an individual reed is struck. Earphones are plugged into the cabinet for the pianist's private enjoyment.

## Flattened Plastic Strip Tells Bearing Clearance

Checking the clearances of main and connecting-rod bearings is simplified with the use of a plastic strip. The strip is laid across the width of the bearing insert at its center. The bearing cap is placed on the bearing insert and tightened. When the bearing cap is removed, the width of the flattened strip is compared with a scale on the envelope which originally contained the plastic. This gives the clearance in thousandths of an inch.

## Milk-of-Magnesia Coating Cures Mechanical Headache

Time-honored as a remedy for indigestion, milk of magnesia has found a new use that cures mechanical headaches. Engineers at General Electric found a coating of the thick liquid the most efficient means of keeping nuts and bolts threadable under high temperatures. After threads have been painted with milk of magnesia, they do not lock together and bind even when subjected to heat intense enough to melt brass.

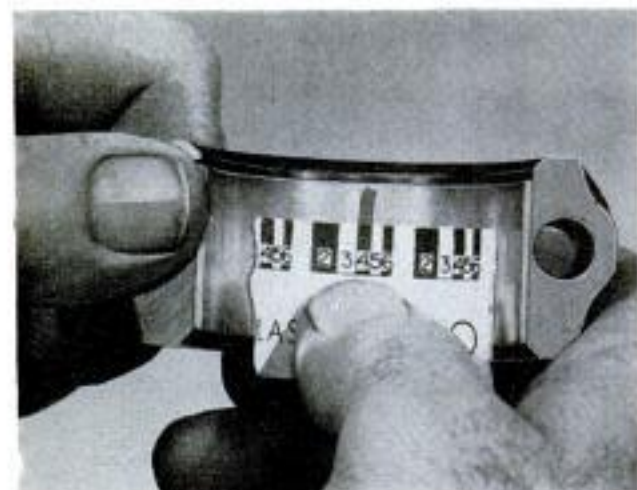





Lubricator, filled every 500 miles, mounts above locomotive wheel and coats wheel flange with graphite grease

## Chain Greases Wheels

A LUBRICATOR that "kisses" grease onto locomotive wheels is prolonging the life of equipment and trackage on a number of western railroads.

The lubricator, which mounts above the drivers, depends on the lateral sway of the engine to swing a grease-impregnated chain against the wheel flange. The chain is a loop which passes slowly up through a reservoir of grease and then down alongside the wheel flange. A wheel that rides the locomotive wheel drives the chain.

When the unit is used by all the trains on a line, the lubricant eventually transfers to the pressure side of rails, switch points, frogs and all roadbed steel. The graphite which forms the base of the grease works into the pores of the steel and forms a thin lubricating crust on the wearing surfaces of the wheel's outer edge.

On one line using the lubricator, locomotive wheel flanges formerly replaced after 35,000 miles lasted 128,000 miles. On another, flange life has been extended from three weeks to six months. In addition to reducing wear, the flange-and-rail lubrication has also been found to increase the effective pulling power of locomotives.



Lubricating chain rotates continually. Swaying motion of train causes chain to slap against wheel flange and deposit its grease

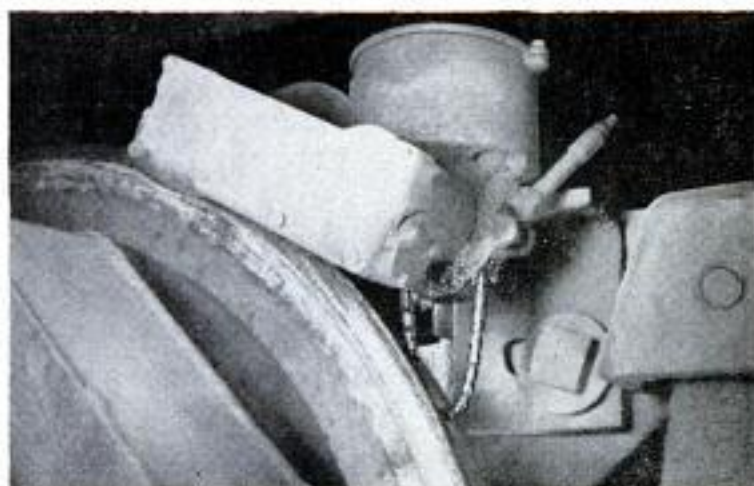



# WHAT'S NEW FOR Your Home

**1. ADHESIVE TILE**, of plastic or rubber, simplifies floor laying. Old floor is swabbed with solvent, plastic backing stripped from tile, and tile pressed into place. The result is a neat, clean job. No adhesive oozes up

**2. COMBINATION TOOL** uncaps and recaps bottles, cuts open vacuum-jar tops, cuts wire and strips wire insulation and has serrated handles to open stubborn covers and scale fish. The tool is made of chromed steel

**3. CONVERTIBLE** air conditioner cools or heats, maintaining a year-round temperature as preset. A 1500-watt radiant-heating panel of glass covers the unit's guarded face. The cooling section is a  $\frac{3}{4}$ -ton unit

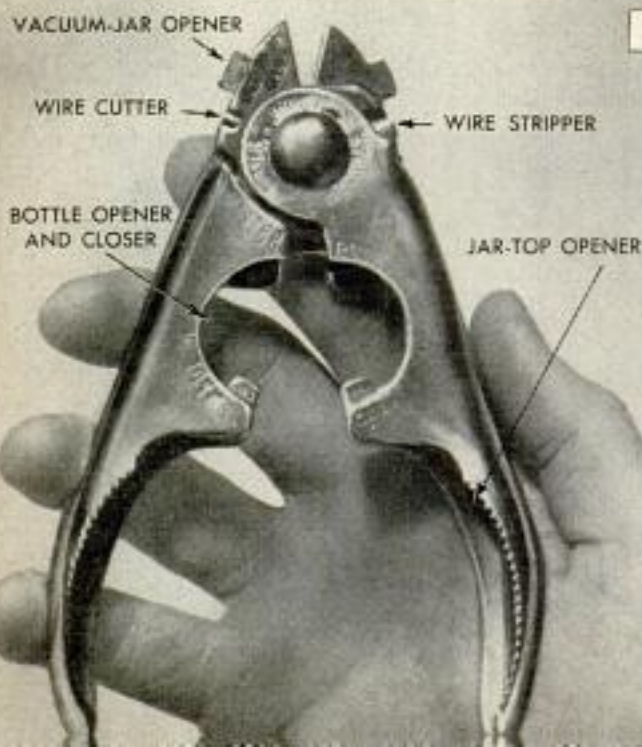





**4. EGG RACK** times boiling, whistles when eggs are done. Rack is then lifted out. Different levels of water, marked on rack, determine hardness of eggs

**5. STEAM-DRIVEN SPIT** of portable barbecue kit gets heat from charcoal fire that cooks meat. Entire unit, with folding legs, packs into a carrying case

**6. GLOWING SWITCH** contains tiny neon bulb in handle that lights when the mercury switch is off, making it easy to find in dark rooms or hallways

**7. TURKEY LIFTER** provides sure grip when hot bird is transferred to platter. An aluminum band with handles, it is placed in roaster before cooking



**8**

**8. RANGE** has removable broiler element that makes storage unit a second oven. Disposable metal foil on oven sides eases cleaning







## Blower Ducts Carry Ashes From Basement—No Baskets Needed

Two similar methods for removing the ashes of coal furnaces promise to relieve the householder of a messy job. In one, ashes are removed from the base of the furnace to a transfer box by means of a bar on an endless chain. A blower shoots the ashes up twin three-inch tubes that

terminate in a box at the side of the house. In the other method, ashes are automatically transferred from the furnace to a closed bin in the cellar. Tubes lead from the bin to outside ducts. The ash truck connects to the ducts and sends air racing through the tubes to pick up the ashes.



## Cedar-Shingle Panels Save Application Time

Several cedar-shake shingles are fastened together in a 32-inch-wide siding panel that is quickly applied. The panel, held together by staples and a wooden spline, needs only five or six nails to fasten it to the backer board. It thus combines the advantages of cedar siding with the fast-application features of composition siding. Application time is cut up to 60 percent, according to the manufacturer. The grooved siding is factory prime coated on the back and the front with resinous sealer.

## Rotating Tines of Ditcher-Terracer Throw Dirt to One Side

Ditching and terracing are performed by a unique tool mounted beneath a tractor. A tilted disk makes the initial cut and a spoked rotor driven by the power take-off flings the dirt to one side. A scraper used

for leveling mounts behind the tractor. The machine can also be used to destroy deep-rooted weeds and break up hard soils. The tool is said to require less power and less maintenance than standard machines.

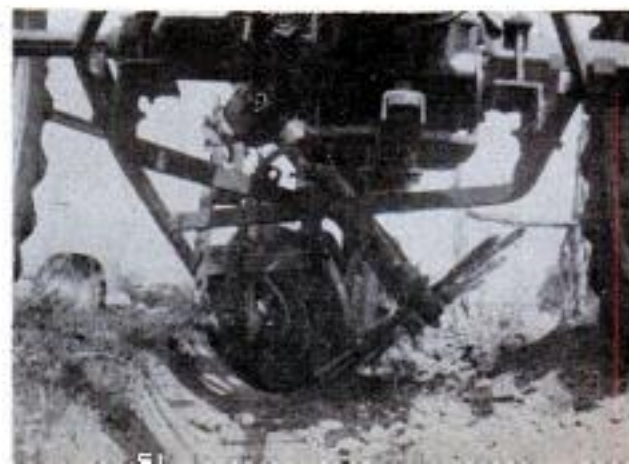



## Museum Superfly Defies Swatters

You'd need to replace your fly swatter with a rifle if insects grew as large as a model at the Cranbrook Institute of Science, Bloomfield Hills, Mich. The specimen, a green bottle fly enlarged 46 times, is one of several gigantic insects on view there. It was made by technician Paul Wright. With one eye on a microscope, Wright worked at night for four months to make the model, using balsa wood, beeswax, steel rods and common pins.

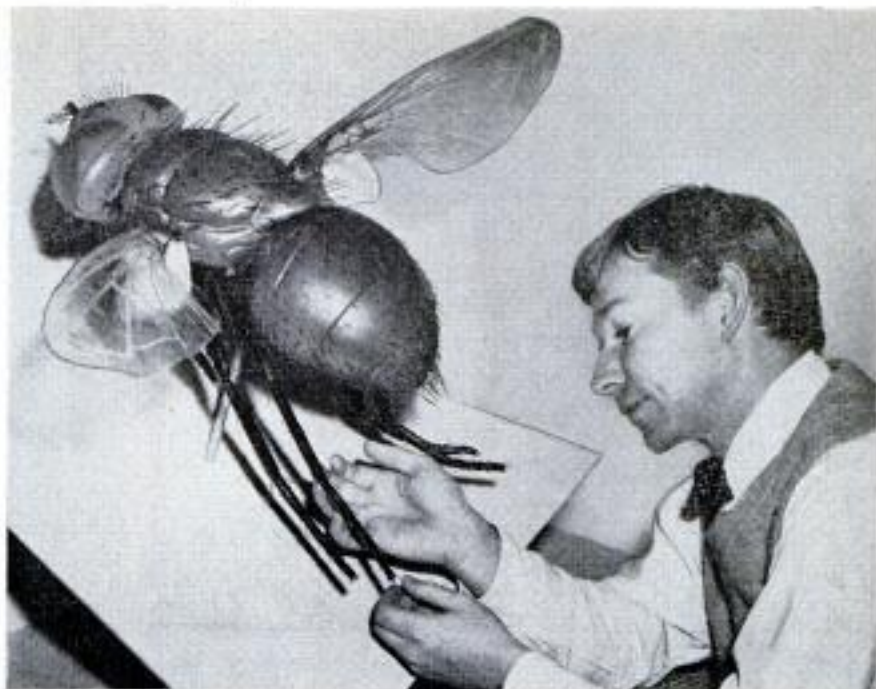

## "Envelope" for Boats

Tough as canvas but only one tenth as expensive, a heavy-duty paper can be used to protect boats stored through the winter. Available for boats up to 33 feet long, the paper is used over A-frames and is impervious to snow, wind, rain or cold. Because it is inexpensive, it can be discarded after each use. Made of two sheets of paper bound with a layer of bituminous asphalt, the paper is further reinforced with a glass-fiber mesh.

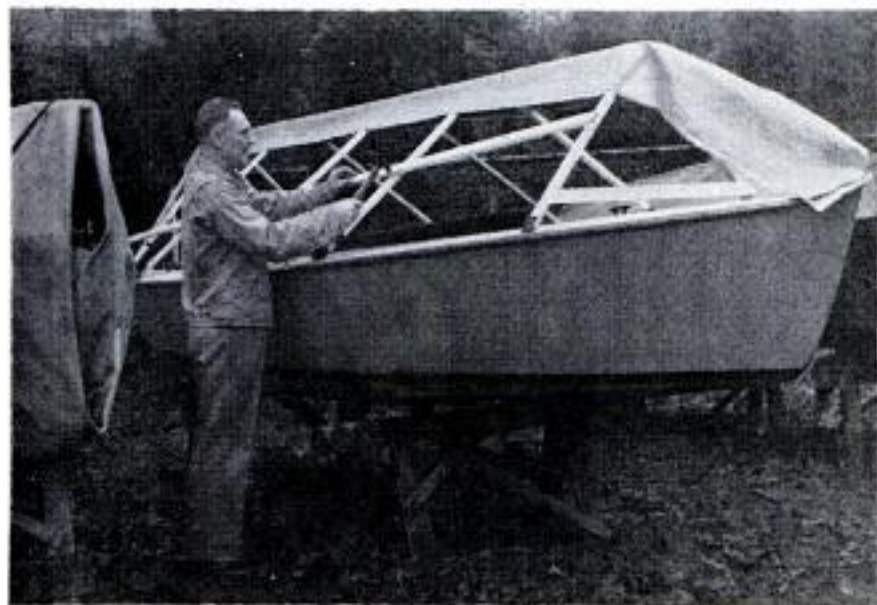

## Magnetic Detector Spots Submarines

Housed in the "stinger," or streamlined projection on the tail of the Navy's versatile Lockheed P2V-7 patrol bomber, is a new type of submarine hunter. The apparatus, called a magnetic airborne detector (MAD) is not to be confused with radar or sonar. It spots subs by registering the disturbances metal makes in the earth's magnetic field. Initials of the device have given this version of the P2V-7 the nickname "MAD Bird."







## Vacuum Cleaner Flushes Dirt Down Sewer

Dirt collected by a revolutionary vacuum cleaner is flushed down the sewer with the dishwasher. The vacuum cleaner operates from a central electric motor and blower installed near the main sewer outlet of the house. Dirt collected by the cleaner is mixed with water in an injection system

and flushed away. A long hose stored in a central location extends or retracts by electrical power and can be carried to any part of the house. An added feature is the ability of the cleaner to suck up water, so that washed floors can be dried quickly and easily without mopping and mop wringing.

## Glass-Fiber Repair Kit

You can patch a hole in an automobile fender, repair a leaky rain gutter or seal a crack in a boat hull with a new glass-fiber repair kit. Wood, brick, metal and other surfaces can be repaired and the patch sanded and painted.



## Stepladder Levels Itself

Hinges consisting of rods angling through vertical steel plates provide self-leveling safety in a new stepladder. When the ladder is placed on an uneven surface, the rods slip to level the steps, and lock them firmly in position.





## Vertical Passenger-Conveyor Belts Take the Place of Elevators

Forerunner of the passenger-conveyor belts now becoming popular is an early vertical version that takes the place of an elevator at the 10-story Quaker Oats plant in Akron, Ohio. Each of the 12 belts installed at the plant carries as many as 20 passengers at one time and travels at a speed of 40 feet per minute. Passengers stand facing the belt on small wooden platforms bolted to the belt. While one half of the belt is ascending, the other half is descending and passengers going down face those going up. Records for the 50 years that such belts have been in use prove that it's safer to use a conveyor than the stairs.

### Offspring of Aluminum

Scientists at Pittsburgh's Carnegie Institute of Technology have developed a new radioisotope of aluminum that has a half life of nearly a million years. The half life, or time in which the isotope will lose half of its radioactivity, of ordinary aluminum is a few minutes at best.

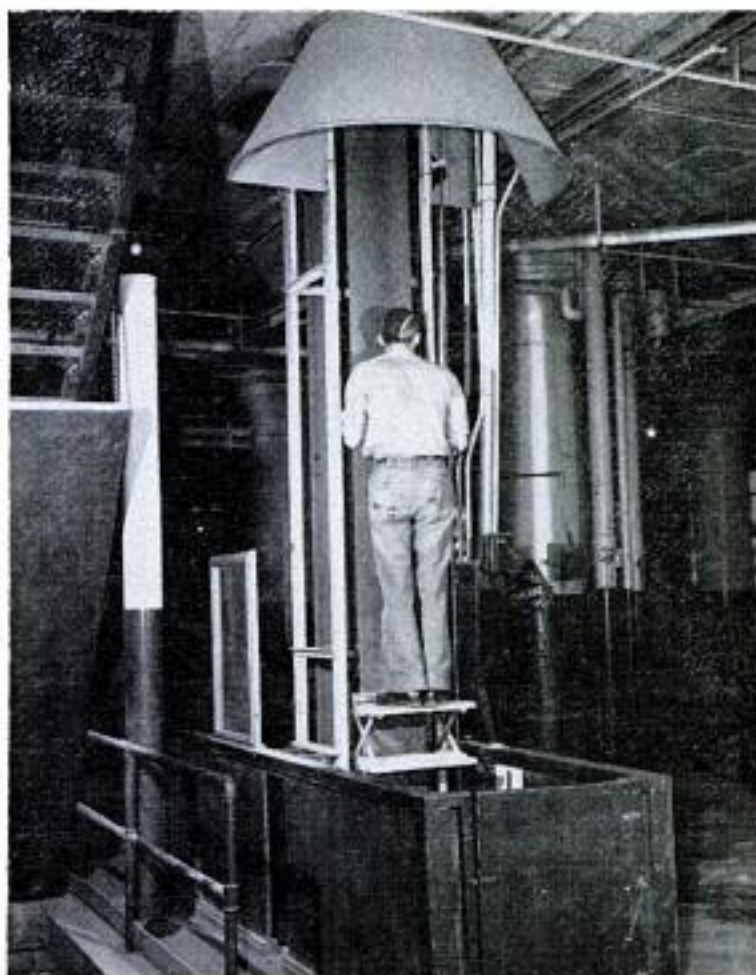

### Stairs on Work Tower End Ladder Climbing

Inside stairs on a rolling work platform allow workmen to carry materials easily up to the top deck. The steel stair sections come in two lengths and are quickly clamped over cross members of the scaffold frame. The roomy landings and deep stair treads are perforated with holes punched up from below to give a safe, corrugated surface. The stair sections are designed to fit a type of work platform that is assembled from tubular-steel scaffolding to meet the needs of a particular job.

### Salt Water Cools Deck

When the jet blast of catapulted aircraft buckled steel plates and charred wooden decking on United States aircraft carriers, the Navy called on the seaman's oldest fire-fighting weapon—salt water. In the area subject to the searing flame of the jet exhaust, hollow aluminum panels were installed and salt water circulated through them.





## Heavy Transport Planes Get Boost From Lightweight Turbojet

Designed primarily as a power plant for drone targets and guided missiles, the small J-44 turbojet engine made by Fairchild Engine and Airplane Corp. has been tested successfully in increasing take-off loads and rate of climb in large transport aircraft. Unlike many earlier jet assists for take-off, the J-44 installation is perma-

nent—not dropped after use—and it uses regular aviation gasoline rather than special fuel. Only 72 inches long and 22 inches in diameter, the J-44 can be installed in retractable or permanent streamlined pods. Tests have shown that the booster jet adds as much as 1000 pounds of thrust during take-off.

## Kit Analyzes Uranium Ore

Uranium prospectors can save time and keep their discoveries secret by analyzing their finds with a portable laboratory kit. The equipment, which can be operated by an amateur, saves days and even weeks of waiting for a laboratory report on a sample of ore. The field analysis takes 30 minutes. Although radioactive material can be spotted by a Geiger counter, an analysis is necessary to determine the concentration of uranium in the ore.



## Portable Plastic Heat Sealer

Packaging of everything from garden seeds to machine tools in thermoplastic has made it necessary to develop machines that seal plastic envelopes. On large production lines this can be done automatically, but hand sealing is necessary for small production or irregular shapes. To speed hand-closing, a heat sealer, which weighs less than a pound and has accurate temperature control from 200 to 450 degrees Fahrenheit, has been developed and marketed.





# SEAT BELTS vs.



# TRAFFIC DEATHS

By Paul N. Janes

**I**T HAPPENS IN the split second after your automobile crashes.

You are slammed about unmercifully. Perhaps your head smashes into the instrument panel or the windshield; possibly a door flips open and you are tossed out to be crushed under the car.

The crash doesn't have to be a bad one. Maybe the only damage to your car is a mangled fender, a dented bumper or a sprung door. But you may get a fractured skull, a crushed chest or a broken neck.

The way motorists are knocked about in accidents is a cause of grave concern to safety experts as well as to automobile builders. Many of them think seat belts may help answer the problem.

Indiana state troopers who have been making painstaking investigations of what happens to human bodies in traffic mishaps are convinced that seat belts in automobiles can save lives, many lives.

Sgt. Elmer C. Paul, director of Auto Crash Injury Research for the Indiana State Police, says "268 of 616 traffic deaths recently investigated by our troopers would have been prevented if seat belts had been worn. Another 104 might have been prevented by seat belts."

Below, two seconds invested in fastening a seat belt may save your life. It would have saved the driver in the crash above







Excellent protection is provided by use of combination seat belt and shoulder harness, although belt alone can save a life

On the negative side, the troopers say that in a limited number of circumstances, a safety belt might cost you your life instead of saving it. In some accidents, it can be more advantageous to be thrown out of a car than to remain inside.

Sergeant Paul says a seat belt usually is of the greatest value in crashes which occur when a car is traveling no faster than 50 or 55 miles per hour.

When your car is in a collision, you are thrown forward or sideways with murderous momentum, unless you are held by some type of restraining device.

If you are traveling only 25 miles per hour and the car is halted instantly, you are likely to be thrown from your seat. And the force of the inside-the-car propulsion increases with the speed the vehicle was traveling.

Sergeant Paul, who has conferred with the major car builders, says drastic changes are on the drawing boards for the years ahead to provide greater protection for motorists. Seat belts may be among them.

Also, he says, Detroit is looking for ways of building doors that will stay closed during an impact, and for steering-wheel designs less menacing to the driver's chest.

The Indiana State Police, working with Cornell University scientists, have been putting traffic mutilation of the human body "under the microscope" since 1949.

With the help of special reports made to them by physicians, the researchers usually are able to determine just what parts of the automobiles inflict the most damage to the occupants.

"It was obvious from the start," says Sergeant Paul, "that many victims would have survived if they had been held firmly in their seats. We would find extensive exterior damage to many of the cars, but little interior damage except that caused by the heads, teeth, chests and arms of passengers."

Depending on the distance between your head and the dashboard, at the time of crash, a belt may not always prevent your head from receiving some injury, although the troopers say the blow probably will be less severe if you are wearing a belt. For full protection, you need a shoulder harness as well as a seat belt.

Sergeant Paul believes the most important function of a seat belt is to keep the occupants of a car from being thrown out through doors that flip open under the impact of a crash.

More than half the victims of crashes studied were thrown from their cars. Some received fatal injuries inside the cars, but most were hurt fatally after being thrown out.

Sergeant Paul doesn't assume that it always is bad luck to be thrown from a car in an accident. Passengers in an open convertible that flips over often are better off because they are thrown clear of the wreckage. It's best to be outside the car, too, if it catches fire or plunges into deep water.

He emphasizes, though, that a seat belt can be flipped open in less than a second. And a belt can be expected to help a victim retain consciousness longer than might be the case otherwise.

None of the 850 vehicles involved in the fatal accidents was equipped with a seat belt, and thus far there have been only a few accidents in which the value of the belts could be tested. But Sergeant Paul says "the evidence that we have is convincing testimony in favor of the belts."

He cites the case of a driver who fell asleep recently while traveling at fast speed. The car went over an eight-foot



embankment, rolled over three times and, while upside down, sheared off a utility pole. The driver, harnessed to his seat in a homemade safety belt, escaped with minor injuries.

Homemade belts may be entirely satisfactory, Sergeant Paul says, if they are made of strong webbing of the type approved by the Civil Aeronautics Administration for use in airplanes. Quick-release-type buckles also are needed and the outer ends of the belt must be anchored to the frame, never to the floor or seat alone.

The state troopers see several other values in seat belts, in addition to the prevention or lessening of injuries in a crash.

The driver who is held tightly in his seat has better control of his car when he is rounding curves or making sudden stops. There's no chance that he will slide forward and have difficulty in operating brakes or accelerator. He doesn't have to brace himself with his feet.

The average driver seems to drive more cautiously when fastened down with a belt.

Sergeant Paul explains it this way:

"The belt is a constant reminder that

Belts may be attached to edge of door. This will keep the door from flying open as a result of impact

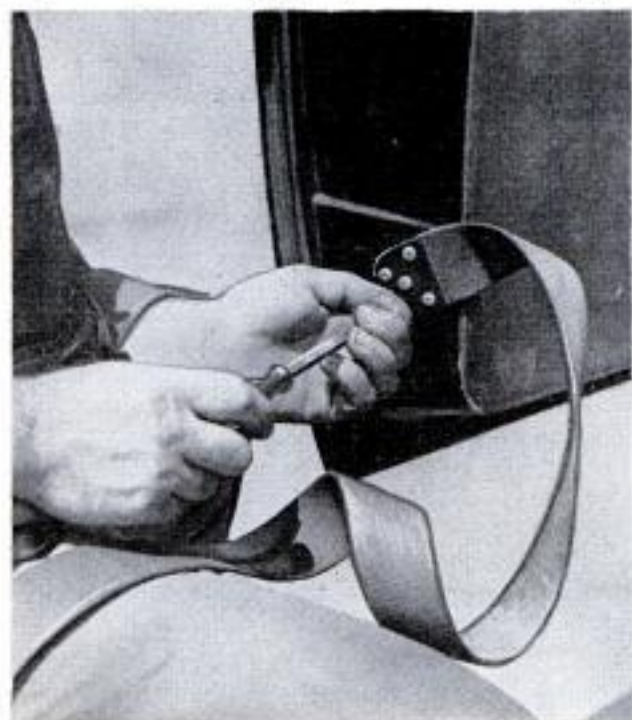

Death resulted when front-seat passenger's head knocked this hole in the windshield. He probably would have survived if he'd been wearing a belt

driving an automobile in today's traffic is extremely serious business."

A seat belt contributes to good posture by holding you erect in your seat, and makes an automobile trip much less tiring because you aren't slipping sideways or forward. Most of the Indiana officers have put seat belts in their own automobiles. That may be the best evidence of all! ★★

#### REQUIREMENTS OF A SAFE SEAT BELT

(as listed by Cornell Aeronautical Laboratory)

1. Minimum breaking strength of webbing should be 2250 pounds when new.
2. Best width is two inches. Being too wide is as undesirable as being too narrow.
3. Belt angle should be about 45 degrees from floor. Ends must parallel sides of car.
4. Buckle must be simple to use and must not slip under 1500-pound load. It must thread only one way so it cannot be improperly worn. Belt length must be adjustable.
5. Cotton webbing is satisfactory. Zigzag stitching with cemented surfaces is desirable.
6. Belts must anchor to frame, never to floor or seat alone. A cross member may be used as anchor if it fastens to frame and will take combined pull of three belts.
7. Each passenger must wear a separate belt. Seat-width belts are not satisfactory.
8. Wear belt at all times—even on short trips. Don't be caught dead sitting on a seat belt!





## Cruiser Mounts Motors On Outrigger Brackets

Use of outrigger brackets for motor installation leaves the cockpit of the Arkansas Traveler 20-foot cabin cruiser free of fumes, gasoline lines and engine controls. The cruiser, which can sleep two adults and a child in the cabin, can be used with either one or two 25-horsepower outboard motors. With dual installation it reaches a speed of 25 miles per hour. The outboard cruiser is of aluminum construction. In addition to the bunks, provision is made for easy installation of a stove, sink and toilet if living aboard is planned.

## Jet-Propelled Fire Boat ➤

Literally jet-propelled is this rubber raft designed in England for use in fighting water-front and marine fires. Three pumps on the raft can deliver 1000 gallons of water a minute. For propulsion, a jet stream from one of the pumps is directed aft.



## ◀ Lift Truck Hoists Nine Drums at Once

Empty oil drums are carried about and stacked in pyramid piles with a 224-inch boom mounted on a lift truck (left). Clamps along each side of the boom are hydraulically actuated to grasp or release nine drums at a time. Two double-acting hydraulic cylinders tilt the boom to a 65-degree angle for stacking.

Freight carried on the inland waterways of the United States rose to 200,000,000,000 ton-miles in 1953, compared with 168,000,000,000 ton-miles in 1952 and the previous all-time high of 182,000,000,000 ton-miles in 1951.



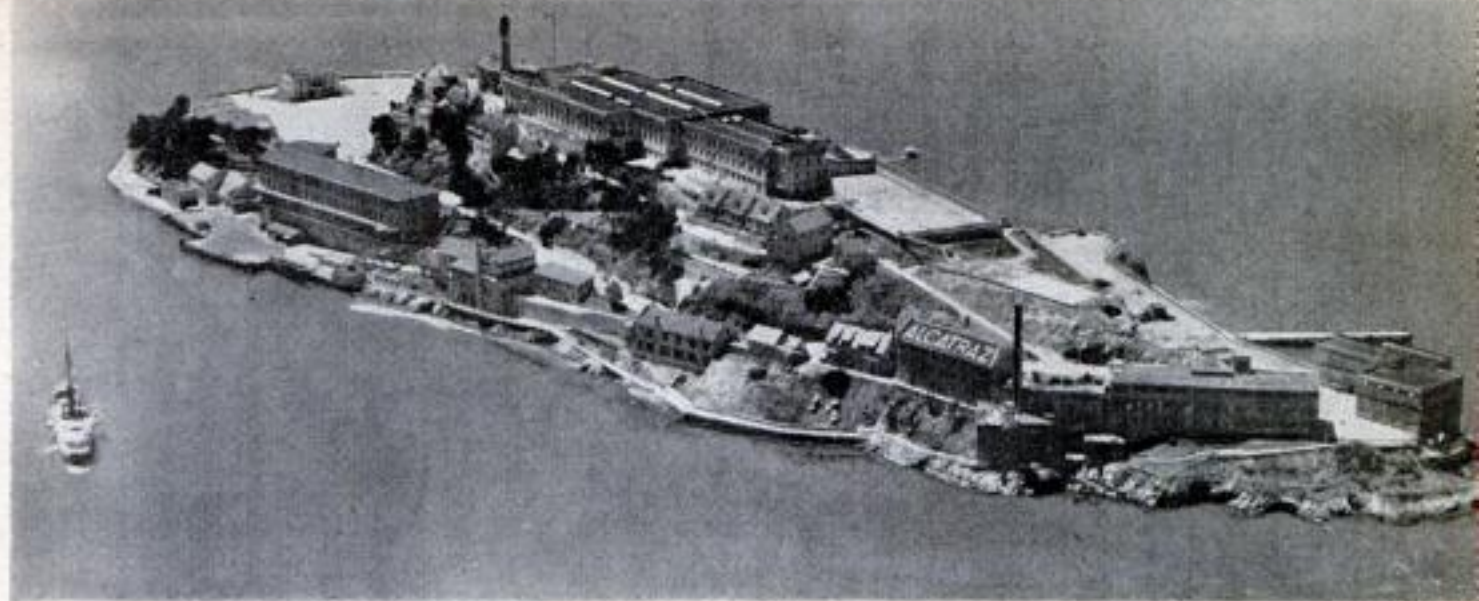

Established in 1933, escapeproof Alcatraz is a model for the world's jail makers

## BIG BOOM IN



*By George Laycock*

Below, forbidding interior of cell block at U.S. Penitentiary, McNeil Island, Wash.

**T**HE JAIL BUSINESS is booming. Jail makers are far behind in their orders and the demand for new cells continues to grow. The only one likely to be even a little bit happy about this is the jail maker.

If you ever spent a night in the pokey the chances are one in four that you were surrounded by the rugged craftsmanship of the Stewart Iron Works at Covington, Ky. This company is the nation's largest manufacturer of prison equipment and makes one fourth of all our compulsory lockups. They view with paternal pride some of the federal government's most imposing compulsory boardinghouses.

It was, for instance, during the '30s that the federal government decided to do something about the arrogant big-time criminals who all too often walked away from some of our antiquated jails. The Department of Justice sent out a call to Covington for Capt. Bob Bunge, one of Stewart's engineers. Bunge, with other members of the presidential committee, searched the land for a prison site. They chose a tiny island a mile and a half off the California coast. Stewart bid on the job, obtained the order and started work on its masterpiece—Alcatraz. No one has yet escaped its barriers of steel and water.

Stewart's engineers are specialists in designing and building state penitentiaries. They have built them in every part of the country, most recently in Utah, Colorado

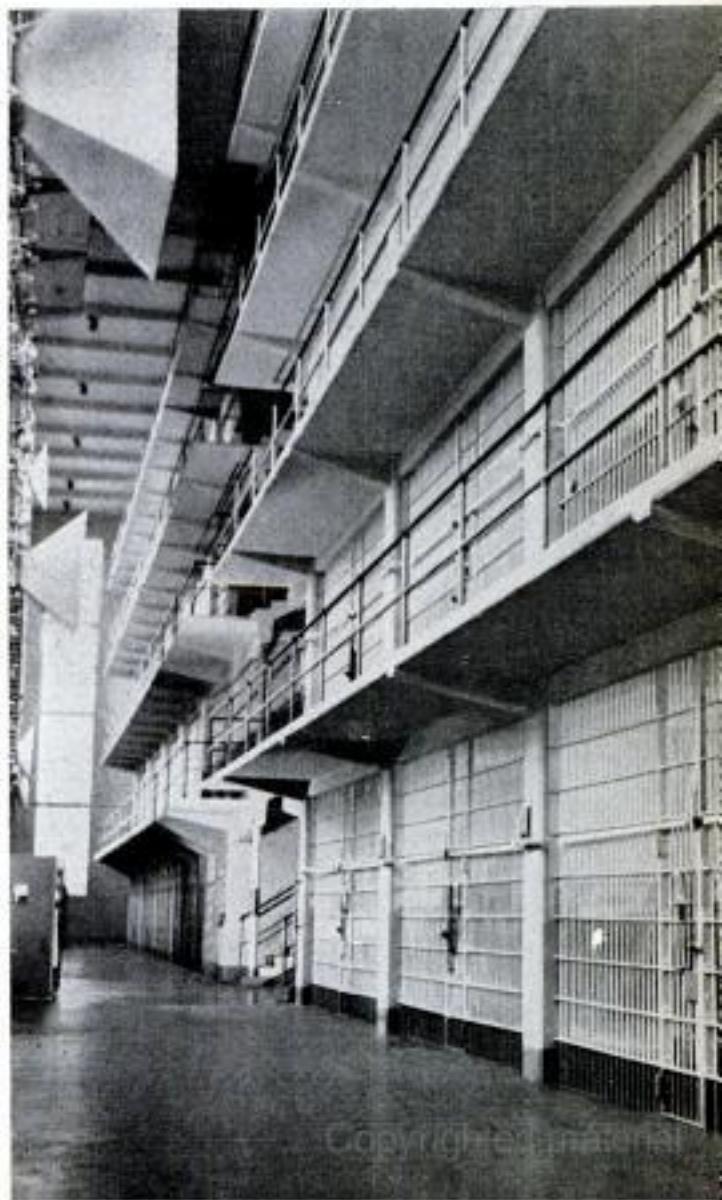



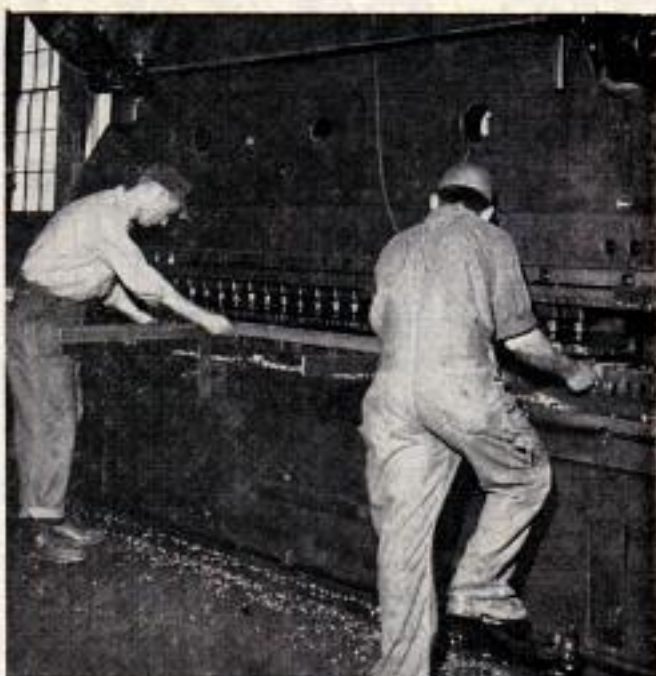
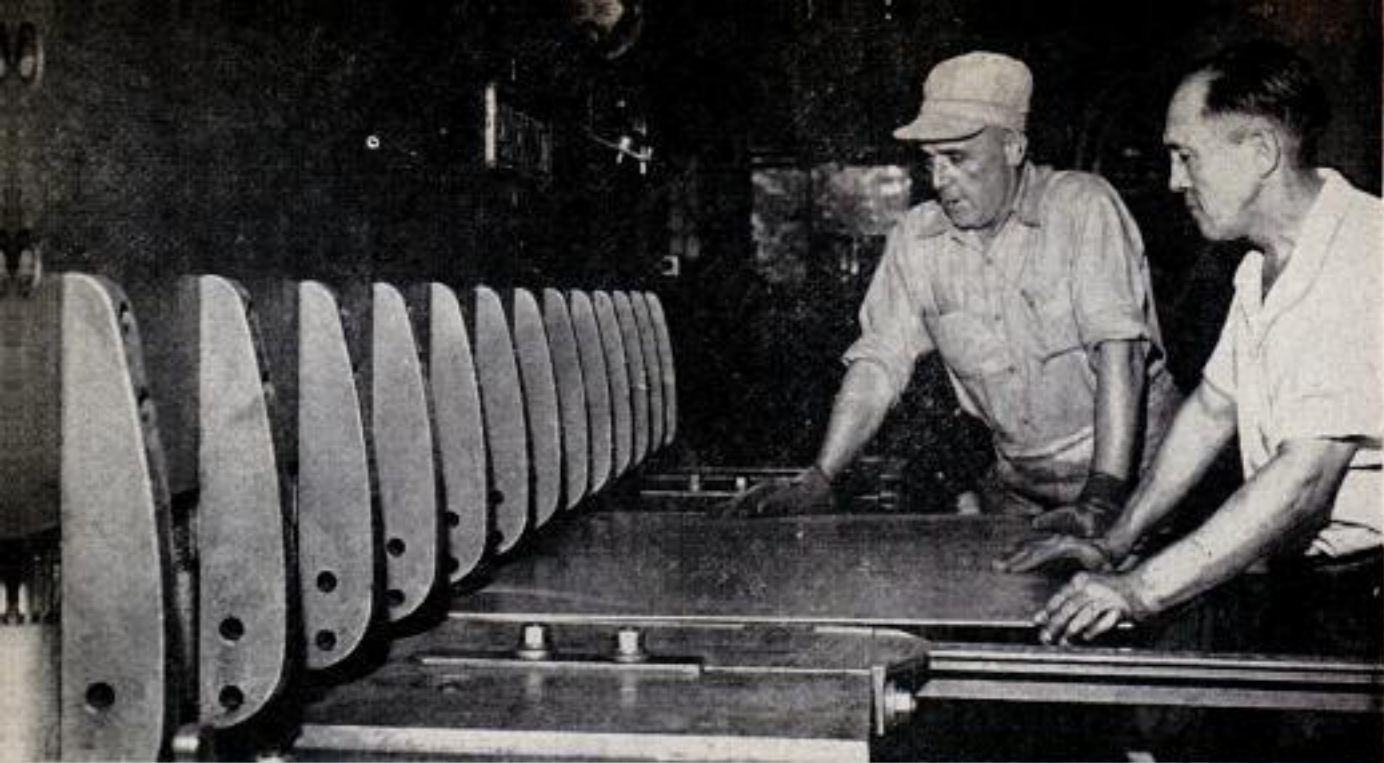

Top, shearing machine at the Stewart Iron Works, famed jail maker, snips off length of quarter-inch steel plate which will be used to construct cell

Above at left, a powerful riveting machine fastens heavy sheet-steel panels to the jail frame

Above, 300-ton multiple punch makes 40 holes at once in half-inch steel. Holes are for riveting

Below, constructing jail grating. This man sees that the steel bars fit snugly in cross members



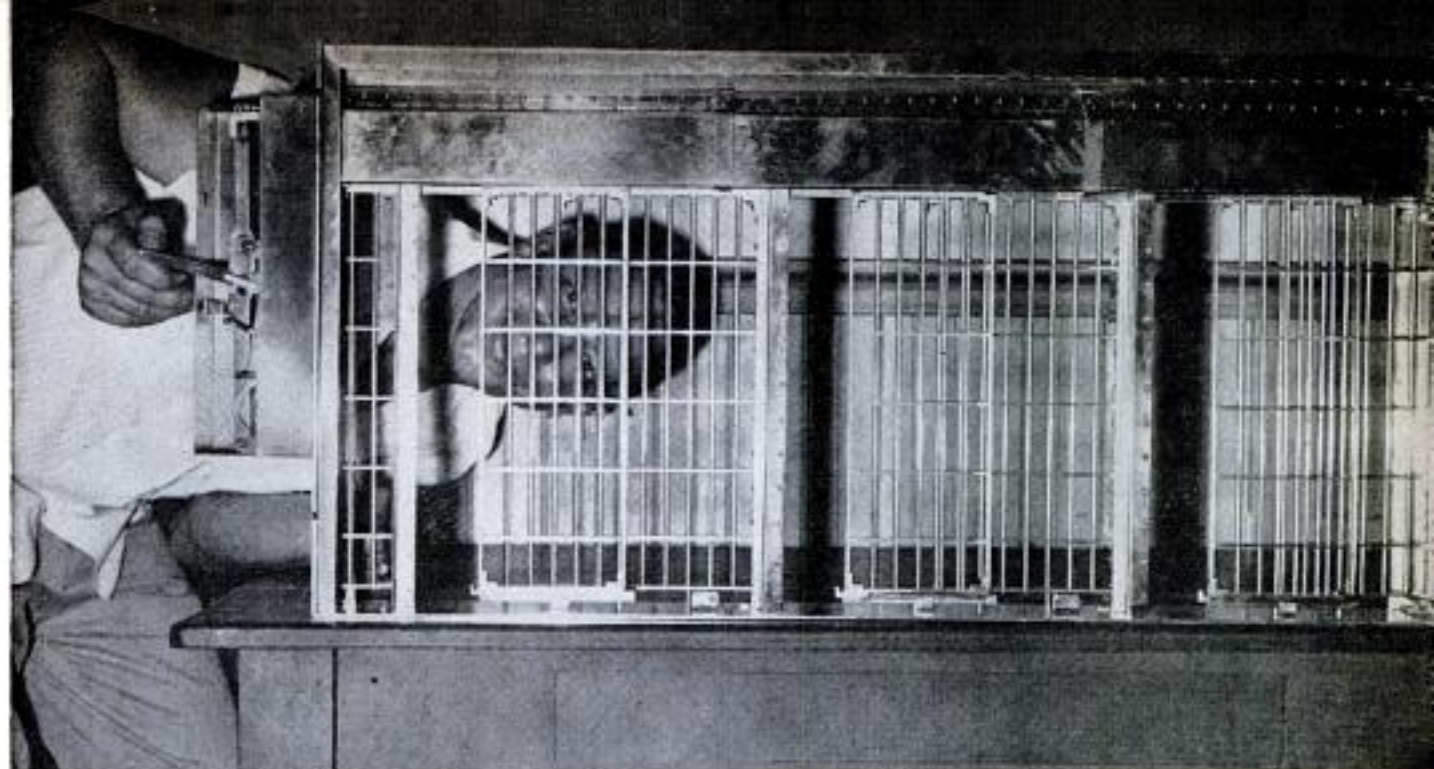

**This \$4000 model of a three-cell jail weighs 125 pounds with case and is used by salesman to display wares**

and New York. Their "interior decorators" designed the cells which replaced the Tombs of New York City. Their smaller jails, including numerous overnight cells in county seats and villages, are scattered across the country. In an average year they'll build a couple of penitentiaries and some 25 assorted jails.

Stewart's jail salesmen, all of them engineers, have an exacting profession. When not in the company's drafting room planning new jobs they are visiting distant cities displaying their wares. Like the Fuller brush man, they carry samples. A sample case and its contents weigh 75 pounds or more for each sample case holds a working scale model of a three-cell jail.

If the buyer prefers to visit the company in Covington he can shop at his leisure in one of the few display rooms in the country equipped with jail cells for the shopper's convenience. Along one wall of the showroom are five full-scale cells. There is a sample of a minimum-security-risk cell which is usually part masonry when finished. Then there is the maximum-security cell for more determined prisoners and this one is all heavy-gauge steel with complete selective, remote-control opening devices on the doors.

Back in the shops some 200 workmen carefully put together the prefabricated parts of made-to-order prison cells. Shearing machines cut sheets of quarter-inch steel plate to size while automatic riveters fasten the steel together to form tops and walls of cells. The average cell measures

six feet by eight feet by eight feet high and contains a ton and a half of steel. The fronts of the cells, including the heavy, suspended, steel doors, are usually built of tool-resistant steel bars. The door has the strength of a solid panel of two-inch steel.

Careful inspection follows, then the newly fashioned cell is loaded on a railroad car and shipped off to its destination. Each of these cells is individually designed to fit a certain building.

One of the few jails built for private

**Engineer with full-scale model of maximum-security cell shows how door control works. One man can easily open or close any combination of up to 50 doors. All doors are operated manually**







Aerial view of the Department of Justice's newest institution, the U.S. Penitentiary at Terre Haute, Ind.

ownership was constructed for a businessman who wanted the back of his rathskeller converted into a cell. He ordered it made of chrome and fashioned in the style of any other Stewart cell. Today this fancy cell is carefully locked and the key kept in the owner's pocket. Locked in the cell is the owner's collection of liquors.

The Stewart Iron Works dates back to 1862, the year the Monitor fought the Merrimac and set the stage for the coming age of steel. At that time Richard Stewart, an enterprising young man around Covington, saw a lesson in this famous battle and decided to go into ironmongering. In his small shop he started to make iron fence. Shortly after his two sons took over the factory, a national movement to make better prisons was launched.

The Stewart brothers, wanting to keep abreast of the trends, started building jails.

Speaking device permits visitors to talk with the prisoners, but baffles prevent passage of objects

During the following years they pioneered in developing new locks and stronger jails to discourage the public charge from acts of vandalism. They developed locking devices that enable the jailer to open all the cells in a prison at once or any combination of them.

Only rarely does some revolutionary idea in jail design come along. Such a one was the revolving, circular jail built in an Indiana town about 50 years ago. The jail, prisoners and all, could be turned around, Lazy-Susan fashion, so only one cell could be brought abreast of the door at a time. The hazard to life in this merry-go-round in case of fire was soon apparent and the structure was abandoned.

The modern jail cell, unlike yesterday's dungeons, has all the modern conveniences for sanitation. Furniture is made of solid steel and bolted to the walls or floor. The bed is usually just a sheet of perforated steel which rules out the chance of a prisoner using part of a bedspring to cut his throat or wrists.

Air is forced into the cell through holes in the rear wall. In the modern jail, a prisoner finds it almost impossible to get tools or anything else from a visitor. He sees his visitors through a small pane of unbreakable glass and below this is a speaking arrangement. Sound can go through the speaking arrangement, but a series of baffles in it prohibits the passage of saws and other hardware. These baffles also keep a visitor from blowing narcotic-laden smoke through the speaking device.

Today's jail bears little resemblance to its forerunners introduced into European

(Continued to page 238)

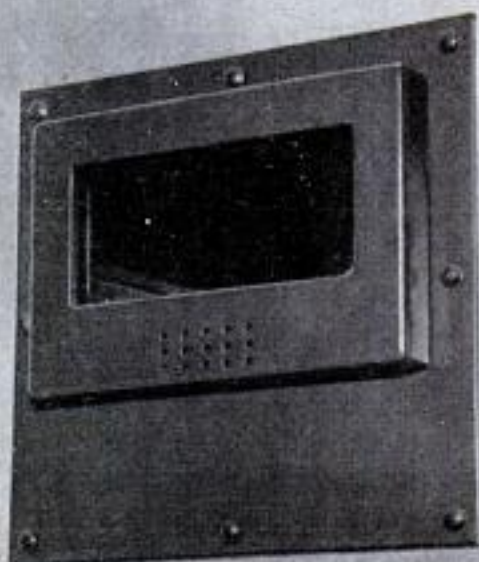





## Reflective Aluminum Insulation Makes Suits for Fire Fighters

Employing the insulation value of aluminum foil's heat reflection, a new fabric called Fyre-Armor has been incorporated into fire-resistant suits and blankets. The suits are so made that life-giving oxygen can be carried in bottles protected from flames and fed to masks inside the fire-

protection helmet. In a demonstration, two men clothed in Fyre-Armor suits carried a third, on a metal stretcher protected by blankets of the same material, through the fierce heat of a fuel-oil fire. Fyre-Armor bounces flame and heat right off the wearer whose body temperature remains normal.

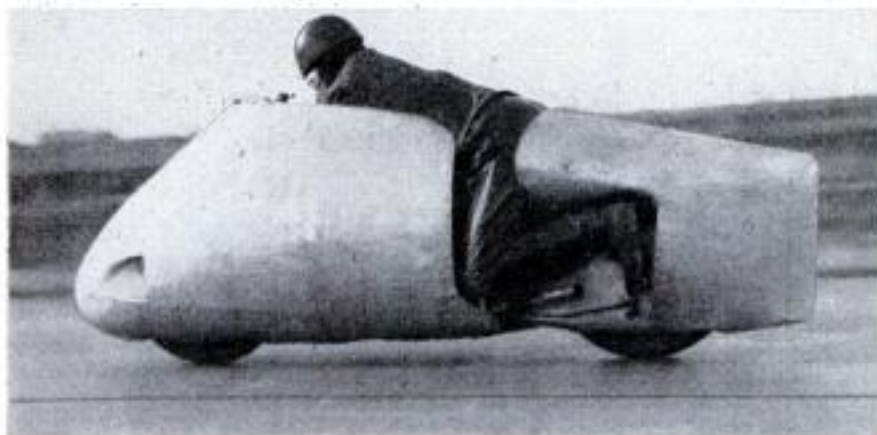

## Streamlined Cycle

Russian motorcyclist A. Novikov claims a world speed record for his streamlined 100-c.c. two-stroke machine. It's driven in a crouched position with legs and body recessed into the shell to decrease wind resistance. A top speed of 100.8 miles per hour was reported reached with an average of 90 miles per hour over a three-mile course.

## "Otter" Totes Cargo

Latest cargo carrier for the Army is the "Otter," an amphibious vehicle. With tracks similar to a tank's, the vehicle can traverse almost any type of terrain at speeds up to 30 miles per hour and carry its cargo across the water. It is powered by a 135-horsepower engine.

University of Chicago and Argonne Laboratory tests on meteorites show they were formed 5,000,000,000 years ago.







### Tubeless-Tire Repair Clamp Holds Hot Patch Under Pressure

Tubeless tires, now standard on most new cars, are repaired permanently by the use of a large clamp that applies a hot patch under pressure. Designed to fit the contour of the tire, the clamp applies a vulcanize patch in any position from bead to bead. It will handle any size tire from the smallest passenger-car sizes through delivery-truck sizes.



### Power Glove for Paralytics

Resembling a light metal glove for thumb and forefinger, a device developed by the Lionel Corporation, makers of toy trains, promises to restore almost normal operation to the hands of paralyzed persons. The jointed sections of the "glove" fit over the thumb and finger in such a way that their actuating cables allow the hand to pick up objects, dial telephones and perform much as it would without paralysis. The cables are powered by a small electric motor, controlled by the other hand or by a mouthpiece-actuated switch.

### You Wouldn't Know It—But There's a Trailer Inside This House

When his family outgrew their trailer home, Gregor Essors of Portland, Ind., launched a building project that completely swallowed the house trailer. A full-size bedroom and a spacious living room were constructed behind the trailer and the en-

tire structure boxed in with a flat roof and a clapboard exterior. The trailer still serves as kitchen and nursery, but it blends completely with the other rooms. Essors, a telephone lineman, did all of the remodeling himself.





## Antitank Rifle Mounted on Jeep

Capable of knocking out any tank at as much as 1000-yard range, a new Jeep-mounted 106-mm. recoilless rifle has been put into service by the U. S. Army. The BAT, or Battalion Anti-Tank gun, weighs less than 500 pounds. When taken from its Jeep mount, it can be carried short distances.



## Electronic Brain Slows Cars in Making up Trains in Freight Yard

Radar and a computer, or electronic brain, have been combined by the Union Pacific Railroad to reduce impact damage to freight as cars are coupled in the North Platte, Neb., yards. The "Electronic Yardmaster" automatically controls speed of cars rolling over the hump to be switched to individual tracks in the classification yard. As each car passes the hump its speed is fed electrically to the computer, as is a radar reading of the distance it must roll be-

fore coupling. The "brain" digests this information and automatically regulates car retarders so that coupling is made at a uniform safe speed of three miles per hour. Originally installed on only eight tracks, the project will include all 42 in the yard.

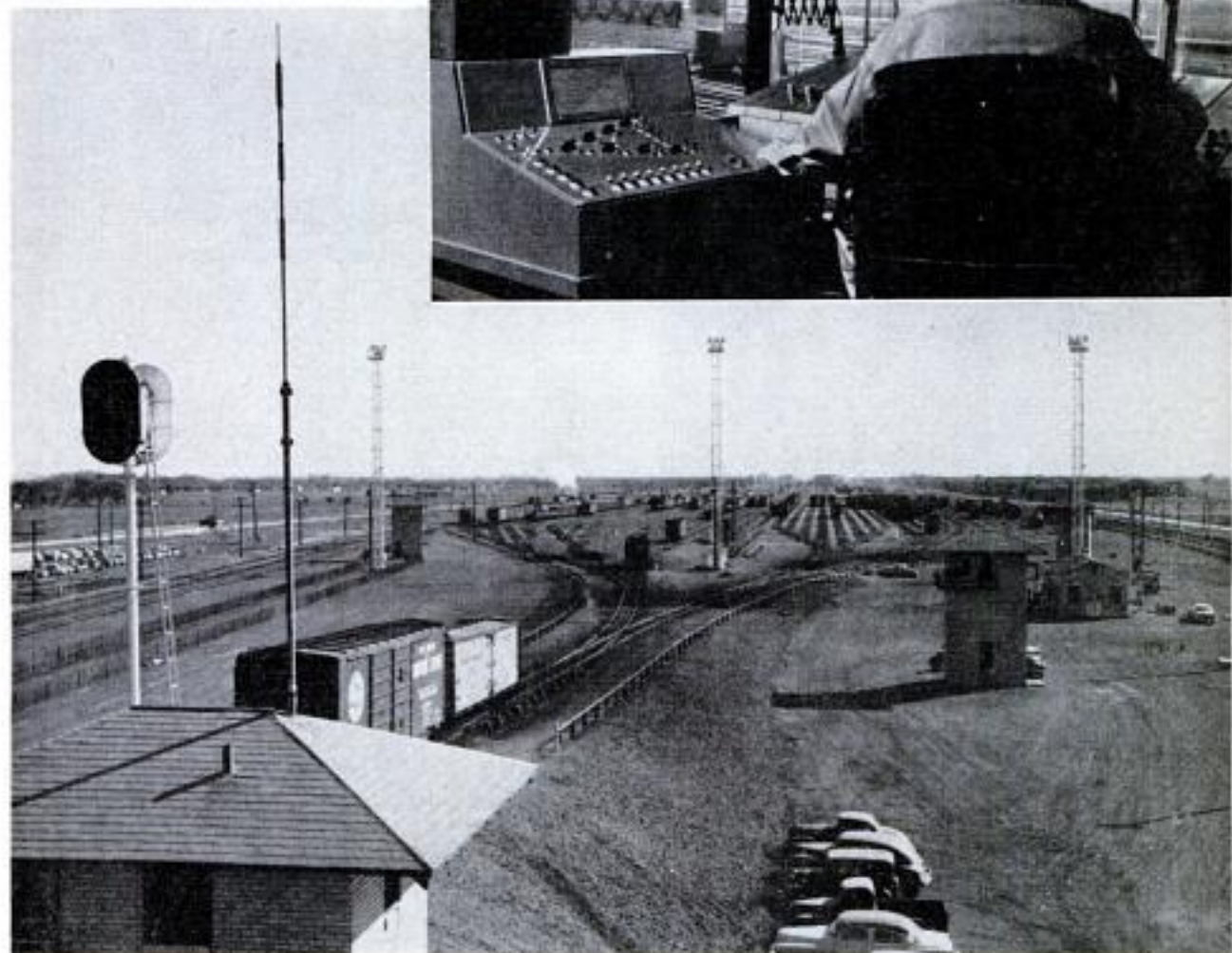





## Radiotelephone "Rings" Pilots

Airplane pilots receive only the messages directed to their respective planes with a radiotelephone developed by Motorola. A tone code radioed from the ground causes a bell to ring or a light to flash in the pre-selected aircraft. Instead of listening to constant chatter between the control tower and various planes, each airman dons his earphones or switches on his speaker only when he receives a call.

## Miniature British Auto Carries Five

Three persons can ride in the front seat and two in the rumble of a three-wheeled British Clipper. The body is of lightweight plastic and the single-cylinder engine is air cooled. Top speed of 40 miles per hour and mileage of 70 miles per gallon are claimed by its noted sports-car manufacturer.



## 100-Power Baby Telescope

Prisms and mirrors make possible a new 100-power telescope only 22 inches long. Easily portable, the unit weighs 30 pounds and is mounted on a small tripod. Its designer, John B. Norman of Tyler, Tex., says that the telescope equals the efficiency of bulkier instruments and allows views of the moon's surface that match photographs taken by the world's largest telescopes. It is designed to meet the needs of amateur astronomers unable to afford costlier units.

## Chromium Protects Cylinders

Chromium plating the cylinder walls of aircraft engines extends the service life of engine cylinders from 1200 to more than 3000 hours of operation, the Navy reports. More than \$15,000,000 has already been saved by the process. By eliminating the corrosion of cylinder bores, the coating reduces by 50 percent the wear on pistons and rings, oil consumption and accumulation of carbon and sludge in oil systems.



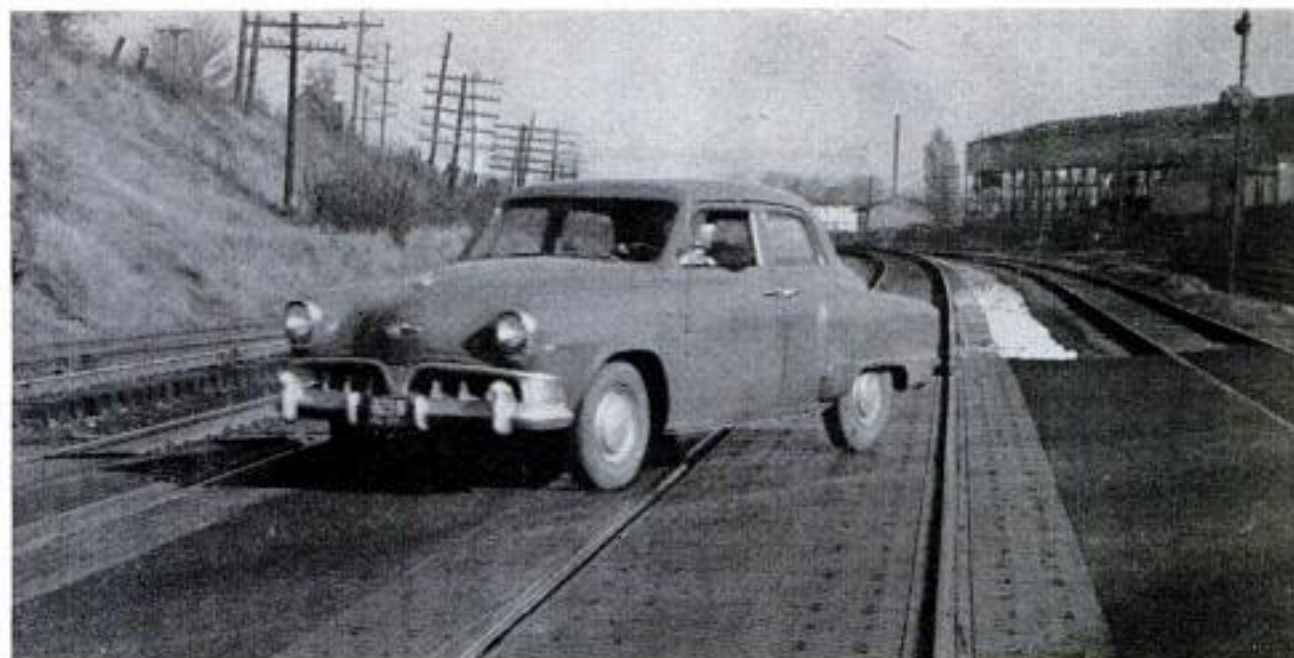

## Rubber Sandwiches For Rail Crossings

Rubber-covered railroad crossings promise to reduce maintenance costs and spare motorists the customary jolting. The rubber roadway is made up of three-inch slabs, including a sheet of heavy-gauge steel sandwiched within each slab. The slabs rest on heavy, treated-wood planking laid on the regular ties. Tapered flanges on the slabs form a watertight wedge to the rail, thus preventing seepage which causes the ties to deteriorate. Smaller rubber slabs used outside the rails are fitted flush with the tops of the rails and these also form a watertight union with the rails. The skid-resistant surface is expected to last indefinitely.



## German Version of Jeep Passes Field Tests

West German defense officials are pleased with the performance of the "Deek," a snub-nosed version of the American Jeep. The little vehicle can race across a bumpy field at 60 miles per hour and climb steep grades. It also has passed extensive tests in fording shallow water.

☐ Westerly jet-stream winds of 150 knots have been recorded at 40,000-foot altitudes near Antofagasta, Chile, while winds at 16,000 feet had but 15-knot speeds at the same time.





Lens attachment (below) on home-movie camera widens image from center section (above) to full-width picture

## Full-Dimensional Home Movies Photographed With Lens Adapter

Full-dimensional home motion pictures are reported easily made with a new Vistascope-lens attachment invented by Albert Bouwers, Netherlands scientist. The attachment, which can be mounted in the lens-shade bracket of the camera, increases the periphery of the picture, and thereby improves dimensional perspective. Fifty percent greater width is achieved than with ordinary lenses. The attachment also must be used with the projector to obtain the full-dimensional effect.



## Miniature Semitrailer Duplicates Full-Sized Over-the-Road Rig

Measuring but 16 feet in over-all length, a miniature semitrailer faithfully duplicates a full-sized rig in most of its particulars. The trailer is a replica of its big brother, and the tractor, composed of parts from half a dozen different automobiles, a few motor-

cycles, wheelbarrows and lawn mowers, is a reasonable facsimile. The small rig can move under its own power and weighs only 450 pounds. Its engine boasts 3½ horsepower and was salvaged from a lawn mower. It rolls on wheelbarrow wheels.





# WADE DEEP

## FOR BETTER FISHING

**I**N THESE DAYS of overfished waters it is the deep-wading angler who catches the most and largest fish. The "big ones"—trout, bass and other game species—are wise and shy, and stay far out from the shore-bound caster. Reach them by proper wading methods and you will discover new thrills in fishing.

Hip boots are conventional equipment for wading but have their limitations. They serve only for shallow water and their rubber soles may slip dangerously on rocks. But if you use good waders, coming above the waist or to the armpits, a new area of

a broad river or typical bass or trout lake will be open to you.

Buy waders with felt soles which won't slip on rocks. Fit them long enough in the leg—three leg lengths are available in most brands—to permit comfortable squatting when going through fences, over logs and through brush. A drawstring pulled tight at the top will prevent leakage of water when you go in too deep. By the same token, the imprisoned air will actually float you if you should step into a deep hole. Thus waders properly worn are not dangerous as sometimes supposed. They

*By Claude M. Kreider*

Angler examines a beauty he caught by wading out into a river. Fisherman equipped with waders can fish almost all the good spots in a river of moderate depth and width

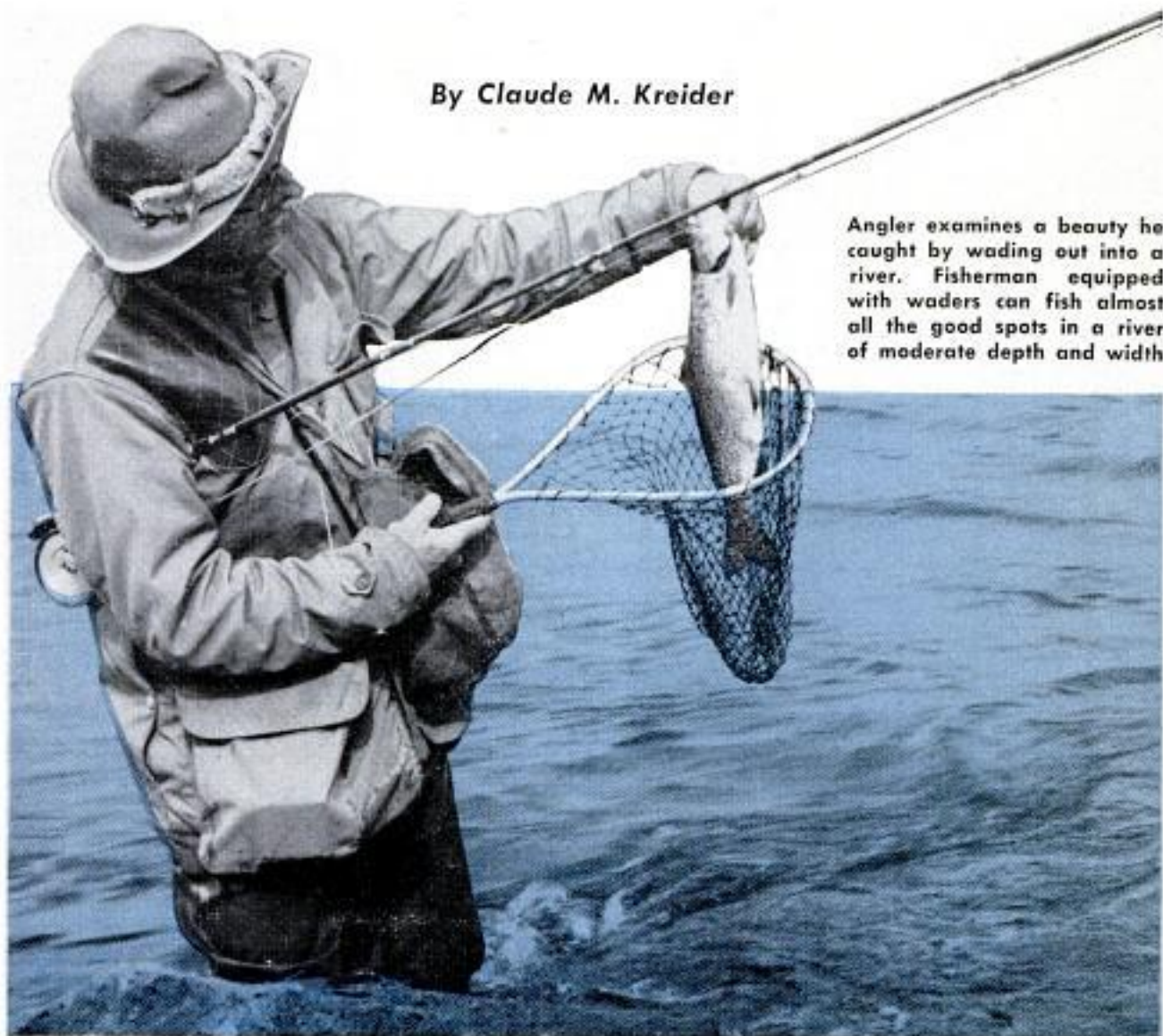





are far safer than hip boots. It is the weight of water inside wading equipment which can drag down an unwary angler.

Waders come in two types. Those with stocking feet are worn with separate shoes of canvas or leather. The canvas shoes have heavy felt soles; the leather "brogues," heavy oak-tanned soles studded with hobnails. The hobnails offer greater security on mossy logs and rocks than felt, but felt soles are more satisfactory for all-around work. Choose the sole best suited to your favorite waters.

Buy the stocking-foot type large enough to permit wearing heavy wool socks inside. The shoes should be a size larger than normal shoe size, and another pair of heavy, cheap socks should be worn outside the wader foot to protect the fabric.

Waders come in several types of rubber-impregnated fabric, and will last for several seasons of use. The new plastic waders, costing less than rubber, are very light, easy to walk in and are good for many weeks of intensive fishing.

Boot-foot waders have a conventional rubber foot and lower leg cemented to the wading fabric. Their advantage over the stocking-foot type is that you do not have to handle wet brogues or shoes separately, and there is nothing to be dried after the day's fishing. You simply roll down the tops and legs of the boot-foot wader and let air circulate inside it to dry out the moisture that accumulates from perspiration.

The wading angler enjoys many advantages over the fellow who must fish from shore. These are most apparent to the fly caster. Out beyond brush and trees, his back cast is clear and untangled at the critical moment when a big fish is rising.

Thus by wading out perhaps 40 feet in a broad stream he can send his offering another 60 to 80 feet, or 120 feet from shore—more than twice the distance possible when shore fishing. And he can turn at right angles to fish up or down the river or lake, past a brushy point or rocky cliff in water impossible

Custom-built waders cover this angler up to the armpits. A tight drawstring prevents leakage of water over the top



to reach from a shore position.

The wading angler learns a new technique in negotiating swift streams. He "reads the bottom." Perhaps a rocky shore line indicates large boulders in the stream bed. That angry swirl below a big boulder or log may mean a deep hole. So he proceeds cautiously, one foot "feeling" while the other is firmly planted.

In heavy current, always "walk like a crab," with short, shuffling steps, legs parallel with the current to offer the least resistance to its power. But if you should slip and go under, there's no cause for panic. Should you go in over your head with a surprised gurgle, you will at once bob to the surface. Imprisoned air will float you if the wader top is drawn tight with its drawstring.

A swift sheet of shallow water flowing over loose gravel can be hazardous. The gravel washes out from under your feet faster than you can walk. If you lose your footing, crawl out to the shore.

The angler fishing with fly or plug-casting tackle will learn a new casting technique when wading deep. The rod arm, instead of being held close to the side, is extended with upper arm at right angles to the body. The cast is made with a strong wrist and forearm movement. A striking fish is hooked with a reverse "screw twist" of the casting wrist, most effective method of all in quickly

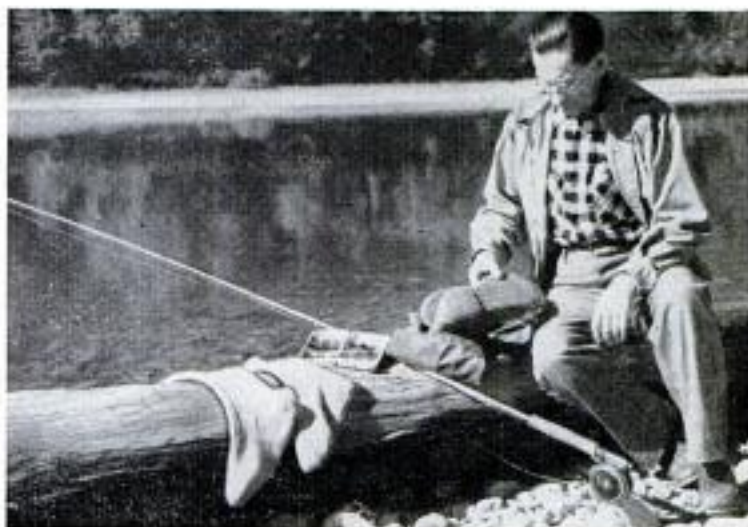

Heavy felt soles on these waders give a good footing in rocky streams. Long wool socks pad the feet and absorb perspiration



Drawstring also holds in air which will float the angler if he goes under. Diagram shows good fishing spots for wader

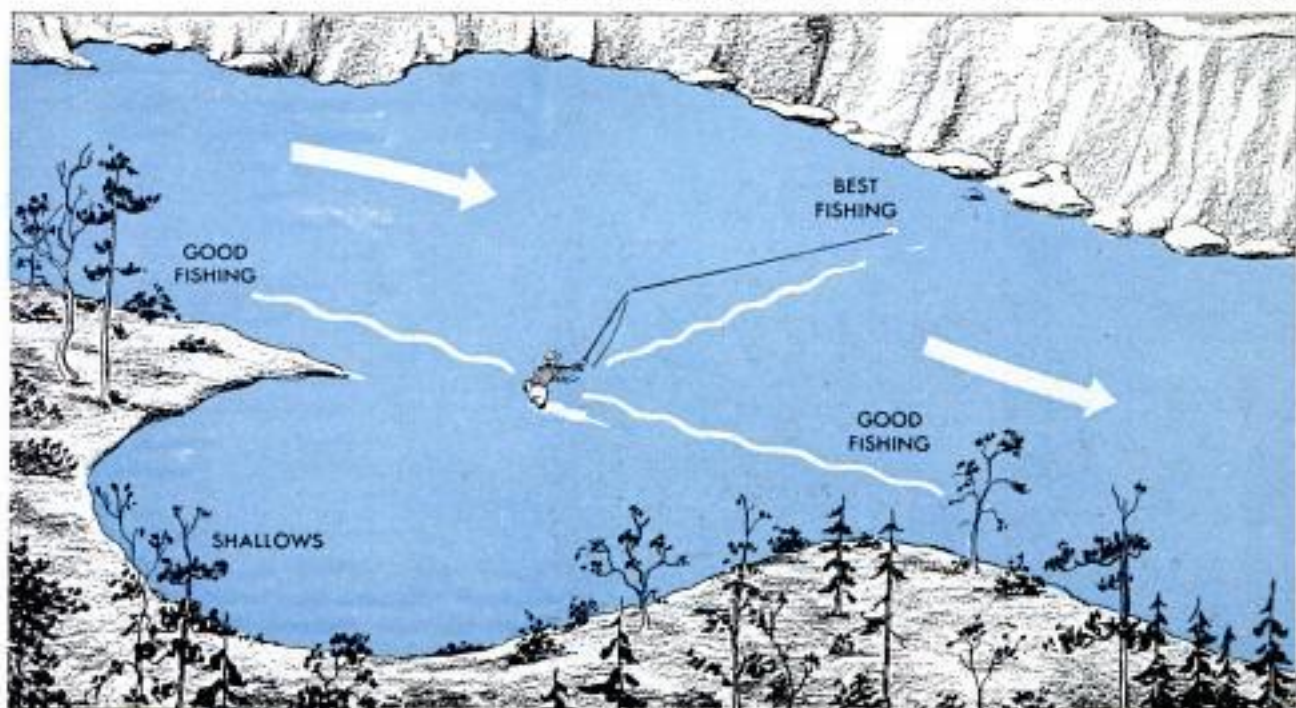





Recently plastic waders have come into common use. They are inexpensive, light in weight and roll into a small bundle. Canvas wading shoes, top, have thick felt soles. Below, in swift water the veteran angler keeps his feet well spread and his legs parallel with the current to reduce pressure

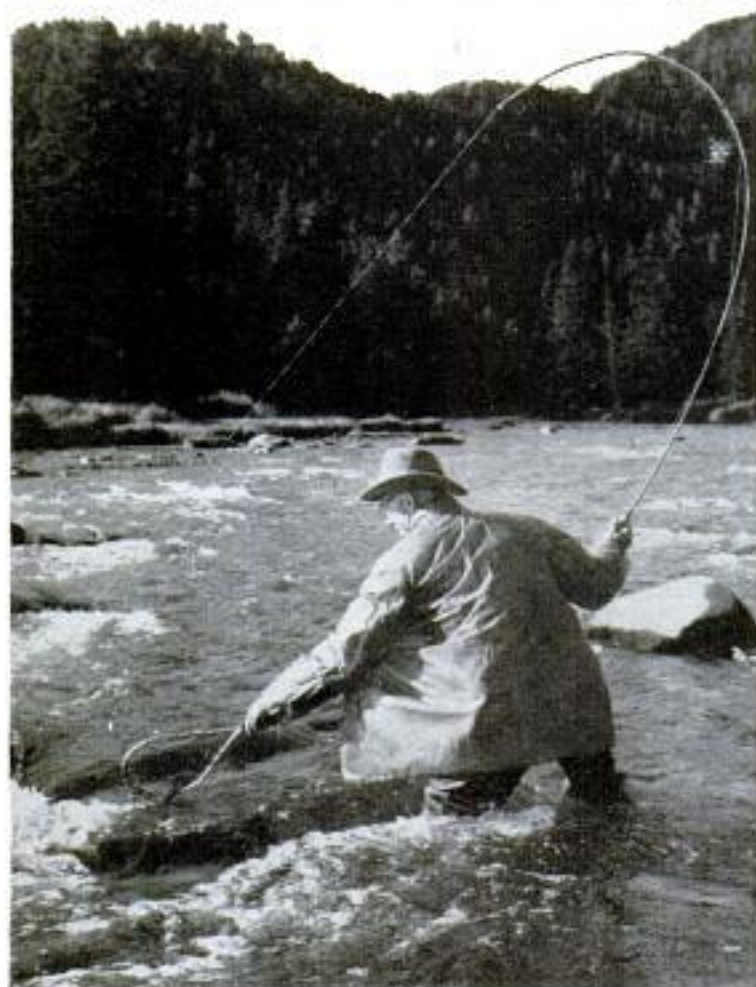

setting the hook in a rainbow trout or black bass.

When extreme distance is required, the fly caster retrieves his line into coils in his left hand, makes one strong false cast, then a "shooting" cast which carries the coiled line out through the rod guides. With practice, a cast of 80 feet is not too difficult when using a properly balanced rod and line. "Balance" means a line of sufficient weight to properly flex the rod, bringing out its potential spring power as the cast is made.

The wading angler has a distinct advantage over the boat fisherman. He is firmly set on his feet. He has better control of his casts. He doesn't have to handle oars. He can hook a rising fish more surely and can fight it more effectively.

When wading, carry the net suspended by a small harness snap from a ring placed high on the shoulder of the fishing jacket. It is out of the way but ready for instant use. Always lead the fish over the submerged net; never try to reach out and "scoop."

In lake fishing, deep wading is often productive. You can fish rough water in which a boat could not be managed. In many small bays and shore indentations where glassy, clear water precludes outwitting a wary old bass, trout or pike from above, your waders can take you out to where a little breeze ruffles the surface.

In many mountain and timber lakes there will be a sloping bottom leading out to the deeper, blue water where you'll find the big fish. Proceed out carefully and seek that magic shelf along which these big ones feed. The color of the water will usually indicate the shelf.

Sink your fly well if fishing with "under surface" patterns, or use a deep-running plug or wobbler to seek out the big fish under the shelf. The food of most large fish is taken below the surface.

The fly purist will find special advantages when fish are rising close inshore. With a brushy shore line he could not cast to these active feeders from the bank, but he can wade far beyond them and cast back toward shore.

Once you've tried long waders, you'll never make a fishing trip without them. ★ ★ ★



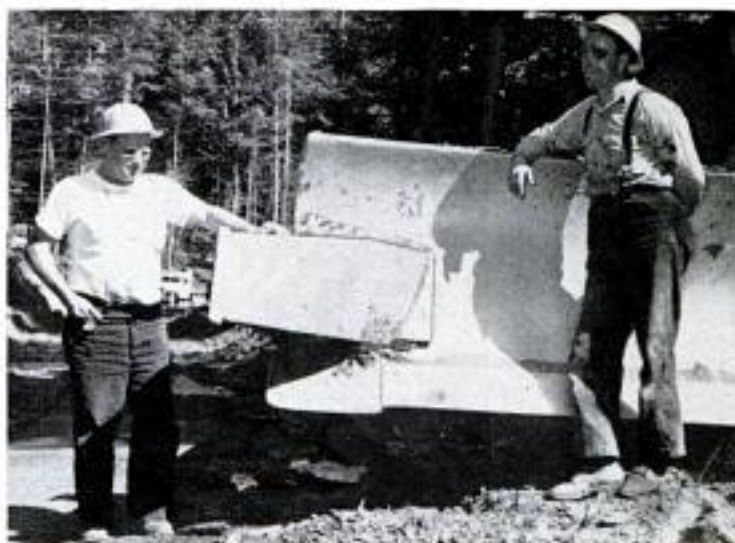

## Stump Splitter Attached to Bulldozer Blade Speeds Removal

Loggers near Kamiah, Idaho, have devised a "stump splitter" that attaches to a bulldozer blade and makes removal far easier and quicker. The splitter, a heavy V-shaped piece of steel, projects forward about four feet and is mounted on the right side of the blade. By ramming the blade into a stump, splitting it and then backing

off and rooting the stump out of the ground, the operator can remove a stump four feet in diameter in 15 minutes. The former method of punching holes in the stump, using blasting powder and removing the blasted stump with a bulldozer, took two men about two hours. The new method saves money and ends danger of explosives.



## Portable Charcoal Stove Heats Cabins or Cooks Meals



Anglers, hunters and campers will take to a portable charcoal stove that has a grill on top and a warming hood below. A hinged lid is opened to expose a grill for cooking. The extensible hood is useful in the winter to keep feet warm. Ice fishers can use it to keep bait pails thawed out and fishing holes open. The compact, lightweight and smokeless stove will also serve as a heater for cabins, tents and garages.

## Double-Edged Weeder ➤

Gardeners can save time with a two-edged hoelike tool that cuts weeds on the push and the pull strokes. It is also useful to edge lawns and flower beds. A long handle makes it possible to stand erect while using the tool.

☞ If a car with a white top and a car with a black top are parked side by side in the hot sun, the lighter-topped car will remain 15 degrees cooler inside, experiments by Fisher Body engineers reveal.





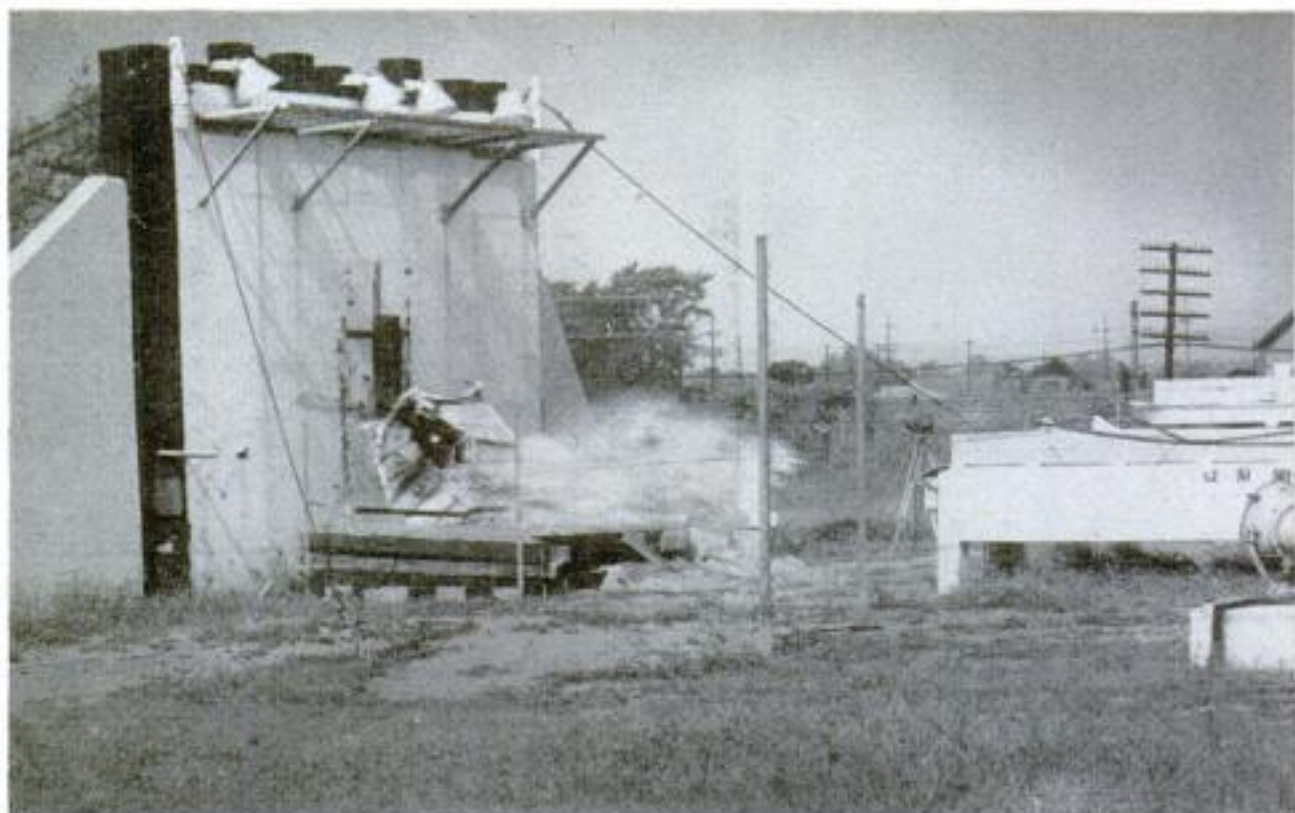

Water sprays from the ruptured neck of an aircraft gas tank slammed against a testing wall at high speed

## FOUND: The Smashproof Gas Tank

Aircraft gas tanks are blasted down this long track by a Navy catapult designed to launch planes from the deck of a carrier

By Paul N. Janes

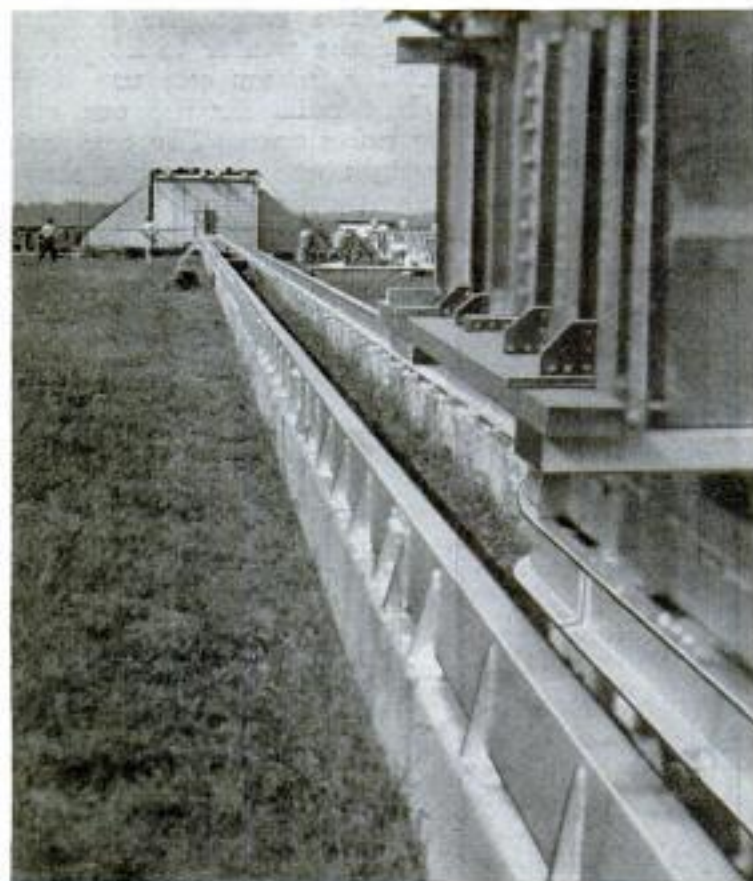

THE CIVIL Aeronautics Administration is steadily losing ground in its efforts to smash airplane gasoline tanks, and is very happy about it.

Failure of tanks to smash under simulated plane-crash conditions means the CAA and two rubber companies cooperating have found a smashproof gasoline tank.

The tank developed by the CAA, the Goodyear Tire & Rubber Co., and the U. S. Rubber Company is of tough nylon fabric, impregnated with synthetic rubber. It is a bladder-cell-type tank with walls .029 to .135 inch thick.

The smashproof tank was tested with \$1,600,000 worth of elaborate equipment at the CAA Technical Evaluation Center at Indianapolis.

Testing equipment includes a Navy Mark IV catapult, normally used to launch planes from carrier decks, a long test track and an all-important solid-steel wall.

Tanks to be tested are enclosed in an aluminum aircraft-wing section, mounted on a track car and



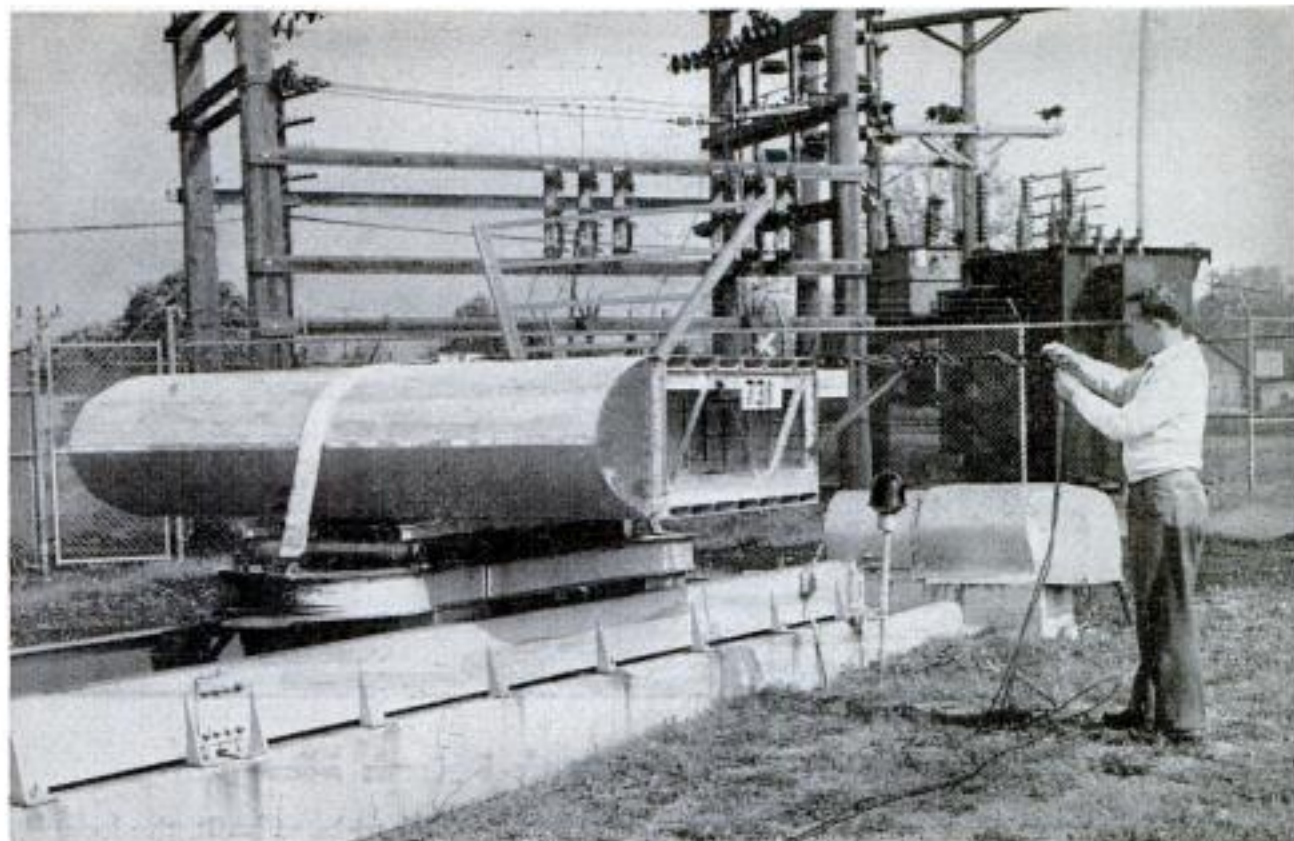

Tanks to be tested are enclosed in a wing section placed on a car that is catapulted down the track

catapulted at the steel wall with tremendous force. Catapult speeds can reach 101 miles per hour, and the wing section usually ends up as scrap aluminum. The early tanks tested ended up as scrap, too. Almost invariably they ruptured, spilling their loads of water with spectacular splashes and spray, just as gasoline can be sprayed from the wing tanks of a crashing airplane.

Even after the new tank was developed, water sprayed out in simulated crashes, but only because of breaks in the filler neck. Redesign ended this defect, and the tanks could be smashed only under conditions simulating crashes so severe that no survivors could be expected, fire or no fire.

Robert J. Schroers, head of the Structures Branch of the CAA Center's Aircraft Division, is confident that the new tank will reduce fire hazards tremendously, making an important contribution to aircraft safety.

"Our investigations have shown that fatalities in the average aircraft accident increase about 25 percent when fire occurs after the crash," Schroers said.

More than 400 different tanks have been fired at the wall. The heaviest used in the tests weighed more than a ton when filled with water and encased in its wing section.

High-speed cameras record what happens when the tanks hit the wall, or sandbags piled in front of it, in tests against a more yielding substance than steel. ★ ★ ★



The aluminum wing section was smashed to scrap, but the bladder-cell tank it held did not lose a drop

Even when battered and twisted in a plane crash, the tank of nylon and synthetic rubber will not rupture





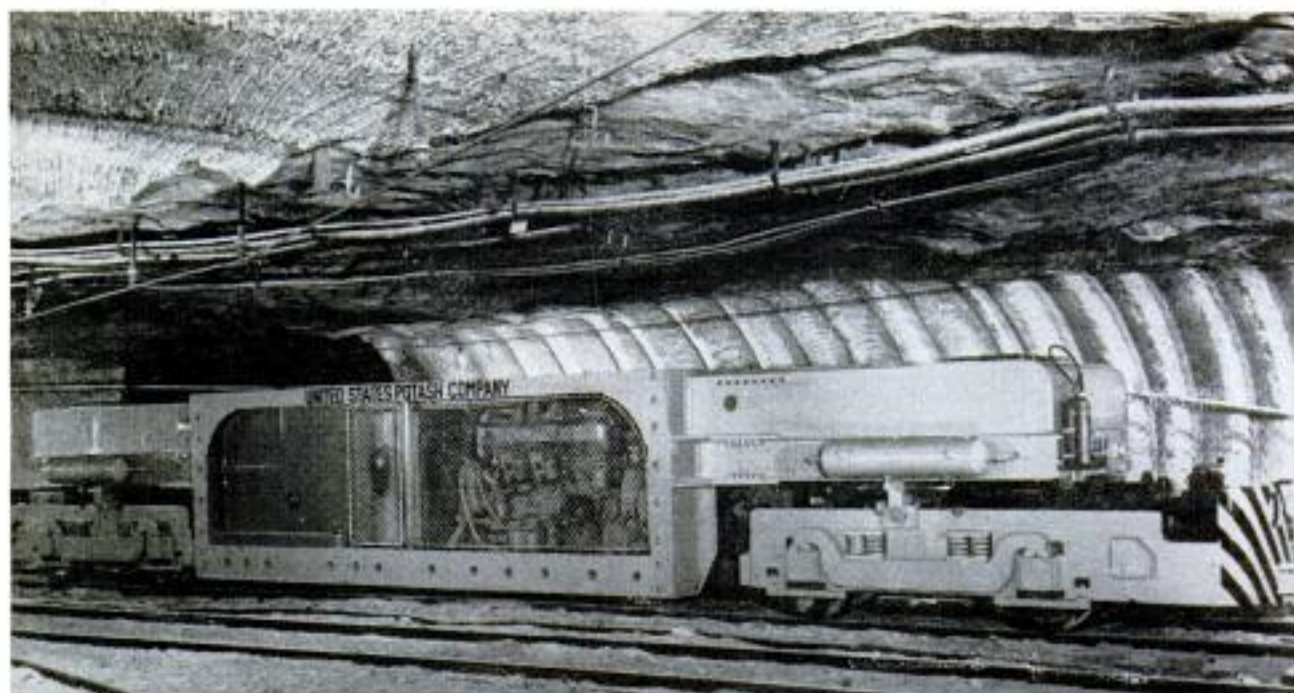

## Low-Slung Locomotive Speeds Through Potash Mine

Not much higher than an automobile, a powerful new diesel-electric locomotive is speeding along the tracks in a potash mine at Carlsbad, N. Mex. The General Electric locomotive is just 6 feet high, but it measures 47 feet long and can roll through the mine at 37.5 miles per hour. Weighing 40 tons, it is rated at 420 horsepower and is capable of pulling up to 1000 tons on a level

track. After it had been built, the locomotive had to be dismantled, lowered section by section through the mine's narrow shaft and reassembled on its underground tracks. A special conditioning system "scrubs" the locomotive's exhaust gases in large water tanks. This reduces the temperature of the gases from 1000 degrees Fahrenheit to 160 degrees or less.

## Machine Perforates Acoustic-Tile Squares in Any Design

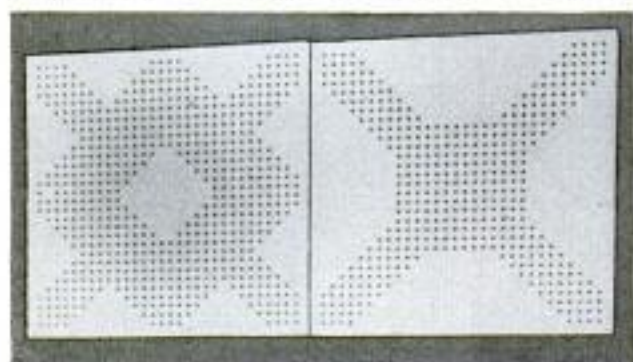

The Zagar gearless drill head (below) can cut 1000 holes at once in an acoustic-tile square (above)

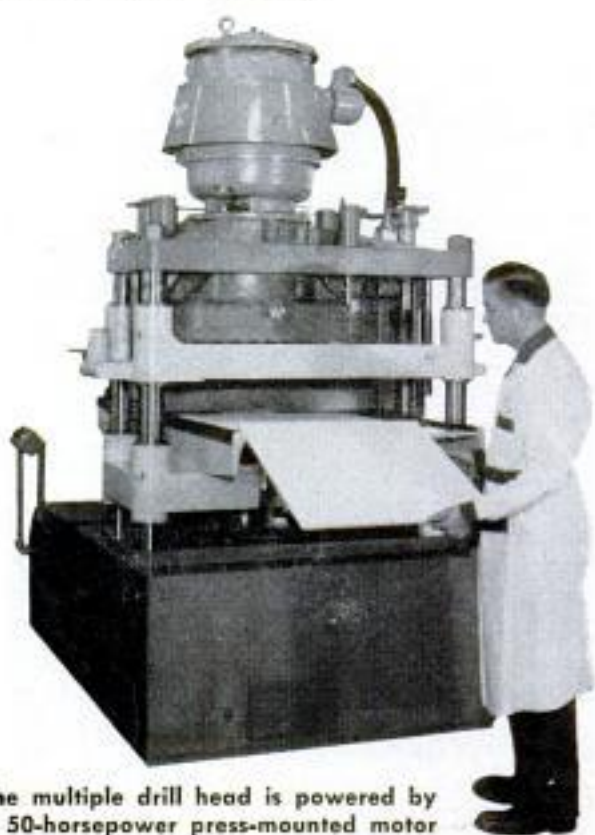

The multiple drill head is powered by a 50-horsepower press-mounted motor



# Artist "Paints" With Sea Shells

COLLECTING sea shells of subtle and wonderful colors has long been the hobby of Francesco Gnata of Venice, Italy. One day it occurred to him that these natural colors of the sea would be perfect for painting seascapes. He ground some shells of various colors to powder and then experimented until he found the right glue for making pictures. His first picture, a nymph rising from the waves, was highly praised by his neighbors along the Lido. So he kept at it and has now completed 40 shell paintings, including a number of portraits. The shell powders give him a variety and shading of colors, including iridescence, which he says are unobtainable in other mediums such as oil or water color. Some of his paintings resemble mosaic pieces when viewed from a distance. The secret, he says, is in the glue he uses.



In doing this portrait, artist Francesco Gnata discovered he was lacking a certain color so he stopped to grind a shell



In picture above, Gnata used his mosaic technique. Below, he inspects shells before sorting them by colors for grinding



The palette of this unorthodox artist of Venice, Italy, has containers which hold powders of various colors made from sea shells picked up on the beach near his home. He uses a special glue to make the powder adhere to the various materials on which he paints seascapes and portraits







## Arctic Buildings Sink in Snow

THE ARMY is sinking a fortune in Arctic ice and snow in the form of Army and Air Force buildings that sink—literally—into the frozen surface of the icecap, until only the vertical towers for entrance and supply are visible. The sinking structures, at least one of which is already installed in Greenland, consist of steel tubes 18 feet in diameter, connected by smaller tubes and entered through the vertical towers. Like submarines, the tubes employ the pressure-hull principle, and they are ballasted to settle evenly and slowly into ice and snow. A special heating system maintains inside temperatures of 72 degrees, even when it is 75 below zero outside. Supplies are dropped from aircraft.

Food and fuel can be supplied to the sinking bases entirely by air drop. Above, a flying boxcar drops a string of oil drums



Larger living and working tubes are connected under the ice and snow by smaller tubes, above. Installations are designed to sink slowly to a predetermined depth in the icecap, until only tops of the access towers are visible above the surface





**ELECTRONICS TODAY**

SOLAR ENERGY is used to power this midget experimental radio transmitter shown in photo A. It was built by Edward Keonjain, a development engineer in the General Electric Electronics Laboratory at Syracuse, N. Y. The self-contained unit uses transistors instead of electron tubes, and selenium solar-energy converters instead of batteries. When light rays strike the selenium, sufficient electrical energy is delivered to the transistors to operate the transmitter. The present range of the transmitter model is about 100 feet. The designer claims that this range can be improved by increasing the number of selenium units.

Miniaturized electronics equipment is now assembled in "dry boxes," of the type shown in photo B, to avoid contamination by dirt or moisture. The Bell Telephone Laboratories engineer is assembling their new ultra-high-frequency transistors in a "dry box" of this description. The new transistor is claimed to withstand 100 volts over a wide range of frequencies.

New "defense minded" automobile radios with dials especially designed to enable motorists to tune in quickly for emergency Civil Defense instructions are demonstrated in photo C by the Chrysler Corporation.

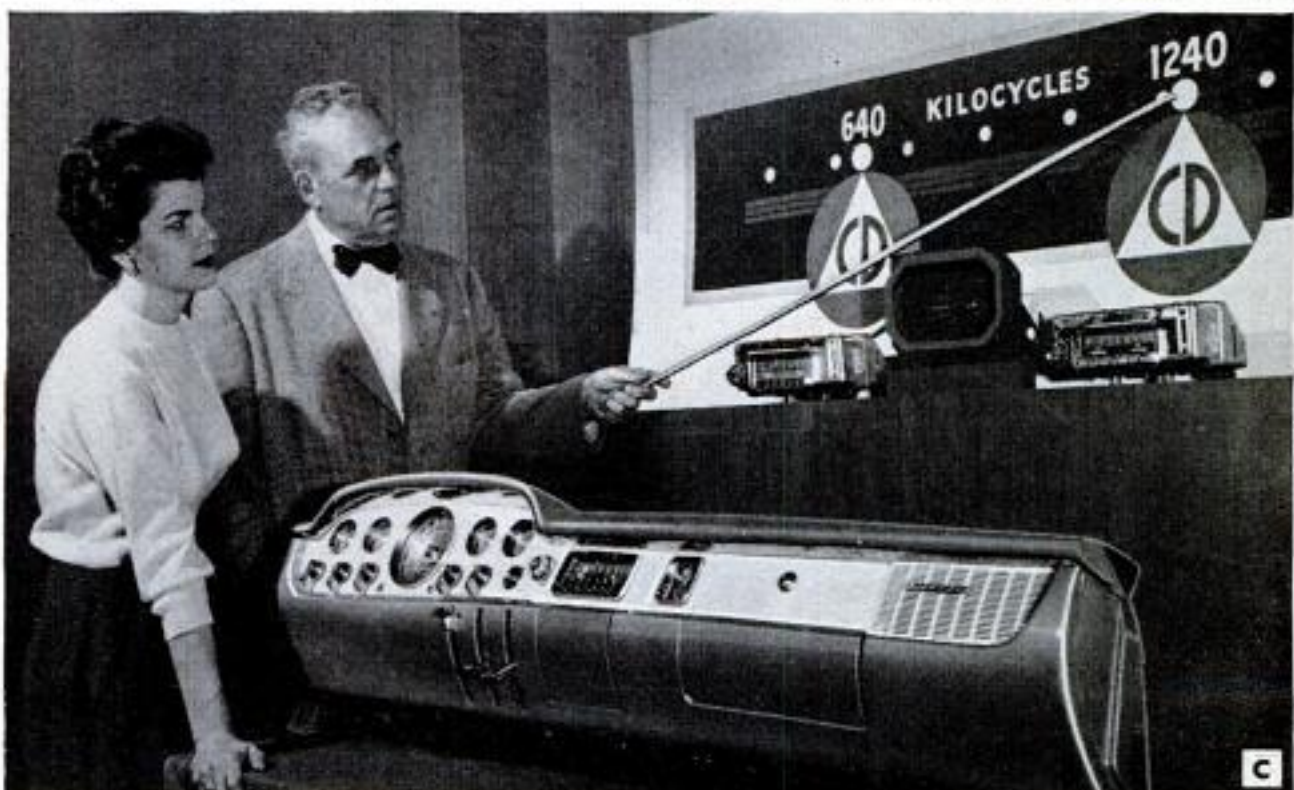



# 1955 "Little Giant" FM

By Frank Correia

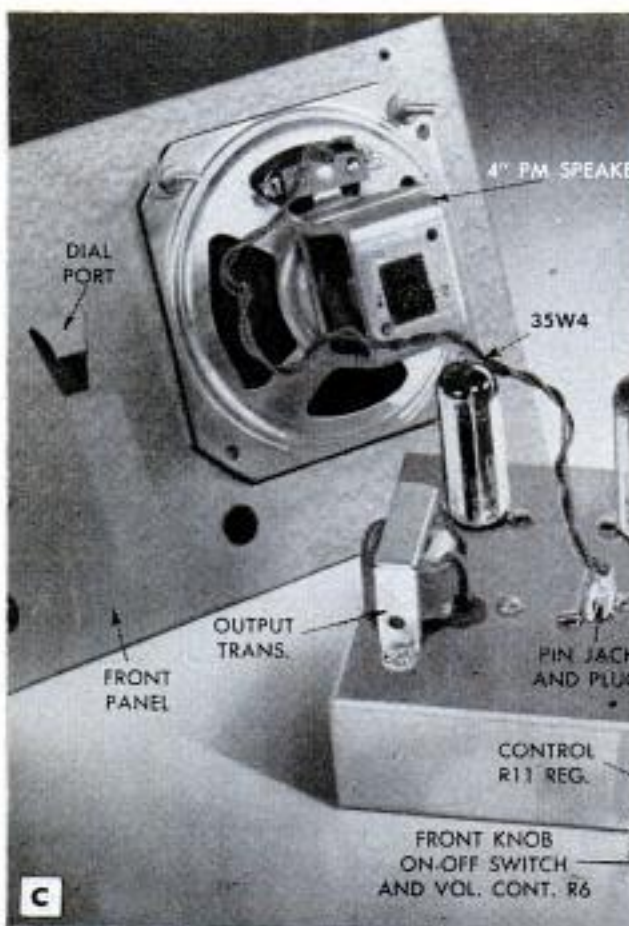
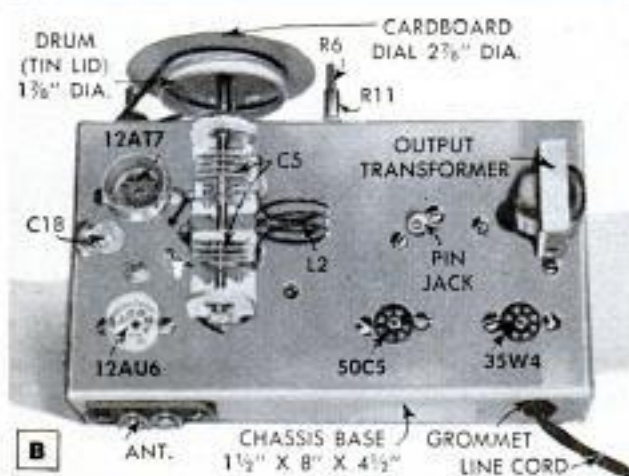
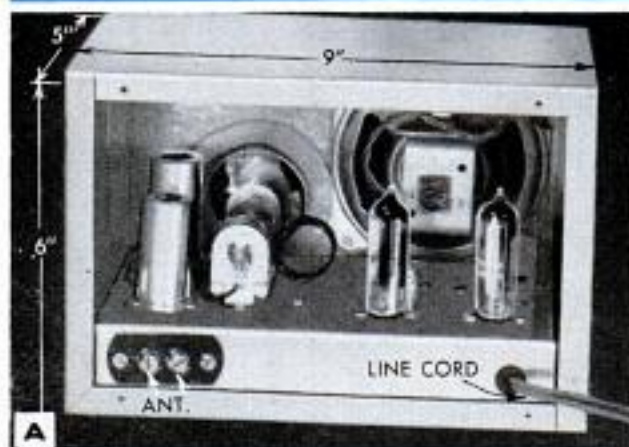

ADVANCING radio students and experimenters who have been wanting to try their hand at FM-receiver construction will find this 1955 model of the annual "Little Giant" construction project both interesting and practical. No special parts, critical adjustments or elaborate test instruments are required. The design of this FM receiver is based on the well-known super-regenerative detector circuit. Although only four tubes, including the rectifier, are employed in this FM receiver, it possesses sufficient sensitivity to operate a loudspeaker at good volume on local FM stations, using any standard VHF type of indoor TV antenna. For fringe areas, or in low signal areas, maximum results are obtained with a roof-type all-direction FM double-dipole Amphenol antenna of the type shown inset in photo D.

The schematic circuit diagram appears in Fig. 2. The 12AU6 tube is connected as an untuned "grounded grid" r.f. amplifier, which serves a dual purpose. It provides equal predetection amplification for all stations in the 88 to 108-megacycle FM band. The output to the r.f. amplifier is capacitively coupled to the tank circuit of the detector which consists of one half of the

## RESISTORS

R1—300-OHM, 1/2-WATT CARBON	R10—150-OHM, 1/2-WATT CARBON
R2—1800-OHM, 1/2-WATT CARBON	R11—50,000-OHM MALLORY DUAL MIDGETROL TYPE UFSAL TAPER No. 4 (REG. CONTROL)
R3—1200-OHM, 1/2-WATT CARBON	
R4—4.7 MEG., 1/2-WATT CARBON	
R5—82,000-OHM, 1/2-WATT CARBON	
R6—500,000-OHM, MALLORY MIDGETROL TYPE URSSA (REAR SECTION)	
R7—560-OHM, 1/2-WATT CARBON	
R8—47,000-OHM, 1/2-WATT CARBON	
R9—100,000-OHM, 1/2-WATT CARBON	
	R12—47,000-OHM, 1/2-WATT CARBON
	R13—(two required in series) 270-OHM, 1-WATT CARBON
	R14—27-OHM, 1/2-WATT CARBON

NOTE—SWITCH FOR THIS DIAL CONTROL IS MALLORY US-26 SPST



# Receiver for Experimenters

12AT7 tube. Here the desired signal is separated from the others by means of the variable tuned circuit, and receives a tremendous amount of amplification before being detected.

After detection, the selected signal receives further amplification, at an audio level, in the second half of the 12AT7 tube, before being applied to the 50C5 power-amplifier tube which drives the loudspeaker. A volume control (R6), in the grid of the audio-voltage amplifier, permits proper adjustment for the desired output level. This control is on the same shaft with the regeneration (reg.) control R11, which adjusts the detector for maximum performance.

An a.c.-d.c.-type power supply, using a 35W4 rectifier, supplies the operating voltages for the various tubes. To eliminate shock hazard, the B-negative end of the supply is isolated from the chassis by a .05-mfd. isolating capacitor, C2.

Although definitely not intended for beginners, construction is quite simple. The chassis is a standard size and all drilling details are given in diagram Fig. 1. All measurements must be followed carefully and accurately. Since commercial dials are expensive, the one for this experimental

(Continued to page 242)

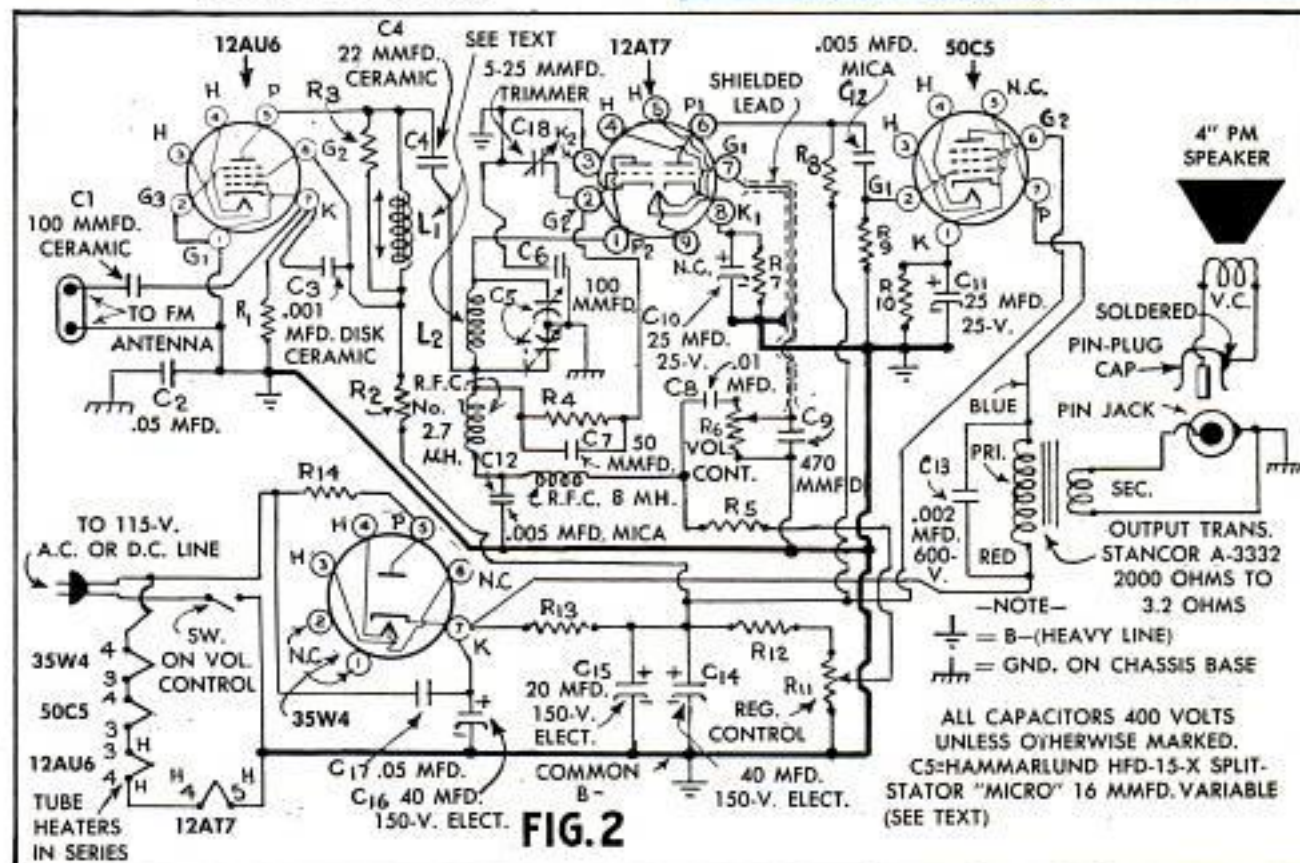
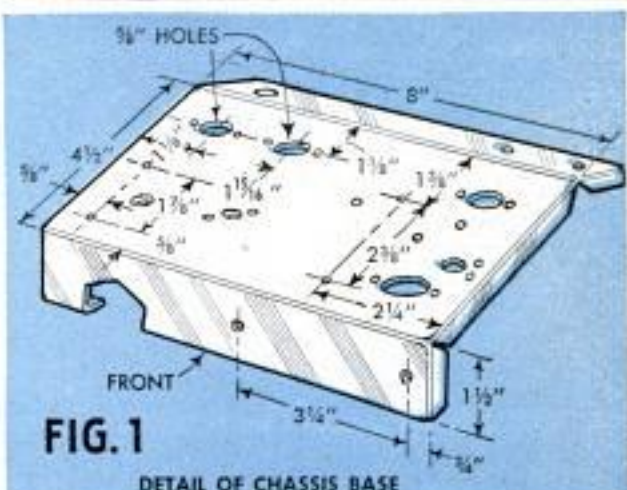
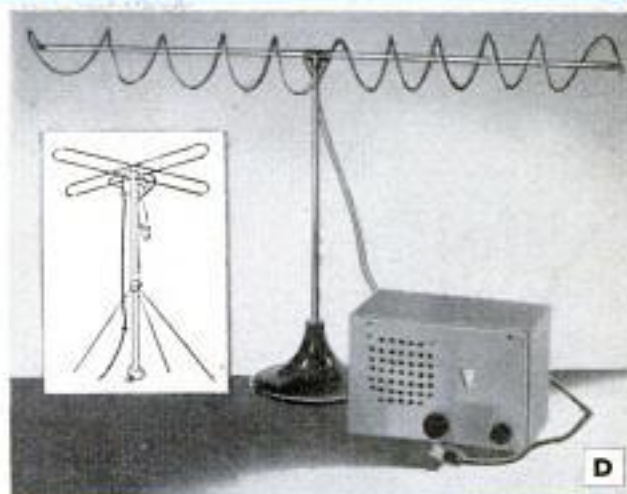



## SOUND IN THE HOME

MODERN sound equipment now enables mother to leave messages and instructions for the children on their return home from school or play, when she goes out shopping or to her bridge game. The instrument she is using in photo A is a new low-priced Timex Magnetic Disk Recorder that plays back the results immediately. It employs a disk and a magnetic eraser, and can also be set to pick up radio and TV sound. It is claimed that a single disk can be used about 10,000 times. By making a minor change in the recording "head" the instrument becomes a phonograph and will play standard 45 r.p.m. records.

The high-fidelity music installation illustrated in photo B is ideal for a small apartment where space is at a premium and does not permit the use of a large conventional cabinet. The record changer and amplifier are conveniently supported on an ordinary clothes rack; this is painted black or any color that will harmonize with your furniture. Two glass shelves are cut to fit the rack and the glass edges are beveled.

A simplified sound-system control is shown in photo C. It is complete with wiring instructions, dial plate and bar knob, and features a Clarostat constant-impedance attenuator.

The streamlined radio-phonograph model illustrated in photo D is the recently introduced Webcor "Midge." The case is balanced to stand in a vertical position for radio playing, or horizontal for record use. A built-in carrying handle is formed within the top slot of the speaker grille.

A new and smart-looking telephone intercom system will accommodate from two to five telephones which can be placed strategically throughout the house. These Direct-A-Call units have four push buttons for buzzing the other telephones separately. The system can be installed by the purchaser. A compact power-supply unit plugs into any 110-volt a.c. outlet. Flat ribbon-like wire interconnects the phones.



A



B

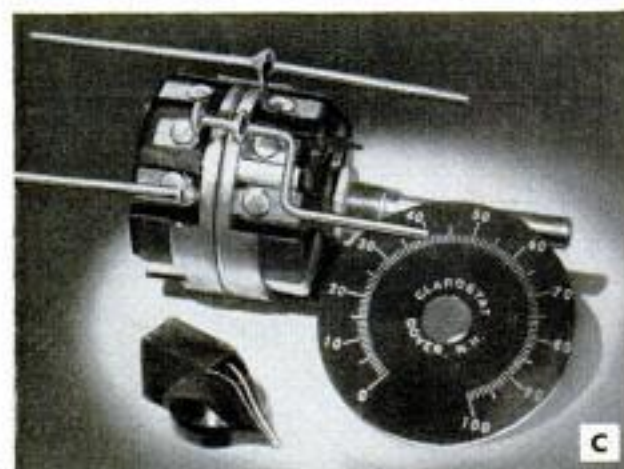

C



D

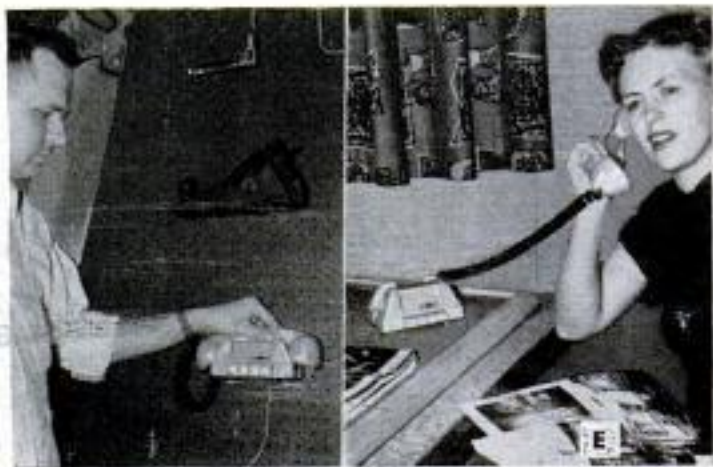

E



the

POPULAR  
MECHANICS

# CRAFTSMAN

## Drafting Desk FOR YOUR HOME

By John Bergen

**D**ESIGNED for the amateur or professional draftsman or artist to use in his home, this double-duty desk hides the unattractive drawing board in a good-looking piece of furniture. With this desk, you can keep your board and a supply of drawing materials in the living room, bedroom or den without disturbing the appearance of the room.

Construction of the desk is typical except for a slide-away top section which reveals the drawing board. The board is hinged on two brackets and supported by a pair of slotted cleats. The cleats are held in position with wing nuts. Note in the



illustration above and the drawing on the following page how the board is pulled up into working position.

Desk top, drawer fronts, end panels and other exposed parts are of hardwood-faced

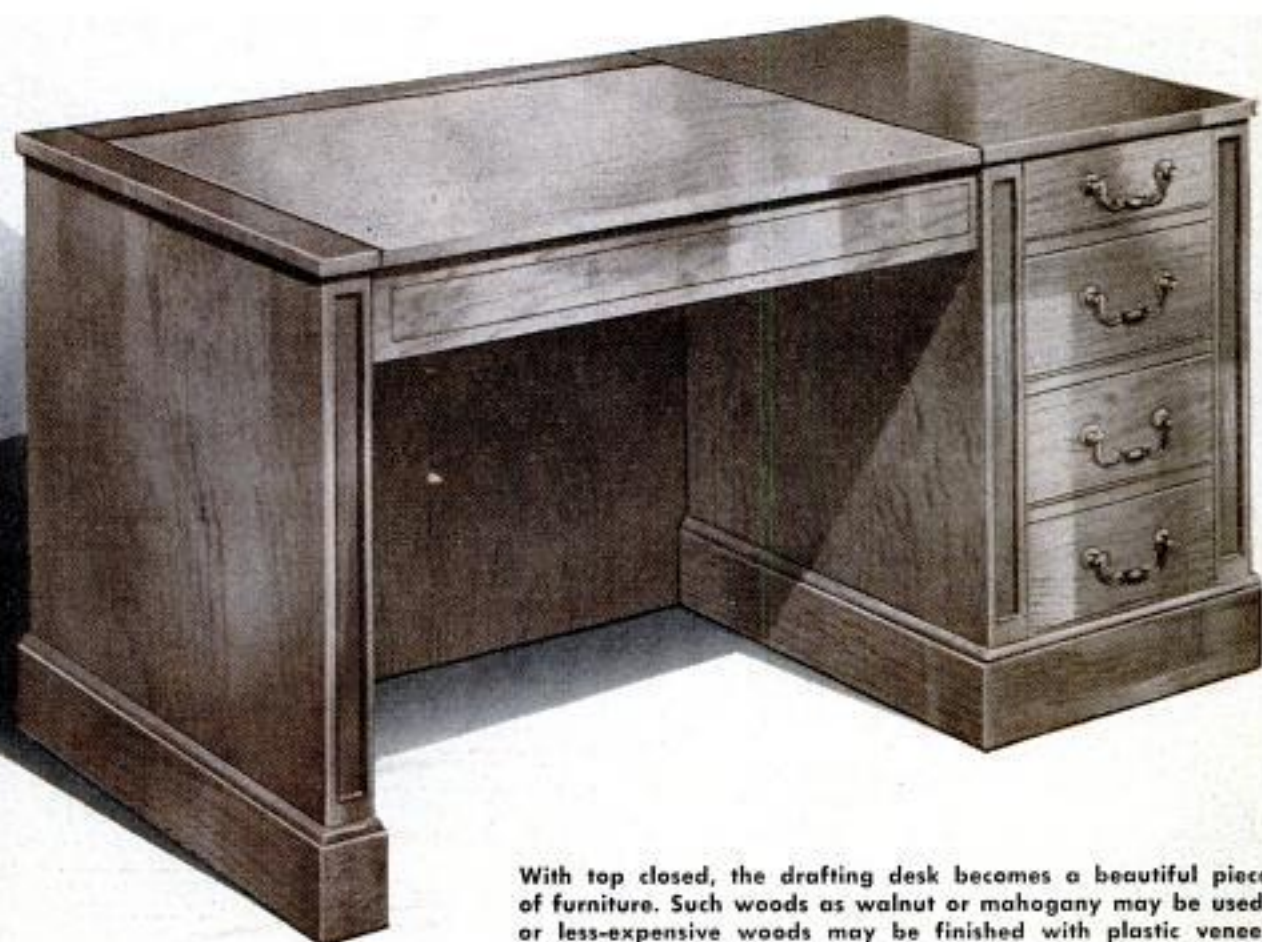

With top closed, the drafting desk becomes a beautiful piece of furniture. Such woods as walnut or mahogany may be used, or less-expensive woods may be finished with plastic veneer



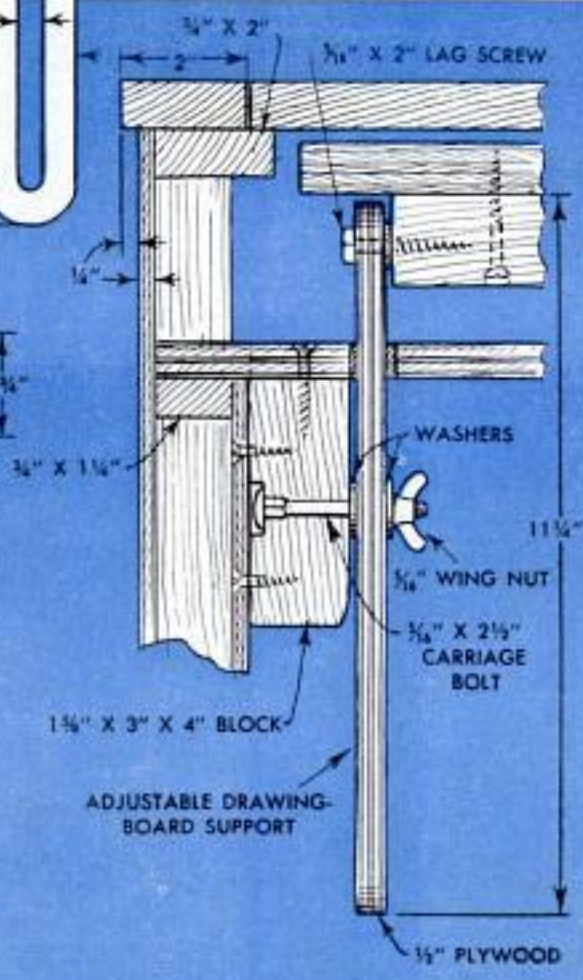
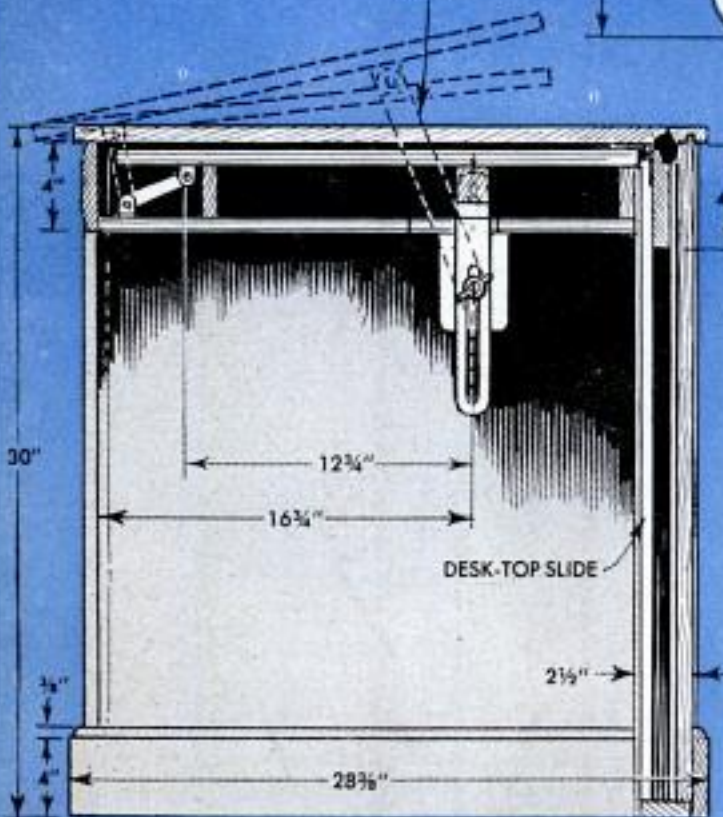
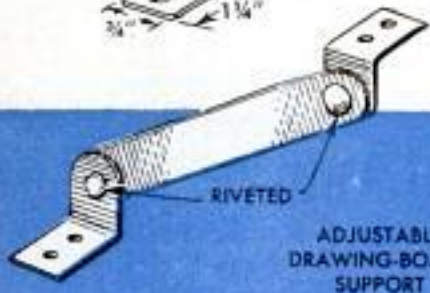
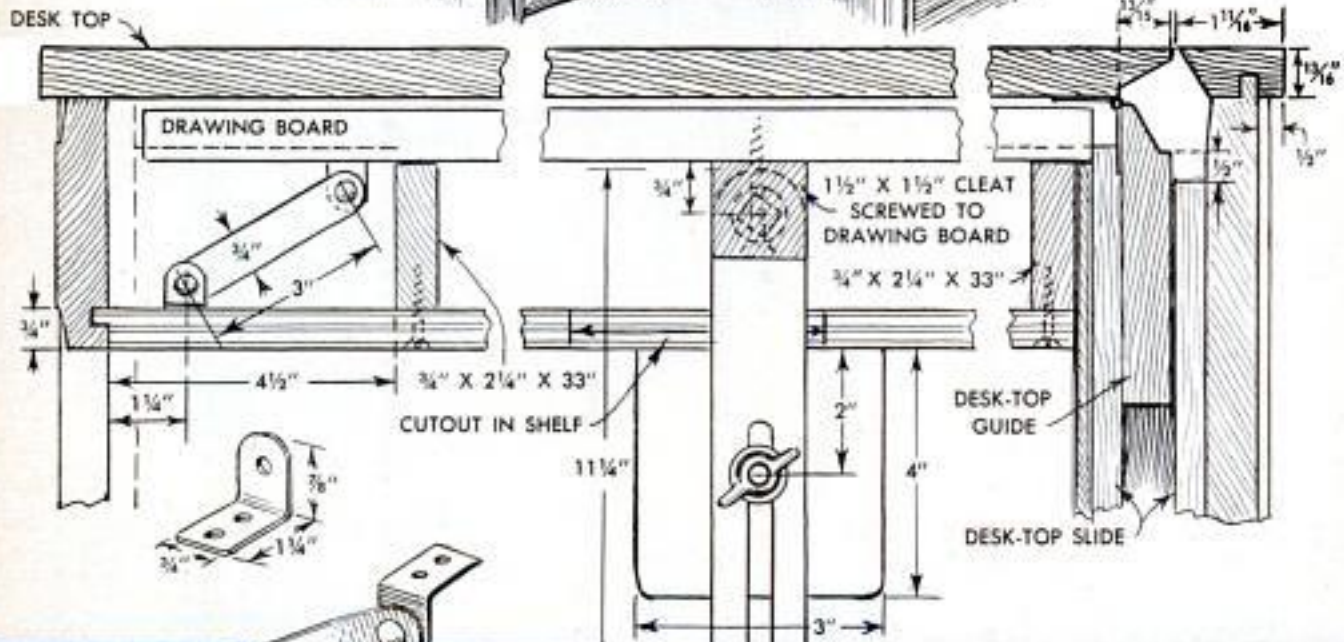
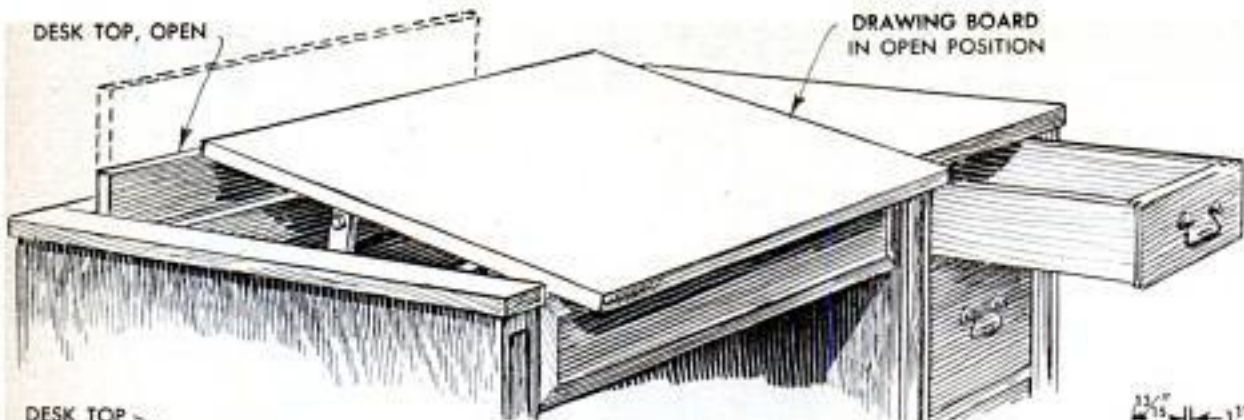



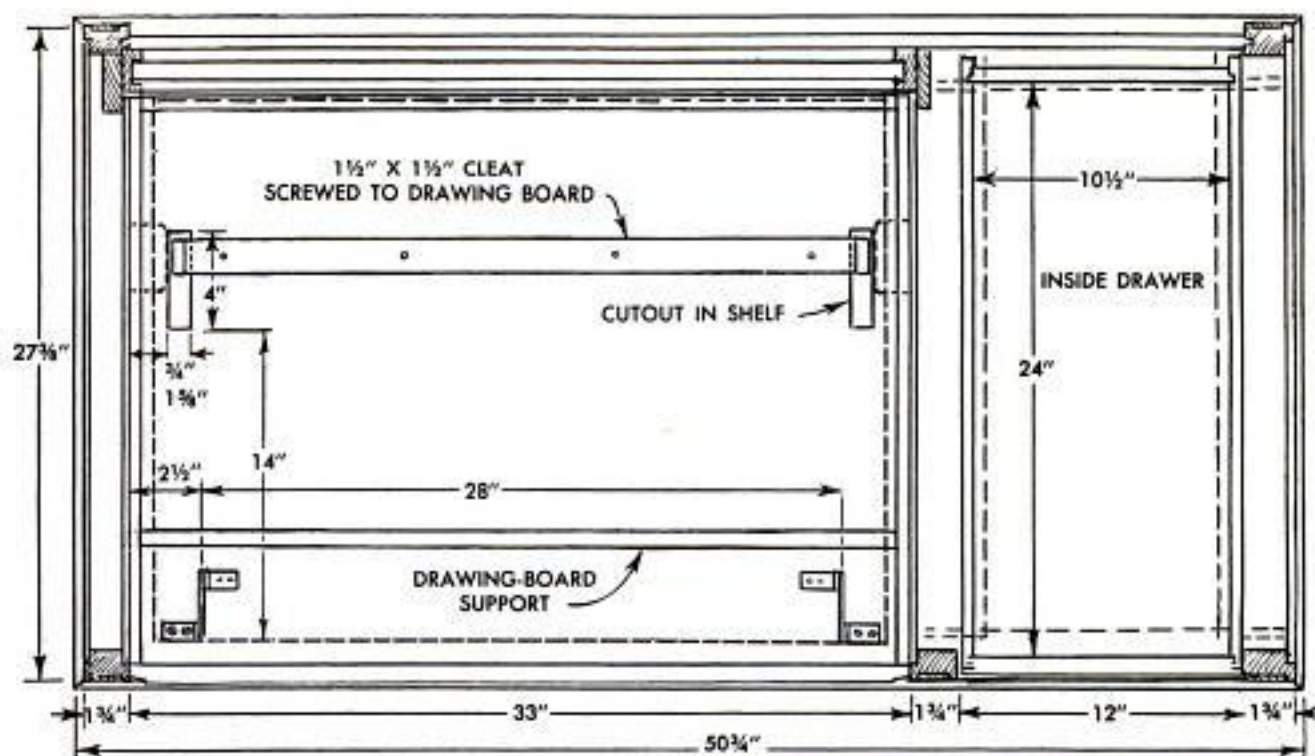

plywood such as mahogany, walnut or birch. Frame members, drawer slides, drawer parts, etc., are of hardwood, while the drawing-board shelf may be of 3/4-in. fir plywood and the drawer bottoms of 1/4-in. hardboard or fir plywood.

The desk top, as shown in the drawings, is made in two parts—one, the top itself and, the other, a guide piece hinged to the

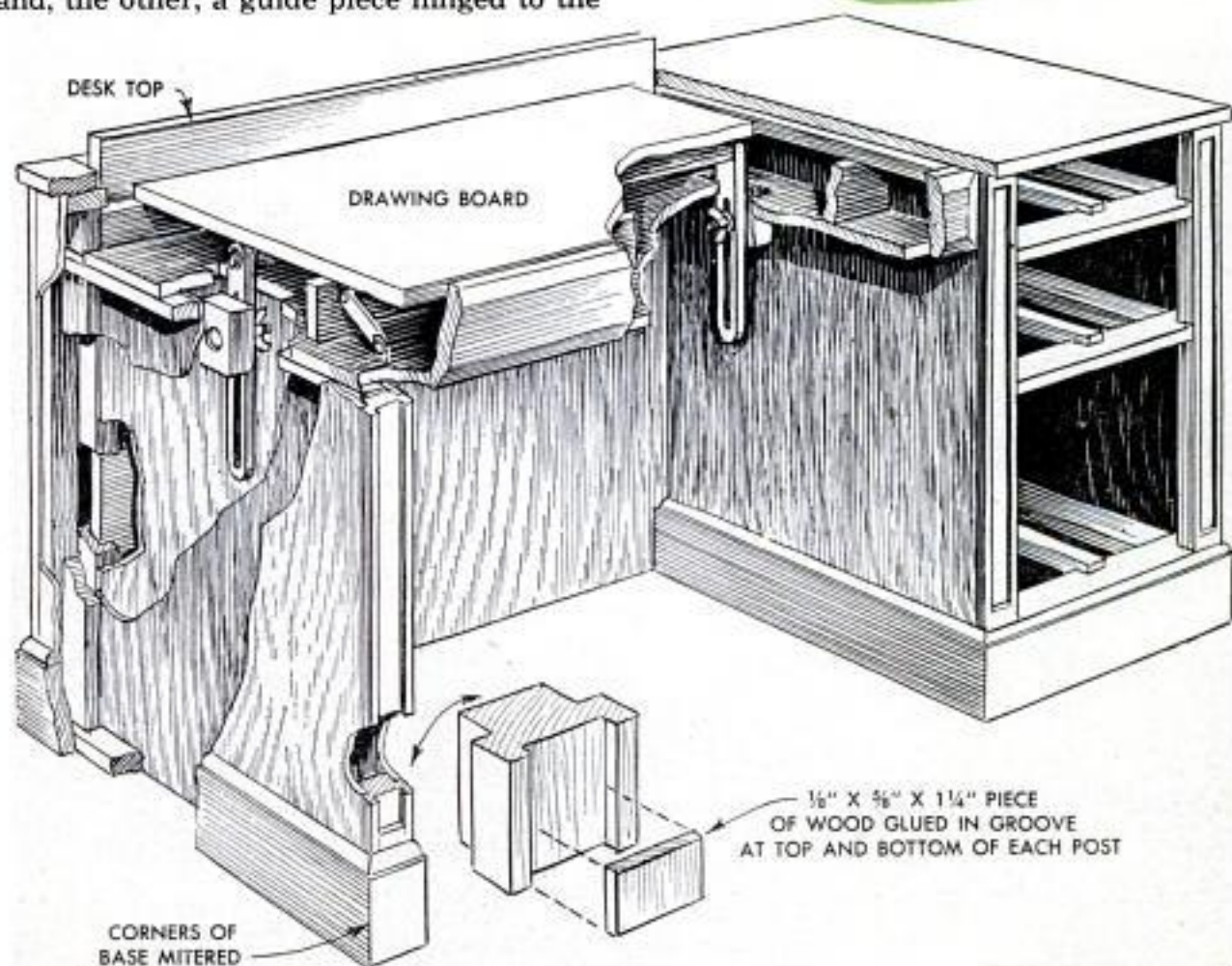
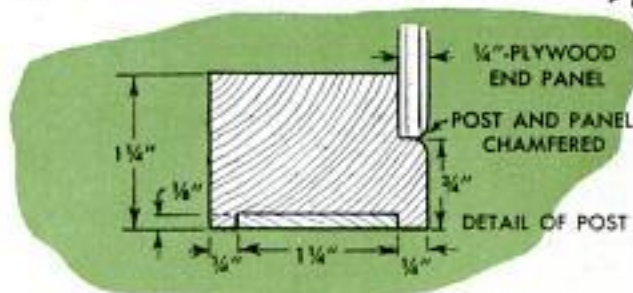





Drawers are made as shown above and detailed below. Carefully check drawer fit before final assembly

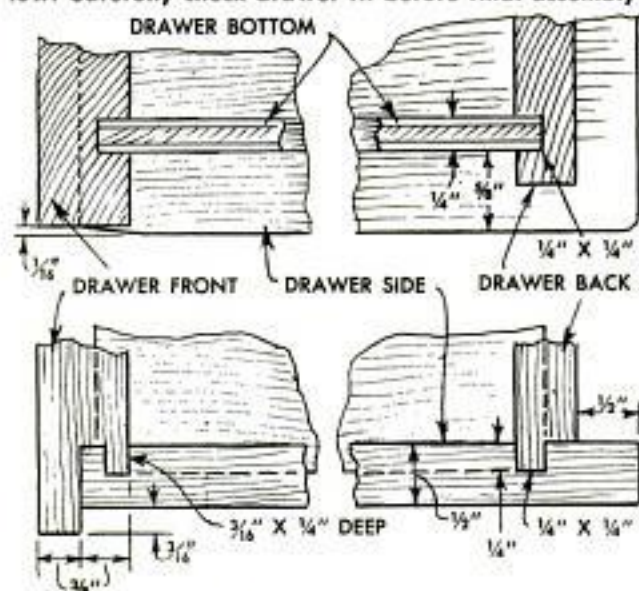

top. The guide piece rides in two vertical slide channels which are grooved lengths of  $\frac{3}{4} \times 1\frac{1}{16}$ -in. hardwood fitted between the two back panels of the desk.

The corner posts of the desk are made of  $1\frac{1}{4} \times 1\frac{3}{4}$ -in. hardwood. The front of each post is grooved  $\frac{1}{8} \times 1\frac{1}{4}$  in. and either one or both sides of the post is rabbeted  $\frac{1}{4} \times \frac{3}{4}$  in. for the  $\frac{1}{4}$ -in. plywood end panels. Both the corner of the post rabbet and the corner of the panel are chamfered to form a V-joint.

The drawers are made as shown in the details at the left, using  $\frac{3}{4}$ -in. plywood for the fronts and  $\frac{1}{2}$ -in. hardwood for the sides and back. The bottoms are of  $\frac{1}{4}$ -in. plywood or hardboard. Drawer guides and slides are made as shown below, tenons being cut on both ends of each guide.

The lower right-hand detail shows a section of the leg base. In this case, the hardwood base is rabbeted  $\frac{3}{8}$ -in. deep along the inside top edge for the plywood end panels. The back base is rabbeted  $\frac{1}{2}$  in. deep for the back panel of the desk. ★★

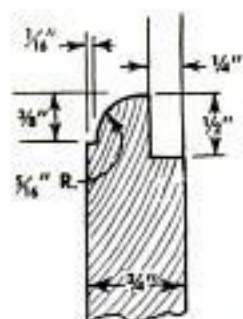
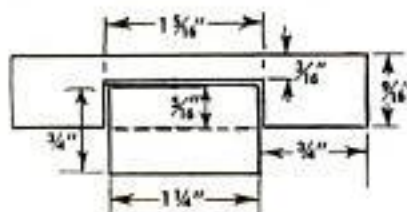

DETAIL TOP OF BASE

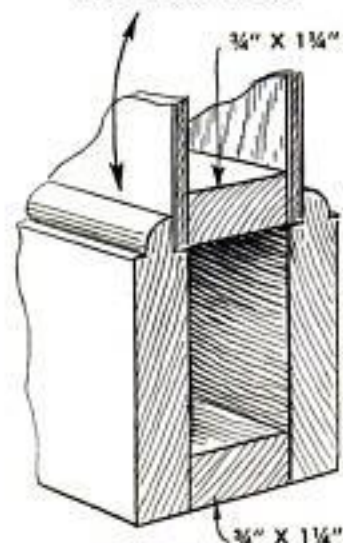

SECTION THROUGH BASE OF LEG

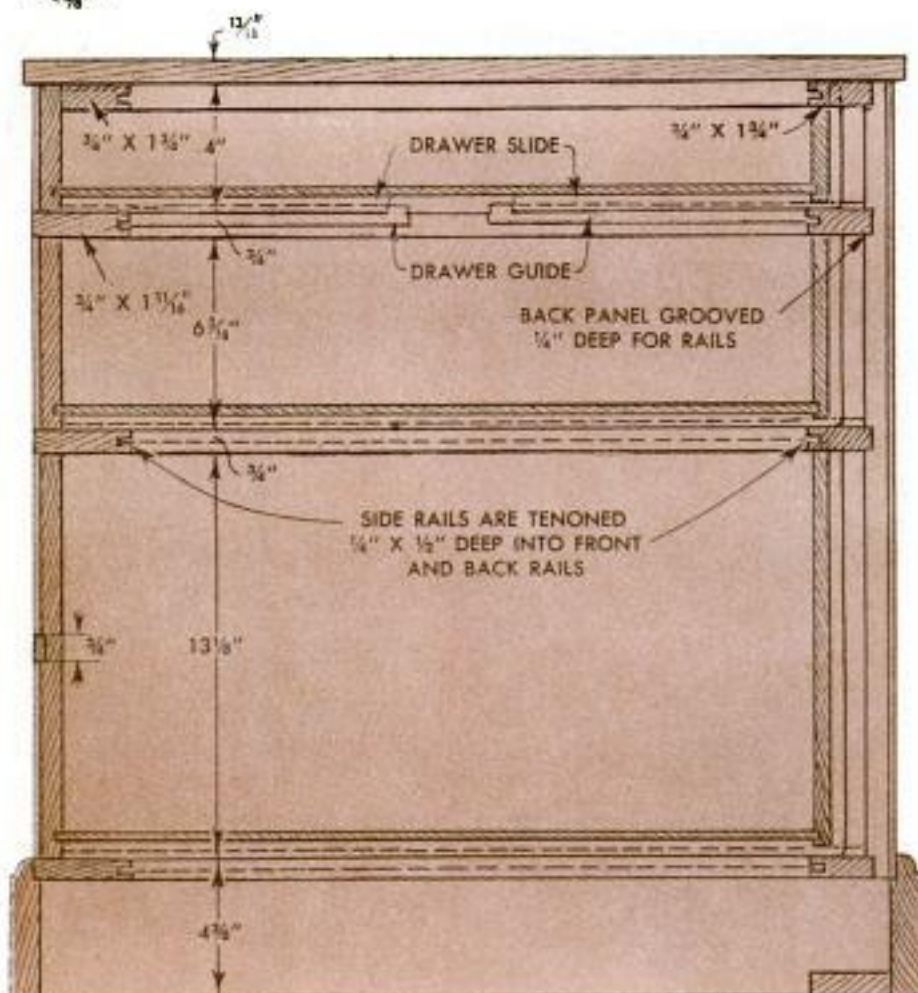



# PLANTER YARD LIGHT

By Harry E. Bilger

FOR SOMETHING UNIQUE in the way of a yard light, mount an ordinary yard lamp on a steel-angle post having a built-in planter. The angle is bent so that the bottom of the post flares outward, and the lower portions of the legs are embedded in a concrete base. The four lengths of angle used for the post are screwed to a 2-in.-square hardwood block at the top and are reinforced at a point just above the flare by a square brace made of flat iron. This is bolted to the legs. Each angle is cut lengthwise from the bottom upward for 3 or 4 in. so that one web of each leg can be bent at right angles to give greater support in the concrete base. The latter is poured in a wooden form, as in the lower right-hand detail. A nail keg is placed in the center of the form to leave an opening in which soil and plants can be added later. The post is held in place by a frame of 2 x 4s while the concrete is poured.

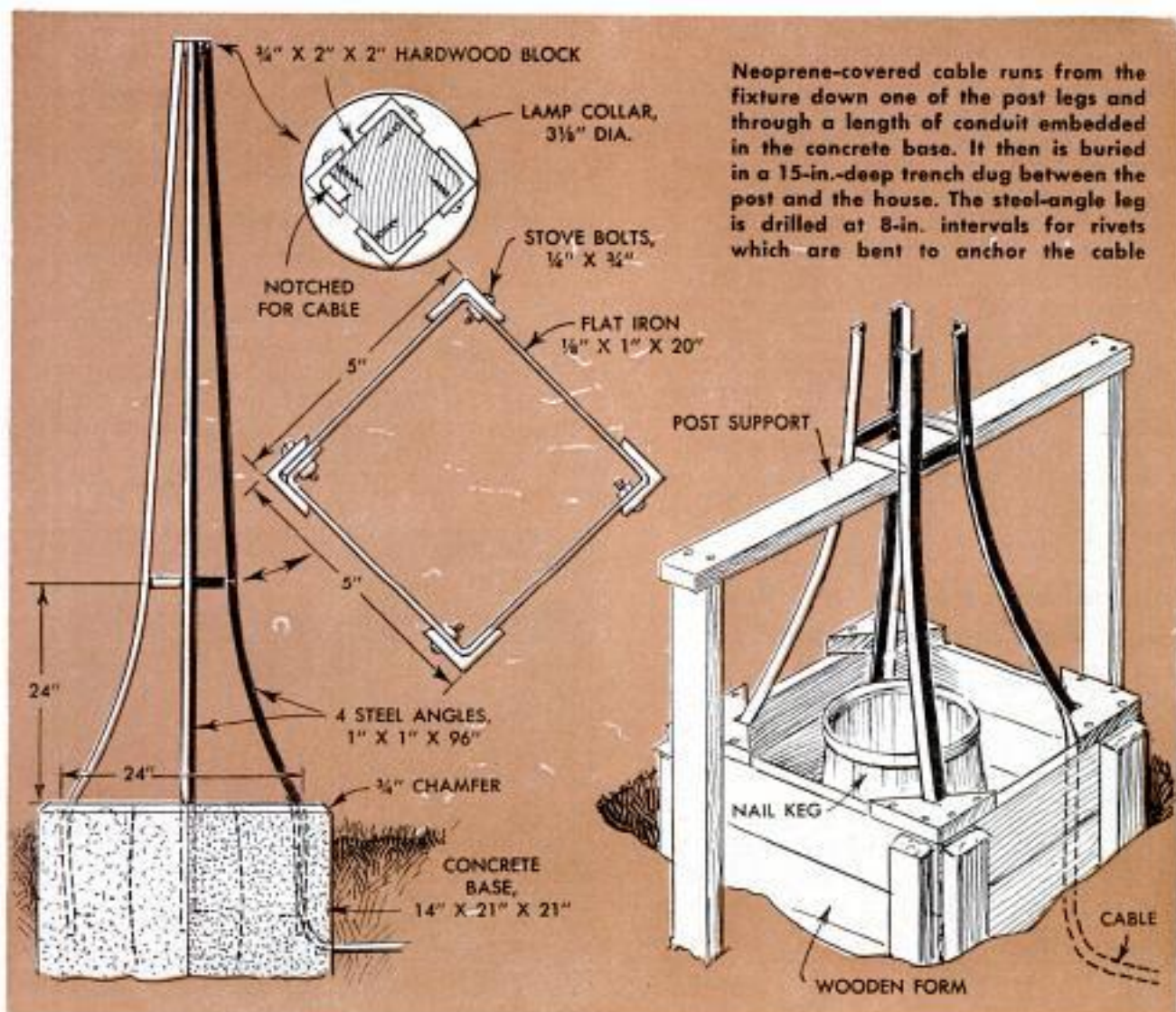
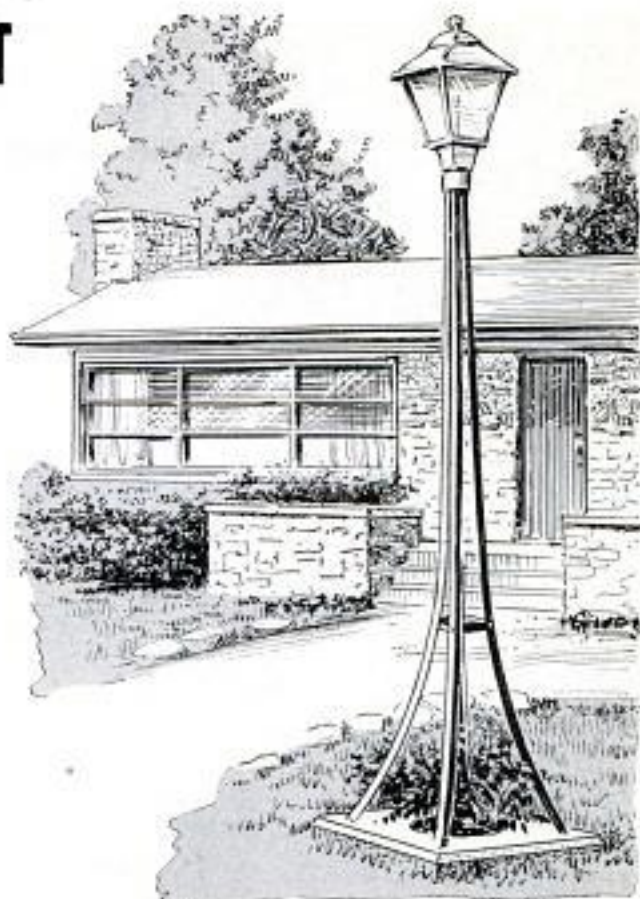

Neoprene-covered cable runs from the fixture down one of the post legs and through a length of conduit embedded in the concrete base. It then is buried in a 15-in.-deep trench dug between the post and the house. The steel-angle leg is drilled at 8-in. intervals for rivets which are bent to anchor the cable



## Trussed Strip of Plywood Provides "Bridge" Over Pool

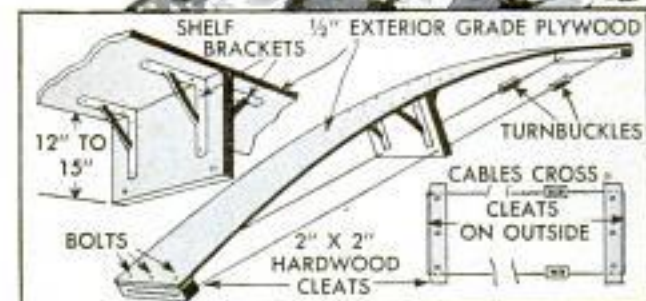

A lightweight, portable bridge that will permit a man to work over small garden pools can be made by bowing a length of  $\frac{1}{2}$  or  $\frac{5}{8}$ -in. exterior plywood and trussing it with wire cables. The plywood should be cut 15 to 18 in. wide and long enough to span the pool, allowing for the fact that curving the plywood will shorten its overall length. The center brace is a piece of  $\frac{3}{4}$ -in. plywood, 12 to 15 in. wide. It is solidly fixed in place by four shelf brackets. Hardwood cleats bolted to each end of the bridge are drilled to receive light wire cables for taking up slack and also to prevent the plywood from twisting. The length of a bridge of this type should not exceed 10 ft., as it would not be rigid enough for safe support, although heavier materials would allow a longer span.

## Nail Holder Extends Arm Reach When Installing Wallboard

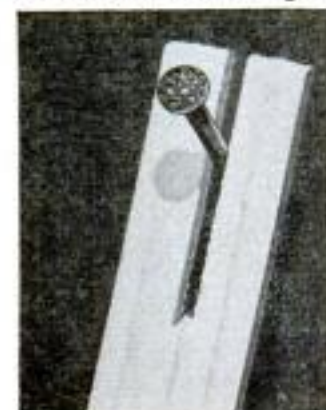

When a job requires driving a large number of nails into a wall at a point beyond normal reach — as when installing sheets of wallboard or plywood — a wooden slat or flat steel slotted at one end will eliminate the need for a

stepladder or working platform. The nail simply is wedged into the slot, then held in place and started with a couple of hammer blows. After the nail is started, the holder is pulled down and the nail is driven the rest of the way.

## Worn Bench Stop Held in Place

A bench stop which has become so worn it drops through the bench opening can be held in place with a rubber band cut from an inner tube. The band is snapped around adjacent stops, then twisted around the worn one. Even though all three stops are loose, the tension of the band will hold them in position.

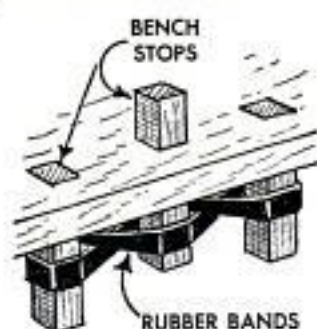

## Neutralize Concrete Floor Before Painting

To increase paint adhesion on concrete floors, apply a solution of zinc-sulphate crystals, 2 to 3 lb., dissolved in water, 1 gal., to the floor as a neutralizer. Apply liberally with a brush and let dry for 48 hours. The surface then is dusted off and painted.

Ted Otsu, Vancouver, B. C., Can.

## Film-Developing Tank Agitated By Motor and Flexible Shaft

A small electric motor and flexible shaft, of the type used in Erector sets, can be used to motorize the constant-agitation process in a film-developing tank. A hole is drilled in the center of the tank-agitator rod to provide a push fit for the driving end of the flexible shaft, while the opposite end is coupled to the motor.

Ken Murray, Colon, Mich.







# THE W-KITE

By H. W. Fowler, Jr.

THE W-KITE, one of the highest fliers and most efficient climbers of all kites, combines the stability of the regular box kite and the strength of the triangular box kite. It flies well without a tail and, in a fair breeze, will "walk" right up to a spot almost directly overhead. It does not pull hard, as does the box, because it adjusts itself constantly. In a fair breeze, it can be fed into the air from the hand and brought back to the hand without ever touching the ground.

The frame is made of any light wood and covered with cellophane. The joints of the frame are tied with string or heavy thread and then coated with shellac or glue. The cellophane cover should not be pulled too tightly, as it may shrink. Where necessary, back the cellophane with a light network of thread tied to the frame. A four-legged bridle is used, the length of the top two legs being about the same as the kite's short struts. The method of attaching the bridle can be seen in the illustration. The size of the kite may be varied provided the proportions of the parts remain the same as pictured.

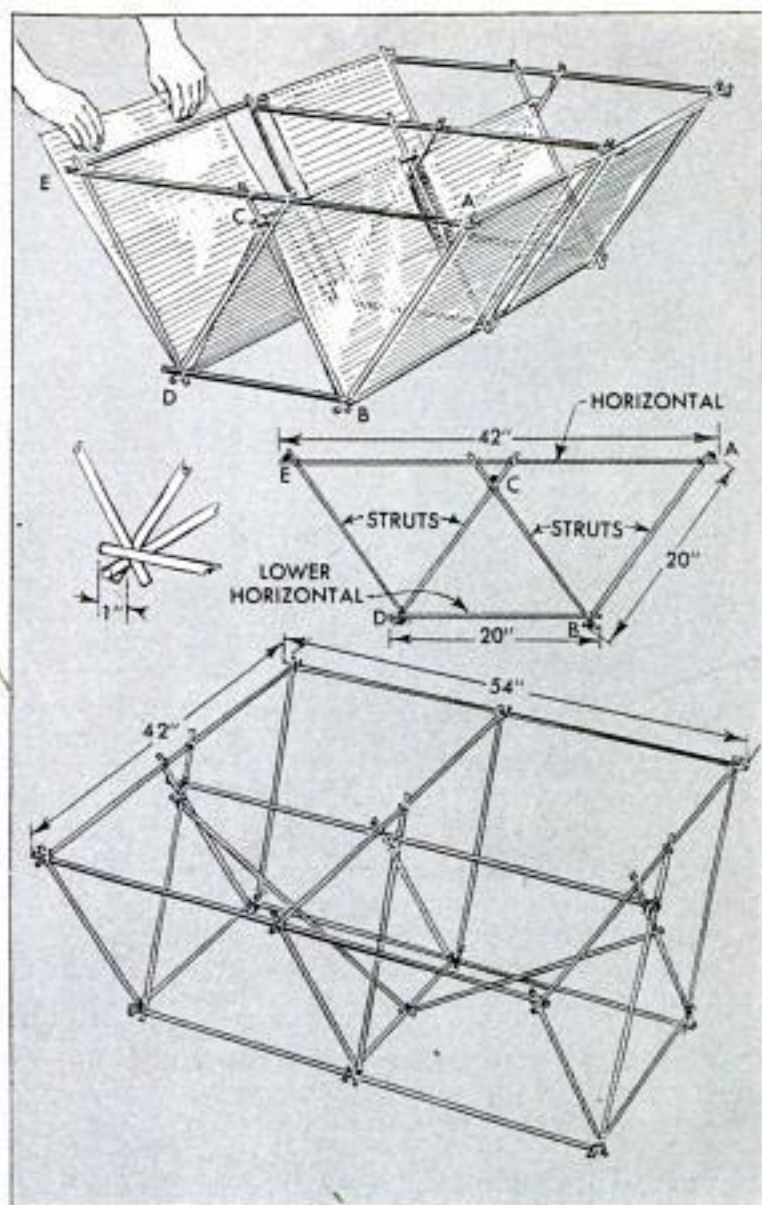



## Storm-Sash Carrying Handle



A full-length storm sash can be picked up and carried under a man's arm by means of this hook-and-rope carrying handle. The two hooks are bent from 8-ga. steel wire. The length of the rope or strong cord, which is tied through the eyes of both hooks, will vary with the length of the carrier's arm. In use, the hooks are placed under one side of the sash and the sash is lifted by grasping the rope at its center.

## Rack for Dowels Improvised With Discarded Sanding Belts

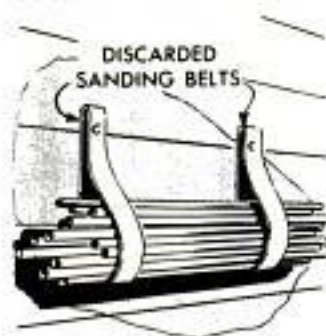

A couple of discarded sanding belts can be used to provide a simply made rack for wooden dowels. Nail the belts to a wall, as indicated, locating them at the same height. If various lengths of dowel result from different jobs, add one or two more belts to accommodate the shorter lengths.

## Too-Frequent House Painting Results in Poor Protection

Painting the exterior of a house too often is not good practice because the heavy layer of paint built up will crack and peel. All the paint then must be removed before another coat can be applied. Research has shown that a single coat of quality paint every four years, or two coats every six

years, is often enough. An exception to the time limit can be made on newly erected houses, where only a base coat and one finish coat have been applied. The paint wears away more rapidly on the fresh wood and repainting can be done sooner.

## Thumbtack Prevents Slipping Of Steel Measuring Tape

When the end hook of a steel measuring tape proved inadequate for holding it in place while measuring long lengths of lumber, one craftsman modified his rule so the end could be thumbtacked in

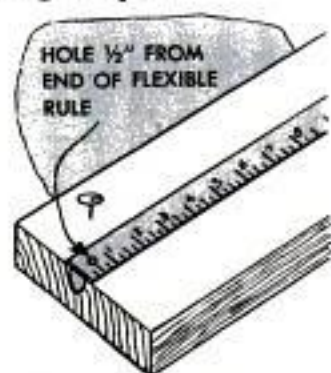

place. A hole was drilled  $\frac{1}{2}$  in. from the end of the rule, just large enough to receive a heavy thumbtack. In use, the rule is hooked to the end of the lumber to position it, then thumbtacked in place.

George Kapitan, New York, City.

## Rubber Tubing Holds Screw On Driver Blade

If you have occasional need to hold a screw on the end of a screwdriver to place the screw in a location where you cannot hold it with your fingers, the job can be done with a short length of rubber tubing. The tubing should be of a size that will fit snugly on the blade of the screwdriver and project just enough to grip the head of the screw. In use, the screw simply is forced into the tubing so the slot in the head aligns with the blade. After the screw is tightened in place the screwdriver is pulled away. The rubber tubing will slip off a roundheaded screw easily, and flatheaded screws generally will pull themselves out of the tubing as they are driven into place.





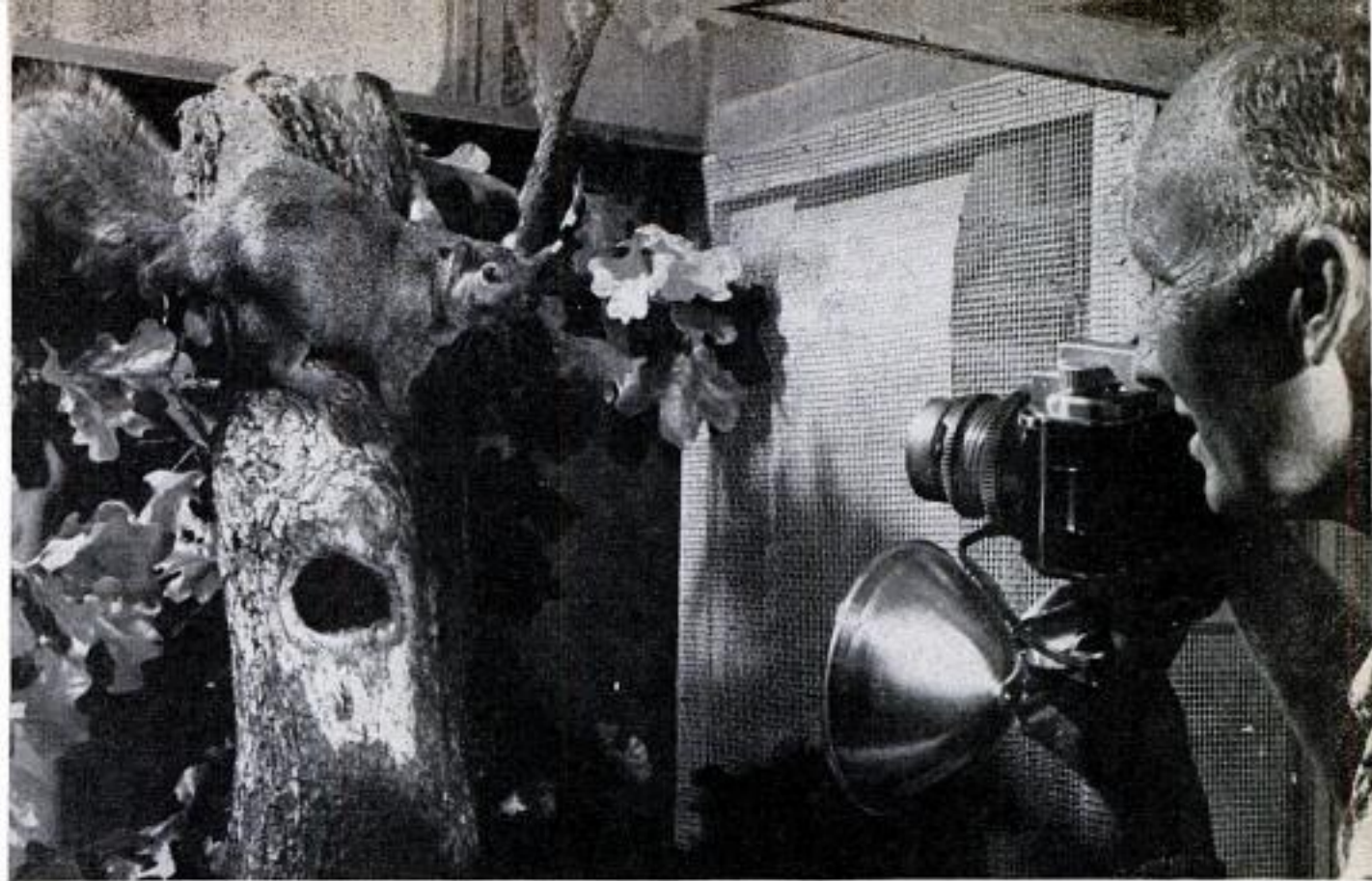

Squirrel is attracted to hollow-tree section with its natural nesting hole where he is easily photographed

## SHOOT 'EM CAGED

By E. P. and Roberta Haddon

**M**AKING CLOSE-UP photographs of small animals is simplified considerably when it can be done under controlled conditions. These can be achieved easily by building a small photographic set in the form of cages, the center section, or stage, containing branches, foliage, etc., to simulate the animal's natural habitat.

The unit pictured on these pages was constructed for the purpose of taking an extensive series of squirrel pictures under simulated natural conditions. However, by isolating the squirrels in cages at both ends of the unit, the setup proved equally useful for photographing other animal subjects. As all members of the rodent family have destructive chisel-like teeth, it was necessary in this case to line the entire unit with hardware cloth.

The center section is 40 in. long, 31 in. high and 25 in. deep, with a screened front panel. For most small animals this is sufficient depth. However, if lenses of long focal length are to be used, a unit of greater depth may be desired. In this case, a center-section extension of the same size as the center section but without front or back panels can be set in position in front of the unit. With this addition, the depth is doubled, and the front of the extension is covered by the same panel used on the original center section.

A reversible back panel, held in place with screw hooks, may be fitted to the center section. One side of the back is covered with screen wire and used when animals are left in the unit for long periods of

The camera went unnoticed by the squirrel shown below as he perched on log to begin shelling a pecan







Rock placed in front of background as perch for crow resulted in interesting series of shots. High-speed lights were used—one at camera and one at the side

time. The other side, which serves as a backdrop, is covered with hardboard painted in the desired color. Sky blue is popular for color shots and flat black proves good for added depth when taking black-and-white photos.

A full-size front panel, fastened with screen-door hooks and eyes, is readily removed for arranging props in the photographic section of the unit. A small hinged door in the front panel permits the photographer to set up his camera close to the opening without obstructions in front of the lens. The door may be lifted out of position by removing the hinge pins, thus eliminating the need for swinging it outward and possibly disturbing the camera setup. If working with birds, the door panel may be a pane of clear glass so the door need not be removed.

The animals are confined in the side cages or released to enter the center cage by lowering or raising pieces of sheet metal which cover the openings between the cages. There is a small door in the front of each cage to permit placing food and water inside. Notice in the photo below that a wooden nesting box is wired to the end of each side cage. These are made of 1 x 12-in. lumber and lined with hardware cloth. Each box is fitted with a hinged side so that it can be opened for photographic purposes



Wild possum released in cage clambered onto small log where it posed for the photograph at the left. Other small animals are equally easy to photograph

Note cage and nest arrangement in photo below. Animals are kept in side cages when not being photographed and wooden nests are provided at the ends

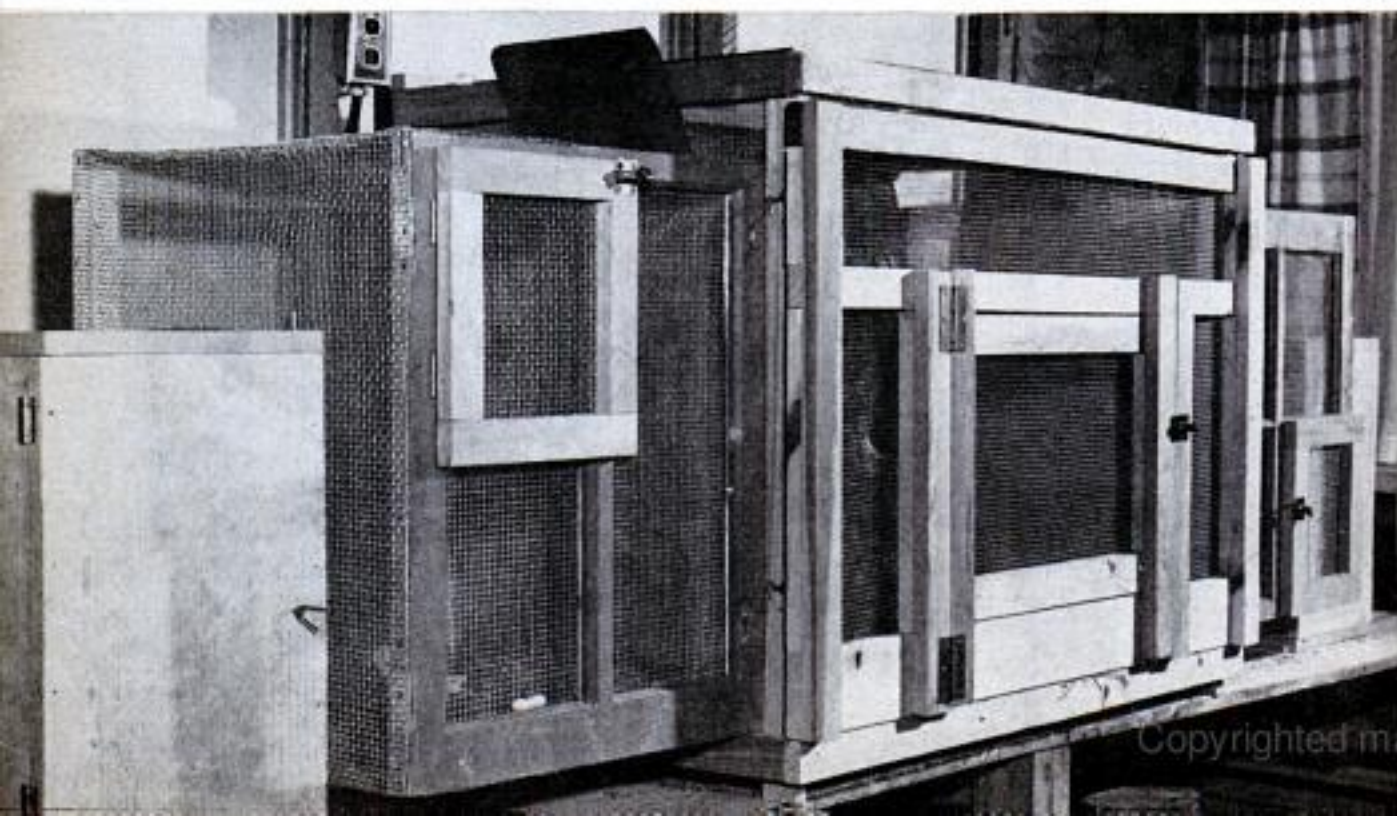



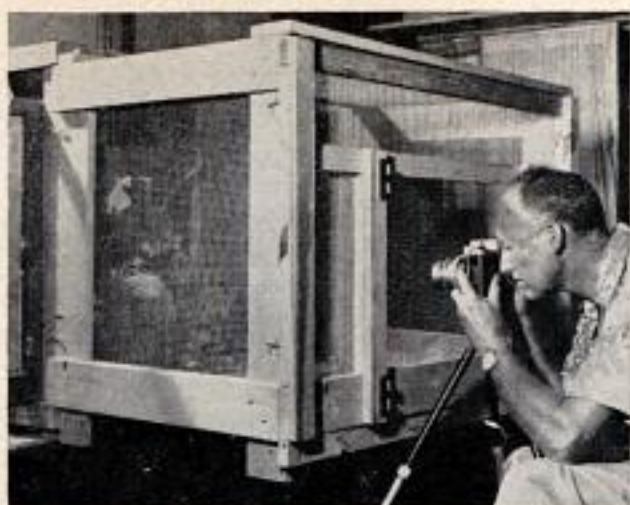

Photographer sets up camera in front of cage, as above, and presets it to cover a definite area of stage when subject will appear to best advantage. Glass top of center section permits use of sunlight outdoors or the placement of flash for backlighting

When greater depth is required, an additional section may be added to the front of the center unit as in the upper right-hand photo. Section is fastened to unit with screen-door hooks, using the same screw eyes which otherwise receive front-panel hooks

Front panel is hooked to center section of cage or to center-extension section. It is removed by releasing four screen-door hooks, giving easy access to stage for arranging props. Like rest of the unit, the front panel is covered with hardware cloth

When the stage setting has been completed and a few nuts placed in it, the squirrels or any other subjects will rush out when the cage door is raised. This permits making close-up detailed studies that would require many days of work out in the field





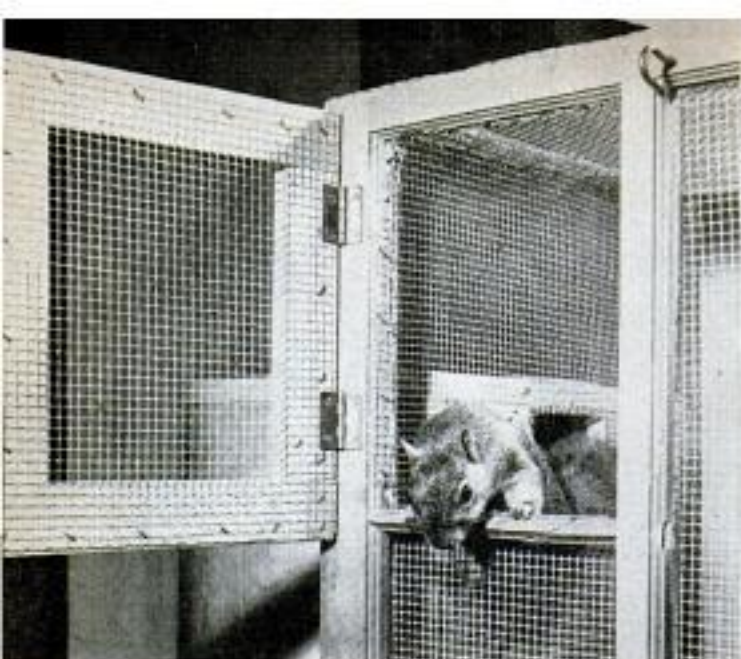

Small doors in side cages permit placement of food and water inside. All inner surfaces are covered with hardware cloth. Old window frame with panes removed was used for front panel of the center section

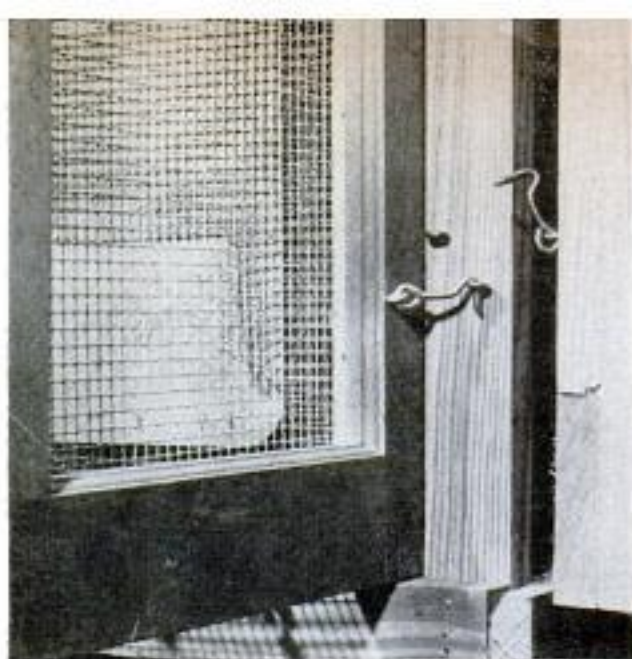

Screen-door hooks and eyes are used to fasten the cages and panels together. This permits the unit to be completely disassembled for cleaning in a matter of minutes and simplifies fitting additions



Photo below shows how small door in center of front panel is removed by pulling hinge pins. Most shots can be taken through this opening. Hardware cloth on door may be replaced with glass for bird photography



or to separate young animals from their parents. The top of the center section is a panel of  $\frac{1}{8}$ -in. plate glass which allows the stage to be lighted from above.

Squirrels, for example, become inquisitive about each new set and seem anxious to inspect it. As they like to climb about on the tree sections placed there for them, it is advisable to be ready, preferably with high-speed flash, so you are able to catch their rapid movements. When given a hollow-tree section, the squirrels immediately begin climbing in and out of the hollow, affording the photographer shots he would spend days obtaining in the field.

Merely placing a subject within the confines of the unit, even with the front removed, gives it a feeling of security that makes it easy to photograph. With some animals, like the squirrels, it frequently is unnecessary to keep the front panel closed at all times, as they will amuse themselves by playing or nibbling on the bark. ★ ★ ★

Squirrel in center photo above and great horned owl, below, are typical subjects photographed in the cage-stage setup. Because of enclosed area, the owl, for example, sat long enough for several exposures





## Fish Bag Hung Over Side of Boat Eliminates Need for Stringer

A live-fish bag that simply hooks to the gunwale of a boat and hangs in the water will quickly prove its value the next time you spend a day fishing for pan fish and do not want to use a stringer. The square frame is made by bending a length of  $\frac{3}{16}$ -in.-dia. iron rod to the dimensions given in the detail. Welding on the hooks can be done at a welding shop or garage. The bag is made from heavy netting or coarse burlap sacking and stitched onto the frame with heavy twine. When not in use, the bag folds into a flat compact bundle. To prevent any possibility of the fish jumping out of the bag, either while in the water



or when carrying it later, a flap to close the top can be made of the same material. It is stitched to the top edge of the bag, and fastened to the front with two snap-type fasteners.—Hi Sibley, Nuevo, Calif.

## Store Electric Extension Cord Without Knots or Kinks

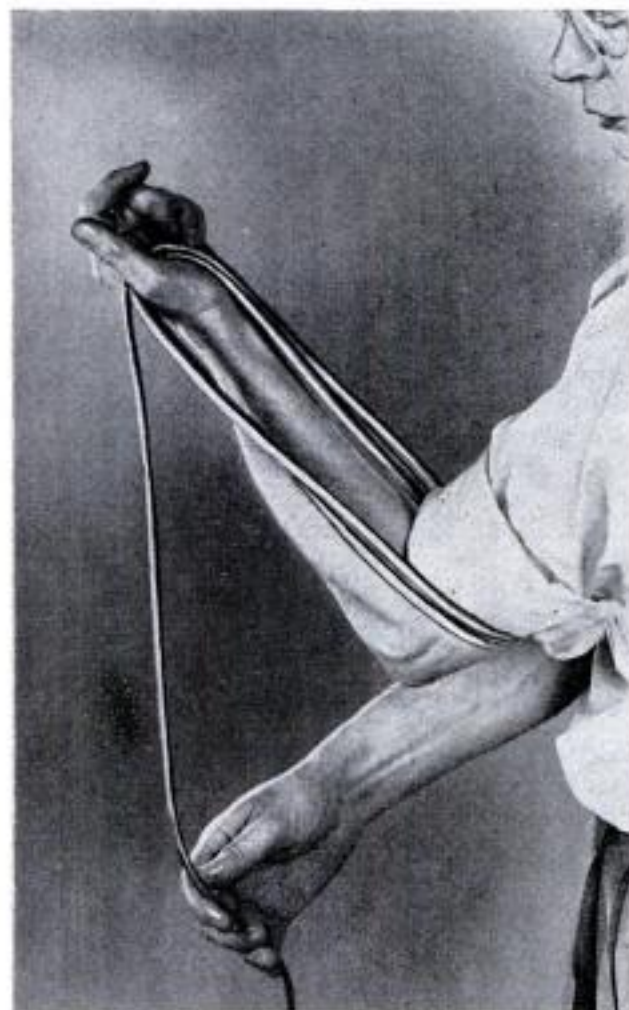

When adding water to an aquarium, to prevent churning up the sand or disturbing the plants, pour it over a small square of wood or paper floated on the surface of the water.

An extension cord will last longer and be ready for use any moment if you coil it neatly for storage as shown. Wrap the cord over the palm and elbow of one arm, allowing the loose ends to extend 18 to 24 in. After removing the coiled cord from the arm, wind one extending end around the coil in a clockwise direction toward the center, and the other in a counterclockwise direction. Then join the plug and receptacle to keep the assembly together.

## Dowel Stops on Sawhorse Hold Work When Planing

Fitting the top of a wooden sawhorse with four stops will permit it to be used to hold work on edge for planing. The stops are made by driving wooden dowels into holes drilled in the top of the sawhorse. The dowels are spaced 1 in. apart.

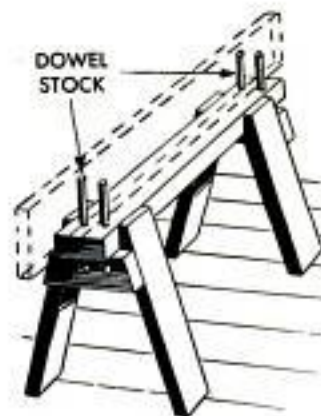

## Small Garden Tools Easily Located

Easily mislaid in yards containing much shrubbery and tall grass, small garden tools, such as hand forks and trowels, will be located more easily if painted orange. This will make them conspicuous.

G. A. Lemmon, Auckland, N. Z.



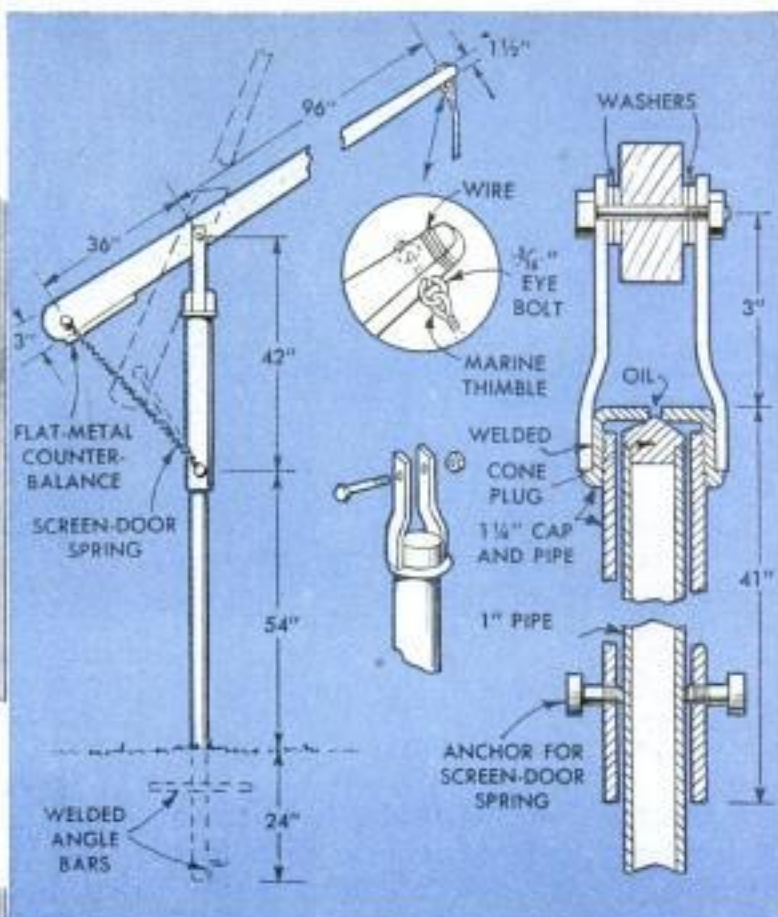

## Wide-Sweeping Tether Gives Dog Freedom

Your dog can be given the freedom of almost the entire yard if he is tied to this wide-sweeping tether. And, because of the spring-loaded sweep arm, there's no danger of his becoming tangled in the tether rope. The upright and tether pivot are made from lengths of 1-in. and 1 1/4-in. pipe as shown in the detail. Pieces of angle iron welded crosswise to the lower portion of the upright anchor it securely in the ground. Note in the right-hand detail how a pipe cap, turned onto a sleeve of 1 1/4-in. pipe, is drilled to pivot on the tip of a cone-shaped steel plug. The hole in the cap also permits

oiling for smooth operation. It may be necessary to use emery cloth to smooth down the area of 1-in. pipe covered by the sleeve. Flat steel, 1/8 in. thick, is suitable for the sweep-arm yoke. The wooden sweep arm is counterbalanced to minimize pull when the dog makes a sudden lunge, and a pair of screen-door springs fastened between the end of the sweep arm and the lower portion of the pivot sleeve keeps the arm raised to take up slack in the tether. Sash cord is excellent for the tether and, especially in the case of a larger dog, a harness is preferable to a collar.

## Roller-Skate Whitewall Wheels Provide Safety Feature



White sidewalls on roller-skate wheels not only will please youngsters by their appearance, but will add a safety measure by being more visible at twilight or nighttime when auto headlights shine on them. The wheels should be washed with a solvent to remove oil, and all rust spots should be sanded bright. White lacquer will provide the most long-lasting job. Reflective glass beads, such as are used in reflective road signs, can be dusted over the wet paint to make the wheels more easily visible. The beads are available at most art-supply stores. A strip of reflective tape on each heel rest also will help visibility.



## Fence Building Is One-Man Job When Pair of Jigs Is Used

Building a corral type of lawn fence becomes a one-man job when a pair of these jigs is used to hold the ends of the planks in place for spacing and nailing. Each jig is a 2 x 4 a little shorter than the height of the posts, and has a bracket nailed to the top which is reinforced with a diagonal brace. A cleat nailed to the underside of the bracket keeps the jig in place when it is hooked over a fence post. Fence planks are located by cleats which are nailed to the jig on the same side as the bracket. To prevent binding of the jig, the cleats are spaced  $\frac{1}{4}$  in. wider than the width of the planks. When using this jig it is possible

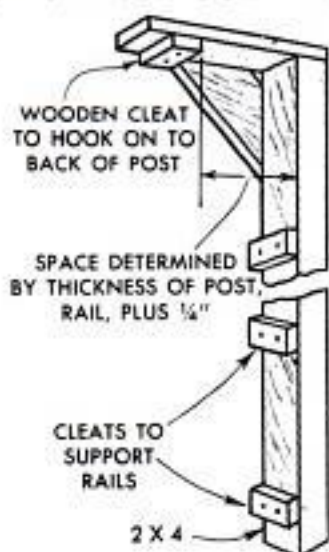

to put up all the planks of one fence section at a time. They then can be given a check for alignment and nailed in place.

Robert D. Wray, Worthington, Ohio.

## Cabinets Around Laundry Equipment Add Appearance and Storage



Photos courtesy Masonite Corp.



## Felt Strips Stop Light Leakage Between Fixture and Ceiling

After installing a flush ceiling fixture, I discovered that light leaked through at several points between the metal trim and the ceiling. This was remedied by strips of felt weather stripping which I fitted around the opening to form a "gasket" between the fixture trim and the uneven plaster.—R. A. Perry, USN, Bainbridge, Md.

Building cabinets around laundry tub and hot-water tank not only improves the appearance of a laundry room but also provides a table-high work surface, storage space for an ironing board and shelves for cleaning supplies. Full use of the tub is maintained by building its cabinet with the back open. Casters on the cabinet permit it to be rolled out of the way. The cabinet around the water tank is built with a double wall on one side to provide space for shelves. The front of the cabinet also has a double wall in which the ironing board is stored.

## Spring Provides Drawer Stop

A simple and effective limit stop for a drawer can be made from a 2-in. length of coil spring. A wood screw is passed through an eye on one end of the spring and driven into the inside surface of the drawer back. The spring is allowed to project about  $\frac{1}{2}$  in. above the top of the drawer. The short projection is rigid enough to prevent the drawer from being pulled all the way out accidentally, but the spring can be bent forward easily when the drawer is installed or needs to be removed.

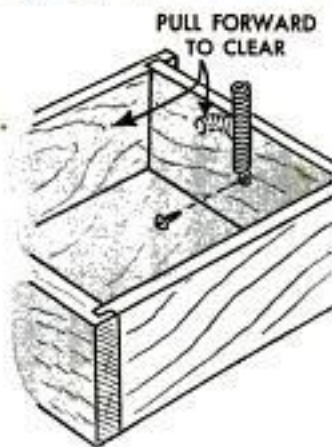





**COARSE SANDPAPER** cemented to the extension tray of a stepladder will provide a nonskid surface for paint buckets and other things which might be placed on it. With such a surface, the danger of the bucket slipping off the tray is lessened considerably



**LIBRARIANS HAVE DISCOVERED** that book covers last much longer under heavy wear when given a coat of white shellac. And the heavy-paper jackets wrapped around school books give better protection when coated with shellac. Thin shellac before applying

**WHEN JACKET CANNOT BE OPENED** because teeth of slide fastener have separated below slide, remove four or five teeth from one side of fastener at top, as below. With this done, fastener slide can be pulled upward and freed to permit removal of jacket

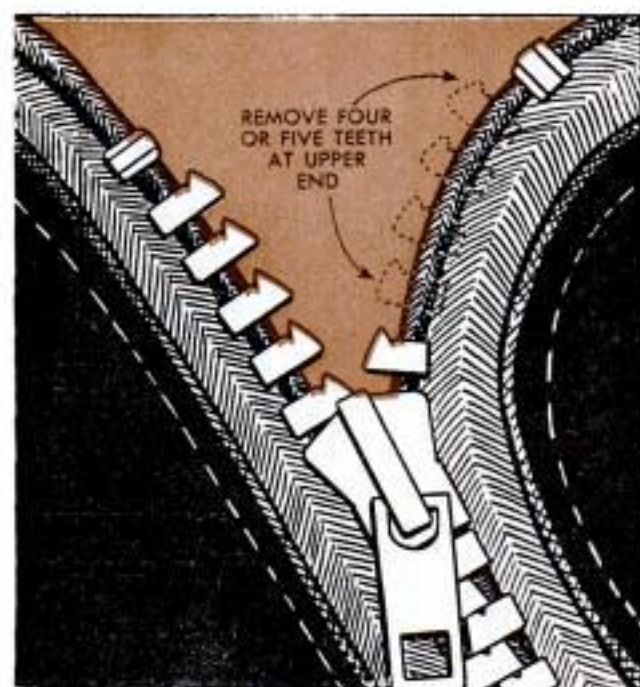

**A POWERFUL YET FLEXIBLE** wrench for removing tight screw caps can be improvised in the kitchen, using a stick of wood and a short leather strap. Wrap the strap around the cap and grip stick and strap ends as shown. Cap will open with light pressure





**LIPSTICK STAINS** can be removed from napkins and towels if they first are rubbed thoroughly with a small piece of butter held in wax paper and then rubbed with absorbent cotton. Repeat as often as necessary, and then wash material with soap and warm water



**SMALL DECORATIVE TOUCHES** can go far in toning up the appearance of a room, and yet they cost little. For example, the leaf-shaped plastic coasters available at most 10-cent stores arranged around the kitchen clock, as shown above, will add a springlike bit of green gaiety. A small tack holds each in place

**IF A GAS LEAK** should develop suddenly in your home you won't have to waste time hunting for a wrench to shut off the gas supply if you keep a cheap one attached permanently to the main valve at the meter

**MOST NAIL-POLISH BOTTLES** are easily upset, but a wider base provided for the bottle by cutting a hole in the top of a cardboard ice-cream container and inserting the bottle will prevent such accidents

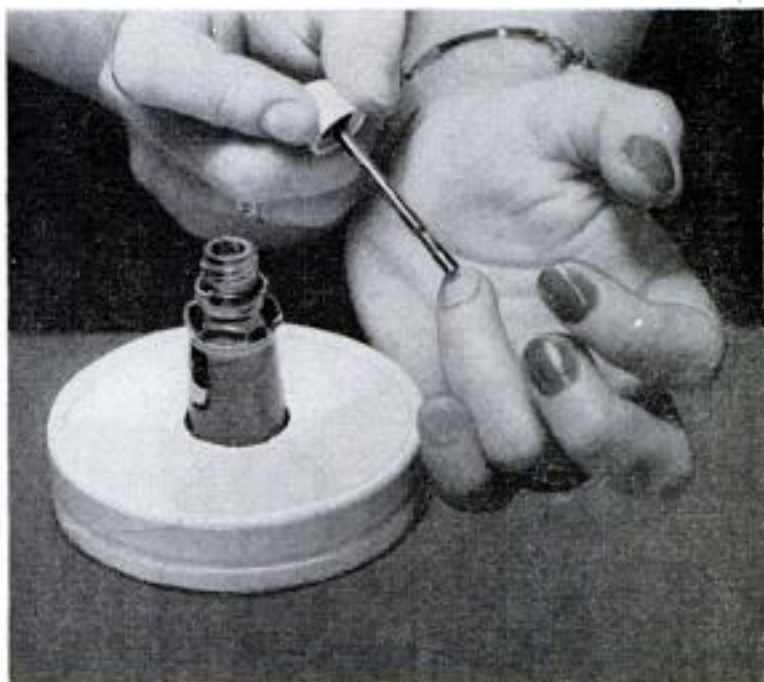
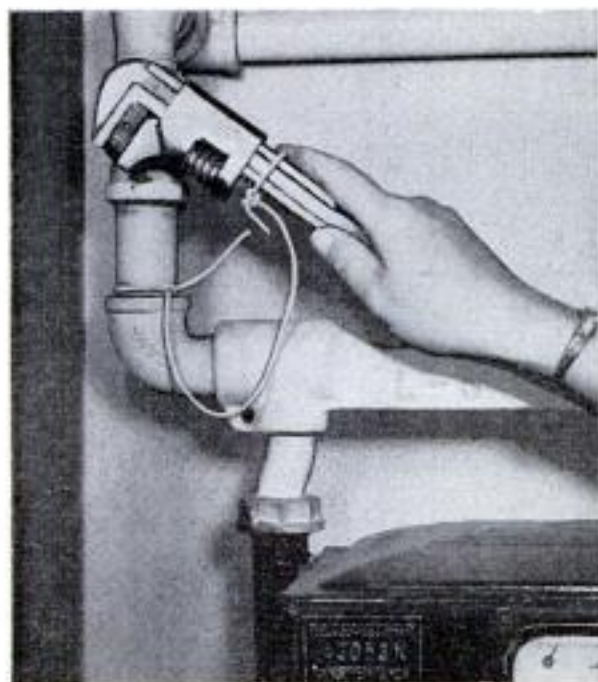



## Using Chain for Top Rung Improves Ladder Safety



Replacing the top rung of a ladder with a length of rubber-covered chain makes it possible to use the ladder against round posts and trees with much less chance of it slipping. The chain should be long enough to hang in a slight arc and rubber hose is used to cover it. The end links of the chain are passed through the rung holes in the ladder sides and held by slipping  $\frac{1}{4}$ -in. steel pins through the links. The ends of the pins are flattened and drilled to receive wood screws which hold the pins on the ladder sides.

## Tubular Rivets Utilized As Bearings for Toys

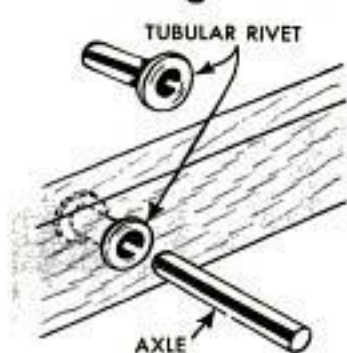

Tubular rivets can be utilized as bearings for the axles of wooden toys. The bearings are installed by drilling a hole just large enough to provide a snug fit for the shank of the rivet. If the cross section

of the toy is narrow enough to permit the end of the rivet to project, a washer can be fitted on the end and the rivet peened over.

## Surface Water Kept Out of Well

Surface water draining into a well or cistern from the pump platform has often been the cause of contamination. To insure against such possibility, use roof-flashing

cement as a watertight seal between pump base and platform. This should be applied liberally with a brush or wooden paddle when the pump is installed, and renewed each time the pump is removed for repairs.

G. E. Hendrickson, Argyle, Wis.

## Prevent Knot From Untying By Dipping in Shellac

A knot in the end of a rope will stay tied and there will be no problem of the rope strands unraveling if it is dipped in shellac. This kink is especially useful where the rope would be inaccessible as, for example, a sash-weight cord inside a window casing.



Paint, lacquer or glue could be used with equally good results if thinned so as to penetrate the fibers of the rope.

## Cutting Glass With Tin Snips

When it is necessary to cut a disk from a sheet of glass and no glass cutter is available, it is possible to do the job by holding the glass underwater and using tin snips. To help prevent the glass from breaking while it is being cut, cement a paper pattern to the glass with rubber cement. When using the snips, the glass actually is not cut in the normal sense of the word. Instead, the glass is "nibbled" away, each nibble being no more than  $\frac{1}{8}$  in. The finished edge will, of course, be rough. When doing this stunt for the first time, practice cutting on scraps of glass before cutting the disk. Plate or heavy window glass usually cannot be cut in this manner.

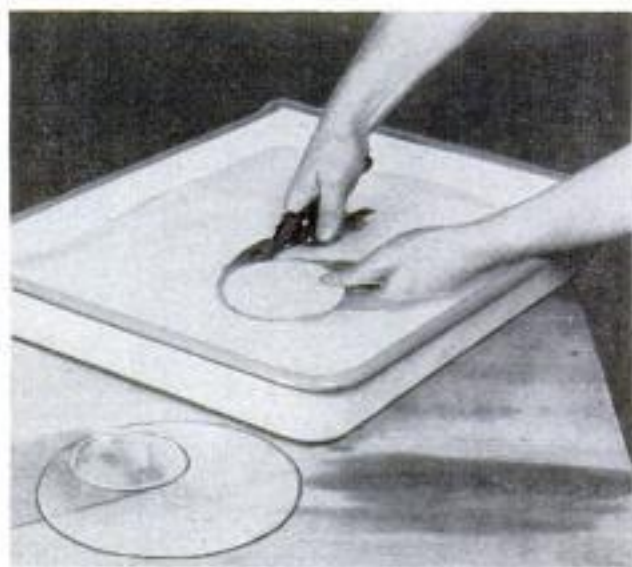



# INTERLOCKING CABINET

This novelty cabinet which features nail-less construction has a practical side, too—it can be taken apart completely in a few seconds for storing, cleaning or refinishing. As a cabinet of this type can be made in any size or shape for any one of a number of purposes, dimensions are not given. You will note that the ends are inserted through slots in the bottom, the front and back panels slip into the endpiece grooves and the top locks the cabinet together.

Albert S. Nelson, Colorado Springs, Colo.



Interlocking cabinet used for radio, above, can be made smaller for jewelry chest or larger for storage

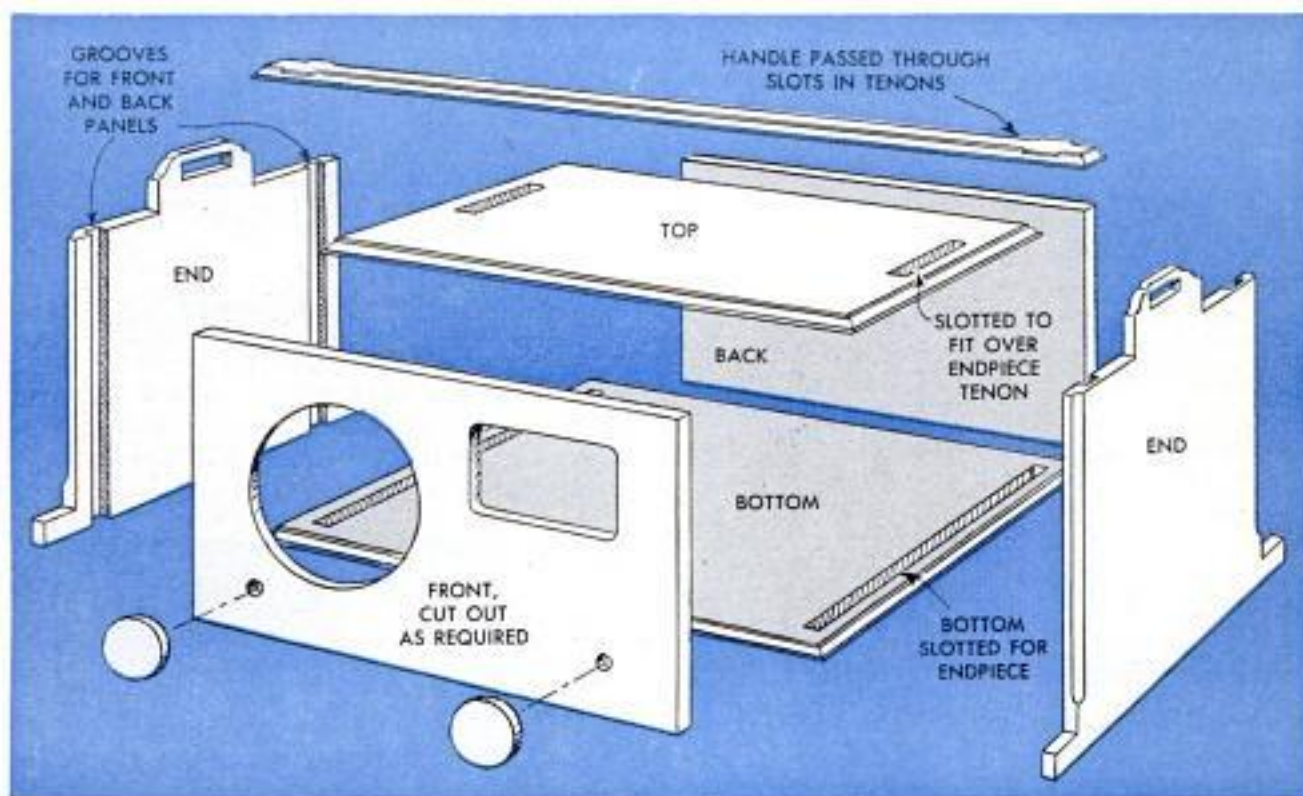

## Color of Paint When Dry Shown by Blotter Test



To determine the exact shade flat wall paint will have when it has dried, brush a little of it on a clean white blotter. The blotter will soak up the oils quickly and leave the pigments on the surface, where they will take on the same color as when dry.

## Glass Blocks Light Dark Closet

Dark closets and small rooms can be made lighter and will appear more spacious, if a panel of glass blocks is installed in a wall adjoining a larger and lighter room. Set the blocks in a picture-type frame, and use mastic, rather than mortar, to cement the blocks in place.



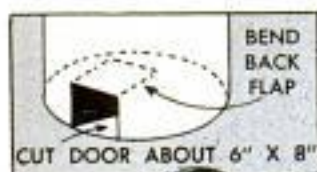

### Efficient Oil-Drum Incinerator Has Improved Draft Door

When converting an oil drum to incinerator, instead of punching draft holes at random around the bottom, cut a 6 x 8-in. draft door in it, as shown in the illustration. Bend the tab inward to form a hood over the draft opening. The greater draft permitted by this door will produce better combustion and will help to reduce all that is burned to finer ashes. These may then be raked out through the draft opening. If the drum is set on bricks at a slight angle, it can be ignited in damp weather simply by pouring a cupful of old crankcase oil into the draft door and touching it off with crumpled paper that has been ignited.

### Towel Bar Provides Shelf Rail



Bottles and cans of chemicals on a shelf in the dark-room will not be knocked off accidentally if a rail is provided by installing a towel bar on the wall above the shelf. Locate the bar at about half the height of the tallest bottle. If various-sized bottles are stored on the shelf, two towel bars may be used. Position the lower bar so shorter containers can be lifted over it and under the upper bar.

### Foil Helps Amateur Painter

Aluminum foil can be used to simplify the jobs of mixing paint and storing brushes. Mold a piece of foil around a water tumbler to make a container for mixing a small amount of paint; when using a large container, simply line it with foil. In

either case, when the job is finished, discard the foil. After a brush has been cleaned, wrap it in foil so it will not dry out or collect dust in storage. When painting must be halted temporarily, wrap the wet brush in foil; it will stay soft and pliant for as long as two or three days.

Tom Riley, Portland, Ore.

### Caster Cups Protect Cabinet Against Ant Invasion

Ants can be kept from climbing the legs of food cabinets by setting the legs in caster cups filled with insecticide. The back and sides of the cabinet should not be allowed to contact a wall which would



allow the ants to climb it and gain entrance in that manner. Another use for the cups would be to protect the legs of tables on which food is served in yard or patio.

### Envelope Made "Lightproof" With Newspaper Lining

Newspaper can be used to make a lightweight letter envelope opaque when it is necessary or desirable to keep its contents private. Fold a piece of newspaper double



and cut it to a size that will fit inside the envelope. Place the letter inside the fold of the newspaper. When the envelope is held in front of a strong light the printing on the newspaper will blend with the writing on the letter, making it impossible to read.

☞ Pipe cleaners make ideal ties for closing plastic refrigerator bags, because they are soft enough not to tear or puncture the plastic.



# Silhouette WALL BRACKETS

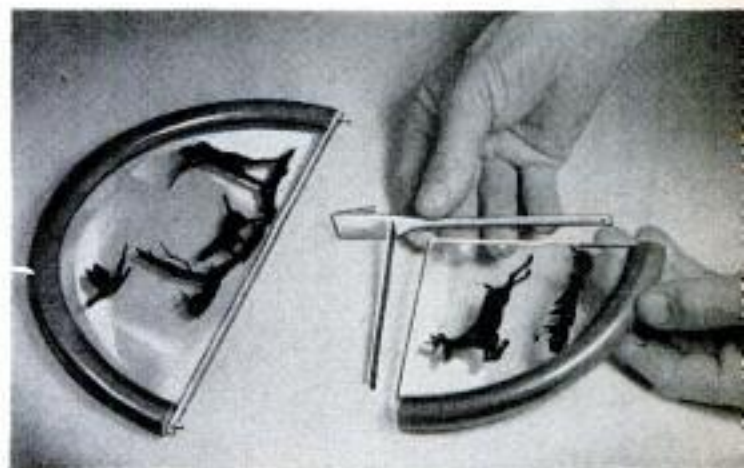
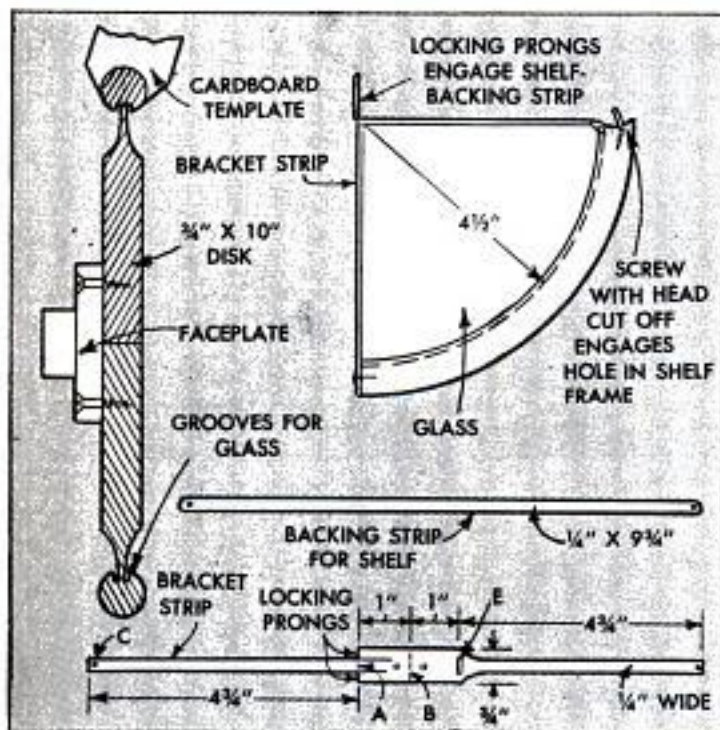

These striking wall brackets, which feature a turned walnut frame and double thicknesses of glass with silhouettes between, will brighten your wall or knick-knack corner. The frames are cut from a ring made by turning a  $\frac{3}{4}$  x 10-in. disk of walnut. The ring is grooved on the inside to take the glass and parted from the center stock of the disk. After both the half-circle and quarter-circle frames are made, the glass is cut to fit and then the sheet-metal

strips which hold the assembly together are made. The backing strip for the shelf is a straight strip with rounded ends. The bracket strip is cut to the dimensions given, bent 90 deg. at point A and then bent at point B as end C is pulled through the slot at E. The final shape of this strip can be seen in the photo at the right above. The ends of the strips are fastened to the frames with brads. Any desired silhouettes may be used.—Benjamin Nielsen, Aurora, Neb.

## Chuck Wrench for Grinder Held by Adhesive Putty

A simple solution to the problem of keeping track of the spanner wrench used on the chuck of small hand grinders is to use a lump of nonhardening glazing compound as a holder. The putty is pressed to the inside of the lid, as shown in the photo, and the wrench, in turn, is pressed against it. The wrench can be removed or replaced in an instant and is less likely to be mislaid.

Ken Murray, Colon, Mich.

When the groove in the top of a paint can becomes filled with paint, it is difficult to replace the lid so that the can is airtight. To keep the groove paint-free, fill it with a length of light rope or sash cord. After using the paint, simply lift out the cord.

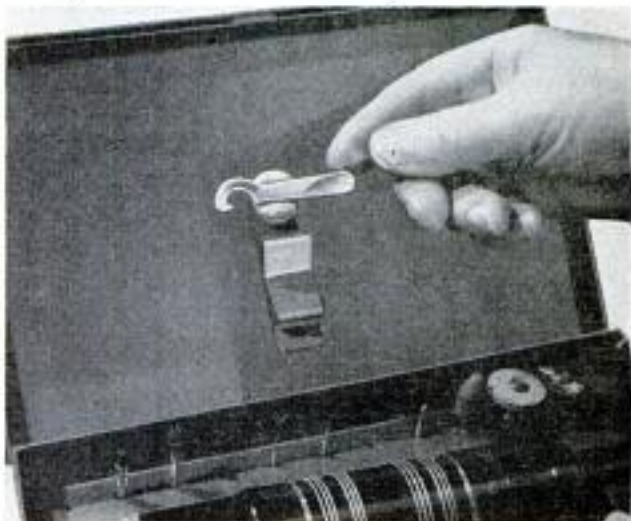



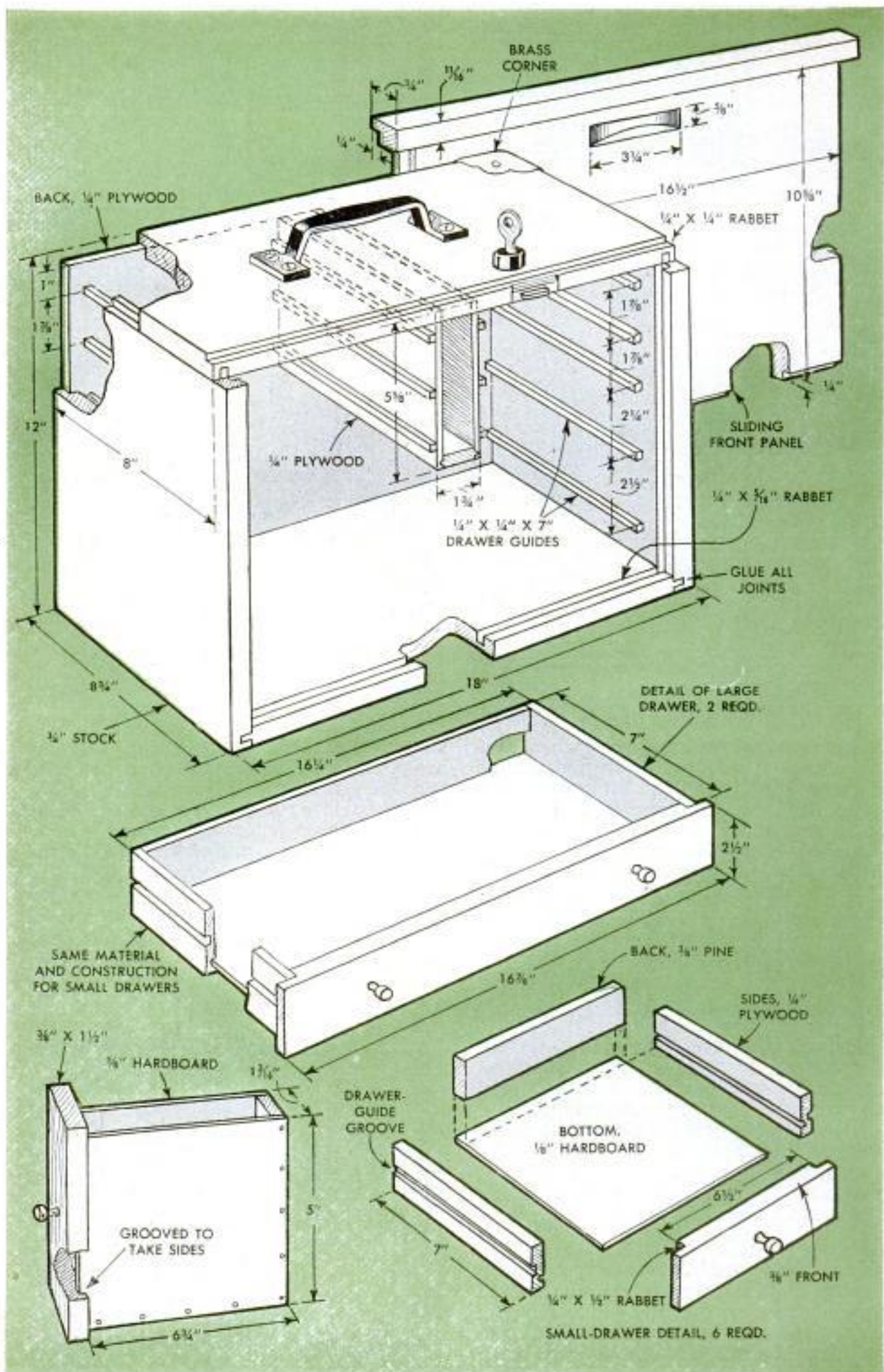



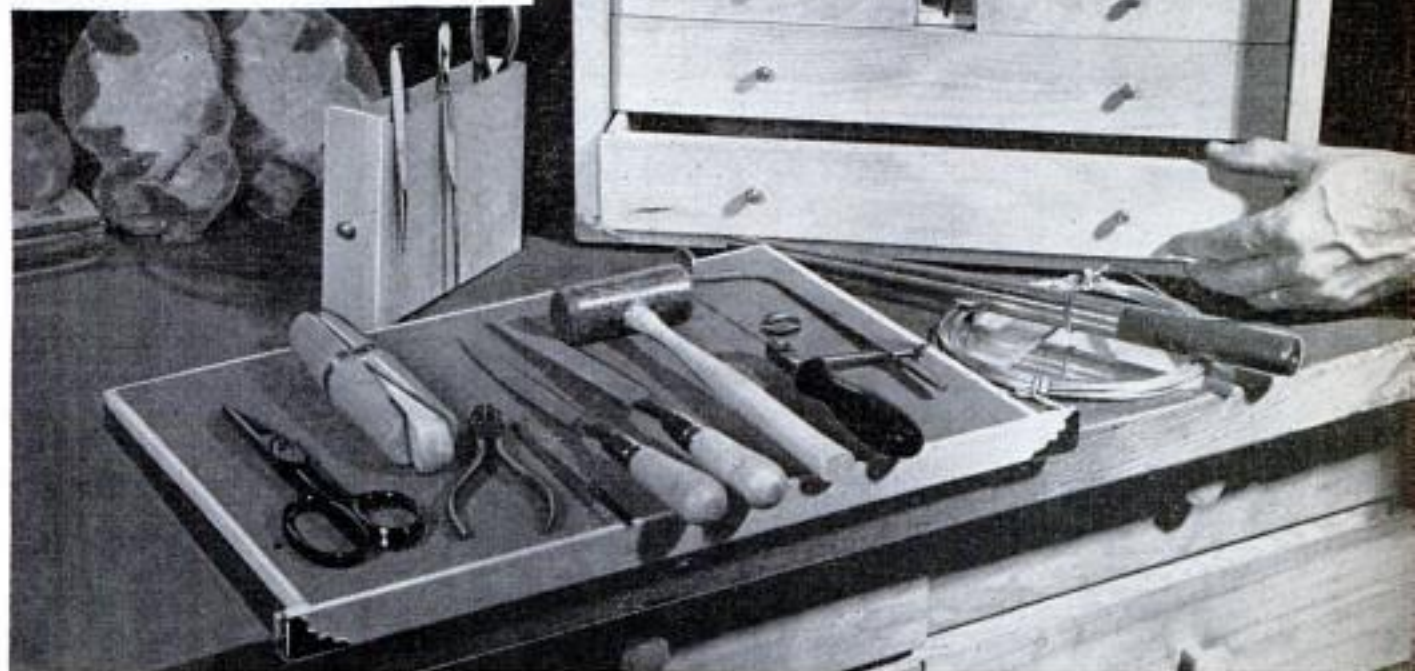

## CHEST FOR HOBBY TOOLS

**C**OMPACT AND GOOD LOOKING, this portable chest is designed to carry and store the small hand tools and supplies of hobbyists. Modelmakers, lapidaries, machinists, leather workers and others will find it a real convenience, but it also can be used as an elegant silver chest or sewing cabinet. The original chest was made from magnolia wood salvaged from some old cabinets and surfaced to clean off the

old finish on both sides. Old wood obtained in this manner usually is of excellent grain and is well-seasoned; however, any hardwood could be used. The plywood parts of the cabinet were made of  $\frac{1}{4}$ -in. ash-surfaced plywood, which is fairly expensive in whole sheets, but many cabinet shops will sell small scrap pieces inexpensively. See construction details on the facing page.

Roland Cueva, Heyburn, Idaho.

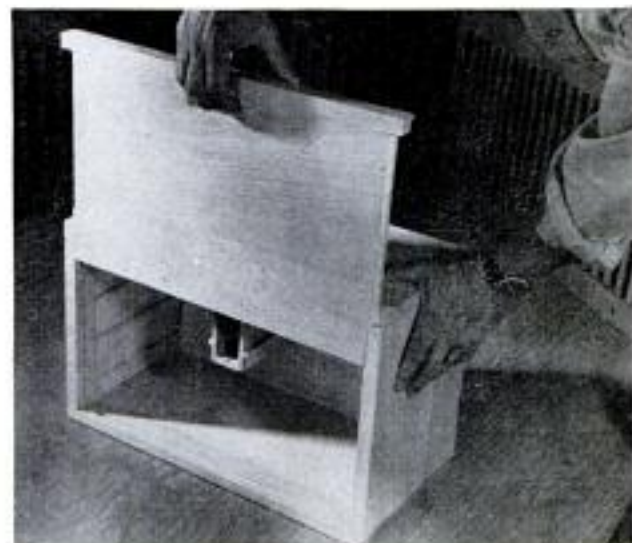
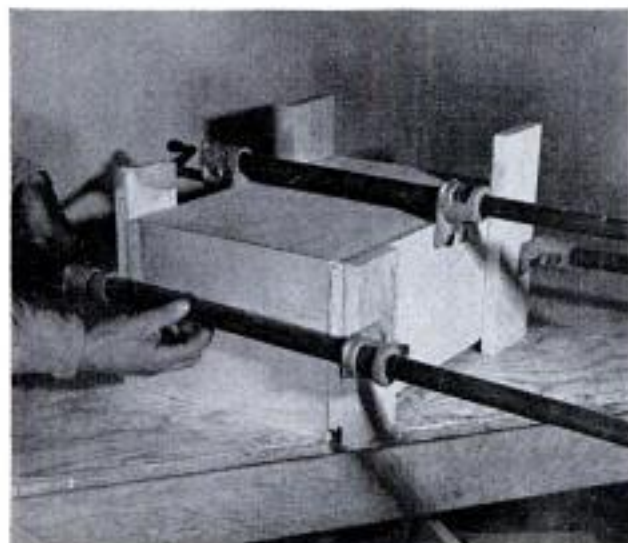



## Card Tables "Locked" Together By Tin Cans Under Legs



When two or more card tables are used for a picnic or other outdoor luncheon, they can be held together by setting the adjacent pairs of legs in tin cans. Use cans that provide a snug fit for two legs and are high enough to prevent the spring of wooden legs from allowing the tops to be forced apart.

## Weights Hung Inside Steel Posts Keep Clothesline Taut

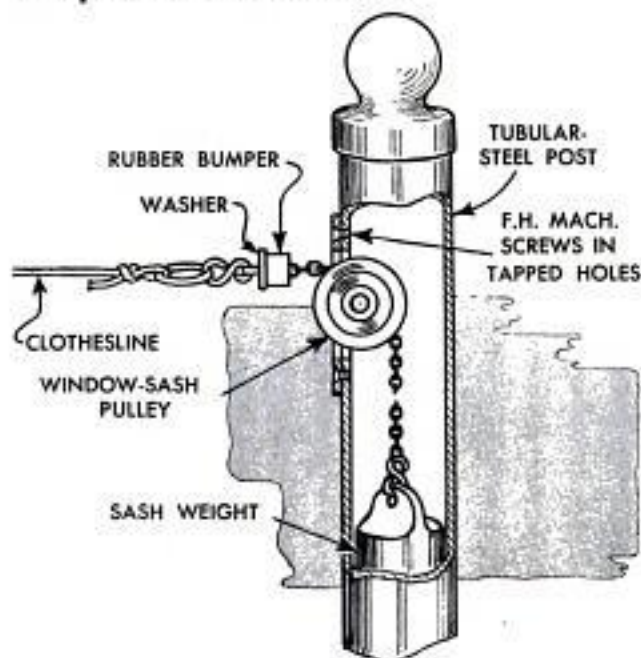

Window-sash weights hung inside steel clothesline posts will provide a means of automatically keeping a line taut. A slot is drilled and filed in each post to accommodate a window-sash pulley, which is attached with flatheaded machine screws

driven into tapped holes in the posts. Sash chain, rather than cord, should be used to support the weights. The clothesline is attached to the chain by means of an S-hook. A steel washer and rubber bumper slipped over the end of the chain prevent the clothesline from being pulled into either post. The posts should be installed so they can be unscrewed from a coupling above ground level in case it is necessary to replace or repair the weights or chains. The length of the line is governed by the weight of clothes that can be hung on it without overcoming the pull of the sash weights.

## Rubber Bumper on Children's Swing Prevents Accidental Injury



The officials of one children's playground have equipped all of the swing seats with rubber bumpers to prevent accidental injuries in the event a child is hit by the moving swing. The bumpers are lengths of garden hose nailed around the edges of the wooden seats. Certain types of rubber weather stripping or strips of foam rubber would serve just as well.

Clarence Leino, West Allis, Wis.

## Prevent Sticking of Prints

Inserted between prints in a tray-type washer, separators cut from plastic window screening will speed up the washing time and keep the prints from sticking together. The screening will not cause abrasion marks and cannot stain the prints. To prevent the edges of the screen from unraveling, coat them with clear nail polish. One set of separators will last for years.





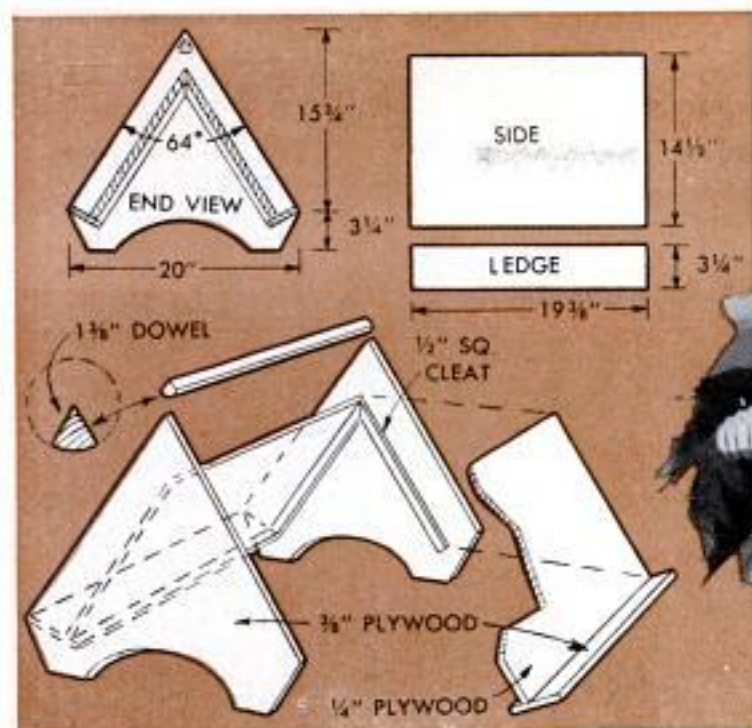

## Plywood Magazine Rack Is One-Evening Project

Even the largest magazines fit neatly on the slanting sides of this magazine rack, and, with the materials on hand, the rack easily can be built in an evening. Ends and ledges of the rack are  $\frac{3}{8}$ -in. fir plywood, the sides  $\frac{1}{4}$ -in. plywood. The sides are screwed to  $\frac{1}{2}$  x  $\frac{1}{2}$ -in. cleats fastened to the ends, the screws being countersunk in the plywood and covered with wood putty. To make the handle of the magazine rack,

a  $1\frac{3}{8}$ -in. dowel the same length as the sides is ripped to a wedge shape, as shown in the detail. The beveled faces of the handle should align with the top edges of the rack ends. For a better finished appearance, the end grain of the plywood may be covered with strips of  $\frac{1}{8}$ -in. stock which are glued in place. Fir plywood can be painted, stained or finished natural.

Elmer W. Ferris, Winnetka, Ill.

## Electrical-Outlet Guard Protects Crawling Baby

This receptacle guard will prevent a crawling baby from pulling electrical plugs part way out and contacting the bare prongs with his fingers. When the light cord or extension needs to be unplugged, the guard is easily removed. The screws that hold the guard to the wall are not completely tightened and a slight squeeze will slip either flange from under the screwhead. The cord then can be pulled through the channel and the guard replaced. The  $\frac{1}{8}$ -in. channel on the original guard was made for light lamp cord. A heavier cord would require a wider channel.

Arne O. Salonen, Raymond, Wash.

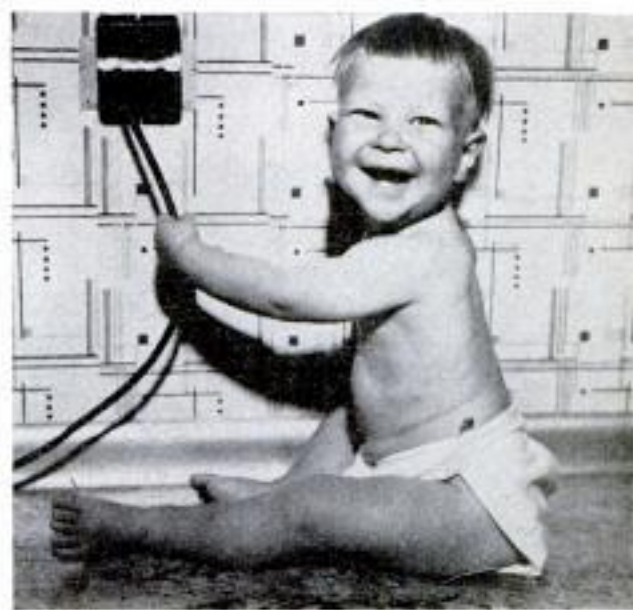
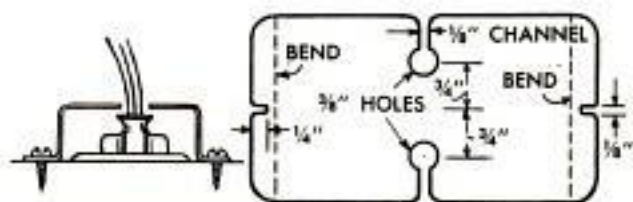

☐ About a week to 10 days before removing seedlings from a cold frame for transplanting, cut deeply through the soil between the rows, using an old carving knife. This severs the long feeder roots and forces each plant to develop a more compact root system.





# JU-BE— THE FAMILY PUNT

By Hi Sibley

**S**OUND, DRY and seaworthy, Ju-be is a lot of boat for the money and time required to build it. Ju-be is three pieces of marine plywood, two chines, a keel, a seat and two side planks fastened together with screws and marine glue. It can be rowed, poled or driven by an outboard motor if fitted with a suitable transom.

Side planks are two  $\frac{3}{4}$  x 12-in. fir or spruce boards, 16 ft. long. The bottom and decks are cut from marine plywood, the bottom  $\frac{3}{8}$  in. thick and the decks  $\frac{5}{8}$  in. thick. The three lower-right-hand details in Fig. 2 show the method of joining the curved ends of the side planks to oak nose-pieces. Note that the width of the nose-piece is given as 4 in. across the narrow outer face. This means that the width of the side planks at both ends should be about 4½ in. to allow for planing flush. Cut the side planks to profile, Fig. 1, then screw the oak chines to the straight section of the side planks, leaving the ends of the chines free. Use marine glue in the joints. Now nail in temporary spreaders and bend the ends of the side planks inward as in the lower right-hand details, Fig. 2. Before screwing the free ends of the chines in place center guide strips as in the lower detail, Fig. 2, to locate the centerline. Once this has been located, fasten the free ends of both chines. Then install the nosepieces, using marine glue in the joints. Next, fit

the bottom ribs, spacing on 22 and 24-in. centers. Note that the midships rib is 2½ in. wide to provide adequate bearing for joining the ends of the plywood panels that form the bottom.

Turn the assembly over and plane all joints flush, fairing the curves so that the plywood bottom panels bear equally on the full width of all members. Spread marine glue on the joining surfaces and unroll



mastic tape over the joint at the chines, the center rib and across the lower edge of the nosepieces. Note the position of the tape with relation to the joint in Fig. 2, the circular detail. Install the bottom panels with 1-in. No. 7 brass screws, countersinking the heads flush and spacing about 1¼ in. apart in a staggered line to prevent splitting the wood. Trim the overhanging portions of the plywood panels flush with the sides and ends. Install the oak keel.

Turn the assembly over and install beams to support the plywood decks. Cut the plywood deck pieces a trifle oversize, fasten in place with screws and glue and plane flush at the edges. Install the oak rubrail at the sheer, or gunwale. Fit an eyebolt at one end (or deck cleats at both ends) for tying up at the shore or pier. Fit seat rails, seat, oarlocks and the false bottom. The pole in Fig. 1 is optional. Finish the boat inside and out with marine paint. ★ ★ ★





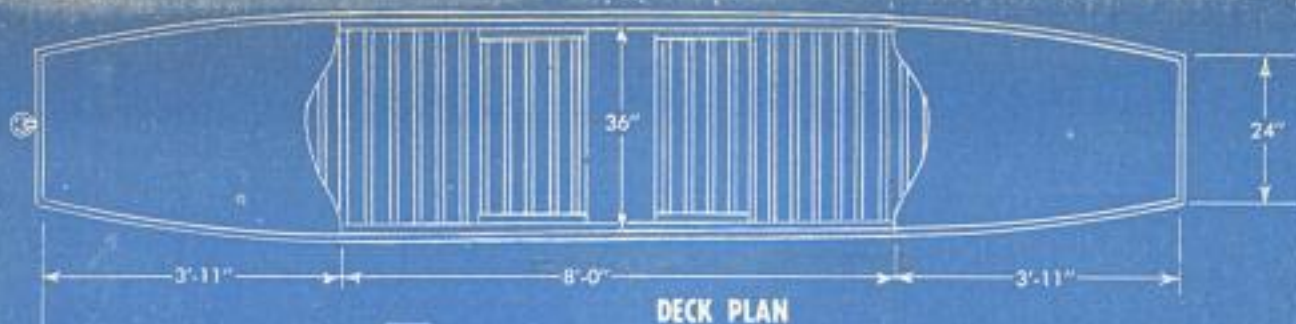

1

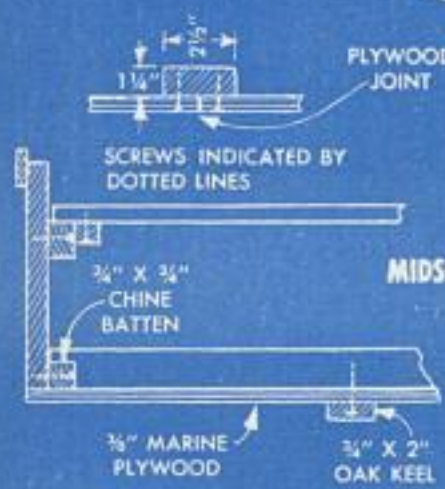
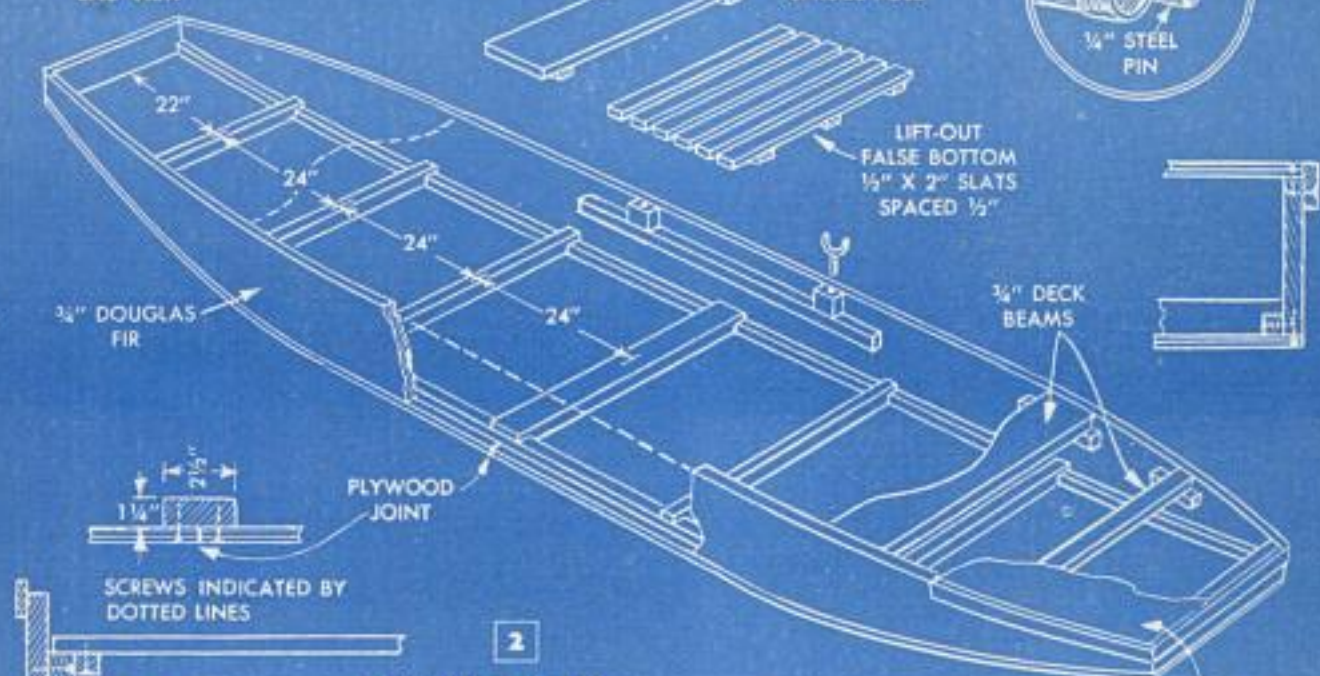
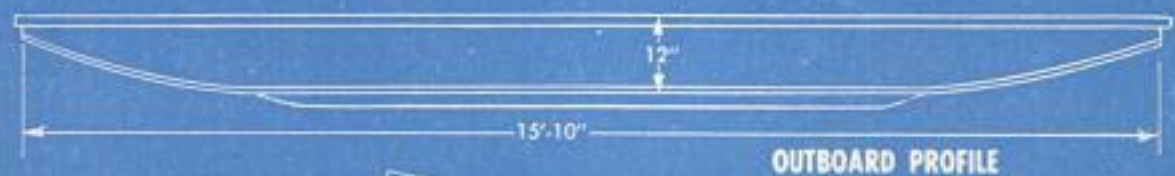

2

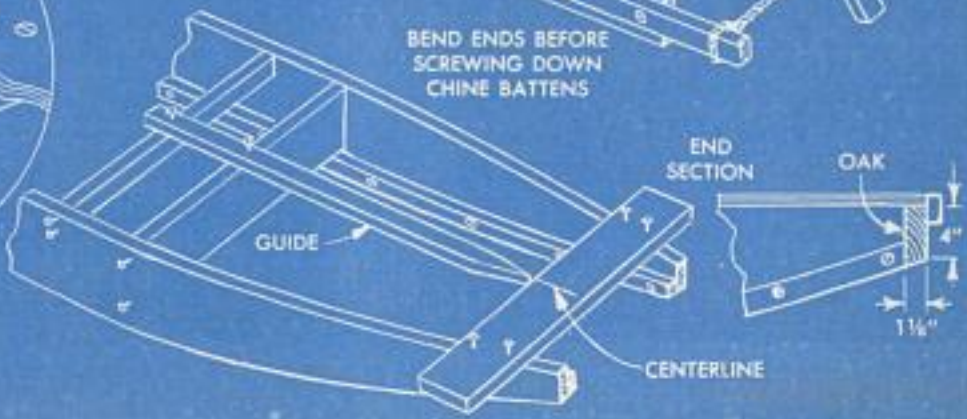
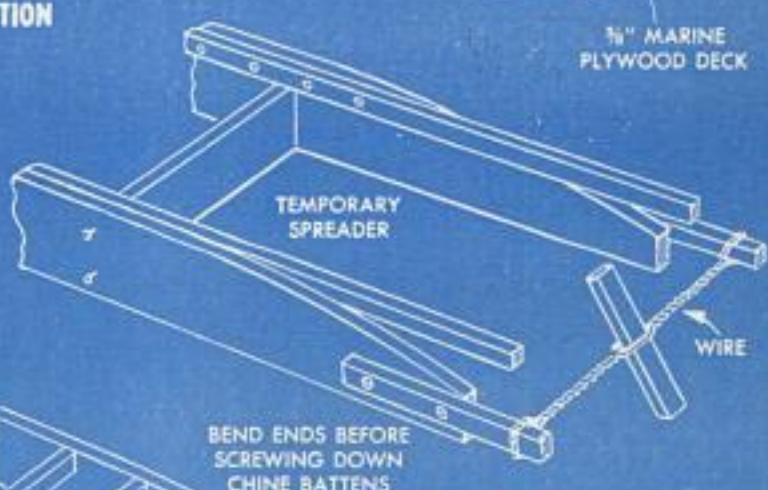



## Ball Bearing in Thimble Holds End of Twine



A ball bearing dropped into a thimble can be used to provide a positive means of holding the end of a length of twine that is run up through a bench or counter top from a ball below. Drill a hole in the top just large enough to be a snug fit for an ordinary sewing thimble. Next, drill or punch a hole in the bottom of the thimble, smoothing the edges of the hole so it will not cut the twine. Pass the twine through the hole in the thimble, then drop a ball bearing of suitable size into the thimble. The weight of the steel ball will permit the twine to be drawn up through the hole, but will not allow it to fall back through.

## Stopper for Screw-Top Can



A cork cemented to the top of a screw cap on a can will provide a stopper that can be removed and replaced quickly when using a liquid such as car or furniture polish.

When the can of liquid is being used, the cap is unscrewed and inverted so the cork can be forced into the opening in the can. When the can is to be stored away, the cap again is inverted and screwed tightly in place.

## Paint Auto Instrument Panel To Improve Appearance

The interior appearance of an automobile often can be improved by painting the instrument panel and window frames on which the finish seems to deteriorate more rapidly than other painted surfaces of the car. A pressure-type can of paint will per-

mit doing a quick and inexpensive job. First, carefully sand the dashboard and window frames with fine sandpaper, removing all rough spots and feathering all scratches. Next, mask the windshield and all chrome trim on the instrument panel. Cover the front-seat upholstery and leave all doors and windows open. Window frames can be removed and painted outside the car. It is best to experiment with the paint spray to get the feel of using it. Painting the frames, which can be wiped clean if the job is not satisfactory, provides a practical method of testing your skill.

Clem B. Martin, St. Petersburg, Fla.

## Suet "Stick" Feeds Birds

An easy way to make suet available to birds is to use a feeder like the one shown. It consists of a 2 x 2 x 7-in. block fitted with perches and a short coil spring for hanging. Suet is held in 1-in. holes drilled in the block just above the perches, which are  $\frac{1}{4}$  or  $\frac{1}{2}$ -in.



dowels glued into drilled holes. Be sure to hang the feeder so the birds will be safe from cats.

Frank A. Javor, North Bergen, N. J.

## End-Grain Splitting Prevented

To prevent breaking the corner of a piece of stock when planing the end grain, clamp it to a piece of scrap wood and hold them in a vise. Any damage done by the over-riding plane then will be to the waste lumber.—R. F. Donovan, Guttenburg, N. J.

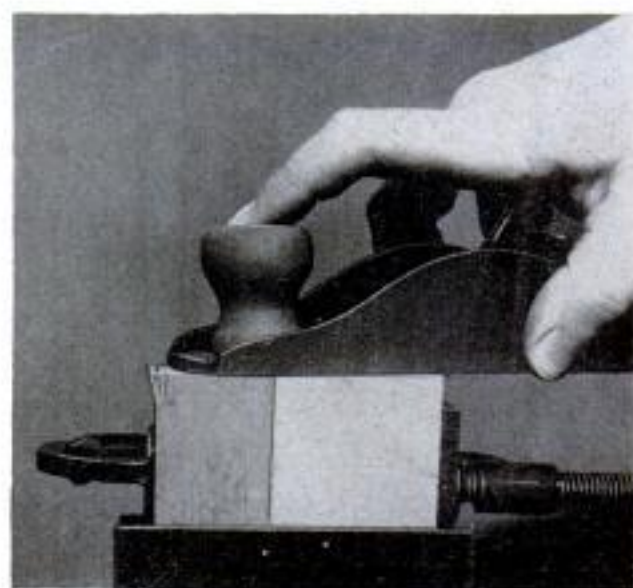



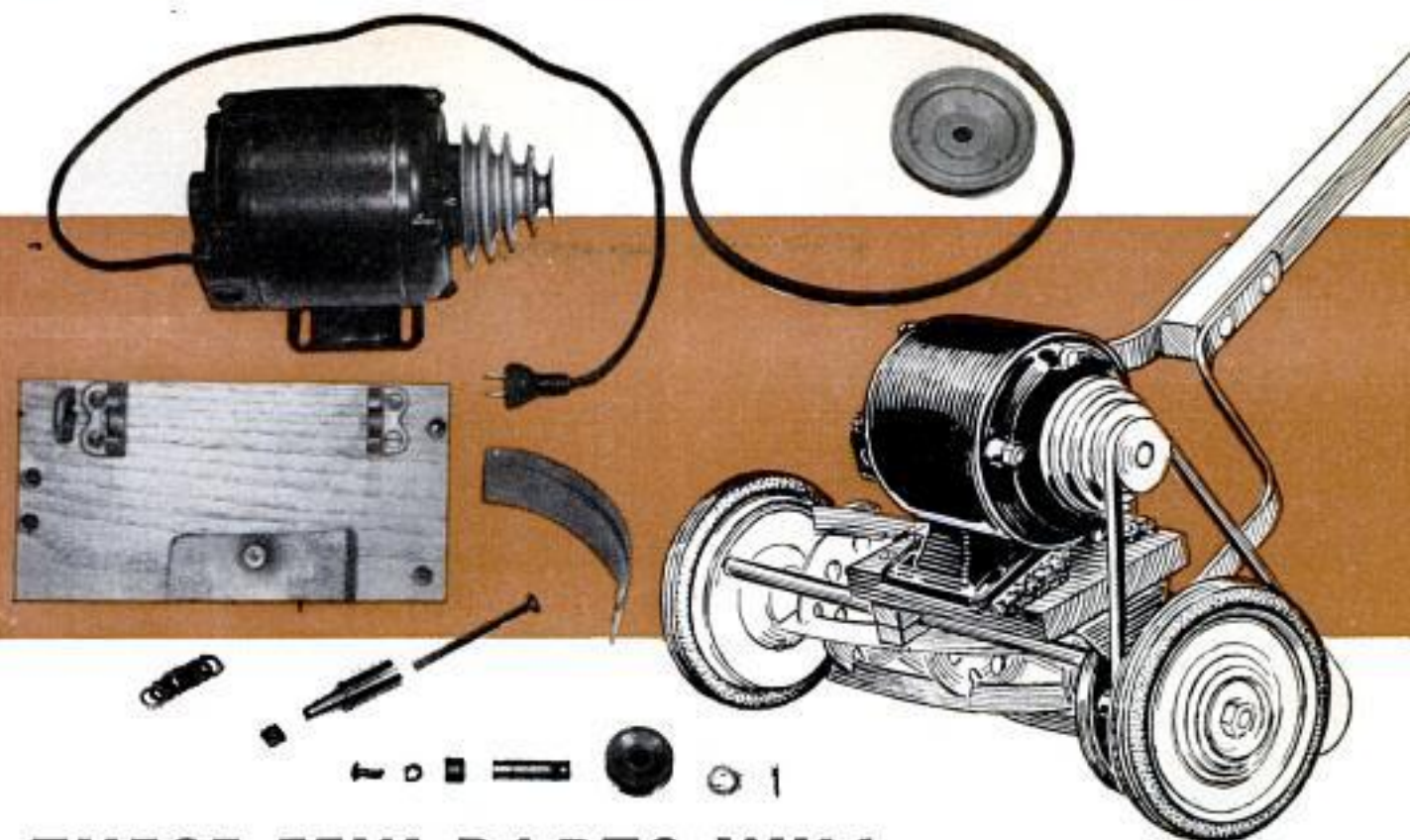

## THESE FEW PARTS WILL MOTORIZE YOUR MOWER

By Harry L. Truchelut

**W**ANT TO TAKE some of the "push" out of your hand mower? You can do it easily with a  $\frac{1}{8}$ -hp. electric motor and a few odd parts. Basically, the job consists of extending the original axle of one wheel to provide pulley clearance, fitting a V-pulley to the blade shaft, adding an idler pulley to the mower-wheel housing and providing a wooden platform for the motor. Fig. 1 shows how a tapered spindle extension is machined to fit into the old axle. The distance between the shouldered section and the outer end of the spindle should be  $\frac{1}{2}$  in. longer than the length of the wheel bearing. The general dimensions given are specifically for an 18-in. Savage (35) mower and it may be necessary to modify them to suit

After removing wheels from mower, pinions and pawls are removed from ends of blade axle. These parts are not needed. Right-hand wheel is replaced

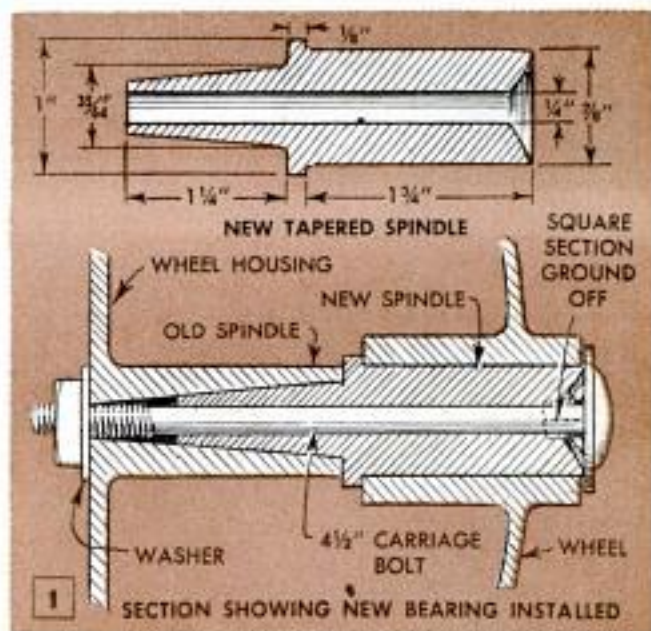

The degree of internal taper in wheel spindle is measured with cardboard template and then new extension spindle is turned to seat accurately in hole

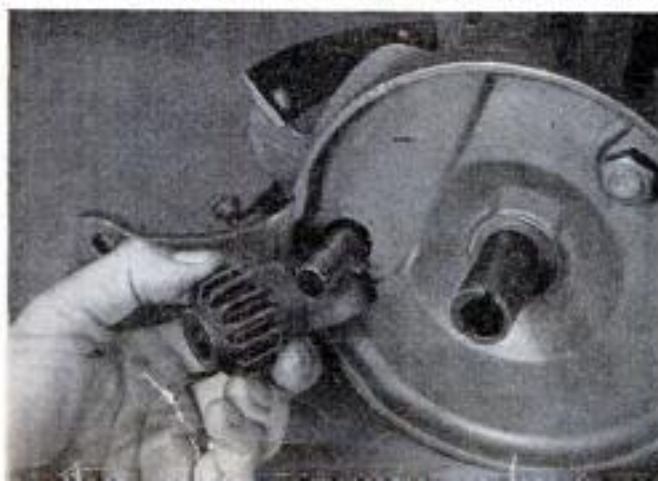



the particular type of mower at hand.

Both wheels must first be removed from the mower so the pinions and the pawls on the blade shaft can be removed and discarded. The right-hand wheel is now replaced. A 4-in. V-pulley with a  $\frac{1}{2}$ -in. hole takes the place of the pinion in the left-hand wheel. You may find it necessary to ream the pulley slightly to make it fit the shaft. The pulley is locked to the shaft with a setscrew bearing on a flat. The latter is formed on the shaft with the edge of a flat file. Washers are placed behind the pulley to keep grass clippings out of the ball bearings.

Fig. 2 details the idler assembly. It consists primarily of a 2-in. V-pulley rotating on a  $\frac{1}{2}$ -in. stub shaft to track freely with the 4-in. V-pulley. A 2-in. V-pulley on a 1725-r.p.m. motor will give a cutting speed of about 860 r.p.m. The end of the idler

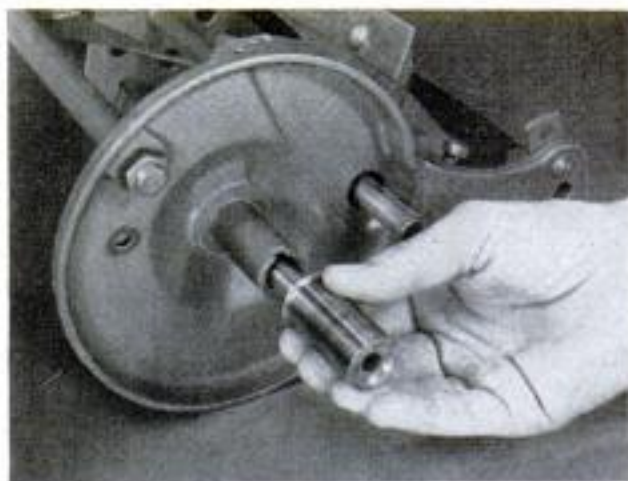

Left-hand wheel spindle is extended to provide clearance for pulleys. New extension shaft is turned from steel to fit tapered bore of spindle. Long carriage bolt holds both extension shaft and mower wheel to housing. Shouldered portion of spindle must fit wheel

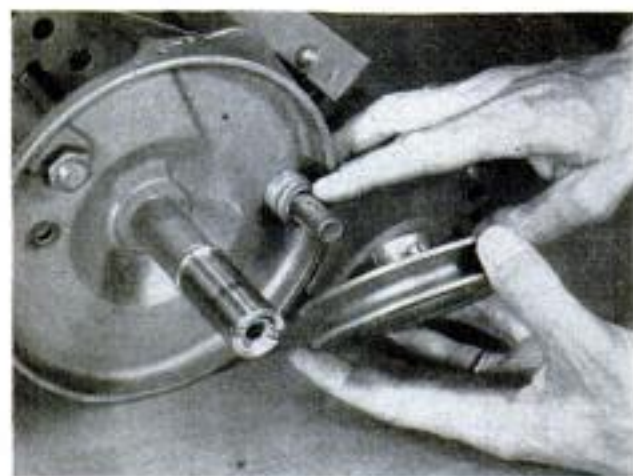

Number of washers needed on blade shaft to keep grass out of bearings is determined by clearance between housing and pulley. Put drop of oil on washers

Stub shaft for idler pulley is mounted to wheel housing with machine screw and lock washers. Spacer sleeve on shaft aligns idler pulley with blade pulley

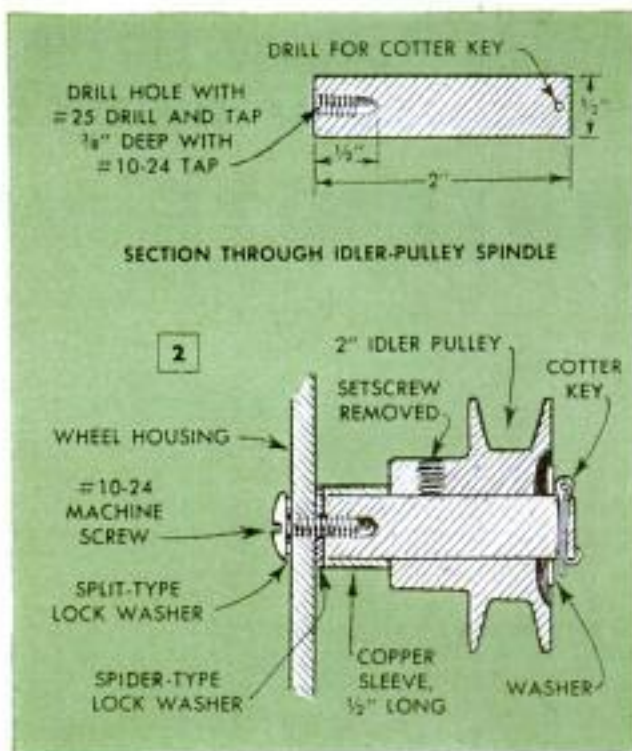
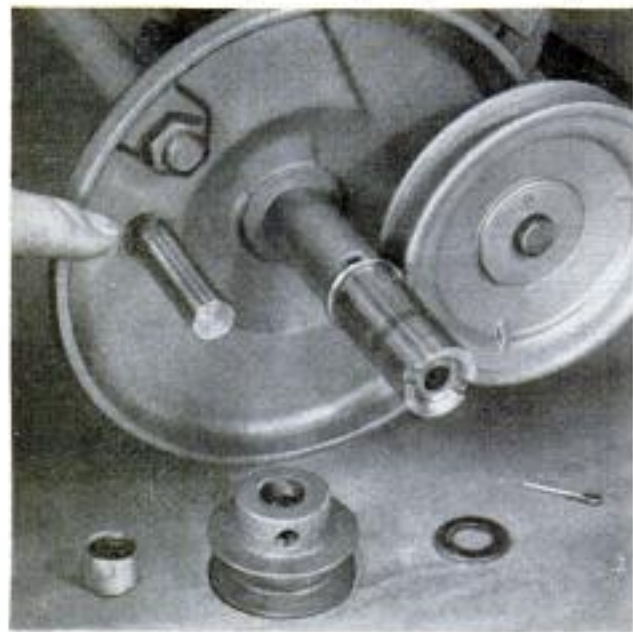

Angle-steel bracket on end of motor platform is bolted to threaded end of protruding mower guard bar. See Fig. 4. Opposite end of platform clamps around bar

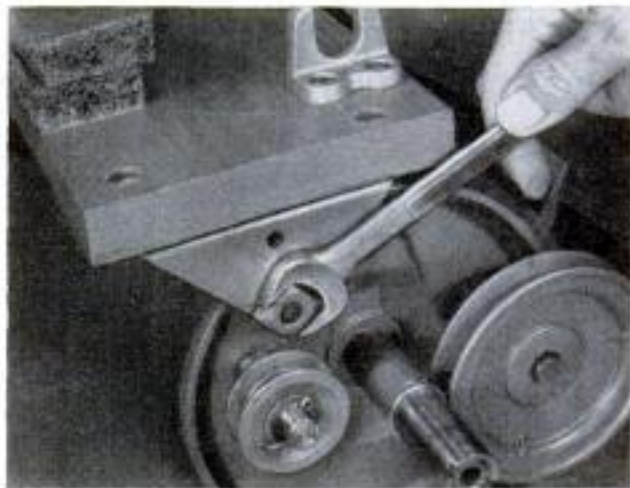



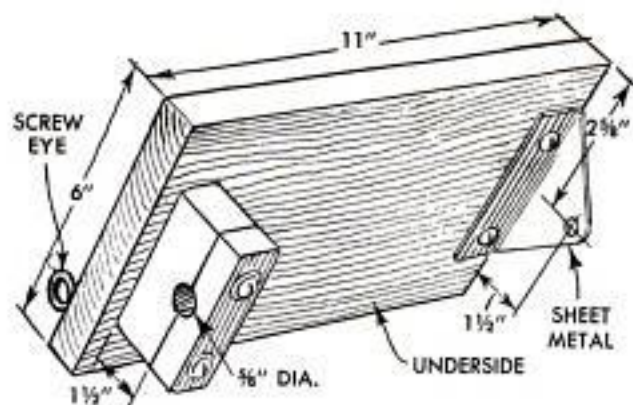

**3** MOTOR-PLATFORM DETAIL

shaft is drilled and tapped for a machine screw which is used to anchor the shaft rigidly to the cast-iron wheel housing. A shoulder is formed on the idler shaft with a short length of copper or steel tubing to bring the idler pulley into alignment with the 4-in. pulley. The setscrew is removed from the idler pulley and a cotter key and washer are used to hold it in place on the shaft. Lubricate with a little grease.

Figs. 3 and 4 detail the motor platform. The motor may be fastened permanently to the platform or held by a floating-type motor rail which permits the motor to be removed easily for use elsewhere. When the latter method is used, a large screw eye is provided to engage the end of the motor-mounting rail and prevent the belt tension from pulling the motor out of the rail clip. A piece of sponge rubber may be used under the motor to take care of belt tension or you can provide a regular adjusting screw in the platform to bear against the base of the motor. Select a standard 1/2-in. V-belt as close to the required length as possible. Belt play can be taken up by turning the adjusting screw. Adding a sheet-metal pulley guard completes the job. Fig. 5 shows how a utility box fitted with a switch and receptacle can be attached to the mower handle to make it convenient to plug in and control the motor. Although a common

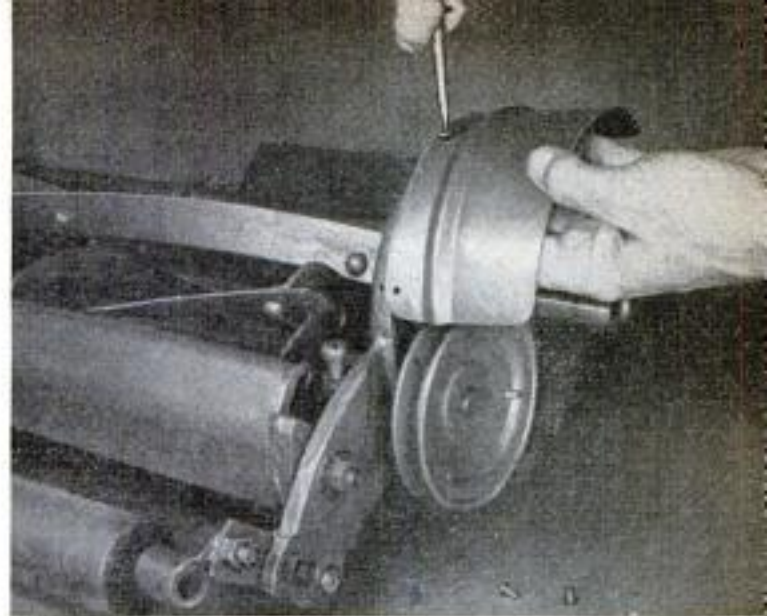
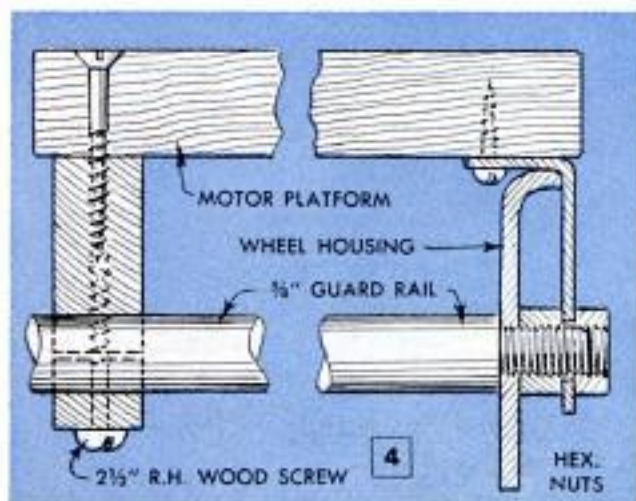

Sheet-metal pulley guard is attached to underside of wheel housing with small machine screws in tapped holes. Where the rim of the housing is not flat, guard can be attached with small angle brackets. Guard keeps tall grass out of the pulleys—can be omitted

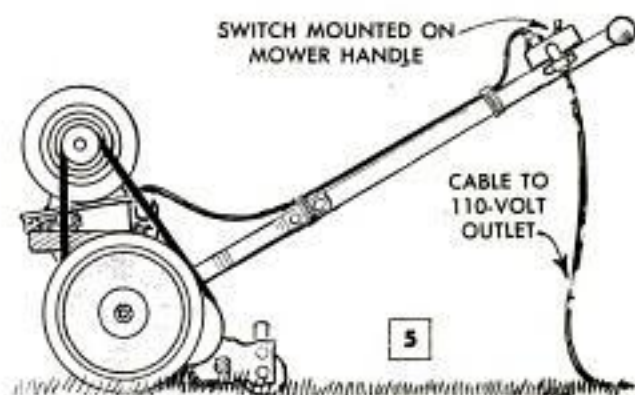

interior-type switch box is shown, you should use a weatherproof outdoor-type box to be perfectly safe. Also, the cord from the motor, as well as the 110-v. extension cord, should be heavily insulated and contain three wires so that the third wire can be grounded both to the switch box and to the 110-v. outlet into which the extension cord is plugged. ★ ★ ★

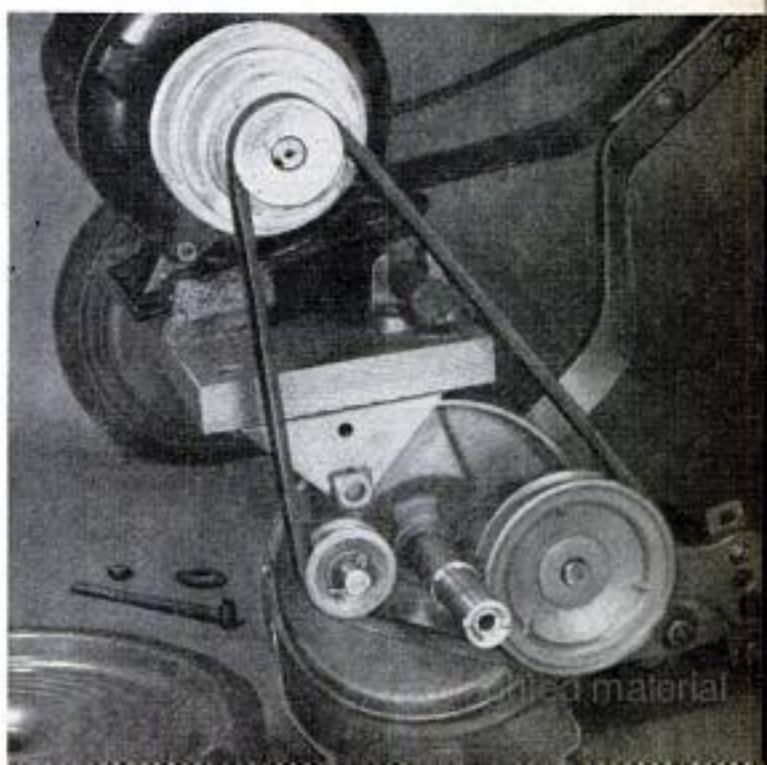



## Guides Speed Photo Cropping



Two L-shaped guides cut from cardboard or fiberboard provide a method of quickly determining the portion of a photo to be retained by cropping. The legs of each "L" are 2 to 3 in. wide and the inside angles must be exactly 90 deg. In use, a guide is held in each hand in the shape of a frame, as illustrated. Moving the guides diagonally toward each other will reduce the uncovered area of the photo to the desired size. To make it easier to keep the guides at right angles to each other, mark them in inches and fractions of an inch.

## Stocking Protects Furled Flag



When storing a large flag such as those used on curbside staffs, a woman's stocking slipped over the furled banner will protect it against soiling. If the flag is to be stored in basement or attic where it might become extremely soiled, a more positive protection would be to wrap it in plastic sheeting or aluminum foil first, then slip the stocking over it.

## Raising Dents in Furniture

Dents in the exposed wood of furniture frequently can be raised with steam. Moisten the dent and the area around it with warm water. Then place a piece of dampened toweling over the dent and apply a hot iron to the cloth, directly over the dent.

In the case of large dents, the operation may have to be repeated several times. After the dent has been taken out, apply a good coat of wax to the area.

W. Dyre Doughty, Tucson, Ariz.

## Bullet-Type Cabinet Catch Silences Rattling Door

A door that rattles because of a slight clearance between the latch and striker plate can be silenced by installing a bullet-type cabinet catch in the doorstop opposite the latch. To prevent the catch from marring the door, a steel-headed thumbtack is forced into the face of the door so the catch bears against it. The light pressure of the catch will hold the striker firmly against the plate.

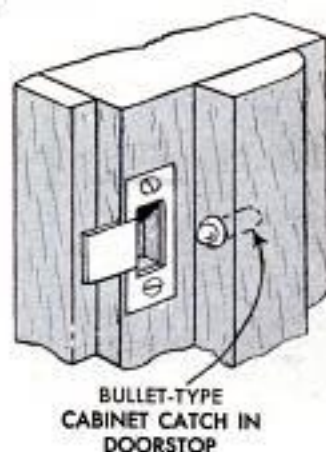

BULLET-TYPE CABINET CATCH IN DOORSTOP

## Fence on Sanding Block Assures Straight Edges

A sanding block fitted with a fence, as indicated in the detail, will assure precision edge sanding at right angles to the side of a board. It is particularly useful in smoothing end grain. To make the block, hinge two pieces of wood together so they grip the sandpaper tightly. Then screw another piece of wood at right angles to the unhinged edge of one of the blocks. The dimensions given permit convenient use of standard sheets of sandpaper. The pressure of the hand on the upper block during the work keeps the sandpaper securely between the blocks.

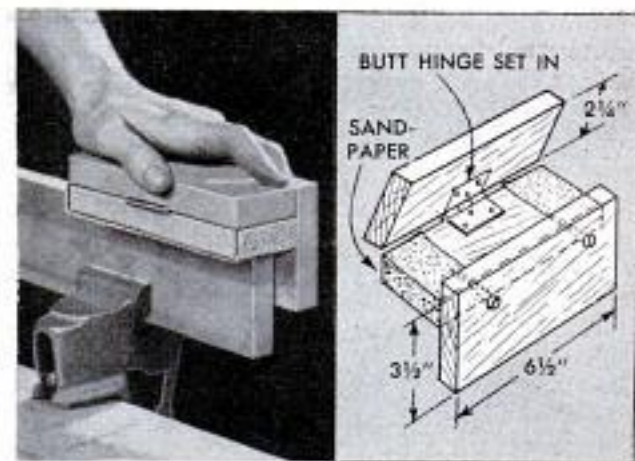

☞ Bottle caps can be slipped under heavy trunks and cases, crimped side up, to provide slides which make a moving job easier.



# BACKSTAND for circular saw

By R. T. Williams

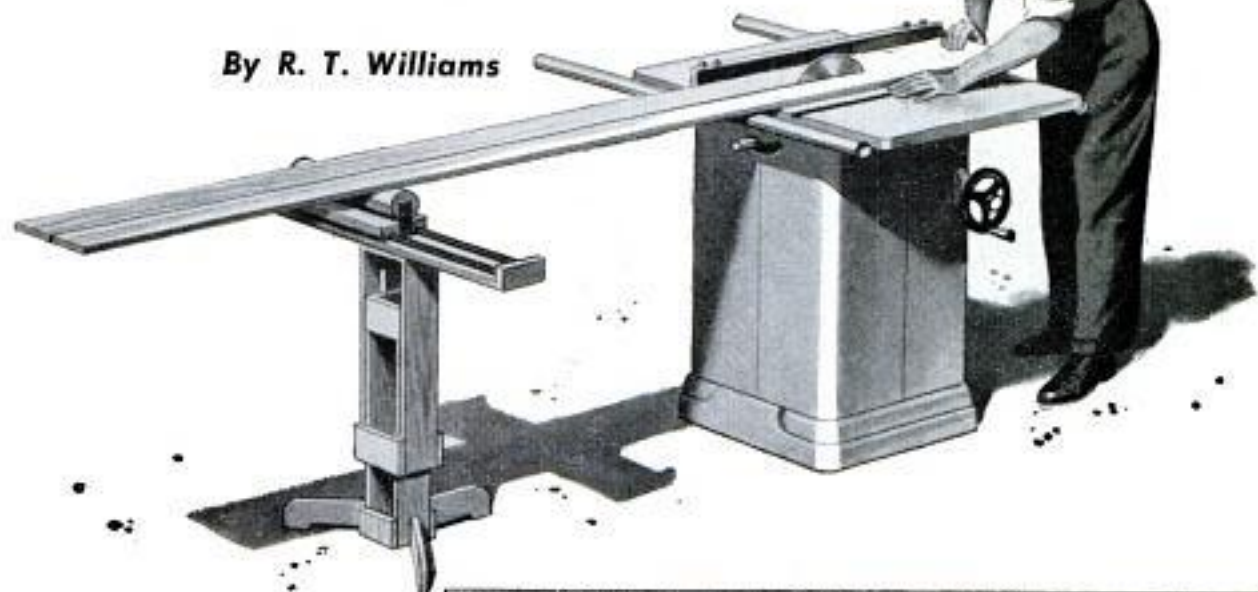

CAREFUL operators of circular saws use a backstand when ripping or cross-cutting long boards. When ripping, the stand supports the board throughout the last half of the cut, making it easy to guide the stock accurately and at the same time preventing it from tipping down and causing the blade to bind. When cross-cutting near one end of the board, the stand supports the long overhang.

An unusual feature of the stand detailed is the sliding roller which permits positioning the roller directly behind the saw blade. The roller also becomes a sliding support when crosscutting with the stand placed at the side of the saw. The unit also can be used as a backstand when working long boards on the jointer.

Before starting construction, check the height of the lowest machine with which the stand is to be used. If necessary alter the dimensions given to obtain the correct minimum height. Use solid stock joined with screws and glue for strength and rigidity. Either hardwood or softwood can be used. Hardwood is best.

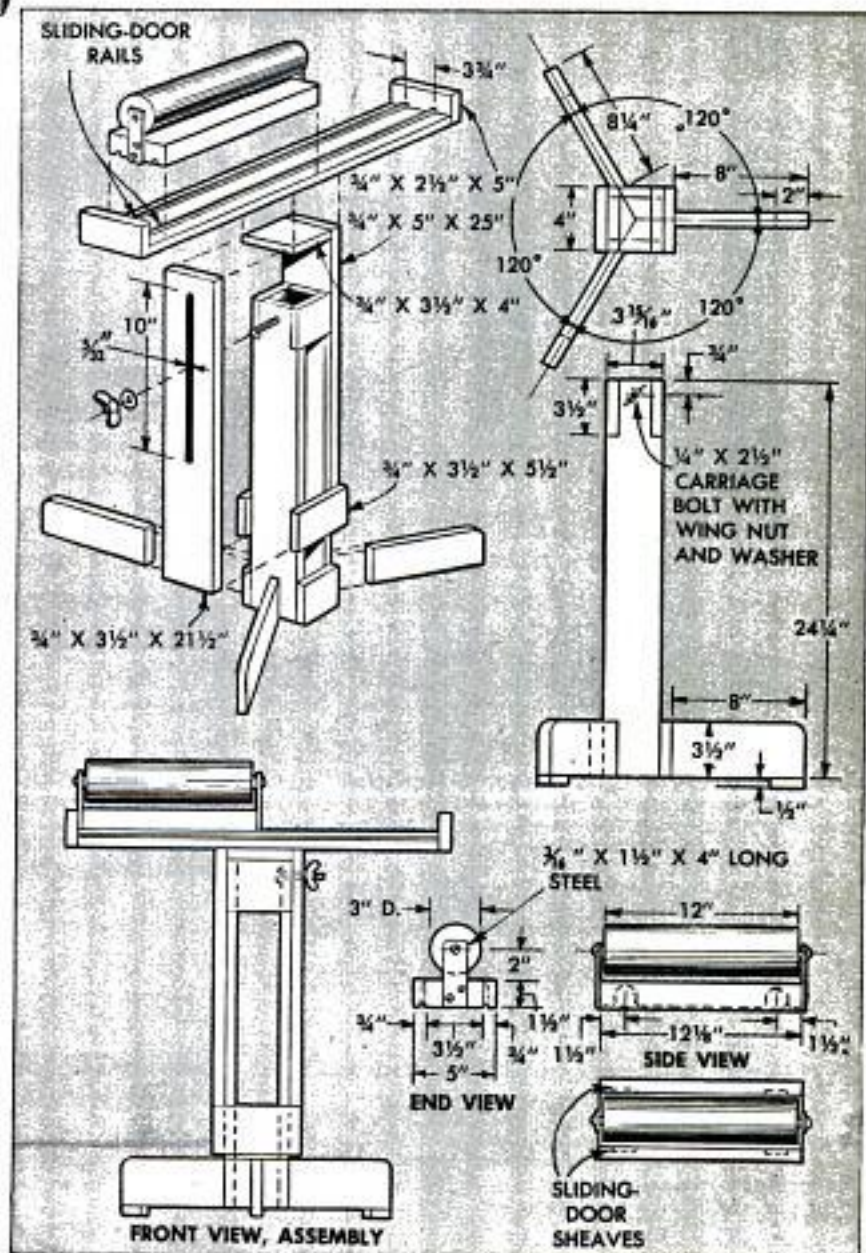



# Taking the Guesswork Out of INTERIOR PAINTING



How to select and use the right paint for the job to avoid common painting failures. Includes data and recommendations for preparing surface, applying deep colors

By E. R. Haan

**H**AS THE do-it-yourself painting bug bitten you yet? It's possible you already are one of the great army of amateur brush swingers who are buying and applying over two thirds of all the paint being sold. While modern paints have taken the word skill out of painting for both Mr. and Mrs. Homeowner, many beginners blithely apply one coat over another without giving too much thought to the importance of proper surface preparation and the right

paint for the job. Such mistakes as applying enamel over one coat of flat paint, or over a waxed or old calcimined surface have been made by many amateur painters with unhappy results.

**Follow reputable dealer's advice:** As there are many brands of paint that vary in formulation, quality and purpose, the job of selecting the right one becomes somewhat confusing. However, after deciding to avoid cheap, questionable paints and to use only those of high quality, the problem simmers down to relying on the advice of a reputable paint dealer. His suggestion will depend on what you are going to paint, the condition of its surface and other considerations as given in the chart at the left.

**What's in a can of paint?** A little knowledge of paint formulation, know-how of painting procedure and the ability to differentiate between various kinds of paint can put you on the right track if you don't want to accept the word of a paint dealer blindly. In a broad sense, paint refers to any liquid coating brushed, rolled or sprayed on surfaces to protect them and to enhance their appearance. In a more restricted sense, paint differs from enamel, varnish and lacquer because of the ingredients used.

Paint in the restricted sense consists of two main ingredients: 1. A pigment or combination of pigments which produces opacity or hiding power. In oil paints the pigments include lead, zinc, titanium, iron and others. 2. A liquid binder (also called

## CHOICE OF PAINT DEPENDS ON ANSWERS TO THESE QUESTIONS

1. **What is to be painted?** Can be plaster, wood, wallboard (dense or porous), paper, fabric, metal, concrete or masonry (dry or damp).
2. **Is surface bare or finished? If finished, with what?** Can be water-reducible paint (casein, resin or rubber base), one-coat flat, finish paint or enamel, varnish, lacquer, penetrating varnish sealer, oil, wax, bituminous paint (on soil pipes), etc.
3. **What is the condition of the surface?** It may be flaking, blistering, wrinkled, cracked, alligatored, badly marred or show bleeding of prior surface.
4. **Is surface subject to excessive heat or dampness?**
5. **Has surface been prepared for repainting and how?**
6. **What color, shade and degree of sheen?** Do you want flat, eggshell, semigloss or gloss?





Many painting failures can be avoided by getting and following the advice of reputable paint dealer

vehicle) which holds the pigment together at a uniform density and forms a film after it has dried. Thinners and driers are added to binders in certain proportions to obtain the right consistency for application and to hasten drying. Oil paints have an oil binder such as linseed oil, soybean oil, tung oil, castor oil and others. Thinners for oil paints include turpentine, mineral spirits and varnish maker's and painter's naphtha.

Water-reducible paints have binders such as glue, casein, protein, resin, oil or latex (rubber) and are thinned with water. As the last three ingredients are in themselves not water-reducible, an emulsifying agent is required to make them so. Water-reducible paints for waterproofing concrete, which contain portland cement in addition to pigments and chemicals, come in dry, powder form. Calcimine consists of chalk and glue in powder form and is dissolved in water.

Varnish consists of an oil and resin solution with thinner and drier added. Varnish stains have some pigment. Enamel differs from oil paint in that it consists of a pigment in a varnish-type binder. It surpasses oil paint in toughness, hardness and resistance to acids and alkalis. Some varnishes and enamels are resistant to alcohol. Enamel may be dull, eggshell, semigloss or gloss.

Lacquer serves the same purpose as varnish and enamel but dries faster and usually produces a thinner film. The principal

ingredients of lacquer are cellulose nitrate (guncotton), resins, plasticizers and volatile solvents such as butyl alcohol. Adding pigment to this combination produces colored lacquer.

**Types of paint as to purpose:** As to their purposes, paint products can be divided as follows: 1. Sealers, also called primers or primer-sealers. 2. One-coat flats. 3. Finish paints, enamels and varnishes to be applied over sealed surfaces. 4. Water-repellent concrete paints. Since paints vary considerably with the use of synthetic resins, pigments, chemically processed drying oils, etc., they require different handling as to thinners, drying time between coats and solvents. Therefore, the importance of following explicitly the manufacturer's instructions on a can of paint cannot be overemphasized.

One of the most common errors in using paint is to neglect stirring it thoroughly so that all the pigment is uniformly suspended in the liquid. Also remember that oil paints should never be applied to damp or wet surfaces as they will not adhere to them. Thinner should be added to paint only in accordance with a manufacturer's instructions, and only the correct type of thinner should be used. For example, to thin water-reducible paint you use water, not turpentine.

**Sealers on bare, porous surfaces:** Bare plaster, wallboard and wood surfaces require a coat of primer-sealer and this must





Use a sponge dipped in household cleaning solution to wash off grease and dirt. Give solution time to work, then wipe wall with clean water



Plaster cracks should be filled before painting with Spackle. Trowel marks should later be sanded smooth

be allowed to dry thoroughly before applying a succeeding coat of finish paint or enamel. Primer-sealer prevents absorption of the binder from paint, which would prevent the paint film from acquiring its desired thickness, hardness, toughness, durability and uniformity of color and sheen. Although shellac does an excellent job of sealing, it creates a surface that is extremely difficult to paint.

Many sealers belong to the varnish family and penetrate porous surfaces only slightly. They may be pigmented or clear. Many sealers are white and can be tinted to the approximate color of the finish coat. Often this is done by adding not more than one part of the finish paint or enamel (made by the same manufacturer) to two parts of the sealer. Water-thinned sealer is tinted with water-reducible colors but not

with any color in oil. Some sealers are for use on walls primarily, some are especially for wood, and others for both. Some sealers are designed for exceptionally porous materials such as soft wallboards. Others are supplied in more or less concentrated form requiring the addition of suitable thinner in certain proportions for surfaces of different porosities, as usually is explained on the can.

Plaster surfaces should be suitably prepared before sealing them, by filling cracks with crack filler or Spackling compound. Trowel marks and other surface projections should be sanded down. Large cracks must be undercut and filled with patching plaster. Such repairs are spot-sealed and the sealer allowed to dry before sealing the entire surface.

After sealer has dried it should produce a uniform sheen. Any flat spots should be recoated. Sealers of the varnish type usually require overnight drying, although a recently developed water-thinned sealer dries so fast that a finish coat can be applied as soon as the circuit of a room has been completed, which is of special advantage to week-end painters. This sealer also bridges hairline cracks, thus eliminating the need of filling them.

Close-grained wood requires only a coat of sealer before painting but open-grained wood must be filled with a suitable paste wood filler. This is wiped across the grain and the surplus removed. After the filler has dried from 18 to 24 hours, the surface is sanded smooth using No. 0 sandpaper. Then the surface is wiped clean and sealer



is applied. When dry, the surface is sanded and cleaned before applying the finish coat.

**Conditioning painted surfaces:** Painted walls and woodwork must be conditioned for repainting. First clean off all traces of oil, grease, wax, soot and dirt, using a household cleaning solution. Apply this with a sponge, allowing enough time for it to dissolve the dirt and oil film before wiping it off with a sponge moistened with clear water. Always start at the bottom of a wall and work up, as this prevents unsightly streaking caused by the solution running down over an uncleaned surface. Calcimine can be removed with plain, hot water. Glossy enamel to be repainted should first be made dull by a cleaning solution of adequate strength, or by using fine steel wool. A dull surface anchors the new paint better than one that is glossy. Cracks also should be filled as previously explained.

Remove all loose, flaking and blistered paint with a scraper, putty knife, No. 0 sandpaper or fine steel wool, tapering the edges of the surrounding paint film. Then seal the spots. Wrinkled paint films, caused by too thick a coat of paint, are removed with paint-and-varnish remover. This is brushed on and allowed to soften the paint before removing it with coarse steel wool. Then all traces of the remover are eliminated by washing with turpentine or benzine.

If a surface to be painted with oil paint or with enamel is covered with a one-coat flat paint, a sealer should be used. Under a microscope such paint resembles a sponge, and will absorb the binder of paint subsequently applied. Then, although the new coat of paint may appear satisfactory, it will be impossible to wash clean.

Where oil paint or enamel is to be applied over a coat of casein paint, it should be removed as much as possible by scrubbing with hot water. After the wall is dry, a suitable sealer then is used before the desired finish coat is applied. Resin-emulsion paints to be so covered need not be removed before redecorating, but a coat of sealer is needed. Rubber-base paints usually provide an impervious surface and serve as a sealer for a subsequent coat.

Where deep-tone colors are to be used, it is especially important to seal a previously painted wall. Without effective sealing deep-tone colors invariably show light and dark spots. Where such trouble occurs the only remedy is to reseal and repaint. An added coat of deep-tone color directly on the first coat only aggravates the condition.

**One-coat flats:** When walls must be covered for appearance at minimum cost, you can use a one-coat flat paint, which is a combination sealer and finish coat. Most water-reducible paints also serve the same



Above, ceilings are always done before the walls. Below, deep-tone colors must be applied evenly to produce a uniform coating. Here a good-quality lamb's-wool roller should be used to apply the paint. Note that a brush has been used first to cut-in around doors and windows, and along ceiling line



purpose. Generally a one-coat flat paint is not as washable as an enamel. A one-coat flat should never be used as a sealer since it renders the subsequent coat less washable. Often one-coat flats are sold in paste form and thinner is added in accordance with the manufacturer's recommendations.

**Finish coats over sealer:** Paints of the lowest gloss generally have the most hiding power and vice versa, although some modern gloss enamels do have remarkable hiding power. Paints of low gloss are usually preferred for living and dining rooms, dens, hallways and bedrooms. Semigloss and gloss enamels are usually best for bathrooms, kitchens, laundries and utility rooms as they are tougher and harder, and will therefore withstand washing more readily. Generally the higher the gloss the more washable the paint is.

The hiding power of enamels also varies with different colors and shades. For gloss





Regular sash brush makes window painting go fast. Masking tape may be used to keep paint off glass

enamels of relatively low hiding power, you can tint the sealer or apply a coat of flat or eggshell enamel of the same color before applying the finish coat. Some manufacturers provide a gloss builder which when added to flat enamels makes them glossy. A gloss builder also tends to deepen the color and makes the enamel thinner, which reduces its hiding power. Gloss builders should be used only in enamel made by the same manufacturer. Also available are "modifiers," which reduce the gloss of enamels. Lacquer should never be applied over an oil paint or over an enamel as the lacquer binder dissolves the old coat, resulting in a ruined finish.

Deep-tone flat paints, when washed, are likely to develop shiny spots caused by the friction of rubbing. This also occurs with light-colored flat paints but is less noticeable. Since a uniform coating of paint is especially desired when applying deep-tone colors, it is best to use a good, lamb's-wool roller. A brush is used for cutting in along edges of trim and at corners, and ceilings are always done before walls. Walls are painted from the top down. A 3-in. brush is used for trim, a regular sash brush for window muntins. On paneled doors, the panels are painted first.

**Water-reducible paints:** Some water-reducible paints are used as purchased in the can while others come in paste form and must be mixed with a specified portion of water by the user. Some are flat and others have varying degrees of gloss. Most of them can be applied directly to bare



In painting paneled doors, coat the molding and panels first, then do the rest. Brush with the grain

plaster or to painted plaster without the use of a sealer, but for others a sealer is sometimes recommended. Those employing casein or protein binders are often referred to as "washable calcimines," but they are less washable than resin or rubber-base paints and regular enamels.

Casein paints should not be applied to walls that are continually damp nor in places where high-humidity conditions may occur, especially in warm climates, as the paint may mildew. Water-reducible paints generally harden to the touch in about a half hour, and a second coat, if necessary, can be applied in two to four hours. However, they develop their maximum toughness after drying for several weeks, after which they can be washed. As a rule, water-reducible paints are used for walls but not advised for woodwork, particularly if it is subject to scuffing or handling and must be repeatedly washed.

**Painting over wallpaper:** Water-reducible paint may be applied over wallpaper if it is well bonded to the wall, does not contain dyes that might bleed through the paint, and if there are not too many thicknesses of paper—only one thickness is best to facilitate later removal. Where casein and resin-emulsion paints are so used, it is possible to remove the paper by steaming, but where rubber-base paints are applied the task of removing the paper becomes very difficult.

**Texture paints:** Plastic paints of both the oil and water-base varieties contain heavy-bodied materials and are used for textured



effects. They are especially useful for covering walls scarred by previous patching. After the paint has been applied and before it sets, designs are worked into the surface by brushing, stippling and troweling, or other means. Since most texture paints set rather quickly, windows and doors of a room in which they are used should be closed to avoid too rapid drying until after the surface has been textured.

**Drying time of paint:** When paint is applied at a temperature from 60 to 75 deg. F., you can be quite sure that the drying time will correspond to that usually indicated on the can, except on very humid days. Lower temperatures lengthen drying time and higher temperatures shorten it. The latter causes the paint to set faster and may cause it to drag under the brush and become "ropy." Fast drying can be retarded by adding some thinner of the proper kind to the paint. High humidity often retards the drying of paints as much as days. Therefore, if possible, clear, dry weather should be selected for painting jobs. ★ ★ ★

Photos courtesy Sherwin-Williams Co. and Pittsburgh Plate Glass Co.

### Marking Location of Water Valve When Lawn Is Regraded

Often, when a lawn is regraded, the pipe containing the water shut-off valve—sometimes called a Buffalo Box—is covered so that it is difficult to locate later. Mark the location of the valve immediately after the regrading by driving an automobile valve, stem down, into the earth. The head of the valve will prevent it from being driven out of sight by heavy rollers or other equipment passing over it.

### Eraser Aids Penpoint Removal

A pencil eraser can be used to aid in removing a penpoint that is jammed in a penholder. Place the eraser on the concave side of the point, then grip point and eraser between thumb and forefinger to pull out the point. The eraser provides a much better grip on the point and also eliminates the discomfort caused by the metal edges.



MARCH 1955

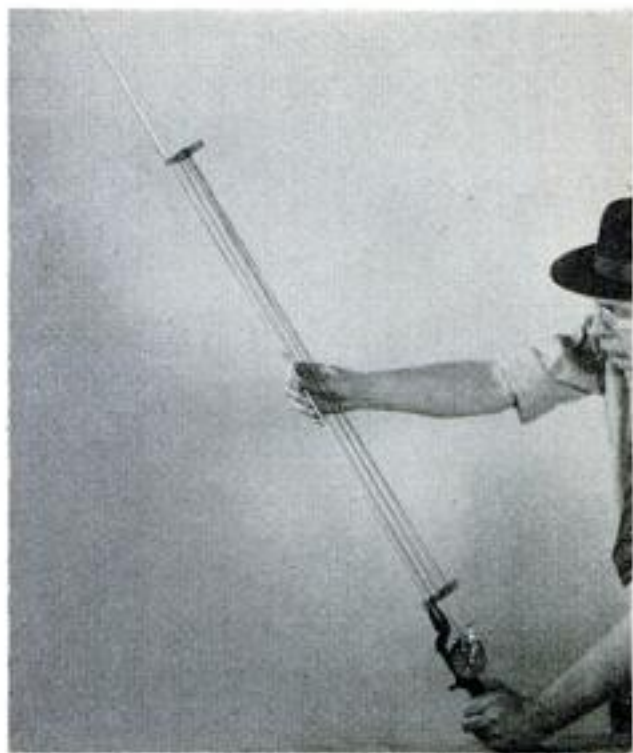

### Fishline Dried on Clothespins Clamped to Rod

Two spring-type clothespins clamped to a fishing rod will provide a means of drying a fishline without the usual problems encountered when it is strung on nails driven into a wall or fence. With the fishing rod leaned against the wall in a corner of the cottage, it is a simple task to rewind the line on the reel before going fishing the next day.

### Replacement Knobs for Kettle Lids Prevent Damaged Bottle Corks

Replacement knobs for kettle lids can be used to minimize damage to corks in photochemical bottles and other containers that are opened frequently. The knobs provide a means of removing the corks with a minimum of twisting and crushing. Just drill a hole through the cork to take the knob screw. Use a washer under the nut. Depending on the size of the cork, it may be necessary to use a longer screw than the one furnished with the knob.—G. E. Hendrickson, Argyle, Wis.



☞ After painting a wall, woodwork or piece of furniture, store a small amount of the paint in a fingernail-polish bottle for future touch-up of nicks or scratches.

203

Copyrighted material



## Clip on Auto Instrument Panel Holds Notes and Papers



For salesmen, travelers and others who need notes and maps handy while driving, a spring clip can be fastened to the instrument panel as a paper holder. The eye of one clip arm is bent slightly and placed under one of the screws that hold the windshield frame in place. A washer may be necessary if the hole in the clip arm is large. The pressure exerted by the clip is strong enough to hold a number of papers, even with the windows of the car open.

Ken Jackson, Spokane, Wash.

## Eliminate Vent-Pipe Freezing By Using Insulation

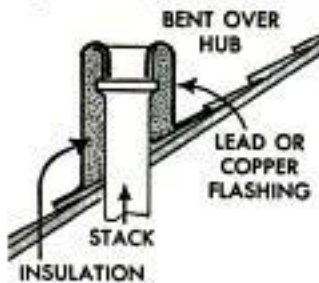

The problem of having the rooftop opening of a vent pipe from a gas-fired furnace freeze shut during sub-zero weather can be overcome by insulating the upper end of the pipe. The insulation is installed in a lead or copper sleeve which is fitted over the pipe so there is a 1 or 2-in. clearance all

around. The bottom of the sleeve is soldered to the roof flashing. After the insulation is installed in the sleeve, the top is bent over so it projects down inside the vent pipe. Another situation where the insulated sleeve could be used is on the upper end of a soil pipe when an automatic washer discharges into the sewer. Hot water from the washer may provide enough water vapor to cause frost to build up in the pipe.

## Dowel Provides Screw Anchor In End Grain of Wood

When screws must be driven into the end grain of a piece of wood, they will hold more firmly if the wood is first plugged with a dowel across the grain, as shown in the illustration. Drill the hole for the dowel so that it is a tight fit, and then coat the dowel with glue before tapping it in.

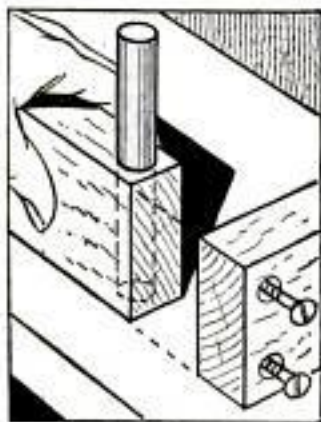

Mrs. Grant Hardy, Hinckley, Utah.

## Fishhook Utilized as Line Guide

An ordinary fishhook can be used to replace a broken line guide on a fishing rod when a regular guide is not available. Bend the eye of the hook at right angles to the shank and tape the shank in place on the rod so that the eye serves as a line guide.

## Twin-Blade Hacksaw Cuts Thin-Wall Tubing

Most of the difficulty encountered when cutting thin-wall tubing with a hacksaw can be eliminated by using two blades in the saw frame. The teeth of one blade should face opposite the teeth in the other. When cutting to an accurate measure, allow for the wider kerf resulting from the double blade.

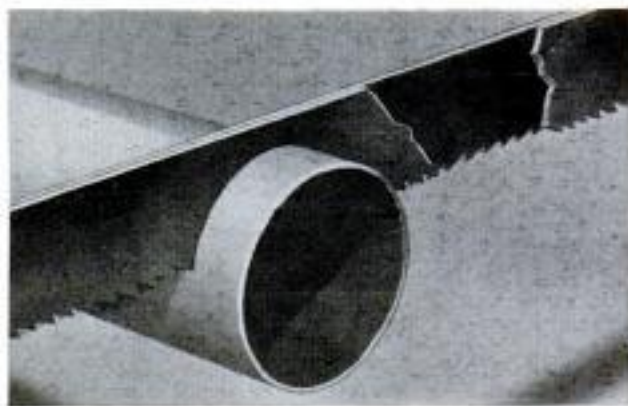

## It's June in January . . .

and cool October in August if you install a modern heating-and-air-conditioning plant in your home. An antiquated plant will waste a lot of high-priced fuel. Replace it yourself and save almost enough on fuel and labor to pay for the air conditioner. See the story on how to do it in the April issue of *Popular Mechanics*; then get busy so you can enjoy a cool summer indoors



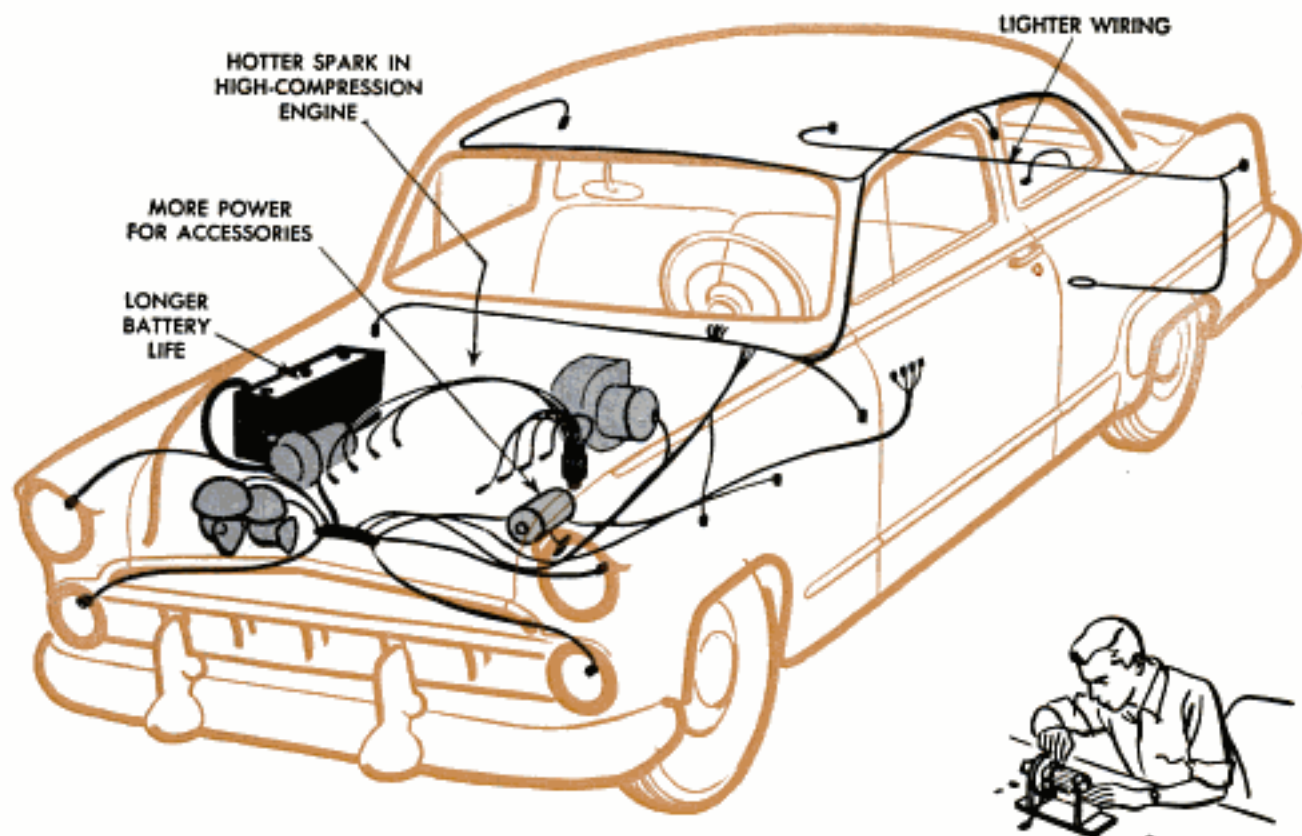

## WHY THE 12-VOLT IGNITION SYSTEM?

**S**TEADILY MOUNTING compression ratios, increased ignition requirements and the increasingly heavy electrical-accessory load are ready answers to the question. As an example, the generator output in the 6-volt system 20-odd years ago averaged about 100 watts. Now an average requirement is more than four times as much. Improved combustion-chamber design and better breathing of today's nimble V8 engine have made it possible to raise compression ratios to 8.5:1 and more, with prospects that the ratios will go even higher in the near future. Because of this, engineers have developed the 12-volt system to provide what might be called an ignition-voltage reserve and at the same time to provide sufficient current to take care of the added electrical load imposed by new accessories. To accomplish the same result with the 6-volt system would mean an added increase in the size of the generator and other electrical units.

The steady climb in compression ratios in the last 8 to 10 years is a result of the search for greater horsepower and better fuel economy over a wide range of road speeds. Greatly improved carburetion, redesigned pistons combined with a shorter stroke and changes in the valve mechanism and manifolding have contributed to better fuel handling through the intake and exhaust systems. These improvements have changed the ignition requirements of the

engine. Increased compression ratios call for an increase in voltage "pressure." A high-compression engine will operate satisfactorily on a 6-volt ignition system when the plugs are new, or nearly new. But with slight changes in the electrode gap due to erosion, a steady increase in the voltage is required in order to force the spark across the gap. Unless there is a voltage reserve the engine likely will miss at the lower speeds. This not only adds up to a waste of fuel but may cause some irregularity in the operation of automatic transmissions. Erratic engine operation will be immediately reflected in unsatisfactory transmission performance and may, in some instances cause damage to the transmission units. Also, with the low reserve of the 6-volt system, it is difficult to tune the engine properly and hold it to a smooth idle for any considerable length of time between servicings. This, of course, assumes that the engine is otherwise in good operating condition and only the low voltage is the source of the trouble.

All main parts of the 12-volt electrical system, with the exception of the battery, are of the same general outward appearance as those of the 6-volt system. The 12-volt battery has 6 filler caps instead of the 3 caps on the standard 6-volt battery. On some 12-volt batteries the terminals are located differently. Other units of the system are altered to handle the increased



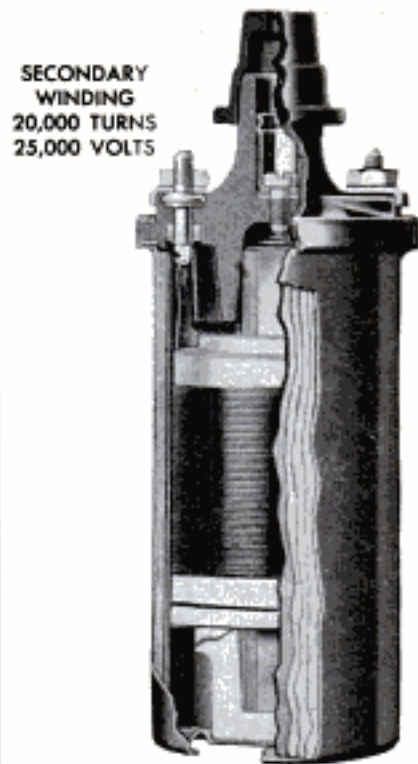
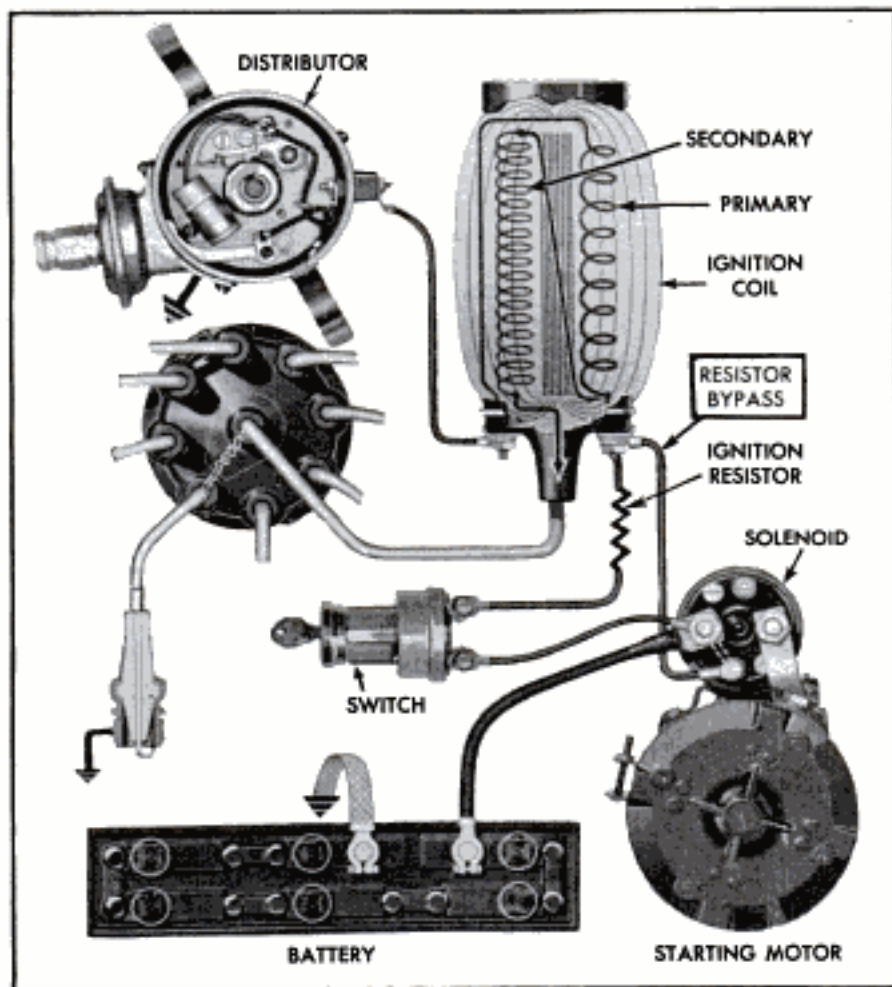

SECONDARY WINDING  
20,000 TURNS  
25,000 VOLTS

PRIMARY WINDING  
200 TURNS, 250 VOLTS

Parts of the 12-volt electrical system vary little in size and appearance from those of the familiar 6-volt system. The 12-volt battery has 6 filler caps

voltage. Generators of 12-volt capacity often have copper-plated field terminals in order to make them easy to identify. The 25-amp. 12-volt generator produces electrical energy equivalent to the output of a 50-amp. 6-volt generator. A 30-amp. 12-volt generator is equivalent in output to a 60-amp. unit in a 6-volt system.

The ignition coil is a most important unit of the 12-volt system. Essentially it is a transformer, its purpose being to step up the low voltage of the generator to 25,000 volts or more, providing an ample ignition reserve at the spark plugs throughout the extremes of engine-speed range. The coil consists of a primary winding of only a few turns of wire linked magneti-

cally with a secondary winding of many turns of wire. The amount of voltage produced in the secondary winding depends on the ratio between the windings of the two coils. Note the relation of the windings in the detail above at the right. The coil used in the 12-volt system has more primary and secondary turns and a higher ratio between the two than does a 6-volt coil of the same size. The greater number of primary turns results in a much-higher electrical inductance in the primary winding. The increased inductance in the primary circuit, plus the higher ratio, makes it possible for the coil to provide a higher secondary-voltage output throughout the entire speed range.

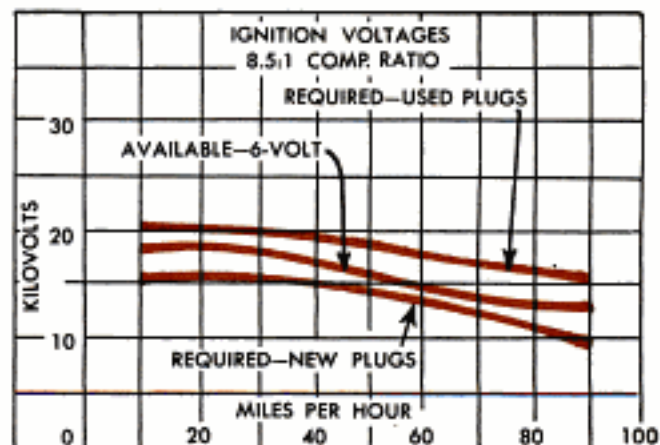
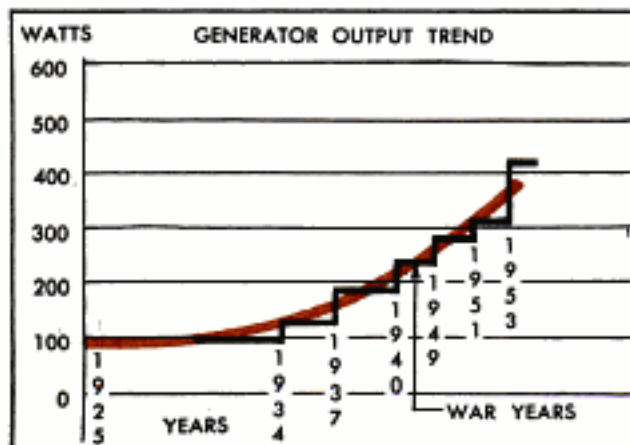



In order to improve ignition performance of the electrical system during the brief period when the starter is turning over the engine, and also to permit the coil to be built into a container, or housing, no larger than that used for 6-volt coils, a portion of the needed coil resistance is built into a special ignition resistor located outside the coil as in the upper left-hand detail on the opposite page. The resistor is wound with wire which changes resistance properties only slightly with changes in temperature. This characteristic prevents excessive primary current at low temperatures such as would be encountered during winter operation in cold climates. Operating in the circuit in this manner the resistor reduces the contact-point oxidation.

As will be noted from the detail the resistor is bypassed while the starter is operating, thereby connecting the ignition coil directly to the battery, making full battery voltage available to the coil and at the same time supplying ample current to the spark plugs. The resistor usually is bypassed in one of two ways depending on the make of car, or the circuit being used. It can be done by a special hookup in the starter solenoid or in the combination ignition-starter switch.

Maintenance procedures for the 12-volt system vary little from those recommended for the familiar 6-volt system. Wear and erosion changes in breaker points, plugs and other parts are not ordinarily accelerated more in the 12-volt system than in the 6-volt system. However, because of other factors such as higher compression, improved fuel handling and operating efficiency in the engine, the 12-volt system is perhaps somewhat more sensitive to changes that occur due to mechanical wear and erosion. Spark-plug electrodes and contact points should be checked at regular intervals, using the recommended type of gauge as in the details at the right. These have been somewhat exaggerated for purposes of clarity. All the regular precautions should be carefully observed when servicing plugs and contact points. In the new engines it is especially important to make sure that the plugs are seated properly when replacing in the engine and are tightened to a uniform tension. Be sure that the plug seat is clean before inserting the plug. Check the washer beforehand. If it is flattened, scored or otherwise damaged replace it. Keep a close watch on the distributor parts which are subject to wear and erosion. A scored cam, due to lack of lubrication, can materially affect the performance of the engine. Use the recommended lubricants. Keep the breaker points adjusted according to the manufacturer's instructions. ★ ★ ★

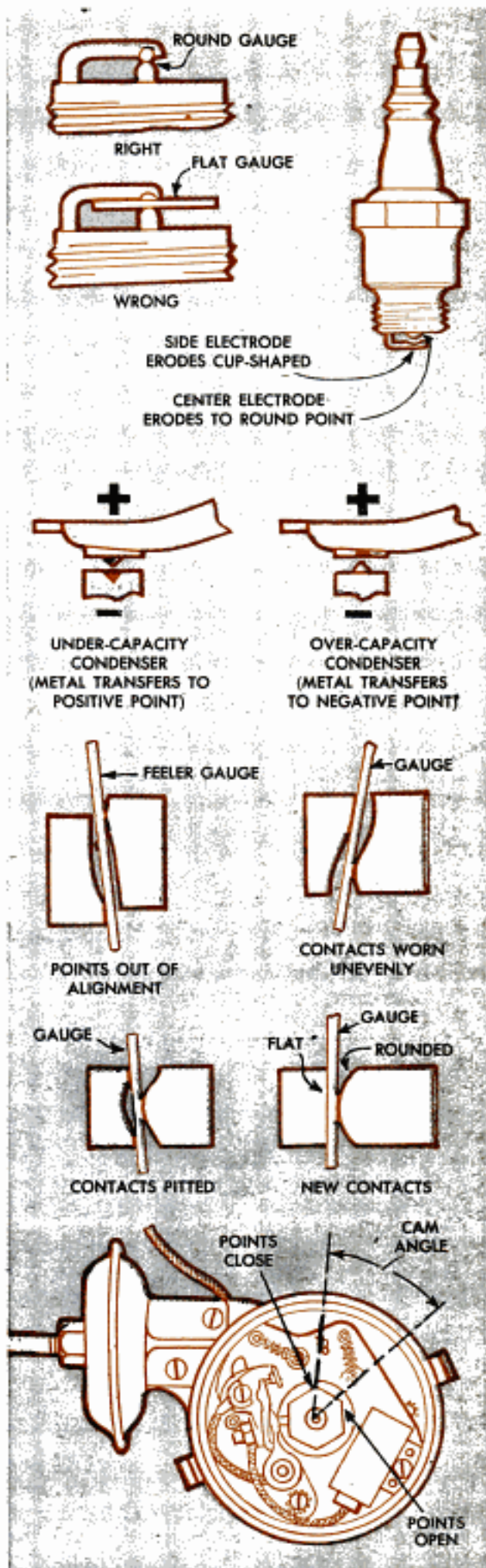





### Prints Held Flat on Cutter By Clear Plastic Sheet

To hold prints flat on a cutting board for uniform trimming, cover them with a sheet of clear plastic or celluloid. The latter should have a hole cut in the center for easy adjustment with your finger. For regular use, the cover can be hinged to the trimmer with a strip of cellulose tape.

### C-Clamp Prevents Splitting When Nailing Thin Wood

When nailing the corners of small boxes and drawers, where the thin wood is likely to split, a C-clamp can be helpful. Clamp two small pieces of wood to the corner, as shown in the photo, before nailing. This arrangement will not only prevent splitting of the thin wood, but also will align the corner better, making a neater job.

Bertram Brownold, Cedarhurst, N. J.

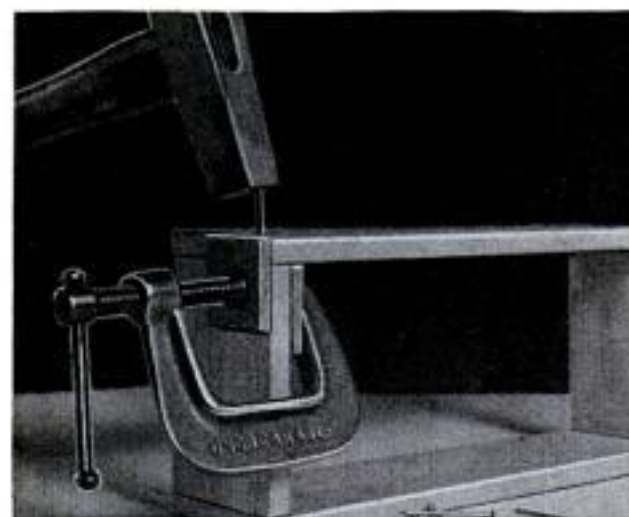

☐ The next time you paint a room, if you coat the doorknobs, hinges and locks with thick soapsuds, any paint splattered on them will wipe off easily along with the soap.

### Rain From Roofs of Hog Sheds Used for Livestock



Rainwater collected from the roofs of the hog houses minimizes the need for hauling water to hogs on the range. Downspouts from the houses are run into small stock-watering tanks where the water is stored until needed. Buckets are used to fill the automatic waterers from the tanks.

### Circles Painted on Drawer Knobs Add Decorative Touch

When refinishing the knobs on dresser drawers, an extra touch of decoration can be added by painting circles in a contrasting color on the faces of the knobs. To accomplish this, fit each knob on a headless screw and chuck the screw in a hand drill held in a vise. Use a small paintbrush and steady your hand on some sort of a rest. Turn the drill slowly so the knob revolves under the paintbrush to provide a perfect circle.—R. F. Donovan, Guttenburg, N. J.

### Single Fence-Line Tank Supplies Two Feed Lots

A single steel tank is used by one farmer to water livestock in two separate feed lots, the tank being located on the fence line. The tank is enclosed in an oversize cast-concrete box, which makes it possible to insulate the tank by packing insulating material down between the tank and the concrete. Both the tank and the box rest on a concrete floor, which eliminates the problem of mudholes.







# SHOP NOTES



Portland Cement Association photo  
Before the concrete mix is delivered to the job the builder must know how much he needs and how it is to be mixed to meet his requirements. Use of an alignment chart eliminates the separate calculations

## ON-THE-JOB ESTIMATES of concrete work

By J. B. Mullen

**C**ONTRACTORS who use ready-mixed concrete in large amounts and wish to specify the mix ratios, as well as other users of concrete who mix their own, can save time and assure reasonable accuracy in computing the required amounts of cement, sand and gravel by using an alignment chart of the type shown in Table 2, page 211. In this way, lengthy computations involving a number of separate calculations are avoided, thus reducing the possibility of a costly error by misplacing a decimal point or dividing instead of multiplying by a conversion factor. By using the chart for

figuring the materials required for a job there's no need to refer to handbooks or tables of constants. When certain values are known the chart can come up with an answer in minutes, eliminating for all practical purposes the slide-rule and pencil-and-paper calculations that often take hours of time on big jobs.

The first step in figuring an ordinary concrete job graphically is to determine the length and cross-sectional areas of the structure. Sidewalks and driveways, also slabs for basementless-house construction are comparatively easy, but foundations



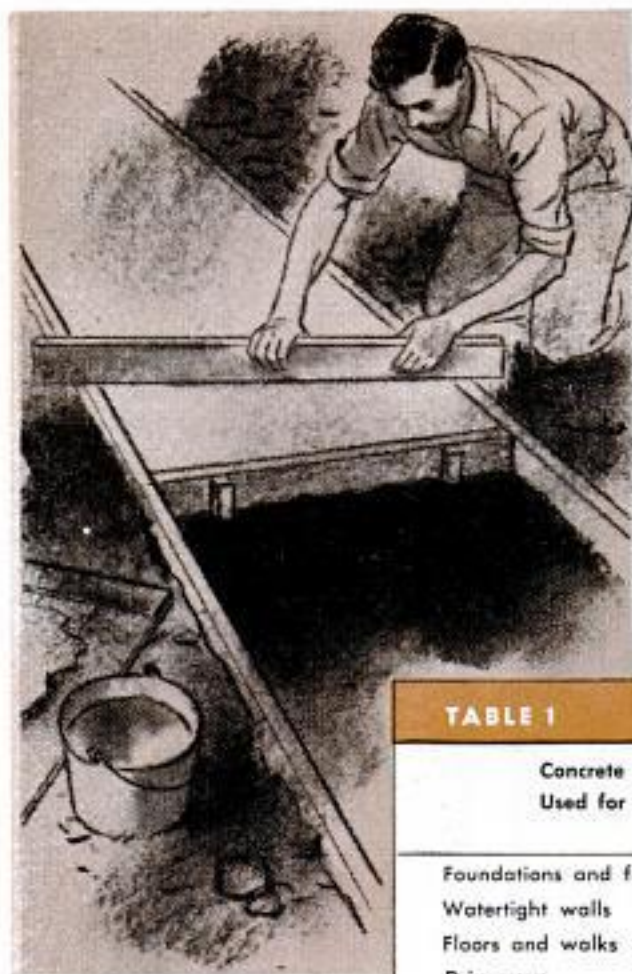

Table of mix ratios gives values commonly used. It may vary somewhat from other recommendations. Amounts of water given are for dry sand. Damp sand requires less water proportionally

TABLE 1 CONCRETE MIX RATIOS			
Concrete Used for	Mix Ratio	Sacks of Cement Per Cu. Yd. of Concrete	Gallons of Mixing Water Per Sack of Cement
Foundations and footings	1:3.75:5	4.4	6.4
Watertight walls	1:2.5:3.5	6.0	5.0
Floors and walks	1:2.5:3	6.6	4.4
Driveways	1:2.2:3.5	6.4	4.3
Floors— 1st	1:2.5:4	5.6	4.9
2-course 2nd	1:2:0	12.6	3.6
Heavy-duty floors	1:1.25:2.5	9.7	3.4
Cast slabs, etc.	1:2:3	6.9	4.9
Watertight tanks, etc.	1:2:3	7.1	4.1

below grade are somewhat more involved, as the wall and the footing areas must be calculated separately and the results added to obtain the total figure. The cross section in square feet is easily found by multiplying the width of a wall or a floor, sidewalk or driveway by the thickness it is to be. Multiply the height of a wall by its thickness and then treat the footing as a separate section. Add the results and you have the full sectional area.

Now, with two values established, you can make several calculations quickly by using the alignment chart on the opposite page. Suppose for purposes of convenience that the sectional area is 7.5 sq. ft. and the length 140 ft. Just lay a straightedge from the value on the area scale (7.5 sq. ft.) to the length determined (140 ft.) on the length-in-feet scale. The first answer will be found where the straightedge crosses the volume scale, in this case 39 cu. yd. The answer in this instance is found in cubic yards although area and length of the structure were in feet. This eliminates converting values, that is, from feet to yards, in

the calculations. For purposes of clarity, one straightedge line has been omitted from the chart. As you will see, the location of the straightedge line will vary with the values determined when finding the sectional area and length of the structure.

After finding the volume you will want to know the number of sacks of cement required for the type of structure you are planning. First, consult the table of mix ratios, Table 1. Suppose for example you are planning the construction of a foundation. The table shows a mix ratio of 1:3.75:5 as being suitable for this type of structure. The value found means that for each sack of cement, 3.75 cu. ft. of sand and 5 cu. ft. of gravel must be mixed. Note also that the table shows recommended quantities of water per sack of cement. The quantities are based on dry sand. If the sand is damp or wet, the amount of water added must be

varied accordingly. Too much water in the mix is a common cause of weak, porous concrete that may partially disintegrate, crack or leak within a comparatively short time. This is especially true if the structure is subjected to unusual stresses such as deep frost, flooding, which may undermine the footing at some point, or a condition that may set up vibration affecting the structure directly.

A straightedge laid on the chart so that it intersects the volume, already found on the volume scale, and the mix-ratio scale, will give you the number of sacks of cement required. Here it should be noted that there are values given on both sides of the mix-ratio scale. The reason is that many mix ratios other than those shown on the right side of the scale are in common use. These may be found in books and manuals on concrete work, along with the number of sacks of cement required for a cubic yard of concrete. If the mix ratio to be used is not found on the right side of the scale, then substitute in the calculation the recommended number of sacks of cement



per cubic yard, using the figures given on the left side of the scale. As a rule the calculation can be carried out quite accurately by substituting the values given.

Next, you will want to know the number of cubic yards of sand and gravel required to complete the mix for the structure you are planning. The mix ratio being used gives the number of cubic feet of sand and gravel required for each sack of cement (3.75 and 5 with a mix ratio of 1:3.75:5). These figures are located on the right-hand scale of the chart below. Then lay the straightedge from these points to the number of sacks required, a value already found, and you have the answers, 25 cu. yd. of sand and 32 cu. yd. of gravel. Note the location of the red lines on the chart which represent the positions of the straightedge. In laying off calculations on a chart of the type shown in Table 2, the most accurate calculations will generally be made with a transparent-plastic rule. This will avoid any possible error in taking the readings from the various scales. When making up a chart be sure to make it on heavy paper that will take inked lines without blotting. The finished chart can be made much more durable by spraying the surface with clear shellac, copal varnish or the clear plastic



solution now supplied in pressurized containers.

Accuracy of charts of this type generally comes within a range of 2 to 3 percent, although the figure may vary somewhat where it is necessary to estimate the reading should the straightedge cross a scale between the marked divisions. Usually it is safer to take the next higher reading in such an instance. ★ ★ ★

TABLE 2

ALIGNMENT CHART FOR CONCRETE

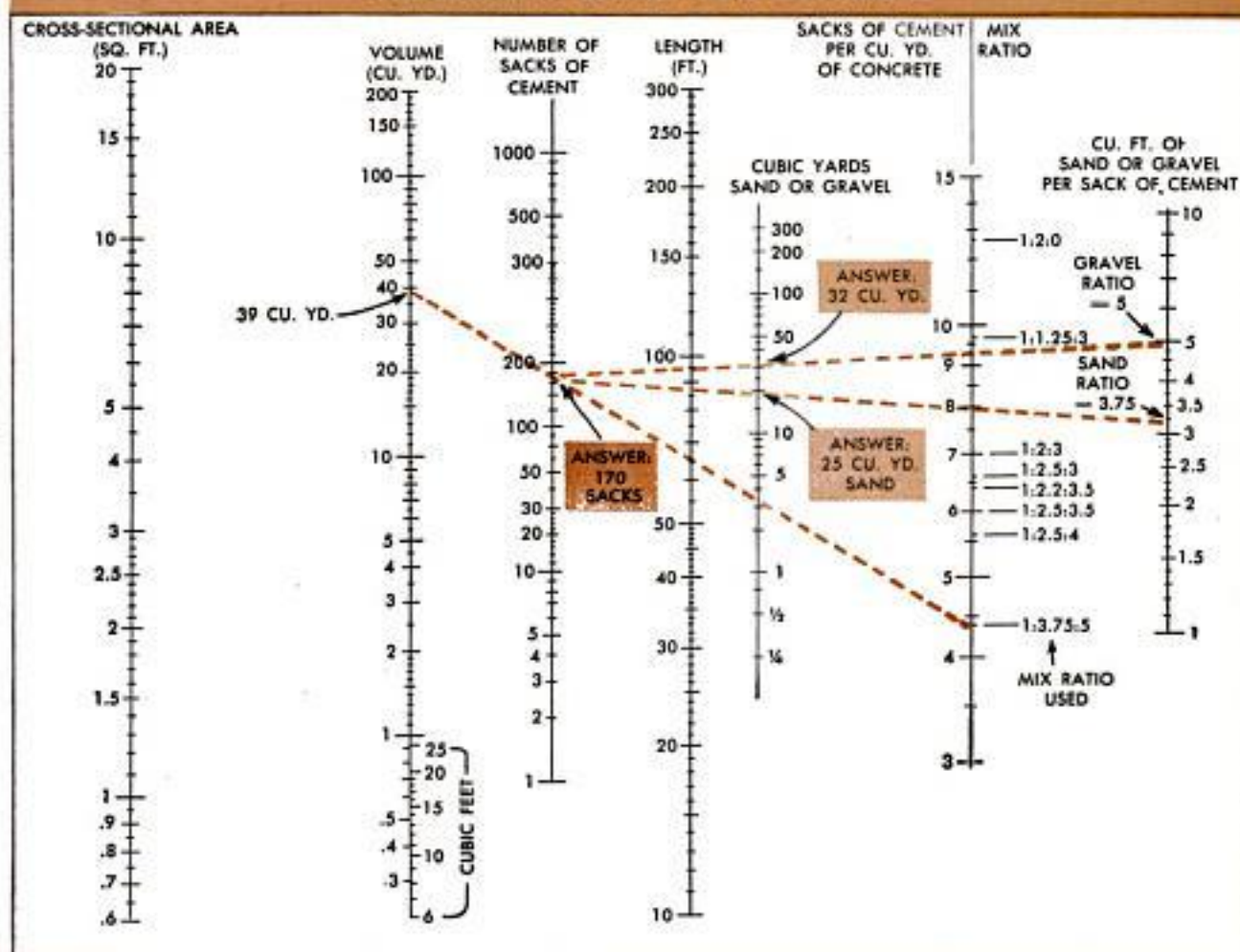





### Automobile Engine on Trailer Powers Portable Elevator

The engine and transmission from an early model car are used on one farm as a power source for a portable elevator. The engine also is portable. It is mounted in its original position in the car chassis which was cut off about 1 ft. behind the instrument panel to make a two-wheel trailer. The front axle was moved back 10 in. from its original location by repositioning the spring hangers so the trailer would balance. Power is transmitted from the engine and transmission to the elevator by a power-take-off shaft from a pull-type mowing machine. One end of the shaft is modified to couple to the driveshaft end of the transmission. The transmission is shifted to reverse to drive the elevator, and the engine is run at idling speed. Do not run the engine for long periods at this low speed.

Ed Mercer, Madison, Wis.

### Varnish Applied to Old Woodwork

Clear varnish or colors in oil may be applied to old woodwork that has been stained and shellacked without peeling or cracking if the shellac is sponged with alcohol. The alcohol will soften the shellac, making it slightly tacky, and the new finish should be applied before it rehardens. To make sure it does not rehardens, work one section at a time, such as a door panel, doorframe or length of baseboard.

### Salvaging Chipped End Mills



Common end-mill cutters that have become chipped at the cutting edges due to abnormal use often can be salvaged by first grinding the end of the mill back until the teeth are restored as nearly as possible and then grinding a concavity into the end of the mill to provide clearance. Grinding must

be done with extreme care to prevent overheating. A mill reground in this manner will perform satisfactorily on light cuts that enter the work from the end. It will not run in from the side. If the mill has an even number of teeth and the two opposite each other are sound, then grind flats on each side.

A. B. Kerswell, San Bernardino, Calif.

### Ends of Dowel Pins Flattened For Use in Oversized Holes

Flattening the ends of dowel pins in the jaws of a vise often will permit them to be used in oversized holes. The sketch shows an exaggerated example of how the ends of the dowels are flattened. A generous amount of glue should be applied

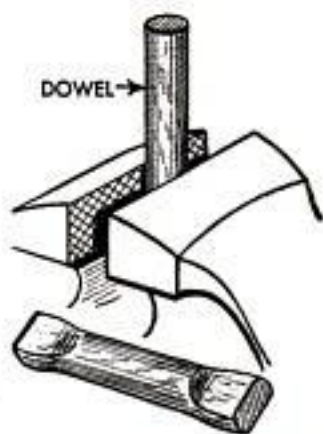

to the dowels when they are inserted to fill the spaces alongside the flats or slivers can be driven in to serve the same purpose.

### Farm Dam Doubles As Roadway

A flood-control dam on one Iowa farm also serves as a road between hay and cattle barns. The dam, which is built across a natural waterway draining a large area, was made wide enough to accommodate tractors and trucks so feed could be hauled to the cattle even during flood season when equipment would bog down in the water-soaked fields below the dam. Built as part of an over-all Soil Conservation Service program, the dam is similar to a pond dam except that it has a 4-in.-tile outlet near its base. After a rainstorm, impounded water drains slowly through the tile and is dispersed over a grassed waterway, thus avoiding erosion.





# Know Your SAW BLADES



By Sam Brown

**C**IRCULAR-SAWING machines of both the bench and floor types generally come equipped with what is known as a combination blade. These blades, Fig. 3, combine the cutting properties of the separate rip and crosscut blades pictured in Fig. 2. The crosscut blade, Fig. 2, has teeth designed and shaped to sever wood fibers at right angles to the blade as it passes through the wood. Note that the teeth are filed at an angle as in Fig. 6. The ripping blade is designed to cut wood fibers which are parallel to the blade, the teeth being filed square across as in Fig. 5. However, the ripping blade will crosscut and the crosscut blade will make ripping cuts, but not with the same facility and speed. The crosscut blade tends



BASIC TYPES OF SAW BLADES—CROSSCUT AND RIP

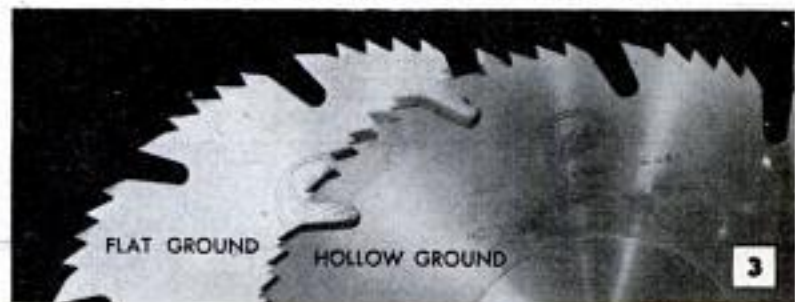

COMBINATION BLADES HAVE BOTH TYPES OF TEETH

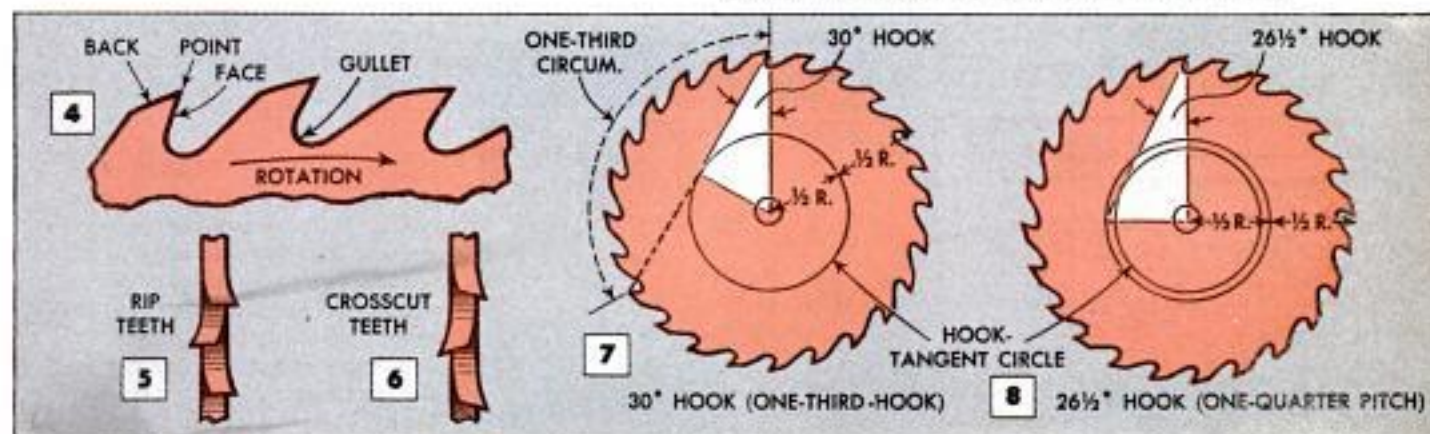



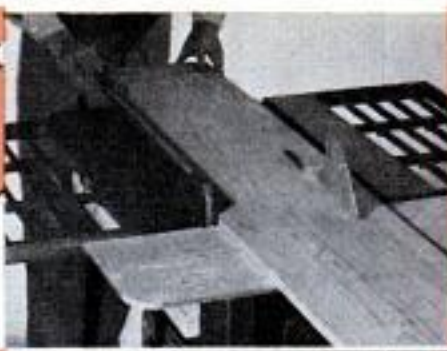
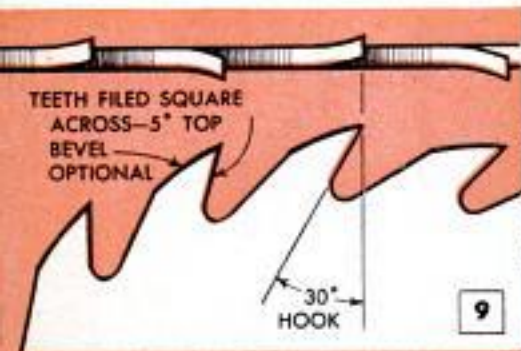

**RIPPING BLADE** with chisel tooth shaped for cutting with the wood grain. Note that the teeth are filed square across and the set is equal to approximately half the thickness (gauge) of the blade. Blade tends to tear the wood on crosscuts but cuts very fast on rip cuts. Top bevel shown is optional but must be uniform

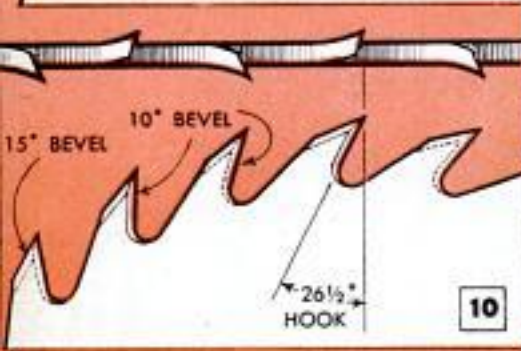

**CHISEL-TOOTH COMBINATION** makes either rip or cross cuts due to the bevels on the face and back of each tooth. Blades for portable saws are often sharpened in this manner. Note the variation in the hook angle from that of the ripping blade. Cuts fairly smooth in hard and soft wood when correctly sharpened

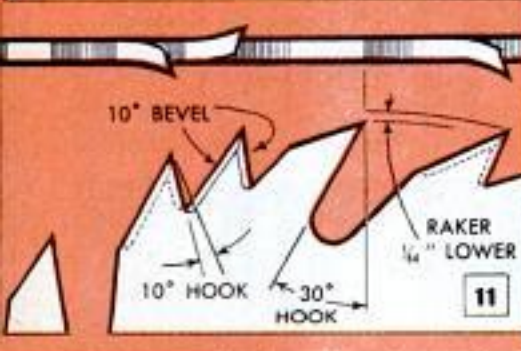

**FAST-CUTTING COMBINATION** has two cutting teeth with one raker tooth per segment. Cutting teeth are larger than similar 4-tooth combination blade which makes a smoother cut. Raker tooth has a 30-deg. hook and is 1/64 in. lower than cutting teeth, which are filed with a 10-deg. hook. Note shape of teeth

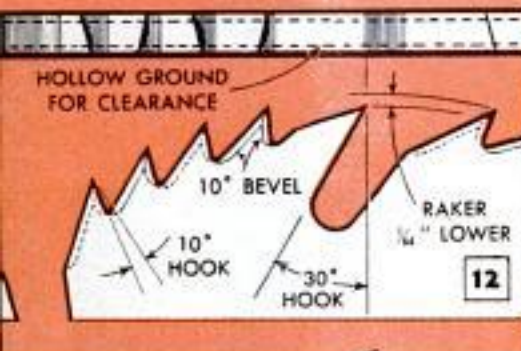

**PLANER BLADE** is hollow-ground for precision work. Teeth run without set but are otherwise identical in profile with the 4-tooth combination. Hollow-grinding gives necessary blade clearance to prevent binding. Note that raker tooth is 1/64 in. lower and has 30-deg. hook

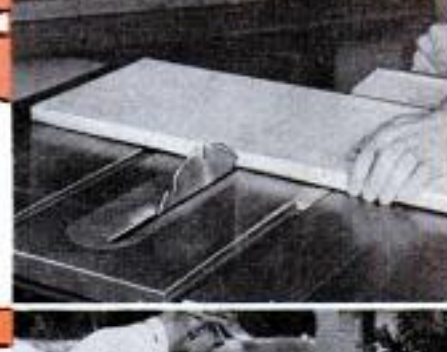
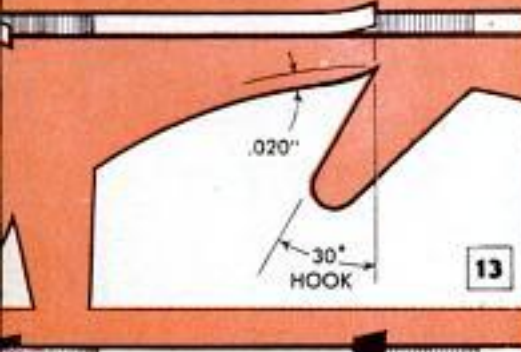

**HIGH-BACK-TOOTH PATTERN** is designed to prevent over-feeding and also to minimize any tendency to kickback. Comes in 8 and 12-tooth types, the latter being best for general work. The 8-tooth blade is especially fast on ripping cuts. Makes a rough cut across grain in softwoods

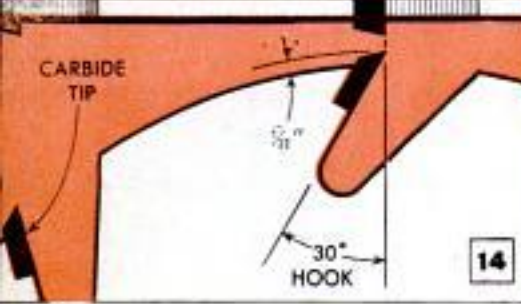

**CARBIDE-TIPPED BLADES** are available in nearly all common types. High-back-tooth type is shown. Rip-cuts smoothly in all woods but tends to tear wood across grain. Carbide tips remain sharp for long periods of continued operation, outlast ordinary blades many times over. Easily honed with special hone





Portable electric saws are favored by many builders. They can be used with nearly all types of blades

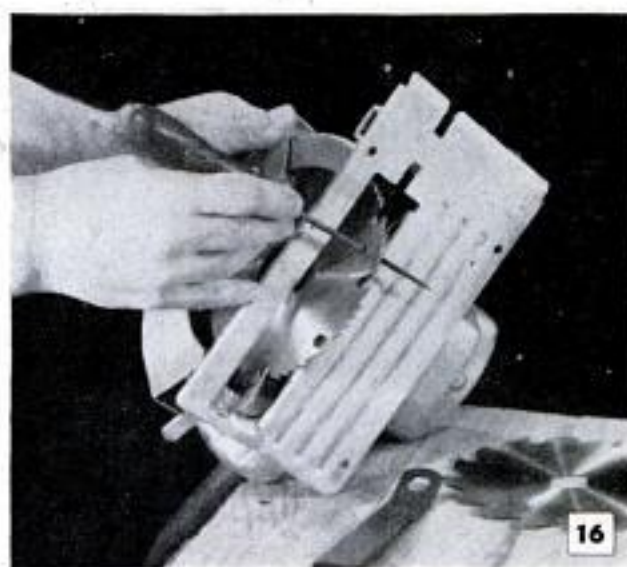

Blades for portable saws often have hole near rim so blade can be locked when removing spindle nut



CHISEL-TOOTH COMB.	CHISEL-TOOTH COMB.	CUTOFF (CROSSCUT)	FLOORING (NAIL-CUTTING)	PLANER (MITER)	FINE TOOTH	6-TOOTH CARBIDE
--------------------	--------------------	-------------------	-------------------------	----------------	------------	-----------------

to heat and "burn" the wood in a ripping cut and the ripping blade leaves a rough edge when used for crosscutting.

In the combination blade, Fig. 3, the two types have been combined by dividing the blade into segments and providing four crosscut teeth and one raker tooth in each segment with a deep gullet between. This arrangement of the teeth permits the blade to cut freely and smoothly both with and across the grain. In the flat-ground blade, Fig. 3, the teeth must be set as in Figs. 5 and 6, but on the hollow-ground blade the teeth run without set. This blade is beveled, or hollow-ground, so that it is several gauges thinner near the hub than at the rim. The hollow-ground blade is generally used by cabinetmakers when cutting stock to finish dimensions as it cuts very smoothly both with and across the grain. A variation of the combination blade is the two-tooth combination blade shown in Fig. 11.

Another variation is the chisel-tooth combination blade, Figs. 4, 9 and 10. These blades cut very fast and due to the metal behind each tooth point, will stand up to heavy cutting for longer periods without sharpening. In sharpening these blades it should be remembered that the shape of the tooth is important. The hook angles

shown in Figs. 7 and 8 apply in a general way to all circular-saw blades with hook teeth. Note also Figs. 9 to 14 inclusive. A one-third hook, Fig. 7, makes the blade cut fast and easy, requiring very little feed pressure when the teeth have been correctly sharpened. Hook-toothed blades will crosscut or rip but as a rule do not produce a smoothness of cut equaling the separate crosscut and ripping blades with teeth especially designed for either type of cut. On rough work where speed is essential this is of no special importance.

Many experienced operators of circular saws make both crosscut and ripping cuts with the blade projecting not more than  $\frac{1}{4}$  in. above the surface of the stock. With the blade in this position there is less danger of injury from a kickback or a flying splinter. Although this is a fairly common practice in commercial woodworking shops, operators of smaller machines having circular blades 6 to 10 in. in dia. generally find they can do somewhat better work with the blade projecting  $\frac{1}{2}$  to  $\frac{3}{4}$  in. Small-diameter blades usually work best in this position. The exception is the hollow-ground, or planer, blade which as a rule should run somewhat higher, about 1 in. with  $\frac{3}{4}$  in. the minimum for blades 8 to



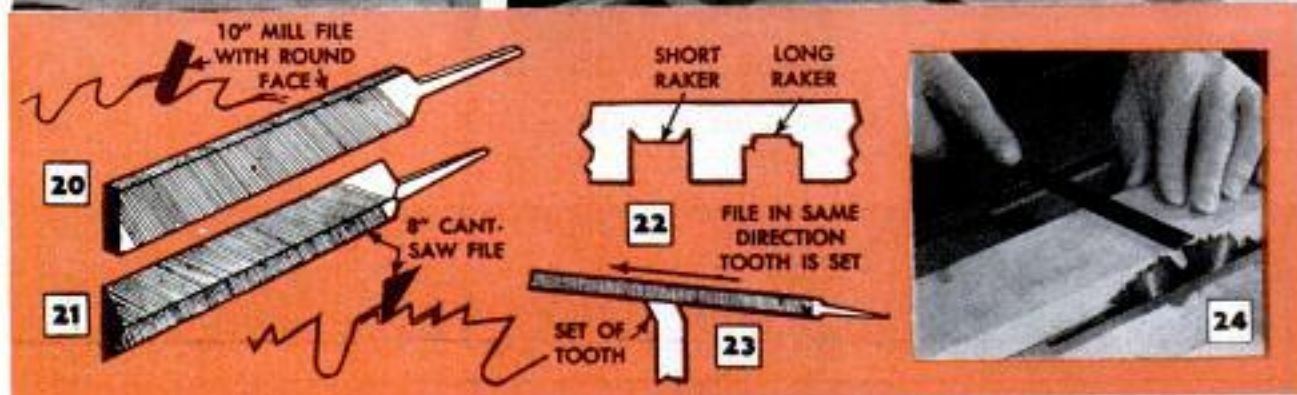

10 in. in dia. One good reason for running the blade as low as is consistent with good results is to offset any tendency of the teeth coming up to lift the stock should the saw kerf narrow suddenly due to a release of stresses in the material being cut.

Circular-saw speeds can vary considerably but manufacturers have more or less standardized on a speed of 3450 to 3600 r.p.m. for blades up to 10 in. in dia. However, there are machines available in which the blade is driven at speeds exceeding 5000 r.p.m. The best-quality 6-in.-dia. blades can be driven at speeds up to 7000 r.p.m. without danger of exceeding stress limits, provided the blade is correctly filed and set.

Figs. 15, 16 and 17 picture various types of blades used on electric handsaws of the type used by builders. The blade types now available are shown in Fig. 17. Note that the flooring blade has the same tooth profile as the cutoff blade, but the teeth are filed square across and the blade is especially hardened to enable it to cut nails without dulling appreciably. The six-tooth carbide blade is the same as that shown in Fig. 14 except that it is adapted to use with portable electric saws. Blades for portable saws generally have a hole in the blade so that it can be locked as in Fig. 16 for removal of the spindle nut.

It's important to keep saw blades clean, especially when used in resinous woods. A thin coating of pitch along the sides of the

teeth plus a tiny tip of the resinous material that tends to collect in the gullet just below the cutting point of the tooth can impair the efficiency of the blade as much as 50 percent. Resinous material can be removed quickly with paint remover as in Fig. 18. There are other products available which are specially made for the purpose. Circular-saw blades should never be allowed to rust. Deep pits caused by rust can have much the same effect as a coating of pitch, especially if the pits are near the points of the teeth.

Filing a circular-saw blade is a simple job, the important thing being to preserve the original form and profile of the teeth. Touch-up filing can be done without removing the blade from the arbor with the setup shown in Figs. 19 and 24. A blade with set teeth can be filed several times before it is necessary to joint and set the teeth. Jointing is important to the smooth running of the blade. It's done as in Fig. 26, using an ordinary oilstone. However, before jointing check the fit of the blade on the arbor. If there is slight play, then make an index mark on the arbor flange as in Figs. 1 and 25 and place the blade on the arbor with the trademark up as in Fig. 1. After jointing and filing, replace the blade in the same position. In filing the combination blades use files of the type shown in Figs. 20 and 21. Be sure to file with the set of the teeth as in Fig. 23. On combination blades of the type having separate raker



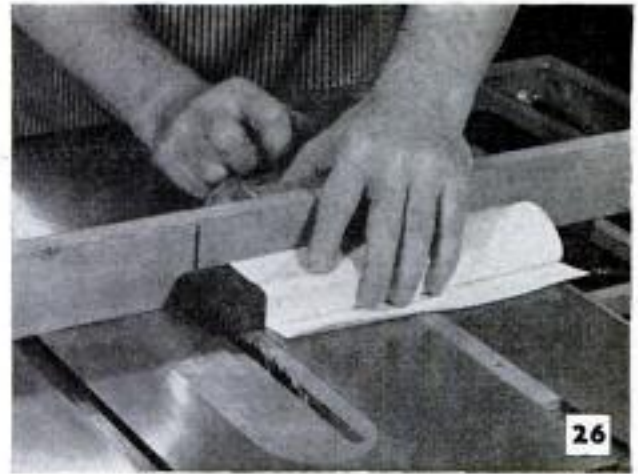
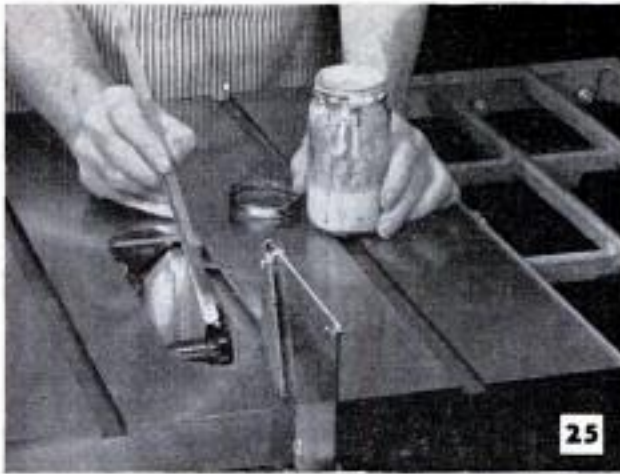

Left, index mark on spindle locates blade after jointing. Right, jointing blade with oilstone before filing

teeth, file the raker teeth about  $\frac{3}{64}$  in. lower than the set teeth. This will give a clean cut as shown at the left in Fig. 22. When filing the teeth always count the file strokes, giving each tooth an equal number and maintaining a uniform pressure throughout the length of the individual strokes. After jointing a blade, Fig. 26, the points of all, or nearly all, of the teeth will be flattened slightly. In filing it is necessary to bring each tooth to a sharp point. This may necessitate going over the blade two or more times, giving each tooth the same number of strokes. Do not file each tooth to a point individually as filed in this way they are almost certain to be of unequal length. When filing remember that you file every other tooth from one side. Then turn the blade and file the alternate teeth.

A handy filing vise for circular blades from 6 to 10 in. in dia. is detailed and pictured in Fig. 27. Saw teeth are easily gummed and reshaped with the setup shown in Figs. 28 and 29 below. ★ ★ ★

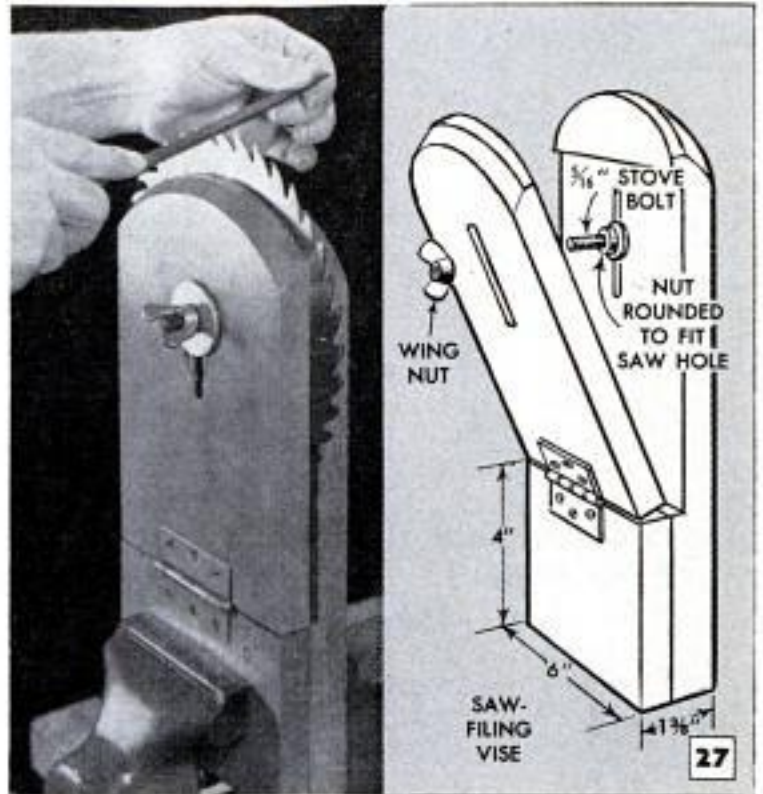

Above, when filing a circular blade it is essential that it be held rigidly to prevent vibration under the file stroke. The vise pictured and detailed is suitable for blades 6 to 10 in. in dia. Below, after blades have been filed several times the shortened teeth will require reshaping and gumming

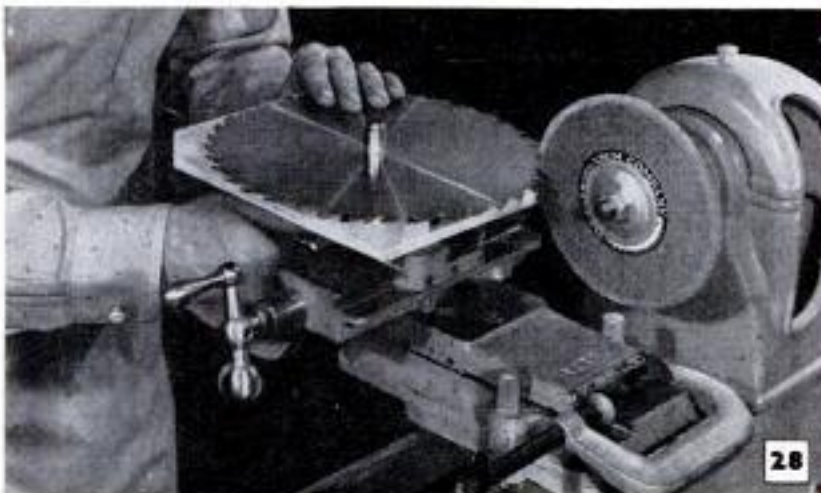



## Grow Poultry-Yard Greens Under Hardware-Cloth Screen

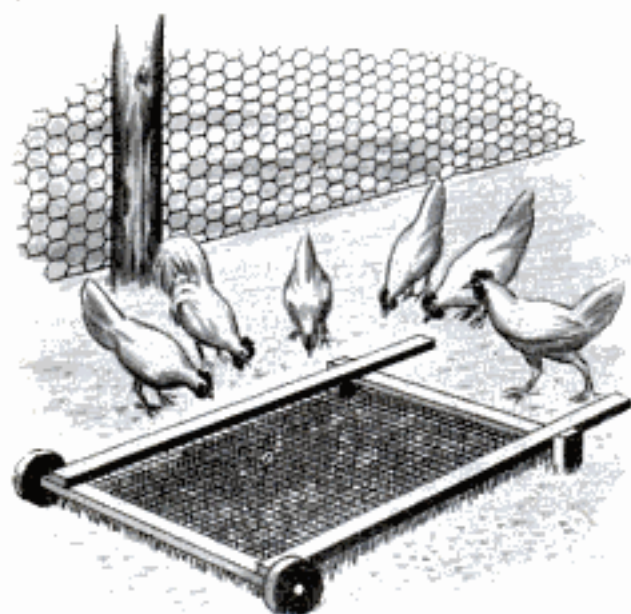

To provide sprouting oats or other green plants for balancing the diet of a dozen or so chickens, one man grew the oats in small plots right in the chicken yard. This was done by using two or more plots and seeding them at intervals so that one plot would always be green. A wheeled screen prevented the chickens from getting at a plot until it was ready for use.

## Bottle Stopper Kept Handy With Rubber Band



When working with volatile liquids, you can seal the bottle temporarily to prevent excessive evaporation by means of a stopper attached to the bottle with a rubber band. The rubber band is put through a hole or slot in the stopper and then taped to the bottle on each side. When the

liquid is in use, the stopper is inverted and slipped over the top to make a temporary seal. To pour the liquid, simply push the stopper to one side. This saves constant corking and uncorking and at the same time prevents excessive evaporation. For storage, the stopper is put into the bottle in the normal way.

## Shrinking Valve-Seat Inserts

One common method of shrinking valve-seat inserts is to chill them with Dry Ice. But when no Dry Ice is available, the carbon dioxide of a fire extinguisher sprayed on the insert will shrink it sufficiently for

easy installation, provided, of course, that the block or head has been properly prepared. For a more accurate fit, machine the shouldered recess oversize to insure a true fit and use an oversized insert. Do not re-face the insert until it has completely "thawed."—Ed Packer, Oak Park, Ill.

## Rivets Set in Steel Block Provide "Branding Iron"

A practical branding iron for marking your name on wooden ladders, tool handles and other personal possessions can be made by fastening round-headed iron rivets in a steel block. The letters first are sketched on the steel block in reverse. (This can be

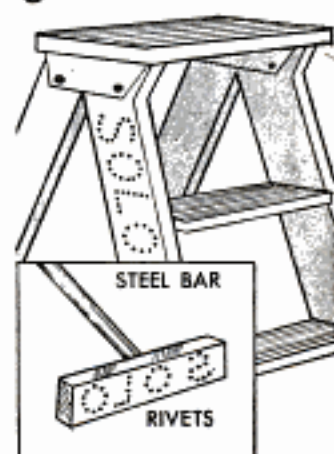

be done by printing or writing on tissue paper, then inverting it on the block and marking through the paper with a center punch.) Then holes are drilled along the marks and the rivets fitted into the holes. The back of the block is drilled and tapped to receive a threaded steel rod which provides a handle. In use, the iron is heated enough to burn into wood, but not so hot that it scorches the surrounding area.

Dan Solo, Oakland, Calif.

## Yardstick Used as Gauge For Fuel-Oil Tank

If you have a 275-gal. fuel-oil tank of the upright type, the inch marks on a yardstick can be used to compute the number of gallons of oil remaining in the tank. An extension is attached to the yardstick to make sure it will touch the bottom of the tank. The number of inches of oil on the yardstick is converted to gallons by consulting the chart below.

A. R. Tanner, Cold Spring, N. Y.

CONVERSION TABLE			
Inches	Gallons	Inches	Gallons
1	2	11	62
2	5	12	69½
3	10	13	77
4	15	14	85
5	21	15	92
6	27	16	100
7	33	17	107
8	40	18	115
9	47	19	123
10	55	20	130

21 in. = 137½ gal. or ½ tank



# SHOPPING FOR TOOLS



**TILTING BANDSAW** tilts forward 7 deg., back 46 deg. and locks securely at any angle between. Table remains in the horizontal position. Has maximum capacity of 12 $\frac{1}{4}$  in. between blade and frame when in vertical position. Cuts wood, plastics, also metals with variable-speed attachment. Table is 14 in. square

Toolkraft Corp., Springfield, Mass.

**MICROMETER** reads direct in ten-thousandths of an inch. Inner thimble reads in thousandths, outer in ten-thousandths on large scale, permitting accurate readings in poor light. Available with carbide spindle and anvil faces. Range is 0 to 1 in.

L. S. Starrett Co., Athol, Mass.



**LATHE CUTOFF TOOL** has been designed to end the problem of chatter when cutting off in the lathe. Tool features an adjustable follower that rides the top of the rotating work to steady cutting tool

**LATHE CUTOFF TOOL** in operation with follower riding top of work. Note that unit is fitted to its own tool holder which fits into the tool post. The follower is adjustable to 2-in. stock

H. D. Herder Tool Specialist,  
2723 E. Michigan Ave., Kalamazoo, Mich.

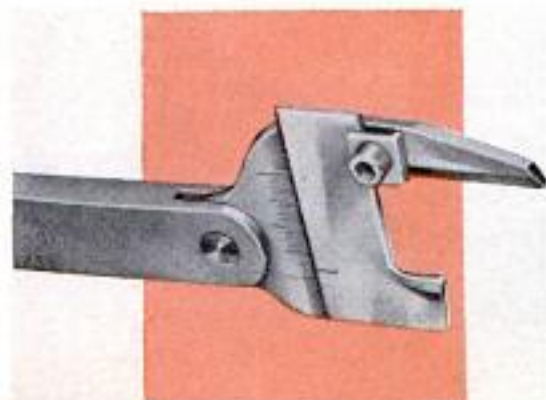



## SHOPPING FOR TOOLS — *continued from preceding page*

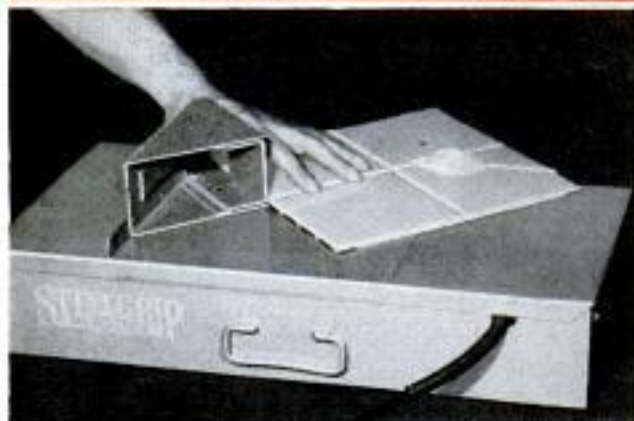

**TINY CIRCULAR SAW** cuts plastic tile, sheet cork and other thin materials with speed and precision. An accessory miter gauge guides tile for angle cuts. High-speed driving motor is mounted in sheet-metal box. Side of the box forms the saw table as pictured

Steelegrip Plastics, 336 N. Central Ave., Chicago 44

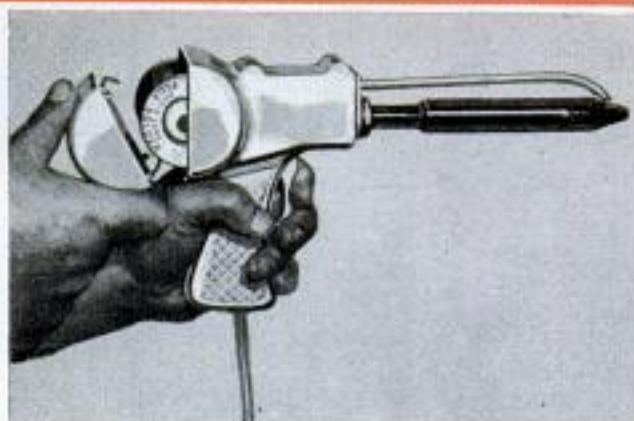

**SELF-FEED SOLDERING GUN** speeds up production on repetitive soldering jobs. Wire solder is fed to the tip by trigger action, making it possible to run continuous joints of uniform strength. Available with two tips and 50, 100 and 150-watt elements

Scotco Products Co., Beverly, Mass.

**PENCIL-SIZE SOLDERING IRON** weighs less than 1/2 oz. and works off auto storage battery or dry cells or model-railroad power pack. Gets into places impossible to reach with any other soldering equipment. Available with 6 or 12-volt elements

Telvac, Box 6001, Arlington 6, Va.



**PLANE-TYPE HANDLE** for files fits nearly all sizes except the largest. Permits two-handed operation on all but smallest files with a degree of accuracy heretofore difficult to accomplish consistently. Two types of handles are available, one for small files, the other for medium to large as pictured

The Circo Co., 1257 King's Highway East, Bridgeport 5, Conn.



**WRECKING BAR** has offset head with twin claws for pulling nails in confined space where conventional bar will not reach. Head is designed to pull nails without bending or twisting, which causes nail to bind and split wood when withdrawn. Bar is 32 in. long

Unique Products, Inc., Box 2263, Reno, Nev.

**PLASTER CUTTER** makes two parallel cuts in plaster for installing electrical conduit in maintenance and repair jobs. Does the trick without cracking or checking the plaster. Waste is removed with a chisel. Adjustable to cut grooves of varying width

Wodack Elec. Tool Corp., 4627 W. Huron St., Chicago 44

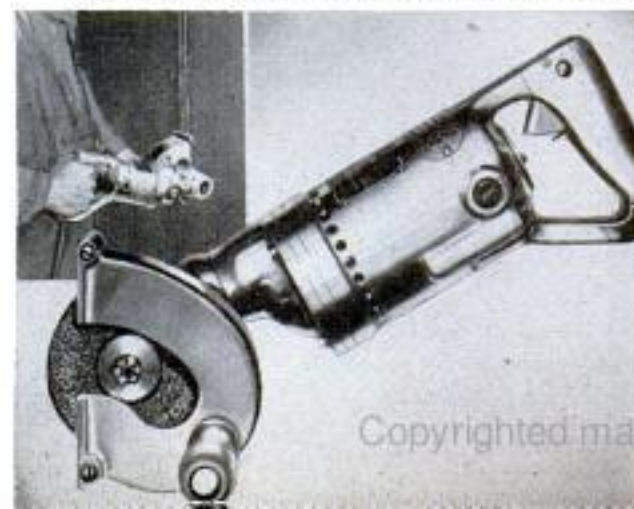



# Texaco Tips On Car Care



## ← Good uses for last winter's anti-freeze

If you have Texaco PT Anti-Freeze in your car radiator, you can put it to good use after it is drained out this spring. It makes an excellent preservative solution for storing wet paint brushes overnight or for short periods of time. It helps prevent rust when smeared on your car bumper and grille.

## How to get → that "cushiony" ride

To ride smoothly, your car needs a lubricant that lasts. That's *Marfak*! Note the protective "collar" of *Marfak* on the front suspension (at right). *Marfak* stays on the job far longer. It's extra-stretchy...forms a tough coating between points of wear and friction. With *Marfak*, you get a *cushiony* ride that lasts for 1,000 miles or more. And remember this: your Texaco Dealer lubricates your car by chart, never by chance. Today, get *Marfak* lubrication. See your Texaco Dealer... the best friend your car has ever had.



**TEXACO DEALERS IN ALL 48 STATES**

*Texaco Products are also distributed in Canada and in Latin America*

THE  
TEXAS  
COMPANY

TUNE IN: TEXACO STAR THEATER starring DONALD O'CONNOR or JIMMY DURANTE on TV Saturday nights. METROPOLITAN OPERA radio broadcasts every Saturday afternoon. See newspaper for time and station.



# How close-up photography can add enjoyment to your hobby

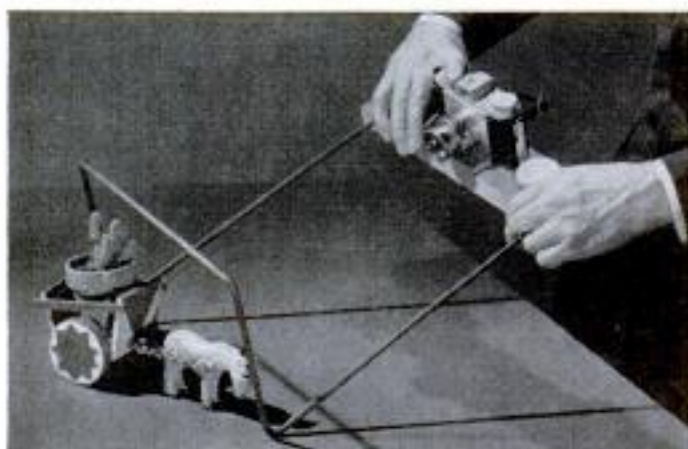
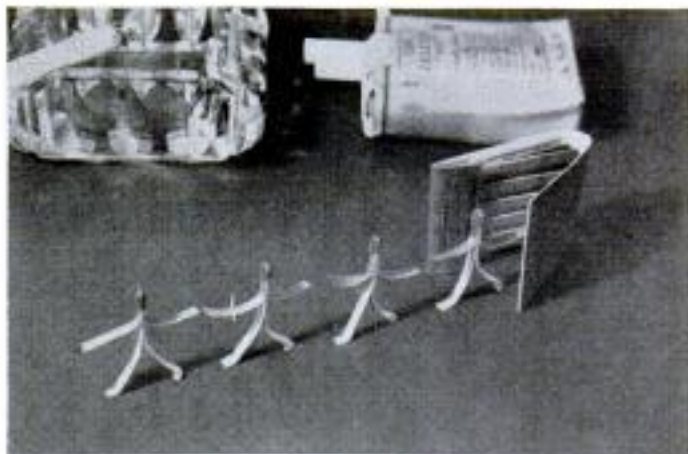

Whatever your hobby is, photography can make it more interesting and rewarding. Comes the time when you put the finishing touches to that scale model car . . . or locate that elusive butterfly to add to your collection . . . or that new African violet puts forth its first blossom—you'll want to record the big event. Here's where close-up shots are really

worth making—especially if you make them in color, for screen projection. Imagine picturing a rose close up, and then showing it in color, 4 or 5 feet wide, on a screen! What's more, close-ups, whether in black and white or color, give you a permanent record. They prove what happened, and they can be enjoyed for years to come.

## How to make close-ups

The average camera does not focus for extreme close ranges, but it can be equipped to do so with a simple supplementary lens, such as a Kodak Portra Lens 1+, 2+, or 3+, or a combination of two of them.

If you set the camera at "infinity," and put a 3+ Portra Lens over its lens, you can bring the camera to just 13 inches from the subject; and, if you set the camera for  $3\frac{1}{2}$  feet, the taking distance can be only 10 inches! The 2+

Portra Lens gives a range of about 13 to 21 inches, and the 1+ a range of about 20 to 45 inches. Each lens comes with a sheet of instructions, distances, and field sizes. Your Kodak dealer will be glad to help you select the lens attachments you may need.

### Focusing and viewing important

Since the range of sharpness is very short when your camera is focused on a near-by subject, proper focusing and view finding are extremely



important. Measure your subject distance accurately to be sure your focus is exactly right.

A great many cameras have the viewfinder on top. Thus, in taking extreme close-ups, much that appears in the top quarter of the viewfinder may not be "seen" by your camera lens. Often this can be avoided by making sure that the center of the object to be photographed is on the same level as the lens.

Such problems as focusing and viewing can be easily solved, however, by the use of what is known as a "focal frame"—a simple wire frame that attaches to the base of your camera, clearly defining the area your lens can catch sharply and also providing camera support (see lower right picture on opposite page). If you would like details on how to

construct a focal frame for your camera, write to our Sales Service Division.

### Table-tops are fun, too

A table-top, as the name implies, is a close-up picture using a table for a stage. The picture of the marching matches, on the opposite page, required the simplest of props. There's no limit to what you can do with a little imagination. Toothpicks, pipe cleaners, fruits and vegetables can be fashioned into figures; table salt or cornstarch makes realistic snow; twigs appear as trees and small rocks as boulders.

For average lighting, ordinary 100-watt bulbs do very well. Most table-top pictures are taken with time exposures. So you'll need some means of holding your camera steady—either a stand or tripod.

## The Kodak Technical Close-Up Outfit

Everything you need for making close-ups in one package. Even if you've never had any photographic experience, you'll find it easy to get fine results for no focusing or meticulous composing is needed. Includes Kodak Pony 828 Camera, bracket, focal frame, Portra Lens and filter in slip-on adapter, and Kodak B-C Flashholder with Kodak Close-Up Flashguard. First time you use it, you'll notice the focal frame defines the field, holds your camera steady, positions the flashholder for proper lighting. You can get the complete outfit for \$62.75, including Federal Tax.



If you have a Kodak Pony 828 or 135 Camera and flashholder, all you need to get is the Kodak Pony Close-Up Kit, \$19.95.



It's easy to get extreme close-ups with both still and movie cameras with Kodak Portra Lenses, from \$2.65.



For table-top time exposures with Kodak Retina and other cameras, the Kodak Table-Top Camera Stand, \$29.50.



Portra Lenses, filters, or other lens attachments fit your camera when you use Kodak Adapter Rings, from \$1.35.



For combining Portra Lenses for stronger effects, use Kodak Retaining Rings, from \$1.15.

*Prices subject to change without notice*

**Eastman Kodak Company**  
Rochester 4, N. Y.

**Kodak**  
TRADE-MARK



# Care and Feeding of Engines

BY  
S. P. CORP



## CHECK THE GENERATOR

It is well to check and test your generator every 5000 miles. First see that the fan belt is tight. The generator can't produce its full output with a slipping fan belt. Then make the following inspection: 1. Remove generator cover and see if there is thrown solder on it. If so, it has been overheated, and should be removed and tested on a test bench. 2. Inspect commutator. If rough and worn, generator should be rewired. 3. Lift carbon brushes to see if spring holds them to commutator and they are free to work up and down. Make sure wire connections are tight. Be careful not to loosen connections when lifting brushes. 4. If brushes and commutator are in good condition but dirty, use carbon tetrachloride to clean them in place. 5. Now, with engine running polish commutator with a strip of 00 sandpaper over a wooden block, held on commutator. To clean brushes, stop engine and use sandpaper under brush as shown. Blow out after sanding. 6. Oil generator with three drops of oil in cups and replace cover.



## INSTALLING FAN BELT

To remove old belt, loosen bolts A, B, and C and move generator toward engine to slip belt off pulleys without forcing; then put on new belt, also without forcing. Adjust tension by moving generator until belt can be moved 5/16" under thumb pressure. Tighten bolt B and recheck tension. Tighten bolts A and B. If belt is too tight it will squeak, and may damage generator front bearing.

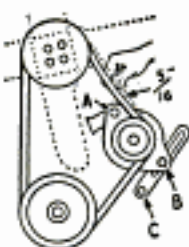

## WRITE FOR NEW FREE BOOKLET

Send a card now for your free copy of "Care and Feeding of Engines," the new illustrated manual on car care which answers dozens of questions. And when you re-ring, insist on Sealed Power KromeX Ring Sets, with chrome on top compression ring and oil ring side rails. Modern engines demand this protection against heat, friction, abrasion, and corrosion! Sealed Power, Dept. G-3, Muskegon, Michigan.



# Sealed Power

## PISTON RINGS

# Clinic for Homemakers



As a service to our readers in solving the hundreds of problems pertaining to a home—inside or out—the editors of *Popular Mechanics* invite you to present your problems to The Clinic Editor for help and advice. Address your questions to The Clinic Editor, *Popular Mechanics Magazine*, 200 East Ontario Street, Chicago 11, Ill.

## Varnish Failure

Q—Early last fall I varnished the floor in a small upstairs room and the finish never dried properly. Even now it is slightly sticky. The floor was not sanded before application of the finish, but I did go over it with steel wool. What caused the failure?

—L.R., Pa.



A—There are several causes, some fairly common, but we would suspect from your description that failure of the varnish to dry in a reasonable time was due to age of the finishing material rather than to other possible causes. Lack of adequate ventilation also could have contributed something. In its present condition the finish will never be satisfactory. We think it will pay to remove the finish back to the bare wood and begin all over again. Sand the floor after removing the finish and apply filler and a sealer. Then finish with one or two coats of floor varnish. Have windows and doors open during the drying period. In some rooms it is necessary to use a fan to assure adequate air circulation.

## Evergreen Care

Q—I have noticed that something is wrong with my evergreen planting. The needles are turning a rusty-brown color, some of the larger limbs having very few needles from the trunk out to the last few clusters near the ends. The undersides of the needle clusters are covered with a fine weblike material. What is a likely cause?

—Y.N., Ohio.



A—Red spiders, or more properly, spider mites are a possible cause of the damage you describe, but we also are inclined to suspect what is known as winter drying. Spider mites and winter drying produce symptoms which are very similar. That is, both result in a slow defoliation of both tall and low-growing varieties of evergreens. Spider mites are tiny insects hardly visible to the naked eye and their webs are spun underneath the foliage clusters, as you describe. To control mites it usually is recommended that the foliage be sprayed early in the season, before new growth starts, with a miscible-oil spray mixed and applied according to

(Continued to page 226)



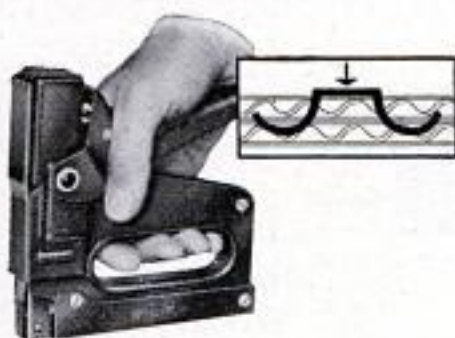
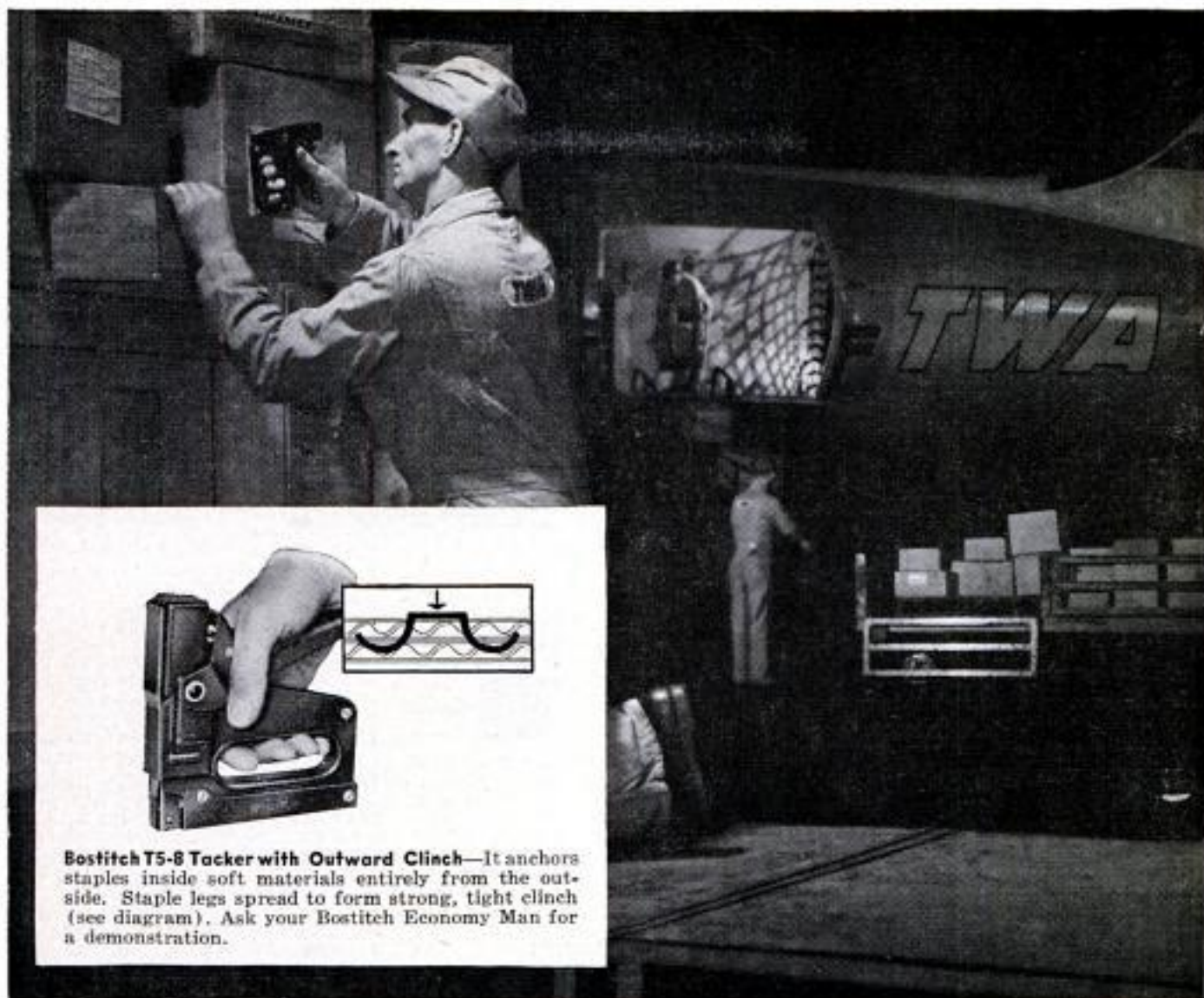

**Bostitch T5-8 Tacker with Outward Clinch**—It anchors staples inside soft materials entirely from the outside. Staple legs spread to form strong, tight clinch (see diagram). Ask your Bostitch Economy Man for a demonstration.

**STAPLES HOLD BETTER AT ONE-TENTH THE COST!**

Trans World Airlines overlook no detail in assuring the safe, swift arrival of air freight shipments. Shipping bills fastened to cartons with even the best tape sometimes tore loose in damp climates. And taping cost \$14 per thousand bills, not counting time taken to apply.

A Bostitch Economy Man suggested stapling the bills with a new Bostitch tacker that "spread-eagles" staple legs inside carton walls. TWA tried it, found stapling four times faster than taping and *far superior in holding power*. Cost: \$1.40 a thousand. Now all major TWA stations are Bostitch-equipped.

## How much can you save by switching to Bostitch stapling?

Your Bostitch Economy Man can tell you. He's one of 350 trained fastening specialists working out of 123 cities in the U. S. and Canada. There are over 800 kinds of Bostitch staplers in his cost-cutting repertoire. Look up "Bostitch" in your telephone directory, or check the coupon at the right.

**Fasten it better and faster with**



**BOSTITCH, Inc., 543 Mechanic St., Westerly, R. I.**

I'd like to know exactly how stapling can cut costs in our fastening operations. I'm particularly interested in the applications checked below:

**HI-SPEED PRODUCTION FASTENING**

- stapling vs. riveting
- stapling vs. spot welding
- stapling vs. screws or bolts
- stapling vs. glue or cement
- stapling vs. tape
- stapling vs. tacks or nails
- stapling vs. solder
- stapling vs. wire or string

**PACKAGING and CARDING**

- sealing bags (cloth, paper or plastic)
- mounting products on display cards
- fastening items to individual cards

**SHIPPING ROOM ECONOMIES**

- preparing cartons for filling
- sealing filled cartons
- lining or padding crates
- applying shipping bills or tags

**BUILDING APPLICATIONS**

- applying asphalt roofing
- laying underfelt
- installing ceiling tile
- applying insulation
- installing low-voltage wiring
- applying shake shingle siding

**OFFICE EFFICIENCIES**

- filing
- routing
- posting
- binding folders and reports
- preparing advertising dummies

Name \_\_\_\_\_ Position \_\_\_\_\_  
 Company \_\_\_\_\_  
 Address \_\_\_\_\_  
 City \_\_\_\_\_ Zone \_\_\_\_\_ State \_\_\_\_\_





C. E. ACKERMAN OF THE ACKERMAN BOAT WORKS, NEWPORT BEACH, CALIF., SEEN WORKING ON "THE NEWPORTER", FIRST OF A NEW LINE OF 40' FIBRE GLASS COVERED SAIL BOATS, SAYS—

## "MY SIOUX ELECTRIC DRILL..."

... has given me such outstanding service, I feel that I owe the manufacturer a letter of appreciation.

"I purchased one of your  $\frac{1}{4}$ " all angle drills\* in 1945, at which time, I also purchased two other Nationally known name drills. The Sioux Electric Drill has given continuous service since, and the first service work it has needed, is a set of brushes. The original brushes started arcing badly last week. The two other drills purchased at the same time, after several major overhaul jobs, gave out completely three or four years ago.

"In case you wish to use this letter in any way you feel it may be beneficial, please feel free to do so, and I would like anyone reading it to know that it was not, in any way, asked for or solicited."

\*SIOUX  $\frac{1}{4}$ " ALL-ANGLE DRILL, No. 1495, \$37.90



### $\frac{1}{4}$ " ELECTRIC DRILL

- Small design • Full Powered
- Light weight • Permanently Lubricated • Pistol Grip

No. RC-1885—\$22.95

### ORBITAL ACTION FLAT SANDER

Working at 4,000 cycles per minute produces finest finish on wood, metal, fibre—anywhere hand sanding is usually employed.



No. RC-1850—\$45.80



### HEAVY DUTY ELECTRIC SAW

Saw through 2x4's at a 45° angle with more blade to spare than with most 6" saws... that means more sharpenings, longer use from each blade! Modern, rugged, powerful!

No. RC-1806—\$74.50

THE TOOLS THE PROFESSIONALS HAVE USED FOR OVER 40 YEARS.

Write for NEW Catalog →



**ALBERTSON & CO., INC.**  
SIOUX CITY, IOWA, U. S. A.

Continued from page 224)

the instructions on the container. As soon as new growth starts, a degree of control can be accomplished by hosing the foliage with water alone. The stream of water from the hose should be directed upward so as to strike the underside of the clusters. Dusting with sulphur or rotenone compounds is sometimes recommended. Spraying the foliage with a glue solution (1 lb. powdered hide glue to 10 gal. of water) has been reported to give good results in the control of spider mites. Winter drying is the result of a rapid loss of water from the foliage during that time when the ground is frozen. Trees in exposed positions are especially susceptible to this form of damage. As a rule, it is possible to prevent winter drying, or winter kill, of the foliage by mulching the ground around the tree trunk to prevent deep freezing early in the season.



### Soundproofing

Q—In our first-floor apartment we are continually annoyed by sounds made by the people occupying the second floor. Even though both floors are carpeted, footsteps, the piano and the other normal sounds are objectionable. Is there any inexpensive, simple way to soundproof the ceilings of the downstairs rooms, something that can be easily applied?

—W.S., N. Y.

A—Unfortunately not, as a complete soundproofing job is comparatively expensive, especially in homes or apartments already built. However, the installation of what are known as acoustical tile on the ceilings of all rooms will result in a partial soundproofing that will very likely reduce noise from above to the point where it is no longer objectionable. These tiles are available in  $\frac{1}{2}$  and  $\frac{3}{4}$ -in. thicknesses and can be applied to the plastered ceilings with a special adhesive. They can be cleaned with a damp cloth and can be painted without affecting their sound-absorption qualities.

### Floor Squeaks

Q—My home is two years old, has full basement and hardwood floors. Lately I've noticed that the floors squeak in several heavily traveled areas through doorways and across the living room. Some of the flooring boards have shrunk, opening narrow cracks here and there. What can I do to cure this defect?—S.R., Iowa.

A—As a rule, squeaks in hardwood floors result from inadequate nailing of both the subfloor and top floor. If the floor boards are not correctly nailed according to recommendations the stresses set up by even slight shrinkage tend to loosen the nails sufficiently to permit movement. Squeaks develop as a result. The cure is comparatively simple if you can get at the subfloor from underneath. There are two methods. One is to drill a line of holes spaced about 6 to 10 in. apart through the subflooring and into the top flooring. The rows of holes are located between the floor joists and should be of the correct size to take flathead screws of the right length to reach through the subfloor boards and into the top-floor boards. The second method is to drill several holes through the subfloor only under the area where the squeaks originate, the holes being large enough to take the nozzle of a caulking gun. Caulking compound forced between the subfloor and the top floor is a reasonably sure cure for squeaks that develop as a result of slight movement of the floor boards. If you can't reach the floor from below in the area where the squeaks originate, it is possible to work from the top of the floor. Locate the floor joists and lightly mark the points at which nails can be driven so that they will strike into the joists. Then at these nailing points lift chips with a gouge, being careful not to break the chip off. Drive a long finishing nail under the chip and set the nailhead below the surface. Then spread glue under the chip and carefully press it back into place, holding it in place with a weight until the glue dries.



# the handiest household plier ever designed

**CHAN NEL LOCK**

**No. 420**

**this one plier grips . . .**

any shape . . .

any size . . .

$\frac{1}{8}$ " through  $1\frac{1}{4}$ "

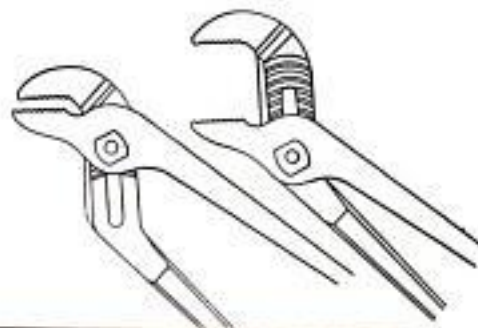

**with a grip that can't slip**

Undercut, interlocking channels and lugs . . . a Channellock exclusive.



Reinforced tension edge for added strength where it counts . . . another Channellock exclusive.

Ask your hardware dealer to show you a Channellock 420. Test its powerful gripping action. Examine the interlocking channels that can't "jump out" no matter how hard you grip. Observe the beautiful full-polished steel finish and the superior quality construction. And then tell the man to wrap it up. You'll soon agree that Channellock is the most useful plier of them all.

*Also available without teeth for special applications. Ask for 420-P.*

ONLY CHAMPION DeARMENT MAKES CHANNELLOCK

**CHAMPION DeARMENT TOOL CO.**  
MEADVILLE, PENNSYLVANIA





**No. 407 GRIPPING PLIER**



Length 7". Capacity  $\frac{1}{8}$ " to  $\frac{5}{8}$ ". Two adjustments. Knurled grips.

This No. 407 plier is primarily intended for battery work. The self-gripping feature insures a positive grip on acid corroded and mutilated terminal nuts. Its adjustable feature also makes it indispensable for many other kinds of work. Polished steel finish.

**No. 410 GRIPPING PLIER**



Length  $9\frac{1}{2}$ ". Capacity  $\frac{3}{16}$ " to  $1\frac{1}{8}$ ". Four adjustments.

Our No. 410 is a heavy-duty self-gripping plier which will hold work of any shape with a positive pipe wrench grip. Will exceed a pipe wrench in usefulness because of its light weight and streamlined design. Polished steel finish.

**No. 417 GENERAL UTILITY PLIER**



Length 7". Capacity  $\frac{3}{8}$ ". Three adjustments. Knurled grips.

The No. 417 is a heavy-duty plier with a gripping power many times greater than the ordinary slip-joint plier. Polished steel finish. Its superiority can only be appreciated by actual use.

Ask your hardware dealer to show you the complete **CHANNEL LOCK** line

**The NEW No. 420 PUMP PLIER**



Length  $9\frac{1}{2}$ ". Capacity  $1\frac{3}{4}$ ". Five adjustments.

The wide range of adjustments of the No. 420 Pump Plier makes it adaptable to a multitude of uses. New strength has been added by the patented design of the tension edge. Interlocking channels and lugs prevent slipping. Wide base lugs provide maximum cross section strength.

**SELECT THE PLIER YOU NEED**

**No. 424 IGNITION PLIER**



Length  $4\frac{1}{2}$ ". Capacity  $\frac{1}{2}$ ". Four adjustments.

This No. 424 ignition plier incorporates the Channellock adjustment feature in order to eliminate wear on the joint bolt and lengthen the life of the tool. A midget plier. Polished steel finish.

**No. 307 BATTERY PLIER LAP JOINT**



Length 7". Capacity  $\frac{1}{4}$ " to  $\frac{5}{8}$ ". Blue finish.

**No. 317 $\frac{1}{2}$  LONG NOSE PLIER with Side-Cutter**



Length  $7\frac{1}{2}$ ". Polished steel finish. Knurled grips. No. 3017 $\frac{1}{2}$  same model without side cutter. Point,  $\frac{3}{32}$ " round.

**No. 326 LONG NOSE PLIER with Side-Cutter**



Length 6". Polished steel finish. Knurled grips. No. 3026, same model without side-cutter. Point  $\frac{3}{32}$ " round.

**No. 337 DIAGONAL CUTTING PLIER Lap Joint**



Length 7". Weight 6 lbs. per doz. Polished steel finish. Knurled grips.

**No. 348 $\frac{1}{2}$  LINEMEN'S PLIER Rounded Nose**



Polished steel finish. Knurled grips. Side-cutter.

No.	Size
346	6"
347	7"
348 $\frac{1}{2}$	8 $\frac{1}{2}$ "

Only **CHAMPION DEARMENT** MAKES **CHANNEL LOCK**



**No. 3048 1/2 LINEMEN'S  
Bevel Nose**



Polished steel finish.  
Knurled grips. Side-  
cutter.

No.	Size
3046	6"
3047	7"
3048 1/2	8 1/2"

**No. 356 END CUTTER**



Length 6". Polished  
steel finish.

**No. 366 FLAT-NOSE  
PLIER**



**with Side-Cutter**  
Length 6". Polished  
steel finish. Knurled  
grips. No. 3066, same  
model without side-  
cutter.

**No. 378 LONG REACH  
DUCK-BILL  
PLIER**



Length 8". Polished  
steel finish.

**No. 3078 LONG REACH  
NEEDLE-NOSE  
PLIER**



Length 8". Polished  
steel finish.

**No. 436 DIAGONAL  
CUTTING PLIER  
Box Joint**



Length 6". Polished  
steel finish. Knurled  
grips. No. 435, same  
model 5" long.

THERE'S A **CHAN NEL LOCK** FOR EVERY JOB.

**No. 437 DIAGONAL  
CUTTING PLIER  
Box Joint**



Length 7". Polished  
steel finish. Knurled  
grips. A popular plier  
with automobile and  
airplane mechanics.

**No. 447 CURVED  
DIAGONAL  
CUTTING PLIER  
Lap Joint**



Length 7". Polished  
steel finish.

**No. 516 SLIP-JOINT  
PLIER  
Thin Nose**



Length 6". Polished  
steel finish. Knurled  
grips.

**No. 537 SLIP-JOINT  
PLIER  
with Side-Cutter**



Length 7". Polished  
steel finish. Knurled  
grips.

**No. 568 ANGLE-NOSE  
PLIER  
Slip-Joint**



Length 8". Polished  
steel finish. Knurled  
grips.

**"SUPERIOR" PLASTIC  
GRIPS FOR PLIERS**

Made of tough, durable plastic  
material. Easy to install, full  
instructions with each pair.  
Plier loss reduced as light blue  
color makes pliers easy to locate  
Gives maximum handle-grip  
comfort.





### BALL PEIN HAMMERS



**No. 20**  
Full Polished Finish  
(Painted Neck)  
**No. 20 1/2**  
Black Enamel Finish  
Dropped Forged  
Hickory Handle  
This hammer avail-  
able from 2 oz. to 3 lb.

### No. 88 LONG NECK ELECTRICIAN'S HAMMER



Designed specially for  
working over conduit  
and nailing junction  
boxes. Full Polished,  
Black Neck. Weight,  
18 oz.

### No. 451 1/2 "Our Pride" NAIL HAMMER



Special Analysis  
Steel. Properly heat-  
treated to insure  
maximum durability  
for claws, face and  
body. Square face  
provides wider strik-  
ing surface at edge of  
face and enables  
easier driving of  
nails close to abutting  
surface and in cor-  
ners. Claws are clean-  
cut and sharp for easy  
gripping of nails of  
all sizes. Lacquered  
handle is moisture  
proof, full octagon,  
nonslipping, and  
easy on the hands.  
Weight, 16 oz.

FOR HIGHEST QUALITY TOOLS BUY **CHAN NEL LOCK**

**CHAN NEL LOCK**  
*"Little Champ"*  
LINE OF PRECISION PLIERS

Only **CHAMPION DEARMENT TOOL CO.** makes **CHAN NEL LOCK**  
MEADVILLE, PENNSYLVANIA



*"Little Champ"*

A wonderful gift for hobbyist and professional craftsman alike... five slim, trim, precision-made beauties for delicate bench work. Just the thing for work in electronics, model making, invention, jewelry and watch repair. Get them individually or as a set of five nested in a useful, velvet lined, plastic case.

### SEND FOR FREE CATALOG!

On these pages, you see only a few of the many items in the complete Champion DeArment Channellock line . . . the products of three-quarters of

a century experience in the design and manufacture of highest quality tools. Send for our Catalog No. PM-55.

**CHAMPION DEARMENT TOOL CO. • MEADVILLE, PA.**  
POPULAR MECHANICS



# The SOLE answer to fit your job

Comfort? Efficient performance on-the-job? The two vital things your work shoes must provide! The answer lies in the soles . . . the *insole* and *outsole*. Both soles have to be suited to your particular job, and to the conditions under which you work.

FRIEDMAN-SHELBY OFFERS YOU the best possible combination of soles. Illustrated are just four of the many special patterns in our work shoe line. Visit your Friedman-Shelby Work Shoe Dealer. Check the features. See why and how they are crafted for individual job needs.



No. 8028-5

Designed for Railroad Men, Policemen, Postmen and Gentlemen Farmers. Boltan sweat resistant leather insole. Leather outsole with smooth, rolled edge. Wear-proof lining from top to toe.



No. 8035-2

Machinists, Service Station and Garage Attendants and Millwrights have endorsed this model with a cushioned insole and arch rest. Oil resistant Neo-Cork outsole.

Friedman-Shelby  
**WORK SHOES**  
CRAFTED FOR YOUR JOB

Available in full range of widths,  
from A to EE.



No. 8084

Meat Packers, Dairy Workers, and many others exposed to wet or slippery conditions, welcome this cushion crepe outsole and heel which helps eliminate walking shock and slipping. Also Boltan sweat resistant leather insole; and water-repellent, storm wetting.



No. 8053-1

Exactly right for Roofers, Carpenters, Painters and Riggers . . . and anyone that needs sure-footed day-long comfort. Boltan sweat resistant leather insole. Vul-Cork slip resistant outsole. Laced to toe flexibility.

For finer dress shoes

ask for these famous brands

John C. Roberts	\$8.95 to \$17.95
Kingsway	\$6.95 to \$ 8.95

MADE BY Friedman-Shelby DIVISION  
INTERNATIONAL SHOE COMPANY • ST. LOUIS 3, MISSOURI





**Weldwood Contact Cement** is brushed on studs and on back of paneling at points of contact. Allow to dry 30 minutes and repeat.

When cement is dry, press panel carefully in position, tap with hammer and wood block—the job's done. And—no nail holes to cover up!



## Panel a room in beautiful wood without a single nail!

**New, easy method of installing Weldwood paneling uses Weldwood Contact Cement for a nail-free job that's good for a lifetime!**

Now you can install big panels of beautifully grained real wood without nails and hard-to-putty nail holes. Using the method shown gives you a solid, clean-looking job that a professional might well envy.

Panel a corner of your den, all-purpose room, living room or bedroom in good-looking, best-selling Weldwood panels: figured walnut, deep-toned mahogany, light birch and elm, exotic blond Korina,<sup>®</sup> knotty pine and many other woods. Some come *already pre-finished* by expert craftsmen—no staining or waxing for you to do.

Ask your lumber dealer to show you the complete Weldwood line including knotty Surfwood<sup>®</sup> that looks like weathered driftwood; Novoply,<sup>®</sup> the wood-mosaic panel; and Weldtex,<sup>®</sup> the original striated paneling. Or see them all, plus superior Douglas Fir Weldwood, at any of the 73 United States Plywood or U. S.-Mengel Plywoods show-rooms in principal cities.

**SEE YOUR LUMBER DEALER**



# Weldwood<sup>®</sup>

**REAL WOOD PANELING**

**United States Plywood Corporation**

*World's Largest Plywood Organization*

Weldwood Building, 55 West 44th Street, New York 36, N.Y.  
and U.S.-Mengel Plywoods, Inc., Louisville, Kentucky

## The PM Precut House

(Continued from page 119)

who have already seen the prototype have asked: "Where did you get the beautiful old barn siding for the outside wall?"

That "barn siding" is a weatherproof half-inch composition board called Homasote, impressed with a deeply indented wood-grain texture that looks and feels like old weathered boards, but costs considerably less than any wood. This is one of the first times it has ever been used on an exterior surface to provide the "board and batten" effect that architect Dave Wilson achieved. Actually, there's nothing new about Homasote as a building material. Smooth-surfaced varieties are on buildings erected in Little America by Admiral Richard Byrd's first South Pole expedition in 1930. They were found in perfect condition under the snow when he went back in 1947. The wood-grained variety is the same material, but far better looking for our kind of house. There's a story about it, too. The technique for making it was discovered accidentally when a worker in the plant where it's made left an old barn board lying on the wet web when he quit at five one afternoon. By morning the web had dried and, when the board was lifted off, the imprint of every knot and bit of raised grain was firmly impressed in the composition board. The panels that come in the kit are the same kind of imprints from actual old-barn siding, specially selected for perfect reproduction.

Today, the material comes in eight-foot panels that vary from 16 to 32 to 48-inch widths. Architects Wilson and Christie have designed our shell with an exterior four-foot module. This means that the studs in the walls are arranged so that the wood-grain-panel edges will always fall on the center of a stud, for nailing. Battens, nailed over every stud, provide an interesting textural effect on the outside wall, and cover the seams between the panels as well.

For interior finish, anything is possible, and every man is his own boss. But in the two-bedroom floor plan used in the prototype, partitions have been figured to conform with the exterior module. Dry-wall and ceiling-panel construction can thus be used throughout, with panel trimming necessary only at the corners of the walls, and the far ends of the ceilings. In all plans, space-wasting halls have been minimized or eliminated to make the most of every square foot of floor space. Island wall dividers and "open walls" are utilized for airy spacious feeling.

A plumbing kit, including everything

(Continued to page 234)



**INSTANT  
LIGHTING**

# DO-IT-ALL TORCH

**NEW CRAFTSMAN 5-PIECE**

## PROPANE TORCH SET

**2300° F. flame that will**

- Solder wire, silver
- Melt lead, etc.
- Remove paint
- Soften asphalt tile
- Sweat copper fittings
- Soften putty, burn weeds
- Thaw frozen pipes, free belts
- Do jobs above and more at a saving

### With these Accessories

**UTILITY BURNER HEAD** has larger flame for heavy duty jobs. Replaces **PENCIL FLAME BURNER HEAD** shown above on angle tube.

**FLAME SPREADER** for preheating large surfaces, laying asphalt tile, paint removal, etc. Use on Utility Burner Head.

**SOLDERING TIP** (Small) for flat surface work in soldering jobs. Has large coverage. Use on Pencil Flame Burner Head.



Regular  
Price \$12<sup>60</sup>  
**SPECIAL PRICE**  
**\$888**  
Complete

**You Save \$372  
Until May 2nd**

**Long-lasting  
throw-away  
cylinder**



## **Burns in any position ..handy and easy to use**

For mechanics, plumbers, electricians, farmers, handymen, hobbyists, etc. You can save now on a complete master torch set. Easily solves any job where you need heat and flame. So safe and simple that anyone can use it. And NOW until May 2nd, Sears offers this entire set at a **special low introductory price!**

**Lightweight**—a little less than 3 lbs.—torch handles easily . . . you can use it with just one hand. Burns in any position—even **upside down!** Does heavy duty work—from removing paint to melting aluminum—at a constant 2300° F. When long-lasting cylinder is empty, throw it away! **Lights instantly** without pumping or priming! Remove protective cap and insert burner assembly . . . turn gas jet, strike a match, and it's lit. Adjust flame.

10-inch cylinder has 2<sup>3</sup>/<sub>4</sub>-inch diameter . . . packs easily in tool box or pocket. Contains 1<sup>1</sup>/<sub>2</sub> liquid pints. Excess-pressure relief valve on top. **UL listed.** All parts of high quality steel. Accessories interchange easily to do many special jobs. This means convenience—with economy—at home, in the shop, or on the job. With instructions. (Replacement cylinders cost \$1.95.) **At your nearest Sears Retail Store. Save \$3.72 until May 2nd only. . . . Set \$8.88**



**CRAFTSMAN** Hand and Power Tools by **SEARS, ROEBUCK and CO.**  
**Famous for fine quality . . . precision performance . . . low price!**



"Handy" SANDY asks:

# WHY NOT DO IT THE EASY WAY?



... with these 3 work-savers



## Flexbac SANDING PAD

On your electric drill cuts sanding time in half. The soft rubber pad of the Flexbac Pad Assembly follows every contour—concave, convex or flat. You sand furniture, boats, woodwork, or anything made of wood, metal or plastic in *half the time* you'd take with ordinary sanding pads and hand sanding. Use RED-I-CUT® Waterproof Paper Discs or HANDY-SANDY Discs—just press 'em on, peel 'em off when done. Kit includes complete Flexbac Pad Assembly, adapter for 1/4" drill, adhesive restorer.



**ONLY \$7** AT YOUR HARDWARE OR MARINE DEALER

Or direct, postpaid, with coupon below



## FURNITURE REFINISHING KIT

Tells you how to do it—gives you the tools to do it with! 16-page instruction book gives you the step-by-step procedures... tells you how to get the most from the 22 cut sheets of professional sanding papers in the kit—including garnet, silicon carbide waterproof, aluminum oxide moulding cloth.

**LESS THAN \$1** AT YOUR FAVORITE HARDWARE OR LUMBER YARD

Or \$1, postpaid, with coupon below



**FREE** ... 16-PAGE BOOK OF "GOOD SHORT-CUTS." Here are nearly all the "Good Short-Cuts" I've used in my column in *Popular Mechanics*, in a handy, pocket-sized booklet—completely indexed. Lots of valuable hints for the craftsman, or for the home "putterer." Pick up a copy at your hardware or lumber dealer; or send the coupon and I'll mail you one.

**CLIP AND MAIL THIS TO ME**

"Handy" SANDY

## CARBORUNDUM

REGISTERED TRADE MARK

Niagara Falls, New York

I usually buy my hardware and tools from

Name of Store.....

Street..... City..... State.....

Send me a FLEXBAC® Pad Sanding Kit. Enclosed is \$7.

Send me.... Furniture Refinishing Kits. Enclosed is \$1 ea.

I'd like the FREE "GOOD SHORT-CUTS" booklet.

My Name.....

Street and Number.....

City..... Zone..... State.....

from shower, sinks and waterclosets to the last pipe joint—especially designed for this house—will be available to anyone who wants it at remarkably low cost from a nationally known mail-order house. Variations in the plumbing can be worked out at greater or lesser cost depending on the arrangement and type of plumbing desired. Or it can be bought from your own supplier in any of the final stages you choose to install it. The shell kit does not include the plumbing package.

The final winterized version of the house indicates some of the unique but easy-to-build features you can include in your completed home. The roll-away closet off the entry is a tricky plywood affair on roller-skate wheels. It houses two sets of golf clubs, almost any number of fishing rods and tackle kits, half a dozen guns; four tennis rackets, a badminton set, two pairs of skis and poles, plus a wide assortment of ammunition and other supplies—in an area only 14 inches wide that slides away inconspicuously into the end of a coat closet.

The two-foot-wide storage wall between bedroom and living room contains a built-in bookshelf desk, a corner sofa made of two Hollywood beds that pull out to sleep a guest couple in solid comfort; or roll under the wall to provide comfortable seating capacity—with backrest cushion supports arranged so no one need lie flat on his back to reach them. The bedroom side has aluminum and cedar-lined cabinets (to discourage mice and moths) all across the top, plus a built-in wardrobe, dresser and luggage compartment. Modular open-face cabinets in the kitchen make china, tableware and kitchen appliances easily accessible, and the dish closet opens into the dining area of the living room for additional step-saving convenience. The refrigerator backs off into the utility closet to provide a face flush with the wall.

No swinging closet doors will ever produce black eyes or bloody noses in our prototype house, since all closet closures are made with simple matchstick-bamboo sliding doors that pull away to one side like the living-room draperies—completely out of the way when open, but as solid-looking as the walls when closed. Each one requires about 15 minutes to install.

The packaged chimney for the heating system went up in one morning. Installation of the gas furnace and water heater took about the same time. The fireplace chimney—an extra, optional item in the prototype—took a mason about nine days to build. Our cost was mostly labor since Rita and I hauled the stone and provided

(Continued to page 236)



# GRAVELY

**More  
for your  
Money!**



## GRAVELY MAKES TOUGH JOBS EASY!

Gravelly does jobs other tractors won't . . . because Gravelly has that *extra* power you need for the tougher mowing, gardening, field and farm jobs. Does a better job, even on *steep slopes!*

You get *more* when you get Gravelly. All-gear drive, power reverse, simple operation. More traction from easy-handled, *balanced* weight. Power attachments quickly interchanged, *securely* mounted, with only four bolts!

See Gravelly's rugged, compact, completely functional design. Not merely assembled, but completely manufactured by specialists who make only Gravelly Tractors and their attachments.

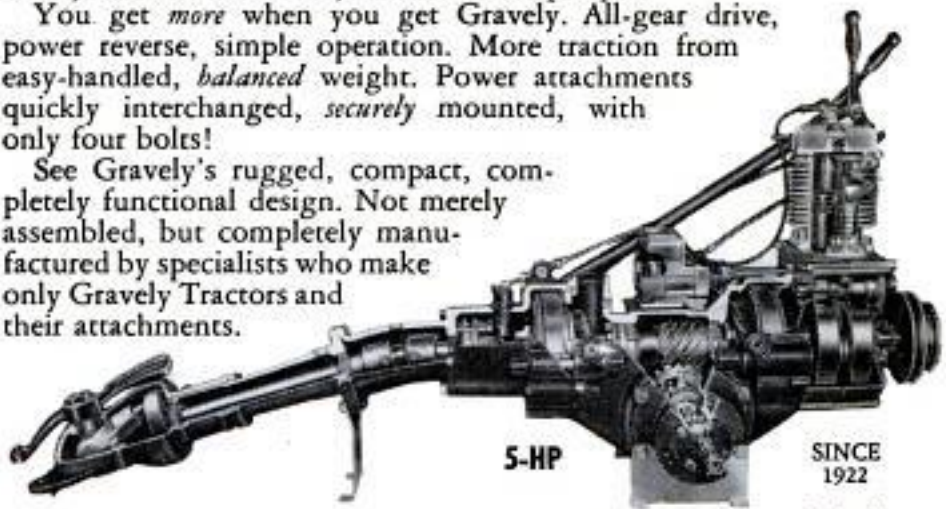

5-HP

SINCE  
1922

## PLUS . . . 21 JOB-RIGHT TOOLS!

Your choice of 21 tools for a versatile tractor that saves time, work and worry *all year long*. Tools to do every mowing, gardening, field and farm job.

Send coupon today for "Power vs. Drudgery", the big booklet that shows how Gravelly equipment solves your upkeep and gardening problems . . . *faster, easier, better!* NEW EASY PAY PLAN.

**GRAVELY TRACTORS, INC.**  
BOX 363 DUNBAR, W. VA.

Please send me "Power vs. Drudgery" Booklet and dealer's name.

NAME \_\_\_\_\_  
ADDRESS \_\_\_\_\_  
CITY \_\_\_\_\_ STATE \_\_\_\_\_



CULTIVATE



MOW WEEDS



SAW  
TIMBER,  
FIREWOOD



MOW  
LAWNS



BLOW  
SNOW



MOW  
LAWNS, WEEDS,  
MULCH  
LEAVES



HAUL

**MAIL TODAY**

**FREE**







*high-quality hand tools  
for finer workmanship*

Do the job easier and better with GREENLEE tools. Auger bits, electric-drill bits, other boring tools, chisels, gouges, spiral screw drivers, push drills, and many more. All expertly made of top-quality materials for long life, fine results. At leading hardware and building supply dealers. Write for folder, Greenlee Tool Co., 2103 Columbia Avenue, Rockford, Illinois.



all of the cement and sand—which you can do, too. That beautiful chimney—cement, flue lining and Heatilator included—cost a total of about \$325.

How all these things were done, and worked out under the cost limits mentioned in the first part of this article, will be covered in three subsequent issues, briefly outlining each construction phase of the house. Naturally, limited space for these articles will not permit a blow-by-blow, how-to-build description of every detail and possible variation in the construction of the house. They'll take you through the fundamental high spots and describe the innovations involved in each basic stage. Where the articles stop, blueprints and a book begin, to show you in accurate detail each phase of construction in all its ramifications. Every kit includes a copy of the book and a set of blueprints or you may secure them separately through *Popular Mechanics Magazine*.

One of the greatest features of the precut house is its remarkable adaptability—which begins at the very foundation. With slight variations for piers, your basic shell is designed to sit on anything you want. We chose the crawl space of concrete block.

How we built it is the subject of the second installment in this series—which also deals with the construction of the shell stage of the house. ★★★



**Repeating Stereo Viewer**

By building a magazine onto a stereo viewer, a California manufacturer has developed a means of watching as many as 50 stereo slides without interruption. The slides fit into a cartridge below the viewer and new ones are brought into the line of vision by turning a knob. The new viewer weighs only a few ounces more than standard viewers.





Enjoy happy hobby hours with **GOTHAM HOBBIES**



**PLEASURE AND FUN FOR THE ENTIRE FAMILY!**

# FULLY ASSEMBLED 1/7 H.P. *Real* DIESEL ENGINE

A perfect power plant for planes, boats, race cars

Enjoy many hours and hours of fun pursuing your hobby with DEEZIL . . . the real diesel engine that runs at 7500 RPM and produces 1/7 HP. Weighs only 5 oz. DEEZIL is not a toy. It's compact, rugged, streamlined. Starts quickly. Simple to install. Every engine test run at our factory to assure perfection. Easy to follow operating instructions.

Ultra precision engine as carefully machine-tooled as giant army engines. Cylinder is honed to .0001 and hand fitted to its individual pistons.

Ideal gift for boys and adults.  
Send cash, check or money order.



**YOURS AT A NEW LOW, LOW PRICE**

over 100,000 sold at a higher price

**NOW \$1.95**  
Plus 5¢ Postage



ACTUAL SIZE

**SPECIAL OFFER!**  
196 page book on model engines  
(Giant new hobby catalog included)  
Only \$1.00 postpaid

MADE IN U.S.A.

OUR \$786 ADVERTISEMENT

**More GOTHAM HOBBY Values to Choose from!**



**SEA BUDE SPEEDBOAT.** 12 1/2" with electric motor, fully assembled, including fittings. \$4.95

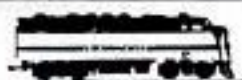

**VARNEY TRAIN OUTFIT.** 88 wheels a-rollin',

ready to run. Twin-drive loco (shown) with trailing B unit and 9 other assorted cars, including freight, flat, tanker, caboose, etc. Magnificent detail, sturdy construction. Also includes 22 sections of snap-together track and power-pak. Absolutely complete \$49.95



**BIG 3 CRAFTING OIL PAINTING OUTFIT.** Start painting at once. Contains everything you need. Three 12"x12" mounted panels, numbered and ready for painting. Large jars of brilliant pure oil colors, plus 3 artist's brushes. Crucifixion and other religious subjects. Set of 3 \$3.95

**READY TO RUN MODELS**  
(Engine included)  
No assembly necessary



**AQUAMITE PLANE and ENGINE.** Ready to fly. All plastic \$9.95



**TURRET MICROSCOPE** 100-300x power.

A real scientific instrument for exploring the unknown. Well constructed. Precision lens. Fine adjustments. Includes 130-page detailed guide containing photos and interesting information \$17.95



**HIGHWAY PIONEER CAR SETS.**

Model shown 1910 Ford. Authentic reproductions of cars from nostalgic early days, plus today's foreign sport cars. Begin your collection with these models. Easy to build. Kit contains all parts and paint, brush and cement. Available in these models: JAGUAR, MERCEDES, ROLLS ROYCE, STUTZ BEARCAT, FORD. Set of 6 complete \$4.95



**ASTRONOMERS TELESCOPE WITH TRIPOD**

30x power. Beautifully designed, compact telescope for viewing the heavens. Precision ground lens. Complete \$22.95



**READY TO RUN AUTOMITE RACE CAR.** High impact plastic. May be run tethered or free \$16.95



**ONE TUBE RADIO KIT**

Not just a toy, but a precision engineered radio with modern circuits and tubes. Will receive local and long distance stations \$7.95



**ADMIRAL FLEET PACK CONSTRUCTION KIT.** Atomic submarine (shown).

Plastic kits the entire family loves to build. Super-detailed exact scale models. No cutting or sanding required. Just assemble. Build all these models: CARRIER FRANKLIN D. ROOSEVELT 21"; BATTLESHIP MISSOURI 20"; HEAVY CRUISER BALTIMORE 17"; DESTROYER SULLIVAN 15"; PT BOAT 9"; CHRIS CRAFT CRUISER 9"; ATOMIC SUBMARINE NAUTILUS 13". Set of 5 complete \$4.95



**PAINT BY NUMBER PICTURE.** "The Last Supper" (shown). Christ gathers His disciples in this farewell scene. Large 18"x24" canvas. Hours and hours of pure enjoyment painting portrait scenes. Professional results by amateurs \$4.95



**READY TO RUN AQUAMITE BOAT.** In-line drive unit. Requires no gears. Twin rudders \$9.95

**ORDER BY MAIL TODAY**  
Specify item desired

Giant new hobby catalog included with every order. A charge of 25c for this catalog is made when ordering separately, but will be refunded on your first order.

**GOTHAM HOBBY CORP.,** Dept. P, 107 E. 126th St. New York 35, N. Y.



## Rotary Tilling at its Best

*and then some\**



Brand  
New  
for '55

2 Big New



Rotary Tillers



Plowing,  
Cultivating,  
Harrowing,  
Discing, Weed-  
ing, Furlowing,  
Lawn Mowing,  
Weed Cutting,  
Clearing  
Fence Rows,  
Felling Trees,  
Clearing Brush,  
Sawing  
Cordwood,  
Bulldozing,  
Snow Plowing,  
Spraying,  
Painting,  
Hauling,  
Auxiliary or  
Emergency  
Power

Write for  
FREE  
Illustrated  
Catalog

AMERICA'S NO. 1 LINE OF GARDEN TRACTORS AND IMPLEMENTS

Dealers: Some territories are still  
open. Write for information.

SIMPLICITY MANUFACTURING COMPANY  
5517 Spring Street • Port Washington, Wisconsin

Real clodbusters!  
These new Simplicity  
Rotary Tillers do every-  
thing a single-purpose  
rotary tiller can — and  
offer you the advantages  
of modern rotary tilling  
*at the price of a single  
implement!* Easy to attach,  
rigid and rugged as a  
single-purpose unit. Ask  
your dealer for a demon-  
stration...he's listed in your  
phone book's yellow pages.

CHOOSE YOUR TRACTOR FROM  
THESE 3 GREAT MODELS  
IN THE 1955 SIMPLICITY LINE!

- 2 H.P. MODEL LA—popular favorite  
at a new low price.
- 2½ H.P. MODEL FA—with 6 for-  
ward speeds AND reverse.
- 5 H.P. MODEL VA—all gear trans-  
mission and power for big jobs.

## Big Boom in Jails

(Continued from page 144)

law enforcement about 1600 for the punish-  
ment of debtors and vagrants. In those  
days food was bought from jailers, sanitary  
devices were nonexistent and the whipping  
pole was usually warm. As late as 1773 the  
state of Connecticut kept prisoners chained  
together in an old mine.

New York erected the first state prison  
in the country in 1796. In Pennsylvania,  
Quakers had formed what they called the  
Philadelphia Society for Alleviating the  
Miseries of Public Prisoners. The  
Quakers influenced the city of Philadelphia  
to build a new jail with 30 individual cells.

The idea spread. Officials thought this  
would give prisoners more time to contem-  
plate their past acts and repent. Today,  
segregation of prisoners is one of the pri-  
mary considerations in planning a prison.

"Regardless of how well a jail is built,"  
says Stewart's chief engineer Milton E.  
Gschwind, "prisoners still break out of  
them. There isn't a piece of steel made that  
can't be cut, even though we use special  
steel bars with tool-resistant cores."

Where is the weakest point in a jail?  
Usually it's in administration. Jail makers  
contend that practically all breaks can be  
traced to one of two causes: 1) Collusion,  
or 2) carelessness.

Some guard, for instance, should have  
known what was afoot in the western peni-  
tentiary where two convicted killers es-  
caped from death row a few years ago.  
They started by hoarding molasses from  
breakfast trays and using shoes to chip  
pieces of concrete off the floor. They  
ground the concrete into powder, then cut  
some string into two-foot lengths, ran the  
string through the molasses and then the  
powdered concrete. Once dry, these made  
a fine abrasive to cut through jail bars.

The cost of a jail varies considerably  
with the situation it is modeled to fit. The  
cost per cell varies anywhere between \$700  
and about \$2500. These prices include the  
door-locking devices which permit guards  
to open cells from another room. Thus, they  
can turn prisoners into the bull pen or ex-  
ercise yard with complete safety. These  
door controls can be operated only by  
hand. It could be rigged to work by elec-  
tricity but the jail makers see this as a  
highly dangerous plan because in case of  
fire the electricity often goes first.

Officials of the Stewart Iron Works like  
to tell about their highest compliment. One  
trusty being transferred to a new jail told  
a Stewart representative: "I guess about  
the only way to get out of here is be paroled  
out." ★ ★ ★





Crescent Standard Pattern Snip, No. S412, 12". Also in seven other sizes 7" to 14".



**COMBINATION PATTERN**  
U412, 12" only.



**HEAVY DUTY SNIPS**  
U416, 16" only.



**CIRCULAR CUTTING SNIPS**  
T412, 12". Also in 7" size.

## CRESCENT SNIPS

All Crescent Snips are forged of selected steel and blades ground on special grinding machines. They are hardened by Crescent's own selective induction process to insure long, satisfactory service. These easy-cutting, well-balanced snips are made in four patterns; standard, circular cutting, combination and heavy duty. Sold by Industrial Distributors and Hardware Dealers everywhere.

**CRESCENT TOOLS**

*Give Wings to Work*

*Sign of the Artisan  
Symbol of Excellence*



Crescent is our trade-mark, registered in the United States and abroad, for wrenches and other tools. Sold by leading distributors and retailers everywhere and made only by **CRESCENT TOOL COMPANY, JAMESTOWN, NEW YORK**



# GET THE BEST... MULTIPLIED

- Not just one "best" tool with makeshift accessories, but the best equipped, complete power workshop money can buy!
- Not only the tools you need for doing five jobs well, but the best tool for scores of standard and unusual operations!
- Not a shop-full of large individual tools, but a single, compact, movable unit with even greater capacity and precision!
- Not just the best speed for sawing, but the best speed for any operation, automatically set by exclusive Speed-Dial.

• Not only the most accurate power tool for the money, but the safest, most modern, largest selling precision power tool as well!

• Not delivered "knocked down" for you to put together but completely assembled, fully adjusted, all ready to plug in! 19" wide, 71" long.

• Not the \$600 you'd pay for comparable tools, motors and benches, but only \$269.50 complete.

**Even your power tool dollars are multiplied with SHOPSMITH!**

**SHOPSMITH IS THE BEST 34" LATHE**—full 16 $\frac{1}{2}$ " swing; the only lathe with universal tool rest that slides parallel to work, dial speed selection, and dial mount which offsets cup center for easy taper turning.

**SHOPSMITH IS THE BEST 12" DISC SANDER**—113 square inches of sanding surface; the only sander with disc feed lever, large tilting table, locking miter gauge and fence for accurate duplicating jigs.

**SHOPSMITH IS THE BEST 9" CIRCULAR SAW**—2 $\frac{1}{2}$ " depth of cut (2 $\frac{3}{4}$ " on 45° bevel); the only saw with quick-change saw arbor, blade-to-fence capacity for cutting 4' x 8' panels exactly in half either way.

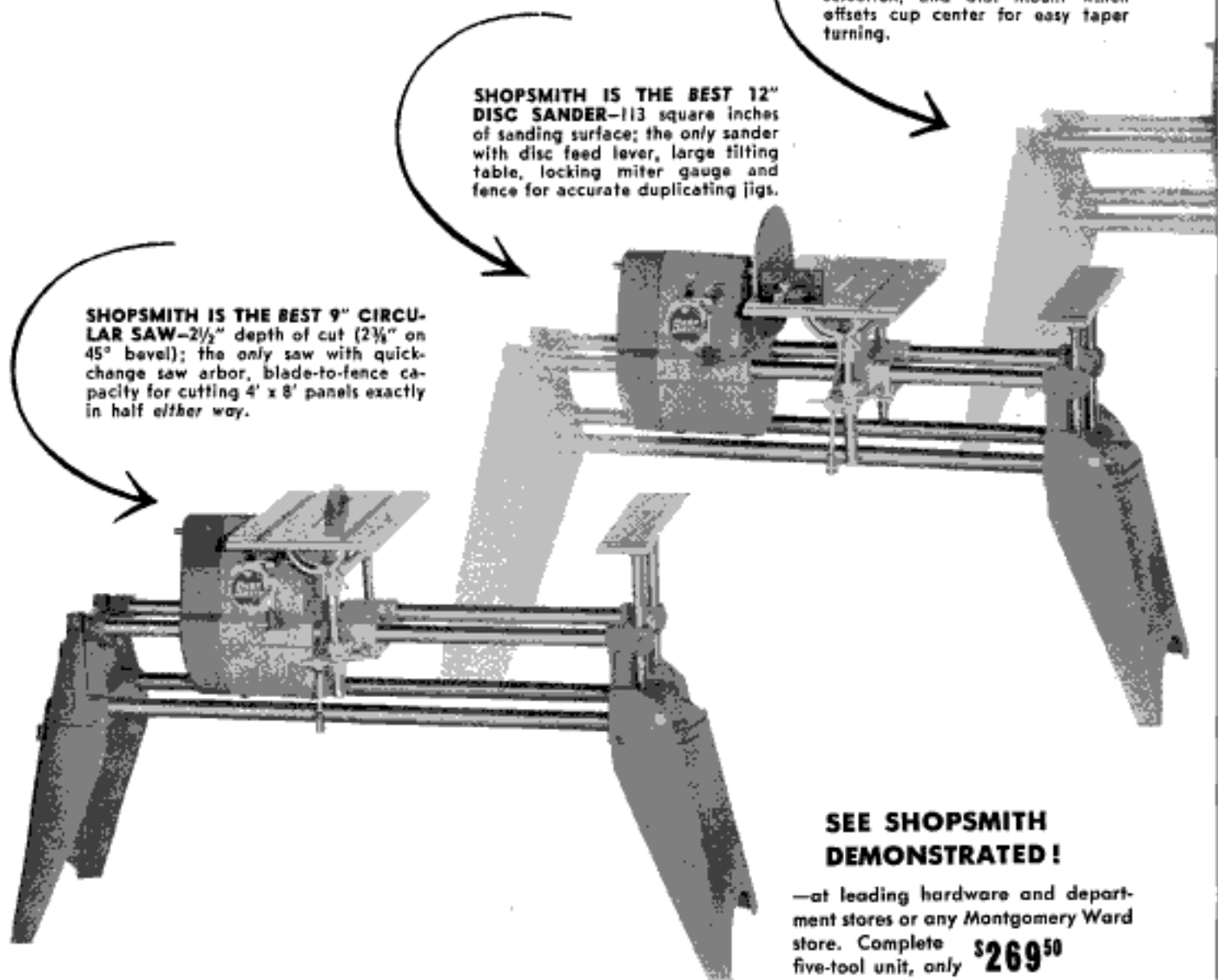

## SEE SHOPSMITH DEMONSTRATED!

—at leading hardware and department stores or any Montgomery Ward store. Complete five-tool unit, only **\$269<sup>50</sup>**



# ...IN SHOPSMITH\*!

SHOPSMITH OFFERS THE ONLY HORIZONTAL DRILL with unlimited side boring capacity, automatic jiggling with locking miter gauge and fence, rack-and-pinion table raising for extra doweling accuracy.

SHOPSMITH IS THE BEST VERTICAL DRILL PRESS—drills to center of 16½" circle; the only drill with dial speed selection, dial depth of quill feed up to 4¼", chuck-to-table capacity up to 25", chuck-to-floor, up to 58".



\*Trademark Reg. U.S. Pat. Off.

## You can do it and do it RIGHT! Dial SHOPSMITH!

Exclusive Speed-Dial eliminates guesswork, assures correct speed for every job. Just set the dial. Speed adjusts automatically—700 to 5200 rpm. No belts to change.



## NEW SHOPSMITH HAS POWER-MOUNT!

For quickly adding 4" jointer, 18" jigsaw, paint spray compressor. Permits operation of combination setups—saw-jointer, jigsaw-sander, etc.



## "POWER TOOL PROJECTS YOU CAN MAKE"

This book shows you how to turn out professional-quality built-ins, furniture and toys. 30 easy-to-build projects. Drawings and step-by-step photos by the hundreds. Shop hints and short cuts. At most newsstands (Fawcett How-To Book 251) or at your SHOPSMITH dealer! Get a copy today!

## MAGNA ENGINEERING CORPORATION

Dept. 293-B at factory nearest you:  
12819 Coit Rd., Cleveland 8, Ohio, OR Menlo Park, Calif.

Please rush two free books (1) "What to Look for When You Buy Power Tools," valuable shop guide; also (2) data-packed 20-page SHOPSMITH catalog with complete details, specifications, accessory information.

Name \_\_\_\_\_

Address \_\_\_\_\_

City \_\_\_\_\_ State \_\_\_\_\_



EVERY SKILLED CRAFTSMAN,  
MECHANICAL HOBBYIST AND  
DO-IT-YOURSELFER SHOULD  
HAVE THIS **NICHOLSON**

# HANDY FILE

Special low price during  
**HARDWARE WEEK**  
April 15-23

**only 60¢**  
(Regularly 76¢)

Like those inseparable Siamese twins, the Nicholson **HANDY FILE** is *two files in one*. Either or both are always at hand... in the single-cut side for smoothing and edge sharpening; the double-cut side for fast stock removal.

Flat forged-on orange-colored handle makes the **HANDY FILE** easy to carry—in hip or leg pocket. Hang-up hole makes it easy to store and find. Cellophane wrapping brings it to you rust-and-moisture free. Made by the world's foremost file manufacturer, you can be sure it is unbeatable in long-lasting quality.

(Also made in Black Diamond brand)

At hardware stores everywhere

FREE new edition of Nicholson's famous 52-page book, "File Philosophy." Write to



**NICHOLSON FILE COMPANY**  
22 Acorn St., Providence 1, R.I.



(In Canada: Nicholson File Company of Canada Ltd., Port Hope, Ontario)

# NICHOLSON FILES

FOR EVERY PURPOSE



## 1955 "Little Giant" FM Receiver For Experimenters

(Continued from page 163)

FM-type receiver is a simple homemade affair, illustrated in photos B and C. The dial drum is an ordinary tin jar cover, having a diameter of  $1\frac{7}{8}$  in., which is soldered to the shaft of the split-stator variable capacitor C5. Punch the center hole carefully with an ice pick or similar pointed instrument. This leaves a small burr on the inside of the cover which is helpful in soldering the drum to the shaft. The drum should be mounted on the shaft before the variable capacitor is fastened to the chassis base. After the tuning capacitor is fastened to the chassis, remove two rotor plates (those nearest the center of the capacitor) this leaves four rotor plates on each section of the split stator. The tuning shaft for C5 consists of a small panel-bearing assembly, the over-all length of which is 3-in. This shaft bearing is a standard type listed in all radio-parts house catalogues for about 30 cents. The shaft can be cut off to the required length. A rubber grommet is pressed on this shaft to provide a firm nonslip seat for a single loop of dial cord by means of which the tuning capacitor is rotated. A wide rubber band covering the dial drum prevents the cord from slipping, and fills in the spiral groove on the jar cover.

Photos A, B, C, D and E show various views of the top and bottom of the chassis and the completed unit mounted in the standard-size aluminum cabinet, 6 in. x 9 in. x 5 in. The front and back covers are removable and are fastened to the cabinet with self-tapping screws. This cabinet is gray in finish and is priced at about \$2.25 in most parts-house catalogues. The 4-in. PM speaker is shock-mounted on rubber grommets; it should be mounted as close as possible to the left and top edges while still permitting the panel to be fastened to the cabinet. The grille holes are drilled

(Continued to page 244)

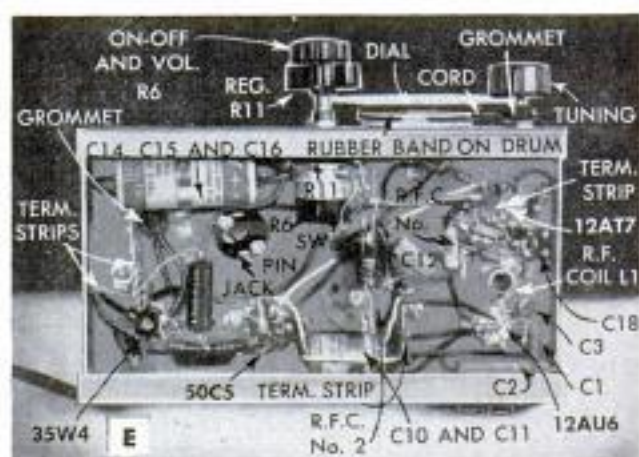



# "Old Timer" Shows Young Pipe Smoker Reason EDGEWORTH SMOKES COOLEST

## Compare the Cuts of Pipe Tobacco



Some brands give you shorts and bits which burn like tinder—fast and hot.

Others give you fine-cut shreds—good for cigarettes, but not so good for pipes.



Only Edgeworth gives you slow-burning "chunks" made for pipes and pipes alone.

**SPECIAL OFFER \$1.50**



### Shows Meaning of "Ready-Rubbed"

Old time smokers knew the secret of cool, even burning. They carefully "hand-rubbed" their tobacco into chunks of just the right size. Now Edgeworth does all this

before the tobacco is packaged. An exclusive process "ready-rubs" Edgeworth into chunks that pack right for a cool smoke without a touch of tongue bite.

## Made Right...Cut Right and Packed Right!

Your true tobacco expert will tell you that white burleys are the world's coolest smoking tobaccos. Edgeworth is a blend of white burleys only—aged for years. It leaves our plant with just the right moisture content for a cool, no-

bite smoke and reaches you in the same condition because only Edgeworth has the Seal-Pak pouch. Air-and-water tight, it promises you fresher tobacco than any other type of pocket pack. No bulky corners in your pocket, either.

### FOR A MILD MIXTURE TRY HOLIDAY

A "custom" blend of five tobaccos selected for mildness and aroma. The only mixture in the Seal-Pak pouch.



Get this new polished aluminum stem "Park Lane" pipe with interchangeable imported briar bowl and exclusive "dri-dome" moisture trap—along with 2 full-sized pouches of EDGEWORTH tobacco. If your dealer cannot supply you, use this handy order blank.

Name \_\_\_\_\_

Address \_\_\_\_\_

City \_\_\_\_\_ State \_\_\_\_\_

Mail with \$1.50 to Park Lane, Larus & Brother Company, Inc., Richmond, Virginia

PM-3

# Edgeworth

AMERICA'S FINEST PIPE TOBACCO FOR OVER HALF A CENTURY



in the simple pattern shown in the photos. Two rows of holes are also drilled in the rear panel to provide ventilation, and a cutout clears the two antenna posts.

The chassis used is aluminum. The holes may be hand drilled and enlarged with a reamer, or chassis punches of required sizes are available at nominal cost. Follow the layout shown in photos B and E; use soldering lugs and rosin-core wire solder for all connections.

Oscillator coil L2 mounts directly on the stator-plate terminals of each section of variable capacitor C5. It consists of three turns of No. 14 enameled wire. The coil length is  $\frac{1}{2}$  in.; the diameter 1 in., and it is air-wound (self-supporting). Coil L1 is the r.f. coil; this is wound on a slug-tuned coil form. The one used was a Cambridge Thermionic Corp., LS3-type form. It is listed in the 1955 Allied Radio catalogue under stock number 72 H 294 and is priced currently at 55 cents. Five turns of No. 20 enameled wire are spaced out to a length of  $\frac{1}{4}$  in., the ends being connected to the terminal lugs provided on the coil form. The tuning slug extends above the top of the chassis base and is slotted for screwdriver adjustment. R.f. choke No. 1 is 2.7 microhenries.

After the wiring is completed the set should be adjusted before it is installed in the cabinet. Accurate adjustment requires

the use of a grid-dip meter or a signal generator. However satisfactory results can be obtained without any test instruments if the coils have been wound correctly. Since the r.f. amplifier stage is broad-tuned, no tracking difficulties are encountered. It is only necessary to adjust the band-set capacitor C18, 5-25 mmfd. ceramic trimmer, so that the entire FM band will be covered. Then adjust r.f. coil L1 for maximum volume in the middle of the band. When the receiver is first turned on, a hiss will be heard through the loudspeaker when the regeneration control R11 is set in the extreme clockwise position. The volume of the hiss should vary as the volume control R6 is rotated. If these indications are normal the set is operating properly and is ready for adjustment.

With the antenna connected, rotate C5 to a half-open position; adjust C18 until a station is heard. Now adjust the settings of the regeneration control and the tuning capacitor C5 simultaneously until the station is heard at maximum volume and clarity. This should occur at a reduced setting of the regeneration control. Calibrate your FM-station settings on the cardboard dial. Detailed student material list R-431 is available from *Popular Mechanics* Radio-TV and Electronics department upon receipt of ordinary letter postage. ★ ★ ★

## EARN EXTRA MONEY the IDEAL way!

SHARPEN POWER OR HAND MOWERS LIKE AN EXPERT!

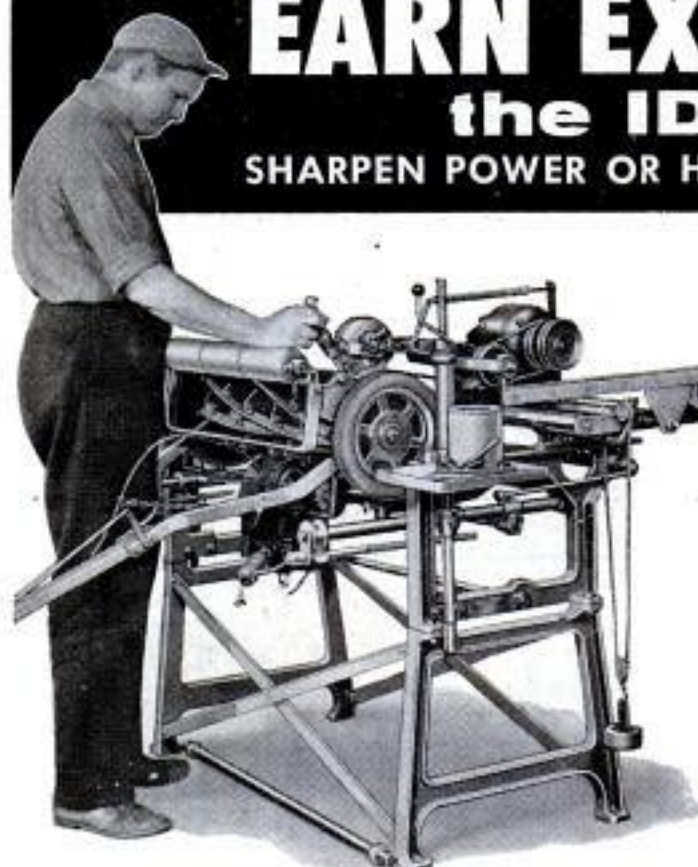

### NO EXPERIENCE NEEDED

You can sharpen your first lawnmower expertly on an Ideal Sharpener. Just put the mower in your Ideal—no need to take it apart—and you'll have a perfect cutting mower in minutes.

### CASH-IN ON THE POWER MOWER BOOM

Start a profitable business full-time, or in your spare time at home. Hundreds of power and hand mowers are in use in your area. It's a real opportunity. Be ready for spring and summer business . . . get your Ideal Lawnmower Sharpener now!

Write for FREE catalog to:

**The FATE-ROOT-HEATH CO.**

Dept. PM-3, Plymouth, Ohio

**IDEAL LAWNMOWER SHARPENERS, THE QUALITY LEADER FOR 52 YEARS!**



**One secret behind one of industry's  
greatest success stories!**

# **M** **MULTI-PLY** **DIAPHRAGM**

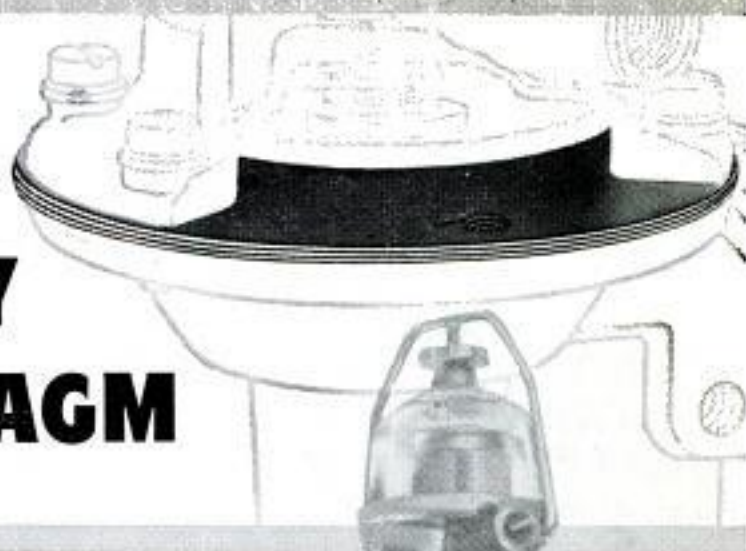

**AC's multi-layer diaphragm multiplies  
fuel pump life expectancy!**

The heart of any mechanical fuel pump is its diaphragm. Normally, as long as the diaphragm lasts, the pump lasts — providing fuel for the engine and extra vacuum for windshield wipers. All AC diaphragms have 3 or more "plys" . . . providing maximum flexibility and life. These benefits can be obtained with no other type of construction. Number of "plys" is tailored to the individual application.

**Tested in use through more than  
a 170° range of temperature!**

The U. S. Army proved the dependability of AC's multi-layer diaphragm over a period of years. *In Africa* — hard driving through 110° of heat and more had no harmful effect on this specially treated fabric. *In Alaska* — maneuvers with thermometers at 60° below zero had no ill effects.



**9 out of 10 cars and trucks on the road  
are equipped with AC Fuel Pumps!**

Few if any other automotive components can lay claim to such nearly universal acceptance. Nine out of ten cars you pass are factory-equipped with AC Fuel Pumps. AC quality dominates the field. *AC builds more, AC sells more — because AC builds them better!*

***Another AC Feature Story that can't be topped!***

***Always look to AC and GM for Leadership!***



AC SPARK PLUG DIVISION • GENERAL MOTORS CORPORATION





## Take a tip from a rusty bolt!

### Don't let harmful engine deposits LOCK UP your car's horsepower!

Just as rust binds a bolt, so deposits shackle your engine, stealing pep, wasting gasoline, causing excessive wear.

Pennzoil with Z-7 keeps vital parts free from all harmful contaminants. Allows the *Tough-Film*® to lubricate completely, *unlocking* horsepower for instant response, for better gasoline economy.

Next time, change to longer-lasting Pennzoil with Z-7. You'll *feel* the difference behind the wheel!

Sound your  for the  
**LONG QUART**

NOW with  
**Z-7**  
the POWER  
INGREDIENT



Switch now at this sign

BETTER DEALERS  
IN EVERY STATE FEATURE PENNZOIL® PRODUCTS

© 1955, The Pennzoil Co., Oil City, Pa., Member Penn. Grade Crude Oil Assn., Permit No. 2

## Bobwhite King

(Continued from page 84)

the first week of March, a time clock turns on a 25-watt bulb over each pen in the middle of the night. Within a month the first eggs appear.

Soon after he started his business, the idea occurred to Lowrance that if aureomycin could improve the health and weight of chickens and hogs, it probably would help his quail.

"I didn't know how to go about it," he says now, a bit ruefully, "so I just started buying aureomycin capsules from our family doctor at 75 cents apiece. The results were astonishing. One batch of quail on aureomycin weighed more at three weeks than other batches weighed at four weeks. And they were far more resistant to disease. Now I use a commercial aureomycin, adding only one teaspoon to a barrel of water. It performs miracles."

The farm superintendent, Eldon Corn, and five other employees are kept busy from April through July gathering and caring for the eggs. All quail eggs are virtually identical in size, not much larger than your thumbnail. During the peak-production period, as many as 9000 eggs will be gathered in one week. Employees place them in trays, 400 to a tray, 8 trays or 3200 eggs to an incubator. They turn the eggs every 8 hours, and for 20 days the eggs incubate in a carefully controlled climate. Nearby is a tank which pipes oxygen into the incubator—another of Lowrance's ideas. On the 20th day the eggs are moved to the hatcher.

Precisely on the 23rd day one of nature's minor miracles occurs. The quail shell is tougher than a chicken shell, and curled up inside is a wet little mass striving for life. On the very top of the chick's beak nature has placed a microscopic spear, similar to a tiny rose thorn. The chick moves his beak around one end of the shell, lifting his head to puncture holes in a perfect circle with his thorn. When the circle is almost complete, this section of the shell folds back as though on a hinge, and through this "doorway to life" steps the newborn chick. Already he is endowed with the fleetness of foot that is his prime protection, for he can run right away from the shell. Within an hour the thorn that unlocked the door has fallen off.

These newborn chicks are not much larger than a bumblebee; you can fit 75 of them on an ordinary dinner plate (which may ultimately be their lot in life) without any overflow. It takes five of these specks of life to weigh one ounce.

(Continued to page 248)



# Young Men With Mechanical Skills



## Can Train With The U.S. Air Force

The U. S. Air Force needs ground personnel...young men who may be trained in technical specialties...men to keep our giant Air Force bombers and jet fighters in the air. Start planning your future today...as an Airman in the U. S. Air Force. You'll earn good pay and learn a skill that may benefit you the rest of your life. Get the facts right now about the opportunities offered by your U. S. Air Force.

**You Go Places—Faster  
in the U.S. Air Force**

## ...In One Of These Exciting, Interesting Specialties

AIRCRAFT MAINTENANCE	GUIDED MISSILES
ATOMIC WEAPONS	ROCKET PROPULSION
COMMUNICATIONS	SUPPLY
CONSTRUCTION	TRANSPORTATION



*STUDENTS—Graduate before  
you enlist*

M-6-PM

**Personnel Procurement Division  
AFPTR-P-4 U. S. Air Force  
Washington 25, D. C.**

Please send me more information on my opportunity as an Airman in the U. S. Air Force.

Name..... Age.....

Address .....

City.....Zone.....State.....



Most losses occur in the first few days of life, so Lowrance keeps the youngsters in electric brooders. They are fed lettuce and Swiss chard, chopped so fine you can scarcely see the particles.

Within a few days the birds are about the size of a quarter, yet they are so fast on their feet you'd have trouble catching one in an unconfined area. Lowrance points out that in their natural state most quail will try to outrun a man, but will fly away from a dog or other four-footed animal.

Quail will peck and kill any of their own kind which are wounded or weak, so when they are five days old Lowrance cuts off the sharp points of their beaks with a painless electric debeaker. After five days in the brooder house and four weeks in the brooding pens, the chicks, no longer requiring controlled heat, are moved outside to one of the 86 rearing pens. Each pen measures 16 by 24 feet, is partitioned down the middle and will handle 600 birds. At this stage in life the chicks are as frisky as kids. In each pen is a sandbox in which they play, and pine boughs through which they climb and hide. At five weeks they are fully feathered and are divided so they have twice as much space. At eight weeks they are at their wildest, and at 16 weeks are fully grown, mature birds. Any quail which are to be released for restocking are

moved to a conditioning pen where they can fly long distances. The pen measures 300 feet long, 10 feet high and 20 feet wide. Corn and other cover are provided, and the quail soon learn to forage for their food, hide and flush at the approach of a human.

Lowrance realizes his profit from three different sources: He sells eggs (at 30 cents apiece) or young birds to folks who are fascinated by the beautiful bobwhite and want to raise them for fun or profit; he oven-dresses some 16,000 birds each year, packs them in Dry Ice and ships them off as table delicacies to restaurants or to individuals as gifts, and he sells young adult birds to hunting clubs, sportsmen and state conservation departments for restocking.

These restocking programs are the nub of the argument over bringing back the bobwhite. One faction argues that pen-reared birds just won't survive in nature. Their program calls for the planting of cover crops and the closing of the hunting season for many years until the relatively few scattered birds can covey up and re-establish themselves.

Lowrance and others on his side of the fence disagree.

"Pen-reared birds can survive just as well as wild ones," Lowrance says vehemently, "if you undertake a restocking

(Continued to page 250)

Buy **EVANS** for  
**EXTRAS**  
in 6, 8, 10 and New 12 Foot  
"WHITE-TAPES"

This is the BUY for your money — the original, reasonably priced "White-Tape" by EVANS. Your measuring tape dollar goes further! Chrome plated, sturdy case. Snow-white Bonderized steel blades with jet markings, easy to read, last longer. Velvet push-pull action. Instant change replacement blades available. 12-foot size, made only by EVANS, has convenient new blade markings in feet and inches as well as regulation inches.

**Evans & CO.** 410 Trumbull St., Elizabeth, N. J.



FREE WITH EVERY TAPE

— this sparkling crystal  
Tenite utility case.

**EVANS**  
**L-O-N-G "WHITE-TAPES"**  
25-50-75-100 Ft. Lengths. Sensibly  
priced from \$3.49. In transparent util-  
ity box. Leather grained vinyl cover.  
Hook ring attachment no extra charge.

**Sold Only Through Retailers**

**EVANS, THE LARGEST PRODUCERS OF STEEL TAPES WORLD-OVER**



Your **KEY**  
to command  
performance



*Super  
Silent!*



#### LATEST NEWS!

Available in variety of striking new  
2-tone color combinations.

**TURN THE KEY.** Your mighty Mercury Mark 55E Merc-Electric responds to the 12-volt electric starter—*right now!* With the electric choke it's as easy as starting your car.

**TAKE THE WRAPS OFF . . .** and listen. You never knew forty horses could be so *quiet*. It's a four! *Complete* engine soundproofing, not just intake and exhaust silencing, makes the Mark 55E super silent. Dyna-Float Suspension floats the engine on rubber shear mounts to keep vibration away from your boat.

**TAKE HER IN**—reluctantly, for this was a cruise that was *all* fun. No need to check the battery . . . it was charged automatically. The *only* 12-volt starter-generator system on any outboard gives you power for starting, for lights, radios, other accessories . . . opens up a new world of *night* outboarding—with a four!

*"A four is bound to be better!"*

KIEKHAEFER

# MERCURY

**mark 55E merc E lectric**  
40 h.p. 4 Cylinders in Line, Alternate Firing  
Thunderbolt Engine — Forward, Neutral, Reverse

See your Mercury dealer  
for a demonstration. Ten  
models for 1955—5 to  
40 h.p. Write for FREE  
Illustrated catalog.



World's only  
4 in line  
Outboard!



© 1955 KIEKHAEFER CORPORATION  
Fond du Lac, Wisconsin  
Features of Mercury motors are protected by  
issued or pending patents.

MARCH 1955

249  
Copyrighted material



# INSTALL YOUR OWN YOUNGSTOWN KITCHEN

You have all  
the tools  
you'll need!



The simplest hand tools—the kind any handyman has in his shop—are all you'll need to install your beautiful, all-steel Youngstown Kitchen.

We supply the instructions—in easy-to-follow booklet form. Send for them now. A steel Youngstown Kitchen will make your home more valuable for years to come . . . and you'll save by installing it yourself!



**STEEL**  
*Youngstown Kitchens*

MAIL COUPON NOW!

Youngstown Kitchens  
Dept. PM-355  
Mullins Manufacturing Corp., Warren, Ohio

Please send me Youngstown Kitchens' 16-page "Do It Yourself" Book and "Installation Manual." I enclose 10c for mailing.

NAME (Please print) \_\_\_\_\_

ADDRESS \_\_\_\_\_

CITY \_\_\_\_\_ ZONE \_\_\_\_\_

COUNTY \_\_\_\_\_ STATE \_\_\_\_\_

© 1955 Mullins Manufacturing Corporation

program in the proper way. It's been done many times. Conservationists who have failed have invariably released the birds in February or March under the impression that, because winter is about over, the birds will have all summer to establish themselves. Actually this is the worst time to release them, as insect life and seeds are at their scarcest.

"Late summer or early fall is the best time to release quail, and the birds should be about eight or nine weeks old."

In discussing restocking programs, Lowrance points out that one or two hunters can plant a few coveys of their own and enjoy good hunting for years. If you want to undertake such a program, he suggests that you first look around for an area tailor-made to support quail. The bobwhite is a "timberedge" bird, so the area should be in the vicinity of a wood lot. A small stream or other source of water should be within a quarter mile of the area, and there should be food patches in the vicinity.

You then approach the farmer, seeking permission to release quail on his property. If he refuses, you'll have to search out another area, but most farmers, according to Lowrance's experience, are glad to cooperate. They have considerable to gain and little to lose. You agree to hunt the birds only with his permission and to share your bag with him. And of course he can hunt the birds himself. In return you ask him to leave a small patch of corn close by, and to encourage the growth of other feeds.

Sometime in September you release at least five pair of quail for each 40 acres you believe can be restocked. In releasing the birds, place the crate in a thick growth of tall weeds and scatter chicken feed in front of it. Open the crate and step out of sight. The quail will walk out, feed on the grain and disappear.

The wily quail soon learn to forage for themselves. During extremely cold weather, though, it's advisable to scatter a few pounds of feed in the thickets.

For one year following the planting the area should be closed to hunting. At the end of that time the birds will have established themselves and may well have split off to form several coveys. From then on you can hunt the area year after year, shooting out a few birds at a time.

There comes a time in almost every hunter's life when he figures his son—or grandson—is just about old enough to learn to handle a gun, to experience the deep satisfaction that comes with a day in the field. The first time you hand over your beloved shotgun to an eager boy, it's quite possible for you present him with his own covey of quail, too. ★ ★ ★



# THE FIRST TILTING ARBOR JIG-SAW Ever!

LOW PRICE

At Last—Angle Cuts Are Easy!

BLADE,  
MOTOR and ARM  
TILT TOGETHER  
45° TO  
EITHER  
SIDE

TABLE DOES  
NOT TILT  
—YOU WORK ON  
A FLAT SURFACE!

CUTS WOOD UP  
TO 2" THICK—also  
Metal, Plastics

The New History-Making

## SYNCRO 2500

### TILT ARBOR JIG SAW

DO-IT-YOURSELFERS! Here's the most important news in jig saw history! Syncro announces a heavy-duty jig saw featuring complete arbor tiltABILITY (first ever!)—20" throat clearance—180 sq. ins. table working surface that remains rigidly level for more accurate, easier sawing and lumber handling. Blower. Self-powered by SUPER-powerful, patented reciprocating motor built in and guaranteed against burn-out during your ownership. Industrially-rated. Weighs 65 lbs. Low cost. See it at stores—send coupon for Free Catalog—before you buy any jig saw!

#### NEW No. 208 SYNCRO JIG SAW

Basic do-it-yourself tool—outperforms any competing jig saw. Cuts 1 1/2" pine, 1" plywood, aluminum, plastic, linoleum. 15" Throat clearance; 100 sq. ins. table. Arm swings 90° for any length cut. Same type self-powered motor as 2500. Low cost. See at Stores—Send coupon.

Remember!

### MORE

LOW PRICE

SYNCRO-MADE JIG SAWS HAVE BEEN SOLD  
THAN ANY OTHER SELF-POWERED MAKE!

SYNCRO CORPORATION, Dept. 1-35, Oxford, Michigan, U.S.A.



FREE  
AUTHORITY  
20-PAGE  
SANDING  
HANDBOOK  
(Includes  
SYNCRO CATALOG)

No. 900

New heavy-duty Syncro sander has built-in sight-saver lamp—outstands all other portables for 5 cost. Re-all other paint, varnish. World's most powerful reciprocating sander motor (patented) included in low cost!

New Kit 900-D has heavy-duty sander 900 in sturdy metal case.

No. 504  
New light-duty Syncro sander best for vertical, overhead and finish jobs. Contains sander in metal case, etc. Low cost.

#### MAIL COUPON

SYNCRO Corporation, Dept. 1-35, Oxford, Mich.

Send Free Sanding Handbook and Catalog of Syncro Jig Saws and Sanders—Low Prices.

NAME \_\_\_\_\_

ST. & NO. \_\_\_\_\_

CITY \_\_\_\_\_ STATE \_\_\_\_\_



free

GET THE  
WORLD'S LEADING  
TV & RADIO CATALOG  
**ALLIED'S 1955**  
ELECTRONIC BUYING GUIDE



308  
VALUE-  
PACKED  
PAGES

Save on  
Everything  
in  
Electronics

World's Largest Stocks... for Builders,  
Experimenters, Amateurs, Servicemen,  
Engineers and Hi-Fi Specialists

Get ALLIED's big 308-page Catalog featuring the world's largest selections of latest top-quality electronic equipment at lowest, money-saving prices. See the newest in custom TV chassis, antennas and accessories; FM and AM Tuners; High Fidelity systems and components; recorders and phonograph equipment; Amateur receivers and supplies; builders' kits; test instruments; industrial electronic supplies—plus thousands of parts, tubes, tools and books. Get everything, get more for your money—send today for your FREE 1955 ALLIED Catalog!



Send  
for  
FREE  
Catalog

ultra-modern facilities to Serve You Best

**ALLIED RADIO**

ALLIED RADIO CORP., Dept. 5-CC-5  
100 N. Western Ave., Chicago 80, Ill.

Rush FREE 1955 ALLIED 308-Page Catalog

Name \_\_\_\_\_

Address \_\_\_\_\_

City \_\_\_\_\_ Zone \_\_\_\_\_ State \_\_\_\_\_

## I Made the First Jump

(Continued from page 93)

shots of the seven-second ejection procedure. We've found that slow-motion color film brings out weaknesses, errors and other important findings that otherwise would never be known.

Take-off was to be at 9 a.m. and I was dressed. Despite a temperature of 90 degrees I wore underwear, a light liner, an antiexposure suit to keep water out, my bright-red suit and soft helmet. All of these items were being tested during the ejections. After I was all set to go, the test was postponed due to unsatisfactory flying conditions at 10,000 feet. We tried again in the afternoon and again cancelled out. The same experience the next day. Then a week end intervened with two more days to think about the jump.

Finally, on Monday I found myself strapped in the navigator's seat, over the open hatch, and watched the runway moving faster and faster beneath the Beast. We were off. I kept my eyes on the altimeter and speed indicator.

While Captain Campbell kept the Beast on course, Capt. Jake Jacobs, the copilot, was delighting in counting down the seconds to the final "fire!" I knew he was eager to press the button that would swish a colonel away. Suddenly I was away at a much higher speed than my previous test.

The wind blast grabs you, pressing from all sides, not painfully, but rather forcefully. One of our men likened this to a "Saint Bernard dog shaking a rabbit in its mouth." Everything worked fine and I found myself dangling under my open parachute looking down at the blue bay 10,000 feet below. I checked my canopy and waved to the encircling fighter pilot that I was okay.

On the way down I had six minutes to prepare for a water landing. I unsnapped the oxygen mask, inflated the underarm life preservers and tightened the neck seal on my exposure suit. I felt swell.

Almost immediately after I hit the water I was pulled aboard a rescue boat and, before undressing, recorded my experiences.

Each of the successive tests went off fine. I made one more jump at 385 knots and we ended this series with Capt. Ed Sperry ejecting at 425 knots. We all were able to hold onto the grip and our legs remained in position. The mission—dedicated to giving our jet-aircrew men a positive and safe method of escape—was a success. All the way along we had been inspired by the certain knowledge that reliable, automatic-ejection equipment is an absolute *must* for jet aircraft. ★ ★ ★



## A NEW LINE OF STARLITE ALUMINUM boats



### STURDY... LIGHT... LOW COST

Six new STARLITE Aluminum Boats for '55 . . . tops in safety, maneuverability, and beauty—yet surprisingly low in cost! Ruggedly constructed—no flimsy hulls—no maintenance worries. Good marine design assures seaworthiness, lightness, and perfect balance . . . feather-touch performance with oars or out-boards, and graceful planing action with even the smaller motors. Full-length spray rails and Styrofoam floats. Easy to lift and carry. Fifteen types to fill every boating need.

WRITE FOR FREE 1955 CATALOG

### YOUR BEST BUY

# STARCRAFT

Dept. Q-3 Goshen, Ind. METAL BOATS

## MAGNETS

GENUINE ALNICO - NEVER WEAKENS

225 lb. PULL

AMAZING, PERMANENT MAGNETS—WILL NOT WEAKEN! NON-ELECTRIC. Retrieve guns, tackle, tools and other steel items from lake, river, plating tanks, drains or other hard-to-reach spots. Recover drills, taps, etc. from sweeping. Clear alley of harmful tacks, nails. Many other uses. Pays for itself quickly. GUARANTEED. Try any magnet one week. Money refunded if you are not well pleased.

No. M-725 (Weights 3 1/2 oz.) Has pull of 225 lbs. on steel block.	\$15.00
No. M-625 (Weights 7 1/2 oz.) Has pull of 125 lbs. on steel block.	\$ 8.50
No. M-575 (Weights 18 oz.) Has pull of 75 lbs. on steel block.	\$ 6.00
No. M-500 (Weights 15 oz.) Has pull of 50 lbs. on steel block.	\$ 4.00
No. M-30 Hobbyist assortment of six small magnets.	\$ 1.50

Send Money Order or Check. We pay postage. No C.O.D.'s.  
MIAMI MAGNET COMPANY, 3240 N. W. 27th Ave., Miami 42, Fla.

## MONEY for MEN ALL FREE

THE PLASTEX Industry needs manufacturers on small scale and for big production of Lamp and Clock Stands, Art Goods and Novelties in Plastex and Marble imitation. Experience unnecessary. Use material makes regular 10¢ store sellers. Rubber moulds furnished for speed production. Small investment brings good returns. We are now placing big Chain Store Orders with manufacturers. Ambitious men have chance for real prosperity. Our Free booklet will interest and benefit you.

PLASTEX INDUSTRIES, Dept. A  
3400 Third Ave. New York 56, N. Y.

Protect your home against  
power interruptions  
with an...

## ONAN Emergency ELECTRIC PLANT

Provides dependable stand-by electricity for heating system, pumps, freezer, lights, appliances. Keeps home safe, livable. Automatic start and stop. Find out how little it costs!

Write for Folder!

**D. W. ONAN & SONS, INC.**  
3299 University Ave. S. E. • Minneapolis 14, Minnesota

A SIZE FOR EVERY NEED  
400 to 75,000 watts.  
Compact, quiet-running,  
easy to install. Gasoline engine powered.

# SCREENS

you put up from  
inside in seconds



## Columbia-matic TENSION SCREENS

Columbia-matics fit outside the window, just like ordinary screens, yet they go up from inside. They are the revolutionary new screening idea that saves you time and money and lets you say good-bye to old-fashioned screen troubles.

Columbia-matics are flexible, full length; need no side frames, just a top rail and spring-loaded bottom rail that holds screen tightly at all times.



Easily installed the first time—anyone can do it. They come in exact sizes, no fitting. All you need is a screwdriver. Rustproof aluminum\* needs no painting, ever. Available with regular or Kaiser Aluminum Shade Screening.



Two patented tension locks anchor bottom rail securely to sill. Press down, they're locked. Flip up, screen swings free. No hardware on sill to snag clothing.

\* Available with galvanized screening in certain western states.

Columbia-matics cost no more than ordinary screens. Millions now in use. Get the facts at your screen dealer's. Or mail coupon.

The Columbia Mills, Inc.  
Dept. PM-3, Syracuse 1, New York  
Send facts on Columbia-matics

Name \_\_\_\_\_

Address \_\_\_\_\_

City \_\_\_\_\_ Zone \_\_\_\_\_ State \_\_\_\_\_

In Canada write: Cresswell Pomeroy, Ltd., Montreal 28



**Amazing new pep,  
handling ease, economy**  
for **4 WHEEL DRIVES!**

OVER 60,000 SETS IN USE AROUND THE WORLD



PAT. NO.  
2,860,064

**WARN HUBS**

**STOP FRONT END DRAG**

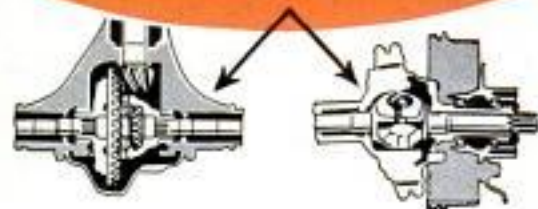

**THE FRONT AXLE STANDS STILL  
IN 2-WHEEL DRIVE RANGE**

Warn Hubs on your 4 W.D. improve performance and cut operating costs in both 2 and 4 wheel drive range! They disengage the front axle assembly for use in 2 wheel drive range, giving your 4 W.D. amazing pep, get-away, speed, and easy steering. They stop front wheel shimmy, reduce front end wear up to 50%, save gas and tires! And when 4 wheel drive is in use, Warn Automatic Hubs stop front axle torque, permitting high road speeds that might otherwise cause front axle breakage!

**USE EITHER 2 OR 4 WHEEL DRIVE ANYTIME!**

Choose the drive you need, as you *shift gears* with Warn Automatic Hubs, or by simple *manual control* with Warn Locking Hubs. Willys models are factory approved, sold exclusively by Willys dealers worldwide. Dodge and all other 4 W.Ds., at dealers or prepaid direct from WARN MFG. CO., Seattle 88, Washington, Riverton Box 6064-A6.

ASK YOUR DEALER FOR **FREE DEMONSTRATION**



**Cartridge Unloader**

Riflemen who like to load their own cartridges can disassemble prepared cartridges quickly and safely with a hammerlike tool. The "hammer head" is a plastic cylinder which has a clip in its cap that holds the cartridge by its rim. A sharp rap of the tool causes projectile and powder to part from the case and fall to the bottom of the cylinder. The cap is unscrewed and the cylinder emptied.

**Trailer-Hitch Lock**

Trailer hitches can't jump loose when they are secured by a new safety lock. It consists of a screw clamp and a spring-steel ring lock, and can be installed quickly with a bolt to the trailer ball or pin. Made of high-tensile carbon steel, the rustproof lock will give years of service.

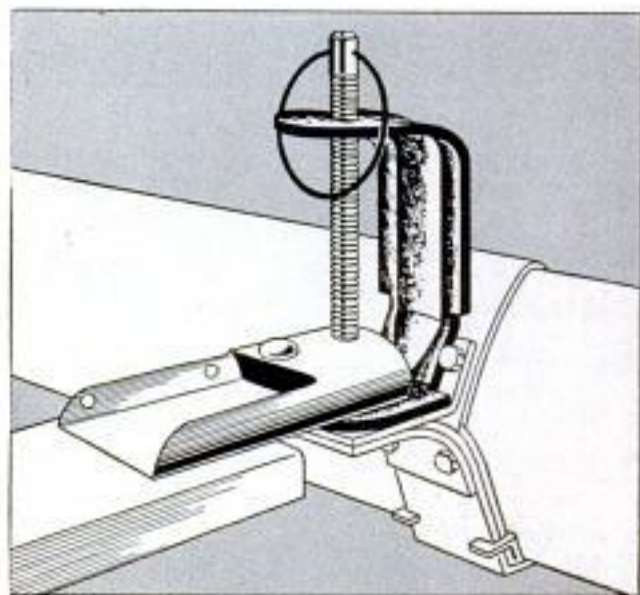



# MAIL SURPLUS SALE OF HOME, FARM AND FACTORY EQUIPMENT

**BELT DRIVEN  
A. C. GENERATOR**



ITEM #700—700 watts, 115 Volts, 60 cycles A.C. 3600 R.P.M. Compact, self-regulating generator with V Belt pulley and double outlet receptacle. Rotation counter-clockwise. May be driven by tractor or auxiliary gasoline engine. Requires 2 HP minimum. Ideal for powering electric tools, oil burner, refrigerator, lights, or other appliances requiring up to 700 watts of power. Dimensions: 10" long x 8" high x 5" wide. Shipping Wt. 27 lbs. F.O.B. Chicago..... **59.50**

**GROBAN  
FOUR-WAY OPEN CENTER  
HYDRAULIC  
CONTROL VALVE**



ITEM #126—Four-way open center control valve, with built-in adjustable relief valve factory set at 1000 P.S.I. Spring loaded neutral position. For use with one double acting cylinder in neutral position cylinder is locked and pump unloaded. Can be used as single unit or mounted in series. Has 3/4" pipe thread inlet and outlet. 1/2" pipe thread cylinder ports. Finger grip handle. Ship. wt. 10 1/2 lbs. **AN OUTSTANDING BUY!** F.O.B. Chicago **21.50**

**MULTI PURPOSE  
HYDRAULIC PUMP  
OR MOTOR**



ITEM #55 Silent, High efficiency, Helical Gear Type Ball Bearing, Hydraulic Pump or Motor. Rated 8 Gal. Per Min. At 1500 R.P.M.—Delivers — 1000 P.S.I.— Reversible Rotation — 3/4" Pipe Thread Inlet and Outlet Ports—1/2" Drain Port—3/4" shaft with keyway and flat for either direct or pulley drive. Dimensions—5 1/2" high, 7 1/4" long, 5 1/4" wide. Shipping weight 18 lbs. F.O.B. Chicago..... **45.50**

**High Pressure GLOBE VALVE**



ITEM #380—Designed for 3000 P.S.I. aircraft hydraulic systems • 3/4" Pipe thread ports • Aluminum alloy body • Alloy steel shaft • Hardened bronze valve seat. Dimensions: W 3 1/2" x H 5 1/2" x D 2". Shipping Wt. 1 1/2 lbs. F.O.B. Chicago..... **5.95**

**FREE SPRING EDITION**  
1955 CATALOG, 52 PAGES, check-full of unsurpassed War Surplus Equipment Bargains for farm, home, factory, workshop. Write letter today.

**ALL ITEMS BRAND NEW!**

**A. C. ELECTRIC GENERATOR**



7 1/2 K.W. (7500 WATTS) single phase, 110/220 volt output, 3 wire system, 2 bearing construction, 5 groove 6" V belt pulley included. Self-excited. Foot mounted. Drive generator from tractor or stand by engine. Ample power for 6 room house. Dimensions: 34" x 11 1/2". Shipping Wt. 420 lbs. F.O.B. Chicago..... **295.00**

Complete control box for these generators includes A.C. rheostat, automatic voltage regulator, field rheostat, and voltmeter, already wired and ready to connect to generator. List price \$167.00. Our Price..... **56.45**

**GROBAN HYDRAULIC SPEED REDUCER**

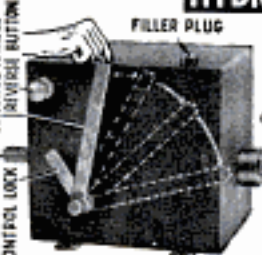

with FINGERTIP CONTROL

USE FOR: • Reamer Drives • Midget Cars • Feed Mills • Canning Machines • Conveyors • Lathes • Milling Machines • Motor Boats • Cream Separators • Garden Tractors • Pumps.

Variable output speeds from 0 to input speed available by moving control handle. Locking handle maintains setting. Use input power of 1/4 to 1 1/2 H.P. Shafts 3/8" diam. Input rotation counter-clockwise facing shaft. Input speed 750 R.P.M. 7 1/2" x 7 1/2" x 11 1/2". Gov't acquisition cost \$428.00. Ship. wt. 31 lbs. Complete with 2 qts. of oil and full instructions. F.O.B. Chicago..... **54.50**

**Brand New! 5-TON BLACKHAWK  
HYDRAULIC LIFT KIT**

Now Only **38.95** Complete

The Complete Kit

For — • Dumping farm wagons • Adjusting depth of plows • Hydraulic sees • Hydraulic jack • Snow plows.

**KIT CONSISTS OF:**

- 1—Brand new Blackhawk Model P-151—Hydraulic hand pump with built-in oil tank and release valve. Dated from 1200 P.S.I.—to 8400 P.S.I. 20" handle. Dim. 8" x 6" x 6" Item #82..... **22.50**
- 1—6 Ft. length double wire braid rubber covered hydraulic hose—rated to 35,000 lbs. Item #278..... **3.95**
- 1—Hydraulic cylinder, 2" bore, 6" stroke, heavy 1" solid steel shaft, will lift 10,000 lbs., using pump pressure. Standard clevis mounting. May be used for double action service. Item #416C..... **12.50**
- 2—5cc. non-foaming hydraulic fluid. All necessary hydraulic fittings. Total ship. wt.—40 lbs. Item #416..... **1.00**

**COMPLETE KIT PRICE \$38.95**  
ALL OF ABOVE INCLUDED F.O.B. Chicago

**ALL BRONZE CENTRIFUGAL PUMP**

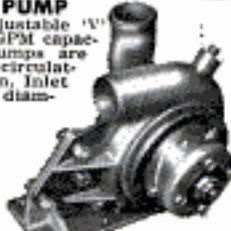

ITEM NO. 384—Equipped with 6" adjustable V pulley, 2" dia. inlet and outlet, 180 GPM capacity. These all bronze Centrifugal Pumps are ideal for use as marine bilge pumps, circulating pumps, fire protection or irrigation. Inlet and outlet take hose with 2 1/4" inside diameter. Dimensions: 11" x 8" x 11".

Total head-feet	Speed	H.P.	GPM
25	3600 RPM	3	180
35	3000 RPM	1 1/2	90
20	2400 RPM	1 1/2	75

Back plate may be rotated for most convenient inlet position. Shipping weight 31 lbs. F.O.B. Chicago..... **29.50**

To place phone orders call WEBster 9-3793  
**GROBAN SUPPLY CO. Dept. PM-3**  
1139 S. WABASH AVE., CHICAGO 5, ILL.

**RUGGED!! 20 TON MASSIVE!!  
CAPACITY  
HYDRAULIC CYLINDER**



• ALL STEEL CONSTRUCTION  
• 7 1/2" BORE—15" STROKE  
• DOUBLE ACTION

ITEM #1715  
• 41,300 LBS. PRESSURE WITH 1000 P.S.I. PUMP OUTPUT.

• UP TO 70,000 LBS.—CAPACITY ON INTERMITTENT SERVICE.  
• SOLID STEEL 2 1/2" PISTON ROD  
• 1" PORTS  
• OVERALL DIAMETER—10 1/4"  
• DISTANCE BETWEEN CENTERS—28 1/4" CLOSED—43 1/4" OPEN.

**IDEAL FOR:**  
• HYDRAULIC PRESSES • DUMP TRUCK HOISTS • TD-18, TD-24 INTERNATIONAL HARVESTER DOZERS AND GRADERS • LEVELING RAMPS • INDUSTRIAL MACHINERY • ROAD MACHINERY • FARM MACHINERY • HYDRAULIC TAIL GATES

Replacement cost—\$260.00. Shipping Wt.—155 lbs. **SPECIAL PRICE F.O.B. Chicago..... 80.00**

**DEPTH CONTROL  
HYDRAULIC CYLINDER**



• ALL STEEL DOUBLE ACTING HYDRAULIC CYLINDER  
• 3 1/2" BORE—8" STROKE  
• 1 1/8" SOLID STEEL, STRESS-RELIEVED, GROUND, POLISHED AND CHROME PLATED PISTON ROD  
• STANDARD 1/2" PIPE THREAD PORTS  
• MOUNTING CLEVIS AND ROD CLEVIS TAKE 1" DIAMETER PINS.

ITEM #438

ASAE Farm Standard construction, center distance closed—20 1/4", opened—28 1/4".

**FEATURING—Adjustable depth control, to set the cylinder stroke anywhere from 4 1/2" - 8".**

**IDEAL FOR USE WITH**  
• PLOWS • DISC HARROWS • HYDRAULIC PRESSES

Will lift 11,520 lbs., using 1200 lbs. per square inch of oil pressure from the pump. Regular list price \$46.50. Shipping Wt.—26 lbs. **SPECIAL PRICE— F.O.B. Chicago..... 24.50**

**HEAVY DUTY 12 VOLT  
D. C. GENERATORS**



ITEM #99—For trucks, autos, marine equipment, construction machinery, 12 Volts—50 amps.—6 bolt mounting flange spline shaft—life time grease-sealed ball bearings. Mfgd. by Leeco-Neville. A.C. cost \$165.00. NOW ONLY... F.O.B. Chicago..... **16.50**

**ORDER DIRECT FROM AD SATISFACTION GUARANTEED**  
Send Payment Or Purchase Order Today

**JEEP OWNERS**  
STA. WAGONS • JEEPSTERS • PICK-UPS!

Take full advantage of 4-wheel drive by installing a Ford V-8 engine—MORE POWER—means less shifting, better traction at lower speeds, greater safety, plenty of power in high. All this is now possible by using our F-1 adaptor plate (Pat. Pending) Conversion Kit \$43.25 incl. FED. TAX. Write for free details or send check or M.O. for prepaid delivery. Order now for early shipment.

**HOOSIER MACHINE PRODUCTS CO.**  
312 S.E. 6th St. Pendleton, Oregon

**FIND \$\$\$\$**



NEW U-238 geiger counter—world's smallest, most sensitive uranium locator. Ideal for prospecting even on hunting, fishing trips! (Full line of mineral and metal locators, too.)

**FREE booklets on request. (Dealer inquiries welcome.)**

**GOLDAK COMPANY 1542 W. Glenoaks Blvd., Glendale, Calif.**



# TWINSULATE\* NOW

and sleep up to 15° cooler this summer



## Insulate Your Home with Gold Bond TWINSULATION

INSULATE your attic now with remarkable new double-action Gold Bond Twinsulation, and you'll; 1. Keep your home up to 15° cooler this summer. 2. Prepare your house for efficient air conditioning. 3. Slash your present fuel bills up to 20% next winter and every winter!

### Pays for itself...then pays YOU!

TWINSULATION gives you so much comfort, so many savings because the rock wool center blocks heat and the aluminum covering reflects heat from either side. Adds extra fire protection, too. Stiff, rugged blankets are easy to install with stapler or nails. Mail coupon for fact-packed new Gold Bond Insulation booklet.

NATIONAL GYPSUM COMPANY, BUFFALO 2, N. Y.

Send for complete How-To-Do-It Booklet on insulating your home... then see your Gold Bond dealer!

NATIONAL GYPSUM COMPANY  
Dept. PM-35, Buffalo 2, N. Y.  
I enclose 10¢ for "Home Insulation" booklet.

Name.....  
Address.....  
City..... County..... State.....

\*Twinsulation is a Reg. T. M. of National Gypsum Company



## Straw Stacked Near Feed Barn Minimizes Handling

Located near a door in the end of a feed barn, the 900 bales of bedding straw stacked in this pile required a minimum of handling when used in the shed. The bales in each tier are elevated and stacked at right angles to the bales in the previous tier to "tie" the whole pile together. To help shed rain, the tiers are stepped in at the top.

## Tractor Seat Folds Back When Driver Stands Up

It is not necessary to straddle a wide seat when standing up to drive this tractor because the seat is hinged to swing out of the way. A spring latch near the front of the seat hooks over a projection on the seat-support arm when the seat is in the normal position. The support arm is hinged at its front end on a pin which passes through two brackets welded to the tractor frame. The seat spring is stabilized by a tubular hydraulic shock absorber fitted between the seat-support arm and the tractor.—L. H. Houck, Jefferson City, Mo.





**10 TIMES FASTER  
THAN RAKE AND HOE!**

**RO-HO  
GARDENER**

Grow better crops, have more fun, save gardening work! 40 rotating hoe points, scuffle knife, and 5 cultivator teeth kill weeds, mulch soil, make extra-fine seed beds. "Every tooth in every blade digs the soil like a spade." Easy as mowing a lawn, RO-HO GARDENER works as you walk.

Write for FREE Folder  
**ROWE MFG. CO.**

1651 Adams St., Galesburg, Ill.



**URANIUM AND METALS**

Easily located with the new M-Scope Detector. Superior Performance. Prices \$35.00 up. Monthly payment plan. Booklets "How to be a Successful Uranium Prospector" — "For Fun and Profit" free upon request.

**FISHER RESEARCH LABORATORY, INC.**  
PALO ALTO CALIF.



**BUILD FINE GRANDFATHER CLOCK NOW**

The simple sensible Red-i-Kut way to thousands here — SAVE HALF. SHOP TESTED PLANS "SPIRIT OF THE CENTURY" Narrow waist 83" tall or stately straight side "SPIRIT OF AMERICA." EASY-TO-FOLLOW photographs PLANS tell all—plus BROCHURE of heavy brass weight Westminster, tube chime, movements, gorgeous dial, 3/4" solid mahogany case kit. Send \$1.00 today — Both plans \$1.50 NOW.



**KUEMPFLER CHIME CLOCK CO., 27 Kuempfler Bldg., Minneapolis 16, Minn.**

**NEW PENN YAN  
BOAT CATALOG**



44 PAGES  
OVER  
100  
MODELS

**FREE!** Get yours today. Many models illustrated in color. Cartops, Trailboats, other outboards, canoes, rowboats described fully. Catalog features amazing new no-soak, work-free, all-wood *Stripites*. Penn Yan Boats, Inc., 34th St., Penn Yan, N. Y.

**CUT PERFECT GROOVES  
WITH Warren WASHERS  
ON YOUR SAW BLADE!**



**NOT ONE — NOT TWELVE — BUT  
40 DIFFERENT CUTS**

Engineered to cut clean, accurate, parallel grooves—just dial the desired width—40 micromatic adjustments—leave on saw for straight cuts. **GUARANTEED.** At your dealers or order direct. Arbor sizes 1/2", 3/4", 1". Send for free booklet

**WARREN WASHERS COMPANY**

Dept. 23, Box 98, North End Station, Detroit, Michigan



ONLY  
\$4.95

Pine panel your kitchen!  
**DO-IT-YOURSELF**  
it's easy with Gold Bond  
Fireproof Grainboard!



**G**IVE your kitchen that warm, cozy pine-paneled look with Gold Bond Gypsum Grainboard. It has all the expensive beauty of fine wood paneling, at a fraction of the cost. Sturdy, fireproof Grainboard is available in two convenient widths — 4 ft. panels or handy 16-in. planks... in Knotty Pine, Bleached Walnut and Dark Walnut. It's ideal for finishing off old walls or adding a den or gameroom.

Lightweight and easy to work, Gold Bond Gypsum Grainboard goes up fast—covers large areas at a time. A hammer and knife are the only tools you need. Cuts easier than wood... just score and snap to fit.

In new construction, these panels can be nailed to studs. Or, in remodeling, you can nail them directly to old walls or over furring strips. Gold Bond Gypsum Grainboard Planks, also excellent for home modernizing, can be quickly laminated over existing surfaces.

**NATIONAL GYPSUM COMPANY**  
BUFFALO 2, N. Y.



**MAIL COUPON TODAY!**

**NATIONAL GYPSUM COMPANY**  
Dept. PM-35, Buffalo 2, N. Y.

Please send me FREE copies of your Do-It-Yourself Grainboard Applications Folders, with full instructions for both nailing and laminating.

Name.....

Address.....

City..... Zone..... State.....



# Last Year's Profit \$3,000!

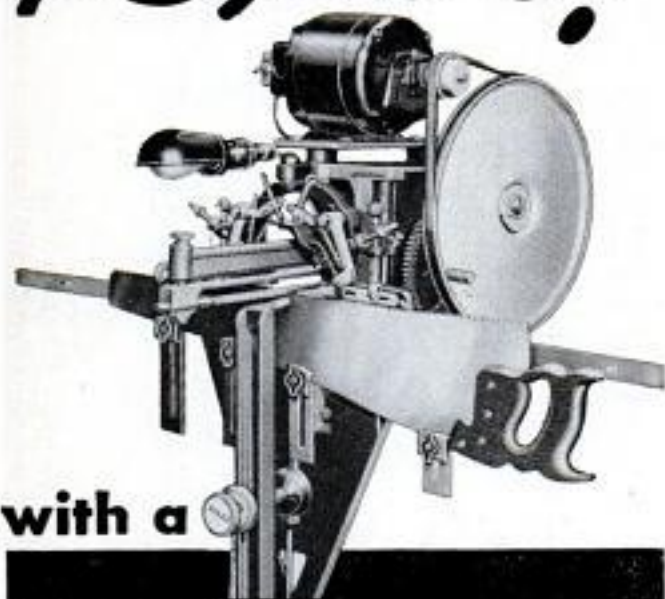

with a

## FOLEY automatic SAW FILER

"Last year's profit amounted to \$3,000. Not so bad for a one-man outfit" — from Chas. C. Hough. James B. Williams wrote us—"I made \$765 last year filing saws, and it sure comes in handy. I do this work in my spare time." Men in communities of all sizes make up to \$3 or \$5 an hour with the Foley Saw Filer working full time or part time.

It's no trick to take care of the saw filing for your neighborhood hardware or lumber dealer — plus looking after the saws for farmers, townspeople, manual training departments and factories. The Foley files all hand saws, also band and cross-cut circular saws. It's a repeat cash business, no canvassing, no eyestrain and no experience needed.

### FREE BOOK Shows How to Start

"MONEY MAKING FACTS" shows just how you can start at home in your spare time working in your basement or garage. It's an immediate cash business that can develop into a full-time repair shop. Send coupon today — no salesman will call.



Send Coupon for **FREE BOOK**

**FOLEY MFG. CO., 316-5 Foley Bldg.,  
Minneapolis 18, Minn.**

Send me free book  
"MONEY MAKING FACTS"

Name \_\_\_\_\_

Address \_\_\_\_\_



### Tray on Heavy-Duty Wheelbarrow Is Section Cut From Boiler

Ideal for pouring concrete into narrow forms, the tray on this wheelbarrow is a section cut from a boiler to which a lip has been welded. The undercarriage is welded angle-steel construction and the handles are steel pipe. The tire and wheel are a heavy-duty unit purchased at a mail-order house.

### Modified Two-Row Corn Planter Now Towed by Tractor

Originally horse-drawn, this two-row corn planter has been modified to be towed by a tractor and controlled by a hydraulic piston. First, the spring-loaded catch in the hand lever was removed so the lever "floated." A steel plate was welded to the front of the lever and drilled to receive the clevis of the piston-rod extension. Two wires also lead from the steel plate to the check-wire mechanism. The latter arrangement automatically releases the check wire when the piston shoves the lever back. The single-acting hydraulic piston is returned by a spring hooked from a bracket on the planter tongue to a bracket on the piston-rod extension. The depth of planting can be adjusted by a U-bolt which is dropped into the proper teeth on the quadrant.

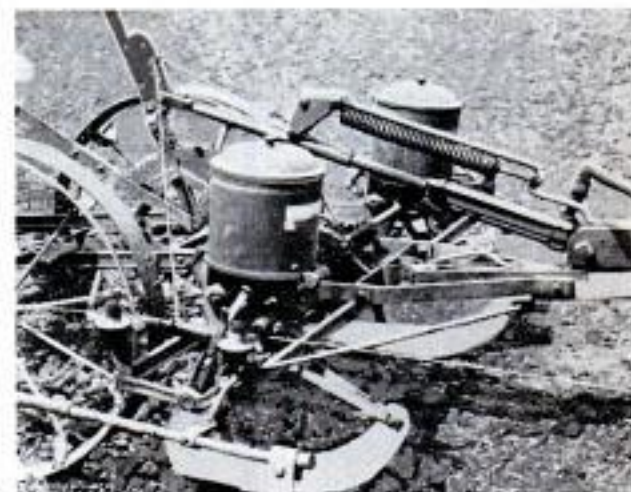



# Popular Mechanics Precut House

Build a Livable Shell from a Precut Kit for Only \$1800

Build a Summer Home With All Conveniences for Only \$2800

Build a Luxury Home for Year 'Round Living for Only \$3800



Designed  
by  
Wilson  
and Christie,  
Architects,  
Towson, Md.

## Build This House Yourself!

Save 65% Easily!

New Popular Mechanics Book and Plans—New Precut Materials Kit—Packaged Plumbing, Heating, Chimney, Etc.—Make Amateur Carpenter's Job Easy

Here is the newest Popular Mechanics "Build-It-Yourself" house. You can build it in three stages, with or without an available kit of materials precut to actual size and shape, for the amazing low price of only \$1800. The first stage will give you the start of a grand home that you can live in while you progress with building. The second stage will give you a fine summer home, with all wanted conveniences, for a total of only \$2800 for both stages. When you add the third stage you have a real luxury home for year 'round living in any climate for only \$3800 total cost. Richard Dempewolf, author of the "Precut House" book and a Popular Mechanics editor built the test house pictured above for even less. Today, the appraised value, including the land is \$12,000.00.

Simplified How-To-Do-It Instructions—Hundreds of Pictures—Working Blueprint Plans!

You can build the house with the book alone. The plans make it easier. The book gives lists of materials required, all measurements and dimensions, suggestions for financing, and tells in words and shows in pictures every detail of construction. Like thousands of others who have built their homes themselves, you can do it too and save up to 70% of the cost. The dream home that seemed impossible is here. This fabulous, economical house, designed by famous architects, especially for amateur builders, is your answer to the home you always wanted.

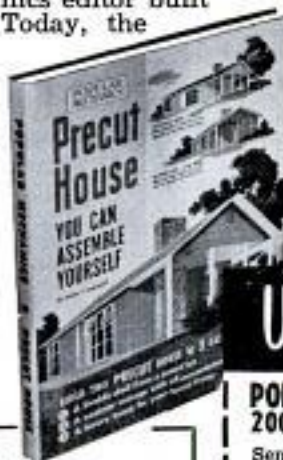

Build It to Your Own Plan in The Same Shell — 2 Bedrooms or 3 With or Without Fireplace—Install Windows Where You Want Them!

Overall size 24 x 46 feet. Note the two typical floor plans shown. Above: Two bedrooms, bath, kitchen, dining room, living room, car port or porch. Below: Three bedrooms, bath, utility room, kitchen, dining area, living room, porch. The "Precut House" book shows many other variations.

### Features of Expensive Homes

The unusual features of the Precut House are: adaptability to various interior arrangements; use of materials designed especially for amateur builders; easy construction; unusual amount of closet and storage space; built in furniture; house that is suitable for city, country and resort; low maintenance cost; complete insulation. All this at a cost so low no other house of similar size can compare with it.

### Money Back Offer

The coupon will bring you the "Precut House" book and plans. Mail it Today. If you do not like what you get or decide not to build this fine house, return either or both within 10 days for full refund of purchase price. Mail coupon today.

### Building the Test House

The test house pictured above was built in eastern Pennsylvania by the author and his wife, neither of whom had any previous building experience. It is a year 'round home, insulated, modern heating and plumbing, fireplace, redwood interior finish, dozens of built-in features and floor-to-ceiling, 9-foot wide picture window. Total man hours required to build—1650. Total cost not including ground and inexpensive foundation—\$3731.23

Use This Coupon To Get Book and Plans

POPULAR MECHANICS PRESS, DEPT. PCH  
200 E. ONTARIO ST., CHICAGO 11

Send at once:

- Popular Mechanics Precut House book \$2.50
- Complete set of ten blueprints \$12.50
- Sets duplicate blueprints @ \$5.00 per set
- I enclose remittance for \$\_\_\_\_\_ Send postpaid.
- Send COD. I will pay postman plus charges. I understand I may return either book or plans, or both, within 10 days if not satisfactory and you will refund full purchase price.

Name \_\_\_\_\_

Address \_\_\_\_\_

City \_\_\_\_\_ State \_\_\_\_\_



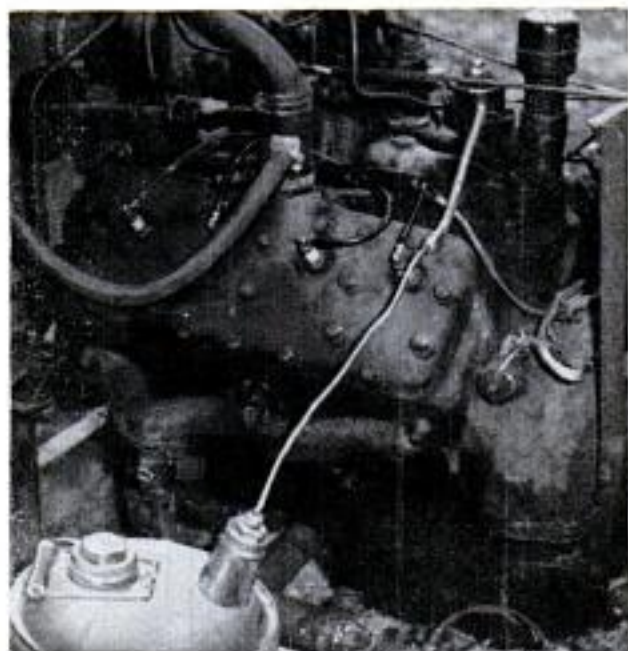

### Portable Gasoline Tank Used On Stationary Auto Engine

The fire hazard and chance of theft of gasoline presented by a tank mounted close to an auto engine used as a stationary power plant are eliminated by using a 5-gal. gasoline can as a portable tank. A length of copper tubing is slipped into the pouring spout of the can and a rubber hose con-

nects the tubing to the fuel pump on the engine. When the engine is shut off, the tubing is lifted out of the can which is carried back to a fire-safe, theftproof location for storage.

### Scouring Pad Provides Strainer

A simple, inexpensive strainer for use on the end of a suction line used in sheep dip, utilizes a copper-mesh scouring pad. The pad is pushed into a 1½-in.-pipe nipple which is fitted with a reducing coupling and bushing to adapt it to the suction line. When the strainer becomes clogged, it can be removed easily for cleaning or replacement.—A. M. Wettach, Mt. Pleasant, Iowa.



NO. 286

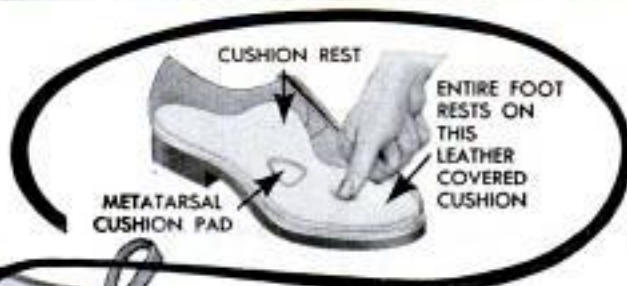

**Non-marking  
Oil Resistant  
corded soles and heels**

### Full Cushion Foot Comfort

Amazing, the comfort you get from these Star Brand Work Shoes! Full cushion insole is soft, resilient, gives snug support, floating comfort, even as you work! And they feature: soft, pliable Burgundy leather uppers—solid leather counters—built in steel shank—yet they look like dress shoes. Try a pair on—soon.



Ask for

# STAR BRAND

## Cush-N-Bilt work shoes

For nearest dealer write:

ROBERTS, JOHNSON & RAND, Div. of International Shoe Co., St. Louis 3, Mo.





# It's Stanley

**For Hammers, Chisels and Rules  
For Balance and Accuracy  
For Satisfaction On the Job**

From THE TOOLBOX OF THE WORLD

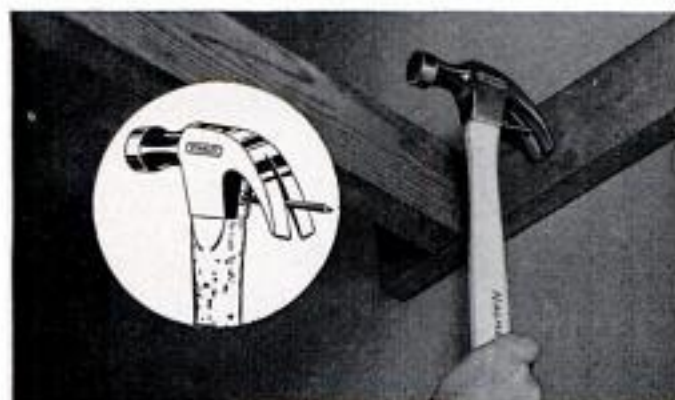

**The Nailmaster.** An extra foot added to your overhead reach. Holds nail while you start it. Super-heat-treated steel head and selected white hickory handle. 16 oz. No. N51½ — \$3.35.

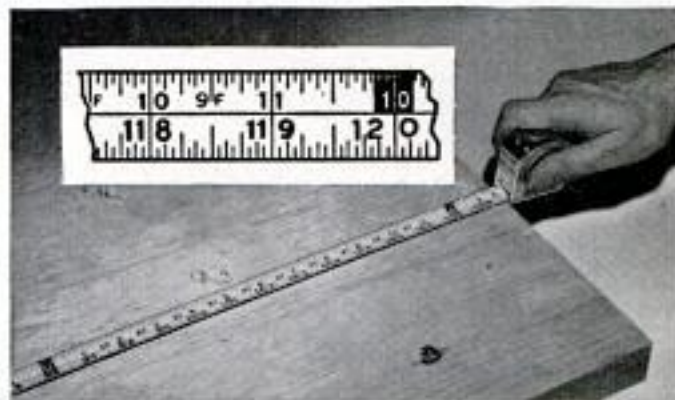

**Long and Wide "Pull-Push" Rule.** Stays rigid for hard-to-reach measurements. True zero hook, true reading mouth and double scale marking for accuracy. 10 ft. No. 3610W — \$2.39.

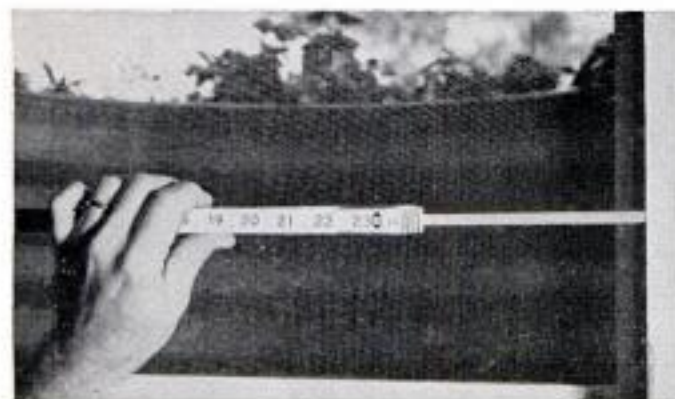

**"100 PLUS" Extension Rule.** Removable 8 in. brass slide for inside measurements. Rule opens to even numbers, convenient marking gauge at 2", 4", 6", 8", etc. Plastic finish, extra thick sticks, long wearing joints. 6 ft. No. X226 — \$2.75.

Other Stanley hammers, chisels, rules, and tools for every wood working job at your favorite hardware store. Ask for Stanley — the best tools you can lay your hands on.



**Stanley Chisel.** The finest chisel steel — precision ground bevel. Protective metal cap on tough plastic handle centers hammer blows and distributes force evenly to keen cutting edge. Sizes from ¼" to 2". No. 60 — 1" — \$2.90.

Send for your copy of the new Pocketbook with over 400 illustrations and hints galore, only 25¢.

**STANLEY** Tools

A Division of The Stanley Works

ELECTRIC TOOLS • HARDWARE • STEEL • STEEL STRAPPING

Stanley Tools  
622 Elm St., New Britain, Conn.  
Gentlemen:  
Please send me a copy of the new Pocketbook edition of "How To Work With Tools & Wood." I enclose 25¢.  
Name \_\_\_\_\_  
Address \_\_\_\_\_  
City \_\_\_\_\_ Zone \_\_\_\_\_ State \_\_\_\_\_



IT'S RADIATOR TROUBLE TIME  
AGAIN!



**NEW!**  
**PERMATEX**  
COOLING SYSTEM

**CLEANER and CONDITIONER**

**A COMPLETE COOLING SYSTEM SERVICE IN ONE PACKAGE!**

1. Cleans out rust and scale
2. Dissolves grease and oil
3. Prevents rust from reforming\*
4. Stops leaks and seepage\*



\*Exclusive!

Clean out your cooling system this spring the easy all-in-one way with all new Permatex Cooling System Cleaner and Conditioner. Cleans out rust and scale—puts grease and oil in suspension and carries it out—and, as a plus, prevents rust from re-forming and seals all leaks. Two compartment containers with cleaner in top and rust preventative, sealer, and neutralizer in bottom.



There's No Other Product Like It!

**PERMATEX COMPANY, Inc.**

Brooklyn 35, New York

Kansas City 15, Kansas

OVER 50 CHEMICAL PRODUCTS FOR BETTER AUTOMOTIVE MAINTENANCE

## Owners Praise Chevrolet's Big-Car Performance

(Continued from page 106)

"Rear doors leak dust. Don't like lights for oil and amperes. Prefer old-type gauges."—North Dakota farmer.

"Dust comes through bottom and back door very bad."—Colorado estate manager.

The questionnaire asked owners to state the one specific change they would like to have made in their new Chevrolet. Almost half of the V8 owners (44 percent) stated

### SPECIFICATIONS 1955 Chevrolet

#### ENGINE

	SIX	V8
Type	6-cyl., in-line, OHV	8-cyl., V-type OHV
Bore and stroke	3-9/16 x 3-15/16 in.	3-3/4 x 3 in.
Displacement	235.5 cu. in.	265 cu. in.
Compression ratio	7.5:1	8.0:1
Brake horsepower	123 at 3800 r.p.m. 136 at 4300 r.p.m.	162 at 4400 r.p.m. (Optional: 180 hp. at 4600 r.p.m.)

#### GENERAL

Shipping weight	3125 lb.	3095 lb.
Steering ratio (over-all)	25.7:1	
Steering wheel, lock-to-lock	5.34	
Turn-circle diameter	38 ft.	
Wheelbase	115 in.	
Tread, front	58.0 in.	
Tread, rear	58.8 in.	
Height over-all	62.1 in.	
Width over-all	74.0 in.	
Length over-all	195.6 in.	
Road clearance	6.5 in.	

#### CAPACITIES

Oil	5 qt.	4 qt.
Water	16 qt.	16 qt.
Gasoline	16 gal.	16 gal.

#### INTERIOR DIMENSIONS

Front-seat width	62.0 in.
Rear-seat width	63.0 in.
Headroom, front	35.7 in.
Headroom, rear	35.4 in.
Legroom, front	43.1 in.
Legroom, rear	40.8 in.

that they did not want any changes. Of the six-cylinder owners, 36 percent were thoroughly satisfied and wanted no change.

In both models, however, the most frequently mentioned change was the front grille. Fifteen percent of the V8 owners and nine percent of the six owners want it restyled. Four percent of the V8 owners said Powerglide should be improved and three percent of the six owners want the front seat to move back farther to accommodate long-legged drivers.

The V8 owners were asked if they had trouble with their engines. Sixty-five percent had no trouble; 27 percent had some trouble; and 8 percent had considerable trouble. Most frequent trouble was oil consumption, with oil leaks, automatic choke and engine noises following in that order.

(Continued to page 264)





The great URANIUM  
rush is on!

**STRIKE IT RICH** with the new  
**MODEL 111B DELUXE  
SCINTILLATOR**



**"I SOLD MY URANIUM  
MINE FOR \$4,000,000..."**

....Says Blanton Burford, amateur prospector who first detected Uranium with a Precision Radiation "Scintillator" on the fabulous Rattlesnake No. 9 claim. Mr. Burford recently sold about 8% of this claim for \$4,000,000. Many others have become Uranium millionaires using Precision instruments. In the past two years over \$3,750,000 in Government bonuses has been paid for Uranium discoveries. Over \$175,000 in bonuses is being paid each month to people just like you. This is in addition to the price paid for the ore.

You too can be a Uranium millionaire! ... and of course you will want to use the new Model 111B "DeLuxe" Scintillator - the first and only instrument that reads in *percentage of Uranium*. With the "percent meter" you know right in the field how valuable your ore is. And that's not all! Only the 111B has a large 1 1/2" diameter crystal and the ultra-sensitive "Multi-Mu" eight tube circuit making it 200 times as sensitive as the best geiger counter.

**IT'S EASY TO USE -**

Burford says "I knew nothing about instruments or prospecting. It was easy. All I did was to follow the instructions that came with my Precision Scintillator."

Don't delay. Cash in on this once in a lifetime opportunity. See your local dealer today for an actual demonstration of Precision quality instruments or write to the factory for your free copy of the new book "64 Questions and Answers on Geiger Counters and Scintillators," and a complete catalog on Geiger Counters, Scintillators, Metal Locators and Mineralights.

**FOR THOSE WHO WANT A SUPERSENSITIVE INSTRUMENT Model 111C "Custom" Scintillator is twice as sensitive as the 111B. It has all the 111B features plus a 2 1/4" diameter crystal. Price only 695<sup>00</sup>**

**DEALERS WANTED**  
Precision dealers are backed by a complete advertising and merchandising program. Write today for detailed information.



The Model 111B "DeLuxe" Scintillator complete with saddle grain cowhide carrying case and shoulder strap -

**ONLY \$495<sup>00</sup>**

**OTHER MODELS AS  
LOW AS \$295**

Visit your local dealer today and receive a free chart showing the value of Uranium Ore.



**"PERCENT METER"**  
reads directly in  
percentage of Uranium

**LARGE 1 1/2"  
DIAMETER CRYSTAL  
200 TIMES AS  
SENSITIVE**

**New ultra-efficient,  
8-tube circuit**

**Would you hitch a diesel  
engine to a kiddy cart?**



A large crystal is of no value  
without a circuit capable of  
handling its output.

**PRECISION'S PLEDGE TO THE PUBLIC**

Every instrument bearing the Precision name has been tested to meet the

**Precision Standard of Quality**

This insures the finest materials, construction, engineering and testing that the ultimate in modern manufacturing techniques can provide. The savings of mass production by the world's largest manufacturer are passed on to the public in a premium product at no premium in price. This pledge is backed by an ironclad

**MONEY BACK GUARANTEE**

When buying instruments, buy the best.

**PRECISION RADIATION INSTRUMENTS, INC.**

2235 PM SOUTH LA BREA AVE., LOS ANGELES 16, CALIFORNIA

**WORLD'S LARGEST MANUFACTURER OF PORTABLE RADIATION INSTRUMENTS**

Please send free copy of "64 Questions and Answers" and complete catalog on Scintillators, Geiger Counters, Metal Locators and Mineralights.

NAME \_\_\_\_\_ ADDRESS \_\_\_\_\_  
CITY \_\_\_\_\_ ZONE \_\_\_\_\_ STATE \_\_\_\_\_





**"My husband says  
Quaker State is best  
for stop-and-go driving!"**



**Super-refined from 100% Pure Pennsylvania  
Grade Crude Oil, world's finest. Famous  
for performance, protection, economy!**

**QUAKER STATE OIL REFINING CORPORATION, OIL CITY, PA.**  
Member Pennsylvania Grade Crude Oil Association

### **More Best-Liked Features of Six**

After the ease of handling, next in order of best-liked features of six-cylinder owners was the exterior styling. Then came visibility, comfort, roadability and economy. Here are typical comments:

"Most beautiful car on the road. Handles like a dream. Ride is excellent."—Kansas farmer.

"I like the view of road from driver's seat as well as the passenger's side. Can see all four fenders."—Ohio service-station manager.

"Rides easy on bumpy roads. You can see bumps but hardly feel them."—Illinois pharmacist.

"Handles just as easy at high speeds as in the city."—Michigan teacher.

"Gas mileage is improvement over the eight-cylinder car I had before."—Illinois salesman.

### **More Complaints of Six Owners**

"I don't like the red-light system for oil and battery gauges. Can't tell how much generator is charging or discharging."—Michigan real-estate salesman.

"Valves are noisy."—Ohio shovel operator.

"Don't like front grille."—Tennessee carpenter.

"Gas mileage is poor. About 1.8 miles per gallon lower than on 1949 Chevrolet in city driving."—Tennessee statistician.

"Shifting is difficult."—New Jersey salesman.

"Unless power unit is completely warmed up, a heavy surging thud is heard in automatic transmission when it shifts."—Colorado bank teller.

### **Miscellaneous Comments**

"I haul five riders beside myself 60 miles every day to and from work. All riders think very well of V8 performance. More comfort due to front-end suspension and wider seats."—Ohio foreman.

"I drive many miles a year over very rough roads. Chevrolet has a very well-built body."—Kansas farmer.

"Front end does not dip when applying brakes."—Minnesota sales engineer.

"Front suspension could be improved. Mine is noisy over bumps and holes in road."—Michigan insurance salesman.

"Dipstick difficult to take out and insert because of master cylinder."—Ohio attorney.

"Radio on extreme right uncomfortable for passenger if driver is to hear. No ash tray for passenger. Driver's ash tray too far to left."—Ohio Army officer.

(Continued to page 266)



## New saw with safety clutch can't stall, can't kick back!

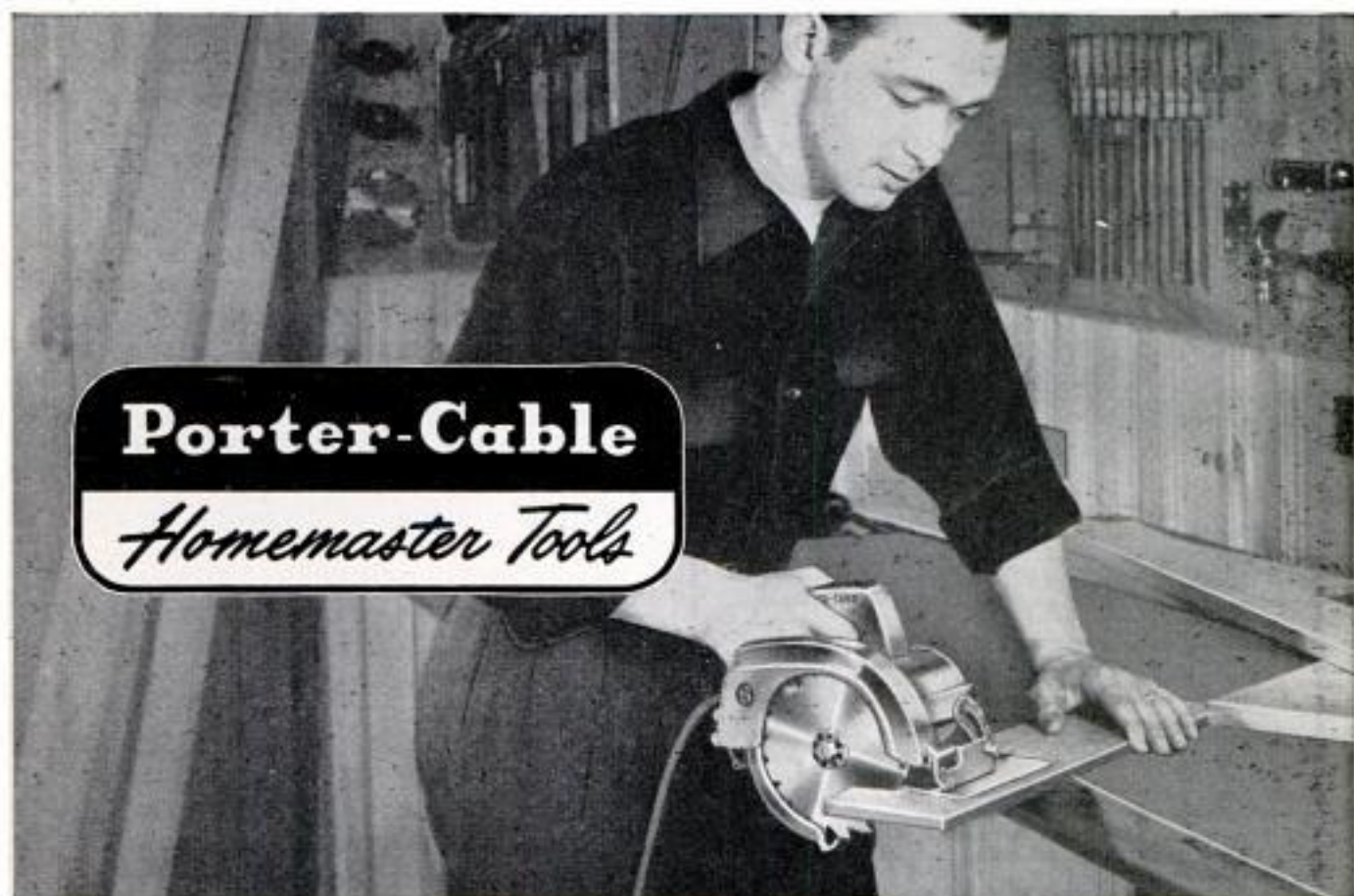

### MODEL 125



**Kickproof Safety Clutch**, telescoping guard. Instant depth control, built-in angle gauge. Cuts 2" dressed lumber at 90°. Powerful 9-amp. motor, ball-bearing construction, helical gears. Unbeatable buy at only **\$49<sup>50</sup>**

Any job's a *safer* job with this new, low-priced Porter-Cable Saw. Exclusive Kickproof Safety Clutch protects against motor burnout and dangerous "kickback"—telescoping guard exposes teeth only where actually cutting. A Porter-Cable *quality* tool throughout—rugged, smooth-running, built to last. Light, handy—a honey for heft and balance, a bear for work. See it soon!

Visit your Porter-Cable Dealer—or mail coupon today

PORTER-CABLE MACHINE CO.  
5143 N. Salina St., Syracuse 8, N. Y.

(In Canada, send to: Strongridge, Ltd., London, Ont.)

Please send me full information on the Homemaster Model 125 Saw and the name of my nearest dealer.

Name.....

Address.....

City.....Zone.....State.....

*Manufacturers of Speedmatic and Guild Electric Tools*



**LET ME SEND YOU PROOF  
THAT YOU CAN BE  
YOUR OWN BOSS  
AT GOOD PAY  
IN THE NEXT 30 DAYS**

Harold Farling  
Sales Mgr.



**SHARPEN LAWN MOWERS IN SPARE  
OR FULL TIME AT GOOD PROFITS**

Thousands of men are earning big money, both spare and full time, in this fine business. You can be just as successful. Starting in your garage or basement, only a small investment will bring you the best lawn mower grinder money can buy, which will enable you to earn a substantial income in a business all your own, without additional equipment. The new Model "B" Universal Lawn Mower Grinder is a precision machine designed and built to sharpen both power and hand mowers with a minimum of effort and time.

The Universal is the only lawn mower sharpener made that allows you to grind both bed-knife and reel blades . . .

**IN A SINGLE SET-UP WITHOUT RE-  
MOVING THEM FROM THE MOWER.**

If you are now working, start this profitable business in spare time. Keep your present job until you develop a full-scale business of your own. Be your own boss like Mr. B. of California, who writes: "The lawn mower grinding business with my Universal Grinder has been a gold mine these last two years." Mr. C.H.R. of Ohio writes: "This season, I have taken in \$3,688.20." If you are 15 years of age, or older, and want a good-paying business of your own with a sound financial future, or if you want to improve your financial status with a spare or full time occupation, the Universal Lawn Mower Grinder, with complete operating instructions, can be your answer.

**ROGERS MFG. CO., Dept. M-35, Lindsey, Ohio**

**SEND THE COUPON BELOW for FREE Information**

**ROGERS MANUFACTURING CO**  
Dept. M-35, Lindsey, Ohio

GENTLEMEN: Please rush me details about the profit possibilities of the Universal Lawn Mower Grinder.

NAME \_\_\_\_\_  
ADDRESS \_\_\_\_\_  
CITY \_\_\_\_\_  
STATE \_\_\_\_\_

**ROGERS MANUFACTURING COMPANY**  
LINDSEY, OHIO, U.S.A.

"No room between steering wheel and seat."—Ohio auto-body repairman.

"Steering wheel should be closer to dash. Short-legged person finds it too close to stomach. Rear seat too low."—Tennessee service representative.

"Body exterior a little rough. Waves in rear-fender panel."—Illinois barber.

"Needs heater under seat. When warm in the back, too hot in front."—Tennessee teacher.

"Poor customer relations."—New Jersey office manager.

"Accelerator pedal should be fixed so your foot wouldn't stick up in the air in town driving."—Kansas railroad engineer.

"In high-speed braking, front end has tendency to weave. Never acts the same on each hard braking."—Illinois salesman.

"Excessive thumping of tires even after having them balanced."—Michigan engineer.

"No place in the station wagon to store jack and lug wrench without rattling."—Kansas oil-field worker.

"Seats very uncomfortable. There is no cushion to speak of. Seats very rigid."—Michigan toolmaker.

"Dealer packed the price of my car by \$200 more than factory-recommended price."—New Jersey store manager.

"Heat riser in manifold rattles just like spark knock."—Tennessee salesman.

"Defrosters should be improved. Top two or three inches of wiper blade do not thaw. Lower portion okay."—Michigan machine-shop superintendent.

As always, the owners with the complaints are much more articulate than those who are completely satisfied. A large number of Chevrolet owners voiced no complaints at all: 36 percent of the six-cylinder owners and 28 percent of the V8 owners making no complaints.

Please turn back to page 103 for Floyd Clymer's road test of the Chevrolet V8.

**Synthetic Natural-Rubber Molecule**

Synthetic rubber with the same molecule as natural rubber has been produced by researchers of Goodrich-Gulf Chemicals, Inc. Natural rubber, which has to be imported by the United States, is unsurpassed for certain uses and accounts for 30 percent of the rubber consumed in this country. Although the new synthetic will cost more to produce than natural rubber, it will in effect place a ceiling on the price of crude rubber and could free the United States from dependence upon foreign sources.



# Now! SKIL Professional Builders Saws at Homeowners' Prices!

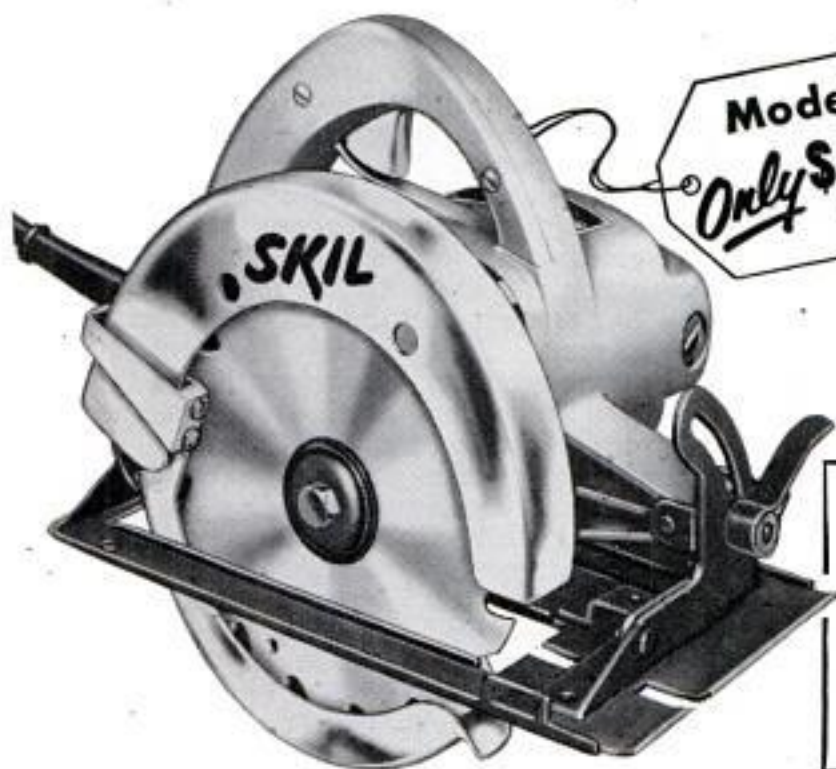

Model 552  
Only \$59<sup>50</sup>



## New! 6½" SKIL Builders Saw!

With this extremely lightweight new SKIL 6½" Saw you can cut dressed 2 x 4's at a 45° angle. Easy, fast cutting in any position. Has high-speed blade (6500 r.p.m.), heavy duty motor with die-cast housing. All ball and needle bearings. Quick setting depth and bevel adjustment.

Now you can have the real thing—a genuine professional carpenter's power saw at a price you would expect to pay for a home craft model.

These heavy duty SKIL Saws are *built* for builders. They have the ruggedness and handling ease that carpenters' saws must have for day-in, day-out use. They have the accuracy needed to hold down building costs. Yet SKIL prices them for every homeowner's pocketbook.

You can tackle any home building job confidently with a SKIL Builders Saw. It often will pay for itself on your first project. Build kitchen cabinets, furniture, whole

rooms—even a new garage or porch—with professional results. Cut plywood panels, sheeting, siding, easily and speedily. You can even cut stone, metals or compositions with special blades.

Have your hardware dealer, appliance dealer or department store show you these SKIL Builders Saws today!

**No other saws at anywhere near the price boast all these features!**

Oversize Motor • Ball and Anti-friction Bearings  
Built-in Bevel and Depth Adjustment  
Telescopic Safety Guard • Trigger-type Switch  
Sturdy Die Cast Aluminum Housing

## 3 Other SKIL Builders Saws to Choose From



### 1. VALUE SPECIAL

SKIL 6" Builders Saw. Model 526. Here's a perfect tool with professional features. Ideally suited to the handyman who does not need a larger saw. Lightweight, sturdy, ready for 101 jobs that need doing. YOURS at a saving that spells real economy \$49<sup>50</sup>

### 2. SKIL 7¼" Builders Saw

Same design as Model 552 illustrated above, Model 553 \$69<sup>50</sup>

### 3. SKIL 8¼" Builders Saw

Same design as Model 552 illustrated above, Model 554 \$79<sup>50</sup>

SKIL makes the most complete line of home and builders power tools. Every one of them offers you the very most—feature for feature—your dollars can buy! See them at your dealers or write for free literature.

**SKIL**  
BUILDERS TOOLS

Made only by SKIL Corporation  
formerly SKILSAW, Inc.  
5033 Elston Avenue, Chicago 30, Illinois  
3601 Dundas Street West, Toronto 9, Ontario  
Factory Branches in All Leading Cities



# Earn More!

get into **BIG PAY**  
**ARC WELDING**

It's EASY  
to do  
arc weld-  
ing!

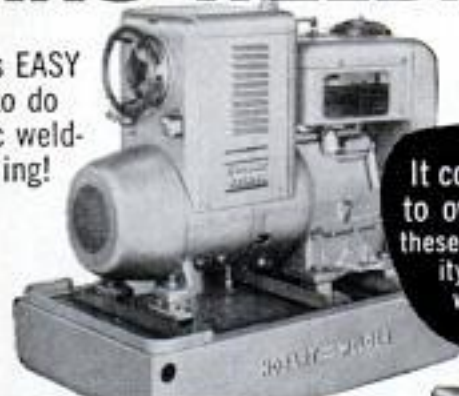

It costs little  
to own one of  
these big capac-  
ity Hobart  
welders

**NEW "Husky-Boy"**  
200 Amp. air-cooled gas engine  
arc welder **WELDS ANYWHERE!**

Equip your lightweight truck with Hobart "Husky Boy." It's a real money maker on emergency repair jobs. Use it in or out of the shop. Ready on a moment's notice to go to work for you.

**BUILD YOUR OWN**, with Hobart's "generator only." Simply connect it to a good used auto engine. Make your own portable welder and get in on the extra profits of arc welding.

**AC POWER OR AC WELDER**. An excellent dual purpose combination. Welds or runs tools, lights, motors independent of power lines. Can be belted or coupled direct to your own gas engine.

**TRANSFORMER TYPE AC WELDER**. A real welder for production and repair work in shops that have only single phase power available.

**300 AMP. ELECTRIC MOTOR DRIVEN** portable welder for average welding requirements. Perfect for production, maintenance, repair, tool room work and all general shop welding.

**Investigate These Big Money Makers Today!**  
Mail coupon for complete details.

**HOBART BROTHERS CO., BOX M-35**  
Troy, Ohio, Phone 21223. "One of the world's largest builders of arc welding equipment."



**Hobart School of Arc Welding**  
Learn profitable arc welding at the non-profit Hobart Trade School. Skilled instructors, G. I. approved. Low cost.

**CLIP THIS COUPON and MAIL!**

**HOBART BROTHERS CO., BOX M-35, Troy, Ohio** **FREE!**  
Without obligation, send complete information on the items checked below:

Husky Boy  Build Your Own  AC Welding—AC Power  AC Transformer Type  Welder's Vest Pocket Guide

300 Amp. Electric Drive  Hobart Trade School  Modern Arc Welding Lessons, \$1.00

NAME \_\_\_\_\_  
ADDRESS \_\_\_\_\_  
CITY \_\_\_\_\_ STATE \_\_\_\_\_



Build Your Own



AC Power—AC Welding



AC Transformer



300 Amp. Electric Drive



Modern Arc Welding Lessons, \$1.00

## Clymer Road Tests the Chevrolet

(Continued from page 103)

unsprung weight and less hopping of the rear end at high speed on rough roads.

Chevrolet has a small turn-circle diameter of only 38 feet curb to curb or 41 feet wall to wall with 5 1/3 turns of the steering wheel from lock to lock.

Chevrolet's new V8 engine provides surprising performance. The car cruises at 90 miles per hour with little effort and will hit a top of 108 on the speedometer (about 101 actual speed).

Acceleration tests were just as surprising. From 0 to 60 miles per hour, the Chevrolet's time was a fast 12.9 seconds. Compare that time with the 1951 Chevrolet's 20.2 seconds and the 1953 Chevrolet's 19.6 seconds.

Gasoline economy was below that of the previous Chevrolets tested. At a constant 60 miles per hour, the 1955 Chevrolet V8 averaged 16.1 miles per gallon; the 1953 Chevrolet six averaged 19.4 miles per gallon, and the 1951 Chevrolet six averaged 18.95 miles per gallon. All three models were equipped with Powerglide. Premium gasoline was used in the 1955 constant-speed tests and standard-grade fuel was used in 1953 and 1951.

The 1955 Chevrolet with the V8 engine weighs 30 pounds less than the same model with the six-cylinder engine. Oil capacity is only four quarts for the V8 and five quarts for the six.

I found no tendency for the car to overheat, even on steep mountain highways or in the hot Mojave desert.

The tubeless tires, now standard equipment, seem to squeal less on corners, but I'll have to experience a blowout and repair a flat before I'll place my unqualified approval on them.

The Powerglide indicator has been moved into the dash directly below the speedometer. I prefer the old location, which was closer to the shift lever and required less eye adjusting.

Powerglide is an excellent transmission. Many improvements have been incorporated in it since it first appeared. There is now less slippage than in the Powerglides of previous years.

The ride is comfortable. I noticed no squeaks or noises in the body, even though no sound-deadening material is used. There were no dust or water leaks evident.

Bumpers are mounted as close as possible to the body and over-all length is only 195.6 inches, the shortest of the Big Three. The hood needs a lower and more sloping front to improve vision directly in front of the

(Continued to page 270)



# Holt's WORLD-FAMOUS Do-It-Yourself Products

For the Motorist  
and the Home

## PISTON SEAL—

For restoring power and compression, stopping piston slap and reducing oil consumption.

## GUN GUM—

For mending leaky mufflers, sealing pipes and joints.

## BATREPAIR—

An acid-proof battery weld.

## HOLTWELD—

For repairing cracked cylinders.

## RADWELD—

For repairing leaky radiators.

## NO-CRODE—

For keeping battery terminals clean.

## SUPERTUNE COMPRESSION PRIMER—

For maintaining top engine tune-up.

## LOY—

For permanently repairing anything broken, cracked, loose or leaky—metal, wood, glass, plastic, porcelain. It's real metal in a tube.



## TRADE MARK Piston Seal

ORIGINAL

**Restores Power and Compression! Stops Piston Slap! Reduces Oil Consumption! Increases Mileage!**

Good for 10,000 miles of carefree driving. Next best thing to a complete motor overhaul... at 1/20 the cost. Today's biggest seller. Millions of tubes have been sold throughout the World during the past 18 years. Undeniably safe for even the finest engines. Endorsed by leading technical automotive experts.

Easy to use

Costs less than \$5

Stop Danger of Carbon Monoxide Gas

**Holt's GUN-GUM MUFFLER SEAL**

Plastic

Mends leaky mufflers—seals pipes and joints

Sets like a weld in a few minutes!  
No Tools Necessary  
Apply by Hand

\$1.69 CAN

Write for full details

At every Auto and Accessory Store  
**TREGLOWN CO., Inc., Fanwood 12, N. J.**  
Canada: 1366 Greene Ave., Montreal 6 (Prices slightly higher in Canada)

Also Eshelman SPORT CARS  
LOWEST PRICE  
70 Miles Per Gal.  
"Commended by Parent's Mag."  
Free Catalog.

## ESHELMAN BOAT TRAILERS

Also BOATS & MOTORS

NONE HIGHER \$79

SAVE MONEY! GET OUR SPECIAL COMBINATION PRICE!

Trailer shipped complete with Hi-speed wheels, tires, tubes, hitch, etc. Write for Catalog.

ESHELMAN 109 Light St., Balto. 2, Md., 333 N. Michigan Ave., Chicago 1, Ill., 7070 Hollywood Blvd., Los Angeles 28, Calif.

## SHOPMASTER'S

NEWEST SENSATION

## COMBINATION POWER TOOL

It's... Circle Saw, Drill Press, Sanders, Router, Shaper, Lathe All In One

For Complete Information Write 25¢  
1204 S. 2nd St., Minneapolis, Minn.

**SHOPMASTER, INC.**



Whenever you're painting, you need **SAVOGRAN** PRODUCTS

... at better paint & hardware stores

Write for free helpful literature  
SAVOGRAN CO., Dept. 63, 25 Huntington Ave., Boston, Mass.

MARCH 1955

SAY YOU SAW IT IN POPULAR MECHANICS

## Get This NEW Catalog of WOOD AND WOODWORKING MATERIALS



World's Largest Selection of Finest Domestic and Imported Woods... Mouldings, Hardware, Tools, — ALL AT LOW MONEY SAVING PRICES!

Your complete wood buying guide and project book. Craftsman is your best, most complete source of finest kiln-dried domestic and rare imported woods, beautiful wood inlays, colorful bandings, matched plywoods, embossed mouldings, carved ornaments, newest woodworking tools, "hard to find" cabinet hardware and fittings... more than 1,500 items! Packed with newest scroll saw patterns, project ideas & money making plans. Enclose 25¢ (refunded with first order) to help pay mailing, handling cost. Write now!

**Craftsman Wood Service Co., Dept. A-53  
2729 S. Mary Street - Chicago 8, Ill.**

**148 PAGES Many in full color**  
packed with rare, fancy & imported woods... veneers, plywoods, patterns, tools, ornaments, hardware... everything for the woodworker.

**MAIL COUPON NOW!**

**CRAFTSMAN SERVICE CO., Dept. A-53  
2729 S. Mary St., Chicago 8, Ill.**  
Enclosed find 25¢. Rush me new Woodworkers' Catalog Handbook.

NAME.....  
ADDRESS.....  
CITY.....ZONE.....STATE.....



## Performance

going up in smoke?



# WORN ENGINE BEARINGS CAUSE OIL PUMPING!

Diagrams show sections of crankshaft (shaded areas) and increasing oil throw-off through wear.

### HERE'S WHY:

1. Normal oil clearance (red). In this case, .0015". Normal oil throw-off (black area).
2. Wear increases oil clearance to .003". Throw-off increased 5 times (black area).
3. Wear increases oil clearance to .006". Throw-off now 25 times normal (black ring).

When excess oil reaches combustion chambers, it burns to engine-fouling carbon.

To restore performance, replace with Federal-Mogul engine bearings, engineered for the job of oil-control!



**FEDERAL-MOGUL SERVICE**

Division Federal-Mogul Corporation

DETROIT 13, MICHIGAN



wheels. However, vision is excellent, both front and rear, with the wrap-around windshield aiding forward vision. Rear-fender tips are high and can be seen by the driver.

Windows open and close easily. There is a lot of hip and shoulder room inside the body and a tall man can get in and out without knocking off his hat. Front-seat backs should have more padding and better springing.

The ventilating system required longer than average for maximum heat to be felt inside the car.

Driving position is excellent as is the angle of the steering wheel. The amount of oil pressure and generator output is unknown for instead of needle gauges red warning lights now notify the driver only when they drop to zero. I prefer gauges that tell what is happening as well as what is not.

The large, fan-shaped speedometer is easy to read except for one thing: The top half of the horn ring is directly in line between the driver's eyes and the speedometer numerals.

As mentioned above, I found the use of premium gasoline necessary. There was considerable pinging when burning regular-grade fuel. However, with the new increased octanes being introduced by major oil companies it might be possible to use regular gasoline in some parts of the country.

I burned two quarts of oil in 400 miles, which caused me to investigate. I asked Chevrolet's engineering department about it and found that the test car had one of the first V8 engines off the production line. The early engines had chrome oil rings that were too hard and were slow to break in or seat. Since then Perfect Circle No. 98 oil rings have been installed in production and the trouble eliminated, says Chevrolet.

It is not unusual for a new model to have some "bugs" and apparently Chevrolet is no exception. The piston-ring weakness was corrected after the first few thousand cars were off the assembly lines. Owners of the early cars are being given new rings where necessary, I understand.

★ ★ ★

### Tortoise Methuselah

At least 177 years old, and probably considerably more than that, is a very much alive tortoise kept as a pet by the royal family of Tongatabu, principal island in the Tonga group. The tortoise was presented to the king of the Tongas by Capt. James Cook, discoverer of the Hawaiian Islands, in 1777. How old the animal was at that time no one knows.



# FOR ASSEMBLY · REPAIR and INSTALLATION WORK

ELIMINATE DROPPING AND FUMBLING HEX HOLLOW-HEAD SET SCREWS and CAP SCREWS

WITH THE **NEW**



OVER 200 TYPES AND SIZES IN STOCK

WALDEN

# in-a-grip<sup>®</sup> WRENCHES

TRADE MARK PATENTS PENDING

WRITE FOR CATALOGUE

MANUFACTURED EXCLUSIVELY BY

**STEVENS WALDEN Inc.**  
480 SHREWSBURY STREET  
WORCESTER, MASSACHUSETTS

FOR OVER 50 YEARS MAKERS OF SPINTITES, GRIP SPINTITES, FORCE-FORMED SOCKET WRENCHES — AND ALL TYPES OF MECHANICS' HAND TOOLS

**SMALL! POWERFUL!**

**ECONOMY TRACTOR**

Unequaled value! Low price! America's finest tractor. Ruggedly built. Easy to operate. 790 lbs. Borg-Warner clutch, trans. and diff 1:90 to 1 reduction. 40% more drawbar pull than ordinary tractors 8-1/4 H.P. engine. 20 quick change implements. HOOD, FENDERS.

Thousands In Use Write for complete details.

Engineering Products Co.  
915 K-3 Niagara Ct.  
Waukesha, Wisconsin

**MACHINE TOOL RECONDITIONING & THE ART OF HAND SCRAPING**  
— ILLUSTRATED —  
SEND TODAY FOR FOLDER DESCRIBING BOOK  
MACHINE TOOL PUBLICATIONS, 382 Holly Ave., St. Paul 2, Minn.

**GOIN' FISHIN'?**

Record-Proved  
**ASHAWAY LINES**  
LAND MORE FISH!

SPECIALIZED lines for every fishing purpose... for your greater fishing pleasure.

**Install Your Own!**

AMERICA'S Most Beautiful ALL-ALUMINUM DOOR CANOPIES AND WINDOW AWNINGS

Smart! Distinctive! Custom-built!

**GUARANTEED 100%**

Designed and engineered by Herbert's—with experience and machinery to sell you a better awning.

COMPLETELY ASSEMBLED WITH BAKED ENAMEL FINISH.

DIRECT FROM FACTORY

WRITE FOR FREE MEASURING CHART AND LITERATURE **Save 50%**

8974 St. Charles Rd. **Herbert's** St. Louis 14, Mo.  
ALUMINUM AWNINGS

NAME \_\_\_\_\_  
ADDRESS \_\_\_\_\_  
CITY \_\_\_\_\_ ZONE \_\_\_\_\_ STATE \_\_\_\_\_





No. 888  
Power Unit  
fully  
equipped  
as 3/8" Drill,  
6" Sander,  
and  
6" Polisher

Powerful? **IT'S**  
**DYNO-MITE**  
U. S. PAT. OFF.

and the start of a complete  
power workshop for only **\$39.95**

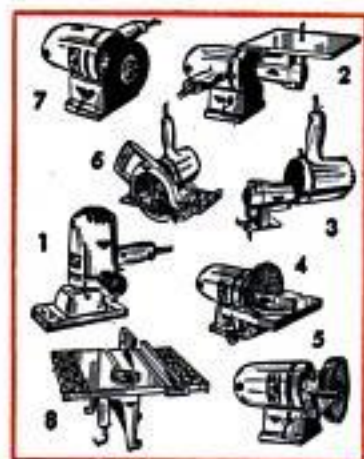

It's the do-it-yourself sensation of the year! For only \$39.95 you get the rugged, 4.0 amp. No. 888 Power Unit — completely equipped as a Drill, Sander and Polisher. Then, by adding inexpensive attachments, you can have: 1) an Orbital Sander — 2) a Table Jig Saw — 3) a Portable Jig Saw — 4) a 6" Disc Bench Sander — 5) a 4" Bench Grinder — 6) a 6" Portable Circular Saw — 7) a Bench Power Unit — 8) a 6 1/4" Circular Bench Saw. Other attachments, too, will soon be ready, including a Drill Stand due April 1. See the No. 888 at your hardware dealer's. Do it today.

For power and performance — ask for

**Millers Falls**  
**Dyno-Mite Power Tools**



FREE FOLDERS on the No. 888 and all the other high-performance Millers Falls Dyno-Mite Power Tools. At your hardware dealer's or write:

MILLERS FALLS COMPANY  
Dept. PM-6  
Greenfield, Mass.



### Newsman Makes Own Camera

Aerial photography is no more complicated than normal ground work for the photographic staff of the Oakland, Calif., Tribune, due to an aerial camera designed by chief photographer Keith Dennison. The "new" camera consists of the back—including the familiar Graphic focal-plane shutter—of a wartime combat model Speed Graphic, the conical lens mount salvaged from an enlarger and a 30-year-old 7 1/2-inch Graflex lens. It uses standard 4-by-5 cut-film holders, speeding developing time over the roll film generally used in aerial cameras.

### Key-Operated Brake Lock

Turning a key in a special unit on the instrument panel and pressing the brake pedal once locks your car in position until you return. The unit, which attaches to the brake's master cylinder, can be installed in any standard car or truck. It protects a car from theft, from rolling downhill or being pushed into the street.

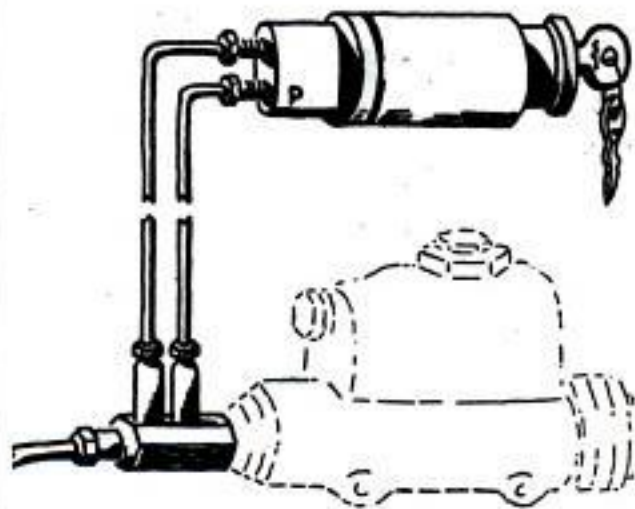

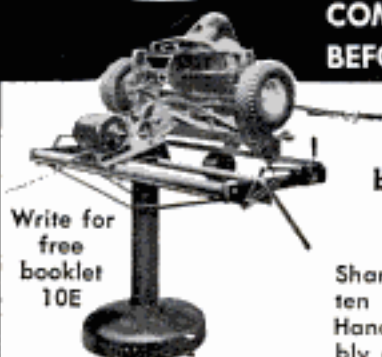

**MODERN****LAWN MOWER SHARPENER****COMPARE  
BEFORE YOU BUY**

Write for  
free  
booklet  
10E

Oil remains in engine while sharpening. Bed knife sharpened in same centers — no attachments needed.

Start your own  
business—increase  
your income

Sharpens any mower in ten to twenty minutes. Handles complete assembly of all reel types including 36 in. power mowers. Handle, wheels, roller, and engine are not removed.

**\$26300**

F.O.B. PASADENA

**MODERN MFG. CO.**

160 N. FAIR OAKS, PASADENA, CALIF.

**JITTERBUG • CATCHES MORE FISH**

Noisy surface bait. World's best hooker — day or night. Gurgling, paddling action of the double-lobed lip makes fish strike hard. 5/8 oz. or 3/8 oz. or 1/4 oz. spinning size \$1.25. Musky size \$2.00.



FRED ARBOGAST CO. INC., 2243 W. North St., Akron 3, Ohio

**FREE** WRITE TODAY FOR YOUR BIG FREE ARBOGAST COLOR CATALOG—FULL OF PICTURES OF CATCHES

**BUILD OR BUY ARC WELDER**

DUNBAR'S Build-Or-Buy PLANS show you how to build a 300 amp. DC Welder the easy way using Aircraft Generator. Our FREE Big Catalog listing 1500 items also lists 3-low-priced DC Welder Kits you can assemble in few minutes. Send 10c today for Complete PLANS, Catalog included.

DUNBAR MFG. CO.

6616 Sylvan Road

Houston 23, Texas

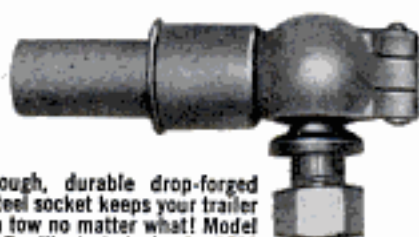
**STRONG, ECONOMICAL  
TRAILER COUPLER**

Tough, durable drop-forged steel socket keeps your trailer in tow no matter what! Model 1-B, illustrated, hauls 2500 lbs., costs only \$4.66 (Fed. tax incl.). Other models to 10,000 lbs. capacity. Write for the dope on our complete line of trailer axles, couplers and parking jacks!

**HAMMER BLOW TOOL CO.**

WAUSAU 13-C, WISCONSIN

**NEW****3/4" WIDE  
Heavy Duty  
TAPE RULE****LUFKIN White Clad  
SUPER MEZURALL**

in 10 and 12 foot lengths  
Designed to make your  
measurements faster and easier



LONG WEARING snow white line with bold jet black figures.

RUGGED 3/4" bonderized steel line is flexible, yet extends unsupported.

16" CENTERS clearly marked with diamond.

CONSECUTIVE INCHES marked on this edge.

FEET & INCHES marked on other edge.

FEATHERWEIGHT Magnesium alloy case is lightest (actually 1/2 lighter) yet stronger than other die cast cases.

ADJUSTABLE end hook permits accurate butt-end or hook-over measurements.

FREE "SEE THRU" plastic box with hinged cover and snap fastener with each Super Mezurall.



**ALSO AVAILABLE WITH THE  
FAMOUS CHROME CLAD LINE**

All metal line is built up with multiple electroplatings — won't chip, crack or peel. Jet black markings won't wear off and they stand out sharp and clear against the chrome white line.

BUY **LUFKIN** TAPES • RULES • PRECISION TOOLS  
AT YOUR HARDWARE OR TOOL STORE  
THE LUFKIN RULE CO., Saginaw, Michigan

347



# New, faster way to strip off finishes



Non-inflammable  
**KLEAN-STRIP**  
peels off paint,  
varnish, lacquer,  
enamel, synthetics.

## IT'S CLEAN—NO AFTERWASH!

Sold at leading paint, hardware and department stores.

Product of

The KLEAN-STRIP Co., Inc.

2340 S. Lauderdale • Memphis 6, Tenn.

## FREE fishing guide to TENNESSEE'S PRIZE-WINNING TVA WATERS.



You catch 'em big in Tennessee! And this handy booklet tells where, when and how. Maps of 19 great lakes showing access roads, 204 boat docks, tourist accommodations, fishing laws, regulations, etc. Write for your free copy. Plan an early trip to Tennessee—where bass, wall-eyes, crappie, bream, stripes, and sauger are biting now!



**NO CLOSED  
SEASON**

*Mail Coupon Today!*

Tennessee Division of Information  
1204 Cordell Hull Building  
Nashville, Tennessee

Please send Free 1955 Fishing Guide

NAME \_\_\_\_\_

ADDRESS \_\_\_\_\_

CITY & STATE \_\_\_\_\_

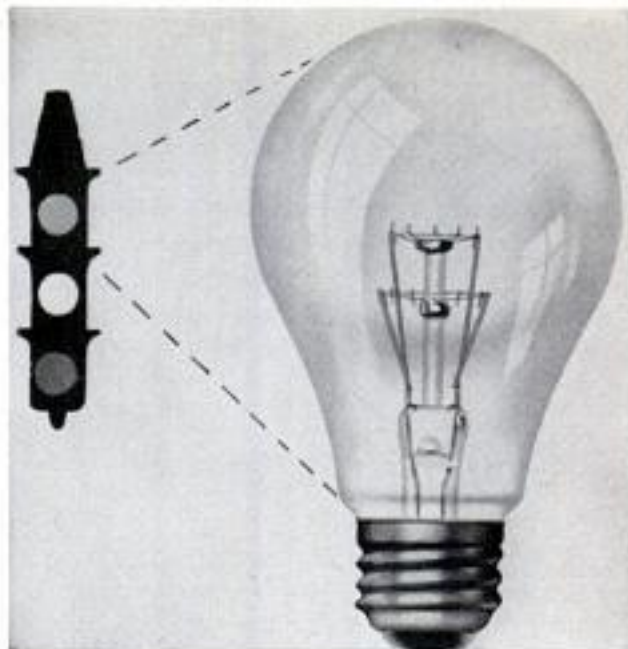

## Light Bulb Has Two "Lives"

Traffic lights equipped with a new bulb don't black out when the filament fails. A second filament inside the bulb goes into use to provide a dimmer light that indicates the bulb needs replacing. The light provided by the second independent filament is only 25 watts as compared with the 50 watts of the main filament. But it is bright enough to serve until the bulb is replaced. The 50-watt filament will burn for 5000 hours, the 25-watt filament for 8000 hours if necessary.

## Holder for Fishing Rod

Fishing rods are held securely in a new rod rest, yet are ready for instant use. The holder is fastened to the top of the tackle box with a special plate. The reel remains upright at all times, and the holder can be tilted to any angle as well as turned in a complete circle. The holder also makes it possible for the fisherman to carry both the tackle box and the rod in one hand. An extra clamp is furnished to attach the holder to the side of a boat.





**Build It Yourself  
and SAVE**

*Two or Three Bedrooms*  
with a choice of exterior styling

**PRECUT and PANELIZED  
for EASY ERECTION**

As low as **\$2395<sup>00</sup>** plus freight and sales tax where applicable

It is easier than you think to build an attractive two or three bedroom home when you select an LFI panelized house package specially designed for easy erection in minimum time. You can save thousands of dollars and have a home that will be the envy of the neighborhood. Your home will be shipped to the building site in factory assembled, panelized sections using architecturally approved construction, and clearly marked precut material. Complete plans, erection instructions and specifications are furnished.

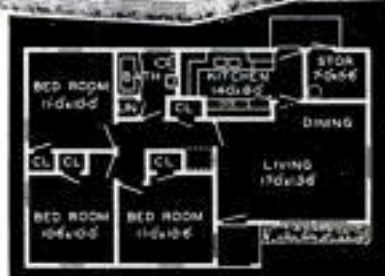

**FILL IN THIS COUPON** for free brochure giving plans, specifications and description of one and two bedroom homes. For complete set of working blueprints giving floor plans, elevation, notes on construction, etc., enclose \$15.00 check or money order.



**LUMBER FABRICATORS, INC.**  
FORT PAYNE • ALABAMA

**LUMBER FABRICATORS, INC.** Department L  
Fort Payne, Alabama

- Please send free brochure  
 Enclosed is \$15.00 for blueprints

NAME .....

ADDRESS .....

CITY.....STATE .....

*Say You Saw It in*  
**POPULAR MECHANICS**

**RELIEVES  
HEADACHE  
NEURALGIA  
NEURITIS PAIN**

**FAST**



**Here's Why...**

Anacin® is like a doctor's prescription. That is, Anacin contains not one but a combination of medically proved active ingredients. Anacin is specially compounded to give **FAST, LONG LASTING** relief. Don't wait. Buy Anacin today.

send for **FREE CATALOG**

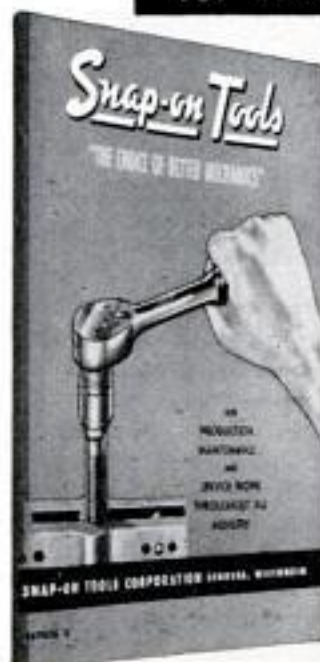

America's Foremost  
*money-making*  
**MECHANICS'**  
**TOOLS**

It's easy to own the same "pay-off" tools used and endorsed by America's top-earning mechanics throughout the automotive, aviation and industrial fields! Snap-on tools help you handle every repair job faster, easier, better. And they **LAST**... pay for themselves over and over again! Start building your own tool set now with basic Snap-on units—add others any time. Genuine Snap-on tools are never sold in stores—direct to users only. Mail coupon for free catalog.

**Snap-on Tools**  
THE CHOICE OF BETTER MECHANICS

Snap-on Tools Corporation  
8062-C 28th Ave., Kenosha, Wis.

Send me free catalog. Occupation \_\_\_\_\_

Name \_\_\_\_\_

Address \_\_\_\_\_

City \_\_\_\_\_ Zone \_\_\_\_\_ State \_\_\_\_\_



**YOUR CAR  
DO THIS?**



**YOU NEED  
AIR LIFTS**

AIR LIFTS smooth away that sharp "dipping" on sudden stops. They also stop dangerous leaning on curves and "bottoming" on bad bumps. These patented pneumatic spring boosters slip inside any coil springs not enclosing shock absorbers. They inflate with air to give your two springs the action of six! Your front end is levelled and raised to new-car riding position, correcting all sag and assuring a far safer, more stable ride. You save tires and cut repair bills, too. See your dealer — now!

**FREE . . . How To Stop Front End Troubles** folder, packed with tips to save you money. Write department 43

**AIR LIFT**

**AIR LIFT COMPANY**  
Lansing, Michigan

**Make Gardening Easy**  
with the amazing new

*Ariens Jr.*

**ROTARY TILLER... ONLY \$129.75**



Prepares garden without plowing, discing, harrowing or spading! Cultivates close to plants, kills weeds all season long without tedious hoeing by hand! 2 h.p. engine. "Paring Knife" tines. Tills 12" wide, up to 6" deep. Tip-toe clutch and other exclusive features which make Ariens Jr. unequalled for construction, looks, performance and price! See it soon!



Visit your dealer or write:

**ARIENS COMPANY • 159 Calumet St. • Brillion, Wis.**

**END FUSE TROUBLES  
FOREVER!**

Guaranteed by  
Good Housekeeping

with a push on this button



NOW  
\$1.50

- Fits like a fuse in any standard fuse socket!
- Just press the Mini-Breaker button to restore service.
- Safe protection against overloads, and short circuits.
- Lifetime protection against electrical fire hazards.

In 10, 15, 20, 30 amps. AC only, 125 volts max.

Listed by Underwriters' Laboratories

**MINI-BREAKER**

Ask for it at your favorite store or write  
Mechanical Products, Inc., Jackson, Michigan.



Paint your house in half the time..SAVE NEARLY 1/2 THE COST!  
**Glidden ENDURANCE IMPERIAL**  
NEW ONE-COAT WHITE HOUSE PAINT!

**THE GLIDDEN COMPANY • CLEVELAND 2, OHIO**



**G E A R S**

**In Stock - Immediate Delivery\***  
Gears, speed reducers, sprockets, thrust bearings, flexible couplings, pulleys, etc. A complete line is carried in our Chicago stock. Can also quote on special gears of any kind. Send in your blueprints and inquiries.

Send for Complete Catalog No. 10  
**CHICAGO GEAR WORKS**  
440-50 N. Oakley Blvd., CHICAGO 12, ILL.

**POWER HACKSAW \$55.75**

LESS MOTOR  
F.O.B. Benton Harbor



- Rugged cast iron construction. Wt. 56 lbs., bronze bearings. Draw cut. Auto. return lift. Auto. shut-off. Vise swivels 45°. Cap. 4"x4".

Send for full details and name of nearest dealer.

**EXCEL MACHINE TOOLS BENTON HARBOR, MICHIGAN**



NOW YOU CAN BUY  
A PROFESSIONAL TYPE  
**GEIGER COUNTER**  
with transistor-amplified, loud speaker

Write for Bulletin VT-27.

Not a toy—but a gadget. Vic-Tic is a full size professional Geiger Counter with a transistor-amplified, loud speaker, adjustable in tone pitch. The ideal instrument for uranium exploration. Weighs only 2 pounds and has 4 sensitivity ranges: (1000, 10,000 and 100,000 c/p.m. plus extra sensitive background range). Furnished with an aluminum-wal. counter tube, batteries, shoulder strap, instructions, manual and Radio Active Sample, complete for \$125.00. Additional accessories available include SIX PACK of high sensitivity Blometh Geiger Tubes (15 times more sensitive than standard tube), hand probe, and deep-hole probe can readily be plugged into built-in jack. Vic-Tic was designed by the same staff of engineers who developed the first instrumentation for Atomic Science. Fully Guaranteed. Order now for immediate shipment.  
**VICTOREEN INSTRUMENT CO. 5806 HOUGH AVENUE CLEVELAND 3, OHIO**



for flawless, scratch-free finishes . . .

# Insist on DREMEL

## STRAIGHT LINE ACTION SANDERS

Did you know there are 4 different sanding actions? In choosing a power sander, it's the kind of sanding action that counts. To do the job right, you must sand with the grain. Sanding across the grain with a circular or orbital motion leaves scratches and swirl marks which scar the finish and show up after varnishing. Only DREMEL STRAIGHT-LINE ACTION sands with the grain, guarantees flawless, scratch-free finishes. Choose from 3 sizes. Hobbyist, craftsman, housewife —there's a DREMEL sander to fit your every sanding and polishing need.



**EXCLUSIVE!**

Quick-action detachable pad. Extra pad free.



**NEW MODEL "53"**, Here's a real powerhouse, driven by a ROTARY MOTOR. Weighs only 5 1/4 lbs., has 24 sq. in. sanding surface. Out-performs others costing much more. Positively the best heavy-duty sander buy on the market. Complete with 2 detachable sanding pads..... **\$34.85**

### STUDY THIS CHART!

Of the four common sanding actions, only Dremel sands 100% with the grain—the only guaranteed scratch-free action approved by finishing experts.

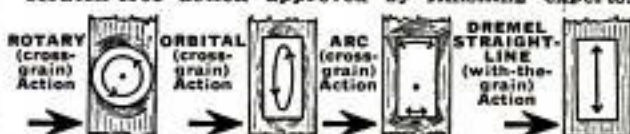

**SEND FOR FREE POWER TOOL CATALOG. SEE YOUR DEALER.** If he cannot supply order direct on 5-day trial, money-back guarantee. Remit in full for postpd. shipment; or send \$2. pay postman balance plus postage and COD.

**DREMEL MFG. CO., Dept. 115-C, Racine, Wis.**



### MODEL 2000

Sander-polisher, 14,400 strokes per min.; wt. 5 lb.; 21 sq. in. surface. Steel carrying case, pad, 25 abrasives.

**\$24.50**

### MODEL A

Sander-polisher-massager. Wt. 2 1/2 lbs.; 12 sq. in. surface. Polish pad, massage pad, 6 abrasives.

**\$14.85**

# MAGNETS

**ASSORTED MAGNETS** with big list of handy uses..... 5 for \$1  
**POWERFUL POCKET MAGNET** ideal for testing metals..... \$1  
**RETRIEVING MAGNET** pulls tools, etc., from tank or lake..... \$4  
**HOT PAD MAGNETS** to insert in your own hot pads..... 8 for \$1  
**BULLETIN BOARD MAGNETS** to "pin-up" memos, etc..... 8 for \$1  
**SLENDER MAGNETS** remove chips from drill holes..... 2 for \$1

Booklet and instructions with each order—Satisfaction Guaranteed  
**PARK MAGNETS, PM-3, 1557 GREENBAY RD., HIGHLAND PARK, ILL.**

## Build Your Own Slip-on Coach In Kit Form—Assemble Yourself



Save money by getting this new slip-on coach in kit form. Fits all pick-up trucks. Easy to assemble yourself in a few hours. Easy to slip on or take off truck. Complete living quarters for 2 or 3. Also boat trailer kits. Trailer blueprints of all kinds. Illustrated literature 10c.  
**COMSTOCK TRAILERS**  
 DEPT. P PARSONS, KANSAS

## Combination Square TRAMMEL HEADS



Make  
**Accurate Compass, Height Gage  
 Outside and Inside Calipers**  
 Heads chrome plated, screw parts protected by cadmium plating, scriber points made of hardened tool steel. Perfect for work on wood, plastic, sheet metal, linoleum, die or tool layout. Hundreds of uses. Comes complete with plated heads, scriber points, pencil tips, special caliper points.  
 Price \$2.95 ea. **POSTPAID 6 Sets \$17.00**

**ENGINEERING RESEARCH ASSOCIATES, INC.**  
 3475 East Nine Mile Road Hazel Park, Michigan

# New! Sensational!



**Everything FAST • MANEUVERABLE • RUGGED • SEAWORTHY • TRIM THAT MAKES A BOAT GREAT!**

It's the new aluminum outboard cruiser by Arkansas Traveler—the Cruiser 20! Amazing performance. A standout in comfort, looks. A ride will convince you. See your Dealer. Ask him!  
**FREE!** Write for colorful new literature on the 18 great Arkansas Traveler Cushion-Air-Glide models for 1955. A size and style for every outboard need. You'll like the prices!  
**ARKANSAS TRAVELER BOATS, 2006 E. 14th, Little Rock, Ark.**

**Arkansas Traveler**  
 CUSHION-AIRE-GLIDE ALUMINUM BOATS



# Floor Surfacing Contractors NEEDED!



- ★ BIG PAY
  - ★ FULL or PART TIME
  - ★ AGE No Barrier
  - ★ Minimum Investment
- ## BE YOUR OWN BOSS

Highly respected profession offers you unusual opportunity to *be your own boss!* Thousands of men from 18 to 80 have found financial security and happiness in this phase of building and remodeling. Pay scale is high—many earn \$50 a day and more. Men even with physical handicaps enjoy this pleasant year 'round work. No schooling or special skill required. Only small investment in sander gets you started. Send for booklet "Opportunities in Floor Surfacing", enclosing 25c in coin or stamps to cover handling.

**SEND..**  
**AMERICAN**  
 FLOOR SURFACING MACHINE CO.  
 535 So. St. Clair St., Toledo 3, O.

## Get Our Big Manual of "HARD-TO-GET" ITEMS

For home craftsmen, wood workers, industrial art departments, furniture repair men, hobbyists, cabinet makers, etc. Send only 50c today for your copy.

A few of the items we sell: Inlays, fancy cabinet wood, lumber, Ebony, Holly, Dimension cut lumber, lignum vitae, Carving Blocks, Turning Squares, 120 kinds of veneers. Abrasive papers, archery woods, bill-board clamps, binswings, bed fasteners, blueprints. Chair braces, brass chain, brass fencing. Craftsmen books, candlestick holders, candlestick sockets, card table hardware, casters. Chair cane, ceramic tiles, clamp nails, crib hardware. Dowels and dowel pins, dowl centers, drawer rollers, felt. Flok finishes, foam rubber, furniture clamps, complete professional finishing materials. Folding tablelegs, hand tools, furniture pulls, modern and period, chest and ornamental hardware, all types of hinges and locks, small box hardware, Inlaid picture kits, inlaid card table tops, leather working tools, Micarta, revolving Lazy Susans, musical movements, moulded wood carvings, Metalcraft material, Moio Sander, nut bowl hardware. Picture frame moldings, Pre Cut Wood Pix, perforated steel panels, pilaster standards, plastics and plexiglass, internal carving bits, plastic polishing compounds. Electric routers, sanders, foot rheostats, hand drills, sprayers, revolving fixtures for television tables, chairs, etc. Floor rash, screw hole buttons, spiral saw blades, sliding door track, sharpening stones, hose cutters specialties, 100 woods, ski woods, platform rocker springs. Table leaf supports, tack rags, thermometer cards, turned furniture legs, typewriter fixtures. Complete upholstery supplies. Veneer presses, wood burning pens, wood working instructions, black and copper wrought iron hardware, zipper wire.

Send fifty cents today (refunded on 1st order) for your copy of the Country's leading Catalog, "Constantine Manual for Craftsmen" to:

**ALBERT CONSTANTINE & SON, Inc.**  
 Dept. PM-3 797 East 135th St. New York 54, N. Y.

## SHEET METAL BRAKES

Forms angles, locks pans, etc. New eccentric clamps. All steel construction. Size 15"-16 gauge steel, \$21.50; 36"-22 ga., \$33.00; 48"-24 ga., \$48.00. Floor Stand, \$7.50.



**IRON BENDER, 10 parts..... \$9.50**  
**FOLDER 15" 1/4 to 1" 24 ga..... \$16.50**  
**VISE BRAKE 12" 20 ga..... \$12.80**  
**SHEAR 7" 16 ga. steel..... \$12.50**  
 (Immediate delivery. Order cash or C.O.D., or send for folder)  
**VYKE MFG. CO., P-2439 15th St., Denver 2, Colo.**

## VARIABLE SPEED HYDRAULIC POWER TRANSMISSION



It has Infinite Speeds 0 to 550. Reverse, Automatic Overload Protection! Adjustable Torque up to 180 inch pounds. 5/8" Input and Output Shafts. It will handle 1/4 to 1 1/2 H.P. Motor. Case measures 7 1/2" long, 7" high, 6 1/2" wide. **VALUE OVER \$300. Shipping Wt. 25#. On C.O.D. Orders we require a 10% only \$54.50**  
 Deposit. Feb. Chicago

**DIRZIUS MACHINE SHOP "L" 1423-25 So. 52nd Ave., Cicero 50, Ill.**

**\$1. SCRIBER of CARBOLOY**  
 Will scribe on hardened steel, ceramics, glass, etc. Designed for close work for TOOL and DIE workers.  
**SIEG KONRAD MANUFACTURING CO.**  
 1636 W. 7th St., St. Paul 2, Minn.  
**\$1.**

## Find URANIUM!!

**GEIGER COUNTERS** for uranium detection. All models and sizes — from low-cost, portable to super-sensitive airborne units. Prices start at \$37.50. Also TREASURE DETECTORS and MINERALITES. **\* FREE INFORMATION \***  
**Detectron CORP.**  
 5528 Vineland, North Hollywood, Calif.

## CO<sub>2</sub> Powered Atomizing Sprayer



**FILL AND RECHARGE in less than 1-Minute**

**Sprays Anything!**

INSECTICIDES • LACQUERS  
 PAINT • DEODORANTS • ETC.

Ideal for home, shop, office, clinic. Holds 10 oz. liquid and CO<sub>2</sub> cartridge for powerful spray. Money back guarantee. No C.O.D.'s  
**\$695** ppd.

STAINLESS STEEL  
**Douglas Mfg. Co., P. O. Box 13073 HOUSTON 19, TEXAS**

IN ONE COMPACT TOOL KIT

**HERE IS EVERY SOLDERING TOOL YOU'LL EVER NEED!**



## DRAKE SOLDERING IRONS

Complete with steel case, solder stand and solder

Why suffer, trying to solder with the wrong soldering tool? With this complete Drake Soldering Tool Kit, you can do every home soldering job quickly, easily! You'll have every size soldering iron you'll ever need!

Special Underwriters' Approved soldering irons fit into single handle assembly, make low price possible. You get a 150 watt, 1 1/4" tip iron for medium-heavy duty; a 100 watt, 3/4" tip iron for light duty; and a 60 watt, 1/4" tip iron for all hobby work. These tools are quality made to give you long service.

All are in toolbox-size steel case with place clamps, safety stand, and two rolls of Drake Solder... See this tremendous value at your hardware store now.

Send Coupon Now for Free Booklet "HOW TO SOLDER"

**DRAKE ELECTRIC WORKS, Inc., Dept. P**  
 3656 Lincoln Avenue, Chicago 13, Illinois

Please rush me your FREE booklet, "How To Solder Effectively" Send to:

NAME.....  
 ADDRESS.....  
 CITY..... ZONE..... STATE.....

**ONLY \$15.95 AT YOUR HARDWARE STORE**





**ONLY "ARCO-SAW"  
CUTS 2x4's!**

**YOURS AT  
\$12.50**

**The Most Useful 1/4" Drill Attachment!**

"ARCO-SAW" has same features, does same work as high priced Portable Saws. Over 1/4 million in use! Complete with Graduated Depth-Bevel-Rip Gages for accurate cuts, Right Angle Steel Gear Drive & Safety-Yoke for safe 1-hand operation and quick-cutting 5" Safecut blade. A quality tool for precision work. **BLADES:** 5" Safecut, Rip, Crosscut, or Combination . . . \$1.75 **SOLD AT BETTER HOWE STORES.** If not available, try this amazing tool on our **UNCONDITIONAL 10-DAY MONEY BACK GUARANTEE.** Send check or M.O. (ppd). C.O.D.'s—plus post.

**ARROW METAL PRODUCTS CO.**

Dept. PM-3 140 West Broadway New York 13, N. Y.

Also  
**Eshelman  
SPORT  
CARS**  
LOWEST PRICES  
70 Miles per Gal.  
Commented  
by "Parents  
Magazine"  
Free Catalog.



**ESHELMAN ROTARY TILLER**  
FOR BETTER GARDENS

Also Walking Tractors from **\$69**

Triply useful — Replaces plowing, disking and cultivating. Turns virgin ground into Garden Bed in 1 operation. Women can operate it. Free Catalog.

Eshelman, Dept. T-53, 109 Light St., Baltimore 2, Md., 333 N. Michigan Ave., Chicago 1, Ill., 7070 Hollywood Blvd., Los Angeles 28, Cal.

**BATTERIES!—START**

—a factory at home and re-cast junk batteries into new; latest achievement. We supply complete instructions and everything needed. Large daily profits!

**BATTERY LABORATORIES, Dept. PM, Minneapolis 4, Minn.**



**Start a NEW BUSINESS!**

or Add to your present Repair Business  
**SHARPEN DULL PIPE WRENCHES**  
PIPE TAPS & DIES  
"GUM" CIRCULAR SAWS  
Also MOTOR DRIVEN ROTARY HONE  
Write for Information

**J. C. MOORE INDUSTRIES**  
BOX M 276 FREDONIA, PA.

**REMOVE PAINT**

... not coat by coat but all in one easy scraping!

Wonder-Paste turns paint, varnish, enamel, etc., to a soft sludge that's easy to remove. Clings to upright surfaces. Excellent indoors or out. At paint and hardware stores.

• Write for leaflet—and advice on your removing problem.

**WONDER-PASTE**

Wilson-Imperial Co., 119 Chestnut St., Newark 5, N.J.



**NOW! MAKE YOUR OWN**  
full-frame  
**ALUMINUM SCREENS**  
in **5** simple  
steps!



**Save Money and Work with  
HOMESHIELD®  
Easy-to-Make SCREEN KITS**

**Eliminates painting and rust!**

- ★ Anyone can make these screens in minutes—No special tools!
- ★ Sturdy ALUMINUM full-frames are durable and rustfree—give full protection.
- ★ Easy-to-handle FIBERGLAS® screening can't rust, corrode or stain!
- ★ Lightweight—installs from inside—No more back-breaking work!
- ★ Kits for full & half-screens—complete with installation hardware & a handy miter box!

Slim, trim, Homeshield Aluminum screens add sparkling new beauty to every window—at low cost!

See your hardware or building materials dealer today or write Dept. KF-3 for FREE literature.

Backed by the world's largest manufacturer of full-frame aluminum screens.





**AMERICAN SCREEN PRODUCTS CO.**

807 N. W. 20th St., MIAMI, FLORIDA

Factories: California • Illinois • Indiana • Texas • Florida



## QUALITY or PRICE?

You Get What You Pay For!



The "Big Boy" 710 W

## 4 Rules... In One

The greatest buy in a  $\frac{3}{4}$ " steel tape, the new BIG-BOY 710 W. Has left to right and right to left reading on both sides of the snow white blade.... Actually has 4 different measuring scales.... Lever lock, exclusive with Master, provides a positive holding action for easy reference.... Double tip allows for easy hook measurements using either side of the blade. (Tip also justifies automatically for one reading butt measurements.) To retail at \$3.25 ea.

### MASTER

MASTER RULE MFG. CO. INC. Middletown, New York  
WOOD AND STEEL TAPE RULES

## Something NEW under the SON!



TILL WITHOUT TOIL  
WITH BOLENS  
M-E MUSTANG  
ROTARY TILLER

Do 5 gardening jobs in 1 operation. PLOW • DISC HARROW • AERATE • CULTIVATE. Tines Guaranteed against Breakage.

Bolens offers a complete line of Rotary Tillers in 3 hp, 4½ hp and 6 hp. AVAILABLE WITH WORK SAVING PLUG-IN ATTACHMENTS.



MAIL COUPON TODAY!

BOLENS PRODUCTS DIVISION  
Food Machinery and Chemical Corporation  
265-3 South Park Street, Port Washington, Wisconsin

I am interested in:

- TILLERS                       MOWERS  
 TRACTORS                     CHAIN SAWS

Name \_\_\_\_\_

Address \_\_\_\_\_

City \_\_\_\_\_ Zone \_\_\_\_\_ State \_\_\_\_\_

## GOSH! what a boat!



In independent tests, Cadillac aluminum boats outperformed 12 leading makes in six ways with different loads and horsepower. They're roomy, light... built to last a lifetime. Car top models take up to 16 h.p. Cadillac exclusive; you can add front and center decks, steering wheel, windshield... by yourself! Write for literature on Cadillac's complete line of aluminum, molded plywood and cedar strip boats.

CADILLAC MARINE & BOAT CO.  
162 Seventh Avenue • Cadillac, Michigan

## Cadillac SWEETEST BOAT AFLOAT

### ACE TOOLS



Be permanently  
tooled-up for every operation  
on your Metal Cutting Lathe.

No. 8-A Ace Tool Set for 9" and 10" Swing Lathes—fits shank size  $\frac{3}{8}$ " x  $\frac{3}{4}$ ". Includes Turning, Cutting-off, Boring, Knurling and Threading Tools with high speed cutters, blades and wrenches. 8 complete tools in fitted steel case—nothing else to buy. See your local dealer or order direct.

ARMSTRONG BROS. TOOL CO.  
5268 W. Armstrong Ave., Chicago 30, Ill.

\$26<sup>35</sup>

## SAVE MONEY on SURPLUS PARTS for MILITARY TYPE TRUCKS & JEEPS

4 & 6 wheel drive. FREE catalog. State make of truck or Jeep. (New Jeep Tops, steel or canvas for all models). AMERICAN AUTO PARTS CO., Inc., 1830 Locust, Kansas City, Mo.

## DO MORE PLANING JOBS WITH LOW COST BELSAW



Exclusive MONEY-MAKING Features: • Full 12½" x 6" capacity • Power feeds at 24" a minute • Provides for Grinding Knives in the Cutterhead • Attachments for Jointing, Rabbering, Tongue, Groove, Matching. Convert low cost rough lumber into high priced cabinet finished stock... Easy to make flooring and popular patterns. Send today for free literature and prices.

Belsaw Machinery Co., 1011 Field Bldg., Kansas City 11, Mo.

Say You Saw It in Popular Mechanics



## SOLVE CITY ROUTES BY HULL AUTO COMPASS

IT'S SAFER and surer to watch your Hull Auto Compass than to hunt for road signs in strange city traffic. Other advantages everywhere you turn. The Hull universal vacuum cup mount with adhesive, installs securely at eye level, away from magnetic interference of dash. Fits all cars.

At better dealers everywhere. Write for literature.



Bearable 16.95  
SUNSHINE 14.95  
NON-ILLUMINATED

HULL MFG. CO. P. O. Box 246, D-3  
WARREN, OHIO

POPULAR MECHANICS

Copyrighted material



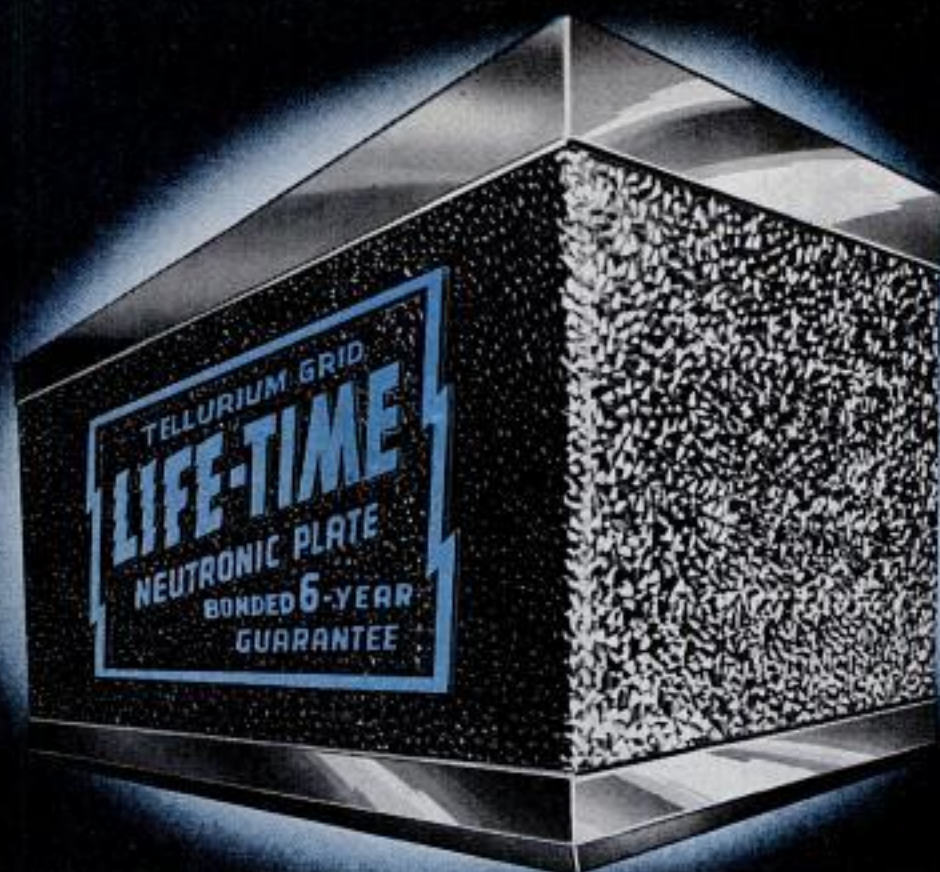

# DRIVE 2 MILES WITHOUT GAS!

## LIFE-TIME BATTERY MAKERS REVEAL SECRET 1954 DISCOVERY...PRODUCE 1,130,000 FOOT-POUNDS FORCE IN CAR SIZE MODEL

Incredible as it would have seemed a few short years ago, our engineers have now succeeded in cramming over one million foot-pounds of useful energy into a small power cube of the size you use in your automobile. The new LIFE-TIME battery development produces greater amperage (engine-turning power) than any battery ever made that will fit your car.

This phenomenal output (1,130,000 foot-pounds) is now confirmed by U.S. Testing Laboratories. It is ample to allow you to drive your car approximately 2.1 miles over level terrain! We might emphasize here that we

are not recommending this procedure as a substitute for gasoline. However, to amuse yourself, you might try running your car on this battery and shifting through the gears meanwhile, just as though the ignition were on. You will be completely flabbergasted at the power and speed generated by this amazing battery alone! But these are engineers' tricks and are not the reason you buy a battery—and this brings us to the secret development which will possibly quadruple the guaranteed six-year peak efficiency life of this battery.

### MEGAPORE MICRO-FILTER



Since mid-1954 LIFE-TIME engineers have been installing this unusual material in all batteries. It is a vast and important improvement over the previous best separator, a plastic-coated fiber sheet. You may be surprised to learn that, even today, the plates in some batteries are separated by thin wooden "shingles" or even heavy paper. These substances are rapidly "digested" by the acid electrolyte and are probably the reason why you have purchased many a battery in your time. Once a separator falls and allows a positive and negative plate to touch, the power from that cell is instantly 100% lost and dead. And once one wooden separator goes the rest are loose behind. There you have the real story of why 57% of all batteries are replaced each

year. To our knowledge, this has never before appeared in print.

The new Megapore Micro-Filter is so fine that it allows only the ion solution to pass, barring even microscopic solids which build up and short out ordinary batteries. The MM-F contains millions of pores which completely circulate the electrolyte and stop "acid-starvation" of the end plates, a condition of even new premium batteries which may cut amperage and starting power up to 10%!

MM-F separators are flexible—will not crack or fail from jars and bumps, will not fail in critical underhood installations in any summer heat or arctic operating conditions known on earth!

### TOOK 1142 CHARGES!

This same LIFE-TIME Battery was depleted and recharged 1142 times. Run starter until battery quits. Then let it rest 30 seconds and it will again start your car.

### DROWNED IN THE OCEAN



The original LIFE-TIME Batteries are now just about reaching their eleventh year. We occasionally hear from present owners that their original model is still putting out the old amps. Here is part of a letter about a more recent experience which a LIFE-TIME Battery went through. Attorney Martin Johnson of Providence, Rhode Island, writes: "My car was completely submerged at the seashore by the hurricane of August 31, 1954. I am most happy to inform you that within two days following the submersion I saved the battery, flushed out the cells and replaced with old battery acid and then recharged it on the generator of the old car. The battery has, I believe, been completely restored and still has its old zing!"

### ORDER BY MAIL

All batteries now shipped are Million Foot-Pound Model with Megapore Micro-Filter (MM-F), catalytic case, Neutronic plates, Tellurium Grids throughout.

6 VOLT (any car) \$29.95 ppd.

12 VOLT (any car) \$34.95 ppd.

IMMEDIATE DELIVERY



DEALERS AND DISTRIBUTORS: Write for complete information on new LIFE-TIME Million Foot-Pound Model with MM-F separators.

Continental Manufacturing Corporation  
Washington Boulevard at Motor Avenue,  
Culver City 9, California

Please ship LIFE-TIME (MM-F) Million Foot-Pounds Battery

6 VOLT (\$29.95 postpaid)  12 VOLT (\$34.95 postpaid)

For.....  
(make, model, year of car)  
(If you wish, send \$5 deposit, balance C.O.D.)  
California residents add 3% state tax.

name.....

address.....

city.....

Copyrighted material



get  
**Master**  
**Padlocks**  
 for  
**POWERFUL**  
**PROTECTION**

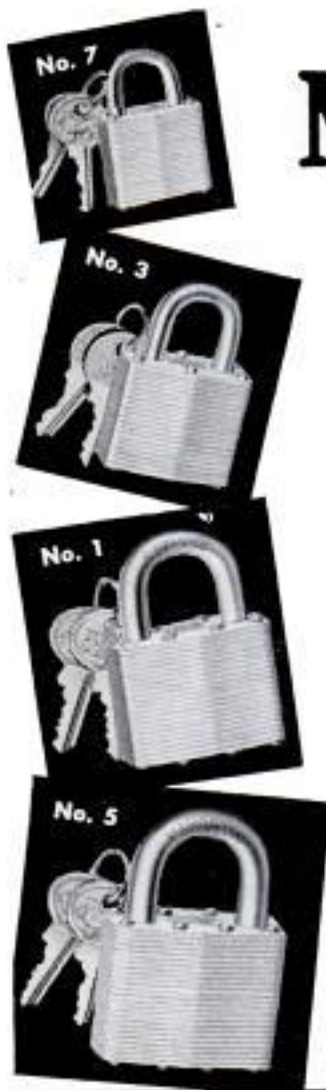

Why make it easy for thieves — when **MASTER PADLOCKS** offer top security at lowest prices? They're the world's most powerful padlocks, laminated like a bank vault door for strength . . . with genuine pin tumbler locking mechanism for extra security. **Get MASTER PADLOCKS** — 25c to \$3.00, in a variety of sizes, at hardware stores and locksmiths everywhere.

**Pin Tumbler Mechanism**

Powerful Protection — precision built into phosphor-bronze springs, nickel-silver pins.

**Brass Cylinder**

Sturdily constructed of extruded brass . . . will not expand or contract with temperature changes.

**Laminated Case**

Stronger than solid steel, with hard-wrought plates riveted under pressures up to 300,000 lbs.

*World's Leading*  
*Padlock Manufacturers*



**Master Padlocks**  
 WORLD'S STRONGEST

MASTER LOCK CO. Milwaukee 45, Wisconsin

**INTERNATIONAL**  
**HI-SPEED COP-SEAL DRILL BIT**

*Insist on the genuine original*

DRILL, SAW, REAM . . . metal, pipe, wood, plastic, Transit, etc. Use with electric drill, slow drill press, lathe, milling machine. Drills own starting hole, upper part of bit is used to cut, saw, ream circles, ovals, squares, scrolls. Easy to use. Ideal for carpenters, mechanics, electricians, plumbers, hobbyists, etc. Abrasive resistant, high speed steel. Flutes ground from solid. Withstands severe continuous use without breaking. Resharpener free. Takes place of up to \$50 in tools. 1" diameter, 2" cutting sections, total length 31". Three types—All Purpose, Wood, Heavy Metal. Specify type needed. Set of three \$11.50. Details on request. Shipped same day. Money-back guarantee. Dealer inquiries invited.

Order Now Send Cash, Check or Money Order to  
**INTERNATIONAL TWIST DRILL CORP.**  
 618 Wyandotte, Rm. 633, KANSAS CITY, MO.

**Only \$3.95**  
 POST PAID

**PUMP MILLIONS GALLONS**  
 with this extra  
**HEAVY DUTY PUMP!!!**

IRRIGATE, SPRAY, DRAIN OR FILL ANYTHING—ANYWHERE! Will not Rust—Clog—or Leak. Patented Seal. Pumps 2800 gph, 420 gph, at 7.5' high or 1000 gph from 20' well. Six blade impeller. Threaded for pipe. 3/4" inlet, 1/2" outlet. Use 1/2 to 3/4 hp motor . . . FULLY GUARANTEED! Send check, M.O. or sent C.O.D. \$8.95 in U. S. Utility 3 blade 2400 gph pump—\$6.95 in U. S.

**U. A. T. ENG. & MFG. CO.** HICKSVILLE 273, NEW YORK

**ASSEMBLE YOUR OWN TILLER . . . SAVE!**

17" Tiller till and cultivator 16" deep

We supply all parts except engine, already painted, plus full instructions. Twelve 8-in. teeth, 12" wide housing and shaft, sprockets, shavers, chis, belts, wheels and handles. Only \$79.00 f.o.b. Field. Send check or money order today!

**RED-E TRACTOR CO.** HICKSVILLE 2 WOODMAN

Say You Saw It in Popular Mechanics

**Save on all PLUMBING JOBS**

When You Build · When Making Improvements · Repairs · Maintenance

Get  
**POPULAR MECHANICS**  
**Home Plumbing**  
**Guide**



How to plan plumbing installations, select materials and fixtures.

How to save money on all plumbing jobs using approved methods.

Easy to Do Professional-Like Jobs and Save Over One-Half

Get the Popular Mechanics **HOME PLUMBING GUIDE**. It shows how you can do every kind of plumbing job yourself and save from a few to hundreds of dollars. Covers plans, layouts, installation, maintenance and repair. Shows what materials to get and use, where to get them and how to do a proper job with approved methods. Few, other than the simplest tools are required and some of these can be rented. Don't pay high prices for work you can do yourself. Get the **HOME PLUMBING GUIDE** for only \$3.50. You will be amazed how jobs you thought difficult are simplified.

Clip This Ad and Mail. Money Back if Not Pleased

Invest only \$3.50. Use the book for 7 days. Then if you are not satisfied return it for full refund of your money. Sent C.O.D. (U.S.A. only) if you prefer.

**15 Ways to Save Money**  
 All about modern home plumbing  
 How to use plumbing tools  
 Getting acquainted with pipe  
 Planning home plumbing systems  
 Installing and maintaining home drainage systems  
 Private sewage disposal systems  
 Causes and cures of drainage troubles  
 Installing home water lines  
 Private water supply systems  
 Water Heaters  
 Water Conditioning  
 Water system troubles and cures  
 Installing and caring for fixtures  
 What to do with valves and faucets

Over 500 How-to-do-it Pictures Guide You



POPULAR MECHANICS PRESS, Dept. HPG-10, 200 E. Ontario St., Chicago 11



# 101 FREE TIPS

For the Handyman  
who works with wood

SEND  
for this informative booklet  
ON

**WOODLIFE**  
The Original  
WATER REPELLENT  
PRESERVATIVE



Anything made of wood — and this folder illustrates 101 items — should have the water repellency, resistance against warping, swelling and shrinking — and immunity against termites and decay — made possible with Woodlife.

Woodlife is the original water repellent wood preservative containing PENTACHLOROPHENOL that should be on every handyman's work shelf — along with this folder which shows how to apply Woodlife to 101 household wood-working projects.

Woodlife is made by the makers of P.A.R., the water repellent, glossless finish that protects and restores the natural beauty of Redwood and Red Cedar.

Send for the "101 TIPS" Booklet, TODAY!

**Protection Products MANUFACTURING COMPANY**  
Dept. Q Kalamazoo, Michigan

When you repair, remodel or build, always ask for  
Woodlife-treated lumber!



ONE OF THE  
**GREATEST  
PAINTING  
DISCOVERIES  
SINCE THE  
BRUSH!...**

## **KWIK-SKRAPE**

Now paint windows as fast as walls! Paint with the same large brush over onto the glass. When paint has set, KWIK-SKRAPE neatly zips the paint off the glass . . . A straight-lined, weather-sealed, professional-looking job in no time! No more fumbling with razor blades. No more cut fingers or scratched glass.

• **GUARANTEED! FASTER, SAFER, CLEANER, STURDY, PRECISION-BUILT, REPLACEABLE, HARDENED STEEL BLADE.** Only \$1.00 brings it to you postpaid. Write today!

**THE B & S CO.**

Dept. PM355  
P.O. Box 1840, New Haven, Conn.

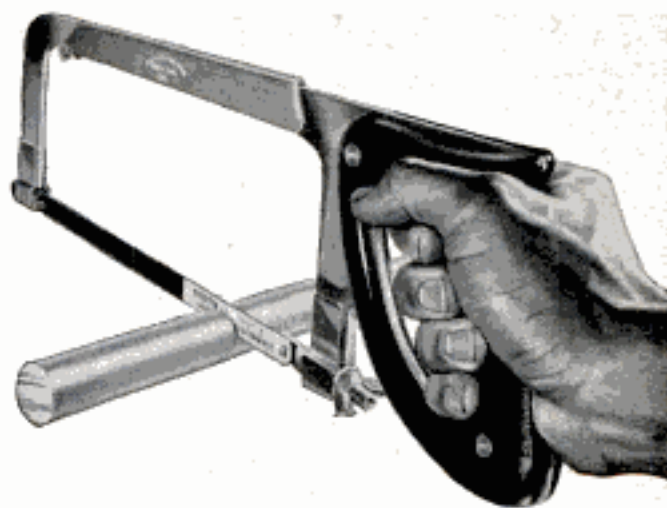

**DISSTON**  
HAS THE EDGE®

## **in metal-cutting tools**

It's true! Whether you buy the great new Disston hack saw blades, Disston circular saws, or Disston metal-cutting band saws, you get master tools that give you smooth, fast cutting.

Disston hack saw blades, for hand or machine use, are the finest made. Because of their rugged strength and super-sharp teeth, they give outstanding performance in industry for cutting a wide variety of metals.

You can buy Disston hack saw blades and frames in your local hardware store. They're useful around the home for cutting bolts off license plates, for cutting tire chains, aluminum tubing, conduit, rods, sheet metal, machine parts. Or use them in the kitchen for frozen foods, bones.

Disston—America's foremost name in hand saws—makes many other great tools for home and industry . . . files . . . hand saws . . . wood circular saws . . . dado heads . . . wood turning chisels . . . garden tools.

Henry Disston & Sons, Inc., 311 Tacony, Phila. 35, Pa., U.S.A.  
In Canada: 2-20 Fraser Ave., Toronto 3, Ontario



## MAKE YOUR ELECTRIC DRILL A COMPLETE HOME WORKSHOP

**FREE  
HOME TRIAL  
EASY PAY PLAN**

Now you can convert your electric drill into a tilt-table saw, vertical drill press, grinder, buffer, disc sander. Big 9" by 12" precision machined cast table. Drill press stroke 4½". Saw blade (5") rips 2 x 4. Try it in your home for 15 days FREE. Write now for special introductory offer. Time limited.

**SAVE  
MONEY  
FACTORY  
TO YOU**  
**\$29.95**



DRILL PRESS



TILT TABLE



GRINDER

**POWER TOOLS INC.** 169B Yates Avenue  
Beloit, Wisconsin

## Sharpen large blades easier!

**CRYSTOLON®  
AXE STONE**



Rounded edges easy to grip. Fast-cutting coarse grain on one side, finer grit on the other side for the finishing touch. A "must" for sharpening axes, hatchets, large knives and many other tools. \$9.8 at better hardware stores or direct.

SEND FOR THE "HOW TO SHARPEN" BOOK — 32 pages of instructions for sharpening household and home workshop tools. Send 10¢ to Behr-Manning, Troy, N. Y., Dept. PM-3.



**BEHR-MANNING**  
division of NORTON Company  
▲ COATED ABRASIVES ▲ SHARPENING STONES ▲ PRESSURE-SENSITIVE TAPES

## SUPER SAW FILER No. 6

**IT'S NEW!** and so simple you can file a saw blindfolded!

**Automatically Controls  
DEPTH — ANGLE — PITCH**

Perfect bevel and angle maintained, and fool-proof depth control for all Rip, Crosscut, and Handsaws. Precision made and calibrated for instant setting at desired angle. Can be used in any vise or clamp. Complete with file only.....



**Automatic  
DEPTH CONTROL  
Rollers**

**\$6.50 ppd.**

## JOINT AND SHARPEN ALL SAWS



**SUPER  
FILER  
NO. 9**

SO EASY to joint and file saws like new. Two hardened steel rollers keep teeth same height. All teeth cut, saw runs true and smooth. \$2.95 ppd. "TRU-CIRCLE" SAW SET Automatically sets teeth at 10" or more. \$2.95 ppd.



**SUPER  
FILER NO. 11**

For both hand and circular saws. Steel rollers give all teeth correct height, pitch and bevel. \$9.95 ppd.



**SUPER DRILL GRINDER**

Sharpens round shank drills like new, using hand or power grinders. \$2.95 ppd.

send for **FREE CATALOG**

A. D. McBURNEY, 5908 Hollywood Blvd., Hollywood 28, Calif., Dept. A-35

## FREE AMAZING NEW BOOK "HOW TO ANSWER ADS"



Never before have you seen anything like this. Tells you in simple language the correct way to answer ads. Gets you quicker replies—better results, and greater satisfaction. Will save you time and money and it's ABSOLUTELY FREE. No obligation whatever. Every reader of advertising should have this booklet. Send a postcard for your copy NOW. F. W. Johnson, Popular Mechanics Magazine, Room 600-A, 204 East Ontario Street, Chicago 11, Illinois.

## HOW TO BUILD Your Own GARAGE

**Save Up to 50% of Usual Cost!**

Get Popular Mechanics' brand new book **How to Build Your Own Garage** by Wayne Leckey, Assistant Shop Notes Editor, and find out how you can build your own garage at savings of 50% of usual cost. Leckey tells in clear step-by-step instructions and shows in big, clear photos, drawings and diagrams how to perform every building operation from laying the concrete to installing the final trim. There are 25 designs. Brick, frame, and concrete block fully covered. Send \$3.50 for your copy. 7-day money back guarantee.

POPULAR MECHANICS PRESS, 200 E. Ontario, Chicago 11, Ill.



**FREE!** INFORMATION YOU SHOULD KNOW NOW ABOUT

## URANIUM PROSPECTING

Uranium is making fortunes overnight. The Government pays up to \$35,000 bonus for uranium finds. But, there is information you should know about uranium prospecting. Get it FREE in a valuable booklet by Dr. Benjamin Schloss, well known scientist who worked on the original war-time atomic bomb project. "How To Make Money Prospecting for Uranium", how to find; how to sell; legal aspects; etc. We'll send this booklet, along with a Geiger Comparator Chart; "How to Select a Geiger Counter" FREE—write today. NUCLEONIC CO. OF AMERICA, 196 DeGraw St., Brooklyn 31, N. Y. Dept. PM-53



## UTICA® Adjustable Wrenches

**FOR THE BEST  
IN  
GOOD TURNS**

Yes, many, many good turns because they offer you a very special UTICA feature. The jaws surfaces are extra hardened by UTICA's own process of electronic induction. Jaws resist nicks and burrs, stay smooth and new-like up to 10 times longer than ordinary adjustable wrenches.

An adjustable wrench is a mighty handy tool, but be sure to look for the name UTICA on the handle. Sizes from 4" up to 18"

LOOK FOR  
THE NAME  
**UTICA®**

No. 91



THE HALLMARK OF QUALITY  
UTICA DROP FORGE & TOOL CORP.  
UTICA 4, N. Y.

In Canada: Adlam Tool & Supply Co., Ltd., Montreal

## Table-top workbench makes gluing easier...



FULL-SIZE PATTERN  
FOR WORKBENCH ONLY 35¢;  
EASI-BILD® Pattern #573. Just trace,  
saw, assemble. Send 35¢ in cash or stamps  
to Elmer's Pattern Dept. PM-35, P.O. Box 215,  
Pleasantville, N. Y.

## ELMER'S® GLUE-ALL makes it better!

Every home craftsman needs this inexpensive, easy-to-make workbench that fastens to any table top. To make gluing jobs easier, it features a vise that doubles as a clamp to hold wood securely. The only other thing you need for perfect gluing jobs is Elmer's Glue-All... the modern plastic glue. It's strong—shear tests of glued joints prove it stronger than the wood itself. Quick-setting, too—and won't stain. Easy to use in the convenient squeeze bottle that eliminates muss and waste. Keep it handy for all gluing jobs. Product of The Borden Company.



1 1/4-oz. 29¢  
8-oz. \$1.00

At leading hardware stores.

## WAR SURPLUS AND OTHER BARGAINS SAVE UP TO 90%

**SENSITIVE ALTIMETER** in 10 Ft. Increments. Famous Pioneer! 0 to 35,000 ft. (Inches of Mercury). Tested and inspected in our own instrument lab. Guaranteed perfect. Approx. Govt. Cost \$150. NOW ONLY \$12.95 PREPAID!



**PIONEER MAGNETIC COMPASS**  
For boats, trucks, cars. By Pioneer Instrument Co., Div. of Bendix, No. 1829-2A. Contains screw-type heeling compensator, removable drawer-type compensator, screw-type horizontal compensator and spider-type compensator. All devices for elimination of errors caused by effects of magnetism. Has constant deviation corrector and course setter. Rotable dial engraved with compass card graduations. Complete with book of instructions, light and mounting screws and shock mounts. Shpg. Wt. 10 lbs. Approx. GOVT cost \$400. NEW, \$18.95

**MICROMETER DEPTH GAUGE**  
With 3 rods to measure all depths from 0 to 3 inches by thousandths. Hardened tool steel lead screw has full 1 inch run. Base is 2 1/2" long, hardened ground and hand lapped. Accuracy guaranteed. Mfd. by Millers Falls Co. GOVT COST approx. \$30. NEW—\$10.95 ppd. USA. In velvet case.

**MICROMETERS** Chrome plated, precision engineered, carefully tooling to give long life. All new 0-1" cap. \$2.25 ea., 1-2" cap. \$3.50.

**"HELIOS" ORIGINAL TOOLMAKERS VERNIER CALIPERS**  
ULTRAPRECISION—Imported. Used by machinists at Lockheed, Douglas, Bendix, GM, RCA, GE Model 51/2E. Genuine Helios. Hardened lapped precision surfaces. 1/1000" and 1/128" graduations. Handy slide roll and thumb lock. Quick, accurate depth. A \$35 value. Satin finish. ALL NEW, just \$8.50. Leather carrying case, \$1 extra.

**NEW PUMP AND MOTOR**  
Pump has 1" connections, built-in relief valve, adjustable up to 1500 lbs. Max capacity 6 GPM. 1 1/2 H.P., 24-volt motor. 4000 RPM. Can be used on 12 or 36 volts. Govt. cost approx. \$350—our price—NEW—\$9.95.

**SENSATIONAL GENERATOR BUY!!**  
**Famous Navy NEA-3 Generator.** Combination AC-DC Type. AC voltage—115 V. DC voltage—24 V. 200 Amp. 2 complete generators in 1... 2 separate fields and 2 separate armatures on same shaft yet no larger than regular aircraft generator. Ideal for home, farm and shop lighting plants by hooking wires to AC side. DC side can be used for welding and operating war surplus low voltage hobby motors and equipment. Weight 54 lbs. NEW. Approx. GOVT. COST \$350. NEW \$27.95 used perfect \$18.00

**SPECIAL CARBON PILE TYPE VOLTAGE REGULATOR** to go with above generator. Incl. mounting base and completely enclosed in steel mesh box. Helios maintain constant current and prevents pulsation. Ideal for installation with above generator for lighting plant. Wt. 5 lbs. Complete NEW. Approx. GOVT. COST \$90. Now only \$7.95

BUY 'EM BOTH SAVE \$5.45! Generator & Regulator together \$30

**AUXILIARY POWER UNIT**  
Ideal for your shop, camp, cottage, farm, trailer, home, boat or mines. Makes a terrific welder for any sized job. 2 cylinder, horizontally-opposed, air-cooled engine. Complete with AC-DC generator. On DC will supply 200 Amps at 24-28 Volts; on AC will supply 10.5 Amps—1200 Watt at 800 Cycle. The DC Generator rating at normal RPM, 5 KW. Operates on cheap gasoline. Economical. No batteries required. Dual Scintilla magnetos. Generator can be removed and engine coupled to other units for other purposes. Mfd. by Lawrence. Comes complete in fire-proof enclosure which cuts motor noise to a minimum. Shpg. wt. case, 398 lbs., net wt., 139 lbs. Like NEW. Complete, guaranteed perfect. Govt. Cost \$4770. Special Now—Model D1, 10 HP with AC-DC Generator described above—\$125.50; also with 300 Amp Generator—\$187.50. Model C2, with 160 Amp Generator, Intermittent 220 Amps, 14.5 HP—\$137.50.

**NEW 1955 CATALOG** Biggest ever... new low prices... Send 25¢ for your copy today. Prices F.O.B. Culver City unless otherwise stated. Check, money order or cash. 25% deposit for C.O.D.

**AIRBORNE SALES CO., INC. DEPT. PM355**  
8501 Stellar Drive, Culver City, Calif.

Also Eshelman Sport Cars  
**LOWEST PRICE**  
70 Miles Per Gal.  
Commended by Parents Magazine  
Free Catalog.

BAKES  
PLOW  
CULTIVATES  
HARROWS  
MULLS  
SPRAYS  
SAWS  
DOZER  
MOWS  
CUTS  
ROLLS  
TILLS  
SNOW  
FLOW

**ESHELMAN**

1 to 8  
H.P. Also  
Walking  
Tractors  
Low 35.

**\$69**

FOR Better LAWNS And GARDENS

Women can operate it. Free Catalog. Write ESHELMAN, Dept. R-53, 109 Light St., Balto 2, Md., 333 N. Michigan Ave., Chicago 1, Ill., 7070 Hollywood Blvd., Los Angeles 28, California.



AMAZING NEW PRODUCT  
FINISHES PLYWOOD EDGES  
WITHOUT GLUE, CLAMPS, NAILS

**WOODTAPE\***

Trade Mark

PLYWOOD EDGING



**REAL WOOD** edging to match BIRCH, FIR, OAK, WALNUT, LIGHT or RED Philippine MAHOGANY plywoods!

Miraculous *pressure-sensitive* WOODTAPE\* replaces old fashioned, complex methods of edge finishing with easiest possible application.

Now any interior plywood project—cabinets, furniture, built-ins—attains the luxurious effect of solid wood by simply pressing WOODTAPE\* onto the prepared edges.

Amateur and skilled craftsmen alike get professional results with this natural wood edging, without expensive tools, clamps, or messy wood fillers.

And surprisingly—WOODTAPE\*, *permanently bonded* to plywood edges in seconds, is immediately ready for your choice of varnish, lacquer, or paint application.

Supply your workshop today with 3/4-inch wide, 4-foot long WOODTAPE\* strips, in sealed packages.

Sold by retail building materials dealers

**WOODTAPE\***

Trade Mark

PLYWOOD EDGING

WOODTAPE DEPARTMENT, Box PM,

ELLIOTT BAY LUMBER COMPANY, 600 W. Spokane St., Seattle 4, Wa

\* Patents Pending in U.S. and Canada

NO SAW LIKE A  
**MAXAW**

—In Performance  
—In Value!



MAXAW 757  
\$69.95

• There's a Cummins Maxaw, with exclusive magic pivot, for every job—every budget. 6 3/8" blades cut 2 1/8" at 90°, 1 3/8" at 45°. More cutability, far less weight.



MAXAW 737  
\$59.95



MAXAW 717, \$49.95

QUALITY PRODUCTS OF

**John Oster**  
Manufacturing Co.

5055 N. Lydell Ave., Milwaukee 17, Wis.

Cummins in Canada: 334 Laurier Ave., Toronto 10

Write Today  
for FREE  
Literature

Copyright 1955 John Oster Manufacturing Co.

Also Eshelman  
SPORT CARS  
LOWEST  
PRICE  
70 Miles Per Gal.  
"Commended by  
Parent's Mag."  
Free Catalog.

MAKES  
PLOWS  
CULTIVATES  
HARROWS  
HAULS  
SPRAYS  
SAWS  
DOZER  
MOWS  
CUTS  
ROLLS  
TILLS  
SNOW PLOW

**ESHELMAN**

FOR BETTER  
LAWNS  
and GARDENS

1 1/2-3-4  
H.P.

Low as  
\$69  
plus  
Tools

Also Power Reverser.  
Women can operate it.  
Free Catalog. Write:  
ESHELMAN, Dept. W-53  
109 Light St.,  
Baltimore, Md.  
333 N. Michigan Ave.,  
Chicago 1, Ill.  
7070 Hollywood Blvd.,  
Los Angeles 28, Calif.



YOU CAN SAVE UP TO 96%

Send dime for new 1955 illustrated catalog of big bargains for Mechanics, Farmers, Gadgeteers, Garages and Outdoorsmen. My prices are unbelievably low.

KARL ORT

Box 22A

Thomasville, Pa.

WAR SURPLUS  
BARGAIN  
BOOK 10¢

Say You Saw It in Popular Mechanics



**START A  
BUSINESS**  
this Quick Way

"I have taken in 100 mowers in 5 weeks since I got my Foley", says George C. Wise.

**FOLEY  
LAWN MOWER  
SHARPENER**

Start in spare time and make a quick CASH PROFIT. The Foley handles up to 3 or 4 mowers per hour—prices run \$1.50 to \$3.00 for hand mowers, \$5.00 to \$8.00 for power mowers. You make 99% profit!

FREE VALUABLE ILLUSTRATED BOOK shows how to sharpen all leading makes of power mowers. Foley prices are low—easy payments available. FREE PLAN tells how to start. Write today—no salesman will call.

FOLEY MFG. CO., 307-5 Foley Bldg., Mpls. 18, Minn.



# Get the muffler with the **TWIN SKINS**



It's easy to see why Genuine Ford Mufflers last longer and give better protection against the escape of exhaust fumes when you see how their outer shell is made up of *two layers* of 26-gauge steel.

***Genuine Ford Mufflers***                      ***are double-wrapped***  
***to give you greater quiet and longer life***

You *know* you're doing right by your Ford when you tell your serviceman you want a *Genuine Ford Muffler*. Every one is made to the *exact* specifications set by the men who first built your Ford. In addition, before they're allowed into production, Genuine Ford Mufflers have to pass many special Ford tests. For instance, they must pass very exacting quiet tests, wear tests of thousands of miles, and they must take 50 successive

backfires without failure.

When replacements will add to your Ford's performance, always specify Genuine Ford Parts—they're exact duplicates of your Ford's original equipment—and they're *made right to fit right to last you longer*.

**Keep your Ford all Ford**

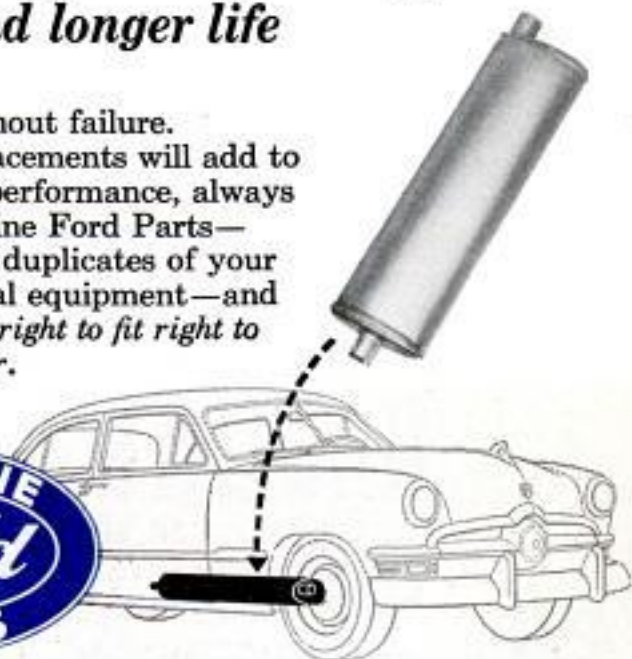





*If your car's dip stick repeatedly shows you need to add oil, your power is fading... and it's time to replace your Piston Rings!*

Having to buy too much oil and gas, and slow pickup reveal POWER FADE! Your rings are badly worn—you're wasting money on lost power.

Top performance is gone. And despite the extra oil used, vital engine parts remain starved for oil. This is not only costly and wasteful, but is a warning of expensive repairs to come later.

See your motor specialist for a ring check-up. If he recommends a ring change, it will pay you to install Hastings replacement rings. They're engineered exclusively for worn engines to quickly stop power fade, oil-pumping and gasoline waste.

All the safety and driving enjoyment of full-powered performance are yours again with Hastings Rings... it's the best money you can spend on your car.

HASTINGS MANUFACTURING CO., HASTINGS, MICHIGAN  
HASTINGS LTD., TORONTO

Piston Rings, Casite, Oil Filters, Spark Plugs

\*TOUGH but oh so gentle



**HASTINGS**

STEEL-VENT PISTON RINGS

*Regular or Chrome-Faced*

\*TOUGH on oil-pumping • GENTLE on cylinder Walls

## STAR PUMPS

LOWEST PRICES EVER OFFERED DIRECT FROM MANUFACTURER  
GUARANTEED UNCONDITIONALLY ONE FULL YEAR



**POPULAR STAR #1000 UTILITY PUMP**  
Pumps up to 3,000 GPH. Use in city, on farm, anywhere an efficient, inexpensive pump is needed. Irrigates, circulates. Uses 1/2 to 3/4 H.P. motor. Reg. \$9.95, Special Factory Price..... **\$675**

**STAR "900" PORTABLE PUMP**  
Powerful unit for any pumping job—booster pump, draining, bailing, spraying, coolants, etc. Threaded for garden hose. No limit to its uses. Self priming, light, quiet. Pulls water 75 ft., pushes 375 ft. on 15 ft. rise, 600 G.P.M. Bronze pump coupled to 1/2 H.P. capacitor type G.E. motor. Reg. \$59.50  
Special Factory Price..... **\$3500**

**STAR DELUXE SUMP PUMP**  
Gives longest trouble-free service, pumps 4218 GPH. Has rugged G.E. 1/2 H.P. motor, 7" non-clogging strainer, 1 1/4" outlet. Mt. 3' 2", shpg. wt. 30 lbs. Bronze finish. Reg. \$59.50  
Special Factory Price..... **\$2900**  
All Bronze Reg. \$67.50  
Special Factory Price..... **\$3500**

Send Check or Money Order

**STAR PUMP COMPANY**

Pump Manufacturers for 22 Years

435 W. GLENSIDE AVE. Dept. P-3 GLENSIDE, PA.  
Write for Catalog, G.E. Elec. Motor Price List.  
Telephone Ogontz 8323

## "FEATHER-LIGHT" LEVEL MAGNIFIES!



### NEW EMPIRE ACRA-LITE NO. 1521

ONE THIRD LIGHTER than aluminum, ACRA-LITE Magnesium levels handle like a breeze! Easier to read, too, with "Full-Vue" magnifying vial cover plates. You'll want yours now! Order from your dealer, or direct.

**EMPIRE LEVEL MFG. CO.**      **EMPIRE ACRA-LITE Level**  
10930 W. Potter Rd., Dept. PM,      No. 1521, 24", Only \$6.70  
Milwaukee 13, Wis.      28", \$7.60, 48", \$13.50

**WELD**

**BRAZE**

**SOLDER**

**CUT**

**4WAY**

**ONLY \$14.75**

*i.e. factory*

**WELDER**

Complete with Twin Carbon Arc Torch and accessories... to handle all metal-craft work.

Acclaimed by thousands of Homeowners, Mechanics and Hobbyists as the welder of 1001 uses. Easily operated from properly wired 110 volt AC or DC line. The ideal gift with a life-long use... Order today on 10 day money back guarantee.

**FOUR-WAY WELDER CO., Dept. F2-C**  
1810 S. Federal St. • Chicago 16, Ill.



**PAGE Garden**  
**1955 line Tractors**  
now ready — low prices!

Ruggedly built riding and walking models, 2 to 6 HP. All gear drive with reverse, no belts or chains. Plow, till, harrow, disc, spray, remove snow, do dozens of other farm and home chores. Also new "Bantam" one-wheel model. Fully Guaranteed  
Low prices — easy terms

Free Catalog Shows over 60 attachments!

NEW "PAGE-BOY" TILLER  
Ask for Details!

**PAGE** 1804 S. 81st St.  
Milwaukee, Wis.



for  
**Saws that Cut**

TODAY...  
TOMORROW...  
ALWAYS...

it's SANDVIK!

Made of genuine Swedish Charcoal Steel... hardened, tempered and filed to produce the finest, sharpest, longest lasting cutting edges you've ever seen. Extra high crown, perfect balance, easy-grip handle. Compare a Sandvik saw with any ordinary make. The difference in the way it cuts will convince you that there's no finer handsaw made.

Be sure to look for the Sandvik "Fish & Hook" trade mark. See your hardware dealer or write us for handsaw folder. Dept. PM-3

"Fish & Hook"  
Brand of Quality



**Sandvik Saw & Tool**

47 WARREN ST., NEW YORK 7

DIVISION OF SANDVIK STEEL INC.  
SANDVIK SAWS SERVE THE WORLD

**AMAZING... VERSATILE  
ARROW GUN TACKER**

No.  
T-50  
12.00

THE  
MODERN METHOD  
FOR **1001**  
DO-IT-YOURSELF  
NAILING  
JOBS

**FASTER!  
CHEAPER!**

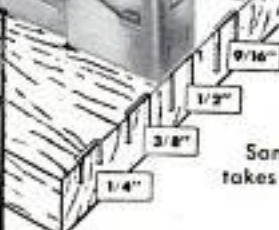

Same machine  
takes all 4 sizes.

The most sensational tool ever devised for fastening insulation, ceiling tile, screens, cornices, linings, etc. Self-feeding, automatic action permits user to staple-tack at desired rate of speed. One-hand operation frees other hand to hold material in place. It all adds up to savings of time, money and effort. Sold at Hardware, Building and Lumber Material Dealers

**ARROW FASTENER COMPANY, INC.**  
ONE JUNIUS ST., BROOKLYN 12, NEW YORK

**TIME SAVING TIPS**

ALL YOU NEED IS A TUBE OF

**DU PONT DUCO CEMENT**

REG. U.S. PAT. OFF.

**FLEXIBLE**



Shoescuffed? Repair leather with strong "Duco" Cement. It flexes—won't loosen as you walk.



Enlarger bellows leak tight? Re-cement with strong, flexible "Duco" Cement.

**STRONG**



Build extra crash resistance into model airplanes with high-strength "Duco" Cement.



Give an old coffee table a new top of ceramic tiles—bonded with strong "Duco" Cement.

**CLEAR**



Replace wood pieces chipped off furniture or moldings with transparent "Duco" Cement—an invisible repair!



Stick back torn wallpaper in a jiffy with "Duco" Cement—clear, won't discolor the paper!

**WATERPROOF**



Build working models of boats with "Duco" Cement—makes 'em extra strong and seaworthy.



Tighten loose handles on scrub brushes with strong "Duco" Cement. It's suds- and water-proof.



A household  
favorite for 25 years



BETTER THINGS FOR BETTER LIVING  
... THROUGH CHEMISTRY



# NEW POND GARDEN TRACTOR

DEALERS WANTED

RIDING OR WALKING TYPES also Rotary Mowers

MAKE EXTRA MONEY

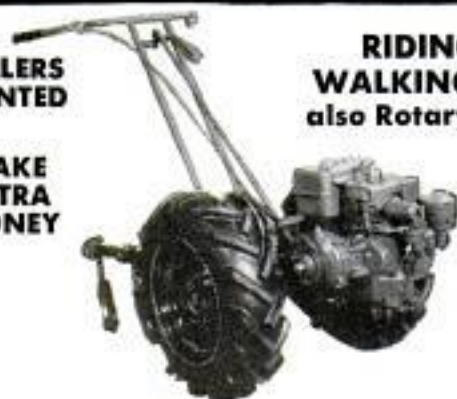

2½ — 3½ — 5 and 8 H. P.

BEFORE PURCHASING, COMPARE OUR LOW PRICES WITH OTHER MAKES.

Full 18" ROTARY MOWER only.....\$72.50  
2½ H. P. Walking Type Tractor.....\$147.50  
4-Wheel Riding Type Garden Tractors are priced from \$247.50 to only \$375. for the 8 H. P.

FULL LINE EQUIPMENT AVAILABLE

Write today for FREE illustrated circular.

POND CO., Box 216-R, Ravenna, Ohio

## The New Model 70 UTILITY TESTER FOR REPAIRING ALL ELECTRICAL APPLIANCES MOTORS • AUTOMOBILES • TV TUBES

As an electrical trouble shooter the Model 70:

- Measures A.C. and D.C. Voltages, A.C. and D.C. Current, Resistances, Leakage, etc.
- Will measure current consumption while the appliance under test is in operation.
- Incorporates a sensitive direct-reading resistance range which will measure all resistances commonly used in electrical appliances, motors, etc.
- Leakage detecting circuit will indicate continuity from zero ohms to 5 megohms (5,000,000 ohms).
- Will test toasters, irons, Broilers, Heating Pads, Clocks, Fans, Vacuum Cleaners, Refrigerators, Lamps, Fluorescents, Fans, Switches, Thermostats, etc.
- Will test all TV tubes for open filaments, inter-plate shorts, burned out tubes, etc.



As an Automotive Tester the Model 70 will test:

- Both 6 Volt and 12 Volt Storage Batteries • Generators • Starters • Distributors • Ignition Coils • Regulators • Relays • Circuit Breakers • Cigarette Lighters • Shop Lights • Condensers • Directional Signal Systems • All Lamps and Bulbs • Fuses • Heating Systems • Horns • Also will locate poor grounds, breaks in wiring, poor connections, etc.

Handsome round-cornered molded bakelite case, 3½" x 5½" x 2¼". Complete with all test leads. Also included is a 62 page book giving detailed instructions for testing all electrical appliances, automotive equipment, TV tubes, etc. Only \$15.85

**SHIPPED ON APPROVAL NO MONEY WITH ORDER — NO C. O. D.**

Try it for 10 days before you buy. If completely satisfied then send \$9.95 and pay balance at rate of \$4.00 per month for 3 months — No interest or Finance Charges Added! If not completely satisfied, return to us, no explanation necessary.

MOSS ELECTRONIC DIST. CO., Inc.  
Dept. D-108, 3849 Tenth Ave., N.Y. 34, N.Y.

Please rush Model 70. I agree to pay \$9.95 within 10 days after receipt and \$4.00 per month thereafter.

Name \_\_\_\_\_  
Address \_\_\_\_\_  
City \_\_\_\_\_ State \_\_\_\_\_

## \$6.95 DRAINS cellars, cisterns, wash tubs; IRRIGATES - CIRCULATES - SPRAYS



Submersible! Won't Rust! Won't Clog!

Original Type P—"Pump of 1,001 Uses"—house, garden, farm. Up to 3,000 GPH; 450 GPH 80' high; or 1800 GPH from 25' well. Use 1/6 to 3/4 HP motor. Motor coupling included. Oil-less bearing. Stainless steel shaft. 1" inlet; 3/4" outlet..... \$695

Exclusive Double-Bearing Heavy-Duty Pumps

TYPE X—2 oil-less bronze bearings for smoother running! longer life. For every pumping need. Up to 7,500 GPH. Use 3/4 to 1 HP motor. 1 1/4" inlet; 1" outlet. Stainless steel shaft..... \$1095

TYPE M—Same as Type X, but with grease-sealed outboard rubber-mounted ballbearing plus oil-less bronze bearing. Best for bell drives..... \$1295

ALL BRASS JET for SHALLOW to 50' DEEP WELL. Up to 50 lb. pressure. Ideal for water systems, sprinkling, irrigation, etc. Use with Type X or M Pump..... \$595

Postpaid if cash with order. (West of Miss., add 50c)

MONEY BACK GUARANTEE

Centrifugal and Gear Pumps in all Sizes

LABAWCO PUMPS, Belle Mead 2, N. J.

## New THREAD-CUTTING MAGIC with Liqui-Moly

Makes your taps cut stainless, aluminum, etc. "like butter". Industrial users report 500% increase in top-life with LIQUI-MOLY ("Fluidized Molybdenum Disulfide, new "miracle lubricant"). Economical — just ONE DROP does it — saves your taps, speeds work, makes even dull taps and dies cut clean, smooth threads fast in ANY metal. Tube, 65c, 2 for \$1. P.P. or at dealers. THE LOCKREY COMPANY, Lub. Div., Southampton 3, N. Y.

## ONE-MAN SAWMILL LOW \$50.00 AS... \$50.00 DOWN

Take BELSAW Portable Sawmill right to the trees—turn out valuable lumber for home and farm—sell to local yards—make up to \$50 a day custom sawing for neighbors. BELSAW lasts a lifetime. No crew needed. Power with tractor or auto engine. Beginners get excellent results. Send today for FREE BOOK.

BELSAW MACHINERY CO  
8110 Field Bldg. Kansas City 11, Missouri

## HELPFUL BOOKS

Send post card asking for FREE catalog

Popular Mechanics Press, 200 E. Ontario, Dept. 601, Chicago 11

## SURPLUS SALE



NEW TOOL POST GRINDERS  
REGULAR PRICE \$125.00  
\$39.50

1-6 H. P. MOTOR  
TAKES WHEELS UP TO 1 1/2" x 4"  
EXTRA GULL EXTERNAL OR  
INTERNAL \$19.50

MONEY BACK GUARANTEE

EDWARD J. NOLAN, PULASKI, NEW YORK

Explosion-Proof, Portable

## ACETYLENE GENERATOR

### PORT-A-MATIC



New, portable acetylene gas generator. Solder, heat, braze—or weld and cut with addition of oxygen. 3 models: Approximately 5 cu. ft., 12 1/2 cu. ft., 25 cu. ft. gas capacities, weighing 30, 50, and 80 lbs. loaded, respectively. Will handle any standard welding equipment for farmers, portable welding operators, repair shops, plumbers, electricians, construction men, even hobbyists.

Write for information and prices.

PORT-A-MATIC, INC. | HILLSBORO, OREGON  
1665 North Connell

SAFE!  
even upside down



# BIGGER SAVINGS and BETTER WORK with this NEW *Atlas* COMBINATION TOOL



ONLY  
**\$111.25**

complete except motor, slightly higher in some areas



Rips, crosscuts, shapes, dados, joints, planes, miters, moulds. Handles 95 per cent of all operations required in furniture building, household construction, remodeling. A compact, portable unit . . . the most practical and efficient of all combination tools. No complicated or time-consuming setups. America's greatest power tool value. Write for NEW FREE CATALOG.

### NEW MODERN FURNITURE PLAN BOOK

JUST ISSUED . . . 16 complete plans . . . only 50c. USE COUPON.



ATLAS PRESS COMPANY  
324 N. Pitcher St., Kalamazoo, Mich.

- Please send me FREE illustrated literature on the new ATLAS Saw-Jointer Combination, and the name of my nearest dealer.
- Am enclosing 50c (65c outside U.S.A.) . . . send MODERN FURNITURE PLAN BOOK.

NAME \_\_\_\_\_  
ADDRESS \_\_\_\_\_  
CITY \_\_\_\_\_ STATE \_\_\_\_\_

Also Child's 2-Pass. Motor Car  
Eshelman Cars Commended by Parents Magazine

### ESHELMAN HOLDS 1 ADULT

**AUTO WITH MOTOR**

**LOWEST PRICE**  
70 Miles Per Gal. Gas  
25 Miles Per Hour



Eshelman  
DEPT. MC-53  
109 Light St.  
Balto 2, Md.  
333 N. Michigan Ave.  
Chicago 1, Ill.  
7070 Hollywood Blvd., L. A. 28, Cal.

Pat. Pend.  
Write for Free Catalog

### ASSEMBLE IT YOURSELF AND SAVE! For Pleasure-Profit-Own Use:



Modern Foam Rubber Arm Chair, Put it together yourself quickly and save over half! Only screw driver and hammer needed. Hard wood frame, foam rubber seat and back, deluxe Metallic Tweed, Red, green, charronze or coffee brown. ORDER NOW! \$5 deposit. Balance C.O.D. Satisfaction Guaranteed. It's simple—easy—fun. Or write for literature. Send TODAY.  
**DECORATOR KATHY**  
4601 W. North Ave. Milwaukee 8, Wis.

ONLY  
**\$34.95**

Complete Kit

## D.C. ARC WELDER

AT A.C. TRANSFORMER WELDER PRICE



No Separate Motor or Engine Required  
Just Plug it in! REG. VALUE \$350.00

• WELDS!  
• CUTS  
• BRAZES!

**140 AMPS. \$85.00**  
I.o.B.

**For Heavy Work to Lightest Fine Job!**  
On a PORTABLE roller stand . . . can quickly be taken to the job. BRAND NEW! General-Electric motor-generator produces DC welding current up to 140 amps. Will handle up to 5/32" rod. Operates on AC or DC, 110 or 220 volts, 25-60 cy. Single or 3-phase. Welds straight or reverse polarity. Heavy-duty Ball Bearing construction. Has 7 welding ranges from 0 to 140 amps. Motor becomes power unit to Grind, Sand, Buff and Polish (with attachments Incl.) #1G-150  
With Complete Accessories Shown . . . \$98.50

Order on 10-DAY FREE TRIAL—Easy Instructions Included  
FREE Catalog of Motors and Electrical Equipment  
ROBERTS ELECTRIC CO., Dept. P-267, 849 W. Grand, Chicago 22, Ill.

SAY YOU SAW IT IN POPULAR MECHANICS

## READY CUT HOMES DO-IT-YOURSELF \$AVE! \$\$\$

BUY DIRECT FROM MILL & SAVE ON LABOR COSTS

You can assemble any of the 57 designs from easy-to-follow plans. Every piece marked, easily identified, ready to erect. You don't have to measure or cut. It's all done economically by precision production machinery (not prefabricated). Save high skilled labor costs and material wastes. Save contractor's profits and overhead. Complete with all hardware, paint, nails, roofing, glass, etc. Sterling Homes are modern—ORDER TODAY - SAVE UP TO 40%

ern designed for comfort and convenience. Plans sold separately.  
FIVE EASY PAYMENT PLANS INCLUDING MONTHLY PAYMENT



PRICED FROM  
**\$2150.00 AND UP**

Send 25c

Color Catalog including Floor Plans

INTERNATIONAL MILL & TIMBER CO., BAY CITY, MICH. DEPT. PM 35





New  
**DELTA**  
 6" Long Bed  
**JOINTER**

# Picture These Two New Rockwell-

For real accurate work, you need a real precision jointer—and here is the finest 6" jointer ever built! It's got all the precise controls, all the flexibility, all the capacity and all the ruggedness you'll ever need—not only for home workshop use, but for industrial applications, too.

That's because Delta engineers talked with hundreds of jointer users to find out exactly what they wanted most. Then all of Delta's years of power tool experience were put behind the design and building of this great new Delta Jointer.

**NEW** longer bed—full 42½". Insures a true cut the entire length of the longest board . . .

**NEW** safety engineered guard provides infinite tension adjustments . . .

**NEW** easy-to-reach hand wheel controls for quick adjustment of infeed and outfeed tables.

Let your Delta Dealer demonstrate the new Delta *Long Bed Jointer* for you now, and send the coupon for complete catalog information.

## WIN UP TO \$1000 WORTH OF DELTA TOOLS

*in Delta User's "Finest Home Workshop" Contest!*

### **NOTHING TO BUY:**

If you now own three or more Delta Tools, you can win up to \$1000 worth of additional Delta Tools of your choice! Or \$750 worth as second prize; \$500 worth for third; \$250 worth for fourth prize. Ten other valuable prizes.

### **EASY TO ENTER:**

Official Entry Form contains all rules, shows how to make out your entry, and must accompany your entry. Get entry form from your Delta Dealer (he's listed in classified pages under "TOOLS" or "MACHINERY") or send coupon on opposite page.

Contest closes July 15, 1955

**DELTA QUALITY COSTS NO MORE**





New  
**DELTA**  
 14" DRILL  
 PRESS

built **DELTA** Tools in Your Shop!

A good drill press is one of the most useful, most versatile tools you can have in your shop—and this all-new Delta is the finest 14" drill press you've ever seen anywhere! It has everything that has made Delta the most popular 14" drill press in the world, *plus* eleven exciting new features that give you even greater precision, speed, versatility, and ease of operation. All this—at no increase in price!

**USE IT FOR DOZENS OF JOBS**

You'll use your new Delta 14" Drill Press for a lot more than drilling in wood, metal and plastics. You'll also rout with it, mortise, shape, finish, tap, and do scores of other special jobs. And you'll do

them all easier, and with more real precision, than you ever thought possible. That's because the Delta 14" Drill Press is a real industrial-quality tool, used today in thousands of production lines and toolrooms all over America.

But a ten-minute demonstration will tell you more than ten thousand words. Your Delta Dealer is listed in the classified pages under "TOOLS" or "MACHINERY"; see him now. And send the coupon for catalog information.

**DELTA** QUALITY POWER TOOLS  
 Another Product by **ROCKWELL**



**SEND THIS COUPON TODAY!**

Delta Power Tool Division, Rockwell Manufacturing Co.  
 502-C N. Lexington Ave., Pittsburgh 8, Pa.

- Please send me catalog on new Delta 6" Jointer.
- Please send me catalog on new Delta 14" Drill Press.
- Please send me name of nearest Delta Dealer who has 6" Jointer and new 14" Drill Press under power.
- Please send Official Entry Form for Delta User's "Fine Home Workshop" Contest.

Name \_\_\_\_\_

Address \_\_\_\_\_

City \_\_\_\_\_ State \_\_\_\_\_

Copyrighted material



# Starrett® GAGES

Preferred by skilled mechanics for dependable accuracy and convenient design features.

## SCREW PITCH GAGE No. 473



30 leaves for pitches from 6 to 60. Positive stop holds leaves in fixed position.

## RADIUS OR FILLET GAGE NO. 178

Size A, 30 leaves, 1/32 to 1/4" radii. Size B, 32 leaves from 17/64 to 1/2".



## THICKNESS GAGE No. 172-A

Nine tapered leaves with case and locking device. Range .0015 to .015". Also with straight leaves.

## WIRE GAGE NO. 287

For gaging steel wire and drill rod sizes from 0 to 36. American Steel and Wire Co. Standard.



SEND FOR IT — ONLY 10¢

Starrett "Tools and Rules" Book  
50 page booklet shows the right tools for any precision measuring job. 100 pictures plus helpful reference tables. Send only one dime. Address Dept. AP.



THE L.S. STARRETT COMPANY • ATHOL, MASS., U.S.A.

**Starrett**

1880-1955  
Commemorating 75 Years  
of Precision Toolmaking

Buy THROUGH YOUR INDUSTRIAL DISTRIBUTOR  
Prompt delivery  
Dependable service  
Quality products

MECHANICS' HAND MEASURING TOOLS AND PRECISION INSTRUMENTS  
DIAL INDICATORS • STEEL TAPES • PRECISION GROUND FLAT STOCK  
HACKSAWS, BAND SAWS and BAND KNIVES

# Weekend Carpenters



Add a professional finish to your jobs with Plastic Wood — the wood filler most carpenters use. Easy to apply... handles like putty, hardens into real wood.

**YOU NEED "PLASTIC WOOD"**

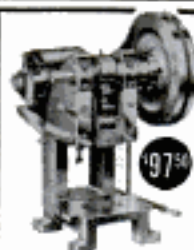

## PUNCH PRESS

2 Ton Power Bench Type  
Make Your Shop Complete  
Powerful — Dependable — Economical  
Easily make your own dies for light stamping, forming, riveting etc. Ideal for production or experimental work. Replaces more expensive presses. Requires only 1/2 H.P. motor. Weight 105 lbs. Fully guaranteed. Only \$97.50 less motor. Write for free circular. Dealer Inquiry Invited

ALVA F. ALLEN, Dept. PM, Clinton, Missouri

## MAKE BIG CASH PROFITS ASSEMBLE YOUR OWN LAWN TRACTOR



NEW!  
YOU CAN MAKE, SILD, PEPPER, PULL LOADS, GRASS, "BOLT", CULTIVATE, REMOVE SNOW

When your neighbors see the fun you have mowing your lawn with RIDE-TRAC, they'll want one too. Make Big Cash Profits in your own neighborhood with our Rider Agent Plan. Complete RIDE-TRAC kit goes together quickly with wrench and screwdriver. RIDE-TRAC makes fun out of all your lawn work. Write today for details of Rider Agent discount.

DELSAW RIDE-TRAC DIVISION  
9001 Field Bldg., 315 Westport Rd., Kansas City 11, Mo.

LIFE-LONG DURABILITY



They last and last. Trouble-free service year in and year out. Free catalog.

**GERSTNER TOOL CHESTS**  
455 Columbia St., Dayton 7, Ohio

## AGENTS — SELL

TOOLS! GUNS! CAMERAS!

Buy tools, photo equipment, sporting goods, jewelry and thousand other nationally advertised products at big discounts. Big profits selling to others. Postcard brings free plan.

Get up to **40% off**

AMERICAN BUYERS SERVICE 631 LINDEN AVE., DEPT. 15 BUFFALO 16, NEW YORK

## MAKE UP TO \$5 AN HOUR WITH

**EASISHARP**



Big profits in your spare time sharpening scissors. We show you how to make money immediately. This is your chance now to have your own business and steady income. Sharpen scissors in less than two minutes! A child can operate it. Weighs only 10 lbs. Every home, barber, tailor — everybody uses scissors and all need sharpening 2 to 4 times a year. Don't let someone else beat you to this opportunity. Write immediately. Manufacturers of Famous Quicksnap Knife Sharpener.

MONEY MAKING SALES PLAN FREE

SERR-EDGE MACHINE CO., 9731 Lorain, Cleveland, O.



**MAKE WROUGHT-METAL FURNISHINGS  
AT HOME with the METL-FORMER**

PATENT PENDING

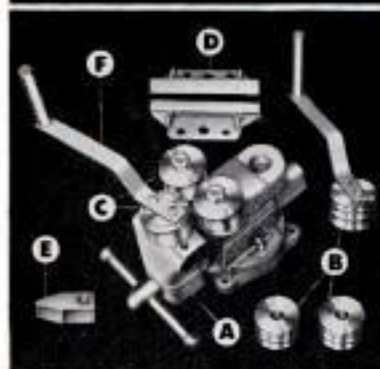

- IT ROLLS
- IT FORMS
- IT BENDS

Complete Metl-Former Kit Just  
**\$29.95**

Prices slightly higher  
west of the Rockies.

**KIT CONTENTS**

- A. Basic Metal-Forming Tool
- B. 3 Tubing and Rod Rollers
- C. 3 Flat Metal Rollers
- D. 1 Sheet Metal Bender
- E. 1 Flat Metal Bending Wedge
- F. 2 Roller Handles

Here's a combination tool, the Metl-Former, which accurately and easily rolls, forms, and bends light metals into wrought-iron and aluminum tables, planters, lamps, and toys—right at home! Controlled Metl-Former fingertip tension lets anyone create useful wrought-metal fixtures and furniture, for the cost of the raw materials. The Metl-Former repays its purchase price with the first items made. There are hundreds of handy items anyone can easily make with this metal-shaping tool. In addition to metal forming, the Metl-Former's rugged vise makes a welcome addition to any workshop. Get the Metl-Former for metal working in the home. See your favorite hardware dealer for the Metl-Former or:



Write us today, for complete information, plus details about the new Drill Stand Attachment which makes a drill press of an electric drill.

SWAYNE, ROBINSON & COMPANY • RICHMOND, INDIANA

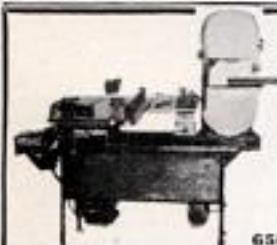

**COMPLETE WOODWORKER  
FOR  
CABINET OR HOME SHOP**

12" band saw—8" circular saw—6" jointer—4" belt sander—shaper—12" swing lathe—drill—etc. Combined or separate machines—bench or floor type. Free circular.

**PAUL KORNAU**

6503 Hamilton Ave., Cincinnati 24, Ohio.

**WORLD'S BEST SMALL TRENCHERS**



Portable DITCH-WITCH digs 2" to 6" clean, even ditches to 36" depth in all types of soil. Complete unit—self propelled—outdigs 8 men. Four rugged models.

Write for illustrated literature.  
**CHARLES MACHINE WORKS**  
620 B Street Perry, Oklahoma

**"DO IT YOURSELF"  
IT'S EASY WITH  
KESTER  
SOLDER**



Soldering's really a "cinch"... when you use time-tested, reliable KESTER... available everywhere.

FREE! "Soldering Simplified"... 16-page how-to-solder booklet. At your dealer or write direct.

**KESTER SOLDER COMPANY**

4251 Wrightwood Avenue Chicago 39, Illinois

**SPINNING...**

*Smooth  
as Silk*

with the **Bronson "Jet"**

Here's polished perfection in spinning—a reel to give your casts wings—to make your aim true as an arrow! It's the Bronson "Jet"...with super-smooth drag, full bail pick-up and hardened roller guide. Drag adjusting nut can't be lost—it's fixed to the spool. See it at your favorite sports shop.

Other Bronson Spinning Reels from \$4.95 to \$17.95. Bronson Reel Company, Bronson, Michigan. Division of Higbie Mfg. Co.

*Whatever your sport—spinning, bait casting, fly fishing—there's a Bronson-made reel to make it more fun!*



No. 500  
**\$14.95**



FREE! Ask your Bronson Dealer for *Spinning the Bronson Way*—a "how to" booklet on spinning.





**IT'S YOURS!**  
**THIS MODERN**  
**6-ROOM**  
**HOME**  
**FOR ONLY**  
**\$ 4548**

**SAVE 30% to 40%  
 BY BUILDING A Liberty Home**

You can save several thousand dollars by building a Liberty Home and, at the same time, own a home of which you will always be proud. Smart-

looking on the outside, homey on the inside. Carefully planned for convenience and comfort, with kitchens that are really a "dream".

**Build the Economical Way!**

Buy direct from our mill at our low factory, freight-paid price. We ship you the lumber cut-to-fit, ready to erect. Doors, windows, roofing, paint, glass, hardware, nails, etc., all included in the price. Plans furnished—also complete building instructions. No wonder our customers write us that we saved them 30% to 40%. Easy terms—monthly payments. Architecturally approved construction. (Not prefabricated.)

**Handsome Big  
 CATALOGUE**

Pictures wonderful homes in colors at money-saving prices. Write for FREE catalogue today.  
 (West of Mississippi, 35c)

**BIG BOOK**  
 of  
**House Plans**  
 in Colors  
**FREE**

**LEWIS MANUFACTURING CO.**  
 1253 Lafayette Ave. Bay City, Mich.

**BUILD YOUR OWN AUTOMATIC  
 PORTABLE SPRAYER AND SAVE**

- 1/3 or 1/2 H.P. Quincy 3 CFM Compressor & pulley..... \$20.50
- 3/4 or 1 H.P. Quincy 9 CFM Twin Cylinder Comp..... \$52.00
- Tank 6 x 20 Wheels Platform handle Welded..... \$12.00
- Tank 12 x 24 Stainless on Wheels 500= tested..... \$27.00
- Tank 15 x 30 Wheels Platform handle Welded..... \$34.50
- 1/2 H.P. A.C. Motor 110 V. Cap. 1725 R.P.M..... \$24.50
- 1 H.P. A.C. Motor 110/220 Cap. 1725 R.P.M..... \$45.00
- Automatic Adjustable Pressure Switch..... \$ 6.50
- Adjustable Pressure Regulator and Gauge..... \$ 6.00

- Hose and Tire Chuck..... \$ 2.50
- Safety Valve..... \$ 1.50
- Check Valve..... \$ 3.75
- Good Qt. Spray Gun..... \$ 8.95
- Better Qt. Spray Gun..... \$ 9.95
- Best Qt. Spray Gun..... \$10.95

**• ORDER FROM THIS AD •**  
 All Prices F.O.B. Chicago

• K-55 Complete Automatic Spray Unit, Knocked Down 1/2 H.P. A.C. Motor, Quincy Compressor, 12 x 24 Stainless Steel Tank on Wheels, All Accessories. **\$97.00**  
 • SK-100 1 H.P. A.C. Motor, 15 x 30 Tank Twin Cylinder, 9 CFM, Quincy Compressor, All Accessories, You Assemble. **\$169.50**  
**ONLY**  
**ALL ORDERS SHIPPED PROMPTLY**  
 Write For **FREE** Catalog: Listing Motors, Compressors: **ALL SIZES.**

**C. MARSHALL SALES, 3546 W. Fullerton Av., Dept. P-3, CHICAGO 47**

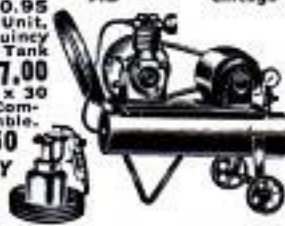

**\$10,000 REWARD**

**ONLY \$49.95**

for uranium finds. All you need is a **GAMMASCOPE** swing counter. Sensitivity equal to most counters costing \$250 and up. Now only \$49.95. Buy no other counter until you see the **GAMMASCOPE** at hardware, sports or mineral stores everywhere or direct from us.

**SHELBY INSTRUMENT**  
 1701 Magnolia Long Beach, Calif.

**SAY YOU SAW IT IN  
 POPULAR MECHANICS**

**BUY AT A DISCOUNT  
 RED-E TRACTORS AND TILLERS**



Tillers—1.5, 2 H.P.—2-wheel tractors—2, 3, 4½, 6 H.P.—4-wheel riding model, 8½ H.P. Send for free folder on full line of tractors and implements.

Buy direct from factory, get a factory discount! **SAVE UP TO 50%!**

**RED-E TRACTOR CO.**  
 Richfield 9, Wisconsin

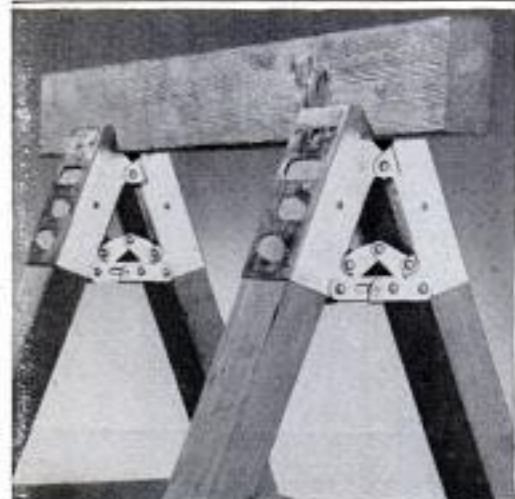

**Chesney**

Latest Development



Model BC 100

**SELF CONTAINED SAW  
 HORSE BRACKET CLAMPS**

Fully automatic. Fits any 2 x 4 common or finished lumber. Sets up or knocks down in seconds. No nails, bolts, screws or miters necessary. 12 permanent grippers actuated by one lever. Just insert wood and close clamp. Self locking. Holds sturdy with absolutely no wobble. No tools needed. Made from 16 gauge zinc plated steel. Use Saw Horses for tables, benches, scaffolding, barricades, etc. See your Hardware, Lumber or Building Supply dealer—or send check or money order to

**\$3.95**

Per Pair  
 Delivered

**Chesney INC.**

**720 TOWNE AVE., LOS ANGELES 21, CALIF.**  
 Dealer and Jobber inquiries invited.



# SCHALK'S WOOD PUTTY



Recommended  
by Peter Putter



Here's the Wood Putty that won't shrink; can be stained with regular wood stains, and so can be used on any kind or color of wood; fills nail holes, cracks in floor, furniture, plywood; sets door pulls. And, when mixed with varnish instead of water, it becomes a waterproof material for boat repairs or exterior use. All you need for 101 odd jobs around home, farm and workshop—Schalk's Wood Putty! At paint, hardware, building supply stores.

## insulate your feet!

Ask for Style 4569

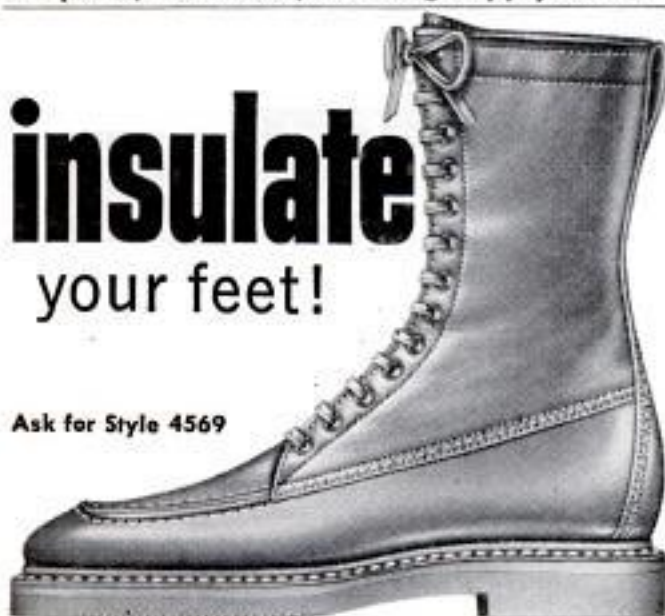

Husky, handsome boots for winter cold — wonderful light-weight insulation. Springy cellular foam insole. Long-wearing comfort cushion crepe outsole with non-slip tread. Beautifully made of soft cowhide, storm welted, full gusset construction. Genuine rawhide laces. Try on a pair soon! Sizes 5/12 & 13—D & EE

Only \$19<sup>95</sup>\*

\*Slightly higher in the West and South

PETERS  
**COUGAR**  
INSULATED SHOES

MARCH 1955

## YOU NEED THIS TOOL!



### SAWZALL PORTABLE ELECTRIC HACKSAW



Works Fast  
Saves Money  
Saves Tempers

2250 STROKES  
PER MIN.

#### NOT AN ATTACHMENT

Buy A Complete HEAVY-DUTY Sawing Tool

USED BY PLUMBERS • HOME BUILDERS and  
REMODELERS • MAINTENANCE and  
SHEET METAL MEN, Etc.

- Does those extra-hard, tedious time-consuming sawing jobs . . . Fast and Easy
- Easy to handle — one hand operation — just 14½" long — weighs only 6¾ lbs.
- Needs No Starting Hole . . . in wood or comparable materials
- Powerful . . . Long Life . . . rugged 1/3 H.P. — 115 V Universal motor — Ball and roller bearings.

CUTS ANY SHAPE...Clean and Fast...Zips right through any sawable material including WOOD, METAL, FORMICA, PLASTIC, NAILS, WIRE, ETC.



Only \$84<sup>50</sup> COMPLETE  
WITH STEEL CARRYING  
CASE and ASSORTED  
SAWZALL BLADES

MILWAUKEE ELECTRIC TOOL CORP.  
5300 W. State Street • Milwaukee 8, Wis.  
Canadian Distributors: Matthew Moody & Son, Montreal



## BUILD YOUR OWN POWER TOOLS— WITH GIL-BILT PARTS KITS

**Exclusive GIL-BILT Build-It-Yourself Features**

- No machining—build easily with hand tools only
- No blueprint reading—step-by-step pictorial plans, full scale patterns, actual photographs
- Sturdy wood, aluminum and steel construction
- Capacity and performance of commercial saws selling from \$60 to \$250.
- Proved performance, Nationally advertised and sold for 7 years. Satisfied customers around the world.

### GIL-BILT 10-in. TILT/ARBOR SAW



- 27x28 in. table, 13 1/2 in. capacity in front of blade
- 10 in. blade cuts 3 1/4 in. deep, tilts full 45 degrees
- Floor model 34" high, table always stays level
- New Departure ball bearing arbor, 3/4" precision shaft turned down for 3/8" bore blades, also, housing, shipped ready to run
- Jackscrew and 4 1/2 in. dia. handwheel lowers and raises blade
- Cast aluminum miter gauge and self-aligning rip fence guide

GIL-BILT Metal Parts Kit includes Plans, ball bearing arbor, miter gauge and bar, rip fence guide, dado insert, lock knobs, jackscrew mechanism and handwheel, and all other metal parts (less blade) . . . . . \$22.95  
 Same Kit with 10" Combination Blade \$25.90  
 Same Kit with 8" Combination Blade \$24.90

### GIL-BILT 12-INCH BAND SAW

- Cuts to center of 24 inch circle
- Handles stock up to 6 inches thick
- 18x18 inch table tilts 45 degrees
- Lower wheel and drive pulley runs on sealed New Departure Ball Bearings; Upper wheel runs on two 5/8" bore Oilite Bronze bearings
- Upper wheel tension and tilt mechanism of cast aluminum, completely assembled
- Upper and lower blade guides. Each has ball thrust bearing, self-lub bronze jaws
- Rigid cast aluminum wheels fully machined ready-to-install. Heavy rubber tires
- Uses standard 78 inch blades up to 3 3/4 in. wide
- Fully enclosed mechanism for utmost safety



GIL-BILT Metal Parts Kit includes Plans, rubber tires, aluminum wheels, 3/4 in. blade, ball bearing spindle, tilt mechanism, blade guides, table tilt segments and all other metal parts. . . . . \$23.95  
 Return Kits in 10 days for refund if not satisfied. For shipments up to 600 miles, add 5%; over 600 add 10%. Amount in excess of actual postage will be refunded.

**ALSO AVAILABLE Plans & Parts Kits for 18-in. Band Saw, Belt Sander, Spindle Shaper, 8-in. Tilt/Arbor Saw**

Order Kit now, or order Plans at \$1.00 each and Kit later less cost of plans. Write for **FREE** Catalog. Dept. 80-C, Lambert Field St. Louis 21, Missouri

### GILLIOM POWER TOOLS

Dept. 80-C, Lambert Field St. Louis 21, Missouri

## DRILL · SAW · REAM · CUT ALL WITH ONE DRILL BIT!

BEAVER SPEED SAW DRILL BITS

ONLY \$2.45 each • 3 for \$7.00 Ppd.

Can be used on any electric drill, drill press, lathe or milling machine. These new improved side cutting drill bits have "tapered-flutes" for additional strength to prevent breakage, and are made of the finest quality American High Speed steel to insure long life. Readily cuts: steel, wood, plastic, aluminum, etc. 3 1/2" long, 2" side cutting section, 1/4" diameter. Specify types desired: 1. All-Purpose 2. Wood 3. Heavy Metal. Money back guarantee! Resharpener free. Save time and money with this multi-purpose drill bit—ideal for enlarging holes, making circles, scrolls, etc. Buy them from your dealer today! Or send cash, check or money order NOW!

SET OF 3 MAKES AN IDEAL GIFT. Distributor inquiries invited.

**BEAVER DRILL & TOOL COMPANY**  
 701 East 5th Street Div. PM-3 Kansas City 42, Mo.

**PLANNING TO BUY OR BUILD A BOAT? LOOK FOR THIS WELDWOOD® TAG**



**IT'S YOUR GUARANTEE** that the plywood used in the boat won't delaminate, is the best made!

**UNITED STATES PLYWOOD CORPORATION**  
 World's Largest Plywood Organization  
 55 West 44th Street, New York 36, N. Y.

## IT'S THE Super-Quiet SCOTT-ATWATER

... THE OUTBOARD THAT BAILS YOUR BOAT!



**SCOTT-ATWATER** has everything you're looking for in an outboard: Bail-a-matic power bailing; smooth, quiet Hush-Spring Mount and Aquamute Exhaust; Stowaway Tank; Complete Shift; Snap-off Hood, many other features.

For **FREE COLOR BOOKLET** on full line—30, 16, 10, 7 1/2, 5 and 3.6 h.p.—write Scott-Atwater Mfg. Co., Minneapolis 13, Minn., Dept. PM-35.



**ALL ABOUT TELEVISION**

Save Money on **TV Purchase, Repair and Service**

You can actually save \$50 to \$100 when you buy a TV set. You can save that much more every year on service with Popular Mechanics **ALL ABOUT TELEVISION** to guide you. Do 9 out of 10 service jobs yourself. Complete simplified instruction and 220 pictures show you how. No previous experience or knowledge of electronics required. Cloth bound edition only \$1.98 postpaid. Money back if not pleased.

POPULAR MECHANICS PRESS, Dept. PM11, 200 E. Ontario St., Chicago 11

## HELPFUL BOOKS

Send post card asking for **FREE** catalog  
 Popular Mechanics Press, 200 E. Ontario, Dept. 601, Chicago 11

Do a Real Professional-Like Job Yourself and **SAVE**

## HOW to PAINT With Brush and Spray

Covers All Painting Methods and Materials

You can do professional-like painting and finishing jobs yourself and save about two-thirds of the cost. Sam Brown, noted craft authority, makes it so easy for you in his book **HOW TO PAINT WITH BRUSH AND SPRAY**. Order your copy now and enjoy this tremendous saving. It covers exterior painting, wall and interior decorating, furniture finishing, concrete painting—every type of painting with brush, spray gun, roller and other methods. Tells what finish is best; what materials to use, etc. No previous experience needed. Fully illustrated. Order by mail. Only \$2.50. Money back if not pleased.

POPULAR MECHANICS PRESS, Dept. PM18  
 200 E. ONTARIO ST., CHICAGO 11, ILL.





GIGANTIC  
SAVE-TO-70%

# MAIL SALE

WAR SURPLUS  
EXCESS INVENTORY  
BANKRUPT STOCK

## NAVY LONG RANGE TELESCOPES

Amazing buy in powerful finest optics, remains U. S. Navy officer's scopes. Only small quantity available.  
16X power, 3" objective lens 31" long. Comes in attractive hardwood case. See for miles. Govt. cost \$157. Prepaid... \$37.30

## PORTABLE DUAL AMPLIFIER

Many uses—telephone repeater, secret eavesdropping unit, laboratory work, remote radio, feed back audio car, etc.  
Consists of 2 complete amplifier units with tubes, with common power supply. Uses small A and B batteries. Beautiful cabinet filled with filters, controls, terminals, etc. Brand new, Govt. cost \$285.  
SALE, Prepaid... \$29.95

## WEED SPRAY OUTFIT

Leading make. Latest design. 5-row (17'). P. T. O. tractor-drive bronze pump. T-jet nozzles, insect controls, gauges, hose. Complete. Only 50 units. List \$175.  
Ppd. in U.S.A. \$97.65

## NAVY AC-DC POWER UNIT

115-volt, 60-cycle  
A 4-star buy! Brand new General Electric 115-v 60-c selenium rectifier unit. Will furnish DC voltage for laboratory work, signaling, power supply systems, experiments. Radio and TV test benches, etc.  
Furnishes pure, well filtered direct current adjustable from 25 to 210 v. Also AC voltage adj. from 50 to 230 v. Attractive cabinet. Rough and fine adjustments, etc. Est. Govt. cost over \$200 F.O.B. Ky. \$19.61

## PUMPS and VALVES

Irrigate. Do it yourself. Our data shows you how. Pumps, Centrifugal 1/2" \$19.95; 1 1/2" \$28.60; Rubber impeller self priming 1/2" \$18; Hi-pressure rotary for weed, cattle spraying \$54; Water System, Automatic. For lifts to 22 ft. 300 gal. per hr. 40 lbs. 110-V 60-C, 1/4 hp motor, Ppd. \$69.50  
Also dozens other pump and valve values. Get our catalog.

## HI-PRESSURE OXYGEN BOTTLE

1800-lb. Air Corps brand new breathing oxygen bottle. Complete with valve. Many experimental uses. Est. Govt. cost \$19. Ppd. \$5.95

## AIR COMPRESSORS AND TANKS

For painting, cleaning, tires, control terminals. Assemble your own outfit.  
Deluxe Kit. Compressor, tank, gauge, regulator, paint gun, fittings. How to build instructions. List \$80. Sale... \$45.49  
Compressor 11-cy \$20; 12-cy \$22; Govt. Air Tanks \$6.79; Regulators \$2.79; Pop off \$1.95; Pres. gauge \$1.89; Finest paint gun \$9.95; Auto. switch \$4.95.



## HYDRAULIC SPECIALS

Save to 80%. Build loaders, lifts, etc.  
Super Special Cylinder, 1 1/2" bore x 4" stroke, one way. Fine for plow lifts, etc. List \$25.50. SALE... \$11.95  
Precision 10" Govt. Cost \$87. SALE... \$3.89  
Cylinder Buy! Finest leading make, 3" bore, 8" stroke, one way. Fine for plow lifts, etc. List \$25.50. SALE... \$11.95  
Cylinders. Two-Way, 2" x 2" \$22.95; 2 1/2" x 2 1/2" \$36.95  
Pump. 1000 lb. 12 gal. \$45.00; Valves. One-way \$18.00; Two-Way \$18.00; Gauges, 1000, 1500, or 3000 lb. \$3.49  
Hydraulic accumulator... \$4.39  
Use for gear and throttle controls on boats, etc.

## BRAZING-SOLDERING OUTFIT

Operates from any 6-v car battery. Battery not included. Intense heat for heavy soldering, light brazing, pre-heating, etc. Many shop uses. Est. Govt. cost over \$7. Ppd. \$2.99

## 110-220 VOLT TRANSFORMER

Genuine Maloney. Steps 110 up to 220 v. or 220-v. down. Also steps 110-v. down to 55-v.  
1000-w. capacity. Size 8 3/4" x 7" x 8". Wt. 25 lbs. Many uses. Govt. cost \$35.50. Ppd. \$19.95

## SPECIAL OF THE MONTH! ARMY TOOL and PARTS CABINET

Size 28" x 21" x 20"  
DeLuxe brand new units. Finest wood cabinet design, 3-section body with 6 easy-pull drawers with total of 22 compartments.  
Some felt-lined. Finest hardware. Wt. Aprx. 90 lbs.  
Ideal for home work shops, repair trucks, tool rooms, garages, etc. Govt. cost \$78.25. Only \$8.91 FOB Northern Ky.

## ARMY POWER PLANTS

Extreme bargains in DeLuxe Army plants and generators. New condition, guaranteed perfect. Be prepared for power failure in peace and war!  
Plants, 1,000 w, 115-v, 60-c... \$189  
Plants, 2,000 w, 115-v, 60-c... \$289  
Plants, 2,500 w, 115-v, 60-c... \$291  
Plants, 3,000 w, 115-v, 60-c... \$349  
Plants, 15,000 w, 115/230-v, 60-c... \$781  
Plants (FOB Lincoln) 25,000 w, 60-c, 115/220/440 v, 1 and 3 phase \$1091.50  
Plants, 7,500 w, 120-v, 60-c... \$691.50  
Generators AC and DC low as... \$58.00  
Plants, DC, 28-v, 1800 w... \$69.50

## SPECIALS FROM PREVIOUS ADS

(See previous recent issues for details)  
Generators, DC 3000W, 115v... \$58.75  
Army First Aid Chest... \$6.95  
Bomb Hoist (hand)... \$27.49  
DeLuxe Tool Chest... \$21.95  
Giant Flood Light... \$49.50  
Car Battery Tester... \$4.31  
Surveyors Level and Tripod... \$3.95

WE PAY all freight, express, parcel post—except where shown "F.O.B."

FREE CATALOG 100's items in our surplus center warehouse.

**BURDEN SALES COMPANY**  
805 "O" St. LINCOLN, NEBRASKA

## Viking TRACTORS & TILLERS



\$89.50 and up

1 and 2-wheel  
Terms as low as \$10 per month

Write for free catalog today!

American Farm Mach. Co., Dept. M-204  
1061-33rd Ave. S.E., Minneapolis, Minn.  
43 Church St., Pawtucket, R.I.

## URANIUM WITHOUT COSTLY GEIGER COUNTERS

Hillion dollar research reveals Gov't. Methods and Surveys for finding this priceless ore. Easy-to-understand instructions and map showing probable deposits. Sent postpaid, tax free for \$4.50. Mail cash, check, money order to URANIUM PROSPECTING CO., 1028 Market St., San Francisco 2, Calif.

## What to Make with CONCRETE

Even little concrete jobs cost big money — mostly for labor. Get Popular Mechanics WHAT TO MAKE WITH CONCRETE and save all the labor cost while making your home or farm ship-shape. Book shows all—tells all — how to make the right mixture, plan, apply and gives 50 professional show cuts. Hundreds of pictures. Only \$2.00 postpaid. Order today. Money back if not pleased.  
POPULAR MECHANICS PRESS, Dept. PM9, 200 E. Ontario St., Chicago 11



## AUTOMATIC RETOOTHER

MAKES NEW PROFITS  
for HAND SAWS



BURR MFG. CO.  
8933-F VENICE BLVD. LOS ANGELES 34, CALIFORNIA

## MAKE IT AT HOME WITH HOMASOTE PANELS



... make it easier  
... make it for less!

Want to build things that are really worth building — and do it without blueprints?

Our Simplified Easi-Bild\* Patterns and "Make-it-at-Home" folders give full instructions — including complete materials list — for making dozens of items such as here pictured — even a new attic room or a lily pool. You build primarily with weatherproof, crackproof Homasote insulating-building board... available (throughout the U.S. and Canada) in many sizes, thicknesses and densities. Homasote works easier than wood — takes any wallpaper, paint or stain.



Hutch Cabinet

For patterns or folders—mail coupon.

For 2' x 2' flooring 18 new ideas  
E. M. Reg. Easi-Bild Pattern Company  
HOMASOTE CO.  
Dept. C-7, Trenton 3, N. J.

I enclose \$..... for patterns or literature as checked:  
 3 Make-it-at-Home folders (10¢)  
 Town & Country Carport #273 (\$1.00)  
 Hutch Cabinet #270 (75¢)  Homasote Boards folder (10¢)  
 NAME.....  
 ADDRESS.....  
 CITY..... ZONE..... STATE.....  
 My lumber dealer is:.....



# ROTO-HOE OFFERS 3 GREAT LINES OF POWER EQUIPMENT

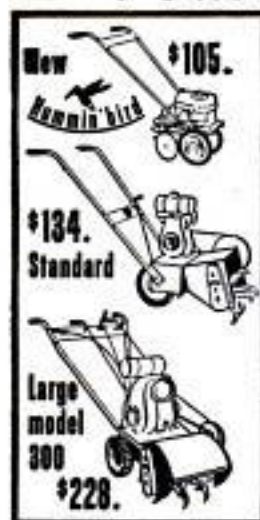

Whatever your need, you can afford one of the models in the 1955 ROTO-HOE line. Complete rotary tillers from \$105. to \$228., all with low cost year 'round use attachments.

## FREE CATALOG

New, in beautiful full color; sent on request, along with nearby dealer's name. Write today; learn how much easier gardening and lawn care can be with ROTO-HOE.

**ROTO HOE & Sprayer Co.**  
BOX 19, NEWBURY, OHIO

*America's Leading Manufacturer of  
Lawn & Garden Equipment*

## New "PULL-GEAR" SPEED-REDUCING PULLEY

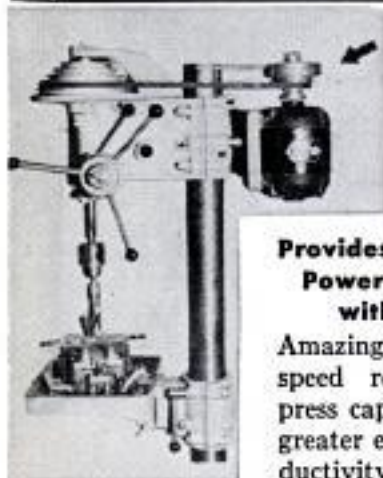

**Provides Correct Speed and Power to Drill Up to 1 3/8" with 1/2 H.P. Motor**

Amazing new internally geared speed reducer doubles drill press capacity. Greater power, greater efficiency, greater productivity.

Provides the correct speed and power for larger drilling, reaming, tapping and boring on light presses. Easily installed in five minutes. Adaptable to all type machines. Spindle speed range approx. 45 to 3000 RPM. Made in 3 motor shaft sizes: 1/2"-5/8"-3/4". Write for literature.

WRITE FOR LITERATURE

**THE PULL-GEAR CO.**  
25427 Mound Road  
Center Line, Mich.

## Only HOLD-E-ZEE The Original AUTOMATIC GRIP SCREWDRIVERS

### PROVIDE THESE FEATURES:

- LOK-BLOK that makes blade twist and impact proof.
- GRIPPER that snaps back—recedes deep into handle, giving full blade use.
- HAND GROUND BITS—chrome vanadium, chrome plated blades.

**YET COST NO MORE THAN ORDINARY SCREWDRIVERS**

UPSON BROS., INC., ROCHESTER 14 N. Y.

Pat'd.

At Leading Dealers  
Everywhere!

## 64" FLEXIBLE SHAFT WOVEN WIRE CORE

USE AS  
ELECTRIC  
DRILL

\$5.95

**REAL BARGAIN**—cannot be duplicated for \$15.00. Coupling fits 1/2" or 3/4" motor shaft (state which); other end fits standard chuck. Durable, heavy. Use it for grinding, polishing, buffing, drilling, etc. Chuck for same only \$1.25. Send check or money order and we will ship P.P. prepaid or C.O.D. Plus Postage. Money refunded if not satisfied.

72" \$6.95

Heavier constr.

**L. C. DOWNEY CO. — Dept. M**  
8004 TRAYMORE AVE., PHILA. 18, PA.

## YOU CAN BUILD A VIOLIN FOR PLEASURE OR PROFIT

Now you can build a rich toned mellow violin modeled after a famous "Strad." YOU CAN MAKE A STRADIVARIUS VIOLIN contains 3 full scale plans plus complete instructions. You work directly from the plans with no confusing scale of dimensions to translate. Detailed instructions for each step including varnishing and stringing—even shows how to build your own tools. Cloth bound. Order today from  
**POPULAR MECHANICS PRESS . . . \$3.50**  
200 EAST ONTARIO STREET, CHICAGO 11, ILLINOIS

## ENJOY TRAVELING WITH AMERICA'S FINEST AUTO COMPASSES



**GUIDEWAY**  
Only \$4.49

**TRAVELITE**  
Illuminated  
Only \$5.49

ONLY COMPASS  
APPROVED BY  
AUTO MAKERS

**DINSMORE**

Shows you the right way—the short cuts. Always accurate and dependable anywhere. Fits all cars. Send for free folder—"Plans, Knives and Compasses"—and name of nearest dealer.

DINSMORE INSTRUMENT CO., 1802-21 Remell St., Flint 1, Mich.

SAY YOU SAW IT IN POPULAR MECHANICS

## make it with 60¢ worth of sand & cement SELL IT FOR \$2000

every home a prospect for these patented "LIFETIME"  
**CONCRETE INCINERATORS**

Make big profits manufacturing rust proof, fire proof, almost indestructible concrete incinerators in your own backyard or garage . . . full or part time. Sell to home-owners, hardware, department and garden supply stores. Phila. manufacturer doing big volume with Sears, Roebuck; large department stores. Easy to follow instructions and all needed equipment supplied. Exclusive protected franchise—No competition! Territories going fast. Write immediately for full details. Dept. M35, T. C. TOR, 2113 Bellevue St., Phila. 40, Pa.



POPULAR MECHANICS

Copyrighted material





**NOW...sink  
screws by power  
in seconds**

Here's a great work and time saver for amateur or professional mechanics. Attach a Supreme Screw Driver Attachment to your 1/4" (or larger) capacity power drill, and sink screws faster than it takes you to read about it. Recommended for all screws up to 3/8" dia., and for both hard and soft woods. Makes assembly of woodworking projects a snap. Another fine tool by the makers of Supreme Brand Chucks . . . America's new favorite. Included are slotted screw bit, Phillips' head bit, and Allen wrench. Also complete instructions. See your hardware dealer or order direct. Send \$4.95 in check or money order. Also Supreme Medium Duty Model #2000—1/4" cap. \$6.95. Satisfaction guaranteed.

Model 3000  
**\$4.95**



**SUPREME PRODUCTS, INC.**  
2222 So. Calumet Ave., Chicago 16, Illinois

**BUILD WITH HYDRAULICS**

Build-Ur-Own Dooze, Hay-Fork, Loader, Hoist, etc. 10c brings PLAN with essential hydraulic information & big Catalog of Hydraulic-kits, Arc Welder-kits, Surplus items and hundreds of electrical bargains. Send for your PLANS today.  
**DUNBAR MFG., 6614 Sylvan Road, Houston 23, Texas**



SAY YOU SAW IT IN  
POPULAR MECHANICS

**NU-WAY HEAVY DUTY CUTTING UNIT**  
with Timken Roller Bearings

PRICE  
**\$16.50**  
WHY PAY MORE



Build your own rotary type lawn or weed cutter. Take the hard work out of weed cutting. Build yourself an up-to-date weed and lawn mower with the Nu-Way heavy duty unit.

WRITE FOR FREE CIRCULAR & BUILDING INSTRUCTIONS  
**TRACTOR-LITE MFG. CO., Adair, Iowa**

CLIP THIS TO GET

**USED WATER  
PUMPS**

**SALE!**  
SEE YOUR  
**GENERAL MOTORS  
DELCO**  
WATER PUMP DEALER



Only your General Motors Delco Dealer sells used water pumps carrying the "Performance Tested" tag . . . your assurance of a good, serviceable used pump. And, for your best buy in new water pumps . . . be sure to check the many exclusive advantages of low cost, high quality Delco Jet and Reciprocating pumps.

- Exclusive Delco Rigidframe Motor for smooth, quiet operation
- Exclusive Delco design assures positive shaft seal for less wear, longer life
- Delco simplified-design Jet pumps have only one moving part—saves maintenance and repair costs

**SUPPLY LIMITED! ACT NOW!**

**FREE!** Water Systems Demonstration and Survey of Your Problem

Write Today! **DELCO APPLIANCE DIVISION**  
**GENERAL MOTORS CORPORATION**  
Dept. PM, Rochester 1, New York

**EXTRA CASH  
IN YOUR SPARE TIME**

with new Foley  
**Circular Saw Grinder**

Earn \$3 to \$5 an hour in your own sharpening business! Low cost Foley Model 314 Grinder restores dull, worn circular saws to like-new condition . . . quickly builds a steady repeat trade.



Reconditions rip, crosscut and combination saws . . . dado heads . . . rotary lawn mower blades and all edged tools. Simple controls guarantee accuracy, easy operation. Complete instructions—no experience needed. Send for free literature today—no obligation.

**FOLEY MFG. COMPANY**  
Send FREE PLAN "Money in

**373-5 FOLEY BLDG.**  
**MINNEAPOLIS 18, MINNESOTA**  
Saw Sharpening."

Name \_\_\_\_\_  
Address \_\_\_\_\_

**FREE NAME-THE-BOAT CONTEST**  
NOTHING TO BUY                      NOTHING TO SELL  
**JUST NAME THIS BOAT AS ILLUSTRATED**



14 Foot, Fiber Glass Out-Board Boat with 40 Complete Air Chambers in Sponson on Each Side From Bow to Transom. Non-Sinkable. Supports 1,000 pounds when filled with water. Made Entirely of Laminated Fiber Glass. Eight Times as Strong per pound as steel. Get your Name in Early. In Case of Tie The Earliest Postmark will be the Winner. Send Name on Postcard with your Name and Complete address to the **B & A COMPANY, 4216 E. 14th Street, Des Moines 12, Iowa.** Decisions of the Judges will be final. Contest closes midnight of March 30, 1955.



# DO-IT-YOURSELF!



## Modernize with prefinished MARLITE PLANK & BLOCK

A hammer, saw, and level are all you need for beautiful walls, quickly installed. Planks (16" x 8") and Blocks (16" square) with exclusive tongue and groove joint are easily applied over old or new walls. Soilproof baked finish fused to a tempered hardboard never needs painting, cleans with a damp cloth. Ten "Companion Colors," plus 4 distinctive wood patterns, practical for every home interior.

Write for free folder and do-it-yourself instructions, or see your lumber dealer. Marsh Wall Products, Inc., Dept. 342, Dover, Ohio, Subsidiary of Masonite Corp.



Marlite Plank and Block. Patent Applied For

Made with genuine Masonite® Tempered Dualux®

## WORKSHOP WONDERS



You'll Find NEW USES Every Day



Does More Jobs Easier than Any Other Tool!

Fixin' is fast—and FUN!—with Vise-Grip. A squeeze of the hand locks jaws onto work with terrific non-slip grip. A super-pliers, all-purpose wrench, wire cutter, hand vise, and clamp—all in one! 7" and 10", cutter optional, \$1.85 to \$2.60. At your dealer—today!

Made Only By PETERSEN MFG. CO., Dept. M-3, DeWitt, Nebr.



## Variable Speed, Gear Head MOTOR

Develops as much as 1/4 HP  
Speed Range 6-600 RPM  
FULLY GUARANTEED \$35.00  
Reg. Price \$1450  
PRE PAID

Such versatile motors are hard to find... applicable for countless Experimental and Laboratory uses. Ideal for building special equipment that save valuable man hours. BALL BEARING! Heavy duty Rheostat adjusts ANY speed from 6 to 600 RPM. Extra heavy-duty series type motor (operates AC or DC), 110 Volt, 25-60 cycle. 5/16" diam. shaft. Rugged cast iron construction! Operates conveyors, jeweler's lathes, timing devices... 1,001 uses! Order from ad. We pay shipping.



## 300 lb. PORTABLE AIR TANK

GOV. SURPLUS! Reg. Value \$37.50  
Holds 300 lbs. air indefinitely (fill at gas station). Complete with Air Gauge, Tire Chuck, 15 ft. Hose, Carrying handle. We pay shipping. Supply limited. \$1595  
PAID PRE

FREE CATALOG of Compressors, Welders, Power Plants  
ROBERTS ELECTRIC CO., Dept. P-269, 849 W. Grand, Chicago 22, Ill.

## METAL WORKERS 4 TOOLS IN 1



1/4 in 1" PUNCHES, FORMS, SHEARS, RIVETS metals up to 10 ga. 1" width, 5 sizes round punches included. Model #10—\$9.95, postpaid. Hex, square, rectangular punches—40c each. BRAKES—up to 90° Bends—16 ga, 12" and 18" widths. Unique feature permits forming of Boxes, Trays, Covers with up to 1" flange edge. 12" Model #12—\$9.95, 18" Model #18—\$14.95, F.O.B. Buffalo. NOTCHING & NIBBLING UNITS—Model N2 "V" Notch 1"x1" and Model N2N 1"x3/4"—\$9.95 each, F.O.B. Buffalo. THREADING DIE—Thread rod stock for 1/8", 3/32" and 3/16" standard nuts \$1.00 postpaid.

ALBERT J. TATU, INC.  
85 Columbia Dr., Dept. PM-3, Williamsville 21, N. Y.



## NEW! ALLEN WRENCH INDEX BOX

First time offered! Durable draw steel. Holds standard set of 11 wrenches from 3/8" across flats to 1 1/32". Fly stands upright for easy selection. Each wrench individually placed, will not fall out. Quality and service GUARANTEED. Send cash, check or money order today! \$1.00 for box only... \$2.50 for box and 11 wrenches. Postpaid.

WAT-NOK SALES CO.  
1515 2ND. AVE. SO., DEPT. PM-15  
MINNEAPOLIS 3, MINN.



## ELECTRIC WELDER AC or DC 110 Volts

The "Little Marvel" all-metal welder, 5-year written guarantee. "Welds 1/8" metal or money back. Repairs tanks, tools, fenders, machine parts, etc. Complete with everything—rods, unit, eye shield, directions. \$6.45 plus 50c postage. Flame torch accessory for soldering, cutting, brazing \$3.95 complete with carbons, brass rods, flux. \$2.00 Deposit on C.O.D. 1/4 inch Transformer Welder \$19.95 F.O.B.

ESSAY MFG. CO., Dept. 51, Quincy 69, Mass.

\$645 Complete



X-acto  
KNIVES • TOOLS  
HANDICRAFT KITS



NO. 82  
KNIFE SET  
\$4.20  
X-ACTO, INC.  
48-45 Van Dam St.  
Long Island City,  
N. Y.

Send 25c for 28-page Catalog

## Say You Saw It in Popular Mechanics

### DON'T DIG 'TIL YOU KNOW WHERE



The most amazing instrument you've ever seen! New MAGNA PROBE traces water, gas, and metal or tile sewer lines. Saves hours of unnecessary digging. Finds hidden springs and underground streams. Just as efficient over concrete as bare ground. Sensitive to depth of 30 ft. Works indoors or outdoors. MAGNA PROBE works by scientific principle of dissimilar metals and elements attracting and opposing one another like magnetic electricity. So simple—a child can use it. GUARANTEED TO WORK!

ONLY \$2.98 Post-paid

Complete with easy-to-use instructions TODAY! Send check or money order (no C.O.D.'s) to:

**THE MAGNA PROBE CO.**  
6022 Mayfield Road Cleveland 24, Ohio



**CUT THE BOLT YOU NEED TO ANY LENGTH**

**HEAT AND BEND TO ANY SHAPE**

24" and 36" lengths

**7 SIZES**  
 $\frac{1}{4}$ "  $\frac{3}{16}$ "  $\frac{1}{2}$ "  $\frac{3}{8}$ "  $\frac{7}{16}$ "  
 $\frac{1}{2}$ "  $\frac{3}{4}$ "  $\frac{3}{4}$ "

**REDI-BOLT**  
**THREADED STEEL RODS**

Ask Your Hardware Dealer or Write  
**REDI-BOLT, Inc., 5320 Indianapolis Blvd., East Chicago, Ind.**

**FREE CATALOG**  
**NEW CHRYSLER BOAT KITS**

BUY DIRECT—SAVE UP TO 2/3  
**FACTORY TO YOU!**  
 No Dealers! You SAVE the BIG PROFIT!

12 MODELS—8 to 14 ft. —\$39 up  
 Finest quality Boat Kits at the lowest prices in history! Mahogany decks. Easy to build.  
 Also: FIBERGLAS-ACCESSORIES-TRAILERS

**CHRYSLER-CRAFT (DEPT. 20) TONAWANDA, N. Y.**

**Also Eshelman SPORT CARS**

**ESHELMAN RIDING MOWER**

Better, Faster, Easier! Just ride along on this deluxe Rotary Mower. Write for literature.  
 Also Garden Tractors from **\$69**

**ESHELMAN CO.,**  
 Dept. M-53, 109 Light St., Baltimore 2, Md.,  
 333 N. Michigan Ave., Chicago 1, Ill., 7070 Hollywood Blvd., L.A.,  
 28, Cal.

3 H.P.

Shoots glaziers' points into hardest wood  
 ask your dealer for **Red Devil** diamond point driver



**Red Devil Tools.**

Get your FREE copy of "HOW TO FIX BROKEN WINDOWS."  
**MAIL COUPON TODAY**

**Red Devil Tools.** Dept. 142  
 130 Colt Street, Irvington, N. J

NAME \_\_\_\_\_  
 ADDRESS \_\_\_\_\_  
 CITY \_\_\_\_\_ ZONE \_\_\_\_\_ STATE \_\_\_\_\_

2014

**How YOU can SAW DRILL GRIND TURN SAND**



**with SUPERSHOP**  
**5 BIG POWER TOOLS IN 1**

- 8" TILTING TABLE SAW
- 1/2" DRILL PRESS
- 8" SANDER
- 30" LATHE
- 5" GRINDER

When you DO-IT-YOUR-SELF with SUPERSHOP you save money and you have fun. You can build a house or a garage — handle BIG jobs. The 8 inch saw cuts 2 1/2 inches deep. Heavy tubular steel frame. 100% Ball Bearing. Lifetime accuracy. Save \$65.05—buy direct from factory. Take advantage of our FREE trial plan.



**DRILL PRESS**



**SANDER**



**LATHE**



**GRINDER**

**FACTORY TO YOU**  
**\$79<sup>95</sup>**  
**EASY PAY PLAN**

**POWER TOOLS INC.** 169 Yates Ave. Beloit, Wisconsin

Please send me your FREE How-To-Do-It Catalog.

NAME \_\_\_\_\_

ADDRESS \_\_\_\_\_ STATE \_\_\_\_\_



**The easy way to paint!**



*Speedy Sprayer*



Favorite of home owners and craftsmen for 20 years! SPEEDY SPRAYER gives your work that professional paint finish everyone admires. Sprays paint, enamel, varnish, lacquer, etc. . . . 4 to 7 times faster than hand brushing! Lightweight, portable, uses any 1/4 H.P. motor. Improved diaphragm principle assures clean, oil-free air. You'll find dozens of time and money saving uses for SPEEDY SPRAYER, including spraying insecticides 2-4-D and DDT. Complete outfit, without motor, only \$36.50.

**ONLY \$36.50**  
LESS MOTOR

At leading hardware, lumber, and auto supply dealers. FREE—write for handy booklet "How to Spray."

**W. R. BROWN CORPORATION**  
2635 N. Normandy • Chicago 35, Ill.

**Now it's here!** THE NEW LEAKPROOF! FOOL-PROOF!



ONE DROP AT A TIME EXACTLY WHERE YOU WANT IT

**ILETTE**  
LUBRICATOR



**\$100** POSTPAID NO CDS

The easy-to-use oiler with 1001 uses. Small—fountain pen size. Super efficient—just squeeze transparent plastic barrel, pressure controls size and number of drops of oil. Leakproof—quadruple locked-in construction plus neoprene washers provides the first completely leakproof oiler on the market. Easy-to-use—simply push in needle and squeeze barrel. Pull needle out to lock. Remove knurled section to fill. Comes complete with oil and cap with clip. Sturdy and beautifully designed. A tested product which functions perfectly in extreme hot or cold climates.

**SEND FOR YOURS TODAY!!**  
**ROBERT'S SALES COMPANY**  
DEPT. PM 1 2220 WALNUT ST. PHILA. 3, PA.

**BARRON Drill Press TOOLS**

FOR WORKSHOP AND INDUSTRIAL USES...



Over 40 precision built woodworking tools and accessories . . . Hi-Speed Router Bits—Rotary Surface Sanders & Drum Sanders—Safety Shaper Cutters—Dovetail Cutters—Large Auxiliary Metal Tables—All Metal Shaper Fences—Spindle Adaptors—Handy Bench Vises. Many other items indispensable for accurate, useful, versatile workshop use. Every tool sold on complete satisfaction or your money back. See your Barron Dealer. Ask for special folder — "24 Extra Uses for Your Drill Press."

**Only \$8.50** COMPLETE

**BARRON TOOL CO. INC.**  
364 Architects Bldg., Detroit 1, Mich.

**FREE** Workshop Guide & Catalog

**BUILD YOUR OWN**

LAWN AND GARDEN TRACTOR



USE ONLY WRENCH AND SCREWDRIVER. Complete kit with all parts fitted and finished. Requires less than three hours assembly time. ACCESSORY KITS for Lawn Mower, Roller, Dump Cart, Hay Mower, Rotary Tiller, Snow Plow, Circular Saw, Emergency Light Plant.

**UNITED STATES FORGE & FOUNDRY CO.**  
CONSTRUCTION EQUIPMENT DIV. POLASKI, NEW YORK

**BUILD YOUR OWN ARC-WELDER**



We show you how to build NEW powerful welder. No rewinding. Uses most any surplus aircraft generator. Easy to build. 75-300 amps. Complete PLANS 35c. Send today and we'll include FREE our Big War Surplus & Electrical Catalog.

**LEJAY MFG. CO., 1247 LEJAY BLDG., MINNEAPOLIS 8, MINN.**

**FREE CATALOG**

Over 300 books on Fishing, Hunting, Home Repairs and Improvements, Bricklaying, Welding, Home Workshop, Power Tools, Hobbies, Crafts, Home Building, Trades, Making Money at Home, Furniture Making, Woodworking, Carving, Photography, Art, Drawing, Mechanisms, Engineering, Refrigeration, Plumbing, Radio-TV, Electricity, Automobiles, Farming, Livestock, Gardening, Decorating, Painting, many, many more. Send for yours today.

**POPULAR MECHANICS PRESS, 200 E. Ontario St., Chicago 11**

**GIGANTIC SURPLUS SALE — SAVE UP TO 85%**

IMPORTED PRECISION SQUARES  
Accuracy Blades—Tempered Precision Ground

2" \$1.50	6" \$2.30 Mfr.
3" 1.70	8" 2.80 Guar.
4" 1.90	10" 3.80 Cert.
5" 2.10	12" 4.80 Incl.

Include Check or M.O. F.O.B. Los Angeles

**METRO PRECISION TOOL CO.**  
1507 S. La Cienega  
Los Angeles 35, Calif., Dept. M3

**NEW HI-SPEED DRILLS**  
30 ea. 1/4" to 1/2" \$3.50  
10 ea. 1/4" to 1/2" \$3.50  
Assorted sizes

**D.C. GENERATORS For Welding**  
P.I. 24V. 200 Amp. \$12.50  
R.I. 30V. 300 Amp. \$21.50  
Guaranteed Perfect! Incl. Diagram

**Convert Your Table Saw to a Jig Saw in 3 Minutes with CIRCLE JIG**



This is not a toy. It uses standard saw blades. Cuts 2 3/4" thick stock—cuts to center of 16" to 24" board. Easy to install on any 1/2" or 3/8" table saw without machining, drilling or tapping—simply clamp on with ordinary wrench. Add a jig saw to your shop at this small cost.

Retail price **\$11.95**

See your dealer or send \$11.95 to  
**VERSA TOOL MFG. CO., INC.**  
401 LAKE AVE. DEPT. M RACINE, WISCONSIN



# SAVE ON PALLEY SPECIAL VALUES DO IT YOURSELF! IT'S FUN! IT'S PROFITABLE!



## NEW 3HP WISCONSIN AIR COOLED GASOLINE ENGINE

An ideal power supply for small farm machinery, air compressors, lighting plants, power tools, small boats, etc. It is a single cylinder, 4 cycle, 3HP gas engine. Air cooled. 2000 RPM. Has a 2 1/2" x 2 1/2" Bore. Comes with Oil Bath Air Cleaner, self-contained Gas Tank & Gauge, Carburetor, Flywheel, etc. Waterproofed. New, in original packing. **59.50**



## NEW OBERDORFER BRONZE CENTRIFUGAL PUMPS

Mfg. by World Famous Oberdorfer Foundries. Have all Bronze, heavy duty housing & impeller, Pinon-Notched stainless steel shaft. Foot mount. Can be driven with 1/12 to 1-1/2 HP motor. These pumps are finest made. DRAIN collars, cisterns, wash tubs, transfer liquids, irrigate, circulate, etc. Dealer discounts available. **BRONZE BEARING TYPE**

A direct drive type pump. Guaranteed finest quality.

INLET	OUTLET	GAL. PER HOUR	PRICE
1/8"	1/8"	up to 240	10.25
3/4"	1/2"	up to 1260	17.50
1-1/4"	1"	up to 2100	26.50

### PULLEY DRIVEN CENTRIFUGAL PUMPS

An advanced design pump. Basically same as pumps above. Has an oversized ball bearing shaft assem. to absorb pulley thrust. Allows operation at 3450 RPM with standard 1725 RPM motor thru 2:1 V-belt pulley ratio. Has mechanical carbon face type seal. Adaptable to any power with pulley drive.

OUTLET	GAL. PER HOUR	PRICE
3/4"	up to 438	21.00
1/2"	up to 1260	27.00
1"	up to 4200	35.50

### BRONZE ROTARY GEAR PUMPS

Precision engineered and made by OBERDORFER. With grease fittings for lubrication. Ideal for heavy duty use in moving SALT WATER, ALCOHOL, HYDRAULIC OIL, CHEMICALS, etc. from one location to another under pressure. Use as shallow well pumps for irrigating lawns and gardens, lubricating production machinery, etc.

1/4" OUTLET FT. HEAD GPH	1/2" OUTLET FT. HEAD GPH	3/4" OUTLET FT. HEAD GPH
20 PSI 246	2 PSI 630	2 PSI 1185
20 PSI 225	20 PSI 610	20 PSI 1160
100 PSI 150	100 PSI 510	100 PSI 1080

• **BRONZE ROTARY GEAR PUMPS** with Adjustable By-Pass Valve Delivers the same gallons-per-hour & foot-head pressure as pumps above.

1/4" 19.25	1/2" 24.25	3/4" 30.50
------------	------------	------------

NOTE: Pumps shown here are only a small part of our complete line of Top Quality, Centrifugal and Gear Type pumps. We can supply these pumps in sizes up to 1 1/2" pipe fitting. Write for our Pump Catalog Sheet.

### SURPLUS HI-PRESSURE PUMPS

#### PESCO HYDRAULIC PUMP

Only 14.95

A gear type pump. Will deliver 2 gal. per min. at 1500 RPM with 1500 PSI. Delivers 6 gal. per min. at 4300 RPM with 1500 PSI. Has .375 cu. in. displacement per rev. 3/4" standard pipe ports, 5/8" male spline drive shaft, 4" pad mount.

#### VICKERS HYDRAULIC ANGLE PUMP

A positive displacement, piston type. Displaces .507 cu. inches per rev. Has capacity of 6 gal. per min. at 3000 RPM with 1000 PSI or 3 gal. per min. at 1500 RPM. **22.50**

Note: This is only a small sample of our tremendous stocks of Hydraulics which include Pumps, Motors, Valves, Tubing, Fittings, etc. Send for Catalog.

### NEW 1/5HP ELECTRIC MOTOR

A 1/5 HP, reversible series wound motor. Turns at 3800 RPM. Operates on 27 volts DC, 16 amps. Has a 12 spline, 9/32" diameter shaft. Size: 4-1/8" x 2-3/8". A NEW surplus bargain **3.95**

### DC GENERATORS

BENCH TESTED

Suitable for adaptation to hose welding units, portable and rural lighting, power plants on boats, etc. Fully reconditioned and guaranteed serviceable.

TYPE	AMPS	VOLTS	PRICE
GI	140	30	17.95
PI	200	24	19.95
RI	300	24	27.95
310 NEW	50	15	19.75

NEA3 - 60 Amp DC - 28.5 Volts or 10.4A, AC - 115 V. - **27.50**

Y-BELT PULLEY KIT. To adapt Y-belt pulley to above generators. . . . \$27.50

RHEOSTAT for control of above Generators. 150 Ohm, 100 Watt \$7.50

### AVIATORS (AN-6500) WINDPROOF & DUSTPROOF GOGGLES

Chamois lined, rubber covered frames. Has REPLACEABLE GROUND LENSES in either clear, amber or green. Frames have special non-fogging breather slits. Nose bar is adjustable. **500 VALUE NEW 2.49**

EXTRA LENSES—Choice of colors listed above. Price per pair **1.00**

### NEW NAVY FLEECE LINED FLIGHT BOOTS

Fully Wool Fleece Lined, including insole and tongue. Has finest, 100% waterproofed, leather uppers. Shoe is heavy duty rubber with non-skid sole. Has a double zipper closure. One zipper for quick release. Laces up back for snug fit. Sizes: Small, Med., Large and Extra Large. A \$22.00 Surplus Value for ONLY **10.88**

## GENUINE SELECT PHILLIPINE MAHOGANY LUAN PLYWOOD

**SAVE 50%**

**BUY DIRECT FROM IMPORTER**

Our prices are LESS THAN DOMESTIC PLYWOOD at WHOLESALE. Due to the terrific demand generated by our national advertising and the amazing acceptance by the American public, we are importing this beautiful Luan Mahogany in BOAT LOADS — making possible further huge savings to you.

This selected LUAN MAHOGANY meets rigid Gov't Specifications. It is WEATHER and WATER RESISTANT. You'll be amazed at the beauty of this fine wood. Its rich golden elegance will thrill you. Rotary cut for beauty and grain. Both sides sanded and ready to use. Bonded with finest resin adhesive. Face side unjointed. Ideal for paneling DENS, OFFICES, HOTELS, CABINETS, etc.

See for YOURSELF FREE SAMPLE on request!

All orders shipped by special truck for LOWEST rates. No order accepted for less than 100 lbs. . . .

(14) 1/4" sheets (10) 1/2" sheets) Min. order 4 sheets

4ft. x 8ft. x 1/4" 32 sq. ft. A \$9.50 VALUE **4.49** FULL SHEET Min. order 4 sheets

## WORLD'S GREATEST DO-IT-YOURSELF TOOL BARGAIN!

### 3400 RPM 1/2HP POWER SAW

COMPARE TO 1245 SHIP UP TO 48.50 10.00 for HOME SHOP

**19.98** Complete with 5 1/2" Blade

**RIPS—CROSSCUTS**

A rugged, professional type, adjustable saw. Cut any angle, 0 to 45°. Has adjustable (0 to 6") rip fence. Safety-trigger switch on handle. Full 1/2 HP Universal AC-DC, 110-120 Volt, 60 cycle motor. Weighs only 8 1/2 lbs. A sensational Value—We sold over 700 Saws in Los Angeles in one week.

EXTRA SAW BLADES—Available in Rip, Crosscut or Combination. Please specify . . . price each **2.95**

### SPORTSMAN'S 12 Pc. IMPORTED COMBINATION KNIFE

Eliminates 12 Individual Items from your Pack or Tool Kit!

(A \$12.95 VALUE) **4.95**

Here is the Perfect, Combination Knife-Tool for every Outdoor Sportsman, Hunter, Camper, Fisherman, Boy Scout, Ranger, Rancher, etc. Think of it! 11. Fine quality Steel Tools, precision made to fold easily into the heavy bone covered body. In one neat, compact unit you have (1) a regular knife, (2) a fork, (3) a spoon, (4) a draw knife, (5) a bone saw and fish scaler, (6) scissors, (7) a can and bottle opener, (8) a cork screw, (9) a nail punch, (10) a screwdriver and (11) a metal file. All this PLUS a genuine leather, belt holster.

ORDER NOW While We Can Guarantee Delivery at this Special Low Price

### SPECIAL 320 PAGE CATALOG

Packed with Bargains in GOVERNMENT SURPLUS - FACTORY CLOSE-OUTS and GENERAL MERCHANDISE! Fully illustrated. Thousands of items in Hand & Power Tools, Precision Instruments, Hardware, Foam Rubber, Outdoor & Sports Equip., Hydraulics, etc. Send 50¢ to cover cost of handling & mailing - credited to first order.

Order from this Ad. Pay by Money Order or Check. 50% deposit with C.O.D.s. All prices F.O.B. Los Angeles.

## PALLEY SUPPLY CO

2263 E. VERNON AVE., DEPT. PM-3 LOS ANGELES 58, CALIF.



**BREEZE** through  
Garden Work—  
Small Farm Chores!

**SHAW**  
"DU-ALL"  
TRACTORS

with AUTOMOTIVE  
Gears—3 speeds  
and reverse

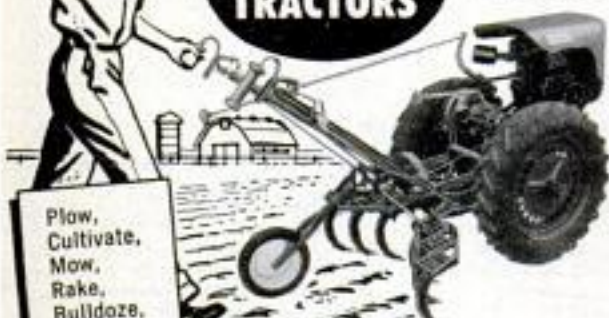

Plow,  
Cultivate,  
Mow,  
Rake,  
Bulldoze,  
Snowplow,  
Saw wood,  
everything!

**New Design 1½ to 5 H. P.  
Walking Tractors**

You just steer... Shaw "Du-All" does the work. Makes fun of those garden, lawn jobs. A "must" for acreages. Four rugged walking models. Two with power turn. Many features: variable speeds, run between or astride rows, independent tool control takes care of uneven rows, etc. Traction is tops. Wide selection of tools. Low prices will surprise you.

**Powerful 5, 8, 12 H. P. Riding Tractors**

You've never had it so easy! Comfortable, practical. Every one a powerhouse! Models to pull 8, 10, 12, 14 inch plows; work between 38" rows. Brakes aid turning. ¾ to 7 mph. Operate belt attachments. Eat up work!



Write Today. Free Literature, low prices on complete Shaw Line, name of nearest dealer. Dealer inquiries invited!

**SHAW**  
"DU-ALL"

**Manufacturing Co.**  
4503 Front St., Galesburg, Kan.  
668-G N. 4th St., Columbus, Ohio

**NEW! Giant AUTOMOTIVE CATALOG**

1955 Edition! Everything for car, truck, custom-styled car, hot rod... at **LOWEST PRICES!** Save up to 50% on all parts, accessories! Only complete automotive buying guide... 50,000 items... 148 pages! Thousands of **hard-to-find parts**; equipment, parts for 1920 to 1955 models; **Hollywood accessories** never before offered; **hi-speed parts**. Send your name and address and 25c (refundable with first \$5.00 order) to:

J. C. Whitney & Co., 1917 Archer, Dept. P-3, Chicago 16, Ill.



**Only 15¢**

**BRINGS YOU PLANS FOR  
A PROFITABLE HOBBY**



"A Ton of  
Strength in  
Every Drop"

For only 15c receive a remarkable set of Rogers Project Plans along with a full jar of Rogers Glue. With these plans you can make beautiful furniture for your home, useful household articles, toys for the children. And with Rogers Glue — the glue with the mighty grip — every joint will be firm and solid. Use Rogers Glue to mend broken articles, too — it's easy to use — does a lasting repair job. Write today for this Special Offer, enclosing 15c. Rogers Isinglass & Glue Co., Gloucester, Mass. Ask for Rogers Glue at your local hardware store.

**ROGERS**

the best LIQUID FISH GLUE  
GLOUCESTER, MASS.



**SPUTTERBUG**

**NEW FLASHY, NOISY  
FLOATING LURE**



Big head spinner makes terrific surface noise — really wakes up the big ones. Many sound and action effects. 9 colors. 5/8 or 1/4 oz. \$1.35 ea.

WRITE FOR  
CATALOG

FRED ARBOGAST CO., INC., 2203 W. North, Akron, O.

**NEW DRILL PRESS STOP**



Fast, effortless, positive locking, micro adjusting. Patented stop accurately set in 12 seconds with one hand. Replace the slow moving, inaccurate, poor locking stop, now on "your" drill press in less than 1 minute.

Delta 15".....\$3.50 Craftsman 15".....\$3.95  
Walker Turner 15" \$3.50 Royal 15".....\$3.95  
Atlas 15".....\$3.95 South Bend 14" \$3.95

Dealers and machine tool manufacturers inquiries invited.

Postage paid except on COD'S. Models for other makes. Send for literature.  
**RICHMOND MACHINE PRODS. CORP.**  
Dept. M-3, 276 Rose Avenue  
Staten Island 6, N. Y.

**Say You Saw It in Popular Mechanics**

**RADIO CONTROL YOUR MODEL**

**PLANES  
BOATS  
CARS**

"CUSTOM ONLY  
MIDGET" **\$9.98**  
RADIO

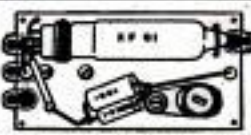

**LICENSE FREE BAND**  
OPERATES SAME AS \$50.00 SETS. INCLUDES 50MG RANGE TRANSMITTER RADIO, RECEIVER RADIO AND CONTROL ACTUATOR ALL 3 EASY ASSEMBLY WITH OUR PARTS AND PLANS \$9.98. PLANS ALONE \$1.

DETAILED INFORMATION 25c

& RADIO CATALOG \$2.50

SPECIAL "SUPPLY SOURCE DIRECTORY" & \$7.00 SUPPLY COUPON... \$1.00

BOOK "RADIO CONTROL OF MODEL AIRCRAFT" CONTAINS 14 PLANS \$3.98

RADIO CONTROL GARAGE DOOR BELLS..... \$1.00

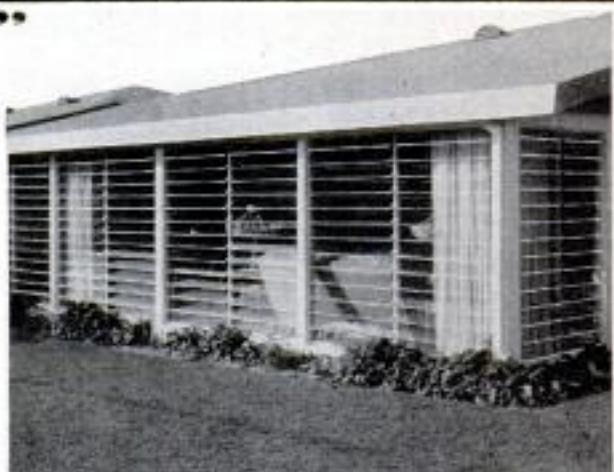

**Build Your "Dream Porch"**

Now, you can do-it-yourself with low-cost SUN-SASH Louvred Windows. They fit any size opening and are installed easily, inexpensively in a matter of minutes. You'll have a cool porch in summer; an extra room for winter use. Send for our free booklet, "Louvred Window Ideas" illustrating over 50 ways to use SUN-SASH for every room in your home.

**Mail  
Coupon  
Today!**

**SUN-SASH Company, Dept. PM-3  
38 PARK ROW, NEW YORK 38, N. Y.**

Name.....  
Address.....  
City..... State.....



## PORTABLE LIGHT PLANTS

### GIANT 2000-2500 WATT PLANT

110-120 v. 60 cyc. AC. absolutely the best made — exclusive dynamically balanced armature; heavy windings develop up to 5000 watt overload for motor starting. Skid mounted — portable. Powered by an easy starting Briggs or Wisconsin 6 HP engine—complete with all accessories engine easily disconnected for other uses. Big outlet box, voltmeter, no wiring necessary. Ample current for all purposes. Factory warranty. (Item 31) Wt. 210 lb. Reg. price \$385. Special at..... **\$299.50**  
Same plant with electric self starter (Item 31a)..... **\$359.50**  
Generator only and control box..... **\$169.50**  
**DUAL VOLTAGE** 110-220 available on any of above models for \$28.00 additional.

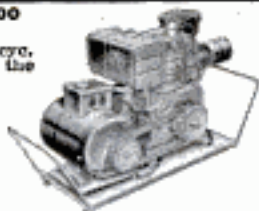

## BUY DIRECT FROM FACTORY SAVE MIDDLEMAN PROFITS

(Item 24)



### 600-700 WATTS PUSH BUTTON START

115 v. 60 cyc. AC. Powered by a rugged 2 HP easy starting Briggs engine. No wiring necessary! Just plug in and operate. Plenty of current for any oil burner, freezer, brooder, emergency lights, etc. which require

up to 700 watts. Ideal for television and radios. Complete with Voltmeter and built-in winding to charge 6 v. auto batteries. (Item 24.) Wt. 75 lbs. Easily fits in car trunk. Be prepared if storm knocks out power lines. Reg. \$275 value..... **\$143.50**

**1000-1200 Watt Plant (Item 45) same as Item 24 but larger generator and engine..... \$199.50**

**LITTLE GIANT—350 WATT (Item 27)** 115 v. 100/150 up. Briggs engine. Perfect for lights, radios, chain saws and power tools. Wt. 65 lbs..... **\$99.75**

**PORTA-POWER 1500-1750 Watt Plant** 115/130 v. 60 cyc. AC. Push button start. Powered by a 4.6 HP Briggs engine. Combines compactness and easy portability with higher output for handling heavier starting loads. Ideal for operating oil burners, sump pumps, freezers, telephones, lights, communication systems, etc. Perfect for contractor's power tools. (Item 20). Wt. 145 lbs. Factory Special Price..... **\$279.50**



(Item 20)

**MASTER-LITE 2500 Watt Plant** 110/120 v. 60 cyc. AC. A powerful plant, ruggedly constructed and yet designed for easy portability. Can be started by rope or built-in 12 v. electric push button start. Built-in winding to charge battery. Powered by a big 5.10 HP Briggs engine, complete with all accessories. Includes control box, voltmeter, and handy plug-in power receptacle. An ideal plant for permanent or stand-by service. Wt. 295 lb. Reg. price \$645.00 **\$329.50**  
(Item 21) Factory Price..... **\$329.50**  
Dual Voltage 110/220 available for above plant for \$30.00 additional.



(Item 21)

**3500 Watt Plant Push Button Start (Item 23)** 115 v. 60 cyc. AC. Similar to above, but larger and 33% more capacity. Wt. 270 lbs. Reg. \$760. Factory Price..... **\$379.50**  
**3500 Watt Dual Voltage Model**—Similar in design to Item 21 above, but with 110/220 v. wire output. Affords choice of either 110 or 220 volts. (Item 23 d.v.)..... **\$409.50**  
We make fully automatic controls to operate any of the above light plants. Write for details. We make all sizes up to 25,000 Watts.

### EXTENSION CORD

Heavy duty and very flexible. Neoprene 14-2 cable. 20 year quality. Wt. 12 lbs. (Item 185) 100 ft. Complete with rubber plug and outlet. A ter. sand rifle buy it only **\$8.95**  
**NO. 12-2 POWER CABLE.** Very flexible rubber covered, special outside shield for grounding power tools, etc. 50 ft. (Item 199) Wt. 8 lbs. **\$6.95.** 100 ft. (Item 200)..... **\$12.95**



### MASTER AIR COMPRESSOR

**COMPARE! This is the only compressor built with a NO RUST stainless steel tank. Safe up to 500 lbs. (Item 208a) High pressure type 14 c.f.m.) Large volume of air for heavy duty service. For paint spraying, inflating truck & auto tires, greasing, sand blasting, etc. Piston type 2" bore compressor with built-in air filter. Master built with high strength alloys and precision bearings. Tank. 12"x24", 2100 cu. in. cap. Equipped with automatic switch that starts and stops motor to maintain desired pressure (up to 150 lbs.) and check valve, safety valve, gauge, shut-off valve, 20 ft. air hose and tire chuck. Beautifully balanced on ball bearing wheels and rubber tires. Don't take chances with used or surplus equipment. Our compressors are factory new and are guaranteed SAFE. Low factory price. 1 1/2 HP Model (cap. 85 lbs.)..... **\$109.50**  
Reg. \$175. (Item 209p)..... **\$129.50**  
1 1/2 HP Model—Heavy duty 3 1/2 motor with unloader switch. (Cap. 150 lbs.) (Item 209a)..... **\$129.50****



Tank Tested up to 500 lbs. per sq. in.

## LESS THAN WHOLESALE

### DIESEL LIGHT PLANT

(Item 1600) Diesel Master—11-12 kw. 110/220 v. AC single or 3 phase. 1800 rpm direct connected. Electric Self-starting. Engineered for permanent power where continuous low-cost, heavy duty service is important. Wt. 1350 lb. Reg. list \$3450.00. Factory price..... **\$1895.00**

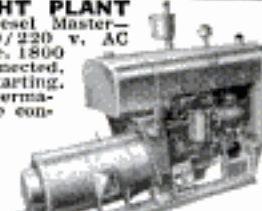

(Item 1600)

**GAS DRIVEN PLANT.** 10-11 kw. 115-230 v. 60 cyc. AC. single or 3 phase, powered by 4 cylinder Wisconsin air cooled engine. Belt driven. Simple, reliable. 5 V-belt drive mounted on rugged steel acid. (Item 217) (with crank start) Wt. 980 lb. Factory price..... **\$1075.00**  
Same plant with self-starter..... **\$1145.00**

### CONDITIONAIRE BARN FANS

Save big money installing your own barn ventilating fan. Efficient propeller type blade moves huge volume of air quietly and effortlessly. Heavy welded frame—pre-drilled for easy installation. Just cut opening and bolt in place. Continuous duty motor. Ideal for keeping barns and chicken houses dry and ventilated. Control manually or with thermostat.



Blade Opening CFM	Wt.	Item	\$27.95
16" 1814"	2025 19 lb.	305a	\$27.95
18" 1914"	3600 27 lb.	345b	\$31.95
20" 2114"	5100 30 lb.	365c	\$39.95

**THERMOSTATS: BARN type (range 40°-60°). Wt. 2 lbs. \$6.95.**

### HI-FLO Centrifugal PUMP

Completely self-priming! No foot valve required. Tremendous capacity—100 gal. per min. 1" Special impeller enables pump to handle muddy or sandy water. Simple to operate—simply start engine and watch the water go. Powered by a rugged, easy-starting 2 HP Briggs engine. Pre-lubricated sealed bearings for years of heavy low-cost service. Big 1 1/2" Model. Item 505. Wt. 20 lbs. **\$134.50**  
Factory price..... **\$134.50**  
2" Model (150 gal. per min.) with 2 1/2 HP engine. Item 502a. 90 lbs. Fact. Spec. **\$154.50**



### 9 TON HYDRAULIC PRESS

A tremendously powerful hydraulic press, capable of exerting 18,000 lbs. pressure. Pays for itself many times over—straightening bent connecting rods, king pins, crank shafts, axles, link pins and bars—or pushing out frozen bearings and bushings. Developed pressure under precise control and visible at all times on accurate gauge. Complete with both large and small anvils and dies to straighten any kind of curve or bend. (Item 464) Wt. 110 lb. Actual list price \$365. Our special close-out price..... **\$69.50**



### SELF-PROPELLED MASTER GARDENER

It's a rotary tiller It's a lawn mower  
It's a power sickle It's a bulldozer  
It's a cultivator It's a snow blower

**NEW! with power reverse—improved, Master Gardener with new extra power and a full gear transmission—providing forward, neutral and Power Reverse! Works for you the year 'round. Prepares mellowed deep seed beds without labor. Built-in power take-off to drive pump, saw, generator, etc. Safety clutch—can't burn out. Has independent clutch on tiller. New gear tread tires assure non-slip traction.**

drive. Performs better—does more than tractors costing twice as much. Converts in minutes to Tiller, Sickle, Power Mower, Snow Blower, etc. Basic self-propelled tractor with famous 2 1/2 hp. Clinton engine complete with rewind starter. Wt. 110 lbs. **\$129.00**

Cultivator..... **\$18.75** Rotary Tiller..... **\$49.95**  
Furrowing Plow..... **\$3.75** Disc Harrow..... **\$5.75**  
Snow Blow..... **\$32.50** Bump wheel barrow..... **\$9.50**  
Rotary Lawn Mower..... **\$39.50**  
Sickle Bar Mower..... **\$9.50**  
Lawn Mower Hitch..... **\$4.75**

Easy payment plan available. Freight paid east of Rockies—half paid elsewhere.

### JET STEAM MASTER

Now, a super efficient portable steam generator that produces live steam at 100 lbs. pressure in 60 seconds from a cold start! Produces large volume of high pressure steam on 2 pints of fuel oil. Instantly cleans sticky grease, dirt, rust, old paint, etc. oil implements and road machinery. Pays for itself in a few weeks. Sterilizes soil. Sterilizes as it cleans—milk equipment, etc.

Fully automatic—oil fired with new, built-in lifetime bronze water circulating pump. Draws water from faucet or bucket. Simple and safe—anyone can use it: built-in safety valve. Complete with 12 ft. of high-pressure steam hose and new triple efficiency steam gun that automatically mixes in soap solution if desired. Wt. 250 lbs. Item 463. **\$329.50**  
Special factory price..... **\$329.50**

### 52 pc. SOCKET SET

Highest quality, guaranteed non-breakable sockets made by Husky. Beautifully matched chrome thin wall alloy absolutely the best. Contains a complete set of 24 sockets in 1/2" drive, 3/4" drive and 1 1/4" drive, plus all necessary extensions, handles, speeders, reversible ratchets, etc.; all uncracked, guaranteed against breakage. A beautiful set of tools that will handle any job in a big doghouse steel box. Wt. 17 lbs. (Item 205) **\$27.95**  
List price \$62.90. Factory special..... **\$27.95**

### 44 Pc. SOCKET SET

(Item 508) Same unconditionally guaranteed, non-breakable sockets as above. Complete range of 21 sockets from 1/4" thru 7/16" (1/4" drive) & 7/16" thru 1-1/16" (1/2" drive). Two extensions, reversible 1/2" ratchet, 3 drift punches, sliding "T" head, all angle coupling, 1 1/2" speeder, 1 1/4" breaker, 5 pc. high chrome alloy combination wrench set and 8 pc. offset wrench set in big doghouse tool box with ample room for other tools. Reg. \$49.50. Wt. 10 lb..... **\$21.95**



Send check or M.O. Prites L.o.b. Factory. 10 day Money back guarantee. SEND 10c for... **BIG 1955 Catalog**

**MASTER MECHANIC MFG. CO., DEPT. EMK Burlington, Wis. WELDING KIT** Two 10 ft. leads, welding helmet, electrode holder, ground clamp. Sold only with welder at..... **\$10.50**





THE  
**BASIC**  
SHOP TOOL

9" x 3' Model C Bench Lathe \$211 f.o.b. factory. Time payment terms available.

## 9" SOUTH BEND LATHE

This South Bend 9" Precision Lathe is the basic tool for your shop. It enables you to perform accurately the same full range of operations done on South Bend Lathes in industry. Also, operations ordinarily performed on other machine tools are made possible through the use of efficient attachments. You get more for your money in a South Bend 9" Lathe.

Write for catalog — see local distributor — look under "Machine Tools" in your classified telephone directory.

**NEW 14" DRILL PRESS**—a ruggedly built tool unsurpassed for accuracy and dependability. Prices start at \$87, f.o.b. factory.

*Write for catalog.*



**SOUTH BEND LATHE WORKS**

*Building Better Tools Since 1906*

455 EAST MADISON STREET, SOUTH BEND 22, INDIANA

A Few of the Many  
Operations You Can Perform



TURNING

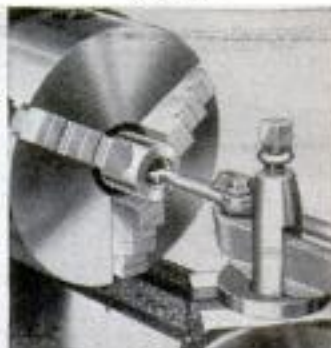

BORING



THREADING



FACING



MILLING



GRINDING



TAPER TURNING



WOOD TURNING





some people have the most fun!

ISN'T IT THE TRUTH! Some folks with modest budgets have more fun than millionaires. Boating families particularly—and Evinrude families *most* of all! For Evinrude has brought something entirely new and wonderfully enjoyable to outboard boating... quiet, vibrationless *Whispering Power!* You ride in *quiet*, for annoying engine noises are cancelled at their source. You ride in luxury—the luxury of utter *smoothness*—with all vibration isolated from your boat. There's motor car handling ease—and even finger-touch electric starting if you wish! SEE YOUR EVINRUDE DEALER—look for his name under “Outboard Motors” in your phone book. He will gladly help you choose the right *Whispering Power* model for any type of boat. **FREE!** Write for full-color catalog of the complete Evinrude line. Mention if you'd like us to include the Evinrude “How to” Book of Outboard Cruising. EVINRUDE MOTORS, 4573 N. 27th St., Milwaukee 16, Wisconsin.

*Evinrude Division of Outboard, Marine & Manufacturing Company.*  
In Canada, Manufactured by Evinrude Motors, Peterborough.



*all are quiet!*

- ELECTRIC BIG TWIN Aquazonic**, 25 h.p.\*  
The *proved* electric starting outboard. \$525†
- BIG TWIN Aquazonic**, standard model. \$430
- FASTWIN Aquazonic**, 15 horsepower. \$347
- FLEETWIN Aquazonic**, 7½ horsepower. \$235
- LIGHTWIN with Fisherman Drive** \$145

\*All ratings OBC certified at 4000 RPM tested in conformity with SAE test code. †Prices F.O.B. factory subject to change without notice.

**Evinrude**

Pioneers in **quiet** Outboard Motors

Copyrighted material



For more pure pleasure... **have a Camel!**



*No other cigarette is so  
rich-tasting, yet so mild!*

● At a time when smokers are choosing their brands more carefully than ever, Camels continue to give more smokers more pure pleasure than any other brand. Clearly, you ought to try Camel's richer blend of mild, costly tobaccos!

"Camels sure agree best with me!" says

*Douglas Leigh*

Douglas Leigh, famous creator of giant Broadway spectacles.

"For 17 years now, I've enjoyed the smooth mildness and good, rich taste of Camels. To me there's just no other brand for mild, flavorful smoking!"



R. J. Reynolds Tobacco Co., Winston-Salem, N. C.

**Make the 30-Day Camel Mildness Test**

Smoke only Camels for 30 days. Find out for yourself how mild, how rich-tasting a cigarette can be!

