



ANNUAL AUTO SECTION

POPULAR MECHANICS

MAGAZINE

WRITTEN SO YOU CAN

FEBRUARY 1955
35 CENTS



PAGES ABOUT CARS —
THE '55 MODELS ON REVIEW ...
PAGE COLOR STORY ON STYLING
ARE FOREIGN CARS BETTER
ENGINEERED?... OWNERS REPORT
COSTS OF OPERATION



QUIET, EVERYBODY... IT'S THE YEAR'S BIG NEWS



1955 SEA-HORSES

SEA-HORSE 25	Electric Starting . 25 hp . .	\$525.00
SEA-HORSE 25	25 hp . .	\$430.00
SEA-HORSE 10	10 hp . .	\$310.00
SEA-HORSE 5½	5½ hp . .	\$210.00
SEA-HORSE 3	3 hp . .	\$145.00



Prices f.o.b. factory, subject to
change. All ratings are OBC
certified brake hp. at 4000 rpm.

For 1955 Johnson presents Suspension Drive in the *new* Sea-Horse 10, the *new* Sea-Horse 25 and the *new* Electric Starting 25. Like the sensational Sea-Horse 5½, which was awarded a special citation by the National Noise Abatement Council, these motors are *float*ed in their stern brackets. They're *quiet*. Vibration disappears—and your hull rides the water with thrilling new smoothness... Your Johnson Dealer will show you. Look for his name under "Outboard Motors" in your classified phone book.

FREE! New Sea-Horse catalog gives complete details. All models fully described. Write for your copy.

JOHNSON MOTORS, 400 Pershing Road, Waukegan, Illinois
In Canada: Mfd. by Johnson Motors, Peterborough

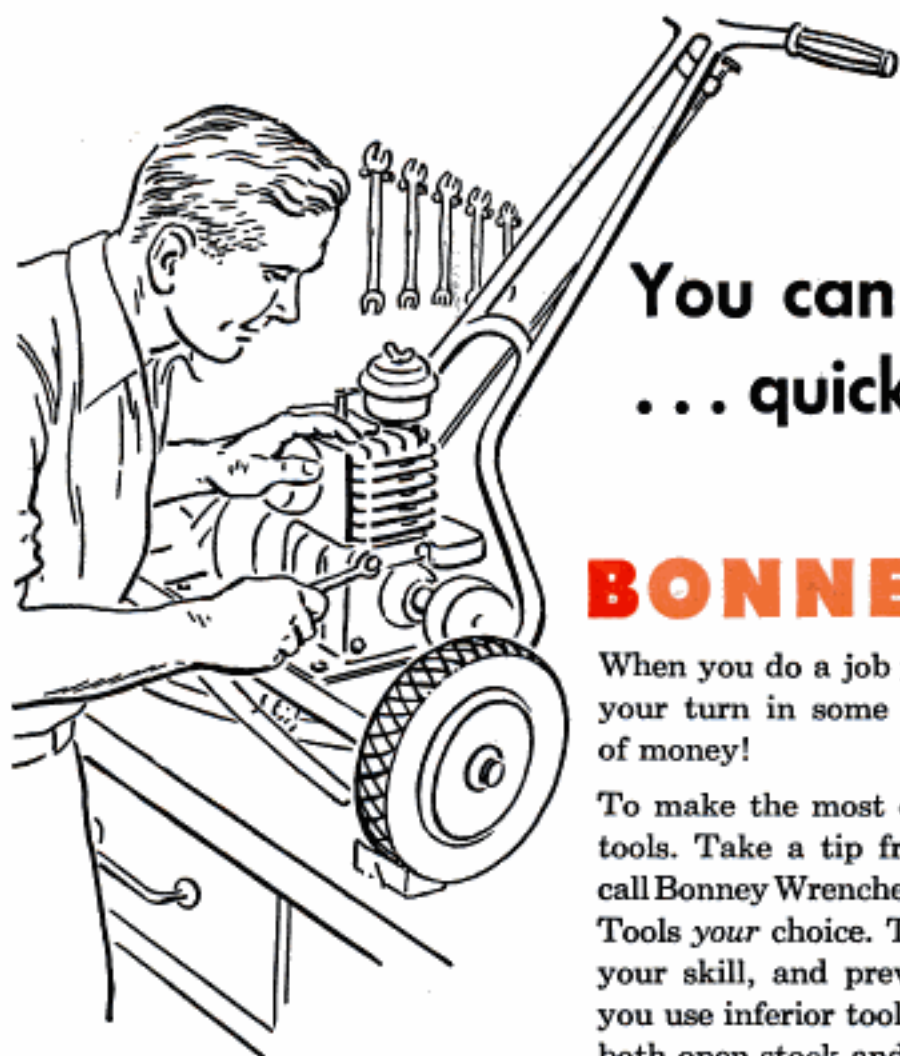
 **Johnson** SEA-HORSES
FOR DEPENDABILITY



You can do it yourself
 ... quicker and better
 with
BONNEY TOOLS!

When you do a job yourself, you don't have to wait your turn in some busy shop; and you save a lot of money!

To make the most of these advantages, use *quality* tools. Take a tip from professional mechanics who call Bonney Wrenches America's finest—make Bonney Tools *your* choice. They help you make the most of your skill, and prevent injuries that happen when you use inferior tools. Bonney Tools are available in both open stock and complete sets. Ask your dealer, or write us direct.



**Start your collection of FINE TOOLS
 with this BONNEY A8 SOCKET SET!**

Here's the most practical basic socket set for home and shop. Contains twelve of the most useful $\frac{1}{2}$ " square-drive double-hex sockets, together with a 15" hinge handle and an 8" cross handle. Helps you make quick work of repairs on lawnmowers and garden tractors, automobiles, washing machines, and other household appliances.

Note! The economy-minded home mechanic or hobbyist will find Bon-E-Con Tools especially suited to his requirements. They are tools any man would value at prices anyone can afford. Bon-E-Con Tools carry the same guarantee as Bonney.



BONNEY FORGE & TOOL WORKS, ALLENTOWN, PENNSYLVANIA

FEBRUARY 1955

This one



6H03-OH3-CFQ0

1955 MERCURY

*Features the World's Most
Modern Spark Plugs . . .*

NEW TURBO-ACTION CHAMPIONS!



Greater clearance in the firing end permits turbulent gases to keep the insulator free of harmful deposits. Heat range, the temperature zone in which spark plugs operate efficiently, is extended to the widest limits in automotive history.

Exclusive, tapered Turbo-Action seating design forms a positive lock with a mating surface in the cylinder head without use of a gasket. Correct installation is automatic and Turbo-Action spark plugs remain firmly fixed and accurately positioned in the combustion chamber.

More evidence that the new **TURBO-ACTION** Champions are the spark plugs in your future:

Another producer of great motorcars—Mercury—now features these sensational new spark plugs as standard equipment on its power-packed 1955 models!

Champion **TURBO-ACTIONS**—with the widest operating range in automotive history—allow you to enjoy to the fullest extent the benefits of sharply increased compression ratios and horsepower of advanced-design power plants. And they supply the entire automobile industry with a key to increased efficiency for engines of the future.

The **TURBO-ACTION** principle involves a larger thread size and an exclusive seating arrangement without gaskets. Thus, these new Champions can be installed only in ultra-modern engines designed to use them.

Your present car will continue to give you peak performance with regular Champions.

With the new **TURBO-ACTION** Spark Plug, Champion once again demonstrates the leadership which makes Champions the first choice of motorists everywhere.

AT ALL LINCOLN, MERCURY AND OTHER CHAMPION DEALERS

CHAMPION SPARK PLUG COMPANY, TOLEDO 1, OHIO

The **FACTS** behind Ford's new Trigger-Torque Power

The world's greatest builder of V-8's brings you all the advantages of high-torque "Go" in 3 new and mighty engines for 1955!

FOR YOUR CAR to do all the things you want it to do—and do them well—it must have the ability to deliver just the right amount of "push" at the rear wheels when you need it. That "push," of course, is the direct result of engine *torque*. And Ford's new engines are capable of delivering much higher torque throughout the full range of driving speeds. The result is new Trigger-Torque power with trigger-quick response available to you in any traffic situation. On the highway, too, you'll pass with the confidence that you've got power to spare.

Ford's many new engine advances make this Trigger-Torque power possible. For example, all '55 Ford engines have higher compression ratios which mean greater efficiency. There are new free-flow induction systems for full breathing and even distribution of fuel. There are brand-new, deposit-resistant turbo-action spark plugs . . . and improved turbo-wedge combustion chambers for more efficient mixing and burning of the fuel-air charge.

In addition, there's Ford's traditional rigid deep-block construction for longer life and smoother operation. There's Ford's famous low-friction design for less wear and more economical use of gas. And every Ford engine features the exclusive power-boosting, fuel-saving Automatic Power Pilot.

NEW 162-h.p. Y-BLOCK V-8

If you haven't driven Ford's new, more powerful Y-block V-8 yet, you're in for some thrilling surprises. For this engine, with its greater displacement (the highest in Ford's field) and higher compression, is another engineering triumph from the world's leading builder of V-8's. In all Fairlane and Station Wagon models, this new engine has a dual exhaust system that reduces back pressure . . . releases more usable power to the rear wheels.

NEW 182-h.p. Y-BLOCK SPECIAL V-8

If you want even greater Trigger-Torque performance you can have Ford's Y-block Special V-8. It's available on all Fordomatic-equipped Fairlane and Station Wagon models. The compression ratio is 8.5 to 1. And the 4-barrel carburetor *really* opens up when you need GO. An "extra" pair of barrels boosts the flow of fuel-air mixture as needed to meet acceleration demands . . . cuts out automatically when a steady speed is resumed.

NEW I-BLOCK SIX

If you prefer sixes, Ford's new I-block Six is America's most modern. It's the only short-stroke, low-friction six in the industry today. And with its higher compression ratio and its improved carburetion system you get higher torque at all driving speeds.

WHY NOT MAKE YOUR OWN TEST DRIVE, THIS WEEK

3 MIGHTY ENGINES FOR 1955



162-h.p. Y-block V-8
272 cu. in. displacement,
7.6 to 1 compression ratio.



182-h.p. Y-block Special V-8
272 cu. in. displacement,
8.5 to 1 compression ratio.



120-h.p. I-block Six
223 cu. in. displacement,
7.5 to 1 compression ratio.

All 3 new Ford engines have these important advances

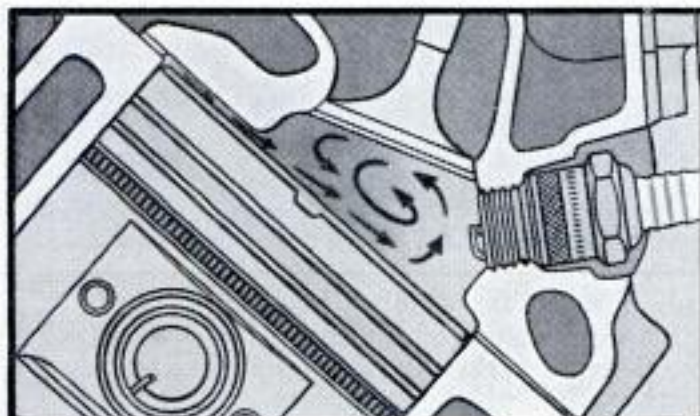

Turbo-Wedge Combustion Chambers are wedge-shaped to swirl fuel and air into a uniform mixture for efficient combustion.

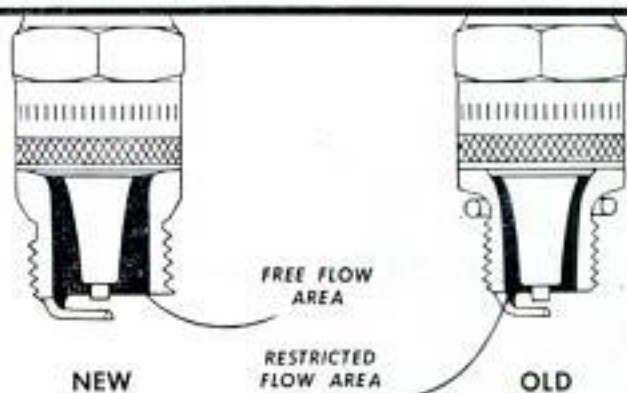

New Turbo-Action Spark Plugs (a Ford "first") resist formation of deposits up to three times as long as conventional plugs.

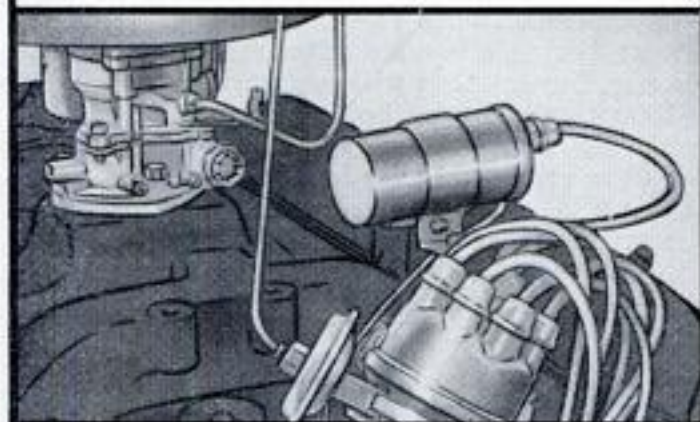

Automatic Power Pilot makes sure just the right fuel-air mixture is ignited at just the right instant to give you more "GO"!

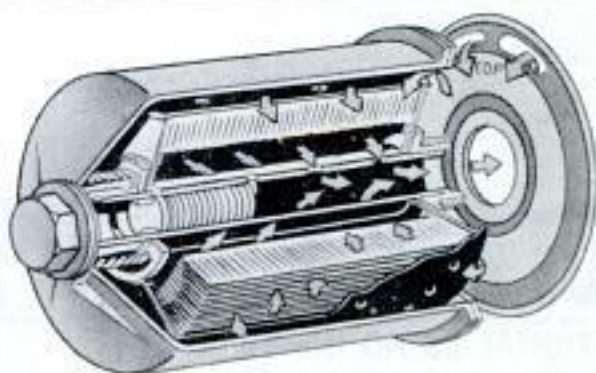

Full-Flow Oil Filter, available on *all* Ford engines, cleans *all* the oil *all* the time . . . protects bearing surfaces from harmful abrasives.

This **FREE SAMPLE LESSON** will prove you can become an expert **BOOKKEEPER... ACCOUNTANT** OR **C.P.A.**

FREE SAMPLE LESSON

We offer you this free sample lesson so that you can prove to yourself that you CAN master Accountancy—quickly, thoroughly—in spare time at home.

You will see exactly how LaSalle's famous "Problem Method" works . . . how you are led step-by-step through actual accounting work—learning by doing and not by study of theory alone. First you tackle easy problems, then more difficult ones—until soon you master them all. And at every step you have the close personal guidance of LaSalle's large staff of C.P.A. instructors.

**Nearly 10%
of all C.P.A.'s
in the U.S. have
been trained by the
LaSalle Problem
Method**

GOOD-PAY JOBS IN 5 BIG FIELDS

If you were an expert accountant right now, chances are you would find yourself among the highest-paid of all professional men and women. Surveys show that accountants earn more than those in other major professions.

There are five big fields of opportunity open to Accountancy-trained men and women . . . opportunities that are wide open and highly inviting, offering maximum income and job security in good times or bad. And under LaSalle's "Problem Method" you can start earning while still learning—either in spare-time or full-time employment . . . or in business for yourself with no capital required.

Get the latest information by sending for our 48-page book, "Accountancy, the Profession That Pays" . . . plus free sample lesson. The coupon at right will bring both to you without cost or obligation. LaSalle Extension, 417 S. Dearborn St., Chicago 5, Ill.

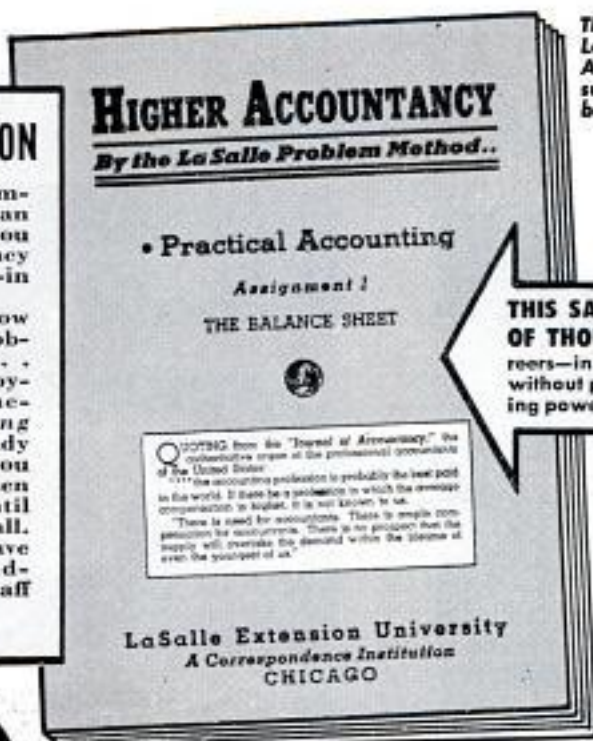

This well-paid LaSalle-trained Accountant's success could be yours.



THIS SAME LESSON HAS STARTED HUNDREDS OF THOUSANDS toward well-paid accounting careers—in business, government, and as C.P.A.'s. Even without previous knowledge, progress is rapid—earning power climbs fast. This sample lesson shows why.

If you have been envying the high incomes and good jobs enjoyed by thousands of men and women Accountants today . . . incomes ranging from \$4,000 to \$10,000 and more per year . . . why not launch such a career for yourself?

Do you doubt that you can?

Then let us send you—without cost or obligation—the same Lesson Number One with which LaSalle

has started several hundred thousand men and women toward successful accounting careers. We want you to see for yourself how this remarkable method, originated by LaSalle, makes Accountancy simple, interesting, practical, and certain . . . how it leads you step-by-step to a complete mastery of Accounting—and on up to the coveted degree of Certified Public Accountant if you so aspire.

It doesn't matter whether you've had previous bookkeeping experience, or whether you don't know a debit from a credit. Whether you wish to qualify as an expert bookkeeper, advanced accountant, cost accountant, auditor, government accountant, income tax specialist, or public accountant . . . you'll find in LaSalle's Problem Method the exact plan to prepare you rapidly and inexpensively—in spare hours at home—without losing a day from your present job.

So right now, today . . . if you are an adult, employed, and earnestly ambitious for rapid advancement in this highest-paying of all professions . . . send your name and address on the coupon below. We'll send the free sample lesson—plus our 48-page book outlining today's career opportunities and how you can qualify for them. A coupon like this has started many thousands toward greater success. It can do the same for you. Mail it today!

Clip Coupon . . . Mail TODAY!

LaSalle Extension University . . . A Correspondence Institution
Dept. 264H, 417 S. Dearborn Street, Chicago 5, Illinois

YES, I want to see how LaSalle's "Problem Method" works . . . how I can qualify for high-pay Accountancy positions. Send Free Sample Lesson—also your 48-page book, "Accountancy, the Profession That Pays" . . . all without cost or obligation.

Name Age

Street Address

City, Zone & State

Present Position



AFTER SHAVING
**Dims Shine
 Feels Fine
 Doesn't Show**



Also available
 in Canada

Finishing touch for every shave!
 Neutral tint - crisp scent!

MENNEN
 AFTER-SHAVE TALC
FOR MEN

(Continued from page 6)

the nail. Congratulations to *Popular Mechanics* and to Mr. Haan.

J. R. Smolenske,
 Advertising Manager,
 Western Division,
 Colorado Fuel & Iron Corp.,
 Denver, Colo.

To the Editor:

Enclosed you will find a photo of a mid-gut car I built for my children. I have made two others for customers. This little car



is approximately 90 inches long, 36 inches wide and 24 inches high. It has a three-horsepower Clinton motor with a centrifugal clutch. The speed is 20-25 miles per hour. The weight is approximately 325 pounds.

Samuel A. Moorehead,
 826 Ute Ave.,
 Akron 5, Ohio

Dispatch From Pago Pago

I have in the past sent you several articles to examine, but all of them were not of any interest to you. I am enclosing photos with an article on the same subject from our local paper. I just want you

(Continued to page 12)



PICK YOUR OWN SUCCESS STORY FROM THIS PAGE

These are the true stories of people who seemed trapped in routine, low-pay shaky jobs. Handicapped by lack of proper training, they couldn't get the things they wanted out of life—more money, a job they liked, security and happiness.

They are a small sample of the thousands of men and women—young and old—who turn to I. C. S. for help. Their will-to-learn plus I. C. S. training have changed the course of their lives.

Are you discouraged with your job and pay and feel you can't improve yourself because of lack of specialized education? Well, these men and women were in the same boat. With I. C. S. training, one of these success stories could be about you.

I. C. S. is the oldest and largest correspondence school. 277 courses. Business, industrial, engineering, academic, high school. One for you. Direct, job-related. Bedrock facts and theory plus practical application. Complete lesson and answer service. No skimping. Diploma to graduates.



Wins \$3000 contest—"After my I. C. S. courses I secured a new position," says Mr. Cecil Rhodes. "My income has more than doubled and I recently won a \$3000 sales contest."



From clerk to Assistant Estimator, thanks to I.C.S. "Any way you look at it," writes Mrs. Edna James, "the time and money one spends for I. C. S. Courses will be repaid a thousandfold."



"As a college graduate, I found I. C. S. very valuable." Robert Lee took the I. C. S. Course in Advertising, is now Promotion Manager for a large corporation. "I. C. S. got me started on the way up," he says.



From \$152 to \$395 a month—"I.C.S. made my engineering work more interesting," Frank Bachtik tells us. "I was a Jr. Draftsman making \$152 a month. My present income is \$395.25 a month."

3 FREE BOOKS—a 36-page pocket-size guide to advancement, a gold mine of tips on "How to Succeed." Also a big catalog outlining opportunities in your field of interest and a sample I. C. S. lesson text.

For Real Job Security—Get an I. C. S. Diploma! ... Easy-pay Plan ... I. C. S., Scranton 9, Penna.

INTERNATIONAL CORRESPONDENCE SCHOOLS

ICS

BOX 92299B, SCRANTON 9, PENNA.

(Partial list of 277 courses)

Without cost or obligation, send me "HOW TO SUCCEED" and the opportunity booklet about the field BEFORE which I have marked X (plus sample lesson):

ARCHITECTURE and BUILDING CONSTRUCTION

- Air Conditioning—Refrig.
- Architecture
- Architectural Interior
- Building Contractor
- Building Maintenance
- Carpenter and Mill Work
- Estimating
- Heating
- Painting Contractor
- Plumbing
- Reading Arch. Blueprints

ART

- Cartooning
- Commercial Art
- Fashion Illustrating
- Magazine Illustrating
- Show Card and Sign Lettering
- Sketching and Painting

AUTOMOTIVE

- Auto Body Rebuilding
- Auto Elec. Technician
- Auto-Engine Tune Up
- Automobile Mechanic

AVIATION

- Aeronautical Engineering Jr.
- Aircraft & Engine Mechanic

BUSINESS

- Advertising
- Bookkeeping and Accounting
- Business Administration
- Business Correspondence
- Public Accounting
- Creative Salesmanship
- Federal Tax
- Letter-writing Improvement
- Office Management
- Professional Secretary
- Retail Business Management
- Sales Management
- Stenographic-Secretarial
- Traffic Management

CHEMISTRY

- Analytical Chemistry
- Chemical Engineering
- Chem. Lab. Technician
- General Chemistry
- Natural Gas Prod. & Trans.
- Petroleum Engineering
- Plastics
- Pulp and Paper Making

CIVIL, STRUCTURAL ENGINEERING

- Civil Engineering
- Construction Engineering
- Highway Engineering
- Reading Struct. Blueprints
- Sanitary Engineering
- Structural Engineering
- Surveying and Mapping

DRAFTING

- Aircraft Drafting
- Architectural Drafting
- Electrical Drafting
- Mechanical Drafting
- Mine Surveying and Mapping
- Plumbing Drawing and Estimating
- Structural Drafting

ELECTRICAL

- Electrical Engineering
- Electrical Maintenance
- Electrician Contracting
- Lineman

HIGH SCHOOL

- Commercial Good English
- High School Subjects
- Mathematics

LEADERSHIP

- Foremanship
- Industrial Supervision
- Leadership and Organization
- Personnel-Labor Relations

MECHANICAL AND SHOP

- Gas—Electric Welding
- Heat Treatment Metallurgy
- Industrial Engineering
- Industrial Instrumentation
- Industrial Supervision
- Internal Combustion Engines
- Machine Design-Drafting
- Machine Shop Inspection
- Machine Shop Practice
- Mechanical Engineering
- Quality Control
- Reading Shop Blueprints
- Refrigeration
- Sheet Metal Worker
- Tool Design Toolmaking

RADIO, TELEVISION

- Industrial Electronics
- Practical Radio TV Eng'ng
- Radio and TV Servicing
- Radio Operating

TELEVISION Technician

- RAILROAD
- Air Brakes Car Inspector
- Diesel Locomotive
- Locomotive Engineer
- Section Foreman

STEAM AND DIESEL POWER

- Combustion Engineering
- Diesel—Elec. Diesel Eng'g
- Electric Light and Power
- Stationary Fireman
- Stationary Steam Engineering

TEXTILE

- Carding and Spinning
- Cotton, Rayon, Woolen Mfg.
- Finishing and Dyeing
- Loom Fix'g. Textile Des'ing
- Textile Eng'g Throwing
- Warping and Weaving

MISCELLANEOUS

- Domestic Refrigeration
- Marine Engineering
- Ocean Navigation
- Professional Engineering
- Short Story Writing
- Telephony

Name _____ Age _____ Home Address _____

City _____ Zone _____ State _____ Working Hours _____ A.M. to P.M. _____

Occupation _____

Canadian residents send coupon to International Correspondence Schools, Canadian, Ltd., Montreal, Canada. . . . Special tuition rates to members of the U. S. Armed Forces.

Our 40th Year

NRI training is thorough, practical, up-to-date. When you enroll with NRI you benefit from our 40 years of successful experience training men at home.

J. E. Smith

President
National Radio Institute
Washington, D. C.



I'll Train You RADIO-

You Practice Broadcasting with Parts I Send

As part of my Communications Course I send you parts to build low-power Broadcasting Transmitter at left, and other equipment. Use it to get practical experience. You put this station "on the air," perform procedures demanded of station operators. An FCC Commercial Operator's License can be your ticket to a bright future. My Course trains you to get your license. Mail Coupon now!

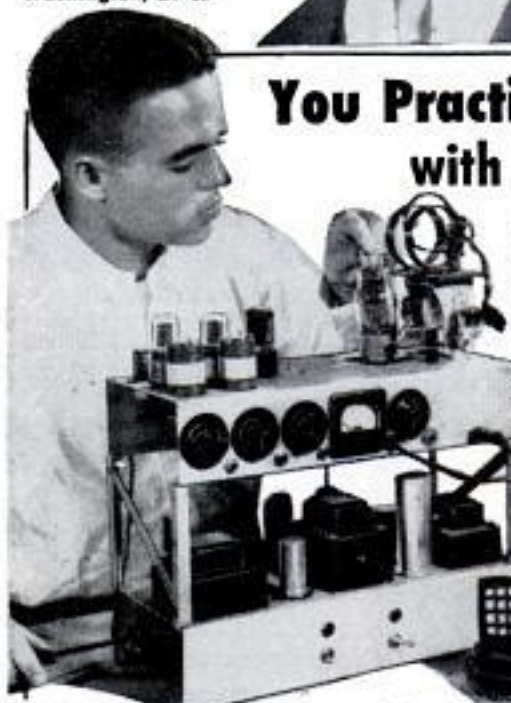

You Practice Servicing with Parts I Send

Nothing takes the place of PRACTICAL EXPERIENCE. NRI training is based on LEARNING BY DOING. You use parts I send to build many circuits common to Radio and TV. You build the modern radio at right. Use Multi-tester you build to make money fixing sets. Many students make \$10, \$15 a week extra fixing neighbors' sets in spare time, starting soon after enrolling. All equipment I send is yours to keep.



Television Is Today's Good Job Maker

Television now reaches from coast-to-coast. More than 25 million Television sets are already in use and require servicing; thousands more sets are being sold every week. About 200 TV stations are now on the air with hundreds more being built. This means new jobs, more jobs, better pay for trained men. The time to act is NOW! Start learning Radio-Television servicing or communications.

Make Extra Money in Spare Time While Learning

Keep your job while training. Many NRI students make \$10, \$15 and more a week extra fixing neighbors' Radios in spare time. The day you enroll I start sending you special booklets that show you how to service sets. Multi-tester you build helps discover and correct Radio troubles, gives PRACTICAL EXPERIENCE on circuits common to radio and TV. Mail coupon today.

I Trained these Men at Home



Thanks
NRI for
Wonderful
Start

"Right now I am doing spare-time repairs on radios and television. In the near future I intend to go into full-time servicing."—C. Higgins, Waltham, Mass.



Switched
from Studio
Work to
Service

"I switched from studio work and am now holding a position as TV service technician. Enjoy my work more and more."—Norman Ward, Ridgefield Park, N. J.



Paid for
Course
Before
Graduation

"By the time I graduated I had paid for my course, a car and testing equipment. Can service toughest jobs."—E. J. Streitberger, New Boston, Ohio.



\$10 to \$15
Week
Spare Time

"Four months after enrolling, was able to service Radios . . . averaged \$10 to \$15 a week spare time. Now have full time business."—W. Weyde, Brooklyn, N. Y.



Employed as
Transmitter
Operator

"A former employer recommended NRI training to me. Now employed as transmitter operator in Harrisburg."—Albert Herr, New Cumberland, Penna.

AT HOME for Good Jobs in TELEVISION

There is Success-Good Pay-Security for You in America's Fast Growing Industry



NRI Training Leads to These Jobs in RADIO-TELEVISION

BROADCASTING
Chief Technician
Chief Operator
Power Monitor
Recording Operator

SERVICING
Home and Auto Radios
Television Receivers
P.A. Systems

MANUFACTURING
Design Technician
Service Manager
Tester
Research Assistant

SHIP AND HARBOR RADIO
Chief Operator
Radiotelephone Operator
Assistant Operator

GOVERNMENT RADIO
Operator in Army, Navy, Marine Corps
Airways Operator
Forestry Dispatcher

AVIATION RADIO
Transmitter Technician
Airport Transmitter Operator

TELEVISION
Pick-up Operator
Television Technician
Remote Control Operator
Service and Maintenance Technician

POLICE RADIO
Transmitter Operator
Receiver Serviceman



Chief Engineer with Station

"I received my License and worked on ships. Am Chief Engineer at WARA, Attleboro, Mass. I am grateful to NRI for preparing me for this position."—R. D. Arnold, Rumford, R. I.

Available to **VETERANS** under G. I. Bills

DO YOU want good pay, a job with a bright future, security? Would you like to have a profitable business of your own? If so, find out how you can realize your ambition in the fast-growing RADIO-TELEVISION industry. Even without Television, the industry is bigger than ever before. Just think, over 115 million home and auto Radios, 3000 Radio Broadcasting Stations, plus 25 million Television sets and about 200 Television Broadcasting Stations. Expanding use of Aviation and Police Radio, Micro-wave Relay, Two-way Radio for busses, taxis etc., are making opportunities for Servicing and Communications technicians and FCC Licensed Operators.

My Training Includes Television

You get practical experience by working on circuits common to both Radio and Television. My graduates are filling jobs, making good money in both Radio and Television. Many NRI trained men start their own Radio and Television servicing business with capital earned in spare time. Let me show you how you can be your own boss; earn \$10 to \$15 a week extra even while still learning. Now is the time to get ready for success in Radio-Television. Coupon below brings you Actual Lesson and 64-page book.

Find Out What Radio-Television Offers You

What will YOU be doing one year from today? Decide now that you are going to know more and earn more. ACT NOW. Send the coupon below NOW for my FREE DOUBLE OFFER. You get Actual Servicing Lesson. Also my 64-page Book, "How to Be a Success in Radio-Television." Read what my graduates are doing, earning, see equipment you practice with at home. Mail coupon now. Send in envelope or paste on postal. J. E. SMITH, President, Dept. SBA, National Radio Institute, Washington 9, D. C. Our 40th Year.

Actual Lesson and 64-page Book BOTH FREE

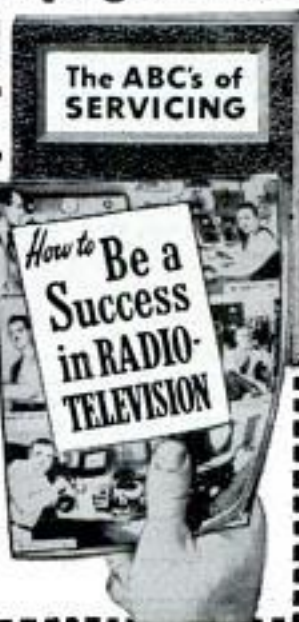

MAIL THIS NOW!

MR. J. E. SMITH, President, Dept. SBA
National Radio Institute, Washington 9, D. C.

Mail me Sample Lesson and 64-page Book, FREE. (No salesman will call. Please write plainly.)

Name.....Age.....

Address.....

City.....Zone.....State.....

VETS write in date of discharge.....

"APPROVED MEMBER, NATIONAL HOME STUDY COUNCIL."

How to Give Yourself a \$168-a-Month RAISE!

**READ THIS, THEN RUSH
THE COUPON TODAY!**

Here's good news for the man who wants to make an *extra* income in "off hours"! We'll set you up in a proven money-earning business at *no cost to you!* We've helped thousands succeed, and we would like to do it for YOU, too!



Can You Spare an Hour a Day?

We'll provide a complete Shoe Business Outfit absolutely *free* and *postpaid*... so you can run from your home the best "shoe store" business in your town! Use this Outfit to take just **2** orders a day from friends, neighbors, relatives, people where you work. Within a month you'll have **\$168 extra** income! An hour a day should be enough! James Kelly of Ohio took so many orders for these popular shoes that he made \$93.55 in just **ONE** evening! Fred Mape of Utah regularly makes \$5 to \$10 every hour he devotes to his Mason Shoe business! There's no limit on what you can earn because **EVERYBODY** wears shoes!

It's *easy* with our famous way of selling shoes. We carry the stock and ship the shoes. All you do is show the styles to people you know and take orders. You'll have a profitable business with no rent or other costs. You keep **100%** of your profit!

Here's Why You'll Make Money!

The demand for Nationally-Advertised Mason Shoes is greater than ever! Yet folks in your community *cannot buy Mason shoes in stores*. These fine shoes will be available *only* from you!

People will fill your pockets with cash again and again for Mason shoes. Steady cash profits every month! Here are five good reasons why: ● You offer **170** fast-selling styles... far more than a store! Take orders for smart **dress shoes**... **sporty casuals**, over 30 kinds of **work shoes**, 70 popular styles for **women!** ● You have an amazing range of sizes and widths—**2½ to 14—AAAA to EEEE**. Even hard-to-fit people can buy from you! ● Because we carry over 200,000 pairs in stock, your customers get **exactly** what they want... no misfits or substitutions! ● You feature exclusive **Velvet-eez** shoes with foamy-soft **air cushion innersoles** that let people "walk on air"—plus other special built-in-comfort features! ● You save customers money and shopping time!

You Get Starting Outfit FREE!

As soon as we receive the coupon we'll send you a Shoe Business Outfit **FREE!** It features the entire Mason Collection in full color, contains 10-second Air Cushion demonstrator, valuable how-to-make money Booklet, Measuring Board... everything else you need to start making cash profits from the first hour! We'll also show you how to earn monthly **Bonus Checks** and win costly prizes **FREE!**

Want to see how much money you can make? For a 2c postcard try it **NOW**... start your exciting business *right away!* **MASON SHOE MANUFACTURING CO.**, Desk MA-538, Chippewa Falls, Wisconsin.

Send For FREE OUTFIT!

Mr. Ned Mason, Vice President
MASON SHOE MFG. CO., Desk MA- 538
Chippewa Falls, Wisconsin

Yes, I'd like to give myself a \$168 a month raise! Please rush my Shoe Business Outfit **FREE** and postpaid, so I can start making *extra money* from my first hour!

NAME.....
ADDRESS.....
TOWN..... STATE.....

(Continued from page 8)



to know that way down here a man is worshiping your excellent magazine. Therefore, I'm sending the enclosures.

T. J. Olotoa,
Pago Pago, Tutuila, Samoa

The single-sheet mimeographed paper told of the arrival in Pago Pago of William Willis, 61-year-old adventurer, aboard his balsa raft after a 115-day solo voyage from Peru. He was greeted by 500 cheering Samoans and Gov. Richard B. Lowe who praised him for surpassing the famed Kon Tiki expedition. The photos are of Mr. Willis being decorated by the governor's wife and of his raft.

To the Editor:

Motorists slow down when they see how seriously the town of Weldon, N. C., takes its mounting toll of traffic fatalities.

Harry J. Miller,
Sarasota, Fla.





INVENTORS

Learn how to protect your invention. The U. S. Patent Laws provide that any new and useful art, machine, article of manufacture, or composition of matter, or any new and useful improvement thereof, may be patented if the act of invention is involved. Therefore, every inventor with a valuable invention should take advantage of the Patent Laws and proceed for patent protection in order to safeguard his rights.

A patent gives the inventor the exclusive right to prevent others from making, using, or selling the invention claimed in the patent for a period of seventeen years.

The Patent Laws were enacted for the benefit of the inventor to give him protection for the features of his invention which are patentable. These features must be properly and concisely set forth and claimed in a formal application for patent, in order to comply with the requirements of the Patent Laws. For that reason, unless the inventor is familiar with patent matters, he should engage a competent registered patent attorney or agent to represent him. We are registered to practice before the U. S. Patent Office and are prepared to serve you in the handling of your patent matters.

A specially prepared booklet entitled "Patent Guide for the Inventor", containing detailed information with respect to patent protection and procedure, together with a "Record of Invention" form will be promptly forwarded to you without obligation upon request.

CLARENCE A. O'BRIEN & HARVEY JACOBSON

Registered Patent Attorneys

51-B DISTRICT NATIONAL BUILDING

WASHINGTON 5, D. C.

This Year!

Thousands Are Accepting Startling NEW FREE BOOKLET OFFER,

Revealing how 33,432 pictures make
Encyclopaedia reference as fascinating
as the latest picture magazine.

The New 24-volume edition is called the
Greatest Treasure a Family Can Possess!



Outlining Sensational

ENCYCLOPAEDIA BRITANNICA

Book a Month PAYMENT PLAN

The new edition of Britannica is the greatest treasure of knowledge ever published, the work of 4,479 of the world's best minds. It is the final authority on factual knowledge, and a constant inspiration that will continuously enrich the lives of yourself and your family.

See the new pictorial method portrayed in the free preview booklet. Mail the coupon today! We are sure you'll be glad to help spread the news by showing your copy to one other family. Fill in and mail the coupon now!

So fascinating, so different, so unlike the average person's idea of an encyclopaedia... Yes, this new Britannica depends vastly on pictures—33,432 of them, over 1,300 pictures average per volume.

That is why we are now prepared to send valuable 32-page preview booklets, containing beautiful, large-size, full-color pictures, to a number of people.

These booklets are sent free and without any obligation except that, because of the high cost of printing, we ask you to show the booklet to one other family, friends or neighbors. That is all you have to do to acquire free this gorgeous and valuable booklet.

EXTRA! FREE! beautiful booklet sent
if you agree
to show it to
a neighbor

ENCYCLOPAEDIA BRITANNICA, INC., DEPT. 37-B
425 N. Michigan Avenue, Chicago 11, Ill.

Please let me have the FREE PREVIEW
BOOKLET and complete details about the
Book a Month Payment Plan. I agree to
show Booklet to a neighbor—there is no
other obligation.

NAME _____

ADDRESS _____

CITY _____ ZONE _____

IN CANADA, WRITE E. B. LTD., TERMINAL BLDG.,
TORONTO, ONTARIO



WHERE-TO-BUY-IT INDEX

Source of supply appears after items commercially available

AUTOMOTIVE

Swiveling wheels make backing easy.....	88
Automatic control maintains automobile cruising speed (C. K. McCullough Co., Inc., Anderson, Ind.).....	103
New transmission has fast reverse.....	126
Automobile production chart.....	145
1955 automobile price lists.....	145
Some of the year's high lights.....	148
Comparing 1955 cars.....	168

AVIATION

Tailless "flying plank" sailplane has all controls on wing (Chance-Vought Aircraft, Inc., Dallas, Tex.).....	94
Muffler silences jets.....	97
New plane hovers at low airspeed.....	103
Two novel warplanes produced in Britain.....	109
Sets helicopter record.....	113

BOATS

Surfboards equipped with motors provide water-sport thrills..	87
Hull of fighting PT boat becomes floating home.....	116
Develops miniature gyrocompass (Marine Division, Sperry Gyroscope Co., Great Neck, N. Y.).....	248

CONSTRUCTION

Giant tubular-steel hangar can be folded up and flown away..	86
Model aids home plans.....	87
Plastic skylights (Wasco Flashing Co., Cambridge, Mass.)....	96
Portable schools solve building shortage.....	108
Helicopter used as "skyhook" to lift cross to church steeple..	113

HOUSE AND HOME

"Beehive" house has 24 sides.....	95
What's New for Your Home— Window sash tilts inward for cleaning (Zan's Lumber & Millwork Co., 7 E. 41st St., Bayonne, N. J.).....	114
Wall-light switch extension for easy reach of children (Delaware Valley Industries, 7916 Forrest Ave., Philadelphia 19, Pa.).....	114
Hood with ventilating fan for kitchen (Pyrne & Co., Inc., P. O. Box 698, Pomona, Calif.).....	114
Chaise longue folds into 12-pound package (Product Sales, Inc., 6400 Herman Ave., Cleveland 2, Ohio).....	115
Seat-cover anchor (Centi-Pin, 2509 Cascade St., Erie, Pa.).....	115
Safety rail and seat for bathtub (Hamlin Mfg. Co., 1725 S. Brand Blvd., Glendale, Calif.).....	115
Veneer "wallpaper" (Berens Organization, Inc., 101 Park Ave., New York City 17).....	115
Squeeze of fingers cleans out flexible drain made of rubber..	127

INDUSTRY

Ocean water distilled for California steam-generating plant..	96
Mechanical "mole" helps irrigation.....	112
Operate railroad switches with walkie-talkie.....	126

MISCELLANEOUS

"Brief case" scale weighs big trucks (Control Cells Corp., 511½ North Hillside, Wichita 6, Kans.).....	86
"Sugar scoop" antenna catches microwaves.....	87
Competition sled gets tunnel test.....	88
Suction cups move TV tubes on line.....	88
Lever on lawn-mower wheel changes height of cut (Moto-Mower Co., Richmond, Ind.).....	94
"Thermal analyzer" secures heat data.....	103
Look what they've done with the telephone.....	104
Steeds in small stable start race when spurred by sunlight..	113
German TV tower houses restaurant and platform.....	113
Traffic lights change color on orders from radio station (Colorado Electronics Corp., Greeley, Colo.).....	123
Engineer turns inventor and puts more fun into kite flying..	126
Heated roller irons clothes.....	127
Human body replaced every year.....	270

(Continued to page 18)

HOW TO MAKE YOUR TIME WORTH \$95 AN HOUR!

Here's part of a letter we got from an I. C. S. student—

"Every spare-time hour I spent earning my I. C. S. diploma has been worth \$95 to me! My position, my \$7000 a year income, my home, my family's happiness—I owe to I. C. S."

Hardly a day goes by without a letter like this coming in from an I. C. S. student... from men and women of all ages who, in their spare time, at home, pulled themselves out of the small-pay rut and put themselves on the road to success.

Take the case of I. C. S. student Frank B. "I was making \$152 a month when I signed up with I. C. S.," he writes. "My present income is \$395.25 a month."

I. C. S. is the oldest and largest correspondence school. 277 courses. Business, industrial, engineering, academic, high school. One for you. Direct, job-related. Bedrock facts and theory plus practical application. Complete lesson and answer service. No skimping. Diploma to graduates.



3 FREE BOOKS—a 36-page pocket-size guide to advancement, a gold mine of tips on "How to Succeed." Also a big catalog outlining opportunities in your field of interest and a sample I. C. S. lesson text.



For Real Job Security—Get an I. C. S. Diploma! ... Easy-pay Plan ... I. C. S., Scranton 9, Penna.

INTERNATIONAL CORRESPONDENCE SCHOOLS



BOX 94299B, SCRANTON 9, PENNA.

(Partial list of 277 courses)

Without cost or obligation, send me "HOW to SUCCEED" and the opportunity booklet about the field BEFORE which I have marked X (plus sample lesson):

- | | | | | |
|-----------------------------------------------------------------------------------------------------------------------------------------------------------------------------------------------------------------------------------------------------------------------------------------------------------------------------------------------------------------------------------------------------------------------------------------------------------------------------------------------------------------------------------------------------------------------------------------------------------------------------------------------------------------------------------------------------------------------------------------------------------------------------------------------------------------------------------------------------------------------------------------------------------------------------------------------------------------------------------------------------------------------------------------------------------------------------------------------------------------------------------------------------------------------------------------------------------------------------------------------------------------------------------------------------------------------------------------------------------------------------------------|-------------------------------------------------------------------------------------------------------------------------------------------------------------------------------------------------------------------------------------------------------------------------------------------------------------------------------------------------------------------------------------------------------------------------------------------------------------------------------------------------------------------------------------------------------------------------------------------------------------------------------------------------------------------------------------------------------------------------------------------------------------------------------------------------------------------------------------------------------------------------------------------------------------------------------------------------------------------------------------------------------------------------------------------------------------------------------------------------------------------------------------------------------------------------------------------------------------------------------------------------------------------------------------------------------------------------------------------------------------------------------------------------------------------------------------------------------------------------------------------------------------------------------------------------------------------------------------------|----------------------------------------------------------------------------------------------------------------------------------------------------------------------------------------------------------------------------------------------------------------------------------------------------------------------------------------------------------------------------------------------------------------------------------------------------------------------------------------------------------------------------------------------------------------------------------------------------------------------------------------------------------------------------------------------------------------------------------------------------------------------------------------------------------------------------------------------------------------------------------------------------------------------------------------------------------------------------------------------------------------------------------------------------------------------------------------------------------------------------------------------------------------------------------------------------------------------------------------------------------------------------------------------------------------------------------------------------------------------------------------------------------------------------------------------------------------------------------------------------------------------------------------------------------|-------------------------------------------------------------------------------------------------------------------------------------------------------------------------------------------------------------------------------------------------------------------------------------------------------------------------------------------------------------------------------------------------------------------------------------------------------------------------------------------------------------------------------------------------------------------------------------------------------------------------------------------------------------------------------------------------------------------------------------------------------------------------------------------------------------------------------------------------------------------------------------------------------------------------------------------------------------------------------------------------------------------------------------------------------------------------------------------------------------------------------------------------------------------------------------------------------------------------------------------------------------------------------------------------------------------------------------------------------------------------------------------------------------------------------------------------------------------------------------------------------------------------------------------------------------------------------------------------------------------------|-----------------------------------------------------------------------------------------------------------------------------------------------------------------------------------------------------------------------------------------------------------------------------------------------------------------------------------------------------------------------------------------------------------------------------------------------------------------------------------------------------------------------------------------------------------------------------------------------------------------------------------------------------------------------------------------------------------------------------------------------------------------------------------------------------------------------------------------------------------------------------------------------------------------------------------------------------------------------------------------------------------------------------------------------------------------------------------------------------------------------------------------------------------------------------------------------------------------------------------------------------------------------------------------------------------------------------------------------------------------------------------------------------------------------------------------------------------------------------------------------------------------------------------------------------------------------------------------------------------------------------------------------|
| <p>ARCHITECTURE and BUILDING CONSTRUCTION</p> <ul style="list-style-type: none"> <input type="checkbox"/> Air Conditioning—Refrig. <input type="checkbox"/> Architecture <input type="checkbox"/> Architectural Interior <input type="checkbox"/> Building Contractor <input type="checkbox"/> Building Maintenance <input type="checkbox"/> Carpenter and Mill Work <input type="checkbox"/> Estimating <input type="checkbox"/> Heating <input type="checkbox"/> Painting Contractor <input type="checkbox"/> Plumbing <input type="checkbox"/> Reading Arch. Blueprints <p>ART</p> <ul style="list-style-type: none"> <input type="checkbox"/> Cartooning <input type="checkbox"/> Commercial Art <input type="checkbox"/> Fashion Illustrating <input type="checkbox"/> Magazine Illustrating <input type="checkbox"/> Show Card and Sign Lettering <input type="checkbox"/> Sketching and Painting <p>AUTOMOTIVE</p> <ul style="list-style-type: none"> <input type="checkbox"/> Auto Body Rebuilding <input type="checkbox"/> Auto Elec. Technician <input type="checkbox"/> Auto-Engine Tune Up <input type="checkbox"/> Automobile Mechanic | <p>AVIATION</p> <ul style="list-style-type: none"> <input type="checkbox"/> Aeronautical Engineering Jr. <input type="checkbox"/> Aircraft & Engine Mechanic <p>BUSINESS</p> <ul style="list-style-type: none"> <input type="checkbox"/> Advertising <input type="checkbox"/> Bookkeeping and Accounting <input type="checkbox"/> Business Administration <input type="checkbox"/> Business Correspondence <input type="checkbox"/> Public Accounting <input type="checkbox"/> Creative Salesmanship <input type="checkbox"/> Federal Tax <input type="checkbox"/> Letter-writing Improvement <input type="checkbox"/> Office Management <input type="checkbox"/> Professional Secretary <input type="checkbox"/> Retail Business Management <input type="checkbox"/> Sales Management <input type="checkbox"/> Stenographic-Secretarial <input type="checkbox"/> Traffic Management <p>CHEMISTRY</p> <ul style="list-style-type: none"> <input type="checkbox"/> Analytical Chemistry <input type="checkbox"/> Chemical Engineering <input type="checkbox"/> Chem. Lab. Technician <input type="checkbox"/> General Chemistry <input type="checkbox"/> Natural Gas Prod. & Trans. <input type="checkbox"/> Petroleum Engineering <input type="checkbox"/> Plastics <input type="checkbox"/> Pulp and Paper Making | <p>CIVIL, STRUCTURAL ENGINEERING</p> <ul style="list-style-type: none"> <input type="checkbox"/> Civil Engineering <input type="checkbox"/> Construction Engineering <input type="checkbox"/> Highway Engineering <input type="checkbox"/> Reading Struct. Blueprints <input type="checkbox"/> Sanitary Engineering <input type="checkbox"/> Structural Engineering <input type="checkbox"/> Surveying and Mapping <p>DRAFTING</p> <ul style="list-style-type: none"> <input type="checkbox"/> Aircraft Drafting <input type="checkbox"/> Architectural Drafting <input type="checkbox"/> Electrical Drafting <input type="checkbox"/> Mechanical Drafting <input type="checkbox"/> Mine Surveying and Mapping <input type="checkbox"/> Plumbing Drawing and Estimating <input type="checkbox"/> Structural Drafting <p>ELECTRICAL</p> <ul style="list-style-type: none"> <input type="checkbox"/> Electrical Engineering <input type="checkbox"/> Electrical Maintenance <input type="checkbox"/> Electrician <input type="checkbox"/> Contracting <input type="checkbox"/> Lineman <p>HIGH SCHOOL</p> <ul style="list-style-type: none"> <input type="checkbox"/> Commercial <input type="checkbox"/> Good English <input type="checkbox"/> High School Subjects <input type="checkbox"/> Mathematics | <p>LEADERSHIP</p> <ul style="list-style-type: none"> <input type="checkbox"/> Foremanship <input type="checkbox"/> Industrial Supervision <input type="checkbox"/> Leadership and Organization <input type="checkbox"/> Personnel-Labor Relations <p>MECHANICAL AND SHOP</p> <ul style="list-style-type: none"> <input type="checkbox"/> Gas—Electric Welding <input type="checkbox"/> Heat Treatment <input type="checkbox"/> Metallurgy <input type="checkbox"/> Industrial Engineering <input type="checkbox"/> Industrial Instrumentation <input type="checkbox"/> Industrial Supervision <input type="checkbox"/> Internal Combustion Engines <input type="checkbox"/> Machine Design-Drafting <input type="checkbox"/> Machine Shop Inspection <input type="checkbox"/> Machine Shop Practice <input type="checkbox"/> Mechanical Engineering <input type="checkbox"/> Quality Control <input type="checkbox"/> Reading Shop Blueprints <input type="checkbox"/> Refrigeration <input type="checkbox"/> Sheet Metal Worker <input type="checkbox"/> Tool Design <input type="checkbox"/> Toolmaking <p>RADIO, TELEVISION</p> <ul style="list-style-type: none"> <input type="checkbox"/> Industrial Electronics <input type="checkbox"/> Practical Radio TV Eng'ng <input type="checkbox"/> Radio and TV Servicing <input type="checkbox"/> Radio Operating | <ul style="list-style-type: none"> <input type="checkbox"/> Television Technician <p>RAILROAD</p> <ul style="list-style-type: none"> <input type="checkbox"/> Air Brakes <input type="checkbox"/> Car Inspector <input type="checkbox"/> Diesel Locomotive <input type="checkbox"/> Locomotive Engineer <input type="checkbox"/> Section Foreman <p>STEAM AND DIESEL POWER</p> <ul style="list-style-type: none"> <input type="checkbox"/> Combustion Engineering <input type="checkbox"/> Diesel—Elec. <input type="checkbox"/> Diesel Eng's <input type="checkbox"/> Electric Light and Power <input type="checkbox"/> Stationary Fireman <input type="checkbox"/> Stationary Steam Engineering <p>TEXTILE</p> <ul style="list-style-type: none"> <input type="checkbox"/> Carding and Spinning <input type="checkbox"/> Cotton, Rayon, Woolen Mfg. <input type="checkbox"/> Finishing and Dyeing <input type="checkbox"/> Loom Fix'g <input type="checkbox"/> Textile Des'ing <input type="checkbox"/> Textile Eng'g <input type="checkbox"/> Throwing <input type="checkbox"/> Warping and Weaving <p>MISCELLANEOUS</p> <ul style="list-style-type: none"> <input type="checkbox"/> Marine Engineering <input type="checkbox"/> Ocean Navigation <input type="checkbox"/> Professional Engineering <input type="checkbox"/> Short Story Writing <input type="checkbox"/> Telephony |
|-----------------------------------------------------------------------------------------------------------------------------------------------------------------------------------------------------------------------------------------------------------------------------------------------------------------------------------------------------------------------------------------------------------------------------------------------------------------------------------------------------------------------------------------------------------------------------------------------------------------------------------------------------------------------------------------------------------------------------------------------------------------------------------------------------------------------------------------------------------------------------------------------------------------------------------------------------------------------------------------------------------------------------------------------------------------------------------------------------------------------------------------------------------------------------------------------------------------------------------------------------------------------------------------------------------------------------------------------------------------------------------------|-------------------------------------------------------------------------------------------------------------------------------------------------------------------------------------------------------------------------------------------------------------------------------------------------------------------------------------------------------------------------------------------------------------------------------------------------------------------------------------------------------------------------------------------------------------------------------------------------------------------------------------------------------------------------------------------------------------------------------------------------------------------------------------------------------------------------------------------------------------------------------------------------------------------------------------------------------------------------------------------------------------------------------------------------------------------------------------------------------------------------------------------------------------------------------------------------------------------------------------------------------------------------------------------------------------------------------------------------------------------------------------------------------------------------------------------------------------------------------------------------------------------------------------------------------------------------------------------|----------------------------------------------------------------------------------------------------------------------------------------------------------------------------------------------------------------------------------------------------------------------------------------------------------------------------------------------------------------------------------------------------------------------------------------------------------------------------------------------------------------------------------------------------------------------------------------------------------------------------------------------------------------------------------------------------------------------------------------------------------------------------------------------------------------------------------------------------------------------------------------------------------------------------------------------------------------------------------------------------------------------------------------------------------------------------------------------------------------------------------------------------------------------------------------------------------------------------------------------------------------------------------------------------------------------------------------------------------------------------------------------------------------------------------------------------------------------------------------------------------------------------------------------------------|-------------------------------------------------------------------------------------------------------------------------------------------------------------------------------------------------------------------------------------------------------------------------------------------------------------------------------------------------------------------------------------------------------------------------------------------------------------------------------------------------------------------------------------------------------------------------------------------------------------------------------------------------------------------------------------------------------------------------------------------------------------------------------------------------------------------------------------------------------------------------------------------------------------------------------------------------------------------------------------------------------------------------------------------------------------------------------------------------------------------------------------------------------------------------------------------------------------------------------------------------------------------------------------------------------------------------------------------------------------------------------------------------------------------------------------------------------------------------------------------------------------------------------------------------------------------------------------------------------------------------|-----------------------------------------------------------------------------------------------------------------------------------------------------------------------------------------------------------------------------------------------------------------------------------------------------------------------------------------------------------------------------------------------------------------------------------------------------------------------------------------------------------------------------------------------------------------------------------------------------------------------------------------------------------------------------------------------------------------------------------------------------------------------------------------------------------------------------------------------------------------------------------------------------------------------------------------------------------------------------------------------------------------------------------------------------------------------------------------------------------------------------------------------------------------------------------------------------------------------------------------------------------------------------------------------------------------------------------------------------------------------------------------------------------------------------------------------------------------------------------------------------------------------------------------------------------------------------------------------------------------------------------------------|

Name _____ Age _____ Home Address _____

City _____ Zone _____ State _____ Working Hours _____ A.M. to P.M. _____

Occupation _____

Canadian residents send coupon to International Correspondence Schools, Canadian, Ltd., Montreal, Canada. ... Special tuition rates to members of the U. S. Armed Forces.

YOU can find over 100 PRACTICAL USES and have LOTS OF FUN with

5 in 1 Miracle Projector

Electric Enlarger and Copy Maker

Magnify & Project

Stamps, coins, maps, slides, specimens, signs, etc. Examine magnified details. Project on paper and screen. Large or small. Easier reading for weak eyes.

Magnifying Reader for Small Detail & Print



Amazingly Useful Invention

Home Fun—Schools—Salesmen—Clubs—Artists—Teachers—Shops—Sign Makers—Doctors—Classroom—Scientists—Students—Movie Maker—Photographers—Lab workers—Printers—Painters—Etc., etc., etc.

HIGH FIDELITY, TRUE VIEW, FULL COLOR

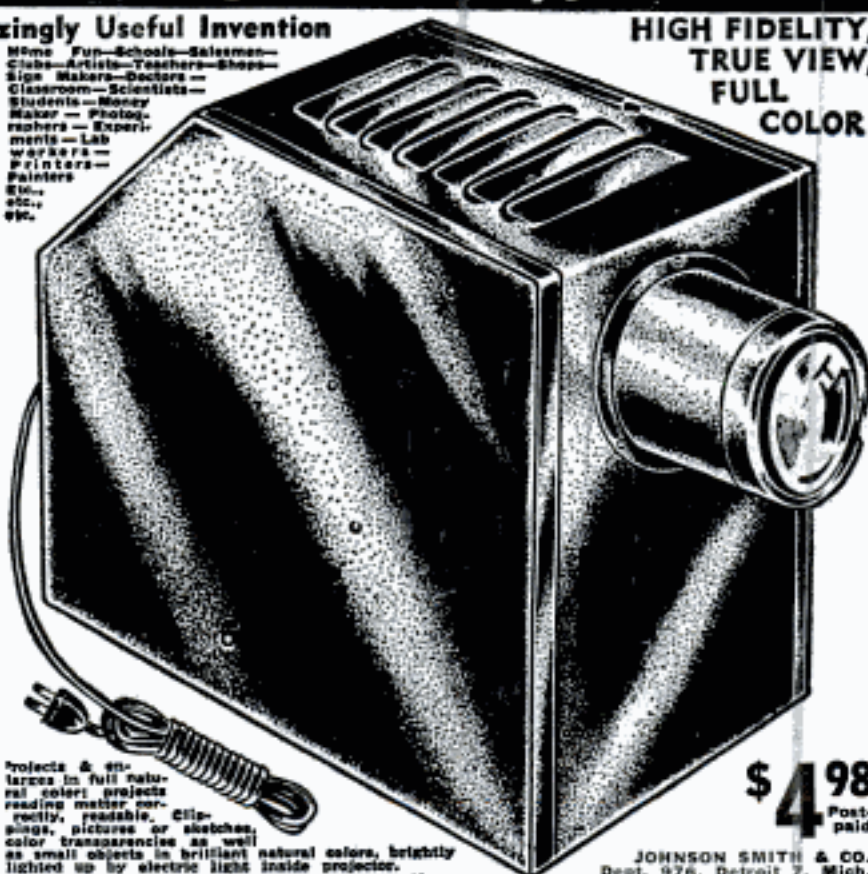

\$4.98
Postpaid

JOHNSON SMITH & CO.
Dept. 976, Detroit 7, Mich.

Learn to Draw & Sketch Signs, Cartoons, Pictures Easily

Posters, Lettering, Comics, Objects

Project sketches, pictures, objects, etc. on drawing paper. Sketch over with pen, pencil, colors, etc. Easy to make any kind of cartoons, drawings, signs, etc. either large or small. Make cartoons from pictures. Easy to do. No skill, no practice.

Copy Any Picture or Object

Project a n d focus it large or small. Make enlargements of plans or drawings. You'll be surprised how accurate a n y practical and entertaining uses you can make. Advertising posters, cartoon sketches of friends, etc., etc., etc.



Large or Small

ing posters, cartoon sketches of friends, etc., etc., etc.

Natural Moving Pictures

Projecting Microscope Gives Live Show

Put ants, insects, flies & other bugs or animated objects under glass & let them walk around. See them in action greatly enlarged and magnified MOVING on screen. Amazing, realistic scientific motion pictures. Like having a projecting microscope.



Make Photo Enlargements and Copies Without Negatives!

Use Any Photo or Picture

Direct positive photo enlargements and prints without negatives using Eastman direct positive paper. Use any black & white or color picture, colored transparency, etc. Easy to do; excellent results. No complicated dark room equipment. Makes correct copy (same as original), large or small. Also useful for making stamps, sketches, signs, etc., etc. EASY, FUN, USEFUL, PROFITABLE.



Big copies of important papers, plans, documents, stamps, sketches, signs, etc., etc. EASY, FUN, USEFUL, PROFITABLE.

Picture Enlarger and Projector

Project 3-Dimension Pictures

Put on your own show by projecting a s a p -shots, pictures, post cards, photos, comics, clipart, etc. on wall or screen. Fine for school, clubs, talks, home shows, telling about your trip, salesman, etc. Full color, correct projection, entirely readable & correct. Special device enables you to project real 3-dimension or stereoscopic pictures. Startling, life-like.



Make Money---Machine Pays for Itself

Many ways to make money. Make photo enlargements, photo copies, give shows, make sketches and drawings and advertising signs, etc. Easy to do---the machine does the work.

projects & enlarges in full natural color. Projects reading matter correctly, readable. Clippings, pictures or sketches, color transparencies as well as small objects in brilliant natural colors, brightly lighted up by electric light inside projector.

Different Show Every Night; No Films

to Buy; No More Expense; Sports, Girl Beauties, Comics, Etc. Your favorite or COMIC PICTURES from papers & magazines. Enlarge action pictures. Project snapshots of your girl, family trip. Project and read comic strips to kids. Large pictures projected in full color. Live ants, flies, bugs and small animals can be projected on screen; watch them in real life action, fighting, eating, playing. Great for amateur scientist experimenter and camera fan.

Make Signs, Sketches, Posters, Cartoons, Lettering, Etc. Quick! Easy! In Black & White or Full Color; From Clippings or Copy; Large or Small Make sketch or cartoon of friends. Posters and signs for clubs, stores, dances. Easy to make, large or small. Project picture or rough sketch right on blank drawing paper. Using pen, pencil or colors, sketch OVER PROJECTED PICTURE. Project photos and make funny, life-like cartoons or sketches. Amazing & practical. As a good artist, even though you never did it before! Lettering and signs easy to do.

Magnifies Stamps, Specimens, Objects for Close Examination; Reader for Weak Eyes Collectors can enlarge objects. Examine in greatly magnified detail. **MAGNIFIES ABOUT 50 AREAS.** Make photo enlargements direct from objects! Enlarges small type, maps, etc., projecting it for easy reading.

Photo Enlarger; Makes Photo Prints, Photo Copies, Etc.—No Negatives Uses Eastman direct positive paper. Correct true-image photos, large or small, from any photo; or even from color prints & color transparencies. Photo enlargements, copies, etc., done cheaply, quickly, easily. \$10-in. enlargement costs 12c; sell up to \$1.00. **NO NEGATIVES.** Made by projecting picture on direct positive printing paper. Duplicate copies of blueprints, diagrams, papers, large or small.

3-Dimension Stereoscopic Pictures By special process you can project 3-dimensional pictures and see in startling, life-like realism. **So-real you expect to reach out and touch them!** Project beautiful girl pictures, travel scenes, etc.

No Skill—No Experience—Fun All Year Round for itself. No experience and no skill to operate. Just plug into any 110-volt AC-DC standard home socket. Years of entertainment and practical uses for every member of the family. Lasts indefinitely; nothing to wear out, so only cost the low price of **MIRACLE PROJECTOR.** Schools, shops, offices, artists, etc., all find many uses for it. Project almost anywhere.

Project on Table, Wall or Ceiling—No Screen Necessary—even on table. No screen necessary—any blank wall or white paper will do. Wonderful for classroom, clubs and salesman.

Electric, Optically Ground Double Lens, Enameled Steel Construction Complete except for lamp bulb; use any household 60 to 100 watt lamp bulb. Steel construction, hand-somely enameled in brilliant colors. Easy carrying. 7 1/2-in. high; 10-in. long. Optically ground and polished lenses; slide focusing so you can **PROJECT FROM VARIOUS DISTANCES** to make picture large or small. Takes pictures up to 3 1/4 x 4 inches. With illustrated instruction booklet, views, etc.

(2 for \$9.45; 3 for \$13.95). COMPLETE. CASH PRICE ONLY. EACH \$4.98

What Users Say: Artist & Signmaker: "Valuable aid; enables anyone to do all kinds of art work without training." Photographer: "Many uses; money maker and money saver." Teacher & Lecturer: "Makes talks ten times more interesting; teaches faster, more fun." Collector: "Magnifies & illuminates specimens for easy study."

Rush This Coupon Today!

Johnson Smith Co., Dept. 976, Detroit 7, Mich.
(Since 1914 America's Leading Novelty House)

Rush _____ Projectors Each \$4.98 Postpaid
Enclosed is \$ _____ Special: 2 for \$9.45
3 for \$13.95

Name _____
Address _____

(Sorry, No C.O.D.'s at This Cash Price)

INVENTORS

If you believe that you have an invention, you should find out how to protect it. The first step is to have a search made of the prior pertinent U. S. patents. If a report on this search indicates that the invention appears patentable you can apply for a patent, and the specifications and claims should be prepared.

The firm of McMorrow, Berman & Davidson, with offices in Washington, D. C., is qualified to take the necessary steps for you. We can make a preliminary search on your invention, advise you whether we think it can be patented, and prepare your application for patent.

Unless you are fully familiar with the U. S. Patent Laws, we recommend that you engage the services of a Registered Patent Attorney to protect your interests. The patent laws are *your* laws. A patent gives you the right to prevent others from making, using or selling the invention claimed in your patent for a period of 17 years.

Use these patent laws for your protection. Investigate whether your invention can be patented. If you have what you believe to be an invention, we suggest that you have this firm make a search for you.

Send for a copy of our Patent Booklet entitled "How To Protect Your Invention," containing information about patent protection and patent procedure. Along with this we will also send you an "Invention Record" form, for your use in writing down and sketching details of your invention. We will mail them promptly. No obligation. They are yours for the asking.

McMORROW, BERMAN & DAVIDSON

Registered Patent Attorneys

PATENTS • COPYRIGHTS • PATENTS

135-B VICTOR BUILDING, WASHINGTON 1, D. C.

HOW TO ELIMINATE STALLING



LAZY PICK-UP



clean your carburetor with **GUMOUT**

If your car's running sick—stalling, with lazy pick-up—chances are it's suffering from a dirty carburetor. Gum and dirt are choking off the vital fuel and air supply.

But—there's no need to tear down the carburetor!

GUMOUT cleans out your carburetor while you drive. Just add **GUMOUT** to your gas tank every two or three months. You'll keep your carburetor sparkling clean the year 'round. There's nothing like it!

GUMOUT is sold by service stations and auto supply stores everywhere. **GUMOUT DIVISION, Pennsylvania Refining Co.** 2671 Lisbon Road, Cleveland 4, Ohio



SEND FOR FREE 46-page "CARBURETOR HANDBOOK." Gives you all the answers. Good to have.

GUMOUT, due to its amazing solvent action, has many additional uses around the home and workshop. If you'd like to know about them, ask for Technical Bulletin 103-G when writing for your free Carburetor Handbook.

(Continued from page 14)

PHOTOGRAPHY

- Kit aids camera close-ups (Eastman Kodak Co., Rochester 4, N. Y.) 94
- Lens-mounted flash unit eliminates shadow from photographs (Bridges Plastic Products, Inc., 1201 E. 63rd St., Los Angeles 1, Calif.).....123
- Elevator tower for movie work.....127

SCIENCE

- Electronic unit lets blind read..... 97
- Lead shield on wheels guards atomic worker.....109
- Inflated protective plastic suit shields atomic worker.....123

Radio-Television, Electronics

- Campus radio network.....229
- Compact two-meter radio transceiver for amateurs.....230
- TV service hints.....232

Craftsman and Shop Notes Index

AUTOMOTIVE

- Regular timing light can be used on 12-volt ignition system..216
- Cleaning of gas-line filter prevents engine troubles.....224
- Seat-protecting cloth held with tire-section "clamp".....228

FARM

- Croquet wickets protect seedlings.....198
- Washing-machine agitator is percolator in feed cooker..... 196
- Hog-weighing scale platform rests on ground.....211
- Homemade farm-garden tiller.....211
- Early seed corn dried in crib by hot-air furnace.....217
- Fence made from implement wheel prevents overturning tub..217
- Section of windmill ladder used as trough stanchion.....217
- Belt from tractor generator drives mower-sickle grinder.....224

HOUSE AND HOME

- Estimating floor-tile needs.....174
- Plastic sheet over drawing protects against smudging.....174
- Shelves on kitchen-cabinet doors provide more accessible storage.....174
- Wire fed through lamp column by using thread and cotton....174
- Adding-machine tape in holder used for shopping lists.....177
- Pickets in fence kept aligned by sheet-metal gauge.....178
- Radio pilot lamp used to replace night light.....184
- Telephone gossip-chair.....185
- Solving Home Problems—
 - Idaho potatoes baked quicker with aluminum nails.....188
 - Accuracy of household scale checked by known weight.....188
 - Large T-strap hinge used as support to hold basement window.....188
 - Finger marks on piano keys removed with pencil eraser....188
 - Fruit-jar rubber used to hold hanger on clothesline.....189
 - Sagging bedsprings renewed with hog rings.....189
 - Paint can held securely on stepladder by turn button.....189
 - Towel bar used as handle for door.....189
 - Razor blade kept safely tacked to back of drawer.....189
 - Repairing cracked laundry tub.....196
 - Weather stripping improves drawer action.....197
 - Faucet washers made smaller.....200
 - Combination smoking stand and magazine rack.....201
 - Sticking dresser drawers eased by thumbtacks on slides.....224

MISCELLANEOUS

- Paper match against candle wick aids lighting in wind.....174
- Ice-glazed sidewalk made safe with wire-mesh covering.....177
- Reflective tape around flagstaff protects it from damage.....178
- "Rollback" toy for small tots utilizes empty coffee can.....178
- Handle for vacuum-bottle cap.....186
- Chemical agitated by syringe easier than with stirring rod....190
- Pieces of hose strung on rope provide bumper for dock.....190
- Shaving-cream hand cleaner.....190

(Continued to page 20)

**Train QUICK
in Big Coyne
Shops**

GREAT OPPORTUNITY FIELDS!



Instructor helping students check the wiring and trace the circuits of television receivers.

Instructor explaining operation and testing of a large Motor Generator.

This big fire-proof building is occupied entirely by Coyne.

TRAINED YOUNG AND OLDER MEN— URGENTLY NEEDED IN VITAL FIELDS!

ELECTRICITY—RADIO—TELEVISION—ELECTRONICS—VITAL in defense program. Trained men whether 16 or up to 50 needed. TRAIN QUICKLY for better rating if drafted—Vital job in industry if not.

TELEVISION-RADIO ELECTRICITY

Here at COYNE you're trained for Television, Testing, Trouble-Shooting on Radio, Public Address, F. M. Sound Units, etc. Many Coyne trained men in good jobs or own well paying Television-Radio businesses of their own.

Big future in Power Plant Work, Motors, Industrial Electronics, Armature Winding, Home and Factory Wiring, Appliances, Refrigeration, Maintenance, Illumination, etc. Lifetime job service to Coyne graduates.

WE TRAIN YOU IN CHICAGO

Our famous Practical-Technical method gives you practical experience on a massive outlay of equipment. Actual shop work plus necessary technical training. You are trained right here in the great Coyne shops. Send for BIG FREE BOOK.

**APPROVED
FOR
VETERANS**

START NOW—PAY LATER

Enroll now, pay most of tuition after graduation. Special plan for men of draft age. We'll help you get part-time work, if you need it to help pay living costs while at Coyne.

B. W. COOKE, President

COYNE

SCHOOL

A TECHNICAL TRADE INSTITUTE
CHARTERED NOT FOR PROFIT
Established 1899
500 S. Paulina Dept. 25-72H
Chicago 12, Illinois

ELECTRICITY ★ TELEVISION ★ RADIO ★ REFRIGERATION ★ ELECTRONICS

LARGEST, OLDEST, BEST EQUIPPED SCHOOL OF ITS KIND IN THE U.S.

Mail Coupon for Big FREE Book!



Whether you prefer Television-Radio or Electricity, train on actual equipment at Coyne. We will send you a Big, fully Illustrated Book. Indicate below which course interests you most. No salesman will call. Mail coupon TODAY.

B. W. Cooke, President
COYNE SCHOOL, 500 S. Paulina St.
Dept. 25-72H, Chicago 12, Ill.

Send me your Big Free book. I am interested in field checked below. This does not obligate me.

TELEVISION-RADIO ELECTRICITY

NAME.....

ADDRESS.....

CITY.....STATE.....

WHAT SECRET POWER DID THIS MAN POSSESS?



BENJAMIN FRANKLIN
(A Rosicrucian)

WHY was this man great? How does anyone—man or woman—achieve greatness? Is it not by mastery of the powers within ourselves?

Know the mysterious world within you! Attune yourself to the wisdom of the ages! Grasp the inner power of your mind! Learn the secrets of a full and peaceful life!

Benjamin Franklin—like many other learned and great men and women—was a Rosicrucian. The Rosicrucians (NOT a religious organization) first came to America in 1694. Today, headquarters of the Rosicrucians send over seven million pieces of mail annually to all parts of the world. Write for YOUR FREE COPY of "The Mastery of Life"—TODAY. No obligation. No salesmen. A non-profit organization. Address: Scribe L.C.A.

**THIS BOOK
FREE!**



The ROSICRUCIANS
SAN JOSE • (AMORC) • CALIFORNIA

SEND THIS COUPON

Scribe L.C.A.
The ROSICRUCIANS (AMORC)
San Jose, California
Please send me the free book, *The Mastery of Life*, which explains how I may learn to use my faculties and powers of mind.
Name _____
Address _____
City _____

(Continued from page 18)

Extra-long rubber bands cut from auto inner tube.....	196
Soap tray hangs on locker door to prevent soiling of clothes..	197
Push handle for coaster wagon keeps it under control.....	200
Whisk-broom guard protects bristles.....	200
Correspondence easily identified by envelope corners.....	204
Treated rope around tent keeps out crawling insects.....	204
Protection for vacuum bottle provided by metal carrier.....	206
Fruit jar holds flashlight in upright position.....	211
Step suspended from front wheel aids truck-engine work.....	216
This gate tips over to open.....	216
Children cannot reach paint on ceiling-high shelves.....	228
Paper tabs identify drawings.....	228

PHOTOGRAPHY

Curled prints straightened.....	184
Razor-blade photo trimmer.....	187
"Slave" lights controlled by hole in cover of photocell unit..	201
Recharging of photoflash unit controlled with electric timer..	204
Variable-intensity safelight.....	205

TOOLS

To renew circular-saw blade.....	204
White tape wrapped on drill bit provides temporary depth gauge	204
Shopping for Tools—	
"Corner" square (Johnson Research & Products, P. O. Box 14, Flossmoor, Ill.).....	225
Power head (Wilton Tool Mfg. Co., 925 Wrightwood, Chicago 14)	225
Blade jig (Riverside Enterprises, 16 Riverside, Corning, N. Y.)	225
Swiveling motor mount (Sutton Mfg. Co., Box 5742, Milwaukie 2, Ore.).....	225
Nonmetallic tape rule (The Lufkin Rule Co., Saginaw, Mich.)	226
Drawing machine (Charles Bruning Co., 4700 Montrose, Chicago 41)	226
Ratchet drive (Kipton Industries, Kipton, Ohio).....	226
Adjustable bore gauges (M. C. Hutto Co., 6516 Detroit Ave., Cleveland 2, Ohio).....	226
Hand nibbler (Adel Tool Co., 4013 N. Milwaukee Ave., Chicago 41)	226
Carpenter's square (Unique Products, Inc., Box 2263, Reno, Nev.)	227
Spirally fluted tap (Shearcut Tool Co., 7045 Darby, Reseda, Calif.)	227
Saber-saw attachment (Delta Power Tool Div., Rockwell Mfg. Co., 436 N. Lexington, Pittsburgh 8, Pa.).....	227
Safety switch (Tricop Co., Inc., 308 W. Center, Akron 2, Ohio)	227
Soldering gun (S. J. Sutton, 228 E. Park, Wheaton, Ill.).....	227
Hole enlarged in sheet metal using file as reamer.....	228

WORKSHOP HINTS

Plastic cap provides insulator to protect flashlight dry cells..	177
Rubber scraper spreads glue.....	177
Tool improvised from needle aids leather craftsman.....	177
Applying hardwood grain to pine.....	178
Miter box held on workbench with cotter-pinned hinges.....	178
Bent bolt prevents nut turning.....	184
Glue spread for wood veneering with windshield-wiper blade..	184
Pegs in narrow board on wall provide tool storage.....	184
Ball bearings easily picked up with "tweezers" bent from wire	186
Cake pan pivoted under shelf provides sorting tray.....	186
Steel "forks" hold screen to aid fitting on the job.....	186
Emergency wrench improvised from bolt and two nuts.....	190
Paintbrushes protected under plastic sheeting.....	190
Adjustable brace on cold frame fits into drilled block.....	196
Pail clamped with hooks and bands when mixing paint on drill press	200
Removable rubber liner in basin provides "self cleaning" pan..	200
Hammer handle stores tacks.....	201
Corrugated cardboard in jar files small drill bits.....	204
V-grooved level permits working from bottom of job.....	206
Quick way to set steady rest.....	211
Large truck-mounted welder provides easy portability.....	216
Altering hand-tightened chuck to take pin drills.....	217
Welded stand for bench grinder permits easy portability.....	224
Stainless steel lubricated for bending operation.....	228
Vise clamped to drill press when not being used.....	228

IMPORTANT NOTICE—It is the intention of this magazine to provide its readers with information regarding the latest developments in the mechanical arts. We take no responsibility as to whether the disclosures contained in our articles are covered by patents and advise readers to investigate this subject before making, using, or selling any of the products, machines, or processes described in order to avoid possible liability for patent infringements.

In Spare Time at Home—Prepare for a Better Job—
or Your Own Business in

TELEVISION RADIO • ELECTRONICS

You build and keep
this valuable Jewel
Bearing MULTI-
METER.



5 INCH
"SCOPE"



You also build and keep
this high quality 5 INCH
oscilloscope—almost a
"must" for Television
servicing.

21 INCH

Build and keep this BIG DTI
Engineered TV set—easily
converted to U.H.F. (DTI offers
another home training, but
without the TV set.)



COLOR TELEVISION

D.T.I.'s program
also includes
training in
Color Television

If the man who is seeking a better job or a business of his own will take time to compare all the opportunities available to him today, he will undoubtedly consider a career in Television-Radio-Electronics.

A bird's eye view of the tremendous opportunities that exist in this fast-growing American industry reveals that hundreds of TV stations are yet to be built, millions of sets to be manufactured, and other millions of existing sets to be serviced from time to time.

Another marked advantage for men 17 to 45 is the fact that they can prepare to enter these profitable fields in their spare time at home or in our modern laboratory in Chicago. Another distinct advantage is the fact that no previous technical experience or advanced education is required.

After a man completes his training at home or in our Chicago Laboratory, he may get the benefit of our effective EMPLOYMENT SERVICE to help him get started.

Again we say—compare these opportunities and advantages. Send for full facts today.

Mail coupon below NOW!

EMPLOYMENT SERVICE

Upon completing either the Chicago Laboratory or Home Training, DTI's long-established, effective Employment Service is ready to help you start earning real money. Get full facts. Mail coupon today.

MODERN LABORATORY

If preferred, you can get all of your preparation in our modern Chicago Training Laboratory—one of the finest of its kind. Ample instructors, modern equipment. Write for details!

(If you are subject to MILITARY SERVICE you'll especially welcome the information we have for you.)

"One of America's Foremost
Television Training
Centers"



You work over
300
Learn-By-Doing
projects

**89 WAYS
TO
EARN
MONEY
IN TELEVISION
RADIO-ELECTRONICS**

ABOVE: You set up your own HOME LABORATORY . . . work with and keep the same type of basic electronic parts used in D.T.I.'s modern Chicago Training Center. Now you can get real Laboratory-type training—AT HOME.



16-mm. HOME MOVIES

You use this 16-mm. motion picture projector and many reels of educational film—a wonderful, exclusive, D.T.I. home aid to help you understand important fundamentals faster . . . easier . . . better. It's almost like having a teacher in your home.

**ACT
NOW!**

Get information packed
publication FREE!!
Mail Coupon Today.

DEVRY TECHNICAL INSTITUTE

4141 Belmont Ave., Chicago 41, Ill. Dept. PM-2-L

I would like the facts, including your valuable information-packed publication showing how I may get started toward a good job or my own business in Television-Radio-Electronics.

Name _____ Age _____
Street _____ Apt. _____
City _____ Zone _____ State _____

D.T.I.'s Training is available in Canada



DEVRY TECHNICAL INSTITUTE

AFFILIATED WITH

DEFOREST'S TRAINING, INC.

CHICAGO 41, ILLINOIS

Inventors

If you consider your invention valuable, take these necessary preliminary steps promptly to protect it by applying for a United States patent.

Sketch and describe your invention. (For convenience in starting action on your invention, use "Evidence of Invention" form offered below.)

Sign, date and have this invention disclosure witnessed by two people capable of understanding your invention.

Have us make a preliminary search among U. S. patents already granted for similar types of invention.

We then prepare a report for you on the probable patentability of your invention and recommend your further course of action.

This firm is registered to practice before the U. S. Patent Office. We are available to assist you in the preparation and prosecution of your application for patent.

We shall be glad to send you promptly and without obligation, an instructive booklet—"Patent Protection for Inventors"—and our convenient "Evidence of Invention" form.

VICTOR J. EVANS & Co. *Merlin M. Evans*
REGISTERED PATENT ATTORNEY
130-B MERLIN BUILDING, WASHINGTON 6, D. C.

Tells How You Can Learn to MOUNT BIRDS!

FREE BOOK **Learn At Home**
Men, Boys, Hunters, Fishermen, mount and save your lovely wild-game trophies. Be a Taxidermist. Mount Birds, Animals, Heads, Fish, Tan skins. YOU learn easily, quickly in spare time. Have a grand home-museum. The finest and the greatest hobby known, for sportsmen. Fun, real profits.

FREE BOOK Yes, FREE. Beautiful strange, valuable Book, telling all about Taxidermy. Contains over 100 beautiful game-pictures. And it's yours FREE, if you rush your request. You can mount all kinds of wild-game, and common specimens too. We can positively TEACH YOU. So GRASP this opportunity. RUSH letter or postal for this amazing FREE BOOK. Don't delay. State your AGE. N. W. SCHOOL OF TAXIDERMY, 2502 Elwood Bldg., Omaha 2, Neb.

A "GOOD HAND" HELPS YOU SUCCEED!
LEARN TO WRITE WELL
Handwriting quickly improves with our easy-to-understand picture lessons! Put your spare time to good use; send today for FREE BOOKLET, "How to Become a Good Penman," or check volumes wanted below at \$1 each: Business Writing Artistic Writing Card Writing Bird & Design Flourishing Engraving Alphabets, COMPLETE SET \$4.50. Ask for price list of penman's supplies.
TAMBLYN SCHOOL of PENMANSHIP
S.A. Ziller, Pres., 442 Ridge Bldg., Kansas City, Mo., USA

REAL ESTATE BE A BROKER

PAYS BIG! SEND FOR FREE, BIG, ILLUSTRATED CATALOG NOW! Graduates report making substantial incomes. Start and run your own business quickly. Men, women of all ages learn easily. Course covers Sales, Property Management, Appraising, Loans, Mortgages, and related subjects. **STUDY AT HOME** or in classrooms in leading cities. Diploma awarded. Write TODAY for free book! No obligation. Approved for World War II and Korean Veterans.
WEAVER SCHOOL OF REAL ESTATE (Est. 1936)
2020 Grand Dept. PM Kansas City, Mo.

LEARN WATCH REPAIRING

AT HOME Modern, original instruction. Prepare for a position or start in business after completing our course. Write Today!
WISCONSIN SCHOOL OF WATCH REPAIRING
2908 N. 44th St. Dept. M Milwaukee 10, Wis.

Secrets of VENTRILOQUISM Now Revealed!

Easy to learn in 60 to 90 days with our Home Study Course. **RESULTS GUARANTEED.** Make Money! Be Popular! Have Fun! Big Opportunity! Radio, Television, Stage Appearances! For FREE information regarding price and terms, WRITE, you must state your age. Dummy Catalog 25c.
FRED MAHER SCHOOL OF VENTRILOQUISM
Box 36, Studio PM-2 Kensington Station Detroit 24, Michigan



EXTRA MONEY Selling EXCLUSIVE PARAGON Cushion Shoes

Even If Now Employed

Enjoy your own lifetime, independent shoe business without investment. Steady repeats. To \$4.00 pair advance commissions. Big bonus. Make \$50 and more a week in full or spare time. 115 latest smart styles. Magic cushion. Easy to start. Write for FREE OUTFIT today!

PARAGON SHOE COMPANY
79 Sudbury St., Dept. 20, Boston 14, Mass.

No. 574
Lo-Line
2 Eyelet
Crushed
Grain

POPULAR MECHANICS

THERE'S A "SECRET" TO EASY AUTO REPAIRS ... and this giant book is it!

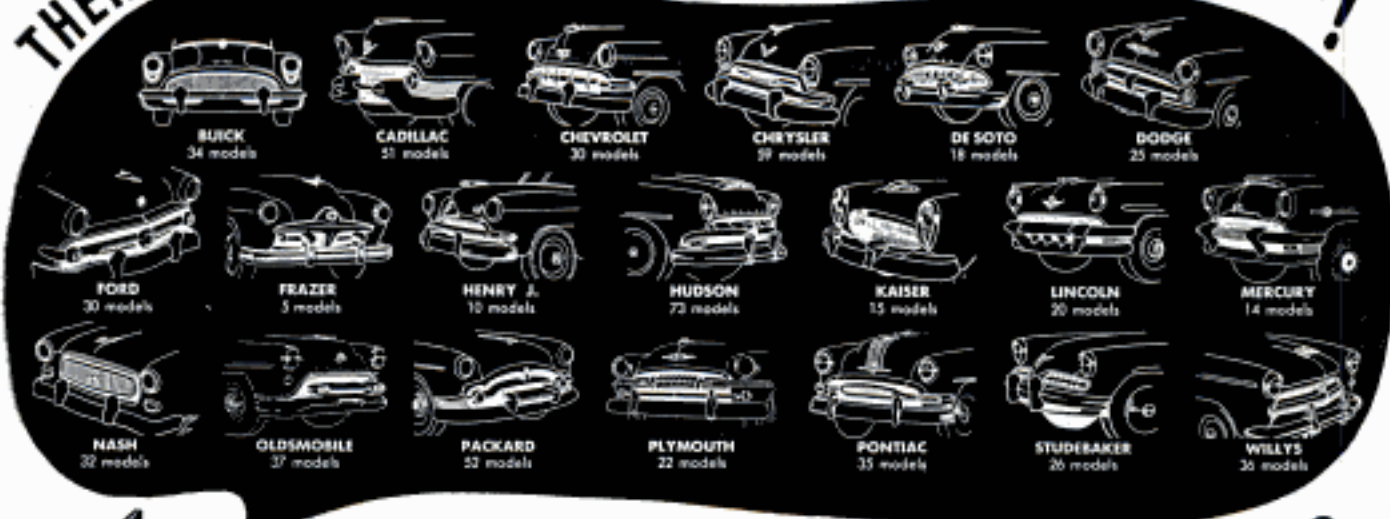

FIX CARS THIS EASIER FASTER WAY!

Handle practically ANY job on ANY make, model or part since 1940

New, Enlarged 1954 Edition!

Weights 4 3/4 pounds!

Has 864 big pages

... each one almost TWICE as big as this magazine page!

Covers EVERY model of the above 20 makes SINCE 1940!

58 Troubleshooting Charts—353 "Quick Checks" Data Tables

2532 clear, how-to-do-it pictures

... and thousands upon thousands of helpful parts and service specifications.

Using this giant Chilton "ALL CARS" auto repair manual is like having 19 of the world's greatest service experts standing by your side.

First they tell you how to locate the trouble. Then they show you how to fix it "slick as a whistle."

Step by step they guide you ... even to telling you what tools to use. No guesswork! No wasted time!

And you don't need a lot of previous experience to do EVERY job fast and right!

Complete, Easy-To-Understand Car Repair Instructions

Just look up the make, model and part of the car you want to fix. Simple, easy instructions PLUS big, clear pictures show you exactly what to do, what shortcuts to take, what changes or adjustments to make,

what parts to replace, what mistakes to watch out for.

From simple tune-ups to carburetor troubles ... from rear end jobs to engine overhauls ... from windshield wipers to ignition systems ... or from clutches, axles, oil pumps, cooling systems and king pins to standard and automatic transmissions, overdrives, power brakes and steering and dozens more, this big book makes each job as clear as A-B-C.

Remember! For over 25 years, previous editions of this famous Chilton "ALL CARS" Manual have been first choice of beginners, garages, schools and for Army-Navy car repair training ... because it has long been recognized as the largest, most complete, fully authentic manual of its kind ... and, because it makes the work so clear that even beginners cannot fail to understand every step.

Covers 14 Years of Cars!

PRACTICE 10 DAYS FREE!

The Chilton Co., Dept. PM-25
5605 Chestnut St., Philadelphia 39, Pa.

Send the big 864-page Chilton "ALL CARS" REPAIR MANUAL (Price \$6.95) for 10-day FREE EXAMINATION. If I like it, I will then promptly remit \$1.95 (plus 35c postage); then send \$2.50 monthly for 2 months. Otherwise, I will return manual postpaid in 10 days and owe you nothing.

(OUTSIDE U.S.A.—Cash only, price \$7.95. Same 10 day return privilege with money refunded.)

Name

Address

City, Zone, State



By the world's largest automotive publishers!

Get the big, complete CHILTON service manual that comes direct from automotive publishing headquarters ... home of AUTOMOTIVE INDUSTRIES, COMMERCIAL CAR JOURNAL and MOTOR AGE magazines, the well-known Chilton FLAT RATE book, etc.!



**WANT A
GOVERNMENT
JOB?**



Start As High As \$4,205.00 a Year
Get Ready Now for Next Examinations in Your Locality

Veterans Get Preference

City Mail Carriers, Post Office Clerks

Clerks and Carriers now get \$3,270.00 the first year on regular and automatically increase \$100 a year to \$4,070.00. Open to men, women 18 to 50.



Railway Postal Clerks

Railway Postal Clerks get \$3,470.00 the first year of regular employment, being paid on the first and fifteenth of each month. (\$144.58 each pay day.) Their pay is automatically increased yearly to \$4,270.00. Advance may be had to Chief Clerk at \$6,565.00 a year. (\$273.54 each pay day.) Men, 18 to 50, only.

3 Days On—3 Days Off—Full Pay

Railway Postal Clerks on long runs usually work 3 days and have 3 days off duty or in the same proportion. During this off duty their pay continues just as though they were working. They travel on a pass when on business. When they grow old, they are retired with a pension.



Many Other Positions

Many other positions are obtainable. Rural Carriers—Stenographers—Typists—Clerks—Border Patrolmen—Customs Inspectors—Meat Inspectors—etc. Those wishing these positions should qualify at once.

Get Free List of Positions

Fill out the following coupon. Tear it off and mail it today—NOW, at once.

Although not government sponsored this investment can result in your getting a big paid government job.

FRANKLIN INSTITUTE, Dept. Z-83, Rochester 4, N. Y.

Rush to me, entirely free of charge (1) a full description of U. S. Government Jobs; (2) Free copy of illustrated 36-page book, "How To Get A U. S. Government Job"; (3) List of U. S. Government Jobs; (4) Tell me what to do to qualify for one of these jobs.

Name _____

Address _____ City _____

Use This Coupon Before You Mislaid it. Write or Print Plainly.

**Shrinks Hemorrhoids
New Way Without Surgery**

Science Finds Healing Substance That Relieves Pain—Shrinks Hemorrhoids

For the first time science has found a new healing substance with the astonishing ability to shrink hemorrhoids and to relieve pain—without surgery.

In case after case, while gently relieving pain, actual reduction (shrinkage) took place.

Most amazing of all—results were so thorough that sufferers made astonishing statements like "Piles have ceased to be a problem!"

The secret is a new healing substance (Bio-Dyne*)—discovery of a world-famous research institute.

Now this new healing substance is offered in ointment form under the name of Preparation H.* Ask for it at all drug stores—money back guarantee. *Reg. U. S. Pat. Off.

FOR BIG MEN ONLY!



SIZES 10 to 16 WIDTHS AAA to EEE

WE SPECIALIZE in large sizes only—sizes 10 to 16; widths AAA to EEE. Low-Tops; Wing Tips; Hand-Sewn Moccasins; Cordovans; Dress Oxfords; Work Shoes; Sox; Slippers; Rubbers. Enjoy the finest in fit, comfort, style at amazingly low cost. Mail only. Write for FREE Style Book TODAY!

SEND FOR FREE CATALOG

KING-SIZE, INC., 548, Brockton, Mass.

'How to MAKE MONEY with Simple CARTOONS'



A book everyone who likes to draw should have. It is free; no obligation. Simply address **FREE BOOK**

CARTOONISTS' EXCHANGE
Dept. 92A Pleasant Hill, Ohio

Finish HIGH SCHOOL AT HOME

Complete 4 Yrs. in 12 Months

Learn More! Earn More! Enter professional or technical schools. Advance Socially. Live a Happier, Fuller Life. Individual Courses or complete schedule. **WRITE FOR SCHOOL BULLETIN.**

ACADEMY FOR ADULTS

30 W. Washington, Dept. PM-25, Chicago, Ill.

POWER MOWERS & KITS

FREE PLANS

LOW FACTORY PRICES DIRECT TO YOU

Build your own quality mower with our LOW COST KITS, Parts, Engines. Free Plans guide you. 3 and 4 Wheel Kits, complete. Parts precision finished, ready to use. Write TODAY for Free Plans, Low Prices, Parts List and Guarantee.



3-WHEEL KIT NO. T-800



America's Finest Power Mowers completely assembled in 3 and 4 wheel models. Belt or direct drive. 18" and 20" sizes. Nationally known make engine. Latest improved features, sturdy construction and money back guarantee fully described in color folder. Write today.

▲ TRIANGLE MANUFACTURING CO., Dept. M-2, Fort Scott, Kansas



**Get more money!
More security! More out of life!**

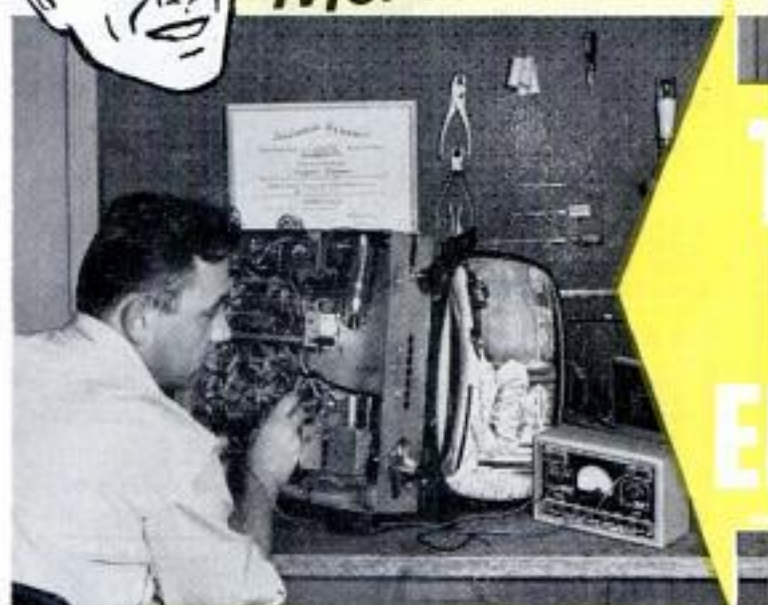

Get the best!

Get National Schools' SHOP-METHOD HOME TRAINING!

Start now! Why wait around for that raise or promotion that may never come? Get started now in high-paying TV-Radio-Electronics! National Schools' SHOP METHOD Home Training prepares you for success in a top-salary job or in your own business. You learn *all three*... Television, Radio, Electronics...in one complete course. Our Shop-Tested lessons and manuals help you master all phases in shortest possible time! Send coupon, find out today!

Located in the "Television Center" of the world, our staff is in close touch with latest developments and opportunities. We give you personalized job placement assistance. We also give you confidential help with both technical and personal problems relating to your training. We show you how to make Part Time Earnings as you progress. Whether you live 30 miles away, or 3,000, you will always be pleased with our prompt, friendly service!

DRAFT AGE? Our home training helps you achieve specialized ratings and higher pay grades if you go in service.

30 MILLION TV SETS

need regular repair! Color TV means more sets than ever before. NOW is the golden opportunity to cash in on this multi-billion-dollar industry. Or "write your own ticket" in broadcasting, manufacturing, and other specialized phases!

**YOUR AGE
IS NO
OBSTACLE!**



**Send for
FREE LESSON!**
FREE BOOK & SAMPLE LESSON
will convince you!
SEND COUPON TODAY!

We send you this precision-tested Multitester! Plus parts to build Oscillators, Receivers, Signal Generator, Continuity Checker, Combination Short Wave and Standard

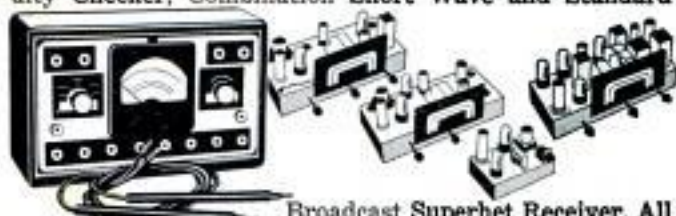

Broadcast Superhet Receiver. All this equipment is part of your National Schools course. **NO EXTRA CHARGES!** Send coupon for free books!

NATIONAL SCHOOLS,
world-famous technical
trade school. Now in our
50th year!



TECHNICAL TRADE TRAINING SINCE 1905
LOS ANGELES 37, California · CHICAGO: 323 West Polk St.
IN CANADA: 811 West Hastings Street, Vancouver, B. C.

- APPROVED FOR G. I. TRAINING
- BOTH HOME STUDY AND RESIDENT COURSES OFFERED

(mail in envelope or paste on postal card)

NATIONAL SCHOOLS, Dept. RB-25

4000 SOUTH FIGUEROA STREET OR 323 WEST POLK STREET
LOS ANGELES 37, CALIFORNIA CHICAGO 7, ILLINOIS

Please rush **FREE BOOK**, "My Future in Radio-Television-Electronics," and **FREE LESSON** at once. I understand there is no obligation, and no salesman will call.

NAME _____ BIRTHDAY _____ 19__

ADDRESS _____

CITY _____ ZONE _____ STATE _____

Check if interested ONLY in Resident Training at Los Angeles.

VETERANS: Give date of discharge _____

TRY CORTINA'S SHORT-CUT TO



MORE MONEY NEW CAREER CULTURAL ENJOYMENT TRAVEL FUN

MAIL COUPON FOR

FREE RECORD

START SPEAKING

SPANISH

OR

FRENCH



ALMOST OVERNIGHT!

MAIL coupon for double-sided, non-breakable record and sample lesson. BOTH FREE! Listen as native instructor speaks to you on record. Let your eyes follow words in sample lesson at same time. Before you realize it, you'll be "chatting" easily in your new language—with a perfect accent!

Now's the time to learn a new language. It gives you such an advantage in business, social life. And here's the easiest way to learn—by listening! You gain a perfect accent (that's all you hear!) You don't learn grammar the "hard way"; you pick it up in CONVERSATION.

MAIL COUPON NOW

There are no "strings" to this offer. But it may end soon. Hurry! Rush coupon with 25c to help cover cost of special packing, shipping. We'll also send FREE book describing full Cortina course. No obligation.

Also:
GERMAN
ITALIAN
RUSSIAN
JAPANESE
BRAZILIAN

CORTINA ACADEMY

(Originators of Phonograph Method)

Dept. 642, 136 W. 52nd Street, New York 19, N. Y.

MAIL AT ONCE FOR *Free* RECORD

CORTINA ACADEMY, Dept. 642, (Est. 1882)
136 W. 52nd Street, New York 19, N. Y.

Please send me a FREE sample record and lesson in (check one)
 SPANISH FRENCH RUSSIAN GERMAN
 ITALIAN JAPANESE BRAZILIAN

and information about full Cortina course. Enclosed is 25c (stamps or coin) to help cover the cost of special packaging, shipping.

Name _____

Address _____

City _____ Zone _____ State _____

PRESTO! MASTER GLAZE ANYONE CAN

LEAVES HARD GLASS-LIKE FINISH
EASY TO APPLY
PROTECTS THE SURFACE
NO SMEAR OR STREAKS AS WITH WAX
LASTS SIX MONTHS TO A YEAR

SEALS THE PORES OF THE SURFACE
WILL NOT FINGER-MARK
EASY TO KEEP CLEAN
NO GILY FILM AS WITH POLISH

SAVES YOU MONEY

Car Owners! Meet Master Glaze—the sensationally different luster for new and used cars! Not a wax—not an oil polish—not a paint!—nothing that "smears" over the surface.

MASTER GLAZE is a unique discovery—a creamy liquid—quick and easy to apply! Gives a hard glass-like surface. Even gasoline cannot dull it! Lasts six months to a year! Amazing luster—beautiful, sparkling clean and brilliant! Doesn't finger-mark—doesn't smear! A match box full glazes an entire car. Seals the pores—protects! NOTHING LIKE IT!

FREE SAMPLE

Just send your name and address to
MASTER GLAZE CO., 7720-814 W. Harwood Ave., Milwaukee, Wis.

LAW FREE BOOK

Write today for FREE book, "THE LAW-TRAINED MAN," which shows how to learn law in spare time through the famous Blackstone home-study course in business and professional law. All instruction material furnished including big 16-vol. law library. Bachelor of Laws (LL.B.) degree awarded. Moderate cost; easy terms. Write today.

Blackstone School of Law,
Founded 1890

225 North Michigan Ave.
Dept. 52, Chicago 1, Ill.

WHY DON'T YOU WRITE?

Writing short stories, articles on science, business, sports, hobbies, shop crafts, local, club and church activities, etc., will enable you to earn extra money. In your own home, on your own time, the New York Copy Desk Method teaches you how to write the way newspaper men learn—by writing. Our unique "Writing Aptitude Test" tells whether you possess the fundamental qualities essential to successful writing. You'll enjoy this test. Write for it, without cost or obligation.

NEWSPAPER INSTITUTE OF AMERICA

SUITE 5595-B, ONE PARK AVENUE, NEW YORK 16, N. Y.

LEARN LOCKSMITHING

Learn this fascinating, profitable trade from experts in your spare time at home! Age or physical handicap no disadvantage. Year around, steady income. Full or part time. Practical, illustrated lessons. You can make money even while learning! All materials and special tools supplied without extra charge.

send for
FREE
BOOKLET



INSTITUTE OF LOCKSMITHING, Dept. P-83
15 PARK AVENUE RUTHERFORD, N. J.
Lic. by N.J. State Board of Education
Approved for Veterans

**Free Book on Arthritis
And Rheumatism**

HOW TO AVOID CRIPPLING DEFORMITIES

An amazing newly enlarged 44-page book entitled "Rheumatism" will be sent free to anyone who will write for it.

It reveals why drugs and medicines give only temporary relief and fail to remove the causes of the trouble; explains a proven specialized non-surgical, non-medical treatment which has proven successful for the past 36 years.

You incur no obligation in sending for this instructive book. It may be the means of saving you years of untold misery. Write today to The Ball Clinic, Dept. 756, Excelsior Springs, Missouri.

START YOUR OWN BUSINESS!

ELECTRICAL APPLIANCE REPAIRING

**SECURITY — INDEPENDENCE
WORK SHORT HOURS**

There are millions of electrical equipment units in daily use . . . in factories, homes, office buildings and on farms. Skilled electrical technicians are needed to keep this equipment in good running condition. Learn at home in spare time.

You can now **BE TRAINED** to fill this **BIG NEED** . . . a need that grows day by day because of new electrical inventions for home and factory.

If you are mechanically inclined, can hold and use tools, we can give you the training and time-saving kits that will enable you to . . . **Command More Money at Work . . . A Better Paying Job Elsewhere . . . Or A Business Of Your Own!**

The **ELECTRONIC KIT**, a multi-purpose trouble detector, and other valuable Shop Method Training is sent to you! All instruction material is written in simple, easy-to-understand language, chock full of hundreds of detailed photos and drawings. Used by servicemen the country over.

We show you how to quickly locate the trouble, how to fix it and what to charge. **ALSO**, how to solicit business and keep business coming to you.

Get Full Facts on how you can get this training at home in your spare time and pay for it out of your earnings while learning!

IN YOUR OWN KITCHEN, BASEMENT, OR GARAGE

You don't need elaborate fixtures or expensive equipment to be a successful repairman. Work as many hours as you wish. The Electrical Appliance Technician is his own boss!

\$5.00 - \$6.00 HOUR

often charged for making ordinary repairs. We show you how to repair refrigerators, vacuum cleaners, washing machines, motors, etc., etc.

AGE IS NO BARRIER

Nor is a minor physical handicap. Work is light, pleasant and **PROFITABLE**.

FREE BOOK

On America's fastest growing industry

CHRISTY TRADES SCHOOL, Dept. D-3903, 4804 N. Kedzie, Chicago 25

CHRISTY TRADES SCHOOL, Dept. D-3903
4804 N. Kedzie Ave., Chicago 25, Ill.

Gentlemen:

Please rush me your **FREE ILLUSTRATED BOOK** about Electrical Appliance Servicing. facts on your Electronic Kit and Special form for paying later from earnings while learning.

NAME _____ Age _____

ADDRESS _____

CITY _____ Zone _____ State _____



EARN WHILE YOU LEARN!

Only had your course a few short weeks and have already made \$800.00. Going to quit my job paying \$250.00 straight salary to operate my own business. — J. D. S., St. Louis, Mo.

I work day times at the shipyard and after 4:00 P. M. I operate from my cellar and garage. I average \$10.00 to \$15.00 clear every day. — Walter Hanby, Brockton, Mass.



SEND COUPON TODAY



NEW BUSINESS PLAN FOR INVENTORS

We are undertaking further product diversification as a part of our current expansion program.

If you have a patented product and would like to go into business with us, we have worked out a plan for the development and marketing of new inventions which you should investigate immediately. Our success has been built on engineering ingenuity, distribution skill and sound management. Preliminary discussions arranged at your convenience.

Contact:

Robert F. Dick, Vice President

ILLINOIS TOOL WORKS

2507 North Keeler Avenue, Chicago 39, Illinois

Manufacturers of Gear Cutting Tools, SHAKEPROOF Fastenings,
Plastic Products and Special Machines



and SCIENTIFIC
MOTOR TUNE-UP

—One of America's

Fastest-Growing Big-Pay Industries!

Get ready now . . . Make a place for yourself in the mighty Diesel industry. Be there to take advantage of the opportunities ahead. The U.E.I. Plan for learning Diesel is simple, practical and is based upon the principle of learning-to-do-by-doing. Includes Auto Engine Tune-Up. You get fundamentals through spare-time home-study, followed by actual shop practice on modern Diesel engines. Experienced instructors guide you step-by-step — you learn the HOW and WHY of Diesel operation, service and maintenance. Get all the facts—mail the coupon and we'll send you a free copy of "Earning Power in Diesel." Mail coupon today!

UTILITIES ENGINEERING INSTITUTE

Dept. DC-43, (Founded 1927) Chicago 14, Ill.

UTILITIES ENGINEERING INSTITUTE, Dept. DC-43
2521 Sheffield Ave., Chicago 14, Illinois

Please send me, without obligation, your free book, "Earning Power in Diesel."

NAME (print)..... AGE.....

ADDRESS

CITY..... Zone..... State.....

Check here for information if you are under 17

TASOPE PHOTO-ENGRAVING PLANTS



Material Cost
Of This Cut 3/4c
Selling Price
\$1.00 And Up

Establish your own profitable PHOTO-ENGRAVING business. Make cuts for newspapers, printers, and advertisers. Make etched name plates, plaques etc. Instructions furnished, no experience necessary. Sold direct from factory since 1931. First five hundred cuts sold locally or by mail will pay for plant and pay you well for your time. Write for FREE catalog.

TASOPE, DEPT. PM-2, AURORA, MO.



OWN a BUSINESS without INVESTMENT

There's big money in your community taking easy orders from garages, service stations, lumber yards for Work Uniforms that advertise! Easy sales, big profits. Repeat business insures future. Represent finest, largest line in the field. Show huge selection of styles, embroidery fabrics, including miracle "wash and wear" Dacron, Orlon, etc. Everything you need to get started sent FREE.

TOPPS, Dept. 612, Rochester, Ind.

SHORTHAND IN 6 WEEKS

Write 120 words per minute

Age no obstacle—Lowest Cost

Famous SPEEDWRITING shorthand. No symbols; no machines; uses ABC's. Easiest to learn and use. Fast preparation for a better position. Nationally used in leading offices and Civil Service. 120 words per minute—50% FASTER than Civil Service requirements. Over 250,000 taught by mail or through classroom instruction. The very low cost will surprise you. Typing available. 32nd Year. Schools in over 400 cities in U.S., Canada, Cuba, and Hawaii.

WRITE FOR FREE BOOKLET TO SCHOOL OF

Speedwriting

Dept. 1502-S, 55 W. 42 St., N.Y. 36

POPULAR MECHANICS

We'll train & establish you in Your Own Business ... even if now employed

We are enlarging this 25-year-old world-wide chain of Duraclean dealerships. Many excellent locations are still available in the U.S.A., Canada, and other countries. If you are reliable and diligent, this is an opportunity to increase your income . . . and have the freedom, financial independence, and prestige of YOUR OWN business.

These are full time dealerships . . . but you can start

in spare time and have a profitable, lifetime business when your present job ends. A Duraclean dealer will train and assist you. He'll reveal his successful, proven methods and sales plans. He'll work with you.

Alert dealers can average \$5 hourly gross profit on service they render plus \$3 on EACH service-man at National Price Guide charges. This business is easy to learn . . . quickly established.

World-wide Service



FREE Booklet tells how!

You Become an Expert in cleaning and protecting Rugs and Upholstery

DURACLEAN cleans by absorption. It eliminates scrubbing . . . soaking . . . shrinkage. Aerated foam, created by electric Foamovator, restores natural lubrication in rugs and upholstery. Dirt, grease and many unsightly spots vanish. Fabrics and floor coverings are cleaned with a new consideration for their life and beauty.

This modern process avoids strong soaps and machine scrubbing, eliminating unnecessary wear and breaking of fibers. Fabric life is increased.

DURACLEANING is done in the home. Customers like this convenience. Fabrics dry in a few hours. Rug pile again stands erect and even. Brilliant colors revive. Furnishings become clean, fresh and enlivened.

DURAPROOF is another year 'round service rendered in the home, office or institution — without removing furnishings. It protects upholstery, rugs, furs, clothing and auto interiors against damage by moths and carpet beetles. U. S. Government says "Moths are present in practically every household . . . No section of country seems free from such infestations." **DURAPROOF** kills moths and carpet beetles. It makes materials non-eatable to both. **DURAPROOF** is backed by an International 6-Year Warranty.



Easy to Learn • No Overhead Expense

Permanent, Growing Market

Service is rendered in homes, offices, hotels, theaters, institutions and to revive used-car upholstery for auto dealers. There is need for these services in almost every building. Duraclean dealers operate from their home, an office or shop, as they prefer. It's easy to learn . . . We quickly train you. Rendering service yourself, at first, prepares you to train and supervise service men.

Repeat and Voluntary Orders

Demonstrations win new customers. **DURACLEAN** Dealers find **REPEAT** and **VOLUNTARY** orders a major source of income. Customers, enthused with results, tell friends and neighbors. Furniture and department stores and others turn over rug and upholstery cleaning and mothproofing to **DURACLEAN** Dealers. We show you 27 ways to get new customers.

We Help YOU Grow

Our **MUTUAL COOPERATION** program gives you many unique and continuous advantages: **National Advertising** in Life, McCall's, House & Garden, Maclean's (Canada) and a dozen others. (See 1/4-page ad in Feb. House Beautiful). Copyright and trademark protection. Certificate approves equipment and materials. **Products Insurance**. **Six-year Warranty**. **Pocket Demonstrators**. **Sales Book**. **Advertising Folders & Cards**. **Tested Ads**. **Ad Cuts & Mats**. **Store Display Cards**. **Radio & TV Musical Commercials**. **Home Show Booth Display**. **Publicity Program** gets **FREE** local newspaper stories, **Prizes**. **Laboratory research** and development. **Duraclean bulletins**. **Resale Service**. **Annual Conventions**. Behind all this is a **25 YEAR OLD** headquarters interested in YOUR personal success. If you want to become the owner of a **DURACLEAN** Service business, you should inquire now. **TODAY**, while territory is still available.

What Dealers Say

- W. Lookiebill: We've had 20 years of pleasant dealings. I'm 65 but am setting my sights for 20 more years.
Gerald Merriman: \$700 cleaning . . . only 13 working days.
P. D. Freidinger: 70% of our business is repeat.
A. Ullman: Every demonstration has been a sale.
Ellsworth: Your advertising certainly has paid dividends.
M. Lassanske: My original investment was returned in about two months. I am not sorry in any way that I started my business 'on a shoe string.'
R. Kimbrough: Finished First White House of Confederacy and am to Duraclean the Governor's Mansion.
Margaret Turner: Took in \$106 in 15 or 18 hours.
L. Johnson: Each customer leads to 3 or 4 more.
T. Komari: We have 1,000,000 yen contract Duracleaning for U. S. Army in Japan.

FREE Booklet

Our first letter and illustrated booklet will explain everything—the two modern, urgently needed services, waiting market, how business grows, your large profit, easy terms and **PROTECTED** territory.



EASY TERMS

A moderate payment establishes your own business—pay balance from sales. We furnish electric machines, folders, store cards, introduction slips, sales book, demonstrators and enough material to return your **TOTAL** investment. Mail coupon today! No obligation.

Duraclean Co. 5-162 Duraclean Bldg., DEERFIELD, ILLINOIS

"OWN a Business" Coupon

DURACLEAN CO., 5-162 Duraclean Bldg., Deerfield, Illinois

Without obligation to me, send booklet and letter giving full details. Tell me how I may OWN a growing business of my own built upon satisfied customers.

Name _____

Address _____

City _____ State _____



**YOU
can
acquire**

**LAW NIGHTS AT HOME!
L. L. B. DEGREE**

LaSalle's famous Law Library—used as reference in many Law libraries and Law offices—has enabled thousands to master Law surprisingly fast, in spare hours at home, for business and professional advancement.

These 14 remarkable volumes, compiled by leading professors and lawyers, cover the whole basic field of Law in condensed, orderly, simplified manner.

You advance rapidly with this great library, plus special lectures furnished. We guide you step-by-step with personalized Problem Method of instruction . . . you learn by doing—handling legal problems—not by memorizing rules.

Send for two FREE 48-page booklets, "Law Training for Leadership," and "Evidence," answering questions about Law and its value to you, and telling how LaSalle Law graduates are winning rapid advancement in business and public life. Mail coupon below. No obligation.

**LA SALLE EXTENSION UNIVERSITY
A Correspondence Institution**

417 S. Dearborn St. Dept. 264L Chicago 5, ILL.

Send me your two FREE booklets described above, without obligation.

Name.....Age.....

Street.....

City, Zone & State.....

REPAIR ANY WATCH



... Swiss or American

No previous experience needed to learn modern watch repair. An enjoyable hobby or profitable career. Unique Sweazey System starts you making repairs right away. Develops your skill step by step. Teaches you modern shop methods . . . professional short cuts . . . mistakes to avoid. Learn by personal attendance or spare time home study. Individual training. Start any time. Free sample lesson. No obligation. Write today!

CHICAGO SCHOOL OF WATCHMAKING
2330 N. Milwaukee, Dept. 125, Chicago 47, Ill.
Founded 1908. Approved for veterans

MAIL COUPON TODAY!

**FREE
SAMPLE
LESSON**

CHICAGO SCHOOL OF WATCHMAKING

2330 Milwaukee, Dept. 125, Chicago 47, Ill.

Send FREE sample lesson. Home study

Resident school

Name..... Veteran

Address.....

City..... Zone..... State.....



**Use my TESTED SALES
PLAN to make an extra
\$50.00 every week!**

Just a few hours each week — evenings, Saturdays — can add \$50 to \$100 to your regular income. Be a factory representative for Charles Chester patented Air-Cushion shoes — bring new comfort to friends, neighbors, co-workers — dress, work, leisure shoes for all the family sold only direct from factory to wearer. No investment is required — you make no deliveries, no collections. Just collect deposit from your customers: we do the rest!

STEADY AUTOMATIC REPEAT BUSINESS

Satisfied customers reorder constantly! CHARLES CHESTER representatives offer more than 140 styles, in a tremendous size range, 1-18, AAA to EEE. No Experience Needed — our tested, proven Sales Plan shows you how! Write today for details and FREE SALES KIT!



RR - DESIGN
1901



**FREE
SALES
KIT!**

CHARLES CHESTER SHOE COMPANY

5 Foundry St., Brockton, Mass.

**BE A
LEADER
IN
AVIATION**

Parks graduates are known worldwide as leaders in aviation — their education is the finest offered. Advance faster . . . earn more in less time! Become a Parksman!

B.S. degree in 3 yrs. from Saint Louis University — Aero. Eng., Aero. Adm., Maint. Eng.

Non-degree courses — A & E Mechanics, Private, Commercial, Instrument, Flight Instructor and Multi-engine Ratings . . . CAA-Approved.

All Parks schooling approved for Veterans. Write for full information.

PARKS COLLEGE ARNOLD HALL
EAST ST. LOUIS, ILL.

**BUILD LUGGAGE AT HOME
WE SELL YOUR PRODUCTS!**

ONLY NEW HOME MONEY-MAKING PLAN IN YEARS!

Make Luggage and cases for traveling, photographers, musicians, salesmen, electronics, tools, portables, 1001 other items. Also repair Luggage. No special equipment needed. BIG Profits. We supply complete instructions, materials—everything. Write for free details and Business Plan. ABARSI CASECRAFT, Dept. G-2, 805 W. Sunset Blvd., Los Angeles 12, Calif.

EARN WHILE YOU LEARN AT HOME
MAKE MONEY 90 WAYS IN PHOTOGRAPHY

If you are OVER 17—good pay, fascinating work await you in photography. Start earning at once as you learn to make money 90 ways with your camera. Our famous, low-cost LEARN-BY-DOING method and INDIVIDUAL guidance train you quickly at home! Write TODAY for FREE catalog. Also Co-ed Resident Training. 40th Year. GI Approved.

NEW YORK INSTITUTE OF PHOTOGRAPHY
Dept. 49, 10 W. 33 Street New York 1, New York



Broken or Loose FALSE PLATE?



Fix it Yourself EASILY in a Few Minutes

Your plates may become broken or loose just when you need them most. With FIX-IT-KIT you can repair your own broken plates. Also tightens loose fitting plates, easily. Get permanent comfort with professional material. Complete instructions. Satisfaction guaranteed or your money refunded. Order Now at a new low price only \$2.98 postpaid — or sent C.O.D.

Make Plates Like New

DENT-FIX DENTAL PRODUCTS, Box 674, Dept. PM-2, Kansas City 41, Mo.

Learn BAKING At Home

Baking is one of America's high industries in WAGES. Nearly DEPRESSION-PROOF. Thorough basic home course lays sound foundation. If you have aptitude, write for FREE Booklet, "Opportunities in Commercial Baking."

NATIONAL BAKING SCHOOL
835 Diversey Pkwy. Dept. 1352 Chicago 14



What about YOUR Future?



"What can be in it for me?"

PLENTY! Better Job!—
Bigger Pay!—Brighter Future!

"How can I be so lucky?"

EASY! On the coupon check the subject that interests you most, then—sign and mail it.



"Then What?"

FACTS! We will send facts which show Your Big Opportunities can be closer than you think!

FULL INFORMATION... NO COST... NO OBLIGATION

Yes, what about your future? Do you look forward into a rather hazy and distant time that you hope will bring you big job promotions, much higher pay, and lasting security? Or are you a realist and know that you are standing at the gateway to your *real* future right now, and that what's ahead for you depends on what you *do today*?

TODAY you can make the *big* decision of your life. You can make the choice that can start you toward richer goals. From the list in the coupon below, choose the career you want and decide to find out

how you can prepare for progress in it, in spare time, at home. Or if you are now in the work you like best, learn how you can start training for quicker promotion and higher earnings. Just *mark* and *mail* the coupon without delay.

American School, since 1897 an educational institution *not for profit*, has enabled others to *earn* more while they *learned* more. That opportunity is offered to you *now*. Learn *all* about it by sending the coupon immediately.

AMERICAN SCHOOL, Dept. G245, Drexel at 58th, Chicago 37, Ill.

Canadian Residents: Write to American School, 1610 Sherbrooke St. West, Montreal

AMERICAN SCHOOL, Dept. G245, Drexel at 58th, Chicago 37, Ill.

Without obligation, please send FREE and postpaid, full particulars about the subject checked below.

- | | | |
|--------------------------------------------------|---------------------------------------------------|-------------------------------------------------|
| <input type="checkbox"/> Accounting | <input type="checkbox"/> Diesel Technician | <input type="checkbox"/> Mechanical Engineering |
| <input type="checkbox"/> Apprenticeship Courses | <input type="checkbox"/> Drafting—Building Trades | <input type="checkbox"/> Plastics Engineering |
| <input type="checkbox"/> Architecture & Building | <input type="checkbox"/> Drafting—Machine Trades | <input type="checkbox"/> Plumbing—Practical |
| <input type="checkbox"/> Automotive Technician | <input type="checkbox"/> Electrical Engineering | <input type="checkbox"/> Private Secretary |
| <input type="checkbox"/> Better Foremanship | <input type="checkbox"/> Electricity—Practical | <input type="checkbox"/> Retail Merchandising |
| <input type="checkbox"/> Bookkeeping | <input type="checkbox"/> Electronics—Industrial | <input type="checkbox"/> Salesmanship—Outside |
| <input type="checkbox"/> Business Management | <input type="checkbox"/> High School Courses | <input type="checkbox"/> Sheet Metal Work |
| <input type="checkbox"/> Civil Engineering | <input type="checkbox"/> Machine Shop Operations | <input type="checkbox"/> Tool Making |
| <input type="checkbox"/> Contracting | <input type="checkbox"/> Mathematics & Slide Rule | |

NAME _____ OCCUPATION _____

HOME ADDRESS _____ AGE _____

CITY _____ STATE _____

The sooner
you **ACT**,
the sooner
YOUR GOAL
can be
REACHED

DRAFTSMEN



**CASH BIG
PAY CHECKS!**

Train Now for
more success,
greater security

**LEARN AT HOME IN SPARE TIME
(or at college in Chicago)**

Check the want ads in any newspaper—SEE the big-pay opportunities open to you as a draftsman. What's more, you can learn this well-paid, prestige profession at home—quickly, easily! No special talent needed. Get complete, step-by-step Chicago Tech lessons in the mail, spend a few pleasant hours studying each week. In a short time you'll be a well-trained draftsman, ready to take your pick of many good jobs. Act now!



Free Information—Mail Coupon Today!

Get FREE TRIAL LESSON plus information about C.T.C. practical training. Learn what successful Chicago Tech graduates say about high pay and opportunities in drafting. No charge, or obligation.

CHICAGO TECHNICAL COLLEGE

B-253 Tech Bldg., 2000 So. Michigan Ave.
Chicago 16, Illinois

Mail me FREE lesson with facts about big opportunities in DRAFTING.

Name _____ Age _____

Address _____

City _____ Zone _____ State _____

BIG PAY JOBS for men who qualify in DIESEL



TRAIN NOW FOR A DIESEL FUTURE. Steady, high-pay jobs await men qualified in Diesel, Tractor and Heavy Equipment. Are you qualified for job and advancement opportunities in this fast-growing field? You can qualify!

COMPLETE DIESEL COURSE NOW AVAILABLE. If you are ambitious and want to get ahead in this big money field, you'll want to know about the complete Diesel home training course now offered by Interstate Training Service. Covers all phases of operation, repair, service. Easy to master in spare time. No interference with present job. Up-to-the-minute. Regularly revised to cover new developments. We invite comparison of material offered. Advisory placement service for our students.



YOU OWE IT TO YOURSELF to investigate Interstate Training Service Diesel Training. Thousands agree it has helped them to better jobs...better pay. It can do the same for you!

WRITE FOR FREE INFORMATION TODAY

INTERSTATE TRAINING SERVICE, Portland 13, Ore.
Please see that I receive FREE 24-page book, "Getting Ahead in Diesel." (A-3-B)

NAME _____ AGE _____
ADDRESS _____
CITY _____ ZONE _____ STATE _____

EXPERIENCE IS THE BEST TEACHER—OUR MANY YEARS PROVES YOU CAN'T GET MORE—WHY PAY MORE? LOW OVERHEAD—LARGE VOLUME SALES & SMALL PROFITS BRING YOU THESE "LOWEST PRICES."

WHAT GOOD IS A TIRE WITHOUT A TUBE? TUBE FREE WITH EVERY TIRE ON REQUEST



WHY PAY MORE!

21 YEARS AT THIS ADDRESS
AN ESTABLISHED POLICY OF CAREFUL SELECTION ASSURES YOU, MANY HAPPY MILES. BE WISE—TRY ONE—YOU'LL BUY MORE! WE WELCOME COMPETITION. NO ONE CAN TOUCH OUR QUALITY & PRICE!

GOOD USED TIRES—NOT RECAPS—NOT RETREADS
TAKE THE 10% DISCOUNT WE OFFER & PUT MONEY IN YOUR POCKET!
EVERYBODY 10% off ON EVERY TIRE



FREE If you buy 2 of 3 PASS, 4 PLY, 32 mos. guarantee tires, We GIVE ONE tire FREE. **FREE**

Socialists in Truck Tires—Selected for Toughest Jobs—Tops in Value		34 MOS. WRITTEN GUARANTEE		34 MOS. WRITTEN GUARANTEE	
600-16	\$5.02	475-15	\$5.12	700-15(6)	\$8.42
600-16(6)	6.32	640-15	4.72	750-16(8)	8.42
650-16	8.52	670-15	5.12	700-17	8.72
650-16(6)	7.02	710-15	5.22	750-17	10.52
700-16	6.12	760-15	5.72	750-15	10.42
750-16(6)	8.32	800-15	6.02	825-15	10.92
550-18	3.92	820-15	6.12	600-20	8.72
550-17	4.22	670-16	5.02	650-20	9.52
650-15	5.02	760-16	7.02	32x6(8)	10.52
700-15	5.12	700-16(6)	7.12	32x6(10)	12.92
				1100-24	22.92

Thousands of tires shipped all over the U.S.A. All tires shipped F.O.B. Phila. Send Check or M.O. with this ad. Dept. 2. No C.O.D.
STANDARD 834 N. Broad St., Philadelphia 30, Pa.

TELEPHONES



Desk Stand Style

Slightly used but in excellent condition

Many Valuable Uses

Inter-House Phones House to Barn, etc.
Loud Speakers Microphones

Educational Purposes, Toys, etc.

Come complete, ready to use with wiring diagrams included. **\$2.75 Postpaid** in U.S.A.

Two complete for only \$5.00
TELEPHONE LAMP KIT—with illustrated instructions for making Desk Telephone Lamp including all parts (harp, nipples, push switch, cord, plug, etc.) \$6.50 Ppd. (Shade is not included).

MICROPHONE, Dept. X-2302, 1760 W. Lunt Ave., Chicago 26, Ill.

SCIENTIFIC CRIME DETECTION



IT'S EASY TO LEARN

Let us teach you in your own home. Learn Finger Printing, Firearms Identification, Police Photography, Criminal Investigation Methods thoroughly, quickly, at small cost. Over 800 of all U. S. Bureaus of Identification employ I. A. S. students or graduates. Write today, stating age.

INSTITUTE OF APPLIED SCIENCE, 1821 Sunnyside Ave., Dept. 1352
Chicago 40, Ill.
(A Correspondence School Since 1910)

Learn CARTOONING

at home in spare time... the quick easy Landon Picture Chart way. Teaches how to originate—today's big need. Scores of successes. Send 10c for Picture Chart (to test ability) and full details. Please state age.

Landon School of Cartooning, 5502 CTS Bldg., Cleveland 14, O.



Learn ACCOUNTING

Business Administration
Bookkeeping, secretarial and allied subjects at home in your spare time or attend nationally approved resident school. Write for FREE Success Book giving complete details on courses, plans, rates and employment opportunities. G.I. approved.



Hills BUSINESS UNIVERSITY AND EXTENSION SCHOOL
629 W. MAIN ST. OKLAHOMA CITY 2, OKLAHOMA

PIMPLES* CUTICURA Relieves Faster

Many doctors report results in 1 to 3 days with new sensational CUTICURA MEDICATED LIQUID. This greaseless, fast-drying, "invisible" antiseptic soothes as it helps heal. It works day and night, even under make-up. 60c at druggists. If your druggist hasn't it don't waste money on substitutes but send us 10c for generous trial size. *externally caused

CUTICURA, Dept. 16BX, Malden 48, Mass.

HOW TO FIX

Brakes, Clutches, Transmissions, Rear Ends, Carburetors — Yes,

ANY PART OF ANY CAR



QUICKLY--
EASILY--
RIGHT!

USED BY U. S.
ARMED
FORCES

NOW—Whether You're a Beginner or an Expert Mechanic —You Can "Breeze Through" ANY AUTO REPAIR JOB! MOTOR'S BIG BRAND-NEW AUTO REPAIR MANUAL Shows You HOW — With 2950 PICTURES AND SIMPLE STEP-BY-STEP INSTRUCTIONS.

Free 7-DAY TRIAL
Return and Pay Nothing
If Not Satisfied

COVERS EVERY JOB ON EVERY CAR BUILT FROM 1940 THRU 1954

YES, it's easy as A-B-C to do any "fix-it" job on any car whether it's a simple carburetor adjustment or a complete overhaul. Just look up the job in the index of MOTOR'S New AUTO REPAIR MANUAL. Turn to pages covering job. Follow the clear, illustrated step-by-step instructions. Presto—the job is done!

No guesswork! MOTOR'S Manual takes nothing for granted. Tells you where to start. What tools to use. Then it leads you easily and quickly through the entire operation!

Same FREE Offer On MOTOR'S Truck and Tractor Manual

Covers EVERY job on EVERY popular make gasoline truck, tractor made from 1946 thru 1954. FREE 7-Day Trial. Check proper box in coupon.

cuts that will amaze you. No wonder this guide is used by the U. S. Army and Navy! No wonder hundreds of thousands of men call it the "Auto Repair Man's Bible"!

Meat of Over 140 Official Shop Manuals

Engineers from every automobile plant in America worked out these time-saving procedures for their own motor car line. Now the editors of MOTOR have gathered together this wealth of "Know-How" from over 140 Official Shop Manuals, "boiled it down" into crystal-clear terms in one handy indexed book!

Covers 685 Models—All These Makes

Buick	Ford	Nash
Cadillac	Frazer	Oldsmobile
Chevrolet	Henry J	Packard
Chrysler	Hudson	Plymouth
Crosley	Kaiser	Pontiac
De Soto	Lincoln	Studebaker
Dodge	Mercury	Willys



Many Letters of Praise from Users "MOTOR'S Manual paid for itself on the first 2 jobs, and saved me valuable time by eliminating guesswork."

—W. SCHROPP, Ohio

He Does Job in 20 Min.—Fixed motor another mechanic had worked on half a day. With your Manual I did it in 20 minutes.

—C. AUBERRY, Tenn.



MAIL COUPON NOW FOR 7-DAY FREE TRIAL

MOTOR BOOK DEPT.
Desk 12, 250 W. 55th St., New York 19, N. Y.

Rush to me at once (check box opposite book you want):

MOTOR'S New AUTO REPAIR MANUAL. If O.K., I will remit \$2 in 7 days, \$2 monthly for 2 months and a final payment of \$6 (plus 35c delivery charges) one month after that. Otherwise I will return the book postpaid in 7 days. (Foreign price, remit \$9 cash with order.)

MOTOR'S New TRUCK & TRACTOR REPAIR MANUAL. If O.K., I will remit \$2 in 7 days, and \$2 monthly for 2 months, plus 35c delivery charges with final payment. Otherwise I will return book postpaid in 7 days. (Foreign price, remit \$10 cash with order.)

Print Name.....Age.....

Address.....

City.....State.....

Check box and save 35c shipping charge by enclosing WITH coupon entire payment of \$6.95 for Auto Repair Manual (or \$8 for Truck and Tractor Repair Manual). Same 7-day return-refund privilege applies.

Over 2,950 Pictures! So Complete,
So Simple, You CAN'T Go Wrong!

BIG BRAND-NEW REVISED Edition. Covers everything you need to know to repair over 685 chassis models—including ALL 1954 CARS. ONE THOUSAND giant pages, 2,950 "This-Is-How" pictures. Over 290 "Quick-Check" charts — more than 22,598 essential repair specifications. Over 225,000 service and repair facts. Instructions and pictures are so clear you can't go wrong!

Even a green beginner mechanic can do a good job. And if you're a topnotch mechanic, you'll find short-

Try Book FREE 7 Days

SEND NO MONEY!

Just mail coupon!

When the postman brings book, pay him nothing. First, make it show you what it's got! Unless you agree this is the greatest time-saver and work-saver you've ever seen—return book in 7 days and pay nothing. Mail coupon today! Address: MOTOR Book Dept., Desk 12, 250 West 55th St., New York 19, N. Y.

not everyone does as well, but E. O. Lockin, who started a business of his own, reports...

for 12 months I've averaged
\$800 PER MONTH INCOME
 —most of it clear profit for me!

● Mr. Lockin expresses his grateful thanks for the opportunity to make a decent living on his own. Many men have discovered how to be independent, to be free of bosses and layoffs. L. A. Eagles grossed more than \$200 his first week. R. E. Traynor says, "I made \$62 gross in one day." Others report gross up to \$12,000 per year.

How much you make depends largely on you. You need no special skill, no large investment.

No shop necessary.

Our **ELECTRIC RUG WASHER** cleans rugs, carpets right on floor... helps to show their natural color and beauty. So efficient and safe, used by largest hotels and railroads.

You take no risk. Machines fully guaranteed. Mail coupon today for complete information including how to start making big profits in YOUR OWN business.

VON SCHRADER MFG. CO., RACINE, WIS.

You, too, can start your own business. No special skill, no large investment required. Mail coupon today for interesting **FREE** book.

VON SCHRADER MFG. CO.,
 210 "R" Pl., Racine, Wisconsin

Send at once (no obligation) your **FREE** booklet containing information about your **ELECTRIC RUG WASHER** and how I can start my own permanent, profitable business.

Name _____
 Address _____
 City _____ Zone _____ State _____

SAY YOU SAW IT IN
 POPULAR MECHANICS

**High School
 at Home**

MANY FINISH IN 2 YEARS

No classes. No time wasted going to and from school. Progress as fast as your time and abilities permit. Standard H. S. texts supplied. Thousands enroll each year in this 58-year-old school. Send for **FREE** descriptive booklet.

AMERICAN SCHOOL, Dept. H245
 Drexel at 58th St., Chicago 37, Ill.

Without obligation, please send **FREE** descriptive booklet.

Name _____

Address _____

Canadian Residents: Complete Canadian Course Available. Write American School, 1610 Sherbrooke St., West, Montreal.

**New FALSE PLATE
 for OLD
 IN 24 HOURS**

Low As Only
\$15.95



Wonderful New Scientific Method Transforms OLD, LOOSE, Cracked or Chipped Plates into LUSTROUS BEAUTY-PINK DUPONT PLASTIC PLATES

MONEY BACK GUARANTEE

Why envy beautiful false teeth of others? We will transform your old, loose, cracked or chipped plate into a beautiful new, lightweight DuPont Beauty-Pink Plastic Plate, using your own teeth. All missing and broken teeth matched and replaced. Your cost amazingly low; actually save many dollars. No impression needed under our new scientific False Plate Method. 24-Hour Service.

SEND NO MONEY Enjoy life again, and save money on beautiful, new, natural-looking plastic plate. Rush name, address for full details sent **FREE**. If your plate is loose, we show you how to make it comfortable, tight-fitting before duplication. **West Dental Laboratory, 127 N. Dearborn St., Dept. T-128 Chicago 2, Ill.**

New MIRACLE WALL CLEANER

QUICK EASY Saves Costly Redecorating
AMAZING INVENTION. Banishes old-style housecleaning mess and mud. No rags—no sticky "gooch"—no red, swollen hands. No more dangerous stepladders. Literally erases dirt like magic from Wallpaper, Painted Walls, Ceilings, Window Sashes. Take orders from friends! Earn money! Act now!

SAMPLES FOR TRIAL Sample offer sent immediately to all who send name at once. Hurry. Postcard will do. **SEND NO MONEY**—just your name. **KRISTEE CO., Dept. 682, AKRON 8, OHIO**

New Way to Improve YOUR ENGLISH

A command of effective English gives you added advantages and better opportunities. Four English handicaps you more than you will ever realize. You can improve your English through Sherwin Cody's 100% self-correcting invention. If you are embarrassed by mistakes in grammar, spelling, punctuation, or pronunciation, this free book "How You Can Master Good English in 15 Minutes a Day" will prove a revelation to you. Send for it now. It is free. No obligation. No agent will call. Address **SHERWIN CODY COURSE IN ENGLISH, 582 Central Drive, Port Washington, N. Y.**

FREE BERRY'S NEW POULTRY BOOK

Gorgeous! Illustrated, describing **DAY-OLD** and **4-WEEK CHICKS**. 50 varieties, veiled or unsexed **AMERICA'S FINEST**; also Ducks, Geese, Guinea, **ORIGINAL BERRY'S FARM**, for over 50 years. Beautiful book and **LOW PRICE LIST FREE**, stamps appreciated. **BERRY'S POULTRY FARM, Box 29, Clarinda, Iowa**

500 TRICKS MAGIC TRICKS
IT'S FUN TO DO MAGIC

Be popular! Amaze—mystify—entertain! For 30 years Douglas has satisfied customers all over the world. Now, you can enjoy this fascinating hobby. Only 10c brings our Catalog **500 Tricks**, containing brand new tricks for pocket, parlor, stage. Join in the fun—send 10c today!
Douglas Magicland, Dept. A, Dallas, Texas

TALL MEN 6 ft. to 6' 11"
FREE STYLE CATALOG NOW READY!
TALL MEN — 6' to 6' 11": Here's a tall story you can believe. Your shopping problems are solved by the country's only specialist in fitting tall men. Complete stock of **EVERYTHING** for the tall man in hard-to-get sizes at easy-to-pay prices. Send for **BIG CATALOG NOW!**
TED THOMPSON, Dept. 162
 6 Green St., Boston 14, Mass.



**IF YOU "EAT, SLEEP
AND LIVE" CARS...**

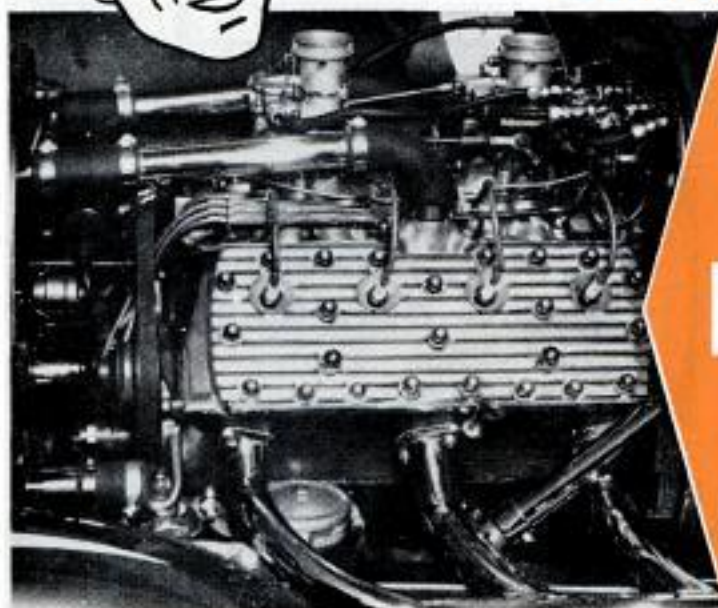

**TURN YOUR
HOBBY INTO
A CAREER!**

Get America's Big-time, Big-future

**AUTO MECHANICS & DIESEL
COURSE**

at Home in Your Spare Time!

Los Angeles' *National Schools*, America's automotive Technical Trade School since 1905, now brings its famous resident Shops and Faculty direct to you at home—to prepare you to earn more money, with job security, in today's fast-moving, opportunity-filled Auto Mechanics Industry!

Get your home training from the "Car Capital of The World"—America's most auto-minded city, center of Hot Rod and Sports Car activity! Mail the coupon below right now!



HERE'S THE GOOD WORD ON OUR "SHOP-METHOD" HOME TRAINING! You master all phases, including Diesel! Every step fully explained. All lessons fully illustrated. Latest equipment and techniques. You complete your training in short time... age and previous experience no obstacle!

EARN WHILE YOU LEARN! You can start Spare Time Earnings in Auto Mechanics soon after enrollment. Many students pay for their training and more this way.

THIS SET OF LIFETIME TOOLS—YOURS plus all-metal tool box, and other equipment. All part of your course, yours to keep.



Send for FREE FACT-BOOK AND SAMPLE LESSON!

NOW! 2 offices to serve you faster! Mail coupon today to one nearest you!

YOU RECEIVE FRIENDLY GUIDANCE both as student and graduate. Our graduate department is always at your service to help you with personal and technical problems. We give you free Job Placement Service, too!

ATTENTION MEN OF DRAFT AGE. Many students have achieved higher rating, prestige, service branch they want, and higher pay due to this training. Mail coupon *at once*.

APPROVED FOR G. I. TRAINING

Both Home Study & Resident Courses Offered

**NATIONAL SCHOOLS
TECHNICAL TRADE TRAINING SINCE 1905**

**LOS ANGELES 37, California · CHICAGO: 323 West Polk St.
IN CANADA: 811 West Hastings Street, Vancouver, B. C.**

MAIL NOW TO OFFICE NEAREST YOU!

(mail in envelope or paste on postal card)

NATIONAL SCHOOLS, Dept. DB-25

**4000 S. FIGUEROA STREET
LOS ANGELES 37, CALIF.**

**OR 323 WEST POLK STREET
CHICAGO 7, ILLINOIS**

Send **FREE** Auto-Mechanics Book and Sample Lesson. No obligation, no salesman will call.

NAME _____ BIRTHDAY _____ 19 _____

ADDRESS _____

CITY _____ ZONE _____ STATE _____

Check if interested **ONLY** in Resident Training at Los Angeles
VETERANS: Give Date of Discharge _____

Men Between 18 and 55
Mail Coupon Now for my TWO
NEW FREE BOOKS
About Present-Day and Future
OPPORTUNITIES in WELDING

Train at Home, in Spare Time, for a Good Future—a Job or Business of Your Own

Jobs in this field pay \$2.25 to \$2.50 an hour and more, with extra benefits, such as paid vacations, insurance, and pension plans. My graduate Raymond Masek, indeed, makes \$6,000 to \$7,500 a year, and many others are also doing splendidly. So get my two new FREE books about the booming opportunities in welding, and investigate for yourself how you may be able to cash in.



E. P. SORENSEN
E. P. Sorensen, famous trainer of men for industry, stands back of your welding instruction all the way through, and offers placement service when you finish.

It's the Coming Trade

Here is the point: Welding is fast replacing the old-fashioned methods of cutting, joining, repairing and processing metals. As a result, in industries of all kinds, welders are desperately needed—as the classified ads in any major newspaper will show. Also, in your garage, or on the farm, there are opportunities to open a business of your own, and be rid of straw-bosses forever. Men trained the practical way I train them are making good. Maybe you can, too. Certainly, you owe it to yourself to clip the coupon now, and find out.

Important in every important industry today



MAIL COUPON TODAY FOR **TWO** FREE BOOKS

UEI
has trained men for industry since 1927

E. P. Sorensen, Pres.
UTILITIES ENGINEERING INSTITUTE, Dept. WC-8,
2523 Sheffield Ave., Chicago 14, Ill.
Yes! Rush free books on Welding. No obligation.

NAME _____ Age _____
ADDRESS _____
CITY _____ Zone or County _____ STATE _____
[] Check here for special information if under 17.

BECOME AN EXPERT IN TRAFFIC

The Traffic Executive today is one of the most important and well paid positions in industry and transportation. Thousands of firms need experts on rates, tariffs, regulations, etc.

We train you thoroly at home in spare time thru the famous LaSalle Problem Method under the guidance of expert traffic authorities.

For nearly 50 years LaSalle has been helping ambitious men get ahead in this interesting and profitable field. Course compiled and reviewed by 175 of the country's leading traffic executives.

Get the facts. Mail coupon today for FREE 48-page book, "Traffic Management—the Fast Growing Profession" and learn of the opportunities in Traffic, and how you can become expert in this field.

LASALLE EXTENSION UNIVERSITY
A Correspondence Institution
417 S. Dearborn St., Dept. 264T, Chicago 5, Ill.

Name.....
Address.....
City.....Zone.....State.....

INVENTORS

PROTECT YOUR INVENTION BY A U. S. PATENT. SEND FOR FREE "INVENTION RECORD" FORM AND "PATENT INFORMATION EVERY INVENTOR SHOULD HAVE".

CARL MILLER
REGISTERED PATENT ATTORNEY
WOOLWORTH BLDG., 35th FLOOR, 25A
NEW YORK CITY

PATENTS

C. A. SNOW & CO.

REGISTERED PATENT ATTORNEYS
WRITE FOR INFORMATION TO
428 SNOW BUILDING, WASHINGTON 1, D. C.

INVENTORS

Send for PATENT INFORMATION Book and INVENTOR'S RECORD without obligation

GUSTAVE MILLER
25-PM WARNER BUILDING
WASHINGTON 4, D.C.

REGISTERED PATENT ATTORNEY
ASSOCIATE EXAMINER
U.S. PAT. OFF. 1922-1929
Patent Attorney & Advisor
U. S. NAVY DEPT. 1930-1947
PATENT LAWYER

INVENTIONS For Sale

Our clients have excellent inventions in many fields to be manufactured and marketed on a cash, royalty or license basis. Full description of clients' inventions will be sent if you state your field of interest. INVENTORS: We also want inventions of every type. Write for details.

GLOBAL MARKETING SERVICE
1404 Mitchell Street Dept. MS Oakland 1, Calif.

HELPFUL BOOKS

Send post card asking for FREE catalog
Popular Mechanics Press, 200 E. Ontario, Dept. 601, Chicago 11

INVENTORS

Whether an invention is patentable can be substantially determined by a search of the U. S. Patent records. Without obligation, write for information explaining the steps you should take to secure a patent.

JOHN N. RANDOLPH
Registered Patent Attorney
201 Columbian Building, Washington 1, D. C.

INVENTORS

I shall be pleased to furnish you, upon request, with full information relative to patent procedure—without any obligation on your part.

PATRICK D. BEAVERS
Registered Patent Attorney
934 Columbian Building Washington 1, D. C.

**It's New! 3 Years in Development
-NOW READY FOR YOU!**



This is the new Sprayberry Training Television Receiver.



You build the new Sprayberry Tester... 18-range Volt-Ohm-Milliammeter readings.



You will build this powerful short wave and broadcast superhet radio receiver.



New Equipment! New Lessons! Enlarged Course!
SPRAYBERRY PRACTICAL TRAINING IN

RADIO-TELEVISION

3 NO OBLIGATION TRAINING PLANS



F. L. SPRAYBERRY
Pres.

You have NO MONTHLY PAYMENT CONTRACT to sign... pay for this outstanding training as you learn!

Mail the coupon at once for my big all-new 56 page FREE CATALOG and FREE Sample Lesson. Get the full story of this remarkable new Training Plan. Read about my 3 NO OBLIGATION PLANS of "packaged unit" instruction. I can prepare you in as little as 10 MONTHS to take your place as a

Trained Radio-Television Technician. You take no risk in enrolling for my Training because you DO NOT SIGN A BINDING TIME PAYMENT CONTRACT. I have been training successful Radio-TV technicians for 22 years...I can prepare you, too, to get into your own profitable Service Shop or a good paying job. Full information FREE and without any obligation. No salesman will call.

NEWEST DEVELOPMENTS

Your training covers U H F, Color Television, F M, Oscilloscope Servicing, High Fidelity Sound and Transistors.

PRACTICE AND TRAIN AT HOME WITH 25 NEW KITS of EQUIPMENT

You get valuable practical experience in construction, testing and shop practice. You build a powerful 2 band superhet radio, the all-new 18 range Sprayberry multimeter, the new Sprayberry Training Television receiver, signal tracer and many other projects. All equipment is yours to use and keep. All your training is IN YOUR HOME in spare hours. I help you earn extra spare time money while you learn. Rush coupon below for all the facts—FREE!

SPRAYBERRY ACADEMY OF RADIO
111 NORTH CANAL STREET, DEPT. 10-U
CHICAGO 6, ILLINOIS



FREE CATALOG AND SAMPLE LESSON

Rush coupon for my catalog "How to Make Money in Radio-Television". PLUS an actual sample Sprayberry Lesson without obligation—ALL FREE. Mail coupon NOW!

SPRAYBERRY ACADEMY OF RADIO MAIL THIS COUPON FOR FREE Dept. 10-U, 111 N. Canal St., Chicago 6, Ill. FACTS AND SAMPLE LESSON Please rush New Catalog and Sample Lesson FREE. I understand that no salesman will call.

Name _____ Age _____

Address _____

City _____ Zone _____ State _____

"My selling time actually shows me a profit of

\$20 TO \$25 AN HOUR

with Science's New Midget Miracle, the
PRESTO Fire Extinguisher

says M. R. Stanley of Montana. Many others "cleaning up"—so can YOU!

THIS is an amazing new kind of fire extinguisher. Tiny "Presto" (about the size of a flashlight) does job of bulky extinguishers that cost 4 times as much, and are 8 times as heavy. Ends fires fast as 2 seconds. Fits in palm of hand. Never corrodes. **Guaranteed for 20 years!** Sells for only \$3.98! Over 2 million already sold!

Show it to civil defense workers, owners of homes, cars, boats, farms, etc., and to stores for re-sale. Make good income. C. S. Melious made \$175 in just first 5 days. C. Kama, \$1,000 a month. Write for **FREE Sales Kit**. No obligation.

(If you want a regular Presto to use as a demonstrator, send \$2.50. Money back if you wish.)

MERLITE INDUSTRIES, Dept. 52
114 East 32nd St., New York 16, N. Y.

(In Canada: Mopa Co., Ltd., 371 Dowd St., Montreal 1, P. Q.)

Science's
New Midget
Miracle—
"PRESTO"

you can be

TALLER

too,
in

Styles
for
Street,
Dress,
Sport.

Premier Grade
\$19.95

DeLuxe Grade
\$21.95

Mail Coupon
for **FREE BOOKLET**

You grow almost 2 wonderful inches taller... the instant you slip your feet into a pair of "ELEVATORS" ... the amazing height-increasing shoes that look as smart, feel as comfortable as any shoes you've ever worn. Yet "ELEVATORS" discreetly add 2 very important inches of height. Try a pair. See all the wonderful things "ELEVATORS" can do for you.

THE ORIGINAL AND GENUINE
ELEVATORS[®]
TRADE MARK
HEIGHT-INCREASING SHOES
"YOUR PERSONAL PEDESTAL"
*TRADE MARK OF STONE-TARLOW CO., INC.

STONE-TARLOW CO., INC.,
Dept. PM 255 Brockton 68, Mass.

Send Free Booklet and name of nearest dealer.
I understand no salesman will call.

NAME _____
(Please Print)

Address _____

City _____ State _____

WOODWORKING

**LEARN
The Easy
Way!**

Low Cost Home Craft Courses Now Available

Make money. Become a skilled woodworker. Interstate's new woodworking course tells and shows how to turn out hundreds of professionally constructed and finished wood projects with hand and power tools. Twenty-two profusely illustrated manuals. Over 1,000 pages. Over 75 projects. Written by expert instructors. The only complete course available today! Get full information without obligation... today.

**HOW TO
BE A
SKILLED
WOOD
WORKER**

Write for FREE Booklet

INTERSTATE TRAINING SERVICE

SCHOOL OF WOODWORKING
DEPT. F-3-B, PORTLAND 13, OREGON



**SEND
FOR THIS
FREE!**

Make money. Know how to break and train horses. Write today for this book **FREE**, together with special offer of a course in Animal Breeding. If you are interested in Galting and Riding the saddle horse, check here () Do it today—now.

BEERY SCHOOL OF HORSEMANSHIP
Dept. 1102 Pleasant Hill, Ohio

Build your own JET ENGINE!



Order these plans today

1. **JET PROPELLED BICYCLE.** Assemble your own. Photos and instructions, \$1.00.
2. **HOW TO MAKE EXPERIMENTAL JET ENGINES.** Seven sheets drawings with information and instructions \$2.50.
3. **BOTH OF ABOVE** in one order \$3.75. **SEND NO MONEY.** Order both at once \$3.75 C.O.D. in USA plus c.o.d. postage. Send check or money order and we pay postage. Get other information too. Rush Order.

J. HOUSTON MAUPIN, Dept. 55, Tipp City, Ohio



Make BIG MONEY!

RAISE CHINCHILLA RABBITS!

Cash Markets Supplied for Your Production
FREE - Illustrated Booklet - **WRITE TODAY!**
ROCK HILL RANCH, SELLERSVILLE 36, PA.

World's Largest Breeder of Chinchilla Rabbits

MONEY in DONUTS

Make new greaseless donuts. Start in kitchen. No smoke. Sell stores. Cash daily. No experience necessary. Free recipes. No obligation. Write! **MARTIN RAY CO., 3605 SO. 15th AVENUE, MINNEAPOLIS 7, MINN.**

BREED New Plant
Varieties

Win up to
\$10,000

THOUSANDS are paid every year by growers, seedsmen, etc. for new varieties. Learn Luther Burbank's secrets, also latest methods. Pave the way to a fascinating, profitable hobby. No experience or costly equipment needed. Let us show you in concise, non-technical form, how to produce "sports", giant forms, doubling, etc., without poisons, in a fraction of former time required.

FREE! Write now for FREE Folder and Facts. The Ascher Co., Dept. M-2
200 Detroit Ave., Concord, Calif.

WITH
RUPTURE-EASER[®]

No Fitting Required

Soft, flexible and washable. Flat foam rubber groin pad holds rupture firmly in place. No steel or leather bands. For men, women, children. Give measurement around lowest abdomen. State side. Postage prepaid except on C.O.D.'s. Delay may be dangerous. Order today! Money-back guarantee.

PIPER BRACE CO.
811 Wyandotte Dept. PM-25 Kansas City 5, Mo.

You Can Walk,
Run, Swim, Dance



Pat. No.
2,008,661
Right or Left
Side
\$3.95

Double
\$4.95

THESE 3 FREE BOOKS

help you uncover
**YOUR HIDDEN
 MONEY-MAKING
 TALENTS!**

Worth more than any treasure are the abilities lying undeveloped within you: Your ability to learn, to direct others, to master the latest developments in any field of business or industry!

THESE three books have started thousands on the road to bigger incomes, better jobs, immediate rewards! They have been proved and improved, printed and reprinted, and now they are offered to you FREE as a service of International Correspondence Schools.

One is the 32-page gold mine of career tips, "How to Succeed." Another is the big I. C. S. catalog outlining opportunities in your field of interest (see list of subjects in coupon). The third is a sample I. C. S. lesson showing you the famous method of spare-time instruction that has brought success to so many.

"X" MARKS THE SPOT! It takes only a few minutes to mark and mail the coupon. It takes

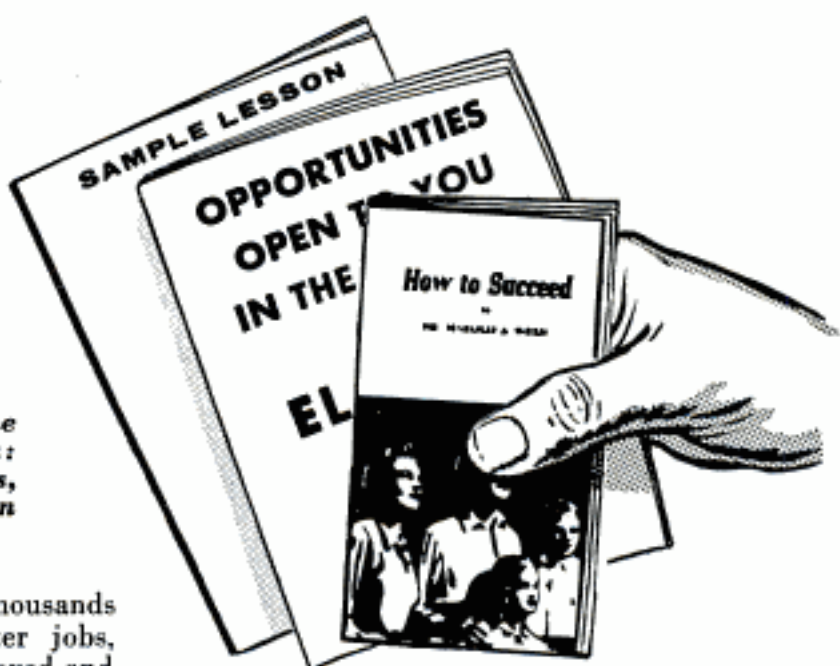

only a few days for these valuable free books to be delivered to you. It would take you years to progress as far in your job as I. C. S. can help you progress in months!

WARNING! These three books are costly. They will be valuable to you *only if you are seriously interested in devoting time, effort and money toward improving yourself!* There is no free and easy short cut to success! I. C. S. offers you a sound, practical method for training yourself at low cost. 277 courses. Complete, personalized lesson and answer service. No scrimping. Bedrock facts and theory plus on-the-job application. Diploma to graduates.

For Real Job Security — Get an I. C. S. Diploma! ... Easy-pay Plan ... I. C. S., Scranton 9, Penna.

INTERNATIONAL CORRESPONDENCE SCHOOLS

ICS

BOX 01299B, SCRANTON 9, PENNA.

(Partial list of 277 courses)

Without cost or obligation, send me "HOW TO SUCCEED" and the opportunity booklet about the field BEFORE which I have marked X (plus sample lesson):

- | | | | | |
|-----------------------------------------------------------------------------------------------------------------------------------------------------------------------------------------------------------------------------------------------------------------------------------------------------------------------------------------------------------------------------------------------------------------------------------------------------------------------------------------------------------------------------------------------------------------------------------------------------------------------------------------------------------------------------------------------------------------------------------------------------------------------------------------------------------------------------------------------------------------------------------------------------------------------------------------------------------------------------------------------------------------------------------------------------------------------------------------------------------------------------------------------------------------------------------------------------------------------------------------------------------------------------------------------------------------------------------------------------------------------------------------|-------------------------------------------------------------------------------------------------------------------------------------------------------------------------------------------------------------------------------------------------------------------------------------------------------------------------------------------------------------------------------------------------------------------------------------------------------------------------------------------------------------------------------------------------------------------------------------------------------------------------------------------------------------------------------------------------------------------------------------------------------------------------------------------------------------------------------------------------------------------------------------------------------------------------------------------------------------------------------------------------------------------------------------------------------------------------------------------------------------------------------------------------------------------------------------------------------------------------------------------------------------------------------------------------------------------------------------------------------------------------------------------------------------------------------------------------------------------------------------------------------------------------------------------------------------------------------------------|----------------------------------------------------------------------------------------------------------------------------------------------------------------------------------------------------------------------------------------------------------------------------------------------------------------------------------------------------------------------------------------------------------------------------------------------------------------------------------------------------------------------------------------------------------------------------------------------------------------------------------------------------------------------------------------------------------------------------------------------------------------------------------------------------------------------------------------------------------------------------------------------------------------------------------------------------------------------------------------------------------------------------------------------------------------------------------------------------------------------------------------------------------------------------------------------------------------------------------------------------------------------------------------------------------------------------------------------------------------------------------------------------------------------------------------------------------------------------------------------------------------------------------------------------------|--------------------------------------------------------------------------------------------------------------------------------------------------------------------------------------------------------------------------------------------------------------------------------------------------------------------------------------------------------------------------------------------------------------------------------------------------------------------------------------------------------------------------------------------------------------------------------------------------------------------------------------------------------------------------------------------------------------------------------------------------------------------------------------------------------------------------------------------------------------------------------------------------------------------------------------------------------------------------------------------------------------------------------------------------------------------------------------------------------------------------------------------------------------------------------------------------------------------------------------------------------------------------------------------------------------------------------------------------------------------------------------------------------------------------------------------------------------------------------------------------------------------------------------------------------------------------------------------------------------------------|-------------------------------------------------------------------------------------------------------------------------------------------------------------------------------------------------------------------------------------------------------------------------------------------------------------------------------------------------------------------------------------------------------------------------------------------------------------------------------------------------------------------------------------------------------------------------------------------------------------------------------------------------------------------------------------------------------------------------------------------------------------------------------------------------------------------------------------------------------------------------------------------------------------------------------------------------------------------------------------------------------------------------------------------------------------------------------------------------------------------------------------------------------------------------------------------------------------------------------------------------------------------------------------------------------------------------------------------------------------------------------------------------------------------------------------------------------------------------------------------------------------------------------------------------------------------------------------------------------------------------------------------------------------|
| <p>ARCHITECTURE and BUILDING CONSTRUCTION</p> <ul style="list-style-type: none"> <input type="checkbox"/> Air Conditioning—Refrig. <input type="checkbox"/> Architecture <input type="checkbox"/> Architectural Interior <input type="checkbox"/> Building Contractor <input type="checkbox"/> Building Maintenance <input type="checkbox"/> Carpenter and Mill Work <input type="checkbox"/> Estimating <input type="checkbox"/> Heating <input type="checkbox"/> Painting Contractor <input type="checkbox"/> Plumbing <input type="checkbox"/> Reading Arch. Blueprints <p>ART</p> <ul style="list-style-type: none"> <input type="checkbox"/> Cartooning <input type="checkbox"/> Commercial Art <input type="checkbox"/> Fashion Illustrating <input type="checkbox"/> Magazine Illustrating <input type="checkbox"/> Show Card and Sign Lettering <input type="checkbox"/> Sketching and Painting <p>AUTOMOTIVE</p> <ul style="list-style-type: none"> <input type="checkbox"/> Auto Body Rebuilding <input type="checkbox"/> Auto Elec. Technician <input type="checkbox"/> Auto-Engine Tune Up <input type="checkbox"/> Automobile Mechanic | <p>AVIATION</p> <ul style="list-style-type: none"> <input type="checkbox"/> Aeronautical Engineering Jr. <input type="checkbox"/> Aircraft & Engine Mechanic <p>BUSINESS</p> <ul style="list-style-type: none"> <input type="checkbox"/> Advertising <input type="checkbox"/> Bookkeeping and Accounting <input type="checkbox"/> Business Administration <input type="checkbox"/> Business Correspondence <input type="checkbox"/> Public Accounting <input type="checkbox"/> Creative Salesmanship <input type="checkbox"/> Federal Tax <input type="checkbox"/> Letter-writing Improvement <input type="checkbox"/> Office Management <input type="checkbox"/> Professional Secretary <input type="checkbox"/> Retail Business Management <input type="checkbox"/> Sales Management <input type="checkbox"/> Stenographic-Secretarial <input type="checkbox"/> Traffic Management <p>CHEMISTRY</p> <ul style="list-style-type: none"> <input type="checkbox"/> Analytical Chemistry <input type="checkbox"/> Chemical Engineering <input type="checkbox"/> Chem. Lab. Technician <input type="checkbox"/> General Chemistry <input type="checkbox"/> Natural Gas Prod. & Trans. <input type="checkbox"/> Petroleum Engineering <input type="checkbox"/> Plastics <input type="checkbox"/> Pulp and Paper Making | <p>CIVIL, STRUCTURAL ENGINEERING</p> <ul style="list-style-type: none"> <input type="checkbox"/> Civil Engineering <input type="checkbox"/> Construction Engineering <input type="checkbox"/> Highway Engineering <input type="checkbox"/> Reading Struct. Blueprints <input type="checkbox"/> Sanitary Engineering <input type="checkbox"/> Structural Engineering <input type="checkbox"/> Surveying and Mapping <p>DRAFTING</p> <ul style="list-style-type: none"> <input type="checkbox"/> Aircraft Drafting <input type="checkbox"/> Architectural Drafting <input type="checkbox"/> Electrical Drafting <input type="checkbox"/> Mechanical Drafting <input type="checkbox"/> Mine Surveying and Mapping <input type="checkbox"/> Plumbing Drawing and Estimating <input type="checkbox"/> Structural Drafting <p>ELECTRICAL</p> <ul style="list-style-type: none"> <input type="checkbox"/> Electrical Engineering <input type="checkbox"/> Electrical Maintenance <input type="checkbox"/> Electrician <input type="checkbox"/> Contracting <input type="checkbox"/> Lineman <p>HIGH SCHOOL</p> <ul style="list-style-type: none"> <input type="checkbox"/> Commercial <input type="checkbox"/> Good English <input type="checkbox"/> High School Subjects <input type="checkbox"/> Mathematics | <p>LEADERSHIP</p> <ul style="list-style-type: none"> <input type="checkbox"/> Foremanship <input type="checkbox"/> Industrial Supervision <input type="checkbox"/> Leadership and Organization <input type="checkbox"/> Personnel-Labor Relations <p>MECHANICAL AND SHOP</p> <ul style="list-style-type: none"> <input type="checkbox"/> Gas—Electric Welding <input type="checkbox"/> Heat Treatment <input type="checkbox"/> Metallurgy <input type="checkbox"/> Industrial Engineering <input type="checkbox"/> Industrial Instrumentation <input type="checkbox"/> Industrial Supervision <input type="checkbox"/> Internal Combustion Engines <input type="checkbox"/> Machine Design—Drafting <input type="checkbox"/> Machine Shop Inspection <input type="checkbox"/> Machine Shop Practice <input type="checkbox"/> Mechanical Engineering <input type="checkbox"/> Quality Control <input type="checkbox"/> Reading Shop Blueprints <input type="checkbox"/> Refrigeration <input type="checkbox"/> Sheet Metal Worker <input type="checkbox"/> Tool Design <input type="checkbox"/> Toolmaking <p>RADIO, TELEVISION</p> <ul style="list-style-type: none"> <input type="checkbox"/> Industrial Electronics <input type="checkbox"/> Practical Radio TV Eng'ing <input type="checkbox"/> Radio and TV Servicing <input type="checkbox"/> Radio Operating | <p><input type="checkbox"/> Television Technician</p> <p>RAILROAD</p> <ul style="list-style-type: none"> <input type="checkbox"/> Air Brakes <input type="checkbox"/> Car Inspector <input type="checkbox"/> Diesel Locomotive <input type="checkbox"/> Locomotive Engineer <input type="checkbox"/> Section Foreman <p>STEAM AND DIESEL POWER</p> <ul style="list-style-type: none"> <input type="checkbox"/> Combustion Engineering <input type="checkbox"/> Diesel—Elec. <input type="checkbox"/> Diesel Eng's <input type="checkbox"/> Electric Light and Power <input type="checkbox"/> Stationary Fireman <input type="checkbox"/> Stationary Steam Engineering <p>TEXTILE</p> <ul style="list-style-type: none"> <input type="checkbox"/> Carding and Spinning <input type="checkbox"/> Cotton, Rayon, Woolen Mfg. <input type="checkbox"/> Finishing and Dyeing <input type="checkbox"/> Loom Fix'g <input type="checkbox"/> Textile Des'ing <input type="checkbox"/> Textile Eng'g <input type="checkbox"/> Throwing <input type="checkbox"/> Warping and Weaving <p>MISCELLANEOUS</p> <ul style="list-style-type: none"> <input type="checkbox"/> Domestic Refrigeration <input type="checkbox"/> Marine Engineering <input type="checkbox"/> Ocean Navigation <input type="checkbox"/> Professional Engineering <input type="checkbox"/> Short Story Writing <input type="checkbox"/> Telephony |
|-----------------------------------------------------------------------------------------------------------------------------------------------------------------------------------------------------------------------------------------------------------------------------------------------------------------------------------------------------------------------------------------------------------------------------------------------------------------------------------------------------------------------------------------------------------------------------------------------------------------------------------------------------------------------------------------------------------------------------------------------------------------------------------------------------------------------------------------------------------------------------------------------------------------------------------------------------------------------------------------------------------------------------------------------------------------------------------------------------------------------------------------------------------------------------------------------------------------------------------------------------------------------------------------------------------------------------------------------------------------------------------------|-------------------------------------------------------------------------------------------------------------------------------------------------------------------------------------------------------------------------------------------------------------------------------------------------------------------------------------------------------------------------------------------------------------------------------------------------------------------------------------------------------------------------------------------------------------------------------------------------------------------------------------------------------------------------------------------------------------------------------------------------------------------------------------------------------------------------------------------------------------------------------------------------------------------------------------------------------------------------------------------------------------------------------------------------------------------------------------------------------------------------------------------------------------------------------------------------------------------------------------------------------------------------------------------------------------------------------------------------------------------------------------------------------------------------------------------------------------------------------------------------------------------------------------------------------------------------------------------|----------------------------------------------------------------------------------------------------------------------------------------------------------------------------------------------------------------------------------------------------------------------------------------------------------------------------------------------------------------------------------------------------------------------------------------------------------------------------------------------------------------------------------------------------------------------------------------------------------------------------------------------------------------------------------------------------------------------------------------------------------------------------------------------------------------------------------------------------------------------------------------------------------------------------------------------------------------------------------------------------------------------------------------------------------------------------------------------------------------------------------------------------------------------------------------------------------------------------------------------------------------------------------------------------------------------------------------------------------------------------------------------------------------------------------------------------------------------------------------------------------------------------------------------------------|--------------------------------------------------------------------------------------------------------------------------------------------------------------------------------------------------------------------------------------------------------------------------------------------------------------------------------------------------------------------------------------------------------------------------------------------------------------------------------------------------------------------------------------------------------------------------------------------------------------------------------------------------------------------------------------------------------------------------------------------------------------------------------------------------------------------------------------------------------------------------------------------------------------------------------------------------------------------------------------------------------------------------------------------------------------------------------------------------------------------------------------------------------------------------------------------------------------------------------------------------------------------------------------------------------------------------------------------------------------------------------------------------------------------------------------------------------------------------------------------------------------------------------------------------------------------------------------------------------------------------|-------------------------------------------------------------------------------------------------------------------------------------------------------------------------------------------------------------------------------------------------------------------------------------------------------------------------------------------------------------------------------------------------------------------------------------------------------------------------------------------------------------------------------------------------------------------------------------------------------------------------------------------------------------------------------------------------------------------------------------------------------------------------------------------------------------------------------------------------------------------------------------------------------------------------------------------------------------------------------------------------------------------------------------------------------------------------------------------------------------------------------------------------------------------------------------------------------------------------------------------------------------------------------------------------------------------------------------------------------------------------------------------------------------------------------------------------------------------------------------------------------------------------------------------------------------------------------------------------------------------------------------------------------------|

Name _____ Age _____ Home Address _____

City _____ Zone _____ State _____ Working Hours _____ A.M. to P.M. _____

Occupation _____ Canadian residents send coupon to International Correspondence Schools, Canadian, Ltd., Montreal, Canada. . . . Special tuition rates to members of the U. S. Armed Forces.

NOW YOU CAN BUILD IT WITH CONCRETE BLOCKS

10 DAYS FREE TRIAL EXAMINATION!

This practical guide shows every step from how-to-plan to how-to-build with one of the most abundant and economical building materials known to man. Over a hundred pictures and cut-away diagrams show exactly what to do and what not to do. Tells how to plan, place corner block, make foundations easily, how to paint for special purposes. A picture story of everything in building any type of structure with concrete blocks, easily and inexpensively.

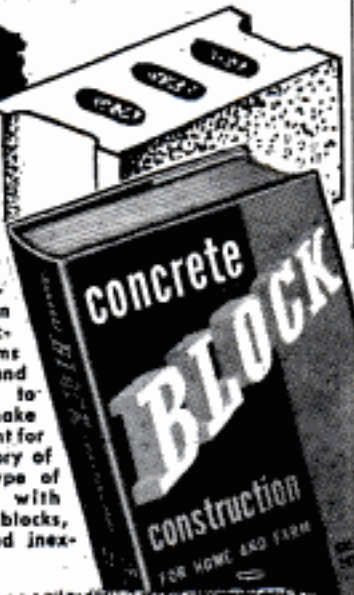

Here's how little this book costs you... or if you don't keep it after 10 days trial, return it and you owe nothing. **\$3.25**

Here's how to apply Mortar

CARPENTRY FOR EVERYONE



A clear explanation of modern carpentry construction including framing, roof constructions, general carpentry work, exterior and interior finish of buildings, building forms and working drawings, and farm buildings. Covers everything you need to know about lumber, tools, joints and splices, floors, stairs, partitions, rafters, etc. Gives short cuts and tricks used by the master carpenter. Easy to understand. 504 pages, 580 illustrations. **\$2.50.** Use 10 day no-cost trial coupon below.

BRICKLAYING — WIRING — PLUMBING

Bricklaying Skill and Practice shows by clear explanations and actual on-the-job illustrations, simplifies the construction of everything from fireplaces to complete buildings. **\$3.50**
Electric Wiring—New book covers job-tested methods of residential and farm wiring, code changes. Show-how for amateur, valuable reference for tradesman, estimator, contractor. **\$4.25**
How to Design and Install Plumbing—Hundreds of how-to-do-it pictures, full-sized blueprints for most every plumbing job. 349 illustrations, 422 pages **\$4.25**

OTHER YOU-CAN-DO-IT BOOKS IN COUPON BELOW

Mail this coupon today—10 days trial at no cost to you American Technical Society, Dept. B-219 848 East 58th Street, Chicago 37, Illinois.

Please rush me the following books I'm checking below to examine at home. If I'm not convinced these books will help me save thousands of dollars by doing my own building and planning, I may return the books and owe nothing.

- Examine at home or no cost.
- CONCRETE BLOCK CONSTRUCTION FOR HOME AND FARM..... \$3.25
 - CARPENTRY..... \$2.50
 - BRICKLAYING... Skill and Practice... \$3.50
 - HOW TO DESIGN AND INSTALL PLUMBING..... \$4.25
 - ELECTRIC WIRING—Residential and Farm..... \$4.25
 - Cabinet Making and Millwork.... \$4.95
 - Steel Square..... \$2.50

Name _____

Address _____

City _____ State _____

- Ten day no-cost trial. If I keep books, will remit by check or money order.
- Send C.O.D. Same return privilege—money refunded.
- I'm enclosing \$_____ in full payment to save postage—same return privilege—money refunded.

FULLY GUARANTEED TIRES COST LESS!

Nationally famous FIRESTONE, GOODRICH U. S. ROYAL, GOODYEAR, and other makes. Every tire selected and inspected for your safety.

SPECIAL DEDUCT 10% ON 4 OR MORE TIRES!
 FREE TUBE ON REQUEST WITH PASSENGER TIRES WHITE WALL OR SNOW TIRES \$1 EXTRA

HIGH GRADE TIRES GUARANTEED 12 MONTHS			
600x16	4.14	700x16	5.14
650x16	4.54	670x15	4.74
650x15	4.34	650x20	7.84
700x15	4.64	700x20(8)	8.94
		32x6(8)	8.84
		32x6(10)	10.84
		750x20(8)	8.54
		750x20(10)	9.94
		825x20	14.24
		900x20	13.34
		1000x20	14.14
		1100x20	16.14

AAA PREMIUM GRADE GUARANTEED 18 MONTHS			
550x15	5.48	700x15	5.98
600x16	5.28	700x16	6.78
600x16(6)	5.88	750x16(6)	7.98
640x15	5.88	750x16(8)	8.98
650x16	5.78	800x15	6.88
650x16(6)	6.98	820x15	7.48
650x15	5.98	710x15	6.09
670x16	6.18	550x18	5.98
		760x15	5.58
		750x20(10)	5.48
		825x20	9.78
		1000x20	10.88
		1100x22	12.88
		1100x20	10.48
		1100x22	12.48
		1100x24	23.98

MILITARY SPECIAL		NEW TREAD GUAR. 24 MOS.	
900x16	10.69	1000x20	19.98
750x20	10.98	1100x20	21.98
AAA GUARANTEED 18 MONTHS		600x16	8.98
900x16	14.98	700x16(6)	9.98
		700x15(6)	15.95
		750x20(8)	24.98

Largest stock of used tires in the East. Thousands of satisfied customers. Write for Free Catalogue. MONEY ORDER OR CHECK WITH ORDER. NO C.O.D.'s

PYRAMID TIRE CO.
 1333-35 North 5th St.
 Dept. M., Phila. 22, Pa.

GIANT BALLOONS

They're really BIG—surplus U. S. Govt. (new overage) Neoprene weather, target balloons. GREAT FUN in the backyard: at parties, picnics, dances, fairs, TERRIFIC for high school and college PROMS. They attract BIG crowds to BUSINESS openings, civic events, conventions, exhibitions, trade shows. ORDER TODAY! Approx. inflated sizes:

- 3 ft. dia., 49¢ — 6 ft. dia., 99¢
- 13 ft. dia., \$1.59 — 20 ft. dia., \$1.95

Postage paid on prepaid orders. Calif. residents please add sales tax.

VOLUME SALES CO., War Assets Division
 Dept. M-255 3930 Sunset Blvd. Los Angeles 26, Calif.

MECHANICAL DENTISTRY

To make Crowns, Plates, Bridgework, etc., for Dentists. Easy practical way to learn mechanical dentistry at home in spare time. FULL EQUIPMENT OF TOOLS AND MATERIALS INCLUDED WITH COURSE. Low tuition. Easy terms. Write for FREE BOOK about this money making profession that is not affected by machine age.

McCARRIE SCHOOL OF MECHANICAL DENTISTRY
 207 N. Broad St., Dept. 38, Philadelphia 7, Pa.

CASTING SECRETS REVEALED

Big money! Cast 1000's of plaques, figurines, etc. with X.L. rubber molds. No exper. little capital req. X.L. rubber pts. \$2.50, qts. \$4 (postage extra). Models, rubber for 3 molds, \$1.50 pd. U. S. only. Send 25c (refundable) for 40 pp fact catalog.

HUGE PROFITS! MORE MONEY!

PLASTIC ARTS STUDIO, Dept. PM2,
 3403 S. Madison St., Muncie, Ind.

Super Powerful All Channel TV RECEPTION IN ALL DIRECTIONS

Rocket DIRECTRONIC MOTORLESS TV ANTENNA

360° Electronically Switched Beam

- No Motors
- No Roof
- Orientation
- No Electric Power
- No Ghosts
- Flick of Switch Clears Picture Instantly

In the city or in an ultra-fringe area, the Directronic will outperform ordinary antennas. Only the Motorless 360° Directronic TV Antenna offers "around the compass" reception WITHOUT Rotors. Clarity of picture will amaze, it's so bright, so sharply defined. AX-599 "Service-man's Array" contains Hi-Pac molded insulator of extremely high tensile strength, 18 hi-tensile aluminum alloy elements, 1 set of connecting studs (3), Universal U-Clamps for masts to 1 1/2". Directronic Beam Selector, 75 feet of Tri-X Cable. Do not remit more than complete purchase price. 25% deposit on C.O.D. orders, please. Money-back guarantee.

NATIONAL ELECTRONICS OF CLEVELAND
 6608 EUCLID AVENUE Dept. P-2 CLEVELAND, OHIO

Let this Imported Italian Accordion make **YOU** the center of your Circle



NOW! 5 DAYS **FREE** TRIAL
LOW WHOLESALE PRICE

**Lifetime
Guarantee**

Miss Mickey Milan,
America's Accordion
Queen, playing her
new and beautiful
S. SOPRANI Moderne



All this is
FREE*
WITH YOUR ACCORDION

- Home study course of instruction.
- Your name in chrome letters on instrument.
- Year's supply of music.
- A de luxe music stand.
- Music Portfolio.
- Life Time Guarantee.

* For Limited time only

**EASY
TERMS**

SAVE BUY DIRECT AT WHOLESALE

Send today for full information and our amazing offer—see, play and hear this superb instrument in your own home—let your friends and family confirm this imported professional model as the accordion of your dreams! Immediate delivery assured from the world's largest selection of leading Italian makes.

PLAY AS YOU PAY

Leading professionals acclaim our instruments as unsurpassed. "A wonderful surprise, truly an 'artist's instrument'", "In a class by itself for beauty and tone", are typical expressions. Easy to own and play with our **FREE** lessons. **TRY BEFORE YOU BUY**—No obligation. Trade-ins accepted.

Get full details of ultra-quality features and our almost unbelievable offer of big discounts to students, professionals, teachers and beginners. Boys and girls learn with ease and make quick progress—playing comes naturally. Children deserve this wholesome outlet leading to desirable associates.

Read These—Culled from Hundreds

"Words cannot express our delight with the accordion: it is indeed a splendid instrument. Again let us express our heartfelt appreciation for having provided the instrument at such a reduced price. Everyone expresses delight with it. All are utterly amazed at its versatility of tone production. It certainly creates a splendid impression for your company!"

Aubrey B. Martin,
Wheeling, W. Va.

"Received our accordion today—we are pleased with such a wonderful instrument. I have talked to my neighbor who taught accordion for 20 years and he praised this accordion highly as a wonderful instrument."

Theodore M. Swiatek
Denver, Colorado

"I am writing you from my studio and enclosing a check for down payment on my accordion which I am very pleased with indeed! I thank you for your very generous trade-in allowance on my old accordion. Thank you also for your very courteous letters."

"I like the way you do business—trigger action and so courteous."
Bill Balduzzi,
Terre Haute, Ind.

"My accordion arrived yesterday and am thrilled and happy over the beautiful instrument and pleased with the tone it gives. It is all that you said it was and more."

Mrs. Fred Richter,
Clear Lake, Wis.



YOU'LL
BE PROUD
TO OWN
THIS
S. SOPRANI
ACCORDION.
PRIDE OF
ITALY AND OH
HOW YOUR
FRIENDS WILL
ADMIRE AND
COMPLIMENT YOU.

Mail Today

ACCORDION MANUFACTURERS & WHOLESALE OUTLET
2003 W. Chicago Ave., Dept. R-25, Chicago 22, Illinois

Please send me your fully illustrated catalog, amazing low wholesale prices, easy terms on the World's largest selection of super-quality imported Italian accordions.

Name _____

Address _____

City _____ Zone _____ State _____

ACCORDION MANUFACTURERS & WHOLESALE OUTLET
2003 W. Chicago Ave. Dept. R-25 Chicago 22, Ill.

PROFESSIONAL-TYPE ELECTRIC HAIR CLIPPER



ONLY
\$10.95

At Your Barber,
Beauty Shop or
Dealer's

Cadet

ELECTRIC HAIR CLIPPER

Saves time and money for the whole family! Has cool-running magnetic motor; fine-tooth blade for close cutting; streamlined plastic case, 110v 60 cycle AC; fully tested by UL. If your barber, beauty shop or dealer cannot supply you, order direct on 10-day money-back guarantee.

ELECTRO TOOL CORPORATION
DEPT. C525-B • RACINE, WISCONSIN

105 POWER SUPER TELESCOPE



Everything for the Astronomer, Hobbyist, Student, and Scout in this complete astronomical super value telescope combination. Set comes ready for immediate use, consists of brilliant 33x-65x-105x telescope, 5 foot hardwood Tripod, carrying case for scope, Star Explorer map and 108 page book "Discover the Stars." The 3 foot telescope (closes to 16 inches) is brass bound, has 4 precision lenses that will bring distant objects, people, moon, stars, ships, etc., 105 times closer. All images erect. The sturdily built tripod is equipped with universal mount that has a 360 degree horizontal range and 180 degree vertical range. It locks in any position with one simple adjustment. The Star Explorer map enables you to find any star automatically. This marvelous all purpose instrument is proclaimed by Scientists as a most unusual development. Everyone that has used it is amazed at its performance and value. It will fascinate the entire family. Shipped to you complete, nothing else to buy, at the amazing low price of.....

\$11.95
POST
PAID

Satisfaction guaranteed or money refunded. We pay all delivery charges. Send check or money order to DEPT. PMS6

CRITERION CO. 331 CHURCH ST., HARTFORD 1, CONN.

INVISIBLE REWEAVING

Make Big Money at Home!

BEFORE **WOMEN (AND MEN, TOO) FIND FINANCIAL SECURITY—AT HOME!**

The demand is endless. Laundries, cleaners, tailors, department stores, homes—everybody needs professional reweaving service sooner or later. And skilled craftsmen are scarce! Learn to make cuts, moth holes, burns, tears DISAPPEAR from coats, suits, dresses, all fabrics almost like magic!

AFTER **AND EARN UP TO \$10 IN AN HOUR AT HOME!**
The ORIGINAL, Complete Professional Course . . .

You need no special education, experience or ability. Age doesn't matter. Learn all the secrets of this fascinating profession in a few short weeks—start earning at once! **FREE GET THRILLING! Make no mistake! FREE DETAILS NOW!** This is a complete, professional course . . . with professional equipment, written by experts. Not a gadget. Not a condensed, unsatisfactory short-cut. FABRICON offers the ORIGINAL home-study course . . . first, best, most-complete in the field. It prepares you for professional work, and for professional earnings. Write TODAY for complete details FREE. FABRICON CO., Dept. 322, 8342 S. Prairie Ave., Chicago 19, Ill.

MEN!

Invisible Reweaving offers as much promise for profit to men . . . as it does to women. A great number of our successful students are men. Men can learn to do the work as well and as quickly as women. Actually, Invisible Reweaving is the perfect "team" business—for man and wife . . . or even the entire family! Write!

LAW Men and women **STUDY AT HOME** for Business Success and **LARGER PERSONAL EARNINGS**, 44 years expert instruction—over 114,000 students enrolled. LL.B. Degree awarded. All text material furnished. Easy payment plan. Send for **FREE BOOK**—"Law and Executive Guidance"—NOW!
AMERICAN EXTENSION SCHOOL OF LAW
Dept. H-1, 664 N. Michigan Ave., Chicago 11, Illinois

Say You Saw It in Popular Mechanics

TRADE MAGAZINES

Business, Vocational, Professional, Hobbies, Agricultural, Educational, Sports. Single current copies. Special get acquainted service. Choose from 4,387—all fields. Current List FREE.
COMMERCIAL ENGRAVING PUBLISHING CO.
344B North Ritter Indianapolis 19, Ind.

DAN LURIE
"America's Most Muscular Man"
—on television's "Big Top!"

FAMOUS DAN LURIE
BARBELLS
with 4 courses—low factory prices
50 lb. set . . . \$ 8.48 | 150 lb. set . . . \$20.48
100 lb. set . . . 13.98 | 200 lb. set . . . 25.98

Write for Order by Mail; 50% with order, bal. C.O.D. Free Catalog Extra wts. 13c per lb., F.O.B. plant
DAN LURIE BARBELL CO.
52-M-2 Bristol St. Dept. 5598 Brooklyn, N. Y.

ORTHO-VENT
"SPRING-STEP" SHOES
CAN DOUBLE YOUR INCOME

Earn \$100, \$200, \$300 per week and more selling Ortho-Vent "Spring-Step" cushion shoes full-time or part-time. Over 160 different styles make this world famous, direct-to-consumer, shoe line a proven money-maker for you! No experience or investment needed! We supply everything you need to start earning money from the very first day. Build lifetime security by selling the world's most comfortable, flexible, lightest weight cushion shoe . . . Ortho-Vent "Spring-Step."

WRITE TODAY!

ORTHO-VENT
SHOE CO., Inc.

Salem, Virginia
Dept. PM-255

DYNAMOMETER CONFIRMS 5 YEAR RESEARCH BREAKTHROUGH!

17 PT. SELF-CLEANING PLUG SHOWS 8 HORSEPOWER GAIN!

Eddie Edmunds
GRASS DYNAMOMETER CHART

Make _____ Year _____
Make _____ Year _____

Test Date _____

Test	Old Spark Plug	New Spark Plug	Change
Top Speed (MPH)	50	58	+8
Acceleration (0-30)	12	10	-2
Gas Mileage (MPG)	22	24	+2

Recommended _____

8 HORSEPOWER GAIN!



IN A TEST that echoed through the farthest corners of the automotive world, this LIFE-TIME Spark Plug still fired clean, hot and steady at 50,000 CAR-MILES!

SPECIAL SINTERED CORUNDUM INSULATOR—Made of gem-like mineral which conducts heat 20 times better than ordinary porcelain. Special shape is designed to vaporize and exhaust wet carbon and oil.

NOW... ORDER REGISTERED SET FOR YOUR CAR AT POPULAR PRICE



PERMANENT GAP—After months of use LIFE-TIME Spark Plugs take at exact factory pre-gap. The new design improves clear speed and idling performance.

SELF-CLEANING FOR LIFE—Continued space including in chamber formed by multiple electrodes recessed along surfaces with each firing stroke.

PLATINUM-NICKEL ALLOY ELECTRODES—Metallurgists find major step beyond platinum-iridium plus electrode. Arcing points of this material have continued to function after the equivalent of 125,000 car-miles.

ELECTRODE RESEARCH, it can now be definitely stated, has probed far into one of the last remaining frontiers of knowledge about the internal combustion engine. Before LIFE-TIME development the spark plug was the most often replaced part of your car. In building the LIFE-TIME Spark Plug's radically advanced electrode design, our engineers knew, from periodic tests that we were on the track of something that would greatly increase plug life. We also suspected that electrode design could actually increase the horsepower of an engine.

HOW PLUGS CAN CAUSE POWER LOSS: Most engineers agree "creeping paralysis," gradual electrode disintegration, carbon build-up, gradually widening gap, all cause premature firing, misfiring and power loss — enough in many cases to waste one gallon in every ten you buy. But there were and are some fine engineering minds who feel that certain conditions of pressure and turbulence within the cylinder cause misfiring even with new conventional plugs.

It was this "suspicion" that clinched Continental Manufacturing Corp. executives' decision to gamble the necessary money and years of time. The end product of this decision is now in mass production, available for your automobile — an amazing spark plug that has — by test — fired clean for 50,000 miles and increased the horsepower of a familiar American car by 12½ per cent at 2,000 RPM.

HOW 17 PT. FIRING WORKS. Note LIFE-TIME's electrode design closely. A circular arcing area consisting of four concave segments. Distance (gap) to center electrode being the same from all points. Electricity has property of arcing from coldest point. Current also arcs more readily from the apex of two planes than from the face of a flat, metallic surface. Note that there are 16 apexes (places where two planes meet) on the outer electrode system — all the same distance from the center electrode. Normal heat and spark erosion are spread



around the entire 360 degrees and around the whole circumference of center electrode.

FULL ROTATING SPARK allows overall cooler electrode temperature for greatly increased life. Also allows a hotter spark to prevent fouling yet the rotating and cooling effect minimizes the common faults of burning, erosion, blistering and resultant insulator failure. Compare this principle with the conventional 2-point spark plug design. Most spectacular spark plug research breakthrough in 50 years allows us to include this unique and unprecedented warranty with every set of LIFE-TIME Spark Plugs. **WE GUARANTEE GREATER GAS MILEAGE — GREATER ACCELERATION — A MAJOR POWER INCREASE — OR YOUR MONEY BACK.**

YOU RECEIVE BY MAIL this registered set of LIFE-TIME Spark Plugs in proper series (heat range and gap) for the car you indicate in coupon below. **NOW AVAILABLE FOR AMERICAN & EUROPEAN PASSENGER CARS, TRUCKS, BOATS, FARM EQUIPMENT, INDUSTRIAL ENGINES.**

INDIVIDUAL INSPECTION—Each LIFE-TIME Spark Plug is tested for firing in oil and for resistance to 10,000 Volts./CM!

DEALERS AND DISTRIBUTORS: The LIFE-TIME Spark Plug is now in full production. Write for full details. Distributors: Please inquire as to status of your territory.



DEAR CAR OWNER: The company has finally gotten this plug out of the race, test and economy-run class and made it available for your car at your price. And believe me, it is all we expected. Everyone knows how to make a miles per gallon test and it is an eye-opener with LIFE-TIME plugs, but here is a way you can make a test 15 minutes after you receive your set. Set the brake and block or jack up the rear end. Engage shift in high and shim accelerator pedal with a stop somewhere in the 25-45 MPH range. Take MPH reading with old plugs and then with new LIFE-TIME plugs at same stop. I figure you will show from 5 to 10 MPH increase. I'd enjoy hearing about your results. Many thanks!

Frank E. Williams
Inventor of LIFE-TIME Spark Plugs



LIFE-TIME Spark Plug Division,
CONTINENTAL MANUFACTURING CORP.
Washington Blvd. at Motor Ave., Culver City 6, California

Gentlemen: Please mail postpaid..... set(s) (registered) of LIFE-TIME Spark Plugs in proper heat range and gap for my car at \$10 per plug (set of six, \$3.95, set of eight, \$7.94). (Or send \$1 per set, balance C.O.D.)

Make of my car is.....Year.....

Model.....No. Cyl.....

I enclose \$.....(check, cash or money order)

Name.....

Address.....

City.....Zone.....State.....

... TURN CONCRETE INTO GOLD!

MAKE UP TO \$75 A DAY IN YOUR OWN BUSINESS

If you want to have your own business — to start a business on your own — here's your big opportunity! New high speed, low cost General block machine produces up to 1,000 concrete blocks a day. Sell all you make to builders, supply houses, and others for homes, factories, buildings, garages. Cash in on the building boom! You can make profits of 100% to 150% — up to \$75 a day! General block machine equipped with 1/2 h.p. electric motor — or can be supplied with gasoline engine — works anywhere, in little space, indoors or out. Operates on ordinary house light socket. Simple, foolproof 3 step operation — so easy a child can do it. Makes superior 3 core blocks any size from 4" to 12". Also makes chimney, sash, corner and other types. Blocks meet any building code anywhere in the country. Materials — sand, water, cement, available anywhere. Simple illustrated operating instructions and mixing formulae for cement and cinder blocks supplied with each machine. Write for FREE folder with full information.

MOTOR DRIVEN

R. L. T. of New York City reports: "MY GENERAL BLOCK MACHINE PAID FOR ITSELF IN FIRST 2 WEEKS!" Hundreds now in use the world over! Write for FREE details today!

EXTRA Amazing illustrated book gives floor plans for 6 sensational concrete block buildings. Tells how to lay blocks, lay out building lines, mix concrete, build steps, porch and concrete floors all at great savings. Written by experts. Can save many times the cost of the machine! Get it now! No strings attached. Send \$1.

BOOK SENT FREE IF YOU BUY MACHINE.
\$1 REFUNDED IF YOU BUY LATER.

GENERAL ENGINES CO.

DEPT. M-25, 307 HUNTER STREET, GLOUCESTER, N. J.

"TOOK IN \$217 FIRST 10 DAYS"

Some make more, some less

We help you to start Your Own All-Year Business

Make Big Money! With our easily operated, highly efficient wall washer, Chas. Stelle took in \$217 gross in first ten days. E. L. Goss took in more than \$10,000 in one year. E. C. Taber wrote, "I made \$400 gross in two weeks." And no wonder—this machine washes walls 6 times faster and better than by hand. **Your Money-making Opportunity.** Enjoy independence—freedom from bosses, layoffs. Customers everywhere—homes, offices, schools, etc. Expenses low, profits high. No shop necessary; operate from home. Can start spare time until your full time is available.



LOSE NO TIME. GET ALL FACTS WITHOUT OBLIGATION

FREE BOOK! MAIL COUPON TODAY!

- VON SCHRADER MFG. CO.
- 210 "W" Pl., Racine, Wisconsin
- Send at once (no obligation) your FREE booklet containing information about your WALL WASHING MACHINE and how I can start my own permanent, profitable business.
- Name _____
- Address _____
- City _____ Zone _____ State _____

more jobs than graduates

Demand for our engineering graduates exceeds supply. Effective placement! Study in this world-famed college... established 1884. New term starts quarterly. Approved for Korean Vets.

Bach. Sc. degree in 27 months

Bachelor of Science in Mechanical, Civil, Electrical, Chemical, Aeronautical, Radio (Television), Administrative Engineering; Business Administration and Accounting. Also 36-weeks certificate course in Drafting. Intensive program; technical fundamentals accented; comprehensive courses.

Small classes; personalized instruction. For earnest, mature students whose time and budget require accelerated courses and modest costs. Preparatory courses.

Beautiful campus in friendly college town. Well-equipped, new and modernized buildings and labs. Enter March, June, Sept., Jan. Write Jean McCarthy, Director Admissions, for Catalog and View Book.



TRI-STATE COLLEGE

425 College Avenue

Angola, Indiana

KEEP OFF

129 NEW FULL SIZE PATTERNS \$1.00

EASY-TO-USE PATTERNS (Just trace on wood, cut out, paint) on 139 Unusual Novelties, Gifts, Lawn Figures up to 22 in., Action (merry-go-round) Windmill, Toys, Useful Gadgets, etc. Artist drawn, Money Back Guarantee. Clip this ad and mail with \$1 bill TODAY.

CRAFTPLANS, Dept. A-256, 1321 S. Michigan, Chicago 5

OIL FILTER REFILLS . . . 10c

Here's News! Ordinary toilet paper makes an ideal oil filter. Laboratory tests prove it cleans oil faster and better than popular makes of filter elements. All you need is a simple set of Retlif Adapter Plates . . . and you can start using toilet paper rolls (costing about 10c) in your present oil filter. For proof and descriptive literature, send name and address to:

RETLIF CORP., Dept. 141, 915 No. Highland Ave., Los Angeles 38, Calif.

Write Like This

YOUR penmanship can be improved in 3 hours or corrected to your satisfaction in 10 hours' practice with my DEFINITE HAND CONTROLS. New way!

WRITE OZMENT BOX 665 34-N, ST. LOUIS, MISSOURI

Complete OUTLINE FREE!

BE A DETECTIVE

WORK HOME or TRAVEL. Experience unnecessary. DETECTIVE Particulars FREE. Write to GEO. P. M. WAGNER, 125 W. 86th St., N. Y.

Blast off with DUAT vacuum AIR HORNS!

ONLY \$9.95

• POSTPAID Money-back Guarantee

Compare with \$25 to \$100 Air Horns

The voice of authority and commanding warning for safer highway driving. One BLAST and those "Road Hogs" really move over. Installed under the hood or on the front fender. Beautiful lacquer finish. Operates from intake manifold. No tank needed. Only \$9.95 complete with cylinder head bracket, steering column lever, hose, fittings, etc. Send check or money order today. We pay postage. \$1.00 deposit required on all C.O.D. orders.

THE PROTECTUROD CO. Dept. 403, 716 N. E. 17th Rd., Fort Lauderdale, Florida

BUILD HELICOPTER GLIDER



The famous new GYRO-GLIDER, world's simplest and safest aircraft, is now available to amateur builders in plans and kits. Send \$1.00 now for three-view drawings with specifications and ask about kits and detailed building and flying instructions.

SENSE AIRCRAFT CORP., Dept. PM-2 P.O. Box 2621 Raleigh, N. C.

ONLY \$1 Name _____ Address _____ City _____ State _____

Greatest Thrill in Flying!

POPULAR MECHANICS

WHAT ALL AUTO MECHANICS WANT TO KNOW

1664 PAGES



This Big Practical Book gives full information with working diagrams covering the principles, construction, ignition, service and repair of modern cars, trucks and buses.

Diesel Engines, Hydramatic & Fluid Drives Fully Explained.

A complete Guide of 1664 pages, with over 1500 illustrations showing inside views of working parts, with instructions for service jobs.

IT PAYS TO KNOW

How to fit pistons—How to locate engine knocks, How to fit connecting rod bearings—How to service main bearings—How to recondition valves—How to time valves—How to adjust fan belts—How to adjust carburetors and chokes, How

to rebuild a clutch—How to service automatic transmissions—How to service brakes—How to adjust steering gear—How to cope with ignition troubles—How to service distributors—How to time ignition—How to "tune up" an engine.



\$4 COMPLETE • PAY \$1 A MO. TO GET THIS ASSISTANCE FOR YOURSELF SIMPLY FILL IN AND MAIL COUPON TODAY.

Step up your own skill with the facts and figures of your trade. Audel's Mechanics Guides contain Practical Inside Trade Information in a Handy Form. Fully illustrated and Easy to Understand. Highly Endorsed. Check the book you want for 7 DAYS FREE EXAMINATION. Send No Money. Nothing to pay postman.

MAIL ORDER



Check NOW!

You Can Look Over Any Guide In Your Own Home — Start the Easy Payments If Satisfied

MAIL THIS TODAY

AUDEL, Publishers, 49 W. 23 St., NEW YORK 10, N. Y.

Please send me postpaid for FREE EXAMINATION books marked to below. If I decide to keep them I agree to mail \$1 in 7 days on each book or set ordered and further mail \$1 monthly on each book or set until I have paid price, otherwise I will return them.

- AUTOMOBILE MECHANICS GUIDE, 1664 Pages. \$4
- TRUCK & TRACTOR GUIDE, 1299 Pages. 4
- DIESEL ENGINE MANUAL, 575 Pages. 2
- MACHINISTS HANDY BOOK, 1650 Pages. 4
- WELDERS GUIDE, 400 Pages. 1
- BLUE PRINT READING, 416 Pages. 2
- MATHEMATICS & CALCULATIONS, 700 Pages. 2
- SHEET METAL PATTERN LAYOUTS, 1100 Pages. 4
- SHEET METAL WORKERS HANDY BOOK, 388 Pgs. 1
- MECHANICAL DRAWING GUIDE, 160 Pages. 1
- MECHANICAL DRAWING & DESIGN, 480 Pages. 2
- AIRCRAFT WORKER, 240 Pages. 1
- TELEVISION SERVICE MANUAL, 434 Pages. 2
- RADIO MANS GUIDE, 1040 Pages. 4
- ELECTRONIC DEVICES, 216 Pages. 2
- ELECTRIC MOTOR GUIDE, 1000 Pages. 4
- WIRING DIAGRAMS (Light & Power), 272 Pgs. 1
- ELECTRICIANS EXAMINATIONS, 250 Pages. 1
- ELECTRIC POWER CALCULATIONS, 425 Pages. 2
- HANDY BOOK OF ELECTRICITY, 1440 Pages. 4
- ELECTRIC DICTIONARY, 9000 Terms. 2
- ELECTRIC LIBRARY, 7000 Pages (12 Book Set) 18
- SHIPFITTERS HANDY BOOK, 250 Pages. 1
- REFRIGERATION & Air Conditioning, 1280 Pgs. 4
- MILLWRIGHTS & MECHANICS GUIDE, 1200 Pgs. 4
- POWER PLANT ENGINEERS GUIDE, 1500 Pages. 4
- ENGINEERS & FIREMANS EXAMS, 525 Pages. 1
- PUMPS, Hydraulics & Air Compressors, 1658 Pgs. 4
- OPERATING ENGINEERS LIBRARY (3 Books). 9
- MECHANICAL DICTIONARY, 950 Pages. 4
- GARDENERS & GROWERS GUIDES (4 Book Set) 6
- CARPENTERS & BUILDERS GUIDES (4 Book Set) 6
- PLUMBERS & Steamfitters Guides (4 Book Set) 6
- MASONS AND BUILDERS GUIDES (4 Book Set) 6
- PAINTERS & DECORATORS MANUAL, 450 Pgs. 2
- HOUSE HEATING GUIDE, 1000 Pages. 4
- OIL BURNER GUIDE, 384 Pages. 1
- HOME APPLIANCE SERVICE GUIDE, 800 Pages. 4

Name _____
 Address _____
 Occupation _____
 Employed by _____

AUDELS Carpenters and Builders Guides 4 vols. \$6



Inside Trade Information for Carpenters, Builders, Joiners, Building Mechanics and all Woodworkers. These Guides give you the short-cut instructions that you want—including new methods, ideas, solutions, plans, systems and money saving suggestions. An easy progressive course for the apprentice and student. A practical daily helper and Quick Reference for the master worker. Carpenters everywhere are using these Guides as a Helping Hand to Better Work, Better Work and Better Pay. To get this assistance for yourself, simply fill in and mail **FREE COUPON** below.

Inside Trade Information On:

How to use the steel square—How to file and set saws—How to build furniture—How to use a mitre box—How to use the chalk line—How to use rules and scales—How to make joints—Carpenters arithmetic—Solving measurement problems—Estimating strength of timbers—How to set girders and sills—How to frame houses and roofs—How to estimate costs—How to build houses, barns, garages, bungalows, etc.—How to read and draw plans—Drawing up specifications—How to excavate—How to use settings 12, 13 and 17 on the steel square—How to build hoists and scaffolds—skylights—How to build seats—How to put on interior trim—How to hang doors—How to lath—lay floors—How to paint.



AUDEL, Publishers, 49 W. 23rd St., New York 10, N. Y. Mail Audel's Carpenters and Builders Guides, 4 vols., on 7 days' free trial. If OK I will remit \$1 in 7 days and \$1 monthly until \$6 is paid. Otherwise I will return them. No obligation unless I am satisfied.

Name _____
 Address _____
 Occupation _____
 Employed by _____

AUDELS HOME APPLIANCE SERVICE GUIDE

This HANDY, Practical "How to Do It" book for Electric & Gas Home Appliance Servicemen, Mechanics & Dealers covers Basic Principles, Servicing, Operation & Repairs of Home Appliances. Tells How to Locate Troubles, How to take Appliances Apart, How to Make Repairs, How to Assemble and Connect. Gives up to date testing methods, wiring diagrams and complete data on each appliance.



IT PAYS TO KNOW HOW TO FIX

Toasters—Pressing Irons—Waffle Bakers—Casseroles—Roasters—Broilers—Coffee Makers—Space Heaters—Water Heaters—Ranges—Home Wiring—Shop Work—Appliance Testing—Fundamental Electricity—Fractional H.P. Motors—Food Mixers—Fans & Blowers—Vacuum Cleaners—Washing Machines—Clothes Dryers

—Ironers—Dishwashers—Garbage Disposers—Refrigeration—Window Air Conditioners—Oil Burners—Drainage Pumps—Gas Ranges, Furnaces & Water Heaters—Bottled Gas Appliances. A SHOP COMPANION THAT ANSWERS YOUR QUESTIONS. Easy to read and understand—over 600 pages fully illustrated—with 500 photos and diagrams—1001 Facts. A ready reference.

\$4 COMPLETE • PAY \$1 A MONTH TO GET THIS SERVICE INFORMATION FOR YOURSELF—FILL IN AND MAIL 7 DAY TRIAL COUPON TODAY.



AUDEL, Publishers, 49 W. 23rd St., New York 10, N. Y. Mail AUDELS HOME APPLIANCE SERVICE GUIDE (\$4) for free examination. If O.K. I will send you \$1 in 7 days; then remit \$1 monthly until \$4 is paid. Otherwise, I will return book promptly.

Name _____
 Address _____
 Occupation _____
 Employed by _____



LIFE OF THE PARTY!

There's nothing like a set of drums in your house to bring the gang together!

Whether artist or amateurs, you and your friends will have great times and loads of fun.

BUY SLINGERLAND—the make that KRUPA uses.

Send for

FREE catalog!

SLINGERLAND DRUM COMPANY

1325 Belden Ave.

Chicago, Illinois

NOW COYNE TRAINS YOU IN SPARE TIME AT HOME

TELEVISION RADIO-ELECTRONICS

Only from famous COYNE do you get this modern up-to-the minute TV Home Training. Easy to follow, Step-by-Step instructions—fully illustrated with 2150 photos and diagrams. Not an old Radio Course with Television tacked on. Personal guidance by Coyne Staff. So practical you can quickly **EARN MONEY** IN A TV-RADIO SALES AND SERVICE BUSINESS—part time or full time. Not only **FINEST TRAINING** but **COSTS MUCH LESS**—pay only for training—no costly extras.

SEND COUPON FOR DETAILS FREE

SEND COUPON BELOW for Picture Folder and full details including **EASY PAYMENT PLAN**. **NO COST OR OBLIGATION**—NO SALESMAN WILL CALL.



B. W. COOKE
President

COYNE ELECTRICAL SCHOOL

FOUNDED 1899

A TECHNICAL TRADE INSTITUTE CHARTERED NOT FOR PROFIT
500 S. Paulina Dept. 25-HT2 Chicago 12, Illinois

B. W. COOKE, President
COYNE ELECTRICAL SCHOOL
500 So. Paulina St., Chicago 12, Ill., Dept. 25-HT2

Send **FREE** Picture Folder and details of your Television-Radio-Electronics Home Training offer.

Name _____

Address _____

City _____ State _____

MAKE EXTRA MONEY

PLASTICS

LEARN AT HOME

LEARN HOW TO MAKE fast-selling PLASTIC NOVELTIES FURNITURE JEWELRY

SIGNS TOYS LAMPS

There are **RICH OPPORTUNITIES** for **MEN AND WOMEN** with "know-how" in **Plastics**. Interstate's new **Plastics** course tells and shows how to make hundreds of fast selling items out of **Plastics**. Gives complete training in fabrication, casting, lamination, molding, internal carving, etc., in simple, easy, step-by-step language and pictures. **Plastics** and **Fabricating Kits** for 23 valuable **Plastic** items come with training at no extra cost. **START A PLASTICS BUSINESS OF YOUR OWN**. No other industry holds such promise for the future. You can make big money manufacturing novelties, toys, signs, etc., in your own home in spare or full time. Don't wait! **Learn NOW** how Interstate's **Plastics** Training qualifies you for success in the **Plastics** field.

PLASTICS AND SUPPLIES FURNISHED FOR 23 VALUABLE PROJECTS

INTERSTATE TRAINING SERVICE
Dept. C-3-B Portland 13, Oregon

STUDY INDUSTRIAL DESIGN

You can train at Art Center School in California with practicing professionals for upper-level jobs in **INDUSTRIAL DESIGN**. Recent graduates have been added to the staff at General Motors, Chrysler, Raymond Loewy, Henry Dreyfuss, etc. Majors in transportation, general product design, structures, community development, furniture design, packaging, display, 4-year degree courses. Learn to combine imaginative design with technical proficiency, coordinate utility and beauty. Stimulating environment. Field trips. Advantages of mild Southern California climate and nearby holiday spots. Coed. Placement service. Established 24 years. New term begins February 7. Write for catalog.

ART CENTER SCHOOL, Edward M. Adams, Director
5353 WEST THIRD STREET, LOS ANGELES 5, CALIFORNIA

"How to Make Money with Simple Cartoons"



A book everyone who likes to draw should have. It is free; no obligation. Simply address

FREE BOOK

CARTOONISTS' EXCHANGE
Dept. 92D Pleasant Hill, Ohio



NEW PENN YAN BOAT CATALOG

44 PAGES
OVER 100 MODELS

FREE! Get yours today. Many models illustrated in color. Cartops®, Trailboats, other outboards, canoes, rowboats described fully. Catalog features amazing new no-soak, work-free, all-wood *Striptites*. Penn Yan Boats, Inc., 34th St., Penn Yan, N. Y.

SOCK-O World's Most Powerful

SUPER SLINGSHOT

SILENT • RIFLE FAST • POWERFUL • ACCURATE
Great for small game, targets. 45 lb. pull. BIG sturdy Stock. Lively, Raw rubber. Sweet shooting! FREE! 100 steel balls, rubber and target. **FREE!!!** Thrilling **SURPRISE PACKAGE** with Two slings at \$2.95. **Harry, get 2! Guaranteed.** Approved by American Small Game Slingshot Assoc.

\$1.50 Wholesale No C.O.D.

SOCK-O, 4860 W. 137 St., Hawthorne, Calif.

COMPLETE NEW FALSE PLATE IN 24 HOURS

FROM YOUR OLD **\$15.95**
NOW LOW AS . . . **\$5.95**

New process transforms old, broken or loose plates into new lightweight plastic plates. **NO IMPRESSION NEEDED.** Let us help you enjoy life again. You will marvel at this revolutionary new method. Using your own old plates, we will remake them completely in only 24 hours. Missing teeth are carefully matched and replaced. Work is done on an absolute **MONEY BACK GUARANTEE.** **SEND NO MONEY** FREE DETAILS. If your teeth are loose, we'll tell you how to lighten them before duplication. Act now.

Tru-Grip Dental Labs., 7th Fl., 127 N. Dearborn, Dept. 70, Chicago 2, Ill.



I Can Make YOU a New Man, Too, In Only 15 Minutes a Day!

CHARLES ATLAS
Holder of title,
"The World's
Most Perfectly
Developed
Man."



PEOPLE used to laugh at my skinny 97-pound body, I was ashamed to strip for sports or for a swim. Girls made fun of me behind my back. THEN I discovered my body-building system, "Dynamic Tension." It made me such a complete specimen of manhood that I hold the title, "The World's Most Perfectly Developed Man."

What's My Secret?

When you look in the mirror and see a healthy, husky, fellow smiling back at you—then you'll be astonished at how fast "Dynamic Tension" GETS RESULTS! It is the easy, NATURAL method and you can practice in the privacy of your own room—JUST 15 MINUTES EACH DAY. Just watch your scrawny chest and shoulder muscles begin to swell . . . those spindly arms and legs of yours bulge . . . and your whole body starts to feel "alive," full of zip and go!

Thousands are becoming husky—my way. I give you no gadgets to fool with. With "Dynamic Tension" you simply utilize the dormant muscle-power in your own body—watch it grow and multiply into real, solid LIVE MUSCLE.

FREE My 32 Page Illustrated Book is Yours
Not for \$1.00 or 10c—But FREE

Send for my book, *Everlasting Health and Strength*. 32 pages of photos, valuable advice. Shows what *Dynamic Tension* can do, answers vital questions. A real prize for any fellow who wants a better build. I'll send you a copy FREE. It may change your whole life. Rush coupon to me personally: **CHARLES ATLAS, Dept. 8P, 115 E. 23rd Street, New York 10, N. Y.**



CHARLES ATLAS, Dept. 8P,
115 East 23 St., New York 10, N. Y.

Send me—absolutely FREE—a copy of your famous book, *Everlasting Health and Strength*—32 pages, crammed with photographs, answers to vital questions and valuable advice. This book is mine to keep, and sending for it does not obligate me in any way.

Name _____ Age _____
(Please print or write plainly)

Address _____

City _____ State _____

Choose
Your
New
Home
from



Garlinghouse HOME PLANS

Choose from Hundreds of
Plans in These Beautiful
PLAN BOOKS
All Styles — 1 to 4 Bedrooms

- **"NEW SMALL HOMES"**
Over 80 new plans in popular new sizes—650 to 1175 sq. ft. floor space, 1, 2 and 3 bedrooms50c
- **"RANCH AND SUBURBAN"**
128 ranch plans most practical for town and country50c
- **"DELUXE SMALL HOMES"**
Our largest selection—155 modern, time-tested designs. \$1.00
- **"HOMES IN BRICK"**
Many of these 115 tested designs of medium and large homes are in color \$1.00
- **"BLUE RIBBON HOMES"**
2nd Edition. 63 pages of homes proved popular by actual sales. Many in color50c
- All 5 above books for \$3.00 Postpaid—
- Our Complete Home Plan Library—18 books and over 1,250 Home Designs—Only \$8.00, a \$2.50 Saving.

Complete Plans for
"Do It Yourself" or
Contracting Part or All

These beautiful books contain hundreds of photographs, colored drawings, floor plans and descriptions—making it easy and economical to select the home you desire to build. Complete working plans, specifications, lumber and mill lists available for each design at Low Cost—enabling you to get contractors bids quickly—or to figure doing part or all the work yourself.

The moderate price of these plans is your best investment when building, since you know in advance what you are getting, thus avoiding misunderstandings. 24 hour service on plans with a money-back guarantee if unused plans are returned in five days. Our plan service used by builders and lumber dealers for over 40 years—America's largest.

**ORDER TODAY — All
Books Mailed Postpaid**

L. F. GARLINGHOUSE CO., INC., Box PM-23 TOPEKA, KANSAS



Glide LIKE AN INDIAN GUIDE

Down the twisting streams, across the ruffled lakes, your Old Town Canoe is your dependable friend for fishing and hunting. Sturdy and strong for long trips, yet light and easy to carry. Perfectly balanced. An Old Town is designed like a birchbark, but built for many years

of adventure and sport. Easy to own.
FREE CATALOG shows all kinds of canoes and outboards, sailboats, dinghies, rowboats.

OLD TOWN CANOES

Old Town Canoe Co., 242 Middle St., Old Town, Maine
PLEASE SEND ME FREE CATALOG

Name _____
Address _____
City _____ State _____



**INSURED TIRE SERVICE
POPULAR BRANDS**

FREE INSURANCE POLICY given with each used tire sold. We guarantee the amount of service you pay for.

Tube Given Free With Each Used Passenger Tire Upon Request

SPECIAL!
Deduct 10% on orders for two or more used tires

YOU CAN'T LOSE!!

Super Quality — Rugged Performance — 15 Months Insured Service			
600x16	\$3.65	670x15	\$3.95
650x15	3.85	670x16	4.05
650x16	4.25	700x15	3.95
700x16	4.45	760x16	4.45
820x15	4.75	820x15	4.95
850x17	5.15	850x17	5.35
900x17	5.55	900x17	5.75
950x17	6.15	950x17	6.35
1000x17	6.75	1000x17	7.15
1050x17	7.35	1050x17	7.75
1100x17	7.95	1100x17	8.35
1150x17	8.55	1150x17	8.95
1200x17	9.15	1200x17	9.55
1250x17	9.75	1250x17	10.15
1300x17	10.35	1300x17	10.75
1350x17	10.95	1350x17	11.35
1400x17	11.55	1400x17	11.95
1450x17	12.15	1450x17	12.55
1500x17	12.75	1500x17	13.15
1550x17	13.35	1550x17	13.75
1600x17	13.95	1600x17	14.35
1650x17	14.55	1650x17	14.95
1700x17	15.15	1700x17	15.55
1750x17	15.75	1750x17	16.15
1800x17	16.35	1800x17	16.75
1850x17	16.95	1850x17	17.35
1900x17	17.55	1900x17	17.95
1950x17	18.15	1950x17	18.55
2000x17	18.75	2000x17	19.15
2050x17	19.35	2050x17	19.75
2100x17	19.95	2100x17	20.35
2150x17	20.55	2150x17	20.95
2200x17	21.15	2200x17	21.55
2250x17	21.75	2250x17	22.15
2300x17	22.35	2300x17	22.75
2350x17	22.95	2350x17	23.35
2400x17	23.55	2400x17	23.95
2450x17	24.15	2450x17	24.55
2500x17	24.75	2500x17	25.15
2550x17	25.35	2550x17	25.75
2600x17	25.95	2600x17	26.35
2650x17	26.55	2650x17	26.95
2700x17	27.15	2700x17	27.55
2750x17	27.75	2750x17	28.15
2800x17	28.35	2800x17	28.75
2850x17	28.95	2850x17	29.35
2900x17	29.55	2900x17	29.95
2950x17	30.15	2950x17	30.55
3000x17	30.75	3000x17	31.15
3050x17	31.35	3050x17	31.75
3100x17	31.95	3100x17	32.35
3150x17	32.55	3150x17	32.95
3200x17	33.15	3200x17	33.55
3250x17	33.75	3250x17	34.15
3300x17	34.35	3300x17	34.75
3350x17	35.35	3350x17	35.75
3400x17	36.35	3400x17	36.75
3450x17	37.35	3450x17	37.75
3500x17	38.35	3500x17	38.75
3550x17	39.35	3550x17	39.75
3600x17	40.35	3600x17	40.75
3650x17	41.35	3650x17	41.75
3700x17	42.35	3700x17	42.75
3750x17	43.35	3750x17	43.75
3800x17	44.35	3800x17	44.75
3850x17	45.35	3850x17	45.75
3900x17	46.35	3900x17	46.75
3950x17	47.35	3950x17	47.75
4000x17	48.35	4000x17	48.75
4050x17	49.35	4050x17	49.75
4100x17	50.35	4100x17	50.75
4150x17	51.35	4150x17	51.75
4200x17	52.35	4200x17	52.75
4250x17	53.35	4250x17	53.75
4300x17	54.35	4300x17	54.75
4350x17	55.35	4350x17	55.75
4400x17	56.35	4400x17	56.75
4450x17	57.35	4450x17	57.75
4500x17	58.35	4500x17	58.75
4550x17	59.35	4550x17	59.75
4600x17	60.35	4600x17	60.75
4650x17	61.35	4650x17	61.75
4700x17	62.35	4700x17	62.75
4750x17	63.35	4750x17	63.75
4800x17	64.35	4800x17	64.75
4850x17	65.35	4850x17	65.75
4900x17	66.35	4900x17	66.75
4950x17	67.35	4950x17	67.75
5000x17	68.35	5000x17	68.75
5050x17	69.35	5050x17	69.75
5100x17	70.35	5100x17	70.75
5150x17	71.35	5150x17	71.75
5200x17	72.35	5200x17	72.75
5250x17	73.35	5250x17	73.75
5300x17	74.35	5300x17	74.75
5350x17	75.35	5350x17	75.75
5400x17	76.35	5400x17	76.75
5450x17	77.35	5450x17	77.75
5500x17	78.35	5500x17	78.75
5550x17	79.35	5550x17	79.75
5600x17	80.35	5600x17	80.75
5650x17	81.35	5650x17	81.75
5700x17	82.35	5700x17	82.75
5750x17	83.35	5750x17	83.75
5800x17	84.35	5800x17	84.75
5850x17	85.35	5850x17	85.75
5900x17	86.35	5900x17	86.75
5950x17	87.35	5950x17	87.75
6000x17	88.35	6000x17	88.75
6050x17	89.35	6050x17	89.75
6100x17	90.35	6100x17	90.75
6150x17	91.35	6150x17	91.75
6200x17	92.35	6200x17	92.75
6250x17	93.35	6250x17	93.75
6300x17	94.35	6300x17	94.75
6350x17	95.35	6350x17	95.75
6400x17	96.35	6400x17	96.75
6450x17	97.35	6450x17	97.75
6500x17	98.35	6500x17	98.75
6550x17	99.35	6550x17	99.75
6600x17	100.35	6600x17	100.75
6650x17	101.35	6650x17	101.75
6700x17	102.35	6700x17	102.75
6750x17	103.35	6750x17	103.75
6800x17	104.35	6800x17	104.75
6850x17	105.35	6850x17	105.75
6900x17	106.35	6900x17	106.75
6950x17	107.35	6950x17	107.75
7000x17	108.35	7000x17	108.75
7050x17	109.35	7050x17	109.75
7100x17	110.35	7100x17	110.75
7150x17	111.35	7150x17	111.75
7200x17	112.35	7200x17	112.75
7250x17	113.35	7250x17	113.75
7300x17	114.35	7300x17	114.75
7350x17	115.35	7350x17	115.75
7400x17	116.35	7400x17	116.75
7450x17	117.35	7450x17	117.75
7500x17	118.35	7500x17	118.75
7550x17	119.35	7550x17	119.75
7600x17	120.35	7600x17	120.75
7650x17	121.35	7650x17	121.75
7700x17	122.35	7700x17	122.75
7750x17	123.35	7750x17	123.75
7800x17	124.35	7800x17	124.75
7850x17	125.35	7850x17	125.75
7900x17	126.35	7900x17	126.75
7950x17	127.35	7950x17	127.75
8000x17	128.35	8000x17	128.75
8050x17	129.35	8050x17	129.75
8100x17	130.35	8100x17	130.75
8150x17	131.35	8150x17	131.75
8200x17	132.35	8200x17	132.75
8250x17	133.35	8250x17	133.75
8300x17	134.35	8300x17	134.75
8350x17	135.35	8350x17	135.75
8400x17	136.35	8400x17	136.75
8450x17	137.35	8450x17	137.75
8500x17	138.35	8500x17	138.75
8550x17	139.35	8550x17	139.75
8600x17	140.35	8600x17	140.75
8650x17	141.35	8650x17	141.75
8700x17	142.35	8700x17	142.75
8750x17	143.35	8750x17	143.75
8800x17	144.35	8800x17	144.75
8850x17	145.35	8850x17	145.75
8900x17	146.35	8900x17	146.75
8950x17	147.35	8950x17	147.75
9000x17	148.35	9000x17	148.75
9050x17	149.35	9050x17	149.75
9100x17	150.35	9100x17	150.75
9150x17	151.35	9150x17	151.75
9200x17	152.35	9200x17	152.75
9250x17	153.35	9250x17	153.75
9300x17	154.35	9300x17	154.75
9350x17	155.35	9350x17	155.75
9400x17	156.35	9400x17	156.75
9450x17	157.35	9450x17	157.75
9500x17	158.35	9500x17	158.75
9550x17	159.35	9550x17	159.75
9600x17	160.35	9600x17	160.75
9650x17	161.35	9650x17	161.75
9700x17	162.35	9700x17	162.75
9750x17	163.35	9750x17	163.75
9800x17	164.35	9800x17	164.75
9850x17	165.35	9850x17	165.75
9900x17	166.35	9900x17	166.75
9950x17	167.35	9950x17	167.75
10000x17	168.35	10000x17	168.75

Whitewalls \$1.00 extra.

Speedy shipments on Mail Orders, F.O.B. Chicago. Insurance policy sent with each order. Deduct 10% on orders for 2 or more used tires. Send CHECK or MONEY ORDER—No COD's.
3701 S. Normal, Dept. PM-31, Chicago 9, Ill.

How to win an Executive's JOB and PAY

Only one thing stands between you and a top executive's pay—the right kind of ability. You may be skilled in your work, yet if not trained in management you are not

GOOD FOR FREE SEEDS & PLAN

NATIONAL NURSERY GARDENS

8463 SO. VAN NESS AVE., DEPT. M-2,
INGLEWOOD 4, CALIFORNIA

Please rush me **FREE SEEDS** and illustrated Plan. I understand I am under no obligation. This is a Free offer from you.

Name _____

Address _____ Zone _____

City _____ State _____

FREE! FREE!

FREE! FREE!

FREE! GENUINE SEEDS

MAIL THIS
Certificate
TODAY

and I'll send you
FREE!
Genuine Seeds and
Illustrated Plan



NEW!
"CHANCE OF
A LIFETIME"
OPPORTUNITY

Earn BIG Money

**SOLD
FOR OVER
\$1,000
EACH!**

**GROW
LIVING**

MING TREES

CAREFULLY GUARDED ORIENTAL SECRETS CAN NOW BE YOURS

Centuries ago, Oriental royalty astounded the world by growing real LIVING miniature "Dwarf Trees". The Emperors jealously guarded the growing secrets of these fabulously beautiful tiny trees, and the death penalty was given anyone giving away the secrets. However, during World War II, the SECRETS GOT OUT to Americans. Now, it's the opportunity of a lifetime for a FASCINATING HOBBY or a QUICK-PROFIT BUSINESS for anyone. Mail certificate today!

GROW THEM AT HOME in your living room, spare room, garage, window sill—anywhere. Fill your home with these beautiful wonders of nature. You start on a shoestring with pennies, but grow trees worth "tens of dollars." NO EQUIPMENT—NO LARGE SPACE—NO EXPERIENCE IS necessary.

SPARE-TIME OPPORTUNITY — for anyone wanting to combine pennies and leisure time to produce wonderful, valuable trees. IT'S A HUNDRED TIMES MORE FASCINATING than any other kind of gardening or hobby, yet can be extremely profitable because miniature specimens are new, rare and wanted by everyone.

GROW HUNDREDS AT ONE TIME — A wonderful idea for making big money. It's easy—nature does most of the work. Think of the profits of large crops when trees may sell

for \$25 each. New short-cut method lets you see results immediately too—no waiting.

TAKES ONLY MINUTES per day! NO LONG HOURS of tedious work—NO STUDYING detailed instructions. It's easier than you think—once you know the secrets.

GROW IN ANY CLIMATE — It's never too cold or too hot to grow most living Miniature Trees.

SOME SOLD FOR AS HIGH AS \$2,000 EACH — but \$25, \$50, or \$100 per tree is common. You pocket all the profit.

WE SUPPLY EVERYTHING — at our risk! Yes, everything you need to start growing beautiful perfect Miniature Trees can be yours—and you don't risk one penny. Our new special plan gives you this amazing opportunity. RUSH THE CERTIFICATE ABOVE TODAY. THIS OFFER IS LIMITED.

NEW SHORT-CUT METHOD

High speed idea eliminates waiting for seed to sprout. Now have a real living Ming Tree almost immediately. Amazing!

ONLY INCHES HIGH!

HELP US FILL HUGE DEMAND!

Orders come from everywhere! The popularity of these Ming Trees is sweeping all America. They're "the latest fashionable decoration 'treasure'".



IN HOMES — As fascinating conversational pieces on the mantle or table in the living room, bedroom, kitchen—anywhere.



IN FLOWER SHOWS — Win Prizes, win praise. Join in competition with these wonderful trees.



FROM INTERIOR DECORATORS — they can't seem to get enough of them for their customers.



IN CLUBS, HOTELS, CHURCHES, SCHOOLS, FLOWER SHOPS, ETC. These rare and exotic trees are extremely popular and in great demand.

© 1953

NATIONAL NURSERY GARDENS
8463 SO. VAN NESS AVE., INGLEWOOD 4, CALIFORNIA



It's Fun! It's Easy!
GROW ALL KINDS OF TREES. Perfect specimens of lovely FIR, fragrant JUNIPER, LEMON, ORANGE, sturdy OAK, PINE, CHERRY—nearly ANY kind, only inches high!



JUNIPER
only 12 inches high

FREE TO NEW MEMBERS...

IMPORTS

FROM FOREIGN LANDS

**NOW! EASY TO START YOUR OWN
BIG-PROFIT IMPORT-EXPORT
BUSINESS AT HOME!**

FREE to new members of the International Traders Guild—many unusual, useful products from France, India, Germany and other foreign lands, and trade bulletins listing hundreds of import bargains. World trade boom offers new, big-money opportunities for men and women! Now you can import at low foreign prices for buyers in your locality at high U. S. prices.

BUY-SELL, WORLD WIDE, WITHOUT CAPITAL. Big profits possible, no investment in goods. Operate a world-wide mail-order business from home, spare or full time. Also, for your own use, big savings on clothes, tools, gems, antiques, watches, cameras, china, silk, toys, etc. (see examples at left). No matter where you live World Trade can be carried on—in small towns or large cities, anywhere. World travel opportunities. Established World Trader shows you how. Teaches you quickly at home.

START AT ONCE—IMPORT PROFITABLE ITEMS Complete training includes many exciting imports that come to you from 'round the world **AT NO EXTRA COST.** Go after big profits **NOW**—importing and exporting. No previous experience is required. 2000 members in 42 countries. 7th successful year. Free details, write Now. Airmail reaches us overnight.

The MELLINGER CO., Exporters-Importers,
Dept. E252 1717 Westwood Blvd., Los Angeles 24, Calif



Pepper Mill 27c



Padlock 3 1/2c



Beer Stein 56c

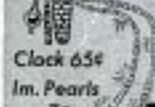

Clock 65c

Im. Pearls 7c



"We operate a profitable **WORLD TRADE BUSINESS FROM OUR HOME**...Thanks to Mellinger"

Mr. and Mrs. H. F. BERKE, N.Y.

MANUFACTURE THIS BEAUTIFUL CONCRETE OUTDOOR FIREPLACE

*Right In Your
Own Backyard*

**\$4.00 Worth of
Sand & Cement
produces this
Attractive
Fireplace.**

**Sells on Sight
from \$60. to \$80.
Easy to start your
own Profitable
Business.**

The General Fireplace Molds and Process are the most amazing and foolproof ever invented. Simple to operate. Two men can produce five fireplaces a day.

BIG DEMAND!!

Sell all you produce to Department Stores, Homeowners, Parks, Nurseries and Picnic Groves. Fireplaces sell on sight. No experience necessary. We supply full operating instructions and equipment plus the know-how that spells **BIG PROFITS.** This is an outstanding opportunity for men of vision and small capital to get into a busy rich paying field. Don't delay, be the only exclusive manufacturer in your own home town. Mail coupon at once for full details as to how you can reserve your territory. **Molds sold only on exclusive franchise.**

GENERAL ENGINES CO., Inc., Dept. MF-25
307 HUNTER ST. • GLOUCESTER CITY, N. J.

Mr. Tor of Philadelphia writes:
Sold 250 in first 4 months. Selling to Sears Roebuck, John Wanamaker, and Gimbel Bros. in Philadelphia area.

Name
Address
City Zone
State

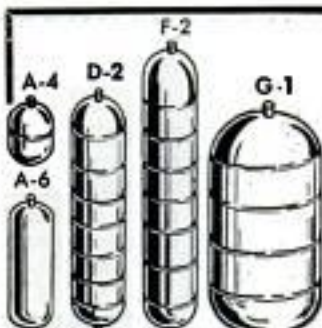

STEEL AIR TANKS

Steel pressure tanks suitable for compressors, pneumatic units, gases, hydraulics, and liquids. Rated at 500 lbs. per square inch pressure. 1/2" standard pipe thread openings on tank ends as shown.

	Size	Wt. Lbs.	Volume	Price
A-4A Carbon Steel—New	7 1/2"x5 1/4"	1 1/2	104 cu. in.	\$1.50
A-4 Stainless Steel—New	7 1/2"x5 1/4"	1 1/2	104 cu. in.	2.50
A-6 Carbon Steel—New	14 1/2"x5 1/2"	3 1/4	280 cu. in.	3.50
D-2A Carbon Steel—New	24"x6"	5	500 cu. in.	4.50
D-2 Stainless Steel—New	24"x6"	5	500 cu. in.	7.50
F-2A Carbon Steel—New	45"x6"	11	1000 cu. in.	8.50
F-2 Stainless Steel—New	45"x6"	11	1000 cu. in.	9.50
F-1 Stainless Steel—New	18"x10"	12	1000 cu. in.	9.50
G-1 Stainless Steel—New	24"x12"	18	2100 cu. in.	12.50

Prices F.O.B. Chicago. Include approx. postage on orders paid for in advance. C.O.D. orders enclose 25% balance rest C.O.D.

U. A. S. Corp. Dept. PM-2, 5637 W. 63rd Pl.
Chicago 38, Illinois

This **FREE** Catalog Brings You
\$60.00 A WEEK
for just 3 orders a day!

No investment, no experience needed. Just show magic cushion comfort to friends, neighbors, co-workers. Advance commissions to \$4.00 a pair, plus Cash Bonus, Paid Vacation, \$25 Reward Offer. Outstanding values for men, women, children. Money back guarantee. Shoe samples supplied without cost. Write TODAY for FREE new 76 page catalog and full details.

TANNERS SHOE CO., 533 BROCKTON, MASS.

- * Plus Extra Cash Bonus
- * Plus Paid Vacation
- * Plus \$25.00 Reward Offer

RUPTURED?

Something different. Light. Cool. No leg straps. No elastic. No pressure on hips or spine. Inexpensive. Worn by Mechanics, Farmers, Doctors, etc., everywhere. Guaranteed. Write

HAND-LOCK PRODUCTS EST. 1893
DEPT. PM, PRESTON, ONT., CAN.

SPEAK AND WRITE LIKE A College Graduate

If you lack complete college training in English you can now become an effective speaker, writer, and conversationalist—without going back to school. With the new CAREER INSTITUTE METHOD you can stop making mistakes in English, build up your vocabulary, speed up your reading, acquire real writing skill, learn the "secrets" of fluent conversation. Method successfully used by thousands. Takes only 15 minutes a day at home. Costs little. 32-page booklet mailed FREE upon request. Send card or letter NOW!

Career Institute, Dept. E-112, 25 E. Jackson, Chicago 4

ENGINEERING DEGREE IN 27 MONTHS

INDIANA TECHNICAL COLLEGE

B. S. DEGREE, Aeronautical, Chemical, Civil, Electrical, Mechanical and Radio Engineering (inc. TV and Electronics), Drafting, 1-yr. G.I. Gov't. approved. Low rate. Earn board. Large industrial center. Students from 48 states, 21 countries. Demand for graduates. Enter March, June, September, December. Write for catalog: 1625 E. Washington Boulevard, Fort Wayne 2, Indiana.

LEARN TO BECOME A GAME WARDEN

or GOVT. HUNTER. Join FORESTRY, FISHERY, or WILDLIFE Services. Excellent opportunities! Good pay \$2500 to \$10,800 a year! Pleasant Work, Prestige, Real Security, Healthful Working Conditions, and Retirement Income can all be yours. Help fill the demand in your area. Make your love of the outdoors become your business. Learn at home in spare time—it's Easy! Fun! Fascinating!

FREE! (if over 17 years old.) Complete, illustrated booklet that gives you complete facts. **SUPPLY LIMITED—send your name and address now—TODAY!**

HOME-STUDY INSTITUTE, Dept R-2 Los Angeles 5, Calif.

No Wonder 900,000 People Have Taken Up This EASY WAY TO LEARN MUSIC!

Here are just a few of them:

Plays Popular and Classical Music After a Few Months

"I did not know a note of music. Within a few months, I could play many selections, popular as well as classical, to the delight of my friends and relatives. I get much enjoyment in playing for others—not to mention myself."—**Lawrence M. Deno, West Chazy, N.Y.**



Surprises Her Friends

"Not long after I received my course, I had friends come in one afternoon—and did I surprise them when I sat down and played several pieces! They were the most surprised people I had ever seen. I told them about the course and how happy I was with it."—**Mrs. Arvin Rogers, Stamps, Ark.**

Plays Songs After First Month

"After the first month I could play any songs with eighth notes. I have played for a couple of dances, and am now studying Heifetz's 'Hora Staccato.'"—**Ivan W. Dayley, Lisec, Nebr.**



Does Better Than Friend Who Has Teacher

"My friend who has been taking lessons from a private teacher for the same length of time, is still doing simple exercises—while she would have been playing popular songs like myself had she taken the U. S. School Course instead."—**Miss Marie Van Mulle, Manitoba, Canada.**

Asked to Play in School Band

"Before I enrolled in your course, I didn't know a note of music. Soon I was asked to play the piano for our school's rhythm band. My teacher was so surprised—and congratulated me on how well I could play in such a short time!"—**Patricia McKee, Delphos, Kansas.**



Plays At Dances

"One thing I especially liked about your lessons is that they can be taken in spare time. I did all my lessons at night after supper. I was able to play pieces for my friends and family within a short time. I also had the enjoyment of playing at dances, which is a lot of fun."—**Charles LeRoy Schnell, Birds Eye, Indiana.**



It Actually Makes Learning to Play a Thrilling Pastime, Instead of Dull Drudgery!

IMAGINE the thrill of starting to play real music in your very first lesson! IMAGINE the joys of learning music WITHOUT stirring from your own home—WITHOUT the bother and expense of having a private teacher—WITHOUT spending months at boring scales and exercises!

No wonder 900,000 people have turned to the U. S. SCHOOL OF MUSIC to make their dream come true! It's quick, easy, inexpensive—and so much FUN!

Costs Very Little!

In just a few weeks, you can be playing REAL MUSIC—even if you don't know a single note now. Not by any "trick" method that merely seems to teach you music. But really playing actual sheet music—so easily and confidently that friends will suspect you've actually "known how" for years! And the cost is only about a TENTH of what you'd pay a private teacher.

Why not let this famous method bring the pleasures of music into YOUR life? New friends. Extra money from playing or teaching. Greater listening pleasure. Possibly a brilliant career. Best of all, the deep personal satisfaction of being able to provide your own entertainment.

FREE BOOK

Mailing the coupon places you under no obligation whatever—and no salesman will call upon you. You will receive by mail our FREE illustrated book showing how easy it is to learn music this modern way. So mail the coupon AT ONCE. Don't delay putting this wonderful accomplishment into your life. U. S. SCHOOL OF MUSIC, Studio A-302, Port Washington, N. Y. (Special Reduced prices on instruments to our students.)



900,000 STUDENTS
57 Successful Years

U. S. SCHOOL OF MUSIC, Studio A-302
Port Washington, New York

Send me your 36 page Illustrated FREE BOOK. No obligation—and no salesman is to call upon me. I'm interested in playing (name instrument).

I do I do NOT—have instrument now.

Name _____ (PLEASE PRINT)

Address _____

City _____ State _____
(Insert Zone Number, If Any)

Choose Your Favorite Instrument

Now it's easy to learn—by note—Piano, Guitar, Accordion, Violin, Hawaiian Guitar, Mandolin, Trumpet, Cornet, Saxophone, Tenor Banjo, Organ, Ukulele, Clarinet, Trombone, Flute or Piccolo. Write your choice in coupon.

Paint STRIPES with New "PAINT PEN"!

Makes Straight, Curved or Parallel Lines!

Just fill glass vial with any color paint. Use like a fountain pen to stripe furniture, bikes, autos, model planes, toys, linoleum, wall board. Beautiful, clean, crisp results every time, like professional painters. No experience needed to draw straight, curved, circular or evenly spaced parallel lines. Can't clog or smear. May also be used with glue, tempera, textile paint, or ceramic underglazes. Paints on wood, glass, plastics, metal, fabrics and paper. Lasts a lifetime. Only \$1 postpaid, complete with tip for 1/16 inch stripe. C.O.D.'s plus postage. Used by industry. Order your Paint Stripping Tool TODAY!

New! "DOUBLE-STRIPE" MODEL Only \$2.95

Newest paint stripping invention. Makes double stripes — one wide and one narrow or two wide or two narrow at the same time. Or adapt quickly for wide or narrow single stripe. Makes 5 combinations. FREE—Send postcard for complete information... or order now... \$2.95.



\$1.00

DEALERS

Master Paint Stripping Tool packed in Display Cartons of 1 dozen. Fast, profitable seller. Write for discounts.

Attention All Home Craftsmen!

New Paint Stripping Tool gives "professional" results every time, yet simple, easy to use. Send \$1 now.

ATTENTION — MANUFACTURERS!

Write today for information about our industrial and production stripping tools.

WENDELL MFG. CO., Dept. 32

4234 Lincoln Ave., Chicago 18, Illinois

6 Other Complete Tools

Complete tools for 1/64, 1/32, 3/64, 5/64, 3/32 or 1/8 inch stripes. \$1.50 each. Extra tips 75c ea. COMPLETE KIT with ALL 7 TIPS, \$5.00. (Also 1/4" tip, only \$1.00). All tips interchangeable.

100 power TELESCOPE

36 inches (closes to 16). Adjustable eyepiece. Guaranteed to bring mountains, craters of the moon, stars, ships, people, distant objects 100x closer. Includes 6 ft. collapsible tripod with steel mounted Aluminum head adjustable any position. You will be surprised first time you look through this scope. Shipped complete ready to use.

BUSSE CO., Hartford, Conn., Dept. 5P2



\$8.95

Post Paid

Send check or money order

I'll Send You This Handsome SAMPLE CASE—FREE!



Make up to
\$30.00 in a Day!

Your Own
Tailored Suits
Without 1¢ Cost

If you want to make more money, spare time or full time, rush the coupon below today for this big, valuable tailoring Sample Case packed with 150 beautiful, big-value suit and overcoat samples. Just show the samples and last-minute styles to friends, fellow-workers, others. Take their orders for fine made-to-measure clothes—and pocket BIG CASH PROFITS in advance. No experience, no tailoring knowledge needed—and no money needed, ever. WE SUPPLY EVERYTHING FREE... sample case, sample suitings, equipment, complete instructions. Start making money first day!

Use Spare Evenings... Weekends... Make Money... Get Suits!

It's easy to make money taking orders in just spare time—lunch-time, evenings, weekends. When men see the fine fit, quality and value of our suits—THEY ORDER! So we make it easy for you to get your own personal suits and overcoats without paying even one penny. Don't wait! Rush coupon with your name, address, and age for FREE Sample Case.

PROGRESS TAILORING COMPANY
Dept. X-216, 500 South Throop Street, Chicago 7, Ill.

PROGRESS TAILORING CO., Dept. X-216
500 S. Throop St., Chicago 7, Ill.

Please rush ABSOLUTELY FREE the valuable Sample Case with suit fabrics and style display. Include instructions, money-making plans and details for getting my own suits without paying one cent.

Name.....Age.....
Address.....
City.....State.....

OWN Your OWN Radiator Repair Business...



\$995
Starts You
Equips You

Earn \$6.75 per hour—\$8,000 to \$12,000 a year—servicing auto-truck-tractor radiators! New modern equipment makes work easy, fascinating, insures finest professional workmanship. Only \$995 starts you—\$100 training course included free by world's largest radiator equipment manufacturer. "Pays-for-itself" financing available.

WRITE for free folder "Want a business of your own?"

INLAND MFG. COMPANY Dept. PM-2

1108 Jackson St., Omaha 8, Nebr.
P.S. — Training alone also available—only \$100. Ask for training school literature.



SAMSON FIBER-GLASS BOWS

THEY DON'T BREAK

FAMILY USES SAME BOW

Ask Dealers for

Stemmler's Archery

CATALOG - Fine Bow Arrows Materials &

HANDBOOK - Instructional literature on

Making & Shooting Archery Tools 75c

L. E. STEMMLER CO., Box 1

MANORVILLE, L. I., NEW YORK

Making Bows & Arrows for over 40 years



Bar Bells

Buy Direct From Factory

Write for free booklet

and price list.

\$8.95
up

INDEPENDENT IRON WORKS

2416 East 23rd Street, Dept. B

Los Angeles 58, Calif.

PLEASE SEND ME

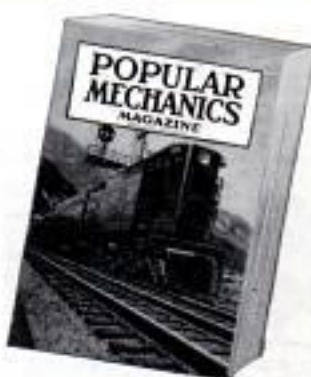

for the
time checked.

I am enclosing . . .

1 year \$3.50

2 years \$6.00

name

address

city

zone

state

Hand this order to your newsdealer or send it to

POPULAR MECHANICS
200 East Ontario St. Chicago 11, Ill.

POPULAR MECHANICS

TRAIN FOR GOOD PAY IN A FIELD THAT ISN'T CROWDED!



NOW! you can LEARN ELECTRIC MOTOR REPAIR
... A good-paying, modern profession



OPPORTUNITIES EVERYWHERE!

Don't drift into a rut! Don't train for something that everybody and his brother are studying! Consider the facts. . . . The average small home has at least 11 electric motors! Big homes have many more—in phonographs, recorders, oil burners, refrigerators, washers, fans, clocks, mixers, cleaners, air conditioners, etc., etc. Millions more in office, industrial, mining, and transit equipment. Be the well-paid expert who can keep them working!

... for only \$6

FOR THE COMPLETE TRAINING

COVERS EVERY MOTOR TYPE IN COMMON USE

Every day, more and more electric motors and motor control systems are being used BOTH in industry and in home appliances. The expert who can install and keep them working properly is a valuable man in this Electrical Age. The pay is surprisingly good. The field is tremendous—and growing rapidly. Trained men find opportunities everywhere for full or part time work. **ELECTRIC MOTOR REPAIR**, the big 560-page training course book teaches you the work step by step—quickly and easily—at home in spare time. There is no other book like it. Ideal for beginners or for actual bench use in busy shops. Thousands already in use in leading vocational schools, shops, and for home study.

SHOWS YOU HOW . . . Every Step of the Way!

Based on what you can learn quickly at home from **ELECTRIC MOTOR REPAIR** you can train for prompt profitable installation, servicing, repairing and complete rewinding of practically any motor in use today.

You learn fast! You learn right!

Every subject is clearly explained by text AND ALSO by more than 900 illustrations and diagrams. You not only read what to do—you SEE how it is done. Quick reference guides tell you how to handle specific jobs. When a certain motor comes in for repairs, just look it up. **ELECTRIC MOTOR REPAIR** tells you what to do—and exactly how to do it.

ELECTRIC MOTOR REPAIR is designed for use right at the service bench. Unique Duo-Spiral Binding divides the book into

two sections so that both text and related diagrams can be viewed together. An instructor standing by your side could hardly do better! **ELECTRIC MOTOR REPAIR** covers the entire field—from alternating- and direct-current motors and generators, etc. to mechanical and electrical and electronic control systems. Right down the line, it explains trouble diagnosing, repair, rewinding and maintenance in a way you can easily understand.

FREE STUDY GUIDE

A unique Study Guide booklet of 500 practical motor study questions—priced and sold separately at 25c—is yours FREE with your request to examine **ELECTRIC MOTOR REPAIR** book. Makes learning easier—speeds up the work! See coupon.

LEARN FAST . . . no lessons to wait for! EARN WHILE YOU LEARN

Practice by repairing motors for friends, neighbors or nearby business houses. Earn while you learn this profitable, fast-growing business!

If sold as a course and sent to you in lesson form, you'd regard **ELECTRIC MOTOR REPAIR** as a bargain at 10 times the price! Instead, you get it all at once—for only \$6. You learn fast . . . and right. Here are just a few of the motor types that are fully covered:

- Split-Phase Motors
- Capacitor Motors
- Repulsion-type Motors
- Polyphase Motors
- Alternating-Current Motor Controls
- Direct-Current Armature Winding
- Direct-Current Motors
- Direct-Current Motor Controls
- Universal, Shaded-pole, and Fan Motors
- D-C-Generators, Synchronous Motors and Generators
- Electronic Motor Controls . . .



Send No Money! PRACTICE 10 DAYS FREE!

DEPT. PM-25, RINEHART & COMPANY, INC.
232 Madison Ave., New York 16, N. Y.

Send me the 560-page **ELECTRIC MOTOR REPAIR** home-training book for 10-day FREE EXAMINATION. At the end of 10 days, I will either return book to you postpaid in good condition or send you the sum of \$6.00 in full payment. Include FREE Study Guide which is mine to keep whether I buy the book or not.

Name _____

Address _____

City, Zone, State _____

(Outside U.S.A. \$8.50 cash only—same return privilege)

"HOW I DOUBLED MY INCOME In Less Than A Year, As A CUSTOM UPHOLSTERER"



**Alvin Lederkramer, Former Low Salaried
Auto Mechanic — Now Earning Big Pay**

"When I enrolled for UTS training I was an auto mechanic earning a meager salary. While learning I earned good spare-time money. After graduation, I got a job in upholstery with better pay than ever before. Now, less than one year later, I've doubled my income. Soon, I'll get into my own business. The future looks bright, thanks to UTS."

**WHAT DO YOU WANT? Your Own Business—A Steady
Job—Substantial Sparetime Earnings—A Better Future?
They're all waiting for you in the Big-Opportunity Field
of Custom Furniture Upholstery.**

AT HOME in spare time, you can do what Alvin Lederkramer and other UTS graduates have done — easily, quickly! Trained upholsterers are scarce. You can earn as you learn to make good money all year 'round at home, in your own shop, or in a well-paid job. The practical N.Y. State-Approved UTS course teaches you custom furniture upholstery, reupholstery, slipcovers, furniture finishing, repairs, —window cornice, cushion and drapery making. You get—FREE—ALL tools, complete frames, materials and fabrics to make beautiful upholstered furniture and slip covers, yours to keep or sell! FREE BOOK, "Your New Way to a Successful Career" with sample lesson shows you how. Tells how you prepare at home for this big pay, big opportunity trade. WRITE TODAY! Training in N. Y. School also available. Upholstery Trades School, Dept. DB-305, 721 B'way, N. Y. 3.

APPROVED FOR VETERAN TRAINING

SEND FOR BIG FREE BOOK

UPHOLSTERY TRADES SCHOOL, Dept. DB-305
721 Broadway, New York 3, N. Y.

Send me your FREE book with sample lesson.
No obligation. No salesman will call.

Home Study In N. Y. School Training

Name _____

Address _____

City _____

Zone _____

State _____

Check here if Korean Veteran

YOU MAKE
SLIPPER
CHAIR
CLUB
CHAIR
OTTOMAN
PLUS
SLIP COVERS
Yours to keep
or sell

PREPARE FOR THE BEST JOBS IN INDUSTRY

**TRAIN
at HOME**
IN YOUR SPARE TIME
or at
ALLIED INSTITUTE
in Chicago

- MECH. ENGINEER
- DRAFTSMAN
- TOOL DESIGNER
- TOOL ENGINEER
- TOOL & DIE MAKER
- MASTER MACHINIST

NO RECESSION FOR ALLIED TRAINED MEN

MORE JOBS THAN GRADUATES Shortages of Draftsmen, Designers, Tool Engineers, Machinists, Tool & Die Makers are so widespread that you can pick a highly paid key job and look forward to Achievement and Security.

You can begin your training in Short Courses and continue progressively to a Bachelor Degree in 26 months.

Allied is approved by Industry, Dept. of Education, Office of Public Instruction, State of Illinois, U.S. Veterans Admin., U. S. Dept. of Justice. Accredited: C. S. A.

**SEND FOR
FREE
BOOKS**

ALLIED SCHOOL of MECHANICAL TRADES
1338-42 South Michigan Ave. Dept. PM-2 Chicago 5, Illinois

SEND ME WITHOUT OBLIGATION INFO. ON YOUR COURSES:

HOME STUDY RESIDENT VETERAN NON VETERAN

NAME _____

ADDRESS _____

AGE _____

CITY _____

STATE _____

Bean's

Free Catalog



Ready February 7
Fully illustrated. 104
pages, showing special
fishing tackle, foot-
wear, clothing and one
hundred and twenty
other leather and can-
vas specialties of our
own manufacture.

L. L. Bean, Inc., 211 Main St., Freeport, Maine
Mfrs. Fishing and Camping Specialties

NEW! CHEAP! AMAZING HEAT INVENTION

OIL BURNER

\$14.75 for Stoves **FITS IN ANY COAL STOVE, RANGE,
\$29.50 for Furnaces** **BOILER OR FURNACE.** No more
shoveling Coal or Ashes.
This Universal Unit
makes one of the quickest,
hottest, cheapest fires known. Sold on
a 60 day Money-Back Guarantee. Send No
Money. You will receive Agents Prices and full details by
sending your name to
NORTHWEST MFG. CO., 12-B Main, Mitchell, South Dakota

FREE AMAZING NEW BOOK "HOW TO ANSWER ADS"

Never before have you seen anything like this. Tells you in simple language the correct way to answer ads. Gets you quicker replies—better results, and greater satisfaction. Will save you time and money and it's **ABSOLUTELY FREE**. No obligation whatever. Every reader of advertising should have this booklet. Send a postcard for your copy NOW. F. W. JOHNSON, Popular Mechanics Magazine, Room 800-A, 204 East Ontario Street, Chicago 11, Ill.

WHEELS WHEELS WHEELS	
7" Disc Wheel 3/8" Tire 3/8" sleeve	45c ea.
8" Disc Wheel 1 1/2" Tire 1/2" sleeve	70c ea.
7" Disc Wheel 1" Tire 1/2" ball bearing	80c ea.
8" Disc Wheel 1 1/2" Tire 1/2" ball bearing	\$1.00 ea.
6" Disc Wheel 1.50 semi-pneum. Tire 1/2" B.B.	\$1.35 ea.
8" Disc Wheel 2" semi-pneum. T. 1/2" B.B.	\$1.50 ea.
10" Disc Wheel 1.75 semi-pneum. T. 1/2" B.B.	\$1.50 ea.
10" Disc Wheel 2.75 semi-pneum. Tire 3/8" B.B.	\$3.10 ea.
12" Disc Wheel 1.75 semi-pneum. T. 1/2" B.B.	\$1.85 ea.

Above wheel prices include hub cap. Plus Postage, C.O.D.'s accepted.
AXLES—Sizes 5/16 in., 3/8 in., 1/2 in.—Cut to size—End holes drilled.

UNITED WHEEL STAMPING CO.
12131 S. PEORIA STREET PM-2 CHICAGO 43, ILLINOIS

LEFAX POCKET SIZE TECHNICAL DATA BOOKS \$1.25 each

Printed on loose leaf, six hole, 6 3/4"x3 3/4" bond paper, each book contains about 140 pages of technical data, presenting condensed, accurate and essential data for the student, engineer, technical worker and business man.

- | | | |
|------------------------------------------------------------------------------------------------------------------------------------------------------------------------------------------------------------------------------------------------------------------------------|----------------------------------------------------------------------------------------------------------------------------------------------------------------------------------------------------------------------------------------|-----------------------------------------------------------------------------------------------------------------------------------------------------------------------------------------------------------------------------------------------|
| Architecture
Home Heating
Illumination
Electrician's Data
Builder's Data
Lumber Data
Air Conditioning
General Math.
Math. Tables
Physics
Chemical Tables
Mechanics of Materials
Power Trans. Mach'y.
Thermodynamic
Tables & Charts | Phys. & Thermodyn.
Data
Phys. & Org.
Chemistry
Metals
Generals
Chemistry
Reinforced Concrete
Building Constr.
Radio
Television & FM
Electricity, AC
Electricity, DC
AC Motors and
Generators | Transformers,
Relays, Motors
Hydraulics
Surveying
Mechanical Drawing
Machine Design
Machinists' Data
Piping Data
Surveying Tables
Trig-Log Tables
Metallurgy
Analytic
Chemistry
Highway
Engineering |
|------------------------------------------------------------------------------------------------------------------------------------------------------------------------------------------------------------------------------------------------------------------------------|----------------------------------------------------------------------------------------------------------------------------------------------------------------------------------------------------------------------------------------|-----------------------------------------------------------------------------------------------------------------------------------------------------------------------------------------------------------------------------------------------|

Write for FREE catalogs (over 2000 listings). See for yourself how helpful LEFAX can be to you. Send \$1.25 for each book (or \$6 for any five books listed above), to

LEFAX Dept. PM-7 PHILADELPHIA 7, PA.

MAKE UP TO \$10 AN HOUR AT HOME WITH 50¢ WORTH OF MICRO-FLUFF

HIGH COST OF LIVING GETTING YOU DOWN

Want to add an extra \$100 or more to your regular monthly pay check in a few **SPARE TIME** hours of pleasant occupation **AT HOME**? That's just the position I was in a few years ago when I ran across an Old-World formula for applying short cotton fibers to practically any surface, in such a manner that it looked and felt just like costly velvet or velour.

THIS PROCESS AMAZED ME

I spent several years experimenting until I developed what I now call the **FLOK-KRAFT MICRO-FLUFF** method. This **NEW METHOD** is far removed from the Old-World way of applying these short fibers. Also it permits the use of tiny fibers of **RAYON** and other modern materials in **MANY COLORS** in addition to cotton.

NO OVERHEAD—NO EXPENSIVE EQUIPMENT

Start in your basement, garage, attic, service porch, or even on a card table in your bedroom. With an hour's practice you can apply a few pennies worth of **FLOK-KRAFT MICRO FLUFF** to a yard or two of butcher paper, and make it look like \$15-a-yard velvet for window displays in the finest jewelry, gift, or department stores, etc. Takes only a few minutes and practically no effort.

MICRO-FLUFF IS BEAUTIFUL AND LONG WEARING

Truly the most amazing material you ever saw, **MICRO-FLUFF** comes in every color of the rainbow, is long lasting, has the **TOUCH** appeal of luxurious velvet or suede, and goes on practically any surface—paper, metal, wood, glass, plastic, plaster, rubber, even sponge-rubber. It is wonderful to line silverware or hosiery drawers, cover and line jewelry boxes, decorate lamps and lamp shades, finish the inside of auto trunks or glove compartments (to protect luggage and accessories from scratching) re-cover women's party shoes, phonograph turntables, etc. Apply to toys, figurines, wall plaques, signs, store displays and a thousand-and-one other items, new or old. **FLOK-KRAFT MICRO-FLUFF** makes old objects beautiful and salable — increases value of many new products by 500%.



BIG-PROFIT ORDERS COME FROM NEIGHBORS, GIFT SHOPS, STORES—ALSO MAIL-ORDER

Every household has one or more items that can be saved from discard by a **FLOK-KRAFT** job. Decorate store display cases and windows (jewelers love this) and also supply them with fast-selling **FLOK-KRAFTED** gift items and other merchandise. Manufacturers are prospects for contracts to apply **FLOK-KRAFT** to furniture, instrument cases, luggage, and hundreds of other products. Every neighborhood needs a **FLOK-KRAFTER**. **HELP US FILL A HUGE DEMAND.**

Since succeeding beyond my wildest dreams in my own **FLOK-KRAFT** business, I have concentrated on helping ambitious men get started in the same way to build a successful future, free of time clocks and nagging bosses. My plan is designed to help you start at home in spare time, and build gradually toward a full-time business with employees working for you. And you can start **RIGHT NOW**. **DON'T SEND ME ANY MONEY**, just your name and address on a postcard, and I'll rush you a **FREE SAMPLE OF FLOK-KRAFT MICRO-FLUFF**, the **FLOK-KRAFT PLAN** and full **FREE** details. I'll also arrange to send you the complete **FLOK-KRAFT MICRO-FLUFF** outfit to try out right in your home, before you agree to buy anything at all. The outfit includes detailed instructions with hundreds of show-how photographs and drawings that make everything simple, right from the start. Also included is our specially designed, high-velocity Applicator and a generous supply of **FLOK-KRAFT MICRO-FLUFF**—everything you need to get going right away. You owe it to yourself to investigate. Rush me your name and address today by Airmail, and I'll show you how to start making money at once!

NELS IRWIN, Coast Industries, Dept. 22,
Los Angeles 61, California

SEND NO MONEY—MAIL COUPON NOW!

Nels Irwin—COAST INDUSTRIES, Dept. 22,
Los Angeles 61, California

Please rush me **FREE** sample, details, etc. I understand that everything you send is free and that I'll be under no obligation now or ever.

NAME _____

STREET _____

CITY _____ STATE _____

Read What Others Say . . .

"Received the outfit and everyone that saw it is very enthused. I only had it about thirty minutes and got an order for a \$100 job."
Mr. C. H., Maryland

"Got \$52.50 for those 7 trunk interiors for about 4 hours work. \$7.50 per trunk."
J. O., Mo.

"... I have received my order and believe me. I'm very pleased and happy as as I've made myself **MORE** than the cost of my supplies already, and I've still got more jobs to do."
Cpl. G. W., S. Carolina

"... pleased with your course and I'm being swamped with work to do."
W. F., Penn.

① I SHOW YOU HOW TO
MAKE MONEY AT ONCE
 ② START YOUR OWN BUSINESS
 IN 2 WEEKS—
 AT HOME
 IN SPARE TIME



METALIZE BABY SHOES

IF YOU ACT NOW, I will show you how to start earning extra money immediately—in spare time or full time. AND I SHOW YOU HOW to start your own profitable business. With my complete course and easy-to-understand illustrated instructions containing trade secrets of ALL metalizing processes PLUS beautifully processed sample metalized baby shoe AND all my tested and proved methods of operating a successful metalizing business. I show you how to start YOUR OWN profitable, fascinating business right in YOUR OWN HOME. Absolutely no experience needed. For PROOF send coupon today for FREE details of my MONEY MAKING PLAN for you and be convinced.

FREE!
 MONEY MAKING PLAN
 Full Details Without Obligation
 MAIL COUPON TODAY!

KIKTAVI CO., Dept. PM-552
 11029 So. Vermont, Los Angeles 44, Calif.

Send me FREE details of your MONEY MAKING PLAN, without obligation.

NAME _____
 STREET _____
 CITY _____ ZONE _____ STATE _____

OFFICIAL ELECTRICAL

Helps you do safe, sure installing and wiring jobs!

NOW you can do work that fully meets latest 1953 National Electrical Code rules for correctness and safety. You can get the EXACT meaning of rules—how they apply to the electrical job you're doing—quickly and easily with this practical handbook. Explains Code rules in simple, clear language—uses diagrams, tables, and photographs so you grasp every point. Protects you against legal violations. Answers questions on materials, wiring, plans, installations.

Index lists rules applying to all types of electrical jobs, arranged under job title. You can be SURE no rule is overlooked. Complete tables give full-load current, wire size, conduit size, and branch fuse rating of all motors. Covers motor wiring, switches, generators, appliances, cable assemblies, transformers, etc.

Covers all types of jobs:
 Farms, Homes, Gas stations, factories, Signal systems, Motor installation, Cranes and hoists, Alarms, many others.

FREE 10-DAY TRIAL

McGRAW-HILL BOOK CO. INC., Dept. PM-2-55
 327 West 41st St., New York 36, N. Y.

Send me Abbott's National Electrical Code Handbook for 10-DAY FREE EXAMINATION. If not satisfied I will return it—pay nothing. Otherwise, I will keep it and send \$7.50, plus postage.

Name _____
 Address _____
 Employed by _____ PM-2-55
 City _____ Zone No. _____ State _____
 (if any)

SAVE DELIVERY COST—Check here if enclosing \$7.50 WITH coupon. Then WE prepay all handling charges. Money back if you return book.



ABBOTT'S NATIONAL ELECTRICAL CODE HANDBOOK

New 8th edition, revised by C. L. Smith, Field Eng., Natl. Fire Protec. Assn.; brand-new arrangement, rules in same order as Code; easier-reading type; fully up to date; most improved edition in 20 years!

Inventors Opportunity

We Are Interested in New Products in Foods, Housewares and Toys, to Manufacture and Sell Thru Our Ten Thousand Outlets

- Will help you develop ideas with our engineering staff.
- Will pay substantial royalty, or purchase outright.
- Will give full protection.
- Will finance your patent.
- Thirty years of successful inventing and marketing.
- References—your own attorney.

James E. Donaldson & Associates
 52 Madison Street, Oak Park, Illinois

LOOK! **A MILLION THRILLS!**
 High Power **BINOCULARS**
 30 DAY FREE TRIAL
 Finest Precision Optics
 Money Back Guarantee
 Easy Pay Plan
 Free! Catalog & Book "How to Select Binoculars"
 Dept. M2 43 E. Green Pasadena, Calif.

33 Models \$9.95 UP
 BUSHNELL Binoculars

STAMMER?

Get your copy of the new 18th edition of my book, "Stammering, Its Cause and Correction," which describes the Bogue Unit Method for scientific correction of stammering and stuttering. Ask, also, for free SPECIAL CHART! 54th year. Benjamin N. Bogue, Dept. 553, Circle Tower, Indianapolis 4, Indiana.

GET THIS **FREE BOOK!**

OWN A... PLYMOUTH?

FIX IT YOURSELF!

Popular Mechanics Magazine has published an Owners Manual covering all 1941 to 1952 models of Plymouth cars. So accurate mechanics use it . . . so simple a woman can understand it.



Save money on your Plymouth repairs. Prevent trouble. Enjoy care-free driving. Increase trade-in value. Avoid major repairs by fixing minor troubles before they get serious. Get sparkling performance at all times. Has 272 pages, more than 350 photos, diagrams, tables, charts, breakdown drawings, plus clear, non-technical directions that make all repairs simple as ABC. Written by Ed Packer with assistance of Chrysler Corporation. Shows you how to diagnose Plymouth troubles by feel, sound, sight, smell and performance. Simple trouble shooting. Permanent repairs. Emergency repairs. Plus, "How to get value from garages."

MONEY BACK IF IT DOESN'T SAVE MORE THAN IT COSTS!

One minor repair will save the cost ten times over. Read it. Then you decide. If you don't see that you'll save more than the cost, send it back for refund. SEND NO MONEY. Send postcard. Ask for PLYMOUTH Manual. Postman will deliver C.O.D. for \$3.50 plus postage. Or, save postage by sending \$3.50 with order. Send today. Save its cost on your next repair.

POPULAR MECHANICS PRESS

200 E. ONTARIO DEPT. 18 CHICAGO 11, ILLINOIS

FREE-A BUSINESS OF YOUR OWN

- No Store to Equip
- No Training Period
- No Investment
- No Stock to Buy

SUBSTANTIAL MONEY-MAKING OPPORTUNITY

Your Total Cost — a 3-cent stamp

All I ask of you is that you like to sell. If you can make a fair living selling anything else, I'll show you how to make tremendous profits as a MASTER Work Garment Salesman, and I'll furnish everything you need, free of charge.

MASTER Work Garment salesmen are cashing a harvest of dollars in hundreds of communities all over America. Men who—a year ago—didn't know what a work garment was, are now buying homes and cars with the profits from a MASTER Dealer franchise. Your sales are volume sales, repeat sales, steady-income-to-you sales. Every business in the country is a prospect for uniforms and work clothes with name-and-advertising embroidery. Stores can't compete. MASTER brings you the world's finest, most complete quality lines in all new styles and fabrics. I supply everything you need—samples, sales material and guidance. Thousands making big money easily. Your territory may be open. Write me today for full details; a postcard will do.—Del. V. Bergstrom, Pres.

GEO. MASTER GARMENT DIV.
308 WATER STREET, LIGONIER, INDIANA



MAKE MONEY WRITING

.. short paragraphs!

You don't have to be a trained author to make money writing. Hundreds now making money every day on short paragraphs. I tell you what to write, where and how to sell; and supply big list of editors who buy from beginners. Lots of small checks in a hurry bring cash that adds up quickly. No tedious study. Write to sell, right away. Send for free facts. **BENSON BARRETT.** 1751 Morse Ave., Dept. 27-B, Chicago 26, Ill.

PORTABLE PRINTING PLANT \$10.95

Complete

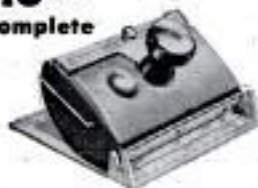

30 DAY TRIAL OFFER

Prints fast, easy. Perfect for post-cards, cartons, envelopes, etc. Costs only a few cents per 1,000. Money-Back Guarantee. Send check or money order to:

THE HEYER CORP., Dept. 255
1856 S. Kostner, Chicago 23, Ill.

Say You Saw It in Popular Mechanics

WAR SURPLUS BARGAINS

\$500,000.00 INVENTORY for QUICK LIQUIDATION

Surplus items—hundreds of them for home, shop, factory, farm and outdoor use. New items, used items, reconditioned items—all at tremendous savings—all priced for quick sale.

Page After Page of Values

This big catalog shows page after page of amazing money saving values. Write for your copy today. Send 10c to cover postage, handling, etc. Write today! SEND TODAY FOR YOUR COPY

10c

Dept. PM-2
CHICAGO 6, ILL.

STARK'S

212 W. Madison St.

Dept. PM-2
CHICAGO 6, ILL.

FEBRUARY 1955

Come on, Buddy, Quit being a BAG of BONES Weaking!

Hi Pal!

LIKE I WAS

IN 10 MINUTES OF FUN A DAY

WIN \$100.00 as I just did

You can do ALL I did! I gained 25 Terrific LBS. of HANDSOME POWER-PACKED MUSCLES all Over!

I improved My HE-MAN LOOKS 1000% I won NEW STRENGTH I won NEW POPULARITY



JIM NORMAN AFTER He Mailed Coupon

Everybody admires Jim's build NOW He's a WINNER in ALL SPORTS



YOU CAN WIN a BIG 15" SILVER CUP* as I just did! with YOUR NAME engraved on it!



I Mailed the Coupon and got these 5 PICTURE PACKED He-Man Courses Which YOU Can NOW get FREE

Before \$1 price goes back Millions Sold for \$1.00

Come on PAL, Now YOU give me 10 PLEASANT MINUTES A DAY In Your Own Home Like Jim Did and I'll give you A NEW HE-MAN BODY for your OLD SKELETON FRAME



NO! I don't care how skinny or flabby you are I'll make you OVER by the SAME method I turned myself from a wreck to the strongest of the strong.

Develop YOUR 520 MUSCLES Gain POUNDS, INCHES FAST!

YES! You'll see INCHES of MIGHTY MUSCLE added to your ARMS and CHEST. Your BACK and SHOULDERS broadened. From head to heels you'll be A WINNER in EVERYTHING you tackle.

Mail the ALL FREE Coupon and get PHOTO BOOK



1. HOW TO MOLD A MIGHTY CHEST
2. HOW TO MOLD A MIGHTY ARM
3. HOW TO MOLD A MIGHTY BACK
4. HOW TO MOLD A MIGHTY GRIP
5. HOW TO MOLD A MIGHTY LEGS

LAST CHANCE — ALL FREE COUPON!

1. Photo Book of STRONG MEN
2. MUSCLE METER 3. FIVE COURSES

Dept. PM-52

Tell Me How To WIN \$100, etc.

Dear George: Please mail to me FREE Jowett's Photo Book of Strong Men and a Muscle Meter, plus all 5 HE-MAN Building Courses: 1. How to Build a Mighty Chest, 2. How to Build a Mighty Arm, 3. How to Build a Mighty Back, 4. How to Build a Mighty Grip, 5. How to Build Mighty Legs—Now all in One Volume "How to Become a Mighty HE-MAN" ENCLOSED FIND 10c FOR POSTAGE AND HANDLING (no C.O.D.'s).

NAME _____ AGE _____
ADDRESS _____
CITY _____ ZONE _____ STATE _____

BECOME AN Electrical Engineer



- Major in Electronics or Power
- Earn B. S. Degree in 36 Months

Over 50% of the nation's industrial leaders began their careers with engineering training. Prepare now for a rewarding future as an Electrical Engineer or Engineering Technician. Enroll at the Milwaukee School of Engineering.

Plan Your Career — Eight Courses Give You Wide Range of Study

ENGINEERING COURSES

Electrical Engineering-Bachelor of Science Degree
Save a valuable year through optional year 'round study.
Electronics major36 months
Power major36 months

TECHNICIAN COURSES

Electro Technician12 months
Electronic Technician12 months
Radio Technician12 months
Radio and Television Technician18 months

SERVICE COURSES

Electrical Service6 months
Radio and Television Service12 months

MECHANICAL TECHNOLOGY COURSES

— Also available, Service and Technician courses 6 to 18 months — Heating, Refrigeration, Welding, Air Conditioning and Mechanical — B.S. Degree in Mechanical Engineering with a major in Design, Metal Fabrication, or Plant Engineering. Also, general 3-month preparatory course.

Terms open April, July, September, January.

Prior Military, Practical or Academic training evaluated for advanced credit. Faculty of specialists. 50,000 former students. Annual enrollment from 48 states and 23 overseas countries. 52nd year. Non-profit. Residence courses only. Send handy coupon today. MS-11A



MILWAUKEE

SCHOOL OF ENGINEERING

MILWAUKEE SCHOOL OF ENGINEERING
Dept. PM-255, 1025 N. Milwaukee St., Milwaukee, Wis.

Send free illustrated career booklets Electrical Technology Mechanical Technology Radio-Television.

I am interested in _____
(name of course)

Name _____ Age _____

Address _____

City _____ Zone _____ State _____

If veteran, indicate date of discharge _____

\$7.18 Worth of STAMPS

(Catalog value)

Yours for **25¢**

338

ALL-DIFFERENT STAMPS



Imported Collection includes Bosnia-Herzegovina — 1917 Assassination Set complete; Spain-Iberia — airmail set of 3; Israel — beautiful jumping stag; Estonia—Nazi-issued "Dorpat" set of 6; Bolivia — 3 action-packed sport stamps; Croatia — giant triangles — plus hundreds more! 338 all-different stamps—guaranteed \$7.18 catalog value — all yours for only 25¢ to introduce our Bargain Approvals. Included, FREE, "Midget Encyclopedia of Stamps." Send 25¢ today.

ASK FOR LOT FO-21

ZENITH CO.

81 Willoughby St., Brooklyn 1, NY



◀ **DING DONG BERMUDA BELL**
for Your Car only **\$4.95**

PHONE-A-LIGHT for FUN and LIGHT ▶

A spotlight that looks like a telephone. Plugs into car cigarette lighter. Fingertip switch. Ideal for finding house numbers. Perfect trouble light. **\$3.95**
10 ft. cord. Only

Prices postpaid. No COD's please.

Guaranteed to delight.

RICHTER CO., ROOM 202, 800 E. 10TH ST., LOS ANGELES 21, CALIFORNIA

PROTECT YOUR EYES! NEW GOGGLES



Now, for new low price, shield precious eyes against flying particles from lathes, grinders, etc. This fine one-piece, full-view goggles—beautifully molded of plastic—yours for only \$1.95 postpaid. Provides complete visibility & perfect protection in workshop, machine shop, on farm. Adjustable headband holds form-fitting goggles comfortably for hours. In clear plastic for shop wear, green-tinted for outdoors (skiers, cyclists, etc.). State which. Order today! Moneyback guarantee. Free folder on this, other unusual items.



ONLY \$1.95 Ppd.

CRAFTLINE, P.O. Box 9197-M, Richmond 27, Va.

Say You Saw It in Popular Mechanics



FIX YOUR CHEVY and SAVE

Brand New Handbook covers every model Chevy from the new 1957's back to 1940! Includes repair and service short cuts for owners and service mechanics. Gives tune-up specifications, how to increase gas and tire mileage, make your Chevy run better, last longer, worth more when you trade. Jammed with pictures and easy-to-follow instructions. Even includes Hot Rods and Speed-ups too! **FIX YOUR FORD** (Same coverage on Ford's servicing and repairing Ford V-8's and 6's from 1932 to and including 1956 models). Other book \$2.95. Both books \$5.50. Money back in 2 days if you want it.

GOODHEART-WILCOX CO., Dept. 224, 1321 S. Michigan Ave., Chicago 5

250 POWER



Complete **Telescope Lens Kit** only **\$3.49** postpaid

Conquer Space. Explore the Universe. Planets. Moon Craters. New Stars, etc. Complete Lens Kit consists of 80 inch focal length ground and polished objective lens, eyepiece lenses for 50 POWER, 100 POWER, 150 POWER, 200 POWER, 250 POWER, and all necessary lens fittings. Easy to make from simple step by step instructions. (Tripod and mount not included.) Money back guarantee.

BUSSE SALES CO., Hartford 1, Conn., Dept. PM 30

Can A Man My Age Become a Hotel Executive



*Even Though He Has No
Previous Hotel Experience?*

**Harry G. Barnes Succeeds
As Assistant Hotel Steward**

"Lewis Hotel Training gave me a new lease on life. Thanks to the Lewis Placement Department, I secured a position of Assistant Steward in a fine hotel. My work is enjoyable, financially rewarding, and bigger and better things to come."

I feel sure of

"How I Stepped Into a BIG PAY Hotel Job"

**Melvin I. Dalrymple Becomes
Assistant Manager As A Result
of Lewis Training**



"Every person desiring to win success in the hotel field should enroll for the Lewis Course. What it taught me about all 'round departmental operations qualified me for the position of Assistant Manager of a big hotel. Anyone can do what I have done with the Lewis School Training."

STEP INTO A WELL-PAID HOTEL POSITION

Important positions, ever-increasing opportunities await trained men and women in essential hotels, motels, clubs, apartment house projects. Lewis graduates are "making good" as managers, assistant managers, stewards, social directors, hostesses and in 55 other types of well-paid positions. Previous experience proved unnecessary in this business, where you're not dropped because you are over 40. Lewis Training qualifies you at home, in spare time or through resident classes in Washington.

FREE book describes this fascinating field. It tells how you are registered FREE in Lewis National-Placement Service. Mail coupon today! Lewis Hotel Training School, Room AB-317, Washington 7, D.C.

COURSE APPROVED FOR ALL VETERAN TRAINING

LEWIS HOTEL TRAINING SCHOOL,
Room AB-317, Washington 7, D. C.

39 TH IN A SUCCESSFUL
YEAR

Send me, without obligation, the Free Book, "Your Big Opportunity." I want to know how to qualify for a well-paid position.

Home Study Resident Training

Name _____
(Print Name & Address)

Address _____

City _____ Zone No. _____ State _____

Check here if eligible for Veteran Training

ALL YOU NEED
IN THIS ONE PACKAGE

5 LBS. **TOOLCAST**
(PHENOLIC CASTING RESIN)

1/2 LB. **ACCELERATOR**
(FOR HARDENING TOOLCAST)

2 1/4 LBS. **ARCOSOL**
(LIQUID FLEXIBLE MOLD MATERIAL)

AMERICAN RESIN CORP.
3215 N. SHEFFIELD AVE.
CHICAGO 13, ILLINOIS

ORDER NOW

NO EXPENSIVE
EQUIPMENT
NEEDED

FEBRUARY 1955

*so complete.. so easy.. you
can make your own models
dies.. fixtures.. art designs
costume jewelry.. novelties
and reproduce items*

a
PLASTIC
home workshop package

\$8.95 immediate delivery

PLUS EASY TO FOLLOW INSTRUCTIONS

Please send me _____ Plastic Home
workshop Package (s)

My check or money order in the amount of
_____ is enclosed. (\$8.95 per com-
plete package anywhere in U.S.A.)

Name _____

Address _____

City _____

Zone State

(prepaid anywhere in U.S.)

48K

Copyrighted material

Bass Fishermen will Say I'm Crazy . . . until they try my method!



**But, after an honest trial, if you're
at all like the few other men to whom
I've told my secret, you'll guard it with your last breath.**

Don't jump at conclusions. I'm not a manufacturer of any fancy new lure. I have no rods or lines to sell. I'm a professional man and make a good living in my profession. But my all-absorbing hobby is fishing. And, quite by accident, I've discovered how to go to waters that everyone else says are fished out and come in with a limit catch of the biggest bass that you ever saw. The savage old bass that got so big, because they were "wise" to every ordinary way of fishing.

This METHOD is NOT spinning, trolling, casting, fly fishing, trot line fishing, set line fishing, hand line fishing, live bait fishing, jugging, netting, trapping, seining, and does not even faintly resemble any of these standard methods of fishing. No live bait or prepared bait is used. You can carry all of the equipment you need in one hand.

The whole secret can be learned in twenty minutes—twenty minutes of fascinating reading. All the extra equipment you need, you can buy locally at a cost of less than a dollar. Yet with it, you can come in after an hour or two of the greatest excitement of your life, with a stringer full. Not one or two miserable 12 or 14 inch over-sized keepers—but five or six real beauties with real poundage behind them. The kind that don't need a word of explanation of the professional skill of the man who caught them. Absolutely legal, too—in every state.

This amazing method was developed by a little group of professional fishermen. Though they are public guides, they never divulge their secret to their patrons. They use it only when fishing for their own tables. No man on your waters has ever seen it, ever heard of it, or ever used it. And when you have given it the first trial, you will be as closed-mouthed as a man who has suddenly discovered a gold mine.

Because with this secret you can fish within a hundred feet of the best fishermen in the county and pull in ferocious big ones while they come home empty handed. No special skill is required. The secret is just as deadly in the hands of a novice as in the hands of an old timer. My secret will be disclosed only to a few men in each area—men who will give me their word of honor not to give the secret to anyone else.

Send me your name. Let me tell you how you can try out the secret method of bringing in big bass from your "fished out" waters. Let me tell you why I let you try out my unusual method without risking a penny of your money on instructions or lures. There is no charge for this information, now or at any other time. Just your name is all I need. But I guarantee that the information I send you will make you a complete skeptic—until once you try it! And then, your own catches will fill you with disbelief. Send your name, today. This will be fun.

ERIC F. FARE

317 S. Milwaukee Ave., Libertyville 4, Illinois

ERIC F. FARE, 317 S. Milwaukee Ave.
Libertyville 4, Illinois

Dear Mr. Fare: Send me complete information without any charge and without the slightest obligation. Tell me how I can learn the secret method of catching big bass from "fished out" waters, even when the old timers are reporting "No Luck."

Name.....
Address.....
City.....Zone.....State.....

LEARN MEAT CUTTING AT NATIONAL Pay After Graduation



The steady dependable trade of Meat Cutting taught easily in 8 short weeks. YOU LEARN BY DOING under actual meat market conditions in big modern school at Toledo.

For beginners or men with experience. Get a profitable store of your own. Remember, PEOPLE MUST EAT! Big pay jobs. Free employment help. Thousands of successful graduates.

Buying, cutting, percentage, pricing, advertising, selling, etc. A complete retail meat education. National School established over 30 years. Get National training NOW. Pay your tuition in easy weekly payments

after you graduate. Send coupon for FREE 52 page school catalog — TODAY. G.I. approved.

National School of Meat Cutting, Inc., Dept. 50-0, Toledo 4, Ohio

Send me your FREE school catalog on National Training at Toledo in Meat Cutting, Meat Merchandising and Self Service Meats. No obligation. No salesman will call.

Name.....Age.....

Address.....

City.....State.....

Approved for training Korean Veterans

WANT TO Write Stories

Articles Mysteries?

FREE Lesson
tells how you
learn at home



Extra Income or Full-time Career

HAVE you ever had an urge to write? Have you or friends had interesting experiences or ideas about people, places, hobbies, sports, business or social activities, that might make interesting stories, articles or scripts for general magazines, trade and technical journals, fraternal publications, TV-radio stations, etc.?

Editors agree: the demand for new writers is greater than ever, and you don't have to be a genius to make money. Many Palmer beginners earn while learning, receiving small but welcome checks for material that may be turned out quickly once you acquire the technique. And now it's easier to learn than you may imagine, through Palmer's unique method of training—for not just one field of writing, but for all: Fiction, Article, TV-Radio. Endorsed by famous authors—including Rupert Hughes, Katharine Newlin Burt, Keith Monroe, A. E. Van Vogt, and by hundreds of successful graduates.

Learn From Successful Writers

You receive individual coaching by professional writers who go over your writing, giving helpful suggestions and showing you how to capitalize on your good points. Thus, your own individual writing style is created. By learning at home you study fast or slow. Save time, effort and money.

FREE Lesson Shows How

So you can see for yourself how you may cash in on your opportunities as a writer, send coupon or simply write for FREE typical lesson package and 40-page book, "The Art Of Writing Salable Stories," explaining the advantages of Palmer's professional home-study instruction. This may well be the important turning point in your life! No obligation. No salesman will call. Send today!

Palmer Institute of Authorship

Since 1917

Member: Nat'l Home Study Council
Desk T-25, 1680 N. Sycamore,
Hollywood 28, Calif.

Approved
For Vets

FREE Palmer Institute of Authorship, Since 1917
1680 N. Sycamore
Hollywood 28, Calif. Desk T-25

Please send me free typical lesson package and illustrated book explaining how your home-study training helps new writers get started. This is confidential. No salesman will call.

Mr.
Mrs.
Miss

Address _____

City _____ Zone _____ State _____

Please print clearly. Veterans: Check here.

SAY YOU SAW IT IN
POPULAR MECHANICS

ENGINEERING DEGREE IN 27 MONTHS

Big Demand for Graduates

Aeronautical, Chemical, Civil, Electrical, Mechanical and Radio Engineering (inc. TV and Electronics)

Hundreds of young men are earning B. S. ENGINEERING DEGREES annually in this recognized institution — year around operation. New terms start quarterly. Many students earn a major part of their college expenses in this large industrial center.

Low tuition. Competent instruction. Thorough, intense, practical program. Modern, well-equipped laboratories including new physics laboratory and modern wind tunnel. Individualized instruction emphasized.

Government approved for G.I.'s. Engineering preparatory courses. Students from 48 states and 21 foreign countries. Enter March, June, September and December. Send coupon for free catalog and full information. Enroll now.

SEND COUPON TODAY

INDIANA TECHNICAL COLLEGE

525 E. Washington Boulevard
Fort Wayne 2, Indiana

Please send me free information on B.S. Engineering Degree in 27 months as checked.

Aeronautical, Chemical, Civil, Electrical,
 Mechanical, Radio-Television

Name _____

Address _____

Free! VALUABLE U.S.A!



Scarce genuine postage stamp as illustrated, picturing first U.S.A. (issued in 1847!); **PLUS** big collection of 30 all-different United States; 19th century, valuable \$5 stamp, etc.: **PLUS** packet beautiful Commemoratives including '93 Columbian, Boy Scouts, Wild West, and many others. **EXTRA!** Big illustrated U. S. catalog and other attractive offers for your consideration. Send 10c to help defray cost of mailing. Act NOW!

H. E. HARRIS & CO.

1615 Transit Bldg., Boston 17, Mass.

CARBURETOR SAVES GAS VACUATING OVERRICH MIXTURES



Car owners who are getting poor gas mileage, and wasting money due to overrich mixtures, will be pleased to learn how to save gas. Easily installed Vacu-matic invention is **Automatic** and operates on the supercharge principle. For cars, trucks, tractors

SALESMEN WANTED! Big Profits!
FOR FREE PARTICULARS, HOW YOU CAN GET ONE ON YOUR OWN CAR FOR INTRODUCING, just send your name and address on a post card to—

VACU-MATIC, 7617-2099 W. State St., Wauwatosa, Wis.

Become a Doctor of PSYCHOLOGY

Win the degree of Ps.D. Learn the secret of contentment, happiness. Solve mental worries. Experience the revelation of truth. Chartered college. Individual help. Write for FREE book. COLLEGE OF UNIVERSAL TRUTH, 5038-B Broadway, Chicago.

200 ONE-EVENING PROJECTS

Start and Finish Any One of These Projects in One Evening!

The editors of Popular Mechanics have assembled 200 projects, any one of which you can start and complete in a single evening. In a few hours' time, using only simple hand tools, you can build a coffee table, magazine rack, end table or scores of other useful projects. There are projects for the entire family. Best of all, any one may be built in just a few hours. No special skills are needed. Even if you have never built anything before, you can build the 200 projects in this big new book!

Step-by-Step Instructions, Show-How Photos, Drawings

First you read how to do it in famous Popular Mechanics step-by-step instructions and then actual photos, drawings and diagrams show you how it is done.

Each Project Costs Just 1c

Just imagine! Each project costs you only 1c. Where else today can you get so much for so little? Fill out and mail the coupon now. Full money-back guarantee, of course.



POPULAR MECHANICS PRESS, Dept. EP-1
200 E. Ontario St., Chicago 11, Ill.

Gentlemen:
Remittance for \$2.00 enclosed. Rush postpaid my copy of 200 ONE-EVENING PROJECTS. Unless it is entirely satisfactory I may return it in seven days for a full refund.

NAME _____

ADDRESS _____

CITY _____ ZONE _____ STATE _____

Send C.O.D. (U.S.A. only). Postage extra.

start a big profit business
with a small investment
**EARN UP TO
\$200 a DAY**

**Manufacturing Exciting New
RAINBOW ROCK**

**Concrete Slump Brick
in your back yard**

Earn big building boom profits with Rainbow Rock, the colorful new building brick that's taking the country by storm. Sell all you can make to contractors, builders, building supply houses. **RAINBOW ROCK CUTS LABOR COSTS BY 1/3!** Amazing low cost machine makes modern slump brick 24" long (3 times the length of ordinary brick) in a variety of widths and pastel colors . . . up to 1500 bricks a day! **NEEDS NO SPECIAL SKILL.** Operates indoors or out. Full instructions and valuable mixing formulae supplied. **YOU CAN START EARNING BIG MONEY NOW. PAY AS YOU PROFIT!** A limited number of machines available on easy payment terms. **NOW** is the time to start. Write today for free literature and full information.

GENERAL ENGINES CO., INC.
Dept. MR-25—307 Hunter Street
Gloucester, N.J. • Gloucester 6-1337



STEEL PIER SENSATION
Luxurious RAINBOW ROCK fireplace wall in living room of the "Home of the Century" in Atlantic City, N. J.'s Steel Pier... acclaimed by over 500,000 Summer, 1953 visitors as the most beautiful they'd ever seen! Endorsed by the Pier's famous architect, William F. S. Koelle.



Makes beautiful, decorative fences, garden walls, garages, outside walls, room separators, etc.

**FREE 1955
ALLIED
TV & RADIO CATALOG**
THE COMPLETE ELECTRONIC SUPPLY GUIDE



**308
VALUE-
PACKED
PAGES**

Save on
Everything
in
Electronics

**WORLD'S
LARGEST
STOCKS**

Everything for Experimenters,
Builders, Amateurs,
Servicemen, Engineers and
Hi-Fi Specialists

Send for ALLIED's big 308-page value-packed buying guide to everything in TV, Radio and Electronics! Largest selections of custom TV chassis, antennas and accessories; FM and AM tuners; High Fidelity systems and components; recorders and phono equipment; Amateur supplies; test instruments; builders' kits; industrial electronic supplies —plus the world's largest stocks of electronic parts, tubes, tools and books. Save on everything in Electronics —send today for your FREE 1955 ALLIED Catalog.



ultra-modern facilities to SERVE YOU BEST



Send for
**FREE
Catalog**

ALLIED RADIO

ALLIED RADIO CORP., Dept. 5-B-5
100 N. Western Ave., Chicago 80, Ill.

Rush FREE 1955 ALLIED 308-Page Catalog

Name _____

Address _____

City _____ Zone _____ State _____



**NEW! VISOR
GOGGLES**
fit over glasses!

For home work shops. Protect your eyes against glare, sparks, flying particles, dirt, grit, etc. Perfect 100% visibility. Relieves eye strain.

Send Check or Money Order
J. & J. GOGGLE CO.
125 CATLIN AVE., RUMFORD 16, R. I.

ORDER NOW
ONLY
\$2.95 p.p.

\$1300 BUILDS INCOME DUPLEX

FINANCIAL SECURITY!

Build your own 24' x 36' concrete block duplex, complete for \$1300. Slab floor, steel windows, wall furnaces, Rock wool insulated. Each side contains 11' x 17' Living Room and Kitchenette, 10' x 11' bedroom, 6' x 9' bath and four closets. Genuine 1/4"-1" scale blueprint, step by step instructions, and material cost list—\$1.00 ppd. Money back guarantee.



BAILEY BUILDERS, 915 Pyramid Bldg., Little Rock, Ark.

RELIEF in ALL

these **COLD** miseries

New Tabcin
BRAND

SNEEZES • WATERY EYES
• FEVERISH FEELING •
HEADACHE • RUNNING
NOSE • GENERAL ACHEs
• THROAT IRRITATIONS
• COUGHING •



BETTER THAN EVER

MILES LABORATORIES, INC., Elkhart, Indiana

NEW! FLASHY • NOISY • TOP-WATER LURE
SPUTTERBUG

"I WANTED ACTION AND I SURE GOT IT"



— says H. C. Marshall of Winter Haven, Fla. "I took these beauties in short order on your new Sputterbug casting bait. Weights were 1-1/2 to 5 lbs. That noisy surface action really wakes up the old grandpappies. "Sputterbug is a floating lure with a large head spinner that creates a terrific commotion in the water when reeled in fast. Can be retrieved slowly for paddling sound or fished in jerks like a popper. Many different effects possible by working your rod.

CHOICE OF 9 BODY COLORS including "Silver Sparkle" finish for extra flash. Rubber Hula Skirt.

\$1.35 each.



SPINNING OR CASTING SIZE

5/8 oz. or 1/4 oz.

FREE WRITE TODAY FOR YOUR BIG FREE ARBOGAST COLOR CATALOG OF BAITS—FULL OF PICTURES OF CATCHES

FRED ARBOGAST COMPANY, INC.

2202 WEST NORTH STREET • AKRON 3, OHIO

Be a CARBURETOR and IGNITION EXPERT



SPECIALIZE—EARN BIG MONEY!

Learn how all these things work by actually doing it. In our school you get the know-how plus the experience. Learn how to overhaul Carburetors, Generators, Starters, Distributors, How to rewire and check for shorts, How to read testing equipment and Diagnose. Write for particulars.

GEO. R. WILLY'S SCHOOL OF CARBURETOR AND AUTOMOTIVE ELECTRICITY
12158 Western Av. Blue Island, Ill. Dept. P-2

BREATHE UNDER WATER



FIND LOST "TREASURE"
HUNT FISHING SPOTS with

DUBL-SNORKL

Underwater adventure... the fascinating new sport is yours with the new DUBL-SNORKL. Permits breathing with ease under water because DUBL-SNORKL with 2 automatic water valves admits a large volume of air. No mouthpiece. Glass window gives full vision. You can do just about everything under water... fish, spear hunt, explore, find lost articles. Age or ability to swim not important. Money-back guarantee. Complete DUBL-SNORKL..... **3.50** PPD

SEND CHECK or M.O. to
ERL SVENDSEN, INC.

"Fine Sports Equipment"
4245 N. Harlem Ave., Chicago 31, Ill.



"DEALERS—Write"

MAKE BIG MONEY—EASY!



\$210.00 and MORE YOURS!
IN A WEEK

Amazing D-FROST-O-MATIC Actually Sells Itself on Dramatic FREE TRIAL!

30,000,000 women need, want to end messy hand defrosting. Sell out of 10 automatically with sure-fire D-Frost-O-Matic **FREE TRIAL**. Leave sensational D-Frost-O-Matic in home day or two, come back and pocket your big profit without effort. Make \$15.00, \$20.00 and more in an hour full or spare time—up to \$210.00 and more in a week!

FREE! Rush name, address on a postcard for exciting big-profit facts and proof, with details of dramatic **FREE TRIAL PLAN** that sells 8 out of 10 automatically. Everything **FREE**, no obligation. Write **TODAY**. **D-FROST-O-MATIC, 173 W. Madison, Dept. E-6, Chicago 2, Ill.**



MUSIC IN THE AIR
Just a wave of your hand

Yes, you can produce music and sound effects by just waving your hand with **MODEL TONE**, the Electronic Musical Instrument.

YOU CAN BUILD YOURSELF

Fine for code practice too. Amaze and entertain your friends. Complete plans, drawings, instructions only \$1.00 postpaid. Money back Guarantee. Rush Order Today!

MODEL ELECTRONICS, Dept. 2

1205 W. McCARTY

JEFFERSON CITY, MO.

ADVERTISING MACHINE

PRINTS & ILLUSTRATES Postal Cards
Write today for **FREE** illustrated **BOOK** of unique advertising plans and money-making ideas for your business. Learn how companies are boosting sales. **CARDMASTER, 1920 Sunnyside, Dept. 12-B, Chicago 40, Ill.**



SEND ME



every month so I am sure to see each new issue. Here's

- \$3.50 for 1 year
- \$8.00 for 3 years

name _____

address _____

city _____

zone _____

state _____

B-25

Hand this order to your newsdealer or send it to

POPULAR MECHANICS
200 East Ontario St. Chicago 11, Ill.

POPULAR MECHANICS

Copyrighted material

New PROFIT-PROVEN* Home-Business!

"I make \$400.00 a week!"



*Proves
Mr. J. T. Anderson,
Inglewood, Calif.

(Notarized statement on file in our
office and open to inspection.)



MAKE BIG MONEY, TOO—printing without a printing press! Learn the secrets of this new MIRACLE PRINTING METHOD . . . build a Big-Pay Business, SPARE or FULL-TIME, right in your own home. Never before has there been such a golden opportunity to turn pennies into dollars in profit! — to build a successful, prosperous future easily, quickly, and enjoyably—AT HOME!

WHAT IS SCREEN PRINT? It's a new, fascinating technique—so amazingly simple and economical it may soon revolutionize the printing industry! Imagine—after only a few short days, you may print many beautiful professional jobs for LESS THAN IT WOULD COST ON A \$5000 PRINTING PRESS!

SCREEN PRINTING IS FUN . . . EASY! If you like to work with your hands and make beautiful things, you'll find no Home Business that provides greater enjoyment, relaxation, and PROFIT. You'll enjoy every moment . . . creating beautiful printed material that may sell for really BIG MONEY!

NO EXPERIENCE OR COSTLY EQUIPMENT NEEDED! Few home businesses offer such BIG PROFITS for so little time, money, or training! You don't need art ability, expensive equipment, or previous experience! You start at home with little or NO OVERHEAD. Yet you can print—almost immediately—on PAPER, GLASS, LEATHER, CLOTH—ANYTHING! Work with all colors, even the vibrant new FLUORESCENT "Glow Colors" that are in such big demand in advertising circles! It's amazing—but true!

START SPARE TIME—ON A "SHOESTRING"! Use your spare time to earn up to \$12.50 per hour, right from the start. Earn 2 INCOMES INSTEAD OF ONE. Print in your garage, basement, spare room—anywhere! Screen Printing requires little space—won't interfere with your household set-up. Later, when you see the TREMENDOUS PROFITS to be made, you may wish to make Screen Printing your full-time occupation. Become your own boss—make BIG MONEY! Others are doing it—why can't you?



HELP FILL THE HUGE, GROWING DEMAND! Businesses in every city, every community have learned—almost "overnight"—of the amazing quality and economy of MIRACLE Screen Printing! You save them up to 50% on many jobs—yet you make up to 300% profit! When the word gets around people come to you—no selling necessary! Because this sensational printing discovery is so new, many Screen Printers sell exclusively by mail!

WE SUPPLY EVERYTHING YOU NEED! Every secret, enough materials to start making money almost immediately can be yours! Never before has such a wonderful "profitunity" been offered to anyone desiring to start a profitable spare or full-time business of his own! We guide you every step of the way with our Personal Counseling Service & Home Business Plan . . . explain how we have helped others, and how we can help you, too! All the CONFIDENTIAL, money-making facts are yours if you MAIL COUPON today—while there's still time for you to get in on the ground floor!

Cor. 1925



and READ what others
are saying about
Screen Print

"My first attempt at Screen
Printing netted me \$40.00."
J.R., Canada

"I would not take \$1000 for it right
now. Just what I have been searching
the world over for"—Mr. R.T., Florida

"Wonderful new method . . . made \$80.00
first week . . . swamped with orders."
R.T., Florida

"Screen Printing is nothing
less than fascinating"
S.M.D., Mass.

PRINT WITHOUT A
PRINTING PRESS!
OR ANY SPECIAL EQUIPMENT



Print Beautiful CLOTH,
FABRICS, GLASS JARS,
NOVELTIES, etc., at home!

MIRACLE Screen Print lets you print on all surfaces, all materials—a big advantage over regular print shops. You provide a service offered only by Screen Printers — may have the entire field to yourself!



PRINT expensive
Posters, Banners,
Labels, Signs, at home!

Realtors, Political Candidates, business firms, many are discovering that Screen Printing is the best answer to their needs. Be the first in your area to fill the huge demand!



PRINT Colorful
ADVERTISING
DISPLAYS at home!

Stores, markets, gas stations, theaters—all businesses need eye-catching displays. Ordinary printers simply can't compete, price-wise, with Screen Printers, on many jobs!

Free!

COMPLETE
REVEALING DETAILS,
Authentic Samples, Proven
Big-Money Opportunity Plan,
Large Illustrated "How To" Booklet.



Screen Print Co., 15127 S. Blvd., Los Angeles 61, Calif.

Learn the Secrets—RUSH COUPON TODAY!

SCREEN PRINT CO., Dept. 22
15127 S. Broadway, Los Angeles 61, Calif.

Gentlemen: Please mail me Free Revealing Details, samples, Opportunity Plan, etc.—All this is sent absolutely Free and sent to me by return mail. I am under no obligation now or ever.

Name _____

Address _____

City _____

Zone _____ State _____



The World's
Most Modern
Masonry



Opportunities Open for Local Manufacturing

From local plants dotting the country has come the Brikcrete used to erect many thousands of buildings—homes, apartments, motels, stores, shopping centers—practically every type of residential, commercial and industrial construction. Why?

Because Brikcrete has more quality features than any other fine masonry—design, size, light weight, insulation properties, range of 14 colors. And a price competitive to lumber! It's an outstanding business opportunity.

High Income Potentials

Freight and distribution costs are by-passed in the manufacture of Brikcrete. By using local aggregates and local labor it's a "direct to user" business. Production economies enable low prices to consumers and generous profit margins to manufacturers.

More plants are needed to operate in protected territories under franchise privileges. Basic machine available on lease or purchase. Write for Brikcrete Book No. 2.

Brikcrete Associates, Inc.
402 West 25th Street
Holland, Mich.

BRIKCRETE

IN CANADA: DUNN MASONRY MACHINERY LIMITED
800 Dundas Highway, Cooksville, Ont.

WHOLESALE Electric Guitars - Parts - Build Your Own
Accordions, amplifiers, double-necks, triple-necks, pickup
mikes, mandolins, non-electric instruments, etc. 1955
Models wholesale. Free Catalog. Free home study
course with instruments. Parts and plans available to
build your own 8 or 8 string or multi-neck electric
Guitar. Martin and Fender available at list price.
CARVIN CO., Box 28 PM2, Baldwin Park, Calif.

FREE! NORTH AMERICA



MOST EXCITING OFFER EVER MADE!

You get this big valuable collection of all-different, all-genuine stamps — including Greenland (North Pole!), Alaska, Confederate States commemorative, St. Pierre, Newfoundland, Sensational Canadian issues picturing Royal Canadian Mounted Police, Indians, moose, walrus, beaver, AND scarce 1851 train stamp. PLUS! United States — ancient 19th century issues, beautiful War & Peace, Army & Navy, bird and animal stamps. Fascinating Commemoratives picturing bucking broncos, Red Cross, Gutenberg & first Holy Bible. Many, many others. EXTRA! Scarce U. S. Telegraph stamp PLUS free bargain lists and other interesting offers for your consideration. Rush Coupon with 10c to help defray cost of mailing.

USE THIS HANDY COUPON

Kenmore Stamp Co. Milford E-547, N.H.
RUSH my FREE North America Collection, scarce Telegraph stamp, bargain lists and other offers. I enclose 10c to help defray cost of mailing.

Name

Street

City State.....

FOOLISH TO PAY MORE, DANGEROUS TO PAY LESS!

TUBE FREE WITH EACH TIRE!
FREE This Pictured Tire Ash Tray Included Now With 2 or More Tires!
If you buy a PAIR, you get a SPARE FREE
If you buy THREE, you get a 4th tire FREE
Does Not include W.W., or truck tires

GOODYEAR, GOODRICH, FIRESTONE, U.S. and others. Partially used tires, "family-safe," not recaps, not retreads. Top grade. Our prices are about 65% off new tire prices. Any defective tire replaced FREE of charge. 34 months written guar. bond.

600-16	\$4.82	670-15	\$4.52	650-15	\$4.62	800-15	\$5.22
650-16	5.02	710-15	4.52	700-15	4.72	820-15	5.42
700-16	5.42	760-15	4.82	550-17	3.92	550-15	4.52
640-15	4.32	WHITEWALL TIRES \$1 EXTRA		550-15	4.52		

TRUCKOWNERS—get the right tire for the right job. Include truck model, make & tire size with order. My "Sure-Fooled" traction tires are recappable later. They're worth the slight difference.

600-16(6)	\$6.42	700-17	\$5.82	750-20	\$10.92
650-16(6)	6.92	750-17	11.12	825-20	17.92
700-16(6)	7.72	600-20	7.92	900-20	17.92
700-15(6)	7.92	650-20	9.32	1000-20	17.92
750-16(8)	8.92	700-20	10.22	1100-20	18.42

600-16 MUD-GRIP, NEW TREAD, 24 MO. GUAR. \$5

MARVIN BLATT 6th & Spring Garden Sts. Philadelphia, Pa. MILITARY MUD-GRIP TIRES AA Guar. 20 Mos. AAA 36 Months 900-16 \$9.82 900-18 \$13.92 750-20 \$7.72 750-20 \$13.82

SEND CHECK OR M.O. & THIS AD FOR INSTANT SHIPMENT.
"Sincerity that was born 27 years ago"

BAZOOK HI-POWER HUNTING & TARGET SLING GUN

Here's real sport ... for hunters and target enthusiasts alike! Pistol accuracy with arrows, steel balls, shot loads, etc. ...

SAMPLE AMMO & EXTRA RUBBER INCLUDED

\$195 PPD NO COD.

500 STEEL BALLS .-\$1.00
MONEY BACK GUARANTEE

Safe indoors ... with soft clay pellets. A marvelous training gun and game for all ages.

UMACO PRODUCTS • P. O. BOX 4133-N • LONG BEACH, CALIF.

Save 50%! Assemble Your Own DIVING LUNG

FREE BOOK SHOWS HOW

We furnish the parts and instructions. Complete outfits \$49.95 and \$59.95. Write for our descriptive literature today!

UNDERWATER SPORTS, INC.
Dept. B, 302 W. Adams
O'Fallon, Ill., P.O. Box 65

HELPFUL BOOKS

Send post card asking for FREE catalog

Popular Mechanics Press, 200 E. Ontario, Dept. 601, Chicago 11

CAR SCRATCHED?

GET PERFECT TOUCH-UPS THE EASY, EXPERT WAY! Your exact matching DuPont paint comes in compact kit containing the same special brushes, paddles, polishing-paste, etc., that Body Shops use. Easy instructions included. For all cars except foreign. Order direct—give year, make, color. Money-back guarantee.

COLOR-PAK, Box 37-20, Summit, N.J.

COMPLETE KIT \$2.50
WITH BOTH COLORS FOR 2-TONES \$3.75

GROW HERBS & SPICES AT HOME

MEN! WOMEN! Earn Spare Time \$\$

Successful home grower tells you how he started growing Herbs as hobby in SMALL APARTMENT and developed a fine, nationwide business. Learn how to make 101 profitable items at home. **BIG-PROFIT** orders come from neighbors, stores, gift shops, many business firms—**ALSO MAIL ORDERS.**

Millions of \$\$ worth used yearly in foods, drinks, cosmetics, perfumes, medicines, etc. **EASY TO GROW** indoors or out. Few plants in kitchen window supply household needs. **HERBS MULTIPLY RAPIDLY**—half-dozen plants soon become hundreds. No big overhead. **SEND NO MONEY.** Instructions including **PLANS FOR 25 WAYS TO MAKE MONEY AT HOME** with Herbs and **LIVING HERB PLANTS** sent for no-risk examination. **FREE**—full details. **WRITE NOW! WORLD OF HERBS, Dept. 62, 601 S. Vermont, Los Angeles 5, Calif.**

FALSE TEETH FIT TIGHT FOR MONTHS WITH Dentyte



Enjoy the comfort and security of snug-fitting dentures. One easy, home application of time-proven Dentyte lasts months. Dentyte is the professional denture liner which forms a firm, but resilient, cushion between plates and gums. Tasteless, odorless—harmless to denture or mouth. Instantly removable. For uppers or lowers. Full size jar (a year's undreamed-of comfort per plate). Send money at our risk. Postpaid only—

\$150

Unconditional money-back guarantee.

Dental Products Corp., Manheim, P-55, Pa.

NO TANKS USED
NEW SIMPLIFIED METHOD
SUCCESS IN THE
ELECTROPLATING
BUSINESS

ELECTROPLATE

ANY OBJECT IN HOME, SHOP, GARAGE OR START
YOUR OWN WELL PAYING ELECTROPLATING BUSINESS



NOW, using NEW plating kit.

It's easy to electroplate any object. Complete kit and instructions on plating metal and non-metal objects, with nickel, copper, chrome, gold, etc., plus full data on obtaining all the business you desire and make **BIG MONEY** full or spare time. **ONLY \$5.95. SEND NO MONEY—every-**

thing sent C.O.D. plus postage—oil
send \$5.95 now and receive it postpaid. Money back in 7 days if not satisfied.
M. Z. SALES CO., Dept. PM-10, 113 W. 42 St., New York 36, N. Y.

PORTABLE GARAGE

\$8.75 (Former Price \$10.00)

USE IT ANYWHERE

- Folds compactly • Keeps rain, snow, dust, salt air, sun away
- Protects your car's finish • Durably constructed of vinyl plastic
- Springtite elasticized bottom, holds securely • Fits all makes
- Direct from MFG. • Enclose payment of \$8.75 plus \$3.35 postage or sent C.O.D. 10-Day Money Back Guarantee.



Plastic Vinyl!

EXTRA HEAVY GARAGE \$10.95 (Formerly \$12.00)

MARDO SALES CORP.

480 LEXINGTON AVE., DEPT. MG-5, NEW YORK 17, N. Y.

FREE
BOOKLET

HOW I MAKE
OVER \$125 WEEKLY

SELLING BOOKS BY MAIL!

YES, I AVERAGE \$125⁰⁰ WEEKLY, SELLING BOOKS BY MAIL. YOU CAN SELL THE SAME BOOKS I DO! YOU CAN START IN YOUR SPARE TIME. NO STOCK TO CARRY. ONLY SMALL INVESTMENT NEEDED.

WRITE NOW TO PAUL COOPER
245-PM TAUNTON, BUFFALO, NEW YORK



Ideal
for ALL
SPORTS!

NOW
Only **88^c**

Germany's
SPECTOSCOPES

The Binoculars you wear
just like eyeglasses!

Optical bargain of '55! Half-million people paid up to 2.98 for these same binocular-spectacles! Closeup, magnified viewing of sports, TV, plays, Nature. Wear 'em all day without fatigue. Individual eye focusing. Featherweight—only 1 oz. West German precision design. Send 88c plus 12c tax & delivery. (Total \$1.) Check, cash or m.o. 5-day money-back guarantee. RUSH—supply limited!

THORESEN'S, Dept. 6-B-90

352 Fourth Ave.

New York 10, N. Y.

EARN BIG PAY

Industry needs skilled mechanics. GREER, leader for more than 50 years in the Trade School field, can train you quickly—You "learn by doing," using the finest equipment, under the supervision of expert technicians.

APPROVED FOR CIVILIANS OR GI'S
—CHOOSE YOUR TRADE—

CHECK HERE	WEEKS
<input type="checkbox"/> DIESEL MECHANICS	20
<input type="checkbox"/> AUTO MECHANICS	20
<input type="checkbox"/> BODY & FENDER	16½
<input type="checkbox"/> GAS-ARC WELDING	4-12
<input type="checkbox"/> REFRIGERATION	13½
<input type="checkbox"/> AIR CONDITIONING	8½
<input type="checkbox"/> MACHINIST TRADE	30
<input type="checkbox"/> ADVANCED MACHINIST (includes tool & die)	32½
<input type="checkbox"/> PIANO TUNING & REPAIR	36

CHOOSE YOUR ENGINEERING COURSE

These courses are intended as terminal education for men who wish to enter the Diesel-Automotive and Refrigeration-Air Conditioning fields as technicians. These courses are designed to prepare men for supervisory positions. Students with a high school education, or equivalent, will be accepted.

- DIESEL AUTOMOTIVE
ENGINEERING2 years
- REFRIGERATION & AIR COND.
ENGINEERING18 months

FREE EMPLOYMENT HELP

Start your career with Greer by checking your interest above and mail coupon for complete information at no obligation.

NAME _____ AGE _____

STREET _____

TOWN _____ ZONE _____ STATE _____

Established 1902 — Over 50,000 Graduates.
53 years of continuous trade school experience
to guide your training.

GREER SHOP TRAINING

2236 S. Michigan Ave.
Chicago 16, Illinois



DRAW ANY PERSON IN ONE MINUTE

Anyone Can Draw With This Amazing New Invention—Instantly! The "Magic Art Reproducer"



NO LESSONS! NO TALENT!

You Can Draw Your Family, Friends, Anything From REAL LIFE—Like An Artist Even if You CAN'T DRAW A Straight Line!

Also Excellent for Every Other Type of Drawing!

- Human Figures • Outdoor Scenes, landscapes, buildings
- Still life, vases, bowls of fruit, lamps, furniture, all objects • Copy photos, other pictures, portraits, etc.
- Copy blueprints, designs, decorations, etc., for woodwork, machine, for needlework, crocheting, knitting • Copy all cartoons.

Complete for only **\$1.98**

FREE with order

A.B.C. Guidance of Figure Drawing
This valuable illustrated guide contains simple guidance on drawing human figures. Includes techniques, shading, proportions, etc., to use with your "Magic Art Reproducer" for added touches to your drawings.



SEND NO MONEY! Free 10-Day Trial!

Just send name and address. Pay postman on delivery \$1.98 plus postage. Or send only \$1.98 with order and we pay postage. 10 Day Trial must satisfy or money will be refunded.

NORTON PRODUCTS, Dept. 5802T, 288 Broadway, N.Y. C.

Yes, anyone from 5 to 80 can draw or sketch or paint anything now... the very first time you use the "Magic Art Reproducer" like a professional artist—no matter how "hopeless" you think you are! Anything you want to draw is automatically seen on any sheet of paper instantly! Then easily and quickly follow the lines of the "picture image" with your pencil... and you have an accurate original drawing that anyone would think an artist had done. Also makes drawing larger or smaller as you wish. Anyone can use it on any desk, table, board, etc.—indoors or outdoors! No other lessons or practice or talent needed!

Have fun! Be popular! Everyone will ask you to draw them. You'll be in demand! After a short time, you may find you can draw well without the "Magic Art Reproducer" because you have developed a "knack" and feeling artists have—which may lead to a good paying art career.

FREE

"BASIC ELECTRICITY — HOW TO PUT YOUR FUTURE IN YOUR OWN HANDS!"

Send today for illustrated brochure containing full information about a revolutionary new "picture" course in basic electricity—the authorized U. S. Navy course just released to the civilian market! Discover how easily, quickly and inexpensively you can equip yourself for a high-paying job in electricity. *Complete 5 Volume course costs less than \$10.* Send for FREE brochure today. No obligation. Simply ask for Booklet "PM-2."

RIDER PUBLICATIONS 480 CANAL STREET NEW YORK 13, N. Y.

FACTORY PRICES—15-DAY MONEY BACK GUARANTEE

NYLON AUTO COVERS

New rubberized DuPont nylon—mildew & water repellent. One side soft fabric not to scratch. Absolutely lightest and strongest cover made. Will protect against all elements. Secured with heavy elastic.



ALSO AVAILABLE
Canvas Auto Cover—Soft & easy to suntan, water, fire & mildew repellent. 14 lbs. . . . \$12.95 + \$2.00 ship.

Give 8 lbs. Car Model Size **\$18.95** plus 55c ship.

DEFENDER TEXTILE CORP., 425 8th way, Dept. PM-2, New York 13, N.Y.

Big Money Recapping Tires

Recap tires with beautiful "Cold Rubber" full treads in your garage or basement. Clear profit of over \$8.00 per tire. Make \$100.00 per day easy. Everyone you know with an automobile is a customer. New low cost equipment now available. We supply easily understood, simplified, manual showing every step. Filled with pictures and success secrets learned during 42 years in recapping business. No experience necessary. Send 25c for complete details and free folder, "How To Make Big Money Recapping Tires"

WEST'S — 1231 MAIN ST. — NAPA, CALIFORNIA

AT LAST! A REAL CLEANER-PRESERVER FOR LEATHER CAR UPHOLSTERIES



Now... beautify, preserve ANY COLOR leather upholstery with ONE leather-nu application. Brings forth the leather's true luster as it cleans—keeps upholstery new looking. Also ideal for leather sporting goods, jackets, furniture, etc. **ORDER NOW!**

ORDER NOW! STEVEN-JAY CO., 5400 N. Clark St., Chicago, Ill.

LEARN TV in KG

UNIVERSAL TV FAMOUS FOR 24 YEARS

1,000's OF SUCCESSFUL GRADS COAST TO COAST
Easy, quick, fascinating. Learn TELEVISION in 36 short weeks of enjoyable companionship in shop training. Wonderful job opportunities. Graduates have choice of many jobs or can establish their own TV repair shop. **YOU CAN START EARNING AS MUCH AS \$150 PER WEEK.** NO limit as time goes on. U.T.S. is an old established school (TV exclusive for 24 years) staffed by expert instructors, headed by one of America's first TV broadcasters. Costs so little to prepare yourself for life. No previous experience needed. Fully approved for Korean Veterans. Also fully approved course in color TV (1st in US). Send coupon now for FREE book on TV Electronic opportunities.

WRITE FOR FREE CATALOG

FILL OUT COUPON

UNIVERSAL TV SCHOOL
1228M Admiral Boulevard, Kansas City, Missouri
PLEASE SEND ME INFORMATION FREE

Name _____ Age _____
Address _____
City _____ State _____
 Check here if Korean Veteran

JEEP OWNERS

STA. WAGONS • JEEPSTERS • PICK-UPS!

Take full advantage of 4-wheel drive by installing a Ford V-8 engine—MORE POWER—means less shifting, better traction at lower speeds, greater safety, plenty of power in high. All this is now possible by using our F-J adaptor plate (Pat. Pending) Conversion Kit \$43.25 Incl. FED. TAX. Write for free details or send check or M.O. for prepaid delivery. Order now for early shipment.

HOOSIER MACHINE PRODUCTS CO.
312 S.E. 6th St. Pendleton, Oregon

NOW! USE YOUR WILLYS OR DODGE AS BOTH A 2 and 4 WHEEL DRIVE



Enjoy 2-wheel drive pep, speed, extra mileage, performance—keep 4-wheel drive power and traction with WARN HUBS. Change 4-wheel to 2-wheel or back in seconds with fingertip control. Front end assembly stands still in 2-wheel drive—ends drag, stops shimmy, cuts front tire wear, increases gas mileage. Willys factory approved. For Willys \$70.00; Dodge Automatic \$122.85 pr. — both sold exclusively by Willys dealers everywhere. Dodge Locking Hub \$74.00, Standard Hub \$23.00 pr. ppd. direct or at Dodge dealers. All hubs guaranteed. Write for literature.

WARN MFG. CO., RIVERTON Box 6064-A4, Seattle 88, Wash.

500

POWER! 50 — 100 — 300 — 500X

Our new quad turret microscope is the most powerful ever placed on the market at this low price. Brilliant optics, four precision optically-ground glass objective lenses, plus optically-ground glass ocular lens (eyepiece). An amazingly versatile, precision-built instrument. It is already a popular favorite in schools and colleges throughout the country. Covered by a money-back guarantee, it is shipped to you postpaid with slides, fitted hardwood cabinet and manual...

\$14.95

postpaid

FREE

Just published! The new '55 catalog of the most outstanding microscopes and accessories ever offered anywhere at such low factory-to-you prices. Included with your order or — write for your free copy today!



10-Day Money-Back Guarantee. Send check or money order, 1/3 deposit on C.O.D. California resident add 3% state tax.

the **AKRON**

24 Akron Bldg., 4379 Sunset Blvd., Los Angeles 29, Calif.

AMAZING NEW TINY RADIO

Really Works—Small as a Pack of Cigarettes!



GETS LOCAL RADIO STATIONS WITH CLEAR BELL-LIKE TONE—NO STATIC OR INTERFERENCE! NEEDS NO TUBES, BATTERIES OR COMPLICATED HOOKUPS! NO AC PLUG INS! Nothing to wear out. Thousands of users —many report years of service. Uses new crystal diode and HI-Q coil. SELF-CONTAINED SPEAKER PHONE. Just the tiny radio to take with you ANYWHERE YOU GO—ON TRIPS, VISITING, ETC.—for real fun and enjoyment —ANYTIME. Merely hook to anything that can act as antenna for local reception. Free DX antenna kit included. **SEND ONLY \$1.00** (incl. ck., mo.) and pay postman \$3.99 C.O.D. postage or send \$4.99 for p.p. delivery. COMPLETE READY TO LISTEN. MIDWAY CO., Dept. PPM-2, Kearney, Nebr.

**DEVELOP A HE-MAN VOICE!**

Write for FREE book "How to Strengthen Your Voice for Greater Success" by Eugene Feuchtinger. No obligation. Book will be mailed at once in plain wrapper, postpaid. Just send your name and address. State age. **PREFECT VOICE INSTITUTE, 210 S. Clinton St., Studio BV-2, Chicago 6, Ill.**

FREE OPPORTUNITY BOOK

- Have a business of your own! Make \$100.00 a week with no investment, no stock to carry.
- Thousands now earning lifetime incomes!
- Send for FREE Opportunity Book at no obligation.

HARRY COHON & SONS, Inc.
1067A Utica Ave., Brooklyn, N. Y.

"TRADE WITH THE HOUSE THAT HELPS YOU SUCCEED"

Say You Saw It in Popular Mechanics

135 ORIENTALS only 25¢

Brought to you from the farthest corners of the earth — this amazing collection of exotic valuable STAMPS of the mysterious Orient! 135 all-different from Borneo, Siam, China, Japan, Hong Kong, Malaya, Sarawak, Singapore, etc. Scarce Airmails; flowers, beautiful girls, temples, mountains, birds, animals. Worth \$2.64 at Catalog prices! PLUS free booklet. EXTRA! Bargain lists, and other fascinating offers for your free examination. **ONLY 25¢! Send TODAY.**

FALCON STAMP CO.

Dept. 163 • Falconer, N. Y.

MEN - WOMEN RAISE

ORCHIDS

IN YOUR LIVING ROOM!

YEAR 'ROUND

No Greenhouse Needed

Any Climate, Maine to California

BIG PROFITS!

Spare or Full Time. Loads of Fun for all the Family!

Fill your home with gorgeous Tropical Orchids. Thrill to the gorgeous beauty of your very own huge purple Cattleyas like those you see in nearly every flower shop. Exquisite Cymbidiums, sometimes with 30 or more blooms on each stalk. Hundreds of others—many grow without soil, getting food from the air. Yellow Orchids, greens, blues, pinks, browns, every rainbow color. No greenhouse needed. Start on card table in your living room. Any climate, Maine to California.

**Successful Home Grower SHOWS YOU HOW**

Louis Schirmer, successful home grower, shows you step-by-step how he and Mrs. Schirmer started with a few plants at home, developed a big-profit business, and grew an Orchid collection now worth a fortune. Learn how Orchids multiply — how one plant may become many, each as valuable as the first. No big investment.

LOUIS SCHIRMER Orchidist



You can grow gorgeous Cattleya Orchids like this in your own home!

Home Growers Coast to Coast Benefit from Schirmer's Help

"A wonderful source, written in simple clear understandable terms."
— G. S. Madsen
"I can tell all the Orchid Lovers in N. H. today!"

Complete Instructions and Living Orchid Plants Sent for You to Examine at Home Without Risk

Complete Directions—secrets of the experts — in simple language, jam-packed with "show-how" drawings, gorgeous full color pictures of Orchids. Also a real blooming-size Orchid plant from the Schirmer's own Gardens. Everything you need to start is yours to examine at home, without risk. FREE—full details. Learn how you may become an Orchid Grower. Send no money! Write today. Airmail is quickest.

TROPICAL FLOWERLAND DEPT. 312
4622 Wilshire, Los Angeles 5, Calif.

**MAIL COUPON NOW!**

Tropical Flowerland Dept. 312
4622 Wilshire, Los Angeles 5, Calif.

Rush me complete free details on your offer of Louis Schirmer's Instructions which show me how to grow Tropical Orchids at home. The instructions will include a blooming-size Orchid Plant and valuable home Profit-Plan. This request does not obligate me in any way.

Name _____

Address _____

City _____ Zone _____ State _____

FREE! U.S. AIRMAIL STAMPS



SCARCE COLLECTION! HARD-TO-GET! ALL DIFFERENT!

Rush coupon today for one of the most exciting offers we've ever made. Imagine! . . . this scarce collection of beautiful, hard-to-get U. S. Airmail stamps all yours absolutely FREE! Only a small fraction of stamps used are Airmail. Yet you can now have these scarce stamps at NO COST! They're all genuine, all different! But that's not all! Also included is a handsome souvenir of World's Rarest Stamp in color! PLUS helpful illustrated booklet "Stamp Collector's Guide"! PLUS valuable 1/2 penny Falkland Island stamp — all this FREE if you act AT ONCE! Other offers included for your free inspection. Don't delay — this rare offer may be withdrawn soon! If coupon has been clipped, send direct to GARCELON STAMP CO., Dept. PM2A, Calais, Maine. (Enclose 10c for postage and handling.)

FREE! Exclusive with us — fascinating story and handsome new folder of the WORLD'S RAREST STAMP once sold for \$1.50, now worth \$50,000! Perfect for your album or to brighten up your room!



FREE! Our valuable STAMP COLLECTOR'S GUIDE — all you need to know to start a collection, how to buy and sell stamps — other helpful hints! Order yours NOW!

FREE! Start your collection of fascinating Falkland Island Stamps with this 1/2 penny beauty! Also full details on how to get 8 more (up to 9 penny)! A rare treat!



GET ALL 4 FREE!

GARCELON STAMP CO., Dept. PM2A, Calais, Maine,
Rush FREE, U. S. AIRMAIL Stamps, RAREST STAMP Souvenir,
FALKLAND ISLAND Stamp and STAMP COLLECTOR'S GUIDE.
Enclosed is 10c for postage and handling (PLEASE PRINT)

AMAZING "OLD WORLD DOPE" MAKES FISH BITE EVERY DAY



Catch your limit every day. "Century-Old" Romany formula for all fresh and salt water fishermen. Worms or minnows—live or artificial bait, doped with GYPSY Fish Bait Oil throws off an irresistible odor which attracts fish like magic.

ORDER BY MAIL Supply so limited, not yet sold in stores. Tested, proven, satisfaction guaranteed. Only \$1.00, 3 for \$2.00. Send cash, check or money order. If C.O.D., charges extra. Order GYPSY Fish Bait Oil from:

FISHERMANS PRODUCTS CO. Dept. 49B
2832 Niazuma Ave. Birmingham, Alabama

GROW HERBS FOR US!

AT HOME — IN YOUR SPARE TIME

Help fill our huge demand — used in expensive medicines. Easy to grow indoors or out—multiply rapidly. Year around Profitability! You grow 'em—we buy 'em! We supply everything you need. Free rare seeds and revealing plan is yours Free for the asking. Be one of the first to profit—rush name and address to: NATIONAL HERB EXCHANGE, Dept. A2, Box 304, Gardena, Calif.

FREE SEEDS Write!

SOMETHING NEW—Safety Award Winner

Home Fire Protection goes UP, UP, UP with necessary FIREALARM. An automatic alarm that warns when fire strikes. Inexpensive at \$12.95 each. Ten Day Money Back Guarantee. Send check or money order. No C.O.D.'s.

HEBEL ENTERPRISE CORPORATION, Dept. 2
1257-18th Street Detroit 16, Michigan

YES! SEND



directly
to my door
every month

I am enclosing

- \$3.50 for 1 year
 \$8.00 for 3 years

name _____

address _____

city _____

zone _____

state _____

A-25

Hand this order to your newsdealer or send it to

POPULAR MECHANICS
200 East Ontario St. Chicago 11, Ill.

A NEW LINE OF STARLITE ALUMINUM boats



STURDY... LIGHT... LOW COST

Six new STARLITE Aluminum Boats for '55 . . . tops in safety, maneuverability, and beauty—yet surprisingly low in cost! Ruggedly constructed—no flimsy hulls—no maintenance worries. Good marine design assures seaworthiness, lightness, and perfect balance . . . feather-touch performance with oars or out-boards, and graceful planing action with even the smaller motors. Full-length spray rails and Styrofoam floats. Easy to lift and carry. Fifteen types to fill every boating need.

WRITE FOR FREE 1955 CATALOG

YOUR BEST BUY

STARCRAFT 

Dept. Q-2 Goshen, Ind. **METAL BOATS**

New Science & Adventure Catalog FREE



Things of interest to students, explorers, experimenters, travelers, readers, and those who want to know more about the world around them. Get more fun and adventure from life. For those with intellectual curiosity. Catalog of articles, films, kits, records, educational materials, sets, guides, directories and books. Also helps for vocational guidance, personality aids, intelligence & aptitude tests, consumer buying help, etc. Includes science kits, display sets, nature specimens, travel guides, pictorial wall charts, maps, language records, bird song records, outline guides to almost every subject, experimental sets, unusual records & music helps, models of prehistoric animals, star globes, list of low-priced non-fiction paper covered books, etc., etc. Send name & address with tie for mailing.

WORLD OF ADVENTURE
Dept. 139 Ann Arbor, Michigan

LOCKSMITHING & Key Making



PRACTICAL UP-TO-DATE COURSE—ONLY \$4.95

Easy-to-learn modern information for self-instruction. How to work on locks, de-code, make master-keys, repair, install, service, etc. For every handyman, home owner, carpenter, mechanic, service station operator, fix-it shop, hardware dealer, gunsmith. 53 plain illustrated lessons.

FULL PRICE ONLY \$4.95. SEND NO MONEY. We'll ship postpaid. Satisfaction guaranteed or refund.
NELSON-HALL CO., 210 S. Clinton St., Dept. BV-2, Chicago 6, Ill.

SHOOTS LIKE A SHOTGUN!

Aristo **SLING**
SHOT

POWERFUL MULTI-SHOT KILLS WILD GAME!
Magazines Reloaded Quickly!

ARISTO Magazines can be used with any Sling Shot. Magazines ONLY \$5 for \$1 postpaid. C.O.D. orders accepted. **SATISFACTION GUARANTEED.**

STRADER PRODUCTS CO.
259 STRADER AVENUE, DEPT. S-501, CINCINNATI 26, OHIO



GUN STOCK WALNUT

COMPLETE WITH 5 MAGAZINES
Loaded with Shot Extra Rubber
ALL FOR ONLY \$1.50
POSTPAID

NOW! SAVE MONEY ON YOUR OWN CUSTOM HI-FI MUSIC SYSTEM

free!



ALLIED'S 64-PAGE HI-FI BOOK SHOWS YOU HOW

Send for "This is High Fidelity" the FREE book that tells you everything you'd like to know about Hi-Fi

DO IT YOURSELF



UNITS JUST PLUG IN



Install in your own fine cabinetry or in existing cabinets



Install in bookshelves or built-in wall

Here's your guide to an easy understanding of Hi-Fi—the new electronic way to bring lifelike music into your home. Shows you how to select a custom Hi-Fi music system for your home at no more than the cost of an ordinary phonograph. Tells you what to look for and how to save money on each unit. Shows many handsome, practical do-it-yourself installation ideas. Offers you the world's largest selection of complete systems as well as individual amplifiers, tuners, changers, speakers and accessories from which to make your money-saving choice. If you love your music you'll want this helpful ALLIED Hi-Fi book. Write for it today—it's FREE.

FREE HI-FI BOOK

ALLIED RADIO
America's Hi-Fi Center

ALLIED RADIO CORP., Dept. A-25
100 N. Western Ave., Chicago 80, Ill.

Send FREE 64-Page Hi-Fi Book

Name

Address

City Zone State

SAVE 75%

ON

WORK CLOTHES!

SURPLUS STOCK FROM MIDWEST SUPPLY FIRM!

Terrific values you've got to see to believe!

SHIRTS 79c

Made to sell for 2.99! Now Only 4 for \$2.99

What a buy! 4 for the price of one! These shirts, though used, are washed, sterilized and ready for long, tough wear. In blue, tan or green. Send name, address, neck size.

PANTS to match Unbelievable 99c

Bargains! Sold for 3.95. Now only 4 for \$3.75

Send waist measure and inside leg length.

COVERALLS... wear 'em used and save \$1.95

plenty! Originally 5.95. Now only 3 for \$5.75

Send chest measurement.

SHOP COATS... fully reconditioned. \$1.79

Take advantage of this rock-bottom price. Send chest measurement. Now only 3 for \$5.00

SATISFACTION GUARANTEED! Your money back if you can

beat these bargains anywhere! You can't lose so order TODAY

for immediate delivery! Pay postman or send money with

your order and save postage. \$1.00 deposit on C.O.D. orders.

GALCO SALES CO. Dept. 132

7120 Harvard Ave. • Cleveland 5, Ohio

SAVE \$65 on this LUXURIOUS \$100 CONTOUR CHAIR

Scientifically correct design for the restful, healthful, relaxing which is so beneficial to heart, nerves, muscles. Adjusts for perfect sitting or reclining... most popular chair in the home. Firestone foam rubber and washable, pliable genuine Duran upholstery. Would cost \$100 or more in any store. Shipped all ready to put together in less than one evening by anyone who can use a screwdriver. No cutting, no drilling, no skill needed. A woman can do it. Order now! Everything needed for only \$34.95, f.o.b. Balto. State color wanted: Forest Green, Strain-Grey, Lipstick Red, Walnut Brown. Enclose \$5 deposit, balance C.O.D. Money back guarantee. Return in 10 days if not satisfied. Order now. **BESTECRAFT, Dept. 98, Matheson Bldg., Baltimore 2, Md.** Make Money Selling and Assembling Contour Chairs For Friends.



\$34.95 For Everything Needed Complete to

Put It Together in 1 Evening

GENUINE FOAM RUBBER

Make Money Manufacturing Concrete Drain Tile



Manufacturers of concrete drain tile are in the driver's seat. Why? Because their basic costs are not burdened by freight, distribution and breakage costs—items which the clay tile people have to pass along. Net results: concrete tile can sell for less, yet show a generous profit. The market is big—and getting bigger. Not only because of increased farm drainage, but also because drain tile are needed in home building, reclamation projects, highway construction, and many other purposes. Tile made on the Champion are outstanding in quality—dense, strong, uniform and truly round. All sizes up to 12" diameter. Easy to make, because the Champion Machine is simple, compact, and requires no skilled labor. Business is a low-investment opportunity, with equipment available on terms. Write for catalog.

W. E. DUNN MFG. CO.
522 W. 24th Street, Holland, Mich.



IN CANADA: DUNN MASONRY MACHINERY LIMITED
970 Dundas Highway, Cooksville, Ont.

FORD Owners SAVE MONEY



Learn How to Make Your Ford Run Better . . . Last Longer . . . and Save Hundreds of Dollars!

Get this book, written especially for you, without one penny of risk and get more out of your car. Mail coupon for **MANUAL FOR FORD OWNERS** today. When the book comes, skip through the pages and see how your investment in one of America's most popular automobiles can be even a better investment than you thought. If you don't agree, send the book back and you'll get your money back.

A Popular Mechanics Book Written Just for You

Not a re-hash of service manuals. A complete new Popular Mechanics book written for the Ford owner by an outstanding automotive authority with the full cooperation of Ford engineers and service directors. It will save you money on repairs and service; make your Ford last longer; give you safe, economical and trouble-free motoring. And this is true whether you take your Ford to a regular service station or service it at home.

Prevents Trouble. Cuts Down on Repair Bills

Nothing like this manual anywhere. It covers all phases of operation, service and maintenance. It has entire chapters on the individual parts of your Ford—battery, ignition, starter, generator, regulator, lighting, fuel system, engine, lubrication, gasoline qualities, cooling systems, transmission, differential, rear axle, brakes, wheel alignment, tire care, body maintenance, trouble shooting on the road, etc. It covers your Ford, new and older models, step by step—bumper to bumper—showing you how parts operate; what can go wrong; how repairs and adjustments should be made and how to avoid all types of trouble.

Money Back if Not Satisfied

Mail the coupon today. Send only \$3.50 or you can pay postman. Money back guarantee protects you.

Official, Authoritative, Practical Information

Written by C. E. Packer, formerly service school instructor and auto show lecturer for automobile manufacturers, Member Society of Automotive Engineers, Special Services Editor of Automobile Digest, contributor to leading magazines, author of some of the biggest selling books on Automotive subjects.

Entire Chapters on Fordomatic and Overdrive

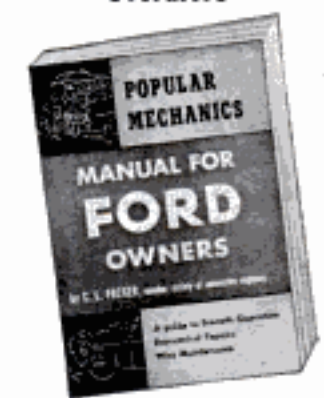

304 Pages. Hundreds of How-To-Do-It Illustrations and Diagrams

The entire book follows Popular Mechanics famous easy-to-read and easy-to-understand style. While primarily intended for the Ford owner, to help him get more out of his car at lower cost, it can be worth its weight in gold to the auto mechanic and service station operator who works, not only on Fords, but on all other makes as well, to which the information in the book can be easily applied.

Order on this Coupon

POPULAR MECHANICS PRESS, Dept. MF-2
200 E. Ontario St. Chicago 11, Ill.

Send Manual for Ford Owners at once. If not satisfactory I will return it within 7 days and you will refund full purchase price.

Remittance for \$3.50 enclosed. Send C.O.D.

Name _____

Address _____

City _____ State _____

ELECTRIFY your SEWING MACHINE

NEW LOW PRICE! \$9.95 90 DAY GUARANTEE



Buy direct from manufacturer and save! Kit comes fully wired, installed in a jiffy. Fits all machines! You get **ALL-NEW PARTS**

- Motor & Bracket
- AC-DC 115v 60c
- Multi-speed foot control
- Cord set & block
- Easy instructions
- Steel pulley & belt

FREE . . . reg. \$2.95 chrome SEWLITE given with every kit.

10 DAY FREE TRIAL—ORDER NOW!

Send no money, pay COD or send money order and we'll pay postage. Please state whether wheel on your machine turns toward you or away from you. Shipping wt. 6 lbs.

SENIOR SEWING MACHINE CO.
Box 142 Dept. PM64 Brooklyn 6, N. Y.

TALK - SING - PLAY OVER YOUR RADIO



with the real Radio Mikel Attachment in a jiffy - full instructions given! Swell for "parties" - "cut in" on or "kid" regular broadcast programs or just on your own broadcast! Amaze your friends - real fun. Beautiful Metallic Plastic 6 in. high!

12 RADIO BROADCAST LESSONS GIVEN with each Mike

SEND NO MONEY Just pay postman \$3.00 COD plus postage or send \$3.30 and we pay postage! Radio Mike is available only from us by mail - guaranteed.

Midway Co., Dept. MPM-2, Kearney, Neb.

RADIO CONTROL YOUR MODEL PLANES BOATS CARS

"CUSTOM MIDGET" RADIO \$9.98

LICENSE FREE BAND

OPERATES SAME AS \$30.00 SETS. INCLUDES LONG RANGE TRANSMITTER RADIO, RECEIVER RADIO AND CONTROL ACTUATOR ALL 3 EASY ASSEMBLY WITH OUR PARTS AND PLANS \$9.95. PLANS ALONE \$1.

RADIOMODELS BOX 36 DEPT. PM BALTIMORE 6, MARYLAND

DETAILED INFORMATION & RADIO CATALOGUE 25c
SPECIAL "SUPPLY SOURCE DIRECTORY" & \$7.00 SUPPLY COUPON... \$1.00
BOOK "RADIO CONTROL OF MODEL AIRCRAFT" CONTAINS 14 PLANS \$3.98
RADIO CONTROL GARAGE DOOR DETAILS..... \$1.00

BOAT KIT SAVES YOU \$200



12 ft. \$97
14 ft. \$129
Freight Incl.

Build this 12-ft. and 14-ft. Sport Runabout from ready-cut parts. Kits include all hardware, etc., to complete boat shown. Models as low as \$39.00 freight included. Send for free folders on kits, fiberglass and accessories.

TAFT MARINE WOODCRAFT
DEPT. PM-2 636-39th AVE., N.E. MINNEAPOLIS 21, MINN.



New 1955 Issue

Catalog of 3200 Novelties, Gadgets, Jokes & Tricks

Send 10c for amazing catalog of novelties, joke articles, funmakers, tricks, gadgets, live animals, scientific supplies, hobbies, planes & boats, unusual seeds, time-savers, cameras, optical goods, projectors, movies, lucky jewelry, religious goods, disguises, masks, musical instruments, stamps, coins, puzzles, fortune tellers, radios, auto & bike accessories, telescopes, magnifiers, compasses, banks, smokers' items, artist supplies, printing sets, engines, motors, shockers, knives, billfolds, guns, rifles, sports, books, games, plants, pennants, emblems, etc. Send name, address and 10c to:

JOHNSON SMITH & CO.
Dept. 940 Detroit 7, Mich.

Here's 10c. Rush me New Catalog!

Johnson Smith & Co., Dept. 940, Detroit 7, Mich.

Name _____

Address _____

The WONDERS of LIQUID PLASTICS



MANUFACTURE ANYTHING WITHOUT TOOLS OR MACHINERY!

No previous experience or special ability required! **NO TOOLS OR MACHINERY** required. . . . The entire process is about as easy as pouring water out of a glass: **THE WONDERS OF LIQUID PLASTICS** make all this possible! Many of the products made with our liquid plastics serve so many diverse and useful functions, many can so easily be converted into beautiful and attractive products that thousands of our customers are now actively engaged in a wide variety of proud and profitable businesses established with the aid of our products and instructions!

UNLIMITED POSSIBILITIES!

Work with **LIQUID IVORY, LIQUID GLASS, LIQUID MARBLE, LIQUID EMERY, LIQUID PORCELAIN, LIQUID WOOD, LIQUID GEMSTONE,** and many other **LIQUID PLASTICS** and in a matter of minutes turn them into an endless and valuable procession of beautiful imbedded jewelry, novelties, ornaments, statuettes, bookends, lamps, pen-sets, lighters, ashtrays, keychains, figurines, carous, **SOUVENIRS**, art and gift products, fishing lures, **BOATS, GADGETS** galore, exquisite **GEMS!** brake gears, tools, dies, forms, handles, dials, knobs, **MACHINE PARTS**, models of inventions, pistol grips . . . the list is endless! The only **LIMITATION** is your **IMAGINATION!** Liquid Plastics are the blessing of every creative and ambitious person . . . with these materials **ANYONE** can create and manufacture by the **THOUSANDS** and at a tiny fraction of what it would cost by any other method! Just send 25c and we will send you our big combination **Instruction-Catalog #19** describing all of the products mentioned above and the methods of use! You'll readily admit it's the most fascinating book of its kind as far as opening new worlds of activity and opportunities for you!

Catalog #19 is devoted exclusively (64 pages) to the art of manufacturing **EVERYTHING** without tools or machinery! Send 25c for it today! We will include valuable book, **THE WONDERS OF LIQUID PLASTICS** absolutely free!

FREE KIT!

CATALOG #20 is filled with fascinating occupations that can be turned into extremely **PROFITABLE** home and shop businesses! **UNLIMITED POSSIBILITIES! UNLIMITED PROFITS!** No previous skill required. Learn Jewellerycraft, Wirecraft, Photocraft, Woodcraft, Machine Shop Practice, Marblecraft, Ceramic Craft, Bolt Making, Mold Making, Model Making, Metalcraft, Metal Enameling, Gemcraft, Plastic Laminating, Basket Weaving, Leathercraft, Embossing, Lampcraft, Feathercraft, Internal Carving, Extruding, Etching, Plating and dozens of other unique and fascinating occupations that can lead to riches! Send only 25c for **CATALOG #20** and receive one outfit mentioned above (our choice) **ABSOLUTELY FREE!** A thousand fascinating and golden opportunities wait for you in these two valuable catalogs!

PLASTICAST CO., Dept. C

P.O. Box 6737, Chicago 80, Ill. (Write to either address)

P.O. Box 987, Palo Alto, Calif.

SAY YOU SAW IT IN POPULAR MECHANICS

NEW INVENTION **REPLATES** by **ELECTROPLATING** RESTORES HOME, AUTO METALS **CHROME-SILVER-GOLD!**

NEW BRILLIANCE WITH SAME PROCESS AS PROFESSIONAL PLATERS

SILVER-CHROME-GOLD



REPLATED, Quickly, Easily Now—with an amazing new invention... **APPL-I-COTER**, you plate hundreds of items, using the mild, safe current of 2 flash-light batteries in its handle. ALL YOU DO is simply hold disk on Applicator to metal, dip brush into solution—and plate as you brush. It's Easy, Quick, Genuine plating.



RESTORES METALS LIKE NEW Replates Silver, Chrome, Nickel, Steel, Gold and Brass—all waxes, Spots, Stains, "Blister." Silverware, Trays, Teapots, Rims of Holloware and other items can look like new again with this exclusive Electroplating process. Restore all your valuable Gold jewelry with amazing **APPL-I-COTER**. The plating you apply becomes an inseparable part of the metal itself!

QUICKLY BUILDS-UP A THICK NEW PLATING WITH EACH APPLICATION.



COMPLETE PLATING KITS:

- MET-L-COTE:** For Chrome & other white metals... **\$3.95**
- SILV-R-COTE:** For Silver-plating with pure Silver... **\$3.95**
- GOLD-COTE:** Gold Plate with 24 K. Gold... **\$6.15**



BRILLIANT AUTO TRIM — You'll be mighty proud of the Dazzling new finish on your car's bumpers and trim after replating with **MET-L-COTE**... and remember, each time you electroplate worn areas you build up a lasting layer of coating that tremendously lengthens the life of original trim.

MET-L-COTE is constantly used in leading hospitals, and in doctors and dentists offices to Replate surgical instruments—Also in hotels and restaurants to **RESTORE** cutlery.

CASH REFUND IF NOT COMPLETELY SATISFIED

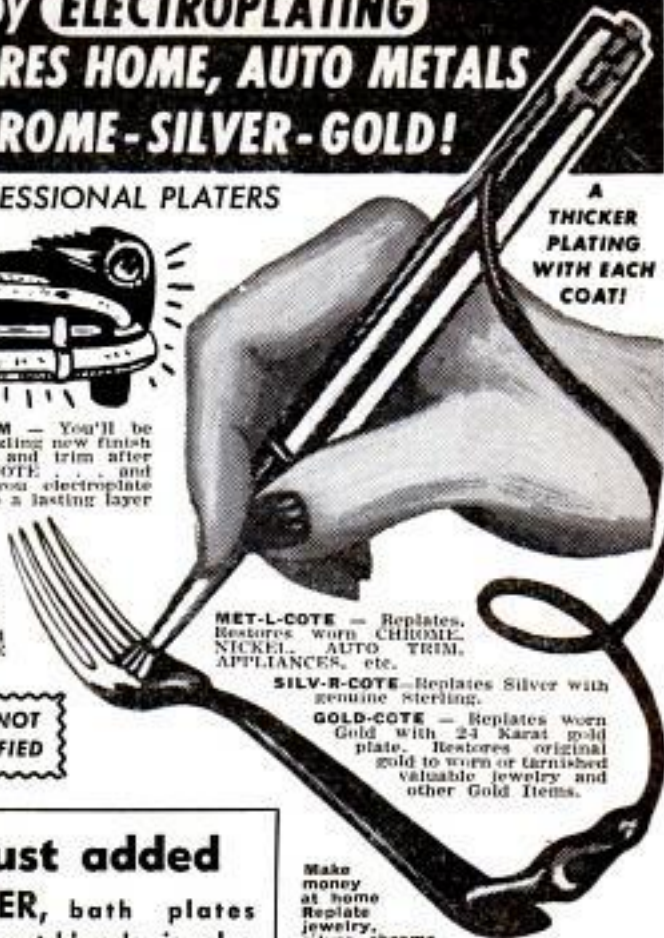

A THICKER PLATING WITH EACH COAT!

MET-L-COTE — Replates, Restores worn **CHROME, NICKEL, AUTO TRIM, APPLIANCES**, etc.

SILV-R-COTE — Replates Silver with genuine Sterling.

GOLD-COTE — Replates worn Gold with 24 Karat gold plate. Restores original gold to worn or tarnished valuable jewelry and other Gold items.

Make money at home Replate jewelry, silver, chrome. Earn up to \$10 per hour.

RESTORE YOUR TREASURES-- MAKE THEM VALUABLE AGAIN

NEW—just added
JNT DIP-COTER, bath plates small items: rings, watchbands, jewelry, etc. Same price as **Appl-I-COTERS**, or save by getting combination sets.

J. N. T. MFG. CO., INC., Dept. PM254
1440 Broadway, New York 18, N. Y.
Please rush electroplating equipment I have checked, including instructions, I enclose full price, sent postpaid—*or* send C.O.D. plus postage.
NAME _____
ADDRESS _____
CITY _____ STATE _____

Appl-I-Coter Set for brush-plating large pieces
Dip-Coter Set for bath-plating small articles
Combination Appl-I-Coter and Dip-Coter Set
Extra Anodes
Extra Solution 2 oz.
Five metal combination set, either Appl-I-Coter or Dip-Coter 19.95
Five metal combination set, both Appl-I-Coter and Dip-Coter 29.95

	Silver	Met-L-Cote	Copper	Gold	Rhodium
Appl-I-Coter Set	3.95	3.95	3.95	6.15	7.95
Dip-Coter Set	3.95	3.95	3.95	6.15	7.95
Combination Set	5.95	5.95	5.95	8.95	12.45
Extra Anodes	.50	.50	.50	1.25	3.50
Extra Solution 2 oz.	1.30	1.50	1.50	3.00	3.25
Five metal combination set, either Appl-I-Coter or Dip-Coter	19.95				
Five metal combination set, both Appl-I-Coter and Dip-Coter	29.95				

AGENTS START BUYING SERVICE AT HOME

GET BIG NAME MERCHANDISE for your clients up to 40% less than reg. price. Operate sparetime. Sales easy as you can give sizeable discounts, still make fat comm. Postcard brings free plan.

AMERICAN BUYERS SERVICE
631-R LINDEN AVE., BUFFALO 16, NEW YORK

GET UP TO 40% OFF

CM-7 New! BIG Money Maker!

Looking for a new product that can make you \$1,000 a month, and up—that puts you out in front of competition? Here it is—**RED COMET** Automatic Fire Extinguishers containing the miracle chemical **CM-7**. Developed by this 23-year-old company after an extensive program of research and laboratory test. **CM-7** has exclusive properties that no other fire extinguishing fluid can offer.

Prospects everywhere—farms, homes, businesses. No experience necessary. No investment. Get the facts on **CM-7!**

FREE use of Master DeLuxe Sales Kit, containing everything you need to start taking orders for Red Comet Automatic Fire Extinguishers the first week. A proven sales maker.

RED COMET, INC. Dept. 319P, Red Comet Bldg. Littleton, Colorado

STAMP COLLECTORS!

319 DIFFERENT STAMPS 25¢

This big imported collection includes: Giant glider aviation set showing real and toy gliders, Israel airport & ancient coin set, Fish & insect life from far-off Ind, Sahara, Guinea, Red Cross Flag, Nurse & Blood Transfusion, Jap Antelope & Bird, curious child artwork plus hundreds of fascinating issues from all parts of the world. Altogether 319 all different stamps cataloging \$7.25—for only 25¢ to introduce our bargain approvals. **BONUS:** Valuable **IMPERF. ERROR** and 48-Page Stamp Dictionary included free as long as they last.

STAMPEX CO., 116-03 Nassau St., New York 38, N. Y.

Say You Saw It in Popular Mechanics

MAKING MONEY IS EASY WITH QUIKSHARP

Get big profits sharpening knives on amazing **QUIKSHARP**. Works on entirely new principle—puts razor edge on any knife in seconds. A child can operate it. We show you how to have your own business and start making money immediately. Everybody uses knives—homes, restaurants, butcher shops, hotels—and all need sharpening 3 to 50 times a year. Don't let someone else beat you to this opportunity. Write today for free money making sales plan.

MANUFACTURERS OF FAMOUS EASISHARP SCISSORS SHARPENER

SERR-EDGE MACHINE CO. 9731 LORAIN AVE. CLEVELAND, OHIO



NEW TYPE BATTERY makes 100,000 STARTS per MONTH month after month!

PATENT PENDING
#408439

"TORTURE TESTS"

by authorized member of American Council of Commercial Laboratories demonstrate amazing performance* of Life-Long—the only battery in the world with a **TEN-YEAR BONDED GUARANTEE** featuring free replacement or money back. These independent laboratory reports prove what you yourself will soon discover in your own car... that your Life-Long Battery gives you faster starts, a hotter spark, brighter lights, sure starts in any weather, ample power for extra electrical equipment.

*Let us send you details of these independent laboratory tests

OVERCHARGE TEST... Life-Long exceeds SAE requirements by 400%, eliminating all possibility of burn-outs through overcharge.

R.P.M. TEST... Life-Long spins your engine 20% faster.

COLD TEST... Life-Long operates efficiently at 70 degrees below zero

HIGH TEMPERATURE TEST... Life-Long operates efficiently at blistering temperature.

**10 YEAR
Bonded
Guarantee**

BACKED BY GREAT WESTERN
ESCROW COMPANY
BOND



**\$1,000
REWARD
OFFER**

*I will pay you
\$1,000 if you can
disprove this claim!*

J. M. Watt
PRESIDENT
LIFE-LONG BATTERY MFG. CORP.

TRY IT!

Tremendous **RESERVE POWER** Insures You a **TROUBLE-FREE BATTERY!**

You insist on "reserve" horsepower in your motor. You need extra emergency power in your battery, too, as insurance against costly, embarrassing battery failure. You get that reserve power with Life-Long—the only battery backed by a 10-year *Bonded Guarantee*.

LIFE LONG

Large corporations, Fire Departments, Police Departments, Taxicab Companies in every part of the country, as well as the U. S. Government and many foreign countries are now buying LIFE-LONG BATTERIES. • LIFE-LONG manufactures a complete line of Industrial, Commercial, Marine and Motor-cycle batteries. Prices on request.

END YOUR BATTERY TROUBLES!

More than 50,000 satisfied Life-Long customers have put an end to annoying battery troubles. \$1,500,000 worth of Life-Long Batteries sold to date—not one failure reported yet!

IF NO DEALER NEAR YOU, USE COUPON

BUY NOW! UNDER MONEY-BACK GUARANTEE

DISTRIBUTOR TERRITORY OPEN

Life-Long Batteries, sold all over U. S. and abroad, are protected by exclusive patents. Some territories are still open for men who recognize this big profit opportunity. Write for details.

COSTS NO MORE

You Can Now Buy a LIFE-LONG TEN-YEAR BATTERY for less than the cost of an ordinary lead acid battery. Look at the money you save!

All 6-volt
LIFE-LONG AUTO BATTERIES—\$29.95

All 12-volt
LIFE-LONG AUTO BATTERIES—\$34.95

A so-called "First Quality" three-year battery costs you \$10.00 a year.

A LIFE-LONG TEN-YEAR BATTERY costs you only \$3.00 a year.

With your ignition switch off and your headlights on, step on your starter until the battery won't start the engine or light the lights. Now wait one minute with headlights off—then step on the starter. The LIFE-LONG BATTERY will start your car instantly with a surge of power that it has regained during that brief 60-second interval! Make this test as many times as you like! One LIFE-LONG dealer has demonstrated this amazing recuperative ability of LIFE-LONG BATTERIES over 500 times with the same battery, with no sign of weakening, yet!

LIFE-LONG BATTERY MFG. CORP., DEPT. PM-1
11766 W. Pico Blvd., Los Angeles 64, California
Please ship Life-Long Battery, 10-year guarantee:
6 volt automotive battery (\$29.95 including tax)
12 volt automotive battery (\$34.95 including tax)

for _____
Make & Model, Year of Car
Cash, check or money order enclosed. Life-Long pays all delivery costs to your door.
Name _____
Address _____
City _____ Zone _____ State _____

Free! 153 GERMANY



Giant and midget-sized **STAMPS**; hated Hitler heads; blood-red swastikas; inflation issues with pre-war face of millions of dollars; Allied and Russian Occupation issues; birds, animals, air-mail stamps—153 all-different, guaranteed worth \$2.46 at Catalog prices. **EXTRA!** Free booklet, bargain lists, and other fascinating offers for your free consideration. Send only 10c to help cover cost of mailing and handling. Act today!

JAMESTOWN STAMP CO., Dept. 161, Jamestown, N.Y.

Let me **PROVE** to YOU
THERE'S BIG MONEY
IN TROPICAL FISH

Breed them at HOME!
SPARE TIME! FULL TIME!

FREE!

America's newest and most profitable Home-Business. Breed rare Tropicals in your living room, garage, basement—anywhere! No experience, no big investment required. Rush coupon below and we will send you all 4 things...

- HOW TO BUILD A \$10,000 BUSINESS IN YOUR LIVING ROOM—COMPLETE!** Revealing! Loaded with photos! Tells how to start spare-time or full-time. How to sell Tropicals by mail order. How much you can earn, how to charge, how many Tropicals you can breed, etc., etc.—loaded with amazing information.
- TROPICAL FISH MULTIPLICATION CHART.** Fascinating and factual. Proof of profits. Tells kinds of Tropicals, number of eggs produced at one birth, how many times a year Tropicals give birth—approximate retail prices of various kinds of Tropicals.
- THERE'S "BIG MONEY IN TROPICALS" STORY.** Interesting success story of a man who built his 8888 business. Now ships to 48 states. Tells how it's possible to earn \$3,000 to \$4,000 a year breeding one species of Tropicals only. You'll be amazed.
- HOW TO GET COMPLETE BUSINESS-IN-A-PACK-AGE!** Unique plan that shows you how to start your own business and pay for it out of profits.



TROPICAL FISH BREEDERS OF AMERICA
Dept. B-2
Los Angeles 61, Calif.

Please rush all 4 things immediately by mail. I lawfully certify that I am over 17 years old.

Name _____
Address _____
City _____ State _____

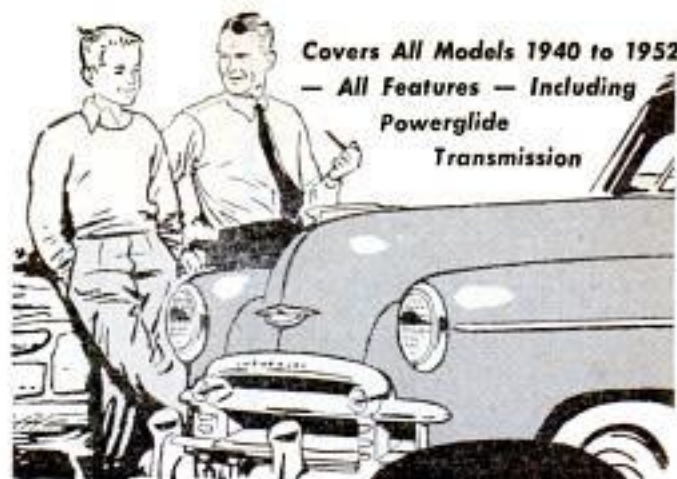

Covers All Models 1940 to 1952
— All Features — Including
Powerglide
Transmission

Get Popular Mechanics Owner's Manual

If you drive a Chevrolet—any model—1940 to 1952—get this owner's manual today. It will save you money on repairs and service; give you safe, economical and trouble-free motoring and protect your investment in your Chevrolet by keeping it constantly at top value. Can easily be worth hundreds of dollars to you in a single year.

Chevrolet Owners

Spend Less to Own and Drive Your Car

Official, Authoritative Bumper to Bumper Information

Prepared by a noted automotive authority and Popular Mechanics editors with the full cooperation of Chevrolet engineers and service specialists. Covers all phases of Chevrolet operation, service and maintenance. 304 pages of practical information and hundreds of photos, diagrams, charts, and sectional views, make every part, every operation, easy to understand. Complete index enables you to put your finger on the information you want instantly.

Prevents Costly Repairs

Explains everything about your car; what can go wrong; how proper adjustment and servicing should be done; how to prevent major troubles and costly repairs later on. Even if you don't service your car at home the manual will save you important money on every day operation.

Mail Coupon Today

Mail coupon now. Send only \$3.50 for prepaid delivery or you can pay postman, plus charges. See money back guarantee in coupon.

Learn All About Chevrolet's Powerglide Automatic Transmission

Know Your Chevrolet Valve-in-Head Engine and How It Operates

Understand Chevrolet's Center Point Steering and Unitized Knee-Action.

Protect Your Investment. Know Your Chevrolet.



POPULAR MECHANICS PRESS
200 East Ontario St., Chicago

Send Manual for Chevrolet Owners at once. If not satisfactory I will return it within 5 days and you will refund full purchase price.

Remittance for \$3.50 enclosed. Send C.O.D.

Name _____

Address _____

City _____ State _____



I MADE
\$14 PER DAY
While still learning!

T. E. R.—WEST VIRGINIA



I MADE
\$800 IN 3 MONTHS
While taking your course!

F. V.—NEW YORK

Get into the

ELECTRIC APPLIANCE REPAIR & SERVICE BUSINESS



OPEN YOUR OWN SHOP
As soon as you enroll, I send you my New Book "How to Open Your Own Business" at no extra cost. PTS training is more than a home study course in electric appliance repair and service. It gives you the "know how" on the operation of your shop from a business standpoint: What to charge, how to get customers. Everything possible is done to start you on the road to success.

WE TEACH YOU:
Electric motors, house wiring, refrigerator, auto ignition, automatic washers, garbage disposals, fluorescent lights, irons, cleaners, etc., at home.

WE TEACH YOU:

Electric motors, house wiring, refrigerator, auto ignition, automatic washers, garbage disposals, fluorescent lights, irons, cleaners, etc., at home.

FULL OR SPARE TIME

SEND FOR THIS FREE BOOK



SPARE OR FULL TIME

You can actually increase your income while still learning—spare or full time

ACT NOW

Want a good-paying business—a job in a fast-growing industry? Send now for your **BIG FREE BOOK**—"My Plan for your Success." Get started **NOW**

EASY TO LEARN

Men of all ages, yes, even the man of 69 can get into this expanding field. A **REAL OPPORTUNITY** for the practical man who wants the **BETTER THINGS IN LIFE**. The easy PTS Home Study Plan prepares you for greater earnings **NOW!**

I SEND YOU A

BIG KIT of TOOLS at No Extra Cost



MAIL THIS COUPON TODAY

PACIFIC TRAINING SCHOOL H. T. ARMSTRONG
11029 S. Vermont Dept. P-552 Los Angeles 44, Calif.
Please send me, without obligation, your free booklet and details.

Name _____
Address _____
City _____ Zone _____ State _____

Enjoy the Fascinating Story of the Horseless Carriage in

Popular Mechanics

AUTO ALBUM

The most intriguing book about the automobile ever printed. It's thrilling, fascinating and informative. From the very first gasoline-propelled buggy to the cars of today and the atomic auto of the future. The first cars—the men who made them—the scrambled start and the development of the fabulous auto industry—the story of auto racing—the growth of the Nation's highways. 166 thrilling action pictures—old-time cars—racing cars—early auto advertising—automotive oddities. Roll call of names of more than 2000 autos made in the U.S. included. Ideal gift book. Cloth bound, only \$3.00 by mail. Money back if not pleased. Paper covered edition \$1.00 at newsstands.

POPULAR MECHANICS PRESS, Dept. PM14
200 East Ontario Street Chicago 11, Illinois



7 POWER BINOCULAR at A NEW LOW PRICE!

Smaller Than A Pack of Cigarettes!

\$14.95



Superb, precision made, all chrome "Miracle Eyes" that weigh only 5 1/2 ounces! Why lug around heavy, cumbersome binoculars needlessly? These handsome, Achromatic 7 POWER glasses have color corrected lenses with shielded fittings thruout. Interior sides of VITAL front and rear Achromatics have been COATED with magnesium fluoride to assure brighter, sharper, clearer images. Increased sales volume permits offering the deluxe "Miracle Eyes" on Sale, for a short period, at only \$14.95 (Reduced from \$19.95).

12 X 50 (Illustrated) Tremendous power with 240 ft. field! Center focus. Weighs 27 oz. 1 5/8" x 7". Achromatic. Color corrected lens. Easy to use-focus. Regularly \$67.50. Sale Priced. Short Period \$39.95.

USE 30 DAYS AT OUR RISK. If not satisfied, return for full refund. Made by skilled optical craftsmen in Japan to rigid UNITED requirements. Carrying case and straps included at above prices. Add 10% Fed. tax. Cash orders postpaid. C.O.D.'s require \$2.00 deposit. **UNITED BINOCULAR CO., Dept. ARF-8908, 9043 S. Western, Chicago 20, DEALERS WANTED.**

HELPFUL BOOKS

Send post card asking for **FREE** catalog
Popular Mechanics Press, 200 E. Ontario, Dept. 601, Chicago 11



World's Largest Selection of Home-Study Books, Courses, Tests... all at low money-saving prices! Train at home for locksmithing, radio, shoe repairing, watch repairing, real estate, mail order business, piano tuning, criminology, hundreds of other money-making subjects. Write today for **FREE "Success Catalog"**. No obligation. **NELSON-HALL CO., 210 S. Clinton St., Dept. 28V-2, Chicago 6, Ill.**

Get This **FREE CATALOG**

LEARN DRAFTING



Veteran Approved

You Get This Professional Set of Instruments at No Extra Cost



IT'S EASY — AT HOME IN YOUR SPARE TIME
Or At The Institute In Cleveland

There's a growing, desperate need for draftsmen—the key men in all industry. CEI can quickly give YOU the necessary skill. Bigger income, jobs, and opportunities are yours with a CEI diploma. Thousands have succeeded. So can you. CEI guarantees to train you until you qualify. Write today!



Home of C.E.I. "ENGINEERING DRAFTING EXCLUSIVELY"

CLEVELAND ENGINEERING INSTITUTE
Extension Division PM-22-E
6300 Euclid, Cleveland 3, Ohio

Please rush your valuable Success Book showing how drafting can increase my pay check.

Aeronautical Mechanical
VETERANS: Give date of discharge _____
NAME _____
ADDRESS _____
CITY _____ STATE _____

CLEVELAND ENGINEERING INSTITUTE



**I call this
machine . . .**

**"my little
money maker"**

It can be put anywhere in the house—in the kitchen, the basement, or the attic and it goes on making money for you whether you're there or not. Three times a day—while you're at work, while you're asleep, or while you're at the movies—it turns out a product that sells for \$6.00 and the cost of raw materials is only 54c. It will make 3 a day or 6 a day, just according to the way you set the switch, and the profit on each one is more than \$5. I'll be glad to tell you how to get one of these little money makers working for you.

By Jack L. Mason

What a fellow makes in his regular job today is hardly enough to make ends meet. Higher taxes, higher costs of food and rent and almost everything else raise hob with the savings account. And I say that what a fellow puts away is even more important than what he makes. It would worry me sick if I couldn't save a little against a rainy day.

And that makes it almost necessary to make some extra money. There are lots of ways to do it, too. The magazines and newspapers are full of ads for agents to sell things. But if I had to make a living by selling, from house-to-house, I'm afraid I'd starve to death. I like to make something with my hands and either sell it by mail or let the stores sell it for me. There are lots of people like me.



Another thing: Lots of men—and women, too—don't want to get mixed up with something that might hurt them on their jobs. They want a plan they can operate at home—in spare time—one that they can work at any time they please and one that doesn't need any rented store or hired help.

And that's where my little money maker rings the bell.

Let's say you're like me. You want to make some extra money but you don't want to do any selling. All right—take a look at what you can do with this machine. I'll give you some facts that I discovered and your own common sense will tell you they're true.

If you're going to make something, it ought to be something that lots of people want—something that lots of people buy. It shouldn't be something that sells at just certain seasons—but all year 'round. And, it shouldn't be any flash in the pan. It's got to be steady—year after year—something that's not here today and gone tomorrow.



Well, give a thought to this: What's more permanent than babies? Ever since I can remember there's been more and more babies born every year. Last year three and a half million. This year more. Next year, more yet. Then answer this question and tie it in with your thinking: What's stronger than mother's love for her baby? And what is more powerful than love or sentiment in making people buy things. Now you've got the idea.

Every year millions of mothers want their babies' first

shoes preserved as mementos. These mothers have the shoes "bronzed" as they call it—by electroplating. Electroplating coats the shoes with copper and preserves them forever. And there's no big company that has a corner on the business of metalizing baby shoes. Almost all of this work is done by little fellows in their kitchens or basements. Lots of orders come to you by mail when you send out circulars letting mothers know you can do the work. Lots of stores take orders, but they have to turn over the work to you. There are six or seven ways to get orders without making any house-to-house calls. The big job is keeping up with them.



You see, you can clean up six pair of shoes in a few minutes. In a few minutes more you can dip them in the hardening solution like you see in the picture. Then you spray them with a conductive coating and hang two pair in the tank on copper wires. Just turn the switch and walk away. The machine does the rest. Eight hours later those shoes are ready to take out of the tank, burnish and mount and ship or deliver. Two pair every eight hours, whether you are asleep, awake or at the movies.



The materials cost 54c a pair. The retail price you get for electroplating is \$6.00—so the profit is more than \$5.00 a pair. Since you can do six pair a day you can see what the profit is, and the beauty of it is that the machine doesn't cost much. Almost anyone can afford the equipment and the book you get tells how to run the machine and how to get orders. Anyone can follow the instructions.

Of course, there's a lot more information than what I can give here. But write me a note or send me a postcard with your name on it and I'll send you all the information right away by mail. I'll show you how to start; what you need to buy; where to get it at the lowest price; how to get orders coming in seven different ways; and everything you want to know about the business. When you get all the facts, you can decide whether you want to get a "little money maker" of your own. Everything I send you now is free—no charge and no obligation. I'll be glad to help you get a start. Address me, Jack L. Mason, 1512 Jarvis Avenue, Chicago 26, Illinois. There's no catch to it. No one will call to try to sell you anything. I'll mail everything free, postage prepaid. Then you can decide. Write to me right away so I can help you get started making money.

**WORLD'S
BEST
WANT-AD
MEDIUM**

CLASSIFIED ADVERTISEMENTS



Advertisements in this section \$1.00 per word, each insertion, minimum 10 words, payable in advance.

To be inserted under proper classification, copy must be in our office the

20th of the second month preceding date of issue

F. W. Johnson, Manager, Classified Advertising

Popular Mechanics Magazine, 200 East Ontario Street, Chicago 11, Illinois

YOU'LL PROFIT

By reading and answering the classified ads in this section. Hundreds of opportunities for you to make and save money

AUTOMOBILES. MIDGET CARS

ANTIQU Automobile color slides, 2x2. Illustrated catalog free. Universal, Box 779A, Beverly Hills, Calif.

FIBERGLAS Automobile materials. Wholesale-retail. Complete information catalog 15c. Gem-O-Lite, Box 686A, North Hollywood, California.

T Ford? Exclusive! Antique and collectors item. Genuine, (notice to user) break in and instructions. Came out with all new T Fords. First time available since then. \$1.00. L. W. Barber, 119 N. W. 4, Oklahoma City 2, Okla.

PATTERNS For stock car number, 16", instructions. Send your number, \$1.30. Robenolt Signs, Romulus, N. Y.

WORLD'S Largest supplier hi-mileage speed equipment. Thousands of items to help double the power, mileage, speed of your car. Amazing fuel savers. Complete customizing parts. Thick photo-catalogue 25c. (Literature free.) Write today. Newhouse Automotive Stores, Los Angeles 22.

FREE Motor magazines; automobile literature, old, new and foreign; glossy photos, dealer books, service manuals, offered with non-profit organization. Write today; get on free mailing list. Auto Maniacs, Stockbridge, Mich.

AUTO SUPPLIES AND EQUIPMENT

FRONT Bumper-fender brace for Fords. Ends pushed-in fenders. Easily installed on all 1952 through 1954 Fords. \$3.00 each, postpaid. Satisfaction guaranteed or your money back! Corsicana Grader and Machine Company, P.O. Box 1017, Corsicana, Texas.

DON'T Drive half blind. Increase road illumination up to 50%. Precision, fully automatic device ensures 100% headlight efficiency. \$6.00 postpaid, insured mail. Print name, address, car make, year, voltage. Money back guarantee. Graham Muir, 521 M Street, West Palm Beach, Fla.

WATER Boosts mileage 20%. Treatise reveals build-yourself injector. \$1.00. Hydrojection, Box 123, Copiague, N. Y.

STOP Seat cover shock. Amazing liquid. Mail \$1.00. Commercial Laboratories, Box 1905, Ft. Worth, Texas.

GENUINE Motor treatment, Lachapelle's, (patented). Only \$3.00 delivered. Increases compression, power. Saves gas, oil, repairs. Money back guarantee. You can't lose. Free circular. Write Joe Dillon, Authorized Warehouse and Agents Distributor, Box 323-5 Bridgeport, Ohio. Exclusive distributorships, agencies open.

PUMP Your own gas. Save money and time. Dependable, accurate pump. Pays for itself. Priced low. Circular free. Kalmend Co., Box 145, Woodland, Calif.

LACHAPELLE'S 100,000 Miles treatment. for \$3.00 makes any gasoline motor better. Ferns, 8120-B Walnut Dr., Los Angeles 1, Calif. Data on request.

HOME Solution in windshield washer cleans off road grease. 25c in coin for information to Box 236, Yamhill, Oregon.

FREE Discount catalog — Speed, power, custom equipment. Almqvist Engineering, Milford 2P, Pennsylvania.

THIEF Chaser—Stops tire, gasoline and auto thieves. Sample offer. Salesmen wanted. Novak Company, 3131 West 13th, Gary 12, Indiana.

BUY Wholesale nationally advertised auto supply, thousands other products at big discount. Free "Wholesale Plan." American Buyers', 629-DD Linden, Buffalo 16, New York.

FORD-T parts. Most complete stock in U. S. for all old cars. Try to stump us. B. S. Wisneski, Milwaukee 7, Wisconsin.

BIG All-new 1955 speed-sport-chrome and custom hot-rod catalog. Entirely new and different. Illustrating thousands nationally known products at tremendous discounts! Send 25c (refundable). Gotham, 1155 Broadway, New York 1, N. Y.

CAR Burning oil? Losing compression? Try Clifford's Compression Seal. \$2 postpaid. Clifford's Engineering, 1329 Seventh, Aurora, Illinois.

NEW And used parts at savings. Complete guaranteed parts service for all models cars and trucks—1924 and later. Largest in the West. Army parts specialists. No catalog, write for quotations. Fast mail order service. Pioneer Auto and Truck Parts Co., 734 W. 13th Avenue, Denver, Colorado.

TAPPET Noises in Fords, Chevrolets and Mercurys stopped with Kaye Tappet Silencers. Free literature. Kaye Products, 2067B S. Layton Blvd., Milwaukee 15, Wis.

AUTO Accessory and parts catalog. 1955 edition—all new! 148 pages. Save up to 50% over 50,000 items, including Hollywood accessories, hi-speed equipment, rebuilt engines, all parts and accessories for all cars and trucks! Hard-to-get parts! Send 25c (refundable). J. C. Whitney, 1919-PM Archer, Chicago 16, Illinois.

ELECTROPLATE Auto parts, novelties, mirrors. Easy, inexpensive home processes. Free booklet. Tyco Metals, Box 13231-BG, Houston 19, Texas.

AUTO TRAILERS

FLORIDA Or California bound? We can help you solve your housing problems. Mail 50c for your copy Guide to Easy Living, Retirement and Travel. Sellhorn's, Box 1950, Sarasota, Fla.

ASSEMBLE Yourself kit. Slip-on cabin coach for pickup trucks. Trailer blueprints. Literature 10c. Comstock Trailers, 585-P, Parsons, Kansas.

TRAILER Building manual, illustrated \$1.00. Circulars 20c. Craftsmann Books, Box 1153, Milwaukee 1, Wis.

EXCEPTIONAL Expanding eight foot trailer. Accommodates family of five. Build yourself. Literature 10c. Framar Company, Wilmington, Mass.

BUILD Your own trailer! Plans for all kinds. Illustrated catalog 10c. Jim Dandy, 125-M, Wausau, Wisconsin.

MOTORCYCLES, BICYCLES, MOTORSCOOTERS AND SUPPLIES

SERVICYCLE \$20.00; Whizzer motorbike \$25.00; Cushman motorscooter \$25.00; midget auto \$25.00. Rush 25c (35c first class mail) for new catalog #957 listing many other amazing bargains in motors, midget cars, motorscooters, motorbikes, construction plans. Associated, Box 534, Toledo, Ohio.

LEATHER Motorcycle jacket. Quilt lined. Boys \$19.00; men, \$24.00 postpaid. Brown, 2739 W. Girard Ave., Philadelphia 30, Penna.

MIDGET Auto \$10. James motorcycle \$15. Cushman motorscooter \$10, less engines; Clinton engine \$4. Whizzer \$15. Four airplane tires \$3. (mailorder only). Send 25c (35c first class mailing) for latest Directory Catalogue Number 83, just out, listing these and hundreds of other bargains in new and used midget cars, motorscooters, homebuilders parts, plans, etc. Midget Motors Directory, Athens 1, Ohio.

REBUILT Bicycle or motorscooter engines. \$17.00 up. Cauffiel Motors, Temperance, Michigan.

RECONDITIONED Motorcycles and motors. Chromium accessories. Complete stock Indian parts. Expert rebuilding. Fast service. Indian Motorcycle Sales, Kansas City 27, Mo.

"BUZZZZ" The motorcycle magazine. International coverage. Thoroughly illustrated. Yearly \$2.00. Sample 25c. 5424-A Sawyer, Chicago 23.

HARLEY-Davidsons — America's best used buys! We pay shipping on motorcycles. Genuine new, used, parts, accessories for current and obsolete models. Send 25c for bulletin, catalog. Knuth's (Harley-Davidson factory dealer), 2491 Fond du Lac, Milwaukee, Wis.

AVIATION

BUILD A man carrying helicopter jet engine yourself. "Practical Ram Jet Design." \$1.00. "Practical Pulse Jet Design." \$1.00. Decker Engine Works, Plasterco, Va.

LIGHTPLANE Building manual, illustrated \$1.00. Circulars 20c. Craftsmann Books, Box 1153, Milwaukee 1, Wis.

FLYING Saucer! Propelled by centrifugal force. Propulsion details. \$1.00. Decker Engine Works, Plasterco, Va.

BUILD Pulse jet helicopter. Plans \$6.00. Rovin Engineering, 800J University Ave., Ithaca, N. Y.

AVIATION Surplus bargain catalogue. One dime. Ort, Thomasville 211, Penna.

FREE: Monthly aircraft, electronic, gadget list. Dick Rose, Everett, Wash.

PROPELLERS. Plans, supplies for air boats, snow sleighs. Catalog 10c. Gano Propellers, Box 3284-A, Ft. Worth, Texas.

CONFIDENTIAL Reports on best paying jobs and careers with airlines, feederlines, aircraft factories, corporations, cropdusters, etc. Pilots, mechanics, all aviation specialties. Experienced and unskilled. Foreign and American. Complete satisfaction guaranteed. Only \$2.00. (Airmail \$2.25). Research Services, Box 2904-PMB, St. Louis 17, Missouri.

PROPELLERS. Plans, kits for snow sleighs, air boats. Immediate delivery, satisfaction guaranteed. Catalog 25c. Banks-Maxwell, Box 3301E, Ft. Worth, Texas.

ELECTRICAL SUPPLIES

STOP Power loss and save money. This triple wall receptacle has beryllium copper coil springs that hold plugs tight. \$2.00 postpaid. U.L. approved, guaranteed. Miles, 7655-A West Myrtle, Chicago 31.

ELECTRIC Pencil: Engraves all metals \$1.50. Beyer Mig., 10511-H Springfield, Chicago 43.

LAMPS—25c Brings bargain catalog showing all parts for repairing, building. Contains instructions for electrifying vases, oil lamps, etc. Gyro Lamps, 5402P Clark, Chicago 49.

LEARN Appliance service. Motors, washers, refrigeration, everything. Booklet. Manager, Box 73136, Los Angeles 3.

LAMP Supplies — Wholesale. Any amounts. All parts for repairing and building lamps. Catalogue 15c. Brown Lamp Co., Box 501-Wellston Sta., St. Louis 12, Mo.

WELDING, SOLDERING, PLATING

"BUILD-UR-OWN" a.c. welder and a.c. power plant with a good used engine and low cost Hobart generator. Welds anywhere and supplies 5 KW stand-by power for any emergency. Write Hobartweld, Box M-253, Troy, Ohio.

300 NEW Gov. surplus a.c. welders with G.E. transformers \$50 up. DuPont Smith, 106 Verbena, Oak Ridge, Tenn.

ACETYLENE Welding outfits new \$49.00; used \$29.00; arcwelders \$49.50. Eagle Welding, Dept. P.M., 5085 Broadway, Chicago 40, Ill.

A.C. Welders. 4 sizes. Lowest prices. Free literature. Holgeron's Serv., Canton, Kan.

ELECTROPLATING Equipment, anodes and solutions for all types of plating. Instructions. Assemble your own plating and save. Free catalog. Ramyr, Dept. E-4, 1624 East First Street, Los Angeles 33, California.

SELF-Training System. Radiator repairing, cleaning, recoring. How to equip small shop at low cost. Supply sources, trade secrets. Instructions. Radiator Service, East Jordan, Mich.

MACHINERY, TOOLS, SUPPLIES

NEW Plumb bob that marks itself. One man operation. \$2.00 postpaid. Plumb Bob, 26 Branch Drive, East Hartford, Conn.

LOOK—Imported German high-speed drill sets. Precision made finest chrome-vanadium steel. Save! Buy direct! Set 60 sizes, 1-60, \$11.95 ppd. (\$24.50 value.) Drill-case included! Set 29 sizes, 1/16-1/8" (64ths), \$14.95 ppd. (Reg. \$37.00.) Drill-stand included! Special, both sets \$24.95 ppd. Satisfaction guaranteed! Supply limited, order now! Precision Tool Supply, 111 Reno, Santa Cruz, Calif.

MICROMETER. One inch \$3.00, two inch \$4.00. Semi-steel frame. Accurate to .0005. Money back guarantee. Postpaid. Lewis Machine Tool Co., Los Nietos, Calif.

PADHACKSAW. It's new; performs the job normally done by 6 different tools. Write Elco Products, 60 Holt St., Dayton 7, Ohio.

BUY Surplus machinery, tools, boats, trucks, etc., from government. List \$1.00. Box US169, East Hartford 8, Conn.

BIG Factory catalog! Buy direct—Save middleman's profits; hundreds of labor saving tools and equipment; tremendous savings. Send 10c. Master Mechanic Mfg., Dept. CL-73, Burlington, Wis.

KEMPSMITH Universal miller, used, guaranteed, automatic table 10x45", motorized, dividing and vertical heads. \$695.00. Third down, balance 12 payments. Orahm, 19 Cleveland Pl., New York City.

NEW Electric drills and saws. 1/4", \$11.75 and \$15.75; 1/2", \$30.75; 6/16" tilting arbor \$44.50 prepaid. Will Surplus, 7829 Racine, Chicago 20.

BUILD Your own hydraulics. Plan with essential hydraulic information and catalog listing hydraulic-kits, motors, welders, surplus items, etc., 10c. Dunbar Mfg., 6602-H Sylvan Road, Houston 23, Texas.

WALLBOARD Tools. T squares \$9.00. Circle cutters \$4.00. Hammers \$6.00. Roll lifters \$3.50. Tool holsters \$5.00. Nail bags \$3.00, \$3.50. Lightbox cutter outer \$24.95. Wallboard Tools, 2309 Waverly Drive, Gary, Indiana.

"TREE Farmer" chain saws, new, direct drive, 21 lb., \$139.50, wholesale. M-G Saw, Coatesville, Penna.

ALLEN Two ton power bench type punch press. \$97.50. Circular, Allen, Dept. PMB, Clinton, Missouri.

SNOWTRACTORS! Army Weasel parts. World's largest supplier. Symington of Seattle. Union Bay Place, Seattle 5, Wash.

SHEBEL Saw filer files all saws. Circular. A. P. Shebel, 730 So. 2nd St., Milwaukee 4, Wis.

ALL Steel woodworking lathes, 5 x 12, \$9.95 prepaid. Circular. Sypher Co., 210 Cherry, Toledo, Ohio.

ENGINES, MOTORS, DYNAMOS

MOTOR Winding calculator that will give you winding data for single and three phase motors from simple iron measurements. Price \$2.00. Clare Coss, Gibsonburg, Ohio.

A.C. generators: 750 watt, \$35.50. Twin cylinder compressors with 1/3 horse \$22.50. Motors, 1 horse \$37.50. Butler, 1883 Milwaukee, Chicago 47.

REWIND Motors yourself, complete instructions \$1.00. Lewis Mfg., Howell, Mich.

OHMMETER. For motor and appliance service, \$7.55, prepaid. Motor Industries, Quincy, Ill.

AMAZING Reverse switch for split-phase or capacitor-start motors \$3.00. Details for stamp. Parks, 105 S.E. 57th Ave., Portland 15, Oregon.

REBUILT 1 1/2 to 3 h.p. engines \$17.00 to \$37.00. Cauffiel Motors, Temperance, Michigan.

WINDING Data. 225 motors, single and three phase, \$1.00. Data Company, Box 7631, Kansas City 28, Mo.

BOATS, OUTBOARD MOTORS

MARINE Conversions, Willys to Cadillac, engines, kits and parts. Catalogue and conversion hints free. Barr Marine, 2706 Castor Avenue, Philadelphia 34, Penna.

FIBERGLASS top marine grade. Yard or kit. Ontario Fiberglass Co., Ontario, N. Y.

BUY Wholesale nationally advertised outboards, thousands other products at big discount. Free "Wholesale Plan." American Buyers', 628-DD Linden, Buffalo 26, New York.

RUBBER-Boat catalogue. Information on paint, dope and preservation. One dime. Ori, Thomassville 27, Penna.

FIBERGLAS Boat coating. Wholesale-retail. Complete information catalog 15c. Gem-O-Lite, Box 686B, North Hollywood, California.

SEA Legs boat kits, prices from \$39.00. Complete kits, including brass wood screws, precut parts, pre-assembled frames, fool-proof illustrated instructions. Write for free literature. Penney Woodcraft Industries, Dept. C-34, Defiance, Ohio.

SAVE Money. Boat accessories catalog. 15 cents in stamps. Garland Frasher Marine Sales, 2626-C Fifth Avenue, Huntington, W. Va.

SIMPLIFIED. Modern plans and patterns. Inboards and outboards 12"-22". Please state type. -Glen Designs, Box 568, Compton, Calif.

68 DESIGNS. 24 Kits, hardware. Stamp brings advance literature. Marinecrafts, 35-M Sorrento, Allston, Mass.

REDUCE Breakage. Plexiglas windshields, side panels, clear or colored. Cut to size. Send 25c for complete catalogue and prices. Direct factory distributor. Delta Products, 1400 Henderson, Fort Worth, Texas.

JOHNSON Outboard specialists. Used parts for all models at substantial savings. Prompt quotations. Specify model serial. Crandall-Hicks, 910 Commonwealth, Boston, Mass.

FULL Size, cut-to-shape boat patterns, blueprints, 7 1/2-38 feet. New 1955 illustrated "Build a Boat" catalog of 50 naval architect-designed cruisers, runabouts, sloops, skiffs, outboard boats, sailing, racing, houseboats, 50c. Marine hardware catalog, \$1.50. Bigger, better 1955 "How to Build Boats" book, \$2.50. PolyWog Houseboat Plans, \$12. Cleveland Boat Blueprint Co., Dept. A-66, 9400 Steinway, Cleveland 4, Ohio.

FIBERGLAS Permanent boat water-proofing. Lowest wholesale prices. Guaranteed materials. Easy application. Full instructions. Complete kits, \$12.60 up. Free literature. Ajax Plastics, Dept. PM, P.O. Box 1323, Fort Worth, Texas.

FREE Catalog! Boat kits, trailers, fiberglass, marine hardware. Luger Industries, Dept. M. 4452 Nicollet, Minneapolis, Minn.

MARINE Conversions for Ford and Jeep engines. Catalog 10c. Lehman Manufacturing Company, 972D Broad Street, Newark 2, New Jersey.

NEW. Used, rebuilt marine motors. Marine conversions, fittings. Free catalog. Stokes Marine Supply, Dept. 24, Coldwater, Michigan.

CONVERT Fords and Jeeps to 100% marine engines with Osco's world famous Convo-Kits. Deluxe catalogue 25c (coin). Oscomotors, 3627B Lawrence, Philadelphia 40, Penna.

AIR Boat plans, supplies, catalog 25c. Banks-Maxwell, Box 3301F, Ft. Worth, Texas.

BOAT Covers, custom and ready made. Also tarpaulins, canvas yard goods, life preservers. Free boat cover catalogue. Morsan, 10-40R 50th Avenue, Long Island City 1, N. Y.

ATHLETIC EQUIPMENT, BODY BUILDING COURSES

ARE You a future star? Find your build rating for football, baseball! Self-rating forms plus athletic build analyzer \$1.00. Athletic Laboratories, 1415 West 63rd, Chicago 36.

FREE Catalogue. 10c for postage appreciated. Dr. Thompson, 919 Fourth, Manhattan 30, Kansas.

BARBELLS. Exercise equipment. Courses. Free booklet. Good Barbell Co., Reading, Penna.

SPORTING GOODS, GUNS, FISHING TACKLE, ARCHERY, TRAPPING

GUNS That won the west. Rare Colt replicas for your den, office, or lodge are available to you now. Literature free. Woolslair, 645-F 30th, Hermosa Beach, Calif.

FREE—Fishing catalog. Newest items. Bargains. Gadgets, beads, spinners, spinning outfits. FinnySports (PM), Toledo 6, Ohio.

SAVE 50% Finest archery equipment. Revealing "How to Bow-fish, Bow-hunt, Make Own Tackle, Improve Accuracy" booklet plus catalog. Send 25c for handling. Malibu Archery, 3156RF Eighth, Los Angeles 5, California.

IMPORTED. Daggers, stilettos, throwing, pocket, hunting knives, etc. Free catalogue. J. D. Clinton, Mt. Clemens 2, Mich.

MOLDS For fisherman's sinkers, jigs, squids, casting and spinning lures. Free catalog. Sweet's Molds, Tonawanda 1, New York.

FREE Fishing catalog—132 pages. Over 3000 hard to find fishing specialties. Netcraft Company, Dept. PM2, Toledo 13, Ohio.

1955 SPIN Reels at wholesale price—Mitchell \$300 \$18.95, Record \$400 \$18.95, Airex Larchmont \$16.75, Aristocrat \$14.50, Vagabond \$10.95, Orvis 100 \$17.95, Zebco #22 \$11.50, Johnson 80 \$10.95. Orders shipped promptly, prepaid. Lombard's, Dept. M, 3141 Bainbridge Ave., Bronx 67, N. Y.

BUY Wholesale nationally advertised sporting goods, thousands other products at big discount. Free "Wholesale Plan." American Buyers', 627-DD Linden, Buffalo 16, N. Y.

GUNS! Guns! Guns! New, used hunting bargains, Mausers, Lugers, Kentuckies, Winchester, antique arms, catalog 50c. Ed Agramonte, Yonkers 2G, N. Y.

SPLITSHOT Sinker mold, \$4.25 postpaid. Sewell Machine Works, Versailles, Ky.

GUNS! Free catalog. Owens Sporting Goods, 2142 E. Tenth, Long Beach 4, Calif.

LEARN Gun repairing at home. Profitable business. Details 10c. Modern Gun Repair School, Box 430-P, Marshfield, Wis.

TENTS, Camping equipment. Send 10c for 100 page tent, camping equipment catalogue—handbook, Morsan, 10-21st 50th Avenue, Long Island City 1, New York.

HOLLOWGLASS Fishing rod kits. Assemble yourself. Save over half. Casting, spinning, fly and boat, \$4.95 up. Full instructions. Free literature. Makit Rod Co., 429 1/2 Fulton, Fort Worth, Texas.

TUBULAR Glass rod kits—Casting, spinning and boat, fresh and saltwater. Build custom rods at home for profit. Free listing of blanks, guides, handles and accessories. Fishermen's novelty key chain 25c. Rodman, Box 41, Wauwatosa, Wisconsin.

SWIMMERS! Send \$3.95 for imported French mask. Catalog of skin divers' equipment and books 25c. Aquafun PM, Davenport, Iowa.

MOLDS—For making fishermen's slinkers. Free illustrated booklet. Reading Instrument Co., Box 78, Reading, Penna.

DELUXE Cleaning service on suede and leather jackets. Expert repairing. Free price list. Write Ed Roper, New Idea Cleaners, Coatesville, Penna.

OLD Guns. Current prices. Free catalog. Pioneer Books, Harriman, Tennessee.

5000 BARGAINS, Firearms, binoculars, war relics. Catalog 50c. Smith Firearms, Runnemeade, N. J.

MANY Modern, antique guns. List 10c coin. Ed Howe, 52 Main, Coopers Mills, Maine.

JAP Rifle altering to 30-06, \$6.00. Japshells, \$3.75. Catalog 5c. T. P. Shop, West Branch 11, Mich.

TAXIDERMISTRY

MODERN Taxidermist magazine, Greenfield Center 2, N. Y. Devoted entirely to taxidermy, methods, photos. Trial year's subscription, \$1.00.

BINOCULARS, TELESCOPES, MICROSCOPES, MAGNIFIERS

BUILD Your own reflector telescope. Complete kits, mirrors, eyepieces, tripods, all other accessories. Request free complete illustrated literature. Criterion Manufacturing, Dept. KPM-2, Hartford, Conn.

ULTRA Powerful telescopes and telescope makers lens kits. Trifling cost. Free literature. Carl Jamer, Manorville, N. Y.

WAR Surplus bargains! Millions of lenses, instruments, telescopes, binoculars, components and complete line of astronomical telescope items. World's greatest optical market place! Send only \$1.00 for beginner's 10-lens kit and big instruction booklet Stock CH. Write for catalog CH free! Edmund Scientific Corp., Barrington, New Jersey.

SALE! Save 40%! Free 52 page, 3 color, informative binocular-telescope catalog, \$3.95 to \$250.00! United Binoculars, 9043 S. Western, A-8608, Chicago 20. Dealers wanted.

DYNASCOPE—New sensational reflector telescope. 65X-130X-167X-4 power finder, fully achromatic, Hardwood folding tripod. Complete ready for use. Send for details. Criterion Manufacturing, Dept. DP9, Hartford, Conn.

SPECIALISTS, Used microscopes and accessories. Unusual prepared slides, supplies, Telescopes, etc. Free catalog. Research Scientific, 60 Wall St., New York City 5.

400X TELESCOPE Makers kit contains focusing tube, erector, 5 lenses and instructions, \$3.75. Giant 100X astronomical telescope complete with tripod, \$15.00. Free information. Suffolk Science, Mattituck 3, N. Y.

IMPORTERS' Amazing prices, precision binoculars, 22 models. Free trial. Folder, "Binocular Selecting," catalog free. Dealers wanted. Prentiss Importers, Mercury Bldg., West Los Angeles 25, Calif.

MICROSCOPES, Prepared slides, biological stains, oculars, illuminators, mechanical stages, objectives, mounting media, parts, specialized equipment. Premium quality merchandise, lowest prices anywhere. Write for free illustrated microscope catalog and price list. Benjamin Miller, 134 W. 32nd St., Rm. 204-A, New York 1, N. Y.

REFLECTING Telescopes, 80X, completely assembled \$29.75. Guaranteed observatory clearness. Free information. Skyscope, 475 Fifth Avenue, New York 17.

PETS—DOGS, BIRDS, RABBITS, HAMSTERS, ETC.

CHINCHILLAS—Fabulous fur animals. Wholesale prices. Leo Hammer, Asheboro, N. C.

CHINCHILLAS \$150.00 Pair. Bright's Chinchillas, 2312 N. 38 Street, Kansas City, Kansas.

RAISE Rabbits. Let me show you how to succeed. Market information and prices of rabbits sent free. A. Johnson, Box 694, Kansas City 41, Mo.

ANGORAS, Chinchillas—World's most profitable rabbits! Catalog free. Grinsteads, Edwardsville, Illinois.

RABBITS, Best quick profits. Booklet free. Tayco Rabbitry, Hapeville, Georgia.

CHINCHILLAS (No rabbit.) Easily raised anywhere. Profitable. Big future. Terms. Hibner Chinchillas, Ithaca, Mich.

FREE—Dog and cat remedies, supplies, toy catalog. Norvet, Hartford 3, Conn.

CHINCHILLAS—Registered. Guaranteed reproduction. Unbelievable prices. Par-West Chinchilla, 1446-A Jones, San Francisco 9, California.

CHINCHILLAS Top-quality registered sturdy young stock, \$75.00 per pair. Slater Chinchillas, 1535 Ruhland Ave., Manhattan Beach, California.

HAMSTERS—Special sale. Write for details. Anderson's Hamstery, 35 Onelda, Pontiac, Michigan.

CHINCHILLAS—Big profits. Send 25c for literature to Tom McGowan, 170 Horton Ave., Valley Stream, L. I., N. Y.

GUINEA Pigs. Cash income. Booklet free. Taylors, 426A, Hapeville, Georgia.

HAMSTERS—Golden; young, \$4.00 pair, fully developed, \$5.00 pair. Adirondack Hamstery, Prospect 64, New York.

HIGH Scoring chinchillas, all ages. Herd improvement males, mated pairs. LK Chinchilla Ranch, 24 Maple St., Orange, Mass.

BEAUTIFUL Pure white pedigreed police puppies. Ansonia Kennels, Mose, N. Dak.

SUPERSONIC Whistle. Trains-calls cats or dogs. Used Hollywood sound stages. High frequency pitch. Pets hear, neighbors don't. \$1.00 postpaid. Totten, Dedham, Mass.

CHINCHILLAS: Top-quality N.C.B.A. registered breeders. Mature, guaranteed bred pairs or sturdy young stock. Terms. C & B Chinchillas, Wycena, Wis.

RACCOONS, Minks—Bred females. Baby skunks. Catalog 25c. Shady Fur Farm, Springfield, Minnesota.

HUNTERS! Raccoon Mountain and Short Creek Kennels now combined. Large number of coonhounds, foxhounds, rabbit-hounds, beaglehounds, bird-dogs, puppies. Free literature and pictures. Trial. Dures Thomas, Owner, Box 464, Boaz, Alabama.

START Right by knowing facts about rabbit raising. Illustrated booklet describing all breeds, housing, feeding, breeding, marketing, 48 pages 10 cents. American Rabbit Breeders Association, 36 Arba Building, Pittsburgh, Penna.

MAKE Money raising chinchillas, mink, pigeons, rabbits, cavies for us. Free catalog. Keeney Brothers, New Freedom 2, Penna.

RAISE Mink: Free booklet, pen plans, inside secrets, feed care. Mink are money makers. Investigate today. Lawrence Mølgard, Brigham City 12, Utah.

RAISE Money-making Angora, New Zealand rabbits. Particulars free. White's Rabbitry, Jackson, Mich.

STANDARD Rabbit Journal, Milton 3, Penna. Year \$1.00. Sample dime. Beginners manual 25c.

GROW Mushrooms, Cellar, shed, and outdoors. Spare, full time, year round. We pay \$3.50 lb. We paid Babbitt \$4,165.00 in few weeks. Free book. Washington Mushroom Ind., Dept. 171, 2954 Admiral Way, Seattle, Washington.

MINK Raising information free. Complete. Lake Superior Mink Farm, Superior, EEl, Wisconsin.

MAKE Big money! Raise Chinchilla rabbits. Cash markets supplied. Write today! Rockhill Ranch, Sellersville 18, Penna.

FARMS, FARM LANDS, REAL ESTATE

FLORIDA, Lakefront homesites on Eustis-DeLand highway. Excellent fishing-hunting. \$10.00 monthly without interest. Complete price \$245.00-\$995.00. Literature. Write Roepke, Eustis, Florida.

BUY Surplus homes, buildings, land from government. Listings \$1.00. Bureau, Box D169, East Hartford 8, Conn.

FLORIDA Beckons for fishing, vacationing, living. 5 acre baby farms about 60 miles from St. Petersburg. Fine for homesites, farm or camp; close to finest hunting, bathing, boating, deep sea fishing. Only \$345.00, \$10.00 down, \$10.00 month. Information write G. B. Potterfield, Owner, Union Building, Department C, Charleston, W. Va.

INVESTIGATE! Compare! Buy bargains! Free literature. Gene Jenkins, Doniphan, Mo.

FLORIDA Winter garden farms—5 acres, 10-acres or 20-acres. Low prices, easy terms. Beautifully wooded. Near famous Panama City pleasure resort. World's finest beaches, lovely lakes. Wonderful fishing, hunting. Florida's most desirable money-making properties. Information free. Wendell Wood, Fountain, Florida.

WARM Shingled houses, gardens, easy payments. Information. Perrys, Brier Hill, Penna.

CALIFORNIA And Oregon ranch lands. \$15 to \$35 acre, 10 to 640 acre tracts. Easy terms. Free catalog. Pacific Lands, 1621-A Cahuenga, Hollywood 28, Calif.

\$5.00 MONTHLY Buys 40 acres productive land; near town; price \$240.00; free list. Box 425-P, Carthage, Mo.

STROUT Catalog—Mailed free. Farms, homes, businesses, 33 states, coast-to-coast, 3357 bargains described. World's largest; 55 years service. Strout Realty, 7-M So. Dearborn St., Chicago 3, Ill.

CANADIAN Tax sale lands for three dollars an acre and up. Small monthly payments. Farms, timber, hunting and fishing camps, minerals. Limited number of properties. Write at once for free catalogue. Tax Sale Service, Room 105, 120 Bloor St., West, Toronto 5, Canada.

ADDRESS—Armstrong, Shook, Missouri. Giant listings, inexpensive lands, mailed free.

FLORIDA—Nice homesites near Ocala national forest in Lake county. Best fishing, hunting. Low prices, easy payments. Folder free. Howard Vernor, DeLand, Florida.

FLORIDA—Beautiful retirement homesites near gulf coast. Excellent hunting, fishing in 9 fresh and salt water rivers, 11 bays and gulf. \$250 at \$10 monthly. Free literature. V. M. Mathews, Box 1406, Asheville, N. C.

HOMESITES \$400—Convenient payments. California's finest garden section. On Morro Bay's scenic shores. Wonderful fishing, boating, bathing. Fertile soil, softest water, temperate climate, congenial community. Free literature. Richard Otto, Department M, San Luis Obispo, Calif.

PLANTS, SEEDS, NURSERY AND GARDEN SUPPLIES

MULTIFLORA Rose. The living self-repairing fence, ornament, erosion control, windbreak, snow fence, etc. Rapid grower. Raise from seed. Free planting guide, write Woodlot Seed Company, Norway 9, Mich.

CASH, Retirement income, grow flowers, retail, wholesale, mailorder, spare-time. Ten professional programs \$1.00. Box 135, Berea, Ohio.

EVERGREENS: Seedlings, Transplants. For growing ornamental landscape. Christmas trees. Quality stock at low prices direct from growers. Write for price list and planting guide. Suncrest Evergreen Nurseries, Dept. PM, Homer City, Penna.

FARM MACHINERY AND SUPPLIES

AMERICA'S Finest weedcutting electric fence controller. Send for free literature. Bandelin Products Co., 213-14th Avenue Northeast, Minneapolis 13, Minnesota.

POULTRY, FARM SUPPLIES

CAPONIZE Cockerels chemically. 100 pellets, implanter included. \$2.00. Success guaranteed. Circular free. Majors Produce, Manhattan 5, Kansas.

GUINEAS, eggs and keets. Ducks, ducklings, eggs. Geese, goslings, eggs. Low prices. Gorgeous catalog free. Berry's Farm, Route 12, Clarinda, Iowa.

POULTRY Farmers, broiler growers, turkey raisers, read the new American Poultry Journal for latest ideas and greater profits. 12 months, 50c. Special offer, 4 years \$1.00. American Poultry Journal, 182 North Wabash, Chicago.

RAISE Turkeys the new way. Write for free information explaining how to make up to \$3000 in your own backyard. Address—National Turkey Institute, Dept. 3, Columbus, Kansas.

PROFITABLE OCCUPATIONS

ATTENTION Dealers: New clear view auto hanger just arriving on market—Retail price \$4.95. Write for dealer's sample \$3.00. American Metalcraft Co., Waterville, Ohio.

WANT A diesel job? New opportunities to increase income. Higher pay. More money. We can help you qualify. Tools. Shop method home training. Write today! Diesel, Tractor, Heavy Equipment Division, Interstate Training Service, Dept. B-3-B, Portland 13, Oregon.

"HOW To Make Money With Simple Cartoons"—A book everyone who likes to draw should have. It is free; no obligation. Simply address Cartoonists' Exchange, Dept. 92CP, Pleasant Hill, Ohio.

WELDING Pays big money. Learn easily at best equipped school in country. Non-profit school with low cost training. G. I. approved. Write Hobart Trade School, Box M-252, Troy, Ohio.

AMAZING Booklet, "How to Build Your Own Mailorder Business." 25c. Continental Publications, 216 W. Jackson, Chicago 6, Ill.

WHOLESALE! 8000 Nationally famous products, 30-80% discounts! Large catalog. Sensational business plans included. Consolidated Distributors, 21-20, Lafayette, Paterson 15, New Jersey.

ANNOUNCING Home study course in commercial baking. Practical basic training. Good field for those with aptitude. Free booklet. "Opportunities in the Baking Industry." National Baking School, 835 Diversey Pkwy., Dept. 3452, Chicago 14.

FREE! "301 Profitable Small Businesses!" Amazing shoestring plans! Work home! Start sparetime! Demand Surveys, Kenmore 23-R, N. Y.

MAKE Money writing short paragraphs! No tedious study. I tell you what to write, where and how to sell; and supply list of editors buying from beginners. Many small checks add up quickly. Write to sell, right away. Send for free facts. Benson Barrett, 1751 Morse, Dept. C-27-B, Chicago 28.

\$50 WEEKLY Working three hours daily. No manufacturing. No selling. No mail-order. Postal brings information. Smith-Williams, 326 E. 5 Street, Dept. 22, New York 9.

SAN Francisco help wanted and opportunity columns airmailed \$1.00. Hubbard, Box 1442, Palo Alto, California.

FOREIGN Construction. Jobs underway and soon starting in South America, Europe, Canada, Asia, Alaska, Middle East, South Pacific. Big pay, tax exemptions. Travel, expense paid. Make your stake now. Send \$1.00 for projects, contractors, application forms, etc. Prompt ppd. reply. Money-back guarantee. DCS Foreign Job News, Bridgeport 2, Ill.

MOST Complete list of U.S. construction jobs coast to coast. Top pay berths. No phones. Latest dope tells who, what, where, when. Send \$1.00. Money-back guarantee. Dempster's Construction News, Bridgeport 2, Ill.

I Average \$125 weekly selling books by mail! So can you! Start sparetime! Work home! Cooper, 247-P Taunton, Buffalo, N. Y.

LABOR Union leaders needed. Opportunities for well paid, satisfying positions. Home or travel expense paid. Book giving full instructions, guidance. \$1.00. Union Job Guidance Bureau, 103-PMC Erie St., Sa'amanca, N. Y.

OVERSEAS Jobs. Many firms hiring truck drivers, laborers, clerks, mechanics, carpenters, pipe fitters, electricians, plasterers and other trades. Pay to \$1500.00 monthly. Transportation paid to and from jobsite. Jobs open in USA, Spain, South America, Alaska, Canada, St. Lawrence project and others. Full information of all contractors with name and address, wage rate both USA and foreign, hours, living conditions, how to apply for job with application blank mailed to you same day order received for \$1.00. Airmail \$1.25. Satisfaction guaranteed or money back. Overseas, Box 2274, Dept. 5, Dallas 21, Texas.

\$10,800 PROFITS! Your own mailorder business! No risk! Success plan free! Treasury, 709 Webster, New Rochelle L-28, N. Y.

MAN Wanted—Are you dissatisfied with your work? Would you like a business of your own? If so, write Rawleigh's, Dept. B-CG-PPM, Freeport, Ill.

FREE Folio "Up to \$45,000; Unlimited Vacations." No merchandise, equipment. Unknown! Work home, sparetime! Haylings, Carlsbad, Calif.

BUY Wholesale thousands nationally advertised products at big discount. Free "Wholesale Plan." American Buyers', 628-R Linden, Buffalo, N. Y.

LEARN Real estate business for highly profitable lifetime career. Study at home. Modern, complete, quicker course. Diploma awarded. Surprisingly low cost. Free literature. Seavy Realty Institute, 1750-B Colorado Blvd., Los Angeles 41, California.

BIG Job opportunities overseas now! Start up to \$20,000. 51 pages of information. Satisfaction guaranteed. Rush! \$1.00 to Decco Company, 1444-G Federal Station, Portland 7, Oregon.

MAILORDER Beginners instruction manual, sources, methods, opportunities. 25c. Carnahan Bros., 5580 Nelson, Cypress, Calif.

OVERSEAS Jobs. Big pay plus allowances paid transportation, 36 page printed report on who to contact to apply for high paying jobs. \$2 postpaid. International Information Service, Dept. M16, Box 101, Kamrar, Iowa.

JOBS Texas Gulf coast. Help wanted, business opportunities. Sunday editions airmailed \$1. Dana Company, Box 387, Lake Jackson, Texas.

CALIFORNIA'S San Fernando valley, world's fastest growing area. List of jobs and business opportunities sent. Get up to date newspaper. "help wanted," employment applications sent return mail. \$1.00. Ronne, Box 44P, Canoga Park, California.

ATTENTION Construction men! Laborers, trades, truck drivers, clerical, engineers, supervisory, many others. Latest copyrighted reports! Who to contact for highest paying jobs. To \$1500.00 monthly. Over 32 countries, including U.S., St. Lawrence project, Spain, South America, Alaska, Europe. Year registration and advisory service. Application forms. Best oil, aviation opportunities. Unconditional guarantee of satisfaction. Write or wire today! \$2.00. Airmailed \$2.25. (C.O.D.'s accepted.) International Reporter, Box 1047-L, St. Louis 1, Missouri.

SUNSHINE California booming! Work, live here. Aircraft, rockets, factories begging for you. Fancy wages. Los Angeles biggest newspaper job ads airmailed \$1.00. Steingo, 5949-2 Guthrie, Los Angeles 34.

MUSHROOMS Grown boxes, barrels. Manureless process 50c. Spawn \$1.00. Gordons, 553 William, Winnipeg, Manitoba.

FOREIGN U.S. jobs to \$18,000. Many overseas countries, fare paid. Skilled-unskilled trades, office. Stamped self-addressed env. brings reply. Job Opportunities, Waseca, 1F, Minn.

MAGAZINE Subscriptions—Largest commissions, bonus. Qualified Publications, 451FB Kingston, Brooklyn 25, N. Y.

IF You are interested in high pay, worldwide corporations need workers. Write Servco, Box 1217, New Orleans 4, La.

\$1300.00 MONTHLY For truck drivers, \$1400.00 monthly for carpenters, electricians, plumbers, mechanics, \$1200.00 for clerks and laborers. Full information and complete foreign listings, with current information on Spain, Korea, Australia, Alaska and Canada, \$1.00. Current information on stateside projects, \$1.00. Dept. 3-B, Opportunities Unlimited, 1110 Commerce Bldg., St. Paul, Minn.

FREE Information. Construction projects require all trades. Ellis, PM-2, Box 207, Westmount, Quebec.

1000 JOBS In California! Immediately available! Information about salary, location, new industries, etc. Send \$1.00 to Personnel Consultants, Box 356-D, Oakland 4, California.

ATTENTION—Construction workers! Latest information, St. Lawrence Seaway \$1.00. Trans-Canada construction opportunities \$1.00. U.S. construction firms operating Canada, Labrador, Newfoundland \$1.00. All three, including application forms, airmailed \$2.25 cash or money-order. Allied Opportunities, Dept. PM2, Box 10, Station B, Hamilton 1, Canada.

FLORIDA Employment. Come to Florida for vacation, work or retirement. Help wanted ads air mailed \$1. Questions answered \$1. Have a job waiting your arrival. Write, Tropical Service, Box 471, Riverside Station, Miami, Florida.

FOREIGN Employment construction work. If interested in foreign projects with high pay write, Foreign Service Bureau, (Dept. PM), Metuchen, New Jersey.

A Real business! House maintenance and repairing. Complete folio shows how \$2. Postpaid. Crusader Enterprises, Fremont, N. H.

MAKE \$10,000 Yearly, public adjusting. Free details. Sterling, Great Neck 16, N. Y.

TYPISTS—Profitable home business. Complete copyrighted information, \$1. Gaunt, 827-B Irving, Chicago 13.

START Your own home mail order business. Beginners instruction booklet 25c. Savaglio, 5646 W. 57th St., Chicago 38, Ill.

ALASKA! Last American frontier. \$1.00 brings 1955 business directory and government map. Military and civilian construction, homestead and highway facts, mining, aviation, fur-farming, grazing, timber, travel directions. Hot list of firms hiring. How-when-where to apply. Alaska Opportunities, Box 92-P, Hollywood 28, Calif.

OVERSEAS, Latin American, Alaska, Canada employment. Originator 1955 "Foreign Service Directory" up-to-minute report on military and civilian construction; oil companies; aviation; transportation; steamship; mining; government job info. How-when-where to apply. Listing firms hiring. \$1.00. Global Reports, Box 833-P, Hollywood 28, Calif.

EVERYBODY Likes candy. Learn to make professionally. Our 44th year. Ragsdale Candies, D6, East Orange, New Jersey.

SECRET Investigation. Experience unnecessary. Investigators particulars free. George Wagoner, 125 M West 86th, New York 24.

HOME Workers needed! Spare time, full time. Assemble luggage and cases with our complete illustrated step-by-step instructions. We sell your product—Supply everything. Manufacturing representative needed in your area immediately. Unlimited profits possible. Investigate at our risk. Free details. Cascraft, 807-G10 Sunset, Los Angeles 13, Calif.

MAKE Flexible molds. Cast figurines, plaques. Free sample. Tooker, 630-M Chestnut, Hamilton, Ohio.

GROW Mushrooms. Cellar, shed, and outdoors. Spare, full time, year round. We pay \$3.50 lb. We paid Babbitt \$4,165 in few weeks. Free book. Washington Mushroom Ind., Dept. 99, 2954 Admiral Way, Seattle, Wash.

FREE Book "505 Odd, Successful Businesses." Work home. Expect something odd! Pacific, Oceanside, Calif.

MAKE New greaseless doughnuts in kitchen. Sell stores. Free recipes. Michael Ray, 3605 South 15th Ave., Minneapolis 7, Minnesota.

RAISE Pheasants on \$100 week plan. Little capital and space can make you independent. Free details. Great Central System, Columbus 20, Kansas.

BE The Popular Mechanics representative in your neighborhood and earn big profits in your spare time. Write Popular Mechanics Magazine, Room 408M, 200 E. Ontario St., Chicago, Ill.

BOOKS, PERIODICALS, PICTURES, POSTCARDS

PICTURE Bible. 320 pages, 160 illustrations; \$5.95. Free literature. Fleisher Enterprises, 343 South, Garwood, N. J.

BOOK Catalogue, 1000 bargains, send 10c. Books Publishers, Amityville 3, N. Y.

"HOW To Live Without Money." Howard. 1772-A Hamburg, Schenectady 4, N. Y.

BOOKS—Government surplus. Free catalog listing fifty other free catalogs on instructional, text and vocational subjects. Three million volumes, new and used. Bargain prices. Long's College Book Co., Dept. PM, Columbus 1, Ohio.

SPARETIME Profits taking subscriptions all magazines. Wholesale catalog free. Cassell Publishers, Westfield, New Jersey.

BOOKFINDING Service. Old and new books. List free. Mail Order Bookstore, 1336-P Southwest Hall, Portland 1, Oregon.

BOOKHUNTERS! All subjects. Send wants! Jaher Book Service, 620-P East 178 Street, New York 57.

FREE Information. Falk's sensational handbook gives instant solutions to 100,000 practical problems. Columbia Graphs, Columbia, Conn.

"SCIENCE Milestones." Records march of science starting 400 years before Christ, right up to date. Amazing facts revealed. 312 pages packed with startling information that will thrill you. A real history of science. \$3.00. Literature free. Popular Mechanics Press, 200-SM East Ontario St., Chicago 11, Ill.

STAG Cartoon booklets! Laughs galore! 24 vest pocket size adult collectors items \$1.00. All different. Free gift with order. Terry Thorne, Dept. PM, Box 8535 Crenshaw Sta., Los Angeles 8, Calif.

BOOKHUNTERS! Scarce, unusual, miscellaneous books supplied. Atlantic Book Service, Cedar Street, Charlestown 29, Massachusetts.

NATIONAL Geographic Magazines. 1888-1952. Periodical Service, Box 465-PM, Wilmington, Delaware.

BOOKS Found! Any author, old or new. Rush titles wanted; no obligation. International Bookfinders, Box 3003-PM, Beverly Hills, California.

BOOKHUNTERS! All subjects. Send wants! College Book Service, 52 W. Kingsbridge Rd., New York 68, N. Y.

FREE: Exciting catalog packed with books covering most everything. Think of it—From cover to cover you will find described and illustrated hundreds of books telling how to fix and how to build almost anything. How to remodel your home; do your own decorating, plumbing, electrical work. Simplified books covering concrete work, carpentry, painting, furniture making and refinishing. How to build your own boat, home workshop tools. Best books on photography, welding, hobbies, homecraft. How to make a home freezer. Send for your free copy now. Popular Mechanics Press, 200-BC East Ontario St., Chicago 11, Ill.

GAMES, TOYS, NOVELTIES

"HE Got Loose!" games are back! Newest release, in color! Original Miami curiosity sensation! Novelty gift game puzzle thriller! For kids eight to eighty! Amaze, amuse, excite your friends, baffle, please, entertain your folks! Learn "He Got Loose!" fast, play quick. Easier than checkers! Looks so simple. Fools so many! Unique chance to be first to spread the fad in your town! Nothing else like it. This is different! Rush \$1, receive 3 game party package postpaid. Lee Games "Fun Special." Postoffice Box 283, Birmingham, Mich.

MAGIC TRICKS, PUZZLES, JOKER NOVELTIES

MAGICIANS Magazine. Trial subscription, 3 months \$1.00. Gen'l, 929 Longwood Ave., Los Angeles 19, Calif.

LEARN Ventriloquism. 3c stamp brings particulars. Smith, 801 Bigelow, Peoria 5, Ill.

VENTRILQUISM Selftaught. My quick, easy instructions, 25c. Ventriloquist, Cal-Allen, Texas.

MAGIC Books, tricks, novelties, wholesale. Information 25c. A. Porsch, Hinton, Iowa.

\$3.00 VALUE Superb magic free! Latest offers and instructive bulletins mailed frequently. Southeast Magic Studio, Box 15-W, Eutawville, S. C.

LEARN Cigarette blowing trick that made Ripley cartoon. \$1.00. Box 117, Omaha, Nebraska.

WORLD'S Greatest puzzle. Baffles! Amazes everyone 25c. Will's, Box 5702, Philadelphia, Penna.

VENTRILQUISM Including set \$1.00. Ward, 624 Clinton St., Brooklyn 31, N. Y.

DOLLAR Magic set free with catalog 25c. 4462-PM Germantown, Philadelphia,

FIFTY Samples, tricks, jokes, novelties \$1.00! Manufacturers, 1746-PM, Philadelphia.

"VENTRILLO," Professional voice throwing instrument and amazing catalog 25c. B-971, Philadelphia 5.

3100 NOVELTIES, Tricks, jokes, gadgets, funmakers, hobbies. Catalog 10c. Johnson-Smith, D833, Detroit 7.

WE Supply every noted magician. Large professional catalog \$1.25. Holden's, 120 Boylston Street, Boston, Mass.

PROFESSIONAL Catalog, 175 pages. 25c. Williams, 900 Plymouth, Ellwood City, Penna.

SENSATIONAL Magician's wand 25c. (Vanishes handkerchief!) Catalog included. Box 1352-PM, Philadelphia 5.

WOODEN Nickel, catalog, trick, 10c. Fun's Magic, 423-P North St. Marys, San Antonio 5, Texas.

BEST Magic, Joker's novelties. Lower prices. Catalog 10c. Top Hat, Evanston 12, Ill.

500 TRICKS, Douglas famous 120-page catalog, only 10c. Fastest service to magicians for 30 years. Send 10c today. Douglas Magicland, Dept. 1, Dallas, Texas.

2500 TRICK Catalogue (512-pages), pocket, parlor, stage. World's finest magic. Catalogue \$2.00 (dollar trick included free). Kanter's, M-1311 Walnut, Philadelphia 7.

COINS, TOKENS, CURRENCY

YOUR Foreign coins are worth money! New 1955 Fell's International Coin Book. Tells how to identify, learn exact value, etc., of every coin ever minted whether or not you know country of origin. Also includes selling, speculating, investment, buying, etc. Clothbound, profusely illustrated. Send no money. Pay postman \$2.50 (plus postage) or send \$2.00 (postpaid) refundable. Fell Publishers, 386M9 4th Ave., New York City 16.

OLD Money wanted. Do you know that coin collectors pay up to \$100.00 for certain U.S. cents? And high premiums for all rare coins? We buy all kinds. Send 4c for large coin folder. May mean much profit to you. Numismatic Co., Dept. 20, Fort Worth, Texas.

FIVE Page bargain list. Five Indian-head cents, 25c. Economy Sales, Box 164, Mansfield, Mass.

FIFTY Indian cents \$2.00, twenty different dates \$1.00. Sayers, 1000 East Unaka, Johnson City, Tennessee.

WRITE For prices of complete 1954-S coinage. Oliver James, P.O. Box 299, San Francisco, California.

12 DIFFERENT "V" nickels, bargain list \$1.00. John Tidwell, 628 West Iris, Nashville 4, Tenn.

40 FOREIGN Coins—\$1.00. Send for list. Valley, Box 66, McAllen, Texas.

SAVE! Bargains—Coins, stamps, Hubers, 210 South Sixth Street, Minneapolis.

FOREIGN Coins, 25 different \$1.00. Webb, 2200 Quintara, San Francisco 16, Calif.

FOREIGN Coins, 10 diff. 30c. Foreign bills, 10 diff. 20c. Lists. Oliver Arnold, Macon, Mo.

\$1,000.00 FOR 1894-S dime. Certain 1913 nickel \$2,000.00. 1901-S quarter \$30.00-\$250.00. Hundreds of others worth \$5.00-\$500.00. Our complete illustrated guarantee buying catalogue 25c. Worthycoin Corporation (D-325), Boston 8, Massachusetts.

APPRAISALS, Certified by expert. Minimum \$1.00. Special collection fees arranged. Numismatic Appraisal Service, Box 456-P, Encino, California.

GET Profit and pleasure in collecting old coins. Send 10c for 56-page illustrated coin catalog. You'll be delighted with it. Send for it now. B. Max Mehl, 370 Mehl Building, Fort Worth, Texas. Largest rare coin establishment in U. S. Established 55 years.

COIN Collector's Magazine. Over 1000 pages per year. Sample copy 30c; \$3.00 per year. Hewitt, 3326-J Milwaukee, Chicago 31.

20 FOREIGN Bills 25c. Lists included. Dwight Musser, Dunbar, West Virginia.

JAPANESE Invasion notes 1c to \$1000.00 set \$1.00. 100pp, illustrated coin catalogue, 25c. Shultz, Salt Lake City 10, Utah.

FREE! Foreign coin, banknote and coin collectors illustrated catalog to approval service applicants. Send 3c postage. Tatham Coinco, Springfield 30, Mass.

INDIAN Cent with bargain lists 10c. Hutchinson, 3463 "I" Street, Philadelphia 34, Penna.

CONFEDERATE And Southern bank notes, 3 different, \$2.00. 50 mixed Indian pennies, \$2.00. Ben's Coin Shop, 31 N. Clark, Chicago 2.

WORLD'S Greatest magazine for coin collector's and wooden nickel 10c. Lawrence Brothers, Anamosa, Iowa.

STAMP COLLECTING

BARGAIN Package offer. Illustrated 4000 space album, packet 200 all different stamps selected to fit album, 2000 hinges, perforation gauge, plus big mixture packet foreign stamps, large illustrated U. S. price list, prize Roosevelt triangle set. All \$1.00 postpaid. Herron, 532 M & M Bldg., Memphis, Tenn.

101 DIFFERENT Worldwide; triangles, commemoratives, pictorials, 10c. Free \$5.00 U.S. stamp. Approvals, V-Ann, G.P.O. 671 M, Brooklyn 1, New York.

SPAIN, 100 Different 10c to approval applicants. 1c approvals. Morrel, 203 Fenimore St., Brooklyn 25, N. Y.

GIVEN! Octagonal stamp; giant triangle; diamond; mammoth and midget stamps, to foreign approval buyers. Gifts with purchases including \$7.00 album. Plymouth, Dept. A-9, Bell, California.

TERRIFIC, Five continents, bicolors, triangles, flowers, animals, commemoratives, 10c approvals. Richardson Stamp Co., Niagara-on-the-Lake 1, Canada.

FINE Approvals. Fast, personal service. What countries do you prefer? I'll send their stamps. Skinner, 438 Locust, Long Beach 12, California.

UNITED States, superb mint sets, famous Americans, authors 60c, poets 95c, educators 75c, scientists 50c, composers 90c, artists 80c, inventors \$1.95. Fine mint U. S. approvals accompany, references required. Merritt Brundige, Cambridge, New York.

FREE 119 Foreign stamps including Africa, Pakistan, China, India, Russia, Scandinavia. Send 10c handling charge. Free stamp magazine. Approvals, Niagara Stamp Company, St. Catharines 11, Ontario, Can.

FREE Complete set of famous Americans, flags, parks and presidentials to approval buyers. Send 5c for 15 of the above stamps plus full particulars. Triboro Stamp Company, 145 Nassau Street, Dept. 102, New York 38, N. Y.

GIGANTIC Collection free. Includes triangles, early United States, animals, commemoratives, British Colonies, high value pictorials, etc. Complete collection plus big illustrated magazine all free. Send 5c for postage. Gray Stamp Company, Dept. PM, Toronto, Canada.

FREE Greatest offer—Croatia Legion set honoring heroes of Russian-German war. Dead country. Also albums, supplies. All to our approval buyers. Bell Stamp Service, S-6, Bell, California.

77 DIFFERENT U.S.—25c. Approvals. Utchits, 1143 D. North Keeler, Chicago 51.

FREE U.S. 72 page catalogue. Contains almost 1000 illustrations; over 10,000 delightful bargains, plus "How to Collect." Stone's, 192 Washington, Boston 8, Mass.

UNMATCHED Offer: 100 different world stamps—20c; 500, 75c; 1000, \$1.50, 25 nudes, \$1.00; 50 birds, \$1.00; 100 pictorials, 75c; 25 triangles, \$1.00; 100 ships, \$1.00; limited supply. Thompson, 906-22 Ave. N.E., Minneapolis, Minn.

OLD Stamps wanted. I will pay \$100.00 each for 1924 green Franklin stamps, rotary perforated eleven (up to \$1000.00 each unused). Send 10c for large illustrated folders showing amazing prices paid for old stamps and coins, Baker-Stamps, (PM-52), Elyria, Ohio.

JAPAN—100 Different. Checkful of commemoratives, high values, pictorials. Exceptional value, just 10c. Appealing approvals accompany. Viking 11-Z Northern Blvd., Great Neck, N. Y.

1000 BEAUTIFUL Mounted stamps for you to look over. Pick and choose at 1c to 5c each! Wolverine Stamp Service, Dept. A-25, Fruitport, Mich.

513 DIFFERENT Worldwide 25c. Jumbo approvals. Charles Streff, 1419 N. American St., Philadelphia 22, Penna.

FIRST U.N. set. Among world's prettiest. Only 10c. Approvals, Welles, Box 1246-R, New York City 8.

FABULOUS Collection—Large U.S. commemoratives. Only 10c. Approvals. Raymax, 39-2 Maiden Lane, New York City 38.

23 BICOLORED British Colonials; catalogue \$1.54, only 25c with approvals. S. Penniston, Norborne, Mo.

U.S. Illustrated price list free. Lush, 6422 Ellsworth, Detroit 38, Mich.

ALBUM! Capacity over 1000 stamps! Only 10c! Stampmart, Hartford 1, Conn.

GAMBLER Collection 25c. No approvals. Merkel Stamps, 45 Cherry, Holyoke, Mass.

50 DIFFERENT British West Indies \$1.00. Anthony Daley, Buckland, Conn.

300 DIFFERENT Given free with approvals. Particulars. Windsor Stamps, 8834 Cornell Ave., Chicago 17.

100 JAPAN 10c. All different, with approvals. Gould's Stamps, Box 631, San Francisco 1, California.

LOOKING For better U.S. approvals? Write, New-Way Stamp, Lawrence, Mass.

BARGAIN United States approvals! Unistate, 730-P No. Lexington, St. Paul 4, Minn.

100 DIFFERENT, British Colonies, 25c. No approvals. Moore Co., Box 1782, Los Angeles 53, Calif.

FREE U.S. illustrated price list. Philatelic House, Rockville Centre, N. Y.

CORONATIONS. 10 Different only 10c with approvals. Seminole Stamps, Box 1138-P, Coral Gables 34, Florida.

FREE 200 Different with approvals. Al Gray, Box 18, Hawthorne, Calif.

20 U.S. Commemoratives, 100 world, 10c. Approvals. Weckerling, Box 442C, La Feria, Texas.

FREE! 25 Different mint China. Approvals. Wright, 6433 Edloe, Houston 5, Texas.

25 U.S. Commemoratives 13c. Segal, 984 Bronx Park South, New York City 60.

FREE! Monaco nude set 3 given new approval applicants, also premium coupon. Mombow, 304M Lynn, East Northport, New York.

60 DIFFERENT British West Indies \$1.00. Rahner, Box 123P, Rome, New York.

99 LATIN American stamps, many pictorials, airm, 10c. Approvals included. Fred Pittsley, South Montgomery, Napa, Calif.

FLOWER Stamps on approval. Apply Loughorn Stamp Shop, 3324 Broadway, Lubbock, Texas.

U.S. mint #948 sheet of two stamps at face, 15c with U.S. or foreign approvals. Ocean Stamps, Box 64-P, Brooklyn 29, New York.

SENSATIONAL! Over 100 different worldwide. Catalog to 25c each. Everything 10c with approvals. Beeman, Box 181, Ingram, Texas.

GERMAN Peace dove set complete 3c. Approvals. George Richie, 1539 Sixth, Alameda, California.

FREE! Rare Ecuador error. Stamp catalogs \$1.50. Given to new approval applicants. Mombow, 304E Lynn, East Northport, New York.

SUPERIOR Worldwide mission mixture. Amazing variety! Half pound \$1.50. Bay Nielsen, 1834B Bayle, Montreal 25, Canada.

FREE! 101 Different, plus unusual Japanese souvenir sheet. Popular pictorial approvals included. Send 10c for mailing. Filand Stamp Co., Box 493, Seattle 11, Washington.

HUNGARY. Aviation diamonds: Migs, gliders, paratroops, given approval buyers. William Deem, Ravenswood, West Virginia.

FREE United States illustrated catalog. Bailey, 44 Bromfield, Boston, Mass.

ATTRACTIVE Penny approvals that satisfy. Rheasme, 6591 11th Ave., Montreal 36, Canada.

CIPEX Souvenir sheet plus 25 different U.S., 10c. Approvals accompany. Village Stamps, 90-39P 214 St., Queens Village 28, N. Y.

100 DIFFERENT France 10c. Approvals. Aronson, 91 Marion, Brookline 46, Mass.

FAROUK—27 Different Egypt only 10c with approvals. Excello Stamp Company, Box 489, Red Bank, N. J.

FREE. 3 Mint San Marino sports plus 30 others. Approvals. Enclose postage. Parkway Stampco, Yonkers, N. Y.

U.S. Approvals, mint, used! Square Deal Teal, 663 Beach, Rochester 12, N. Y.

50 U.S. Commemoratives, old-new, 25c. Lists. Weatherby, Medina, Ohio.

U.S. Mint specials! Flag set, \$1.00; Tipex-CipeX souvenir sheets, 60c. Free price list. Brooks, 2352A East 23rd Street, Brooklyn 29, New York.

ASTONISHING Gift. 40 U.S. with superior approvals. Send 5c for postage. Sparta, Box 1082, Rochester 3, N. Y.

U.S. Commemoratives. 100 mixed 25c. Ray Worth, 321 So. Cicero, Chicago 44.

1,000 DIFFERENT World stamps \$1. Bacon, Box 342, Wellsville, N. Y.

150 DIFFERENT U.S. and foreign stamps 25c. Approvals. Anzac's, 53 Bromfield, Boston 8, Mass.

AIRMAILS 25 Different Central and South American 25c. Hugh Watchorn, Box 310, Middlebury, Vermont.

50 DIFF. Finland. 10c with approvals. Carroll's, W310-A Sprague, Spokane, Wash.

COMPARE! 400 Different worldwide, 25c. Approvals. Farmer, 4913 Rosewood, Los Angeles 4, Calif.

TURKEY—50 Different (worth 50c). Only 10c with approvals! Saxon, Vista, California.

FREE Interesting collection! 100 U.S., British 10c, 555 world \$1.00. Bristol Stamps, Collinsville, Conn.

QUEEN Elizabeth triangles, New Zealand #B22-23 (catalog 45c) only 10c with approvals. Variety Stamps, 57-P Circuit, Newton Highlands 61, Mass.

THREE Beautiful mint new issue sets free to serious collectors desiring good clean approvals, honest prices, prompt service. Wilvanian Stamps, Box 472, Slatersville, R. I.

U.S.—75 Different, 10c. Approvals. Farmer, 4913 Rosewood, Los Angeles 4, Calif.

"SOUTHERN Cross." Brazil's first airmails. Only 30,000 issued. Catalogue value \$5.00. This scarce mint set, seven varieties complete, 25c with approvals. Louis Golden, 6721 Eastwood, Philadelphia 49, Penna.

MINT U.S. plate blocks and bargain lots. Free lists. Philip Mantus, Setauket, N. Y.

WORLD Approvals. From 33,000 collection. Chur, Box 117, Williamsville 21, N. Y.

STAMP Magazine, plus triangle, diamond giant, airmail and commemorative stamps. 10c. Approvals included. Counter's, Box 643-A, Philip, S. D.

PICTURESQUE U. S. first day covers, ten for \$1; blocks \$2. We buy old covers, postcards, stamps. Mitty Stamp Co., 154 Nassau, New York 38, N. Y.

329 DIFFERENT Worldwide stamps 25c, including Hitler heads, British colonies, French colonies, rarities, unusuals. Fascinating story approvals. Canada Stamp Company, 19118 Main St., Niagara Falls, New York.

FREE U.S. stamps, 1943 occupied nations flag, airmails, commemoratives, included in collection of 25 different U.S. plus \$5.00 stamp. Everything for 10c mailing charge. Approvals. Willett Company, Box 511-F, Port Chester, N. Y.

AMAZING Savings: Picture stamps by the thousands. Choose choice ones for pennies. Approvals postpaid both ways. Costs nothing to try us. The Elders, El Venado Dr., Puente, Calif.

ROMAN States set free. Approvals. WBR, Box 758, Wilkes-Barre, Penna.

WANTED—Stamp collections, accumulations, covers. Gold, 62-95P Saunders, Rego Park 74, N. Y.

VALUES! Send 10c. Gets you Austria Mother's Day set worth 35c with exciting approvals. Kingsway Stamps, 263P Kings Highway, Brooklyn, N. Y.

ARMY-Navy unused set 30c. Illustrated price list 10c, deductible on \$1.00 order. Standard, 10840E Woodview, Parma Hts. 30, Ohio.

FREE Sample stamp newspaper, information on collecting, special lists. Approvals. Littleton Stamp Co., Littleton A1, N. H.

325 DIFFERENT Worldwide collection: includes everything. Airmails; complete sets; triangles; bi-colors; birds; flowers; animals. Everything (catalogs over \$5.00) 25c to approval applicants. Century Stamps, Dept. PM, 111 West 94th Street, New York 25, New York.

14,000 DIFFERENT—Yours on our streamlined systematic club plan for only 50c weekly. Big shipment every two weeks. Details free. Sjoquist, Box 217, Valley Stream 75, New York.

WASHINGTON Bicentennial set, used, complete only 15c to applicants for our medium priced United States and Canada approvals. NACO, 682 Pearl, Benton Harbor, Michigan.

FREE 105 British colonials, pictorials, Mauritius, Tanganyika, Pakistan, Nigeria, Rhodesia, Singapore. Fascinating story approvals. Send 10c handling, please. Canada Stamp Company, 19218 Main St., Niagara Falls, New York.

WORLD'S Largest stamp (7½ x 14 inches). A real curiosity! Retail for 50c, only 3c to approval applicants. Tatham Stamp Co., Springfield 30, Mass.

WEIRD Diamond shape coffee stamp! Lovely flower triangle! First American big commemorative, Greenland, idol dancer, etc. Free with approvals. Capital Stamp Co., Little Rock 2, Ark.

UNITED States—58 different including 8 airmails, 15 commemoratives, 10c. Approvals. Sunset, Box 47, South Gate, Calif.

126 DIFFERENT. Includes triangle, diamond, airmails, old United States, British Colonies, animals, others; 10c with approvals. Cactus Stamps, Desert Springs 2, Calif.

U.S. 40 different 10c, 40 different commemoratives 25c. Both 30c. Seidenberg, Appleton, Wis.

100 OLD United States between 1861 and 1935, \$1.00. Roush Stamps, 51 Chestnut, Mansfield, Ohio.

1500 MIXED Foreign stamps \$1.00. No approvals. Aaron, 789 Valencia, San Francisco 10, Calif.

FREE! Big United States catalog. Valuable guide and check list. Hundreds of illustrations. Approvals. Harrisco, 1010 Transit Building, Boston 17, Mass.

100 PICTORIALS. Giant and triangle stamps, 15c with approvals. Bilislands, Box 1101P, Spokane 10, Wash.

12,000 PENNY Approvals waiting for you. Many from exotic countries, pictorials, airmails, new issues. Tilbury, Box 862, Newark 1, New Jersey.

MINT U.S. approvals. Russell Patrick, 3550 East 42nd, Indianapolis 26, Indiana.

125 UNITED States different commemoratives, etc., 25c. C. P. Steger, Steger, Ill.

U.S. commemoratives, 33 different 10c. Approvals. White, 516A Avenue L, Brooklyn 30, N. Y.

MONACO Nudes complete 10c. Approvals. Royal Stamp Company, Tamaqua, Penna.

TRY A selection of our low priced approvals. J & G Stamp Service, 332P East 149 St., Bronx 51, N. Y.

TRIANGLES. Bi-colors and large pictorials. Worldwide on approval! Cole, 43-A Rinevalt, Buffalo 21, N. Y.

POCKET Stock book full of popular stamps. Value \$1.00, only 10c with approvals. Pot-O-Gold Stamps, Litchfield, Conn.

EXCITING New book, "How to Collect Stamps, Coins, Paper Money." Packed with amazing facts; information worth dollars. Fully illustrated, 160 pages, 75c. Popular Mechanics Press, 200-ST E. Ontario St., Chicago 11, Ill.

BARGAIN Hunters attention! Free stamp magazine, 1000 interesting stamps for your approval inspection. Completely catalogued, substantially reduced. Free tongs and hinges with purchase. Niagara Stamp Company, St. Catharines 31, Ontario, Can.

WHOLESALE Price lists for dealers. Progressive, 270G Burkhardt, Cincinnati 15, Ohio.

DIFFERENT. 500, 50c; 1000, \$1.25; 2000, \$2.75; 5000, \$11.00. Approvals. K. S. Holmes, London, Canada.

WONDERFUL Offer. 7 complete mint sets only 10c with approvals. Reich (M26), 1033 Lawrence, Chicago 40.

UNITED Nations cover free to applicants of U.S. or British Colonial approvals. A. Taylor, Skyland, N. C.

FREE U.S. illustrated bargain catalogue. Rothberg's, 53 Bromfield, Boston 8, Mass.

TWO \$5.00 U. S. stamps plus 20 different, 10c with U. S. approvals. Irwin Stamp Co., Box 1105, Brooklyn 30, N. Y.

100 DIFFERENT U. S., 40c with U. S. approvals. Faith, 1319½ Westminster, Alhambra, California.

ECONOMICAL 1/2c-1c-2c-Approvals, 22,000 varieties available. Dresel, Box 270-n, New York 25, N. Y.

50 DIFFERENT Bulgaria 10c! Approvals. Ensign Stamp Company, Dept. M, Berdan Avenue, Paterson 2, New Jersey.

NUDES Set: Colorful approvals 10c. Atlas, 2830-M, Eisenhower, Racine, Wis.

225 STAMPS For only 10c! This mammoth value includes airmails, pictorials; stamps from strange countries cataloguing up to 25c each! Also approvals. Mystic Stamp Company, Camden 30, New York.

50 DIFF. U. S. commemoratives 25c. Mammoth packet list free. Econopackets, Box 168, Riverside 9, Calif.

WOW! 153 All different Germany, 10c. Zeppelins, semi-postals, airmails, high values, big bargain lists and approvals included. Jamestown Stamp, Jamestown 512, New York.

STAMPS Wanted. Mint and used, collections, accumulations, Good grades only. Buy outright if bargain. What have you? Write, give details. Vanroy Shirk, Lebanon, Penna.

300 DIFFERENT. Triangle, airmail, pictorials, etc. 25c. 500 mixed U. S. 25c. Carlton's, Tujunga, Calif.

200 DIFFERENT. Including Roosevelt triangle. 10c to approval applicants. M. Avalon Stamp Company, Springfield, Mass.

50 DIFFERENT Argentine 10c. Approvals. Reuter, 611 W. 49th Pl., Los Angeles 37.

AMAZING Offer! 200 United States stamps—including commemoratives, airmails, high denominations to \$1.00. Only 10c to approval applicants! Illustrated bargain lists free. Mystic Stamp Co., Dept. 80, Camden, New York.

100 DIFFERENT Spain 25c. Penny approvals included. Reed, Box 980, Chicago 90, Ill.

OLD Searee U.S. seconds on approvals. Slight imperfections, lowest prices. Herfield, Clintonhill Sta., Newark 8, N. J.

SPEND Pennies! Not dollars! Thousands of fascinating stamps to choose from our 1c and 2c approvals. No premiums. Just honest value. Pat F. Knowles, Box 2247, Van Nuys, Calif.

50 DIFFERENT United States 5c with bargain approvals, lists, Bookman, Manatee 1, Florida.

U.S. Mint 797 SPA sheet, 10c to U.S. approval applicants. M. Haycock, 153M 74th St., Brooklyn 9, N. Y.

25 FRENCH Colonies 5c; approvals sent. Adlez, 367-M Park Ave., Newark 7, New Jersey.

200 DIFFERENT! Plus Macau, Rhodesia, Mauritius, etc. Only 10c to approval applicants. Eviden, Box 128, Valley Stream 50, New York.

GIANT Approvals, thousands different, 70c each. Wahl's Stamp Exchange, 708P Farragut, Chicago 31, Ill.

FREE Sample! Interesting, illustrated, informative! National Stamp News, Anderson, South Carolina.

ESTONIA Carrier pigeon set free. Approvals, Canyon Stamps, Box 808, San Fernando, California.

FREE—British, Spanish, French Colonial collection, Approvals. Pleasure Stamps, 1865P—52nd, Brooklyn 4, New York.

FREE French West Africa pictorials, approvals. Eagle, 6916 Roosevelt Boulevard, Philadelphia 49, Penna.

ANTIQUES, RELICS, INDIAN GOODS, CURIOS

QWUITschuerrbelluaichen. Crowded for space. Selling 600 historical firearms, 30,000 prehistorical, stone age Indian relics, collectors cartridges, coins, Confederate money, Revolutionary, civil, Indian Wars, flintlocks, muskatoons, revolvers, swords, bayonets, bullet molds, powder flasks, Blunderbusses, pepperboxes, stage coach, Winchester, buffalo carbines, Kentucky rifles, Derringers, frontiers, Arrowheads, tomahawks, gempoints, steer-deer-buffalo horns, eagle feathers, bo-wood, violin wood, mounted pheasants, quail, squirrels, deerheads, owls, Agates, fossils, mineral, Daguerrotypes, gold dollars, duelling pistols. Send 35c for profusely illustrated catalog. Helkes, Wenona, Ill.

4 FINE Arrowheads \$1.00. 6 gem arrowheads \$2.00. List free. Lear's, Glenwood, Arkansas.

UNITED States silver dollars \$1.75 each postpaid. Fred Birch, Box 634, Deer Lodge, Montana.

DARK Africa genuine native handmade ivory ebony carvings. Marvelous gifts. Particulars 25 cent stamp. Vessiere, B.O. 2482, Leopoldville, Belgian Congo.

4 SELECTED Arrowheads \$1.00. List 5c. H. Talburt, Calico Rock, Ark.

PRECIOUS STONES, MINERALS

"GENUINE" Red Arizona rubies (garnets). Send quarter for packet. Bitner's, Box 1025B, Scottsdale, Arizona.

GEMCUTTING. Silvercraft authority. Illustrated magazine tells how. Cut rocks, make jewelry. 150 ads illustrating equipment, offering gems for collectors, cutters. Postal brings literature. Lapidary Journal, Del Mar 2, Calif.

GENUINE Quartz crystal stars. 60 sparkling facets. Drilled for earrings, pendants. 7/8" \$12.00 doz., sample \$1.75. Wholesale jewelry catalog 50c. Diagem Jewels, Hampton Bays 11, New York.

MINERAL Specimens, mineral light, books, Geiger counters. Write, Minerals, Winston, New Mexico.

PETRIFIED Clamshells in rock \$2.00. NatureLore, Box 71, Beaverton, Oregon.

FOOL'S Gold from famous gold camp 25c; nuggets, delicate dendrites, magnetite, uranium 75c. Martin's, Leadville, Colo.

TEN Beautiful highly polished genuine gems. Only \$1.00. Baroque shapes. O'Brien's, 1116-M Wilcox, Hollywood 38, Calif.

GEMSTONES. Mineral specimens. Every variety. Lowest prices. Free booklet. Plummer's, 4720 Point Loma Ave., San Diego 7, Calif.

SAPPHIRE, Topaz, tourmaline, garnet, peridot. 5 uncut gem specimens. \$1.00. O'Brien's, 1116M Wilcox, Hollywood 38, Calif.

HOBBIES AND COLLECTIONS

50 DIFFERENT Army embroidered patches \$1. Other bargains. Insignia Mart, 703A Broadway, New York 3, N. Y.

FREE! Leathercraft catalog. Do it yourself! Tandy Leather, Box 397AH, Tulsa, Okla.

WANTED Old cigarette cards. Write Charles Bray, East Bangor, Penna.

MINIATURE Bible—Postage stamp size, 224 pages, legible. \$1. Auron, 45 School Street, Dorchester 24, Massachusetts.

NAZI Medals, ribbons, souvenirs. Big packet \$1.00. Illustrated lists. Medcrafts, 1923 34th St. S.W., Calgary, Canada.

UNUSED Matchbook covers. 100 different \$1.00. 36 page catalog 25c. Match-cover album \$3.00. Charles Edelman, 1311C East 84, Cleveland 3, Ohio.

INVENTING Can be an interesting and profitable hobby. Write for complete particulars. Institute of American Inventors, Dept. 40-E 631-E St., N.W. Washington 4, D. C.

CAMERAS, PHOTO SUPPLIES

PHOTOGRAPHY For pleasure or profit. Learn at home. Practical basic training. Long established school. Free booklet. American School of Photography, 835 Diversey Parkway, Dept. 3431, Chicago 14.

BUY Wholesale nationally advertised cameras, photo supplies, thousands other products at big discount. Free "Wholesale Plan." American Buyers, 629-RR Linden, Buffalo 16, N. Y.

ROLLEICORD IV. 12.5 Xenar case, spotless, \$111.47. Vito III, f2, new, \$99.75. Free catalogue. 1001 bargains. Dealer's Mart, 54 Beverly Rd., New Rochelle, N. Y.

GOLDE 2x2 Numanumatic projector, 300w blower, \$41.44. Viewlex V-33L projector, 300w blower, \$43.25. TDC Headliner, 200w, \$24.42. SVE Skyline 500, 500w blower, \$57.70. All factory boxed. Free bargain catalogue. Dealer's Mart, 54 Beverly Rd., New Rochelle, N. Y.

BARGAIN Prices on new and used photo supplies. Send 10c for latest catalog. Photoshop, 132A West 32nd St., New York City 1.

OIL Coloring photographs—A fascinating hobby or profitable sideline for those with artistic talent. Learn at home. Easy simplified method. Free booklet. National Photo Coloring School, 835 Diversey Parkway, Dept. 3431, Chicago 14.

20 TO 50% Discount everything photographic, giftware. Free catalogue. Dart, 3812 E. Atlantic Avenue, Brooklyn 24, New York.

FREE! Free! Free! Central Camera Co., photographic headquarters since 1899, saves you money on all photographic equipment. Send for Central Camera Co.'s free photographic bargain list today: Central Camera Co., Dept. 2-B, 230 S. Wabash, Chicago 4, Ill.

CAMERA Repairmen greatly needed! You can learn manufacturers' service methods at home, in your spare time! Free, big illustrated book tells how: Write today. National Camera Repair School, Dept. PM11, Englewood, Colorado.

PHOTO Lampshades, reproducing your cherished photographs. Free brochure. Coast O'Maine Studio, Boothbay Harbor 2, Maine.

BASS Says: Quality cameras since 1910. When in Chicago visit the camera cross roads of the world, or write us for your favorite equipment, new or used. Satisfaction guaranteed. Bass Camera Co., Dept. AG, 179 W. Madison St., Chicago 2, Ill.

DISCOUNTS To 40%—Cameras, projectors, tape recorders, lenses. Write for individual quotations, no catalogs. Classified Camera D, 2375 E. 65 St., Brooklyn, N. Y.

PHOTO FINISHING

PHOTOS Copied. 20 wallet-size deluxe prints \$1.00. Original picture returned. Send any size photo or negative. Federal Wallet-Size Photo Co., Dept. PM-3, P.O. Box 2448, Kansas City 6, Mo. (No c.o.d.'s please.)

24 REGULAR Prints from 12 exposure rolls 29c, with this ad only. Skrudland, River Grove, Ill.

WALLET Photos, double weight silk finish, for gifts, applications, made from any picture of you, your baby, wedding, etc., 20 for \$1. Money back guarantee. Send picture (returned unharmed) and \$1. Delco, Box 362M, Upper Darby, Penna.

JUMBO Prints, 8-exposure roll 30c; 12 exposure, 45c; 16 exposure 55c. Reprints, oversize 4c. Guaranteed quality. Mail Order Photo Service, Box 297, Watertown, Wisconsin.

FREE Roll of film plus money back if not delighted with Delco's oversize prints in albums. Special! 8 or 12 exposure roll 39c with this ad. Delco Film Lab., Box 362M, Upper Darby, Penna.

ENLARGEMENTS! Ten 5x7's \$1.25. Charles R. Casler, Vernon Center, New York.

CANADIANS: Photos copied, 16 wallet-size prints \$1.00. Original picture returned. Send any size picture or negative. Order from Canadian firm, save duty. Columbia Wallet-size Photo Company, P.O. Box 248, New Westminster, B. C. (No c.o.d.'s please.)

SPECIAL Introductory offer. 8 jumbos 25c, 12-35c. Western Photo, PM25, Box 298, San Francisco 1, Calif.

TRIAL Offer—Good with ad only. One roll film developed, 8 exposures 25c, 12 exposures 35c. King sized, dated prints from roll only. Don't send negatives. Sir Walter Photo, Raleigh, N. C.

ENLARGEMENTS! Eight 5x7's or five 8x10's, \$1.00. Wilart Enlargers, Box 967, Little Rock, Ark.

12 EXPOSURE Rolls 39c, jumbo prints. Guaranteed work, one day service. Lincoln Studios, Dept. K, Box 13, Lincoln, Nebraska.

PARTICULAR? Custom finishing guaranteed. 8 jumbos 35c, 12-50c. Special! 35mm. 36 exposures \$1.10. Free mailer. Flash-Photo, Box 36G, Brooklyn 4, N. Y.

GUARANTEED Quality. Fast service. Eight jumbos in beautiful super pak plastic ring binder albums only 35c. Send for free mailers and particulars of our complete photo finishing service. Grand Fotos, G.P.O. Box 1410, New York 1, N. Y.

TOP Quality. Fast service. 8 jumbos 35c in beautiful super pak album, 16 contacts 40c. Reprints—Jumbos 4c; contacts 3c. Satisfaction guaranteed. Write for free mailers and circulars. Fast-X-Photo, Box A, Jersey City, N. J.

6 OR 8 Picture roll 35c. 12 or 16 picture roll 55c. Each roll developed and printed in handy album pack. Send coin with roll. No c.o.d.'s. Mailing containers sent free. Deluxe Film Service, Box 1268-A, Shreveport, Louisiana.

12 JUMBOS From any size roll developed 25c with this ad only. S. Skrudland, Lake Geneva, Wis.

MOTION PICTURES AND SOUND EQUIPMENT

FREE! Blackhawk's fall sale catalog new and used 16mm., 8mm. films, used 16mm. sound projectors, new 2"x2" color slides. Blackhawk Films, 1118 Eastin, Davenport, Iowa.

UNUSUAL Bargains 16mm. sound films. Adair Company, 6900 Roosevelt, Oak Park, Illinois.

8-16MM. Silent-sound films. Latest subjects. Free catalogue. Sample film 10c. Garden Film, 1355 East New York Ave., Brooklyn 12, N. Y.

RECORDING Tape, new, etc., sold below wholesale. Box 1404-A, San Francisco 1.

EARN Up to \$15.00 daily with your movie projector. Metcalf, 10806 Glenroy, Chicago 43.

BARGAINS. Sale, rent, 8-16 silent, sound films, equipment. Trades accepted, bought. Mogull's, 112 W. 48, New York 36.

TAPE Recorders, accessories. Best buys. Boynton Studio, 10 Pennsylvania, Tuckahoe, New York.

16 MM. Sound-used projectors and films. Rental, sale, exchange, bargain prices. Free lists. National Cinema, 71 Dey Street, New York City.

TAPE Recorders, tapes, accessories. Unusual values. Dressner, Box 66M, Peter Stuyvesant Station, New York City 9.

5,000 8-16MM. Silent-sound films. International, 2120 Strauss, Brooklyn 12.

MOVIE Camera film: 8mm. roll \$1.50, 16mm. 100' \$3.00. Free processing. Better Films, 742 New Lots, Brooklyn, N. Y.

8 & 16MM. Professional national parks movies in Kodachrome. 1st 10c Ideal, 4644 W. Geary, San Francisco 18, California.

SAVE 50%! Guaranteed-fresh color. b.&w. movie film! 8mm., 16mm. Free catalog! Eso-R, 47th Holly, Kansas City 12, Missouri.

WILD Animal and bird movies. 8 mm. or 16 mm. beautiful color or b.&w. Also 2x2 color slides. Send for free catalog. Wild Life Films, 5151-A Strohm Ave., N. Hollywood, Calif.

MUSIC AND MUSICAL INSTRUMENTS

WHOLESALE! Complete line musical instruments, phonographs, tape recorders. Send 50c (refundable) for large wholesale musical merchandise catalog. Strauss Music Company, 25-B Lafayette, Paterson, New Jersey.

VIOLINMAKERS. Repairers. Fine tone wood, and all violin supplies. Send for free wholesale price list. International Sales, 414-M E. Baltimore St., Baltimore 2, Md.

PHONOGRAPH Records cheap. Catalogue, Paramount, M-313 East Market, Wilkes-Barre, Penna.

SONGWRITERS: Large recording company may record your song. National sales and promotion if selected. No charge for melodies. Send song material to Music Makers, Dept. E-6, Box 2507, Hollywood, California.

FREE Records of your song. Your words, my melody. Free information. Johnny Mack's Melody Mart, 1094 West 39th Street, Dept. A, Los Angeles 37.

POEMS Wanted for musical setting. Send poem for immediate consideration and free rhyming dictionary. Richard Brothers, 24 Woods Building, Chicago.

ABC Accordion Repair Guide explains hundreds of simplified, authentic repairs. Send \$1 to Alfred Fischer, P.O. Box 402, Bellingham, Washington.

LATEST Music news from Hollywood. Read Music-Of-The-West Magazine (10th big year). Trial 6 month subscription \$1.00. 4900 Marathon Pl., Hollywood 29.

RECORDING Artist wants song poems. Free examination. Send poems. Gregory, 1695 Broadway, New York City 19.

ACCORDIONS: Buy direct from importer—save 50% and more. Five days free trial; lifetime guarantee. Trade-ins accepted. Big color catalog free. Write today. Accordion Manufacturers & Wholesalers Outlet, Dept. 25-M, 2003 West Chicago Ave., Chicago 22, Illinois.

POEMS Needed for new songs. Send poems for free examination, details. Immediate consideration. Songcrafters, 2724 Arcade Station, Nashville, Tenn.

PLAY Piano the first day! Copyrighted secret. Details free. Miracle Method, Box 5203P, Phoenix, Arizona.

ELECTRIC Guitars, amplifiers. Wholesale. Free catalog. Carvin, PM, Baldwin Park, California.

POPULAR Songs. How to write and sell them. Write for free booklet Successful Songwriting. Gateway Songs, Box 2470, Hollywood 28, Calif.

1954 ACCORDIONS—Wholesale. Free catalog. American Accordion Center, PM-3, 5328 Belmont, Chicago.

WANTED! Poems for musical settings. Write Songwriters' Service, Clifton, N. J.

ACCORDIONS. Wholesale to everyone. Save up to 60%. All national known brands. Free catalogue. Del Principe, 29 South Cicero, Chicago 44.

SONGPOEMS Wanted. Mail to: Tin Pan Alley, Inc., 1650 Broadway, New York 19, N. Y.

SONGWRITERS! Protect your ideas! Hold all songs, poems! Write for safe correct procedure first! Song Service, Dept. P, 333 W. 56th St., New York 19, N. Y.

POEMS Wanted for musical setting. Send poems. Free examination. Five Star Music Masters, 630 Beacon Bldg., Boston, Mass.

WRITE Songs. Big money and reputation. Write for information. J. Gordon Pub. Co., 4700 South California Avenue, Chicago.

SONGWRITERS! Send poems, songs. Music Service, 243 West 72nd St., PM, New York 23.

POEMS Wanted for musical setting. Send poems. Free examination. Crown Music Company, 1476 Broadway, New York City 36.

SONGWRITERS—Success, fame, fortune if talented. Songs revised, composed, published, promoted by largest firm. Free appraisal. Since 1943. Postcard to Nordyke Publishing Co., 7070 Hollywood Blvd., Hollywood 28, PM, Calif.

RADIO, TELEVISION AND ELECTRONICS

FREE Radio tester, soldering iron. Build and keep 15 high quality radios—Only \$19.95 complete. No experience required. Enclose 25c for valuable Radio-TV Repair Guide and kit catalog. Progressive Edu-Kits Inc., 497 Union Ave., Dept. PM26, Brooklyn 11, N. Y.

FREE 308 Page 1955 television-radio-electronics catalog! World's largest stocks, lowest prices. Complete supplies for builders, experimenters, amateurs, servicemen. Latest builders' kits, TV, Hi-Fi, photos, records, P.A. Thousands of parts, tubes, test instruments, books, diagrams. Top quality money-saving values. Get your copy now! Allied Radio Corp., 100 N. Western Ave., Dept. 34-B-5, Chicago 80, Ill.

TURN Off blabby commercials from your easy chair. Special gadget with instructions—\$1.00. Tele-Union Products, P.O. Box 29, Cape May, New Jersey.

REPAIR Your TV. Prepared exclusively for you. Plus additional service. Make, model, \$2.00. Personal TV, Box 66A, Little Neck, N. Y.

TAPE Recording, the most helpful, how-to-do-it magazine in the audio field, makes you this special, money-back guarantee offer: If, after reading your first issue, you aren't completely convinced that Tape Recording can help you get better results and greater use from your machine in business, home, church or school, keep the issue and we'll immediately refund your \$2.00 (one year's subscription). You don't risk a penny. Send your \$2.00, cash, check or money order to: Tape Recording Magazine, Severna Park 6, Maryland.

SIMPLIFIED Radio Builder's Handbook plus latest "Electronic Experimenter" issue 25c. Alena, 296 East Broadway, New York City 2.

"DANGER High voltage" metal signs, 3"x12", baked enamel, \$1 ea. Allsigns, 2029-M Bradley, Chicago 12.

WRIST Radio, 400 mile reception while wearing! Build-your-own book, \$1.98. Huckert, Box 7400, Washington 4, D. C.

FCC License training. Beginners get first class commercial operator license in 8 weeks. Residence or correspondence. Grantham School, Dept. 6E, 6064 Hollywood Blvd., Hollywood 28, California.

ARMCHAIR Remote channel changer. Works on most TV sets. \$1.50. Satisfaction guaranteed. TV Tuner, Box 295, Elmhurst, Ill.

15 TESTED One-tube circuits 25c, including "radiobuilder," catalog. Laboratories, 328-C Fuller, Redwood City, Calif.

FREE! Newark's 1955 catalog. Select the fast, easy, dependable way from the new electronics reference book. Full of the latest releases and largest selections of radio, TV, amateur, electronics and high fidelity equipment. Send for your copy now! Newark Electric Co., 223 W. Madison St., Dept. PM-2, Chicago 6, Ill.

REPAIR Your own TV. Instructions compiled exclusively for your set. Simple as replacing light bulb. Send set name, chassis, model number, \$1.95. LS Engineering, Box 4113-PM-2, North Hollywood, Calif.

MAKE Simple, tubeless, batteryless, distance-getting radio. Genuine Melomite crystal, detector, illustrated instructions. 50c postpaid. Allen, 427-PM5, Clinton, Missouri.

TV Trade-in sets. Philco, Emerson, G.E., Admiral, Motorola, Tele-King, others. List available 10"—\$17, 12" to 17"—\$20 up. Washtek Service Co., 1501 Boston Rd., Bronx, N. Y. DA 3-9281.

COLOR Television! Enjoy 3 color screen now. Easily attached. Details free. Zingo Products, Johnstown 77, New York.

BUSINESS OPPORTUNITIES

MAIL Order plan, proved winner, practical, workable, profitable. Send now for copyrighted fact-packed booklet and complete plan, both for only 25c postpaid. Satisfaction guaranteed. Maine Industries, 22 Dartmouth, Bangor, Maine.

BIG Profits in spare time! I'll send assortment full-size samples fine foods, household necessities to ambitious men—women who need money. Friends, neighbors buy eagerly. Send no money. Just write Blair, Dept. 31NB-2, Lynchburg, Va.

DIRECT Factory distributors wanted for well known automotive product. \$1000 inventory turns over fast with 50% profit. Exclusive sales rights. Write Sales Manager, 6329 Wilson Ave., St. Louis 10, Mo.

EARN \$150 Per week! Learn concrete block masonry in 24 weeks. Get catalog. Shaw Trade School, Lomita 3, Calif.

IMPORT-Export opportunity, profitable, world-wide, mail-order business from home, without capital; or travel abroad. Established world trader ships instructions for no-risk examination. Experience unnecessary. Free details. Mellinger E702, Los Angeles 24.

BRUSH Plating outfits connect to a battery, no tanks necessary. Your opportunity to make good income silvering mirrors, plating articles in the shop and home at low cost. Free particulars, Gunmetal Co., Ave. H, Decatur, Illinois.

START Your own business on credit. Your own boss. 1661 of our dealers sold \$5,000 to \$28,500 in 1953. We supply stocks, equipment on credit. 200 home necessities. Sales experience unnecessary. Pleasant profitable business backed by world-wide industry. Write Rawleigh's, Dept. B-U-PPM, Freeport, Ill.

START Home business—Make gold plated costume jewelry. Beginners kit \$1.00. Completed sells for \$3.00. Catalog 25c. Don-Bar Novelty, Dept. E-82, 3511 Armitage, Chicago 47.

BECOME A game warden, or join forestry, park, lookout, wildlife conservation services. Enjoy outdoor work, good pay, real security. Complete information free! Write Home-Study Institute, 3156FY West Eighth, Los Angeles 5, California.

LEARN Sewing machine repair, electrify, trade, sell. How to make big money at home sparetime. New zigzag machines, parts, etc., wholesale. Free details. Taylor Service, Hamilton PM-2, Ohio.

OWN A business without investment! Write for free display. America's finest work uniforms embroidered to advertise. Prospects, profits unlimited. Topps, Dept. 532, Rochester, Indiana.

FREE! Private labels! Exclusive sales! Own a business! Sell radio PL stores, mailorder. We supply product, plan, literature; you furnish executive management and employ salesmen VitaMins, 2908PMA Beverly, Los Angeles 37.

MEN Wanted—Build luggage and cases at home. We sell your products, supply complete instructions, materials, everything. No special equipment needed. Free details. Cascraft, 805-G14 Sunset, Los Angeles 12, Calif.

FREE! "301 Profitable Small Businesses!" Amazing shoestring plans! Work home! Start sparetime! Deumant Surveys. Kenmore 23-R, N. Y.

START A buying service, buy wholesale thousands nationally advertised products. Make big profits selling at stable discounts. Postcard brings details. American Buyers, 627-R Linden, Buffalo, N. Y.

COLOR Concrete with chemicals. Marble-glaze cement benches, pottery. Start home, shop. Hundred beautiful designs: birdbaths to waterfalls. Your chance for fame, fortune. 10c brings sample, pictures. Hollywood Cementcraft, 6527-R Wonderland, Hollywood 46, California.

MAKE 70c Profit on \$1 sales. Make \$2.44 profit on \$3 sales. World's famous French-type perfumes. Begin earning first day. Details free. "Husk" O'Hare, 5732 North Kenmore, Chicago 40, Illinois.

WHOLESALE! 8,000 Nationally famous products. 30-80% discounts! Large catalog. Sensational business plans included. Consolidated Distributors, 21-11 Lafayette, Paterson 15, New Jersey.

BARGAINS—Lists hundreds terrific bankrupt, closeout, merchandise bargains every month. Also sources 100,000 items wholesale. Many 15-25c on retail dollar! 6 issues, \$1.00. Money back if 1st issue unsatisfactory. Bargains, Box 591-DO, Lynn, Mass.

A Big-paying business for a man in his 50's. One of our men makes \$11,000 in a year, other top men in their 50's earn up to \$5,000 to \$9,000 right from the start. We pay earnings in advance. Require no investment. Write confidential letter to Vice President, Dept. PM, Box 676, Dayton 1, Ohio.

FLEXIBLE Rubber molds for plaster and Marbleite figurines. Sample and large illustrated catalog 25c, refunded on first order. K-C Novelties, Dept. 125, Easthampton, Mass.

OPERATE Your own cafe, diner. My guide reveals ways to start on only minor investment. I did it, so can you when you know how. Write Restaurant Arts, BU12, Fremont, Ohio.

MONEY in shear sharpening. Repeat business. Details free. W. Zell, Summitville PM-2, Indiana.

MAILORDER Instruction course. Eliminate mistakes. Ransie, Box 1719-B, Richmond 14, Virginia.

SHINE Cars without polish. New invention. Lightning seller. Cars gleam like mirror. Samples sent on trial. Kristee 109, Akron, Ohio.

MINIATURE Trees. Why pay \$2.00-\$10.00 for growing secrets? Free details. Tiny Trees, 5038 N. Winthrop, Chicago 40.

\$1,000 MONTHLY Possible in collection agency business. Free details. Write Cole Associates, Syracuse 2, N. Y.

I Average \$125 weekly selling books by mail! So can you! Start sparetime! Work home! Cooper, 246-P Taunton, Buffalo, N. Y.

LIQUID Marble—Brushed, sprayed! Mold novelties, tile. Particulars free. Marbleizing Service, Edwardsville, Illinois.

MAKE Perfumes, other products. Sell mailorder. Formula catalogue free. International, 6347 Parnell PM-2, Chicago 21, Illinois.

MAIL Circulars, 100% commission. Free details. Fisher's, Dept. M2, 4750 So. Central, Los Angeles 11, California.

FORTUNES Made raising crickets and fishworms. Write for free information. Carter Farms, Plains, Ga.

TIN-Cans. Turn them into cash. Nine methods. Instructions 50c. Charles Company, 12-DCP, Norwood, Ohio.

TRADE Business, vocational diversion magazines. Late copies. Get-acquainted service. More than 4,300 publications, all fields. Current list free. Commercial Engraving Publishing Company, 34C North Ritter, Indianapolis 19, Indiana.

OPERATE Profitable home mail order business. Details free. Bud E. Hine, Box 93, Battle Creek, Michigan.

NEWSPAPERS. Turn them into cash. Eighteen methods. Instructions 50c. Charles Company, 12-DCR, Norwood, Ohio.

OPERATE "Escalator" mailorder system, selling our products or any products. Most revolutionary mailorder system known. Write: Selbyco, Decatur 153, Ill.

SELL Popular Mechanics and all other magazine subscriptions. Free catalog, supplies. Subscription Service Company, Dept. A, P.O. Box 2070, Birmingham, Alabama.

WRITERS! Authors! Columnists! Get endless supply ideas. Instructions 50c. Charles Company, 12-DCS, Norwood, Ohio.

EARN \$2.00 Hour! I do—making sandals. Youngs, 1308-PM, South First, Arcadia, California.

MAKE Money growing miniature trees on your window sill. Free seed and plan. National Nursery, Dept. FC, Inglewood 4, Calif.

MAKE Strange new plastic, easily. Durable, attractive—101 uses. 800% profit. Exclusive territory. Bays Laboratories, Oklahoma City 9.

SAWDUST. Turn it into cash. Twenty methods. Instructions 50c. Charles Company, 12-DCN, Norwood, Ohio.

FREE Folio "Up to \$45,000; Unlimited Vacations." No merchandise, equipment. Unknown! Work home, sparetime! Haylings, Carlsbad, Calif.

WANTED! Home producers, by manufacturers in our clearing house service. Become subcontractor, casting plastic products for these companies. Thousands of easy-to-make items required for consumer-industrial use. Cash in at home, without previous experience. Plastic Service Associates, Dept. 2-PM, East Boston 28, Mass.

OPPORTUNITY Seekers names. None over 60 days. From advertising in magazines. All seeking ways to make money at home. 500 \$3.00, 1,000 \$8.00 typed on gummed labels. Try 1,000 you will be back for more. Ken-West Distributors, 7-K South Harlem St., Worcester 4, Mass.

OLDSTERS Earn \$30.00 daily. Pleasant inside work. Rexem, 5511 North Avenue, Chicago 39.

CO-PUBLISH "Progressive Mail Trade" Sample and details, dime. Bud E. Hine, Box 93, Battle Creek, Michigan.

\$3.00 TO \$5.00 Per hour. Spare or full time. Electrical appliance repairing. Learn at home. Tremendous opportunity for mechanically inclined men. Details sent free. ATI, 5944 N. Newark, Dept. C11, Chicago 31, Ill.

METALLIZED Baby shoe mountings, supplies, instructions. Foster, 1520 Ardmore, Chicago 26.

PROFITABLE Home business importing unusual gift items. Negligible initial capital needed. Foreign sources supplied. Details free. Itracdo, Columbian Bldg., Washington 1, D. C.

PART Time or full time. Your own business, selling name brands. No inventory required. H. B. Davis Corp., 145-W, W. 15 St., New York City.

FOR Proof of what you can do in specialty manufacturing, get our literature. It's free! Miller, Chemist, 1517-B, Tampa, Florida.

WINNING Mail order plans. Merchandise, books. Details free. Mid-State, Box 214-A, Syracuse 1, N. Y.

YOUR Own jewelry business. Send one dollar for sample kit. Sell for \$2.50. Free catalog. Ebert, Box P183, East Orange, New Jersey.

ANYBODY Can pour candy figurines. New aluminum mold and formula—\$4.95. Candimold, 17 S. 3rd St., Phoenix, Ariz.

MONEY Making Ideas Magazine tells how. Sample 25c. Franklin Publishing, Roanoke 7, Virginia.

\$46 FROM Square foot plywood; jigsaw necessary. Details free. Woodarts, X-38, Bridgewater, Mass.

START Spare-time mailorder business. Gedgard, Box 798-E, New York 1, N. Y.

\$10.00 PER Hour tax accounting. Kennedy Associates, Craft Press Bldg., Chambersburg, Penna.

ADVERTISING Book matches—Cash in on big demand; sell union label matches. Cuts for all businesses and political parties. Free powerhouse selling kit, low prices, protection guaranteed on repeat orders. Cash commissions. Superior Match Co., Dept. MX-255, 7530 Greenwood, Chicago.

PIANO Tuning learned quickly at home. Tremendous field! Be independent. Information free. G. I. approved. Empire School of Piano Tuning, Champaign, Ill.

\$150.00 DAILY In mail possible. Amazing facts free. Clifton's, 105 F. Northeast, Ephrata, Washington.

OWN A mail-order paper products business. Sell envelopes, tags, bags, boxes, wholesale. Tremendous demand. Steady profits. No capital necessary. Omaha Envelope Service, Dept. 30, 4721 California, Omaha 3, Neb.

START Profitable wholesale lumber, wood products business. Sell by mail. No investment. Chas. Webster, Guttenberg, Iowa.

\$70 WEEKLY Home, spare time. Simplified mail bookkeeping. Immediate income, easy! Success revealing information. Auditax, 34651AG, Los Angeles 34.

\$150 WEEK—Easy! Start home Venetian blind laundry. Revealing book free. AT Co., 101 S. 44th, Philadelphia 4, Penna.

BUY Radios, watches, appliances at wholesale prices. Rush 50c for catalog to Edward Clemens, 318 West Bridge St., Morrisville, Penna.

FREE Electroplating information. Money making plans. (Formula included). Send postcard for your copy. Highly paid, interesting, uncrowded field. Plater D. Hyde, 327 West 120th Street, Los Angeles 61, California.

OWN, Operate, route Wishing Wells. Place these new \$8.50 skill games on counters in cafes, luncheonettes, clubs, etc. Collect coins weekly. Write, Legalsharr, Box 929, Long Beach 1, California.

GROW Herbs and spices at home (many rare and unusual). Make 101 useful and salable products. Big profit orders come from neighbors, gift shops, restaurants, etc. Also mail orders. Window box supplies household needs. Successful home grower shows you how. Free, full details. Herb Center, 601-P, So. Vermont Ave., Los Angeles 5, Calif.

BUDGET Your wholesale costs, 1000s of personal and household items. Tremendous discounts. Catalog and budget club plan. Send \$1.00 no risk deposit, refundable on 1st order. Join today. Cooperative, Box 1296, Eustis, Florida.

BUILD Your own mail order business. Copyrighted booklet tells how. Over 30 years experience. Only 25c postpaid. The Gerwigs, 366 South Huron, Columbus 4, Ohio.

REVOLUTIONARY New product. Amazing result producing sales plan. Thousand dollars monthly after first month is common. Not sold in stores. Details. Hartmann, Southold, L. I., N. Y.

GROW Orchids at home—Profitable, fascinating. Year round, Maine to California. No greenhouse. Gorgeous cattleyas, cymbidiums, etc. Successful home grower shows you how. Full details free. Flowerland, 4623-PL Wilshire, Los Angeles 5.

FISHWORM Breeder's book—\$1.00 postpaid. Literature free. Dixdok, Kent, Ohio.

HANDY Men in small towns! Assemble and sell the finest three channel aluminum combination storm window. Work full or part time. Your cost, 1/3 of retail price. \$100 starts you in business. Write for details. No obligation. All-Time Mfg. Co., Dept. PM, New Britain, Conn.

MAKE Big money at home! Invisible weaving pays up to \$10.00 profit in an hour. Make tears, holes disappear from fabrics. Constant demand from laundries, cleaners, homes, brings steady earnings. Details free. Fabricon, Dept. AE, 8342 S. Prairie, Chicago 19, Illinois.

OPERATE Mailorder. Inexpensive manual shows how. Free details. Bureau, Box 596, Toronto, Canada.

GROW Expensive herbs for us! Big profit home-business of your own. Year around profitability! We supply everything necessary! Send for free rare seeds and revealing plan. National Herb Exchange, Box 304-H, Gardena, California.

START Your own business at home. Sell subscriptions for popular magazines. Liberal commissions. Send for supplies, etc. DeSales Magazine Service, 60 East 42nd St., New York 17, N. Y.

CELESTIAL Clock. Amazing science toy tells time by stars. 3 sample clocks, \$1.00 prepaid. Corn Weather Control, P.O. Box 8992, Fort Worth 7, Texas.

FREE Information about world's best mailorder guide. Mailtest, P.O. Box 2, Little River Sta., Miami 38, Florida.

URANIUM Prospecting and mining. Send \$5 for maps, guides, etc., showing what to look for and where. Complete information. Samples available on request. International School of Uranium, P.O. Box 324, Millbrae, California.

MAKE Money! Start a mailorder business. Copyrighted instructions \$1.00. Money-making Home Enterprises, 817-D Park S.W., Canton, Ohio.

MAIL Cards, circulars for advertisers. Siegel, Box 183, Knickerbocker, New York City 2.

MAKE Money at home. Mail letters featuring select merchandise. Get \$10. orders in every mail. 100% profit. Everything furnished. Write: Nu-Way Enterprises, Box 747, Detroit 31, Michigan., Div-M.

PACKAGE Bulk merchandise at home. We supply everything. No selling, ready market. Free details. Commercial Packers, 4021 Marathon, Los Angeles 29.

DOLLARS In personalized baby record books. Sell by mail. Eleven thousand new prospects daily. Use same literature we do. No-Co-Ro, Oakland 6, California.

MONEY In sparetime fixit shop at home. Repeat cash business. Experience unnecessary. No selling. Free booklet explains. Victor Foley Company, Columbia Heights, Minnesota.

BOOKKEEPERS. Increase earnings operating sensational bookkeeping service. Kern, 5632 Lankershim, North Hollywood, California.

MAKE Money at home as renewal headquarters for all magazines. Liberal commissions. No experience — no capital needed. Supplies furnished. Write for free catalog. McGregor Magazine Agency, Dept. 500B, Mount Morris, Ill.

PRINT Without a printing press! Amazing new method! Print colorful signs, banners, cards, posters, glasswear; anything at home. Big profits. Money-making opportunity! We supply everything. Beautiful sample, home-business plan free! Write Screen-Print Company, Los Angeles 61, California.

WE Love our mailman—He leaves over \$1000.00 monthly in our rural mailbox. My college professor husband drafted a scientific home mailorder method. We bought a Texas ranch, live as we always wanted. Now we sell the Ranch Mailorder Method. Operates anywhere. Inquire: Eveningshade Ranch, Helotes, Texas.

EXPORT Business made easy! Substantial income, home operated, low overhead, no merchandise buying. Complete setup service. Hermes Exports, 152 West 42, New York 18.

INVESTIGATE Earthworm breeding! Pleasant, profitable home industry! Part-time! Full time! Free revealing facts, information! Write Earthmaster System, 45D, El Monte, Calif.

UNUSUAL Home mailorder business. Fascinating, clean, profitable. Ready to operate. Angora House, PM2, Springfield, Illinois.

BUY Wholesale. Thousands items. Start home mailorder business. Literature free. Russell, Box 481, Roseburg, Ore.

BE Listed! Receive latest-best low-cost starting book-merchandise mail selling offers. National, Box 88A, Dorchester 22, Mass.

POPCORN And potato chip equipment. Eakins, Box 933-A5, Springfield, Ohio.

FOR The best mail order deal in America write Modern Enterprises, Cynthia, Kentucky.

EXTRA Income. Do leathercraft easy way. Free information. Tandy Leather Company, Box 791-Q8, Fort Worth, Texas.

PARTNERSHIPS. How to start. Withdraw. Oust undesirable partner. Particulars free. Reynard, Box 1265-A, Peoria, Ill.

LIQUID Rubber. Make flexible molds. Free sample. Chaney, 1130 E. 16th St., Jacksonville 6, Fla.

MEN—Income from local information. No selling. Neherco, LaVerne, California.

RUBBER Molds for casting plaques, figurines, novelties. Catalog illustrating over 100 fast sellers, 10c. Castcraft Studios, 308-PM Marion Street, Brooklyn 33, N. Y.

BUY Wholesale thousands items. Lists free. Triple J, Industries, 132 Berkshire, Bridgeport 8, Conn.

NEWEST Spare, full-time home business. \$5 to \$10 hour possible. Paint with suede. The finish with touch and eye-appeal. Beautiful auto dashboards, signs, radios, toys, figurines, lamps—1001 others. Complete, step-by-step instructions sent for no-risk examination. Free details. Coast, Los Angeles 61.

START Home manufacturing business. Make cleaners, soaps, polishes, cosmetics. Free literature. Kemix, Park Ridge, Ill.

IMPORT-Export mailorder opportunities! Details. Warner, Box 6, Fort Scott, Kansas.

FREE Wholesale kit guarantees you 33% to 60% profit on cameras, appliances, typewriters, etc. Arrow Distributing, 154F Nassau St., New York 38.

MAKE Flexible molds. Cast figurines, plaques. Free sample. Tooker, 630-R Chestnut, Hamilton, Ohio.

NEW-Different home business opportunity! Address-mail literature featuring real merchandise. Everything furnished. Mills, 1752-A, Garden Ave., Lorain, Ohio.

METALIZE Baby shoes, jewelry, gifts. Bronze, gold, silver. Free bulletin. Kiktavi, 7217-PY South Broadway, Los Angeles 3.

HAVE Home business mailing postcards offering real merchandise. Big earnings. Write: Mednis, 10 Port Norfolk, Boston 22, Massachusetts.

NATURAL Molding rubber, extra thick. Free sample. Flock, W. Wooley, 115-A Donald, Peoria, Ill.

ELECTROPLATE Auto parts, novelties, mirrors, baby shoes. Easy, inexpensive home processes. Free booklet. Tyco Metals, Box 13231-MM, Houston 19, Texas.

BOOKKEEPERS. Keep books, small firms spare time. Manual latest technique by C.P.A., \$3.00. Modern Business, Box 406, Youngstown 1, Ohio.

MAKE Money at home—Mail cards, circulars feature real merchandise. Everything furnished. Big earnings. Philip's, Box 3-P, Boston 22, Mass.

RECAST Old batteries into new. Latest achievements. Battery Laboratories, Minneapolis.

MAKE Rubber stamps, repair dolls; learn silk screen printing. Catalogue (60 ideas) free. Universal, Box 1076-A, Peoria, Ill.

TO \$40.00 Weekly. Sparetime, home operated mailorder business. Successful beginner's plan. Everything supplied. Lynn, 10420-M National, Los Angeles 34, Calif.

COPUBLISH Mail Sale Advertiser, leading mail order paper. Details, latest copy, dime. Vanroy Shirk, Lebanon, Penna.

SCHEMER Magazine. Canfield 1, Ohio, monthly mailorder ideas, plans. Year \$1.00. Sample 20c.

PLASTERCRAFT Molds, liquid rubber, plasters, floccs, candle supplies. Catalog and manual free. Blue Rapids Supply, Blue Rapids, Kansas.

BUY It wholesale! Manufacturers, distributors offer 850,000 items. Literature free. Olsen, 1231-A East Third St., Duluth 5, Minn.

\$25 WEEKLY Working two hours daily at home. Lycke, Box 2471-A, Cleveland 12, Ohio.

GROW Mushrooms. Cellar, shed, and outdoors. Spare, full time, year round. We pay \$3.50 lb. We paid Babbitt \$4,165.00 in few weeks. Free book. Washington Mushroom Ind., Dept. 172, 2954 Admiral Way, Seattle, Washington.

BREED Rare tropical fish at home. Earn big money! Learn secrets! Help fill huge demand. Amazing opportunity! Free plan. Tropicals, 1008-F Los Angeles St., Los Angeles 15.

RESILVERING Mirrors, formula 50c; two-way lookout mirrors. (No one sees you), 50c; coppered mirrors, 50c. All \$1.00. Nelko-Mir, Box 3463-J, Chicago 34.

MAKE Money spare or full time, casting metal toys and novelties. Big wholesale and chain store demand for autos, soldiers, ashtrays, banks, etc., keeps manufacturers busy. Production moulds furnished for up to 100 and more castings per hour. No experience or special place necessary. Write for information and illustrations of patterns needed. Metal Cast Products Co., Dept. A, 1696 Boston Road, New York 60, N. Y.

OPERATE Profitable mail order business. Write Walter Service, 4159-A East 112th, Cleveland 5, Ohio.

MINK Raising information free. Complete. Lake Superior Mink Farm, Superior, E.E1, Wisconsin.

COLORGLAZED Concrete pottery made without molds. Patented method. Cemetery products, novelties, tiles. Basement leak-sealing. Money-making projects. Booklet, details free. Men only. National Potteries Company, Grand Rapids, Minnesota.

FREE Book "505 Odd, Successful Business" Work home. Expect something odd! Pacific, Oceanside, Calif.

FIX Typewriters. Free booklet describes our modern, inexpensive home-study course. Factory methods taught. Write Typewriter, Building 1, Tarentum, Penna.

BUY Wholesale thousands items. Lists free. Cottage Industries, Omaha 12, Nebr.

MONEY In new greaseless doughnuts. Start in kitchen. No smoke. Sell stores. Free recipes. M. Ray Company, 3605 South 15th Ave., Minneapolis 7, Minn.

BRONZED Baby shoe supplies, instructions, mountings. Metal bookends, \$1.50 pair. Free catalog. National Bronze Supply, Box 56, Los Angeles 32, Calif.

MAILORDER Home business! Details stamp. Shirley, 20-Raspeburg, Baltimore 6, Maryland.

VENDING Machines—No selling. Operate a route of coin machines and earn amazing profits. 32-page catalog free. Parkway Machine Corporation, Dept. 72, 715 Esser St., Baltimore 2, Md.

BRONZE Baby shoes, Instructions, equipment and mountings for genuine electroplated process. Free catalog. Hollywood Bronze Supply, Dept. B-3, 1624 East First Street, Los Angeles 33, Calif.

NEW Exceptionally profitable plans. Ideas for home operated mail business. Rush name. Miller, 1881-P Roxbury Road, East Cleveland 12, Ohio.

START Venetian blind laundry, patented machine. Free information. Jet Company, 522 N. Rural, Indianapolis 1, Indiana.

INFORMATION Worth dollars. Free details. Wolfe, 8106 So. Park Ave., Chicago 19.

MAILORDER—Operate profitable home business using free advertising method. Revealing information free. Seidel, 6000-HF Sunset, Los Angeles 28.

MONEYMAKING OPPORTUNITIES

"HOW To Make Money With Simple Cartoons"—A book everyone who likes to draw should have. It is free; no obligation. Simply address Cartoonists' Exchange, Dept. 92-CM, Pleasant Hill, Ohio.

FREE! "301 Profitable Small Business" Amazing shoestring plans! Work home! Start sparetime. Deumant Surveys, Kenmore 23-R, N. Y.

COST Of things going up faster than your income? You can make more full or part time as a Rawleigh dealer. Write for full particulars. Rawleigh's, Dept. B-RR-PPM, Freeport, Ill.

FREE! Leathercraft catalog. Do it yourself! Tandy Leather, Box 397AM, Tulsa, Okla.

NEW "x11" Ultra-blue signs. 7c, retail 50c. Sample free! Lowy, 812 Broadway, Dept. 842, New York 3.

HOMEWORKERS Profitability packet 10c. O'Dell's, 33401 So. 6th St. Road, Springfield, Illinois.

OPERATE Cafe, diner, Guide reveals easy way to start on "peanuts" invested. Write Restaurant Arts, MO12, Fremont, Ohio.

START Own mail business. Limited offer. Write, Rockaway-Hall, Rockaway 4, Oregon.

LITERATURE Explaining scores of profitable opportunities, 25c. Rebill, Manitowoc, Wisconsin.

WHOLESALE! 8,000 Nationally famous products. 30-80% discounts! Large catalog. Sensational business plans included. Consolidated Distributors, 21-12 Lafayette, Paterson 15, New Jersey.

LEARN Technical metaphysics and insure your future. Easy, inexpensive correspondence course. Simplest method known. Diploma. Write: Premier College of Technical Metaphysics, 2532 McKenzie St., Vancouver, B. C., Canada.

FREE Particulars. Many profitable money-making opportunities. Kosiol's, 3545 Maryland Gary, Indiana.

START A buying service, buy wholesale thousands nationally advertised products. Make big profits selling at sizable discounts. Postcard brings details. American Buyers, 630-R Linden, Buffalo, N. Y.

FREE Booklet "Money Making Facts" tells mechanically inclined men how to start sparetime business at home. V. Foley Company, Columbia Heights, Minnesota.

ACME Saw sharpeners are the finest you can own. Don't be satisfied with less. Send for free literature. Max Mfg. Co., 138 Stockton Ave., San Jose 26, California.

ELEVEN Exceptionally profitable mail-order plans. Hamilton, Box 288-MC, Marietta, Ohio.

\$200 MONTHLY Possible raising earth-worms! Backyard garage, basement. Complete illustrated booklet explains raising, feeding, packing, marketing. 25c postpaid! Ozark Worm Farm-J, Willow Springs, Missouri.

INCREASE Your income, turn your spare time into cash—Making quick-selling, highly profitable lamps and fiber glass shades. Every home a prospect for one or more. Hundreds already doing it, so can you. No experience needed. No special tools required. Gearon's big, new 72 page 1955 illustrated Catalog No. 8 will show you how, quickly. One special 8-page section shows 6 beautiful lamps in kit form, ready for you to assemble. Another 12-page section shows you how to make stunning, ultra-modern fiber glass shades. Page after page filled with wide variety of other attractive shades, shade frames, figurines, and lamp bases. Also oil lamp converters, boring compound, and all kinds of cords, sockets, pipes, harps, finials, bases, and hundreds of other parts. Everything you need. And you can buy everything wholesale, sell at retail, make big profits, fast. Send only 25c right now for Gearon's big 1955 catalog and wholesale price list. Like hundreds of others, you'll be glad you did. Gearon Co., Dept. 503-B2, 27 S. Desplaines, Chicago 6, Ill.

FREE Folio "Up to \$45,000; Unlimited Vacations." No merchandise, equipment. Unknown! Work home, sparetime! Haylings, Carlsbad, Calif.

\$100 WEEK Sparetime; different, proven, successful plan. Herco, 319-B Sea Street, Quincy 69, Mass.

OUR Book "Home Factory" tells how to make and sell 101 products used daily. Tells where to buy materials wholesale. 50c. Ken-West Distributors, 7-K South Harlem St., Worcester 4, Mass.

MAKE Money, address and mail new self-selling catalog; we fill orders. Send 25 cents for sample and complete details. Lombard, 296 West 5th, South Boston 27, Mass.

SELL Religious mottoes. Send no money. We trust you. Crystalglo, Sidney, Ohio.

MEXICO Imports wholesale. Tooled handbags, painted skirts. Free souvenir coin, details. Frontier, 2909 Pershing, El Paso, Texas.

OPPORTUNITY Package! Mail dealers propositions, home businesses, sensational offers. 25c. Steinberger Press, 1274-L Stebbins, New York City 59.

WANT Success? "Magic Key" gets amazing results! Details free. Litho Publishing Company, 1627 Belmont, Seattle 22, Wash.

MONEY By mail, selling retail merchandise. Cooperative plan, details free. Atlantic Publications, Box 1103, Riverdale, Md.

JIGSAW Bandsaw owners, let your machine bring extra profits, fun. Free details. Nu-Art, Box 2235, Boston, Mass.

I can teach you how to direct money-raising campaigns for churches, hospitals, institutions. Earned \$3065 in six weeks on my first campaign. Started spare time on less than \$50. Two months low cost course backed by thirty years experience. Unlimited field. William Arbogast, 229 East Mason Avenue, Alexandria, Virginia.

"**MONEY** Getter's Bulletin." Six issues \$1. Sample 25c. Carpenter Company-PM, Tulsa 16, Okla.

FASCINATING, Profitable, sparetime home enterprises. Details 25c (refundable). Bowles, W-12, Brockway, Ore.

WORKING At home brings important money. Free details. Columbia, 1249 Ferguson, Newport News, Virginia.

FREE Formula illustrates how independence with fantastic profits can be yours for shoestring investment. Independence, 819 Dufferin, London, Ontario, Canada.

FOREIGN Employment construction work. If interested in foreign projects with high pay write. Foreign Service Bureau, Dept. PM, Metuchen, New Jersey.

BOOKS! Novelties! money making opportunities! Free lists! 101 Hedden Ter., Newark 8, N. J. Flenie Thompson.

FORTUNE Positively offers wealth and power to any man with sufficient courage and tenacity to employ the same simple method that actually produced every single one of the world's great fortunes. Your acceptance of this real challenge could be your life's upward turning point. "Beckoning Fortune" tells you how. \$2.00 postpaid. Phillips Company, Box 6817, Towson 4, Md.

MEXICAN Featherbird pictures. Enormous profits. Sample picture 25c. Mexican Importing, Northern Pacific 1190, Albany, Oregon.

MAGIC Money independence and security guaranteed for you at home. Send postal for full information. Granite Traders, Wolfeboro, New Hampshire.

SPARETIME Profits taking subscriptions all magazines. Wholesale catalog free. Caswell Publishers, Westfield, New Jersey.

EARTHWORMS: Raise for profit, bait. El Sobrante Earthworm Farm, 749 Rincon, El Sobrante 11, California.

MAKE To \$4.50 hour doing common pen lettering. National Artists, 801 1/2-A North Marsalis, Dallas 3, Texas.

EARN \$50.00 Daily making mats, shoes and mud guards from old tires. S and S Patents Inc., 1307 North Clark St., Chicago 10, Ill.

15 MILLION Dollars paid in '53 for suggestions! If your company has a system you can earn regularly. It's easy! Send \$1.00 for booklet, "Dollars for Ideas" and year's membership, in Suggesters Club, Box 227, Harvey, Ill.

PROFIT! Prestige! Publish a magazine under your own name! Only \$3 per month! Sample, details 3c! Filmer, 910 Marion, Pharr 22, Texas.

RECEIVE Latest book selling and money-making opportunities. Write: Tradewinds, Box 8238, Chattanooga, Tennessee.

EARN At home. Several ideas to choose from. No mail order. No selling. Folder free. Todaro, 433-A Motheral, Monessen, Penna.

ATTENTION: Typewriter owners. Make handsome profits. Write today. Groves Company, 682, Hastings 2, Nebraska.

GENERAL Contest Bulletin. Issued monthly. Sample, 25c. 1609 1/2 East 5th, Duluth, Minn.

GROW Mushrooms. Cellar, shed, and outdoors. Spare, full time, year round. We pay \$3.50 lb. We paid Babbitt \$4,165.00 in few weeks. Free book. Washington Mushroom Ind., Dept. 173, 2954 Admiral Way, Seattle, Washington.

50,000 ARTICLES Wholesale. Source directory, dime. Nelko, Box 3462-DR, Chicago 54.

READ Progressive Mailtrade, the magazine that tells how to make money by mail. Dime brings sample and special offer. Progressive Mailtrade, Box 357, Sheboygan, Wisconsin.

WINNING Prize contests is fabulous, confidential, home opportunity! Send stamp! National Contest Bulletin, Box 2685-P, Miami 16, Florida.

FREE Book "505 Odd, Successful Businesses." Work home. Expect something odd! Pacific, Oceanside, Calif.

BUILD Sales by recruiting productive distributors selling direct or to retail outlets. Secure most concentrated circulation through classified columns of Salesman's Opportunity. Write for facts, Gilbert, Salesman's Opportunity, Room 1700, 28 East Jackson, Chicago 4.

SELL—Buy Titania gems. More brilliant than diamonds. \$9.75 carat wholesale. Free catalogue. Diamonite, 1404-M Mitchell, Oakland 1, California.

SCHOOL Seniors—Sell classmates America's most beautiful graduation name cards. Largest selection. Highest commission. Outsell all others. Free sample kit. Printcraft, Dept. M, 1509 Maple Street, Scranton 5, Penna.

FORMULAS. PLANS, ETC.

NEW Formulas, free literature. Dr. Hertzstein, 511 Thomas, Grand Rapids, Mich.

FREE Formula catalog. Anything analyzed \$35.00. Western Chemical, Salem, Oregon.

FORMULAS, 10,000 for \$5.00. Authentic, reliable, practical. Brockway, 1145 High, Topeka 1, Kansas.

FOR Proof of what you can do in specialty manufacturing get our literature. It's free! Miller, Chemist, 1517-P, Tampa, Florida.

ANY Formula \$3.00. Catalog—Mfg. Treatise 10c. J. Belfort, 193 N. Clark, Chicago 1.

FORMULAS: All kinds. Latest, best. Literature free. Kemikal, Park Ridge, Ill.

REAL Manufacturing formulas. Lists free. Cummings, Chemist, Gordon Ave., Syracuse 4, N. Y.

PRODUCT Analysis, manufacturing formulas, processes developed. Moderate fees. Plastics, Box 1574, Boston 4, Mass.

PLASTICS

LEARN Plastics at home. Complete kit—\$5.98 postpaid. Dime brings sample plastic, three experiments, full details. Plastic Projects, Box 5151, Detroit 35, Mich.

PLASTICS Home-craft course for men and women. Tells and shows how to make hundreds of fast selling plastics products. All plastics and materials for 23 projects included in course. No special tools needed. Course pays for itself. Write for free booklet. Interstate Training Service, Dept. D-3-B, Portland 13, Oregon.

NEW Liquid casting plastic. Clear, colors. Embed flowers, insects, coins. Saw, drill, carve. Send 25c for "How to Cast With Liquid Plastic" and proved success plan showing how to make money at home. Castolite, Dept. B-101, Woodstock, Illinois.

MONEY Galore making signs, desk signs, door plates and etc., using our plastic letters and accessories. Send name and \$1.00 for beautiful sample desk sign and information. Micro Sign Products, 2909 Santa Monica Blvd., Santa Monica, Calif.

PLEXIGLAS, Fiberglass, polyester, acetate, vinylite. Fast service. Wholesale-retail. Catalog 15c. Gem-O-Lite, Box 686P, North Hollywood, California.

PLEXIGLAS, Lucite. Square foot cost, 1/16", \$1.10; 3/16", \$1.45; 3/16", \$1.75; 1/4", \$2.15; 5/16", \$3.28; 1/2", \$4.38. Colors, add 10%. Send 15c for postage. Aristocrat Plastics, Inc., 35 Clarkson St., New York City.

PLASTICS, All types. Plexiglas, vinyl, acetate, teflon, nylon, polyethylene. Rods, sheets, tubing, film. Send 25c for complete catalogue and prices. Direct factory distributor. Delta Products, 1400 Henderson, Fort Worth, Texas.

PLASTIC, Sheets, rods, tubes, etc. Free list. Plastic Supply Co., 2901 N. Grand Blvd., St. Louis 7, Mo.

PLEXIGLAS, Lucite sq. ft. (12"x12") cost 1/16" \$1.14, 1/8" \$1.50, 3/16" \$1.85, 1/4" \$2.20. Add 10% for postage. Almac Plastics, 600 Broadway, New York 12, N. Y.

PLEXIGLAS Sheets—Cut to size. Clear. All thicknesses. Standard outdoor translucent colors. McClarin Plastics, P.O. Box 168H, Hanover, Penna.

MONEYMAKING Liquid casting plastic. Complete kit \$3.00. Handbook only 50c. Kemnitz Corporation, 2755 N. 5, Milwaukee 12, Wisconsin.

CHEMISTRY

SPECTROSCOPE For quick chemical analysis \$3.00. Kutting Sons, Los Altos, Calif.

GEIGER Counters, especially designed for college, high school or home laboratory use. Complete with manual of experiments, \$139.95. Atomic Laboratories, Box 343, Berkeley, California.

CHEMICALS, Supplies. Catalog 20c. Laboratory Sales, Box 161-A, Brighton, Mass.

NEW Idea chemical and apparatus outfits for home experimenting, photo-scales, microscopes, chemicals, biologicals and laboratory supplies in small quantities. Catalog 25c. Established 1931. John H. Winn, 124A West 23rd St., New York, N. Y.

CHEMICALS And apparatus for industrial, analytical, and private laboratories. Catalog 25c. Dept. M-50, Biological Supply Co., 1176 Mt. Hope Ave., Rochester 20, N. Y.

ILLUSTRATED Catalog: Chemistry, mineralogy, biology 20c. Tracey Laboratories, Evanston, Illinois.

AGENTS WANTED

FREE Box of all occasion greeting cards just for sending your name and address. Permit us to tell how you too can make big money during your spare time showing friends, neighbors Elmira's sparkling line of all occasion greeting cards. No obligation to buy. To receive your gift box with details and samples on approval, send post card today to Elmira Greeting Card Co., Dept. 198, Elmira, N. Y.

NEED More money to live on? Increase your weekly income \$20 to \$25 or more in spare time. Supply Rawleigh products to consumers. Also openings for full time dealers. Write Rawleigh's, Dept. B-DD-PPM, Freeport, Ill.

MEN, Women, make money spare time plus new car as bonus for encouragement. Amazing hosiery guaranteed to wear without holes, snags, and runs, or replaced free. For example, lovely 60 gauge nylons guaranteed for as long as 1 1/2 years, or replaced free. Write Wilknit, 1752 Washington, Greenfield, Ohio.

AT Last! Something new and sensational in everyday cards, 21 for \$1. Make extra money fast! Show satin, velour, metallic cards. Get orders easy. Big line \$1 assortments, scented stationery, personalized napkins, gift items. Imprints free. Several \$1 boxes on approval. Pure Co., 2901 Locust, Dept. 540-B, St. Louis 3, Mo.

RUN A spare-time greeting card and gift shop at home. Show friends samples of our new 1955 all-occasion greeting cards and gifts. Take their orders and earn up to 100% profit. No experience necessary. Costs nothing to try. Write today for samples on approval. Regal Greetings, Dept. 112, Ferndale, Michigan.

MAKE Big money selling Sunshine's exclusive everyday cards. Nationally famous assortment sells on sight for \$1.00. Many others. Beautiful stationery, gift wraps, novelties, deluxe 21 card assortment, etc. Send postcard today for sample kit on approval. Sunshine Art Studios, Inc., Dept. PM-2, Springfield 1, Mass.; Pasadena 3, California. (East of Rockies address Springfield office.)

WEDDING Invitations, personalized napkins. Wholesale prices. Sperry-Print, Williamsport 45, Penna.

SEND \$1.00 For 25 gold foil letters. Frank Watkins Signs, 1241 Overton Park, Memphis, Tenn.

NEW Sponge wall cleaner. Erases dirt like magic. Wallpaper, painted walls, ceilings. Saves redecorating. Lightning seller. Samples sent on trial. Kristee 68, Akron, Ohio.

EXTRA Money every week. I'll send you full-size Blair household products. Show them to friends and neighbors. You can make big extra profits. Write Blair, Dept. 31NB-1, Lynchburg, Va.

I Average \$125 weekly selling books by mail! So can you! Start sparetime! Work home! Cooper, 245-P Taunton, Buffalo, N. Y.

BUY Wholesale — 25,000 items. Catalog 25c. Matthews, 1472-B5 Broadway, New York City 35.

SEND Postcard for free money-making kit guaranteed direct-from-mill nylons, lingerie, blouses, men's and children's wear. American Mills, Dept. 448, Indianapolis.

MAKE Money at home as renewal headquarters for all magazines. Liberal commissions. No experience, no capital needed. Supplies furnished. Write for free catalog. McGregor Magazine Agency, Dept. 500A, Mount Morris, Ill.

CLEANS Windows without mess. Strange dry cleaning-cloth. Replaces liquids. Windows gleam. Samples sent on trial. Kristee 67, Akron, Ohio.

BUY Wholesale thousands nationally advertised products at big discount. Free "Wholesale Plan." American Buyers, 629-R Linden, Buffalo, N. Y.

REPRODUCTIONS Of customers' snap shots on lamp shades, tiles, brooches, plaques. Artistic, unique. Selling full or part time profitable and pleasant. Wells Studio, 14040 Euclid Avenue, Cleveland, Ohio.

POWER Mowers, \$42. Chain saws, \$129. Terms. Sales kit, free. Farmco-PM, Excelsior Springs, Mo.

WHOLESALE! 8000 Nationally famous products. 30-80% discounts! Large catalog. Sensational business plans included. Consolidated Distributors, 21-10, Lafayette, Paterson 15, New Jersey.

COLLEGE. High school students. Profitable opportunity. Free souvenir, details. Frontier, 2909 Pershing, El Paso, Texas.

BIG Money selling waitresses, beauticians, others, guaranteed uniforms \$3.98 up. Dacrons, nylons, cottons. Sizes 9-52. Free uniform and gift plans. Full, part time. Experience unnecessary. Free full color catalog. Upland Uniforms, 208 East 23rd, Dept. G-8, New York City.

MAKE Money introducing world's cutest children's dresses. Big selection, adorable styles. Low prices. Complete display free. Rush name. Harford, Dept. N-3341, Cincinnati 25, Ohio.

BEAUTIFUL Feather pictures. 200% profit! Free sample. Apartado 9036, Mexico 1, D. F.

PROFITABLE Deal selling magnetic pencils to waitresses, nurses. Sample \$1.00. Nicholson, Universal City 2, Calif.

BUY Wholesale. Catalog 35c (refundable). Carlton, 3007 Wharton, Philadelphia 46, Penna.

EASY Handwork makes fast-selling useful articles. Sample free. Sunmade Company, Brockton 64, Massachusetts.

HIGH Earnings, selling complete line of granite cemetery memorials. Artcraft Memorials, St. Cloud, Minnesota.

PROFIT 100%. Removes rust from guns, tools, machinery. Rustoff Company, 650 46th, Des Moines 12, Iowa.

MAKE Money giving away free hosiery! Introduce amazing nylon stockings (guaranteed against runs and snags) and men's children's hosiery (guaranteed one year) by giving away free trial pairs regardless whether or not final purchase is made! Earn up to \$3 hour spare time. Mail postcard today for free samples men's and women's hosiery with complete money-making outfits. Nothing to pay now or later. Absolutely no obligation. Kendex, Babylon 23, N. Y.

60% PROFIT On cosmetics — Famous nationally advertised Hollywood Cosmetics pay 60%! Make \$25 day up! Hire others. For free samples, details, write Studio Girl, Glendale, Calif., Dept. PM-25.

CASH In on tremendous demand for new low-priced burglar alarm for automobiles, homes, stores, auto service stations and other property. 288% profit. Unique sample offer. Northwest Electric Co., 132-B Main, Mitchell, S. Dak.

BARGAINS. Job lots, close-outs! Save up to 50% on clothing, hosiery, notions, drugs, toiletries, gifts, jewelry, television, etc. 2000 items. 25c brings wholesale bargain catalog with special get acquainted offer which includes free \$1.00 merchandise certificate. Reliable Jobbers, 311-B North Desplaines, Chicago.

APPLIANCES. Cameras, watches! Large wholesale catalogue! Cam Company, 6866PM—20th Ave., Brooklyn 4, N. Y.

THOUSANDS Articles wholesale. Supply source directory 10c. Idealer, Park Ridge, Illinois.

CALIFORNIA Sweet smelling beads. Sensational sellers. Particulars free. Mission, 2328 FR, W. Pico, Los Angeles 6, Calif.

PROFITS To 150% selling finest everyday greeting cards. New 21-card \$1.00 assortments, unusual gifts, 100 fast-sellers. Valuable gift bonuses. Assortments on approval, stationery samples free. \$1.00 gift free for prompt action! Creative Cards, 4401 Cermak, Dept. 525-A, Chicago 23.

MAKE Easy money. Sell famous \$3 CO-2 fire extinguisher. Wholesale or direct. Fast sales, liberal profits. Fire Killer Mfg. Co., Dept. E, 115 W. 17th Street, Hazleton, Penna.

TREMENDOUSLY Profitable. Sell religious articles. Different. New. Write J. Cross Company, North Attleboro, Mass.

FREE Wholesale kit guarantees you 33% to 60% profit on cameras, appliances, typewriters, etc. Arrow Distributing, 134G Nassau St., New York 38.

EASY Extra income — Sell sensational new silicone scorch resistant ironing board cover. Good Housekeeping approved. Terrific \$1.98 seller! Send for free complete selling kit. Sample cover \$1.10. Menell Products, Dept. P—P.O. Box 431, Midtown Station, New York 18, N. Y.

HAVE A complete store in your pocket. Buy wholesale and make big profits. Send for free general merchandise catalog now. Jay Norris, Dept. P, 445 Broome St., New York City.

PRINTING. Advertising salesmen — Excellent moneymaking sideline selling decalcomania name plates, small quantities. Automobile initials, sign letters. Free samples. Ralco, XL, Boston 19, Mass.

GOLD Or silver letters, numbers. Windows, doors, trucks. 1" to 6", 500% profits. Free samples. Atlas-T, 544 West 79th, Chicago 20.

MAKE Extra money. Sell front door name plates to friends, neighbors. Retail \$1.98; you make \$1.00! Free selling kit. Modern Engraving Co., P.O. Box 194, Boston 14, Mass.

SCHOOL Seniors — Be popular with classmates. Have spending money galore. Details free. Craftcards, Box 235-L, Pittsburgh 19, Pennsylvania.

\$1.00 PROFIT Selling \$2.95 photo enlargement deal. Allen Studio, Riegler Bldg., Little Rock, Ark.

AGENTS — 300% Profit selling genuine gold window letters; stores and offices. Free samples. Metallic Sign Letter Co., 431-D North Clark, Chicago.

YOUR Own business—Used suits \$1.50, overcoats 65c, mackinaws 35c, shoes 12½c, ladies coats 30c, dresses 15c. Enormous profits. Catalog free. Moro, 1218AA South Jefferson, Chicago 7.

INCREASE Your income—Personal initialed buckles, belts, cap badges. Free information. Hook-Fast, Box 480 (PM), Roanoke, Va.

NEW Push button salt-pepper dispenser. Sprays it out! Can't clog. Can't spill. King, 55-P Oleander, West Springfield, Mass.

SALESMEN—DISTRIBUTORS

\$40 DAILY Commission and more, easily possible for hard hitting salesman to travel smaller towns securing slow pay accounts for collection. Demand is tremendous. No selling, no collecting, no investment. Fast moneymaking proposition for aggressive salesman. United Financial Service of America, 247 Plymouth Bldg., Dept. 99, Minneapolis 3, Minn.

WILL You wear new suits and topcoats without one penny cost and agree to show them to friends? You can make up to \$30.00 in a day even in spare time, without canvassing. Stone-Field, 532 South Throop St., Dept. X-926, Chicago 7, Illinois.

AMAZING Discovery, Master Glaze, puts brilliant glasslike surface on cars. Free sample, information. Big commission. Master Glaze, Dept. 821, 7720 Harwood, Milwaukee, Wis.

GET New shirt outfit free; make \$90.00 weekly on 3 average orders a day. Famous quality made-to-measure dress and sport shirts at \$3.95 up sell fast to all men. No experience needed. Full or part time. Write: Packard Shirt Co., Dept. 848, Terre Haute, Ind.

BE Independent. Sell Rawleigh products. Good nearby locality open. Write today. Rawleigh's, Dept. B-D-r-PM, Freeport, Ill.

ANYONE Can sell famous Hoover uniforms for beauty shops, waitresses, nurses, doctors, others. All popular miracle fabrics, nylon, dacron, orlon. Exclusive styles, top quality. Big cash income now, real future. Equipment free. Hoover, Dept. L-100, New York 11, N. Y.

RICH Opportunity for men in their 50's. Healthful, pleasant occupation. No investment needed. 150 of our men made \$500 to \$3,000 in one month; many just beginners. Heckman made \$104 first 2 hours; Crowley made \$224 first day; exceptional earnings. Openings available. (If you live in Canada write President, Dept. PM-2, 25 Industrial St., Leaside, Ontario.) In U. S. — President, Dept. PM-2, Box 711, Fort Worth 1, Texas.

BIG Money-making opportunity. Exclusive line work uniforms. Jackets, pants, shirts, coveralls. Advertising embroidered. Every business prospect. Outfit free. Master Div., 312 Water, Ligonier, Ind.

AD Matches! Sell amazing designs—10, 20, 30, 40 and 240-light book matches. Bigger spot cash commissions; every business a prospect. Low prices for high quality. Repeats. Start without experience; men, women; full, part time. Buy nothing! Sales kit furnished. Match Corp., Dept. PM-62, Chicago 33, Illinois.

BIG Sales to stores. Plastic self-adhering letters and signs. Interchangeable. Reusable. 1208—20th Avenue, San Francisco 22.

NEW Chemical discovery. Pro Auto Wax, easy way to car beauty. Free sample, information. Amazing profits. Burford Auto Finishes, 1660-20th Street, Santa Monica, Calif.

FOUR \$3.00 Sales daily can be earning you \$1250 monthly in 12 months. Be first send \$1.00 for complete starting outfit. Levely Lady, Dept. A, Box 333, Baton Rouge, La.

BUY Wholesale thousands nationally advertised products at big discount. Free "Wholesale Plan." American Buyers, 630-DD Linden, Buffalo, N. Y.

SALESMEN Distributors. Introduce Barton's cannibalism remedy to poultry supply dealers. Guaranteed to produce results. Exclusive territory. Generous commissions. Lyles Products Co., Galesburg, Ill.

100% PROFIT. Fast money for you! Take orders for Sweet Georgia Brown cosmetics. Colored people buy quick. Free sample. Write Valmor 2451-PF Michigan, Chicago 16.

DISTRIBUTE Flashlights, electric lanterns to dealers. 10,000 available monthly. Samples \$2.00, refundable first order. Ashland Steel Company, Box 944, Ashland, Ky.

ADVERTISING Book matches—Cash in on big demand; sell union label matches. Cuts for all businesses and political parties. Free powerhouse selling kit, low prices, protection guaranteed on repeat orders. Cash commissions. Superior Match Co., Dept. M-255, 7530 Greenwood, Chicago.

RETIRED Men earn extra money selling sales books, cafe checks, other forms for business concerns. Liberal commissions weekly. Order repeat regularly. Experience unnecessary. Write for easy plan. Kansas City Salesbook Co., 1018-B Baltimore, Kansas City 6, Missouri.

SALESMEN: Over \$50.00 daily. New colossal industrial and store deal. Samples furnished. Durawear, 53 West Jackson, PM-2, Chicago 4.

ADVERTISING Specialty salesmen—Show America's newest, sensational low-priced imprinted advertising specialties. Buyers everywhere. Big commissions advanced. Samples furnished. Charms & Cain, 37 West VanBuren, Dept. PM-25, Chicago 5.

TOP Men earn \$12,000 and more in a year in a profitable selling career. Call on owners and users of heavy duty equipment. Moly lubricants and other top quality specialized products provide repeat business regularly. Top earnings immediately. No collection or delivery worries. Write E. J. Baker, Dept. 789, Box 676, Dayton, Ohio.

MY Free outfit puts you in a fine business! Just 2 sales a day brings you up to \$217 extra a month in big money shoe business! Complete line of air cushion shoes for men, women. Just rush postcard for your powerful free selling outfit! Mason Shoe, Dept. MC 60, Chippewa Falls, Wisconsin.

SELL Thermojet—Sensational electrical appliance, attaches to cold water faucet. Converts cold tap water into hot in 2 seconds. Nothing like it on the market. Guaranteed for full year and will last a lifetime. Demonstrates instantly, no sales talk. Retail for \$19.95. Sample \$11.95. Quantity prices on request. Thermo Appliance Corp., 722 Middleneck Road, Great Neck, N. Y.

75c PROFIT On each dollar! Luxurious stainless steel tableware, guaranteed 50 years. Can't rust, tarnish or stain. Looks like sterling silver. 30, 50 and 75 piece sets, open stock, attractive chests. Write orders on commission or go in business for yourself. Use our catalogues with only your name. Have agents, others sell for you. Offer women set free for every two sets they sell to friends. Many other money-making plans. We can also ship under your label. Rush postcard for free catalogue, plans, etc. No obligation. Topval Corp., Lindenhurst 51, New York.

QUALITY Ties—Your profit 189%. Catalog free. Loren Specialties, 4351-A-2 Flournoy, Chicago 24.

NO Car needed. Let me prove you can make up to \$25.00 a day with one of America's finest line of cushion shoes direct. Daily commission, full or part time. We welcome men of mature years. Write Charles Eaton, President, Charles Chester Building, Brockton, Mass.

BIG Money selling amazing new spray-on-window light filter for factories, offices, stores, trucks, autos. Big profits. Sales plan free. Glasstint, Dept. PM-2, Consumers Bldg., Chicago 4.

30,000,000 WOMEN Want amazing new automatic refrigerator defroster. You sell 8 out of 10 on sure-fire free trial. \$250.00 weekly profit not uncommon. Rush postcard for guaranteed plan. D-Frost-O-Matic, Dept. D-102, 173 W. Madison St., Chicago 2, Illinois.

DISTRIBUTORS — Salesmen wanted. Very good profits. Steady repeat business. Write Favorite Records Company, Box 841, Chicago 90, Ill.

SELL Book repair shop service. National chain. Your own business. Professor Martin, Alsen, North Dakota.

EDUCATIONAL AND INSTRUCTION

WANTED: More new writers for TV-radio, magazines, business publications, motion pictures. Learn at home for extra income or exciting full time career. Many students earn while learning. Professional instruction. Send today for free lesson and book. Palmer Institute of Authorship, Desk TM-25, 1680 N. Sycamore, Hollywood 28, California.

IF You like to draw, sketch or paint write for talent test (no fee). Give age and occupation. Write, Dept. PM-25, 500 South 4th Street, Minneapolis 15, Minn.

LAW Trained men are business leaders—Learn at home in spare time. Low cost, easy terms. LL.B. degree conferred. Free catalog gives complete information. LaSalle Extension University, A Correspondence Institution, Dept. L 842, 417 So. Dearborn, Chicago 5.

IT'S Fun learning a language by Linguaphone's world standard conversational method. At home, quickly, easily learn to speak French, Spanish, German, Russian, Japanese, Modern Greek—29 languages available. It's like living in another country. Save time, work, money. Send for free book. Linguaphone Institute, 63025 Radio City, New York 20.

PRACTICAL Nursing—Learn easily at home, spare time. Big demand, good earnings. High school not necessary. Write for free booklet. Wayne School, Dept. PG-28, 2525 Sheffield, Chicago 14, Ill.

INVESTIGATE Accidents—Thousands of insurance companies, airlines, and steamship lines use claim investigators. Learn this fascinating work, easily, quickly. Free book, now! Universal Schools, Dept. 102, Box 8203, Dallas 5, Texas.

WANT A diesel job? New opportunities to increase income. Higher pay. More money. We can help you qualify. Tools. Shop method home training. Write today! Diesel, Tractor, Heavy Equipment Division, Interstate Training Service, Dept. B-3-B, Portland 13, Oregon.

X-RAY Technicians in great demand. Fascinating work. Good pay. We train you at home. Free catalog. National Institute, Desk 7, 4868 1/2 Sheridan, Chicago 40.

HIGH School—No classes. Study at home. Spare time. Diploma awarded. Write for free catalog HF-51, Wayne School, 2527 N. Sheffield, Chicago 14, Ill.

WELDING Training pays at Hobart Welding School, Box M-251, Troy, Ohio. VA contract. Best equipment. Catalog free.

MAILORDER Instruction course. Eliminate mistakes. Ransie, Box 1719-A, Richmond 14, Virginia.

BLUEPRINT Reading for machine and building trades. Train at home. Learn to read blueprints with confidence in 10 easy lessons. Literature free. Belton School, 1059M North Lawndale, Chicago 51, Ill.

UNHAPPY? Restless? Dissatisfied? Uncover your hidden abilities, aptitudes, personality with psychological testings. Do tests at home. Receive complete analysis prepared from tests by professional psychologists. Low cost, confidential. Write Psychologic Testing Institute, Dept. 234, 201 N. Wells St., Chicago, Illinois.

COMPLETE Your high school at home in spare time with 58 year old school. Texts furnished. No classes. Diploma. Information booklet free. American School, Dept. X245, Drexel at 58th, Chicago 37, Illinois.

OUTDOOR Work—Study for game warden, park, forestry, fish, lookout, guide, patrol and wildlife conservation service. Details free. Write Delmar Institute, D-5, Whittier, Calif.

DOCTOR Psychology degree by correspondence. College Cosmic Science, 7645 North Sheridan, Chicago 26.

U.S. Civil service jobs! Men-women, 18-55. Start high as \$350.00 month. Qualify now! 21,000 jobs open. Experience often unnecessary. Get free 36-page book showing jobs, salaries, requirements, sample tests. Write: Franklin Institute, Dept. A-24, Rochester, N. Y.

ART Airbrush, profitable. Free booklet. School, 341 Bridge Street, Brooklyn 1, New York.

MEDICAL Laboratory technique. Learn at home. Catalog free. Century College, Desk 4, 9 East Ohio, Chicago 11, Illinois.

CORRESPONDENCE Courses, educational books bought, sold, rented. Catalog free. Willard Bayles, 211 Essex, Hackensack, New Jersey.

WAKE Up with our thought and behavior motivation control plan and go, go, go! Be what you desire. Write for amazing free self-training "know-how" today. President Ballard, Box 1924-H, Louisville 1, Ky.

USED Correspondence courses, books, bought, sold, rented. Catalog free. Educational Exchange, Summerville, Ga.

CORRESPONDENCE Course. Overcome self-consciousness. Personal. Confidential. Free literature. The Leavitt Science, Clinton, Illinois.

CORRESPONDENCE Courses, educational books, rented, sold, bought. World wide service. Catalog free. Magnolia Press, Box 1272-P2, Burbank, Calif.

LEARN While asleep: It's easy. Results guaranteed. See "Personal" column.

SUCCESS In business, social life—Strengthen your voice! Free booklet. State age. Prefect Voice Institute, 210 South Clinton, Studio 2BV-2, Chicago 6.

OWN Collection agency office. Pays big! Free details. Franklin Credit, Roanoke 7, Va.

12 STEPS To success. New self-analysis technique shows you how to become successful by selling your strong points and overcoming your weak points. Send \$1.00 to Reeves-North, Personal Consultants, 8, 1129 Buena Vista Drive, Spokane 44, Washington.

APPLIED Success dynamics. Free details. A-D Psychology Ctr., Box 847, Ocean Park, Calif.

EARN College degree, remain employed. Write: Brentwood College, Box 19-721, Los Angeles 19, California.

CLERGYMEN'S. Laymen's courses. Free bulletin! Midwestern Bible School, 517 Merchants Bank Building, Indianapolis.

AVOID Failure! Six lessons small business management. Auditor-business advisor established 1929. Text distributed nationally. Write! Wm. Grosnick, 115 State, Springfield 3, Mass.

DRAFTSMEN—Urgent demand. Train now. Pay later. Free details. Industrial Training, 1704-A Frederick, Fort Worth 7, Texas.

POSITIVE Success. Secrets free! Write today. Success School, Sparta 7, Michigan.

INVESTIGATOR Training. Phillips Secret Service System, 1917-B North Keneth, Chicago 39.

GOVERNMENT Positions pay well. Home training for exam, \$9.95, entire cost. Refunded if don't pass, 47 years training experience. Order, or write immediately. Oment Instruction, Box 665-34CS, St. Louis, Mo.

AUCTIONEERING. Be an auctioneer. Earn big money. Term soon. Write for catalog. Kansas City Auction School, Suite 307, Shankman Building, 3119 Troost, Kansas City, Missouri.

BE A real estate broker. Study at home. Write for free book today. GI approved. Weaver School of Real Estate, 2020C Grand, Kansas City, Missouri.

LEARN Appliance service. Motors, washers, refrigeration, everything. Booklet. President, Box 73136, Los Angeles 3.

STUDY By correspondence for Doctor's degree in Psychology, Metaphysics and Divinity. College of Divine Metaphysics, Dept. P-M, 2811 North Illinois St., Indianapolis 8, Indiana.

HIGH School diploma at home. Licensed teachers—Approved materials. Southern States Academy, Box 144-MX, Station E, Atlanta, Georgia.

SECRET Investigation. Experience unnecessary. Investigators particulars free. George Wagner, M125 West 86th, New York 24.

PHYSICAL Therapy and massage. We train you at home. Earn big profits from your own private practice or work with hospitals and doctors. Free catalog. National Institute, Desk 4, 4868 1/2 Sheridan Road, Chicago 40, Illinois.

GROW Mushrooms. Cellar, shed, and outdoors. Spare, full time, year round. We pay \$3.50 lb. We paid Babbitt \$4,165.00 in few weeks. Free book. Washington Mushroom Ind., Dept. 174, 2954 Admiral Way, Seattle, Washington.

EARN While you learn. Auto and diesel mechanics master this top paying trade. Many graduates earn \$100 a week and up. Approved for Korean veterans. For free information write Dept. No. 256, Nashville Auto-Diesel College, Nashville 3, Tenn.

BOOKKEEPERS! Increase your earnings! Operate your own simplified "Dollar-A-Week" bookkeeping and tax service. Full or spare time. Details free. No obligation. Ellis, Box 200, Cedar Grove, North Carolina.

MEDICAL Laboratory technicians in great demand. We train you in your own home. Catalogue free. Imperial Technical Institute, Box 973-J, Austin, Texas.

USED Correspondence courses and books sold and rented. Money back guarantee. Catalog free. (Courses bought.) Lee Mountain, Pisgah, Alabama.

PIANO Tuning pays. Learn this profitable profession at home easily with patented Tonometer and mechanical aids. No knowledge music necessary. Diploma granted. Write for booklet, Niles Bryant School, 3731 Stockton Blvd., Dept. P, Sacramento 20, California.

PLAYS, STORIES, MANUSCRIPTS

STORY Writing. Home training, for television; radio; short stories. Free 34-page sample lesson and outline. H. D. Balingier, Established 20 years, 1509 Crossroads, Hollywood, California.

NO Luck finding a book publisher? Write for free Booklet P.M. Vantage Press, 120 W. 31, New York.

SPECIAL SERVICES

DETROIT Help wanted ads air mailed, \$1.00. Murch, 2205 W. Philadelphia, Detroit 6, Mich.

ENGINEERING Difficulties solved—Fifth year pregraduate mechanical engineers. Inquire Deltoid, Box 3055, University Station, Columbus, Ohio.

FREE 100 Items sources 25c. Variety Mart, P.O. Box 331P, McKeesport, Penna.

INFORMATION On anything. Ferguson Research Specialists, 119-14 141 St., South Ozone Park 36, N. Y.

PACIFIC Northwest job opportunities \$1.00. Baker, 1412 Jefferson Ave., Yakima, Wash.

CARTOONING, COMMERCIAL ART, SHOWCARD & SIGN PAINTING, TATTOOING

"HOW To Make Money With Simple Cartoons"—A book everyone who likes to draw should have. It is free; no obligation. Simply address Cartoonists' Exchange, Dept. 92C, Pleasant Hill, Ohio.

FREE Trial cartooning lesson. No obligation. V. Vande Linde, Madison, W. Va.

MAKE Money painting signs at home. Amazing, easy instruction tells how. With 324 illustrations (18 in colors.) \$5 postpaid. Literature free. Eric Matthews, 2325 Cass, St. Louis 6, Missouri.

PAINT Signs with our perforated patterns. Vande Linde Signs, Madison, W. Va.

BARGAINS: Wonderful courses, drawing, painting, cartooning, lettering. Free catalog. Art Book Shop, Arnold 8, Mo.

CARTOONISTS: Amateur, professional. Prepare for animation with Max Fleischer's plan. Write Vera Coleman, Lincoln Building, New York, N. Y.

CHALK Talks. Laugh producing program \$1.00. Catalog 10c. Balda The Cartoonist, Oshkosh, Wisconsin.

TATTOOING Course, supply brochures 25c. Zeiss, 728 Lesley, Rockford, Illinois.

LEARN Sign painting at home. Test lesson free. Ben Kerns, Box 812-PM, Greenville, S. C.

PAINT Signs with master patterns. Set 1 1/2" to 12" high \$1.00; sample 3c. Eyerly, B-583, Newton, Iowa.

9 ALPHABET, 3 Numerical pattern sets and raised wood letter catalog, \$1.00. Sign Letter Distributors, P.O. Box 101, Mineola, N. Y.

ARTISTS' SUPPLIES

IF Interested in artist frames, canvas, canvas boards, Red Sable brushes, etc., be sure to get our money saving price lists before buying. International Sales Co., 414 E. Baltimore St., Baltimore 2, Md.

WHOLESALE Prices — Drafting equipment, artists' supplies. Catalogue. Gordon's, 219-M Madison, Chicago 6.

ADVERTISING AGENCIES, LETTER WRITERS, FOR ADVERTISERS

24K GOLD Embossed leather key cases, with your 3 or 4 line ad. 1 post \$14 per 100, 2 post style \$18 per 100. Samples 50c. Arizadeo, Box 1456, Minneapolis 6, Minn.

ADVERTISING—Display, classified. Experts since 1893. Interesting budget brochure free. Newmark's Agency, 217-7th Ave., New York.

FREE Copy, layout service. Mailorder ad, 1,600,000 nationwide circulation, \$28.70 inch, 24-word classified, 20 big Sunday newspapers, \$30. Advertising ratebook free. Chicago Advertising Agency (Established 1900), Chicago 4.

FREE! 1955 Advertisers Rate and Data Directory, 52 pages! E. H. Brown Advertising Agency, 20 N. Wacker, Chicago 6.

500 RECENT Cash buyers \$2.00. McQuilian, Box 471, Baton Rouge, La.

MAILING Lists, most any classification. 1000 names \$5.00. 1000 your circulars mailed with ours \$4.00. 5000 your circulars printed and mailed \$12.95. Write Dixie Mailers, King, North Carolina.

ADS Placed in out of town newspapers and magazines. Low rates. Catalogue free. Ideas that pay. Baker Advertising Agency, Successors Ankrum Agency, 189 W. Madison, Chicago 2.

ADVERTISE: 24 Words, 100 Canadian newspapers \$3.50. Lists free. Advertising Bureau, 10511-C Springfield, Chicago 43.

RUBBER STAMPS AND OFFICE SUPPLIES

RUBBER Stamps 30c. Offset printing \$6.50—1000, 8 1/2"x11", 16 lb. Catalog 10c, refundable. Esco 125 Print, 8 Holt, Dayton 7, Ohio.

3 LINES Pocket or cushion \$1.00. Hansen, 4906-P Ohio, Chicago 44.

FREE Style list stock stamps. Criterion, Box 2326, Denver 25, Colo.

LINE 25c; 2-45c! 3-63c. Stamp Works, Auburn, Nebraska.

RUBBER Stamps by professional craftsmen, 3 lines \$1.00. Price list, South Coast Press, P.O. Box 2074, San Bernardino, Calif.

TYPEWRITERS, DUPLICATORS, OFFICE DEVICES

TYPEWRITERS, Reconditioned, largest stocks; bargains; "Addometers"; pricelist. Equipment, 2710 Tracy, Kansas City 9, Missouri.

RECONDITIONED Typewriters, duplicating, printing devices, \$25.00 up. Supplies. Appliances, DixieGraph, King, N. C.

PRINTING, MULTIGRAPHING, MIMEOGRAPHING, GUMMED LABELS

1000 EMBOSSED Cards, \$3.95. 4-line stamp, choice of 800 emblems, \$2.00 postpaid! Accuracy guaranteed. Samples. Parr, 426-F Ontario, Burbank, Calif.

1,000 STATEMENTS \$4.99. Free printing catalogs. Erco, Bronx 72, N. Y.

PRINTING, Photo-offset, mimeographing, prices, samples free. Mimeo, Madison, Tennessee.

1000 EMBOSSED Cards \$2.95 postpaid. Offset printing: 1000 8 1/2"x11, 20 pound, \$6.45. Samples, Jaynar, Box 723B, Oak Lawn, Illinois.

FREE Catalog business, personal printing. 500 8 1/2 x 11 letterheads \$3.50 postpaid. D & M Sales Co., Sebastopol, Calif.

PRINTING And office supplies wholesale. 20,000 items. Literature free. Royal, Box 368-X, Cleveland 27, Ohio.

100 8 1/2 x 11 LETTERHEADS, Printed carefully, \$1.00 postpaid. Envelopes same. Race Printers, Hudson, New York.

PRINTING By Ace. Samples, catalog free. P.O. Box 262, Lyndhurst, N. J.

OFFSET Printing, \$5.50—1000, 8 1/2"x11, 16 lb. National Letter, 1463 Broadway, New York City 36.

100 LETTERHEADS Or #6 3/4 envelopes \$1.00. Two colors \$1.50. Broadbrook, Botsford, Conn.

BUSINESS Cards. Printing. Reasonable. Free samples. Lites, 5352-PM Princeton, Chicago 9.

"STYLED-For-sales" printing, fairly priced (postpaid). Dollar-saving combinations. Mageeprint, Durham 2, Connecticut.

125 LETTERHEADS (8 1/2"x11), 125 envelopes, \$2.95. Fender Press-G, Carson, Iowa.

GET Our prices first. Crane, Box 7625-D, Kansas City, Missouri.

QUALITY Printing. Booklets, publication, catalogs, stationery. Free catalog. Adams Printers, 30 W. Washington, Chicago 2, Illinois.

MIMEOGRAPHING — Reasonable. Any copy. Mailers Service, Box 606-A, Chicago 90, Ill.

BUSINESS Stationery. Letterheads, envelopes, cards, invoices, statements, office forms. Samples free. Oren, Printer, Valliant, Okla.

ILLUSTRATED Business letterheads; catalog 10c. Howprint, 723-G Eunice, Webster Groves 18, Missouri.

PRINTING-Office supply catalog 25c. Refundable. Wallace, 1072 Tower Grove, Saint Louis 10, Missouri.

MIMEOGRAPHING — Letters, pricelists, formulas, instructions. Lowest prices. Lem's Letter Shop, 3710 Stanton, Detroit 8.

500 3/4x2 1/4 FOUR Line gummed stickers 50c. Red border \$1.00. Morits Printery, Saginaw, Mich.

PRINTING OUTFITS AND SUPPLIES

MAKE Your own self-molding rubber stamps and printing cuts. Plexirubber, Argyle 1, Wisconsin.

MAKE Your own cuts. Free literature. Plastarubber, Box 4308-M, Mobile, Ala.

PRESSES, Type cabinets, supplies. List for stamp. Lincoln Press Company, 230-B Hartwell, Fall River, Mass.

PRINT Your own. Free details. Devine, 3594 Los Flores, Lynwood, Calif.

DO Your own printing. Save money. Simple rules. We supply everything. Print for others; good profit. Raised printing like engraving too. Have home shop. Details free. Kelsey Presses, V-11, Meriden, Connecticut.

PRINTING Presses, type, supplies. Lists 3c. Turnbaugh Service, Loysville, Penna.

PRESSES, Supplies, paper. Catalog 10c. Custom, Box 211-P, Springfield, Missouri.

PATENT ATTORNEYS

INVENTORS. Learn how to protect your invention. Unless the inventor is familiar with patent matters, he should engage a competent registered patent attorney or agent to represent him. We are registered to practice before the U.S. Patent Office and prepared to serve you in handling your patent matters. "Patent Guide for the Inventor" containing detailed information concerning patent protection and procedure with "Record of Invention" form will be forwarded to you upon request—without obligation. Clarence A. O'Brien & Harvey Jacobson, Registered Patent Attorneys, 518-A District National Building, Washington, D. C.

INVENTORS—Take these preliminary steps toward patent protection. Sketch and describe your invention. Sign, date and have this disclosure witnessed by two people who understand your invention. Have us make a preliminary search among U.S. patents already granted for similar types of invention. We report on the probable patentability of your invention and recommend your further course of action. Write for our instructive booklet, "Patent Protection for Inventors" and convenient "Evidence of Invention" disclosure form. Victor J. Evans & Co., 131-B Merlin Building, Washington 6, D. C.

INVENTORS—If you believe you have an invention, you should find out how to protect it. The firm of McMorrow, Berman & Davidson with offices in Washington, D. C., is qualified to take the necessary steps for you. Send for copy of our patent booklet "How to Protect Your Invention." We will also send you an "Invention Record" form. No obligation. They are yours for the asking. McMorrow, Berman & Davidson, Registered Patent Attorneys, 124-Y Victor Building, Washington 1, D. C.

CANADA—Ramsay Company Registered, 273 Bank Street, Ottawa, Canada.

INVENTION Record form free and "Patent Information Every Inventor Should Have." Carl Miller, Registered Patent Attorney, Woolworth Building, New York.

REGISTERED Patent attorney offers services. Sanders, 6430 Evans, Chicago 37, Illinois.

PATENTS — Irving L. McCathran, 315 McLachlen Bldg., Washington 1, D. C. Registered Patent Attorney.

C. A. Snow & Co.—M427, Snow Building, Washington 1, D. C. Registered Patent Attorneys. Write for information.

INVENTORS: When you are satisfied that you have invented something of value write me, without obligation, for information as to what steps you should take to secure a patent. Write Patrick D. Beavers, Registered Patent Atty., 935 Columbian Bldg., Washington 1, D. C.

PATENTS. "Proof of Invention" free. E. E. Vrooman, Registered Patent Attorney, 307 McKim Building, Washington 5, D. C.

"INVENTOR'S Guide" and "Record of Invention" free on request. Frank P. Ledermann, Registered Patent Attorney, 154 Nassau Street, New York City.

INVENTORS: Without obligation, write for information explaining the steps you should take to secure a patent. John Randolph, Registered Patent Attorney, 203 Columbian Bldg., Washington 1, D. C.

FOR INVENTORS

INVENTORS—If you believe you have an invention, you should find out how to protect it. The firm of McMorrow, Berman & Davidson with offices in Washington, D. C., is qualified to take the necessary steps for you. Send for copy of our patent booklet "How to Protect Your Invention." We will also send you an "Invention Record" form. No obligation. They are yours for the asking. McMorrow, Berman & Davidson, Registered Patent Attorneys, 134-Z Victor Building, Washington 1, D. C.

INVENTORS—This firm is registered to practice before the United States Patent Office and available to assist you in the preparation and prosecution of your patent application. "Patent Protection for Inventors" booklet containing detailed information and steps to take toward patent protection sent promptly upon request. No obligation. Victor J. Evans & Co., 132-B Merlin Building, Washington 6, D. C.

EXPERIMENTAL And patent development of wood projects. Models designed and built. Details free. Telesis Company, 2205—38 Street, Des Moines 10, Iowa.

INVENTORS: Profit from copyrighted "One Inventor's Experience" or money back. Send \$1. R. E. McLean, 5703 South Benton, Kansas City 30, Missouri.

"HOW To Apply for Patent by Yourself." by Z. de Sauvan, Nat. Att., Box 687, Alhambra, Calif.

WHO Will cash in on your idea? Every inventor should read "How to Manufacture and Promote Your Own Invention." Gives planning, procedures, actual costs of patents, parts, materials, assembly, distribution of product successfully promoted by inventor. \$1. Bryn, 422 Washington Bldg., Washington 5, D. C.

PATENT Searches, including copies of nearest patents, \$5.00. Reports airmailed within 48 hours. More than 100 registered patent attorneys use my service. For free invention protection forms, write Miss Ann Hastings, P.O. Box 176, Washington 4, D. C.

PATENT Searches \$5.00. 48-hour service. Free invention protection forms. Write Raymond L. Smith, Patent Searcher, 622 Sheraton Building, Washington 5, D. C.

PATENT Searches \$5.00. 48-hour airmail service. Invention protection forms free. Write Patent Engineering Service, 711 14th Street, N. W., Washington 5, D. C.

INVENTORS. A booklet telling you how and where to find out what I have learned in 11 years as an inventor, \$1.00. Mark Smith, Box 29, Glen Ridge, N. J. Money refunded if returned within 10 days.

INVENTORS Handbook. Fact-packed, necessary information. \$3.00 postpaid. Federal Institute, 304 Chestnut Street, West Hempstead, N. Y.

INVENTIONS Wanted. Patent pending only. Stark Corporation, Cedarburg 1, Wisconsin.

INVENTORS: If you have an invention for sale, patented or unpatented, write Institute of American Inventors, Dept. 40A, 631-E St. N.W., Washington 4, D. C.

"INVENTOR'S Guide" and "Record of Invention" free on request. Frank P. Ledermann, 154 Nassau Street, New York 38, N. Y.

INVENTION Record form free and "Patent Information Every Inventor Should Have." Carl Miller, Registered Patent Attorney, Woolworth Building, New York.

SEARCHES—Put your patent searches in the hands of a registered patent attorney or agent, as he qualifies to give a worthwhile patentability report. Record of invention form upon request and information on patent protection. Patrick D. Beavers, Registered Patent Attorney, 436 Columbian Bldg., Washington 1, D. C.

CASH For your idea. 200 manufacturers need inventions, patented or unpatented. List free. Invention Bureau, 208M Clinton, Oak Park, Ill.

INVENTORS. Learn how to protect your invention. Unless the inventor is familiar with patent matters, he should engage a competent registered patent attorney or agent to represent him. We are registered to practice before the U.S. Patent Office and prepared to serve you in handling your patent matters. "Patent Guide for the Inventor" containing detailed information concerning patent protection and procedure with "Record of Invention" form will be forwarded to you upon request—without obligation. Clarence A. O'Brien & Harvey Jacobson, Registered Patent Attorneys, 31A-A District National Building, Washington, D. C.

INVENTORS: Information on patent procedure furnished on request, without obligation. John Randolph, Registered Patent Attorney, 202 Columbian Building, Washington 1, D. C.

PATENT Searches, \$5.00, including patent copies. Same reliable search as conducted for patent attorneys. Free protection forms. Fast, accurate service. Patent Service Institute, 945-A Pennsylvania Avenue, Washington 4, D. C.

PATENTS FOR SALE

STEAM Bath, shower, and sun bath. All in one cabinet. Can be used in every home. Electrically operated. John Ruth, P.O. Box 72, North Madison, Ohio.

INVENTORS: Test the commercial value of your patented or unpatented inventions, quickly and inexpensively. Write for free information. Institute of American Inventors, Dept. 40-B, 631-E St. N.W., Washington 4, D. C.

INVENTIONS WANTED

ATTENTION Inventors! Sell your invention to manufacturers, investors, through the pages of: "Gadgets Patents & Invention News." Write Inventors' Service Bureau, 847 W. Roscoe, Chicago 13, Illinois.

INVENTIONS. New ideas wanted by manufacturers. Otto Grube, Egg Harbor, N. J.

INVENTIONS Sold — Commission basis. National Patent Sales, 1312 East 44th, Richmond 24, Virginia.

INVENTORS: If your invention is adaptable to our business we will contract on cash or royalty. If not, we will try to place. Free booklet. Kessler Corporation, 52X, Fremont, Ohio.

LET Us send you our current brochure describing our service to inventors. Inventors' Mart, Esperson Bldg., Houston 2, Texas.

PATENTED; Unpatented. Write for our inventions wanted list and particulars of foremost promotions service. Superior, 338-344 North Rodeo, Beverly Hills, Calif.

INVENTIONS Wanted. Patented, pending—only. Inventors Patent Exchange, Hartford 1, Conn.

INVENTIONS Wanted. Patented; unpatented. Tremendous manufacturers lists. Global Marketing Service, 1404 Mitchell, Oakland 1, California.

INVENTORS: Hundreds of manufacturers have requested our assistance in locating marketable new products. Complete information free. Institute of American Inventors, Dept. 40-D, 631-E St. N.W., Washington 4, D. C.

CASH Buyers for ideas and inventions. Write National Inventors Institute, 4097 East 131st St., Cleveland 5, Ohio.

FROM Center American Industry, National Research & Development Corporation seeks patented or unpatented inventions for development or sale. Write for booklet A, Room 324, 11 West 42 Street, New York, N. Y.

INVENTIONS Promoted. Patented or unpatented. A-1 service for inventors since 1911. Write Adams Fisher Co., 5418 Idaho, St. Louis, Mo.

INVENTIONS Wanted. Patented or patent pending. 24 years experience promoting inventions. National Service Bureau, 3120 Meramec, St. Louis 18, Mo.

SALES And promotion. Patented or unpatented inventions. Canadian. U.S. service. Free particulars. Canadian Patent Enterprises, 31 Leighland East, Burlington, Ont., Canada.

MODELS, MODEL SUPPLIES

BUILD Miniature passenger hauling live steam locomotive with file and drillpress. We do machine work, you bolt it together. Catalog 50c. Little Engines, Wilmington, California.

BALSA Wood and model aircraft. 40-page catalog 10c. Sig Co., Montezuma, Iowa.

1955 CAR Models, 1/25 scale, all metal, chrome trim. Send for catalog! Cars & Hobbies, Dept. PM-23, 2333 Haddon, Chicago.

BIGGEST. Most complete illustrated model railroad catalog, 600 cast items. HO and O. 10c. Selley, 744 Clay, Winter Park 3, Fla.

POWER Models. Unusual steam, gasoline and traction engines, fittings, metals. Anniversary catalog 50c. Chas. Cole, Ventura, Calif.

SHIP And yacht model fittings; blueprints. Send 25c for illustrated catalog listing hundreds of items. A. J. Fisher, 1002-1 Etowah Ave., Royal Oak, Mich.

SHIP And other scale models. Most complete line in New England. Kits, fittings, plans, books, tools, engines, motors. Illustrated catalog 25c. James Bliss & Co., Inc., Dept. SM, 342 Atlantic Ave., Boston 10, Mass.

SHIP Models and yacht supplies. Complete, large 68 page catalogue 50c. Bill Wild's, 510 East 11 St., New York City 9.

MANUFACTURING

COMPLETE Working drawings and patterns for heavy duty electric router thoroughly tested in production. Woodwork, Box 292, Hartsdale, N. Y.

MODELS — Small for manufacturing. Metals, plastics, etc. Milburn, Burlington, Kentucky.

HOME CRAFTSMEN

129 NEW Full size jigsaw patterns. Unusual novelties, gifts, lawn figures up to 22 inches high, action (merry-go-round) windmill, toys, useful gadgets. Artist drawn, \$1. Craftplans, 1321-A South Michigan, Chicago 5.

101 FULL Size patterns. Smart, new, gifts, novelties, lawn figures, shelves, action windmills, alphabets. Plus "Make Money Jig Sawing." Only \$1.00. Mastercraft 25M, 7041 Olcott, Chicago 31, Illinois.

FREE Aircraft catalog. Designs imprinted brass, copper, aluminum for metal pictures; burnt wood etchings; glorified glass, mirrors; pre-sketched paintings. Profitable art hobbies. Dept. PM, Thayer & Chandler, 910 W. VanBuren, Chicago 7, Illinois.

FREE! Leathercraft catalog. Do it yourself! Tandy Leather, Box 397AC, Tulsa, Okla.

LEATHERCRAFT. Metal tooling, textile painting, beadcraft, shellcraft, many other crafts. Fun, easy, profitable! Free, big, illustrated catalog. Write today. Kit Kraft, Dept. 222, Box 1086, Studio City 1, Calif.

LEATHERCRAFT For pleasure or profit. Make easy-to-assemble purses, belts, gloves, woolskin toys, 100 other items for gifts or to sell. Send 10c today for big catalog. Largest leathercraft stock in U.S. J. C. Larson Co., 820 S. Tripp, Dept. 4950, Chicago 24.

90 ALL New, full size lawn ornament and novelty patterns, up to 20" high. Only \$1.00. Mastercraft 22M, 7041 Olcott, Chicago 31, Illinois.

PLASTICS Home-craft course for men and women. Tells and shows how to make hundreds of fast selling plastics products. All plastics and materials for 23 projects included in course. No special tools needed. Course pays for itself. Write for free booklet. Interstate Training Service, Dept. D-3-B, Portland 13, Oregon.

16 NEW Lawn chairs, 22 picnic tables, benches, trellises, etc. All 38 plans with necessary full size patterns, \$1.00. Mastercraft 23M, 7041 Olcott, Chicago 31, Ill.

WOODWORKING Course for home craftsmen. Twenty-two manuals. Over 1,000 pages. 75 training projects. Only complete home training program available today. Carefully written, profusely illustrated. Covers everything from wood selection to final finishing. Complete instruction in care and use of all hand and power tools. Prepared by expert manual training instructors. Write for free booklet. Interstate Training Service, Dept. G-3-B, Portland 13, Oregon.

CAN And brush holder eliminates dripping paint, messy hands. \$1.00 ppd. Terry Products, Box 581, Merrick, N. Y.

DIAGRAMS: Model controls, timers, intercoms, organs, etc. \$1.00 each. List free. Parks, 105 S.E. 57th, Portland 15, Oregon.

CERAMIC. Copper enameling, supplies. Fabulous glazes, colors, kilns, findings, everything! Catalogues 25c. Sunkroft's, Panama City, Florida.

39 FULL Size jig saw patterns of beautiful shelves, ornaments, toys, novelties. Plus "How, Where to Sell." Only \$1.00. Mastercraft 24M, 7041 Olcott, Chicago 31, Illinois.

BUY Wholesale nationally advertised power, hand tools, thousands of other products at big discounts. Free "Wholesale Plan." American Buyers', 628-RR Linden, Buffalo 16, N. Y.

LEATHERCRAFT. Tremendous stock of leather, tools, supplies, and kits. In leather business over forty years. Send 10c for big catalog. Sax Bros., 1111 No. 3rd, Dept. PM-2, Milwaukee 3, Wisconsin.

MAKE A million lamps, no two alike, information 25c. Cy Products, Dept. 2-E, Lafayette, La.

28 LAWN Ornaments, other patterns 15-20" high. Dutch boy, girl, pirate, bull terrier, Mexican boy, girl, dwarf, penguin, flower girl, 25 novelties. \$1.00. Strother, Dept. 14, Belington, West Virginia.

MAHOAGANY Miter boxes. Sixteen inch \$3.50; twenty inch \$3.95; postpaid cash with orders. Send fifteen cents for folders many other homecrafter items. Eastern Hills Lumber Company, Station M, Cincinnati 27, Ohio.

LEATHERCRAFT And leather repair supplies. Free catalog. Luggage and handbag supply, 119 West Second Street, Los Angeles 12, Calif.

FREE Make-it-yourself craft catalog, low-cost kits and supplies. American Handicrafts, Box 1479-AQ, Fort Worth, Texas.

JIGSAW Owners attention! Start earning money at home cutting out wooden novelties and souvenirs. Write H. Cook, Dept. A, 4407 S. Normal Ave., Chicago 9, Ill.

VIOLINMAKERS. Repairers, amateurs, professionals. Fine tone European wood. Materials, tools, patterns, instructions. Illustrated catalogue 10c. Premier Violin Supplies, Division PVM, 430 South Broadway, Los Angeles 13, California.

35 FULL-Size lawn and animated weather-ervane patterns \$1.00 postpaid. Lincoln Studio, Columbia, Conn.

LEATHERCRAFT For pleasure and profit. Big new illustrated catalog of leathers, easy-to-make projects, tools accessories, supplies. Send 10c today. Tanart Leathercraft Co., Dept. PM, 149 N. 3rd Street, Philadelphia 6, Penna.

FREE "Do-it-yourself" leathercraft catalog. Tandy Leather Company, Box 791-H8, Fort Worth, Texas.

MONEY From scrapwood. Patterns and instructions \$1.00. Jigsaw necessary. Lynds, Medway 9, Mass.

LEATHERCRAFT Supplies at lowest prices. "Craftool" stamps. Catalog 10c. Crown Leather, 22 Spruce Street, New York 38.

LEATHER. Tools, lacings, supplies. Free catalog. National Handicraft, 199 William St., New York 7.

STYLECRAFT Sure fire hits. "Pre-traced" leather kits. Handbags, billfolds, filigree belts, over fifty other projects. Patterns on leather. Why trace? Just carve, assemble and lace. Large assortment "precarved" kits also available. Send 25c for catalog, free folder. Refunded first order. Apache Leather Company, 2804 E. Washington St., Phoenix, Arizona.

KNOCKDOWN Cedar chests. Lumber and veneers. Free price list. Giles & Kendall Company, Huntsville, Ala.

FREE Information. Money-making full size patterns. Professional designs. Furniture, gift shop items. Write Jigsawers, 117 Worth, New York 13.

KNOCKDOWN Cedar chests and lumber. Free price list. Bedford Lumber Company, Shelbyville, Tennessee.

FIGURINE Catalog, 1955 edition, 800 illustrated items including Mrs. Helm's paints, enamels; Helen's water color paints, etc., only 35c. Klosterman, Dept. K, 954 Arcade, St. Paul 6, Minnesota.

DO IT YOURSELF

BUILD 10 Amazing machinist tools that can't be bought anywhere! Save \$100! Free literature. Progressive Tool Designers, 2161X So. 76th Street, Milwaukee 14, Wisconsin.

CHAIN Saws: Complete, engine and parts, just assemble machined parts in 1/2 hour, save \$150, pay only \$129.50. M-O Saw, Coatesville, Penna.

WHITTLE Miniature seagull. U-carvit kit \$1 postpaid. Bernard Blake, Cleveland, Florida.

MAKE Your own beautiful awnings for a fraction of regular cost. Plan \$1.00. Henkemeyer, Box 36, St. Cloud, Minn.

SAVE \$1,000.00. 10 Money saving mix-it-yourself formulas. Used every day. You can make tooth powder, furniture polish, silver cleaner, polish, etc. Send \$1.00 for complete formulas. Mix-it-Yourself Corp., 53 West Jackson, Dept. E, Chicago 4.

TV Trouble? Fix it yourself. Be ready for trouble. Our new revolutionary TV trouble shooting guide shows you how in easy, fast, safe steps. 80% cases guaranteed. No experience necessary. Send \$1.00 now. Sentinel Electric Company, Box 2693-A, Kansas City 42, Missouri.

BUILD Any "O" gauge track for less than 4c a foot. Full details for \$1.00. O. J. Gingerich, Wellman, Iowa.

CLOCK Movements—Gorgeous dials, plans, kits. See ad page 253.

MAKE Your own carports, patio tops, partitions, from plexiglas reinforced plastic sheets. \$1.00 (refundable on first order) brings plans list, samples, prices and instructions. Agria Company, P. O. Box 7484, Pittsburgh 13, Penna.

3-DIMENSION Projector. Build it yourself. Free folder, Victor Specialties, 775-D Main Street, New Rochelle, N. Y.

ROTARY Mower unit, 18 or 20 inch blade. Timken bearing, \$10.50, literature. H. T. Mfg. Company, Spirit Lake, Iowa.

YOU Cast metal, free literature. Castings, Box 124, Lynwood, California.

LEARN While asleep: It's easy. Results guaranteed. See "Personal" column.

BUILD Mechanical remote control TV channel changer. Ten minute job; no wiring required. Works on most sets. Instructions included. \$1.50. Satisfaction guaranteed. TV Comfort, Box 295, Elmhurst, Ill.

SAVE 50-75%. Build it yourself, tools, household appliances. Wholesale catalog. Nuebelings-M, Sicklerville, N. J.

GENUINE Tooling leather "do it yourself billfold kit" only \$1.00 postpaid. First 500 customers receive free gift. Miles Crafts, 3220-P Fish Avenue, New York 69.

WATER Softener tanks, zeolite, parts to make your own unit. McCarthy Company, 2930 W. Burleigh, Milwaukee 10, Wis.

FURNITURE—Wrought iron legs and frames! You assemble. Free catalogue. Phillips Furniture, East Peoria 8, Illinois.

GEIGER Counter and metal detector kits. Inexpensive, educational. Free literature. Electronic Applications, 5024 Lee Highway, Arlington 7, Va.

DO-IT-YOURSELF. Build a power mower with Handy-Dandy conversion kit. \$19.50, prepaid in U.S.A. Fits 16" to 20" mower. LeClaire Mfg. Co., LeClaire, P. M., Iowa.

WATCHES, OLD GOLD, JEWELRY

WATCHMAKERS' Journal contains instructive articles for watchmakers and beginners. Sample copy 20c. Dean Co., Box 3218-M, Daytona Beach, Fla.

WATCH And clock repairing books for hobbyists. Free information. North American, Dept. 15-B, 2320 N. Milwaukee, Chicago 47, Illinois.

RONSON Lighter free with watches. Catalog 25c. James, Box 1161, Miami 7, Florida.

UNREDEEMED Diamond, 1-carat, \$295, 30-day refund. Free catalog. Broff's Diamond Loan Association, 411 Smithfield, Pittsburgh, Penna.

RHINESTONES. Jewelry settings, cameos, sequins, beads, hobby kits. Catalog free. J & M Novelties, Dept. CB-3, Griffith, Indiana.

USED And new watches. \$2 up. Southern Watches, Gray, Georgia.

HIGHEST Prices for gold, silver, platinum, diamonds, watches, gold teeth. Satisfaction assured. Goods returned if offer unsatisfactory. United Smelting Works (Old Reliable), 6-B East Monroe, Chicago 3.

MAKE Costume jewelry for fun and profit. Catalog 25c. Bergen Arts, 128M Main, Hackensack, N. J.

HIGHEST Cash for old gold, broken jewelry, gold teeth, watches, diamonds, silverware, spectacles, platinum. Free information. Satisfaction guaranteed. Rose Refiners, Heyworth Bldg., Chicago 2.

AMATEUR—Professional watchmakers' supplies; correspondence instructions; repairing. Bengale Company, Culver City, California.

COSTUME Jewelry supplies. Catalog and samples. 35c. Largest line in America. Milady-Fair Co., G.P.O. Box 1328, New York City 1.

FREE Sample pair of earrings shows you how easy it is to make beautiful costume jewelry. Over 5000 styles listed in new catalog, 25c. Barry's, 188 Ardsley Court, Newark, N. J.

TOBACCO, SMOKERS' SUPPLIES

INVENTED Wilson pipe reamers for myself. Pipe smokers run me wild! Result—Three sizes handsome brass reamers \$2. Satisfaction guaranteed. Folder. Hy Wilson, Reamers, Hudson, Indiana.

FOR THE HOME

FOAM Rubber furniture cushions. Factory seconds. 50% discount. Free catalog. Perma-Foam, 140-C Main Street, East Orange, New Jersey.

FOAM Rubber slabs, sheets for cushions, mattresses, upholstery. Lowest prices. No seconds. Write Bestcraft, Dept. 99, Mathieson Bldg., Baltimore 2, Maryland.

RAZORS, BLADES, SHARPENING

BEAUTIFUL Guaranteed electric shavers, limited time, \$4.00. Berco Company, 1802 Cherry, Toledo 8, Ohio.

OF INTEREST TO WOMEN

GOOD Money in weaving. Weave rugs at home for neighbors on \$69.50 Union Loom. Thousands doing it. Booklet free. Union Looms, 153 Post St., Boonville, N. Y.

A Dress shop in your home. No investment. Liberal sales commissions. Write Bellecraft Fashions, 111-Y8 Eighth Ave., New York City.

MAIL Order magazine, sample copy, 25c. Clark, Box 3602, Miami 23, Florida.

MAKE. Sell, artificial flowers, wood-fibre Easter corsages, chenille dolls, jewelry, novelties. Easy starting kits, leaves, rhinestones, everything! Catalog 10c. Profitkrafts, 4511732 Lorain, Cleveland 2, Ohio.

COLGATE'S Lustre-Creme shampoo, 4 lbs. \$4.85. Geller, 2089 Matthews Ave., New York City.

MAKE Big money at home! Invisible reweaving pays up to \$10.00 profit in an hour. Make tears, holes disappear from fabrics. Constant demand from laundries, cleaners, homes, brings steady earnings. Details free. Fabricon, Dept. C, 8342 S. Prairie, Chicago 19, Illinois.

BIG Money and independence for you at home. Write Granite Traders, Wolfeboro, New Hampshire.

DRESSES 24c; Shoes 39c; men's suits \$4.95; trousers \$1.20. Better used clothing, free cat. Transworld, 164-AH Christopher, Brooklyn 12, N. Y.

PROFITABLE Home business. Make fast-seller chenille monkey trees, dolls, flowers. Terrific holiday demand. Information free. Velva, Bohemia 16, N. Y.

GROW Mushrooms. Cellar, shed, and outdoors. Spare, full time, year round. We pay \$3.50 lb. We paid Babbitt \$4,165.00 in few weeks. Free book. Washington Mushroom Ind., Dept. 176, 2934 Admiral Way, Seattle, Washington.

WANTED—MISCELLANEOUS

GM71-HV Discarded injector parts wanted. Bares, 7120 Carnegie, Cleveland 3, Ohio.

WANTED—Documents, autographs, valentines, correspondence, envelopes, other Americana before 1900. Stine, Kingshighway, Edwardsville, Illinois.

QUICKSILVER. Sterling, silver solders, precious metals. Wholesale Terminal, Norwood, Massachusetts.

SCRAP Mercury (quicksilver) containers supplied—Tantalum, bismuth, tungsten. Metallurgical Products Company. Established 1909. 33th and Moore Sts., Philadelphia 45, Penna.

FOR SALE—MISCELLANEOUS

AMAZING Bargains! Amplifiers—Save 50%. Tremendous savings: Accordions, pianos, organs, typewriters, movie equipment, binoculars, recorders, hi-fi systems, Abelmart, 466 Belmont, Paterson, New Jersey.

HEARING Aid batteries, wholesale. Free list. Habs, Box 51, York, Penna.

OLD Wall telephones. Working order, oak cabinets, hand crank for ringing. \$5.00 each. Telephone Co., Turtle Lake, Wisc.

PERSONAL

BORROWING By mail. Loans \$50 to \$600 to employed men and women. Easy, quick. Completely confidential. No endorser. Repay in convenient monthly payments. Details free in plain envelope. Give occupation. State Finance Co., 323 Securities Bldg., Dept. C-227, Omaha 2, Nebraska.

REMAINS 25c. Classifieds \$1.00. Highco Service, Box 3782, Birmingham 11, Ala.

LETTERS Remailed New York, Newark, vicinity 25c. Newark help wanted columns airmailed \$1.50 weekly. Box 511, Livingston, N. J.

INTRODUCTORY Offer. Your social security card sealed in plastic 25c. Johnson, 1171 Smith, Birmingham, Michigan.

UNCLAIMED Stocks, bonds and bank accounts information and registration papers \$1.00. Institute of American Inheritance Research, Box 5340-A, Chicago 80, Ill.

LETTERS Remailed from Panama or Canal Zone. 25c each, 6 for \$1.00. Confidential. McOliney, Box #161, Gatun, Canal Zone.

LEARN While asleep! Illustrated booklet shows how, easily, inexpensively. (\$2.00). Results guaranteed. Sleeplearning Research Association C-1, 114 S. 38th Ave., Omaha, Nebraska.

GOMEZ Trevina, Mexican law. Bank references. P.O. Box 263, El Paso, Texas.

25c REMAINING! Mail forwarded daily. Monthly rates. Carpenter Company-PM, Tulsa 16, Okla.

HOUSTON Remail 25c. Tex-Mail, Box 9243, Houston 11, Texas.

ENTERTAINERS! Win popularity! Spark your speech with fresh, amusing anecdotes. Folio of forty, \$1.00. Forrest Miller, 322 Raub, Easton, Penna.

LETTERS Remailed from Kansas City 25c; receiving, forwarding address, \$5 monthly. Confidential. Sterling Services, P.O. Box 505, Kansas City 41, Mo.

LETTERS Remailed 25c. Write for first class personal mailing address rates. McLaughlin, 800 Stewart, Columbus 6, Ohio.

LETTERS Remailed 25c. Los Angeles, San Francisco, Portland, Ore. Return address furnished. \$2.00 monthly. Pearl, 1358 6th Ave., San Francisco.

MEXICAN Law. General Practice Attorney. 1203 Arizona St., El Paso, Texas.

"HOW Can I find out?" You can! Information confidentially developed. Any matter, person, problem. Worldwide. Officially licensed. Established 1922. William Herman, 170 Broadway, New York City.

LETTERS Remailed 25c. Personal forwarding address. Monthly rates. Hicks Service, Box 1347, Washington 13, D. C.

PORTRAIT in oils. Modern-impressionistic, by the renowned E. John Shay, see Fate magazine advertisement for particulars. Send any photograph. \$25.00 prepaid. P. O. Box 4102, Panorama City, California.

BIG Mail! Attractive offers! Magazines, etc.! 6c! Filmer, 9101 Marion, Pharr, Texas.

MISCELLANEOUS

LEATHERCRAFT. Everything needed by beginners, advanced hobbyists and professional leatherworkers. Largest stock of supplies in U.S. Moderate-priced tooling leathers, top quality calfskins, tools, supplies, kits. Send 10c for big catalog. J. C. Larson Co., 820 S. Tripp, Dept. 4451, Chicago 24.

DOOR Cushion. Eliminate floor steps. Prevent knob from hitting wall. 40c. 3—\$1.00 pp. Moneyback guarantee. Engineering Enterprises, 489 Avery St., Elmhurst, Illinois.

"8 MISTAKES Parents Make." Every parent should have this new book about child training. It is free; no obligation. Simply address Parents Association, Dept. 672, Pleasant Hill, Ohio.

BEAUTIFULLY Chrome plated 50 caliber shell cigarette lighter. Stands 3½ inches high. Makes wonderful gift, souvenir or decoration. \$2.00 postpaid. Same lighter in natural finish \$1.00 postpaid. Send check or M.O. to Estanex, 1924 South Fairfield Ave., Chicago 8, Illinois.

URANIUM is everywhere! You need a professional Geiger counter, \$139.50. Finest available. Rugged for field use, long-life batteries. This can be your fortune. Send \$25.00. Balance C.O.D. Money back guarantee. Free catalog. Atomic Sales Company, 409 W. Arbor Vitae, Inglewood 18, Calif.

DELICIOUS Homemade health cookies, body-building. \$1.79 batch. Violet Lewis, 259 Spruce St. Bridgeton, New Jersey.

BUY Wholesale through our club membership. Save up to 50%. No catalogs to buy. Details free. Consumers Buyers Service, 117-56 St., Sacramento 16, California.

I Average \$125 weekly selling books by mail! So can you! Start sparetime! Work home! Cooper, 246-P Taunton, Buffalo, N. Y.

HAIRCUT As you like it. Booklet 25c. Mastrolia, 32-20CG 89th Street, Jackson Heights 69, New York.

VIGOROUS Health. Amazing method. Inquire. Solar Health, Box 1061-V7, Escondido, Calif.

SPEED—Sparkle diamond and jewelry cleaner. Diamonds need cleaning often to restore brilliance. Do professional job at home. \$1.00 postpaid. Money back guarantee. Send remittance with order to Wright Products Company, Dept. B, Mt. Orab, Ohio.

TREASURE. Metal, mineral locators microscope type. Latest electronic design \$75.00 up. Geiger counters, scintillators, mineralights for uranium prospecting \$35.00 up. Fully guaranteed. Monthly payment plan available. Books "How to Be a Successful Uranium Prospector," "For Fun and Profit." Literature free upon request. Fisher Research Laboratory, Inc., Palo Alto, Calif.

WHOLESALE! 8,000 Nationally famous products. 30-80% discounts! Large catalog. Sensational business plans included. Consolidated Distributors, 21-13, Lafayette, Paterson 15, New Jersey.

COMPLETE Geiger kit \$10.00. Free details. Devine, 3594 Los Flores, Lynwood, Calif.

STUPENDOUS Mental power. Inquire. Delmar, Wisdom, Box 1061-S7, Escondido, Calif.

LUXURIOUS Tableware sets. Lifetime guarantee. Bargains. Free catalog. Kenya, Box 5165-P, Pittsburgh 6, Penna.

AMAZING Mimeographed penmanship books. Highly illustrated. "Business Writing" \$1. "Ornamental Writing" \$1. "Short Cuts to Business Writing" 25c. T. M. Tevis, A-25, Chillicothe, Mo.

FREE Gift catalog. Beautiful, unusual items. Shalack, Box 869, Grand Central Station, New York 17.

PERPETUAL Calendar. 2400 year. 50 cents. Franklin Calendar Co., 1129 South Illinois Street, Indianapolis 25, Ind.

EARN Money evenings, copying and duplicating comic cartoons for advertisers. Adservice, Argyle 1-A, Wisconsin.

AMAZING Tools pulling 8000 pounds for farmers, autoists, industrialists. New products delivered from U.S.A. or Canada. Free particulars. Products Information, 1324 Hornby, Vancouver, Canada.

"HOW to Make Money prospecting for Uranium." Free booklet. Geiger Company, 195-M Sackett Street, Brooklyn 30, N. Y.

BUY Wholesale thousands nationally advertised products at big discount. Free "Wholesale Plan." American Buyers, 631-DD Linden, Buffalo, N. Y.

GEIGER Counter tube, large, \$7.00, postpaid. High voltage supplies, circuits, sensitive prospecting instruments. Mineralights, Western Radiation Lab., 1107 W. 24th Street, Los Angeles 7, Calif.

BOOKKEEPING Records simplified with instructions, tax dope. Farm \$1.00; business \$1.50, details free. Hoover Business Service, New Madison 4, Ohio.

"SKETCHOGRAPH." Every desk, workbench and briefcase should have one. 7 precision drawing tools in one. Price \$1.00. Free literature. Klas Enterprises, Inc., 6728 W. Warren, Detroit 10, Mich.

ANSWERS: Each question of fact answered. \$1. Charles Winchell, Box 953, Baltimore 3, Maryland.

PHOTO Lampshades. Use your negatives or pictures. For information write Conaways, Box 7261, San Antonio 10, Tex.

DIRECTORY Of government surplus disposal agencies. Send \$2.00. Directories Diversified, P.O. Box 2348, Minneapolis 14, Minnesota.

BUY Wholesale 450,000 products. Literature free. Carter, Box 6011-H, Chicago 80.

THE Automatic tie-presser \$2.95. (Patented.) Bentley Manufacturing Co., Hobart, Ind.

AMAZING Burglar alarm. Protects your home against burglary. No wires, no battery. Guaranteed for life \$4.95. Claude Adside, Box 65, Kendall, Florida.

MAGNETS—Permanent alnico. Never loses magnetism. Many uses. Excellent for map, bulletin work. Number 3, 12 for \$1.00. Number 5 stronger (magnetic pot holder magnets) six for \$1.00. Quantity prices. Pritt Co., Dept. MA-2, 12 West 27 St., New York City.

CIGARETTES—Roll 200 guaranteed to please for 75c. Particulars free. Pete Moberly, Box 782, Owensboro, Ky.

AVOID Unpleasant shocks from static electricity. Carry a shock eliminator. Send \$1.00 to Linus Linnebar, 4209 Oak St., Kansas City 11, Missouri.

HOME Recording Exchange Directory. \$2.00. Davis Enterprises, Dept. M, Box 604, Hawthorne, California.

DELICIOUS Fresh ground coffee 33½c lb. postpaid. Name, address of dealer \$1.00. Coffee, R-3, Box 94, Bend, Oregon.

PORTABLE Drafting machines. Illustrated folder. Drafting Equipment Co., 504 Randolph, Meadville, Penna.

GERMAN Manufacturer directory! 800 pages, English-Spanish index. \$9.00 postpaid insured. Burke Associates, Manchester, Mass.

GEIGER Counters, kits and assembled models. All include radioactive sample. Send for details. Geiger Counters, Box 111, Sta. A., Hartford 6, Conn.

VIGOROUS Health. Amazing solar health system. Inquire. Box 1061-S7, Escondido, Calif.

CLOGGED Drains opened by new powerful chemical called Sursolvent. Removes grease, soap, tree roots, etc., without expensive digging and electric rodding machines. Simple to use. Mix with water and pour down sink. Postal brings free details. Electric Sewer Cleaning Co., Allston 34, Mass.

300 BIG Mails guaranteed. Samples, plans, offers, propositions, 12 months listing. \$1.00 refundable. Wright Publications, 2270 Hubbard, Memphis 8, Tenn.

RECEIVE Magazines, samples, catalogues. Mails from everywhere. Offers, hundreds. Get listed 25c. Rorick, Box 86, Cincinnati 26, Ohio.

GOLD, Silver, metal detectors. Geiger counters for uranium. Mineralights. Sensational new fully guaranteed models. None finer. Information free. Detectron Corp., 5420 Vineland Ave., North Hollywood, California.

TREASURE Finders for gold, silver and minerals. Money back guarantee, best available! Also Geiger counters for uranium prospectors, free information. Write Goldak Company, 1541 West Glenoaks, Glendale 1, Calif.

GROW Mushrooms. Cellar, shed, and outdoors. Spare, full time, year round. We pay \$3.50 lb. We paid Habbitt \$4,165.00 in few weeks. Free book. Washington Mushroom Ind., Dept. 175, 2954 Admiral Way, Seattle, Washington.

PANNING Gold—Free lesson; catalogue of mining, mineral books, supplies. Old Prospector, Box 729D1, Lodi, Calif.

URANIUM, Gold, silver, treasure. New power-packed, highly sensitive metal detectors and Geiger counters. Kit and factory assembled models from \$34.50. Lightest weight, guaranteed. Free literature. Electronic Applications, 5024 Lee Highway, Arlington 7, Va.

SNOOPER Geiger counter. Only \$29.95 complete. Super-sensitive. Pocket size. Find a fortune in uranium. Order now. Send \$5.00, balance C.O.D. Money back guarantee. Free catalog, scintillator and larger uranium and metal detectors. Precision Radiation Instruments, 2235 CPM So. LaBrea, Los Angeles 16, Calif.

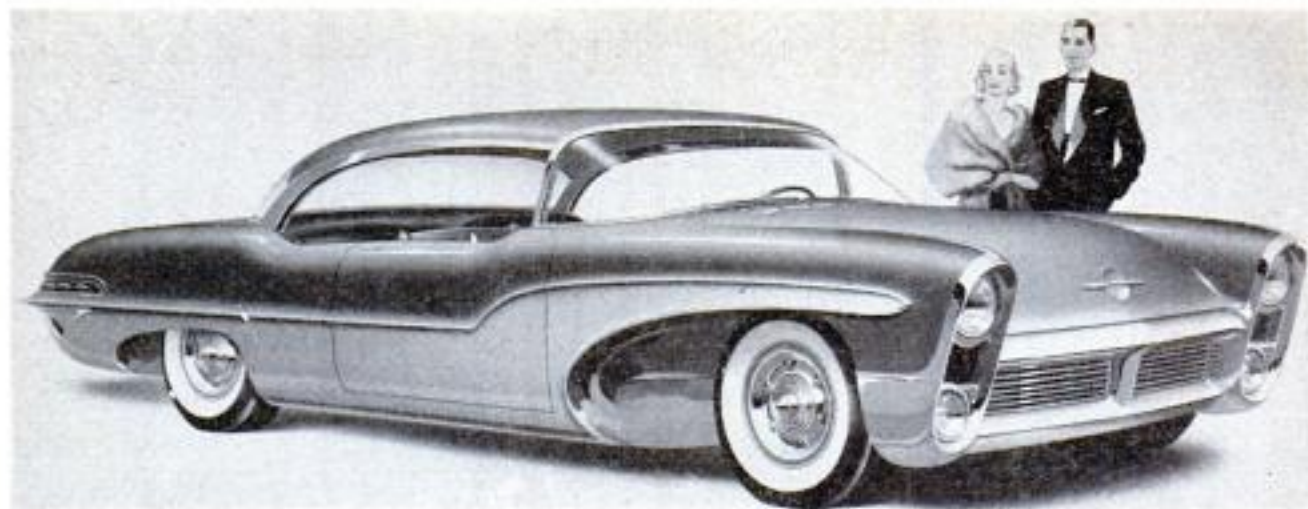

OLDSMOBILE 88 DELTA two-door has four individual seats, front two rotating for easy entry. All glass has blue tint. Scoops in headlight enclosures feed air to front brakes. Car even has built-in wastebasket

Three of 1955's Crop of Dream Cars

CHEVROLET BISCAYNE also has four separate seats. It's a four-door. Concave side panels, inboard headlights, Corvette-type bumper, absence of rear fenders and the "receding hairline" windshield are style features



PONTIAC STRATO-STAR has a roof that seems to float, so slender are the cantilever pillars that hold it up. Hinged panel in roof above each door lifts up automatically as door opens so you won't crack your skull

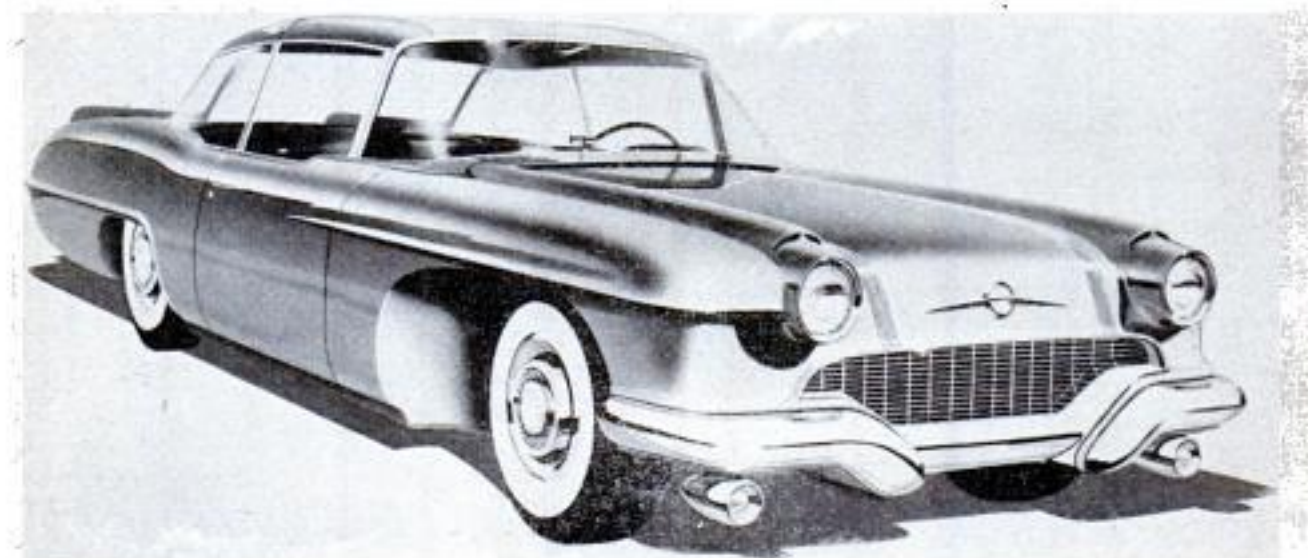



**Start your own
spare time business**

earn **cash**
filing
saws

Make \$3 to \$5 an hour with the FOLEY SAW FILER

BE YOUR OWN BOSS! Here's a proven, repeat, cash business you can start in your basement or garage in spare time. Make a good *extra* income with the Foley Saw Filer, right at home—no matter whether you live in a big city, suburb, small town or on a farm. Saws are used everywhere—in every home, by carpenters, farmers, schools, factories,—and there's a growing demand for saw sharpening from home owners working on "Do It Yourself" projects.

You can make up to \$3 or \$5 an hour—\$20 to \$30 a week in spare time—with the Foley Saw Filer, because of the speed and marvelous accuracy of this automatic machine. After buying a Foley Saw Filer, James Henson wrote us: "I have filed saws by hand for 20 years and considered myself *good*. I take it back—the Foley does a much better job than I could ever do by hand." It's the **ONLY** machine which sharpens ALL saws—all kinds of hand saws, band saws and cross-cut circular saws. No experience is necessary—no eye strain. "The first saw I sharpened with my Foley Filer came out 100%"—Clarence Parsons.

NO CANVASSING. Work will come in to you as soon as people know you are in the saw sharpening business. J. H. Ratleff reports: "Have had 43 hand saws and 26 circular saws in the first 12 days. Customers are well pleased". Read what D. C. Depuy says: "After almost two years I am still doing work for my first customers and business is growing steadily. Foley machines are everything you claim for them. I am 77 years old".

FREE PLAN shows how to start.

This free book "*Money Making Facts*" shows you just how to get plenty of saws to sharpen without canvassing. Here's a year 'round business with no overhead expense—no charge accounts—no stock of goods to carry—and you can start with a modest investment. It will help you pay for rent or groceries, buy a new car or home. With a Foley Saw Filer you need never worry about being out of work. Get the facts—begin making an extra cash income in spare time, and later develop into a full-time repair shop. Send the coupon or postcard today for Free Plan—no obligation, no salesman will call.

**This coupon
can start you
in your own
business**

FOLEY MANUFACTURING CO., 216-5 Foley Building, Minneapolis 18, Minn.

Please rush "*Money Making Facts*" and Free Plan showing how to start a spare time cash saw filing business with the Foley Saw Filer.

Name _____

Address _____

(Use margin for address if necessary)



**MONEY
MAKING
FACTS**

THESE MEN MAKE MONEY— WHY DON'T YOU?

\$600 First Year—"I am happy to report . . . I finished my first year of filing saws and in that year I filed 678 saws and took in around \$600. That isn't bad for a beginner, is it?"—Paul F. Stevens.

Wives say O.K.—"When I purchased the Foley Filer years ago, we had hard times and my wife did not approve, but I scraped up enough to make a payment and get started. Now my wife thinks it is the best investment I ever made. I have paid for a home and have a nice business built up."
—Harry Hawkins.

"My wife thought it was a waste of money to buy a Foley Filer. She wanted to buy furniture instead. The first year I made enough spare time to doubly pay for the machine, so we both won."
—Mr. Drye.

\$765 in Spare Time—"I made \$765 last year filing saws in my spare time and it sure comes in handy."
—J. B. Williams.

Sharpened 5,000 Saws—"I have done 4 or 5 thousand saws in my spare time in the 4½ years since I got the Foley outfit, and they are all coming back with repeat orders."
—Len Cresco.

1955 DREAM CARS



BUICK WILDCAT, a four-passenger convertible, has a curved-top windshield. Air scoops in front bumper and rear fenders cool its brakes



CADILLAC ELDORADO sedan is a four-seater, too. It has no center post between its doors. Front seats swing to side for easy entry and exit

More dream cars on
pages 72 and 78



LA SALLE coupe has four independently sprung aluminum wheels. Exhaust goes through frame member, comes out below the door

GMC EXPEDIER is a "dream truck" with a front-wheel drive so floor is a mere 13 inches above ground



YOU CAN SAVE \$\$\$ ON TAXES

...with an Individual TAX SAVER!

Sold With
a Money-Back
Guarantee!

Here's How the TAX SAVER Helps YOU:

- You need not be an accountant—it's simple and easy to use
- Outlines authorized tax deductions
- Itemizes your tax deductions as they occur
- Provides monthly and yearly summaries of deductions
- Provides more accurate information than estimates for tax returns
- Can save you many, many dollars on the tax you pay
- Becomes a permanent record and a basis of proof in case of investigation

PAY ONLY YOUR FAIR SHARE!

VAN LOON BROS., DPM-2, BOX 8758, UNIVERSITY PARK STATION, DENVER 10, COLO.

CLIP AND MAIL NOW!

VAN LOON BROS., Dept. PM-2
Box 8758, Univ. Pk. Station,
Denver 10, Colo.

Gentlemen: I enclose \$..... (50c each)
for.....INDIVIDUAL TAX SAVERS. If I am
not satisfied after examination, I may return
it within ten days and receive a full refund
of purchase price.

Name.....
Address.....
City & State.....

City & State.....

ALL OUR TIRES SOLD ON AN UN-
CONDITIONAL ROAD HAZARD GUAR-
ANTEE FOR THE LIFE OF THE TIRE

SAVE! SAVE! SAVE!

Buy now—save—get best value! All good
used tires. No recaps or retreads. Uncondi-
tional road hazard guarantee for the life of
the tire!

600x16	\$5.00	640x15	\$4.95	32x6.8	\$11.95
600x16 (1)	6.75	670x15	5.00	32x6.10	12.75
650x16	5.50	710x15	5.45	700x20	12.50
650x16 (1)	7.25	760x15	5.90	760x20.8	15.50
700x16 (1)	7.00	800x15	6.35	750x20.10	17.50
550x17	4.75	820x15	6.35	825x20	21.50
700x15	5.35	650x15	5.45	WHITEWALL	\$1.00 EXTRA

DUPLI-WEAR RE-TREADS. WE DUPLICATE THE TREAD,
THE APPEARANCE AND THE SERVICE OF A NEW TIRE.
670x15 \$6.45 | 710x15 650x16 \$7.45 | 800x15 \$9.45
600x16 760x15 650x15 820x15

Quick Service on Mail Orders. All tires shipped F.O.B. Chicago.
Send check or money order. No. COD's.

DUPLI-WEAR

2148 S. Western, Dept. PM-2,
Chicago, Ill.



HELPFUL BOOKS

Send post card asking for FREE catalog

Popular Mechanics Press, 200 E. Ontario, Dept. 601, Chicago 11

AN OUTSTANDING BUY

PORTABLE COMPRESSOR UNIT WITH 22 GALLON TANK

Heavy duty, 1/2 h.p. capacitor AC motor, 125
lbs. capacity. Complete with rubber tired
wheels, all valves, gauges, cord, plug, air
hose, tire chuck, paint spray gun. NOTHING
ELSE TO BUY. Ship wt. 90 lbs. FOB CHICAGO

UNASSEMBLED... \$82.95 ASSEMBLED... \$92.95



Send for FREE 112 page
Illustrated Catalog of Many More
Farm — Home — Workshop — Buys

Write to **WELLWORTH TRADING COMPANY**
Dept. E-2
1832 S. WABASH AVE. CHICAGO 16, ILL.

SURPLUS LIGHT STAND

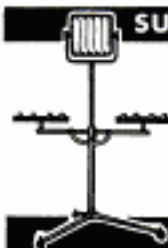

Portable metal tripod
on casters. Est. to 12" \$10.95

6 tube
fluorescent head \$10.95

4 swivel socket
incandescent head \$6.95

SEMLER INDUSTRIES, INC.

British Navy COMPASSES



Survey
Model P-10
7 1/2" diam. Marine
Steering Compass \$10.95

Model O2 Compass
and Pelorus
6 1/2" diam. \$12.95

SOUND POWERED PHONE



No batteries needed. Voice generates
current. 25 mile range. Perfect intercom
— shop, office, farm, etc.

War Surplus Now Only \$10.95

Money Back Guarantee

6853 Lankershim Blvd. • No. Hollywood, Calif.

Guaranteed for Life of your car

The

Metalloy Grid Battery

Custom
Built
for Today's
Driving
Conditions



Electomic Plates and Cells

ELECTOMIC Lifetime Battery . . . \$19.95

\$34.95 VALUE ONLY \$19.95 IF YOU INSTALL IT YOURSELF. FACTORY DIRECT TO
YOU. THE WORLD'S GREATEST BATTERY IMPROVEMENT IN OVER 40 YEARS.

GUARANTEED FOR THE LIFE OF YOUR CAR—AS LONG AS YOU OWN IT.
"METALLOY" GRIDS (SILVER-NICKEL-TELLURIUM) PLUS ACTIVATED OXIDES PRODUCE
ELECTOMIC PLATES AND CELLS GIVING INSTANTANEOUS STARTING
POWER—FAR GREATER CAPACITY EVEN AT FRIGID TEMPERATURES—WITH-
STANDS TERRIFIC VIBRATION. ELECTOMIC LIFETIME BATTERIES OUT-PERFORM
ALL OTHER BATTERIES—EXCEED GOVERNMENT SPECIFICATIONS . . . ORDER
YOURS TODAY. MAKE EXTRA MONEY—BE THE FIRST IN YOUR AREA TO INSTALL
FOR OTHER CAR OWNERS. ACT QUICKLY—DON'T MISS THE OPPORTUNITY OF
A LIFETIME. FILL IN ORDER FORM BELOW AND AIR MAIL TODAY.

ELECTOMIC LIFETIME BATTERIES, DEPT. PM 114
801-85th Ave., Oakland 21, California

Please Ship (Cash, Check, Money Order Enclosed)

- 6 volt Pass. Car Electomic Lifetime Batteries @ \$19.95 (inc. tax)
 12 volt Pass. Car Electomic Lifetime Batteries @ \$24.95 (inc. tax)

FOR

Make and Model, Year of Car

NAME

ADDRESS

CITY..... ZONE..... STATE.....

Million-Mile Road Test Reveals Simple Way to Get:

- ★ 5 to 9 more horsepower
- ★ 27% more miles per gallon
- ★ Smoother Idling
Faster Pickup

70,000 Miles Without an Overhaul

...from any make, any model, any year car!

A few months ago, a fleet of test cars pulled off the proving ground track and into the shops of one of the largest automobile manufacturers in the world. Outwardly, these cars still looked identical after their endurance runs. Then the mechanics tore down the engines and miked the bearings, rings and pistons. Most of them were ready for overhaul. But some of them still had three more lifetimes to run!

Special lubricants? They were all using oil you could buy anywhere for about 40¢ a quart.

The secret? Better oil filtration. Here's why: the moving parts in your engine never touch each other. They're always separated by a thin film of oil. Keep abrasives from getting into that film of oil and, *theoretically*, your engine should never wear out.

Today, the development of two inventions makes it possible for any engine to approach the life and performance that engineers know is theoretically possible. Here are the two inventions:

One is a simple \$3.95 Fuel Monitor designed to give you improved carburetion, more miles per gallon, smoother idling and increased speed and power.

The other is a revolutionary anti-acid, anti-friction Life-Time oil filter which has already increased engine life to 250,000 miles in highway tests.

Both of these inventions are possible only because of the discovery of an amazing metal—sintered bronze.

What is Sintered Bronze and What Good is it?

We make sintered, or porous, bronze by fusing together millions of tiny bronze balls under heat and pressure. The result is an extremely fine screen—much finer than any screen that could be woven of metal or even cloth.

Originally, sintered bronze was used mainly to filter liquid oxygen and other extremely cold rocket and jet fuels, plus superheated gases.

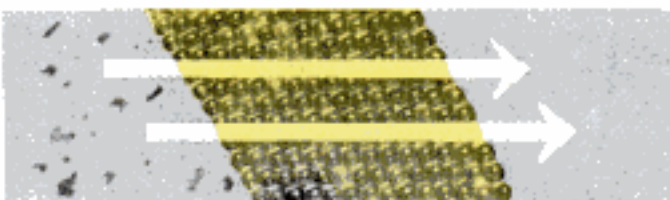

Carbon and abrasives can't get through spaces between bronze balls; oil stays dark, proving no additives have been removed.

Our engineers used this experience to pioneer the development of the Life-Time® automotive filter you have read articles about in magazines like this one.

The Life-Time Fuel Monitor: How it Works

If you've ever dropped a lighted match into a pail of gasoline, you know that gasoline won't explode. Only gasoline vapor will explode. The more raw,

unvaporized gasoline your carburetor delivers to the cylinders, the more gas you waste. The more highly vaporized a mixture your carburetor puts out, the more mileage and power you get from your gasoline.

Increased Vaporization

Most improved carburetors try to increase vaporization by doing something to the gasoline *inside* the carburetor. The Life-Time Fuel Monitor simply tackles the same problem in a different

way *before* the gasoline gets to the carburetor. Attached to your carburetor just like an ordinary gas filter, the Life-Time Fuel Monitor has a porous bronze element which:

- (1) removes water from gasoline, plus tiny amounts of low-volatility petroleum tars which interfere with complete vaporization;
- (2) tends to equalize gasoline pressure;
- (3) removes gums, rust flakes and other impurities before they can foul carburetor jets permanently or even momentarily. Result: you save \$20-\$35 in periodic carburetor cleaning expense, and get improved mileage and performance.

MILES BETWEEN OVERHAULS



MILES:	20,000	40,000	60,000	80,000	100,000
NO OIL FILTER	[Car icon]				
FILTER CHANGED EVERY 1000 MILES		[Car icon]			
LIFE-TIME BRONZE FILTER (NEVER CHANGED)				[Car icon]	
LIFE-TIME BRONZE FILTER AND FUEL MONITOR (Tests still in progress)					[Car icon]

ROAD TESTS in cars of all makes and models prove engine life is virtually unlimited when gums, tars and damaging abrasives are kept out of oil and fuel systems.

Genuine Life-Time Oil Filter Gives Your Engine 250,000-Mile Protection Against Acid, Abrasive Damage

Here's the original, genuine Life-Time® permanent bronze oil filter tested and approved by the editors of leading automotive and scientific magazines. The only bronze oil filter ever to pass government shock and vibration tests, the genuine Life-Time® filter removes all abrasives—including granular, diamond-hard carbon which gets through other filters—plus acid-producing water. In addition to preventing acid formation, the Life-Time oil filter has a special acid-neutralizing component which actually destroys residual acids that have already formed in your oil system.

How the Life-Time® Oil Filter Works



Test vehicles have already exceeded the 250,000 mile mark with the Life-Time® filter. You never change it; just rinse it out and it is good as new.

Dirty oil enters at top. Impurities, stopped by bronze screen, fall to bottom of case. Filtered oil, including additives, returns to lubrication system.

*Don't confuse the original, genuine Life-Time filter with imitations and "improved" substitutes. Only the original, genuine Life-Time filter has passed government shock and vibration tests and meets military filtering requirements. Look for this trademark: **LIFE-TIME**

Try the Life-Time Fuel Monitor and Life-Time Oil Filter for 30 Days at Our Risk!

You can try either or both on this guarantee: you must be convinced they do everything we say, or money back, no questions asked!

For complete Life-Time oil filter unit, including case (fits any car), send make, year and model of your car and \$12.95 (we pay shipping).

Life-Time oil filter conversion kit, which replaces your present filter pack with Life-Time bronze, is \$6.95 for most

cars (send make and number of present filter when ordering). Conversion kits for Buicks with hydraulic lifters and for cars with full flow systems: \$13.95.

Or send only \$2 deposit, pay C.O.D. charges on arrival. But do it today—don't waste another cent on filter pack replacements!

To try the Life-Time Fuel Monitor, simply send \$3.95 (we pay postage) or send \$1 deposit, pay C.O.D. charges on arrival. If you're not convinced in 30 days it's worth four times the price: money back, no questions asked!

LIFE-TIME PERMANENT BRONZE FILTERS



Continental Manufacturing Corporation, Dept. CPM-2
Washington Boulevard at Motor Avenue, Culver City, California © 1954

Continental Manufacturing Corporation, Dept. CPM-2
Washington Blvd. at Motor Ave., Culver City, Calif.

Gentlemen:

I will road test the products checked below in my _____ (make, model, year of car)
 Fuel Monitor (\$3.95)
 Oil Filter (\$6.95 for conversion kit; \$13.95 for full-flow; \$12.95 for complete unit, including element).

I enclose cash; you pay shipping
 \$2 deposit; will pay C.O.D. charges on arrival.

You will refund my money for either or both products if I return them within 30 days.

Name _____

Address _____

City _____ Zone _____ State _____

DEALERS AND DISTRIBUTORS: find out how you can cash in on demand generated by two-page and four-page ads in national magazines, plus radio and TV network shows and full-page newspaper ads. Write today for full information on Life-Time Fuel Monitors, Oil Filters, Batteries, Spark Plugs and Power Brakes. Continental Manufacturing Corporation, Dept. CPM-2, Washington Blvd. at Motor Ave., Culver City, California.

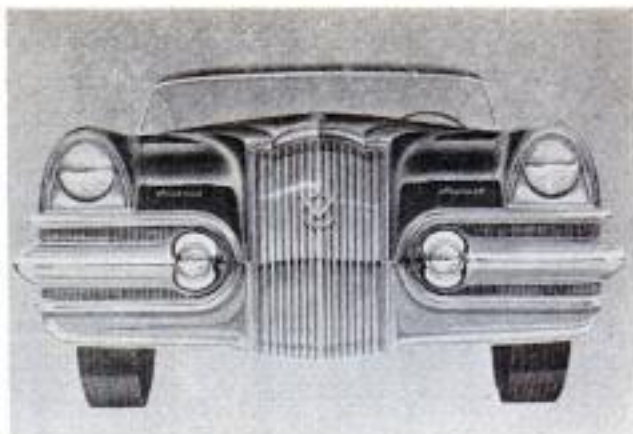
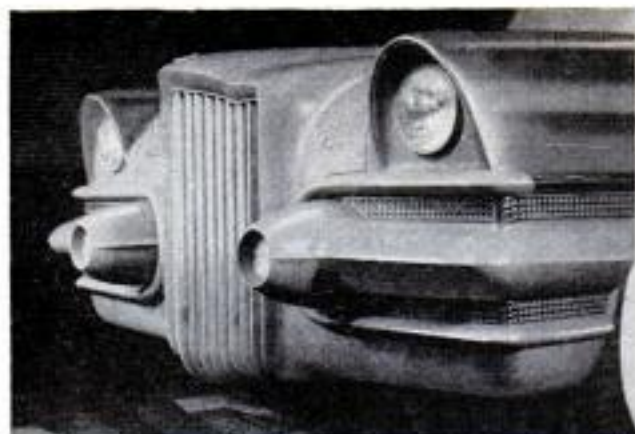

1955 DREAM CARS



PACKARD'S REQUEST was designed to answer requests of many classic-car lovers who asked that the traditional Packard front grille be modernized. The chassis is regular 1955 Packard design

More dream cars on pages 72 and 74

LA SALLE sport sedan, left, has V6 fuel-injection engine, encloses all brake and fuel lines in a central structural tube of chassis. The emergency-brake unit is located behind the rear axle

Koenig ALL-STEEL CABS for JEEPS SAFETY FOR PASSENGERS AND CARGO

- ★ **PROTECTION**—from weather and burglary.
- ★ **SAFETY**—All-steel, welded construction. No rivets. Safety glass used throughout.
- ★ **COMFORT**—Full air-spaced head lining and door lining. No vibration.
- ★ **CONVENIENCE**—Roll-down windows, full opening. Available in full cabs (cover entire body), and half-cabs (cover front passenger compartment).

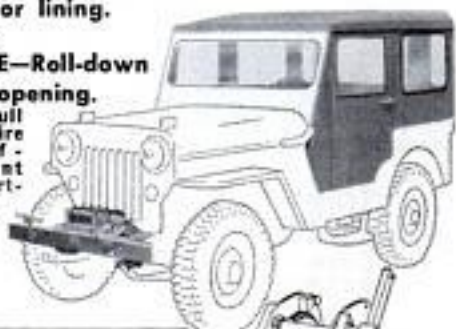

KING POWER WINCHES

For all Willys Jeeps, 4 W. D. Trucks and 4 W. D. Station Wagons, and all other make trucks.

Gets you out of mud, sand, snow — out of ditches or gullies, and up hills. Moves machinery, logs and heavy objects. Makes hoisting or clearing jobs easier, safer.

KOENIG CABS and **KING WINCHES** available through **KAISER-WILLYS** Distributors and Dealers.

KING GALVANIZED HAND WINCHES

Tested over 1000 lbs. Capacity 100' 1/4" cable. All-steel construction with bronze-bearings. Mounts horizontally or vertically. Right or left hand. Adjustable handle lever. Positive ratchet, either direction.

Write for descriptive literature.

Koenig *Free*
IRON WORKS
Dept. M. 2214 Washington Ave. HOUSTON 10, TEXAS

DEGREASER! engine shampoo

QT. SIZE CONCENTRATE
MAKES 2 GALLONS



Takes cling out of oil and grease . . . emulsifies it . . . so that all dirt may be hosed off as easily as you rinse hands under water faucet.

Launders engines faster, more completely, and safer than steam cleaning (warm the engine). Self scouring action brings out factory new appearance . . . provides accurate visual inspection . . . Gunked engines run cooler.

Get Genuine Gunk in quart and larger sizes at better wholesale auto suppliers throughout the country . . . Flatly refuse imitations.

Extra strength, ready-to-use Gunk in pint containers is available from any of the Harley-Davidson Motorcycle Dealers everywhere.

The **CURRAN CORPORATION**, Lawrence, Mass.

Make SURE, SAFE INSULATED ELECTRICAL CONNECTIONS

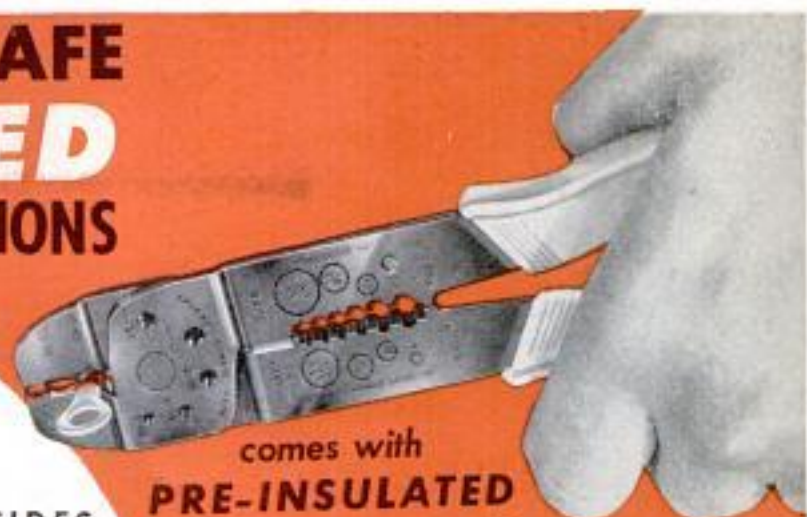

The New SUPER *CHAMP* Hand Tool

The ONE Tool for ALL Wire Sizes used in Home Wiring, Appliances, Automobiles.

DOES ALL THESE THINGS BESIDES

CRIMPS Solderless Terminals and Connectors without solder or tape for safe connections.

CUTS Wire, making clean, sharp cut through insulation and Conductor.

STRIPS Wire sizes #22-#10. Gauges assure proper length for sure, safe-crimp.

SHEARS Bolts and screws without damaging threads — no filing or hack sawing.

comes with
PRE-INSULATED

Splices

Connectors

Terminals

FREE with Each TOOL

T. W. Berger, Inc., National Distributor
Aircraft-Marine Products, Inc.
1315-F American Bldg., Cincinnati 2, Ohio

Send me post paid the new super Champ Hand Tool, I am enclosing \$3.95. (Ohio residents add 12c sales tax.)

check money order

NAME

ADDRESS

CITY.....ZONE.....STATE.....

ORDER DIRECT — USE COUPON

Satisfaction guaranteed or money back.
Send check or money order for \$3.95.
(Ohio residents add 12c sales tax.)

T. W. Berger, Inc.

National Distributor Consumers and Dealers

AIRCRAFT-MARINE PRODUCTS, Inc.
1315-F American Bldg., Cincinnati 2, Ohio

Only
\$3.95

Post Paid

Popular Mechanics Book for Pleasure or Profit 23 BOATS You Can Build

Build the boat you have always wanted. Build it for fun or to sell at a profit. Get Popular Mechanics 23 BOATS YOU CAN BUILD — row boats, canoes, sail boats, power boats and other craft including a 23 foot cabin cruiser. Book includes more than 500 photos, plans, diagrams and working drawings, plus step by step instructions that anyone can follow. Only simple tools needed. Material list of lumber, hardware, fittings, etc., included. Order today under money-back guarantee. Only \$2.00 postpaid.

POPULAR MECHANICS PRESS, Dept. PM3, 200 E. Ontario St., Chicago 11

Amazing CAR CARRIER



You can carry it in
your glove compartment

The most amazing car carrier ever designed. Store it in your glove compartment. Takes only seconds to install for use! Great strength—made of extruded aluminum. Fits all model cars. Fastens securely with Vise-Type Screw Mold on gutter.

Ideal for hauling Fishing Poles, Skis and other sports equipment as well as lumber, pipes. With set on each side of car strap down boxes, suit cases, camping equipment. No fuss, no bother. On and off in a jiffy. Will not rust or wear. Strong, sturdy, secure. Every car owner should have a set in his glove compartment. **ORDERS YOURS TODAY!** Money Back Guarantee. Send check or money order. No C.O.D.'s please.

Per Pair
ONLY
\$2.50

The McCOOK HOOK Box 87, Dept. PM-2,
Orland Park, Illinois

Holt's 'WORLD FAMOUS' "Do-It-Yourself" PRODUCTS

HOLT'S ORIGINAL Piston Seal

does help in
6
important ways

- 1—reduces oil consumption
- 2—restores compression
- 3—stops piston slap
- 4—increases miles per gallon
- 5—improves performance
- 6—makes engine quieter

Good for 10,000 miles of carefree driving. Next best thing to a complete motor overhaul . . . at 1/20 the cost. Today's biggest seller. Millions of tubes have been sold throughout the World during the past 18 years. Undeniably safe for even the finest engines. Endorsed by leading technical automotive experts. Easy to use. Costs less than \$5.

\$1.69
CAN

Holt's GUN-GUM MUFFLER SEAL

Mends leaky mufflers—
seals pipes and joints

Sets like a weld in
a few minutes.
Apply by hand

At Every Auto and Accessory Store
TREGLOWN CO., Inc.

Fanwood 8, N. J.

CANADA: 1366 Greene Ave., Montreal 6

Prices slightly higher in Canada

Write
for full
details

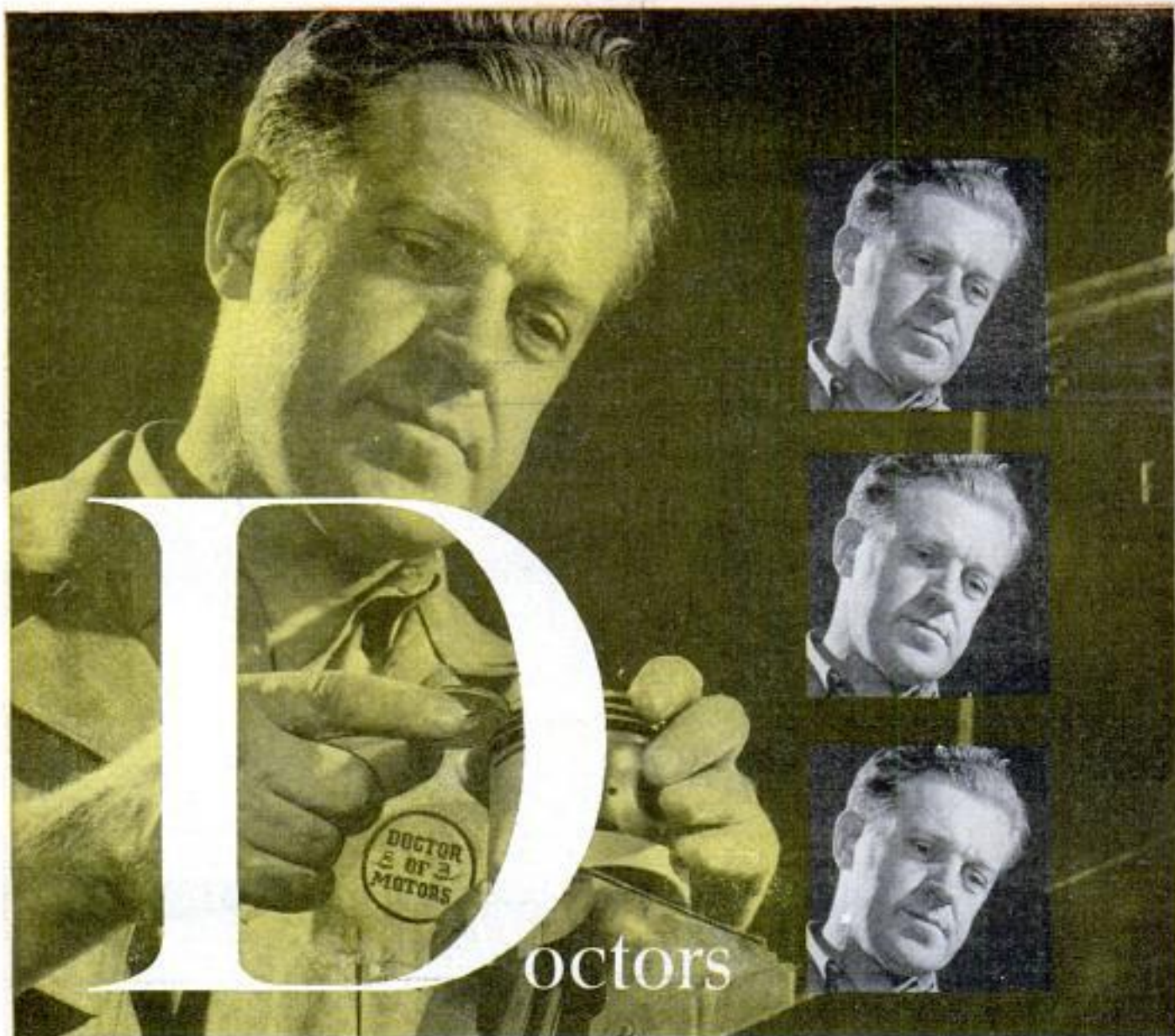

Doctors of Motors everywhere

prefer Perfect Circles...the piston rings that assure thousands of extra miles at peak performance!

THIS PERFORMANCE ASSURED BECAUSE:

1. In Perfect Circle's 2-in-1 Chrome set, both top ring and oil ring are plated with thick, solid chrome!
2. Entire area of ring travel gets complete wear protection assuring longer engine life!
3. No tedious break-in...rings are lapped-in at factory!

This adds up to thousands of extra, satisfying, economical miles with sustained power and positive oil control. No wonder the preference is for Perfect Circles! Perfect Circle Corporation, Hagerstown, Indiana; The Perfect Circle Co., Ltd., Toronto, Ontario.



Perfect Circle 2 in 1 chrome piston rings
The Standard of Comparison



CAP to the Rescue

By Frank Burnham

IT WAS MIDWINTER 1942. Twenty-four agonizing hours had passed since the four-engine Liberator gave up the ghost and crashed with a thundering roar on a wind-swept saddle near the crest of 13,000-foot Little Baldy.

The blizzard slashing northern New Mexico gave little comfort to nine survivors. Those less hurt did what they could to make their comrades comfortable, but the situation seemed hopeless. Having cheated death once they might easily succumb to cold and biting wind. A night and a day passed. One searching Flying Fortress spotted them but the food and medical supplies it dropped were snatched by the wind, to settle beyond reach on crags below the tiny saddle.

Back at the search base the mission commander was faced with what seemed an impossible task. Ground parties could never reach the scene in time. Helicopters couldn't cope with the

His plane nosed over in a simulated crash, the "survivor" in an Alaska winter exercise signals a CAP "rescue" aircraft





The CAP crew of an Air Force liaison plane, on a training mission, searches for "wrecked" aircraft



Spotting the "wreck," the search plane radios CAP headquarters where location is plotted on a map



The map is shown to target-confirmation pilot, who flies to scene to radio directions to ground party

First aid given, "casualty" is placed in Stokes litter and lowered over cliff to waiting aircraft



Skilled woodsmen and first-aid specialists make up the ground team dispatched to aid "crashed" pilot

Stretcher bearers carry "patient" from evacuation plane to hospital in last step of rescue exercise

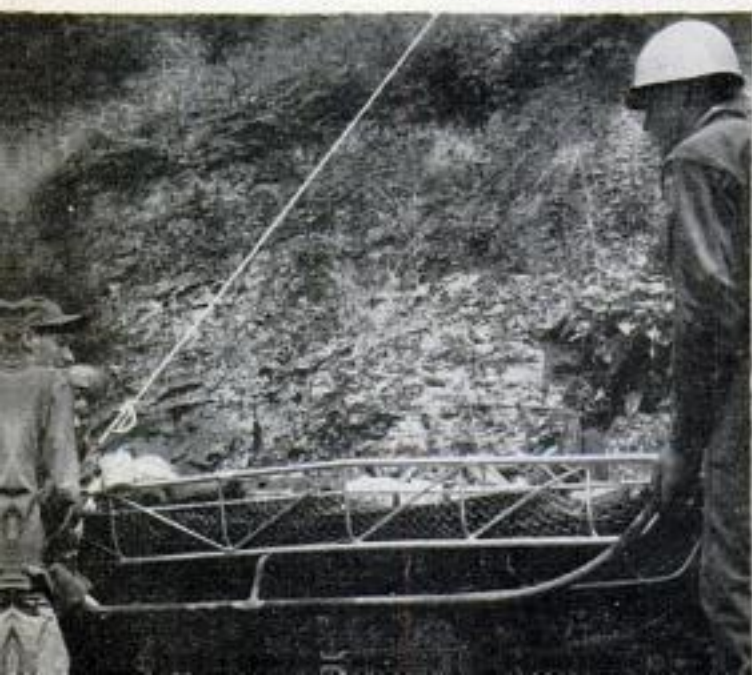



Injured 84-year-old Tom West (foreground) awaits CAP removal from Seldovia, Alaska, to Anchorage

13,000-foot altitude and swirling winds. The only hope was to turn the job over to the newly formed Civil Air Patrol.

In a short time Capt. Norman Kramer, CAP squadron commander from Alamosa, Colo., and his observer, First Lt. Arthur Mosher, were winging their way to the crash scene in their tiny, single-engine Taylorcraft. Mountain winds racked the little plane. The engine sputtered and gasped in what seemed a violent protest against the rarefied atmosphere.

Kramer nursed the plane to 13,000 feet

and swung in over the saddle. There lay the shattered bomber. He circled in closer, allowed for wind drift and dropped packages of medical supplies from less than 100 feet above the wreck. He saw them drift into the hands of the survivors, then turned his plane back to the base for another load of vitally needed supplies.

On the second trip Kramer and Mosher took a better look at the tiny saddle of firm ground. "I'm going to try and land, Art," Kramer told his companion. With misgivings the observer nodded, "Okay by me."

CAP ground-rescue units, using snowmobiles loaned by the U. S. Forest Service, make radio contact with search plane flying over rugged Rocky Mountain terrain





CAP ground teams work in all types of terrain. A Nevada Jeep squadron bivouacs in the desert country of Big Smoky Valley



This rebuilt wartime communications-command truck now serves the CAP, which does not confine its work to aviation. In time of flood (below), cadets operating a portable radio keep sandbaggers in touch with flood-control headquarters



The little plane dragged the area, then swung in. Fighting gusts all the way, Kramer cut power just as the landing gear touched. The plane bucked to a halt.

This heroic action did more to boost the morale of the marooned airmen than the actual delivery of the badly needed supplies. After a short conference, Kramer fired up his flying flivver and took off. The altimeter read 12,800 feet which he thinks may be the highest any light plane had ever landed or taken off.

Six times that day Kramer piloted his Taylorcraft up to the mountaintop bringing in more medical supplies, food and blankets. The miniature airlift made it possible for the injured crewmen to survive until the next day, when a ground party reached them.

The selfless action of the unpaid, civilian volunteers of the Civil Air Patrol like Norm Kramer and Art Mosher became one of the legends of World War II. Those legends have become a heritage which serves as an incentive for today's members of a new, streamlined Civil Air Patrol.

Recently, Navy Ensign John Meder's Banshee jet suddenly burst into flame at 26,000 feet. Seconds later the ejection seat had shot him from the smoke-filled cockpit. His parachute opened with a pop that burst its seams. Instead of lowering him gently toward the Illinois landscape it sent him plunging earthward.

The ground came up with a smash that knocked Meder out. When consciousness returned, Meder tried calmly to consider his position. Search planes probably would not see him in the brush where he lay. Using his elbows, he wormed foot by foot toward a near-by field. He saw a farmer plowing about a quarter of a mile away. He lit a smoke grenade and called wildly. The farmer did not notice, and Meder lapsed into unconsciousness again.

Meanwhile the 49th Air Rescue Squadron at Selfridge Air Force Base, Mich., had ordered every Civil Air Patrol squadron in Illinois and Indiana into action. Thirteen hours after Meder left his crippled plane, CAP pilots Vince Causeway and John Zonge, flying different planes, both spotted him



A CAP communications bus kept contact with the outside world after the 1953 tornado ravaged Flint, Mich.

lying in a soy-bean field more than nine miles from where his jet had crashed.

A half hour later Lt. Col. L. H. Whan, Director of Communications for the Illinois Wing of CAP, arrived in a radio car.

Today Meder is on the mend. His doctors say the full credit is due the volunteers of the Civil Air Patrol. A few more hours and he would have been dead.

The files at Civil Air Patrol National Headquarters in Washington are full of such stories. The unique outfit has been called our "neighborhood air force" and its members, "America's flying minutemen." No more descriptive names could be coined. The members of CAP fly from one-way grass strips and multimillion-dollar metropolitan airports in 2248 communities across the nation and in the territories of Hawaii, Alaska and Puerto Rico. They fly whenever and wherever needed.

In 1953 this organization of more than 80,000 (including 45,000 non-flying members) established an impressive record in search and rescue work. As the civilian auxiliary of the United States Air Force, CAP performed 12,290 hours of aerial search, 66 percent of the total search and rescue hours flown in the United States on missions ordered by the Air Force's Air Rescue Service. CAP's more than 7500 fixed, mobile, portable and airborne radio stations were indispensable in achieving this record.

(Continued to page 264)

FEBRUARY 1955



Radio trailer of Richlands, Va., CAP squadron worked 24 hours a day contacting aerial observers during serious forest fire

More than 2500 fixed communications stations are operated by the CAP in all 48 states, Alaska, Hawaii and Puerto Rico

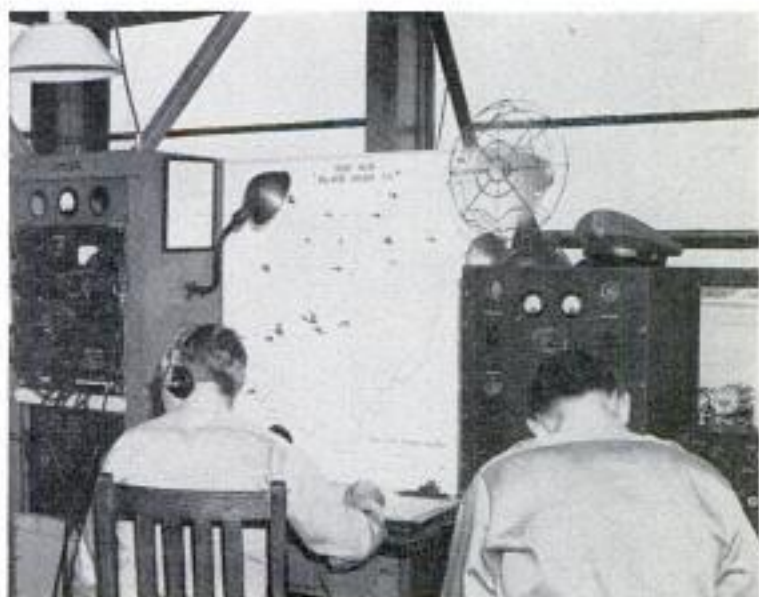

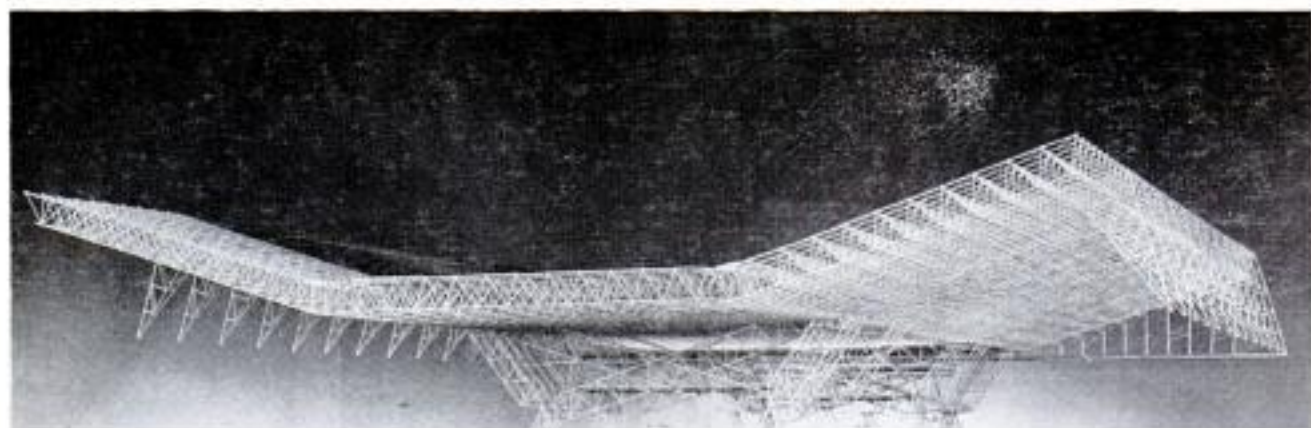

The tubular-steel framework of this big hangar is held together by a simple pin-locked coupling (below)

Giant Tubular-Steel Hangar Can be Folded Up and Flown Away

Capable of housing six huge B-36 bombers for repair or eight for storage, a hangar designed for the Air Force by Illinois Institute of Technology has no exterior supports and can be entered from any side as hanging doors slide out of the way. The hangar features a butterfly, or double-cantilever, roof structure of tubular-steel trusses resting on center supports of the same basic design. Heart of the structure is a coupling of interlocking forgings held together by wedge-shaped pins. The coupling holds the tubular members in place. Couplings can be assembled by unskilled labor. Each 10-foot modular section can be folded into a shipping package about 20 feet long by 10 feet deep by 3 feet wide.

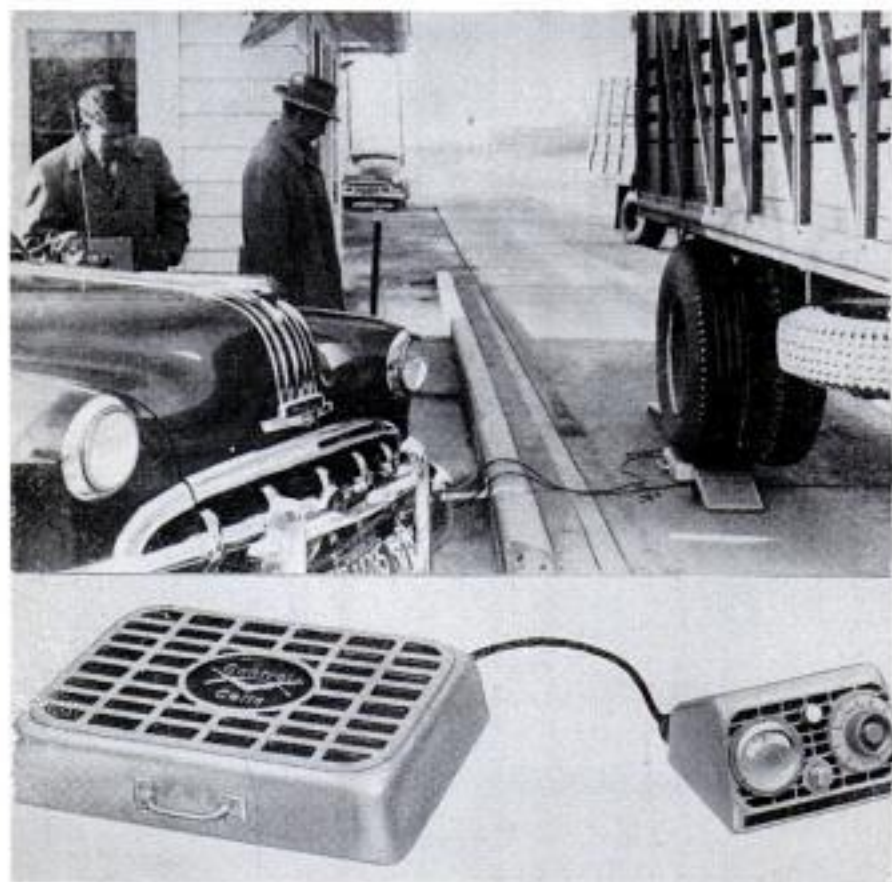

"Brief Case" Scale Weighs Big Trucks

Up to 10,000 pounds can be weighed on a portable scale that easily fits a brief case and has a weight of 35 pounds. The scale, which is electronic, operates on batteries or alternating current. Unaffected by weather or moisture, the scale withstands an overload of 4000 pounds and maintains accuracy within one percent. It can be used to weigh trucks, lumber, livestock and a host of other items.

Britain's newest television station is to be built beneath the site of the old Crystal Palace, with a 640-foot steel mast as the only major construction aboveground.

Surfboards Equipped With Motors Provide Water-Sports Thrills

"Motorized splinters" are becoming popular with water-sports fans. They are surfboards powered by outboard motors. Made of plywood, the "splinters" are 7 feet long and 3½ feet wide. They scoot along at up to 40 miles per hour under the thrust of a 10-horsepower motor. The motor is locked in a stationary position and the pilot turns his craft by shifting his weight from one side of the platform to the other. A slight shift produces a shallow turn and an abrupt shift all the way over to one side turns the craft sharply. Most of the owners equip their boards with throttle controls on the handles and with auxiliary gas tanks for long trips.

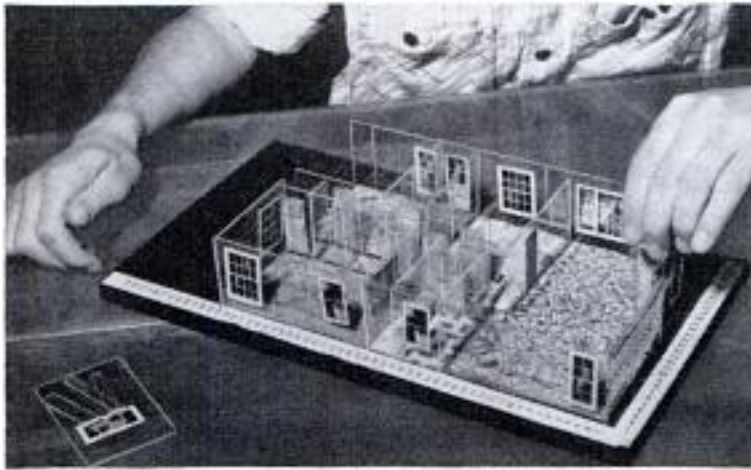

Model Aids Home Plans

Future homeowners can build a model of their proposed house with a new kit. Using plastic walls, windows and partitions, they can adjust rooms and locate closets, chimneys and fireplaces. A handbook helps to estimate the cost of any given arrangement. Charts, price lists and building information are furnished. After the model is made, it can be decorated and furnished with cutouts taken from magazine illustrations.

"Sugar Scoop" Antenna Catches Microwaves

Microwave antennas shaped like giant sugar scoops may soon appear on Bell-system relay routes. The horn-reflector antennas may eventually handle up to about 20,000 telephone circuits or 30 television programs at one time. At the same time, they would handle radio systems in certain megacycle bands. Microwaves are deflected from the curved back of the receiving antenna and fed into amplifiers at each station. The strengthened signals are changed to a different frequency and directed by a similar transmitting antenna toward the next station.

☐ The first gas-turbine military tank, the prototype of Britain's new Conqueror tank, is being demonstrated in England.





Competition Sled Gets Tunnel Test

Bobsledders normally catch plenty of wind in their teeth, but Arthur Tyler and Edgar Seymour of Rochester, N. Y., even go after artificial wind. Wishing to test the effect of streamlining on the speed of their sled, they took it to the New York University wind tunnel to reproduce wind conditions found on regular sled courses. Tyler and Seymour plan to enter the 1956 Olympic Winter Game competition.

Suction Cups Move TV Tubes on Line

Deposit of chemicals on the screen surface of TV picture tubes is controlled by one man as the tubes move down Sylvania Electric Products' production line. The chemical, carried in solution, is deposited on the screen in a carefully controlled settling period. Then powerful suction cups lift the bulb from the line, overturn it to empty chemicals into a trough and place it on a drying conveyor. Cups replace hand turning of tubes.

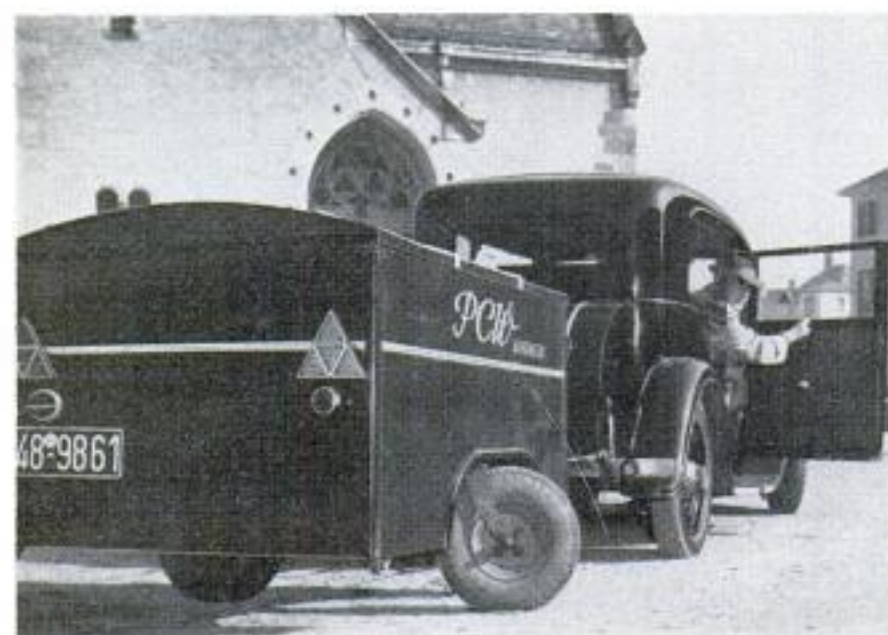
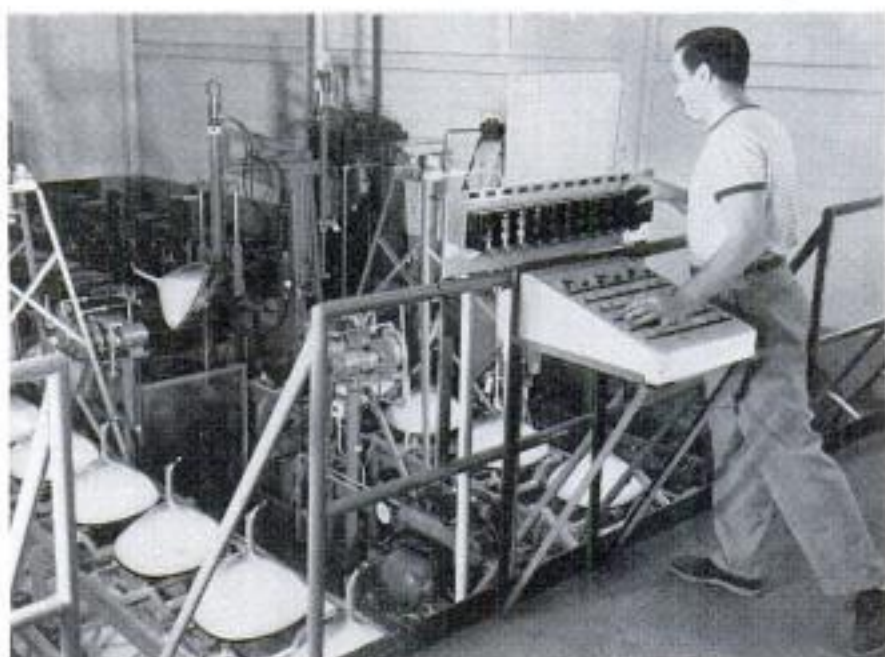

Swiveling Wheels Make Backing Easy

It's easy to drive backward with a new German trailer, according to the manufacturer. The two small wheels of the trailer have a decentralized suspension. As a result, they give the motorist better control of the trailer when going backward.

☐ America's scheduled international airlines carried 2,670,000 passengers more than 3,660,000,000 miles in a year without a fatal accident.

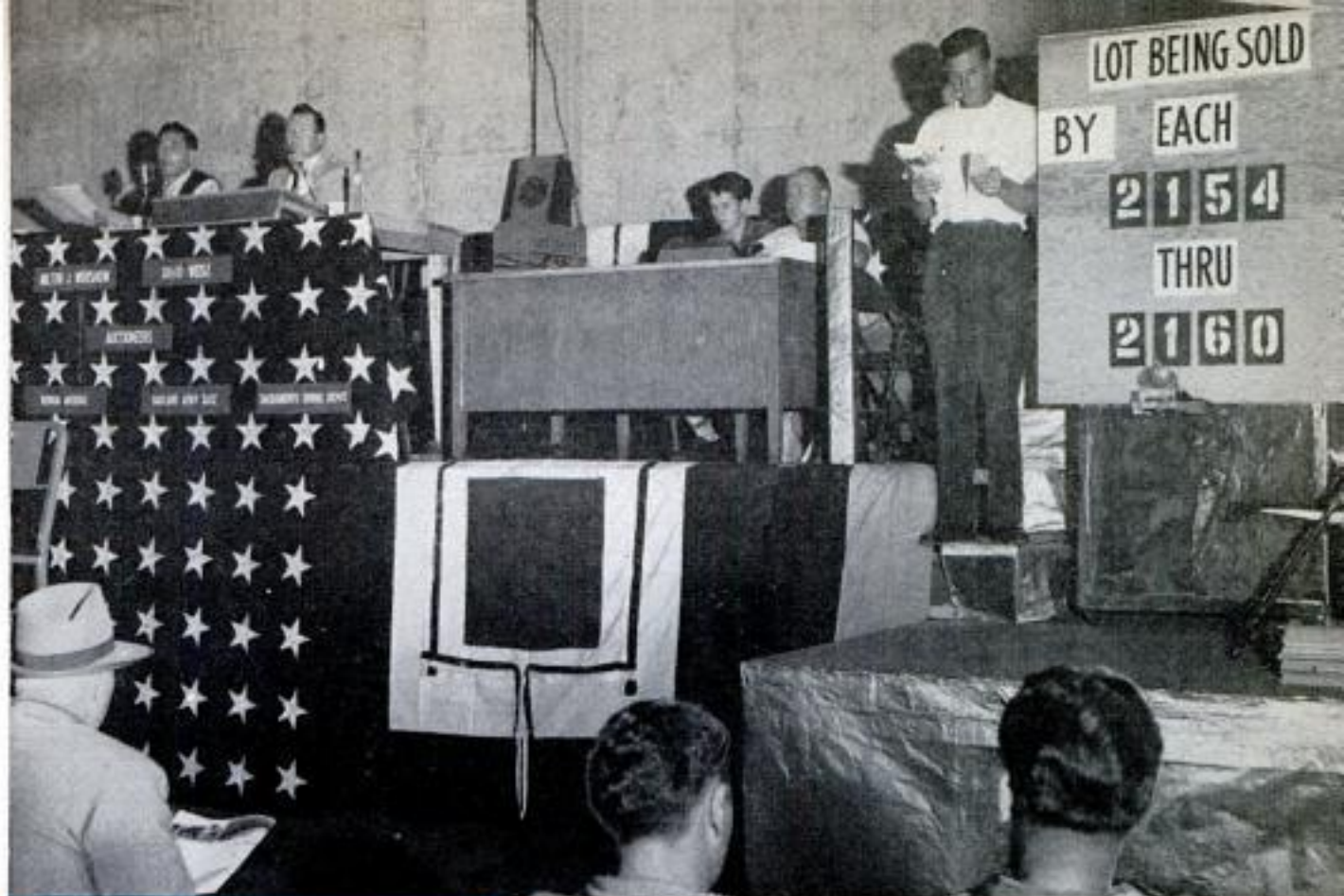

The World's Biggest Clearance Sale

Billions of dollars in surplus Army, Navy and Air Force materiel are going under the auctioneer's hammer. You want a steel boat, dishpan, radar tube or an Army truck?

CAN YOU USE 200,000 pairs of brown shoelaces or a Signal Corps radio truck or 3429 pairs of mukluks? Do you need 40,000 pounds of crankshafts and differentials? A lift truck or a lifeboat? Or a railroad tank car?

If so, see Uncle Sam the auctioneer. The government is selling these items and thousands of others to the highest bidders.

Right now our military warehouses and storage areas are crammed with \$5,000,000,000 worth of surplus war materials and these are being offered to the public in "Operation Cleansweep," the greatest clearance sale of all time. Eighteen months from now



By
Thomas E. Stimson, Jr.

Busy bidders at huge auction keep one eye on illustrated catalogue describing numbered lots and the other on auctioneers

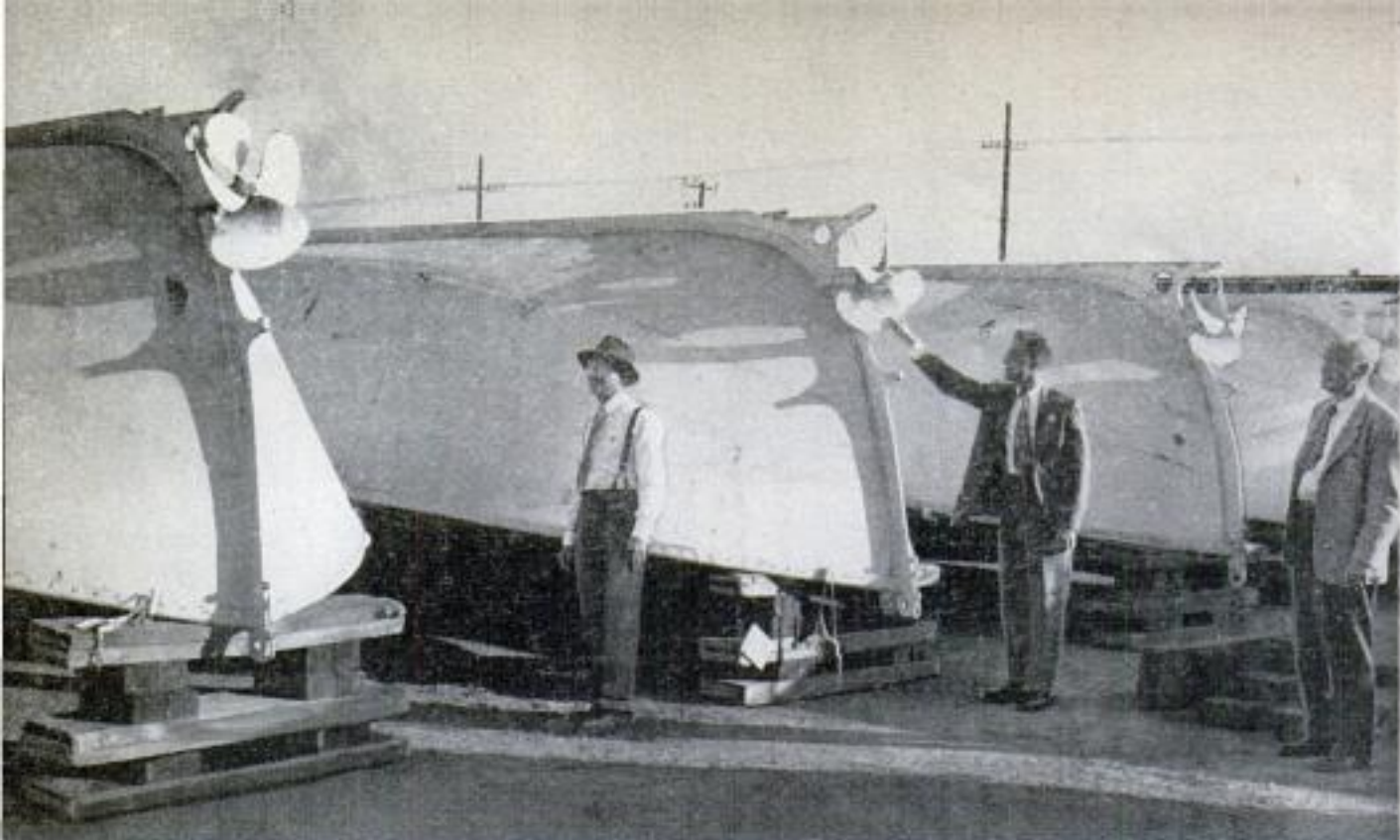

Prospective buyers examine steel lifeboats no longer considered worth keeping by the Defense Department

the Department of Defense expects to have sold off all the materiel left over from the last war that no longer is needed.

Most of the commodities and equipment will be disposed of in a series of public auctions. To help would-be purchasers learn where and when the auctions will be held and what will be sold, the Department of Defense has prepared a booklet titled "How to Buy Surplus Personal Property from the U.S. Army, Navy and Air Force." It's available by sending 15 cents to the Superintendent of Documents, Government Printing Office, Washington 25, D. C.

Don't expect to put in a bid for a single radio tube or half a dozen pairs of shoes that are just your size at one of the

sales. Unavoidably, items like those are offered in large wholesale quantities. Yet the government is doing everything it can to make it easy for small buyers to bid for no more than they need. Jeeps and trucks, for instance, are now auctioned off individually instead of in lots of 100 or more. You may be able to bid on a single bench grinder or one walk-in refrigerator; on the other

Radio tubes of all sizes originally costing some \$900,000 were auctioned off at one multimillion-dollar sale of surplus left over from last war





A variety of cooking utensils from potato mashers to meat cleavers is displayed in a military warehouse

hand, items like marine signal pennants or waterproof corrugated boxes are up for sale in lots of several thousand each.

In the largest single auction held so far, at Sharpe General Depot, Lathrop, Calif., equipment that originally cost \$26,000,000 was sold in three days' time. The property occupied so much space that it had to be displayed at depots in three near-by cities as well as at Sharpe. The items were so diversified that six weeks were required to make up the 48-page illustrated catalogue that described the property. The catalogue was mailed to 10,000 prospective bidders in the United States and in 13 foreign countries.

More than 1000 bidders visited the depots



These heavy-duty four-wheel-drive trucks were put on sale after close inspection by board of experts

Well, whataya know? Here a fascinated buyer discovers a motorized railroad scooter among some odd trucks





to inspect the goods and then assembled in a warehouse for the auction itself. Floor auctioneers walked the floor, trailing telephone cords behind them, and relayed individual bids to the auction platform. A sale was completed on an average of one every two minutes.

Many of the bidders were wholesale dealers in war-surplus materiel and most of their purchases will wind up on the shelves of retail war-surplus stores. Also present were individuals who bid for used staff cars and got them for several hundred dollars each. Farmers bought pickup trucks for around \$250, as well as machinery they could convert for agriculture. Construction firms were present to buy tractors and earthmoving equipment. Municipalities and irrigation districts sent representatives to bid on equipment they needed. Even a motion-picture company had a man present to bid for life rafts and life jackets needed for a forthcoming picture.

One wholesale dealer bought 96,000 pairs of wool socks for less than nine cents each, another paid \$7.50 for 50,000 waterproof matches. A third bought 25,000 brass cabin-door hooks for a dime apiece. Spare parts for a locomotive were auctioned off for \$1100, and 775,000 six-volt lamp bulbs went for \$56,000. An assortment of marine equipment including compasses, boat hooks, asbestos sheeting and signal lamps went for \$2100.

More than 3300 lots and items were sold in all. Commodities included beds and bedding, clothing, fire-fighting equipment, hardware, lathes and milling machines, office furniture and supplies, photographic equipment, plumbing, rope, tents and miscellaneous vehicles. Radio and radar tubes and an entire warehouse of electrical equipment ranging from whip antennas to wire went under the hammer.

A 1942 motorcycle sold for \$125. Ten tractor-mounted, hydraulic-powered, circular timber saws brought \$2000. Thirty dictating machines sold for \$1200 for the lot,

Acres of huge aircraft tires were sold at one auction for \$4 a ton. Discarded as unsafe, most of them will go into scrap



Some interested buyers inspect rows of gasoline and diesel power plants of all sizes lined up in a field

and a truckload of photo supplies including 2600 plastic funnels went to a bidder for \$600.

Occasionally, someone became excited and paid more for an item than he could buy it for on the open market. One man bid \$225 for a drill press, well used, that lists at \$175 brand new. Small power plants, too, frequently brought more than their original cost simply because their value has gone up since their time of purchase.

Much military equipment has no obvious use in civilian life and a man who is clever enough to figure out a way of converting it stands a chance of making a good profit. What can you do with a waterproof plastic cover for a rifle, for instance? One dealer bought a half million. Unless he figures out a better use he plans to chop them into one-foot lengths, seal the bottoms, and sell them as handy pouch bags.

If you were a rancher would you need a big Army searchlight? One rancher from Klamath Falls bought eight of them. He turns them on after dark and prevents the wild ducks from eating his barley crop.

Could you use \$250,000 worth of jungle hammocks? One surplus dealer could, because he already had arranged to dispose of them through stores in tropical countries. Why did another bidder pay \$1.90 each for 5600 second-hand cotton comforters? Because they are needed by furniture movers for use as padding.

The Department of Defense is out to get every cent that it can for its surplus materials and officials were greatly pleased when the big Sharpe auction

brought 13 cents for every dollar the government originally paid for the property. This seems a low return until you realize that everything is sold on an "as is" basis. A million dollars' worth of bomber tires sold for only \$4 per ton, but the tires were so worn out that they were no longer safe for use on aircraft. Cars and trucks that went for a couple of hundred dollars each were wartime vehicles no longer considered economical to operate.

Much war-surplus materiel is new, of course, and Vincent C. Tolino of the Supply and Logistics Branch of the Department of Defense explains why it goes on the block.

"Why sell brand-new field boots, for instance? Because we are overstocked. The average soldier in Korea wore out a pair of boots every six weeks and we had to keep

(Continued to page 260)

This happy bidder finds himself the new owner of 500,000 plastic covers for infantry rifles. He must find a civilian use



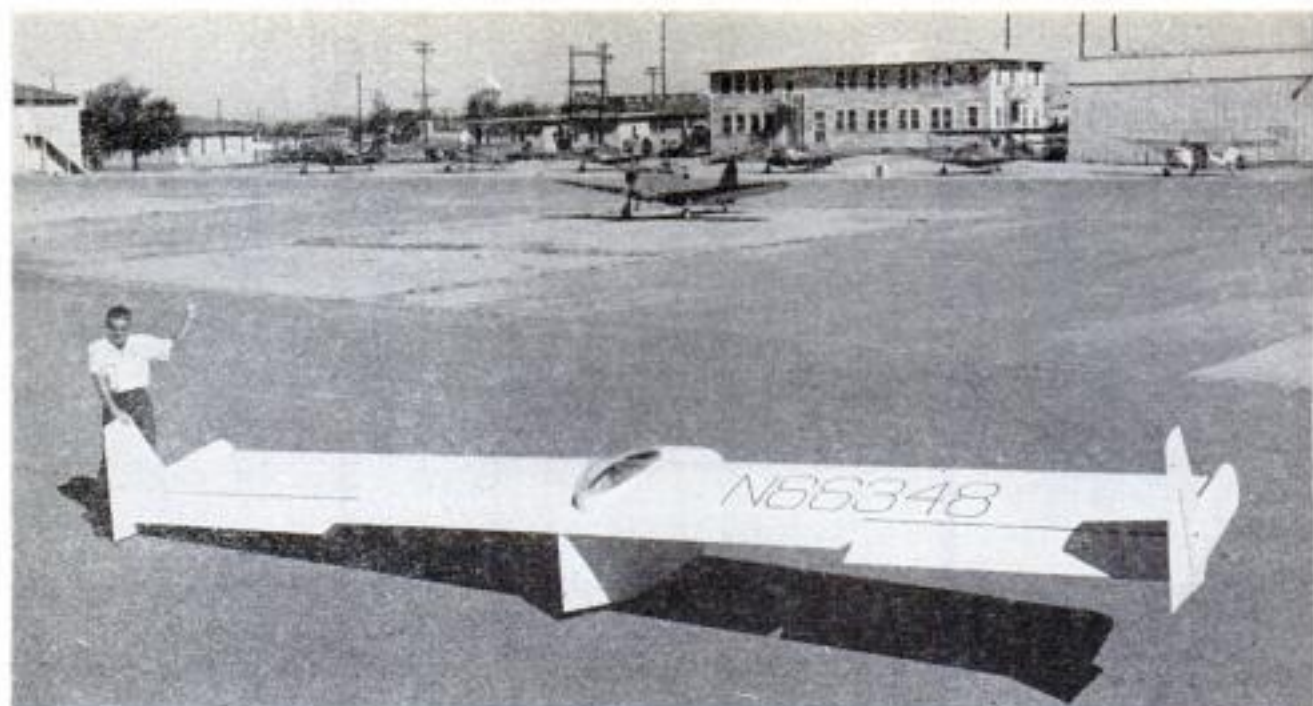

Tailless "Flying Plank" Sailplane Has All Controls on Wing

Nicknamed the "Flying Plank," a radically designed sailplane without tail assembly has been developed by an aircraft test engineer. The sailplane consists pri-

marily of a 26½-foot wing, with vertical controls mounted at either wing tip, and a small cockpit in the center of the wing. Empty weight is about 180 pounds.

Kit Aids Camera Close-Ups

It's easy to shoot close-up color photographs of plants, stamps and other small objects with equipment that attaches to the Kodak Pony 135, Model B or 828 camera. An L-shaped frame mounted on six-inch rods extending from the front of the camera is placed directly on the subject. The sides of the frame indicate the edges of the resulting picture. A cover for the flash bulb reduces light intensity to ¼ normal brilliance, and guards the subject from heat. Special lens and filters are supplied.



Lever on Lawn-Mower Wheel Changes Height of Cut

On a new rotary lawn mower you change the cutting height without tools simply by moving a lever on each of the front wheels. This raises or lowers the wheels, changing the height of the blade from the ground. The lever has five different positions, varying the cutting height of the blade from one to three inches. Inset shows the easily adjusted lever.



“Beehive” House Has 24 Sides

TAKE SOME CONCRETE and redwood, glass and rocks, stir with the imagination of an architect—and presto! You have a “beehive” house that makes headlines. The house is built around a freestanding rock fireplace and its domed roof has glass risers. There are 24 sides to the house, but they are angled so slightly the effect is round. Drawing a radius from the fireplace, folding partitions form pie-shaped living areas in the central part of the home. The kitchen and garage are located in a fan-shaped, flat-roofed section adjoining the dome. Most of the furnishings are built-in slabs of concrete that bisect the glass and redwood walls. The home was designed by architect George Frank Ligar for Louis Adrian, musical director of the Los Angeles Civic Light Opera, and built high in the Hollywood, Calif., hills where it has a breath-taking view of the city.

Top, Jane Adrian stands in pie-shaped bedroom separated from living room by folding partition. Right, chimney is encircled by skylight at top of dome. Below, kitchen and garage are in the fan-shaped section



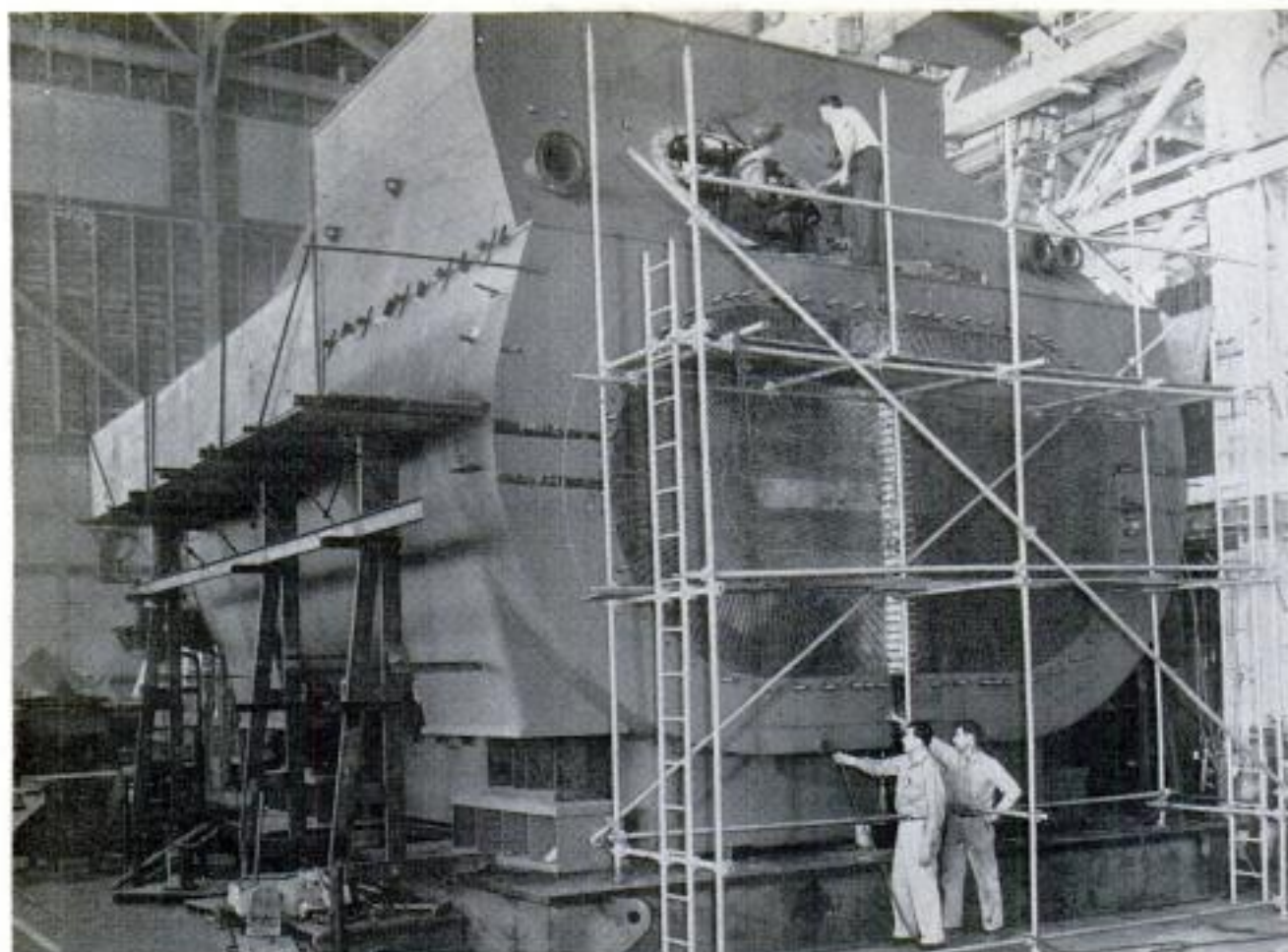

Ocean Water Distilled for California Steam-Generating Plant

Faced with a lack of adequate fresh water at the site of a new \$44,000,000 steam-electric generating plant at Morro Bay, Calif., the Pacific Gas and Electric Company has turned to the common marine practice of distilling sea water for use in its boilers.

Two sets of three-stage sea-water evaporators are being installed at the plant, one for each of the two giant boilers. Each evaporator system will have a capacity of 50 gallons of fresh water a minute, 72,000

gallons a day, and the water will be run through condensers after leaving the boilers, so that it can be used again and again.

The stills will be heated by steam, the first stage by live steam from the boilers themselves, and the second and third will employ steam for heating from the first and second stills. They will operate at progressively lower temperatures, all below the boiling point and under vacuum, so that water can be evaporated at comparatively low heat.

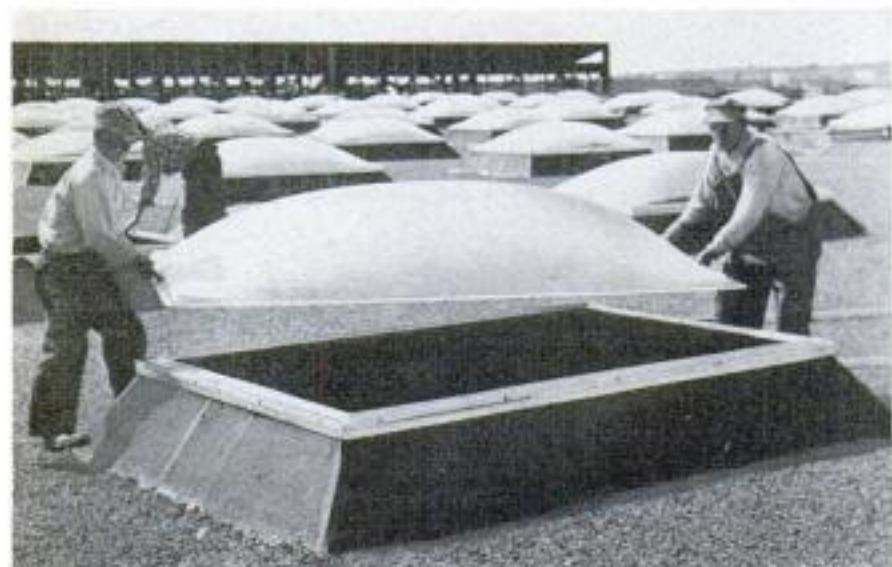

Plastic Skylights

All interior natural lighting in the 400-by-500-foot administration building of the Army's new Tobyhanna, Pa., Signal Corps depot is provided by dome-shaped plastic skylights. The flat roof of the huge building is set with 585 skydomes, each 64 by 96 inches and having a rise of 19 inches at the center to provide natural drainage. The skydomes are set into aluminum frames.

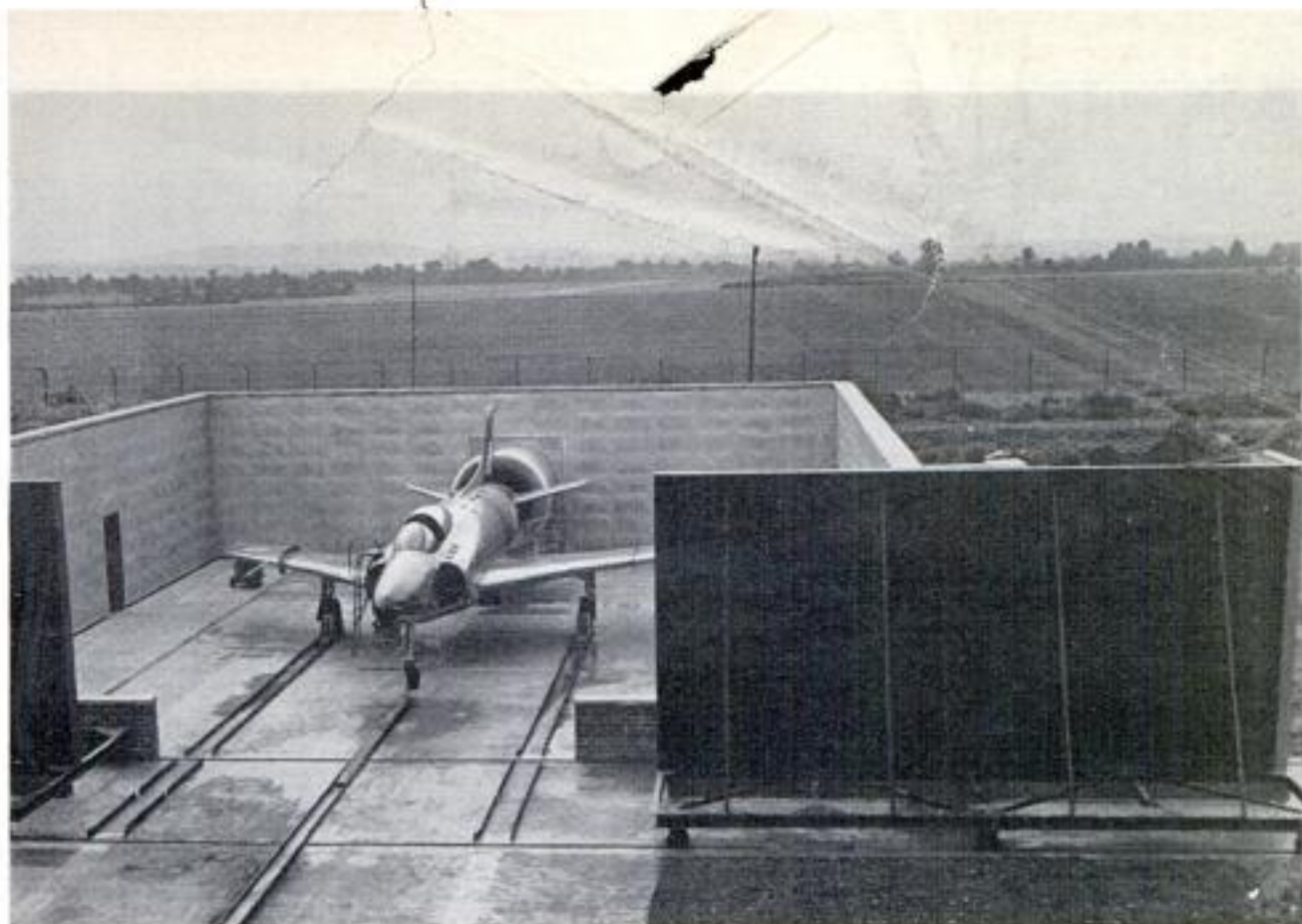

Muffler Silences Jets

Anyone who has heard jet engines being tested can testify that when the afterburner is cut in, the noise is almost more than humans can endure. Faced with this problem, engineers at Britain's Supermarine works developed a pen in which planes can be enclosed while their jet power plants are tested or broken in. The muffler, which fits over the tail pipe of the anchored airplane, reduces the jet roar so greatly that near-by observers are not conscious that an engine is being tested at all.

Electronic Unit Lets Blind Read

Blind persons can read an ordinary newspaper with a unit that employs an electronic eye and translates words into coded vibrations. The subject holds a pickup device in one hand while resting the fingers and thumb of the other hand on vibrating prongs. An amplifier-relay unit changes the optical image, as seen by the pickup, into electrical impulses which cause vibrations.





Outdoor background is shot through a slightly tilting glass plate on which the letters of title are pasted



TITLE TRICKS

FOR HOME MOVIES

By *Shep Shepherd*

Fishing-line spool serves as base for camera on frame. Bolt threaded on both ends screws into camera-tripod socket and nut goes on other end to hold it to frame

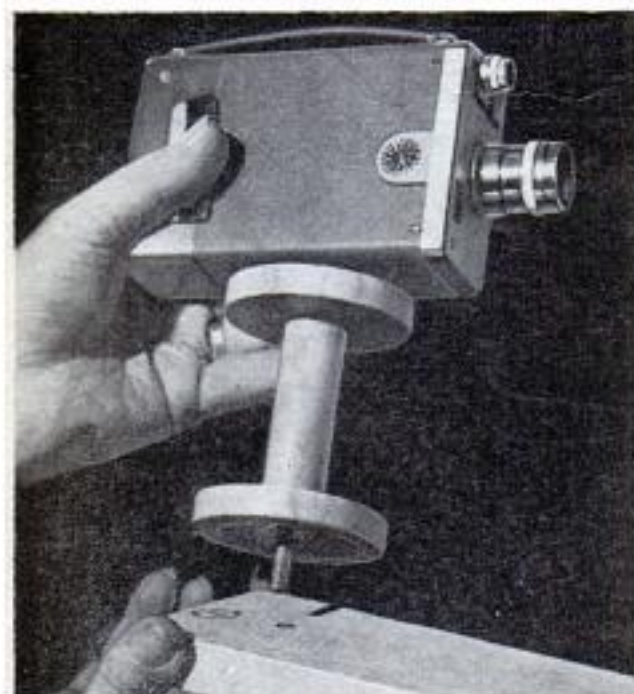

IT'S A RARE amateur who adds titles to the home movies he produces, but good titling can multiply the interest of a film. A movie without titles is half finished.

Keep titles in mind as you shoot. Often, you'll find them ready-made in the form of signs, brochures and maps. Shoot them as you find them and splice them into proper position in the film when you edit it.

The best titles are made by using a commercial set of titling letters. They must be used on a flat surface with the camera pointing down or arranged on a perpendicular level in front of the camera lens. Align the lens with the exact center of the title area. Don't trust the view finder on close-up titling work. Buy a good titler or build one. Constructing your own titler is not difficult. Any arrangement in which the movie camera can be drawn backward in a direct line for three feet will serve the purpose.

The following table gives the field of view at various distances for a $\frac{1}{2}$ -inch lens on an 8-millimeter camera and a one-inch lens on a 16-millimeter camera:



Road signs are ready-made titles. They should be easy to read, so move in for a close-up if necessary

*Distance of lens
from title:*

10 inches
15 "
20 "
24 "
30 "
40 "

Field of view:

3 by 4 inches
4½ by 6 "
6 by 8 "
7½ by 9½ "
9 by 12 "
12 by 16 "

Letters of title seem to jump into place if step-by-step pictures are taken as they are moved into position

No supplementary lenses are needed when the last two title areas are used with universal focusing lenses and the last four with focusing lenses. Two sets of block letters, one inch and two inches in height, serve for almost any titling job.

A title should remain on the screen long enough to be read by the slowest reader. A good system is to read the title through twice as you film it. Don't cram a title with too many words. Keep it rather simple. If you can't say all that is necessary in one title, use two, for there's nothing to be gained by crowding too many words on the screen. But it's good to be concise.

The white letters should be used on a medium or black background for black-and-white film and on colored backgrounds for color film. By lighting the letters from one direction only, some interesting shadow effects will result, but don't overdo it. When a single light source is used it cannot be too near the title area or uneven lighting will result. Three feet is about as close as you should place the light for a 9-by-12-inch or smaller title area.

If the titling letters are used on a flat surface, other items may be added to make the title more interesting. For a hunting film you might add a couple of





Floral wallpaper used as background is in mood with the title and the movie itself. Use only one design throughout each movie



Missing letter in misspelled title rushes in at last moment, squeezes into place. It is moved between two-frame exposures

Invert camera, shoot as letters in title are tossed into tackle box. In reversed film, letters jump from box to fingers to title



shotgun shells, or put some lures in the title of a fishing film. Keep it simple to avoid a cluttered appearance. One interesting method of presenting titles is accomplished by photographing them on a miniature stage complete with curtains opened by hidden strings.

There are two methods by which titles may be made with moving backgrounds. One is by pasting the title letters on a sheet of clear glass and filming any desired scene with the glass in front of the camera. One objection here is that the focus must be on the title, which may result in an out-of-focus background. The universal focusing lenses used with some 8-millimeter cameras will produce good results with this method. The second and best method is to film the title against a black background, rewind the film and re-expose it on some appropriate scene. This second exposure should run a little longer than the first so the action background will still be seen after the title has faded out. Several titles can be filmed against the same background in this manner. The effect is best if the title changes are made by dissolves.

Dissolves are made simply by overlapping fade-ins and fade-outs. To make a fade-in, start the camera running on the title with the aperture completely closed, then open it to the correct reading as the camera runs. To make a fade-out simply reverse the process, closing the aperture at the end of the scene while the camera is still running. Fades should last no longer than about two seconds. The dissolve is made by first making a fade-out, then rewinding the film to the beginning of the fade-out and making a fade-in on the new scene or title.

A third method of creating moving backgrounds for titles involves the use of a projector and a transparent screen. A sheet of ground glass will serve as the screen. The title letters are arranged on the smooth side of the glass and a suitable picture is projected on the other, or ground side. The projector faces the ground side while the camera faces the smooth side. Both are started simultaneously. In this case there can be no light used on the title. A meter reading may be taken directly from the



Title is superimposed on moving scene by pasting it on ground-glass and projecting movie on rear of glass

projected image on the camera side of the glass.

A professional touch can be added to your movies by the use of animated titles if the animation isn't overdone. Here are a few examples: Using a horizontal surface, with camera shooting down, place the first letter of the title just out of view at one edge. Expose two frames and move the letter about $\frac{1}{2}$ inch into the camera view. If your camera does not have a single-exposure release a quick up-and-down movement of the regular release will do. Expose two more frames and move the letter another half inch. Repeat until the letter is in place. The second letter should follow the first by an inch or so, then the third, and so on. The letters may approach their respective positions from different directions if desired. Each letter should be lined up with a ruler when it reaches its proper place in the title, but the ruler must never show in the title. After the title is completely assembled, continue the exposure as for a regular title. On the screen the letters will be seen rushing into the picture and lining up where they belong. If you want to amuse your audience leave one letter out and have the title form itself with one word obviously misspelled. The missing letter

then comes rushing in, finds its place, nudges the letter already there, that letter moves over and the prodigal takes its place. A variation would have two letters end up in the wrong positions and then change.

The same effect can be accomplished by inverting the camera or the title and removing the letters one at a time as the two-frame exposures are made. In this case the complete title is sufficiently exposed before the first letter is withdrawn. In editing, this part of the film is cut out, turned end for end and replaced, and the letters then come in one by one and take their places.

Animated maps can be created in a similar manner. Show the route of your trip by making a heavy ink line or pencil mark about $\frac{1}{4}$ inch long at the starting point, exposing two frames, extending the line another $\frac{1}{4}$ inch, exposing two more frames and so on. As the line reaches cities or parks, stop and write out their names.

For a fishing film spell out the title with block letters. Place an open tackle box or creel in the scene. Turn the camera upside-down and expose the film steadily as you pick up the letters one at a time and toss them back into the tackle box or creel. Reverse the film end for end and the letters are seen to jump out of the box only to be

A wooden box three inches deep serves as stage to display title. Curtains are pulled back by string or ribbon

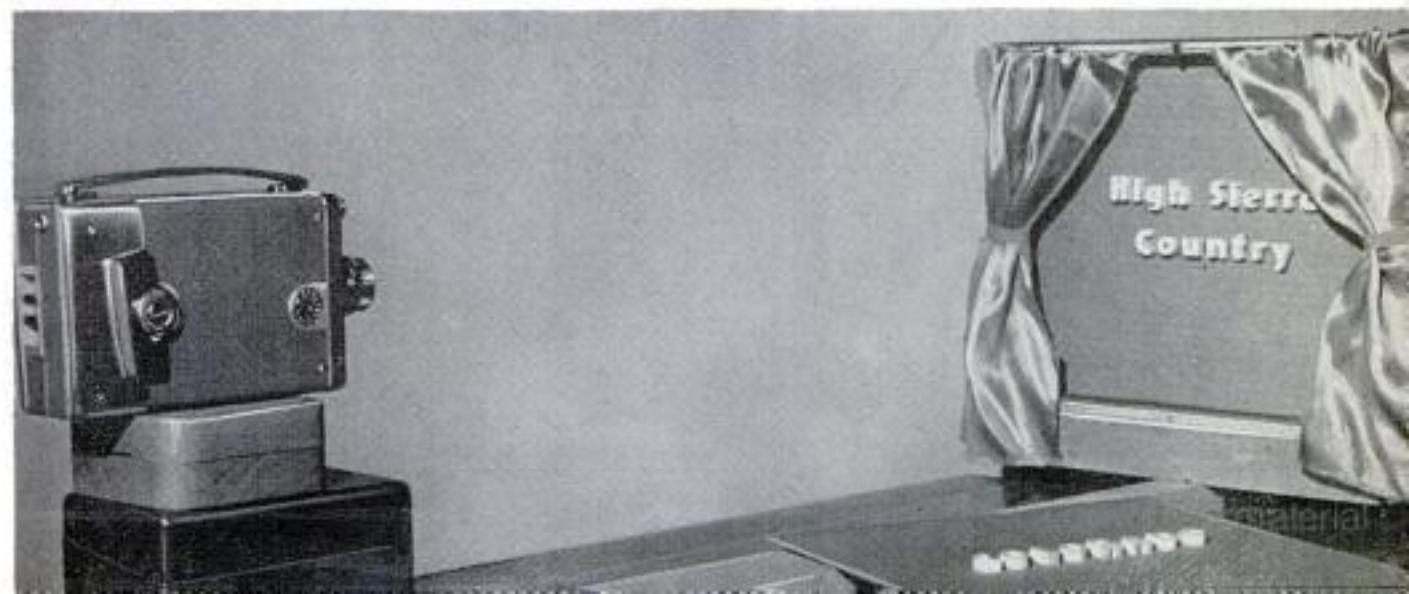

ALBERTA

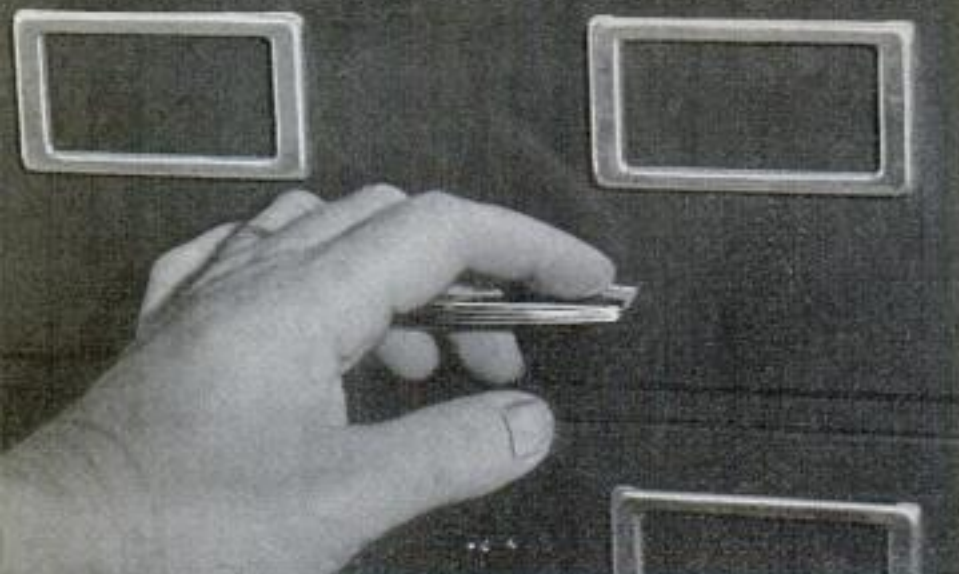

Letters of title seem to rise from floor and balance on edge of drawer in trick shot using inverted camera and reversed film. Actually, the title is first placed on the drawer. When it slams, letters fall to floor

caught in the fingers and put in place to spell out the title.

Vary this by opening a drawer part way and balancing the letters upright on its edge. Invert the camera and expose as you reach into the scene and close the drawer, knocking the letters to the floor. In the picture, when the film is reversed, a hand is seen opening the drawer and the letters leap up to balance on its edge.

Use this trick of inverting the camera on any title that can be made to disappear. Scratch a title in wet sand at the seashore. Invert the camera and make the exposure as waves wash over and obliterate the title. In the picture the title appears to be left by receding waves. A variation is to write the title in snow, film with the camera inverted as you wipe away the letters with a tree limb.

Your own imagination will discover

Route of trip moves across the map and place names appear as result of marking a half inch or quarter inch each time, then exposing two frames



many ways of applying the inverted-camera technique.

Your title animations should be smoothly and conservatively done. Use one method of animation throughout. A mixture of tricks calls too much attention to how the titles were made and not enough to what the titles had to say.

There should be a main title at the beginning of the film giving information as to the subject to follow. This might be "Pacific Fishing," or "Idaho Elk." It should be short but prominent. Follow with screen credits if desired and subtitles giving other pertinent information. Subtitles should

precede any change of location or activity in the movie. The "Pacific Fishing" film, for instance, might have been accumulated from several locations over an extended period of time. Thus there should be subtitles reading something like this: "Catalina Island, April 1954," and following the scenes taken at Catalina another subtitle reading, perhaps, "Balboa, May 1954," and so on. Subtitles will make the movie more interesting and there may come a time when you won't remember all the places.

Don't saturate a movie with titles. There should be just enough to supply needed information. A properly titled film needs not a single spoken word of explanation.

When the finished film is edited for insertion of titles, cut part of any scene that is too long. Cut out badly exposed and out-of-focus scenes entirely. You may have to be hard-boiled with yourself about it,

for sentimentality may temporarily outweigh such errors of photography, but get them out! There should not be a single scene left in that needs an apology or an explanation. No scene is so important that it rates spoiling the continuity of the whole.

In movie making as in still photography, the chief ingredient in the formula for success is horse sense seasoned throughout with a liberal sprinkling of know-how. ★★★

New Plane Hovers At Low Airspeed

Utilizing an airfoil that scoops air through the wing, from top to bottom, the Lanier Paraplane (derived from its wing features) can hover at the low flying speed of 19 miles per hour. The aircraft has a top speed of 120 miles per hour and can land or take off in 150 feet, according to its designer. It is powered with a 90-horsepower engine and carries the pilot and one passenger.

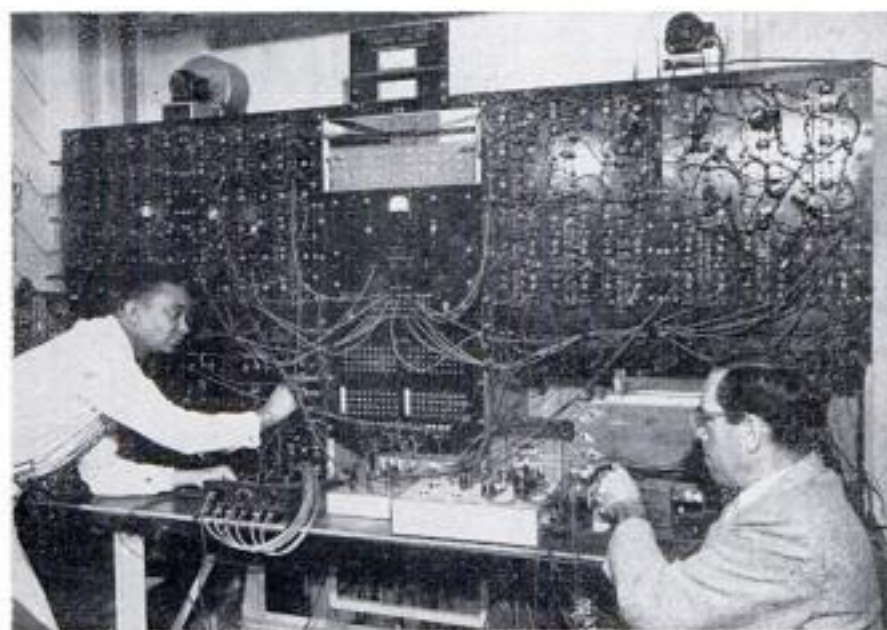

"Thermal Analyzer" Secures Heat Data

With a "thermal analyzer" used at U.C.L.A. you can turn the sun on and off, change the color of the roof and reproduce all the other conditions that affect the heating and cooling of a home. The complicated maze of tubes and resistors is actually an electronic model of a home. By twisting a knob, the effect of insulation in walls or ceiling can be determined. Operating other switches reproduces the effects of winds.

Automatic Control Maintains Automobile Cruising Speed

You can maintain a uniform speed on the road with a new auto accessory. A control mounted on the steering post is set at the desired cruising speed. For normal highway driving, you don't have to touch the gas pedal. A unit beside the fan belt measures engine speed and regulates vacuum in a line running to a unit mounted on the fire wall. This unit exerts pressure on the throttle rod to increase or decrease speed. You can go over your limit by pressing the accelerator or slow down by stepping on the brake.

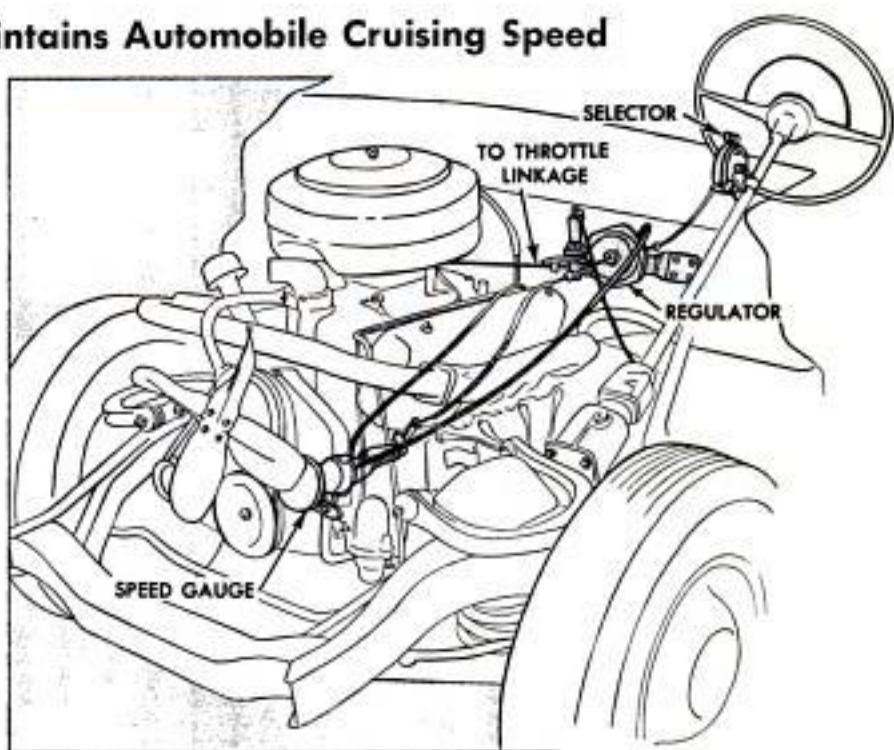



You don't miss important calls when you are out if you have the Automatic Answering device. Your voice answers the phone and gives calling parties the message you dictated before you left. The machine then records any incoming messages (above)



Dialing in the dark is no guesswork with light that automatically illumines dial when handset is lifted. Light operates on current from baseboard-mounted transformer



The relaxed gentleman below is talking on the telephone, even though the handset remains on the base. He merely pressed an "on" button and started talking. A microphone in the base picks up his voice. He listens to small speaker on the desk

Look
**What They've Done
 With the Telephone**

No plugs to plug, no cords to tangle with a streamlined cordless switchboard like that at left. Operator makes connections through simple movement of key switches

It is no longer necessary to hide the telephone since it now comes in four two-tone combinations and eight solid colors, from bright yellow to soft neutral gray (below)

Bell System photos





Breitkreutz walker aids a toddler. Chair has adjustable legs, arms and back for practicing sitting balance

Handy Man for the Handicapped

By Jeffrey Fleece

ALBERT J. "Spike" Breitkreutz, 59-year-old Denver man, has overcome his own physical disabilities to develop a hobby in which equipment contrived and made in his small workshop has aided hundreds of handicapped persons.

An accidental miracle led Spike, after battling for years against arthritis, now overcome, and a weak heart, now simply ignored except for routine caution, to his place in society as handy man for the handicapped.

After a bout in the hospital in 1950, Spike Breitkreutz designed and made three little wooden hobbyhorses on wheels in his small garage shop. He turned them over to the city firemen to give away. And then the miracle happened.

One of the hobbyhorses was given to a three-year-old boy who had not walked since polio struck him. Despite his parents' doubts, the boy demanded to be put on the horse. In a few weeks he was

"riding" all over the house, propelled by his own weak legs. The exercise finally enabled him to develop enough strength to walk alone.

When Mr. Breitkreutz heard of this recovery, he determined to devote his life to helping the handicapped. The news of



Stationary bicycle permits leg exercise. Roller on rear wheel stiffens pedaling



Weakened muscles need special chairs even for resting. Victims of polio, cerebral palsy, multiple sclerosis, muscular dystrophy and other diseases have been helped by Breitzkreutz devices. Tricycles below are modified for use by crippled children



Spike's horses spread rapidly, and now crippled children from Vermont to California and even in Germany are riding the more than 400 hobbyhorses "foaled" in his garage.

The horses are especially useful for very small children with cerebral palsy, polio or other crippling ailments who cannot understand the necessity of dull and arduous exercises with normal equipment. With a horse to ride, exercise becomes play.

Spike has made over a dozen variations of the original hobbyhorse to suit individual children's capacities. Some are stationary, but most have swiveled ball-bearing casters so a child can move the horse in any direction his weakened muscles will allow him to go.

"One of the many nice things about this hobby of mine," Spike says, "is that so many different problems need working out. There are almost as many differences in these youngsters' abilities as there are muscles in the body, and nearly everything I make needs some special variation or adjustment."

As he saw more and more handicapped youngsters in his visits to homes and hospitals, Spike found more ways to help the handicapped with his skilled hands. Besides the horses, in four years he has made over 300 other devices to ease the lives of people of all ages who have physical disabilities.

It is no trouble to find people who need the help of a handy man like Spike. Few hospitals can afford all the equipment they need for physical therapy. Local chapters of organizations fighting polio, cerebral palsy, multiple sclerosis, muscular dystrophy and other crippling diseases know people who need help. Veterans' organizations keep in touch with men seriously disabled by war wounds.

In Denver, many of these groups frequently call on Spike for help. They are never refused.

Seat backs and pedal straps from Spike's workshop enable crippled children to ride tricycles, special chairs give their twisted muscles the greatest possible rest, all kinds of special devices and custom-made adaptations of normal equipment improve their strength and muscle control.

Spike has also found ways to help adults in their fight to overcome or minimize the effects of crippling diseases or accidents. A simple elevator powered by a 1/4-horsepower motor lifts a paraplegic veteran's wheel chair up onto his porch, a special typewriter table high enough to accommodate a wheel chair helps another veteran make his own living, various attachments on beds and even inside iron lungs enable the weakest victims of polio to exercise.

Spike works closely with doctors and physical therapists in every stage of his work, teaming his own ingenuity with their knowledge of patients' needs and abilities.

Many of the devices Spike makes could not be bought for any price, and those that could are usually too expensive for families whose budgets have been wrecked by long-term hospital bills. That is another reason Spike's hobby has been a blessing to so many—he does not accept a cent for his work from anyone. He has kept expenses down by figuring ways to use discarded lumber and parts from junked washing machines, roller skates, toys, bomber gun turrets, car differentials and lawn mowers. And when the expense for materials has become greater than his own limited income can stand, businessmen and organizations have always helped him out.



Just standing is hard work for this youngster, but the play table makes it fun. Breitkreutz accepts no money for the work he does



Special "duck shoes" for the crippled promote walking stability. The plywood play table at right can be adjusted up or down to fit children of different ages





Lightweight steel framework of building goes up quickly. The finished unit can be transported in one piece

Portable Schools Solve Building Shortage

SCHOOLS THAT FOLLOW the children around meet shifting population problems in California. Forty-seven portable steel buildings, which consist of classroom, washroom and kindergarten units, can be moved quickly and set up end to end to provide the necessary facilities. The buildings have lightweight steel framing which is anchored to concrete piers with steel straps, plastered exterior and interior walls, composition-and-gravel roofing,

acoustical-tile ceilings and asphalt-tile floors. Chalk boards, tack boards, sinks and cabinets are built-in. Open walkways along one side of the buildings are covered with metal awnings which also shade the windows. Electric lines and wiring for the bell and fire-alarm systems are easily detached or connected to other buildings. Water, gas and sewer connections are quickly made. The low-cost schools are moved intact from one site to another.

Sections placed end to end form one long building. Metal awnings shield walkways and keep direct sunlight out

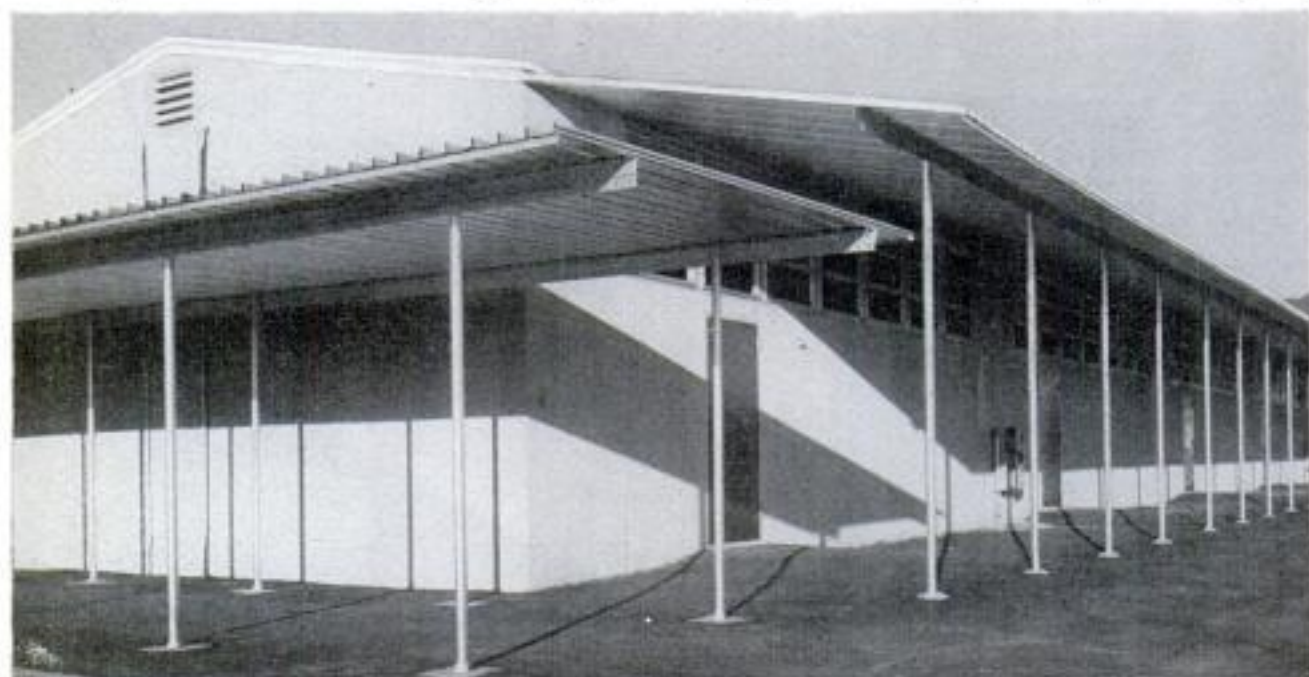

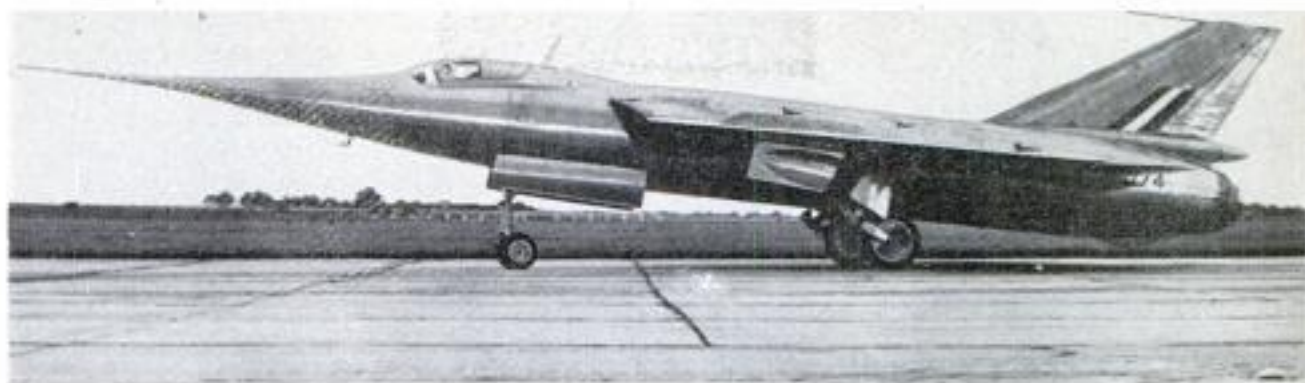

The new Fairey Delta D-2 is expected by its British makers to exceed 1200 miles per hour in level flight

Double-folding wings cut storage space needed for the Gannet

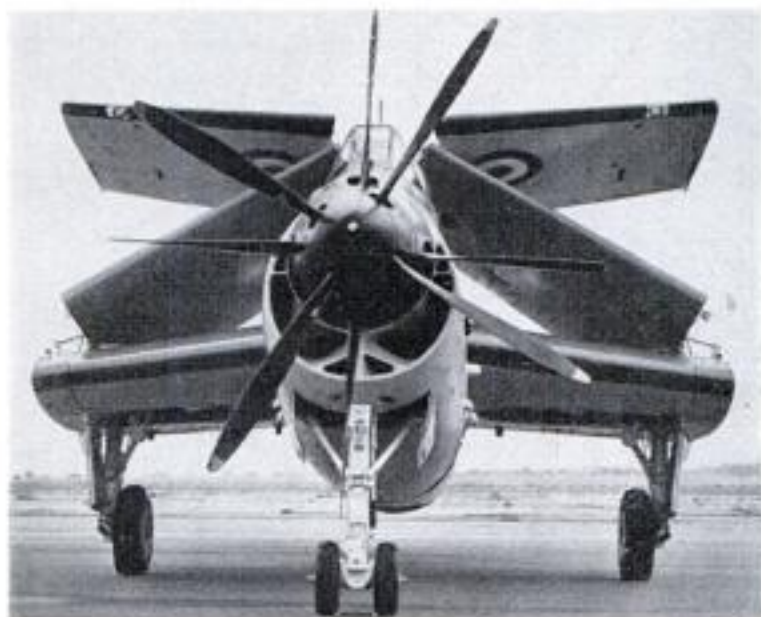

Two Novel Warplanes Produced in Britain

Two new British military aircraft are attracting world attention for different reasons. One of these, the Fairey Delta D-2, resembles the Douglas Skyrocket, rocket-powered speed-record holder. The Delta, however, is powered by a conventional turbojet engine. Because its long, needlelike nose can be lowered to give the pilot better taxiing vision, it has been nicknamed the "Droopsnoot." The other new British aircraft is the Fairey Gannet, driven by contrarotating propellers. Wings of the Gannet fold twice to make it extremely compact for carrier or hangar storage.

Lead Shield on Wheels Guards Atomic Worker

Electric motors propel a heavy, three-sided lead shield used in handling radioactive materials at Argonne National Laboratory near Chicago. The barrier, which is four inches thick, has a lead-glass window through which the operator looks as he manipulates "hot" materials with tools which pass through ball joints located below the window. By moving either of two handles located on the chassis, the operator drives and steers the five-ton unit. The handles control independent motors that move the front wheels, which allows great mobility. The unit is used in removing radioactive materials from a cyclotron while its 280-ton magnet is energized.

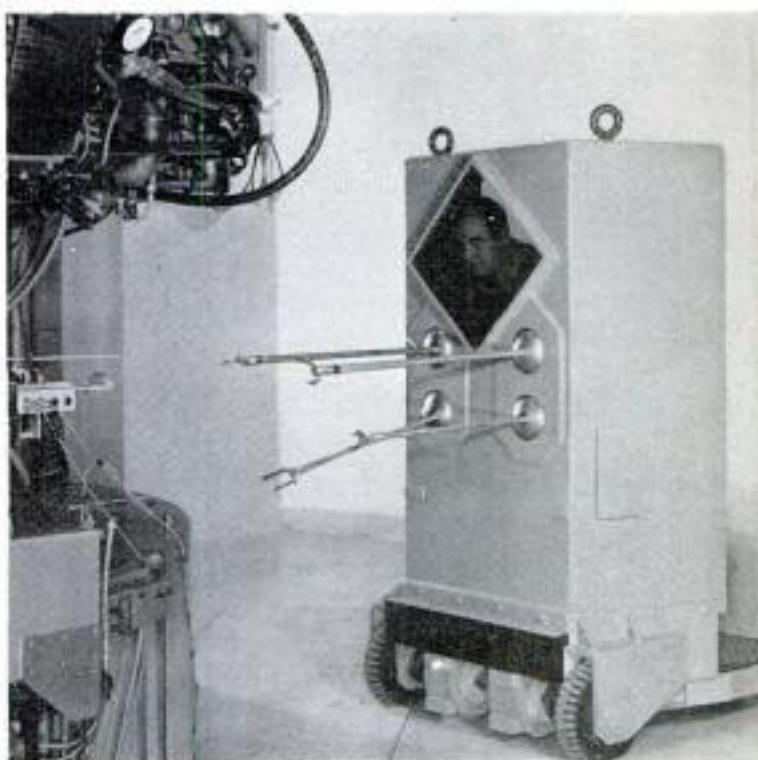



Operator of the world's largest metal-cutting bandsaw cuts die blanks from control station at head of machine

Giant Dies Cut on "Big Bertha" Bandsaw

Work is steered to cutting saw by wheel, which controls three power-driven tables holding and guiding die blank



AIRPLANE-TYPE controls and periscope vision like that on a submarine feature the world's largest metal-cutting bandsaw, a machine essential to the tooling necessary for production of modern high-speed military aircraft. The big saw and its companion die filer, also the largest machine of its kind, produce the gigantic extrusion dies which form aluminum channels, spars and stress skin sections in sizes heretofore impossible to fabricate. Extrusion of aluminum members as long as 110 feet and up to 34 inches wide eliminates many man-hours formerly consumed in making small assemblies and then riveting them together.

The "Big Bertha" bandsaw unit is 15 feet 10 inches high and weighs 16,000 pounds. It can handle 10-ton steel die blanks up to 26 inches thick and 52 inches in diameter. The operator sits in a control station at the head of the machine and guides the die blank against the narrow saw with an airplane-type control wheel. He watches his work through a periscope that projects an image of the cutting area into a mirror directly in front of him.

Made, like the saw, by the Do-All Co., of Des Plaines, Ill., the filer performs the final finishing operations on the contour-sawed dies. The filer is remarkable in that it directs the file toward the surface to be finished, rather than the work to the file, as is the case with many other similar but smaller machines. ★ ★ ★

Operator gets close-up of work through mirror mounted just above control wheel

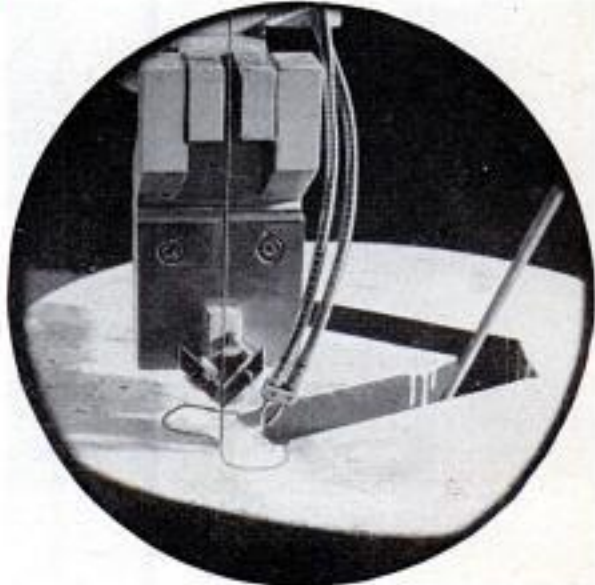

Final finish is given cut die on filer, which moves file against work, rather than the reverse, which is usual arrangement. Entire frame moves with precision at light touch on double control and guide handles

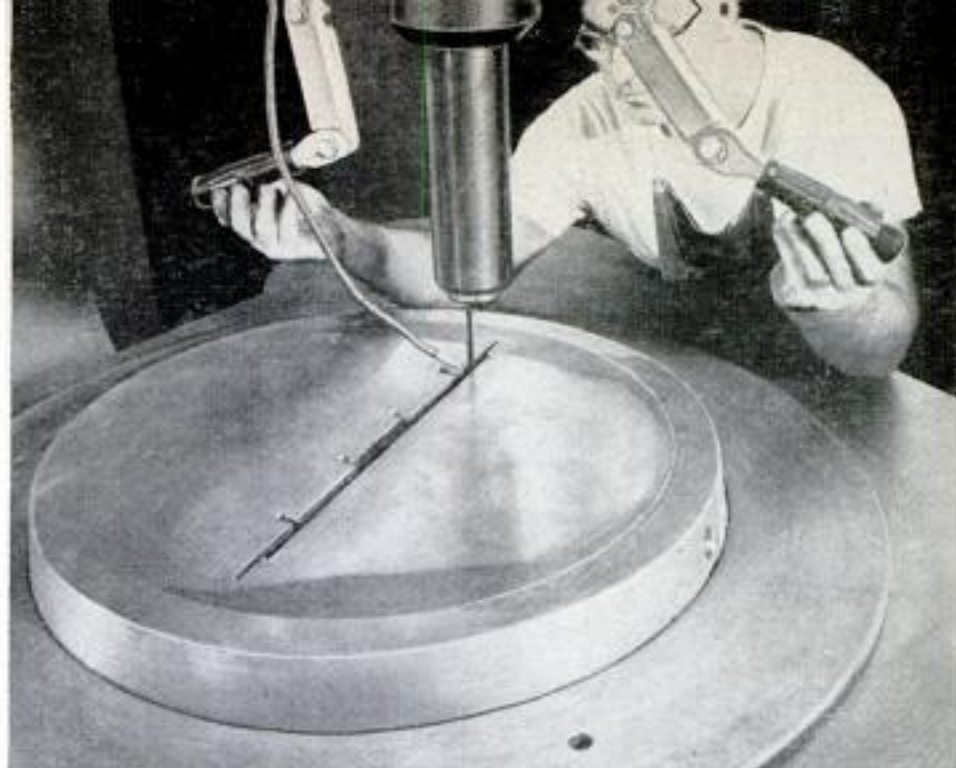

These aluminum extrusions were turned out by giant presses equipped with dies sawed and finished on the "Big Bertha" bandsaw and the moving-file jig filer. Extrusion of large members saves manufacturing time

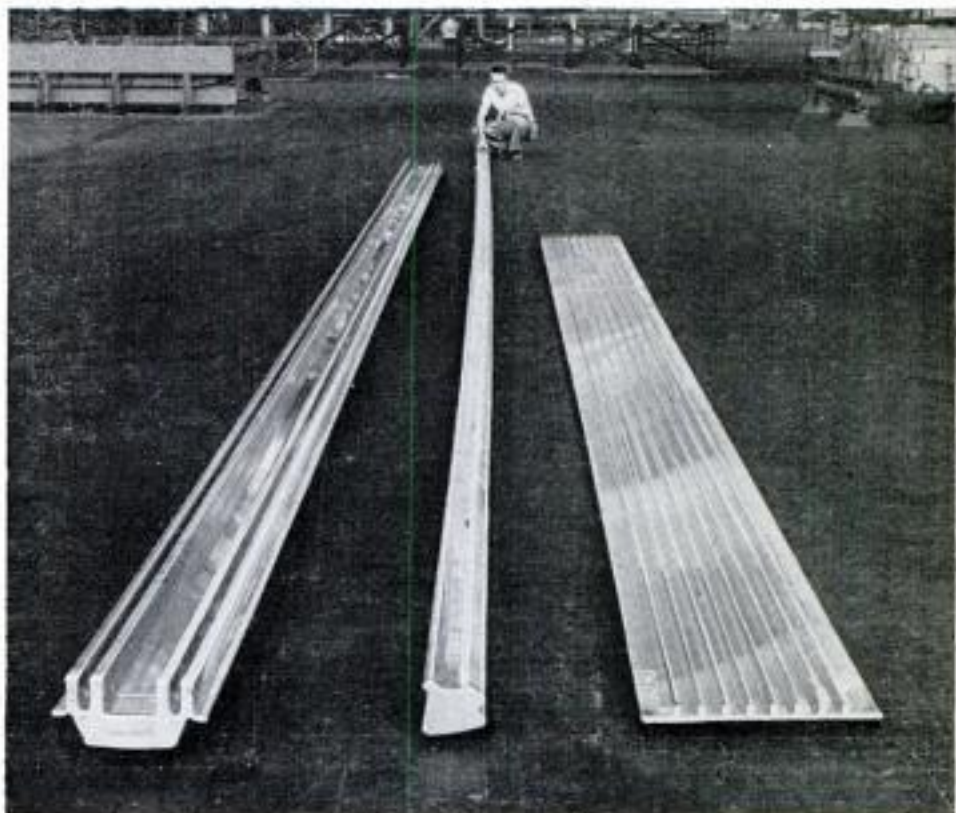

Blade in the Big Bertha bandsaw is 40 feet long, and is welded into single piece after insertion in guide hole drilled in die blank. Contour-saw method allows cut directly along layout line drawn on work

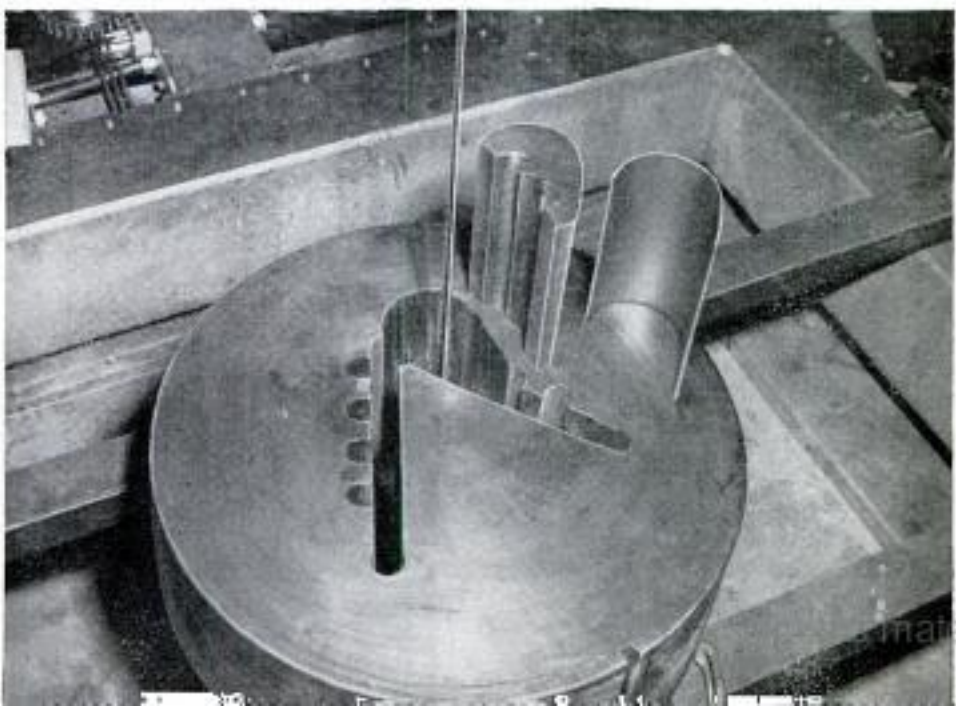



Steeds in Snail Stable Start Race When Spurred by Sunlight

Martin Witter, age 10, of Lynwood, Calif., gets a snail's-eye view of one of his stable of racing chariots. Martin contends he has the only snail stable in the country, and he uses the mollusks as both steeds and

drivers. The snails are goaded into action when placed in the sunlight, which warms their shells. Record time for a snail chariot in competition over a three-foot course is five minutes.



Mechanical "Mole" Helps Irrigation

Subsurface irrigation tunnels are dug by a mechanical "mole" that helps get water to the roots of crops planted in tightly packed clay soils. The mole, a torpedo-shaped metal object, is drawn through the soil behind a subsoiler blade 14 to 22 inches below the surface, the tunnels being spaced some 36 inches apart. Moling is done before the crop is planted, while the main irrigation ditches are shaped after the crop emerges from the ground. Earth from the ditching operation that plugs the tunnel entrances is removed or allowed to dry out to insure the flow of irrigation water into the tunnels.

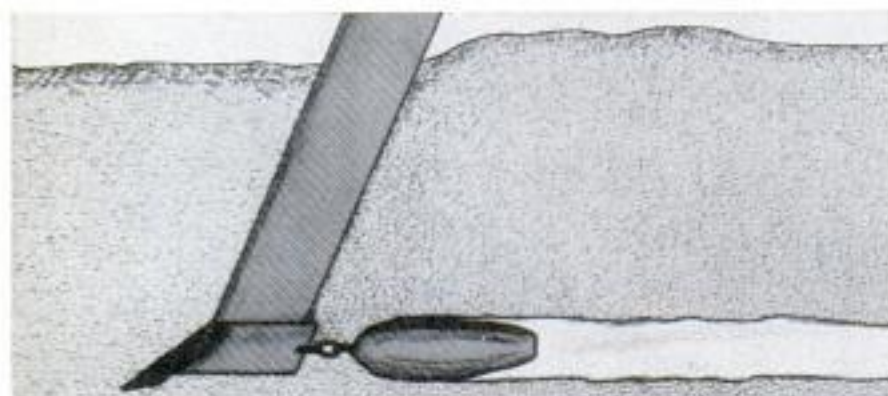

Multiple-spindle drills that bore up to 300 holes per second are being used in the manufacture of acoustical tile.

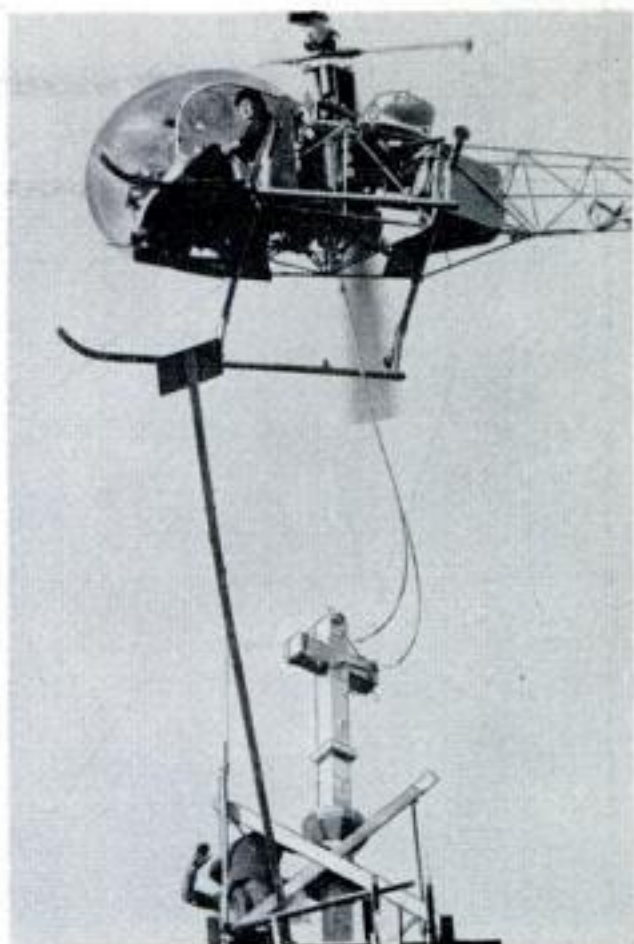
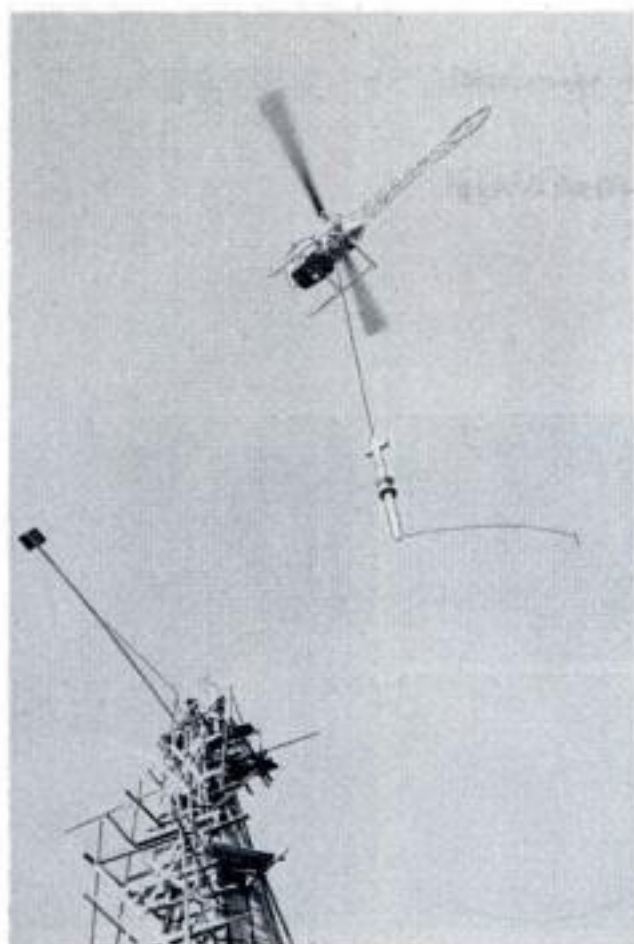

Helicopter Used As "Skyhook" to Lift Cross To Church Steeple

Helicopters have been put to many odd uses, but it remained for the people of Avesta, Sweden, to use one as an architectural "skyhook." Wanting to put a new, 300-pound cross atop their church steeple,

the builders sought an easy means of lowering it into place from above. The helicopter was the answer. It lowered the cross into the waiting hands of workmen on top of the steeple.

German TV Tower Houses Restaurant and Platform

Not content with the conventional built-up steel-girder construction, the South German Broadcasting System is planning a tubular television tower at Stuttgart, American Zone, that will house a restaurant and observation platform near its top. The platform and eating place will be reached by twin elevators running up the interior of the tube and the antenna itself will surmount them. The entire structure will be almost 500 feet tall.

Sets Helicopter Record

An unofficial world's helicopter-altitude record of 24,500 feet has been set by Army warrant officer Billy I. Wester, flying a Sikorsky XH-39. Previous record was 22,110 feet, achieved by the Air Force.

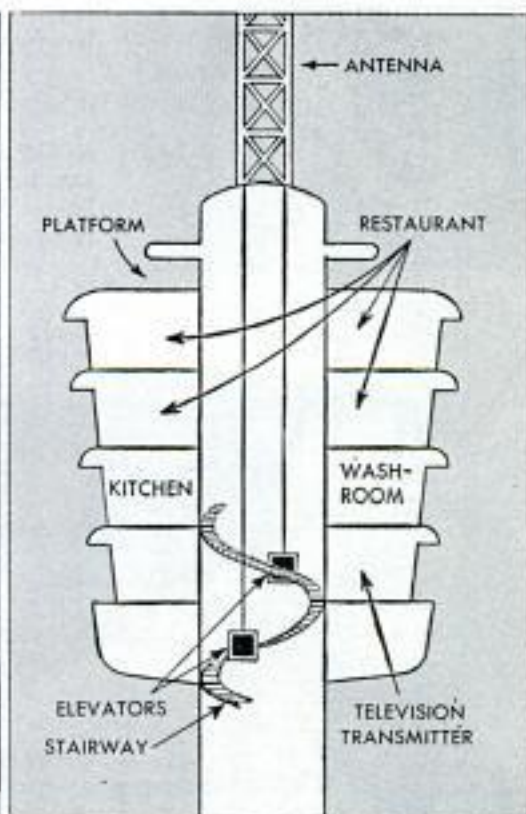
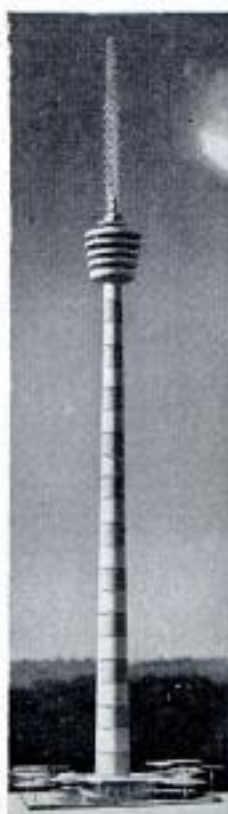

WHAT'S NEW FOR

Your Home



WINDOW SASH can be tilted inward for cleaning. Pivots at bottom of each sash hold it in the channel during tilting or allow easy removal. Steel cables attached to coil springs allow raising or lowering in the normal sliding position. Unit is quickly installed in standard frame

SWITCH EXTENSION brings wall-light switch within easy reach of small children, permits them to get their own drinks of water after lights are out, or allows easy operation of a switch when it is obstructed by furniture. Shockproof plastic cord connects extension to switch

HOOD with ventilating fan which whisks away cooking odors and smoke can be installed under cabinets, requires only 4½ inches of clearance below them. Hood tilts for easy cleaning of its underside, or can be removed for servicing of fan. Built-in light illuminates range beneath

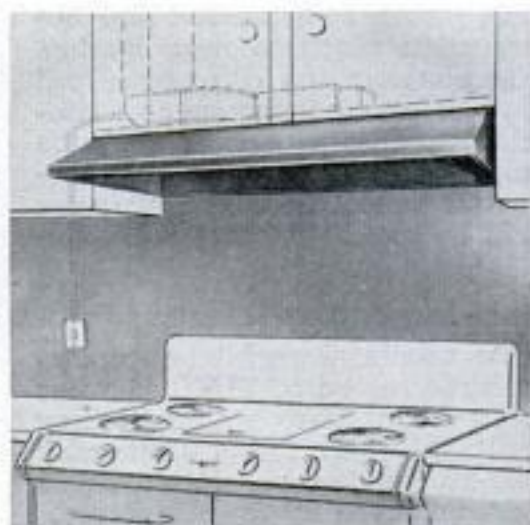

CHAISE LONGUE folds into a neat 12-pound package that is easily carried on trips. Headrest and cushions are inflated with a pump or by lung power. It adjusts to four positions to permit use as a lounge, cot or chair. The unit has lightweight steel-tubing framework and is covered with fadeproof plastic



SEAT-COVER ANCHOR holds cloth firmly in place, prevents bunching and wrinkling. Barbs of holder are pressed deep into chair covering. A locking barb secures the holder so it won't slip out. It can be used also on beds to hold sheets or baby blankets in place, or in autos to fit throw covers to seats



SAFETY RAIL and seat for bathtubs reduces accidents that happen when people are getting in or out of the tub. Especially useful for the handicapped and elderly, it fastens firmly to the side of the tub, furnishes a secure handhold. The seat is covered with colorful plastic. Steel rails are chrome-plated

VENEER "WALLPAPER" is so pliable it can be wrapped around a lead pencil, yet is genuine wood. Only 1/85 inch thick, it is bonded to a cotton backing and is applied to the wall in much the same manner as wallpaper. It comes in a variety of hardwoods and applies easily to any hard, smooth, dry surface





Cox relaxes in a lounge chair on the broad deck of the former PT boat while his wife feeds their canary



Living room still shows signs of their home's origin as a PT boat. They plan to install a ceiling soon



Eighty-foot craft, now a home, is tied up in the harbor near the Air Force base where Cox is stationed

Hull of Fighting PT Boat Becomes Floating Home

TO AIR FORCE Lt. Col. Homer Cox and his wife, home sweet home is a former PT boat. In the Air Force since 1930, Cox was a combat pilot in World War II and flew 25 missions in Korea. Two years ago he was assigned to Roslyn Air Force Base, Roslyn, L. I., N. Y. Unable to find a home, he located an 80-foot PT boat which had seen service against the Japanese in World War II. The craft originally cost the Navy about \$40,000, but the Coxes bought the hull for \$1000. It now is anchored in the harbor at Roslyn. Since they bought this boat, they have spent about \$3500 on interior renovation. They installed modern cooking equipment in the galley-mess hall. The deck makes a fine place to relax on warm days. The Coxes plan to put in a ceiling, and eventually to install motors. Then, in three years, when Cox is eligible for retirement, they plan to sail for the Canary Islands and make their home there.

Mrs. Cox prepares meals in the former galley, now equipped with modern stove and other conveniences



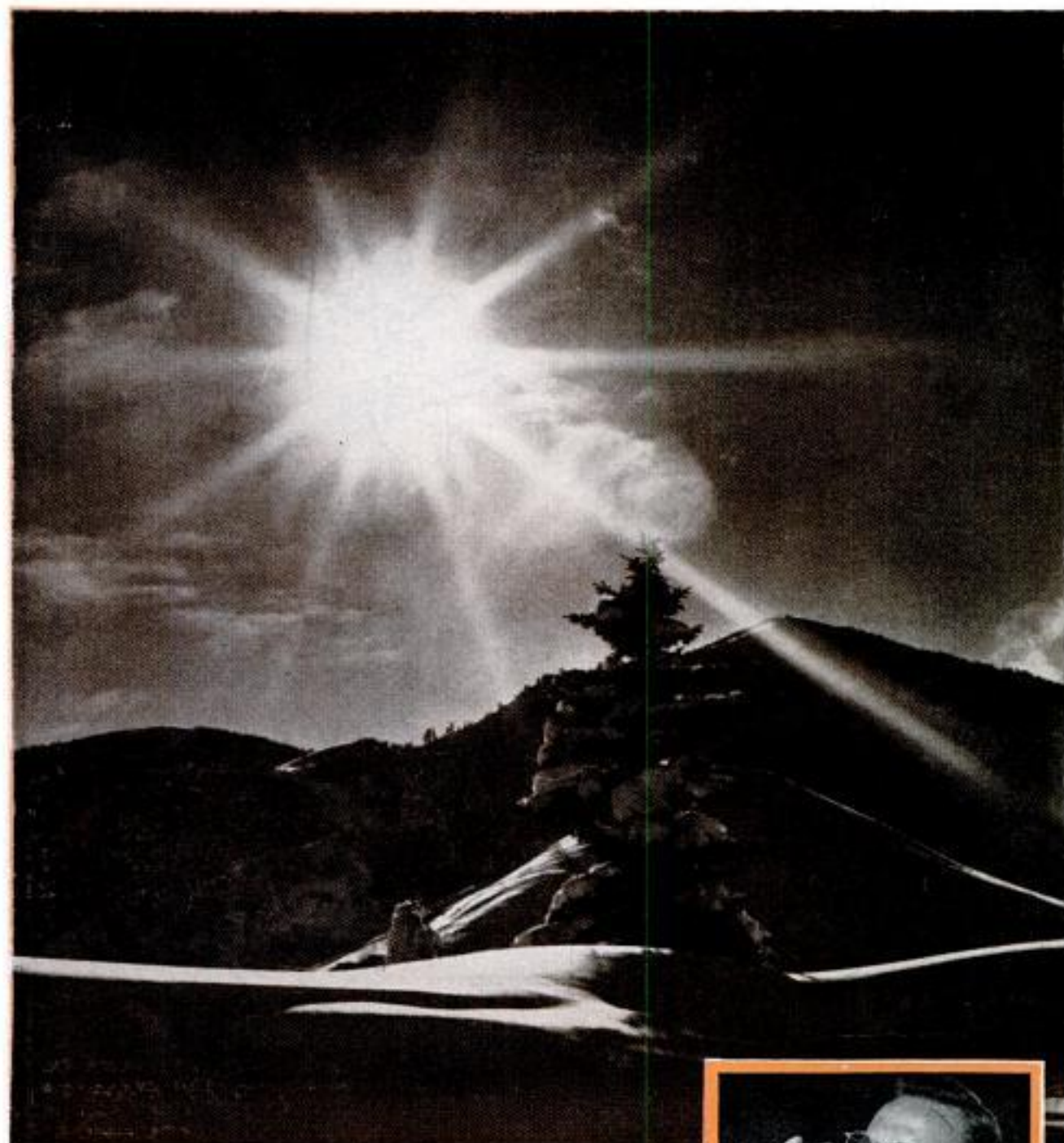

Convair photo
Flashlight reflector lights a cigarette to demonstrate solar energy

After the Atom— Power From the Sun

By Clifford B. Hicks

THE PRIESTS of ancient Egypt worshipped the sun as Amen-Ra, the God of Gods, and with good reason, for it is the greatest potential source of energy known to man. From this shimmering glob of gas, radiation showers out into empty space and goes on and on forever. An infinitesimal part of its radiant energy leaps 93,000,000

miles through empty space to impinge upon the speck of matter which man calls Earth.

Without this radiant energy—sunlight—life in any form would be impossible. Man burns sunlight, in altered form, in his body for food and in his machines for fuel. Nature converts sunlight into every kind of nourishment from hominy grits to sirloin

Man Now Uses Sunlight Trapped by Nature

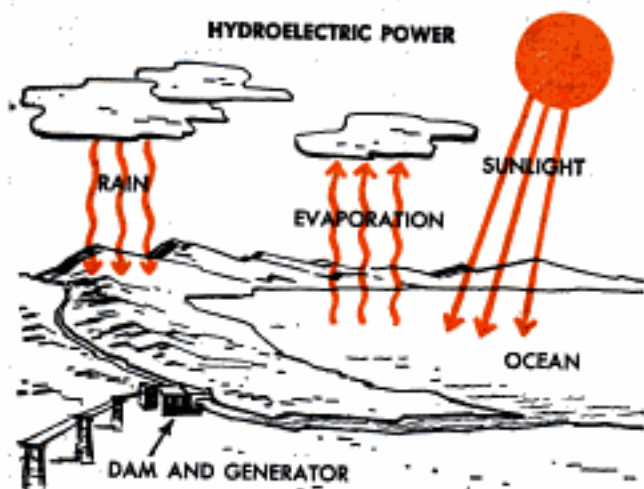

Solar energy evaporates water, which then falls as rain. We recapture energy with dam and generator

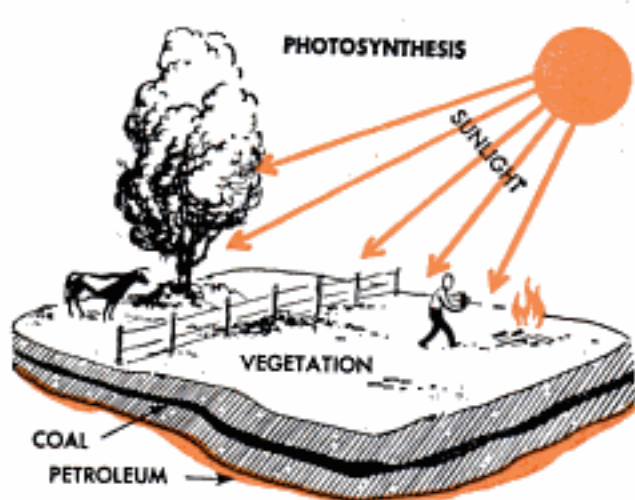

Green plants grow through photosynthesis, producing food and fuel. Coal, petroleum are trapped sunlight

How Man Hopes to Capture More Solar Power

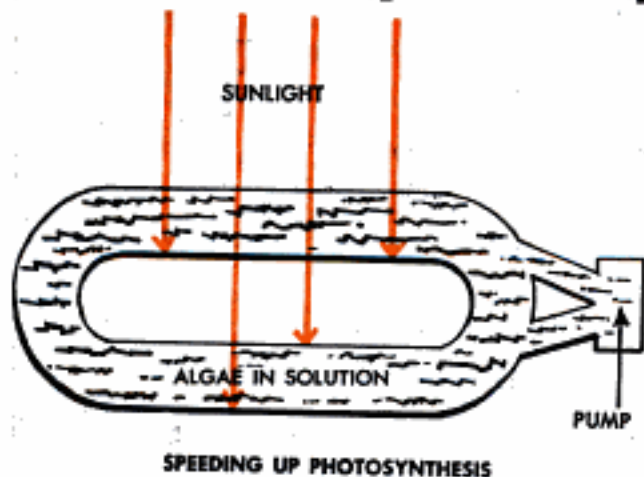

Algae—unicellular plants—are circulated in plastic tube. They can double their weight in a few hours

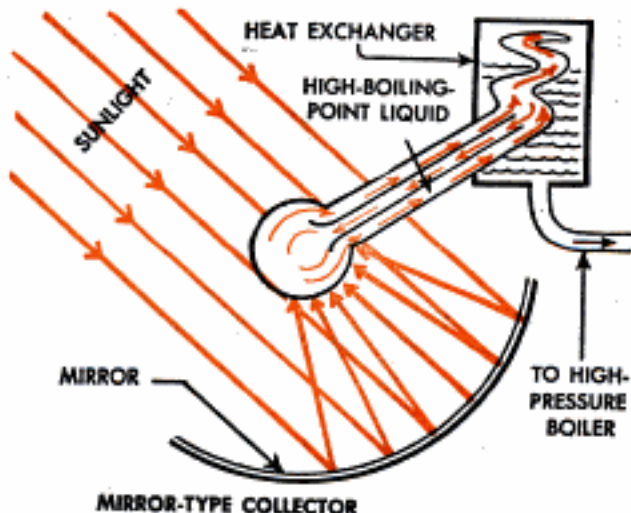

Parabolic mirror focuses the sun's rays on a small area to heat liquid, which runs high-pressure boiler

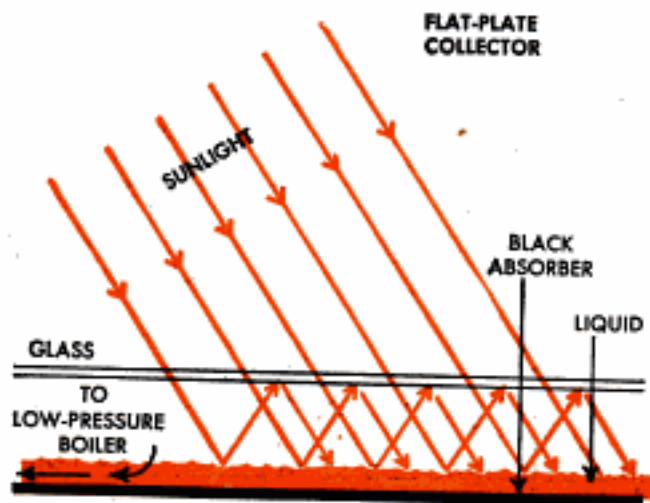

Rays penetrate glass to heat liquid. Absorber changes rays' wavelength so they can't escape through glass

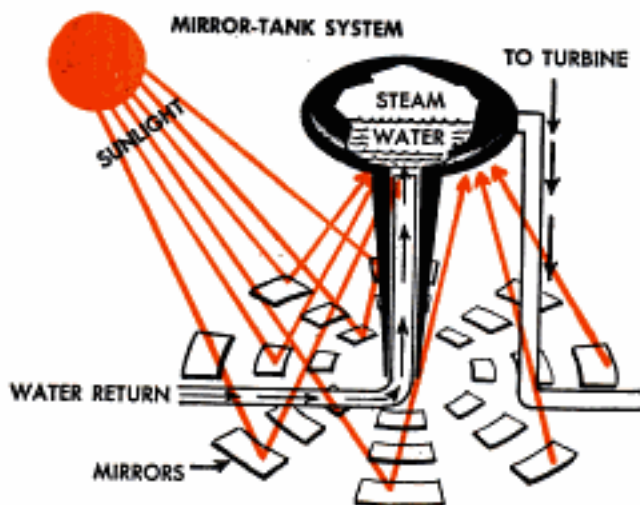

One proposal is to focus sun's rays on a black tank, heating the interior to convert water into steam

steak, and into every kind of energy from gasoline to hydroelectric power.

If you could sell, at today's market value, all the energy that falls freely on your back yard, you could retire for the rest of your life. Those areas of the earth which are least valuable to man for other purposes receive the largest share of the sun's bounty; a 16-square-mile area of worthless Arizona desert receives enough energy to support the current power needs of all the people of this country. Every hour Old Sol pours down upon the welcoming earth as much energy as there is in 21,000,000,000 tons of coal.

Yet man has always been baffled in his attempts to trap this tremendous flow of free energy. It is as elusive as a handful of sand. So far he has been able to hold only a grain or two, for all his efforts. He has been forced to buy his energy requirements secondhand. A tree, through the magic of photosynthesis, converts solar energy into wood, and man burns the wood to recover the trapped energy. In days long before man strode the earth, mighty forests captured the sunlight, then died and were buried beneath the earth's surface. Today man feverishly digs this "sunlight" out of the earth in the form of coal, or pumps it out as petroleum. When the sun pours its energy down upon the vast oceans, the water evaporates into clouds, the clouds drift over the land, the water falls as rain, and man captures an infinitesimal part of the solar energy with hydroelectric dams.

For centuries man has known that he is paying dearly for his secondhand dealings. The process of photosynthesis is only one tenth to one half percent efficient, and when man burns wood, coal or gas he succeeds in liberating only a small fraction of the energy it imprisons.

Great minds long have tried to untangle the baffling knot of direct-solar-energy utilization. All man has to show for these efforts are a few cold-drink stands in the Arizona desert that use the heat of the sun to power air conditioners, and a scattering of water heaters in Florida.

Just within the past few years, science has started unraveling the knot. Men trained to take a long view of history point out that the



New York University photo

Doctor Telkes demonstrates experimental stove. Mirrors on flaps deflect rays to a heat-storage chemical inside the box

world is spending its coal and oil reserves with shameful abandon. Authorities disagree about the time we have left—a good estimate may be 160 years. All the reserves of atomic power might last another 75 years. The point is not precisely how long we'll have these reserves of power, but that the bank account is continually diminishing and it's inevitable that we'll go broke. Where will our grandchildren, or our grandchildren's grandchildren, find the energy resources necessary to survive?

Developed in India, this solar stove has a mirror four feet in diameter which focuses the sunlight on a pressure cooker

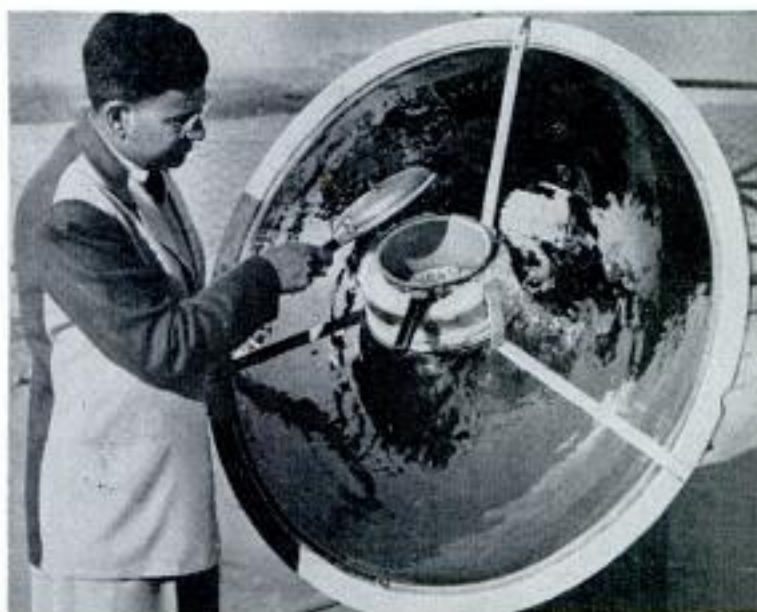



Coovair photos

Biggest solar mirror in this country is used as a research tool. Sun's rays are focused by 120-inch aluminum mirror to dime-size focal point. Furnace develops temperature of 8500 degrees F.

Specimens of metal and ceramic materials are placed in focal point to determine their heat resistance. After test they are so hot the operator must handle them with asbestos gloves



Many scientists — including those prominent in the field of atomic-energy research — feel that the harnessing of solar energy may well be man's biggest achievement, and it may come in the last half of the 20th century. They point to just a few recent developments that may be hints of things to come:

A solar furnace is being used to test metals and ceramics by melting them almost instantly.

A solar stove has been developed which shows great promise of giving underprivileged areas of the world free fuel for cooking. Other solar cooking methods are under development.

Ingenuous solar traps are capturing sunlight to heat homes at various spots in the United States.

Within the past few months man has succeeded in converting sunlight directly into electrical energy.

Man is currently trying to

capture the tremendous barrage of energy that strikes the earth in several ways:

1. *Solar mirrors.* When you were a child you probably used a reading lens to light a match or burn a hole in a piece of paper. You were using the same principle as a parabolic solar mirror which focuses the rays of the sun on one spot.

Dr. Charles G. Abbot of the Smithsonian Institution has done more work with solar mirrors than any other scientist. For years he has been working the kinks out of a solar-steam power plant. A mirror focuses the sunlight on a single point. Through this point circulates a liquid which is heated almost within a finger snap and passed on to a heat exchanger. Here the heat is transferred to water, producing steam which flows to a high-pressure boiler. The boiler operates a small generator to produce electricity. Doctor Abbot's power plant achieves the surprising efficiency of converting 15 percent of the intercepted solar energy to mechanical work and improvements promise to raise this to 20 percent. Doctor Abbot figures that a two to five-horsepower solar boiler of this type should produce electrical power at a cost of about one cent per kilowatt hour. Such a unit might prove feasible for a small home installation, but cost factors and the fact that the efficiency goes down as the size of the installation is increased make it unlikely that a big solar mirror will generate all the electricity for a city.

The largest solar furnace in this country is being used by Convair to study various metals and ceramic materials. Rays from the sun are collected by a 120-inch aluminum mirror and reflected to a dime-size focal point. The heat at this spot melts a steel bolt in seconds. When conditions are ideal, the furnace develops a temperature

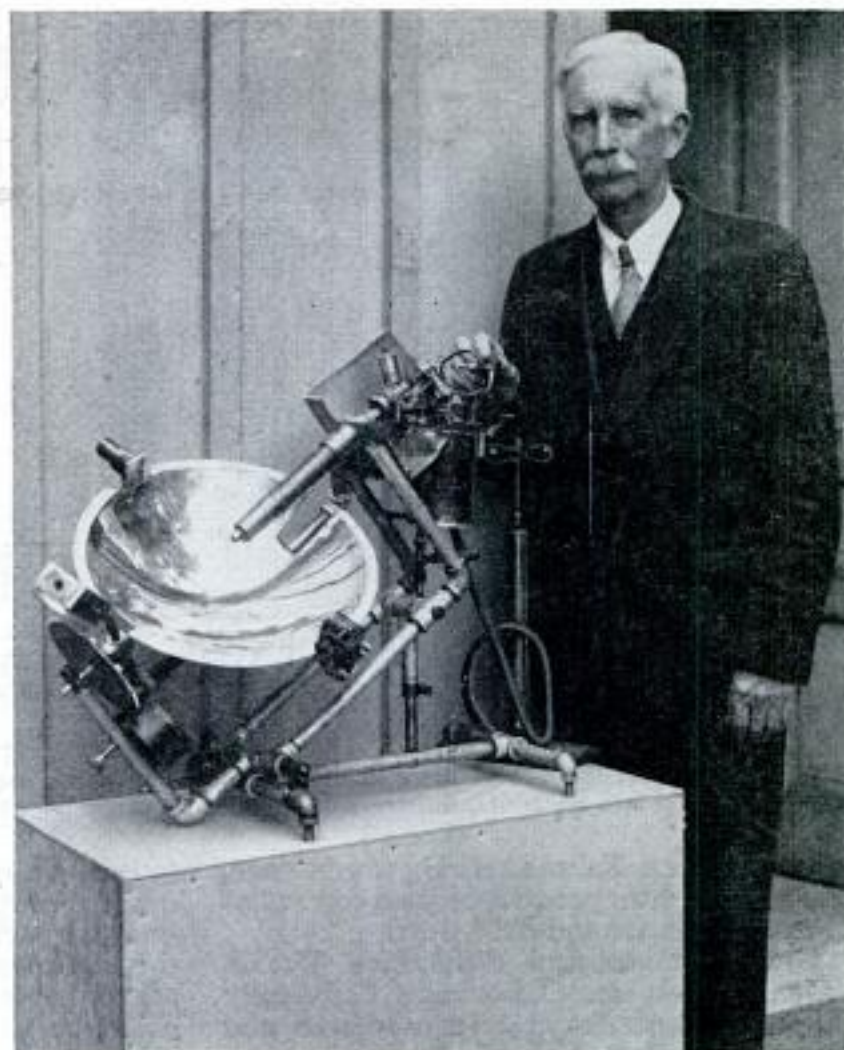

Smithsonian Institution photo

Doctor Abbot's solar-steam power plant uses a parabolic mirror. The little plant has the surprisingly high efficiency of 15 percent

Materials tested by the big solar furnace on the opposite page frequently crack or flake due to the thermal shock at the focal point

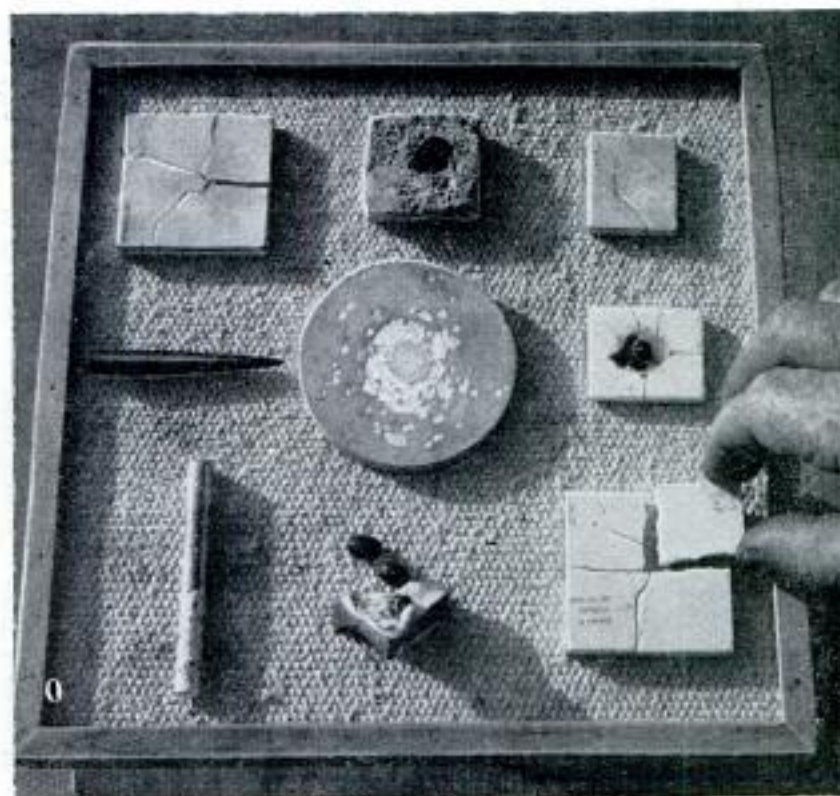

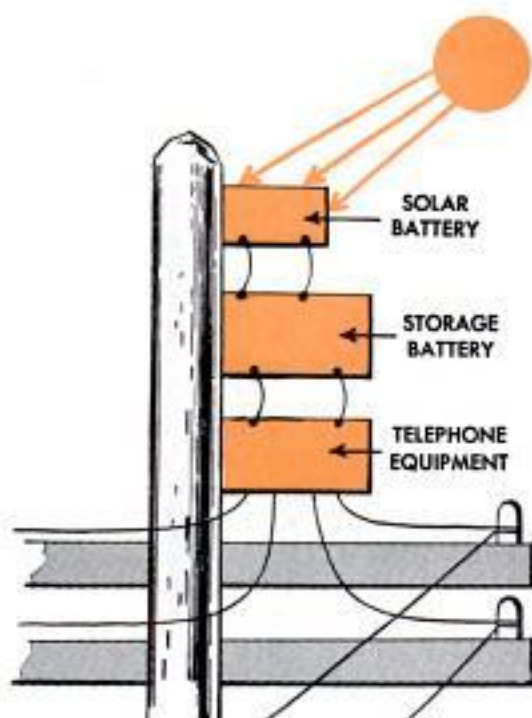
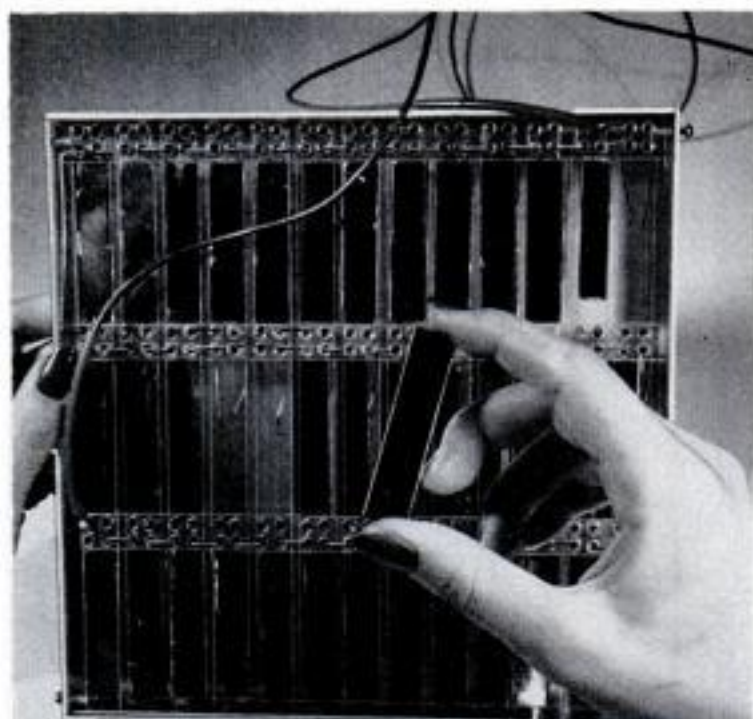

Bell Telephone Laboratories

Silicon strips about the size of razor blades are linked in series in the Bell solar battery. They convert sunlight directly into electricity. Battery may be used to power phone equipment through a storage battery

of 8500 degrees Fahrenheit. By comparison, the temperature produced by an oxyacetylene torch is around 5800 degrees.

Despite theoretical difficulties, Dr. J. Allen Hynek, an Ohio State University scientist, suggests that immediate and large-scale efforts be made to develop mirror systems for human needs.

"A black hemisphere, mounted on a tower and serving as an energy collector, could supply modest power needs at a relatively small cost," he says.

This hemisphere, he suggests, might look something like a water tower. Covering several acres around it would be an array of mirrors that would deflect the sun's rays

to the hemisphere. Sufficient heat would be developed inside the tank to convert water to steam, which then could supply an industrial plant with all its power needs. He also suggests that a much larger plant could be built in a valley. Ten-thousand mirrors, each a yard square, would be installed on the surrounding mountains. The mirrors would produce a 50-foot image of the sun a mile away, which would be focused on the 50-foot black sphere in which steam would be generated. This system theoretically would bring more than 100 gallons of water per minute to a boil. Its efficiency would be only 10 percent, but it could develop hundreds of thousands of horsepower for industrial purposes.

A smaller mirror system already seems practical for some purposes. One of the biggest problems of peoples in underdeveloped areas is the shortage of fuel for cooking. Vegetation is prematurely cut down for fuel in India and other countries, laying open the land to soil erosion. Millions of families in India and Egypt burn dried animal dung as fuel, depriving the land of natural fertilizer. Experts estimate that the use of animal fertilizer for cooking cuts the productivity of the land by nearly one half. One answer to this problem would be a stove that burned some other

(Continued to page 252)

In solar generator, small crystal between two Plexiglas posts catches sun's rays, produces electricity to run the motor at left
Air Force photo

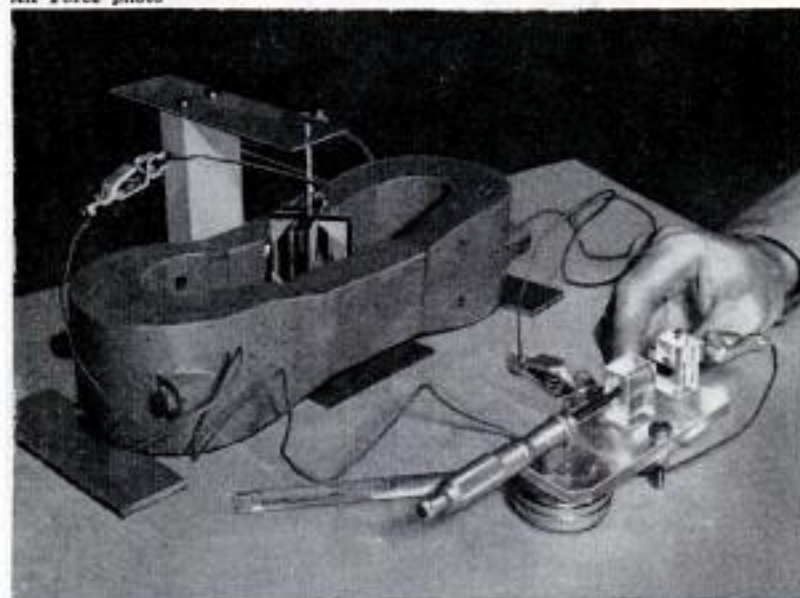



Shadow in photograph at left, made with ordinary unit, is eliminated in right picture by Focalite flash

Lens-Mounted Flash Unit Eliminates Shadow From Photographs

Fitted around the lens frame, instead of being mounted on a separate bracket, a new photographic flash unit provides shadowless illumination. With ordinary

flash guns, the bulb is some distance from the lens and therefore casts a shadow. Focalite throws light along the same lines as those from the subject to the lens.

Inflated Protective Plastic Suit Shields Atomic Worker

Looking for all the world like an inflated robot, a British atomic-research worker poses in the latest thing in protective clothing. The protective suit is of plastic and completely sealed. To prevent contamination from radioactive dust or gases, it is filled with compressed air supplied through the hose entering the helmet at the throat.

Traffic Lights Change Color On Orders From Radio Station

Traffic lights in Greeley, Colo., turn red and green according to radio signals broadcast from police headquarters. Transcribed pulsations are fed into the transmitter by tape recorders and picked up by the receivers on the traffic lights. Decoding units and switches on the lights do the rest. Each intersection has a unit which automatically takes over control of the lights in case of radio failure. The system offers great flexibility in traffic control and can be installed for an estimated \$800 per intersection as compared with \$3500 for the conventional system.





Want Latin American drums? Bratman can find them on shop's shelves

Young lady vibrates string to produce a bear's growl in the drum



House of Noises

Pop goes the plunger and pop goes a champagne cork

Bells? Here's everything from sleigh to mission bells





Bratman, a former drummer himself, now has a collection of strange African and Latin American drums



Shop owner experiments with stack of bicycle bells. Below, rubbing blocks produces puffing locomotive

ON THE OFF CHANCE you ever need a pig's grunt, a Scotland Yard whistle or a lion's roar, you can find it in the New York shop of Carroll Bratman. He has all these and some 2000 other sounds in a collection of strange noises. Bratman, a former drummer, now provides exotic percussion instruments to orchestras, and everything from the roar of a jet plane to the wail of a baby for television and radio programs. If you want a fog horn or an ice-cream-cart bell, he'll provide the real thing, but if you want an owl's hoot he'll give you a whistle instead of an owl. Bratman feels that recordings don't sound like the real thing. ★ ★ ★



Whistles make animal sounds. Right, girl blows into fog horn





Inventor William A. Pruett demonstrates his kite yacht, which drops parachute or glider from kite altitude

Engineer Turns Inventor and Puts More Fun Into Kite Flying

Kites have been flown for thousands of years, and probably the third or fourth boy or man to fly one thought of sending "messages," perforated pieces of paper or leaves, up the string to the airborne kite. Now William A. Pruett, a Covina, Calif., refrigeration engineer and sideline inventor has come up with an improvement on the small boy's message. It is a "kite yacht," consisting of a mainsail like a kite itself

and a vertical pilot sail, all mounted on a stick that rides the kite string on pulleys. The advantage of Pruett's kite yacht is that a miniature parachute, glider or other object can be attached to it and released automatically to sail down or drop when the yacht reaches the kite itself. Upon release of the carried object, the yacht wings fold and it returns down the string for another run.

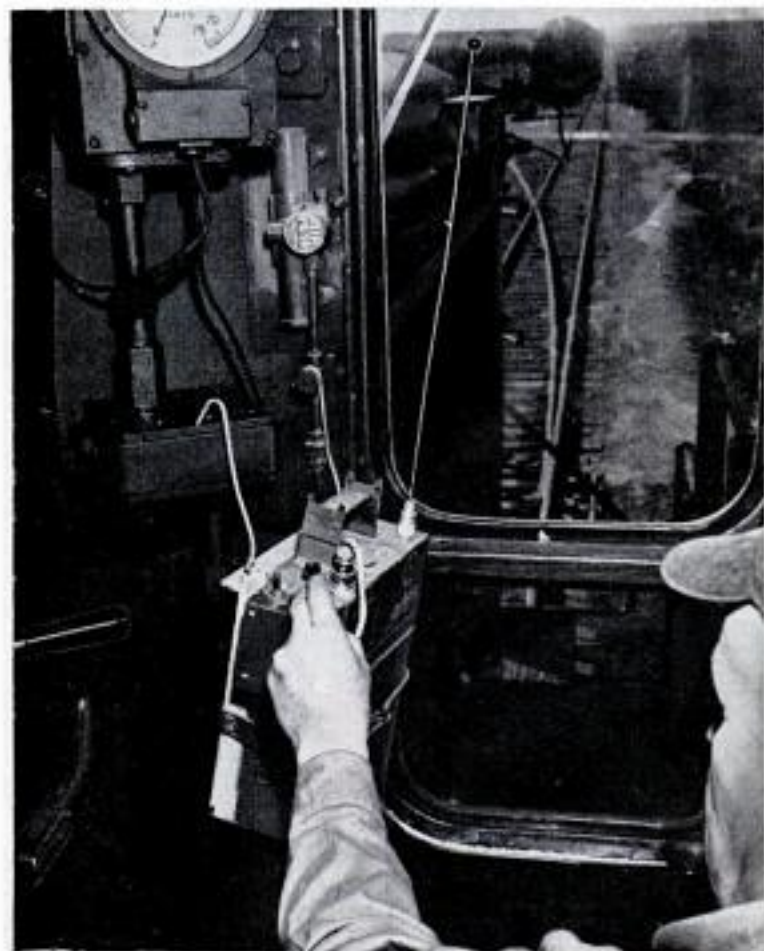

Operate Railroad Switches With Walkie-Talkies

Locomotive engineers now are using walkie-talkie radio transmitters to operate switches by remote control. The little transmitters are used in locomotives of the Santa Fe Railway. The transmitters have been modified by removing the microphone and replacing it with an oscillator which sends out two special tones. The engineer merely presses a red or green button. One of the tones then is broadcast to a receiver at the switch, which sets the switch as instructed.

New Transmission Has Fast Reverse

Capable of shifting from full speed forward to full speed reverse in $1\frac{1}{2}$ seconds, a new transmission for industrial machines has been developed by the American Gear and Manufacturing Co. It is a hydraulically controlled planetary compound unit.



Squeeze of Fingers Cleans Out Flexible Drain Made of Rubber

There's no need to call the plumber when the sink clogs up if it's equipped with a new rubber drain. All the housewife has to do is squeeze the flexible drain to force the particles down the drainpipe. The unit, developed in Austria, has only two parts which replace a dozen or more parts in the

conventional drain. The inner piece is a cone which forms an odor lock. The outer piece is the trap body, which can be fitted in place in less than five minutes without tools. The drain is unaffected by liquids at normal household temperatures, including lye and acids.



Heated Roller Irons Clothes

According to its German inventor, a new electric roller iron is easier to handle and as efficient as a standard iron. Exhibited at the Novelty and Inventions Fair in Nuremberg, it is not in production.

☐ Almost 13 civil aircraft a day are being built in the United States and more than 75,000 have been produced since World War II ended.

Elevator Tower For Movie Work

Stretching out to a height of 70 feet, a camera tower devised in Hollywood can be used for "up" or "down" shots. The six-ton tower is mounted on four wheels and is easily moved by truck or tractor. Its platform can accommodate both camera and sound men. The tower is designed particularly for outdoor shooting, as sound stages have numerous platforms on which cameras can be mounted for overhead shots.



The council rooms of the Pentagon can scarcely be more closely guarded than the styling studios of an automobile manufacturer. The fanfare that accompanies the first appearance of the gleaming new model in the show windows of dealers at year's end is preceded by more than two years of secret work by stylists and engineers, model sculptors and diemakers.

To bring you the story of a brand-new car, the 1955 Plymouth, from its very beginning to its assembly-line production, the Editors of *Popular Mechanics* have worked closely with the Chrysler Corporation for many months. We take you now behind the scenes for this story in diary form, accompanied by eight pages of color photographs made especially for *PM* readers. This feature begins our 48-page automobile section for 1955.

Diary of a New Car

By **ARTHUR R. RAILTON**
Automotive Editor

May 15, 1952

Chrysler Corporation executives meet to plan the 1955 models. They agree that the '55 cars must be all new, with all-new bodies and frames. Plymouth will have a new V8. Dimensions are tentatively set; all models must be longer and lower.

May 16, 1952

Styling director Virgil Exner briefs the heads of Plymouth, Dodge, DeSoto and Chrysler styling studios. He wants to see sketches of their ideas for 1955.

May 20, 1952

Studio heads bring in their sketches of suggested styles. Exner approves some, modifies others. The clay room is instructed to start working on $\frac{3}{8}$ -size clay models.

May 23, 1952

Full-size blackboard drawings are begun. These will prove out the proposed dimensions of the new bodies, making certain the lower lines still leave room for running gear and passengers.

May 29, 1952

Carpenter shop begins work on wooden skeleton that will support the full-size clay models.

June 6, 1952

Plymouth studio head, Henry King, asks chassis engineer to check full-size drawings to determine how much more the hood line can be lowered on the $\frac{3}{8}$ clay now being molded. Air cleaner keeps hood too

(Continued to page 137)

It starts as a sketch, an idea...

Styling begins on the drawing board. This painting was the start of the 1955 Plymouth ➤





The first clay models are $\frac{3}{8}$ actual size. On them, basic flaws in proportion are spotted and corrected

... is worked in clay and on paper...

Scale drawings keep stylists in check—so the seats won't be too low or the hood too flat for an engine

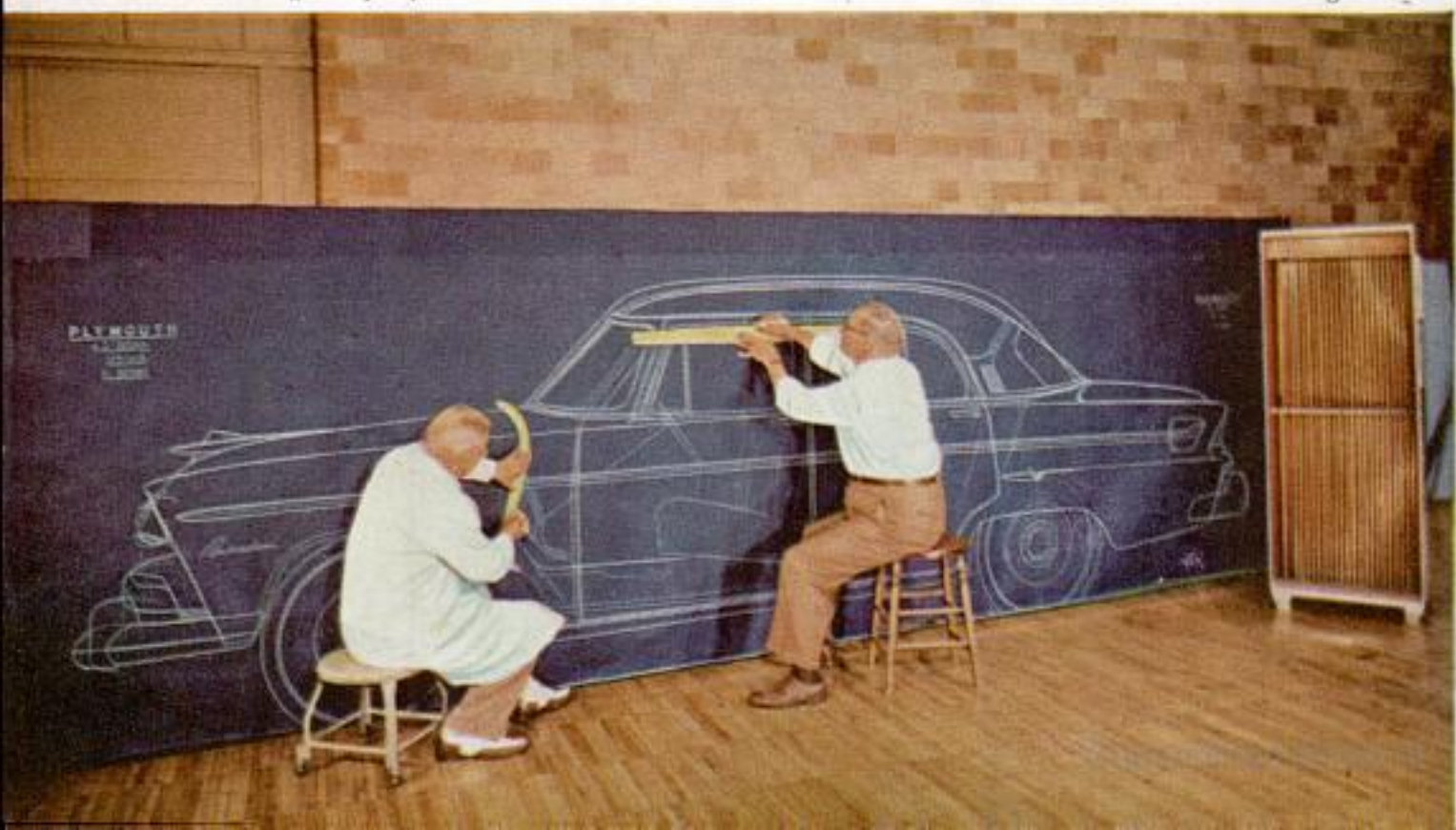

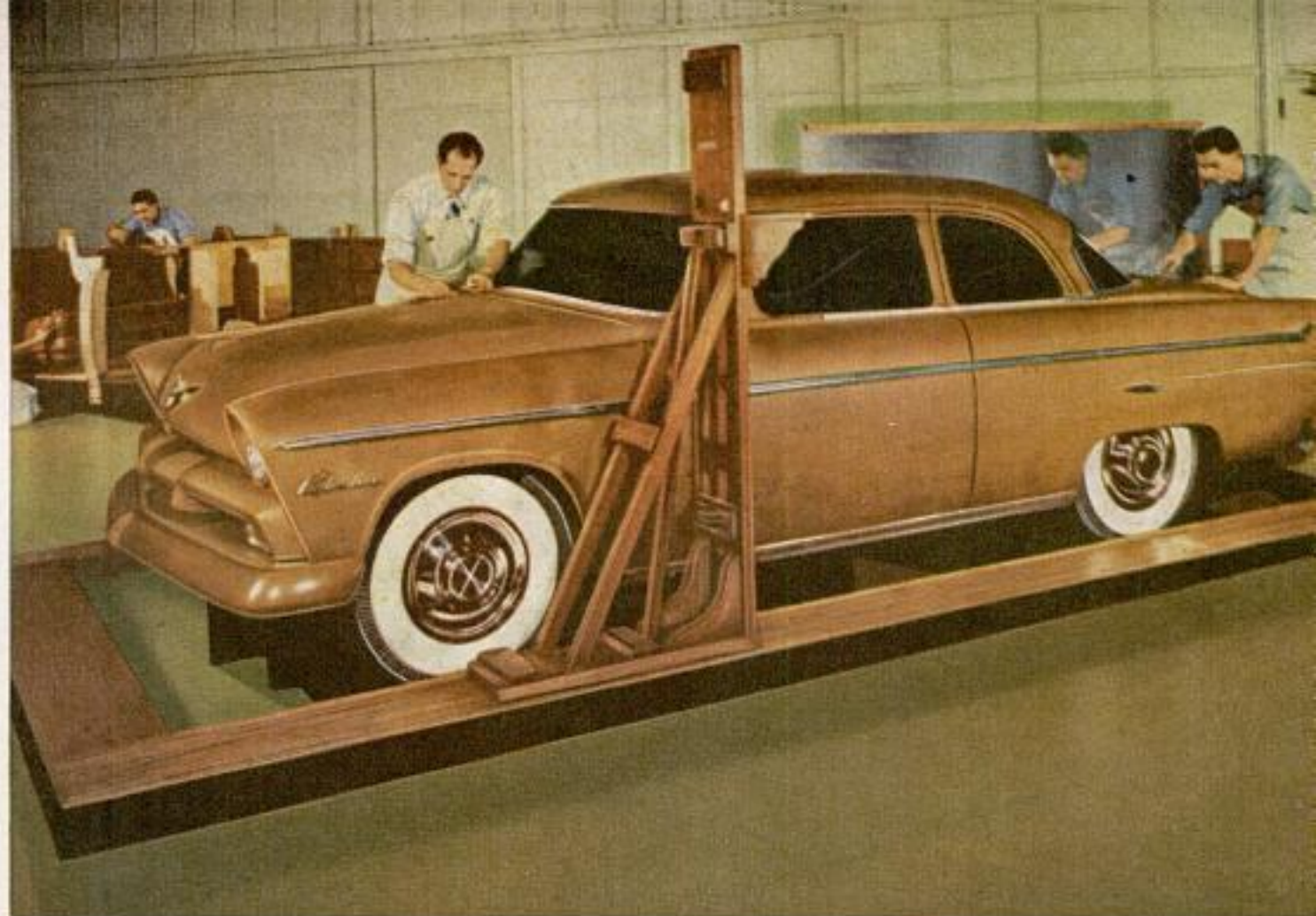

Once $\frac{3}{8}$ -size clay is approved, designs are modeled in full-scale clays. Tin foil simulates chrome trim

... takes on a style, personality...

Full-size clay models, like this Dodge, weigh up to five tons. A wooden skeleton supports the weight





From many sketches, a taillight design is selected for Plymouth—it is the one on the brown background

... taillights are sketched, molded ...

By use of a mirror, two different bodies (right, station wagon; left, sedan) are formed on a single clay

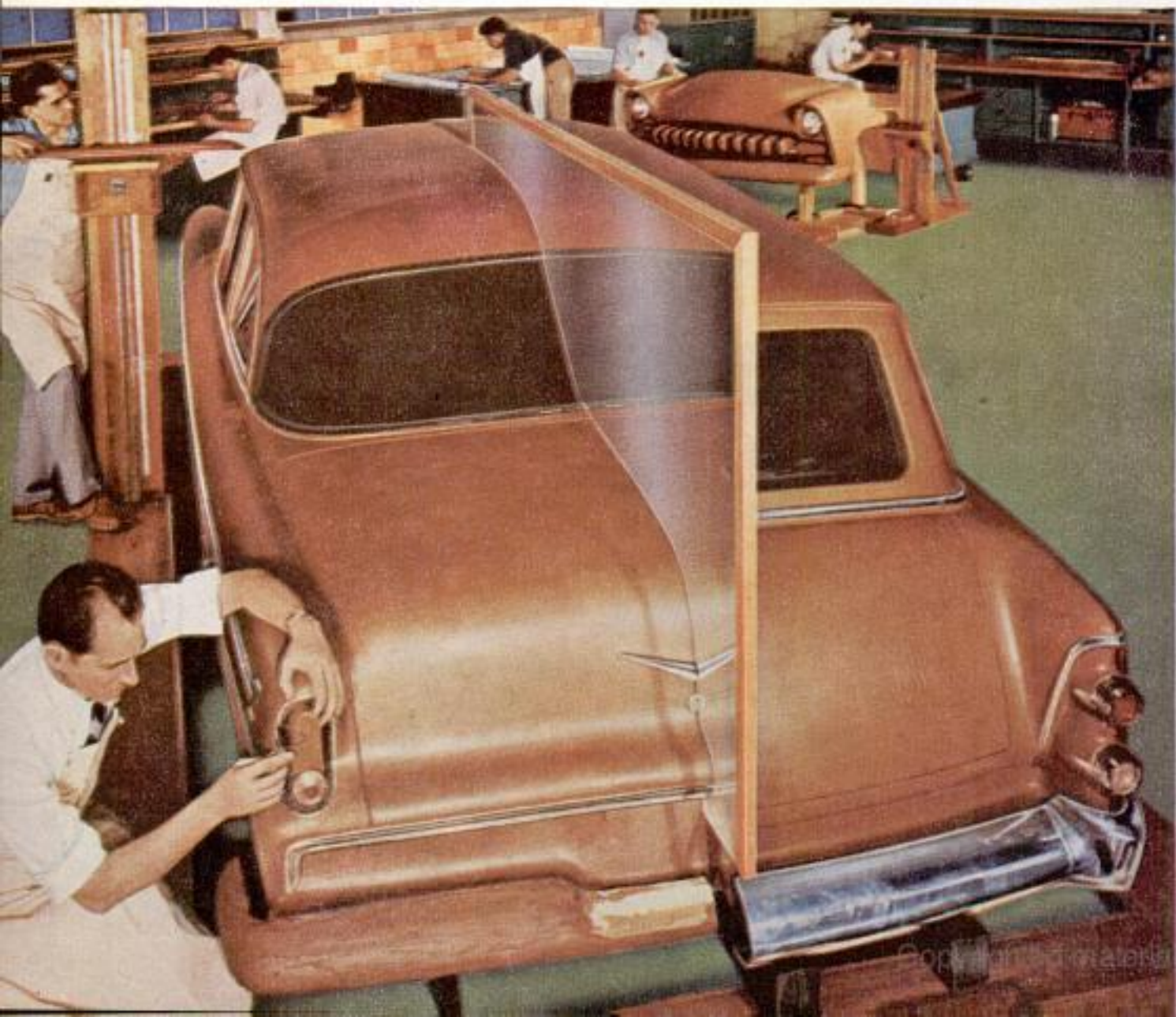



Details chosen from precise artist's rendering are transferred in full size to a clay instrument panel

... dashboards, seats, the whole car, ...

Interior appointments are worked out in clay room. Half of each seat is in one style, half in another





When the clay models have been okayed, plastic mockups are built. Until recently, these were wood

... body in plastic - a beautiful shell...

It looks real, but it is just the final plastic mockup. Full approval of the styling has now been given



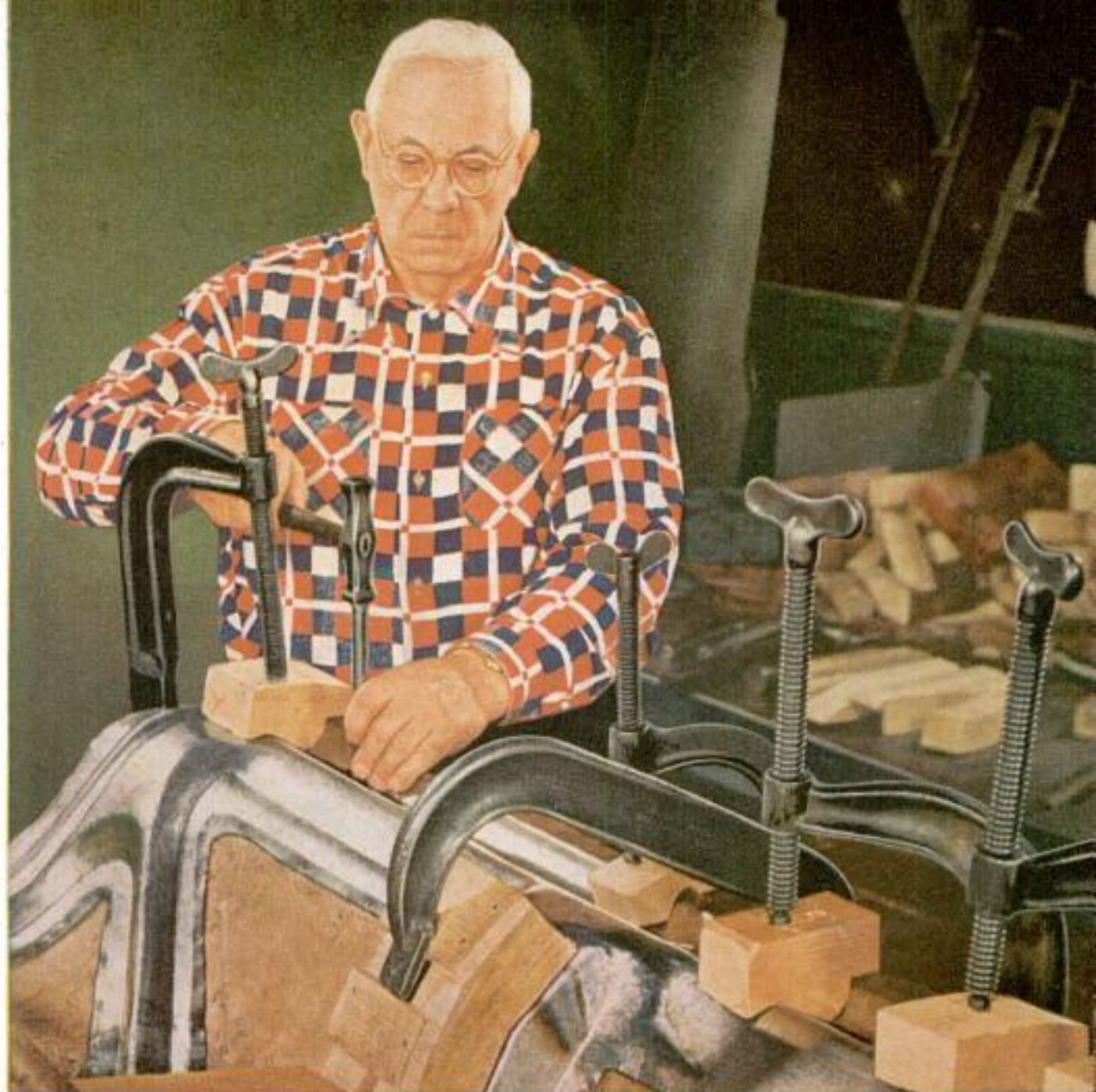

Hammer forms of hardwood are shaped and metal pounded around them, forming prototype parts

... sheet metal pounded and fitted ...

Prototypes take months to build. Handmade panels are laboriously fitted together, welded, painted

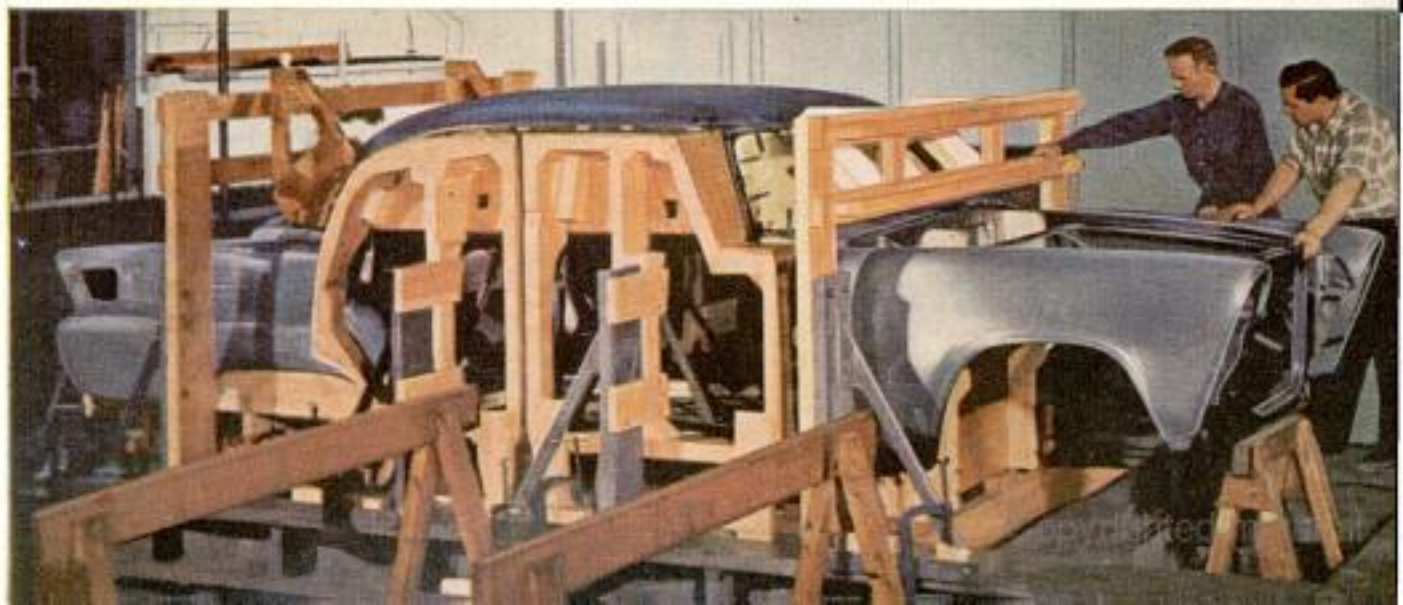



← While the prototype Plymouths are being produced, craftsmen are making die models of handsome mahogany from which production dies will be formed



With its V8 engine in place, prototype Plymouth is almost ready to be shipped to proving grounds

... Now complete - the car is born.

Stylist Exner steps out of a 1955 Plymouth. After months of work, it is now a reality



Diary of a New Car

(Continued from page 128)

high to suit the stylist. Engineers are asked to redesign it so hood line can be dropped.

June 10, 1952

Tin foil added to $\frac{3}{8}$ clay to simulate chrome trim. Exner says rear end sticks up too high. Clay is shaved off to lower it.

June 12, 1952

King suggests to Exner that the lowered hood line is now too low. It has a "down-cast" look, he says. Can it be raised slightly? Exner tells him to go ahead.

(NOTE: Designing in clay goes on continuously. Nothing is firm as of this moment. The stylists are striving for an okay on the major body surfaces so work can begin on roughing out the big body dies—a slow, time-consuming operation.)

June 16, 1952

Plymouth's $\frac{3}{8}$ clay models completed. Exner selects the two best designs and tells King to have them made in full-size clay, incorporating some changes suggested by Plymouth executives and other changes suggested by Exner.

June 23, 1952

Clay room reports wooden bucks for the full-size models are now covered with clay and are ready for shaping.

(NOTE: The buck is made of clear maple and is strong enough to support up to five tons of clay. This clay is modeled in an air-conditioned atmosphere. Summer temperatures would cause clay to sag.)

June 25, 1952

King gives Exner a selection of grille and taillight treatments. Exner chooses several to be modeled in clay. He asks for bolder, stronger shapes. "Heavy them up, they're too fragile looking."

June 30, 1952

Blackboard drawings are completed. Construction of seating buck begins based on these drawings.

(NOTE: The seating buck is an exact, full-size mockup of the interior. Designers can get in, sit down and sense exactly how the finished car will feel to driver and passengers.)

July 7, 1952

Tool engineers are consulted about the Plymouth rear-fender shape now on clay. They advise that the bend is too sharp. The

metal will probably tear or wrinkle in production stamping. That would mean an expensive metal-finishing job. Clay is worked down to soften the curve and eliminate this problem.

(NOTE: During the styling period, tool engineers are often called in to advise on such matters.)

July 11, 1952

Plymouth's top executive says more grille identification must be worked into the front end. The new car has to have some features to mark it as a Plymouth even though it is to be all new.

August 5, 1952

Exner selects two grille designs from among the clay models and tells King to work them into the four-door sedan now being clayed up. One is very simple; the other ornate. He suggests a different headlight treatment. Rear-deck line is now approved.

September 15, 1952

Seating buck completed. Body men feel that the forward overhang of the curved windshield is excessive. It gives a "basement window" feeling, they say. To correct it, the roof line is drawn back slightly. Seating position, pedal and steering-wheel locations are approved.

November 28, 1952

Full-size clay models completed for all divisions. Executives meet to okay them. Clays are moved out into the daylight. Current models (1953 cars) are driven alongside for comparison. Executives must decide: Are the 1955 designs hot enough? Will they look new two years from now when introduced? Imperial, Chrysler and DeSoto clays are approved with many minor changes. However, Dodge and Plymouth are rejected. Exner admits he is not satisfied with front-end sheet-metal design. He describes major changes he would like to make. Executives give him authority to go ahead.

December 1, 1952

Exner and King have worked all week end on new front-end sketches for Plymouth. Drastic changes are made in hood lines and fenders. No changes were necessary in major body panels.

(NOTE: There is no time for a $\frac{3}{8}$ clay. Work of remodeling full-size clay begins at once with styling changes being made right in the clay. Clay room works hours of overtime on the new front end and fenders.)

December 2, 1952

Work begins on the hammer forms for the major roof and body panels unaffected by front-end revisions.

(Continued to page 242)

Parade of 1955 Cars

By Leo Donovan, *PM's* Automotive Correspondent

IT WILL BE a long time before another year like 1955 hits the automobile industry. Let's see why.

These 1955 models boast of all-new bodies: Chevrolet, Ford, Plymouth, Pontiac, Dodge, DeSoto, Chrysler, Imperial, Mercury and Hudson. These models have new engines: Chevrolet, Plymouth, Pontiac, Dodge, Chrysler, Packard, Nash and Hudson.

Packard has a new torsion-bar suspension with an automatic load "levelizer" (see page 148 for details).

This is the year of the wrap-around windshield. It is the year of hooded headlights and reverse-slant taillights. It is the year that marked the end of the inner tube,

as tubeless tires became standard. It is the year of the four-door hardtop sedan (see photograph below).

In the industry, this may be the year known as 19V8 instead of 1955. The V8 engine has taken over, with every make except Kaiser and Willys offering the V-type engine.

Almost without exception, the new cars have bounced horsepower upward sharply. Average horsepower for the industry this year is 181. Compare that with the 1951 average of 118—a jump of 63 horsepower in only four years.

It is literally the most colorful year in history. Colors once reserved for taxicabs
(Text continued to page 280)

Buick

Buick raised horsepower to 188 on the Special and 236 on all other models. A variable-pitch stator in the Dynaflo (see page 148) provides faster getaway

at wide-open throttle. It has announced a four-door sedan with hardtop styling (below). Body changes include a new mesh grille, straight-back rear fenders

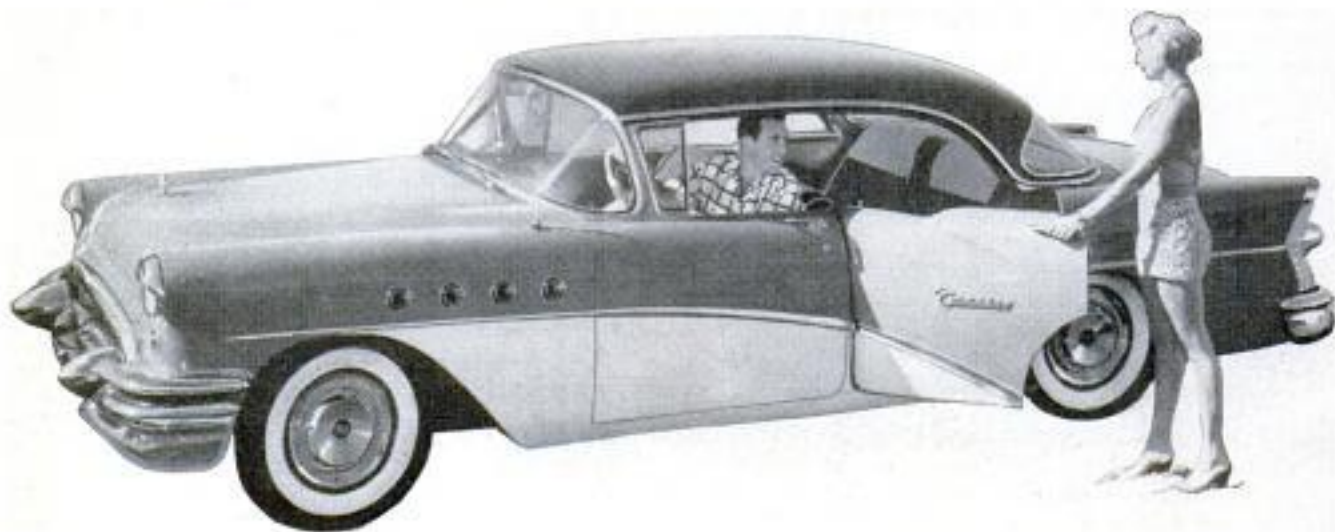



Cadillac

Cadillac also boosted horsepower. It is now 250 and the Eldorado sports convertible develops 270. The engine has a new carburetor, water pump and a more

rigid crankshaft. Hydra-Matic is improved. Tinted glass is now gray instead of green. The grille has been reworked a bit as has brightwork on the sides

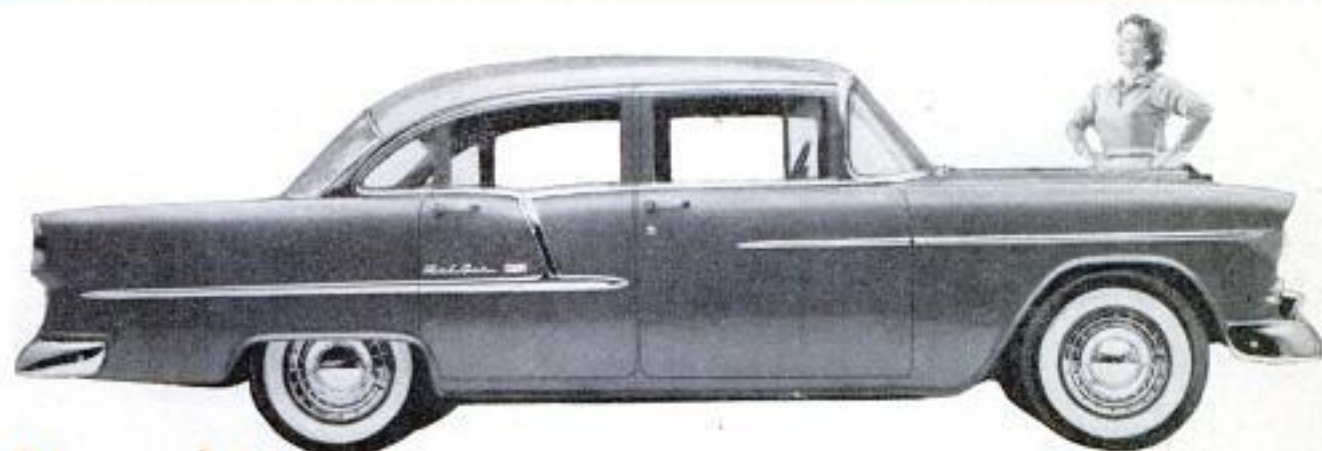

Chevrolet

Chevrolet engineers have been busy. They cut weight of frame 18 percent yet it's 50 percent more rigid. New V8 engine weighs 30 pounds less than the six.

Front suspension reduces "nose diving" when you put on brakes. Body and frame are more integrated (page 149). Lower body looks longer—is actually shorter

Chrysler

Chrysler has a new body, featuring long, low lines, striking two-tone effects and prominent taillights. Mechanical changes are many: The Windsor's new V8

engine develops 188 horsepower on regular gasoline; the New Yorker V8 has 250 horsepower; rear springs are five inches farther apart, increasing stability





DeSoto

DeSoto is broad and low with a glued-to-the-road look. Front tread is almost four inches wider than 1954. Rear springs are five inches farther apart. The

V8 engine has hemispherical combustion chambers, uses regular-grade fuel. Four-barreled Fireflite has 200 horsepower; two-barreled Firedome has 185



Dodge

Dodge has horsepower variety this year. Take your choice of 123, 175, 183 and 193. As on all Chrysler Corporation models, the control lever of automatic

transmission is on the dashboard. The Lancer hardtop (above) features three-tone color combinations. Its style treatment emphasizes Dodge's long, taut look

Ford

Ford's top line, the Fairlane, has a curving chrome line (below) to set it apart from other Fords. The hardtop model is 2.4 inches lower than in 1954 and

has a chrome arch over its roof. All models have flatter hoods, longer rear decks. Hooded headlights, reverse-angle rear fenders make them appear longer

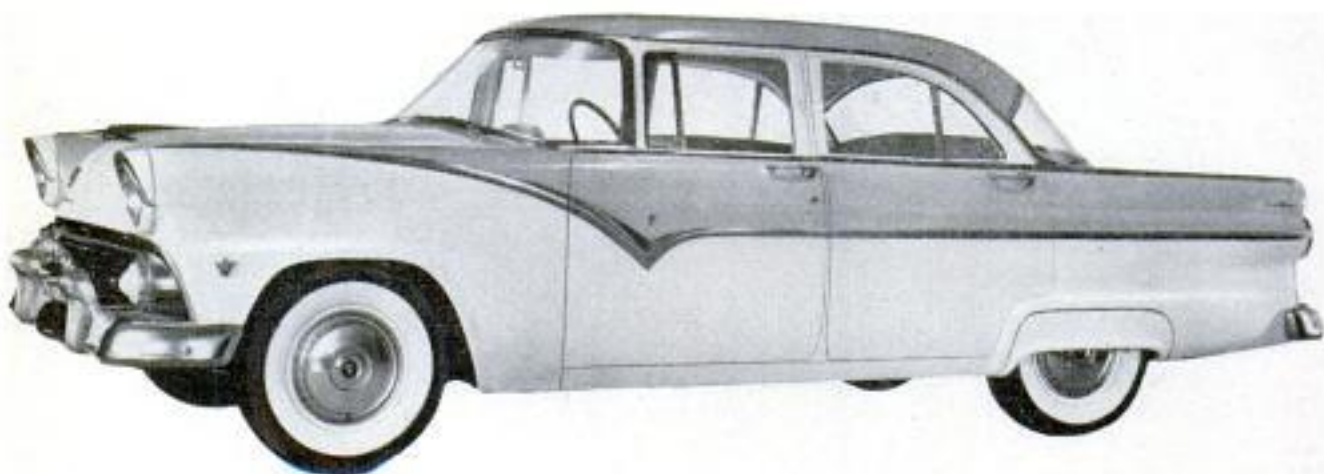

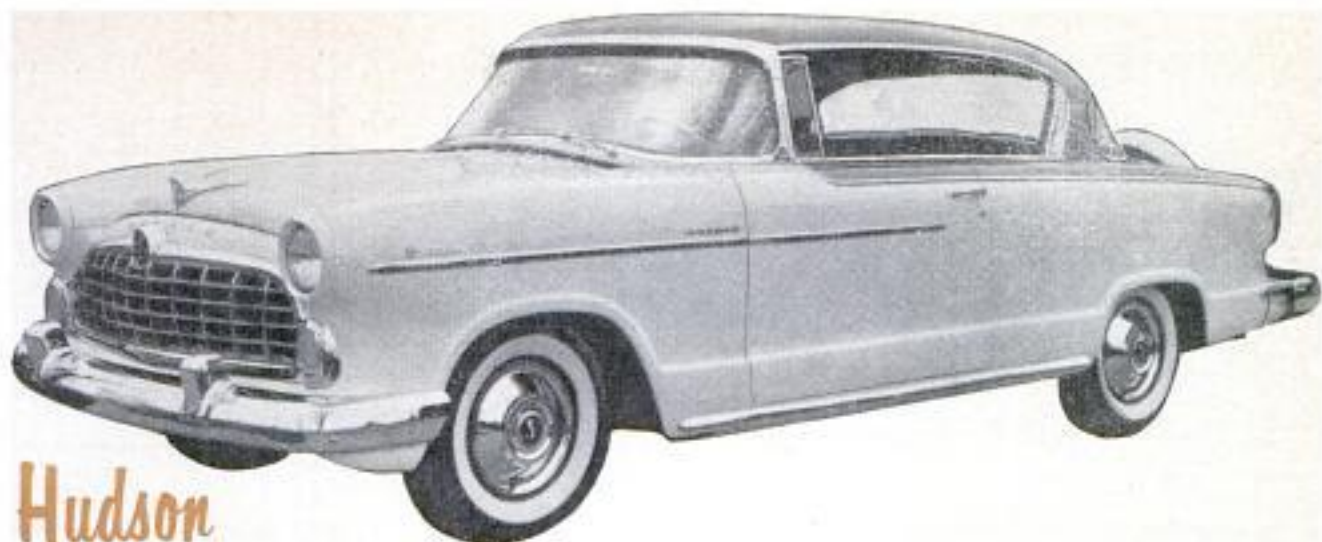

Hudson

Hudson, first all-new product of American Motors, offers three models for 1955: A Wasp 6, a Hornet 6 and a Hornet V8. Almost the only recognizable part

of the all-new styling is the Hudson insignia in the wide-mesh front grille. Along with Nash, it has the widest front seats in the industry (see page 168)



Imperial

Imperial is Chrysler's bid in the "ultra ultra" field. Entirely distinctive and built on its own assembly line, its styling is unlike that of other Chryslers.

Full-wheel cutouts in fenders provide a sporty look. Big taillights, mounted saucily atop rear fenders, quickly identify this prestige car from any angle

Kaiser for 1955 is only slightly changed after last year's restyling. Retained is the supercharger that

cuts in on demand to boost horsepower when needed, cuts out to save gasoline when the extra power is unnecessary. Only one model, the Manhattan, is being made this year

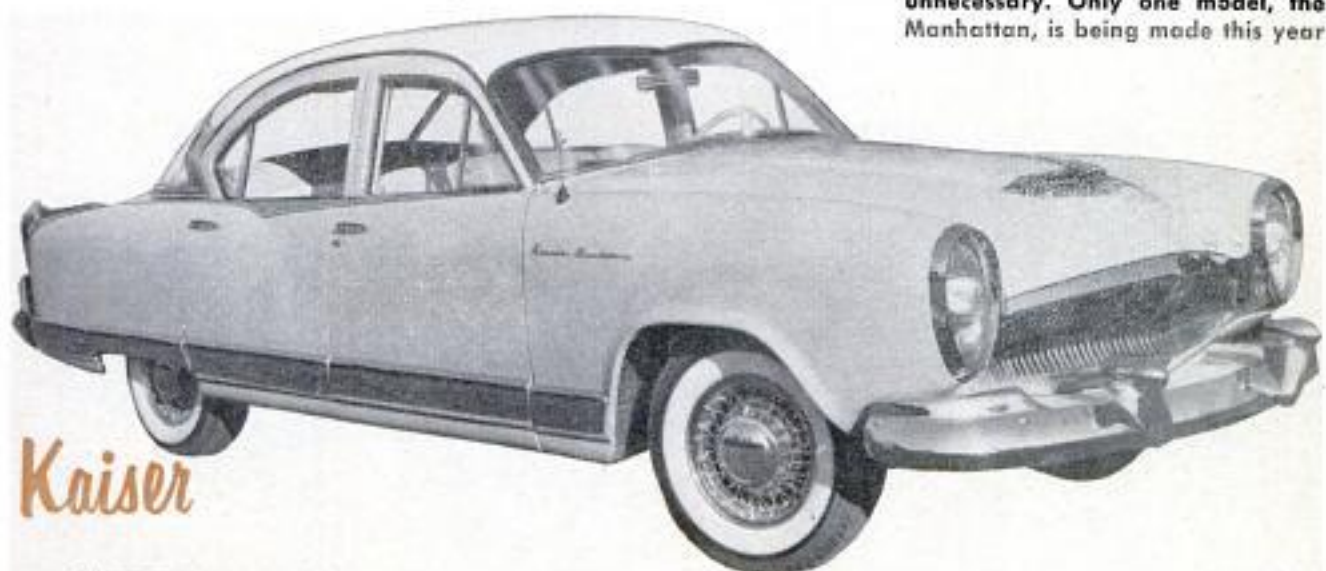

Kaiser



Lincoln

Lincoln's story is mostly mechanical as it offers greater displacement and power plus its own new automatic transmission that has a low-gear start at

wide-open throttle for faster getaway. Also new is a push-button lubrication system (see page 149). The front grille is restyled as are fenders, taillights

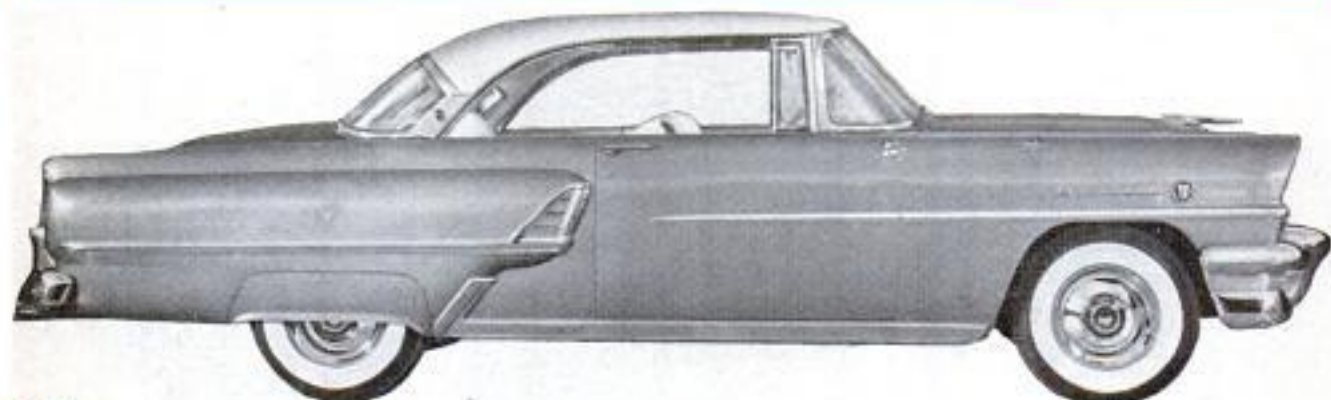

Mercury

Mercury has a longer wheelbase, a greater over-all length and more power than last year. The new body features canted headlights and bold character lines

in its rear fenders. The new top line, Montclair, is 2½ inches lower than 1954 Mercury and develops 198 horsepower. Other models have 188 horsepower

Nash has given its body styling a bold, new look with grille-mounted headlights, similar to those on the Nash-Healey sports car. The front fenders

sweep forward, their graceful curve unbroken except by small parking lights. Nash offers three models: the Statesman 6, Ambassador 6 and Ambassador V8



Nash



Oldsmobile

Oldsmobile, which began the trend toward striking color treatments last year, changed its two-toning

slightly. Its front grille has been restyled as have the taillights. Biggest news is the announced four-door hardtop sedan, out this spring. Power has been boosted by a high-lift camshaft, improved breathing



Packard

Packard came out with two major mechanical changes. It offers the industry's most powerful V8 and a new

torsion-bar suspension that has an automatic load levelizer (see page 148 for details). No matter how much weight is in the car, body height is constant. Bodies have new windshield, grille and rear fenders

Plymouth's 167-horsepower V8 engine has a new type of combustion chamber (page 149). Bodies are lower, wider and 10 inches longer than last year. Seats are

roomier: Front seat is 3.2 inches wider; rear seat is 5.9 inches wider. Reverse-angle fenders, both front and rear, make it look even longer than it is

Plymouth



Pontiac



Pontiac's bold grille makes it easy to identify on the highway. Behind the grille is a new V8 engine of 180 horsepower. The engine features a crankcase-ventilation system that forces harmful vapors out efficiently; a reverse-flow cooling system; full-pressure lubrication; ball-pivot valve rocker arms

Rambler



Rambler is now sold by both Nash and Hudson dealers. Biggest change for 1955 was the removal of the full skirts from the front wheels. This reduced the turn-circle diameter sharply. Now the Rambler is the most agile car in the industry. The front grille is also new

Studebaker

Studebaker has restyled its front end for 1955 and added considerable brightwork to emphasize its low

lines. It re-introduced the President with a new V8 engine of 175 horsepower. The Commander V8 has the industry's shortest stroke, an important factor in long engine life. Champion 6 now has 101 horsepower



Willys



Willys has restyled the front grille and taillights on its 1955 models and cut prices to where its hard-

top (above) is the lowest-priced in the industry. Mechanically, the car is unchanged from last year

PRICE RANGES OF THE 1955 AUTOMOBILES

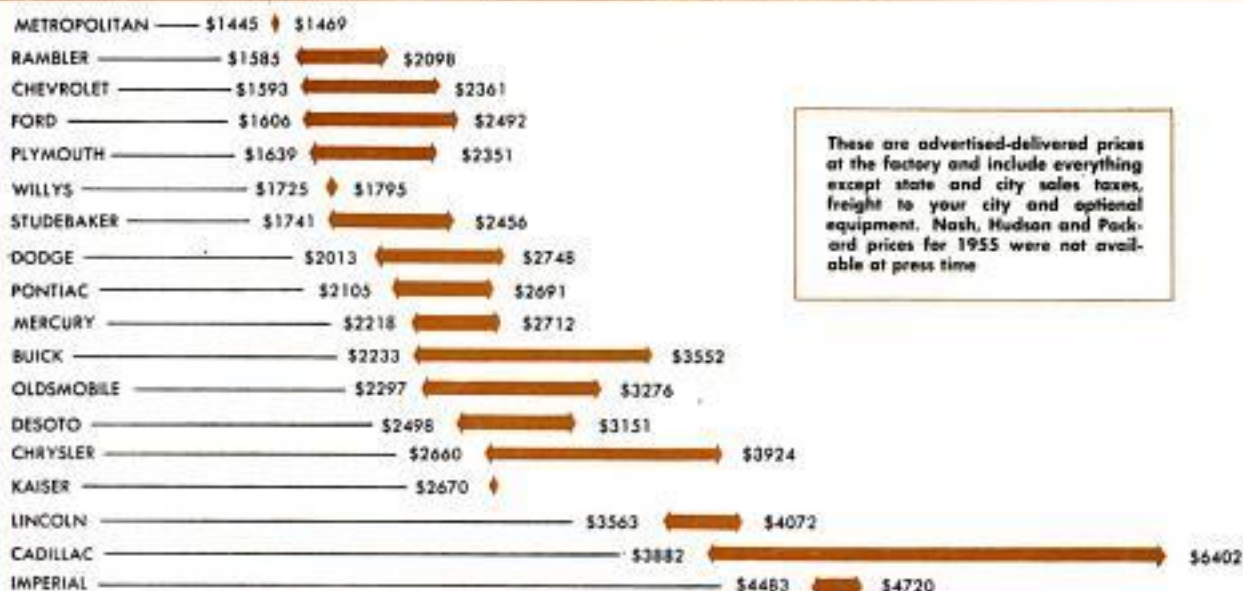

PRODUCTION OF AUTOMOBILES DURING 1954 BY MAKES

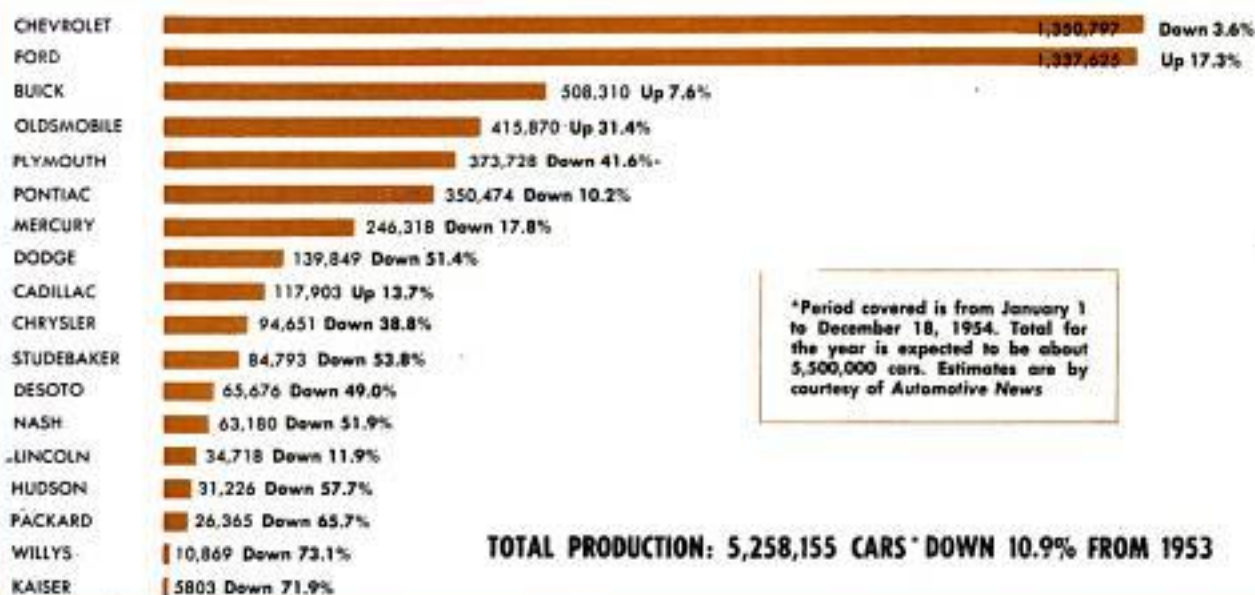

Specifications of the

	LOWEST PRICE 4-DOOR SEDAN	SHIPPING WEIGHT	WHEELBASE	OVER-ALL LENGTH	OVER-ALL WIDTH	OVER-ALL HEIGHT	OVER-ALL STEERING RATIO	TURN-CIRCLE DIAMETER	DISPLACEMENT	MAXIMUM HORSEPOWER	COMPRESSION RATIO	MAXIMUM TORQUE	BORE AND STROKE
METROPOLITAN Four	\$1445†	1875	85.0	149.5	61.5	54.5	21.0	36	73.2	42	7.2	62	2.58x3.50
RAMBLER Six	\$1695	2630	108.0	186.3	73.5	59.4	21.7	39	195.6	90	7.3	150	3.13x4.25
WILLYS Six	\$1725	2778	108.0	189.9	72.0	60.8	22.4	40	226.2	115	7.3	190	3.31x4.38
CHEVROLET Handshift Six	\$1728	3125	115.0	195.6	74.0	62.1	25.7	38	235.5	123	7.5	207	3.56x3.94
Powerglide Six	1906	3220	115.0	195.6	74.0	62.1	25.7	38	235.5	136	7.5	209	3.56x3.94
V8	1827	3095	115.0	195.6	74.0	62.1	25.7	38	265.0	162*	8.0	257	3.75x3.00
FORD Six	\$1753	3126	115.5	198.5	75.9	61.0	25.3	41	223.0	120	7.5	195	3.62x3.60
V8	1853	3236	115.5	198.5	75.9	61.0	25.3	41	272.0	162*	7.6	258	3.62x3.30
PLYMOUTH Six	\$1781	3129	115.0	203.8	74.6	60.1	N.A.	40	230.0	117	7.4	194	3.25x4.63
V8	1884	3246	115.0	203.8	74.6	60.1	N.A.	41	260.0	167*	7.6	231	3.56x3.25
STUDEBAKER Six	\$1783	2805	116.5	202.3	70.4	59.8	19.5	39	185.6	101	7.5	152	3.00x4.38
Commander V8	1919	3075	116.5	202.3	70.4	60.0	24.0	39	224.3	140	7.5	202	3.56x2.81
President V8	2311	3220	120.5	206.3	70.4	60.0	24.0	40	259.2	175	7.5	250	3.56x3.25
DODGE Coronet 6	\$2093	3295	120.0	212.1	74.5	60.3	N.A.	43	230.0	123	7.4	194	3.25x4.63
Coronet V8	2196	3395	120.0	212.1	74.5	60.6	N.A.	42	270.0	175*	7.6	240	3.63x3.26
Custom Royal V8	2473	3485	120.0	212.1	74.5	60.6	N.A.	42	270.0	183*	7.6	245	3.63x3.26
NASH Statesman 6	N.A.	N.A.	114.3	202.3	78.0	61.8	23.7	40	195.6	100*	7.5	155	3.13x4.25
Ambassador 6	N.A.	N.A.	121.3	209.3	78.0	62.3	25.5	42	252.6	130*	7.6	220	3.50x4.38
Ambassador V8	N.A.	N.A.	121.3	209.3	78.0	62.3	N.A.	N.A.	320.0	208	7.8	276	3.19x3.50
PONTIAC Chieftain V8	\$2164	3501	122.0	203.2	75.4	60.5	25.0	42	287.2	180	8.0	264	3.75x3.25
Star Chief V8	2362	3546	124.0	210.2	75.4	60.5	25.0	43	287.2	180	8.0	264	3.75x3.25
HUDSON Wasp 6	N.A.	N.A.	114.3	202.3	78.0	61.8	N.A.	38	202.0	104*	7.5	158	3.00x4.75
Hornet 6	N.A.	N.A.	121.3	209.3	78.0	62.3	N.A.	40Ⓟ	308.0	160*	7.5	264	3.81x4.50
Hornet V8	N.A.	N.A.	121.3	209.3	78.0	62.3	N.A.	40Ⓟ	320.0	208	7.8	276	3.19x3.50
MERCURY V8	\$2276	3450	119.0	205.5	76.4	61.2	25.4	42	292.0	188	7.6	274	3.75x3.30
Montclair V8	N.A.	3480Ⓟ	119.0	205.5	76.4	58.8	25.4	42	292.0	198	8.5	286	3.75x3.30

3.81

1955 Cars

	LOWEST PRICE 4-DOOR SEDAN	SHIPPING WEIGHT	WHEELBASE	OVER-ALL LENGTH	OVER-ALL WIDTH	OVER-ALL HEIGHT	OVER-ALL STEERING RATIO	TURN-CIRCLE DIAMETER	DISPLACEMENT	MAXIMUM HORSEPOWER	COMPRESSION RATIO	MAXIMUM TORQUE	BORE AND STROKE
BUICK													
Special V8	\$2291	3742	122.0	206.7	76.2	60.4	26.7	42	264.0	188	8.4	256	3.63x3.20
Century V8	2548	3807	122.0	206.7	76.2	60.6	26.7	42	322.0	236	9.0	330	4.00x3.20
Super V8	2876	4141	127.0	216.0	80.0	62.5	24.1†	43	322.0	236	9.0	330	4.00x3.20
Roadmaster V8	3349‡	4278	127.0	216.0	80.0	62.7	24.1†	43	322.0	236	9.0	330	4.00x3.20
OLDSMOBILE													
Eighty-Eight V8	\$2362	3711	122.0	203.4	77.8	60.5	27.5	42	324.3	185	8.5	320	3.88x3.44
Super 88 V8	2503	3762	122.0	203.4	77.8	60.5	27.5	42	324.3	202	8.5	332	3.88x3.44
Ninety-Eight V8	2833	3864	126.0	212.4	77.8	60.5	27.5	43	324.3	202	8.5	332	3.88x3.44
DESOTO													
Firedome V8	\$2498	3870	126.0	217.9	78.3	60.6	N.A.	44	291.0	185	7.5	245	3.72x3.34
Fireflite V8	2727	3940	126.0	217.9	78.3	60.6	N.A.	44	291.0	200	7.5	274	3.72x3.34
CHRYSLER													
Windsor V8	\$2660	3925	126.0	218.6	79.1	60.6	N.A.	44	301.0	188	8.0	275	3.63x3.63
New Yorker V8	3494‡	4160	126.0	218.8	79.1	60.9	N.A.	44	331.0	250	8.5	340	3.81x3.63
KAISER													
Manhattan 6	\$2670	3275Ⓞ	118.5	215.6	74.9	60.3	25.0	38	226.2	140	7.3	215	3.31x4.38
PACKARD													
Clipper V8	N.A.	3795	122.0	214.8	78.0	62.0	27.3	43	320.0	225	8.0	325	3.81x3.50
Clipper Custom V8	N.A.	3930	122.0	214.8	78.0	62.0	27.3	43	352.0	245	8.5	355	4.00x3.50
Patrician V8	N.A.	4355	127.0	217.4	78.0	62.3	30.9	45	352.0	260	8.5	355	4.00x3.50
LINCOLN													
V8	\$3563‡	4235	123.0	215.6	77.6	62.7	26.1	46	341.0	225	8.5	332	3.94x3.50
CADILLAC													
Series 62 V8	\$3977‡	4370	129.0	216.3	79.8	62.0	21.3‡	43	331.0	250	9.0	345	3.81x3.63
Series 60 V8	4728‡	4540	133.0	227.3	79.8	62.0	21.3‡	45	331.0	250	9.0	345	3.81x3.63
Series 75 V8	6187‡	5015	149.8	237.1	79.8	63.9	21.3‡	52	331.0	250	9.0	345	3.81x3.63
IMPERIAL													
V8	\$4483‡	4565	130.0	223.0	79.1	61.2	N.A.	45	331.0	250	8.5	340	3.81x3.63

NOTES AND EXPLANATIONS

All specifications, except the Metropolitan, are for four-door sedan models. All dimensions are in inches except turn-circle diameter (whole number of feet) and displacement (cubic inches). Torque is in pound feet. Prices include all charges except freight, state and local sales taxes and optional equipment.

† Two-door hardtop. No four-door model available.

Ⓞ Estimated

‡ Automatic transmission included in this price

‡ Power steering standard and included in price

* Power packs available: Chevrolet 180 hp.; Ford 182 hp.; Plymouth 177 hp.; Dodge 193 hp.; Nash Statesman 110 hp.; Nash Ambassador 140 hp.; Hudson Wasp 114 hp.; Hudson Homet Six 170 hp.

FOR INTERIOR DIMENSIONS SEE PAGE 168

Packard suspension has two sets of torsion bars. Long bars are for springing. The shorter set has automatic tightener to keep body always at the same height

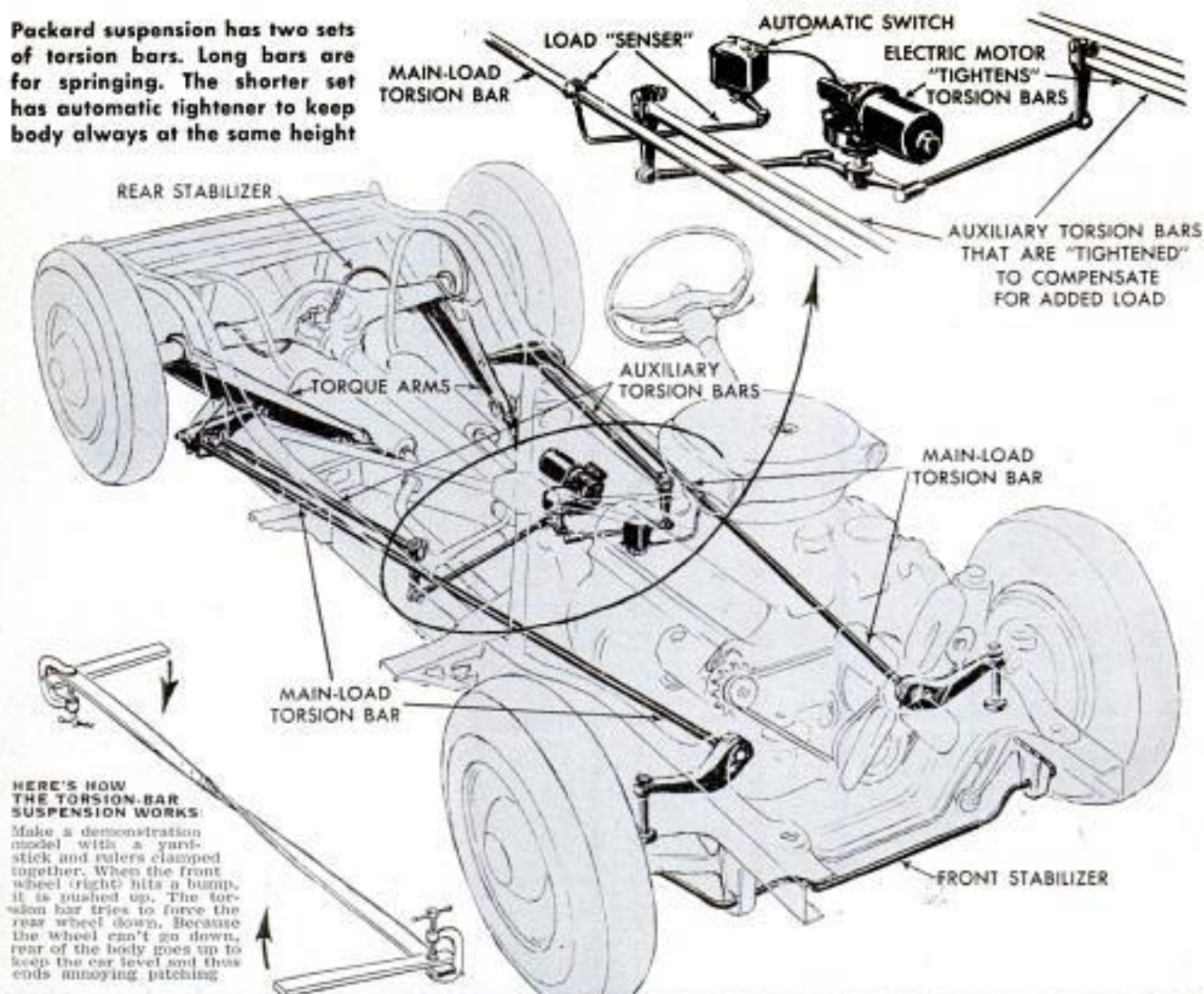

HERE'S HOW THE TORSION-BAR SUSPENSION WORKS
 Make a demonstration model with a yardstick and rulers clamped together. When the front wheel (right) hits a bump, it is pushed up. The torsion bar tries to force the rear wheel down. Because the wheel can't go down, rear of the body goes up to keep the car level and thus ends annoying pitching.

Some of the Year's High Lights

Biggest in the industry is Packard's V8 engine. It develops 260 horsepower, 355 foot-pounds of torque

Buick's Dynaflow gets more zoom by varying pitch on stator blades. Sketch shows how piston moves blades

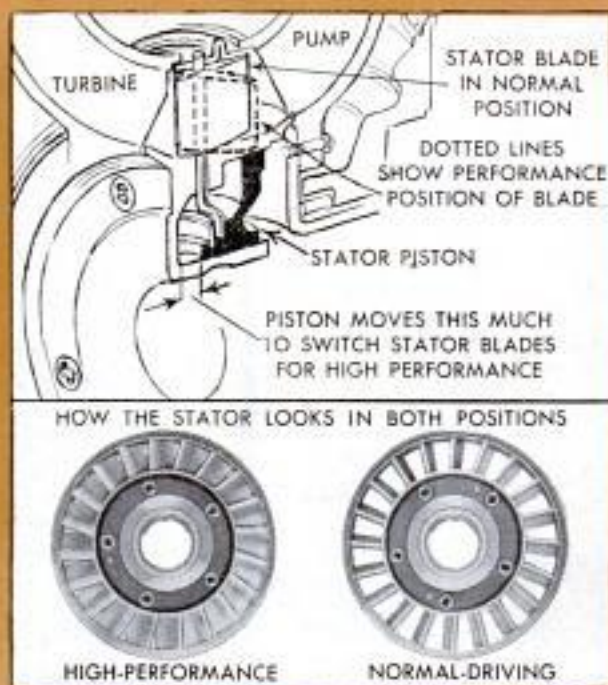
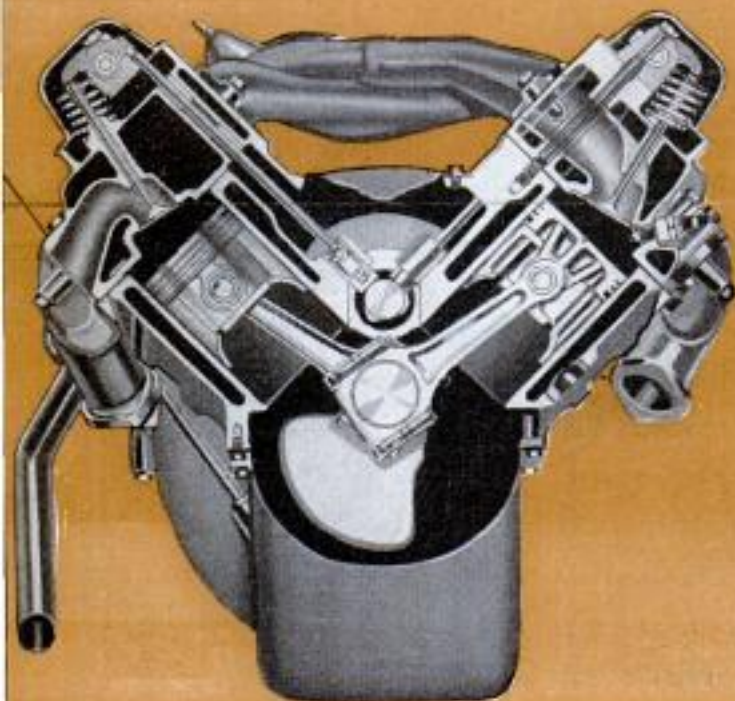

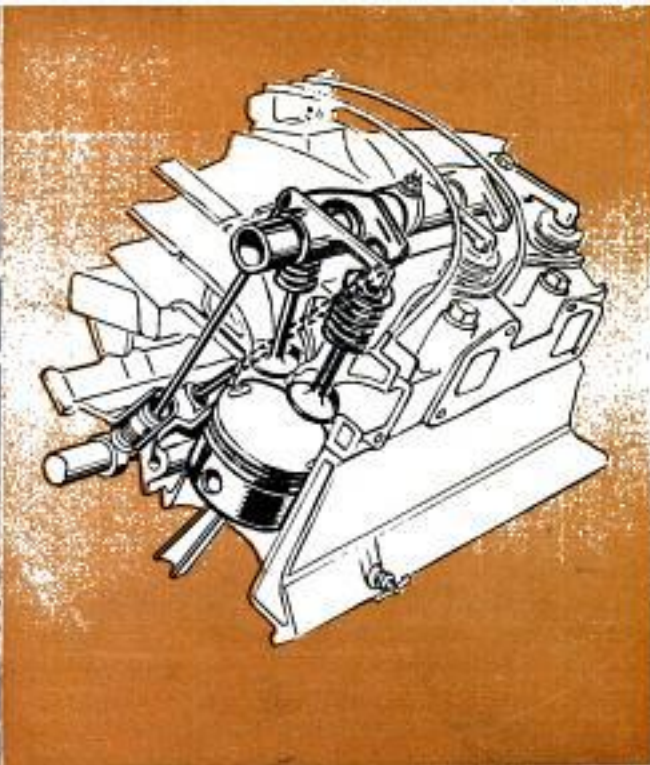
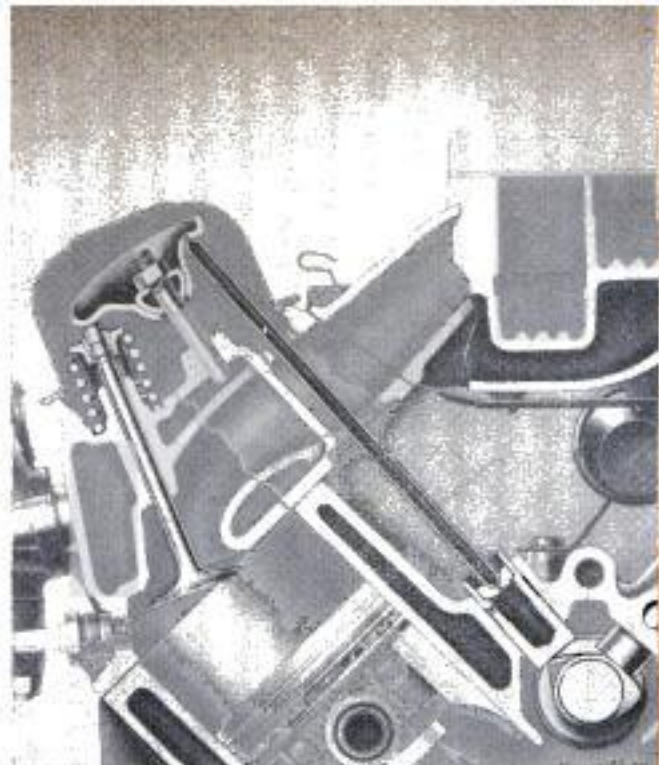

Above, Chevrolet came up with a new idea in valve-train design. Rocker arms are mounted on pedestals instead of pivoting on a shaft. This simplifies the design, helps make the V8 lighter than the old six

Top right, valve train on Plymouth V8 is new also. Note how dotted push rod cuts across under the shaft. This gives a modified hemispheric combustion chamber without requiring costly double rocker-arm shafts

Chevrolet's double-wall cowl assembly forms a strong structural arch as well as plenum chamber for heater (incoming air is shown by colored arrows). Arch provides solid foundation below wrap-around windshield

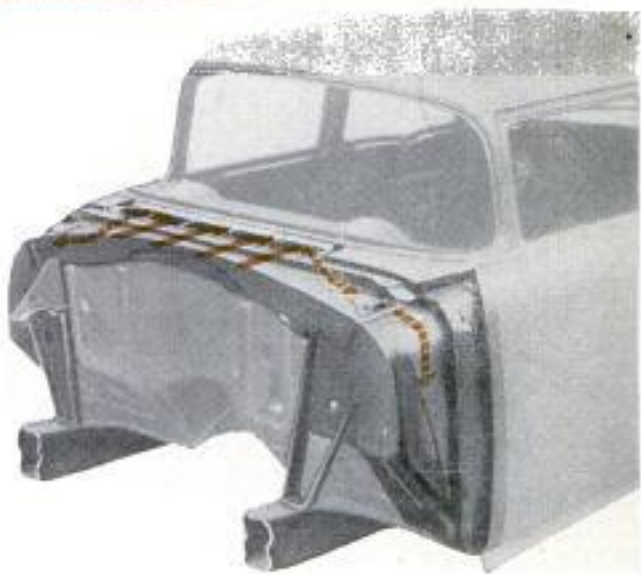

Below, Lincoln-Mercury offers a push-button lubrication system (extra cost). Plastic tubing (white lines on drawing) takes grease to 11 fittings each time you push button on dash. Once a year you fill reservoir

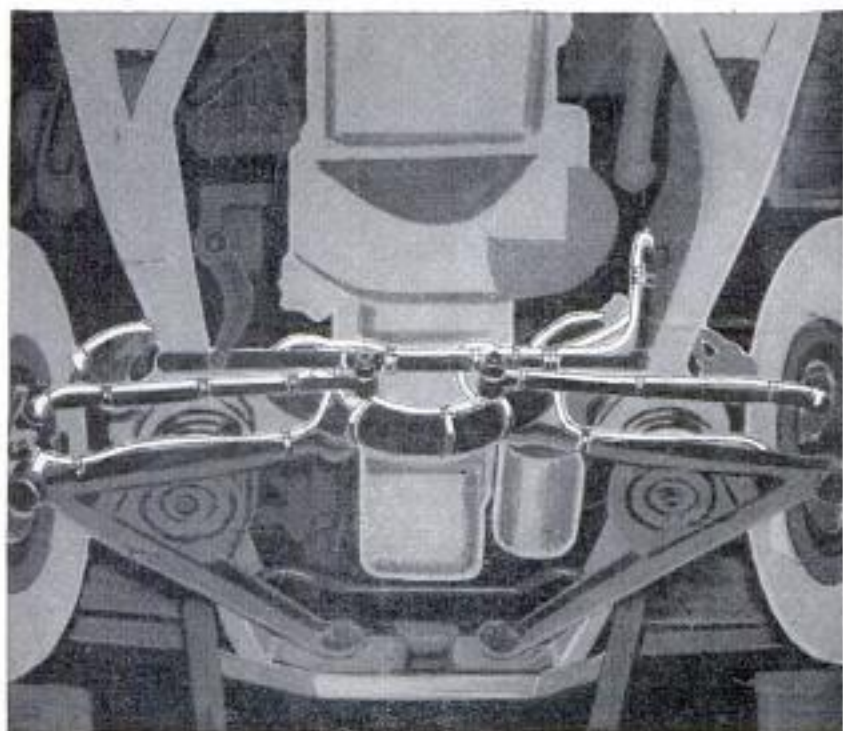



What Does It Cost to Own a Car?

Another Popular Mechanics Report by Owners from Coast to Coast

By Arthur R. Railton, Automotive Editor

IF YOU KEEP wondering where your money goes every month, here's a suggestion: Look in your garage! The family buggy, new or old, costs an amazing amount of cash every year. The most recent PM Poll proves that!

We asked owners of all makes of automobiles (cars ranging in age from one to

six years) how much they had spent on their cars during the previous 12 months. The questionnaire mailed to these owners (selected at random by an independent organization) covered every possible expense except financing charges. Here, in summary, are the high lights of that nationwide survey.

EACH OF THE \$6130 THE AVERAGE OWNER SPENDS DURING HIS SIX-YEAR OWNERSHIP IS DIVIDED THIS WAY:

AT FIRST, MOST OF EACH DOLLAR GOES FOR FIXED COSTS, BUT BY THE 6th YEAR, RUNNING COSTS AND FIXED COSTS ARE ALMOST EQUAL

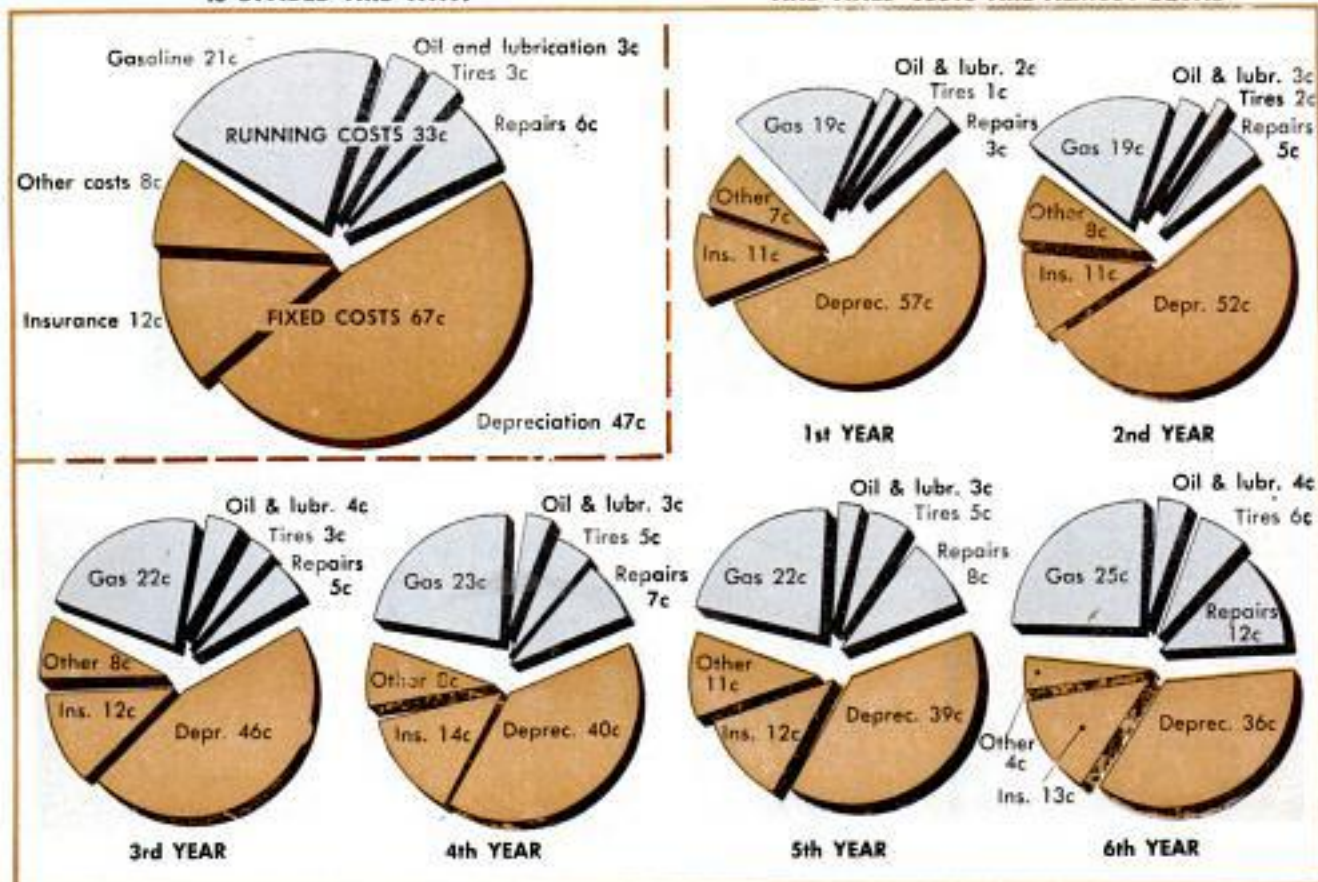

THE AVERAGE OWNER SPENDS A TOTAL OF \$6130 ON HIS CAR IF HE KEEPS IT 6 YEARS
(averaging 10,942 miles each year)



If you buy a car new and keep it for six years averaging 11,000 miles a year, you will spend \$20 a week for that privilege. At least, that's what the average owner in the survey spent—\$1055 a year. In six years that totals \$6130—two or three times the first cost of the car, in most cases.

It cost the average owner 9.6 cents a mile over the six-year period for the convenience of riding in his own car. But, you say, that is only the average. What about the

HOW WERE COSTS COMPUTED?
Would you like to know how these costs were computed? *PM* will mail a copy of the questionnaire used by the owners in this survey to any reader sending in a self-addressed envelope.

WALLET-SIZE SPECIFICATIONS
Available for 10 cents in coin is a table containing specifications of all the 1955 automobiles printed in wallet size for handy reference.

Address requests to Bureau of Information, *Popular Mechanics Magazine*, 200 East Ontario St., Chicago 11, Ill.

OWNERS REPORT THAT THE LESS EXPENSIVE CARS ARE ALSO CHEAPER TO RUN

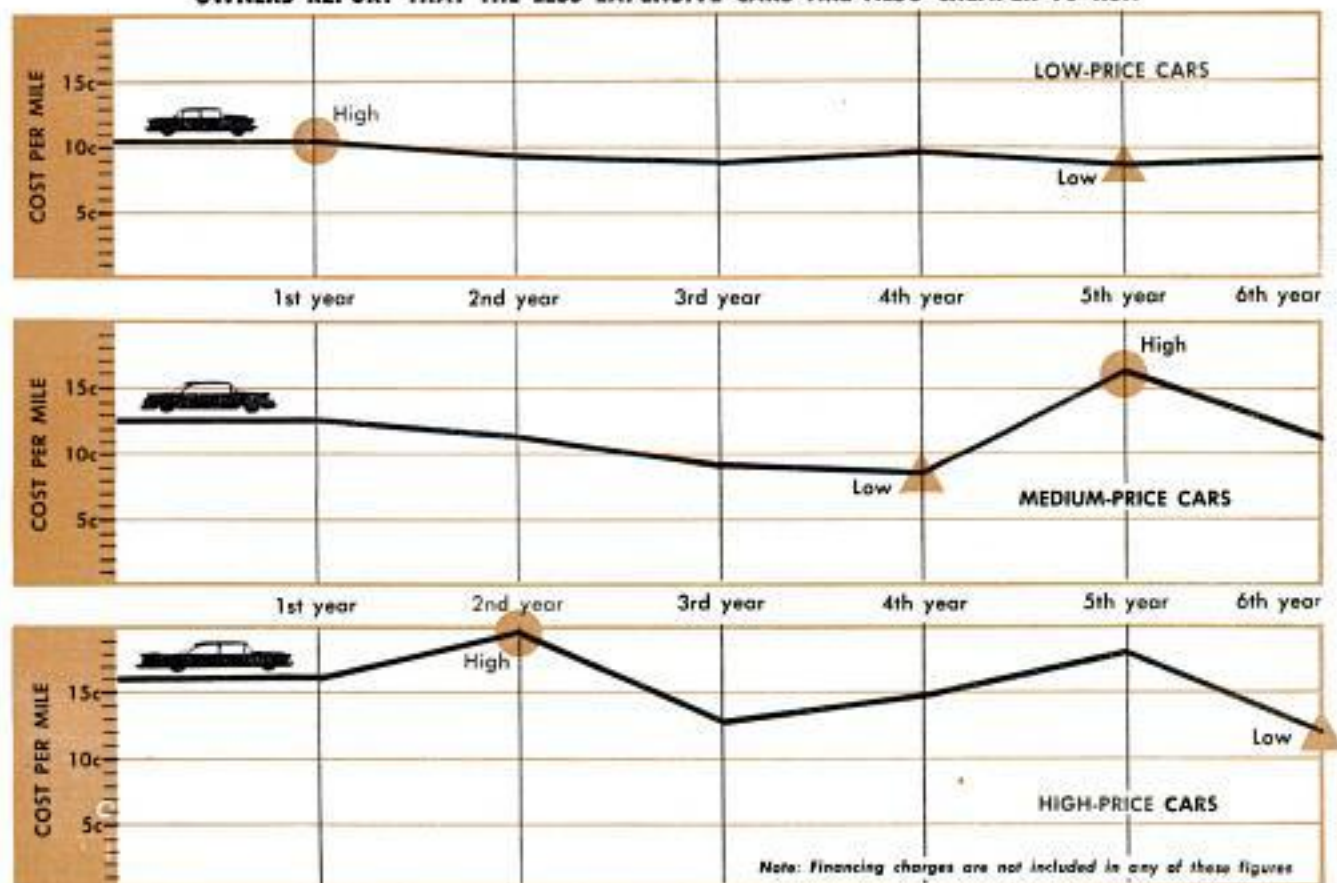

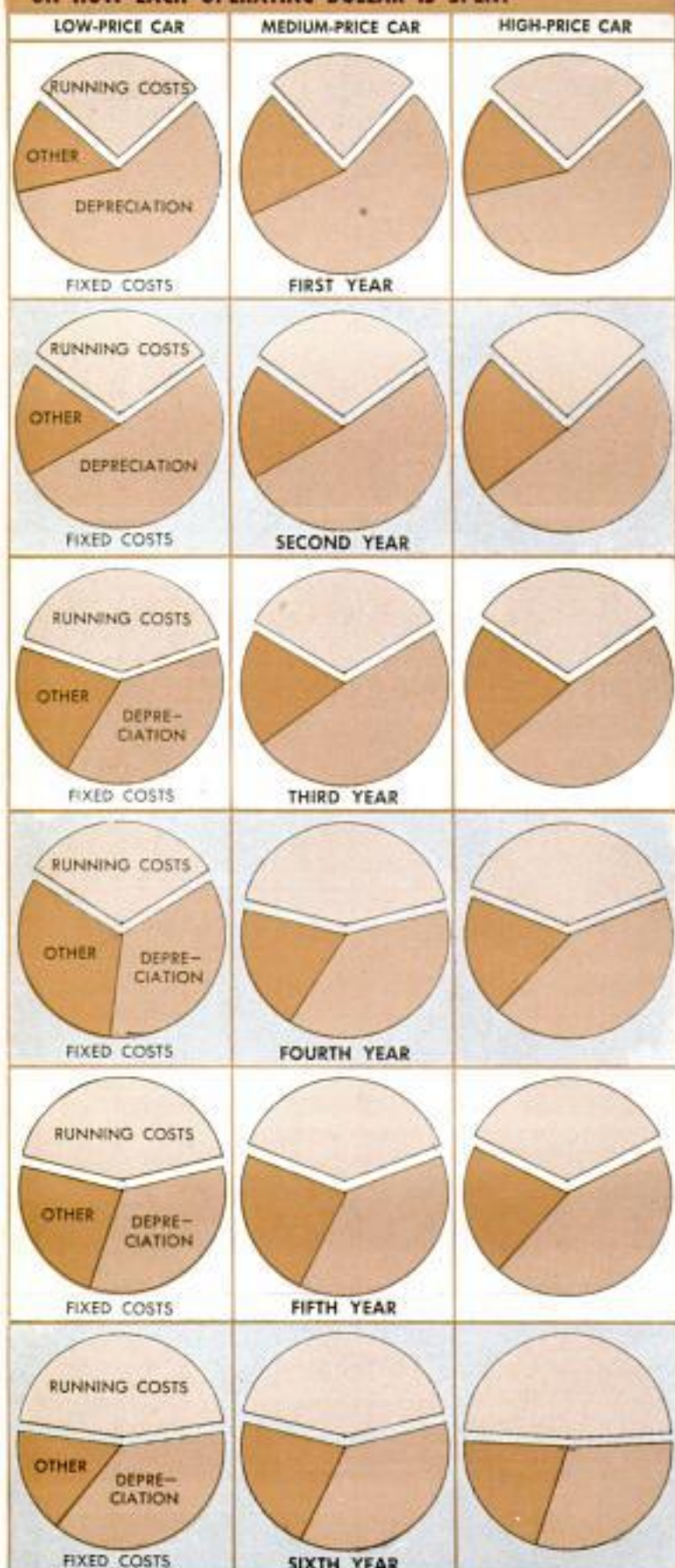

ORIGINAL PRICE OF THE CAR SEEMS TO HAVE LITTLE EFFECT ON HOW EACH OPERATING DOLLAR IS SPENT

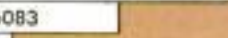

BUT DRIVING A LOW-PRICE CAR DOES SAVE CONSIDERABLE MONEY, OWNERS REPORT

TOTAL EXPENSES OVER THE SIX-YEAR PERIOD

Average owner of high-price car spent \$7255	
Average owner of medium-price car spent \$6083	
Average owner of low-price car spent \$5019	

fellow who drives one of the low-price cars and gets pretty good gasoline mileage?

Well, right off, let's get this gasoline-mileage point cleared up. Out of the \$6130 the average owner in the survey spent in six years, the amount that went for gasoline was only 21 percent or \$1287—that's only one dollar out of every five spent on the car. It is about \$215 a year or just over \$4 a week.

If you discovered some miraculous way to double your gasoline economy—say from 14 to 28 miles per gallon (and let me know if you do)—you would end up saving \$2 a week. Your total weekly car cost would be \$18 instead of \$20. So you see gasoline costs are really only a small part of the total cost. An increase of 10 percent in gasoline mileage (from 14 to 15½ miles per gallon) would save you only 40 cents a week.

Or look at it this way: Suppose you are trying to decide on a new car and you have narrowed it down to two makes. One will get 20 miles per gallon, the other only 15. But the 15-mile-per-gallon car costs \$100 less to buy. If you decide on the 20-mile-per-gallon car for its operating economy, you will have to drive it 20,000 miles to get that \$100 back.

Of course, that's an oversimplification, because it is likely that the 20-mile-per-gallon car is lighter and would therefore cost less for tires, oil and other expenses. But it is a fact that gasoline costs are only a fraction of total costs and, in the average owner's mind, have been greatly exaggerated in their importance.

Does that mean we should all buy big cars? Isn't there any saving in the lighter, low-price cars?

Of course there is, but it is more than a gasoline saving. If fuel were the only saving, it would hardly be worth-while from an economy standpoint. Fortunately, all costs are less on a lower-price car—tires, repairs, taxes, depreciation, insurance—everything.

The owner of a low-price car spends an average of \$837 a year on his car; the owner of a medium-price car spends \$1014; the owner of the high-price car \$1209 a year.

So you see that the low-price car does save you money—almost \$400 a year over the high-price car and

THE AVERAGE OWNER SPENDS 9.6 CENTS A MILE TO DRIVE HIS CAR

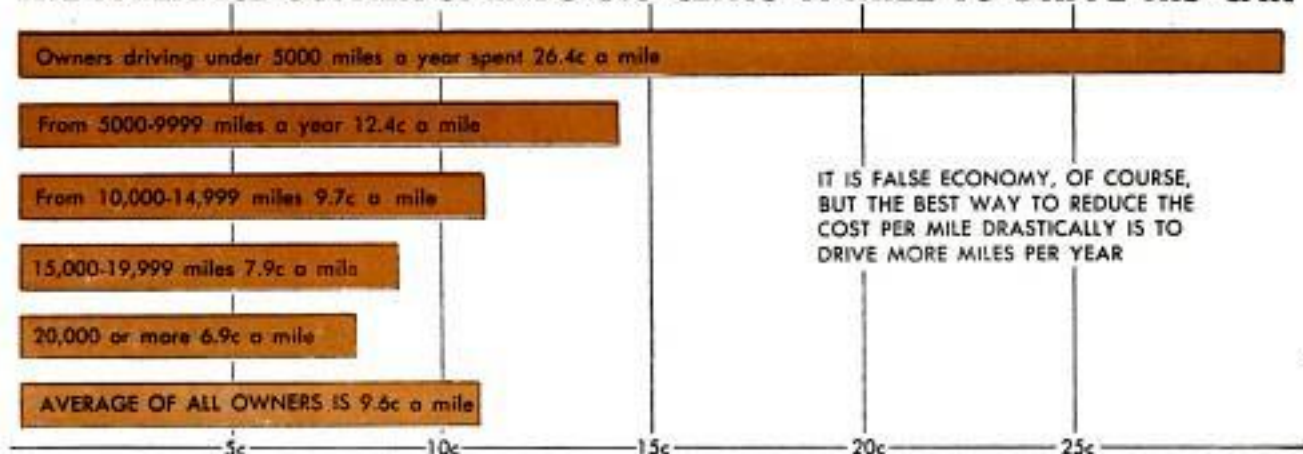

nearly \$200 over the medium-price model.

Many owners refuse to believe that an annual cost of \$1055 is typical. After all, that's about as much as it costs per year to buy a house! They refuse to believe it, that is, until they start to add up the figures.

First, there are the fixed costs. These go on whether you drive 100 miles or 25,000 miles a year. And since these take the biggest chunk of your car's budget, there is little or no saving in not using your car regularly.

The first rule could be: If you own a car, use it!

Over the six-year period, these fixed costs ate up 67 cents out of every dollar the average owner spent. Since he spent \$6130, the fixed costs come to \$4107 or \$684 a year. That is \$13 a week, before you even take the car out of the garage.

Remember these are not wild guesses. These are actual costs as reported by owners.

The biggest fixed cost is the declining market value of the car—you call it depreciation. On the average, depreciation accounted for 47 cents in each dollar spent. It varies as the car gets older, starting out at 57 cents in the first year and dropping to 36 cents by the sixth year. But it is always the major cost of operation.

The second largest of the fixed costs is insurance (although some foolhardy owners in the survey reported that they didn't carry any). Insurance averaged 12 cents of each dollar.

Other fixed costs are taxes, licenses, parking fees, garage costs and so on. These add up to 8 cents on the dollar.

(Continued to page 298)

FOR EACH MILE HE DRIVES, THE OWNER SPENDS HIS PENNIES LIKE THIS:

Owners driving 1-4999 miles a year: Total 26.4c a mile

Running costs 8.2c a mile				Fixed costs 18.2c a mile		
Gas	Oil & lubr.	Tires	Repairs	Ins.	Others	Deprec.
4.0c	.8c	.8c	2.6c	3.7c	3.4c	12.1c

Owners driving 5000-9999 miles a year: Total 12.4c a mile

Running costs 3.7c a mile				Fixed costs 8.7c a mile		
Gas	Oil & lubr.	Tires	Repairs	Ins.	Others	Deprec.
2.2c	.4c	.4c	.7c	1.7c	1.0c	6.0c

Owners driving 10,000-14,999 miles a year: Total 9.7c a mile

Running costs 3.2c a mile				Fixed costs 6.5c a mile		
Gas	Oil & lubr.	Tires	Repairs	Ins.	Others	Deprec.
2.0c	.3c	.3c	.6c	1.1c	.6c	4.8c

Owners driving 15,000-19,999 miles a year: Total 7.9c a mile

Running costs 2.8c a mile				Fixed costs 5.1c a mile		
Gas	Oil & lubr.	Tires	Repairs	Ins.	Others	Deprec.
1.9c	.3c	.3c	.5c	.9c	.5c	3.7c

Owners driving 20,000 miles or more a year: Total 6.9c a mile

Running costs 2.9c a mile				Fixed costs 4.0c a mile		
Gas	Oil & lubr.	Tires	Repairs	Ins.	Others	Deprec.
1.9c	.3c	.3c	.4c	.6c	.5c	2.9c

Running costs 3.2c a mile				Fixed costs 6.4c a mile		
Gas	Oil & lubr.	Tires	Repairs	Ins.	Others	Deprec.
2.0c	.3c	.3c	.6c	1.2c	.7c	4.5c

AVERAGE OF ALL OWNERS:
Total 9.6c a mile

The Changing Automobile

THE FIRST CARS weren't styled—they were just built. Early car makers were too busy making a machine that would run to spend time giving it style. Yet the early cars had an undeniable style.

Nobody knows exactly when the automobile stylist took over, but today he is on an equal footing with the engineer—indeed, at times he seems more influential.

To trace the evolution of styling, PM, helped by stylists at Chrysler, Ford, General Motors and Packard, selected representative models of the period from 1900 to the present and beyond. The cars are typical of the year in which they were made and are not necessarily pioneers.

The 1960 prediction is by Richard Teague, Packard's chief stylist. ★ ★ ★

Sketches by Robert Korla,
PM Artist

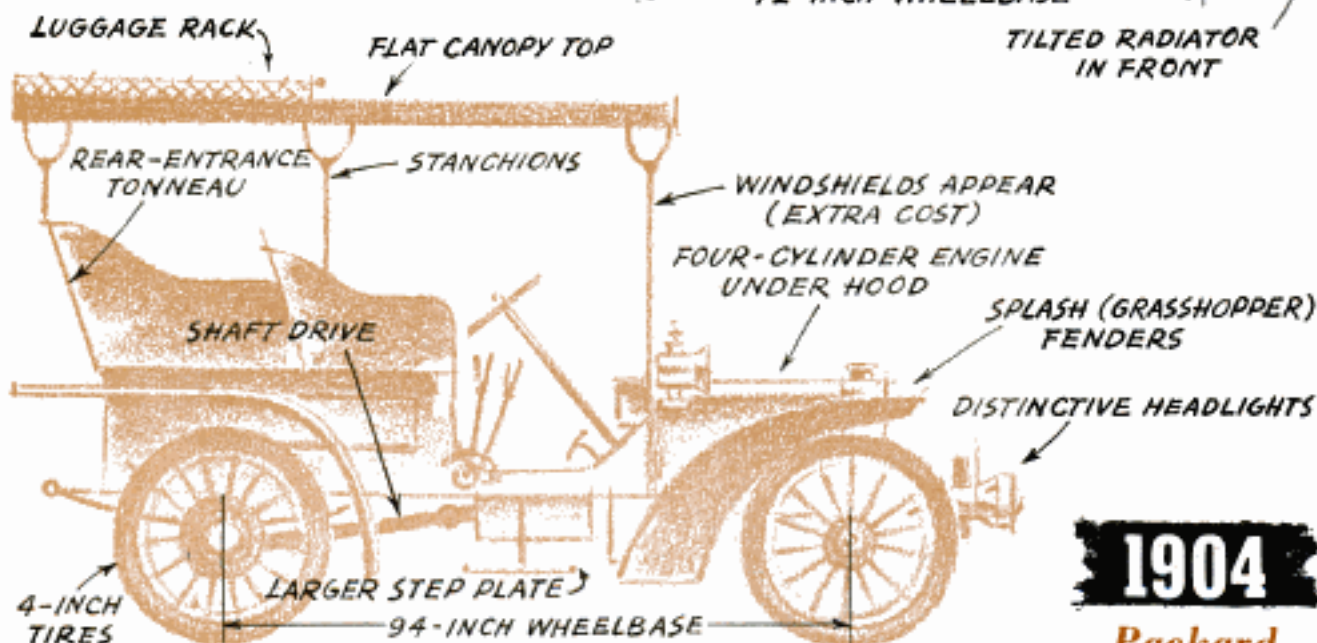
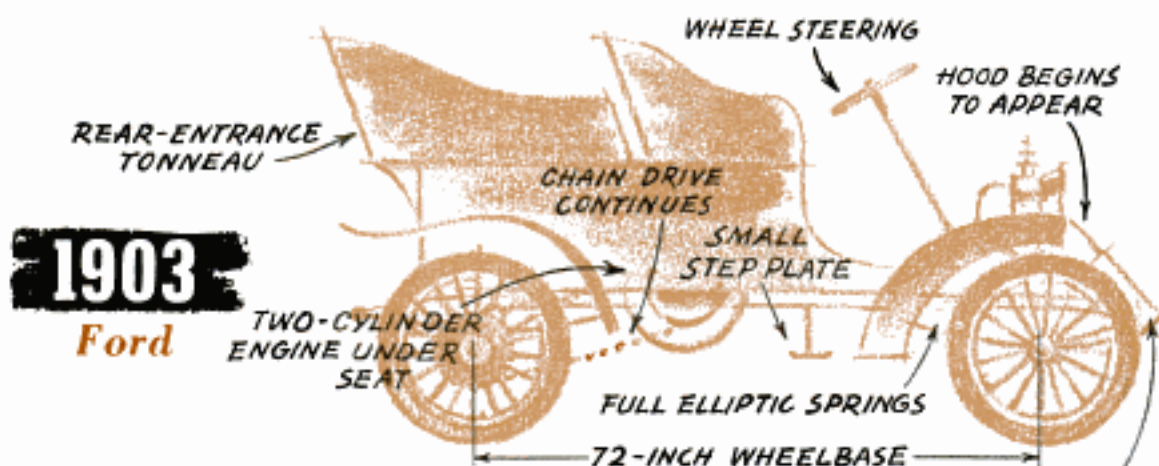
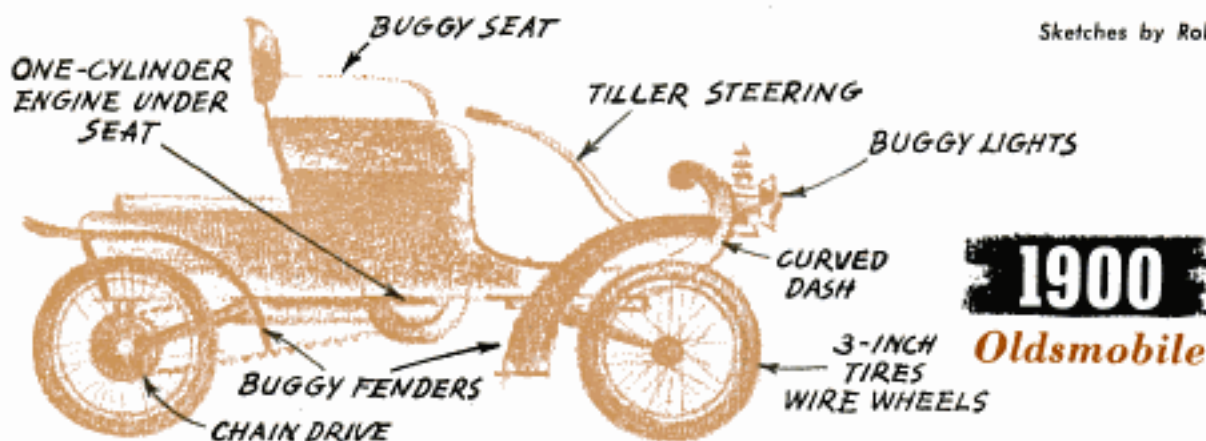

POPULAR MECHANICS

1906
Pierce

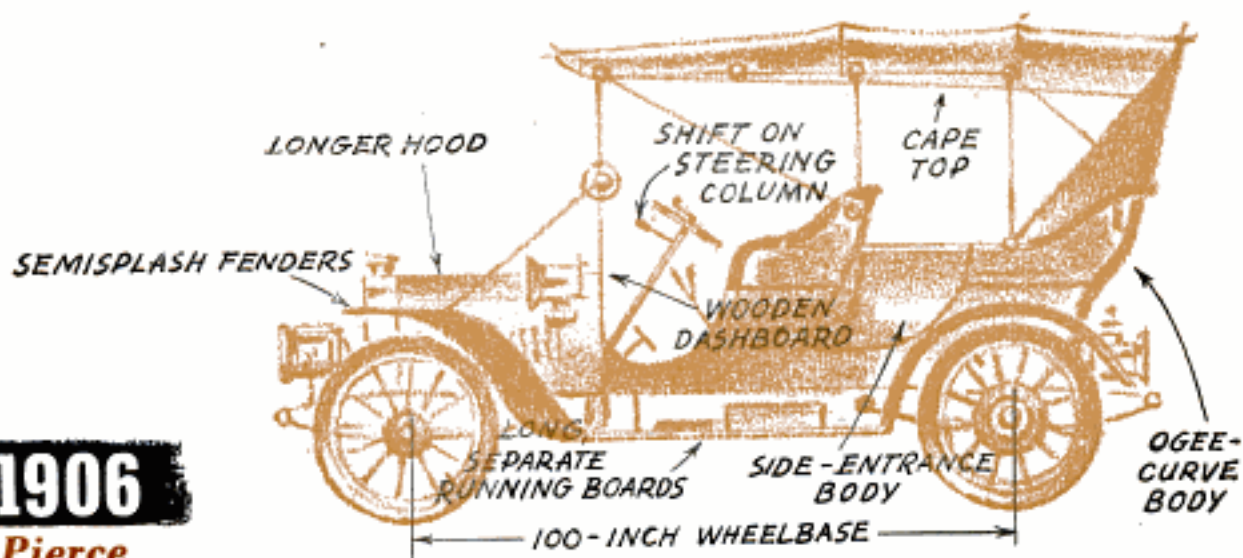

1912
Winton

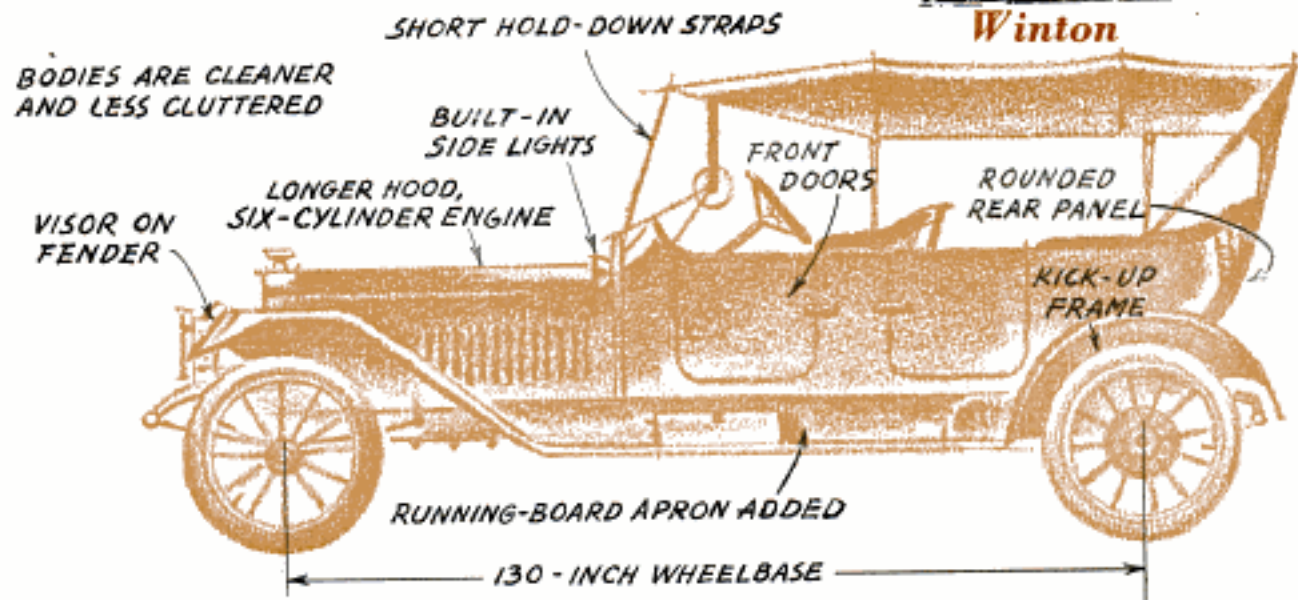

1915
Cadillac

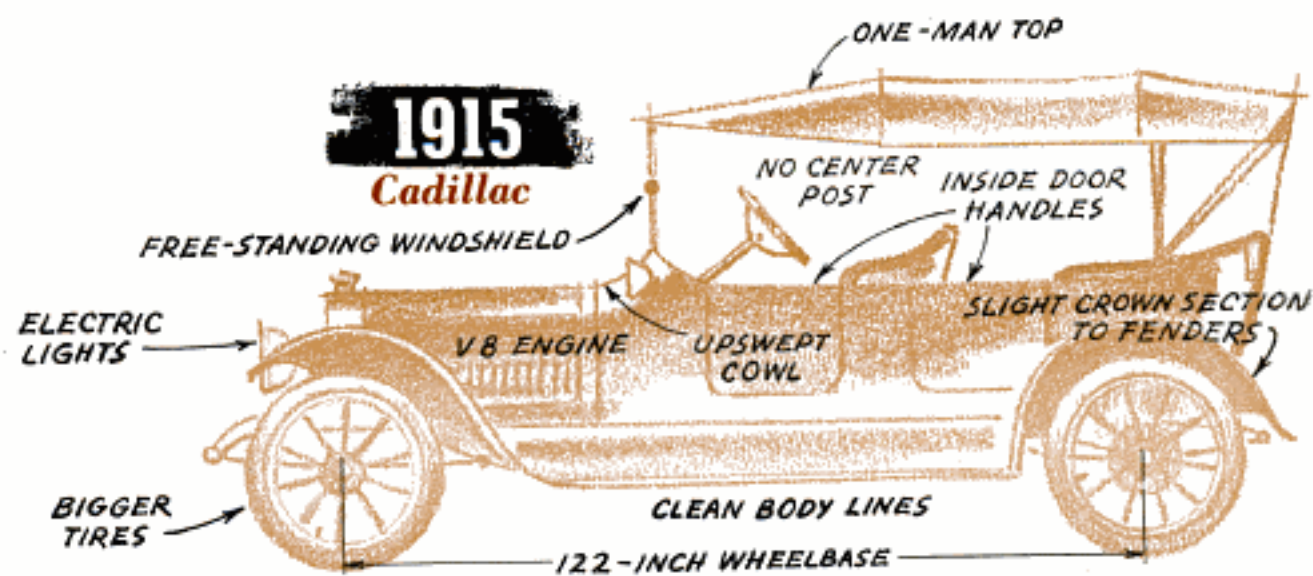

1918

Marmon

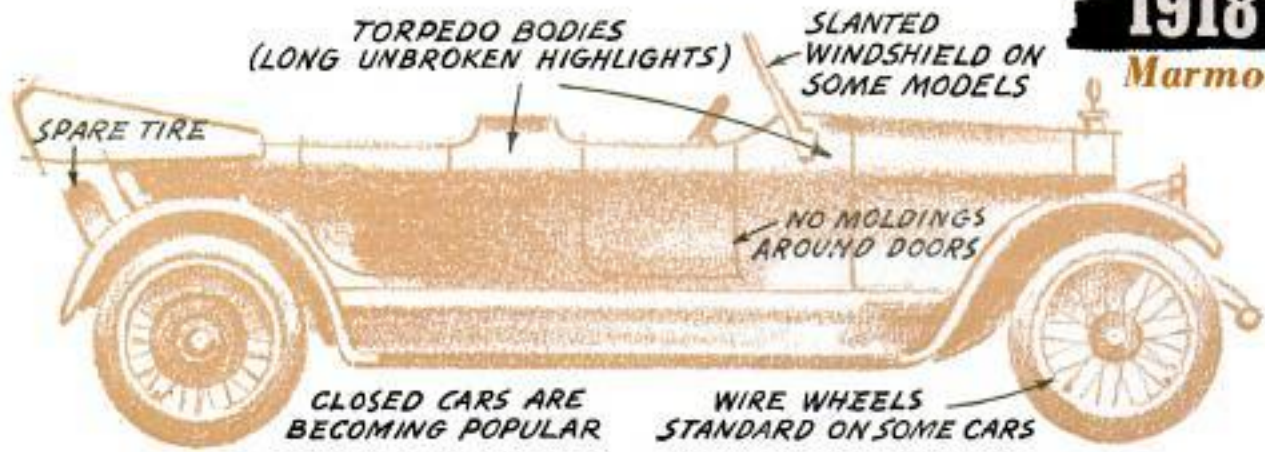

1923

Dodge

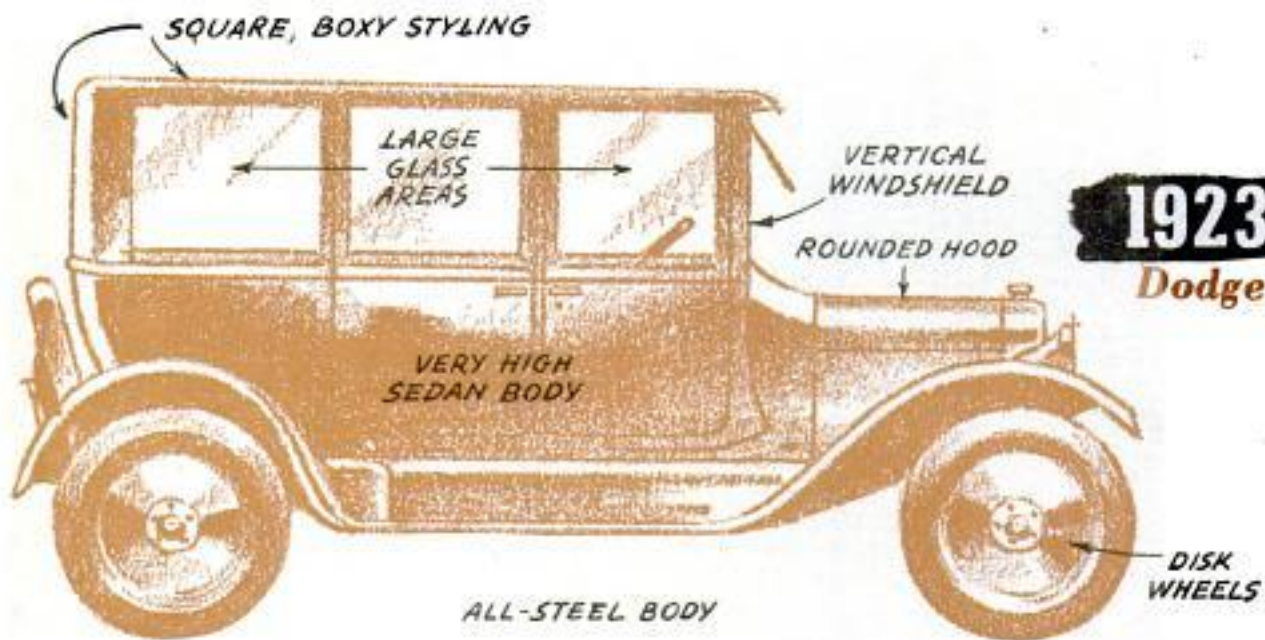

1927

Nash

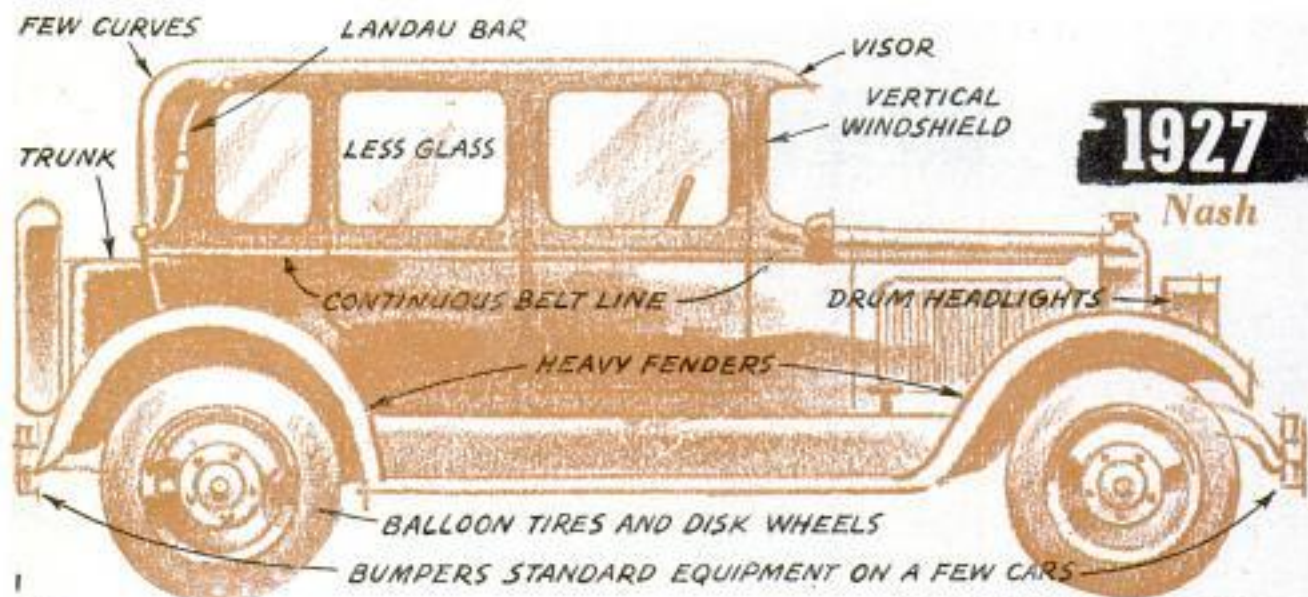

POPULAR MECHANICS

1932

Pontiac

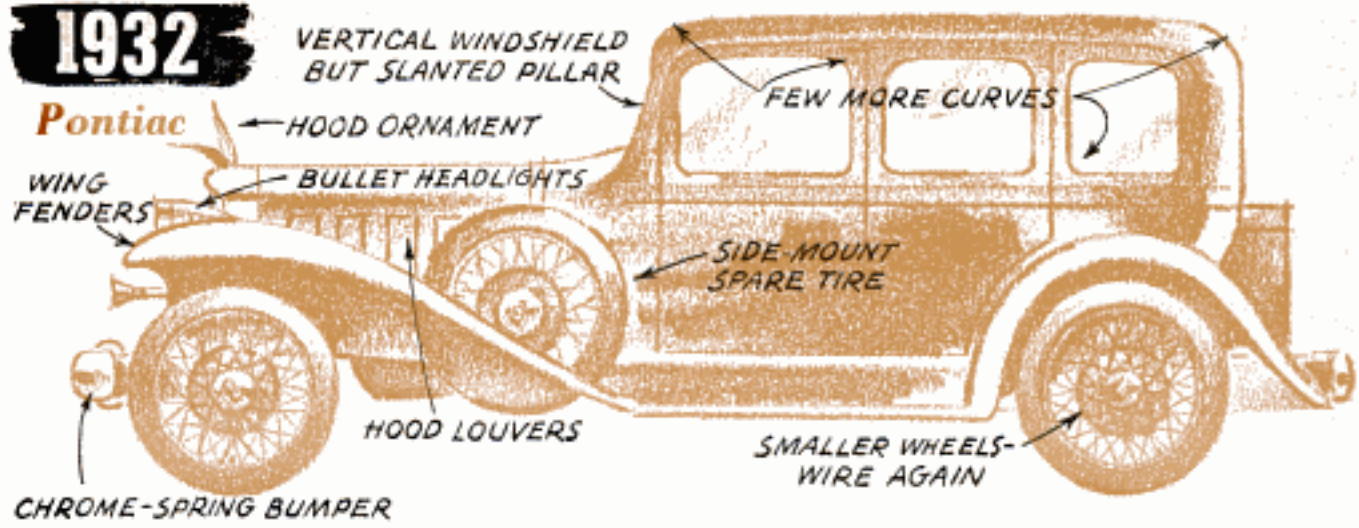

VERTICAL WINDSHIELD
BUT SLANTED PILLAR

FEW MORE CURVES

HOOD ORNAMENT

WING
FENDERS

BULLET HEADLIGHTS

SIDE-MOUNT
SPARE TIRE

HOOD LOUVERS

SMALLER WHEELS-
WIRE AGAIN

CHROME-SPRING BUMPER

1937

Buick

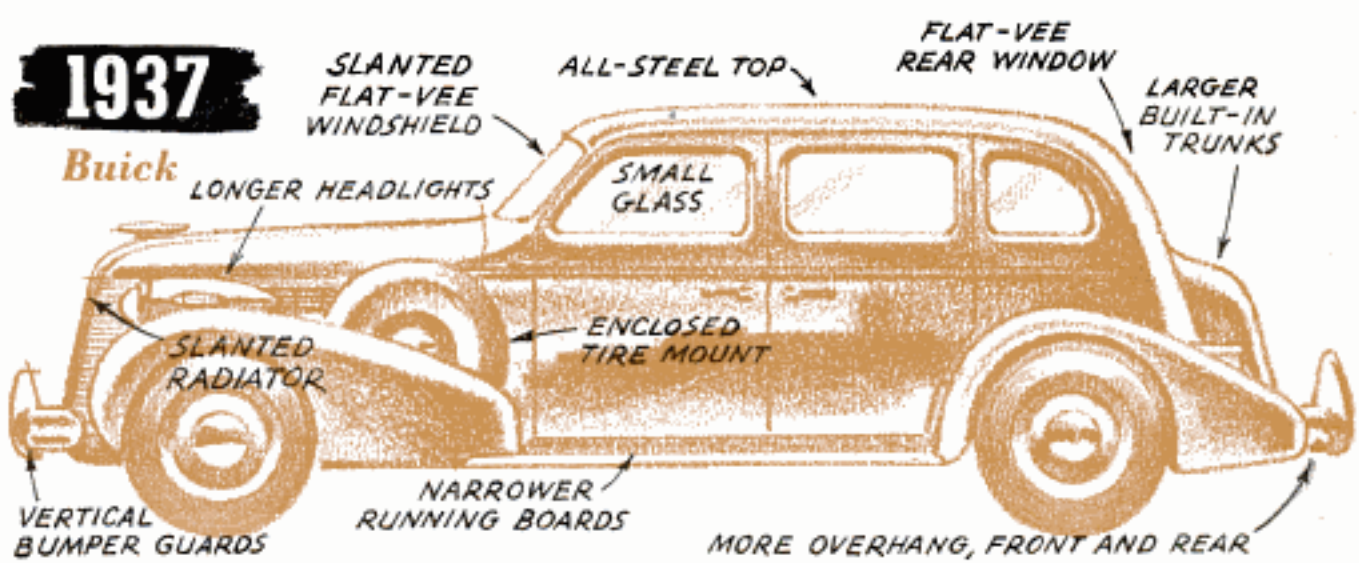

SLANTED
FLAT-VEE
WINDSHIELD

ALL-STEEL TOP

FLAT-VEE
REAR WINDOW

LARGER
BUILT-IN
TRUNKS

LONGER HEADLIGHTS

SMALL
GLASS

SLANTED
RADIATOR

ENCLOSED
TIRE MOUNT

VERTICAL
BUMPER GUARDS

NARROWER
RUNNING BOARDS

MORE OVERHANG, FRONT AND REAR

1939

Studebaker

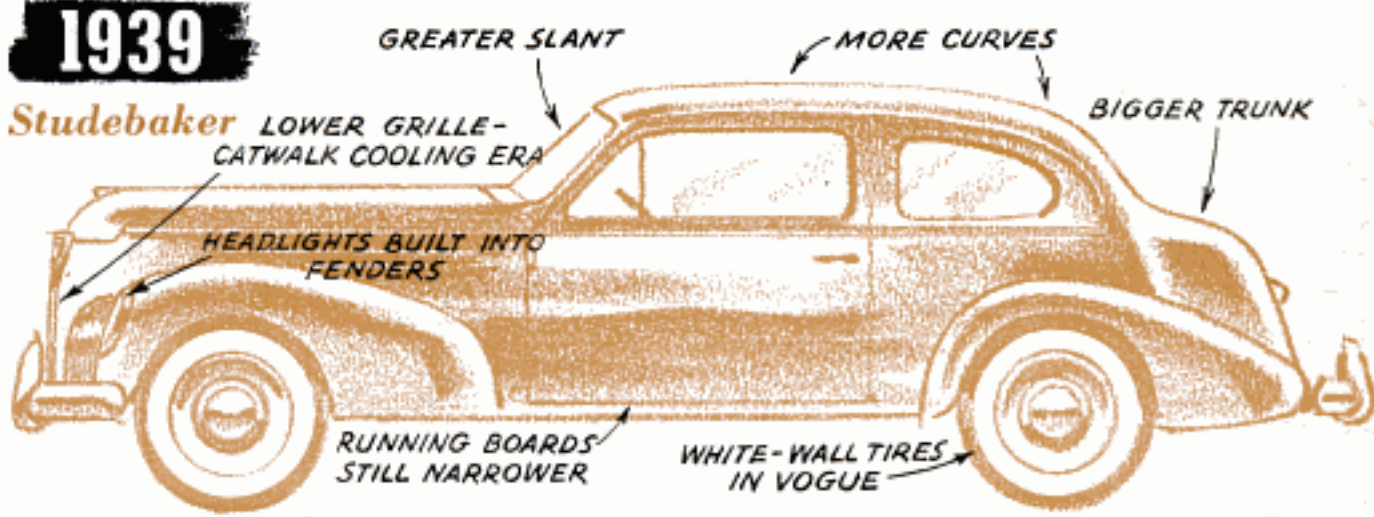

GREATER SLANT

MORE CURVES

BIGGER TRUNK

LOWER GRILLE-
CATWALK COOLING ERA

HEADLIGHTS BUILT INTO
FENDERS

RUNNING BOARDS
STILL NARROWER

WHITE-WALL TIRES
IN VOGUE

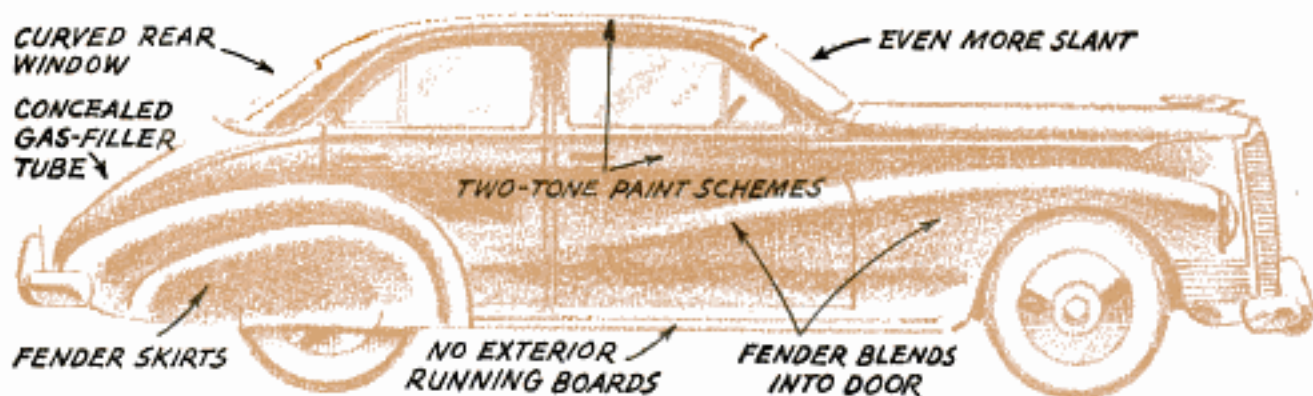

1941

Packard

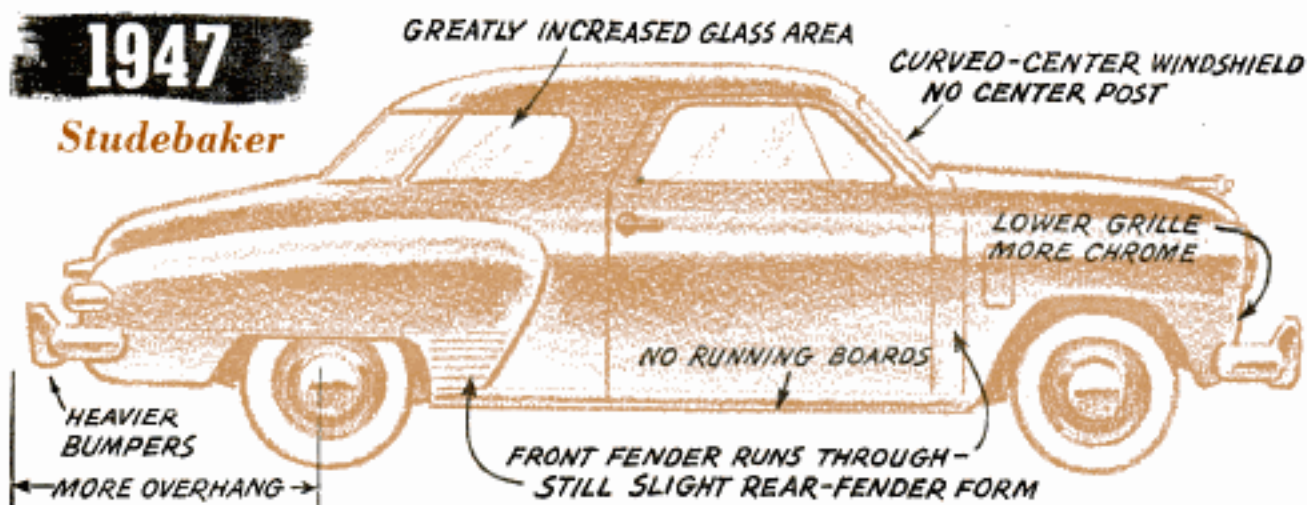

SQUARED PASSENGER COMPARTMENT

SHORT, FLAT HOOD

1949

Ford

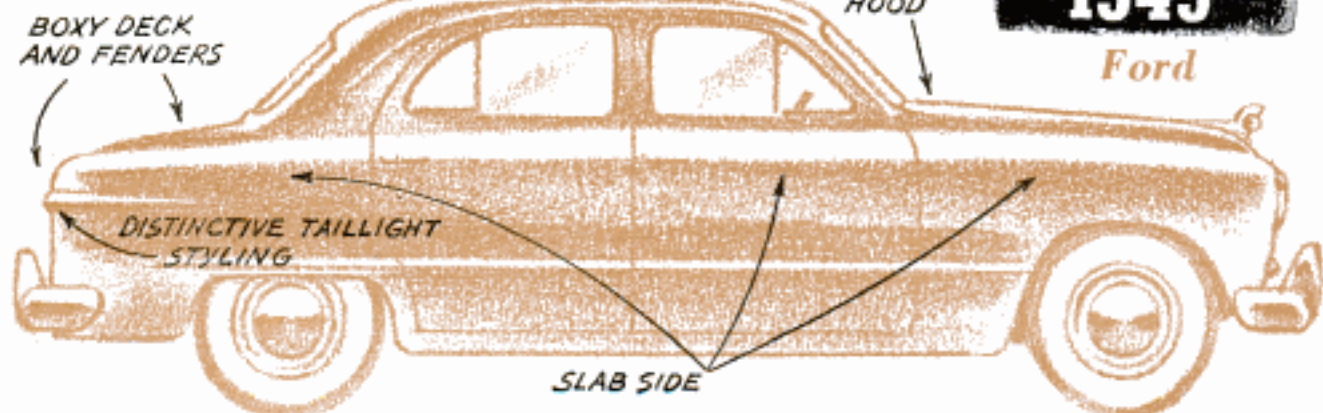

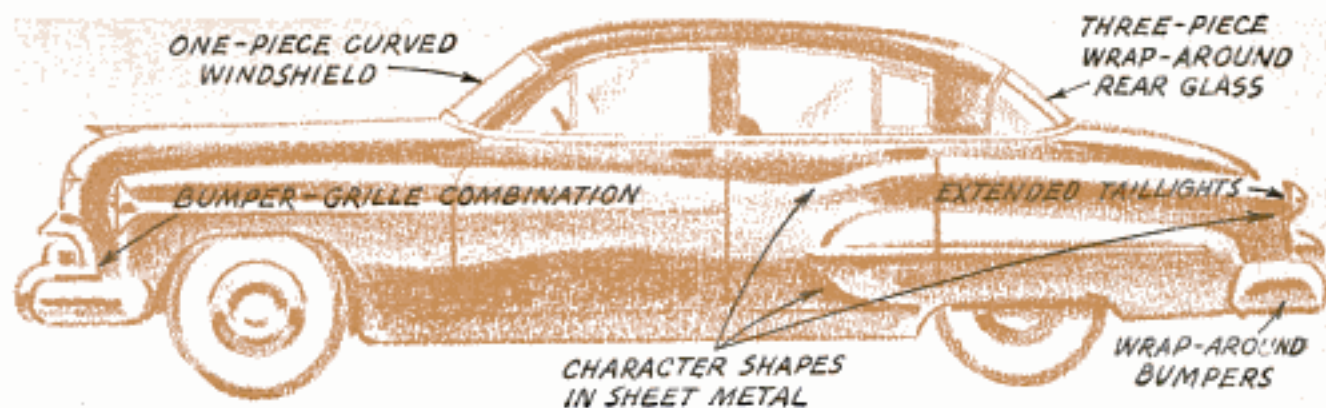

1950
Oldsmobile

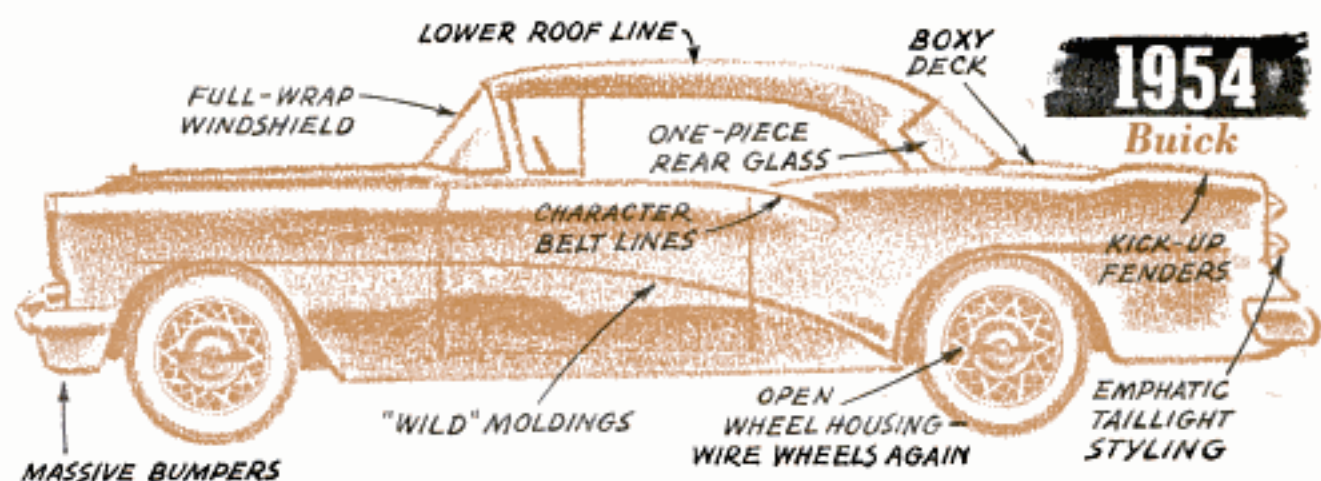

1954
Buick

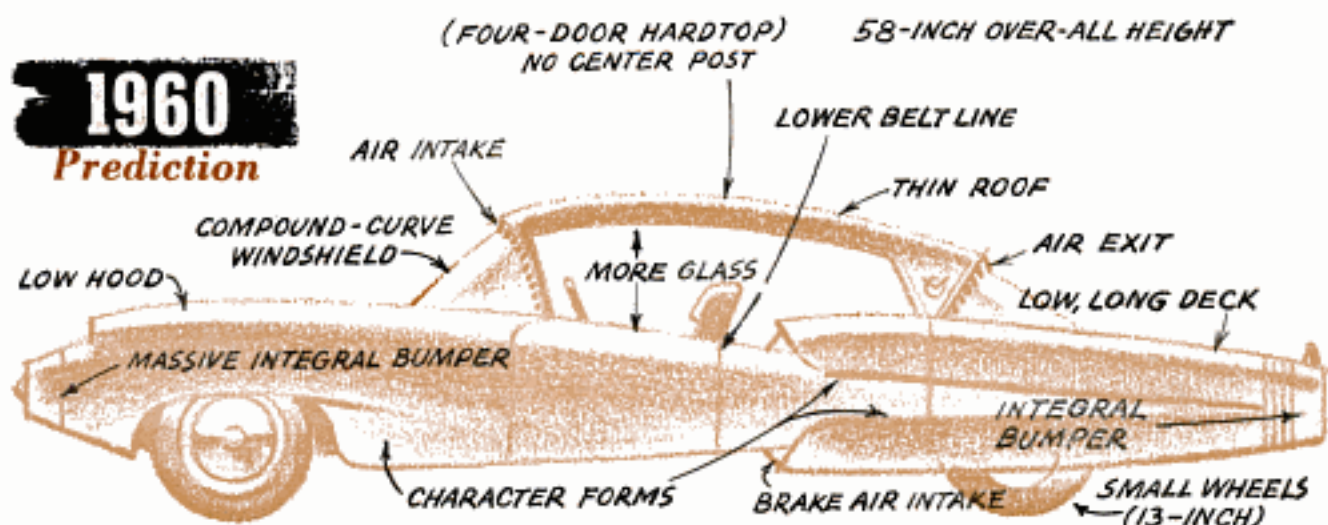

1960
Prediction



VOLKSWAGEN



ISO ISETTA



MERCEDES 300S

Are European Cars Better?



BENTLEY CONTINENTAL



2 C.V. CITROEN



PANHARD



LANCIA lighted material

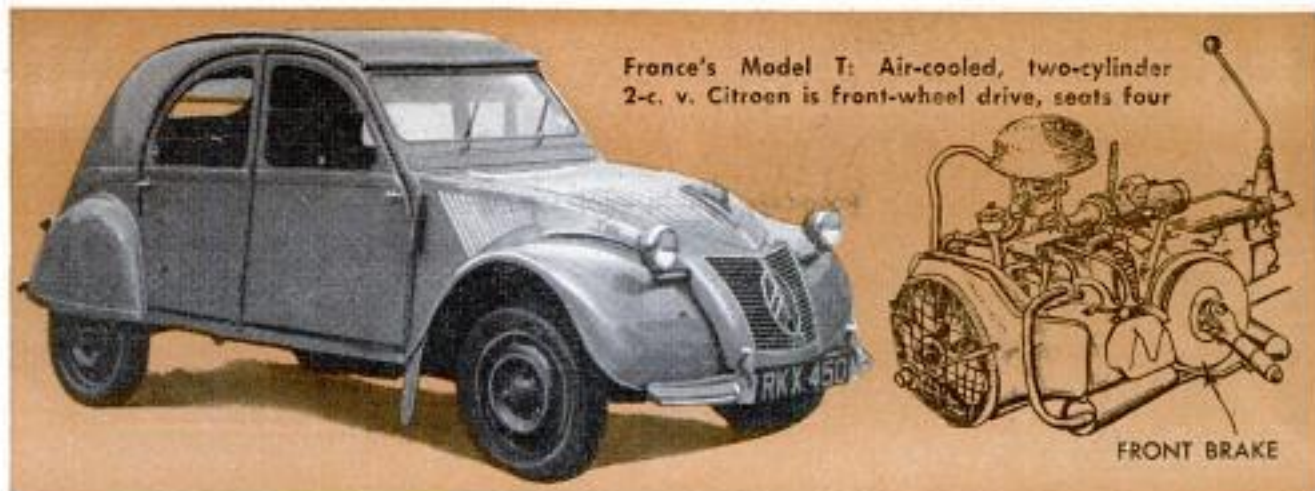

France's Model T: Air-cooled, two-cylinder 2-c. v. Citroën is front-wheel drive, seats four

FRONT BRAKE

By Roger Huntington

Member, Society of Automotive Engineers

IS THE WEALTHIEST nation in the world—the one that operates three times as many cars as all the rest combined—dragging its feet in automotive engineering?

You could get that idea. We read about such European realities as V6 engines, independent rear suspension, torsion-bar springing, air-cooled engines, fuel injection and many others. Europe even has automatic chassis-lubrication systems, springs that adjust from the dashboard for a hard or soft ride, built-in hydraulic jacks and

oil-level indicators so you don't have to fuss with a messy dipstick.

What do we have over here? The overhead-valve V8 is becoming standardized in our cars. Chassis layouts are almost stereotyped. Cars are as similar as men's hats—you have to be an expert to tell them apart. It almost looks as though the engineers are playing second fiddle to the artists in Detroit!

Probably the most striking example is the chassis. With open-road cruising speeds going up all the time (100 miles per hour

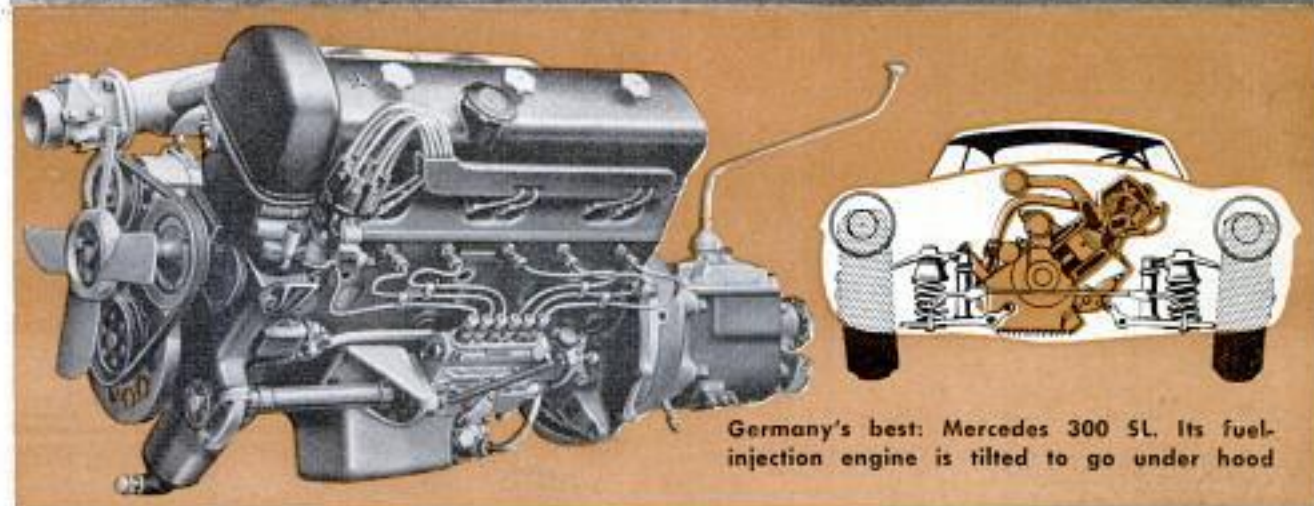

Germany's best: Mercedes 300 SL. Its fuel-injection engine is tilted to go under hood

SUSPENSIONS

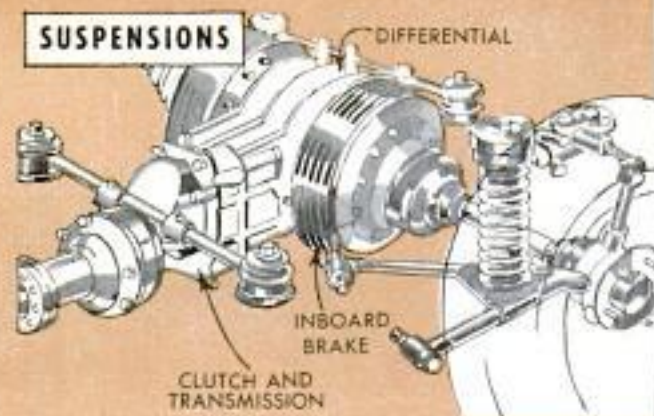

Italy's Lancia Aurelia V6 keeps unsprung weight at a minimum by this independent rear suspension

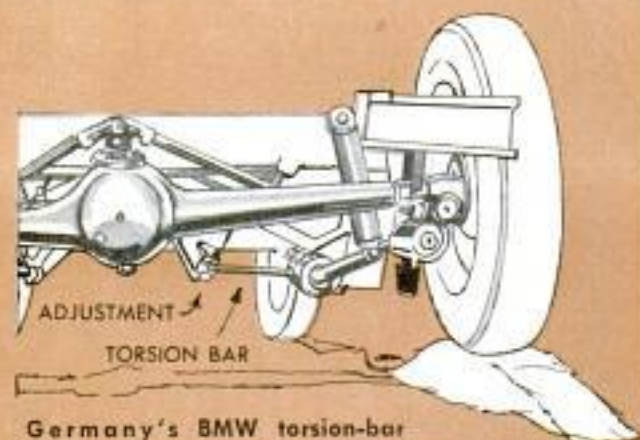

Germany's BMW torsion-bar suspension can be adjusted to suit the owner's preference

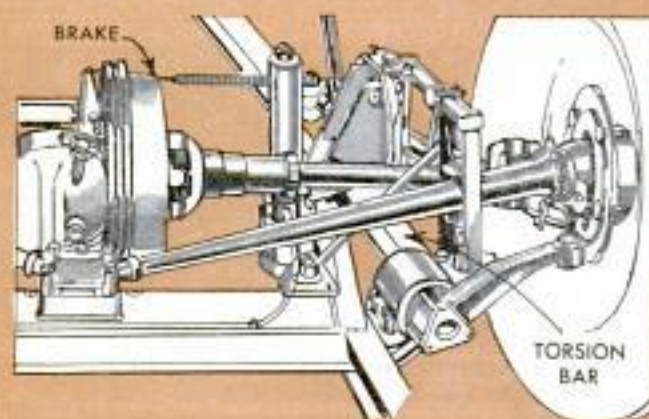

England's Lagonda has independent rear suspension, inboard brakes and torsion-bar springing

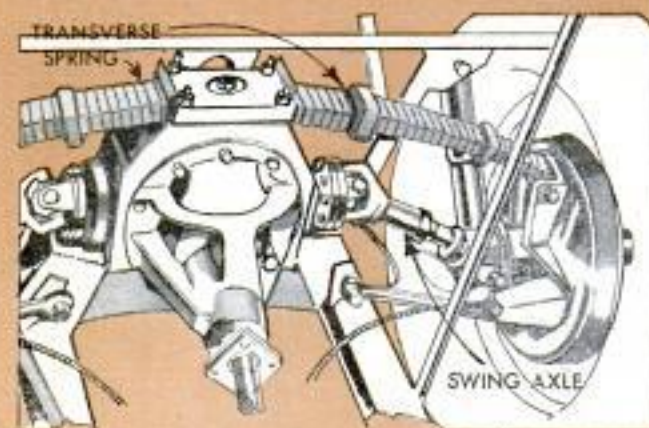

England's A. C. Ace uses a leaf spring with swing axles to provide independent suspension at rear

is not too distant), the present Detroit suspensions are just not going to be adequate to assure a good ride together with easy handling and reasonable safety at these speeds. And that is even allowing for the smooth superhighways of tomorrow.

What has to be done is no secret. Many experts agree that we must move the heavy mass of the transmission to the rear of the car to give better weight balance and less pitching at high speeds. And, very likely, the rear wheels should be independently sprung as the front wheels have been on our cars for many years. Unsprung weight (the weight that bounces up and down with the wheels) will be greatly reduced and the whole car will ride and handle better at high speeds. You might even mount the rear brakes inboard on the differential case to reduce unsprung weight even more.

If this is what we need, where can we find it today? We find it in Europe!

One of the most "roadable" cars today is the Italian Lancia and it has the chassis layout described above. Mercedes-Benz has had independent rear suspension for 20 years. The tiny, inexpensive Volkswagen has it. So does the German Borgward, the French 2 c.v. Citroen (the Model T of Europe which has a front-wheel drive with inboard brakes—it also has a unique front-rear linked suspension and a shift lever in the dashboard!).

Both the Citroen and the Volkswagen are low-price cars, so it can't be said that these are costly, handmade examples.

In brakes, the boys across the Atlantic are ahead, too. Huge finned drums with air scoops for cooling are common. Some cars use the patented "Al fin" process, in which an aluminum drum is bonded to a thin iron liner to give better drum cooling. Probably the most significant new development is the two-trailing-shoe brake from the famed Girling Company in England. The shoes are pivoted so there is no self-energizing effect, or braking force, caused by friction pulling the lining against the drum. The necessary extra force is supplied by a special vacuum booster. Performance of these brakes is said to be practically unaffected by changes in lining friction and temperature, so there is virtually no "fade" on the road during prolonged heavy braking.

Then there are disk brakes, used mostly on sports cars, but expected soon on the larger sedans—in England especially. Disk brakes get more air to the braking surfaces than conventional shoe brakes and provide excellent cooling. Good braking depends upon cooling.

Europe does some cute tricks with engines. Air cooling is found on many small cars. It is cheaper, gives a lighter engine and it eliminates worries about freezing in

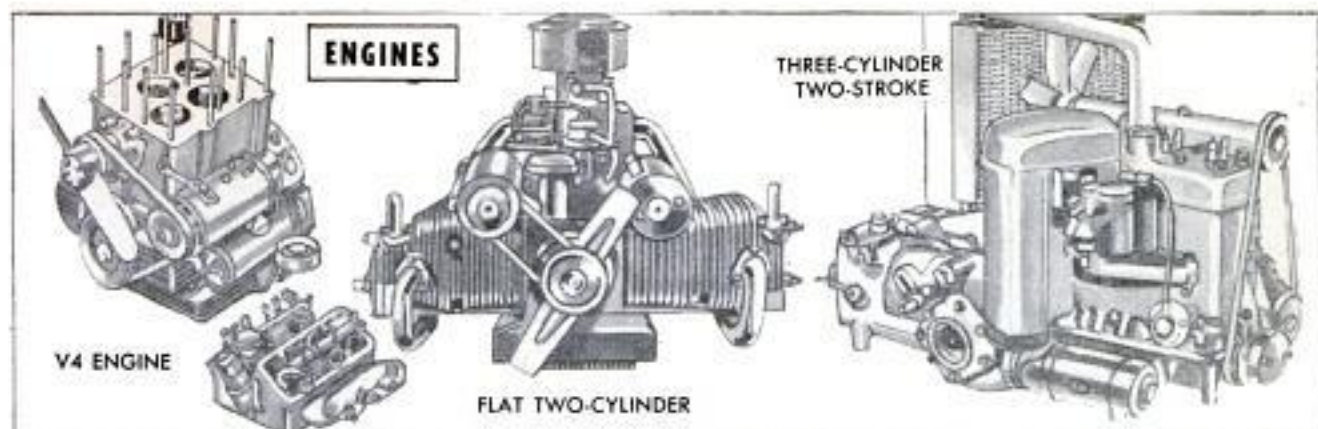

Europe's engines have variety. Here are the Lancia V4, Panhard air-cooled flat twin, D.K.W. three-cylinder

winter and boiling over during the summer.

The little French Panhard has a tiny air-cooled two-cylinder engine with a front-wheel drive. In the 1954 LeMans race one of these two-cylinder cars was driven for 24 consecutive hours, averaging 80 miles per hour. This engine has a displacement of 45.4 cubic inches—the smallest American engine is four times larger with 186 cubic inches (Studebaker Champion).

Other famous air-cooled engines are the flat four of the Volkswagen (rear-mounted) and the two-cylinder 2 c.v. Citroen. The Citroen is an unadorned, basic car with evidence of careful design. It has a centrifugal clutch that prevents stalling in traffic. With this clutch you don't have to use the

clutch pedal when starting up or shifting. It carries four persons plus luggage. Of course, its top speed is just over 40 miles per hour, but it does average from 50 to 60 miles per gallon fully loaded. The two-cylinder overhead-valve engine has a 25.9-cubic-inch displacement—one seventh the size of the economical Studebaker Champion engine! The engine is a sealed unit. When it needs repairs, you trade it in for a new one for \$42!

Other interesting engines in Europe are the V4 and V6 of Lancia (Italy) and the three-cylinder D.K.W. (Germany), a two-stroke engine that drives through the front wheels. This tiny, three-cylinder engine

(Continued to page 292)

BODY STRUCTURES

Volkswagen has a smooth underside as the controls are in center tube that is its main support



Like many foreign cars, Lancia, above, uses no frame. This four-door body also has no center post between doors. Weight: 1800 pounds. Much light alloy is used

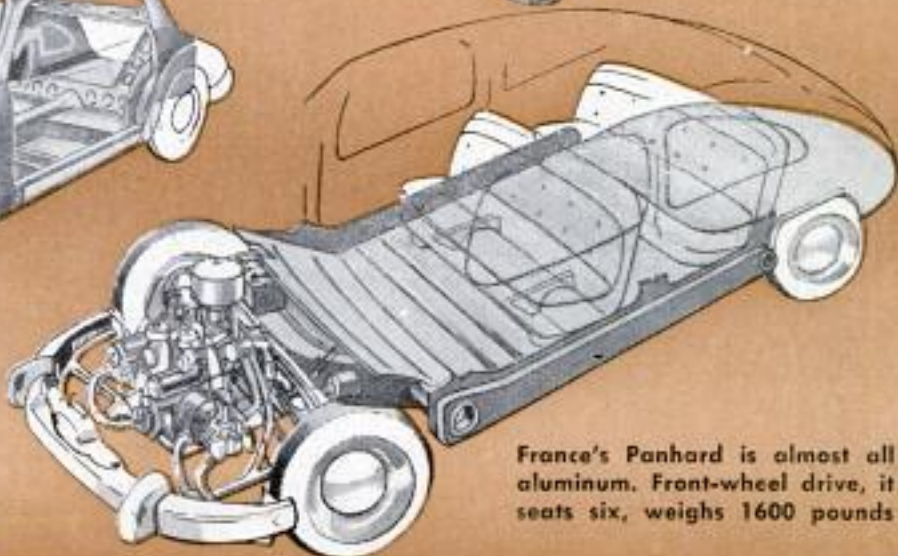

France's Panhard is almost all aluminum. Front-wheel drive, it seats six, weighs 1600 pounds

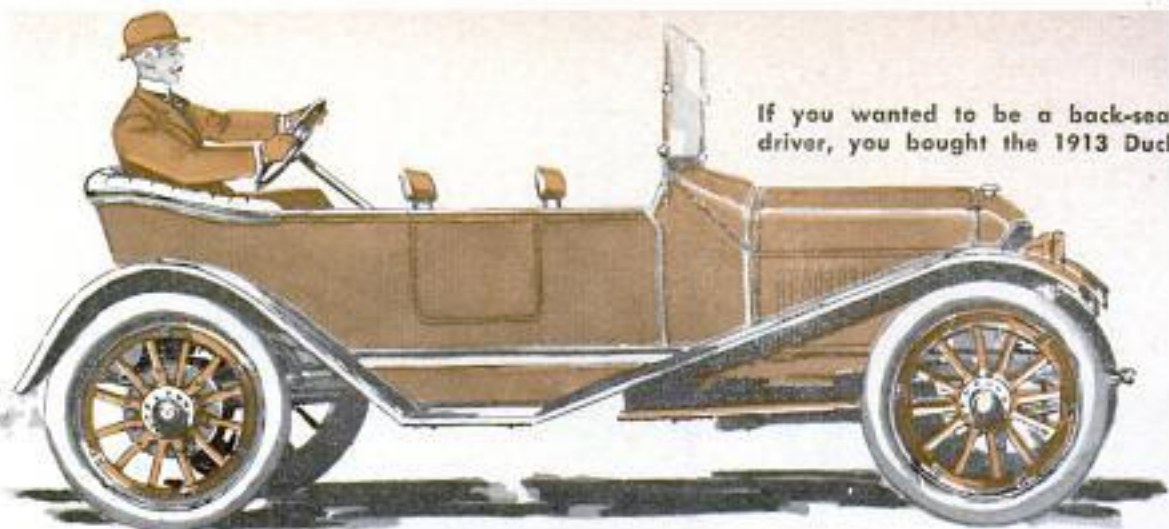

If you wanted to be a back-seat driver, you bought the 1913 Duck

THEY ALSO RAN

By
**Floyd
Clymer**

THEY DON'T BUILD CARS like they used to!" How many times have you heard that? Or even said it yourself? Well, take it from me—it's a good thing they don't!

Building cars is a science today (with not just a little showmanship added). It wasn't always so scientific. There was a time when, with no more engineering training than came from a childhood spent with an Erector Set, an imaginative mechanic could bring out a "revolutionary" automobile—one that would (he claimed) make every other car obsolete in the morning.

In 1955 you've got to be a graduate engineer before they'll let you design an ash

Even smart horses were said to be fooled by Uriah Smith's automobile that had a horse's head up front

tray for the back seat. As a result, cars are better today. But, let's face it, they are a lot less exciting.

These Erector Set engineers came up with a load of ideas. Every month or so, a "new and revolutionary" machine was announced. Usually (not always, but almost always), the new and revolutionary car fizzled out and quietly became an "also ran" in the race for public acceptance.

Take the car designed by Uriah Smith of Utah. Gasoline buggies did frighten horses and no wonder—they even frightened humans at times. So Smith decided to fool the horse into accepting the automobile as a relative. To put over his deception, Smith mounted a fake horse's head on the front

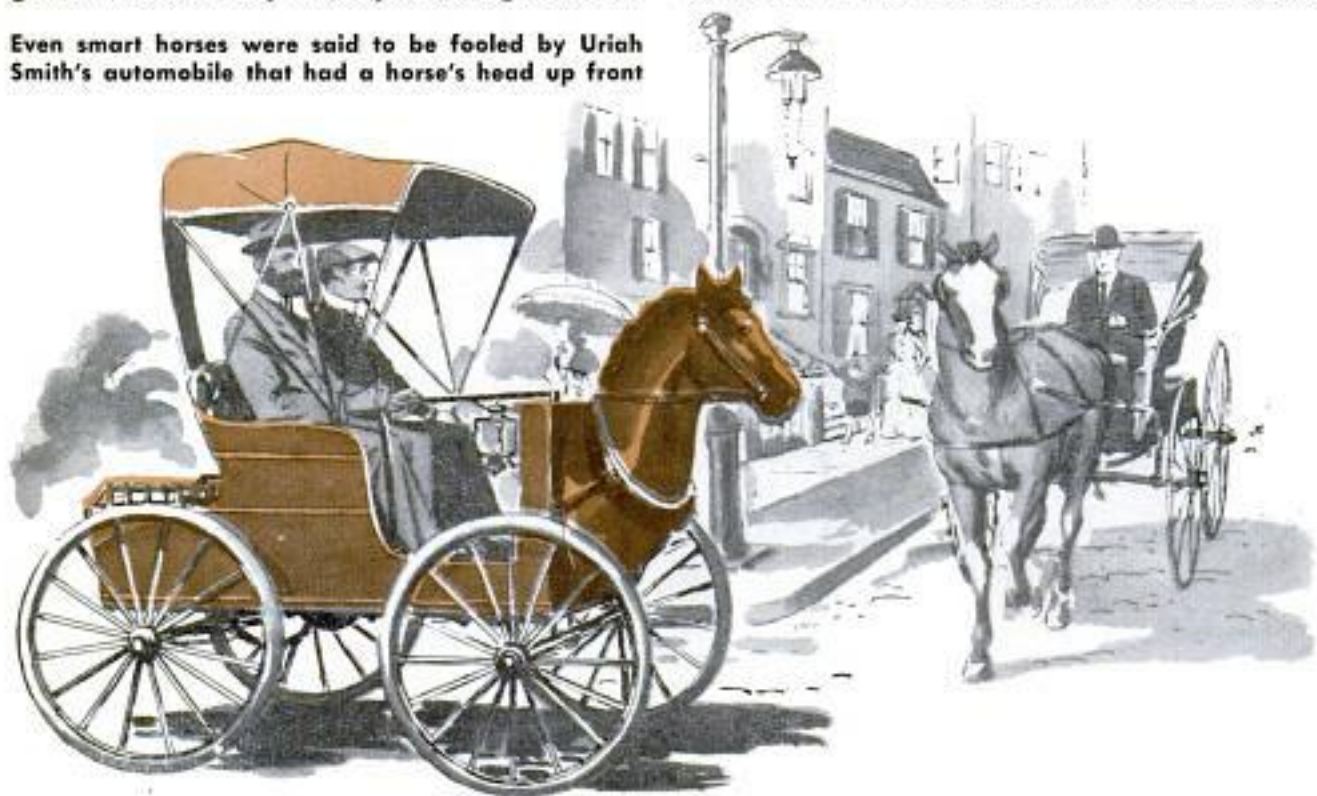

With eight wheels to smooth the bumps, this weird car was called the Octoauto

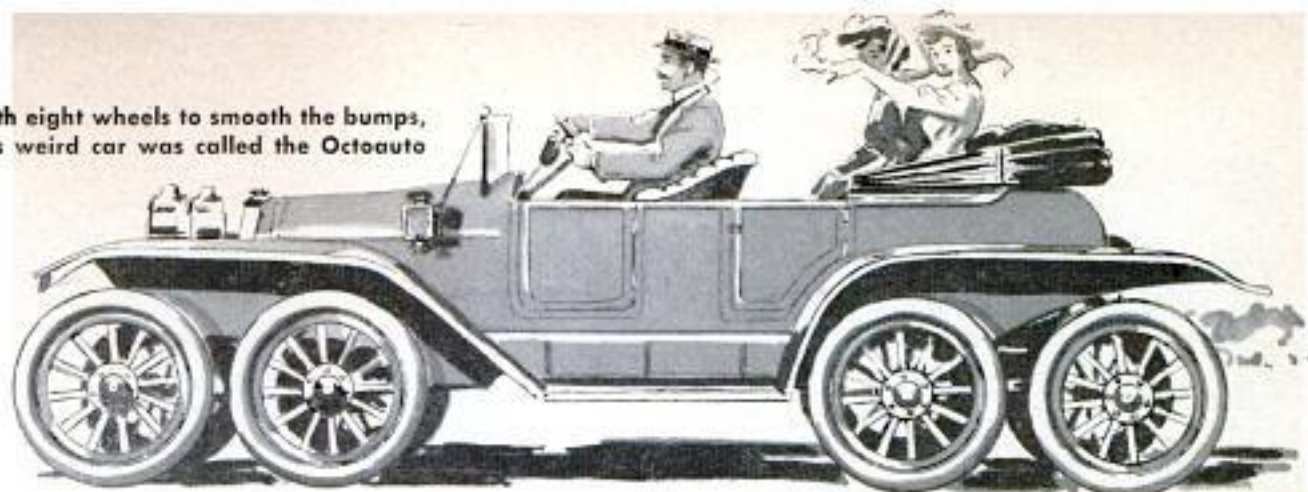

of the automobile (which at that point in its evolution still looked like a buggy).

A horse, seeing this king-size hood ornament, was supposed to be fooled into passing it by undisturbed. Smith claimed his invention would fool horses. There's no evidence that it fooled people very much.

A New Jersey inventor named Phelps was also a man with an idea. He saw no sense in discarding the wagon just because the gasoline engine had arrived. After all, the engine merely replaced the horse, not the wagon.

As Phelps saw it, the engine was simply a mechanical horse—something that should be hitched up like any other horse. He attached a tractorlike machine to the front end of a wagon. In that way, the family could sit in the same seats, enjoy the same ride, look out from under the same fringe as when Dobbin was around. But instead of the clatter of hooves, there was the rattle of valves and connecting rods. Father didn't even have to learn to drive—the tractor was controlled by reins just like the horse!

There was something appealing about the rotary engine. Inventors, professional and amateur alike, set out to make a fortune with it. Rotary engines were expected to solve all the problems of the temperamental automobile. They spun like a pinwheel as they ran. The spinning kept them cool and

Why get rid of the old buggy? With a Phelps tractor to replace the horse, you even used the reins for steering

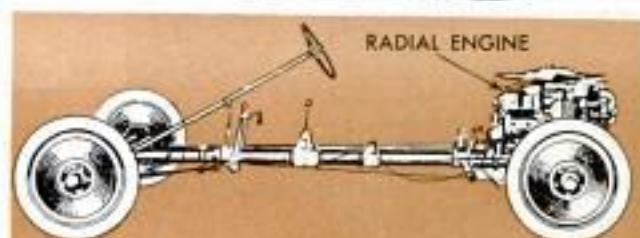
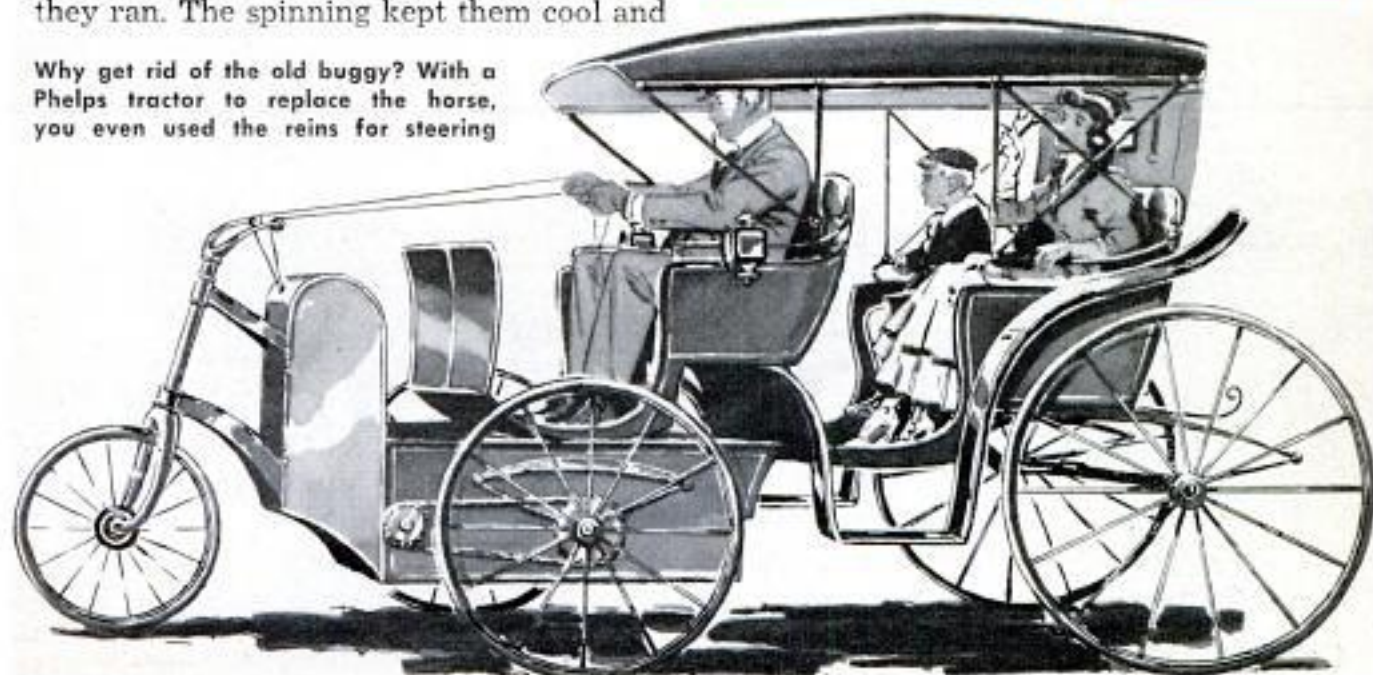

Radial engine of 1922 Julian (above) did not revolve. Rotary engine on Eagle (below) did

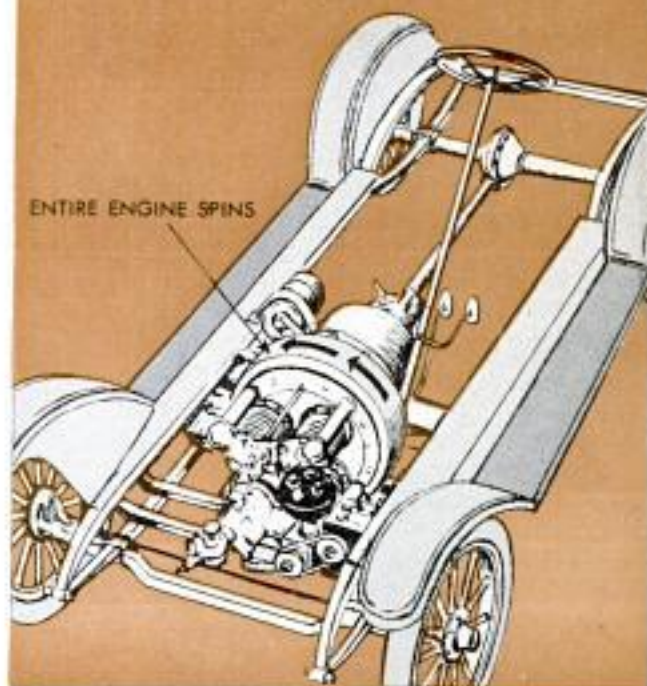



Car bodies should be woven like a basket, said one manufacturer. They won't dent or rust and you can wash them with a hose

also had a gyroscopic effect that made the car stable on corners.

The Eagle car of 1915 boasted a five-cylinder rotary engine with horizontal cylinders. Other inventors arranged the cylinders vertically around a hub like spokes in a wheel (similar to the air-cooled radial aircraft engine of today except that these old engines spun).

But the 1915 Eagle had horizontal cylinders and the whole engine rotated like a log in a North Woods birling contest. It was easier to keep the cylinders lubricated when they were horizontal, the inventor claimed. A man named Adams had tried a similar idea years before in Iowa without much success. The Eagle had no more success in 1915.

The gyroscope was another favorite of the inventors. One car was called the Gyroscope Car. Billed as "the simplest automobile in the world," it had a horizontal flywheel to give "gyroscopic stability in running. No skidding. Takes turns at any speed." That was in 1908—another also-ran!

Today's transmissions are standardized to a point where only an engineer can tell them apart. But years ago, things were different. There were

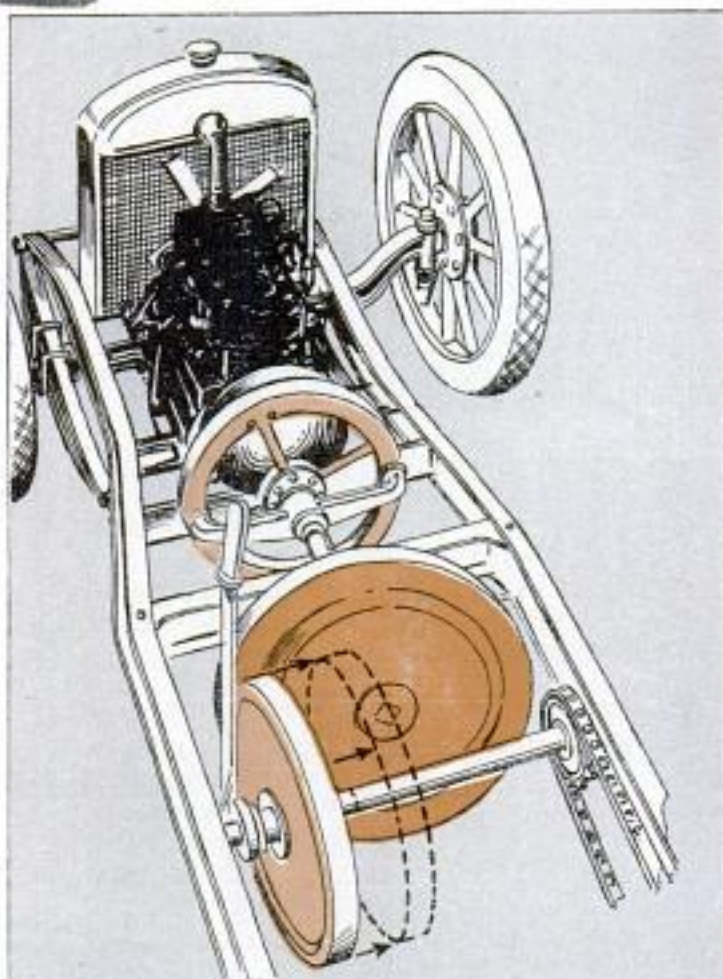

Friction-drive transmissions used a big sliding wheel against a disk to provide "gear" ratios

Best known gasoline-electric car was the Owen Magnetic. An electric motor turned drive shaft

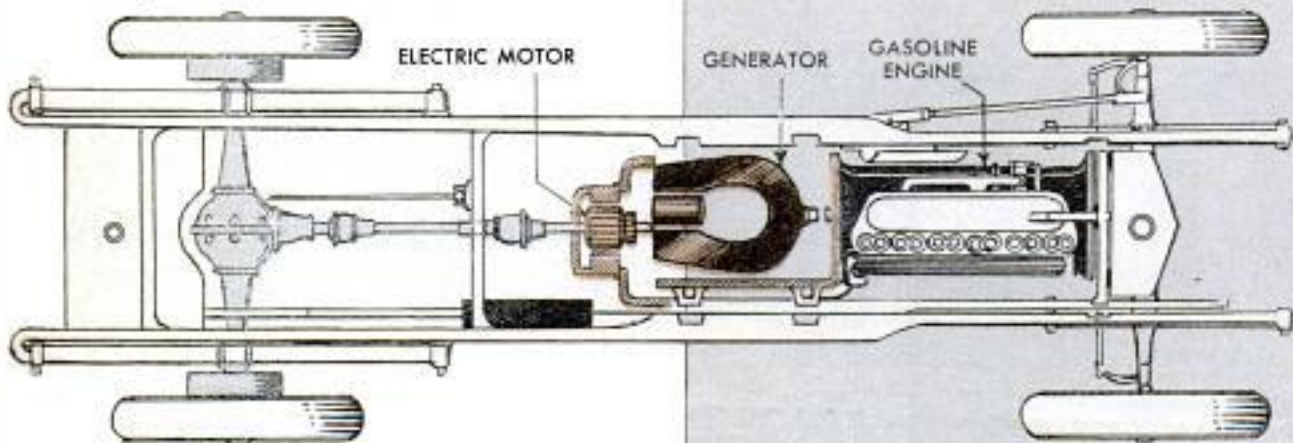

It was predicted that every young blade would have a motorized buckboard. Motor and power wheel were a bolt-on unit

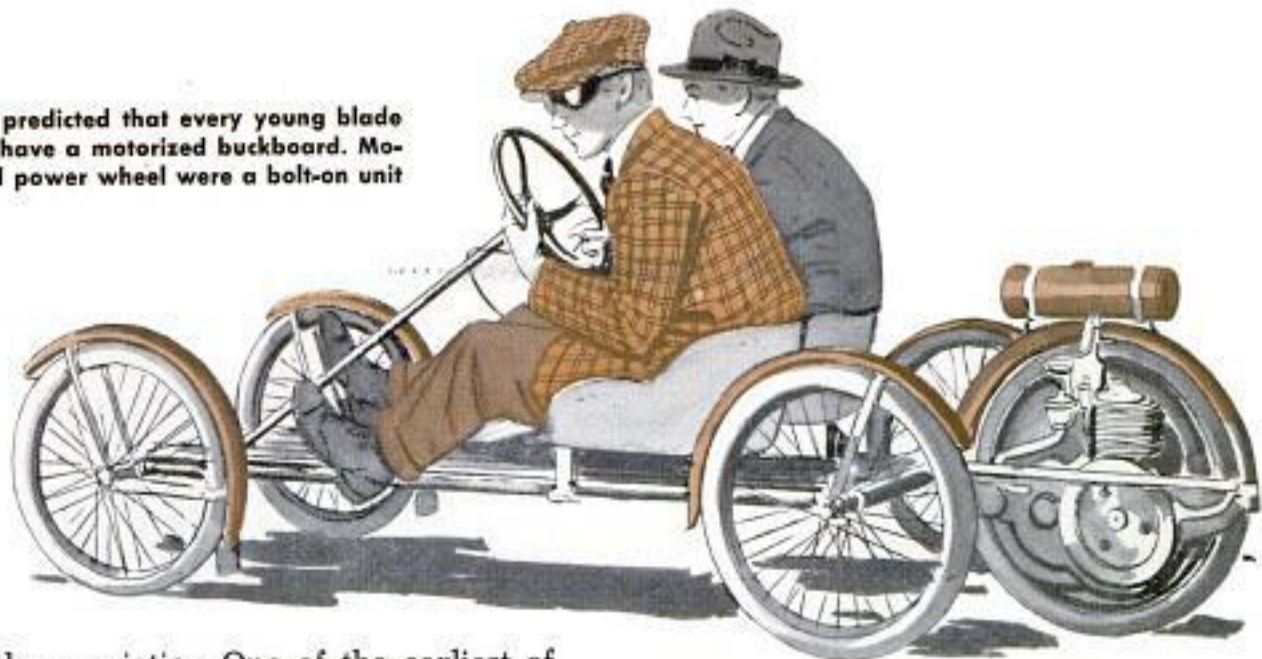

countless varieties. One of the earliest of these was certainly no also-ran. It was the planetary system, now an essential part of every automatic transmission. But we're not concerned here with those that survived. We're discussing those that dropped out along the way.

Definitely an also-ran was the friction-drive transmission. There were many designs in this field. The lack of gears and the simple construction made it appealing.

The Cartercar was probably the most successful of the makes using friction transmissions. It got an unlimited number of

(Continued to page 284)

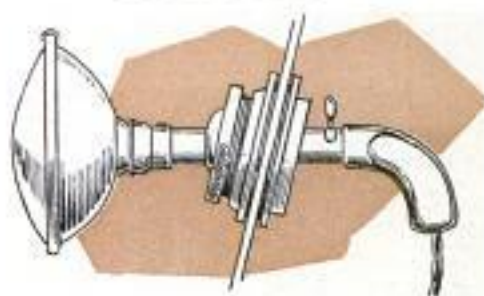

Windshield-mounted spotlight, above, was author's contribution to the list of automotive also-rans



Above, all cars should be one-eyed, said some. Left, gasoline-electric truck had same theory as a diesel locomotive

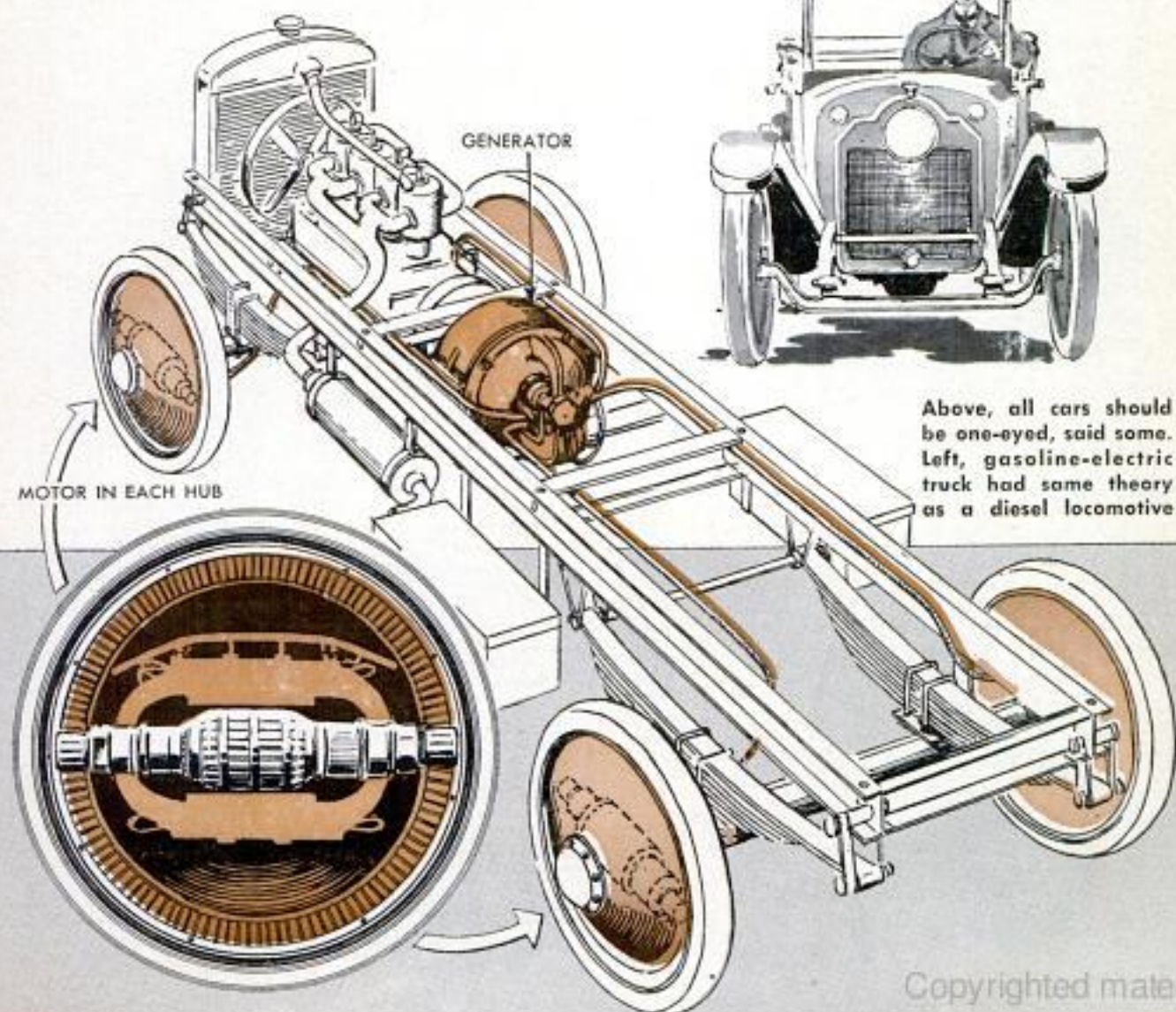

COMPARE THE 1955 CARS

AVE.

HIP-ROOM

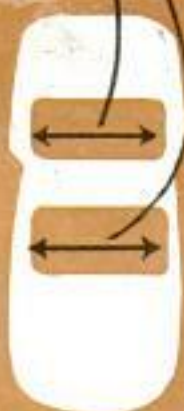

AVE.

HEAD-ROOM



AVE.

LEG-ROOM

FRONT-SEAT ROOM

HEADROOM (inches)		LEGROOM (inches)		HIPROOM (inches)	
Hudson	37.5	Kaiser	45.4	Hudson	65.0
Nash	37.5	Chrysler	44.6	Nash	65.0
Packard	36.7	DeSoto	44.6	Buick Super	64.9
Buick Super	36.6	Imperial	44.6	Buick Roadmaster	64.7
Cadillac 75	36.5	Dodge	44.5	Cadillac 75	64.4
Rambler	36.5	Plymouth	44.5	Cadillac 62	64.3
Clipper	36.0	Ford	44.3	Cadillac 60	64.3
Studebaker	36.0	Lincoln	44.3	Chrysler	63.3
Buick Roadmaster	35.9	Rambler	44.0	DeSoto	63.3
Cadillac 62	35.8	Mercury	43.8	Kaiser	63.3
Cadillac 60	35.8	Buick Roadmaster	43.6	Clipper	62.8
Kaiser	35.8	Mercury Montclair	43.6	Packard	62.8
Chevrolet	35.7	Clipper	43.5	Buick Special	62.5
Buick Special	35.6	Packard	43.5	Buick Century	62.5
Buick Century	35.6	Cadillac 75	43.4	Dodge	62.5
Oldsmobile	35.6	Cadillac 62	43.3	Imperial	62.5
Pontiac	35.6	Cadillac 60	43.3	Plymouth	62.5
Dodge	35.5	Buick Super	43.2	Lincoln	62.3
Lincoln	35.5	Chevrolet	43.1	Oldsmobile	62.3
Mercury	35.4	Oldsmobile 88	42.9	Chevrolet	62.0
Ford	35.1	Oldsmobile Super 88	42.9	Pontiac	61.8
Chrysler	35.0	Oldsmobile 98	42.8	Willys	61.0
DeSoto	35.0	Pontiac	42.7	Mercury	60.6
Imperial	35.0	Hudson	42.5	Mercury Montclair	60.6
Plymouth	35.0	Nash	42.5	Ford	60.5
Willys	34.6	Studebaker	42.5	Rambler	60.0
Mercury Montclair	33.5	Buick Special	42.3	Studebaker	59.5
		Buick Century	42.3		
		Willys	41.6		

REAR-SEAT ROOM

HEADROOM (inches)		LEGROOM (inches)		HIPROOM (inches)	
Hudson	36.0	Cadillac 75	55.0	Buick Super	65.7
Nash	36.0	Packard	48.8	Buick Roadmaster	65.7
Packard	35.9	Imperial	48.4	Cadillac 62	65.2
Pontiac	35.9	Cadillac 62	46.3	Cadillac 60	65.2
Cadillac 62	35.6	Cadillac 60	46.3	Hudson	64.5
Cadillac 60	35.6	Buick Roadmaster	45.6	Nash	64.5
Rambler	35.5	Buick Super	45.1	Chrysler	64.0
Chevrolet	35.4	Dodge	45.0	Kaiser	63.1
Buick Super	35.2	Chrysler	44.8	Pontiac	63.1
Buick Roadmaster	35.1	Plymouth	44.5	Chevrolet	63.0
Cadillac 75	35.1	Oldsmobile Super 88	44.3	Dodge	62.8
Studebaker	35.0	Oldsmobile 98	44.0	Plymouth	62.8
Dodge	34.9	Clipper	43.8		
Lincoln	34.7	Oldsmobile 88	43.8	Buick Special	62.4
Imperial	34.6	Lincoln	42.8	Buick Century	62.4
Oldsmobile 88	34.6	Mercury	42.8	Oldsmobile 88	62.4
Plymouth	34.6	Pontiac Chieftain	42.8	Lincoln	62.1
Chrysler	34.5	Pontiac Star Chief	42.7	Oldsmobile Super 88	62.1
DeSoto	34.5	Ford	41.9	Oldsmobile 98	62.1
Ford	34.2	Buick Special	41.8	Clipper	62.0
Mercury	34.2	Buick Century	41.4	Imperial	62.0
Willys	34.1	Studebaker Pres.	41.0	Packard	62.0
Buick Special	34.0	Chevrolet	40.8	Willys	61.0
Buick Century	34.0	Mercury Montclair	40.6	Mercury Montclair	60.5
Clipper	34.0	Hudson	40.1	Ford	60.3
Kaiser	33.8	Nash	40.1	Mercury	60.3
Oldsmobile Super 88	33.8	Kaiser	39.6	Rambler	59.5
Oldsmobile 98	33.8	Rambler	39.5	Cadillac 75	59.1
Mercury Montclair	32.2	Studebaker Champ.	39.0	Studebaker	59.0
		Studebaker Comdr.	39.0		
		Willys	37.9		

ENGINE SIZE AND POWER

DISPLACEMENT (cubic inches)	HORSEPOWER	POUNDS PER HP. (shipping wt. + hp.)	
Packard	260	Clipper Custom	15.9
Clipper Custom	250	Buick Century	16.1
Lincoln	250	Chrysler N. Yorker	16.6
Cadillac	250	Chrysler	16.7
Chrysler N. Yorker	236	Clipper	16.7
Imperial	236	Packard	16.7
Buick Century	236	Buick Super	17.5
Buick Super	236	Cadillac 62	17.5
Buick Roadmaster	236	Mercury Montclair	17.6
Clipper	225	Buick Roadmaster	18.1
Lincoln	225	Cadillac 60	18.2
Oldsmobile Super 88	202	Imperial	18.3
Oldsmobile 98	202	Studebaker Pres.	18.4
DeSoto Fireflite	200	Oldsmobile Super 88	18.6
Mercury Montclair	198	Lincoln	18.8
Buick Special	188	Dodge Royal V8	19.0
Chrysler Windsor	188	Chevrolet V8	19.1
Mercury	188	Oldsmobile 98	19.1
DeSoto Firedome	185	Dodge Coronet V8	19.4
Oldsmobile 88	185	Plymouth V8	19.4
Dodge Royal V8	183	Pontiac Chieftain	19.5
Pontiac	180	DeSoto Fireflite	19.7
Dodge Coronet V8	175	Pontiac Star Chief	19.7
Studebaker Pres.	175	Buick Special	19.9
Plymouth V8	167	Ford V8	20.0
Chevrolet V8	162	Cadillac 75	20.1
Ford V8	162	Oldsmobile 88	20.1
Kaiser 6	140	DeSoto Firedome	20.9
Studebaker Comdr.	140	Chrysler Windsor	20.9
Chevrolet		Studebaker Comdr.	22.0
Powerglide 6	136	Chevrolet	
Nash Ambassador 6	130	Powerglide 6	23.7
Chevrolet		Kaiser 6	24.1
Handshift 6	123	Willys 6	24.2
Dodge 6	123	Chevrolet	
Ford 6	120	Handshift 6	25.4
Plymouth 6	117	Ford 6	26.1
Willys 6	115	Dodge 6	26.8
Studebaker Champ.	101	Plymouth 6	26.8
Nash Statesman 6	100	Studebaker Champ.	27.8
Rambler 6	90	Rambler 6	29.2

Note: Data on Nash and Hudson V8 engines not available

WHAT MAKES AUTOMATIC TRANSMISSIONS AUTOMATIC?

By Ed Packer

NOW THAT MOST CARS are equipped with automatic transmissions that require simply placing a speed-selector lever in one position and leaving it there for most driving conditions, the clutch pedal and gearshift lever are fast becoming as obsolete as running boards. But, what makes an automatic transmission automatic?

All automatic transmissions have three main parts. The first part is a fluid coupling or a torque converter, which replaces the conventional friction clutch. However, some of these transmissions retain a friction clutch which is located between the engine and the fluid coupling or torque converter. It is automatically released and engaged by hydraulic controls. At high speeds it is engaged for direct drive and the torque converter is ineffective. The second part of an automatic transmission is the gearing; planetary-gear sets replace the conventional sliding gears. The third, and most important, part of an automatic transmission is the hydraulic controls. Hydraulic controls make an automatic transmission truly automatic.

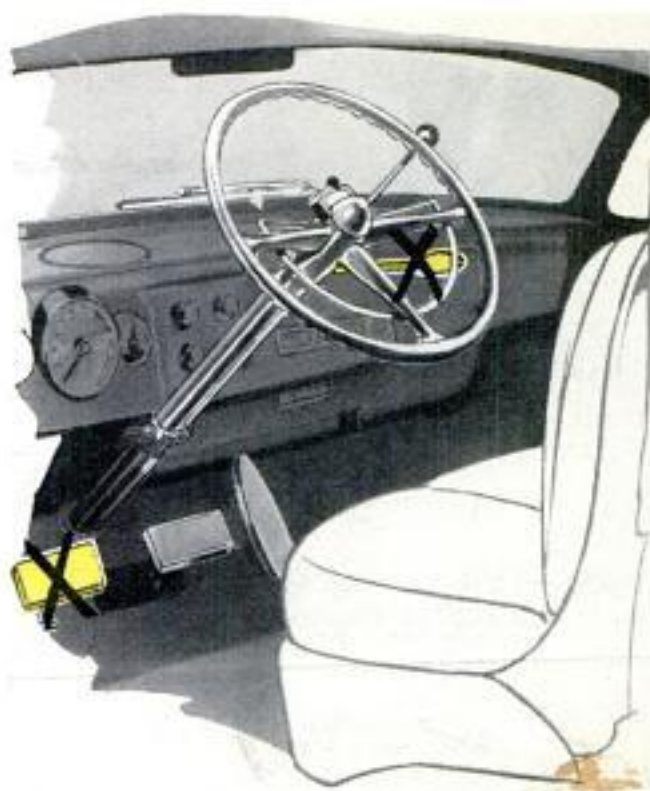

Disregarding friction clutches, which differ in operation from conventional clutches only because they are engaged and disengaged automatically, the first part of an automatic transmission will be either a fluid coupling or a torque converter.

The action of a fluid coupling generally is described as two fan blades facing each other in a closed housing containing oil. When one fan, the driving impeller which is connected to the motor, rotates, it forces oil against the other blade, the driven turbine which is connected to the transmission gears, and causes it to rotate.

The fluid coupling and torque converter

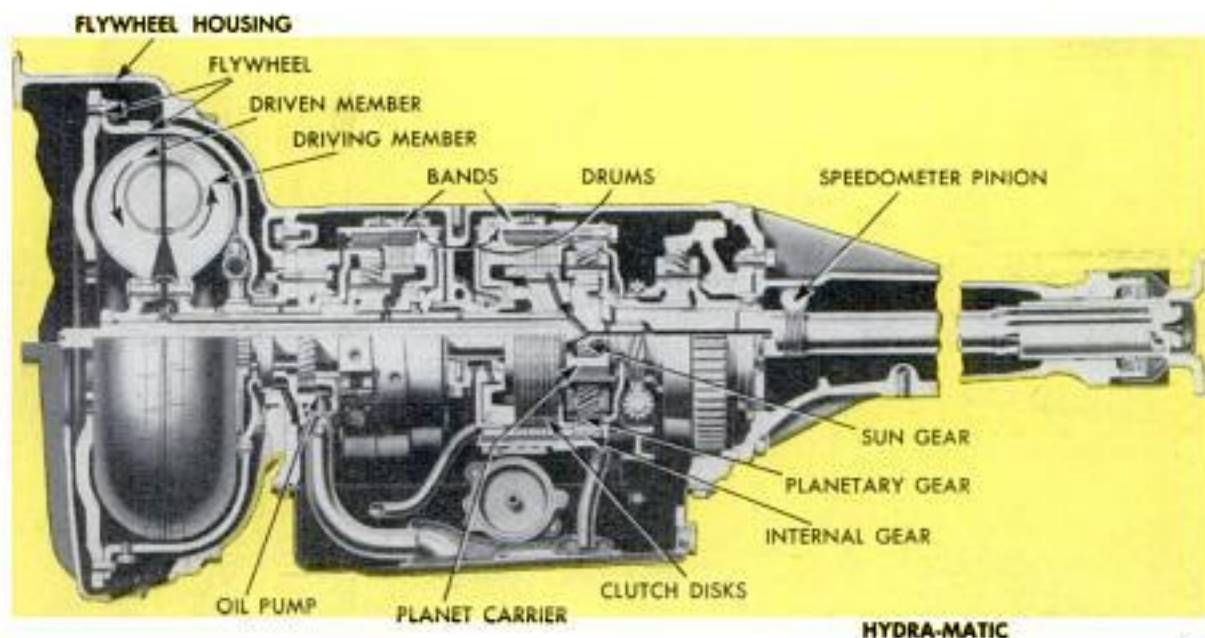

1

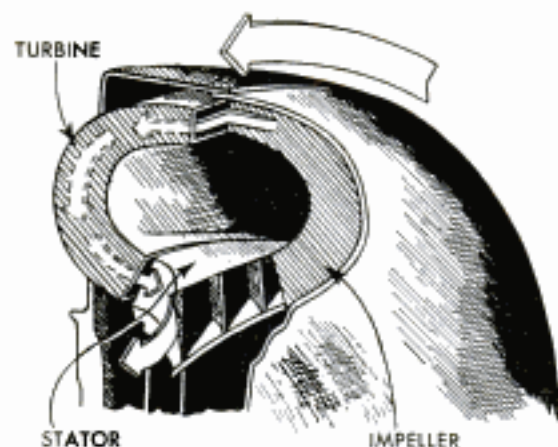

2

Figs. 2 and 3 show oil flow in torque converter. In Fig. 3, pin-wheel tips represent flow



3

are similar in that both include a driving impeller and driven turbine, which receives the power for transmission. The main difference between the two is the use of one or more reaction members, called stators, in the torque converter. The stators have curved blades which change the direction of the oil. As shown in Fig. 2, oil leaving the turbine is discharged through the stator blades in a direction more nearly paralleling the direction of the rotation of the impeller. The oil then recirculates through the impeller and goes back through the turbine.

One late-model transmission has variable-pitch stator blades which function much like the blades on a variable-pitch airplane propeller. The pitch is controlled by the position of the foot throttle.

Fig. 3 is a rough diagram, showing the oil flow inside a torque converter, the tips of the pin wheel representing the flow of oil through the impeller to the turbine and back through the stator blades as the torque-converter assembly rotates.

Since the oil discharged into the impeller from the stator is already in motion, when it leaves the impeller it will have the energy added by the impeller, plus the energy it had when it entered. This is the reason for the seeming paradox of getting more torque from a torque converter than is originally given it by the engine.

As the turbine speed approaches that of the impeller, stator torque drops off toward zero; the effect being somewhat like a man pushing a sled down a snowy hill. At first he would push hard, then, as the sled picked up speed, it would run away from him. Because of this type of

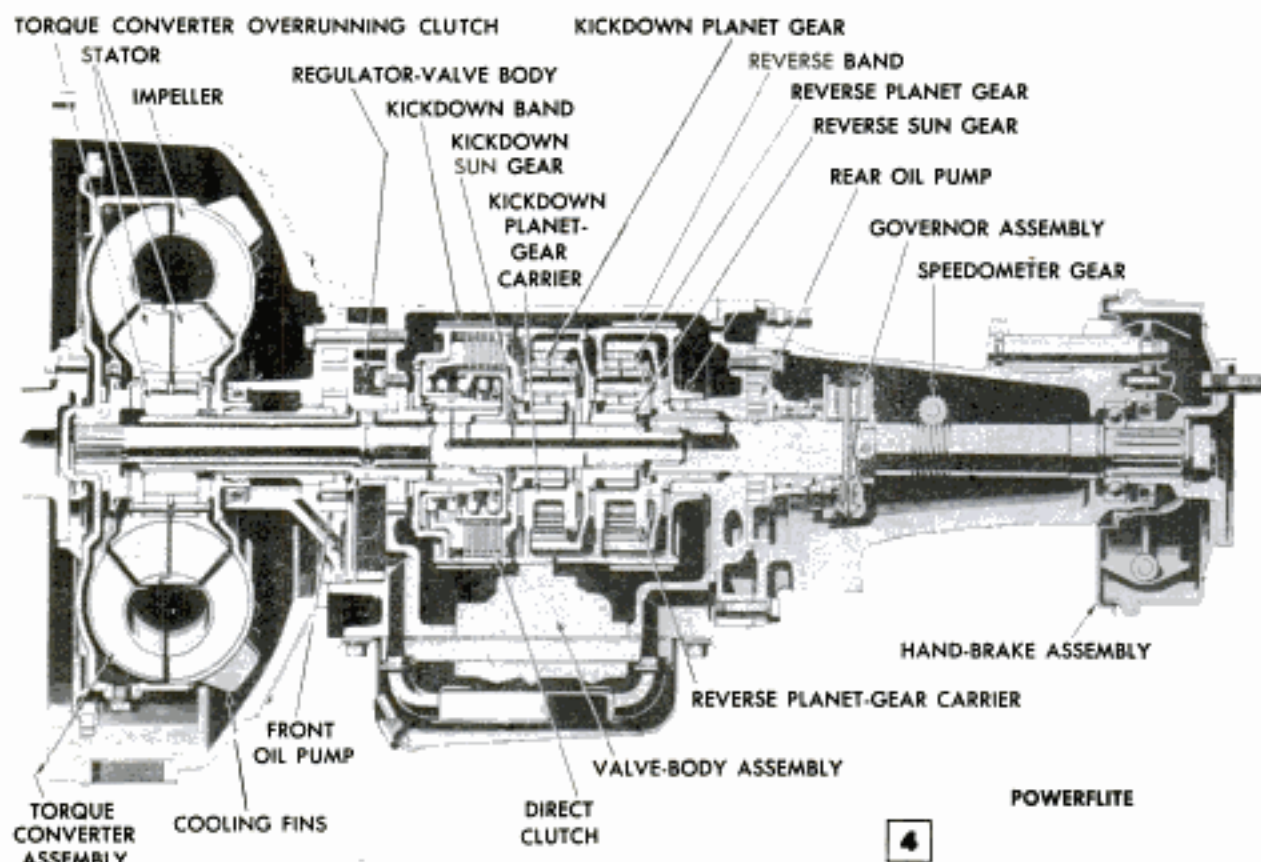

4

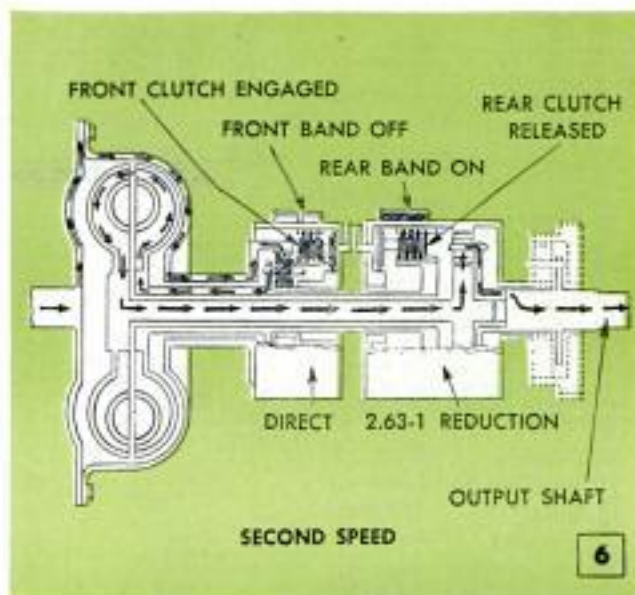
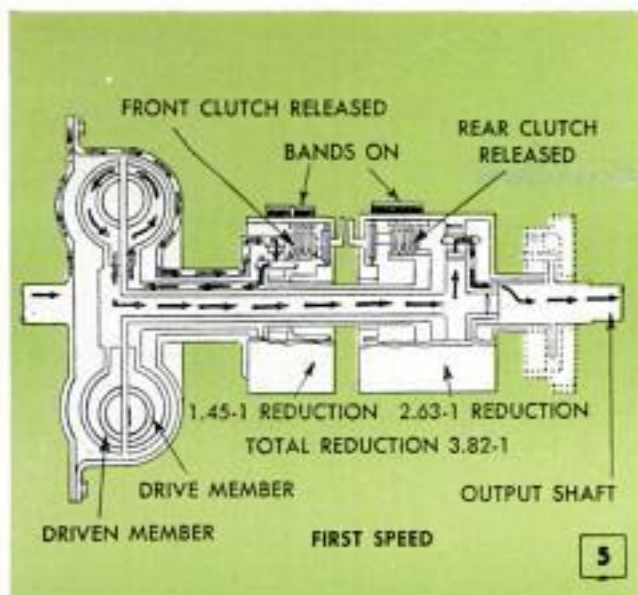

The sketches on this page show the paths of power flow through an automatic transmission with fluid coupling, two forward and one reverse planetary gear

Fig. 5 is first gear. Both bands on, both clutches off. Second speed, Fig. 6, has rear band and front clutch engaged, front band and rear clutch are released

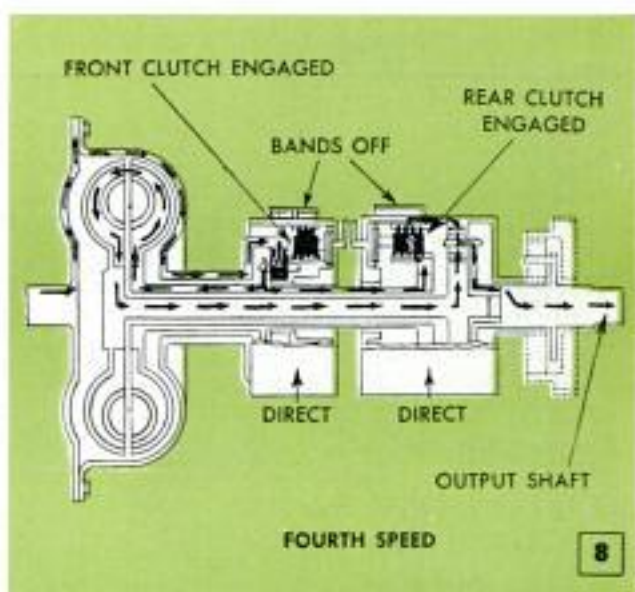
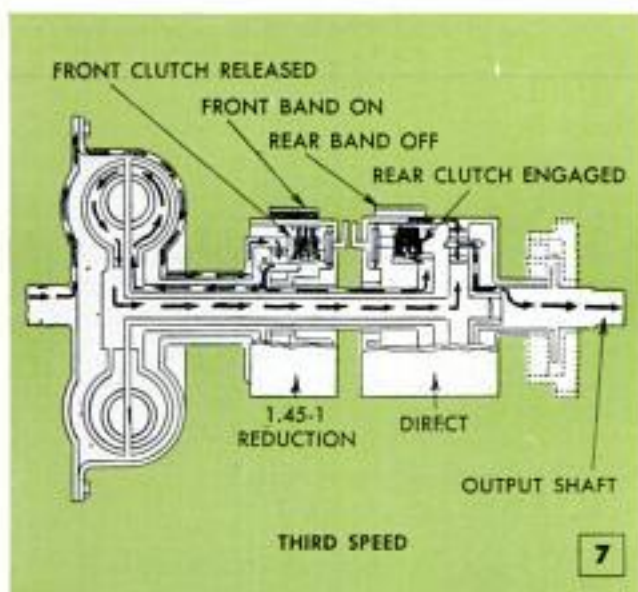

Third speed, Fig. 6, reverses the setting of second. In third, the front band and rear clutch are engaged, front clutch and rear band released. For reverse, Fig. 9, below, reverse planetary is anchored, front band on

Fourth speed, Fig. 8, is direct drive. Both bands are off, both clutches engaged. Fig. 10, below, shows neutral. Both clutches off, both brake bands released. Reverse planetary gear idles except when anchored

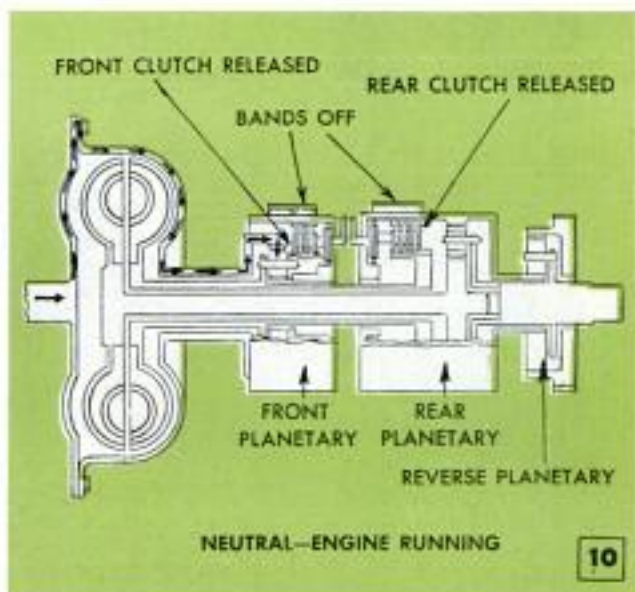
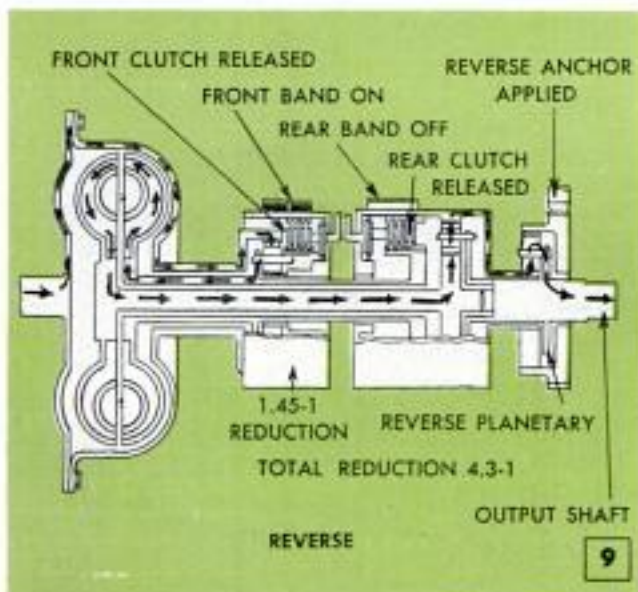

COMPARISON OF AUTOMATIC TRANSMISSIONS

Name of Unit	Cars Using	Type of Fluid Drive		Positive Clutch	Torque Multiplication Available (to One)				
		COUPLING	CONVERTER (No. of Elements)		CONVERTER	PLANETARY GEARS			
					1st	2nd	3rd	4th	
Hydra-Matic	Cadillac Hudson (Jet)	X	—	No	—	3.82	2.63	1.45	1
	Kaiser								
	Lincoln								
	Nash								
	Oldsmobile								
Dynaflow	Buick		X -4	No	2.45	1.82	1		
	Packard		X -4	Yes	2.55	1.82	1		
Powerglide	Chevrolet		X -3	No	2.10	1.82	1		
Studebaker	Studebaker		X -3	Yes	2.15	2.31	1.43	1	
Fordomatic	Ford		X -3	No	2.10	2.44	1.48	1	
Merc-O-Matic	Mercury		X -3	No	2.10	2.44	1.48	1	
	Chrysler		X -3	No	2.60	1.72	1		
Powerflite	DeSoto		X -3	No	2.60	1.72	1		
	Dodge		X -3	No	2.60	1.72	1		
	Plymouth		X -3	No	2.60	1.72	1		
	Imperial		X -3	No	2.60	1.72	1		
Hudson	Wasp		X -3	Yes	2.10	2.31	1.44	1	
	Hornet		X -3	Yes	2.10	2.31	1.44	1	

characteristic, the stator has an over-running clutch that permits it to turn freely when it no longer provides a boost in torque. The torque converter then functions very much like a fluid coupling.

All automatic transmissions contain one or more planetary-gear sets, Figs. 12 and 13. The planetary gear consists of a center, or sun, gear, one or more planet gears (usually three) meshing with the sun gear and an internal gear whose teeth mesh with the planet gears. The planet gears are held by a planet carrier which permits

them to rotate on their own shafts. Thus, the sun gear, planet gears and internal gear all can rotate on their own shafts and also rotate around or inside each other.

In one automatic transmission, the sun gear is fastened to the input, or driving, shaft, while the planet carrier is fastened to the output, or driven, shaft. Other transmissions use various arrangements in coupling the parts of the planetary gears to the driven shaft and driving shaft.

A brake band is placed around the outside of the internal gear, so it can be held

FORDOMATIC—MERC-O-MATIC

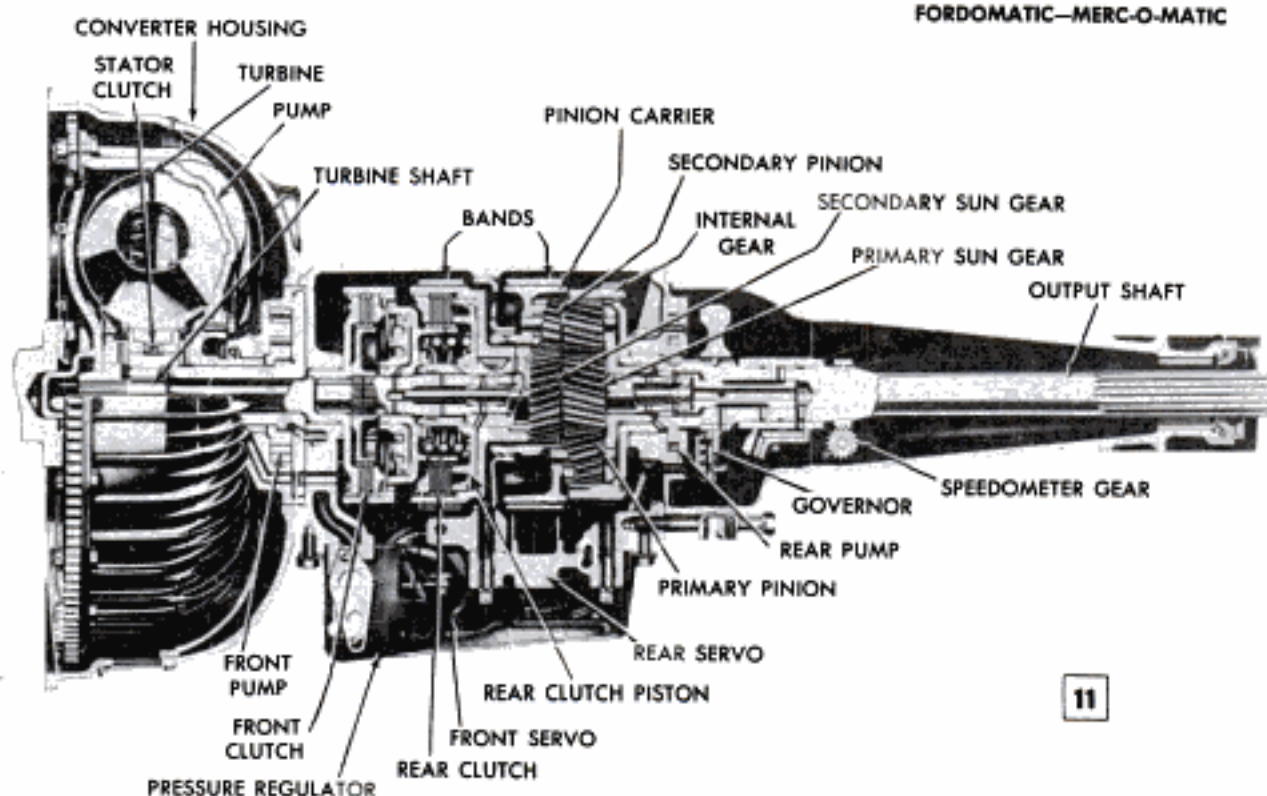

11

stationary when desired. A multiple-disk clutch is fitted in the planetary-gear set to permit locking the planet carrier to the internal gear. A three-planetary-gear, including reverse, transmission is illustrated in Figs. 5 to 10, inclusive. Basically, when both brake band and clutch are released, a planetary gear is in neutral, Fig. 10. When the internal gear is held with the brake band, Fig. 12, the planet gears revolve around the sun gear inside the internal gear, resulting in a reduction of movement and an increase in torque to the rear wheels. When the brake band is released and the planet-gear carrier and internal gear are locked together with a multiple-disk clutch, Fig. 13, they turn as a unit with the sun gear, providing direct drive.

The third part of an automatic transmission is the hydraulic controls, Fig. 14. Oil, under pressure, must be available to actuate the various controls. It is kept at a constant pressure by a pressure-regulator valve in the hydraulic-control system. Maintaining this pressure is one of the reasons an automatic transmission requires extra engine power. The selector lever on the steering column controls the manual valve which directs the oil to the proper location for the desired speed or direction. Speed changes also can be made by using the foot throttle, which sometimes is linked directly to a shifter valve, Fig. 14. The shifter valve provides a means of downshifting when extra acceleration is needed.

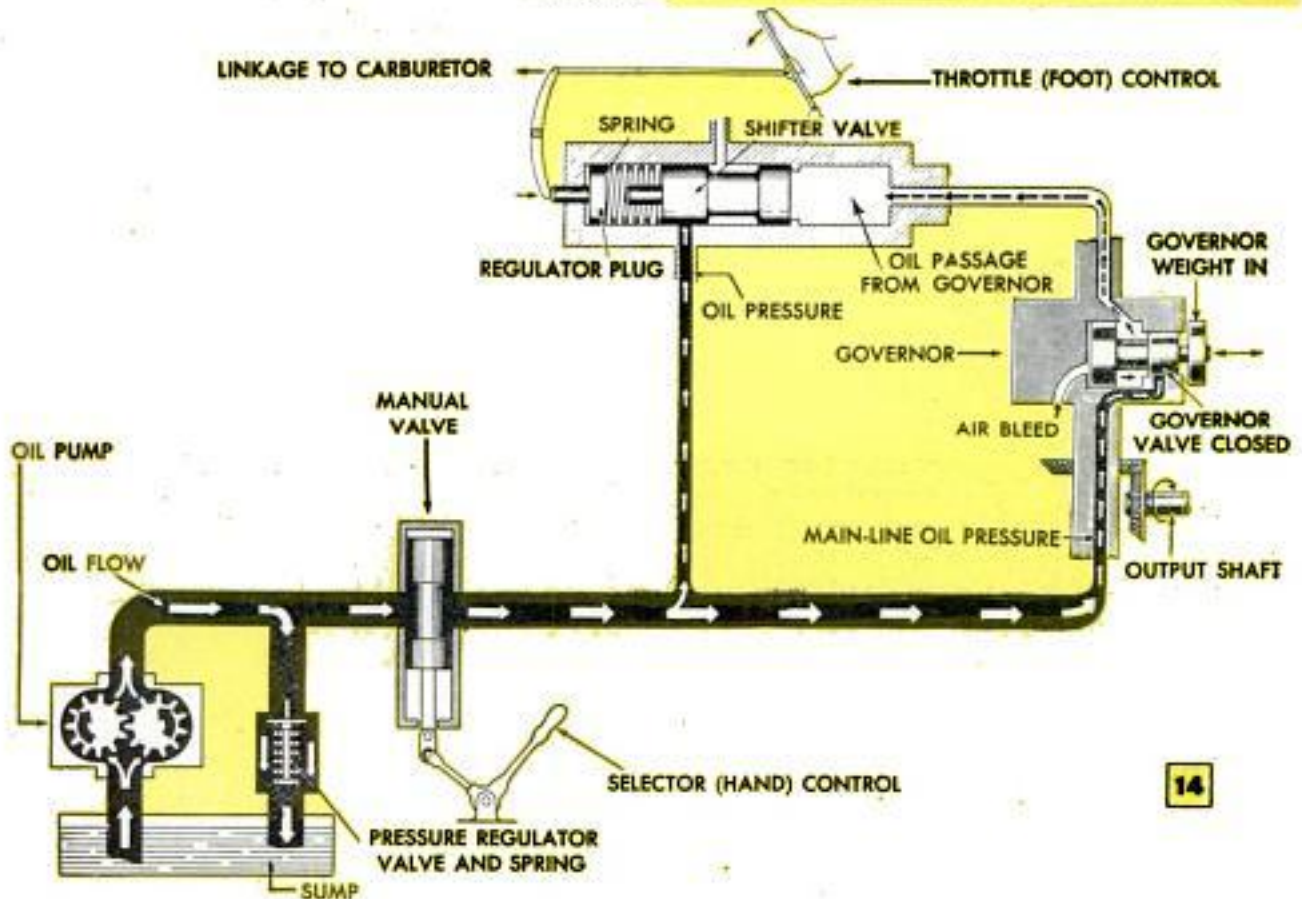
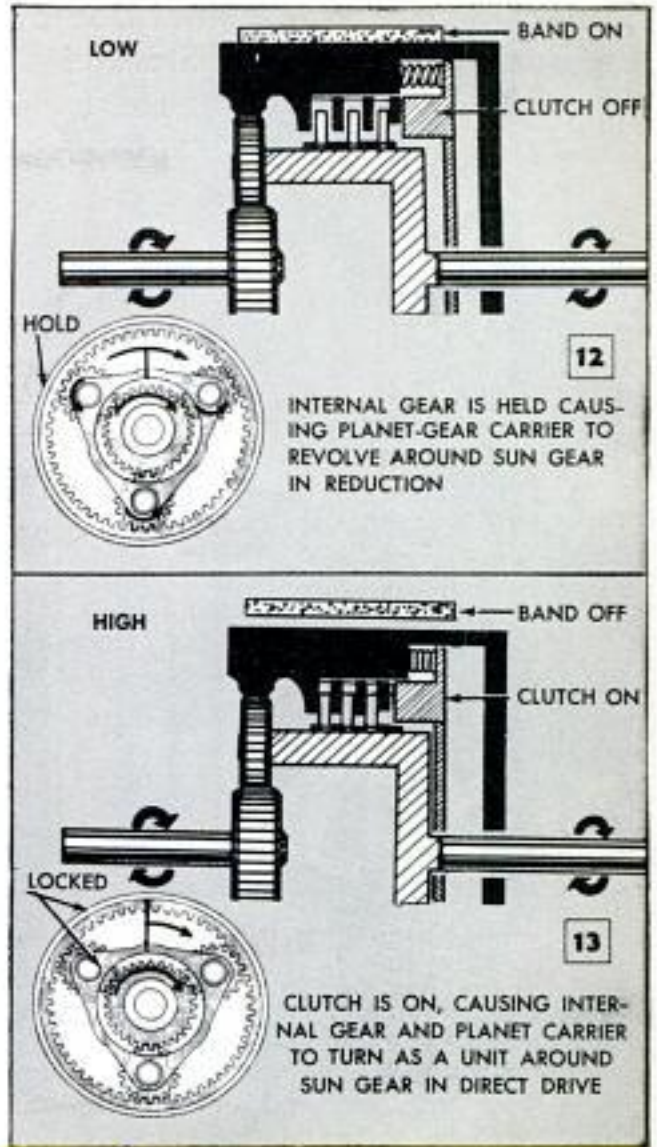

Shelves on Kitchen-Cabinet Doors Provide More Accessible Storage



Much of the inconvenience of stooping to reach into kitchen base cabinets can be avoided by attaching shelves to the doors. Then, when the doors are opened, most of the items are within easy reach. The shelves are rounded at the corners to clear the frame as the door is opened and a railing of metal weather stripping is screwed to the edges to prevent articles from sliding off. Depth of the cabinet shelving is reduced to provide clearance for the shelves on the door.

Paper Match Against Candle Wick Aids Lighting in Wind



If you have difficulty lighting a candle because of wind or dampness, bend a paper match so it can be held with its head against the wick. When flame is applied to match, it will ignite and fire the wick.

Estimating Floor-Tile Needs

Here is a quick and simple method of determining the number of 9 x 9-in. tiles needed to cover the floor of a room. First

multiply the length of the room by the width to determine the square feet. Next, double the square footage and subtract 10 percent of the number. The difference will be the number of tiles required. For example: A room is 8 x 14 ft., or 112 sq. ft. Double the number is 224 sq. ft. Subtract 10 percent, which is 22, and the answer is 202 tiles.—Tom Riley, Portland, Ore.

Plastic Sheet Over Drawing Protects Against Smudging

To prevent smudging a pencil drawing when adding lettering, use a sheet of celluloid or clear plastic in which a "window" is cut, as a shield over it. The edges of the window will hold the paper smoothly in place, and the transparent plastic



will permit more accurate spacing and location of the lettering than would a piece of paper used for the same purpose.

Wire Fed Through Lamp Column By Using Thread and Cotton

When ordinary methods do not permit feeding a wire through a lamp column which has a number of sharp curves and bends, a bit of cotton and a length of thread may be used to do the job. Tie the thread to the cotton which then is pushed into the lamp column with a toothpick or skewer. Now, feeding the thread carefully, blow into the column so the cotton is forced to the other end. When the cotton emerges, tie a heavy twine to it and pull it back through the column. The twine now can be used to pull through the wire for the lamp.

Ken Murray, Colon, Mich.

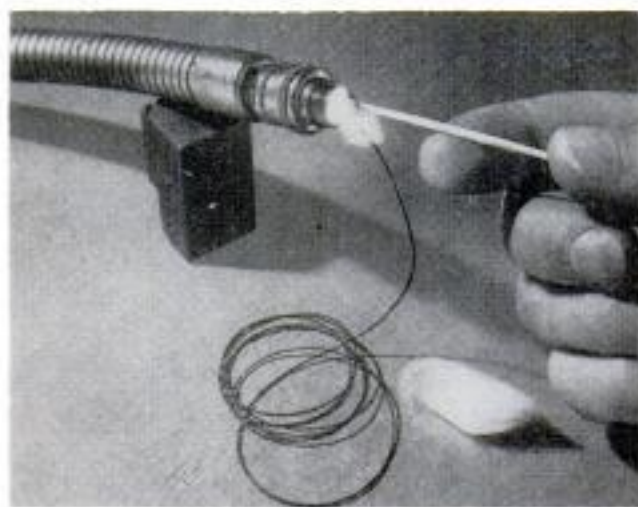

Whip Those Horses

By Fritz Springmann



WHEN "BREAKING IN" a new car, it should not be driven fast, nor should it be babied. High-speed driving will result in scuffed pistons and rings, and scored cylinder walls; consistently slow driving will guarantee an owner that his engine never will be properly broken in.

The drivers for the research department of the Union Oil Company of California, among others, use the "whip" technique when breaking in a new car; alternating periods of slow driving with a few seconds of fast driving.

Because modern heavy-duty motor oils give so much protection, they actually tend to retard proper break-in. In a new engine it is necessary, temporarily, to defeat the purpose of the tough oil film which coats the parts inside. The parts must be made to wear against each other. However, the wear must be controlled. Using the whip on the horses under the hood will provide a driver that means of control.

When a new car is ready to be broken in for test work by an oil company, a professional driver drives it for about 1/2 hr., or until the engine is thoroughly warmed.

Usually, the driving is done on a stretch of highway where the traffic is light.

The stretch of highway is approached at a speed of 25 m.p.h. Then, using a half-

throttle acceleration, the car is whipped up to 35 m.p.h. At 35, the throttle is released and the car allowed to drop back to 25 m.p.h. After a short run at 25, the car is again whipped to 35. This procedure is repeated for 100 miles. At the end of each 100 miles, the whip is stepped up 5 m.p.h. From 25 to 35 in the first 100 miles, the whip is stepped up to 30 to 40 in the second hundred, then 35 to 45, and so on, until the legal speed limit is reached. Beginning at the 35-to-45-m.p.h. period, a full-throttle whip is alternated with a half-throttle whip.

The whip provides the proper break-in conditions because when the engine is started on the run, the oil film on the cylinder walls is hot and thin. When the engine suddenly is accelerated, it works harder and, for just an instant, the oil film on the high spots in the metal of the cylinder wall and piston is ruptured, upper detail, page 176. In that instant, tiny metal particles are ground off.

When the throttle is released, the engine "relaxes" and oil flows back to the cylinder

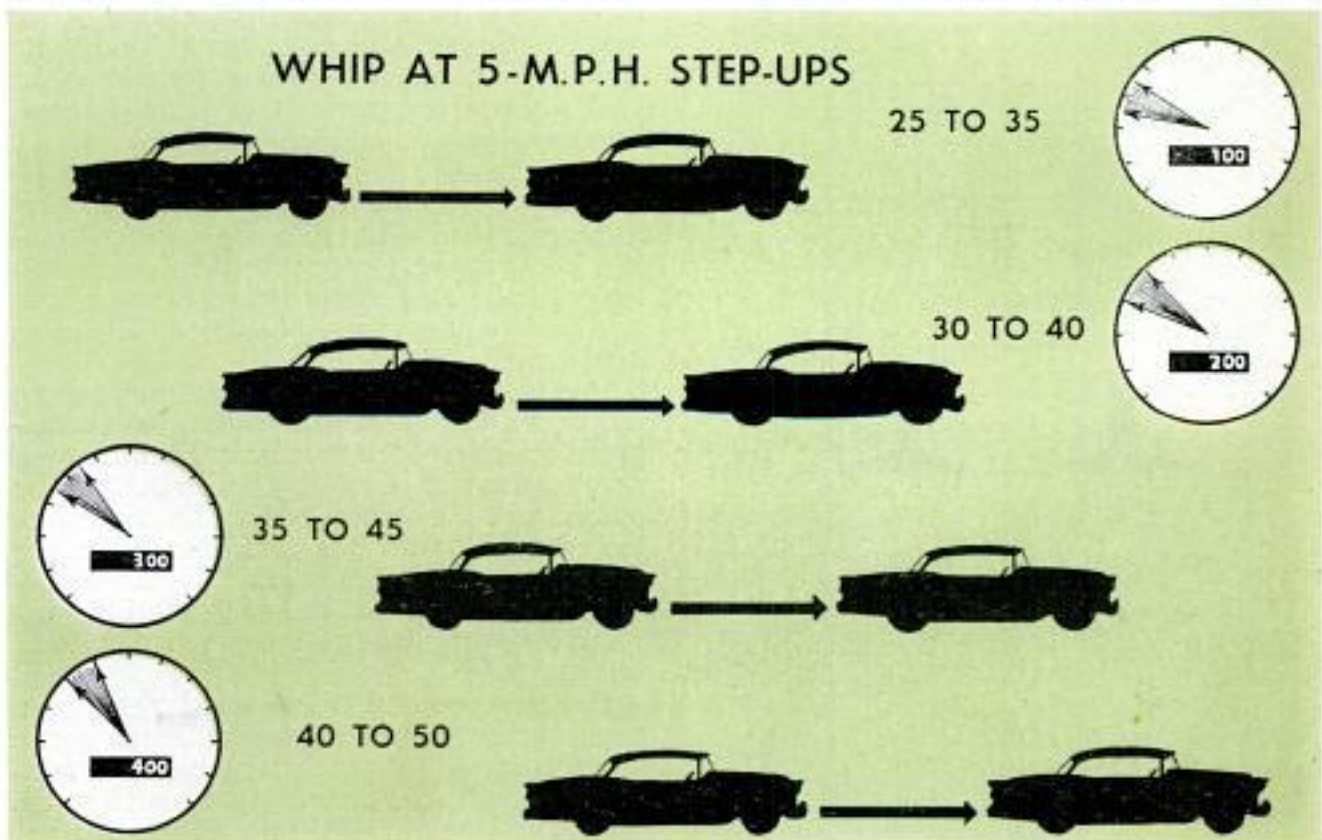

Do's and Don'ts for the New-Car Owner

Do:

Keep the engine hot and running during the break-in period. Plan a 3 or 4-hr. trip. Continuous driving is best for break-in.

Use high-octane gasoline during break-in. Detonation—knocking—resulting from low-grade gasoline, is particularly harmful to a new engine. The uncontrolled explosive force of the knock slams the piston against the cylinder wall, causing excessive wear at the top of the stroke. Also, there is possibility of damage to the rings.

Follow the manufacturer's recommendations. Thousands of miles on prototype engines have provided him with information unavailable to anyone else. It's in his interest, as well as yours, that the engine be broken in properly to assure a long and efficient life.

Have the engine well broken-in when it is taken in for the periodic new-car inspections. It is difficult, if not impossible, for a mechanic to diagnose possible difficulties in an engine that is not well run-in.

Don't:

Drive for long periods of time at high speeds. Steady, fast driving allows the metals to touch and wear, but there is no polishing action. Lift your foot occasionally and let the motor ease off so oil will get into the ring and cylinder-wall areas.

Idle the engine any more than is necessary. When a car idles, oil flow is low, no matter what the pressure gauge shows. Lubrication to the new, rough cylinder walls and rings is inadequate. Scuffing—localized wear—can result and cause permanent damage.

Warm up the car in the morning by idling it slowly. Start the engine, allow a half minute or so for the oil to circulate, then drive away. An engine warms best by working; it does not work at an idling speed.

Try jack-rabbit starts from a stop light. The sudden acceleration scrapes the oil from the cylinder walls and bare metal-to-metal contact occurs. Scored cylinder walls and broken rings are often the result.

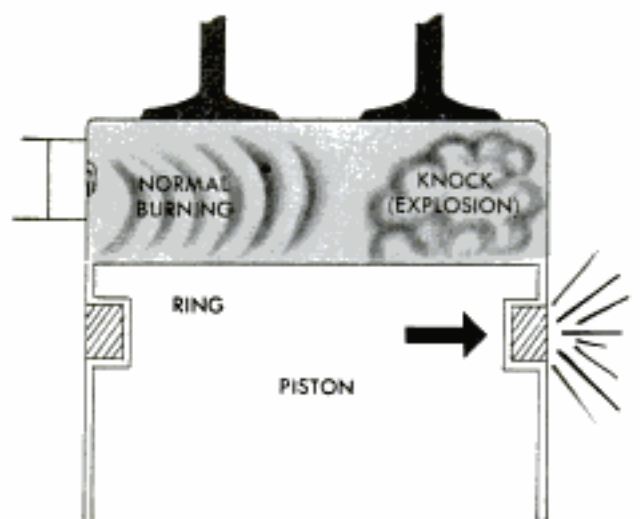
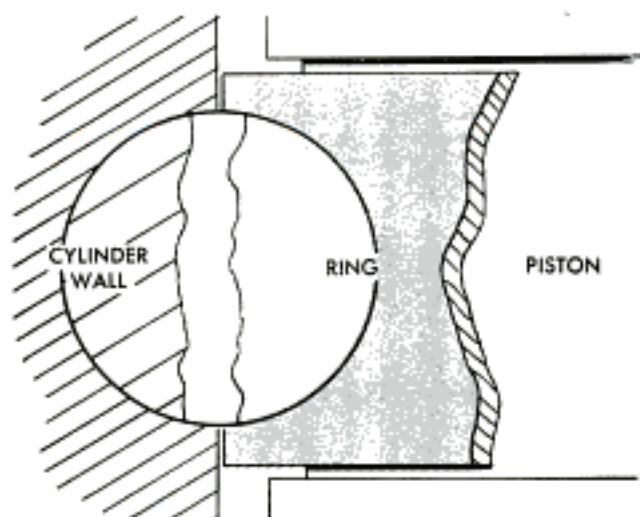

walls. The oil, under pressure, polishes the spots where the metal has been ground off. Slow speed and slow acceleration are used to grind these first high spots. Then, as more metal is removed and polished, the engine is speeded up and the accelerations are more rapid.

The whip technique, in spite of its name, conforms with the recommendations of car manufacturers. Also, the normal conditions of heavy traffic fit the whip technique. In traffic there are periods of slow driving, alternating with sudden accelerations, or whips.

A few words of caution about breaking in an engine: Do not idle the engine excessively. Four or five minutes is much too long; piston-ring manufacturers specifically advise against long periods of idle with new rings.

Use a premium-grade gasoline during the break-in period. Detonation from low-grade gasoline is particularly harmful to a new engine; the explosive force behind the detonation slams the piston rings against the cylinder walls, causing faster wear near the top of the piston stroke, see lower detail at left. Normal-burning gasoline assures an even impulse over the full face of the piston.

The glass-smooth, well-fitted parts of a properly broken-in engine will not break down the oil film when the engine is suddenly accelerated or driven at high speeds.

Just remember, when the engine is new, whip those horses! ★★★

Tool Improvised From Needle Aids Leather Craftsman

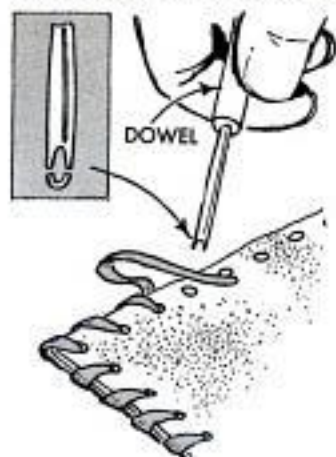

A tool made by modifying a darning needle can be used by the amateur leather craftsman to speed the job of lacing or binding with leather thongs. First, the point of the needle is pushed into a short length of wooden dowel to provide a handle

for the tool. Next, the top of the needle is broken off to form a two-tined fork. The fork fits over the leather thong and is used to force it through the holes.

Rubber Scraper Spreads Glue

A rubber plate scraper, the blade of which has been notched saw-tooth fashion to a depth of $\frac{1}{2}$ in., provides a practical glue spreader. Such a spreader distributes the glue evenly over large areas and is easy to clean when the job is finished.

Plastic Cap Provides Insulator To Protect Flashlight Dry Cells

The dry cells in a flashlight will not be dead when the light is needed if it is stored with the plastic cap from a tube of toothpaste fitted in the contact spring at the bottom of the case. Even if the switch is turned on accidentally, the cap will effectively insulate the spring from the dry cell and prevent a complete electrical circuit. It takes only a moment to unscrew the end of the flashlight and remove the cap when the light is to be used.

Ken Murray, Colon, Mich.

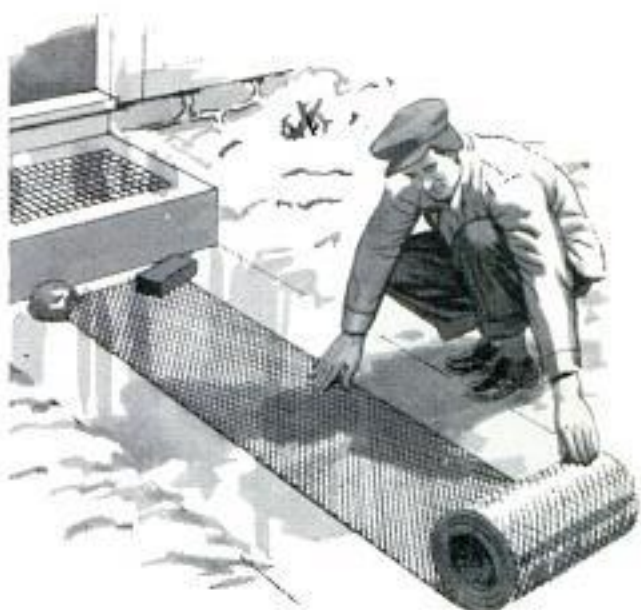
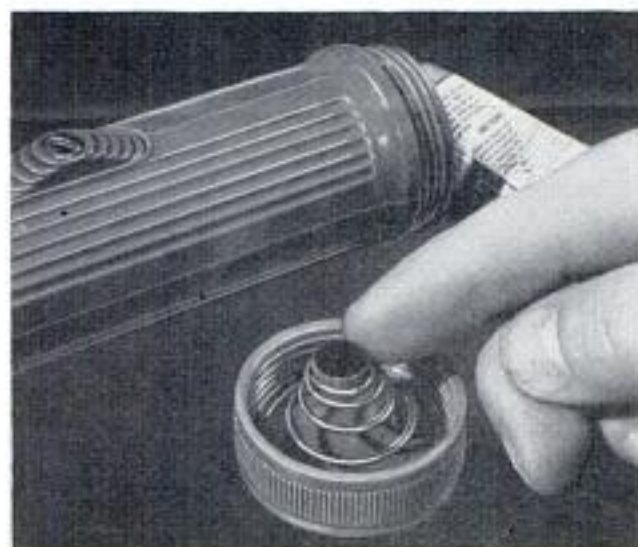

Ice-Glazed Sidewalk Made Safe With Wire-Mesh Covering

The danger of slipping on an icy sidewalk can be reduced if the sidewalk is covered with small-size wire mesh. A roll of the mesh 24 in. wide and the length of the sidewalk can be kept at hand and unrolled when necessary. To keep the mesh flat, weight the ends and points along the edges with bricks. A person's weight on the mesh will cause it to grip the ice and prevent it from slipping. The mesh has several advantages over the spreading of salt on the walk, the biggest one being that salt may kill grass near the sidewalk.

Adding-Machine Tape in Holder Used for Shopping Lists

A plentiful supply of paper on which to write notes and shopping lists is assured by a roll of adding-machine tape in this holder. The base of the holder is cut from $\frac{1}{4}$ -in. plywood, and is $3\frac{1}{2}$ x 12 in. The dimensions of the slotted brackets are determined by the size of the roll of paper, which should be purchased before they are cut. The roll is slipped over a $\frac{1}{4}$ -in. dowel which then is dropped into the slots. Lengths of coat-hanger wire are bent and fitted into holes drilled in the base to provide paper guides.

Dorothy Marshall, Palisades Park, N. J.

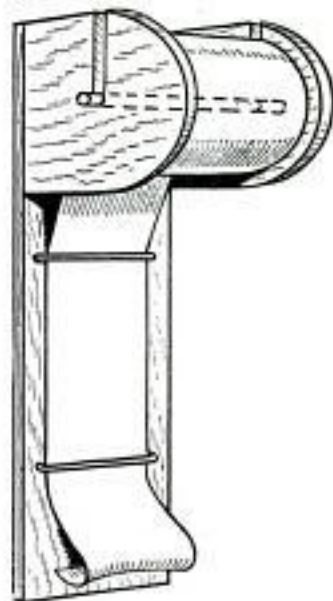

Pickets in Fence Kept Aligned By Sheet-Metal Gauge



Pickets are spaced evenly and parallel and the bottom ends all kept level with a gauge cut and shaped from sheet metal. The gauge, shown in the detail, hangs from the top rail of the fence, rests against the bottom rail and supports the bottom of picket being nailed. The width of the gauge will depend on the spacing desired between pickets. The length of the pickets and the distance they are to be kept above the ground determines the length of the gauge from the top to bottom bend.

William B. Eagan, Louisville, Ky.

Miter Box Held on Workbench With Cotter-Pinned Hinges

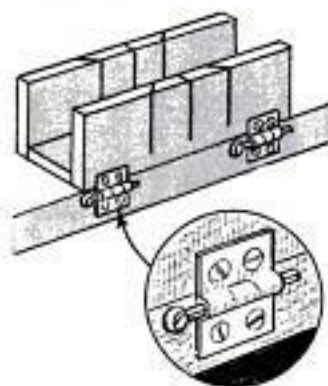

The problem of holding a wooden miter box firmly on a workbench top can be solved by using a pair of butt hinges with removable pins. The hinges are screwed to the miter box and to the front edge of the workbench at any

desired location. The regular hinge pins then are removed and replaced with cotter pins, to permit quick installation or removal of the miter box.

Applying Hardwood Grain to Pine

Pine and other inexpensive woods can be grained in imitation of more expensive woods by applying ground color and grain-

ing or top color, then using a graining comb. In the more common of several procedures, the ground color is brushed on first and allowed to dry completely. The graining color, which is of a thick, puttylike consistency, must be thinned with turpentine so it can be brushed. A teaspoonful of japan drier added to each pint of ground color and graining color will speed drying. Apply the graining color, then, while it is still wet, use the graining comb to get the desired grain effect. One or more coats of varnish should be applied over the graining when it is thoroughly dry.

Francis W. Henry, Pottsville, Pa.

Reflective Tape Around Flagstaff Protects it From Damage

To reduce the chances of having a curb-mounted flagstaff broken or damaged by a carelessly parked car, one merchant wrapped it with reflective tape to make it more conspicuous. The tape was applied in a spiral from the ground up to a point clearly visible to any driver.



"Rollback" Toy for Small Tots Utilizes Empty Coffee Can

Mystifying and amusing to small children, this coffee-can toy will automatically return to the person who rolls it on a smooth surface. To make it, solder a length of wire to the inside of the lid and one to the inside of the bottom of the can. Bend the ends of the wires to form hooks into which rubber bands are fitted as shown in the photo. The two bands are tied together and a fishing sinker or other weight is tied or taped at the knot.

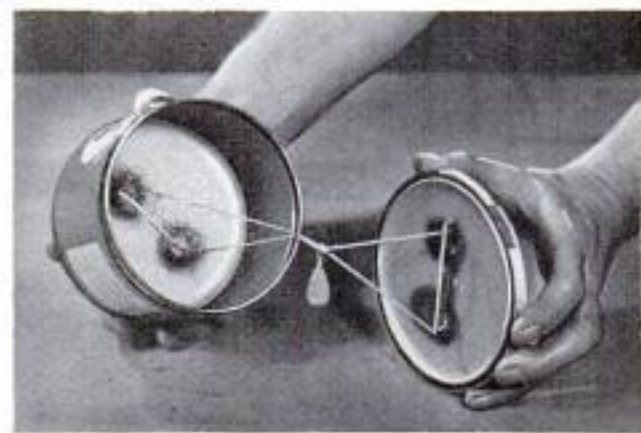

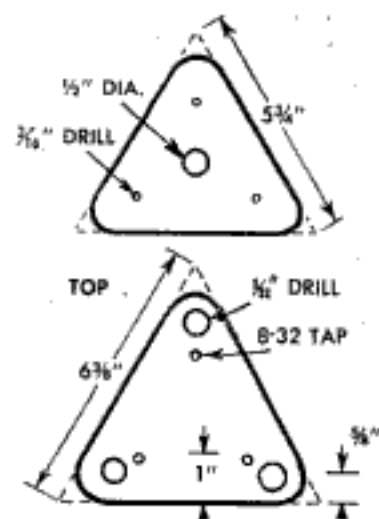
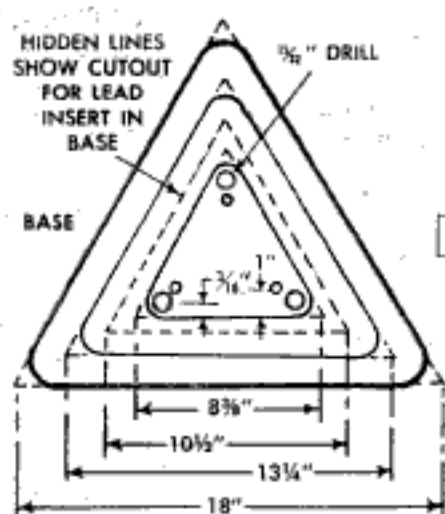
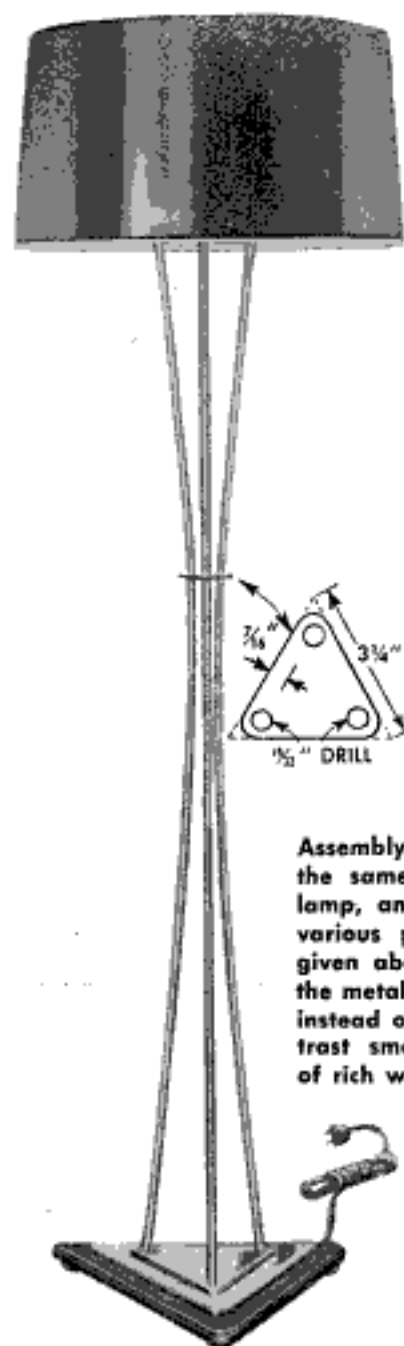

Assembly of the floor lamp is the same as for the table lamp, and the sizes of the various parts required are given above. If you prefer, the metal parts can be brass instead of aluminum to contrast smartly with a base of rich walnut or mahogany

birch plywood. The top assembly of each lamp consists of two triangular-shaped members of $\frac{1}{4}$ -in. aluminum. In the case of the table lamp, the bottom piece of the top assembly and the upper piece of the base assembly are drilled to take three $18\frac{1}{2}$ -in. lengths of $\frac{3}{8}$ -in.-o.d. aluminum tubing. The floor lamp requires three 56-in. lengths of $\frac{1}{2}$ -in.-o.d. tubing. Check the exact diameter of the tubing before drilling the holes so they will be a fairly tight fit over the ends of the tubes, and drill the holes at a 7-deg. inward angle. The tubes are locked to the top and base assemblies by slitting the ends for a distance of $\frac{1}{4}$ in. and then crimping the metal over as shown in Fig. 1. Collars sliced from larger tubing conceal the crimped ends and serve as spacers between the upper and lower aluminum plates. The tubes are held securely by the top plate which is drilled to set down

over a socket nipple and also drilled for three roundheaded chrome machine screws. Registering holes tapped in the bottom plate permit bolting the top plate firmly against the collars and crimped ends of the tubing. Notice that one of the collars, as well as the nut on the socket nipple, is slotted to admit the electric cord. Practically the same clamping method is used to hold the tubes to the base. Here, however, collars are omitted and shallow recesses are made in the second member of the base to house the crimped ends of the tubes so that the aluminum top plate may be pulled down flush with screws. Bases for both the table and floor lamp are weighted with lead which is held in a recess made in the underside of the base. Proper curvature of the tubing is maintained by a $\frac{1}{4}$ -in. spacer plate which is drilled as indicated and slipped over the ends of the tubes before the top assembly is attached. In the case of the table lamp, the plate should be positioned $6\frac{3}{4}$ in. down from the top and $17\frac{1}{4}$ in. down from the top of the floor lamp. It will be necessary to hand-bend the curvature of the tubes for the table lamp before assembly.

All metal parts of the lamps should be polished before assembly. If a soft finish is desired, simply remove any scratches in the metal with fine emery cloth and finish up with crocus cloth or Wetordry paper. If a buffing wheel is available, the aluminum parts can be given a chromelike polish. Either type of finish may be protected from tarnishing with a coat or two of clear metal lacquer.

Each lamp should be fitted with a three-way switch and bulb, the floor lamp being 100, 200, 300 watts and the table lamp 50, 100, 150 watts. A 20-in. shade is about right for the floor lamp, whereas a 16-in. shade, held by a 9-in. harp, is recommended for the table lamp. Rubber feet are added to the corners of the bases to provide clearance for the lamp cord.

Refinishing Old Tables

By
Walter E. Burton

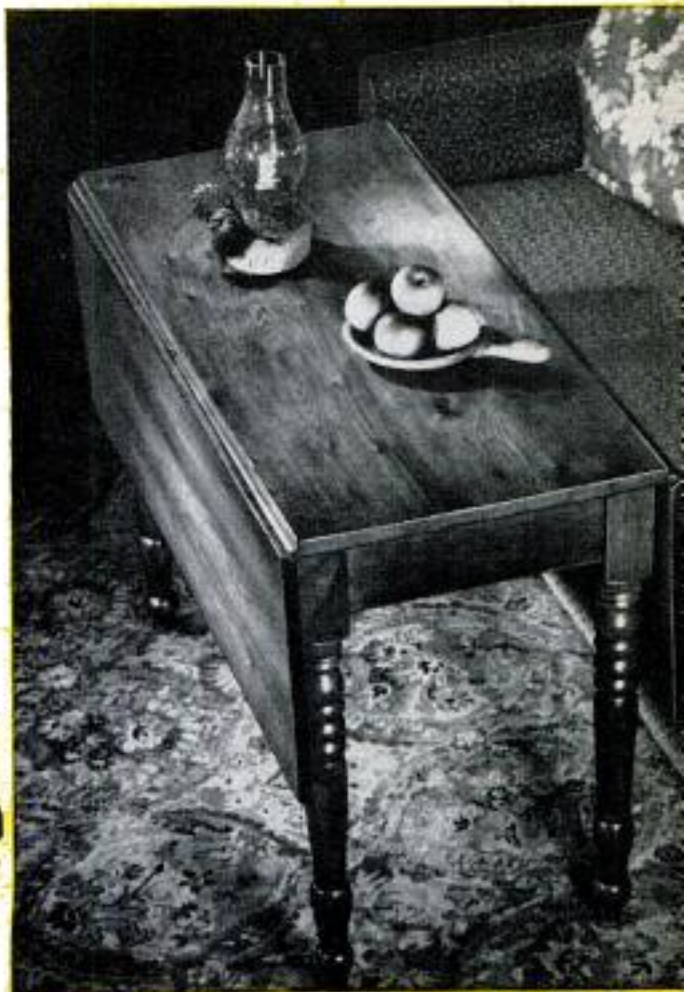

ONCE A FAMILIAR ITEM in almost every home, the old drop-leaf table still can be found in many an attic or basement. These tables usually were made of fine cabinet woods, such as walnut or cherry, and are capable of being transformed into pieces of furniture welcome in present-day decorative schemes.

In fact, the drop-leaf table in restored condition is a popular antique-dealer item that usually commands a good price. These tables, however, often are over-restored,

the charming imprints of age having been ruthlessly planed, scraped or sanded away. In carrying out the refinishing process on such tables, or any other antique, you can save time and work while achieving a more pleasing appearance by taking it easy on the smoothing and sanding operations. A little unevenness and a few dents and stains lend an air of authentic age to the table. The photos on the following two pages take you through the steps of refinishing a typical drop-leaf table. ★ ★ ★

When refinished table in photo above is compared to the time-worn original in the photo at the right, the striking effects of refinishing become readily apparent. Natural beauty of the walnut grain was brought out, hinges repaired and joints reglued. Yet enough of the patina of age was allowed to remain in the table so it did not lose character as a fine antique piece





The first step in refinishing table is to take it apart. In this case, it was easy as the joints were fairly loose. Then the finish is stripped off with a commercial remover. A dull knife blade or a wad of steel wool can be used for removing the softened varnish from the turned portions of the legs. Wash off the remover with turpentine or other solvent. It is extremely important that all traces of remover be eliminated from the surface before the new finish is applied



After all parts of the table have been cleaned of old finish and glue, reglue mortise and tenon joints of legs and apron. The groove noticeable in the apron may be used for clamping it to table top later

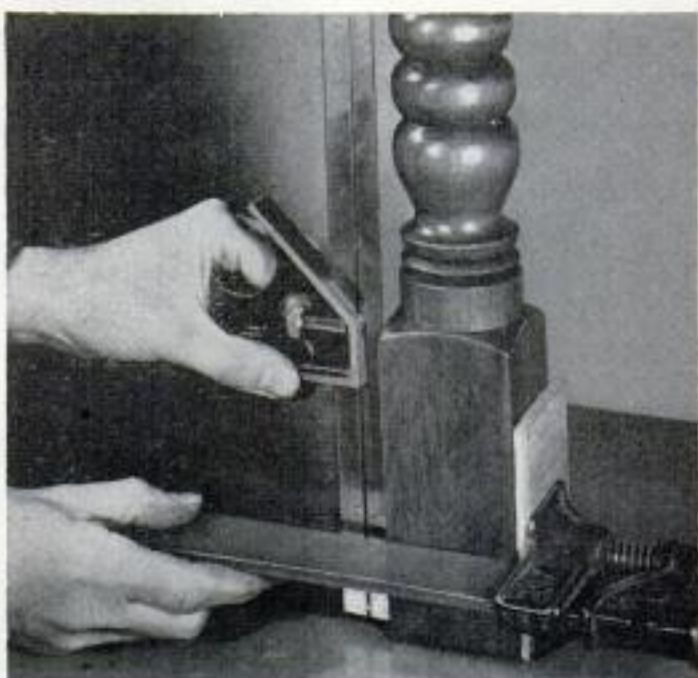

When gluing apron to legs be sure that parts are clamped at right angles. If alignment is not satisfactory, the leg usually can be swung into the desired position by shifting clamp pressure slightly

Joints of the table top and leaves each originally contained two dowels. Where boards are warped, two additional dowels are added between original pair. Glue is applied to board edges as well as to dowels

When leaf or table-top joint is sound except for a few inches at one end, pry open joint with knife, clean out with thin strip of steel or saw blade and apply glue with same tool. Then clamp joint for drying

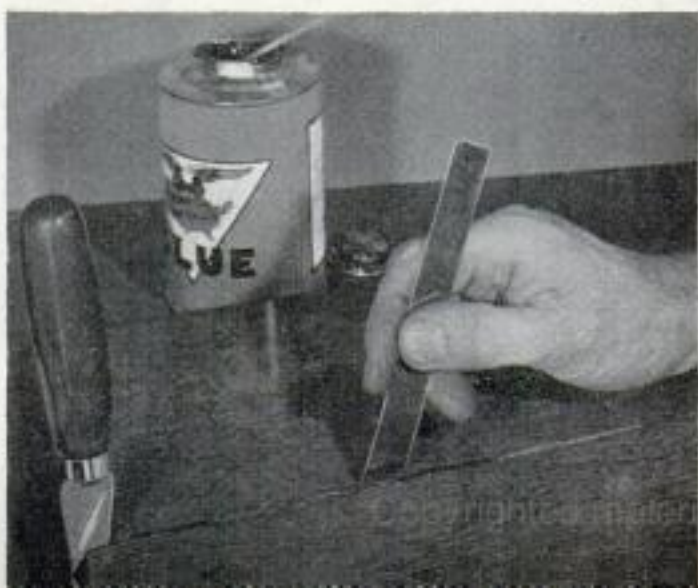

To straighten badly warped boards, make parallel cuts in the backs of the boards with a circular saw. Space cuts about 1 inch apart and make them in direction which will aid straightening. Cuts should be of a depth equal to $\frac{2}{5}$ to $\frac{3}{4}$ thickness of boards. Except in severe cases of warping, cuts should not run all the way to edges of wood. To straighten boards, lay them concave-side-down on several thicknesses of wet newspaper placed preferably on concrete floor. Paper should be directly under the warped portions only

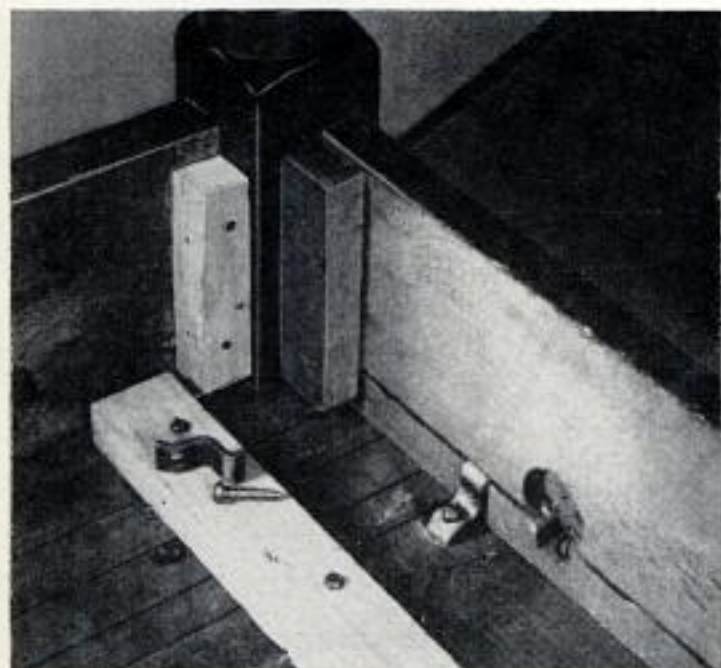
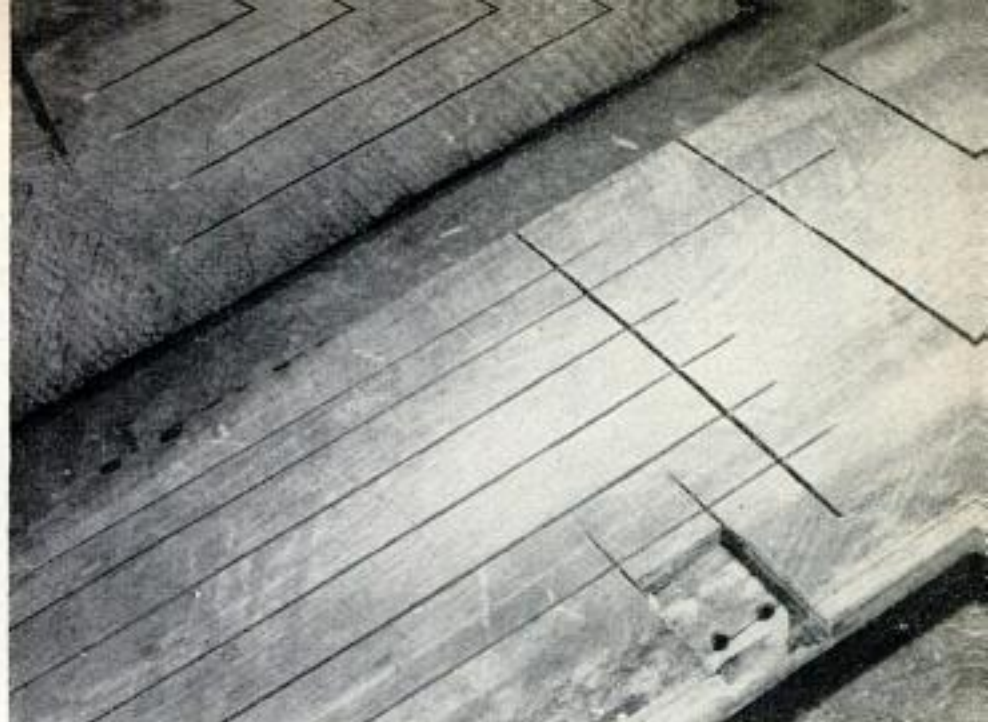

After the boards are straight and before they have a chance to warp again, plane the edges, fit the joints, glue and clamp. Screw the table top to the aprons, reinforcing with steel clamps if necessary

Damaged spots that are objectionable can be filled with inlays of the same kind of wood. First cut recess, and an inlay to fit it snugly. Then apply inlay with quick-drying cement and sand flush with surface

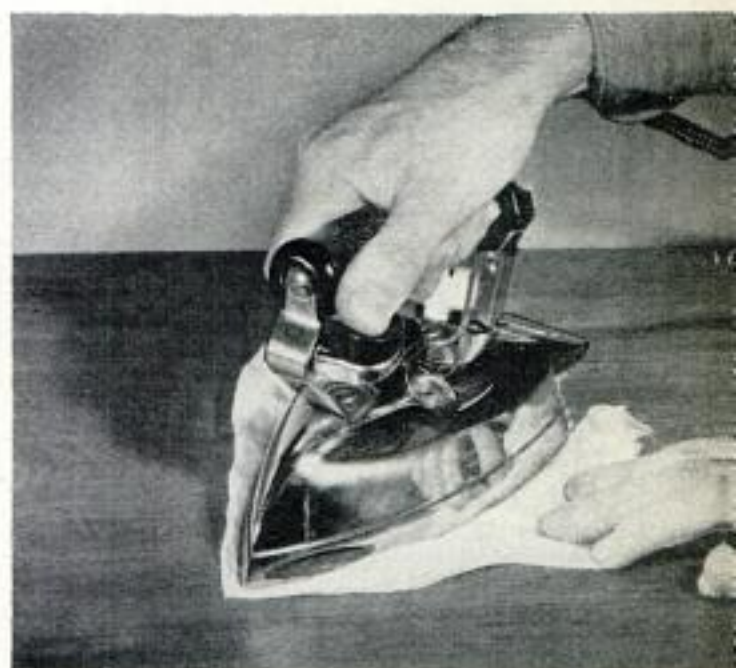
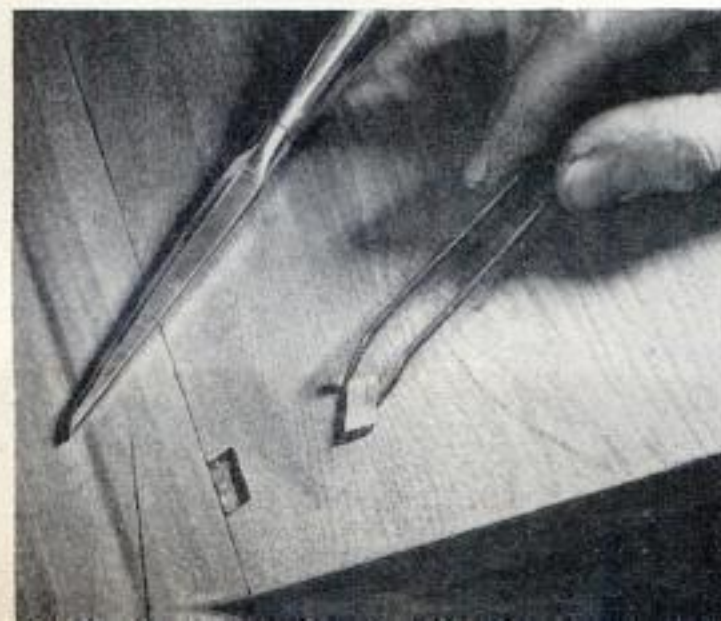

A few dents in table contribute to appearance of age. However, dents that you want removed can be "erased" by steaming the wood with a wet cloth and a hot iron. Raised area is sanded after wood dries

After table is ready for finishing, it is given three coats of shellac each of which is sanded. When shellac has dried, surface is waxed with furniture wax of proper color or a suitable wax-base shoe polish



Pegs in Narrow Board on Wall Provide Tool Storage

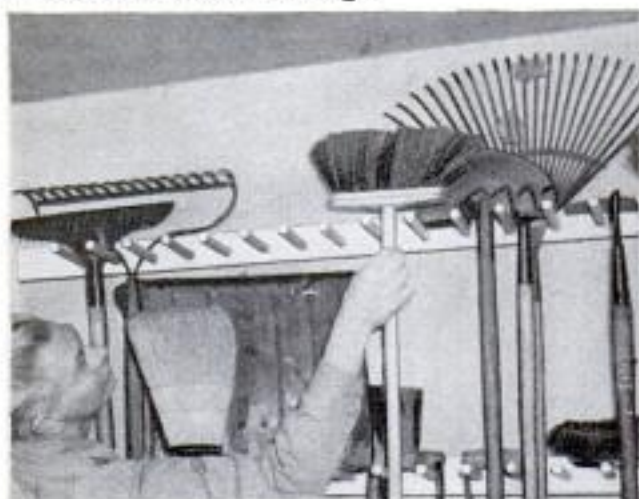

One method of hanging shovels, rakes, brooms and other outdoor tools in a garage or tool shed is to use rows of pegs spaced uniformly on a narrow board nailed to the wall studs. The pegs are $\frac{1}{2}$ -in. dowels about 8 in. long, glued into holes drilled at a slight downward angle. The pegs are long enough to hold even bulky and odd-shaped tools and several smaller tools may be hung on the same peg. Thus, maximum storage is provided in a minimum of space.

Bent Bolt Prevents Nut Turning

Turning a nut on a carriage bolt usually is quite difficult if the bolt itself turns in the hole in which it is inserted. This can be remedied by bending the shank of the bolt so it will become wedged against the side of the hole when the nut is tightened.

Radio Pilot Lamp Used To Replace Night Light



Often used as a night light, the small round bulb of the type shown at the left in the photo has a disappointingly short life. However, pilot-light bulbs, such as are used in radios, cost no more, provide as much light and last several times longer than the regular round bulbs. A radio pilot light is shown at the right in the photo,

fitted in the adapter which is required when the smaller pilot bulb is used in a regular-size socket. The adapter costs only a few cents and the bulbs are available either clear or colored.

Glue Spread for Wood Veneering With Windshield-Wiper Blade

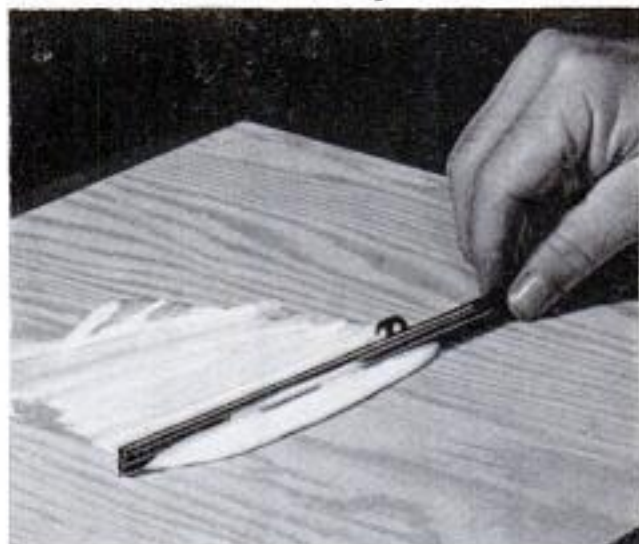

A windshield-wiper blade makes an excellent tool for spreading glue on a large surface when doing veneer work. The rubber of the blade passes over irregularities easily and produces a coat of glue of uniform thickness. Also, the chance of the glue drying more rapidly in one spot than another is reduced because a large area can be covered more quickly than with other types of applicators.

Curled Prints Straightened

Photographic prints which have a tendency to curl after drying can be straightened by rolling them in a roll of shelf paper. The prints are placed face downward, as shown in the photo, so that the curl is reversed. Two hours is sufficient time to straighten small photos; large prints should be left in the roll overnight.

O. A. Nelson, Seattle, Wash.

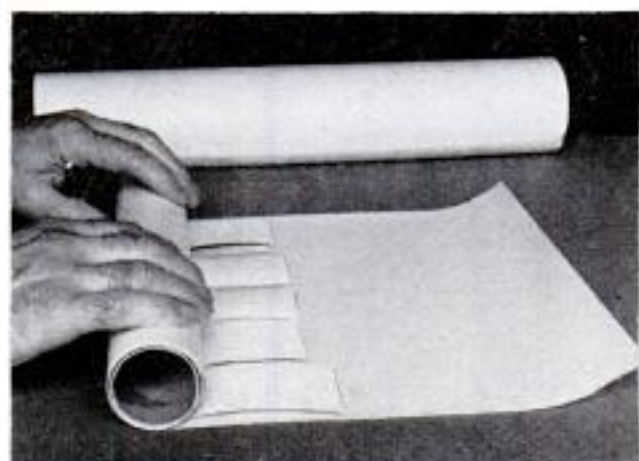

TELEPHONE GOSSIP-CHAIR

By I. M. Fenn

GRACEFULLY PROPORTIONED to go well with a wall telephone shelf, this little chair can be nested under it when not in use. Walnut and mahogany are appropriate woods to use in the case of period furniture; birch and maple to match blond modern pieces. Start by making full-size paper patterns of all the scroll-cut parts. Both front and rear legs of the chair should be bandsawed in pairs, cutting two thicknesses of stock at one time and sanding the edges while both parts are still temporarily tacked together. Except for the seat, all the parts are doweled and glued. Before actual assembly, counterbored holes are made in the side and front seat rails for fastening the seat with screws. Corner blocks are added to provide rigidity.

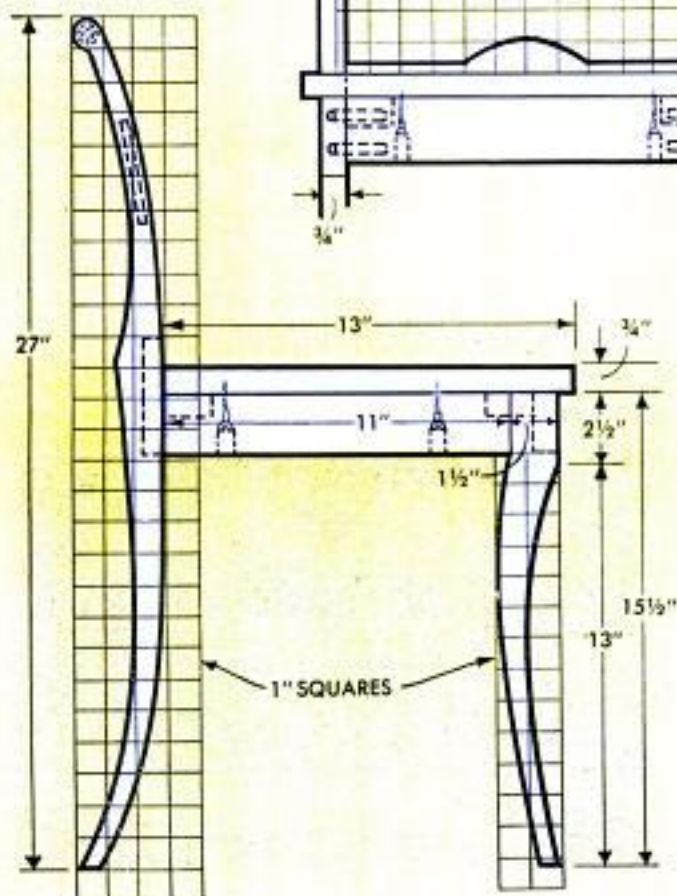
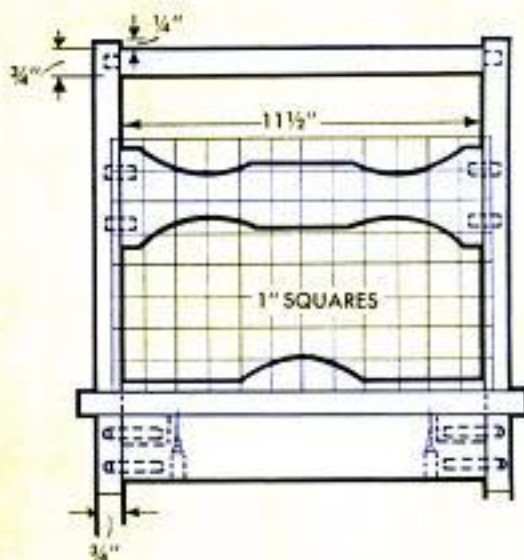

Simple Steel "Forks" Hold Screen To Aid Fitting on the Job



The problem of holding storm windows and screens on edge for planing, when fitting them on the job, was solved by one carpenter with a simple steel "fork." The fork is shaped from steel rod, as shown in the detail, and the bottom ends of the rod are ground to a point. In use, the fork is driven into the soil and the window or screen fitted inside. To provide firmer support and to permit planing in either direction, two forks should be used, one being placed at each end.

Ball Bearings Easily Picked Up With Wire "Tweezers"

The usually frustrating job of picking up small ball bearings with your fingers and placing them in a bearing race can be sim-

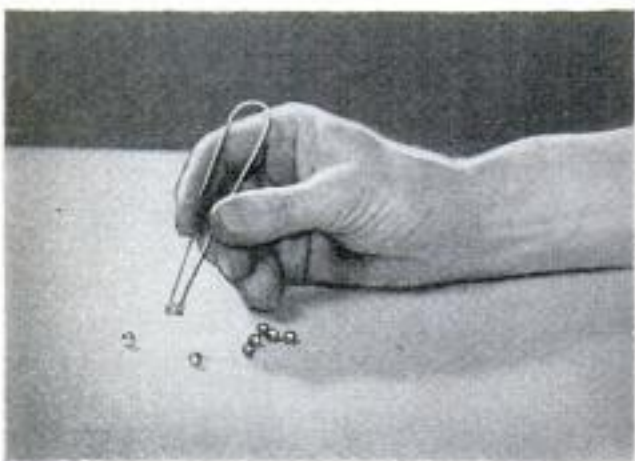

plified by bending a pair of "tweezers" from wire. First, form a small eye in each end of a 10-in. length of 14-ga. wire. Next, bend the wire in a U-shape so the two eyes align when the tweezers is pinched together. The eyes will fit against the curved surface of the balls and they can be picked up with comparative ease.

Enno R. Haan, Evanston, Ill.

Cake Pan Pivoted Under Shelf Provides Sorting Tray

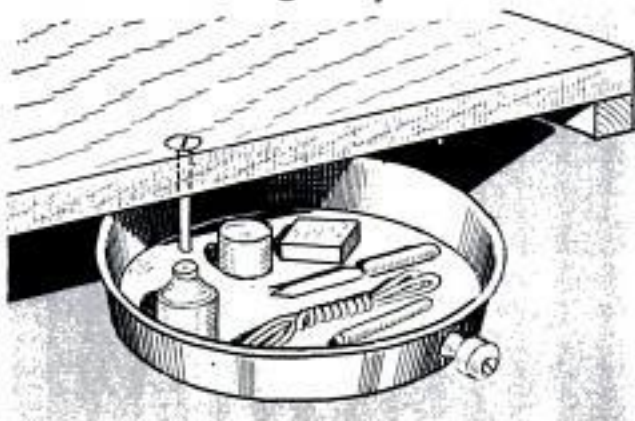

If the shelf of your workshop cabinet becomes crowded with nuts, bolts and odds and ends, install a sorting shelf to aid in sorting the items. Simply bolt a cake pan to the underside of the shelf, so that it may be swung out when needed, or back out of the way when not in use. For greater convenience, a wooden drawer pull might be attached to the outside of the pan to serve as a handle.

Handle for Vacuum-Bottle Cap

A metal or plastic vacuum-bottle cap which usually becomes too hot to hold comfortably when filled with hot liquid, can be handled easily when fitted with a paper handle. The handle is made by folding a piece of fairly tough paper to form a strip about $\frac{1}{2}$ or $\frac{3}{4}$ in. wide. The strip should be long enough to pass completely around the cup with the ends projecting far enough to provide a comfortable hand-grip for the user.



Razor-Blade Photo Trimmer

By E. Peter Smith

LARGE IN SIZE but small in cost, this cutting board uses a sliding cutting blade in place of the conventional arm.

The base is $\frac{3}{4}$ -in. plywood, cut to the shape shown. Screwed to one edge and allowed to project $\frac{1}{16}$ in., a length of $\frac{1}{8}$ -in. flat steel provides a cutter bar. A sheet of $\frac{1}{8}$ -in. hardboard covers the rest of the board. White-enameled hardboard with inked numbers is used for a scale and screwed to the board at right angles to the cutter bar. The guide fingers, shaped as in the detail, slide on a rail made of $\frac{3}{16}$ -in. drill rod. Each guide is held in position with a thumbscrew turned into a nut soldered on the inside of the guide. The rail is threaded at both ends and bolted to the board through the scale. The wooden guide-tube brackets are not notched to receive the brass guide tubes until the cutter block has been mounted and the blade aligned. The cutter block is drilled oversize and the hole lined with brass shim stock to provide a bushing. A single-edge razor blade is mounted on the block with screws so it can be adjusted. The pressure arm is screwed, or riveted, to a Z-shaped strip of brass which is soldered to a butt hinge. The hinge, in turn, is screwed to the base.

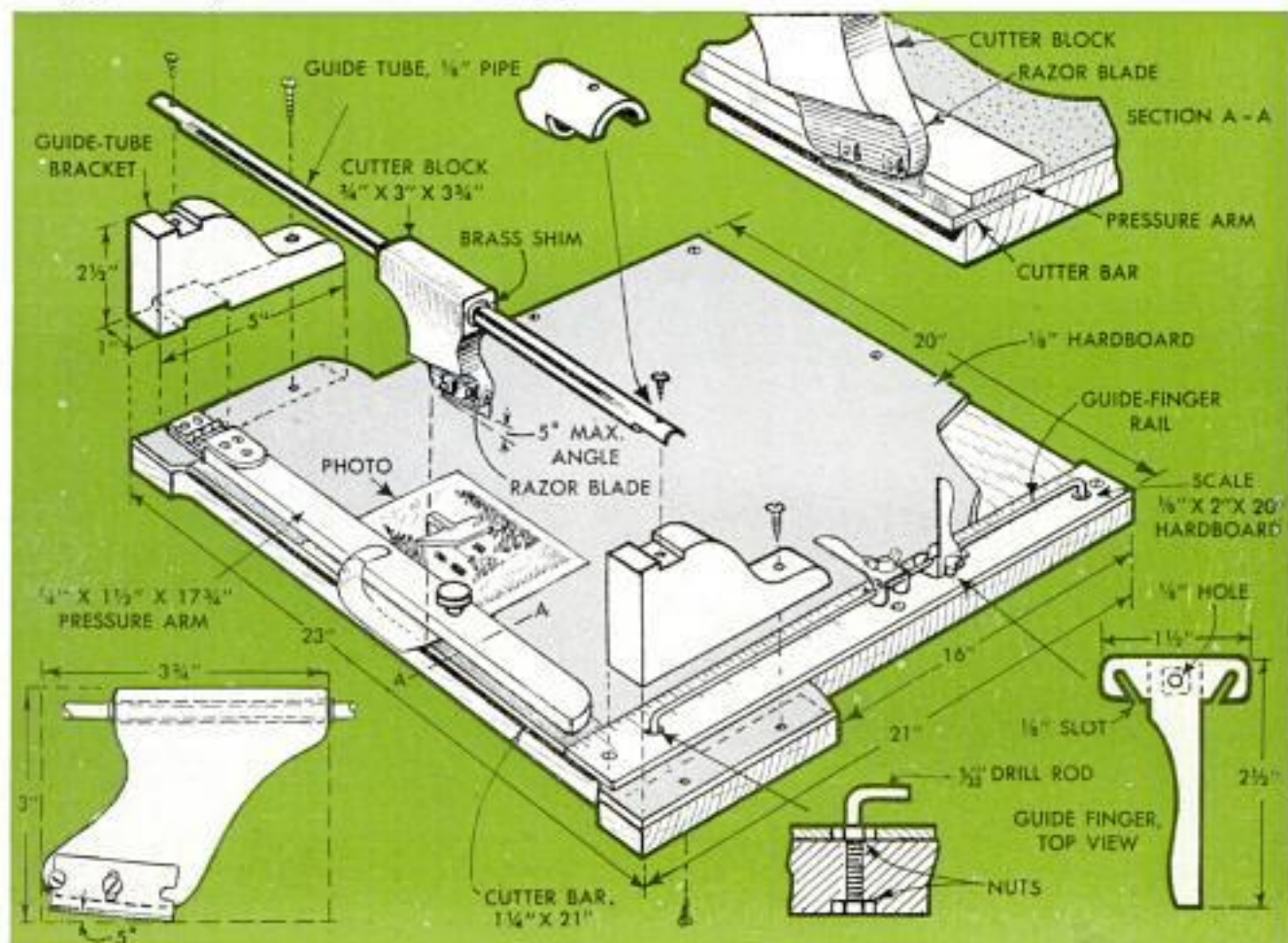
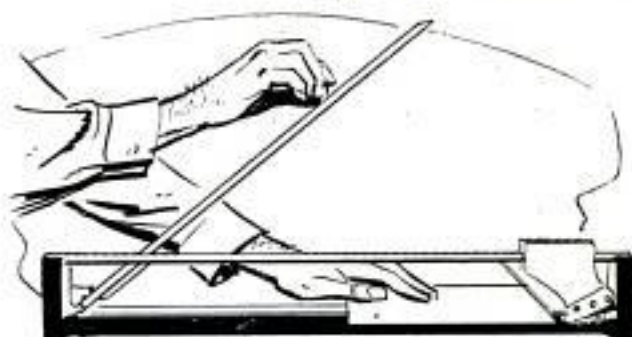

Solving

HOME PROBLEMS



ACCURACY of a household scale can be checked by placing a known weight, such as a five-lb. sack of sugar or salt, on it. If the adjustment knob has been set properly at zero, the scale should be accurate within an ounce or two at this weight.

A LARGE T-STRAP HINGE can be used as a support to hold a basement window open. The hinge should be attached to one side of the window frame, so that it will swing out freely to hold the window open, as shown, or fold back flat against the frame when window is closed.

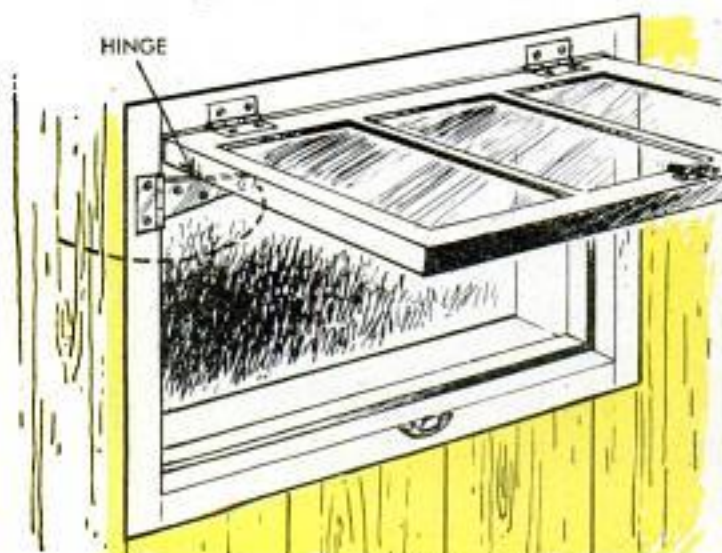

IDAHO POTATOES can be baked quicker and with better results if aluminum nails are inserted lengthwise through the potatoes before they are put in the oven. The nails conduct heat to the core of the potato and thus cut the baking time, improve texture and keep the skin from bursting.

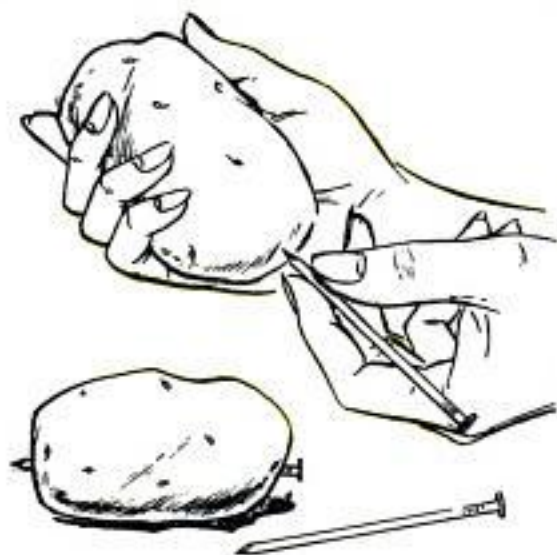

FINGER MARKS on piano keys often can be removed with an ordinary pencil eraser, which will fit easily between the black keys and get into all corners. For difficult spots, requiring cleaning fluid, wrap the eraser with a cloth soaked in the fluid. The eraser will make the application of fluid easier in difficult places.

WHEN HANGING GARMENTS on a clothesline for airing, you can prevent them from sliding along the line by knotting a fruit-jar rubber over the line as illustrated and then hooking the hanger into the looped rubber



WOVEN BEDSPRINGS which have begun to sag can be renewed by clamping hog rings across pairs of wires in the sagging area. The illustration shows the manner in which the rings are applied. They may be purchased at many hardware stores and the pliers used to clamp them may be borrowed or rented

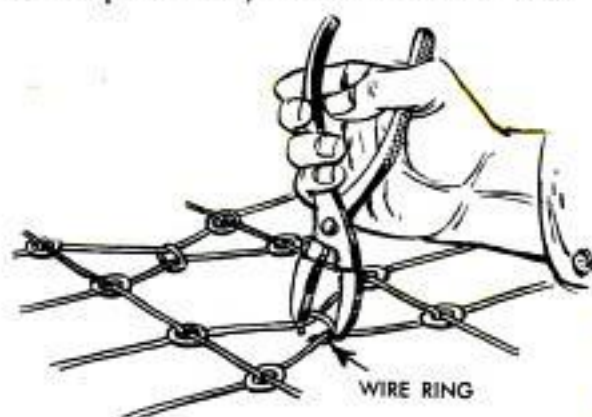

THE RAZOR BLADE used for sewing needs can be kept at hand and yet safely out of the reach of small children if it is inserted in a heavy-cardboard strip tacked to the back of one of the sewing-machine drawers, as shown. It requires only a moment to remove the drawer to find the blade, and it is not likely that the children will discover the hiding place

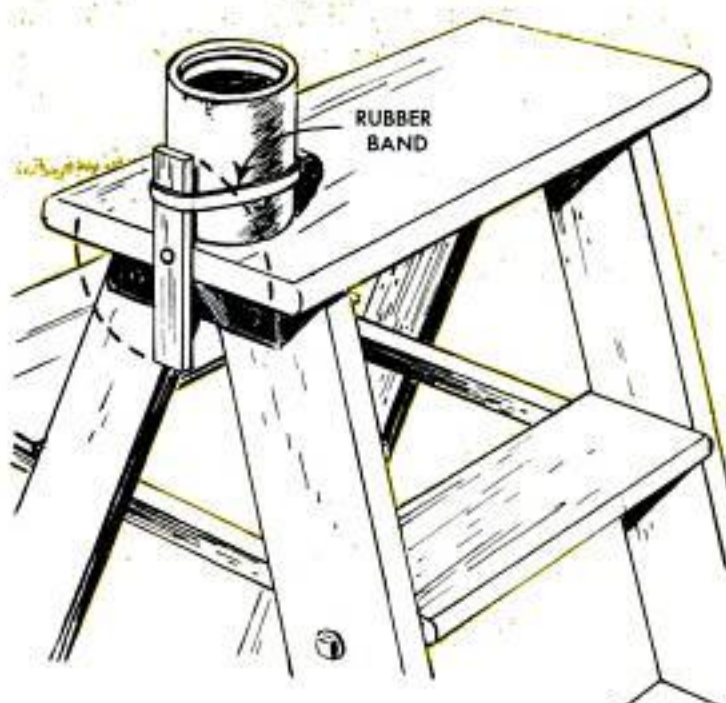

PAINT CANS used on a stepladder won't be overturned if the top step of the ladder has been equipped with a wooden turn button. With the turn button in a vertical position, the paint can is placed against it and held securely in place by means of a large rubber band

ATTACHED AS A HANDLE for a screen or storm door, a steel towel bar makes it easier for children of all sizes to open the door. The bar is long enough to be handy for adults as well as children





Pieces of Hose Strung on Rope Provide Bumper for Dock

Prevent scratched paint on boats and damage to outboard motors by installing this simple bumper strip along the projecting edges of a small dock. The bumper consists of a length of rope on which are strung a number of short pieces of rubber garden hose. The rope is stapled to the dock between the lengths of hose. Arrange the bumper so that a single length of hose fits around each piling, as shown in the detail.—Norm Jacky, Fond du Lac, Wis.

Paintbrushes Protected Under Plastic Sheet



To assure that paintbrushes which are stored in containers of solvent remain in good condition, seal the brush in the container with plastic sheeting. Wrap the sheet around the brush and seal it to the jar with a rubber band. When so sealed, the liquid in the container has much less chance of evaporating and allowing brush to dry.

Shaving-Cream Hand Cleaner

Brushless shaving cream makes an excellent waterless hand cleaner. A tube of the cream can be carried easily in the glove compartment of a car for "dry" washing the hands to remove dirt and grease after changing a flat tire. Also, using the cream

on your hands after working on greasy machinery will permit soap and water to do a better final job of cleaning. For extra convenience, wrap the tube in an old towel that can be used to wipe off the cream.

Chemical Agitated by Syringe Easier Than With Stirring Rod

Chemical mixtures that must be mixed constantly to prevent the precipitation of solids in a liquid, can be kept in agitation more easily with a bulb syringe than with a stirring rod. Drawing the mixture into the syringe and expelling it causes a more general movement and mixture of the solution than stirring. Also, the chemical can be dispensed with more accuracy from a syringe than when poured from a beaker or graduate.



Emergency Wrench Improvised From Bolt and Two Nuts

In an emergency, if no tools are available, an adjustable wrench can be improvised from a heavy bolt and two nuts. The two nuts, threaded on the bolt, provide the adjustable jaws. They should be set to a snug fit on the nut or bolt on which the "wrench" is used. Because of the shallow throat of such an emergency wrench, it sometimes is necessary to apply pressure downward with one hand to keep it from lifting. The longer the bolt, of course, the greater the amount of leverage.

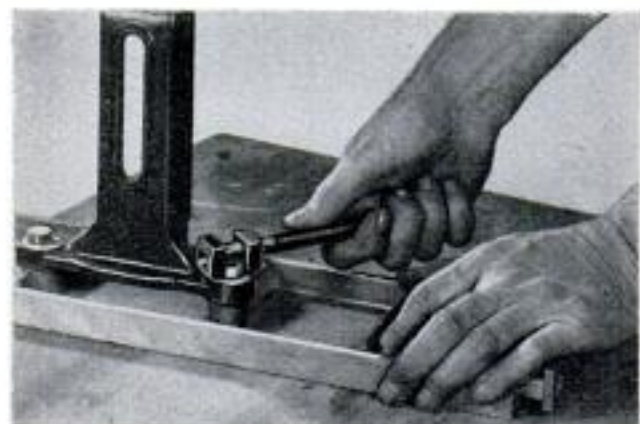

ⓄAn effective scraper for use on paint that is peeling can be made by rolling a piece of screen wire and binding it with friction tape. The frayed ends of the screen wire make a serviceable wire brush.

PILOT FLASH

for PORTRAIT WORK

By John M. Avery

BEING ABLE TO OBSERVE beforehand the lighting effect on a subject when using a flash is a great help in taking portraits, especially of children. This is made possible with a unit the author calls pilot flash. It consists of a relay and two sockets of the cleat-receptacle type, the latter being wired in series to hold a flash-bulb adapter and a 100-watt bulb. The unit is mounted on a light stand, plugged into the 110-volt line, and used remotely from the camera. In use, the relay is opened by the current from the flash gun and the flash bulb fires. Then the relay closes and remains closed until the flash gun is fired again. This shorts out the flash-bulb socket, allowing a new flash bulb to be inserted in the socket without danger of firing. The 100-watt pilot light burns continuously except for the split second when the bulb fires. This arrangement tends to reduce the brilliance of the flash which startles children, since to them the light of the pilot bulb simply seems to become brighter momentarily and then to dim.

If your camera is equipped with a synchro-shutter, it will not be necessary to have a second flash gun. A double extension outlet can be mounted on the camera and both shutter cord and relay cord plugged into it. When this is done, it is advisable to add a couple of flash-gun dry cells to the pilot-flash unit to operate the relay. It is advisable also to put a midget connector in the relay cord to avoid plugging the relay into the 110-volt line since this would burn it out. Use a 100-watt bulb as it allows about one ampere to pass which is advisable where flash bulbs are fired in a 110-volt circuit.

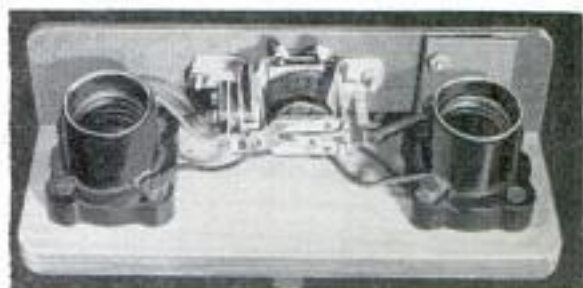

Above, a 2-volt, single-pole, double-throw photo-flash relay having a d. c. coil is required in addition to two plastic cleat sockets. These are screwed to an L-shape wooden base, 8 in. long

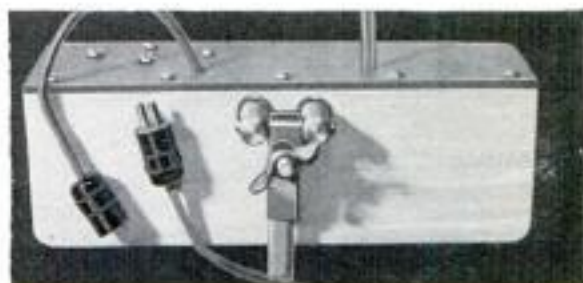

Above, unit is attached to light stand with modified swivel clamp. Note midget connector in relay cord. Below, Graffite bayonet shutter cord plugs into receptacle on camera

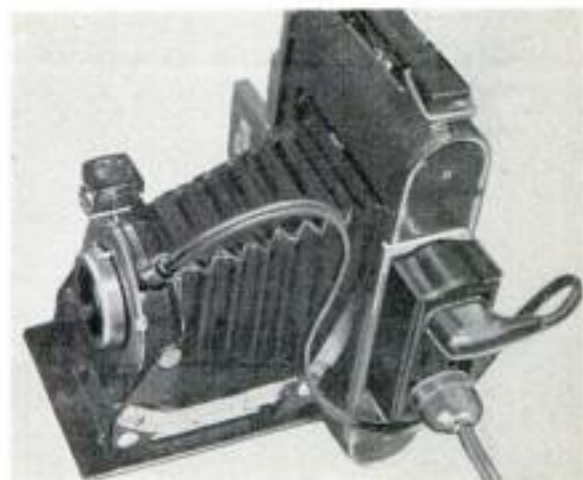
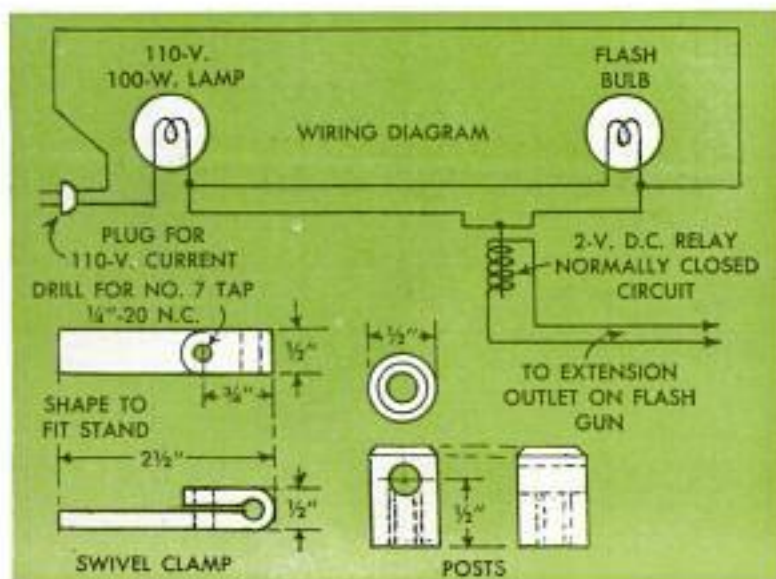

WTM 56



TOY ARMOR

By W. M. Dierks

MADE FROM "TIN CAN" sheet metal, this toy armor gives the little "general" some realistic equipment to wage his own war on the playroom floor. The four units pictured above can serve as prototypes for a battery of 105-mm. guns, the 1 1/2-ton trucks to pull them, plus as many armored cars and 76-mm. tanks as you might want to build. The drawings below and on the following three pages show how the parts for each unit are cut and assembled.

The barrels of the 76 and 105-mm. guns are made by sweat-soldering together sec-

tions of tubing and cartridge casings. The trails of the "105" are hinged to the carriage bolster with pins as in the details. Wheels for the gun, as well as the other units, can be taken from toy cars, turned from wood or made from metal disks fitted with hard-rubber tires. In all cases, axles are of heavy wire while small fittings are of light-gauge wire. Note that gun turrets pivot on the tank and armored car with pins soldered to the undersides of the turrets. The tank tread is made from 3/8-in. elastic tape. The olive-drab paint for the armor is obtained by adding green to red enamel. ★ ★ ★

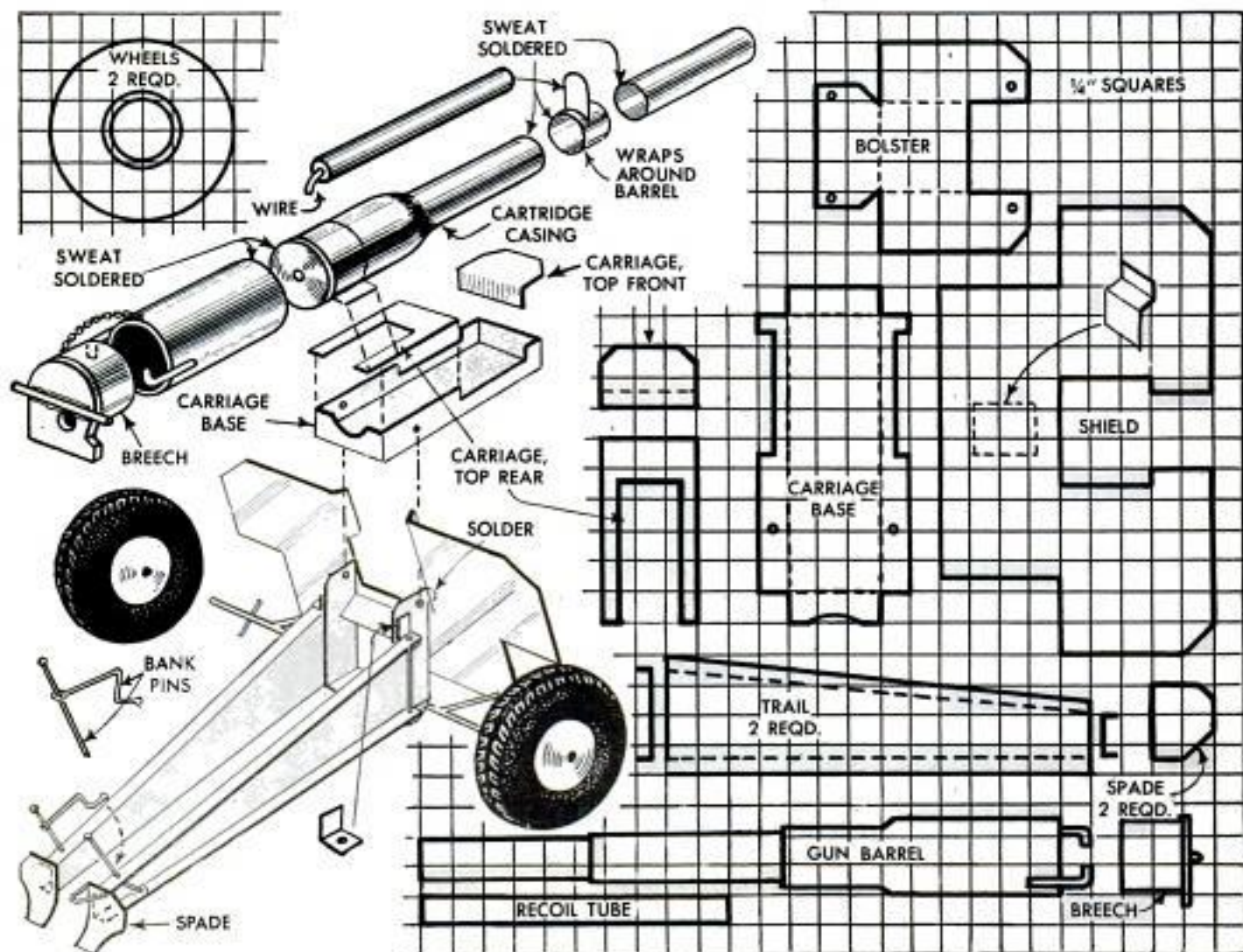

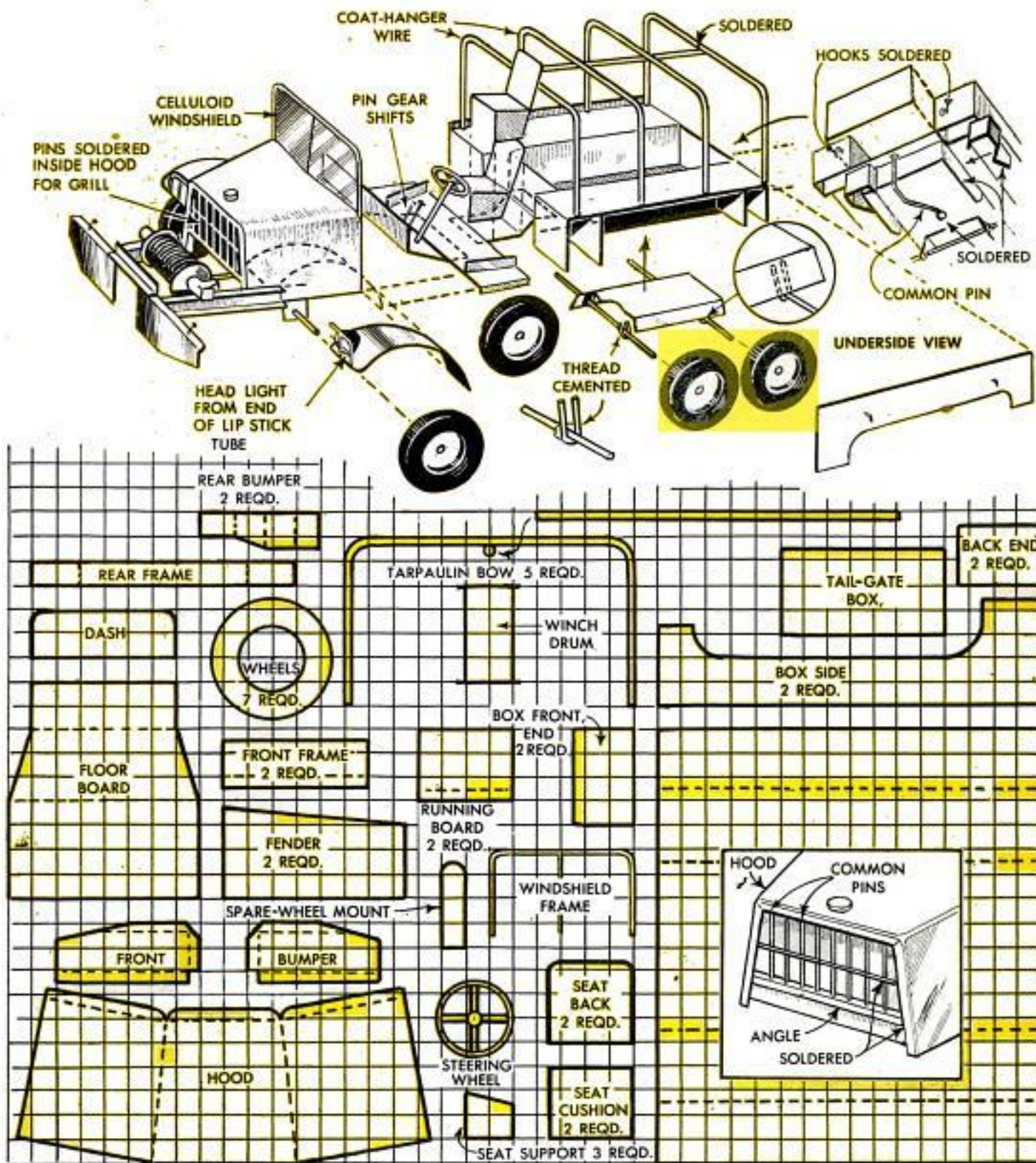
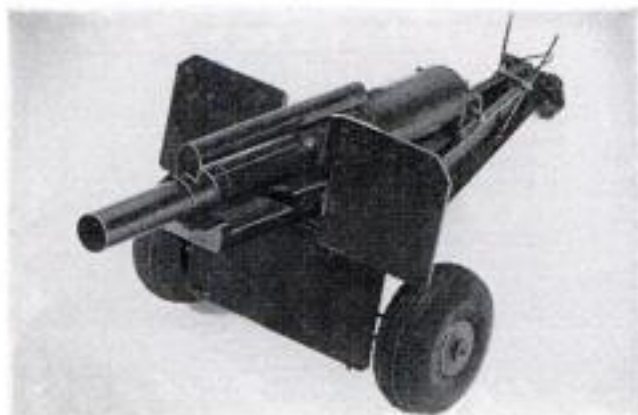
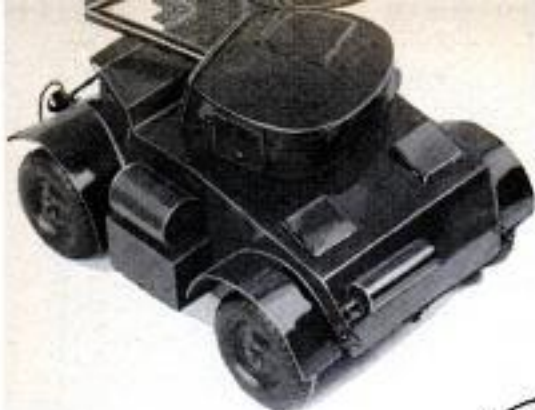

Photo below shows 76-mm. gun with trails clamped together ready for towing. Bent pins form trail clamp



Tarpaulin of 1½-ton truck was made from old GI handkerchief. Any olive-drab material could be used





ARMORED CAR

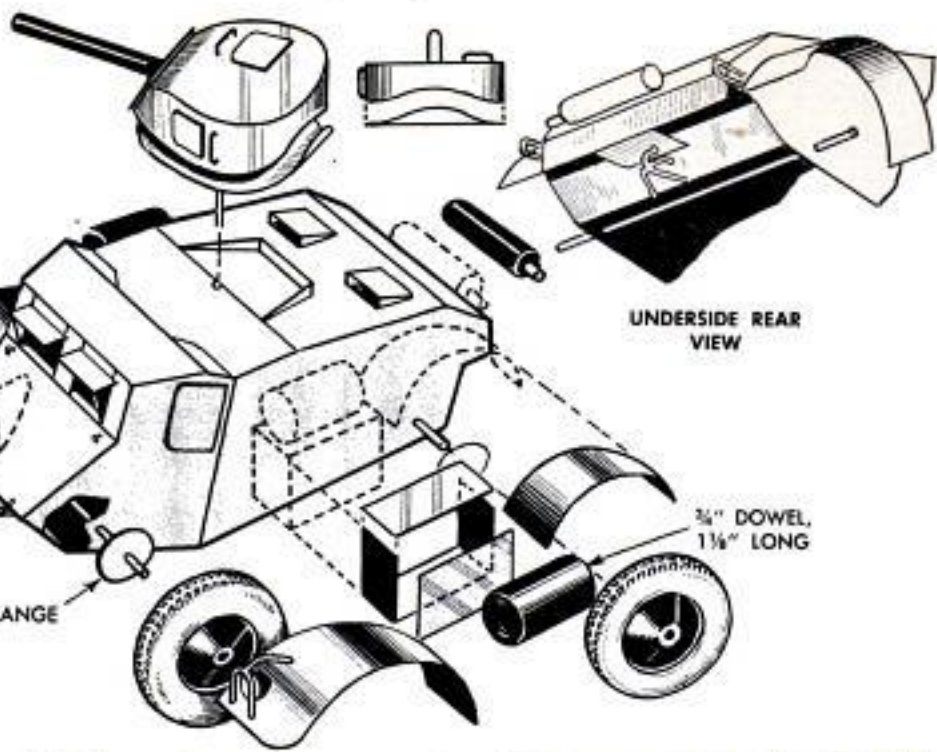

UNDERSIDE REAR VIEW

HUB FLANGE

$\frac{3}{4}$ " DOWEL,
1 $\frac{1}{2}$ " LONG

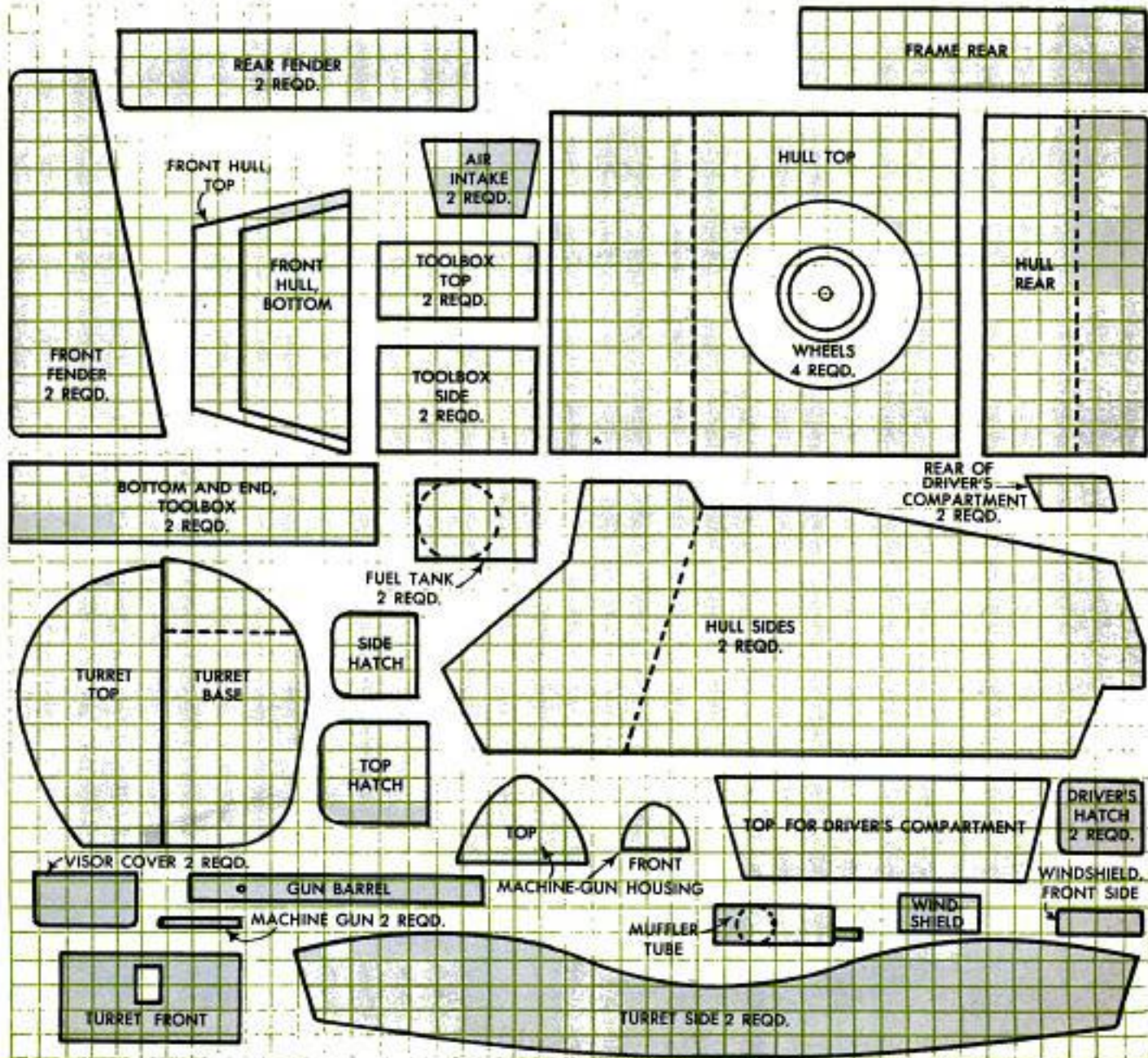



The three photos above show the detailing of the 76-mm. tank. Note the air-intake screen, the headlights and the pivoted gun turret. The idler wheels are made from .38-cal. cartridges, others from sheet metal or wood

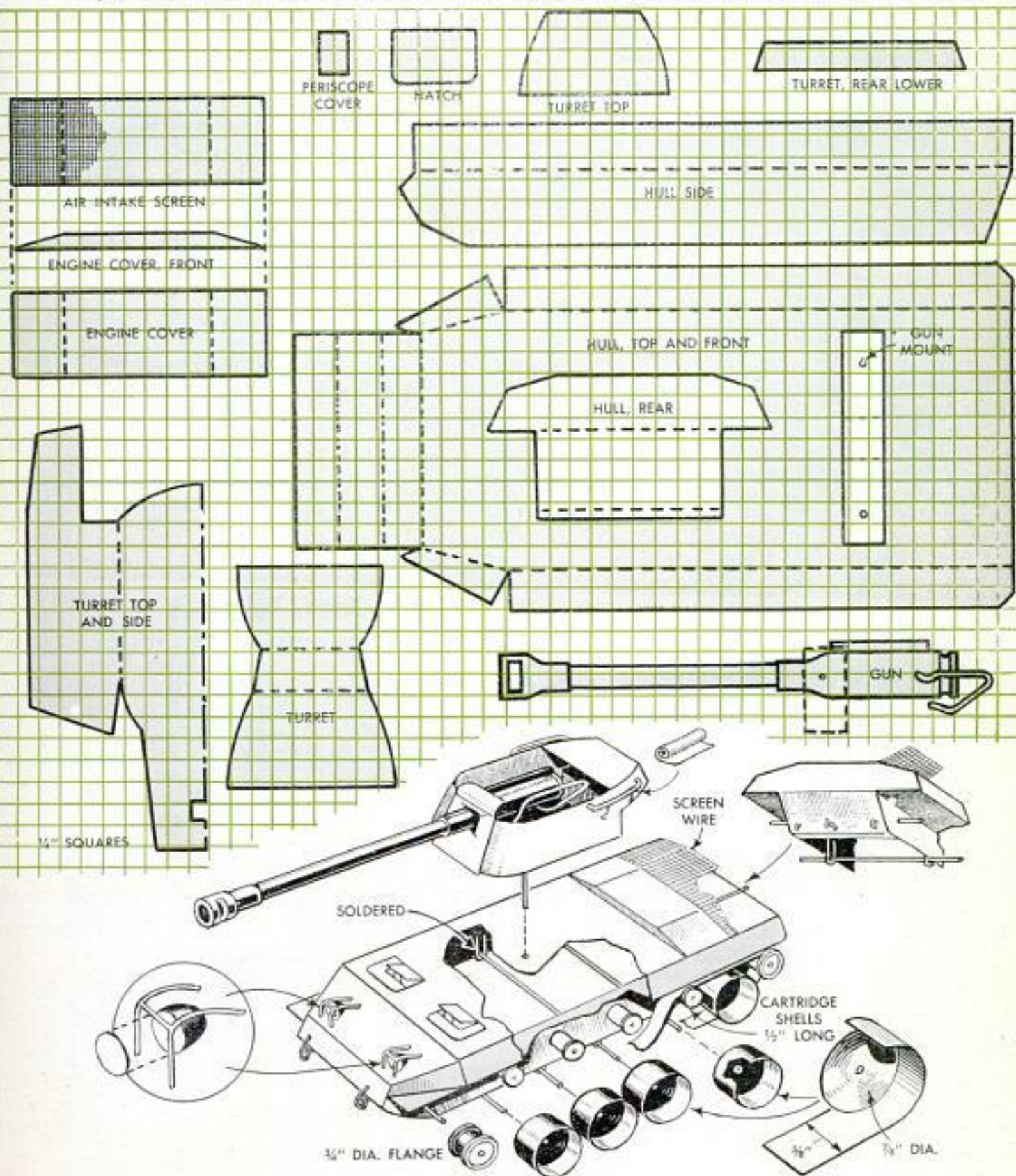

Adjustable Brace on Cold Frame Fits Into Drilled Block



The hinged glass cover of a cold frame can be adjusted to the various openings required by weather changes by a simple adjustable brace and drilled block. The brace is a length of steel rod with an eye bent into one end. A wood screw is inserted through the eye and driven into the edge of the cold-frame cover just snugly enough to permit the brace to be moved easily. A wooden cleat screwed to the side of the cold frame has a number of holes drilled in it to receive the lower end of the brace. Adjustment is made by fitting the brace into the hole which holds the cover at the desired opening.

Croquet Wickets Protect Seedlings



A quick method of protecting a seedling from being trampled is to shield it with two or more croquet wickets. Simply force the wickets into the ground, to form a wire

shelter over the plant. Identification tags may be wired to the wickets.

Repairing Cracked Laundry Tub

A leaking cement laundry tub can be repaired by using a mixture of fine sand and cement to patch any cracks. Chisel out the crack to a depth of about $\frac{1}{2}$ in. and wide enough to provide a slight undercut. Use a mixture of sand, 2 parts, to cement, 1 part, and add just enough water to make

a stiff mortar. Pack the mixture firmly into the crack and smooth it flush with the surface of the tub. After the cement has begun to set, fill the laundry tub with water so the repaired place is submerged, and allow to cure for several days. *Caution:* Some older types of laundry tubs are made of soapstone, in appearance and texture very much like soft slate. This type of tub must be repaired with aquarium cement.—Art Fenn, Chicago.

Washing-Machine Agitator Used As Percolator in Feed Cooker

The task of stirring stock feed while it is being cooked can be almost eliminated by using the agitator from a discarded washing machine to provide a percolator. Place the agitator in the kettle on two or three metal blocks so there is space under it for the boiling mash



and water to circulate. Metal agitators from older-type washers should be used. Plastic agitators in newer-type washers may be warped by the heat of boiling water.

Extra-Long Rubber Bands Cut From Auto Inner Tube

When cutting rubber bands from an inner tube, it is possible to cut an endless band of much greater length than usually is supposed. The more oblique the angle is cut, the longer will be the band. The angle can be carried to the extent of starting the cut almost parallel with one edge and cutting around the tube a number of times until the opposite edge is reached.

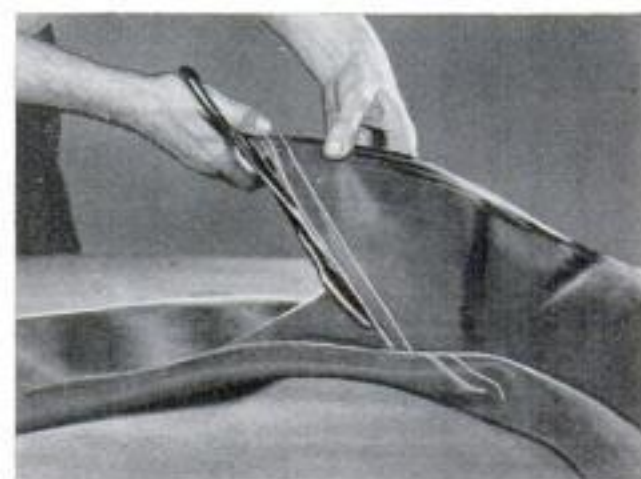

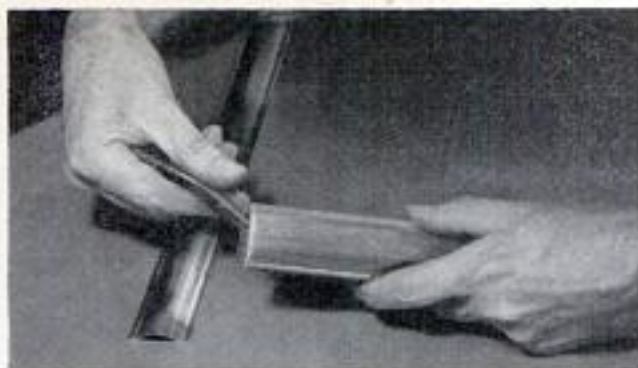

Arched portion of weather stripping is pulled until it projects $\frac{1}{4}$ in. beyond base portion. Then end is folded over and flattened against adhesive back



To prevent the arched portion from shifting endwise, two or three punch marks are made in the two parts along the margin of metal and near the folded end



After end of the weather stripping has been folded back and cut to proper length, protective paper backing is carefully peeled from adhesive coating on metal



To install, merely press weather stripping firmly against wooden cleats added to sides of opening. Strips provide cushioning guides to sides of drawer

WEATHER STRIPPING Improves Drawer Action

Cabinet drawers having excessive side clearance which causes them to twist and bind can be made to operate smoothly by installing spring-bronze weather stripping along the sides of the drawer opening. Having an adhesive back for easy installation, the stripping is mounted in the manner shown in the detail so that its arched surface presses against the drawer sides. There should be a clearance of slightly more than $\frac{1}{8}$ in. on each side for the weather stripping.

By W. E. Burton

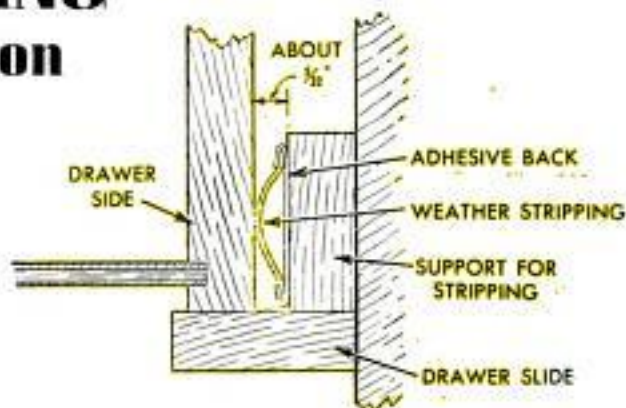

Soap Tray Hangs on Locker Door to Prevent Soiling of Clothes

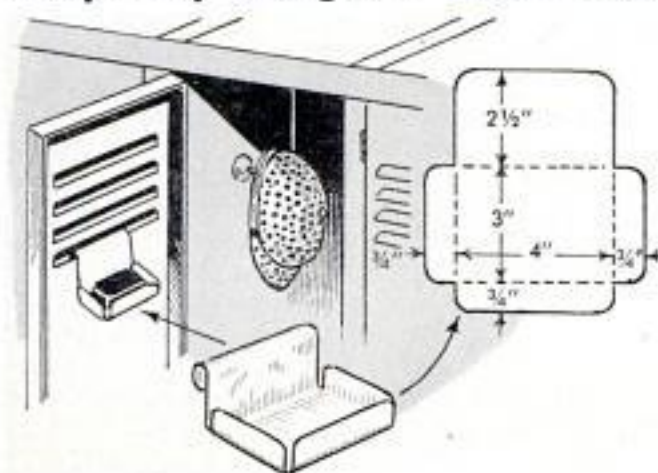

This soap tray provides a way to keep wet bars of soap from soiling other articles in your locker. Using the dimensions in the sketch, lay out the shape of the tray on a piece of light sheet metal. After cutting it out, bend up the four sides. The top of the long side is bent over in the opposite direction to form a hook which is hung in the ventilating louver of the locker door. The sharp edges of the tray should be filed.
Norm Jacky, Fond du Lac, Wis.

☐ An empty thread spool slipped over a nail in the garage or workshop provides a hanger that will not tear work clothes.

WTM 56



Make Your Own PLASTIC BAGS AND COVERS

By M. G. Winterton

Large dustproof covers and bags like those shown above and below are made with heat-seaming method



DUST COVERS and bags that will protect valuable equipment, tools and appliances are made quickly from polyethylene plastic. Food and freezer bags are one of the most readily available and inexpensive sources of this material.

The bags or covers are made by "heat welding" two or more layers of plastic together with a household pressing iron. This is possible when the plastic is placed over an aluminum-foil reflective pad for welding. However, without the reflective pad, one side of the plastic would get too much heat while the other side would not get enough and lamination would be poor.

After the pattern for the desired bag or cover has been drawn on tracing paper, the sheets of plastic are placed on the aluminum-foil pad and the pattern positioned over them. Then the plastic outside the lines of the pattern is pressed with the iron and the waste is cut away, leaving a seam about $\frac{1}{8}$ in. wide. For items that must withstand rough usage, two or more thicknesses of plastic may be used for each panel. Bags may be fitted with waxed-thread drawstrings as in the photos. ★ ★ ★

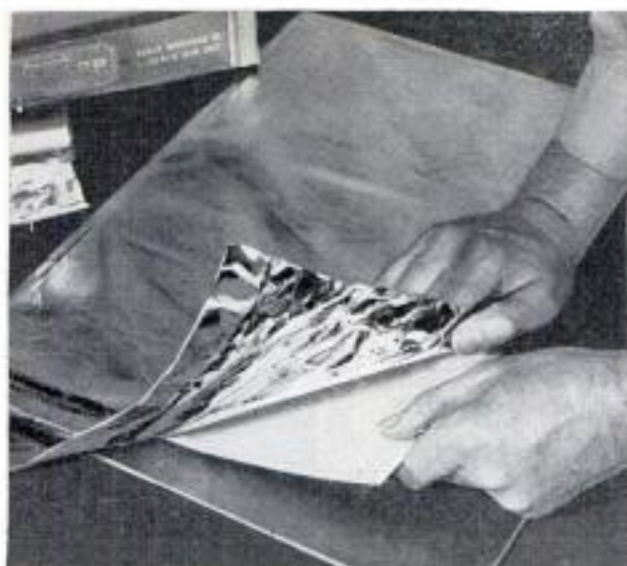

Heat-reflecting pad is made by placing two layers of asbestos paper over piece of hardboard and covering with aluminum foil turned over hardboard edges



Food and freezer bags, purchased in packages like those shown above, are best source for the polyethylene-type plastic required for heat-seaming method



With tracing-paper pattern in position, plastic is heat-welded with iron. The iron is set for low heat

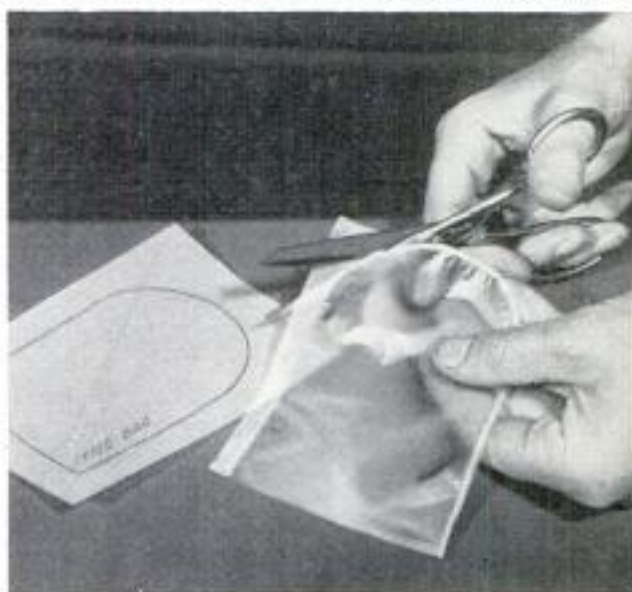

Most of heat-welded portion of plastic is cut away, leaving a 1/8-in. seam as strong as plastic itself

Top of bag is turned back twice and drawstrings are anchored with eyelets set on opposite sides of bag

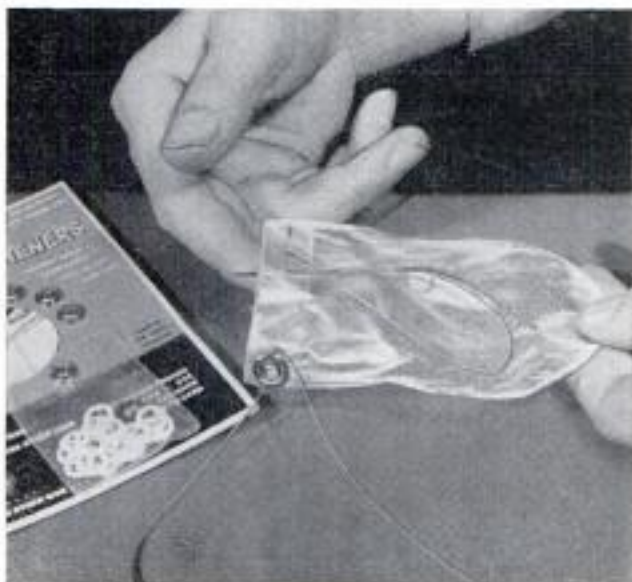

Drawstrings are stitched through bag sides from both directions and then brought through opposite eyelets

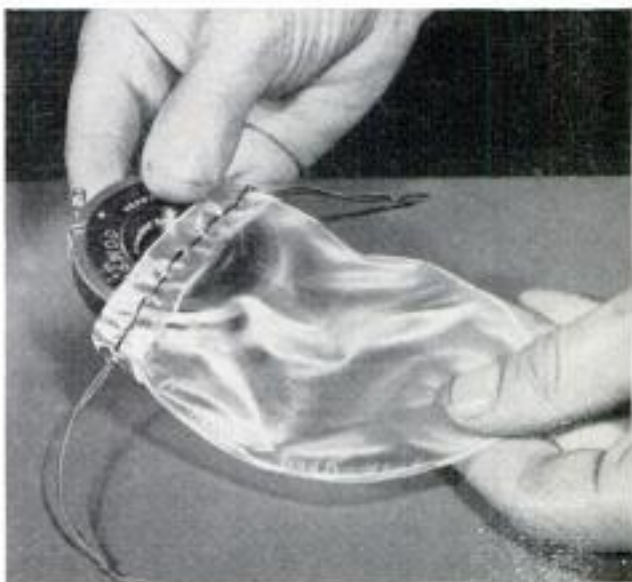

Push Handle for Coaster Wagon Keeps It Under Control

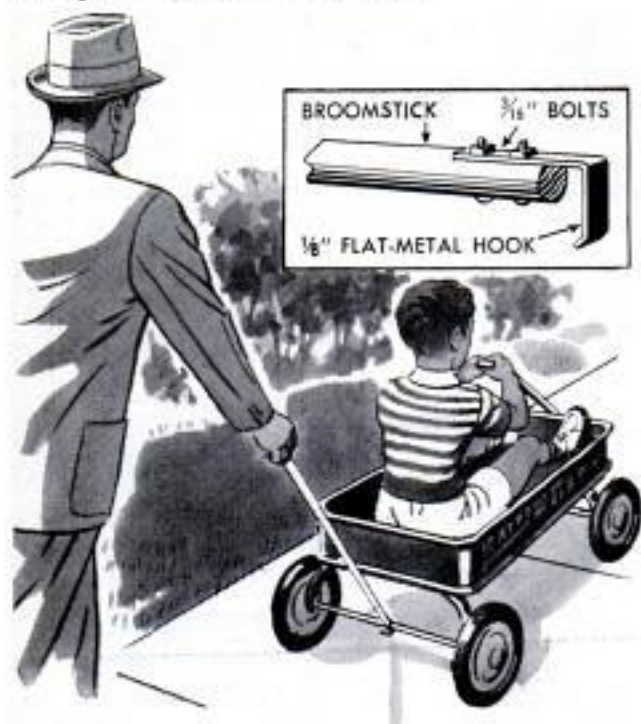

Instead of pulling your youngster in his wagon, use this push handle to let him have the fun of steering while you maintain control of his speed. The handle consists of a length of broomstick which has a flat-steel hook bolted to one end. The handle eliminates stooping, while the hook slipped over the back axle keeps the wagon under control when descending hills or going off curbs. A cross or shovel-type grip on the handle might be more comfortable if the handle is to be used frequently.

Removable Rubber Liner in Basin Provides "Self Cleaning" Pan

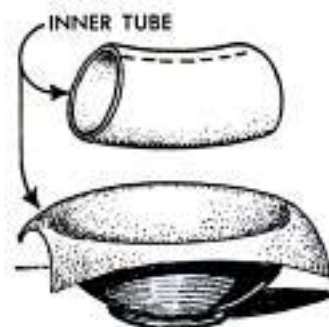

When mixing small amounts of plaster or concrete for patching and repairing around the house, one home craftsman uses a "self cleaning" container, which consists of a hand basin fitted with a sheet of rubber cut from an inner tube. When a job is finished, the rubber is lifted from the basin and shaken free of any dried and hardened particles.

Max Franklin, Hunter, Okla.

Faucet Washers Made Smaller

New faucet washers that are a little too large can be reduced in diameter by rotating them against a piece of fine abrasive

paper. A hand or electric drill is ideal for rotating the washer. Just force it over a drill that provides a snug fit in the screw hole. Be careful not to overdo it and make the washer too small.

James L. Creasy, Martinsburg, W. Va.

Pail Clamped With Hooks and Bands When Mixing Paint on Drill Press

Two wire hooks and two rubber bands provide a means of clamping a paint pail to a drill-press table when the press is used to mix paint. The hooks are fitted over the edge of the paint pail and the bands are looped over them and over the projecting ends of a dowel slipped

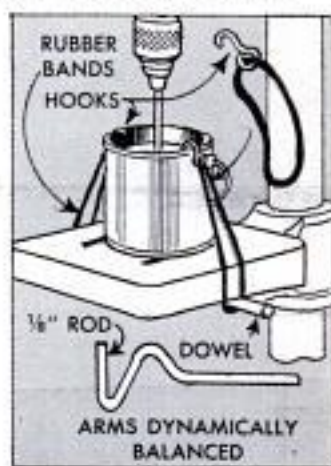

under the table. The stirring rod consists of a length of $\frac{3}{16}$ -in. metal rod bent to a modified Z-shape. Use the lowest drill-press speed and keep the stirring rod submerged to prevent throwing out paint.

Whisk-Broom Guard Protects Bristles

A whisk broom that is frequently removed from the glove compartment of a car and just as often is jammed back into it will soon become ragged and useless unless the bristles are protected by a guard. The guard can be made by cutting a long strip of rubber from an inner tube and wrapping it snugly around the bristles. The ends of the strip are fastened with rubber cement so the guard keeps its shape. In use, the guard is slipped off the ends of the bristles and replaced by sliding down from the handle.



Combination Smoking Stand and Magazine Rack

For the person who smokes while he reads, this combination ash-tray-and-magazine rack will fill a definite need. The rack easily is carried from one room to another, furnishing a handy supply of both reading and smoking materials. Either plastic or wood could be used in the construction and finished to match or contrast with the furniture. Hardboard also could be used in combination with wood and provide the added advantage of light weight. The smoking section of the rack could be designed to accommodate a purchased or handmade smoking set, consisting of an ash tray,

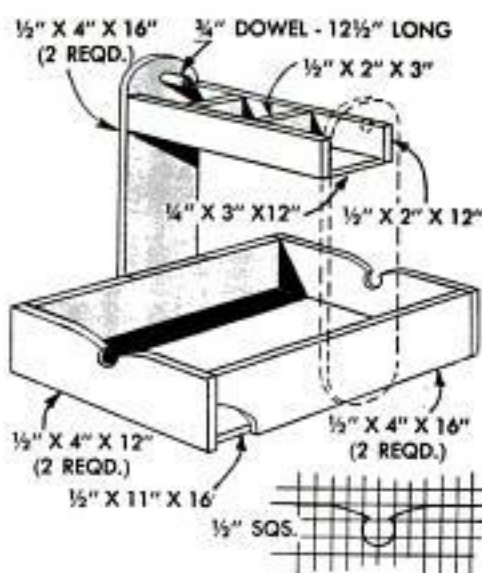

cigarette box and match or lighter holder. Or, if preferred, simply line one compartment with metal to provide an ash tray.

cigarette box and match or lighter holder. Or, if preferred, simply line one compartment with metal to provide an ash tray.

"Slave" Lights Controlled by Hole in Cover of Photocell Unit

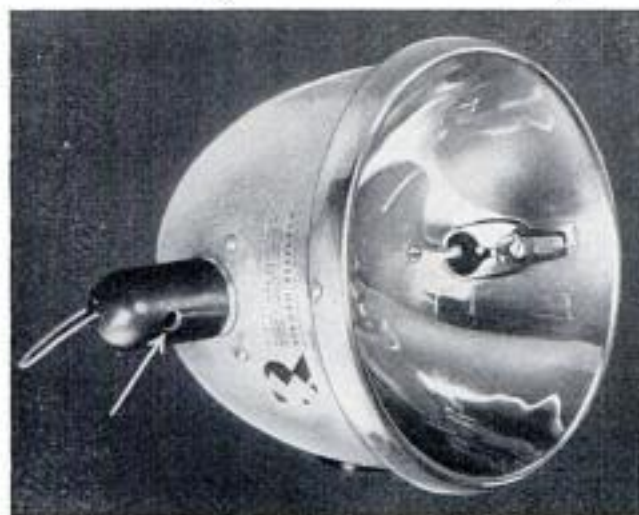

The action of photo slave-flash units of the photocell type can be controlled so they will not flash when used in the presence of bright lights or near other flash guns if the photocell unit is covered with its protective cap in which a $\frac{1}{4}$ -in. hole has been drilled. To accurately locate the hole, re-

move the cap from the cell and measure from the top base of the flash unit to the tip of the forked anode in the photocell. Replace the cap and measure the same distance from the base and mark the location of the hole. (The measurements are necessary because not all photocell caps seat at the same distance above the flash unit, nor are all anodes the same distance above the base.) In use, the cap is fitted on the photocell with the $\frac{1}{4}$ -in. hole pointed toward the flash unit that will be used to trigger the light. The hole in the cap must be covered when the unit is not being used.

Kenneth E. Peney, St. Paul, Minn.

Hammer Handle Stores Tacks

For those occasional jobs around the house that require driving a few tacks, you will find it highly convenient to have an assortment of tacks in the handle. Bore a hole in the center of the end of the handle, not over 3 in. deep, and provide it with a snug-fitting cork.

The Know-How of Interior Painting . . .

makes the difference between success and failure, both as to final appearance and as to the lasting quality — and it takes just as long to do a poor job as a good one. So, why not find out how to avoid common paint failures in next month's story on interior painting, which includes data on sealers, one-coat flat paints and recommendations for applying popular deep-tone colors



PhotoKinks 58



CABINET for your ENLARGER

By Robert E. Dalton

TWO UNUSUAL features make this enlarger cabinet especially adaptable to use in basement or closet darkrooms where height and floor space are limited. Use of the cutting board, or trimmer, as a supplementary easel gives two easel heights with relation to the floor and also two projection distances in relation to the enlarger. The trimmer is hinged to the cabinet side-panel extensions and swings out of the way when not in use. Loose-pin hinges permit its removal when desirable. A hinged drop leaf, supported by hinged wings, is attached to the opposite panel extension as in the lower right-hand photos.

The cabinet, detailed on the opposite page, is made from $\frac{1}{4}$ -in. plywood and 2 x 2-in. stock for framing in the manner shown. In the detail, the plywood bottom has been omitted for the sake of clarity. This is

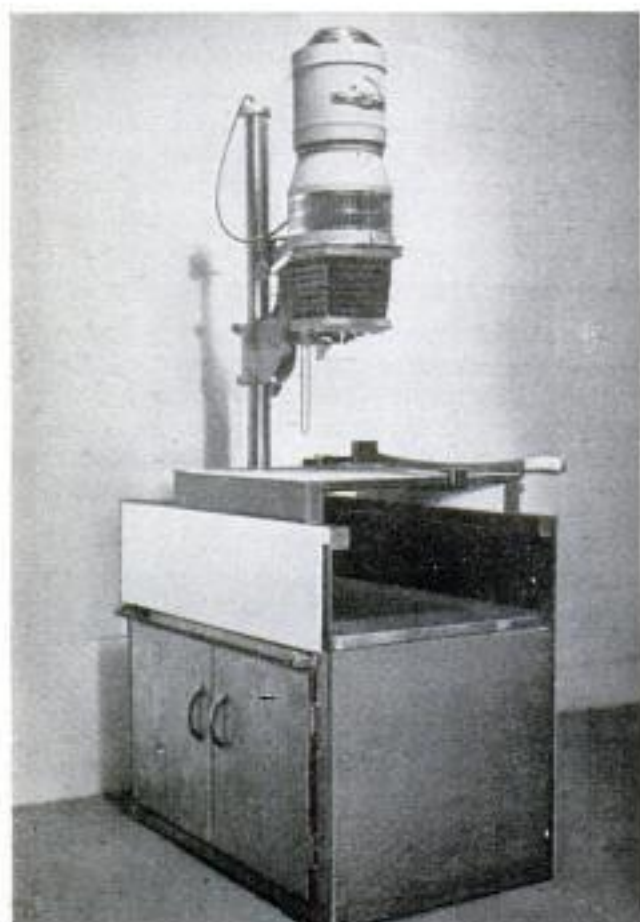

Photos above, left and below picture the convenience features of this enlarger stand which has been designed and built for use in limited space. Note use of trimmer as an auxiliary easel, also folding shelf

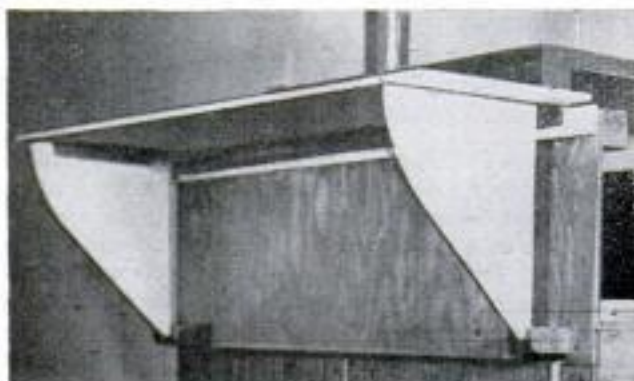

of $\frac{5}{8}$ -in. plywood which is of sufficient rigidity to support the weight of a printer and other items which may be stored in the lower compartment. The top of the cabinet, which is about $5\frac{1}{4}$ in. below the top of the extended side panels, also is of $\frac{5}{8}$ -in. plywood. For a heavier enlarger, use $\frac{3}{4}$ -in. plywood. Parts can be joined with nails, but the use of screws and glue will result in a much more durable and rigid cabinet. Doors are of $\frac{3}{8}$ -in. plywood and are hinged to fit flush in the opening to the compartment. Friction cabinet-door catches hold them in the closed position. Note that the folding leaf must be set out the thickness of the wings by means of a strip as in the upper right-hand detail. Note also that it swings on a continuous, or piano-type, hinge. This prevents the leaf from sagging at the center. The trimmer is hinged to the opposite panel of the cabinet and swings up and over so that it does not interfere when using the regular easel.

The dimensions given are those of the original cabinet. These can be altered proportionally if desired. Sand all exposed surfaces, finish with a coat of sealer and paint in the color desired.

★ ★ ★

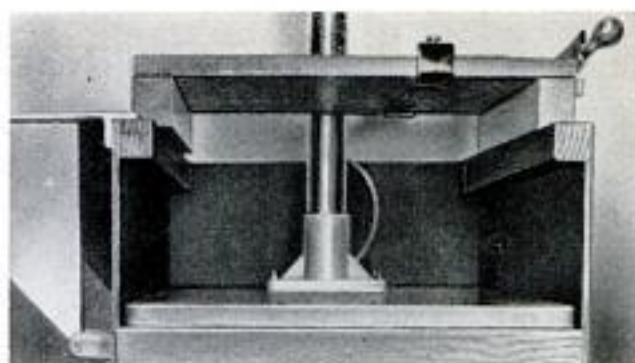

Above, a front view showing how the enlarger easel fits into the upper open-end compartment of the cabinet. Below, the folding shelf, or leaf, swings on a piano-type hinge to prevent sagging at the center

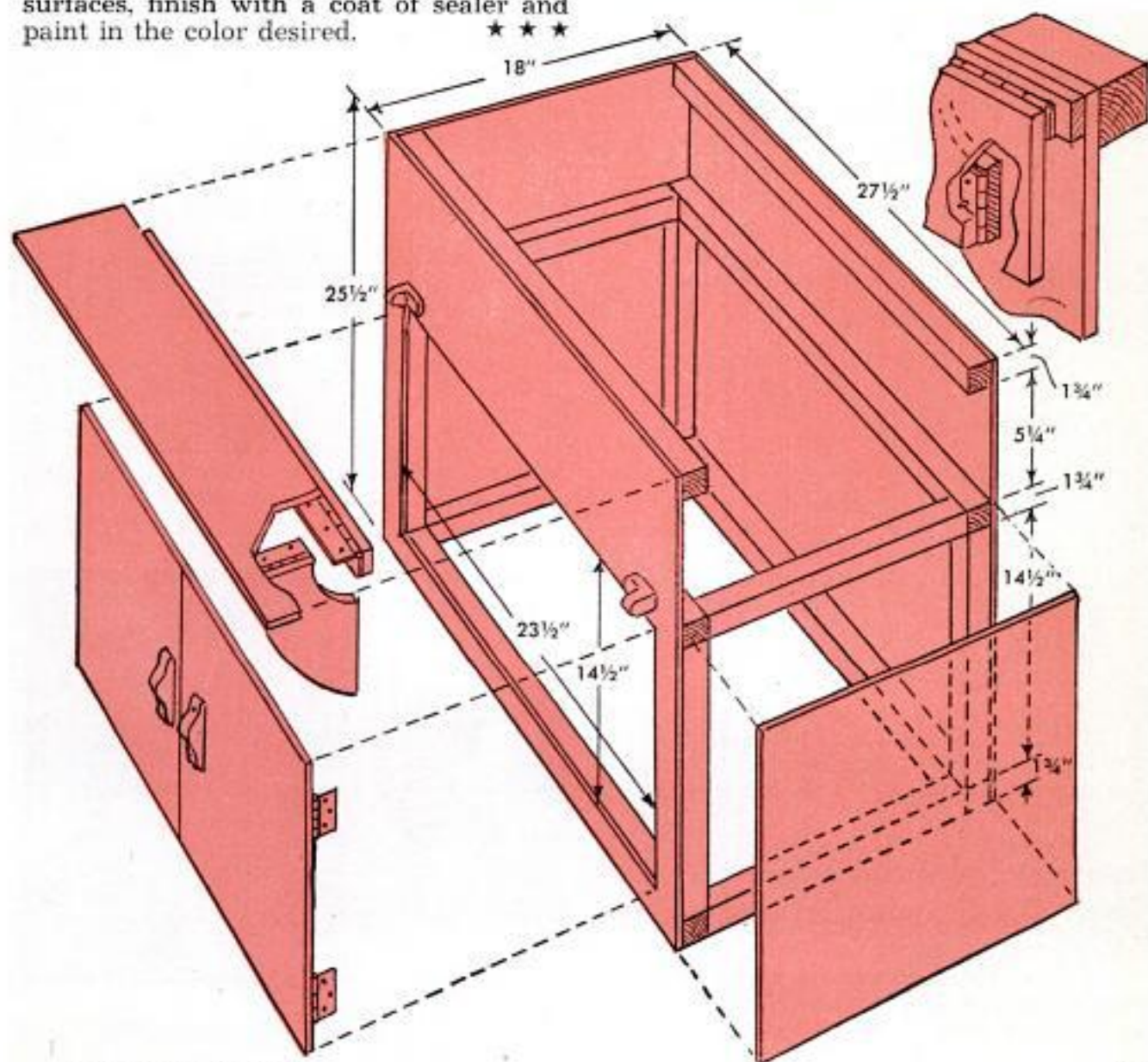
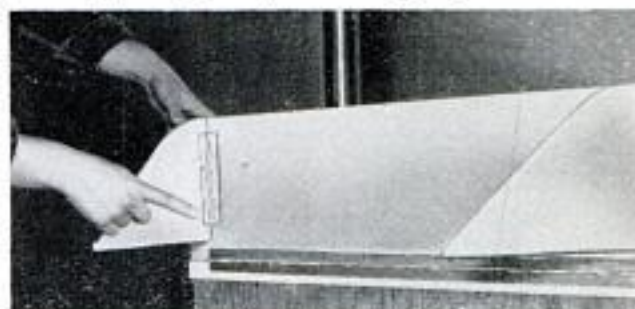

Recharging of Photoflash Unit Controlled With Electric Timer



One photographer who uses an electronic repeating-flash unit has found that recharging the unit is less troublesome if a timer is used to control the charging time. After a full day of use, the flash unit may require as much as eight hours of charging time. With the timer set to turn off the charger when the required charging has been completed, the danger of overcharging is eliminated.

Correspondence Easily Identified By Envelope Corners

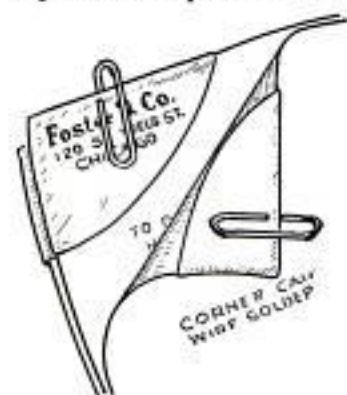

To quickly identify papers and correspondence from various firms in a letter file, one office worker uses the corners of the envelopes carrying the return names and addresses of the firms. These are cut off and clipped

over the packets of papers from the corresponding firms. Thus, the name and address are immediately visible for easy location and quick reference.—G. E. Hendrickson, Argyle, Wis.

Treated Rope Around Tent Keeps Out Crawling Insects

Campers who sleep out in pitched tents can protect themselves to a certain extent from crawling insects by encircling the tent with a rope soaked in an insecticide

or insect repellent. The rope can be held in position by large staples driven over it into the ground. The area within the rope can be cleared of insects before the tent is pitched by spraying with DDT applied under a tarpaulin that has been spread on the ground.

White Tape Wrapped on Drill Bit Provides Temporary Depth Gauge

A quickly improvised depth gauge for a hand drill is a piece of white adhesive tape wrapped around the bit at the desired depth. When using the tape be careful not to drill too deeply because the tape will fray easily or be pushed up the drill bit.



To Renew Circular-Saw Blade

One carpenter, not wanting to discard circular-saw blades damaged by nails in cutting old lumber, found that the blades could be renewed by setting the teeth in the opposite direction. After reversing the set, he filed the teeth to shape and resharpened them.—Robert Micals, Freehold, N. J.

Corrugated Cardboard in Jar Files Small Drill Bits

Often-used small drill bits can be filed for quick selection by rolling a strip of corrugated cardboard into a cylinder and placing it in a shallow, wide-mouthed glass jar. The bits will fit into the openings in the corrugations and the proper size can be seen at a glance. A small amount of oil poured over the cardboard will aid in preventing the bits from rusting.

E. V. Reyner, Townsend, Mont.

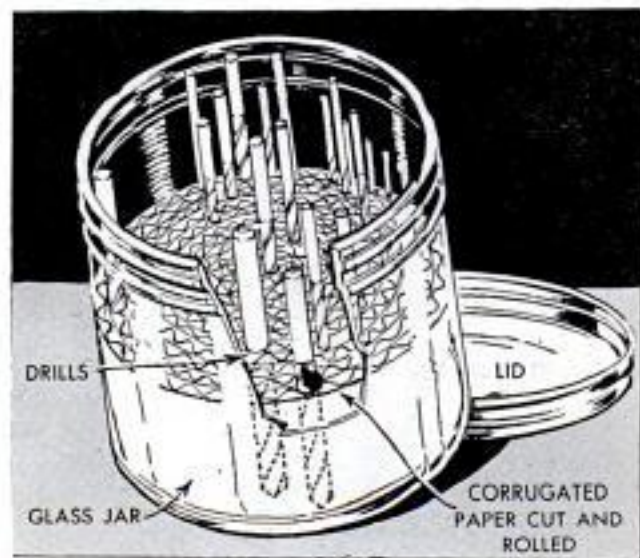

POPULAR MECHANICS

Variable-Intensity SAFELIGHT

By
Walter E. Frisbie, Jr.

SAFE ILLUMINATION for processing all photo papers, from the slowest contact types to the ultrasensitive projection papers, is provided by this adjustable safelight which simply slides on rails in an open shelf to vary the exposed area of the filter and, thus, the amount of light.

As indicated in the detail, the light box has two sides which are 1/2-in.-thick stock, rabbeted to receive the 1/8-in.-thick filter. The ends and top of the box can be lighter material. The porcelain socket, fitted in the top of the box to hold a 40-watt bulb, is wired through a toggle switch on the front of the box. The toggle also provides a handle for pulling the box forward. The filter is an 8 x 10-in. Kodak Wratten, series OA safelight filter, obtainable at most photo-supply stores. A strip of red or black tape is used to insure a light-tight seal between the filter and box at the front and back.

The shelf has two bracket sides cut from 1/4-in. plywood. The rear section of the shelf floor is 1-in. stock; the rails which run to the front are 1 x 1s, as is the cross brace.

The completed box-and-shelf assembly is light enough to be screwed to the wall, or supported on an existing shelf.

When the light box is pulled forward to expose the entire filter, maximum safe illumination for contact papers of the Azo type is provided. For more-sensitive papers requiring less light, the filter area is decreased by sliding the box back.

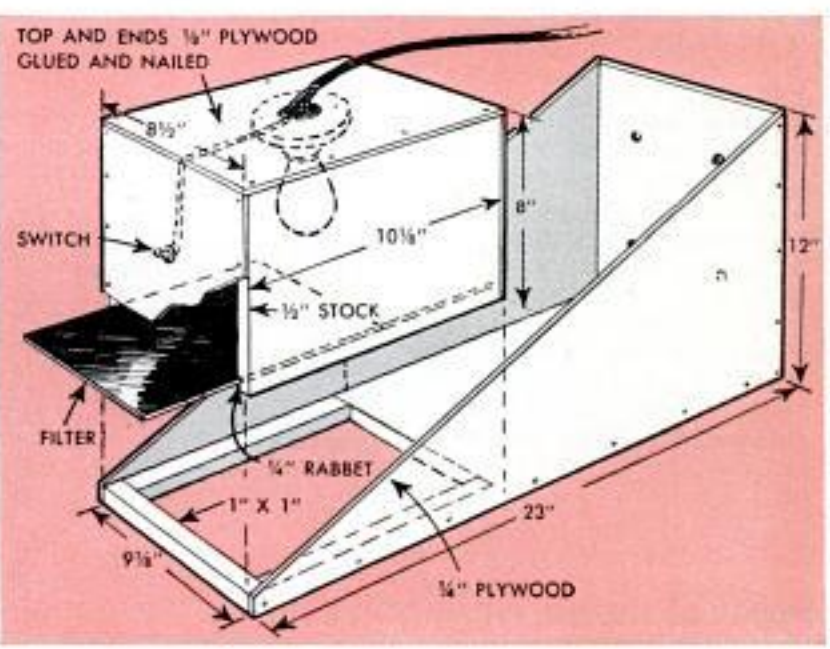
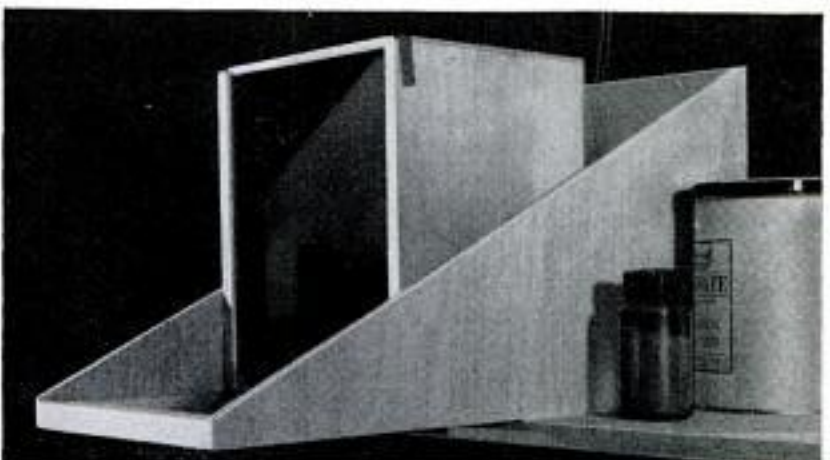
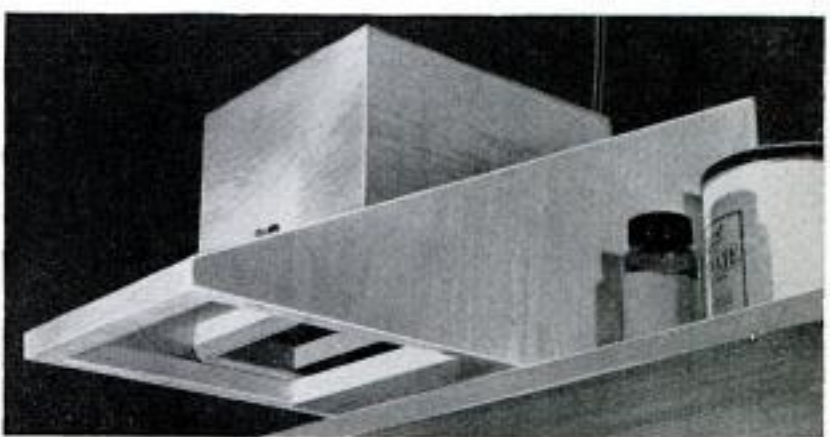
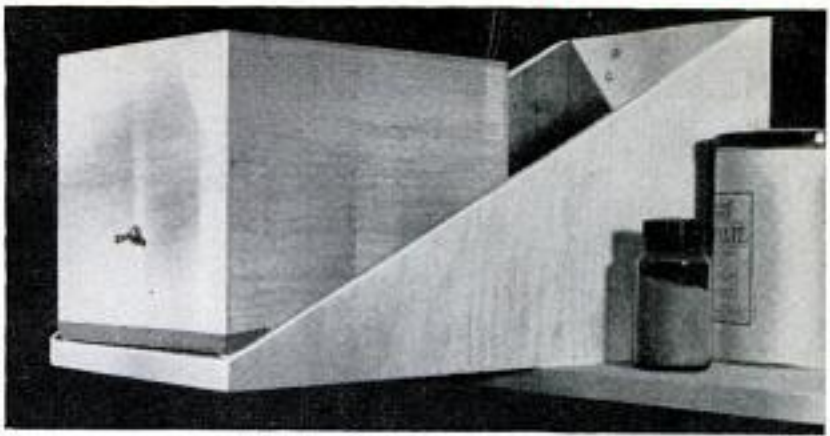

Protection for Vacuum Bottle Provided by Metal Carrier

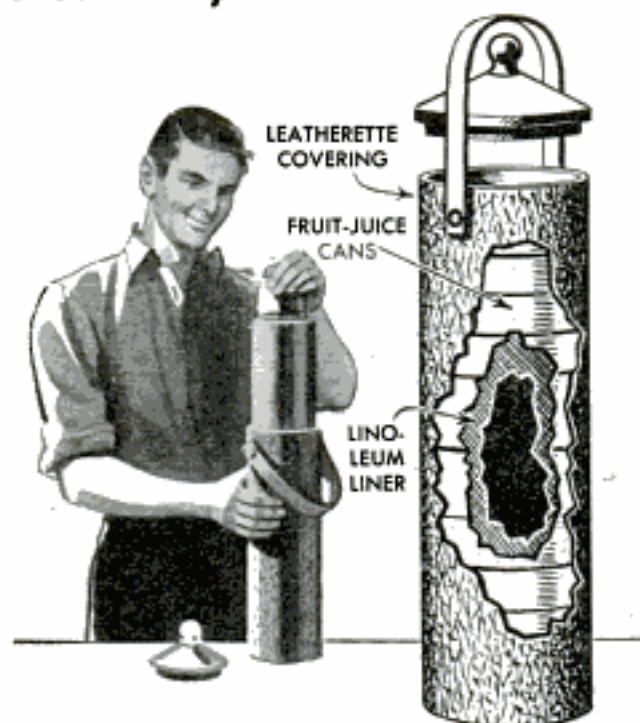

Protection against damage, plus extra insulation, is provided for a 1-qt. vacuum bottle by a carrier made from two empty fruit-juice cans. The top of one can is removed, as well as both ends of the other, and the cans are soldered together end to

end. The resulting cylinder then is lined with a scrap piece of linoleum and leatherette is cemented to the outside to provide a finished appearance. The lid of the carrier can be a wood turning, or a small saucepan lid might be used. The handle of the carrier is a leather strap riveted near the top.

Martin L. Seltzer, Des Moines, Iowa.

V-Grooved Level Permits Working From Bottom of Job

A V-groove cut in a wooden level permits it to be used for setting tanks, forms and structures where it is not possible or convenient to place the instrument in the normal position. The groove is sawed

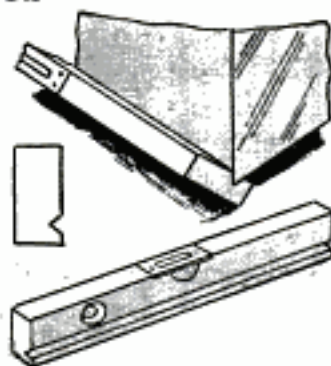

the length of the level, near the bottom edge, and exactly parallel with the bottom. In use, the level is held so the V-groove fits firmly against the bottom edge of the job, as shown in the sketch.

Sea shells can be made into ornaments and ash trays if they are cleaned first and then given two coats of white shellac.

Popular Mechanics Bookshop

NEW FULL-SIZE PATTERNS

Simply trace patterns on wood and saw to the traced lines. Authentic designs by professional designer. Every step made easy for building at home. Complete material list and step-by-step instructions included.

Crusette. Utility Outboard.

No. 101. Length 12 feet, beam 4½ feet. Ideal for fishing, picnics. 4 patterns in set. \$2.00

Trundle Beds. No. 102

Safer beds for children. One tucks away under the other. 3 patterns in set. \$1.50

Modern Cocktail Table.

No. 103. Plank top, metal grill insets in sides. 1 pattern. 50c

Modern Step Table. No. 104

Modern and stylish. 24 inches high. 1 pattern. 50c

Toys for the Children. No. 105

Giraffe drawing board and Bucking Bronco. 1 pattern. 50c

Juvenile Chest Robe. No. 106

Two drawers, shelf, hanging storage. 2 patterns \$1.00

Cupola and Weathervane.

No. 107. Can be made of metal or tempered hardwood. 1 pattern. 50c

Personal Work Bench. No. 108

Drawer and sliding doors. Storage space. 2 patterns. \$1.00

Valances and Trims. No. 109

Adjustable. Decorative. 12 designs on 1 pattern. 50c

Decorative Wall Shelves.

No. 110. Modern or traditional styling. 2 in 1. 50c

TV Chair. No. 111

Foam-rubber upholstery. 2 patterns. \$1.00

Modern Tub Chair. No. 112

Real all-out lounging chair. 2 patterns. \$1.00

Sofa Bed. No. 113

Sagless-type wire springs built-in. 2 patterns. \$1.00

Love Seat. No. 114

48 inches between arms. 2 patterns. \$1.00

All patterns are available from

POPULAR MECHANICS BOOK DEPT., 208 E. Ontario St., Chicago 11, Illinois



SHOP NOTES

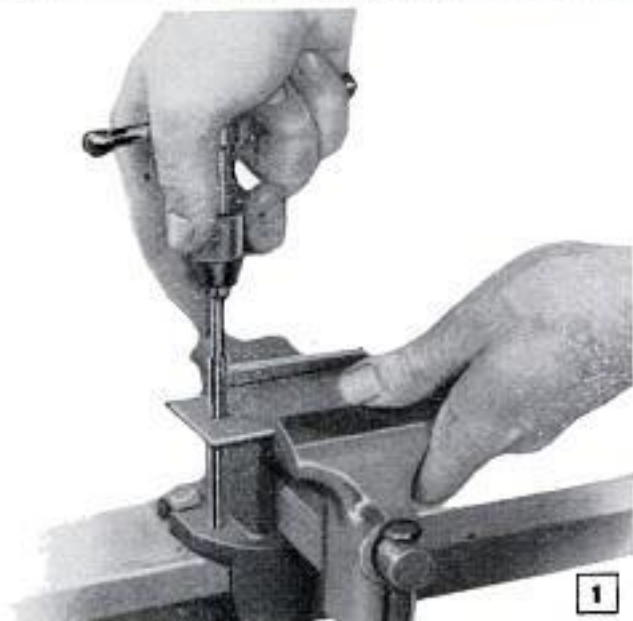

1

How to use HAND REAMERS, COUNTERBORES and COUNTERSINKS

HAND REAMERS are used to enlarge holes to finished diameters for fitting pins, spindles and other precision parts. For precision fits you cannot depend on using a twist drill only, since a hole thus made usually is from .004 to .006 in. larger per inch of drill diameter than the diameter of the drill. A drilled hole also may not be perfectly round, straight or smooth.

How reamers work: A reamer is a cylindrical or cone-shaped tool having longitudinal cutting edges separated by flutes, Figs. 1 and 2. How reamers remove metal from the sides of a hole is shown in Fig. 2. Cylindrical reamers have a uniform diameter so that the sides of a finished hole will be parallel. These are known as straight reamers. Cone-shaped reamers produce tapered holes.

The cutting edges and flutes of both straight and taper reamers may be either straight or helical, Fig. 3. Generally a helical-fluted reamer is preferred for high accuracy as it cuts with a shearing action and has less tendency to chatter than a straight reamer. It also is better to use in holes

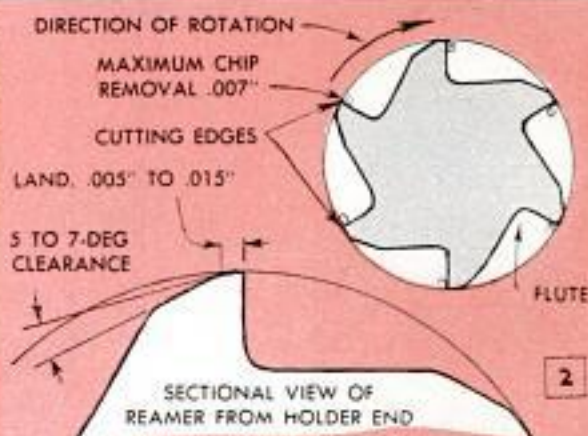

2



STRAIGHT, SOLID REAMER WITH STRAIGHT FLUTES



STRAIGHT, SOLID REAMER WITH HELICAL FLUTES



EXPANSION REAMER, HOLLOW

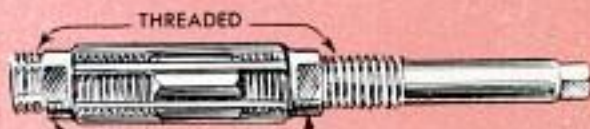

ADJUSTABLE REAMER, REMOVABLE BLADES



TAPER-PIN REAMER, SOLID



COMBINATION TAPER AND STRAIGHT



REPAIRMAN'S REAMER FITS CHUCK OF BRACE



PIPE-BURRING REAMER

3

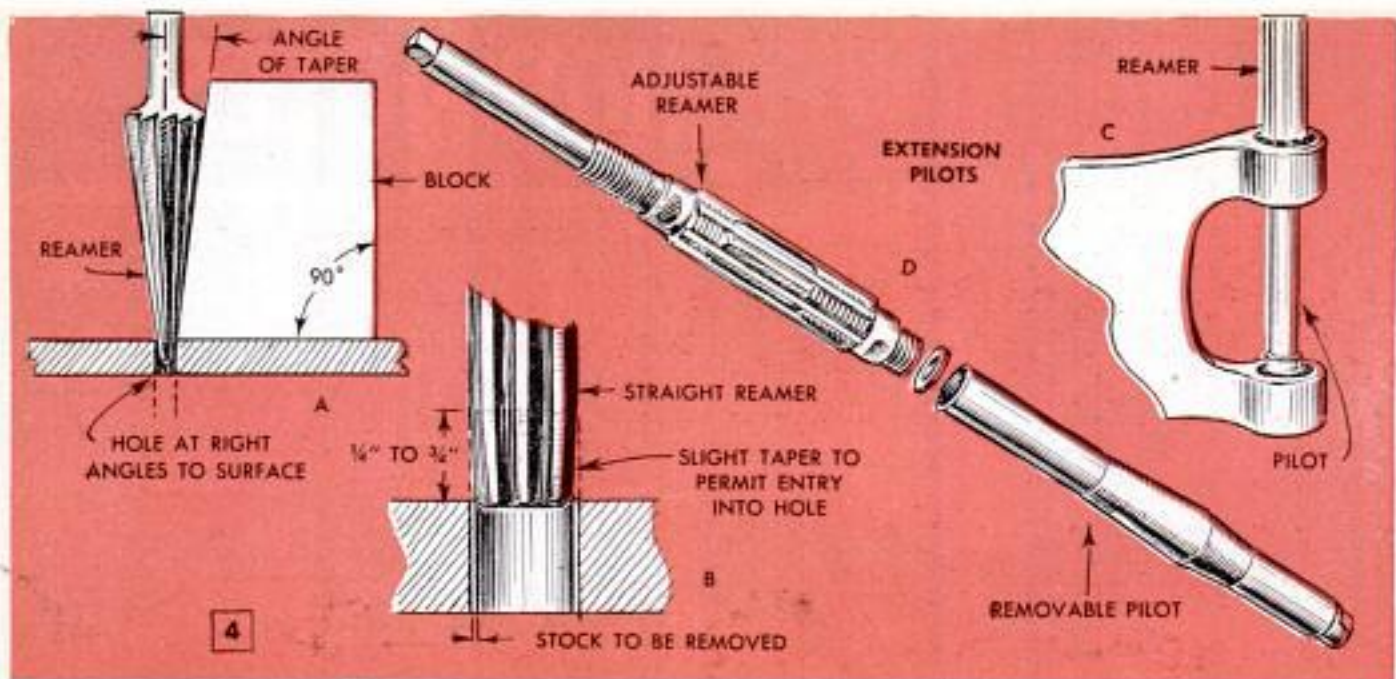

having keyways or grooves. Reamers are hardened and the cutting edges are precision ground. Standard reamers are right-hand (clockwise rotation).

Hand reamers usually are made of carbon steel or high-speed steel and they range in diameter from $\frac{1}{8}$ to 2 in. Sizes increase by $\frac{1}{32}$ -in. steps up to the 1-in. dia., and by $\frac{1}{16}$ -in. steps from 1 to 2-in. dia. Each reamer overlaps the next smaller one in size. The shank end of reamers is ground square so it can be held with a tap holder. Some hand reamers, such as those used for removing internal burrs on pipes, have square tapered shanks, permitting them to be chucked in ordinary hand braces.

Straight reamers: The straight reamer, Fig. 3, is made from a solid piece of steel and cuts to a specified diameter. The expansion reamer has a hollow steel body which is slotted longitudinally so that a tapered screw plug that turns inside will expand the cutting diameter a few thousandths of an inch. The adjustable reamer has removable blades that fit in tapered grooves cut in the threaded body of the tool. The blades can be moved back and forth in the tapered grooves by means of adjusting nuts to vary the cutting diameter about $\frac{1}{32}$ in. The blades of an adjustable reamer must be held tightly between the adjusting nuts when in use as any looseness may cause blade breakage.

All straight reamers, except bottoming reamers, have a slight taper for a short distance from the starting end, as shown in detail B, Fig. 4. This permits the flutes to enter a hole easily. A bottoming reamer is used to finish a blind hole. As it has no taper, but only a slight bevel at the end of each flute, it must be handled carefully to avoid chipping cutting edges at the starting

end. The reamer must be started straight.

Taper reamers: Taper reamers, Fig. 3, differ in their degree of taper. The Morse taper is approximately $\frac{5}{8}$ in. per ft., the Brown & Sharpe taper about $\frac{1}{2}$ in. per ft. Others, known as repairman's reamers, have as much as $1\frac{1}{8}$ in. taper per ft., while pipe-burring reamers have still more. Taper-pin reamers have a taper of $\frac{1}{4}$ in. per ft. Holes produced with them accommodate taper pins used for securing pulleys and gears to shafts. There also are combination reamers that are tapered about one third or one half the cutting length.

Precision fits by reaming: To obtain a precision fit, drill a hole slightly under-size, then finish it with a reamer of the diameter required. The hole should not be more than .007 in. smaller than the finish size, when reaming by hand. Removing a greater thickness than this places too much strain on the cutting edges. This is especially true of taper reamers where a hole should be the largest possible size to allow the reamer to finish it along its entire depth.

How to handle reamers: When possible, hand reaming should be done with the tool held in a vertical position as shown in Figs. 1 and 8. This makes it easier to start squarely with the surface of the work, and also allows the chips to clear more readily. The work should always be held rigidly, in a vise when possible. Although a reamer tends to follow the hole, it should be started squarely. When using a straight reamer, check the starting position with a square held in two positions at right angles to each other, as in Fig. 6. Check a taper reamer similarly with a square block having one side cut to match the taper.

Small reamers can be handled most conveniently when they are held in a chuck-

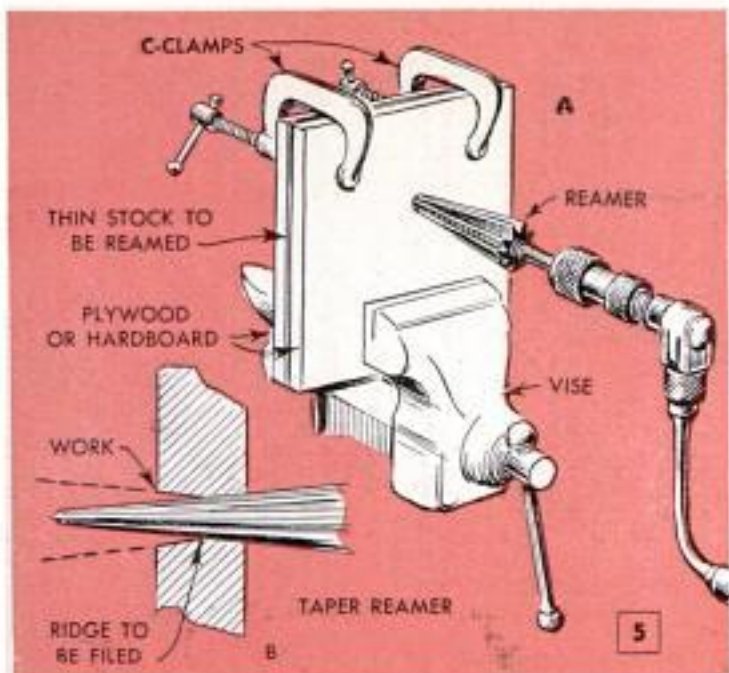

type tap holder, Fig. 7. Grasp the holder so that the palm of the hand is directly over the center of the handle as shown. This position will transmit pressure centrally to the tool. The balanced grip gives you a delicate feel when turning and minimizes the possibility of breaking the tool from side strain. A two-handle tap holder, Fig. 8, is best for longer reamers that require more turning leverage. When using a brace to turn a taper reamer as in Fig. 9, be sure that the tool is square with the face of the work. This can be checked by sighting downward and also sideways.

When reaming two holes in line with each other, as when reaming kingpin bushings, detail C, Fig. 4, alignment of a reamer is assured by using one fitted with an extension pilot, or guide. Detail D shows how an adjustable reamer can be fitted with interchangeable extension pilots.

To enlarge holes in thin stock, which is likely to bend when using a taper reamer in a brace, hold the work between two pieces of plywood or hardboard clamped together and mounted in a vise, detail A, Fig. 5. On heavier stock, where a precision fit is not needed, you can ream from both sides of the work as in detail B, Fig. 5. The ridge left at the center can be removed with a half-round file if necessary.

Turning pressure and feed: Since reamers are hardened they cannot be subjected to excessive lateral pressure as this may break them. Always turn a reamer slowly but quite firmly and at a uniform speed. Be especially careful when reaming cored holes in castings where scale may dull the cutting edges. Always turn a reamer in a clockwise direction, even when pulling it backward to disengage it. Turning it in the opposite direction will dull the cutting

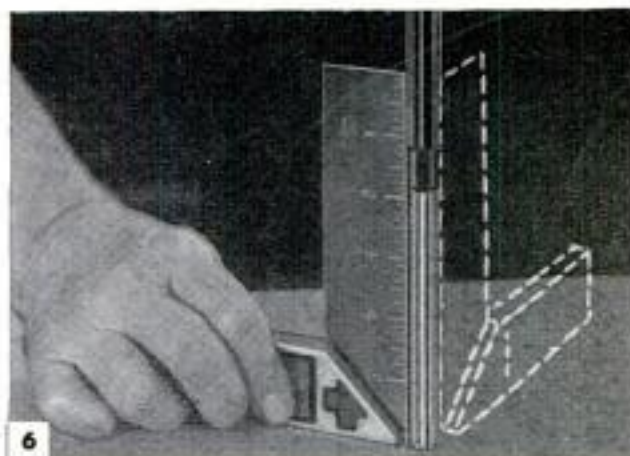

Hand reamers are started accurately with a square



Grip chuck wrench in this manner for accurate work

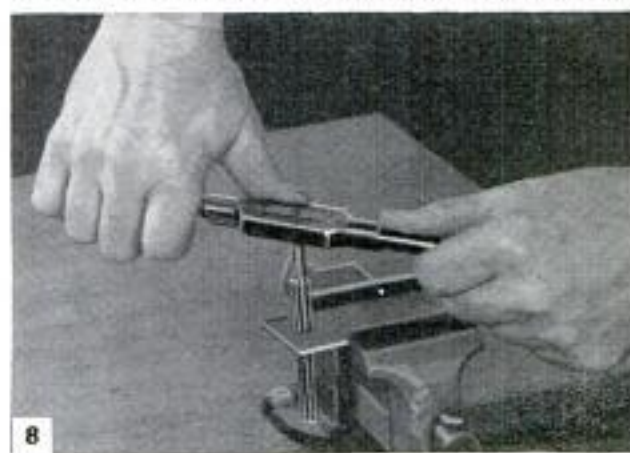

Above, two-handed wrench is best for long reamers

Below, light pressure prevents breakage of reamer

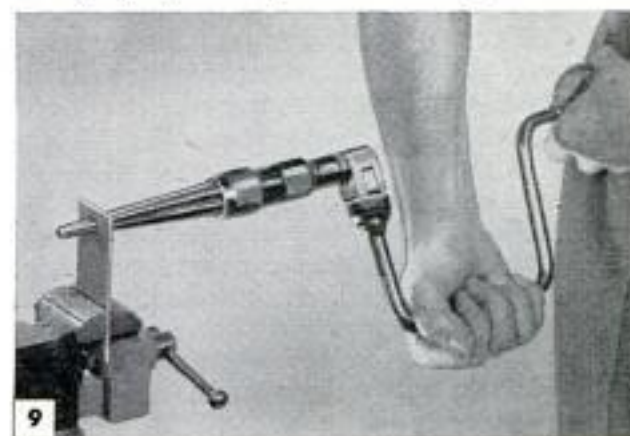

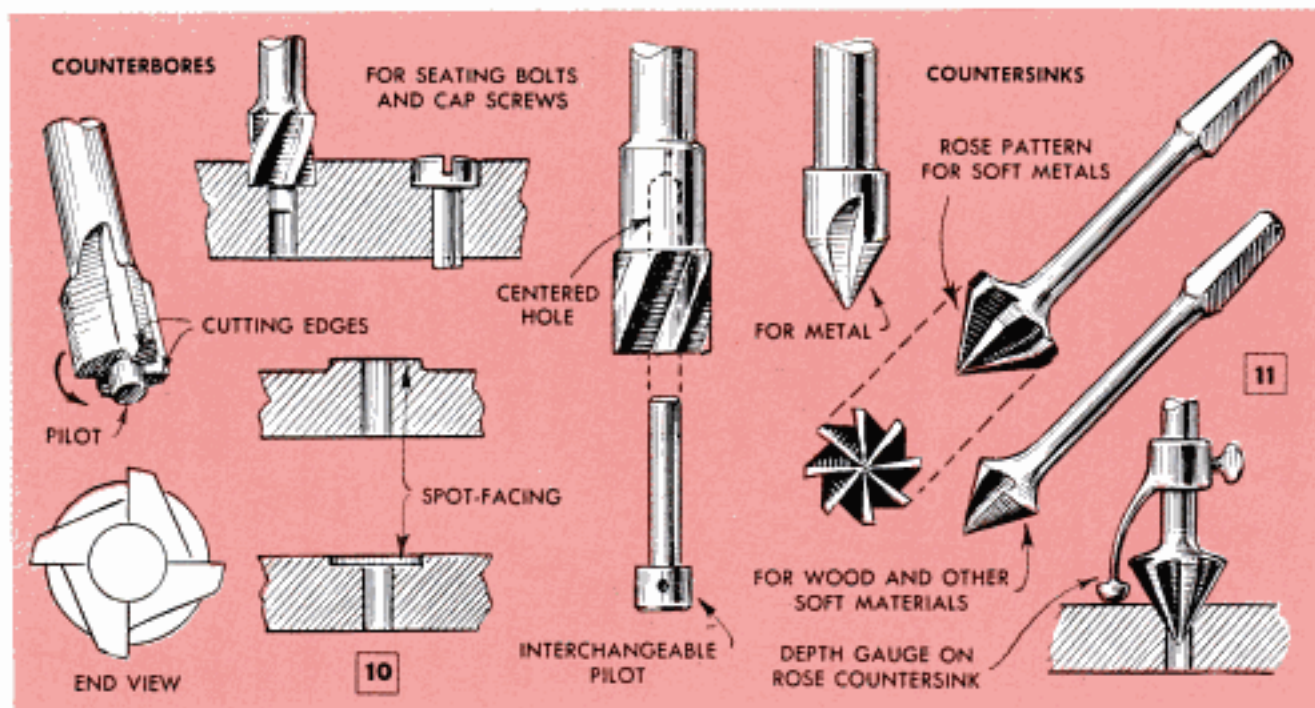

edges. Downward pressure, or feed, on a reamer should be controlled carefully by feel so that the tool will have the required bite but will not bind in the hole.

Lubrication and chattering: When reaming steel or wrought iron, lubricate the cutting edges with cutting oil or light machine oil. Cast iron is reamed dry. When using a lubricant, remove the tool from the work frequently and brush chips out of the flutes. Clogged flutes may score the hole. Chattering, which produces a wavy surface, may result from reaming too fast, or from misalignment. It also can be caused when there are dull spots on the cutting edges. Some reamers have irregularly spaced cutting edges to counteract the tendency to chatter.

Reamer care: Handle and store reamers carefully. Don't permit them to lie on a bench or loosely in a toolbox or a drawer where the edges may become nicked from contact with other tools. To protect reamers against rust, where humidity is high, keep them in moistureproof plastic wrappings, in separate compartments of partitioned boxes or drawers. Resharpening reamers necessarily reduces their size. This is generally a factory operation and the average mechanic should not attempt it without the special equipment required.

Counterbores: Counterbores, Fig. 10, are similar to reamers. However, they differ in that they are end-cutting as well as side-cutting. Ordinarily they are used for seating heads of bolts and cap screws below the surface. Counterbores also are used for spot-facing, an operation that produces a surface seat for a bolt head or nut at right angles to the bolt axis, Fig. 10.

Counterbores are provided with a guide,

or pilot, which fits into the hole to be counterbored and keeps the tool in perfect alignment with the hole. Some counterbores are drilled centrally to take interchangeable pilots of various sizes, Fig. 10. The cutting edges of a counterbore are formed by flutes which may be either spiral or straight. The larger counterbores usually have four flutes. Small ones have only three. For iron and steel, use counterbores having 15-deg. spiral flutes, but for brass use those having straight flutes. Use a cutting lubricant on steel and wrought iron. Cast iron is worked dry. Counterboring can be done by hand but is accomplished better by using a drill press.

Countersinks: Like counterbores, countersinks, Fig. 11, are end-cutting tools but they have conical cutting heads and are used mostly for enlarging holes at an included angle of 82 deg. to take flatheaded screws. Countersinks may also be used to remove the burr from punched holes. Most countersinks are not provided with a pilot end. The shanks are either round for insertion in a hand drill, or have a square taper for use in a brace. The flutes may be either spiral or straight. Some countersinks are designed for metal only, others for wood only and others for both wood and metal. The cutting depth of a countersink can be controlled by using a depth gauge. Countersinks having a 60-deg. point are sometimes referred to as center reamers, although these usually are called center drills, particularly the type combining a reamer with a twist drill. They are used for forming center holes in the ends of work to be mounted between centers in a lathe. Center drills must be started with extreme care to prevent breakage. ★ ★ ★

Fruit Jar Holds Flashlight In Upright Position



FRUIT JAR

A quart fruit jar can be used as a "light stand" when it is necessary to hold a flashlight in a vertical position for working under a car or other restricted location. A smaller jar also can be used if it is partially filled

with sand to weigh it down and prevent it from tipping over.

Homemade Farm-Garden Tiller

Power from the gasoline engine of this homemade garden tractor is transmitted to the driving wheels through a series of V-belts and pulleys, and the jackshaft provides a double reduction through sprockets and a roller chain to drive the tiller. The teeth of the tiller are tool steel and are arranged on the shaft in staggered rows so they cultivate the ground between 18-in. crop rows. The base of the gasoline engine is mounted on rods in the steel-angle frame. A clutch rod, actuated by a lever on the tractor handle, slides the engine backward or forward to tighten or release the drive belt.

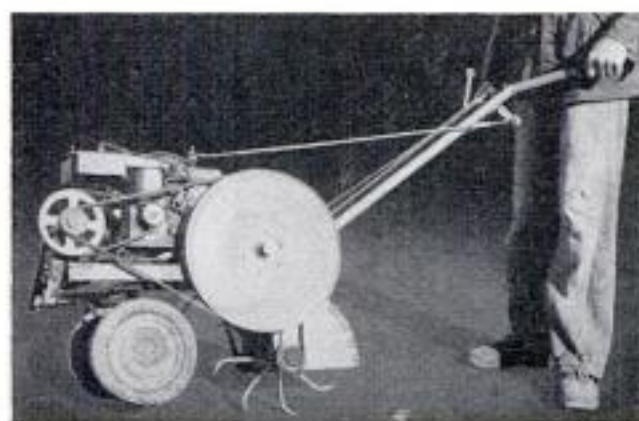
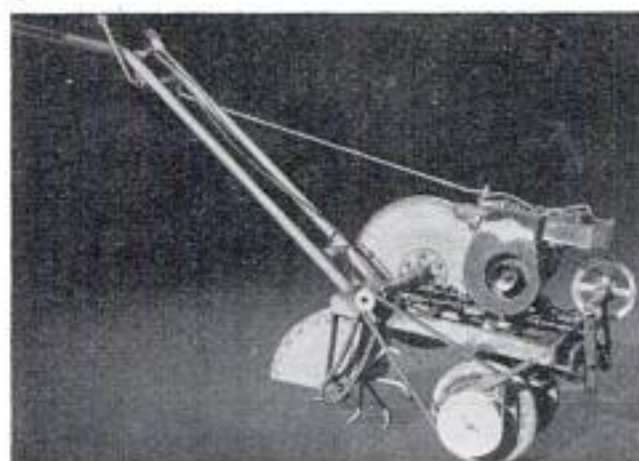

FEBRUARY 1955



Hog-Weighing Scale Platform Rests on Ground

To facilitate weighing pigs in its swine-selection program, the University of Wisconsin designed and built the portable spring scale shown in the photograph. The platform of the scale rests on the ground until the animal walks onto it. The spring scale then is hooked into the chains which are bolted to the platform and the platform is lifted until it swings clear and the animal's weight is registered. The scale is hung from a 6-ft. lever which is supported by a chain hung from the steel-tubing arch. The arch fits over two vertical lengths of tubing that are welded to brackets. Each bracket has two legs which are riveted loosely so they fold together when the arch is removed and the scale is disassembled for transporting. A chain between each set of legs positions them and acts as a flexible brace to prevent their spreading too far.

Ed. Mercer, Madison, Wis.

Quick Way to Set Steady Rest

A quick method of accurately setting a lathe steady rest is to chuck a short length of material, of the same diameter as the work to be turned, in the headstock chuck. Slide the steady rest over the piece and move it as close to the chuck jaws as possible. With the lathe turning at low speed, adjust the steady rest. Next, remove the short piece and replace it with the work to be turned. Finally, slide the steady rest out to the desired position and lock it in place.—Alton H. Deibert, Munising, Mich.

211

SN 56

Off-Center TURNING

By Sam Brown



OFF-CENTER turning is a useful wood-lathe technique that makes it possible to turn tapers and ovals in a wide variety of shapes and sizes. The four splayed legs of the lamp table pictured above are examples of the practical application of spindle turning by the off-center method. The legs are of the club-foot, or spade-foot, type with a square top section and a swell, or barrel shape, at the center of the turned section. Some handwork is required to finish the spade foot, although the job is produced very nearly complete in the lathe as will be seen from the five stages of the work shown in Fig. 8. Turning procedures for

both taper and barrel shapes are pictured in Figs. 4 to 11 inclusive.

Oval turning: The oval spindle is the basic form of off-center turning. A hammer handle is a good example. To work a turning to finished size, make a simple layout as in the left-hand detail, Fig. 1. This will enable you to locate both the true centers and the off-centers on the ends of the stock. Before mounting between lathe centers, be sure that

the material is large enough to include the long diameter of the oval. When the work is to be offset at both ends and turned to the oval shape throughout the length, off-centering is done on the square.

With the centers laid out, mount the stock on the true centers and turn into round. Then mount on the first pair of off-centers ready for turning the first side. If the round is more than $1\frac{1}{4}$ in. in diameter, reduce the lathe speed to about 500 r.p.m., or less. Turn only with scraping tools such as the spearpoint and round-nosed chisels. The gouge and skew chisels, which are cutting tools, tend to run too deeply on the interrupted cut. After the work has been turned into round, some wood turners pencil a ridge line on the work as in Fig. 2.

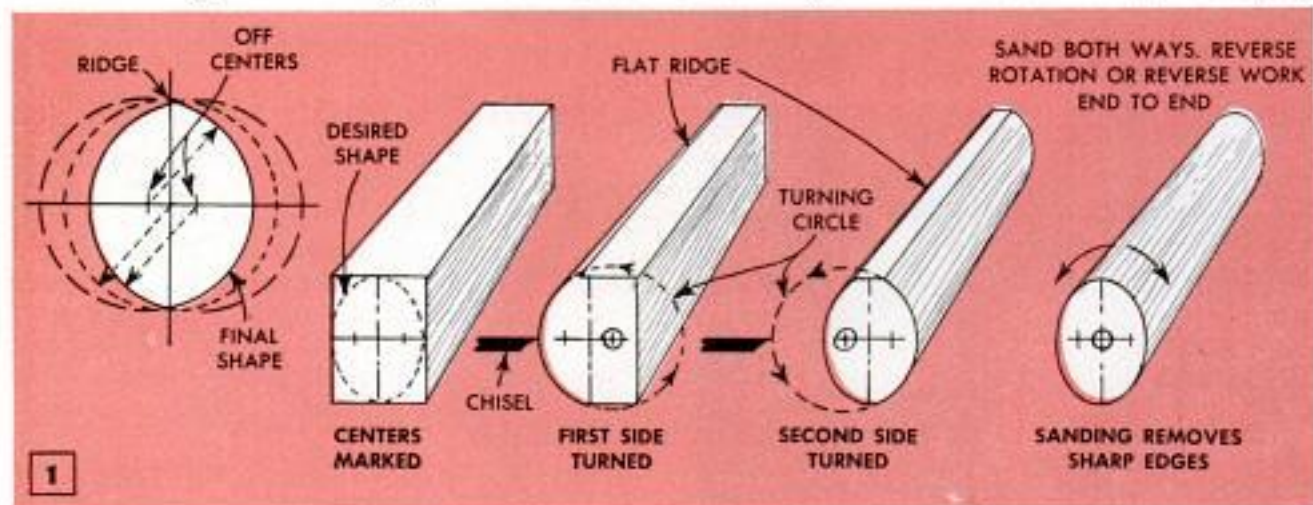

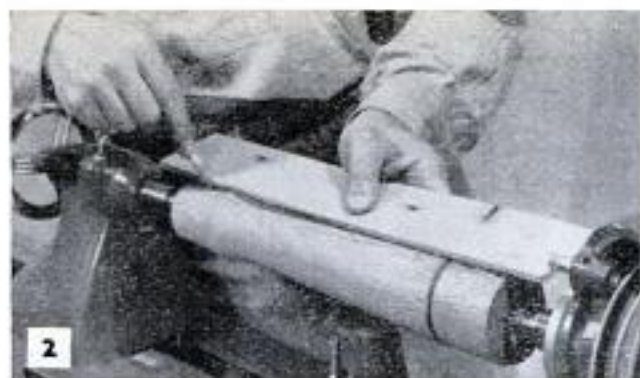

After turning work into round, mark ridge line the full length of turning. Turn offset side to line



Locate the offset centers from the two flat sides of work. Here the offsets are made on the diagonal



Body of turning and front of foot are turned down on true center



Toe is not a full circle and it must be measured from the flat side

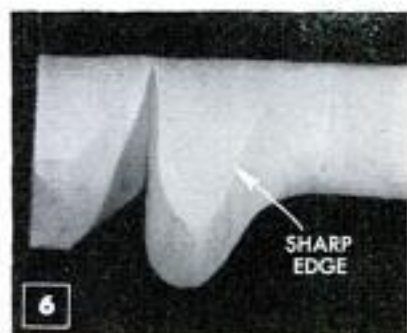

Work is off-centered at lower end only to turn heel of foot

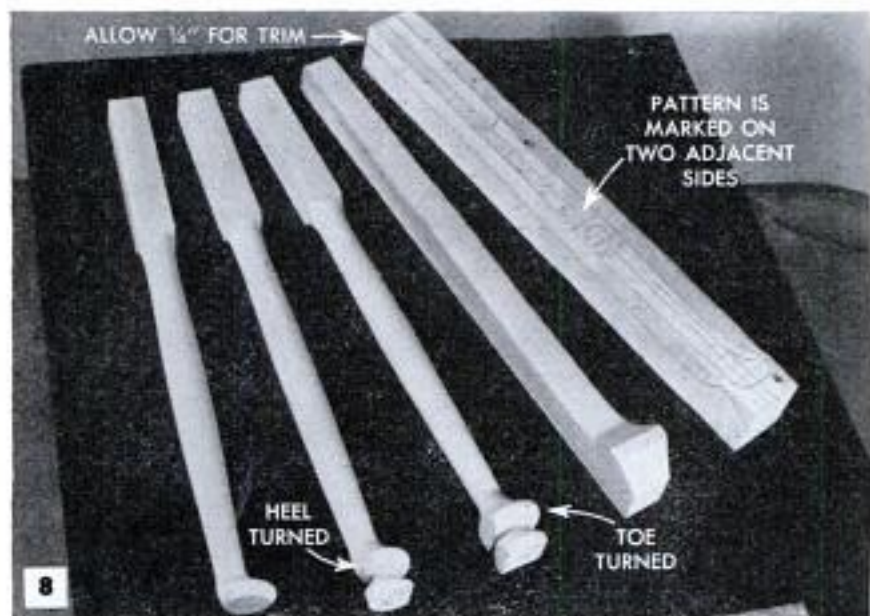

First step in turning the spade, or club, foot is to mark the pattern on two adjacent sides of the turning square. Then saw to rough shape

Careful sanding smooths the foot ready for finishing in color desired

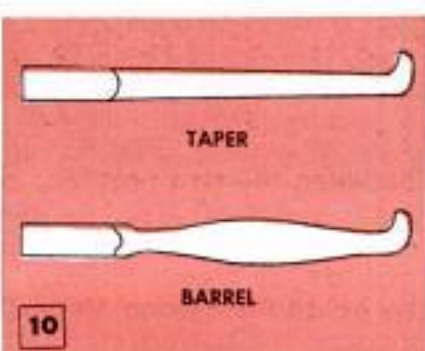

Light filing and sanding are necessary to remove sharp edges and shape foot to the required contour. Waste piece is sawed off



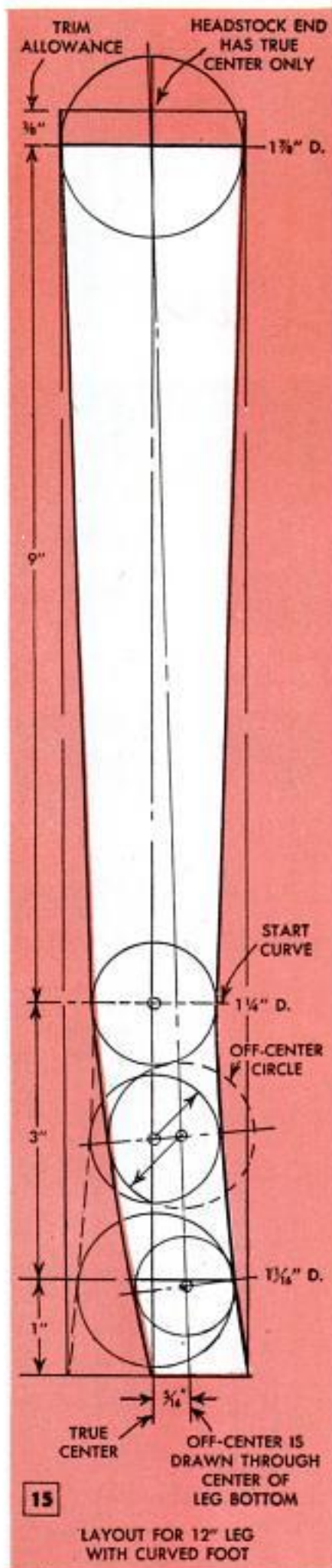

First step in making curved foot is turning into round on true center

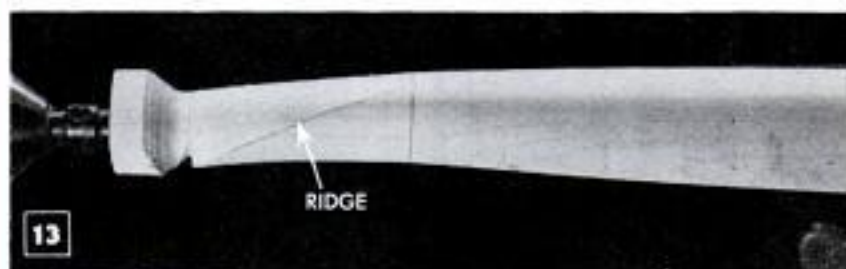

Work is then off-centered at one end to turn heel of curved foot. Second step forms a sharp ridge at approximately point indicated



In the final step, ridges are removed by sanding and filing to contour

When off-centered, the stock forms a double image as it rotates, making it fairly easy to determine the correct contour by eye alone. After the first cut is finished to the ridge line, shift the stock to the second pair of off-centers and work the second cut to the ridge line. Then finish the sharp ridges by sanding the work while mounted on the true centers.

Usually it is better to work a long oval on rectangular, rather than square stock. This saves both material and time. Instead of running the ridge down to a sharp line, it is left as a narrow flat which is easily sanded out to a smooth curve. However, in smoothing the work while rotating in the lathe, the sandpaper tends to cut faster on the leading edge. This often makes it necessary to shift the work end-for-end to obtain a true contour.

Spade foot: The spade foot, or club foot, is turned by off-centering at the tailstock end only. If the top is to be a square section, as in the lamp table, Figs. 16, 17 and 18, off-centering must be done on the diagonal, Fig. 3. Just as in turning a plain oval shape, the desired contour is determined by making a layout of the arcs with a compass. Off-centering 1/2 in. is a good average for this type of work. When making splayed legs be sure to make an allowance for trimming at the top end, Figs. 8 and 17. Also in sanding, Fig. 9, it is helpful to recenter the work between the two previous centers.

Curved foot: This is very similar to the spade foot, except for the variation in the shape of the work. In making the layout the diameter at the bottom end should be held to the same dimension as the straight taper. The amount the bottom end is turned out determines the off-

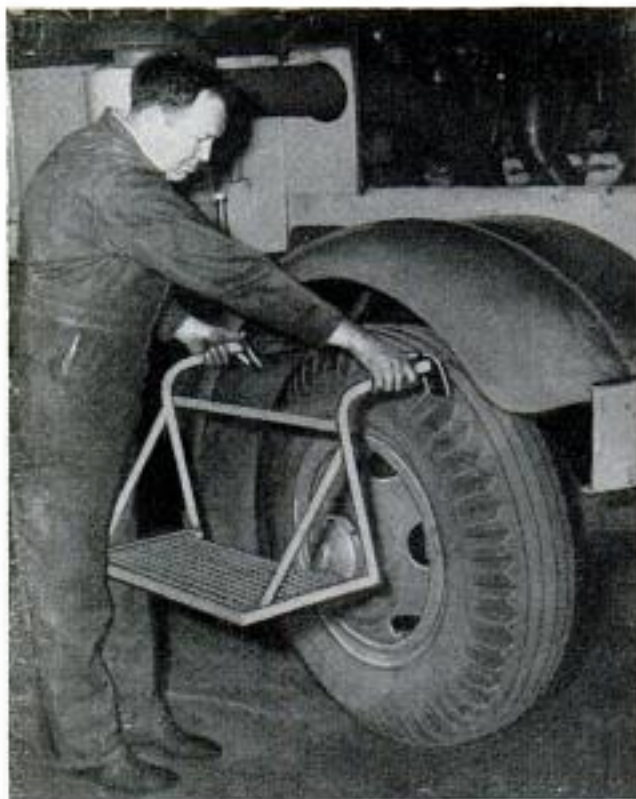

Step Suspended From Front Wheel Aids Truck-Engine Work

Working on the engines of big trucks was made considerably easier in one garage by building platforms or steps that are suspended from hooks which fit over the tire on the front wheel. The steps are of angle-steel construction and so designed that even a short man can reach all the engine components on one side.

R. M. Ogden, San Anselmo, Calif.

Regular Timing Light Can Be Used On 12-Volt Ignition System

Ignition mechanics do not need to buy a special timing light for tuning cars with a 12-volt ignition system. A regular 6-volt light which receives current from the car battery can be used by hooking it across just one half of the 12-volt battery. The light then is fired by No. 1 plug, as usual, it not being affected by the voltage change.

Ed Packer, Chicago.

This Gate Tips Over to Open



Requiring no swing space, hinges, hasps or latches, this farm gate is made from four strands of wire and two spreaders of a length equal to the height of the gateposts. First, the

spreaders are laid horizontally in front of each of the gateposts and the four strands of wire are stapled loosely to each spreader so that they are uniformly spaced. Then the ends of the strands are brought together and stapled to the second post on each side of the fence opening, as shown, the staples being driven into the posts at ground level. All four wires should be drawn to a uniform tension. To close the gate, simply tip it up to the vertical position and slip a wire loop over each spreader and gatepost.—B. M. Franklyn, Hunter, Okla.

Large Truck-Mounted Welder Provides Easy Portability

In order to have a large-capacity welder always close at hand, one farmer mounted a 200-amp. welder on his pickup truck so it was driven by the truck engine. Installations will vary with different makes of trucks. The installation illustrated shows the generator mounted on the front end of the truck to engage a power shaft driven by the engine. In other cases, the generator may be driven from a power take-off or may involve driving the generator from the fan belt. Also, it is possible to use a twin pulley on the fan shaft and drive it from this. The remainder of the welding unit is mounted under the hood on a frame bolted to the truck frame.

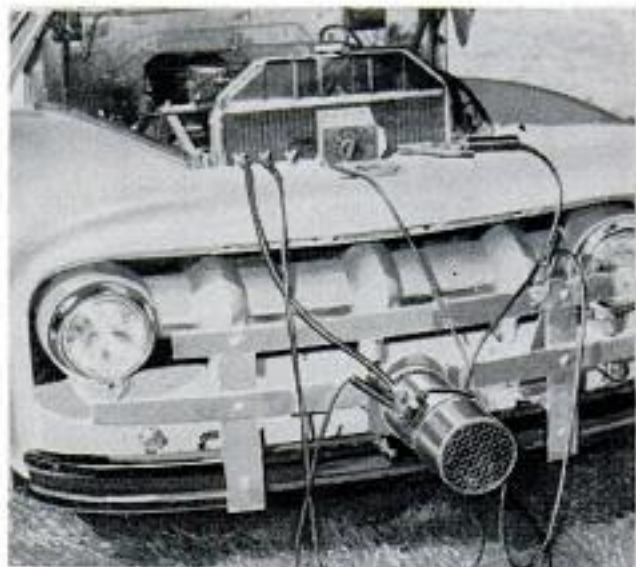

☛ If the edge of an aluminum sink smudges the clothing of anyone leaning against it, rub the aluminum with steel wool and apply two thin coats of shellac.

Fence Made From Implement Wheel Prevents Overturning Tub



A round tub used for watering farm animals can't be overturned easily if it is placed inside a guard made from a discarded implement wheel. The hub is cut from the wheel and the spokes bent outward at right angles to the rim, the spokes being heated, if necessary, to permit

bending. The spoke ends are forced into the ground and the tub is set inside the rim, as shown in the sketch. The diameter of wheel should be just slightly larger than that of the tub.

Altering Hand-Tightened Chuck To Take Pin Drills

Some hand-tightened chucks on hand drills and drill presses, which will not close tightly enough to hold pin drills, can be altered to do so by using a flat hex nut. The nut is dropped into the threaded hole in the chuck before it is screwed onto the drill spindle. The nut has the effect of lengthening the threaded portion of the spindle, which forces the chuck jaws together more tightly.

Gilbert C. Close, Hawthorne, Calif.



Early Seed Corn Dried in Crib By Hot-Air Furnace

To dry out his early harvested seed corn, one farmer installed this hot-air furnace in the driveway of his double cornercrib. Two overhead bins, each holding 250 bu. of corn, are piped for hot air from the furnace, and the corn is put into these when it comes from the field. Four days and nights of drying, with a temperature of 95 to 100 deg. thermostatically maintained, slowly reduce the moisture in the corn to 12½ per cent. When the corn is dried, it is shelled and elevated to storage bins.

Section of Windmill Ladder Used As Trough Stanchion

Ladder sections salvaged from a dismantled windmill can be utilized, without change, as stanchions, or dividers, on livestock-feeding troughs. As shown in the sketch, a ladder section can be nailed to the posts on either side of a fence-line calf-feeding trough. Hinged to one edge of a hog trough, the ladder section provides a divider that can be swung out of the way for cleaning the trough.

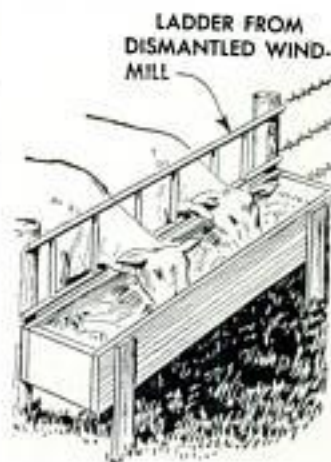

☛ If you find it difficult to make wallpaper adhere to plaster that has a chalky surface, apply a thin coat of shellac.

KEEPING YOUR WORKSHOP TOOLS SHARP

by E.R. Haan

The Equipment

1



POWER GRINDER



HAND GRINDER



GRINDING WHEELS
 ALUMINUM-OXIDE
 60 TO 80 GRIT
 SPEED
 3000 TO 5000
 SURFACE FEET
 PER MINUTE

S.F.P.M. — WHEEL DIA. X 3.1416
 X R.P.M.



WEAR GOGGLES



SAFETY-GLASS SHIELD

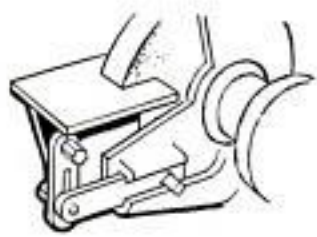

ADJUSTABLE TOOL REST

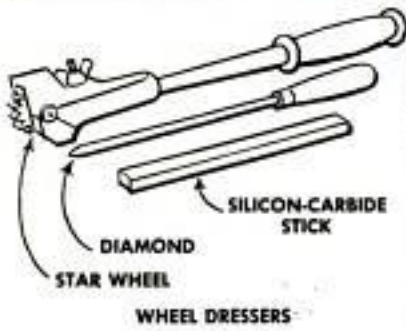

WHEEL DRESSERS

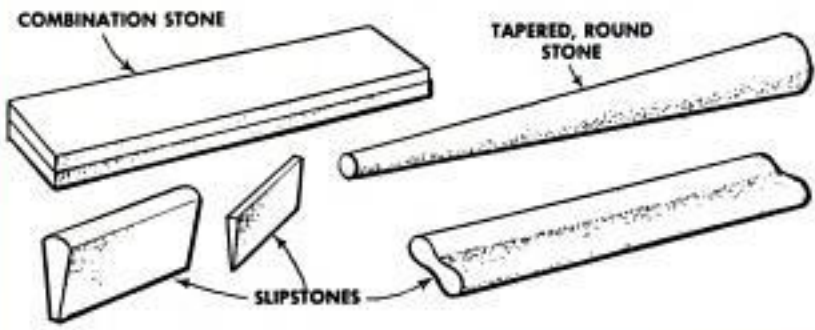

COMBINATION STONE

TAPERED, ROUND STONE

SLIPSTONES

A KEEN CUTTING EDGE is more than just one or two bevels ground along the length of a blade or across one end. It's also the result of simple know-how combined with the ability to perform several manual operations simultaneously. The sharpening of hand tools is easy after you learn the trick of maintaining uniform pressure, uniform length of stroke and a uniform position freehand. In accomplishing the desired result, whether you rough-grind on a power grinder, a hand grinder or the coarse side of a combination oilstone, the technique is much the same. You can finish the edge by fine-grinding on the fine side of the oilstone by hand, or on a honing wheel mounted on a power grinder. The end result will be the same, the only differ-

ence being that the power-driven unit will do the job in much less time.

Sharpening equipment: Fig. 1 shows the hand and power units most commonly used in sharpening hand tools in the workshop. You can do an acceptable job of sharpening common tools with only a combination oilstone. But you can produce a much keener edge by rough-grinding on a wheel of medium grade (grit), finish-grinding on a fine wheel and then slipstoning or stropping on a leather strop. Carvers and others accustomed to really sharp tools don't consider the edge practical to use unless it will pass at least two of the five sharpness tests shown in Fig. 2. One advantage of wheel-grinding is that the bevel is ground slightly concave (hollow ground) due to curvature

5 Sharpness Tests

2

SIGHTING
ACROSS
EDGE



SHAVING
TEST



FINGERNAIL
TEST

NAIL DRAGS WHEN
MOVED LIGHTLY
ALONG EDGE



PAPER-CUTTING TEST



SHARP
EDGE
HAS NO
"FEATHER"

Grinding Procedure

3

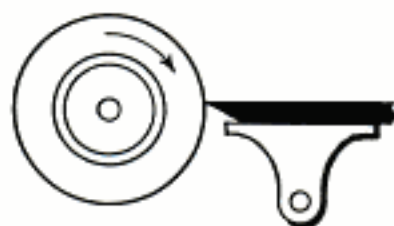

EDGE GROUND SQUARE
ACROSS TO REMOVE NICKS



CHECKING PLANE IRON
WITH TRY SQUARE

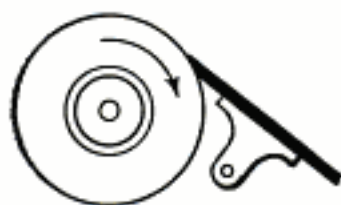

WHEEL ROTATES AGAINST
EDGE WHEN GRINDING BEVEL



TOOL MOVED BACK AND FORTH
ACROSS WHEEL FACE



DIPPING IN WATER
KEEPS EDGE COOL
WHILE GRINDING

of the wheel. A disadvantage of wheel-grinding is a tendency of the wheel to draw the temper of fine-edged tools such as carver's chisels and gouges, pocketknives and socket and butt chisels with narrow blades. To prevent this possibility, use a wheel of medium grit, drive it at the correct speed and use a very light pressure while the tool is in contact with the wheel.

Grinding procedures: Note the grinding procedures in Figs. 3 and 4, and especially the positions of the tool when grinding on the face and side of the wheel. If the edge is nicked, square it on the face of the wheel as in Fig. 3. Check the squareness of the edge with a try square before and after grinding. This is especially important on plane irons and wide-bladed chisels. When

sharpening on a grinding wheel, dip carbon-steel tools in water frequently, Fig. 3. Tools of high-speed steel, such as twist drills, should be ground dry with very light pressure.

Grinding on either the side or face of the wheel forms a burr, or wire edge, Fig. 4. This is removed by honing or fine-grinding, Fig. 5. Some users of chisels often hone a second bevel as in one of the details in Fig. 5. This is an advantage in certain types of work where it is necessary to lift heavy chips.

Using oilstone and strop: Users of edge tools generally carry sharpening one step further to include stropping, Fig. 5. Some craftsmen prefer to make a strop by cementing a strip of top-grain leather to a

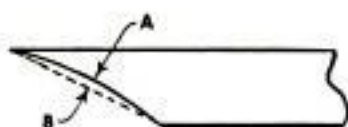

A—CONCAVE BEVEL GROUND ON FACE OF WHEEL

B—STRAIGHT BEVEL GROUND ON SIDE OF WHEEL

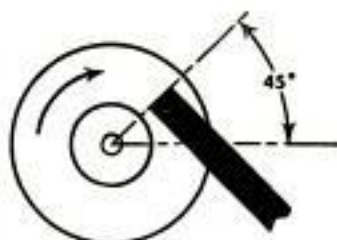

POSITION OF TOOL WHEN GRINDING ON SIDE

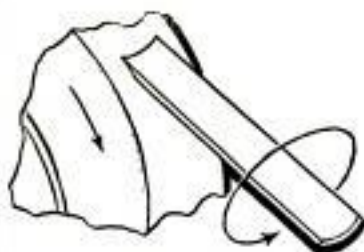

OUTSIDE BEVEL OF GOUGE GROUND ON FACE OF WHEEL



OUTSIDE BEVEL OF GOUGE GROUND ON SIDE OF WHEEL



4



PLACE A FEW DROPS OF OIL ON THE OILSTONE BEFORE USING



TOOL IS PUSHED EDGE FIRST OVER STONE

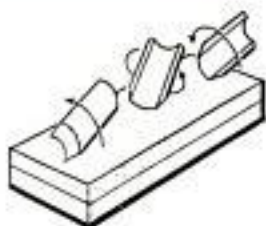

OUTSIDE BEVEL ON GOUGE FORMED BY ROLLING SWEEP

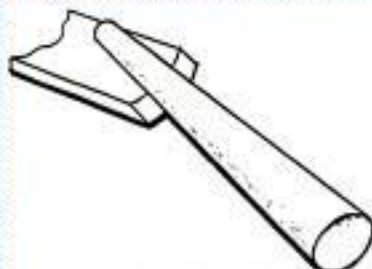

USE TAPERED STONE ON INSIDE BEVELS



GRINDING FORMS BURR ON EDGE



5

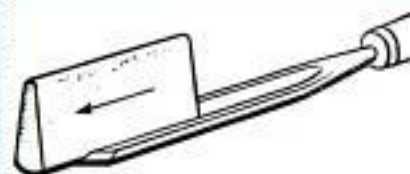

BURR ON GOUGE REMOVED WITH SLIPSTONE

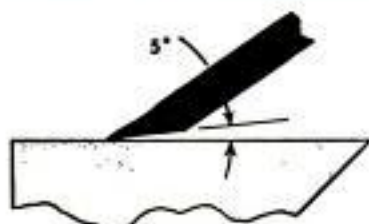

HONE A SLIGHTLY SHORTER BEVEL

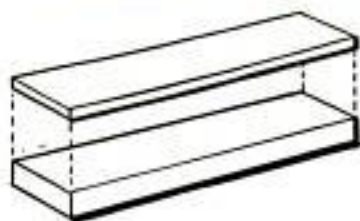

2" X 12" LEATHER STRIP GLUED TO WOODEN BLOCK

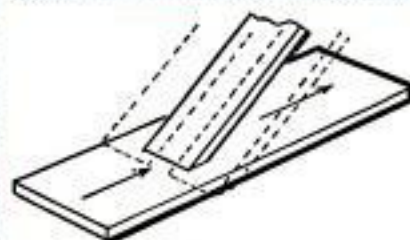

SHARP EDGE OVERHANGS STROP



RAZOR STROP

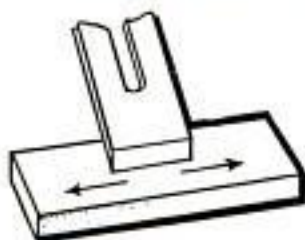

FLAT SIDE OF TOOL MOVED OVER STONE



PLANE IRON AND CHISEL HOLDER ADJUSTABLE TO CORRECT BEVEL

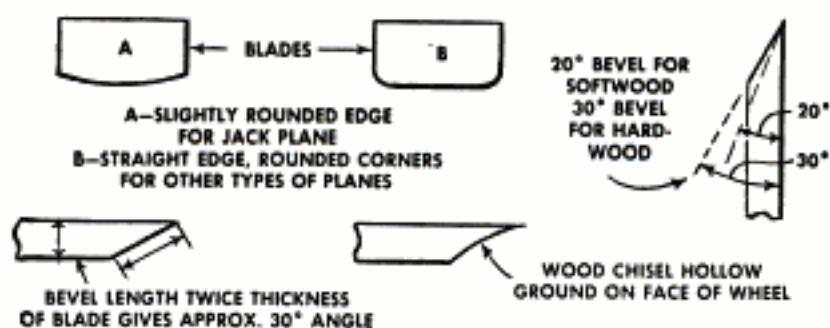

Chisel and Plane Blades

6

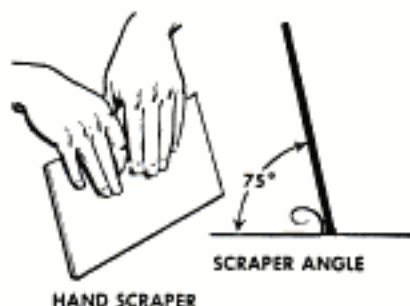
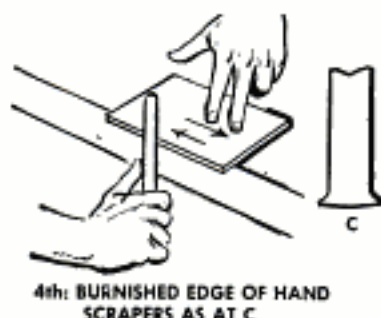
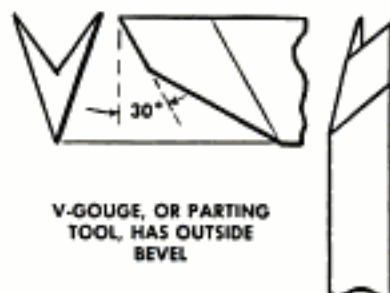
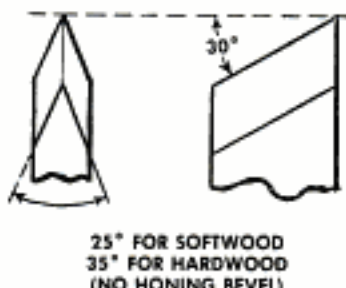
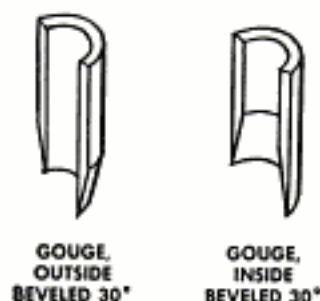

Hand and Cabinet Scrapers

7

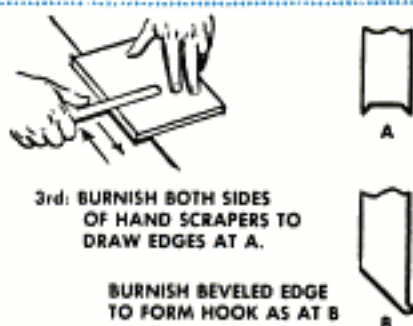
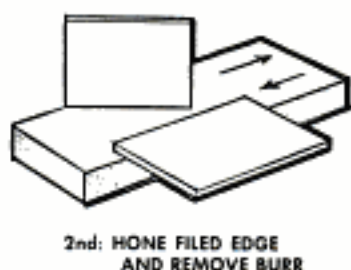
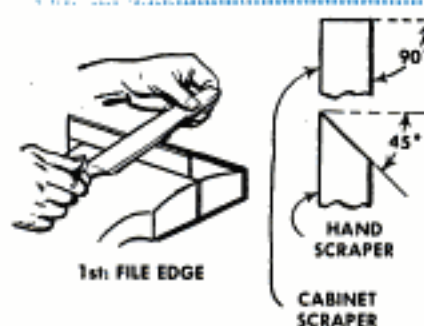

hardwood block. A piece of leather belting is excellent, but be sure that it is not contaminated with embedded grit, as this would make it entirely unsuited to the purpose. Carvers and whittlers often use a razor strop for finishing the edge of pocket-knife blades, Fig. 5. Some prefer to strop against the edge as indicated by the arrows, others make the stropping strokes in the opposite direction. It can be done either way, but the latter method is perhaps the most preferable. In any case the leather should be in good condition. Do not use old razor strops or leather that is cracked or roughened by long use for other purposes. A few drops of neat's-foot oil rubbed into the surface usually will condition it for use as a strop. Some craftsmen impregnate the leather with polishing rouge, but this is

hardly necessary unless it is desirable to speed up the removal of the invisible wire edge left by honing. In stropping tools sharpened with a single bevel, such as plane irons and chisels, it is common practice to stroke the bevel over the strop in one direction with the edge trailing. Some craftsmen say they get better results by alternating the strokes so that the edge overhangs the strop as indicated by the dotted lines in one of the details in Fig. 5. Others use a back-and-forth stroke but impart a rotary motion across the surface of the strop, the tool overhanging the edges of the strop alternately. There is no hard-and-fast rule but it is a common practice in stropping to stroke the tools with the edge trailing. It is not so much the type of stroke that is used, but rather is uniformity

CARVER'S CHISEL

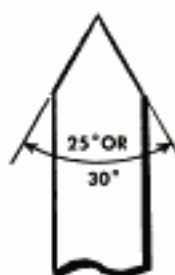

8

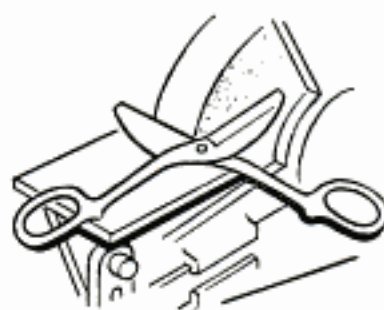
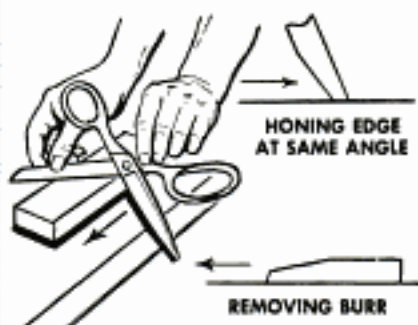
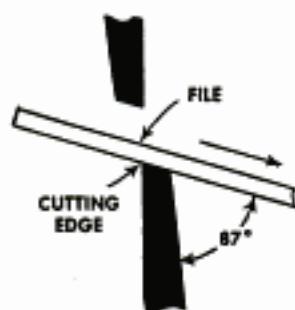
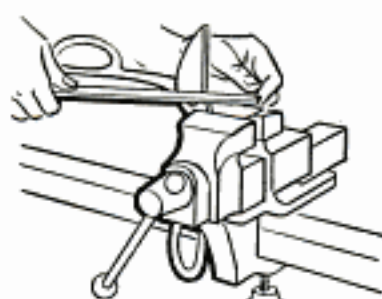

of motion and pressure that produces a razor-keen edge for smooth work.

Chisels and plane irons: For rough work the edge of a plane iron should be rounded slightly as at A in the upper-left-hand detail, Fig. 6. For surfacing and jointing where accuracy is important, the iron should be ground straight across, detail B, with the corners only slightly rounded to prevent scoring the work. In both details, A and B, the contours have been somewhat exaggerated for purposes of clarity.

Cabinet scrapers: Although the scraper is a smoothing tool like the hand plane, the edge is formed by burnishing after rough filing or grinding is done. There are three cutting-edge shapes commonly used as in views A, B and C, Fig. 7. For average work on large surfaces, cabinetmakers generally prefer the hooked edge B as it cuts somewhat faster, although not as smoothly on softer woods as edges A and C. To form the edges A and C, the scraper is filed or ground square across and the cutting edges formed by burnishing as in the third and fourth steps. When using either of the hooked-edge scrapers, B and C, cabinetmakers generally prefer to pull the scraper across the surface at an angle of about 75 deg. However, on certain types of work better results will be obtained by pushing the scraper.

When used for paring, a hand chisel cuts in much the same manner as a plane iron. The exception is that the depth of cut of the plane iron is controlled mechanically while the depth the chisel cuts must be controlled manually. Gouges, skew chisels (used by turners and carvers) and the various types and sizes of V-gouges, or veiners, belong in this classification.

Shears, scissors and snips: The technique of sharpening tools which shear metals and fabrics differs somewhat from that for other common edged tools. This is due to the shear-cutting action necessary to sever the material and also to the comparatively heavy pressures to which the edges are subjected in ordinary use. When filing tinner's snips, it's a common practice to file with the edge and remove the burr by honing, Fig. 8. In grinding, the wheel runs against the edge, the blade being stroked across the face of the wheel under light pressure. This avoids any tendency to serrate which might result from application of heavy pressure and a slower stroke.

Auger bits: Sharpening dulled auger bits is quite simple to do if you use a file especially shaped for the purpose, Fig. 9. The spurs are always filed on the inside unless it is necessary to remove a nick. Then it is permissible to file on the outside of the spur as in one of the details in Fig. 9.

Twist drills: In grinding twist drills it's important to maintain the same angle across the leading edges and the correct clearance angle from the leading to the trailing edges. The former is 59 deg. for average work, with a clearance angle of 12 to 15 deg., Fig. 10. Although twist drills can be ground freehand on the side of the grinding wheel with a reasonable degree of accuracy, better results will be obtained from the use of a drill-grinding jig, Fig. 10.

Hand crosscut and rip saws: The eight steps in Fig. 11 show the procedure in jointing, setting and filing handsaws. Although the plunger-type setter is commonly used, some craftsmen prefer to set the teeth with a pin punch. This is done with a hardwood backing block. ★★★

Auger Bits

9

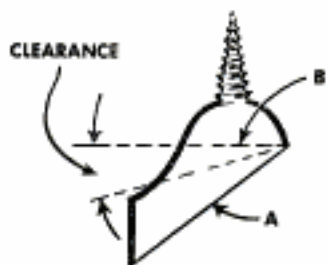
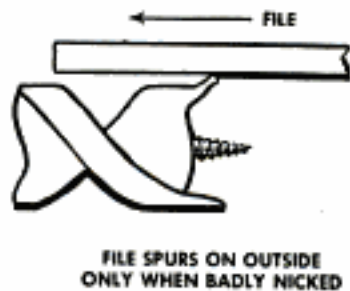
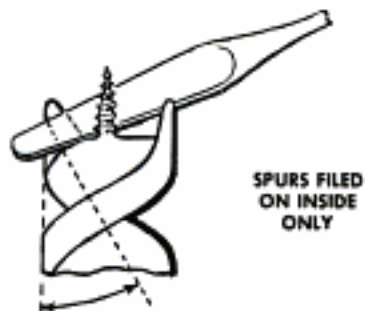

Twist Drills

10

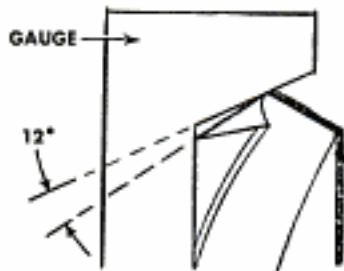
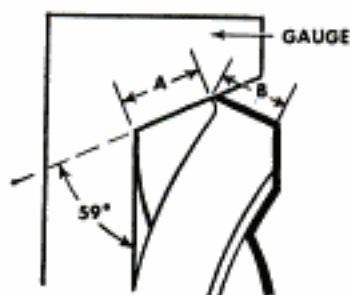

DRILL-GRINDING JIG

Hand-Crosscut and Rip Saws

11

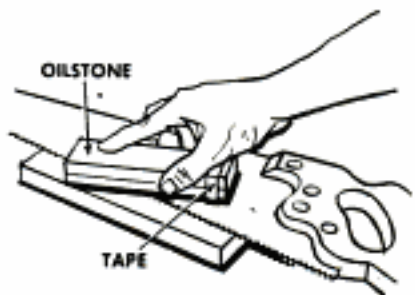
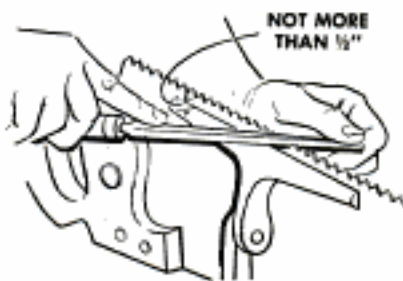
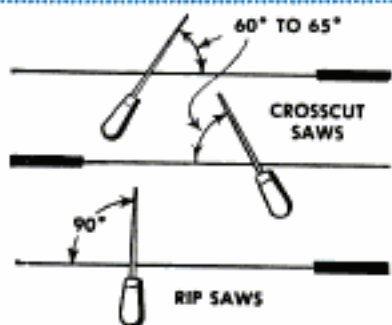
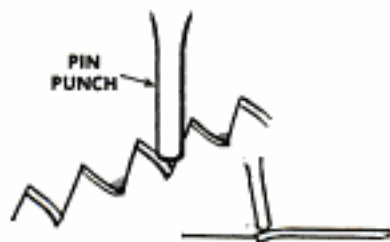
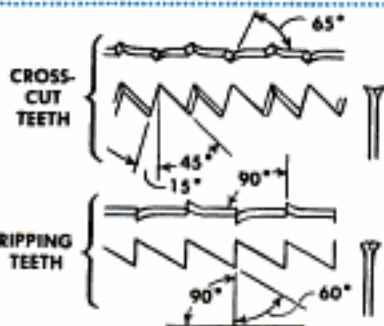
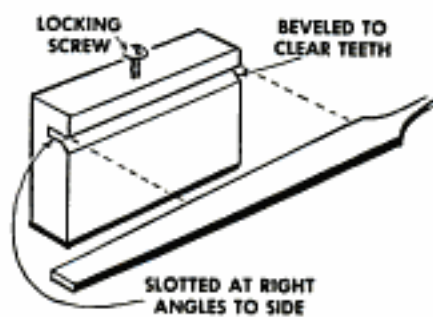
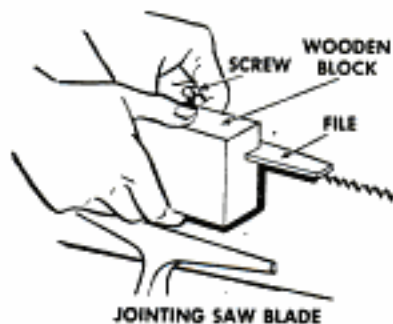

Belt From Tractor Generator Drives Mower-Sickle Sharpener



By installing a dual V-belt pulley and extra belt on the generator of his tractor, one farmer provides a means of driving a mower-sickle grinder bolted temporarily to the front axle. The fan belt drives the generator in the conventional manner, while the second belt on the generator drives the grinder.—L. H. Houck, Jefferson City, Mo.

Sticking Dresser Drawers Eased By Thumbtacks on Slides



Overloaded dresser drawers that are difficult to slide in and out can be made to work more easily by using ordinary thumbtacks in the drawer slides. Force the tacks into the slides a short distance back from the front edge of the dresser. Rubbing wax along the bottoms of the drawers where they contact the tacks will also help the drawers slide easily.

Howard E. Moody, Upper Jay, N. Y.

Cleaning of Gas-Line Filter Prevents Engine Troubles

A number of engine troubles of late-model cars, which are blamed on defective fuel pumps and clogged gas lines, actually are due to dirt and sediment collecting in a small filter located in the gas line between the carburetor and fuel pump. To avoid

trouble from this filter, clean it periodically by unscrewing the threaded fitting, removing the element and soaking it in gasoline. Compressed air can be used to blow out the dirt in an element that is badly clogged. It is advisable to buy a new unit if the old one cannot be cleaned. Under no circumstances should the filter be taken out of the line, since particles of dirt then may pass into the carburetor and cause trouble.

Stuart Foster, Columbus, Ohio.

Welded Stand for Bench Grinder Permits Easy Portability

When machinery is pulled into the barnyard for emergency repairs, it saves time and steps to have a bench grinder close to the job. The double-end grinder, shown in the photo, is bolted to a 12-in. length of 10-in. steel channel. The channel is welded to a length of 1½-in. steel pipe cut to a convenient work-surface height. On the original stand, the base was salvaged from a discarded sign. However, any circular shape, cut from plate or fabricated from flat bar, would furnish an equally good base. The circular shape allows the grinder and stand to be rolled to the job. An extra-long cord should be provided so the grinder can be used in any part of the yard.



Stemmed glassware need not be discarded when broken if part of the stem still remains, for this can be pressed into the soil of an indoor planter, making a small vase for cut flowers.

SHOPPING FOR TOOLS

1. SWIVELING MOTOR MOUNT provides for correct tension and release of V-belts when changing speeds on drill presses and other power equipment where the motor is mounted with the shaft in the vertical position. Fits nearly all small drill presses and takes motors up to $\frac{1}{2}$ hp. Consists of two cast-iron plates pivoted together so that they open and close in a manner similar to a hinge. A ratchet-type cam holds setting when belt has been adjusted to correct tension for job

Sutton Mfg. Co., Box 5742, Milwaukie 2, Ore.



2. BLADE JIG holds narrow bandsaw blades in position for filing by hand or on a jigsaw fitted with a special chuck for holding three-cornered files. Jaws take either standard or skip-toothed blades from $\frac{3}{16}$ to $1\frac{1}{4}$ in. wide. As many as three teeth can be filed at a time by coiling blade and locating teeth in exact register before clamping in the jig. In this way the file stroke will sharpen three teeth simultaneously as in photo. Jig-filing results in accurate tooth spacing and preserves uniformity and correct tooth shape

Riverside Enterprises, 10 Riverside, Corning, N. Y.



3. POWER HEAD is actuated hydraulically so that work held in vise can be positioned for compound-angle work on drill presses, milling machines and shapers. Unit can be attached to wall, workbench or machine tables. Head swivels to any desired position, either vertically or horizontally and is held in any position by applying pressure hydraulically. Tension on head can be controlled from release to full holding capacity when it is necessary to move the work, adjust vise, or change position of unit vertically

Wilton Tool Mfg. Co., 925 Wrightwood, Chicago 14

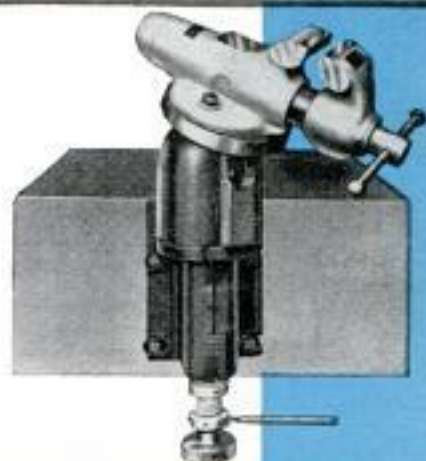

4. "CORNER" SQUARE simplifies the job of determining, bisecting and transferring angles in cabinet-making, counter-top fitting and tile setting where speed and accuracy count. Unit is especially useful when fitting counter tops between walls in rooms slightly off-square at corners. Measurements can be taken and transferred to the materials to be cut with an accuracy and speed unequaled by other methods. Legs are 18 and 24 in. long. Links connect legs to slide on graduated bar from which reading is taken

Johnson Research & Products, P. O. Box 14, Flossmoor, Ill.



SHOPPING FOR TOOLS

(Continued from preceding page)



5

5. HAND NIBBLER cuts steel steel up to 18 gauge, aluminum and other soft metals to 16 gauge. Cuts in any direction, makes square corners on inside cuts, radius corners from the edge of the stock, cuts in and out from the edge, removing square, rectangular or curved section. Makes clean, sharp-edged cut and leaves straight edges without burrs

Adel Tool Co., 4013 N. Milwaukee Ave., Chicago 41



6

6. ADJUSTABLE BORE GAUGES are a major advance in fast, accurate bore-gauging at inspection bench or at machine. Double-ended, gauges are set go and no-go to the hole specification and are identified by green and red. No-go end also is notched for identification. Special design of gauges enables operator to detect defects as bellmouth, out-of-round and taper

M. C. Hutto Co., 6516 Detroit Ave., Cleveland 2, Ohio

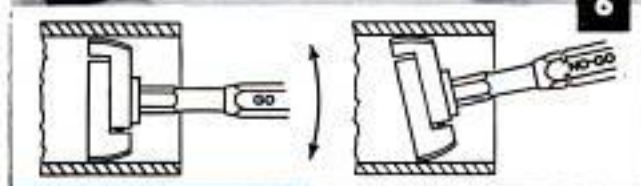

7. RATCHET DRIVE for conventional-type screwdriver gives greater leverage and longer reach. Ratchet is fitted into a detachable palm-type handle similar to that on a brace. Driving lug of reversible ratchet fits socket in screwdriver handle. Available as a kit containing two drivers and ratchet drive, one driver for Phillips screws, one for standard slotted screws

Kipton Industries, Kipton, Ohio

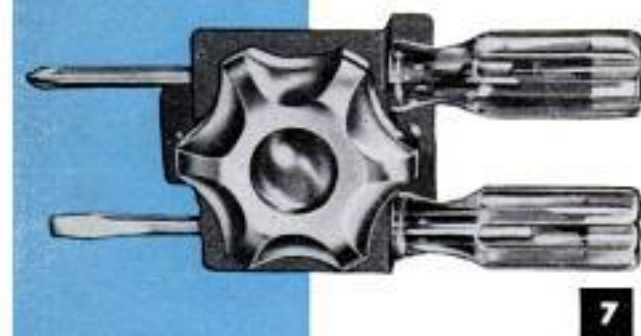

7

8. DRAWING MACHINE for draftsmen, engineers and technical illustrators makes accurate pictorial drawings which require ellipse forms drawn with mathematical precision. Two settings determine the minor and major diameters. Once set, related ellipses can be drawn repeatedly without variation in size. This feature is especially useful in making exploded views

Charles Bruning Co., 4700 Montrose, Chicago 41

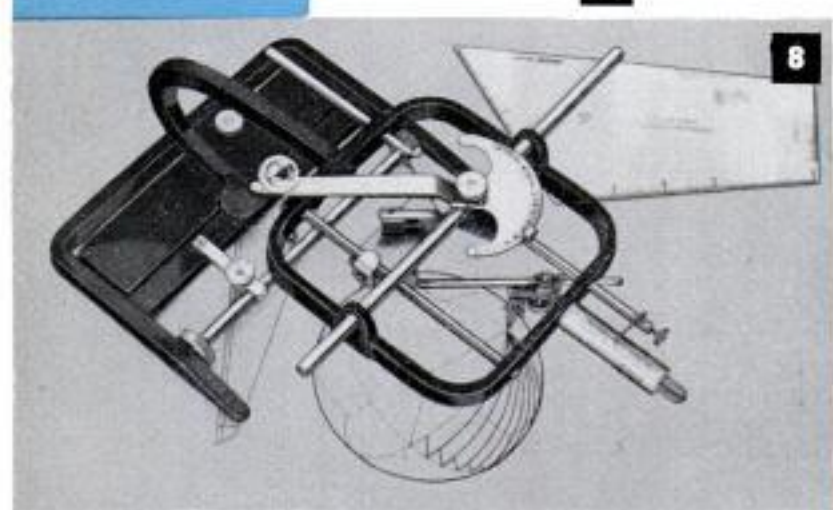

8

9. NONMETALLIC TAPE RULE has bold markings protected by a special plastic coating compounded to resist abrasion, cracking, mildew and repeated soaking and drying. Maintains dimensional stability under adverse conditions. High safety factor is provided by nonmetallic construction when working near high-tension electrical circuits. Case is made of leather

The Lufkin Rule Co., Saginaw, Mich.



9

10. SAFETY SWITCH for portable electric drills and drill presses utilizes drill-chuck key as a "circuit breaker." Motor cannot be started until key has been inserted in the switch as in detail. Only then will switch operate normally to start and stop motor. Eliminates the danger from chuck keys left lying on moving parts of the machine or in the chuck

Tricop Co. Inc., 308 W. Center, Akron 2, Ohio

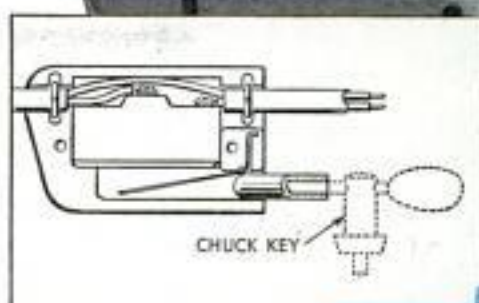

11. SABER-SAW ATTACHMENT for circular saw fits underneath the saw table as in the lower photo. Unit tilts with the saw arbor, making it possible to cut curves at any angle within the limits of the tilting device. Crosscuts, rips and curve-cuts stock up to 2 1/4 in. thick. Also can be used for sanding and filing, either vertically or at an angle. Easily installed and removed

Delta Power Tool Div., Rockwell Mfg. Co., 430 N. Lexington, Pittsburgh 8, Pa.



12. SPIRALLY FLUTED TAP produces self-locking internal threads which largely eliminate the use of ordinary bolts, nuts, locknuts, cotter pins and locking rings in types of assemblies where bolts and pins are used as fasteners. Threads can be cut to extremely close tolerances, also various classes of fits, snug, tight and extra-tight. Threads take regular cap screws

Shearcut Tool Co., 7045 Darby, Reseda, Calif.



13. CARPENTER'S SQUARE automatically indexes to the correct angle for cutting rafters or other angular cuts used in framing. A simple turn of a dial gives the correct angle for 14 standard rafter cuts, including jack and cripple rafters. Can also be set for stair-riser cuts, sheathing cuts and octagon and polygon shapes. Easily adjusted to different widths

Unique Products, Inc., Box 2263, Reno, Nev.



14. SOLDERING GUN spotlights the work by means of a 10-watt bulb housed in barrel of gun and controlled by a separate switch. Gun is of the thermostatically controlled type which prevents overheating during idle periods while work is in progress. Comes in two sizes, one for light jobs such as radio and electrical work, the other for industrial jobs

S. J. Sutton, 228 E. Park, Wheaton, Ill.

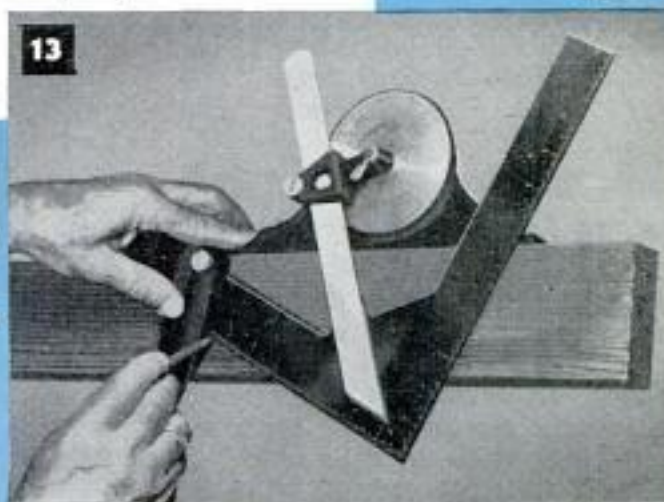



Children Cannot Reach Paint On Ceiling-High Shelves

In order to store paints, insecticides and other potentially dangerous material where it cannot be reached by children, one homeowner built shelves just under the ceiling of his garage. The shelves can be reached only by using a stepladder, which is stored on wall brackets too high for the children to reach.

Paper Tabs Identify Drawings

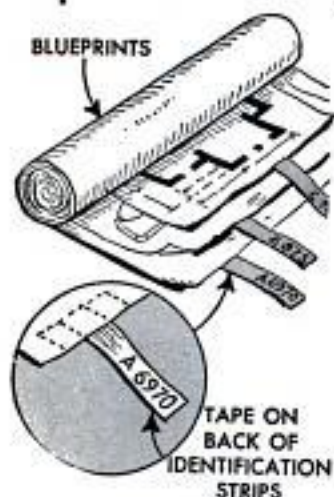

Paper tabs taped to one edge of blueprints or drawings of different sizes will prevent them from becoming misplaced when they are rolled together. Each tab is numbered or lettered to identify the particular drawing, then taped to the right-hand edge. When the drawings are

rolled together, keep the edges with the tabs fairly well aligned. Also, if possible, assemble the drawings so that one tab is not hidden behind another.

Leonard W. Mitchell, Carrsville, Ky.

Hole Enlarged in Sheet Metal Using Round File As Reamer

A round file, used as a reamer, will overcome the problem of drilling a large hole in sheet metal without tearing the metal. A hole first is drilled just large enough to admit the small end of a round file, then the file is chucked in a brace and turned counterclockwise with a light feed into the hole. Turning it counterclockwise prevents

the right-handed helix of the file teeth from binding in the hole. If the hole needs to be quite large, progressively larger sizes of files might be used.

Charles R. Haynes, Vestal, N. Y.

Seat-Protecting Cloth Held With Tire-Section "Clamp"

A narrow section cut from an auto-tire casing provides an excellent "clamp" for holding a mechanic's protective cloth in place on a car seat. Slipped over the top edge of the seat back, the clamp has sufficient tension to keep the cloth from being pulled down when the mechanic sits on the seat. Be sure that enough of the cloth hangs behind the seat back to protect against soiling by the clamp.



Stainless Steel Lubricated For Bending Operation

To prevent stainless-steel sheets from tearing while being bent in a sheet-metal brake, lubricate the area of the bend with tallow. The stainless steel tears because the sliding jaw of the brake digs into the surface instead of sliding.

Vise Clamped to Drill Press When Not Being Used

Clamped directly to the drill-press table by its own jaws, a drill-press vise will be instantly available, yet out of the way when not in use. Also, the removable jaws of the vise will not be misplaced since they are held in place by the clamping action.

H. Hanscom, Elmhurst, Ill.

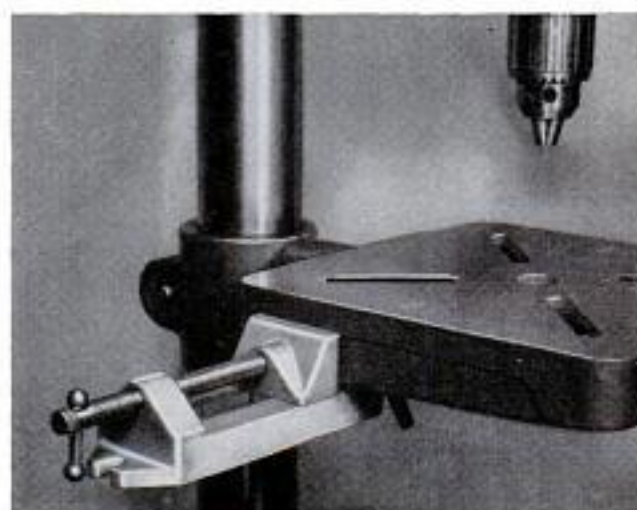

CAMPUS RADIO NETWORK

By Marvin Weisbord

STUDENTS living in Hillcrest and Currier dormitories on the State University of Iowa campus in Iowa City have the unique pleasure of being able to tune in on their own tiny radio network each night, Monday through Friday.

Usually they get four or five hours of "easy to take" music for studying or just plain relaxing. The music is on records played by fellow students in the dormitories. A leased telephone wire connects station studio WVOC (which stands for Woman's Voice on Campus), photo A, and station HILC (Hillcrest, the men's dormitory, photo C). The wire enables the girls to listen to the boys' shows and vice versa. They alternate hours of air time.

Each station has its tiny transmitter, illustrated in photo B, and other necessary broadcasting equipment. The signals can be picked up on standard radio sets between 600 and 700 kilocycles within the area of their "closed circuit" operation which limits them to the dormitories. The equipment was built by a former student.

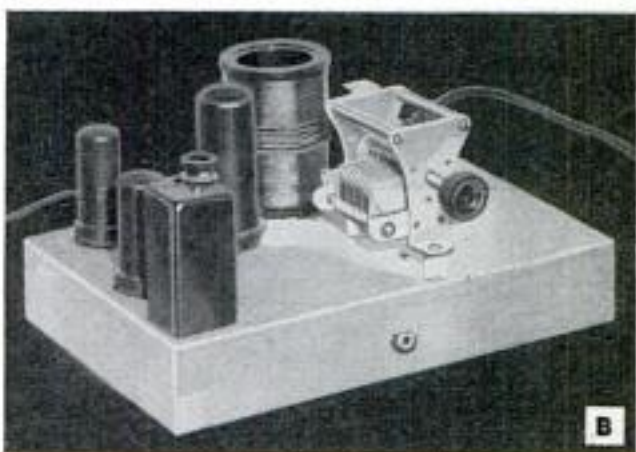

COMPACT TWO-METER RADIO

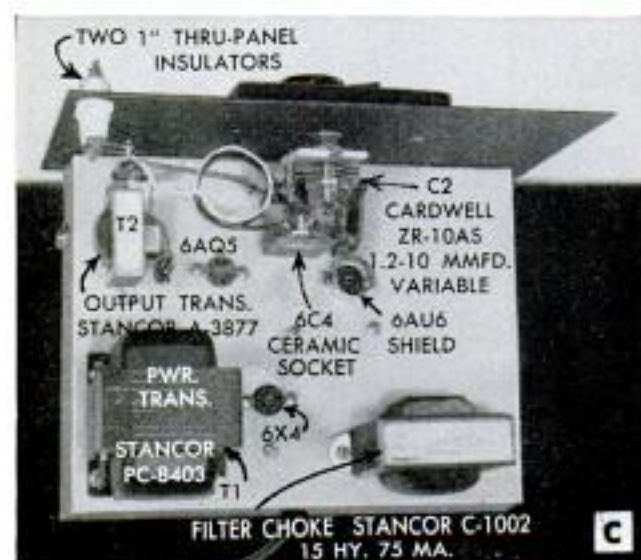
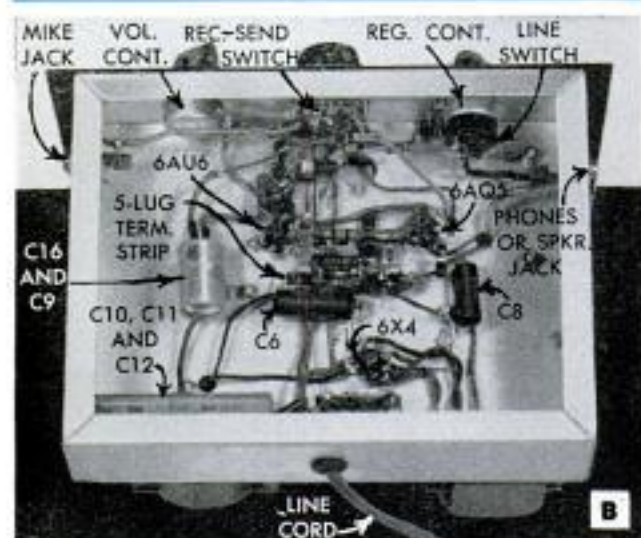
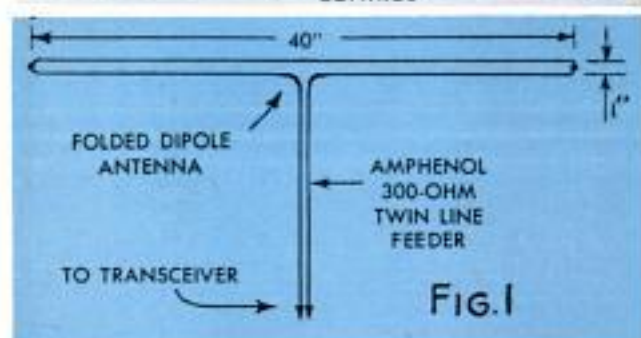
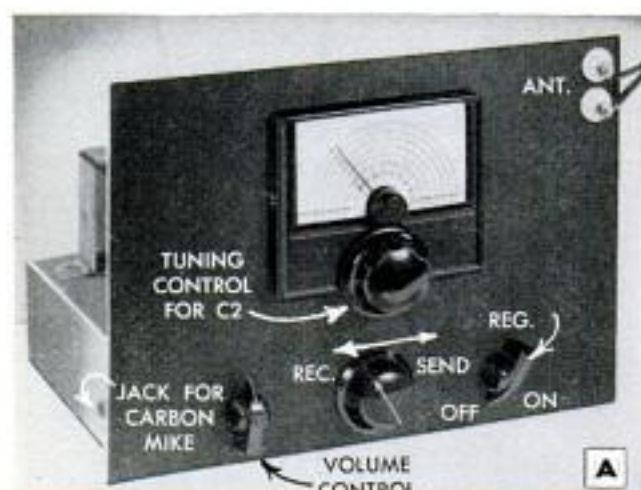

MANY RADIO AMATEURS now working at comparatively low frequencies hesitate to branch out into the 144-mc. band because of the high cost and complexity of VHF equipment. The two-meter transceiver described in this article permits the experimentally inclined amateur to investigate this uncrowded portion of the frequency spectrum at a relatively small cost. Any amateur radio operator, except one holding a novice-band license, can build and operate this compact combination transmitter and receiver.

This compact unit employs four tubes, including a rectifier, which are utilized for both transmission and reception. A built-in send-receive switch instantly converts the receiver into a transmitter, and again into a receiver, so that reception and transmission on the same frequency can be accomplished by merely flipping the switch.

The range is limited to local communication distance depending upon the height of the antenna and its location. No difficulty should be encountered for local contacts in areas free from hills and high buildings.

Crystal control is not required for operation at 144 mc., however it is necessary that the entire emission be kept within the limits of the band. A good folded-dipole antenna is important for maximum results and rotation is desirable if possible. A simple dipole may be made as shown in Fig. 1 and tacked to a lightweight wooden frame for rotation. This simple two-meter phone transceiver should provide many hours of entertainment and valuable experience in VHF operation.

A complete schematic circuit diagram is shown in Fig. 2 and the resistor chart appears at upper right. All unmarked, paper-type, fixed capacitors are 600-volt types. The electrolytic filter condensers C10, C11

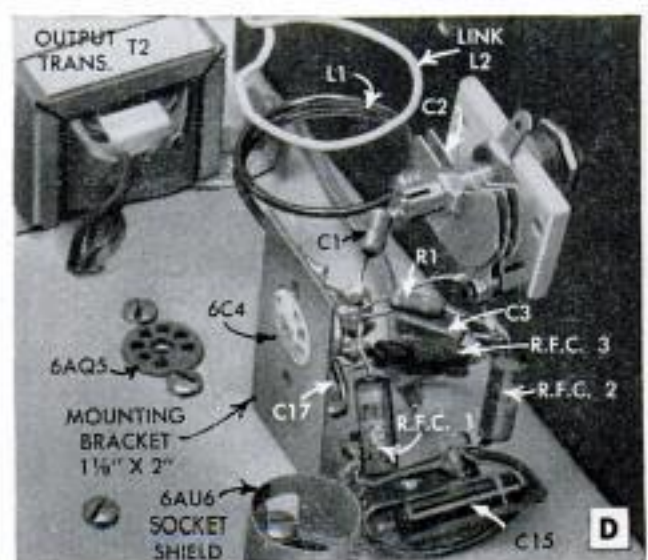

TRANSCIVER FOR AMATEURS

By Lothar Stern and
Frank Correia, W9SLX

and C12 are 16 mfd. each and are in a single triple-section unit as will be noted in the underside photo, B. All front-panel controls are shown in photo A. Photos B, C and D should be studied carefully for the layout details which are simple and not critical except for the parts shown in close-up photo D. In this close-up photo it will be noted that the 6C4 tube socket is mounted on a bracket in the center of the chassis so that all leads of components connecting the tube to tuning capacitor C2 can be made as short and direct as possible. It is highly important that these leads be kept short.

In the "receive" position, the 6C4 tube is employed in a super-regenerative detector circuit whose high gain and simplicity make it ideal for transceiver purposes. This is followed by an audio amplifier using a 6AU6 as a voltage amplifier and a 6AQ5 as a power amplifier. In the "transmit" position, the 6C4 is converted into the well-known Colpitts oscillator which is plate modulated by the output of the audio amplifier. A carbon microphone in the cathode of the 6AU6 provides sufficient output for proper modulation.

(Continued to page 246)

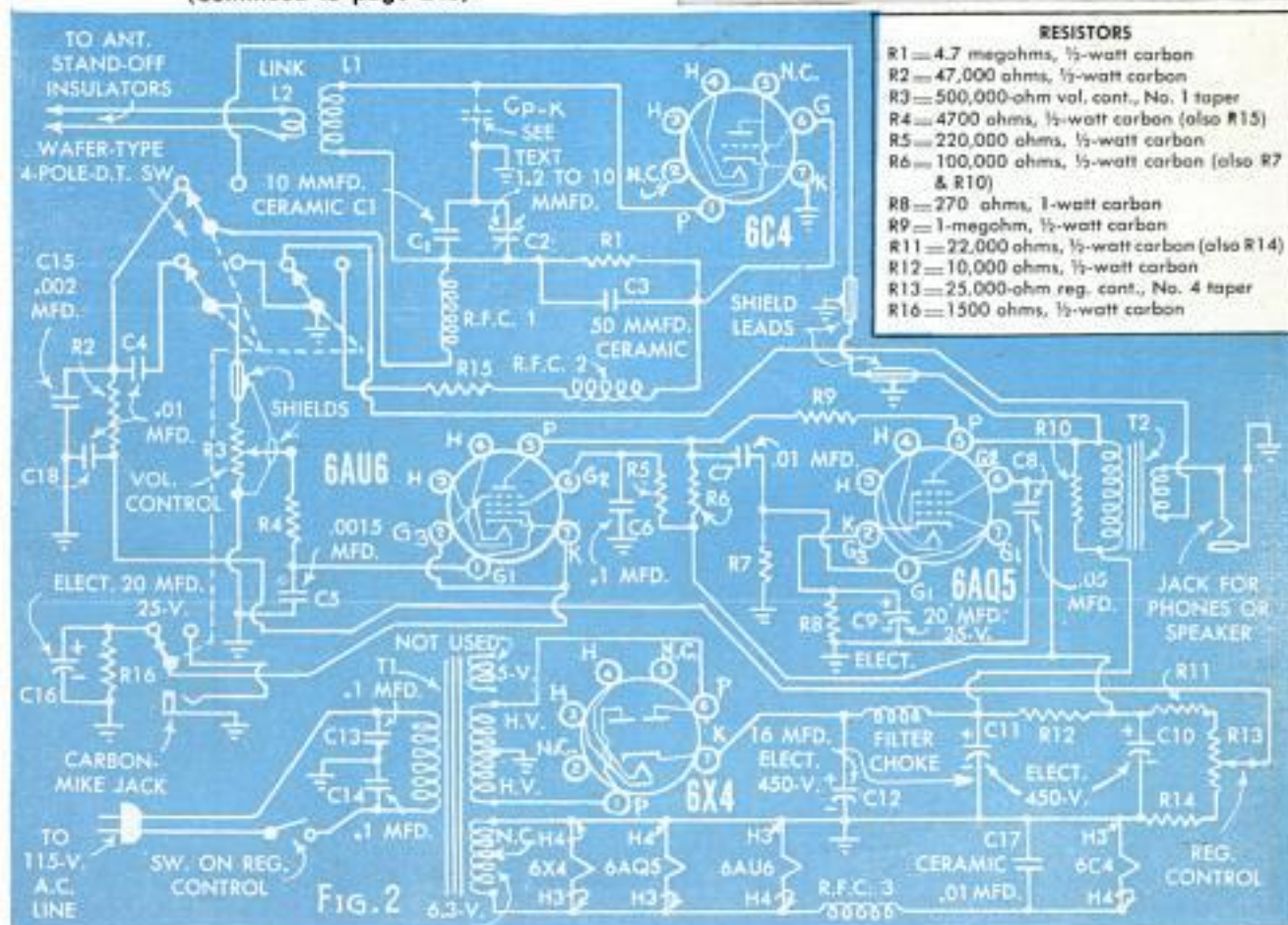
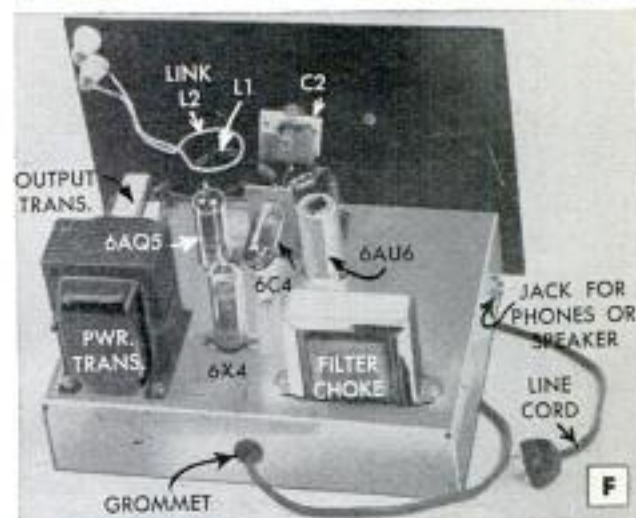

TV SERVICE HINTS

By H. F. Leeper

SERVICEMEN confronted with the necessity for removing tarnish and corrosion from TV-tuner turrets, or any other electrical contacts, will find a device called a "tuner-eraser" easy to use and it will not harm the contacts. It contains a chemically treated material formed as an eraser for convenient handling, as shown in photo A.

When unable to bring a TV receiver into proper focus, tapping the focus coil, as indicated in photo B, with the handle of a well-insulated screwdriver, or rubber mallet, may indicate defects. The coil could be loose and improperly placed or a broken wire could be the cause of the trouble. Such tapping is done with the receiver in operation, therefore care should be taken not to contact any part with the hand.

Picture flickering is sometimes caused by a loose high-voltage picture-tube cap. To check the cap, first disconnect the receiver power-line cord; then ground the cap terminal before attempting to make a tighter fit. A pair of long-nose pliers may then be used, as illustrated in photo C.

Many TV receivers use clamps on the underside of the chassis to hold various wires near ground potential as in photo D. It is a good idea to mark such wires before disturbing when necessary to replace a certain part. After replacement, make sure the same wires are placed in the original position to avoid necessity for realigning.

There are several types of ion-trap magnets for replacement on TV-picture tubes. Two types are shown in photo E. The one already on the tube is held in place with a thumbscrew; the other with a spring. These magnets are usually marked with an arrow for the side to be installed pointing towards the face of the picture tube.

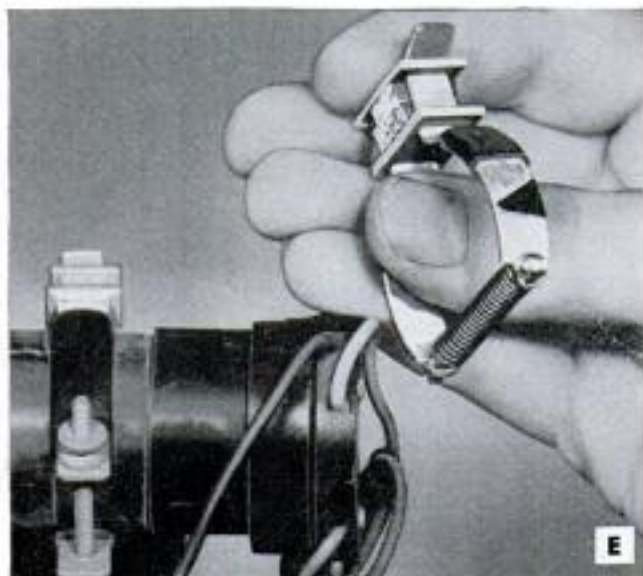
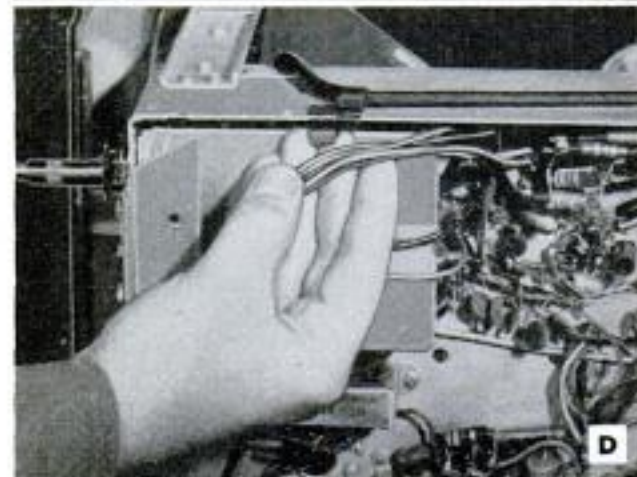
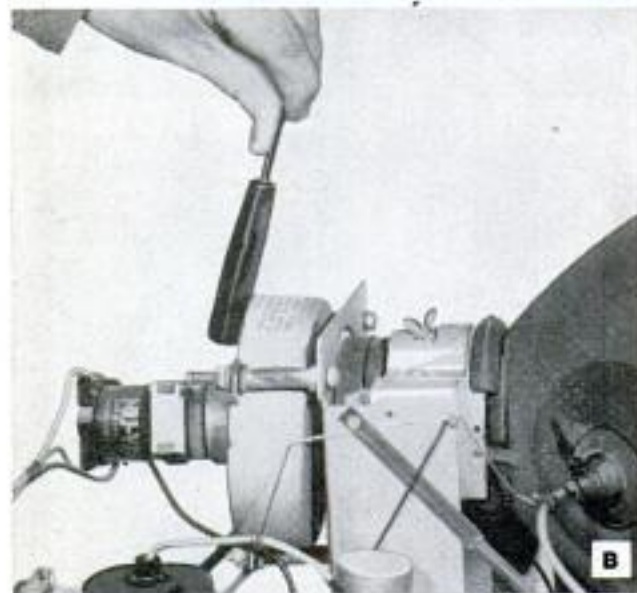

You can do a 10'x12' Room

WITH IMPERIAL TRIMMED AND PASTED WALLPAPER

It's easy to hang these new Imperial Washable Wallpapers! Just open the package and the paper is *completely ready*. No muss or fuss . . . just fun. You simply cut a strip to the proper length, wet it and slide it into place . . . then watch how easy it is to match the pattern because of the special "slip" and precision trimming of Imperial Trimmed and Pasted Wallpaper.

Thrifty! As low as 94¢ a single roll! Imperial's selection of colors and patterns is as wide and pleasing as its price range. So see your Imperial Washable Wallpaper dealer without delay. He'll give you decoration hints and recommend a competent craftsman, if you prefer.

*Prices vary slightly in different localities.



Wet it . . . Just cut a strip to the desired length from a roll and dip it into Imperial's special water container furnished at your dealers. No pasting! No trimming!

Hang it . . . Lift the strip from the container to your wall. Slide paper into position with a sponge. Patterns match easily, for you have plenty of time to position paper.

Enjoy it . . . And you *will*—for a long, long time—because Imperial Wallpapers stay lovely and washable year after year. Their handsome decorator patterns bring extra charm to new walls and hide hideous cracks in old ones!

NOTHING WASTED WITH IMPERIAL TRIMMED AND PASTED WALLPAPER



Save your excess wallpaper and you can have an attractive wastebasket covered with Imperial's handsome Trimmed and Pasted Wallpaper! You can do it in a jiffy.



Wallpaper on a chest of drawers! This novel idea is catching on like wildfire. Imperial's Trimmed and Pasted Wallpaper sticks perfectly on properly prepared surfaces.



Closets are much more attractive wallpapered with Imperial Trimmed and Pasted. Ugly cracks and unsightly scuff marks disappear. Use a paper that brightens closets.



Here's an idea we'll bet you've never dreamed of! Yet—how smart and original. Cover the top of a coffee table with your excess Imperial Trimmed and Pasted Wallpaper.



Send 25¢ to Dept. F-1 for samples for the *one* style and *one* color scheme checked below, and picture story of "How To Hang." MY HOME IS MODERN..... RANCH..... COLONIAL..... PROVINCIAL..... 18th CENTURY..... THE COLOR SCHEME IS GRAY..... GREEN..... ROSE..... BLUE..... BEIGE.....

The pattern shown is Imperial's 71564.

Guaranteed for 3 years to clean according to instructions and not to fade or it will be replaced without charge. Imperial Washable Wallpaper is Color-Locked.

IMPERIAL PAPER AND COLOR CORPORATION, GLENS FALLS, N. Y.

beyond

the sound barrier...

to a new world of quiet!

Something New . . . something wonderful has happened to outboard boating! **Gone** is the barrier of jangling sound that stood between you and complete enjoyment of the water!

Gone are the strident engine noises—the raucous “lows”—the shrill “highs”—throughout the full range of objectionable sound frequencies. We’ve tuned them out . . . or sealed them in . . . muffled them . . . canceled them! *At all speeds*—slow, medium, top! We’ve left you nothing to *hear* but the swish of the bow wave beneath the motor’s pleasant purr.

Gone, too, is nerve wracking vibration. **Gone** is the arm-tiring tingle of the steering handle. **Gone** is all “engine shake” from the hull . . . completely isolated from boat and passengers by the all-direction cushioning of Aquasonic mountings. We’ve left you nothing to *feel* but the boundless surge of power that is utterly smooth!

Here is your future in boating fun . . . *Whispering Power*, smooth as sailing! It’s yours to enjoy in any size boat, small family runabout to cruiser. See your Evinrude dealer—look for his name under “Outboard Motors” in the yellow pages of your phone book. Choose from a complete range of Aquasonic models, 7½ to 25* horsepower. Time payments available. For free full-color catalog of the 1955 Evinrude line, write **EVINRUDE MOTORS**, 4546 N. 27th Street, Milwaukee 16, Wisconsin.

big twin *Aquasonic* with electric starting

Last word in fine outboard performance! Big Twin’s 25 thrilling horsepower, now velvet smooth and whisper quiet. *Plus* finger-touch starting . . . electric starting that you *know* is right . . . tested and proved in millions of miles **\$525** of owner service.

Standard Big Twin Aquasonic . . . \$430



*Power ratings are OBC certified brake HP at 4000 RPM tested in conformity with SAE test code. Prices f.o.b. factory, subject to change without notice.



Write for Free Catalog

Big full-color catalog describes complete line of Evinrude models for 1955. Priced as low as \$145 for the Lightwin with famed Fisherman Drive. Send for your copy today!

Evinrude

quiet *Outboard Motors*

A DIVISION OF OUTBOARD, MARINE & MANUFACTURING COMPANY
In Canada: Manufactured by Evinrude Motors, Peterborough

Copyrighted material

Put your skills to work

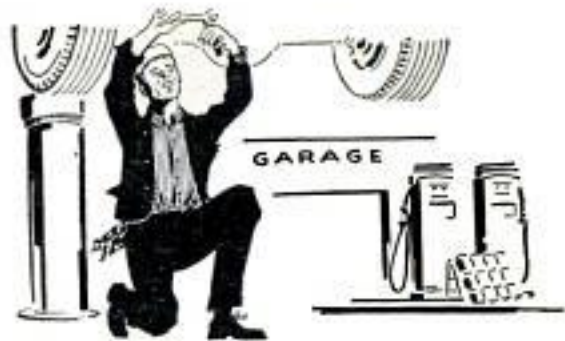

Young men who are interested in mechanics, electronics or other technical specialties have an interest in the U. S. Air Force. As an Airman, you may have an opportunity to develop your technical ability and learn an interesting, exciting, and good paying skill. Act today and put your skills to work tomorrow. Put them to work where they'll do the most good...put your skills to work in the U. S. Air Force.

You go places—faster in the U. S. Air Force

**You may train with the
U. S. Air Force in one of
these interesting specialties**

AIRCRAFT MAINTENANCE	CONSTRUCTION
ATOMIC WEAPONS	GUIDED MISSILES
COMMUNICATIONS	ROCKET PROPULSION
TRANSPORTATION	



*STUDENTS—Graduate before
you enlist*

Personnel Procurement Division
AFPTR - P-4 U. S. Air Force
Washington 25, D. C.

M-4-PM

Please send me more information on my opportunity
as an Airman in the U. S. Air Force.

Name Age

Address

City Zone ... State

You can make your own pictures right in the kitchen



No need for a special home darkroom

Modern photo developing and printing equipment is simple, easy-to-use, modest in price.

There's plenty of enjoyment in taking pictures but, if you're looking for a real thrill, try developing and printing them yourself.

It's fascinating to watch the scenes you've taken "come to life" . . . to see familiar sights suddenly reappear as if by magic. Added to this is the pleasure your family and friends will get from those extra prints you make for them.

Of course your photo dealer is always ready to have your film processed for you, but if you want to enjoy this fun

and fascination of doing it yourself, don't hesitate any longer.

With today's equipment there's a minimum of fuss and bother to home photo-making. Most of the steps can be done in room light and your set-up need not be elaborate.

Above is an arrangement suitable for your kitchen. And, on the opposite page, the equipment shows how simple it all is—step by step.

Your local photo dealer has illustrated booklets to get you started on this rewarding family hobby. See him soon, won't you?

THIS INEXPENSIVE LINEUP LETS YOU START RIGHT NOW



Kodacraft Roll-Film Tank with aprons for easy developing of 620-120, 127 films. \$2.53.

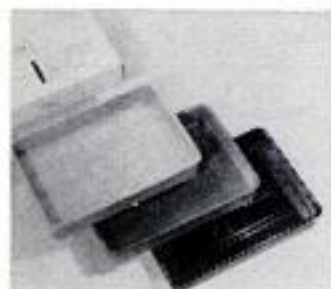

Kodacraft Rocker Tray Set includes three 5" x 7" trays, with rocker for uniform developing. \$1.95.

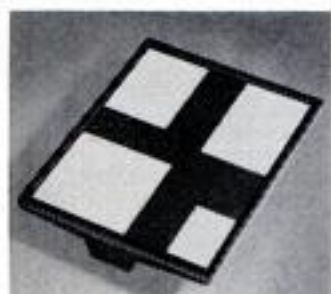

Kodacraft Printing Frame with masks for 9 negative sizes. Accepts 4 1/4" x 5 1/2" paper. \$1.95.

You can develop that roll of film at home tonight . . .

The most convenient developing procedure is to use a small tank, such as Kodacraft Roll Film Tank. Handy Kodak Tri-Chem Pack contains developer, stop bath and fixer chemicals. You just mix with water. Put developer solution in tank. Step into any darkened closet to load the film in the tank. The rest of the operation is carried on in ordinary room light. Agitate film in developer, then in stop bath, and finally in the fixer. Remove film from tank, wash in sink, and dry overnight. Your photo dealer has detailed, easy-to-follow instructions. It's so simple even a child can learn in no time.

. . . print the pictures tomorrow (Kodak Velite Paper lets you do this in subdued room light.)

Simply place negative in Kodacraft Printing Frame; lay sheet of Velite Paper on negative; close printing frame; expose to ordinary lamp bulb for few seconds. Place exposed paper in tray of developer solution; in about a minute you'll have your picture appearing. Developed print is then placed in stop bath and next the fixer. Wash print and dry on blotter.



Kodak Tri-Chem Pack contains enough chemicals for processing two complete rolls of film. \$.25.



Kodak Velite Paper makes prints in lighted room. 25 sheets, 2 1/2" x 3 1/2" and larger. From \$.38.



Kodak Blotter Roll for efficient print drying. Capacity—60 average-size prints. \$2.88.

CONVENIENT PHOTO DEVELOPING AND PRINTING SETS AVAILABLE



Should you desire, your photo dealer can provide you with complete developing and printing equipment in handy kit form.

Kodacraft Advanced Photo-Lab (right) contains Kodacraft Metal Printer, Kodacraft Roll-Film Tank, Kodacraft Rocker Trays, Kodak Velite Paper, darkroom lamp, graduate, thermometer, film clips, stirring rod and instructions. \$14.95.

Kodacraft Photo-Lab Outfit (left) includes all items of Advanced Photo-Lab except offers Kodacraft Printing Frame (with mask set) instead of Metal Printer and is without lamp and stirring rod. \$9.75.



Prices subject to change without notice

Eastman Kodak Company, Rochester 4, N. Y.

FEBRUARY 1955

Kodak
TRADE-MARK

237

Copyrighted material

Care and Feeding of Engines



BY
S. P. CORP

FROZEN DOOR LOCKS

When freezing makes a door lock inoperative, try heating the key with a match, then quickly insert key into lock. Heat of key will melt ice. *But be sure to remove key before it freezes in!* Another method is to force alcohol through keyhole.

To prevent lock-freezing, mix 3 oz. of melted paraffin with 12oz. carbon tetrachloride and apply with an oil can, after first oiling with benzene or naphtha and working key in and out to clean lock. Apply carbon tet. mixture to door button and work up and down to insure penetration.



BENZENE

ALIGNING CONVERTIBLE DOORS

If a convertible top fails to lock correctly, check door alignment first, and inspect body bolts. Incorrect adjustment of body bolts can distort body on frame and cause trouble with doors and top. Start by loosening all body bolts and driving a short way to settle body on frame. Then tighten all bolts to 2 foot-pounds of

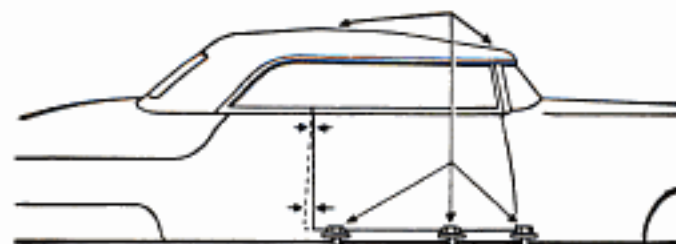

SHIM BODY BOLT HERE TO CORRECT THIS FIT

torque. If a door is tight at top and open at bottom, put a shim on body bolt at rear of door. If door is open at top and tight at bottom, shim bolts at front and rear of door, leaving bolt in center tight. Sometimes you will need to add shims on only one side of car. Use door alignment as a guide. If, however your doors are in alignment, correct alignment of top by adjusting the top linkage.

NEW BOOKLET ANSWERS CAR QUESTIONS



This new illustrated Sealed Power manual, "Care and Feeding of Engines," answers questions about everything from Air Cleaners to Windshield Wipers. Includes facts about Sealed Power KromeX Ring Sets and Motor Parts. Every car owner should have a copy. Get yours FREE by writing to Sealed Power, Dept. G-2, Muskegon, Michigan. A postal card with your name and address will do the trick.

Sealed Power

PISTON RINGS

Clinic for Homemakers



As a service to our readers in solving the hundreds of problems pertaining to a home—inside or out—the editors of *Popular Mechanics* invite you to present your problems to The Clinic Editor for help and advice. Address your questions to The Clinic Editor, *Popular Mechanics Magazine*, 200 East Ontario Street, Chicago 11, Ill.



Stucco Defect

Q—My home has stucco exterior walls. It is about 30 years old and lately I have noticed that the stucco is loose in several places at the corners and along the foundation. Apparently it was applied over wood lath and has loosened. Can I repair these defects myself? What materials are used?

—W.K., Ill.

A—We would hesitate to recommend that you undertake this job yourself, unless you have had some experience in applying stucco, especially patches which require skill in application in order that the new surface will match the old. For this reason we would suggest that you consider employing a contractor experienced in the application of stucco. In general, procedures must be adapted to the requirements of each individual job, the first step being to remove the loose material without damaging stucco adjacent to that which is defective. Usually the material can be lifted off in small pieces and generally it will break easily at the point where it adheres to the lath. All material between the lath should be removed before applying the new coat. Some builders drive nails, such as galvanized roofing nails, into the sheathing to anchor the patch firmly. Others prefer to apply a wire mesh, cutting this to a close fit in the area to be patched and stapling it in place. The mixes used for patching vary somewhat, but a common one is one part portland cement to three parts aggregate, the latter varying in size according to the type of finish required to match the original.



Hanging Gutters

Q—The half-round gutters on my home are badly rusted and leaking at several points. What troubles me is how to attach the hangers. I want to use the strap-type hangers and I have been told they should not be nailed over the shingles, but placed underneath. How?

—W.B., Fla.

A—We assume you intend to install the same type of gutters, that is, the half-round type. Also, we agree with the information you have been given, that the hangers should be placed with the tabs under the shingles rather than on top. This can be

(Continued to page 240)

Texaco Tips On Car Care

How to keep from getting • stuck in ice and snow—→

To avoid getting stuck in ice and snow, keep a container filled with a mixture of sand and ordinary rock salt in your car trunk. Then, if your rear wheels begin to spin, sprinkle a handful of the mixture directly in front of each rear wheel. It is also good to let a little air out of the rear tires for more traction. Shift into second gear (or "Drive" with automatic transmissions) and give it only a moderate amount of gas—do not race the engine. Doing this, you should move out of any impeding snow or ice. For best mileage — both tires and gasoline — don't forget to reinflate your tires promptly.



← How to get the best all-'round performance from your engine

Rugged road tests—millions of miles of both low-temperature mountainous driving and hot desert high-speed runs in more than a hundred new cars—were conducted recently by an independent research organization. The purpose was to find the best motor oil for today's high-compression engines. Results: Test engines using Havoline (1) had greater gasoline and oil economy, (2) showed no appreciable wear, (3) and were much cleaner. Havoline will give you all-'round performance that no other motor oil can deliver . . . regardless of price. For more engine power, greater gasoline mileage and new-car liveliness that *lasts*, get Havoline today.

See your Texaco Dealer . . . the best friend your car has ever had.



TEXACO DEALERS IN ALL 48 STATES

Texaco Products are also distributed in Canada and in Latin America

TUNE IN: TEXACO STAR THEATER starring JIMMY DURANTE or DONALD O'CONNOR, on TV Saturday nights. Metropolitan Opera radio broadcasts every Saturday afternoon. See newspaper for time and station.

HERE'S HOW YOU CAN DO

A Better Paint Job!



Use Baker Brushes and you'll paint faster; easier, *better!* Baker Brushes always pick up a full load of paint, so you dip less. Paint spreads more evenly, and with fewer strokes. To be sure of best results, ask for Brushes by Baker.

SEND FOR FREE BOOKLET "How to do a good paint job". Send card (and name of retailer, if you wish) to Baker Brush Co., Inc., 83 Grand St., N.Y.C. 13.



BRUSHES by BAKER

ROLLERS, TOO!

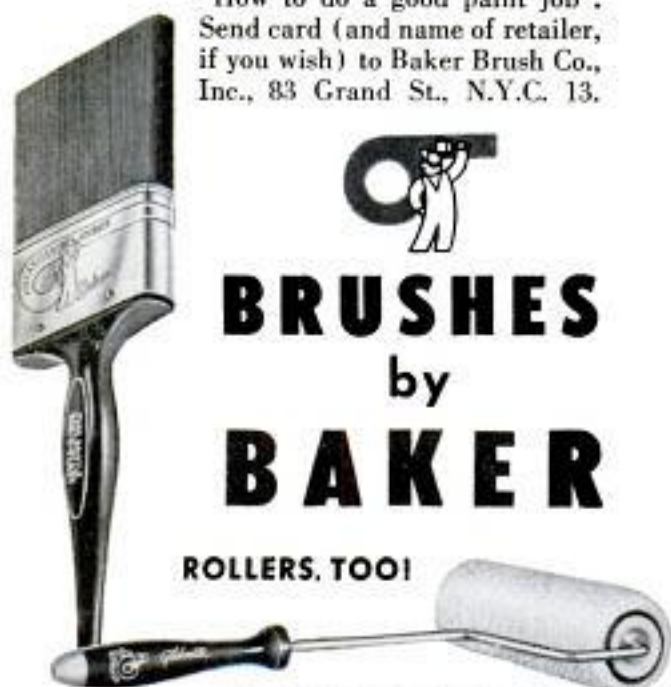

AMERICA'S FINEST PAINTING TOOLS

(Continued from page 238)

done quite easily by lifting the butts of the first course far enough to permit nailing the hanger tabs through the butts of the lower course into the roof boards. Care must be taken in this operation not to break the butts of the top course as they are lifted. As a rule it will not be necessary to withdraw the nails holding the shingles. If aluminum gutter hangers are used, fasten them with aluminum nails. If the hangers are of steel, then use galvanized nails. In some cases it may be necessary to cut off a portion of the hanger tabs in order to make it easier to force them under the shingles at the point where the latter are lifted.

Painting Overhead

*Q—*I always have trouble with paint dripping and running down the brush handle when painting overhead both inside on walls and ceilings and outside on siding. Painting cornices and ceilings is where I have the trouble. I have thought of attaching a kind of drip cup to the brush, but there seems to be no practical application of this kind. Isn't there some way this annoyance can be prevented?—U. M., Calif.



*A—*Simply mix the paint to a somewhat heavier consistency than that ordinarily used and add a small quantity of japan drier, about two tablespoonfuls to the quart of outside paint. For inside work you'll have less trouble with a paint roller, although it is possible to mix inside paints to a heavier consistency than that normally recommended and still produce good work without spattering or dripping from the brush. As you dip the brush, form the habit of slapping off the excess against the inside of the container. It also will help to clean the brush occasionally while in use, using a solvent such as lacquer thinner in order to loosen paint that gradually works down to the base of the bristles. Whip out the residue of the solvent after cleaning by striking the brush lightly over the edge of a board.

Tile Joints Open

*Q—*During the summer I laid a linoleum-tile floor in my bathroom. Just lately I've noticed that the joints have opened unevenly across the floor. Probably this has been going on for some weeks, but at this time the joints seem to have opened to 1/32 in. or more. What could be the cause, and the remedy, if any?—E.K., Mo.

*A—*It is difficult to guess at long range just what is the cause. There is the possibility that if you laid the tile during exceptionally hot weather the opening of the joints is due to shrinkage of the individual tiles. However, this seems unlikely as trouble due to this cause is not at all common. We think it more probable that the cause is shrinkage of the subfloor, the underlayment, if any, or the floor joists. Perhaps all three have contributed to the condition, especially if the house is new. Also, undue shrinkage of the floor joists and the subfloor may have been brought about by some abnormal condition, such as drying out of the members after having been exposed to unusually high humidity in the basement, or concentrated dampness due to a leak in the plumbing. Another cause, less common but still a possibility, is failure to spread the cement uniformly at the time of application. A varying thickness of the cement film can cause slight movement of the tile when setting and possibly a gradual opening of the joints after a period of time. If, at the time of application, the subfloor was not carefully leveled by planing or scraping, then springing of the underlayment may be a cause of the tile joints opening as you describe. The only way to remedy this condition is to drill small holes from underneath through the subfloor and force calking compound in the space between the underlayment and the top of the subfloor. This usually proves an effective remedy.

Build that extra bedroom yourself . . . it's easy!

A few hours of your spare time can turn a dusty attic into that extra bedroom you've always wanted. It's an easy job . . . fun for the whole family. Simply finish the walls and ceiling with Armstrong Temlok® Interior Finish. You'll be surprised at how little it costs, and the finished room will add permanent value and comfort to your home.



- 1.** You build, decorate, and insulate in one simple application when you remodel with Temlok. Available in tile, plank, and board forms, Temlok is an inexpensive, easy-to-handle wood fiber material. It's factory finished for lasting beauty, adds fuel-saving insulation to the room.

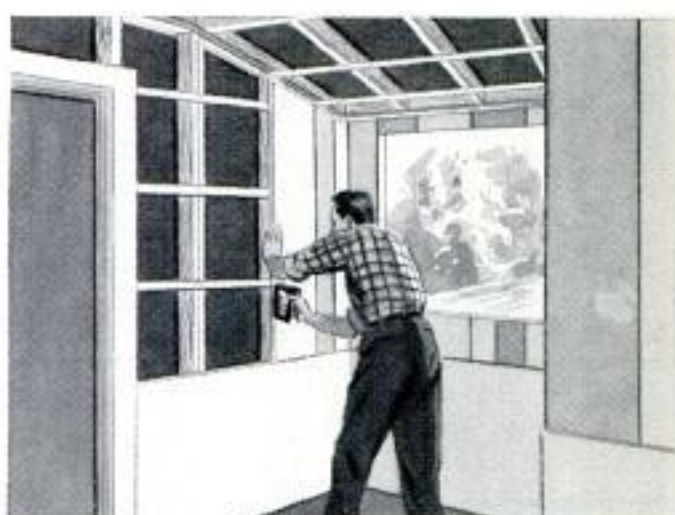

- 2.** Walls are no problem with Armstrong Temlok Plank. The long planks go up fast over wood furring. The exclusive Lok-Bevel® joint makes stapling or nailing extra easy, assures neat, even joint lines. Attractively pre-finished in a random "Suntan Blend," Temlok Plank needs no further painting.



- 3.** The ceiling's done in no time with Armstrong Temlok Tile. The Lok-Bevel joint hides all nails or staples, helps you do a really professional-looking job. Temlok Tile comes factory painted in Snow White or Light Ivory. Temlok Tile also comes with noise-absorbing perforated surface.



- 4.** Some gay decorative touches and the room is done . . . ready for daughter, son, or overnight guest. It can double as a sewing or hobby room, too. You'll be so proud — and the family will be so pleased — you'll want to "Temlok" the basement next for that much-needed family workshop.

Ask your lumber or building materials dealer for full details on Armstrong Temlok. He'll be glad to show you samples and give you help with your remodeling plans. For your copy of the free booklet, "New Ways to Remodel Your Home," write Armstrong Cork Company, 3702 Watch Avenue, Lancaster, Pennsylvania.

* Trade-Mark

Armstrong TEMLOK

M-67® Monowall® • Cushiontone® • Hardboards • Insulating Wool • Counter-top Cement



I built this tool house faster,
better with my better-built
BLACK & DECKER SAW!



Really straight cuts were never easier, thanks to line-of-cut visibility!

The lift lever on the lower guard sure made pocket-cuts safe and easy!



To make rafter cuts, I sawed each one the long way first, then put all the rafters side by side, set my bevel angle and depth, and finished 14 with just one bevel cut!



**Black & Decker 6"
Heavy-Duty Saw**
\$64.50

Features built-in depth and bevel adjustments—specially designed, better-built B&D motor. Safe, thanks to telescoping guard.

Cuts 2 inches deep. See it at your dealer's. Extra! Get your Tool House Pattern and "Handy Tips" book! Mail coupon.

See "Tools-Electric" in phone directory for

Black & Decker

PORTABLE ELECTRIC TOOLS

The Black & Decker Mfg. Co., Dept. M025, Towson 4, Md.

Gentlemen: Please send me

Easi-Bild* Garden or Tool House pat. #51 (price: 50¢)

"Handy Tips" booklet (price: 25¢)

Name _____

Address _____

City _____ Zone _____ State _____

PT. M. REG. EASI-BILD PATTERN CO.

Diary of a New Car

(Continued from page 137)

(NOTE: Hammer forms are wooden shapes around which sheet metal is pounded to make the panels for hand-built prototypes.)

February 16, 1953

Sheet-metal shaping starts on Plymouth prototypes. Although complete design has not yet been approved, work continues on the major body panels. Wooden buck to support plastic mockup is being built in carpenter shop.

(NOTE: The plastic mockup will be the next step. It is an actual-size model that looks like a real car. It has glass windows, chromed moldings. It is an empty plastic shell supported on wooden blocks.)

March 23, 1953

Plymouth grille design is approved. Proving-ground tests are started so engineering can be sure the air flow is adequate for cooling under all conditions.

May 18, 1953

Revised Dodge and Plymouth clays are shown to top brass. This time they are enthusiastic. No changes suggested on the revisions.

(NOTE: Exner and King had been under terrific pressure up to this point because these revised front-end designs had to be right—time was running out. Revisions could be made at this point only under a costly, around-the-clock "crash" program.)

May 20, 1953

Plaster casts are made of the revised clays for forming plastic mockups. Layout men take templates of all body surfaces for final drawings to be used in production.

(NOTE: Styling has been finalized and now engineers have to convert the stylists' design into practical production procedures.)

May 26, 1953

Clays of instrument panels presented. Exner convinces Plymouth executives they should adopt dash-mounted shift lever on automatic-transmission models. Dashboards have to be restyled accordingly.

June 1, 1953

Proving-ground tests of the Plymouth V8 engine start. Engine is installed in a 1953 sedan.

June 15, 1953

Instrument-panel styling approved.

September 10, 1953

Plastic mockup shows up an unattractive

(Continued to page 244)

GRAVELY

**More
for your
Money!**



GRAVELLY MAKES TOUGH JOBS EASY!

Gravelly does jobs other tractors won't . . . because Gravelly has that *extra* power you need for the tougher mowing, gardening, field and farm jobs. Does a better job, even on *steep slopes!*

You get *more* when you get Gravelly. All-gear drive, power reverse, simple operation. More traction from easy-handled, *balanced* weight. Power attachments quickly interchanged, *securely* mounted, with only four bolts!

See Gravelly's rugged, compact, completely functional design. Not merely assembled, but completely manufactured by specialists who make only Gravelly Tractors and their attachments.



5-HP

SINCE
1922

(Dealerships
open in
some areas.)

PLUS . . . 21 JOB-RIGHT TOOLS!

Your choice of 21 tools for a versatile tractor that saves time, work and worry *all year long*. Tools to do every mowing, gardening, field and farm job.

Send coupon today for "Power vs. Drudgery", the big booklet that shows how Gravelly equipment solves your upkeep and gardening problems . . . *faster, easier, better!* NEW EASY PAY PLAN.

GRAVELLY TRACTORS, INC.
BOX 263 DUNBAR, W. VA.

Please send me "Power vs. Drudgery" Booklet and dealer's name.

NAME _____

ADDRESS _____

CITY _____ STATE _____



CULTIVATE



MOW WEEDS



SAW
TIMBER,
FIREWOOD



MOW
LAWNS



BLOW
SNOW



MOW
LAWNS, WEEDS,
MULCH
LEAVES



HAUL

FREE



MAIL TODAY

**Why walk?
Why drive?**

GET TO THE JOB ON A

**Harley-Davidson
165**

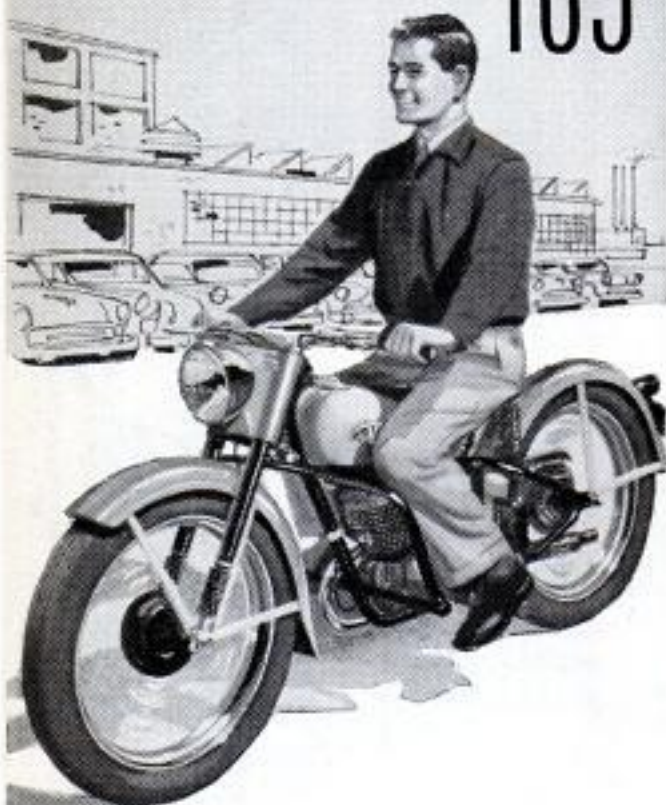

WHY walk when you can ride? And why go through the agony of driving a car . . . when a 165 gets you there faster? It's the world's most practical transportation . . . safe, easy-to-ride and so economical, too. Lets you sleep later in the morning and gets you home earlier at night. Takes the irritating "jam" out of traffic . . . and there's *always* room for the 165 in any parking lot.

See the 165 at your dealer's now. Easy-pay plan. Send for *FREE* illustrated literature. Write: Harley-Davidson Motor Company, Department P, Milwaukee 1, Wisconsin.

AVERAGES UP TO

80

*Miles
per
Gallon.*

SAFE AND ECONOMICAL FOR SCHOOL AND PLAY

"sag" in Plymouth rear fender, due to high light on metal crease or character line. The line is raised so it "reads right," as stylists say.

(NOTE: This mockup is the first model that accurately shows how the finished car will look. Normally, only comparatively minor changes can be made now. However, the "sagging" rear fender is considered a serious enough fault to change the die models. Trim details are worked over now because the model reflects light just like a real car. High lights can be studied. Major body surfaces cannot be changed because wooden models for dies have been under fabrication for some time.)

November 9, 1953

Suggested changes completed on plastic mockup. Plymouth's 1955 design is finished.

November 10, 1953

Full-scale surface master draft is started.

(NOTE: It is a highly technical drawing with three superimposed elevations. It is drawn on aluminum sheet so it won't change shape.)

November 27, 1953

All major parts of Plymouth prototype are completed. Assembly begins in experimental body shop.

January 15, 1954

Mahogany die models of major body panels are finished and sent to tool-and-die shops.

(NOTE: From this date on, diemaking is a continuous process as the wooden die models are completed.)

April 7, 1954

Assembly of first hand-built Plymouth V8 prototype is completed.

(NOTE: This four-door sedan, in contrast with production cars, has taken many months to build. It was painstakingly pounded out and assembled. Altogether six such Plymouth prototypes were made. These are the first models that operate—that prove out all the planning.)

April 19, 1954

Proving-ground tests begin on the first hand-built prototypes.

August 13, 1954

Assembly plants shut down for change-over to 1955 models.

September 27, 1954

First 1955 Plymouth comes off the production line.

November 17, 1954

The public sees the 1955 Plymouth for the first time—30 months after the initial meeting on May 15, 1952. ★ ★ ★

News About Glues

FOR "DO-IT-YOURSELFERS"

FROM UNITED STATES PLYWOOD CORPORATION
World's Largest Plywood Organization

FAMED WIZARDS WITH WOOD MAKE GLUE JOBS EASY!

A Weldwood Glue for Every Purpose

New! Weldwood® Contact Cement

... now you can glue without clamps or presses!

Revolutionary new adhesive! First it dries — then it bonds. And it grips instantly, permanently, on contact. No clamps or presses needed — not even a single nail! It's actually a wonderful new shop tool for you. Try it today.



3 BIG USES:

(1) To apply Micarta and other laminates in kitchen, bath, or to furniture; (2) to put up plywood panels without nails; (3) to make or mend 1001 things around home, shop, garage. Ask for leaflet.

America's Fastest Selling Wood Glue

Weldwood Plastic Resin Glue

Makes joints actually stronger than the wood itself. Highly water-resistant, stain-free, rot-proof. First choice of amateur and "pro" cabinet makers and wood workers. For making or mending things, it's deservedly, America's most popular wood glue.



New! Weldwood® Presto-Set® Glue

Amazing new glue used everywhere to make or mend things

Bonds wood to wood, cloth to wood, wood to composite board, paper to paper or cloth. For scrap books, art object repairs, leather, shop work, hobbies, etc.

Perfected at last! A white liquid glue worthy of the Weldwood name. So easy to use, works so well in home, hobby or shop, it's become the darling of "do-it-yourself" families.

Because Weldwood Presto-Set Glue sets so fast (20 to 30 min. on soft woods — somewhat longer on hard woods), you can often complete a project in one session! Forms a powerful, lasting bond that does credit to any craftsman! Also available in jars.



AND FOR A PERFECT FINISH—USE THESE WIZARDS WITH WOOD

FIRZITE®

... "WHITE" for woody blond or pickled effects (easily tinted). A "must" undercoat on fir plywood. "Clear" to tame that wild grain on fir plywood.



SATINLAC®

... the modern way to get that natural finish on any wood. Gives a costly hand rubbed look. Brings out and preserves the wood's full beauty.

At all hardware, paint and lumber dealers.

FREE!
HELPFUL LEAFLETS
MAIL COUPON
NOW

UNITED STATES PLYWOOD CORP., Dept. 284, 55 West 44th St., N. Y. 36, N. Y.

Send me leaflets on:

- Weldwood Presto-Set Glue Weldwood Plastic Resin Glue
 Weldwood Contact Cement Firzite Satinlac

NAME _____

ADDRESS _____

CITY _____ STATE _____

IN INDUSTRY...



The Jacobs Ball Bearing Super Chuck . . . unmatched for gripping power, accuracy and durability. The chuck for heavy duty drilling.

AND IN THE

HOME SHOP



The Jacobs Multicraft Geared Key Chuck . . . the tight-fisted grip of fine light weight power tools. Multicraft is a simplified version of Jacobs' rugged Super Chuck.

This is another practical example of how Jacobs engineering skill converts industrial experience into practical benefits for the home shop tool user.

When you buy power tools for your shop, look for Jacobs on the chuck. Whether you prefer the Multicraft Geared Key Chuck shown here, or the Rubber-Flex Hex-Key model, there is none better than Jacobs. The Jacobs Manufacturing Company, West Hartford 10, Conn.



Jacobs

CHUCKS

If it's a Jacobs it holds

Two-Meter Radio Transceiver

(Continued from page 231)

Construction is simplified by using a relatively large chassis base, and the circuit design permits the use of a metal front panel which virtually eliminates hand-capacity effect while tuning over the band. A Milen type 10039 midget dial provides sufficient bandspread to make tuning on this 144-mc. band easy. When mounting the dial make a template to locate the mounting holes accurately. The front panel is fastened to the chassis by the large hex nuts that mount the two controls and the send-receive switch. It is a good idea to include small angle brackets on each side to give added support between panel and chassis.

The power transformer T1 is a Stancor PC-8403 with a 117-volt, 60-cycle primary; the h.v. secondary is 500 volts @ 70 ma. d.c., center-tapped; 6.3 volts @ 2.5 amp., and 5 volts @ 2 amp. Note that the 5-volt secondary winding is not used in this unit. Also note that there is no connection to the 6.3-volt-winding center tap. The output transformer T2 is a Stancor A-3877 single-plate to voice-coil type; primary 5000 ohms @ 40 ma. d.c.; the secondary is 4 ohms. The filter choke is a Stancor C-1002, 15 hy. @ 75 ma. d.c., 400 ohms d.c. resistance. R.F.C. 1 and R.F.C. 2 are 3.3 mh. each. R.F.C. 3 consists of 11 turns of No. 24 enameled wire close-wound on any commercial-TV filament choke or similar form.

Proper adjustment of the transceiver, while not difficult, requires some test equipment which should be a part of every licensed radio amateur's station. Since only a single-tuned circuit is used, no tracking problems are encountered. The tank circuit consists of coil L1, capacitors C1 and C2, and the plate-to-cathode interelectrode capacity of the 6C4. L1 consists of two turns of No. 10 enameled wire, 1 $\frac{3}{8}$ in. in diameter, spaced the diameter of the wire. This coil and the capacitors provide a bandspread of exactly 4 mc. (from 144 to 148 mc.) as indicated by an accurately calibrated grid-dip test meter. If this type of meter is not available, an absorption-type wavemeter or a high-frequency signal generator can be used for making the proper adjustments. L2 is a single-turn coil of the same diameter made with No. 20 insulated hook-up wire.

Since the interelectrode capacity of 6C4s varies, a careful check of the frequency spread must be made to mark the edges of the two-meter band, which should be clearly shown on the face of the dial.

Either earphones or speaker may be used. A hiss should be heard in the

(Continued to page 248)

AC OIL FILTERS

-rescue engines from themselves!

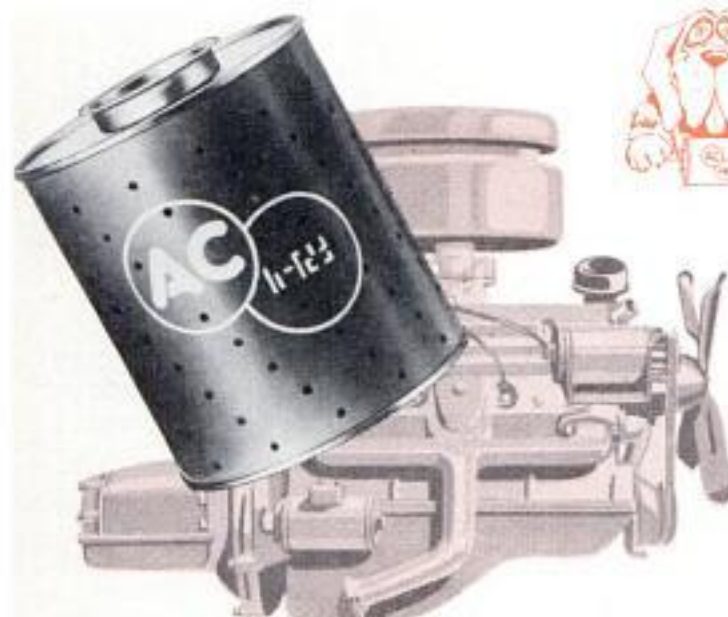

Long ago engineers realized that internal combustion engines produce something besides power. That something is a destructive combination of dust, dirt, grit, metal particles, carbon and acids that are picked up by the lubricating oil and recirculated. An oil change alone is not the solution. The oil itself needs the kind of protection AC Oil Filters give—filtering out the damaging grit—rescuing engines from themselves!

AC CUSTOM-ENGINEERED OIL FILTERS

Special Material • Special Method • Special Form



For years AC engineers worked to secure *better* filtering than density-type cotton fibre packing could provide. They found it in *paper!* Not any ordinary paper, but a *special* material fabricated to such exacting porosity standards that it freely passes oil while stopping foreign matter as tiny as 1/100,000th of an inch. Then AC developed a special curing process making the filtering material impervious to water and crankcase acids. AC accordion-folds this material so that it gives ten times the filtering area.

Atomic Research Techniques Insure AC Maintaining Oil Filter Supremacy!

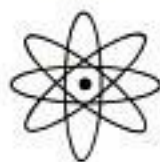

Radiochemical techniques are being employed today as a part of AC's continuous product improvement program. Radioisotopes have been called into laboratory use in perfecting the filtering element, and the laboratory work, with customary AC engineering thoroughness, is backed up by proving ground and road test procedures. You can be sure AC Oil Filters will remain at the head of the class.



**...have your AC
dealer change your filter
every 5000 miles.**

AC SPARK PLUG DIVISION



GENERAL MOTORS CORPORATION

Watch BIG TOWN on NBC-TV

AC ENGINEERING WITH GM RESOURCES CAN ALWAYS BE LOOKED TO FOR LEADERSHIP

NEW IRWIN BIT*
SPEEDBOR "88"

**Exclusive hollow
ground point →**

**steps-up
efficiency of small
1/4" electric drills**

Now bore faster, cleaner, deeper holes with small 1/4" electric drills and drill presses. No clogging, no binding. No wobble, no run-off either. New Irwin Speedbor "88" wood bits with exclusive hollow ground point and new spade-type cutters breeze through hard or soft woods, plywood, plastic. Forged in one piece from solid bar of special high carbon steel and hardened full-length to stay sharp much longer. Easy to resharpen with hand file. Size markings on both sides of head for quick selection. Hang-a-Bit hole for storing on nail or pin. Sizes 6/16" to 16/16". See the new Irwin Speedbor "88" when you visit your independent hardware dealer. *Patent Pending



only
69¢
each
any size
6/16" to
16/16"



**SPEEDBOR "88"
ROLL SETS**
Durable red plastic rolls with individual pocket for each bit. Available in 4, 6 and 11 bit sets. Compact roll conveniently fits in tool box or on workshop shelf. As low as \$2.98.

at your independent hardware dealer

IRWIN
Wilmington, Ohio

the original solid
center auger bit
•
screw drivers
screw driver bits

"receive" position as the regeneration control is advanced; this disappears as signals are tuned in. It should be possible, by varying the regeneration control, to retain the hiss as capacitor C2 is varied over its entire tuning range. If not, a slight reduction in the value of R2 is indicated. Conversely, if this hiss cannot be eliminated by turning the regeneration control to minimum, the value of R2 should be increased. Adding the small ceramic capacitor (C p-k), 3 to 5 mmfd., indicated by dotted lines, between plate and cathode of 6C4 will increase the bandspread. In this case, however, decrease the inductance of L1 in order to cover the desired band. In the "transmit" position the grid bias should not exceed 60 volts negative as measured with a vacuum-tube voltmeter, for any setting of the tuning capacitor. Negative voltages ranging from 25 to 50 volts are normal. Excessive voltage indicates too much drive which may damage the 6C4 tube.

Some practice is necessary for operating this transceiver; for best reception the degree of antenna coupling is quite critical. Too much coupling will prevent super-regeneration, and too little will seriously decrease the input signal strength. To adjust the coupling, it is suggested that the transceiver be switched to the "receive" position and the tuning capacitor C2 be fully closed. With an antenna connected, the coupling loop should be brought near the tank coil to the point where the detector can just be made to oscillate when the regeneration control is at maximum. As the tuning capacity is varied, this most-sensitive condition can be maintained by rotating the regeneration control counterclockwise. The degree of coupling need not be changed when switching to the "transmit" position. Detailed student material list R-430 is available from *Popular Mechanics'* Radio-TV and Electronics department upon receipt of ordinary letter postage.★★★

Develops Miniature Gyrocompass

Weighing just 1/100 as much as its bigger and older brother, a miniature gyrocompass has been adopted by the Navy for landing craft and other small vessels. The small gyrocompass was developed by the Sperry Gyroscope Co., Great Neck, N. Y. It permits small craft to obtain true-north readings at all times and not be dependent on the variations of the magnetic compass. A master gyrocompass for large vessels weighs 900 pounds and stands four feet high. The little brother weighs nine pounds and occupies less than 1/2 cubic foot of space.

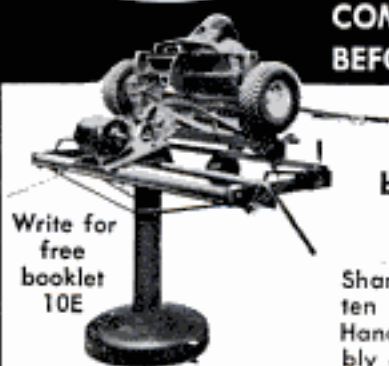
MODERN**LAWN MOWER SHARPENER****COMPARE BEFORE YOU BUY**

Write for free booklet 10E

Oil remains in engine while sharpening. Bed knife sharpened in same centers — no attachments needed.

Start your own business—**increase your income**

Sharpens any mower in ten to twenty minutes. Handles complete assembly of all reel types including 36 in. power mowers. Handle, wheels, roller, and engine are not removed.

\$26300**MODERN MFG. CO.**

F.O.B. PASADENA

160 N. FAIR OAKS, PASADENA, CALIF.

Carpenters' NAILPULLER Pocket size!

Powerful, Easy to Use, Handy as a Hammer!

Satisfaction guaranteed up to tenpenny nails.

POSTPAID U.S. ONLY

\$174

No C.O.D. No Stamps.

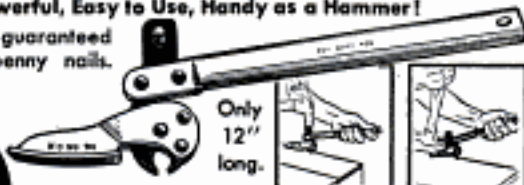

Only 12" long.

Carpenters' favorite. Convenient in tight places, carries in pocket. Tool steel counteracting jaws driven into wood under nailhead. Double leverage with hammer. All steel, rustproofed.

K-D Mfg. Co., 526 N. Plum St., Lancaster, Pa.

**MAGNETS** 225 lb. PULL
GENUINE ALNICO—NEVER WEAKENS

AMAZING, PERMANENT MAGNETS—WILL NOT WEAKEN! NON-ELECTRIC
Retrieve guns, tackle, tools and other steel items from lake, river, plating tanks, drains or other hard-to-reach spots. Recover drills, taps, etc. from sweeping. Clear alley of harmful tacks, nails. Many other uses. Pays for itself quickly. **GUARANTEED.** Try any magnet one week. Money refunded if you are not well pleased.

No. M-725 (Weights 54 oz.) Has pull of 225 lbs. on steel block. \$15.00
No. M-625 (Weights 70 oz.) Has pull of 125 lbs. on steel block. \$ 8.50
No. M-575 (Weights 18 oz.) Has pull of 75 lbs. on steel block. \$ 6.00
No. M-500 (Weights 15 oz.) Has pull of 50 lbs. on steel block. \$ 4.00
No. M-30 Hobbyist assortment of six small magnets. \$ 1.50

Send Money Order or Check. We pay postage. No C.O.D.'s.

MIAMI MAGNET COMPANY, 3240 N. W. 27th Ave., Miami 42, Fla.

2 GREAT AUTO BARGAINS

NEW KING MIDGET for 1955, lower priced, improved performance. Drive it for 75c per week. Rider agents wanted, earn your own car. Also just out **KING MIDGET**

JUNIOR chassis, finely engineered, ready to run, and priced at less than the retail cost of parts. Agents wanted. Get all the facts—send 25c for literature, special prices and proposition on both cars, or \$1 (refunded first order) for this plus actual assembly book and service manual.

MIDGET MOTORS MFG. CO.
ATHENS 1, OHIO



Rush Coupon for FREE

1955 Catalog of

AUTO PARTS and Accessories



World's Largest Selection Everything for Your Car, Truck, Hot Rod or Custom Style Car

156 PAGES
50,000 ITEMS

Saves You UP TO 50%

Get your FREE copy now . . . this is the only complete buying guide to everything you need for your car, truck, custom styled car or hot rod. You'll save up to 50% buying-by-mail from Whitney!

Choose from thousands of hard-to-find items . . . new and replacement equipment for cars from 1920 to 1955. See newest Hollywood accessories not offered in stores; high speed and power parts, custom styling equipment . . . all at lowest prices! Guaranteed satisfaction or money back. Fast shipment. Mail coupon for free copy now.

EXTRA! Rush coupon and get valuable Safety Chart FREE with catalog. Please enclose 25c to help pay catalog mailing and handling costs. We will credit 25c on your first order for \$5.00 or more. Mail coupon NOW!

J. C. WHITNEY & CO., 1917 PP-22 Archer Ave., Chicago 16, Illinois

JUST A FEW OF THE 50,000 ITEMS LISTED IN THIS BIG NEW CATALOG

Auto radios	Transmissions
Hi-Speed Equipment	Custom Style Acces.
Mufflers, pipes	Tires Tubes
Engines, parts	Ignition Parts

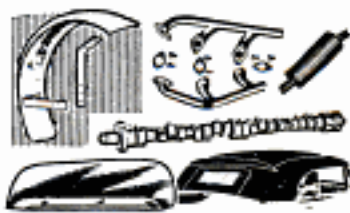

MAIL THIS COUPON TODAY!

J. C. Whitney & Co., 1917 PP-22 Archer Avenue, Chicago 16, Illinois

Rush giant 1955 catalog of auto parts and accessories at sale prices. I enclose 25c to cover part of mailing and handling cost, which will be credited to me on my first \$5.00-or-more order.

Name.....

Address.....

City..... State.....

Win up to \$1000 Worth of

HERE ARE SOME
OF THE DELTA
POWER TOOLS YOU
CAN WIN

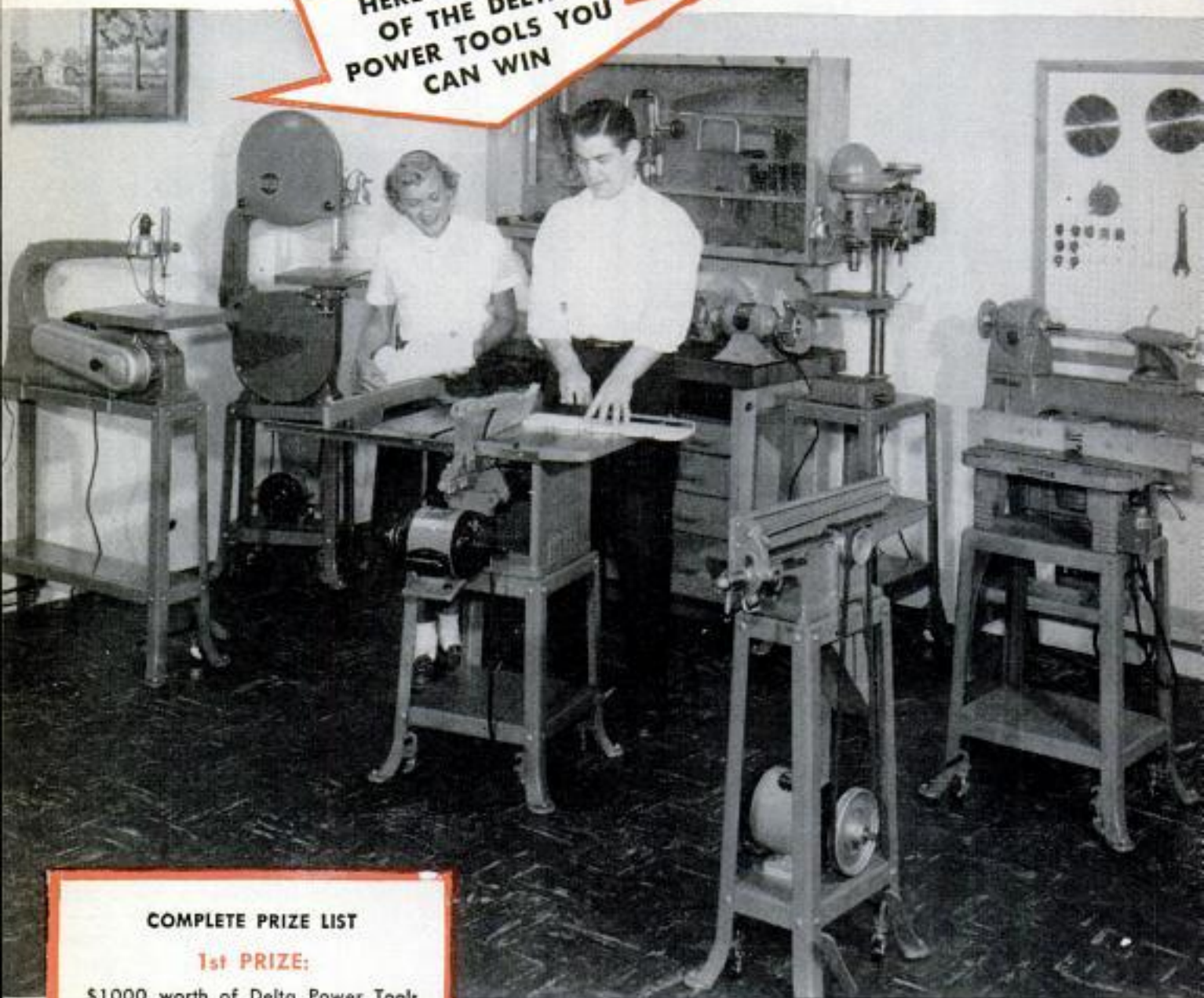

COMPLETE PRIZE LIST

1st PRIZE:

\$1000 worth of Delta Power Tools and accessories of your choice.

2nd PRIZE:

\$750 worth of Delta Power Tools and accessories of your choice.

3rd PRIZE:

\$500 worth of Delta Power Tools and accessories of your choice.

4th PRIZE:

\$250 worth of Delta Power Tools and accessories of your choice.

PLUS: Ten honorable mention certificates, each worth \$10 in Delta Power Tools or accessories.

Win the Delta Tools You've Always Wanted . . .

If you're now a Delta owner, no one needs to tell you about Delta quality. It's there in the rugged feel of your Delta machines, in the smooth way they operate, in the almost complete freedom from maintenance problems, and in the fine precision work they help you turn out more easily. And now you have a chance to get *more* Delta tools—absolutely *free*. What would you like next? A Delta Unisaw, the finest circular saw made for industry and the home? . . . A Band Saw? Scroll Saw? Grinder? Have you seen Delta's new 6" Jointer, with extra long bed? Or the brand new Delta 14" Drill Press with eleven exciting new features?

Whatever it is you want most, now's your chance to get it—and more. So, get your entry form for the big Delta Users' "FINEST HOME WORKSHOP" Contest, and get going *now!*

DELTA QUALITY MAKES THE DIFFERENCE

Copyrighted material

Fine DELTA Power Tools

in Delta Users' "Finest Home Workshop" Contest!

A Contest to Discover the Best Home Workshop
Use of the Finest Tools Made Today

Nothing to Buy

If you now own three or more Delta Power Tools, you are eligible to win up to \$1000 merely by sending us a picture of your shop, and telling, in your own words, *why* you like Delta tools. There's nothing to buy, no red tape. And the big prizes are all in the form of good-as-cash certificates which you can redeem at your Delta Dealer for Delta tools of *your* choice!

Easy to Enter

Here's all you do to compete for the big first prize (\$1000 worth of Delta tools) and fourteen other valuable power tool prizes:

1. Get an official entry form, either from your Delta Dealer (listed under "TOOLS" or "MACHINERY" in the classified pages of your phone book), or by sending the coupon on this page.
2. In not more than 150 words, complete this statement: "I like Delta Power Tools because . . ." No fancy writing needed. Just tell us, in your own words, *why* you like your Delta Tools. Statements will be judged on sincerity and logic.
3. Take a picture of your workshop that shows the tool arrangement to best advantage. Use your own flash equipment, or borrow a friend's. Pictures will not be judged on professional photographic skill, but on practical arrangement for most efficient use of available space. If there are any special features of your shop of which you are proud, tell us about them in a note pasted on the back of your shop photo.
4. Mail entry form, statement, and photo to: Contest, Delta Power Tool Division, Rockwell Manufacturing Co., Pittsburgh 8, Pa.

Easy to Win

Remember, you don't have to have an expensive shop to win this contest. Entries will be judged not on the amount of money you've spent to build and equip your shop, but on the common sense you've shown in selecting and using your tools, and on your ingenuity in utilizing available shop space efficiently.

Here are the complete contest rules:

- Contestants must live in the United States or Canada, and own three or more individual Delta Power Tools, or a complete DeltaShop, Delta's one-motor combination of the four basic power tools—saw, jointer, drill press and sander.
- Employees of Rockwell Manufacturing Company or its advertising agency—or members of their families—are not eligible to compete.
- Entries must be on or accompanied by an official entry form. Elaborate or "dressed up" entries will be discarded.
- Contest closes July 15, 1955. Entries must be postmarked on or before that date.
- Winners will be notified by mail on or before November 1, 1955. Complete list of winners will be supplied on request.
- Decision of judges is final. In case of ties, duplicate awards will be made.
- All entries become the property of Rockwell Manufacturing Company, and none will be returned.
- Awards will be in the form of certificates redeemable at authorized Delta Dealers in Delta Power Tools and accessories up to the face value of the certificate.

Get Your Entry Blank NOW!

If you own three or more Delta Tools, you have as good a chance as anyone to win \$1000 worth of additional Delta Tools, or any one of the other fourteen valuable Delta power tool and accessory prizes. So get started now! Get your entry form from your Delta Dealer (listed under "TOOLS" or "MACHINERY" in the classified pages of your phone book), or send the coupon below.

Delta Power Tool Division, Rockwell Manufacturing Co.
502B N. Lexington Ave., Pittsburgh 8, Pa.

Please send me an official entry blank for the Delta Users' "FINEST HOME WORKSHOP" Contest.

Name _____

Address _____

City _____ Zone _____ State _____

Copyrighted material

DELTA QUALITY POWER TOOLS
Another Product by **Rockwell**





After the Atom — Power From the Sun

(Continued from page 122)

fuel. And what better fuel is there than sunlight?

Dr. Maria Telkes, a leading authority in the field of solar-energy utilization, has evolved a sun stove which shows great promise of meeting this need. Doctor Telkes emphasizes that her stove is still in the development stage. Nevertheless, in tests in the New York area in October when there was a haze over the city, the stove prepared rice and cooked green vegetables which are the staples of India. Furthermore it roasted chicken, broiled steak and fish and baked bread. Even when the outdoor temperature was under 70 degrees Fahrenheit the sun stove developed a temperature of 300 degrees. The stove is so promising that the Ford Foundation is backing it with a grant of \$45,000 for research and development.

Unlike other solar furnaces, the sun stove uses flat mirrors instead of parabolic ones. For this reason it may eventually be produced for under \$5. The stove is simply a box with a glass window. Four flat-surface mirrors unfold outward as flaps around the window. The mirrors deflect sunlight into the stove, where the heat is trapped and stored by a chemical. The chemical retains the heat for more than an hour after sundown, making it possible to cook an evening meal at the time it is usually prepared. Food is slipped into the back of the stove on a tray. There's no upkeep problem, and even a child can learn to adjust the flaps for maximum heat. Though the solar stove is unimpressive in appearance, it could bring about an economic revolution in India.

The sun stove is a partial answer to the greatest puzzle facing the proponents of solar mirrors. This is the problem of heat storage. A second form of solar-energy utilization shows far greater promise than simply using a mirror to collect the sun's rays.

2. *Flat-plate collectors.* The principle here is the same as that used in a greenhouse. Prof. H. C. Hottel of the Massachusetts Institute of Technology Solar Energy Project looks on this as the most promising of all methods of solar-energy utilization.

Suppose you built a trough and painted the bottom of it black. Now cover the trough with a sheet of ordinary glass, which transmits short light rays but reflects long waves. Next you circulate a liquid or

(Continued to page 254)

Motorists prefer

FRAM

more than 2 to 1

Surveys prove it . . . and in many cases the preference for FRAM Oil Filters more than equals the preference for the next two most popular brands combined!

Here's why: FRAM is engineered for extra-high filter efficiency . . . keeps oil clean, cuts wear, saves power and reduces repair bills.

There's a FRAM Cartridge engineered for your car. See your FRAM Dealer today!

Send FRAM boxtop or 25c for big, colorful, 68 page Vacationland America Book describing motor trips throughout America!

FRAM
OIL • AIR • FUEL • WATER
FILTERS

FRAM CORPORATION, Providence 16, R. I.
Fram Canada Ltd., Stratford, Ont.

"TINY ATOM" ELECTRIC MOTORS for HOBBY — RESEARCH — INDUSTRY



Many thousands of these tiny motors are daily solving problems, motivating hobby items—model railroad equipment—research project devices—industrial models. We also make, for easy motor power application, — gears, pinions, worm drives, speed reducers and parts kits. This list may solve a problem for you.

- *No. 3-100—Tiny Atom Motor, 1 1/2-3V. **\$2.00**
- For higher voltages **\$2.50**
- *No. 5002—2-speed metal motor **\$3.00**
- *No. 98—Open steel frame motor with gear, pinions, pulley and worm **\$4.00**
- No. 3113—Tiny Atom motor assembly kit with many accessories **\$3.00**
- No. 1300—Small accessories kit **\$1.00**
- No. 3700—Large accessories kit **\$3.00**
- No. 4000—Deluxe accessory kit with motor **\$5.00**
- No. 700—Super-Power kit with motor, speed reducer, all accessories **\$10.00**
- No. 88—Kit of 8 pulleys—2 belts **\$2.00**
- No. 3000—Variable speed gear unit **\$4.00**

* Item is illustrated
All Wilson's motors have Permanent Alnico V Magnets. Catalog FREE on request.

Rec'd with order and we pay postage in U.S.A. No C.O.D. Add 2% Sales Tax for delivery in Ohio. Write Dept. PM.

For quick delivery see your local dealer — or order direct



WILSON'S OF CLEVELAND

425 Lakeside Ave., N.W. • Cleveland 13, Ohio

make your own Gems 29⁵⁰ F.O.B.

The Gem Maker comes complete with all necessary equipment, including a super-charged diamond blade for sawing, and all wheels for grinding, shaping and polishing; also complete instructions. The complete equipment as shown, less motor and belt, for only \$29.50, f.o.b., Burlington, Wisconsin. Write today for information and literature.

B & I MANUFACTURING CO.
Dept. S Burlington, Wis.

BUILD FINE GRANDFATHER CLOCK NOW

The simple sensible Red-i-Kut way as thousands have — SAVE HALF. SHOP TESTED PLANS "SPIRIT OF THE CENTURY" Narrow waist 83" tall or stately straight side "SPIRIT OF AMERICA." EASY-TO-FOLLOW photographic PLANS tell all—plus BROCHURE of heavy brass weight Westminster, tube chime, movements, gorgeous dials. 3 1/2" solid mahogany case kits. Send \$1.00 today — Both plans \$1.50 NOW.

KUEMPEL CHIME CLOCK CO., 27 Kuempel Bldg., Minneapolis 16, Minn.

SPRINGFIELD 2-WHEEL TRACTOR

Finest tractor on 2 wheels, 3 h.p. engine. Positive reverse. Perfect balance. Welded frame. All attachments. Other tractor and tiller models described in free catalog.

SEND FOR 1955 CATALOG
Quick Mfg. Inc., 3257 E. Main, Springfield, Ohio.

DO IT YOURSELF

It's Easy With ...

Soldering's really a "cinch" ... when you use time-tested, reliable KESTER ... available everywhere.

FREE! "Soldering Simplified" ... 16-page how-to-solder booklet. At your dealer or write direct.

KESTER SOLDER COMPANY
4251 Wrightwood Avenue Chicago 39, Illinois

FREE

SEND FOR THIS 8-PAGE AUTHORITY

SURFACE PREPARATION SANDING HANDBOOK

THIS SURFACE NEEDS PLANING
Your Sander will level any board — even one so warped you can't get it flat for a job.

THIS SANDING ISN'T ENOUGH
If you're not using a Sander, you'll never get a smooth finish.

SAW CORNERS
More of them in the corner than in the rest of the board.

THESE ARE THE WOODS
Start your sanding after you've put the board in the sander. You wouldn't use a cold chisel — why not a Sander (and Yourself) in the sanding?

EVERY "DO-IT-YOURSELF" NEEDS THIS FREE BOOK!

Brand new pocket size handbook explains sanding technique on wood, metal, glass, plastic; shows correct methods and names proper tools for removing surfaces of different types of woodwork. Book lists sandpaper grades and uses; tells how to sand hard-to-reach places, etc. Helps you save time, money on home projects — invaluable to beginners, experts. Lavishly illustrated. Send Coupon for your FREE copy now.

SYNCRO

QUALITY SANDERS

No. 900

NEW HEAVY-DUTY SYNCRO SANDER HAS BUILT-IN "SIGHT-SAVING" LAMP

Husky new "900" removes paint, varnish — outlasts all other portables by running over 1,500 hours without breakdown in exhaustive laboratory tests. Easiest to use. Most powerful reciprocating sander motor (patented). Priced LOW. Rush coupon for details!

AMERICA'S FINEST VERTICAL and OVERHEAD and FINISHING SANDER

Low money-saving price includes sturdy metal carry-storage case. Get facts now.

No. 504 in Metal Case

Mail Coupon for SANDER CATALOG and NEW HANDBOOK Both FREE!

SYNCRO CORPORATION
Dept. 1-25, Oxford, Michigan

Send my Free 8-page SANDING HANDBOOK, SYNCRO SANDER CATALOG, LOW PRICES!

NAME _____

ST. & NO. _____

CITY _____ STATE _____



Your choice of Block, Strip or Ranch Plank design

Just lay prefinished Bruce oak flooring right over your old floors...no sanding or finishing

You can give your home new beauty at low cost with a prefinished Bruce Hardwood Floor. Completely finished—even waxed—at the factory, this highest quality oak flooring can be nailed right over old floors. No sanding or finishing...no mess or smell. Ready for use as soon as laid. Made in strip or block (parquet) design.

"Scratch Test" Finish — The Bruce factory-applied finish is baked into the pores of the wood. The "Scratch Test" (left) will prove to you that this durable finish does not scratch or chip or mar like an ordinary floor finish.



Moderate in cost — A new Bruce Hardwood Floor will cost you less than a good rug or carpet. Easy to keep clean and beautiful, too. It's just the thing to use in fixing up or adding a room. Let your lumber dealer give you an estimate. Mail coupon below for colorful literature.

MAIL FOR FREE LITERATURE

E. L. Bruce Co., Box 397-O, Memphis 1, Tenn.
Send complete information on prefinished Bruce Hardwood Floors.

Name.....

Address.....

City..... State.....



Bruce Hardwood Floors

Product world's largest hardwood flooring maker

gas through the trough. Sunlight penetrates the glass and strikes the painted bottom. Here most of the heat is absorbed, and the little that is reflected bounces back as long waves. These can't penetrate back through the glass, so they bounce back to the bottom of the trough again. The heat builds up quickly inside the trough and the liquid or gas absorbs it. The heat is carried away in the liquid and used to heat a home or even to operate a steam engine.

Such flat-plate collectors, according to M.I.T. experiments, can be built for about \$2 per square foot. If this cost can eventually be cut in half by cutting the cost of the glass, large installations may well become economically feasible.

Flat-plate collectors have been used to heat several research homes across the country. One advantage is that the collector actually can form the house roof. The American Glass Company has developed glass shingles for this purpose. Enthusiasts in this field predict that many homes of the future will have glass roofs that trap the heat and carry it to storage areas within the home where it can be drawn off as needed. Even in the area of Boston, according to M.I.T. experiments, a flat-plate collector with an area half the floor area of the house can provide practically all the heat required. One authoritative report estimates there will be 13,000,000 solar-heated homes in this country by 1975.

Proponents of flat-plate collectors point out that they are a partial answer to the heat-storage problem because the heat is stored in chemicals or a gravel bed within the home.

But so far, nature herself is the biggest storehouse of solar energy, and man now is looking to nature as a guide for the capture of sunlight. If man could only improve on nature's own conversion system, would he not profit by an increased yield of energy?

3. *Photosynthesis.* Each year the green plants of the earth combine 160,000,000,000 tons of carbon and 25,000,000,000 tons of hydrogen. As an incidental result, 400,000,000,000 tons of oxygen are set free for the animal kingdom to breathe. Man still doesn't know how photosynthesis occurs, but he is making strides toward a speed-up of the process.

Dr. George R. Harrison, Dean of the M.I.T. School of Science, points out that an acre of corn land in the latitude of New York, which has an average 1000 horsepower of sunshine, is likely to produce annually a ton of food as corn kernels and a ton of fuel as stalks and cobs. If you burn the food in your body and burn the stalks

(Continued to page 256)

See How Little It Costs
to Build a Ready-Cut

Liberty Home

Ranch-type home,
64 feet wide, with
three bedrooms

\$5350



\$3128

Freight-Paid
Prices
As Low
As
\$2608



What "Liberty" Owners Say

Ahead \$2,000 to \$3,000

"We have moved into our 'Liberty' home and are more pleased with it every day. I think I would be safe in saying we are ahead \$2,000 to \$3,000 by buying your Liberty Home and doing the work ourselves."

Saved \$4,000 to \$6,000

"Compared to a local contractor's price to build a home equal to my 'Liberty,' I will be saving \$4,000 to \$6,000; so you can see why I have such enthusiasm for Liberty Homes."

Save 30% to 40%

You can save several thousand dollars when you build a Liberty Home! Buy direct from our mill at our low, factory, freight-paid price. We ship you the lumber cut-to-fit, ready to erect. Doors, windows, roofing, paint, glass, hardware, nails, etc., all included in the price. Plans furnished—also complete building instructions. No wonder our customers write us that we saved them 30% to 40%. Easy terms—monthly payments. Architecturally approved construction. (Not prefabricated.)

Visit a Liberty Home!

Many thousands of Liberty Homes have been built in all parts of the country. If you would like to visit and inspect the model that suits you best, write us and we will give you its location.

Handsome Big CATALOGUE

Pictures wonderful homes in colors at money-saving prices. Write for FREE catalogue today.
(WEST OF MISSISSIPPI, 35c)

BIG BOOK
of
House Plans
in Color
FREE

LEWIS MANUFACTURING CO.

1252 Lafayette

Bay City, Mich.

SHOPMASTER'S

NEWEST SENSATION

COMBINATION POWER TOOL



Drill Press, Sander,
Beamer, Sander, Curbs
All in One

For Complete Information Write Dept. 10V
1214 S. 3rd St., Minneapolis, Minn.

SHOPMASTER, INC.

SET-UP - KNOCKDOWN SAWHORSE with Jiffy BRACKETS



No nails or bolts... use 2x4's for legs. 2x4 or wider for crossbar. Rugged, sturdy, easy to move, saves storage space. Sold by hardware and building material dealers, or order direct.

GRAND HAVEN STAMPED PRODUCTS CO., Grand Haven, Mich.

PAGE TILLERS

Makes tough jobs easy!

New 1955 "Page-Boy"

3 Models—1½-2½-3½ HP.

Tills,
Cuts Grass,
Blows Snow!

Tiller, mower, snow blow attachments easily shifted. Safe and easy to operate. Rugged steel frame, adjustable rubber tired wheels. So handy around the home or farm!



FREE CATALOG—Complete tractor line with all attachments

PAGE 1804 S. 81st St.
Milwaukee, Wis.

★ LOW PRICED
★ EASY TERMS
★ FULLY GUARANTEED



Painting's a **SNAP**

with **DURAVAL**

A TEXOLITE[®] PAINT PRODUCT

- 23 ready-to-use colors; over 100 decorator blends, many more you can create yourself from just two colors.
- It's rubberized—it's scrubberized.
- Dust-free in just 20 minutes...leaves no "painty" odor; minimizes brush marks.
- Thrifty—one gallon covers up to 450 sq. feet. Brushes or rollers come clean in ordinary water.

For further information see your TEXOLITE paint dealer, or write Dept. PM 2, 300 West Adams Street, Chicago 6, Illinois.

*T. M. Reg. U.S. Pat. Off.

UNITED STATES GYPSUM

the greatest name in building



and cobs as fuel, you get back less than one thousandth the original solar energy. Forests are similarly inefficient in storing energy. How, ask solar scientists, can we raise this efficiency?

One answer, they feel, lies in the depths of the ocean. Surprisingly, nine tenths of all photosynthesis occurs in the sea. Algae are unicellular plants which, under ideal conditions, can double their weight every 10 hours. This is a striking gain through photosynthesis.

One particular kind of algae—Chlorella—seems to deserve special study. The Arthur D. Little Company, on behalf of the Carnegie Institution, has carried on experiments in Chlorella culture. Chlorella is introduced into water inside a plastic tube. Pumps circulate the water to expose the algae to sunlight. The company estimates that through this system about 50 tons of algae could be produced per acre in one year. The biggest hitch is the cost of a plastic culture outfit, which runs about \$20,000 per acre.

The ideal form of solar-energy utilization, of course, is not the improvement of natural photosynthesis or the capture of the sun's heat, but some device that absorbs sunlight and gives off electricity in return. Such instruments are already in existence.

4. *Converting sunlight directly into electricity.* The ordinary photoelectric cell (as in a photographer's light meter) is a wonderful device that produces electricity directly from sunlight. So far it has produced only enough electricity to operate instruments and swing open supermarket doors. However, it may be possible that some day this system can be improved.

The biggest news in the field of solar-energy utilization is the development of "solar batteries" and "solar generators."

At the Wright Air Development Center, Donald C. Reynolds and Lt. Col. Gerard M. Leies have discovered the surprising ability of cadmium sulphide, a yellow powder commonly used as a pigment in paint, to convert light directly into electricity. The powder is processed into crystal form. The crystal in the present model is about the size of a sugar cube, but it can be thin as a razor blade and still work efficiently. Attached to opposite sides of the crystal are electrodes, one made of silver and the other of indium. A wire runs from the positive electrode to a motor or battery and back to the negative electrode to form the circuit. The solar generator is as simple as that.

When sunlight strikes the battery, it induces an electrical potential which is carried off by means of the electrodes. The

(Continued to page 258)

You Get These ADDED Utility Holders



9 DIFFERENT SETS AVAILABLE

No. 1 and 5 — Wall-Klip Socket Wrench Sets; 11 or 19 pc. in sizes you use the most; plus metal holder that becomes a handy wall hanger.

No. 2-3 and 4 — Double-Duty Wall-Bracket Wrench Sets; Box End or Combination Wrenches all in popular assortment of sizes; With holder that becomes handy wall-bracket.

with Socket and Wrench Sets AT YOUR INDESTRO DEALER'S

Look for the store that sells big-value Indestro Tools, to get this exclusive bargain. Buy Indestro Socket or Wrench Sets and you get, *without additional cost*, Wall-Klip or Hanger for holding these tools in easy reach. The handiest thing you ever saw for your garage, home work shop or hobby bench.

YOU GET CONVENIENT WALL-KLIP . . .

When you buy Indestro Socket Sets which include all the most needed sockets and handles. Held in Double-Duty Wall-Klip that mounts on the wall.

YOU GET HANDY WALL HANGER . . .

When you buy these Indestro Wrench Sets which include wrenches you use most. Packaged in patented, exclusive design, Klip-Tite Wall-Bracket Holder that opens into hanger as shown.

If you cannot find a hardware, implement, auto supply or variety store that sells Indestro Tools, write us for name and address of the Indestro dealer nearest your home.



INDESTRO MFG. CO.

NORTH KILDARE at SCHUBERT • CHICAGO 39, ILLINOIS

BUY AT A DISCOUNT RED-E TRACTORS AND TILLERS



Tillers — 1.5, 2 H.P.; 3-wheel tractors — 2, 3, 4½, 6 H.P.; 4-wheel riding model, 8½ H.P. Send for free folder on full line of tractors and implements.

Buy direct from factory, get a factory discount! SAVE UP TO 50%! 

RED-E TRACTOR CO.
Richfield 9, Wisconsin

Find HIDDEN TREASURES

GEIGER COUNTERS (as shown) for Uranium Detection. TREASURE DETECTORS for gold, silver, etc. Lightweight, ultra sensitive. None finer. Also Mineralights for Tungsten.

• INFORMATION FREE •

Detectron Co.
5420 Vineland, North Hollywood, Calif

POWERFUL!

Man, here's light! 1/4-mile beam — 15,000 beam candle power. Compact, easy to carry, built to last! Uses two 6-volt batteries. See your dealer.



\$6.50
less bats.

Delta POWER-KING ELECTRIC LANTERN

YOU CAN START A \$40 A DAY BUSINESS IN YOUR SPARE TIME



Andy Phillips says: "MyBELSAW Sharp Smith gives me big profits at low expense — I can run 35 to 40 circular saws in an 8-hour day — that makes me \$40 cash."

"I also get BIG EXTRA PROFITS... up to \$4 an hour... by grinding planer and jointer knives — there's always a demand for this kind of work."

You can start this REPEAT CASH business in your own home or garage while you are working at your regular job. Easy to operate, no experience needed. "Pays for itself from just 65 jobs." — Harvey Jensen

For as little as \$15 down payment, you can get your BELSAW SHARP SMITH rushed to you.

FREE book tells how
YOU can start making money the very day your BELSAW SHARP SMITH arrives. Earns \$4 to \$5 an hour in your SPARE TIME sharpening and setting circular saws for builders, lumber yards, factories... Plus BIG EXTRA CASH, precision grinding planer and jointer knives, plane irons, wood chisels and drill bits. Hundreds of jobs in your own neighborhood. No extra equipment needed, no canvassing. Send today for your Free copy of "Life-Time Security."

BELSAW MACHINERY CO
3706 Field Building Kansas City 11, Mo.



How you can get perfect paint jobs every time!

Even the best paint won't conceal a surface that's cracked, blistered or scratched. For a professional-looking job you must strip the surface clean . . . and that's what Klean-Strip Paint Remover does, easily and quickly.

Klean-Strip is totally unlike ordinary paint removers that dissolve the finish and are so messy to use. Klean-Strip actually breaks the bond between finish and surface . . . removes many coats with one application. It's clean, fast-acting and easy to use . . . leaves the surface smooth and dry, ready to paint without neutralizing or afterwash.

Use Klean-Strip on furniture, woodwork, walls, metal. It peels off any finish. Buy it when and where you buy paint.

NON-INFLAMMABLE

KLEAN-STRIP

"PEELS OFF PAINT"

THE KLEAN-STRIP CO., INC.
2340 South Lauderdale, Memphis 6, Tenn.



Only the good
and Shark
Chisels



best is
enough

Brand
ARE TOPS!

Shark Brand Chisels are made of genuine Swedish Charcoal steel hardened, tempered and honed to a razor sharp edge the way only Swedish tool makers can do it!

"Shark Brand" Chisels actually hold their edge longer — much longer than ordinary brands and are designed to make professionals approve and amateurs amazed. See them at your hardware dealer, but be sure to look for the "Shark Brand" trade mark—it's your assurance of perfection—or, if you prefer, write us for new chisel folder and prices. Dept. PM-2

Sandvik Saw & Tool

47 WARREN ST., NEW YORK 7
DIVISION OF SANDVIK STEEL INC.

crude model first built at Wright developed enough current to operate an electric clock. By increasing its size, making other improvements that seem possible, and then hooking a number of these generators in relays, scientists see no reason why they can't step up the voltages tremendously.

According to the Air Research and Development Command, the conversion powers of the generator are so great that a wafer-thin slab of crystal 4 by 14 feet, built into the roof of a house, would supply enough current to operate all the home's lights, stove, refrigerator and other appliances. Scientists aren't going overboard to the extent that they predict you'll soon be able to buy a roof panel that will eliminate your electric bill. But there's no doubt that they are excited over the discovery.

Bell Laboratories has developed a solar battery which is similar in theory to the solar generator, except that a crystal of silicon is used instead of cadmium sulphide.

So far the crystals have been made about razor-blade size. Extremely sensitive to light, they are linked together electrically and deliver power from the sun at 50 watts per square yard of surface. It's amazing to hold a battery not much larger than a cigarette pack, point it toward the sun and watch it spin a little electric motor. It's even more amazing to realize that this magic process consumes nothing in the battery, that there are no moving parts and that, theoretically, the solar battery will keep right on operating forever. The Bell battery, even at this point, is from 8 to 10 percent efficient and thus compares favorably with the steam or gas engine. Scientists calculate that about 60 acres of land covered with the crystals would produce 30,000 kilowatts of power.

The solar battery has a great deal of significance in the field of communications because telephone messages travel at low voltages. Bell engineers are already testing the battery as a power source for rural telephone lines. In such an installation the battery simply is fastened to a telephone pole. The electricity it generates flows into a storage battery on the same pole and this provides the current to carry the message.

These are the first gropings in what might be called a new science, a solar science. Workers in the field use understatement, but are enthusiastic about the future. They point out that nature has tied the knot of solar-energy utilization mighty tight, but so far they see no reason why it can't be untied. And because the life of man is bound up in this knot, they foresee gradually accelerating research until science at last is able to take advantage of Old Sol's bountiful gift of energy. ★★



Thrill your child with this drop-leaf desk and bookcase!

get complete detail drawings, photograph and directions in
FREE PATTERN KIT 305

—along with the picture-packed booklet, "Friendly Home Ideas in Western Pine." Write for it to Western Pine Association, Dept. 305-N, Yeon Building, Portland 4, Oregon.

the Western Pines

- * IDAHO WHITE PINE
- * PONDEROSA PINE
- * SUGAR PINE

This desk — scaled to a child's proportions — is just like a grown-up's with pigeonholes, pencil racks, drawer, shelves and cabinet. And the mellow woods of the Western Pines* lend their own special charm to the simple New England design.

It costs so little to build this desk with the woods of the Western Pines. You'll find that they cut clean and accurately with hand or machine tools and take all finishes well.

Ask your local lumber dealer for the woods of the Western Pines — he'll be glad to give you an estimate!

TODAY'S WESTERN PINE TREE FARMING GUARANTEES LUMBER TOMORROW

FREE CATALOG
NEW CHRYSLER BOAT KITS

BUY DIRECT—SAVE UP TO 2/3 FACTORY TO YOU!
No Dealers!
You SAVE the BIG PROFIT!

12 MODELS—8 to 14 ft. —\$39 up
Finest quality Boat Kits at the lowest prices in history! Mahogany decks. Easy to build.
Also: FIBERGLAS—ACCESSORIES—TRAILERS

CHRYSLER-CRAFT (DEPT. 20) TONAWANDA, N.Y.



BURKS
SUPER TURBINE PUMPS
LAST LONGER

ONLY PUMP WITH LIFE-LOK FEATURE



Thanks to the LIFE-LOK feature, the BURKS Super Turbine Water System lasts up to 40% longer than any other kind, delivers more gallons per minute and provides "like-new" performance and efficiency when other types would be worn out. It's completely automatic—self-priming.

FREE BOOK PICTURES PUMP DETAILS
Send today for "The Story of Burks"—a 32-page book giving detail drawings, graphs, etc. See why BURKS is finest engineered system . . . why it delivers more water per hour . . . why it's the finest water system you can buy. Write to—
DECATUR PUMP CO., 61 Elk St., Decatur 70, Ill.

NEW POND GARDEN TRACTOR

DEALERS WANTED

MAKE EXTRA MONEY

RIDING OR WALKING TYPES also Rotary Mowers



2½ — 3½ — 5 and 8 H. P.

BEFORE PURCHASING, COMPARE OUR LOW PRICES WITH OTHER MAKES.

Full 18" ROTARY MOWER only.....\$72.50
2½ H. P. Walking Type Tractor.....\$147.50
4-Wheel Riding Type Garden Tractors are priced from \$247.50 to only \$375. for the 8 H. P.

FULL LINE EQUIPMENT AVAILABLE
Write today for **FREE illustrated circular.**
POND CO., Box 216-Q, Ravenna, Ohio

free

**GET THE
WORLD'S LEADING
TV & RADIO CATALOG
ALLIED'S 1955
ELECTRONIC BUYING GUIDE**



**308
VALUE-
PACKED
PAGES**

Save on
Everything
in
Electronics

**World's Largest Stocks... for Builders,
Experimenters, Amateurs, Servicemen,
Engineers and Hi-Fi Specialists**

Get ALLIED's big 308-page Catalog featuring the world's largest selections of latest top-quality electronic equipment at lowest, money-saving prices. See the newest in custom TV chassis, antennas and accessories; FM and AM Tuners; High Fidelity systems and components; recorders and phonograph equipment; Amateur receivers and supplies; builders' kits; test instruments; industrial electronic supplies—plus thousands of parts, tubes, tools and books. Get *everything*, get *more* for your money—send today for your **FREE 1955 ALLIED Catalog!**



**Send
for
FREE
Catalog**



ultra-modern facilities to Serve You Best

ALLIED RADIO

**ALLIED RADIO CORP., Dept. 5-BB-5
100 N. Western Ave., Chicago 80, Ill.**

Rush **FREE 1955 ALLIED 308-Page Catalog**

Name _____

Address _____

City _____ Zone _____ State _____

The World's Biggest Clearance Sale

(Continued from page 93)

a steady supply of boots in the pipe line en route to him. But soldiers don't wear out their boots so rapidly in peacetime and now an excess quantity is on hand. It's better business to sell them off than to keep them in storage.

"Obsolescence is another reason for selling property. When a new style of lightweight underwear is adopted there's nothing to do with the older underwear except to sell it. And a lot of electronic equipment is being disposed of now. All of a sudden subminiaturization has made much of the older equipment too heavy and cumbersome to carry around."

For a time after the war you could buy a complete aircraft gunnery turret or a complicated aircraft gunsight, then all such strategic military equipment was withdrawn from sale and the present procedure is to break the material up into scrap. This rule may be relaxed in the future and then you'll be able to buy at surplus such armament as shotguns or gun turrets.

Before any branch of the military puts equipment up for sale it first circularizes the other branches to learn whether the equipment can be used there. Lifeboats in the Army's possession, for instance, are first offered to the Navy, Marine Corps and Air Force and are put up for sale only if the other services can't use them.

Too, war-surplus materials are granted free to universities, schools, and hospitals that can use the equipment. Military academies, the Boy Scouts, the Civil Air Patrol and other agencies may get surplus materiel for which they have need. All the rest is sold by public auction.

A lot of war surplus was sold in the past by the sealed-bid method, then it was learned by trial last year that public auctions bring a greater return. Now the Department of Defense is contemplating a combination of the sealed-bid and the public-auction methods. Under this system a distant bidder who can't attend the auction would forward a sealed bid that stipulates the top price he would pay for an item in the catalogue.

The auction would be held in the regular way except that when bidding ends, the auctioneer would open any sealed bids and read them aloud. If a sealed bid happened to be higher than the bids made from the floor, the bidders who are present would then get a chance to top the price announced by the auctioneer.

What Uncle Sam the auctioneer is trying to do is to save every cent that he can of the taxpayers' money. ★ ★ ★

**RELIEVES PAIN OF
HEADACHE • NEURALGIA
NEURITIS**

FAST

The way
thousands of
physicians
and dentists
recommend



Anacin® relieves headache, neuralgia, neuritis pain fast because Anacin is like a doctor's prescription—that is, Anacin contains not just one, but a combination of medically proven, active ingredients in easy-to-take tablet form. Thousands have been introduced to Anacin through their own dentist or physicians. If you have never used Anacin, try these tablets yourself for incredibly fast, long-lasting relief from pain. Don't wait. Buy Anacin today.

**KROIL LOOSENS
RUSTY FROZEN PARTS**



12,000 industrial plants now use Kroil for emergencies like frozen bolts, pipe threads, bearings, etc. Kroil creeps into millionth inch spaces to dissolve rust and dried grease . . . guaranteed to loosen stuck-together metal parts or money back—gallon \$3.85 f.o.b. Factory or send \$1.50 for two 8 oz. spout cans postpaid.

KAND LABS., 1032 Thompson Lane, NASHVILLE 11, TENN.

NEW SHOP SMITH HAS POWER-MOUNT

Add jointer, jigsaw, band saw, etc. . . . set up tool combinations (saw-jointer, jigsaw-sander, many others) in seconds! Takes no extra floor space. See the new SHOPSMITH® today. Complete 5-tool unit, \$269.50. Write for free 20-page catalog. **MAGNA ENGINEERING CORP.,** Dept. 280-B, 12819 Coit Road, Cleveland 8, Ohio, or Menlo Park, Calif. *T.M. Reg.

AN UNUSUAL OPPORTUNITY!!!!

Famous **MZB** German Precision Calipers & Micrometers UP TO HALF REGULAR PRICE

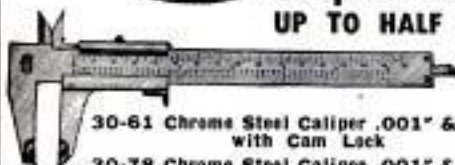

- 30-61 Chrome Steel Caliper .001" & 1/128" . . . \$7.00 with Cam Lock
 - 30-78 Chrome Steel Caliper .001" & 1/128" . . . 6.00 with Set Screw
 - 30-41 Z Micrometer 0 to 1" to read .0001" . . . 9.95
- Add 35c for postage—No C.O.D.
MONEY BACK GUARANTEE
Genuine Leather Case for above caliper 75c each

INTER-CONTINENTAL TRADING CORP.
90 WEST STREET NEW YORK 6, N. Y.

Get This NEW 1955
Craftsman Catalog of
WOOD
AND WOODWORKING
TOOLS AND EQUIPMENT



Everything
for the
Woodworker
and His
Shop!

World's Largest Selection of
Finest Domestic and Imported
Woods . . . Mouldings, Hard-
ware, Tools . . . ALL AT LOW
MONEY SAVING PRICES! . . .

Your complete wood buying guide and project book. Craftsman is your best, most complete source of finest kiln-dried domestic and rare imported woods, beautiful wood inlays, colorful bandings, matched plywoods, embossed mouldings, carved ornaments, newest woodworking tools, "hard to find" cabinet hardware and fittings . . . more than 1,500 items! Packed with newest scroll saw patterns, project ideas and money making plans. Enclose 25c (refunded with first order) to help pay mailing and handling cost. WRITE TODAY!

Craftsman Wood Service Co., Dept. A-52
2729 S. Mary Street • Chicago 8, Ill.

CRAFTSMAN WOOD SERVICE CO., Dept. A-52
2729 S. Mary St., Chicago 8, Ill.

Enclosed find 25c. Rush me new WOODWORKERS' CATALOG HANDBOOK.

NAME _____
ADDRESS _____
CITY _____ ZONE _____ STATE _____

148
PAGES

Many in
Full Color
packed with
rare, fancy &
imported
woods . . .
veneers, ply-
woods, pat-
terns, tools,
ornaments,
hardware . . .
everything
for the wood-
worker.

MAIL
COUPON
NOW!

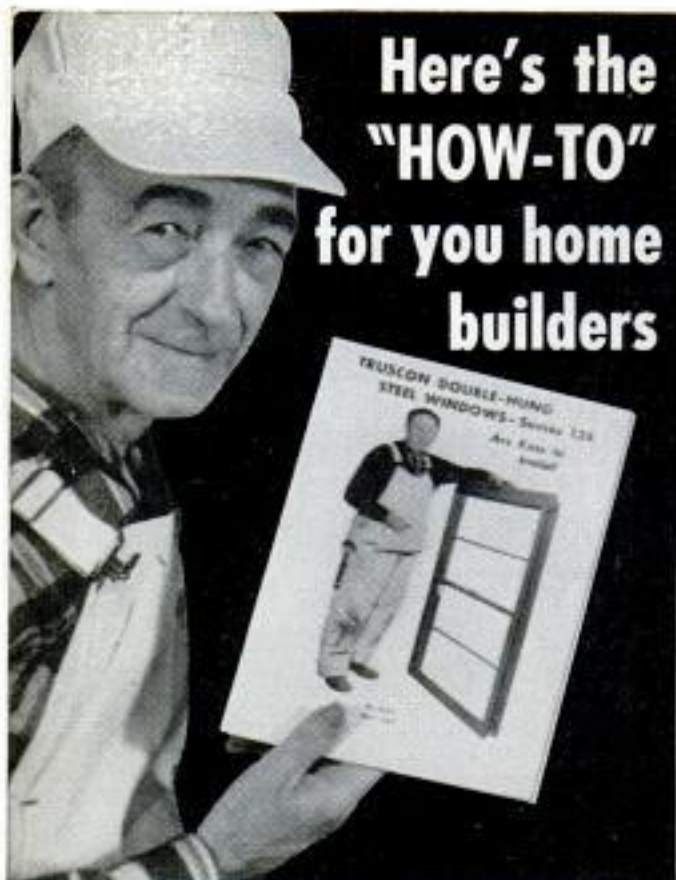

Here's the
"HOW-TO"
for you home
builders

FREE BOOK shows how to install Truscon Series 138 Double-Hung Steel Windows yourself!

Clear pictures and explanation are easy to follow. Complete step-by-step guide to methods the professionals use. You see and learn how to install these weather-resistant windows in frame, brick veneer, masonry and concrete block construction. The proper sizes for window openings. How to anchor and level. How to caulk, and where. Where to install flashing. How to prepare for plastering. How to install stool. How to handle shingles. How to glaze. Everything you need to know for a professional-looking installation!

You buy Truscon Series 138 Steel Windows from your dealer complete. Hardware is attached. Stainless steel weatherstripping and tape balances are in place. Send for your book today. See the wide range of Truscon Series 138 sizes and types at your building supply dealers.

**TRUSCON STEEL DIVISION
REPUBLIC STEEL
YOUNGSTOWN 1, OHIO**



TRUSCON STEEL DIVISION, REPUBLIC STEEL

1126 Albert Street • Youngstown 1, Ohio

Please rush free book showing me how to install Truscon Double-Hung Steel Windows, Series 138.

Name _____

Address _____

City _____ Zone _____ State _____

Doors on Portable Hog Shelter Provide Shade and Ventilation



Built on skids and without a floor, this 8 x 12-ft. hog house may be towed to a new location whenever necessary. All four sides are fitted with hinged doors, as shown in the photo, which may be raised individually according to the weather or season. The raised doors also provide a sunshade during the hot summer months.

Tank Fitted With Float Valve For Hog Watering

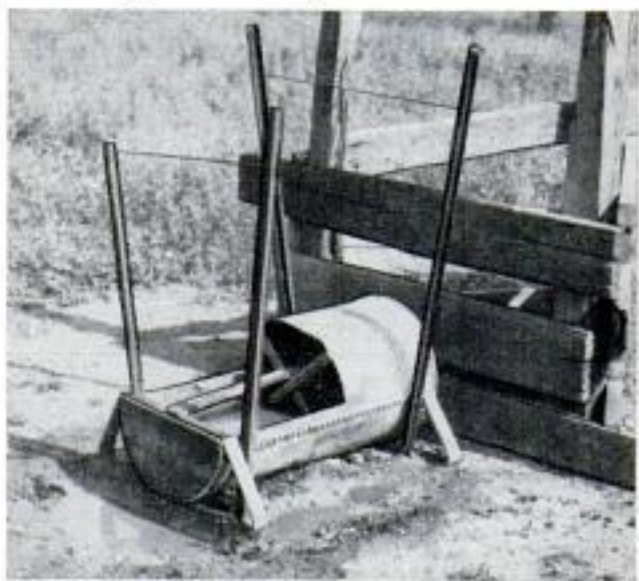

One farmer made an inexpensive hog waterer by cutting away part of one side of a discarded hot-water tank. A float valve, placed in the covered end of the tank, is connected to the farm water-supply system, thus assuring a constant supply of fresh water. Steel flats are shaped and welded to the tank to provide legs. Short lengths of steel angle are welded across the tank to keep the hogs away from the float valve and out of the water. Steel fence posts are driven into the ground to hold the tank in place. The tank is easily moved to any location on the farm where there is a connection to the water supply.

Kenneth R. Imig, Watseka, Ill.

EARN EXTRA MONEY the IDEAL way!

SHARPEN POWER OR HAND MOWERS LIKE AN EXPERT!

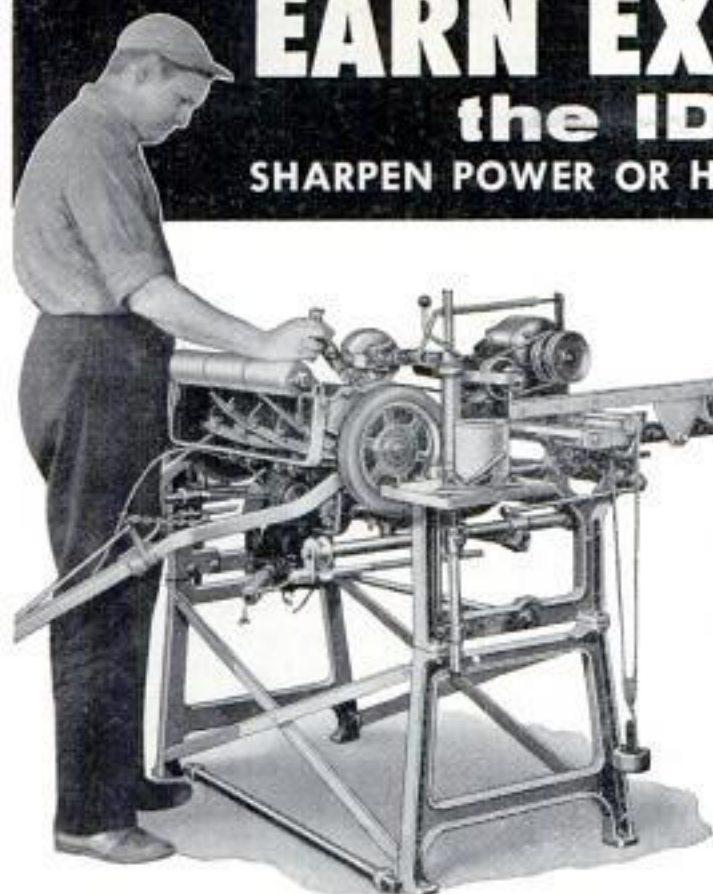

NO EXPERIENCE NEEDED

You can sharpen your first lawnmower expertly on an Ideal Sharpener. Just put the mower in your Ideal—no need to take it apart—and you'll have a perfect cutting mower in minutes.

CASH-IN ON THE POWER MOWER BOOM

Start a profitable business full-time, or in your spare time at home. Hundreds of power and hand mowers are in use in your area. It's a real opportunity. Be ready for spring and summer business . . . get your Ideal Lawnmower Sharpener now!

Write for FREE catalog to:

The FATE-ROOT-HEATH CO.

Dept. PM-2, Plymouth, Ohio

IDEAL LAWNMOWER SHARPENERS, THE QUALITY LEADER FOR 52 YEARS!

**GLASS COVER
Your
BOAT!**

MAKE IT PERMANENTLY LEAK-PROOF — STRONGER — SAFER

TOMAHAWK shop methods, professional materials, detailed illustrated instructions permit you to glass cover your boat at home. Takes few hours, lasts indefinitely. TOMAHAWK GLASS COVERING is EASIER, CHEAPER, BETTER.

For details write

TOMAHAWK BOAT MFG. CORP.
TOMAHAWK 6, WIS.

WORLD'S BEST SMALL TRENCHERS

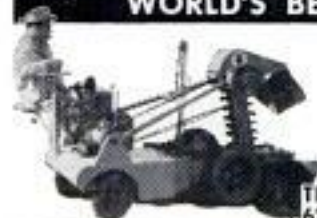

Portable DITCH-WITCH digs 2" to 6" clean, even ditches to 36" depth in all types of soil. Complete unit—self propelled—outdigs 8 men. Four rugged models.

Write for illustrated literature.
THE CHARLES MACHINE WORKS
620 B Street Perry, Oklahoma

**CUT PERFECT GROOVES
WITH Warren WASHERS
ON YOUR SAW BLADE!**

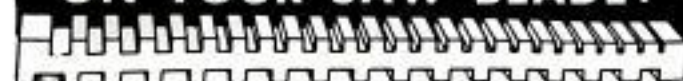

**NOT ONE — NOT TWELVE — BUT
40 DIFFERENT CUTS**

Engineered to cut clean, accurate, parallel grooves—just dial the desired width—40 micromatic adjustments—leave on saw for straight cuts. **GUARANTEED.** At your dealers or order direct. Arbor sizes 1/2", 3/4", 1". Send for free booklet

WARREN WASHERS COMPANY

Dept. 22, Box 98, North End Station, Detroit, Michigan

**SAVE HUNDREDS OF DOLLARS
THE MALL WORKSHOP WAY**



A—Slitting Saw	\$7.95
B—Reciprocating Saw	\$14.95
C—Belt Sander	\$16.50
D—Screwdriver	\$10.95
E—Drill Stand	\$16.50
F—Jig Saw	\$16.50
G—Wood Planer	\$14.95
H—Orbit Sander	\$15.95
I—Metal Nibbler	\$17.95
J—Right Angle Kit	\$16.50

You can own a complete power tool workshop at a fraction of the cost of buying a separate power tool for each job. The MALL electric drill (model 149B) is the only power source you need to run these and many other low-cost attachments. The drill, with geared chuck, costs only \$23.95. Mail this coupon for complete information about the MALL "add-as-you-go" plan.

MALL TOOL COMPANY PORTABLE POWER TOOLS
GASOLINE—ELECTRIC—AIR

7805 S. Chicago Ave., Chicago 19, Ill.

RUSH me big, free MALL Drill Attachment Catalog No. 15.

Name _____

Address _____

HEI-148

The easy way to paint!

Speedy Sprayer

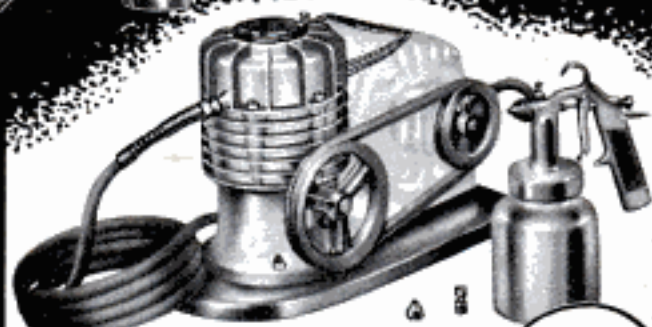

Favorite of home owners and craftsmen for 20 years! SPEEDY SPRAYER gives your work that professional paint finish everyone admires. Sprays paint, enamel, varnish, lacquer, etc. . . . 4 to 7 times faster than hand brushing! Lightweight, portable, uses any 1/4 H.P. motor. Improved diaphragm principle assures clean, oil-free air. You'll find dozens of time and money saving uses for SPEEDY SPRAYER, including spraying insecticides 2-4-D and DDT. Complete outfit, without motor, only \$36.50.

ONLY
\$36.50
LESS
MOTOR

At leading hardware, lumber, and auto supply dealers. FREE—write for handy booklet "How to Spray."

W. R. BROWN CORPORATION
2635 N. Normandy • Chicago 35, Ill.

WORKSHOP WONDERS

with
WISE-GRIP

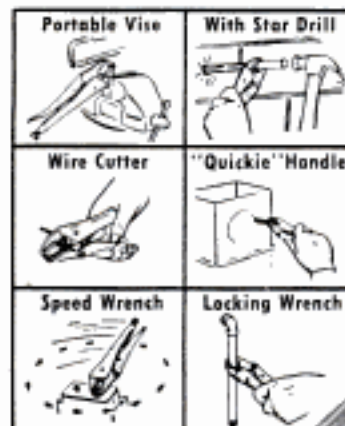

**World's
HANDIEST
Do-It-Yourself
Tool!**

Does more jobs easier than any other tool! Locks onto work with **Ton-Grip**. Won't slip. Is actually super-pliers, adjustable wrench, portable vise, clamp, pipe wrench, locking wrench—all in one! 7" and 10", cutter optional. \$1.85 to \$2.60 at your dealer.

Made Only By PETERSEN MFG. CO., Dept. M-2, DeWitt, Nebr.

CAP to the Rescue

(Continued from page 85)

When pilots—civilian or military, professional or amateur—fall out of the sky, CAP members take to their planes and to their radios, operating as a closely knit, well-organized search organization.

The Civil Air Patrol has been doing this sort of thing for 12 years. All volunteers, its members are continually expanding their scope of activity. Today, it stacks up as a key unit in Civil Defense for the evacuation of civilians, aerial reconnaissance and as a hub for communications in the event of an enemy attack.

Airplanes aren't the only means of transportation used. In Utah, CAP members take to horseback to perform ground search, while in the Florida Everglades they use swamp buggies and air boats. Nearly every CAP unit situated near a body of water has a boat for rescue purposes. In New Hampshire, an underwater rescue team made up of former Navy frogmen has been organized against the day when the wing might be faced with the problem of going beneath the surface of one of the state's many lakes and ponds to extricate victims of a plane or boat disaster.

CAP members work and fly without pay. They are charged an annual assessment for membership in the patrol and they buy their own uniforms—the USAF uniform with distinctive CAP insignia, as authorized by Congress.

More than three quarters of the 7000 light planes available for CAP use are owned by individual members who do receive reimbursement in the exact amount paid for fuel and oil burned on missions ordered by the Air Force. This, however, doesn't help defray the cost of insurance and wear on their private planes, nor does it pay the hospital and doctor bills of members injured in line of duty. It is significant that approximately 40 CAP members have lost their lives on missions since the inception of the Civil Air Patrol just six days before Pearl Harbor. More often than not, they must fly through weather that would ground even the birds.

A typical story is that of Capt. Bob Mason of the Alaska Wing. Tom West, an 84-year-old cannery employee, fractured a hip in Seldovia, an isolated wilderness community. Radio brought the message that the old man needed medical attention available only in Anchorage. CAP was asked to evacuate the patient by air.

Mason volunteered despite reports of high winds and minus-45-degree temperatures. It took three hours to start the

(Continued to page 266)

LAFAYETTE'S

BARGAIN SALE!

WESTERN ELECTRIC HEARING AID

Brand new, in original Western Electric's jewelry case. Supplied with receiver, receiver cord, battery cord and plug (less batteries). Money back guarantee. Act now while they last! Uses Burgess AX306 and 8B batteries at \$1.55 per set.



Reg. Price **\$85.00** Our Price **14.95**

PRECISION GEIGER COUNTER



29.95

Geiger counter featuring high sensitivity to radioactive substances and extremely compact design. Detects uranium ore, cosmic rays, radium and x-rays by instantly producing a load series of clicks in earphone.

Uses a miniature amplifier tube, one 22.5V. hearing aid battery and one flashlight battery. Strong plastic case 1 1/2" x 3" x 5". Supplied complete with headset, batteries, radio-active sample and instructions. Shpr. Wt. 3 lbs.

Model 108 **29.95**

WELLER SOLDERING KIT

Kit includes 250 watt instant heat - dual spotlite Weller iron - ample supply of kester solder - soldering tin - smoothing tin - tin interchange wrench - two instruction booklets - sturdy metal case for convenient storage. Shpr. Wt. 3 lbs.



Weller 8250-AK Net **10.99**

PRECISION DRAFTING SET



11 Pieces - Fitted Felt-Lined Case. Made in Germany, of heavy brass, nickel plated and polished. Instruments include 1 1/2" Compass with needle and pen points and lengthening bar, 3/16" Divider, three 3/16" sidewheel bow dividers with needle point, pen point and pencil point, 2" Ruling pen, extra handle for pen or pencil, capsule with extra leads. Your money back - if this set is not worth twice our price!

2.75

F-13 **NET 2.75**

TIMER-SWITCH SALE 3.95

Automatically turns on radio, television sets, toasters, coffee-makers, etc. - at any pre-set time within 12 hour period; also tells time. Requires 3 1/2" diameter round hole. Depth behind dial face 2 1/2". Shpr. Wt. 1 1/2 lbs. MS-62, for 110V/60 Cy AC



NEW POCKET AC-DC VOM MULTITESTER

1,000 ohms per Volt



AC-DC MULTITESTER. An ideal portable unit that meets the need for a compact, yet rugged test instrument. Uses full 3" rectangular meter with large easy to read scale. Uses 1% precision resistors, jeweled D'Arsonval microamp meter movement. Ranges: AC-DC and output volts 0-5, 0-25, 0-250, 0-1000V. DC current 0-1, 0-10, 0-100, 0-1000 mA; Resistance 0-10k and 0-100k ohms. Size 4 1/2" x 3 1/4" x 1 1/2". Supplied complete with test leads and batteries. Shpr. Wt. 2 1/2 lbs.

MODEL RW-27C Complete - Singly, ea. **9.95** In lots of 3, ea. **9.45**

3 LENS TURRET MICROSCOPE

100X-200X-300X 6.75

Precision built for accuracy and long lasting service. Triple position turret holds 3 achromatic color-corrected objectives for magnification of 100X, 200X and 300X power. Dual knob focusing. High-grade micro-optics used throughout. Complete with fitted wood carrying case and sides. Shpr. Wt. 4 1/2 lbs.



F-10 **NET 6.75**

BAROMETER



F-11

NET

3.95

Produced in Germany by expert craftsmen - unquestionable quality - unbelievable price! Calibrated in 1/100", 1/10" and inches from 26" to 32". Ivory porcelainized metal scale with black and red lettering reading: Stormy - Rain - Change - Fair - Very Dry. Richly polished mahogany stained hardwood case, 5 1/2" in diameter by 1 1/2" deep. Tells weather 12 to 24 hours in advance.

TWIN LENS IMPORTED CAMERAS

2 1/4" x 2 1/4" Negatives With F3.5 Coated Lens A 69.50 VALUE!

29.95



- * Built-in Flash Synchronization
- * Fingertip Focusing
- * Sportfinder
- * 9 Speed Shutter, 1 to 1/200 Sec.
- * Double Exposure Prevention
- * Matched Coated Lenses are Coupled in Helical Mount
- * Accepts 120 Roll Film

Stock No. F-32 **29.95**

30 POWER TELESCOPE



All metal - Chrome trimmed! Precision machined body. Hand ground, hard coated, achromatic lenses. Sharp, clear, brilliant images. In the same manner as fine binoculars. Brings objects 30 times closer! Smooth, easy sliding focus. Collapses to 7" - extends to 13 1/2". As always you must be satisfied - or return for immediate refund. Shpr. Wt. 1 lb.

F-59 **NET 7.50**

BINOCULARS NEVER BEFORE AT THIS PRICE

Imported Direct Prism-Coated Lenses with order, Add 10% Fed. Tax



- All-Metal Construction
- Individual Focus
- Complete with Leather Case & Straps

F-105, 8 x 30 with case... **NET 19.95**
F-15, 7 x 35 with case... **NET 22.50**
F-103, 7 x 50 with case... **NET 24.95**
F-104, 12 x 50 with case... **NET 32.50**

Lafayette Radio Dept. LB Write for FREE Catalog
BRONX, N.Y. 542 E. Fordham Rd.
NEWARK, N.J. 24 Central Ave.
PLAINFIELD, N.J. 139 West 2nd St.
BOSTON, MASS. 110 Federal St.
100 SIXTH AVE. NEW YORK, N.Y.
Include postage with order.

BUILD YOUR OWN LAWN AND GARDEN TRACTOR

USE ONLY WRENCH AND SCREWDRIVER
Complete kit with all parts fitted and finished. Requires less than three hours assembly time.
ACCESSORY KITS for Lawn Mower, Roller, Dump Cart, Hay Mower, Rotary Tiller, Snow Plow, Circular Saw, Emergency Light Plant.

UNITED STATES FORGE & FOUNDRY CO.
CONSTRUCTION EQUIPMENT DIV. PULASKI, NEW YORK

GEARS

In Stock - Immediate Delivery
Gears, speed reducers, sprockets, thrust bearings, flexible couplings, pulleys, etc. A complete line is carried in our Chicago stock. Can also quote on special gears of any kind. Send in your blueprints and inquiries.

Send for Complete Catalog No. 10
CHICAGO GEAR WORKS
440-50 N. Oakley Blvd., CHICAGO 12, ILL.

REMOVE FINISHES EASILY

Wonder-Paste is different. Takes the hard work out of removing varnish, paint, enamel, etc. Finish comes off easily—not coat by coat, but in one scraping. Use it on furniture, trim, floors, etc. At paint and hardware stores.

• Write for leaflet—and advice on your removing problem.

WONDER-PASTE

Wilson-Imperial Co., 119 Chestnut St., Newark 5, N.J.

Do-It-Yourself Upholstering

new and old Now Possible

with NO-SAG SPRING KITS

EASY TO INSTALL
• COMPLETE INSTRUCTIONS FURNISHED

USE POPULAR MECHANICS DESIGNS
IDEAL FOR BUILT-IN FURNITURE

12 Ft. NO-SAG SPRINGS and Fastenings, Hardware in Separate Kits:

For Seats 9 ga. **\$1.95**
For Backs 11 ga. **\$1.85**

Available at Upholstery Supply Houses or send check or money order direct to

DISTRIBUTORSHIPS AVAILABLE

no-sag
NO-SAG SPRING COMPANY
21590 HOOVER RD. • DETROIT, MICH.



PREPO the torch that does it all!

• Here's the hottest, handiest, lightest hand torch ever... with six interchangeable burners and tips from which to choose. Instant flame! Instant heat! Uses low-cost Prepo Fuel in the convenient throw-away tank. Each tank lasts for hours of continuous full-flame use.

\$6.45

Price includes torch as shown. Other burners and tips at slight additional cost. Prepo Fuel tanks 59c at your dealer.

PREPO CORPORATION
EDGERTON, WISCONSIN

"I'm all set"

says the Hollingshead Service Center



Look for this handy display stand. It's all set to help you at service stations equipped to solve car-care problems like a clogged radiator.



\$4.25

FORMULA III

Hollingshead
CAMDEN 2, NEW JERSEY

engine of the L-5 ambulance plane because of the penetrating cold. He battled gusty winds and uncertain weather only to find the Seldovia air strip drifted with snow. He made a ticklish landing and his take-off with the injured passenger was one that will provide food for "hangar flying" for many a year to come.

Many of CAP's veteran pilots say you can usually expect a mission when the weather is the worst because in most cases old Mother Nature herself sets up the conditions that result in a call for "Help!"

For instance, a hurricane stranded Thomas Robertson of Mission, Tex., his 16-year-old son, and a friend, H. S. Watkins of Donna, in four feet of salt water on a strip of Gulf Coast beach. They'd been out surf casting.

Alerted by Mrs. Robertson when her husband failed to return on time, CAP planes were grounded for hours by hurricane winds. As soon as possible three planes piloted by members Harvey Ferguson, Slim Nagy and Maj. John Cooper, commanding officer of the McAllen Squadron, took off in the early morning hours. A few hours later Ferguson sighted the fishermen weakly waving a flag improvised from their shirts. They had been without food or water for more than 48 hours and had spent much of the time standing in waist-deep water.

Ferguson elected to try to set his L-5 liaison plane down on a soggy strip of beach much too short for anything but extreme-emergency landing. Scores of training hours paid off and he took one of the victims out on the first flight. A change in tide gave him more room for his second sortie and he evacuated the remaining storm victims.

Actually, weather disasters account for much of CAP's work such as a ticklish job done for a family named Redington. Timmy, his father, Joe, and his young mother were cold. There was little food left in their packs and the weather-beaten cabin in which they sought shelter from the icy Alaskan wind offered little protection from the biting cold. It seemed weeks since they had mushed out of sight of their own snug little cabin at Flat Horn Lake on the long, overland trek to Anchorage to spend Christmas with Timmy's grandparents. When the combination of unpredictable Arctic weather and a strange sickness among the sled dogs marooned the trio midway in their journey the future appeared black indeed.

At the first slackening of the wind, Joe braved the stinging cold to stamp out in the clean, white blanket of snow 20-foot letters spelling out "FOOD." To the little

(Continued to page 268)

ALL ABOUT TOBACCO...INCLUDING SEVERAL REASONS WHY
Edgeworth Never Bites Your Tongue



Some brands give you shorts and bits which burn like tinder—fast and hot.



Others give you fine-cut shreds—good for cigarettes, but not so good for pipes.



Only Edgeworth gives you slow-burning "chunks" made for pipes and pipes alone.



Edgeworth's Way with White Burley Has Never Been Equalled

Tobacco experts know white burleys are the world's coolest smoking tobaccos. Edgeworth is a blend of aged burleys only. Other tobaccos use white burley too—but nobody yet has found how to process tobacco to give it the even-burning, cool-smoking character of Edgeworth "Ready-Rubbed".

What "Ready-Rubbed" Means to Your Smoking Pleasure

Old-Timers knew the secret of cool, even burning. They "hand-rubbed" their tobacco until it crumbled into chunks of just the right size. Now before Edgeworth is packed, an exclusive process "ready-rubs" it to give you a cool smoke with never a touch of tongue bite.

YOU'RE SMARTER SMOKING

This Amazing Pouch Means Cooler Smoking!



Edgeworth leaves our plant with just the right moisture content for a cool, no-bite smoke. Every pouch is that way when you open it, for only Edgeworth has the Seal-Pak pouch. Air-and-water tight, it promises you fresher tobacco than any other pocket pack.

Forgotten in Tackle Box—Edgeworth Still Fresh

A fisherman left an unopened Edgeworth pouch in his tackle box for a year. When found, the tobacco was still moist and cool smoking.



FOR A COOL MIXTURE TRY HOLIDAY

A blend of five tobaccos selected for mildness and aroma—in the Seal-Pak pouch.



SPECIAL OFFER \$1.50

Get this new polished aluminum stem "Park Lane" pipe with interchangeable imported briar bowl and exclusive "dri-dome" moisture trap—along with 2 full-sized pouches of EDGEWORTH tobacco. If your dealer cannot supply you, use this handy order blank.

Name _____

Address _____

City _____ State _____

Mail with \$1.50 to Park Lane, Larus & Brother Company, Inc., Richmond, Virginia.

PM 2

Edgeworth

AMERICA'S FINEST PIPE TOBACCO FOR OVER HALF A CENTURY

Looking for Something?

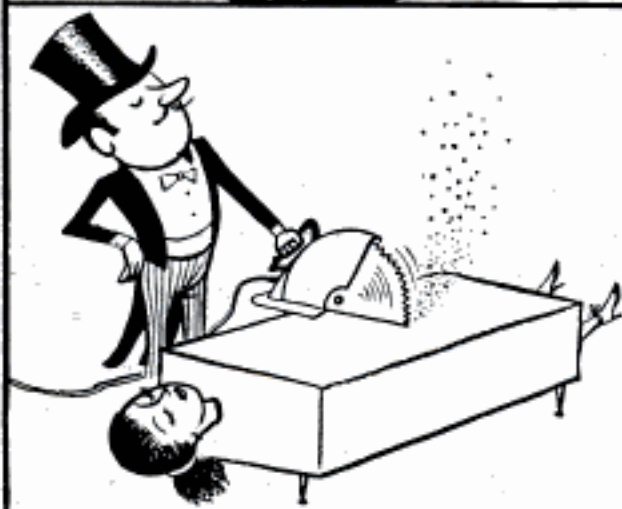

**FOR ALL HOME
WORKSHOP EQUIPMENT
LOOK IN THE
'YELLOW PAGES'
OF YOUR TELEPHONE DIRECTORY**

family this represented their sole hope of survival.

In Anchorage, the worried grandparents sent out an anxious call for help. Air Rescue Service in Alaska turned the mission over to the Alaskan Wing of the Civil Air Patrol. Meanwhile drifting snow swept across the single-word message. Enough of it was visible, however, to attract the alert eyes of CAP members Warren Day and George Richie who swooped low over the area in their ski-equipped L-16 liaison plane and sized up the situation below. A quick radio message brought an ARS helicopter to the spot and in minutes the threat of triple tragedy had been erased by hot soup, warm blankets and friendly words.

Missions of this kind are a daily occurrence in the huge area of responsibility assigned to the Civil Air Patrol as part of its role as the civilian auxiliary of the United States Air Force.

Twelve-year-old David Smith, and another Reno, Nev., boy, Hart Tisdale, were rescued after they had been missing for more than 20 hours in the high Sierras west of Reno in temperatures which dropped below freezing during the long night.

The boys left home on their saddle horses without telling their families of their intention to cross Mount Rose to Lake Tahoe. When they failed to return by nightfall, their parents notified Washoe County Sheriff C. L. Young.

For many months Young had worked closely with the Nevada Wing, Civil Air Patrol, especially the Washoe Jeep Squadron—a ground-search and rescue unit built around the use of a fleet of radio-equipped Jeeps. Young promptly called the nearest unit of the Jeep Squadron.

The entire squadron was alerted immediately and within a half hour small groups of bright-yellow Jeeps were scouring the trails and roads into the Sierras which stretch up to 8500 feet west of Reno. Platoons of Jeeps systematically worked trail after trail in the freezing cold, maintaining contact with one another by radio.

Just before daylight one Jeep commander led his vehicles along the rough trail bordering Hunter Lake where they came upon the two boys huddled over a dying fire. Aside from exposure and hunger, the boys suffered no ill effects.

The rescue was the third problem faced by the Washoe Jeep Squadron within 14 days. The other missions included search for a missing plane and for two lost hunters.

A nation-wide network of fixed, mobile and airborne communications stations operating on special radio frequencies assigned to the Civil Air Patrol by the Air

(Continued to page 270)

THIS ALADDIN 5-ROOM HOUSE

\$1985

FREIGHT PAID

Slightly Higher West of Missouri River



BUILD IT YOURSELF and SAVE!

Aladdin houses are designed so that they can be built by ANYONE. All the lumber is cut to EXACT size at the mill. Each piece is marked. You get detailed drawings showing how the parts fit together. And the lumber you get is top grade—

HOW YOU SAVE UP TO 30%

You don't have to stop to measure and cut Aladdin lumber. That has been done by precision machines at the mill. Even if you hire a carpenter to help you his time is spent in BUILDING—not measuring. Is it any wonder you save hundreds of dollars! Aladdin was the first to originate this easy, "Do-it-Yourself" Readi-Cut System of building 49 years ago. Today, more than ever before, Aladdin Readi-Cut Houses are being built by Aladdin customers who save up to \$20 a day for every day they work on the job. You, too, can build your own Aladdin home!

103 PLANS TO CHOOSE FROM

NO DEALERS' OR AGENTS' PROFITS IN ALADDIN PRICES—BUY DIRECT!



WHAT YOU GET WHEN YOU BUY AN ALADDIN HOUSE

- ALL THE LUMBER accurately cut to fit, marked and numbered ready to erect practically without use of a saw.
- SIDING
- MILLWORK
- FLOORING
- WINDOWS
- DOORS
- TRIM
- COMPLETE DRAWINGS & INSTRUCTIONS
- MOULDINGS
- HARDWARE
- PAINT
- GLASS
- NAILS
- ROOFING



EXCITING NEW HOME DESIGNS FOR 1955!

SEE THEM IN THE LATEST BOOK OF ALADDIN HOMES →



THE ALADDIN CO.
BAY CITY, MICHIGAN

Est.
49
Years



THOROUGHLY DRY. No matter how much money you spend you can't get finer quality. Thousands of Aladdin houses—many 30 to 40 years old and still in excellent condition—are proof of this.

ON LABOR—18% ON WASTE!



QUALITY: ALL EXPOSED LUMBER IS GUARANTEED TO BE CLEAR AND KNOTLESS

WHAT READI-CUT MEANS

The picture at the right shows how each piece of Aladdin lumber is cut to EXACT size at the mill—mitred and bevelled for perfect fit. Aladdin houses are designed to meet the most exacting building standards in both construction and materials.

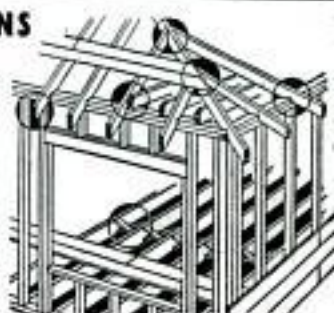

IMMEDIATE DELIVERY

GOOD HOUSES NEVER GROW OLD—ALADDIN HOUSES ARE NOT PREFABRICATED

**NEW! BEAUTIFUL PRE-FINISHED
HARDWOOD PANELING
YOU PUT UP WITHOUT NAILS!**

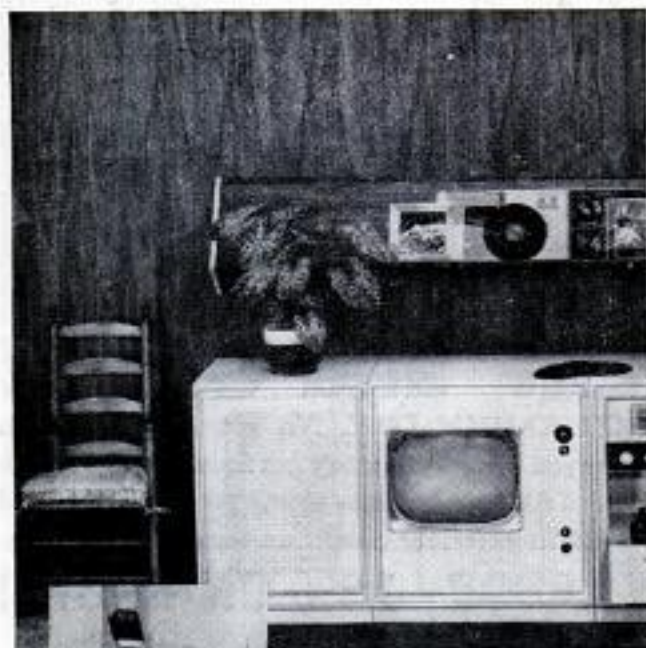

New pre-finished Weldwood paneling comes in figured walnut or light oak, 32" x 96" or 48" x 96", both 1/4" thick.



Brush Weldwood Contact Cement on studs and panel backs at points of contact. Let dry 1/2 hour and repeat. When dry, position panel; tap with hammer and wood block — job's done!

Here's real wood paneling that needs no staining or waxing—and you install it with a brush! New Weldwood panels come already *pre-finished* and waxed by expert wood craftsmen. You can put them up with new Weldwood Contact Cement—no nails, no hard-to-cover-up nail holes.

Panel a wall in your living room, dinette or den—Weldwood gives a lift and sparkle to the whole room. An 8' x 12' wall in pre-finished walnut costs about

\$78 — other unfinished decorative paneling from \$23 for 8' x 12' area. See your lumber dealer for pre-finished and regular Weldwood paneling and superior Douglas Fir Weldwood, or visit any of the 73 United States Plywood or U. S. - Mengel Plywoods showrooms in principal cities.

Ask your lumber dealer for



Weldwood®

Pre-finished Hardwood Paneling

UNITED STATES PLYWOOD CORPORATION

World's Largest Plywood Organization

55 West 44th Street, New York 36, New York

U. S. - Mengel Plywoods, Inc., Louisville, Kentucky

Force is CAP's greatest asset in its role of providing search and rescue and disaster relief to the general public.

When Brighton, N. Y., was rocked by a series of earth-shaking gas-main explosions and all means of communicating with the outside world were cut off, Civil Air Patrol communicators bridged the gap in less than an hour. Spotting mobile-radio rigs at critical spots throughout the city, they relayed specific requests for various types of assistance to a fixed station outside the danger area which was in contact with other CAP stations in near-by communities. The emergency net enabled rescuers to dispatch to each separate location the exact type of equipment and assistance needed.

CAP communicators provide emergency communications for fire fighters battling raging timber fires in scores of states. On-the-spot reports from the fire lines via CAP radio enable area supervisors to make better distribution of their forces while air-to-ground communications link the fire fighters to observation planes spotting new outbreaks and reporting progress of old fires.

There's no limit to the scope of CAP rescues and duties. Disaster—all kinds—is their business.

From the youngest of the 45,000 cadet members of the CAP (14½ to 18 years) to 91-year-old "Dad" Montee of Los Angeles, the oldest member of the Civil Air Patrol, these modern flying minutemen truly live up to their motto, *Semper Vigilans* — Always Vigilant.

When you need them you'll find their single-engine putt-putt planes Johnny-on-the-spot. ★ ★ ★

Human Body Replaced Every Year

Your body may seem to you to be much the same as it was a year ago, plus or minus a few pounds or inches, but it is 98 percent new, according to Dr. Paul C. Aebersold of the Isotopes Division of the Atomic Energy Commission. Use of radioactive isotopes in physiological study has shown that the various elements making up the body replace themselves at varying rates. "In a week or two, half the sodium atoms will be replaced with other atoms," Doctor Aebersold said. "The case is similar for hydrogen and phosphorus. Half the carbon atoms will be replaced in a month or two. And so the story goes for nearly all the elements. In a year, approximately 98 percent of the atoms in us will be replaced by other atoms that we take into our system in our air, food and drink."

30 Horsepower!



Meet the power leader
of the *Super-Quiet*
SCOTT-ATWATER line!

Here's your partner for glorious outboarding adventure—a motor with that vital *extra* power that means breathtaking speeds and flashing acceleration.

The Scott-Atwater 30 h.p. brings new luxury to outboarding with *Bail-a-matic* power bailing; smooth, quiet *Hush-Spring* Mount, *Aquamute* Exhaust, Intake Silencer; Push-Button Electric Starting (optional); Complete Shift with Safety-Zone Shiftlock; new Free-Flow V-Valves; Automobile-Type Dual Exhausts; Remote Control Connections; *Stowaway* Fuel Tank; Snap-off Hood.

See this new pacemaker among quality outboards at your dealer's now—his name is in your phone book classified section. Or send for free color booklet on the full line: 30, 16, 10, 7½, 5 and 3.6 h.p. Write Scott-Atwater Mfg. Co., Inc., Minneapolis 13, Minn., Dept. PM-25.

NOW
FIVE
BAIL-A-MATIC
MODELS!



SCOTT-ATWATER
30 H.P. \$459.50
WITH ELECTRIC
STARTER \$549.50
FOB Factory

Horsepower certified by OBC.
Price information subject to change.

FIVE *Super-Quiet* **SCOTT-ATWATER** MOTORS... AND THEY ALL BAIL YOUR BOAT!

"Handy" SANDY says:



You can always use a

**GOOD
SHORT-CUT**

... here are some
you'll prize!

Fixing bulges in linoleum calls for a really sharp knife and some good fresh linoleum paste. Slit the bulge, slip in a good supply of paste with a narrow-bladed knife, then put a heavy weight on the slit and leave it overnight.

Whether repairing linoleum or laying it, your knife **MUST** be sharp. I've seen plenty of people hurt because a dull tool slipped. Sharp tools are far safer to handle, because they'll do exactly what you want them to do. A No. 109 Combination Stone by CARBORUNDUM will keep them sharp and is basic to your tool collection... economical to buy—long lasting. Your hardware store or building supply dealer has a wide range of sizes for you to choose from.

You can't plane a plywood edge—so if a cabinet door binds, try a piece of Extra Coarse Flint Paper (wrapped around a 3"-square block of $\frac{3}{4}$ " wood to save your fingers). Works fine. Another good product by CARBORUNDUM. Matter of fact, CARBORUNDUM makes five outstanding Flint Papers: Extra Fine—Fine—Medium—Coarse—Extra Coarse. A few sheets of each on your workshop shelf will equip you for any refinishing job in the house.

Easy-as-pie way to store sanding discs: just "borrow" a pie tin from the kitchen. Cut it in half... tack the rim to a wall or the back of your bench, open end up. Return the unused half to the house, if you dare... on second thought, better make two storage "racks".

Or you can make a trade with your wife—the pie tin for a sheet of Fine Emery Cloth by CARBORUNDUM. Tell her a few stitches in it now and then with her sewing machine is the best way to keep the needle sharp and efficient... make sewing easier.

What home upkeep short-cuts have YOU discovered that other folks would like to know about? Send 'em to me on a postcard—a separate card for each idea—and I'll pay you \$5.00 right away for every one I can use in later columns. Even if I can't use 'em (on account of duplicates, and such) I'll send you a worthwhile little gift for your trouble.

Better send me a postcard anyhow, and ask for a fine new booklet, "HOW TO SAND," which the CARBORUNDUM folks have just printed. There's no charge. Just address your card to me...



"Handy" SANDY
CARBORUNDUM

REGISTERED TRADE MARK

Niagara Falls, New York

90-24

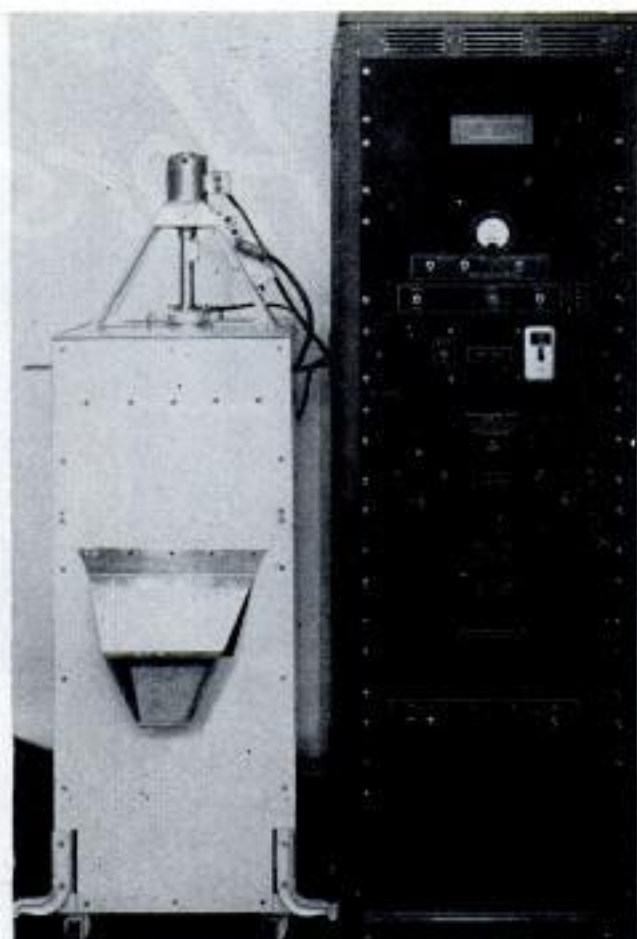

Tosses Out 18,000 Coins an Hour

Ideal for slot-machine plungers, but reserved for U. S. Treasury use, is a newly devised machine that can weigh and sort 18,000 coins an hour. Designed and built by the Bureau of Standards, the machine balances new coins against a perfect coin of predetermined weight and tosses all good ones into one hopper and rejects into another. The sorter consists primarily of a whirling flywheel whose axis has a pendulum action. As coins are fed into the wheel through the hub, they slip into a slot where their weight counterbalances the perfect coin. If vibration is set up through imbalance of the pendulum, the coin causing the imbalance is rejected.

Jet Noise "Deafens" Tubes In Plane's Radio Equipment

When a jet pilot thinks the roar of his engine is deafening him so that he cannot hear his radio he may be partially wrong. The noise is "deafening" the tubes of his radio, not his own ears. Armour Research Foundation engineers maintain that exceptionally loud noise can cause failure or malfunction of small tubes and relays in radio and radar sets, and they point out that the sound level may approach a deafening 150 decibels 10 feet from the tail pipe of a jet engine.

easier with new
PARAGON Power Sprayer

One man with this compact 12-gal. Paragon can *effectively* spray insecticides, disinfectants, weed killers whitewash, water-type sprays, silicone-type waterproofing solutions. Latest type spray gun produces mist for wide coverage or stream 25 feet high. Pump delivers up to 1½ gals. a minute. Trouble free. Low priced. See your dealer or write us for literature on both hand and power sprayers.



CAMPBELL-HAUSFELD Co.
45 State Street
Harrison, Ohio

CAMPBELL-HAUSFELD

SMALL! POWERFUL!
ECONOMY TRACTOR

Unequaled value! Low price! America's finest tractor. Ruggedly built. Easy to operate. 790 lbs. Borg-Warner clutch, trans. and diff 140 to 1 reduction. 40% more drawbar pull than ordinary tractors 8-1/4 H.P. engine. 20 quick change implements. HOOD, FENDERS.

Thousands in Use Write for complete details.
Engineering Products Co.
915 K-2 Niagara Ct.
Waukesha, Wisconsin

TOP QUALITY

Built of the finest materials, Gerstner Chests are acknowledged top quality everywhere. Free catalog.

GERSTNER TOOL CHESTS
455 Columbia St., Dayton 7, Ohio

CUT RADIO CHASSIS HOLES IN 1-1/2 MINUTES OR LESS

Quickly make accurate round, square, key, or "D" openings . . . in metal, bakelite or hard rubber . . . with GREENLEE Radio Chassis Punches. Simply turn with a wrench. Many sizes. Write for details. Greenlee Tool Co., 2102 Columbia Avenue, Rockford, Illinois.

PLANNING TO BUY OR BUILD A BOAT?

LOOK FOR THIS WELDWOOD® TAG

IT'S YOUR GUARANTEE that the plywood used in the boat won't delaminate, is the best made!

UNITED STATES PLYWOOD CORPORATION
World's Largest Plywood Organization
55 West 44th Street, New York 36, N. Y.

Build your own
FIREPLACE
INDOOR - OUTDOOR

FREE Booklet shows how



Booklet gives Complete instructions.

- Foundation
- Steel heat-circulating form
- Cold and warm air ducts
- Mantel or decorative front

Fireplace form set on foundation includes firebox, damper, down draft shelf and smoke dome.



Brick, stone or cement block can be used around the form.



Save time, money and materials with **PRICE** steel fireplace forms.

Build this outdoor fireplace in **ONE DAY!**

• Use inexpensive concrete blocks with the Pyro-Grill steel form and complete the job in a day. Includes grill, grate, draft control. Removable for winter storage. \$19.95 at Buffalo.

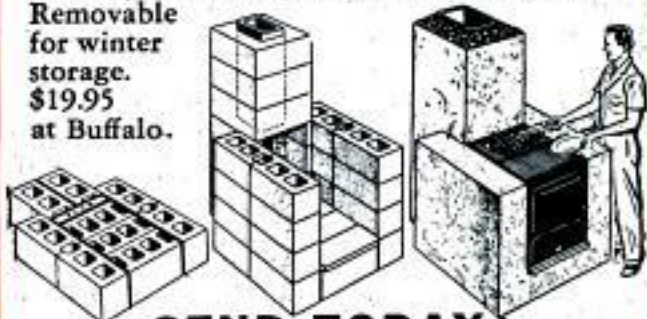

SEND TODAY!

- Please send —
- Directions for building heat-circulating fireplace, free.
 - Book "100 Fireplace Ideas". Pocket size book, free.
 - Larger book, 8½ x 11, beautifully illustrated, 25c.
 - Build outdoor fireplace in 1 day. Also, 10 beautiful designs, free.

Name.....

Street.....

City.....

PRICE FORMS AVAILABLE FROM YOUR DEALER

PRICE FIREPLACE HEATER & TANK CORP.
267 W. Austin Street, Buffalo 7, New York

ADD-A-ROOM NOW!

... it's easy with triple value
Gold Bond Insulation Board

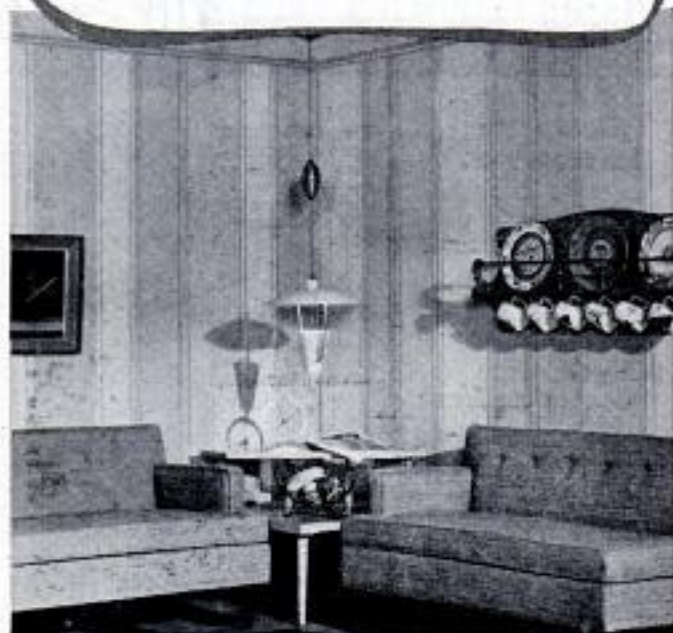

GOLD BOND Insulation Board, Plank and Tile decorate, insulate *and* sound condition all at the same time.

Whether adding a new room or remodeling an old one, give it smart good looks with these pre-finished planks and tiles in ivory or combinations of pastel colors. The tiles make a handsome ceiling and increase the rest and quiet of your room. Ready-cut and ready to install, there's no painting or decorating needed. Gold Bond Planks and Tiles are made from "live" southern pine fibres, keep furnace heat *in*, and summer heat *out*!

Send today for your copy of "Interiors by Gold Bond," the fascinating booklet that has helped thousands to new home beauty.

NATIONAL GYPSUM COMPANY
BUFFALO 2, N. Y.



MAIL COUPON TODAY

NATIONAL GYPSUM COMPANY
Dept. PM-25, Buffalo 2, N. Y.

Enclosed is 10¢. Please send me my copy of
"Interiors by Gold Bond."

Name

Address

City Zone State



Aluminum Screens

You can make your own aluminum-framed window screens with a kit that includes all materials and step-by-step instructions. Aluminum frame sections, glass-fiber screening, corner locks, a handy miter box for cutting frame sections at an angle, and complete installation hardware are packed in the kit. A hammer, saw, screwdriver and sharp knife are the only tools needed to make screens of any dimensions.

Exhaust Pressure

Powers Road Sander

Blowing a fan-shaped coating of sand or grit under the rear wheels, an exhaust-powered sander provides traction on snow or ice-covered roads. The sand or grit is carried in a large hopper in the trunk. When a steering-column button is pushed, a valve near the end of the exhaust pipe is opened diverting some of the exhaust pressure into the sanding system. This pressure blows through the delivery tubing, forcing sand under the rear wheels. A whistling sound is made by the blowing action, informing the driver that he is using sand. The device can be installed on any car in an hour, the manufacturer says.

Scientists Bore Hole in Glacier

Seven scientists from the California Institute of Technology are planning to drill a deep hole in Saskatchewan Glacier in the Canadian Rockies. With a hot-pointed electric drill they will cut a hole 1500 feet deep from the surface to the bottom of the ice. A pipe then will be left in the hole. For years its deformation will be used to measure the flow of the river of ice.

Scared
to
Change
Fuses?



MINI-BREAKER®

The lifetime replacement for old-fashioned fuses

- Fits like a fuse in any standard fuse socket.
- Lifetime protection against electrical fire hazards.
- Protects against overload and short circuits.
- Just press the shockproof Mini-Breaker button to restore service.

NOW \$1.50—in 10, 15, 20, 30
amps. AC only, 125 volts. max.

Listed by Underwriters' Laboratories, Inc.



MINI-BREAKER®

Ask for it at your favorite store or write
Mechanical Products, Inc., Jackson, Michigan

ARMSTRONG LATHE TOOLS

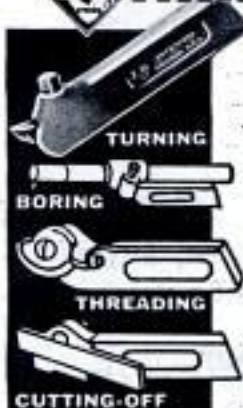

There is a correct ARMSTRONG TOOL HOLDER for every operation on Lathes, Planers, Slotters and Shapers. Shown at left are:

1. *Turning Tool*—for roughing, finishing and fillet work.
2. *Boring Tool*—for boring and internal threading.
3. *Threading Tool*—for thread cutting.
4. *Cutting-off Tool*—for lathe cutting-off work.

ARMSTRONG Lathe Tools are designed to give greater strength, maximum clearance and correct cutting angle. They are the most efficient and economical lathe tools you can buy. Write for Catalog

OVER 250 SIZES AND TYPES **ARMSTRONG BROS. TOOL CO.**
5268 W. ARMSTRONG AVE. • CHICAGO 30, ILL.



Today's Best Boating Buys!

Luxury 'Seafarer', exciting new molded plywoods, sturdy and economical. Newly designed, beautifully finished. See them at Chicago Boat Show. Outstanding aluminum boats.



WAGEMAKER CO., Dept. 60, Grand Rapids, Mich.

Use Gold Bond
TWINSULATION
America's New No. 1 Home
Insulation Value!



TWINSULATION gives you more for your insulation dollar! It provides *double* insulation action... the rock wool center *blocks* heat and the aluminum covering *reflects* heat from both sides. Blan-

kets add extra fire protection... the rock wool center is fireproof and the aluminum covering is flame resistant. The blankets are permanent... the rock wool fibres can't deteriorate.

AND NEW GOLD BOND TWINSULATION Blankets are rugged, easy to install. They give you greater savings on heating—and air conditioning—and add year 'round comfort, too! Send today for the new illustrated Gold Bond "Home Insulation" book below. Shows you how to install the right insulation yourself.

NATIONAL GYPSUM COMPANY
BUFFALO 2, N. Y.



MAIL COUPON TODAY!

NATIONAL GYPSUM COMPANY
Dept. PM-25, Buffalo 2, N. Y.

I enclose 10¢ for "Home Insulation" booklet.

Name.....

Address.....

City..... Zone..... State.....

MORE SANDING AREA

than any sander in
its price class

25 square
inches



only **2 $\frac{1}{16}$ "** high...
fits under tight places

LOWEST SANDER DESIGN

TERRIFIC POWER
with unequalled endurance
only **\$14⁹⁵** model 700

The Newest Power Sander and Polisher on the Market

As efficient as any rotating motor-driven sander, plus these quality features: straight-line action, no bucking, sands *with* the grain and goes all the way into corners; powerful 60 cycle reciprocating motor gives 14,400 strokes per minute; exclusive insulation gives smooth, quiet operation; push-button control; 8 foot cord.

Weller SANDERS
816 Packer Street
Easton, Pa.

AVAILABLE AT HARDWARE STORES

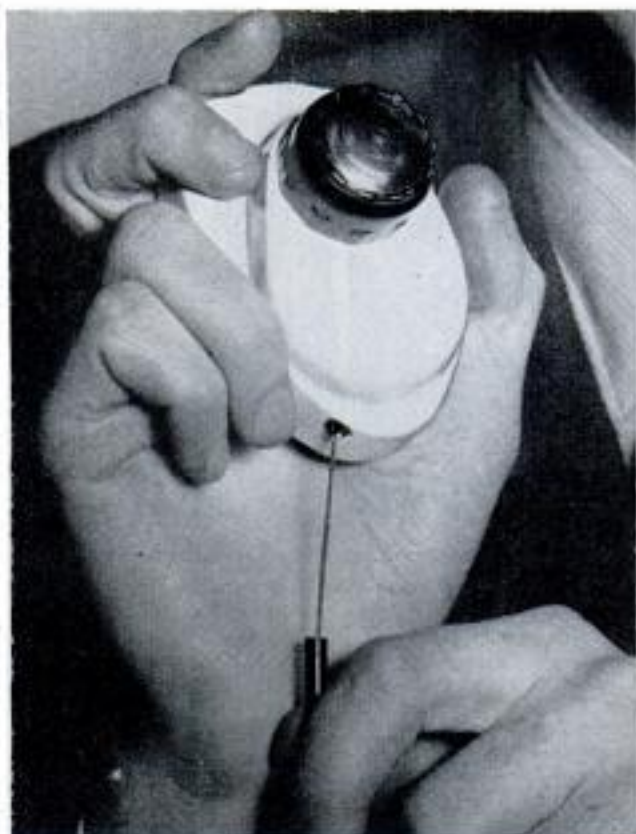

Nonelectric Shaver Is Operated by String

You don't need electricity for a mechanical razor developed in Germany. Instead, you pull a string that spins a tiny flywheel inside the razor. The flywheel spins for about a minute after one pull of the cord, giving the rotary cutter a faster speed than an electric model. The durable, low-cost razor has only three moving parts.

Letter Folder Creases Four Sheets at One Time

Up to 1000 letters per hour can be folded with the aid of a new manually operated office appliance. Four sheets can be inserted in the device at once. With one motion the operator sharply creases the paper to provide neat folds for easy insertion in the envelopes.

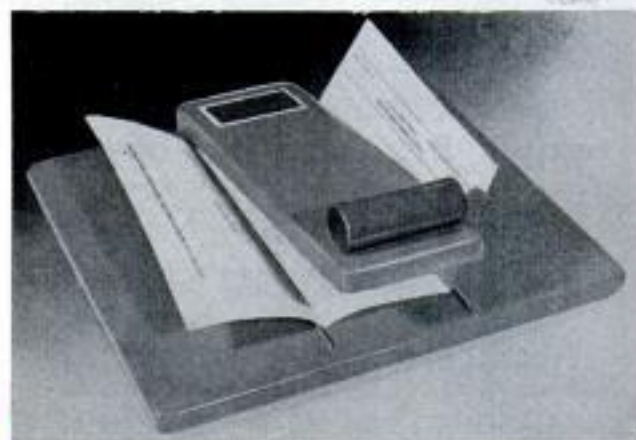

GREAT SURPLUS SALE OF HOME, FARM AND FACTORY EQUIPMENT

GROBAN FOUR-WAY OPEN CENTER HYDRAULIC CONTROL VALVE

ITEM #126—Four-way open center control valve with built-in adjustable relief valve factory set at 1000 P.S.I. Spring loaded neutral position. For use with one double acting cylinder. In neutral position cylinder is locked and pump unloaded. Can be used as single unit or mounted in series. Has 3/4" pipe thread inlet and outlet, 1/2" pipe thread cylinder ports. Finger grip handle. Ship. wt. 10 1/2 lbs.

AN OUTSTANDING BUY!
F.O.B. Chicago **21.50**

PESCO GEAR TYPE HYDRAULIC PUMP

Compact — Powerful — Reliable
ITEM #160—Especially designed for belt drive from fan belt, power take-off, drive pulley, electric motor or small gas engine. Equally suitable for direct coupling.

Pedestal type mounting with two bolt holes for 3/4" hold-down bolts. Standard 1/2" pipe thread inlet and outlet ports. Delivers 4.5 GPM at 1000 PSI at 2800 RPM with 4 HP. Hardened steel gears turn in dense oilite bronze bearings. Rotation—clockwise facing shaft. Guaranteed trouble-free service. Ship. wt. 6 lbs. F.O.B. Chicago **22.50**

DOUBLE ACTION HYDRAULIC CYLINDER

ITEM #310—3 1/2" bore, 11" stroke. Alloy steel cylinder wall. Micro-honed and all steel 1 1/8" diameter piston rod. 19 1/2" overall length closed. Clevis mounting at base and shaft. Will lift 9625 lbs. with 1000 PSI Pump Pressure. Uses 3/8" tubing fittings. (Fittings to pipe thread: two 3/8" MPT @ 35c.) A \$102.00

value. Shipping weight 11 lbs. FOB Chicago... **25.00**

PORTABLE ELECTRIC LIGHT PLANT

ITEM #334
Compact Electric Plant suited for small homes, cabins, campers, hunting and fishing camps, trailers and small electrical home appliances. Operating costs: About 5c per hour. Sturdily constructed for dependable service. Net weight only 88 lbs. Can be carried from place to place, or transported in trunk of car.

250-350 Watt—110 Volt—D.C. Model PE-77D. Powered by easy starting 1 Cylinder, 4 Cycle Briggs-Stratton Engine complete with muffler, starting rope and oil bath air cleaner, direct coupled to a 250-350 Watt Generator with twin plug-in outlets. Engine speed 2650 R.P.M. Shipping Wt. 110 lbs. Commercial List Price \$225.00

WAR SURPLUS PRICE
Special Value F.O.B. Chicago **75.00**
At Only... **OTHER SIZES IN STOCK**
FROM 350 W. TO 25,000 W.

ALL ITEMS BRAND NEW!

A. C. ELECTRIC GENERATOR

7 1/2 K.W. (7500 WATTS) single phase, 110/220 volt output. 3 wire system. 2 bearing construction. 5 groove 6" V belt pulley included. Self-excited. Foot mounted. Drive generator from tractor or stand by engine. Ample power for 6 room house. Dimensions: 34" x 11 1/2". Shipping Wt. 420 lbs. F.O.B. Chicago. **295.00**



GROBAN HYDRAULIC SPEED REDUCER

with FINGERTIP CONTROL
USE FOR: Reamer Drives • Midget Cars • Feed Mills • Canning Machines • Conveyors • Lathes • Milling Machines • Motor Boats • Cream Separators • Garden Tractors • Pumps.
Variable output speeds from 0 to input speed available by moving control handle. Locking handle maintains setting. Use input power of 1/4 to 1 1/2 H.P. Shafts 5/8" diam. Input rotation counter-clockwise facing shaft. Input speed 750 R.P.M. 7 1/2" x 7 1/2" x 11 1/2". Gov't acquisition cost \$428.00. Ship. wt. 31 lbs. Complete with 2 qts. of oil and full instructions. F.O.B. Chicago. **54.50**

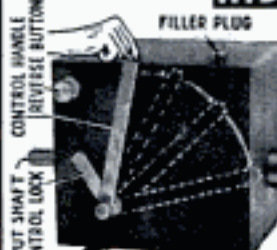

Brand New! 5-TON BLACKHAWK HYDRAULIC LIFT KIT

Now Only 44.45 complete
The Complete Kit
For — • Dumping farm wagons • Adjusting depth of plows • Hydraulic press • Hydraulic jack • Snow plows.
KIT CONSISTS OF:
1—Brand new Blackhawk Model P-351—Hydraulic hand pump with built-in oil tank and release valve. Rated from 1200 P.S.I.—to 5400 P.S.I. 20" handle. Dim. 8"x6"x6" Item #82..... **22.50**
1—6 Ft. length double wire held rubber covered hydraulic hose—tested to 20,000 lbs. Item #2784..... **3.95**
1—Hydraulic cylinder. 2 1/2" bore, 7 1/2" stroke, 1 1/2" stainless steel shaft, will lift 10,000 lbs. using pump pressure. Standard clevis mounting. May also be used for double action service. Item #355A..... **17.00**
2-Qts. non-foaming hydraulic fluid..... **1.00**
All necessary hydraulic fittings. Total ship. wt.—40 lbs. **\$44.45**
COMPLETE KIT PRICE.....
ALL OF ABOVE INCLUDED F.O.B. Chicago



ITEM #91 300 AMP. D. C. GENERATORS

IDEAL FOR WELDING GENERATOR
Type B-1, rated 300 Amps.—30 Volts, Mfd. by Jack & Heintz. Government Acquisition Cost \$286.80. Ship. wt. 55 lbs. Dimensions: 16"x10"x7". Complete with instructions to connect as Welder. F.O.B. Chicago. **35.00**

HEAVY DUTY 12 VOLT D. C. GENERATORS

ITEM #99—For trucks, autos, marine equipment, construction machinery, 12 Volts—50 amps.—6 bolt mounting flange spline shaft—life time grease—sealed ball bearings. Mfd. by Leeco-Neville. Acq. cost \$165.00. **NOW ONLY... F.O.B. Chicago 16.50**



FREE WINTER EDITION 1955 CATALOG 52 PAGES chuck-full of unsurpassed War Surplus Equipment Bargains for farm, home, factory, workshop. Write letter today.

ORDER DIRECT FROM AD SATISFACTION GUARANTEED

Send Payment Or Purchase Order Today

To place phone orders call WEBster 9-3793

GROBAN SUPPLY CO. Dept. PM-2
1139 S. WABASH AVE., CHICAGO 5, ILL.

SELF-PRIMING ALL BRONZE & MONEL GEAR PUMP

ITEM #383—USE FOR:
• Sprinkling • Irrigation • Insecticide Spraying • Sump Pump • Fuel Transfer • Home Water Systems • Dewatering • Salt Water, Chemical, Acid Pumping



FEATURES • Needle Bearing Construction • 1 1/2" Pipe Thread Inlet, 1 1/4" Hose Outlet • Standard 3/4" Keyed Shaft • All Bronze Body & gears, Monel Shaft • Equipped with Drain Cocks, Grease Cup, Steel Internal Drive Gears for long, trouble free service.

CAPACITY: From 10 to 80 Gal. Per Min. At Speeds from 550 to 2400 Rev. Per Min. Using from 1/2 to 6 Horse Power. For Pressures to 60 lbs. Ship. wt. 58 lbs. U. S. Navy Cost \$168.00. F.O.B. Chicago **39.50** Two for Chicago **75.00**

D. C. ARC WELDER NEW MODEL 353

ITEM #65 For Stationary or Portable Use. **HEAVY DUTY RANGE TO 250 AMPS.**
Ideal for:
• Farm
• Garage
• Factory
• Workshop
Welds Anything From Auto Fenders To Tractor Frames



- Dial Type Rheostat Control
- Use 1/16" to 1/4" Rod
- Generator-type Welder
- Reactor Coil for Smooth Even Arc
- Use 7 1/2 H.P. Electric Motor or 10 H.P. Gasoline Engine
- Run at 2500 R.P.M.
- Available with Either Flat Belt or Double V Pulley
- Complete Operating Instructions

Shipping wt. 107 lbs. \$350.00 Value. Standard Model F.O.B. Chicago. **99.50**
Deluxe Model—with "Magic Terminal" for low amperage range welding. (Between 30-100 amps.) F.O.B. Chicago. **119.50**

BELT DRIVEN A. C. GENERATOR

ITEM #700—700 watts, 115 Volts, 60 cycles A.C. 3600 R.P.M. Compact, self-regulating generator with V Belt pulley and double outlet receptacle. Rotation counter-clockwise. May be driven by tractor or auxiliary gasoline engine. Requires 2 HP minimum. Ideal for powering electric tools, oil burner, refrigerator, lights, or other appliances requiring up to 700 watts of power. Dimensions: 10" long x 8" high x 6" wide. Shipping Wt. 27 lbs. F.O.B. Chicago. **59.50**



Floor Surfacing Contractors NEEDED!



- ★ BIG PAY
- ★ FULL or PART TIME
- ★ AGE No Barrier
- ★ Minimum Investment

Highly Respected Profession Offers You Unusual Opportunity to BE YOUR OWN BOSS

Thousands of men of all ages have found financial security and happiness in a phase of the building and remodeling industry that has become as necessary as the hammer and nails. The pay scale is high for those who are willing to work; many earn \$50 a day and more. No great physical stamina required—men from 18 to 80, even with physical handicaps, enjoy this pleasant year 'round indoor work where earnings are limited only by the amount of time you devote to it. The American Floor Surfacing Machine Co., a 50-year-old pioneer firm and leader in the industry, shows you how to quickly make good in this stable business. No schooling, no special talent or skills required. Only small investment in sander gets you started. Send coupon for "money-making booklet" entitled "Opportunities in Floor Surfacing"—enclose 25c in coin or stamps to cover handling.



AMERICAN

FLOOR MACHINES

SEND ↓

The American Floor Surfacing Machine Co.
535 So. St. Clair St.
Toledo 3, Ohio

Here is 25c in stamps or coin for booklet "Opportunities in Floor Surfacing", telling me how I can start my own floor sanding business.

Name.....

Street.....

City..... State.....



Visual Radiation Detector

Glasses that provide a visual reaction to deadly gamma rays have been developed in West Germany. The left lens of these glasses, or goggles, resembles a telescopic-camera mount, and contains a special screen that reacts to gamma rays, revealing contaminated areas. Use of the glasses for Civil Defense has been suggested.

"Logbook" for the Car

Motorists, traveling salesmen and deliverymen can record expenses and other facts on a "logbook" that attaches to the dashboard of a car or truck. A roll of ordinary adding-machine tape is inserted in one end, threaded through the log and fastened to a roller at the other end. As the user fills the exposed section of the paper with notations he turns a dial, storing the data on the roller and exposing more paper for further notes.

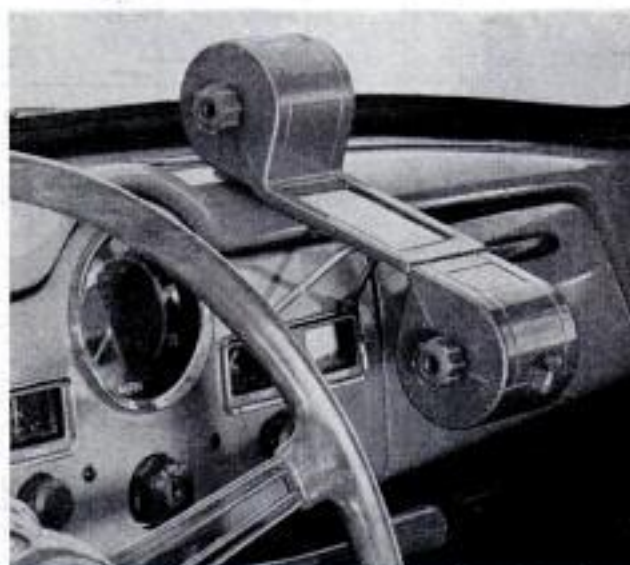

Buy EVANS for EXTRAS

in 6, 8, 10 and New 12 Foot
"WHITE-TAPES"



FROM
98¢

FREE WITH EVERY TAPE

— this sparkling crystal
Tenite utility case.

This is the BUY for your money — the original, reasonably priced "White-Tape" by EVANS. Your measuring tape dollar goes further! Chrome plated, sturdy case. Snow-white Bonderized steel blades with jet markings, easy to read, last longer. Velvet push-pull action. Instant change replacement blades available. 12-foot size, made only by EVANS, has convenient new blade markings in feet and inches as well as regulation inches.



EVANS
L-O-N-G "WHITE-TAPES"
25-50-75-100 Ft. Lengths. Sensibly priced from \$3.49. In transparent utility box. Leather grained vinyl cover. Hook ring attachment no extra charge.
Sold Only Through Retailers

Evans & CO. 410 Trumbull St., Elizabeth, N. J.

EVANS, THE LARGEST PRODUCERS OF STEEL TAPES WORLD-OVER



URANIUM AND METALS

Easily located with the new M-Scope Detector. Superior Performance. Prices \$35.00 up. Monthly payment plan. Booklets "How to be a Successful Uranium Prospector" — "For Fun and Profit" free upon request.

FISHER RESEARCH LABORATORY, INC.
PALO ALTO CALIF.



Print Your Own

Cards, Stationery, Advertising, labels, circulars, photo and movie titles, church work, tags, etc. Save money. Sold direct from factory only. Raised printing like engraving, too. **Print for Others, Good Profit.** Have a home print shop. Easy rules supplied. Pays for itself in a short time. Write for free catalog of outfits and all details.

KELSEY PRESSES, N-37 MERIDEN, CONN.

FILE SAWS THE RIGHT WAY



SO EASY with this new filing jig and jointer anyone can now sharpen any handsaw like new! When file hits hardened steel rollers teeth are finished and EXACTLY THE SAME HEIGHT. All teeth cut and saw runs true and smooth. Jig and instructions \$2.95 postpaid. FREE FOLDER.

SHARPEN YOUR CIRCULAR SAWS

The RIGHT WAY on your own saw table. Sharpens rip, cutoff, hollow ground and combination blades—6" to 10". Saws stay round with correct bevel. Precision made, easy to use. GUARANTEED. Only \$8.95. Includes \$3.00 Grinding Wheel.

"TRU-CIRCLE" saw set automatically sets teeth at 10° or more. \$2.95

AT DEALERS OR POSTPAID
SEND FOR FREE CATALOG

A. D. McBURNEY, Dept. A-25
5908 Hollywood Blvd., Hollywood 28, Calif.

MILL IT...ON YOUR LATHE!

PALMGREN

MILLING ATTACHMENT

3 SIZES

No. 250 Illustrated

2 1/2" JAW Only **24.75**

CONVERT LATHE
IN 10 SECONDS



Now you can Mill, Slot, Grind, Groove, Square Shafts, Saw at Angles, Recess and many other important jobs. SAVE TIME and MONEY! Why send work out or use costly methods when a PALMGREN MILLING ATTACHMENT will solve your problem.

Precision built, it has accurate graduations for rotary angle adjustments, also graduated vertical feed screw. Fits South Bend, Atlas, Craftsman, Logan, Sheldon and all other lathes. Thousands now in use in small and large machine shops, repair shops, railroads, schools, home work shops, etc. ORDER SIZE NEEDED TODAY!—It will quickly pay for itself.

IMMEDIATE DELIVERY

No.	Width Jaws	Depth Jaws	Jaws Open	Weight Pounds	Fits Tool Post	Price F.O.B. Factory
150	1 1/2"	1"	1 3/4"	6 1/2	1" Dia.	\$18.75
250	2 1/2"	1-7/16"	2 1/4"	11	1 1/4" Dia.	24.75
400	4"	1 1/2"	2 3/4"	25	2" Dia.	39.75

Order From Your Dealer or Jobber: Write for Circular No. 202
Mfrs. of PALMGREN PRODUCTS Since 1915

CHICAGO TOOL and ENGINEERING CO.

8365 South Chicago Ave.
Chicago 17, Ill.

JUST A FEW OPERATIONS YOU CAN DO ON YOUR LATHE!

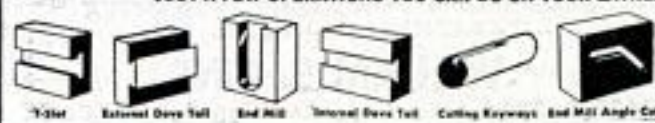

UNMATCHED
FOR **low cost**
TRANSPORTATION

Cushman
PACEMAKER

CUSHMAN
is tops . . .
75 miles per
gallon . . .
¾¢ per mile
total operat-
ing cost . . .
goes every-
where.



Ask your
nearest dealer
for FREE demon-
stration or write for
illustrated literature.

CUSHMAN MOTOR WORKS, inc.
958 No. 21 Lincoln, Nebraska

HAND HYDRAULIC PUMP

Single or double
designs to 20,000 PSI



With or without reservoir. Standard reservoirs 70, 160, 910 cu. in. capacity. Interchangeable pistons 3/8-1/2-3/4 inch. 1 inch piston (special) 1/4" N.P.T. Pipe connection. 18" handle. Unit can be bolted or welded in position.

Can be used on hydraulic test stand, to actuate hydraulic cylinders, jigs, fixtures, as booster in hydraulic system. All pumps have release screw to relieve system. All steel construction.

SEND TODAY FOR FREE DESCRIPTIVE
LITERATURE AND PRICE LIST.

WILLIAM S. PINE

1635 E. 22nd St. Los Angeles 11, Calif.

Parade of 1955 Cars

(Continued from page 138)

and florist delivery trucks are now common to the family car. Two-tone combinations are almost the rule. Buyers who want something really flashy are forced to go to three-tone jobs (and many are available). Question: How will the taxicab companies paint their cabs so they will stand out among such color schemes?

These new colors, particularly the off-pinks, beiges and pastels, look most unappetizing under a coat of mud and slush. Washed and polished on the showroom floor, they are indeed appealing, especially to the women. But in the mud—oh, well, the car-washing business should boom.

There is another problem that arises from these exotic colors. Nobody minded when he saw another blue car that exactly matched his blue car, or another black car that matched his black car. But when a buyer picks out an ultraflashy two-tone job to be distinctive, it is bound to come as a jolt to see scores of them exactly like it around town. And that is certain to happen in a mass-production business.

Someone has asked: What's left for 1956? Well, here's one color trick that may even be out before the 1956 cars—colored tires to match the car paint. From the tread down to the white sidewalls the rubber will be colored in a selection of hues.

The Plymouth is more than 10 inches longer than last year. The Chevrolet is a fraction of an inch shorter, the Ford a fraction longer. But they all look much longer. The reason is a stylist's trick. These experts discovered that what makes a car look long is not the distance from bumper to bumper, but the length of the high-light line—that shiny horizontal line of sheet metal running from the headlights to the taillights. To make a car appear long, stylists extend the front fenders forward and the rear fenders backward until both are almost even with the bumper limits. This is the reason for the many hooded headlights and reverse-angle taillights in 1955.

Oldsmobile, with its so-called "vogue" styling of curved chrome moldings that outline two-tone color schemes, made a larger percentage gain in sales last year than any other car (see page 145). This year, perhaps as a result, almost all cars seem to be imitating that styling trick.

By the time you read this you may know that Studebaker made a midseason switch to wrap-around windshields. The new styling should be hitting the dealers' showrooms about now. The changeover was made during an inventory shutdown in the

(Continued to page 282)

POPULAR MECHANICS

FAMOUS LITTLE LIBRARY OF USEFUL INFORMATION

Complete Set of 126 BOOKS only \$17.95

25 BOOKS	\$3.75
12 BOOKS	\$2.00
5 BOOKS	\$1.00

SINGLE BOOK 25c

Here at amazingly low cost is the practical help and information you have always wanted. Articles in previous issues of Popular Mechanics have been classified according to subject and are now available in these handy reprint booklets.

Check titles wanted, clip ad, mail today.

HOME WORKSHOP

Power-Driven Saws—74: How to build.
 Drill Presses, Plane, Grinders—79.
 Sanders—80: Details on 8 machines.
 Wood & Metal-Turning Lathes—81.
 Filing Machine, Hacksaw, Cutoff Wheel, Shaper—82: Full details on these.
 Metal Lathe Tools—101: How to build.
 Workbenches and Tool Cabinets—47.
 Spray Painting—84: Proper methods.
 From Pattern to Casting—91: How castings are made in sand molds.
 How to Use a Circular Saw—135.
 Jigsaw Technique—136: How to use.
 Bandsaw Know-How—137: Techniques.

HOME IMPROVEMENTS

Painting Your House Inside and Out—117.
 Simple Home Improvements—104: Save money.
 Building Extra Rooms in Your Attic—23: Add to the value of your home.
 Basement Playrooms—24: Build an attractive playroom in your basement.
 House Wiring—89: How-to-do-it.
 Curing Leaky Basements—45.
 Fitting Home Game Room—55.
 Built-in Fixtures—78: Several.
 Lower Your Fuel Cost—31: Practical kinks that will save you hundreds of dollars.
 Hanging Wallpaper—38: Hints and tricks.
 Ridding the Home of Insect-Pests—107.
 Constructing Indoor & Outdoor Fireplaces—88: Details on stone fireplaces.

CRAFTWORK • HOBBIES

Games and Puzzles—131: Have fun at home.
 Model Planes You Can Build—129: Several.
 Fun With Your Model Railroad—127.
 How to Make Novelty Jewelry—126.
 Working with Plastics—61: Novelties, etc.
 25 Shelves You Can Make—64: Wall shelves, etc.
 Novelties Turned on Lathe—62: Dishes, etc.
 Projects in Plastics—112: How to use.
 Inlay Pictures—Veneering—63.
 Whittling and Wood Carving—65: Methods.
 Action Toys—66: 21 easy-to-make toys.
 Marionettes—113: How to make and use.
 High Flying Kites—67: How to build.
 Windmills & Weathervanes—68.
 Lamps in Wood, Metal, Plastic—69: Several.
 Bows and Crossbows—115: How to make.
 Playground Equipment—73: 8 projects.
 Metal Craft—28: Simple instructions.
 Weaving and Recasing—37: Full details.
 Gem Cutting—42: How to cut and polish.

USING TOOLS

How to Use Your Drill Press—125.
 Correct Measurements—106: How to obtain.

Tool and Saw Sharpening—92: Tricks and hints.
 Technique of Using Drills and Wood Bits—90.
 Successful Wood Turning—32.
 How to Read Blueprints—71: Tells you how.
 Metal Turning Lathe Kinks—99.
 Operating a Metal Turning Lathe—100.
 Heat Treating and Case Hardening—102.
 Working with Glass—103: Cutting, etc.
 Using Basic Tools—120: Tips and hints.

WELDING • SOLDERING

Rewinding & Servicing Electrical Motors—78: Repairing and rewinding motors.
 Electrical Appliances, How to Fix—111.
 Electromagnets & Solenoids—44.
 Transformer Construction—41: Directions.
 The Boy Electrician—43: Five projects.
 Soldering & Brazing—17: Tells how to.
 Arc & Spot Welders—5: How to use & build.
 Build Your Own Relays—123: Instructions.
 Home Burglar Alarms, Secret Locks and Time-Setting Systems—128.
 Welding with Arc and Gas—134: Tips.

AUTOMOBILE BOOKS

House Trailers—121: Build it yourself.
 Automobile Kinks & Shortcuts—10.
 Building Trailers—Small Teardrop and Utility—27: Can be built in your spare time.
 Motor-Driven Midget Car & Scooter—34.
 Curing Auto Electrical Troubles—95.

BUILD A BOAT

14 Ft. Outboard Runabout—2: How to build.
 Rowboats, Bicycle Boat, Small Dinghy—83.
 Small Sail Boats—84: For young sailors.
 Two Outboard Runabouts—85: 14 ft. & 12 ft.
 Build Your Own Canoe, Kayak, Surfboard—30: Complete building details.
 Fast Class-E Ice Yacht—22: Build your own.

GARDENING HELPS

Lawn and Garden Equipment—124.
 Handy Farm Implements—114: How to build.
 Tractor Attachments—116.
 Backyard Gardening—39: Helpful hints.
 Lawn & Garden Novelties—72: Easy to build.
 Trellises, Pergolas, Fences—76.
 Lawn & Garden Furniture—77.
 Colored Concrete Garden Furniture—6.
 Farm & Garden Tractors—8: How to build.

PHOTOGRAPHY

Home Movie Equipment—118: How to use.
 Photo Lighting—119: Helpful information.
 Photo Enlargers—1: Complete plans.
 Photo Printers & Dryer—25: Describes three.
 Photo Darkroom Equipment—96.
 Picture Projector, Trick & Table Top Photography—97: Tips on how to make.
 Photo Kinks—98: Money-saving ideas.

FURNITURE MAKING

Furniture Upholstery and Repair—122.
 Rustic Furniture—18: How to build.
 Children's Room Furniture—51.
 Book Ends—52: Good selection from 10 designs.
 Small Tables—54: Interesting styles.
 Desks—53: Many varied designs.
 Smoking Stands—56: Seven designs given.
 Plain & Novelty Wood Finishing—40.
 Book Cases—59: Eight designs.
 Magazine Racks—49: Ten attractive racks.
 Clock Cases—50: Several types.
 Serving Trays for Every Occasion—53.

MISCELLANEOUS

Cleaning Formulas—11: Make your own.
 Re-Silvering Mirrors—70: How to do it.
 How to Build a Concrete Block Machine—110: Make your own block machine.
 It's Easy to Tie Knots—105.
 Chemical Experiments—93: Several.
 Taxidermy—9: How to mount small animals.
 Log Cabins and Tourist Cottages—14.
 Magic for Everybody—29: Simple tricks.
 Trapping Small Animals—33: How to trap.
 Training Your Dog—35: Tricks and obedience.
 Small Furnaces—36: For melting copper, etc.
 Electroplating with Copper, Nickel, Chromium, Lead, Zinc, Cadmium—86.
 Plating Non-Metallic Objects—Plating with Gold, Silver, Alloys—87.
 Telescopes—20: Design and construction.
 Poultry Houses—108: How to build.
 Guns & Decoys—109: Clean guns, make decoys.
 For Better Business—130: Timely tips.
 For Better Business—132: Saves time.
 For Better Business—133: For smooth operation.

USE THIS HANDY ORDER COUPON NOW!

POPULAR MECHANICS PRESS
 200 E. Ontario St., Chicago 11, Ill.
 I enclose \$_____ (U.S. currency may be mailed if carefully wrapped) for "Little Library" booklets numbers:

25 Books	12 Books	5 Books	1 Book
\$3.75	\$2.00	\$1.00	25c

NAME _____

ADDRESS _____

CITY _____ ZONE _____ STATE _____

\$35,000 REWARD FOR URANIUM



Here's your chance to "cash in!" Over \$3,750,000 in Government Bonuses have been paid for URANIUM discoveries in the past 2 years. Currently \$175,000 a month is paid to people like you.

Precision Geiger Counters and Scintillators are the finest instruments made for URANIUM prospecting. These highly sensitive instruments are compact, lightweight and ruggedly built for field use. Prices start at \$29.95.

CONTACT YOUR NEAREST DEALER

or write direct to factory for
FREE 12-PAGE CATALOG and
our 24-PAGE BOOKLET with
"64 QUESTIONS AND ANSWERS
ON GEIGER COUNTERS
AND SCINTILLATORS."



DEALERS WANTED

MAIL TODAY FOR FREE INFORMATION

Name _____ Title _____
Company _____
Address _____ City _____ State _____

PRECISION RADIATION INSTRUMENTS, INC.
2235 PMS. La Brea, Los Angeles 16, California
World's Largest Manufacturer of Portable Radiation Instruments

BUILD 15 RADIOS

AT HOME WITH THE NEW IMPROVED
1955 PROGRESSIVE RADIO "EDU-KIT"

ONLY **\$19⁹⁵** COMPLETE

*Now Includes High Fidelity
Signal Tracer & Code Oscillator*

All Parts, Instructions, Soldering Iron,
Tester Included. Money Back Guarantee.
PROGRESSIVE "EDU-KITS" INC.
497 Union Ave. Bklyn. 11, N. Y.

PROGRESSIVE "EDU-KITS" INC.

Dept. PM-526, 497 Union Ave., Brooklyn 11, N. Y.

RUSH ME THE FOLLOWING:

- Free Descriptive Literature—No Obligation.
 Free Valuable Radio and TV Guides—No Obligation.

Name _____
Address _____
City _____ Zone _____ State _____

last weeks of December. Most of the engineering had been done about two years earlier when the decision to bring out a wrap-around was turned down. It is to be available only on the sedan models—the low-slung coupes won't have it. The buyer will have a choice—wrap-around or no-wrap on sedans.

Chevrolet will soon be selling the Corvette station wagon, the Nomad. It will be metal, not plastic like the original model. The Corvette will get a souped-up V8 engine to compete with the Thunderbird.

And so that closes another model year in this most hectic of all mass-production industries. It is an industry where the question "will it sell?" is as important as "will it run?" Is the merchandising approach being carried too far? Some critics seem to think so.

At a recent conference on design, two such critics verbally slugged the car designers. The art director for an international oil company said that as far as he was concerned, the car makers had "lost another customer" with their "longer, lower, wider" look. The editor of a cultural magazine said that the 1955 designs made cars look "like a tipped-over jukebox on wheels."

What do you say? That's the only thing Detroit wants to know—the sales figures will be the answer. ★★★



Versatile Tool for Anglers

Three different tools for anglers are combined in one handy new implement. The main section of the tool is a pair of clippers, similar to fingernail clippers, for cutting lines and leaders. A blade with a double point swings out for use in removing small hooks from the fish. The third tool removes leaders from flies.



The Right STANLEY Tool



The rugged little work horse of the workshop in 90% of your woodworking jobs. Versatile, light weight and high speed, its motor is used to power the plane shown. *H15 Router — \$39.95.*

New! Router-Plane Kit

Combines H15 and H106 with gauge and bit in handy fitted carrying case. *H100 — \$89.95.*



This tool is a wonder for smooth and easy planing. Just right for fitting storm and screen doors and windows, trimming wood, plastic or aluminum veneers on table and counter tops. When you have H15 Router, Kit is all you need to convert to power plane. *H106 Plane Adapter Kit — \$29.50.*

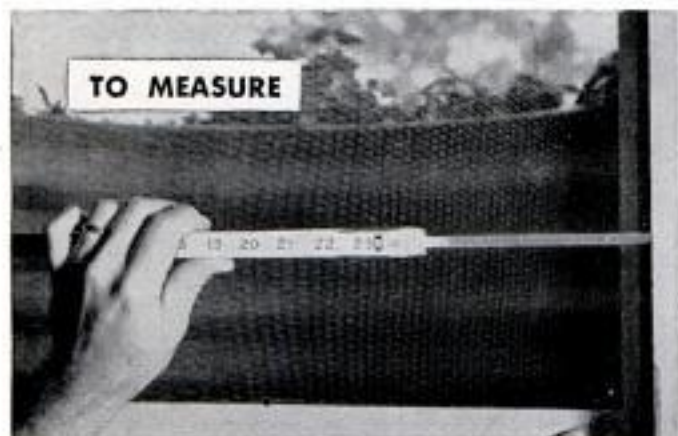

Accurate measurement is fundamental in jobs of all kinds. Here is a new Stanley Zig-Zag Extension Rule with accuracy-plus features. Extra thick first leg has brass slide for inside measurements. Rule opens to even numbers, convenient marking gauge at 2", 4", 6", 8", etc. Plastic finish on sticks and nickel silver joints ensure longer useful service. *6 ft. No. X246 Extension Rule — \$2.10.*



The standard for mechanics, repair men and well-equipped handymen everywhere. Just a push for lead holes in plaster or wood. Handle returns automatically after every stroke. Drill points cannot pull out when tool is in use. All metal, chromium plated, with 8 drill points in magazine handle. *No. 41 "Yankee" Push Drill — \$6.00.*

STANLEY

The Stanley Works

Tools • Electric Tools

HARDWARE • STEEL STRAPPING • STEEL

Department TE, The Stanley Works,
623 Elm St., New Britain, Conn.

Gentlemen:

Please send me () free Tool Catalog
() free Electric Tool Catalog

Check Catalog(s) you want.

Name _____

Address _____

City _____ Zone _____ State _____

NEW EASY WAY TO MAKE ALUMINUM STORM WINDOWS



**SAVES
TIME
SAVES
MONEY**

**USE
ALUMINUM REDI-ROD
... PRECISION CUT
ON THE YOODOO®
MITRE BOX TOOL**



You don't have to be "handy with tools" to make aluminum storm windows this new easy way... and save literally hundreds of dollars in the process. With the new Yoodoo Tool, you can make a complete storm window in about half the time. It eliminates tedious measuring... guides your saw cuts accurately... positions drilled holes right on the nose. Complete, easy-to-follow instructions are included with each Yoodoo Tool. Don't wait! Start your set of Aluminum Redi-Rod storm windows as soon as possible.

**AT YOUR LOCAL HARDWARE STORE
or write REDI-BOLT, Inc.
5330 Indianapolis Boulevard, East Chicago, Indiana**

They Also Ran

(Continued from page 167)

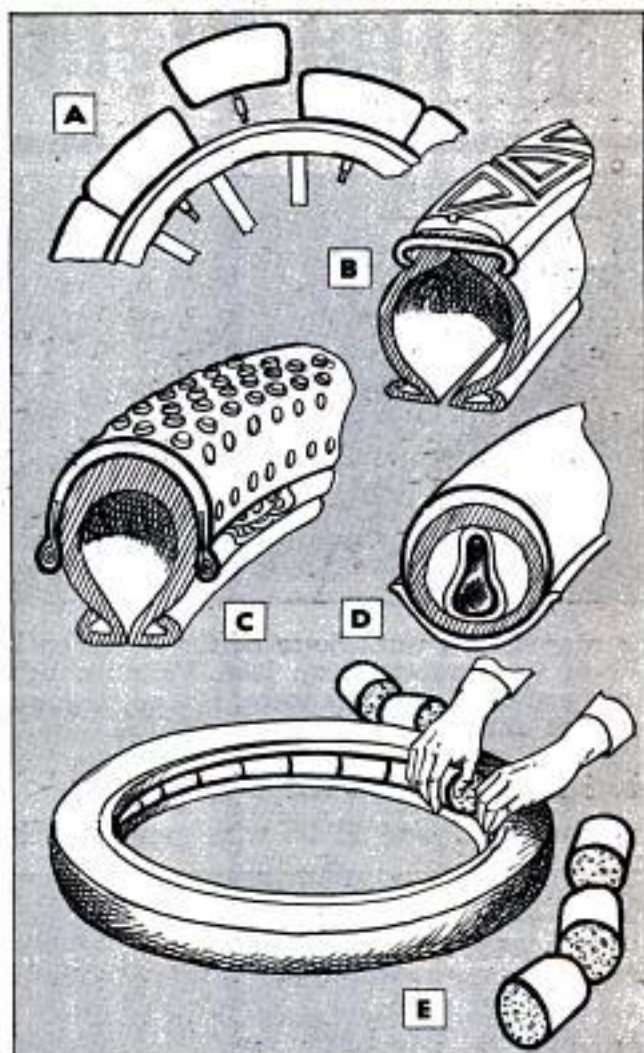

There were almost as many tire ideas as there were automobiles in the early days. Here are just a few: A. Segmented tire; B. steel-rimmed tire with rubber tread cemented to it; C. hobnailed tread that slips over any tire; D. punctureproof tires of almost solid rubber; and E. sponge-rubber fillers to replace tube

power ratios by sliding a friction-tired wheel across a revolving disk that was spun by the engine. As the friction wheel approached the center of the disk, the speed output was reduced and the power ratio increased tremendously. There was said to be "no hill the Cartcar couldn't climb." To increase speed, the driver moved the wheel toward the perimeter of the disk. The car then accelerated without jerking or gear changing. To reverse, the driver moved the wheel past dead center. Very simple, very practical, but an also-ran.

Probably no invention caused more comment than the Octoauto built in 1911 in Columbus, Ind. This strange vehicle had eight wheels, hence its name. There were two axles in front as well as two axles in the rear.

(Continued to page 286)

Enjoy happy hobby hours with **GOTHAM HOBBIES** PLEASURE AND FUN FOR THE ENTIRE FAMILY!

FULLY ASSEMBLED 1/7 H.P. *Real* DIESEL ENGINE

A perfect power plant for planes, boats, race cars

Enjoy many hours and hours of fun pursuing your hobby with DEEZIL . . . the real diesel engine that runs at 7500 RPM and produces 1/7 HP. Weighs only 5 oz. DEEZIL is not a toy. It's compact, rugged, streamlined. Starts quickly. Simple to install. Every engine test run at our factory to assure perfection. Easy to follow operating instructions.

Ultra precision engine as carefully machine-tooled as giant army engines. Cylinder is honed to .0001 and hand fitted to its individual pistons.

Ideal gift for boys and adults. Send cash, check or money order.

YOURS AT A NEW LOW, LOW PRICE

over 100,000 sold at a higher price

NOW \$1.95
Plus 5¢ Postage



ACTUAL SIZE



SPECIAL OFFER!
196 page book on model engines
(Giant new hobby catalog included)
Only \$1.00 postpaid

MADE IN U.S.A.

OUR 378th ADVERTISEMENT

More GOTHAM HOBBY Values to Choose from!

SEA HARE SPEEDBOAT. 12 1/2" with electric motor, fully assembled, including fittings. **\$4.95**

VERNEY TRAIN OUTFIT. 88 wheels a-rollin', ready to run. Two-drive loco (shown) with trailing B unit and 9 other assorted cars, including freight, flat, tanker, caboose, etc. Magnificent detail, sturdy construction. Also includes 22 sections of snap-together track and power-pak. Absolutely complete. **\$49.95**

BIG 3 CRAFTING OIL PAINTING OUTFIT. Start painting at once. Contains everything you need. Three 12"x12" mounted panels, numbered and ready for painting. Large jars of brilliant pure oil colors, plus 3 artist's brushes. Crucifixion and other religious subjects. Set of 3 **\$3.95**

READY TO RUN MODELS
(Engine Included)
No assembly necessary

AEROMITE PLANE and ENGINE. Ready to fly. All plastic. **\$8.95**

TURRET MICROSCOPE 100-300x power. A real scientific instrument for exploring the unknown. Well constructed. Precision lens. Fine adjustments. Includes 130-page detailed guide containing photos and interesting information. **\$17.95**

HIGHWAY PIONEER CAR SETS. (Model shown 1910 Ford) Authentic reproductions of cars from nostalgic early days, plus today's foreign sport cars. Begin your collection with these models. Easy to build. Kit contains all parts and paint, brush and cement. Available in these models: JAGUAR, MERCEDES, ROLLS ROYCE, STUTZ BEARCAT, FORD. Set of 6 complete. **\$4.95**

ASTRONOMER'S TELESCOPE WITH TRIPOD 30x power. Beautifully designed, compact telescope for viewing the heavens. Precision ground lens. Complete. **\$22.50**

READY TO RUN AUTOMITE RACE CAR. High impact plastic. May be run tethered or free. **\$10.95**

ONE TUBE RADIO KIT Not just a toy, but a precision engineered radio with modern circuits and tubes. Will receive local and long distance stations. **\$7.95**

ADMIRAL FLEET PACK CONSTRUCTION KIT. Atomic submarine (shown). Plastic kits the entire family loves to build. Super-detailed exact scale models. No cutting or sanding required. Just assemble. Build all these models: CARRIER FRANKLIN D. ROOSEVELT 21"; BATTLESHIP MISSOURI 20"; HEAVY CRUISER BALTIMORE 17"; DESTROYER SULLIVANS 15"; PT BOAT 9"; CHRIS CRAFT CRUISER 9"; ATOMIC SUBMARINE NAUTILUS 13". Set of 5 complete. **\$6.95**

PAINT BY NUMBER PICTURE. "The Last Supper" (shown). Christ gathers His disciples in this farewell scene. Large 18"x24" canvas. Hours and hours of pure enjoyment painting portrait scenes. Professional results by amateurs. **\$4.95**

READY TO RUN AQUAMITE BOAT. In-line drive unit. Requires no gears. Twin rudders. **\$8.95**

GOTHAM HOBBY CORP., Dept. P, 107 E. 126th St. New York 35, N. Y.

ORDER BY MAIL TODAY
Specify item desired
Giant new hobby catalog included with every order. A charge of 25c for this catalog is made when ordering separately; but will be refunded on your first order.

Your ideas are easy to build with Upson Panels



idea

From ugly attic to beautiful extra room with crackproof Upson Strong-Bilt Panels for walls. Easy-to-work, clean, many sizes. Upson Ceiling Tiles finish job. See your lumber dealer.

idea

More storage space in bedroom with Upson Strong-Bilt Paneled Wardrober. Simple carpentry all it takes. Rugged Strong-Bilt paints beautifully. Be sure, insist on Upson Panels.



idea

Your "rec" room finished with stunning Upson Striated Panels. Smart effect in two-tone. Upson ☆ Panels cut out for decorative mobiles. See your lumber dealer today.



Upson Panels available in variety of sizes, thicknesses, surfaces. Cost less than many other panel materials, yet give you the most beautiful finished job of all. Leave in natural color or paper, paint. If lumber dealer is out of stock, he can get Upson Panels for you in just a few days.

FREE DETAILS, MAIL COUPON



PROVEN QUALITY YOU CAN TRUST UPSON

The Upson Company

5112 UPSON POINT, LOCKPORT, N. Y.

Please rush FREE details on _____

TYPE OF PANEL

NAME _____

ADDRESS _____

CITY _____ STATE _____

The logic (if that's the word for it) behind the design was that since Pullman coaches with 12 wheels rode better than ordinary coaches with 8 wheels, automobiles with 8 wheels would ride better than those with 4 wheels. Complicated, isn't it?

Anyway, since each wheel carried only one eighth the load, a bump only felt one eighth as bad, said the manufacturer. Of course, there were eight small bumps instead of four large bumps! But that's another story.

It turned out that the eight-wheeled vehicle was not easy to steer, as you could have guessed. So the company solved this problem by bringing out the Sextoauto the following year. This model still had the dual axle and the four wheels in the rear, but it was reduced to a normal two wheels in front.

The Sextoauto was advertised as "The Octoauto's Sister." That proved it was scientific, the company thought. The advertisement stated that there was "not a single experiment embodied in the whole car . . . an old and accepted principle . . . bound to revolutionize automobile construction where comfort in riding is a consideration." Well, look around you. See any six-wheeled cars?

"Like a light canoe, skimming the surface, delicately responding to the slightest feathery motion of a noiseless paddle, the Owen Magnetic is under complete mastery of its owner's finger touch." Thus read an advertisement for an electric-powered car that carried its own generator. It had the smooth-power advantage of the electric, plus the convenience of the gasoline engine. The gasoline engine spun a generator which fed current to an electric motor attached to the drive shaft. It was called "the car of a thousand speeds" because it required no gearshifting. And it did operate as smoothly as any car before or since.

Not much different was a gasoline-electric truck which also had a generator hooked up to the gasoline engine. In this vehicle, the electricity powered four small electric motors, one inside each wheel hub. The design gave it a four-wheel drive and shift-free operation. It was also a four-wheel drive without steering problems, there being no front differential needed. The principle is the same as used in the diesel locomotives that pull today's trains.

A New Jersey motor company attacked the body problem in a revolutionary way with the "Gadabout" (\$450 completely equipped). The body was woven of reed, like a basket. This made it lightweight and strong. And it could be curved gracefully.

(Continued to page 288)

The speedy, easy way to get professional sanding results

SKIL

2 1/4" Belt Sander

Anybody can get professional finishes with this SKIL Belt Sander. It's so easy to handle—lightweight, compact, smooth-operating... in any position. Sands flush to vertical edges and corners. It will handle all your jobs, from rough to final finishing.

Whatever your project—finishing cabinets and furniture, smoothing plaster walls, removing primer coats, boat building, home repairs of all kinds—here's the sander you need. It's rugged, practical, hard-working.

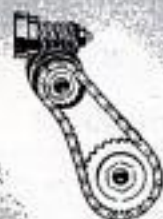

Dependable, long-life combination worm and chain drive.



Extra power motor, high-quality long-life bearing.



Comfortable, hand-fitting handles.



Flush sanding belt for reaching into corners.



Trigger switch in contour handle. Instant control.



Strong, lightweight die-cast aluminum motor housing.

See all its other features at your dealer's!

SKIL

HOME SHOP TOOLS

Made Only by SKIL Corporation
formerly SKILSAW, Inc.
5033 Elston Ave., Chicago 30, Ill.
In Canada, Skilltools, Ltd.
3601 Dundas St. W., Toronto 9, Ont.



Model 505



SEVENTY-FIVE YEARS OF PRECISION TOOLMAKING

From the invention of the combination square to a line of more than 3000 fine tools. From a room in a small machine shop to the largest manufacturing plant in the world devoted exclusively to the production of mechanic's hand measuring tools and precision instruments, dial indicators, hacksaws, band saws, band knives and precision ground die and flat stock. This is the contribution made to industry and to millions of skilled craftsmen by Laroy S. Starrett and the company which he founded.

On the occasion of our 75th Anniversary Year, the many Industrial Supply Distributors who make STARRETT products available to you join us in our pledge to maintain the STARRETT reputation for quality, precision and prompt, dependable service.

THE L. S. STARRETT COMPANY • ATHOL, MASS., U.S.A.



MECHANICS' HAND MEASURING TOOLS AND PRECISION INSTRUMENTS
DIAL INDICATORS • STEEL TAPES • PRECISION GROUND FLAT STOCK
HACKSAWS, BAND SAWS and BAND KNIVES

Another advantage claimed for the Gadabout was that it couldn't be scratched or dented. In fact, "slight bumps and bruises do not affect it in any way" reported a trade journal of the day.

As for cleaning it (which was the chief objection of such a body, wrote the automotive reporter), this was really very simple. It took but a minute to remove all the upholstery and floor boards. Then "if desired, a hose can be turned directly through the body, cleaning it thoroughly in a few minutes."

Engines were not always reliable in the early days so it was no wonder that inventors thought in terms of "spares." An inventor named Carter built a twin-engine car in 1908. When one engine went dead, the driver could always get home on the spare. Or, if more power was needed, both could be operated at the same time.

A similar approach was the convertible engine, of which several appeared. One, the Enger convertible 12, was what we would call a V12 today. There were two slanting banks of six cylinders each. By moving a lever, the driver cut off the ignition and lifted all valves on one bank so the engine ran on only six cylinders. This was the economy setting. When he approached a hard climb, he pulled back on the lever and all 12 cylinders roared into action.

And for those who just wanted to be different there was the Duck, built in 1913. It was the "newest, latest, best thing ever produced in the auto line." It was "new, exclusive, like no other, something you will want."

Well, it was different all right!

It was a touring car that was driven from the back seat. (This must have been for the original back-seat driver.) Of course, space in front of the driver could be used only for luggage (the ad said it was "a touring car of great luggage capacity"). It was only fair that nobody block his view of the road—he did have to see where he was driving. As you might expect, the Duck came and went with little more than a few quacks.

There were solutions to the tire problem, too. Tires of many separate segments made checking tire pressure an all-day operation. There were a dozen or more valve stems on each wheel. But for this trouble, you did have a tire that went flat in only one spot at a time. With it, you could still drive home when you did get a puncture—of course, it was to the accompaniment of a noticeable "ka zump" every time the flat segment came around.

There were sponge-rubber cylinders you

(Continued to page 290)

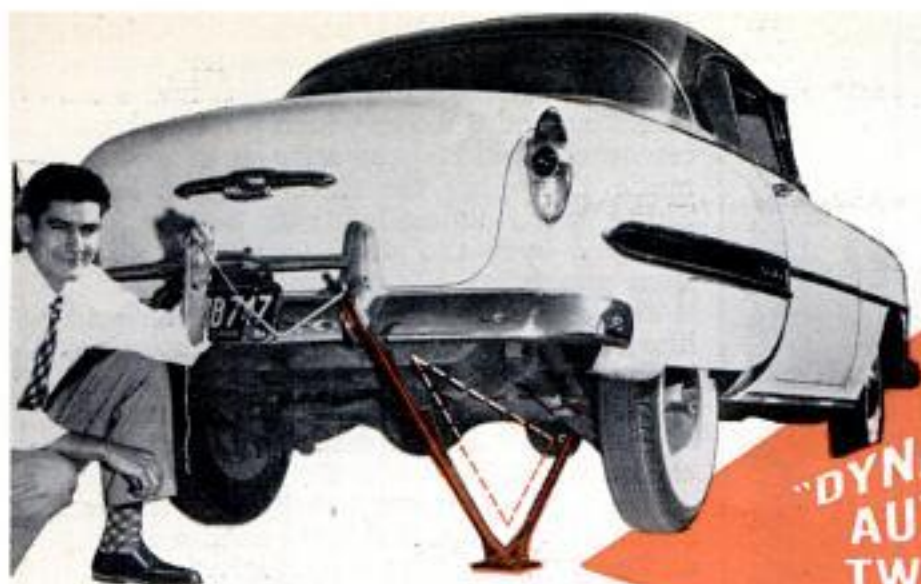

**NEW
"DYNAMIC TRIANGLE"
AUTO JACK LIFTS
TWO TONS WITH A
PIECE OF THREAD!**

BRILLIANT AMERICAN ENGINEER MAKES FIRST ADVANCE IN MANUAL LIFTING IN 2500 YEARS—since Archimedes' invention of the hydraulic screw. This fascinating and immensely practical invention is the talk of the automotive industry. This is the first automotive lift or jack to use the "dynamic triangle" principle instead of the straight line lift. It is now in production and can now be purchased by mail.

STUDY THIS DRAWING

When the handle is turned this **DOUBLE LIFT** jack **FIRST** lifts the car body **JUST** enough to clear the wheel. Then when the weight of the car body on the **REAR** leg of the triangle builds up, a part of this weight is transferred in the form of lifting energy to the **FORWARD** leg of the triangle—gently raising the wheel off the ground. The "V" on the forward leg engages the solid axle of all passenger cars and light trucks. First lifts bumper, then lifts wheel. Supports both bumper and wheel.



EVER WORRIED ABOUT THIS?

jacked up. This new invention will stay in place. **TRIANGULAR SUSPENSION MAKES CAR RESIST MOVEMENT.** When the Double Lift Jack is in use, the front or rear end of your car is actually resting on an inverted tripod (two jack legs and opposite wheel). With conventional jacks the car is resting on two points (jack itself and opposite wheel). With two point suspension, the car can roll off if the other wheels are not braked or blocked. With three point suspension it can't. Sounds tricky and it is, but just try it. Here's another way to put it. The principle is the same. You can walk away from a camera tripod and it'll stay there. Try walking away from a bipod.

The **DOUBLE LIFT "DYNAMIC TRIANGLE" JACK** is in production and in limited stock at the factory **NOW**. **GIVE IT THESE TESTS**—if you don't think it performs better than we say, ship it back and we will return your money.



FOLDS UP—FITS IN ANY TRUNK

DISTRIBUTORS - DEALERS — Double-Lift Jacks now in full production. Write for full sale details.



USE IT ON A TREACHEROUS SIDE HILL

USE IT ON A STEEP HILL



Here is a jack your wife or teen age daughter can use with ease when you're not there—and you don't have to worry about "jack" accidents. Send this coupon in with your check, cash or money order.

\$13⁹⁵ Postpaid in U.S. only

MID-CONTINENT MFG. CO., INC.

3613 Aviation Blvd., Manhattan Beach 2, Calif.

Gentlemen:

Please ship me immediately _____ **DOUBLE LIFT** jack(s) @ \$13.95 each including shipping cost, on money back guarantee. (Or send \$5. balance C.O.D.)

Name _____

Address _____

City _____ Zone _____ State _____

California residents please add 3% state tax.

DO-IT-YOURSELF and
Save Over 50%
on Extruded Aluminum
COMBINATION WINDOWS
and DOORS



For a limited time you get regular \$9.95 Combination Window Kit for only \$8.95 f.o.b. factory—compare this quality, extruded aluminum window with any \$25 window. Due to elimination of assembly costs and mass production to meet increasing demand, and because you "do it yourself," you save as much as 50% on all U-Fab-It-Urself "Home Comfortizing Products."

KITS INCLUDE: All parts factory cut, drilled, mitered and hardware attached. The following Complete Line of U-Fab-It-Urself Kits engineered for easy assembly with household tools:

- COMBINATION WINDOWS
- PICTURE WINDOWS
- COMBINATION DOORS
- BASEMENT WINDOWS
- SCREEN DOORS—SCREENS
- CASEMENT WINDOWS

Send for
FREE BOOK
 on Complete Line
 of Deluxe
 Combination
 Windows
 and Doors.

"Satisfaction Guaranteed"

U-FAB-IT-URSELF, INC.

Worthington, Ohio

Please rush details of **SPRING SPECIAL**—\$9.95 Kit for **ONLY \$8.95** f.o.b. plant. **PM-255**

Name

Address

City..... State.....

stuffed into the tire instead of a tube. These never went flat, at least not from a puncture. There were tires that had steel bands around them to which the tread was cemented. You had the softness of a pneumatic tire, plus the durability of steel. There were hobnailed slip covers that clamped over the tires to protect them from punctures.

There were tubeless tires. One was built like a garden hose with only a tiny airspace in the center. This was permanently sealed when the tire was made. It never went flat. It was almost solid rubber and must have ridden like it.

Finally, there were two inventions that should not be omitted from such a listing as this one. One was a spotlight that was installed by drilling a hole in the windshield. It was aimed like a pistol—in fact, its handle was shaped like a pistol grip. The light was a success for a while—sold half a million or so. Then it flopped. Another was a headlight dimmer that let you select any degree of brightness from full bright down to a faint glow for your headlights. It never did sell very well and soon was made illegal by state laws regulating headlights.

The man who manufactured and sold these two also-rans is the fellow who wrote this article. ★★★



Rubber Car Stopper

Your car stops at the right place in the garage when it hits a small cylinder attached to a rubber skirt. The weight of the wheel on the rubber skirt prevents the cylinder from rolling away, so there's no need to fasten it to the floor. A block for just one wheel is all that's needed. Reflecting disks help spot it at night.

new Thor SpeedWrench...

greatest 1/2" Square Drive Electric
IMPACT WRENCH
ever built—regardless of price!



\$89⁵⁰
complete

exclusive patented
**FINGER-TIP
REVERSE**



Now, you can set and remove nuts, drive and remove screws, drill in steel, wood, stone . . . tap drive and extract studs . . . no limit to its uses. This impact wrench does EVERYTHING!

One hand operation, one switch efficiency. MORE POWER... MORE RIGID CONSTRUCTION!

Easily triples capacity and dollar profits in your shop. Here's the low-priced power-packed impact wrench you've been waiting to buy.

Write for complete specifications on ALL Thor AUTOMOTIVE and SHOP SPEEDTOOLS!



***100 SpeedDrill**

A fistful of power. 1/4" cap. in steel... 1/2" in wood. HEAVY DUTY RADIAL & END THRUST BALL BEARING ON SPINDLE. \$25.00



***128 SpeedGrinder**

All-purpose 1/4 H.P. grinder for home, maintenance man, and garage. 6" x 1/4" face wheels. \$32.50



***1500 SpeedSander**

Heavy duty industrial orbital action sander. Larger platen. EXTRA power. 18 times faster than hand sanding... \$54.50



SpeedTools

SpeedWay Manufacturing Co.
a division of Thor Power Tool Company
Cicero 50, Illinois

ONAN Electric Plants for light and power anywhere!

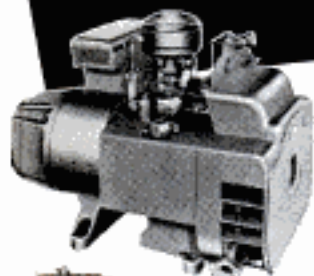

Emergency Power for homes, farms, business

Supply essential current when regular power source is interrupted. Prevents losses and hardships. 1 to 75KW. Gasoline-driven. (Model shown—10CW, 10,000 watts A.C.)



Portable Power for tools, lights

Carry them to any spot for labor-saving, plug-in electric power. Light weight, air-cooled. To 10KW. Gasoline-driven. (Model shown—07AH, 750 watts A.C.)



Electricity for cabins, resorts

Bring conveniences of electricity to any remote spot. Use regular 115-volt A.C. appliances and equipment. 400 to 75,000 watts. Gasoline-engine-driven.



Marine Electric Plants

Enjoy electrical conveniences afloat. Install below decks. Compact, smooth-running, quiet. Water-cooled marine design. 400 to 3,000 watts. Gasoline-driven.

(Model shown—MKH, 400 to 1,000 watts)

Write for Folder!

D. W. ONAN & SONS INC.

3297 University Ave., S.E., Minneapolis 14, Minn.



New! Pella® WOOD FOLDING DOORS

Decorative • Convenient • Economical

Now you can use the floor and wall space that swinging doors waste. Pella Wood Folding Doors fold compactly against the door jamb like an accordion. Ideal for closets, bedrooms, kitchen . . . and as folding partition between living and dining rooms. Anyone can install, quickly, easily. Completely packaged with hardware, fittings, installation instructions. Heights to 10', widths to 30'. Natural wood finishes and unfinished. Investigate today!

CLIP AND MAIL TODAY

ROLSCREEN COMPANY
Dept. G-81, Pella, Iowa

Please send complete literature on Pella Wood Folding Doors.

NAME _____

ADDRESS _____

CITY _____

ZONE _____ STATE _____

Are European Cars Better?

(Continued from page 163)

(because it is a two-stroke design it runs like a six-cylinder of four-stroke design) cruises all day at over 60 miles per hour and has a top speed of 74 miles per hour. It goes 30 miles on a gallon of gasoline.

Fuel injection is another significant development. The new Mercedes-Benz 300 SL now offers it. With fuel injection you squirt gasoline into each cylinder on the suction stroke instead of using a carburetor to mix the fuel and air outside the cylinder. This permits much closer control so there are no lean cylinders. You squeeze more work out of each drop of gasoline. The tricky problem of breathing restrictions is solved also and you get more power at the same time you get more economy. This six-cylinder engine of only 182.8 cubic inches puts out 240 horsepower and in top gear it has a range of 16 to 150 miles per hour.

Of course, the Mercedes-Benz 300 SL is expensive (\$7400), but so are some of our cars and with them you don't get fuel injection.

The V8 engine has just about killed off the in-line layout in the United States. In Europe, on the other hand, they are working hard to refine the short-stroke six and are finding low friction and high economy they never dreamed of.

Then there is the very effective diaphragm-type main bearing on the British Lagonda and Aston-Martin cars. This gives 360-degree support around the bearing.

One British car has an electric radiator fan with automatic controls that turn it on when water temperatures reach a certain level. On the highway, where you don't need a fan and it merely eats up horsepower uselessly, making plenty of noise to boot, the electric fan cuts out.

Mercedes-Benz carries cooling water around the oil sump, warming the oil when the car is cold and cooling it at high speeds. The Volkswagen has an oil radiator in its cooling system for the same reason.

But to the American car owner all this may be too technical to be exciting. After all, our cars do all right without fuel injection and torsion-bar springing (this latter is another feature of the Volkswagen and many European cars).

Let's look at some other points that are not so technical. How would you like it if you never had to bother having your car greased? With some European cars you don't.

The British Daimler has an automatic lubrication system that provides a supply of grease to chassis points every time the

(Continued to page 294)

Clean both sides INDOORS!



You can clean or paint both sides of a removable R.O.W window from *inside* the house—no need for ladders or sitting on sills.

See your local lumber dealer or write for free folders.

R.O.W. SALES CO.
1338-80 ACADEMY AVENUE • FERNDALE 20, MICHIGAN
Please send me, without obligation, your free folders.

Name _____

Address _____

City _____ Zone _____ State _____

R.O.W. is the registered trade-mark of the R.O.W. Sales Co.

WELD **BRAZE**
SOLDER **CUT**

4WAY
ONLY \$14.75
f.o.b. factory

WELDER
Complete with Twin Carbon Arc Torch and accessories... to handle all metal-craft work.

Acclaimed by thousands of Homeowners, Mechanics and Hobbyists as the welder of 1001 uses. Easily operated from properly wired 110 volt AC or DC line. The ideal gift with a life-long use... Order today on 10 day money back guarantee.

FOUR-WAY WELDER CO., Dept. F2-B
1810 S. Federal St. • Chicago 16, Ill.

ASSEMBLE YOUR OWN TILLER... SAVE!

12" Tiller fits and cultivates in 4" deep

We supply all parts except engine, already painted, plus full instructions. Twelve 4-in. teeth, 12" wide housing and shaft, sprockets, sheaves, chain, belt, wheels and handle. Only \$18.00 f.o.b. Richfield. Send check or money order today!

RED-E TRACTOR CO. RICHFIELD 17 WISCONSIN

A HULL AUTO COMPASS LETS YOU "SEE" THROUGH DARK AND STORM

● Poor visibility when looking for road signs, landmarks, similar guides is one of the countless circumstances which make it easy to get lost... unless you drive by Hull Auto Compass. Keeps the way to your destination clear. Note that Hull universal vacuum cup mount with adhesive installs at eye level, away from magnetic interference of dash.

WRITE FOR LOCAL DEALER'S NAME, FREE LITERATURE
HULL MFG. CO. P. O. Box 246, D-2 WARREN, OHIO

Beaconlite 16.45
ILLUMINATED STRAIGHTWAY 14.45
NON-ILLUMINATED

send for **FREE CATALOG**

Snap-on Tools
"THE CHOICE OF BETTER MECHANICS"

America's Foremost money-making MECHANICS' TOOLS

It's easy to own the same "pay-off" tools used and endorsed by America's top-earning mechanics throughout the automotive, aviation and industrial fields! Snap-on tools help you handle every repair job faster, easier, better. And they LAST... pay for themselves over and over again! Start building your own tool set now with basic Snap-on units—add others any time. Genuine Snap-on tools are never sold in stores—direct to users only. Mail coupon for free catalog.

Snap-on Tools
"THE CHOICE OF BETTER MECHANICS"

Snap-on Tools Corporation
8062-B 28th Ave., Kenosha, Wis.

Send me free catalog. Occupation _____

Name _____

Address _____

City _____ Zone _____ State _____

HALF-CLEAN ISN'T CLEAN ENOUGH



...in motor oil, too!

Half-clean oil wears an engine. Clean oil protects an engine. And Hastings Oil Filter Cartridges—when replaced as normally recommended—*keep oil clean from filter change to filter change!*

The reason for Hastings amazing performance is Densite—a new filtering material that absorbs dirt through its *entire* depth. And only Hastings has Densite!

Next time you change oil—change your filter cartridge, too. Ask for Hastings and have clean oil all the time!

HASTINGS

OIL FILTER CARTRIDGES



OIL FILTER DIVISION • HASTINGS MANUFACTURING COMPANY
HASTINGS, MICHIGAN

Oil Filters, Piston Rings, Casite, Spark Plugs

engine warms up from cold. A tank near the exhaust pipe responds to engine heat, forcing grease into all chassis bearings. All you do is fill a reservoir every year or so.

Many European cars (like the Mercedes-Benz and the Czech Skoda) have had one-shot systems for years. In these the driver presses a lever in the passenger compartment and the car is greased. An accessory available in England is powered by a flexible cable hooked into the speedometer linkage. As you drive, various ports are opened automatically and grease is forced into chassis points in metered amounts pre-set by the manufacturer.

Europe has many other features in its cars that would excite the envy of an American driver: Self-emptying ash trays; ride control from the dashboard through adjustment either of shock absorbers or torsion-bar stiffness; side and rear-window defrosters; automatic transmissions that can be shifted by hand if you wish. The British Jensen features an all-plastic four-passenger-sedan body and cruises at 90 miles per hour with a 140-horsepower engine. Plastic panels are used in the Singer Hunter. Many cars use aluminum panels. The French Panhard is virtually all aluminum, even its body, chassis and engine.

But, American manufacturers say, the cost of such items is too great. Is it? Is cost a good argument against four-wheel independent suspension when the tiny French Renault has it?

Obviously, we should not copy any single European car complete. There is no argument about the quality of our American cars. The United States offers the buyer more car per dollar than any other country in the world. For brute straight-line performance, we can't be beat. Many of our stock cars will out-run all but the hottest European sports-racing cars.

No cars in the world give an easier ride over long distances at 70 miles per hour on good roads.

Our cars are designed to provide dependable, foolproof operation. You don't have to be a mechanic to drive one. Our cars require little or no skill to start, to drive or to stop. No other country has cars that are so easy to operate and so free of annoying bugs.

But there are European features we could pick up and put in our designs without weakening any of our strong points.

Packard is making the first real step forward in suspension in an American car in many years with its torsion-bar suspension and its self-leveling feature. Lincoln and Mercury are offering a push-button-lubrication system as an optional extra

(Continued to page 296)

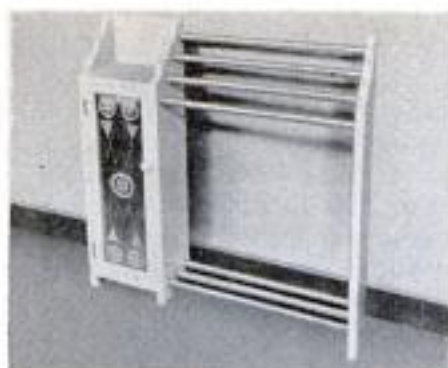

Bathroom Valet. Handiest addition your bathroom could have. Decorative storage cabinet door is made of hammered aluminum sheet. Requires wood, Do-It-Yourself Aluminum Tubing and sheet. Easi-Bild Pattern #29.



Serving Tray. Combines serving tray and stand in a useful and beautiful piece of furniture. Aluminum, Weldwood, Naugatop, Redwood and fasteners provide needed materials. Easi-Bild Pattern #52.



Weather vane. Pennsylvania Dutch design enhances the appearance of your house. Aluminum tubing, sheet, fasteners and wood are all you need. Easi-Bild Pattern #524.



Look for this rack containing Tubes • rods • bars • a wide variety of sheet designs • angles • fasteners • screen and storm sash sections • window hardware • Reynolds plastic film • trim strip.

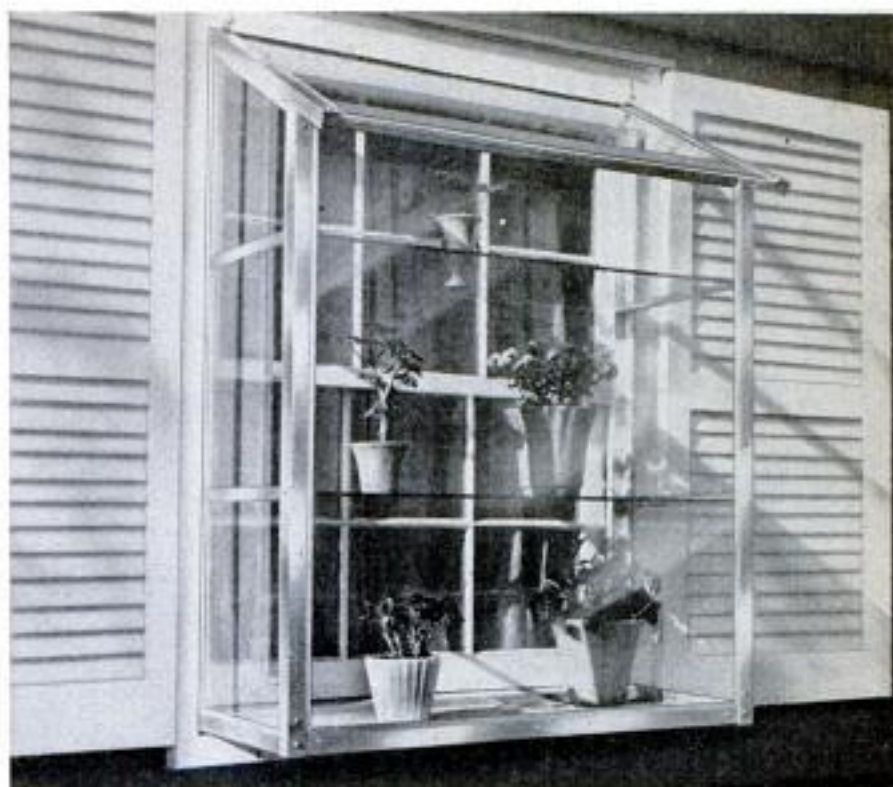

Window Greenhouse. Have your own window conservatory—green things growing all year long. Can be made to fit any window. Requires glass, Do-It-Yourself Aluminum storm sash sections, angles and fasteners. Has three 14" glass shelves. Easi-Bild Pattern #566.

MAKE THESE 4 "AROUND-THE-HOUSE" IDEAS A REALITY

with Reynolds *Do-It-Yourself** Aluminum and your ordinary wood-working tools

Now is the ideal time to start any or all of these new do-it-yourself projects. Easy and quick to build whether you have a workshop or not. New Easi-Bild† patterns are simple to follow. Your nearby hardware or building supply dealer has Reynolds *Do-It-Yourself* Aluminum and dozens of suggestions for other uses.

REYNOLDS DO-IT-YOURSELF* ALUMINUM

is also available in Canada

*T. M. REYNOLDS METALS CO. †T. M. EASI-BILD PATTERN CO.

Reynolds Aluminum Service Corporation
2494 South Third Street, Louisville, Kentucky

Enclosed please find \$_____ for the following Easi-Bild patterns:

- No. 29 Bathroom Valet—35¢ No. 52 Serving Tray and Table—25¢
 No. 524 Weather vane—35¢ No. 566 Window Greenhouse—50¢

Name _____

Address _____

City _____ Zone _____ State _____



Do more jobs better
 ... in less time...
 at lower cost
 with an Atlas

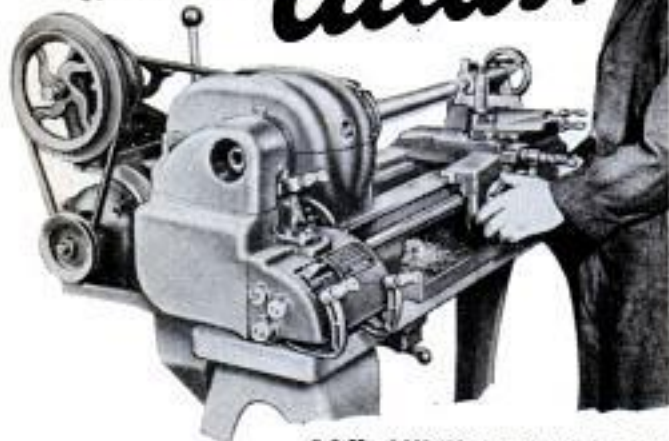

10" QUICK-CHANGE LATHE

For experimental, development and hobby work . . . or small parts production, ATLAS Precision Lathes give you many more important features that increase accuracy, speed production and cut costs than any other lathes in the lower price field!

They're the only low-cost 10" and 6" lathes to give you the precision and dependable service of Timken Tapered Roller Bearings! The ATLAS 10" Quick-Change Lathe (illustrated above) with instant selection of 54 threads or feeds, instantly reversible power cross and longitudinal feeds, 16 spindle speeds, V-Belt drive, massive precision ground bed, 5 3/4" swing over carriage and 4 to 240 threading range assure you for greater ease and speed of operation, and a much wider work range than any other lathe at or near its low price!

A feature by feature comparison will be a revelation to you! Before you buy, see your nearest ATLAS Dealer . . . use coupon below for latest catalog.



TIMKEN TAPERED ROLLER BEARINGS



QUICK-CHANGE GEARS



HEAVY-DUTY PRECISION GROUND BED



ATLAS 6" - 10" **\$145⁰⁰** F.O.B. Factory
 LATHE PRICES START AT

DEPENDABLE QUALITY TOOLS SINCE 1911

SEND FOR FREE CATALOG

ATLAS PRESS CO., 2-24 N. Pletcher St., Kalamazoo, Mich.
 Please send latest information on ATLAS Tools.

10" Lathe; 6" Lathe; Drill Press;
 Miller; Shaper; Grinder-Hone

NAME _____

ADDRESS _____

CITY, STATE _____

this year. Nash and Hudson have had unitized construction, similar to that used in many European cars, for years. Chrysler puts disk brakes on its big Imperials.

You shouldn't get the idea that European cars are perfect. Anyone who has owned one knows that many minor details are poorly done (and it is in this department that our American cars excel). Light switches sometimes act up, heater and defroster motors are often noisy, door locks balk at times. But these minor points are not our concern here. In the big things, the major engineering, Europe's cars do offer a challenge our domestic products cannot ignore. ★ ★ ★



Insulating Spray

Mineral fibers and binders can now be sprayed onto walls and ceilings to form a lightweight insulating blanket 1/4 to 1 1/2 inches thick. The new surface slows heat transfer, deadens sound, fireproofs and solves condensation problems. The mineral fibers, in combination with a water mist, are applied with a spray gun after the walls are coated with an adhesive spray. A light tamping to attain correct density follows. If desired, the resulting surface can be painted or given a textured appearance with a finishing coat. The material can be applied to any clean, rigid surface such as metal, plaster, wood or concrete. It is said to be permanent and crackproof.

Ⓞ Lumps of ore up to eight inches long and weighing 10 pounds each are carried along by a high-pressure stream of water in a newly developed, abrasion-resisting rubber hose used in mining and refining.

Home "Fix-it" Tips



Plastic Wood permanently repairs furniture, replaces rotted wood, and fills knot holes and gouges. Apply it like putty—it hardens into real wood.

YOU NEED "PLASTIC WOOD"

7 PC. SCREW DRIVER SET

GENUINE "OXWALL"
GET ACQUAINTED OFFER

You can have an individual full-size screwdriver for every type of screw—including Phillips. All six screwdrivers are tempered, oil hardened, tool steel blades with flameproof, shockproof amber handles. They are heavily magnetized to pick up and hold screws. This is a \$4.85 value and each set carries an unconditional written guarantee. **ONLY \$1.00**

FREE metal wall rack is yours for prompt action.

Kindly add 25c for postage and handling. Order yours today and avoid disappointment. No C.O.D.'s.

MONEY BACK GUARANTEE

ECONOMY SALES

Dept. 1-P, 1710 68th Ave., Philadelphia 26, Pa.



BUILD OR BUY ARC WELDER

DUNBAR'S Build-Your-Own PLANS show you how to build a 300 amp. DC Welder the easy way using Aircraft Generator. Our **FREE** Big Catalog listing 1500 items also lists 3-low-priced DC Welder Kits you can assemble in few minutes. Send 10c today for Complete PLANS. Catalog included.

DUNBAR MFG. CO. 6600-DW Sylvan Road Houston 23, Texas

FREE BOAT KIT CATALOG 8' to 14' Models from \$39.95 incl. freight

- Assemble your own boat
- No experience necessary
- Save 1/2 to 2/3 "factory built" prices



12 ft. Runabout Pictured.

Write: Marine Hardware, Fiberglass, & Trailers

LUGER INDUSTRIES DEPT. 5 4432 NICOLLET AVE. MINNEAPOLIS 9, MINN.

WONDER DRILL SAW BIT



DRILLS OWN STARTING HOLE

Combination bit for electric drills. Use as a drill, saw or reamer. Use for circles, ovals, squares, inside, hard-to-reach work. Works equally well in metal, pipe, wood, plastic, etc. Easy to use. Every carpenter, mechanic, electrician, plumber, hobbyist needs one. Made of abrasive resistant, hi-speed steel. Stands severe, continuous use without breaking. Resharpener free. Use with electric drill, slow drill press, lathe or milling machine. 1/2" diameter, 2" cutting section, total length 3 1/2". 3 types—wood, metal or all purpose. Set of 3, \$5.75. Details on request. Dealer inquiries invited. Money Back Guarantee. Shipped same day. Send check or money order to

WONDER DRILL COMPANY

Box 8321, Dept. PM 2

Kansas City 5, Mo.

Now only \$1.95

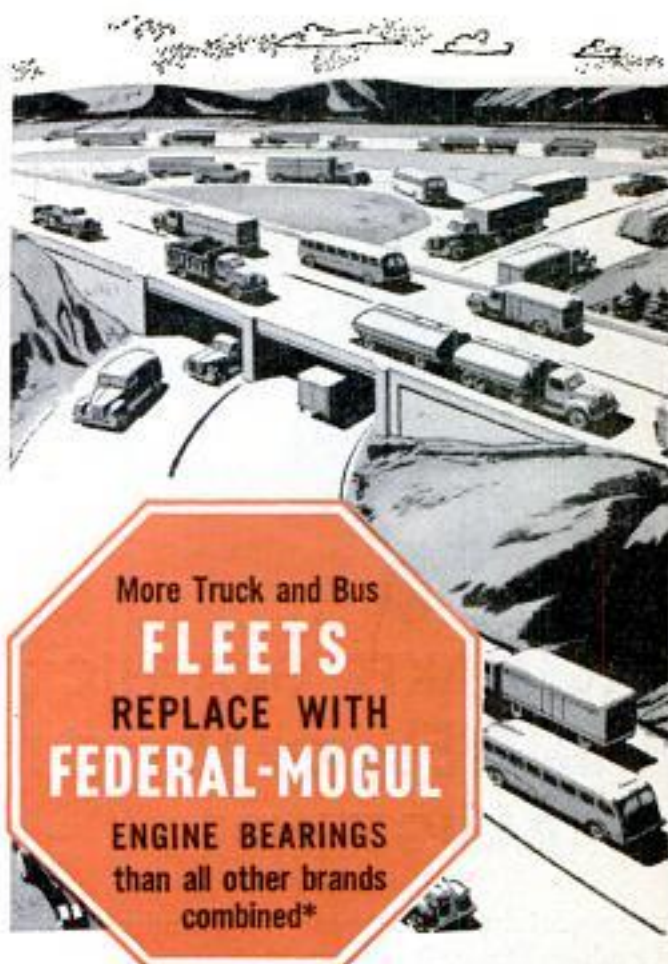

More Truck and Bus
FLEETS
REPLACE WITH
FEDERAL-MOGUL
ENGINE BEARINGS
than all other brands
combined*

To restore Full, Clean Power in Your Car do as the Fleets do . . . replace with Federal-Mogul Bearings

*The men who run America's great truck and bus fleets know how to recondition engines for best results. For example, a recent independent industry questionnaire, involving 83,360 trucks and buses, disclosed this fact: 66.7% of the vehicles surveyed get Federal-Mogul engine bearings as *first choice* for replacement. Do as the experts do! In reconditioning your car engine, install Federal-Mogul Oil-Control bearings. They restore full, clean power, pick-up and economy! They cost no more, yet have led the replacement field for 30 years . . . because of quality! Federal-Mogul Service, Division Federal-Mogul Corporation, Detroit 13, Michigan.

for New Power . . .

FEDERAL-MOGUL
Oil Control Bearings

BEARING MANUFACTURERS TO THE AUTOMOTIVE INDUSTRY SINCE 1899



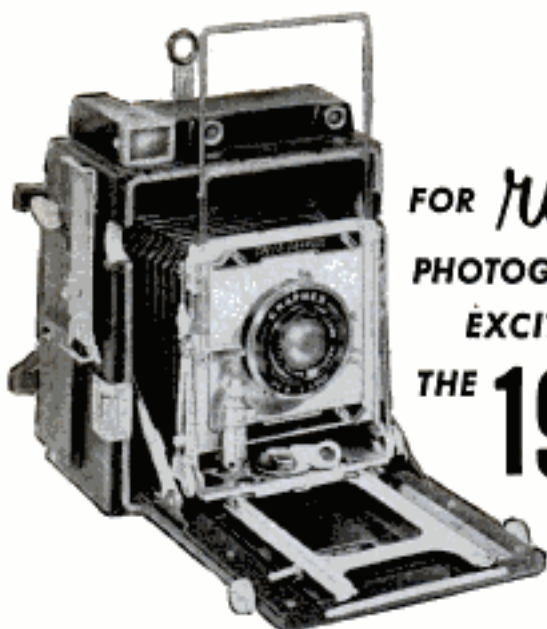

FOR *real*
PHOTOGRAPHIC
EXCITEMENT
THE **1955**

PACEMAKER GRAPHIC® with NEW GRAPHIC® RANGEFINDER

- Completely new Graphic Rangefinder with built-in Rangelite for night focusing.
- Light-weight, impact resistant . . . rangefinder housing is independent of mechanism.
- Interchangeable cams for interchangeable lenses are quickly coupled to rangefinder. Cams are stored on inside of each lens-board.
- Rangelite is self-powered for use with all types of flash including B-C and electronic.
- Optical viewfinder has built-in automatic parallax correction.

NEW FLEXIBLE WIRE FRAME FINDER

Stainless spring steel, full image wire frame finder. Withstands shocks and other sharp impacts without danger of changing front standard alignments.

ASK YOUR GRAFLEX DEALER FOR DEMONSTRATION OF THE 1955 PACEMAKER GRAPHIC OR WRITE DEPT. PM-25 . . . ENTER THE 1955 \$10,000 GRAFLEX PHOTO CONTEST.

GRAFLEX®

Prize-Winning Cameras

ROCHESTER 8, NEW YORK

What Does it Cost to Own a Car?

(Continued from page 153)

If you drive less than the average of 11,000 miles a year, these costs will be proportionately higher. If you drive more, they will be lower. The more you use the car, the more miles you get for your dollar.

Study the charts at the bottom of page 150 and you will see how much of the total bill is in fixed costs. By the sixth year, fixed costs have dropped to 53 cents out of each dollar, but at no point in the six-year study do they amount to less than half.

Figured by the mile, car costs are even more enlightening. In their first year, the low-price models averaged 10.4 cents a mile (and this does not include financing charges). Medium-price cars averaged 12.6 cents a mile and high-price cars, 16.0 cents a mile.

At no other point during the six-year study did the cost per mile of low-price cars equal that of the first year. This would seem to indicate that it is never cheaper to buy a new car than to have your old one repaired—at least not for the first six years. In the other two price classes, however, costs per mile did exceed the first year's during later years (see chart, bottom of page 151).

To compare the cars in the three price brackets, look over the chart on page 152. There is no great variation in how each dollar is spent. However, the total spent did vary considerably as mentioned previously (chart at bottom of page 152).

Owners in the survey who averaged under 5000 miles a year had the amazing cost of 26.4 cents per mile. In contrast, owners driving over 20,000 miles a year spent only 6.9 cents for each mile (see chart, top of page 153). But even for the 20,000-mile driver, the biggest single cost per mile was depreciation. It amounted to 2.9 cents per mile, while gasoline costs were only 1.9 cents per mile.

So if you decide to cut costs by leaving your car in the garage, you won't save much. You get more for your dollar by using your car more—even though it costs money to do it!

Here are some other interesting points brought out by the survey:

- Generally, the low-price cars cost less in repairs than high-price cars, even when five or six years old. You probably won't save anything by buying a high-price used car rather than a low-price model—the big cars seem to wear out as fast as the smaller ones and they cost more to repair when they do.

- Even when new, the high-price cars

(Continued to page 300)

SMALL INVESTMENT PUTS YOU IN GOOD PAYING BUSINESS OF YOUR OWN

Sharpen Lawn Mowers in Spare or Full Time at Good Profits

Thousands of men are earning big money, both spare and full time, in this fine business. You can be just as successful. Starting in your garage or basement, only a small investment will bring you the best lawn mower grinder money can buy, which will enable you to earn a substantial income in a business all your own, without additional equipment. The new Model "B" Universal Lawn Mower Grinder is a precision machine designed and built to sharpen both power and hand mowers with a minimum of effort and time.

The Universal is the only lawn mower sharpener in the world that allows you to grind both bed-knife and reel blades . . .

IN A SINGLE SET-UP WITHOUT REMOVING THEM FROM THE MOWER.

If you are now working, start this profitable business in spare time. Keep your present job until you develop a full-scale business of your own. Be your own boss like Mr. B. of California, who writes: "The lawn mower grinding business with my Universal Grinder has been a gold mine these last two years." Mr. C.H.R. of Ohio writes: "This season, I have taken in \$3,688.20." If you are 15 years of age, or older, and you want a good-paying business of your own with a sound financial future, or if you want to improve your financial status with a spare or full time occupation, the Universal Lawn Mower Grinder, with complete operating instructions, can be your answer.

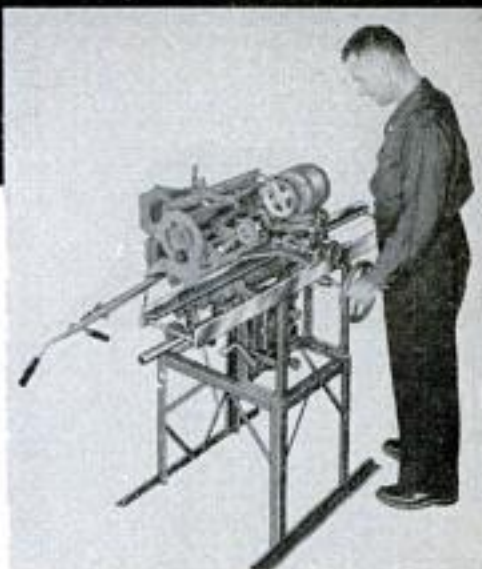

SEND THE COUPON BELOW
for FREE information.

ROGERS MANUFACTURING CO.

Dept. M-25, Lindsey, Ohio

Gentlemen: Please rush me details about the profit possibilities of the Universal Lawn Mower Grinder.

NAME _____

ADDRESS _____

CITY _____

STATE _____

ROGERS MANUFACTURING COMPANY
LINDSEY, OHIO, U.S.A.

POWER HACKSAW \$55.75

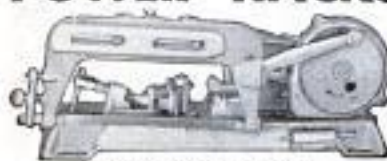

Send for full details and name of nearest dealer.

LESS MOTOR

F.O.B. Benton Harbor

● Rugged cast iron construction. Wt. 56 lbs., bronze bearings. Draw cut. Auto. return lift. Auto. shut-off. Vise swivels 45°. Cap. 4"x4".

EXCEL MACHINE TOOLS BENTON HARBOR, MICHIGAN Dept. PM-25

Also Eshelman Sport CARS LOWEST PRICE

70 Miles Per Gal. Holds 1 Adult Free Catalog.

RAKES
PLOW
CULTIVATES
HARROWS
HAULS
SPRAYS
SAWS
DOZER
MOWS
CUTS
ROLLS
TILLS
SNOW
FLOW

ESHELMAN



1 to 8 H.P. Also Walking Tractors Low as... \$69

FOR Better LAWNS And GARDENS

Women can operate it. Free Catalog. Write **ESHELMAN**, Dept. R-52, 109 Light St., Balto 2, Md., 333 N. Michigan Ave., Chicago 1, Ill., 7070 Hollywood Blvd., Los Angeles 28, Calif.

FREE WOODWORKERS SUPPLY CATALOG

80 ILLUSTRATED PAGES

of information and low prices on hardwood plywood in full sheets or cut to size, veneers and hardwoods. Plus complete listings on glues, cabinet hardware, furniture trim, lamp parts, metals, finishing materials, tools and other helpful information for the home craftsman.

WRITE FOR FREE COPY TODAY

MINNESOTA WOODWORKERS SUPPLY CO.
1713 OLSON HIGHWAY MPLS. 5, MINN.

Give your CAR a
"MIRROR"
FINISH
in Minutes

Finish Wood, Metal,
Stone, Plastics, Too . . .

with



MODEL
"300"

OSCILLATING ELECTRIC MOTOR-DRIVEN Sander-Polisher

\$33.75

Smooth electric power takes the place of "elbow grease" when you polish your car with the new JTC Model "300" Oscillating Electric Sander-Polisher. You'll get a high-gloss "mirror" finish—with no messy "swirl" effects—in 74% less time, 95% less work!



- ★ Ball bearing construction throughout ★ Direct drive (no belts or gears to wear) ★ Light in weight
- ★ No motor brushes ★ 1,450 RPM ★ UL approved



See it at your tool dealer before you polish your car again!
Polishing Kit includes: Sponge Rubber Contour Pad, Lambs Wool Pad, \$4.95

"The Sander Used Most Extensively by Tool Rental Services"

Write to Dept. PM-10 for FREE booklet "Sanding Tips"



JUNIOR TOOL COMPANY
Mfrs. of Electric Motor Specialties
975 W. First St. • Azusa, California

BUILD YOUR OWN POWER TOOLS - GIL-BILT WITH PARTS KITS

Exclusive GIL-BILT Build-It-Yourself Features

- No machining—build easily with hand tools only
- No blueprint reading — step-by-step pictorial plans, full scale patterns, actual photographs
- Sturdy wood, aluminum and steel construction
- Capacity and performance of commercial saws selling from \$80 to \$250.
- Proved performance. Nationally advertised and sold for 7 years. Satisfied customers around the world.

GIL-BILT 10-in. TILT/ARBOR SAW



- 27x28 in. table, 13 1/2 in. capacity in front of blade
- 10 in. blade cuts 3 1/4 in. deep, tilts full 45 degrees
- Floor model 34" high, table always stays level

- New Departure ball bearing arbor, 3/4" precision shaft turned down for 3/8" bore blades, alum. housing, shipped ready to run
- Jackscrew and 4 1/2 in. dia. handwheel lowers and raises blade
- Cast aluminum miter gauge and self-aligning rip fence guide

GIL-BILT Metal Parts Kit includes Plans, ball bearing arbor, miter gauge and bar, rip fence guide, dado insert, lock knobs, jackscrew mechanism and handwheel, and all other metal parts (less blade) \$22.95

Same Kit with 10" Combination Blade \$25.90
Same Kit with 8" Combination Blade \$24.90

WITH PARTS KITS
PLANS ONLY \$1.00 EACH POSTPAID

GIL-BILT 12-INCH BAND SAW

Ball bearing drive, rigid cast aluminum wheels, rubber tires. Handles stock up to 6 inches thick. Cuts to center of 24" circle. • 18 x 18 inch tilt table.

Capacity and performance of band saws selling for \$80 and up. Plans and all metal parts in kit with 1/4" blade \$23.95.



GIL-BILT 18" BAND SAW

Ball bearing drive, rigid cast aluminum wheels, rubber tires. Cuts to center of 36" circle, tilt table. Capacity and performance of band saws selling for \$270 and up. Plans and all metal parts in kit with 1/4" blade \$37.95.

GIL-BILT BELT SANDER

Driver drum and pulley turns on sealed New Departure ball bearings. Belt operates in either vertical or horizontal position. Tilt table. Capacity and performance of sanders selling for \$45 and up. Plans and all metal parts in kit with rubber tires and cloth sanding belt \$16.95.

With GIL-BILT simplified plans, you build easily with hand tools only. Advertised and sold for 7 years. Thousands in use the world over.



ALSO AVAILABLE
Plans & Parts Kits for Spindle Shaper, 8-in. Tilt-Table Saw

Return Kits in 10 days for refund if not satisfied. For shipments up to \$50 value, add 5%; over \$50 add 10%. Assorted tax rates of actual postage will be refunded. Order Kit now, or order Plans at \$1.00 each and Kit later less cost of plans. Write for FREE Catalog.

GILLIOM POWER TOOLS DEPT. 80-B, LAMBERT FIELD ST. LOUIS 21, MISSOURI

Say You Saw It in Popular Mechanics

WELD IT YOURSELF! IN A JIFFY!

Weld, Cut, Braze, Solder IRON, STEEL, BRONZE, BRASS, ALUMINUM & OTHER METALS

Tool and Equipment breakdowns are always annoying and costly. Don't let them bother you. Get a Dynamic Arc Welder. You can do expert work on your very first job. Welders operate from any properly wired 110 V. AC line. Also make your own wrought iron furniture, railings, fences & knick-knacks. Repair fenders, & bodys, etc. with the handiest "tool" in your workshop. A Dynamic Welder will pay for its low cost of \$38.50 F.O.B. in both time and money.

DYNAMIC INDUSTRIAL type transformer Arc Welder 75 amp. output for industrial or Workshop use.

DYNAMIC WELDER CO.
Dept. D2-B, 1808 S. Federal Chicago 16, Ill.

EASY PAY PLAN
Low down payment. Pay as you weld. Sold on money-back guarantee. Send for details. Complete outfit only
\$38.50
f.o.b. factory



Free Details and "How to Weld"

cost more for repairs than the low and medium-price models. The average high-price-car owner spent \$81.16 for repairs during the first year. The medium-price-car owner spent only \$26.49; the low-price owner, a mere \$13.81. Of course, some of this spread may be due to the fact that high-price-car owners are more critical—and can afford to be. But even allowing for that factor, the figures seem to favor the cheaper cars.

• There doesn't seem to be any point in the annual-cost scale where it is "right" to trade. Apparently, the longer you own a car, the less it costs you per year—through the six-year period of our survey, at least. Repair costs did increase during the period, but not drastically. And the drop in annual depreciation more than offset the increase in repair bills.

• The make that gave the biggest bargain in costs, as reported by the owners, averaged 8.9 cents a mile. The most expensive make as far as costs are concerned averaged 21.3 cents a mile. So that's the spread you can figure your costs within if you drive between 5000 and 15,000 miles a year—from 8.9 cents to 21.3 cents a mile.

• Most owners are amazed to find out how much it does cost to own a car. Almost all stated that manufacturers should do something to reduce this cost.

They were asked to select the things they would be willing to give up in order to lower costs. These are what they would give up: Top speed (59 percent would get along with less if it would cut costs), annual style changes (56 percent would do without this), de luxe trim (52 percent), horsepower (48 percent), over-all size (35 percent), automatic transmission (33 percent), acceleration (19 percent) and interior space (a mere 7 percent would sacrifice roominess for lower costs).

• The most frequent single-cost complaint of the owners was insurance rates. Many of them asked why their rates keep going up when they, themselves, have never had an accident. Many suggest some sort of a refund of premiums to owners who drive all year without an accident.

Altogether the survey proved some interesting points about automobile costs. A careful study of the charts that illustrate this article will provide the reader with a clear picture of where a large chunk of his money goes each year. With more and more people buying new cars, with more families moving into the two-car category, with cars becoming larger and having more "extras," it is apparent that the public has decided that the cost is worth-while. It is up to each owner to decide for himself, of course.

GIVE YOUR CAR THE SAME MIRACLE POWER TUNE-UP AUTO ENGINEERS DO!

Modern engines need more lubrication than even premium oils can give. Auto engineers themselves tune up their engines with Miracle Power.

Even new cars can develop sticky valves, noisy hydraulic valve lifters, and sluggishness. That's because engines get as hot as 1400°F, oils burn at about 550°F, and oil can't lubricate after it's burned.

But Miracle Power *always* provides lubrication. You pour it in your gas and oil, and the colloidal synthetic graphite it contains is carried to every part of your engine. The graphite forms a breath-like protective lubricating film on all metal surfaces. The film impregnates metal as butter does bread. It won't burn or drain off, and it doesn't build up on itself. It protects even in those vital five minutes after

you start your car... when oil is still being pumped from your crankcase.

Car makers recommend Miracle Power



Miracle Power is the only product of its kind approved by and specially packaged for important car makers and their dealers—Ford (shown here), Kaiser, Willys. It has to be good.

Prove it yourself. Add an 85c-can to your oil and gas every 1000 miles; use the 39c-size in gas between treatments. Your valve troubles will disappear, you'll burn less oil, your car will start like a breeze even on cold mornings, and your engine will deliver everything it's got.

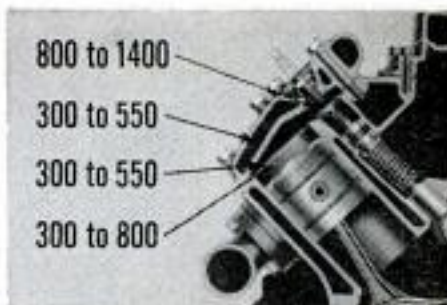

Oil burns at 550°F, but engine heat rises to 1400°F. You need more than oil to lubricate your engine. You need Miracle Power—which always lubricates and won't burn away!

Follow the lead of auto engineers. Get Miracle Power at car dealers, garages, service stations. It treats the engine, not the oil.



THE AP Miracle Power Division
PARTS CORPORATION
 AP Building Toledo 1, Ohio
 Mufflers • Pipes • Miracle Power • dgf 123

<p>Also Eshelman SPORT CARS WORLD'S LOWEST PRICE 70 Miles Per Gal. Holds 1 Adult Free Catalog.</p>	<p>ESHELMAN FOR BETTER LAWNS and GARDENS</p> <p>1 1/2 3.6 H.P.</p> <p>Also Power Reverse. Women can operate it. Free Catalog. Write: ESHELMAN, Dept. W-52 109 Light St., Balto., Md. 333 N. Michigan Ave., Chicago 1, Ill. 7070 Hollywood Blvd., Los Angeles 28, Calif.</p>
------------------------------------------------------------------------------------------------------------------------------------	---------------------------------------------------------------------------------------------------------------------------------------------------------------------------------------------------------------------------------------------------------------------------------------------------------------------------------------

RAKES
 PLOWS
 CULTIVATES
 HARROWS
 HAULS
 SPRAYS
 SAWS
 DOZER
 MOWS
 CUTS
 ROLLS
 TILLS
 SNOW PLOW

Low as \$69 Plus Tools

MAGNETS

ASSORTED MAGNETS with big list of handy uses.....\$ for \$1
POWERFUL POCKET MAGNET ideal for testing metals.....\$1
RETRIEVING MAGNET pulls tools, etc., from tank or lake.....\$4
HOT PAD MAGNETS to insert in your own hot pads.....8 for \$1
BULLETIN BOARD MAGNETS to "pin-up" memos, etc.....8 for \$1
SLENDER MAGNETS remove chips from drill holes.....2 for \$1
 Write for free booklet. 100% satisfaction guaranteed.....**POSTPAID**
PARK MAGNETS, PM-2, 1557 GREENBAY RD., HIGHLAND PARK, ILL.

CLING-SURFACE V-BELT DRESSING

can SAVE you many dollars in

★ A few drops of Cling-Surface SERVICE BILLS!

stops squeaking and slipping belts on washers, driers, refrigerators, water pumps, home power tools, air compressors, power lawn mowers, furnace blowers, garden tractors, etc. If your dealer can't supply you

Send 50¢ to: **CLING-SURFACE CO.**
 1047 Niagara St. Buffalo, N. Y.
 Canada: send 75¢ to **CLING-SURFACE CO.**
 243 College St. Toronto 2, Ont.



Lasting REPAIRS take only a few minutes



Smooth-On No. 1 does these and dozens of other repair jobs in a matter of minutes.

It's an iron cement that expands and hardens like metal. Use it for tightening loose screws, anchoring bolts in concrete, resetting wobbly furniture parts, stopping leaks in pipes, boilers, and home or auto radiators. Smooth-On Repair Handbook is yours free on request. Ask at your hardware store, or write us. Dept. 37

SMOOTH-ON MANUFACTURING COMPANY
 572 Communipaw Avenue, Jersey City 4, N. J.

SMOOTH-ON

FEBRUARY 1955

301

Strongest Extension Rule EVER DESIGNED

The 996X GUARDSMAN

To retail at \$2.00

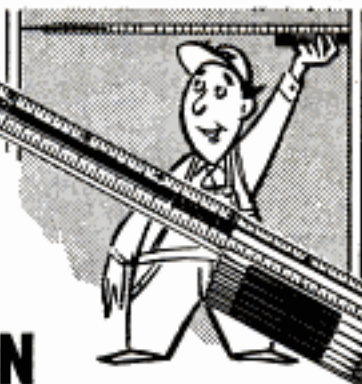

Here is the strongest most practical wood rule ever designed! New aluminum extension slide is 3 times stronger than old style brass slide. . . . Black anodized finish with bright silver figures and graduations makes the 996X rust proof, easier reading. . . . Quality straight grain white maple "thick sticks" and exclusive Master spring joint give you the strength, and sweet joint action, a craftsman wants in a wood rule. Ask your hardware dealer about the Guardsman 996X Extension Rule today. It's unconditionally guaranteed for 6 months.

MASTER

MASTER BROS. MFG. CO. INC. Middletown, New York

WOOD AND STEEL TAPE RULES

new Uranium Detector GEIGERSCOPE

\$5

PROFESSIONAL MODEL



Check mineral specimens for uranium with this amazingly sensitive, inexpensive optical radioactivity detector. FOR PROSPECTORS, ENGINEERS, HOBBYISTS, everyone interested in atomic energy. Thousands used in field, labs and mills. Durable, portable as pocket watch; needs no power source. Complete with uranium ore sample. Radium standard. Weatherproof holster. Complete instructions. UNCONDITIONAL GUARANTEE.

ATOMIC PROSPECTOR'S HANDBOOK

\$1

Valuable data on radioactive ores, field, lab and mill methods, and map. Everything you need know about this vital new field! Send for Handbook or Geigerscope separately. . . . better yet, order both today!

We Pay Postage

KEN RESEARCH

Sales Dept.

681 MAIN STREET • HACKENSACK 15, N. J.

\$6.95 DRAINS cellars, cisterns, wash tubs; IRRIGATES - CIRCULATES - SPRAYS



Submersible! Won't Rust! Won't Clog!
Original Type P—"Pump of 1,001 Uses"—house, garden, farm. Up to 3,000 GPH; 450 GPH 80' high; or 1800 GPH from 25' well. Use 1/8 to 3/4 HP motor. Motor coupling included. Oil-less bearing. Stainless steel shaft. 1" inlet; 3/4" outlet. \$6.95

Exclusive Double-Bearing Heavy-Duty Pumps

TYPE X—2 oil-less bronze bearings for smoother running; longer life. For every pumping need. Up to 7,500 GPH. Use 1/4 to 1 HP motor. 1 1/4" inlet; 1" outlet. Stainless steel shaft. **\$1095**

TYPE XB—Same as Type X, but with grease-sealed outboard rubber-mounted ball-bearing plus oil-less bronze bearing. Best for belt drives. **\$1295**

ALL BRASS JET for SHALLOW to 50' DEEP WELL. Up to 50 lb. pressure. Ideal for water systems, sprinkling, etc. Use with X or XB Pump. **\$595**

Postpaid if cash with order. (West of Miss., add 50c)

MONEY BACK GUARANTEE
Centrifugal and Gear Pumps in all Sizes

LABAWCO PUMPS, Belle Mead 2, N. J.

New Parallel Clamp



Faster adjustment. Hardened Jaws & Spin Nuts. Greater capacity. Jaws open full six inches. Throat reach 4 1/4", 5 1/4" & 6 1/4".

4 1/4" — \$4.75 ea. Pr. — \$9.00
5 1/4" — \$5.25 ea. Pr. — \$10.00
6 1/4" — \$5.75 ea. Pr. — \$11.00

A must for the Tool & Die Maker. Fine for Wood Working. Postpaid, send Check or Money Order to

ESSANER PRODUCTS
Box 71, Spring Arbor, Michigan
Money refunded if not entirely satisfied

BATTERIES!—START

—a factory at home and re-cast junk batteries into new; latest achievement. We supply complete instructions and everything needed. Large daily profits!

BATTERY LABORATORIES, Dept. PM, Minneapolis 4, Minn.



BUILD Your Own GARAGE



Save Up to 50% of Usual Cost!

Build your own garage and save! Wayne Leckey, Popular Mechanics Assistant Shop Notes Editor, tells and shows how in his new book *How to Build Your Own Garage*.

No Previous Building Experience Required

If you can use a hammer and a saw you can build your own garage. Leckey tells how in simple step-by-step instructions and shows how in big, clear photos, drawings and diagrams. Everything is covered from the laying of the foundation right up to and including applying the final trim.

25 Designs—Brick, Frame and Concrete Block Construction. Complete Building Data

There are 25 different designs from which you may choose. Brick, frame and concrete block construction is fully covered. Leckey tells and shows how to pour the foundation, erect the framework, erect the roof, apply insulation and shingles, lay the driveway, install trim, flower boxes, etc. It's all there for you to read and see.

7-Day Money Back Guarantee

Get your copy of this valuable book today. Read and use it for seven days and if it isn't entirely satisfactory return it for a full refund. Send only \$3.50 for your copy to

Dept. 90
POPULAR MECHANICS PRESS
200 E. Ontario, Chicago 11, Ill.

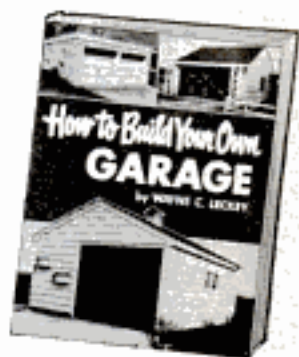

A NEW DO-IT-YOURSELF IDEA

SAVE
UP
TO
50%

follow easy instructions INSTALL YOUR OWN HEATING SYSTEM

Engineer-Designed, for new or old homes. Choice 3 nationally advertised gas, oil or coal furnaces, everything complete — nothing else to buy. Includes step-by-step instructions. Thousands already installed. Unit for 2 bedroom home only \$195.00.

Valuable franchise territory available.

PACKAGED COMFORT HEAT inc.

1495 WARRENSVILLE CENTER ROAD • CLEVELAND 21, OHIO
originators of PACKAGED COMFORT HEATING SYSTEMS



WRITE FOR ILLUSTRATED CATALOG

MONEY for MEN ALL DATA FREE

THE PLASTEX Industry needs manufacturers on small scale and for big production of Lamp and Clock Stands, Art Goods and Novelties in Plastex and Marble imitation. Experience unnecessary. Use material makes regular 10c store sellers. Rubber moulds furnished for speed production. Small investment brings good returns. We are now placing big Chain Store orders with manufacturers. Ambitious men have chance for real prosperity. Our Free booklet will interest and benefit you.

PLASTEX INDUSTRIES, Dept. A
3400 Third Ave. New York 56, N. Y.

THE BEST
IN PLIERS?

CHAN NEL LOCK

CHAMPION DEPARTMENT TOOL CO., MEADVILLE, PA.



ELECTRIC WELDER AC or DC 110 Volts

The "Little Marvel" all-metal welder, 5-year written guarantee. Welds 1/8" metal or money back. Repairs tanks, tools, fenders, machine parts, etc. Complete with everything — rods, unit, eye shield, directions. \$6.45

plus 50c postage. Flame torch accessory for soldering, cutting, brazing \$3.95 complete with carbons, brass rods, flux. \$2.00 Deposit on C.O.D. 1/4 inch Transformer Welder \$19.95 F.O.B.

ESSAY MFG. CO., Dept. 51, Quincy 69, Mass.

\$6.45
Com-
plete

Wheel-Horse garden tractors

Reg. U. S. Pat. Off.

2 1/2 or 3 1/2 h.p.
pulls 8"
plow



only
\$275

You can't beat a Wheel-Horse for trouble-free performance... mighty pulling power... amazing low price! Pulls 8" plow. Big "traction-master" wheels. Smooth-running 2 1/2 or 3 1/2 h.p. engine. Five speeds. Reverse. Fifteen attachments. Guaranteed!

Wheel-Horse Products Co.

Dept. P-2, 2643 Dixieway North, South Bend, Indiana

A New Workshop Idea!

5 full size power tools
1 motor runs them all!

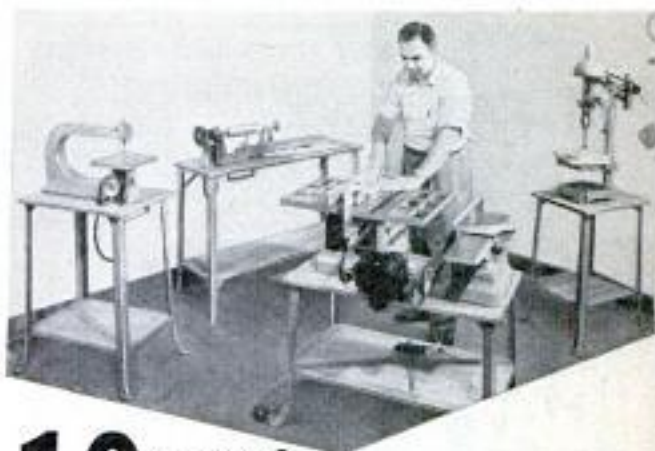

10 second motor changeover!

Think of it, 5 full size, professional quality, individual power tools—all operated from a single motor and priced to fit any budget! The secret of this revolutionary power tool idea lies in an exclusive Duro development—the "quick change" motor mount. It permits you to bring the motor to each tool—quickly, easily—in a matter of seconds! You can now do woodworking the correct, safe way, at convenient heights, without interference from other tools. All units remain preset for immediate operation. There's no need for repeated knocking down and setting up, making adjustments, changing guides, attachments and cumbersome tool positioning.

Build Your Shop A Unit At A Time

The Duro Master workshop can be started with any single unit or combination of units to suit your need and budget. You buy only what you need when you need it. You can begin your workshop with a drill press, sander, circular saw, jig saw, or any combination of tools. Each unit can be equipped with the "quick change" motor mount and is operated with same motor.



Send for FREE 16 Page Catalog giving full details, specifications and prices on the DURO MASTER WORKSHOP.

DURO METAL PRODUCTS CO.

2656 N. Kildare Avenue • Chicago 39, Ill.

Gentlemen: Please rush me your FREE 16 page booklet on the new DURO MASTER WORKSHOP.

Name.....

Address.....

City and State.....

My dealer is:.....

BOAT KITS

OVER 60 MODELS for 1955

Inboard or outboard—Dinghies to cruisers—8-21'—World's most complete line of real performance boats. Advanced design—modern styling—finest materials—easier to assemble! \$49.50 up.

SEND 35c for 1955 CATALOG

40 pages — includes hardware, paint, fittings, trailers, Armor-Glass, etc. **SPECIAL OFFER:** Catalog plus valuable book "Boat Selection, Operation, Maintenance" \$1.00.

(DEALER INQUIRIES INVITED)

NEW SUPER-XXX FIBERGLAS

Permanently leak-proof your boat! End annual painting and caulking forever! Easy to apply on any boat. Hundreds of uses. **SEND 10c for FOLDER** and measuring chart or send \$1.00 for folder, chart and TWO valuable booklets: "How to Use Armor-Glass" and "How to Build Fiberglass Boat or Auto." **PATCH-REPAIR KIT: \$5**—includes generous supply Fiberglass plus plan for tool or tackle box.

(DEALER INQUIRIES INVITED)

OVER 150 MODERN PLANS with FULL-SIZE PAPER PATTERNS

Build your boat the modern way—the easy way, with Custom-Craft patterns. Save time-money. Material lists, building procedure included. Racing classes—cruisers—inboards—outboards—sailboats, etc. 6-36'—plywood or planked. **SEND 35c for DESIGN CATALOG** or send \$1.00 for design catalog plus boat building handbook . . .

CUSTOM-CRAFT • DEPT. 7 • BUFFALO 7, N. Y.

ARMOR GLASS

BOAT PLANS

CUSTOM-CRAFT • DEPT. 7 • BUFFALO 7, N. Y.

THE NEW DALTON Model D-500 ELECTRIC PORTABLE JIG SAW

7 SAWS IN ONE!

does the work of a RIP . . . CROSS CUT . . . COPING . . . JIG . . . SCROLL . . . BAND and KEYHOLE SAW CUTS ANY MATERIAL! SAWS ANY SHAPE!

RIPS and CROSS CUTS 2x4's

Makes fast, smooth cuts . . . no jumping or chattering. Has the capacity to rip and cross cut 2 x 4's. The only other similar type device on the market that can match this amazing performance costs almost three times as much!

Specially built Dayton motor assures smooth, steady cutting. A built-in compressor blows sawdust away from guide line.

SPECIFICATIONS

• 4 to 1 gear reduction. • All gears hardened steel. • Motor exposed for cool running. • Oilite bronze bearings. • Air is pumped from top down through the center section, cooling unit as well as blowing sawdust from line.

IT CUTS wood — plastics — metals — composition boards — hard rubber and others.

IT SAWS circles — curves — straight lines — intricate designs.

Complete with 5 different blades

\$48⁰⁰

SHIPPED ON APPROVAL
NO MONEY WITH ORDER — NO C. O. D.

Try it ten days before you buy. If completely satisfied then send \$15.00 and pay balance at rate of \$11.00 per month for 3 months — No Interest or Finance Charges Added. If not completely satisfied, return to us, no explanation necessary.

KAPNER HARDWARE, INC.
Dept. A-128, 2248 Second Ave., N. Y. 29, N. Y.

Please rush one D-500 Jig Saw. I agree to pay \$15.00 within 10 days after receipt and \$11 per month thereafter.

Name _____
Address _____
City _____ Zone _____ State _____

NEW . . . SENSATIONAL! 6 IN 1 THREADING DIE HOLDER

Now . . . Perfectly straight threads without tool cutting. New "HANDY SIX" die holder in precision made and will cut good, straight threads on any lathe, also adaptable for drill press or by hand.

ONLY 4.75 PPD.
2 for \$9.00



Anyone can quickly cut 1/4" to 1/2" threads, also 3/8" pipe, with the "HANDY SIX" Threading Die Holder. Made for standard 1" round dies. Easy to use in lathe, drill press or by hand. Back of holder rests against tail stock on lathe guiding die onto thread. Cuts straight threads every time, as face of die and back of holder are parallel. Made of high strength precision aluminum casting, (not zinc). Money back guaranteed.

SPECIAL Die Holder with 6 Adjustable dies, sizes and threads of your choice—\$8.75, Ppd.
SEND CHECK OR M. O. TODAY!
MOHR TOOL & MFG. CO., Dept. PM-2, Box 63, Maywood, Ill.

Heavy-Duty, High Capacity

PUMPS

Impossible to duplicate at this price . . . or money back!



FACTORY TO YOU!

- Centrifugal, all purpose water pumps
 - Brass Laundry Tubs, Cylinders & Castings, Ingalls, Ill.
 - Film Tanks, Swimming Pools
 - Easy to Install, Safe, Guaranteed
 - Chrysler Bronze Bearings
 - Up to 8,000 gals., Lifts to 100 Ft.
 - Self adjusting Automatic Seal
 - 1/2" Ground & Polished Shaft
- Send Check, Money Order or C.O.D. to
High Point Pump Mfg. Co.,
ERIAL, NEW JERSEY

SURPLUS SALE



\$39.50 NEW TOOL POST GRINDERS
REGULAR PRICE \$125.00

1-6 H. P. MOTOR
TAKES WHEELS UP TO 1/2" x 4"
EXTRA QUILL EXTENSION OR
INTERNAL \$19.50

MONEY BACK GUARANTEE
EDWARD J. NOLAN, PULASKI, NEW YORK

Save on all PLUMBING JOBS

When You Build - When Making Improvements - Repairs - Maintenance

Get POPULAR MECHANICS Home Plumbing Guide



How to save money on all plumbing jobs using approved methods.

Easy to Do Professional-Like Jobs and Save Over One-Half

Get the Popular Mechanics HOME PLUMBING GUIDE. It shows how you can do every kind of plumbing job yourself and save from a few to hundreds of dollars. Covers plans, layouts, installation, maintenance and repair. Shows what materials to get and use, where to get them and how to do a proper job with approved methods. Few, other than the simplest tools are required and

some of these can be rented. Don't pay high prices for work you can do yourself. Get the HOME PLUMBING GUIDE for only \$3.50. You will be amazed how jobs you thought difficult are simplified.

Clip This Ad and Mail. Money Back if Not Pleased

Invest only \$3.50. Use the book for 7 days. Then if you are not satisfied return it for full refund of your money. Sent C.O.D. (U.S.A. only) if you prefer.

- 15 Ways to Save Money**
All about modern home plumbing
How to use plumbing tools
Getting acquainted with pipe
Planning home plumbing systems
Installing and maintaining home drainage systems
Private sewage disposal systems
Causes and cures of drainage troubles
Installing home water lines
Private water supply systems
Water Heaters
Water Conditioning
Water system troubles and cures
Installing and caring for fixtures
What to do with valves and faucets

Over 500 How-to-do-it Pictures Guide You



POPULAR MECHANICS PRESS, Dept. HPG-10, 200 E. Ontario St., Chicago 11

READY CUT HOMES

\$2150 AND UP DIRECT FROM MILL

YOU SAVE the items which help make today's building cost expensive: high labor cost, contractor's profit and overhead, insurance, architect's fees. Cut-to-Fit eliminates usual lumber and material waste, also costly mistakes. Anyone can assemble. Simple, easy-to-follow plans furnished and each part numbered. Complete with all lumber, roofing, nails, glass, hardware, paint, doors, windows. Freight paid. Low-cost building plans sold separately if desired. 57 Homes and Floor Plans.



5 EASY PAY PLANS
COLOR CATALOG



INTERNATIONAL MILL & TIMBER CO.
Dept. PM25 Bay City, Mich.



BRONZE FOUNDRY

Schools and Home Workshops

Make your own castings of aluminum, copper, bronze, silver. Foundry sets are available in three sizes including 2400 Deg. F. blast Furnaces. \$22.50; \$29.50; and \$42.00. f.o.b. Kansas City. Free Circular.

KANSAS CITY SPECIALTIES CO. P. O. Box 6022, Dept. P-2
KANSAS CITY, MO.

CRESCENT TOOLS

Give Wings to Work

ASK YOUR
HARDWARE
DEALER



NEW DRILL PRESS STOP

Fast, effortless, positive locking, micro adjusting. Patented stop accurately set in 12 seconds with one hand. Replace the slow moving, inaccurate, poor locking stop. Use on "your" drill press in less than 1 minute.

Delta 15".....	\$3.50	Craftsman 15".....	\$3.95
Walker Turner 15".....	\$3.50	Royal 16".....	\$3.95
Atlas 15".....	\$3.95	South Bend 14".....	\$3.95

Postage paid except on COB'S. Models for other makes. Send for literature.

RICHMOND MACHINE PRODS. CORP.

Dept. M-1, 276 Rose Avenue
Staten Island 6, N. Y.

Dealers and machine tool manufacturers inquiries invited.

Viking TRACTORS & TILLERS



\$89.50
and up

1 and 2-wheel
Terms as low as
\$10 per month

Write for free catalog today!

American Farm Mach. Co., Dept. F-204
1061-33rd Ave. S.E., Minneapolis, Minn.
43 Church St., Pawtucket, R.I.

TOP SPEED For RACING or FUN



These famous AQUA-JET propellers won twice as many times in the "National Stock Outboard Championship" as all other wheels, custom built included. Inexpensive stock propellers, requiring no alteration of lower unit, each specifically engineered for motor used 5HP to 50 HP. Write for FREE 1955 catalog — the Outboarder's Bible. Shows how to get better performance from any boat and motor combination — for pleasure or racing — also fine line of boat trim. Michigan Wheel Company, Dept. P-72, Grand Rapids 3, Mich.

air-cooled
gas engine drive

"Husky Boy" arc welder

welds
anywhere

earns
bigger
profits

A small
investment
puts you
in business!



"Husky Boy"

"Husky Boy" 200 amp. welder driven by a 2 cylinder air-cooled engine. Perfect for outside or around the shop welding. Handles the big pay jobs.

200 Amp. AC Welder-AC Power Combination, four cylinder air-cooled engine. Furnishes 200 amperes of welding current and 5,000 watts of AC power alternately. Easily mounted on your truck or trailer for quickly getting to where it's needed on a moment's notice.

AC Power or AC Welder. An excellent dual purpose combination available in 200 or 300 amp. welding sizes. Can be belted or coupled direct to your own gas engine.

Transformer Type AC Welder 250 amp. A real welder for production and repair work in shops that have only single phase power available.

Investigate these money makers today!

Fill out and mail coupon for complete information on these machines—learn how they can earn bigger profits for you.



AC Power—AC Welding



AC Power—AC Welding



AC Transformer



Hobart School of Arc Welding

Learn arc welding quickly by actual on the job experience at the non-profit Hobart Trade School. Complete or partial courses. G. I. approved.

HOBART BROTHERS CO., BOX M-25
Troy, Ohio, Phone 21223

"One of the world's largest builders of arc welding equipment"

Modern Arc Welding Lessons

200 fully illustrated pages. Learn practical arc welding in your spare time... Only \$1.00.

Clip and Mail!

HOBART BROTHERS CO., Box M-25, Troy, Ohio

Please send additional data on items checked:
 "Husky Boy" AC Power—AC Welding
 AC Transformer Hobart Welding School
 Welding Lessons, \$1.00

free!

Welder's Vest Pocket Guide

NAME _____

ADDRESS _____

CITY _____

STATE _____

Make BIG SAVINGS With FACTORY-DIRECT PRICES!



COMBINATION TOOLBOX-FIELD DESK

U. S. Army surplus, 19"x20"x10 1/2" deep, 3 compartments plus drawer. Top folds up to use as desk top. Made of strong fibre. Metal fittings. Has 2 clasps plus hasp, lock and key. Carrying handle. Use as toolbox, storage, etc. \$26.00 Value . . . Only \$4.95 or 2 for \$9.00.

ELECTRIC LIGHT PLANTS

Why worry about power failure? Buy peace of mind now. It costs less than you think! You get protection for the rest of your life against power failure caused by sleet storms, hurricanes, floods or disasters. Factory-to-you prices, the lowest ever! Write today for free booklet that outlines size and type of plant needed to do your job!



ELECTRIC WINCHES—Direct-to-you Prices

1/2 HP motor gearhead driven winch with drum. Will lift 500 lbs. Pull 1100 lbs. \$98.00
 3/4 HP Electric Ball Bearing. Compact gear box. 12 RPM drum speed. . . . \$165.00
 3/4 HP, same as above. More lifting power, greater speed. . . . \$185.00
 Super-duty 3/4 HP Ball Bearing, with 24 to 1 worm gear reducer. Length 30", Width 26", Height 17". Pull 2500 lbs. Complete with 100 ft. of aircraft cable, up-and-down buttons \$245.00
 (All electric motors Heavy-Duty, Repulsion-Induction, Instant Reverse, 110 V single phase, 3 phase available).
 Complete Stock of Limit Switches, Magnetic Brakes, Magnetic Reversing Switches, Aircraft Cable

CABLE 1/4" pre-formed aircraft cable 17c ft.
 3/16" pre-formed aircraft cable 12c ft.

BOOSTER FANS

Fit any 8" to 12" furnace pipe. Mounting frame, 7" blade, 110 v motor, 60 cyc, 1550 rpm with 6' cord. Silent operation. Easy to install. Warm these rooms with long runs. List \$11.95. Our price . . . \$6.95; two for \$11.95; three for \$14.95. Buy one for each room! REGISTER FAN for hot or cold air with bracket ready to mount motor. 7" blade, 6' cord ONLY . . . \$7.50; two for \$12.95; three for \$16.95.



Here are only a few big \$\$\$ savings! More in our catalog!

Air Compressor	Electric Motors	Hand Truck	Rubber Cable
Air Tank	Electric Switches	Hydraulic Cylinder	Rubber Wheels
Block & Tackle	Elevator	Hydraulic Stackers	Saw Tables
Blowers	Drawing	1 Beam Trolley	Shower Sprays
Bomb Trailer	Elevator Incline	Lawn Mower	Starters
Buzz Saw	Fans, Exhaust	Sulky	Tools
Compressor	Booster	Magnetic Starter	Transformers
Accessories	Gas Engines	Mail Chain Saw	Whiting Hoist
Clutches	Generators	Mail Grinder	Winch, Electric
Conveyors	Grinders	Pumps	Winch, Hand
Belt Tools	1/2 Ton Wagon	Reduction Gear	Fire Extinguisher
Drop Cords	4 Wheel Fire Pump		4 Wheel Trailer

Get this catalog! 88 pages, packed with useful charts, information, plans for dummy & incline elevators, more than 1100 tool and equipment items at money-saving, factory-to-you prices. Send 25c (refund with first order) or write on company letterhead for free copy.

C&H ELECTRIC MACHINE Co. Inc.

434-N W. Juneau Ave., Milwaukee 3, Wisconsin

Also ADULT
1 Passenger
SPORT CAR
LOWEST
PRICE
Write for
Free Catalog

ESHELMAN 70 MILES PER GAL. GAS CHILD'S AUTO WITH MOTOR

STURDY, SAFE FOR KIDS
 Commended by "Parent's Mag." Write for Free Catalog.
 Eshelman, Dept. MC-52
 109 Light St.,
 Balto., Md.
 333 N. Michigan Ave.,
 Chicago-1, Ill.
 7070 N. Wood Blvd.,
 Los Angeles 28, California Pat. Pend.



DO MORE PLANING JOBS WITH LOW COST BELSAW

Exclusive MONEY-MAKING features:



- Full 12 1/4 in. x 6 in. capacity
- Power feeds at 24 ft. a minute. (Easily adjusted for lower feed rate)
- Machined cast iron bed; adjustable rolls, total bed length 42 in.
- Provides for Grinding Knives in the Cutterhead.
- Attachments for Jointing, Rabbeting, Tongue, Groove, Matching.

Belsaw Multi-Duty Planer for cabinet shops, builders, lumber yards, woodworking plants and spare time work shops. . . Now you can convert low cost rough and random size lumber into high priced cabinet finished stock . . . Easy to make flooring and popular patterns. Belsaw quickly returns cost with savings on raw material . . . profits on finished stock.

Send Today for FREE literature on Belsaw, the LOW COST, high speed production planer.

BELSAW MACHINERY CO

1010 Field Bldg. • Kansas City 11, Missouri



Lift Truck Bumper Jack



Employing the principles of the lift truck, a Milwaukee manufacturer has produced a bumper jack that raises either end of an automobile completely off the ground. The jack is hydraulic and has a capacity of 1 1/2 tons. A spring-loaded caster provides positive three-point positioning.

One-Man-Power Tractor Moves House Trailers

House trailers and similar vehicles can be jockeyed into tight spots with little wear and tear on drivers or towing automobiles through use of a small hand-powered endless-track tractor. The miniature tractor has two treads, each activated by a hand lever, and fits under the trailer-jack column. Manipulation of the levers moves the trailer into any desired position.

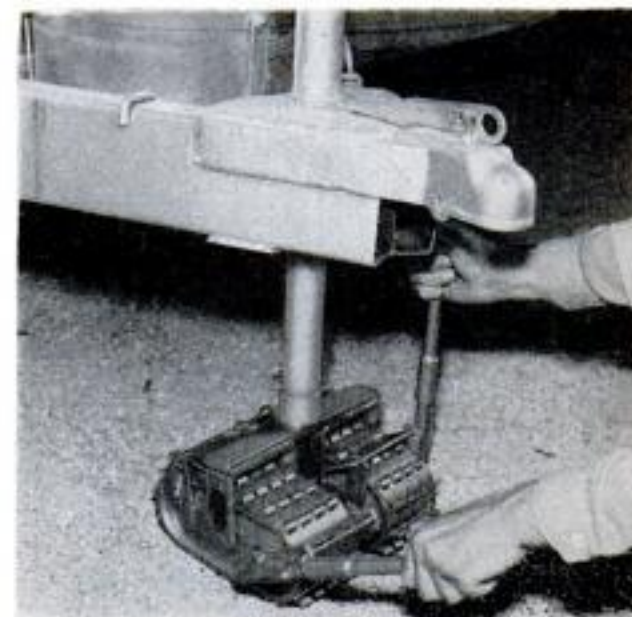

WORLD'S MOST USEFUL HOBBY TOOL!

DREMEL Moto-Jig Saw with Built-in Rotary Motor!

Share a hobby with your family!
Work with wood, plastics, metals!

**HAVE FUN! SAVE MONEY!
SEE WHAT YOU GET FOR \$23.50!**

Thousands of families have already discovered this new DREMEL way to productive, exciting hobby fun. You owe it to yourself to see and try this amazing new jig saw that is taking the country by storm. What a performer—nothing like it on the market today! The DREMEL is the only jig saw in its price class with a real rotary motor. Why, it even cuts 2x4's! Saws intricate scrolls . . . delivers 3,450 strokes per minute! Compare it—you'll agree it out-performs others costing many dollars more.

Make 1001 Valuable Projects! Do Your Own Household Repairs! Build Lawn Furniture, Valances, Cabinets, etc. Make Toys, Decorations!

Work in plastics, metals, as well as wood. Start enjoying a family jig-saw hobby. It's wonderful training for the kids . . . saves you plenty on the things you make!



cuts 1 1/2" stock any length!

table tilts, raises, lowers!



Complete with Rotary Motor

\$23.50

10 project plans FURNISHED FREE!

We'll get you started! With every purchase of a DREMEL Moto-Jig Saw, we'll give you the complete plans for making 10 practical projects. You'd pay several dollars for similar plans elsewhere. **SEE YOUR DEALER.** If he cannot supply, order direct on 5-day trial, money-back guarantee. Remit in full for postpaid shipment; or send \$2 now, pay postman balance plus COD fee.



DREMEL MFG. CO., Dept. 115-B Racine, Wis.



**NO. 77
VIZI-DOME
WOODCARVING
SET \$3.40**

**X-ACTO, INC.
48-41 Van Dam St.
Long Island City, N. Y.**

Send 20¢ for 28-page Catalog

METAL WORKERS 4 TOOLS IN 1



"4 in 1" PUNCHES, FORMS, SHEARS, RIVETS metals up to 16 ga. 1" width, 5 sizes round punches included. Model #10—\$9.95, postpaid. Hex, square, rectangular punches—40¢ each. BRAKES—up to 90° Bends—16 ga. 12" and 18" widths. Unique feature permits forming of Boxes, Trays, Covers with up to 1" flange edge. 12" Model #14—\$18.95. 18" Model #18—\$14.95. F.O.B. Buffalo. NOTCHING & NIBBLING UNITS—Model N2—1/2" Notch 1"x1" and Model N2N 1"x3/4"—\$9.95 each. F.O.B. Buffalo. THREADING DIE—Thread rod stock for 1/4", 5/32" and 3/16" standard nuts \$1.00 postpaid.

**ALBERT J. TATU, INC.
85 Columbia Dr., Dept. PM-2, Williamsville 21, N. Y.**

New! PAINT MIXER NO MORE TIRESOME STIRRING OR SHAKING BY HAND

14" Rod, 3" propeller.
All Stainless Steel.
(Pt. Pend.)

**BLENDS
YOUR PAINT
IN SECONDS!**

Gives you a smooth, thorough texture, takes the work out of mixing. So simple to use—just attach to any 1/4" drill.

**ONLY
\$1.95
PPD.**



SATISFACTION GUARANTEED

**GASPE MFG. CORP., Dept. 2
401 BROADWAY, N.Y.C. 13, N.Y.**

No. C.O.D.

Enjoy "City Water Service"

wherever you buy...or build!
costs less to buy

MODERN NO-TANK PUMP

Goolds Balanced-Flow Jet is a full-capacity shallow-well water system—yet small enough to install easily anywhere. You save because there's *no* costly tank, fewer fittings to buy. Self-adjusting flow delivers exact amount of water wanted at one or more taps at the same time, within capacity. Trouble-free, quiet, can't lose its prime!



...less to install!

GOOLDS pumps inc.

DEPT. PM-255, SENeca FALLS, N. Y.

Enclosed is 10¢. Send 20-page pump booklet and distributor's name.

Name.....

Address.....

YOU GET MORE WITH GOOLDS

PIONEER WORK SAVERS
 NOW BETTER THAN EVER—GREAT NEW 1954
SHAW
 "DU-ALL"
Garden and Small Farm Tractors

Plow.. Cultivate.. Mow.. Rake.. Bulldoze..
 Saw Wood.. Make Many Other Hard Jobs Easy



Low New Prices
 Walking Tractors \$99.50 up.
 Riding Tractors \$298.50 up.

Sturdy 1½ to 5 H.P. Walking Tractor

Best for all around garden and lawn work. Variable speeds, adjustable wheel widths, individual gang tool controls. 3 speed and reverse automotive

gears on 3 and 5 H.P. models. Superb traction, deep plowing, easy handling. All wanted tools and attachments.

Rugged, Low Cost 2½, 5, 8 H.P. Streamliner

Powerful, practical, streamlined, comfortable. Pulls 8, 10, 12 inch plows, cultivates between 38" rows, bulldozes, mows lawns, operates belt attachments. 3 speeds and reverse automotive transmission. Friction brakes. ¼ to 7 M.P.H. Nothing else like it in a tractor that will get the work done.



Inexpensive New Tiller... Lawn Mower

Nine inch rotor pulverizes 12 inch swath 6 inches deep. 1½ H.P. Extremely low cost. Rotor quickly replaced with single wheel for lawn mowing, hauling, etc.

Also larger 8, 12 H.P. riding tractors with 3 speeds and reverse automotive gears.



See the SHAW Dealer Write direct for FREE CATALOG complete Shaw line.

SHAW MANUFACTURING CO.
 4502 Front St., Galesburg, Kansas
 668-G N. 4th St., Columbus, Ohio

Safety Switch Stops Tractor When Driver Leaves Seat

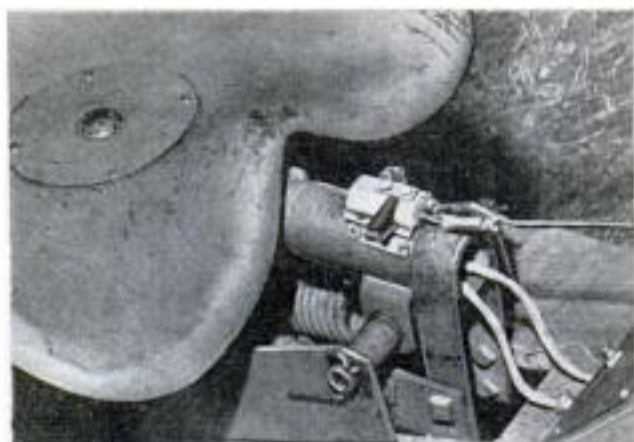

One farmer devised this safety switch which stops the tractor instantly should the operator be thrown accidentally from the seat while working in terraced fields or when crossing ditches or grassed waterways. An automobile-stop-light switch is mounted on the tractor-seat support and wired around the ignition switch. The safety switch is actuated by a rod, one end of which is attached to the steering post. The other end of the rod is hooked to the switch arm in such a way that it is easily detached when the tractor engine is to be controlled with the regular ignition switch. When the rod is in position, the operator's weight depresses the seat sufficiently to hold the safety switch in the "on" position. Should the operator be thrown from the seat, the rod opens the safety switch, thus breaking the ignition circuit and stopping the engine.

Extra Plowshare Utilized On Two-Bottom Tractor Gang

An extra plowshare can be attached to a two-bottom tractor plow when two do not make a full load for the tractor. The plow and beam shown in the photograph were taken from a horse gang. The beam was utilized to position the plow in relation to the two in the tractor gang.



AMERICA'S LARGEST STOCKS of JEEP PARTS **LOWEST PRICES! SATISFACTION GUARANTEED!**

The King of Jeeps

THE JEEP KING ALL STEEL CAB
 All steel tops completely insulated. All windows equipped with Pittsburgh Safety Glass. Free sliding door windows. Inside of doors enameled black. Tops primed for painting.

HALF CAB \$115.00 FULL CAB \$165.00 F.O.B. OHIO



EASILY INSTALLED JEEP KING SNOW PLOW
 Takes 2 minutes. Blade size 22" x 72". Strut tubes and blade designed to withstand maximum load. Adjustable safety chains. Complete. F.O.B. Chicago



FRONT AXLE SHAFTS

LONG A6030 army 800611 civilian	\$40.65	SHORT A6031 army 800612 civilian	\$34.48
----------------------------------------------	----------------	-----------------------------------------------	----------------

FREE JEEP CATALOG!
YOURS FOR THE ASKING! WRITE FOR IT TODAY!

Thousands of other Jeep parts and accessories available. SHOP BY MAIL—Order Direct From This Today. TERMS: Net cash with order. Open account to rated firms only. C.O.D. shipments should have 25% deposit with order.

BERG TRUCK & PARTS CO., INC.
 1608 S. WABASH AVE., DEPT. 10, CHICAGO 16, ILLINOIS

General SURPLUS SALE!

BUILD YOUR OWN ARC WELDER OR LIGHT PLANT D-C GENERATOR

\$12.95 used good condition 140 Amps, 24 V. D. C. Gives Up to 250 Amps at Int. duty. Instructions New **\$19.50**

RHEOSTAT #27. Heavy Duty for Regulating Voltage on D.C. Generators **\$6.95**

Stock No. 711 D.C. Generator #1 Jack & Meintz. 300 Amp. 30 Volts. Gov't. cost \$300.00. For Welder & Light plant. Instructions **\$25.50**

115 V. A. C. GENERATOR

No. 511 A.C. D.C. Generator. Ideal A.C. Light Plant & D.C. Battery Charger or welder. 1250 Watts, 80 cy. 30.9 Amp. 115 V. A.C. & 200 Amps. 30 V. D.C. Gov't. cost \$250.00. Instructions. Used, good condition **\$17.50 NEW \$27.50**

CARBON PILE VOLTAGE REGULATOR. For maintaining voltage & check pulse. **\$6.95** Non on D. C. Generators

ECLIPSE MOTOR & GEAR UNIT. Makes ideal GARAGE MOTOR (PENER). Lawn Mower Drive, etc. Gear ratio 28:1. 24-32 V. D.C. motor for belt or direct drive. O. Cost over \$200.00. Wt. 20 lbs. #281. Instructions. **\$12.95**

ALUMINUM AIR FILTERS. NEW. 2" Thick in metal frame. 10"x33"x2". Wt. 7 lbs. Permanent. (Fig. 4). **\$2.95 ea. 3 for \$9.95**

HYDRAULIC SOLENOID CONTROL VALVES. Bendix #81560. For remote control & hydraulic cylinders. For 24 V. D. C. & applicable for 110 V. A. C. Cap. 1500 P.S.I. **\$35.00** value. (Fig. 6). Instruction **\$3.95 ea. \$7.50** per pair.

SENSATIONAL SELSYNS. Two or more connected together work on 110 V. A. C. For controlling distance, operation, etc. (Fig. 5). Instructions incl. **\$8.95** per pair postpaid.

BEAM ROTATOR MOTOR. Reversible Geared. 2 RPM For TV, ham, etc. For 24 V. D.C. & 110 V. A. C. (by simple change in connection). (Fig. 7). Instructions. =10. **\$12.50**

SOLENOID #804. Gives 1/2" or 1 1/4" travel. Powerful for locks, switches, toys, etc. For 24 V. D.C. & applicable for 110 V. A.C. (Fig. 8). Instructions **\$2.95 ea. \$4.95** per pair postpaid.

CUNO OIL FILTER. Aircraft Type Filters without cartridge replacement. Std. 3/4" ports **\$4.95** Postpaid. For trucks or tractors order Parolator Filter #M1255. 1" I.P. ports. (Fig. 9). **\$4.95** Postpaid.

VICKERS UNLOADING VALVE. Unloads at 1000 P.S.I. & cuts in at 850 P.S.I. 1/2" ports **\$9.95** Send CHECK OR M. ORDER PRICES F.O.B. KCMO EXCEPT when marked POSTPAID U.S.A.

MAKES IDEAL WINCH HOIST AIRCRAFT STARTING MOTOR

Operates on 12 to 32 Volts. Gives High torque, power & slow speed. Applicable for moving heavy loads. Belt or direct drive. **\$9.95** O. cost \$300.00

PUMPS FOR ALL PURPOSES

BLACK & DECKER MOTOR & PUMP UNIT. For aquarium, fluid metering coolant, etc. 1/30 H.P. 1200 R.P.M., 2 G.P.H., 1/4" ports. For 24 V. D.C. & applicable for 110 V. A. C. (Fig. 1). Instructions **\$8.95**

CHANDLER EVANS LARGE VOLUME WATER PUMP for oil, insecticides, etc. 400 G.P.H. 1/2" Drive spline shaft. 1" ports. **\$7.95** (Fig. 2)

THOMPSON CENTRIFUGAL PUMP & MOTOR. For fuel, hot water heating circulator, etc. 300 G.P.H. For 24 V. D.C. & applicable for 110 V. A.C. (Fig. 3). Instructions **\$7.50**

BENDIX #548. For Vacuum, Air Fluid Pressure, or as auto drain case pump, etc. 150 G.P.H. **\$7.95** R.P.M. 3/4" Ports. (Fig. 4). Instructions **\$8.95**

GEAR, SPEED REDUCERS, ETC.

SPEED REDUCER. 5:1 or 10:1 ratio. 20 degree angle. Rated 2 H.P. **\$6.45** Postpaid.

RIGHT ANGLE DRIVE. 1:1 ratio through 30 degree bevel gears. Drive & take off shafts are 3/8" dia. Size 3 1/2"x2 1/2"x1 1/4". (Fig. 4). **\$3.50** Postpaid.

GEAR UNIT. Angle drive type. 1 input, 2 output shafts, 1:1 ratio. Rated 10 H.P. Size 10"x8"x4". (Fig. 5). **\$5.95**

ELECTRIC ACTUATOR. For lifting, lowering, etc. 1/4 H.P. Motor with 3" travel actuator. For 24 V. D.C. & applicable for 110 V. A.C. Rated 2800 lbs. (Fig. 6). Instructions **\$7.50**

VOLTMETER D.C. 30 Volt with zero center. 300 Ohms. Easy to calibrate. (Fig. 1). **\$4.95** Postpaid.

D. C. AMMETER. Range 0 to 300 Amps. (Fig. 1). **\$4.95** Postpaid.

TACHOMETER INDICATOR. Aircraft type. Kollsman #358K-03. Range 0 to 1000 R.P.M. New. (Fig. 2). **\$7.95**

HYDRAULIC PRESSURE GAUGE. 0 to 2000 P.S.I. 1/2" Ports. (Fig. 1). **\$3.50**

BOMB INTERVOLUMETER. Will release current at fixed time. Size 2"x2"x3 1/2". For 24 V. D.C. & applicable for 110 V. A.C. (Fig. 3). Instructions. **\$6.95**

FIRE EXTINGUISHER & INSECTICIDE PUMP. 4 Gal. 1 ft. hose & nozzle. Used, good condition (add **\$2.95** postage) Wt. 15 lbs. **\$2.95** (postage)

BUILD YOUR OWN HYDRAULIC HOIST 1/2 TON NEW

#511 Double action 3" Bore, 21" Stroke, 1 1/4" dia. shaft, clevis mnt. Instructions for hoist & hyd. Loader incl. O. cost over \$200.00. **\$39.50**

NEW HYDRAULIC CYLINDERS

No. 11. Double Action. 1 1/2" Bore, Stroke 6", 5/8" dia. shaft, Clevis type. **\$7.95**

No. 17. Double Action. Bore 1 1/2", Stroke 9 3/4", 3/8" dia. shaft. **\$9.95**

No. 303. Double Action. 2" Bore, 11 1/2" Stroke, 1 1/2" dia. shaft. **\$12.50**

No. 111. Double Action. 3" Bore, 24" Stroke, Dia. shaft 1-3/16". Clevis type. 31" length. **\$32.50**

No. 12. Double Action. 4" Bore, 10 1/2" Stroke, Dia. shaft 1-5/16". Clevis mnt. Gov't. cost over \$200.00. **\$25.50**

HYDRAULIC PUMP BARGAINS. Romeo Positive Displacement Rotary Pump. Large Capacity. 600 G.P.H. at 1750 R.P.M. #RD4420. (Fig. 5). **\$9.95**

WEAVER HYDRAULIC HAND PUMP. With built in relief. 2000 P.S.I. (Fig. 4). **\$8.95**

STRAIGHTWAY CONSTANT DISPLACEMENT PUMP. 400 G.P.H. 3750 R.P.M. 1250-1500 P.S.I. with built in relief. \$150.00 value. **\$17.50**

VICKERS CONSTANT DISPLACEMENT PUMP. New #P-28-2713-25-2E. 400 G.P.H. 3750 R.P.M. 1500 P.S.I. 3/8" Cu. in. rev. (Fig. 3). **\$17.50**

PESCO GEAR TYPE HYD. PUMP. 227 cu. in. Rev. 198 G.P.H. at 1750 R.P.M. 1500 P.S.I. 3700. (Fig. 8). **\$8.95**

HYDRAULIC CONTROL VALVES. No. 21 FOUR WAY. Off at neutral, with built-in relief for limit of cylinder stroke & 3 positions. Raise, lower & hold. 1/2" ports. **\$9.95**

No. 227. FOUR WAY. Poppet type. 1500 P.S.I. 3/8" ports. 2 handle control. **\$7.95**

FOUR-WAY SOLENOID VALVES for 24 V. D.C. & applicable for 110 V. A.C. Off in neutral. 1/2" ports. #324. **\$8.95**, #1213. 3/4" ports. **\$9.95**

PESCO #397-D HYDRAULIC FLOW EQUALIZER. For 2 systems or 2 cylinders. 1500 P.S.I. \$50.00 value. **\$9.95**

HYDRAULIC ACCUMULATORS. Ball Type. 2000 P.S.I. 5 1/4" dia. **\$5.50**, 7 1/4" dia. **\$8.50**, 10 1/4" dia. **\$12.95**. (Fig. 1)

SIMMONDS ACCUMULATOR. (Fig. 2). Up to 3000 P.S.I. Cap. 60 cu. in., 3/4" 16ths. steel. New. **\$9.95**

HYD. ACCUMULATOR. (Fig. 3) 20" Long. 4 1/2" dia. 2000 P.S.I. **\$12.50**

ROMEC PUMP & MOTOR UNIT. Positive displacement. Rotary Type. 24 V. D.C. 28 H.P. 2500 R.P.M. 900 G.P.H. 3/4" Ports. O. cost over \$150.00. New **\$19.50**

275 HOW-TO BOOKS—GIANT CATALOG FREE

How-to-do-it books on hunting, fishing, shop tools, concrete work, welding, plastics, carpentry, photography, boat building, gardening, auto repair, etc., in the new giant 40-page Popular Mechanics Book Catalog. Send postcard for your free copy! Write Dept. CT3, Popular Mechanics Press, 200 E. Ontario, Chicago 11

Say You Saw It in POPULAR MECHANICS

ONE-MAN SAWMILL LOW \$500 AS... \$50 DOWN

Take BELSAW Portable Sawmill right to the trees—turn out valuable lumber for home and farm—sell to local yards—make up to \$50 a day custom sawing for neighbors. BELSAW lasts a lifetime. No crew needed. Power with tractor or auto engine. Beginners get excellent results. Send today for FREE BOOK.

BELSAW MACHINERY CO
8119 Field Bldg. Kansas City 11, Missouri

NEW SELF CONTAINED SAW HORSE BRACKET "SPEED" CLAMPS

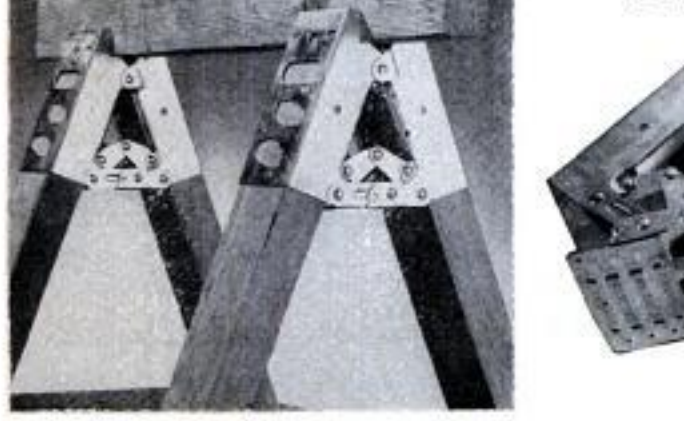

Fully automatic. Fits any 2 x 4 common or finished lumber. Sets up or knocks down in seconds. No nails, bolts, screws or miters necessary. Just insert wood and close clamp. Self locking. Holds sturdy with absolutely no wobble. No tools needed. Made from 16 gauge, zinc plated steel. Use Saw Horses for table, benches, scaffolding, barricades, etc. See your Hardware, Lumber or Building Supply dealer—or send check or money order to:

\$3.95 Per Pair

Chesney INC.

720 TOWNE AVE., LOS ANGELES 21, CALIF.

JUST for YOU ...

BROCHURE

Save money ... get economical and faster car operation, guard against leaks and anti-freeze seepage. Know your car's cooling system. Write today for your copy of "Truths ... Consequences" booklet. IT'S FREE



GET YOURS NOW Hurry!

"Truths ... Consequences" was written by automotive engineers for car owners, fleet operators, garage mechanics, farmers, service station men and car dealers. Send a postcard for your copy today.



BAR'S PRODUCTS SUPPLY, Inc.
Dept. PM, 5871 S. Telegraph Rd., Dearborn, Mich.



Trailer-Mounted Welding Generator Driven by Tractor Power Take-Off

Needing a portable welding unit for making machinery repairs in the field, one big-farm operator mounted a welding generator on a trailer improvised from an old Chevrolet chassis and fitted a drive shaft to operate the generator from the power take-off of a truck or tractor. To step up the speed of the generator to the welding stage, a four-speed truck transmission is mounted on the chassis and the input shaft is connected to the take-off shaft. The output shaft is connected to the generator with universals. This arrangement permits the generator to be run at the proper speed without racing the tractor engine.

John Krill, N. Lima, Ohio.

YOU BUILD EICO KITS

in one evening. SAVE 50% & LEARN

Easy Instructions | Vacuum Tube Voltmeter
38 Instruments | **KIT \$25.95** Wired \$39.95

Write now for FREE Catalog . . . PM-2

Electronic Instrument Co., Inc. • 84 Withers St. • Brooklyn 11, N.Y.

BUILD YOUR OWN AUTOMATIC PORTABLE SPRAYER AND SAVE

1/4 or 1/2 H.P. Quincy 3 CFM Compressor	\$20.50
3/4 or 1 H.P. Quincy 7 CFM Twin Cylinder Comp.	\$52.00
Tank 6 x 20 Wheels Platform Welded	\$12.00
Tank 12 x 24 Stainless on Wheels	\$27.00
Tank 15 x 30 Wheels Platform Welded	\$34.50
1/2 H.P. A.C. Motor	\$24.50
1 H.P. A.C. Motor	\$45.00
Automatic Adjustable Pressure Switch	\$ 6.50
Adjustable Pressure Regulator and Gauge	\$ 6.00
Hose and Tire Chuck	\$ 2.50
Safety Valve	\$ 1.50
Check Valve	\$ 3.75
Good Qt. Spray Gun	\$ 8.95
Better Qt. Spray Gun	\$ 9.95
Best Qt. Spray Gun	\$10.95
—K-55 Complete Automatic Spray Unit, Knocked Down 1/2 H.P. A.C. Motor, Quincy Compressor, 12 x 24 Stainless Steel Tank on Wheels. All Accessories. \$97.00	
FREE Qt. Spray Gun. SPECIAL	
—SK-100 . . . 1 H.P. A.C. Motor, 15 x 30 Tank Twin Cylinder, 9 CFM, Quincy Compressor. All Accessories, You Assemble. FREE Qt. Spray Gun.	
ONLY \$169.50	

ALL ORDERS SHIPPED PROMPTLY
Write For FREE Catalog: Listing Motors, Compressors: ALL SIZES.

C. MARSHALL SALES, 3546 W. Fullerton Av., Dept. P-2, CHICAGO 47

Rack for Storing Milk Cans

Welded together from pipe and steel angles, a rack on the wall in the milkhouse of one dairy farm provides a place for milk cans and other equipment to be stored and dried. Two pipe crosspieces on the bottom shelf will hold only cans, while four pipes used for the upper shelf provide a place for drying strainers and other smaller equipment. Because the rack is up out of the way, the stored cans present no problem when the milkhouse floor is hosed down.

A. M. Wettach, Mt. Pleasant, Iowa.

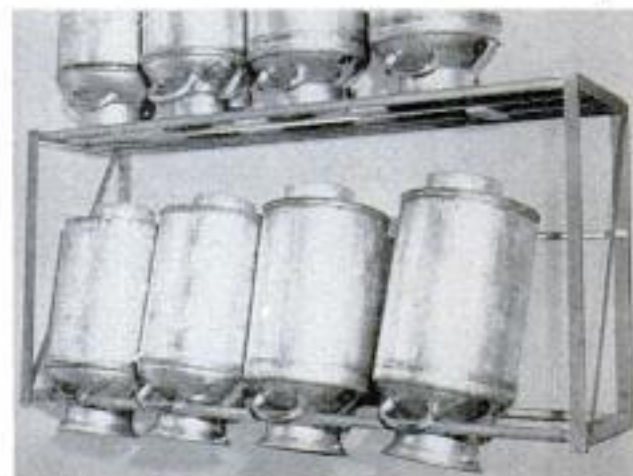



HANDY FLEXIBLE ROTA-SHAFT

ONLY \$3.95

Converts motor, drill press, electric drill into a handy rotary tool. Attaches in a jiffy! Use for grinding, polishing, sharpening, cleaning, milling, engraving, carving on metal, plastics, wood, leather, glass. Handles 1/2" diameter tools, 40-inch overall length. Made of finest materials. Comes complete with buff and sanding discs ready to use. ORDER TODAY. Send check or money order for \$3.95 plus 40c for postage. C.O.D. orders accepted. If for use on a motor—specify exact size of motor shaft diam. and add 35c to cover cost of motor coupling. GUARANTEED. TEN DAY TRIAL.



STRADER PRODUCTS CO.,
259 Strader Ave.,
Dept. S-101,
Cincinnati 26, Ohio

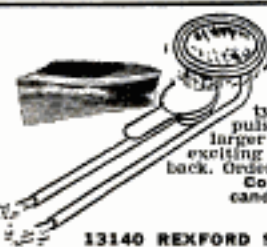

TWIN JET MOTOR

Astonishing steam powered jet motor fired by live flame. Use it to power model motor-boats, speed boats, other types of model ships. Gives off water propulsion sound. Can be used in tandem for larger model types of steam ships. Many other exciting uses. Guaranteed—satisfaction or money back. Order today.

Complete with cup candle fire box, only \$2.00

NOR-RAY TOOL

13140 REXFORD ST., DEPT. PM-2, BLUE ISLAND, ILL.

HELPFUL BOOKS

Send post card asking for FREE catalog
Popular Mechanics Press, 200 E. Ontario, Dept. 601, Chicago 11



WHAT AN IDEA!

So revolutionary they'll try to copy it, but never will. It's fully protected by U.S. Patents. It's Planetric magic—the amazing Mystery Machine X 231. Engineered to solve your individual wood-working problems, it's practically your own personal custom-made machine. Yet it's mass-produced to sell at an unbelievably low price. It saws, sands, buffs, grinds, turns, drills.

Write today for full details.

AMERICAN MACHINE & TOOL CO., Royersford, Penna. Dept. 541

Also Eshelman SPORT CARS
LOWEST PRICES
70 Miles per Gal.
Holds 1 Adult.
Free Literature.



ESHELMAN ROTARY TILLER FOR BETTER GARDENS

Also Walking Tractors from \$69

Triply useful—Replaces plowing, discing and cultivating. Turns virgin ground into Garden Bed in 1 operation. Women can operate it. Free Literature. Eshelman Co., Dept. T-82, 109 Light St., Baltimore 2, Md., 333 N. Michigan Ave., Chicago 1, Ill., 7070 Hollywood Blvd., Los Angeles 28, Cal.

NEW AUTOMOTIVE DISCOVERY

FREE TRIAL

IN YOUR CAR!

REPLACES IDLE ADJUSTMENT SCREW IN YOUR CARBURETOR

FITS ALL CARS

HOLES FOR AIR FLOW

THE AMAZING NEW GANE "air-flow" NEEDLE

THE OBJECTIVE IS TO GIVE YOUR CAR

- MORE MILEAGE
- FASTER PICK-UP
- EASIER STARTING
- BETTER IDLING

INSTALL IT YOURSELF in only 5 minutes

Users report up to 25% MORE MILEAGE, EASIER STARTING, FASTER PICK-UP, and SMOOTHER IDLING—with this SENSATIONAL NEW automotive product. NOW, test them in your car AT OUR EXPENSE. Check mileage and engine performance. If satisfied (as ONE MILLION other users are) after two full weeks, send \$1.50 per needle (8 cyl. cars take 2). If not entirely satisfied—just return them—FAIR ENOUGH! Send card TODAY—specify MAKE of car and carburetor. SEND NO MONEY—TRY BEFORE YOU BUY—PAY POSTMAN NOTHING.

NEWHOUSE AUTOMOTIVE INDUSTRIES, Dept. 280
5805 E. REVERLY BLVD. LOS ANGELES 22, CALIF.

WAR SURPLUS AND OTHER BARGAINS SAVE UP TO 90%



AUXILIARY POWER UNIT

Ideal for your shop, camp, cottage, farm, trailer, home, boat or mine. Makes a terrific welder for any sized job. 2 cylinder, horizontally-opposed air-cooled engine. Complete with AC-DC generator. On DC will supply 200 Amps at 24-28 Volts; on AC will supply 10.5 Amps—1200 Watt at 800 Cycle. The DC Generator rating at normal RPM, 5 KW. Operates on cheap gasoline. Economical. No batteries required. Dual Scintilla magnetos. Generator can be removed and engine coupled to other units for other purposes. Mfd. by Lawrence. Comes complete in fire-proof enclosure which cuts motor noise to a minimum. Shpg. wt. 398 lbs., net wt., 138 lbs. Like NEW. Complete. Guaranteed perfect. Govt. Cost \$4770. Special Now—Model D1, 10 HP with AC-DC Generator described above—\$125.50; also with 300 Amp Generator—\$157.50, Model C2, with 160 Amp Generator, Intermittent 220 Amps, 14.5 HP—\$137.50.



SENSATIONAL GENERATOR BUY!!

Famous Navy AC-DC Generator Combination AC-DC Type. AC voltage—115 V, 10.5 Amp., 1200 Watt. DC voltage—24 V, 200 Amp. 2 complete generators in 1... 2 separate fields and 2 separate armatures on same shaft yet no larger than regular aircraft generator. Ideal for home, farm and shop lighting plants by hooking wires to AC side. DC side can be used for welding and operating war surplus low voltage hobby motors and equipment. Weight 54 lbs. NEW. Approx. GOVT. COST \$350. NEW \$27.50. Used Perfect \$18.00.



SPECIAL CARBON PILE TYPE VOLTAGE REGULATOR

to go with above generator. Incl. mounting base and completely enclosed in steel-mesh box. Helps maintain constant current and prevents pulsation. Ideal for installation with above generator for lighting plant. Wt. 5 lbs. Complete NEW. Approx. GOVT. COST \$90. Now only \$7.95

BUY 'EM BOTH -- SAVE \$5.45! Generator & Regulator together \$30

NEW PUMP AND MOTOR

Pump has 1" connections, built-in relief valve, adjustable up to 1500 lbs. Max capacity 6 GPM, 1 1/2 H.P., 24-volt motor, 4000 RPM. Can be used on 12 or 36 volts. Govt. cost approx. \$350 — our price — NEW — \$9.95.



GEAR HEAD MOTOR

Use to turn antenna, open or close doors and windows, barbecue, displays, etc. Approx. 1 RPM. Set for 140° turning with limit switches that can be removed for full 360° turning. Operates on 24 Volt DC, 1/2" shaft dia. 3" wide, 10" long. Wt. 4 lbs. High speed 7000 RPM, 1/10 HP motor, micro-switches, reduction gears, mounting brackets—a bonanza for hobbyists. Approx. Govt. Cost \$90. In perfect condition, now just \$3.50. Mfd. by Barber-Colman Company.

MICROMETER DEPTH GAUGE

With 3 rods to measure all depths from 0 to 3 inches by thousandths. Hardened tool steel lead screw has full 1 inch run. Base is 2 1/2" long, hardened ground and hand lapped. Accuracy guaranteed. Mfd. by Millers Falls Co. GOVT COST approx. \$30. NEW—\$10.95 ppd. U.S.A.



"HELIOS" ORIGINAL TOOLMAKERS VERNIER CALIPERS

ULTRAPRECISION — Imported. Used by machinists at Lockheed, Douglas, Bendix, GM, RCA, GE. Model 51/2E. Genuine Helios. Hardened lapped precision surfaces. 1/1000" and 1/128" graduations. Handy slide roll and thumb lock. Quick, accurate depth. A \$35 value. Satin finish. ALL NEW, just \$6.50. Leather carrying case, \$1 extra.

MICROMETERS Chrome plated, precision engineered, carefully tested to give long life. All new 0-1" cap. \$2.25 ea., 1-2" cap. \$3.50.



PRECISION GROUND SQUARES

Production engineer's Squares. Accuracy guaranteed. Mfd. by Wright & Moore, Sheffield, Eng. Square blades hardened & tempered. Individually packed in wood box. Brand NEW. Fraction of original cost. 2"—\$2.25, 3"—\$2.50, 4"—\$2.75, 5"—\$3, 6"—\$3.25, 9"—\$6.50, 12"—\$8.25.

SENSITIVE ALTIMETER

in 10 Ft. Increments. Famous Pioneer! 0 to 35,000 ft. (Inches of Mercury). Tested and inspected in our own instrument lab. Guaranteed perfect. Approx. Govt. Cost \$150. NOW ONLY \$12.95 PREPAID!



NEW 1955 CATALOG

Bigest ever... new low prices... Send 25c for your copy today. Prices F.O.B. Culver City unless otherwise stated. Check, money order or cash. 25% deposit for C.O.D.

AIRBORNE SALES CO., INC. DEPT. PM255
8501 Stellar Drive, Culver City, Calif.

IF YOU SAW IT IN POPULAR MECHANICS

\$1. SCRIBER of CARBOLOY
Will scribe on hardened steel, ceramics, glass, etc.
Designed for close work for TOOL and DIE workers.

SIEG KONRAD MANUFACTURING CO.
1636 W. 7th St., St. Paul 2, Minn.
\$1.

**DON'T BE FROZEN OUT
THIS WINTER!**

**GET UNĚK'S
3 way
protection
kit
only \$3.49**



includes
three amazing new products

1 NEW KEY-HOLE Anti-Freeze

A new chemical formula that ends the danger of tiny droplets of moisture freezing in your car door or trunk locks. A quarter tube-full squeezed into the key opening will protect you against lockouts all winter! Will not stain finish or fabrics. Ideal for protecting exposed padlocks, garage door and mail box locks!

protects
locks
all
winter



2 prolong your motor's "heart-beat" the ignition system

NEW! ELEK-TRIC SHIELD

gives instant starts in cold damp air
Now! you can prevent annoying motor stalling in traffic on damp, rainy days, and hard starting in cold weather. Applied to ignition wire connections at the spark plugs and distributor cap, Elek-trik Seal dries in minutes to form a perfect non-cracking sealant—ensuring your motor a full hot spark for easy starting, and smooth going on cold, damp days! Makes a perfect sealant for your outboard motor's ignition in summer too! **NOT A VARNISH!**



STOP BATTERY FAILURE

caused from short circuiting corrosion

with NEW BATTERY SHIELD

Ascorbic acid, felt battery post washers, impregnated with a corrosion killing ingredient that prevents short circuiting, corrosion "seal" from forming for the life of your battery. Actually helps your battery to longer life by preventing short circuit drains. No motorist should be without Battery-Shields!



DON'T DELAY! Get this 3 way protection against DAMP DAYS TODAY!

10 DAY MONEY BACK GUARANTEE

JUST send \$3.49 for kit (post paid)



UnĚk Products Co.
Oconomowoc,
Box 184 Wisconsin

**23
BOATS
YOU CAN
BUILD**



**You Can Build These Boats Without Experience
With Few Tools, and Little Time to Spare!**

And the best part is that after you have completed your boat, you will know it is seaworthy as well as eyeworthy. This book, a few tools, and some time each day in your garage or basement, is all you'll need to complete the boat of your dreams. Nothing is left to the imagination. Everything is planned for you before you turn back the cover of the book. All you do is follow simple step-by-step instructions and show how photos and drawings.

tion rowboat, and 12-foot plywood outboard, are available in this one chapter alone. All are easy to construct, and beautiful to own. Step-by-step instructions, photographs and illustrations, plus important material lists carry you right through from the forming of the keel to the last coat of paint and varnish.

Building and Service Hints Provided

You'll learn how to build your boat right the first time. Success in building a boat depends on two things. Knowing beforehand exactly what type boat you want to build and then getting started correctly on the construction. With this book it's simple. Material lists are supplied where essential, listing lumber required, hardware, sailcloth, fittings, etc. Also included are hundreds of hints for building your boat right, the best boat for beginners, and tips on servicing boats after they are built.

Half a Million Persons Build Their Own

There are more than half a million persons in the United States who regularly build boats for pleasure or for profit. They form a cross section of American life. And theirs is a double reward—the fun of building the boat, and the thrill of using it when it is finished.

Special Chapter on Boats for Sportsmen

If you are a sportsman, hunter, fisherman, trapper, or just plan to use your boat for pleasure, this chapter contains ideal craft for your use. Perhaps you have a canoe in mind, or a rowboat that can be carried on your auto. Maybe you have always wanted a duckboat but have been reluctant to purchase one because of the expense. All these boats plus a 3-sec-

Partial Listing of Boats

Think of being able to build and own the following boats: "Su-Lu" the PT-type Plywood Dinghy, 11-ft. Skiff, "Sport" a V-Bottom Inboard, "Tramp" a 15-ft. Sailing Knockabout, "Sea Craft" a 25-ft. Cabin Cruiser, "Zephyr" a 14-ft Sailing Dinghy, "Arrowhead" a 21-ft. Sloop, a bicycle Boat, Motor-driven Paddle Board, "Skimmer" a Sturdy Plywood Kayak, "Skip" a Pram-Type Dinghy, "Tiny" a 6-ft. Training Ship, and many more, from large to small and at a fraction of the purchase cost!

7-Day Money Back Guarantee

Send for your copy of 23 BOATS YOU CAN BUILD today. Read and use it for 7 days. If it isn't entirely satisfactory return it for a full refund.

Use This Handy Order Coupon

**POPULAR MECHANICS PRESS
200 E. Ontario St., Chicago 11, Illinois**

Gentlemen:
Please send my copy of 23 BOATS YOU CAN BUILD. Enclosed is my remittance of \$2.00. If I am not completely satisfied with the book I will return it for a full refund after 7 days.

Name _____
Address _____
City _____ Zone _____ State _____

For Her... THE FINEST KITCHEN VENTILATING SYSTEM

Easily built into your present kitchen or your new home

TRADE-WIND KITCHEN VENTILATOR

DISCHARGE THROUGH ROOF OR WALL

HEAT ALONG CEILING

FILTER

TWO GENUINE CENTRIFUGAL BLOWERS

FILTER

STOVE

The Trade-Wind Super Clipper is the only equipment that gives you complete kitchen ventilation. Powerful dual blowers installed in the cabinet over the range have 2 inlets, both equipped with washable filters. One inlet under the hood eliminates all cooking heat, grease and odors. A second one at the ceiling discharges heat and keeps the entire house clean. 4 other top quality models available. Easy to install in your new or existing home.

MAIL COUPON FOR COMPLETE INFORMATION

TRADE-WIND MOTORFANS, INC.
7755 Paramount Blvd., Dept. PM, Rivera, Calif.
Please send information on Trade-Wind Ventilators.

Name _____
Address _____

POPULAR MECHANICS

GIGANTIC MAIL SALE

WAR SURPLUS EXCESS INVENTORY BANKRUPT STOCK

CAR BATTERY TESTER

Instantly detect weak or bad cells. Press against all terminals. Reads cell voltage under discharge. Every car owner should have one. List \$7.95. SALE \$4.31

BLOWER - 6 Volt

Efficient squirrel cage type Navy blower. Operates on 6 volts DC. Useful cars, trailers, etc. 100 c.f.m. Intake 2 1/2". Discharge 2 1/4". Overall dimensions 6" x 6" x 7". List \$13.95. SALE \$8.90

PRESSURE GAUGE (8 1/2" dial)

Finest Navy pressure gauge. Precision type gauge 0-100 lbs. Use for water, air, gas, steam. Place on city water to show pressure variation, etc. List \$29.50. SALE \$4.69

REMOTE TEMPERATURE GAUGE

Range 100°-215° F. 2 1/4" dial. Hundreds uses. Install on hot water heaters, cars, etc. Complete with 30' tubing, immersion bulb, etc. Easy to mount. Lot #101. Govt. cost net \$19.50. SALE \$2.89. Lot #102 Same, but 60°-160° F range. SALE \$2.96

ARMY PARTS CLEANER

Air turbo solvent cleaner. Makes dirty, greasy parts shiny bright. 25" x 20" x 20". \$29.95

DELUXE DRAW KNIFE

Marvelous Navy draw knife. Polished steel. Rosewood folding handles. 8" razor sharp blade. List \$3.99. SALE \$1.98

SURVEYORS LEVEL

Leading make complete with rod, tripod, case. Instructions \$37.95. Level-transits also at \$77.50

NAVY BRONZE PUMPS

Leading make. All bronze centrifugal type. 2" inlet. 1 1/2" outlet. 140 gal. per minute. 1 1/4" x 1 1/4" x 8". A real water mover. Govt. cost over \$50. SALE \$24.61

HYDRAULIC SPECIALS

Save to 80%. Build loaders, lifts, etc.
 Super Special Cylinder, 1 1/2" bore x 4" stroke. Precision. Govt. Cost \$87. SALE \$3.89
 Cylinder. Buy! Finest leading make. 3" bore, 8" stroke, one way. Fine for plow lifts, etc. List \$25.50. SALE \$11.95
 Cylinders. Two-way. 2" x 10" \$22.85. 2" x 24" \$28.90. 1" x 24" \$39.90. One-way. 2 1/2" x 42" \$36.95
 Pump. 1000 lb. 12 gal. \$45.00; Valves. One-way \$18.00; Two-way \$18.00; Gauges. 1000, 1500, or 3000 lb. \$3.49.
 Hydraulic accumulator \$4.39

NAVY PRESSURE SWITCH

Precision type. Turns motors, alarm, etc. on-off. Use on water, air, steam. Range 15-60 p.s.i. Set on at 40, off at 80. Adjustable. Lot 107. List \$19.50. SALE \$4.81

AIR COMPRESSORS AND TANKS

For painting, cleaning, tires, control terminals. Assemble your own outfit.
 Deluxe Kit. Compressor, tank, gauge, regulator, paint gun, fittings. How to build instructions. List \$80. Sale \$45.49
 Compressor (1-cyl) \$20; (2-cyl) \$52; Govt. Air Tanks \$6.79; Regulators \$2.79; Pop off \$1.95; Pres. gauge \$1.89; Finest paint gun \$9.95; Auto. switch \$4.95.

GIANT FRESNEL LIGHT

Amazing 110-V with intensifier fresnel, 12 ft. adj. tripod, spare bulbs, expensive case, etc. Cost over \$200. \$49.50

SPECIAL OF THE MONTH AUTO TROUBLE SAFETY LITE

Popular genuine Westinghouse High-way Safety Light Kit. Thousands in use. Marvelous for plenums, campers, tire or engine trouble, etc. Will light large area. Consists of high intensity sealed beam 6.0 volt Mazda light. 12' cord, lamp snap-on stand; plugs into cigarette lighter. Complete with "Caution" Scotch light sign. \$5 value. SALE \$2.71

HEAVY POWER PLANTS

Marvelous values in finest plants and generators. Unconditionally guaranteed perfect. Be prepared for any emergency in peace or war.
 Plants, 1,000 w, 115-v, 60-c. \$189
 Plants, 2,000 w, 115-v, 60-c. \$289
 Plants, 3,500 w, 115-v, 60-c. \$391
 Plants, 5,000 w, 115-v, 60-c. \$489
 Plants, 10,000 w, 115/230 60-c. \$781
 Plants (Ford Lincoln) 25,000-w, 220/440-v, 60-c, 3 p. \$691.50
 Plants, 7,500 w, 120-v, 60-c, 3 p. \$1091.50
 Generators AC and DC low as \$58.00

SPECIALS FROM PREVIOUS ADS

(See previous recent issues of this magazine for details.)
 Gar-Wood 12,000 lb. winch. \$169.50
 Selsyn Synchronous Motors (Gr.) \$12.97
 Portable Govt. Air Tank \$15.95
 Deluxe Army Tool Chest \$21.95
 Bomb Hot-1540 g. \$27.49
 Robot Control Cylinder \$23.89
 Army First Aid Chest \$6.95
 Generators DC, 3000-W, 115-V. \$88.75
 Army Automotive Tester \$14.67

WE PAY ALL FRT.—POSTAGE

ORDER FROM AD or write us for big FREE CATALOG! 1000s of items! Motors, sporting goods, hand and electric tools, watches, lamps, etc., etc. We pay all freight.

BURDEN SALES COMPANY

804 "O" Street LINCOLN, NEBRASKA

FREE CATALOG

Over 300 books on Fishing, Hunting, Home Repairs and Improvements, Bricklaying, Welding, Home Workshop, Power Tools, Hobbies, Crafts, Home Building, Trades, Making Money at Home, Furniture Making, Woodworking, Carving, Photography, Art, Drawing, Mechanics, Engineering, Refrigeration, Plumbing, Radio-TV, Electricity, Automobiles, Farming, Livestock, Gardening, Decorating, Painting, many, many more. Send for yours today.

POPULAR MECHANICS PRESS, 200 E. Ontario St., Chicago 11

FIND \$\$\$\$

NEW U-238 geiger counter—world's smallest, most sensitive uranium locator. Ideal for prospecting even on hunting, fishing trips! (Full line of mineral and metal locators, too.)



GOLDAK COMPANY 1542 W. Glenoaks Blvd., Glendale, Calif.

HI STANDARD GUID-O-DRILL

Fits any portable drill. Do more work better, faster and easier. Easy to install. Easy to use. Drills or reams a perfect hole every time... vertical... horizontal or at any angle. Added feature Built In Depth Gauge to assure accuracy. Complete with instructions \$6.95 post paid and full guarantee.

Send for free catalog "Do it better-easier" tools
EAGLE PRODUCTS
 BOX 84 A-43 MERIDEN, CONN.

150 MILES PER GALLON!

Engineers have done it! You can shoot for it. Make the start toward this unbelievable but possible economy with a perfect car, a perfectly tuned and efficient engine.

REMEMBER! — ONE COLD START CAN EQUAL 3 to 5 CAR-MILES. Starting your car on a cold morning can use as much gasoline as it takes to drive the average car owner to work. Here is a truly remarkable invention designed to stop this waste. Try it!

ELECTRONIC SPARK INTENSIFIER

Quickly fitted into the center hole of the distributor cap of any car, truck or tractor. Instructions included, never wears out. It pays for itself many times over in gas and battery savings. This amazing invention gives quicker starting, improves combustion, cuts wasteful misfiring. HERE'S HOW IT WORKS — Intensifier controls 25,000 volts or more for micro-seconds, "meters" built-up voltage charge at proper time for top efficiency. It also contains built-in point protector for plugs and ignition points. It also cuts down on car radio interference for reasons which have not been fully determined. Give it the A/C/D test, try it one of these cold mornings. If you can't feel the increase in power and starting pep, send it back for full refund. The Spark Intensifier is backed by our ironclad guarantee.



200 postpaid

A FERRARI GUARANTEED PRODUCT

STOP BURNING OIL RESTORE COMPRESSION

Make a peppy youngster out of an old car with the recommended blue-seal TWO STEP treatment. HERE'S HOW you use our MOTOR RENEW KIT.

STEP NO. 2

Squeeze the self-depositing mineral compound into each piston (as directed). Fills in scores and worn areas of rings and walls, restoring compression and power. Pays for itself in a few days in reduced gas and oil usage.

Our guarantee also applies to MOTOR RENEW KIT. Return empty container for full refund if you are not satisfied with immediate results. \$6.95 postpaid complete. Sorry No C.O.D.'s

FERRARI Department PM-2
 11424 BIONA DRIVE
 LOS ANGELES 68, CALIF.

Fishermen!



3
BOOKLETS
AND FISHING
CALENDAR
FREE!



LOADED WITH TIPS ON SPINNING BAIT CASTING, FLY FISHING!

Want to catch more fish? Have more fun? Get *three* interesting, helpful booklets: "New Ways to Use Spinning Tackle," "How to Choose and Use Fly Fishing Tackle," "Catching Big Fish—Bait Casting." Packed with information! Sent to you, **FREE** and **POSTPAID!** We'll also send you the famous Joe Godfrey Fishing Calendar, showing best days to fish in 1955.



SHAKESPEARE CO.
Dept. PM-2, Kalamazoo, Michigan.
Please send me your three Free fishing booklets and 1955 Pocket Fishing Calendar

Name _____
Address _____
City & Zone _____ State _____

SAY YOU SAW IT IN
POPULAR MECHANICS

Now you can spray



New 3-in-one Oil-Spra lubricates and forms a barrier against rust! No more messy rags—oily fingers! Sprays oil at touch of button!

"3-IN-ONE" OIL



Briggs & Stratton
2-H.P., 4-Cycle GAS ENGINE
AIR COOLED FULLY GUARANTEED
Reg. Price \$68.00
SPECIAL OFFER \$37.50 SAVE!
while they last feb

Powers Farm, Home & Industrial Tools
• Garden Equipment • Pumps • Compressors

GOV'T SURPLUS Briggs & Stratton leads the world in dependable, trouble-free performance. A precision-built 2-horsepower, 4-cycle engine with advance styling and economical operation. Kick or rope start—sure fire ignition in all weather. Positive, automatic splash-lubrication system. 2 Qt. gas tank. Float feed carburetor with adjustable idle speed and automatic governor. Oil bath air cleaner. Complete with muffler. 3 Piston rings for added compression. 2000-3600 RPM adjustable speed range.
SUPPLY LIMITED! IMMEDIATE DELIVERY! ORDER FROM AD FREE CATALOG of Compressors, Generating Plants, Motors
ROBERTS ELECTRIC CO., Dept. P-254, 849 W. Grand, Chicago 22, Ill.

SHEET METAL BRAKES

Forms angles, locks pans, etc. New eccentric clamps. All steel construction. Size 15"-16 gauge steel.
\$21.50; 36"-22 ga., \$33.00;
48"-24 ga., \$48.00. Floor Stand, \$7.50.
IRON BENDER, 10 parts..... \$9.50
FOLDER 15" 1/4 to 1" 24 ga..... \$16.50
VISE BRAKE 12" 20 ga..... \$12.50
SHEAR 7" 16 ga. steel..... \$12.50
(Immediate delivery. Order cash or C.O.D. or send for folder)
WYKE MFG. CO., P-2439 15th St., Denver 11, Colo.

AGENTS — SELL TOOLS! GUNS! CAMERAS!

Buy tools, photo equipment, sporting goods, jewelry and thousand other nationally advertised products at big discounts. Big profits selling to others. Postcard brings free plan.
AMERICAN BUYERS SERVICE 831 LINDEN AVE., DEPT. 8
BUFFALO 16, NEW YORK

HELPFUL BOOKS

Send post card asking for **FREE** catalog
Popular Mechanics Press, 200 E. Ontario, Dept. 601, Chicago 11

Now Bigger and Better Than Ever!
BUY the **NEW EMRICK CHALLENGER 77 WORKSHOP**
Most versatile power tool on the market today. Big 30" lathe. Sturdy drill press. 8" sander, grinder. New instantly adjustable all-angle saw. Saws, drills, grinds without changing set-up. Handles big jobs, home repairs. A money-maker. Now priced at **ONLY \$77.00**. Buy direct. Cash or easy payments. Order now or write today for **FREE** literature.
EMRICK INC. 2515 Miller Road, KALAMAZOO, MICHIGAN

5 GREAT TOOLS ALL IN ONE
FREE TRIAL MONEY-BACK GUARANTEE

Build Your Own ELECTRIC EYE

—for amazing automatic operation of light electrical devices, toys, trains, circuits, etc. Famous photocell kit designed by electronic engineers for experimental use by hobbyists, teachers and students. The photocell relay is so sensitive that it will respond to light directed from an incandescent light bulb. Enables you to improvise countless exciting automatic applications. Complete **POTOLECTRIC PHOTOCCELL KIT** combines all electronic components and metal case with instructions for assembly; also wiring diagrams and schematic. Now only \$14.50 postpaid. Guaranteed to satisfy or money refunded. **WORNER ELECTRONIC DEVICES, Dept. 22, Rankin, Ill.**

How good are the "miracle" oil filters?

by Fred Harris

"Is it possible that any Oil Filter—no matter how revolutionary in design—can actually make a car's engine last up to 150,000 miles before requiring an overhaul?"

"Is there really such a thing as an Oil Filter Cartridge that filters efficiently forever . . . that never needs replacement?"

If you're an average car owner and have seen the many recent ads on these new all-metal "miracle" filters, then you probably have asked yourself the above questions. You wonder, can anything be that good? Do Porous Bronze Filters really offer such remarkable advantages? If so, then which type should I buy?

Here Are The Facts

Make no mistake — Porous Bronze Oil Filters (every last one of them) *do* a remarkable job of filtration! Because of their porous (or sintered) bronze walls, they filter out incredibly small abrasives as well as acid-forming moisture, *without* soaking-out detergents. They make engines last thousands of miles longer . . . reduce repair costs. And save *even more* of your hard-earned cash because they *eliminate* costly cartridge replacements forever. Yes, *any* Porous Bronze Filter is going to save you a whale of a lot of money.

So maybe you'll agree you

ought to benefit from one of these "Miracle" Oil Filters. But, that puts you back right where you started. Which one should you get? Possibly I can help you make your decision.

Can It Be Transferred When You Trade-In Your Present Car?

There are more than 30 different type filter housings in the various-make cars. The cylindrical shaped bronze element fits all of them and can be transferred to your next car. What good is a "Lifetime" cartridge if it only fits your present car?

Does It Have a Double Acid Barrier?

All Bronze Filters strip out most acid-causing moisture. But is that enough? This same cylindrical shaped model has what is called a Free-Magnesium barrier which neutralizes remaining acids. This prevents acid-wear or "etching" of cylinder walls and bearings.

Does It Have Enough Filtering Area?

How About Wall Strength?

The cylindrical IMPROVED-LIFETIME brand averages 43% more area than other designs. This naturally provides greater filtering capacity and efficiency. According to an Independent Testing Laboratory, it is also 93% stronger. This is not just "talk"

. . . you can obtain a Notarized photo-copy FREE upon request.

Is It Easy to Install?

Does It Have a Critical Gasket Seal?

Because IMPROVED-LIFETIME is a complete, factory sealed unit (self-sealing on center-post) the right way is the *only* way to install it! Takes only 5 minutes. No gaskets to cause installation difficulties. An important point to consider.

Are Prices Honestly Stated?

You *can't* buy any "Full-Flow" Bronze Filter for \$6.95. If you drive any car with a "Full-Flow" oil system (as listed in the ad below), you have to pay more. IMPROVED-LIFETIME tells you, *before* you buy, exactly what cars use this system. This saves delay of reordering and possible unexpected "extra charges" later on. Read the ads *very carefully*, for your own protection!

Hope We've

"Helped Clear The Air"

Inasmuch as our Company was the originator of all "Lifetime" Bronze Oil Filters, we are vitally concerned with your knowing the facts. Read *all* the filter ads, then make up your own mind. After you've seen them all, we feel sure you will want to turn back to this page. Full details are given below on our 30-day trial offer. ★ ★

IMPROVED-LIFETIME

Trade-Mark

Not Just Claims... But Honest Facts:

1. First Cost = final cost. No more "Packs" to buy.
2. Transfer from one car to next; Fits them all.
3. Removes all grit; can't soak up detergents.
4. Complete with Acid Neutralizer added.
5. Greatest wall strength; most filtering area.
6. No "tricky" gasket seals. (Factory sealed.)
7. 5 minutes to install; Right way is only way.
8. Occasional kerosene rinse cleans like new.
9. Prices clearly stated for each make of car.
10. Originators of "Lifetime" Brand Oil Filters.
11. All models available for immediate delivery.
12. Double your money back guarantee.

Porous Bronze Oil Filter

ONLY \$2.00

With Order — Balance C.O.D.

HOW TO ORDER

"BY-PASS": For Most Cars.
"FULL-FLOW": For Buick V8;
Olds V8; Pontiac V8; '52-'55
Ford '6" & Linc; '54-'55
Ford V8 & Merc.; '46-'55
Chrysler.

COMPLETE FILTER UNIT: For cars with no filter case.



MILLIONS OF FUSED BRONZE SPHERES . . . filter out abrasive particles as small as 39 millionths of an inch!

MAIL THIS COUPON TODAY!

30 DAY FREE TRIAL! DOUBLE YOUR MONEY BACK GUARANTEE!
Try, Test IMPROVED-LIFETIME 30 days! If not 100% satisfied, return for full refund. This amazing filter is guaranteed for 10 years . . . far stronger than other designs or DOUBLE YOUR MONEY BACK!

DEALERS! JOBBERS!

Now you can fill the booming demand with just 2 sizes for all cars & light trucks (Instead of 20 or 30). Write or wire today!



ENGINE PRODUCTS MFG. CO Dept. 27B
5801 E. Beverly Blvd., Los Angeles 22, Calif.

I enclose \$2. Will pay balance plus small C.O.D. charge on delivery.

I enclose \$_____ in full payment. Ship prepaid.

RUSH "By-Pass" Filter Element at \$6.95

RUSH "Full-Flow" Filter Element at \$11.95

RUSH Complete Filter (Incl. Case) at \$12.95

I understand that if I am not completely satisfied I may return for full refund within 30 days.

CAR YEAR _____ MAKE _____ MODEL _____

NAME _____

ADDRESS _____

CITY _____ ZONE _____ STATE _____

© 1955



No gripping job too rugged! Increases pressure 10 times from handle to jaw. Four jaw adjustments to 1 1/4"... Chrome plated. Every P&C tool guaranteed — "the BEST tool money can buy". Ask your dealer for the P&C Compound Plier!



THE P & C COMPOUND PLIER
GIVES YOUR GRIP THE
STRENGTH OF 10!



Buy your P&C Tools from this Self-Service Display in tool stores. Send 10c TODAY for P&C's big catalog. All the dope on over 500 tools.

**P & C HAND FORGED
TOOL COMPANY**
Dept. H1 • Box 5926
Portland 22, Oregon



MAKE WROUGHT-METAL FURNISHINGS
AT HOME with the **METL-FORMER**
PATENT PENDING



● IT ROLLS
● IT FORMS
● IT BENDS
Complete Metl-Former Kit Just
\$29⁹⁵

Prices slightly higher west of the Rockies.
KIT CONTENTS
A. Basic Metal-Forming Tool
B. 3 Tubing and Rod Rollers
C. 3 Flat Metal Rollers
D. 1 Sheet Metal Bender
E. 1 Flat Metal Bending Wedge
F. 2 Roller Handles

Here's a combination tool, the Metl-Former, which accurately and easily rolls, forms, and bends light metals into wrought-iron and aluminum tables, planters, lamps, and toys—right at home! Controlled Metl-Former fingertip tension lets anyone create useful wrought-metal fixtures and furniture, for the cost of the raw materials. The Metl-Former repays its purchase price with the first items made. There are hundreds of handy items anyone can easily make with this metal-shaping tool. In addition to metal forming, the Metl-Former's rugged vise makes a welcome addition to any workshop. Get the Metl-Former for metal working in the home. See your favorite hardware dealer for the Metl-Former or:

Write us today, for complete information, plus details about the new Drill Stand Attachment which makes a drill press of an electric drill.

SWAYNE, ROBINSON & COMPANY • RICHMOND, INDIANA



Get Our Big Manual of "HARD-TO-GET" ITEMS

For home craftsmen, wood workers, industrial art departments, furniture repair men, hobbyists, cabinet makers, etc. Send only 50c today for your copy.

A few of the items we sell: Inlays, fancy cabinet wood, lumber, Ebony, Holly, Dimension cut lumber, lignum vitae, Carving Blocks, Turning Squares, 120 kinds of veneers, Abrasive papers, archery woods, bill-board clamps, binewings, bed fasteners, blueprints, Chair braces, brass chain, brass fencing, Craftsmen books, candlestick holders, candlestick sockets, card table hardware, casters, Chair cane, ceramic tiles, clamp nails, crib hardware, Dowels and dowel pins, dowel centers, drawer rollers, felt, Flock finishes, foam rubber, furniture clamps, complete professional finishing materials, Folding tablelegs, hand tools, furniture pulls, modern and period, chest and ornamental hardware, all types of hinges and locks, small box hardware, Inlaid picture kits, Inlaid card table legs, leather working tools, Micarta, revolving Lazy Susans, musical movements, moulded wood carvings, Metalcraft material, Moto Mander, nut bowl hardware, Picture frame mouldings, Pro Cut Wood Pix, perforated steel panels, plaster standards, plastics and plexiglass, internal carving bits, plastic polishing compounds, Electric routers, sanders, foot rheostats, hand drills, sprayers, revolving fixtures for television tables, chairs, etc. Floor rush, screw hole buttons, spiral saw blades, sliding door track, sharpening stones, home owners specialties, 100 woods, ski woods, platform rocker springs, Table leaf supports, tack rags, thermometer cards, turned furniture legs, typewriter fixtures, Complete upholstery supplies, Veneer presses, wood burning pens, wood working instructions, black and copper wrought iron hardware, silver wire.

Send fifty cents today (refunded on 1st order) for your copy of the Country's leading Catalog, "Constantine Manual for Craftsmen" to:
ALBERT CONSTANTINE & SON, Inc.
Dept. PM-2 797 East 135th St. New York 54, N. Y.

VARIABLE SPEED HYDRAULIC POWER TRANSMISSION



It has Infinite Speeds 0 to 550. Reverse, Automatic Overload Protection; Adjustable Torque up to 180 inch pounds, 5/8" Input and Output Shafts. It will handle 1/2 to 1 1/2 H.P. Motor. Case measures 7 1/2" long, 7" high, 6 1/2" wide. VALUE OVER \$300. Shipping Wt. 25#. On C.O.D. Orders we require a 10% Deposit. **\$54.50** only Fab. Chicago

DIRZIUS MACHINE SHOP "K" 1423-25 So. 52nd Ave., Cicero 50, Ill.



SEA LEGS \$69.00
QUALITY BOAT KITS
Write for FREE literature DEALER INQUIRIES INVITED
PENNEY WOODCRAFT INDUSTRIES
1301-09 Ottawa Ave., Dept. M-52 Defiance, Ohio

SAY YOU SAW IT IN
POPULAR MECHANICS

Erect it yourself and SAVE!



GARAGES \$279^{UP}
Steel frame
Aluminum siding & roofing
Overhead door—Shipped anywhere
Other buildings for all purposes
Write for Folder
JOHN COOPER CO., 306 2nd St., Hackensack, N. J.



The Modern PLASTIC
for lasting Home Repairs

PERMANENTLY mends cracks or holes in wood, tile, stone or plaster. Sticks and stays put—Does not chip, shrink or fall out. Easy to use. Economical. Mold it, chisel it, polish or paint it. The big 4-lb. can is obtainable from your lumber, paint or hardware dealer at \$1.25; or will be shipped direct postpaid (in U. S.) for \$1.50. Complete satisfaction guaranteed or your money refunded.

DONALD DURHAM CO.
Box 804-T Des Moines, Iowa

NEW Govt. Release!
Original
Cost
\$444.00



**HOMELITE "Carryable"
GENERATING PLANT**

**1500 WATT
60 CYCLE, \$189.00** fob

Single Phase, A.C.

Carrying handles for
easy portability. Fits
easily in car trunk

Fully
Guaranteed

Save Hundreds of \$ \$ \$

PAYS FOR ITSELF! Saves time, labor and money. Provides on-the-spot power for CONSTRUCTION, etc. where none is available or expensive to run in. LARGE ENOUGH for Flood-lights; Saws; Pumps; and many more labor-saving, heavy-duty machines. Ideal as a stand-by emergency power plant to duplicate house current. Plenty of power for lights, refrigerator, deep freeze, oil burner, radio, etc. Specifications below CAN'T BE MATCHED anywhere at this price!

GENERATOR 1500-1700 Watts, 115 Volts, 60 cycle, single phase, A.C. Overload capacity well above its rated output. Excellent automatic voltage regulation plus Field Rheostat for even closer adjustment. Built-in Shok-mounted Volt Meter. Oversize brushes.

ENGINE Famous Homelite single cylinder engine. Air cooled; two cycle. Easy rope start. Dust and rain-proof ignition system. Built-in automatic governor. Foolproof pressure vapor lubrication system. Adjustable jet-type carburetor.

This Precision power plant has ball and needle bearings throughout and runs only 30 seconds to operate. Satisfaction Guaranteed.

SUPPLY LIMITED! IMMEDIATE DELIVERY! ORDER FROM AD
FREE Catalog of Compressors, Motors and Welders
ROBERTS ELECTRIC CO., Dept. P-250, 849 W. Grand, Chicago 22, Ill.



SAVE YOUR FINGERS

It mounts your portable saw for better, faster, safer cut-off or mitering. Hinged track automatically clamps work as you saw. Attached quickly to work bench. Strong, lasting.

\$27 (Without Saw) F.O.B. FACTORY - Order now.
MARVIN W. COLEMAN 4140P SYRACUSE, DEARBORN, MICHIGAN

TRUCK BUMPER GUIDES



HEIGHT - 28 INCHES
Universal Clamp Fits all trucks
ONLY \$5.95 per pair
Send check or money order.
No C.O.D.'s please, to—
MCCORD INDUSTRIES
JOPPA AND SATYR HILL RDS.
BALTIMORE 14, MARYLAND

Say You Saw It in Popular Mechanics

File Saws for PROFIT..



**BeMaCo
Rapid Saw Filer**

Make way for more business, increased profits with the BeMaCo Rapid Saw Filer. You can file more hand saws faster with better control when you use this easy-to-operate power filer. Engineered right... Priced right! **Write for details—today!**

Immediate
Delivery!
Order
Today!

Hand
Saw
Division
14-C

BEAVER MFG. CO.
800 ISIS AVENUE • INGLEWOOD, CALIF.

**HERE'S YOUR COMPLETE
POWER TOOL WORKSHOP**

**FOR
ONLY
\$7995**

**FACTORY
TO YOU**

8" SAW

- TRY SUPERSHOP FREE
- WE PAY FREIGHT
- YOU BE THE JUDGE
- EASY PAY PLAN

• Why does Power Tools Inc. make such an unusual offer? Our business is manufacturing and selling power tools direct to people like yourself. We have had experience with hundreds of thousands of people regarding their home workshop requirements. Supershop meets these requirements. This has been proven.

The combination of direct selling, advanced design and efficient manufacturing enables us to give the greatest power tool value in America today. That is why we have the courage to make you this offer.

This free trial is truly free. The machine is prepaid to your door and if it does not satisfy you, you return it at our expense. If you keep Supershop you pay the low factory-to-you cash price — or easy payments to fit your budget.

Write for free information. Mail the handy coupon — or send a postcard. We'll mail you colorful brochures on Supershop — and full details on the FREE TRIAL HOME OFFER. Absolutely no obligation.

POWER TOOLS INC. 168 YATES AVE. BELOIT, WISCONSIN

POWER TOOLS INC • BELOIT, WIS.

Send me your FREE brochures on Supershop and complete information about the Free Home Trial Plan. I am under no obligation.

NAME _____

ADDRESS _____

CITY _____ STATE _____



1/2" DRILL PRESS



8" SANDER



30" LATHE



8" GRINDER



500-WATT POWER PLANT

NEW Gov. Release! \$33000
Original Gov. Cost

One Emergency Use
and it's paid for! \$7950
SPECIAL ONLY PRE-PAID

FULLY GUARANTEED

Briggs & Stratton Gas Engine • Compound-Wound Generator

PORTABLE!! Worth its weight in gold in event of power line interruptions—and for many daily farm, home and construction jobs. Priced at less than cost of gas engine alone! OPERATES! Light bulbs up to 500 watts; incubator and brooder heat lamps (keeps chicks alive in power failures); 1/2" electric drills; 6" blade power hand saws (where lines are expensive to run up); food mixers; vacuum cleaners; floor polishers; AC-DC radios; electric hedge trimmers; shallow well pumps; many more machines.

Compound wound generator has max. output of 500 watts, 115 volts DC (although rated by army at 250 Watts for severe climatic conditions). Powered by Briggs & Stratton 1 1/2 HP, 4-cycle 2700 RPM, easy-to-start engine that operates 3 HOURS ON 1 1/2 GAL. OF GAS. Automatic governor maintains full voltage regardless of load. Standard duplex outlet receptacle with built-in filter and condenser eliminates static in radio reception. Cushion mounted for vibrationless operation. Instruction manual included.

Included CARRYING CASE with FREE Handles and "Latch-on" locks **WE PAY SHIPPING**

SUPPLY LIMITED! IMMEDIATE DELIVERY! ORDER FROM AD
FREE Catalog of Compressors, Motors and Welders

ROBERTS ELECTRIC CO., Dept. P-252, 849 W. Grand, Chicago 22, Ill

AMAZING BARGAINS—SAVE TO 100% 75 MOUNTED WHEELS and MINIATURE CUTTERS

Regular \$11.00 Value, Only \$4.50 Post Paid
For cutting and grinding on wood, metal or plastic. Includes 26 mtd. wheels and points on 3/32" shanks; 24 miniature cutters on 3/32" shanks; 25 short shank min. cutters. Will fit all electric drills and hand grinders.

FLEXIBLE SHAFT \$9.50 Value \$4.95

Post paid Fits all electric drills & hand power tools, 35 3/4" long. Oilite bearings. Core of specially wound, high carbon steel wire in flexible steel casing. Will accommodate tool shafts up to 1/2" dia. For lathes, electric drills, etc.

10 Hi-Speed Steel & Carbon Drills \$1.00 Post paid
5 Woodworkers Drills \$2.95 From 1/4" to 5/8" on 1/4" shank
5 Hi-speed steel Drills \$1.95 1/4" to 1/2" Diameter.

SCHUPACK SUPPLY CO., 7331 Cottage Grove, Dept. M-63 Chicago 19, Ill.
NEW ILLUSTRATED CATALOG, 10c



earn BIG PROFITS

Sharpening Hand Saws

The Foley Saw Retooter cuts perfect new teeth right over old ones in less than 1 minute, without removing saw handle. Makes filing easy. Takes all hand saws 4 to 16 points per inch. Relieves eye-strain. No experience needed.

FREE Foley Price Guide of saw sharpening charges. A valuable chart of actual prices. Send coupon today. No salesman will call.

FOLEY MFG. CO., 270-S Foley Bldg., Minneapolis 10, Minn.
Send FREE Price Guide and Foley Retooter circular.

Name _____
Address _____



TESTS LIVE OR DEAD CIRCUITS UP TO 600 VOLTS!

NEW Desco CIRCUITRACER — thousands in use — by Auto-Lite, Bendix, General Electric, electricians, servicemen. For all electrical, Hi-Fi, radio-TV, automotive, aircraft, marine. Locates grounds, opens shorts. Tests tube filaments; plates, screens; vibrators, output voltages. Ind. AC or DC. Ind. through 20 megohms res. Tests your wiring before you apply power. Kit includes incand. signal light, neon lamp, batteries, 12-pp book "Tracer Tips." Rugged lifetime constr. Ironclad money-back guarantee.

COMPLETE KIT \$4.95 POSTPAID
Does job of instruments from \$15 to \$50
Circuitracer
DESCO MFG. CO., 601A E. WALNUT, PASADENA 1, CALIF.

make those "HIGH, HARD ONES" ... with the new



12 FT. BIG CHIEF

3/4" Wide White Blade



- Handy 10-second Blade Change
- Double graduations—feet and inches
- Easy action Swing-Tip

By the Originators of the Wide Blade Rule

If measuring is a part of your job or hobby, make it a pleasure with Carlson's new, longer BIG CHIEF. It gives you the extra length and rigidity you need to make those high, inside measurements without strain or fuss... makes measuring a one-man proposition. Why put off owning the one rule that gives you all the features you need in a steel tape rule?

PRODUCED UNDER PATENTS 2059209, 2510939, 2629180 AND PAT. PENDING
CARLSON & SULLIVAN, INC. MONROVIA, CALIFORNIA

Also Eshelman SPORT CARS
LOWEST PRICE 70 Miles per Gal. Holds 1 Adult. Free Literature.

ESHELMAN RIDING MOWER

Better, Faster, Easier! Just ride along on this deluxe Rotary Mower. Write for literature.
Also Garden Tractors from \$69
ESHELMAN CO., Dept. M-52, 109 Light St., Baltimore 2, Md., 333 N. Michigan Ave., Chicago 1, Ill., 7070 Hollywood Blvd., L.A. 28, Cal.

BUILD YOUR OWN ARC-WELDER

We show you how to build NEW powerful welder. No rewinding. Uses most any surplus aircraft generator. Easy to build. 75-300 amps. Complete PLANS 35c. Send today and we'll include FREE our Big War Surplus & Electrical Catalog.

LEJAY MFG. CO., 1247 LEJAY BLDG., MINNEAPOLIS 8, MINN.

FREE "HOW TO ANSWER ADS"



Never before have you seen anything like this. Tells you in simple language the correct way to answer ads. Gets you quicker replies—better results, and greater satisfaction. Will save you time and money and it's ABSOLUTELY FREE. No obligation whatever. Every reader of advertising should have this booklet. Send a postcard for your copy NOW. F. W. Johnson, Popular Mechanics Magazine, Room 600-A, 204 East Ontario Street, Chicago 11, Illinois.

Porter-Cable

Homemaster Tools

CENTRIFUGAL PUMP AND MOTOR



\$20 VALUE
995

DELIVERS up to 700 G.P.H.

For draining cellars, fish ponds, sumps, water circulators, etc. Powered by the famous G.E. 110 volt, 60 cycle motor. Has 1" standard pipe inlet, 3/4 inch I.D. hose outlet. A Gov't Surplus Bargain. Completely Reconditioned. Motor is rewound and checked for serviceability. Ready to run. Your satisfaction fully guaranteed. Order while stocks last.



HOIST 2875

WITHOUT MOUNT

Ideal for Garages, Machine Shops, Trucks, Boats, etc. Has a 2500 lb. lift capacity through a 24 to 1 gear ratio. A bronze worm gear drive. 18 ft. of high tensile, steel cable - 3/16" diameter. NEW!

WINCH HOIST - Same as above with a free-spool, pull-out clutch. **2975**

HOIST MOUNTING FRAME Specially designed for above winches. Allows easy universal mounting. Price of Frame Only **450**

PORTABLE WINCH HOIST

NEW LIFTS 1500 POUNDS Made for U.S. Navy Bureau of Ordnance as a Bomb Hoist. Has a 21 to 1 gear ratio, 40" tubular arm extension with a 3" pulley on the end. Drum has 12 ft. of 3/16", high tensile strength steel cable. The operating handle has a ratchet brake ideal for "swing about", truck or platform loading. **NOW 2250** A \$125.00 Surplus Value.

ARMY FIELD PHONES

A private phone or intercom system. Easy to operate. Ideal for use on farms, target range, mountains or forest or any place portable two-way communication is desired. Gives clear reception up to 15 miles. Uses two standard batteries. Set contains ringing generator, leather carrying case and one phone. Several of these phones may be used on one line. Reconditioned and checked out. Price per each phone - only **1495** Price for a system - two sets... **2950**

NEW HYDRAULIC CYLINDERS

Due to great customer demand we are now manufacturing a complete line of Hydraulic Cylinders. To fill all your requirements for size - bore - stroke and length. Most sizes in stock. All guaranteed to give up to 3000 PSI. Write for further info.

SURPLUS HYDRAULICS

Our Surplus stocks include over 100,000 Hydraulic Cylinders in 106 types & sizes. Adapt these wherever tremendous power is needed to push, pull, hoist, drive, etc. Also in stock - Hydraulic Pumps, Motors, Valves, Fittings, etc. See our catalog!

No. 29 Surplus SPECIAL. Gives 20,000 lbs. thrust using 1500 PSI line pressure as delivered from our hydraulic pumps. Will give up to 40,000 lbs. thrust with 3000 PSI pressure. Has 4" bore; 18" stroke; 30-1/2" long... **2995 USED 4395 NEW** also can be used on a low pressure air system.

DO IT YOURSELF! IT'S FUN! IT'S PROFITABLE!



SAVE 50%

GENUINE SELECT
PHILIPPINE MAHOGANY
LUAN PLYWOOD

BUY DIRECT FROM IMPORTER

Our prices are LESS THAN DOMESTIC PLYWOOD at WHOLESALE. Due to the terrific demand generated by our national advertising and the amazing acceptance by the American public, we are importing this beautiful Luan Mahogany in BOAT LOADS - making possible further huge savings to you.

This selected LUAN MAHOGANY meets rigid Gov't Specifications. It is WEATHER and WATER RESISTANT. You'll be amazed at the beauty of this fine wood. Its rich golden elegance will thrill you. Rotary cut for beauty and grain. Both sides sanded and ready to use. Bonded with finest resin adhesive. Face side unjointed. Ideal for paneling DENS, OFFICES, HOTELS, CABINETS, etc.

3 1/2" x 6 1/2" x 3 mm approx. 1/8" thick
18 sq. ft.
A \$5.00 VALUE
Min. order 8 sheets

See for YOURSELF
FREE SAMPLE on request!

All orders shipped by special truck for LOWEST rates. No order accepted for less than 100 lbs. (4) 1/4" sheets (8) 1/2" sheets.

4 ft. x 8 ft. x 1/4" 32 sq. ft.
A \$9.50 VALUE
Min. order 4 sheets

★ WORLD'S GREATEST DO-IT-YOURSELF TOOL BARGAINS ★

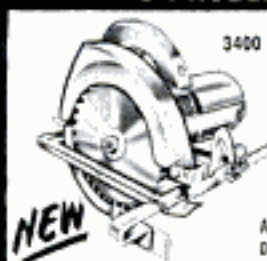

3400 RPM 1/2 HP POWER SAW

compares to saws selling up to \$250
Ideal for HOME or SHOP

1998

Complete with 5 1/2" Blade

CUTS THROUGH A 2 x 4 LIKE A KNIFE THROUGH BUTTER - RIPS - CROSSCUTS

A rugged, professional type, adjustable saw. Cut any angle, 0 to 45°. Has adjustable (0 to 8") rip fence. Safety-trigger switch on handle. Full 1/2 HP Universal AC DC, 110-120 Volt, 60 cycle motor. Weighs only 6 1/2 lbs. A sensational Value - We sold over 700 Saws in Los Angeles in one week

NEVER BEFORE AT OUR LOW PRICE!

Complete with Genuine Leather Holster!

SPORTSMAN'S 12 Pc. IMPORTED COMBINATION KNIFE

Eliminates 12 Individual Items from your Pack or Tool Kit!
(A \$12.95 VALUE) **495**

Here is the Perfect Combination Knife-Tool for every Outdoor Sportsman, Hunter, Camper, Fisherman, Boy Scout, Ranger, Rancher, etc. Think of it! 11, fine quality Steel Tools, precision made to fold easily into the heavy bone covered body. In one seat, compact unit you have (1) a regular knife, (2) a fork, (3) a spoon, (4) a drawknife, (5) a bone-saw and fish-scaler, (6) scissors, (7) a can and bottle opener, (8) a cork-screw, (9) a pencil, (10) a screwdriver and (11) a metal file. All this PLUS a genuine leather, belt holster.

ORDER NOW While We Can Guarantee Delivery at this Special Low Price

PORTABLE SHOVEL
G.I. Surplus, 20" handle. Blade folds to form pick. Carry in car for emergency in mud or snow. Ideal for camper, etc. **129**

ARMY PICKMATTOK
Has 12" steel head with Mattok on one side pick on the other. 1 1/2" hard-wood handle. Belt case. **129**

NEW 9 PIECE DRAWING KIT
Suitable for Artist, Architect, Draftsman, Student, etc. Has 9 separate pieces - one 7 1/2" divider, one each: 3/4" bow divider, bow pencil and bow pen with wheel adjustment and reversible needle point; one 4 1/2" ruling pen with extra handle; one capsule of leads. Complete in velvet lined, two flap case. **598**

ARMY D-12 MAGNETIC COMPASS
Originally used as standard navigational equipment on all Army Aircraft. A real War Surplus BARGAIN. Has a rotating verge range ring, calibrated in 1 degree increments from 0 to 360°. Two parallel grid wires for N-S alignment. Ideal for airplane, boat, etc. **1250**

100-200-300 POWER MICROSCOPE

Ideal gift for Student, Amateur Scientist, Botanist, etc. This is NOT A TOY but is a precision instrument comparing to others selling up to \$75. Has a triple, revolving lens turret with 100-200-300 Power, fully ground and polished objective lenses. Adjustable plano sub-stage mirror, Left & right hand focusing. All-metal, inlaid body. Comes in a hardwood case. **895**

400 VALUE 189
DEPTH GAUGE
Depth Gauge & Protractor. Made of finest quality steel. Has double-face, 6" scale in 32's and 64's. Has thumb-screw lock on head. Increments and numbers are engraved. Made by Millers-Fells or Union.

OFFICER'S LENSATIC POCKET COMPASS 395
All-purpose precision instrument. Ideal for hunter, hiker, camper, prospector, boy scout, surveyor, etc. Can be used for map orientation, taking azimuth reading, etc. Has 360° rotating bezel ring marked in 3° notches for easy computation. Also has a special 'peep' sight & hair-line guide in cover for taking bearings. A \$5.95 value

SHEEPLINED FLYING BOOTS 1088 NEW
Fully lined with sheepskin. Soft, warm & comfy. Have genuine leather uppers & rubber lowers. Zipper front closure. Laces up back for snug fit. Sizes: Sm., Med., Lg., X Lg.

NEW NAVY WADER BOOTS 349
A Surplus Bargain. Made of top quality, rubberized NYLON - vulcanized to Latex rubber shoe. Shoe is insulated against cold and has gripped sole. Boot is high height. Order one size larger than shoes. Sizes: 8, 9, 10, 11 and 12.

NAVY WADING SUIT 995
Makes Surf or Deep Stream Fishing a real pleasure. Also ideal for use wherever it is necessary to protect the body or clothes from mud, silt, moisture, etc. Made to top Government specifications. Originally designed for use as an overboard suit in landing operations. Of heavy duty rubberized canvas with vulcanized seams. Has built-in rubber boots and gloves. Sizes: Medium and Large. **3500 VALUE NEW**

NAVY WADERS 795 NEW
Made to top Gov't specifications. Of finest quality rubber with warm felt inner lining. Comes up to your chest. Have built-in boots, shoulder straps & vulcanized seams. \$25.00 value. Sizes: Small, Med., Large.

320 Pg. CATALOG
Packed with Bargains in GOVERNMENT SURPLUS, FACTORY CLOSE-OUTS, & GENERAL MERCHANDISE. Fully illustrated. Has thousands of items for Hobbyist, Gadgeteer, Mechanic, Sportsman. Send 50¢ to cover our handling & mailing - Refunded on 1st order.

PALLEY SUPPLY CO
2263 E. VERNON AVE., DEPT. PM-2
LOS ANGELES 58, CALIF.

Save \$40!



... WITH AMAZING
"ARCO JIG-SAW"
 ONLY \$10⁹⁵

How Much Will This Saw Really Do For You?

The answer is simple: everything a \$55 portable jig saw will do! Why? Because "ARCO JIG-SAW" has power to spare! It fits any 1/4" electric drill, and most drills have as much power as the built-in motors of the most expensive jig saws. So why pay more? "ARCO JIG-SAW" cuts straight lines, circles, intricate patterns in wood, plastics, metals—however large—even cuts 2x4's! Starts inside holes without boring. Exclusive "Air-Jet" blows away sawdust. Converts to Table Model with "ARCO STAND" Sturdy Casting \$2.75 6 Extra Blades \$1.95

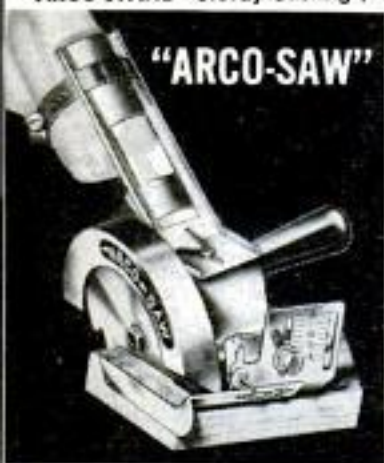

"ARCO-SAW"

CUTS 2x4's!

Fits any 1/4" drill. Has same features as high priced Portable Saws. Over 1/4 million in use! Complete with Depth-Bevel-Rip Gages for accurate cuts. Right Angle Steel Gear Drive & Safety-Yoke for safe one-hand operation and quick-cutting 5" Safe-cut blade....

\$12.50

BLADES — 5" Safe-cut, Rip, Crosscut, or Combination \$1.75

SOLD AT BETTER HOWE STORES. If not available, try these amazing tools on our UNCONDITIONAL 10-DAY MONEY BACK GUARANTEE. Send check or M.O. (ppd). C.O.D.'s—plus post.

ARROW METAL PRODUCTS CO.

Dept. PM-2, 140 West Broadway, New York 13, N. Y.

Say You Saw It in Popular Mechanics

BARRON Drill Press TOOLS



ROTARY PLANER

Planes • Rabbits
 Tenons • Panels
 Routs • Bevels

Only \$8.50 COMPLETE

BARRON TOOL CO. INC.
 364 Architects Bldg., Detroit 1, Mich.

FOR WORKSHOP AND INDUSTRIAL USES...

Over 40 precision built woodworking tools and accessories... Hi-Speed Router Bits—Rotary Surface Sanders & Drum Sanders—Safety Shaper Cutters—Dovetail Cutters—Large Auxiliary Metal Tables—All Metal Shaper Fences—Spindle Adapters—Handy Bench Vises. Many other items indispensable for accurate, useful, versatile workshop use. Every tool sold on complete satisfaction or your money back. See your Barron Dealer. Ask for special folder — "24 Extra Uses for Your Drill Press."

FREE
 Workshop Guide & Catalog

CONCRETE 'DRINKS' WATER STOP IT WITH 'SILICONIZ'

Instantly stops unhealthy dampness of concrete, brick, stucco or block walls; cuts efflorescence, freeze-cracking, paint-peeling. Masonry will not "drink," or absorb and transmit water when Siliconiz-treated. No furring, sheeting or plastering—just brush or spray on. Developed by originators and manufacturers of LIQUI-MOLY. \$4.50 per gallon (covers 200 sq. ft.), 5 gals. \$18.75, drum prices on request.

THE LOCKREY COMPANY, Bldg. Prod. Div., Southampton 2, N. Y.



Do-It-Yourself! Install "LO-GLO" On Your Fuel Oil System!

"Lo-Glo" tells you, inside your home, when your fuel oil supply is low! Eliminates going out to read gauge, or running out of fuel. Operates on 110-V. AC, stepped down. Complete kit easy to install, fits any tank, sure in operation. Write for details today!

WRIGHT PRODUCTS COMPANY
 P.O. BOX 167 MT. GRAB, OHIO

SAVE MONEY on SURPLUS PARTS for MILITARY TYPE TRUCKS & JEEPS

4 & 6 wheel drive. FREE catalog. State make of truck or Jeep. (New Jeep Tops, steel or canvas for all models). **AMERICAN AUTO PARTS CO., Inc., 1830 Locust, Kansas City, Mo.**

For Best Results! Use

a white glue — invisible when dry
 DAMP-PROOF HARMLESS

WILHOLD GLUE Finest Quality

Always Dependable

WILHOLD PRODUCTS CO., Los Angeles 31 • Chicago 44



GET THESE CARBIDE POCKET TOOLS



POINT PROTECTOR



SPECIAL OFFER

\$1.50
 EACH

MARK ON STEEL, GLASS, GEMS, CERAMICS with this new scribe. Tip is tungsten carbide — hardest man-made metal — diamond lapped for accuracy. Will outlast steel many times over.



SPECIAL OFFER

\$1.25
 EACH

GENUINE SUPER STRENGTH ALNICO PERMANENT POCKET MAGNET lifts up to 7 ounces. Picks up lost screws, holds small parts, separates steel from other metals.

These tools are used by mechanics, machinists, maintenance men, tool and gauge makers, and aircraft workers. Both with satin-finish light weight aluminum handle, knurled for easy holding. Made by leading industrial tool maker. Send stamps, money order or check. No C. O. D.'s please. Order today from:

Wendt-Sonis Company, Dept. PM, Hannibal, Mo.

PORTABLE LIGHT PLANTS

HI-LINE 6000 WATT PLANT
 Push Button Start 115-230 v. 60 cyc. A.C. A brute of a power plant with a rugged 14.6 hp. Wisconsin engine. Plenty of electricity for ranges, water heaters, freezers, pumps, machinery, etc. Affords both 110 and 220 volts. Ideal where heavy current is needed. Wt. 590 lbs. Easily worth \$895. With crank start. **Factory price \$585.50**
 Same plant, but with self-starter, Generator and control box only, best driven. Use your own engine or tractor. Wt. 240 lbs. (Item 163) **Factory price \$345.00**

Variable Speed Selector

Heavy duty, made by **B. F. GOODRICH** for industrial use. Provides instant speed changes for any drive. For machine tools, dryers, printing, conveyors, production lines, hoists—any operation requiring variable speed. Employs reliable "trouble free" planetary system. No hydraulic power losses. Infinite range, smooth operation, easy installation. 3 sizes: 1 1/2 hp. 30 lbs.; 1-2 hp. wt. 55 lbs.; 2-3 hp. wt. 105 lbs.; Reg. list \$328, \$252 and \$332. Our price... **\$79.50, \$89.50 and \$114.50**

9 TON HYDRAULIC PRESS

A tremendously powerful hydraulic press, capable of exerting 18,000 lbs. pressure. Pays for itself many times over—straightening bent connecting rods, king pins, crankshafts, axles, link pins and bars—or pushing out frozen bearings and bushings. Developed pressure under precise control and visible at all times on accurate gauge. Complete with both large and small anvils and jigs to straighten any kind of curve or bend. (Item 464) Wt. 110 lb. Actual list price \$365. Our special close-out price... **\$69.50**

52 pc. SOCKET SET

Highest quality, guaranteed non-breakable sockets made by Husky. Beautifully matched chrome trim will allow absolutely the best. Contains a complete set of 28 sockets in 1/2" drive, 3/8" drive and 1/4" drive, plus all necessary extensions, handles, speeders, reversible ratchets, etc.; all succeed, guarantee that will handle any job in a big doghouse steel box. Wt. 17 lbs. (Item 205) List price \$62.90. **Factory special... \$27.95**

MASTER DC ARC WELDERS
 Now! a portable, rugged, industrial type welder with terrific performance, yet at a price hundreds of dollars less than you'd expect. Senior model made for years of trouble-free, continuous service. High capacity DC welding unit enables you to tackle any job with confidence—easily welds anything up to 2" plate using from 1/16" to 1/4" rods. Built-in stabilizer and cooling system makes easy to strike and hold. Dual control rheostat provides low heat soldering, brazing and welding from 30 to 300 amps. Complete with instructions, guarantee and triple V-belt or flat pulley. You can pay more, but you can't buy a better welder.
WELDER ONLY—DUAL CONTROL MODEL. Same as above, but drive with your tractor, jeep or gas engine of 14 HP or more. (Item 280) **\$119.50**
WELDER ONLY—STANDARD MODEL. Same as above but with single rheostat for heavy metal welding only. (Item 38.) **\$99.75**
COMPLETE POWER MASTER (Illustrated above) powered by a 14-hp. air cooled Wisconsin engine. Wt. 480 lbs. (Item 280) Complete with welder costing \$1200. **Factory Special... \$449.50**
WELDING KIT Two 10 ft. leads, welding helmet, electrode holder, ground clamp. Sold only with welder at... **\$10.50**

BUY DIRECT FROM FACTORY PROFITS

600-700 WATTS PUSH BUTTON START
 115 v. 60 cyc. AC. Powered by a rugged 2 HP Briggs engine. No wiring necessary! Just plug in and operate. Plenty of current for any oil burner, freezer, brooder, emergency lights, etc. which require up to 700 watts. Ideal for television and radios. Complete with Voltmeter and built-in winding to charge 6 v. auto batteries. (Item 24.) Wt. 75 lbs. Easily fits in car trunk. Prepared if storm knocks out power lines. Reg. \$275 value... **\$143.50**
1000-1200 Watt Plant (Item 45) same as Item 24 but larger generator and engine... **\$199.50**
LITTLE GIANT—350 WATT (Item 273) 115 v. DC 1 1/2 hp. Briggs engine. Perfect for lights, radios, chain saws and power tools. Wt. 65 lbs... **\$99.75**

PORTO-POWER 1500-1750 Watt Plant
 115/120 v. 60 cyc. AC. Push button start. Powered by a 4.5 HP Briggs engine. Combines compactness and easy portability with higher output for handling heavier starting loads. Ideal for operating all burners, sump pumps, freezers, television, lights, communication systems, etc. Perfect for contractor's power tools. (Item 20.) Wt. 146 lbs. **Factory Special Price \$279.50**

MASTER-LITE 2500 Watt Plant
 110/120 v. 60 cyc. AC. A powerful plant, ruggedly constructed and yet designed for easy portability. Can be started by rope or built-in 12 v. electric push button start. Built-in winding to charge battery. Powered by a big 5.10 HP Briggs engine, complete with all accessories. Includes control box, voltmeter, and handy plug-in power receptacle. An ideal plant for permanent or stand-by service. Wt. 225 lb. Reg. price \$645.00 (Item 21) **Factory Price \$329.50**
 Dual Voltage 110/220 available for above plant for \$30.00 additional.
3500 Watt Plant Push Button Start (Item 23) 115 v. 60 cyc. AC. Similar to above, but larger and 33% more capacity. Wt. 270 lbs. Reg. \$760. **Factory Price \$379.50**
3500 Watt Dual Voltage Model—Similar in design to Item 21 above, but with 110/220 3 wire output. Affords choice of either 110 or 220 volts. (Item 23 d.v.)... **\$409.50**
 We make fully automatic controls to operate any of the above light plants. Write for details. **We make all sizes up to 25,000 Watts.**

EXTENSION CORD
 Heavy duty and very flexible. Neoprene 14-2 cable. 20 year quality. Wt. 12 lbs. (Item 185) 100 ft. Complete with rubber plug and outlet. A terrific value at only **\$8.95**
NO. 12-2 POWER CABLE. Very flexible rubber covered, special outside shield for grounding power tools, etc. 50 ft. (Item 199) Wt. 8 lbs. **\$6.95.** 100 ft. (Item 200) Wt. 16 lbs. **\$12.95**
NO. 10-2 POWER CABLE. Heavy duty, very flexible, rubber covered, 50 ft. with male and female fittings. Wt. 9 lbs. (Item 592a) **\$10.45** 50 ft. without fittings (Item 592) **\$9.95**

JET STEAM MASTER
 Now, a super efficient portable steam generator that produces live steam at 100 lbs. pressure in 60 seconds from a cold start! Produces large volume of high pressure steam on 2 pints of fuel oil. Instantly cleans sticky grease, dirt, rust, old paint, etc. old implements and road machinery. Pays for itself in a few weeks. Sterilizes soil. Sterilizes as it cleans—milk equipment, etc. Fully automatic—oil fired with new, built-in lifetime bronze water circulating pump. Draws water from faucet or bucket. Simple and safe—anyone can use it! built-in safety valve. Complete with 12 ft. of hi-pressure steam hose and new triple efficiency steam gun that automatically mixes in soap solution if desired. Wt. 250 lbs. Item 463. **\$329.50**
 Special factory price.

FROM FACTORY TO YOU

GIANT 2000-2500 WATT PLANT
 110-120 v. 60 cyc. AC. absolutely the best made—exclusive dynamically balanced armature; heavy windings develop up to 5000 watt overload for motor starting. Skid mounted—portable. Powered by an easy starting Briggs or Wisconsin 8 HP engine—complete with all accessories; engine easily disconnected for other uses. Big outlet box, voltmeter, no wiring necessary. Ample current for all purposes. **Factory warranty.** (Item 31) Wt. 210 lb. Reg. price \$585. **Special at... \$299.50**
 Same plant with electric self starter (Item 31a)... **\$359.50**
Generator only and control box... \$169.50
DUAL VOLTAGE 110-220 available on any of above models for \$28.00 additional.
3000-3500 WATT PLANT (Item 198) 110-220 v. 60 cyc. AC. Best Drive. Wis. engine Push Button Start. Wt. 370 lbs. **\$439.50**
Heavy duty... \$439.50
GENERATOR ONLY for belt drive... \$239.50

HEATING & VENTILATING FAN
 (Item 10) Easily installed in furnace pipes. Forces even heat to all rooms. Over range removes kitchen smoke and odors. Powerful, continuous duty motor, 110-120v. AC. Mount in wall or ceiling to ventilate any area. Quiet, super-efficient fan moves huge volume of air. (400 to 600 CFM).
 8" Pipe, wt. 5 lb. **\$6.85**
 10" Pipe, wt. 6 lb. **\$7.85**
 12" Pipe, wt. 7 lb. **\$8.85**
 14" Pipe, wt. 8 lb. **\$9.85**
HEAVY DUTY FAN. Semi-enclosed motor, suitable for spray booths, restaurant exhausts, poultry houses, etc. 10" Fan, wt. 8 lbs. (Item 10E) ... **\$11.95**
 12" Fan, wt. 10 lbs. (Item 10D) ... **\$12.95**

CONDITIONAIRE BARN FANS
 Save big money installing your own barn ventilating fan. Efficient propeller type blade moves huge volume of air quietly and effortlessly. Heavy welded frame—pre-drilled for easy installation. Just cut opening and bolt in place. Continuous duty motors. Ideal for keeping barns and chicken houses dry and ventilated. Control manually or with thermostat.
Blade Opening CFM Wt. Item
 16" 184 2925 19 lb. 363a **\$27.95**
 18" 214 3600 27 lb. 365b **\$31.95**
 20" 244 4100 30 lb. 345c **\$39.95**
THERMOSTATS: BARN type (range 40°-60°). Wt. 2 lbs. **\$6.95.**

HI-FLO Centrifugal PUMP
 Completely self-priming! No foot valve required. Tremendous capacity—100 gal. per min. . . . Special impeller enables pump to handle muddy or sandy water. Simple to operate—simply start engine and watch the water go. Powered by a rugged, easy-starting 2 HP Briggs engine. Pre-lubricated sealed bearings for years of heavy-duty service. Big 1 1/2" model. Item 207. Wt. 70 lbs. **\$134.50**
 Factory price... **\$134.50**
2" Model (150 gal. per min.) with 2 1/2 HP engine. Item 502a. 90 lbs. Fact. Spec. **\$154.50**

MASTER AIR COMPRESSOR
COMPARE! This is the only compressor built with a **NO RUST** stainless steel tank. Safe up to 500 lbs. (Item 209a) High pressure type (4 c.f.m.) Large volume of air for heavy duty service. For paint spraying, inflating truck & auto tires, greasing, sand blasting, etc. Piston type 2" bore compressor with built-in air filter. Master built with high strength alloys and precision bearings. Tank, 12"x24", 2100 cu. in. cap. Equipped with automatic switch that starts and stops motor to maintain desired pressure (up to 150 lbs.) and check valve, safety valve, gauge, shut-off valve, 20 ft. air hose and tire chuck. Beautifully balanced on ball bearing wheels and rubber tires. Don't take chances with used or surplus equipment. Our compressors are factory new and are guaranteed **SAFE.** Low factory prices. 1 1/2 HP Model (cap. 85 lbs.) Reg. \$175. (Item 209p) ... **\$109.50**
 1 1/2 HP Model-heavy duty R.I. motor with unloader switch. (Cap. 150 lbs.) (Item 209a) ... **\$129.50**

Send check or M.O. Prices f.o.b. Factory. 10 day Money back guarantee. SEND 10c for... **BIG 1955 Catalog**
MASTER MECHANIC MFG. CO., DEPT. 603 Burlington, Wis.

MORE ACCURACY • VERSATILITY • DEPENDABILITY FOR YOUR MONEY

SOUTH BEND gives you quality that counts — quality that pays off in better and faster metal working by means of more accuracy, versatility and dependability.

Compare the South Bend 7" Shaper and Pedestal Grinder with any others on this basis. You'll find that their quality actually gives you more value on a dollar-for-dollar basis. The best way to prove this is in your own plant. Let our distributor show you how both of these efficient machine tools can best be used in your production, toolroom or maintenance work.



8" Pedestal Grinder — \$245

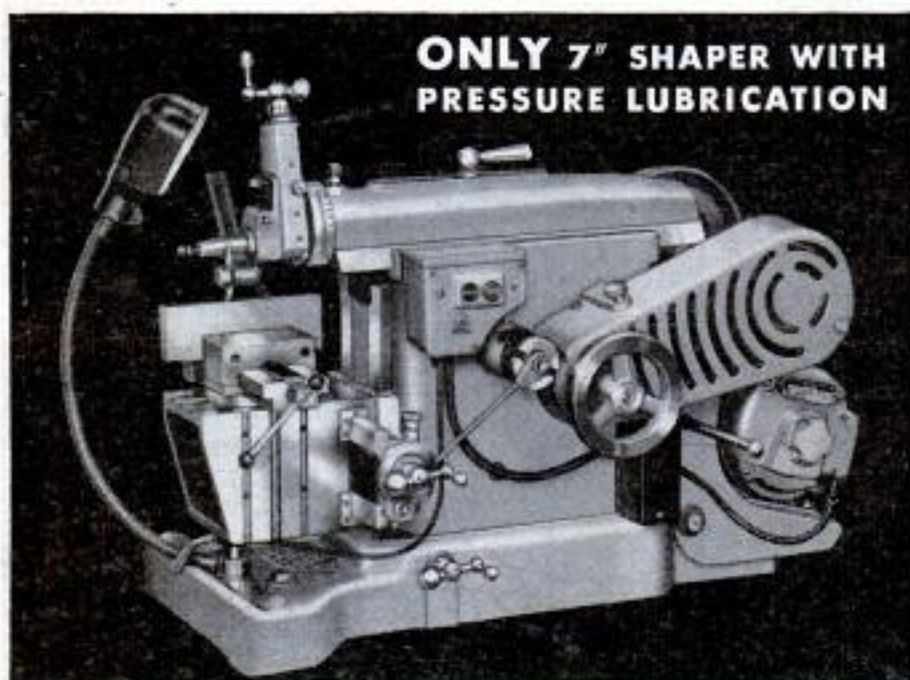

**ONLY 7" SHAPER WITH
PRESSURE LUBRICATION**

7" Precision Bench Shaper — \$551 (Prices f.o.b. factory, less motors)



SEND INFORMATION CHECKED:



9" and 10" BENCH LATHES



10" to 16-34" FLOOR LATHES



DRILL PRESSES



TOOL GRINDERS



1/2" & 1" Collet TURRET LATHES



7" BENCH SHAPERS

Name _____ Street _____

City _____ State _____

Building Better Tools Since 1906 • SOUTH BEND LATHE • South Bend 22, Indiana



No wonder it's called
"Miracle Vinyl-Flooring"!



MATICO ARISTOFLEX

RESISTS GREASE, ACID, ALKALI AND GRIME!

You'll call it "miracle flooring," too, when you see for yourself how rugged, durable MATICO Aristoflex shrugs off household acid, alkali and grease... stays new and sparkling looking with easy damp moppings. Biggest miracle of all is the price! Produced especially to meet the needs of homeowners everywhere, MATICO

Aristoflex is low in cost... gives you more for your money. And you can install economical Aristoflex in every room in your home... from basement to attic. See Aristoflex in 12 rich, clear colors at your MATICO dealer soon. You'll find him listed in your classified telephone directory.



MASTIC TILE CORPORATION OF AMERICA

Joliet, Ill. • Long Beach, Calif. • Newburgh, N. Y.

Manufacturers of:

Aristoflex • Confetti • Parquetry • Asphalt Tile • Cork Tile • Plastic Wall Tile

40188

INSTALL IT YOURSELF AND SAVE!



It's easy! Just mark a straight line through the center of your room in both directions, using a chalk and line. Be careful not to cover up your guide lines.



With a notched trowel, spread adhesive over one-half of your room at a time. Leave only a thin coat of adhesive on the floor.



After adhesive becomes tacky, snap the tiles into place. Do not slide tiles or adhesive will push up between the tiles.



Here's the best part! Show your wife your handiwork. (Don't tell her what a cinch it is with MATICO's easy-to-follow instructions).

FOR MORE PURE PLEASURE!

No other cigarette is so rich-tasting
yet so mild as **CAMEL!**



Wm. H. Brockman, REAR ADMIRAL, U. S. N. (Ret.)

"In 24 years I've tried 'em all. Nothing beats Camels for flavor... and the more years you smoke 'em, the more you appreciate their mildness!"

WM. H. BROCKMAN,

Commander of the first *Nautilus*, submarine which sank Japanese carrier at Battle of Midway, was awarded three Navy crosses. A Baltimore chemical company executive today, he is one of many American business leaders who are long-time Camel smokers.

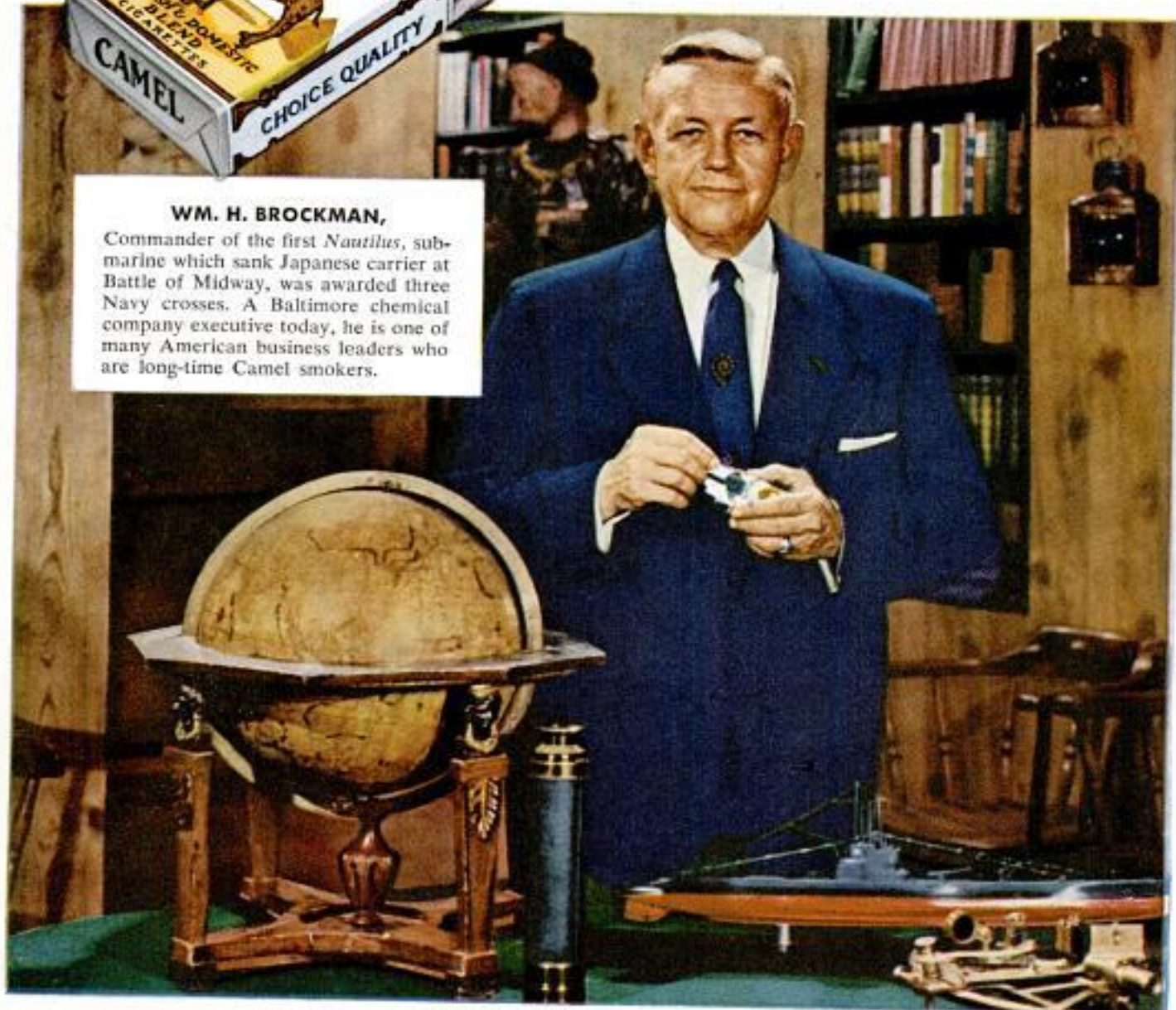

R. J. Reynolds Tobacco Co., Winston-Salem, N. C.

Unanimously, long-time Camel smokers confirm this fact: no other cigarette is so agreeably mild, yet so rich in flavor!

The secret is in Camel's blend of costly tobaccos, never matched by *any* other brand.

**Make your own 30-day
Camel Mildness Test**

Smoke only Camels for 30 days. See for yourself why Camels' cool mildness and richer flavor agree with more people than any other cigarette!