

POPULAR MECHANICS

MAGAZINE

WRITTEN SO YOU CAN UNDERSTAND

REG. U.S. TRADE MARK, GREAT BRITAIN, NO. 40428

REG. U.S. PAT. OFF.



In This Issue
12 NEW CARS FOR '55



THE PLYMOUTH V8 righted mate

Hoeta

FORD THUNDERBIRD

*The New Personal Car with the Sports Car Flair
Features the Spark Plugs in Your Future,*

NEW **TURBO-ACTION** CHAMPIONS!



The spark plug in your future is definitely the new Turbo-Action Champion which powers the mighty Ford Thunderbird.

So superior is the performance of this new Champion in the very latest design, high-output engines that other leading automobile manufacturers soon will follow the Thunderbird in adopting it as standard equipment.

Besides overcoming the number one problem of modern high-compression engines—fouling at continual low-speed driving—Turbo-Actions clear the way for higher compression, higher horsepower engines of the future.

Because of their new seating design and larger thread size, Turbo-Action Spark Plugs will fit only those new engines designed for them.

Your present car, however, will continue to give you top performance with regular standard Champions.

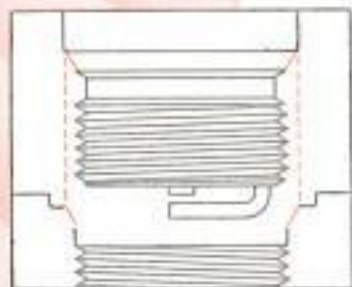

Greater clearance in the firing end permits turbulent gases to keep the insulator free of harmful deposits. Heat range, the temperature zone in which spark plugs operate efficiently, is extended to the widest limits in automotive history to meet the requirements of new, high-output engines.

Exclusive tapered Turbo-Action seating design forms a positive lock with a mating surface in the cylinder head without using a gasket. Correct installation is automatic and Turbo-Action Spark Plugs remain firmly fixed and accurately positioned in the combustion chamber.

AVAILABLE AT FORD AND OTHER CHAMPION DEALERS

CHAMPION SPARK PLUG COMPANY, TOLEDO 1, OHIO

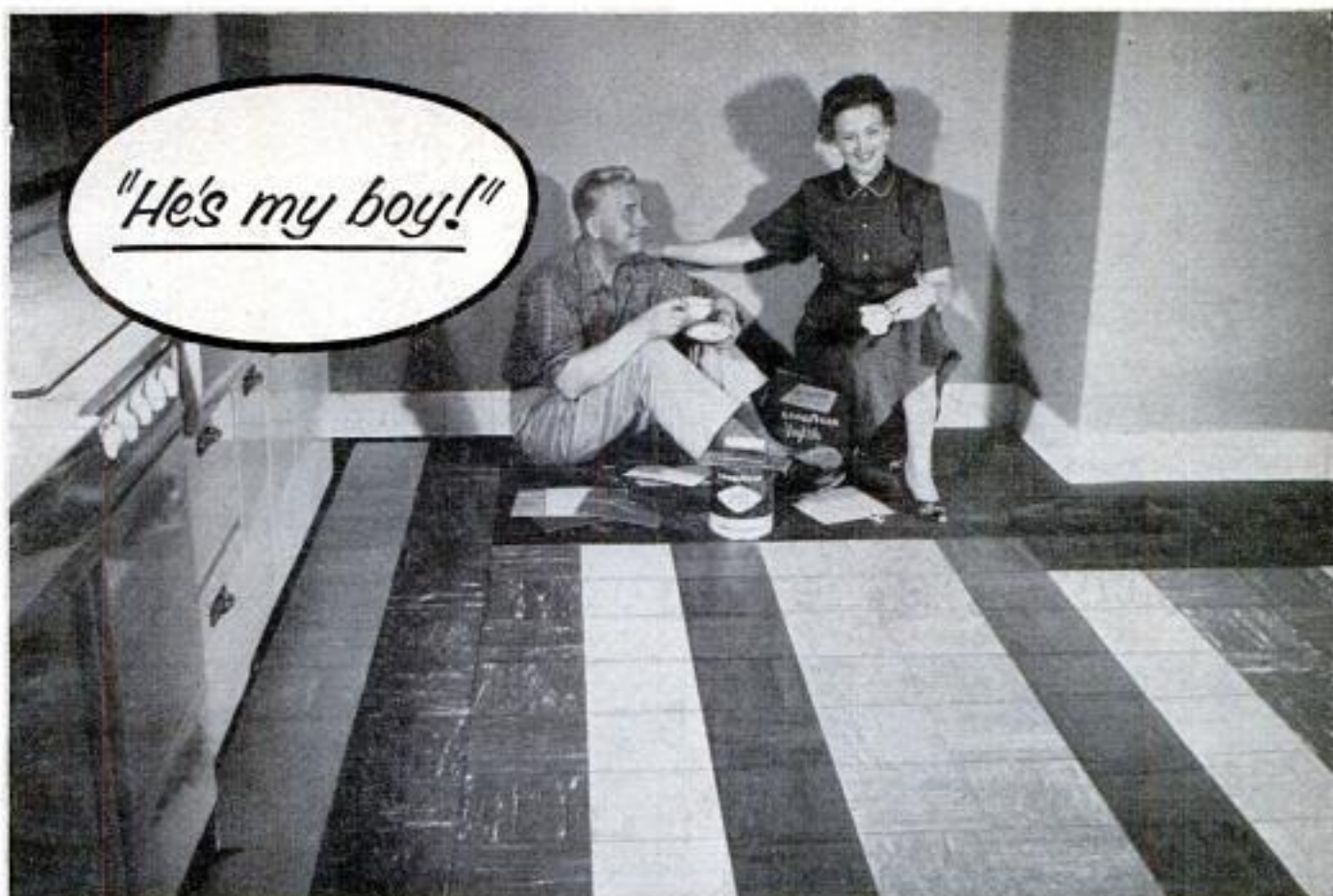

Do you see what my smart husband has done? As an anniversary present he gave me a complete new kitchen — and added the finishing touch *himself* by installing a brand-new sparkling floor of marvelous Goodyear All-Vinyl! (The picture's in black and white, but I wish you could see the *colors* of those tiles!)

Honest, when he went downtown and came back with that handy little Goodyear installation kit, a can of adhesive and 3 cartons of tile—I said, "Who's going to do it?"

"Me," Bill replied, as he thumbed through the instruction folder. And he did—a beautiful job—in one day!

Now I've got a floor as modern as the rest of my new kitchen! You can spill practically anything on it and it wipes clean as a whistle. Best of all — *it never needs waxing*, because it's 100% all-vinyl construction — pre-polished at the factory to a natural, lasting luster. No wonder I love my wonderful husband!

Note: If you'd like to get a folder that gives all the facts on how easy it is to install Goodyear All-Vinyl in your own home—plus full-color suggestions—then just drop a post card to:

Goodyear, Flooring Department X-8318, Akron 16, Ohio

Never
needs
waxing!



FLOR-MASTER INSTALLATION KIT provides all tools and instructions needed to do a professional flooring job in jig time. Yours at a low price at better flooring dealers' where Goodyear All-Vinyl Flooring is sure to be featured.

Flor-Master—T. M. The Goodyear
Tire & Rubber Company, Akron, Ohio

GOODYEAR *All-Vinyl Flooring*

FOR FLOORS • WALLS • COUNTER TOPS — BY THE TILE OR YARD

This One



81EU-L77-4XQ0

DECEMBER 1954

1

Copyrighted material

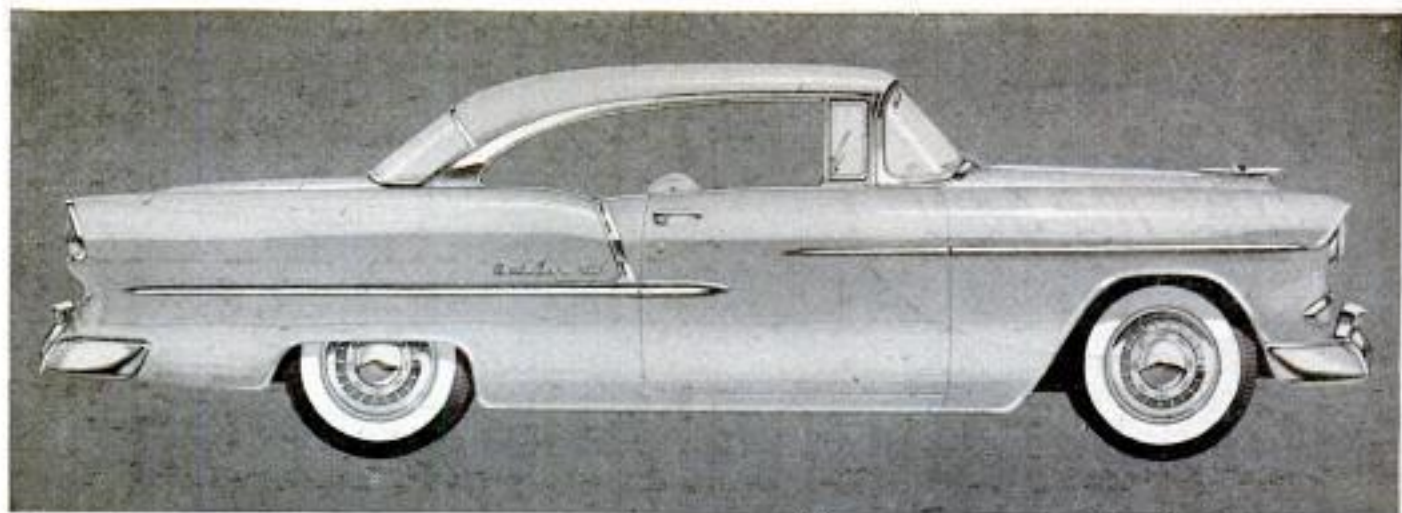

The smartest yet—1955 Chevrolet Bel Air Sport Coupe

Everything's new everywhere you look!

the motoramic

Chevrolet for '55

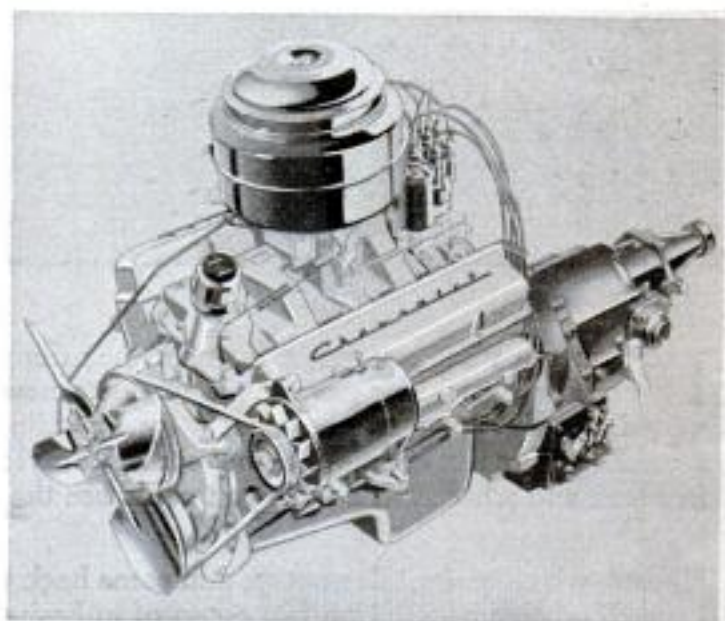

*New 162-h.p. V8 has 8 to 1 compression ratio—
and the shortest stroke in the low-price field.*

NEW Show-Car styling—new Sweep-Sight windshield—three new engines ("Turbo-Fire" V8 and two new "Blue-Flame" 6's)—new Glide-Ride front suspension—new outrigger rear springs—new Anti-Dive braking control—new ball-race steering—new 12-volt electrical system—new standard shift transmission or (optional at extra cost) new Overdrive transmission or improved Powerglide, new and improved automatic power helpers.

Chevrolet pulled out all the stops this year, threw every ounce of engineering and production skill into creating a car that is brand-new all the way through. We can't even begin to list all the changes here . . . all the new handling ease, roadability, riding comfort, visibility and wrapped-in-plush luxury. You'll have to drive it to know what the word *new* really can mean . . . when the world's leading manufacturer of cars touches off a revolution! See your Chevrolet dealer for a demonstration. . . . Chevrolet Division of General Motors, Detroit 2, Michigan.

More Than a New Car...a New Concept of Low-Cost Motoring!

Popular Mechanics Magazine

Registered in U. S. Patent Office and Canada

H. H. WINDSOR, Founder

H. H. WINDSOR, JR., Editor and Publisher



Next Month

THAT CAR Floyd Clymer is inspecting leads all sports cars in total sales in this country. It leads the pack in foreign-car sales, just as it frequently leads the pack in road races, for it is one of the fastest production cars in the world. Recognize it? It's the Jaguar, a sleek little machine that's equally at home in front of a country club or whipping around a corner at Watkins Glen. Ever wonder just what a Jaguar driver is thinking as he zips past you? Does he really like his car, or is he just showing off? You'll find out next month when the owners themselves report on this most popular of all foreign makes. Floyd Clymer's expert road test is included as usual

Information not listed on articles in the index, starting on page 12, frequently is listed in the WHERE-TO-FIND-IT LIST, which is available to readers without charge. A copy may be obtained by writing to the Bureau of Information, Popular Mechanics, 200 E. Ontario, Chicago 11, Ill.

Published monthly by Popular Mechanics Company, 200 E. Ontario St., Chicago 11, Ill. H. H. Windsor, Jr., president; Wm. Harrison Petricola, exec. vice-pres.; D. F. Windsor, vice-president and secretary-treasurer; H. H. Windsor III, vice-president; Clover L. Perkins, advertising manager; Alan M. Deyoe, circulation manager. Single copy in the United States and Canada, 35 cents; subscription rates in the United States and possessions, Canada, Philippines and countries of the Pan-American Postal Union, 1 year \$3.50; 2 years \$6.00; 3 years \$8.00. To all other countries add \$1.00 a year over United States prices for overseas postage. If you plan to move, notify us at least 30 days in advance so you will not miss an issue. Give both your old and new addresses. Entered as Second Class Matter, September 15, 1903, at the Post Office at Chicago, Illinois, under Act of March 3, 1879. Entered as Second Class Matter at Post Office Dept., Canada. Registered as Second Class Matter at the Post Office at Mexico, D. F., Mexico, June 20, 1950. Copyright 1954 by Popular Mechanics Company. Copyright under International Copyright Union. Copyright in France. All rights reserved under Pan-American Copyright Union. Printed in the United States of America.

DECEMBER 1954

Volume 102 DECEMBER 1954 Number 6

Address all communications to: 200 E. Ontario St., Chicago 11, Ill.

Managing Editor.....Roderick M. Grant
Assistant Managing Editor.....Wayne Whittaker
Shop Notes and Crafts Editor.....James R. Ward
Radio-Television, Electronics Editor.....Frank L. Brittin
Associate Editor.....Clifford B. Hicks
Associate Editor, Automotive.....Arthur R. Railton
Associate Editor.....George E. Moise
Associate Editor, Shop Notes and Crafts.....Wayne C. Lecky
Assistant Editor, Shop Notes.....W. Clyde Lamme
Assistant Editor, Crafts.....Frank N. Stephany
Assistant Editor, Makeup.....John C. Dalen
Automotive Correspondent.....Leo Donovan
Art Director.....Frank Beatty

Assistant Editors

Leonard F. Hiltz, Jay W. Hedden, Elliott H. McCleary, Emily Mullaney
Eastern Editor.....Richard F. Dempewolf
Empire State Bldg., Room 2906, New York City 1
Western Editor.....Thomas E. Stimson, Jr.
Suite 1010, 3460 Wilshire Blvd., Los Angeles 5, Calif.
London Manager.....Douglas W. Wedderspoon
Eagle House, Jermyn St., London S. W. 1, England
Director, Bureau of Information.....Allan Carpenter
200 E. Ontario St., Chicago 11

In This Issue . . .

Gamma Ray Magic - - - - -	81
Oh, for the Life of a Cameraman - - - - -	90
New Cars for 1955 - - - - -	94
Everything's on Wheels - - - - -	106
Model Railroad With Sound Effects - - - - -	113
What's New for Your Home - - - - -	132
That Wonderful Volcanic Popcorn - - - - -	136
Mountain Goats on Two Wheels - - - - -	142
Look Inside a Dummy's Head - - - - -	154
Radio, TV and Electronics - - - - -	161

For the Craftsman . . .

Modernized Fireplace - - - - -	165
What You Should Know About Clothes Driers - - - - -	170
Solving Home Problems - - - - -	178
Earth Hauler for Young Engineers - - - - -	181
Fine Finishes for Fir - - - - -	186
Rubber-Stamp Christmas Cards - - - - -	190
Six Projects Using Tile - - - - -	193
New Cars Combine Economy With Performance - - - - -	198
Shopping for Tools - - - - -	218

Other items, and manufacturers of available products described, are listed on pages 12, 14 and 16

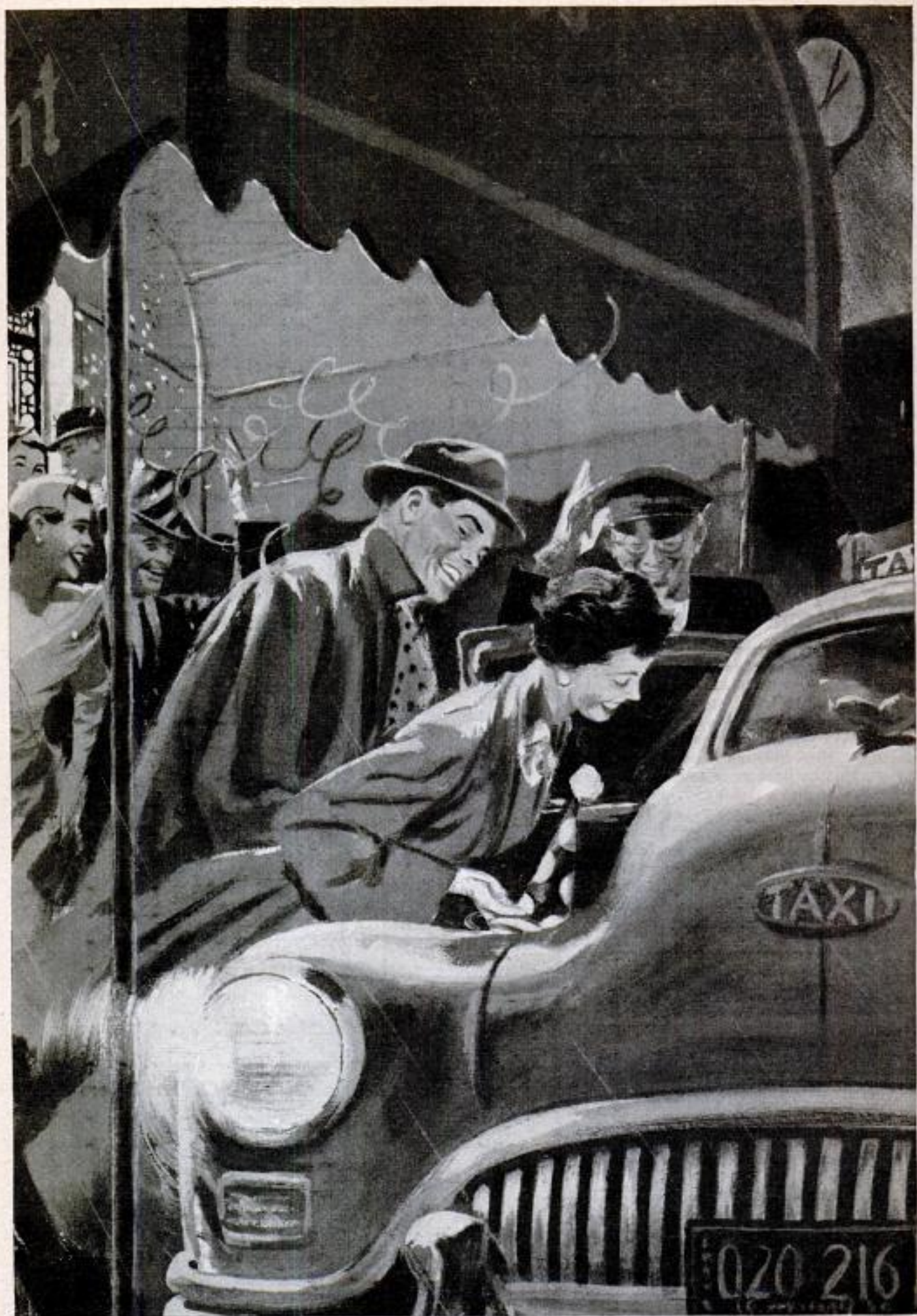

Sometimes it's smart to leave your car home. It may help you...

save up to 40% on your auto insurance!

Read why careful drivers get top-notch protection at rock-bottom rates with

STATE FARM MUTUAL

As long as some folks insist on mixing alcohol and gasoline, there'll be times when you'll be better off *not* driving.

And knowing when *not* to drive can help you save money on your auto insurance.

It can help you qualify for membership with State Farm Mutual. And the cost of State Farm insurance is lower—in many areas as much as 40 percent lower—than the cost of ordinary auto insurance.

That's because State Farm aims to insure *only* careful drivers. Careful drivers cost less to insure. We pass the saving back to State Farm members in the form of *low rates*.

Some of the other advantages we offer are:—dependability. State Farm insures more than 3 million cars, more by far than any other company...

—semiannual payments at no extra cost—a real convenience for the budget-minded...

—fast, fair, friendly claim service through our own 7,000 agents and 700 claim expeditors.

For full details—and the exact amount you can save—call the nearest agent listed under "State Farm Insurance" in the yellow pages of your phone book. Or write: State Farm Mutual, Dept. J-17, Bloomington, Illinois

Can You Qualify?

State Farm aims to insure careful drivers only. Drivers who can be counted on to:

- Avoid mixing alcohol and gasoline
- Be patient in heavy traffic
- Obey speed laws
- Heed crossing signals
- Make full stop at stop signs
- Always signal stops and turns
- Have car checked regularly
- Pass only when coast is clear

STATE FARM MUTUAL

"the careful driver insurance company"



FREE TO MEMBERS!

Ask your agent for your new State Farm insignia (like above) in bright red headlight-reflecting Scotchlite. Display it proudly on left rear car bumper to identify yourself as "careful driver, soundly insured"... to provide emergency reflection when parked or if taillight fails.

State Farm Insurance is written only by the
State Farm Mutual Automobile Insurance Co.
and its wholly owned affiliates:

State Farm Life Insurance Company
State Farm Fire and Casualty Company

Home Office: Bloomington, Illinois. Field claim offices in 325 principal cities. 7,000 agents in 40 states, District of Columbia, and Ontario, Canada

Hear "Jack Brickhouse Sports News" Saturdays and "Cecil Brown News Commentaries" Sundays over Mutual Stations. Check local radio listings.

Step Up Your Pay LEARN TO FIX APPLIANCES at Home in Spare Time

Fast Growing Field for men who know this Profitable Trade

Get into a field where you can do important work, have a secure future. Electrical appliance repair offers OPPORTUNITY FOR YOU.

Every wired home has an average of 8 electrical appliances. Up to 10 million new appliances are being sold every year. Owners pay well to keep them in repair and enjoy the convenience they provide. That means a fast growing need for trained men.

Learn and Earn with Tester You Build

Our training includes the parts to build a sturdy, portable appliance tester following our illustrated, easy-to-understand instructions. This multi-use tester helps you locate electrical defects quickly and easily, equips you to do professional trouble-shooting. You use it to learn electrical appliance repair techniques. Gives you the practical training of actually building the tester and a valuable piece of equipment for future use.

Earn \$3, \$4, \$5 an Hour Spare Time

Start soon to repair electric toasters, fans, irons, mixers, vacuum cleaners, etc. for your neighbors and friends. Spare time work done at your convenience in your basement, garage, or spare room can earn you from \$3 to \$5 an hour. See how easy it is to increase your earning power—how you can pay for this training many times over with the money you'll earn in your spare time. Mail coupon.

Train Now for Greater Security Low Price—Easy Terms

Today's automatic electric appliances need expert servicing. The man who knows this good trade has a secure future. Put your spare time to good use. Enroll now for \$2.50 down and \$5.00 a month. A small investment can assure a better future. Address Electrical Appliance Training, National Radio Institute, Dept. AN-4, Washington 9, D.C.

FREE Lesson and Book
MAIL this NOW

NATIONAL RADIO INSTITUTE

DEPT. AN4, WASHINGTON 9, D. C.

Please send me lesson and book free. (No salesman will call.)

Name _____ Age _____

Address _____

City _____ Zone _____ State _____

in this corner.....

THE EDITORS



To the Editor:

I wish I could adequately express how pleased I am with the entire presentation of the Survey House (PM, Oct. 1954).

Everything about it was superb—the copy, the art, the layout, everything!



It was also quite a surprise to receive 42 inquiries in Monday's mail, inasmuch as the magazine did not appear on our local newsstands until that day.

Rudolph A. Matern,
Jamaica, Long Island, N. Y.

Mr. Matern was the architect of our Survey House, designed for the October issue from the desires of our readers as expressed in 3561 answers to questionnaires about their ideal home. At the time this is written, 1909 readers had inquired about blueprints of the house.

Tidings From Hong Kong

Through the U. S. Information Agency we hear that PM is doing its bit of missionary education among the Chinese at Hong Kong. Following is a story just received from the Agency's Washington office:

The U.S. Information Agency's library in Hong Kong is not only providing young Chinese with a knowledge of English and a glimpse of the culture and way of life of far off United States, but it is turning their young minds into constructive channels of science and research.

This came to light when Mr. Haitz T. Y.

(Continued to page 8)

5 reasons why ACCOUNTANCY



offers you **MORE MONEY . . . and SUCCESS!**

REASON #1. If you were an expert accountant right now, chances are you would find yourself among the highest-paid of all professional men and women. Even back in "depression years," surveys showed that accountants earned more on the average than men in other major professions.

REASON #2. The demand for accountants is great—everywhere. All businesses must have trained accountants to cope with ever-growing requirements. It's a profession offering wide opportunity—always—to the man who knows.

REASON #3. You can fit into any business, anywhere in the country—because accounting principles are universal. Think what this means in terms of security and independence!

REASON #4. Accountancy is open to all. Any man or woman of good intelligence, who enjoys figure work and is willing to follow LaSalle's systematic "problem method" plan, can rapidly qualify for a highly profitable, enjoyable life-time career . . . and he doesn't have to finish his training before beginning to "cash in."

REASON #5. Without losing a day from your present work, you can prepare in spare hours at home, at low cost, under LaSalle's step-by-step "Problem Method" of "learning by doing." This famous plan accounts for LaSalle's remarkable record of having trained nearly 10 per cent of all Certified Public Accountants in the U. S. . . . and of having put many thousands of others into high-paying careers.

Send today for Free Sample Lesson and "Accountancy, the Profession That Pays." Learn about the five great fields of opportunity . . . and LaSalle's time-tested plan for helping men and women to rapid advancement, higher income, greater prestige and professional standing. The coupon below will bring this information to you—without cost or obligation.

MAIL THE COUPON—NOW

GET FREE SAMPLE LESSON



LaSalle Extension University
— A Correspondence Institution —
Dept. 1264H, 417 S. Dearborn St., Chicago 5, Ill.

Please send me, free of all cost or obligation, a sample lesson in Accounting . . . also, your 48-page illustrated book, "Accountancy, the Profession That Pays."

Name.....Age.....
Address.....
City, Zone, State.....

LASALLE
417 S. Dearborn St.,
CHICAGO 5, ILL.

DECEMBER 1954

7

HOW TO FIX ANY PART OF ANY CAR

QUICKLY--EASILY--RIGHT!



FREE 7-DAY TRIAL

Whether you're a beginner or an expert mechanic—now you can "breeze through" any "fix-it" job from simple carburetor adjustment to complete overhaul. Just look up job in index of MOTOR'S Brand-New 1954 Auto Repair Manual. Follow simple step-by-step directions, clear pictures. Presto—the job is done!

No guesswork! MOTOR'S MANUAL takes you from "scratch"—shows WHERE to start, WHAT tools to use. Covers EVERY job on EVERY car built from 1940 thru 1954!

Everything You Need to Know "Boiled Down" from 140 Official Shop Manuals

NEW, REVISED and greatly ENLARGED. Edition contains the "meat" from over 140 OFFICIAL shop manuals—simplified for YOU. 22,598 essential repair specifications on over 685 chassis models. ONE THOUSAND big pages. More than 2,050 "this-is-how" pictures. 225,000 service and repair facts. Leads beginners every step of the way. Time-saving factory repair procedures for experts. Instructions and pictures so clear you CAN'T go wrong. Used by U. S. Army and Navy.

Try Book FREE 7 Days

SEND NO MONEY! Pay postman nothing. Make Manual show you what it's got. Unless you agree this is the greatest time and work saver you've ever seen—return book in 7 days and pay nothing. Mail coupon today to MOTOR—Book Dept., Desk 1M, 250 W. 55th St., New York 19, N. Y.

MOTOR'S AUTO REPAIR MANUAL

Covers 685 Models All These Makes

- | | |
|-----------|------------|
| Buick | Kaiser |
| Cadillac | Lincoln |
| Chevrolet | Mercury |
| Chrysler | Nash |
| Crosley | Oldsmobile |
| De Soto | Packard |
| Dodge | Plymouth |
| Ford | Pontiac |
| Frazer | Studebaker |
| Henry J | Willlys |
| Hudson | |

Some FREE Offer On MOTOR'S Truck and Tractor Manual

Covers EVERY job on EVERY popular make gasoline truck, tractor made from 1946 thru 1954. FREE 7-Day Trial. Check proper box in coupon.



(Continued from page 6)

Chang came by the library to get some old magazines . . . In particular he wanted back issues of *Popular Mechanics*.

Not long before, Chang's 15-year-old son had created a crude microscope through which he discovered the fascinating activity of the amoeba world. Overjoyed with the new toy he had made by copying a drawing from *Popular Mechanics*, young Chang attempted a miniature telescope.

Now, in the evening, his father explained, the youngster is discovering stars which he had been unable to see with his naked eye. In the daytime he watches fishing boats in the distant harbor.

Thus absorbed with invention, young Chang plods away at mastering English, so that he can better understand the text under the drawings and build more instruments of the sort which open up new horizons.

"I find my children have improved reading ability in English and increased common sense in scientific knowledge," Chang told the Director of the U.S. Information Agency's library. "There are thousands of children and teen-agers in Hong Kong benefited by the library just as mine are."

To the Editor:

Your article in August about the Florida airboat is very interesting but you don't have to go all the way to Florida to find airboats. The Susquehanna River north of Harrisburg is quite popular for the up and coming airboat. In June 1953 an airboat traveled from Millersburg, Pa., up the Susquehanna via the North Branch all the way



to Oswego, N. Y. The airboat we built here at the airport is strictly a fishing boat and can traverse any spot in the river as long as the ground is wet.

Eugene C. Breiner,
Shop Foreman,
Danville Airport,

To the Editor:

I am very grateful for this opportunity to write you. I am a Korean boy living in

(Continued to page 10)

MAIL COUPON NOW FOR 7-DAY FREE TRIAL

MOTOR BOOK DEPT.
Desk 1M, 250 W. 55th St., New York 19, N. Y.

Rush to me at once (check box opposite book you want):

MOTOR'S New AUTO REPAIR MANUAL. If O.K., I will remit \$2 in 7 days, \$2 monthly for 2 months and a final payment of \$5 (plus 35¢ delivery charge) one month after that. Otherwise I will return the book postpaid in 7 days. (Foreign price, remit \$9 cash with order.)

MOTOR'S New TRUCK & TRACTOR REPAIR MANUAL. If O.K., I will remit \$2 in 7 days, and \$2 monthly for 3 months, plus 35¢ delivery charge with final payment. Otherwise I will return book postpaid in 7 days. (Foreign price, remit \$20 cash with order.)

Print Name..... Age.....

Address.....

City..... State.....

Check box and save 35¢ delivery charge by enclosing WITH coupon entire payment of \$6.95 for Auto Repair Manual (or \$8 for Truck & Tractor Repair Manual.) Same return-refund privilege.

For real job security...

FILL THE GAPS IN YOUR

TRAINING



THE pressure is mounting. Competition for jobs is growing fast. Business and industry are tightening up. Every man or woman holding a good job is now, in effect, "on probation."

Are there "weak spots" in your training? Now's the time to get after them! Six months from now may be too late.

How can you fill the gaps — quickly? International Correspondence Schools can help you! There's no faster, surer way to get exactly the training you need!

You have 277 famous, spare-time I. C. S. Courses to choose from: trade, industrial engineering, office, executive, high school. Or you can arrange for "refresher" courses, advanced training or special instruction combining two or more specific business or technical subjects.

I. C. S. has the most complete line-up of job-related instruction you can find anywhere. Courses are tailored to fit your needs. This means you waste no time on subjects you can't use. You lose no time traveling back and forth to classes. You set your own schedule—no interference with business or social activities.

Find out for yourself how quickly, how thoroughly I. C. S. can fill the gaps in your training! No obligation. Just mark and mail the coupon!

3 FREE BOOKS

32-page, pocket-size gold mine of facts, "How to Succeed," plus catalog outlining opportunities in field that interests you! Also, free sample lesson.

For Real Job Security—Get an I. C. S. Diploma!

I. C. S., Scranton 9, Penna.

INTERNATIONAL CORRESPONDENCE SCHOOLS



BOX 5637-L, SCRANTON 9, PENNA.

(Partial list of 277 courses)

Without cost or obligation, send me "HOW TO SUCCEED" and the opportunity booklet about the field BEFORE which I have marked X (plus sample lesson):

- | | | | | |
|-------------------------------------------------------------------------------------------------------------------------------------------------------------------------------------------------------------------------------------------------------------------------------------------------------------------------------------------------------------------------------------------------------------------------------------------------------------------------------------------------------------------------------------------------------------------------------------------------------------------------------------------------------------------------------------------------------------------------------------------------------------------------------------------------------------------------------------------------------------------------------------------------------------------------------------------------------------------------------------------------------------------------------------------------------------------------------------------------------------------------------------------------------------------------------------------------------------------------------------------------------------------------------------------------------------------------------------------------------------------------------|------------------------------------------------------------------------------------------------------------------------------------------------------------------------------------------------------------------------------------------------------------------------------------------------------------------------------------------------------------------------------------------------------------------------------------------------------------------------------------------------------------------------------------------------------------------------------------------------------------------------------------------------------------------------------------------------------------------------------------------------------------------------------------------------------------------------------------------------------------------------------------------------------------------------------------------------------------------------------------------------------------------------------------------------------------------------------------------------------------------------------------------------------------------------------------------------------------------------------------------------------------------------------------------------------------------------------------------------------------------------------------------------------------------------------------------------------------------------------------------------------------------------------------------------------------------------------------------------------|-------------------------------------------------------------------------------------------------------------------------------------------------------------------------------------------------------------------------------------------------------------------------------------------------------------------------------------------------------------------------------------------------------------------------------------------------------------------------------------------------------------------------------------------------------------------------------------------------------------------------------------------------------------------------------------------------------------------------------------------------------------------------------------------------------------------------------------------------------------------------------------------------------------------------------------------------------------------------------------------------------------------------------------------------------------------------------------------------------------------------------------------------------------------------------------------------------------------------------------------------------------------------------------------------------------------------------------------------------------------------------------------------------------------------------------------------------------------------------------------------------------------------------------------------|--------------------------------------------------------------------------------------------------------------------------------------------------------------------------------------------------------------------------------------------------------------------------------------------------------------------------------------------------------------------------------------------------------------------------------------------------------------------------------------------------------------------------------------------------------------------------------------------------------------------------------------------------------------------------------------------------------------------------------------------------------------------------------------------------------------------------------------------------------------------------------------------------------------------------------------------------------------------------------------------------------------------------------------------------------------------------------------------------------------------------------------------------------------------------------------------------------------------------------------------------------------------------------------------------------------------------------------------------------------------------------------------------------------------------------------------------------------------------------------------------------------------------------------------------------------------------------------------------------|------------------------------------------------------------------------------------------------------------------------------------------------------------------------------------------------------------------------------------------------------------------------------------------------------------------------------------------------------------------------------------------------------------------------------------------------------------------------------------------------------------------------------------------------------------------------------------------------------------------------------------------------------------------------------------------------------------------------------------------------------------------------------------------------------------------------------------------------------------------------------------------------------------------------------------------------------------------------------------------------------------------------------------------------------------------------------------------------------------------------------------------------------------------------------------------------------------------------------------------------------------------------------------------------------------------------------------------------------------------------------------------------------------------------------------------------------------------------------------------------------------------------------------------------------------------------------------------------------|
| <p>ARCHITECTURE and BUILDING CONSTRUCTION</p> <ul style="list-style-type: none"> <input type="checkbox"/> Air Conditioning—Refrig. <input type="checkbox"/> Architecture <input type="checkbox"/> Building Contractor <input type="checkbox"/> Building Maintenance <input type="checkbox"/> Carpenter and Mill Work <input type="checkbox"/> Estimating <input type="checkbox"/> Heating <input type="checkbox"/> Painting Contractor <input type="checkbox"/> Plumbing <input type="checkbox"/> Reading Arch. Blueprints <input type="checkbox"/> Steamfitting <p>ART</p> <ul style="list-style-type: none"> <input type="checkbox"/> Cartooning <input type="checkbox"/> Commercial Art <input type="checkbox"/> Fashion Illustrating <input type="checkbox"/> Magazine Illustrating <input type="checkbox"/> Show Card and Sign Lettering <input type="checkbox"/> Sketching and Painting <p>AUTOMOTIVE</p> <ul style="list-style-type: none"> <input type="checkbox"/> Auto Body Rebuilding <input type="checkbox"/> Auto Elec. Technician <input type="checkbox"/> Auto-Engine Tune Up <input type="checkbox"/> Automobile Mechanic | <p>AVIATION</p> <ul style="list-style-type: none"> <input type="checkbox"/> Aeronautical Engineering Jr. <input type="checkbox"/> Aircraft & Engine Mechanic <p>BUSINESS</p> <ul style="list-style-type: none"> <input type="checkbox"/> Advertising <input type="checkbox"/> Bookkeeping and Accounting <input type="checkbox"/> Business Administration <input type="checkbox"/> Business Correspondence <input type="checkbox"/> Certified Public Accounting <input type="checkbox"/> Creative Salesmanship <input type="checkbox"/> Federal Tax <input type="checkbox"/> Letter-writing Improvement <input type="checkbox"/> Managing Small Business <input type="checkbox"/> Office Management <input type="checkbox"/> Retail Business Management <input type="checkbox"/> Sales Management <input type="checkbox"/> Stenographic-Secretarial <input type="checkbox"/> Traffic Management <p>CHEMISTRY</p> <ul style="list-style-type: none"> <input type="checkbox"/> Analytical Chemistry <input type="checkbox"/> Chemical Engineering <input type="checkbox"/> Chem. Lab. Technician <input type="checkbox"/> General Chemistry <input type="checkbox"/> Natural Gas Prod. & Trans. <input type="checkbox"/> Petroleum Engineering <input type="checkbox"/> Plastics <input type="checkbox"/> Pulp and Paper Making | <p>CIVIL, STRUCTURAL ENGINEERING</p> <ul style="list-style-type: none"> <input type="checkbox"/> Civil Engineering <input type="checkbox"/> Construction Engineering <input type="checkbox"/> Highway Engineering <input type="checkbox"/> Reading Struct. Blueprints <input type="checkbox"/> Sanitary Engineering <input type="checkbox"/> Structural Engineering <input type="checkbox"/> Surveying and Mapping <p>DRAFTING</p> <ul style="list-style-type: none"> <input type="checkbox"/> Aircraft Drafting <input type="checkbox"/> Architectural Drafting <input type="checkbox"/> Electrical Drafting <input type="checkbox"/> Mechanical Drafting <input type="checkbox"/> Mine Surveying and Mapping <input type="checkbox"/> Ship Drafting <input type="checkbox"/> Structural Drafting <p>ELECTRICAL</p> <ul style="list-style-type: none"> <input type="checkbox"/> Electrical Engineering <input type="checkbox"/> Electrical Maintenance <input type="checkbox"/> Electrician <input type="checkbox"/> Contracting <input type="checkbox"/> Lineman <p>HIGH SCHOOL</p> <ul style="list-style-type: none"> <input type="checkbox"/> Commercial <input type="checkbox"/> Good English <input type="checkbox"/> High School Subjects <input type="checkbox"/> Mathematics | <p>LEADERSHIP</p> <ul style="list-style-type: none"> <input type="checkbox"/> Foremanship <input type="checkbox"/> Industrial Supervision <input type="checkbox"/> Leadership and Organization <input type="checkbox"/> Personnel-Labor Relations <p>MECHANICAL AND SHOP</p> <ul style="list-style-type: none"> <input type="checkbox"/> Gas—Electric Welding <input type="checkbox"/> Heat Treatment <input type="checkbox"/> Metallurgy <input type="checkbox"/> Industrial Engineering <input type="checkbox"/> Industrial Instrumentation <input type="checkbox"/> Industrial Supervision <input type="checkbox"/> Machine Design-Drafting <input type="checkbox"/> Machine Shop Inspection <input type="checkbox"/> Machine Shop Practice <input type="checkbox"/> Mechanical Engineering <input type="checkbox"/> Quality Control <input type="checkbox"/> Reading Shop Blueprints <input type="checkbox"/> Refrigeration <input type="checkbox"/> Sheet Metal Worker <input type="checkbox"/> Tool Design <input type="checkbox"/> Toolmaking <p>RADIO, TELEVISION</p> <ul style="list-style-type: none"> <input type="checkbox"/> Electronics <input type="checkbox"/> Practical Radio—TV Eng'ng <input type="checkbox"/> Radio and TV Servicing <input type="checkbox"/> Radio Operating <input type="checkbox"/> Television—Technician | <p>RAILROAD</p> <ul style="list-style-type: none"> <input type="checkbox"/> Air Brakes <input type="checkbox"/> Car Inspector <input type="checkbox"/> Diesel Locomotive <input type="checkbox"/> Locomotive Engineer <input type="checkbox"/> Section Foreman <p>STEAM AND DIESEL POWER</p> <ul style="list-style-type: none"> <input type="checkbox"/> Combustion Engineering <input type="checkbox"/> Diesel—Elec. <input type="checkbox"/> Diesel Eng's <input type="checkbox"/> Electric Light and Power <input type="checkbox"/> Stationary Fireman <input type="checkbox"/> Stationary Steam Engineering <p>TEXTILE</p> <ul style="list-style-type: none"> <input type="checkbox"/> Carding and Spinning <input type="checkbox"/> Cotton, Rayon, Woolen Mfg. <input type="checkbox"/> Finishing and Dyeing <input type="checkbox"/> Loom Fixing <input type="checkbox"/> Textile Designing <input type="checkbox"/> Textile Eng'g <input type="checkbox"/> Throwing <input type="checkbox"/> Warping and Weaving <p>MISCELLANEOUS</p> <ul style="list-style-type: none"> <input type="checkbox"/> Domestic Refrigeration <input type="checkbox"/> Marine Engineering <input type="checkbox"/> Ocean Navigation <input type="checkbox"/> Shipfitting <input type="checkbox"/> Short Story Writing <input type="checkbox"/> Telephony |
|-------------------------------------------------------------------------------------------------------------------------------------------------------------------------------------------------------------------------------------------------------------------------------------------------------------------------------------------------------------------------------------------------------------------------------------------------------------------------------------------------------------------------------------------------------------------------------------------------------------------------------------------------------------------------------------------------------------------------------------------------------------------------------------------------------------------------------------------------------------------------------------------------------------------------------------------------------------------------------------------------------------------------------------------------------------------------------------------------------------------------------------------------------------------------------------------------------------------------------------------------------------------------------------------------------------------------------------------------------------------------------|------------------------------------------------------------------------------------------------------------------------------------------------------------------------------------------------------------------------------------------------------------------------------------------------------------------------------------------------------------------------------------------------------------------------------------------------------------------------------------------------------------------------------------------------------------------------------------------------------------------------------------------------------------------------------------------------------------------------------------------------------------------------------------------------------------------------------------------------------------------------------------------------------------------------------------------------------------------------------------------------------------------------------------------------------------------------------------------------------------------------------------------------------------------------------------------------------------------------------------------------------------------------------------------------------------------------------------------------------------------------------------------------------------------------------------------------------------------------------------------------------------------------------------------------------------------------------------------------------|-------------------------------------------------------------------------------------------------------------------------------------------------------------------------------------------------------------------------------------------------------------------------------------------------------------------------------------------------------------------------------------------------------------------------------------------------------------------------------------------------------------------------------------------------------------------------------------------------------------------------------------------------------------------------------------------------------------------------------------------------------------------------------------------------------------------------------------------------------------------------------------------------------------------------------------------------------------------------------------------------------------------------------------------------------------------------------------------------------------------------------------------------------------------------------------------------------------------------------------------------------------------------------------------------------------------------------------------------------------------------------------------------------------------------------------------------------------------------------------------------------------------------------------------------|--------------------------------------------------------------------------------------------------------------------------------------------------------------------------------------------------------------------------------------------------------------------------------------------------------------------------------------------------------------------------------------------------------------------------------------------------------------------------------------------------------------------------------------------------------------------------------------------------------------------------------------------------------------------------------------------------------------------------------------------------------------------------------------------------------------------------------------------------------------------------------------------------------------------------------------------------------------------------------------------------------------------------------------------------------------------------------------------------------------------------------------------------------------------------------------------------------------------------------------------------------------------------------------------------------------------------------------------------------------------------------------------------------------------------------------------------------------------------------------------------------------------------------------------------------------------------------------------------------|------------------------------------------------------------------------------------------------------------------------------------------------------------------------------------------------------------------------------------------------------------------------------------------------------------------------------------------------------------------------------------------------------------------------------------------------------------------------------------------------------------------------------------------------------------------------------------------------------------------------------------------------------------------------------------------------------------------------------------------------------------------------------------------------------------------------------------------------------------------------------------------------------------------------------------------------------------------------------------------------------------------------------------------------------------------------------------------------------------------------------------------------------------------------------------------------------------------------------------------------------------------------------------------------------------------------------------------------------------------------------------------------------------------------------------------------------------------------------------------------------------------------------------------------------------------------------------------------------|

Name _____ Age _____ Home Address _____

City _____ Zone _____ State _____ Working Hours _____ A.M. to P.M. _____

Occupation _____

Canadian residents send coupon to International Correspondence Schools, Canadian, Ltd., Montreal, Canada. . . . Special tuition rates to members of the U. S. Armed Forces.

WHAT SECRET POWER DID THIS MAN POSSESS?



BENJAMIN FRANKLIN
(A Rosicrucian)

WHY was this man great? How does anyone—man or woman—achieve greatness? Is it not by mastery of the powers within ourselves? Know the mysterious world within you! Attune yourself to the wisdom of the ages! Grasp the inner power of your mind! Learn the secrets of a full and peaceful life!

Benjamin Franklin—like many other learned and great men and women—was a Rosicrucian. The Rosicrucians (NOT a religious organization) first came to America in 1694. Today, headquarters of the Rosicrucians send over seven million pieces of mail annually to all parts of the world. Write for YOUR FREE COPY of "The Mastery of Life"—TODAY. No obligation. No salesmen. A non-profit organization. Address: Scribe K.E.Y.

THIS BOOK FREE!



The ROSICRUCIANS

SAN JOSE • (AMORC) • CALIFORNIA

—SEND THIS COUPON—

Scribe **K.E.Y.**

The ROSICRUCIANS (AMORC)
San Jose, California

Please send me the free book, *The Mastery of Life*, which explains how I may learn to use my faculties and powers of mind.

Name _____

Address _____

City _____

(Continued from page 8)

Seoul, capital city of Korea. About a month ago I was donated an amazing American magazine titled *Popular Mechanics* by my friend who are working in the American soldiers camp. When I opened the page first I found that there was really wonderful articles in the contents. So I introduced the magazine to all my friend. Now I am reading your magazine with much pleasure, so I could not off my hands from the magazine at any place. I am very anxious to be your everlasting reader.

Kim Sung Chul,
308 Bo Kwang Dong,
Yong San Koo, Seoul, Korea.

☆ ☆ ☆

In our July 1953 issue we presented this wind maker as an orchardist's friend, protecting citrus groves from frost damage. Now it's trying out for a new job. Four of the wind towers have been installed experimentally along the New Jersey Turnpike to test their effectiveness in dissipating fog along the highway.



☆ ☆ ☆

"Model Railroad With Sound Effects" is the subject of our color story in this issue. Chet Tayloe of North Hollywood, Calif., is a realist. He wanted a model railroad that not only looked but sounded like the real thing. Here he is installing the loudspeaker in a church to produce subdued organ music, the sound of a choir singing, even parts of a sermon that can be heard as the whistling trains roll by. Don't miss the story beginning on page 113.



You Practice **SERVICING** with Kits I Send You

Nothing takes the place of PRACTICAL EXPERIENCE. That's why NRI training is based on LEARNING BY DOING. You use parts I send to build many circuits common to Radio and Television. With my Servicing Course you build the modern Radio shown at left. You build a Multimeter and use it to help make \$10, \$15 a week fixing sets in spare time while training. All equipment is yours to keep. Coupon below will bring book of important facts. It shows other equipment you build.

You Practice **BROADCASTING** with Kits I Send You

As part of my Communications Course I send you parts to build low-power Broadcasting Transmitter at left. Use it to get practical experience. You put this station "on the air" ... perform procedures demanded of broadcasting station operators. An FCC Commercial Operator's License can be your ticket to a bright future. My Communications Course trains you to get your license. Mail coupon. Book shows other equipment you build for practical experience.

I Will Train You at Home in Spare Time to be a **RADIO-TELEVISION** Technician



TELEVISION

Making Jobs, Prosperity
25 million homes have Television sets now. Thousands more sold every week. Trained men needed to make, install, service TV sets. About 200 television stations on the air. Hundreds more being built. Good job opportunities here for qualified technicians, operators, etc.



America's Fast Growing Industry Offers You Good Pay, Success

Training PLUS opportunity is the PERFECT COMBINATION for job security, advancement. When times are good, the trained man makes the BETTER PAY, gets PROMOTED. When jobs are scarce, the trained man enjoys GREATER SECURITY. NRI training can help assure you and your family more of the better things of life. Radio is bigger than ever with over 3,000 broadcasting stations and more than 115 MILLION sets in use, and Television is moving ahead fast.

N.R.I. Training Leads to Good Jobs Like These

I TRAINED THESE MEN

"An transmitter-studio operator at KPAT. Most important day of my life was when I enrolled with NRI."—Elmer Frewaldt, Madison, S. Dakota.

"Made my first \$100 from spare time work before I finished my course. Now I average better than \$10 a week, spare time."—Frank Horer, Lorain, Ohio.

"I've come a long way in Radio and Television since graduating. Have my own business on Main Street."—Joe Travers, Asbury Park, New Jersey.

"I didn't know a thing about Radio. Now have a good job as Studio Engineer at KMMJ."—Bill Delsell, Central City, Nebraska.

BROADCASTING: Chief Technician, Chief Operator, Power Monitor, Recording Operator, Remote Control Operator. **SERVICING:** Home and Auto Radios, Television Receivers, FM Radios, P.A. Systems. **IN RADIO PLANTS:** Design Assistant, Technician, Tester, Serviceman, Service Manager. **SHIP AND HARBOR RADIO:** Chief Operator, Radio-Telephone Operator. **GOVERNMENT RADIO:** Operator in Army, Navy, Marine Corps, Forestry Service Dispatcher, Airways Radio Operator. **AVIATION RADIO:** Transmitter Technician, Receiver Technician, Airport Transmitter Operator. **TELEVISION:** Pick-up Operator, Television Technician, Remote Control Operator.

Start Soon to Make \$10, \$15 a Week Extra Fixing Sets

My training is practical, complete; is backed by 40 years of success training men at home. My well-illustrated lessons give you basic principles you need and my skillfully developed kits of parts "bring to life" things you learn from the lessons. I start sending you special booklets that show you how to fix sets the day you enroll. Multimeter you build with my parts helps you discover and correct set troubles, helps you make money fixing neighbors' sets in spare time while training. Many make \$10, \$15 a week extra this way.

Mail Coupon—Find Out What Radio-Television Offer You

Act now to get more of the good things of life. I send actual lesson to prove NRI home training is practical, thorough. My 64-page book "How to be a Success in Radio-Television" shows what my graduates are doing and earning. It gives important facts about your opportunities in Radio-Television. Take NRI training for as little as \$5 a month. Many graduates make more than the total cost of my training in two weeks. Mail coupon now to: J. E. SMITH, President, Dept. 4NA, National Radio Institute, Washington 9, D. C. Our 40th year.

AVAILABLE to all qualified VETERANS UNDER G. I. BILLS

Good for Both—FREE

MR. J. E. SMITH, President, Dept. 4NA, National Radio Institute, Washington 9, D. C. Mail me Sample Lesson and 64-page Book, FREE. (No salesman will call. Please write plainly.)

Name.....Age.....
Address.....
City..... Zone..... State.....
VETS write in date of discharge



Mail Today—Tested Way to Better Pay

WHAT ALL AUTO MECHANICS WANT TO KNOW

1664 PAGES



This Big Practical Book gives full information with working diagrams covering the principles, construction, ignition, service and repair of modern cars, trucks and buses.

Diesel Engines, Hydramatic & Fluid Drives Fully Explained.

A complete Guide of 1664 pages, with over 1500 illustrations showing inside views of working parts, with instructions for service jobs.

IT PAYS TO KNOW

How to fit pistons—How to locate engine knocks. How to fit connecting rod bearings—How to service main bearings—How to recondition valves—How to time valves—How to adjust fan belts—How to adjust carburetors and chokes. How

to rebuild a clutch—How to service automatic transmissions—How to service brakes—How to adjust steering gear—How to cope with ignition troubles—How to service distributors—How to time ignition—How to "tune up" an engine.



\$4 COMPLETE • PAY \$1 A MO. TO GET THIS ASSISTANCE FOR YOURSELF SIMPLY FILL IN AND MAIL COUPON TODAY.

Step up your own skill with the facts and figures of your trade. Audels Mechanics Guides contain Practical Inside Trade Information in a Handy Form. Fully illustrated and Easy to Understand. Highly Endorsed. Check the book you want for 7 DAYS FREE EXAMINATION. Send No Money. Nothing to pay postman.

MAIL ORDER



Check NOW!

You Can Look Over Any Guide In Your Own Home — Start the Easy Payments If Satisfied

MAIL THIS TODAY



AUDEL, Publishers, 49 W. 23 St., NEW YORK 10, N. Y.

Please send me postpaid for FREE EXAMINATION books marked (x) below. If I decide to keep them I agree to mail \$1 in 7 Days on each book or set ordered and further mail \$1 monthly on each book or set until I have paid price, otherwise I will return them.

- AUTOMOBILE MECHANICS GUIDE, 1664 Pages. \$4
- TRUCK & TRACTOR GUIDE, 1299 Pages. 4
- DIESEL ENGINE MANUAL, 575 Pages. 2
- MACHINISTS HANDY BOOK, 1650 Pages. 4
- WELDERS GUIDE, 400 Pages. 1
- BLUE PRINT READING, 416 Pages. 2
- MATHEMATICS & CALCULATIONS, 700 Pages. 2
- SHEET METAL PATTERN LAYOUTS, 1100 Pages. 4
- SHEET METAL WORKERS HANDY BOOK, 388 Pgs. 1
- MECHANICAL DRAWING GUIDE, 160 Pages. 1
- MECHANICAL DRAWING & DESIGN, 480 Pages. 2
- AIRCRAFT WORKER, 240 Pages. 1
- TELEVISION SERVICE MANUAL, 434 Pages. 2
- RADIOMANS GUIDE, 1040 Pages. 4
- ELECTRONIC DEVICES, 216 Pages. 2
- ELECTRIC MOTOR GUIDE, 1000 Pages. 4
- WIRING DIAGRAMS (Light & Power), 272 Pgs. 1
- ELECTRICIANS EXAMINATIONS, 250 Pages. 1
- ELECTRIC POWER CALCULATIONS, 425 Pages. 2
- HANDY BOOK OF ELECTRICITY, 1440 Pages. 4
- ELECTRIC DICTIONARY, 9000 Terms. 2
- ELECTRIC LIBRARY, 7000 Pages (12 Book Set) 18
- SHIPFITTERS HANDY BOOK, 250 Pages. 1
- REFRIGERATION & Air Conditioning, 1280 Pgs. 4
- MILLWRIGHTS & MECHANICS GUIDE, 1200 Pgs. 4
- POWER PLANT ENGINEERS GUIDE, 1500 Pages. 4
- ENGINEERS & FIREMANS EXAMS, 525 Pages. 1
- PUMPS, Hydraulics & Air Compressors, 1658 Pgs. 4
- OPERATING ENGINEERS LIBRARY (3 Books). 9
- MECHANICAL DICTIONARY, 950 Pages. 4
- GARDENERS & GROWERS GUIDES (4 Book Set) 6
- CARPENTERS & BUILDERS GUIDES (4 Book Set) 6
- PLUMBERS & Steamfitters Guides (4 Book Set) 6
- MASONS AND BUILDERS GUIDES (4 Book Set) 6
- PAINTERS & DECORATORS MANUAL, 450 Pgs. 2
- HOUSE HEATING GUIDE, 1000 Pages. 4
- OIL BURNER GUIDE, 384 Pages. 1
- HOME APPLIANCE SERVICE GUIDE, 800 Pages. 4

Name _____
 Address _____
 Occupation _____
 Employed by _____

P-12

WHERE-TO-BUY-IT INDEX

Source of supply appears after items commercially available

AUTOMOTIVE

Motor-bike driver lies down to race.....	86
German four-wheel "scooter".....	112
Boy-size trailer built for junior.....	120
Auto transport uses special alloys to reduce weight 8000 pounds.....	124
Dolly lifts wreck and tows it away (City Carriage Co., 709 E. Washington Blvd., Fort Wayne, Ind.).....	126
Compact camping trailer uses Cadillac fenders (Younkens Machine, Inc., 100 W. Valencia, Burbank, Calif.).....	127
Sweden builds plastic sports car that weighs under 2000 pounds.....	129
Air conditioner cools motorists (Airtemp Division, Chrysler Corp., 1600 Webster St., Dayton 1, Ohio).....	145
Come-apart automobile stars on television.....	149
Plastic camp trailer has bed in drawer.....	158

AVIATION

Stryker frame in plane protects airborne patient.....	87
Swiss salvages fortune from wrecked wartime British bomber. 87	
Plane radio rings bell.....	88
Jet sports plane is tailless.....	121
Tiny British jet flies 600 m.p.h.....	126
"Skis" for wheeled plane permit landing on water (All American Engineering Co., Inc., DuPont Airport, Wilmington, Del.).....	140

BOATING AND FISHING

Standardize nautical mile.....	87
Canvas boat fits into pack.....	104
First nuclear submarine "hears" through rubber panels set into hull.....	120
Outboard pushes islands around.....	140

CONSTRUCTION

High-speed milling machine cuts through aluminum like butter.....	86
Scaled-down drilling rig prepares youngsters for oil fields.....	88
Roller snuggles up to walls (Ardwall Manufacturing Co., Oconomowoc, Wis.).....	101
Salt firms gravel roads.....	152

FARM

Hydraulic hog-moving trailer loads and unloads itself.....	129
One-cylinder engine powers tiny tractor.....	135
On-again off-again fence (Cosom Industries, Inc., 6012 Wayzata Blvd., Minneapolis 16, Minn.).....	147
Tubular-steel framework supports storage bin.....	152
Tractor umbrella with electric fan keeps dust and heat from operator.....	159

HOUSE AND HOME

Needle ties rag-strip ends for home rugmaking (Miracle Industries, Ralph St., Bensenville, Ill.).....	112
Aluminum garage door is made with build-it-yourself kit.....	126
Big mixer without motor operated with hand crank.....	128
What's New for Your Home—	
Midget drier to dry hose (Tibbits Mfg. Co., Inc., 34 W. Chestnut St., Alliance, Ohio).....	132
Sharpening tool (The Prospectors, Pacific Bldg., Santa Monica, Calif.).....	132
Built-in broiler (Admiral Corp., 3800 Cortland St., Chicago 47).....	132
In-the-wall bed can fold into two-by-four wall (Aeae Equip. Co., Inc., 199 Pierce St., Birmingham, Ala.).....	132
Back-saving mop (Ben-Me. 5398 Alhambra Ave., Los Angeles 32, Calif.).....	133
Sit-down sink (Elkay Mfg. Co., 1874 S. 54th St., Chicago).....	133
Bed-rail extensions provide leg room (Ralph Howard Co., 3714 Creston Dr., Indianapolis 22, Ind.).....	133
Garbage can on wheels (Health Standard Co., Box 571, Sherman, Tex.).....	133
Single-step escalator designed for home use.....	148

INDUSTRY

Fast cable layer.....	134
Wheelbarrow mortar mixer.....	140
Steel building uses new arch.....	145
Sugar-cane cleaner.....	146
Synthetic rubber resists heat.....	146
Electronic pipeline saves figuring (Standard Electric Time Company, Springfield, Mass.).....	147
Mobile service station takes grease job to the machinery.....	159

PHOTOGRAPHY

Oh, for the life of a cameraman.....	90
Camera case permits underwater shots.....	125
Zoomar TV lens for movie camera (Zoomar, Inc., Glen Cove, Long Island, N. Y.).....	125
Flash synchronizer has built-in tester (Jen Products, Inc., 419 W. 42nd St., New York City 18).....	125
Stereo pictures measure reserves.....	158

MISCELLANEOUS

Split-ring mount holds gun sight (W. R. Weaver Co., El Paso, Tex.).....	86
Hot plate with oven broils and bakes.....	88
Ice-packed butter dispenser cuts only one pat at a time (AA Metal Products, Inc., 15106 S. Broadway, Gardena, Calif.).....	101

(Continued to page 14)



INVENTORS

Learn how to protect your invention. The U. S. Patent Laws provide that any new and useful art, machine, article of manufacture, or composition of matter, or any new and useful improvement thereof, may be patented if the act of invention is involved. Therefore, every inventor with a valuable invention should take advantage of the Patent Laws and proceed for patent protection in order to safeguard his rights.

A patent gives the inventor the exclusive right to prevent others from making, using, or selling the invention claimed in the patent for a period of seventeen years.

The Patent Laws were enacted for the benefit of the inventor to give him protection for the features of his invention which are patentable. These features must be properly and concisely set forth and claimed in a formal application for patent, in order to comply with the requirements of the Patent Laws. For that reason, unless the inventor is familiar with patent matters, he should engage a competent registered patent attorney or agent to represent him. We are registered to practice before the U. S. Patent Office and are prepared to serve you in the handling of your patent matters.

A specially prepared booklet entitled "Patent Guide for the Inventor", containing detailed information with respect to patent protection and procedure, together with a "Record of Invention" form will be promptly forwarded to you without obligation upon request.

CLARENCE A. O'BRIEN & HARVEY JACOBSON

Registered Patent Attorneys

41-M DISTRICT NATIONAL BUILDING

WASHINGTON 5, D. C.

FREE BOOKLET REVEALS HOW 33,432 PICTURES

now make Encyclopaedia
reference as fascinating as
the latest picture magazine



The New 24-volume edition

ENCYCLOPAEDIA BRITANNICA

called the Greatest Treasure a Family Can Possess!
Now on Book a Month Payment Plan

The new edition of Britannica is the greatest treasure of knowledge ever published, the work of 4,479 of the world's best minds. It is the final authority on factual knowledge, and a constant inspiration that will continuously enrich the lives of yourself and your family.

See the new pictorial method portrayed in the free preview booklet. Mail the coupon today! We are sure you'll be glad to help spread the news by showing your copy to one other family. Fill in and mail the coupon now!

So fascinating, so different, so unlike the average person's idea of an encyclopaedia . . . Yes, this new Britannica depends vastly on pictures—33,432 of them, over 1,300 pictures average per volume.

That is why, we are now prepared to send valuable 32-page preview booklets, containing beautiful large size full color pictures, to a number of people.

These booklets are sent free and without any obligation except that, because of the high cost of printing, we ask you show the booklet to one other family, friends or neighbors. This is all you have to do to acquire free this gorgeous and valuable booklet.

EXTRA! FREE! beautiful booklet sent

if you agree
to show it to
a neighbor



ENCYCLOPAEDIA BRITANNICA, INC., DEPT. 32-B
425 N. Michigan Avenue, Chicago 11, Ill.

Please let me have the FREE PREVIEW
BOOKLET and complete details about the
Book a Month Payment Plan. I agree to
show Booklet to a neighbor—there is no
other obligation.

NAME _____

ADDRESS _____

CITY _____ ZONE _____

IN CANADA, WRITE E. B. LTD., TERMINAL BLDG.,
TORONTO, ONTARIO

(Continued from page 12)

"Lawn Maker" sprays seed, fertilizer and water on embankment	105
Plastic plants made with kit (Marlo Studios, 1157 Belmont Ave., Chicago 30)	105
Design paint peels off glass (A-Peeling Paint Co., 3463 Ashton Ct., Palo Alto, Calif.)	112
Game-bird "guzzler"	120
Fire-fighting trailer battles blaze until fire trucks arrive	121
Wooden wings fail "bat man"	121
Knee deep in cypress knees	122
Radiation controls model train equipped with Geiger tubes	124
Automobile-engine exhaust safely inflates German mattress	125
Diners eat "hot" meal on heated furniture	128
Tiny radioactivity scope fits into shirt pocket (Ken Research, Inc., 831 Fifth Ave., River Edge, N. J.)	128
Harmless "gun" frightens dogs	129
Will cattails become source of food and fiber in the future?	134
Three lubricants packed in kit (Giferaft, 1234 E. 47th St., Chicago 15)	134
Flashlight beams teach 12 pupils the intricacies of dancing	135
Frozen-food locker pulled out of floor	135
Why not design your own machinery?	141
Quartz infrared lamp resists water splashing (General Electric Lamp Div., Cleveland 13, Ohio)	145
Reading machine for blind transmits message by touch	146
Back-pack vacuum cleaner (M. D. Stetson Co., 64 E. Brookline St., Boston 18, Mass.)	146
Electric train shifts to monorail	148
Liquid insulating plastic shockproofs tool handles (Ecker Industries, 2509 Irving Ave. So., Minneapolis 5, Minn.)	148
Propeller replaces blade to convert chain saw into outboard motor (Lombard, 38 Main, Ashland, Mass.)	152
Branding with harpoons	152
Iron with pivoting point reaches around corners	153
Alarm spots thieves, fire and even kills mice! (Alertronic Corp., Long Island 1, N. Y.)	153
Glove compartment is for the birds	159
Pedals operate canoe rudder (W. L. Jones, 222 Glen Rd., Webster Groves 19, Mo.)	160
Motor-on-a-wheel shunts rail cars	160

Radio-Television, Electronics

Television today—	
TV set has top-panel tuning (Setchell Carlson, Inc., New Brighton, Minn.)	161
Ruggedness test for TV set (Allen B. DuMont Laboratories, Inc., 760 Bloomfield Ave., Clifton, N. J.)	161
Printed circuits in TV receivers (Admiral Corp., 3800 Cortland St., Chicago 47)	161

Craftsman and Shop Notes Index

AUTOMOTIVE

Weight helps car up icy ramp	168
Extension for trouble light permits use on trailer	180
Thawing frozen fuel line	216

FARM

Wire hooks on poultry-mash pan permit removal for cleaning	207
Slotted sections of oil drum provide "stile" in fence	207
Sliding door operates better when pull-handle is centered	210
Valves for farm water system located in pit with pump	210
Corn cobs tied to pull-cords help locate them in dark	212
Guard for tractor rear wheel lifts leaning cornstalks	212
Paddles on tractor-mounted auger force dirt away from hole	212
Sawdust prevents egg soiling	212
Hinging top portion of crib wall reduces scooping height	216
Portable air compressor utilize old car parts	216
"Cattleproof" gate latch locked with steel pin	217
Junked refrigerator unit provides compressed air	220
Durable mailbox support from old plow beam	220

HOUSEHOLD HINTS

Tipproof dog pan	168
Potatoes impaled on metal holder baked quickly without marks	180
Silk stocking "shoehorn" used when donning snug boots	180
Sagging tube-type clothes pole reinforced with pipe	180
Improvised holder for flag utilizes pipe clamps	189
Washer under clothesline knot holds in oversize hole	189
"Off" indicator for range	202
Taped jaws of adjustable wrench prevent damaging chrome fixtures	212

HOUSE AND HOME

Modern wrought-iron table lamp improvised from tripod	167
Coins serve as gauges to mark clearance when hanging door	176
Solving Home Problems—	
Kitchen trays last longer	178
Screen door protected with conduit	178
Rewinding window-shade roller	178

(Continued to page 16)

IMPORTANT NOTICE—It is the intention of this magazine to provide its readers with information regarding the latest developments in the mechanical arts. We take no responsibility as to whether the disclosures contained in our articles are covered by patents and advise readers to investigate this subject before making, using, or selling any of the products, machines, or processes described in order to avoid possible liability for patent infringements.

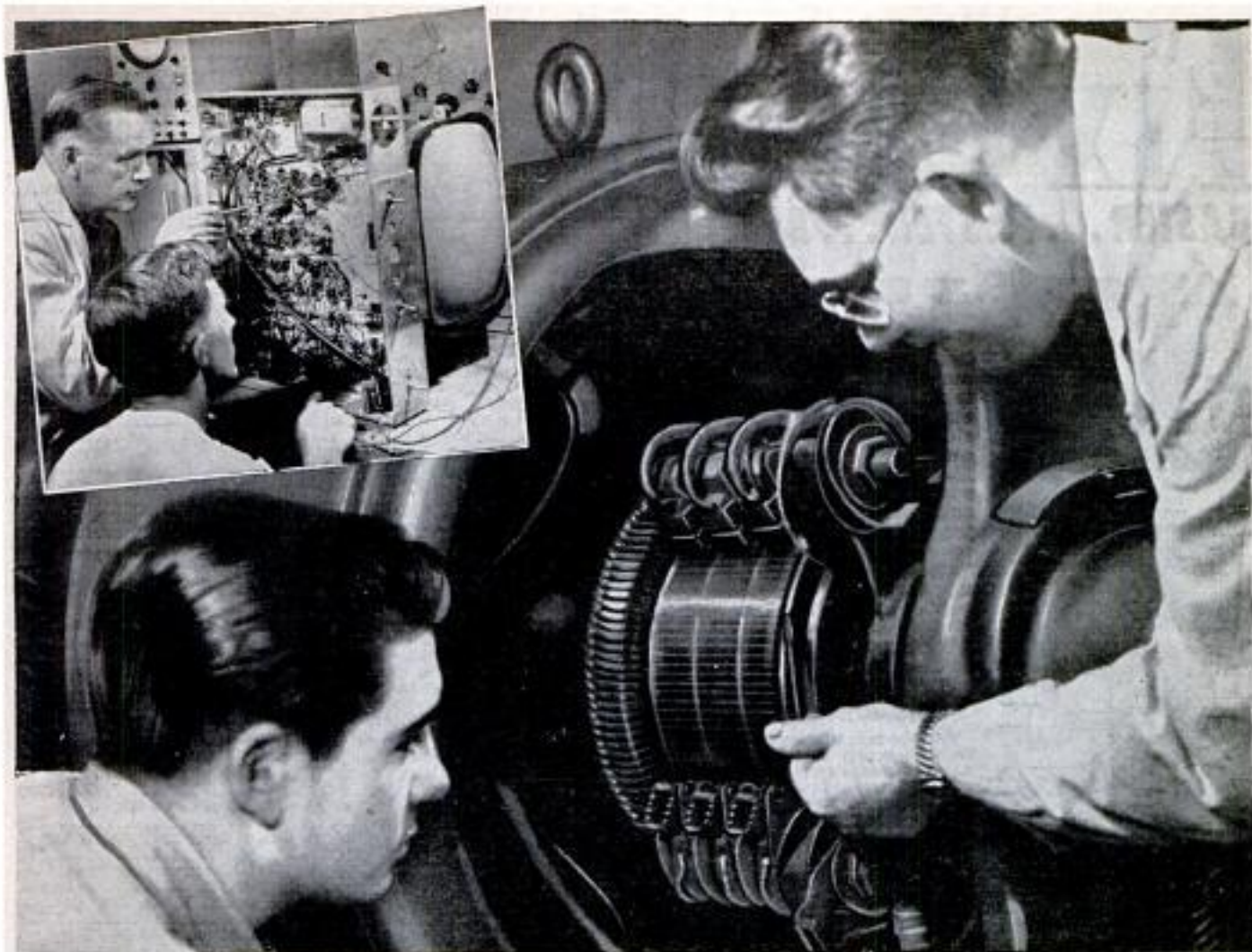

TRAIN FOR A FUTURE IN Electricity or Television-Radio

IT'S THE ACTUAL SHOP TRAINING AT
COYNE THAT MAKES THE DIFFERENCE!

Prepare quickly at Coyne for a career with a future!

Trained men are vitally needed now whether 17 or up to 45. Get a better rating, if drafted—an essential job in industry, if not in A FIELD THAT OFFERS A REAL FUTURE.

WE TRAIN YOU IN CHICAGO

Learn the easier, practical way at Coyne, on real, full size equipment. No advanced education or previous experience needed. You learn *better* the Coyne way.

Train in the shops of Coyne—where thousands of successful men have trained for over 55 years—Coyne is the largest, oldest, best equipped school of its kind—established in Chicago in 1899.

FINANCE PLAN Enroll now. You may pay most of tuition later. We have a special plan for men of draft age.

CLIP COUPON NOW for big new illustrated Coyne book. No obligation; no salesman will call. Get vital facts now!

APPROVED
FOR
VETERANS

Mail Coupon
Today for
**BIG FREE
BOOK**

Check whether interested in
ELECTRICITY or TELEVISION-
RADIO or both.



B. W. COOKE, President
COYNE ELECTRICAL SCHOOL
500 S. Paulina St., Chicago 12, Ill., Dept. 94-72H

Send BIG FREE book and details of your training offer. This does not obligate me and no salesman will call. I am interested in:

ELECTRICITY TELEVISION-RADIO

Name.....

Address.....

City..... State.....

B. W. COOKE President **COYNE** FOUNDED 1899
ELECTRICAL SCHOOL

A TECHNICAL TRADE INSTITUTE CHARTERED NOT FOR PROFIT
500 S. PAULINA, CHICAGO, Dept. 94-72H
ELECTRICITY ★ RADIO ★ TELEVISION ★ REFRIGERATION ★ ELECTRONICS

Fix Cars!

EASIER... FASTER... BETTER

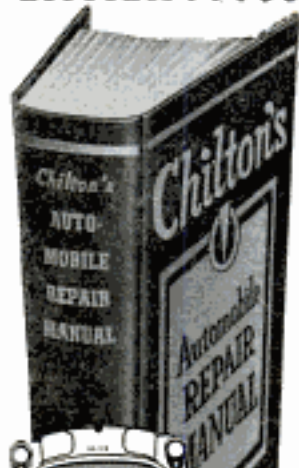

...any make, model, part

Using this giant 4 3/4-pound Chilton "ALL CARS" repair manual is like having 19 of the world's leading service experts standing by your side, telling you what to do and exactly how to do it. Even beginners who have never repaired cars before can handle practically any job with this big manual to guide them. It isn't a "study" book. You just look up the make, model and part you want to fix. Every step is so clearly explained it's next to impossible to go wrong.

BY THE WORLD'S BIGGEST AUTOMOTIVE PUBLISHERS

Ask the men who know! You'll find the Chilton All Cars Manual in almost every auto shop... and widely used in schools, Army-Navy training etc. for guiding beginners. From simple tune-ups to complete engine overhauls... from overdrives to automatic transmissions, it gets right down to brass tacks in helping you handle every job fast, easy and right. Published and revised each year by Chilton, publishers of Motor Age, Automotive Industries, the Flat Rate Book, etc. It's the book the experts use... written so you can understand every word even without previous experience! Send coupon for 10-day free trial. You be the judge!



New, enlarged edition
Covers every model of these 20 makes since 1940!

Weights 4 3/4 pounds.
Has 864 big pages...
58 troubleshooting charts
353 "Quick Check" data tables
2532 "How-to-fix-it" pictures
... and thousands upon thousands of parts and service specifications.



PRACTICE 10 DAYS FREE!

The Chilton Co., Dept. PM-124
56th & Chestnut Sts., Philadelphia 39, Pa.

Send the 864-page Chilton "ALL CARS" REPAIR MANUAL (price \$6.95) for 10-day FREE EXAMINATION. If I like it, I will promptly remit \$1.95 (plus 35c postage); then send \$2.50 monthly for 2 months. Otherwise, I will return manual postpaid in 10 days and owe nothing.

(OUTSIDE U.S.A.—Cash only, price \$7.95. Same 10 day return privilege with money refunded.)

Name _____
Address _____
City, Zone, State _____

(Continued from page 14)

Winding sewing-machine bobbins.....176
Small cork holds ring-type potlid.....179
Protect waxed floors.....179
Toothbrush with massaging tip cleans dust.....179
Repairing carved molding on fireplace.....179
Slide fasteners locked with safety pin.....179
Thread used for basting.....179
Gummed-paper tab lifts glass for trial fitting in sash.....184
Thermometers check the humidity in your home.....185
Envelopes are sealed faster with felt dauber.....189
Warped and sagged storm door corrected by single brace.....189
Rabbeted molding nailed to wall provides picture display.....192

MISCELLANEOUS

Facing mirrors furnish artist right or left-hand model.....167
Curtain rod provides holder for sandpaper strips.....168
Christmas candle.....169
Pencil attached to doorbell permits fast stipling.....175
Timer trips shutter of camera for self-portraits.....176
Test tubes inverted on corks dry without clouding.....176
Extra turn in shoelace prevents easy loosening.....180
Treated cellulose sponge hastens negative drying.....184
Oversize ring fitted to finger with adhesive tape.....184
Easy way to draw stars.....192
Doll's lost "eyesight" restored with wooden support in head.....197
Wedge-shape ice-fishing shelter is light and portable.....197
Ant colony destroyed by fumes pumped into hill.....202
Slip-roll projects.....214
Bits of paper on press rollers removed by old toothbrush.....216
Filter in kerosene-stove line prevents clogged burners.....202
"Pocket size" ripping wedge bent from flat key.....202

TOOLS

Hole in motor and base aligned by grinding points on bolts.....167
Length of wire straightened by using hand drill.....168
Open-end rack on wall stud holds long-handled tools.....184
Covers on jaws of pipe wrench permit use on chrome fixtures.....185
Clamp-type lathe dog used as drill-press vise.....207
Broken lathe center repaired using drill rod.....212
Rivet heads cut with chisel for quick and safe removal.....216
Compound-angle setup on lathe carriage.....217

Shopping for Tools—

Blade holder for plane irons (Wm. M. Rosenfeld, 1436 67th Ave., Philadelphia 26, Pa.).....218
Circular-saw guard (Shopmaster, Inc., 1214 S. Third St., Minneapolis 15, Minn.).....218
Inspection magnifier (Badger Sales Co., 2251 W. Pico Blvd., Los Angeles 6, Calif.).....218
Metal shaper and vertical mill (West Machinery & Supply Co., 6 E. Northfield Ave., Livingston, N. J.).....218
Pocket-size lumber rule (Gumtape Corp., P. O. Box 614, Hillside, N. Y.).....218
One-ton bench punch press (Alva F. Allen, 1015 N. Third St., Clinton, Mo.).....219
Hatchet-type soldering iron (Hexacon Electric Co., 162 W. Clay Ave., Roselle Park, N. J.).....219
Knife grinder (Greyco Products, 149 Longmeadow Rd., Buffalo 23, N. Y.).....219
Multiple-purpose anvil (Miracle Mfg. Co., 124 E. 9th St., St. Paul 1, Minn.).....219
Adjustable collet stop in lathe aid when machining short rods.....220

WORKSHOP HINTS

Enlarged screw and bolt holes repaired with wooden dowels.....180
Glue container cleaned easily.....184
Heating element of soldering iron can be repaired temporarily.....189
Sheet-metal guard on ax prevents damage to handle.....192
Hinge and nail used as punch to make holes in leather.....192
Valve cap for removing cores.....197
Solder permits emergency use of nut with worn threads.....202
Hole drilled in hammer head speeds clinching of nails.....207
Bolts modify framing square for use as angle gauge.....207
Diameter of metal shaft reduced in wood lathe with two files.....212
Worn pump coupling repaired by upsetting threads.....220
Strips of masking tape cut to uniform length.....220

Glass Measures Radiation

Production-line irradiation of foods and drugs may be aided by the use of a special glass which produces an orange fluorescence under ultraviolet light after being exposed to atomic radiation. The silver-activated phosphate glass is now used by the Armed Forces in radiation-detection lockets. The glass, used in connection with instruments which measure fluorescence, would be a rapid and simple means of gauging radiation intensity. It is expected to be used in a study of food preservation by radiation now being conducted by the Army Quartermaster Corps.

INVENTORS

If you believe that you have an invention, you should find out how to protect it. The first step is to have a search made of the prior pertinent U. S. patents. If a report on this search indicates that the invention appears patentable you can apply for a patent, and the specifications and claims should be prepared.

The firm of McMorrow, Berman & Davidson, with offices in Washington, D. C., is qualified to take the necessary steps for you. We can make a preliminary search on your invention, advise you whether we think it can be patented, and prepare your application for patent.

Unless you are fully familiar with the U. S. Patent Laws, we recommend that you engage the services of a Registered Patent Attorney to protect your interests. The patent laws are *your* laws. A patent gives you the right to prevent others from making, using or selling the invention claimed in your patent for a period of 17 years.

Use these patent laws for your protection. Investigate whether your invention can be patented. If you have what you believe to be an invention, we suggest that you have this firm make a search for you.

Send for a copy of our Patent Booklet entitled "How To Protect Your Invention," containing information about patent protection and patent procedure. Along with this we will also send you an "Invention Record" form, for your use in writing down and sketching details of your invention. We will mail them promptly. No obligation. They are yours for the asking.

McMORROW, BERMAN & DAVIDSON

Registered Patent Attorneys

PATENTS • COPYRIGHTS • PATENTS

1359 VICTOR BUILDING, WASHINGTON 1, D. C.

DRAFTSMEN



**CASH BIG
PAY CHECKS!**

Train Now for
more success,
greater security

LEARN AT HOME IN SPARE TIME
(or at college in Chicago)

Check the want ads in any newspaper—SEE the big-pay opportunities open to you as a draftsman. What's more, you can learn this well-paid, prestige profession at home—quickly, easily! No special talent needed. Get complete, step-by-step Chicago Tech lessons in the mail, spend a few pleasant hours studying each week. In a short time you'll be a well-trained draftsman, ready to take your pick of many good jobs. Act now!



Free Information—Mail Coupon Today!

Get **FREE TRIAL LESSON** plus information about C.T.C. practical training. Learn what successful Chicago Tech graduates say about high pay and opportunities in drafting. No charge, or obligation.

CHICAGO TECHNICAL COLLEGE

5-252 Tech Bldg., 2000 So. Michigan Ave.
Chicago 16, Illinois

Mail me **FREE** lesson with facts about big opportunities in **DRAFTING**.

Name _____ Age _____

Address _____

City _____ Zone _____ State _____

Say You Saw It in Popular Mechanics

McNess **WANTS MEN**
TO RUN **McNESS FARM HOME STORES**

**Wonderful Work
for Man with Car**

Use your car as McNess Farm Home Store. Call on same homes month after month. Every farm family becomes your friend. Farmers depend on McNess Farm Home Stores for countless necessities—save orders for you—buy everything they can because McNess quality is tops, values are best, and every sale is guaranteed. Premiums, special offers, new products help you make good money from start.

WE SUPPLY CAPITAL

You supply car. We'll supply capital and sales know-how. You start making money first day. There's no finer, more enjoyable work anywhere. Pays well, permanent, no boss, no age limit. No sales experience necessary. This can easily be the biggest paying job you've ever had. Write today for free McNess Dealer Book. No obligation. (16)

THE McNESS CO., 165 Clark St., Freeport, Ill.



**Use Your
CAR
to Raise
Your
PAY**



**FULLY GUARANTEED
TIRES COST LESS!**

FREE TUBE ON REQUEST
WITH PASSENGER TIRES

Nationally famous **FIRESTONE, GOODRICH, U. S. ROYAL, GOODYEAR**, and other makes. Every tire selected and inspected for your safety.

WHITE WALL OR SNOW TIRES \$1 EXTRA

HIGH GRADE TIRES GUARANTEED 12 MONTHS

600x16	4.14	700x16	5.14	32x6(8)	8.84	825x20	14.24
650x16	4.54	670x16	4.74	32x6(10)	10.84	900x20	17.34
650x18	4.34	650x20	7.84	750x20(8)	8.54	1000x20	14.14
700x18	4.64	700x20(8)	8.94	750x20(10)	9.94	1100x20	16.14

AAA PREMIUM GRADE GUARANTEED 18 MONTHS

550x15	5.48	700x15	5.98	760x15	5.58	750x20(10)	14.98
600x16	5.28	700x16	6.78	850x17	5.48	825x20	18.68
600x16(6)	5.58	700x16(6)	7.98	600x20	9.78	900x20	18.98
640x15	5.68	750x16(6)	8.98	650x20	10.88	1000x20	19.98
650x16	5.78	800x15	8.88	700x20	12.88	1000x22	21.98
650x16(6)	6.98	820x15	7.48	32x6(10)	10.48	1100x20	20.98
650x18	5.98	710x15	6.08	32x6(10)	12.48	100x22	21.98
670x16	6.18	550x18	5.98	750x20(8)	12.98	1100x24	23.98

MILITARY SPECIAL

NEW TREAD GUAR. 24 MOS.

AA Guaranteed 12 Months—

600x16 8.98
600x16(6) 9.98
700x15(6) 15.95
750x20(8) 24.98

AAA GUARANTEED 18 MONTHS

900x16 14.98 • 750x20 16.48

Largest stock of used tires in the East. Thousands of satisfied customers. Write for Free Catalogue. **MONEY ORDER OR CHECK WITH ORDER.** **NO C.O.D.'s**

PYRAMID TIRE CO.
1333-35 North 5th St.
Dept. M., Phila. 22, Pa.



FUN AT XMAS

These **GIANT BALLOONS** are a barrel of fun at dances, parties—**TERRIFIC** for high school & college **PROMS**. Great sport in back yards, picnics, etc. Wonderful way to **ATTRACT CROWDS** to new business, to sales, to civic events, conventions, Trade shows, exhibitions... they're money makers. Surplus U. S. Govt. (new-overage) neoprene weather, target balloons. Approx. inflated sizes:

3 ft. dia., 49¢ — 6 ft. dia., 99¢
13 ft. dia., \$1.59 — 20 ft. dia., \$1.95
• Calif. res. please add sales tax
Postage paid on prepaid orders

VOLUME SALES CO., War Assets Division
Dept. M-1254 3930 Sunset Blvd. Los Angeles 29, Calif.

REAL ESTATE

PAYS BIG! SEND FOR FREE, BIG, ILLUSTRATED CATALOG NOW! Graduates report making substantial incomes. Start and run your own business quickly. Men, women of all ages, learn easily. Course covers Sales, Property Management, Appraising, Loans, Mortgages, and related subjects. **STUDY AT HOME** or in classrooms in leading cities. Diploma awarded. Write **TODAY** for free book! No obligation. Approved for World War II and Korean Veterans

WEAVER SCHOOL OF REAL ESTATE (Est. 1936)
2020 Grand Dept. PM Kansas City, Mo.

Secrets of VENTRILOQUISM Now Revealed!

Easy to learn in 60 to 90 days with our Home Study Course. **RESULTS GUARANTEED.** Make Money! Be Popular! Have Fun! Big Opportunities! Radio, Television, Stage Appearances! For **FREE** information regarding price and terms, **WRITE.** You must state your age. Dummy Catalog 25¢.
FRED MAHER SCHOOL OF VENTRILOQUISM
Box 36, Studio PM-12 Kensington Station
Detroit 24, Michigan

SCIENTIFIC CRIME DETECTION

There's a Thrill in Bringing a Crook to Justice.
A Steady Pay Profession
Good Times or Bad.
We have taught thousands this exciting, profitable, pleasant profession. Let us teach you, too, in your own home. Learn

Finger Printing, Firearms Identification, Police Photography and Criminal Investigation thoroughly, quickly and at small cost.

Over 800 of All U. S. Bureaus of Identification employ students or graduates of I. A. S. You, too, can fit yourself to fill a responsible crime detection job with good pay and steady employment. But don't delay—get the details now. Let us show you how easily and completely I can prepare you for this fascinating work, during spare time, in your own home. You may pay as you learn. Write today, stating age. No salesman will call.

(A Correspondence School Since 1916)

INSTITUTE OF APPLIED SCIENCE
1920 Sunnyside Ave., Dept. 1359, Chicago 40, Ill.

**Be A
FINGER
PRINT
Expert**

FREE!!!
Send for Thrilling
Book "HOW TO
OF CRIME"

Now IN YOUR OWN HOME Learn

TELEVISION

RADIO-ELECTRONICS

the Amazingly Effective

D. T. I. WAY

—with the aid of BOTH HOME EQUIPMENT and HOME MOVIES

NO PREVIOUS EXPERIENCE NEEDED

Now... get
**EVERYTHING
YOU NEED**

for real Laboratory-
type training
AT HOME



1. Build over 300 fascinating experiments from 16 BIG SHIPMENTS of Electronic-Radio parts which you KEEP.

2. Build valuable commercial-type test equipment—as shown to the left—which you KEEP. This includes a quality 5 INCH oscilloscope and jewel bearing Multi-Meter—both highly useful for Television work.

3. Build and keep a big 21 INCH TV Set. (D.T.I. offers another home training in Television-Radio-Electronics, but without the TV set.)

4. Use a 16 mm. movie projector and new series of highly instructive movies—a wonderful aid to help you grasp important fundamentals faster... easier... better.

5. Enjoy well-illustrated, easy-to-read lessons with handy FOLD-OUT diagrams.

6. Get an honest-to-goodness EMPLOYMENT SERVICE to help you get a good job after graduating—or assistance in starting your OWN SALES AND SERVICE BUSINESS. Mail coupon today for the complete details.

D.T.I.'s Training is available in Canada

Above:
Work over
300
fascinating
experiments
with this
equipment

What will mailing the coupon below do for YOU? Just this! You'll find out about one of today's most remarkable... practical ways to prepare to get into America's amazing billion dollar opportunity field of TELEVISION-RADIO-ELECTRONICS. You'll see how to get into fascinating work that pays well... that offers one of America's most promising futures... that enables you to start your own business almost "on a shoe string," if you prefer this to a job opportunity.

And above all, you'll get some GOOD NEWS especially welcomed by men anxious to earn REAL MONEY in this thrilling field. For you'll see that NOW you can get the kind of practical, laboratory-type training so desirable for making real progress in Television-Radio-Electronics AND WITHOUT LEAVING HOME.

You'll see that DeVry Technical Institute sends everything needed to set up your own HOME LABORATORY.

You get and keep the same type of basic electronic equipment used in our modern Chicago Training Laboratories. You get home training that includes the knowledge and experience gained from training thousands of students first hand in Chicago.

And to top it all, you use DTI's amazingly effective and exclusive home training aid—INSTRUCTIVE MOVIES. But why not get the complete story? Mail coupon today for information-packed literature.

MODERN LABORATORIES

If you prefer, get all your preparation in our new Chicago Training Laboratories—one of the finest of its kind. Ample instructors, modern equipment. Write for details!

MILITARY SERVICE!

If you're subject to military service, the information we have for you should prove very helpful. Mail coupon today.

Get this
information-
packed
publication

FREE!

Mail Coupon Today

DEVRY TECHNICAL INSTITUTE, Dept. PM-12-K
4141 BELMONT AVE., CHICAGO 41, ILL.

I would like your valuable information-packed publication showing how I can get started toward a good job or my own business in Television-Radio-Electronics.

Name..... Age.....
Street..... Apt.....
City..... Zone..... State.....

DEVRY TECHNICAL INSTITUTE

AFFILIATED WITH
DEFOREST'S TRAINING, INC.
CHICAGO 41, ILLINOIS



**YOU
can
acquire**

**LAW NIGHTS AT HOME!
L. L. B. DEGREE**

LaSalle's famous Law Library—used as reference in many Law libraries and Law offices—has enabled thousands to master Law surprisingly fast, in spare hours at home, for business and professional advancement.

These 14 remarkable volumes, compiled by leading professors and lawyers, cover the whole basic field of Law in condensed, orderly, simplified manner.

You advance rapidly with this great library, plus special lectures furnished. We guide you step-by-step with personalized Problem Method of instruction . . . you learn by doing—handling legal problems—not by memorizing rules.

Send for two FREE 48-page booklets, "Law Training for Leadership," and "Evidence," answering questions about Law and its value to you, and telling how LaSalle Law graduates are winning rapid advancement in business and public life. Mail coupon below. No obligation.

**LA SALLE EXTENSION UNIVERSITY
A Correspondence Institution**

417 S. Dearborn St. Dept. 1264L Chicago 5, ILL.

Send me your two FREE booklets described above, without obligation.

Name.....Age.....

Street.....

City, Zone & State.....

**"How to Make Money with
Simple Cartoons"**



A book everyone who likes to draw should have. It is free; no obligation. Simply address **FREE BOOK**

CARTOONISTS' EXCHANGE
Dept. 912D Pleasant Hill, Ohio

**High School
at Home**

MANY FINISH IN 2 YEARS

No classes. No time wasted going to and from school. Progress as fast as your time and abilities permit. Standard H. S. texts supplied. Thousands enroll each year in this 57-year-old school. Send for FREE descriptive booklet.

AMERICAN SCHOOL, Dept. H945
Drexel at 58th St., Chicago 37, Ill.

Without obligation, please send FREE descriptive booklet.

Name.....

Address.....

Canadian Residents: Complete Canadian Course Available. Write American School, 1610 Sherbrooke St., West, Montreal.

REWARD

If you would like to be a success in life, remember that success is not a gift, but a reward! If you would like more money, happiness in marriage, advancement in your work, an improved personality . . . study Napoleon Hill's "Science Of Success." Write Dept. PM for free, "Personal Analysis Questionnaire," which will show how you rate on the 17 Success Principles.

NAPOLEON HILL INSTITUTE

(A Division of the W. Clement Stone Organization)

5316 SHERIDAN ROAD CHICAGO 40, ILLINOIS

LEARN TO BECOME A GAME WARDEN
or GOVT. HUNTER, Join FORESTRY, FISHERY, or WILDLIFE Services. Excellent opportunities! Good pay (\$2500 to \$10,800 a year). Pleasant Work. Prestige, Real Security, Healthful Working Conditions, and Retirement Income can all be yours. Help fill the demand in your area. Make your love of the outdoors become your business. Learn at home in spare time—it's Easy! Fun! Fascinating!
FREE! (if over 17 years old.) Complete, illustrated booklet that gives you complete facts. **SUPPLY LIMITED**—send your name and address now—**TODAY!**
HOME-STUDY INSTITUTE, Dept. R 12 3156 W. 8th St., Los Angeles 5, Calif.

A "GOOD HAND" HELPS YOU SUCCEED!
LEARN TO WRITE WELL
Handwriting quickly improves with our easy-to-understand picture lessons! Put your spare time to good use; send today for **FREE BOOKLET**. "How to Become a Good Penman," or check volumes wanted below at \$1. each: Business Writing Artistic Writing Card Writing Bird & Design Flourishing Engraving Alphabets. **COMPLETE SET \$4.50.** Ask for price list of penman's supplies.
OUR 53rd YEAR
TAMBLYN SCHOOL of PENMANSHIP
S.A. Ziller, Pres., 442 Ridge Bldg., Kansas City, Mo., USA

BUY IT WHOLESALE!
GET UP TO 40% OFF
Start a Buying Service at Home. SPARETIME. GET BIG-NAME MERCHANDISE FOR SELF AND CLIENTS UP TO 40% LESS THAN REG. PRICE. SALES EASY, AS YOU CAN GIVE SIZEABLE DISCOUNTS. STILL MAKE FAT COMMISSIONS. Post Card brings FREE COPY "The Wholesale Plan".
FREE! "THE WHOLESALE PLAN"
American Buyers Service
• 631-R Linden Ave., Buffalo 16, N. Y. •

Say You Saw It in Popular Mechanics

TELEPHONES



Desk Stand Style
Slightly used but in excellent condition
Many Valuable Uses
Inter-House Phones House to Barn, etc.
Loud Speakers Microphones
Educational Purposes, Toys, etc.

Come complete, ready to use with wiring diagrams included. **\$2.75** Postpaid in U.S.A.
Two complete for only \$5.00
TELEPHONE LAMP KIT—with illustrated instructions for making Desk Telephone Lamp including all parts sharp, nipples, push switch, cord, plug, etc.)
... \$6.50 Ppd. (Shade is not included).

MICROPHONE, Dept. X-2102, 1760 W. Lunt Ave., Chicago 26, Ill.

POPULAR MECHANICS

GET INTO RADIO-TELEVISION ELECTRONICS by Shop-Method Home Training

GOOD JOBS AWAIT THE TRAINED RADIO-TV TECHNICIAN

There is a place for you in the great Radio-Television-Electronics industry when you are trained as National Schools will train you at home!

Trained technicians are in growing demand at good pay—in manufacturing, broadcasting, television, communications, radar, research laboratories, home Radio-TV service, and other branches of the field. National Schools Master Shop-Method Home Training, with newly added lessons and equipment, trains you in your spare time, right in your own home, for these fascinating opportunities. OUR METHOD IS PROVED BY THE SUCCESS OF NATIONAL SCHOOLS TRAINED MEN, ALL OVER THE WORLD, SINCE 1905.

EARN WHILE YOU LEARN

Many National students pay for all or part of their training with spare time earnings. We'll show you how you can do the same! Early in your training, you receive "Spare-time Work" Lessons which will enable you to earn extra money servicing neighbors' and friends' Radio and Television receivers, appliances, etc.



Signal Generator

Audio Oscillator

T.R.F. Receiver

National Schools Training is All-Embracing

National Schools prepares you for your choice of many job opportunities. Thousands of home, portable, and auto radios are being sold daily—more than ever before. Television is sweeping the country, too. Co-axial cables are now bringing Television to more cities, towns, and farms every day! National Schools' complete training program qualifies you in all fields. Read this partial list of opportunities for trained technicians:

- Business of Your Own • Broadcasting
- Radio Manufacturing, Sales, Service • Telecasting
- Television Manufacturing, Sales, Service
- Laboratories: Installation, Maintenance of Electronic Equipment
- Electrolysis, Call Systems
- Garages: Auto Radio Sales, Service
- Sound Systems and Telephone Companies, Engineering Firms
- Theatre Sound Systems, Police Radio
- And scores of other good jobs in many related fields.

TELEVISION TRAINING

You get a complete series of up-to-the-minute lessons covering all phases of repairing, servicing and construction. The same lesson texts used by resident students in our modern and complete Television broadcast studios, laboratories and classrooms!



MASTER ALL PHASES!

Get Master Shop-Method Home Training from an Established Practical Resident School with its own Training Shops, Laboratories, Studios — almost 50 Years of Successful Experience in Training Ambitious Men.

We Bring National Schools To You!



You also receive this Multitester

Superheterodyne Receiver

LEARN BY DOING

You receive and keep all the modern equipment shown above, including tubes and valuable, professional quality Multitester. No extra charges.

FREE! RADIO-TV BOOK AND SAMPLE LESSON!

Send today for National Schools' new, illustrated Book of Opportunity in Radio-Television-Electronics, and an actual Sample Lesson. No cost—no obligation. Use the coupon now—we'll answer by return airmail.

APPROVED FOR VETERANS AND NON-VETERANS Check coupon below

Both Resident and Home Study Courses Offered!



NATIONAL SCHOOLS

Dept. RB-124
4000 S. Figueroa St., Los Angeles 37, Calif. or 323 West Polk St., Chicago 7, Ill.

GET FACTS FASTEST! MAIL TO OFFICE NEAREST YOU!

(mail in envelope or paste on postal card)
NATIONAL SCHOOLS, Dept. RB-124
4000 S. Figueroa Street Los Angeles 37, Calif. or 323 West Polk Street Chicago 7, Ill.
Send FREE Radio-TV Electronics book and FREE sample lesson. No obligation, no salesman will call.

NAME _____ BIRTHDAY _____ 19____
ADDRESS _____
CITY _____ ZONE _____ STATE _____
 Check here if interested in Resident School Training of Los Angeles.
VETERANS: Give Date of Discharge _____

Learn ELECTRIC APPLIANCE REPAIR IN YOUR SPARE TIME AT HOME



START YOUR OWN BUSINESS

WITH A POTENTIAL MARKET OF 50,000,000 CUSTOMERS

New shop-method, home-training system gives you electrical know-how that used to take years to learn. Learn at home by building valuable testing kits, repairing your own and neighbors' appliances. It is not unusual for appliance repairmen to charge on the basis of \$5.00-\$8.00 an hour.

FREE ILLUSTRATED BOOK
Shows you how you learn every phase of electrical appliance. How to make money while you learn. Write today for your FREE copy.

CHRISTY TRADES SCHOOL
Dept. D-3703
4804 North Kedzie Ave., Chicago 25

ONE BUSINESS THAT IS NOT AFFECTED BY STRIKES, DEPRESSIONS OR POLITICS

EXPERIENCE IS THE BEST TEACHER—OUR MANY YEARS PROVES YOU CAN'T GET MORE—WHY PAY MORE?
LOW OVERHEAD—LARGE VOLUME SALES & SMALL PROFITS
BRING YOU THESE "LOWEST PRICES."

WHAT GOOD IS A TIRE WITHOUT A TUBE?
TUBE FREE WITH EVERY TIRE AT NO EXTRA COST

WHY PAY MORE!
AN ESTABLISHED POLICY OF CAREFUL SELECTION ASSURES YOU, MANY HAPPY MILES. BE WISE—TRY ONE—YOU'LL BUY MORE! WE WELCOME COMPETITION. NO ONE CAN TOUCH OUR QUALITY & PRICE!

GOOD USED TIRES — NOT RECAPS — NOT RETREADS
TAKE THE 10% DISCOUNT WE OFFER & PUT MONEY IN YOUR POCKET!
EVERYBODY MAY TAKE **10% off** ON EVERY TIRE
15 MONTHS WRITTEN GUARANTEE

600-16 \$3.52	820-15 \$4.92	600-20 \$7.52	32x6(8) \$8.72
650-16 4.22	700-15 3.92	650-20 7.62	32x6(10) 10.72
700-16 4.42	670-15 4.02	700-20 8.82	900-20 13.22
650-15 3.82	710-15 4.32	750-20 8.52	1000-20 14.02
760-15 4.42	550-17 3.72	825-20 14.12	1100-20 16.82

FREE If you buy 2 or 3 PASSENGER, 32 mos. guarantee tires, We GIVE ONE tire FREE. **FREE**

Specialists in Truck Tires—Selected for Toughest Jobs—Tops in Value
32 MOS. WRITTEN GUARANTEE 34 MOS. WRITTEN GUARANTEE

600-16 \$5.02	475-19 \$5.12	700-15(6) \$8.42	700-20 \$10.62
800-16(6) 6.32	640-15 4.72	750-16(8) 8.42	750-20(10) 15.02
650-16 5.52	670-15 5.12	700-17 8.72	750-20(8) 12.72
650-16(6) 7.02	710-15 5.22	750-17 10.52	825-20 17.92
700-16 6.12	760-15 5.72	750-15 10.42	900-20 17.62
750-16(6) 8.32	800-15 6.02	825-15 10.92	1000-20 18.52
550-18 3.92	820-15 6.12	600-20 6.72	1100-20 17.02
550-17 4.22	670-16 5.02	650-20 9.52	1100-22 17.92
650-15 5.02	760-16 7.02	32x6(8) 10.52	1000-22 17.92
700-15 5.12	700-16(6) 7.12	32x6(10) 12.92	1100-24 22.92

DeLuxe WHITE WALLS \$1.00 extra

Thousands of tires shipped all over the U.S.A. All tires shipped F.O.B. Phila. Send Check or M.O. with this ad. Dept. 2, No C.O.D.

STANDARD 834 N. Broad St., Philadelphia 30, Pa.

SHORTHAND in 6 WEEKS

Famous SPEEDWRITING shorthand. 120 words per minute. No symbols; no machines; uses ABC's. Easiest to learn, write and transcribe. Lowest cost. 250,000 taught by mail. For business and Civil Service. Typing available. 32nd year. Write for FREE booklet to: SCHOOL OF

Speedwriting

Dept. 1512-4, 55 W. 42 St., New York 36 (R)

LEARN WATCH REPAIRING

AT HOME Modern, original instruction. Prepare for a position or start in business after completing our course. Write Today!

WISCONSIN SCHOOL OF WATCH REPAIRING
2908 N. 44th St. Dept. M Milwaukee 10, Wis.

STOPS FOGGY WINDSHIELDS

NEW Chemical Mitt

Amazing Discovery! Autoists acid over new FOG-STOP Windshield Cleaner. Simply glide over windshield chemically-treated Mitt—at once glass sparkles crystal clear. Blurry mist, frost, sleet, snow disappear like magic. Stops fogging. Sells like wild!

SAMPLES FOR AGENTS Sample offer sent immediately to all who send name at once. Hurry. Postcard will do. SEND NO MONEY—just your name.

KRISTEE CO., Dept. 679, AKRON 8, OHIO

WELD YOUR WAY AHEAD!

Learn Arc and Gas Welding In Spare Time

Your opportunities are greater when you learn to use this great tool of modern industry. Training in welding opens the door to many key industries. Now you can train at home with UEI's practical course. Includes techniques, metallurgy, blueprints, shop practices, other important phases.

Write For FREE Facts! You can follow home-study training with actual shop practice. High school diploma not necessary. Write NOW!

UTILITIES ENGINEERING INSTITUTE

2523 Sheffield Ave., Dept. WC-7, Chicago 14, Ill.



EVERY MASON WILL WANT THIS MASONIC QUIZ BOOK

or

"Ask Me Another, Brother"

A real help to every Lodge Officer, Master Mason or Masonic Student.

Does not disclose any Secret Work, but gives authoritative information on Masonic history, ritual.

Includes such questions as:

- What did Masons have to do with the Boston Tea Party?
- What reference is made to the Catholic Church in Masonic teachings?
- Has every President of the United States been a Mason?

\$3 284 pages, 5 1/2 x 8", bound in cloth, and a distinct addition to the library of any man, even though he is not a Mason. Postpaid or C.O.D. plus postal charges.

A Gift that every Mason will appreciate

ORDER YOUR COPY TODAY

THE CHARLES T. POWNER CO.
Dept. DL, 407 S. Dearborn, Chicago 5, Illinois

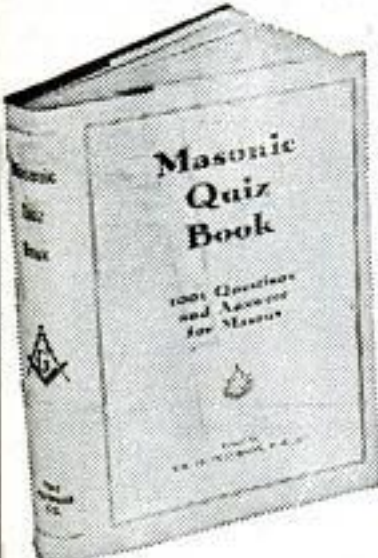

Now! Earn \$5..\$8..\$10..up to \$12⁵⁰ per Hr.

SPARE TIME!

Sensational New HOME-BUSINESS!

AMAZING NEW PRINTING SECRETS CAN BE YOURS

For Pleasure & Profit. Once you learn the closely guarded printing secrets of Screen-Print there's virtually no limit to how much "extra money" you can earn. SPARE-TIME WORK—For FULL-TIME PROFITS. Screen-Printing is the most fascinating Home-Business ever! Learn in a few days and start making money immediately. Even earn while you learn—it's amazing!

LEARN AN "EXTRA TRADE"

MEN! WOMEN! Learn Screen-Printing and make up to \$200 per week—even working for someone else. Learn Screen-Printing and you learn an "extra trade."

PRINT WITHOUT A PRINTING PRESS!

OR ANY SPECIAL EQUIPMENT

SCREEN PRINT
TRADE MARK REG.

WHAT IS SCREEN PRINTING?

It's a revolutionary new method of printing—WITHOUT an expensive printing press. This amazing new development lets you print quantities of 25, 50, 100, 500 or even 1,000 in many cases, FOR LESS THAN YOU CAN PRINT ON A \$5,000 PRINTING PRESS. Just put anything under a screen and take out beautiful products of printing—no expensive plates or "cans" needed. No big overhead. Never has such an opportunity been offered the spare-time person who wants to make "Extra Income" in his home. This amazing NEW INDUSTRY can mean huge spare time profits for you.

PRINT IN COLORS—EVEN NEW FLUORESCENT COLORS

There's no limit to the number of colors you can use. It's easy to print in luminescent, "glowing" fluorescent colors, too. (These "brilliant" new inks can ONLY be printed satisfactorily by the Screen-Print method.) Screen-Print lets you print on paper, cardboard, leather, glass, wood, plaster, fabrics—anything!

NO ART NECESSARY—EASY TO LEARN

Anyone (young or old) can be a Screen-Printing expert—he doesn't have to be a "Rembrandt" either. Beautiful printing can be produced WITHOUT doing any art whatsoever—simple tracing is all that's necessary in most cases. Simplified photo method ELIMINATES ALL HAND WORK. No camera needed.

One of America's FASTEST GROWING BUSINESSES!

Hundreds are already profiting handsomely with Screen-Print. This New method may revolutionize the printing business, as we know it today! Get the facts NOW!

A BUSINESS OF YOUR OWN

Be your own boss. Operate from the corner of your kitchen or garage. Build a successful future with a few cents worth of materials. Screen-Printing is the opportunity to establish a spare-time business without sacrific-

ing job or pay check—have 2 INCOMES INSTEAD OF ONE.

"I already make 75% of my expenses doing Screen-Printing only sparetime" says Mr. E. L., Ontario.

THERE'S \$555 IN ADVERTISING!

Here's your chance to GET INTO ADVERTISING—one of the largest paying businesses in America. Most Screen-Printing is used for advertising purposes. Materials cost you 10%—you can earn 90%—few businesses offer this high profit.

HUGE DEMAND! ENORMOUS PROFITS!

Millions of shops, stores, theaters, markets—almost any business needs Screen-Printing done for them. It's possible to even do your business by mail. No house-to-house selling either. You can make \$10 to \$20 profit on each dollar of cost on some jobs. Here's...

YOUR "Chance of a Lifetime" OPPORTUNITY to "cash-in" on a new printing method not generally known. We supply everything you need! From easy step-by-step instructions—secrets plus materials enough to make money immediately. A complete ready-made BUSINESS PLAN guides you every step of the way. This all can be yours—at our risk. Space here does not permit telling you all the terrific opportunities of Screen-Print. Don't waste a minute — mail coupon NOW! TODAY!—and get all the FREE FACTS and ACTUAL SAMPLE.



PRINT colorful ADVERTISING DISPLAYS at home!

You've seen thousands of them in stores, gas stations, theaters, markets — everywhere! Many of these displays are printed by Screen-Printing in brilliant "eye-catching" colors.



PRINT expensive SIGNS, BANNERS, POSTERS, LABELS, etc. at home!

EVERY BUSINESS, large or small, needs these items—they order them almost daily. It's possible to specialize in Screen-Printing banners alone and get all the orders you can take care of.



PRINT beautiful CLOTH, FABRICS, GLASSES, NOVELTIES, etc. at home!

Because you can Screen-Print on any kind of materials, there are thousands of uses. Print lamps, glassware, ties, calendars, draperies, wall paper, flags, dress materials, balloons, bowls, etc. Orders come from gift shops, manufacturers, markets, department stores, etc.

FREE MY BOOKLET AND ACTUAL SAMPLE OF SCREEN-PRINTING. TELLS ALL THE FACTS ABOUT MY HOME-BUSINESS OPPORTUNITY PLAN.



Mr. C. J. Nowak
GENERAL MANAGER



FREE BOOKLET AND REAL SAMPLE MAIL TODAY!

Screen-Print Co., Dept. 2C
15130 S. Broadway, Los Angeles 61, Calif.
P.O. Box 61007 South Station

Dear Mr. Nowak: Please rush me booklet, facts, sample and entire Home-Business Plan. All this is Free. No salesman will call. I am under no obligation now or ever.

Name _____
Address _____
City _____ Zone _____ State _____

PROFESSIONAL-TYPE ELECTRIC
HAIR CLIPPER



ONLY
\$10⁹⁵

At Your Barber,
Beauty Shop or
Dealer's

Cadet

ELECTRIC HAIR CLIPPER

Saves time and money for the whole family! Has cool-running magnetic motor; fine-tooth blade for close cutting; streamlined plastic case. 110v 60 cycle AC; fully tested by UL. If your barber, beauty shop or dealer cannot supply you, order direct on 10-day money-back guarantee.

ELECTRO TOOL CORPORATION
DEPT. C524-M • RACINE, WISCONSIN

Shrinks Hemorrhoids
New Way Without Surgery

Science Finds Healing Substance That Relieves Pain—Shrinks Hemorrhoids

For the first time science has found a new healing substance with the astonishing ability to shrink hemorrhoids and to stop bleeding—without surgery.

In case after case, pain was relieved promptly. And, while gently relieving pain, actual reduction (shrinkage) took place.

Most amazing of all—results were so thorough that sufferers made astonishing statements like "Piles have ceased to be a problem!"

The secret is a new healing substance (Bio-Dyne®)—discovery of a world-famous research institute.

Now this new healing substance is offered in ointment form under the name of *Preparation H*.* Ask for it at all drug stores—money back guarantee. *Trade Mark

AVIATION Pays You More
With a Schooling
at PARKS

NOW! A&E MECHANIC LICENSE COURSE

45-week course, all phases aircraft & engines. Enrollment Dates: Jan. 3; Sept. 1, 2, 1955.

FLIGHT COURSES—Private, Commercial, Instrument, Instructor, Multi-Engine.

DEGREE COURSES—B.S. degree in 3 yrs. from Saint Louis University — Aero. Engineering, Maint. Engineering, Aero. Administration.

All Parks Schooling Approved for Veterans
Write Today.

PARKS COLLEGE ARNOLD HALL
EAST ST. LOUIS, ILL.

EARN WHILE YOU LEARN AT HOME MAKE MONEY 90 WAYS IN PHOTOGRAPHY

If you are OVER 17—good pay, fascinating work await you in photography. Start earning at once as you learn to make money 90 ways with your camera. Our famous, low-cost LEARN-BY-DOING method and INDIVIDUAL guidance train you quickly at home! Write TODAY for FREE catalog. Also Co-ed Resident Training. 46th Year, GI Approved.
NEW YORK INSTITUTE OF PHOTOGRAPHY
Dept. 49, 10 W. 33 Street New York 1, New York



LEARN TO THROW THE BOOMERANG

A Fascinating Sport
and Unique Gift

SEND FOR
YOURS
TODAY

Flight Tested—Guaranteed to Return
Golden Red, Jade Green or Natural
with Story and Instructions \$2.00 ea.

CARVED by Postpaid
COL. JOHN M. GERRISH

4409-M S.W. Parkview Lane, Portland 1, Ore.

Say You Saw It in Popular Mechanics

USE THIS PORTABLE SHOWROOM

TO START YOUR OWN BRAND NAME BUSINESS!

Imprint your own name on this catalog. We'll be your warehouse for 1001 nationally advertised items including APPLIANCES • JEWELRY • RADIOS • CAMERAS • TOYS • ETC. Separate confidential price list. SEND FOR FREE CATALOG TODAY!

O. FAUST, Dept. PM 1254 223 N. 8th St. • PHILA. 6, PA.

Learn BAKING At Home

Baking is one of America's high industries in wages. Nearly DEPRESSION-PROOF. Thorough basic home course lays sound foundation. If you have aptitude, write for FREE Booklet. "Opportunities in Commercial Baking."
NATIONAL BAKING SCHOOL
835 Diversey Pkwy. Dept. 1359 Chicago 14, Ill.



① I SHOW YOU HOW TO
MAKE MONEY AT ONCE

② **START YOUR OWN BUSINESS**
IN 2 WEEKS—
AT HOME
IN SPARE TIME



METALIZE BABY SHOES

IF YOU ACT NOW, I will show you how to start earning extra money immediately—in spare time or full time. AND I SHOW YOU HOW to start your own profitable business. With my complete course and easy-to-understand illustrated instructions containing trade secrets of ALL metalizing processes PLUS beautifully processed sample metalized baby shoe AND all my tested and proved methods of operating a successful metalizing business. I show you how to start YOUR OWN profitable, fascinating business right in YOUR OWN HOME. Absolutely no experience needed. For PROOF send coupon today for FREE details of my MONEY MAKING PLAN for you and be convinced.

FREE!

MONEY MAKING PLAN

Full Details
Without
Obligation

MAIL COUPON TODAY!

KIKTAVI CO., Dept. PM-5412
7217 So. Broadway, Los Angeles 3, Calif.
Send me FREE details of your MONEY MAKING PLAN, without obligation.

NAME _____
STREET _____
CITY _____ ZONE _____ STATE _____

**It's New! 3 Years in Development
-NOW READY FOR YOU!**

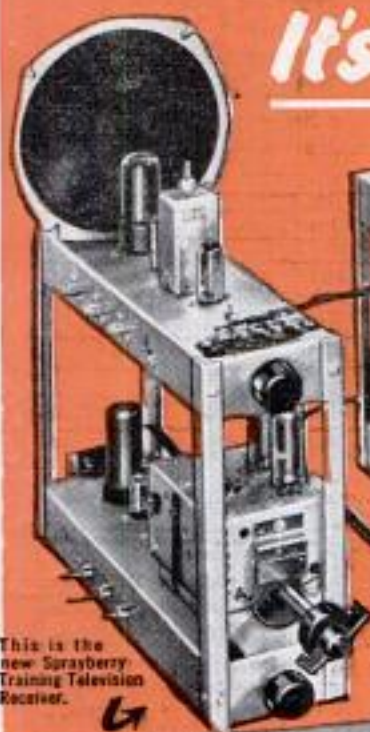

This is the new Sprayberry Training Television Receiver.



You build the new Sprayberry Tester... 18-range Volt-Ohm-Milliammeter readings.

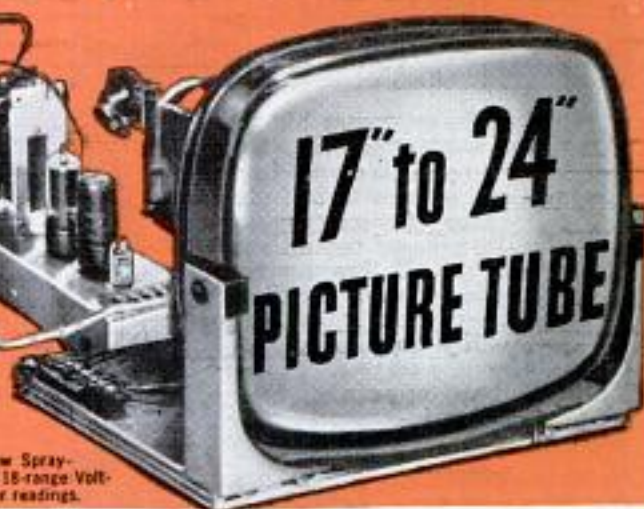

You will build this powerful short wave and broadcast superhet radio receiver.

New Equipment! New Lessons! Enlarged Course!
SPRAYBERRY PRACTICAL TRAINING IN
RADIO-TELEVISION
3 NO OBLIGATION TRAINING PLANS



F. L. SPRAYBERRY
Pres.

You have NO MONTHLY PAYMENT CONTRACT to sign... pay for this outstanding training as you learn!

Mail the coupon at once for my big all-new 56 page **FREE CATALOG** and **FREE Sample Lesson**. Get the full story of this remarkable new Training Plan. Read about my **3 NO OBLIGATION PLANS** of "packaged unit" instruction. I can prepare you in as little as **10 MONTHS** to take your place as a **Trained Radio-Television Technician**. You take no risk in enrolling for my Training because you **DO NOT SIGN A BINDING TIME PAYMENT CONTRACT**. I have been training successful Radio-TV technicians for 22 years...I can prepare you, too, to get into your own profitable Service Shop or a good paying job. Full information **FREE** and without any obligation. No salesman will call.

NEWEST DEVELOPMENTS

Your training covers U H F, Color Television, F.M., Oscilloscope Servicing, High Fidelity Sound and Transistors.

PRACTICE AND TRAIN AT HOME WITH 25 NEW KITS of EQUIPMENT

You get valuable practical experience in construction, testing and shop practice. You build a powerful 2 band superhet radio, the all-new 18 range Sprayberry multitester, the new Sprayberry Training Television receiver, signal tracer and many other projects. All equipment is yours to use and keep. All your training is **IN YOUR HOME** in spare hours. I help you earn extra spare time money while you learn. Rush coupon below for all the facts—**FREE!**

SPRAYBERRY ACADEMY OF RADIO
111 NORTH CANAL STREET, DEPT. 10-S
CHICAGO 6, ILLINOIS



FREE CATALOG AND SAMPLE LESSON

Rush coupon for my catalog "How to Make Money in Radio-Television". **PLUS** an actual sample Sprayberry Lesson without obligation—**ALL FREE**. Mail coupon **NOW!**

SPRAYBERRY ACADEMY OF RADIO MAIL THIS COUPON FOR FREE Dept. 10-S, 111 N. Canal St., Chicago 6, Ill. **FACTS AND SAMPLE LESSON**
 Please rush New Catalog and Sample Lesson **FREE**. I understand that no salesman will call.

Name _____ Age _____
 Address _____
 City _____ Zone _____ State _____

not everyone does as well, but E. O. Lockin, who started a business of his own, reports...

for 12 months I've averaged

\$800 PER MONTH INCOME

—most of it clear profit for me!

● Mr. Lockin expresses his grateful thanks for the opportunity to make a decent living on his own. Many men have discovered how to be independent, to be free of bosses and layoffs. L. A. Eagles grossed more than \$200 his first week. R. E. Traynor says, "I made \$62 gross in one day." Others report gross up to \$12,000 per year.

How much you make depends largely on you. You need no special skill, no large investment.

No shop necessary. Our ELECTRIC RUG WASHER cleans rugs, carpets right on floor... helps to show their natural color and beauty. So efficient and safe, used by largest hotels and railroads.

You take no risk. Machines fully guaranteed. Mail coupon today for complete information including how to start making big profits in YOUR OWN business.

VON SCHRADER MFG. CO., RACINE, WIS.

You, too, can start your own business. No special skill, no large investment required. Mail coupon today for interesting FREE book.



VON SCHRADER MFG. CO.,

W10 "R" Pl., Racine, Wisconsin

Send at once (no obligation) your FREE booklet containing information about your ELECTRIC RUG WASHER and how I can start my own permanent, profitable business.

Name _____

Address _____

City _____ Zone _____ State _____

SAY YOU SAW IT IN POPULAR MECHANICS

SEE HOW EASY IT IS Step by Step!



BE AN ARTIST

Enjoy a Profitable Career or a Satisfying Hobby



Enjoy painting, commercial art, cartooning at home in your spare time. You can earn while learning. We teach fundamentals. Step-by-step method helps beginners quickly. Low tuition, easy terms. Our 40th year. Coupon brings FREE book, "Art for Pleasure & Profit." TRIAL PLAN. No salesman.

Washington School of Art Studio 1212 N Washington 5, D.C.

Name _____ Address _____ Age _____ City, Zone, State _____

Capra Gems

more dazzling than diamonds

FREE Booklet

Get full facts, FREE, on the most amazing discovery by modern science—CAPRA GEMS. A miracle of science described in recent issues of Saturday Evening Post and Reader's Digest. They're more dazzling than diamonds, yet cost much less. CAPRA GEMS' refractive quality is actually higher than diamonds! Brilliantly beautiful, dazzling CAPRA GEMS are hand cut, hand polished and hand selected... priced within the reach of all who love fine gems. A 1-carat diamond stone costs you approximately \$1000. A comparable choice selected, 1-carat CAPRA GEM is yours for \$24, federal tax included... and can be bought in small easy payments.



GET THE FACTS NOW

Valuable illustrated booklet shows a wide selection of men's and women's rings. Gives full details, including prices and settings... shows all CAPRA GEMS actual size. Limited supply, so send today without delay. No charge, no obligation. Get all the facts on CAPRA GEMS... more dazzling than diamonds.

SEND NO MONEY

CAPRA GEM CO., Dept. PM-12, P.O. 5145, Philadelphia 41, Pa.

Learn ACCOUNTING Business Administration

Bookkeeping, secretarial and allied subjects at home in your spare time or attend nationally approved resident school. Write for FREE Success Book giving complete details on courses, plans, rates and employment opportunities. G.I. approved.



Hills BUSINESS UNIVERSITY AND EXTENSION SCHOOL 619 W. MAIN ST. OKLAHOMA CITY 2, OKLAHOMA

Learn MECHANICAL DENTISTRY

To make Crowns, Plates, Bridgework, etc., for Dentists. Easy practical way to learn mechanical dentistry at home in spare time. FULL EQUIPMENT OF TOOLS AND MATERIALS INCLUDED WITH COURSE. Low tuition. Easy terms. Write for FREE BOOK about this money making profession that is not affected by machine age.

McCARRIE SCHOOL OF MECHANICAL DENTISTRY 207 N. Broad St., Dept. 36, Philadelphia 7, Pa.

BE A DETECTIVE

WORK HOME or TRAVEL. Experience unnecessary. DETECTIVE Particulars FREE. Write to GEO. P. M. WAGNER, 125 W. 86th St., N. Y.

BUILD LUGGAGE AT HOME WE SELL YOUR PRODUCTS!

ONLY NEW HOME MONEY-MAKING PLAN IN YEARS!

Make Luggage and cases for traveling, photographers, musicians, salesmen, electronics, tools, portables, 1001 other items. Also repair Luggage. No special equipment needed. BIG Profits. We supply complete instructions, materials—everything. Write for free details and Business Plan. ABARSI CASECRAFT, Dept. G-12, 805 W. Sunset Blvd., Los Angeles 12, Calif.

RAISE GIANT FROGS BIG DEMAND



MILLIONS USED YEARLY! Good prices year round! Breeder lays up to 20,000 eggs yearly. Nation-wide markets waiting for all you can ship. Get ready now for next spawn. New book tells how! Small pond starts you. Men and Women send for my illustrated FREE folder today. Do it now!

ALBERT BROEL-7 P.O. Box 506. New Orleans 1, La.

FREE AMAZING NEW BOOK "HOW TO ANSWER ADS"



Never before have you seen anything like this. Tells you in simple language the correct way to answer ads. Gets you quicker replies—better results, and greater satisfaction. Will save you time and money and it's ABSOLUTELY FREE. No obligation whatever. Every reader of advertising should have this booklet. Send a postcard for your copy NOW. F. W. JOHNSON, Popular Mechanics Magazine, Room 600-A, 204 East Ontario Street, Chicago 11, Ill.



**IF YOU "EAT, SLEEP
AND LIVE" CARS...**

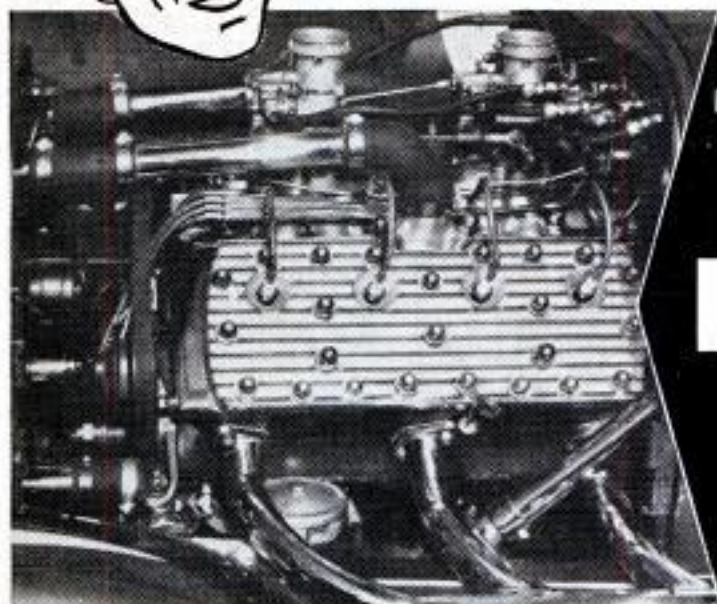

**TURN YOUR
HOBBY INTO
A CAREER!**

Get America's Big-time, Big-future

**AUTO MECHANICS & DIESEL
COURSE**

at Home in Your Spare Time!

Los Angeles' *National Schools*, America's automotive Technical Trade School since 1905, now brings its famous resident Shops and Faculty direct to you at home—to prepare you to earn more money, with job security, in today's fast-moving, opportunity-filled Auto Mechanics Industry!

Get your home training from the "Car Capital of The World"—America's most auto-minded city, center of Hot Rod and Sports Car activity! Mail the coupon below right now!

HERE'S THE GOOD WORD ON OUR "SHOP-METHOD" HOME TRAINING! You master all phases, including Diesel! Every step fully explained. All lessons fully illustrated. Latest equipment and techniques. You complete your training in short time... age and previous experience no obstacle!

EARN WHILE YOU LEARN! You can start Spare Time Earnings in Auto Mechanics soon after enrollment. Many students pay for their training and more this way.

THIS SET OF LIFETIME TOOLS—YOURS plus all-metal tool box, and other equipment. All part of your course, yours to keep.

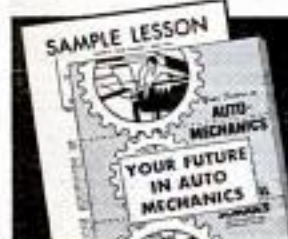

Send for FREE FACT-BOOK AND SAMPLE LESSON!

**NOW! 2 offices to serve you faster!
Mail coupon today to one nearest you!**

YOU RECEIVE FRIENDLY GUIDANCE both as student and graduate. Our graduate department is always at your service to help you with personal and technical problems. We give you free Job Placement Service, too!

ATTENTION MEN OF DRAFT AGE. Many students have achieved higher rating, prestige, service branch they want, and higher pay due to this training. Mail coupon at once.

APPROVED FOR G. I. TRAINING

Both Home Study & Resident Courses Offered

**NATIONAL SCHOOLS
TECHNICAL TRADE TRAINING SINCE 1905**

**LOS ANGELES 37, California · CHICAGO: 323 West Polk St.
IN CANADA: 811 West Hastings Street, Vancouver, B. C.**

MAIL NOW TO OFFICE NEAREST YOU!

(mail in envelope or paste on postal card)

NATIONAL SCHOOLS, Dept. DB-124

4000 S. FIGUEROA STREET
LOS ANGELES 37, CALIF.

OR 323 WEST POLK STREET
CHICAGO 7, ILLINOIS

Send **FREE** Auto-Mechanics Book and Sample Lesson. No obligation, no salesman will call.

NAME _____ BIRTHDAY _____ 19 _____

ADDRESS _____

CITY _____ ZONE _____ STATE _____

Check if interested **ONLY** in Resident Training at Los Angeles
VETERANS: Give Date of Discharge _____

Here's the Kind of MEN I Build!



CHARLES ATLAS

Will You Let Me
**PROVE I Can Make
YOU a New Man?**



THOMAS MANFRE
One of
Charles Atlas' pupils... winner of Atlas Championship Cup.

I don't care how old or young you are, or how ashamed of your present physical condition you may be. Just give me 15 minutes a day, and I'll start giving you RESULTS that you can SEE, FEEL, and MEASURE with a tape! I can broaden your shoulders, strengthen your back, develop your whole muscular system INSIDE and OUTSIDE! I can add inches to your chest... give you a vise-like grip... make your legs powerful... help

cramp your body so full of strength, red-blooded vitality.

ity your friends will be amazed! WRITE FOR FREE BOOK, 32 pages about how "Dynamic Tension" changed me from 97-lb. weakling into "World's Most Perfectly Developed Man"—and what I'll prove it can do for YOU. CHARLES ATLAS, Dept. 8M, 115 E. 23rd Street, New York 10, N.Y.

CHARLES ATLAS, Dept. 8M, 115 East 23rd St., New York 10, N.Y.

Send me—absolutely FREE—a copy of your famous book, "Everlasting Health and Strength"—32 pages, crammed with photos and valuable advice. No obligation.

Name _____ Age _____
Address (Please print or write plainly) _____
City _____ State _____



I'll Send You This Handsome SAMPLE CASE—FREE!



Make up to
\$30⁰⁰ in a Day!

Your Own
**Tailored Suits
Without 1¢ Cost**

If you want to make more money, spare time or full time, rush the coupon below today for this big, valuable tailoring Sample Case packed with 150 beautiful, big-value suit and overcoat samples. Just show the samples and last-minute styles to friends, fellow-workers, others. Take their orders for fine made-to-measure clothes—and pocket BIG CASH PROFITS in advance. No experience, no tailoring knowledge needed—and no money needed, ever. WE SUPPLY EVERYTHING FREE... sample case, sample suitings, equipment, complete instructions. Start making money first day!

Use Spare Evenings... Weekends... Make Money... Get Suits!

It's easy to make money taking orders in just spare time—lunch-time, evenings, weekends. When men see the fine fit, quality and value of our suits—THEY ORDER! So we make it easy for you to get your own personal suits and overcoats without paying even one penny. Don't wait! Rush coupon with your name, address, and age for FREE Sample Case.

W. Z. GIBSON, INC., Dept. U-516
500 South Throop Street, Chicago 7, Illinois

W. Z. GIBSON, INC., Dept. U-516
500 S. Throop St., Chicago 7, Ill.

Please rush ABSOLUTELY FREE the valuable Sample Case with suit fabrics and style display. Include instructions, money-making plans and details for getting my own suits without paying one cent.

Name _____ Age _____
Address _____
City _____ State _____



"WE FOUND A NEW LIFE
IN MOTEL MANAGEMENT"



"Dissatisfied with our routine jobs, we became Motel Managers, thanks to your home study training. Now we earn good pay, work and live in beautiful surroundings." This is typical of the many who have taken the National Motel Training at home, in their spare time. 50,000 Motels offer new opportunities. Write for FREE information today!

NATIONAL MOTEL TRAINING
404 Lake St., Dept. PM-12, Oak Park, Ill.

EARN
WHILE YOU
LEARN



UPHOLSTERY BE YOUR OWN BOSS

AT HOME—Earn more right from the start. Get a better job—be your own boss. UTS easy course teaches you professional furniture upholstery, reupholstery, slip-covers, drapery. FREE—tools, frames, materials to make beautiful upholstered furniture and slip covers. Free Illustrated Book—SAMPLE LESSON—Write Upholstery Trades School, Dept. CX-309, 721 Broadway, New York 3, N. Y.

MAKE YOUR OWN POGO STICK

SAVE!

Comparable
to any \$8.
Pogo Stick.

ALL
METAL...
SIMPLY AND
QUICKLY
ASSEMBLED.

Complete kit—Finest materials—ready to assemble. For weights up to 100 lbs. \$3.50. Over 100 lbs. \$4.50 ppd. Specify weight.

U. S. INDUSTRIES, 803 Macy Street, Los Angeles 12, Calif. Dept. PM-124

Become a Doctor of PSYCHOLOGY

Win the degree of Ph.D. Learn the secret of contentment, happiness. Solve mental worries. Experience the revelation of truth. Chartered college. Individual help. Write for FREE book. COLLEGE OF UNIVERSAL TRUTH, 5038-B Broadway, Chicago.



XMAS MONEY

It's easy with this beautiful all wood 11 in. high SWISS MUSICAL CHURCH. Regular Retailer \$7.50. Complete kit \$3.95. Add 50¢ postage.

PILTZECKER SWISS IMPORTS, Wood-Ridge, N. J.



send
for
FREE
BOOKLET

LEARN LOCKSMITHING

Learn this fascinating, profitable trade from experts in your spare time at home! Age or physical handicap no disadvantage. Year around, steady income. Full or part time. Practical, illustrated lessons. You can make money even while learning! All materials and special tools supplied without extra charge. INSTITUTE OF LOCKSMITHING, Dept. P-61 15 PARK AVENUE RUTHERFORD, N. J. Lic. by N.J. State Board of Education Approved for Veterans

WANT TO Write Stories Articles Mysteries?

FREE BOOK
shows how you
learn at home



Would you be willing to spend a few hours a week learning to write so you may earn \$300-\$1200 a year part-time? Or many thousands full-time? FREE book, "Art of Writing Salable Stories," and typical lesson material show how to get started writing stories, radio-TV scripts, articles, business items. Many students earn while learning. (A. B. Aretz sold first 3 stories for \$225). Endorsed by famous authors, scores of successful graduates; approved for veterans. Send today for FREE book and lesson material. PALMER INSTITUTE OF AUTHORSHIP, Since 1917 1680 N. Sycamore Hollywood 28, Calif. Desk T-124

INSURED TIRE SERVICE
POPULAR BRANDS

FREE INSURANCE POLICY given with each used tire sold. We guarantee the amount of service you pay for.
Tube Given Free with Each Used Passenger Tire Upon Request

SPECIAL! Deduct 10% on orders for two or more used tires

YOU CAN'T LOSE!!

GOODYEAR SUBURBANITE TYPE SNOW TIRES
New Tire Guarantee—Factory Rebuilt
BEST WINTER TRACTION OF ALL!

670x15	\$8.95	710x15	650x16	\$9.90
600x16		760x15	650x15	

Super Quality — Rugged Performance — 15 Months Insured Service

600x16	\$3.85	670x15	\$3.95	700x16	\$4.45	760x16	\$4.75
650x15	3.85	670x16	4.05	710x15	4.35	820x15	4.95
650x16	4.25	700x15	3.95	760x15	4.45	850x17	4.85

Supreme Quality — Nothing Finer — 30 Months Insured Service

600x16	\$5.25	475x19	\$5.45	700x15	\$10.45	700x20	\$12.50
600x16 (6)	6.75	640x15	4.95	750x16 (8)	15.95	750x20 (8)	15.50
650x16	5.75	670x15	5.35	700x17	11.95	750x20 (10)	17.50
650x16 (6)	7.25	710x15	5.45	750x17	16.45	825x20	21.50
700x16	6.35	760x15	5.95	750x15	10.95	900x20	19.95
750x16 (6)	8.45	800x15	6.35	30x5	11.25	1000x20	20.45
550x18	4.95	820x15	6.35	600x20	10.95	1100x20	21.25
550x17	4.75	850x15	5.35	650x20	11.75	1000x22	21.95
650x15	5.25	670x16	5.15	32x6 (8)	11.95	1100x22	22.75
700x15	5.35	700x16 (6)	10.25	32x6 (10)	12.75	1100x24	25.95

Whitewalls \$1.00 extra.

MIDLAND TIRE SALES
3701 S. Normal, Dept. PM-29, Chicago 9, Ill.

Become an Electrical Engineer



Major in Electronics or Power BS Degree in 36 months



Prepare now for a career as an electrical engineer or engineering technician—and take advantage of the many opportunities in these expanding fields.

You can save a year by optional year 'round study. At MSOE previous military, academic, or practical training may be evaluated for advanced credit.

Enter Radio and Television — courses 12 to 18 months

You can be a radio technician in 12 months. In an additional 6-months you can become a radio-television technician with Associate in Applied Science degree. Color television instruction is included in this program.

These technician courses may form the first third of the program leading to a degree in Electrical Engineering. Twenty-one subjects in electronics, electronic engineering and electronic design are included in these courses.

Courses also offered: radio-television service (12 mos.); electrical service (6 mos.); general preparatory (3 mos.).

Terms — January, April, July, Sept.

Faculty of specialists. 50,000 former students — annual enrollment from 48 states, 23 foreign countries. Non-profit institution. 51st year. Courses approved for veterans. Residence courses only.

MS-68



MILWAUKEE SCHOOL OF ENGINEERING

MILWAUKEE SCHOOL OF ENGINEERING
Dept. PM-1254, 1025 N. Milwaukee Street
Milwaukee 1, Wisconsin

Send FREE illustrated booklets
 Career in Electrical Engineering,
 Career in Radio-Television.

I am interested in..... (name of course)

Name.....Age.....

Address.....

City.....Zone.....State.....

If veteran, indicate date of discharge.....

LOOK! A MILLION THRILLS!



High Power BINOCULARS

30 DAY FREE TRIAL
Finest Precision Optics
Money Back Guarantee
Easy Pay Plan

Free! Catalog & Book
"How to Select Binoculars"

Dept M92 43 E. Green
Pasadena, Calif.

BUSHNELL Binoculars

TASOPE PHOTO-ENGRAVING PLANTS



Material Cost
Of This Cut 1/4c
Selling Price
\$1.00 And Up

Establish your own profitable PHOTO-ENGRAVING business. Make cuts for newspapers, printers, and advertisers. Make etched name plates, plaques etc. Instructions furnished, no experience necessary. Sold direct from factory since 1931. First five hundred cuts sold locally or by mail will pay for plant and pay you well for your time. Write for FREE catalog.

TASOPE, DEPT. PM-12, AURORA, MO.

Free Book on Arthritis and Rheumatism

HOW TO AVOID CRIPPLING DEFORMITIES

Explains why drugs and medicines give only temporary relief and fail to remove the causes; tells all about a specialized non-surgical, non-medical treatment which has proven successful for the past 35 years. Write for this 44-page FREE BOOK today.

Ball Clinic Dept. 756 Excelsior Springs, Mo.

SEND FOR

Free Record

START SPEAKING
FRENCH
OR
SPANISH ALMOST OVERNIGHT!

HERE'S the easiest way to learn FRENCH, SPANISH, Russian, German, Italian, Japanese or Brazilian. Listen to FREE 2-sided non-breakable record. Let your eyes follow words in FREE sample lesson. Almost at once you'll be chatting in a new language with a perfect accent! That's all you hear! No memorizing needed. Just listen—imitate! It's that easy! Offer may end soon. Rush 25¢ to help cover cost of special packaging, shipping. State language you want. We'll also send free information on full Cortina course. CORTINA ACADEMY, Dept. 6412, 136 W. 52nd St., New York 19.

AMAZING NEW ASTRONO-SCOPE* & TRIPOD

POWERFUL! ACCURATE! COMPLETE!

IDEAL FOR

- Astronomers
- Students
- Hobbyists
- Scouts
- Sportsmen
- Plane Spotters
- Target Spotters
- Mountain Climbers
- Sea & Land Observers



\$8.95

POST-PAID

Sky High Value at a Down-To-Earth Price! Amazing New Astrono-Scope* Combination — another Big "CRITERION FIRST" — A brilliant variable 20x, 45x, 70x, power adjustable eyepiece, 3 foot telescope, brass bound, with 4 precision lenses that will bring distant objects, moon, stars, ships and people 75 times closer. Can also be used as powerful compound microscope. All aluminum tripod with non-slip rubber tips. Universal mount makes easy, smooth adjustment to any position. **FREE** — 108-page book "DISCOVER THE STARS." A marvelous complete all-purpose instrument ready to use, in a Christmas Gift Package all for the amazing price of \$8.95.

Money Back Guarantee

*Reg. U. S. Pat. Office

Send Check or Money Order DEPT. PMA 4

CRITERION CO. 331 CHURCH ST. HARTFORD 1, CONN.

Super TELESCOPE

Aluminum TRIPOD

Hi-Power MICROSCOPE

Astronomy BOOK

...TURN CONCRETE INTO GOLD!

MAKE UP TO \$75 A DAY IN YOUR OWN BUSINESS

If you want to have your own business — to start a business on your own — here's your big opportunity! New high speed, low cost General block machine produces up to 1,000 concrete blocks a day. Sell all you make to builders, supply houses, and others for homes, factories, buildings, garages. Cash in on the building boom! You can make profits of 100% to 150% — up to \$75 a day! General block machine equipped with 1/2 h.p. electric motor — or can be supplied with gasoline engine — works anywhere, in little space, indoors or out. Operates from ordinary house light socket. Simple, foolproof 3 step operation — so easy a child can do it. Makes superior 3 core blocks any size from 4" to 12". Also makes chimney, sink, corner and other types. Blocks meet any building code anywhere in the country. Materials — sand, water, cement, available anywhere. Simple illustrated operating instructions and mixing formulae for cement and cinder blocks supplied with each machine. Write for **FREE** folder with full information.

MOTOR DRIVEN

R.L.T. of New York City reports: "MY GENERAL BLOCK MACHINE PAID FOR ITSELF IN FIRST 2 WEEKS!" Hundreds now in use the world over! Write for **FREE** details today!

EXTRA

book gives floor plans for 6 sensational concrete block buildings. Tells how to lay blocks, lay out building lines, mix concrete, build steps, porch and concrete floors all at great savings. Written by experts. Can save many times the cost of the machine! Get it now! No strings attached. Send \$1.

BOOK SENT FREE IF YOU BUY MACHINE. \$1 REFUNDED IF YOU BUY LATER.

GENERAL ENGINES CO.

DEPT. M-124, 307 HUNTER STREET, GLOUCESTER, N. J.

HOW TO BUILD YOUR OWN CONCRETE BLOCK HOME
Only \$1 Prepaid

OWN Your Own Business



PATENTED PORTABLE EQUIPMENT

\$5 per hour

Clean and Mothproof rugs and upholstery "in the home", office, institution. If now employed, you can operate in spare time and build a permanent full-time business.

Alert dealers can gross \$5 hourly profit on service they render plus \$3 on EACH serviceman. We locally train and assist you. Easy to learn . . . quickly established.

DURACLEAN cleans by absorption! No scrubbing, soaking or shrinkage. Dirt and grease vanish . . . matted pile rises . . . colors revive. Furnishings used again same day.

DURAPROOF resists moths and carpet beetles. Your service backed by an International Money Back 6 Year Warranty.

We furnish enough material to return your total investment. Send TODAY for **FREE** booklet explaining details and **EASY TERMS**.

DURACLEAN CO., 4-16D DURACLEAN BLDG. DEERFIELD, ILL.

LAW FREE BOOK

Write today for **FREE** book, "THE LAW-TRAINED MAN," which shows how to learn law in spare time through the famous Blackstone home-study course in business and professional law. All instruction material furnished including big 16-vol. law library. Bachelor of Laws (LL.B.) degree awarded. Moderate cost; easy terms. Write today.

Blackstone School of Law,
Founded 1890

225 North Michigan Ave.
Dept. 59, Chicago 1, ILL.

500 TRICKS MAGIC TRICKS

IT'S FUN TO DO MAGIC

Be popular! Amaze—mystify—entertain! For 30 years Douglas has satisfied customers all over the world. Now, you can enjoy this fascinating hobby. Only 10c brings our Catalog 500 Tricks, containing brand new tricks for pocket, parlor, stage. Join in the fun—send 10c today!

Douglas Magicland, Dept. A, Dallas, Texas

WATCHMAKING

Learn at home • **FREE** sample lesson • Approved for Vets.
CHICAGO SCHOOL OF WATCHMAKING
2330 N. MILWAUKEE AVE., DEPT. 1124A, CHICAGO 47, ILL.



SEND FOR THIS **FREE!**

Make money. Know how to break and train horses. Write today for this book **FREE**, together with special offer of a course in Animal Breeding. If you are interested in Galting and Riding the saddle horse, check here () Do it today—now.

BEERY SCHOOL OF HORSEMANSHIP
Dept. 11012 Pleasant Hill, Ohio

Broken or Loose FALSE PLATE?

Fix it Yourself **EASILY** in a Few Minutes

Your plates may become broken or loose just when you need them most. With **FIX-IT-KIT** you can repair your own broken plates. Also tightens loose fitting plates, easily. Get permanent comfort with professional material. Complete instructions. Satisfaction guaranteed or your money refunded. Order Now at a new low price only **\$2.98** postpaid — or sent C.O.D.

DENT-FIX DENTAL PRODUCTS, Box 674, Dept. PM-12, Kansas City 41, Mo.



WORLD'S LOWEST PRICED ADDING MACHINE

IDEAL FOR BUSINESS AND PERSONAL USE—GUARANTEED ACCURATE. Not a toy. Operates with only a finger flick. Adds, subtracts, multiplies, divides. Counts up to one billion. Pays for itself over and over. Ideal Gift—for Business, Income Tax and School use. **MONEY BACK GUARANTEE.** Send name and address. Pay postman only \$2.95 plus postage. (Send full cash if outside U.S.) Beautiful rich-looking Leatherette Case included at no extra cost. Money back in 10 days if not delighted. **AGENTS WANTED.**

CALCULATOR MACHINE CO., (Mfrs.)
Box 35 Glenview, Illinois

Give him a longer lifetime of happy smoking!

YELLO-BOLE

for Christmas



\$1 and up

FREE! ELIZABETH II EMPIRE STAMPS

Rush reply today for Elizabeth II stamps, Coronation and others. All genuine, all different — from Falkland Islands, Ceylon, Seychelles, South Africa, Tristan da Cunha! PLUS FREE "Stamp Collector's Guide", and souvenir of World's Rarest Stamp. Other valuable offers included for your FREE inspection. Enclose 10c for postage and handling to GARCELON STAMP CO., Dept. 12 PMO, Calais, Maine.



FREE OPPORTUNITY BOOK

- Have a business of your own! Make \$100.00 a week with no investment, no stock to carry.
- Thousands now earning lifetime incomes!
- Send for FREE Opportunity Book at no obligation.

HARRY COHON & SONS, Inc.
1067A Utica Ave., Brooklyn, N. Y.

"TRADE WITH THE HOUSE THAT HELPS YOU SUCCEED"



Write Like This

YOUR penmanship can be improved in 3 hours or corrected to your satisfaction in 10 hours' practice with my **DEFINITE HAND CONTROLS**. New way!

WRITE **OZMENT** BOX 665
34-N. ST. LOUIS, MISSOURI

Complete OUTLINE FREE!

Finish HIGH SCHOOL AT HOME

Complete 4 Yrs. in 12 Months

Learn More! Earn More! Enter professional or technical schools. Advance Socially. Live a Happier, Fuller Life. Individual Courses or complete schedule. **WRITE FOR SCHOOL BULLETIN.**

ACADEMY FOR ADULTS
30 W. Washington, Dept. PM-1204, Chicago, Ill.

MAKE EXTRA MONEY **PLASTICS** **LEARN AT HOME**

There are RICH OPPORTUNITIES for MEN and WOMEN with "know-how" in Plastics. Interstate's new Plastics course tells and shows how to make hundreds of fast selling items out of Plastics. Gives complete training in fabrication, casting, lamination, molding, internal carving, etc. in simple, easy, step-by-step language and pictures. Plastics and Fabricating Kits for 23 valuable Plastic items come with training at no extra cost. **START A PLASTICS BUSINESS OF YOUR OWN.** No other industry holds such promise for the future. You can make big money manufacturing novelties, toys, signs, etc., in your own home in spare or full time. Don't wait! Learn NOW how Interstate's Plastics Training qualifies you for success in the Plastics field.

PLASTICS AND SUPPLIES FURNISHED FOR 23 VALUABLE PROJECTS

INTERSTATE TRAINING SERVICE
Dept. C-3-N Portland 13, Oregon

LEARN HOW TO MAKE fast-selling PLASTIC NOVELTIES FURNITURE JEWELRY SIGNS TOYS LAMPS

WRITE TODAY!

FOR YOUR TECHNICAL & VOCATIONAL TRAINING

COME TO THE **UNIVERSITY OF HOUSTON**

(Located in Fabulous Houston, Texas)

Select from these fascinating fields:

- | | |
|-----------------------------------------------------------|-----------------------------------------------|
| <input type="checkbox"/> Air Conditioning & Refrigeration | <input type="checkbox"/> Drafting |
| <input type="checkbox"/> Auto Body & Paint | <input type="checkbox"/> Electricity |
| <input type="checkbox"/> Auto Mechanics | <input type="checkbox"/> Electronics |
| <input type="checkbox"/> Auto Upholstery & Trim | <input type="checkbox"/> Machine Shop |
| <input type="checkbox"/> Furniture Upholstery | <input type="checkbox"/> Radio Servicing |
| <input type="checkbox"/> Diesel | <input type="checkbox"/> Television Servicing |
| <input type="checkbox"/> Stationary Engineering | <input type="checkbox"/> Welding |
| | <input type="checkbox"/> Woodworking |

PREPARE FOR YOUR FUTURE NOW . . . with very latest methods and extensive equipment, at modern U. of Houston College of Technology. Open to high school graduates, or equivalent. Beautiful campus — 250 wooded acres in Houston, Texas—city of tomorrow. Air-conditioned classrooms and residence halls. University TV and radio stations. Full college activities, sports, social life. Co-educational. Co-op work-study programs . . . earn part of tuition and expenses with part-time job in your own career field, while you learn. Personal vocational counselling. G.I. approved — V.A. on campus. Job placement assistance. Feb., June, Sept. semesters. Mail coupon now for **FREE** fully-illustrated brochure. No obligation. Do it today!



EZEKIEL W. CULLEN BUILDING

University of Houston, College of Technology
Dept. 1C4—Houston 4, Texas

Without cost or obligation, please send me fully-illustrated brochure and full particulars. I am interested in subject marked X above.

Name _____ Age _____

Address _____

City _____ State _____

Let Me Show You How to Make \$15²⁰ an Hour

— SPARE TIME OR FULL TIME

I wish you could read the pile of letters on my desk. They're from men like you, who wanted to make good money "on their own." But without risking their savings. And without "high pressure selling." I showed them how.

"I put in just 5½ hours of work," writes Hugh Sadler of N. J., "at a profit to me of over \$10 an hour." A. E. Faugh of Colo. writes: "Best deal I ever had—made \$36.12 in 2 hours." And C. Kama of Texas writes: "I made more than \$1000 a month, and haven't touched bottom yet."

What's my proposition? A chance for you to introduce to folks in your area a new kind of low-cost protection against FIRE.

Maybe you've seen my amazing little "Presto" Fire Extinguisher advertised in Life Magazine. It's only about the size of a flashlight. But it does the job of bulky old-style extinguishers that cost 4 times as much and are 8 times as heavy. It puts out fires fast as 2 seconds. It never corrodes. It's guaranteed for 20 years. Yet it sells for only \$3.98!

You don't have to have the "gift of gab." Just take a minute to demonstrate the Presto—and owners of homes, cars, boats, etc. are "sold" at once. Each sale nets you as much as \$2.18 clear profit. Send me your name and address on a postcard. I'll send you my proposition, Free Sales Kit and new book "How to Make Money With Presto" right away. No obligation. (Send \$2.50 too if you want a regular Presto you can use as a demonstrator—returnable for free refills or refund any time.) Write me personally: **ALVIN WESLEY, Merlite Industries, Dept. 512, 114 East 32nd St., New York 16, N. Y.** IN CANADA: *Mopa Co. Ltd., 371 Dowd St., Montreal 1, P. Q.*



ALVIN WESLEY



PLAY RIGHT AWAY

—even if you don't know a single note now!

NOW it's EASY to learn ANY instrument. No boring exercises. Even if you don't know a single note now, we'll have you playing delightful pieces RIGHT AWAY—right from your FIRST lesson! And properly, BY NOTE. Simple as A-B-C. Make amazing progress. No special "talent" needed. Learn at home in spare time, without a teacher. Only a few cents per lesson. Soon you can play any piece you wish. 900,000 students. (Now in our 56th successful year.)

FREE 36-PAGE ILLUSTRATED BOOK

—just send this ad. with your name and address filled in below, to: **U. S. School of Music, Studio 3012, Port Washington, N. Y.** (No obligation, no salesman will call.)



Name _____

Address _____

HERE'S A PROFITABLE BUSINESS FREE!

MONEY MAKING OPPORTUNITY FOR YOU WITHOUT INVESTMENT!

No experience needed to act as our Local Dealer for **MASTER** Work Uniform garments. Every business concern a prospect. Advertising embroidered on garments is a big sales feature. Stores can't compete. You can easily earn up to many thousands of dollars yearly. We supply all Sales Equipment FREE. Write **GEO. MASTER GARMENT DIV., 281 WATER STREET, LIGONIER, INDIANA**



RUPTURED

BE FREE FROM TRUSS SLAVERY

NOW there is a new modern Non-Surgical treatment that permanently corrects rupture. These Non-Surgical treatments are so certain, that a Lifetime Certificate of Assurance is given. Write today for our New FREE Book that gives facts that may save you painful and expensive surgery, and tells how non-surgically you may again work, live, play and love and enjoy life in the manner you desire. There is no obligation. **Excelsior Hernia Clinic Dept. 8305 Excelsior Springs, Mo.**



OWN WORLD'S FINEST CRYSTAL RADIO

Complete Kit Only **\$9.95** Money Back Guarantee
Plays anywhere. Needs no batteries or electric current. Excellent performance guaranteed. Germanium crystal diode can get stations over 500 miles away. Head phones, aerial kit included. Nothing else to buy. Assembled in minutes. Popular 5"x4½"x6½" personal size. Send \$2.00 deposit now, we'll mail C.O.D. plus postage. Satisfaction guaranteed. **IDEAL FOR CHRISTMAS GIFTS!**
JAEGER & CO., P.O. BOX X246 SKOKIE, ILL.

Learn CARTOONING

at home in spare time . . . the quick easy Landon Picture Chart way. Teaches how to originate—today's big need. Scores of successes. Send 10¢ for Picture Chart (to test ability) and full details. Please state age. **Landon School of Cartooning, 5412 CTS Bldg., Cleveland 14, O.**



STAMMER?

Get your copy of the new 18th edition of my book, "Stammering, Its Cause and Correction," which describes the Bogue Unit Method for scientific correction of stammering and stuttering. Ask, also, for free **MPRECH CHART**: 53rd year, Benjamin N. Bogue, Dept. 543, Circle Tower, Indianapolis 4, Indiana.



REPRODUCE ANY OBJECT QUICKLY, EASILY

Now you can easily and quickly make reproductions of any object, in any quantity, right at home, overnight. Make perfect copies of anything of wood, metal, clay, plastic, glass, with new **RUBBER MOLD** method. No tools or special skills needed. Send for complete kit \$10.00 only \$2.95 postpaid. Brochure M12 gives complete, easy step-by-step instructions only 10¢. **SCULPTURE HOUSE, 304 W. 42nd St., New York 36, N. Y.**



EYEGGLASS CLIP-CASE 1.50
Worth \$2.00 Post paid

Handsome, rugged Cordovan finish Cowhide with strong jeweler's spring brass clip keeps case and glasses secure in any pocket. Gift boxed. Check or M.O. Satisfaction guaranteed.

UNIVERSAL CASE CO. 6453 Santa Monica Los Angeles 38, Calif.

BUILD HELICOPTER GLIDER

The famous new **GYRO-GLIDER**, world's simplest and safest aircraft, is now available to amateur builders in plans and kits. Send \$1.00 now for three-view drawings with specifications and ask about kits and detailed building and flying instructions. **BENSEN AIRCRAFT CORP., Dept. PM-12 P.O. Box 2621 Raleigh, N. C.**

ONLY \$1 Name _____ Address _____
City _____ State _____

Greatest Thrill in Flying!

INVENTORS

WE recommend that you take the following preliminary steps toward patent protection. Make a disclosure of your invention; sign, date and have your disclosure witnessed by two people who understand your invention; authorize us to conduct a preliminary search among previously granted U. S. patents for similar types of invention. We give you a report on the probable patentability of your invention and our recommendation for further course of action.

Let us send you a copy of our instructive booklet, "Patent Protection for Inventors" and our convenient "Evidence of Invention" disclosure form. No obligation.

VICTOR J. EVANS & Co. *Merlin M. Evans*
REGISTERED PATENT ATTORNEY
930-P MERLIN BUILDING, WASHINGTON 6, D. C.

MAKE MONEY WRITING .. short paragraphs!

You don't have to be a trained author to make money writing. Hundreds now making money every day on short paragraphs. I tell you what to write, where and how to sell; and supply big list of editors who buy from beginners. Lots of small checks in a hurry bring cash that adds up quickly. No tedious study. Write to sell, right away. Send for free facts. **BENSON BARRETT, 1751 Morse Ave., Dept. 27-P, Chicago 26, Ill.**

SAVE \$65 ON THIS \$100 CONTOUR CHAIR

- Goodyear Air Foam Cushioning
- Duran Upholstery
- Easy to assemble—hammer, screw-driver only.
- Green, Gray, Red, Brown
- Money back Guarantee

Everything Complete Kit Only needed to put together in one evening **\$34.95**

ORDER NOW. \$5 deposit. Balance C.O.D. Or write for literature. **WESTCRAFT CO., Dept. 51, Mathison Bldg., Baltimore 2, Md.**



AT LAST! SIMPLIFIED TRIGONOMETRY NO SQUARE ROOT—38 LESS FORMULAS

Color diagrams clarify, by separating known and unknown dimensions. Right triangle sides named. Pocket size plastic dial chart. \$1.00 plus 3c stamp. No C.O.D.'s. **TRIG-AID SALES, Dept. PM-12, 4133 Warwick, Long Beach 8, Calif.**

Send for **FREE** 112 page Illustrated Catalog of Farm, Home, and Workshop Bargains.

Write to **WELLWORTH TRADING COMPANY**
Dept. D12

1832 S. WABASH AVE. CHICAGO 16, ILL.

WHILE THEY LAST! 107 "IRON CURTAIN" Stamps

Sensational Stalin stamp plus 106 others, all different, from Russia, Bulgaria, Romania, Czechoslovakia, Ukraine, etc. Hard-to-get, smuggled from behind the infamous Iron Curtain! Guaranteed worth nearly \$2.50 at Standard Catalog prices! ALSO valuable booklet "How to Recognize Rare Stamps" and other fascinating offers. All for only 10c covering postage and handling. Send Today! **KENMORE STAMP CO., Milford OH 453 N.H.**



250 POWER



Complete Telescope Lens Kit **only \$3.49** postpaid

Conquer Space, Explore the Universe, Planets, Moon Craters, New Stars, etc. Complete Lens Kit consists of 80 inch focal length ground and polished objective lens, eyepiece lenses for 50 POWER, 100 POWER, 150 POWER, 200 POWER, 250 POWER, and all necessary lens fittings. Easy to make from simple step by step instructions. (Tripod and mount not included.) Money back guarantee.

BUSSE SALES CO., Hartford, Conn., Dept. PM 28

Relief in ALL these COLD miseries

New Tabcin®

- SNEEZES • WATERY EYES
- FEVERISH FEELING •
- HEADACHE • RUNNING NOSE • GENERAL ACHEs
- THROAT IRRITATIONS
- COUGHING •

BETTER THAN EVER



MILES LABORATORIES, INC., Elkhart, Indiana

MECHANICS

—EARN BIG PAY—

Industry needs skilled mechanics. GREER, leader for more than 50 years in the Trade School field, can train you quickly—You "learn by doing," using the finest equipment, under the supervision of expert technicians.

APPROVED FOR CIVILIANS OR GI'S

—CHOOSE YOUR TRADE—

- DIESEL MECHANICS 20 Weeks
- AUTOMOTIVE MECHANICS 20 Weeks
- BODY & FENDER REPAIR 16 2/3 Weeks
- GAS ARC WELDING 4 to 12 Weeks
- REFRIGERATION 13 1/2 Weeks
- AIR-CONDITIONING 8 1/2 Weeks
- MACHINIST TRADE 30 Weeks
- ADVANCED MACHINIST (includes tool & die) 32 1/2 Weeks
- PIANO TUNING & REPAIR 36 Weeks

CHOOSE YOUR ENGINEERING COURSE

- DIESEL AUTOMOTIVE ENGINEERING 2 Years
- REFRIGERATION & AIR COND. ENGINEERING 18 Months

FREE EMPLOYMENT HELP.

Start your career with Greer by checking your interest above and mail coupon for complete information at no obligation.

NAME _____ AGE _____
STREET _____
TOWN _____ ZONE _____ STATE _____
Established 1902 — Over 50,000 Graduates.

GREER SHOP TRAINING

2236 S. Michigan Ave.
Chicago 16, Illinois

TRAINED MEN NEEDED

BIG PAY—GOOD FUTURE

- TELEVISION ELECTRONICS
 DIESEL AUTO

WHY WORK FOR LOW PAY or risk being out of a job??? Usually the properly trained man has a steady job... through good times or bad. Even back during DEPRESSION there was a big demand for Bailey Trained men.

In only 5½ to 6 months we can train YOU to enter one of the big pay fields!

No previous experience or special education necessary. With our method of training you do not spend years pouring over books, figures, charts and graphs. You learn by rebuilding, repairing, testing and operating the most modern equipment, under the guidance of experienced, courteous and friendly instructors. This method of training gives you the experience and confidence required to step right into the big pay jobs without spending years as a mechanic's helper.

It's EASIER and COSTS LESS than you may think to get this residence shop training... we help you find part-time jobs while in school—full-time jobs after graduation. Check subject above in which you are interested and mail for complete information.

BAILEY Technical SCHOOLS

Veteran Approved

1634 S. Grand St. Louis 4, Mo.

NAME.....AGE.....

STREET.....

TOWN.....ZONE.....STATE.....

CHEAPER-THAN-WHOLESALE—FAMILY SAFE TIRES



PARTIALLY USED & A TUBE FREE
FREE This Pictured Tire Ash Tray With Your Name With 2 or More Tires!
If you buy a PAIR, you get a SPARE FREE
If you buy THREE, you get a 4th tire FREE
Does Not include W.M., Spa-tires or truck tires

GOODYEAR, GOODRICH, FIRESTONE, U. S., and others. Factory adjusted tires, change-offs—Not Recaps, Not Retreads. **FINEST PREMIUM GRADE.** Our prices are about 65% Off New tire prices. Any defective tire replaced FREE of charge. 34 Months Written Guarantee Bond.

600-16	\$4.51	650-15	\$4.61	SPECIALIZE IN	650-20	\$8.81
650-16	5.01	700-15	4.71	TRUCK TIRES	700-20	9.71
700-16	5.41	800-15	5.21	500-16 (6)	55.91	10.21
640-15	4.31	820-15	5.41	650-16 (6)	6.81	825-20
670-15	4.51	850-17	3.91	700-16 (6)	7.21	900-20
710-15	4.51	825-18	3.91	700-15 (6)	7.71	1000-20
760-15	4.87	750-14TR	8.71	700-17	7.91	1100-20
WHITEWALL TIRES \$1 EXTRA		750-17	10.31	1000-22		16.81

SNOW-TIRES Goodyear Suburbanite type or "Snow-Grip" traction. \$7
Factory rebuilt, any car. Guaranteed 26 Mos.

MARVIN BLATT 6th & Spring Garden Sts. Philadelphia, Pa.
MILITARY MUD-GRIP TIRES
AA Quar. 20 Mos. AAA 36 Months
900-16 \$10.21 900-16 \$13.91
750-20 9.71 750-20 13.57

Send Check or M.O. & this ad to save C.O.D. Coll. Charles "Sincerity that was born 27 years ago"

DAN LURIE FAMOUS DAN LURIE

"America's Most Muscular Man" —on television's "Big Top."



BARBELLS

with 4 courses—low factory prices

50 lb. set... \$ 8.48 150 lb. set... \$20.48

100 lb. set... 13.98 200 lb. set... 25.98

Write for Free Catalog Order by Mail: 50% with order, bal. C.O.D. Extra wts. 13c per lb., F.O.B. plant

DAN LURIE BARBELL CO.

52-M-12 Bristol St., Dept. 459-M, Brooklyn, N. Y.

BENJAMIN SUPER CO₂ GAS CARBINE—\$16.50

NEWEST TARGET RIFLE—22 IDEAL FOR SMALL GAME



ECONOMICAL SAFE-NON-TOXIC ACCURATE-CONVENIENT PRACTICAL. Easy to operate—No spring recoil—No pumping. Uses low cost Soda Cartridges Cal. .22 Benjamin H-C Pellets and Darts.

Benjamin CO₂ Gas Pistols Also Available

WRITE FOR FREE ILLUSTRATED FOLDER OF ALL MODELS BENJAMIN AIR RIFLES AND BENJAMIN AIR PISTOLS BENJAMIN AIR RIFLE CO. 896 MARION ST., ST. LOUIS 4, MO. U.S.A.

Paint STRIPES with New "PAINT PEN"!

Makes Straight, Curved or Parallel Lines!

Just fill glass vial with any color paint. Use like a fountain pen to stripe furniture, bikes, autos, model planes, toys, linoleum, wall board. Beautiful, clean, crisp results every time, like professional painters. No experience needed to draw straight, curved, circular or evenly spaced parallel lines. Can't clog or smear. May also be used with glue, tempera, textile paint, or ceramic underglazes. Paints on wood, glass, plastics, metal, fabrics and paper. Lasts a lifetime. Only \$1 postpaid, complete with tip for 1/16 inch stripe. C.O.D.'s plus postage. Used by industry. Order your Paint Stripping Tool TODAY!



\$1.00

DEALERS

Master Paint Stripping Tool packed in Display Cartons of 1 dozen. Fast, profitable seller. Write for discounts.

Attention All Home Craftsmen!

New Paint Stripping Tool gives "professional" results every time, yet simple, easy to use. Send \$1 now.

ATTENTION—MANUFACTURERS!

Write today for information about our industrial and production stripping tools.

WENDELL MFG. CO., Dept. 3-P
4234 Lincoln Ave., Chicago 18, Illinois

6 Other Complete Tools

Complete tools for 1/64, 1/32, 3/64, 5/64, 3/32 or 1/8 inch stripes, \$1.50 each. Extra tips 75c ea. COMPLETE KIT with ALL 7 TIPS, \$5.00. (Also 1/4" tip, only \$1.00). All tips interchangeable.

New! "DOUBLE-STRIPE" MODEL Only \$2.95

Newest paintstripping invention. Makes DOUBLE stripes—one wide and one narrow or two wide or two narrow at the same time. Gradapt quickly for wide or narrow single stripes. Makes 5 combinations. FINE—Send postcard for complete information... or order now... \$2.95.

PLEASE SEND ME



for the time checked. I am enclosing . . .

- 1 year \$3.50
 2 years \$6.00

name _____

address _____

city _____

zone _____

state _____

C-124

Hand this order to your newsdealer or send it to

POPULAR MECHANICS
200 East Ontario St. Chicago 11, Ill.



NOW — MAKE DO-IT-YOURSELF PROJECTS EASY

GET THESE NEW POPULAR MECHANICS DO-IT-YOURSELF BOOKS

- 1. HOW TO PAINT INSIDE AND OUT.** Complete guide to home painting. Covers both interior and exterior work as well as surface preparation, types of paint and necessary equipment.
- 2. HOW TO LAY LINOLEUM AND TILE.** It's easy to do a professional floor or wall tiling job with this book to tell and show you how. Simply follow step-by-step directions and photos.
- 3. HOW TO REMODEL YOUR BASEMENT AND ATTIC.** Convert your damp basement or unused attic into usable living space. Includes construction details and finishing suggestions.
- 4. HOW TO TAKE CARE OF YOUR LAWN.** A finer, greener lawn can be yours. Instructions cover preparation, fertilization, seeding, watering, mowing, etc.
- 5. HOUSE WIRING AND ELECTRICAL REPAIRS.** If you wish to add a few new outlets, or do a complete re-wiring job you'll find step-by-step instructions in this book.
- 6. SMALL BOATS YOU CAN BUILD.** Take your choice from several sturdy seaworthy rowboats, runabouts and sailboats. All are completely detailed to make actual construction easy.
- 7. PLUMBING REPAIRS MADE SIMPLE.** Save money by making the majority of your plumbing repairs yourself. Covers leaking valves and faucets, clogged drains, and many other repairs.
- 8. FENCES, GATES, TRELLISES AND WALKS.** Beautify your

- home with these attractive, easy-to-build garden ornaments. Several designs of each are included with building details.
- 9. BUILT-IN FURNITURE FOR YOUR HOME.** Make your home more livable and efficient with well-designed built-in furniture. Includes built-in television, bookshelves, etc.
- 10. BUILD YOUR OWN BARBECUE.** Hours of summer-time fun are yours with a sturdy attractive outdoor barbecue. Includes several designs each with detailed plans and instructions.
- 11. LAWN AND GARDEN PROJECTS.** Make your garden your restful summer-time living room. Build chaise longue, attractive comfortable lawn chairs and other garden furniture.
- 12. THREE LOW-COST HOMES YOU CAN BUILD.** Includes a concrete block house you can build for less than \$4500; a story and one-half modified Cape Cod and an 81-ft. ranch for \$7450.
- 13. 125 SIMPLE HOME REPAIRS.** Save hundreds of dollars on home repairs. Includes complete directions for correcting sticking doors, squeaking floors, gutter maintenance and more.
- 14. SIMPLE TV REPAIRS.** Make many television repairs yourself. Tells how you can correct most television defects; how to change tubes and make adjustments for improved reception.
- 15. HOW TO MODERNIZE YOUR KITCHEN.** Now—have a modern kitchen with up-to-date conveniences. Includes layouts, cabinet construction details and all necessary information.

**ONLY
25¢
EACH**

6 FOR
\$1.25

15 FOR
\$2.75

USE HANDY ORDER COUPON BELOW

POPULAR MECHANICS PRESS, 200 E. Ontario, Chicago 11

Gentlemen: Please send copies of book nos.: 1: 2: 3: 4: 5: 6: 7: 8: 9: 10: 11: 12: 13: 14: 15: (circle numbers desired)

Remittance enclosed

Send C.O.D. I enclose \$ _____

Name _____

Address _____

City _____ Zone _____ State _____

AUDELS HOME APPLIANCE SERVICE GUIDE

This HANDY, Practical "How to Do It" book for Electric & Gas Home Appliance Servicemen, Mechanics & Dealers covers Basic Principles, Servicing, Operation & Repairs of Home Appliances. Tells How to Locate Troubles, How to take Appliances Apart, How to Make Repairs, How to Assemble and Connect, Gives up to date testing methods, wiring diagrams and complete data on each appliance.



IT PAYS TO KNOW HOW TO FIX

Toasters—Pressing Irons—Waffle Bakers—Casseroles—Roasters—Broilers—Coffee Makers—Space Heaters—Water Heaters—Ranges—Home Wiring—Shop Work—Appliance Testing—Fundamental Electricity—Fractional H.P. Motors—Food Mixers—Fans & Blowers—Vacuum Cleaners—Washing Machines—Clothes Dryers—Ironers—Dishwashers—Garbage Disposers—Refrigeration—Window Air Conditioners—Oil Burners—Drainage Pumps—Gas Ranges, Furnaces & Water Heaters—Bottled Gas Appliances.

A SHOP COMPANION THAT ANSWERS YOUR QUESTIONS. Easy to read and understand—over 800 pages fully illustrated—with 500 photos and diagrams—1001 Facts. A ready reference.

\$4 COMPLETE • PAY \$1 A MONTH
TO GET THIS SERVICE INFORMATION FOR YOURSELF—FILL IN AND MAIL 7 DAY TRIAL COUPON TODAY.



AUDEL, Publishers, 49 W. 23rd St., New York 10, N. Y.
Mail AUDELS HOME APPLIANCE SERVICE GUIDE (\$4) for free examination. If O. K. I will send you \$1 in 7 days! then remit \$1 monthly until \$4 is paid. Otherwise, I will return book promptly.

Name _____
Address _____
Occupation _____
Employed by _____ P-12

Build your own JET ENGINE!



Order these plans today

1. JET PROPELLED BICYCLE. Assemble your own. Photo and instructions. \$1.00.
2. HOW TO MAKE EXPERIMENTAL JET ENGINES. Seven sheets drawings with information and instructions \$2.95.
3. BOTH OF ABOVE in one order \$2.75. SEND NO MONEY. Order both at once \$3.75 C.O.D. in USA plus c.o.d. postage. Send check or money order and we pay postage. Get other information too. Rush Order.

J. HOUSTON MAUPIN, Dept. 55, Tipp City, Ohio

ENGINEERING DEGREE IN 27 MONTHS

Big Demand for Graduates

Aeronautical, Chemical, Civil, Electrical, Mechanical and Radio Engineering (inc. TV and Electronics)

Hundreds of young men are earning B. S. ENGINEERING DEGREES annually in this recognized institution—year around operation. New terms start quarterly. Many students earn a major part of their college expenses in this large industrial center.

Low tuition. Competent instruction. Thorough, intense, practical program. Modern, well-equipped laboratories including new physics laboratory and modern wind tunnel. Individualized instruction emphasized.

Government approved for G.I.'s. Engineering preparatory courses. Students from 48 states and 21 foreign countries. Enter December, March, June and September. Send coupon for free catalog and full information. Enroll now.

SEND COUPON TODAY

INDIANA TECHNICAL COLLEGE

5124 E. Washington Boulevard
Fort Wayne 2, Indiana

Please send me free information on B.S. Engineering Degree in 27 months as checked.

- Aeronautical, Chemical, Civil, Electrical,
 Mechanical, Radio-Television

Name _____

Address _____

INVENTORS

PROTECT YOUR INVENTION BY A U. S. PATENT. SEND FOR FREE "INVENTION RECORD" FORM AND "PATENT INFORMATION EVERY INVENTOR SHOULD HAVE".

CARL MILLER

REGISTERED PATENT ATTORNEY

WOOLWORTH BLDG., 35th FLOOR, 124A
NEW YORK CITY

PATENTS

C. A. SNOW & CO.

REGISTERED PATENT ATTORNEYS
WRITE FOR INFORMATION TO
428 SNOW BUILDING, WASHINGTON 1, D. C.

INVENTORS

Send for PATENT INFORMATION Book and INVENTOR'S RECORD without obligation

GUSTAVE MILLER
124-PM WARNER BUILDING
WASHINGTON 4, D. C.

REGISTERED PATENT ATTORNEY

ASSOCIATE EXAMINER
U. S. PAT. OFF. 1922-1929
Patent Attorney & Advisor
U. S. NAVY DEPT. 1930-1947
PATENT LAWYER

INVENTIONS WANTED

If you want to market, or sell, your invention for cash or royalties, write for our Free Booklet. Send no drawings. We also welcome hearing from firms, or private capital, wishing to review inventions in any field. We will be glad to send notice of our clients' inventions.

GLOBAL MARKETING SERVICE

1404 Mitchell Street Dept. PD Oakland 1, Calif.

HELPFUL BOOKS

Send post card asking for FREE catalog

Popular Mechanics Press, 200 E. Ontario, Dept. 601, Chicago 11

INVENTORS

Whether an invention is patentable can be substantially determined by a search of the U. S. Patent records. Without obligation, write for information explaining the steps you should take to secure a patent.

JOHN N. RANDOLPH

Registered Patent Attorney
201 Columbian Building, Washington 1, D. C.

INVENTORS

I shall be pleased to furnish you, upon request, with full information relative to patent procedure—without any obligation on your part.

PATRICK D. BEAVERS

Registered Patent Attorney
934 Columbian Building Washington 1, D. C.

WOODWORKING

**LEARN
The Easy
Way!**

Low Cost Home Craft Courses Now Available

Make money. Become a skilled woodworker. Interstate's new woodworking course tells and shows how to turn out hundreds of professionally constructed and finished wood projects with hand and power tools. Twenty-two profusely illustrated manuals. Over 1,000 pages. Over 75 projects. Written by expert instructors. The only complete course available today! Get full information without obligation...today.

**HOW TO
BE A
SKILLED
WOOD
WORKER**

Write for FREE Booklet

INTERSTATE TRAINING SERVICE
SCHOOL OF WOODWORKING
DEPT. F-3-N, PORTLAND 13, OREGON

CASTING SECRETS REVEALED

Big money! Cast 1000's of plaques, figurines, etc. with X.L. rubber molds. No exper., little capital req. X.L. rubber pte. \$2.50, pts. 84 (postage extra). Models, rubber for 3 molds, \$1.50 ppd. U. S. only. Send 25c refundable for 40 pp fact catalog.

**HUGE PROFITS!
MORE MONEY!**

PLASTIC ARTS STUDIO, Dept. PM2,
3403 S. Madison St., Muncie, Ind.

ESSENTIAL FOR AMERICAN FLYER TRACK!

MODEL RAILROAD

R. R. SPIKE SETTER

Complete with Nail Spikes

Aligns and sets spikes; eliminates track distortion due to direct hammer blows; pulls up track in a jiffy—allows even a child to change layout or add track safely and quickly.



**\$1 POST PAID COMPLETE!
MONEY BACK
GUARANTEE**

HAYDEN INDUSTRIES,
Box 239, Norwood, Mass.

FREE BOOKLET **HOW I MAKE OVER \$125 WEEKLY**
SELLING BOOKS BY MAIL!
YES, I AVERAGE \$125⁰⁰ WEEKLY, SELLING BOOKS BY MAIL. YOU CAN SELL THE SAME BOOKS I DO! YOU CAN START IN YOUR SPARE TIME. NO STOCK TO CARRY. ONLY SMALL INVESTMENT NEEDED.
WRITE NOW TO PAUL COOPER
245-PM TAUNTON, BUFFALO, NEW YORK

BUY DIRECT and SAVE UP TO 1/2 on ITALIAN ACCORDIONS EASY TERMS



Accordions of famous makes and breath-taking beauty now can be yours! Mail coupon for FREE Color Catalog and amazing Wholesale Prices.

Act NOW!



**5 DAYS
FREE
TRIAL**

**MONEY
BACK
GUARANTEE**

**MAIL
COUPON
NOW**

TRY BEFORE YOU BUY

World's largest selection direct from Importer to you! 30 models to choose from. SATISFACTION GUARANTEED or your money back. Trade-ins accepted. Terms as low as \$10 monthly. Write today!

**Big
Color
Catalog
FREE!**

Send me Free Color Catalog—full details.

Name _____

Address _____

City _____ State _____

ACCORDION MANUFACTURERS & WHOLESALE OUTLET

2003 West Chicago Ave., Dept. R-124 Chicago 22, Ill.

LEARN MEAT CUTTING AT NATIONAL

Pay After Graduation



The steady dependable trade of Meat Cutting taught easily in 8 short weeks. YOU LEARN BY DOING under actual meat market conditions in big modern school at Toledo.

For beginners or men with experience. Get a profitable store of your own. Remember, PEOPLE MUST EAT! Big pay jobs. Free employment help. Thousands of successful graduates.

Buying, cutting, percentage, pricing, advertising, selling, etc. A complete retail meat education. National School established over 30 years. Get National training NOW. Pay your tuition in easy weekly payments

after you graduate. Send coupon for FREE 52 page school catalog — TODAY. G.I. approved.

National School of Meat Cutting, Inc., Dept. 50-M, Toledo 4, Ohio

Send me your FREE school catalog on National Training at Toledo in Meat Cutting, Meat Merchandising and Self Service Meats. No obligation. No salesman will call.

Name _____ Age _____

Address _____

City _____ State _____

Approved for training Korean Veterans

LOOK WHAT YOU CAN BUILD IN METAL WITH AMAZING SELFWELD

SO EASY . . . you weld with no hands. Just touch "Selfweld" to the work and press a switch. It's as easy as turning on a light. Makes metalworking easy as woodcraft.

• Build garden carts, wagons, ornamental railings, tool stands, furniture.

• Repair toys, garden tools, car fenders.

Also solder copper pipe, wiring, sheet metal, torch heat, braze, cut metal with the "Linewelder 100".

PERFECT CHRISTMAS GIFT

. . . **ORDER NOW.** Lincoln "Selfweld" Kit includes: "Linewelder 100" welder, shield, cable, electrode holder, "Selfweld" electrodes. Price only \$99.00 F.O.B. Cleveland, Ohio.



MAIL COUPON TODAY

The Lincoln Electric Company, Dept. 2904
Cleveland 17, Ohio

Name _____

Address _____

City _____ State _____

Send me the Lincoln Selfweld Kit _____ enclosed is check _____ money order _____ for \$ _____

Send Selfweld Bulletin giving more information on home welding.

Say You Saw It in Popular Mechanics

RADIO

Engineering. All phases radio & electronics theory & practice; television; FM; broadcasting; servicing; aviation, marine & police radio. Prepare for good

pay; 18-month course. Graduates in demand by major companies. Enter Jan., March, June, Sept. Regular campus life. Write for catalog. VALPARAISO TECHNICAL INSTITUTE, Dept. D, Valparaiso, Ind.



The World's
Most Modern
Masonry



Opportunities Open for Local Manufacturing

From local plants dotting the country has come the Brikcrete used to erect many thousands of buildings—homes, apartments, motels, stores, shopping centers—practically every type of residential, commercial and industrial construction. Why?

Because Brikcrete has more quality features than any other fine masonry—design, size, light weight, insulation properties, range of 14 colors. And a price competitive to lumber! It's an outstanding business opportunity.

High Income Potentials

Freight and distribution costs are by-passed in the manufacture of Brikcrete. By using local aggregates and local labor it's a "direct to user" business. Production economies enable low prices to consumers and generous profit margins to manufacturers.

More plants are needed to operate in protected territories under franchise privileges. Basic machine available on lease or purchase. Write for Brikcrete Book No. 2.

Brikcrete Associates, Inc.
4679 Division Ave., So.
Grand Rapids 8, Mich.

BRIKCRETE

IN CANADA: DUNN MASONRY MACHINERY LIMITED
800 Dundas Highway, Cooksville, Ont.

Enjoy Modern Living • Make Your Home Worth More With This Popular Mechanics Book . . .



759 PICTURES

Above: How to lay a new roof over the old.

Right: New walls over the tired old walls. A few of the 83 modern kitchen ideas.

Below: Modern ceilings for old basements.

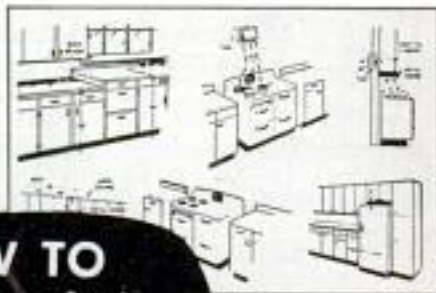

HOW TO Remodel Your Home



With Data on New Materials and Products Available to Home Owners

Here are hundreds of ways you can make a modern home out of an old house, make the house worth more and save money while doing it. If you own an old house or intend to buy one, get "How to Remodel Your Home" by E. R. Haan, formerly technical editor for Popular Mechanics. You can do the modernizing yourself or have it done for this vital book contains 547 methods and 759 illustrations covering complete modernization, adding rooms and living space, installing new kitchens and baths, adding closets, wardrobes, rumpus rooms. Complete face-lifting jobs for the outside and morale building jobs for the inside.

Learn the joys and conveniences of modern living with this vital book prepared especially for the home owner. Mail coupon for your copy today.

Money Back if You Want It.

Get the book now. Check it for information that will help you improve your home for appearance, convenience and value. If not fully pleased, return the book in 7 days and Popular Mechanics will refund every penny you have paid.

Big Book.
Same Size as
This Magazine.

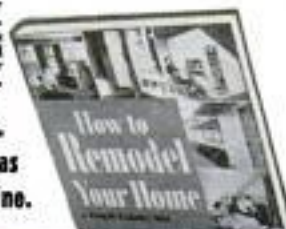

What to Do! How to Do It! How to Cut Costs and Save

In this book—17 big helpful sections. They are:

From old to new—Your modern kitchen—Better bathrooms—Basement rumpus rooms—Curing wet basements—Attic space and dormers—Adding rooms to the outside—Porches and breezeways—Utilizing idle space—New look for outside walls—Modern interior walls—Heat-loss and humidity controls—Roof framing and covering—Windows that modernize—Entrances and doors—Variety in floors—Wiring, plumbing heating. In all—547 money-saving articles you can use.

Use Coupon to Get Remodeling Book

POPULAR MECHANICS PRESS, 200 E. Ontario St., Chicago 11

Send at once "How to Remodel Your Home," postpaid for \$2.95. I understand I may return the book in 7 days for full refund.

Remittance for \$2.95 enclosed. Send book postpaid.

Send COD. I will pay postman.

Name _____

Address _____

City _____ State _____

Tells How You Can Learn to

FREE MOUNT BOOK BIRDS!

Learn At Home

Men, Boys, Hunters, Fishermen, mount and save your lovely wild-game trophies. Be a Taxidermist. Mount Birds, Animals, Heads, Fish, Tax skins. YOU learn easily, quickly in spare time. Have a grand home-museum. The finest and the greatest hobby known, for sportsmen. Fun, real profits.

FREE BOOK Yes, FREE. Beautiful strange, valuable Book, telling all about Taxidermy. Contains over 100 beautiful game-pictures. And it's yours FREE, if you rush your request. You can mount

all kinds of wild-game, and common specimens too. We can positively TEACH YOU. So GRASP this opportunity. RUSH letter or postal for this amazing FREE BOOK. Don't delay. State your AGE. N. W. SCHOOL OF TAXIDERMY, 2512 Elwood Bldg., Omaha 2, Neb.

STUDY INDUSTRIAL DESIGN

You can train at Art Center School in California with practicing-professionals for upper-level jobs in INDUSTRIAL DESIGN. Recent graduates have been added to the staff at General Motors, Chrysler, Raymond Loewy, Henry Dreyfuss, etc. Majors in transportation, general product design, structures, community development, furniture design, packaging, display. 4-year degree courses. Learn to combine imaginative design with technical proficiency, coordinate utility and beauty. Stimulating environment. Field trips. Advantages of mild Southern California climate and nearby holiday spots. Coed. Placement service. Established 23 years. New term begins February 7. Write for catalog.

ART CENTER SCHOOL, Edward M. Adams, Director
5353 WEST THIRD STREET, LOS ANGELES 5, CALIFORNIA

BECOME AN EXPERT IN

TRAFFIC

Traffic men earn \$4,000 to \$10,000 and up. Thousands of firms need experts on rates, tariffs, regulations. We train you thoroughly in spare time at home for executive traffic jobs. Personal training under traffic authorities. Placement counsel and help. Write for free 48-page book "Traffic Management—the Fast Growing Profession."

LASALLE Extension University, 417 So. Dearborn St.
A Correspondence Institution Dept. 1264T Chicago 5, Ill.

\$2.95 OR 2 FOR \$5.00!

Genuine Telephone Company Upright Telephones, tested and guaranteed with 50 ft. of wire and inter-connection instructions. Complete line of telephones, dial, magneto, etc. Write for free list. All shipments F.O.B.

TELEPHONE ENGINEERING CO.
Dept. 1284 Simpson, Pa.

BEING PUSHED AROUND??



Why take any more nonsense from bullies, wise guys and other pests? The next time they try to set smart—give them the surprise of their lives! It's easy when you know POLICE JIU JITSU! This complete, fully illustrated course comes to you in one volume. The same as taught to police, marines, "G" men, soldiers, sailors and members of the U. S. Coast Guard. By all means, just pin \$1 to this ad and we will send POLICE JIU JITSU to you postpaid by return mail. Satisfaction guaranteed or your money back.

BOOKS PUBLISHING CO., AMITYVILLE, N. Y.

OIL FILTER REFILLS . . . 10c

Here's News! Ordinary toilet paper makes an ideal oil filter. Laboratory tests prove it cleans oil faster and better than popular makes of filter elements. All you need is a simple set of Retlif Adapter Plates . . . and you can start using toilet paper rolls (costing about 10c) in your present oil filter. For proof and descriptive literature, send name and address to:

RETLIF CORP., Dept. 135, 1239 No. Highland Ave., Los Angeles 38, Calif.

FREE SAMPLE LESSON

WATCHMAKING

CHICAGO SCHOOL OF WATCHMAKING
2330 Milwaukee, Dept. 1124, Chicago 47, Illinois

Show me without obligation how I can learn watch repairing at home. Rush free sample.

Name _____ Veteran

Address _____

City _____ Zone _____ State _____

**MAKE up to \$10 AN HOUR
AT HOME with 50¢ worth of...
MICRO-FLUFF**



FREE SAMPLE!

HIGH COST OF LIVING GETTING YOU DOWN? Want to add an extra \$100 or more to your regular monthly pay check in a few SPARE TIME hours of pleasant occupation AT HOME? That's just the position I was in a few years ago when I ran across an Old-World formula for applying short cotton fibers to practically any surface, in such a manner that it looked and felt just like costly velvet or velour.

THIS PROCESS AMAZED ME. I spent several years experimenting until I developed what I now call the FLOK-KRAFT, MICRO-FLUFF method. This NEW METHOD is far removed from the Old-World way of applying these short fibers. Also it permits the use of tiny fibers of RAYON and other modern materials in MANY COLORS in addition to cotton.

NO OVERHEAD, NO EXPENSIVE EQUIPMENT. Start in your basement, garage, attic, service porch, or even on a card table in your bedroom. With an hour's practice you can apply a few pennies worth of FLOK-KRAFT MICRO-FLUFF to a yard or two of butcher paper, and make it look like \$15-a-yard velvet for window displays in the finest jewelry, gift, or department stores, etc. Takes only a few minutes and practically no effort.

MICRO-FLUFF IS BEAUTIFUL AND LONG WEARING. Truly the most amazing material you ever saw, MICRO-FLUFF comes in every color of the rainbow, is long lasting, has the TOUCH appeal of luxurious velvet or suede, and goes on practically any surface—paper, metal, wood, glass, plastic, plaster, rubber, etc. It is wonderful to line silverware or hosiery drawers, cover and line jewelry boxes, decorate lamps and lamp shades, finish the inside of auto trunks or glove compartments (to protect luggage and accessories from scratching) re-cover women's party shoes, photograph turntables, etc. Apply to toys, figurines, wall plaques, signs, store displays and a thousand-and-one other items, new or old. FLOK-KRAFT MICRO-FLUFF makes old objects beautiful and salable—increases value of many new products by 500%.

BIG-PROFIT ORDERS come from neighbors, gift shops, stores of all kinds. Every household has one or more items that can be saved from discard by a FLOK-KRAFT job. Decorate store display cases and windows (jewelers love this) and also supply them with fast-selling FLOK-KRAFTED gift items and other merchandise. Manufacturers are prospects for contracts to apply FLOK-KRAFT to furniture, instrument cases, luggage, and hundreds of other products. Every neighborhood needs a FLOK-KRAFTER. HELP US FILL HUGE DEMAND.

Since succeeding beyond my wildest dreams in my own FLOK-KRAFT business, I have concentrated on helping ambitious men get started in the same way to build toward a successful future, free of time clocks and nagging bosses. My plan is designed to help you start at home in spare time, and build gradually toward a full-time business with employees working for you. And you can start RIGHT NOW. DON'T SEND ME ANY MONEY, just your name and address on a postcard, and I'll rush you a FREE SAMPLE OF FLOK-KRAFT MICRO-FLUFF and full FREE details. I'll also arrange to send you the complete FLOK-KRAFT MICRO-FLUFF outfit to try out right in your own home, before you agree to buy anything at all. The outfit includes detailed instructions with hundreds of show-how photographs and drawings that make everything simple, right from the start. Also included is our specially designed, high-velocity Applicator and a generous supply of FLOK-KRAFT MICRO-FLUFF—everything you need to get going right away. You owe it to yourself to investigate. Rush me your name and address today by Airmail, and I'll show you how to start making money at once!

NELS IRWIN, Coast Industries, Dept. 2C
Los Angeles 61, California



NEW MOSSBERG CATALOG

To make your Christmas selection easy

Complete lineup of rifles, shotguns, telescope sights and spotting scope, — all at low Mossberg prices — each readily obtainable at your dealer's.

Clip and fill in coupon now so you'll have plenty of time to pick a "Mossberg"



O. F. MOSSBERG & SONS, INC.
49712 St. John St., New Haven 5, Conn.

Send me without delay your new Christmas catalog of Mossberg Firearms available at my dealer's.

Name.....

Street.....

City..... (Zone)..... State.....

Say You Saw It in Popular Mechanics

NOW! — A 39½¢ STORM WINDOW that protects your family all winter!

TRANSPARENT AS GLASS—FLEXIBLE AS RUBBER—TENSILE STRENGTH OF OVER 1 TON PER SQ. INCH—100% WATERPROOF — WON'T CRACK EVEN AT 53 DEGREES BELOW ZERO!



This amazing new storm window seals out wintry blasts and costs only 39½¢ per window! A product of the Reynolds Aluminum Corp. Comes in rolls 36" by 432" complete with Adheso borders. Cut with scissors to your window size, then press on with Adheso border . . . that's all! Each roll enough for 10 medium sized windows. Won't peel, fade, rattle or shatter! 108 sq. feet for \$3.95. 5-Day Money-Back Guarantee. Send 3.95 check, cash or m.o. CODs plus fees. Order from:

CONSUMERS MART, Dept. 6-N-47, 352 Fourth Ave., New York 10, N. Y.

FREE! IMPORTS

To New Members

FROM FOREIGN LANDS

Free to new members of the International Traders Guild — many unusual, useful products from France, Japan, Germany and other foreign lands, and trade bulletins listing hundreds of import bargains to sell at high U. S. prices. Also requests from overseas buyers for U. S. exports. Opportunity, men — women, profitable, world-wide, mail order business at home; or travel abroad; no capital needed. 2,000 members in 42 countries. 7th successful year. FREE details. Mellinger Co., Dept. A25C, 1717 Westwood, Los Angeles 24, Calif.



YOUR PHOTO ON STAMPS 400% PROFIT printing photo stamps for others. Start a mail order business of your own. Complete kits and supplies available for you to print these actual size small photo stamps in your own dark room. You can make your own printer. Send \$2.00 for complete drawings on do-it-yourself photo stamp printer. (Refundable on assembled kits.)

The DILOI WESTERN CO.
P.O. Box 93, Pomona 6, California

DRAW The First Day! NO LESSONS! NO TALENT!



New Amazing Invention—"Magic Art Reproducer." You can draw Your Family, Friends, Anything From REAL LIFE—Like An Artist Even If You CAN'T DRAW A STRAIGHT LINE! Anything you want to draw is automatically seen on any sheet of paper thru the "Magic Art Reproducer." Then easily follow the lines of the "picture image" with a pencil for an original "professional looking" drawing. Also reduces or enlarges. SEND NO MONEY! Free Trial! Pay Postman on delivery \$1.98 plus postage. Or send only \$1.98 with order and we pay postage. Money Back Guarantee.

NORTON PRODUCTS, Dept. 5812-S, 296 Broadway, N. Y.

WHOLESALE Electric Guitars - Parts - Build Your Own

Accordions, amplifiers, double-necks, triple-necks, pickup mikes, mandolins, non-electric instruments, etc. 1955 Models wholesale. Free Catalog. Free home study course with instruments. Parts and plans available to build your own 6 or 8 string or multi-neck electric guitar. Martins and Fender available at list price.



GARVIN CO., Box 28 PM12, Baldwin Park, Calif.



NOW YOU CAN HAVE YOUR OWN "PRIVATE LINE!"

Two precision phones, completely self-contained.

Enables you to talk & hear up to 1-mi. as clearly as a regular telephone. Built-in double buzzer system. Ideal for inter-office, store-home, home-barn, home-garage, invalids, inside, outside, etc. Nothing else to buy—nothing to assemble. Also makes perfect Xmas gift for children or adults. Shipped complete with 50' of double wire. Only \$6.95 pp. No COD's. 10 day money-back guarantee.

D & D SALES CO.

1428 Park Road, N. W.

Wash. 10, D. C.



What to Make with CONCRETE

Even little concrete jobs cost big money — mostly for labor. Get Popular Mechanics' **WHAT TO MAKE WITH CONCRETE** and save all the labor cost while making your home or farm ship-shape. Book shows all—tells all — how to make the right mixture, plan, apply and gives 50 professional short cuts. Hundreds of pictures. Only \$2.00 postpaid. Order today. Money back if not pleased.

POPULAR MECHANICS PRESS, Dept. PM9, 200 E. Ontario St., Chicago 11



Build Your Own Fireplace, Driveways, Walks, Etc.

HELPFUL BOOKS

Send post card asking for FREE catalog

Popular Mechanics Press, 200 E. Ontario, Dept. 601, Chicago 11

Catalog of 3000 Novelties 10c

Send 10c for amazing catalog of novelties, live animals, scientific supplies, hobbies, funmakers, planes & boats, looms, magic tricks, joke articles, unusual seeds, gadget time-savers, cameras, optical goods, projectors, movies, lucky jewelry, religious novelties, disguises, musical instruments, stamps, coins, puzzles, fortune tellers, radios, auto & bike accessories, telescopes, magnifiers, compasses, banks, smokers' gadgets, artists' supplies, printing sets, emy gines, motors, shockers, knives, billfolds, guns, rifles, sports, books, games, plants, etc. Send 10c (3 for 25c—get for friends!).

JOHNSON SMITH & CO., Dept. 928, Detroit 7, Michigan

How to **CRACK** the education barrier



Is there an "education barrier" between you and promotion? Are young college graduates being brought in to fill positions above you?

You can break down that barrier . . . gain real security, responsibility, prestige . . . *surprise fellow employees and win their respect.* You can match yourself against the smartest of the college boys and come out a **WINNER.** Here's how!

AN HOUR A DAY THE I. C. S. WAY!

If you can spare an hour a day, if you have the determination to make good, if you're willing to invest pennies now for dollars later on—then I.C.S. can help you. You can be a man or woman, young or old, skilled or unskilled. So long as you

can understand simple language and illustrated training manuals, you need have no doubts. The I.C.S. hour-a-day plan is **SUCCESS-PROVED.** You learn while you earn—anywhere, any time. And the cost?—*less than a quarter a day!*

Just pick the subject you want!

Only I.C.S. offers you such a wide range of subjects to choose from. Drafting. Engineering. Television. Aeronautics. Business. High School. 391 courses in all. *I.C.S. is the oldest, largest home-study school. It is also the best known in business and industry.*

Free catalog plus free book!

When you mail the coupon below, you get a complete catalog on the subject you check with information about employment opportunities, training requirements, etc. And you get "How to Succeed"—36 pages of valuable tips on winning recognition, pay raises, success. Also, free sample lesson.

For Real Job Security—Get an I. C. S. Diploma!

I. C. S., Scranton 9, Penna.

INTERNATIONAL CORRESPONDENCE SCHOOLS

ICS

BOX 5640-L, SCRANTON 9, PENNA.

(Partial list of 277 courses)

Without cost or obligation, send me "HOW TO SUCCEED" and the opportunity booklet about the field BEFORE which I have marked X:

- | | | | | |
|-------------------------------------------------------------------------------------------------------------------------------------------------------------------------------------------------------------------------------------------------------------------------------------------------------------------------------------------------------------------------------------------------------------------------------------------------------------------------------------------------------------------------------------------------------------------------------------------------------------------------------------------------------------------------------------------------------------------------------------------------------------------------------------------------------------------------------------------------------------------------------------------------------------------------------------------------------------------------------------------------------------------------------------------------------------------------------------------------------------------------------------------------------------------------------------------------------------------------------------------------------------------------------------------------------------------------------------------------------------------------------|------------------------------------------------------------------------------------------------------------------------------------------------------------------------------------------------------------------------------------------------------------------------------------------------------------------------------------------------------------------------------------------------------------------------------------------------------------------------------------------------------------------------------------------------------------------------------------------------------------------------------------------------------------------------------------------------------------------------------------------------------------------------------------------------------------------------------------------------------------------------------------------------------------------------------------------------------------------------------------------------------------------------------------------------------------------------------------------------------------------------------------------------------------------------------------------------------------------------------------------------------------------------------------------------------------------------------------------------------------------------------------------------------------------------------------------------------------------------------------------------------------------------------------------------------------------------------------------------------|-------------------------------------------------------------------------------------------------------------------------------------------------------------------------------------------------------------------------------------------------------------------------------------------------------------------------------------------------------------------------------------------------------------------------------------------------------------------------------------------------------------------------------------------------------------------------------------------------------------------------------------------------------------------------------------------------------------------------------------------------------------------------------------------------------------------------------------------------------------------------------------------------------------------------------------------------------------------------------------------------------------------------------------------------------------------------------------------------------------------------------------------------------------------------------------------------------------------------------------------------------------------------------------------------------------------------------------------------------------------------------------------------------------------------------------------------------------------------------------------------------------------------------------------------|---------------------------------------------------------------------------------------------------------------------------------------------------------------------------------------------------------------------------------------------------------------------------------------------------------------------------------------------------------------------------------------------------------------------------------------------------------------------------------------------------------------------------------------------------------------------------------------------------------------------------------------------------------------------------------------------------------------------------------------------------------------------------------------------------------------------------------------------------------------------------------------------------------------------------------------------------------------------------------------------------------------------------------------------------------------------------------------------------------------------------------------------------------------------------------------------------------------------------------------------------------------------------------------------------------------------------------------------------------------------------------------------------------------------------------------------------------------------------------------------------------------------------------------------------------------------------------------------------------|------------------------------------------------------------------------------------------------------------------------------------------------------------------------------------------------------------------------------------------------------------------------------------------------------------------------------------------------------------------------------------------------------------------------------------------------------------------------------------------------------------------------------------------------------------------------------------------------------------------------------------------------------------------------------------------------------------------------------------------------------------------------------------------------------------------------------------------------------------------------------------------------------------------------------------------------------------------------------------------------------------------------------------------------------------------------------------------------------------------------------------------------------------------------------------------------------------------------------------------------------------------------------------------------------------------------------------------------------------------------------------------------------------------------------------------------------------------------------------------------------------------------------------------------------------------------------------------------------|
| <p>ARCHITECTURE and BUILDING CONSTRUCTION</p> <ul style="list-style-type: none"> <input type="checkbox"/> Air Conditioning—Refrig. <input type="checkbox"/> Architecture <input type="checkbox"/> Building Contractor <input type="checkbox"/> Building Maintenance <input type="checkbox"/> Carpenter and Mill Work <input type="checkbox"/> Estimating <input type="checkbox"/> Heating <input type="checkbox"/> Painting Contractor <input type="checkbox"/> Plumbing <input type="checkbox"/> Reading Arch. Blueprints <input type="checkbox"/> Steamfitting <p>ART</p> <ul style="list-style-type: none"> <input type="checkbox"/> Cartooning <input type="checkbox"/> Commercial Art <input type="checkbox"/> Fashion Illustrating <input type="checkbox"/> Magazine Illustrating <input type="checkbox"/> Show Card and Sign Lettering <input type="checkbox"/> Sketching and Painting <p>AUTOMOTIVE</p> <ul style="list-style-type: none"> <input type="checkbox"/> Auto Body Rebuilding <input type="checkbox"/> Auto Elec. Technician <input type="checkbox"/> Auto-Engine Tune Up <input type="checkbox"/> Automobile Mechanic | <p>AVIATION</p> <ul style="list-style-type: none"> <input type="checkbox"/> Aeronautical Engineering Jr. <input type="checkbox"/> Aircraft & Engine Mechanic <p>BUSINESS</p> <ul style="list-style-type: none"> <input type="checkbox"/> Advertising <input type="checkbox"/> Bookkeeping and Accounting <input type="checkbox"/> Business Administration <input type="checkbox"/> Business Correspondence <input type="checkbox"/> Certified Public Accounting <input type="checkbox"/> Creative Salesmanship <input type="checkbox"/> Federal Tax <input type="checkbox"/> Letter-writing Improvement <input type="checkbox"/> Managing Small Business <input type="checkbox"/> Office Management <input type="checkbox"/> Retail Business Management <input type="checkbox"/> Sales Management <input type="checkbox"/> Stenographic-Secretarial <input type="checkbox"/> Traffic Management <p>CHEMISTRY</p> <ul style="list-style-type: none"> <input type="checkbox"/> Analytical Chemistry <input type="checkbox"/> Chemical Engineering <input type="checkbox"/> Chem. Lab. Technician <input type="checkbox"/> General Chemistry <input type="checkbox"/> Natural Gas Prod. & Trans. <input type="checkbox"/> Petroleum Engineering <input type="checkbox"/> Plastics <input type="checkbox"/> Pulp and Paper Making | <p>CIVIL, STRUCTURAL ENGINEERING</p> <ul style="list-style-type: none"> <input type="checkbox"/> Civil Engineering <input type="checkbox"/> Construction Engineering <input type="checkbox"/> Highway Engineering <input type="checkbox"/> Reading Struct. Blueprints <input type="checkbox"/> Sanitary Engineering <input type="checkbox"/> Structural Engineering <input type="checkbox"/> Surveying and Mapping <p>DRAFTING</p> <ul style="list-style-type: none"> <input type="checkbox"/> Aircraft Drafting <input type="checkbox"/> Architectural Drafting <input type="checkbox"/> Electrical Drafting <input type="checkbox"/> Mechanical Drafting <input type="checkbox"/> Mine Surveying and Mapping <input type="checkbox"/> Ship Drafting <input type="checkbox"/> Structural Drafting <p>ELECTRICAL</p> <ul style="list-style-type: none"> <input type="checkbox"/> Electrical Engineering <input type="checkbox"/> Electrical Maintenance <input type="checkbox"/> Electrician <input type="checkbox"/> Contracting <input type="checkbox"/> Lineman <p>HIGH SCHOOL</p> <ul style="list-style-type: none"> <input type="checkbox"/> Commercial <input type="checkbox"/> Good English <input type="checkbox"/> High School Subjects <input type="checkbox"/> Mathematics | <p>LEADERSHIP</p> <ul style="list-style-type: none"> <input type="checkbox"/> Foremanship <input type="checkbox"/> Industrial Supervision <input type="checkbox"/> Leadership and Organization <input type="checkbox"/> Personnel-Labor Relations <p>MECHANICAL AND SHOP</p> <ul style="list-style-type: none"> <input type="checkbox"/> Gas—Electric Welding <input type="checkbox"/> Heat Treatment <input type="checkbox"/> Metallurgy <input type="checkbox"/> Industrial Engineering <input type="checkbox"/> Industrial Instrumentation <input type="checkbox"/> Industrial Supervision <input type="checkbox"/> Machine Design—Drafting <input type="checkbox"/> Machine Shop Inspection <input type="checkbox"/> Machine Shop Practice <input type="checkbox"/> Mechanical Engineering <input type="checkbox"/> Quality Control <input type="checkbox"/> Reading Shop Blueprints <input type="checkbox"/> Refrigeration <input type="checkbox"/> Sheet Metal Worker <input type="checkbox"/> Tool Design <input type="checkbox"/> Toolmaking <p>RADIO, TELEVISION</p> <ul style="list-style-type: none"> <input type="checkbox"/> Electronics <input type="checkbox"/> Practical Radio—TV Eng'ing <input type="checkbox"/> Radio and TV Servicing <input type="checkbox"/> Radio Operating <input type="checkbox"/> Television—Technician | <p>RAILROAD</p> <ul style="list-style-type: none"> <input type="checkbox"/> Air Brakes <input type="checkbox"/> Car Inspector <input type="checkbox"/> Diesel Locomotive <input type="checkbox"/> Locomotive Engineer <input type="checkbox"/> Section Foreman <p>STEAM AND DIESEL POWER</p> <ul style="list-style-type: none"> <input type="checkbox"/> Combustion Engineering <input type="checkbox"/> Diesel—Elec. <input type="checkbox"/> Diesel Eng's <input type="checkbox"/> Electric Light and Power <input type="checkbox"/> Stationary Fireman <input type="checkbox"/> Stationary Steam Engineering <p>TEXTILE</p> <ul style="list-style-type: none"> <input type="checkbox"/> Carding and Spinning <input type="checkbox"/> Cotton, Rayon, Woolen Mfg. <input type="checkbox"/> Finishing and Dyeing <input type="checkbox"/> Loom Fixing <input type="checkbox"/> Textile Designing <input type="checkbox"/> Textile Eng'g <input type="checkbox"/> Throwing <input type="checkbox"/> Warping and Weaving <p>MISCELLANEOUS</p> <ul style="list-style-type: none"> <input type="checkbox"/> Domestic Refrigeration <input type="checkbox"/> Marine Engineering <input type="checkbox"/> Ocean Navigation <input type="checkbox"/> Shipfitting <input type="checkbox"/> Short Story Writing <input type="checkbox"/> Telephony |
|-------------------------------------------------------------------------------------------------------------------------------------------------------------------------------------------------------------------------------------------------------------------------------------------------------------------------------------------------------------------------------------------------------------------------------------------------------------------------------------------------------------------------------------------------------------------------------------------------------------------------------------------------------------------------------------------------------------------------------------------------------------------------------------------------------------------------------------------------------------------------------------------------------------------------------------------------------------------------------------------------------------------------------------------------------------------------------------------------------------------------------------------------------------------------------------------------------------------------------------------------------------------------------------------------------------------------------------------------------------------------------|------------------------------------------------------------------------------------------------------------------------------------------------------------------------------------------------------------------------------------------------------------------------------------------------------------------------------------------------------------------------------------------------------------------------------------------------------------------------------------------------------------------------------------------------------------------------------------------------------------------------------------------------------------------------------------------------------------------------------------------------------------------------------------------------------------------------------------------------------------------------------------------------------------------------------------------------------------------------------------------------------------------------------------------------------------------------------------------------------------------------------------------------------------------------------------------------------------------------------------------------------------------------------------------------------------------------------------------------------------------------------------------------------------------------------------------------------------------------------------------------------------------------------------------------------------------------------------------------------|-------------------------------------------------------------------------------------------------------------------------------------------------------------------------------------------------------------------------------------------------------------------------------------------------------------------------------------------------------------------------------------------------------------------------------------------------------------------------------------------------------------------------------------------------------------------------------------------------------------------------------------------------------------------------------------------------------------------------------------------------------------------------------------------------------------------------------------------------------------------------------------------------------------------------------------------------------------------------------------------------------------------------------------------------------------------------------------------------------------------------------------------------------------------------------------------------------------------------------------------------------------------------------------------------------------------------------------------------------------------------------------------------------------------------------------------------------------------------------------------------------------------------------------------------|---------------------------------------------------------------------------------------------------------------------------------------------------------------------------------------------------------------------------------------------------------------------------------------------------------------------------------------------------------------------------------------------------------------------------------------------------------------------------------------------------------------------------------------------------------------------------------------------------------------------------------------------------------------------------------------------------------------------------------------------------------------------------------------------------------------------------------------------------------------------------------------------------------------------------------------------------------------------------------------------------------------------------------------------------------------------------------------------------------------------------------------------------------------------------------------------------------------------------------------------------------------------------------------------------------------------------------------------------------------------------------------------------------------------------------------------------------------------------------------------------------------------------------------------------------------------------------------------------------|------------------------------------------------------------------------------------------------------------------------------------------------------------------------------------------------------------------------------------------------------------------------------------------------------------------------------------------------------------------------------------------------------------------------------------------------------------------------------------------------------------------------------------------------------------------------------------------------------------------------------------------------------------------------------------------------------------------------------------------------------------------------------------------------------------------------------------------------------------------------------------------------------------------------------------------------------------------------------------------------------------------------------------------------------------------------------------------------------------------------------------------------------------------------------------------------------------------------------------------------------------------------------------------------------------------------------------------------------------------------------------------------------------------------------------------------------------------------------------------------------------------------------------------------------------------------------------------------------|

Name _____ Age _____ Home Address _____
 City _____ Zone _____ State _____ Working Hours _____ A.M. to P.M. _____
 Occupation _____

Canadian residents send coupon to International Correspondence Schools, Canadian, Ltd., Montreal, Canada. . . . Special tuition rates to members of the U. S. Armed Forces.

ARE YOU DRIVING *Holes* IN YOUR CAR?



A cupful of anti-freeze escaping into your engine can cause serious damage. Don't let this happen to you! Bar's Leaks, containing Rhizex, will STOP WATER LOSS AND DANGEROUS ANTI-FREEZE SEEPAGE!

Bar's Leaks contains tiny soft particles which fill any minute holes or cracks and anneal in the heat of the engine, thus forming a permanent seal. A combination of oil and fine non-abrasive particles, resists rust chemically and inhibits scale mechanically. Bar's Leaks scrubs away damaging deposits and maintains a stable lubricative coolant which prolongs the life of your water pump.

Your car needs a Bar's Leaks PREVENTATIVE MAINTENANCE TREATMENT every 5000 miles.

Approved and used by world's largest automobile manufacturers

\$1.00 IN U.S.A. and CANADA

FREE: Write for new brochure, "Truth and Consequences"

BAR'S LEAKS

BAR'S PRODUCTS SUPPLY, INC.
5871 S. Telegraph Rd., Dearborn, Mich.



I HELPED T.E.H. MAKE \$14 A DAY WHILE STILL LEARNING!

T. E. H.—West Virginia, "By the time I finished half your course, I was making \$14.00 per day. I have made enough on the side to more than pay for the course."

H. T. ARMSTRONG

Learn **ELECTRIC APPLIANCE** REPAIR & SERVICE

WE TEACH:

How to Repair
Washing Machines
Vacuum Cleaners
Electric Ranges
Lamps, Motors,
Irons, etc.,

REFRIGERATION
and
House Wiring
At Home
In Your
Spare Time!

For a man handy with tools, and happiest when working with his hands, OPPORTUNITY is Wide Open Today in this great and growing field. Everyone is a customer for the man trained to service electric appliances.

Open Your Own Shop

Our practical Home Course teaches you this business from A to Z—preparing you to take a well paid job or open your own shop. You can actually start in your basement or garage with the tools we send you . . . before finishing.

We Include An **ELECTRICAL APPLIANCE TESTER**
A Big Kit of Tools at NO EXTRA COST

MAIL THIS COUPON for FREE BOOK

H. T. ARMSTRONG
PACIFIC TRAINING SCHOOLS Dept. P-5412
7217 S. Broadway, Los Angeles 3, Calif.

Dear Sirs: Please send me, without obligation, your free booklet and complete details.

Name _____
Address _____
City _____ Zone _____ State _____

200 ONE-EVENING PROJECTS

Start and Finish Any One of These Projects in One Evening!

The editors of Popular Mechanics have assembled 200 projects, any one of which you can start and complete in a single evening. In a few hours' time, using only simple hand tools, you can build a coffee table, magazine rack, end table or scores of other useful projects. There are projects for the entire family. Best of all, any one may be built in just a few hours. No special skills are needed. Even if you have never built anything before, you can build the 200 projects in this big new book!

Step-by-Step Instructions, Show-How Photos, Drawings

First you read how to do it in famous Popular Mechanics step-by-step instructions and then actual photos, drawings and diagrams show you how it is done.

Each Project Costs Just 1c

Just imagine! Each project costs you only 1c. Where else today can you get so much for so little? Fill out and mail the coupon now. Full money-back guarantee, of course.



POPULAR MECHANICS PRESS, Dept. EP-1
200 E. Ontario St., Chicago 11, Ill.

Gentlemen:

Remittance for \$2.00 enclosed. Rush postpaid my copy of 200 ONE-EVENING PROJECTS. Unless it is entirely satisfactory I may return it in seven days for a full refund.

NAME _____
ADDRESS _____
CITY _____ ZONE _____ STATE _____
 Send C.O.D. (U.S.A. only), Postage extra.

SEND ME



every month so I am sure to see each new issue. Here's

- \$3.50 for 1 year
 \$8.00 for 3 years

name _____
address _____
city _____ zone _____ state _____
B-124

Hand this order to your newsdealer or send it to

POPULAR MECHANICS
200 East Ontario St. Chicago 11, Ill.

POPULAR MECHANICS

**more jobs
than graduates**

Demand for our engineering graduates exceeds supply. Effective placement! Study in this world-famed college... established 1884. New term starts quarterly. Approved for Korean Vets.

Bach. Sc. degree in 27 months

Bachelor of Science in Mechanical, Civil, Electrical, Chemical, Aeronautical, Radio (Television), Administrative Engineering; Business Administration and Accounting. Also 36-weeks certificate courses in Surveying, Drafting, Secretarial Science. Intensive program; technical fundamentals accented.

Small classes; personalized instruction. For earnest, mature students whose time and budget require accelerated courses and modest costs. Preparatory courses.

Beautiful campus in friendly college town. Well-equipped, new and modernized buildings and labs. Enter Jan., March, June, Sept. Write Jean McCarthy, Director Admissions, for Catalog and View Book.



TRI-STATE COLLEGE

4124 College Avenue Angola, Indiana



SAMSON FIBER-GLASS BOWS

THEY DON'T BREAK

FAMILY USES SAME BOW

Ask Dealers for

Stemmler's Archery

CATALOG - Fine Bow Arrows Materials &

HANDBOOK - Illustrated Instructions on

Making & Shooting Archery Table 75c

L. E. STEMMLER CO., Box 3

HANDKIVILL L. I., NEW YORK

Making Bows & Arrows for over 40 years

RUPTURED?

Something different. Light. Cool. No leg straps. No elastic. No pressure on hips or spine. Inexpensive. Worn by Mechanics, Farmers, Factory workers, etc., everywhere. Guaranteed. Write

HAND-LOCK PRODUCTS EST. 1893 DEPT. PM, PRESTON, ONT., CAN.

FREE BOAT KIT CATALOG

12 ft. Runabout Pictured.

- Assemble your own boat
- No experience necessary
- Save 1/3 to 2/3 "factory built" prices
- Prices include freight and paint

8' to 14' Models from \$39.25



Marine Hardware, Fiberglass & Trailers

LUGER INDUSTRIES Kit Division 4452 NICOLLET AVE. MINNEAPOLIS 9, MINN.

"MARY-MAC" MOTOR MESSAGE HEALTH CUSHION!

Terrific sales! Factory-Dealer 100% profit! Sells in stores \$97.50. Agents-Dealers low list \$59.50, less 50%. Dealers factory cost \$29.75, postpaid. World's finest "Delta" Special Motor Dupont Upholstered Firestone Fomez-Cushioned, 10"x13"x5", heavy duty. Full year warranty. Amazing, reduces like magic, aches, pains disappear. Plug in 110-volt.

Rush M-order \$29.75.

McDANIEL MFG. CO., INC.

1012 Powhattan, Dallas, Tex.



Say You Saw It in Popular Mechanics

Want a Government Job?

START AS HIGH AS \$4,205.00 A YEAR

Prepare NOW for next exams

MEN-WOMEN Thousands of appointments being made. 36-page Book FREE.

FRANKLIN INSTITUTE (Not Gov't Controlled)

Dept. X-83, Rochester 4, N. Y.

Write: Rush FREE (1) 36-page book with list of U. S. Gov't Jobs; (2) Tell me how to qualify.

Mail Coupon Today. SURE. Name _____ Age _____ Address _____

free!

308 VALUE-PACKED PAGES



1955 ALLIED

TV & RADIO CATALOG

SAVE ON EVERYTHING IN ELECTRONICS

World's Largest Stocks... Everything for Experimenters, Builders, Amateurs, Servicemen, Engineers & High Fidelity Specialists.

Send for ALLIED's big 308-page value-packed buying guide to *everything* in TV, Radio and Electronics! Largest selections of custom TV chassis, antennas and accessories; FM and AM tuners; High Fidelity systems and components; Amateur supplies; recorders and phono equipment; test instruments; builders' kits; industrial electronic supplies—plus the world's largest stocks of electronic parts, tubes, tools and books. Get *everything*—get *more* for your money—send today for your FREE 1955 ALLIED Electronic Supply Catalog.



ultra-modern facilities

TO SERVE YOU BEST!

Send for FREE Catalog

ALLIED RADIO

ALLIED RADIO CORP., Dept. 5-M-4
100 N. Western Ave., Chicago 80, Ill.

Rush FREE 1955 ALLIED 308-Page Catalog

Name _____

Address _____

City _____ Zone _____ State _____



BIG PROFIT making Concrete Drain Tile

Millions of dollars' worth of drain tile are used every year for farm drainage, building construction, reclamation projects, highways, and other purposes. And the big swing is to concrete tile because it's better and costs less. Sales potentials are BIG.

Concrete drain tile is locally manufactured of local materials, for direct selling to local users or contractors. Useless costs—freight, distribution, breakage—are eliminated. While worth more than clay tile, concrete tile can sell for less and still earn a handsome profit.

Tile made on the Champion Machine are strong and uniform. Truly round. All sizes up to 12" diameter. Easy to make because the Champion is simple to operate.

Get The Champion Facts

Write for the Champion book. Tells about concrete drain tile as an outstanding manufacturing opportunity. Describes the machine and outlines liberal payment terms.

CONCRETE EQUIPMENT CO.
522 Ottawa Ave., Holland, Mich.

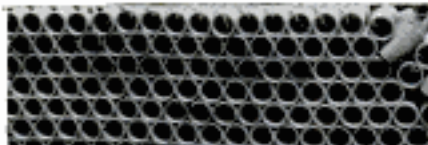

IN CANADA: DUNN MASONRY MACHINERY LIMITED
970 Dundas Highway, Cooksville, Ont.

PUMP WATER FAST!

Drains Wash Tubs, Cellars, Cisterns. Famous #7 pumps 2800 gph. 420 gph. at 75' high or 1600 gph. from 25' well. Sturdy rustproof alloy metal. Six blade impeller. 3/4" inlet, 1/2" outlet. Standard pipe threaded. Uses any 1/2 to 3/4 H.P. Motor. Will not leak or clog. Iron clad guarantee. Send check, M.O., or sent C.O.D. **\$8.95** W.S.S.

Irrigate, Fill Tanks, Draw Well Water. Heavy duty #8 pumps 7000 gph. —1000 gph. 75' high 3000 gph. from 25' well. Rustproof alloy metal. 8 blade impeller. 1" inlet, 1" outlet. Standard pipe threaded. Will not leak or clog. Iron clad guarantee. Send check, M.O., or sent C.O.D. **\$11.95** W.S.S.

Free Catalogue—Gear Pumps, Large Centrifugal Pumps, Deep and Shallow Well Pumps, Sump Pumps.

MOORE MANUFACTURING CO.
SWEDESBORO 1, NEW JERSEY

Say You Saw It in Popular Mechanics

BUILD your own TV Set

YES. Build your own top-quality TV Set. We supply complete equipment, tools, instruction as part of America's finest Home-Study TV Course. Be a highly-paid TV Technician. Install, Repair, Service all makes of sets. No experience needed. Many excellent jobs now open. Or start your own business. Send today for big FREE Book, "You and Television."

COMMERCIAL TRADES INSTITUTE
Dept. T2-12 1400 Greenleaf Ave. Chicago 26, Ill.

WAR SURPLUS BARGAINS

WAR SURPLUS BARGAINS

\$500,000.00 INVENTORY for QUICK LIQUIDATION

Surplus items—hundreds of them for home, shop, factory, farm and outdoor use. New items, used items, reconditioned items—all at tremendous savings—all priced for quick sale.

Page After Page of Values

This big catalog shows page after page of amazing money saving values. Write for your copy today. Send 10c to cover postage, mailing, etc. Write today! SEND TODAY FOR YOUR COPY

10c

STARK'S 212 W. Madison St.
Dept. PM-1254
CHICAGO 6, ILL.

23 BOATS YOU CAN BUILD



You Can Build These Boats Without Experience With Few Tools, and Little Time to Spare!

And the best part is that after you have completed your boat, you will know it is seaworthy as well as eye-worthy. This book, a few tools, and some time each day in your garage or basement, is all you'll need to complete the boat of your dreams. Nothing is left to the imagination. Everything is planned for you before you turn back the cover of the book. All you do is follow simple step-by-step instructions and show how photos and drawings.

Building and Service Hints Provided

You'll learn how to build your boat right the first time. Success in building a boat depends on two things. Knowing beforehand exactly what type boat you want to build and then getting started correctly on the construction. With this book it's simple. Material lists are supplied where essential, listing lumber required, hardware, sailcloth, fittings, etc. Also included are hundreds of hints for building your boat right, the best boat for beginners, and tips on servicing boats after they are built.

Special Chapter on Boats for Sportsmen

If you are a sportsman, hunter, fisherman, trapper, or just plan to use your boat for pleasure, this chapter contains ideal craft for your use. Perhaps you have a canoe in mind, or a rowboat that can be carried on your auto. Maybe you have always wanted a duckboat but have been reluctant to purchase one because of the expense. All these boats plus a 3-sec-

tion rowboat, and 12-foot plywood outboard, are available in this one chapter alone. All are easy to construct, and beautiful to own. Step-by-step instructions, photographs and illustrations, plus important material lists carry you right through from the forming of the keel to the last coat of paint and varnish.

Half a Million Persons Build Their Own

There are more than half a million persons in the United States who regularly build boats for pleasure or for profit. They form a cross section of American life. And theirs is a double reward—the fun of building the boat, and the thrill of using it when it is finished.

Partial Listing of Boats

Think of being able to build and own the following boats: "Su-Lu" the PT-type Plywood Dinghy, 11-ft. Skiff, "Sport" a V-Bottom Inboard, "Tramp" a 15-ft. Sailing Knockabout, "Sea Craft" a 25-ft. Cabin Cruiser, "Zephyr" a 14-ft. Sailing Dinghy, "Arrowhead" a 21-ft. Sloop, a Bicycle Boat, Motor-driven Paddle Board, "Skimmer" a Sturdy Plywood Kayak, "Skip" a Pram-Type Dinghy, "Tiny" a 6-ft. Training Ship, and many more, from large to small and at a fraction of the purchase cost!

7-Day Money Back Guarantee

Send for your copy of 23 BOATS YOU CAN BUILD today. Read and use it for 7 days. If it isn't entirely satisfactory return it for a full refund.

Use This Handy Order Coupon

POPULAR MECHANICS PRESS

200 E. Ontario St., Chicago 11, Illinois

Gentlemen:

Please send my copy of 23 BOATS YOU CAN BUILD. Enclosed is my remittance of \$2.00. If I am not completely satisfied with the book I will return it for a full refund after 7 days.

Name _____

Address _____

City _____ Zone _____ State _____

Get info.. PLASTIC LAMINATING AT HOME!



Get **ORDERS** and **CASH** from your mailman—do work in **SPARE TIME** at home—or expand into **FULL TIME** business. Send coupon for Free facts about the newest and most fascinating of all home operated businesses. For the first time a simplified machine brings the fabulous profits of **Plastic Sealing and Plastic Laminating** within the reach of the small operator. Anyone can learn to operate the machine with a few minutes practice—then with our **Magic Mail Plan** can get mail orders pouring in daily with cash in every envelope. **No canvassing—no selling.** We even

Make \$20 to \$30 a Day by.. MAGIC MAIL PLAN!

supply the circulars you mail to bring back cash and orders. Don't waste a minute. Rush your name. We'll send you **FREE** and postpaid, pictures, prices, details, and all the facts you need to start. Mail coupon or send name on postcard. No charge. Warner Electric Co., 1512 Jarvis Av., Dept. L-10-P, Chicago 26, Ill.

Make Thousands of Beautiful Art Creations
COSTUME JEWELRY • CIGARETTE BOXES
TRAYS • CANDLESTICKS • COASTERS
LAMP BASES • BOOK ENDS...ALL IN
SPARKLING COLORED PLASTIC



WARNER ELECTRIC CO., 1512 Jarvis Av.
 Dept. L-10-P, Chicago 26, Ill.
 At no cost to me, please rush complete details postage prepaid. I am under no obligation.

Name _____
 Address _____
 City _____ Zone _____ State _____

THIS MAN... is taking out of the machine a Plastic Sealing Job—ordered by mail—only 11¢ in material cost brings back \$2.58 in cash by mail. Capacity of machine: **\$25.00 profit per hour of operation.**

WHEELS WHEELS WHEELS

- 7" Disc Wheel 3/4" Tire 3/4" sleeve..... 45¢ ea.
 - 8" Disc Wheel 1 1/4" Tire 1 1/4" sleeve..... 70¢ ea.
 - 7" Disc Wheel 1" Tire 1/2" ball bearing..... 80¢ ea.
 - 8" Disc Wheel 1 1/4" Tire 1/2" ball bearing..... \$1.00 ea.
 - 6" Disc Wheel 1.50 semi-pneum. Tire 1/2" B.B..... \$1.35 ea.
 - 8" Disc Wheel 2" semi-pneum. T. 1/2" B.B..... \$1.50 ea.
 - 10" Disc Wheel 1.75 semi-pneum. T. 1/2" B.B..... \$1.50 ea.
 - 10" Disc Wheel 2.75 semi-pneum. Tire 5/8" B.B..... \$3.50 ea.
 - 12" Disc Wheel 1.75 semi-pneum. T. 1/2" B.B..... \$1.85 ea.
- Also wheel prices include hub cap, Pins Postage, C.O.D.'s preferred.
AXLES—Sizes 5/16 In., 3/8 In., 1/2 In.—Cut to size—End holes drilled.

UNITED WHEEL STAMPING CO.
 12131 S. PEORIA STREET PM-12 CHICAGO 43, ILLINOIS

LOCKSMITHING & Key Making

PRACTICAL UP-TO-DATE COURSE—ONLY \$4.95
 Easy-to-learn modern information for self-instruction. How to work on locks, de-code, make master-keys, repair, install, service, etc. For every handyman, home owner, carpenter, mechanic, service station operator, fix-it shop, hardware dealer, gunsmith. 53 plain illustrated lessons. **FULL PRICE ONLY \$4.95. SEND NO MONEY.** Just pay postman plus C.O.D. postage. Or send \$4.95 with order. We'll ship postpaid. Satisfaction guaranteed or refund.
NELSON-HALL CO., 210 S. Clinton St., Dept. MW-2, Chicago 6, Ill.

Sling Ho the hunting slingshot
SLING AT 50 LB. TENSION SHOTS ACCURATELY
 —50 YDS—
 JUST DROP \$1.00 CASH IN ENVELOPE
SLING-HO • BOX 1173 • BEVERLY HILLS, CAL. *After Radio*

FREE 2 lengths of 3/8" rubber tubing
 1/4" Steel Collapsible Frame

SAY YOU SAW IT IN POPULAR MECHANICS

ELECTRIFY your SEWING MACHINE

XMAS OFFER!
\$9.50 NEW LOW PRICE!

Kit comes fully wired, installed in a jiffy. Fits all machines!
 You get **ALL NEW PARTS**:
 • Motor & Bracket
 • AC-DC 115v 60c
 • Multi-speed foot control
 • Cord set & block
 • Easy instructions
 • Steel pulley & belt

FREE . . . Reg. \$2.95 chrome **SEWLITE** given with every kit

10 DAY FREE TRIAL—MONEY BACK GUARANTEE!
 Send \$5 deposit, pay postman balance plus postage. Please state whether wheel on your machine turns toward you or away from you. Shipping wt. 6 lbs. Orders on 5 or more \$8.00. We also sell sewing machines.

GEORGE KESSLER
 1616 East 7th St. (Dept. M) Brooklyn 30, N. Y.

WHOLESALE TOOL CATALOG

MAKE EXTRA MONEY

Start Your Own Business
 Sell tools part time, full time. Save money for your industrial and institutional use. **A MILLION DOLLAR INVENTORY AT YOUR FINGERTIPS.** Stanley, Millers Falls, Plumb, Disston, Wiss, & other Nationally advertised tools up to 50% discount.

No Investment Required. Send \$1 Deposit for Dealers Card and mammoth wholesale catalog. \$1 refunded on first purchase or returned if you are not 100% satisfied.

SILVO HARDWARE CO., Dept. PM-12, 106 Market St., Phila. 6, Pa.

PREPARE FOR BETTER JOB, BIGGER PAY IN SPARE TIME AT HOME

Today, choose the job you want—and prepare for it in time you might otherwise waste. Or if you are already in the work you like best, start training now for quicker promotion and increased pay. During more than 50 years **AMERICAN SCHOOL** has helped ambitious people to reach higher goals. Check subject that interests you and mail coupon for full information.

AMERICAN SCHOOL, Dept. G945, Drexel at 58th, Chicago 37, Ill.

Without obligation, please send **FREE** and postpaid, full particulars about the subject checked below.

<input type="checkbox"/> Accounting	<input type="checkbox"/> Drafting—Building Trades	<input type="checkbox"/> Plastics Engineering
<input type="checkbox"/> Air Conditioning	<input type="checkbox"/> Drafting—Machine Trades	<input type="checkbox"/> Plumbing—Practical
<input type="checkbox"/> Architecture & Building	<input type="checkbox"/> Electrical Engineering	<input type="checkbox"/> Private Secretary
<input type="checkbox"/> Automotive Technician	<input type="checkbox"/> Electricity—Practical	<input type="checkbox"/> Refrigeration
<input type="checkbox"/> Better Foremanship	<input type="checkbox"/> Electronics—Industrial	<input type="checkbox"/> Retail Merchandising
<input type="checkbox"/> Bookkeeping	<input type="checkbox"/> High School Courses	<input type="checkbox"/> Salesmanship—Outside
<input type="checkbox"/> Business Management	<input type="checkbox"/> Machine Shop Operations	<input type="checkbox"/> Sheet Metal Work
<input type="checkbox"/> Contracting	<input type="checkbox"/> Mathematics & Slide Rule	<input type="checkbox"/> Tool Making
<input type="checkbox"/> Diesel Technician	<input type="checkbox"/> Mechanical Engineering	

NAME..... OCCUPATION.....
 HOME ADDRESS..... AGE.....
 CITY..... STATE.....
 Canadian Residents: Write American School, 1610 Sherbrooke St. West, Montreal

MAIL COUPON NOW



"The Good Shepherd"

GIVE FOR XMAS OR MAKE IT YOURSELF AMERICAN WOODCRAFT JIGSAW KITS

An interesting hobby for family and friends. You start with materials, pattern and easy to follow, completely illustrated instructions. You finish with a decorative, colorful, professionally assembled GENUINE WOOD INLAY, 11 3/4" x 11 3/4".

American kits contain Genuine Wood Veneers from all over the world, glue, finishing materials, back panel, instructions, chart of woods and where grown, space for personal signature.

All materials guaranteed highest quality.

Illustrated
"Coming in at Dawn"

No. 2050
Coming in at Dawn
No. 2051 (Companion Piece)
Christmas Cheer

3.45 2 FOR **6.75**
EACH (Sent Postpaid)

No. 2061
The Good Shepherd
No. 2062 (Companion Piece)
Christ in Gethsemane

4.85 2 FOR **9.45**
EACH (Sent Postpaid)

Send Check or M. O.



AMERICAN WOODCRAFT SUPPLIES, Inc.

Dept. PM-12 4702 W. Augusta Blvd. Chicago 51, Ill.

AMAZING NEW TINY RADIO

Really Works—Small as a Pack of Cigarettes!



GETS LOCAL RADIO STATIONS WITH CLEAR BELL-LIKE TONE—NO STATIC OR INTERFERENCE! NEEDS NO TUBES, BATTERIES OR COMPLICATED HOOKUPS! NO AC PLUG INS! Nothing to wear out. Thousands of users—many report years of service. Uses new crystal diode and HI-Q coil. SELF-CONTAINED SPEAKER PHONE. Just the tiny radio to take with you ANYWHERE YOU GO—ON TRIPS, VISITING, ETC.—for real fun and enjoyment—ANYTIME. Merely hook to anything that can act as signal generator and to ground. **SEND ONLY \$1.00** (bill, ck., mo.) and pay postman \$3.99 C.O.D. postage or send \$4.99 for p.p. delivery. COMPLETE READY TO LISTEN. MIDWAY CO., Dept. PPM-12, Kearney, Nebr.

It's EASY to play The MUSICAL SAW



the Glass-O-Phone the Jazz-O-Nette, Musical-Pitchfork, Flute-O-Phone

If you can whistle or hum a tune, you can play these remarkable Novelty Instruments. They are played entirely by ear. Low priced. Write for FREE literature. **MUSSEHL & WESTPHAL, Est. 1921** 10 FORT ST., FORT ATKINSON, WISCONSIN

Paratrooper Knife (Fallschirmjager)

Specially designed knife for the German paratrooper, W.W. II. A rare souvenir and excellent hunting knife. Originally designed for use as an infighting weapon and to cut

\$3.95 EACH
POST PAID



ONE HAND
OPENING



All metal.

Cadmus Industries

29 CRAFT BLDG., 5864 HOLLYWOOD BLVD., HOLLYWOOD 28, CALIF.

OWN A... PLYMOUTH?

FIX IT YOURSELF!

Popular Mechanics Magazine has just published a new Owners Manual covering all 1941 to 1952 models of Plymouth cars. So accurate mechanics use it... so simple a woman can understand it.



Save money on your Plymouth repairs. Prevent trouble. Enjoy care-free driving. Increase trade-in value. Avoid major repairs by fixing minor troubles before they get serious. Get sparkling performance at all times. Has 272 pages, more than 350 photos, diagrams, tables, charts, breakdown drawings, plus clear, non-technical directions that make all repairs simple as ABC. Written by Ed Packer with assistance of Chrysler Corporation. Shows you how to diagnose Plymouth troubles by feel, sound, sight, smell and performance. Simple trouble shooting. Permanent repairs. Emergency repairs. Plus, "How to get value from garages."

MONEY BACK IF IT DOESN'T SAVE MORE THAN IT COSTS!

One minor repair will save the cost ten times over. Read it. Then you decide. If you don't see that you'll save more than the cost, send it back for refund. **SEND NO MONEY.** Send postcard. Ask for PLYMOUTH Manual. Postman will deliver C.O.D. for \$3.50 plus postage. Or, save postage by sending \$3.50 with order. Send today. Save its cost on your next repair.

POPULAR MECHANICS PRESS

200 E. ONTARIO DEPT. 18 CHICAGO 11, ILLINOIS

Have a Motorized Shop at Low Cost Make Your Own POWER TOOLS

Popular Mechanics Book Shows How to Make 60 Machines from Scrap and Discarded Materials

Get SIXTY POWER TOOLS AND HOW TO BUILD THEM, the sensational new Popular Mechanics book. Build your own lathe, drill press, sander, circular and band saw and other power tools at a cost of only a few dollars each. Use old auto parts, pipe and wood and odds and ends that cost little or nothing. Every detail of construction is given in plain language you can understand and follow. Hundreds of pictures and plans show every step to follow in making the power tools you want. Clip this ad and mail with name, address and only \$2.50, or we will send C.O.D. (U.S.A.). You'll be amazed with the fine, practical tools you can make and how little they cost. Your money back if you return the book in 7 days. Order today.



Over 250 Pictures

POPULAR MECHANICS PRESS, Dept. PT-1, 200 E. Ontario St., Chicago 11

ELECTRIFY your SEWING MACHINE

NEW LOW PRICE! \$9.95 90 DAY GUARANTEE



Buy direct from manufacturer and save! Kit comes fully wired, installed in a jiffy. Fits all machines! You get **ALL-NEW PARTS**

- Motor & Bracket
- AC-DC 115v 60c
- Multi-speed foot control
- Card set & block
- Easy instructions
- Steel pulley & belt

FREE . . . reg. \$2.95 chrome SEWLITE gives with every kit.

10 DAY FREE TRIAL—ORDER NOW! send no money, pay COD or send money order and we'll pay postage. Please state whether wheel on your machine turns toward you or away from you. Shipping wt. 6 lbs.

SENIOR SEWING MACHINE CO.
Box 147 Dept. PM62 Brooklyn 6, N. Y.

YOUR OWN BUSINESS EARN \$25 DAY SPARE TIME

Operate your OWN profitable Venetian Blind Laundry business. Earn \$25 day—spare time! . . . and build a permanent, lifetime full-time business. Clean Venetian Blinds from Homes, Offices, Institutions, etc. Easy to learn and operate. New, uncrowded field. Previous experience unnecessary.

Write NOW for full information—No obligation.

A. L. LAUNDRY CO. 101 So. 44th St., Philadelphia 4, Penna.



FREE BIG BOOK

earn as TAX EXPERT

\$15 HOUR

Tax Consultants earn to \$5,000 annually in spare time preparing income tax returns and operating monthly tax service for business men. Dignified home—office business. Experience unnecessary. We train you; help you start. State approved. Write today for free prospectus.

UNION INSTITUTE, Lakewood 2-R, N. J.

YOU BUILD EICO KITS

In one evening, SAVE 50% & LEARN

Easy Instructions Vacuum Tube Voltmeter
38 Instruments KIT \$25.95 Wired \$39.95

Write now for FREE Catalog . . . APM-12



Electronic Instrument Co., Inc. • 84 Withers St. • Brooklyn 11, N. Y.

LAW

Men and women **STUDY AT HOME** for Business Success and **LARGER PERSONAL EARNINGS**, 44 years expert instruction—over 114,000 students enrolled. LL.B. Degree awarded. All text material furnished. Easy payment plan. Send for **FREE BOOK**—"Law and Executive Guidance"—NOW!

AMERICAN EXTENSION SCHOOL OF LAW
Dept. H-1, 664 N. Michigan Ave., Chicago 11, Illinois

HOW TO BUILD Your Own GARAGE

Save Up to 50% of Usual Cost!

Get Popular Mechanics' brand new book **How to Build Your Own Garage** by Wayne Lecky, Assistant Shop Notes Editor, and find out how you can build your own garage at savings of 50% of usual cost. Lecky tells in clear step-by-step instructions and shows in big, clear photos, drawings and diagrams how to perform every building operation from laying the concrete to installing the final trim. There are 25 designs. Brick, frame, and concrete block fully covered. Send \$3.50 for your copy. 7-day money back guarantee.

POPULAR MECHANICS PRESS, 200 E. Ontario, Chicago 11, Ill.



NOW COYNE TRAINS YOU IN SPARE TIME AT HOME

TELEVISION RADIO-ELECTRONICS

Only from famous COYNE do you get this modern up-to-the minute TV Home Training. Easy to follow, Step-by Step instructions—fully illustrated with 2150 photos and diagrams. Not an old Radio Course with Television tacked on. Personal guidance by Coyne Staff. So practical you can quickly **EARN MONEY** IN A TV-RADIO SALES AND SERVICE BUSINESS—part time or full time. Not only **FINEST TRAINING** but **COSTS MUCH LESS**—pay only for training—no costly extras.

SEND COUPON FOR DETAILS FREE

SEND COUPON BELOW for Picture Folder and full details including **EASY PAYMENT PLAN, NO COST OR OBLIGATION—NO SALESMAN WILL CALL.**

B. W. COOKE President
COYNE ELECTRICAL SCHOOL FOUNDED 1899

A TECHNICAL TRADE INSTITUTE CHARTERED NOT FOR PROFIT
500 S. Paulina Dept. 94-HT2 Chicago 12, Illinois

B. W. COOKE, President
COYNE ELECTRICAL SCHOOL
500 So. Paulina St., Chicago 12, Ill., Dept. 94-HT2

Send FREE Picture Folder and details of your Television-Radio-Electronics Home Training offer.

Name _____
Address _____
City _____ State _____

AMAZING HI-LIFE BATTERY GUARANTEED TO START FOR THE ENTIRE LIFE OF YOUR CAR!



New HI-LIFE BATTERY gives you tremendous extra "kick" for cold winter starts, reserve emergency power, extra power for radios, lights, and multiple electric devices of today's modern cars. Completely recuperates in **JUST ONE MINUTE!** Run your HI-LIFE completely down until dead. Wait just one minute! When you step on your starter, you'll receive the same surge of power—just like new again! HI-LIFE BATTERY has been thoroughly tested, completely investigated—proven by automotive experts. Now used by leading taxi companies, truck operators, Government bureaus—praised by auto owners from coast to coast. Sizes to fit every car. Don't wait. Order your HI-LIFE BATTERY today. Send check or M.O. with coupon below.

MAKE THIS TEST RECUPERATIVE POWER

Let HI-LIFE BATTERY run completely dead using starter motor. Wait just one minute. Step on starter. You'll receive the same tremendous surge in power—as though nothing had happened. You can repeat this test literally hundreds of times without any change in battery power.

POSITIVELY GUARANTEED FOR LIFE OF CAR! Each HI-LIFE BATTERY is guaranteed to give satisfactory service for as long as the original purchaser owns the car or vehicle for which the battery was purchased.

SOME CHOICE DEALERSHIPS-DISTRIBUTORS AREAS OPEN

MAIL COUPON NOW

HI-LIFE BATTERY CORP., West Scranton, Pa.

Gentlemen: I must be satisfied with HI-LIFE BATTERY. It is guaranteed to last the life of my car. Please ship:

6 Volt automobile battery—\$31.95 (includes tax-freight prepaid).

12 Volt HI-LIFE BATTERY—\$35.95 (includes tax-freight prepaid).

For _____
Make and Model—Year of Car or Tractor
 Check M.O. enclosed.

Your Name _____
Address _____
City _____ Zone _____ State _____

GROW MIDGET TREES

\$1000 worth on your window sill!

EARN MONEY SPARE TIME!

Learn the ancient Oriental Technique. Grow Ming Trees—perfect, living specimens—BUT ONLY INCHES HIGH! Elm, Cypress, Oak...any kind. All BLOOM, even BEAR tiny, delicious fruit. New "Miracle Growing Method"—NO WAITING! Taken only minutes a week... sell for up to \$25, \$50, even \$250 each! FABULOUS \$\$\$ OPPORTUNITY! Everyone wants one. It's easy, fun, NO EXPERIENCE NEEDED. We supply everything. Write today—we'll send you

FREE! Genuine Seeds & Plan

NATIONAL NURSERIES, Dept. M-12, 8403 S. Van Ness Ave., Inglewood 4, Calif.



Covers All Models 1940 to 1952
— All Features — Including
Powerglide Transmission

Get the **NEW Popular Mechanics Owner's Manual**

If you drive a Chevrolet—any model—1940 to 1952—get this new owner's manual today. It will save you money on repairs and service; give you safe, economical and trouble-free motoring and protect your investment in your Chevrolet by keeping it constantly at top value. Can easily be worth hundreds of dollars to you in a single year.

Chevrolet Owners
Spend Less to Own and Drive Your Car

Official, Authoritative Bumper to Bumper Information

Prepared by a noted automotive authority and Popular Mechanics editors with the full cooperation of Chevrolet engineers and service specialists. Covers all phases of Chevrolet operation, service and maintenance. 304 pages of practical information and hundreds of photos, diagrams, charts, and sectional views, make every part, every operation, easy to understand. Complete index enables you to put your finger on the information you want instantly.

Prevents Costly Repairs

Explains everything about your car; what can go wrong; how proper adjustment and servicing should be done; how to prevent major troubles and costly repairs later on. Even if you don't service your car at home the manual will save you important money on every day operation.

Mail Coupon Today

Mail coupon now. Send only \$3.50 for prepaid delivery or you can pay postman, plus charges. See money back guarantee in coupon.

Learn All About Chevrolet's Powerglide Automatic Transmission

Know Your Chevrolet Valve-in-Head Engine and How It Operates

Understand Chevrolet's Center Point Steering and Unitized Knee-Action.

Protect Your Investment. Know Your Chevrolet.



POPULAR MECHANICS PRESS
200 East Ontario St., Chicago

Send Manual for Chevrolet Owners at once. If not satisfactory I will return it within 5 days and you will refund full purchase price.

Remittance for \$3.50 enclosed. Send C.O.D.

Name _____

Address _____

City _____ State _____

STAMP COLLECTORS!

322 DIFFERENT STAMPS **25¢**

With 8 Exciting Topical Groups

This valuable imported collection includes the **NEW CROATIA U.P.U. SET** of 4, gorgeous South Seas U.P.U. set, Roosevelt Memorial group including scarce underground issues, United Nations Issue from far off Islands, Sports contests from riotous **TRIESTE**, **TRIANGLES GALORE**, multicolored **BIRDS, ANIMALS, FLOWERS, PLUS HUNDREDS** of other fascinating issues. A total of 322 all different stamps cataloging more than \$6.50 for only 25c, to introduce our **FAMOUS BARGAIN APPROVALS**. Money back if not delighted. **FREE: 48-PAGE STAMP DICTIONARY AND GUIDE.**

STAMPEX CO., 116-RM, Nassau St., New York, N.Y.

It's Crosman for Christmas

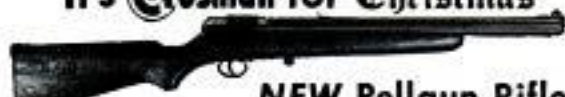

NEW Pellgun Rifle

Here is a high-compression air rifle that is the best value in the Pellgun market. Accurate... hard hitting power. Safety, adjustable sight, sport styled stock. Ask your dealer for a demonstration. **\$14.95**

CROSMAN ARMS CO., FAIRPORT, N. Y. Dept. 45

Say You Saw It in Popular Mechanics

LEARN TV in KC

FAMOUS FOR 24 YEARS



1,000's OF SUCCESSFUL GRADS COAST TO COAST

Easy, quick, fascinating. Learn TELEVISION in 36 short weeks of enjoyable companionship in shop training. Wonderful job opportunities. Graduates have choice of many jobs or can establish their own TV repair shop. YOU CAN START EARNING AS MUCH AS \$150 PER

WEEK. NO limit as time goes on. U.T.S. is an old established school (TV exclusive for 24 years) staffed by expert instructors, headed by one of America's first TV broadcasters. Costs so little to prepare yourself for life. No previous experience needed. Fully approved for Korean Veterans. Also fully approved course in color TV (first in U.S.A.). Get the full story today.

FREE CATALOG

FILL OUT COUPON

UNIVERSAL TV SCHOOL
1228M Admiral Boulevard, Kansas City, Missouri

PLEASE SEND ME INFORMATION FREE

Name _____ Age _____

Address _____

City _____ State _____

Check here if Korean Veteran

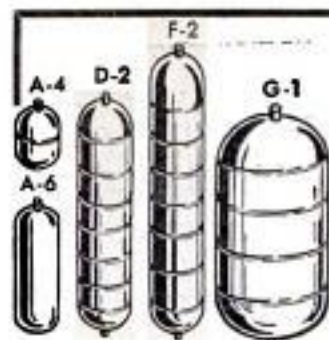

STEEL AIR TANKS

Steel pressure tanks suitable for compressors, pneumatic units, gases, hydraulics, and liquids. Rated at 500 lbs. per square inch pressure. $\frac{1}{4}$ " standard pipe thread openings on tank ends as shown.

	Size	Wt. Lbs.	Volume	Price
A-4A Carbon Steel—New	7 $\frac{1}{2}$ "x5 $\frac{1}{4}$ "	11 $\frac{1}{2}$	104 cu. in.	\$1.50
A-4 Stainless Steel—New	7 $\frac{1}{2}$ "x5 $\frac{1}{4}$ "	11 $\frac{1}{2}$	104 cu. in.	2.50
A-6 Carbon Steel—New	14 $\frac{1}{2}$ "x5 $\frac{1}{2}$ "	3 $\frac{1}{4}$	280 cu. in.	3.50
D-2A Carbon Steel—New	24"x6"	5	500 cu. in.	4.50
D-2 Stainless Steel—New	24"x6"	5	500 cu. in.	7.50
F-2A Carbon Steel—New	45"x6"	11	1000 cu. in.	8.50
F-2 Stainless Steel—New	45"x6"	11	1000 cu. in.	9.50
F-1 Stainless Steel—New	18"x10"	12	1000 cu. in.	9.50
G-1 Stainless Steel—New	24"x12"	18	2100 cu. in.	12.50

Prices F.O.B. Chicago. Include approx. postage on orders paid for in advance. C.O.D. orders enclose 25%, balance sent C.O.D.

U. A. S. Corp. Dept. PM12, 5637 W. 63rd Pl. Chicago 38, Illinois

AMAZING MYSTERY BUTTON



Startles Everybody. With this Electronic Button you can make your own Telephone-Amplifier—Detectophone. Attach this button to piece of cardboard—transmit conversation to another room. Music also transmitted to distant places. Most interesting electrical apparatus ever discovered. Enables you to perform hundreds of experiments. So tiny it can be concealed in dozens of places. A Pre-War Product. Electronic Button including 5000 word instruction booklet with 50 illustrated experiments, postpaid, only **\$100**

ELECTRONIC PRODUCTS COMPANY, PM-12, SAINT CHARLES 9, ILL.



DEVELOP A HE-MAN VOICE!

Write for FREE book "How to Strengthen Your Voice for Greater Success" by Eugene Feuchtinger. No obligation. Book will be mailed at once in plain wrapper, postpaid. Just send your name and address. State are. PERFECT VOICE INSTITUTE, 210 S. Clinton St., Studio MW-2, Chicago 6, Ill.

YES! SEND



directly to my door every month

I am enclosing

- \$3.50 for 1 year
 \$8.00 for 3 years

name _____

address _____

city _____ zone _____ state _____

Hand this order to your newsdealer or send it to

POPULAR MECHANICS
 200 East Ontario St. Chicago 11, Ill.

FREE

A NEW HOME INDUSTRY



OPPORTUNITIES UNLIMITED **JEWELRY GEMS** **HANDLES KNIVES - DIALS** **STATUES FIGURINES**

Let us show you how extremely easy and PROFITABLE it is to make beautiful and useful things out of LIQUID PLASTIC, LIQUID MARBLE, LIQUID IVORY, LIQUID GLASS, CERAMICS, ETC. - as easy as pouring water out of a glass! Make novelties, jewelry, gifts, artware, toys, tools, dials, gadgets, ceramics - a million useful things! We supply everything—MATERIALS and INSTRUCTIONS! Sent only 25c for big 64 page catalog of casting materials, molds and accessories and we will include free of extra cost a remarkable book, "THE WONDERS OF LIQUID PLASTICS" - that will open your eyes to wonders you never dreamed of! Send 25c today—this may be the lucky coin that will start the most fascinating and profitable phase of your life!

PLASTICAST COMPANY, (Dept. C)
 P.O. Box 4737 (Write to either address) P.O. Box 987 Palo Alto, Calif.
 Chicago 80, Ill.



PLASTIC LAMINATING

This remarkable Plastic Laminating Machine will earn \$18.00 an hour right in your kitchen! Big profits laminating Business, Social Security, Identification, Credit CARDS of all kinds, photos, passes, clippings, plaques, etc. Prices from \$30 and up. Easy terms. Will accept any equipment in trade. Literature free.
PLASTICAST CO. (Address above)

HELPFUL BOOKS

Send post card asking for FREE catalog
 Popular Mechanics Press, 200 E. Ontario, Dept. 601, Chicago 11

PREPARE FOR THE BEST JOBS IN INDUSTRY

- MECH. ENGINEER
- DRAFTSMAN
- TOOL DESIGNER
- TOOL ENGINEER
- TOOL & DIE MAKER
- MASTER MACHINIST

NO RECESSION FOR ALLIED TRAINED MEN

MORE JOBS THAN GRADUATES Shortages of Draftsmen, Designers, Tool Engineers, Machinists, Tool & Die Makers are so widespread that you can pick a highly paid key job and look forward to Achievement and Security.

You can begin your training in Short Courses and continue progressively to a Bachelor Degree in 26 months.

Allied is approved by Industry, Dept. of Education, Office of Public Instruction, State of Illinois, U.S. Veterans Admin., U.S. Dept. of Justice, Accredited: C. S. A.

SEND FOR **FREE BOOKS**

ALLIED SCHOOL of MECHANICAL TRADES
 1338-42 South Michigan Ave. Dept. PM-12 Chicago 5, Illinois

SEND ME WITHOUT OBLIGATION INFO. ON YOUR COURSES:

- HOME STUDY RESIDENT VETERAN NON VETERAN

NAME _____

ADDRESS _____ AGE _____

CITY _____ STATE _____

SURE THEY'RE GOOD!

...you set
the standards
yourself



Products with brand names that you call for again and again are literally just what you order, because you yourself are constantly dictating their quality standards.

Your approval is the measuring stick that manufacturers go by. *You* decree how a seam will be sewn, an edge ground, a design balanced. *You* say if a flavor will be sharpened, a fragrance tempered, an angle softened, a color heightened. Products stand or fall on your acceptance . . . so their makers keep quality up, UP to the point that keeps you buying.

Man, you're the boss. And lady, you couldn't be closer to quality control if you sat in the manufacturers' collective lap.

Guide to good buying: the ads in this magazine.

BRAND NAMES FOUNDATION INCORPORATED

A NON-PROFIT EDUCATIONAL FOUNDATION
37 WEST 57 STREET, NEW YORK 19, N. Y.

**WANT QUALITY? PATRONIZE THE DEALER
WHO PROVIDES YOUR FAVORITE BRANDS**



NEW COLLAPSIBLE ANCHOR

NON-FOULING

Folds for Carrying — Light Weight 7½ lbs. — Cadmium Plated — Dependable Release Mechanism — For small boats up to 18 ft. Ohio Residents add 24c for sales tax.

\$7.95 POSTPAID

\$8.50 West of the Mississippi

DEALER INQUIRIES ACCEPTED

LAKE ANCHOR CO., BOX 903, YOUNGSTOWN, OHIO



SAVE MONEY ON TV REPAIRS

Correct 80% of TV Troubles Yourself

Follow our easy instructions—complete your own repairs

This simplified guide **FOR YOUR EXACT SET** compiled by experts. Lists over 100 different troubles and remedies. Includes easy to understand adjustments; special, easy to read tube layout chart showing where each tube is located in YOUR SET. Many other features. **MONEY BACK GUARANTEE.** Send make of set, year, model no. TODAY with ONLY \$2.00, (cash, check or money order) to **TELE-CARE, Box 87, San Fernando, Calif.**

Enjoy the Fascinating Story of the Horseless Carriage in



Popular Mechanics AUTO ALBUM

166 Illustrations

The most intriguing book about the automobile ever printed. It's thrilling, fascinating and informative. From the very first gasoline-propelled buggy to the cars of today and the atomic auto of the future. The first cars — the men who made them — the scrambled start and the development of the fabulous auto industry—the story of auto racing—the growth of the Nation's highways—166 thrilling action pictures—old-time cars—racing cars—early auto advertising—automotive oddities. Roll call of names of more than 2000 autos made in the U.S. included. Ideal gift book. Cloth bound, only \$3.00 by mail. Money back if not pleased. Paper covered edition \$1.00 at newsstands.

POPULAR MECHANICS PRESS, Dept. PM14
200 East Ontario Street Chicago 11, Illinois

Build Your Own Walks, Driveway, Outdoor Fireplace, Steps, Etc.

What to Make With CONCRETE

The terrific high costs of even little concrete jobs are mostly for labor. Get Popular Mechanics **WHAT TO MAKE WITH CONCRETE** and save all the labor costs while making your home or farm ship-shape. You can lay foundations, sidewalks and driveways; build steps, outdoor fireplaces, sandboxes, tennis courts, garden and swimming pools and other installations at very little cost. Book shows all — tells all — how to make the right mixture, plan, apply and gives 50 professional short cuts. Hundreds of pictures. Only \$2.00 postpaid. Order today. Money back if not pleased.

POPULAR MECHANICS PRESS
Dept. PM17, 200 E. Ontario Chicago 11, Ill.



NOW! USE YOUR WILLYS OR DODGE AS BOTH A 2 and 4 WHEEL DRIVE



Enjoy 2-wheel drive pep, speed, extra mileage, performance—keep 4-wheel drive power and traction with **WARN HUBS**. Change 4-wheel to 2-wheel or back in seconds with fingertip control. Front end assembly stands still in 2-wheel drive—ends drag, stops shimmy, cuts front tire wear, increases gas mileage to 6 m.p.g. For Willys \$70.00, Dodge \$74.00 pr.; also Standard Hub for Willys \$20.00, Dodge \$23.00, Land Rover \$24.00 pr.; Automatic Hub for Willys \$122.83 pr., all post. Money back guarantee. Dealers or direct. Write for folder.

WARN MFG. CO., RIVERTON Box 6064-A3, Seattle 88, Wash.

RADIO CONTROL YOUR MODEL PLANES BOATS CARS

CUSTOM MIDGET RADIO ONLY \$9.98

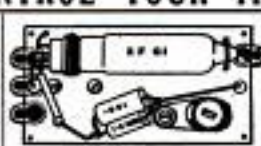

DETAILED INFORMATION & RADIO CATALOGUE 25c
SPECIAL "SUPPLY SOURCE DIRECTORY" & \$7.99 SUPPLY COUPON... \$1.00
MODE "RADIO CONTROL OF MODEL AIRCRAFT" 14 PLANS \$3.98
RADIO CONTROL GARAGE BODE DETAILS... \$1.00

OPERATES SAME AS \$22.00 SETS INCLUDES ICOM RANGE
TRANSMITTER RADIO, RECEIVER RADIO AND CONTROL ACTUATOR ALL 3 PARTS ASSEMBLY WITH OUR PARTS AND PLANS \$9.98. PLANS ALONE \$1.

RADIO MODELS BOX 36 DEPT. PM BALTIMORE 6, MARYLAND

JEEP OWNERS

STA. WAGONS • JEEPERS • PICK-UPS!

Take full advantage of 4-wheel drive by installing a Ford V-8 engine — **MORE POWER**—means less shifting, better traction at lower speeds, greater safety, plenty of power in high. All this is now possible by using our F-J adaptor plate (Pat. Pending) Conversion Kit \$43.25 incl. F.B. TAX. Write for free details or send check or M.O. for prepaid delivery. Order now for early shipment.

HOOSIER MACHINE PRODUCTS CO.
312 S.E. 6th St. Pendleton, Oregon

Say You Saw It in Popular Mechanics

15 X 65 "SUPER VISION"

Enjoy tremendous power, wide field of view, brilliant illumination. Streamlined design, using lighter, stronger metals, make this 15 power binocular easier to hold and use than many glasses half its power! Water-dust resistant. Objective lens almost 3" across! 8 1/2" x 2 1/2" interior slides of VITAL prisms and front and rear Achromatics COATED with magnesium fluoride for sharp, crisp images—made in Japan by skilled optical craftsmen. **30 DAY NO RISK TRIAL.** Return for refund if dissatisfied. Cash orders preferred. C.O.D.'S require \$2.00 deposit. AIR MAIL SHIPMENT \$4.00 extra! Leather case, straps included! Add 10% Federal tax. UNITED BINOCULAR CO., 9043 S. Western, Dept. ARF-8708, Chicago 20. DEALERS WANTED.



Learn the Secrets BREED RARE tropical fish



KIND OF FISH	EGGS OR YOUNG PRODUCED AT ONE BIRTH	APPROX. RETAIL PRICE OF FULL-GROWN FISH
Swordtail	20 to 100	\$1.00 to \$4.00 Pr.
Red Betta	70 to 200	3.00 to 4.00 Pr.
	100 to 150	6.00 to 11.00 Pr.

... IN YOUR HOME... SPARE ROOM, BASEMENT, GARAGE... ANYWHERE!

EARN BIG MONEY—SPARE TIME
New "Chance of Lifetime" opportunity! Start your own spare or full time business once you know the revealing breeding secrets. It's fascinating! It's Fun! Breed EXOTIC and graceful "Angel Fish", BEAUTIFUL "Gourami" that are 12 DIFFERENT COLORS, "Fighting Fish" THAT FIGHT UNTIL DEATH; "Danio" that are STRIPED LIKE A ZEBRA, TRANSPARENT FISH—hundreds of expensive varieties. Some fish lay 300 to 600 eggs at one time. (Some very rare fish have sold for over \$75 a pair.) Get into PARTNERSHIP WITH NATURE and let nature multiply your profits for you. **NO EXPENSIVE EQUIPMENT—NO EXPERIENCE NECESSARY. WE SUPPLY EVERYTHING YOU NEED.** HELP FILL HUGE DEMAND from stores, offices, theaters, hotels, etc. New plan lets YOUR MAILMAN BRING YOU ORDERS. Investigate TODAY.

FREE! Colorful "How To Do It" success BOOK-LET, REPRINTS, breeding BROCHURE and ALL DETAILS. Rush coupon today!

RUSH this Coupon TODAY!

Tropical Fish Breeders of America, Dept. DC
15127 S. Broadway
P. O. Box 61007 So. Station
Los Angeles 61, California

Dear Sir:

Please rush me all Free Details.

Name _____

Address _____

City _____

State _____

Your Age _____

Build it Yourself! Furniture • Furnishings • Work Benches • Children's Toys • Shelves • Boat • Cupola • Weathervane • With

Popular Mechanics
NEW

FULL SIZE PATTERNS

Authentic Designs by Professional Designer
Trace Patterns on Wood and Follow Simple Guides
Every Step Made Easy for Building at Home.

Now you can make modern furniture, a fine work bench, toys for the children, fancy shelves, even a 12-foot motor boat and other things you want and need. But best of all, you can save money and turn out articles with that sought-after professional look. Popular Mechanics presents the first group of many new full size patterns for home craftsmen. They are the designs of John Bergen, noted furniture designer, working with the craft editors of Popular Mechanics—the big name in home shop and craft projects.

So easy to use, these full size patterns make play of most wood-working jobs.



Modern Step Table

No. 104. New and original design to match cocktail table Number 103. 28 x 18 inches. Upper step 24 inches high. A modern and stylish addition to any living room. 1 pattern. 50 cents



Modern Tub Chair

TV Chair

No. 112. A real all-out lounging chair in attractive modern design. Seat is 22 inches deep, 24 inches wide. Over all, 28 x 27 inches. 27 inches high. Simple foam rubber upholstery over Sagless type wire springs. Your choice of cover. 2 plans. \$1.00

No. 111. Beauty and comfort are well combined in this TV Chair. Seat 22 inches deep, 24 inches wide. Overall, 27 1/2 x 32 1/2 inches. 26 1/2 inches high. Uses simple Sagless type wire springs. Instructions included for easy-to-do upholstering with new foam rubber method. 2 patterns. \$1.00



Trundle Beds

No. 102. Space-saving, safer beds for young people. No ladder to climb. Easier to make up. One bed tucks away under the other. Size 90 x 45 1/2 inches. Top bed 40 inches high. Lower bed 23 inches high. Storage cabinet in head. Springs included in patterns. Uses standard size mattress. 3 patterns in set. \$1.50



Decorative Wall Shelves

No. 110. Two attractive, distinctive wall shelves you can build to beautify your home. You can choose either modern or traditional styling. Modern shelf with metal trim is 28 x 16 x 8 inches. Traditional design is 29 1/2 x 16 x 8 inches and includes attractive fret work. Drawers can be eliminated if desired. 2 shelves in one pattern. 50 cents



Modern Cocktail Table

No. 103. Beautiful new and original design with plank top and metal grill inserts in sides. 40 x 19 inches. 15 1/2 inches high. Fun to make and a joy to own. 1 pattern. 50 cents



Personal Work Bench

No. 108. Here's a compact, sturdy workbench designed to stand up under frequent use and provide a maximum amount of work space in a small area. Top is 44 x 20 inches. 35 inches high. Drawer and sliding doors. Completely enclosed, it provides a large amount of storage space for tools, materials, etc. 2 patterns. \$1.00

Juvenile Chest Robe



No. 106. A good-to-look-at and convenient-to-use wardrobe for the little folks room. 30 inches wide, 16 inches deep, 39 inches high. Has two drawers, shelf and hanging storage space. Cabinet and drawer construction simplified. 2 patterns. \$1.00

A Genuine Professional-Like Job With Any Pattern You Choose

FULL PURCHASE PRICE REFUNDED ON ANY PATTERN THAT DOES NOT PLEASE YOU

Each pattern lists the materials needed and shows you what type and size of lumber to choose. Then you lay the patterns on this lumber, trace, saw, smooth edges and put the pieces together. It's as easy as that, for every nail, screw, bolt, dowel and joint to be glued, is located for you on the pattern. You can't go wrong. You can't make a mistake.

If you can use a hammer and a saw and other simple tools, you can do a genuine professional-like job with any pattern you choose. What's more you'll get a lot of fun and personal satisfaction making good-to-look-at and useful things and save more money than you spend.



Love Seat

No. 114. Beautify your home with this smartly designed, comfortable love seat. A truly fine piece of furniture you can be proud to own. Modernized Lawson style goes well with either modern or traditional furnishings. 48 inches between arms. 21 inches deep. Overall, 55½ x 29 inches. Upholstery is new Sagless type wire springs with foam rubber padding. Your choice of covering material. 2 patterns in set. \$1.00

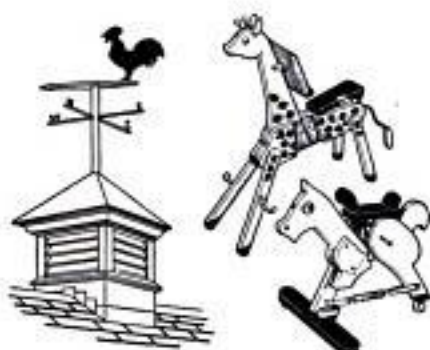

Cupola and Weathervane

No. 107. Design and style that invites use on home in town, on farm, or on garage or other smaller building. Cupola is 24 x 24 inches. 34 inches high plus height of weathervane, which can be made of metal or tempered hardboard. 1 pattern. 50 cents



Sofa Bed

No. 113. A full size sofa by day and a comfortable bed for one by night. Sagless type wire springs built-in. Uses standard size 4½ inch, foam rubber or other mattress. Removable bolster. Overall size 78¾ x 29¾ inches. Height 33 inches. 2 patterns in set. \$1.00



Valances and Trims

No. 109. Add charm and beauty to your home quickly and inexpensively with these drapery valance designs and other attractive designs for interior use around windows, cabinets, between wall cabinets in kitchen, etc. and for exterior use on porches, gables, etc. Merely trace patterns on the wood, saw to traced lines and then assemble. Finishing suggestions are included. Adjustable for various widths and lengths. 12 designs on 1 pattern. 50 cents

Toys for the Children

No. 105. The "Giraffe Drawing Board" with board mounted on the long neck and adjustable seat. "Bucking Bronco" the riding toy with delightful action. Patterns include assembly instructions and painting suggestions. Both on one pattern. Build these for your children today. 50 cents

Order by Number or Use the Coupon

Select from this listing of the first 14 sets of Popular Mechanics full size patterns. Every article shown has actually been built from one of the patterns. Every pattern has been proven for design, correct fit of parts and construction details and is guaranteed to please you or the full purchase price will be refunded. Order on handy coupon.

Order Blank for Popular Mechanics Patterns

Popular Mechanics Press • 200 E. Ontario St. • Chicago 11 MS-1

Send at once. Popular Mechanics Full Size Patterns as indicated below. Remittance for \$_____ enclosed. Send postpaid. I understand that any pattern which does not please me may be returned within 7 days for full refund of purchase price.

___Crusette, Utility Outboard (101)	\$2.00	___Personal Work Bench (108)	\$1.00
___Trundle Beds (102)	1.50	___Valances and Trims (109)	50c
___Modern Cocktail Table (103)	50c	___Decorative Wall Shelves (110)	50c
___Modern Step Table (104)	50c	___TV Chair (111)	1.00
___Toys for Children (105)	50c	___Modern Tub Chair (112)	1.00
___Juvenile Chest Robe (106)	1.00	___Sofa Bed (113)	1.50
___Cupola and Weathervane (107)	50c	___Love Seat (114)	1.50



CRUSETTE

12 Foot Utility Outboard

No. 101. Build this sturdy 12-foot utility outboard at amazing savings using only ordinary hand tools. Previous experience is not necessary. A fine seaworthy craft, ideal for fishing, family outings and other general utility uses. Length 12 feet. Beam 4½ feet. Complete material list and step-by-step instructions included. 4 patterns in set. \$2.00

Name _____
Address _____
City _____ State _____

BUILD 15 RADIOS

AT HOME

With the New Improved 1955 Progressive Radio "EDU-KIT"

ONLY \$19.95

NOW INCLUDES

HIGH FIDELITY, SIGNAL TRACER, CODE OSCILLATOR

- Attractively Gift Packed
- Free Soldering Iron
- Absolutely No Knowledge of Radio Necessary
- No Additional Parts Needed
- Excellent Background For Television
- 10-Day Money-Back Guarantee
- School Inquiries Invited
- Sold in 79 Countries



Complete

WHAT THE PROGRESSIVE RADIO "EDU-KIT" OFFERS YOU

The "Edu-Kit" offers you a Home Radio Technician Course at a rock-bottom price. You will learn how to identify Radio Symbols and Diagrams; how to build radios, using regular radio schematics; how to wire and solder in a professional manner. You will learn how to operate Receivers, Transmitters, and Audio Amplifiers. You will learn how to service and trouble-shoot radios. You will learn code. You will receive training for F.C.C. license. In brief, you will receive a practical basic education in Radio, worth many times the small price you pay.

THE KIT FOR EVERYONE

It is not necessary that you have even the slightest background in science or radio. The "Edu-Kit" is used by young and old; by radio schools and clubs; by Armed Forces personnel and Veterans for training and rehabilitation. No instructor is required. Instructions are complete, simple and clear. You cannot make a mistake.

PROGRESSIVE TEACHING METHOD

The "Edu-Kit" uses the principle of "Learn by Doing." Therefore you will build radios, perform jobs, and conduct experiments to illustrate the principles which you learn. You begin by learning the function and theory of each of the radio parts. Then you build a simple radio. Gradually, in a progressive manner, you will find yourself constructing more advanced multi-tube radio sets, and doing work like a professional Radio Technician. The "Edu-Kit" Instruction Books are exceedingly clear in their explanations, photographs and diagrams. These sets operate on 105-125 V. AC/DC. Adapter for 210-250 V. AC/DC available.

The Progressive Radio "EDU-KIT" is Complete

You will receive every part necessary to build fifteen different radio sets. Our kits contain tubes, tube sockets, chassis, variable condensers, electrolytic condensers, mica condensers, paper condensers, resistors, line cords, selenium rectifiers, tie strips, coils, hardware, tubing, Instruction Manuals, etc. A soldering iron is included, as well as an Electrical and Radio Tester. Complete, easy-to-follow instructions are provided. In addition, the "Edu-Kit" now contains lessons for servicing with the Progressive Signal Tracer, F.C.C. instructions, quizzes, High Fidelity. The "Edu-Kit" is a complete radio course, down to the smallest detail.

TROUBLE-SHOOTING LESSONS

Trouble-shooting and servicing are included. You will be taught to recognize and repair troubles. You will build and learn to operate a professional Signal Tracer. You receive an Electrical and Radio Tester, and learn to use it for radio repairs. While you are learning in this practical way, you will be able to do many a repair job for your neighbors and friends and charge fees which will far exceed the cost of the "Edu-Kit." Our Consultation Service will help you with any technical problems which you may have.

FREE EXTRAS

- Electrical & Radio Tester • Electric Soldering Iron • TV Book
- Radio Trouble-Shooting Guide • Consultation Service • Quizzes
- F.C.C. Training

PROGRESSIVE "EDU-KITS" INC.

497 Union Ave., Brooklyn 11, N. Y.

MAIL TODAY—Order shipped same day received. 10-Day Money-Back Guarantee. INCLUDE ALL FREE EXTRAS.

- RUSH ME the Following—Include all Free Extras:
- "EDU-KIT" Postpaid, I enclose full payment of \$19.95
 - "EDU-KIT" COD—I will pay \$19.95 plus postage
 - Outside USA: "Edu-Kit" Postpaid, Enclose full payment \$20.95
 - Outside USA: 210-250V. AC/DC Adapter, Enclose \$2.50
- More details on "EDU-KIT" Free—No Obligation
FREE Radio-TV Servicing Literature. No Obligation

NAME _____

ADDRESS _____

PROGRESSIVE "EDU-KITS" INC.

497 Union Ave. Dept. PM-524 Brooklyn 11, N. Y.

READY CUT HOMES

\$2150 AND UP
Freight paid. Save up to \$1000 on production method. More compared with builders' prices. Anyone can assemble with simple plans furnished. Complete, including paint, hardware, roofing, glass, nails, etc. Send 25c in coin for full color catalog, 57 modern low priced homes and floor plans. Complete building plans ready for filing at low cost. Sold separately if desired. Five Easy Payment Plans including monthly payments.



NEW COLOR CATALOG FOR ONLY 25c

INTERNATIONAL MILL & TIMBER CO., Bay City, Mich., Dept. PM 124

NO TANKS USED
NEW SIMPLIFIED METHOD
SUCCESS IN THE
ELECTROPLATING
BUSINESS

ELECTROPLATE

ANY OBJECT IN HOME SHOP, GARAGE OR START YOUR OWN WELL PAYING ELECTROPLATING BUSINESS



NOW, using NEW plating kit.

It's easy to electroplate any object. Complete kit and instructions on plating metal and non-metal objects, with nickel, copper, chrome, gold, etc., plus full data on obtaining all the business you desire and make BIG MONEY full or spare time. ONLY \$5.95. SEND NO MONEY—everything sent C.O.D. plus postage—OR send \$1.35 now and receive it postpaid. Money back in 7 days if not satisfied.

M. Z. SALES CO., Dept. PM-8, 113 W. 42 St., New York 36, N. Y.

ENGINEERING DEGREE IN 27 MONTHS

INDIANA TECHNICAL COLLEGE

B. S. DEGREE, Aeronautical, Chemical, Civil, Electrical, Mechanical and Radio Engineering (inc. TV and Electronics), Drafting, I. Y. Gov't. approved. Low rate. Earns board. Large industrial center. Students from 48 states, 21 countries. Demand for graduates. Enter December, March, June, September. Write for catalog, 1612 E. Washington Boulevard, Fort Wayne 2, Indiana.

Catalog of Popular Educational Materials

Packed with over 1,200 self-help, home educational items. Make your life more fun, more profitable, and more interesting. Covers hobbies, vocational guidance, aptitude tests, wall charts and maps, consumer guidance, travel, foreign languages, public affairs, slides, records, science materials, pocket books on everything from Art to Zoology, etc. Catalog 10c.

WORLD OF ADVENTURE, Department 116, Ann Arbor, Michigan

MONEY in DONUTS

Make new grouseless donuts. Start in kitchen. No smoke. Sell stores, Cash daily. No experience necessary. Free recipes. No obligation. Write! MARTIN RAY CO., 3605 SO. 15th AVENUE, MINNEAPOLIS 7, MINN.



MINIATURE ENGINES

GASOLINE — STEAM

BUILD THEM YOURSELF—IN YOUR OWN SHOP WITH YOUR OWN TOOLS

Anyone with a 6" or 10" lathe and a drill press can make them.

Send for Free Illustrated Catalog of Miniature Engine Castings and Drawings

OPTURA MODELS
P.O. BOX 536-F PARK RIDGE, ILL.

GROW ORCHIDS AT HOME

BIG PROFITS!! SPARE—FULL TIME

World's most thrilling hobby—profitable home business. Single Orchid plant may multiply into many—each as valuable as the first. Successful home grower shows you how! Raise gorgeous Cattleyas, Cymbidiums, Epidendrums, on living-room table. Big-profit orders come from friends, neighbors, florists, etc.—also Mail Orders. Illustrated secrets of the experts in simple "show-how" language AND blooming-size Orchid plants sent at NO RISK. Everything you need to start—for pleasure or profit. FREE—full details—SEND NO MONEY. Write today. TROPICAL FLOWERLAND, Dept. 31C, 4622 Wilshire Blvd., Los Angeles 5, California



**WORLD'S
BEST
WANT-AD
MEDIUM**

CLASSIFIED ADVERTISEMENTS



Advertisements in this section \$1.00 per word, each insertion, minimum 10 words, payable in advance.
To be inserted under proper classification, copy must be in our office the
20th of the second month preceding date of issue
F. W. Johnson, Manager, Classified Advertising
Popular Mechanics Magazine, 200 East Ontario Street, Chicago 11, Illinois

YOU'LL PROFIT

By reading and answering the classified ads in this section. Hundreds of opportunities for you to make and save money

AUTOMOBILES. MIDGET CARS

1934 DISTRIBUTOR Superignition. Starting, pep, mileage. \$5.50. EG, Elmsford, N. Y. Dealers.

FREE Motor magazines; automobile literature, old, new and foreign; glossy photos, dealer books, shop manuals, offered with non-profit organization. Write today; get on free mailing list. Auto Maniacs, Stockbridge, Mich.

BUILD Midget auto. Complete drawings, pictures and list of parts \$1.00. Lee's Midget Autos, Box 82, Avila, California.

RACING, Rodding, restyling requirements! Al Price's "Speed Shangri-La," 64 Afton, PM-112, Rochester 12, N. Y.

CLYMER New books just out. 1954 Indianapolis "500" race, 400 illustrations, technical data, full race history, \$1.50—Clymer latest Historical Scrapbook (Early Auto Equipment) includes 1000 illustrations of once famous auto supplies, gadgets, parts, includes Model T. Humorous, educational, \$1.50—Cars of the Stars and Movie Memories is Clymer's latest antique automobile book, shows famous fabulous cars of early movie stars and historical movie sets. Educational and humorous, \$2.50. Car-Toons, new book of auto cartoons, laughs and gags, \$1.00. Complete instruction manuals, 1909 Packard, \$1.50; Chevrolet Manual includes early "490," Superior and Chevrolet V-8 models, \$1.50; Cord Front-Drive with Lycoming 8 engine, \$1.50; 1914 Cadillac, \$1.50. These instruction manuals are priceless and collectors' items, giving tremendous information. Golden Anniversary Album of Famous Cars, includes complete history of Ford, Cadillac, Nash and Willys, also 100 year Studebaker history. This historical album is chock full of photographs and company histories throughout the fifty years of five famous pioneers, \$2.00. All prices postpaid. Catalog free. Floyd Clymer, Dept. A, 1260 S. Alvarado, Los Angeles, Calif.

JEEP Owners—V8 conversion kits—Read "Hoosier Machine Products" Ad. Page 51.

WORLD'S Largest supplier hi-mileage speed equipment. Thousands of items to help double the power, mileage, speed of your car. Amazing fuel savers. Complete customizing parts. Thick photo-catalogue 25c. (Literature free.) Write today. Newhouse Automotive Stores, Los Angeles 22.

AUTO SUPPLIES AND EQUIPMENT

CAR Burning oil? Losing compression? Try Clifford's Compression Seal. \$2 postpaid. Clifford's Engineering, 1329 Seventh, Aurora, Illinois.

NEW And used parts at savings. Complete guaranteed parts service for all models cars and trucks—1924 and later. Largest in the West. Army parts specialists. No catalog, write for quotations. Fast mail order service. Pioneer Auto and Truck Parts Co., 734 W. 13th Avenue, Denver, Colorado.

FREE Literature. Garage door operator easily made with your motor. Economical. Best Tools Inc., Box 92, Berwyn, Illinois.

TAPPET Noises in Fords, Chevrolets and Mercurys stopped with Kaye Tappet Silencers. Free literature. Kaye Products, 2067B S. Layton Blvd., Milwaukee 15, Wis.

ELECTROPLATE Auto parts, novelties, mirrors. Easy, inexpensive home processes. Free booklet. Tyco Metals, Box 13231-BG, Houston 19, Texas.

BRUSH Plating outfits connect to a battery. No tanks or shop required. Free particulars. Gunmetal Co., Ave. J., Decatur, Ill.

AUTO Accessory and parts catalog, 1955 edition—all new! 148 pages. Save up to 50% over 50,000 items, including Hollywood accessories, hi-speed equipment, rebuilt engines, all parts and accessories for all cars and trucks! Hard-to-get parts! Send 25c (refundable). J. C. Whitney, 1919-PM Archer, Chicago 16, Illinois.

BE Safe with Safety Span easy to use on rear view mirror, a safety device for your automobile, tell at a glance distance car is behind you, only \$1.00. Libjo Inc., 9725 Beach Blvd., Jacksonville, Fla.

SPEED Equipment. Any car. Send year, make, and \$1.00 for full particulars. Refundable with purchase. Power, 327 West 117th, Hawthorne, California.

AUTO Radios wholesale. Deluxe custom Studebaker, Hudson, Kaiser \$57.51 including serial. Literature. Cherry Radio, 1438 Belfield Ave., Philadelphia 40, Penna.

FOR A better motor longer, use Lachapelle's 100,000 miles treatment. Ferns, Box 71827-B, Los Angeles 1, Calif. Free data.

END Oil changing! Refine your oil as you drive! Refinol antiquates all other oil filters. Free booklet on saving your car or tractor motor. International Refinol Company, 8848 W. 47th, Brookfield, Ill. "Chicago's technical suburb."

MECHANICS' Illuminated inspection mirror, \$1.25. She'll want one, too! Electronics, Box 46, Frankfort, Indiana.

WINDSHIELD Wiper cable repair kits. Most cars use cables. Does job costing \$7.00. Dealers wanted. Mail \$1.00. Ark, Box 24, Kingston, N. Y.

BUY Wholesale nationally advertised auto supply, thousands other products at big discount. Free "Wholesale Plan," American Buyers', 629-DD Linden, Buffalo 16, New York.

TIRES—First quality, lifetime guarantee. Unbelievable discounts. Free catalog. American Tire Co., 153 Truman, New Haven, Conn.

LATEST Custom accessories. Items not in stores. New low prices. Push button doors, trunks, windows, etc. New illustrated catalog, biggest ever. 25c. Eastern Auto, 3319-A, South Grand, Los Angeles 7, California.

THUNDERBOLT Ignition unit boosts motor power, saves gas. Slips on distributor in 10 seconds. \$2.98 postpaid. Money-back guarantee. Free literature. Auto Products, 723 W. North Avenue, Baltimore 17, Maryland.

GANE Air-flow needle increases gas mileage. Write for free trial. Gane, 191 E. Tremont, Pasadena 3, California.

FORD-T Parts. Most complete stock in U.S. for all old cars. Try to stump us. B. S. Wisneski, Milwaukee 7, Wisconsin.

THIEF Chaser—Protect your car, tires and accessories from theft. 20 year guarantee. Free wholesale catalog. Salesmen wanted. Novak Company, 3131 West 13th, Gary 112, Indiana.

SELL Magic concentrate. Makes quick acting safe wsw tire cleaner, or excellent liquid soap. Reduces costs drastically. Sample \$1.00. Motor conditioner, more snap, pep, go. Three \$1.00 treatments \$2.00. Kar-Kleen Products, Box 629, Jacksonville Beach, Fla.

SWITCH Attachment, auto door light switches. Insures privacy night driving, drive-in theatres, restaurants, hunting, fishing. \$1 postpaid. Deactivator, Anderson, S. C.

GENUINE Motor treatment, Lachapelle's, (patented). Only \$3.00 delivered. Improves compression, power. Saves gas, oil, repairs. Money back guarantee. You can't lose. Free circular. Write Joe Dillon, Authorized Warehouse and Agents Distributor, Box 323-4 Bridgeport, Ohio. Exclusive distributorships, agencies open.

SENSATIONAL Send-no-money free trial bargain offers! Try famous Gale Hall engineering automotive instruments for seven days, then send payment or return merchandise! \$10.75 Testmaster compression tester, only \$3.98! \$11.70 engine analysis vacuum gauge and fuel pump tester, 5", only \$4.55! (3 1/2", formerly \$8.10, now \$3.98!) Mile-O-Meters: \$9.75 standard, now \$4.55! (Illuminated, \$4.98!) \$14.75 deluxe, now \$6.98! (Illuminated, \$7.55!) Write today. Supply limited! (Add 40c postage to each price.) New England Surplus Sales, Dept. PM-12, Newburyport, Mass.

KWIK-Start Co. system starts cars faster. 6000 No. Menard, Chicago 30, Ill.

NOW You can get the amazing gasoline additive, Tri Cresyl Phosphate, you read about in Reader's Digest. Concentrated, with a startling de-moisturizing agent, it zooms your car's power. Gives you faster get-away, quicker starting. Reduces engine wear. Prevents excessive carbon and corrosion. Helps eliminate frozen gas lines. Doubles spark plug life. Sky-rockets performance of "regular" gas, 10-day money-back guarantee. Enough to "powerize" 100 gals. only \$2.95. Sorry no c.o.d.'s. Mail your order today to: Power Research, 32 Hawthorne Drive, Decatur, Illinois.

FREE Air-water boosts mileage 20%. Avoid costly gadgets! Investigate treatise revealing principles, diagrams, inexpensive applications. Positive results. \$1.00. Hydrojection, Box 123, Copiague, N. Y.

BOTHERED By bright lights in your rear view mirror? Order Reflecto Brite Lite Dimmer today. Money back guarantee. Send \$1.00 for prepaid shipment. Reflecto, 232 PM, Ravenna, Ohio.

CAR Burning oil? Losing compression? Try Miracle Seal. \$2.00 ppd. Miracle Seal, M-4750 S. Central Ave., Los Angeles 11, Calif.

AUTO TRAILERS

EXCEPTIONAL Expanding eight foot trailer. Accommodates family of five. Build yourself. Literature 10c. Fra-Mar Company, Jones Avenue, Wilmington, Mass.

BUILD Your own trailer! Plans for all kinds. Illustrated catalog 10c. Jim Dobby, 125-M. Wausau, Wisconsin.

ASSEMBLE Yourself kit. Slip-on cabin coach for pickups. Trailer blueprints. Literature 10c. Comstock Trailers, 545-P, Parsons, Kansas.

AIRPLANE Wheels, tires, tubes; new, used. Write for free list and prices. Chris Stoltzfus, Box 470, Coatesville, Penna.

MOTORCYCLES, BICYCLES, MOTORSCOOTERS AND SUPPLIES

RECONDITIONED Motorcycles and motors. Chromium accessories. Complete stock Indian parts. Expert rebuilding. Fast service. Indian Motorcycle Sales, Kansas City 27, Mo.

"BUZZZZ" The motorcycle magazine. International coverage. Thoroughly illustrated. Yearly \$2.00. Sample 25c. 5424-A Sawyer, Chicago 25.

1949 **SERVICYCLE** \$15. Midget car \$25. Maytag twin engine \$5. Four tires for \$3. Send 25c for new Directory Number 62. Just out, listing these and hundreds of other bargains in motorscooters, midget cars, homebuilders parts, plans, engines, etc. (35c by First Class Mail.) Midget Motors Directory, Athens, Ohio.

REBUILT Bicycle or motorscooter engines. \$17.00 up. Send \$1.00 for catalogs. Cauffiel Motors, Temperance, Michigan.

MOTORBIKE Enthusiasts! Now you can convert your bicycle into a powerful 60 m.p.h. motorbike for \$19.00 complete. (No dismantling.) Simply clamp on bicycle. (Motorcycle style.) Complete instructions \$1.00. Instructions and drawings \$2.00 postpaid anywhere. J. Benzick, Jr., New Prague, Minnesota.

HARLEY-Davidsons — America's best used buys! We pay shipping on motorcycles. Genuine new, used, parts, accessories for current and obsolete models. Send 25c for bulletin, catalog. Knuth's (Harley-Davidson factory dealer). 2491 Fond du Lac, Milwaukee, Wis.

AVIATION

PROPELLERS, Plans, supplies for air boats, snow sleighs. Catalog 10c. Gano Propellers, Box 3284-A, Ft. Worth, Texas.

HELICOPTER—1 Man. Build own. Earn money. Same. Plans—\$3.00. Kerrigan Aircraft, 16325 Bramall, Detroit, Michigan.

AIRCRAFT Engines, all makes 65 to 300 hp. for snow sleds and water boats. Aircraft parts and accessories. Free list. Vestco, Box 5305 T.A., Denver, Colo.

PROPELLERS, Plans, kits for snow sleighs, air boats. Immediate delivery, satisfaction guaranteed. Catalog 25c. Banks-Maxwell, Box 3301E, Ft. Worth, Texas.

NEW And used headquarters for automotive and airplane parts and accessories. Our prices are low prices. Dee Jon's Sales Co., 2826 Kelton Avenue, West Los Angeles, California.

HELICOPTER Pulse jet plans. 6 inch diameter. \$4. Wolford, Sullivan, Ohio.

BUILD Jet helicopter. 1 man. Plans \$6.00. Rovin Engineering, 219 Lytton Ave., Pittsburgh 13, Penna.

CONFIDENTIAL Reports on best paying job openings and careers with airlines, aircraft factories, corporations, cropdusters, etc. Pilots, mechanics, all aviation specialties. Experienced and unskilled. Foreign and American. Complete satisfaction guaranteed. Only \$2.00. (Airmail \$2.25). Research Services, Box 2804-PM, St. Louis 17, Missouri.

BUILD A helicopter jet engine yourself! "Practical Ram Jet Design"—\$1.00. Decker Engine Works, Plasterco, Va.

ELECTRICAL SUPPLIES

ELECTRIC Pencil: Engraves all metals \$1.50. Beyer Mfg., 10511-H Springfield, Chicago 43.

LAMPS—25c Brings bargain catalog showing all parts for repairing, building. Contains instructions for electrifying vases, oil lamps, etc. Gyro Lamps, 5402P Clark, Chicago 40.

LEARN Appliance service. Motors, washers, refrigeration, everything. Booklet. Manager, Box 73136, Los Angeles 3.

LAMP Supplies — Wholesale. Any amounts. All parts for repairing and building lamps. Catalogue 15c. Brown Lamp Co., Box 501-Wellston Sta., St. Louis 12, Mo.

WORK Lights, extension cords, 25, 50, 100 feet. Circular free. Nassau Dropcord Co., 304 Chestnut Street, West Hempstead, N. Y.

BATTERIES, GENERATORS

EDISON Nickel storage batteries. Any voltage, any amperage. Unconditionally guaranteed. Power plants, generators, motors. Literature. Hawley Smith Co., Croton Falls 1, N. Y.

AIR CONDITIONING

AIR Conditioning systems cleaned—vacuum and steam method—commercial and industrial contracting anywhere in U.S.A. A Ventilation Cleaning Service, 469 West Willis, Detroit 1, Michigan.

WELDING, SOLDERING, PLATING

"BUILD-UR-OWN" a.c. welder and a.c. power plant with a good used engine and low cost Hobart generator. Welds anywhere and supplies 5 kw stand-by power for any emergency. Write Hobartweid, Box M-1243, Troy, Ohio.

A.C. Welders, 4 sizes. Lowest prices. Free literature. Holgeron's Serv., Canton, Kan.

ELECTROPLATING Equipment, anodes and solutions for all types of plating. Instructions. Assemble your own plater and save. Free catalog. Ramyr, Dept. E-4, 1624 East First Street, Los Angeles 33, California.

SELF-Training System. Radiator repairing, cleaning, recoring. How to equip small shop at low cost. Supply sources, trade secrets, instructions. Radiator Service, East Jordan, Mich.

WELDERS, \$29.50, \$54, \$79.50. Morris, 1070 Inner Drive, Schenectady, N. Y.

MACHINERY, TOOLS, SUPPLIES

SHEBEL Saw filer files all saws. Circular. A. P. Shebel, 730 So. 2nd St., Milwaukee 4, Wis.

ALL Steel woodworking lathe, 5 x 12, \$9.95 prepaid. Circular. Sypher Co., 210 Cherry, Toledo, Ohio.

ALLEN One ton power bench type punch press. \$97.50. Circular. Allen, Dept. PMB, Clinton, Missouri.

\$16.50 PRECISION 2" Three jaw universal chuck with #2 Morse taper arbor. Key \$8.95 prepaid. Ideal for turning-headstock, tailstock, turrets. For button dies. Guaranteed. Prehler Company, 1625 Milwaukee, Chicago 47.

COMPLETE Home shop woodworking machinery. Free bulletin. Paul Kornau, 6503 Hamilton Ave., Cincinnati 24, Ohio.

BUY Surplus machinery, tools, boats, trucks, etc., from government. List \$1.00. Box US213, East Hartford 8, Conn.

MICROMETERS Cleaned, oiled, adjusted, calibrated; factory expert, \$2.00 cash. Dundon, 925 Pomeroy, Kalamazoo, Mich.

18 CADMIUM Machine screws, lock-washers, nuts, for 50c. 4/40; 6/32; 1/4" and 1/2". Duszak Products, Box 1702, Wilmington, Del.

ACETYLENE Welding outfits, new \$49.00, used \$29.00; arcwelders \$49.50. Eagle Welding Dept. PM, 5085 Broadway, Chicago 40, Ill.

SPECIAL Tools for woodworking machines. Free lists. Dixieing, 7301-A N.W. 10th Ave., Miami 36, Florida.

CARBIDE 3/8 Sq. tool (V or broadnose) \$1.00. Carbide 3/8 masonry drill \$1.00. Postpaid. Any 6, \$5.00. Other sizes. Tools, 319 Loma Ave., Syracuse, N. Y.

NEW Hand tool pulls 6000 pounds. Free literature. Multi-Use Puller, Box 971-N, Uptown, Hoboken, New Jersey.

TAPPO Chuck wrench, drill press attachment, assures precision hand-tapping, reaming. Fits 6A-33 key style chucks. \$3.75 postpaid. Gilbert Manufacturing Co., 139-P Riverview Ave., Elkhart, Indiana.

IMPORTED Tools. Xmas holiday specials. Micrometers \$5.99 each, vernier calipers with scale for 1/128" and 1/10 mm. only \$5.88. Bakalich, 4510 Rodeo Road, Los Angeles 16, Calif.

SAVE Up to 1/3 home shop tools, sporting goods. Raymon Roush, Hongland, Ind.

CARBIDE Tipped scriber, \$1.00 post paid. Money back guarantee. Box 417, Royal Oak, Mich.

TOOL Post: Turns thousands of different size concave, convex radii 0" to 4". No special tools to grind. Radius Tool, Box 476, Wellston 12, Mo.

MAGNETIZED Set, 6 quality screwdrivers. Grand gift. Only \$2.00. Tool Sales Co., 441 Ethel Ave., Grand Rapids 6, Mich.

ELECTRO-Pen, easy to make plans \$1.25. writes any metal, operates on toy transformer, car battery. Remie, 2946 Tyburn, Los Angeles 39, Calif.

BUILD Your own hydraulics. Plan with essential hydraulic information and catalog listing hydraulic-kits, motors, welders, surplus items, etc. 10c. Dunbar Mfg., Box 12206-B, Houston 17, Texas.

BIG Factory catalog! Buy direct—Save middleman's profits; hundreds of labor saving tools and equipment; tremendous savings. Send 10c. Master Mechanic Mfg., Dept. CL-53, Burlington, Wis.

ENGINES, MOTORS, DYNAMOS

REBUILT 1 1/2 To 3 h.p. engines \$17.00 to \$37.00. Cauffiel Motors, Temperance, Michigan.

WINDING Data, 225 motors, single and three phase, \$1.00. Data Company, Box 7631, Kansas City 26, Mo.

A.C. Generators, 750 watt \$38.50. Twin cylinder compressors with 1/2 horse \$22.50. Motors, 1 horse \$37.50. Butler, 1885 Milwaukee, Chicago 47.

BOATS, OUTBOARD MOTORS

BOAT Patterns. Literature and illustrated boat construction book \$1.00. German Boat Company, West Saginaw, Mich.

FIBERGLASS Repair kits, \$1.00 and \$2.75. Repairs wood, fiberglass boats. Cover 8 foot pram for \$9.95. Free estimate for your boat. Ace Plastics, Box #204, Lockland, Ohio.

FIBERGLASS Top marine grade. Yard or kit. Ontario Fiberglass Co., Ontario, N. Y.

BUY Wholesale nationally advertised outboards, thousands other products at big discount. Free "Wholesale Plan." American Buyers', 628-DD Linden, Buffalo 26, New York.

58 DESIGNS, Catalog 25c. Kit, hardware catalog 15c. Marinecrafts, 55-M Sorrento, Allston, Mass.

PLYWOOD Boat plans, 21 for \$1.00. Catalog boat building plans 25c. The Rudder, 15 Murray Street, New York 7.

AIRPLANE Engines, all makes 65 to 300 h.p., for air boats, snow sleighs; complete power package, test run, ready to install. Write for descriptive list and prices. Chris Stoltzfus, Box 470, Coatesville, Penna.

SIMPLIFIED, Modern plans and patterns. Inboards and outboards 12' to 22'. Please state type. Glen Designs, Box 568, Compton, California.

SEA Legs boat kits, prices from \$39.00. Complete kits, including brass wood screws, pre-cut parts, pre-assembled frames, fool-proof illustrated instructions. Write for free literature. Penny Woodcraft Industries, Dept. C-31, Defiance, Ohio.

MARINE Conversions for Ford and Jeep engines. Catalog 10c. Lehman Manufacturing Company, 972D Broad Street, Newark 2, New Jersey.

NEW, Used, rebuilt marine motors. Marine conversions, fittings. Free catalog. Stokes Marine Supply, Dept. 24, Goldwater, Michigan.

BUILD Marine engines with Federal conversion kits. Federal Marine Motors, 9011 Cottage Grove Ave., Chicago 19, Illinois.

FREE Catalog! Boat kits, trailers, fiberglass, marine hardware. Luger Industries, Dept. KD, 3207 Fremont South, Minneapolis, Minnesota.

CONVERT Fords and Jeeps to 100% marine engines with Osco's world famous Convo-Kits. Deluxe catalogue 25c (contn). Oscomotors, 3627B Lawrence, Philadelphia 40, Penna.

AIR Boat plans, supplies, catalog 25c. Banks-Maxwell, Box 3301F, Ft. Worth, Texas.

BOAT Covers, custom and ready made. Also tarpaulins, canvas yard goods, life preservers. Free boat cover catalogue. Morsan, 10-40R 50th Avenue, Long Island City 1, N. Y.

FULL Size, cut-to-shape boat patterns, blueprints, 7½-38 feet. New 1954 illustrated "Build a Boat" catalog of 50 naval architect-designed cruisers, runabouts, sloops, skiffs, outboard boats, sailing, racing, houseboats, 50c. Marine hardware catalog, \$1.50. Bigger, better 1954 "How to Build Boats" book, \$2.50. PolyWog Houseboat Plans, \$12. Cleveland Boat Blueprint Co., Dept. A-66, 9400 Steinway, Cleveland 4, Ohio.

ATHLETIC EQUIPMENT, BODY BUILDING COURSES

BARBELLS. Exercise equipment. Courses. Free booklet. Good Barbell Co., Reading, Penna.

SPORTING GOODS, GUNS, FISHING TACKLE, ARCHERY, TRAPPING

BIG Gunsmith catalog, 48 pages just out! 1001 tools make ideal Christmas gifts for amateurs and professionals. Moderate prices. Mail 25c postage today. Frank Mittermeier, Est. 1936, 3577 E. Tremont, Dept. P, Bronx 65, New York.

FOR Christmas an original Thompson fly-tying kit, \$12.50. Catalog available 10c. D. H. Thompson, 335 Walnut Avenue, Elgin, Illinois.

MOLDS—For making fishermen's sinkers. Free illustrated booklet. Reading Instrument Co., Box 76, Reading, Penna.

DELUXE Cleaning service on suede and leather jackets. Expert repairing. Free price list. Write Ed Roper, New Idea Cleaners, Coatesville, Penna.

100 GOOD Fishing spots in Canada. \$1.00. Box 247, Terminal A, Toronto, Canada.

OLD Guns. Current prices. Free catalog. Pioneer Books, Harriman, Tennessee.

BARGAIN List—Guns, toys, cameras. Jacken, 1136 West 7th, Plainfield, N. J.

BUY Wholesale nationally advertised sporting goods, thousands other products at big discount. Free "Wholesale Plan." American Buyers', 627-DD Linden, Buffalo 16, N. Y.

FREE Fishing catalog—132 pages. Over 3000 hard to find fishing specialties. Net-craft Company, Dept. PM12, Toledo 13, Ohio.

AIR Mattresses, sleeping bags, tents (direct from manufacturer), camping equipment. Low prices. Send 10c for 72 page illustrated tent-camping equipment-tent maintenance catalogue. Mor-San Sales, 10-21R 50th Avenue, Long Island City 1, New York.

GUNSMITH'S Magic bluer. Easy to apply, no special equipment required, \$1 postpaid. Send for free gun, reloading supplies, archery and binocular catalogue No. 5. Gun Shop, Baker, Oregon.

2000 GUNS! Guns! Merry Christmas! Hunters, shooters, collectors. All guns and accessories. Bargain catalog 50c. Agramonte, 201 Warburton, Yonkers 2G, N. Y.

5000 BARGAINS. Firearms, binoculars, war relics. Catalog 50c. Smith Firearms, Rummelde, N. J.

180 PROFUSELY Illustrated pages antique pistols, swords, daggers, armor, etc. 50c. Robert Abels, M860 Lexington Ave., New York 31.

MANY Modern, antique guns. List 10c coin. Ed Howe, 52 Main, Coopers Mills, Maine.

JAP Rifle altering to 30-06, \$6.00. Jap-shells, \$3.75. Catalog 5c. T. P. Shop, West Branch 11, Mich.

PORTABLE Blinds: For duck, crow, goose shooting. Very light 4 x 5 ft. woven natural Tule mats. Strong. Excellent on duck boats and permanent blinds too! \$3.00 delivered. Peacock Broom Co., 915 Bryant St., San Francisco, Calif.

IMPORTED, Daggers, stiletos, throwing, pocket, hunting knives, etc. Free catalog. J. D. Clinton, 94 Church, Mt. Clemens 2, Michigan.

CALL Elk, deer, coyotes, foxes, etc. Original Animal Calls. Burley, Idaho.

MOLDS For fisherman's sinkers, jigs, squids, casting and spinning lures. Free catalog. Sweet's Molds, Tonawanda 1, New York.

TAXIDERMY

MODERN Taxidermist magazine, Greenfield Center 2, N. Y. Devoted entirely to taxidermy, methods, photos. Trial year's subscription, \$1.00.

BINOCULARS, TELESCOPES, MICROSCOPES, MAGNIFIERS

LOWEST Prices all sizes binoculars, telescopes, microscopes. Free catalogue. Joe's Binocular Sales, 4827 Second Blvd., Detroit 1, Michigan.

SAVE 25%! Get interesting facts. Free 52 page binocular, telescope catalog, \$3.95 to \$250.00! United, 9043 S. Western, A-7008, Chicago 20. Dealers wanted.

DYNASCOPE—New sensational reflector telescope 65X, 130X, 167X, 4 power finder fully achromatic, hardwood folding tripod, complete ready for use. Send for details. Criterion Manufacturing, Dept. DP7, Hartford, Conn.

IMPORTERS' Amazing prices, precision binoculars, 22 models. Free trial. Folder, "Binocular Selecting," catalog free. Dealers wanted. Prentiss Importers, Mercury Bldg., West Los Angeles 25, Calif.

40X, 100X, 200X, 400X Telescope easily made. Perfect lenses and instructions \$3.00. H. Jamer, Manorville, N. Y.

400X TELESCOPE Makers kit contains focusing tube, erector, 5 lenses and instructions, \$3.75. Giant 100X astronomical telescope complete with tripod, \$15.00. Free information. Suffolk Science, Mattituck 3, N. Y.

SPECIALISTS, Used microscopes and accessories. Unusual selection prepared slides. Microscopy supplies. Scientific oddities. Telescopes and equipment. Many more interesting items. See them in our 1955 illustrated catalog, free. Research Scientific Supplies Inc., 60 Wall Street, New York 5, N. Y.

MICROSCOPE Slides, 15/\$5.95 postpaid, plant, animal, quality guaranteed. Lake-side Biological Products, Ripon, Wisconsin.

REFLECTOR Telescope kits from \$6.25. Mirrors and mirror cells, diagonals, focusing mounts, tripods, tubing, oculars. Fully guaranteed. Free illustrated catalog. Visit our store 166 Church St., New York, N. Y. Send orders and inquiries to Esco Products, Dept. PM-7, 1428 Willow Avenue, Hoboken, N. J.

WAR Surplus bargains! Million of lenses, instruments, telescopes, binoculars, components! World's greatest optical market place! Send only \$1.00 for beginner's 10-lens kit and big instruction booklet Stock CH. Write for catalog CH free! Edmund Scientific Corp., Barrington, New Jersey.

TELESCOPES—8" Refractor. Many others. Rasmussen-Reece, Amsterdam, N. Y.

MICROSCOPES, Prepared slides, biological stains, oculars, illuminators, mechanical stages, objectives, mounting media, parts, specialized equipment. Premium quality merchandise, lowest prices anywhere. Write for free illustrated microscope catalog and price list. Benjamin Miller, 134 W. 32nd St., Rm. 204-A, New York 1, N. Y.

TELESCOPES, Microscopes, binoculars for quarter century. Big bargain scientific catalog 10c. Harry Ross, 70 West Broadway, New York 1, N. Y.

REFLECTING Telescopes, 60X, completely assembled \$29.75. Guaranteed observatory clearness. Free information. Skyscope, 475 Fifth Avenue, New York 17.

MAKE 6" Telescope reflector. Glass, abrasives, instructions—\$10.50. P. Cameron, Box 65, Inwood 96, N. Y.

PETS—DOGS, BIRDS, RABBITS, HAMSTERS, ETC.

MAKE Money raising chinchillas, mink, pigeons, rabbits, cavies for us. Free catalog. Keeney Brothers, New Freedom 2, Penna.

CHINCHILLAS (No rabbit.) Easily raised anywhere. Profitable. Big future. Terms. Hibner Chinchillas, Ithaca, Mich.

RAISE Mink; Free booklet, pen plans, inside secrets, feed care. Mink are money makers. Investigate today. Lawrence Mould, Brigham City 12, Utah.

RAISE Moneymaking Angora, New Zealand rabbits. Particulars free. White's Rabbitry, Jackson, Mich.

MAKE Big money! Raise Chinchillas rabbits. Cash markets supplied. Write today! Rockhill Ranch, Sellersville 15, Penna.

FOR Sale: A few outstanding coon-hounds, beagle, and rabbithounds. Prices from \$15.00 to \$40.00. Free literature. Trial. Dures Thomas, Box 288, Albertville, Alabama.

STANDARD Rabbit Journal, Milton 3, Penna. Year \$1.00. Sample dime. Beginners manual 25c.

GROW Mushrooms, Cellar, shed, and outdoors. Spare, full time, year round. We pay \$3.50 lb. We paid Babbitt \$4,165.00 in few weeks. Free book. Washington Mushroom Ind., Dept. 171, 2954 Admiral Way, Seattle, Washington.

MINK Raising information free. Complete. Lake Superior Mink Farm, Superior, EE1, Wisconsin.

RAISE Mink. Get yours free. Wild. We'll teach you. Information free. Wildmink, Box 324, Superior, Wis.

WEIMARANERS, St. Bernards, Boxers, Hof Kennels, 5136 Cascade Rd. S.E., Grand Rapids 6, Mich.

FREE—Dog and cat remedies, supplies, toy, catalog. Norvel, Hartford 3, Conn.

ANGORAS, Chinchillas—World's most profitable rabbits! Catalog free. Grinsteads, Edwardsville, Illinois.

HAMSTERS—Golden; young, \$4.00 pair, fully developed, \$5.00 pair. Adirondack Hamstery, Prospect 50, New York.

CHINCHILLAS: Moving necessitates selling complete herd. (2) pairs, (2) females, (2) males. Registered excellent breeding stock. Price \$950.00. Write Charles Huebsch, Clinton, Conn. Phone Clinton 6-8226.

RABBITS, Wonderful home enterprise. Booklet free. Tayco Rabbitry, Hapeville, Georgia.

RAISE "Wil" strain rabbits. Free information. Wilson's Rabbitry, Greer, South Carolina.

GUINEA Pigs. Cash markets. Booklet free. Taylors Company, Hapeville, Georgia.

MINK, Easily raised anywhere. Highest quality breeders. Free information. Huebel Minkery, LeSueur, Minnesota.

CHINCHILLAS—Registered. Guaranteed reproduction. Unbelievable prices. Far-West Chinchilla, 1446-A Jones, San Francisco 9, California.

PARAKEET Breeders Newspaper, Box 46, West Bend, Wis., \$1.50 year, sample 15c.

SAINT Bernards, Weimaraners, Boxers, Hof Kennels, 5136 Cascade Rd. S.E., Grand Rapids 6, Mich.

CHINCHILLAS—Big profits. Free literature. Tom McGowan, 170 Horton Ave., Valley Stream, L.I., N. Y.

HAMSTERS—Retail and wholesale. Prices free. Anderson's Hamstery, 35 Oneida, Pontiac, Michigan.

FARMS, FARM LANDS, REAL ESTATE

OZARK Home lands. Reasonable. Listings mailed free. Write Armstrong, Shook, Missouri.

GOVERNMENT Land where and how to buy, 25c. National Tax Service Bureau, 2520A, David Stott Bldg., Detroit, Mich.

FLORIDA—Nice homesites near Ocala national forest in Lake county. Best fishing, hunting. Low prices, easy payments. Folder free. Howard Vernor, DeLand, Florida.

FLORIDA—Beautiful retirement homesites near gulf coast. Excellent hunting, fishing in 9 fresh and salt water rivers. 11 bays and gulf, \$250 at \$10 monthly. Free literature. V. M. Mathews, Box 1406, Asheville, N. C.

HOMESITES \$400—Convenient payments. California's finest garden section. On Morro Bay's scenic shores. Wonderful fishing, boating, bathing. Fertile soil, softest water, temperate climate, congenial community. Free literature. Richard Otto, Department M, San Luis Obispo, Calif.

STROUT Catalog—Mailed free. Farms, homes, businesses, 35 states coast-to-coast, 3,357 bargains described. World's largest; 54 years' service. Strout Realty, 7-M So. Dearborn St., Chicago 3, Ill.

\$5.00 MONTHLY Buys 40 acres productive land, near town; good fishing. Price \$240.00. Box 425-P, Carthage, Mo.

FLORIDA, Lakefront homesites on Eustis-DeLand highway. Excellent fishing-hunting. \$10.00 monthly without interest. Complete price \$245.00-\$995.00. Literature. Write Roepke, Eustis, Florida.

SELLING Retirement home like rent. List free. Ferrys, Brier Hill, Penna.

FLORIDA—5 Acres high dry land near beaches, have homestead and garden. Only \$395.00, \$10.00 down, \$10.00 month. Information write G. B. Potterfield, Owner, Union Building, Department W, Charleston, West Virginia.

HOUSTON Money-maker properties — Buy beautiful guaranteed homesteads in popular southside addition, for \$345. Payable \$15 monthly, America's fastest growing city; second largest seaport. Information free. Preston Wood, Box 413, Houston, Texas.

FARM And business catalogs free! 4 big editions, Florida, Northeastern states. West's, M-12, Pittsburgh 17, Penna.

COME To Florida—Buy 10-acres in Florida's famous tung belt for \$995. Easy terms. Then let us plant your money-making tung grove. Guaranteed. Now growing hundreds beautiful groves for others. Particulars free. Wendell Wood, Fountain, Florida.

CALIFORNIA Ranch and home sites \$395. Easy terms. 100% oil rights. 10c brings catalog. Pacific Tax Sales, 1621-A Cahuenga, Hollywood 28, Calif.

PLANTS, SEEDS, NURSERY AND GARDEN SUPPLIES

MULTIFLORA Rose. The living self-repairing fence, ornament, erosion control, windbreak, snow fence, etc. Rapid grower. Raise from seed. Free planting guide, write Woodlot Seed Company, Norway 9, Mich.

INSTRUCTIONS For dwarfing plants and trees. Send \$1.00 to Trees, Box 5368, Detroit 11, Michigan.

POULTRY, FARM SUPPLIES

POULTRY Farmers, broiler growers, turkey raisers, read the new American Poultry Journal for latest ideas and greater profits. 12 months, 50c. Special offer, 4 years \$1.00. American Poultry Journal, 182 North Wabash, Chicago.

RAISE Turkeys the new way. Write for free information explaining how to make up to \$3000 in your own backyard. Address—National Turkey Institute, Dept. 3, Columbus, Kansas.

PROFITABLE OCCUPATIONS

OVERSEAS, Canadian, Latin American, Alaskan employment. Originator 1954 "Foreign Service Directory" gives up-to-minute facts on civilian and military construction, mining, oil companies, steamship lines, aviation. How-when-where to apply with application form. Free, hot list of firms hiring this month. \$1.00, Global Reports, Box 883-P, Hollywood 28, Calif.

WHOLESALE! 8000 Nationally famous products. 30-80% discounts! Large catalog. Sensational business plans included. Consolidated Distributors, 21-20 Lafayette, Paterson 15, New Jersey.

EARN \$3.50 Hour sparetime. Learn professional furniture refinishing. Repair scratches, nicks, dents, cigarette burns, chips, etc. Write Refinishing, 3800B Maple N.E., St. Petersburg, Fla.

SELL Popular Mechanics and all other magazine subscriptions. Free catalog, supplies. Subscription Service Company, Dept. B, P.O. Box 2070, Birmingham, Alabama.

BUY Wholesale thousands nationally advertised products at big discount. Free "Wholesale Plan." American Buyers', 628-R Linden, Buffalo, N. Y.

"HOW To Make Money With Simple Cartoons"—A book everyone who likes to draw should have. It is free; no obligation. Simply address Cartoonists' Exchange, Dept. 912CP, Pleasant Hill, Ohio.

FREE! "301 Profitable Small Businesses!" Amazing shoestring plans! Work home! Start sparetime! Deumant Surveys, Kenmore 23-R, N. Y.

LABOR Union leaders needed. Opportunities for well paid, satisfying positions. Home or travel expense paid. Book giving full instructions, guidance, \$1.00. Union Job Guidance Bureau, 103-PMA Erie St., Salamanca, N. Y.

CALIFORNIA Employment. California's population increasing over 400,000 per year—become part of it. Have a job waiting your arrival. Complete listings, information. \$1.00 Satisfaction guaranteed. Midcentury, Box 48461, Los Angeles 48, Calif.

LOS Angeles help wanted columns large Sunday editions air-mailed \$1.00. Corbet, 385 Walnut Ave., Long Beach, California.

OVERSEAS, Latin American, Alaska, Canada employment. Originator 1954 "Foreign Service Directory," up-to-minute report on military and civilian construction; oil companies; aviation; transportation; steamship; mining; government job info. How-when-where to apply. Listing firms hiring. \$1.00. Global Reports, Box 883-P, Hollywood 28, Calif.

FOREIGN-U. S. jobs. South America, Alaska, Spain. Fare paid. 1000's U.S. jobs to \$18,000. Trades, offices, factories. Stamped self addressed envelope brings reply. Job Opportunities, Waseca 1D, Minn.

WELDING Pays big money. Learn easily at best equipped school in country. Non-profit school with low cost training. G.I. approved. Write Hobart Trade School, Box 1242, Troy, Ohio.

MAN Wanted—Are you dissatisfied with your work? Would you like a business of your own? If so, write Rawleigh's, Dept. L-GG-PPM, Freeport, Ill.

MAILORDER Beginners instruction manual, sources, methods, opportunities, 25c. Carnahan Bros., 5580 Nelson, Cypress, Calif.

MUSHROOMS Grown boxes, barrels. Manureless process 50c. Spawn \$1.00. Gordons, 553 William, Winnipeg, Manitoba.

FLORIDA Job opportunities. Let this 24-page job guide help you plan your new life in the nation's fastest-growing state. \$1 postpaid. Satisfaction guaranteed. Florida Job Guide, Box 2061, Dept. A, Miami 12, Florida.

NEED Extra cash? Get it selling Blair's unusual line of household and food products. Every housewife a prospect. Products sent on free trial. Write Blair, Dept. 31MY-1, Lynchburg, Va.

WANT A diesel job? New opportunities to increase income. Higher pay. More money. We can help you qualify. Tools, Shop method home training. Write today! Diesel, Tractor, Heavy Equipment Division, Interstate Training Service, Dept. B-3-N, Portland 13, Oregon.

SECRET Investigation. Experience unnecessary. Investigators particulars free. George Wagoner, 125 M West 86th, New York 24.

ALASKAN Jobs! Over 150 new construction projects with names, addresses companies hiring. Thousands needed. Highest wages. Military, private construction, mining, fishing, lumbering, aviation, railroads, homesteading. Skilled, unskilled workers. Salary information. Alaskan map included. Sample application \$1.00 complete. Alaskan Opportunities (PM), Box 362, Kenmore, Washington.

FOREIGN Employment construction work. If interested in foreign projects with high pay write Foreign Service Bureau, Dept. PM, Metuchen, New Jersey.

HOME Workers needed! Spare time, full time. Assemble luggage and cases with our complete illustrated step-by-step instructions. We sell your product—Supply everything. Manufacturing representative needed in your area immediately. Unlimited profits possible. Investigate at our risk. Free details. Cascraft, 807-G10 Sunset, Los Angeles 12, Calif.

MAKE Flexible molds. Cast figurines, plaques. Free sample. Tooker, 630-M Chestnut, Hamilton, Ohio.

GROW Mushrooms. Cellar, shed, and outdoors. Spare, full time, rear round. We pay \$3.50 lb. We paid Babbitt \$4,165 in few weeks. Free book. Washington Mushroom Ind., Dept. 99, 2954 Admiral Way, Seattle, Wash.

BE The Popular Mechanics representative in your neighborhood and earn big profits in your spare time. Write Popular Mechanics Magazine, Room 408M, 200 E. Ontario St., Chicago, Ill.

FREE Book "505 Odd, Successful Businesses." Work home. Expect something odd! Pacific, Oceanside, Calif.

MAKE New greaseless doughnuts in kitchen. Sell stores. Free recipes. Michael Ray, 3605 South 15th Ave., Minneapolis 7, Minnesota.

RAISE Pheasants on \$100 week plan. Little capital and space can make you independent. Free details. Great Central System, Columbus 20, Kansas.

ST. Lawrence Seaway started. Latest information, listing contracts awarded with application form. \$1.00 cash or money order. Airmailed \$1.25. Allied Opportunities, Box 10, Station B, Dept. PM 12, Hamilton, Ontario.

CALIFORNIA Opportunities. Work better, live better. Skilled, unskilled, highest pay. Help wanted ads air mailed \$1. Questions answered \$1. Research, 4016 Mountain Drive, San Bernardino, California.

GROW Miniature trees. Fascinating, profitable. Complete instructions, including Banzai method, supply sources; simplified, condensed. \$1.00, returnable. Revealer, 1749 Gr. Concourse, New York 53.

AUCTIONEERING, Home study course. Diploma granted. Auction School, Ft. Smith, Ark.

ATTENTION Construction men! Trades, truck drivers, laborers, clerical, engineers, supervisory, many others. Latest copyrighted reports on who to contact to apply for high paying jobs in over 42 countries, including U.S., St. Lawrence Project, Spain, South America, Alaska, Europe, etc. Pay up to \$1500.00 monthly. Usually transportation paid, overtime, other advantages. Included are: best aviation, oil, mining company listings. Year registration and advisory service. Application forms. Unconditional money-back guarantee of satisfaction. Immediate service! All only \$2.00. Airmailed \$2.25. (COD's accepted.) International Reporter, Box 1047-PJ, St. Louis 1, Missouri.

FREE Information. Construction projects require all trades. Ellis, PM-12, Box 207, Westmount, Quebec.

EXCLUSIVE Franchise—Business, realty, industrial financing. Capital raised for your business and others. Earn \$100.00 weekly up. \$2.00 full information. By Field, Phoenix Factors, 1008 5th Ave., New York 28.

OVER 60? Want employment? (No selling!) Send for free brochure "400 Salaried Positions and Profitable Occupations for People Over 60." MCB, 405-R Gorham Bldg., Minneapolis 3, Minn.

\$1300.00 MONTHLY For truck drivers, \$1400.00 monthly for carpenters, electricians, plumbers, mechanics, \$1200.00 for clerks and laborers. Full information and complete foreign listings, with current information on Spain, Korea, Australia, Alaska and Canada, \$1.00. Current information on stateside projects, \$1.00. Dept. 3-L, Opportunities Unlimited, 1110 Commerce Bldg., St. Paul, Minn.

MAGAZINE Subscriptions—Largest commissions. Bonus. Qualified Publications, 451DB Kingston, Brooklyn 25, N. Y.

FREE Folio "Up to \$45,000; Unlimited Vacations." No merchandise, equipment. Unknown! Works itself, home! Hayling, Carlsbad, Calif.

TOYS You can make for pleasure, profit. Cannons, guns, trucks, hydroplane, wagons, furniture, playhouse, table, chairs, doll house. No special tools needed. Real simple to make from easy to understand drawings, photos. 160 pages. \$2.00. Popular Mechanics Press, 200-MT East Ontario St., Chicago 11, Ill.

IF You've had motorcycle experience—Become a motorcycle dealer. Low investment. Company training. Triumph, Baltimore 4, Md.

BE A Merchant Marine officer for adventure, travel. Start \$5000-\$7000 a year. Send \$1.00 for information. Povilasukas, 212 E. 3 St., New York 9, N. Y.

WANTED, Men and women. Get the job you want, where you want it at wages from \$689.00 to \$1500.00 monthly. Major American companies need thousands all types workers. Actual job openings in countries throughout the world. Construction, mining, oil, aviation industries need labor, engineers, truck drivers, technicians, carpenters, etc. Your chance to set aside that big nest egg. Complete information. \$1.25 airmail, \$1.00 regular. World Wide Employment Reports, Dept. PM10, Box 273, Dallas, Texas.

BOOKS, PERIODICALS, PICTURES, POSTCARDS

SAVE! Do your own bookbinding, repairs with "Bind-A-Kit." Used by hobbyists, camps, shut-ins, libraries, groups, schools. \$3.00 postpaid. Dept. P, W. E. Jackson & Co., 63 Washington St., Providence 3, R. I.

SENSATIONAL! Read "Flying Saucers on the Attack." Only \$3.50. Melvin Margulis, 2141 Prospect Ave., Bronx 57, New York.

BOOKHUNTERS! Scarce, unusual, miscellaneous books supplied. Atlantic Book Service, Cedar Street, Charlestown 29, Massachusetts.

SPARETIME Profits taking subscriptions, all magazines. Wholesale catalog free. Cassell Agency, Westfield 2, New Jersey.

NATIONAL Geographic Magazines, 1888-1952. Periodical Service, Box 465-PM, Wilmington, Delaware.

BOOKS Found! Any author, old or new. Rush titles wanted; no obligation. International Bookfinders, Box 3003-PM, Beverly Hills, California.

BOOKHUNTERS! All subjects. Send wants! Jaher Book Service, 620-P East 178 Street, New York 57.

BOOKHUNTERS! All subjects. Send wants! College Book Service, 52 W. Kingsbridge Rd., New York 68, N. Y.

BOOKS—Government surplus. Free catalog listing fifty other free catalogs on instructional, text and vocational subjects. Three million volumes, new and used. Bargain prices, Long's College Book Co., Dept. PM, Columbus 1, Ohio.

ALL Sports bookfinder! Any sport subject. Send wants. Osmo Tuuskula, Box 462, Worcester 1, Mass.

DEBTS Worry you? Job in danger and with it your house or car? For new hope read The Toboggan. \$1.25. Heron House, Publishers, Winslow, Wash.

PUBLICATIONS By famed physician-psychologist-author C. Franklin Leavitt. Your Personal Problems and How to Solve Them; Self Mastery Through Understanding; How to Plan Your Life. Free literature. The Leavitt Science, Clinton, Illinois.

BOOK Catalogue, 1000 bargains, send 10c. Books Publishers, Amityville 3, N. Y.

AMAZING New book gives instant solutions to 100,000 practical problems. Details free. Columbia Graphs, Columbia, Connecticut.

"SCIENCE Milestones": New, thrilling history of science, and the men who made it. More fascinating than fiction. 300 pages, 8 1/2 x 11. Packed with pictures. \$5.00. Descriptive literature free. Windsor Press, Book Dept., 200 E. Ontario St., Chicago 11, Ill.

CATALOG Of 1200 popular educational and self-help materials, pocket-books, etc. 10c. World Adventure, D238, Ann Arbor, Michigan.

FREE: Exciting catalog packed with books covering most everything. Think of it—From cover to cover you will find described and illustrated hundreds of books telling how to fix and how to build almost anything. How to remodel your home; do your own decorating, plumbing, electrical work. Simplified books covering concrete work, carpentry, painting, furniture making and refinishing. How to build your own boat, home workshop tools. Best books on photography, welding, hobbies, homecraft. How to make a home freezer. Send for your free copy now. Popular Mechanics Press, 200-BC East Ontario St., Chicago 11, Ill.

GAMES, TOYS, NOVELTIES

PLAY Amazing BM game. Make money having fun. Details free. Deming Products Co., 841 Bennett Street, Jackson, Mich.

PEGLESS Cribbage board, sliding pointers, large numbers, will please any cribbage player. \$2.95 prepaid. Curtis Products Co., No. Woodstock, N. H.

MAGIC TRICKS, PUZZLES, JOKER NOVELTIES

WE Supply every noted magician. Large professional catalog \$1.25. Holden's, 120 Boylston Street, Boston, Mass.

PROFESSIONAL Catalog. 175 pages. 25c. Williams, 900 Plymouth, Ellwood City, Penna.

MAGIC Courses. Catalog with seven lessons free! Success School, Sparta 6, Michigan.

3100 NOVELTIES, Tricks, jokes, gadgets, funmakers, hobbies. Catalog 10c. Johnson-Smith, D852, Detroit 7.

SENSATIONAL Magician's wand 25c. (Vanishes handkerchief!) Catalog included. Box 1352-PM, Philadelphia 5.

40 JUGGLING Stunts. Easily learned. \$1.00. J. R. Bates, Riverton, Ky.

WOODEN Nickel, catalog, trick, 10c. Fun'n Magic, 423-P North St. Marys, San Antonio 5, Texas.

ZANTO'S Dissolve free! Zanto, Waverly, Ohio.

BEST Magic. Joker's novelties. Lower prices. Catalog 10c. Top Hat, Evanston 12, Ill.

MAGIC Course. 10 professional lessons in pocket, parlor, and club magic. Easy to do. No special apparatus. \$2.00. Yohe, 101 Criss St., Pittsburgh 34, Penna.

LARGE Professional magic catalog 50c and free 50c trick. Lerro Magic, 8111-5th Ave., Brooklyn 9, N. Y.

SEND 50c for \$3 worth of astounding tricks. Refundable. Starling Co., 2206 Starling Ave., New York City 82.

STRAIGHTJACKET Escape secret 25c. Chinese coin trick 25c. Escape acts, handcuffs, magic. Trudel, 117 Salem St., Lowell, Mass.

VENTRILOQUISM Taught quickly! Home study! Results guaranteed! Information free! Write, giving age. Dummy catalog 25c. Fred Maher School, Box 36, Kensington Station, Detroit 24, Michigan, Studio P.M.-L.

\$3.00 VALUE Superb magic tricks only 25c to new acquaintances. Magic offers and instructive bulletins mailed frequently. Southeast Magic Studio, Box 15-W, Eutawville, S.C.

500 TRICKS, Douglas famous 120-page catalog, only 10c. Fastest service to magicians for 30 years. Send 10c today. Douglas Magicland, Dept. 1, Dallas, Texas.

2500 TRICK Catalogue (512-pages), pocket, parlor, stage. World's finest magic. Catalogue \$2.00 (dollar trick included free). Kanter's, M-1311 Walnut, Philadelphia 7.

JOIN Magic club, save 25% a year. Write 1414 N. 43rd, East Saint Louis, Illinois.

LEARN Ventriloquism. 3c stamp brings particulars. Smith, 801 Bigelow, Peoria 5, Ill.

COINS, TOKENS, CURRENCY

WANTED—1894-S dime. Pay \$1,000.00. Certain 1913 nickel \$1,500.00. 1901-S quarter \$30.00 to \$250.00. Hundreds of others. Know their true value. Complete illustrated catalogue 50c. Worthycoin Corporation (D-516), Boston 8, Mass.

APPRAISALS. Certified by expert. Minimum \$1.00 per coin. Special collection fees arranged. Numismatic Appraisal Service, Box 456-P, Encino, California.

15 DIFFERENT Indian cents \$1.00; 1954 United States proof set \$3.25; buying handbook \$1.00. 1955 64-page bargain catalogue 35c. Bebee's, 4514 North 30th Street, Omaha 11, Nebraska.

PAPER Money! 10 different countries—\$1.00. Lists. Dwight Musser, Dunbar, W. Va.

COIN Collectors newspaper, sample copy 25c. \$2.00 yearly. Numismatic News, Iola, Wisconsin.

AMERICAN Coins! Stamps! Bargains! Sullivan's, 127-PP East Fourth, St. Paul 1, Minnesota.

OLD Money wanted. Will pay \$100.00 for 1894 dime, S. mint. \$50.00 for 1913 Liberty head nickel (not buffalo). Big premiums paid for all rare coins. Send 4c for large coin folder. May mean much profit for you. Numismatic Co., Dept. 20, Fort Worth, Texas.

30 FOREIGN Coins \$1.00. 10 Indian-head pennies \$1.00. Valley Coinco, Box 66, McAllen, Texas.

FIFTY Indian cents \$2.00, twenty different dates \$1.00. Sayers, 1000 East Unaka, Johnson City, Tennessee.

FIVE Page bargain list, five Indian-head cents, 25c. Economy Sales, 159 Dean, Mansfield, Mass.

BARGAINS—U.S. coin lists. Huber, 210 South Sixth Street, Minneapolis.

40 DIFFERENT Selected coins, \$1.00. Oddehon, Box 482, St. Louis, Mo.

COIN Collectors 1955 catalog. Over 40 pages, many bargains. Send 50c. James, Inc., 300 West Main, Louisville 2, Ky.

FOREIGN Coins, twenty different each from a different country, \$1.00 postpaid. Webb, 330 Gough, San Francisco 2, Calif.

JAPANESE Invasion notes 1c to \$1000.00 set \$1.00. 100pp. illustrated coin catalogue, 25c. Shultz, Salt Lake City 10, Utah.

FREE! Foreign coin, banknote and coin collectors illustrated catalog to approval service applicants. Send 3c postage. Tatham Coinco, Springfield 30, Mass.

INDIAN Cent with bargain lists 10c. Hutchinson, 3463 "I" Street, Philadelphia 34, Penna.

CONFEDERATE And Southern bank notes, 3 different, \$2.00. 50 mixed Indian pennies, \$2.00. Ben's Coin Shop, 31 N. Clark, Chicago 2.

GET Profit and pleasure in collecting old coins. Send 10c for 56-page illustrated coin catalog. You'll be delighted with it. Send for it now. B. Max Mehl, 370 Mehl Building, Fort Worth, Texas. Largest rare coin establishment in U. S. Established 54 years.

WORLD'S Greatest magazine for coin collector's and wooden nickel 10c. Lawrence Brothers, Anamosa, Iowa.

COIN Collector's Magazine. Over 1000 pages per year. Sample copy 30c; \$3.00 per year. Hewitt, 7320-J Milwaukee, Chicago 31.

U.S. Large cent, 2c, 3c all for \$1. Bargain list included. Delmaco, Box 1123, Wilmington, Del.

UNITED States Rare Coin Value Guide, 48 pages 50c. Fortunes in rare coins. Ideal, 4644-P Geary, San Francisco 18, California.

STAMP COLLECTING

329 DIFFERENT Worldwide stamps 25c. including Hitler heads, British colonies, French colonies, rarities, unusuals. Fascinating story approvals. Canada Stamp Company, 1907 Main St., Dept. 118, Niagara Falls, New York.

BARGAIN Hunters attention! Free stamp magazine, 1000 interesting stamps for your approval inspection. Completely catalogued, substantially reduced. Free tongs and hinges with purchase. Niagara Stamp Company, St. Catharines 31, Ontario, Can.

AUSTRALIA: 47 Different, 10c. Illustrated lists free. Leslie Anderson, Seaside Heights, N. J.

100 DIFFERENT World 10c gift set. Bellet, Mapledale, Hazel Park, Mich.

WHOLESALE Price lists for dealers. Progressive, 2700 Burkhardt, Cincinnati 15, Ohio.

DIFFERENT, 500, 50c; 1000, \$1.25; 2000, \$2.75; 5000, \$11.00. Approvals. K. S. Holmes, London, Canada.

5 MINT Blocks free to approval applicants. A. H., 1207 Northland Ave., Buffalo 15, N. Y.

315 DIFFERENT Foreign stamps including animal, flower and other topical. Air-mails, coronation and triangle stamps. 25c with approvals. Hathaway, P.O. Box 145PM, Garden City, N. Y.

MACAO Flower set, 10c with approvals. Seminole Stamps, Box 1138-P, Coral Gables 34, Florida.

WONDERFUL Offer. 7 complete mint sets only 10c with approvals. Reich (M28), 1633 Lawrence, Chicago 40.

ALBUM! 32 Pages! Only 10c! Approvals. Hartford Stampmart, Hartford 1, Conn.

UNITED Nations cover free to applicants of U.S. or British Colonial approvals. A. Taylor, Skyland, N. C.

WEST Indies, French Africa, over 100 others, only 10c! Approvals included. Cole, 43-A Rinevalt, Buffalo 21, N. Y.

WORLDWIDE, 50 All different, absolutely free, just to introduce our incomparable approvals. Kent Stamp Company, GPO Box 87, Brooklyn, N. Y.

FREE U.S. illustrated bargain catalogue. Rothberg's, 53 Bromfield, Boston 8, Mass.

TWO \$5.00 U. S. stamps plus 20 different, 10c with U. S. approvals. Irwin Stamp Co., Box 1105, Brooklyn 30, N. Y.

100 DIFFERENT U. S., 40c with U. S. approvals. Faith, 1339 1/2 Westminster, Alhambra, California.

ECONOMICAL 15c-1c-2c-Approvals, 22,000 varieties available. Dresel, Box 270-n, New York 25, N. Y.

FABULOUS Collection—Roosevelt and dictator stamps. Mammoth fascinating collection of Roosevelt and dictators including Stalin, Tito, Franco, Lenin, Hitler and great many others plus free booklet and bargain lists. All for 10c with approvals. Jamestown Stamp, Jamestown, Dept. 413, N. Y.

50 DIFFERENT Bulgaria 10c! Approvals. Ensign Stamp Company, Dept. M, Berdan Avenue, Paterson 2, New Jersey.

NUDES Set: Colorful approvals 10c. Atlas, 2830-M, Eisenhower, Racine, Wis.

EXOTIC Oriental collection, 105 all different stamps from Borneo, Hong Kong, Malaya, Sarawak, Korea, Japan and many other strange countries of the Far East plus free booklet and bargain lists. All for only 10c to new approval customers. Jamestown Stamp Co., Jamestown, Dept. 313, N. Y.

223 STAMPS For only 10c! This mammoth value includes airmails, pictorials; stamps from strange countries cataloguing up to 25c each! Also approvals. Mystic Stamp Company, Camden 80, New York.

50 DIFF. U. S. commemoratives 25c. Mammoth packet list free. Econopackets, Box 168, Riverside 9, Calif.

WOW! 153 All different Germany, 10c. Zeppelins, semi-postals, airmails, high values, big bargain lists and approvals included. Jamestown Stamp, Jamestown 512, New York.

STAMPS Wanted. Mine and used, collections, accumulations. Good grades only. Buy outright if bargain. What have you? Write, give details. Vanroy Shirk, Lebanon, Penna.

300 DIFFERENT. Triangle, airmail, pictorials, etc. 25c. 500 mixed U. S. 25c. Carlton's, Tujunga, Calif.

200 DIFFERENT, including Roosevelt triangle, 10c to approval applicants. M. Avalon Stamp Company, Springfield, Mass.

50 DIFFERENT Argentine 10c. Approvals. Reuter, 611 W. 40th Pl., Los Angeles 37.

AMAZING Offer! 200 United States stamps—including commemoratives, airmails, high denominations to \$1.00. Only 10c to approval applicants! Illustrated bargain lists free. Mystic Stamp Co., Dept. 80, Camden, New York.

100 DIFFERENT Spain 25c. Penny approvals included. Reed, Box 980, Chicago 90, Ill.

OLD Scarce U.S. seconds on approvals. Slight imperfections, lowest prices. Herfield, Clintonhill Sta., Newark 8, N. J.

SPEND Pennies! Not dollars! Thousands of fascinating stamps to choose from our 1c and 2c approvals. No premiums. Just honest value. Pat F. Knowles, Box 2247, Van Nuys, Calif.

OLD U.S. approvals. Low prices. MacG., 2905 Observatory, Cincinnati 8, Ohio.

50 DIFFERENT United States 5c with bargain approvals, lists. Bookman, Manatee 1, Florida.

U.S. Mint 797 SPA sheet, 10c to U.S. approval applicants. M. Haycock, 153M 74th St., Brooklyn 9, N. Y.

850 MIXED U.S. old-new 25c. Lists. Weatherby, Medina, Ohio.

25 FRENCH Colonies 5c; approvals sent. Adlez, 367-M Park Ave., Newark 7, New Jersey.

WEIRD Diamond shape coffee stamp! Lovely flower triangle! First American big commemorative, Greenland idol dancer, etc. Free with approvals. Capital Stamp Co., Little Rock 2, Ark.

200 DIFFERENT! Plus Macau, Rhodesia, Mauritius, etc. Only 10c to approval applicants. Evden, Box 128, Valley Stream 50, New York.

FREE Stamp collection—100 different stamps from Europe, Africa, Asia, Scandinavia, Balkans, etc. 3c to approval applicants. Tatham Stamp Co., Springfield 30, Massachusetts.

S.P.A. Sheet at face! Mint Smoky Mountain miniature only 10c with U.S. mint approvals. Send dime today. Western, Box 1689P, Salinas, California.

GIANT Approvals, thousands different, one cent each. Wahl's Stamp Exchange, 7008P Farragut, Chicago 31, Ill.

UNITED States commemorative price list free. James Cunningham, 101 Terrace, Hasbrouck Heights, N. J.

FREE Sample! Interesting, illustrated, informative! National Stamp News, Anderson, South Carolina.

ISRAEL. Free illustrated pricelist. Levy, 8854—20th Avenue, Brooklyn 14, N. Y.

65 ALL Different U. S. stamps. Includes 50 year olds, commemoratives, airmails and \$5.00 stamp. Only 15c. Approvals. Willett Co., Box 511-L, Port Chester, New York.

U.S. 40 Different commemoratives 25c. No approvals. Seidenberg, Appleton 944, Wis.

MONACO Nudes complete 10c. Approvals. Royal Stamp Company, Tamaqua, Penna.

PACKETS—World, different. 3,000, \$7.00; 5,000, \$19.00; 10,000, \$50.00; 20,000, \$256.00! 30,000, \$600.00. Russell, Box 2011D, Natural Bridge Station, St. Louis 15, Mo.

20 DIFFERENT Topicals without approvals 10c. K. Affleck, Vienna 4, Virginia.

FREE Stamp magazine. 327 different stamps 25c. Including Indonesia, Newfoundland, British Colonies, Vatican, Red Russia, Hitler heads, Indian states, animals, airmails, French Colonies, rarities, unusuals. Wonderful bargain. Approvals. Niagara Stamp Company, St. Catharines 21, Ontario, Canada.

101 TRIANGLES, Diamonds, mysterious rectangles. Treacherous African warthog, leopard, beautiful nudes, Confucius, 10c. Approvals. Imperial, 2545P Fourth, San Diego 3, Calif.

CHRISTOPHER Columbus mint bi-colors. Be first to get this beautiful set honoring the discoverer of America. This plus another navigator set of mint multi-color stamps from St. Thomas and Principe for only 10c to approval applicants. U. S. or foreign. Clark Stamp Co., Dept. A-43, Muskegon Heights, Mich.

FREE: Hong Kong, Singapore, British Guiana, Latvia, with our attractive pictorial approvals. Name country you collect. Herbon Stamps, 17137 Barlow Ave., Detroit 5, Mich.

FINE Approvals. Fast, personal service. What countries do you prefer? I'll send their stamps. Skinner, 438 Locust, Long Beach 12, California.

FREE Pricelist—Pictorial mixtures, miniature collections. Amazing bargains. George P. Cochran, 1383 Hillcrest, Akron 7, Ohio.

20,000 DIFFERENT World \$175.00; 10,000, \$47.00; 5,000, \$13.00; 3,000, \$8.50. Gould's, Box 831, San Francisco 1, Calif.

THE Discriminating collector will enjoy our U. S. "Stamps of Quality" price list. Request yours today! Eibolms, 821 Hayes, Racine, Wis.

FREE Animals, birds, triangles, flowers, ships, locomotives, kings, dictators, multi-colored, historical, geographical, musical, battles, giants, midgets and over 100 others. Fascinating story approvals. Send 10c handling, please. Canada Stamp Company, 1907 Main St., Dept. 318, Niagara Falls, New York.

JAPAN—100 Different. Chockful of commemoratives, high values, pictorials. Exceptional value. Just 10c. Appealing approvals accompany. Viking, 11-Z Northern Blvd., Great Neck, N. Y.

GREATEST Free offer—Croatia exile government air set; gorgeous birds, natural colored triangles. Also albums, supplies. All to our approval buyers. Bell Stamp Service, Dept. S-3, Bell, California.

GIGANTIC Collection free. Includes triangles, early United States, animals, commemoratives, British Colonies, high value pictorials, etc. Complete collection plus big illustrated magazine all free. Send 3c for postage. Gray Stamp Company, Dept. PM, Toronto, Canada.

FIRST U.N. set. Among world's prettiest. Only 10c. Approvals. Welles, Box 1246-R, New York City 8.

WORLDWIDE. Variety packets 100, 10c; 500, 75c; 1000, \$1.75; 5000, \$13.75. Philatelic House, Rockville Centre, N. Y.

WORLD'S Finest approvals. 1/2 Scott. Palmstamp, P.O.B. 35211, Los Angeles 35, Calif.

UNITED States giant 100 page illustrated catalogue, 12c. Victoria, 6185 Evanston, Indianapolis 20.

50 DIFF. Uruguay 10c to approval applicants. Elco Stamp Co., 882 Pearl, Benton Harbor, Mich.

100 DIFFERENT Beautiful pictorials 25c. Scott, 2653 Midwood, Toledo 6, Ohio.

FREE Lavishly illustrated U.S. catalog. Ace, 1431 Grace, Cleveland 7, Ohio.

BEAUTIFUL Sets, Packets, Approvals. Free album to beginners. Freeman, 18 Main, Peterborough, N. H.

FREE United States catalogue. Almost 1,000 illustrations. Over 10,000 delightful bargains. Stones, 192 Washington, Boston 8, Mass.

300 DIFFERENT Given free with approvals. Particulars. Windsor Stamps, 6834 Cornell Ave., Chicago 17.

FREE—U.S. 35 different with superior approvals. Sparta, Box 1082, Rochester 3, N. Y.

FREE! Big United States catalog. Valuable guide and check list. Hundreds of illustrations. Approvals. Harrisco, 463-V Transit Bldg., Boston 17, Mass.

TRIANGLES, Triangles, 44 different triangles only \$1.00 with approvals. Hobbycrafts, Bandon, Oregon.

FREE—105 Different British Colonies, Aden to Zanzibar! High catalog; pictorials. Approvals. Send 10c for mailing. Kenmore, Milford 8T, N. H.

MINT U.S. special introductory offers! 33 different mint U.S. commemoratives \$1.99 different mint U.S. commemoratives \$5.20 different mint U.S. air post stamps \$3.60 different mint U.S. regular issues \$5.11 different mint commem. plate blocks \$2. All select mint. Satisfaction guaranteed. Mint U.S. approvals, free list accompany. Russell Patrick, 5550 East 42nd Street, Indianapolis 26, Indiana.

FREE! South Sea Islands, Cook, Niue, Samoa, Tokelau, Norfolk, Papua and New Guinea, latest issues. Maps, animals, etc. Premium coupon to new approval applicants. Moublow, Box 278E, East Northport, New York.

50 BIG, Beautiful picture stamps, 25c. Thousands of beauties in approvals for pennies. Postpaid both ways. Dusty Farnam, Box 227E, Van Nuys, Calif.

FREE 200 Different with approvals. Al Gray, Box 18, Hawthorne, Calif.

50 SAN Marino 10c with approvals. J. Moyle, Twain Harle, California.

VATICAN City airmail set of 3 only 3c. Approvals. Goliath Co., Bethlehem Y1, N. H.

66 DIFFERENT U. S.—10c. Approvals. Utechs, 1143D North Keeler, Chicago 51.

THOUSANDS Of stamps can be added to your collection at 1 and 2c each. Ask to see our big approval books of attractive, low priced approvals. Everything catalogued according to Scott's. Large discounts. Modern Stamp Co., Dept. A-7, Ferrysburg, Mich.

FREE Complete set of famous Americans, flags, parks and presidentials to approval buyers. Send 5c for 15 of the above stamps plus full particulars. Triboro Stamp Company, 145 Nassau Street, Dept. 112, New York 38, N. Y.

U.S. Fine mint complete sets. Bicentennial \$2.50, parks \$1.40, aeronautics 60c, Hawaii overprints \$1.50. Christmas special: All above \$5.50. Free bargain list. Philip Mantius, Setauket, N. Y.

FREE! Obsolete U.S. occupation set. To approval applicants only. Riedell, Greensburg, Penna.

U.S. Mint Tipex-Cipex souvenir sheets 60c. Free price list. Brooks, 2352A East 23rd Street, Brooklyn 29, New York.

ZEPPELIN Set free, with approvals. Variety Stamps, 57-P Circuit, Newton Highlands 61, Mass.

ARMENIA Pictorials, value 65c. free with approvals. Exotic, Box 755, Miami Beach 39, Florida.

AMAZING Savings: Picture stamps by the thousands. Choose choice ones for pennies. Approvals postpaid both ways. Costs nothing to try us. The Elders, El Venado Dr., Puente, Calif.

250 DIFFERENT 25c. No approvals. MacMar, 55 Auckland, Orchard Park, N. Y.

FREE! Prized set of 4 United Nations stamps, sample stamp newspaper. Send 10c to cover handling costs. Approvals. Littleton Stamp Co., Littleton C1, N. H.

AUSTRALIA Set 8c. Approvals. Mrs. Van Housen, R.F.D.-1, Highland Mills, N. Y.

WANT More for your dollar? Try our low priced, neat, attractive approvals. Books of 500 and 1,000 U. S. or foreign. We also have a premium card which will earn you free albums. Write today. Roseland Stamp Co., Dept. A-33, Spring Lake, Mich.

CANADA, 125 Different including high values. \$1.00. P. Lajambe, 61 Vaudreuil St., Hull, Que., Canada.

SUPERIOR Worldwide mission mixture. Amazing variety! Half pound \$1.50. Baye Nielsen, 4407B St. Catherine, Montreal 6, Canada.

EXCITING Topical sets! Five different only 10c with colorful pictorial approvals. Pirland Stamp Co., Box 493, Seattle 11, Washington.

100 DIFFERENT Worldwide stamps 10c to approval applicants. Ladue Stamp Co., 9815 Clayton, St. Louis 17, Mo.

U.S. Mint commemorative plate number blocks bought and sold. Free appraisals, price lists. Wm. Kuehl, 3125 East K, Tacoma 4, Wash.

FREE. Scott's International Album. Other premiums. Particulars with approvals. Raymax, 35-Z Malden Lane, New York 38.

MAGNIFYING Glass only 10c with picturesque approvals. Charles Manning, 32 Choir Lane, Westbury, New York.

FREE! 25 Different mint China. Approvals. Wright, 6435 Edloe, Houston 5, Texas.

FREE! 107 Iron Curtain stamps — All different — Russia, East Germany, Romania, Poland, sensational Stalin stamp; many smuggled from Communist territory. Free book "How To Recognize Rare Stamps" included. All for 10c. Approvals. Kenmore, Milford OH-446, N. H.

FREE! Fascinating, valuable special lists, collector's supplies, U.S. and foreign stamps, mixtures, packets, sets, singles, coins and paper money. Approvals. Littleton Stamp Co., Littleton MI, N. H.

135 DIFFERENT U.S. commemoratives \$1. Request approvals. Harold Holub, 18 East 198th Street, New York 68, N. Y.

20 JAPAN All different free with depression priced approvals. Goble Approvals, 931-A Emwell, Ferndale 20, Mich.

ESTONIA Carrier pigeon set free. Approvals. Canyon Stamps, Box 808, San Fernando, California.

FREE 25 Portugal. Approvals. Walter Kotowski, 19265 Eureka, Detroit 34, Mich.

RECEIVE Sample copy of "The Stamp World." Write to Stoka, 10511 South Peoria Street, Chicago 43, Illinois.

BEGINNER And intermediate approvals. Joyce, 701 Elm St., Salisbury, N. C.

U.S. — 75 Different, 10c. Approvals. Farmer, 4913 Rosewood, Los Angeles 4, Calif.

RETURNED From three years in Europe. Trunk full collections, mixtures, sets, albums, miscellaneous stamps. Tremendous bargains. Lists free. Alatelo, Maynard, Massachusetts.

FREE Congo, Ceylon, Libya, with approvals made up to your order. Far Stamps, 8491-B Meadow, Van Dyke, Mich.

MAPS Of Mozambique free. Three values with our beautiful custom made approvals. Greenfield Stamps, 7122-A Greenfield, Dearborn, Michigan.

CIPEX Souvenir sheet plus 25 different U.S. 10c. Approvals accompany. Village Stamps, 90-39P 214 St., Queens Village 28, N. Y.

25 DIFFERENT Ships, trains, flowers, animals 25c. Approvals. Hayek, 396 Mountainview Road, Englewood, N. J.

CHRISTOPHER Columbus, beautiful pictorials from Panama. Complete set of ten, 10c with approvals. Louis Golden, 6721 Eastwood St., Philadelphia 49, Penna.

LOOK! 10 Foreign sets, 10c. All different, complete. Approvals. Farmer, 4913 Rosewood, Los Angeles 4, Calif.

ISRAEL 100 Different \$6.50 to approval applicants. Reilly's Stamps, Box 323, Compton, California.

MOZAMBIQUE Company set free. Approvals. Weitz, Box 83P, Orange, N. J.

FREE! Giant packet including triangles, Siam, Malaya, approvals, etc. 3c postage. Kensington Stamp Co., Buffalo 15, N. Y.

1500 STAMPS \$1.00. Good variety. World wide. Many pictorials. No approvals follow. Satisfaction guaranteed. Whalen, 1435 First Ave., Oakland 6, Calif.

FREE — British, Spanish, French Colonial collection. Approvals. Pleasure Stamps, 1865P-32nd, Brooklyn 4, New York.

A Steal! 249 different cataloguing over \$6.42. 25c with beautiful bargain approvals. Kingsway Stamp Co., Box 64, Brooklyn 23, New York.

66 U.S., Foreign, 10c. Approvals. W. Milnes, 27 Becker, Manton 9, R. I.

FREE French West Africa pictorials, approvals. Eagle, 6916 Roosevelt Boulevard, Philadelphia 49, Penna.

EXCELLENT Approvals at 1/2 catalogue. Tobacco, Box 255, Gloversville, N. Y.

STALIN, Roosevelt giants, 1ft. 50 others, 5c. Approvals. Blubonnet, Box 3084, Waco, Texas.

U.S. Commemoratives, 33 different 10c. Approvals. White, 516 Avenue L, Brooklyn 30, N. Y.

BEGINNERS! 1-2c Approvals. Povilauskas, 212 E. 3 St., New York 9, N. Y.

NOT 5, Not 10, but 15 giant stamps 10c with approvals. Premiums each purchase. Heritage Hobbies, 52 1/2 Balmforth, Danbury, Conn.

MINIATURE Collections. Bargains galore! Free lists. Lucky Stamps, Cossayuna, N. Y.

ANTIQUES, RELICS, INDIAN GOODS, CURIOS

4 SELECTED Arrowheads \$1.00. List 5c. H. Talbert, Calico Rock, Ark.

4 FINE Arrowheads \$1.00. 6 gem arrowheads \$2.00. List free. Lear's, Glenwood, Arkansas.

UNITED States silver dollars, \$1.75 each, postpaid. Guaranteed genuine. Liberty head or Pence. Carry one as lucky pocketpiece. Fred Birch, Box 634, Deer Lodge, Montana.

PRECIOUS STONES, MINERALS

JOIN The thousands whose hobby is gem cutting, jewelry making, mineral collecting. Send only \$3.00 today — for 12 monthly issues of national how-to-do-it magazine. Sample copy 25c. Gems & Minerals, Dept. A-12, Palmdale, California.

FIND Strategic rare minerals. You may be overlooking some worth a fortune: uranium, vanadium, tungsten, columbium, tantalum, bismuth, nickel, cobalt, chromium, titanium, molybdenum, manganese, platinum, etc. Learn how to find and identify them. Send for free copy "Overlooked Fortunes." Duke's Research Laboratory, Box 666, Dept. O, Hot Springs, New Mexico.

TWO Gem ruby garnets, India 1/2", each \$1.00 prepaid. Eckert Mineral Research, Florence, Colorado.

GUARANTEED Genuine rough diamonds. Importer offers one carat \$18.00. Also other sizes. Cresco Trading Company, 522B Fifth Avenue, New York City.

"GENUINE" Red Arizona rubies (garnets). Send quarter for packet. Bitner's, Box 1023B, Scottsdale, Arizona.

TEN New Mexico minerals \$1.50, six fluorescents \$1.00, fool's gold 25c. Free literature. Minerals, Winston, New Mexico.

GENUINE Baroque gemstone bracelet in silver. Assemble it yourself and save. Free literature. Simpson's, 2005 N. Big Spring, Midland, Texas.

TEN Beautiful highly polished genuine gems. Only \$1.00. Baroque shapes. O'Brien's, 1116-M Wilcox, Hollywood 38, Calif.

GEMCUTTING, Silversmith authority. Illustrated magazine tells how. Cut rocks, make jewelry. 150 aids illustrating equipment, offering gems for collectors, cutters. Postal brings literature. Lapidary Journal, Drawer B, Palm Desert, Calif.

GEMSTONES, Mineral specimens. Every variety. Lowest prices. Free booklet. Plummer's, 4720 Point Loma Ave., San Diego 7, Calif.

SAPPHIRE, Topaz, tourmaline, garnet, peridot, 5 uncut gem specimens, \$1.00. O'Brien's, 1116M Wilcox, Hollywood 38, Calif.

FIND Tungsten, mercury, uranium with Mineralight. Free brochure. Write Dept. PM8, Ultra-Violet Products, South Pasadena, California.

HOBBIES AND COLLECTIONS

CIRCUS Wagons, railroad cars. Enclose stamp. Box 181, Omaha 7, Nebr.

WANTED — Cigarette, tobacco cards. Write Charles Bray, East Bangor, Penna.

MILITARY Miniatures; U. S. Marines, American Revolution, Civil War, Custer's Cavalry. Illustrated catalog 25c. Bussler Miniatures, 59 Russell Park, Quincy 69, Mass. Dept. B.

NAZI Medals, ribbons, flags. Illustrated lists. Big packet \$1.00. Free sources lists. Medcrafts, 1923 34th St. S.W., Calgary 2, Canada.

50 DIFFERENT Army embroidered patches \$1. Other bargains. Insignia Mart, 703A Broadway, New York 3, N. Y.

FREE Leathercraft catalog. Do-It-Yourself. Write Tandy Leather, Box 397-AH, Tulsa, Oklahoma.

RAISE Beautiful, exotic 18-inch tall trees in your home. Nature's masterpieces! Thrilling, profitable hobby. Grower's kit details free. Miniature Forests, 325 Bankers Trust Bldg., Indianapolis 4, Indiana.

COLOR Glass-replicas of old patterns of goblets, tumblers, small window pieces, lamps, etc. Send 10c for illustrated folder. Dixie Gifts, 902 N. Washington, Kokomo, Ind.

UNUSED Matchbook covers. 100 different \$1.00. 36 page catalog 25c. Match-cover album \$3.00. Charles Edelman, 1311C East 84, Cleveland 3, Ohio.

FOREIGN Medals, clearance catalog 10c; 37 American different emblems \$1.00. Hobbyguild, 550B-5th Ave., New York.

NEW — 15 Different match covers 10c. Box 202, Rochester 1, N. Y.

INVENTING Can be an interesting and profitable hobby. Write for complete particulars. Institute of American Inventors, Dept. 40-E 631-E St., N.W. Washington 4, D. C.

CAMERAS, PHOTO SUPPLIES

BASS Says: Quality cameras since 1910. When in Chicago visit the camera cross roads of the world, or write us for your favorite equipment, new or used. Satisfaction guaranteed. Bass Camera Co., Dept. AG, 179 W. Madison St., Chicago 2, Ill.

PHOTOGRAPHY For pleasure or profit. Learn at home. Practical basic training. Long established school. Free booklet. American School of Photography, 835 Diversey Parkway, Dept. 3432, Chicago 14.

SCENEX Camera takes real action photos, standard 828 film. Camera, leatherette case, 2 rolls film, \$1.98 c.o.d. Speedway, 2320 N. Raynor, Joliet, Ill.

BUY Wholesale nationally advertised cameras, photo supplies, thousands other products at big discount. Free "Wholesale Plan." American Buyers, 629-RR Linden Buffalo 16, N. Y.

20 TO 40% Discount. Everything photographic. Dart, 3812E Atlantic Avenue, Brooklyn 24, New York.

DISCOUNTS To 40% — Cameras, projectors, tape recorders, lenses. Write for individual quotations, no catalogs. Classified Camera D, 2375 E. 65 St., Brooklyn, N. Y.

CHRISTMAS Special: Stereo camera, viewer, slidemounts. Complete outfit only \$15.00. Keys Stereo, 3823 E. 7th, Long Beach 4, Calif.

100X TELEPHOTO Attachment easily made for your camera. Perfect lenses and instructions \$1.95. H. Jamer, Manorville, N. Y.

LEICA G, f2, w/synch, \$115.00, IIIC, f2 ctd., \$154.00, IIIc, f2 ctd., \$209.50, IIIIf, f1.5 ctd., \$265.00. All flawless and w/cases. Free bargain catalogue. Dealer's Mart, 54 Beverly Rd., New Rochelle, N. Y.

SAVE On photo supplies! Latest catalogue and camera guide. Send 10c. Photo-shop, 132 W. 32d St., New York, N. Y.

PHOTO FINISHING

JUMBO Prints, 8-exposure roll 30c; 12 exposure, 45c; 16 exposure 55c. Reprints, oversize 4c. Guaranteed quality. Mail Order Photo Service, Box 297, Watertown, Wisconsin.

ENLARGEMENTS! Eight 5x7's or five 8x10's, \$1.00. Wilart Enlargers, Box 967, Little Rock, Ark.

12 EXPOSURE Rolls 39c. Jumbo prints. Guaranteed work, one day service. Lincoln Studios, Dept. K, Box 13, Lincoln, Nebraska.

PARTICULAR? Custom finishing guaranteed. 8 jumbos 35c, 12-50c. Special! 35mm. 36 exposures \$1.10. Free mailer. Flash-Photo, Box 36G, Brooklyn 4, N. Y.

SPECIAL Offer — 8 Jumbos 25c; 12, 35c with this ad. Western Photo, PM124, Box 298, San Francisco 1, Calif.

PHOTOGRAPHS (Cent) each. Details, samples, 10c. 113 Oregon, Fall River, Mass.

THE Photo Mill. Immediate service. Eight exposure roll developed and one print each good negative 30c; two, 40c; one jumbo each 35c; two 65c. Write for complete prices and mailers. The Photo Mill, Dept. K, 1511 Hennepin, Minneapolis, Minn.

PHOTOS Copied. 20 wallet size prints \$1.00. Send any size negative or photo. Mel's Photo, Box 106M, Brooklyn 20, N. Y.

PHOTO Lampshades. Your negatives or pictures. Write Conaways, Box #7261, San Antonio 10, Texas.

PHOTOS Copied. 20 wallet-size deluxe prints \$1.00. Original picture returned. Send any size photo or negative. Federal Wallet-Size Photo Co., Dept. PM-4, P.O. Box 2448, Kansas City 6, Mo. (No c.o.d.'s please.)

GUARANTEED Quality. Fast service. Eight jumbos in beautiful super pak plastic ring binder albums only 35c. Send for free mailers and particulars of our complete photo finishing service. Grand Fotos, G.P.O. Box 1410, New York 1, N. Y.

ROLL Developed and 16 prints 40c. Free mailers. Fast service. Mayfair Photos, Box 617-K, Toledo 1, Ohio.

BEAUTIFUL Enlargement from each picture on roll. 8 exposure 35c; 12 exposure 45c. Cut Rate Photos, Dept. B-4, Janesville, Wis.

TOP Quality. Fast service. 8 jumbos 35c in beautiful super pak album. 16 contacts 40c. Reprints—Jumbos 4c; contacts 3c. Satisfaction guaranteed. Write for free mailers and circulars. Fast-X-Photo, Box A, Jersey City, N. J.

6 OR 8 Picture roll 35c; 12 or 16 picture roll 55c. Each roll developed and printed in handy album pack. Send coin with roll. No c.o.d.'s. Mailing containers sent free. Deluxe Film Service, Box 1268-A, Shreveport, Louisiana.

TWO Beautiful prints from each picture on roll. 8 exposure 35c, 12 exposure 45c. Thirty-three years of satisfied customers. Quick service. Lens Photos, Dept. J-4, Janesville, Wis.

12 JUMBOS From any size roll developed 25c with this ad only. S. Skrudland, Lake Geneva, Wis.

MOTION PICTURES AND SOUND EQUIPMENT

RENT 16MM. sound feature pictures—\$3.95, three days, including delivery, return postage. 25-minute short subject programs, \$2.49. Big catalog free. Eastin Pictures, 129 Eastin Bldg., Davenport, Iowa.

YELLOWSTONE—Banff. Twenty color slides \$2.00. Eddings, Corning R3, N. Y.

FREE! Blackhawk's fall sale catalog new and used 16mm., 8mm. films, used 16mm. sound projectors, new 2"x3" color slides. Blackhawk Films, 1051 Eastin, Davenport, Iowa.

SALE, 10,000 Films 8-16, sound, silent. Mogul's, 112 W. 48th, New York 36.

"ENTIRE Life Story of Christ." 8mm., 16mm., sound and silent, purchase or rent, state projector. Hemenway Film, 31F Church St., Boston 16, Mass.

TAPE Recorders, tapes, accessories. Unusual values. Dressner, Box 66M, Peter Stuyvesant Station, New York City 9.

5,000 8-16MM. Silent-sound films. International, 3120 Strauss, Brooklyn 12.

MOVIE Camera film: 8mm. roll \$1.50, 16mm. 100' \$3.00. Free processing. Better Films, 742 New Lots, Brooklyn, N. Y.

8 & 16MM. Professional national parks movies in Kodachrome, list 10c Ideal, 4644 W. Geary, San Francisco 18, California.

SAVE 50%! Guaranteed-fresh color, b.&w. movie film! 8mm., 16mm. Free catalog! Eso-R, 47th Holly, Kansas City 12, Missouri.

WILD Animal and bird movies, 8 mm. or 16 mm. beautiful color or B&W. Also 2x2 color slides. Send for free catalog. Wild Life Films, 5151-A Strohm Ave., N. Hollywood, Calif.

MUSIC AND MUSICAL INSTRUMENTS

WRITE Songs for pay! My new easy method reveals professional secrets of profitable songwriting. Free information. Meadowlark Music School, 300 Sumner Road, Colorado Springs, Colorado.

1954 ACCORDIONS—Wholesale. Free catalog. American Accordion Center, PM-8, 5329 Belmont, Chicago.

WANTED! Poems for musical settings. Write Songwriters' Service, Clifton, N. J.

ACCORDIONS, Wholesale to everyone. Save up to 60%. All national known brands. Free catalogue. Del Principe, 29 South Cicero, Chicago 44.

SONGPOEMS Wanted. Mail to: Tin Pan Alley, Inc., 1650 Broadway, New York 19, N. Y.

FREE Record of your song. Your words, my melody. Free information. Johnny Mack's Melody Mart, 1094 West 39th Street, Dept. A, Los Angeles 37.

SONGWRITERS! Protect your ideas! Hold all songs, poems! Write for safe correct procedure first! Song Service, Dept. P, 333 W. 56th St., New York 19, N. Y.

POEMS Wanted for musical setting. Send poems. Free examination. Five Star Music Masters, 630 Beacon Bldg., Boston, Mass.

WRITE Songs. Big money and reputation. Write for information. J. Gordon Pub. Co., 4700 South California Avenue, Chicago.

SONGWRITERS! Send poems, songs. Music Service, 243 West 72nd St., PM, New York 23.

POEMS Wanted for musical setting. Send poems. Free examination. Crown Music Company, 1476 Broadway, New York City 36.

SWISS Musical movements \$1.90. Helax, 218 West 72nd Street, New York 23.

PLAY Piano the first day! Copyrighted secret. Particulars free. Miracle Method, Box 5203P, Phoenix, Arizona.

SONGWRITERS; Sensational new offer. Write for free information. Magic Melodies, Studio 8-C, McRae Bldg., Jackson, Mississippi.

SWISS Music movements—Make musical toys, boxes, novelties. Send \$2.50 for Christmas or nursery unit and free pattern. It's a profitable hobby. Free tune list. Maritime, 13 E. 60, New York 22.

PLAY Popular piano at once with Dial-A-Chord. Points out the keys to play for any song. 95 chords. With music. \$7. O. Nelson, 102, 1651 E. 93, Cleveland 6, Ohio.

SPANISH Guitar playing. More music, less effort, no difficult lingering, different tuning, music simplified. Instruction \$1.00. Satisfaction guaranteed. Will Hughes, Box E2, Depoe Bay, Ore.

SONGWRITERS: Large recording company may record your song. National sales and promotion if selected. No charge for melodies. Send song material to Music Makers, Dept. E-4, Box 2507, Hollywood, California.

ELECTRIC Guitars, amplifiers. Wholesale. Free catalog. Carvin, Baldwin Park, California.

SWISS Musical movements. Finest. \$2.50. Spielman, 131 West 42nd, New York 36.

SONGS Or song poems needed for publication and commercial recording. Quick action. Celebrated expert offers you free copy of "Secrets of Song Success." Honest deal designed to benefit all concerned. Mail songs or poems now. Rexright Music Co., Dept. A, 5617 Hollywood Blvd., Hollywood 28, Calif.

SONGPOEMS Wanted for musical setting. Send poems. Free examination, details. Songcrafters, Arcade, Box 2724, Nashville, Tenn.

SONGWRITERS—Success, fame, fortune if talented. Songs revised, composed, published, promoted by largest firm. Free appraisal. Since 1943. Postcard to Nordyke Publishing Co., 7070 Hollywood Blvd., Hollywood 28, PM, Calif.

RADIO, TELEVISION AND ELECTRONICS

CRYSTAL Radio experimenters. Write Leslie Halel, 305 Hope, Lakewood, N. J.

TAPE Recorders, accessories. Best buys. Boynton Studio, 10 Pennsylvania, Tuckahoe, New York.

PORTABLE Crystal radio receives without antenna, ground. Plans 50c. Kit-carphone \$4.95. David, Box 6008, Kansas City 10, Missouri.

REPAIR Your TV. Prepared exclusively for you. Plus additional service. Make, model, \$2.00. Personal TV, Box 66A, Little Neck, N. Y.

TV Trade-in sets. Philco, Emerson, G.E., Admiral, Motorola, Tele-King, others. List available. 10"—\$17, 12"—\$20 up. Washtek Service Co., 1501 Boston Rd., Bronx, N. Y. DA 3-9281.

BUILDER'S Pictorial construction projects. Free list. Alena, 286 East Broadway, New York 2.

RADIO Diagrams \$1.00, television \$2.00. Give make, model. Diagram Service, 672-PM, Hartford 1, Conn.

MAKE Simple, tubeless, batteryless, distance-getting radio. Genuine Melomite crystal, detector, illustrated instructions. 50c postpaid. Allen, 427-PM5, Clinton, Mo.

RADIO One tube kit. Parts, tube, phone, batteries, instructions, nothing else to buy. \$7.95. Less phone and batteries, \$4.95. Crystal radio kit \$1.50; preassembled \$1.75. Crystal radio plans and germanium diode, \$1.00. Plans and Clearco detector, 50c. Free catalogue. Clearco Crystal Company, Box 1857, Milwaukee, Wis.

FREE Radio tester, soldering iron. Build and keep 15 high quality radios—Only \$19.95 complete. No experience required. Enclose 25c for valuable Radio-TV Repair Guide and kit catalog. Progressive Edu-Kits Inc., 497 Union Ave., Dept. PM24, Brooklyn 11, N. Y.

FREE 308 Page 1955 television-radio-electronics catalog! World's largest stocks, lowest prices. Complete supplies for builders, experimenters, amateurs, servicemen. Latest builders' kits, TV, Hi-Fi, phonos, records, P.A. Thousands of parts, tubes, test instruments, books, diagrams. Top quality money-saving values. Get your copy now! Allied Radio Corp., 100 N. Western Ave., Dept. 34-M-4, Chicago 80, Ill.

15 TESTED One-tube circuits 25c, including "Radiobuilder," catalog. Laboratories, 328-C Fuller, Redwood City, Calif.

REPAIR Your own TV. Send make, chassis and model number. Free offer. MG Electronics, 4809 Walnut Street, 39, Philadelphia, Penna.

HI-FI equipment at lowest prices! Buy direct from manufacturer and save! Top quality Hi-Fi, AM, FM, AM-FM tuners, audio amplifiers, pre-amplifiers, test instruments—wired or in kit form! Approved Electronic Instrument Corp., Dept. M, 928 Broadway, New York 10, N. Y.

COLOR Television! Enjoy 3 color screen now. Easily attached. Details free. Zingo Products, Johnstown 77, New York.

TV Diagrams for your receiver—Any make, model, year from 1946 on! Factory authorized! 48 hour service! Just tell us the make and model. Only 70c for all the facts! Department M, Electronics Research Publishing Co., 480 Canal Street, New York 13.

BUSINESS OPPORTUNITIES

TRADE Magazines. See late copies through our easy to get acquainted service. Choose from 4,387 covering all fields. Current list free. Commercial Engraving Publishing Company, 34C North Ritter, Indianapolis 19, Indiana.

FREE—Everything you need to make big money selling world's famous French-type perfumes. Tremendous profits can be yours between now and Christmas. "Husk" O'Hare, 5732 North Kenmore, Chicago 40, Illinois.

OPERATE "Escalator" mailorder system, selling our products or any products. Most revolutionary mailorder system known. Write: Selbyco, Decatur 163, Ill.

WANTED! Home producers, by manufacturers in our clearing house service. Become subcontractor, casting plastic products for these companies. Thousands of easy-to-make items required for consumer-industrial use. Cash in at home, without previous experience. Plastic Service Associates, Dept. 12-PM, East Boston 28, Mass.

NEW Company would like to start you earning money by raising mushrooms, easy do it anywhere cellar, shack, garage. Send to: The Mushroom Lab, P.O. Box 236, Lawrence, Mass.

OPPORTUNITY Mail Magazine, book-let, propositions. Only 10c. Your Best Company, 200 W. 34th St., New York 1.

BEGINNER'S Guide to successful mail order. Only \$1.98. Publisher, Box 1859, Port Arthur, Texas.

LIQUID Rubber. Make flexible molds. Free sample. Chaney, 1130 E. 16th St., Jacksonville 6, Fla.

SELL Popular Mechanics and all other magazine subscriptions. Free catalog, supplies. Subscription Service Company, Dept. A, P.O. Box 2070, Birmingham, Alabama.

GROW Orchids at home—Profitable, fascinating. Year 'round, Maine to California. No greenhouse. Gorgeous cattleyas, cymbidiums, etc. Successful home grower shows you how. Full details free. Flowerland, 4622-PJ Wilshire, Los Angeles 5.

MEN Wanted—Build luggage and cases at home. We sell your products, supply complete instructions, materials, everything. No special equipment needed. Free details. Cascraft, 805-G12 Sunset, Los Angeles 12, Calif.

START A buying service. Buy wholesale thousands nationally advertised products. Make big profits selling at sizable discounts. Postcard brings details. American Buyers, 629-P Linden, Buffalo, N. Y.

LIQUID Marble—Brushed, sprayed! Mold novelties, tile. Particulars free. Marbleizing Service, Edwardsville, Illinois.

BECOME A game warden, or join forestry, park, lookout, wildlife conservation services. Enjoy outdoor work, good pay, real security. Complete information free! Write Home-Study Institute, 3156DR West Eighth, Los Angeles 5, California.

START Your own business on credit. Your own boss. 1661 of our dealers sold \$5,000 to \$28,500 in 1953. We supply stocks, equipment on credit. 200 home necessities. Sales experience unnecessary. Pleasant profitable business backed by world-wide industry. Write Rawleigh's, Dept. L-U-PPM, Freeport, Ill.

FREE! "301 Profitable Small Businesses!" Amazing shoeing plans! Work home! Start sparetime! Deumant Surveys, Kenmore 23-R, N. Y.

FREE! Private labels! Exclusive sales! Own a business! Sell radio PI, stores, mailorder. We supply product, plan, literature; you furnish executive management and employ salesmen. VitaMins, 2908PMA Beverly, Los Angeles 97.

MEN—Income from local information. No selling. Neherco, LaVerne, California.

IMPORT-Export opportunity, profitable, world-wide, mail-order business from home, without capital; or travel abroad. Established world trader ships instructions for no-risk examination. Experience unnecessary. Free details. Mellinger ATOC, Los Angeles 24.

ADVERTISING Book matches—Cash in on big demand; sell union label matches. Cuts for all businesses and political parties. Free powerhouse selling kit, low prices, protection guaranteed on repeat orders. Cash commissions. Superior Match Co., Dept. MX-1254, 7530 Greenwood, Chicago.

COST Of things going up faster than your income? You can make more full or part time as a Rawleigh dealer. Write for full particulars. Rawleigh's, Dept. L-RR-PPM, Freeport, Ill.

LEARN Sewing machine repair, electrify, trade, sell. How to make big money at home sparetime. New zigzag machines, parts, etc., wholesale. Free details. Taylor Service, Hamilton PM-12, Ohio.

FREE Gift. With each order featuring real merchandise. 100% profit. Everything furnished. Information free. C. D. Crider, P. O. Box 156, Delhi, La.

MAKE \$480 Month, part time, in six months, sponsoring food supplement salesmen. Ground floor deal. \$5.45 brings trial 30-day supply, regular \$14.95, kit. Vitron, Box 307, Baldwin Park, California.

OPERATE Your own mail order business! At home in spare time. Start right. Avoid costly mistakes. "Mail Order Business Manual" shows you how! Details free. Bud E. Hine, Box 93, Battle Creek, Michigan.

MAKE Extra money between now and Christmas. Sell subscriptions to all popular magazines. Liberal commissions. For supplies write DeSales Magazine Service, 60 East 42nd St., New York 17, N. Y.

1000% PROFIT Guaranteed! Plastic laminating photos, documents, etc. No experience or machinery needed! Machineless laminating kit \$1. Berea Photos, Berea, Ohio.

MAILORDER—Operate profitable home business using free advertising method. Revealing information free. Seidel, 6000-HF Sunset, Los Angeles 28.

EARN \$2.00 Hour! I do—Making sandals. Youngs, 1308-PM, South First, Arcadia, California.

START Spare-time mailorder business. Gedgard, Box 798-A, New York 1, N. Y.

WELDERS, Make ornamental iron railings. Instructions \$1.00. J. O'Connor, Milan, Ohio.

\$20.00 DAILY Possible. Sharpening barber, beauticians scissors. Details free. Wayne Zell, Summitville 2, Indiana.

WINNING Mail order plans. Merchandise, books. Details free. Mid-State, Box 214, Syracuse 1, N. Y.

BUY Wholesale. Nationally known brands. Large catalog \$1.00—refundable. Hill Products, Sellersville, Penna.

\$1000 MONTHLY Possible in collection agency business. Free details. Write Cole Associates, Syracuse 2, N. Y.

ENJOY Benefits and profits from co-publishing "Progressive Mail Trade" magazine. Sample copy and details 25c. Bud E. Hine, Box 93, Battle Creek, Michigan.

MAKE Perfumes, other products. Sell mailorder. Formula catalogue free. International, 6347 Parnell PM-12, Chicago 31, Illinois.

\$70.00 WEEKLY Guaranteed. Home, spare time. Simplified mail bookkeeping. Immediate income, easy! Free success book. Auditax, 34631AE, Los Angeles 34.

WHOLESALE! Buy early large Xmas catalog 50c nationally advertised appliances, jewelry, watches, etc., terrific reductions. International Sales Co., 175 Fifth Ave., New York 10, N. Y.

MAKE Money at home. Guaranteed. 300 small, profitable businesses. Leeway, Mountain View-2, Oklahoma.

SAWDUST. Turn it into cash. Twenty methods. Instructions 50c. Charles Company, 12-DCH, Norwood, Ohio.

INVESTIGATE Earthworm breeding! Pleasant, profitable home industry! Part; full time! Free revealing facts, information! Write Earthmaster System, 8W, E2 Monte, Calif.

RUBBER Molds for casting plaques, figurines, novelties. Catalog illustrating over 100 fast sellers. 10c. Castcraft Studios, 508-PM Marion Street, Brooklyn 33, N. Y.

PROFITS To \$5 hour doing plastic title-plate engraving with "Dupliscaler" engraving, carving machine. Details, sample 25c. Desco Distributors, 5262-D Van Nuys, Van Nuys, Calif.

INCREASE Your income. Build your own mail order business. Copyrighted booklet tells how. Only 25c postpaid. Satisfaction guaranteed. The Gerwigs, 366 South Huron, Columbus 4, Ohio.

EXPORT Business made easy! Substantial income, home operated, low overhead, no merchandise buying. Complete setup service offered. Hermes Exports, 152 West 42, New York 18.

PRINTING—At wholesale prices. Dealers wanted. Sell by mail! Free samples, selling plans. Sutton Printing, Box 853-M, Waycross, Georgia.

MAIL Order plan by manufacturer. Big profits. We deliver. Sibert Mo. Company, Newark 3, N. J.

HOW To set up and run a mirror shop! Resilvering mirrors. Making chipped glass nameplates. Electroplating salts and rectifiers. John Sprinkle V60, Marion, Ind.

BUY Wholesale thousand items. Lists free. Triple J. Industries, 132 Berkshire, Bridgeport 8, Conn.

FREE Details. Profitable home mailorder business. Everything supplied. Holly's, Box 439, Jacksonville, N. C.

MONEY For you in publishing business. Details 10c. Decco Company, Portland 7, Oregon.

PROFITABLE Mail-order import business. Send \$1.00 for imported gift worth \$2.00 and free details. Transamerican, Box 815-A, Atlanta 1, Georgia.

NEWEST Spare, full-time home business. \$5 to \$10 hour possible. Paint with suede—The finish with touch and eye-appeal. Beautify auto dashboards, signs, radios, toys, figurines, lamps—1001 others. Complete, step-by-step instructions sent for no-risk examination. Free details. Coast, Los Angeles 61.

FREE Literature. Fishworm breeder's book—\$1.00 postpaid. Dixdok, Kent, Ohio.

FREE Wholesale kit guarantees you 33% to 60% profit on cameras, appliances, typewriters, etc. Arrow Distributing, 154F Nassau St., New York 38.

MAIL Circulars. 100% commission. Free details. Fisher's, Dept. M12, 4750 So. Central, Los Angeles 11, California.

BUY Wholesale 450,000 products. Literature free. Carter, Box 6011-P, Chicago 80.

FREE Polio "Up to \$45,000; Unlimited Vacations." No merchandise, equipment. Unknown! Works itself, home! Hayling, Carlsbad, Calif.

PROFITABLE Home collection office. Experience unnecessary, big demand. Particulars free. E. Borum, R12, 411 West Walnut, Kalamazoo 42, Michigan.

OPPORTUNITY For Christmas to make fast money. Metropolitan Wholesale Appliance Distributors, 19-21 White St., Paterson, N. J. 40, 60 to 80% off on name brand appliances and jewelry. \$1.00 for wholesale catalog. If not satisfied money back within 10 days.

UNUSUAL Mail order ideas, sources. Details free. Fax, Box 241, Brownwood, Texas.

BUY Wholesale and save 50%. Name brand merchandise and Xmas gifts. Big profit selling your friends or your own use. \$1.00 for big 1955 catalog. Rake's, 607 Spring Garden, Philadelphia 23, Penna.

FINANCIAL Security and success in business can be yours! Make us prove it. Write to Success Unlimited, Box 1045, Solvang, Calif.

UNUSUAL Mail order plan pays \$100.00 per car commission. No investment required. Take orders only. Brand new 1955 automobiles equipped with directional signals, windshield washers, license plates, Federal and Michigan sales taxes. Prices start at: Ford \$1620, Chevrolet \$1663, Plymouth \$1725, Dodge \$1850, Pontiac "8" \$2111, Buick "Special" \$2222, Mercury \$2270, Oldsmobile \$2290. Other equipment additional. Also Lincoln, DeSoto, Chrysler, Studebaker, Nash, Packard, Hudson. Details on request. Harry Harwoods, 20058 Renfrew, Detroit, Michigan.

MOTEL And resort managers needed. Approximately 5000 new motels built each year. This expanding business sorely needs competent and trained motel managers. Ideally suited to couples, 30 to 60. Good pay and secure future. Send \$1 for complete information on Motel Home Training. Mr. L. I. Heater, International Motels, Inc., Dept. PM, Millbrae, California.

FOOD Mailorder business. Home operated. Everything supplied. Successful proven method. Free samples, details. Frazer Foods, Desert Springs 11, Calif.

\$500 MONTHLY Possible raising earthworms. My "senior kit" best yet for beginners. Complete, nothing else to buy. Get facts with raising instructions. Send 25c (refundable). Multiple Cabin Services, Kalkaska 1, Michigan.

START Home manufacturing business. Make cleaners, soaps, polishes, cosmetics. Free literature. Kemix, Park Ridge, Ill.

IMPORT-Export mailorder opportunities! Details. Warner, Box 6, Port Scott, Kansas.

COMMISSION Circulars—Offering real merchandise. Send for samples and details. Products, Box 23, Boston 17, Mass.

POPCORN and potato chip equipment. Eakins, Box 933-A, Springfield, Ohio.

PART Time or full time. Your own business, selling name brands. No inventory required. Manhattan-W, 225 W. 57 St., New York City.

BRONZE Baby shoe mountings, beautiful designs, all-metal ashtrays, bookends, picture frames, \$2.25 each. Free literature. Bronzcraft Mountings, Greenville Station, Jersey City, New Jersey.

HOME Business jays amazing profits. \$40.00 daily possible, sharpening circular saws. No experience needed. Jobs in your own neighborhood. Free book tells how. Belsaw, 34A Field Bldg., Kansas City 11, Mo.

MAIL Order. Details free. Lexington Mail Service, 5511 Monroe, Chicago 44.

MAKE Flexible molds. Cast figurines, plaques. Free sample. Tooker, 630-R Chestnut, Hamilton, Ohio.

AMAZING Home business plans. Write. Falcon House, Winnebago 2, Illinois.

FORTUNES Made raising crickets and fishworms. Guaranteed raising and marketing instructions. \$1.00. Carter Farms, Plains, Georgia.

NEW—Different home business opportunity! Address-mail literature featuring real merchandise. Everything furnished. Mills, 1752-A, Garden Ave., Lorain, Ohio.

METALIZE Baby shoes, jewelry, gifts. Bronze, gold, silver. Free bulletin. Kikavi, 7217-PY South Broadway, Los Angeles 3.

HAVE Home business mailing postcards offering real merchandise. Big earnings. Write: Mednis, 10 Port Norfolk, Boston 22, Massachusetts.

NATURAL Molding rubber, extra thick. Free sample. Flock, W. Woolley, 115-A Donald, Peoria, Ill.

ELECTROPLATE Auto parts, novelties, mirrors, baby shoes. Easy, inexpensive home processes. Free booklet. Tyco Metals, Box 13231-MM, Houston 19, Texas.

BOOKKEEPERS. Keep books, small firms spare time. Manual latest technique by C.P.A., \$3.00. Modern Business, Box 405, Younstown 1, Ohio.

MAKE Money at home—Mail cards, circulars feature real merchandise. Everything furnished. Big earnings. Philip's, Box 3-P, Boston 22, Mass.

RECAST Old batteries into new. Latest achievements. Battery Laboratories, Minneapolis.

MAKE Rubber stamps, repair dolls; learn silk screen printing. Catalogue (60 ideas) free. Universal, Box 1076-A, Peoria, Ill.

START Venetian blind laundry. Profitable lifetime business. New machine. Free booklet. F. C. Co., 442 N. Seneca, Wichita 12, Kansas.

HOW And where to obtain capital. Particulars free. Star Service, Wapakoneta, Ohio.

TO \$40.00 Weekly. Sparetime, home operated mailorder business. Successful beginner's plan. Everything supplied. Lynn, 10420-M National, Los Angeles 34, Calif.

COPUBLISH Mail Sale Advertiser, leading mail order paper. Details, latest copy, dime. Vanroy Shirk, Lebanon, Penna.

SCHEMER Magazine, Canfield 1, Ohio, monthly mailorder ideas, plans. Year \$1.00. Sample 20c.

PLASTERCRAFT Molds, liquid rubber, plasters, flocks, candle supplies. Catalog and manual free. Blue Rapids Supply, Blue Rapids, Kansas.

BUY It wholesale! Manufacturers, distributors offer 850,000 items. Literature free. Olsen, 1231-A East Third St., Duluth 5, Minn.

\$25 WEEKLY Working two hours daily at home. Lycke, Box 3471-A, Cleveland 12, Ohio.

GROW Mushrooms. Cellar, shed, and outdoors. Spare, full time, year round. We pay \$3.50 lb. We paid Babbitt \$4,165.00 in few weeks. Free book. Washington Mushroom Ind., Dept. 172, 2954 Admiral Way, Seattle, Washington.

\$46 FROM Square foot plywood; jigsaw necessary. Write: Woodarts, Bridgewater, Mass.

BRED Rare tropical fish at home. Earn big money! Learn secrets! Help fill huge demand. Amazing opportunity! Free plan. Tropicals, 1008-F Los Angeles St., Los Angeles 15.

RESILVERING Mirrors, formula 50c; two-way lookout mirrors, (No one sees you), 50c; coppered mirrors, 50c. All \$1.00. Nelko-Mir. Box 3462-J, Chicago 54.

LIVING Miniature ("Ming") trees only 10 to 20 inches tall. Grow at home. Big profits! Spare time opportunity. Fascinating! Amazing! Write for free seed and plan. National Nursery, Dept. FC, Inglewood 4, California.

MAKE Money spare or full time, casting metal toys and novelties. Big wholesale and chain store demand for autos, soldiers, ashtrays, banks, etc., keeps manufacturers busy. Production moulds furnished for up to 100 and more castings per hour. No experience or special place necessary. Write for information and illustrations of patterns needed. Metal Cast Products Co., Dept. A, 1898 Boston Road, New York 60, N. Y.

OPERATE Profitable mail order business. Write Walter Service, 4159-A East 112th, Cleveland 5, Ohio.

GOOD Paying business silvering mirrors, plating autoparts, reflectors, bicycles, bathroom fixtures, etc., by late method. No tanks or shop required. Outfit furnished. Free booklet. Gunmetal Co., Ave. H, Decatur, Illinois.

MINK Raising information free. Complete. Lake Superior Mink Farm, Superior, E.E. Wisconsin.

COLORGLAZED Concrete pottery made without molds. Patented method. Cemetery products, novelties, tiles. Basement leak-sealing. Money-making projects. Booklet, details free. Men only. National Potteries Company, Grand Rapids, Minnesota.

FREE Book "505 Odd, Successful Businesses." Work home. Expect something odd! Pacific, Oceanside, Calif.

FIX Typewriters. Free booklet describes our modern, inexpensive home-study course. Factory methods taught. Write Typewriter, Building 1, Tarentum, Penna.

MONEY In new greaseless doughnuts. Start in kitchen. No smoke. Sell stores. Free recipes. M. Ray Company, 3605 South 15th Ave., Minneapolis 7, Minn.

BRONZED Baby shoe supplies, instructions, mountings. Metal bookends, \$1.50 pair. Free catalog. National Bronze Supply, Box 56, Los Angeles 32, Calif.

MAILORDER Home business! Details stamp. Shirley, 20-Raspeburg, Baltimore 6, Maryland.

MAKE Money at home as renewal headquarters for all magazines. Big Christmas sales profits now. Liberal commissions. Supplies furnished. Write for free catalog. McGregor Magazine Agency, Dept. 500B, Mount Morris, Ill.

MILLION Articles wholesale. Supply source directory 10c. Idealer, Park Ridge, Illinois.

VENDING Machines—No selling. Operate a route of coin machines and earn amazing profits. 32-page catalog free. Parkway Machine Corporation, Dept. 72, 715 Encor St., Baltimore 2, Md.

BRONZE Baby shoes. Instructions, equipment and mountings for genuine electroplated process. Free catalog. Hollywood Bronze Supply, Dept. B-3, 1624 East First Street, Los Angeles 33, Calif.

MONEY In saw sharpening sparetime at home. Repeat cash business. Experience unnecessary. No selling. Free booklet explains. Victor Foley Company, Columbia Heights, Minnesota.

FLEXIBLE Rubber molds for plaster and Marblette figurines. Sample and large illustrated catalog 25c, refunded on first order. K-C Novelties, Dept. 74, Easthampton, Mass.

BUY Wholesale direct! Save yourself 66% on 10,000 nationally advertised appliances, sporting goods, watches, furniture, auto parts, toys, giftwares. Sell at tremendous savings to individuals, organizations. Amazing profits! Free "wholesale idea." National Buyers Service, Box 426EA, Oakland, California.

BIG Profits owning your own wholesale merchandising business. No investment! America's greatest wholesale appliance, homewares, jewelry, sporting goods catalog in color with your own name. We drop ship. Free brochure. General Wholesalers, Box 1195EG, Chicago; Box 3058EG, San Francisco.

MAILORDER Magazines, business opportunities, samples, details, 25c. A. W. Vornheder, 11321 East 39th, Terrace, Kansas City 29, Missouri.

NEW Exceptionally profitable plans. Ideas for home operated mail business. Rush name. Miller, 1881-P Roxbury Road, East Cleveland 12, Ohio.

UNUSUAL Homework opportunity, spinning Angora sparetime for us. Men, women. Angora House, PM, Springfield, Illinois.

ELECTROPLATING Turns spare time into dollars. "Professional Electroplating Technique." Information free. Plater C. Hyde, 327 West 120th Street, Los Angeles 61, California.

SELL By mail! "How to Build Your Own Mail Order Business" tells how. Satisfaction guaranteed. Only 25c. La Roche, Merritt Island, Florida.

BUY Wholesale thousands items. Lists free. Cottage Industries, Omaha 12, Nebr.

START Venetian blind laundry, patented machine. Free information. Jet Company, 522 N. Rural, Indianapolis 1, Indiana.

FREE New 280-page book. 2000 businesses, farms, income properties for sale throughout America. Specify type of business desired, and general location. Book No. 76, 5400 Wilshire, Los Angeles, Calif.

WHOLESALE! 8,000 Nationally famous products. 30-80% discounts! Large catalog. Sensational business plans included. Consolidated Distributors, 21-11 Lafayette, Paterson 15, New Jersey.

INFORMATION Worth dollars. Free details. Wolfe, 8106 So. Park Ave., Chicago 19.

STAY Home. Sell merchandise by mail! Everything furnished. Orders filled. Big earnings. National, Box 88-A, Dorchester 22, Mass.

MAKE Big money at home! Invisible reweaving pays up to \$10.00 profit in an hour. Make tears, holes disappear from fabrics. Constant demand from laundries, cleaners, homes, brings steady earnings. Details free. Fabricon, Dept. AE, 8342 S. Prairie, Chicago 19, Illinois.

MONEYMAKING OPPORTUNITIES

JIGSAW. Bandsaw owners, let your machine bring extra profits, fun. Free details. Nu-Art, Dept. B, Box 2235, Boston, Mass.

WITHOUT Requiring any greater effort than the work you now do for just a mere living, "Beckoning Fortune" takes you along the same path actually trod by every successful man in his rise to wealth and power. It could be your life's turning-point. \$2.00 postpaid, Phillips Company, Box 6817, Towson 4, Maryland.

WHOLESALE! 8000 Nationally famous products. 30-80% discounts! Large catalog. Sensational business plans included. Consolidated Distributors, 21-12 Lafayette, Paterson 15, New Jersey.

INCREASE Your income, turn your spare time into cash—Making quick-selling, highly profitable lamps and fiber glass shades. Every home a prospect for one or more. Hundreds already doing it, so can you. No experience needed. No special tools required. Gearon's big, new 72 page 1954 illustrated Catalog No. 8 will show you how, quickly. One special 8-page section shows 6 beautiful lamps in kit form, ready for you to assemble. Another 12-page section shows you how to make stunning, ultra-modern fiber glass shades. Page after page filled with wide variety of other attractive shades, shade frames, figurines, and lamp bases. Also oil lamp converters, boring compound, and all kinds of cords, sockets, pipes, harps, finials, bases, and hundreds of other parts. Everything you need. And you can buy everything wholesale, sell at retail, make big profits, fast. Send only 25c right now for Gearon's big 1954 catalog and wholesale price list. Like hundreds of others, you'll be glad you did. Gearon Co., Dept. 503-B12, 27 S. Desplaines, Chicago 6, Ill.

FREE! "301 Profitable Small Businesses!" Amazing shoeing plans! Work home! Start sparetime. Deumant Surveys, Kenmore 23-R, N. Y.

"HOW To Make Money With Simple Cartoons"—A book everyone who likes to draw should have. It is free; no obligation. Simply address Cartoonists' Exchange, Dept. 912-CM, Pleasant Hill, Ohio.

START A buying service, buy wholesale thousands nationally advertised products. Make big profits selling at sizable discounts. Postcard brings details. American Buyers, 630-R, Linden, Buffalo, N. Y.

"GIFTS And Gadgets" the handcrafters' own catalog of what they make, use and sell. Send 25c. Dept. PM, Home Industries Association, 1727 K Street N.W., Washington 6, D. C.

LEARN Technical metaphysics and insure your future. Easy, inexpensive correspondence course. Simplest method known. Diploma. Write: Premier College of Technical Metaphysics, 2332 McKenzie St., Vancouver, B. C., Canada.

CASH In on billion-dollar industry; new proven, successful idea. Write Heroo, 319 Sea Street, Quincy, Mass.

AMAZING. New home business. Profits two ways. Guaranteed. Write R. Casto, Kenna 1, West Virginia.

NEED Money? Raise earthworms. Write for sales plan. Earthworm Gardens, 102 Peacock Building, El Monte, Calif.

SELL Religious mottoes—Send no money. We trust you. Crystalglo, Box 96, Sidney, Ohio.

EARN At home. Several ideas to choose from. No mail order—No selling. Folder free. Greenplay, 541 West Third, Reno, Nevada.

PROFITS. Mail, typing, sewing! 35c each, all three \$1.00. Baker, 1412 Jefferson Ave., Yakima, Wash.

NINE Home work money making plans, and mail order magazine, all for 25c. Satisfaction guaranteed. Clement Moore, Publisher, Box 456R, New Egypt, N. J.

CHINCHILLAS. Unusual terms, three years to pay, no interest or carrying charges. Box 348, Manhattan Beach, Calif.

START A profitable subscription business in spare time! We need men and women (young or old) as representatives for all leading national magazines. Liberal commissions paid for new and renewal subscriptions. Start earning money in this pleasant work at once! Clip this ad and send with your name and address to: Agency Bureau, Dept. PM, Hearst Magazines, 250 West 55th St., New York 19, N. Y.

IMPROVED Easy method. Make colorful Christmas cards, advertising displays, etc. Send \$2.50, get easy instructions. Free important materials to first 1000 customers. Remle, 2946 Tyburn, Los Angeles 39.

\$200 MONTHLY Possible raising earthworms! Backyard, garage, basement. Complete illustrated booklet explains raising, feeding, packing, marketing. 25c postpaid! Ozark Worm Farm-J, Willow Springs, Missouri.

MONEYMAKING Plans. Name, address brings information. Multiservice, B-8032, South Charleston 3, W. Va.

CHANCE Of a lifetime to make a fortune. At home sparetime. Capital, experience, unnecessary. Write: AAA., 100 Airport Blvd., San Antonio, Texas.

TYPISTS! Make money at home! Mailing Service, 2 Madison, Greencastle, Ind.

EARN Money at home! "How-To-Do-It" Magazine tells how. Samples, instructions. 25c. White, Wetmore, Texas.

PROFIT! Prestige! Publish a magazine under your own name! Only \$3 per month! sample, details 3c! Filmer, 910 Marion, Pharr 22, Texas.

RECEIVE Latest book selling and money-making opportunities. Write: Trade-winds, Box 8258, Chattanooga, Tennessee.

CHRISTMAS Trees bring big profits. Complete "know-how" 25c. Timberline, Box 332, Glens Falls, New York.

FREE Folio "Up to \$45,000; Unlimited Vacations." No merchandise, equipment. Unknown! Works itself, home! Hayling, Carlsbad, Calif.

EARN At home. Several ideas to choose from. No mail order. No selling. Folder free. Todaro, 433-A Motheral, Monessen, Penna.

NEW 7"x11" Ultra-blue signs. 7c, retail 50c. Sample free! Lory, 822 Broadway, Dept. 828, New York 3.

MECHANICS Investigate profits with Cup-L Rivets 2500 uses. Fast, easy, clean. Nothing equals. \$1.00 for literature, sample. Cup-L Rivets, 31486 West, South Laguna, California.

FREE Leathercraft catalog. Do-It-Yourself. Write Tandy Leather, Box 397 AM, Tulsa, Oklahoma.

BOOKKEEPERS! Forget debits, credits, double entry! Govt. investigators want records, not systems. More firms use our simple, inexpensive method than any other. Popular demand. Unlimited earnings. Age no barrier. Live anywhere. Amazing details free. Penna. Business Service, Box 923, York 3, Penna.

EARN \$50.00 Daily making mats, shoes and mud guards from old tires. S and S Patents Inc., 1397 North Clark St., Chicago 10, Ill.

FOREIGN Employment construction work. If interested in foreign projects with high pay write Foreign Service Bureau, Dept. P.M., Metuchen, New Jersey.

PRINTING And office supplies wholesale. 20,000 items. Literature free. Royal, Box 368-A, Cleveland 27, Ohio.

ATTENTION: Typewriter owners. Make handsome profits. Write today. Groves Company, 682, Hastings 8, Nebraska.

MONEY Troubles? Lack rising costs with little home business. Send 25 cents for new booklet containing dozens of plans and ideas. Atlantic Publications, Box 1103, Riverdale, Maryland.

GENERAL Contest Bulletin. Issued monthly. Sample, 25c. 1009 1/2 East 5th, Duluth, Minn.

100% PROFIT! Mexican featherbird pictures. Hot sellers! Edmunds, 3009-P Weaver Ave., Baltimore 14, Md.

GROW Mushrooms. Cellar, shed, and outdoors. Spare, full time, year round. We pay \$3.50 lb. We paid Babbitt \$4,165.00 in few weeks. Free book. Washington Mushroom Ind., Dept. 173, 2954 Admiral Way, Seattle, Washington.

SPARETIME Profits taking subscriptions, all magazines. Wholesale catalog free. Cassell Agency, Westfield 2, New Jersey.

50,000 ARTICLES Wholesale. Source directory, dime. Nelko, Box 3462-DR, Chicago 54.

READ Progressive Mailtrade, the magazine that tells how to make money by mail. Dime brings sample and special offer. Progressive Mailtrade, Box 357, Sheboygan, Wisconsin.

WINNING Prize contests is fabulous, confidential, home opportunity! Send stamp! National Contest Bulletin, Box 2685-P, Miami 16, Florida.

FREE Book "505 Odd, Successful Businesses." Work home. Expect something odd! Pacific, Oceanside, Calif.

BUILD Sales by recruiting productive distributors selling direct or to retail outlets. Secure most concentrated circulation through classified columns of Salesman's Opportunity. Write for facts. Gilbert, Salesman's Opportunity, Room 1700, 28 East Jackson, Chicago 4.

SELL—Buy Titania gems. More brilliant than diamonds. \$9.75 carat wholesale. Free catalogue. Diamondite, 1404-M Mitchell, Oakland 1, California.

SCHOOL Seniors—Sell classmates America's most beautiful graduation name cards. Largest selection. Highest commission. Outsell all others. Free sample kit. Printcraft, Dept. M, 1509 Maple Street, Scranton 5, Penna.

FORMULAS, PLANS, ETC.

EXPERIENCED Druggist offers ten profitable formulas for 50c. Reed, 3140 View, Fort Worth, Texas.

CHEMICAL Product analysis. Metals, powders, solutions. Turners Laboratories, 2316 Brown, Evanston, Ill.

300 YEAR Calendar in your head. Know day of week when date's known. Code \$1.00. Krystop, Felton, Calif.

LIFETIME Business! Manufacture extremely profitable products! Lists free! Thermolab, Peoria 4, Ill.

FREE Formula catalog. Anything analyzed \$35.00. Western Chemical, Salem, Oregon.

FORMULAS, 10,000 for \$5.00. Authentic, reliable, practical. Brockway, 1145 High, Topeka 1, Kansas.

FOR Proof of what you can do in specialty manufacturing get our literature. It's free! Miller, Chemist, 1517-P, Tampa, Florida.

ANY Formula \$3.00. Catalog—Mfg. Treatise 10c. J. Belfort, 192 N. Clark, Chicago 1.

FORMULAS: All kinds. Latest, best. Literature free. Kemtial, Park Ridge, Ill.

REAL Manufacturing formulas. Lists free. Cummings, Chemist, Gordon Ave., Syracuse 4, N. Y.

PRODUCT Analysis, manufacturing formulas, processes developed. Moderate fees. Plastics, Box 1574, Boston 4, Mass.

PLASTICS

TUBE For water level. See Hydrolevel ad in "Make It Yourself" classification.

PLASTIC Sheets, rods, tubes, etc. Free list. Plastic Supply Co., 2901 N. Grand Blvd., St. Louis 7, Mo.

NEW Liquid casting plastic. Clear, colors. Embed flowers, insects, coins. Saw, drill, carve. Send 25c for Castolite Creations Manual and proved success plan showing how to make money at home. Castolite, Dept. P-101, Woodstock, Ill.

PLASTICS Home-craft course for men and women. Tells and shows how to make hundreds of fast selling plastics products. All plastics and materials for 23 projects included in course. No special tools needed. Course pays for itself. Write for free booklet. Interstate Training Service, Dept. D-3-N, Portland 13, Oregon.

LEARN Plastics at home. Complete kit—\$5.98 postpaid. Dime brings sample plastic three experiments, full details. Plastic Projects, Box 5151, Detroit 35, Mich.

CASTING Plastic, crystal like, new formulation, 1 1/2 pounds liquid Numold and complete kit including colors and instructions. Start profitable hobby at home, make your own Christmas gifts. Only \$6.00 postpaid. Information on request. Virginia Research Laboratory, Dept. D-12, Marion, Virginia.

PLEXIGLAS, Lucite. Square foot cost 1/16", \$1.16; 1/8", \$1.53; 3/16", \$1.88; 1/4", \$2.23; 5/16", \$3.28; 1/2", \$4.38. Colors, add 10%. Send 15¢ for postage. Aristocrat Plastics, Inc., 55 Clarkson St., New York City.

PLEXIGLAS, Lucite sq. ft. (12"x12") cost 1/16" \$1.14, 1/8" \$1.50, 3/16" \$1.85, 1/4" \$2.20. Add 10% for postage. Almac Plastics, 600 Broadway, New York 12, N. Y.

MONEYMAKING Liquid casting plastic. Complete kit \$3.00. Handbook only 50c. Kemnitz Corporation, 2755 N. 5, Milwaukee, Wisconsin.

PLEXIGLAS Sheets—Cut to size. Clear. All thicknesses. Standard outdoor translucent colors. McClarin Plastics, P.O. Box 168H, Hanover, Penna.

CHEMISTRY

NEW Idea chemical and apparatus outfits for home experimenting, photo-scales, microscopes, chemicals, biologicals and laboratory supplies in small quantities. Catalog 25c. Established 1931. John H. Winn, 124A West 23rd St., New York, N. Y.

CHEMICALS, Supplies, Catalog 20c. Laboratory Sales, Box 161-A, Brighton, Mass.

CHEMICAL Problems Investigated, \$3.00 and up. Factual inquiries \$2.00. Any chemical located. Fabian Chemical Co. (Consultants, Analysts, Distributors), 5992 Terrebonne, Montreal, Can.

ION Exchange chromatography chemistry set \$4.00. Free literature. Chemlab, 800-B Delaware, Berkeley, Calif.

AMAZING New book of science. Experiments, formulas and catalogue of laboratory supplies. Only 25c. National Scientific Co., Dept. PM-12, 2304 W. North Ave., Chicago 47, Ill.

CHEMICALS And apparatus for industrial, analytical, and private laboratories. Catalog 25c. Dept. M-50, Biological Supply Co., 1176 Mt. Hope Ave., Rochester 20, N. Y.

ILLUSTRATED Catalog: Chemistry, mineralogy, biology 20c. Tracey Laboratories, Evanston, Illinois.

BUY IT WHOLESALE

WHOLESALE! 8000 Nationally famous products. 30-80% discounts! Large catalog. Sensational business plans included. Consolidated Distributors, 21-14 Lafayette, Paterson 15, New Jersey.

WHOLESALE! Nationally advertised appliances, bicycles, toys, aluminumware. 500% profits. Catalog 10c. Schibani, 1403 North 21st, Birmingham 4, Alabama.

BUY Radios, watches, appliances at wholesale prices. Rush 50c for catalog to Edward Clemens, 318 W. Bridge St., Morrisville, Penna.

THREE "Checkmate" bankers approved balloon pens \$1.00 postpaid. Money back guarantee. Sorry no c.o.d.'s. Cal-Pen Company, P.O.B. 3164, San Francisco 19, Calif.

INDIVIDUALS. Nationally advertised merchandise. Wholesale. Tremendous discounts. Kingsley, Chepachet, Rhode Island.

BUY Wholesale Hoover steam iron \$10.75. Terrific savings. Appliances, cameras, typewriters. Free catalog. Camera Shoppe, Box 601-X, Mt. Vernon, New York.

DO Your Christmas shopping, year around buying from your easy chair at big savings. Jewelry, silverware, watches, appliances, toys, power tools. Hundreds of other items. Send 25c for big name brands catalog. Refundable on first purchase. Karlen House, 210 Fifth Avenue, New York 10, New York.

BUY Wholesale direct! Save up to 66 2/3% on nationally advertised appliances, home-wares, watches, cameras, sporting goods, toys, giftwares. Free catalog. Wholesalers Mart, Box 6125ER, Houston, Texas.

SAVE 50-75% On your Xmas shopping. Free gift with every catalog. Nueblings-M, Sicklerville, New Jersey.

FREE Catalogue. Famous brand watches. Tremendous discounts. Econ-O-Mart, Box 535B, Morristown, New Jersey.

WHOLESALE Catalogue, known brands. \$1.00 (refundable). Box 82, Avila, Calif.

BARGAINS, Job lots, close-outs! Save up to 50% on clothing, hosiery, notions, drugs, toiletries, gifts, jewelry, television, etc. 2000 items. 25c brings wholesale bargain catalog with special get acquainted offer which includes free \$1.00 merchandise certificate. Reliable Jobbers, 311-B North Desplaines, Chicago.

AGENTS WANTED

REMARKABLE High-level position. Big income, even spare time, with new 1955 car as bonus! Amazing guaranteed nylons. Big demand. Write Wilknit, 17412 Wash., Greenfield, Ohio.

MAKE Extra money this winter. Sell our Fit-U Ice Creepers, gives complete protection on icy surfaces, fits all sizes. Big discounts. Staatsburg Tool Corp., P.O. Box 188, Staatsburg, N. Y.

LABORATORY Approved engine reconditioner. Upper lube, crankcase additive. Sells \$6.50, costs \$3.00. Year's engine protection. Komo, Box 2453, Oklahoma City 8, Okla.

MAKE Easy money! Sell famous \$3 CO2 fire extinguisher, wholesale or direct. Fast sales, liberal profits. Fire Killer Mfg. Co., 115 W. 17th St., Hazleton, Penna.

STRANGE "Dry" window cleaner. Sells like wild. Replaces messy rags, liquids. Simply glide over glass. Samples sent on trial. Kristee 64, Akron, Ohio.

BIG Spare-time earnings. Appliances, aluminumware, housewares, watches, clocks, luggage, silverware, toys, gifts. Free 93 page color catalog. Merit Home Products, Dept. PM12, 107 Manhattan Ave., Brooklyn 6, N. Y.

MEN'S "Stretch" socks bring profits! Details, prices free. Frank Thomas, Box 2206-PM, Ft. Pierce, Florida.

BE A magazine agent. Highest profits. Experience unnecessary. Trade Press, 3119 Troost, Kansas City 9, Mo.

10 GOLD Letters \$1.00. Signs painted. Frank Watkins Signs, 1241 Overton Park, Memphis, Tenn.

BUY Wholesale thousands nationally advertised products at big discount. Free "Wholesale Plan." American Buyers, 629-R Linden, Buffalo, N. Y.

BIG Profits selling ties (\$2.00 value) \$8.50 dozen. Free catalog. Empire Cravats, 611C Broadway, New York 12.

TAKE Rubber stamp orders. Free details. Stamps, Box 2326, Denver, Colo.

BUY Wholesale—Thousands items. List free. A Sales, 18PM City Terrace, Newburgh, N. Y.

MAKE Money at home as renewal headquarters for all magazines. Big Christmas sales profits now. Liberal commissions. Supplies furnished. Write for free catalog. McGregor Magazine Agency, Dept. 509A, Mount Morris, Ill.

BUY Wholesale—25,000 items. Catalog 25c. Matthews, 1472-B3 Broadway, New York City 36.

CHAIN Saws. Timber, wood, brush. Money makers. Easy terms. Farmco-PM, Excelsior Springs, Mo.

BEAUTIFUL Feather pictures. 200% profit! Free sample. Apartado 9036, Mexico 1, D. F.

MAGNETIC Magnepad—Sensational kitchen helper sells itself. Retail \$1.00. Sample 35c. Swanson, 3418-P East 8th, Kansas City 24, Mo.

SENSATIONAL, 6 Piece saw set, value \$4.98, rush \$1.00. Samples. Guaranteed. Import House, Toms River, New Jersey.

MAN Or woman with spare time to try our food and household products, at home, and supply neighbors. Make good money. Big box of full-size products sent on free trial. Blair, Dept. 31MY-2, Lynchburg, Va.

IMPROVEMENT Car-trucks: barbells, sporting goods. EG Mfg., Elmford, N. Y.

MUSIC Greeting cards. All occasions. Dorby Publishers, Parsonage, Cummington, Mass.

MAN To earn \$150 up per week. Long needed invention. Advertised worldwide. Prospects everywhere. Full or part time. Exclusive. No investment. Free use of samples. Write Red Comet, Inc., Dept. 358-N, Littleton, Colorado.

60% PROFIT On cosmetics—Famous nationally advertised Hollywood Cosmetics pay 60%! Make \$25 day up! Hire others. For free samples, details, write Studio Girl, Glendale, Calif., Dept. PM-124.

BEAUTIFULLY Different. Mounted colorful real butterflies, centered "Kents" quotation in picture 8 1/2 x 8 1/2. Sample \$3.00 postpaid. Catalog free. Symonds, 636 Broad Street, Meriden, Conn.

MAKE Money introducing world's cutest children's dresses. Big selection, adorable styles. Low prices. Complete display free. Rush name. Harford, Dept. N-1341, Cincinnati 25, Ohio.

EXTRA Money. Jewelry—Each piece an original, will not be duplicated. Details free. Paas Laboratory, 13 Dogwood Road, West Orange, N. J.

TREMENDOUSLY Profitable. Sell religious articles. Different. New. Write J. Cross Company, North Attleboro, Mass.

KILL Odors electronically. Ozone fixture with bulbs. \$7.00 wholesale. Duro 3162 West 139, Cleveland 11.

NAMEPLATES For homes, desks. Free sample. Whitney Signs, West Springfield, Mass.

BONUS Plan! Bonus given for every order you send in from our wholesale catalog. Free details. Pette Company, 1554-PM West 11 St., Brooklyn 4, New York City.

FREE Wholesale kit guarantees you 33% to 60% profit on cameras, appliances, typewriters, etc. Arrow Distributing, 154G Nassau St., New York 38.

EARN 40% On \$6 to \$8 sales Flint Aero Triple Electrode spark plugs. Outlast ordinary plugs 3 times. Greater gasoline mileage. More power. Sell every car owner with sensational "card plan" without stock investment. Sell car, truck, tractor, taxicab fleets as salesman-distributor. Excellent income. Prove Flint your car. Retail \$1.00; cost 60c. Write for free income plans! Mehren Industries, 8666-M Pico, Los Angeles 35, California.

EARN \$30 A day! Sell Dab-It, amazing pocket-size, stick-form, "no-ring spot remover. Works like magic! Guaranteed! Fantastic appeal, profits! Free details! M & M Specialties, Inc., Dept. M-1, 842 Third Ave., New York 22, N. Y.

EARN \$46.80 A day! Sell Car-Glo, amazing silicone, wax treated cloth. Cleans cars with one wipe. Fantastic automotive market wide open for this sensational profit-maker! Start earning immediately! Send for free sales kit. M & M Specialties, Inc., Dept. M-3, 842 Third Ave., New York 22, N. Y.

FREE Hosiery! Sensational new way to earn to \$3 hour spare time! Introduce amazing hosiery by giving away free pairs to every man and woman, regardless whether or not final purchase is made! Nationally known luxurious nylon stockings guaranteed against runs. New miracle one size two-way stretch nylon socks, fit any size. Never sags or droops. Guaranteed one full year! Buy nothing. Deliver nothing. Advance cash plus huge cash bonus to 40%. Additional hose and gifts extra bonus. Postcard brings you samples of stockings and socks with money-making outfits absolutely free. No obligation. Kendex, Babylon 94, N. Y.

EARN \$200 A week and up! Amazing profits are yours selling Seal-Tite miracle puncture-proofing discovery! \$1.98 tube stops flats forever. Sure-fire appeal to America's 40,000,000 motorists! Complete sales kit free on request. M & M Specialties, Inc., Dept. M-2, 842 Third Ave., New York 22, N. Y.

ADVERTISED Watches, diamonds, pens, wholesale. International, 61R Roberts, Portland 4, Maine.

APPLIANCES, Cameras, watches! Large wholesale catalogue! Cam Company, 6306PM-20th Ave., Brooklyn 4, N. Y.

"FOG-Stop" windshield cloth. Instantly removes blurry mist, frost, sleet, snow. Stops windshield fogging. Samples sent on trial. Kistee 51, Akron, Ohio.

EASY Handwork makes fast-selling useful articles. Sample free. Sunmade Company, Brockton 64, Massachusetts.

EASY Extra income—Sell sensational new silicone scorch resistant ironing board cover. Good Housekeeping approved. Terrific \$1.98 seller! Send for free complete selling kit. Sample cover \$1.10. Menell Products, Dept. P—P.O. Box 431, Midtown Station, New York 18, N. Y.

HAVE A complete store in your pocket. Buy wholesale and make big profits. Send for free general merchandise catalog now. Jay Norris, Dept. P, 445 Broome St., New York City.

PRINTING, Advertising salesmen—Excellent moneymaking sideline selling decalcomania name plates, small quantities. Automobile initials, sign letters. Free samples. Ralco, XL Boston 19, Mass.

CALIFORNIA Sweet smelling beads. Sensational sellers. Free particulars. Mission, 2328PM West Pico, Los Angeles 6, Calif.

GOLD Or silver letters, numbers. Windows, doors, trucks, 1" to 6". 500% profits. Free samples. Atlas-T, 544 West 79th, Chicago 20.

\$1.00 PROFIT Selling \$2.95 photo enlargement deal. Allen Studio, Riegler Bldg., Little Rock, Ark.

MAKE Extra money. Sell front door name plates to friends, neighbors. Retail \$1.98; you make \$1.00! Free selling kit. Modern Engraving Co., P.O. Box 194, Boston 14, Mass.

AGENTS—300% Profit selling genuine gold window letters; stores and offices. Free samples. Metallic Sign Letter Co., 431-D North Clark, Chicago.

YOUR Own business—Used suits \$1.50, overcoats 65c, mackinaws 35c, shoes 12 1/2c, ladies coats 30c, dresses 15c. Enormous profits. Catalog free. Moro, 1218AA South Jefferson, Chicago 7.

SCHOOL Seniors—Be popular with classmates. Have spending money galore. Details free. Craftcards, Box 235-L, Pittsburgh 19, Pennsylvania.

OWN Your own profitable wholesale merchandising business. No investment! Sell nationally advertised appliances, homewares, jewelry, sporting goods everybody buys. Your own name catalog in color! We drop ship. Free brochure. General Wholesalers, Box 1195EF, Chicago; Box 3058EP, San Francisco.

INCREASE Your income—Personal initialed buckles, belts, cap badges. Free information. Hook-Fast, Box 480 (PM), Roanoke, Va.

PROFITS Unlimited in your own wholesale buying service. Save yourself 66% on 10,000 nationally advertised appliances, homewares, jewelry, sporting goods. Big profits selling others at discount! Free details. National Buyers Service, Box 426EC, Oakland, California.

NEW Push button salt-pepper dispenser. Sprays it out! Can't clog. Can't spill. King, 55-P Oleaner, West Springfield, Mass.

WHOLESALE! 8000 Nationally famous products. 30-80% discounts! Large catalog. Sensational business plans included. Consolidated Distributors, 21-10 Lafayette, Paterson 15, New Jersey.

JUST Take orders. We deliver. Gadgets. Send 25c. Miss Ann, Jackson Heights 72, New York.

SALESMEN—DISTRIBUTORS

\$2 FIRE Extinguisher, costs you as low as 50 cents. Many other profitable pressurized spray can products. Send name. Strobel Aerosol Co., 2412 Market, Louisville, Ky.

BIG Money as landscape advisor! Opening up new areas and need several good men. Must be aggressive, over 30 years and have car. Previous sales experience valuable but not required—as you will be trained by our own successful company representative using new unique method. Men with ability and desire to get ahead can make \$100 weekly. If successful you will be considered for district manager. Franklin, Box 202, Newark, New York State.

PAINT And varnish brushes. Manufacturer direct to dealer. Hardware, paint, variety and chain stores. Lucrative commissions. Bond required. Ontell Brush Company, 77 St. Francis Street, Newark 5, New Jersey.

SALESMAN—\$50.00 In a day definitely assured, selling brand new item going to every type of food and beverage store, factories, laboratories, hospitals, etc. Samples furnished. Utility Durawear, 53 West Jackson Blvd., Dept. PM-12, Chicago 4, Illinois.

BUY Wholesale thousands nationally advertised products at big discount. Free "Wholesale Plan." American Buyers, 630-DD Linden, Buffalo, N. Y.

ADVERTISING Book matches—Cash in on big demand; sell union label matches. Cuts for all businesses and political parties. Free powerhouse selling kit, low prices, protection guaranteed on repeat orders. Cash commissions. Superior Match Co., Dept. M-1254, 7530 Greenwood, Chicago.

ANYONE Can sell famous Hoover uniforms for beauty shops, waitresses, nurses, doctors, others. All popular miracle fabrics—Nylon, dacron, orlon. Exclusive styles, top quality. Big cash income now, real future. Equipment free. Hoover, Dept. J-100, New York 11, N. Y.

EARN Up to \$20 per order, selling guaranteed custom tailored clothes. Retail \$44.75 up. Free selling outfit. Homeland Tailors, Dept. B, Baltimore 3, Maryland.

BIG Money-making opportunity. Exclusive line work uniforms. Jackets, pants, shirts, coveralls. Advertising embroidered. Every business prospect. Outfit free. Master Div., 262 Water, Ligonier, Ind.

100% PROFIT. Fast money for you! Take orders for Sweet Georgia Brown cosmetics. Colored people buy quick. Free sample. Write Valmor, 2451-Lt Michigan, Chicago 16.

AD Matches! Sell amazing designs—10, 20, 30, 40 and 240-light book matches. Bigger spot cash commissions; every business a prospect. Low prices for high quality. Repeats. Start without experience; men, women; full, part time. Buy nothing! Sales kit furnished. Match Corp., Dept. PM-60, Chicago 32, Illinois.

TOP Men earn \$12,000 and more in a year in a profitable selling career. Call on owners and users of heavy duty equipment. Moly lubricants and other top quality specialized products provide repeat business regularly. Top earnings immediately. No collection or delivery worries. Write E. J. Baker, Dept. 789, Box 676, Dayton, Ohio.

RETRACTABLE Pens, three \$1.00, dozen \$3.00. Circulars, Arcade, Silver Lake, Ind.

RED Hot item on key chain. Sample board \$1.00. 100% profit. Lawn Vending Co., 6110 So. Washtenaw Ave., Chicago 29, Ill.

SELL "Dandy"—Fast moving automotive accessory. Dandy, Box 5, Columbus, Ind.

30,000,000 WOMEN Want amazing new automatic refrigerator defroster. You sell 8 out of 10 on sure-fire free trial. \$250.00 weekly profit not uncommon. Rush post-card for guaranteed plan. D-Frost-O-Matic, Dept. T-102, 173 W. Madison St., Chicago 2, Ill.

DISTRIBUTORS. Large profits. Terrific repeat orders. Unique Italian brooms. Write Peacock, 400 Montgomery Street, San Francisco, California.

NEW Jobs open in selling! Send name, address for five free issues of Opportunity Magazine's money-making guide, listing hundreds of companies who'll pay you well, full or part-time. No experience needed. Opportunity, 28 E. Jackson, Dept. 17, Chicago 4, Ill.

BAR Items and bar gags at wholesale. Resell at 40% profit. Distributors wanted. Collins Products, Box 465, North Hollywood, Calif.

SELL Book repair shop service. National chain. Your own business. Professor Martin. Aisen. North Dakota.

PANTASTIC New money-making plan. Sell nothing, yet make to \$141 weekly! Luxurious stainless steel tableware, guaranteed 50 years. Can't rust, tarnish or stain. Successor to sterling silver. Just leave samples with women and offer set free if they sell only two sets to their friends! Complete "career" 30-piece set retail only \$19.95, your profit \$14! Post-card brings free details. Better still, save time by mailing \$1 for four piece sample place setting and cloth holder of \$3.95 for complete 30-piece set postage prepaid. Your money back if returned within 30 days. Topval Corp., Lindenhurst 31, N. Y.

DEALERS. Contractors, suppliers. Buy direct. Make \$50.00 to \$75.00 on single sale. Amazing, new low cost electric garage door operator retails for as little as \$139.50. Attaches to any overhead door up to 18 ft. wide. Easy to install, preassembled at factory. Completely automatic. Operates door in all kinds of weather right from car. Discounts and dealerships granted to reputable dealers, contractors and suppliers. Write for literature, prices and discounts. Door-O-Matic Co., P.O. Box 10-12, Russia, Ohio.

EDUCATIONAL AND INSTRUCTION

IT'S Fun learning a language by Lingua-phone's world standard conversational method. At home, quickly, easily master French, Spanish, German, Italian, Chinese, modern Greek—29 languages available. Save time, work, money. Send for free book. Linguaphone Institute, 8312 RCA Building, New York 20.

APPLIED Success methods. Free details. A-D Psychology Ctr., Box 847, Ocean Park, Calif.

WANTED: More new writers for TV-radio, magazines, business publications, motion pictures. Learn at home for extra income or exciting full time career. Many students earn while learning. Professional instruction. Send today for free lesson and book. Palmer Institute of Authorship, Desk TM-124, 1630 N. Sycamore, Hollywood 28, California.

INTERESTING Correspondence courses in German language. Catalog free. Schatz Books, Sparta, Michigan.

COMPLETE Your high school at home in spare time with 57-year-old school. Texts furnished. No classes. Diploma. Information booklet free. American School, Dept. X945, Drexel at 58th, Chicago 37, Illinois.

STAMMERS' Home cure. J. Allen, Box 114, Saskatoon, Sask, Canada.

MEDICAL Laboratory technique. Learn at home. Catalog free. Century College, Desk 2, 9 East Ohio, Chicago 11, Illinois.

WANT A diesel job? New opportunities to increase income. Higher pay. More money. We can help you qualify. Tools. Shop method home training. Write today! Diesel, Tractor, Heavy Equipment Division, Interstate Training Service, Dept. B-3-N, Portland 13, Oregon.

AUCTIONEERING. Be an auctioneer. Earn big money. Term soon. Write for catalog. Kansas City Auction School, Suite 307, Shankman Building, 3119 Troost, Kansas City, Missouri.

WELDING Training pays at Hobart Welding School, Box M-1241, Troy, Ohio. VA contract. Best equipment. Catalog free.

OIL Painting; condensed course; introductory lesson \$1. Prickett, Bar Harbor, Maine.

WANT U. S. gov't. job? Men-women, 18-35. Start high as \$350.00 month. Qualify now! 23,000 jobs open. Experience often unnecessary. Get free 36-page book showing jobs, salaries, requirements, sample tests. Write: Franklin Institute, Dept. Y-24, Rochester, N. Y.

EARN College degree, remain employed. Write: College of Letters and Science, 338 So. Western, Los Angeles 5-B, California.

3800 USED Correspondence courses, catalog \$1.00. Art \$3.95. EG, Elmsford, N. Y.

ARTISTS Make money—Booklet free. Drawing, painting, advertising art, cartooning; one enjoyable course; start at home. Write for free illustrated book, "Art for Pleasure and Profit." Our 40th year. Washington School of Art, Studio 4212 N, Washington 5, D. C.

AVOID Failure! Six lessons small business management. Auditor-business advisor established 1929. Text distributed nationally. Write! Wm. Grosnick, 115 State, Springfield 3, Mass.

DRAFTING—Learn from registered professional engineer. Lowest priced simplified method. Placement service. Write Genco, 32-B Greenacre Road, Westwood, Mass.

INDISPENSABLE! Life improvement techniques you should know. Free. Write Applied Christian Psychology, Inc., Box 1924-F, Louisville 1, Ky.

BLUEPRINT Reading for machine and building trades. Train at home. Learn to read blueprints with confidence in 10 easy lessons. Literature free. Belton School, 1059H North Lawndale, Chicago 51, Ill.

CORRESPONDENCE Courses, educational books bought, sold, rented. Catalog free. Willard Bayles, 211 Essex, Hackensack, New Jersey.

CORRESPONDENCE Courses, books, rented, sold, bought, Catalog free. Press, Box 1273-P, Burbank, Calif.

FREE Voice book! Shows you how you can train for strong, confident voice. Sound masculine! Perfect Voice Institute, 210 South Clinton, Studio 2MW-2, Chicago 6.

FREE Leathercraft catalog. Do-It-Yourself. Write Tandy Leather, Box 397AE, Tulsa, Oklahoma.

BE A real estate broker. Study at home. Write for free book today. GI approved. Weaver School of Real Estate, 2020C Grand, Kansas City, Missouri.

LEARN Refrigeration mechanics. Complete illustrated course. Free booklet. Mechanics School, 7217-PM South Broadway, Los Angeles 3.

LEARN Appliance service. Motors, washers, refrigeration, everything. Booklet. President, Box 73136, Los Angeles 3.

NEW. Uncrowded profession, part, full time. Know people. Analyze handwriting, earn big fees. Business men, housewives, doctors, attorneys, teachers use and report success from radio, writing, lecturing, teaching, consultation, court work. Trial lesson free. Give age. Igas, Inc., 414 Wilhoit Building, Springfield, Missouri.

MIDLAND Linotype School. Charles City, Iowa. Civilian and Veteran Courses. Free placement. Established 1909.

HIGH School diploma at home. Licensed teachers—Approved materials. Southern States Academy, Box 144-MX, Station E, Atlanta, Georgia.

STUDY By correspondence for Doctor's degree in Psychology, Metaphysics and Divinity. College of Divine Metaphysics, Dept. P-M, 2811 North Illinois St., Indianapolis 8, Indiana.

SECRET Investigation. Experience unnecessary. Investigators particulars free. George Wagner, M125 West 86th, New York 24.

PHYSICAL Therapy and massage. We train you at home. Earn big profits from your own private practice or work with hospitals and doctors. Free catalog. National Institute, Desk 4, 4868½ Sheridan Road, Chicago 40, Illinois.

GROW Mushrooms. Cellar, shed, and outdoors. Spare, full time, year round. We pay \$3.50 lb. We paid Babbitt \$4,165.00 in few weeks. Free book. Washington Mushroom Ind., Dept. 174, 2954 Admiral Way, Seattle, Washington.

EARN While you learn. Auto and diesel mechanics master this top paying trade. Many graduates earn \$100 a week and up. Approved for Korean veterans. For free information write Dept. No. 236, Nashville Auto-Diesel College, Nashville 3, Tenn.

INVESTIGATOR Training. Phillips Secret Service System. 1917-B North Keneth, Chicago 39.

BOOKKEEPERS! Increase your earnings! Operate your own simplified "Dollar-A-Week" bookkeeping and tax service. Full or spare time. Details free. No obligation. Ellis, Box 200, Cedar Grove, North Carolina.

MEDICAL Laboratory technicians in great demand. We train you in your own home. Catalogue free. Imperial Technical Institute, Box 973-J, Austin, Texas.

USED Correspondence courses and books sold and rented. Money back guarantee. Catalog free. (Courses bought.) Lee Mountain, Pisgah, Alabama.

UNIVERSITY Degrees by residence and correspondence. Golden State University, Hollywood, Calif.

PIANO Tuning pays. Learn this profitable profession at home easily with patented Tonometer and mechanical aids. No knowledge music necessary. Diploma granted. Write for booklet. Niles Bryant School, 3731 Stockton Blvd., Dept. P, Sacramento 20, California.

"INDUSTRIAL Drafting Opportunities." Free booklet. Write—Industrial Training, 1704-A Frederick, Fort Worth 7, Texas.

OWN Collection agency office. Pays big! Free details. Franklin Credit, Roanoke 7, Va.

LEARN Logic and increase speed and accuracy in thinking. Dr. John Henry Melzer, Georgetown, Ky.

CAMERA Repairs men greatly needed! You can learn manufacturers' service methods at home, in your spare time! Free, big illustrated book tells how! Write today. National Camera Repair School, Dept. PM11, Englewood, Colorado.

PLAYS, STORIES, MANUSCRIPTS

WRITE For pay, new easy way. Based on your daily experiences, thoughts. Free information. Creative Ability Developer, 1819 Gilpin, Denver 18, Colorado.

NO Luck finding a book publisher? Write for free Booklet PM. Vantage Press, 120 W. 31, New York.

BUSINESS SERVICE

GERMANY Address lists. Anything manufactured \$1.00. Haven, Leidschestraat 106, Amsterdam.

SPECIAL SERVICES

\$1.00 BRINGS Illustrated pictures, B.C. antiques, coins and stamps. Confidential mailing service. Joseph Smith, Paseo Colon 321, Lima, Peru.

INFORMATION On anything. Ferguson Research Specialists, 116-14 141 St., South Ozone Park 36, N. Y.

MIAMI'S Largest Sunday newspaper, 25c. Letters remailed, 25c. Clark, Box 3602, Miami 23, Florida.

CARTOONING, COMMERCIAL ART, SHOWCARD & SIGN PAINTING, TATTOOING

CARTOONISTS: Amateur, professional. Prepare for animation with Max Fleischer's plan. Write Vera Coleman, Lincoln Building, New York, N. Y.

FUN With drawing. An instructive gift. Copy, enlarge, reduce. Highly satisfactory. Complete set \$1.25 postpaid. Agents wanted. Sketch-O-Graph, P.O. Box 606, Martinez, California.

FREE Trial cartooning lesson. No obligation. Write V. Vande Linde, Madison, W. Va.

DRAW Lightning-quick cartoons! Be a television artist. Chalk talk and cartooning. \$1.00. Graphic Arts, 2826 Texas, Vernon, Tex.

"HOW To Make Money With Simple Cartoons"—A book everyone who likes to draw should have. It is free; no obligation. Simply address Cartoonists' Exchange, change, Dept. 912C, Pleasant Hill, Ohio.

CHALK Talks. Laugh producing program \$1.00. Catalog 10c. Balda The Cartoonist, Oshkosh, Wisconsin.

TATTOOING Course, supply brochures 25c. Zeiss, 728 Lesley, Rockford, Illinois.

LEARN Sign painting at home. Test lesson free. Ben Kerns, Box 813-PM, Greenville, S. C.

PAINT Signs with master patterns. Set 1 1/2" to 12" high \$1.00; sample 3c. Eyerly, B-583, Newton, Iowa.

PAINT Signs—Have your own profitable business. Biggest complete course with 324 illustrations (18 in colors). Only \$5 postpaid. Descriptive circular free. E. C. Matthews, 2323 Cass, St. Louis 6, Mo.

9 ALPHABET, 3 Numeral pattern sets and raised wood letter catalog, \$1.00. Sign Letter Distributors, P.O. Box 101, Mineola, N. Y.

ADVERTISING AGENCIES, LETTER WRITERS, FOR ADVERTISERS

CANADIAN Mailing lists. Any classification. 1000 names \$2.00. Payne's, 162 McKittick, Kentville, N. S., Canada.

BEFORE Advertising get instructive Ad-Guide and Ratebook, 10c. Ideas developed. Advertisements prepared free. Chicago Advertisment Agency (Established 1900), Chicago 4.

CIRCULARS—Hand distributed. Fast! 6x9, \$4.00, 1000; 9x12, \$5.00. King Distributors, 101 Investment Bldg., Pittsburgh, Penna.

FRESH Mailing lists. Guaranteed. Any classification. Free literature. Transamerican, Box 815-A, Atlanta 1, Georgia.

ADVERTISING—Display, classified. Experts since 1893. Interesting budget brochure free. Newmark's Agency, 217-7th Ave., New York.

MAILING Lists, most any classification. 1000 names \$5.00. 1000 your circulars mailed with ours \$4.00. 5000 your circulars printed and mailed \$12.95. Write Dixie Mailers, King, North Carolina.

ADS Placed in out of town newspapers and magazines. Low rates. Catalogue free. Ideas that pay. Baker Advertising Agency, Successors Ankrum Agency, 189 W. Madison, Chicago 2.

ADVERTISE; 24 Words, 100 Canadian newspapers \$5.50. Lists free. Advertising Bureau, 10511-C Springfield, Chicago 43.

RUBBER STAMPS AND OFFICE SUPPLIES

FREE Style list stock stamps. Criterion, Box 2326, Denver 25, Colo.

FLATTERING Suggestions for Christmas—3 line pocket stamp with ink pad \$1.00. Gunned labels, printed 3 lines, 500, 50c. Complete printing and offset service. Money back guarantee. Catalog 10c refunded. Esco-1124-Print, 8 Holt, Dayton 7, Ohio.

BARGAIN Catalogue—Office supplies and equipment free. 1000 embossed business cards \$3.75. Guild, 2702 Georgia Avenue, Washington, D. C.

LINE 25c; 2-45c; 3-65c. Stamp Works, Auburn, Nebraska.

RUBBER Stamps by professional craftsmen. 3 lines \$1.00. Price list. South Coast Press, P.O. Box 2074, San Bernardino, Calif.

TYPEWRITERS, DUPLICATORS, OFFICE DEVICES

RECONDITIONED Typewriters, duplicating, printing devices, \$25.00 up. Supplies. Appliances. DixieGraph, King, N. C.

TYPEWRITERS—Govt. surplus, office size typewriters \$23 up. Free list. Meshna, 580B Lynn, Malden 48, Mass.

ROYAL Quiet deluxe portable typewriters, new, \$85.78. Corona Silent, latest, factory boxed, \$85.93. Free catalogue. 1001 bargains. Dealer's Mart, 54 Beverly Rd., New Rochelle, N. Y.

USED Typewriters! All makes. List free! Typewriter Exchange, Bedford, Penna.

PRINTING, MULTIGRAPHING, MIMEOGRAPHING GUMMED LABELS

SALES And order books, envelopes, statements, E-R Press, New York City 72. Free catalog.

MIMEOGRAPHING—High quality, reasonable prices. Free samples, pricelists. Mail-Me-Mimeo, 920 Vanburen, Milwaukee 2.

100 LETTERHEADS Or envelopes \$1.00. Two colors \$1.50. Broadbrook, Botaford, Connecticut.

100 ENVELOPES, Printed 2-colors \$1.25. Box 523, Rochester 2, N. Y.

MIMEOGRAPHING—Letters, pricelists, formulas, instructions. Lowest prices. Lem's Letter Shop, 8710 Stanton, Detroit 2.

500 3/4x2 1/4 FOUR Line gummed stickers 50c. Red border \$1.00. Moritz Printery, Saginaw, Mich.

QUALITY Printing, Booklets, publications, catalogs, stationery. Free catalog. Adams Printers, 30 West Washington, Chicago 2, Illinois.

OFFSET Printing \$6.50—1000, 8 1/2x11, 16 lb. National Letter, 1463 Broadway, New York 36.

TWO Color 8 1/2x11 letterheads, 500, \$4.00. Samples. D'Yarmett Printing, Newark, Ohio.

100 8 1/2x11 HAMMERMILL Letterheads and 100 envelopes postpaid \$1.95. H. Hudson, Centredale, R. I.

ATTRACTIVE Circulars \$1.50 1,000. Labels, stickers. Samples. Fame, 291 Ellis, San Francisco 2, Calif.

PRINTING, Offset, mimeographing—Samples, prices, free. Mimeo-Press, Madison, Tennessee.

50 PERSONAL Cards 50c. Raised printing business cards \$3.95 M. Wedding invitations \$5.50. Samples. Bell, 1401 1/2 North 16th, Birmingham, Alabama.

ILLUSTRATED Business letterheads; catalog 10c. Howprint, 723-G Eunice, Webster Groves 19, Missouri.

FREE Catalog business, personal printing. 500 8 1/2 x 11 letterheads \$3.50 postpaid. D & M Sales Co., Sebastopol, Calif.

POSTPAID Quality printing. Save 35%. Free samples. Liddin, 3813-D Winslow, Ft. Worth 9, Texas.

1000 EMBOSSED Cards \$4.00. Samples. Simon, 1536 Hoe Ave., New York 60.

SALESBOOKS, 25c. \$2.85 Postpaid. Gropp, 466 Harman St., Brooklyn 37, N. Y.

ENVELOPES—6 1/2". Printed, 500, \$3.25; 1000, \$3.75; 2000, \$6.50; f.o.b. Hargraves, Box 517, Corning, N. Y.

1000 BUSINESS Cards \$2.95. Job printing, mimeographing, offset, rubber stamps. Samples. Scull's, Dept. E-4, 121 West 25th Ave., Wildwood, New Jersey.

BUSINESS Cards, 1000—\$2.50. Rush service. Samples. Fuller's, 303 Amherst, Providence 9, Rhode Island.

BUSINESS Cards, Printing, Reasonable. Free samples. Lites: 5352-PM Princeton, Chicago 9.

QUALITY Offset printing—Budget prices, samples, quotations free. Gibraltar Printers, 1610 North Second, Clinton, Iowa.

PRINTING—Office supply catalog 25c. Refundable. Wallace, 1072 Tower Grove, Saint Louis 10, Missouri.

PRINTING OUTFITS AND SUPPLIES

PRESSES, Cutters, automatics, type-cases, cabinets, galleys. Requirements? Bulletins—stamp. Barclay, 175 Wooster, New York 12.

PRESSES, Type, cabinets, supplies. List for stamp, Lincoln Press Company, 220-M Hartwell, Fall River, Mass.

MAKE Your own self-molding rubber stamps and printing cuts. Plexirubber, Argyle 1, Wisconsin.

DO Your own printing. Save money. Simple rules. We supply everything. Print for others; good profit. Raised printing like engraving too. Have home shop. Details free. Kelsey Presses, V-11, Meriden, Connecticut.

PRINTING Presses, type, supplies. Lists 3c. Turnbaugh Service, Loysville, Penna.

PRESSES, Supplies, paper. Catalog 10c. Custom, Box 211-P, Springfield, Missouri.

PATENT ATTORNEYS

INVENTORS—If you believe you have an invention, you should find out how to protect it. The firm of McMorro, Berman & Davidson with offices in Washington, D. C., is qualified to take the necessary steps for you. Send for copy of our patent booklet "How to Protect Your Invention." We will also send you an "Invention Record" form. No obligation. They are yours for the asking. McMorro, Berman & Davidson, Registered Patent Attorneys, 134-V Victor Building, Washington 1, D. C.

INVENTORS—If you have a valuable invention, you are advised to authorize a preliminary search through appropriate classes of United States patents. This firm is registered to practice before the patent office and is available to make such search and report to you concerning the probable patentability of your invention. Instructive booklet with "Evidence of Invention" form sent upon request. Victor J. Evans & Co., 931-P Merlin Building, Washington 6, D. C.

CANADA—Ramsay Company Registered, 273 Bank Street, Ottawa, Canada.

INVENTION Record form free and "Patent Information Every Inventor Should Have." Carl Miller, Registered Patent Attorney, Woolworth Building, New York.

INVENTORS. Learn how to protect your invention. Unless the inventor is familiar with patent matters, he should engage a competent registered patent attorney or agent to represent him. We are registered to practice before the U.S. Patent Office and prepared to serve you in handling your patent matters. "Patent Guide for the Inventor" containing detailed information concerning patent protection and procedure with "Record of Invention" form will be forwarded to you upon request—without obligation. Clarence A. O'Brien & Harvey Jacobson, Registered Patent Attorneys, 41B-K District National Building, Washington, D. C.

REGISTERED Patent attorney offers services. Sanders, 6430 Evans, Chicago 37, Illinois.

"INVENTOR'S Guide" and "Record of Invention" free on request. Frank P. Ledermann, Registered Patent Attorney, 134 Nassau Street, New York City.

PATENTS—Irving L. McCathran, 315 McLachlan Bldg., Washington 1, D. C. Registered Patent Attorney.

PATENTS. "Proof of Invention" free. E. E. Vrooman, Registered Patent Attorney, 507 McKim Building, Washington 5, D. C.

INVENTORS: When you are satisfied that you have invented something of value write me, without obligation, for information as to what steps you should take to secure a patent. Write Patrick D. Beavers, Registered Patent Atty., 935 Columbian Bldg., Washington 1, D. C.

C. A. Snow & Co.—M427, Snow Building, Washington 1, D. C. Registered Patent Attorneys. Write for information.

INVENTORS: Without obligation, write for information explaining the steps you should take to secure a patent. John Randolph, Registered Patent Attorney, 203 Columbian Bldg., Washington 1, D. C.

FOR INVENTORS

INVENTORS: Learn how to protect your invention. Unless the inventor is familiar with patent matters, he should engage a competent registered patent attorney or agent to represent him. We are registered to practice before the U.S. Patent Office and prepared to serve you in handling your patent matters. "Patent Guide for the Inventor" containing detailed information concerning patent protection and procedure with "Record of Invention" form will be forwarded to you upon request—without obligation. Clarence A. O'Brien & Harvey Jacobson, Registered Patent Attorneys, 41A-K District National Building, Washington, D. C.

INVENTION Record form free and "Patent Information Every Inventor Should Have." Carl Miller, Registered Patent Attorney, Woolworth Building, New York.

SEARCHES—Put your patent searches in the hands of a registered patent attorney or agent, as he qualifies to give a worthwhile patentability report. Record of invention form upon request and information on patent protection. Patrick D. Beavers, Registered Patent Attorney, 936 Columbian Bldg., Washington 1, D. C.

INVENTORS: Information on patent procedure furnished on request, without obligation. John Randolph, Registered Patent Attorney, 202 Columbian Building, Washington 1, D. C.

INVENTORS: If you have an invention for sale, patented or unpatented, write Institute of American Inventors, Dept. 40A, 831-E St. N.W., Washington 4, D. C.

"INVENTOR'S Guide" and "Record of Invention" free on request. Frank P. Ledermann, 154 Nassau Street, New York 38, N. Y.

CASH For your idea. 280 manufacturers need inventions, patented or unpatented. List free. Invention Bureau, 208M Clinton, Oak Park, Ill.

COMPLETE Services for inventors. "Record of Invention" form free. Write National Inventors Institute, 4097 East 131st St., Cleveland 5, Ohio.

PATENT Searches, \$5.00, including patent copies. Same reliable search as conducted for patent attorneys. Free protection forms. Fast, accurate service. Patent Service Institute, 945-A Pennsylvania Avenue, Washington 4, D. C.

INVENTION Promoting specialist, patented, unpatented. Free details. Inventors Promotion Services, 152 West 42, New York 18, New York.

MAKE Money from ideas, patents. Get "Inventors Hand Book." Tells how. Send \$1.00. We have buyers. Inventors Creative Service, 354 South Spring, Los Angeles 13, Calif.

MAKE Money inventing. You can. Starting information free. Ken-Tec, Box 595, Garland, Texas.

A Million dollar, non-profit foundation, develops, patents and markets your invention, for a share of profits. Name and address of firm \$2.00. W. Bishop, Secretary, 382 North Second Ave., Phoenix, Arizona, P.O. Box 2581.

PATENT Searches, including copies of nearest patents, \$5.00. Reports airmailed within 48 hours. More than 75 registered patent attorneys use my service. For free invention protection forms, write Miss Ann Hastings, P.O. Box 176, Washington 4, D. C.

INVENTORS—This firm is registered to practice before the United States Patent Office and is available to assist you in the preparation and prosecution of your patent application. "Patent Protection for Inventors" booklet containing detailed information and steps to take toward patent protection will be sent upon request. No obligation. Victor J. Evans & Co., 932-P Merlin Building, Washington 6, D. C.

PATENT Searches \$5.00. 48-hour airmail service. Invention protection forms free. Write Patent Engineering Service, 711 14th Street N. W., Washington 5, D. C.

INVENTORS: Save dollars! Avoid costly mistakes. Get facts I learned in obtaining and promoting 30 U.S. patents. Send \$1 today for "One Inventor's Experience." R. E. McLean, 5703 South Benton, Kansas City 30, Missouri.

PROFESSIONAL Engineering service for inventors. Models made. Patent drafting. Patent specification writing. Retail testing. Quickly and reasonably. James E. Pettie, Box 616, Martinsville, Virginia.

PATENT Searches \$5.00. 48-hour service. Free invention protection forms. Write Raymond L. Smith, Patent Searcher, 622 Sheraton Building, Washington 5, D. C.

INVENTORS—Send for free patent information book and inventor's record. Registered Patent Attorney, Associate Examiner, Patent Office 1922-29; Patent Attorney & Advisor, Navy Department 1930-47. Gustave Miller, 124A Warner Building, Washington 4, D. C.

INVENTORS—If you believe you have an invention, you should find out how to protect it. The firm of McMorrow, Berman & Davidson with offices in Washington, D. C., is qualified to take the necessary steps for you. Send for copy of our patent booklet "How to Protect Your Invention." We will also send you an "Invention Record" form. No obligation. They are yours for the asking. McMorrow, Berman & Davidson, Registered Patent Attorneys, 134-T Victor Building, Washington 1, D. C.

PATENTS FOR SALE

INVENTORS: Test the commercial value of your patented or unpatented inventions, quickly and inexpensively. Write for free information. Institute of American Inventors, Dept. 40-B, 631-E St. N.W., Washington 4, D. C.

INVENTIONS WANTED

INVENTORS: If your invention is adaptable to our business we will contract on cash or royalty. If not, we will try to place. Free booklet. Kessler Corporation, 512X, Fremont, Ohio.

INVENTIONS Wanted, Patented; unpatented. Foremost promotion service. Full particulars free. Superior, 338-344 North Rodeo, Beverly Hills, Calif.

INVENTORS Don't sell your invention, patented or unpatented, until you receive our offer. Write Cowgill, Box 298, Marion, Ohio.

INVENTIONS Promoted, Patented or unpatented. Established 1911. Write Adam Fisher Company, 5418 Idaho, St. Louis, Mo.

INVENTIONS Wanted, Patented, pending only. Inventors Patent Exchange, Hartford 1, Conn.

INVENTIONS Wanted, Patented; unpatented. Tremendous manufacturers lists. Global Marketing Service, 1404 Mitchell, Oakland 1, California.

INVENTORS: Hundreds of manufacturers have requested our assistance in locating marketable new products. Complete information free. Institute of American Inventors, Dept. 40-D, 631-E St. N.W., Washington 4, D. C.

INVENTIONS Wanted, Patented or patent pending. 23 years experience promoting inventions. National Service Bureau, 3120 Meramec, St. Louis 18, Mo.

CASH Buyers for ideas and inventions. Write National Inventors Institute, 4097 East 131st St., Cleveland 5, Ohio.

BROKERS With complete service for inventors. The Invention Mart, Spring, Tex.

FROM Center American Industry, National Research & Development Corporation seeks patented or unpatented inventions for development or sale. Write for booklet A, Room 324, 11 West 42 Street, New York, N. Y.

INVENTIONS Wanted, patented or pending. M. Martin, P.O. Box 593-D, Healdsburg, Calif.

WE Finance, develop, promote inventions, patented, unpatented. Inventors Research, 1154 North Western, Hollywood 29, Calif.

INVENTIONS, Ideas wanted for development, manufacture. Write: Wadsworth Manufacturing Co., Wadsworth 9, Ohio.

PATENTS Promoted since 1931. Jacqueline Harvey, Century Building, Washington 1, D. C.

MANUFACTURING

DESIGNING, Manufacturing, Machinery, inventions, models. Henry, Engineer, 2136 E. Monmouth, Philadelphia, Penna.

SMALL Lot manufacturing. Wood, metal, plastics. McKinney, Route 3, Box 144A, Wichita 15, Kansas.

MODELS — Small lot manufacturing. Metals, plastics, etc. Milburn, Burlington, Kentucky.

WOOD Patterns, Metal castings. Send drawing. Kochan, 4002 E. 54, Cleveland 5, Ohio.

LIVE Steam engine, 10 1/2" high, ready-to-run, \$5.95 postpaid. Catalog 50c. Merlo, 50-18 94 Str., Elmhurst 73, N. Y.

1954 CAR Models. 1/25 scale, all metal, chrome trim. Send for catalog. Cars & Hobbies, Dept. PM-21, 2333 Haddon, Chicago.

MODELS, MODEL SUPPLIES

BIGGEST, Most complete illustrated model railroad catalog. 600 cast items. HO and O. 10c. Selley, 744 Clay, Winter Park 1, Fla.

1380 AIRPLANES, Boats, autos "Plans-book" \$1.00. Gull Model, Overlea 6, Maryland.

BUILD Miniature passenger hauling live steam locomotive with file and drillpress. We do machine work, you bolt it together. Catalog 50c. Little Engines, Wilmington, California.

POWER Models, Unusual steam, gasoline and traction engines, fittings, metals. Anniversary catalog 50c. Chas. Cole, Ventura, Calif.

SHIP And yacht model fittings; blueprints. Send 25c for illustrated catalog listing hundreds of items. A. J. Fisher, 1602-1 Etowah Ave., Royal Oak, Mich.

SHIP And other scale models. Most complete line in New England. Kits, fittings, plans, books, tools, engines, motors. Illustrated catalog 25c. James Bliss & Co., Inc., Dept. SM, 342 Atlantic Ave., Boston 10, Mass.

BALSA Wood, Grade AAA. Free sample, price list. Sig Mfg. Co., Montezuma, Iowa.

SHIP Models and yacht supplies, Complete, large 68 page catalogue 50c. Bill Wild's, 510 East 11 St., New York City 9.

HOME CRAFTSMEN

MONEY From scrapwood. Patterns and instructions \$1.00. Jigsaw necessary. Lynds, Medway 9, Mass.

GENUINE Leather "do it yourself billfold kit" only \$1.00 postpaid. First hundred customers will receive special surprise gift free. Miles Crafts, 3220-P Fish Avenue, New York 69.

FREE "Do-It-Yourself" leathercraft catalog. Tandy Leather Company, Box 791-Q6, Fort Worth, Texas.

BIG Savings leather—Now, for first time, you can buy full sides of top grain cowhide at our special, amazingly low "tannery-to-you" prices. For details, write Dept. 1, W. D. Byron & Sons, Williamsport, Md. Fine cowhide tanners since 1832.

LEATHERCRAFT Supplies at lowest prices. "Craftool" stamps. Catalog 10c. Crown Leather, 22 Spruce Street, New York 133.

METALCRAFT: Complete stock of tools and all the craft metals. Free catalog. Patterson Brothers, 15 Park Row, New York 3, N. Y.

LEATHER, Tools, lacings, supplies. Free catalog. National Handicraft, 199 William St., New York 7.

129 NEW Full size jigsaw patterns. Unusual novelties, gifts, lawn figures up to 22 inches high, action (merry-go-round) windmill, toys, useful gadgets. Artist drawn. \$1. Craftplans, 1321-A South Michigan, Chicago 5.

STYLECRAFT Sure fire hits. "Pre-traced" leather kits. Handbags, billfolds, filigree belts, over fifty other projects. Patterns on leather. Why trace? Just carve, assemble and lace. Large assortment "precarved" kits also available. Send 25c for catalog, free folder. Refunded first order. Apache Leather Company, 2804 E. Washington St., Phoenix, Arizona.

KNOCKDOWN Cedar chests. Lumber and veneers. Free price list. Giles & Kendall Company, Huntsville, Ala.

FREE Information. Money-making full size patterns. Professional designs. Furniture, gift shop items. Write Jigsaws, 117 Worth, New York 13.

KNOCKDOWN Cedar chests and lumber. Free price list. Bedford Lumber Company, Shelbyville, Tennessee.

HEATING. Do it yourself. Heat loss, installation plan, specifications, furnace provided. Save 50%. Tomco, 4112 Musko-gee, Des Moines, Iowa.

FIGURINE Catalog, 1955 edition, 800 illustrated items including Mrs. Helm's paints, enamels; Helen's water color paints, etc., only 35c. Klosterman, Dept. K, 954 Arcade, St. Paul 6, Minnesota.

16 NEW Lawn chairs, 22 picnic tables, benches, trellises, etc. All 38 plans with necessary full size patterns, \$1.00. Mastercraft 125M, 7041 Olcott, Chicago 31, Ill.

BEAUTIFUL Redwood burl for home-crafts. Sample free. Artwood, Santa Rosa, California.

101 FULL Size patterns. Smart, new, gifts, novelties, lawn figures, shelves, action windmills, alphabets. Plus "Make Money Jig Sawing." Only \$1.00. Mastercraft 125M, 7041 Olcott, Chicago 31, Illinois.

BUY Wholesale nationally advertised power, hand tools, thousands other products at big discounts. Free "Wholesale Plan." American Buyers', 628-RR Linden, Buffalo 16, N. Y.

89 FULL Size jig saw patterns of beautiful shelves, ornaments, toys, novelties. Plus "How, Where to Sell." Only \$1.00. Mastercraft 124M, 7041 Olcott, Chicago 31, Illinois.

HERE'S Something every hobbyist, gadgeteer or mechanic needs on his bench. Get rid of that old gear or flat iron you now use. I have a 3/4 x 6 x 10" cold rolled steel plate, flat enough for experimental layout. Could be the base for that new rig you're thinking of or just a good solid surface for punching or hammering on. \$5.00 each, weight 10 lbs. I pay postage. Metal Plate, R.D. 2, Bound Brook, N. J.

LEATHERCRAFT Of highest quality for advanced hobbyists, professionals and crafts classes. Careful grading assures a uniform selection of tanning and carving leathers, fine calfskins, kits and projects. Quality guaranteed. Complete stock of accessories, tools, supplies. Save time by using this one source for all your leathercraft requirements. All orders shipped same day received. Send 10c today for big, new illustrated catalog. Act now! J. C. Larson Co., 820 S. Tripp, Dept. 4750, Chicago 24.

LEATHERCRAFT, Metal tooling, textile painting, beadcraft, shellcraft, many other crafts. Fun, easy, profitable! Free, big, illustrated catalog. Write today. Kit Kraft, Dept. 262, Box 1088, Studio City 1, Calif.

WOODWORKING Course for home craftsmen. Twenty-two manuals. Over 1,000 pages, 75 training projects. Only complete home training program available today. Carefully written, profusely illustrated. Covers everything from wood selection to final finishing. Complete instruction in care and use of all hand and power tools. Prepared by expert manual training instructors. Write for free booklet. Interstate Training Service, Dept. G-3-N, Portland 13, Oregon.

PLASTICS Home-craft course for men and women. Tells and shows how to make hundreds of fast selling plastics products. All plastics and materials for 23 projects included in course. No special tools needed. Course pays for itself. Write for free booklet. Interstate Training Service, Dept. D-3-N, Portland 13, Oregon.

LAMP Size cypress knee with nipple installed \$2.00. Cy Products, Dept. 2A, Lafayette, La.

LEATHERCRAFT. Tremendous stock of leather, tools, supplies, and kits. In leather business over forty years. Send 10c for big catalog. Sax Bros., 1111 No. 3rd, Dept. PM12, Milwaukee 3, Wisconsin.

SEA Horse shell assortments, \$1 and \$3. Vista House of California, Box 716, Manhattan Beach, Calif.

CHRISTMAS Candlestick kits. New, different. Make lovely gifts. \$2.50 pair. Spencer's, 243 Albion Pl., Cincinnati 19, Ohio.

LIFE Size Santa with Pack. 5 ft. pattern. Simple, unique construction directions for achieving life-like appearance. \$1.00 postpaid. Walker Studio, 212-S, 4343 Lindell, St. Louis 8, Missouri.

LEATHERCRAFT Pre-cut kits, tools, patterns, instruction books. Stylecraft, Craftool, others. Catalog 10c. Whitman Saddle Mfg. Co., 1725 Powers St., C-12, Cincinnati 23, Ohio.

LEATHERCRAFT And leatherwork fundamentals. Latest book a beginner must have to succeed. \$1.75 mailed. Leather, 358 E. Broadway, Long Beach 2, Calif.

CHILDREN'S Knockdown platform rockers. Springs, duran, lumber, etc. 100% parts. Make this for Christmas. \$6.75 each. Matching ottoman \$1.00 each, both p.p. Send check or money order to Carpenter Furniture Co., P. O. Box 1449, Birmingham, Ala.

STEEL And aluminum angles, flats, rounds, threaded bars, sheets, easy to build screen and window stock (all in ready to use lengths). Also drills, dies, rubber tired wheels and supplies for many home-shop projects, repairing, building, toy-making, etc. Write for prices (freight allowed). Steelkraft, Box 94, Freedom, Penna.

MAHOGANY Miter boxes and many other home crafter items! Send fifteen cents for folders! Eastern Hills Lumber Co., Station M. Cincinnati 27, Ohio.

LEATHERCRAFTERS: Everything you need. Catalog 10c. Art Leather, 411 Joseph Ave., Rochester 5, N. Y.

FREE Leathercraft catalog. Do-It-Yourself." Write Tandy Leather, Box 397AC, Tulsa, Oklahoma.

ALPHABET Patterns.—Monograms, numerals. 14 sets 1/2"-4" high. \$1.00 postpaid. Walker Studio, A-212, 4343 Lindell, St. Louis 8, Missouri.

RAZORS, BLADES, SHARPENING

SAVE 4c Each. Double-edge blades. Free sample or 25c for two months supply. Jan-lee, Box 122, Merchantville, N. J.

DO IT YOURSELF

FURNITURE—Wrought iron legs and frames! You assemble. Free catalogue. Phillips Furniture, East Peoria 8, Illinois.

GEIGER Counter and metal detector kits. Inexpensive, educational. Free literature. Electronic Applications, 5034 Lee Highway, Arlington 7, Va.

DO It yourself kit. Knife with one blade and five interchangeable tools. Awl, file, chisel, screwdriver, can opener and cap lifter in billfold size Vinylite case. Handy for sportsmen. Ideal gift, \$2.00 postpaid. No c.o.d. Satisfaction guaranteed. Free circular. Earl B. King, 611 S. Pickwick, Springfield 4, Mo.

LEVEL For foundations, floors, sewers, contour plowing, any distance, based on principle that water seeks its level. Make this accurate level yourself—save time and money. 50 ft. clear tough vinyl tube .287" o.d. and complete illustrated instructions postpaid \$5.95. Moneyback guarantee. Hydrolevel, 53 DeSoto, Ocean Springs, Mississippi.

BUILD Inexpensive concrete blockmaker. Motor-hand. Also mixer. (Both for less than \$10.) Then make blocks for 5 room house for \$95. Write. C. Lee, Mountain View, Oklahoma.

COMPLETE Foam rubber catalog sent free! Foam Rubber Products, Box M, 908 Marquette, Minneapolis, Minnesota.

DO-IT-Yourself. Build a power mower with Handy-Dandy conversion kit. \$19.50, prepaid in U.S.A. Fits 16" to 20" mower. LeClaire Mfg. Co., LeClaire, P. M., Iowa.

MAKE Your own. Do it yourself. Get new report and treatise on sugar, sweets, calcium and tooth decay. Easy to understand methods for better tooth and mouth cleansing. Save money and help prevent decay. Simple and easy. Free formula included. Ingredients in your home. You'll be glad you saw this. Postpaid \$1.00. Money back guarantee. J. W. Brooks, Research Consultant, 137 No. Chatsworth Ave., Larchmont, New York.

LEATHERCRAFT Supplies. Handbag, billfold kits, Catalog 25c, refundable. Free advice. Folders. Phil Thiel, 305 Broadway, Seaside, Oregon.

CLOCK Movements—Gorgeous dials, plans, kits. See ad page 257.

BUILD 10 Amazing machinist tools that can't be bought anywhere! Save \$100! Free literature. Progressive Tool Designers, 2101M S. 76th Street, Milwaukee 14, Wisconsin.

CLEVENGER'S All cold ornamental iron instructions, \$2.00. Box 1001, Santa Rosa, Calif.

ELECTRO-Pen, easy to make plans \$1.25, writes any metal, operates on toy transformer, car battery. Remler, 2946 Tyburn, Los Angeles 39, Calif.

3-D Projector, thrilling performance, takes Stereo Realist slides. Nineteen detailed full size drawings \$5.00. Illustrated circular 10c. Victor Specialties, 775 D Main Street, New Rochelle, N. Y.

EASILY Built basement window greenhouse. Plans \$1.00. Jays, 2112 Portland, Minneapolis 4.

STAINLESS Steel fastenings: Handy do-it-yourself assortments, \$2.00 ea. Choice of sheet metal, or machine screws, or nuts (pp). Catalog 25c. Star Stainless, 655 Union Blvd., Paterson 2, N. J.

HOW To paint. Do it yourself. Illustrated instructive book, 25c. Catalog free. Popular Mechanics Press, 200-HP E. Ontario St., Chicago 11, Ill.

BE Your own plumber. You can. Few inexpensive tools and our instructive book, "Home Plumbing Guide," shows and tells you how. Hundreds of photographs and diagrams. Easy to follow. 160 pages. \$3.50. Catalog free. Popular Mechanics Press, 200PG East Ontario St., Chicago 11, Ill.

WATCHES, OLD GOLD, JEWELRY

WATCHES Overhauled \$4.50. One year's guarantee. Berkowitz, 1150 Castlehill, New York 62.

WATCH Materials: I specialize in close cuts. Write Fred Harmon, Box 441, Somerset, Ky.

COSTUME Jewelry supplies. Catalog and samples. 35c. Largest line in America. Milady-Fair Co., G.P.O. Box 1328, New York City 1.

FREE Sample pair of earrings shows you how easy it is to make beautiful costume jewelry. Over 5000 styles listed in new catalog, 25c. Barry's, 188 Ardsley Court, Newark, N. J.

UNREDEEMED Diamond, 1-carat, \$295. 30-day refund. Free catalog. Broff's Diamond Loan Association, 411 Smithfield, Pittsburgh, Penna.

WATCHMAKERS' Journal contains instructive articles for watchmakers and beginners. Sample copy 20c. Dean Co., Box 3218-M, Daytona Beach, Fla.

RHINESTONES, Jewelry settings, cameo, sequins, beads, hobby kits. Catalog free. J & M Novelities, Dept. CP-3, Griffith, Indiana.

WATCH And clock repairing books for hobbyists. Free information. North American, Dept. 14-L, 2320 N. Milwaukee, Chicago 47, Illinois.

WATCH Repairing—Modernized correspondence course. Free information. WatchHealing Institute, Box 34715-A, Los Angeles 34.

AMATEUR—Professional watchmakers' supplies; correspondence instruction; repairing. Bengale Company, Culver City, California.

HIGHEST Prices for gold, silver, platinum, diamonds, watches, gold teeth. Satisfaction assured. Goods returned if offer unsatisfactory. United Smelting Works (Old Reliable) 6-B East Monroe, Chicago 3.

COSTUME Jewelry supplies. Free catalog. Send \$2.25 for four gross rhinestones, value \$5.00. Ebert, Box P183, East Orange, New Jersey.

MAKE Costume jewelry for fun and profit. Catalog 25c. Bergen Arts, 128M Main, Hackensack, N. J.

TOBACCO, SMOKERS' SUPPLIES

FREE Booklet, "How to Blend Pipe Tobaccos." Tobacco Blending, Box 1171, Louisville 1, Ky.

SMOKERS Have fun when asked for cigarette. Unit reusable, one dollar. Box 146, Dayton, Ohio.

PIPE Smokers! Cigar smokers! Free illustrated catalog offers fabulous savings on choice imported and domestic pipes, cigars, tobaccos, supplies. Write Wally Frank, Dept. 1, 150 Nassau St., New York 38, N. Y.

FOR THE HOME

DO Your merchandise shopping at home. Illustrated catalog 25c, refundable first order. D & M Sales Co., Sebastopol, Calif.

AUTOMATIC Fire alarm systems. Write, Di Medio, 1748 Jarvis Avenue, New York 61.

FOAM Rubber furniture cushions. Factory seconds. 50% discount. Free catalog. Perma-Foam, 140-C Main Street, East Orange, New Jersey.

OF INTEREST TO WOMEN

NEW Plastic mending tape. Just press on! Repairs clothing instantly. Lightning seller. Samples sent on trial. Kristee 107, Akron, Ohio.

WEAR Earlaures, successor to earrings. Inquire Miller, Box 10104, Tampa 9, Fla.

DRESSMAKERS. Sewers, wholesale lists. Dress, suitings, formal fabrics. Box 883, Norwalk, Conn.

PROFITABLE Home business. Make fast-seller chenille monkey trees, dolls, flowers. Terrific holiday demand. Information free. Velva, Bohemia 16, N. Y.

NYLONS 14c. Anklets 6c, socks 9c, print 17c, panties 12c, dresses 50c, slips 47c, undershirts 17c, robes \$1.65, spreads \$2.65. Jewelry \$1.25, watches \$3.50, electric razors \$2.00, aspirin \$1.00—1,000, brushes 9c, razor blades 1 1/2c, pens 8c, combs 1 1/2c. Complete stock list, picture catalogue. 25c. Send immediately. Silbert's, Chattanooga 4, Tennessee.

GROW Mushrooms. Cellar, shed, and outdoors. Spare, full time, year round. We pay \$3.50 lb. We paid Babbitt \$4,163.00 in few weeks. Free book. Washington Mushroom Ind., Dept. 176, 2954 Admiral Way, Seattle, Washington.

ELECTRIC Razor (AC), ideal for making underarms and legs beautiful! Wonderful Christmas gifts—guaranteed! \$5.00 postpaid. The Buyer's Mart, Box 666A, Stillwater, Oklahoma.

EXTRA Money every week. Send for free catalog. Dealer prices on watches, diamonds, home needs, jewelry, gifts, electrical appliances. Marshall Sales, 2016 Edmondson Avenue, Baltimore 23, Md.

\$200 OR More for your child's photo, all ages—types, if used for magazine, calendar, billboard advertising. Send one small photo for approval. Print child's, parents' name, address on back. Returned 30 days. No obligation. Spotlight, 5864-LPM Hollywood, Hollywood 28, California.

MAKE Big money at home! Invisible reweaving pays up to \$10.00 profit in an hour. Make tears, holes disappear from fabrics. Constant demand from laundries, cleaners, homes brings steady earnings. Details free. Fabricon, Dept. C, 8342 S. Prairie, Chicago 19, Illinois.

FOR SALE—MISCELLANEOUS

OLD Wall telephones. Working order. oak cabinets, hand crank for ringing. \$5.00 each. Telephone Co., Turtle Lake, Wisc.

WANTED—MISCELLANEOUS

QUICKSILVER, Sterling, silver solders, precious metals. Wholesale Terminal, Norwood, Massachusetts.

SCRAP Mercury (quicksilver) containers supplied—Tantalum, bismuth, tungsten. Metallurgical Products Company, Established 1909, 35th and Moore Sts., Philadelphia 45, Penna.

PERSONAL

INTERESTED, Investigate. New York City help wanted columns air mailed to you—\$1.00. Rudge, P.O. Box 995, New York 7, N. Y.

LETTERS Remailed 25c, or have mailing-receiving address in Columbus for \$2.00. McLaughlin, 800 Stewart, Columbus 6, Ohio.

"HOW Can I find out?" You can! Information confidentially developed. Any matter, person, problem. Worldwide. Officially licensed. Established 1922. William Herman, 170 Broadway, New York City.

LETTERS Remailed 25c. Personal forwarding address. Monthly rates. Hicks Service, Box 1547, Washington 13, D. C.

MEXICAN Law office. Bank references. P.O. Box 41, Juarez, Chih., Mexico.

PORTRAIT In oils. Modern-impressionistic, by the renowned E. John Shay, see Pate magazine advertisement for particulars. Send any photograph. \$25.00 prepaid. P. O. Box 4102, Panorama City, California.

HOLLYWOOD Or Pasadena postmark. Letters remailed 25c. Box 552E, Pasadena, California.

PERSONAL Name plates—doors, desks. Details free. Advance Products, 31 Radium Street, Pittsburgh 14, Penna.

LETTERS Remailed 25c each. Confidential. Ace Service, Box 186, Tampa 1, Fla.

PRACTICING Psychologist, author, will accept limited number of ambitious men, women for one year course of study by correspondence. Information free. Give age, occupation. Address: H.S.U., Box 2397NS-PM, Springfield, Missouri.

LOVELAND Remail 25c. B. A. Ogden, P.O. Box 86, Loveland, Ohio.

BIG Mail! Attractive offers! Magazines, etc. 6c! Filmer, 9101 Marion, Pharr, Texas.

BORROW By mail from Postal Finance Co. Employed men and women can easily obtain \$50 to \$600 fast, entirely by mail. Repay in small monthly payments. Friends, relatives, employer, tradespeople will not know you are applying for loan. Advise occupation, amount wanted. Postal Finance Co., 300 Keeline Bldg., Dept. 7Z, Omaha, Nebraska.

CONFIDENTIAL Remail 25c, personal receiving forwarding address, monthly rates. Classifieds \$1.00. Business transacted. Associated Enterprises, Box 224, Rome, Illinois.

SAN Francisco postmark! Letters remailed. 35c. Private receiving-forwarding address available. Monthly rates. Memo-Mart, Box 3244, San Francisco 19, Calif.

USE My address. \$3 month. Hedgpath, Box 539, Alhambra 23, California.

NEW Orleans or Baton Rouge remails 25c. 10 scenic postcards \$1.00. McQuillan, Box 471, Baton Rouge, La.

LETTERS Remailed 25c. Personal forwarding address. Monthly rates. Evergreen Service, Box 4072, Magnolia Station, Seattle, Washington.

SURPRISE Your friends. Send postcards from fabulous Venezuela! Will airmail you three lovely color views for \$1. You address, return and we reairmail. Satisfaction guaranteed. Letters reairmailed 50c. Confidential. Al's Mailing Service, Apartado 2511, Caracas, Venezuela.

LETTERS Remailed. Niagara Falls, Buffalo, 25c. Thomas, 54B Central Lane, N. Tonawanda, N. Y.

CHRISTMAS Letters, cards remailed Santa Claus, Indiana, postmark, 25c each. Tellejohn, PM, Holland, Indiana.

LETTERS, Remailed, forwarded, 25c. Foster, 830 Terry, Cincinnati 5, Ohio.

CANADA'S Capitol remails 25c. Also monthly, confidential. 193 Lansdowne, Ottawa.

HOLLAND Remail \$1.00. 5 scenic view-cards \$1.00. Beautiful framed reproductions of old Dutch painters \$5.00. John Haven, Leidschestraat 108, Amsterdam.

HELP Wanted ads San Jose and San Francisco airmailed \$1.00. B. J. Bassett, 3826A Rayanna Ave., Santa Clara, Calif.

JAPAN—Letters reairmailed \$1. Dalevi, 569, 3-chome, Shimo-Meguro, Meguro-ku, Tokyo.

OHIO, Remailing. 25c each stamped letter. Box 146, Dayton, Ohio.

LETTERS Remailed 25c. Miami, Washington, New York, Chicago. Mann's, Danville, Virginia.

LETTERS Remailed mile-high. 25c. Kirby, 5060 Lincoln, Denver 16, Colo.

MIAMI Or Hollywood, Florida. Letters remailed. 25c. Classified \$1.00. Hopes, Box 126, Hollywood, Florida.

BUSINESS And help wanted ads airmailed from fabulous Houston \$1.00. Remails 25c. Tex-Mail, Box 9243, Houston, Texas.

GET 6 Post cards from Maine (Vacationland). You address and I'll remail. All for \$1.00. Harold Haley, Bar Mills, Maine.

ESTABLISH Chicago address. Mail forwarded daily. Details. Remails 25c. Confidential, 20-C West Jackson, Chicago 4.

HOLLYWOOD Remails 25c. Five scenic postcards \$1.00. Confidential receiving-forwarding address. Monthly rates. Any business transacted. California Mailing Service, Box 1442, Hollywood 28, California.

MISCELLANEOUS

AMAZING Combination tool. Sharpens knives, scissors, garden tools, etc., expertly. Includes glass cutter. \$1.00 postpaid. Ohio residences add sales tax. Arkay Company, Dept. S-7, 3733 Marburg Ave., Cincinnati 9, Ohio.

FREE—Gadget, gifts and home-novelty catalog. 180 interesting, useful items. Economy Buyers, 210 Fifth Avenue, New York 10, New York.

FLORIDA County maps—Large detailed showing lakes, streams, roads and trails. Ideal for hunting, fishing, locating property. Send county name and dollar. List free. Godfrey's Map Service, Winter Haven, Fla.

VEGETARIAN Foods. Low fat content. Cost less than meat. Four, one pound cans, \$2.00. Postage paid. Nes-pak Foods Co., Inc., 95 Bridge Street, Lowell, Mass.

BUY Wholesale thousands nationally advertised products at big discount. Free "Wholesale Plan." American Buyers, 631-DD Linden, Buffalo, N. Y.

BUY Wholesale cameras, appliances, gift ware. Catalogue 50c (refundable). Dart, 3812 E. Atlantic Avenue, Brooklyn 24, N. Y.

CLOGGED Drains, cesspools and septic tanks cleaned by new powerful chemical. Sursolvent removes grease, soap, tree roots, etc., without expensive digging and electric rodding machines. No pumping necessary. Mix with water and pour down drain. Free details. Electric Drain Cleaning Co., Boston 24, Mass.

RECEIVE Magazines, samples, catalogues. Mails from everywhere. Offers, hundreds. Get listed 25c. Rorick, Box 86, Cincinnati 26, Ohio.

GOLD, Silver, metal detectors. Geiger counters for uranium. Mineralights. Sensational new fully guaranteed models. None finer. Information free. Detectron Corp., 5420 Vineland Ave., North Hollywood, California.

SELECTIVE Metal and mineral detector. Revolutionary design. Distinguishes metals from black magnetic sands. Readily detects metals under salt water. Also Geiger counters. Free literature. Gardiner Electronics Company, 2018 N. Dayton, Phoenix, Arizona.

TREASURE Finders for gold, silver and minerals. Money back guarantee, best available. Also Geiger counters for uranium prospectors, free information. Write Goldak Company, 1541 West Glenoaks, Glendale 1, Calif.

GROW Mushrooms. Cellar, shed, and outdoors. Spare, full time, year round. We pay \$3.50 lb. We paid Babbitt \$4,185.00 in few weeks. Free book. Washington Mushroom Ind., Dept. 175, 2954 Admiral Way, Seattle, Washington.

PANNING Gold—Free lesson; catalogue of mining, mineral books, supplies. Old Prospector, Box 729D1, Lodi, Calif.

TREASURE—M-Scope Geiger counters, mineral locators. Why buy something inferior when you can buy the best at a lower price? Backed by years of experience. Fully guaranteed by factory. Detects minerals, metals, gold, silver, coins. Payment plan available. Proven superior performance. Free 16 page illustrated booklet. Fisher Research Lab., Inc., Palo Alto, California.

URANIUM, Gold, silver, treasure. New power-packed, highly sensitive metal detectors and Geiger counters. Kit and factory assembled models from \$34.50. Lightest weight, guaranteed. Free literature. Electronic Applications, 5024 Lee Highway, Arlington 7, Va.

GERMAN Manufacturer directory! 800 pages. English-Spanish index. \$9.00 postpaid insured. Burke Associates, Manchester, Mass.

BEAUTIFULLY Boxed exquisite Cameo set with genuine diamond. Necklace, earrings set comes with a good-as-gold written guarantee. \$19.95 value—Christmas special \$6.00! Send payment with order to Fleming's, Box 5223, St. Louis 10, Mo.

GEIGERS, Scintillators, several lines new and used, first rental plan catalogues. U.S. wall map uranium deposits postpaid \$1.25. Micromatic Associates, 2322 W. Whittier Blvd., Montebello, California.

WHOLESALE! 8000 Nationally famous products. 30-80% discounts! Large catalog. Sensational business plans included. Consolidated Distributors, 21-13 Lafayette. Paterson 15, New Jersey.

SNOOPER Geiger counter. Only \$29.95 complete. Super-sensitive. Pocket size. Find a fortune in uranium. Order now. Send \$5.00, balance C.O.D. Money back guarantee. Free catalog, scintillator and larger uranium and metal detectors. Precision Radiation Instruments, 2335 CPM So. LaBrea, Los Angeles 16, Calif.

BARGAINS Galore! Gifts-gadgets catalogue 15c. Center Industries, Mt. Auburn, Illinois.

GEIGER Counter tube, large, \$7.00, postpaid. High voltage supplies, circuits, sensitive prospecting instruments. Mineralights. Western Radiation Lab., 1107 W. 24th Street, Los Angeles 7, Calif.

HANDWRITING Analyzed! Personality, future remodeled! Bijou, Box 1727-HR, Hollywood 28, California.

IMPERATIVE! Get the truth about your dynamic powers within. Free. Write Applied Christian Psychology, Inc., Box 1924-N, Louisville 1, Ky.

EARN Money evenings, copying and duplicating comic cartoons for advertisers. Adservice, Argyle 1, Wisconsin.

MEN'S Leather link belts, natural, black, tan or brown. 3/4", 1", 1 1/4" widths. State lengths. Postpaid \$2.25, two for \$4.00. Cash with order. Ann Craft, Box 5364, Columbus 19, Ohio.

SPECTRUM—Fire makes leaping colored flames in the fireplace, bringing happiness to the family. One box \$1.29; two boxes \$2.25. We pay postage in U.S. Satisfaction guaranteed. Vernon Green, 806 Paris Avenue, Rockford, Illinois.

MAKE Your own home repairs. Why hire others to do it? You can save hundreds of dollars. New book packed with 646 illustrations (192 pages) shows you how to do each job without previous experience. Written so you can understand it. Send for your copy of "Guide to Home Repairs." \$2.50. Popular Mechanics Press, 200-HR East Ontario St., Chicago 11, Ill.

SEPTIC Tanks, cesspools, toilets, cleaned, deodorized with Tru-Septic. No mixing, no bother. Guaranteed. 4 treatments costs only \$1.75 at your dealer, or order direct. Earl Young Co., Encino, California.

UNUSUAL Gift pendant and gold filled chain complete \$6.95. Genuine onyx engraved with 24 karat gold, one choice, fancy letter, school, religious and fraternal emblems. Check, money order only. Satisfaction guaranteed. Majestic Gem Co., 35 Maiden Lane, New York City.

EXCITING Mails, rare offers, attractive plans, unusual opportunities, profitable hobbies, sample magazines, money making secrets. Year's listing 25c. Mulino Crafts, Mulino, Oregon.

FREE Information, simple way to figure acreage. Carmean, Hutchinson, Kans.

BUY Everything wholesale, national brands. Catalogue 25c. York, 175-A Fifth Avenue, New York City 10.

SHRUNKEN Head paperweights. Excellent duplication. \$3.00. Wallace, 614 North 6th Ave., Phoenix, Arizona.

ARE Flying saucers real? 8 x 10 photolithograph, speculation, \$1.00. Box 3095-PM, Riverside, California.

SENSATIONAL Gift item! Mailed prepaid when desired anywhere U.S.A. Two attractively framed matching simulated oil paintings \$1.00. Free circular. Kennedy's, 1100 W. Cary, Richmond, Va.

REMODEL Your own home. Save hundreds of dollars. New, amazing book shows you how. Written so you can understand it. Step by step instructions make it easy. Fully illustrated, 400 photographs, hundreds of diagrams. 160 pages. \$2.95. Literature free. Popular Mechanics Press, 200-HR East Ontario St., Chicago 11, Ill.

FOOL Your friends. Mail five movie star cards from fabulous Hollywood or pictureque Hawaii. Send \$1.00 to Smith, 38,622, Hollywood 38, Calif.

CATALOG Of 1200 popular educational and self-help materials, pocket-books, etc. 10c. World Adventure, D423, Ann Arbor, Michigan.

SWAPPERS, Read Hoboswap Monthly. Only quarter from Traders, Alger, Mich.

LEARN How to ripen fruits, nuts, blown prematurely from trees. How frozen chicks came to life again. 800 catalogued, copy-righted problems, answers, including above, for only one dollar. "Doc" Hartmann, Southold, L. I., N. Y.

"HOW To Make Money in Uranium." At last a concise 32 page guide for the beginner. Answers questions on prospecting, claims, Geiger and scintillation counters, geology, mine operation, partnerships, etc. \$1.00 postpaid. Radiation Detection, 513-I North Santa Fe, Pueblo, Colorado.

"X-RAY Mind." Stupendous mental power. (Details 10c), Krishnar Institute, Box 842-87, Escondido, Calif.

AMAZING NEW ADHESIVE FILM

GUARANTEED TO PERMANENTLY JOIN ANY COMBINATION DESIRED . . . Metal • Glass • Wood • Bakelite • Polystyrene • Acetate • Felt • Paper • Leather • Fabrics, etc.

TWEEZLE—An adhesive that's completely new . . . made for the home workshop or home. Excellent for repairing and joining most anything . . . furniture, name plates, medallions, ornaments, etc. Want to put leather on glass? Join plastic with wood? Hang pictures without marring walls? Repair your rubber hose? Tweezle does all this and more!

Comes in flexible sheets. Just cut to required size, dip in solvent, lay on with tweezers. It grips firmly at once . . . creates an amazingly strong bond when dry. No ordinary glue can compare with it! Tweezle adheres and insulates at the same time.

\$1 brings you enough Tweezle to repair, reinforce and join scores of objects. (No C.O.D.'s) Money Back Guarantee.

HALCYON MFG. COMPANY Dept. PM, 537 Johnson Avenue, Brooklyn 37, N. Y.

DO IT YOURSELF FOAM RUBBER SOFA BED \$160 Val. KIT

Save over \$100. Sofa COMPLETE KIT by day—single bed by night. Easy assembly. 6' 3" long "No Sag" springs. Goodyear 4 1/2" Air Foam mattress. Presewn covering. Tan, Gray, Green, Red. Money back guar. Order now. \$10 deposit. Bal. C.O.D. Or write for literature.

BESTCRAFT CO., Dept. 92
Mathieson Bldg., Balto. 2, Md.

\$59.95



\$35,000 REWARD FOR URANIUM

Here's your chance to "cash in!" Over \$2,500,000 in Government Bonuses have been paid for URANIUM discoveries in the past 2 years. Currently \$150,000 a month is paid to people just like you.

Precision Geiger Counters and Scintillators are the finest instruments made for URANIUM prospecting. These highly sensitive instruments are compact, lightweight and ruggedly built for field use. Prices start at \$29.95.

CONTACT YOUR NEAREST DEALER or write direct to factory for FREE 12-PAGE CATALOG, describing URANIUM and Metal detectors.

DEALERS WANTED

PRECISION RADIATION INSTRUMENTS, INC.
2235PM S. La Brea, Los Angeles 16, California
WORLD'S LARGEST MANUFACTURER OF PORTABLE RADIATION INSTRUMENTS



Learn REFRIGERATION AND AIR CONDITIONING

FREE! PLAN FOR YOUR SUCCESS

EXTRA CASH NOW—Spare time at home—Earn while you learn by doing with Easy Home Course. **START YOUR OWN BUSINESS**—No Experience Needed. Special tools & equipment furnished. Send for **FREE BOOK**—TODAY!

MECHANICS TRAINING SCHOOL—Dept. P-5412
7217 South Broadway • Los Angeles 3, California

FREE BOOK



TALK—SING—PLAY OVER YOUR RADIO

with the real Radio Mike! Attaches in a jiffy—full instructions given! Swell for "parties"—"cut in" on or "kid" regular network programs or put on your own broadcasts! Amaze your friends—real fun. Beautiful Metallic Plastic 6 in. high!

12 RADIO BROADCAST LESSONS GIVEN with each mike

SEND NO MONEY Just pay postman \$3.99 COD plus postage or send \$3.99 and we pay postage! Radio Mike is available only from us by mail—guaranteed. Midway Co., Dept. MPM-12, Kearney, Nebr.

OWN A... FORD?

FIX IT YOURSELF!

Popular Mechanics Magazine has just published a new Owners Manual covering all 1941 to 1952 models of Ford cars . . . So accurate mechanics use it . . . so simple a woman can understand it.



Save money on your Ford car repairs. Prevent trouble. Enjoy care-free driving. Increase trade-in value. Avoid major repairs by fixing minor troubles before they get serious. Get sparkling performance at all times. Has 272 pages, more than 350 photos, diagrams, tables, charts, breakdown drawings, plus clear, non-technical directions that make all repairs simple as A B C. Written by Ed Packer with the assistance of the Ford Motor Company. Shows you how to diagnose all Ford troubles by feel, sound, sight, smell and performance. Simple trouble shooting. Permanent repairs. Emergency repairs. Plus, "How to get value from garages."

MONEY BACK IF IT DOESN'T SAVE MORE THAN IT COSTS!

One minor repair will save the cost ten times over. Read it. Then you decide. If you don't see that you'll save more than the cost, send it back for refund. **SEND NO MONEY.** Send postcard. Ask for the Ford Manual. Postman will deliver C. O. D. for \$3.50 plus postage. Or, save postage by sending \$3.50 with order. Send today. Save its cost on your next repair.

POPULAR MECHANICS PRESS
200 E. Ontario, Dept. 90, Chicago 11, Illinois

FACTORY PRICES—10-DAY MONEY BACK GUARANTEE

NYLON AUTO COVERS

New rubberized DuPont nylon—mildew & water repellent. One side soft fabric not to scratch. Absolutely lightest and strongest cover made. Will protect against all elements. Secured with heavy elastic.



ALSO AVAILABLE
Canvas Auto Cover—Soft 6 oz., suntan, water, fire & mildew repellent. 14 lbs. . . \$12.95 + \$1.00 ship. Extra heavy plastic cover . . . \$7.95 + 85c ship.

Give 8 lbs. Car Standard Model Size **\$18.95** plus 95c ship.



BOAT COVERS New treated army canvas 10 oz. before treatment, 17 oz. after treatment. Water, fire & mildew resistant. Double stitched, brass grommets, shaped, green. add 3% shipping

FINISHED SIZES: 4 1/2'x13' \$9.95 | 6'x17' \$11.95 | 8'x24' \$19.95
6'x15' \$10.95 | 8'x20' \$16.95 | 12'x30' \$37.50
RECTANGULAR TARPS TO ORDER AS ABOVE, 10c SQ. FT.

NYLON TARPULINS Incredibly strong new Neoprene rubber coated DuPont nylon. Wt. 8 oz. sq. yd. Water & mildew treated. Hemmed, brass grommets, green. Made to your size. (Min. size 9 x 3, add 3% for shipping) **11c sq. ft.**
STOCK SIZES: 7x6 \$4.25; 7x9 \$6.50; 9x9 \$8.25; 9x12 \$12.95; 9x15 \$13.95; 9x20 \$18.95; 12x12 \$14.95; 12x20 \$24.95

DEFENDER TEXTILE CORP. 425 D'WAY, DEPT. PM-12, NEW YORK 13, N. Y.

MONEY FOR MEN ALL DATA FREE

THE PLASTEX Industry needs manufacturers on small scale and for big production of Lamp and Clock Stands, Art Goods and Novelties in Plastex and Marble imitation. Experience unnecessary. See material makes regular 10c store sellers. Rubber molds furnished for speed production. Small investment brings good returns. We are now placing big Chain Store Orders with manufacturers. Ambitious men have chance for real prosperity. Our Free booklet will interest and benefit you.

PLASTEX INDUSTRIES, Dept. A
3400 Third Ave. New York 56, N. Y.

SOCK-O World's Most Powerful

SUPER SLINGSHOT
SILENT • RIFLE FAST • POWERFUL • ACCURATE
Great for small game, targets. 45 lb. pull. BIG sturdy Stock. Lively. Raw rubber. Sweet shooting! FREE! 100 steel balls, rubber and target. FREE!!! Thrilling SURPRISE PACKAGE with Two slings at \$2.95. Harry, get 2! Guaranteed. Approved by American Small Game Sling-shot Assoc.

SOCK-O, 4860 W. 137 St., Hawthorne, Calif.

\$1.50 Wholesale No C.O.D.

NEW! Giant AUTOMOTIVE CATALOG
1955 Edition! Everything for car, truck, custom-styled car, hot rod . . . at **LOWEST PRICES!**
Save up to 50% on all parts, accessories! Only complete automotive buying guide . . . 50,000 items . . . 148 pages! Thousands of hard-to-find parts; equipment, parts for 1930 to 1955 models; **Hollywood accessories** never before offered; **hi-speed parts.** Send your name and address and 25c (refundable with first \$5.00 order) to:
J. C. Whitney & Co., 1917 Archer, Dept. P-12, Chicago 16, Ill.

Guaranteed for Life of your car

The **NEW Metalloy Grid Battery**

Custom Built for Today's Driving Conditions

ELECTOMIC Lifetime Battery METALLOY GRIDS

Electric Plates and Cells

ELECTOMIC LIFETIME BATTERIES, DEPT. PM 114
601-85th Ave., Oakland 21, California

Please Ship (Cash, Check, Money Order Enclosed)

6 volt Pass. Car Electomic Lifetime Batteries @ \$19.95 (inc. tax)
 12 volt Pass. Car Electomic Lifetime Batteries @ \$24.95 (inc. tax)

Build it YOURSELF

Heathkit

BROADCAST BAND RECEIVER KIT

Have you ever experienced the thrill of building your own radio? Invest a few of your dollars—a few hours of your time, and build a truly worthwhile broadcast band receiver. Transformer operation eliminates potential shock hazard characteristic of "economy" AC-DC sets. Operates as radio, phono, amplifier, or tuner. Fine tone quality, excellent sensitivity. Simplified Construction Manual outlines basic theory of radio principles. Actually a radio course in itself. Price includes tubes—speaker—chassis, etc. Every part you need! Order your Heathkit Radio Kit today.

MODEL BR-2
\$17.50
SHPG. WT. 10 LBS. (LESS CABINET)

OTHER "BUILD IT YOURSELF" Heathkits

- Oscilloscope
- Vacuum Tube Voltmeter
- Signal Generator
- Amateur Transmitter
- Communications Receiver
- Multimeter
- Handitester
- Hi-Fi Amplifier
- Hi-Fi Preamplifier
- Battery Eliminator
- Signal Tracer
- Tube Checker

(And many others)

WRITE FOR Free CATALOG

HEATH COMPANY
BENTON HARBOR 17, MICHIGAN

Complete description of all Heathkits

Say You Saw It in Popular Mechanics

PLYWOOD BOAT KITS

12 FT. \$97.00
14 FT. \$129.00
Freight Included

Send for free folders on all models as low as \$39.00 freight included

TAFT MARINE WOODCRAFT
Dept. PM-12, 636 39th Ave., N.E., Minneapolis 21, Minn.

ELECTOMIC Lifetime Battery . . . \$19.95

\$34.95 VALUE ONLY \$19.95 IF YOU INSTALL IT YOURSELF. FACTORY DIRECT TO YOU. THE WORLD'S GREATEST BATTERY IMPROVEMENT IN OVER 40 YEARS.

GUARANTEED FOR THE LIFE OF YOUR CAR—AS LONG AS YOU OWN IT. "METALLOY" GRIDS (SILVER-NICKEL-TELLURIUM) PLUS ACTIVATED OXIDES PRODUCE ELECTOMIC PLATES AND CELLS GIVING INSTANTANEOUS STARTING POWER—FAR GREATER CAPACITY EVEN AT FRIGID TEMPERATURES—WITHSTANDS TERRIFIC VIBRATION. ELECTOMIC LIFETIME BATTERIES OUT-PERFORM ALL OTHER BATTERIES—EXCEED GOVERNMENT SPECIFICATIONS . . . ORDER YOURS TODAY. MAKE EXTRA MONEY—BE THE FIRST IN YOUR AREA TO INSTALL FOR OTHER CAR OWNERS. ACT QUICKLY—DON'T MISS THE OPPORTUNITY OF A LIFETIME. FILL IN ORDER FORM BELOW AND AIR MAIL TODAY.

FOR _____
Make and Model, Year of Car

NAME _____
ADDRESS _____
CITY _____ ZONE _____ STATE _____



Whatever your hobby

Model building, whittling, Indiancrafts, leather, plastics or any other creative handicraft

x-acto knives, tools & sets

designed by craftsmen and precision-made for fine craftsmanship

will help you do a better job

and get more fun and satisfaction from your hobby.

Send for 16 page booklet "Helpful Hints" on use of modeling tools—FREE.
X-acto 28 page catalog—20¢



dept. M-12

x-acto, Inc.
48-41 Van Dam Street
Long Island City 1, N. Y.

make your hands more creative with x-acto

Build a Better Garage for One Half the Cost!

Get New Popular Mechanics Book Before You Build, Buy or Plan Any Garage



Over 500 Pictures

Build It Yourself or Have it Built—Either Way You Save and Get a Better Garage

The Answer to All Garage Problems

Here is the answer to every garage problem. If you can use a hammer and saw, you can save hundreds of dollars on a fine new, modern garage. Get "How to Build Your Own Garage," Popular Mechanics' simplified How-to-Do-it book for the amateur builder and follow the pictures and instructions. If you prefer to have your garage built by others, get this book first for it can solve any garage problem you may have.

Car Ports, Garages—Brick, Block, Frame—They're All Here!

Also valuable information on attractive garage doors; how to dress up a garage; space for storage, workshop, recreation, automatic door operators, planning and making your own driveway—plus pictures and instruction for every construction detail if you want to build your garage yourself.

Prepared especially for the inexperienced builder by Wayne C. Leckey, associate crafts editor of Popular Mechanics, with the assistance of many builders, manufacturers and associations in the building, lumber and hardware fields, it TELLS HOW in simplified, step-by-step instructions—SHOWS HOW with hundreds of plans, diagrams and actual photographs.

Money Back Guarantee

Mail the coupon for "How to Build Your Own Garage" today. Use the book for 7 days and return it for full refund if it does not please you. You can't lose under the P. M. guarantee of satisfaction or your money back.

25 Designs to Choose From

Every type—every style—every size. All shown in actual photographs to help you make your own choice. Actual building plans available for many of the garages shown.



Two-car frame garage amateur can build and getting garage under cover with large sheets of plywood. Both illustrations from the book.

Use This Money Back Coupon

POPULAR MECHANICS PRESS, Dept. GB-2
200 E. Ontario St., Chicago 11, Ill.

Send at once, "How to Build Your Own Garage" under your 7 day trial, money-back guarantee. Remittance for \$3.50 enclosed. Send postpaid. Send C.O.D. (U.S.A. only). I will pay postman \$3.50 plus charges.

Name _____

Address _____

City _____ Zone _____ State _____

NOW! FABULOUSLY ACCURATE MICRO-GROOVE RIFLING

in a Beginner's .22!

only \$13.85

New Marlin Model 100. Single-shot, bolt action, shoots Short, Long and Long Rifle .22 cartridges.

Automatic ejection. Real walnut stock. Simple one-screw take-down for cleaning. Sturdy, SAFE—with the sensational accuracy of Marlin's exclusive new MICRO-GROOVE RIFLING.

See it at your Marlin dealer now—the new Marlin Model 100.

THE NAME FOR GAME

Marlin

FINE GUNS SINCE 1870

*Slightly higher west of Rockies

LIFTS, MOVES HEAVY LOADS



2-Wheel hand truck, with 4-speed hydraulic lift platform, loads and unloads trucks, stacks merchandise, raises dies, kegs and motors for easy handling. Hand operated. Capacity 500 lbs. Grand Shop Caddy Model 4036 lifts 36", Model 4054 lifts 54" from floor level. Grand Distributors in principal cities.

Write for complete information.

ALLIED MFG. & SALES CO.
3101 W. Grand Ave., Chicago 22, Ill.

MAGNET 'MAGIC

HOBBYISTS - GADGETEERS - INVENTORS

Delight in our Permanent Alnico Magnets. Guaranteed. Box of 7 assorted sizes - Only \$1.25 postpaid. Literature of our 1001 other uses FREE on request. Send check or money order - NO C.O.D.'s.

KRIEGER ENTERPRISES, INC.
444 Spitzer Bldg. Toledo 4, Ohio

Fix it for keeps with Du Pont DUCO Cement

- STRONG!
- TRANSPARENT!
- WATERPROOF!
- FLEXIBLE!



Better Things for Better Living...through Chemistry

PUNCH PRESS

2 Ton Power Bench Type
Make Your Shop Complete
Powerful - Dependable - Economical

Easily make your own dies for light stampings, forming, riveting etc. Ideal for production or experimental work. Replaces more expensive presses. Requires only 1/2 H.P. motor. Weight 105 lbs. Fully guaranteed. Only \$97.50 less motor. Write for free circular. Dealer Inquiry Invited.

ALVA F. ALLEN, Dept. PM, Clinton, Missouri

ELECTRIC MOTOR

A low-cost, dependable motor with many uses. Ideal for displays, pumps, fans, heaters, toys. No radio interference. Every one guaranteed. Write for free catalog.

\$150
Post paid

PENNSYLVANIA WHOLESALE DISTRIBUTORS
103 N. 6th STREET PHILADELPHIA 6, PA.

MILLING ATTACHMENT FOR DRILL PRESSES

Ideal for home and shop. Hardened and ground spindle. 5" x 12" table top, 10" longitudinal travel, 7" cross slide. Only \$77.75 complete for 13", 14" or 15" drill press; 16" and 17" brackets \$2.00 higher. Also End Mill Grinding Attachment only \$6.50. Illustrated circular on request.

WATERBORG MACHINE CO.
2830 Rapids Drive Racine 2, Wis.

FREE AMAZING NEW BOOK "HOW TO ANSWER ADS"

Never before have you seen anything like this. Tells you in simple language the correct way to answer ads. Gets you quicker replies—better results, and greater satisfaction. Will save you time and money and it's ABSOLUTELY FREE. No obligation whatever. Every reader of advertising should have this booklet. Send a postcard for your copy NOW. F. W. Johnson, Popular Mechanics Magazine, Room 600-A, 204 East Ontario Street, Chicago 11, Illinois.



Give the gift of carefree motoring!



STEWART-WARNER MOTOR MINDER®

Checks engine performance on-the-road - Shows how to save gas, avoid repair bills!

If he drives, here's the perfect Christmas gift! The Stewart-Warner Deluxe Custom Model Motor Minder checks engine performance—as he drives! See how to s-t-r-e-t-c-h gas mileage. This combination engine analyzer and driving gauge shows performance of plugs, valves, carburetor, manifold, piston rings, etc. Warns of trouble. Illuminated Dial. Simple installation.

only \$10.95
It's the gift that pays for itself!

Get it at your dealer's. If he cannot supply you, send us his name and address with your check or money order for \$10.95. Motor Minder will be sent prepaid!

STEWART-WARNER

Instrument Division, Dept. N-124
1840 Diversey Parkway, Chicago 14, Illinois

BUILD YOUR OWN POWER TOOLS - GIL-BILT

WITH GIL-BILT PARTS KITS

PLANS only \$1.00 EACH POSTPAID

GIL-BILT 10" TILT/ARBOR SAW

Sturdy wood, steel and aluminum construction, NEW DEPARTURE ball bearings. Capacity and performance of floor saws selling for \$150 and up. Plans and all metal parts in kit with 10" comb. blade \$25.90, less blade \$22.95.

GIL-BILT 12" BAND SAW

Sturdy wood, steel and aluminum construction. Ball bearing drive, rigid cast aluminum wheels, rubber tires. Cuts to center of 24" circle, tilt table. Capacity and performance of band saws selling for \$80 and up. Plans and all metal parts in kit with 1/4" blade \$23.95.

GIL-BILT 18" BAND SAW

Sturdy wood, steel and aluminum construction. Ball bearing drive, rigid cast aluminum wheels, rubber tires. Cuts to center of 36" circle, tilt table. Capacity and performance of band saws selling for \$270 and up. Plans and all metal parts in kit with 1/4" blade \$37.95.

GIL-BILT BELT SANDER

Sturdy wood, steel and aluminum construction. Driver drum and pulley turn on sealed New Departure ball bearings. Belt operates in either vertical or horizontal position. Tilt table. Capacity and performance of sanders selling for \$45 and up. Plans and all metal parts in kits, with rubber tires and cloth sanding belt \$18.95.

With GIL-BILT simplified plans, you build easily with hand tools only. Advertised and sold for 7 years. Thousands in use the world over.

ALSO AVAILABLE Plans & Parts Kits for Spindle Shaper, 8-in. Tilt-Table Saw

Return Kits in 10 days for refund if not satisfied. For shipments up to 600 miles, add 2%; over 600 add 10%. Amount in excess of actual postage will be refunded. Order Kit now, or order Plans at \$1.00 each and Kit later less cost of plans. Write for FREE Catalog.

GILLIOM POWER TOOLS DEPT. 80-M, LAMBERT FIELD ST. LOUIS 21, MISSOURI

END FUSE TROUBLES FOREVER!



with a push on this button



- Fits like a fuse in any standard fuse socket!
- Just press the Mini-Breaker button to restore service.
- Safe protection against overloads, and short circuits.
- Lifetime protection against electrical fire hazards.

In 10, 15, 20, 30 amps. AC only, 125 volts max.
Listed by Underwriters' Laboratories

MINI-BREAKER®

Ask for it at your favorite store or write
Mechanical Products, Inc., Jackson, Michigan.

do it faster...better!



PLIERS,
CHISELS,
PUNCHES,
SNIPS,
ADJUSTABLE
WRENCHES

Buy wherever
fine tools are
sold in U. S.
and Canada.

KRAEÜTER

TELEVISION! CAMERAMAN, REPAIRMAN.

Learn at home, in spare time. No experience needed. We send you 15 Radio-TV kits including TV receiver. Earn while you learn. Write for free TV Book, free sample lesson, etc. APPROVED FOR VETS. RADIO-TELEVISION TRAINING ASSOCIATION Dept. M-12 52 East 19th St. New York 3, N. Y.

AMAZING BARGAINS

MAKE YOUR OWN POWER UNIT

Here's a power unit PACKED WITH BRUTE FORCE! Does all those hard, heavy jobs that ordinary power tools cannot handle. Easily made from vacuum cleaner type motor, a gear reduction drive and a few homemade parts. Can be used for turning large nuts & bolts, digging post holes, drilling large holes in wood or metal, driving power tools and machinery, lifting, pulling, pushing, or any job where slow speed with high take-off power is required. YOU CAN'T STALL IT! Lightweight, easy to handle. Has 1,000's of uses in Home, Garage, Shop, Factory. Order #511A Gear Reduction Box (86 to D) NEW. Priced at only.....

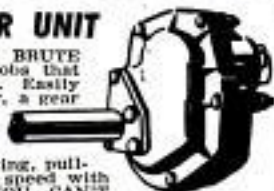

\$11.88
Delivered

Bendix Hyd. Pump & Motor. 3 1/2 G.P.M. 800 P.S.I. 12, 24 or 32 Volt D.C. NEW. Only \$9.98 Express Collect. Order #468A.

Generator 200 Amp. 24 Volt D.C. good used. Order #323A. \$14.95 Express Collect. Makes A #1 Welding Generator.

SEND DIME TODAY FOR DESCRIPTIVE LITERATURE ON HUNDREDS OF OTHER BARGAINS.

KARL ORT Dept. P.M. 12 York, Penna.



How to save money on all plumbing jobs — using approved methods.

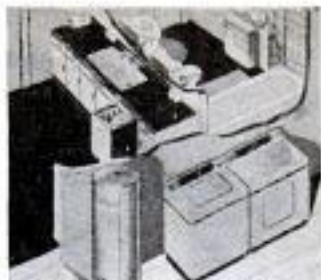

How to select materials and fixtures.

Save on Plumbing Costs

When You Build · When Making Improvements
Repairs · Maintenance

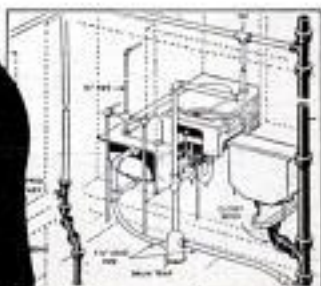

How to plan and lay out plumbing installations.

15 Ways to Save Money in Your Own Home

- All about modern home plumbing
- How to use plumbing tools in your home
- Getting acquainted with pipe
- Pointers on planning home plumbing systems
- Installing and maintaining the home drainage system
- Your own private sewage disposal system
- The causes of drainage troubles and how to cure them
- Home water lines and how to install them
- Valves and faucets and what to do with them for best and most economical service
- Your own private water supply system
- All about water heaters and automatic supply
- Methods and advantages of water conditioning
- Water system troubles and how to prevent and cure them
- How to install plumbing fixtures and take care of them for longer life

Do All Kinds of Jobs Yourself With Home Plumbing Guide

Got a leaky faucet; a clogged drain; a noisy hammering water pipe? Want to add a bathroom to your home, install a new kitchen, or even build a home? Then you need Popular Mechanics' HOME PLUMBING GUIDE. It shows how you can do every kind of plumbing job yourself and can easily save you hundreds of dollars. Savings on even a small job will pay for this practical book many times over. It covers plans and layouts, installation, maintenance and repair of all home plumbing systems; tells you what materials to get and use and how to do a proper job with approved methods.

Over 500 Pictures and Diagrams and Hundreds of Money-Making Tips

Simple everyday jobs, bigger remodeling and improvement jobs and complete installations are made clear and simple and easy to follow. Few, other than the simplest tools are required and some of these can be rented. Pipe, materials and fixtures are available from mail order houses, hardware dealers and supply houses. Don't pay high prices for work you can do yourself. Get the HOME PLUMBING GUIDE. You will be amazed how the practical text and hundreds of how-to-do-it pictures show simply jobs you thought might be difficult.

Mail Coupon, Money Back if You Want It

Get the HOME PLUMBING GUIDE today. Only \$3.50. Read it. Study it. Put the vital information it contains into practice. Then if you are not satisfied return the book for a complete refund of your money. Order today.



Mail Coupon Today for Money Back Home Trial

POPULAR MECHANICS PRESS, Dept. HPG-1
200 East Ontario Street, Chicago 11, Ill.

Send Popular Mechanics HOME PLUMBING GUIDE in cloth binding at once. I understand I may return the book in 7 days for full refund of my money.

- Remittance for \$3.50 enclosed. Send postpaid.
- Send C.O.D. (U.S.A. only) I will pay postman plus charges.

Name _____

Address _____

City _____ Zone _____ State _____

An Outstanding METAL HAND PUNCH with unusual performance

Needed by every Mechanic in every Shop

No. 5 Jr. HAND PUNCH

CAPACITY—1/4" THRU 1 1/2"
Ga. Mild Steel. 3/32" —
1/8" — 5/32" — 3/16" —
7/32" — 1/4" — 9/32" —
Punches and Dies Furnished.



THROAT
DEPTH
2 inches

Weights
2 3/4 lbs.

only \$9.25

ORDER YOURS TODAY!

Write for FREE Catalog on other tools.

Postpaid in
U.S.A.

WHITNEY METAL TOOL CO., Dept. PM-12, Rockford, Ill.



BRONZE FOUNDRY

Schools and Home Workshops

Make your own castings of aluminum, copper, bronze, silver. Foundry sets are available in three sizes including 2400 Deg. F. blast Furnaces. \$22.50; \$29.50; and \$42.00. f.o.b. Kansas City. Free Circular.

KANSAS CITY SPECIALTIES CO. P. O. Box 8022, Dept. P-12
KANSAS CITY, MO.

BOLENS GARDEN TRACTORS M-E ROTARY TILLERS POWER MOWERS CHAIN SAWS

BOLENS PRODUCTS DIVISION

Food Machinery and Chemical Corporation

265 S. PARK ST. PORT WASHINGTON, WIS.



Print Your Own

Cards, Stationery, Advertising, labels, circulars, photo and movie titles, church work, tags, etc. Save money. Sold direct from factory only. Raised printing like engraving, too. **Print for Others, Good Profit.** Have a home print shop. Easy rules supplied. Pays for itself in a short time. Write for free catalog of outfits and all details.

KELSEY PRESSES, N-37 MERIDEN, CONN.



Precision HAND-TAPPING on Drill Press or Miller!

TAPPO Chuck Wrench — Used by Master Craftsmen for Precision Hand-TAPPING and REAMING. No Experience Needed! TAPPO Chuck Wrench fits Key-Style Chucks, size EA 33 0-1/2 in. **MONEY BACK GUARANTEE!** Order NOW. Send Cash, Check or Money-Order. (Dealer Inquiries Invited)

\$375

GILBERT MFG. CO. 139-M RIVERVIEW AVE. ELKHART, INDIANA POSTPAID

NEW LOW-PRICED QUALITY TOOLS!

This durable PORTABLE HACK SAW ATTACHMENT easily saws metal, wood, and plastics. Fast action, simple to use. All around tool gives years of service. Mousing of aluminum alloy casting. Complete with 2 blades. Satisfaction guaranteed. Order today! Send check or money order. Immediate shipment, postage paid.

\$1595

Fits any 1/2" electric drill

DURA-TOOL

Write today for Free Catalog on entire line of tools!

CLIZBE BROS. MFG. CO., PLYMOUTH, INDIANA

I'VE TRIED THEM ALL—
THERE'S NOTHING THAT
DOES THE JOB LIKE
PLASTIC WOOD!



Plastic Wood is stronger—resists weather. Sands down to a smooth, hard finish. Professional craftsmen have preferred Plastic Wood for more than 50 years because it takes paint, varnish and other finishes best. Will not chip, crack or peel . . . won't pull away! In cans and tubes.

In natural, white and 8 wood colors.

"PLASTIC WOOD"

SAVE MONEY on SURPLUS PARTS for MILITARY TYPE TRUCKS & JEEPS

4 & 6 wheel drive. FREE catalog. State make of truck or Jeep. (New Jeep Tops, steel or canvas for all models). **AMERICAN AUTO PARTS CO., Inc., 1830 Locust, Kansas City, Mo.**

SAY YOU SAW IT IN
POPULAR MECHANICS

D.C. ARC WELDER

AT A.C. TRANSFORMER WELDER PRICE

\$350.00 VALUE
ONLY

Fully Guaranteed \$85.00 f.o.b.

200 Amps. Belt Driven

Model # LG-200 Can't be Matched!

Pays for itself immediately!

For field and shop use! Ideal for machinery break-downs in field. Operates at 3000 RPM off any tractor, jeep, truck or 5 HP electric motor . . . any engine of 10 HP or more (old auto engine is excellent). Welds anything from Tractor frames to Sheet metal. Make your own special equipment for Farm, Shop or Factory. Does 1,001 jobs! **WELDS, CUTS, BRAZES** steel, cast iron, galvanized, bronze, aluminum, tool steels and stainless steels. Straight or reverse polarity. Welds 1/32 to 1/2" plate, cuts 3/4" plate. Uses 1/16 to 3/16" rods. **COMPARE FEATURES:** Brand New! Compact. Reactor-type series winding for EVEN ARC. Rheostat for pin-point heat control. Large brushes for extra long life. Oversize ball bearings. Air cooled by internal fan. Complete with 2-groove V pulley. Direct current makes arc striking and welding easier. Output is 30 to 200 amps. **ACCESSORIES AT A BUY!** Two 15-ft. cables. Ground Clamp. 300 amp. electrode holder. Ass't electrodes. Helmet. Simplified instructions. **COMPLETE OUTFIT (shpgt. wt. 85 lbs), only \$98.50 f.o.b. FULLY GUARANTEED!** You can't go wrong. Send for our

LIMITED OFFER! 10-DAY FREE TRIAL! ORDER FROM AD Use it for 10 days. Be 100% satisfied or money back!

FREE . . . CATALOG of Motors, Electrical BUYS! **ROBERTS ELECTRIC CO., Dept. P-240, 849 W. Grand, Chicago 22, Ill.**

AUTHENTIC

SCALE MODEL

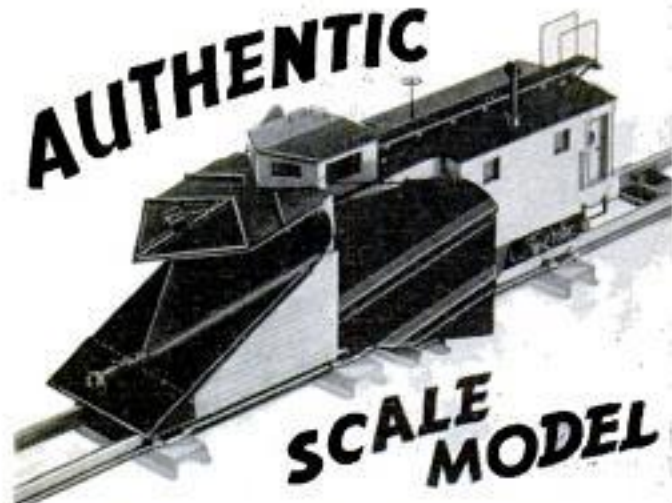

B & M SNOWPLOW KIT

Proudly display this authentic, superdetailed B & M "Winged" Snowplow on your desk, mantle or TV set. This eye-catching, ornamental Kit has won instant favor among Model Rails and Hobbyists of every type. Easy to build. Ideal for gifts. Profitable to sell. Precision cut basswood. S Gauge, 3" x 8 3/4". Complete with trucks and 2 oz. 30c tube of AMBROID CEMENT, \$6.95. At your Hobby Shop or mailed direct for 25c extra.

AMBROID**WEYMOUTH 78, MASS.**

seal up DRAFTS

...save FUEL!

BUY *Bridgeport*
INNER-SEAL
WEATHER *Live Rubber* STRIPPING



Make your home more comfortable — seal up air leaks effectively with INNER-SEAL, the flexible, easy-to-install weather strip. INNER-SEAL's exclusive patented construction makes a pressure-tight seal that keeps heat IN, keeps cold OUT. Neoprene coated INNER-SEAL is waterproof, abrasive-resistant, durable. Adjusts perfectly even on warped frames . . . lasts for years.

INNER-SEAL is available in handy "do-it-yourself" Queen B and B Paks — in the lengths you need to weather-strip doors, windows and storm windows! Complete directions printed inside every pak.

Ask for your FREE copy of "Why & How To Weather-Strip". Available where you buy your hardware or building supplies.



OR, WRITE: DEPT. PM12,

BRIDGEPORT FABRICS, INC., BRIDGEPORT 1, CONN.

find URANIUM with ATOMS

**Gun Type**

The "PROSPECTOR", Model GC-238—a portable, light (2 3/4 lbs.) ultra-sensitive Geiger Counter for radio-active ore prospecting. The first to utilize a patented Printed Circuit. Uses low voltage batteries. 5 methods of indication—flashing neon light, response & meter with 3 ranges of sensitivity. \$84.50 complete. RADIAC CO., INC., 489 Fifth Ave., Dept. PM-12, N.Y. 17, N.Y.

SCINTILLATION COUNTERS
150-times more sensitive than a Geiger Counter. Currently used by Atomic Energy Commission for Uranium prospecting. Excellent for airborne, mobile or foot prospecting. From \$299.50 up.

Prospector**\$84.50**

make your own Gems 29⁵⁰ For

The Gem Maker comes complete with all necessary equipment, including a super-charged diamond blade for sawing, and all wheels for grinding, shaping and polishing; also complete instructions. The complete equipment as shown, less motor and belt, for only \$29.50, f.o.b., Burlington, Wisconsin. Write today for information and literature.

B & I MANUFACTURING CO.

Dept. 5 Burlington, Wis.

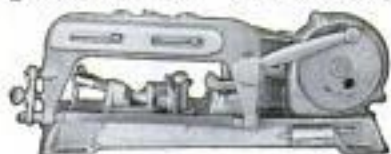

POWER HACKSAW \$55.75

LESS MOTOR
F.O.B. Benton Harbor

Send for full details and name of nearest dealer.

• Rugged cast iron construction. Wt. 56 lbs., bronze bearings. Draw cut. Auto. return lift. Auto. shut-off. Vise swivels 45°. Cap. 4"x4".

EXCEL MACHINE TOOLS BENTON HARBOR, MICHIGAN

\$6⁹⁵ DRAINS cellars, cisterns, wash tubs; IRRIGATES - CIRCULATES - SPRAYS



1,001 USES—HOUSE, GARDEN, FARM
Original All-Purpose Pump has 2400 GPH capacity; 300 GPH 75' high; or 1500 GPH from 25' well. Use any 1/8 to 3/4 HP motor. Stainless steel shaft. 1" inlet, 3/4" outlet. Motor coupling included.

DOES NOT CLOG OR RUST!
Postpaid if cash with order. (West of Miss. add D.C.) MONEY BACK GUARANTEE. Larger Centrifugal Pumps, and Gear Pumps in all sizes. LABAWCO PUMPS, Belle Mead 7, N. J.

ROTARY MOTOR

FOR DOOR OPENERS, AIR SHUTTER CONTROLS, GATE CLOSERS, ETC.



12 V.D.C. gear-motor converted for 115 vac. 3/4" dia. x 1 1/2" L. Shaft, 1.5 RPM @ 75 inch lbs. Two self contained relays for automatic stop and reversal for three variable pre-set positions over 180 degrees. (May be bypassed for 360 degree rotation.) Meas. 4 1/4" x 5 1/2" x 4 1/4". Precision built for U.S.A.F. by White Rodgers. Send only \$8.75 plus est. postage for motor

and voltage converter (115 VAC to 12 VDC). Send 10c in coin or stamps for latest catalog listing motors, rectifiers, timers, transformers, counters, electro-mechanical equipment.

SOUNDTRONICS • 632 ARCH ST., PHILADELPHIA, PA.

FREE CATALOG

Over 300 books on Fishing, Hunting, Home Repairs and Improvements, Bricklaying, Welding, Home Workshop, Power Tools, Hobbies, Crafts, Home Building, Trades, Making Money at Home, Furniture Making, Woodworking, Carving, Photography, Art, Drawing, Mechanics, Engineering, Refrigeration, Plumbing, Radio-TV, Electricity, Automobiles, Farming, Livestock, Gardening, Decorating, Painting, many, many more. Send for yours today.

POPULAR MECHANICS PRESS, 200 E. Ontario St., Chicago 11

HELPFUL BOOKS

Send post card asking for FREE catalog

Popular Mechanics Press, 200 E. Ontario, Dept. 601, Chicago 11

BACK AGAIN!
4 TOOLS IN 1
Bigger! Improved!

the complete
Metal Work Shop
 Patent No.
 2053309

**SHEARS
 FORMS
 PUNCHES
 RIVETS**

ONLY **9.95** Postage Paid
 Send check with order.
 No. C.O.D.'s.



BIGGER! SIMPLIFIED OPERATION—one compact unit offers more than ever before. 5 Punch sizes— $\frac{1}{8}$ "
 $\frac{5}{32}$ " $\frac{3}{16}$ " $\frac{7}{32}$ " and $\frac{1}{4}$ ". Shears and forms up to 1"
 wide, 16 ga. steel. Rivet dies included. **SPECIAL**—
 Threading dies for $\frac{1}{8}$ " $\frac{5}{32}$ " and $\frac{3}{16}$ " stock only \$1.00.
NEW—Hand Brakes—handle up to 16 ga. 12" Model—
 \$9.95. 18" Model \$14.95. **NEW!** Notch Units—handle
 up to 16 ga. Available in 90° Notch 1" x 1" or Slotting
 Punch 1" x $\frac{3}{4}$ ". Only \$9.95 each. Special shapes available.
SAVE! BUY AT WHOLESALE—Send 50c in coin or
 stamps for big 82 page Wholesale Catalog of Name
 Brand Products.

SATISFACTION GUARANTEED OR FULL REFUND
ALBERT J. TATU, INC. 85 COLUMBIA DRIVE, Dept. PM 12
 WILLIAMSVILLE 21, N. Y.

DON'T BE CAUGHT WITH A DEAD BATTERY



Amazing "New Life" battery rejuvenator
 stops build-up of plate sulfates... keeps bat-
 tery automatically charged. Use lights, heater,
 radio, as much as you like. Get faster starting!
 Greater power! **RECHARGING IS UN-
 NECESSARY!** Only one treatment needed!
 Money back guarantee. Rush \$1.00 to:

JSM PRODUCTS CO. • 1118 Castleton Rd., Dept. 7, Cleveland 21, OHIO

DELCO MOTOR

You can't beat this sensational buy! Triple
 Rubber Mounted Motor for fans, refrigeration,
 air-conditioning units, etc. 1/75 H.P., 115
 Volt, 50-60-Cy. A.C., 1500 R.P.M. Over-all Ht.
 7 7/8". Tested! Powerful! Quiet! Immediate de-
 livery. **ORDER NOW!**
 Weight, 3 lbs. complete
 with blade.



\$6.95*

FREE! Send for large Electrical,
 Plumbing & Motor Catalogue.
NATIONWIDE SUPPLIES INC.
 Miami 42, Florida

*Plus postage. send
 check or money order 3740 N.W. 27th Ave.

PAGE Tractors

Do The Job Faster—Easier—At Less Cost!

NEW

"PAGE-BOY"
 TILLER
 Ask for
 Details!



Rugged 1955 riding, walking,
 models 2 to 6 HP. All gear drive
 with reverse. Over 60 attach-
 ments! No belts, no chains.
Fully Guaranteed!

Over 25 years' experience

Free Catalog—

PAGE 1804 S. 81st St.
 Milwaukee, Wis.

Carpenters' NAILPULLER Pocket size!

Powerful, Easy to Use, Handy as a Hammer!

Satisfaction guaranteed
 up to tenpenny nails.

POSTPAID
 U.S. ONLY

\$1.74

No C.O.D.
 No Stamps.

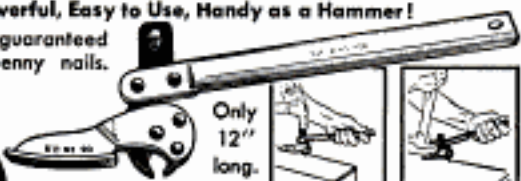

Carpenters' favorite. Convenient in tight places,
 carries in pocket. Tool steel counteracting jaws
 driven into wood under nailhead. Double leverage
 with hammer. All steel, rustproofed.
K-D Mfg. Co., 526 N. Plum St., Lancaster, Pa.

EVERY SANTA NEEDS A SAW!



Ask for an **ATKINS** this Christmas



ATKINS SAW DIVISION
BORG-WARNER CORPORATION
 INDIANAPOLIS 9, INDIANA



**Do-It-Yourself
 Upholstering
 new and old
 Now Possible**

with **no-sag** SPRING KITS



CHAIRS



SOFAS

EASY TO INSTALL
**COMPLETE INSTRUCTIONS
 FURNISHED**

USE POPULAR MECHANICS
 DESIGNS

IDEAL FOR BUILT-IN
 FURNITURE

12 Ft. NO-SAG SPRINGS
 and Fastenings, Hardware
 in Separate Kits:

For Seats 9 ga. \$1.95

For Backs 11 ga. \$1.85

Available at Upholstery Supply
 Houses or send check or money
 order direct to

DISTRIBUTORSHIPS AVAILABLE

no-sag
NO-SAG SPRING COMPANY
 21590 HOOVER RD. • DETROIT, MICH.



"...and bring Daddy some Bonney wrenches"

Daddy's been prompting *this* lad. Not a bad idea, either. A word to the right person *now* will pay off at Christmas.*

Any man wants wrenches he can be proud of. That means Bonney wrenches—mechanics themselves call them America's finest.

Your Santa Claus can buy Bonney wrenches wherever fine tools are sold—in open stock or complete sets.



Bon-E-Con tools, also, carry the famous Bonney guarantee. They're tools any man would value—at prices anyone can afford.



* *Confidentially, men, it would be smart to leave this page where the right person can't miss it!*

BONNEY FORGE & TOOL WORKS, ALLENTOWN, PENNSYLVANIA

POPULAR DECEMBER 1954 MECHANICS

WRITTEN SO YOU CAN UNDERSTAND IT
VOL. 102 NO. 6

GAMMA RAY MAGIC

By Dr. Samuel S. Jones

*Research Associate at the Knolls Atomic Power
Laboratory, Schenectady, N. Y.*

YOU CAN'T SEE, hear, touch, taste or smell them, but they are a very real ingredient of the Atomic Age. They are gamma rays, a powerful and penetrating product of nuclear fission. They can be a deadly enemy or helpful servant. It all depends on how you handle them. But either way, gamma radiation is a relatively little-used form of energy that has great promise for the future.

This prophetic usefulness doesn't come entirely from the amount of gamma energy available. It will never replace coal and oil as an abundant heat source. But gamma rays can serve a different purpose because of the peculiar way they are absorbed in matter. As if shot from a battery of infinitely small atomic machine guns, gamma-ray bullets go deep into the heart of whatever they strike. The mysterious things that happen then are nothing short of magic.

First a word about gamma radiation itself. Actually it's made of the same stuff as ordinary light—but gamma rays are much more powerful. A piece of common cardboard will stop visible light; a gamma ray

Doctor Jones, shielded from gamma rays by nine feet of water in the tank below him, observes the eerie glow produced by cylinders of radioactive cobalt

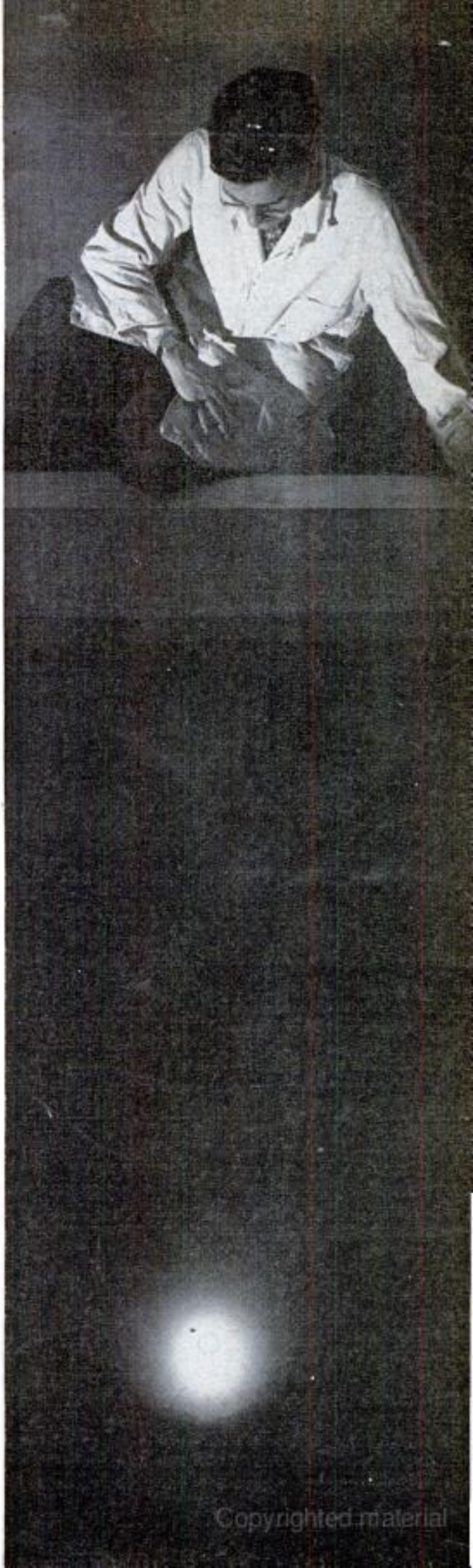



Irradiation-produced gases in a plastic bar cause it to expand when heated, while the same heat has no effect on an untreated bar of the same material

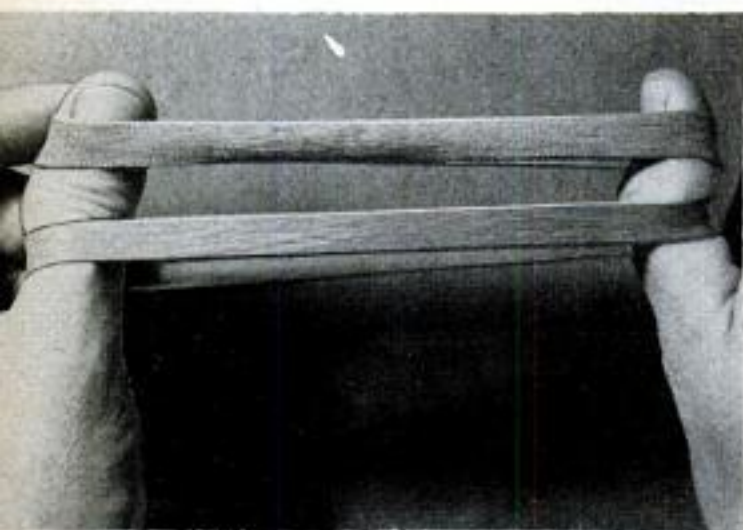

Slight irradiation causes a rubber band to crack and lose its elasticity (above), while two hours' exposure to gamma rays changes acrylonitrile from a liquid to a dry popcornlike polymer (below)

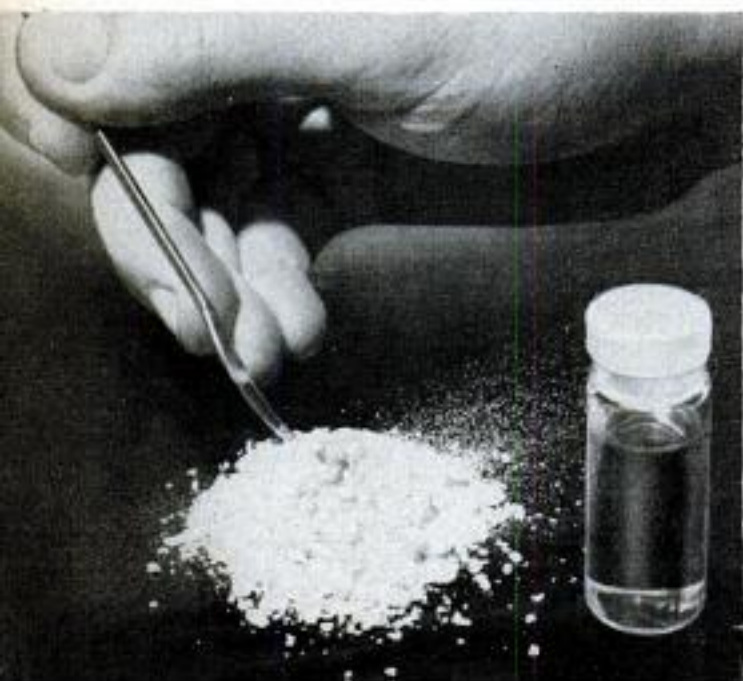

will go right through it. Gamma rays are more like the X rays that medical laboratories use to photograph the inside of the human body. In fact, gamma rays are identical to those X rays except that they often are more energetic and penetrating than X rays. Some gammas will go through more than a foot of steel before they are stopped.

The cores of some unstable atoms send out gamma rays; they were known long before the discovery of nuclear fission. Certain natural radioactive elements like radium give off gamma rays, and they can also be made in large high-voltage machines such as cyclotrons and Van de Graaff generators. But these sources are puny compared with the tremendous quantities of gamma radiation that have been produced by splitting the uranium atom. Gammas are released not only during the splitting process but are also emitted from the two halves of the split atoms, known as fission products. Although they are generated by nuclear fission, gamma rays contain only a small part of the total energy released in splitting the atom. But since they have a devastating, deadly nature all their own, they have to be reckoned with before the power of the atom can be used. For example, this is an important concern at the Atomic Energy Commission's Knolls Atomic Power Laboratory in Schenectady, N. Y., where scientists and engineers of the General Electric Co. are working together to develop a power reactor for a submarine. In the process of extracting power from the nuclear reactor, thick shields of lead and water have to be set up to protect men and certain materials from gamma-ray damage. Generally, gammas are more of a plague than a help in this business of making atom engines.

In order to find out how gamma rays attack matter around an atomic engine, KAPL scientists have set up two intense-radiation sources. To make these sources, pieces of cobalt metal looking much like ordinary iron were cooked for months inside highly radioactive uranium furnaces, or piles, like those at Oak Ridge and Hanford. In these intense-radiation fields the cobalt became highly radioactive itself and highly charged with deadly gamma rays. Then the cobalt was removed from the pile and put into metal capsules. These loaded capsules are the heart of the gamma-ray sources, and must be shielded to protect the scientists who use them. One of the capsules is a hollow cylinder containing about seven ounces of radioactive cobalt shielded by lead. The other source contains approximately 2½ pounds of cobalt and is made up of 10 separate capsules shielded in a tank of water. It is one of the

largest gamma sources of its kind anywhere. Nearly \$100,000,000 worth of radium, about twice the world's present supply, would be needed to equal the strength of this source—yet the cobalt for this unit cost only about \$17,000.

The lead-shielded source is a strange-looking piece of equipment. This type of shield was first used at Oak Ridge. There's a big lead cylinder that sits on a dolly so that it can move back and forth across the top of an even bigger lead-block base. The whole mass of metal, about 14,000 pounds of it, is mounted on wheels so it can be moved about the laboratory. The gamma-ray source is in the center of the lead cylinder when it is not in use. The source capsule is mounted on a steel rod and moves up and down inside the shield like a hand-driven piston. There are two square holes in the lead base block, one near each end. They are the irradiation cavities where the source is used. You set up an experiment in one of these cavities while the source and cylinder are at the other side of the block. Then you move the source, inside the cylinder, until it is directly over the test setup in the cavity. The irradiation starts when you lower the source from the top cylinder into the cavity by a hand-operated ratchet mechanism. During the irradiation, the source sits in a cup in the cavity and irradiates intensely everything around it. But the hottest spot of all is in the center of the hollow source cylinder. If a man were in a radiation field as intense as that, he would receive a fatal dose in about three seconds.

Around KAPL they call it the "Cobalt Pit." That's the place where the laboratory's biggest cobalt gamma source is lo-

Irradiation of a liquid mixture of acrylonitrile and styrene produces a solid that breaks its container



Many ordinary everyday substances are changed by gamma rays. Irradiated paper discolors and breaks into charred bits

cated. In the inky blackness of the pit building you can barely see the white curb that borders a 5000-gallon concrete water tank. But from the edge of the pit you become immediately aware of a dull blue glow in the depths below. As your eyes become accustomed to the darkness, the blueness gets bigger and you see the shadows in the water. The blue light surrounds 10 rod-shaped objects about six inches high, set in a circular pattern on a steel plate. These 10 objects are gamma-source capsules containing radioactive cobalt, the source of the uncanny blue light. No electricity is involved here. It's another of the supernatural characteristics of powerful

Flexible plastics, resistant to heat and corrosive chemicals, break down after exposure to gamma rays

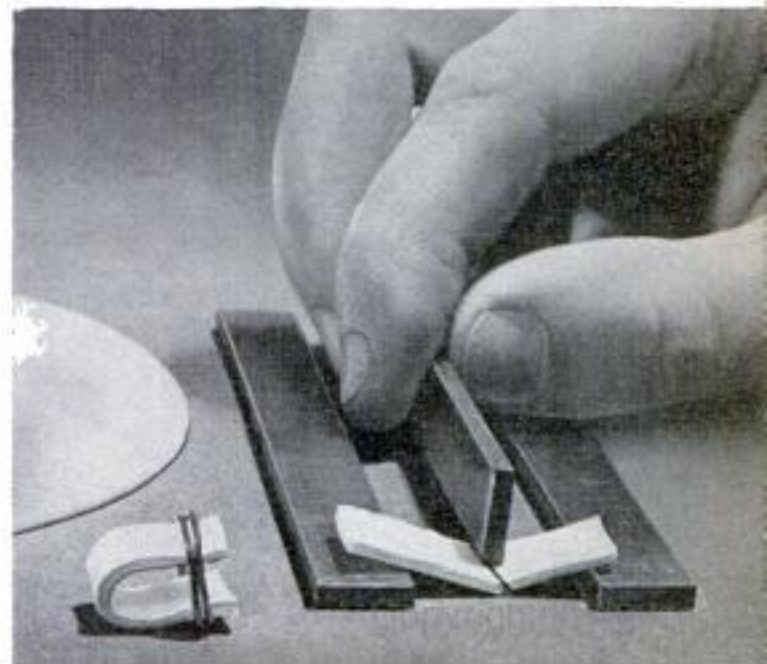



Ordinary glasses become sunglasses after irradiation (above). The cylinders of irradiated cobalt under nine feet of water in the tank below are as radioactive as \$130,000,000 worth of radium



gamma radiation. Day and night, week after week, the light burns on, fed by this peculiar form of energy. It will be five years before the radiation from this "hot" cobalt dies to half its present intensity.

In the center of the source pattern, where the blue light is brightest, is the battlefield where building materials for atom engines are tested. Here, six-thousand-billion gamma-ray bullets come tearing through each square inch of area every second. Only those materials that survive this inhuman bombardment can be used in many parts of a nuclear engine. Some make the grade easily, many do not. They may instead be transformed into something quite different from the original material. The weird way these changes take place is sheer radiation magic.

But what is the nature of this radiation magic? What forms of matter can take it and what happens to those that can't? Scientists have found that generally the result depends on the kind of atomic building blocks used to make the material, and the way in which these blocks are held together.

The deadly effect of gamma rays on living things is well known from long experience. Man, one of the most complex forms of life, is one of the most vulnerable. Death would begin within a few seconds after exposure to intense gamma radiation, yet there would be no immediate sensation of illness or pain. Within a day or so after the body was pierced by these billions of invisible bullets, however, nausea would begin; later, fatigue and fever would be noticed as well as loss of hair. As the days became weeks, cell destruction would increase and finally death would occur.

But living things are not alone affected. Weird changes take place in the common things around us when they are gamma-irradiated. Ordinary glass objects may turn brown, yellow, gray, blue or other colors; heat them in the oven and their new color fades away. Chemical changes occur in many sol-

ids as well as liquids. A brand-new pair of shoestrings might disintegrate at your touch; paper, even wood, begins to fall apart after extended exposure to high gamma radiation.

Different materials follow their own pattern of radiation degradation, sometimes unpredictably. One family of flexible plastics will become hard and brittle, another softens and exudes gas. Paint blisters, changes hue. A gamma-ray attack on insulation might render electric wiring useless. Explosive hydrogen gas may be released by some materials in decomposing. Rubber, one of the commonest materials used by man, sickens quickly under radiation and an automobile left exposed would shortly be damaged, its antifreeze transformed into a corrosive acid, its gasoline and oil possibly thickened to a syrup. Some liquids turn into solid plastics that burst their own containers, some commercial plastic materials crumble into popcornlike pellets or powder.

Metals alone seem to withstand the assault of gamma radiation, yet metals, too, can be affected when rust forms from contact with caustic chemicals produced from irradiation of other materials.

What happens to food under gamma radiation is still a subject of experiment. Scientists know that the rays would help preserve food by killing all the germs that would bring on decay. However, the radiation might also make the food harmful for human consumption. Possibly it would also render the food unappetizing in color and flavor. So far, animals have been the principal guinea pigs for testing an irradiated diet, but human feeding studies are scheduled for the near future.

Nevertheless, when science has learned more about gamma rays and their power for good and evil, they may be put to very useful service in preservation and sterilization of foods and drugs.

Already gamma rays are being put to use in hospitals for the treatment of cancer; fatal in heavy doses, the rays in proper dosage at the right time and place can save lives. The products from atomic reactors, such as radioactive cobalt, are among the cheapest sources of this lifesaving radiation. They are useful, too, in seeing where

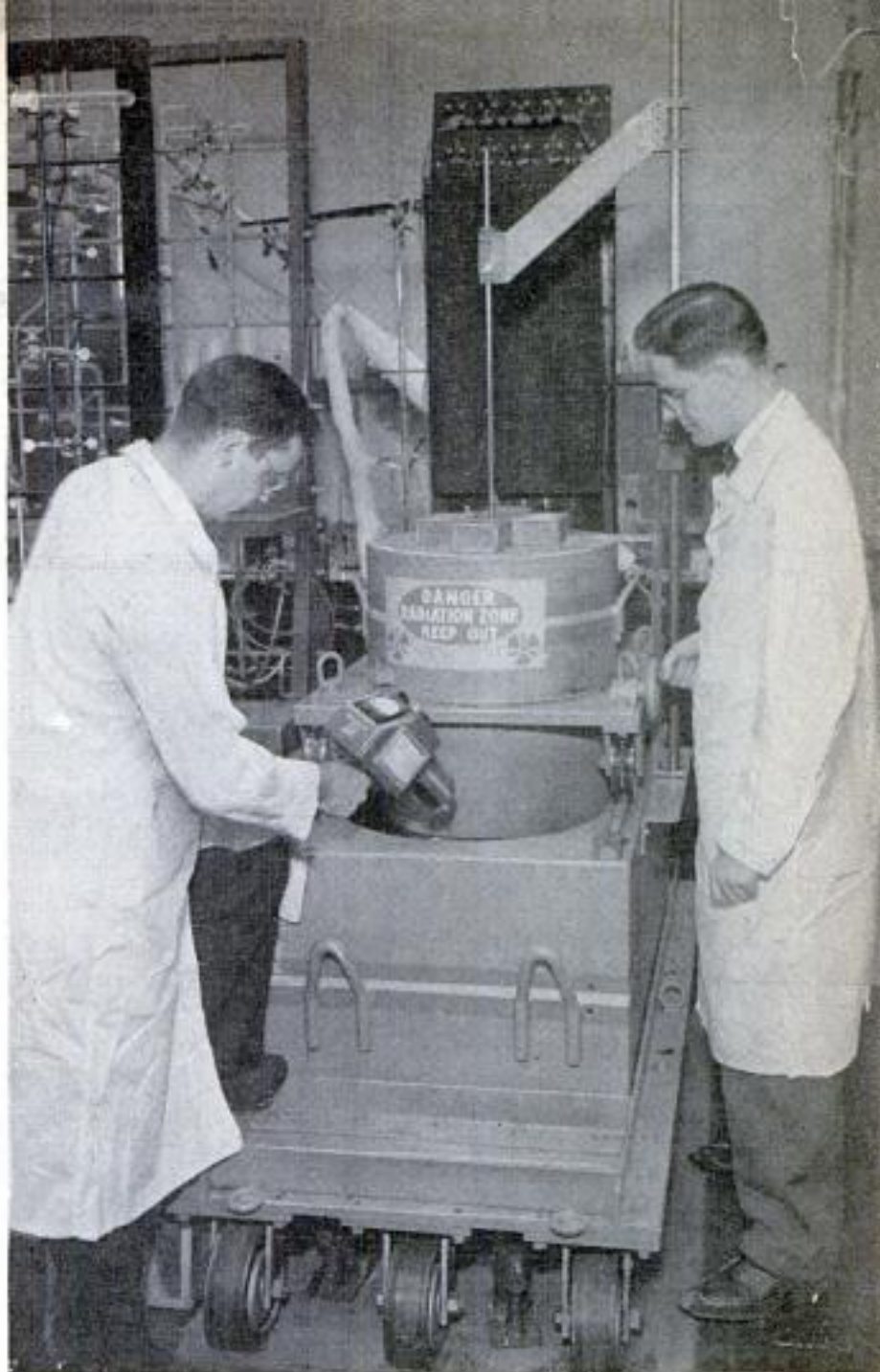

Seven tons of lead shield a piece of irradiated cobalt no bigger than your index finger in this rolling material-testing machine, checked with a radiation counter for possible gamma-ray danger

the human eye cannot penetrate—through thick metals—to discover hidden flaws in castings. Scientists are learning how to produce porous, spongy plastics by the expansion of gas produced inside the material by radiation; the product may prove valuable as insulating material. Conversion of sawdust into food for livestock by irradiation is another potential development.

Eventually gamma rays should prove a very useful servant for mankind. Today they are confined to the laboratory behind danger signs and lead shields. Tomorrow, science will learn to harness this unusual energy to benefit civilization. ★ ★ ★

☛ Chemical "extenders" tested by the Department of Agriculture multiply the length of time that sprays containing DDT, aldrin and lindane remain effective.

High-Speed Milling Machine Cuts Through Aluminum Like Butter

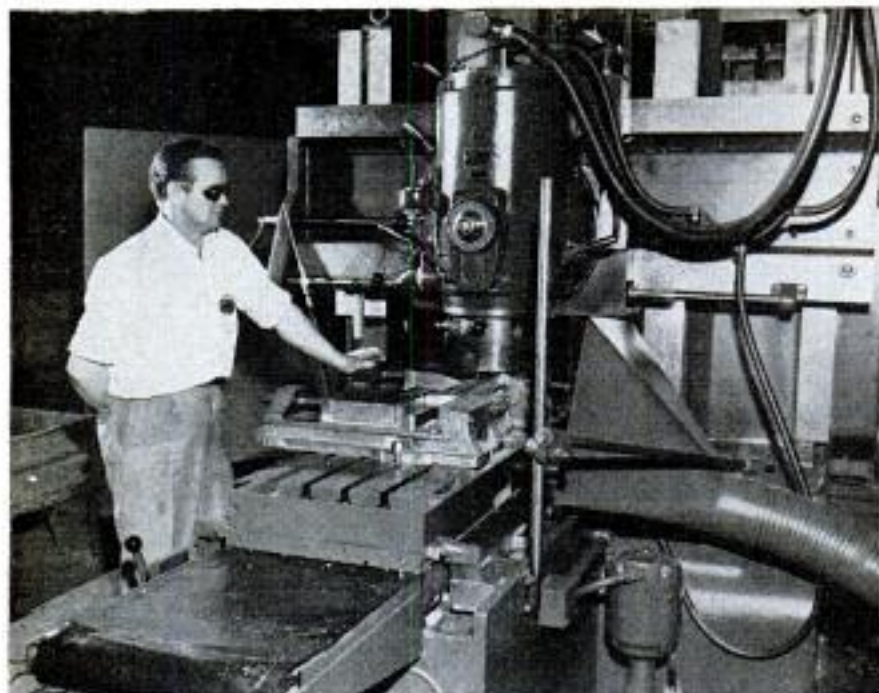

Cutting a four-inch furrow in a 48-inch bar of aluminum in only eight seconds, a high-speed milling machine is setting new records in the aircraft industry. The machine has a table-travel speed of 375 inches per minute, compared with the usual 60 inches per minute of conventional machines. Maximum capacity is reached at 10,700 revolutions per minute. Warpage of the work is eliminated by the cutter design which transfers the intense frictional heat into the chips rather than into the metal being milled.

Split-Ring Mount Holds Gun Sight

On a new rifle mount for a telescopic sight there are no large screws or "ears" to catch in brush or clothing. The new mount is the split-ring type. The sight is easily slipped on or off without changing the point of impact. Bases are available for side and top mounts. The new accessory for .22-caliber rifles is made for scopes of $\frac{3}{4}$, 1 and 1.023-inch diameters. No base is required on some rifles.



Motor-Bike Driver Lies Down to Race

Wind resistance is reduced to a minimum by a streamlined body that is placed over a German motorcycle. The driver lies on his back and looks ahead through a slanting transparent screen. With such extreme streamlining, the motorcycle, a 50-cubic-centimeter NSU is said to go as fast as a normal 500-cubic-centimeter model. The speed tests were run near Munich, Germany.

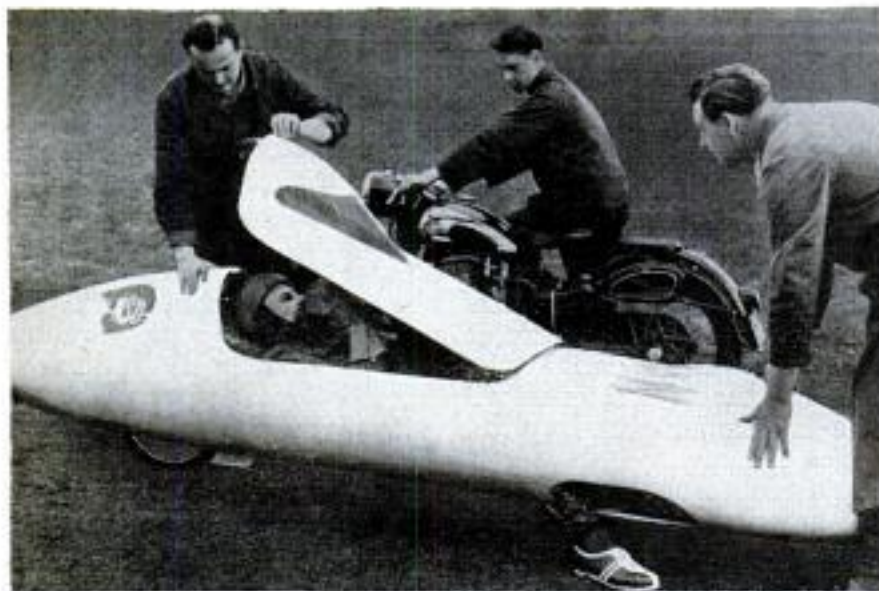



Swiss Salvages Fortune From Wrecked Wartime British Bomber

Considerably more than scrap-metal price has been realized by an enterprising Swiss who raised a British Lancaster bomber from Lake Constance into which it crashed during World War II. Fees paid by sightseers have more than paid original salvage costs. In addition, thousands of

gallons of gasoline in leakproof tanks proved salable, and the advertising value of a waterproof Swiss wristwatch found in the wreckage brought a good price from the maker, who plans to use it for advertising purposes. The plane will remain on display as long as the public is interested.

Stryker Frame in Plane Protects Airborne Patient

Paraplegics, polio victims and burn cases can be airlifted to hospitals near their homes or flown to distant hospitals if they're encased in a Stryker frame. The frame, used in hospitals for years, protects the patient from injury during bumpy rides and enables him to be turned face up or face down. Paraplegics and burn patients must be moved every two hours. In turning, the patient is sandwiched between two mattresses and turned by releasing a pin in the frame.



Standardize Nautical Mile

American ships and planes will now use a nautical mile four feet shorter than the one previously used. The international nautical mile, which is 6076.10333 feet, will replace the U.S. nautical mile, which is 6080.12 feet. The change was recently brought about by international agreement.

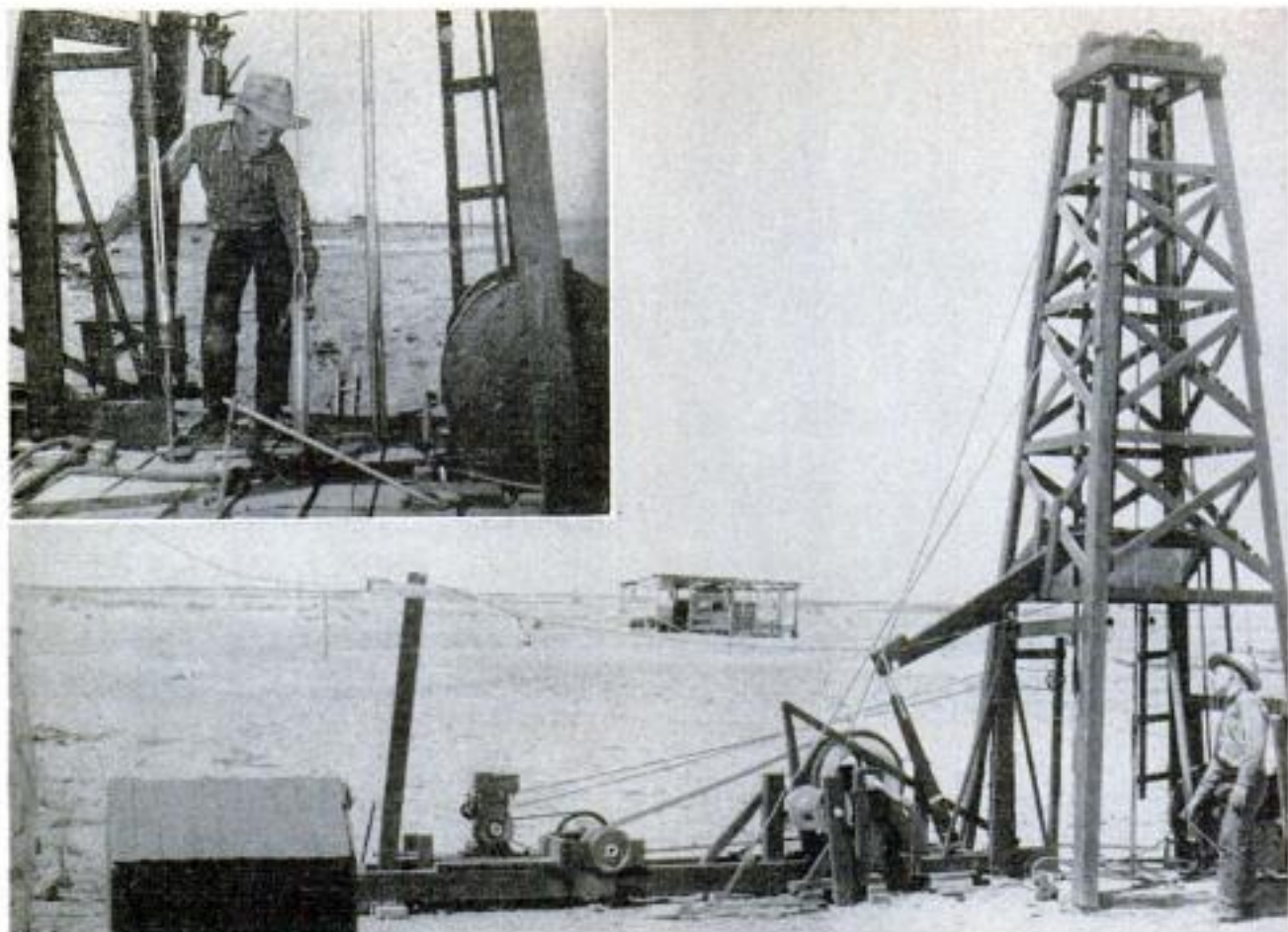

Scaled-Down Drilling Rig Prepares Youngsters for Oil Fields

You could hardly expect it to strike oil, but a drilling rig built by Jim Hammond of Artesia, N. Mex., has sent three sons to near-by oil fields as qualified drillers and tool dressers and is well under way in the training of a fourth. The rig is a scaled-down model of the standard cable tooler, which opened most of the nation's shallow oil pools. Every part of the rig, including

the walking beam which pushes and pulls the tools during the drilling, was reproduced in exact detail. Powered by a 2½-horsepower gasoline motor, the rig has a complete set of scaled-down tools, drilling bits and drilling stems. It drills a 2¼-inch hole to 100 feet. The wooden derrick stands 15½ feet, less than one fourth as high as its original counterpart.



Hot Plate With Oven Broils and Bakes

You can broil or bake foods with a German hot plate that has an oven. A cover is placed over the hot plate when the oven below is to be used. The table-top range has a three-position heat control and can be carried in the car.

Plane Radio Rings Bell

Simplification of radio procedure for airline pilots is effected by tone decoders to be purchased by United Air Lines. The devices ring a bell in an individual airplane cockpit when ground radio operators wish to contact a flight and the pilot tunes only his own calls.



Motor Mount Swings Inboard For Ease in Handling

Outboard motors can be swung overboard or inboard with ease on a new pivoting mount. Two brackets are installed on the transom of the boat. The motor mount slips onto pins on these brackets. The motor can be left permanently installed on the mount, with the mount then serving as a convenient way to carry the motor.

Buoy Locates Downed Airmen

To aid rescuers searching for survivors of aircraft down at sea, the Woods Hole Oceanographic Institution has developed for the Navy a drift buoy capable of transmitting an automatic distress signal to radio direction finders for 60 hours. The floating buoy, released on impact with the water, automatically starts broadcasting on the distress channel upon immersion. It also displays a dye marker and a small incandescent light to enable survivors in rafts to locate it and take it in tow. The buoy is designed to have almost exactly the same rate and direction of drift as standard Navy aircraft rafts.



DECEMBER 1954



Typewriter Prints Music

Musical scores are printed quickly and legibly by a typing unit with 33 keys. The device contains all the essential characters for music notation, and is expected to be a boon to all composers, arrangers, copyists and music printers. It was invented by Robert Keston of San Francisco, after nine years of work on the project.

Electric "Bunsen Burner"

Ingenious use of a highly polished, nearly conical mirror to concentrate heat has enabled the German inventor of an electrical "Bunsen burner" to focus as much as 1000 degrees centigrade on a heated object. Shaped rather like the base of an old-fashioned oil lamp, the burner shell, with mirror interior, surrounds a vertical electrical heating unit to throw heat upward through a vent. The inventor claims his heater eliminates the gas fumes and heat loss of the conventional gas burner. It takes only a minute to heat up.



Oil-shale deposits of Colorado, Utah and Wyoming make up one of the world's greatest fuel reserves, containing more than 100,000,000 barrels of petroleum.

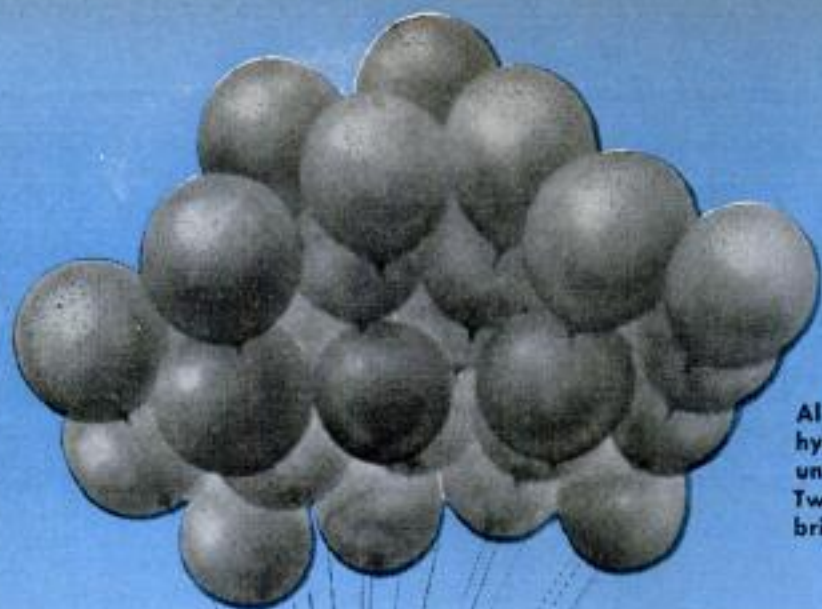

Al Mingalone harnessed himself to 30 hydrogen-filled balloons to get an unusual angle shot of a Maine fair. Two rifle shots pierced balloons to bring him down safely 13 miles away

Oh, for the Life of a Cameraman

LIKE MOST photographers, Al Mingalone is always looking for an unusual camera angle. At a fair at Old Orchard Beach in Maine, he decided that an aerial view would be nice, so he tied himself to 30 plastic balloons filled with hydrogen and headed straight up. The experiment worked too well; in no time he had reached an altitude of 600 feet and was still ascending. A local priest sized up the situation, grabbed a rifle and punctured enough balloons to assure Mingalone's safe descent 13 miles from the fair grounds. Hazardous stunts add spice to the lives of cameramen who brave fires, explosions and dangerous vantage points to secure exciting pictures. They prove here that a photographer intent on a good shot cannot be discouraged by daggers or lions. ★ ★ ★

Pickaback photographer, J. S. Scott, rides a skier down Sun Valley slopes and snaps passing scenery



Sonnee Gottlieb, assigned to cover testing of safety device, swings in mid-air after collapse of scaffold





Photographers flee for their lives as flames from bottled-gas field threaten near-by gas-storage tanks



Navy photographer instinctively tries to cover camera with helmet as explosion scatters debris



Some men, like Arthur Sasse of INS, would rather enter a lion's cage than miss a good picture. As his trainer stands by, Simba snarls at the birdie



Dick Sarno braves flying daggers to get target view of circus knife thrower, and hopes that flash-bulb bursts won't affect his accuracy

Detroit Listening Post



By Leo Donovan

MOST OF THE 1955 cars have been unveiled so let's measure the contestants.

At this writing, the horsepower ratings of 13 cars are known. Twelve of them have more horsepower than in 1954. One (the Rambler) has its horsepower unchanged. The average increase in maximum output per car is a whopping 32.1 horsepower.

Although we have no records on this, it is a good bet that these figures represent the biggest jump in automotive history for a single model year. It is also a good bet that such boosts can't happen every year!

Displacements are up also, accounting in many cases for the increased horsepower. The average increase in displacement per engine is 15 cubic inches.

Body-dimension changes are not so drastic, although the trend toward longer cars does continue somewhat. Of the 18 new cars checked, 7 are longer, 4 are shorter, and 7 unchanged. The average increase in length of the 18 cars is 1.3 inches.

Incidentally, an interesting statistic is the total increase in length of these 1955 cars. If all 18 of them were lined up bumper to bumper, they would occupy 24 more inches of street than the same models did last year. What does that mean? Simply that highways will be just a little more crowded again next year.

Billion-Dollar Investment

What the auto industry offers this year represents the largest investment in new engines and bodies ever presented. Conservative estimates are that more than a billion dollars were spent by the automobile companies for machine tools and equipment to build the 1955 models.

Egged on by the sales departments, the engineers have come up with the increased horsepower the salesmen say the public expects. But some top production men are beginning to sour on this horsepower race.

In fact, conversations with engineers of various companies lead one to suspect that the horsepower ratings have been taken out of their hands almost completely. The

weakness in the whole system is that there is no easy and accurate way for the public to check up on production engines. It is generally agreed that if the engine you get in your new car puts out 85 percent of its advertised horsepower that's about all you can expect. And when you subtract the loss caused by water pump, generator, muffler, air cleaner and other items, the rating drops far below that advertised.

The six-cylinder engine won't be an orphan this year despite the introduction of four new V8 engines. However, the percentage of sixes on the highways is plummeting. Chevrolet, for years the top seller of six-cylinder engines, is now installing V8s in half its production. It expects to increase this percentage later.

Which Twin Has the V8?

There is no doubt that the V8 is being accepted both by the industry and public. But why? Nobody seems to be certain.

One leading engineer (who is among the three top V8 men in the business and, for that reason, whose identity cannot be disclosed) stated privately that neither he nor any of his staff could consistently detect any difference in the way the V8 model and the six-cylinder model performs.

He disclosed that he has put engineers in an unmarked car, let them drive it, and then tell him whether it was powered by the V8 or the six and they couldn't with any regularity. And he is willing to make a wager that the public can't either.

With many cities and some states basing licensing fees on taxable horsepower, the increases in displacement are going to mean it will cost you more to put your new car on the road. In some cities, a Ford V8 license now costs as much as a Cadillac's.

Late Arrivals

Still to be heard from with 1955 models are Packard, Nash, Hudson, Kaiser and Willys. The last two are on the indefinite list. Packard is expected in January; Nash and Hudson in late January also, although they may be delayed until February. There is a big story in the Nash-Hudson operation as American Motors engineers work out the problem of making two completely different looking automobiles with identical body shells.

Packard will probably lead the horsepower race. It has the advantage of coming out late and can set its figures after all the others are through. Its new V8 engine is the biggest in the industry, displacement-wise. It is conventional in design, and predictions of crystal-ball gazers to the contrary notwithstanding. It's a big, powerful overhead-valve V8 with plenty of iron in the block for future modifications.

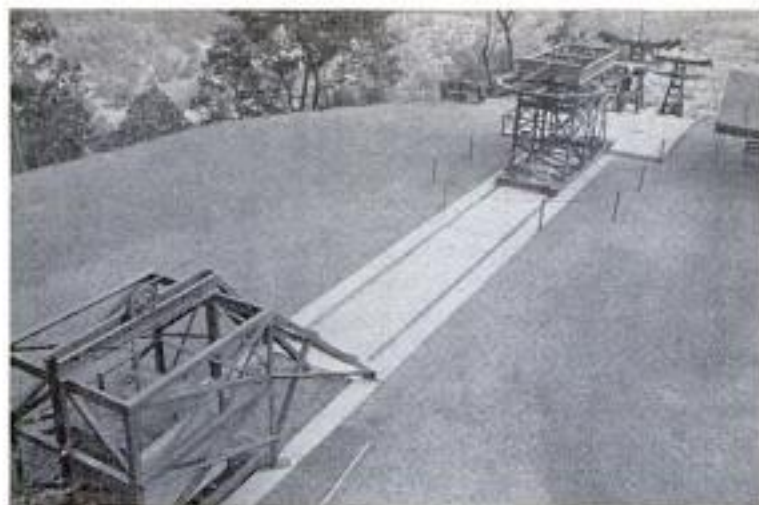

Cable anchored by five-ton weight keeps tension on pulley tower



Tower on Rails Tops Chair Lift

Sightseers instead of skiers ride a new chair lift at Gatlinburg, Tenn., in the Great Smoky Mountains. During its first season the 50-chair lift carried thousands of passengers past a resort-hotel swimming pool, across a sparkling mountain stream and up a pine-covered mountain slope. A large bull wheel, mounted on a tower at the top, serves as a pulley for the line. The tower

rides on a narrow-gauge track and is connected to a cable anchored on a second tower by a suspended concrete block weighing 10,000 pounds. This maintains a constant tension on the line if many or few passengers are being carried.



Homemade Auto For Amputee

William Jewsbury, legless amputee of Fort Scott, Kans., has no trouble getting around now that he has his own private automobile. With the help of a friend, Jewsbury built the tiny vehicle from old automobile and motorcycle parts with a small air-cooled engine for power. A ramp drops down at the rear so Jewsbury can pull his wheelchair aboard. Still in his chair, he starts, drives and stops the tiny car which carries him along at 18 miles per hour.

Sports Car in Kit

Sold either as a complete unit or in knock-down-kit form, the Grantham Stardust is a new entry in the sports-car field. The Stardust kit is supplied without engine. The assembled unit is powered by an engine specified by the buyer.





Horsepower 188 and 236
 Displacement: 284.0 and 322.0
 Over-all length: 206.6 and 215.9

1955 Buick

Buick, after an all-new body in 1954, offers a major face lift and considerable mechanical improvements. The front grille is a honeycomb design with huge bumper projections. Rear fenders run straight back without the 1954 step-up styling. Taillights are larger and set in a chrome housing. Horsepower is away up, with all but the Special boasting 236 horsepower. Variable-pitch stator blades on the Dynaflo improve performance about 10 percent. When you floor the accelerator, the blades adjust for top performance; when you release it, they return to an economy setting.

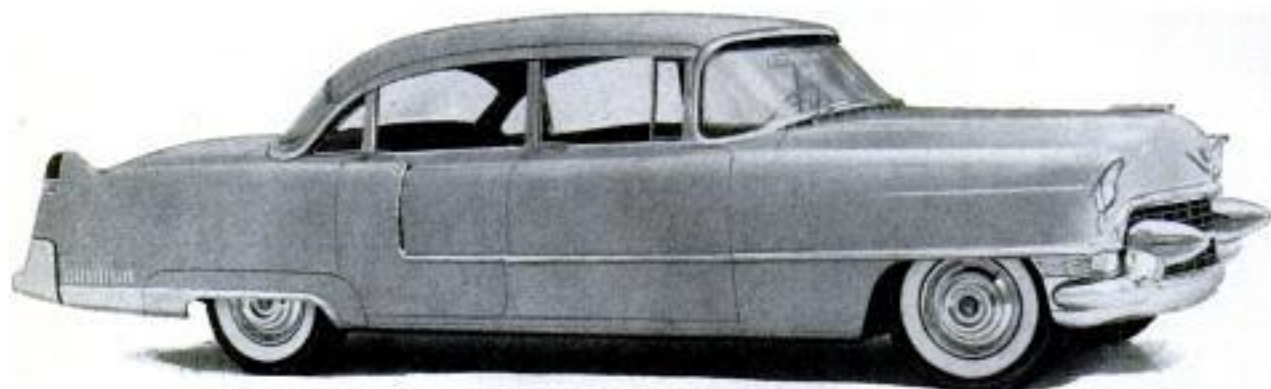

Horsepower: 250 and 270
 Displacement: 331.0
 Over-all length: 216.3, 227.3 and 237.1

Cadillac continues its body styling with only minor changes. Most obvious is the shortened vertical stone guard on the rear door. It now runs into a horizontal chrome strip from the front fender. Grille and bumper projections are restyled as are front parking lights. A narrow center post is featured on four-door sedans. Horsepower is up and the new Eldorado sport convertible (which has sharklike tail fins, right, similar to those on the El Camino show car) develops a whopping 270 horsepower. Owners of regular models have to be content with 250 horsepower.





Horsepower: 188 and 250
Displacement: 301 and 331
Over-all length: 218.6 and 218.8

1955 Chrysler

Chrysler has an all-new style for 1955. Its downward-sloping hood and bold grille design emphasize the car's width and lowness. Unusual two-tone paint jobs provide a sporty look. Taillights are slender vertical lines to accent rear-end styling. Other features are wrap-around windshield, dash-mounted shift lever and cockpit-styled instrument panel. The new 188-horsepower Windsor V8 engine uses a modified hemispherical combustion chamber. The New Yorker series develops 250 horsepower.



Horsepower: 185 and 200
Displacement: 290.8
Over-all length: 217.8 and 218.6

1955 DeSoto

DeSoto is also all new for 1955. Both its V8 engines have hemispheric combustion chambers and twin rocker-arm shafts. Both use regular fuel yet develop 185 and 200 horsepower. Also new are flush door handles, "gull wing" dashboard, wrap-around windshield, improved suspension, and a long, sleek hardtop called the Sportsman.





1955 Dodge

Horsepower: 123, 175, 183 and 193
 Displacement: 230.0 and 270.0
 Over-all length: 212.1

Dodge offers a sleek new styling all its own, unlike previous years when it bore a family resemblance to other Chrysler products. Longer than last year by as much as 16 inches in some models, Dodge has a low, slender look. Power options of up to 193 horsepower are available. There are three engines this year: The six and two V8s (one has a single rocker-arm shaft, the other has two, as did the 1954 engine). The Lancer hardtop sports a three-tone paint job, first in the industry. Other features: Suspended pedals; twin-jet taillights; wrap-around windshield; wider doors.

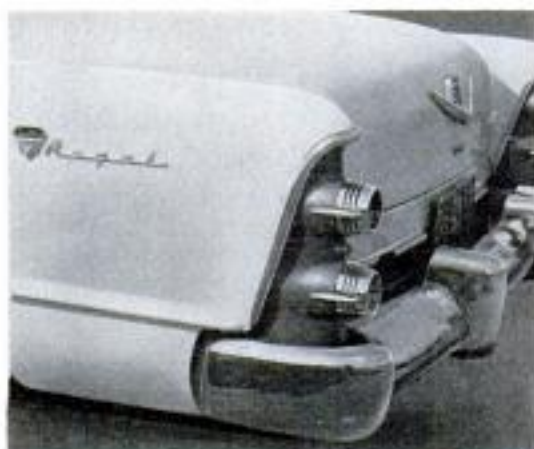

Horsepower: 120, 162 and 182
 Displacement: 223.0 and 272.0
 Over-all length: 198 (approx.)

1955 Ford

Ford, too, has a new styling for 1955. Its top line is now the Fairlane (the name of the late Henry Ford's estate). Fairlane models have a sweeping chrome trim from headlight to taillight, dipping abruptly on the front door panel. One hardtop has a chrome arch over the roof from beltline to beltline. Horsepower is now 162 on regular V8 models (last year: 130) and an optional 182 on Fairlane and station wagons at extra cost by addition of dual exhaust, four-barrel carburetors, special intake manifold.





Horsepower: 250
Displacement: 331.0
Over-all length: 223.0 and 242.5

1955 Imperial

Chrysler has given the Imperial a distinctive body style for 1955, making it a separate line from Chryslers. A low-production prestige car, the Imperial is immediately identified by twin tail-lights mounted saucily atop rear fenders. Low and long, the car has full wheel cutouts and no protruding hood ornament. All models have 250 horsepower. Crown Imperials (the top line) feature the industry's only disk brakes.



Horsepower: 225
Displacement: 341.0
Over-all length: 215.6

1955 Lincoln

Lincoln has a new torque-converter transmission of its own design (it used Hydra-Matic before). It features a low-gear breakaway start. Horsepower is up, and dual exhausts standard. Push-button lubrication system greases car as you drive. You press a button on dashboard and 11 chassis points are instantly greased.





Horsepower: 188 and 198
Displacement: 292.0
Over-all length: 206.3

1955 Mercury

Mercury has a new top line, the Montclair, 1½ inches lower than other models (which are an inch lower than 1954 bodies). Horsepower is up; four-barrel carburetors standard. Merc-O-Matic is improved for faster starts. Brakes have greater lining area. Like Lincoln, it has push-button lubrication for front end. Touch a button on the dash and grease is forced into 13 chassis points. Reservoir holds a year's supply of grease. It's optional at extra cost.



1955 Oldsmobile

Horsepower: 185 and 202
Displacement: 324.0
Over-all length: 203.4 and 212.4

Oldsmobile has boosted horsepower to 202 by combustion-chamber modifications, high-lift camshaft, increased compression and larger exhaust valves. Two-barrel carburetor is standard on 88 models, four-barrel on others. Front end is restyled with hooded headlights. The word "Oldsmobile" stands upright in block letters on the front grille. A new side molding continues the flashy two-tone combinations so popular on 1954 Oldsmobiles.





1955 Plymouth

Horsepower: 117, 157, 167 and 177
 Displacement: 230.2, 241.6 and 259.3
 Over-all length: 203.8

Plymouth has the most radical style change in its history. Over 10 inches longer, it features front fenders that slant forward rakishly. The new overhead-valve V8 has 157 and 167 horsepower and an optional power pack to boost it to 177. The inline six is still available. Other features: Wrap-around windshield; dash-mounted shift lever; reverse-angle taillights; and unusual two-tone paint combinations.



Horsepower: 90
 Displacement: 195.6
 Over-all length: 178.3 and 186.3

For the first time since it was brought out, the Rambler is not the Nash Rambler. It is now being sold by both Nash and Hudson dealers as the Rambler. Most important improvement in the 1955 models is a drastically reduced turn-circle diameter made possible by cutting the fender skirts away from the front wheels. Front tread is now slightly wider than the rear. Turn-circle diameter is 36 feet on two-door models, the shortest in the industry and six feet less than on the 1954 Ramblers.



Kits Teach Youngsters Weather Forecasting, Other Sciences

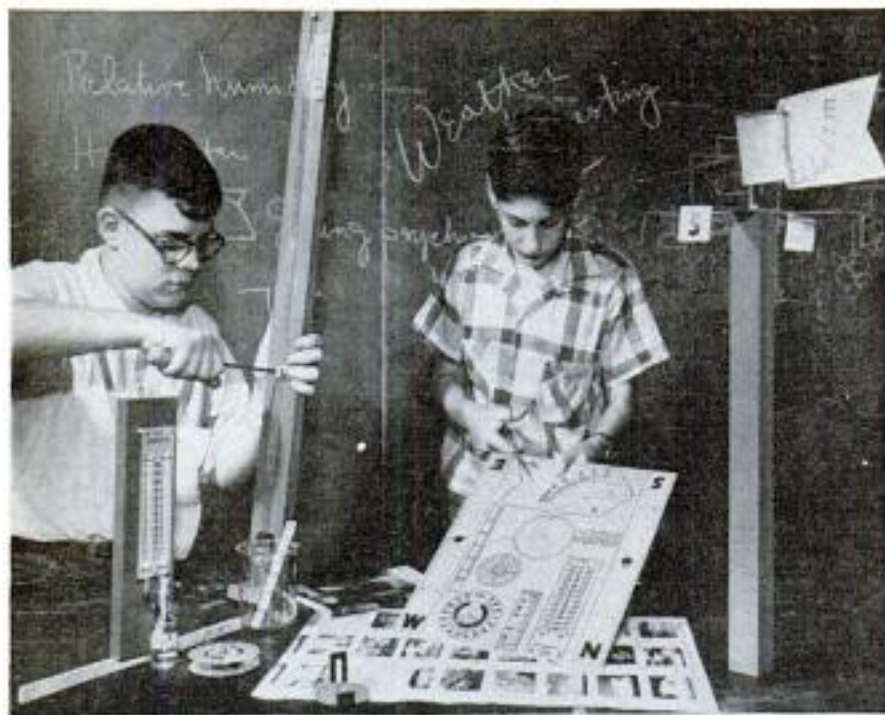

Youngsters with a scientific bent can teach science to themselves with a new series of hobby kits. With the weather kit, the young scientist can gauge humidity and wind velocity, chart cloud formations and make his own weather forecasts. An electronics kit includes parts for a two-tube radio and a transmitter. With the medical training kit the child learns first aid and hygiene. An optical kit has the parts for building telescopes and microscopes, and a geology kit contains rock samples and tools for collecting specimens.

Streamlined Sidecar Designed for Racing

Hardly big enough for the passenger's feet, a tiny, streamlined sidecar on a B.M.W. motorcycle offers little more than a toe hold during a race. The motorcycle itself is housed in a completely streamlined enclosure. The function of the passenger is to prevent the cycle from tipping on high-speed turns by leaning inward as much as possible. The winning motorcycle in the sidecar event averaged 93.2 miles per hour at a recent Italian race.



Mechanical Center For Football Drill

Centers can practice blocking while quarterbacks perfect their ball handling if a centering machine developed by California's San Jose State College football coaching staff is used. The spring-actuated machine delivers the ball to the quarterback just as a center would. It cannot be used by single-wing quarterbacks or punters, as the quarterback must be directly behind the "center" to trigger it by arm pressure.



Ice-Packed Butter Dispenser Cuts Only One Pat at a Time

Sanitary is the word for a refrigerated butter dispenser that cuts a fresh pat each time one is needed. Chipped ice in the dispenser keeps two pounds of butter at spreading temperature. A trigger at the base of the machine is pressed with the edge of the bread-and-butter plate each time a new pat is wanted. An electric motor starts and the cutting mechanism goes into operation. The machine, designed for restaurants, saves time, labor, prevents waste and minimizes handling of the butter.

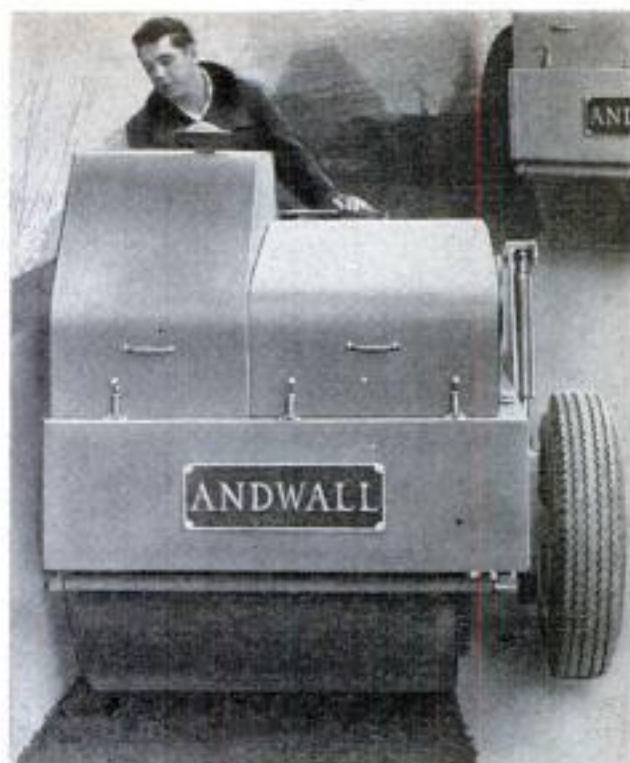

Roller Snuggles Up to Walls

When a new power roller can't get close enough to walls or bridges, the operator simply removes one of the front wheels. With the right wheel removed, the machine needs a clearance of only 1½ inches. Just three bolts are loosened to remove a wheel. The operator can raise or lower the wheels by the flick of a hydraulic lever. The two-ton roller uses liquid ballast.

Parrots Tour French Zoo in "Rubberneck" Bus

Parrots are privileged characters at the Vincennes Zoo near Paris. They even have their own "rubberneck" bus that is pushed around the grounds by an attendant. The feathered sightseers are a popular attraction

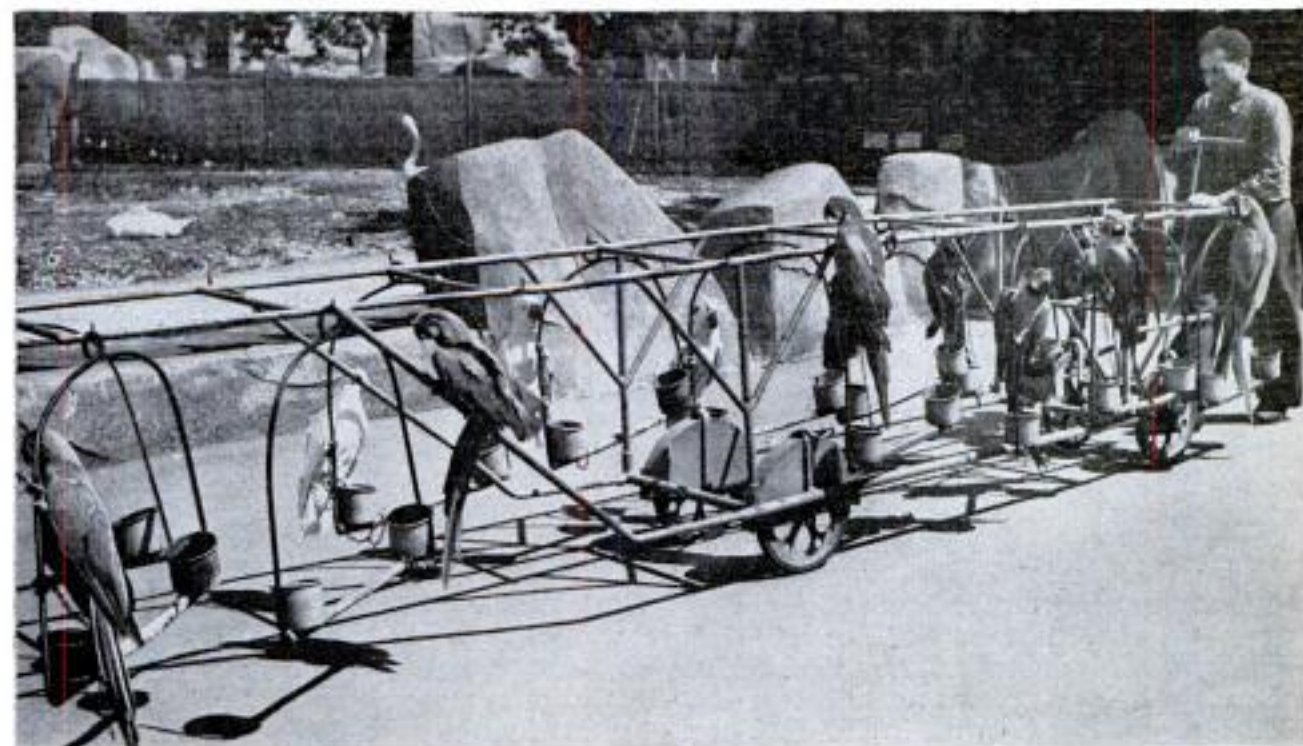



Transpolar flights from Los Angeles to Copenhagen go over some of the world's most inhospitable terrain

Modern Vikings Over the Pole

By Eliot Tozer

IN THE THOUSAND YEARS since Leif Ericson set foot on North American soil no man was able to establish a successful trade route through the Northwest Passage until last month. On the 15th of November, Scandinavian Airlines System (SAS), whose pilots and crewmen trace their ancestry back to Ericson and his Viking band, opened a new route across the Northwest Territories from Copenhagen, Denmark, to Los Angeles.

SAS's ships, a far cry from the "long ships" sailed by the Viking Ericson, are four-engined Douglas DC-6Bs that cruise with pressurized comfort at 285 m.p.h.

SAS, like all pioneers, faced some staggering problems in setting up this first scheduled airline operation over the top of the world. And the problems that the two pilots and their seven crewmen face on each and every one of the twice-weekly flights are almost as bad. For these crews of nine specially trained airmen fight a constant battle on three fronts: Weather, communications and navigation.

Strangely enough, the weather, even though most flight plans take the specially equipped aircraft near the North Pole, is the least of the crew's difficulties. In fact, winter weather at cruising altitudes—12,000 feet westbound and 17,000 feet east-

bound—is better over the Pole than it is on the regular North Atlantic run because the route passes through the stable high-pressure area that hovers between eastern Alaska and northern Greenland during the entire year.

As in most such high-pressure systems, visibility is good, cloud cover seldom exceeds 50 percent and there is no turbulence or bumpiness. Ice that forms on wings and tail is almost always soft rime ice, like the frost in a refrigerator, rather than the hard "clear" ice that forms in thunderstorms and cold fronts.

On the ground, however, weather is a major problem. Blowing snow blots out runways in minutes and sometimes causes delays of an hour or more. Ice fog smothers the airport at Churchill, an SAS alternate, for a week at a time. And "wind chill," a combination of cold and wind, sometimes forces SAS to keep its aircraft engines turning over all during the regular route stops at Winnipeg, Canada, and Bluie West 8, a U.S. Air Force base in Greenland.

"Still," says Capt. Mikal Aschim, "starting the engines is not our critical problem. Rather it is preventing the hydraulic lines from freezing."

Communication by radio is a headache first of all because there are so few stations

north of 70 degrees north latitude where SAS does much of its flying. So the airline has built its own ground stations at Churchill, Frobisher Bay and Winnipeg.

But the major communications problem arises about once each month during "ionospheric storms" that crackle through the upper air in the Aurora Zone, a broad belt several hundred miles wide around the North Pole. At such times, all communication except that over very short distances is blacked out completely. The storms, which last about 48 hours, can be predicted by the Ionospheric Forecasting Institute in Washington, D. C., about two days in advance.

Still, SAS's pilots and navigators say that weather and communications difficulties are minor compared to the problem of navigating their 52-ton aircraft across the thousands of miles of churning ice ridges and black arctic seas.

Landmarks are few and darkness blacks out even these during many months of the year, so the navigators of the sleek ships, *Arild Viking* and *Leif Viking*, must depend on chart and compass.

Much of the Arctic is still inadequately mapped and, within 1000 miles of the Magnetic Pole, the magnetic compass is useless. Because the horizontal lines of force of the earth's magnetic field are so weak above 60 degrees north, the needle on the compass whirls crazily.

So the navigator loses all reference to the earth, navigationally speaking, as he approaches the Arctic Circle. In figuring his headings for the three-part 23-hour flight—sometimes in total darkness—he must use a gyrocompass whose accuracy depends upon a tiny wheel spinning at more than 20,000 r.p.m. This Bendix Polar Path compass is so accurate that it "drifts" no more than one degree per hour.

But Polar Path was not the only answer needed. Because the lines of longitude converge at the Pole, SAS had to adopt the new grid-navigation system in which a special grid is laid over the Polar Projection charts—like the chart on the UN flag—with Grid North running along the Greenwich Meridian.

The navigators on SAS's *Royal Viking*

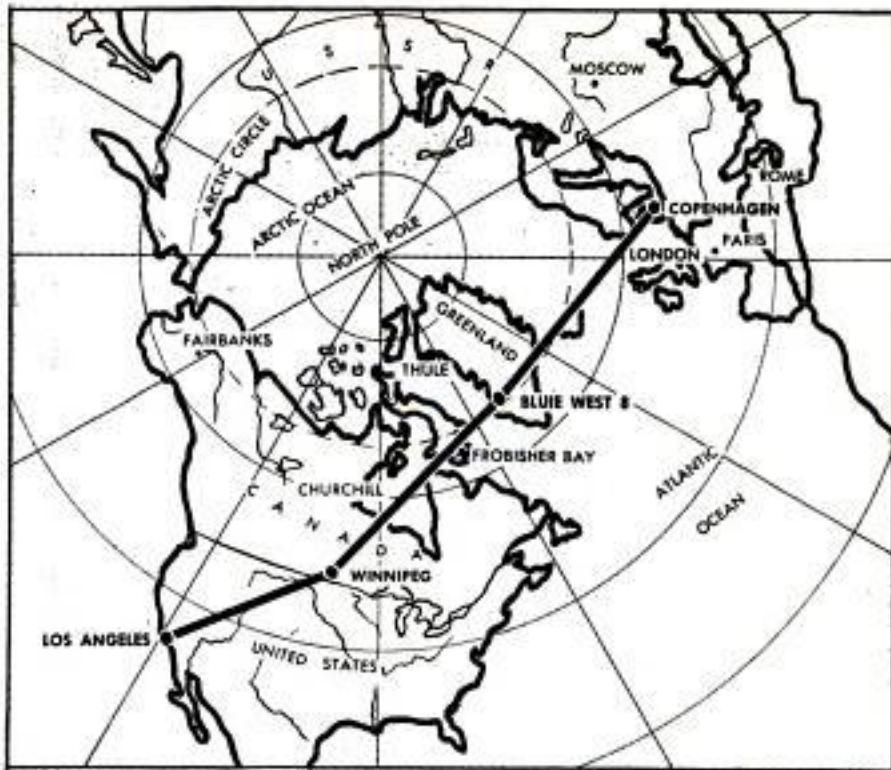

Winnipeg and Blue West 8 are regular stops along the route; Frobisher Bay and Churchill are alternate stops. Thule can be used in an emergency

flights across the Pole also determine their position—as navigators have for 13 centuries—by the stars. During the spring and autumn equinoxes, when the stars are not visible, they take repeated sun shots. And when the sun itself is below the horizon—but there is still daylight—they take sun shots with a polarized sunlight analyzer known as the Pfund Sky Compass.

The navigators, using these special
(Continued to page 260)

The Polar Path compass, utilizing a gyro flywheel spinning at 22,000 r.p.m., determines course when magnetic compasses are useless in polar regions





Width and flat bottom of the canvas boat make it hard to upset

Canvas Boat Fits Into Pack

CANVAS and metal pipes form a lightweight boat that can be knocked down and carried in a back pack. Equipped with three seats and accommodating three people and gear, the assembled boat has a flat bottom and will not readily tip over. It takes only 15 minutes to assemble the boat without tools. The boat consists of heavy, 18-ounce duck impregnated with synthetic rubber stretched over tubular-aluminum framework. The canvas is seamless and presents no problem in folding. The craft requires no maintenance except thorough drying before storage. For occasional patching, a kit is provided, and holes can be repaired as easily as punctures in an inner tube. Two models of the boat are made. One measures 13 feet and weighs 37 pounds. The other is 9 feet long and weighs 36 pounds. Both boats are 44 inches at the beam and measure 14 inches deep at midship.

Disassembled, boat fits into a pack sack for easy portage. Below, it is put together in 15 minutes. Straps lash the canvas to its aluminum-pipe frame

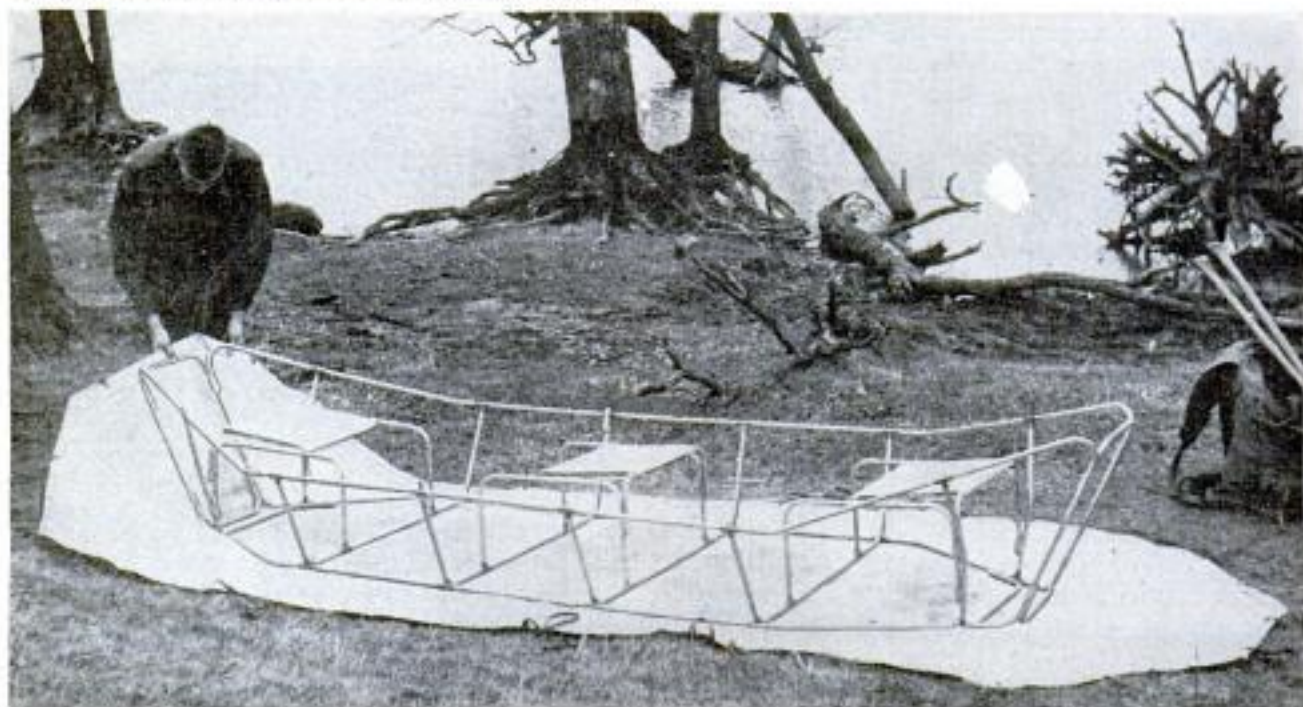



"Lawn Maker" Sprays Seed, Fertilizer and Water on Embankment

More than two acres of embankment per hour is seeded, watered and fertilized with a unit owned by the New Jersey Turnpike Authority. The truck-mounted "lawn maker" moves slowly along the shoulder of the turnpike while an operator directs a fine, even spray upon the near-by slope. Limestone and commercial fertilizer are mixed with the water in a 1000-gallon tank which has an agitator resembling a lawnmower reel. A reversible series of narrow

knives scrapes the inside of the tank to prevent the formation of sludge. In the conventional "flosser," as the machine is called, limestone often forms a sludge on the bottom of the tank which crushes gears, cracks shafts and breaks off agitating vanes. An auxiliary tank permits the application of just seed and water or fertilizer and water. The unit replaces conventional seeders, which cannot operate on all slopes, and hand-seeding, which is expensive.

Plastic Plants Made With Kit

Simulated plants can be made of plastic by the amateur equipped with a new kit. The realistic plants duplicate the translucent, flexible nature of the real articles, are not easily damaged and resist flame. A kit includes directions for making one of five different plants, a can of colored plastic (enough for five or six plants), an aluminum leaf mold, wire stem, wire to support the leaves and wax tape for binding stem to leaves. The liquid plastic is ladled into the mold which is placed in a hot kitchen oven for one minute. The baked leaf is stripped from the mold and attached with others to the stem. A plant can be completed in minutes.



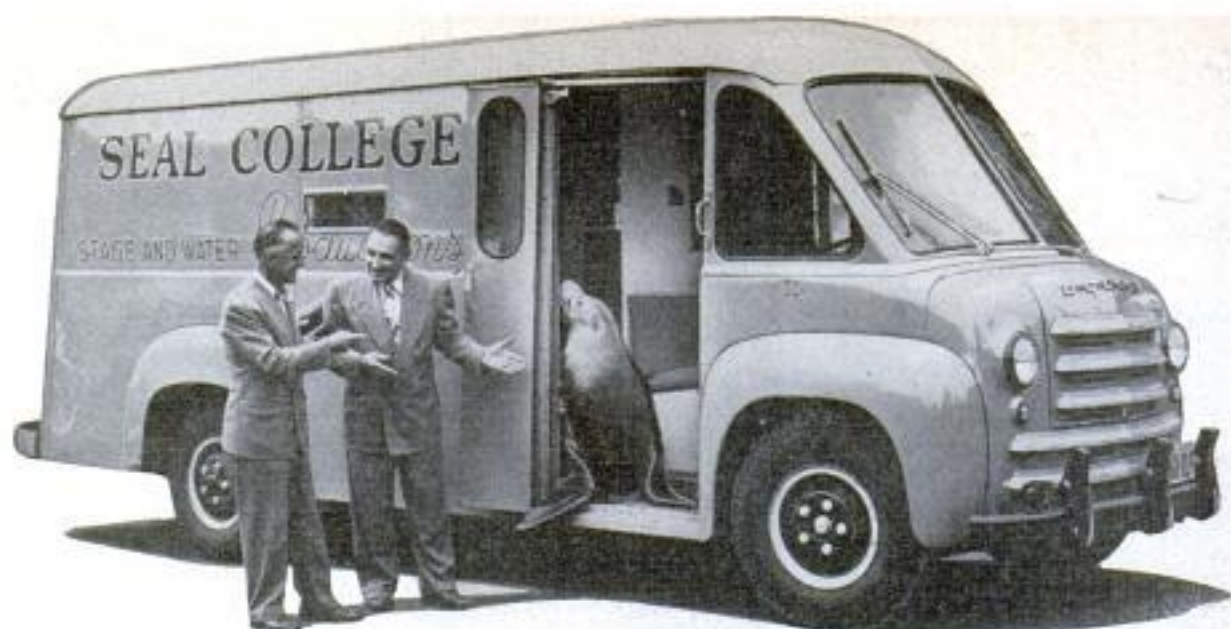

Even seals are on wheels. This performer swims in his private tank inside the truck on cross-country tours

EVERYTHING'S ON WHEELS

WESTERN MOVIES made the itinerant peddler famous—he and his wagon of pots, pans, socks and other essentials were standard fixtures of the wild-west plot, and still are. But he is different now. He is motorized and specialized. Once successful because of the wide-open spaces, he is now in demand for the opposite reason—traffic congestion. Mrs. America

doesn't like to haul the kids downtown through traffic, to drive block after block in search of a parking space, just to buy a pair of shoes. Today, the shoe store drives up, parks in the driveway and the family is outfitted in minutes. Mother likes it, the kids like it and, most of all, the shoe man likes it. On these six pages are examples of how everything's on wheels today.

Equipped to handle any wiring job, a mobile electrical shop in Iowa gets its work orders via radiotelephone





All sections of big cities as well as scattered settlements in rural areas are served by mobile libraries

ON WHEELS

TV sets are repaired and antenna installations tested right on the site with this electronics lab built inside a Dodge truck

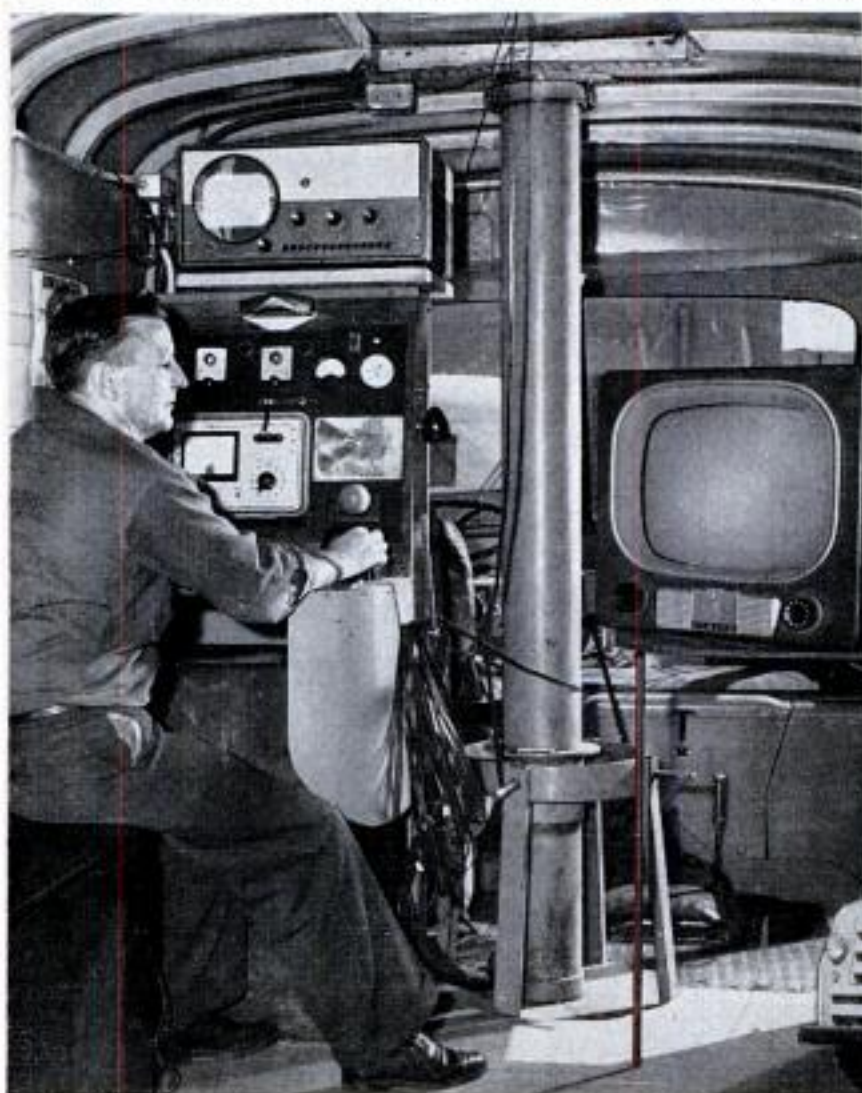



Children wear out a lot of shoes and buying new ones is mighty convenient when the shoe store drives up and parks in your driveway



Iron-lung patients are moved in a specially equipped truck that has all the required hospital facilities built into it. Right, another walk-in van has a full set of office equipment for on-the-spot demonstrations





In an air-conditioned, fireproof trailer is a mobile art museum that brings fine paintings to Virginia schools



By parking two big trucks, each with expanding walls, alongside each other and coupling them as shown below, this company hauls its own mobile auditorium seating 100 persons anywhere in the country for sales meetings





California shipyard workers get hot meals served from a cafeteria in a truck. Prepared foods are kept hot by electricity. The truck also has a grill and refrigerators

Women don't go downtown to look at wallpaper now. They look over samples inside a mobile decorator's shop





Salesmen, like this sporting-goods man, can drive up with a complete display and park outside a dealer's store

What woman could resist when a salesman drives up in his appliance truck, right, and offers to do her laundry? A washer, drier and ironer do the work. He makes the sale



And the baker rolls now, below. Hot rolls are sold at your doorstep from the truck





German Four-Wheel "Scooter"

Just the right size for a housewife to use in shopping or for the commuter to take to the station, a tiny, German two-seater has a completely enclosed, weatherproof body. The two-cylinder rear engine drives the car 40 miles on a gallon of gasoline. Tread at the rear is about one half that of the front.

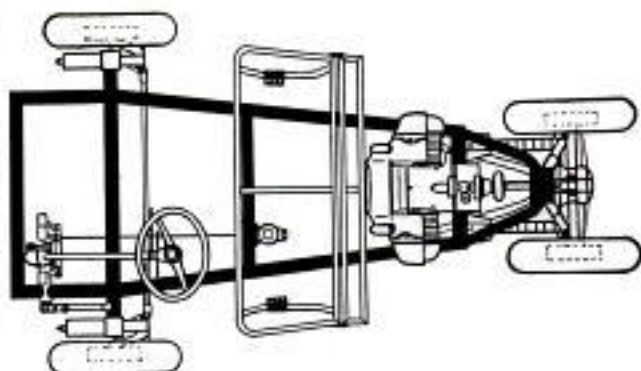

Design Paint Peels Off Glass

Christmas designs painted on glass with a new plastic-base paint peel off in one piece when it's time to remove them. Patterns to be followed are taped on the other side of the window that is being decorated. Besides the Christmas paint kit, which contains patterns for holly leaves, snowflakes, Christmas trees and snowmen, a Halloween kit and a children's everyday kit are available. Decorations can be pulled off glass surfaces within five minutes after they are applied. No scraping is necessary.

Needle Ties Rag-Strip Ends For Home Rugmaking

People who make their own rag rugs are helped by a simple "knotting" needle used to join the rag strips. Two strips to be joined are pushed down over the needle and the end of one of the strips is shoved through the needle's eye. When the rag strips are pulled off, the strip in the eye is passed through the slit in the center of each strip, joining the strips permanently. The device eliminates the usual need for sewing the strip ends.





Small station along route is complete to baggage trucks and stationmaster. Coal in background is genuine

MODEL RAILROAD *With Sound Effects*

By Thomas E. Stimson, Jr.

TOLUCA LINES' Number 17 now arriving on Track Four! Tiara & Tidewater Excursion Special departing on Track Two in five minutes. All abo-o-board!"

There was a realistic screech of wheel brakes as Toluca Lines' streamlined Number 17 came to a stop in front of the passen-

ger station, together with a sharp hiss of steam from its heavy mountain-type locomotive. Less than a minute later (five minutes on the system's geared 6-to-1 clock) the Tiara & Tidewater Special pulled out, its departure marked by the clicking of wheels on the switch points and

Tayloe's collection of hand-built engines includes wood burners as well as modern diesels. Models of old and new trains run on the same tracks





Realistic stores line the railroad siding. Subdued organ music issues from white church beside railroad trestle

with the chuffing of its tiny exhaust stack.

In the next 10 minutes (one hour on the clock) the Special skirted a headland overlooking the Pacific, made the long circuitous climb up the Tehachapi Loop into the mountains, passed some slow freights on other tracks, whistled for the crossings at Grand Junction and Virginia City and ran through some busy industrial areas. By the time it returned to the union station at Toluca it had traveled a distance equal to 12 miles of actual railroad.

By that time, too, evening was coming on and the clouds that were moving across Monterey Bay had taken on a sunset tint. Lights appeared inside the railroad stations as darkness descended, as well as in the drug store and the other buildings along the tracks. Train lights and locomotive headlights began to shine from the trains that were under way or standing at the stations.

The Tiara & Tidewater, along with the

Cedar Valley Railroad, the Toluca Northern and the Prickly Ridge & Pacific, is an affiliate of Toluca Lines, the big central system that is located in the basement of Chet Tayloe's home in North Hollywood, Calif.

Daytimes, Tayloe is manager of a branch of the Security-First National Bank; in the evenings he and his friends operate a model-railroad system that in realism and complexity compares with an actual full-scale railroad system.

Tayloe is "president" of Toluca Lines, M. D. Swerdfeger (a dispatcher for Los Angeles Metropolitan Coach Lines) operates the Tiara & Tidewater, while E. S. Hammack, a commercial artist, is president and general manager of the Prickly Ridge & Pacific. The companies have interlocking directorates, issue complimentary tickets and passes, and the officials use special railroad stationery for writing to each other.

To provide the space he needed for the



joint railroad system Taylor had to remove 60 truck-loads of dirt from under his home, then build new foundations to support the house. The model layout is 65 feet long and 25 feet wide and there is a sunken walkway along its center from which all parts of the layout may be reached. The system is actually two systems in one, there being some 1200 feet of "O" gauge ($\frac{1}{4}$ inch to the foot) and 800 feet of "O" narrow-gauge track.

Two months ago the final "mile" of narrow-gauge track was completed and the occasion was fittingly noted by a "golden spike" ceremony attended by model railroaders of the neighborhood, including Dick Wessel, television star who helped build some of the background scenery, and by A. D. Jack Scott, paint-store manager who installed some of the narrow-gauge trackage.

Taylor has been working on the layout for three years (it's the seventh he has built) and expects to finish it in another year. During the last few months he and his two sons have been completing the sound system and the lighting effects so that he can offer new surprises to model-railroading friends who will visit him during the Christmas holidays.

For some of his sound effects Taylor carried a tape recorder to the Los Angeles railroad yards and recorded typical train and locomotive noises. For sounds of a train in the distance he drove into the mountains and picked up the whistle of a train coming around a curve, complete with echoes. For the announcements of arrivals and departures at the Toluca station he recorded the voice of a train announcer who called the names of trains used on the miniature system. Other sound effects include the hooting of a boat's whistle in Monterey Bay and the noisy activities of a sawmill. Loud speakers concealed in different parts of the layout bring these sounds realistically to listeners' ears. Parts of a sermon, choir singing and subdued organ music issue from a speaker concealed inside a white church that stands on a diminutive hill overlooking the Toluca business section.

Lighting effects, including the cloud projector, are controlled from one of the main operating panels. Here the main overhead basement lighting may be dimmed and turned off to simulate evening and night, at the same time that



Weathered boathouse held by Taylor has faded advertising posters tacked to sides and half-finished boat with shavings

Part of trackage runs right across the top of the main control panel. Panel controls trains, lighting, cloud and sound effects



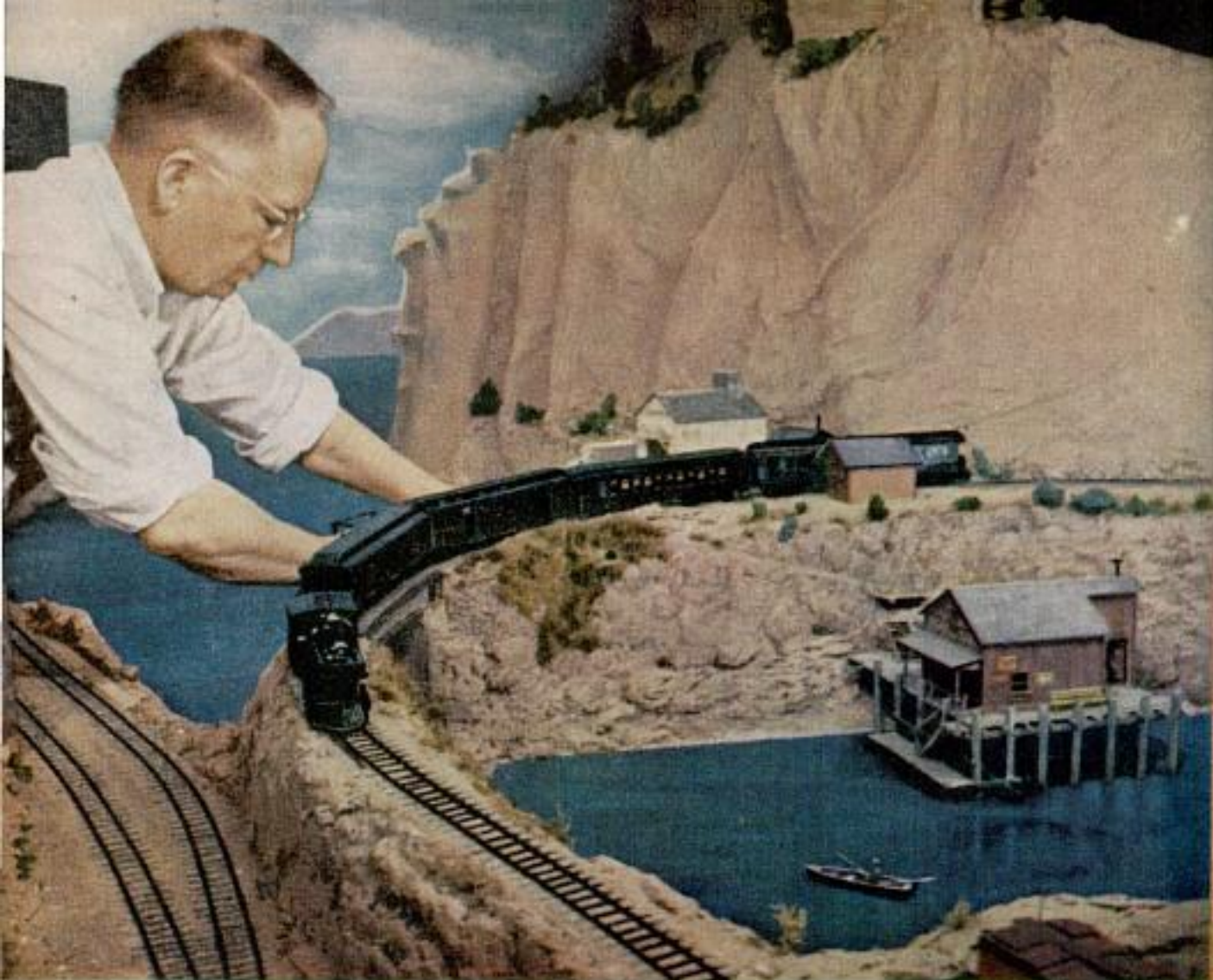

One curve of the railroad fronts on the "ocean." This is the site of fish cannery nearing completion

lights in buildings and trains are turned on. The lights on trains that are standing dead at the stations are operated by a special high-frequency circuit through the tracks with no interference with the regular circuit that supplies the current to the locomotive motors.

Train operation is "two-cab block control," meaning that two men may each operate his own train on the main lines in any

Cattle pen with whitewashed rails and loading dock holds a pair of toy cows awaiting rail shipment

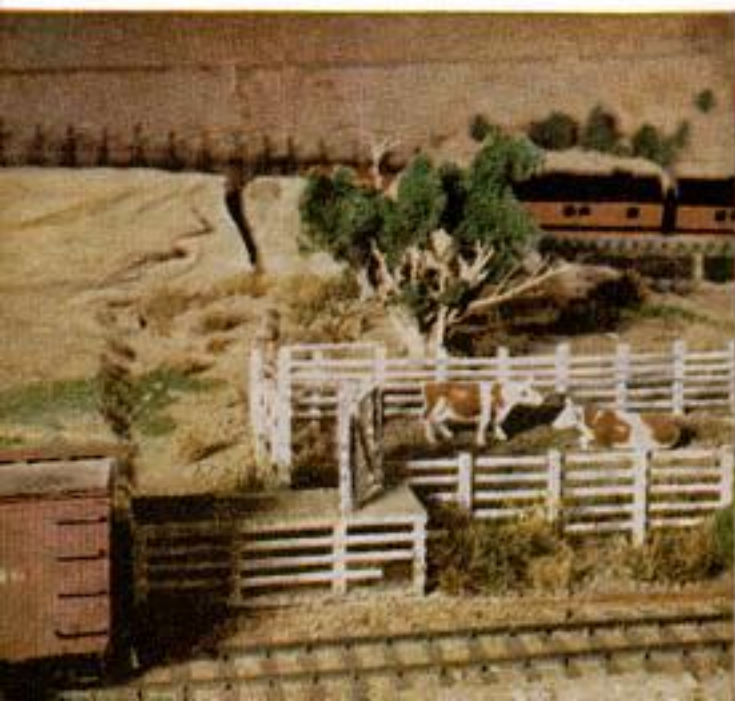

direction without danger of a collision. A similar control panel allows simultaneous operation of two trains on the narrow-gauge portion of the system. And, in the large freight yards, two men may each make up their own freight trains preparatory to moving them out onto the main line.

Rolling stock includes 30 locomotives and 125 cars, all hand-built to scale and using a minimum of stock model parts. The principal trains include a copy of the Southern Pacific "Daylight" passenger train that is operated behind either a steam locomotive or a diesel, a typical "Overnight Express" with a steam engine built from sheet metal, brass tubing, wood and other materials, and an old-time Virginia & Truckee steam engine with two wooden passenger cars. This last train was built by Swerdfeger, who also operates the narrow-gauge "San Juan Express," a scale copy of the D&RGW train that used to operate between Alamosa and Durango in Colorado. The model was built, in fact, after Swerdfeger and Tayloe rode that train before the line was abandoned. The original engine itself is now on exhibition at Knott's Berry Farm some 40 miles from Tayloe's home.

(Continued to page 228)



Drawing shows complete layout of basement railroad

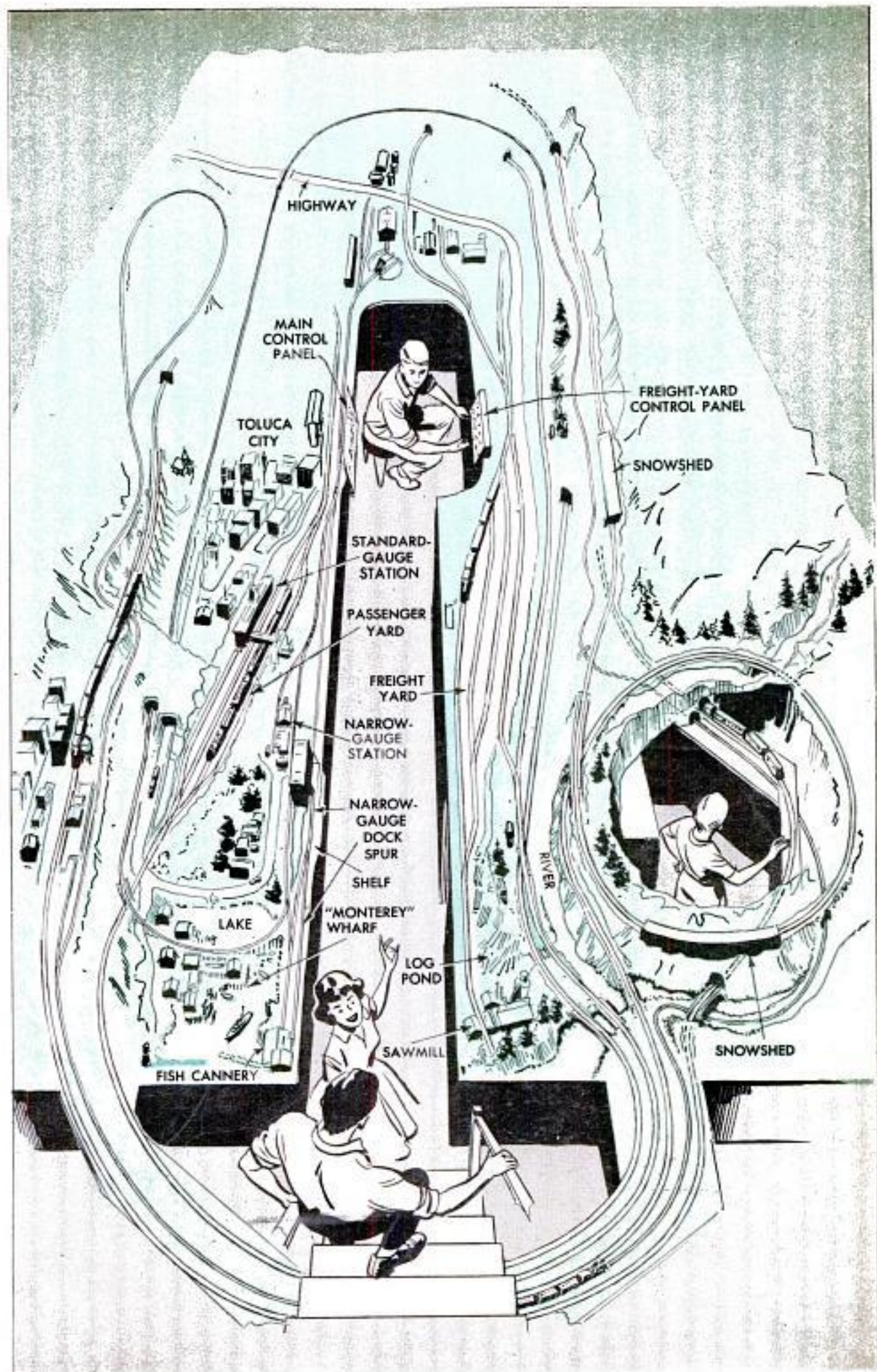



Entrance to Frontierland in fabulous Disneyland will be through stockade-type gates of an old fort

FAIRYLAND OF YESTERDAY

FORTY PASSENGERS at a time will get a realistic impression of space travel in a huge moon rocket being built near Los Angeles as part of Walt Disney's \$9,000,000 Disneyland recreation park.

Strapped to their seats, the passengers will thrill at the vibration and roar of the simulated take-off, listen to the staccato

commands of the rocket captain over the intercom, watch the earth recede below them through a huge viewing port in the rocket's chamber floor and will even experience the sensation of weightlessness in midspace—all without leaving the ground.

Near the Tomorrowland area in which the rocket is located, visitors will find an



Above, model of the castle being built in Fantasy Land. It will be 80 feet high. Below, models of the 105-foot sternwheeler and old train for the park

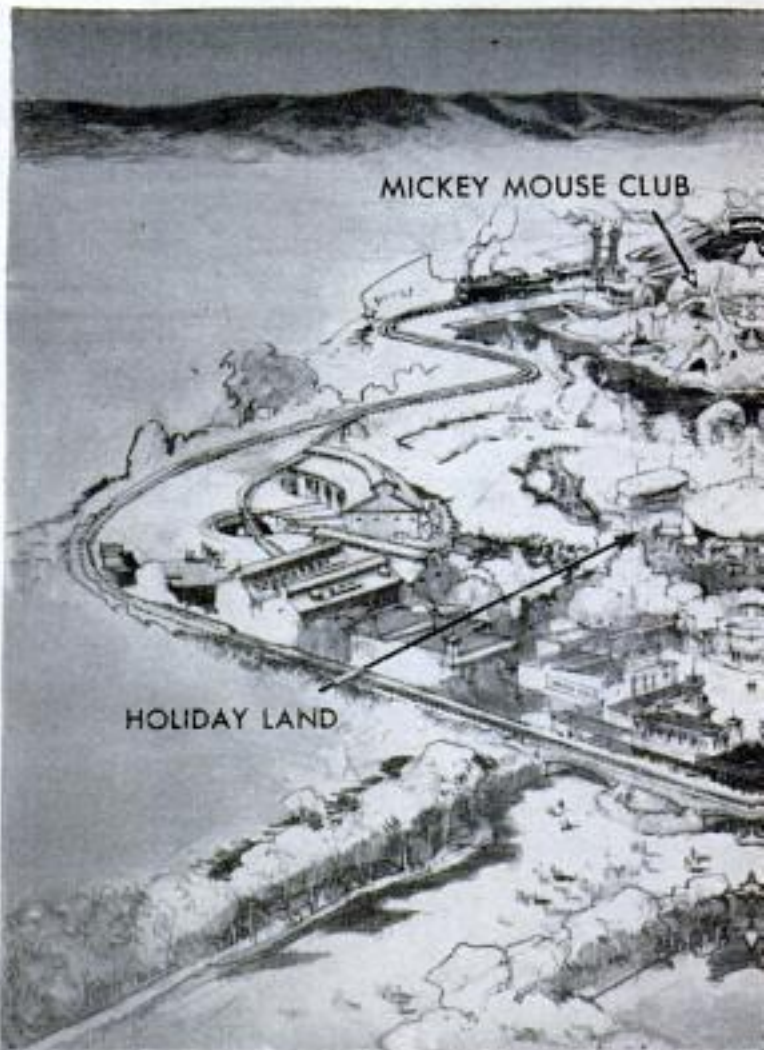



Tomorrowland will offer rides on monorail cars and a stationary rocket ship for simulated trips to the moon

AND TOMORROW

authentic Frontierland complete with Indians and frontiersmen. Here they may shoot muskets at painted buffalo and other game targets or board a 105-foot stern-wheeler for a cruise past replicas of famous landmarks. In other areas they may ride an explorer's boat through tropical

settings, visit a diamond mine or full-scale sets of Disney motion pictures, or ride on Dumbo the Flying Elephant.

Including picnic areas and the storybook castles of Fantasy Land, the project occupies 160 acres. Parking for 10,000 cars will be provided. ★ ★ ★

The wonders of Disneyland cover 160 acres at Anaheim, Calif., and will be open for inspection next May

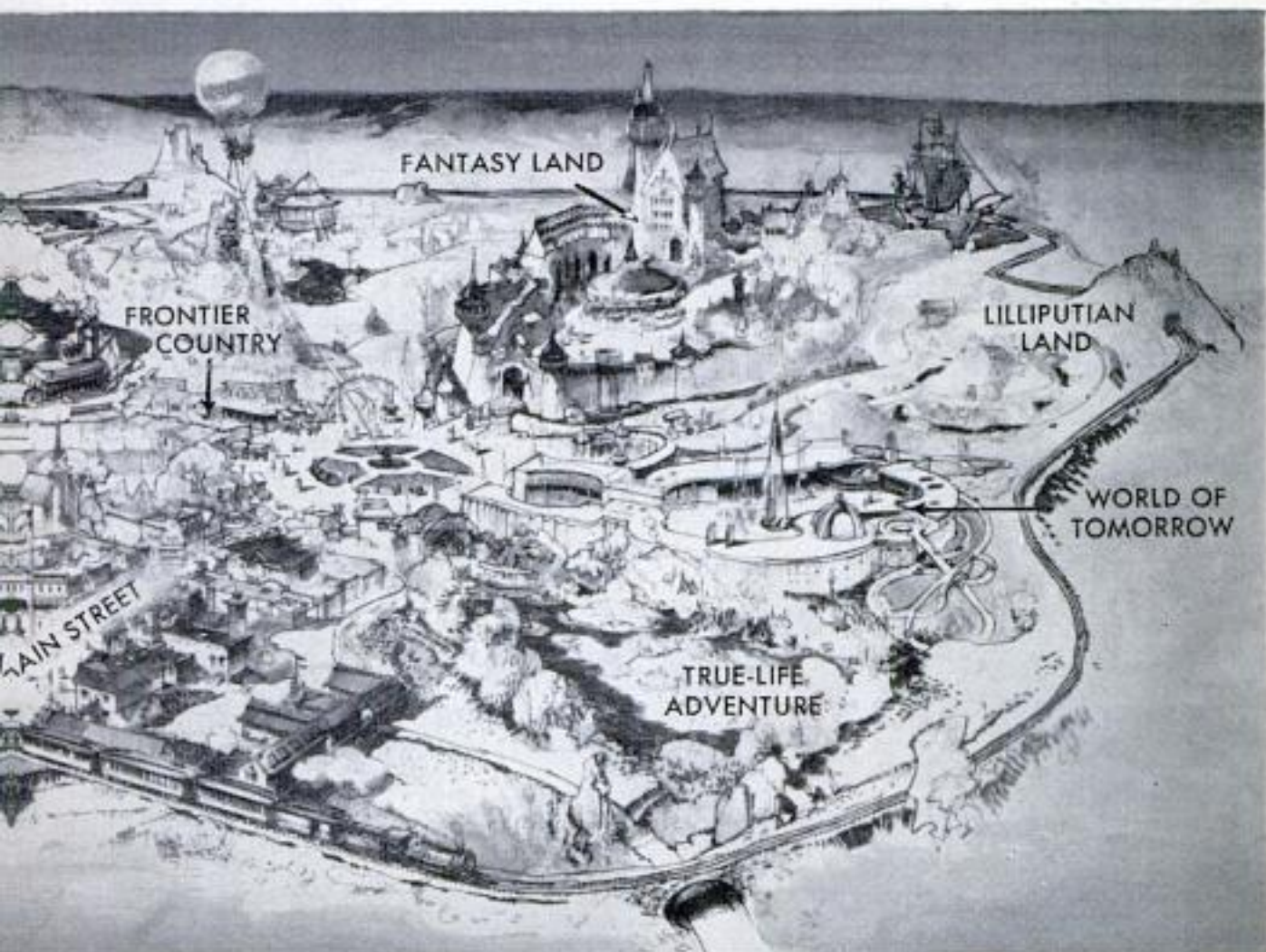



Boy-Size Trailer Built for Junior

Eyes pop and traffic stops in Flint, Mich., when seven-year-old Billy Rucker takes to the road with his "house on wheels." A specially made present from his father, a trailer-company official, it's only 32 inches wide and 40 inches high. Billy pulls it around with a battery-powered small-size tractor.

Game-Bird "Guzzler"

Plastic "guzzlers" catch rainwater to quench the thirst of upland game birds in California. Made of laminated plastic, the guzzlers are easy to transport and install, and appear to be leakproof. The sloping end of the guzzler serves as an apron for catching rainwater and as an entrance for the thirsty birds.



First Nuclear Submarine "Hears" Through Rubber Panels Set Into Hull

Built into the steel skin of the *Nautilus*, first nuclear-powered submarine, are rubber panels through which the submarine "hears." The panels will withstand the same pressures as the hull. They house sonar gear which is used to detect other

vessels by sound signals. The special rubber, developed by Goodrich, permits undistorted passage of the signals. Sound travels through the panels in about the same way it travels through sea water. The panels are installed at both bow and stern.

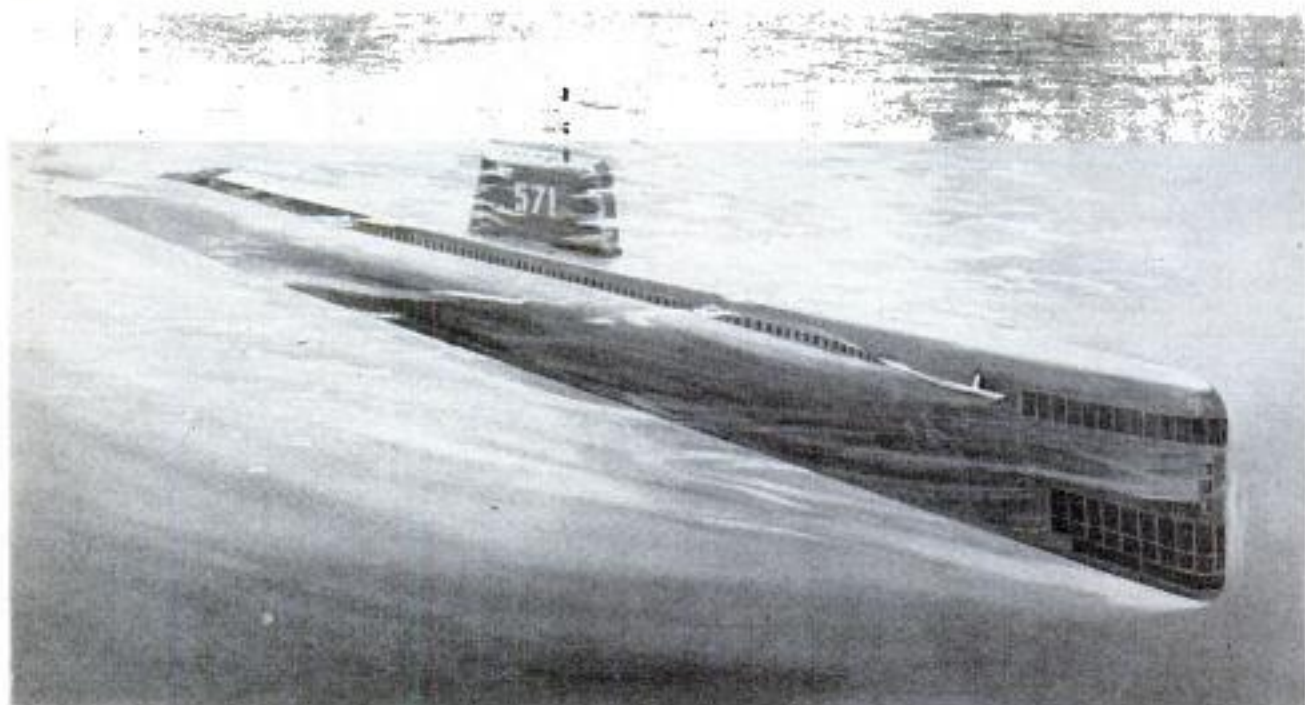

Fire-Fighting Trailer Battles Blaze Until Fire Trucks Arrive

"First aid" for fires on the Dryden Poultry Farm at Modesto, Calif., is supplied by a special trailer that is hitched to an auto and sped to the blaze. It contains "wet water" supplied under pressure, 75 feet of hose connected to the trailer tank and 125 feet of hose that can be connected to a ranch hydrant. Two portable fire extinguishers, wrenches, reducers and other equipment are carried. The outfit combats fires only until fire trucks arrive.

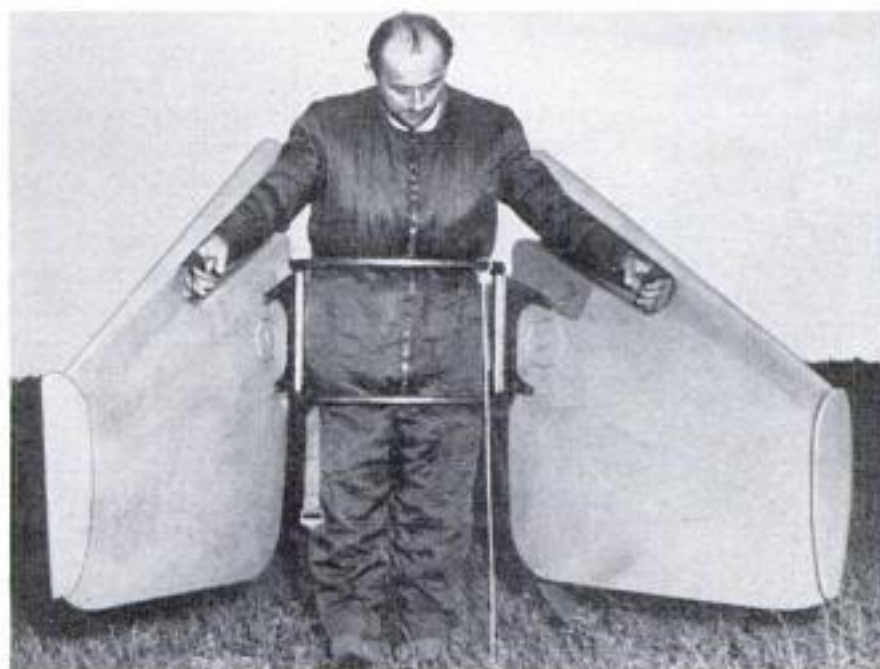
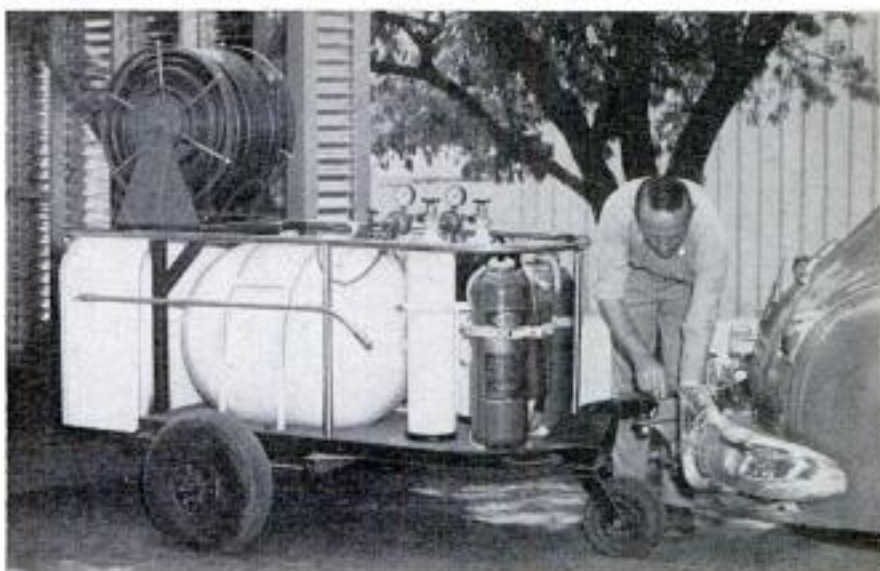

Wooden Wings Fail "Bat Man"

Men can flap through the air like birds if they're equipped with the proper artificial wings, believes Frenchman Leo Valentin. He recently tried to prove his theory with a pair of wings made of lightweight wood strapped to his body. Dropped from a plane flying at 10,000 feet, he soon saw his error and opened a parachute he'd thoughtfully brought along. Valentin has tried out many types of wings in the past, with no success.

Jet Sports Plane Is Tailless

Jet powered and tailless, a French sports plane has a top speed just over 310 miles per hour. The Payen PA-49 is 17 feet long, has a 15-foot wingspan and weighs only 1400 pounds.

Chemists of Gulf Research and Development Co., Pittsburgh, report that addition of a small amount of a colorless gas, boron trifluoride, to gasoline reduces deposits in automobile engines.

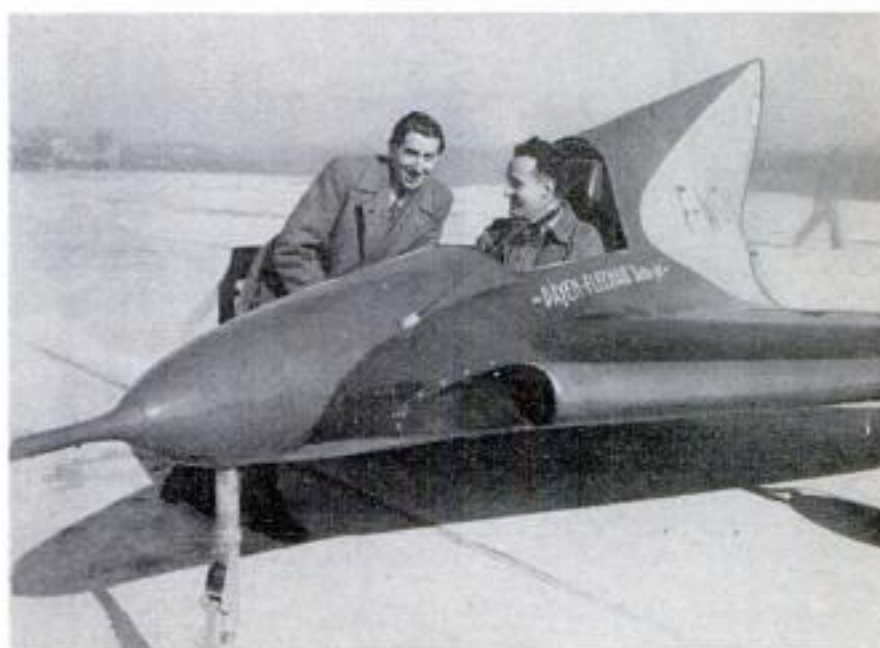



Gaskins prepares to cut knee in Fisheating Creek Swamp, Florida. Knees must be carefully selected

Knee Deep in Cypress Knees

TO MOST PEOPLE cypress knees — those odd-shaped growths of wood that extend upward above the swamp water from the spreading roots of the bald cypress — are just another curiosity. Cypress-swamp visitors, along with forestry experts, wonder just what they are. To Tom Gaskins of Florida's Fisheating Creek Swamp they are bread and butter. They make his living.

For 20 years Gaskins has been cutting, peeling and drying cypress knees for the market, and for the past decade he has been making it pay.

Cypress knees grow in fantastic shapes, and Gaskins has discovered that they can be made to grow in even more fantastic shapes with a little encouragement. If they have to force themselves around a foreign object such as a bottle or an arrowhead they very obligingly assume even more grotesque formations.

The decorative value of the queer configurations assumed by cypress knees is what Gaskins sells. The knees, like driftwood, are nature's "objets d'art," and Gaskins considers them as such.

Some craftsmen make the knees into lamps and vases. Tom did once, but lately he has been satisfied to sell them in much the same form as they appear in nature.



At left a knee that grew in four prongs. Next, one that surrounded an arrowhead. Gaskins says two at right resemble gossiping women



There is a lot more to getting them ready for market than just wading out into the knee-deep waters of the swamp and cutting knees. They require long and careful processing before they are ready to grace a southern curio shop and, possibly, your living room.

After they are cut, the knees must first be peeled, a process Gaskins worked out with the aid of the Agriculture Department's Forest Service. The bark comes off straight surfaces easily, but for years Gaskins was stumped by the bits remaining in the crevices of the wood. He tried oil and lye and acid, and still finished up with kindling wood. Then the Forest Service suggested boiling, and the intricate bark design loosened up enough for Gaskins to work it loose with the tiny tools dentists usually use to work on your teeth.

After they are peeled, the roots must be dried for a year. The warm Florida sun turns them to a honey tan that is the envy of many a two-week vacationist. But during the process they cannot get wet, so Gaskins must keep a continual eye on the weather, ready to wheel his homemade carts loaded with drying knees to shelter at the first hint of a tropical rainstorm.

In addition, the cypress knees tend to split and dry unevenly unless they also get air in their centers. To achieve this Gaskins worked out his own oversize power drill that cuts holes in each knee. The holes also provide convenient apertures for the pegs of the drying racks. ★ ★ ★

Politics in cypress. The elephant and the donkey, below. The knee, next right, is called "Woman Dancing With a Two-Headed Monster." Far right, a "Madonna and Child"

This enormous and fanstastically twisted cypress knee stands 50 inches high. A Gaskins favorite, it has been named "Mrs. Hippo"



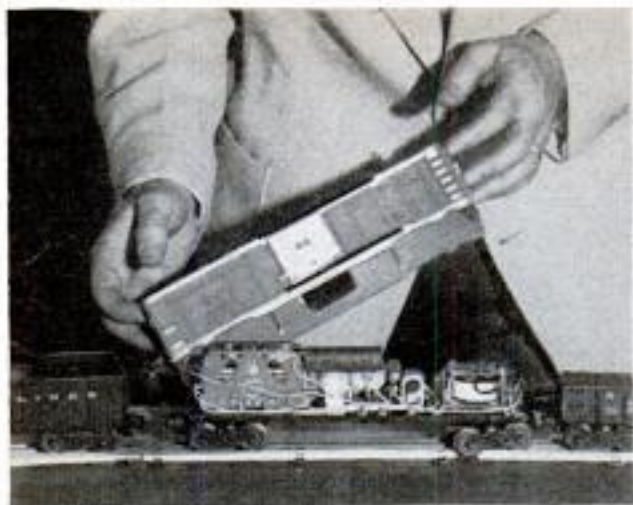

Radiation Controls Model Train Equipped With Geiger Tubes

Any radioactive material will control the model electric train of Garth Driver, an instrument engineer at Richland, Wash. The train is a standard model, but Driver has mounted Geiger tubes inside the engine and caboose, and built transistor amplifiers and switching gear into a freight car in the center of the train. By holding a cardboard disk containing radioactive cobalt in front of the train, Driver can make it back up. A disk held near the caboose makes it go forward, and when



Driver holds disks near both ends the train stops completely. Impulses received by the Geiger tubes are transmitted to the amplifiers and switch gear to determine the direction the train will run.

Auto Transport Uses Special Alloys to Reduce Weight 8000 Pounds

Lightweight metals and alloys are used in a new automobile-transport truck that weighs 8000 pounds less than the conventional models. Aluminum and light steel alloys replace heavier metals in runways, skids, fenders, wheels and trailer body, re-

ducing weight by three tons. This permits the elimination of a third axle on the unit, saving another ton. According to the developers, the machined-aluminum wheels stay in perfect balance, allowing tires a 100,000-mile run before recapping.



Automobile-Engine Exhaust Safely Inflates German Mattress

It takes only 40 seconds for the sleepy motorist to inflate an air mattress with the help of the engine exhaust. One end of a flexible tube fits over the tailpipe and the other over the intake valve of the mattress. To prevent permanent "sleep" from occurring, a special filter in the tube is said to absorb the lethal components of the exhaust gases. The device is made by a company in Munich, Germany. It is not necessary for the user to turn off the automobile engine to connect or disconnect the unit to the exhaust pipe.

Flash Synchronizer Has Built-In Tester

Built into the back of the synchronizer housing, a tiny indicator light (see arrow) prevents wasted film due to bad bulbs and inadequately charged units. When ready to take a shot, the photographer simply flicks the indicating light upward with his finger. The light flashes on to indicate sufficient charge and a good bulb. The lamp is part of a new line of flash units which can be custom-fitted to any camera equipped with built-in synchronization. A direct-reading exposure calculator is mounted on the back.



DECEMBER 1954



Camera Case Permits Underwater Shots

Underwater photographs can be taken with a Rolleiflex equipped with an underwater casing. The unit permits normal camera operations, including focusing, selecting shutter speeds, lens setting and change of filters. It also mounts a flash. A rubber-covered cord makes handling safe and easy.

Zoomar TV Lens for Movie Camera

Adapted from the lens made famous by television, a movie-camera Zoomar lens provides the photographer with everything from normal focal length, to telephoto, to wide angle, all in one lens. All you do is push the zoom lever (located below the lens) forward to come in, pull it back to come out of the scene. The lens is available for all 16-mm. cameras and no alterations are required.





Aluminum Garage Door Is Made With Build-It-Yourself Kit

You can assemble a new aluminum garage door in 45 minutes with only a screwdriver and a pair of pliers. The door is marketed in a build-it-yourself kit that weighs only 42 pounds. Matched color markings guide the homeowner in assem-

bling the door. The kit includes the door panels, locking handle, weatherstripping and pull rope. The door is available in two sizes, eight feet by seven feet and nine feet by seven feet, and with either a track or jamb-type operating mechanism.



Tiny British Jet Flies 600 M.P.H.

Recent British entrant in the lightweight fighter race is the Folland Midge, a development aircraft about half the size of the largest fighters. Despite jet thrust of only 1640 pounds, the 4500-pound, 20-foot wingspan Midge has been clocked at speeds in excess of 600 miles per hour.

Dolly Lifts Wreck And Tows It Away

Any passenger car becomes a tow truck for disabled vehicles with a new car dolly. The dolly consists of a lever with a movable fulcrum mounted on two pairs of dual wheels. It is backed up to the disabled vehicle and its wheels are locked. As the towing car moves forward, the dolly lifts itself and the wreck into traveling position. No pumping is required.

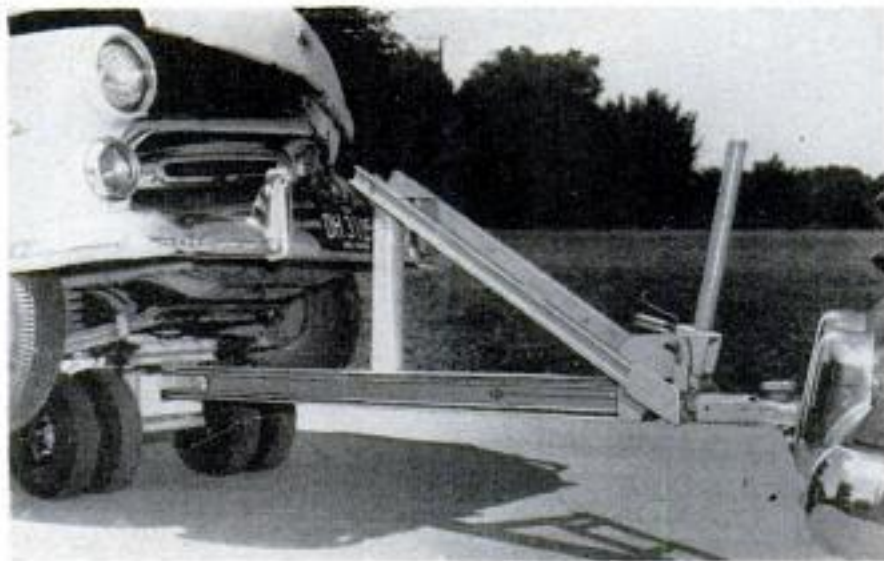



Compact Camping Trailer Uses Cadillac Fenders

YOU MIGHT THINK you're seeing double when C. W. Younkens of Burbank, Calif., drives past pulling his camp trailer. The trailer is formed of two Cadillac rear fenders that match those on Younkens' automobile. It is painted to match his car. At the camping site, the trailer opens up to form a 12 by 14-foot canvas-covered room. Inside the trailer itself are storage cabinets, a three-burner butane stove with oven, a sink with a 12-gallon water supply and an icebox. Two persons can sleep inside the trailer and five more in the canvas-floored area around the trailer. Younkens made the trailer for his own use and says that similar trailers could be made with Lincoln, Buick or Oldsmobile fenders. Total weight of the unit, including



the big canvas tent, is about 1400 pounds. It takes about 35 minutes to set it up at the camp site. The trailer has the same width and road clearance as a Cadillac passenger car. Its front section is made of molded plastic.





Big Mixer Without Motor Operated With Hand Crank

Developed in England, a low-cost kitchen appliance resembles an electric mixer except that it has no motor. The housewife operates a hand crank which is geared to turn the beaters rapidly. Another handle controls the height of the beaters and their position in the rotating bowl.



Tiny Radioactivity Scope Fits Into Shirt Pocket

You can detect radioactivity with a one-ounce plastic device the size of a pocket-knife. The user darkens the room and then holds the specimen against one end while he looks through the other. The tiny unit contains a lens and a phosphor-coated screen which registers flashes of the rays.



Diners Eat "Hot" Meal On Heated Furniture

If a German engineer has his way, you'll be able to dine outdoors in comfort any time of the year. The designer has come up with a dining table for chilly weather. Electric heaters warm the diners from above, from the backs of the chairs and from the table itself. And their legs don't get cold either—they're warmed by heaters under the table.

Even Beds Go King-Size

Aware of the increasing average height of American men, the bedding industry has agreed on standard dimensions of a king-size bed. It will be 82½ inches from end to end. This will comfortably sleep any six-foot four-inch basketball player, and would even accommodate a six-foot ten-inch man. U.S. Army records show that the number of men over six feet tall has increased 70 percent since 1918.



Hydraulic Hog-Moving Trailer Loads and Unloads Itself

Moving hogs to clean pasture is a simple chore on the Irvin Fritz farm in Franklin County, Ind. Fritz has built a tractor trailer that loads and unloads itself. He backs up to a hog house filled with a sow and her pigs, flicks a hydraulic control, and the trailer lowers to scoop up the coop. Another flick of the lever dumps the house at its new location. A hydraulic piston mounted on the trailer is connected to the tractor's hydraulic system.

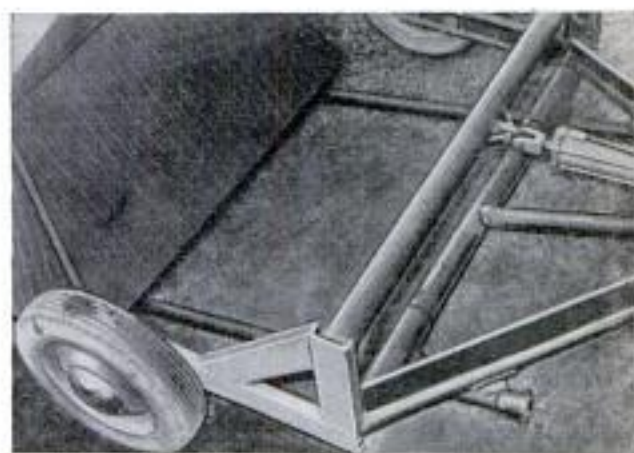

Sweden Builds Plastic Sports Car That Weighs Under 2000 Pounds

Weighing less than 2000 pounds fully loaded, Sweden's first plastic-body sports car will go 97 miles per hour with its economical 70-horsepower engine. It accelerates from 0 to 60 in just under 8 seconds. The chassis is of tubular construction, stiffened with a strong

sheet-metal "backbone." The metal parts are perforated to save weight. Lightness was the principal aim of the car's designers. Called the Volvo Sport, the car is being produced for export only. It has twin carburetors, a 7.8:1 compression ratio, high-lift cam and overhead valves. A 27-pound plastic hardtop roof can be fitted to the car in a few seconds. Production rate is said to be one a day and the principal market is expected to be in South America. It is not being billed as a competition car, but rather as a fun car for the sportsman driver.

☛ Spraying nitrogen in solution on leaves of growing wheat has increased protein content of the grain 9 to 17 percent.

Harmless "Gun" Frightens Dogs

Now you can chase dogs from your lawn and shrubs with a harmless "gun" that does nothing but frighten the animals. A small metal box on a 10-inch spike contains a cap and firing mechanism activated by a thin nylon cord stretched near the ground. When a dog touches the cord he sets off a small explosion and scares himself out of the yard.



ESCAPE AT SIX FATHOMS

—"Deep six," the submariners call their salt-water school for emergency exits

By Fred Harden

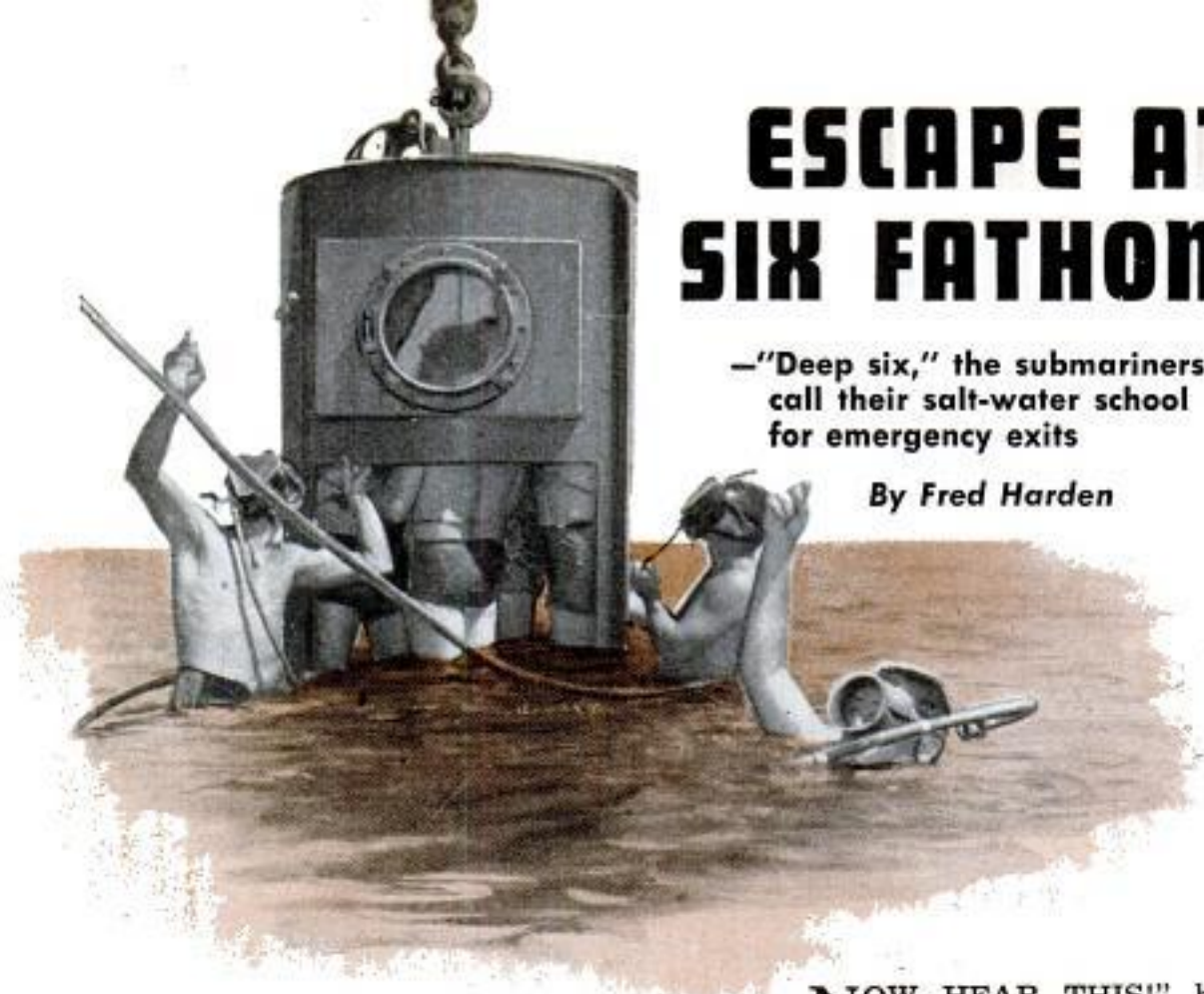

Divers supervising the drill give signal to lower bell loaded with trainees. Inside bell, trainees wear Momsen Lungs while a supervising diver stands by to prepare them for the ascent



NOW HEAR THIS!" boomed the loudspeakers. "The crew off the *Sea Dog*—fall in on the starboard side of the ship for 'deep sixing'."

Sailors, clad only in swim trunks, ran to the rail of the little submarine-rescue ship, the *USS Penguin*. Each clutched a strange piece of equipment resembling a canvas water bag, a Momsen Lung. It was their first drill in underwater-escape technique, an exercise that is held nearly every week in the warm tropical waters off Key West, Fla. In minutes the first group of men would strap on their Lungs, be lowered six fathoms into the sea and cast loose to float to the surface.

The six-fathom (36-foot) release point gives "Operation Deep Six" its name, and the drill is a realistic rehearsal for men who may someday be forced to vacate a sunken submarine.

Most of Uncle Sam's undersea sailors pick up this training when they pass through the sub school in New London, Conn. But there are some who transfer to subs directly from surface ships, and others who must requalify every year. Most of these men get their escape training at Pearl Harbor, in a special tank similar to the 100-foot-deep tank at New London.

The rest train in the waters off Key West, home port for a large number of the Navy's Atlantic Fleet boats, where Gulf and Atlantic waters crisscross and trainees get the feel of real currents.

Operation Deep Six off the *Penguin* revolves around a "half bell," built especially for the open-sea exercises. It resembles an opened tin can turned upside down and has a platform beneath on which trainees stand as the bell sinks into the sea.

An air hose runs from the *Penguin's* mammoth air compressor to the bell and provides enough air to keep the water out. Water comes no higher than the chests of the men. Two air bottles mounted inside the bell are used to fill the Momsen Lungs before trainees ascend.

With the *Penguin* at anchor, the bell is hoisted over the side by a huge boom and the operation is ready to begin.

"First five over the side," says the senior diver of the *Penguin*.

Two qualified divers from the *Penguin* take their stations with the bell. One stands by inside to charge the artificial lungs and to man the ship-to-bell intercom. The other follows the bell down and then accompanies each trainee during his ascent. With the first five aboard, word passes from the

bell to the ship: "Take her to six." As the bell is lowered, air pressure increases.

At the desired depth, the trainees test their Lungs by ducking under the surface. If all Lungs are working well, the *Penguin* diver charges them with fresh air and the men are ready to make their ascents.

A line runs from the platform of the bell to the main deck of the *Penguin*, so that the men will have something to guide them upward on an even course.

Ascents from a hundred feet have been made successfully without the Momsen Lung, but this is not a recommended practice. A "free ascent" requires a cool head. Contrary to popular belief, you can never run out of breath when you start from the bottom up. Your lungs fill continuously as you rise and unless you exhale often your lungs will burst. This is where the Momsen Lung comes in handy. It exhales for you.

Even with a hundred men taking the training, it's not until the cry "Number One on the surface" that everyone breathes a little easier. From then on, it's a matter of arithmetic.

Aside from its importance as a training exercise, escape training is a great morale booster. It's good to know you can escape if you have to. ★ ★ ★



Ship's divers stand by as the bell is lowered into the sea. Five trainees descend at a time

Skilled divers follow trainees to the surface to guarantee a proper ascent

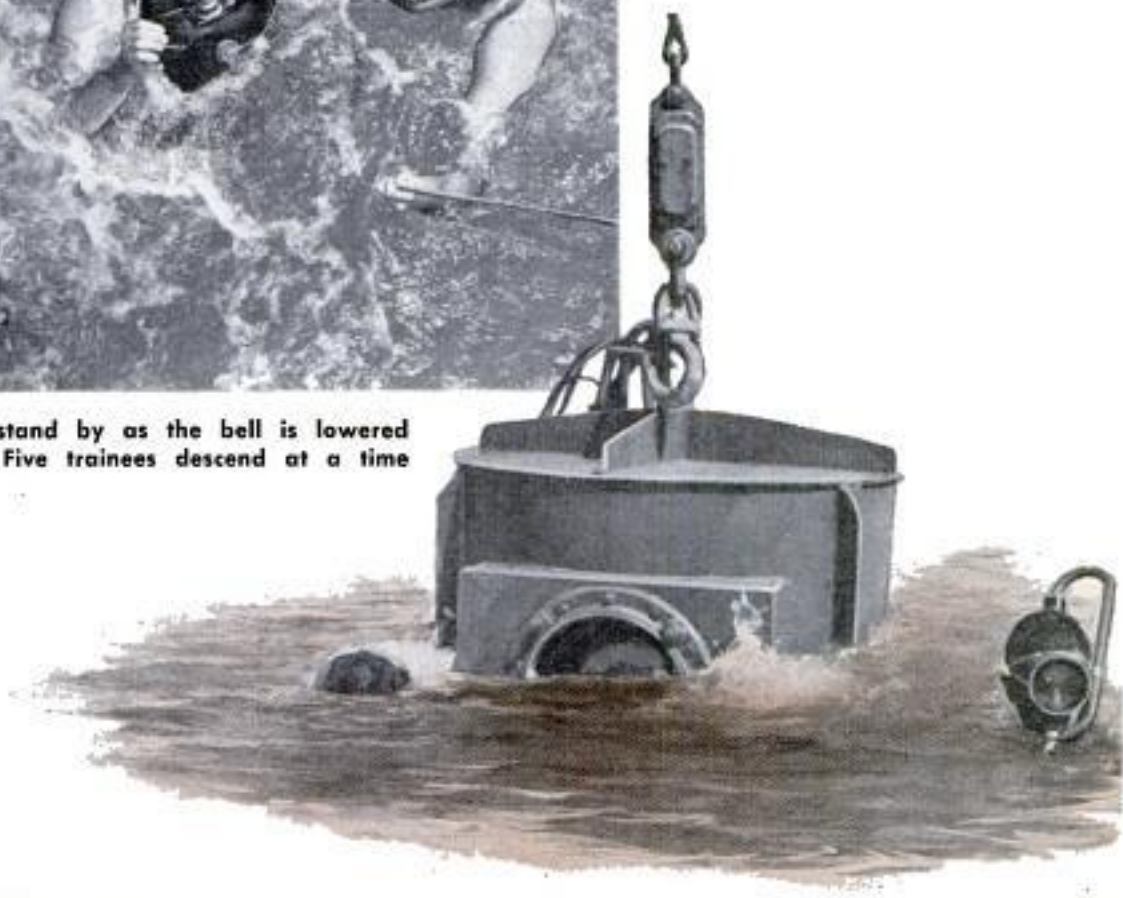

WHAT'S NEW FOR Your Home



1. MIDGET DRIER will dry hosiery in five minutes, can be used to warm the bathroom on a chilly day or as a hair drier. The unit is portable or can be mounted on the wall of bathroom or nursery. It has a tumbling action which is easy on lingerie, and comes equipped with a 60-minute timer switch



2. SHARPENING TOOL will put a new edge on knives, scissors, lawn mowers, hoes, axes and all kinds of household and gardening tools with a few light strokes. The sharpener is easily adjusted with a setscrew for all types of blades. A small wheel on one end of tool makes an efficient glass cutter



3. BUILT-IN BROILER with finger-tip control can be raised or lowered without burning the hands in this electric range. Height of the broiler can be adjusted as much as two inches with a simple lever. The lever fits any one of seven slots and provides an easy means of heat control without removing food



4. IN-THE-WALL BED is so thin it can fold into any standard two-by-four wall space. A flush door or panel hung on concealed hinges hides this comfortable bed when it is not in use. The key assembly is also concealed and is easily unlocked by inserting a key through a small hole in the door



5. SIT-DOWN SINK has a shallow bowl designed so knees and legs can slide easily underneath. The peninsula-type sink has three bowls, a shallow one for preparation and deep ones for rinsing and dish-washing. A swivel-mounted faucet serves all three. Two-bowl design is available for counter arrangement in conventional plans. It's made of stainless steel

6. BACK-SAVING MOP can be angled to six different positions, enabling the housewife to clean under beds, dressers and other hard-to-reach areas without bending or stooping. The angled position makes it much easier to dust door and wall moldings without moving the furniture. Simple attachment can be put on any mop by merely sawing through handle

7. BED-RAIL EXTENSIONS provide that extra leg room and are available in four and six-inch sizes. Made of solid hardwood and equipped with two metal bed fasteners, the extensions require no tools to attach them to the bed rail and footboard. Regular-size mattress can be used with four-inch extension, but the larger size requires extra-length mattress

8. GARBAGE CAN ON WHEELS can be pushed or pulled with ease, parked at the back door or a far corner of the yard. The can is mounted on two rubber-tired wheels and the lid is attached to a spring-actuated handle that serves to lift the lid or hold it tight on the can. This garbage holder is not easily upset and can also be used for gathering leaves or trash



Will Cattails Become Source of Food and Fiber in the Future?



Cattails — those big “weeds” that grow in swamps — may someday be an important source of food and fiber. Research at Syracuse University has shown an amazing number of uses for the plant. The roots or rhizomes could be eaten like potatoes or ground up to make flour. The flour can be fermented to produce ethyl alcohol. Research shows that soft fibers may be extracted by chemical treatment of the stems and leaves. These fibers can be used to stuff furniture and make string, burlap and webbing. Cattails have a prolific yield. On one acre 140 tons of rhizomes can be produced.

Fast Cable Layer

Two men can bury a mile or more of cable a day with a rig designed for a Massachusetts power company. A deep plow attached to the drawbar of a Caterpillar tractor grooves a trench and the cable is simultaneously laid in the bottom. Two cable reels carrying about one mile of wire are mounted on a sled which is dragged behind the tractor. As it is pulled along, the sled covers and smooths the cut.

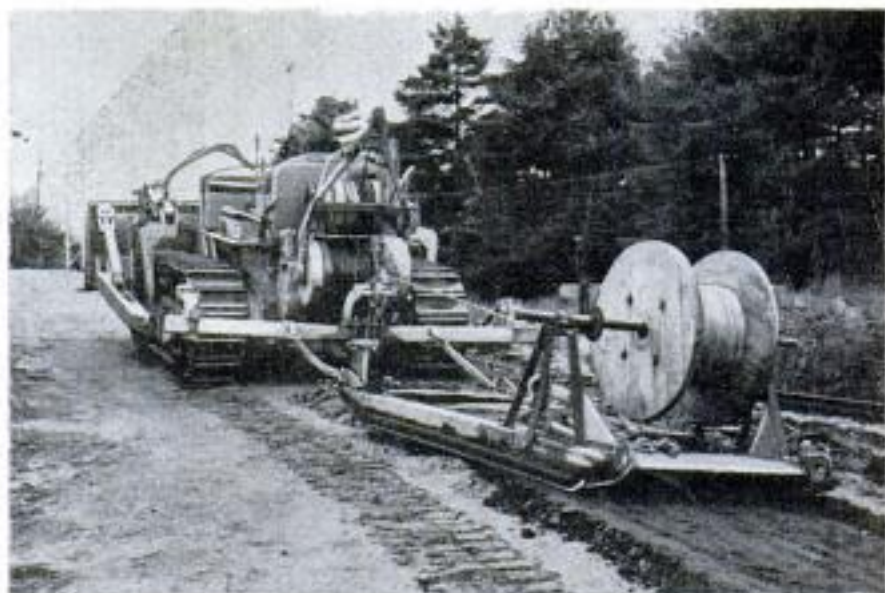

Three Lubricants Packed in Kit

Three lubricants, each in a squeezable plastic dispenser, are contained in a compact plastic case. One of the lubricants is all-purpose oil for use on household appliances, hinges and fishing reels. Another is graphite powder, suitable for use on auto doors. The third lubricant is liquid graphite for automobile speedometer cables.

Flashlight Beams Teach 12 Pupils the Intricacies of Dancing

Students quickly learn even the most intricate dance steps by following a pattern of lights projected on the floor by a mechanical dancing teacher. The machine stands on three legs of aluminum tubing and has long arms that stand out straight to support a series of lights. Rods connect to the feet of the human dancing teacher so they project the pattern of her foot movements on the floor. As many as 12 students can follow the beam at a time and, no matter how inept they may be, none ever steps on the teacher's toes.

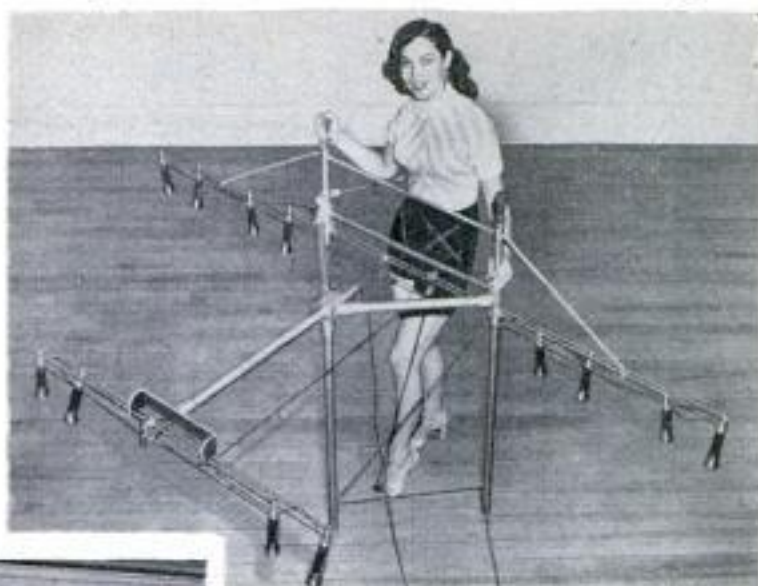

Frozen-Food Locker Pulled Out of Floor

Rented lockers for frozen food are pulled up out of the floor in a Franklin, Calif., plant. The installation takes two thirds the space and one half the electricity needed by a conventional locker plant, where customers must enter the freezing room. Each locker consists of a tall, shelved wooden crate open on one side and a top cover that fits snug in the floor of the room above the freezing chamber. The customer removes his padlock from a steel ring on the lid and inserts the hook of a power lift that is mounted on tracks above the customer's head. The chain lift pulls the locker up until the desired number of shelves is exposed.

One-Cylinder Engine Powers Tiny Tractor

If you're looking for a tractor that roars and has bulging "muscles," you won't be interested in a homemade model built by Donald Aspy of Jay County, Ind. He took a tiny one-cylinder engine from a Delco light plant and hooked it up to a Dodge truck gearbox, a Studebaker rear end and various assorted parts reclaimed from wrecks and junked cars. Very small and maneuverable, the tiny tractor hauls wagons around Aspy's property and is so useful that his neighbors have talked him into making several others for them.

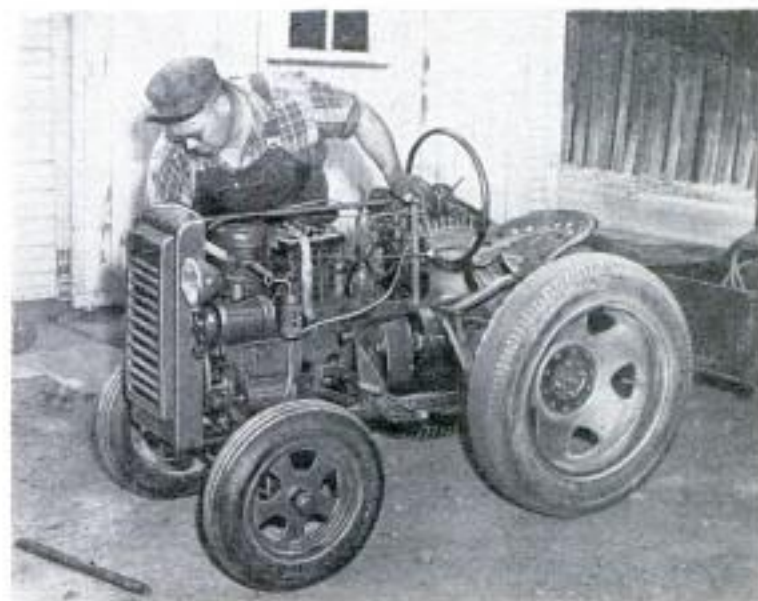



That Wonderful Volcanic Popcorn

Photomicrograph of expanded perlite particle shows myriad tiny glass-sealed dead-air cells that compose it

By Charles Ballenger and Richard Dunlop

VOLCANIC LAVA from the wastelands of western America is being popped like popcorn to produce a material that can slash construction costs, cut heating bills and increase fire protection.

In some forms, the volcanic popcorn promises to increase the storage space in your refrigerator, help place cheaper meat and fruit on your table and perform hundreds of industrial tasks. It even provides Hollywood movie makers with realistic dandruff for actors.

This new pearl-gray material is called perlite in both its raw and processed forms. It is a glassy volcanic lava known to man for thousands of years, but it took a metallurgist working in a little Arizona town to discover its unusual properties.

Since the beginning of time, the lava flows in our western lands have existed in the badlands, in the mountains and the desert. The badlands are like a close-up view of the moon, forbidding and lonely. Men in their search for minerals passed them by.

Perlite itself is so razor-edged it will cut a hiker's boots to ribbons. It is too brittle and sharp for roadbeds. It is no wonder that the rattlesnake and the Gila monster had the perlite barrens to themselves.

Now, however, perlite is a bonanza

mineral. Expanding or popping perlite transforms it into a coarse, lightweight aggregate. Combined with plaster, perlite aggregate is causing a basic change in the plastering industry. With cement it forms an extremely lightweight concrete which promises to save huge quantities of steel.

Moreover, perlite is absolutely fireproof. It makes highly effective insulation and soundproofing.

Dr. Harry Huntzicker, director of research for United States Gypsum says: "If, in the laboratory, we were to take natural elements and combine them into a perfect aggregate, we probably would end up with perlite."

The processing of this perfect aggregate is almost an engineer's dream in simplicity. No deep burrowing in the earth is necessary as perlite can be scooped up from the surface. After being crushed and graded, perlite is heated in furnaces at a temperature between 1400 and 2200 degrees Fahrenheit. Rapid parching explodes the grains of perlite into kernels which look something like tiny dried peas. Then the material is ready for use.

Easy as all this sounds, the process went undiscovered until 15 years ago when Lee Boyer happened upon it quite by accident. Boyer, who was operating an assay office

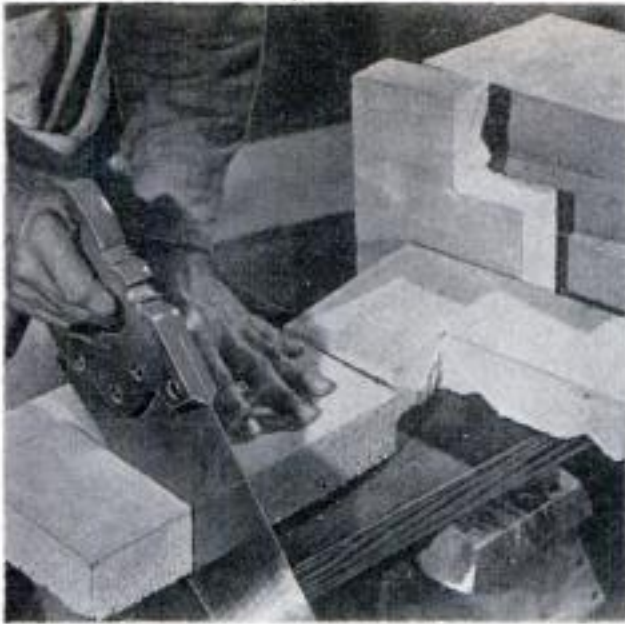

Lightweight slabs or blocks of perlite concrete can be sawed, nailed, drilled or channeled with ease



Perlite concrete poured over metal lath becomes lightweight roof deck and insulation for hangar

in Superior, Ariz., had taken an ancient assay furnace and converted it into an open-end firebox. For months he experimented with the furnace in the hope of fusing a mixture of silicates into a new insulating material for the telephone company.

One day he brought in a sack of crumbled perlite from the great lava flows on the slopes of near-by Picket Post mountain. Acting on a hunch, he threw a shovelful of the brittle stuff on the flames and peered into the furnace to see what would happen. Suddenly the perlite began to pop. The exploding particles bombarded the interior of the furnace and whizzed out on the floor at his feet. He cut off the flames

and stood watching with amazement until the popping stopped. Then he picked up a handful of the expanded perlite and examined it curiously.

With a microscope Boyer could make out a cellular structure with sealed pores. He realized immediately that perlite would be remarkably resistant to the conduction of heat. Boyer then took raw and expanded perlite samples to the Arizona Department of Mineral Resources in Phoenix. There it was found that raw perlite contains from two to five percent of water sealed in the pores. When it is heated, the water changes into steam and the perlite explodes. It is thought that this water was trapped when the erupted lava and accompanying steam

Hill of perlite near Colorado Springs was formed by cooling lava. Rocky Mountain region is source of perlite





Life preservers made from solid perlite concrete float easily. Weight of perlite concrete is 25 to 35 pounds per cubic foot

were cooled rapidly beneath the waters of a lake or stream.

The department's tests not only confirmed Boyer's observation on insulating qualities of perlite, but revealed that perlite was absolutely fireproof, extremely lightweight and had many other valuable properties.

Back in Superior, Boyer set up a pilot plant for the production of perlite. While experimenting, he used the mineral as an aggregate with gypsum plaster in place of sand. To test it he plastered the office building and outdoor screen of a Phoenix drive-in theater. After 13 years of exposure to the blazing Arizona sun and chilling desert nights, the plaster is as sound and uncracked as the day it was applied.

War shortages cut off further development and only now are the potentialities of perlite becoming evident, particularly in the building industry. Processing plants are springing up all over. Perlite is usually crushed and screened at the mine. It is then shipped, unpopped, to an expansion plant near the market. Huge freight savings are made because one carload of perlite blows up to 10 or more carloads of the finished product. In the most modern expansion plants, the substance is handled pneumatically from start to finish.

The expansion of perlite was not a patentable principle and soon a host of independent producers were in the field. Today,

nearly all the big gypsum processors have staked out their claims in the perlite industry and the race to market the new material is on in a big way.

The ultraconservative building industry always has been slow to accept new methods and materials. But perlite has met every requirement of the contractors. Builders and architects are employing perlite plaster and concrete in the construction of skyscrapers, apartments, warehouses, farm buildings and especially private homes.

Perlite plaster can cut by at least 15 percent the amount of steel needed in a skyscraper, according to the architectural firm of Holabird & Root & Burgee. This amount of steel in a typical building is devoted to supporting masonry required to give the steel itself essential fireproofing, since steel has a relatively low melting point.

With light steel and light aggregate plaster, the architects found about 20 pounds per square ground foot could be saved in a typical 12-story building over the conventional steel frame fireproofed with concrete. This resulted in a 40-percent saving in cost.

The lightweight steel frame went up faster with less labor, and greater flexibility of design was possible. The steel used in this technique is more plentiful than the steel in larger rolled beams commonly used.

Interior walls made with the perlite plaster weighed 12 pounds per square foot instead of 40 pounds. Perlite plaster and concrete used with aluminum building materials make the new 30-story Alcoa Building in Pittsburgh the lightest office building of its size ever built. Total weight of the building's exterior walls was only 40 pounds per square foot as against about 150 pounds for conventional walls. A neighboring skyscraper with 6000 square feet less floor space used nearly twice as much structural steel.

The greater fireproofing and insulating qualities of perlite plaster and concrete contributed to another saving in the Alcoa Building. The exterior wall of a typical office building has a four-inch facing and eight-inch backup wall. With perlite, a four-inch backup wall provided the same insulation and adequate strength. This added the equivalent of a floor and a half of rentable space to the building. Space in a swanky office building doesn't exactly rent for peppercorn, and Alcoa is reported to be quite

happy about the added revenue.

One of America's biggest plastering contractors has found that because perlite plaster is only half as heavy as sand plaster, his men can, with less fatigue, put on 50 percent more perlite plaster by hand in a day.

Because of a new plastering machine developed for use with lightweight aggregates such as perlite, walls can be put up much faster. Sand plaster and concrete are too heavy for the machine but, when perlite is the aggregate, the machine is able to blow the material onto the walls at such a clip that a workman can do four times as much wall area in a day as the fellow who is troweling sand plaster by hand.

In a new 12-story Cleveland apartment project, builders were able to save 45 tons of steel by the use of perlite plaster on ceilings and for column fire protection. This amounted to a cash saving of more than \$8000 in the 100-dwelling-unit structure.

Perlite is processed and packaged under rigid quality controls at the plant. It is delivered to the building site in neat bags. For many jobs a premixed perlite and gypsum is available. All the plasterer has to do is add water. For special jobs, perlite and gypsum must be blended at the site.

The bags of perlite are so lightweight that they can be stored on the floor where the work is being done. Because the materials are out of the weather, they do not have to be thawed before use.

All of these advantages will help save you money when you set out to build or buy a home constructed with perlite.

Even the building methods are unusual. You go to see your new house. The walls are up and the building is ready for plastering. A truck pulls up, loaded with perlite and gypsum plaster packaged in neat, ready-to-use sacks. Also on the truck is an odd-looking contraption which turns out to be a plastering machine. Workmen run a long hose into the house, pour mixed plaster into the machine and add water. They spray on the plaster with such speed that you're in your house weeks sooner than you expected.

(Continued to page 234)

DECEMBER 1954



Plaster made with perlite instead of sand weighs only a third as much as ordinary plaster, is both decorative and fireproof



Perlite core fill for concrete blocks can double insulating effect of wall. Perlite insulation can't rot, decay or settle. Spraying machine below does the work of four plasterers. Light weight of plaster made with perlite makes spraying possible



"E-Z On (F) American Bildvok Co. 139
2801 W. Pershing Road
Chicago 9, Illinois

Copyrighted material



Outboard Moves Islands Around

Islands — the floating kind made up of aquatic plants and weeds—sometimes drift over bathing beaches or select fishing spots in the Minnesota lake resort area. When this happens resort owners get out the outboard motorboat and push or tow the island to a spot where it can't hurt fishing or swimming.

Portable Mortar Mixer Pushes Like Wheelbarrow

Frank Ray, of Winfield, Kan., has built a mortar mixer that he pushes around like a wheelbarrow. It mounts a small electric motor that drives a cam and revolves the mortar pan. A paddle unit is mounted off-center on the cam so the paddles stir the mix as the container turns. Ray uses the mixer to supply fresh mortar for block and brick laying on his new poultry house. He simply shovels in the correct proportions of cement and sand and lets the machine do the rest.

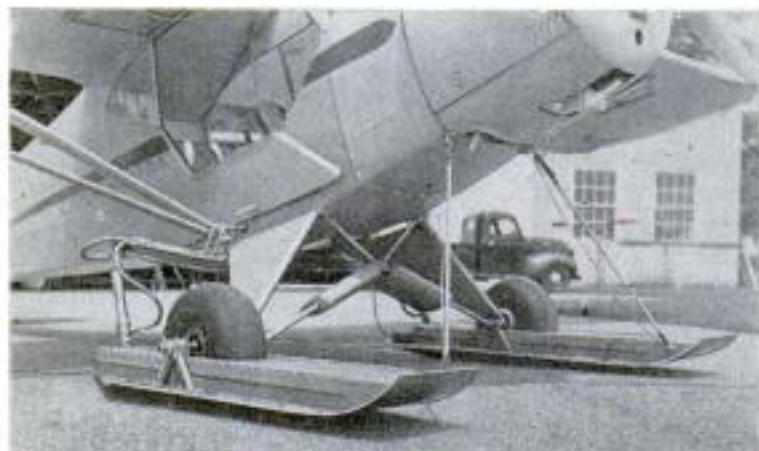

"Skis" for Wheeled Plane Permit Landing on Water

Standard airplanes can alight on land, water, ice, snow or mud with a new type of landing gear. The equipment looks like a pair of skis. Each "ski" is elevated slightly from the ground and has a hole in it for the wheel, so that conventional landings can be made on airport runways. On water, the plane comes down and skis on the water's surface until it taxis up and onto a beach, ramp or float. Safe take-offs and landings can be made on a strip only two or three plane lengths long. Water take-offs are made by starting on a short ramp and then skiing on the surface of the water until airborne. The manufacturer envisions its use on large transport planes. Then it would be possible for large planes to land in Chicago on a ramp in Lake Michigan or in Manhattan along the Hudson River.

Why Not Design Your Own Machinery?

By the Rev. C. H. Lange

Pastor, Faith Lutheran Church, Detroit, Mich.

EVEN A MINISTER must take time for relaxation and I find my diversion among my tools in the workshop. I've built most of the furniture for our home and study.

But my greatest pleasure in my avocation has been in designing and building small machines for home use. Perhaps these machines will give others some ideas.

About three years ago we purchased a small piece of property on Lake Huron. Our main problem was how to keep the grass cut. Who wants to take seven hours of fishing time to cut an acre of grass with a 20-inch mower?

Also, about that time, my nine-year-old son suggested that he wanted a car. Well, with odds and ends plus a little gas engine I built a miniature car which he still drives around the countryside. It suddenly occurred to me that he could also work while he played, so the following winter I built a "convertible" which he can ride but which can be converted into a rotary mower.

But even with two 20-inch rotary mowers it still took us four hours to cut the grass. Too much time wasted when fishing was good!

The result was our triple rotary. Powered with an eight-horsepower engine, it leaves our lawn looking like a golf course with less than two hours of work.

During the past year I've also built a motorized fish scaler and an electric tree sprayer. And I've come to the conclusion that nothing can beat pattering around in a workshop as a way to relax—usefully!

Motorized tree sprayer, shown below, and a power-driven fish scaler were also designed by the author



Big mower at left is driven by an eight-horsepower engine. Boy rides car his father designed and built

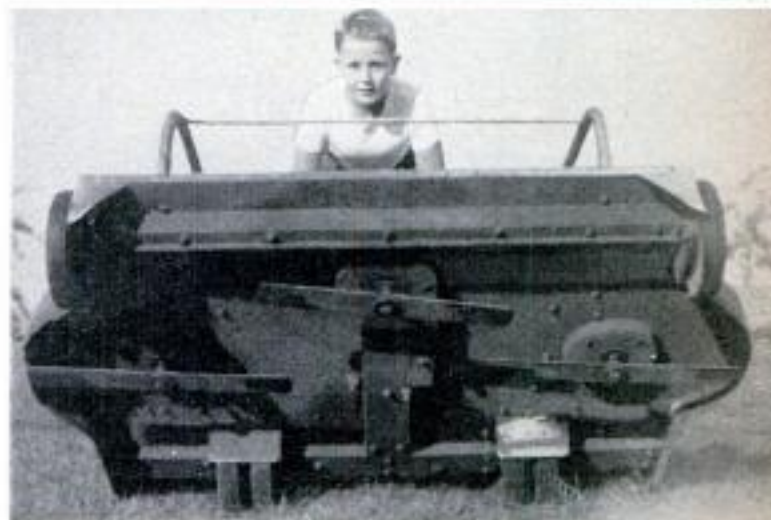

Bottom of the big mower shows the three blades that chop down grass and small brush in a broad swath

Two 20-inch mowers go to work on the lawn. The one at the left is converted from the miniature auto



Mountain Goats On Two Wheels

By Arthur R. Railton

LIKE A MAN seeing his first giraffe, you'll say "Impossible!" when you see your first motorcycle hill climb.

It does look impossible. At Mount Garfield, near Muskegon, Mich., where the national hill climb is an annual event, the hill stabs upward at a 45-degree angle, its summit higher than a 30-story building. It is so steep that walking down is difficult—walking up is for the athletic only.

The surface is unpaved. Just enough grass pushes through the loose soil to give an illusion of firmness. Once the cycles begin chewing it up, the surface becomes as unstable as spaghetti.

Yet the contestants (at least some of them) roar to the top in well under 10 seconds. And with no running start. There is a 25-foot level stretch before the hill tilts abruptly upward, but that's only long enough for a rider to get his balance.

Runs are timed to the hundredth second. The fastest time wins—

PM photos by Don Hanick



Spewing sand and smoke behind him, a rider heads for the top of Mount Garfield, Michigan's 45-degree hill-climbing site

Riders get a 25-foot level run before breaking the string. The backstop shields spectators from dirt thrown up by rear wheel

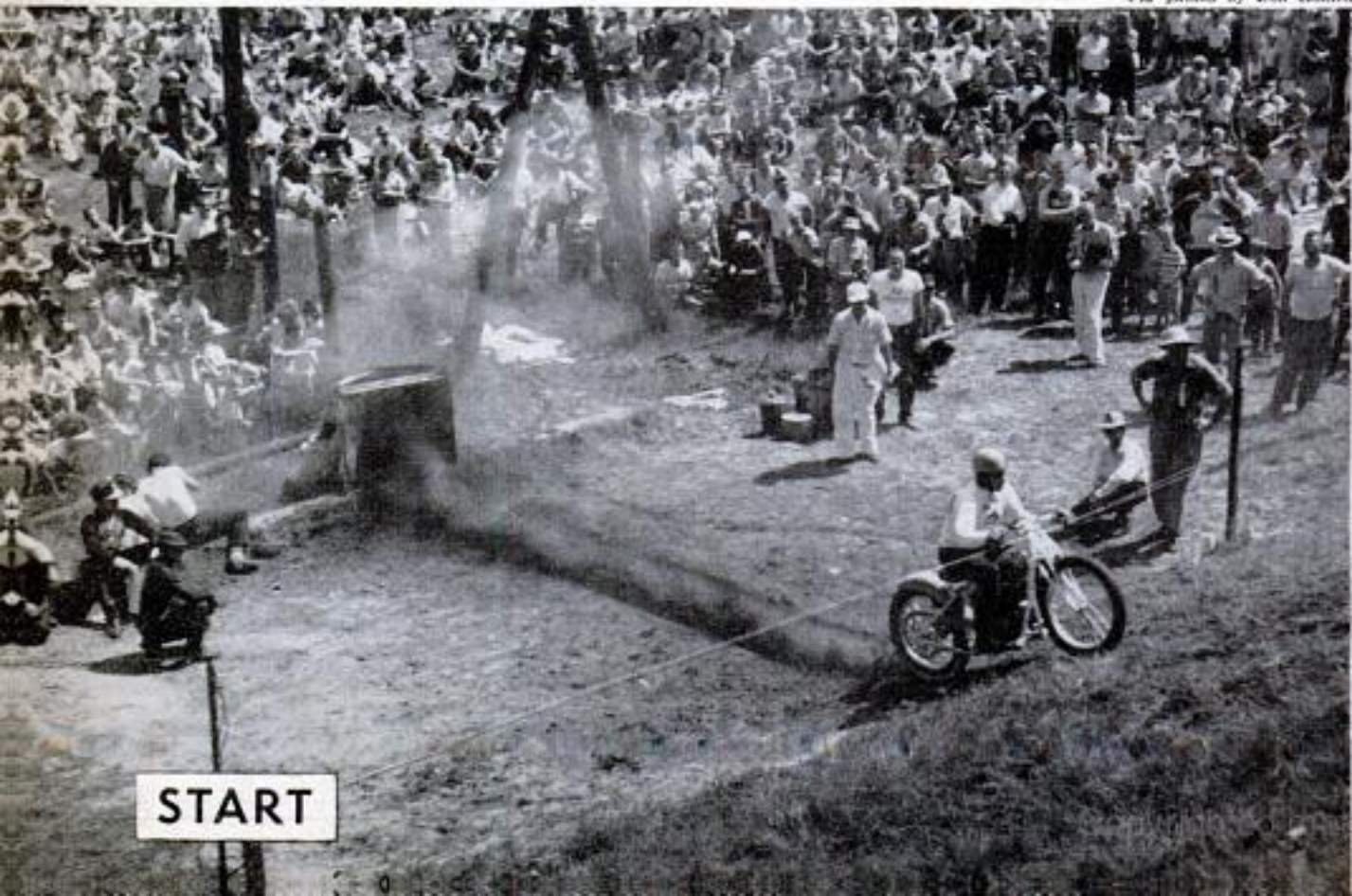

START



With the finish line just ahead of him, this rider goes airborne as his cycle hits a bump

each rider competes against the clock only.

Hill climbs are noisy. Riders can't afford such useless weight as mufflers. They call their cycles "home brew" designs. Unlimited modification is permitted, the only restriction being displacement. Successful riders rebuild their machines until no factory can claim them. Frames are home-made, being longer and lighter than stand-

ard. Valves, cams and heads are special.

Fuels are secret mixtures of everything explosive. Alcohol is the basic ingredient. It burns cooler. (Because cooling fins are chopped off cylinders to reduce weight,

Over the top comes a rider as far below the crowd cheers him on. Record time for this hill is 7.54 seconds





Contestants have to walk back down the hill, but their machines are carried down by a ski lift in reverse. Note the heavy chains on the rear wheel



Safety rules require an automatic device to stop the engine if the rider is thrown off. When the thong is pulled from the handle-bar clip, ignition is grounded



Above, gymnastics don't win climbs! Rider is about to go over. Below, breaking timing string at start

engines run hot.) To the alcohol, riders add benzol, nitromethane and other ingredients.

To start his ride, the cyclist revs up the crackling engine at the base of the hill. When it sounds right, he signals his helper (often another contestant) to drop in the gear, called the "dog." The rear wheel spins and up the hill he goes.

There's no gear shifting. The machine has only one gear. There is no time for shifts when trying to climb 30 stories in eight seconds.

The rear wheel, studded with heavy chains, digs its way up the slope, spitting dirt behind it like a dog burying a bone in sand. With skill and luck, the rider makes it to the top. If he's thrown off his bike, an automatic cutoff stops the engine. Alert officials, stationed along the slope, grab the cycle before it can tumble back down and destroy itself. ★ ★ ★

Skill is required to keep both wheels on the ground. Winning rides are usually straight, fast, uneventful



Air Conditioner Cools Motorists

Several gasoline stations in the Southwest have added a new item to their list of free services—"spot" air conditioning. A large hose attached to a three-ton portable air conditioner is poked into the car. Hot air in the automobile is replaced with a refreshing cool, dry blast. Airplane factories are also using the unit to cool workers on hot jobs.



Quartz Infrared Lamp Resists Water Splashing

Quartz instead of glass is used in a tubular infrared lamp that won't shatter even when cold water is poured on its red-hot surface. The lamp is slightly larger in diameter than a cigarette and produces 100 watts of energy per inch of tube length—four times the energy concentration of a standard 250-watt bulb. A 5-inch bulb of 500 watts and a 10-inch bulb of 1000 watts are made. The heating element is the standard coiled tungsten filament. No warm-up period is required for the lamp, which has a rated life of 5000 hours. It is designed for heating, cooking, drying and baking applications. Visible light as well as infrared radiation is produced, an advantage in some applications.

Steel Building Uses New Arch

An arch-type steel building combining simplicity and great strength has been introduced for farm and industrial use by a Milwaukee firm. The building achieves strength through use of a new corrugated-steel arch panel with a deep vee at one edge. The vee of one panel locks and bolts into the vee of the next, so that the panels become both the structural members and the sheathing. Windows fit into the arches.

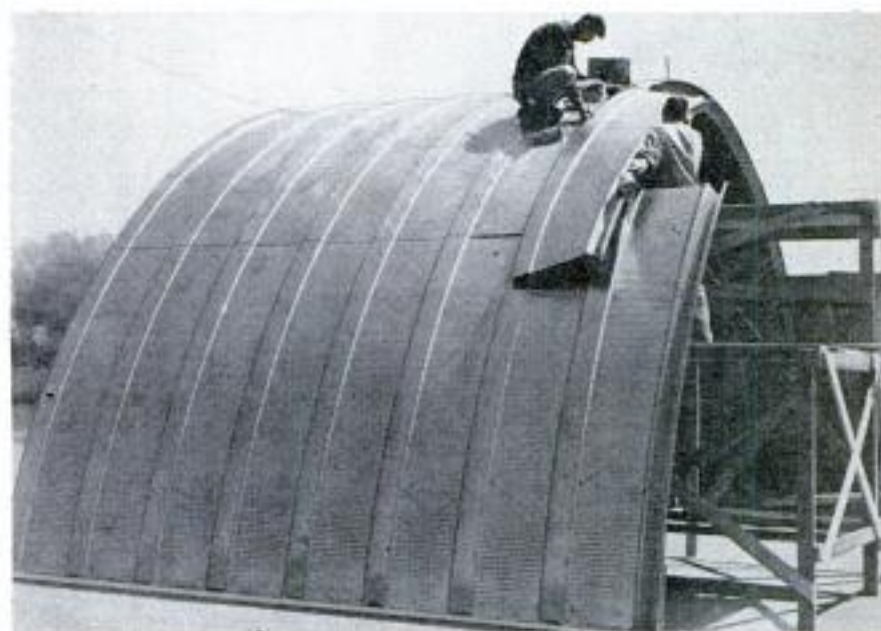



Reading Machine for Blind Transmits Message by Touch

Blind persons can read an ordinary newspaper with a machine invented by an Italian electrical engineer. A photoelectric cell mounted on a framework is placed over the reading material. Electrical impulses are transmitted letter by letter to corresponding rods on the keyboard of the reception box. The blind operator "reads" the rods with his finger tips. The instrument, if successful, could revolutionize the reading habits of blind people. At present, they must depend upon scarce, expensive Braille translations.

Sugar-Cane Cleaner

Installed on a plantation in Hawaii, a huge machine cleans sugar cane to prepare it for the mill. The machine does work which formerly required 219 men. When cane arrives at the plant it is loaded by crane on a belt system that moves on a track 84 feet long. Cane moves up the belt to the top where loose gravel, dirt and sand fall through openings while the cane is washed. The cane and light trash then ascend another conveyor and are washed twice more.



Back-Pack Vacuum Cleaner

Janitors can reach areas that were previously inaccessible with a vacuum cleaner that straps to the operator's back. The cleaner is designed for use in schools, hospitals, churches and other large buildings. A $\frac{3}{4}$ -horsepower motor and a dust bag are housed in the back-pack unit which weighs 10 pounds. The unit also can be pulled around on casters. Attachments are available for cleaning upholstery, books, Venetian blinds and furnaces.

Synthetic Rubber Resists Heat

Poly-FBA, a synthetic rubber developed for use in jet airplanes, can withstand oils, gasoline and temperatures up to 400 degrees Fahrenheit. The fluorine-containing material resists the effects of synthetic oils which damage all rubber compounds.

Electronic Pipe Line Saves Figuring

Planning pipe-line networks is speeded and simplified with an electronic circuit that represents the pipe line itself. Interchangeable vacuum-tube resistors are used in place of pipes. Different lengths, diameters and roughness of pipe, source and pressure of water and rates of discharges are all duplicated. The first analyzer to be produced came with 600 "pipes" in the form of vacuum tubes. In 58 hours, it provided figures that would have taken one man with a slide rule as long as two years to produce.

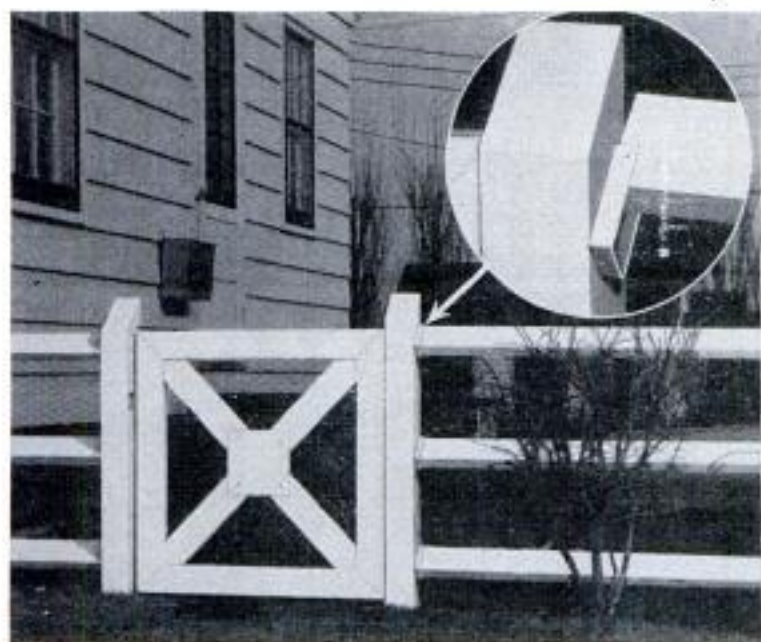
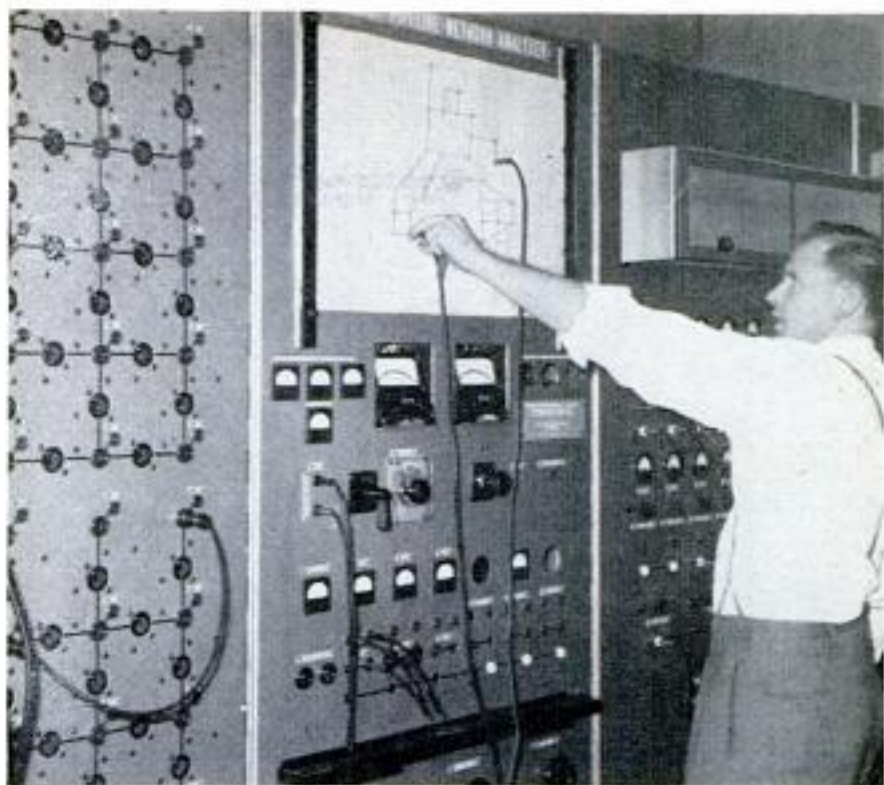

On-Again Off-Again Fence

Fence rails slip in place quickly and just as quickly are removed for lawn mowing or access when installed with aluminum brackets. The brackets are nailed to the posts and the rails slip into them as into a mortise. To mow the grass under the fence you simply lift out the bottom rail. Brackets are available in different sizes.

"Corkscrews" in the Sky →

Spectators at a recent Royal Air Force fire-fighting show were amazed to see "corkscrews" of foam shooting into the sky from high-pressure nozzles. The show included a contest between firemen of the RAF, the U.S. Air Force and other groups

Sources of available products described in this issue are indexed on pages 12, 14 and 16. Sources of further information on other articles are listed in the WHERE-TO-FIND-IT LIST, which is available to readers without charge from Bureau of Information, *Popular Mechanics*, 200 E. Ontario St., Chicago 11





Single-Step Escalator Designed for Home Use

Next best thing to an Escalator is a moving stairstep that rolls up and back on metal guide rails. Designed for the home use of invalids, it is cable driven by an electric motor and has duplicate control buttons at top and bottom. The operating mechanism is installed beneath the stairs. When not in use, the rolling platform forms a double-width bottom step.



Liquid Insulating Plastic Shockproofs Tool Handles

One dip of a tool handle into a liquid insulating plastic gives it a thick and durable coat. This renders the tool shockproof for standard home electrical work. Tools can be redipped until the desired thickness is reached. The handle is heated, dipped into the liquid, slowly removed and then heated once more to harden the coating. This gives a handle that is good looking, rustproof, won't slip and is comfortable to hold. The plastic can also heatproof cooking-utensil handles.



Electric Train Shifts to Monorail

Model trains have caught up with—and even surpassed—the latest proposals of railroad designers. Fritz Krueger, a Berlin engineer, has designed an electric train that will run on two rails or a monorail. The one-rail system is similar to proposals for full-size monorails. Krueger's train runs along the normal two-rail layout, and at the end of the track it rolls onto a single large rail without losing speed. The designer hopes a full-size train will be built.



Shown here slightly separated are the car's four sections which permit it to be moved from studio to studio

Come-Apart Automobile Stars on Television



If the television script calls for an intimate look into the back seat only this much of the car is used. The hole in the roof is for microphone and lighting

WHEN THE National Broadcasting Company wants an automobile for a scene in one of its television dramas, it assembles it right on the scene. Because of the necessity for moving the car from one studio to another, the NBC property department had to cut the body into several pieces so it would go through the small doors of the studios. The car, a 1954 Ford, has no chassis, being simply a body with nonfunctional wheels that can be placed in position for effect. The various body sections are mounted on casters and held together by hasps. Holes are cut in the roof to admit lights and microphones. Windshield and rear window are removable when necessary to eliminate glare. The job of slicing the body into sections had to be done carefully to avoid noticeable joints that would destroy the realism when the car is used on television. The various sections, like the back seat, can be used separately.

Neatly assembled, the car appears to be real. The casters are easily hidden in the shadows under the car





Myers' layout includes revolving tree, amusement park and church. Boy in church doorway pulls rope to ring bell



CHRISTMAS-TREE

Merry-Go-Round

Seesaws move and dolls push swings in playground. Street lamps look down on two boys fishing in stream

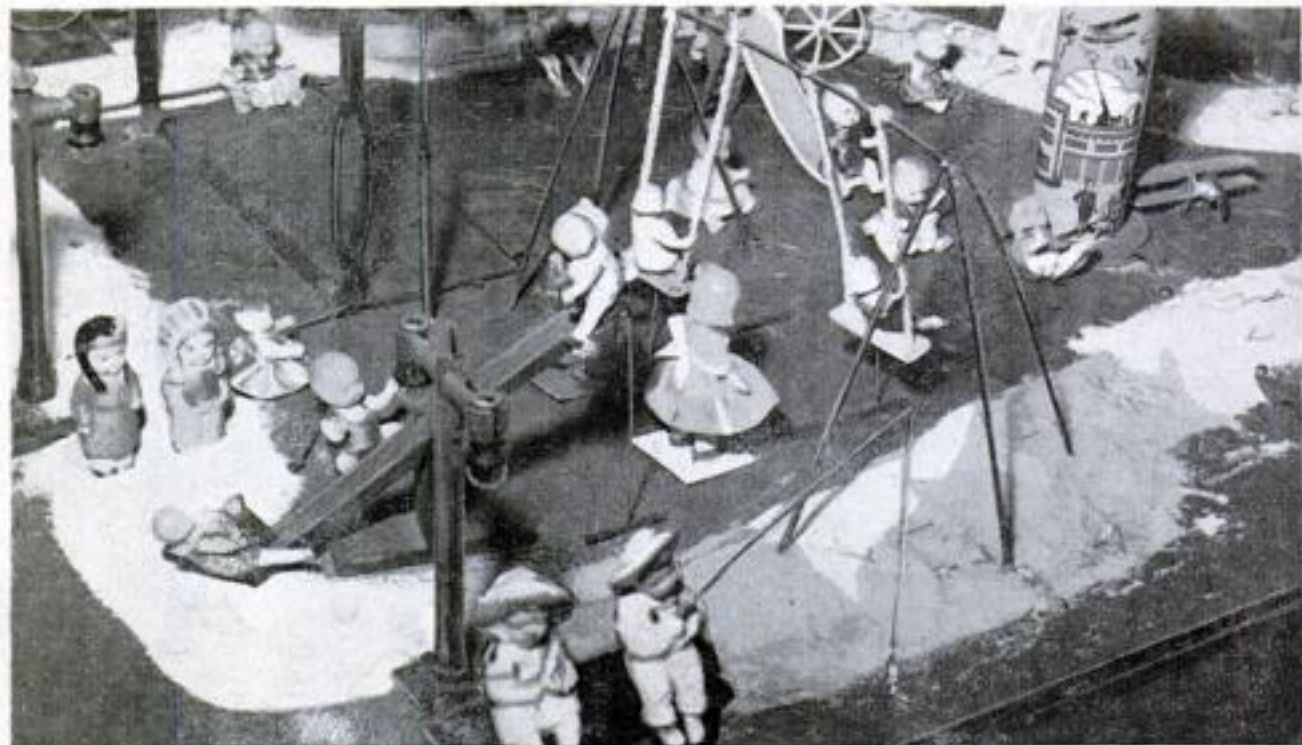

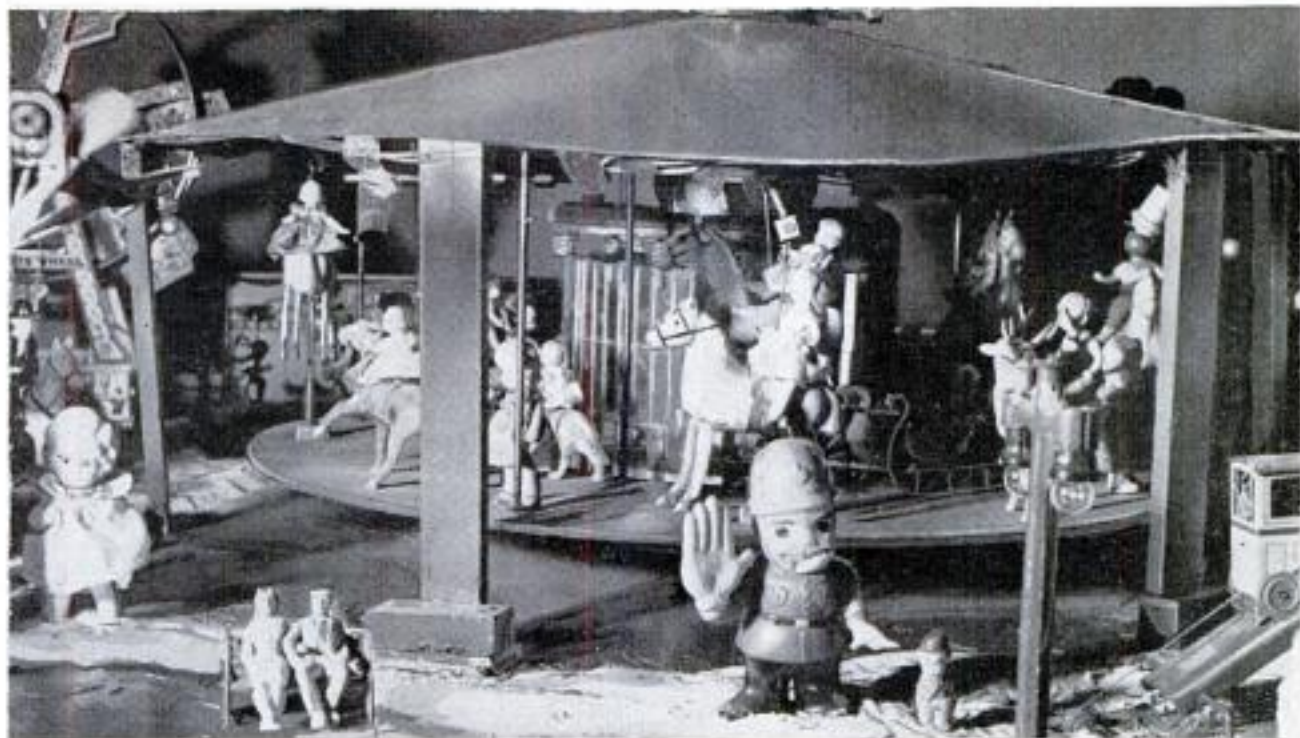

Merry-go-round is the base of the revolving Christmas tree. Carousel horses came from a five-and-ten store

NEW ORLEANS youngsters flock to the home of J. T. Myers during the Christmas season to view his mechanized Yuletide display. While a big Christmas tree loaded with 156 lights and over 1000 ornaments revolves, dolls in a playground push other dolls in swings. From a bridge, boys fish in a stream and beneath them sleek ships and swift cruisers speed through real water. There's also a swimming pool with a slide, board and swimmers.

Mr. Myers started the display 38 years ago when he used assorted gears and the motor of an electric fan to revolve his Christmas tree. Each Christmas since then, new features have been added. For 1953, it was a roller coaster that circles "Christmas Tree Island" every 60 seconds. Like all of the other turning, twisting, swinging, jumping and racing acts, it is powered by a central $\frac{1}{4}$ -horsepower motor that furnishes drive at the same time for the religious section. Across the bridge is a church. At its entrance, a doll pulls a bell rope and steel bars beneath the stage clang like a church bell. Carols issue from a hidden phonograph. Above the two islands an angel announces Christ's birth to the shepherds and the Wise Men travel an endless belt to the manger. A smaller-size motor operates this section. ★ ★ ★



Roller coaster was 1953 addition. A chain pulls it to the top of tallest slide before its one-minute journey around island. A single $\frac{1}{4}$ -horsepower motor beneath the platform powers every part of the display except the Wise Men on the wall above.

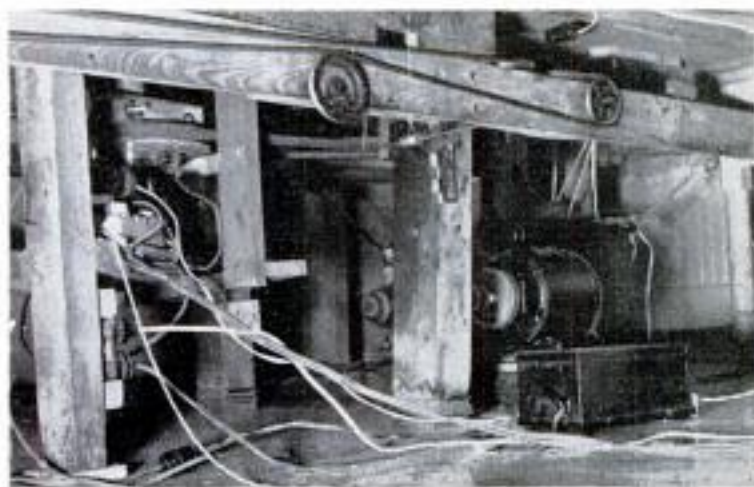

Propeller Replaces Chain to Convert Saw Into Outboard Motor



With a new propeller attachment you can convert one make of chain saw into an outboard motor. The attachment replaces the saw chain. Only two bolts on the the saw must be removed and replaced to make the quick conversion from saw to motor. Clamped to the boat, the resulting outboard motor has ample power, permits 360-degree steering and can be adjusted to any water depth.

Branding With Harpoons

In projects aimed at determining the migratory habits of two large animals, the Canadian government is resorting to novel methods of "branding." Identification tags will be harpooned into the tough hides of walrus in an effort to study their population and movement, and buffalo are being marked with paint sprayed from a helicopter. Instead of going through the dangerous business of roping and branding the buffalo, a government mammalogist flown over the animals leans out and squirts paint at them.

Tubular-Steel Framework Supports Storage Bin

Tubular-steel sectional frames that can be assembled quickly to make temporary silos or storage bins are being produced for farm use by a Milwaukee manufacturer. The framework is lined with paper when used as a silo or grain-storage bin, and with snow fence for corn storage. A metal cap roofs the structure.

Salt Firms Gravel Roads

Brine is being used to compact gravel roads. The brine, which has lower surface tension than water, mixes with particles of sand and gravel and allows them to push closer together. Thus the road compacts into a harder mass. Both roadbeds and surfaces stay in condition for a longer time with less maintenance. The treatment also tends to keep moisture from freezing and thereby reduces heaving. One county in Ohio uses 15,000 to 20,000 gallons of brine per mile of road.

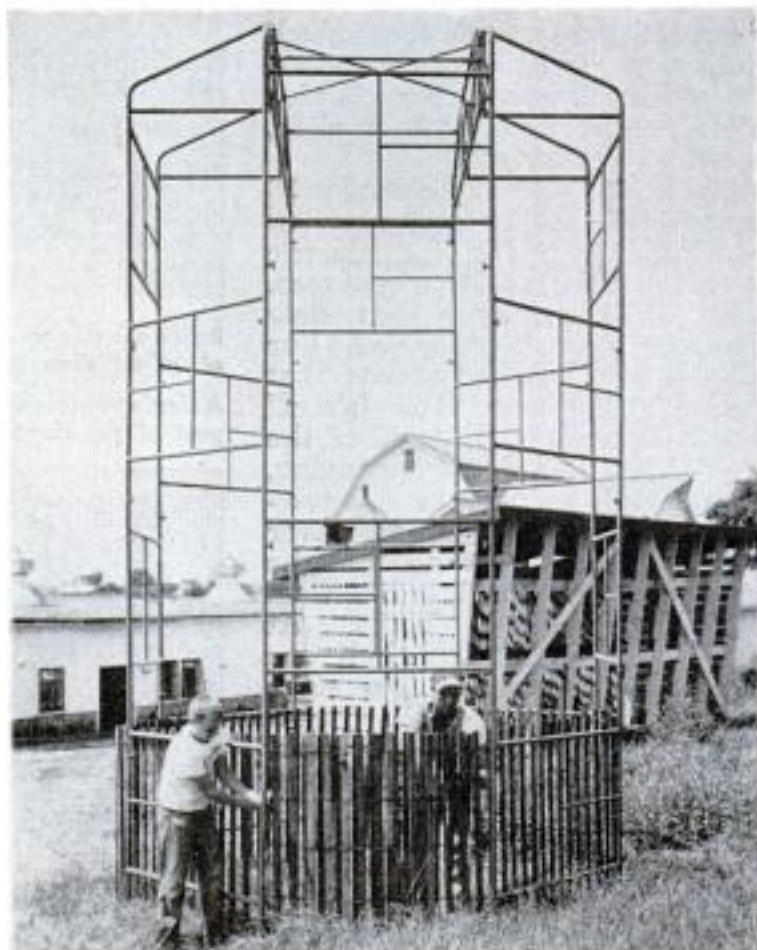



Alarm Spots Thieves, Fire And Even Kills Mice!

Thieves or fire, it makes no difference to an ultrasonic burglar alarm which detects either one and, as a bonus, kills any mice that might stray onto the premises. The alarm sends out sound waves at 19,200 cycles per second, too high-pitched for humans to hear. The waves rebound from the walls of the room in a barrage of detection. Any motionless object does not alert the device, but if an intruder so much as lifts an arm, the alarm is sounded. Or it can be set so that patrol dogs can roam through the area without tripping the alarm, but should a man enter, the alarm sounds. It can also be set so that any movement of warm air above a flame sets it off. Finally, these ultrasonic waves get rid of rodents by forcing them to kill



themselves by crashing into obstacles in a wild attempt to escape the maddening noise which is within the scope of their hearing range.



Iron With Pivoting Point Reaches Around Corners

Time and tempers are saved by an electric iron with a pivoting front point that reaches around corners. The iron presses hard-to-reach spots that would require several extra movements with a conventional iron. Movement of the point is controlled by a twist of the handle. The product was shown at the German Inventors' Exhibition in Wiesbaden, Germany.

University of Wisconsin scientists are developing a method for aging cheddar cheese with ultrasonic waves which requires only one half to one third the present aging time.



Cecil Gough holds one of the ventriloquist dummies he makes as a hobby. On the bench are examples of the stages of making a dummy head—the plaster molds, the plastic-cloth head and a completed head on stick

By Marshall L. Lincoln

A MAN WHO EARNS MONEY with his spare-time hobby is no dummy. That's why Cecil Gough of Hartford City, Ind., was smart to start making ventriloquist dummies as a hobby after he retired from the drug business.

While giving him a relaxing activity, his "dummy business" also has given him some useful extra income, since his dummies sell for \$50 to \$150, depending on their complexity. Since starting his interesting hobby in 1949, he has sold between 35 and 40 dummies.

Gough puts a lot of natural inventiveness and mechanical ability into his hobby—and he finds a well-equipped woodworking shop comes in handy, too.

A granddaughter's interest in puppets caused Gough to start making a ventriloquist dummy for her five years ago. He admits his first attempt was rather crude, but it made him decide to learn how to build a really good dummy.

Since then he has made quite a batch of really good dummies — dummies which have been sold to ventriloquists all over the United States and some to people in

foreign lands. Recently, he shipped a dummy to a soldier in Nuremberg, Germany. He said this sale shows the far-reaching effect of a tiny classified ad he has been using for several years.

Gough learned his basic technique from books and the rest came through experience and a constant effort to make his figures more lifelike.

The torsos and heads of Gough's dummies are of Celastic, a plastic cloth which can be molded into any shape after it is softened with acetone. After it has hardened, the material retains its shape even if soaked in water. Such material is used by some shoe manufacturers in sole construction and also used by orthopedic craftsmen. Gough says it is ideal for his purpose because it is lightweight and easy to work.

To construct the head for a dummy, Gough first makes a head mold of modeling clay. Plaster of paris is then poured around this clay model to get two molds: A mold of the back half of the head and a mold of the front half.

From the two hollowed-out molds, he makes a one-piece plaster mold which

Inside a Dummy's Head

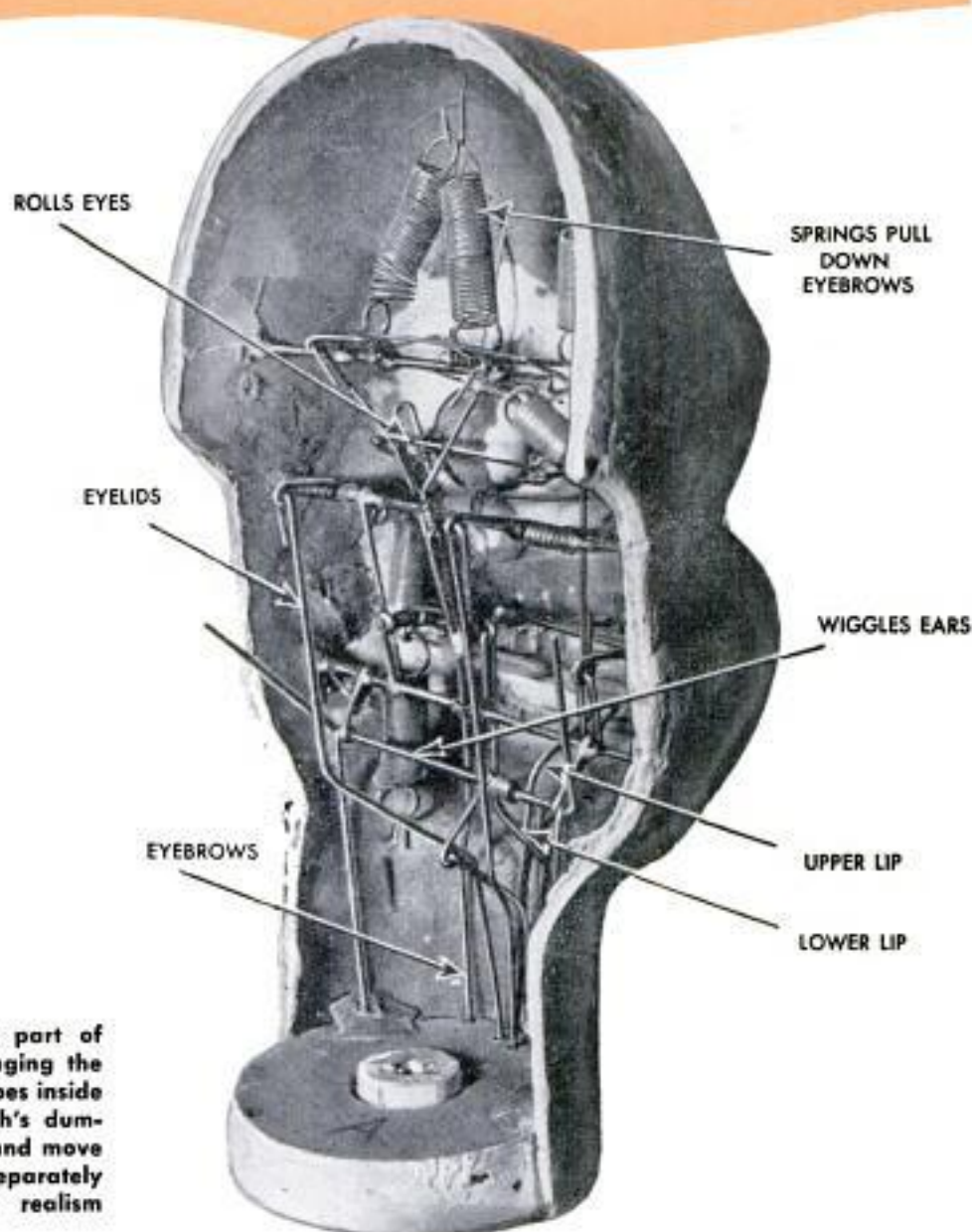

By far the most difficult part of making a dummy is arranging the intricate mechanism that goes inside the head. Some of Gough's dummies can wink either eye and move the upper or lower lip separately—all in the interest of realism

resembles the clay head. This plaster head is called a "male head."

The plastic cloth is then softened with acetone and fitted around this mold. After the cloth has dried, he cuts it down the sides and removes the cloth in two pieces—the front and back. These pieces retain the shape of the plaster male head.

At this stage of the game, Gough begins to install the complicated mechanism which goes inside the head of each of his dummies. This mechanism is put in the front half of the cloth head.

His figures have much more than mere moving jaws. He installs levers, springs, weights and triggers in such profusion that,

when completed, a Gough dummy will wink either or both eyes, roll its eyes from side to side or up and down and move its lips. Some of his dummies can move either lip independent of the other. He now has a model that will stick out its tongue.

After all the necessary mechanism is installed, the two halves of the head are fastened together and flesh-color paint is applied.

The head, which is not connected to the body, is mounted on a long stick the ventriloquist holds in his hand during a performance. A hole in the back of the torso enables the performer to reach inside the dummy's body to grasp this stick.

Mounted on the stick are several triggers which operate the lip and some of the eye movements. Other eye movements are controlled by weights—for instance, when the head is tilted to one side, the eyes roll to the other.

Gough buys costume wigs and rebuilds them to fit the dummy heads or makes wigs from Saran or mohair.

The hands are made of the plastic cloth and painted flesh color. Gough's wife makes the costumes for his dummies—everything else is made by Gough in his garage workshop, which contains everything from power saws, drill press and lathe to tiny screwdrivers and tweezers.

After he had been making the dummies for a while, Gough decided he should know more about the problems faced by a performer in front of an audience so that he could build dummies which would be easy to operate.

To solve this problem, he took a correspondence course in ventriloquism and began performing before clubs and other groups in Hartford City and near-by towns.

Not only does this performing help him learn how to make the dummies easier to handle, but it gives him an extra thrill from his hobby.

Several times ventriloquists have called on Gough to have him rebuild dummies they bought from other dummy makers. Gough smiles with pride when he tells of such jobs because he likes to feel that his dummies are better than many others on the market.

By working steadily, he could make

1—Lifelike eye movements are one of the important factors in making a good dummy. An audience watches a dummy's eyes just as you do another person's. Tilting this dummy head causes the eyes to roll in a natural fashion due to well-placed weights inside the head

2—Here Gough demonstrates what he considers one of the neatest tricks performed by his best dummies. The lower lip is moving without the upper one showing the slightest tremble. All moving parts of the dummy's head are controlled from the stick by a skilled operator

3—In the hands of an experienced ventriloquist, this dummy head can produce a quick and natural wink with either eye. Gough constantly studies expressive movements of the human face with which to endow his dummies. He can now make a complete dummy in one week

4—The pose indicated here is of a "supercilious sneer." This effect is produced by lifting the dummy's upper lip without moving the lower one. Gough reports that this expression is particularly popular with ventriloquists who like to use dummy to ridicule themselves

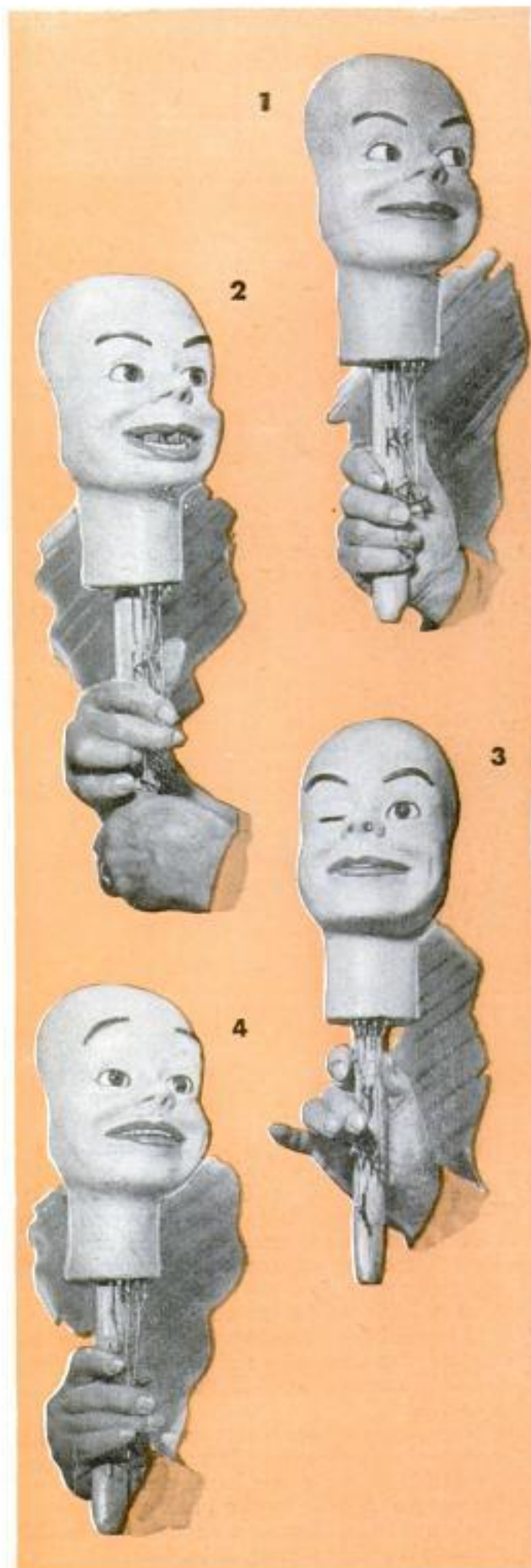



Gough holds two types of heads he makes. Left, American type with loose jaw that bobs up and down. Right, English type moves the lips only

a complete dummy in one week, Gough says, but he prefers to work on the figures for a few hours, then turn to something else to keep his mind from becoming stale.

Often children write to Gough asking him to make a dummy for them, but he tries his best to refuse them without making them feel badly, since he realizes few people other than experienced ventriloquists know the amount of work which goes into a good dummy.

Gough doesn't mind doing the work for someone who will sincerely appreciate his efforts, though, for his garage dummy factory has provided him with an ideal after-retirement occupation which furnishes him with a source of extra income. ★ ★ ★

5—Newest dummy on which Gough is working has a special trigger that makes its hair stand up when the ventriloquist wants it to. The head shown here is unfinished. Dummies that can perform some unusual or surprising antic are in great demand by the professional ventriloquists

6—As every TV watcher knows, ventriloquist's dummies have a variety of personalities. Gough is making this one for an operator who wants a sassy character. The dummy can stick out its tongue when provoked or haughtily raise its eyebrows in addition to other conventional tricks



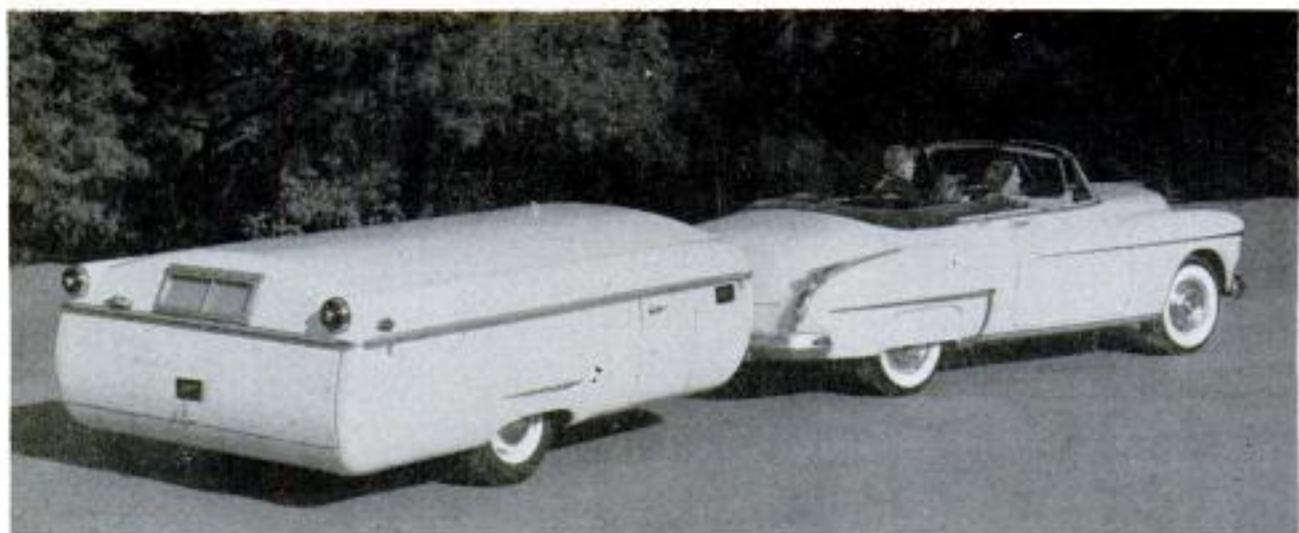

Plastic Camp Trailer Has Bed in Drawer

Dentproof and rustproof, a streamlined plastic camping trailer expands at night to sleep three persons in comfort. There are two fixed bunks inside the trailer and a third bunk is fitted in a drawer which slides out from the rear. In the front end is a complete kitchen, including a two-burner stove, refrigerator, water tank, cupboards and sink. It sells for about \$1500.

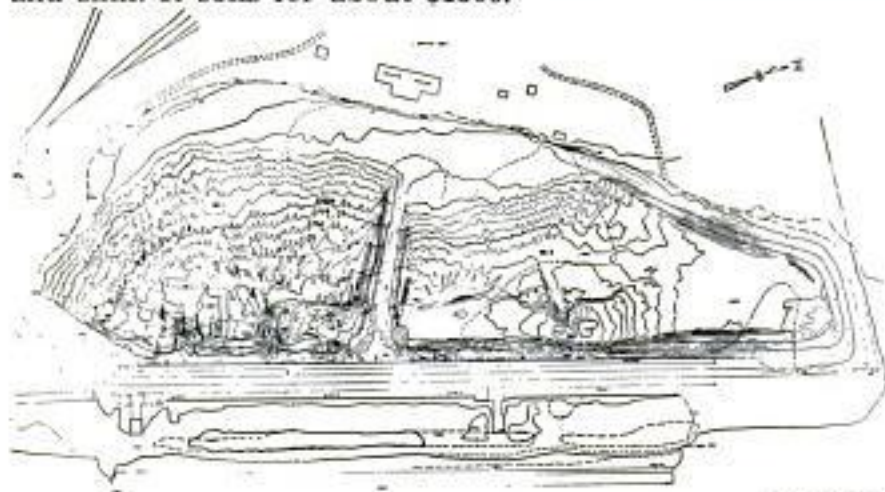

Stereo Pictures Measure Reserves

Stereo pictures taken from the air are now used to measure piles of coal, ore, pulpwood and sawdust. An airplane carrying a mapping camera flies over the area and takes two pictures within seconds to make a stereo pair of photos. These are viewed with a simple stereoscope for a general estimate or used in a precise stereo-plotting machine for an accurate figure. With the machine, an exact drawing is made with contour lines. Thus the pictures are reduced to a series of areas of known thickness on the drawing. From this, it is easy to estimate the volume of a pile.

Contour drawing, top, was made with machine from stereo shots

One of a pair of stereo photos, left, used to make the drawing

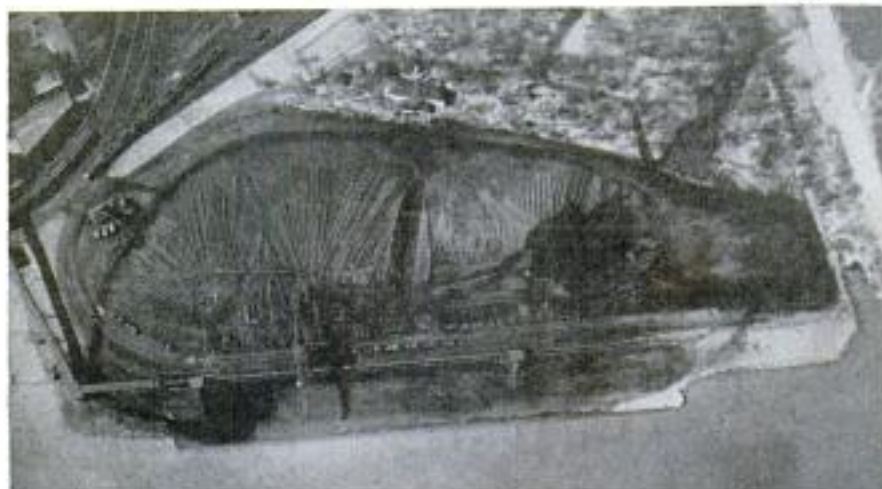

Mobile Service Station Takes Grease Job to the Machinery

Carrying its services wherever needed, a mobile service station is powered by a small engine that propels it over rough ground or up steep ramps. Designed for the lubrication of heavy machinery, the mobile unit has a six-horsepower Wisconsin engine. It does grease jobs, oil changes and other maintenance operations. It has an air compressor and a delivery hose for inflating tires. Standard 100-pound drums of oil and lubricants fit in carriers on the bed of the vehicle.

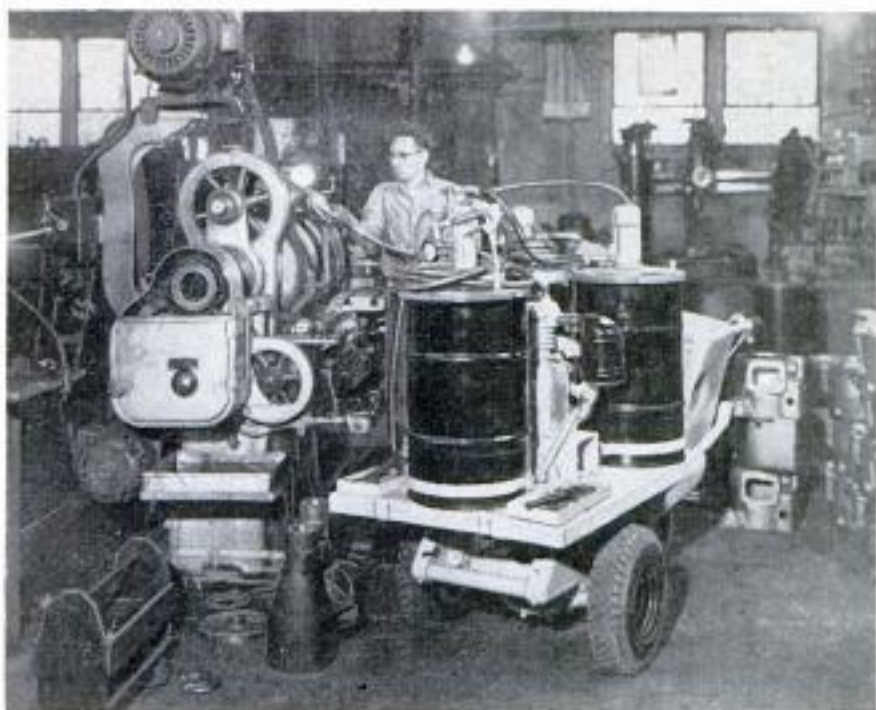

Tractor Umbrella With Electric Fan Keeps Dust and Heat from Operator

Tractor operators are protected from heat and dust by an aluminum umbrella that contains a fan. The 12-inch electric fan at the top of the hood pushes a curtain of air down around the operator. It not only cools him, but keeps out dust, insects, fumes and spray or dusting chemicals. A deflector above the operator prevents the air from blowing directly on him. The adjustable unit can be mounted on practically any self-propelled farm or construction equipment. The fan is powered by the machine's battery. The adjustable umbrella is mounted on a telescoping steel tube.

Glove Compartment Is for the Birds

Probably the world's only winged motorist is an Australian peachface lovebird named "Tweety," who lives in Santa Monica, Calif. Tweety's owner discovered that his pet refused to eat and became ill when left alone or with strangers. So he built a cage into the glove compartment of his car. Now, wherever he goes, Tweety goes with him. There's even a porch for the bird.

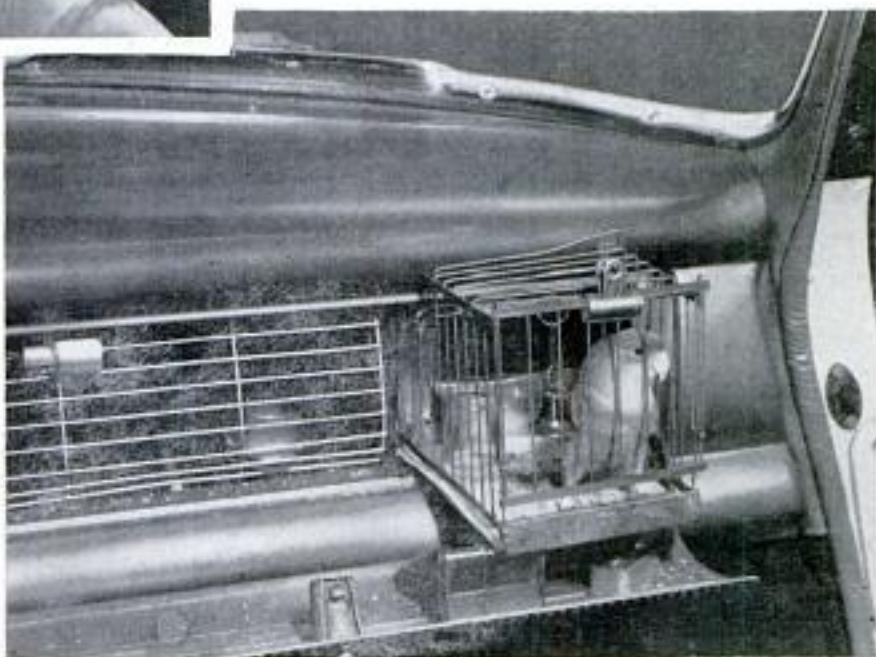



Pedals Operate Canoe Rudder

Anglers can "float fish" without paddling in a canoe equipped with a steering system. The fisherman paddles to the fishing spot, then fishes with the breeze to his back as he steers with his feet. A bracket is attached to the canoe, and the aluminum rudder mounted in the bracket. Cables run from the rudder to the pedals. The rudder swings free and has no effect unless the pedals are pushed. It deflects to one side or rides up over rocks and snags without damage.

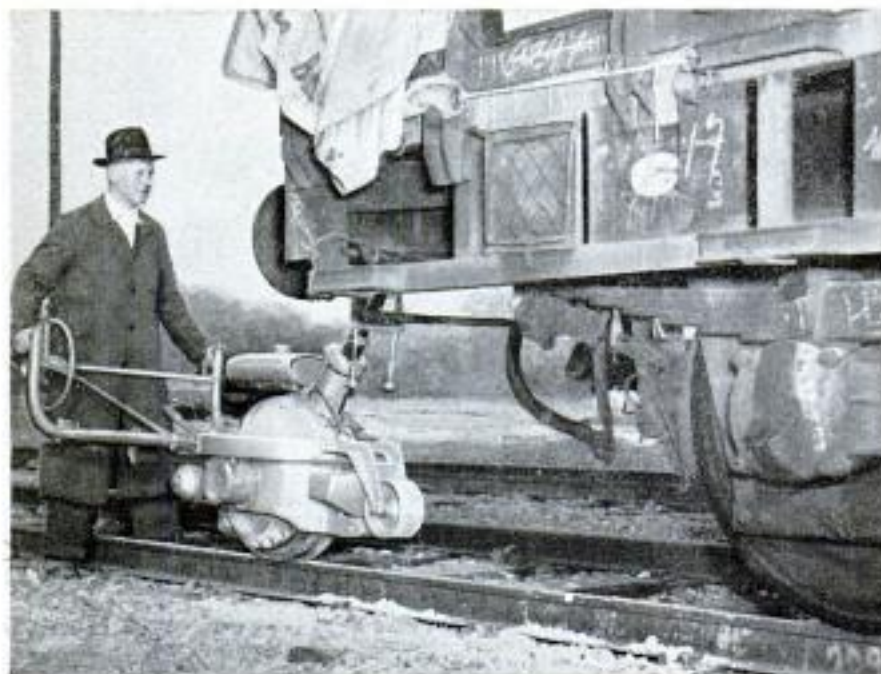

Motor-on-a-Wheel Shunts Rail Cars

Freight cars are shunted by a new one-wheel pusher, eliminating the need for locomotives in many yard operations. The motor-on-a-wheel was developed in Germany. It can move cars weighing up to 100 tons.

Lockheed Aircraft Corporation has converted its factory fleet of 120 gasoline-powered towing tractors and fork-lift trucks to propane fuel. Cost of the change-over: \$22,000. Annual saving in expense: \$40,000.

RADIO *Television* ELECTRONICS

TELEVISION TODAY

RECENT improvements in some TV sets include convenient top-panel tuning. The young lady tuning the Setchell-Carlson model, in photo A, no longer needs to bend or kneel; tuning is accomplished while standing comfortably an arm's length away—far enough away for accurate adjustment. Another feature of this television receiver is the Unit-ized chassis which consists of individual plug-in units.

Although it is not common practice to dunk television receivers, photo B shows a 21-inch Du Mont table model being dropped into the Passaic River at East Paterson, N. J., for a ruggedness test. It is claimed that it did not suffer from the fall or the dunking, and operated perfectly after being hauled out and dried. Other torture tests include shaking, freezing and prolonged exposure to dampness and heat in specially constructed chambers. Although TV receivers may never be subjected to such abuse in the home, most manufacturers make sure that their products will give years of service.

High-speed robot machines that automatically assemble printed circuits equivalent to approximately one half of a television receiver chassis in a matter of seconds, are now in operation in the Admiral Corporation plant. A 30-foot-long battery of complex machines into which electrical components such as resistors and wire jumpers are automatically fed delivers a completely assembled, printed-circuit board. Eight tubes are used in this section, both sides of which are shown by the young lady at the left in photo C. The completed section is displayed at the right.



CHILDREN'S PLAYROOM PHONO

By Dr. R. C. Hitchcock

ENAMELED WHITE and decorated with colorful decals, this easy-to-build phonograph cabinet and amplifier unit will brighten up any child's playroom and provide many hours of entertainment. Built-in record-storage space encourages the child to put away records in a safe place when finished with them. The completed unit shown in photos A, E and F has good-quality output and plays all three speeds.

An absolute minimum of tubes is used; a full-wave rectifier 5Y3-GT, a pentode output tube 6K6-GT, and a dual triode input 6SL7-GT. These are all full-sized tubes.

The closed-top cabinet has few dust-collecting surfaces as, for instance, note that grille cloth on the side is mounted flush. The amplifier panel is recessed protecting the knobs and dial-light jewel. Finished, this cabinet is 14 $\frac{5}{8}$ in. high, 13 $\frac{5}{8}$ in. wide and 10 $\frac{7}{8}$ in. deep. It is made of $\frac{3}{8}$ -in. white-pine plywood and weighs 17 pounds without records. Record sizes up to 10 inches can be played and stored.

The grown-up features, seldom found in a small phono are: All speeds, turnover crystal pickup, power transformer, dial light, twin angled speakers and storage space for records. The turnover crystal pickup is to let your child find out how to work a good phono player, and the way to teach him is with his own instrument. Later you can trust him with your hi-fi job.



A

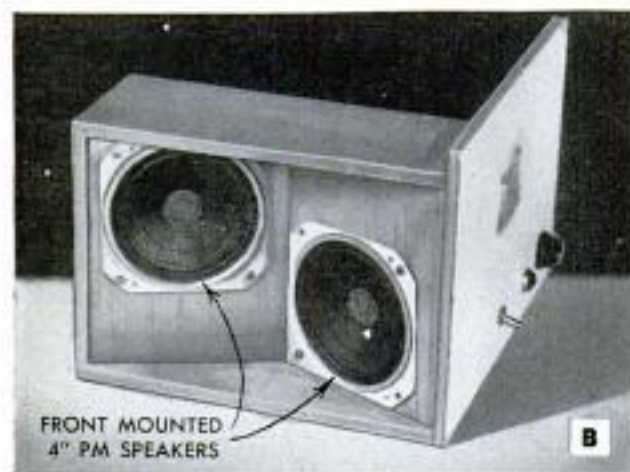

FRONT MOUNTED
4" PM SPEAKERS

B

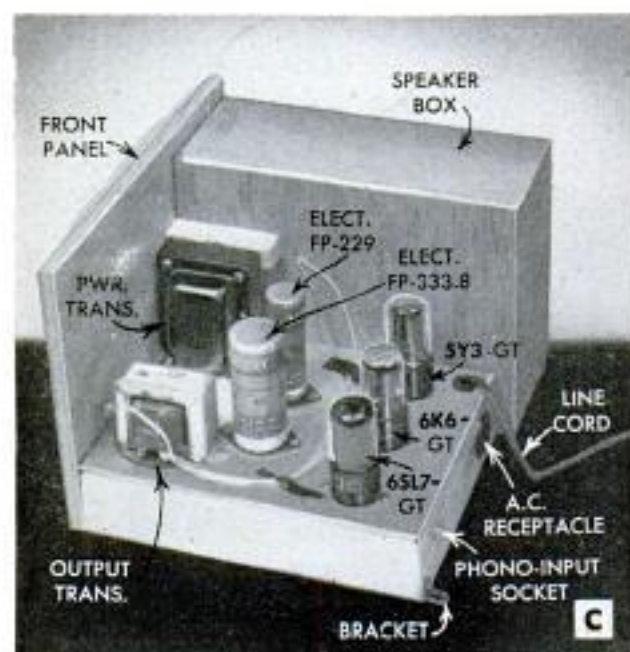

C



D

POPULAR MECHANICS

HAS GROWN-UP FEATURES



Characteristic of large amplifiers is the power transformer. This also eliminates the shock hazard of transformerless a.c.-d.c. amplifiers. The speakers are angled to provide wide-angle sound distribution, a really unusual feature in a small phono. In the interest of simplicity there is no tone control. The volume control is at the right of the dial light, and the on-off switch at the left. Although no claim is made for high fidelity, as it does not include push-pull output, the output is 1.5 watts at 2.5 percent IMD (intermodulation distortion) which is excellent and enough volume. At 1.8 watts the IMD is 5 percent, which is still good. The chassis base is 2 x 7 x 9-in. zinc-plated steel listed in most parts catalogues for about \$1.00. The power transformer specified has a plate winding of 470 volts center-tapped, 40 ma.; a 5-volt, 2-amp. winding, and a 6.3-volt 2-amp. winding. The h.v. leads are red, and the h.v. center-tap lead is red and yellow. The 5-volt leads are yellow. The 6.3-volt leads are green and the 6.3-volt center tap is double (heavy) green. The exact layout of the chassis base is not critical but should follow photos C and H. In order to provide short leads for minimum hum and feedback, mount the tube sockets for the 5Y3-GT and the 6K6-GT with their keys pointing together. The key of the 6SL7-GT should point toward the front of the chassis.

The Mallory electrolytic condenser units, FP-229 and FP-333.8, are top-mounted. The Bakelite washer is on top of the chassis. Use fillister or round-head screws to hold Bakelite washers—do not use binding-head screws which would ground the condenser-unit can. The common bus wire (heavy black) is bare No. 14 tinned-copper wire. The only place the common bus is grounded is at the phono-input jack. This is automatic as there is a strip of metal on the jack mounting which connects to the chassis as soon as the jack is bolted in place. A complete schematic circuit diagram appears in Fig. 2; all resistor and capacitor values are given.

Use 1/2-in. rubber grommets for the power-transformer leads, and the a.c. line cord. The phono-motor outlet is in use when the power switch is on, and off when the power switch is turned off.

With the use of a Stancor A-3824 output

(Figs. 1 and 2 shown on page 164)

(Text continued to page 236)

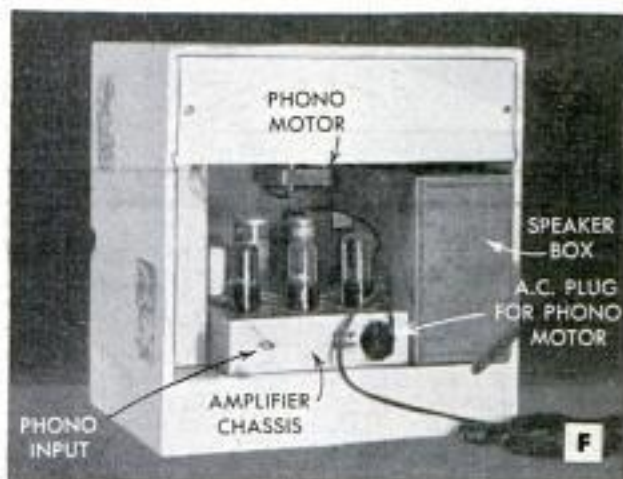

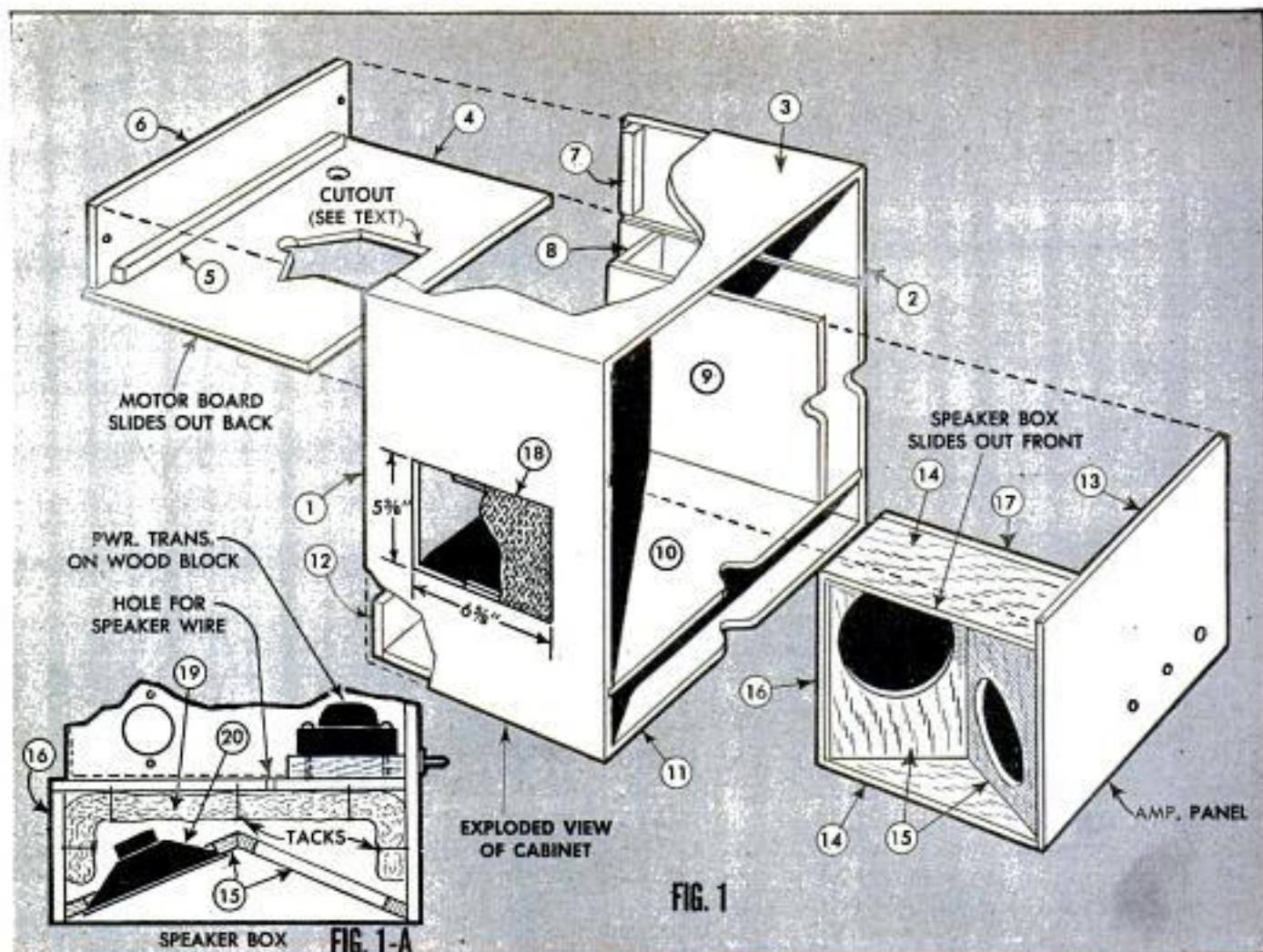
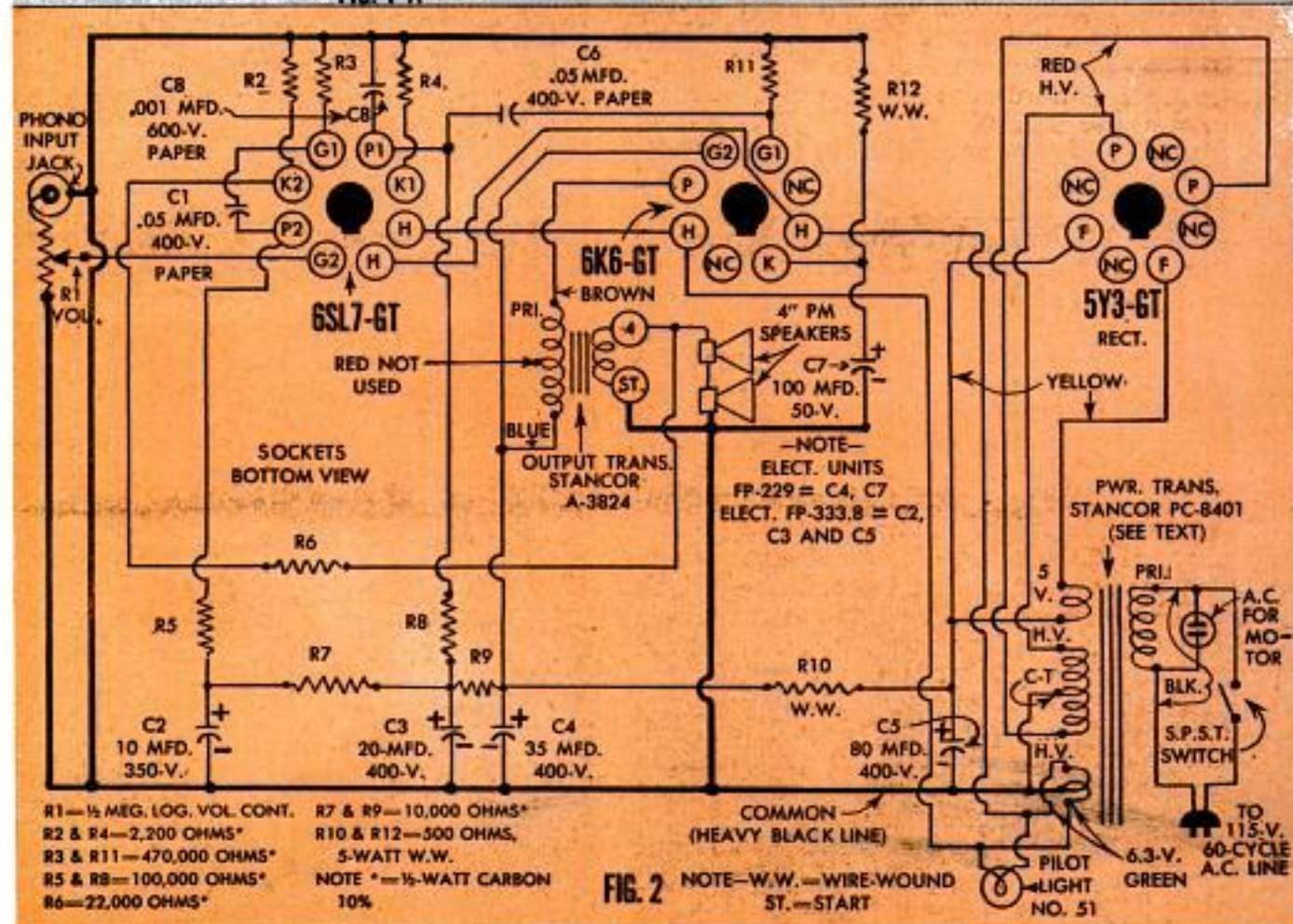

FIG. 1



the

POPULAR
MECHANICS

WTM 56

CRAFTSMAN

MODERNIZED FIREPLACE

By A. G. Barows

DON'T LET an old-fashioned fireplace discourage you from using modern furniture. We faced this problem and discovered that, with a minimum of cost, we could modernize our fireplace and its bookshelves to blend in with our bleached-mahogany furniture. The finished job, as you can see in the photograph, is very attractive, yet it can be done by the average handy man using a handsaw, a coping saw and a hammer.

If made with expensive wood paneling and marble, the cost of this new mantel would have been prohibitive. But by using ordinary plywood and plastic veneer, I was able to build it for a surprisingly small amount of money. Plastic veneer is a decal type of wood finish which comes in a variety of beautiful wood grains and rare marbles that can be applied over the plywood with little difficulty.

To begin the project, I removed the doors from the old bookcase and filled the screw holes of the hinges with wood putty. The gas heater in the fireplace was removed and the gas pipe capped. Then all the surfaces

This is how the fireplace looked before modernization. The bookshelves on each side were also veneered

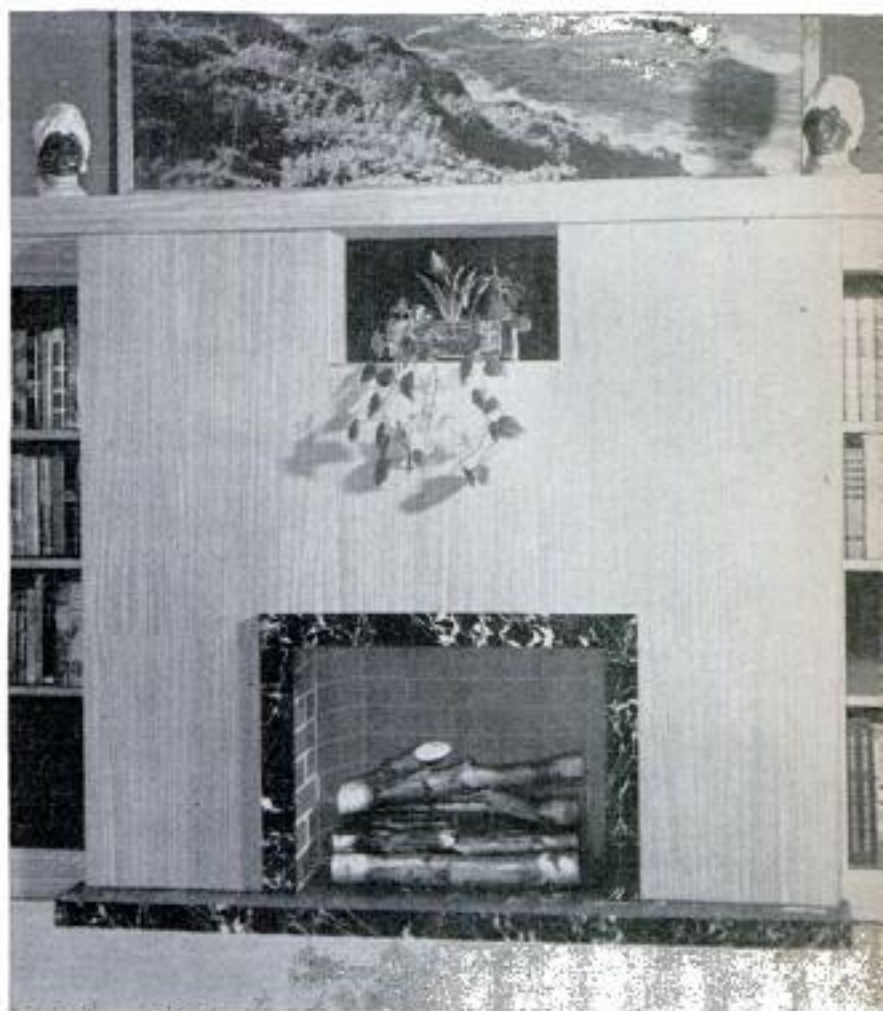

It's hard to believe that this lovely modern fireplace was once an old-fashioned brick-and-mahogany installation

of the bookcase were steel-wooled preparatory to applying the plastic veneer.

We retained the knickknack shelf of the old fireplace and built the plain-panel front out almost flush with original top shelf. The entire unit was constructed of economical $\frac{1}{4}$ -in. fir plywood and 1 x 3-in.

A back view of the front panel of the fireplace shows how panels are braced with 1 x 3 lumber





Above, each section of the front panel should be tried to make certain of the fit for best results

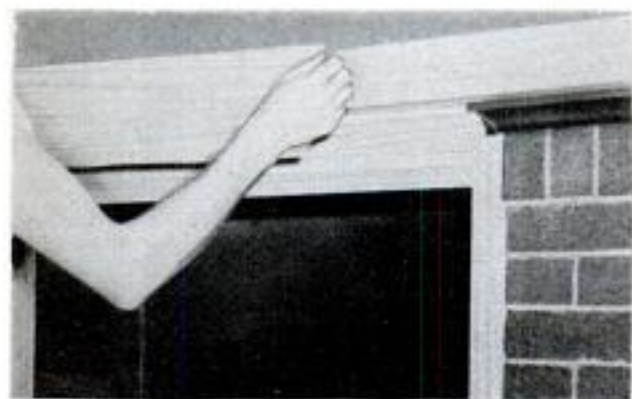

The plastic veneer is cut to size before application, as above. Application is not difficult and, if a little care is used, final appearance is like fine wood paneling. Below, mirror backs up small shelf



lumber. It is best to make the base first, and this is done by building a framework to extend about 6 in. out from the front panel. Then a piece of plywood is cut to the shape of the fireplace floor and the two side panels of the fireplace are cut. These are nailed to the frame and glued at the joints.

The front of the fireplace is made from three plywood panels. The center panel runs from the knickknack shelf to the top of the fireplace opening. The two side panels run from the top shelf to the base. These three panels are butted together and joined across the back with two 1 x 3-in. boards. Two side strips are cut from plywood also and nailed to the completed front panel. A strip of quarter round may be used to brace them at each corner.

The knickknack shelf also is nailed to the front panel. Three pieces of 1 x 3-in. lumber form the trim for the fireplace opening. These are located in place, and holes drilled for them, but are left off until the plastic veneer is applied. All joints in the construction are glued, and all nails are set and filled. The entire unit is then sanded and given two coats of shellac. Then, after being steel-wooled and tried for fit, the fireplace is ready to be covered with plastic veneer.

Instructions for applying the plastic veneer come with it, but here are some helpful suggestions: Cut all the pieces of the veneer to size before beginning application. Purchase the slow-setting cement which gives you more time to get it smoothed out. And take pains to see that the finished job is smooth. Coat the finished mantel with clear varnish or lacquer after applying the veneer. Leave the high gloss on the marble veneer, but use steel wool to remove the gloss from the wood-veneer finish to give it a more natural look. ★ ★ ★



Mirrors Furnish Artist Right or Left-Hand Model

By using two facing mirrors which are hinged to lengths of 2x4, one artist is able to use himself as a model. Depending on which reflection he copies, his own left hand will appear as either right or left hand. Each length of 2 x 4 has a U-shaped bracket made of flat steel screwed to one end. The bracket hooks over the end of the drawing board to support the mirror and permits a quick change of the angle of the mirror. An adjustable lid support allows the mirrors to be set at any vertical angle.



Modern Wrought-Iron Table Lamp Improvised From Tripod

A very attractive modern table lamp, in the popular wrought-iron theme, can be made easily from a photographer's table-

top tripod. First remove the pan head from the tripod and mount a standard lamp socket in its place. The setscrew in the lamp socket is secured to a 1/4-in.-dia. machine screw which is attached to the tripod top. Wire the socket, using a suitable length of lamp cord, and finish the lamp by attaching a clamp-on-type lamp shade, available from most notion stores. For best appearance, paint the tripod a flat black. If desired, you can make your own shade, using the wire frame from an old shade. Cover the frame with any material, such as road maps, unusual wallpaper, etc., to blend in with the decorations in the room in which it is to be used.—John J. Borzner, Fayetteville, N. Y.



Holes in Motor and Base Aligned By Grinding Points on Bolts

To aid in overcoming the difficulty of aligning bolt holes in motors and machines with the holes in base plates to which they are to be bolted, file or grind a three-cornered point on the ends of the bolts. As the motor is moved, the point will allow the bolt to drop into the hole in the base plate when the holes are aligned.—Hugh Lineback, Stillwater, Okla.



Potatoes Impaled on Metal Holder Baked Quickly Without Marks



Potatoes are baked quickly and thoroughly with no pan marks when they are impaled on the points of a metal holder that slides into the oven. The holder is a sheet of fairly heavy aluminum into which V-cuts are made with a cold chisel to provide tabs or points. After the points are bent at right angles to the sheet, the chiseled edges are filed smooth and the projections shaped into slightly rounded points. One end of the sheet is bent or rolled to provide a convenient handle.

Tipproof Dog-Food Pan



A dog will not tip its feeding pan if the pan is anchored with a croquet arch and a rubber band cut from an inner tube as pictured. A 1-lb. coffee can provides an ideal feeding pan as its straight sides are suitable to be retained by the band. An arch shaped from a piece of heavy wire may be substituted for the croquet arch if one is not readily available.

Weight Helps Car Up Icy Ramp

Frequently, even after the main roads are clear, garage ramps and inclined driveways remain coated with ice, making it difficult to put the car in the garage. One

motorist found that by putting sandbags totaling 200 lb. in his trunk and lowering the air pressure in the rear tires to 20 lb., he could back his car up inclined driveways with very little difficulty.

R. E. Hawes, Marietta, Ohio.

Curtain Rod Provides Holder For Sandpaper Strips

Draftsmen and artists will find that a length of flat curtain rod can be used as a holder for the strips of sandpaper used to touch up pencil points. The strips are cut slightly wider than the rod so they fit snugly inside. A cord

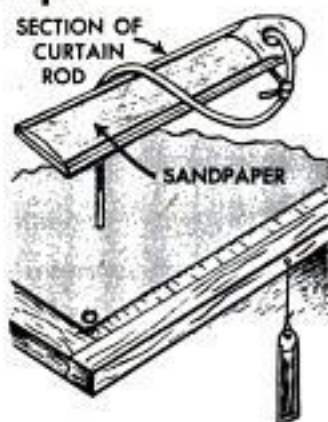

passed through a hole drilled in the rod permits it to be hung at a convenient location along the edge of the drawing board where it will not contact the clothing of the artist.

Length of Wire Straightened By Using Hand Drill

A length of bent or moderately kinked small-gauge wire can be straightened by gripping one end with a vise and twisting the free end with a hand drill. When the wire is chucked in the drill, pull it to keep it under tension and turn the drill slowly. As soon as the wire is straight, loosen the chuck, pull away the drill, then remove the other end from the vise. Wire heavier than No. 12 gauge is too difficult to straighten by this method as a higher tension and turning force are required than can be applied with a drill.

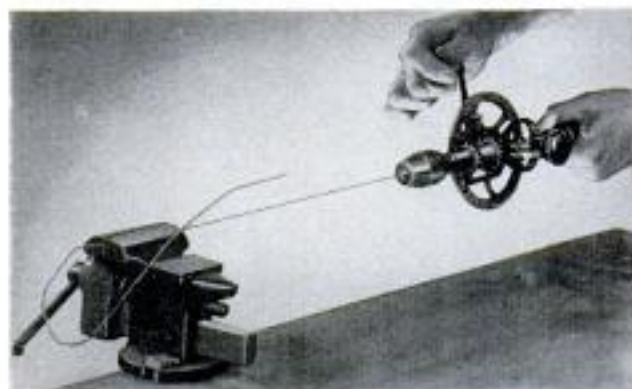

When making brooches or other jewelry having a pin back, place the pin back above center so the piece will hang flat and not tip out at the top when worn.



CHRISTMAS CANDLE

GREET YOUR GUESTS and extend holiday salutations to passers-by with this giant glowing candle outside your front door. The cheerful glow is provided by tubular lamps in the flame and inside the red plastic body of the candle. Construction is not difficult. First, a framework is built, then the electric wiring is installed and, finally, the outer covering is applied.

The bottom of the candle framework is an 8-in. disk screwed to an 8 x 8-in. block of 2-in. lumber. Vertical support for the top ring of the frame is provided by a 2 x 2, 35 1/4 in. long, which fits in a notch cut in the edge of the disk. Both disk and ring are fastened to the support with angle brackets.

Two porcelain receptacles are used in the wiring of the candle. One is screwed to the center of the disk, the other to the vertical support. The latter receptacle is fitted with a plug, a 3-way socket and two adapters to hold the upper lamps.

The outer covering of the candle consists, first, of a layer of plastic-coated metal screen which is covered with wrapping paper. A piece of red plaster sheeting is thumbtacked over the wrapping paper.

The top of the candle is a pie tin in which a hole is cut for the top lamp. Plastic-coated screen is formed into the shape of a flame, then is covered with several layers of glue-coated, red tissue paper.

The candle drippings are made by draping an irregularly cut piece of cloth over the pie tin and slowly pouring melted paraffin over it. The base shield of the candle is a collar cut from corrugated paper and coated with roofing cement.

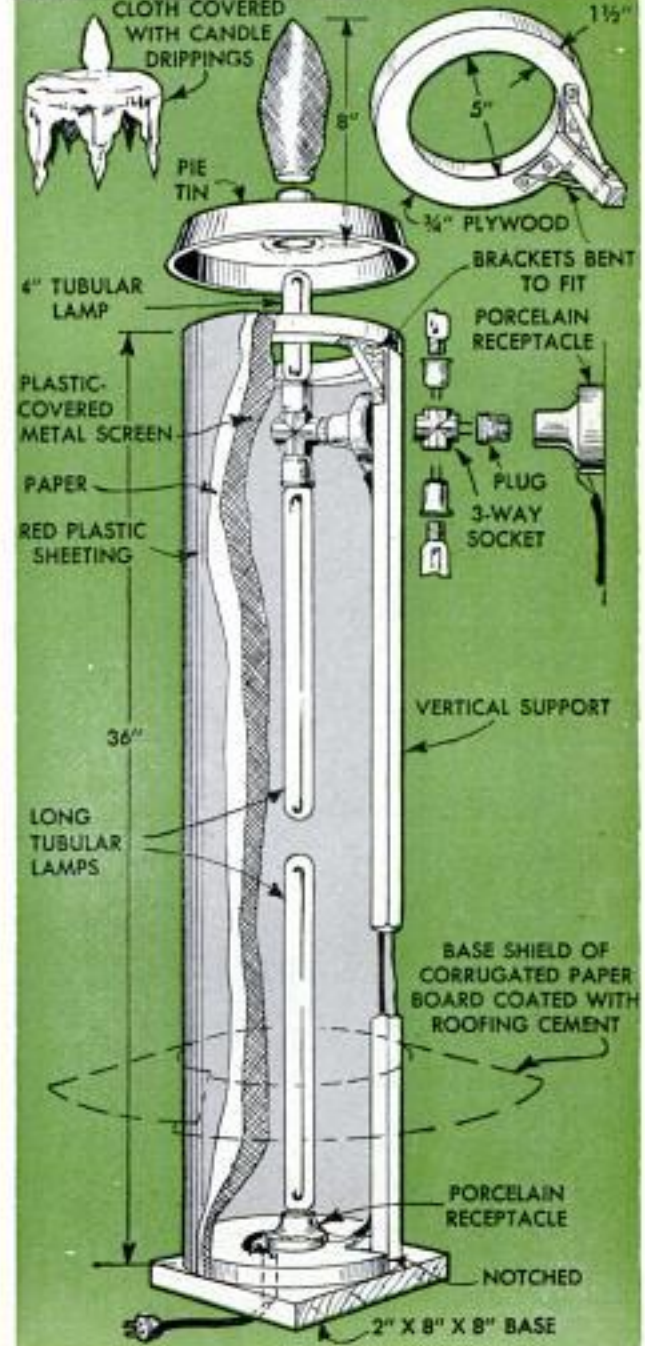



Roper photo



Westinghouse photo



Frigidaire photo

**WHAT YOU SHOULD
KNOW ABOUT
CLOTHES
DRIERS**

By John B. Mullen



Kelvinator photo



Sorge photo

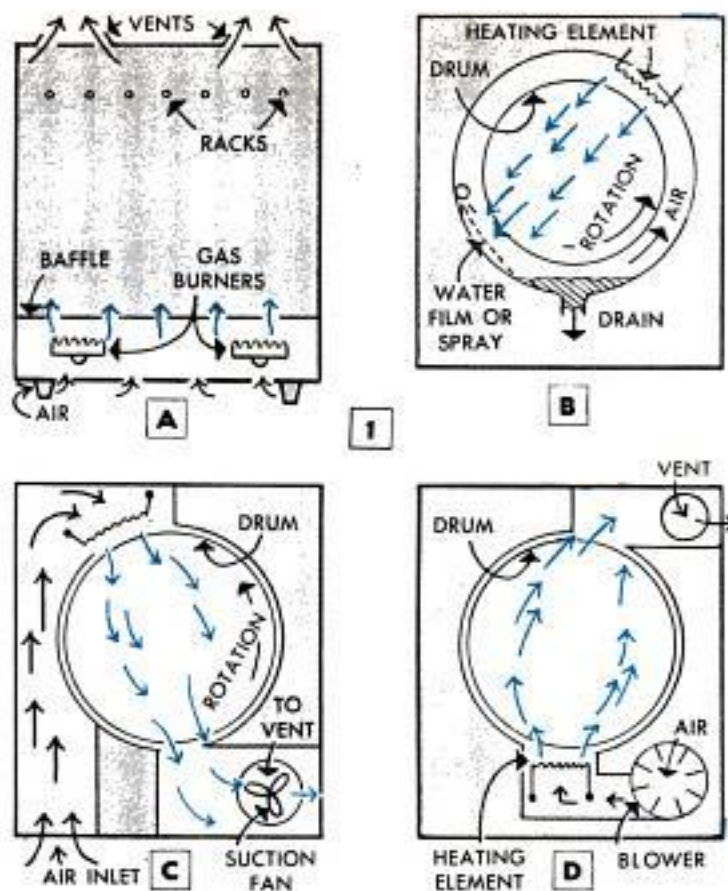

ARE YOU IN THE MARKET for an automatic clothes drier? Like shopping for a new car, you'll find an array of gleaming models boasting exclusive features from built-in sun lamps to musical timers. Knowing the various types on the market, how they work and are installed will be helpful in making your selection when you head for the appliance department. The three general types are pictured in Fig. 1; condenser type, B, suction type, C and forced-air type, D. Early type gas-heated drier, A, which circulated warmed air by convection only, is a system no longer used in modern domestic driers.

Condenser driers: In condenser driers of the air-condenser type, the clothes are tumbled and heated in a perforated cylinder and, as the water is converted to vapor it escapes through the condensing system. Here the hot, moisture-laden air passes through a series of tubes cooled by fan-circulated air on the outside. The moisture condenses on the tubes, carrying with it whatever lint is carried out of the cylinder, while the condensed water collects in a pan at the bottom. This must be removed and dumped after each load, or the water can be piped to a floor drain if desired. The air condenser extracts over half of the moisture from the air leaving the drying chamber, the balance being mixed with the air that cools the condenser and blown out into the room.

In condenser driers of the water-con-

denser type, the moisture-laden air from the cylinder is cooled by passage through a stream or spray of cold water which extracts the moisture and the lint. The water-condenser type, of course, requires both a supply pipe for water and a connection to the drain. There is a sump pump for discharging the water in case a floor drain isn't available. Such driers require about 15-20 gal. of water per cycle to operate. Although the clothes in a condenser-type drier are continually tumbled, the air circulation is produced by convection and by the escape of vapor-saturated air to the condenser; on the other hand, because the movement of air is at a minimum, they never require venting. This convenience is partly offset by the nuisance of emptying the drip pan after each load or by the requirement of a drain and water supply.

Suction driers: Most driers depend on movement of warm air for their action, although in some the gas or electric heater is placed adjacent to the drum so there is some direct heat applied to the cylinder as well. Usually the air blower is near the vent so that the air is under suction as it passes through the drum. Some driers provide an adjustable temperature control, allowing the operator to preset the degree of heat as well as the drying time. This permits using a low temperature for delicate fabrics, and higher temperatures for faster drying of cottons. Other suction-type driers have a preset operating temperature

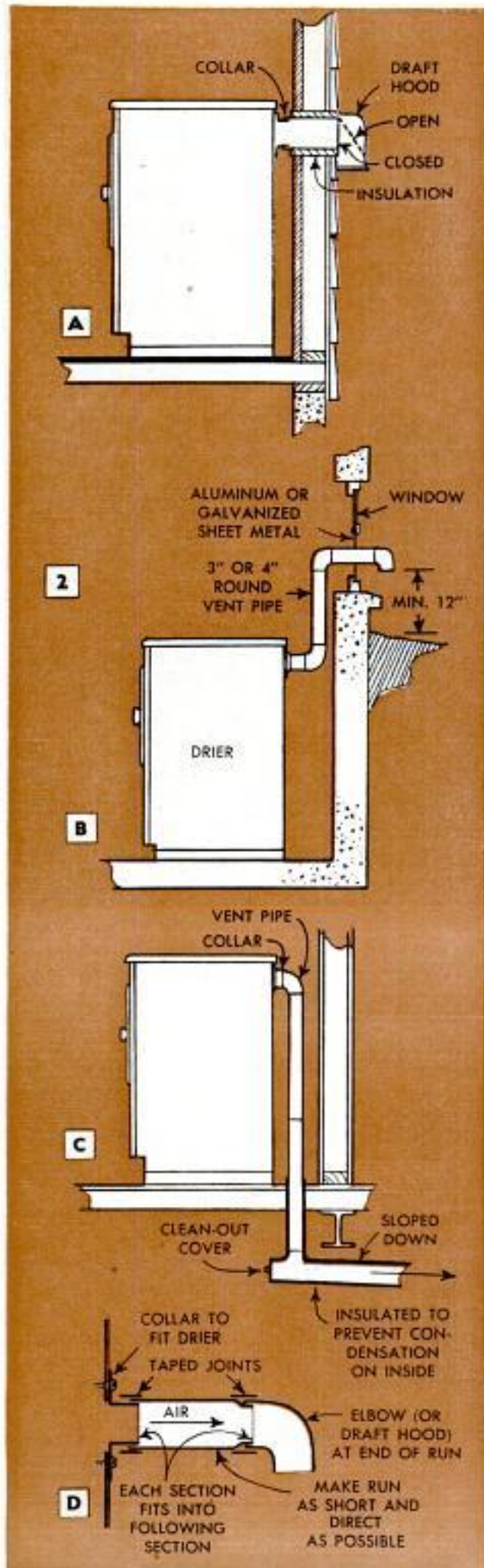

A Short, direct line through outside wall is best installation. Draft hood keeps out cold and rain

B Driers in basements can be vented through a nearby window by replacing a pane of glass with sheet metal. Elbow may be used in place of draft hood

C Installations on inside wall in kitchen or utility room can be vented to outside through basement. Vent pipe should be insulated to prevent condensation where basement or crawl space is not well ventilated

D All vent pipes should be made as short and direct as possible. See that there are no obstructions in the vent pipe that would catch and accumulate lint

which is roughly equivalent to the low temperature of the adjustable types. This has the advantage of simpler operation and eliminates any danger of overheating delicate textiles by forgetting to reset the thermostat. Usually, these driers circulate a relatively large volume of air. The construction and path of air circulation of one drier of this class is shown on page 173.

Besides the suction-type driers that draw warm air through the clothes, there are a few driers that operate with the blower fan or turbine on the intake side and blow the air through the clothes. These move a somewhat larger volume of air at somewhat lower temperatures than other types, which is claimed to give the closest approach to natural drying conditions and the least possibility of overheating or "cooking" the clothes. Air temperature in these machines is preset so they have the added convenience of simpler control, and no chance of damaging delicate fabrics by forgetting to turn the thermostat to "low."

Cutaway view of air-condensing-type drier. Heated moist air from drum is drawn out through tubes of condenser where over half of water is condensed to collect in drip pan. Tubes of condenser are cooled by room air drawn in through the right-hand grill



Venting: All driers of the warm-air type have an outlet, or vent, from which the moisture-laden warm air is blown out into the room. Usually this is located on the back, occasionally on the top. However, discharging upwards of 3000 cu. ft. of warm, humid air into a room may steam up windows or cold surfaces, sometimes makes the room uncomfortably warm, and may even make the air in the room humid enough to slow down the action of the drier. For this reason, most manufacturers recommend venting the drier to the outside. This is easily done by fitting a 3 or 4-in. pipe, depending on the make of drier, to the exhaust opening from the drier. Vents should be as short and direct as possible. Some methods of venting are shown in Fig. 2. A draft hood will prevent rain, snow and cold air from entering the vent when the drier is not operating.

The lint problem: The amount of lint removed from a batch of clothes always surprises a person when they first use a drier. However, the lint is not caused by the action of the drier, but rather by normal wear on the textile fibers and by the washing. The same amount of lint is removed

Cutaway view of suction-type warm-air drier. Warm air flows from intake at top, through drum and lint screen, then to blower and out vent at the rear



SPECIFICATIONS DOMESTIC CLOTHES DRIERS

Code No.	MAKE	Type *	RATING			DIMENSIONS		Drum Size (cu. ft.)	Capacity (lb. dry)	Time Range	Thermostat P—Preset A—Adjustable	Motor Hp.	Fan c.f.m.	FEATURES					
			Electric		Gas	36" Height Is Standard								Signal End of Time	Shut Off When Dry	"Sun Lamp"	"Safety Door"	Drying Without Heat	Other
			Watts @ 230 v.	Watts @ 115 v.		BTU per Hr.	Width												
1	Frigidaire	AC	4400	1550	—	30	26½	5.7	8	85	A	1/6	—	STD.					
2	Hotpoint	WC	4700	—	—	31	28¾	4.8	8	90	A	1/6	—						
3	Maytag	WC	4800	—	—	31½	26½	5.2	9	110	A	1/6	—		✓				
4	ABC	VA	4400	1300	18,000	30	26	6.0	9	120	P	1/6	122		✓				
5	Apex †	VA	4600	—	15,000	30	24¾	5.1	8	60	P	1/6	—	STD.					
6	Bendix	VA	4700	1450	19,000	30	26	5.8	9	75	P	1/3	120	OPT.	✓				
7	Blackstone	VA	4600	—	18,000	29	25	—	9	90	A	1/6	✓			✓			
8	Easy	VA	4500	—	15,000	29¾	25½	5.1	9	180	A	1/4	90	✓	STD.	✓	Lint-Signal		
9	General Electric	VA	4700	1400	—	31	26½	—	9	140	P (2)	1/6	100		STD.	✓	Sprinkler		
10	Hamilton †	VA	4700	1600	18,000	31	26¾	5.3	8	130	A	1/6	—	STD.					
11	Kelvinator	VA	4800	1700	—	30	27	—	9	120	P	1/6	120	✓		✓			
12	Roper	VA	—	—	18,000	31	26	—	9	120	P	1/4	100		STD.	✓			
13	Speed Queen †	VA	4500	—	18,000	30	26	5.3	8	120	A	1/6	—						
14	Temco †	VA	—	—	15,000	30	25	5.0	8	120	P	1/4	—	STD.					
15	Thor †	VA	4500	—	—	30	26¾	—	8	(1)	P	1/6	90	✓					
16	Whirlpool	VA	4200	—	20,000	29	25¾	5.2	10	60	A	1/6	80	✓	STD.	✓			
17	Norge	PA	4200	1100	18,000	31	26¾	6.0	9	120	P	1/3	150		STD.	✓	Can dry without tumbling		
18	Westinghouse	PA	4600	1500	—	31	27	—	9	180	P	1/6	125	✓	✓	✓			
19																			
20																			

†—DID NOT SUBMIT DATA
*—TYPES:

AC—AIR CONDENSER
WC—WATER CONDENSER

VA—VACUUM AIR
PA—PRESSURE AIR

(1) CONTROLS DRYNESS, NOT TIME
(2) THERMOSTAT PRESET, BUT POWER INPUT ADJUSTABLE

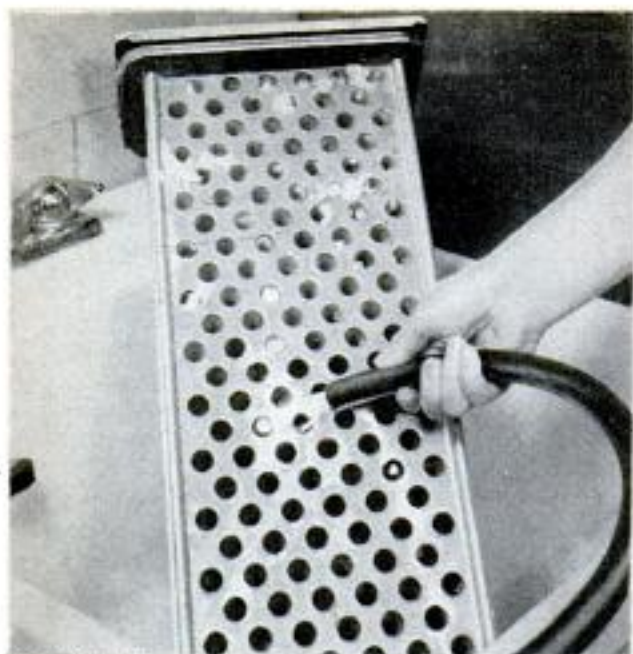

Frigidaire photos

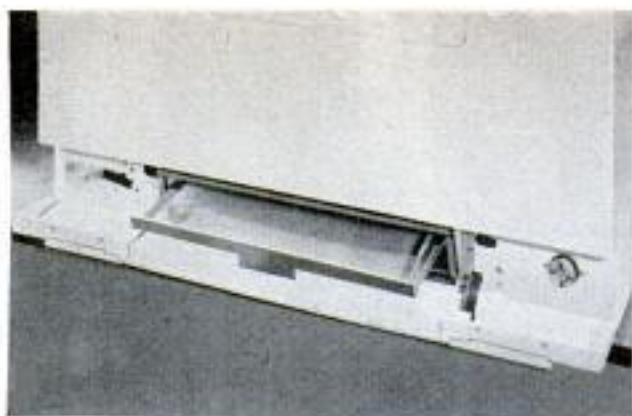

Above, lint screen of warm-air drier should be cleaned after each use. Left, lint is removed from condenser of air-condenser drier by flushing with water

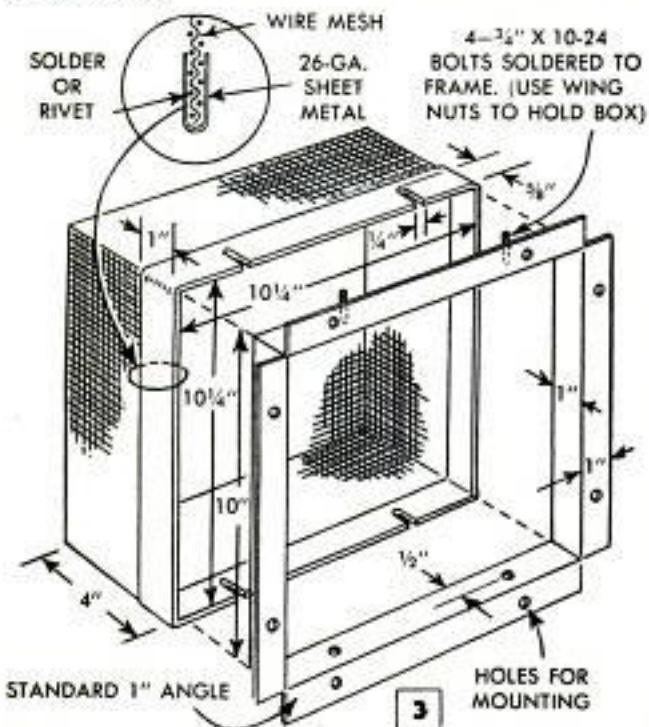

from clothes dried outdoors, but it blows away so it is never noticed. All driers of the air-circulating type provide a lint trap located in a drawer or compartment near the vent. This should be cleaned out regularly, usually after each use. Naturally a lint trap with a large area will impede air flow less than a small one. Lint traps are sometimes removed permanently when an outside vent is used. However, if the discharge is near shrubs or a window, this requires putting a screened lint box over the outside vent, as shown in Fig. 3.

Driers of the water-condensing type eliminate the lint problem almost completely by discharging the lint down the drain with the cooling water. With driers of the air-condenser type, the lint collects on the condenser which must be removed and cleaned like the lint trap in other driers. However, this usually means just a thorough washing under a faucet.

What clothes can be dried? Most clothes that can be laundered can be put through a drier. A brief chart listing a few of the types of fabrics and the problems they impose is given on page 175. One absolute

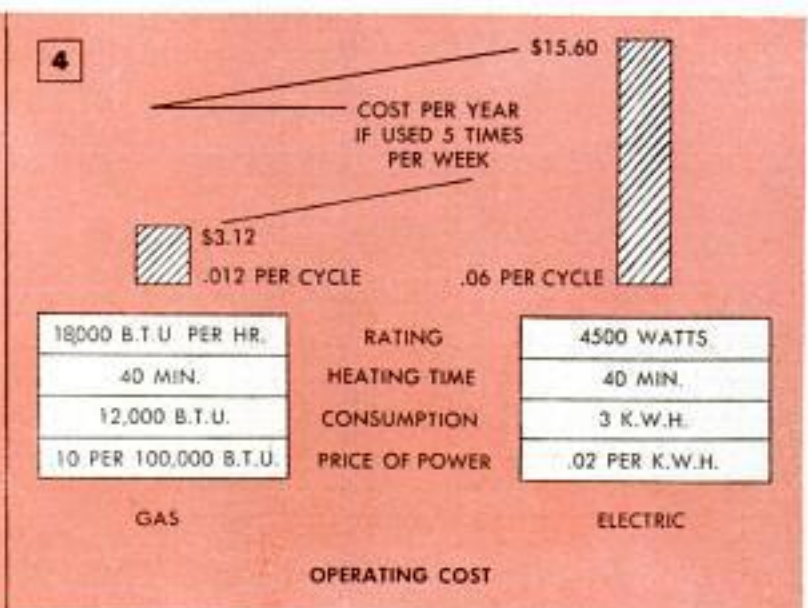
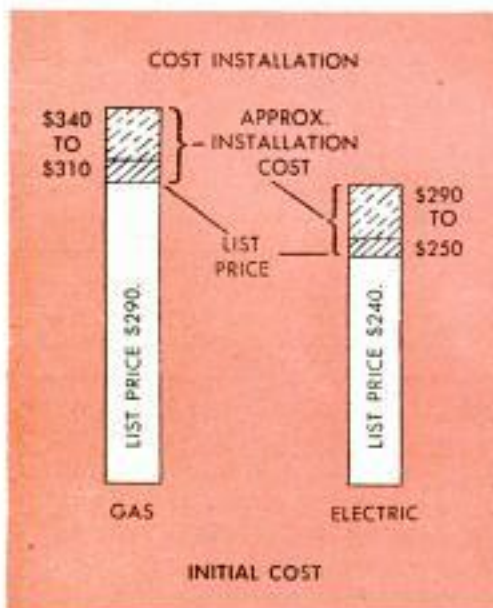

"don't" is this: Home-dry-cleaned garments *must not* be put in the drier because of the danger of fire.

Special features: Nearly every manufacturer has a few special features, some of which may appeal to you and influence your choice. About half of the makers provide a "safety door" feature so that heat and drum rotation stop if the door is opened during a cycle to check progress of drying. Most driers have an interior light, and many of them also have a sun lamp as either an extra or standard feature. This gives the clothes an ultraviolet, or ozone, treatment to eliminate any "cooked" odor. An attractive feature offered by two models is a control that shuts off the drier when the clothes are dry, thus preventing over-drying which tends to give the clothes a harsh, stiff feel. One drier has an attachment for sprinkling the clothes while tumbling. The same drier allows drying without heat or tumbling.

Care and maintenance: Here, as on most domestic appliances, manufacturers have outdone themselves in simplifying problems. Motors are permanently lubricated and require no attention. Bearings on the drum supports may require lubrication once a year or so. Apart from keeping the machine clean and caring for the lint trap, there's little additional maintenance.

Installation: Driers should be leveled but need not be fastened down. Gas models usually require a 3/8-in. supply pipe and shutoff valve, while electric models for 230-volt operation should have a three-wire independent circuit with No. 10 wire. A disconnecting switch with fuses according to manufacturers' recommendations should be provided. Driers can either be connected directly to the line with conduit or cable, or connected to a 3-pole outlet with a pigtail connector such as is used on electric ranges. Some electric driers can be plugged into a 115-volt circuit, provided it is wired with No. 12 or larger wire fused

	RECOMMENDED			Caution Required	Not Recommended	No
	No Special Precaution	Special Methods Req'd.	Short Time and/or Low Heat			
Cotton	■					
Linen	■					
Wool Blankets	■					
Knit Wool					■	
Other Wool				▨	■	
Silk			▨			
Rayon			▨			
Nylon, Orlon, Etc.			▨			
Knit Cotton				▨		
Rubberized Fabric		■	▨		■	
Plastic		■				■
Feather Pillows	■					
Foam-Rubber Pillows				▨		■

for 20 amps., and provided no other equipment is on the same circuit at the same time. Drying time will be two to three times as long on 115 volts as on 230 volts.

Gas or electric: There's not much to choose in operation between the gas and electric drier. In fact, in models that include both types, the only difference is in the heating unit itself and the controls. Apart from the question of availability of adequate gas or electric power, however, there is a difference in cost. The electric drier is less expensive but the gas drier will cost appreciably less to operate. The costs given in Fig. 4 are average for de luxe models. Stripped-down electric models range from \$170 to \$200; gas models with pilot light instead of automatic lighting cost about \$260. ★ ★ ★

Pencil Attached to Doorbell Permits Fast Stippling

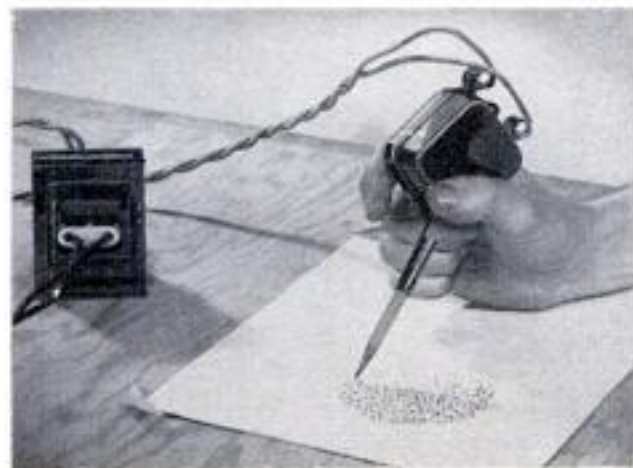

DECEMBER 1954

An automatic stippling device, improvised by attaching a pen or pencil to an ordinary doorbell, will reduce the time required by an artist to stipple a drawing. Remove the bell and frame of the doorbell unit, leaving just the vibrator, bell clapper and arm. Cut off the clapper and straighten the arm. Then solder a short length of metal tubing, slit lengthwise to hold a pen or pencil, to the arm. Some adjustment of the electric contacts may be necessary to obtain the best operation. Also, practice will be required to determine the right spacing between the paper and pencil and the speed of the pencil across the paper.

Timer Trips Shutter of Camera For Taking Self-Portraits



For taking self-portraits, one photographer improvised a timer for tripping the shutter on his camera by remote control. He tied a 1-oz. fishing sinker to a 6-ft. length of light fishline, and linked the fishline to

the arm of his timer with a rubber band. With the timer placed on the floor alongside the tripod, the fishline is draped across the shutter release like a pulley. When a picture is to be taken, the timer is set and, when it rings, the fishline rides over the shutter release smoothly, actuating it without jerking or vibration. There is no possibility of damage to the shutter, and no adjustment for tripod height is needed.

Ivan Grosvenor, Indian Rocks, Fla.

Test Tubes Inverted on Corks Dry Without Clouding

To drain and dry washed test tubes so they do not become clouded with moisture, and are dust-free when used again, one laboratory worker inverts them over corks glued to a convenient shelf. The corks are

sanded flat on two sides to allow the moisture to drain away and air to circulate inside the tubes. Several sizes of corks are used to accommodate various sizes of test tubes. The corks can be shellacked to make them waterproof.

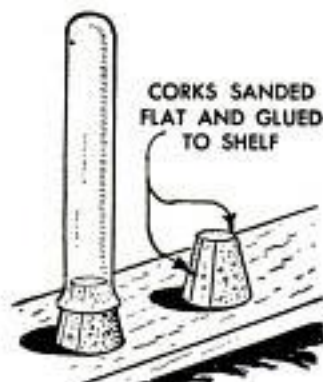

Coins Serve as Gauges to Mark Clearance When Hanging Door

After a door has been trimmed to fit snugly in its frame, the thicknesses of worn coins can be used to determine the required clearances. A thin dime is used as a gauge to mark the top and hinge sides and a worn nickel is used for the lock side. Remove the door from the frame and plane down to these marks, beveling the back edges of the two sides. Mortise the door for the hinges, setting the upper hinge 7 in. from the top of the door and the lower hinge 11 in. from the bottom. Mortise the doorframe and install the other half of the upper hinge $7\frac{1}{16}$ in. from the top of the frame. This will give $\frac{1}{16}$ -in. clearance at the top when the door is hung. Now hang the door on the top hinge and mark the frame for the lower hinge. With both hinges installed,

hang the door and mark any tight spots to be planed for the final fit. The doorknob should be installed about 36 in. from the floor.—G. A. Schoenfelder, Amana, Iowa.

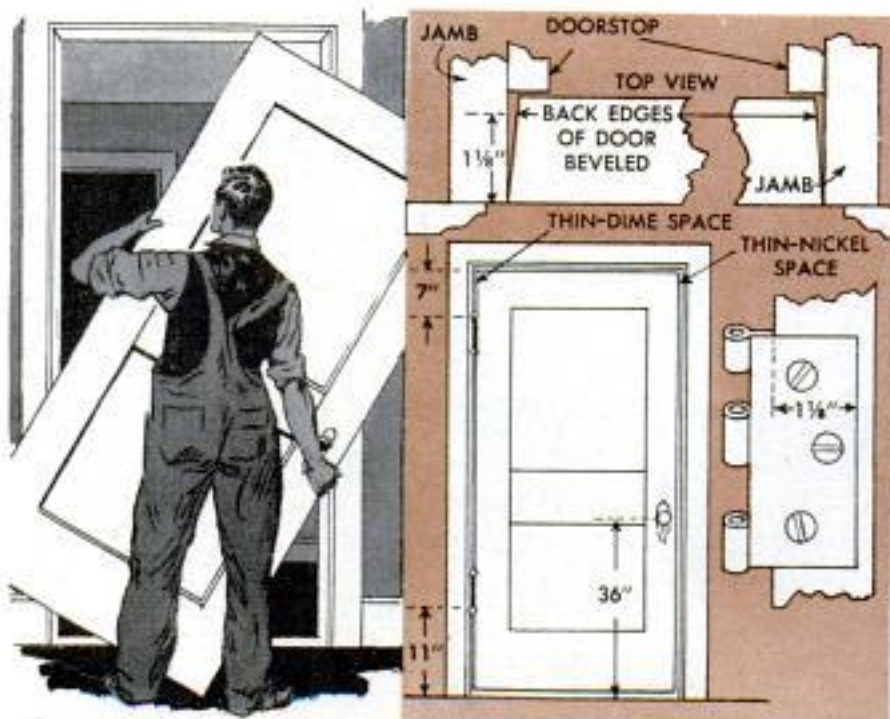

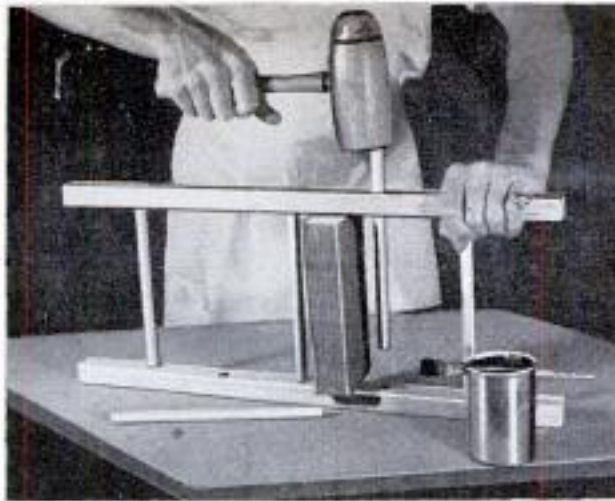

The two sides are identical and are made by driving pieces of 1/2-in. dowel through two rails made of 1 x 1-in. stock. Scrap of wood holds rails apart



DOLL CRIB WITH DROP SIDE

When it comes time for the little girl in your house to put her dolls to bed, she'll love doing it in this crib that is a model of the real thing. Sturdily constructed of plywood set into grooves in a frame of 1 x 1-in. stock, it has a drop side that slides up and down on metal curtain rods secured to the head and foot. Two hardwood turn buttons operated simultaneously by a dowel handle firmly support the drop side in the raised position

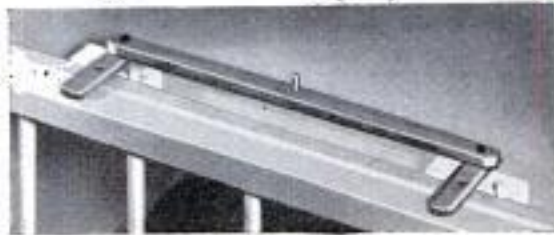
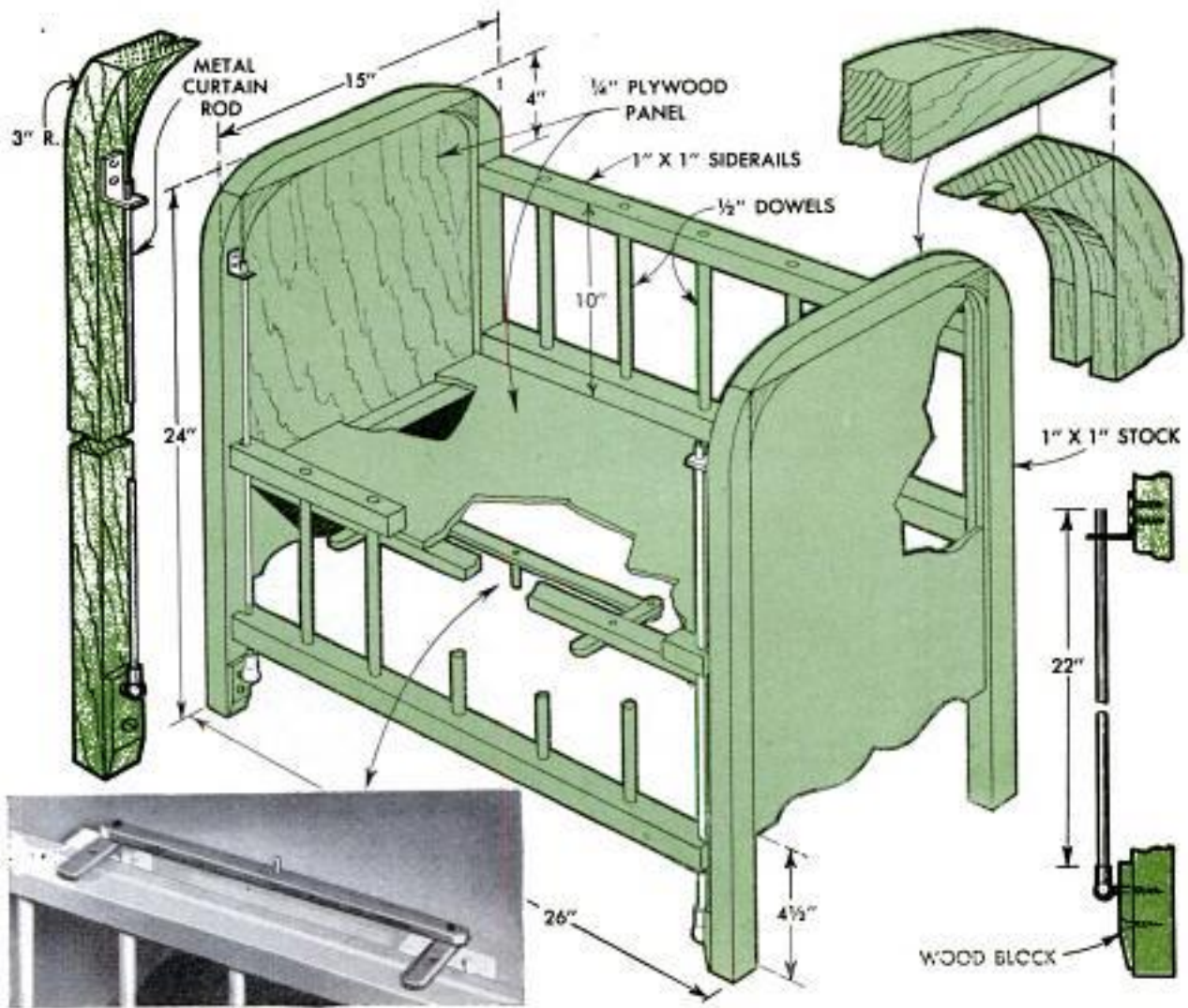

HOME PROBLEMS

1—KITCHEN TRAYS last longer and are easier to keep clean if they are coated with shellac. A coat or two of clear shellac protects either metal or wooden tray from wear and scratches, meanwhile preventing the staining of the original tray finish



2—SCREEN DOOR will be protected from damage by small children if the lower portion of the door is fitted with one or more guards which also serve as handles. The guards are lengths of thin-wall conduit fastened horizontally across screened section

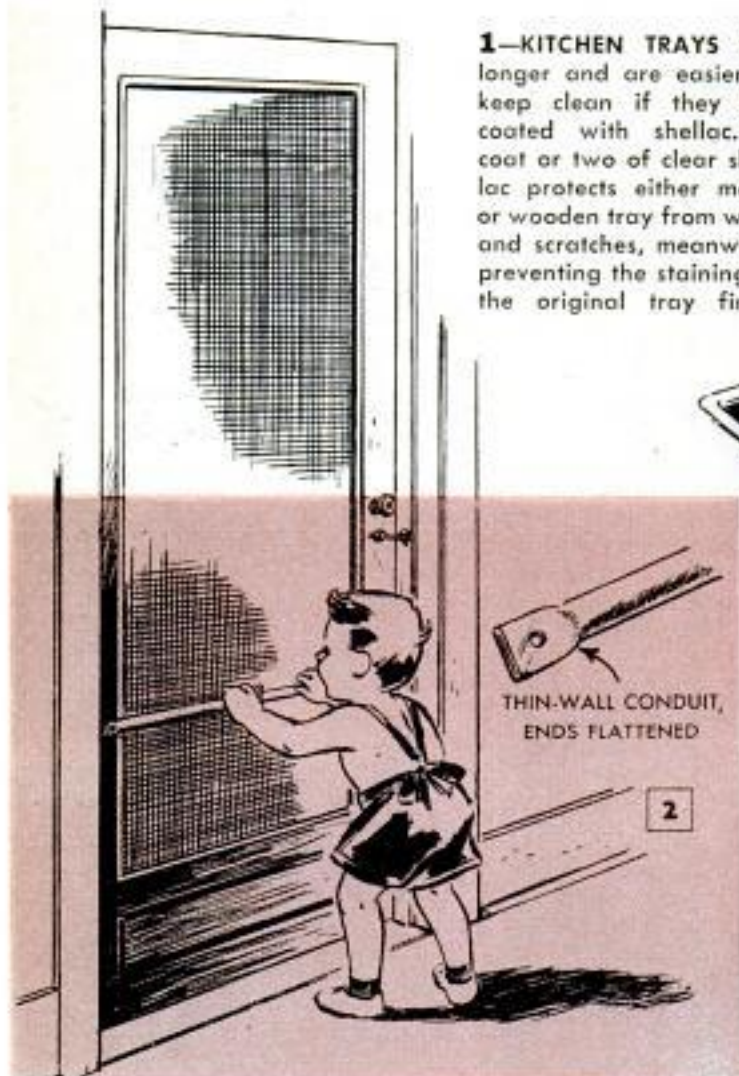

4—WINDING BOBBINS on the sewing machine often will cause a spool left on the spindle to rotate and tangle the thread. To prevent this, wrap a rubber band around the arm of the machine, thus providing sufficient friction to keep spool from spinning too fast

3—REWINDING WINDOW-SHADE ROLLER is done quickly and easily by inserting shaft end in key-hole. This holds shaft while the roller is rotated

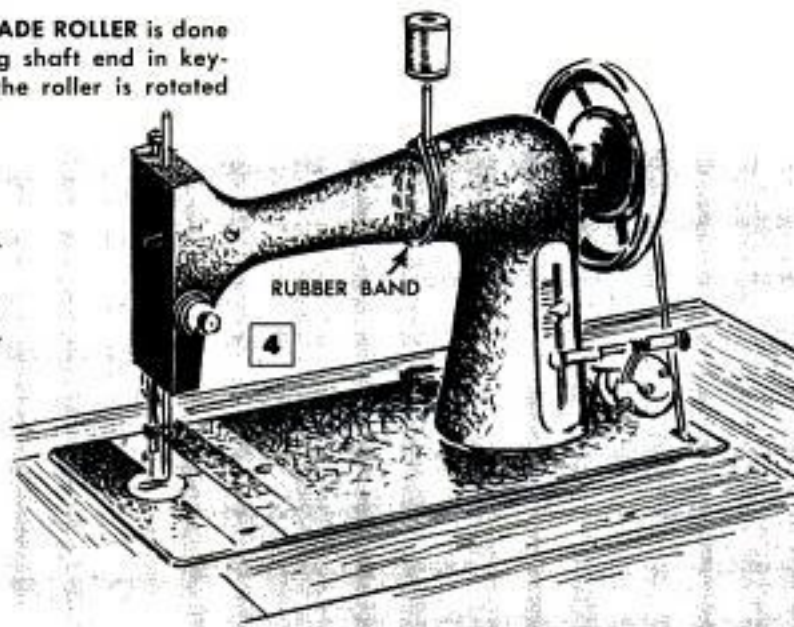
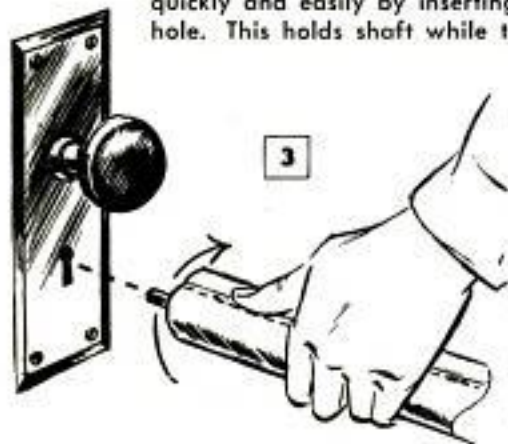

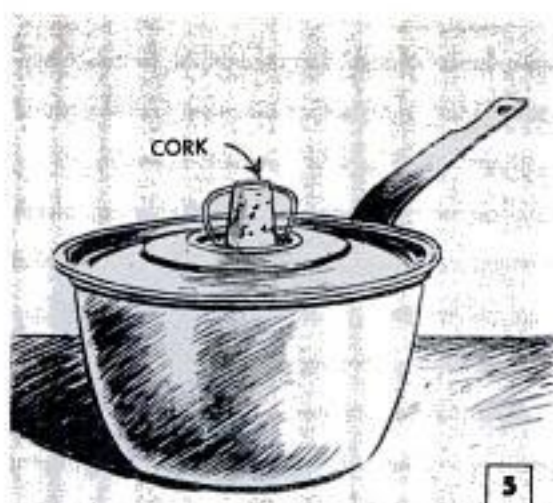

5—SMALL CORK holds ring-type potlid handle vertically to keep it from becoming too hot to pick up. Top and bottom of cork are grooved so one end will rest over raised portion of lid and other end will engage the ring



6—PROTECT WAXED FLOORS from being marred by legs of chairs, tables and other furniture by applying a coat of paste wax to the ends of the legs before replacing the furniture in the room

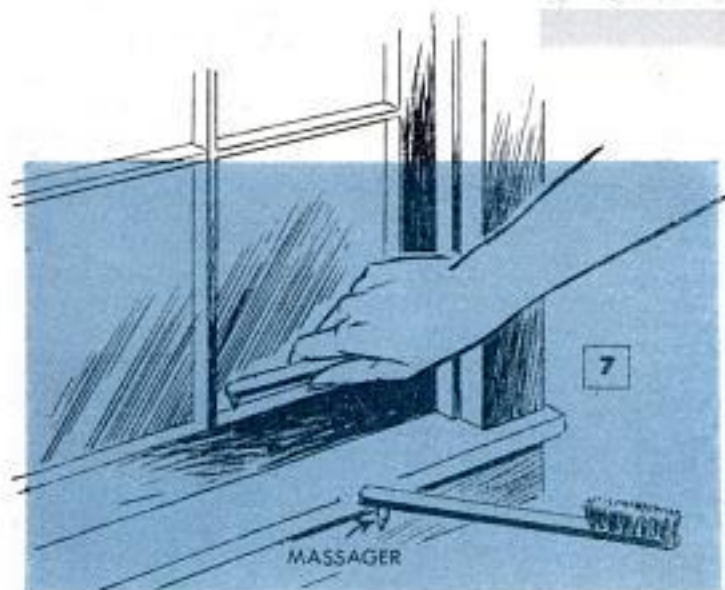

7—TOOTHBRUSH of the type having a massaging tip comes in handy for cleaning dust from hard-to-reach corners. Tapered rubber tip is easy to work into windowpane, door-panel molding

8—WHEN CARVED MOLDING on fireplace mantel becomes chipped or broken, it often can be repaired with wood putty. Work putty to shape of molding and finish to match the mantel

9—SLIDE FASTENERS on children's garments which are not provided with locking tabs frequently work open. To prevent this, lock in place with an ordinary safety pin inserted from the inside of the garment so that it will keep the fastener slide from moving downward

10—THREAD used when basting cotton material does not have to be pulled after sewing if nylon basting thread has been used. When ready to remove the basting, simply press this portion of the material with a hot iron. The heat from the iron will destroy the nylon completely

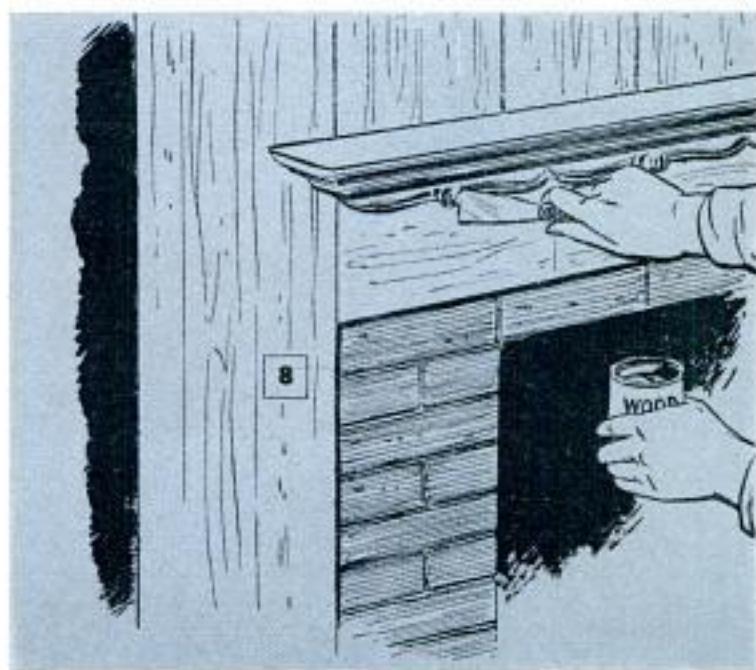

Extension for Trouble Light Permits Use on Trailer



An auto trouble light, of the type that plugs into a cigarette lighter, can be modified so that it may be extended for use as an emergency taillight on a trailer. As shown in the photo detail, the cord is cut about 6 or 8 in. from the light and the cut ends are fitted with male and female sockets. A length of lamp cord is fitted with sockets in the same manner, so it can be used to lengthen the extension. The extension also will allow using the trouble light anywhere around the outside of the car.

Tom Riley, Portland, Ore.

Sagging Tube-Type Clothes Pole Reinforced With Pipe

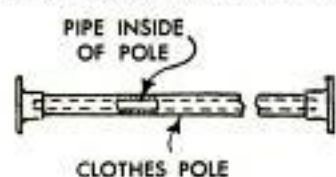

Tubing-type clothes poles that sag under the weight of many garments can be reinforced by inserting a length of pipe inside the tubing.

The pipe should be long enough to be supported by the end brackets, and of the largest diameter that will fit inside the tubing.—Andy Vena, Philadelphia, Pa.

Silk Stocking "Shoehorn" Used When Donning Snug Boots

To overcome the difficulty of pulling snug-fitting rubber boots over heavy socks, one fisherman uses a silk stocking in much the same manner as a shoehorn. The stocking is slipped down part way into the boot so that its smooth surface can facilitate

sliding the heel of the foot into the boot. After the foot is all the way in, the stocking is removed easily by pulling on the free end.

Extra Turn in Shoelace Knot Prevents Easy Loosening

If you have the problem of frequently retying a small child's shoelaces, here's a simple trick that will save your time and temper. After tying a regular bow-knot, bring the last loop through twice as shown in the detail, and pull the knot tight. The knot will not work



loose and can be released by pulling one of the lace ends in the usual manner. To prevent the child from accidentally pulling the lace ends, tuck them under the lacing.

Enlarged Screw and Bolt Holes Repaired by Wooden Dowels

The difficulty of resetting or keeping the screws tight on old furniture because the screw or bolt holes are enlarged from years of use may be overcome by plugging them with dowels. To do this, drill out the hole to take the dowel tightly. Cut the dowel so it will come flush with the surface of the wood, then coat it with glue and tap it in place. Sand the end of the dowel and surrounding wood while the glue is still wet. The sanding dust and glue will act as a filler for small irregularities. After the glue is completely dry, relocate the holes and drill as though it were the original wood.—R. F. Donovan, Guttenberg, N. J.



EARTH HAULER For Young Engineers

By William P. Kupka

PINT-SIZED construction engineers who are planning extensive operations next summer in a back-yard sandbox will be delighted to receive this jumbo-sized earth hauler to add to their equipment.

The bases of both the tractor and the trailer are cut and shaped from $\frac{3}{4}$ -in. stock to the dimensions given in the detail on page 183. Next, four axle hangers are cut from $\frac{3}{4}$ x $1\frac{1}{2}$ -in. stock. These are drilled to receive $\frac{3}{4}$ -in. dowel axles and nailed to the bases. The axles for the trailer are centered in the hangers, while the tractor axles are placed 1 in. back from center. The hoist base is $1\frac{1}{4}$ x $2\frac{1}{4}$ x 6 in. with a bevel cut on one end so the top measures $5\frac{1}{2}$ in. A piece of $\frac{1}{16}$ -in. sheet metal is fitted to the top of the hoist base and a 12-in. length of flat iron is fitted to the underside of the trailer base to form the drawbar. Holes are drilled in line through the hoist base, trailer base and drawbar to receive $\frac{1}{4}$ x 3-in. bolts and the assembly is bolted together. The end of the drawbar is bent downward to provide a loose fit for the tractor hitch.

The U-shaped hoist is bent from 1-in. flat iron and is 10 in. high and 1 in. wide at the top. The braces between which the crank and drum fit are 6 in. long. A 60d spike is bent cold to form the crank and inserted through two $\frac{7}{16}$ -in. holes drilled 3 in. from the lower ends of the braces. Then two $1\frac{3}{4}$ -in. washers or sheet-metal



disks are soldered to the spike to form the drum, and two smaller washers are fitted on the crank between the drum and the hoist braces when the hoist is assembled.

The front, bottom and back of the hopper are of $\frac{3}{4}$ -in. stock cut to the dimensions given in the detail. The sides, which are $\frac{1}{4}$ -in. plywood, are fitted with curved overlays on the inner surfaces to support a sheet-metal floor. After the hopper is assembled, the sheet metal is nailed to the edges of the overlays. The hopper is attached with two 3-in. strap hinges.

To form the hoist cable, a 14-in. length of picture wire is tied to a screw eye driven into the hopper front. The wire is passed over the top pulley and down to the drum, the end of the wire being pushed through a hole drilled in one of the drum flanges.

Painted a bright yellow to contrast with the black tires, the earth hauler presents a realistic appearance

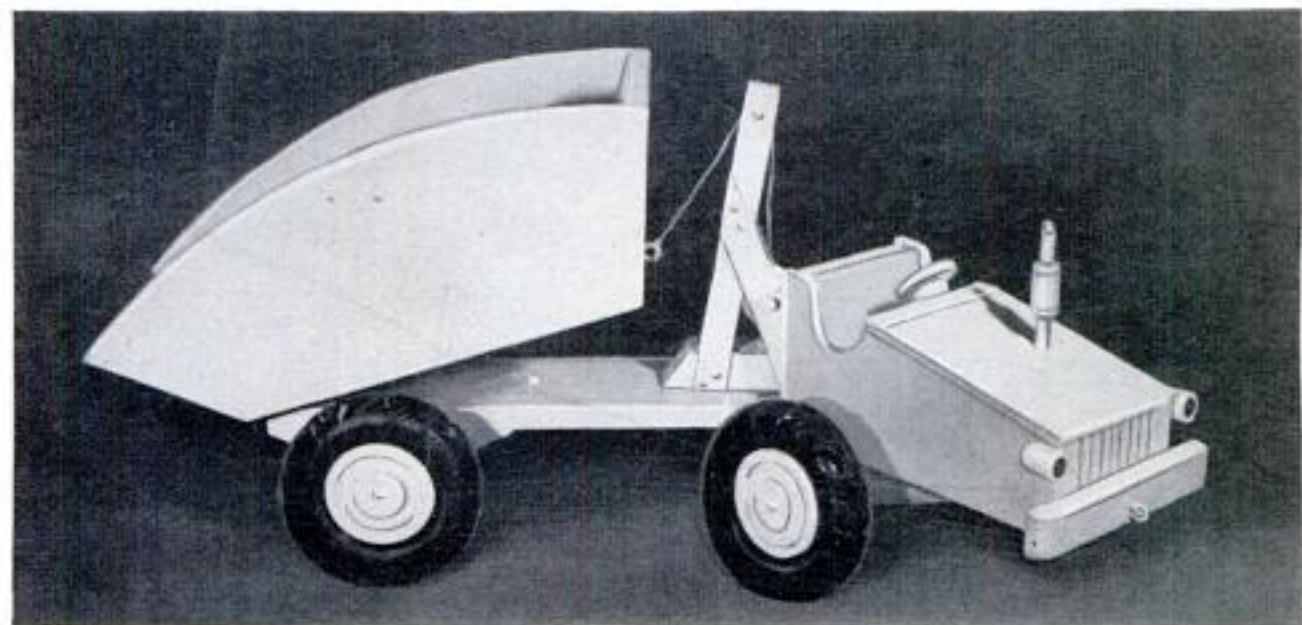

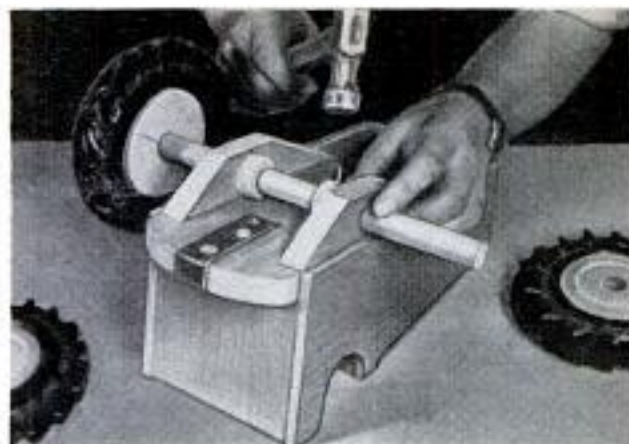
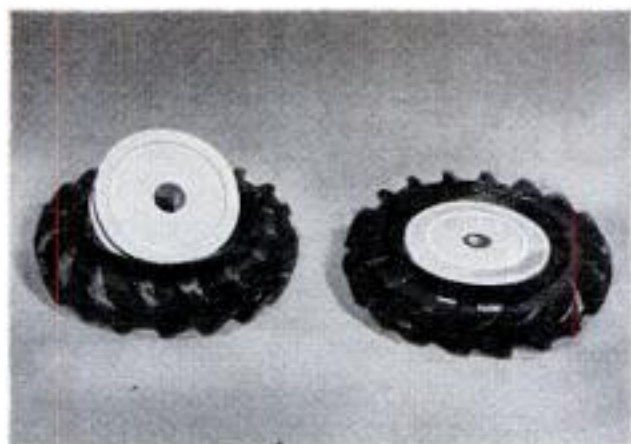

Tires taken from ash trays are fitted on turned wheels

Axes are fitted with collars and revolve in hangers

The tractor assembly starts with the radiator grille which is carved from a piece of $\frac{3}{4}$ -in. stock, as shown in the upper right-hand detail on page 182. The edge view gives the dimensions of the grooves. The dashboard is 4 x 5 in. and the seat back is $4\frac{3}{4}$ x 5 in. The three pieces are nailed to the tractor base, being located by using the side of the tractor as a template. The tractor sides and the top of the engine hood are $\frac{1}{4}$ -in. stock. The flat-iron tractor hitch extends from the seat back around the rear edge of the tractor base and about 4 in. on the underside of the base.

the grooves being $\frac{3}{8}$ in. wide by $\frac{1}{4}$ in. deep. The wheels are designed for tires taken from novelty ash trays. Four disks, 1 $\frac{1}{2}$ in. in dia., are cut from 26-ga. sheet metal to provide hub caps. Drill a screw hole in the exact center of each disk and nail the disks over the centers of the wheels. Mount the wheels by driving a screw through the holes in the hub caps into the axles.

The axles are fitted with spacing collars which fit inside the two hangers. The spacers between the wheels and hangers are $1\frac{1}{4}$ -in. disks, $\frac{5}{8}$ in. thick and are drilled to receive the axles. The wooden wheel disks are turned and grooved for the tires,

Fit the exhaust pipe and muffler into a hole drilled through the hood and $\frac{3}{8}$ in. deep into the base. Locate the hole 5 in. from the front and 1 $\frac{1}{2}$ in. from the left-hand side of the hood. The steering wheel is a 2-in.-dia. disk mounted on a 2-in. length of $\frac{1}{4}$ -in. dowel. The headlights are shaped from 1-in. dowel, 1 $\frac{1}{4}$ in. long.

A handle for pulling the toy can be made by bending a length of $\frac{1}{4}$ -in. steel rod as shown in the detail. ★ ★ ★

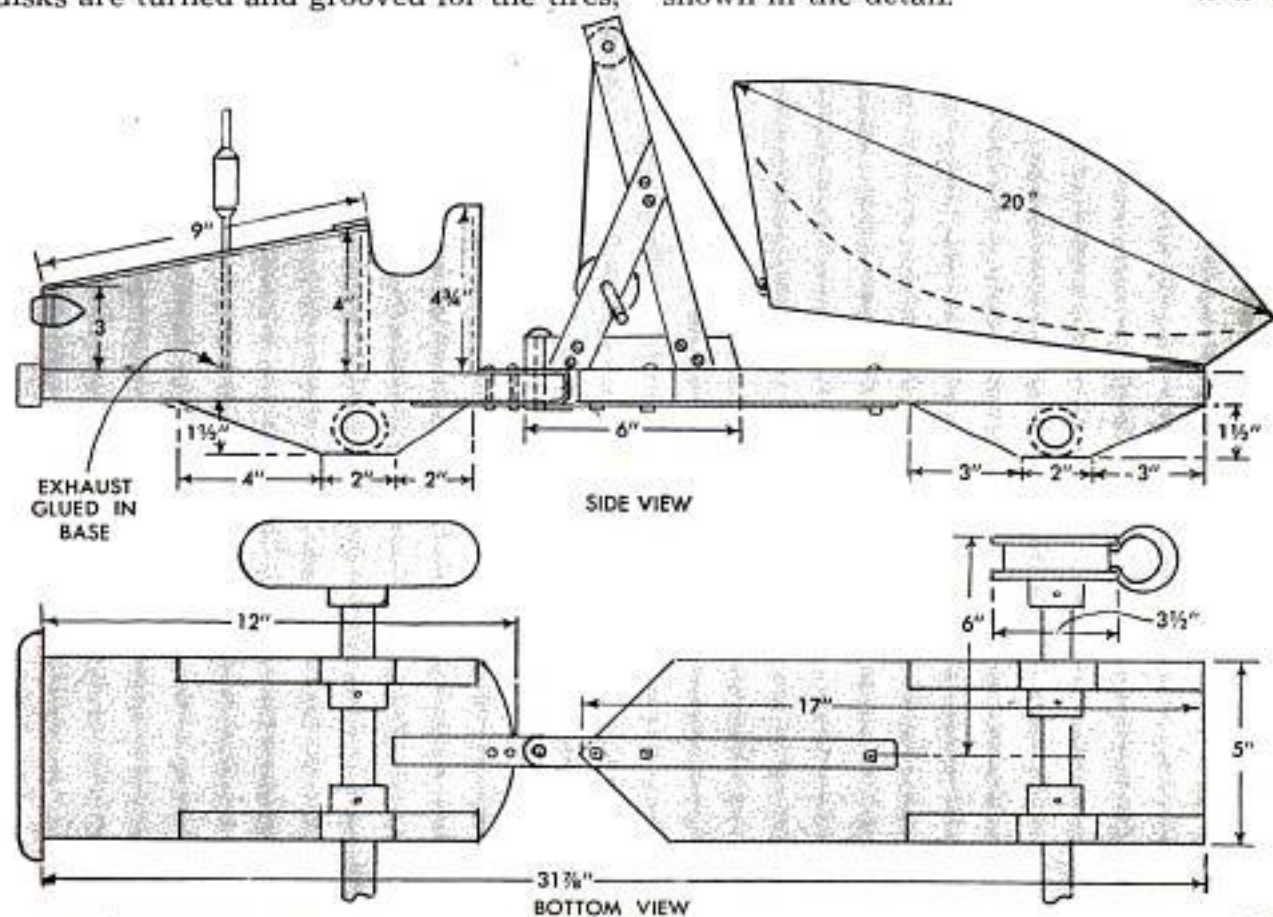

Open-End Rack on Wall Stud Holds Long-Handled Tools



Shovels, rakes and other tools that present a storage problem because of their length can be quickly removed from a rack made by nailing a short length of lumber to a wall stud in the garage or tool shed. The openings between the ends of the board and the adjacent wall studs permit the tools to be removed without lifting them. Also, no floor space is required as would be the case if the tools were stacked against the wall or stored on a horizontal rack.

Oversize Ring Fitted to Finger With Adhesive Tape



FLESH-TINTED
ADHESIVE TAPE

An oversize ring can be fitted to your finger temporarily by using a piece of adhesive tape. Use flesh-colored tape, cut to about half its width, and wrap it around the ring where it will be visible from the palm side only. Two or three turns of the tape usually are enough to make the ring fit snugly.

Glue Container Cleaned Easily

If you frequently use small quantities of glue, abrasives or patching plaster, make a container by cutting a hollow, rubber ball in half. Being flexible, such a container

can be cleaned easily by flexing the sides to loosen the dried material. Also, during use, all of the material is easily scraped out, thus cutting down on waste.

Jerome Toomey, Long Beach, Calif.

Gummed-Paper Tab Lifts Glass For Trial Fitting in Sash

To make it easier to lift the pane out of the sash during trial fittings, fold a strip of heavy gummed paper as shown in the illustration and attach it to the glass. In addition to simplifying the lifting of the glass,

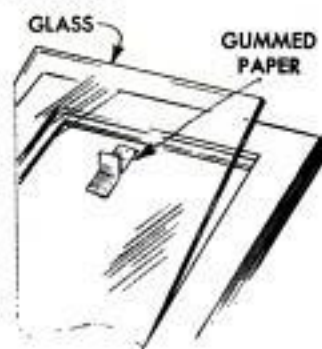

the tab also reduces the chance of breaking or chipping the glass, which might happen if a screwdriver or a knife was used to pry up the pane.

Treated Cellulose Sponge Hastens Negative Drying

Photo negatives can be dried more quickly after washing if they are wiped with a cellulose sponge that has been treated with a liquid wetting agent. Squeeze part of the water from a moistened sponge, add 3 or 4 drops of the wetting agent and work it into the sponge. Pass the treated sponge lightly over the wet negative. It will absorb most of the water, leaving a clean, shining surface with no pressure marks. The negative will be completely dry in less than an hour.—Ken Murray, Colon, Mich.



❑Candlewick bedspreads will not be "de-tufted" during laundering if they are placed in a large, cotton laundry bag before being put into the washing machine.

Thermometers Check Humidity in Your Home

HUMIDITY TABLE																					
RELATIVE HUMIDITY READINGS ARE PERCENTAGES																					
Dry-Bulb Ther- mometer	Difference in degrees between wet and dry-bulb thermometers:																				
	1	2	3	4	5	6	7	8	9	10	11	12	13	14	15	16	17	18	19	20	21
50° F.	93	87	81	74	68	62	56	50	44	39	33	28	22	17	12	7	2				
51	94	87	81	75	69	63	57	51	45	40	35	29	24	19	14	9	4				
52	94	88	81	75	69	63	58	52	46	41	36	30	25	20	15	10	6	0			
53	94	88	82	75	70	64	58	53	47	42	37	32	27	22	17	12	7	3			
54	94	88	82	76	70	65	59	54	48	43	38	33	28	23	18	14	9	5	0		
55	94	88	82	76	71	65	60	55	49	44	39	34	29	25	20	15	11	6	2		
56	94	88	82	77	71	66	61	55	50	45	40	35	31	26	21	17	12	8	4		
57	94	88	83	77	72	66	61	56	51	46	41	36	32	27	23	18	14	10	5	1	
58	94	89	83	77	72	67	62	57	52	47	42	38	33	28	24	20	15	11	7	3	
59	94	89	83	78	73	68	63	58	53	48	43	39	34	30	25	21	17	13	9	5	1
60	94	89	84	78	73	68	63	58	53	49	44	40	35	31	27	22	18	14	10	6	2
61	94	89	84	79	74	68	64	59	54	50	45	40	36	32	28	24	20	16	12	8	4
62	94	89	84	79	74	69	64	60	55	50	46	41	37	33	29	25	21	17	13	9	6
63	95	90	84	79	74	70	65	60	56	51	47	42	38	34	30	26	22	18	14	11	7
64	95	90	85	79	75	70	66	61	56	52	48	43	39	35	31	27	23	20	16	12	9
65	95	90	85	80	75	70	66	62	57	53	48	44	40	36	32	28	25	21	17	13	10
66	95	90	85	80	76	71	66	62	58	53	49	45	41	37	33	29	26	22	18	15	11
67	95	90	85	80	76	71	67	62	58	54	50	46	42	38	34	30	27	23	20	16	13
68	95	90	85	81	76	72	67	63	59	55	51	47	43	39	35	31	28	24	21	17	14
69	95	90	86	81	77	72	68	64	59	55	51	47	44	40	36	32	29	25	22	19	15
70	95	90	86	81	77	72	68	64	60	56	52	48	44	40	37	33	30	26	23	20	17
71	95	90	86	82	77	73	69	64	60	56	53	49	45	41	38	34	31	27	24	21	18
72	95	91	86	82	78	73	69	65	61	57	53	49	46	42	39	35	32	28	25	22	19
73	95	91	86	82	78	73	69	65	61	58	54	50	46	43	40	36	33	29	26	23	20
74	95	91	86	82	78	74	70	66	62	58	54	51	47	44	40	37	34	30	27	24	21
75	96	91	87	82	78	74	70	66	63	59	55	51	48	44	41	38	34	31	28	25	22



Have you ever wondered what the humidity was in your home, so you could increase or lower the capacity of the humidifier in your heating plant to assure the health and comfort of your family? A simple psychrometer—an instrument for determining humidity—can be made by utilizing two ordinary thermometers. The thermometers should be fairly accurate and agree within a degree or two. Mount both thermometers on a panel of hardboard or plywood, as shown. Cut off the back plate of one thermometer so the bulb projects beyond the panel. The latter will be the "wet bulb" thermometer, with a cotton wick fitted over the bulb. A cotton shoe-string will do. Thread the other end of the wick through the small end of a medicine dropper and knot the wick so it cannot slip out. Drive a screw eye into the panel between the thermometers to hold the rubber bulb of the dropper. Then, to fill the dropper, simply slip the glass portion out of the rubber bulb and submerge it in water. Attach a strong cord or chain, fitted with a swivel, to the top of the panel.

To use the psychrometer, fill the dropper with water and saturate the wick throughout its length. Then whirl the panel in the air for about 10 to 15 seconds and quickly note the readings of the thermometers. Check the wet-bulb first, as it rapidly changes. Next, note the dry-bulb reading. Now subtract the wet-bulb reading from the dry-bulb reading. Refer to the table above, looking down the scale along the left-hand side to locate the dry-bulb reading. Then go across on this line to the column which corresponds to the difference between the two readings.

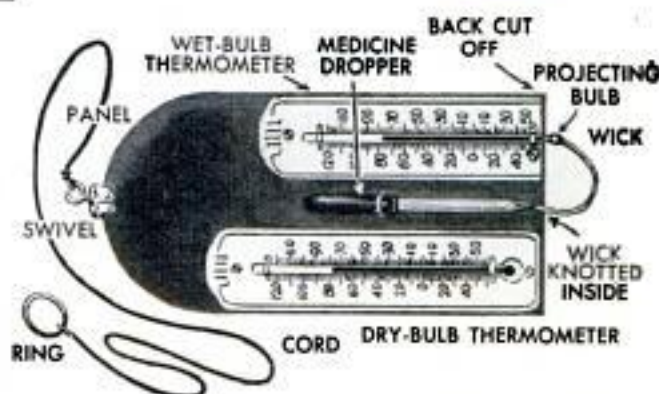

For example, if the dry-bulb reading was 70 deg., and the wet-bulb reading was 55 deg., the difference between the two would be 15 deg. Looking down the left-hand column of the humidity table, we find the dry-bulb reading of 70 deg. Then we go across on this line to the column headed "15," which is the difference between the two readings. The figure given in this column shows that the relative humidity is 37 percent.

Covers on Jaws of Pipe Wrench Permit Use on Chrome Fixtures

In an emergency, a pipe wrench often can be used to turn a chrome-plated nut or fixture by covering the teeth of the jaws with a soft-metal cover. Aluminum, brass or copper may be used, as it will not mar the chrome if used carefully. The covers can be shaped so that they snap over the pipe-wrench jaws and stay in place by tension.

☛ A nail dipped into colorless nail polish before it is driven will "stay put" longer. And screws that work loose can be replaced permanently if the polish is brushed into the hole before resetting the screw.

SN 56

fine finishes

for fir

and other SOFTWOODS



Monsanto Chemical Company photo

By Sam Brown

FIR PLYWOOD can be finished so it is satin-smooth to the touch and handsome in appearance if the correct finishing materials are used properly. Most important of these materials is a phenolic-resin primer-sealer, a penetrating type of finish that dries in the wood and equalizes the density of the hard and soft grains. Paint-

ing or staining wood treated in this manner results in an even tone without the dark and light streaks which usually result on untreated wood.

Natural fir: A natural finish on any wood means that it is finished with only a clear top coat and is not stained or colored in any way. To apply the natural finish, first sand the wood smooth, finishing with a 3/0 garnet sandpaper. Apply clear phenolic-resin primer-sealer with a brush, mop or cloth. Let it dry for 5 min. or until some areas start to dry and show "flat." Then, with a soft cloth, rub the wet areas into the dry area and finally rub the whole job with long strokes, parallel to the grain. The finish will be dry enough to permit moderate handling, but must be dried for at least 8 hr. before it can be sanded. When it is thoroughly dry, sand lightly with 6/0 garnet. Brush or wipe off the sanding dust and apply any conventional clear topcoat such as shellac, varnish or lacquer. Because the wood has been well sealed with the phenolic-resin solution, only one coat of the top dressing is required, especially if the finish is to be protected with a coat of furniture wax.

Enamel finish: Paints and enamels can be used to provide an excellent finish on fir if the wood is given a suitable undercoat

MATERIALS

PRIMER-SEALER: As applied to plywood, primer-sealer is a phenolic resin in solution with tung oil and mineral spirits. Sold as a trade-name product (Rez, Firzite, etc., and also as Plywood Sealer, Floor Sealer, etc.) Many of the so-called "penetrating wood finishes" are the same material. Light amber in color; very fluid, is almost the consistency of water.

COLORED SEALER: Primer-sealer as above, with pigment coloring added. Sold in several shades of red, green and gray.

WHITE SEALER: Primer-sealer with white pigment added.

COLORS-IN-OIL: Available at all paint stores in tubes, cans. May be added to clear primer-sealer to produce desired color.

SANDPAPER: 3/0 garnet for bare wood. 6/0 to sand all finish coats; alternate use of 2/0 steel wool is practical.

CLOTH WIPER: Cheesecloth or other soft, clean cloth.

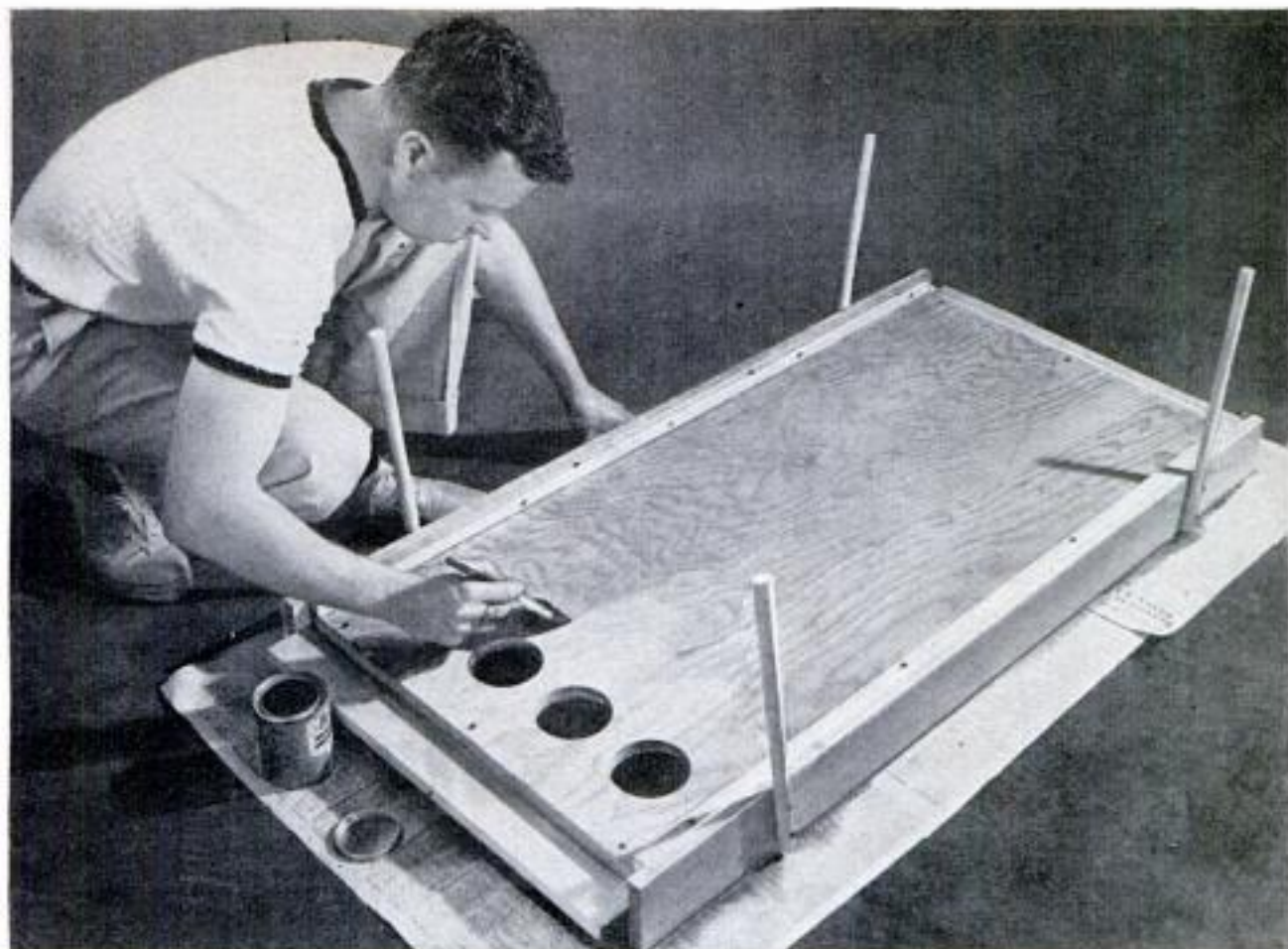

Douglas Fir Plywood Association photos

Above, phenolic-resin primer sealer is first coat on bare plywood. Right, center, when primer-sealer is completely dry, it is sanded with 6/0 garnet. Bottom photo, finish coat is applied after sanding

of either clear or white phenolic-resin primer-sealer. One coat of enamel over the primer-sealer often is enough to provide a satisfactory finish. The top photo on this page shows clear primer-sealer being applied. Notice that the bottom of the table is being sealed, as well as the surfaces that will show. When dry, the primer-sealer is sanded or steel-wooled, center photo. The bottom photo shows the finish coat of enamel being applied.

Blonde toning: A lighter-than-natural finish can be given to fir plywood by applying a coat of white primer-sealer, which is wiped off after drying for about 5 min. After it has dried for 8 hr. it is sanded with 6/0 garnet paper. Apply a coat of clear varnish. When the varnish is dry, rub it down with 4/0 steel wool and apply a coat of paste furniture wax. Although the over-all tone of the wood will be quite light, the grain pattern will be distinct.

If a blonde tone with less grain pattern is desired, first apply a coat of clear primer-sealer and let it dry thoroughly. Next, apply the white primer-sealer and wipe it off. Allow the wiped coat 8 hr. to dry, then cover it with clear varnish, as with the other blanding method.



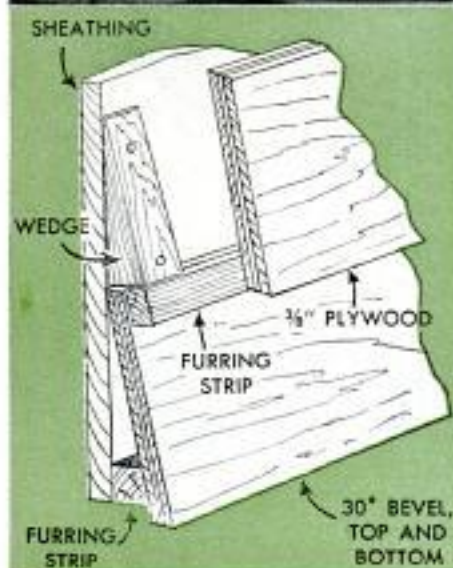

Exterior-grade fir plywood can be sealed with clear primer-sealer. A more common procedure is to use a regular grade of exterior primer thinned with 1 pt. of raw linseed oil per gallon of house paint

If you wish to use the blonde finish on a piece of furniture or other fir-plywood surface, experiment on scraps of plywood to determine which of the two finishes you will like the most.

Color tones: A wide variety of color tones can be applied to fir plywood and other soft woods. Phenolic primer-sealer is available in many colors, as well as clear or white. Also, you can add colors-in-oil or oil stain to either clear or white primer-sealer. If the tube oil colors are used, mix the color pigment separately with a little turpentine or mineral spirits until the solution is fluid enough to combine readily with the primer-sealer. Deeper colors will, of course, require a greater proportion of color pigment; lighter shades or tints will require less. Also to be remembered is the fact that most pigments have a greater intensity when dry than when wet. Allow a sample of the colored stain or sealer to dry thoroughly before judging the color.

Uniform color tones with a subdued-grain effect are usually obtained by using two coats of the desired color. The first coat is wiped off while still wet. The second coat then is applied over the dried first coat and blended with a brush or soft cloth. This color-toning method will produce a flat fin-

ish which must be covered with a coat of varnish, shellac or lacquer to produce a surface gloss.

Exterior fir: Clear or white primer-sealer makes an excellent first coat for exterior plywood. Alternately, the common method of using a good exterior primer thinned with raw linseed oil can be used. It is most important to seal all edges on exterior plywood, and this operation often is done more easily before assembly as shown in the inset photo above.

The detail below the photo shows a method used to apply plywood strips to form a "bevel siding" effect. For best results, the furring strips and wedges should be painted before they are covered.

Outdoor furniture made of fir plywood should be given a first coat of primer-sealer to assure protection for the wood.

Other woods: Primer-sealer is effective on all woods. It is used on pine, redwood and cypress in exactly the same manner as on fir. It is not as satisfactory on open-grain hardwoods, although it is effective as a pigment stain over a paste filler. When used as a color toner on close-grained hardwoods, it is applied to the bare wood. More than one coat is used when a deeper tone is desired. ★ ★ ★

Warped and Sagged Storm Door Corrected by Single Brace

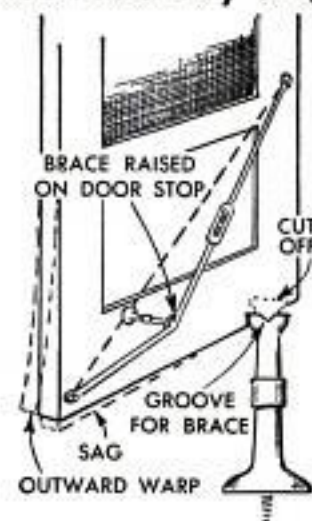

When a combination storm door develops an outward warp and sag near the bottom of the opening edge, a single turnbuckle brace and metal doorstop will correct both troubles. The turnbuckle brace goes on the inside of the door, diagonally upward from the lower corner of the opening edge. The

doorstop is modified by cutting off the portion that holds the rubber bumper, and filing a groove in the stop to receive the brace. The stop then is placed at the center of the warp and the brace is tightened.

Improved Holder for Flag Utilizes Pipe Clamps



Wishing to fly the flag for a holiday, but not having a regular flagstaff holder, one homeowner improvised one by using two $\frac{1}{2}$ -in. pipe clamps. The clamps are screwed to a window frame, porch column or other convenient location. A nail, slipped

into a hole drilled in the flagstaff, provides a bearing pin which rests against the top clamp and holds the staff in place.

Paul Smith, Portland, Oregon.

Washer Under Clothesline Knot Holds in Oversize Hole

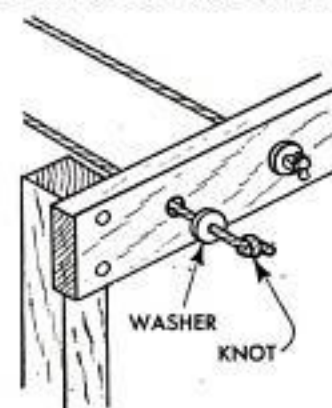

If a bored hole in a clothesline support is oversized and lets the knotted end of the line pull through, a steel washer solves the problem. Use a washer that will slip over the rope, but not through the hole.



Envelopes Are Sealed Faster With Felt Dauber

When sealing a large number of envelopes, such as wedding invitations or Christmas cards, you can use the felt dauber from an empty shoe-polish bottle to speed the work. Wash the bottle and dauber and put in a small amount of water. A quick sponge with the wet dauber across each envelope flap will moisten it for sealing.—Blanche Campbell, Las Vegas, Nev.

Heating Element of Soldering Iron Can Be Repaired Temporarily

When the heating element of an electric soldering iron has parted, it can be repaired temporarily to provide several hours' service. First, carefully disassemble the iron and examine the wire for the break. Then gently twist the broken ends together with tweezers or pointed-nose pliers. A new element should, of course, be installed as soon as it is practicable.

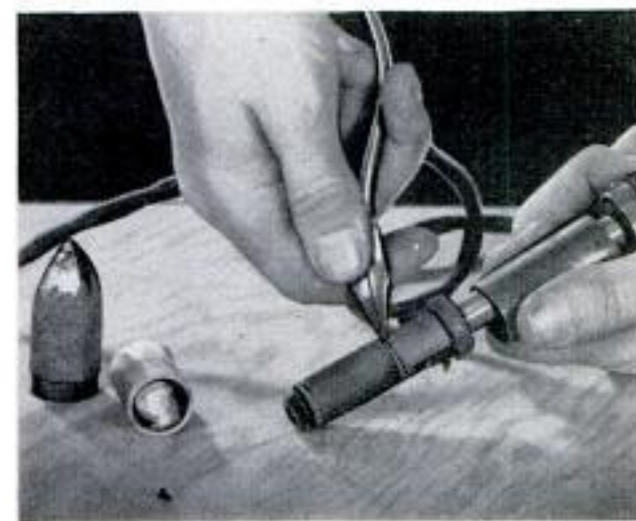

RUBBER-STAMP

WTM 56

Christmas Cards

By Theodosia Carpenter



Above, melted beeswax is poured on glass of picture frame to a thickness of $\frac{1}{8}$ in. Use only beeswax.



Above, a series of snowflake designs is cut in wax with stylus. Each flake can be printed in different color on Christmas card if mounted on individual blocks. Below, liquid rubber is poured over design.



MAKING YOUR OWN Christmas cards is fun, it's easy and it's inexpensive when you cast your own printing blocks in rubber. With this novel method you can produce personalized cards that really say "Merry Christmas" to your friends. The materials needed to make these printing blocks are an inexpensive "dime store" picture frame, beeswax (obtainable at most drug or hardware stores) and a supply of liquid rubber which can be bought at hobby shops and art-supply stores.

The beeswax is melted and poured over the glass of the picture frame to a depth of about $\frac{1}{8}$ in. Be sure that the glass is tight in the frame so that the hot wax will not run out. And note, too, that only beeswax can be used. Paraffin and other common waxes are too brittle. If the beeswax is uneven or too thick, the excess is scraped off to make a level surface.

Next, the design you have selected is traced lightly on the surface of the wax, using carbon paper. You can make original



sketches or use designs obtainable from a number of sources. The two patterns at the bottom of page 190 are typical card designs you can use. Now the lines of the design are cut into the wax with a regular stylus or with a very hard pencil sharpened to a moderately fine point. Each line of the design must be cut clear through to the glass, and the stylus should be held vertical as the cuts are made. The progress of the work can be checked by holding the frame to the light. Only those portions of the design where the glass is completely free of wax will print in the final design.

When this beeswax mold is completed, a very thin layer of liquid rubber, sometimes called latex molding compound, is poured over the design. The thinner this first layer is, the better the results will be. After pouring, hold the frame up so the underside of the mold is visible and, with the fingers, work the liquid rubber into any portions of the design which may not have been completely filled. Remove any bubbles, then allow the rubber to set 12 to 24 hours.

Pour another layer of liquid rubber, somewhat thicker than the first, over the hardened layer and allow this to set also. Now the rubber casting can be pulled away from the beeswax mold. Clean any wax from the completed plate. Then, using rubber cement, mount the printing plate on a smooth block of wood.

Use water-soluble linoleum-block ink to print with your cast-rubber printing block. The ink comes in a tube. A small amount is squeezed onto a sheet of glass, and a roller is moved back and forth on it until the ink is evenly distributed. Then it is rolled across the printing block. With the paper resting on a hard, smooth surface, the block is pressed down on it, in the same way that a standard rubber stamp is used. If, in printing the first picture, you find that the rubber plate is taking up ink and making smudges between the lines of the design, remove the plate from the mounting board and cut out the excess rubber between the lines.

When two or more colors are desired, make the whole design in one casting. Then cut out the portions of the design to be printed in each color and mount these on separate blocks. In this case, the blocks should be of exactly the same size. A T-square or the corner of a box should be used to help align each block. ★ ★ ★

DECEMBER 1954



After the liquid rubber has set, above, it is pulled away from the beeswax mold. All wax is cleaned from the plate.



Above, using rubber cement, the finished printing plate is mounted on a wooden block. Below, after inking with linoleum-block ink, the printing block is used like a regular rubber stamp to reproduce the original design.

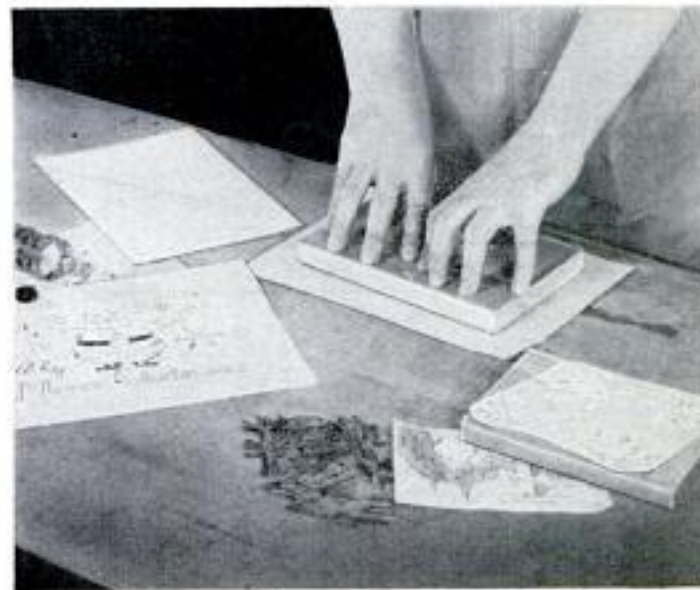

191

Copyrighted material

Rabbeted Molding Nailed to Wall Provides Picture Display



A simple mounting for displaying a number of photographs or paintings can be made by nailing two strips of rabbeted molding to the wall with finishing nails. The molding should be spaced to accept the largest picture that will be displayed; smaller pictures can be framed in matboard cut to fit. The rabbet in the molding should be wide enough to accept a pane of glass as well as the pictures.

Easy Way to Draw Stars

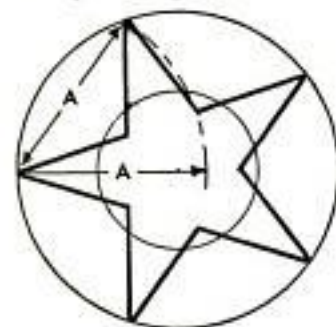

Although drawing a five-pointed star might seem difficult, it actually is quite easy. First, scribe a circle having a diameter equal to that of the desired star. Next, using the same center, inscribe a circle having a diameter one half that of the first one. Then set the compass points to a distance equal to the radius of the large circle plus $\frac{1}{3}$ the radius of the

Weave Your Own Cloth...

Handweaving once was a necessary skill in every American household. Now it's back again, this time as a creative and practical hobby that permits you to make your own material for suits, skirts, topcoats, etc., in your home at a surprisingly low cost. Read the story about the loom that makes this possible in next month's issue

small circle, line A in the detail. Walk the compass around the circumference of the large circle, marking each point of contact. Now join opposite points with straight lines to form a five-pointed star.

Hinge and Nail Used as Punch To Make Holes in Leather

In the absence of a leather punch a butt hinge and a nail can be used as a substitute. The nail, which must be a snug fit in a screw hole of the hinge, is ground or filed square across to form a sharp edge. The material to be punched is placed between

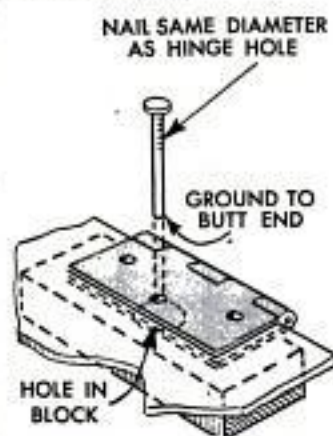

the folded leaves of the hinge which then is located over a hole or slot in a block of wood. A hammer is used to drive the nail through.

Sheet-Metal Guard on Ax Prevents Damage to Handle

There will be no more kidding about the "beavers chewing your ax handle," if a metal shield is nailed around the handle close to the head. This part of the handle is subject to nicks and splintering, and such a guard will eliminate frequent replacement of the handle. Use heavy sheet metal and drill it for the nails. A neater job can be done by using copper or brass rivets.

E. R. Haan, Evanston, Ill.



☐ A drop of water carefully placed on the top surface of a genuine diamond will remain in globule form, but will spread out if the stone is glass or paste.

Six Projects USING TILE

By Bertram Brownold

COMBINING COLORFUL TILE with hardwood, plywood and metal offers the home craftsman a new field of interesting projects. Two kinds of tile can be used for these projects. The first is glazed ceramic tile, which may be purchased either plain or with painted pictures under the glaze. The latter, of course, is the more expensive variety. The plain glazed tile may be decorated by hand-painting or with easily applied decals which afford a wide selection of designs.

The other type of tile available is the colorful plastic group of the type ordinarily used for wall covering. These come in many solid colors and a variety of marbled finishes. They are available in several sizes, are easy to work and are especially suitable for those projects where the tile has to be cut. This tile, of course, is not satisfactory for use on projects where it is likely to be exposed to considerable heat. Neither is it recommended for tray or table tops where it is likely to be scratched or

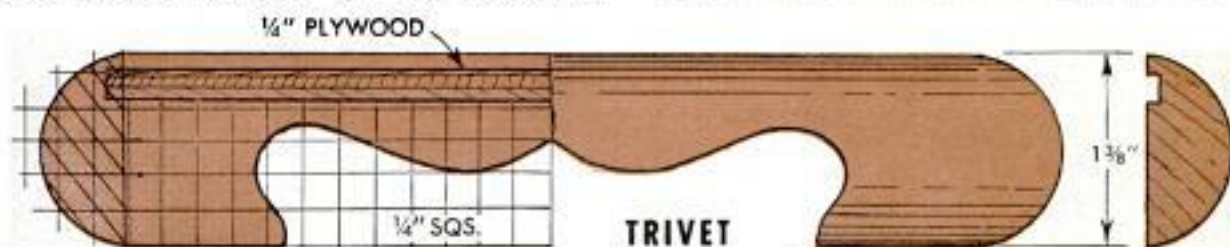
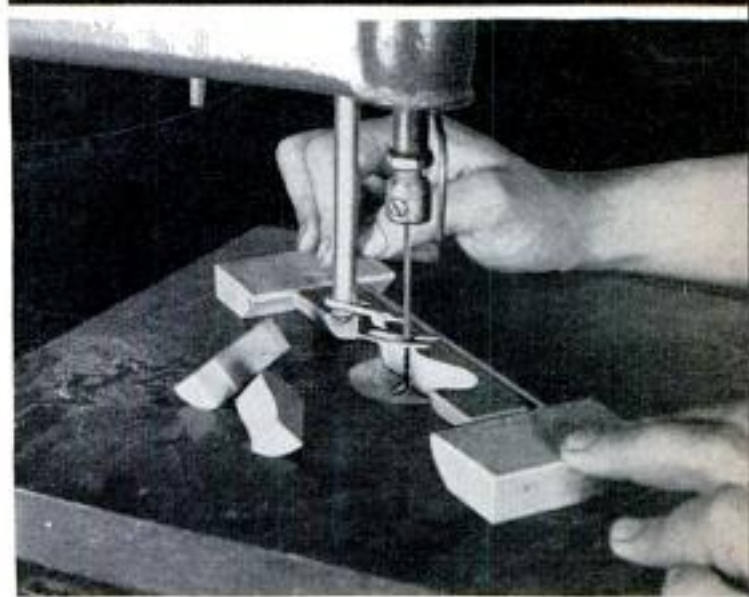

Trivet for hot dishes is made from half-round molding, plywood and a 6 x 6-in. ceramic tile. The trivet base consists of four pieces of molding, each piece being 7 1/4 in. long after the corners have been mitered. Before the corners are mitered, however, the molding is grooved 1/4 x 1/4 in., a distance of 1/4 in. from the top edge. This groove receives the edges of a 6 1/4-in.-sq. panel of 1/4-in. plywood. After mitering, the molding is jigsawed according to the squared

pattern above. As shown in the photo directly above the detail, the molding section may be held level for jigsawing by nailing a block to each mitered end, the block being beveled 45 deg. to match the miter. Blocks are nailed and glued in the corners of the trivet base as in the photo below. When the base has been finished, a ceramic tile is cemented over the plywood. A plastic tile should not be substituted in this case because it would be subjected to much heat

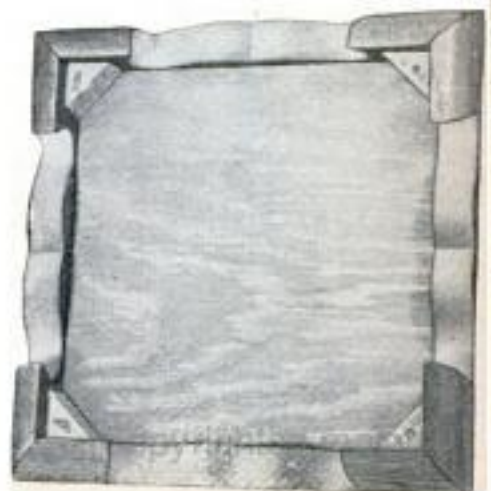
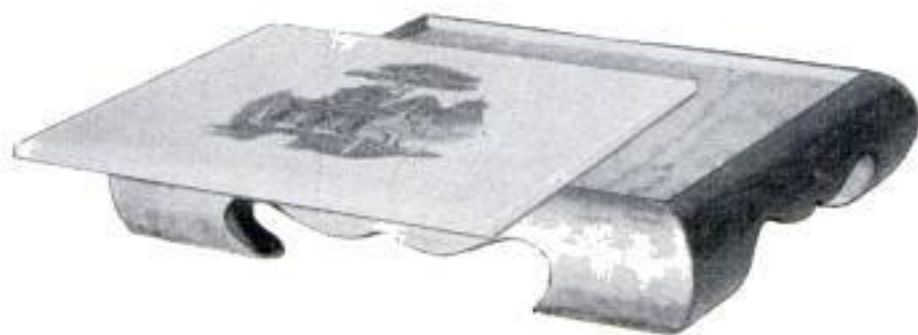

SHADOW BOXES

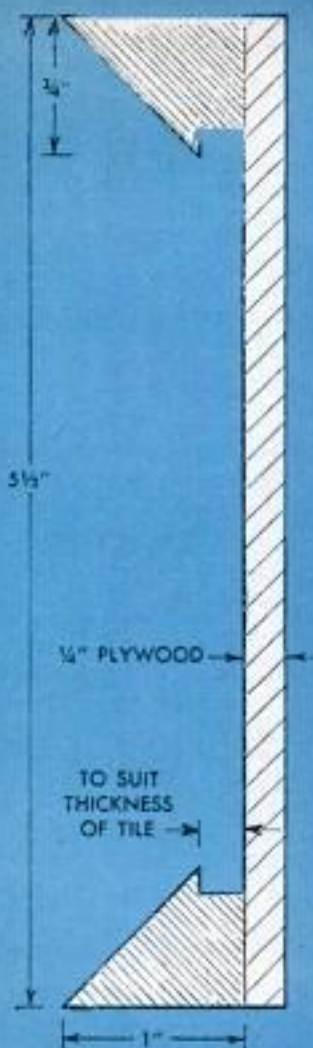
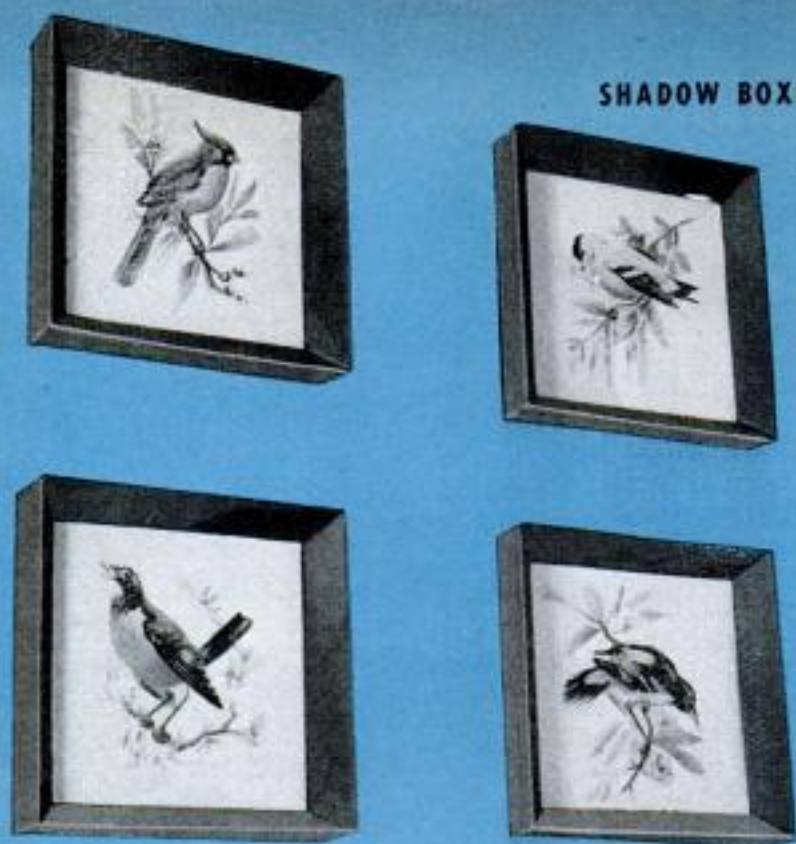

Mounting ceramic tiles in shadow-box frames provides an interesting and unusual wall decoration. The frames are made from beveled molding and $\frac{1}{4}$ -in. plywood as shown in the detail at the right. The molding is rabbeted to receive the edge of the tile and the four corners are mitered. Nailing the plywood backing to the four pieces of molding holds the joints tight. Paint the molding black or in a color that harmonizes with the tile pictures before assembling the frames. Then set the tile inside the frame and attach the plywood backing

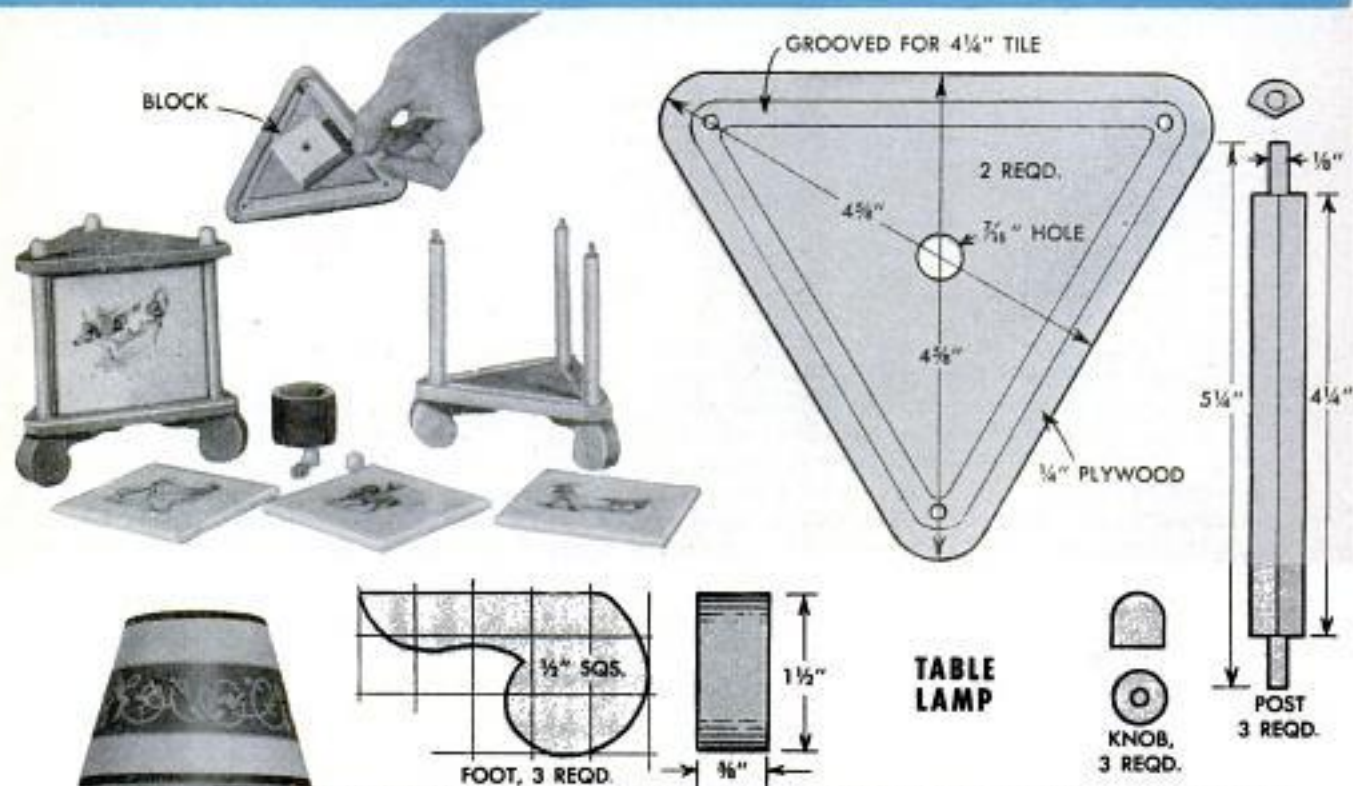

Table lamp for child's room features three ceramic tiles on a triangular-shaped lamp base. The base consists of two triangular pieces of $\frac{1}{4}$ -in. plywood cut to the dimensions given in the detail. These are grooved to receive the tiles and drilled for tenons cut on the ends of three posts. The latter may be $\frac{3}{8}$ -in. dowel or $\frac{3}{8}$ -in.-sq. stock. Jigsawed feet are added and wooden knobs are fitted over the post tenons after assembly



PLANT BOX



This attractive plant box is faced with a decorative ceramic tile set in a contrasting frame. The box, which will handle a fair-sized potted plant, is made of $\frac{1}{2}$ -in. plywood or lumber. Note that tongue-and-groove joints are used in assembling the sides of the box and that the corners of the base are mitered. The bottom of the box may be glued and bradded between the side members or set in grooves cut horizontally near the lower edges of the sides. The molding for the tile frame is beveled and rabbeted to receive the edges of the tile. The frame is painted and the tile dropped in place before the top piece of molding is applied. The handles are of sheet brass, copper or aluminum and bent to form a finger grip

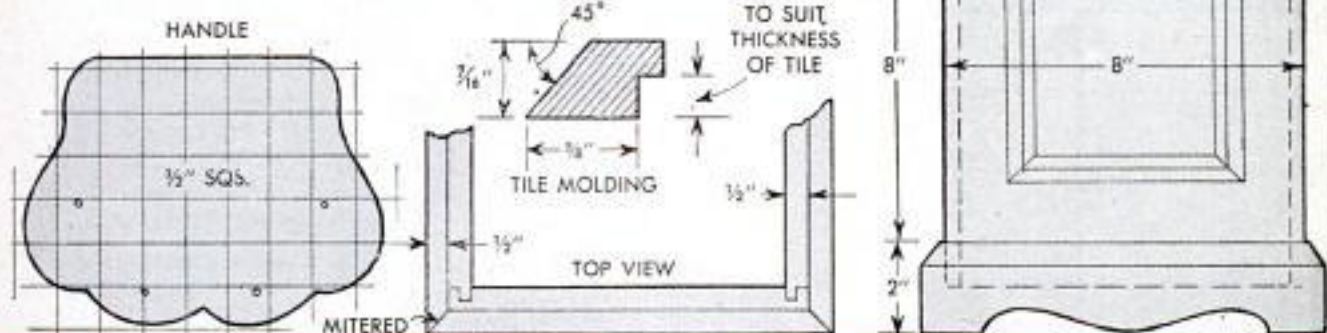

SERVING TRAY

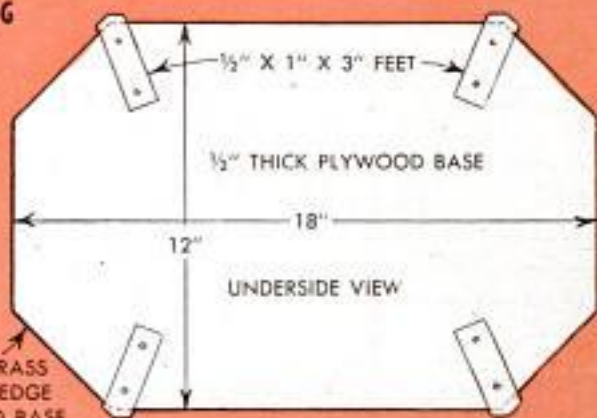

Six plastic or ceramic tiles and eight pieces of plywood make up the geometric design covering the top of this serving tray. The base of the tray is a 12 x 18-in. panel of $\frac{1}{2}$ -in. plywood cut as shown in the detail. Nail a length of 1-in.-wide sheet brass around the edges of the panel to form the sides of the tray, using brass escutcheon pins. The ends of the brass strip overlap about $\frac{1}{4}$ in. and are riveted together. A pair of twisted-wire handles is anchored to the tray by means of pieces of sheet metal screwed to the underside of the plywood. The feet are 3-in. lengths of $\frac{1}{2}$ -in. stock

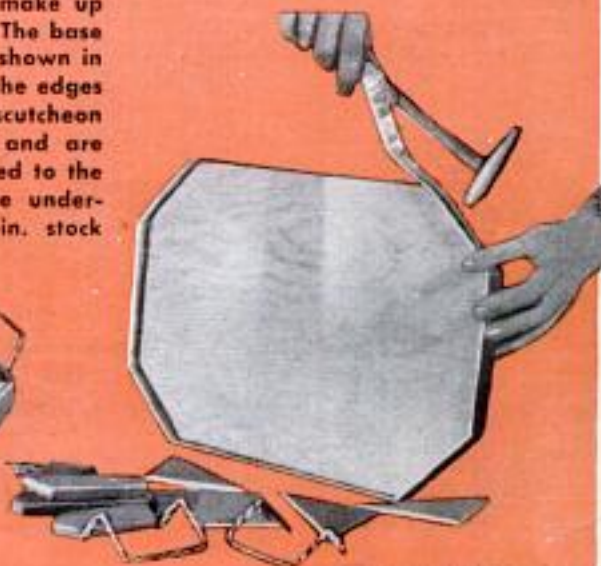

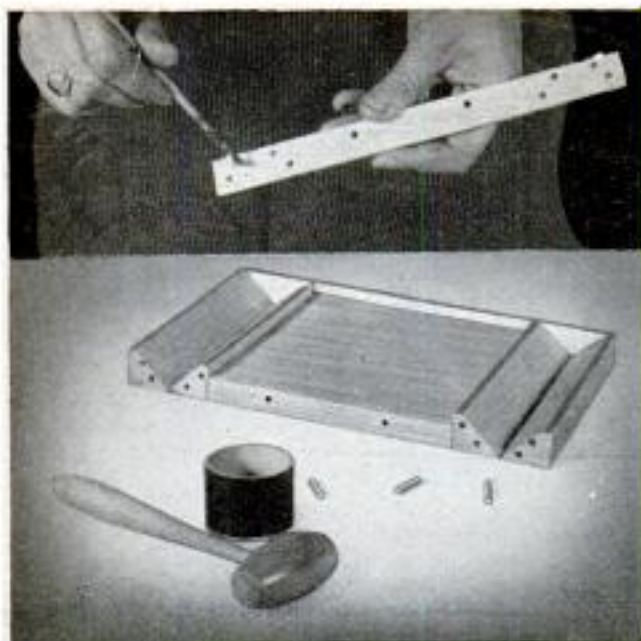

The cheese-and-cracker server features novel dowel-peg construction. Five pieces of hardwood form two cracker troughs and base for tile tray

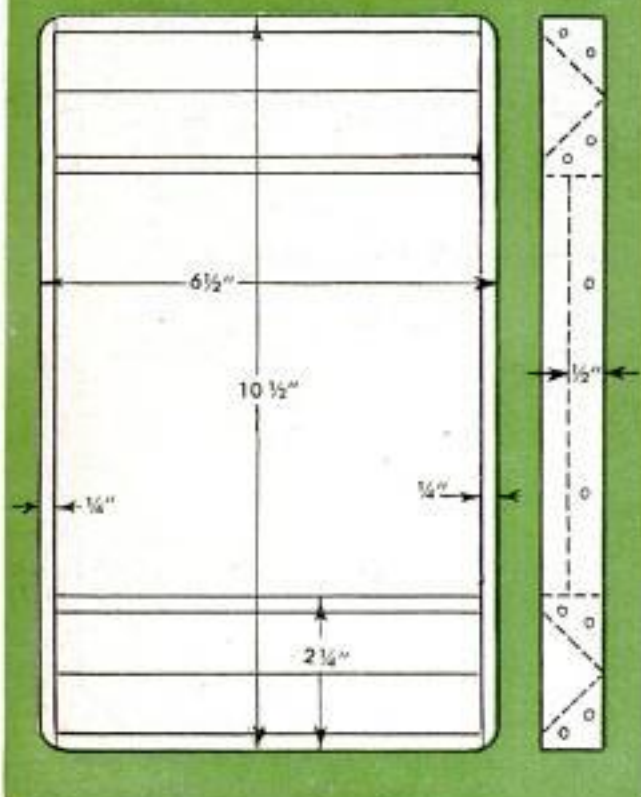

scored. In most other cases, however, the plastic tile can be substituted for the ceramic tile if you like. Decorative decals also may be applied to the plastic tiles, which are then given a coat of lacquer.

Neat workmanship and careful finishing are important to the appearance of the project and, of course, enhance the interest of the tile itself. As far as finishing is concerned, you probably will want to paint the wooden portions of the projects or use a wood stain followed by a clear finish. If hardwood or hardwood-faced plywood is used in the projects, it preferably is finished natural.

You will find that either a pigmented oil or nongrain-raising stain will do for this type of finishing. The pigmented oil stains are excellent for softwood as well as certain close-grained hardwoods, such as maple and birch. The nongrain-raising stain is best when finishing any of the open-grain woods. The stains may be coated with shellac, lacquer or varnish after they have dried thoroughly. This requires anywhere from 30 min. to a couple of hours depending on the stain used. Then the finish may be rubbed and polished to a final high gloss. ★ ★ ★

CHEESE-AND-CRACKER SERVER

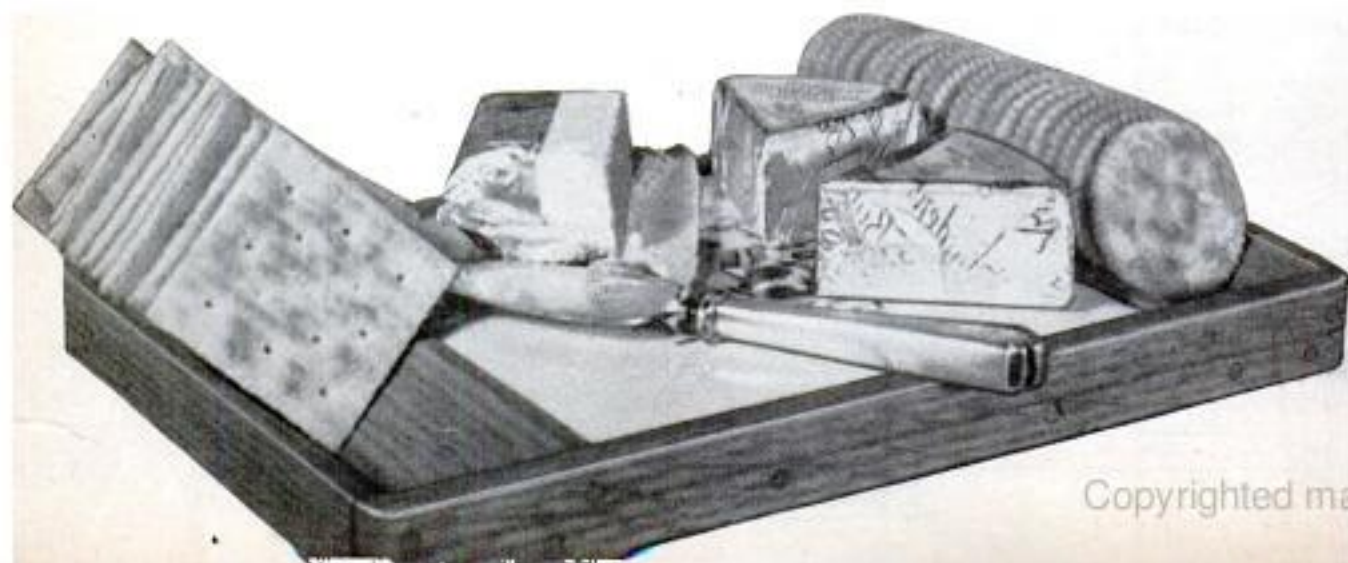

Wedge-Shape Ice-Fishing Shelter Is Light and Portable

Overcoming the disadvantages of most ice-fishing huts, this neat little shelter may be rolled up to carry under your arm or stored in the trunk of your car, and its wedge shape offers little resistance when pointed into the wind. The uprights are 1-in. dowels, fitted with $\frac{3}{8}$ -in. steel pins at both ends. The cross-pieces are drilled to fit over the pins and the canvas covering is fitted with grommets for the same purpose. Roundhead screws near the lower ends of the uprights project enough to catch in the grommets on the bottom edge of the canvas. A

drill to make holes in the ice for the steel pins at the lower ends of the dowels is nothing more than a 6-in. length of $\frac{1}{2}$ -in. steel tubing with notches or teeth filed in

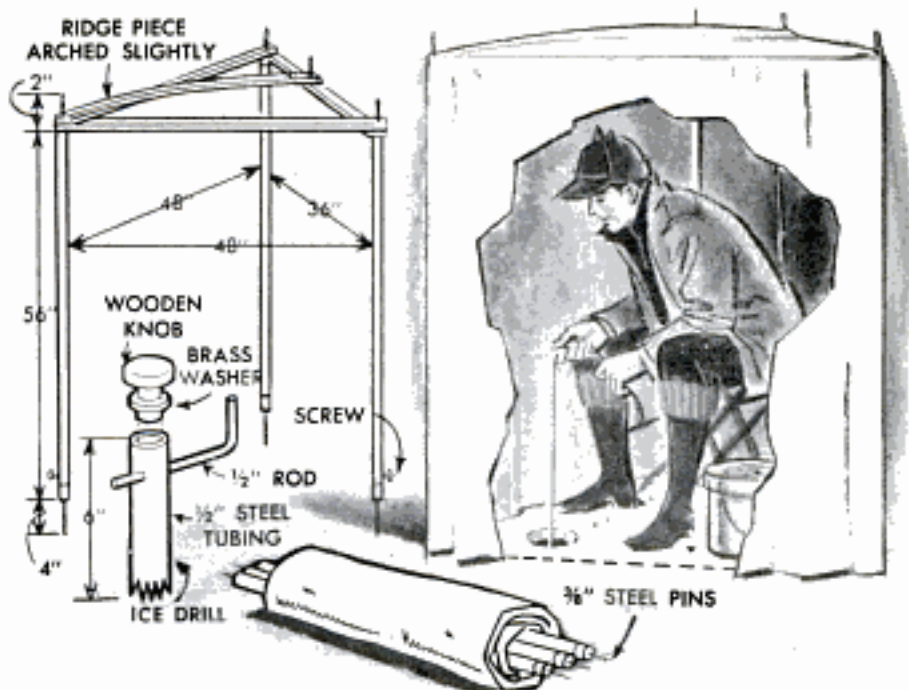

the lower end. The wooden knob, or handhold, turns on a brass washer as the drill is forced into the ice by the crank.

Hi Sibley, Nuevo, Calif.

Doll's Lost "Eyesight" Restored With Wooden Support in Head

A simple wooden support often will restore the "sight" to a doll whose movable eyes have been poked back into its head. The reason for the eyes falling out is that one or both of the recesses molded inside the doll's head to receive the ends of the eye spindle have been broken. To restore the eyes, remove the doll's head from the

body, tip the head forward and replace the spindle in the broken recesses. Next, cut a wooden strip slightly longer than the distance from the back of the head to the spindle. File or grind a slight radius in the end of the support and lubricate it with a drop of oil. Gently force the support into the head against the spindle. Some adjustment may be necessary. If the support is too long it will bind and the eye spindle will not turn.

Basil Jackson, Toronto, Ontario, Can.

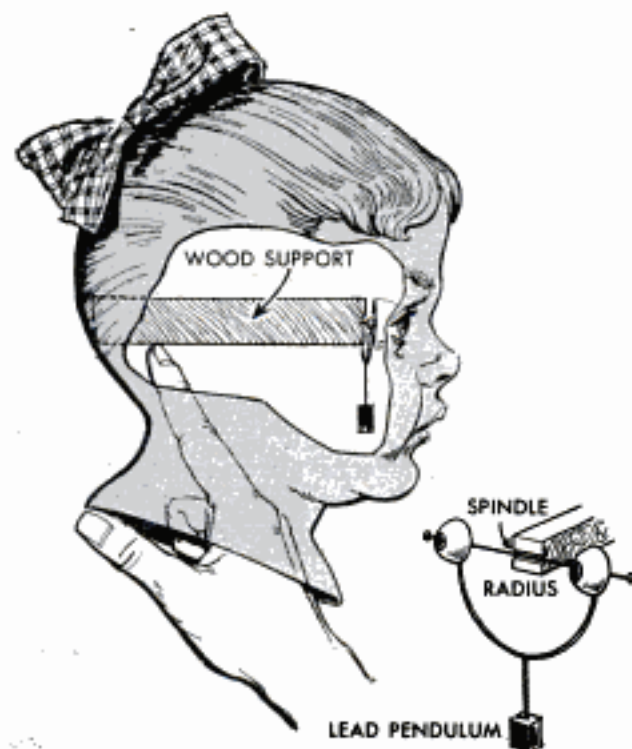

Valve Cap Carried on Pencil

Screwed to the end of a round wooden pencil, a valve cap used to remove inner-tube valve cores will not be easily mislaid. A clip on the pencil will permit carrying it conveniently in the breast pocket of overalls. The cap is forced onto the end of a pencil which has no eraser, and the metal of the cap will cut threads in the soft wood of the pencil body.

G. E. Hendrickson, Argyle, Wis.



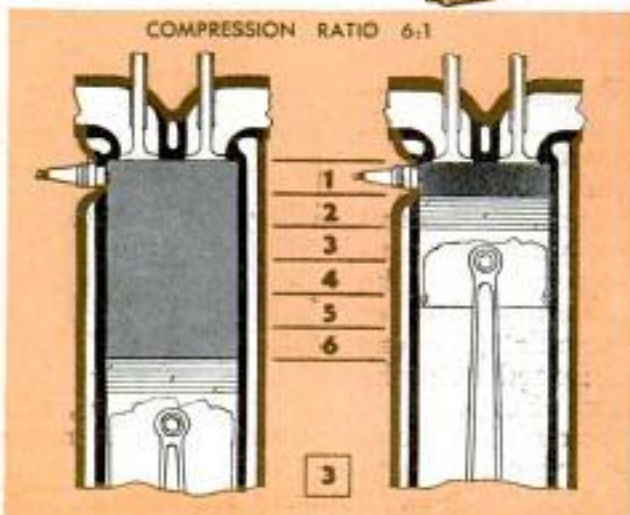
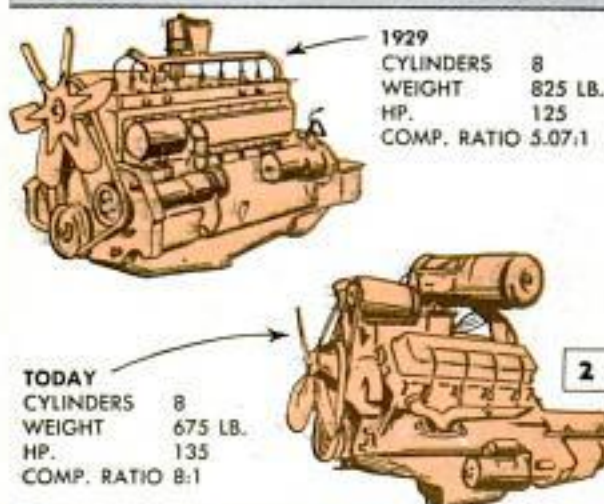
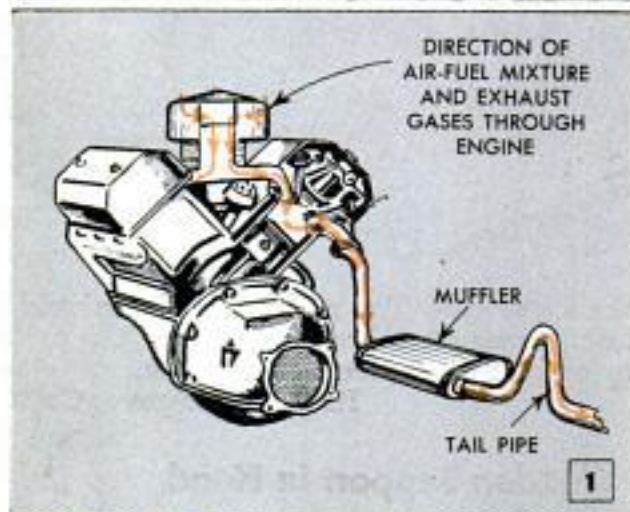

New Cars Combine ECONOMY *with* PERFORMANCE

By Ed Packer

THRILLING NEW SNAP and go have been given to your new car through hidden mechanical improvements of which you may not be aware. But you can't help but be aware of the nimble getaway and the impressive economy of fuel and lubricants throughout the average driving range. All functioning parts of the car—engine, ignition, transmission, overdrive and rear axle—have been re-engineered to produce these results.

For example, a tremendous amount of experimentation and design skill have been devoted to facilitating the passage of fuel mixtures and gases through the engine, and the result of all this effort is a marked increase in power and performance. Improvements have been made in air cleaners, carburetion, manifolding and muffler construction, as shown in Fig. 1. One of the improvements resulting in high performance with economy is the steady increase in engine power and a corresponding decrease in the weight of the unit. Note the comparisons in Fig. 2 and Fig. 3. Although the fundamentals of four-cycle engine operation have not changed appreciably, the constant increase in the compression ratio has stepped up the power output proportionally. Heat and pressure within the combustion chamber at the top of the cylinder have risen with the compression ratio resulting in much higher efficiency. The position and relation of engine parts on the intake, compression, power and exhaust strokes are shown in Figs. 4 to 7 inclusive. From these it can be seen that

uniformity of compression in engines of the latest types is of the greatest importance. Engineers and mechanics generally agree that the maximum allowable variation in compression pressures is 10 lb. or less. This means that valves, rings, pistons, plugs and head gaskets must be maintained in first-class condition; otherwise the engine cannot be properly tuned for peak performance. A simple calculation will make clear what a 10-lb. variation can mean. This value represents about 10 lb. per sq. in. Taking the average area of the piston as 10 sq. in. this adds up to a 100-lb. variation in pressure. When the charge is fired, the increase in pressure can build up to 400 lb., which is about the maximum variation the average engine can handle without becoming noticeably rough and inefficient.

It takes a lot of air to keep an engine running smoothly and efficiently, 16 to 17 parts of air to 1 part fuel. Put another way, to burn 1 gal. of gasoline the engine requires about 1230 cu. ft. of air. These values will emphasize the importance of servicing the air cleaner, Figs. 9 and 10. Air cleaners are of the oil-bath type, Fig. 9, and the filter type, Fig. 10. In the oil-bath cleaner, dust particles are trapped in the oil reservoir and it is important to make sure that the oil is maintained at the correct level and, also, that it is changed at regular intervals to prevent an accumulation of "sludge" from building up to the bottom of the air-intake tube. In the filter-type cleaner the filter element should be removed regularly, washed in a solvent and reoiled according to instructions.

One of the products of combustion is water vapor and when this combines with certain other combustion residues present in the engine it forms an acid that will etch bright-metal surfaces. Approximately 1 gal. of water is produced for every gallon of fuel burned, Fig. 8. At operating temperature this remains in the vapor form and passes out of the engine through the tailpipe and the crankcase ventilating system, Fig. 12. However, short runs in cold weather are not always of sufficient duration to bring the engine to operating temperature. During the warm-up period there is a certain amount of blowby, Fig. 11. This passes the piston in the form of raw fuel and the products of incompletely burned fuel, particles of carbon and resins. Contamination of the oil in the crankcase results, as most of these by-products reach the crankcase in the liquid form rather than as a vapor, which would be removed by the ventilating system. When the car must be driven under these conditions, it is advisable to install a high-temperature thermostat in the cooling system and check

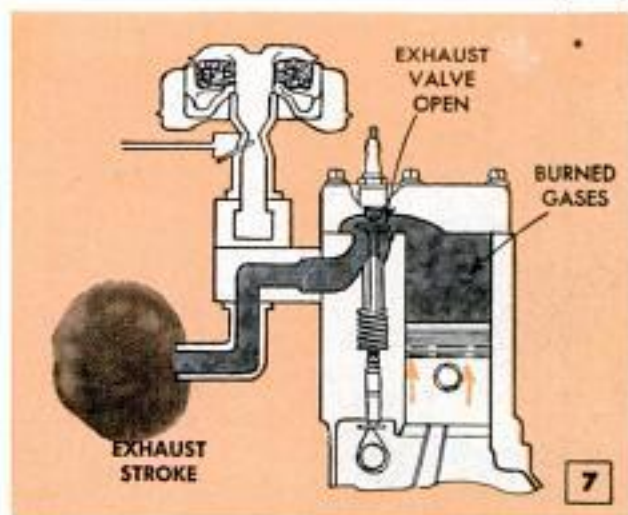
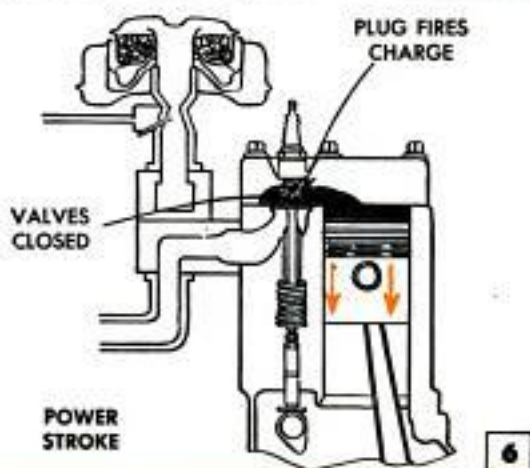
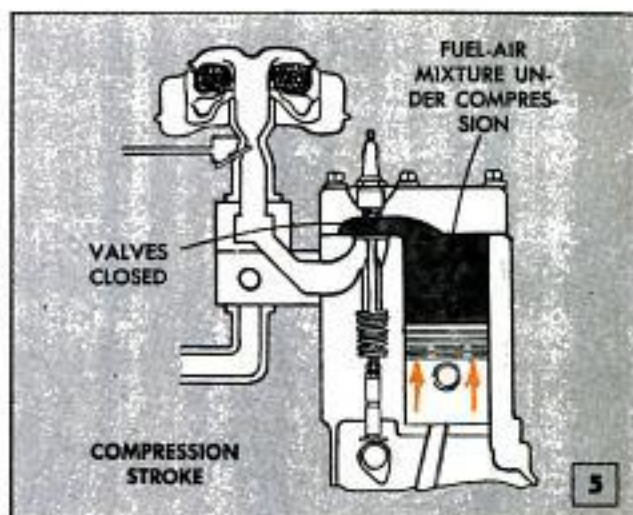
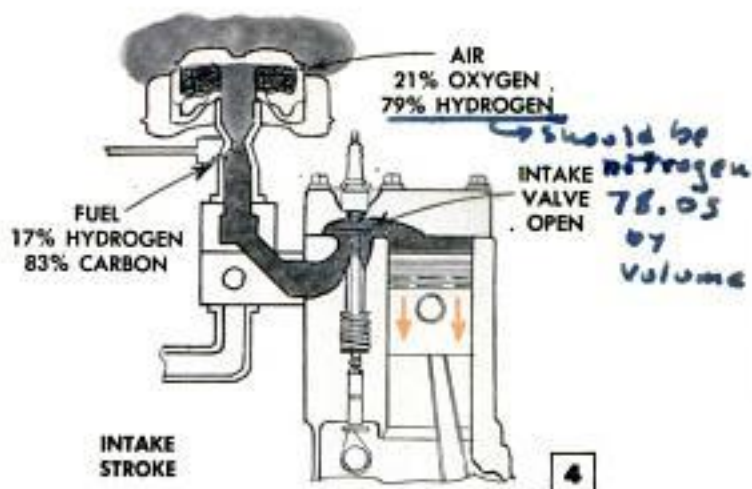

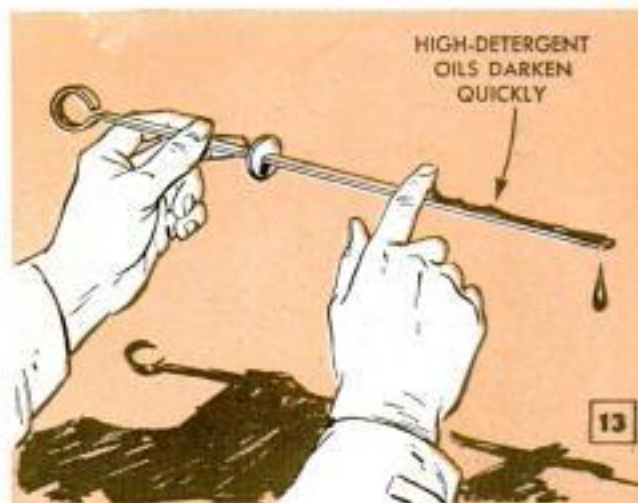
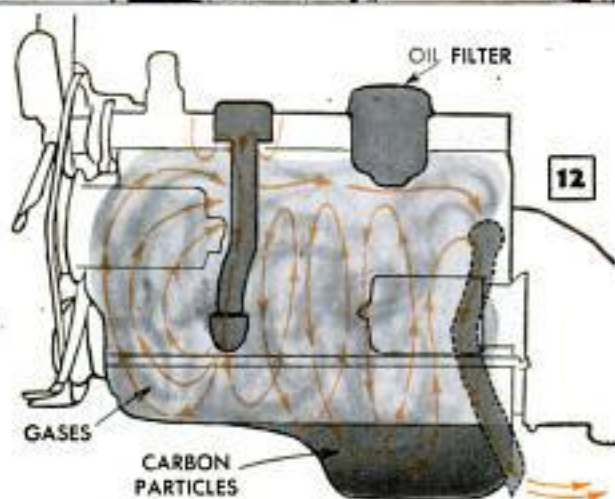
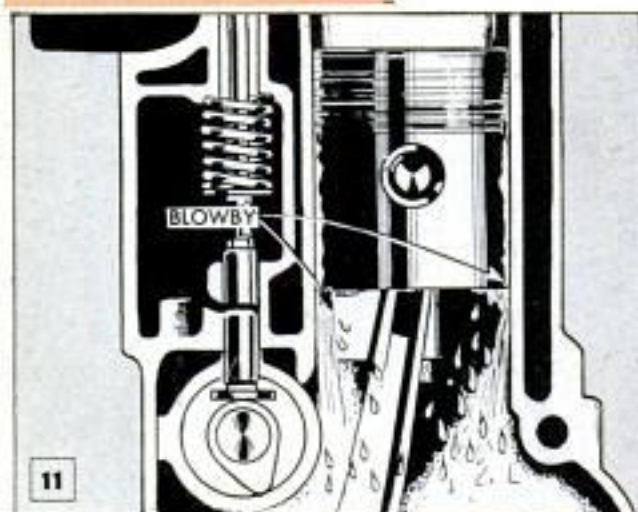
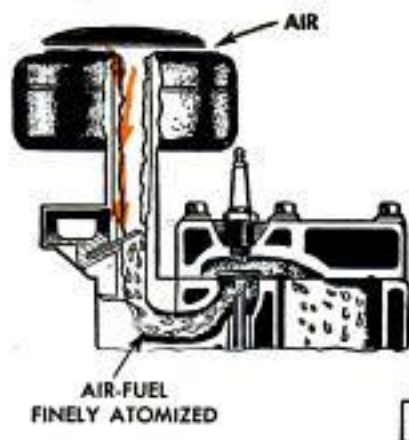
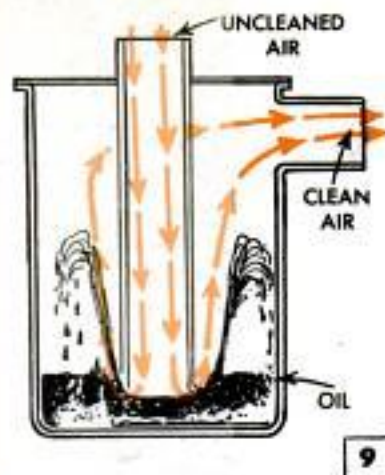
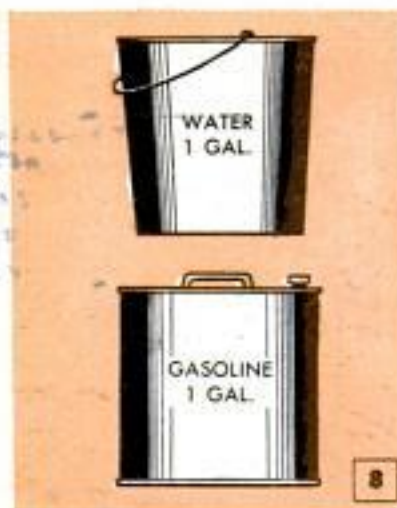

the heater valve on the exhaust manifold at regular intervals. These simple precautions will assure fast warm-up and less acid damage to the engine. Acid-neutralizing crankcase oils are often recommended for cars driven under these conditions.

Nearly all cars with automatic transmissions come equipped with hydraulic valve lifters. Any condition that tends to produce excessive formation of sludge will affect the proper operation of the lifters. On cars using the same oil in the transmission and crankcase it is necessary to change the oil filter every 5000 miles or less, according to the manufacturer's instructions. Cars driven far enough and fast enough to bring the engine temperature to normal and hold it at this level for a period of time will show very little wear due to sludging, even after many thousands of miles. High-detergent oils should be used according to the manufacturer's instructions. When used in accordance with recommendations they are good engine cleaners and, ordinarily, car owners need not be alarmed when an examination of the dipstick shows the oil to be quite dark a short time after an oil change, Fig. 13. However, in older engines in which a detergent oil is used for the first time, the oil on the dipstick may appear to be somewhat thicker than normal and also heavy with grit and carbon. When this is the case, bring the engine to operating temperature and drain and replace the oil immediately.

When there appears to be excessive sludging in an engine in good condition it's well to keep in mind the possibility of a leak through the cylinder-head gasket, Fig. 14. If the oil appears milky or just mildly cloudy, a gasket leak usually can be suspected. The gasket should be replaced.

Another cause of blowby and the resulting excessive formation of crankcase sludge is defective spark plugs, or the use of plugs of the incorrect heat range for the engine and the type of driving. Note the mechanical difference between the hot and

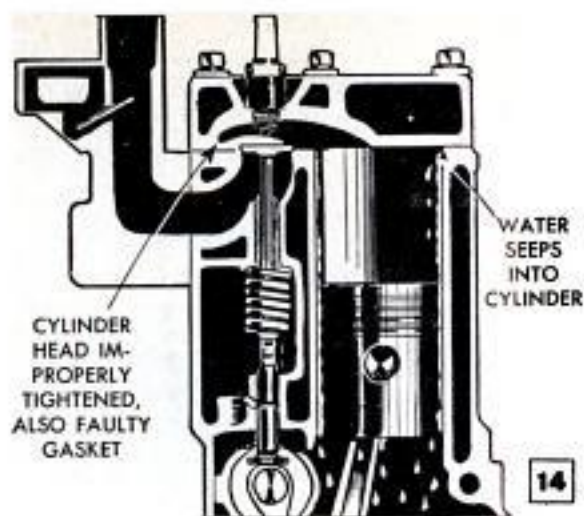

cold plugs detailed in Fig. 15. If you make long trips daily at cruising speeds you probably will be safe in using a cold plug both winter and summer. On the other hand, if most of your driving is intermittent and then only short trips, including an occasional long period of idling, use a hot plug. The tip of a plug that is firing regularly generally will be coated with a light-gray residue of an ashy consistency, Fig. 16. If the residue is white or blistered, the plug is running a little too hot. If the tip is black and sooty, the plug is too cold. However, it should be kept in mind that what appears to be a faulty condition of the plug may be due to an engine defect such as stuck or poorly seating rings, worn or burned valves and, in rarer instances, a clogged air cleaner. Such defects must be corrected for efficient plug performance.

All late-model car engines have a heat-control valve built into the exhaust manifold. Fig. 17 shows how this valve directs hot exhaust gases around the intake manifold to preheat the fuel mixture during the warm-up period. As the engine warms to operating temperature, the valve gradually moves to the fully closed position in Fig. 18, permitting the burned gases to pass directly through the exhaust manifold. The correct operation of this valve is essential for quick warm-up and smooth, economical operation of the engine. If the valve should stick in the open, or hot, position the engine will lose power and may overheat. This is due to overexpansion of the fuel charge before it reaches the cylinders. This, in turn, results in a loss of compression. If the valve sticks in the closed position there will be a waste of fuel nearly equivalent to that caused by running with the choke partially or fully closed.

Fig. 19 shows one type of heat-control valve. The location of the valve and the shape and size of the exterior parts varies in different cars. Check periodically to see that the weight moves freely. ★ ★ ★

Certain illustrations and technical information courtesy of Chrysler Corp., Ethyl Corp., and AP Parts Corp.

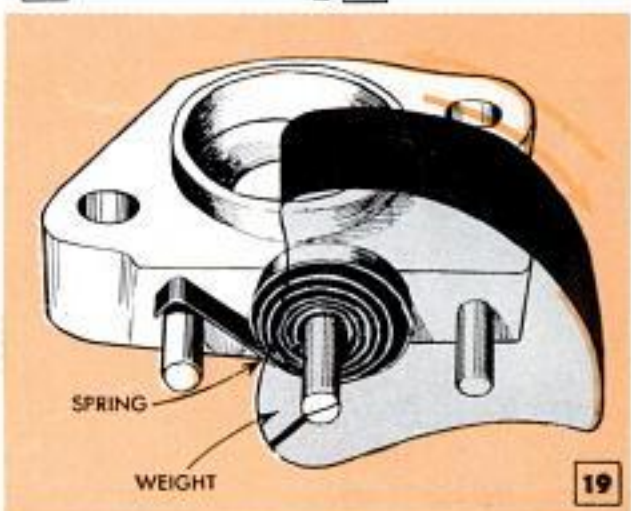
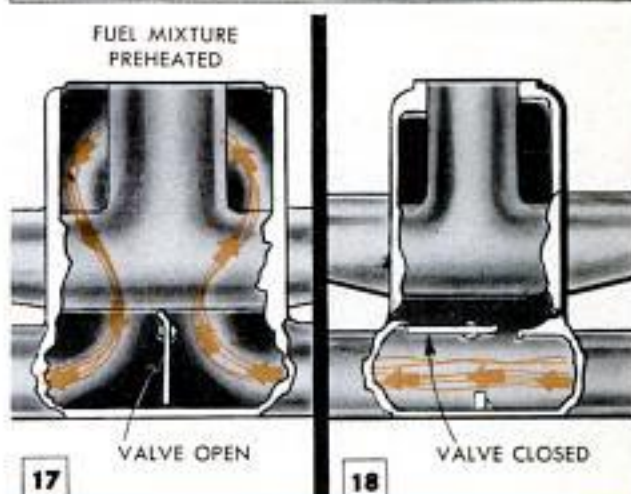
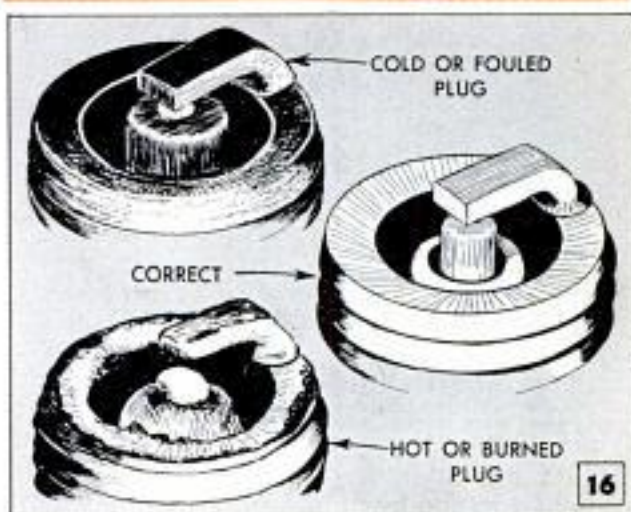
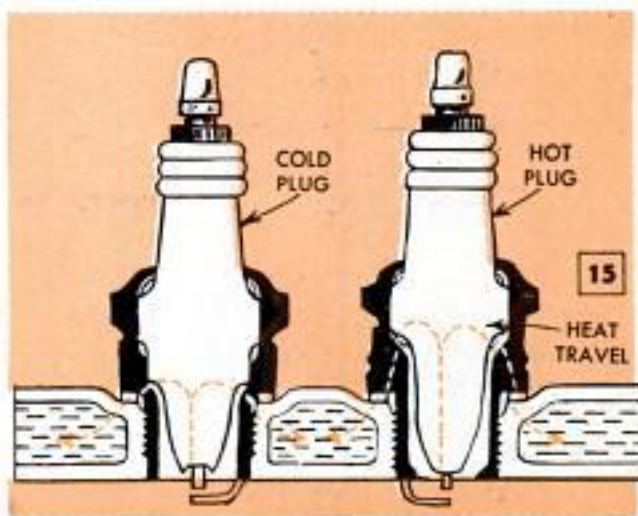

Ant Colony Destroyed by Fumes Pumped Into Hill



The fumes of any one of several chemicals, such as gasoline, carbon tetrachloride and various types of DDT solutions, will destroy ants if the fumes are forced into the ant hill under pressure. This can be done with a tire pump. Solder the valve stem from an auto-tire tube over a hole punched in the bottom of a tin can or small pail. In use, a rag saturated with chemical is placed over the ant hill, the tin can is held tightly over the rag and air pressure is supplied by a tire pump. The pump need be worked only a few minutes since the fumes will be forced into the ant hill by only a slight increase in air pressure. Note: Observe caution when handling any volatile liquid since the fumes are dangerous in confined areas.

"Pocket Size" Ripping Wedge Bent From Flat Key



A practical ripping wedge, which can be carried in your pocket or on a key chain to be handy at all times, can be made by giving a half-twist to the shank of a flat key. The wedge also could be cut from heavy-gauge sheet metal.

"Off" Indicator for Range

If your electric-range dial does not have control lights, paint a wedge-shaped arrow

with bright nail polish at the top of each dial. The point of the wedge is directed at the dial and will indicate at a glance whether the burner is off or not.

Lester Schultz, Cicero, Ill.

Solder Permits Emergency Use Of Nut With Worn Threads

In an emergency a nut in which the threads are badly worn can be used by tightening it on the bolt over a short length of wire solder. The solder will be forced into the worn threads where it will take up the slack and permit the nut to be tightened.

Hugh Lineback, Stillwater, Okla.

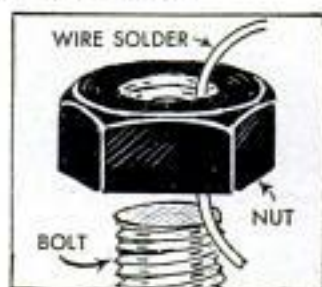

Filter in Kerosene-Stove Line Prevents Clogged Burners

The burners and fuel lines of a kerosene stove not already equipped with a filter can be kept free of clogging sediment by installing a filter of the type used for automobile gasoline lines. The filter is sold as an accessory to be connected in the gasoline line between the carburetor and the fuel pump; it contains a filter element of either ceramic or metallic material. To install it in the stove, the line between the tank and the first burner is removed and replaced with shorter pipe nipples and a union to accommodate the filter. Periodic cleaning of the filter is done by removing the filter bowl and washing it and the filter element with gasoline. If available, compressed air can be used to blow dirt out of the element.

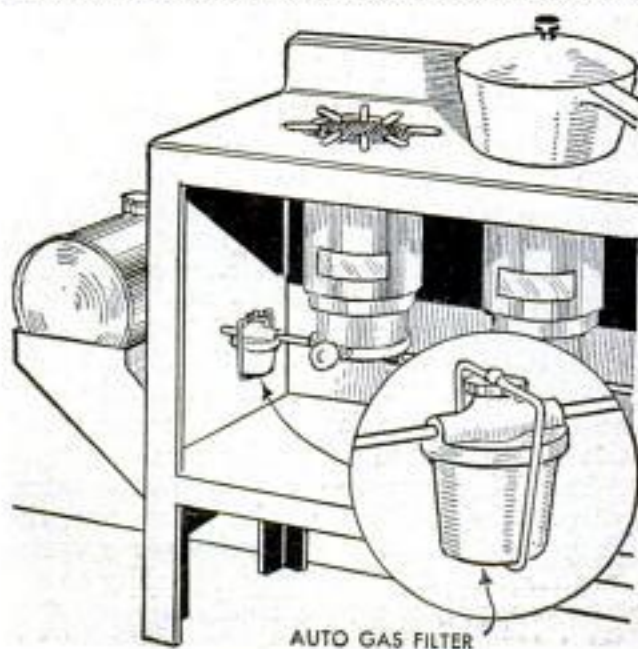

POPULAR MECHANICS



LOCATING FACEPLATE for Your Lathe

SSMALL SHOPS having limited equipment frequently encounter problems of precise hole location and spacing on jigs, fixtures and other close-tolerance parts where it sometimes is necessary to hold finish dimensions and spacings to .0005 or less. One machinist solved the problem by improvising a locating faceplate consisting of two principal parts, a sliding member which can be positioned laterally with relation to the axis of the lathe and a multi-tapped faceplate which is furnished as a lathe accessory. The slide can be located within very close limits by means of stop blocks of known dimensions. Only general over-all dimensions and machining instructions are given in the details as some adaptations must be made to suit the work to be done, also certain variations must be made to adapt the unit to use of lathes of different swings. As dimensioned, the unit is suitable for use on a 9-in. lathe.

The accuracy that can be expected of the unit is proportional to that built into it.

Guides and the fixed stop are doweled to faceplate. Ends of guides are machined to faceplate radius.



By J. C. Magee

Note in the details that the slide and the rails, or guides, are specified as cast iron. Tool steel or even mild steel can be used, although the latter would not ordinarily be recommended for extremely fine work. In any case, the parts are machined and ground all over with parallel faces, sides and ends. Also it is necessary to check the

The slide mounted and clamped in place for boring $\frac{1}{2}$ -in. hole. Slot ordinarily is milled after boring.

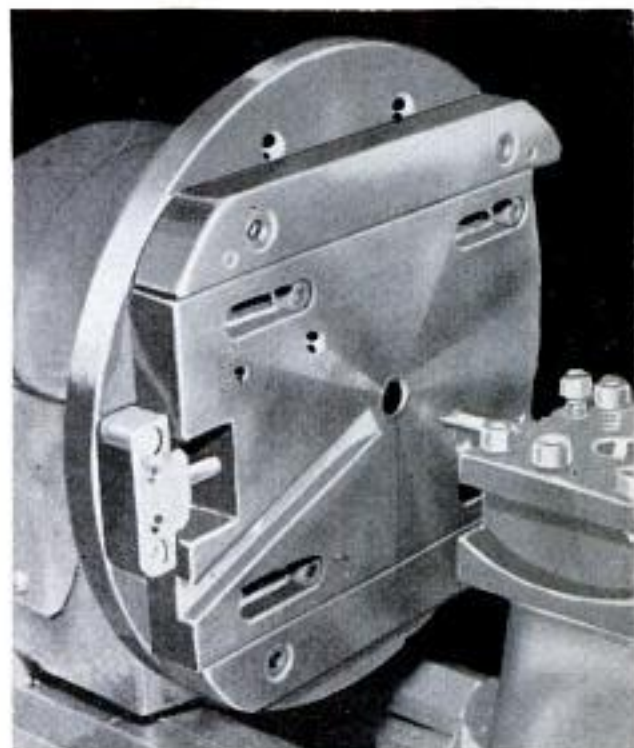
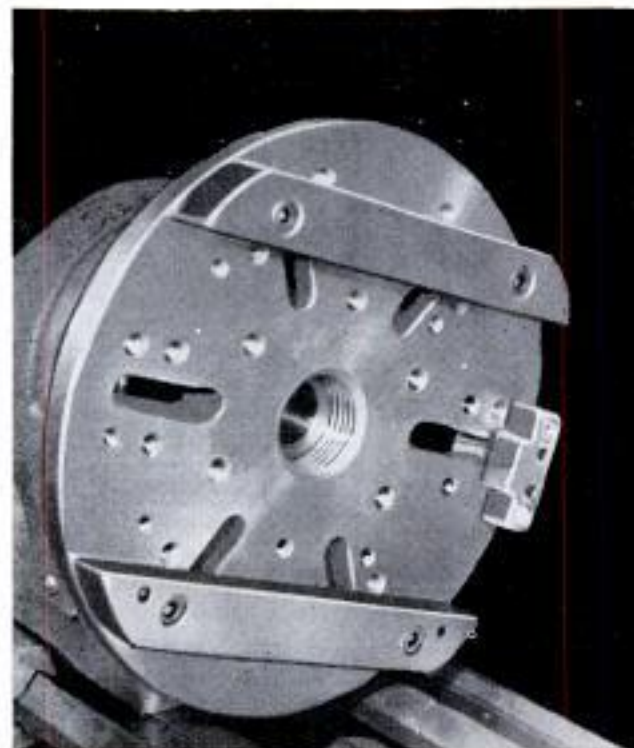

Trouble Light on Pole for Hard-to-Reach Places

You can make this handy trouble light for exploring dark corners and out-of-the-way places by mounting an electric-light socket on a pole handle. The handle, which may be cut from either a dowel or broom-

stick, is drilled at one end to take a 1/8-in. pipe nipple screwed into the wire outlet of the socket. A strong connection can be made by drilling the hole slightly under-size and turning the nipple as it is forced into the hole so it cuts threads in the wood. Another hole is drilled at a right angle to the first hole to permit the cord from the light socket to be run through the pipe nipple and back along the handle. The cord is stapled to the handle to prevent it from becoming entangled with any obstructions. A light-bulb guard is improvised from pieces of 1/4-in. wire mesh which are soldered together after being shaped. — George Kapitan, New York City.

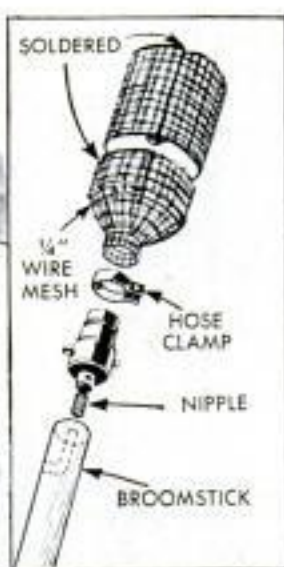

Feeler Gauge Insures Accurate Boring of Turrethead

Confronted with the problem of boring holes to a tolerance of plus or minus .003 in the turrethead of his lathe, one machinist who had only a straight-cutter boring bar used a length of steel bar and a feeler gauge to achieve the required accuracy. The boring bar is inserted in the chuck with the hole in the bar in a horizontal position. Reference marks are made on the chuck and headstock, and the cutting tool is set to bore about 1/16 in. undersize. Then, with a short length of flat-steel bar locked in the tool post, move the carriage so the bar is in line with the cutting tool. Hold a .003 feeler gauge against the cutter and run the cross-feed up until the flat steel just contacts the gauge. Moving the feeler gauge up and down with the fingers will indicate when the flat bar and the cutter are just contacting the gauge. Clamp the flat bar tightly in the tool post, note the micrometer reading of the cross-feed sleeve and remove the feeler gauge. Then move the tool post from the cutter and start boring. Measure the diameter of the bored hole. To increase the diameter ac-

curately, move the tool post back to align with the cutter and back it out to the desired amount by watching the micrometer reading on the cross-feed. Rotate the chuck to bring the two reference marks in line, loosen the cutting tool and gently push it to contact the .003 feeler gauge held between it and the flat bar. Tighten the tool bit, remove the gauge and start boring again. It is important that the tightness of the feeler gauge is the same both times. Kenneth Loo, Lawndale, Calif.

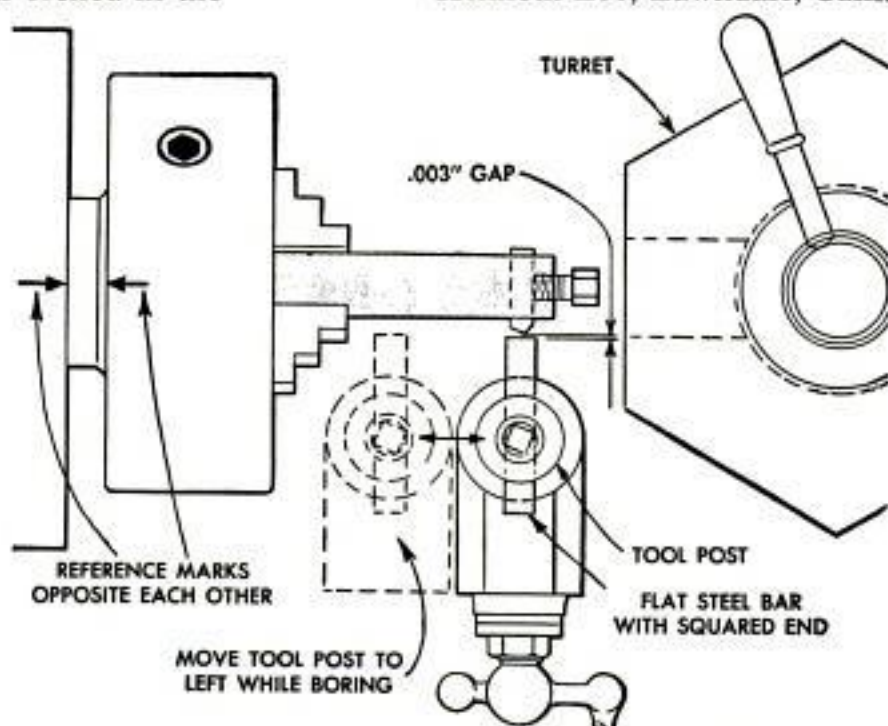

POPULAR MECHANICS

Clamp-Type Lathe Dog Provides Emergency Drill-Press Vise

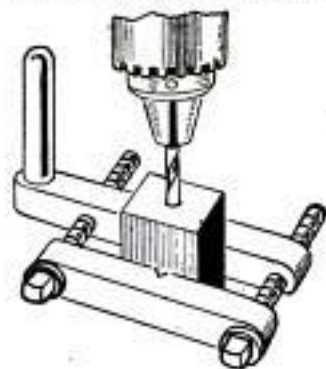

In an emergency, when no drill-press vise is available, an ordinary clamp-type lathe dog can be used to hold small work to be drilled. Square, round or irregularly shaped work can be accommodated.

Bolts Modify Framing Square For Marking Duplicate Angles

Two stove bolts, each fitted with two square nuts, will permit using a framing square as a gauge to duplicate a number of angles, as when cutting stair stringers or rafters. Place the square at the desired angle on the board and slip the two bolts onto the inside edges of the square. Make sure the nuts are resting flat on the board, then tighten the bolt with a screwdriver. The square now can be moved along the edge of the board for marking the duplicate angles.—

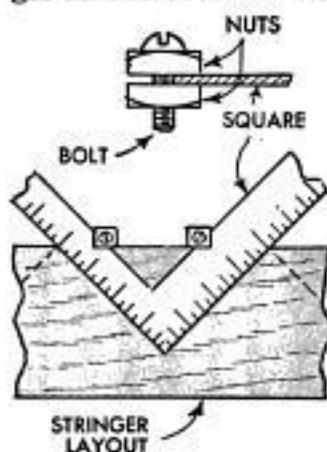

Louis Booker, Louisville, Ky.

Wire Hooks on Poultry-Mash Pan Permit Removal When Cleaning

If it is rigged so the suspending wires are easily detached, the swinging mash pan in the poultry house can be cleaned more quickly and with less work. Wire hooks are provided by twisting together two doubled strands of wire of equal length. The free lower ends of the wire then are bent upward to form four hooks which engage holes punched in the rim of the pan. The wires are bent outward slightly to provide a tension for holding the pan; a light hand pressure then will release the hooks from the pan.

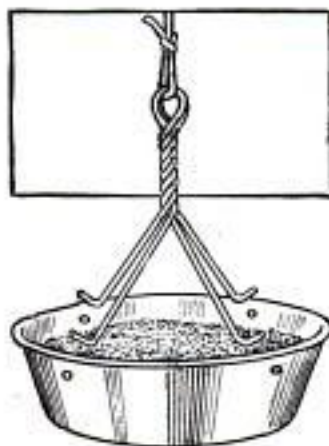

DECEMBER 1954



Slotted Sections of Steel Oil Drum Utilized as "Stile" Over Fence

In a location where a regular gate is not practical in a barbed-wire fence, but where it is necessary to cross the fence frequently, a "stile" can be made by cutting an empty steel oil drum into two sections. One section should be about twice the length of the other, and both sections are slotted to fit over the wire. Half the surface of each drum thus sits on either side of the fence to provide steps on both sides.

Hole Drilled in Hammer Head Speeds Clinching Nails

If you have frequent occasion to clinch nails, a small hole drilled in the side of the hammer head will aid in doing the job more quickly and neatly. The end of the nail is caught in the hole and bent back, so that the point will penetrate the wood when the extending nail is hammered flat. Drill the hole just slightly larger than the size of the nails most commonly used.

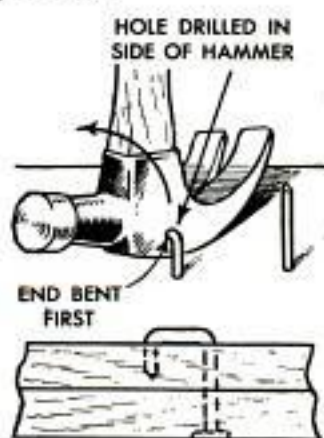

When installing pipe covering, use a miter box and a hacksaw to get straight cuts and to prevent crushing of the covering in a bench vise.

207



5¢ WORTH OF ELECTRICITY

How to Calculate Home Power Costs for Modern Lighting and Appliances

By J. B. Mullen

WHEN YOU PLAN to add new home electrical appliances or replace old equipment with more efficient units, it's interesting and often profitable to calculate accurately the total power requirements and, from this figure, average up the costs. In many instances the added wattage will entitle you to a lower rate classification, thus reducing rather than increasing costs.

A simple alignment chart you can make yourself will give the answer accurately without any involved computation. For purposes of illustration, suppose that your present rate is 5 cents per kilowatt hour for the first 100 kilowatt hours and 3 cents for over 100 kilowatt hours (k.w.h.). Then you would normally use the 3-cent rate in estimating the operating cost of additional appliances. On the other hand, if you are estimating the cost of operating present equipment or replacements, it usually is better to determine an average rate. This

can be obtained by dividing the total bill by the total number of kilowatt hours used. In some cases the total may place you in an even lower rating. However, it should be understood that rates vary. Those given are only representative.

The table below lists average wattage requirements for common electrical appliances. Name plates on appliances usually give the electrical characteristics, model numbers and types in a manner similar to that shown. A typical example of how computations are made quickly by means of the alignment chart is shown by colored lines on the opposite page. First determine the wattage requirements and the operating time. Connect these two values on the chart by means of a straightedge, noting that a 3000-watt unit operated 20 hours consumes 60 k.w.h. of electricity. Note that the second position of the straightedge gives an operating cost of \$1.50 at a 2½-cent-per-kilowatt-hour rate. Again the values given are only representative, but they do show the very low cost of operating modern home appliances. A more graphic illustration is shown at the top of the opposite page. The appliances pictured can be operated for the time given on approximately 5 cents' worth of electricity at 2 cents per kilowatt hour. ★ ★ ★

POWER REQUIRED BY TYPICAL APPLIANCES

Appliance	Watts
Range	8,000 - 15,000
Clothes drier	4,400 - 4,800
Automatic washer	600 - 900
Ironer	1,200 - 1,600
Iron	900 - 1,200
Broiler or deep frier	600 - 1,800
Refrigerator	350 - 700
Freezer	350 - 1,000
Radiant heater	600 - 1,500
Toaster	900 - 1,200

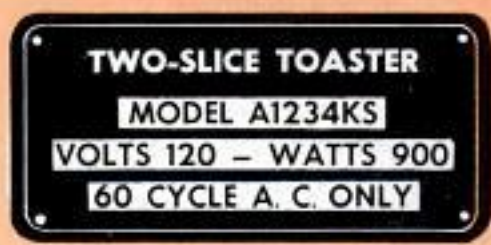

FIND WATTS ON NAME PLATE

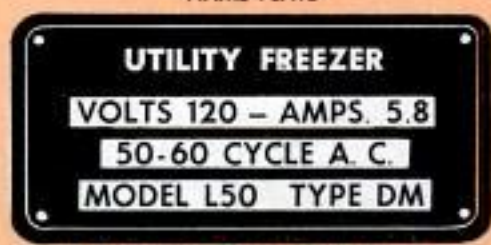

IF WATTS ARE NOT SHOWN USE THE FORMULA WATTS = VOLTS X AMPS.



60-WATT LAMP



1000-WATT TOASTER



7-AMP
AUTOMATIC WASHER



4500-WATT DRIER



300-WATT TV SET



41 1/2
HR.



2 1/2
HR.



3
HR.



33
MIN.



8 1/2
HR.



MORE THAN 5
WORKING DAYS



200 SLICES
OF TOAST



5 BATCHES
OF LAUNDRY



1 BATCH
OF CLOTHES



DAYS OF
ENTERTAINMENT

ALIGNMENT CHART FOR COST OF ELECTRICITY

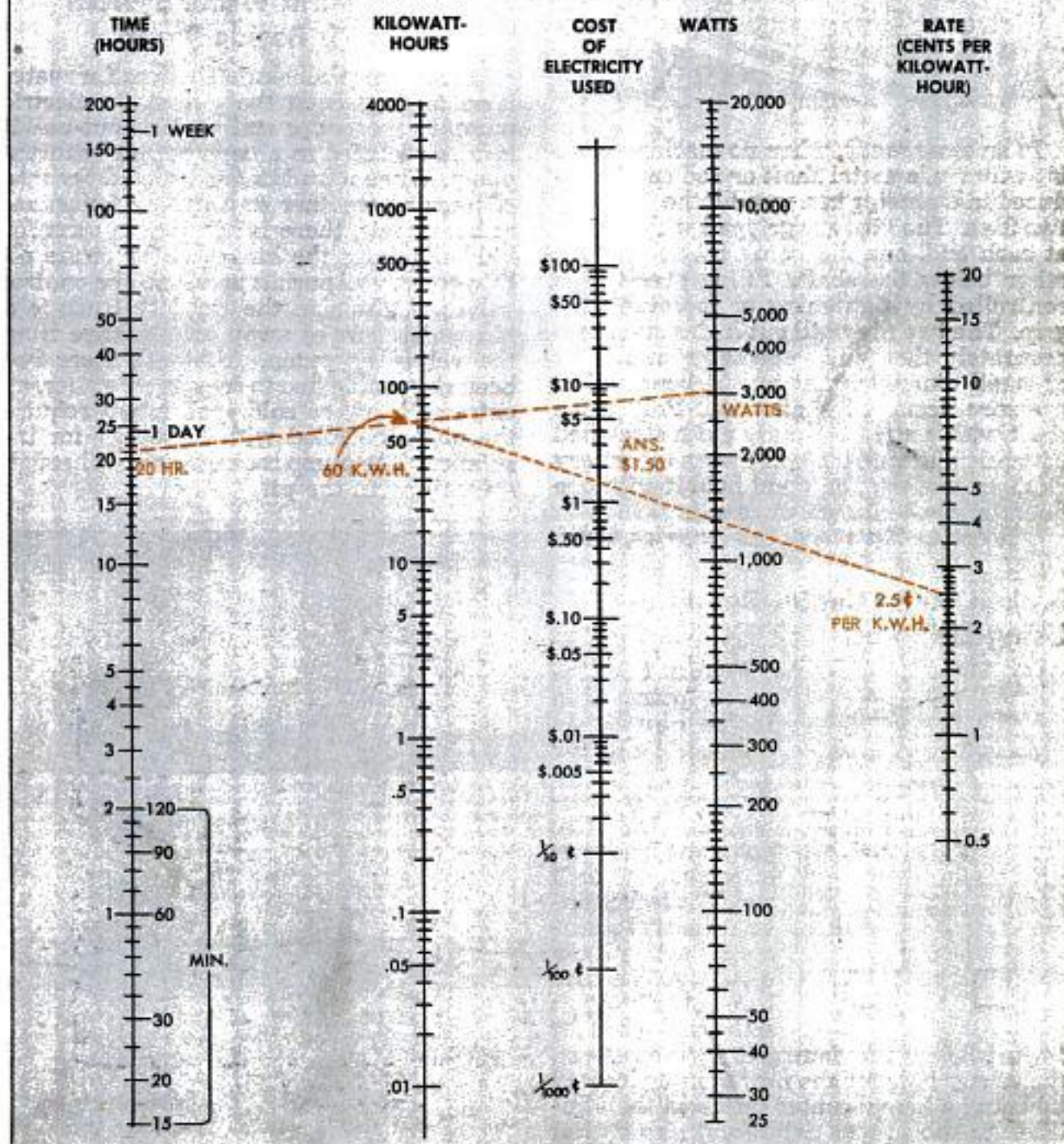

Diameter of Metal Shaft Reduced In Wood Lathe With Two Files



In an emergency, when no machine lathe is available, a metal shaft or rod can be reduced in diameter in a wood lathe by using two files. The files are gripped with a hand at each end, one file being above and the other below the shaft. Filing pressure is controlled by tightening or loosening the grip. The two files will cut faster and more accurately than one, especially on a shaft of small diameter that would bend under pressure from only one file. Polish the shaft with a strip of emery cloth stretched between the hands. Do not wrap the emery cloth around the shaft and hold it with one hand; serious injury can result.

Ralph C. Tattersall, Los Angeles, Calif.

Broken Lathe Center Repaired Using Drill Rod

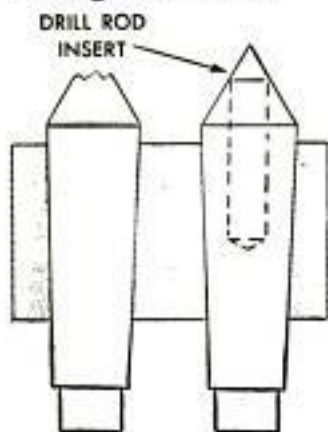

When the tapered point of a lathe center is damaged or broken, it can be renewed by center-drilling the point and inserting a length of drill rod. The lathe center first is annealed, then chucked in the headstock of a lathe and faced off

to just below the damaged portion. Next, the center hole for the new point is located by using a heavy center drill and then finished to the proper depth and size with a

regular twist drill. Drive a length of drill rod into the finished hole, chuck it in the lathe and machine it to 60 deg. When the machining is finished, retemper the point to provide the original hardness.

C. W. Woodson, Chicago.

Sliding Door Operates Better When Pull-Handle Is Centered

Much of the difficulty in operating a large sliding barn door is due to the fact that the pull is located at one side of the door, throwing most of the door weight on one roller. By placing the pull-handle in the center of the door the weight is evenly distributed on both rollers and the door can be opened more easily.

Valves for Farm Water System Located in Pit Beside Pump

On one farm all shutoff valves for water lines leading from the automatic electric pump to the house and various out-buildings are located in a concrete pit with the pump. When a building is isolated because of freezing weather or a line or faucet requires repair, there is no need to hunt for hidden valves; the hinged cover of the pit lifts quickly to permit access to the control valves. A drain in the pit floor leads to a tile which carries away any leakage from the valves or pump. Although there has been no trouble due to freezing weather, an extremely severe cold spell might require the pit to be filled with loose hay for insulation. The pump motor is wired through a fuse box in the pit.

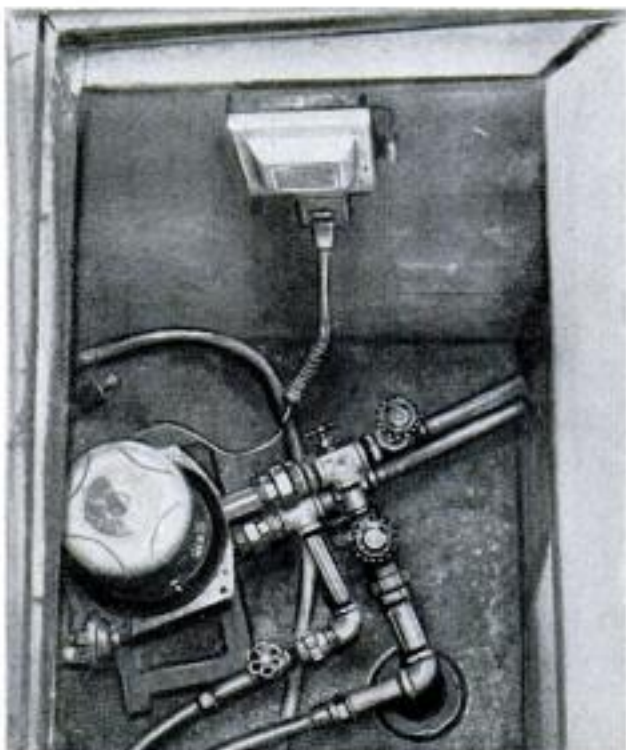

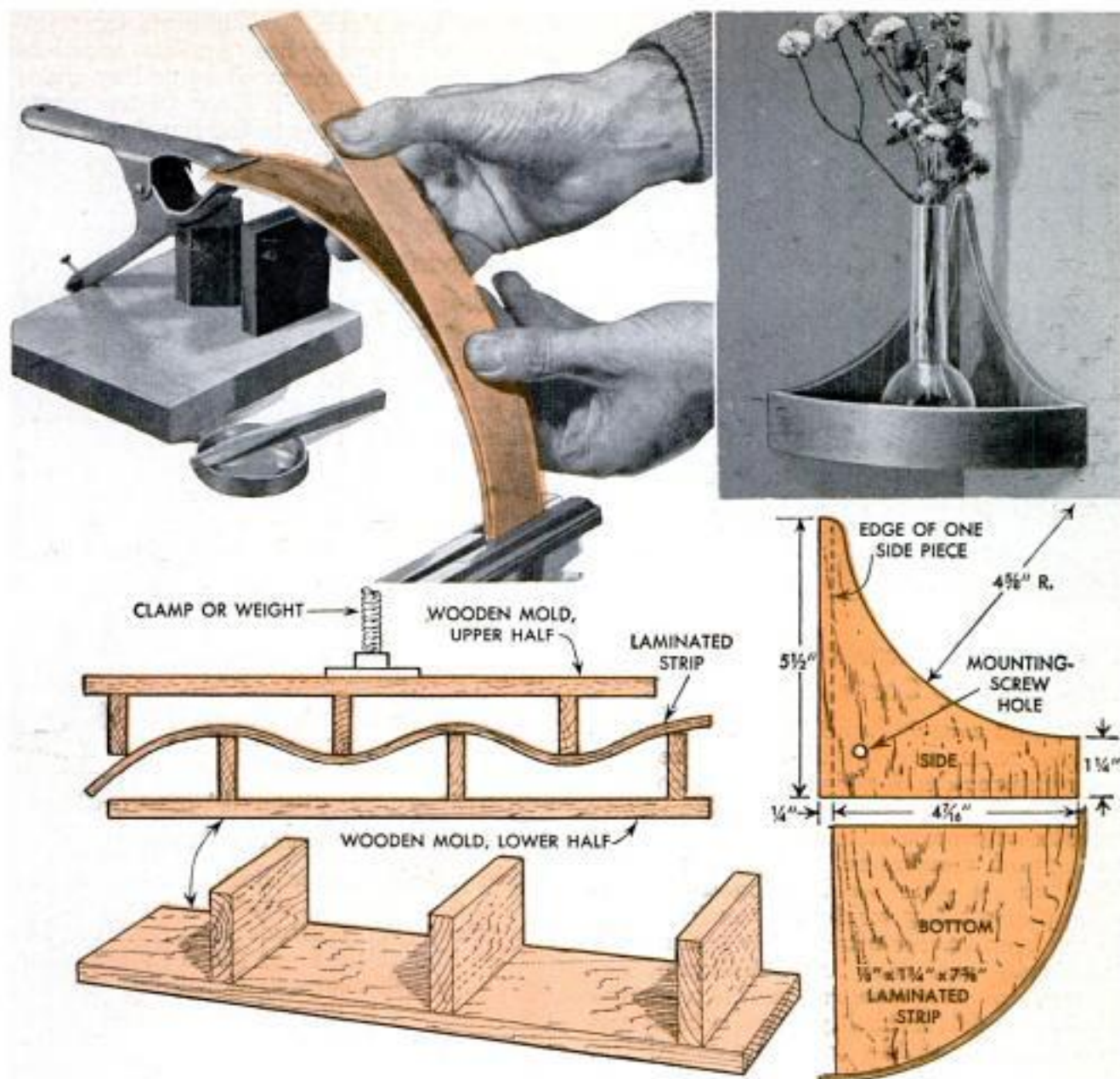

Mold-Bending Small Wooden Parts

By Walter E. Burton

A SCROLLED corner shelf, such as the one shown in the upper right-hand photo, assumes a new and more attractive appearance with the addition of a curved gallery or edging strip that can be made with a simple bending jig. The edging can be made from either a solid piece or a strip of solid stock faced with attractively grained hardwood veneer. Steaming or soaking is desirable when bending solid stock, but a veneered or laminated strip can be bent to the desired curve as it is assembled.

A simple curve can be produced by clamping one end of a wooden strip in a vise and tying or weighting down the opposite end. Holding the opposite end with a clamp fastened to a weighted block, upper left-hand photo, has the added advantage of

holding the ends of the laminations tightly together when a veneered strip is assembled and bent.

Rings, or segments of rings, can be made by bending the strips around a section of pipe, a large tin can or other cylindrical form. Heavy cord or tape is used to hold veneered strips together and on the form.

Single or reverse curves can be bent in a strip by clamping it in a bending jig, consisting of an upper and lower mold, or form, as in the center detail.

In all cases, whether bending a solid or veneered strip, the ends of the finished curve will require trimming and fitting. Therefore, make sufficient allowance by beginning the job with slightly longer materials than required for the finished part.



Guard for Tractor Rear Wheel Lifts Leaning Cornstalks

Leaning cornstalks will not be flattened beyond reach of a towed corn picker if a guard is provided for the rear tractor wheel as indicated. The guard is made from three lengths of pipe, one long pipe being used as a guard, and the other two as brackets. The assembly is welded together, flat-steel plates being welded to the free ends of the brackets for attachment to the tractor frame and rear axle. Although not shown, a piece of steel rod bent to a narrow U-shape is driven tightly into the front end of the guard to slide under the cornstalks.

Ed Mercer, Madison, Wis.

Taped Jaws of Adjustable Wrench Prevent Damaging Chrome Fixture



An adjustable wrench can be used on chrome-plated fixtures on a sink or wash basin without causing damage if the jaws are faced with strips of tape. Two or more layers of

friction or adhesive tape should be used and should be allowed to project slightly beyond the edges to prevent the sharp corners from contacting the chrome.

Sawdust Prevents Egg Soiling

Because of the present practice of grading, mud-stained eggs bring a much lower price, so poultry farmers find it profitable

to keep them clean. To eliminate the mud stains, one farmer has shallow wooden trays filled with fine sawdust or hay chaff mounted on boards in front of the nest. The sawdust adheres to the hens' feet and keeps the mud from the eggs.

Corncobs Tied to Pull Cords Help Locate Them in Dark

Finding the pull cords of overhead barn lights in the dark was simplified by one farmer who attached corncobs to the ends of the cords. The cords are inserted through holes drilled or punched in the soft core of the cobs. Painting the cobs with white or luminous paint makes them still easier to find.



Paddles on Tractor-Mounted Auger Force Dirt Away From Hole

Two steel paddles bolted to an 18-in. length of 2-in. pipe, which is mounted on a tractor-drive posthole auger, force the drilled dirt away from the hole and also act as a depth gauge. The paddles are flat steel, $\frac{1}{4}$ x 2 x 18, and are curved away from the direction of rotation to minimize the danger of the operator being injured.

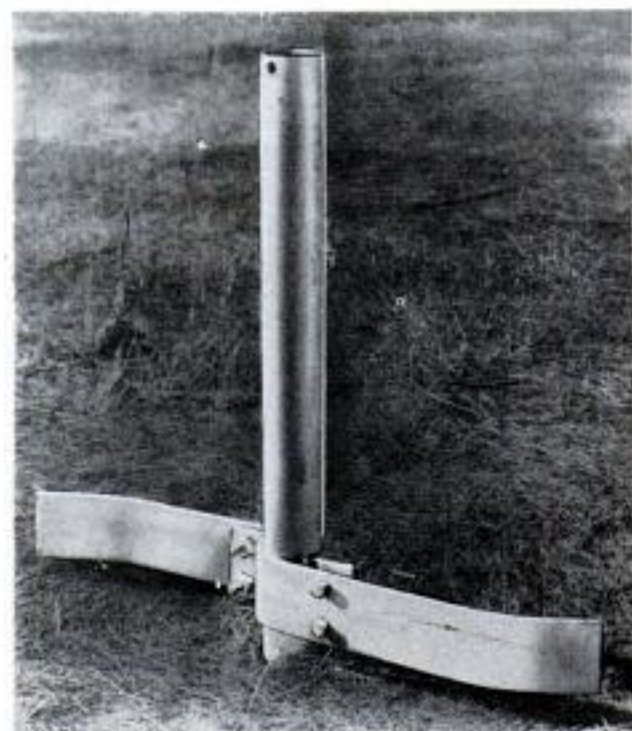

BRACED FLOORS STRENGTHEN NEW BUILDINGS

By F. A. Strenge

TESTS CARRIED OUT at U. S. Forest Products Laboratory show that diagonal bracing of floors increases wind resistance of large buildings, especially long dairy barns and similar structures which have large areas directly exposed to wind pressure. In such buildings diagonally braced floors transfer the wind load to the end walls and foundation, increasing resistance to bowing, in some cases as much as 30 times. This was determined at the Laboratory by using model floor structures as large as 18 x 48 ft. and applying lateral pressures equivalent to winds up to 100 miles per hour.

The tests showed that a pair of diagonal braces of 1 x 6-in. stock added greatly to the rigidity of the floor structure when nailed across either the top or bottom of the floor joists as in the upper photo at the right. As pictured, the diagonals extend from the two corners of the frame to the header on the opposite side at approximately a 45-deg. angle. Two 8d nails were driven through the diagonal into each joist.

The researchers also tested floor structures with diagonals spaced various distances apart and all running one way as in the center photo showing a partially completed floor. This gives the same rigidity as a diagonal subfloor with a top floor laid the long way. While this proved by far the stiffest construction, it was determined that sufficient rigidity is obtained from two diagonals in all except extremely large structures. In barns already built it is recommended that diagonal bracing be nailed across the bottom of the exposed joists. In unusually long structures it is advisable to use more than two diagonals. However, it is important that these be accurately spaced and correctly nailed.

The researchers emphasize that this type of bracing is not a substitute for poor construction of the framing in other parts of the structure. All joint fastenings used in framing the building should be of the approved type.

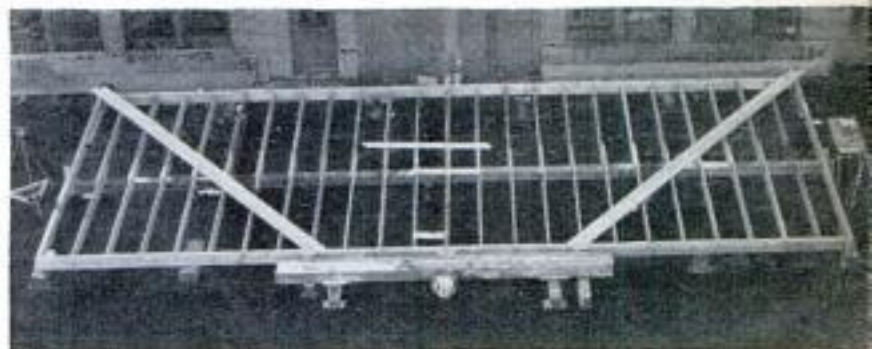

In structures of average size, two diagonal braces have been found to be ample floor bracing for conventional floor framing. Larger buildings and those with long floors require more

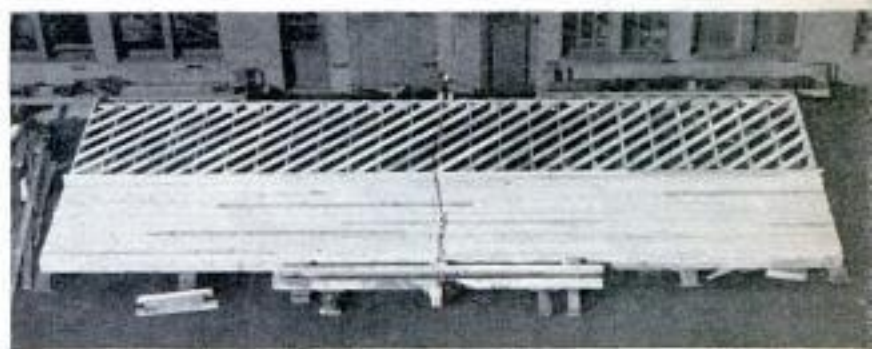

Above, a partially completed model floor frame with spaced diagonal braces laid one way under lengthwise flooring. This construction proved by far the stiffest on exceptionally long floor frames. Below, the finish flooring is laid the long way

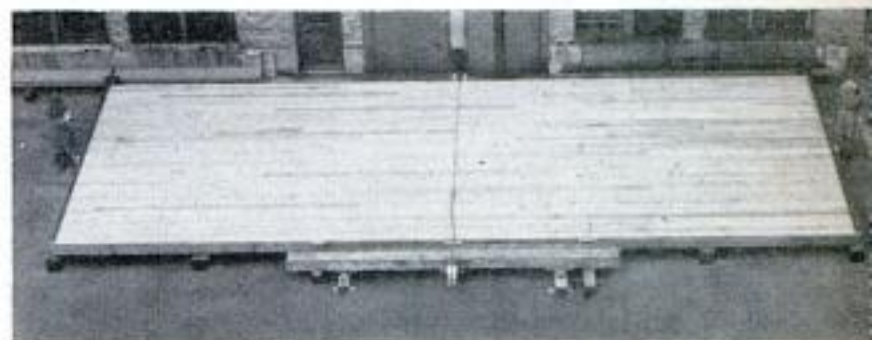

WTM 56

PROJECTS

BIRD FEEDER

Slip roll will not form complete cone, hence a ball top finishes the bird-feeder roof. Lower edge is bent up in 8 sections on brake after cone is rolled and riveted

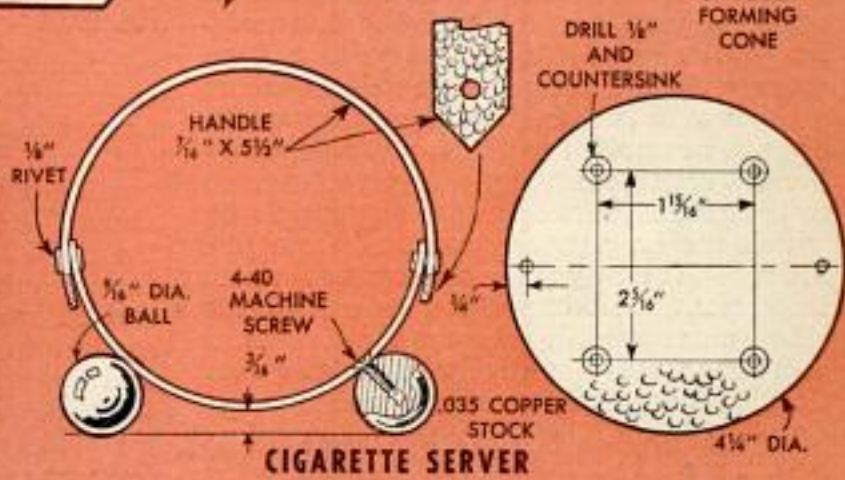
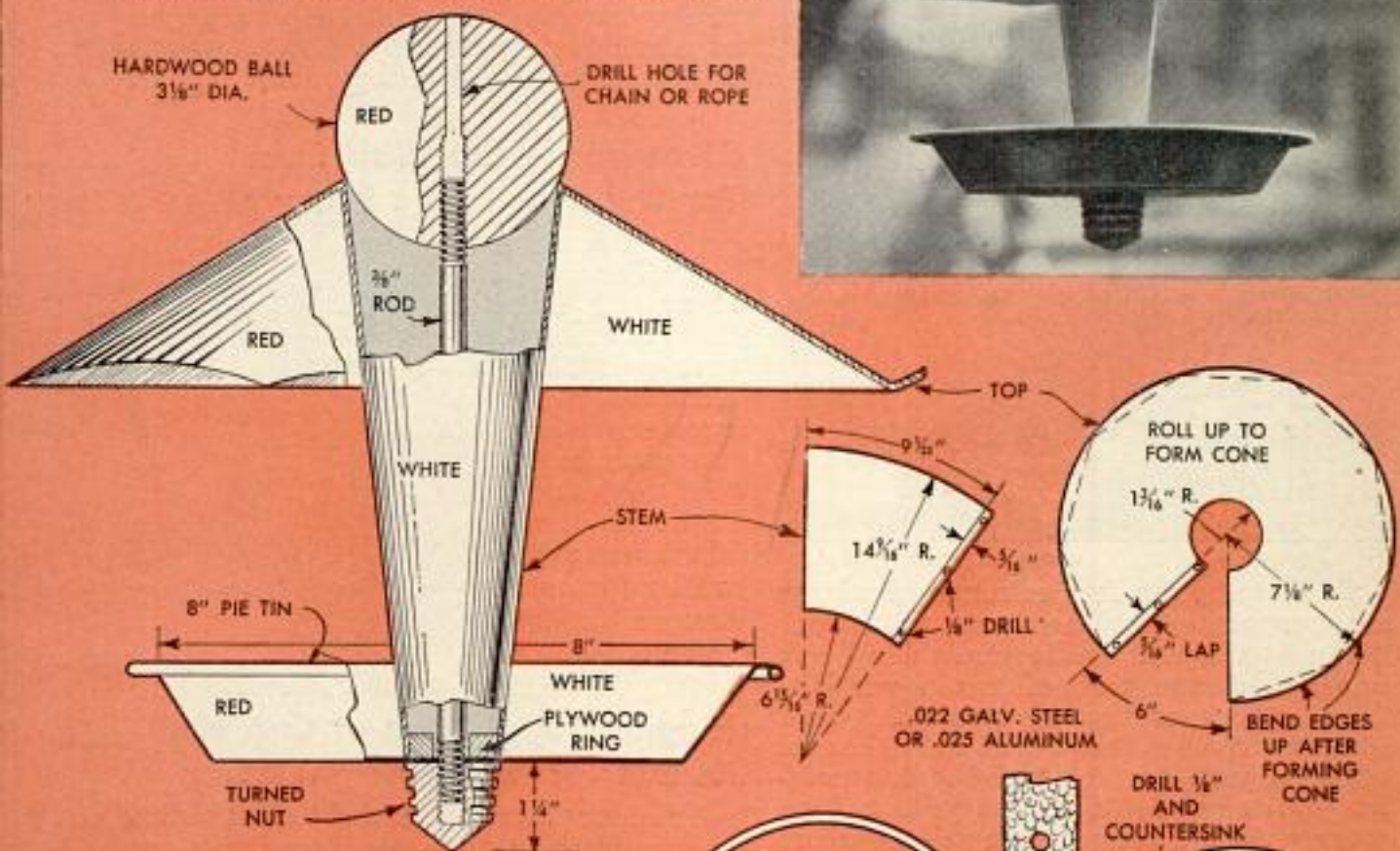

The cigarette server is a good project for the hobbyist who likes to work in metal. Its easily duplicated parts make it simple to mass-produce the unit with limited equipment. It also can be enlarged, using the same design, to make a handy firewood carrier

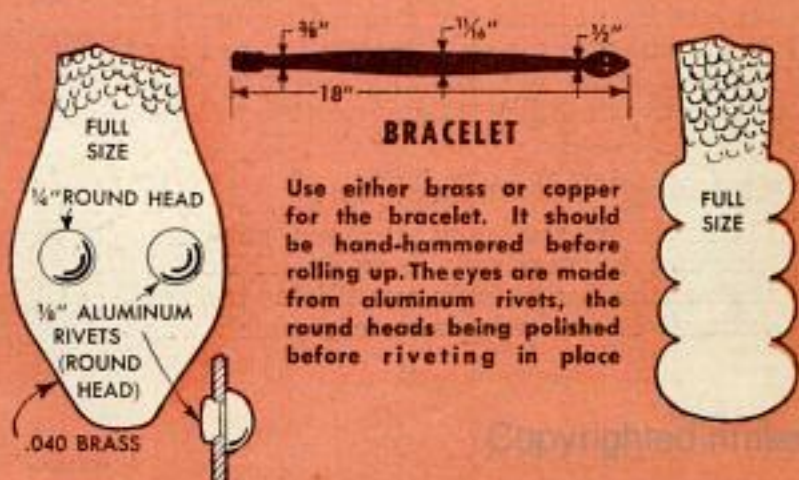

Use either brass or copper for the bracelet. It should be hand-hammered before rolling up. The eyes are made from aluminum rivets, the round heads being polished before riveting in place

Farmer's Portable Air Compressor Utilizes Old Car Parts



To increase the service range of a large air compressor for farm use, the owner mounted the unit on an underslung cart improvised from parts of an old car. Underslung axles were made by welding steel spindles to short lengths of steel channel which, in turn, are welded to the side members of the frame in a vertical position. Pipe spacers welded between the side members also serve as braces. Compressor supports, or feet, are bolted to the frame side members. Vertical members of flat steel welded to the handle bars form a reel, or rack, on which the long power cord and hose line are wound loosely when not in use. A small implement toolbox welded to one of the side frames provides storage for air chucks and a long, valve-controlled air nozzle used for cleaning chaff from radiators.

Bits of Paper on Press Rollers Removed by Old Toothbrush

Printers will find a discarded toothbrush helpful for scraping bits of torn paper from the rollers of a printing press. This will not only reduce chances of getting ink on the hands but will also eliminate the need for using a knife for this purpose with the resultant possibility of damaging the rollers.

Thawing Frozen Fuel Line

Unable to start my car one sub-zero morning because of a frozen fuel line, I thawed the line quickly by utilizing the hot exhaust of my neighbor's car which was

parked in the same garage. To direct and play the exhaust over the frozen line, I used the hose from our vacuum cleaner, pushing it over the tail pipe of the running car. In a matter of minutes, the line was thawed sufficiently to start the engine.

Caution: the exhaust gases of an automobile engine contain a high percentage of carbon monoxide which is lethal. Never start a car unless the garage doors are open to provide adequate ventilation.

Donald D. Hubbard, Bellwood, Ill.

Rivet Heads Cut With Chisel For Quick and Safe Removal

The job of cutting off rivet heads is greatly simplified if the head is first crosscut with a cold chisel. Each quarter of the head then can be chiseled away and the lighter hammer blows required will reduce the danger of flying fragments.

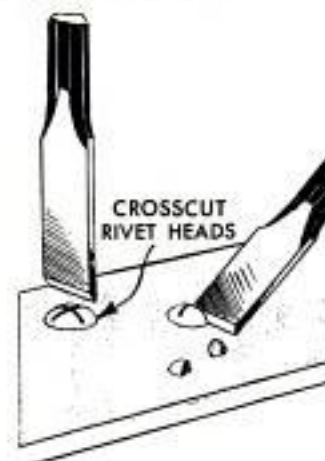

Hinging Top Portion of Crib Wall Reduces Scooping Height

To reduce labor and speed the unloading of corn from a trailer into a corn crib, one farmer hinged the upper third of the slatted wall. When opened down, the hinged portion had the effect of lowering the wall about 3 ft. and permitted unloading from the full length of the trailer and filling the full length of the crib. When the corn started spilling over the edge, the hinged section was raised and nailed into place and the crib completely filled by scooping the corn over the top of the wall.



Compound-Angle Setup Fits on Lathe Carriage

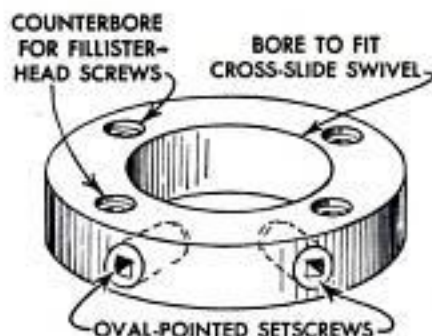

By Hugh Botts

Compound-angle drilling, sawing, milling and grinding can be done in the lathe by mounting an angle vise on a swiveling adapter made as in the detail above. A lathe milling vise is screwed to the adapter which replaces the swiveling base of the compound. The milling vise holds the angle vise rigidly in position for light work. No dimensions are given on the adapter ring, as it must be made to fit the lathe. It should be bored and reamed to a snug, press fit over the compound-swivel boss. When work is set up at a compound angle make sure that all projections are in the clear before engaging the automatic cross-feed on the carriage.



"Cattleproof" Gate Latch Locked With Steel Pin

Using an eyebolt and an L-shaped pin made from a $\frac{3}{8}$ -in. steel round, one farmer



has made a simple gate latch which permits easy closing of the gate, but which is shielded to prevent its being opened by livestock. An eyebolt is passed through a hole drilled in the fence post and tightened with the eye in a horizontal position. Two lengths of angle steel are bolted vertically to the gate web to form a channel. Before bolting the angles in place a slot is cut part way across one web of each angle. When installing, the slots are located so that the eyebolt passes through them when the gate is fully closed. When the pin is dropped into the eyebolt and turned flat against the angles, the animals cannot reach it. A length of chain welded to the pin and to the angle prevents loss of the pin.

Table salt, if applied immediately to ink that has been spilled on a carpet, will absorb most of it almost instantly. The salt may be picked up in a vacuum cleaner.

SHOPPING FOR



1. CIRCULAR-SAW GUARD is molded of red transparent plastic that won't shatter, chip or corrode. Guard is formed with an open front and its transparency permits the operator to see cutting operations from any angle as well as from directly in front of blade. Guard raises and lowers as the stock passes underneath. Blade is guarded throughout length of cut

Shopmaster, Inc., 1214 N. Third St., Minneapolis 15, Minn.

2. INSPECTION MAGNIFIER reaches those hard-to-get-at places and illuminates and magnifies tiny parts so that they are readily examined in detail and from all angles. Has a maximum reach of 14½ in. and an over-all length of 17 in. Can be inserted in openings as small as ⅜-in. dia. Unit is fitted with system of achromatic lenses and prisms giving 5X magnification

Badger Sales Co., 2251 W. Pico Blvd., Los Angeles 6, Calif.



3. POCKET-SIZE LUMBER RULE reads directly in board feet on even and odd lengths up to 16 bd. ft. Blade can be extended 10 lineal feet and held firmly at any desired point by means of a simple thumb lock. Large, black-on-white numbers make the rule easy to read under difficult conditions. Hook end provides for one-hand use. Steel blade is readily replaceable

Lamitape Corp., P.O. Box 614, Hillside, N. Y.

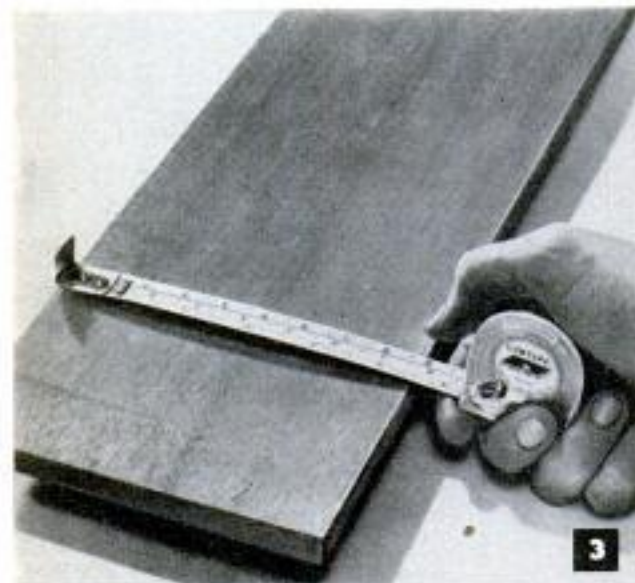

4. BLADE HOLDER eliminates the inaccuracies of free-hand sharpening of plane irons, chisels and scrapers. Holds the blade edge true with the sharpening stone and maintains the correct angle on the bevel as the blade is ground or honed. Available in several sizes to take blades of any standard width, either plain or slotted. Especially effective for honing plane irons

William M. Rosenfeld, 1436 Sixty-Seventh Ave., Philadelphia 26, Pa.

5. METAL SHAPER AND VERTICAL MILL mounts on the bed of a small bench lathe as pictured below and on the opposite page. Simple conversion heads make the change from shaper to vertical mill in a matter of minutes. Both units utilize the lathe carriage for controlled longitudinal and transverse feeds. Tool collar is graduated to .001. Head swivels 360 deg.

West Machinery & Supply Co., 6 E. Northfield Ave., Livingston, N. J.

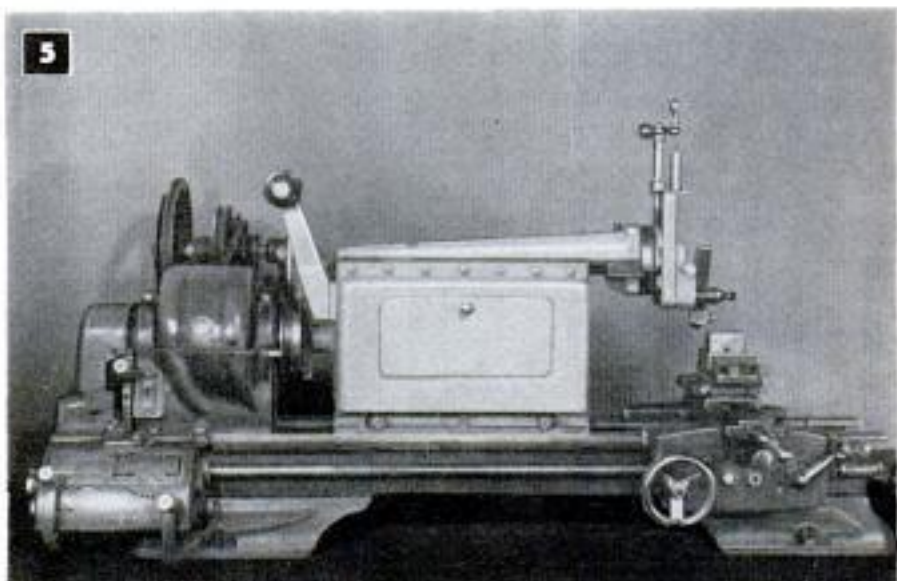

TOOLS

6. KNIFE GRINDER has formed wheels that give a hollow grind on tools, shears and instruments requiring razor-keen cutting edges. The fixture, or head, carries two aluminum disks with curved faces on 13, 14, 15 and 16-in. radii respectively. Special abrasive disks are attached to the faces of both disks. A special blade guide assures precision grinding of cutting edges

Treyco Products, 140 Longmeadow Road, Buffalo 23, N. Y.

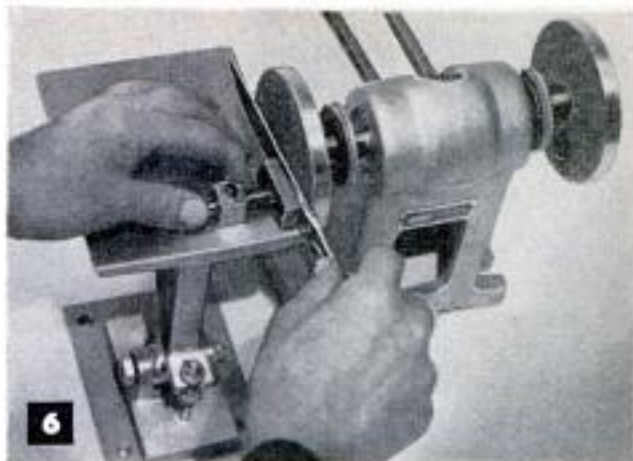

7. ONE-TON BENCH PUNCH PRESS is ideal for short runs on small parts because of its flexibility and the savings possible due to the small size of the dies. In some cases, punches and dies can be made from cold-rolled stock for use on soft metals. The ram moves on machined ways and is provided with a gib for wear take-up. Weighs 105 lb. and requires 1/4-hp.

Alvp F. Allen, 1015 N. Third St., Allen Bldg., Clinton, Mo.



8. MULTIPLE-PURPOSE ANVIL has usable surfaces that are rounded, V-shaped, flat, also parallel for all practical purposes. Can be used as a V-block for drilling operations on round stock. Curved surface at one end can be used for making bends to a uniform radius. Curved surfaces also permit its use as a backup iron, or bumper, for straightening sheet metal

Miracle Mfg. Co., 127 E. Ninth St., St. Paul 1, Minn.

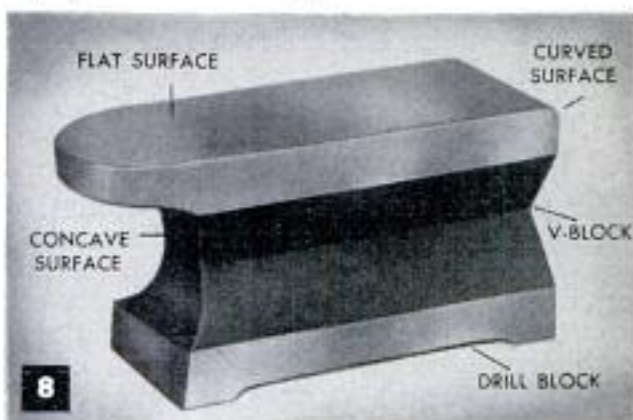

9. HATCHET-TYPE SOLDERING IRON outperforms conventional irons on many kinds of work on instruments, electronic equipment and jewelry. Due to its small size and the work angle of the handle it can reach into hard-to-get-at places without requiring the operator to assume fatiguing hand and arm positions. Operates on a.c. or d.c., 110-220 v. Weighs only 3 oz.

Hexacon Electric Co., 162 W. Clay Ave., Roselle Park, N. J.

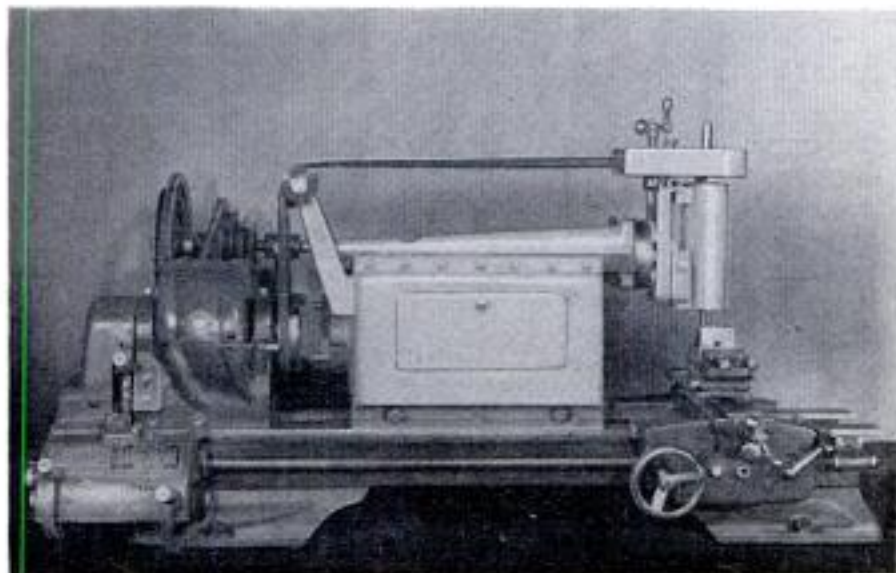

Durable Rural Mailbox Support From Old Plow Beam



To provide a durable, weather-resistant support for a roadside mailbox, one farmer used a plow beam set on end in a concrete-filled milk can. The mailbox was mounted on the upper end of the plow beam and the milk can partly sunk into the ground to hold it upright.

John Krill, North Lima, Ohio.

Strips of Masking Tape Cut to Uniform Length

Strips of masking tape are cut easily to a uniform length by first tearing off a number of strips slightly longer than the length required and sticking these side by side to a piece of hardboard. Then the strips cut to the required length by means of a straightedge and a safety-razor blade.

Adjustable Collet Stop in Lathe Aid When Machining Short Rods

Machining a number of short rods or other round stock to duplicate lengths can be done by using the adjustable collet stop shown. The work is inserted in the collet and held lightly against the stop while the collet is tightened. The lathe carriage then

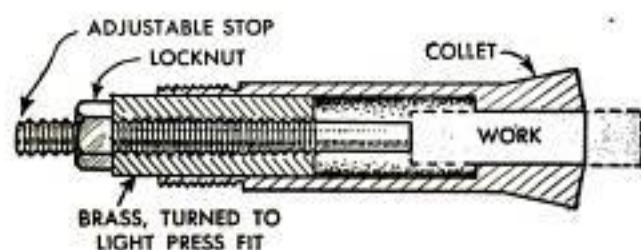

is locked in position and the cutting tool fed to the work in exactly the same location for each piece. The stop consists of a brass plug turned and ground to a press fit in the collet, and an adjustable threaded stop rod held in position by a locknut. The plug is drilled and tapped $\frac{3}{16}$ -24 to receive the adjustable stop. The stop is shouldered $\frac{1}{4} \times 1$ " and threaded $\frac{3}{16}$ -24 for the plug.

C. W. Woodson, Chicago.

Worn Pump Coupling Repaired

An emergency repair of a pump-rod coupling that has loosened because of worn threads can be made by lightly pounding the end of the coupling with a hammer. This will upset the threads somewhat and cause a much tighter fit. However, new couplings should be installed as soon as possible to avoid a sudden breakdown.

Junked Refrigerator Unit Provides Compressed Air

Compressed air is supplied in one farm-machinery shed by a compressor unit salvaged from a junked commercial refrigerator. (This particular model requires that the line on one side be plugged and only the discharge be used.) Mounted high on a wall out of the way, the compressor is connected to a small storage tank fitted with an adjustable safety valve that may be set at any desired pressure. The supply hose from the compressor is long enough to reach all four wheels of any piece of farm machinery or equipment in the shed. The electric motor is protected against an overload by being wired through a fuse that will carry just slightly more current than the starting load of the motor.

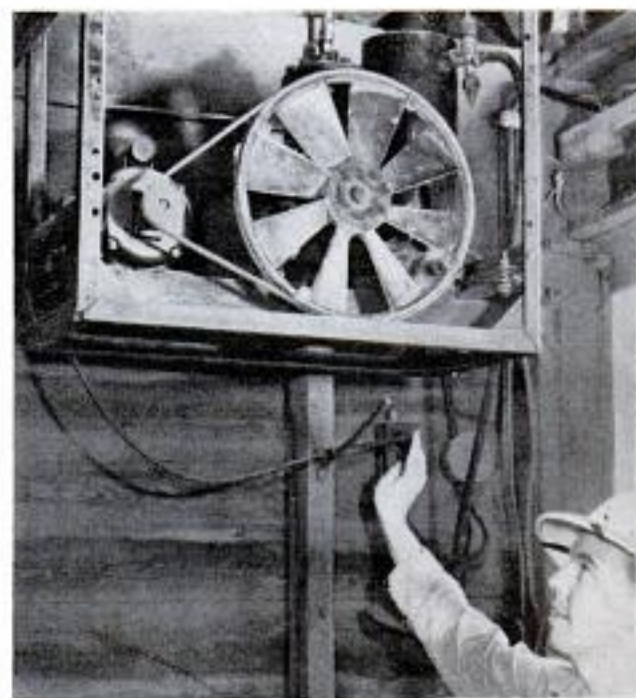

How to sound condition your basement workroom

Much of the enjoyment and relaxation of working in your basement can be spoiled by disturbing noise. Cut down the annoying effects of power tools, hammering, and sawing by sound conditioning your basement with a ceiling of Armstrong's Cushiontone® or Perforated Temlok Tile. Besides absorbing noise, these tiles provide an attractive ceiling finish you can install yourself.



- 1. Economical wood fiber materials.** Both Cushiontone and Temlok Tile are low in cost, attractive in appearance. They are factory-finished, can be washed or repainted if desired. Cushiontone's noise-trapping holes are arranged in an attractive "Full Random" pattern, while Temlok's perforations are in neat straight rows.

- 2. Installation is easy.** Start by nailing up 1" x 3" seasoned wood furring strips at right angles to the joists on 12" centers. Furring should be shimmed where necessary to provide a level surface for nailing or stapling. If existing ceiling is plaster, gypsum board, or any other smooth, firm surface, Cushiontone can be cemented directly to it.

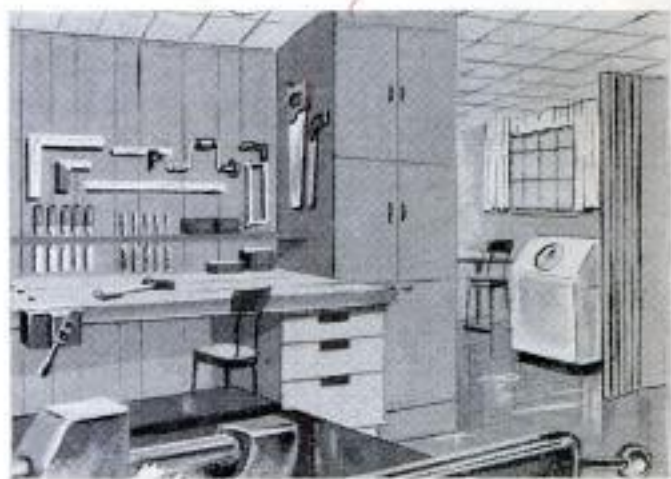

- 3. A professional-looking job is assured** by the special Lok-Bevel joint on Temlok Tile. Use four 1 1/4" 3d box nails or four staples with 1/2" legs for each tile. With Cushiontone, use flathead or collar nails in shallow-drilled corner holes. Nailheads should be 1/4" or 3/32" wide; nails at least 1/2" longer than thickness of Cushiontone.

- 4. Job's done in a few hours.** You'll have a good-looking, practical ceiling that will solve your basement noise problem permanently. In fact, your family will probably be so pleased with the new-found quiet, they'll want you to sound condition the kitchen, den, and TV room with Armstrong's Cushiontone or Perforated Temlok Tile.

Your building materials dealer will be glad to give you full details on Full Random Cushiontone, Perforated Temlok Tile, and Armstrong's other building materials. For a free booklet on Cushiontone and Temlok acoustical ceilings, write Armstrong Cork Company, 3912 Watch Avenue, Lancaster, Pennsylvania.



ARMSTRONG'S CUSHIONTONE

Temlok® • M-67® Monowall® • Hardboards • Insulating Wool • Counter-top Cement





Easy-to-use materials for printing pictures—ideally suited for beginners. **Kodacraft Printing Kit**, \$5.25.



Essentials for developing and printing pictures, including roll-film tank. **Kodacraft Photo-Lab Outfit**, \$9.75.



Complete developing, printing equipment incl. metal printer. **Kodacraft Advanced Photo-Lab**, \$14.95.



For efficient print drying. Capacity—60 average-size prints. Use it over and over. **Kodacraft Blotter Roll**, \$2.88.



Easy to use. Simple to load in dark. Takes 620, 120, and 127 roll films. **Kodacraft Roll-Film Tank**, \$2.53.



For simultaneous development of two rolls of 828 or 135 film. **Kodacraft Miniature Roll-Film Tank**, \$2.53.

Shop here for that just-right Kodak gift for everyone



These two pages are a sample of what you can see at your Kodak dealer's. He'll be happy to help you choose the right gift for every name on your Christmas list.



For accurately controlling darkroom solution temperatures. Choice of four **Kodak Thermometers**, from \$55.



New-type printing frame of steel construction. Includes a set of masks. **Kodacraft Printing Frame**, \$1.65.



Converts tray to efficient, trouble-free washer for prints or films. **Kodak Automatic Tray Siphon**, \$4.50.



3 trays with rockers for uniform developing of average-size prints. **Kodacraft Rocker Tray Set**, \$1.95.



For handling prints in tray; for stirring solutions. Handle top crushes chemicals. **Kodak Stirring Paddle**, \$35.



Includes three cups for darkroom work with both papers and films. **Brownie Darkroom Lamp Kit**, \$1.75.



New darkroom safe-lamp provides direct or indirect illumination—or both. **Kodak 2-Way Safelamp**, \$5.25.



Can be used either from a drop cord or in a wall plug. Includes safelight filter. **Kodak Dark-room Lamp**, \$5.75.



For wall, shelf, bench. Includes switch, cord, safelight filter. **Kodak Adjustable Safelight**, \$9.75.



Tilting base, minute and split-second hands, large dial. Intervals up to 60 minutes. **Kodak Timer**, \$7.95.



Cool, circline fluorescent lamp, and integrating-sphere lamphouse are prominent features in each enlarger. **Kodak Hobbyist Enlarger** (left), \$57.50, complete with $f/6.3$ lens. **Kodak Fluorolite Enlarger** (right), \$99.50 (lens extra).



Kodak Enlarging Lenses range from 50mm. $f/4.5$ "Ektanon" to 4-inch $f/4.5$ "Ektar." All superb value, from \$15.



For determining correct printing time—saves both paper and time. **Kodak Projection Print Scale**, \$1.15.



View-type camera with long bellows. **Kodak Fluorolite Camera Combination**, \$69.50 (less lens).



Expertly made Kodak Field Cases make cameras easy to carry, offer sound protection together with smart appearance. Include fine-quality leather cases (left), and durable simulated leather cases (right). **Kodak Field Cases**, from \$2.65.



Automatically trips shutter, permits photographer to get into picture. **Kodak Auto-Release**, \$3.86.



Provides dependable "flash" for most internally synchronized cameras. **Kodak Standard Flashholder**, \$7.95.



B-C (battery-condenser) flash insures longer battery life, sure "synch." **Kodak B-C Flashholder**, \$9.95.



For quick, easy multiple lighting. Lumaclad reflector. **Kodak Flashholder Extension Unit**, Model 1, \$11.



Condenser-type power for dependable "flash." **Kodak B-C Flashpack** (without 22½ volt battery), \$2.95.



Versatile battery-condenser flash system. **Kodak Ektalux Flashholder** (including bracket), \$19.75.



Holds your camera and flash extension unit on most flat or tubular surfaces. **Kodak Flexi-clip**, \$4.95.



For Brownie Hawkeye and Kodak Duaflex III Cameras. Exceptionally easy to attach. **Kodalite Flashholder**, \$4.



Permits close-range picture taking with most fixed-focus cameras. **Kodak Close-Up Attachment**, \$1.63.



New, a filter designed for inexpensive box cameras—emphasizes clouds. **Kodak Cloud Filter**, \$1.85.



It's easy to get extreme close-ups with both still and movie cameras with **Kodak Partra Lenses**, from \$2.65.



Shades camera lens and reduces sky flare—attaches to adapter ring. **Kodak Lens Hood**, from \$1.75.



Popular yellow (K2), red (A), and green (X1) filters to fit most cameras. **Kodak Wratten Filters**, from \$1.75.



500-watt lamp; automatic take-up changer; impeller blower. **Kodaslide Signet 500 Projector** (f/3.5 lens), \$72.50.



Vertical slide-feeding mechanism, cool operation, elevating device. **Kodaslide Merit Projector**, \$23.95.



Two superb color slide projectors. **Kodaslide Highlux III Projector** (left), 300-watt; quiet fan; blower, carry case, \$54.75. **Highlux II** (right) gives brilliant 200-watt projection. Converts to Highlux III. \$35.35. Carry Case, \$7.50.



Handiest way to view 2 x 2-inch color slides. Magnifies 4 times. Folds flat. **Kodaslide Pocket Viewer**, \$1.95.



Compact storage for 200 Kodak Ready-Mounts, 66 glass slides. **Kodaslide Ready-File**, \$1.95.



Holds 240 cardboard or 96 glass slides. **Kodaslide Compartment File**, \$3.94.



Holds 360 2 x 2-inch or 160 stereo slides. **Kodaslide Flexo File**, \$9.95.



Materials for mounting 50 color transparencies in glass. **Kodak Slide Kit**, \$3.63.

Prices include Federal Tax where applicable and are subject to change without notice.

Many Kodak dealers offer convenient terms

Care and Feeding of Engines



BY
S. P. CORP

CHECKING SHOCK ABSORBERS

If your car has gone over 25,000 miles, it's a good idea to check the shock absorbers—not just for comfort, but because non-operative shocks can cause hard steering on curves, and wandering. Stand on bumper, bounce vigorously up and down, then step off quickly. If car continues to bounce, replace your shock absorbers. If it comes to rest on the first bounce, they are O.K. If inspection on a hoist shows much oil on the shocks, your seals are leaking fluid, and shocks should be replaced. Also check to be sure each shock is tight on its rubber bushings, otherwise you will have an annoying rattle.



DOOR GLASS TROUBLE

If window or door glass drops by itself, note whether handle is up or down when closed. It should be straight down. If up, weight of handle with vibration

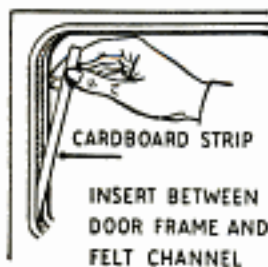

CARDBOARD STRIP
INSERT BETWEEN
DOOR FRAME AND
FELT CHANNEL

will tend to pull it down, lowering glass. To correct, remove handle by pressing trim plate inward and disengaging small pin with icpick, or removing horseshoe clip. Replace handle in proper position, installing pin or clip before releasing pressure on trim plate. If glass rattles, lower it, remove molding screws and take off molding. Slip thin pieces of

waterproof cardboard behind glass run channel on hinge side of door. Before replacing molding, run glass up to be sure there is enough tension to keep it from rattling.

YOURS FOR THE ASKING

You'll find a wealth of helpful car-care information in the free illustrated manual, "MORE POWER, Less Gas, Less Oil." It's yours for the asking. Just address a card to Sealed Power, Dept. G-12, Muskegon, Mich. And when you re-ring, be sure to use Sealed Power KromeX Ring Sets—with chrome-faced top compression ring and chrome-faced side rails on the steel oil ring. You'll get more than double normal ring mileage! There's nothing like chrome for fighting heat, friction, abrasion and corrosion—and there's no other ring set equal to KromeX!



Sealed Power

PISTON RINGS

Clinic for Homemakers



As a service to our readers in solving the hundreds of problems pertaining to a home—inside or out—the editors of *Popular Mechanics* invite you to present your problems to The Clinic Editor for help and advice. Address your questions to The Clinic Editor, *Popular Mechanics Magazine*, 200 East Ontario Street, Chicago 11, Ill.

Concrete Over Brick

Q—My basement is floored with bricks laid loosely and although it is in fair condition and reasonably level, I would prefer to have a concrete floor over the whole area, which is approximately 24 x 36 ft. There is some seepage through the present floor in the spring and fall. I'm told not to lay concrete over the bricks. How about this, can it be done or not?

—M.O., Mich.



A—Of course, it can be done, but we would hesitate to recommend the procedure. The principal reason being the possibility that the bricks might slowly disintegrate after a time in a manner similar to cinders. This would be due to constant absorption of moisture. The end result would be cracks in the concrete floor due to lack of adequate support. If we can judge from your description, local drainage conditions must be better than average or you would experience more trouble from water seepage. Assuming that the basement walls and footings are in good condition, we believe it would be best to remove the brick floor, put in a gravel fill to a depth of at least 6 in. (tamped), then lay a waterproof membrane over grout and finish with at least 3 in. of concrete. The new floor can be poured against a 3/4-in. oiled spacer board at the wall. After the concrete has set, the spacer board is removed and the opening filled with hot tar, poured flush with the surface of the floor. This will form an effective seal against water seepage.

Dry-Well Drainage

Q—I have just moved into a new home and am trying to decide whether to use splash pads to carry away water from the gutter downspouts or drain these into dry wells. I'm advised against the latter, although they would make by far the neater installation. What is your opinion? Why shouldn't I choose the dry-well method of drainage?—L.B., Ky.



A—We would be inclined to agree with your advisers, although the dry wells might prove satisfactory where natural drainage conditions are such

(Continued to page 226)

THE GREATEST INVENTION SINCE THE HAND SAW . . .

New **Amf** DeWalt "Power Shop" brings out the expert in you!

Today, AMF DeWalt® "Power Shop" is everywhere known and accepted as the one really safe, accurate, easy-to-use machine. It's so designed that even the inexperienced can *expertly* do everything in home woodworking.

Whether you're modernizing, decorating or repairing your home, AMF DeWalt is your best investment. See it demonstrated today. At your DeWalt Dealer's or fine hardware and department stores.



\$229 delivered (saw blade and custom-built 1/2 H. P. motor included). EASY TERMS.

All these exclusive extra-value advantages!



TOP-SIDE CUTTING! No guesswork—no mistakes. You always see the cut because layout marks are visible and easy to follow.



PROFESSIONAL ACCURACY! Calibrated scales for miter, bevel and rip are visible above table. Instantaneous settings!



EASY TO USE! You control ball-bearing travel head in radial arm. Moves smoothly, precisely. All cuts perfect—no spoilage.



COMPLETE VERSATILITY! One powerful direct-drive motor accommodates any circular tool—gives full home workshop flexibility.



NO FLOOR SPACE NEEDED! Builds into your workbench! When not in use radial arm swings conveniently out of way, freeing work area.



HOME SAFETY FEATURES! "Stop" red controls, UL*-approved motor, safety key switch, auto-float safety guard (optional).

*Underwriters' Laboratories, Inc.



PLUS BIG CAPACITY and many more extra-value features—all explained in new FREE 20-PAGE COLOR BOOKLET!

Another **Amf** Product

DEWALT

POWER TOOLS

DeWalt Inc. • Lancaster, Penna., U.S.A.
IN CANADA: DeWalt Canada Ltd., Guelph, Ontario

Send this coupon today!

AMF DeWalt, Dept. PM-54-12, Lancaster, Penna.

Please send me free illustrated booklet "The Greatest Invention Since The Hand Saw" showing how your Power Shop makes me a woodworking expert, saves money in my home.

Please send me free blueprint "Building A Home Workbench."

Name.....

Address.....

City..... Zone..... State.....

HOW TO FINISH OFF YOUR ATTIC



This free book makes it easy...

You can turn wasted attic space into beautiful extra rooms in a jiffy! These pages of step-by-step, easy-to-follow instructions tell you how to floor, frame, trim and paint. And how to insure comfort with efficient, sanitary, permanent Fiberglas* Insulation! Write for your copy and get started—now!



OWENS-CORNING

FIBERGLAS

1-8-60 U.S. PAT. OFF.

Owens-Corning Fiberglas Corporation
Dept. 178-L
Toledo 1, Ohio

Please rush a copy of the "How To Do-It-Yourself" book to:

NAME _____

STREET _____

CITY _____ ZONE _____ STATE _____

*Fiberglas is the trade-mark (Reg. U. S. Pat. Off.) of Owens-Corning Fiberglas Corporation.

(Continued from page 224)

that all surface water is drained away to a considerable depth in a short time. Dry wells are most effective in loose, porous soils and in sandy soils where there is sufficient slope to carry away sub-surface water. One serious fault of the dry well is its tendency to fill with sand and spill particles and also surface debris if it is not properly covered. In some cases builders offset this tendency by burying a large drain tile, 24 to 36 in. in dia., with the bell end up. This is filled with coarse gravel and a small quantity of sand and protected with a cast-concrete cover which fits into the offset at the bell end. There also are metal seep wells available which are said to be quite effective for the purpose. However, if the soil in the area is a heavy clay or loam having comparatively poor drainage characteristics, then we would recommend that you consider the installation of splash pads.



Reducing Humidity

Q—My home is one-story, ranch type with a crawl space under the floors. There are vents in the concrete foundations. In summer there is considerable moisture on the ceilings and walls. In cold weather, frost has formed on the north wall of an unheated room. This condition has damaged the paint and paper. Is there any remedy?

—J.L., Wis.

A—We assume that the floors are of wood with wooden joists. Moisture rising from the grade under the floors will penetrate these materials into the rooms above and very likely is causing at least a part of the trouble you are experiencing. However, there are other sources of excess water vapor in the rooms, such as cooking, laundering and bathing, shower-bathing especially. During the winter months, the moisture content of the air in the rooms may rise to a very high level. You can reduce this to some extent by ventilating the entire house at regular intervals. The installation of a kitchen ventilating fan often proves a definite help. Also, we think it would be advisable to cover the area under the floors with smooth roll roofing laid with 4-in. tarred laps. Weight the roofing with a thin layer of sand, especially at the edges where it meets the foundation wall. It may also be advisable to increase the total free area of the vents in the foundation wall.

Repairing Porcelain

Q—I want to repair a wall-type apron sink so that I can use it in a basement apartment. The porcelain is chipped on the bottom near the outlet and also near the top of the apron in a couple of places. None of the chipped areas is large, but they are unsightly. I understand that there are porcelain-repair materials available which can be applied without heating or any other special preparation of the surface. Are these reliable for the purpose?—C.T., Wash.

A—Of course, it is not possible or practical to produce a repair having the durability and smoothness of the original finish. However, the preparations available for this purpose are said to be quite effective. These generally are liquids, heavily pigmented, that dry and harden on exposure to the air, in a manner similar to enamels. If the chipped areas are large, 2 sq. in. or more in area, then we are doubtful about the advisability of attempting a repair. Smaller areas can be repaired with a fair degree of success. When using any of the preparations referred to, it's important to follow the manufacturer's instructions in all details. Usually these will direct you to make sure that the chipped area is thoroughly clean. This usually requires a careful scrubbing to remove any soapy deposit embedded in the tiny crevices. Also, instructions usually direct that you apply the preparation in successive layers. In some cases, it is advisable to build up the repair material to a height slightly above the surrounding surface. After drying it is leveled by sanding with very fine sandpaper, 6/0 or finer.

BOYS! Get **ERECTOR**[®] and build hundreds of action models

Put together these gleaming STEEL precision parts and create hundreds of toys! Illustrated "How to Make 'Em" book in every set. But you can do your own inventing! Models whistle, "choo-choo," light up and puff smoke. Tell Dad you want ERECTOR and see displays at stores. For *free* ERECTOR and Gilbert Toy Book write Gilbert Hall of Science, 207 Erector Square, New Haven 6, Connecticut.

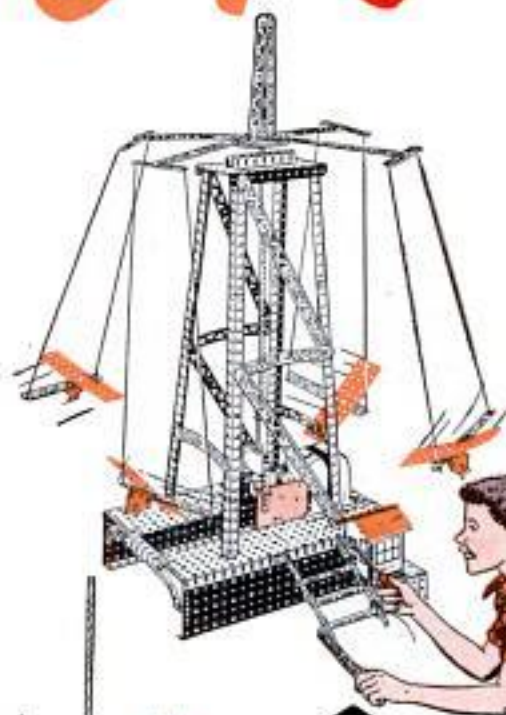

Make this high-swinging airplane ride with ERECTOR No. 6½.

No. 6½ has over 350 parts—sturdy girders, gears, wheels, etc. "Powerhouse" electric engine features many speeds (including reverse) to put *action* into your models. Builds pile driver, elevator, lift bridge, hundreds of other wonderful toys that work.

\$13.95*

Square Girder Construction

Precision-matched parts easily lock together with nuts and bolts. Can't wobble or warp. Build bridges that hold more than 200 pounds. Parts have lasting gleam.



*ERECTOR prices slightly higher Denver and West



Huge ferris wheel turns fast or slow; reverses. Made with ERECTOR No. 8½.

The all-electric set (No. 8½) has nearly 16 pounds of parts! Includes 4-speed forward and reverse electric engine, electric lights, electromagnet! Build a mighty crane, oil drilling rig, portable derrick, etc. Heavy gauge steel chest.

\$24.50*

WORLD'S MOST FASCINATING
CHRISTMAS GIFT

JR. ENGINEERS
AT WORK
WITH ERECTOR!

ERECTOR
PRICES
START AT
\$2.00*

MORE
SANDING AREA
*than any sander in
its price class*

25 square
inches



only **2 $\frac{15}{16}$ "** high...
fits under tight places

LOWEST
SANDER DESIGN

IDEAL
CHRISTMAS GIFT
only \$14.95
model 700

**The Newest Power Sander
and Polisher on the Market**

As efficient as any rotating motor-driven sander, plus these quality features: straight-line action, no bucking, sands *with* the grain and goes all the way into corners; powerful 60 cycle reciprocating motor gives 14,400 strokes per minute; exclusive insulation gives smooth, quiet operation; push-button control; 8 foot cord.

Weller

SANDERS

816 Packer Street
Easton, Pa.

AVAILABLE AT HARDWARE STORES

Model Railroad With Sound Effects

(Continued from page 116)

One fascinating train is a complete 15-car Sells-Floto circus train built by Elbert Swerdfeger, son of M. D. Swerdfeger. The passenger, baggage and flatcars of the train are precise copies, painted to match the originals and loaded with the same equipment carried by the full-sized cars. The model of the tent car, for instance, carries the stakes and canvas of a tiny circus tent that actually can be unrolled and erected. A typical flatcar is loaded with a water truck complete with barrels, an animal cage with a hippo inside and a gaudily painted band wagon.

The scaled-down circus cars are supreme examples of the modelmaking art. Other examples are some of the boxcars that carry advertising on their sides in the best railroad tradition. The sign on one boxcar reads "Eat Swerdfeger's Buttercup Brand Pickles" while another advertises "Scott County Canned Foods." In coloring, arrangement and style of printing the little signs are exactly like those often seen on freight cars.

Many model railroaders build locomotives and trains of convincing realism and then destroy the whole illusion by using background scenery so crude that it seems to have been assembled from a toy store. Chet Tayloe carries his realism all the way into the background and even humanizes the layout here and there with traces of humor.

On a circus poster pasted to the side of a tiny shed, for example, you'll find a penciled cartoon apparently scrawled there by an idle boy. Down near one of the railroad cuts the modelmaker is building a typical hobo "jungle" with tiny figures crouched around a campfire that consists of a miniature glow lamp, wired from below.

Not content with the church that he placed on a hill, he built a graveyard beside it and then, as a final touch, removed a section of the imitation turf to provide a freshly dug grave. Now some of his friends complain that the freshly dug earth, being moist, should be slightly darker than the rest of the dirt!

Tayloe builds his mountain backgrounds of plaster and burlap that is draped over rough board forms while the plaster is still wet. Then it is shaped into the exact shapes desired. An imposing cliff was created by making a plaster mold of the flat face of a big slab of coal, then using burlap and colored plaster to make a cast for use as the cliff. This plaster copy retains all the indentations and cleavage lines of the

(Continued to page 230)

The CHRISTMAS GIFT

that has everything any
homecraftsman or
hobbyist needs

FOR SCORES OF
MONEY-SAVING
JOBS

Perfect gift to give or receive . . .
useful all year 'round. Each kit includes:

- Weller 8250A Soldering Gun—
250 watts
- Famous Kester Solder—general
purpose spool
- Soldering Tip—for all kinds of
soldering
- Smoothing Tip—for mending
and sealing
- Cutting Tip—for plastic tile, etc.
- Wrench—for tip interchange
- Instruction Booklets—handy
soldering and homecraft hints
- Metal Case—for storage and carrying

Nothing else to buy for soldering, sealing, cutting, mending,
joining and smoothing. Makes professional results easy.

only \$14.95

MODEL 8250AK

NEW WELLER GUNS AND KITS ARE AVAILABLE AT HARDWARE DEALERS

Junior SOLDERING GUN

- New, Compact Design
- Heats in 5 Seconds
- Over 100 Watts
- Trigger Switch Control
- Dual Spotlights

The ideal homecrafters' soldering tool.
No other soldering gun or iron offers the
professional quality, practical features and
low price of the Weller JUNIOR.

MODEL
8100

\$7.95

Weller

THE FINEST TOOLS FOR THE FINEST CRAFTSMEN

ELECTRIC CORPORATION

816 Packer St., Easton, Pa.

SOLDERING GUNS • SOLDERING KITS • POWER SANDERS

Looking for Something?



**HOBBY
SUPPLIES**

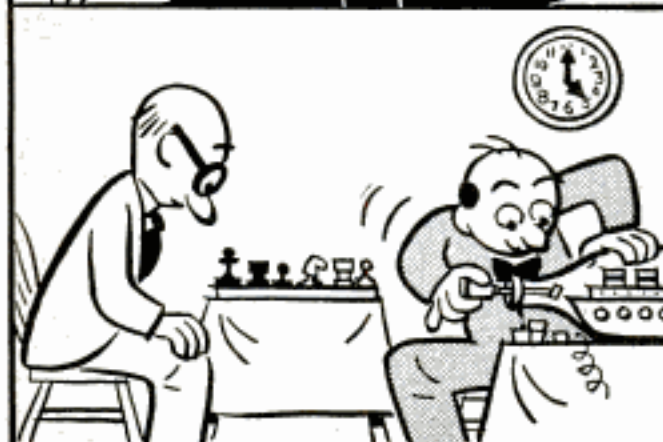

**FROM HARDWARE
TO HOBBY SUPPLIES**

**LOOK IN THE
'YELLOW PAGES'
OF YOUR TELEPHONE DIRECTORY**

original and now has the appearance of an imposing granite wall.

Fibrous insulation board, split and torn to various shapes, makes a good imitation of uneven ground and so this is used for most of the foregrounds in the layout. Shrubbery trimmed to shape and dipped in paint becomes realistic trees. Small pine cones sprayed a dull green and placed on their bases side by side will represent a distant fir forest on one mountaintop that is not yet finished.

Backgrounds and foregrounds are painted by hand or by spray, using water paints to avoid a shine, and mostly in dull reds, browns and grays that imitate the colors of nature.

Waves on the model ocean at one end of the layout are created by bending wire screen to the shape of the combers, then coating the screen with a surface of casting plaster. The waves are painted green with flecks of white for foam. The placid surface of a lake is imitated by a flat sheet of cardboard, water-colored to give the varying hues of blue-green desired, then varnished for the sparkling effect of water. The edges of the lake are simply filled in with loose sand. Aquarium sand mixed with varnish and shaped by hand with a straightedge makes a strong, realistic roadbed for the railroad trackage.

The principal construction materials for the model buildings are Bristol board, paper and thin sheets of soft pine. To get the effect of shingles, Tayloe overlaps thin strips of paper, glued in place. The columns of a grain elevator came from cardboard mailing tubes. Painted in imitation of concrete and boxed at the top, they look like the real thing.

All the buildings in the layout are realistic and yet one is outstandingly so. This is a shed labeled "Captain Billy's Boat Yard" that stands on pilings overlooking a lake. Created by E. S. Hammack, it has the atmosphere as well as the appearance of a dilapidated boathouse. There is a sea gull resting on the roof, tiny Coca Cola and Dr. Pepper signs plastered on its walls, and even a case of soft-drink bottles tipped against a wall. On one side of the boathouse a rowboat is under construction, as evidenced by the scaled-down sawdust and wood chips lying beneath it.

Complete as it appears to be, the model-railroad layout is far from finished. Still to be added are the sawmill and its pond, a waterfall and river along which real water will flow, a mine in the mountains with ore cars on mine trackage, and numerous industrial buildings. Tayloe and his friends are working on these parts of the layout now. ★ ★ ★

New Sure Way To GET YOUR CAR STARTED EVERY DAY THIS WINTER



Never Overcharges . . .

START-O-MAGIC

automatically keeps your
battery at full charge

It's plenty cold . . . you're in a hurry . . . you touch the starter and away you go—that's START-O-MAGIC!

Don't let your battery run down. Whenever you put your car away, simply plug START-O-MAGIC into the cigarette lighter socket on the dashboard, connect to any electrical outlet, press the charging button, and forget about it.

The next time you want to use the car, whether it's the following morning, a week later, or two months later, you'll find your battery fully charged, but *never* overcharged.

START-O-MAGIC has a new totally different type safety circuit that delivers 6 amps until *any* battery is fully charged, and then automatically switches over to "Battery Saver" circuit. There's no danger of overcharging, no matter how long you leave it connected.

When the average battery is run down due to frequent starting in city driving, balky starting in sub-freezing weather, heavy use of lights, heater, radio or other accessories, faulty voltage regulation, or because a car has been idle too long—START-O-MAGIC will recharge it overnight, and keep it fully charged until needed.

START-O-MAGIC is made by Franklin, the company that has been manufacturing battery chargers for the nation's leading battery makers and the automotive industry for over 25 years.

Send for your START-O-MAGIC today . . . and enjoy troublefree starting throughout the year.



As reported by Popular Mechanics
in November, 1954 issue. Page 111

Only **START-O-MAGIC** has all these features

- Plugs instantly into lighter socket on dashboard.
- Recharges overnight. Keeps battery fully charged indefinitely.
- Won't overcharge—"Battery Saver" circuit switches in automatically.
- Two indicator lights tell if battery is fully charged or not.
- Extends life of battery.
- Perfect for 2-car families where one car is idle for several days.
- For boat owners—keeps battery in top shape for week-end use and during winter storage.
- Economical—uses only 10¢ worth of electricity per month in steady use.
- Fully Guaranteed. Underwriters Approved.

For 6 volt
batteries **\$21⁷⁵**

For 6 and 12 volt
batteries—\$26.50.

ORDER NOW! BE PREPARED FOR EASIER COLD WEATHER STARTS

FRANKLIN MANUFACTURING CO., INC.

65 22nd Avenue N.E., Minneapolis 18, Minnesota

Send me— 6 Volt START-O-MAGIC at \$21.75.

6/12 Volt START-O-MAGIC at \$26.50.

Enclosed is \$ _____ check money order.
FULL AMOUNT Franklin will pay postage.

Send C.O.D. Enclosed is \$5 down payment. I will pay post-
man balance and postage.

Name _____

Address _____

City _____ State _____

SPEED-DIAL **on NEW SHOPSMITH* Mark 5 PINPOINTS THE RIGHT SPEED FOR EVERY JOB!**



Find the right speed for any job and you're on the way to safer, more accurate work. Now SHOPSMITH with Speed-Dial makes it easy to find the exact speed . . . makes accurate work possible for everyone.

Just set exclusive Speed-Dial for the job you

want—Saw, Jointer, Jigsaw, Dadoing, Sanding, etc. No bothersome belts and pulleys to change. No more "next best" speeds to spoil your craftsmanship. An infinitely variable selection of speeds from 700 to 5200 rpm.

*T.M. Reg. U. S. and Foreign Countries

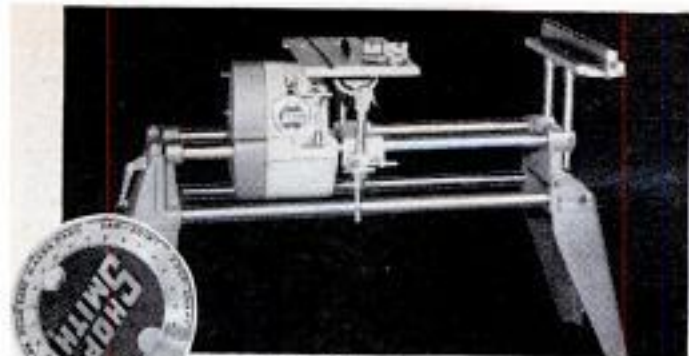

For sawing—Cross-cutting, ripping, doing, molding . . . each has a separate Speed-Dial setting. Powerful 9" circular saw cuts 2" lumber even at 45° angle. Adjustable extension table supports work up to 48" from blade. Quick-change saw arbors for easy blade switches.



For sanding—Individual Speed-Dial settings for coarse, medium and fine sanding of plastics, metal or wood. Big 12" disc has 113 sq. in. of sanding surface. Disc feeds into work. Depth control dial and built-in jigs assure precise duplication of work *without repeated measurements.*



For drilling—Different Speed-Dial settings to cover a complete range of drilling wood, metal, plastics. Vertical Drill Press drills to center of 16½" circle, handles floor drill press operations with up to 58" between chuck and floor . . . has depth control dial and ready-made jigs.

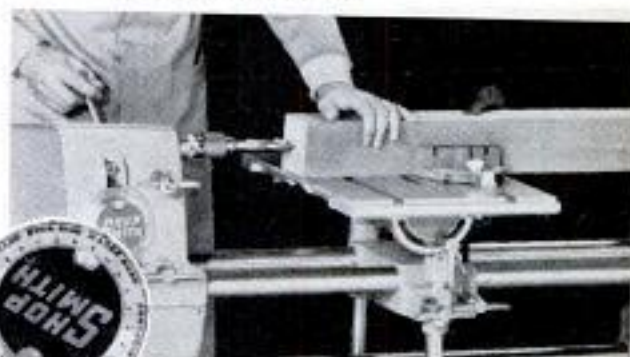

For horizontal boring—Low-speed settings for large-diameter boring. Other Speed-Dial settings for doweling, routing, shaping. Unlimited capacity for drilling in a horizontal plane. Rigid fence support with adjustable table height makes drilling for doweling easy and accurate.

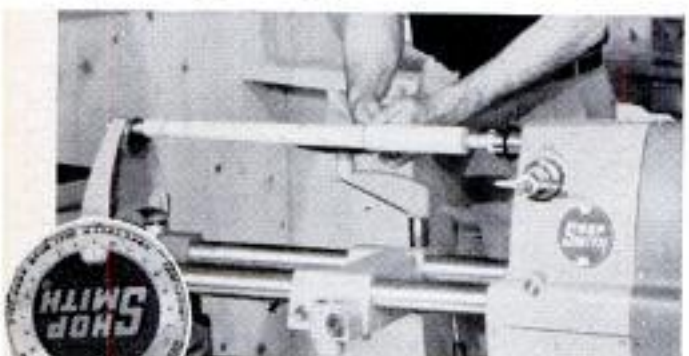

For wood turning—Individual Speed-Dial settings for turning a full range of diameters. SHOPSMITH is unexcelled as lathe, with 16½" swing and 34" between centers. Tool rest slides parallel to work without constant readjustment. Exclusive eccentric cup center mount for turning tapers.



Another SHOPSMITH Mark 5 exclusive—New POWER MOUNT! Add jointer, jig-saw, bandsaw, etc., with twist of a handle, one turn of a setscrew. Complete range of Speed-Dial settings available for every POWER MOUNT operation.



Want a SHOPSMITH for Christmas? Let us help. Clip and mail coupon right now. We'll write to your favorite Santa and tell her what wonderful things you could do for the whole family if you were to receive a SHOPSMITH Mark 5 for Christmas.

See the new SHOPSMITH Mark 5 at your hardware or local Montgomery Ward store. It's the modern power tool that comes ready to plug in and go to work. No extras to buy. Complete with powerful built-in ¾-hp. motor and bench. Only **\$269.50!**

MAGNA ENGINEERING CORPORATION

Dept. 277-B, at factory nearest you.
12819 Coit Rd., Cleveland 8, Ohio, OR
Menlo Park, California.

Please put the SHOPSMITH bug in the ear of

_____ Name and Address

Please rush me FREE 20-page SHOPSMITH catalog.

Name _____

Address _____

City _____ State _____

B.F. Goodrich

ASPHALT

FLOOR TILE



3
THINGS
SOLD
ME!

THE SAVINGS — I saved plenty by installing this moderately-priced floor tile myself!

EASY INSTALLATION — Precision-cut edges and true corners make installation a simple job — especially when you use the B. F. Goodrich Self-Installation Kit. And you can install it on, above or below grade!

DURABLE BEAUTY — It's beautiful, yet stands up under the rough treatment my youngsters give it.



Available in 24
beautiful colors

B. F. Goodrich Co., Dept. PM11,
Flooring Div., Watertown 72, Mass

Name.....

Address.....

City.....State.....

That Wonderful Volcanic Popcorn

(Continued from page 139)

Once in the house, you find that the outstanding insulating properties of perlite cut your heating bills substantially.

If a guest drops a carelessly snuffed cigarette into the wastebasket, perlite walls will keep the fire from spreading through the house. In Underwriters' tests, flames licked at one side of a perlite-concrete wall for four hours before the average temperature on the unexposed side reached a moderate 132 degrees Fahrenheit.

There are still drawbacks to the use of lightweight aggregates. They are about 10 percent more expensive than sand, and must be applied in a slightly different way. But processors are sure they can slash the price as new furnaces and better handling methods come into use.

As perlite becomes cheaper, sand becomes more dear. The "sharp" sand suitable for plaster and concrete is getting more expensive every year as deposits near large cities are exhausted.

Some of perlite's special characteristics help cut home-building costs. It can be blown or poured into walls and between the joists of attic floors where it does a first-rate job of insulation. When used in this way, it doesn't absorb moisture and doesn't settle. Because it is inorganic, it is insect and rodent proof and does not decay.

New refrigerators lined with perlite are space savers. Because its walls don't have to be thick, a 10-cubic-foot refrigerator with perlite insulation takes no more space than a seven-cubic-foot conventional box. There is extra room for vegetable storage.

Cold-storage warehouses and icehouses built of perlite are under way. Perlite is used to line refrigerated railway cars and ships. Space saved by this remarkable insulation means lower shipping costs and a reduction in fruit and meat prices.

Radio stations are using perlite as sound-proofing. It is being employed as a flattening element and extender for rubber-base paints. It makes an excellent refractor, an abrasive, or a packing material replacing fibers. It is an ingredient in soaps and fertilizers. Drillers pump perlite-gypsum plaster as a sealer into oil wells. The bilges of ships are filled with it to prevent excessive collection of water with its foul odors and dangerous oil slicks. Automotive and air-conditioning filters made of perlite are very efficient.

Hundreds of other uses for the miracle mineral are expected. Since the day perlite first popped like popcorn before the amazed eyes of Lee Boyer, industry has found it to be a material of real importance. ★ ★ ★



Ask her for the
FINEST POWER TOOLS MADE

**MILLERS FALLS
TOOLS**

SINCE
1868

Faster than 10 Men with Handsaws. Millers Falls portable electric saws are powerful, safe, easy to use. Built-in angle and depth adjustments, adjustable ripping guide. No. 600 — a new, fine-quality 6" saw, \$43.50. No. 610, shown — husky, heavy-duty 6" model, \$59.50. No. 700 — larger, with full 7" blade, \$67.95.



Mighty useful. There's power to spare for hundreds of jobs with this rugged new Millers Falls 1/4" Drill. No. 1814 Drill alone, \$22.35. In complete, accessory-packed Deluxe Drill Kit No. 8142, \$42.25. Other Millers Falls drills from \$19.85 — kits from \$29.95.



Fits any 1/4" electric drill. For work in corners, between studs, and other hard-to-get-at places. No. 2130 Universal Right-Angle Drive \$4.95



Sand and polish with any 1/4" electric drill. Complete with 5" rubber pad, 5" lambswool bonnet, two 5" sanding discs. No. 2120 Universal Buffing and Sanding Attachment, \$8.45.

Universal Jig Saw Attachment. Converts any 1/4" electric drill into an efficient saw that cuts straight or curves. Capacity 3/4" in wood, 1/8" in metal. Needs no starting hole in wood — cuts own way through. Complete with 4 saw blades. No. 2140, \$10.95.



New "Dyna-Mite" Power Wood Bits with high-speed steel blades. Stay sharp 10 times longer — even cut through wire nails without damage. 6 diameters — 3/8" to 1" — all with 1/4" shanks. Singly or in sets. No. 8006 set of 6, \$6.45.



Here's the Spectacular New
Millers Falls 888 POWER UNIT

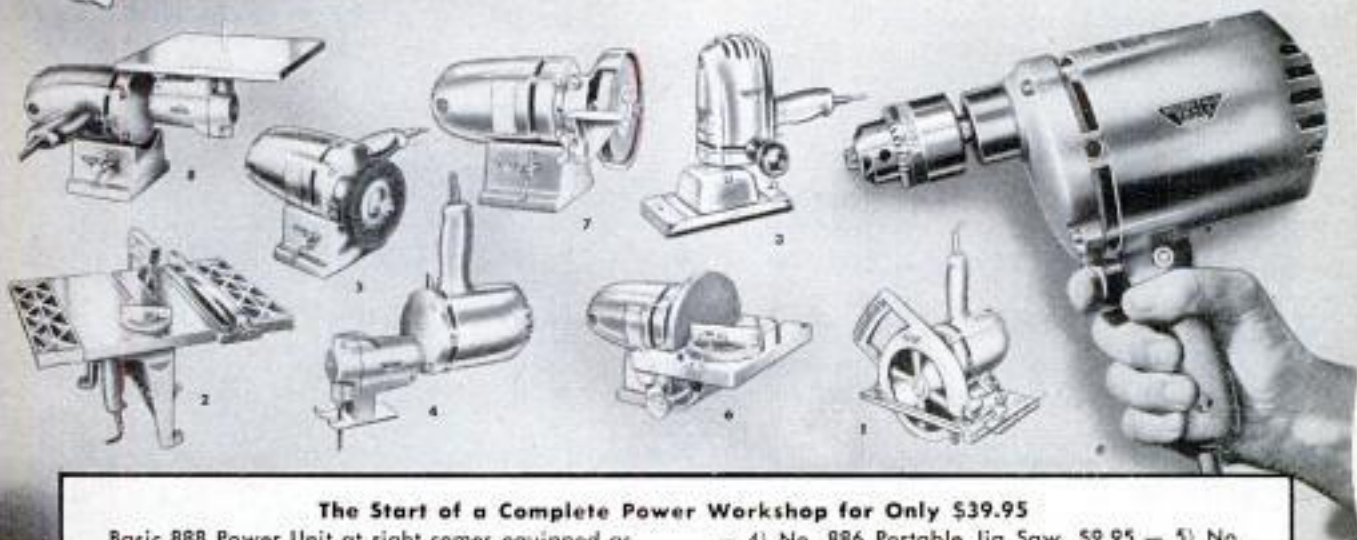

The Start of a Complete Power Workshop for Only \$39.95

Basic 888 Power Unit at right comes equipped as a powerful (4.0 amps.) 3/8" drill, 6" disc sander, and 6" polisher — \$39.95. It converts into 8 additional power tools by means of beautifully engineered, inexpensive attachments: 1) No. 8811 6" Portable Saw, \$15.95 — 2) No. 883 6" Bench Saw, \$22.95 — 3) No. 882 Orbital Sander, \$15.50

— 4) No. 886 Portable Jig Saw, \$9.95 — 5) No. 881 Bench Stand, \$2.95 — 6) No. 889 6" Disc Bench Sander (also requires No. 881 Stand), \$7.95 — 7) No. 8810 4" Bench Grinder (also requires No. 881 Stand), \$5.95 — 8) No. 887 Jig Saw Table (converts No. 886 to Bench Saw), \$1.75. Special Bulletin at your hardware store or on request.

If your dealer cannot supply you, send us his name. Millers Falls Co., Dept. PM-5, Greenfield, Mass.

FREE

SEND FOR THE

1955**308-PAGE**

value-packed **ALLIED**
TV & RADIO CATALOG
 world's most complete
ELECTRONIC SUPPLY GUIDE



Everything for Experimenters,
 Builders, Amateurs, Servicemen,
 Engineers & Hi-Fi Specialists

Get ALLIED's big 308-page Catalog featuring the world's largest selections of latest top-quality electronic equipment at lowest, money-saving prices. See the newest in custom TV chassis, antennas and accessories; FM and AM tuners; High Fidelity systems and components; recorders and phono equipment; Amateur supplies; test instruments; builders' kits; industrial electronic supplies—plus thousands of parts, tubes, tools and books. Get *everything*, get *more* for your money—send today for your FREE 1955 ALLIED Catalog!

Ultra-modern facilities to
 SERVE YOU BEST

SAVE ON
 EVERYTHING



WORLD'S
 LARGEST
 STOCKS

Send
 for FREE
 Catalog

ALLIED RADIO

ALLIED RADIO CORP., Dept. 5-MM-4
 100 N. Western Ave., Chicago 80, Illinois

Rush FREE 1955 ALLIED 308-Page Catalog.

Name _____

Address _____

City _____ Zone _____ State _____

Children's Playroom Phono Has Grown-Up Features

(Continued from page 163)

transformer specified, the negative feedback resistor R6 value is correct, and gives 24 db feedback. The speakers must be correctly phased; that is, the cones must go in and out together. To check them, connect them in series with a 1½-volt dry cell. If one goes in and the other goes out, interchange the two leads to just one.

CABINET BILL OF MATERIALS

Item	Req'd.	Name	Size Inches
1	1	Left side	3½ x 14½ x 107½
2	1	Right side	3½ x 14½ x 107½
3	1	Top	3½ x 13½ x 107½
4	1	Motor board	3½ x 13½ x 107½
5	1	Brace	3½ x 3½ x 11½
6	1	Top back	7½ x 3-7/16 x 13
7	2	Motor board backstop	3½ x 3½ x 3½
8	1	7-in. album back	3½ x 1-11/16 x 7-9/16
9	1	7-in. album side	3½ x 8 x 7-9/16
10	1	Amp. and Spkr. shelf	3½ x 13½ x 107½
11	1	Bottom	3½ x 13 x 107½
12	1	10-in. record rack	3½ x 13 x 1-15/16
13	1	Amp. Spkr. panel	7½ x 7-9/16 x 107½
14	2	Spkr.-box top and bottom	3½ x 9½ x 3-7/16
15	2	Spkr. boards	3½ x 6¼ x 5
16	1	Spkr.-box rear	3½ x 6¼ x 3-7/16
17	1	Spkr.-box side	3½ x 9½ x 7
18	1	Piece grille cloth	7 x 9
19	1	Piece glass fiber	3½ x 6¼ x 12
20	2	Jensen type 4J4, 4" PM speakers	

All cabinet-construction details appear in Fig. 1, and the key numbers refer to the corresponding numbers of the items in the cabinet bill of materials. Use glue and No. 18 headless brads, 7/8 in. long. The template for the cutout in the motor board comes with the 3-speed phono motor which is a type SS General Industries unit. The pickup is a turnover crystal type Model 7D As-tatic. The Jensen type 4J4, 4-in. PM speakers are about \$2.11 each. Detailed student material list R-429 is available from Popular Mechanics Radio-TV and Electronics department upon receipt of ordinary letter postage. ★ ★ ★

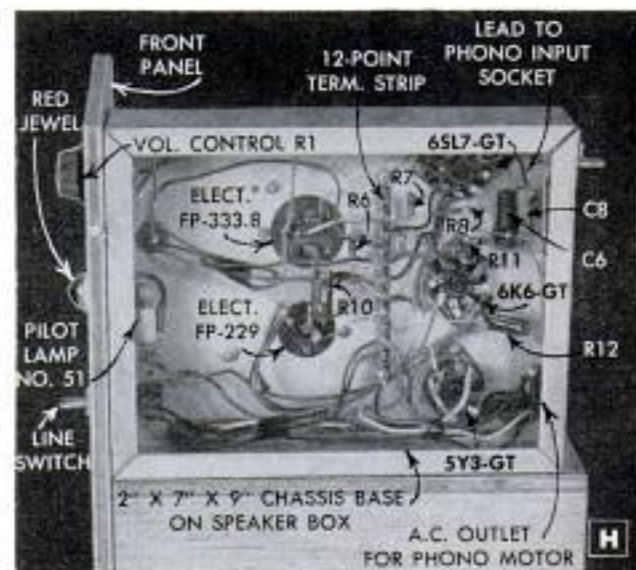



You Can Make SURE, SAFE INSULATED

ELECTRICAL CONNECTIONS

Only
\$3.95
Postpaid

One Tool for
all Wire Sizes Used in
Home Wiring, Appliances, Autos

New Super **CHAMP** HAND TOOL
with PRE-INSULATED
SPICES CONNECTORS TERMINALS



FREE WITH EACH TOOL

Crimps Solderless Terminals and Connectors without solder or tape.

Cuts Wire Making Clean Cut through Insulation and Conductor.

Strips Wire Sizes #22-10 for best possible crimp.

Shears Bolts and Machine Screws without damaging thread.

AMP AMP Trade-Mark Reg. U.S. Pat. Off.
Order today—use coupon

T. W. Berger Inc.

National Distributor for Dealers and Consumers
Aircraft-Marine Products Inc.
1315-D American Bldg., Cincinnati 2, Ohio

ORDER DIRECT—USE THIS COUPON

T. W. Berger Inc.
National Distributor Champ Tool
1315-D American Bldg., Cincinnati 2, Ohio
Send me postpaid new super Champ Hand Tool. I am enclosing \$3.95. (Ohio residents add 12c Sales Tax)

Check Money Order

Name _____

Address _____

City _____ Zone _____ State _____



EARN YOUR OWN KING MIDGET. We want rider agents to demonstrate and sell the World's Lowest Priced Automobile. Fully assembled or bolt together parts. If there is no dealer near you send 25c for detailed literature with agents proposition, or \$1 (refund first order) for this plus actual assembly book and service manual.

MIDGET MOTORS MANUFACTURING CO., ATHENS 1, OHIO

Say You Saw It in Popular Mechanics

MODERN LAWN MOWER SHARPENER

Service departments of leading Lawn Mower manufacturers use the Modern Lawn Mower Sharpener. One lever moves lawn mower into grinding position. Gasoline and oil remain in engine while sharpening, no dismantling of wheels, roller or handle. The Modern is a precision bed knife grinder—no extra grinder to buy. Imitated but never equaled—Compare before you buy. If it isn't a Modern it can't be Modern (Prices subject to change without notice)



WRITE FOR FREE BOOKLET 100

\$263.00
with motor
F.O.B.
PASADENA

MODERN MFG. CO.
160 N. Fair Oaks - Pasadena 1, Calif.



improve your home with
MASONITE PRESWOOD®

Build your own room divider!

Save money! Build this room divider-desk with strong, grainless Masonite Preswood® and plan #AE-295. Works like wood. 33 types and thicknesses at your building materials dealer's.

Send for "Idea Book." Lists free plans.

NATURALLY STRONGER WITH LIGNIN

MASONITE® CORPORATION

Dept. PM-12, Box 777, Chicago 90, Ill.

Please send me your "Idea Book."

Name.....

Address.....

Town.....Zone.....

County.....State.....

"Masonite" signifies that Masonite Corporation is the source of the product

Workshop Lamp Mounted on Wooden Turntable Adjusts Easily

Mounted on a turntable base and pivoted for tilting, this handy workshop lamp may be adjusted to practically any position. The reflector, which is improvised from a bread

pan, can accommodate a 150-watt bulb. To mount a porcelain receptacle in the reflector, holes that correspond with those in the receptacle base are drilled in a small, wood-

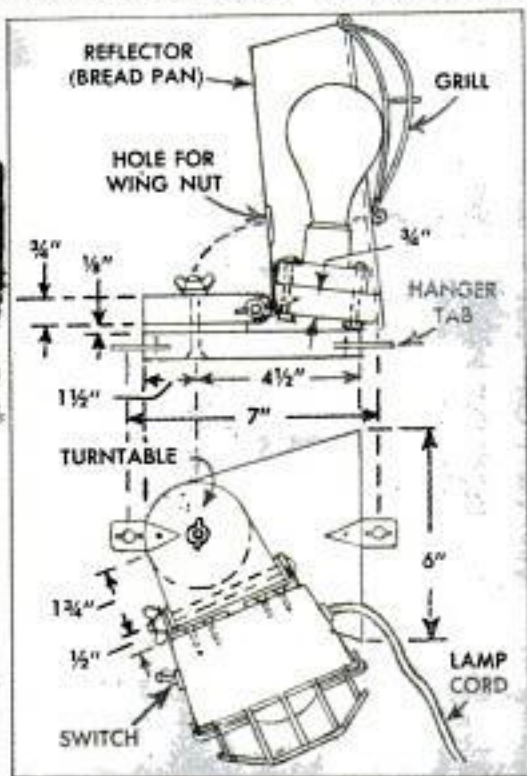

en block, then both block and receptacle are bolted to the bottom of the inside of the reflector. Flat-steel angle brackets, screwed to the back of the reflector and into the block, pivot on a bolt inserted through a hole drilled through the front edge of the upper leaf of the turntable. Leaves of the turntable rotate on a 1/8-in. hardboard disk, 3 in. in dia., and are assembled with a bolt and wing nut. A hole cut in the back of the reflector permits it to be folded flat against the turntable without interference from the wing nut. Slotted hanger tabs on the opposite end of the lower leaf permit hanging the light.

It's easy to make these **REPAIRS**

You can make loose metal, wood, or plastic parts tight; anchor bolts in concrete to stay; seal cracks in metal; tighten loose screws and fixtures in wood, metal or tile—with Smooth-On No. 1, the iron cement of many uses. Just mix, and fix. Smooth-On No. 1 hardens quickly like iron, and expands as it sets. Forced into any opening, its unique expanding action makes the repair. Keep a can on hand, it will not deteriorate. Smooth-On No. 1 is at your hardware store.

FREE Repair Handbook

40 pages, many illustrations, easy directions for ingenious time and money saving repairs you can make yourself. Write for your free copy.

SMOOTH-ON MFG. CO., Dept. 37M
570 Communipaw Ave., Jersey City 4, N. J., U.S.A.

SMOOTH-ON

THE IRON CEMENT OF MANY USES

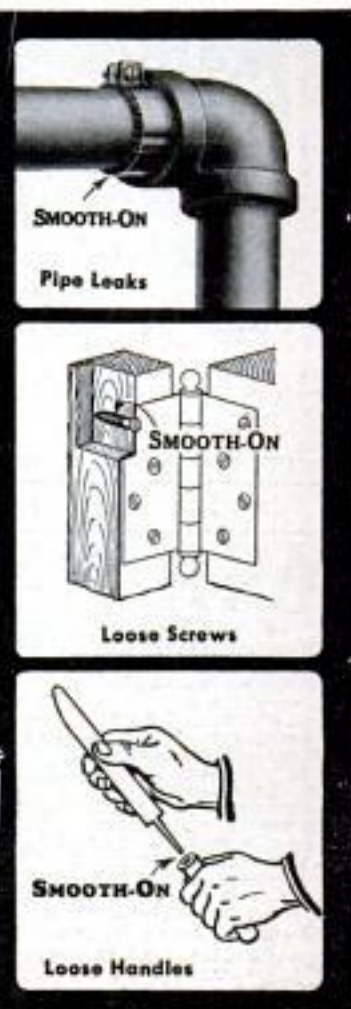
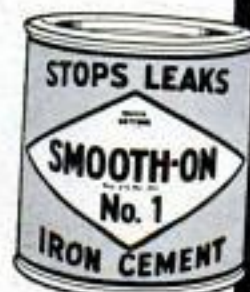



SAVE \$\$\$ on the
most practical combination
and the Season's greatest tool
VALUES*



SAW-JOINTER COMBINATION

No. 9401 Combination . . .

8" ball bearing saw, 4" bronze bearing jointer
SPECIAL XMAS-SAVINGS PRICE ONLY

\$99⁹⁸

No. 9400 Combination . . .

8" ball bearing saw, 4" ball bearing jointer
SPECIAL XMAS PRICE

\$130⁸⁸

The Christmas gift of a lifetime, at a bargain price you'll find only at your Atlas dealer's. The one really practical combination power tool that will quickly and easily handle all the basic operations required in every woodworking job — from building a home to making cupboards or fine furniture. Both combinations feature the famous Workshop 8" ball bearing tilt/arbore circular saw — the safest, most accurate and efficient of all power saws. And there's a choice of a 4" ball bearing jointer or a 4" bronze bearing jointer. Both tools mount on one husky, easy-to-move stand, and both are powered by one motor. Double economy, double efficiency, sensational values. SEE THEM AT YOUR ATLAS DEALER'S, TODAY!

- COMPLETELY PORTABLE . . . rolls where you want it on big casters, furnished.
- MOTOR REMOVES IN 4 SECONDS FOR USE WITH OTHER TOOLS.
- COMPACT . . . TAKES LITTLE ROOM . . . MEASURES 28" x 28" x 38" HIGH.

THESE VALUES AVAILABLE FOR A LIMITED TIME ONLY. SEE YOUR ATLAS DEALER TODAY.

Atlas Press Company

1224 N. PITCHER ST.

KALAMAZOO, MICHIGAN

8" ball bearing tilt/
arbore saw . . . regular
\$54.75 value — XMAS
SPECIAL
ONLY..... **\$47.88**



4" bronze bearing
jointer-planer . . .
regular \$31.50 value
XMAS SPE-
CIAL ONLY.. **\$27.88**



11 1/4" drill press . . .
regular \$41.50 value
XMAS SPE-
CIAL ONLY.. **\$36.39**



Grinder-hone . . . reg-
ular \$31.50 value
XMAS SPE-
CIAL ONLY.. **\$26.50**



13" jig saw . . . reg-
ular \$24.75 value
XMAS SPE-
CIAL ONLY.. **\$21.33**



10" band saw . . .
regular \$47.50 value
XMAS SPE-
CIAL ONLY.. **\$41.88**



*All prices slightly higher
west of Rockies.

ATLAS PRESS COMPANY

1224 N. Pitcher St., Kalamazoo, Michigan

Please send me FREE literature, and the name of my nearest ATLAS dealer:

NAME _____

ADDRESS _____

CITY _____ STATE _____



Get Good Performance the Way Big Fleets Do...

Commercial Motor Freight, Inc., Columbus, Ohio, Uses Federal-Mogul Engine Bearings

Around the clock, and across the nation, our big truck fleets carry America's goods to market.

Dependable engine performance is essential. As do many fleets, Commercial Motor Freight, Inc., relies on Federal-Mogul engine bearings to help maintain delivery schedules.

Federal-Mogul Oil-Control bearings have led the replacement field for 30 years—*because of quality!* Enjoy this quality in *your* passenger car driving for business or pleasure. *Ask your mechanic!* FEDERAL-MOGUL SERVICE Division, Federal-Mogul Corporation, Detroit 13, Michigan.

for New Power . . .

FEDERAL-MOGUL

Oil-Control Bearings

BEARING
MANUFACTURERS
TO THE
AUTOMOTIVE
INDUSTRY
SINCE 1899



Extension Aids in Arrangement Of Upper Christmas-Tree Lights

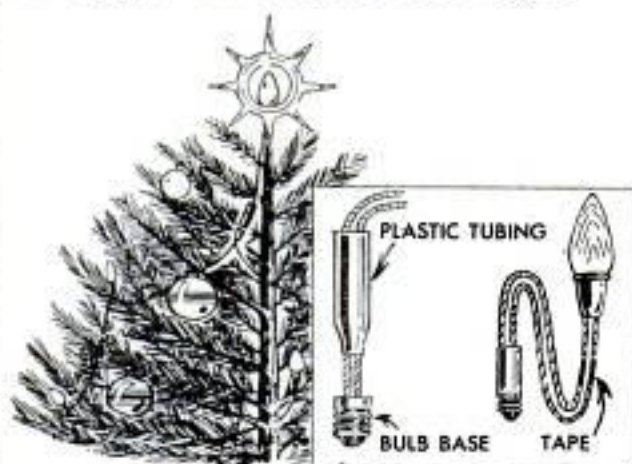

The problem of arranging strings of lights on a Christmas tree so that one of the bulbs can be positioned to illuminate a treetop ornament can be eliminated if this lightweight extension cord is used. The extension is made by removing the glass and cement from the base of a discarded bulb and soldering two wires to the inside. One wire goes to the shell, the other to the contact point. A length of plastic tubing—the tapered barrel of a fountain pen is excellent—is cemented to the base and taped to the wires. The wires now are cut to the desired length, and a bulb socket with its wires is taken from a spare string of lights and spliced to the ends of the extension wires. In use, the extension is screwed into the closest socket of the string of lights nearest the top, in place of the bulb.—Lance Werner, Cleveland, Ohio.

Eraser Props Photo Thermometer



Drilling a rectangular pencil eraser and pressing it over a stirring-rod type of dark-room thermometer provides a prop to hold the thermometer at an angle in the bottom of the tray. This not only makes the thermometer easier to remove from the tray, but also keeps it from rolling. In this way, the indexed side of the thermometer can be held in the upward position so that the temperature may be read at a glance, and breakage held to a minimum.—H. Klein, Philadelphia, Pa.

**RELIEVES PAIN OF
HEADACHE • NEURALGIA
NEURITIS**

FAST

The way
thousands of
physicians
and dentists
recommend



Anacin® relieves headache, neuralgia, neuritis pain fast because Anacin is like a doctor's prescription—that is, Anacin contains not just one, but a combination of medically proven, active ingredients in easy-to-take tablet form. Thousands have been introduced to Anacin through their own dentist or physicians. If you have never used Anacin, try these tablets yourself for incredibly fast, long-lasting relief from pain. Don't wait. Buy Anacin today.



MAGNETS **225 lb. PULL**
GENUINE ALNICO—NEVER WEAKENS

AMAZING, PERMANENT MAGNETS—WILL NOT WEAKEN! NON-ELECTRIC
Retrieve guns, tackle, tools and other steel items from lake, river, plating tanks, drains or other hard-to-reach spots. Recover drills, taps, etc. from sweeping. Clear alley of harmful tacks, nails. Many other uses. Pays for itself quickly. **GUARANTEED.** Try any magnet one week. Money refunded if you are not well pleased.
No. M-725 (Weights 54 oz.) Has pull of 225 lbs. on steel block. \$15.00
No. M-675 (Weights 40 oz.) Has pull of 175 lbs. on steel block. \$10.50
No. M-625 (Weights 70 oz.) Has pull of 125 lbs. on steel block. \$ 8.50
No. M-575 (Weights 18 oz.) Has pull of 75 lbs. on steel block. \$ 6.00
No. M-500 (Weights 15 oz.) Has pull of 50 lbs. on steel block. \$ 4.00
No. M-30 Hobbyist assortment of six small magnets. \$ 1.50
Send Money Order or Check. We pay postage. No C.O.D.'s.
MIAMI MAGNET COMPANY, 3240 N. W. 27th Ave., Miami 42, Fla.



Treasure - Minerals - COINS

Easily located with new Light-weight M-Scope Detector. Superior performance, lowest price, monthly payment plan.

FREE LITERATURE
FISHER RESEARCH LAB., INC.
PALO ALTO CALIF.

A BIG-VALUE HOME!

You get most for your money in a roomy, convenient, furnished and equipped Schult. Insulated for all-season family comfort. Quality, value famed for 20 years! Find out...



SEND FOR FREE FOLDER



SCHULT CORP. DEPT. 3212, ELKHART, IND.

DECEMBER 1954

241



Your tools
are handier and
so are you...

when you hang 'em on
USG*
**PERFORATED
HARDBOARD**

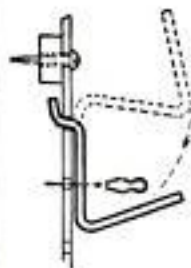

Fixtures slide
easily into
the 3/16"
perforations

You'll be a better craftsman with your tools neatly arranged and ready to use, hanging on USG Perforated Hardboard right over your work bench. This precision-perforated, smooth-both-sides board goes up in minutes with nails or screws, giving you storage exactly suited to your needs.

You'll find dozens of uses for this premium USG DURON® hardboard product. Attached to any wall, door or framing member, it makes worlds of new storage space—ideal for garden tools, shoes, brooms, pans, hats, a hundred things.

USG Perforated Hardboard is a DURON Hardboard product manufactured by U. S. Gypsum.

FREE PLAN BOOK

12 pages of easy-to-follow plans for making useful things with regular DURON hardboard. Ask your U.S.G. dealer or write Dept. PM-12, 300 W. Adams, Chicago 6.



*T. M. Reg. U. S. Pat. Off



UNITED STATES GYPSUM

The Greatest Name in Building

Science Speeds Shaving With "Canned Lather"!

That's right! They've invented a gadget that makes shaving faster, easier, more pleasurable! Now you can get rich, creamy lather right out of a can . . . ready to use!

No brush to slow you down . . . no greasy cream to clog your razor. Just push valve . . . out comes lather! That's AERO SHAVE . . . the wonderful new "canned lather" that contains 3 beard-softeners to wilt toughest whiskers in a jiffy . . . *plus soothing lanolin to protect your skin against shaving irritation.*

Get AERO SHAVE Lather Bomb today . . . in the handy metal container with the turret top that won't leak when you travel.

Not 79¢ . . . Not 69¢ . . . Only **59¢**

USE "PUSH-BUTTON" LATHER

AERO SHAVE



Also economical King Size—12 oz. only 98¢

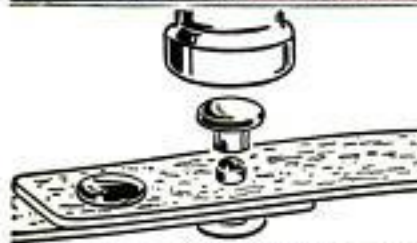

SPEEDY RIVETS

simply swat
with a hammer

Fasten leather, cloth, paper, plastics. Quick, secure, permanent repairs . . . ideal for craftwork, too. Simply make a hole in each part to be fastened, push rivet together through holes, place on firm surface and swat with a hammer. Gilt, nickel, black, brown finishes. Large (6 per card) or small (10 per card) sizes.

AT HARDWARE
COUNTERS
EVERYWHERE

15¢
per card



THE **DOT** LINE

3229 S. Ashland Ave., Chicago 8, Ill.

Small Photoprints Dried Quickly By Use of Warm Clothes Iron



Small photographic prints can be dried quickly by rolling them onto the bottom of a clothes iron as shown. First, be sure that all foreign matter is removed from the iron. Then, set the thermostat to get the lowest heat possible, and apply the prints in the usual manner.—Ken Murray, Colon, Mich.

Guard for Tractor Radiator Made From Gravel Screen

Where conditions permit, a radiator guard made from steel gravel screen will protect the radiator of a tractor from damage by heavy stalks and reduce the chances of it being clogged by hay. A flange bent on all four sides of the guard holds it away from the radiator. Ears are provided to bolt it to the frame or shell of the radiator in such a way that it can be removed for cleaning.—L. H. Houck, Jefferson City, Mo.

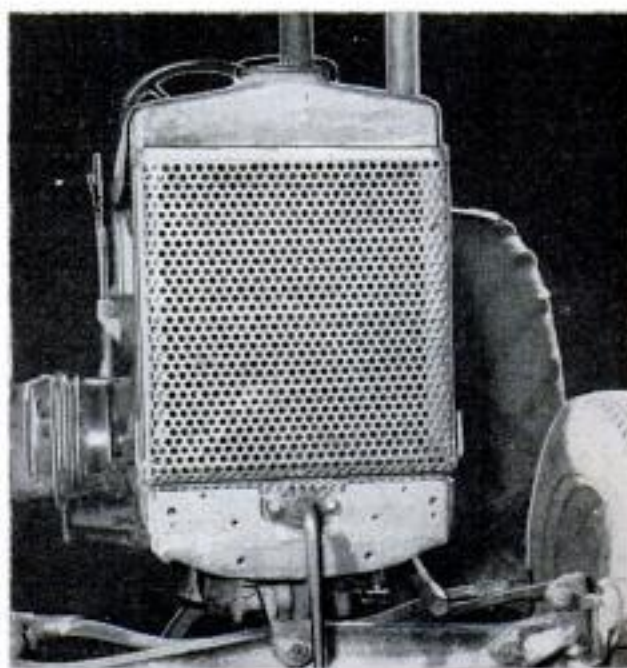

Amazing New Tool! It's Complete!

for the first time a
modern power tool
as simple to run as a
modern appliance

Just Plug It In!

SHOPMASTER'S 8" TILTING ARBOR CIRCLE SAW



with **BUILT-IN MOTOR**
and **TABLE EXTENSIONS**

Features special motor that develops up to $\frac{3}{4}$ horse power torque. Has new master view indicator, finger tip control. Blade cuts $2\frac{1}{2}$ " depth and tilts to a full 45°. Table size with extensions is 16"x30". Comes complete with stand, saw, table extension, built-in motor, cord, mitre gauge, stop rods, rip fence, 8" Roc-edge saw blade, plastic guard. All for only \$99.50.

- No Motor To Buy!
- No V-Belts To Buy!
- No Pulleys To Buy!
- No Table To Build!

Look at the big
Control Panel!

As simple to run
as a toaster!

What rugged
construction!

\$99.50

MAIL TODAY

SHOPMASTER, Inc. Rm. 10T
1214 S. 3rd St., Minneapolis, Minn.

Please send me complete information
about the New Shopmaster Circle Saw.

Name

Address

City State

Practical storage wall houses built-in aquarium

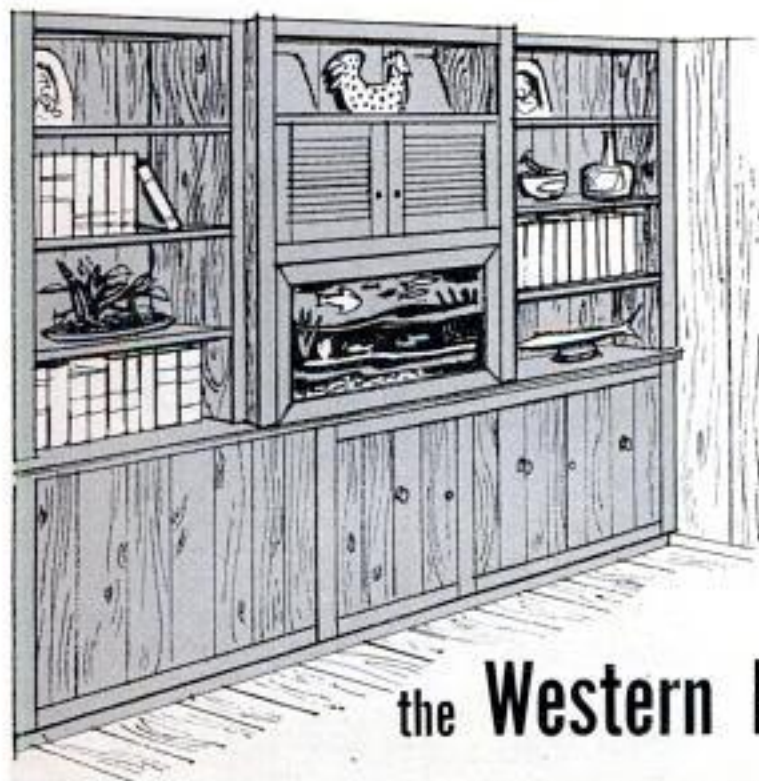

get complete detail drawings and
illustrated, easy-to-follow directions in

FREE PATTERN KIT 326

along with the new picture-packed booklet,
"Friendly Home Ideas in Western Pine." Write for
it to Western Pine Association, Dept. 326-N,
Yeon Building, Portland 4, Oregon

This storage wall shows off a lively fish collection in a handsome setting of Western Pine wood. If you're not aquarium-minded, you can build additional shelves into the center section of this functional unit.

You'll find it costs little to build with the easy-to-work woods of the Western Pines*. Carefully selected, well-seasoned, they take all finishes without grain-raising. See these friendly woods at your local lumber dealer—ask him for an estimate!

the Western Pines

- * IDAHO WHITE PINE
- * PONDEROSA PINE
- * SUGAR PINE

TODAY'S WESTERN PINE TREE FARMING GUARANTEES LUMBER TOMORROW

From the start of the
job to the finish...



CHAN NEL LOCK

TRADE MARK REG. U. S. PATENT OFFICE

pliers are busy



here's why

Look for the Channellock line when you're shopping for hand tools. Channellock pliers offer features that you can't get with other makes. And when you buy a Channellock plier, ask to see the full line—you'll find a style and model to do any job better.



CHAN NEL LOCK

TRADE MARK REG. U. S. PATENT OFFICE

THE PLIER DESIGN THAT OBSOLETE ALL OTHERS
CHAMPION DEPARTMENT TOOL CO. • MEADVILLE, PA.

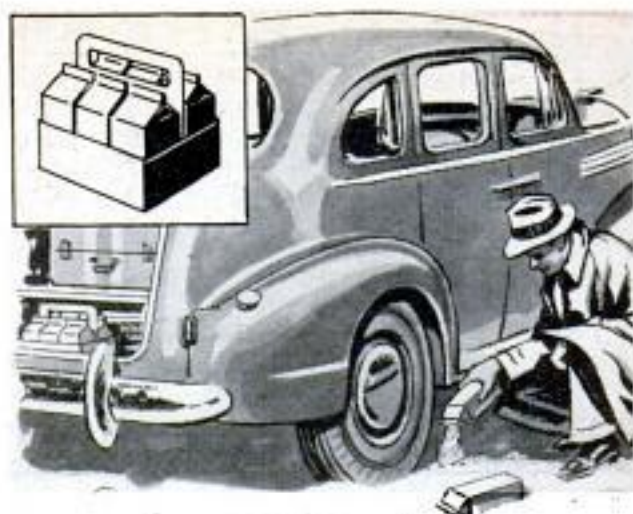

Sand Carried in Milk Cartons Provides Winter Driving Aid

Although a supply of dry sand is an invaluable cold-weather driving aid, storing and handling the gritty substance in a car presents a problem. This can be overcome by using quart-size waxed milk containers, six of which can be fitted in a cardboard "carry home" carton such as is used for soft drinks, and carried neatly and securely in the trunk of the car. The quart-size container is easily handled to apply sand to the rear wheels as required. Be sure that the milk containers and sand are dry before filling the containers.—R. M. Woodbury, Natick, Mass.

Rust Specks Removed From Prints With Oxalic Solution

Brown specks on photo prints, caused by particles of rust in the wash water, can be removed with a solution of oxalic acid. Oxalic-acid crystals, 30 grains, are mixed with water, one ounce, and the resulting solution is applied to the rust specks with a pointed toothpick or clean penpoint. Blot the speck immediately and the stain will completely disappear from the print.

O. A. Nelson, Seattle, Wash.

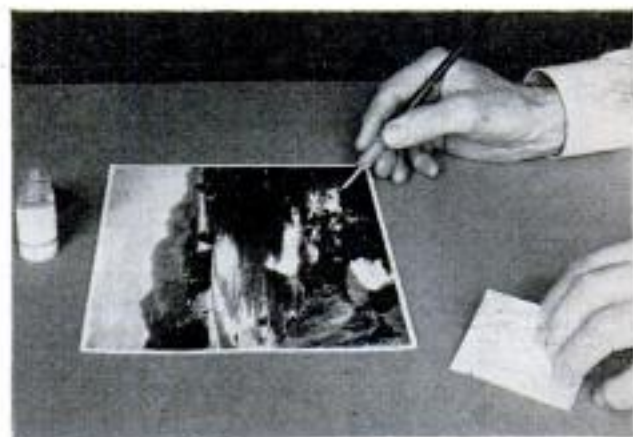



The New
Model 670-A

SUPER-METER

A COMBINATION VOLT-OHM MILLIAMMETER PLUS
CAPACITY REACTANCE INDUCTANCE AND DECIBEL MEASUREMENTS

SPECIFICATIONS:

D. C. VOLTS: 0 to 7.5/15/75/150/750/1,500/7,500
Volts. A. C. VOLTS: 0 to 15/30/150/300/1,500/3,000
Volts. OUTPUT VOLTS: 0 to 15/30/150/300/1,500/
3,000 Volts. D. C. CURRENT: 0 to 1.5/15/150 Ma.
0 to 1.5/15 Amperes. RESISTANCE: 0 to 1,000/
100,000 Ohms. 0 to 10 Megohms. CAPACITY: .001
to 1 Mfd. 1 to 50 Mfd. (Good-Bad scale for check-
ing quality of electrolytic condensers). REACT-
ANCE: 50 to 2,500 Ohms. 2,500 Ohms to 2.5 Meg-
ohms. INDUCTANCE: .15 to 7 Henrys. 7 to 7,000
Henrys. DECIBELS: -6 to +18, +14 to +38, +34
to +58.

ADDED FEATURE:

Built-in ISOLATION TRANSFORMER re-
duces possibility of burning out meter
through misuse.

The Model 670-A comes
housed in a rugged
crackle-finish steel cabi-
net complete with test
leads and operating in-
structions

\$28⁴⁰



The New
Model TV-11

TUBE TESTER

- Uses the new self-cleaning Lever Action Switches for individual element testing.
- Because all elements are numbered according to pin-number in the RMA base numbering system the user can instantly identify which element is under test. Tubes having tapped filaments and tubes with filaments terminating in more than one pin are truly tested with the Model TV-11 as any of the pins may be placed in the neutral position when necessary.
- The Model TV-11 does not use any combination type sockets. Instead individual sockets are used for each type of tube. Thus it is impos-

sible to damage a tube by inserting it
in the wrong socket.

• Free-moving built-in roll chart provides
complete data for all tubes.

• Phone Jack on front panel for plug-
ging in either phones or external am-
plifier will detect microphonic tubes or
noise due to faulty elements and loose
external connections.

Operates on 105-130
Volt 60 Cycles A. C.
Hand-rubbed oak cabi-
net complete with
portable cover

\$47⁵⁰

The New Model TV-40

C.R.T. TUBE TESTER



A complete picture tube tester
for little more than the price
of a "make-shift" adapter!!

Tests all magnetically deflected
tubes... in the set... out of
the set... in the carton!

Model TV-40 tests picture tubes in
the only practical way to efficiently
test such tubes: that is by the use
of a separate instrument which
is designed exclusively to test
the ever increasing number
of picture tubes!

Tests ALL magnetically
deflected picture tubes
from 7 inch to 30 inch
Tests for quality by the
well established emission
method. All readings on
"Good-Bad" scale.

Tests for inter-element
shorts and leakages up
to 5 megohms.

Tests for open elements.

EASY TO USE: Throw switch up
for quality test... read direct on
"Good-Bad" scale. Throw switch
down for all leakage tests.

Model TV-40 comes absolutely
complete - nothing else
to buy. Housed in round
cornered, molded bakelite
case. Only

\$15⁸⁵

The New Model 70 UTILITY TESTER FOR REPAIRING ALL ELECTRICAL APPLIANCES MOTORS • AUTOMOBILES • TRUCKS



As an electrical trouble shooter the
Model 70: • Measures A.C. and D.C.
Voltages. • Measures current consump-
tion while the appliance under test
is in operation. • Measures all resis-
tances commonly used in electrical
appliances, motors, etc. • Tests Toast-
ers, Irons, Broilers, Clocks, Vacuum
Cleaners, Refrigerators, Fluorescents,
etc.

As an Automotive Tester the
Model 70 will test: • Both 6 Volt
and 12 Volt Storage Batteries •
Generators • Distributors • Igni-
tion Coils • Relays • Condensers
• Directional Signal Systems •
All Lamps and Bulbs, etc.

Handsome round-cornered molded bakelite case.
Complete with all test leads. Also included is a
64 page book giving detailed instructions for
testing all electrical appliances, automotive
equipment, etc. Only

\$15⁸⁵

SHIPPED ON APPROVAL NO MONEY WITH ORDER - NO C.O.D.

Try any of the above in-
struments for 10 days be-
fore you buy. If completely
satisfied then send down
payment and pay balance
as indicated on coupon. **No
Interest or Carrying
Charges Added!** If not
completely satisfied return
unit to us no explanation
necessary.

MOSS ELECTRONIC DISTRIBUTING CO., INC.
Dept. D-87, 3849 Tenth Ave., New York 34, N. Y.

Please send me the units checked. I agree to pay down
payment within 10 days and to pay the monthly balance
as shown. It is understood there will be no carrying, interest
or any other charges, provided I send my monthly
payments when due. It is further understood that should I
fail to make payment when due, the full unpaid balance
shall become immediately due and payable.

Name _____

Address _____

City _____ Zone _____ State _____

Model 670-A, Total Pr. \$28.40
\$7.40 within 10 days. Balance
\$3.50 monthly for 6 months.

Model TV-11, Total Pr. \$47.50
\$11.50 within 10 days. Balance
\$6.00 monthly for 6 months.

Model TV-40, Total Pr. \$15.85
\$3.85 within 10 days. Balance
\$4.00 monthly for 3 months.

Model 70... Total Pr. \$15.85
\$3.85 within 10 days. Balance
\$4.00 monthly for 3 months.

Wife cramped for closet space?



YOU CAN INSTALL A **NOVOPLY**[®] SLIDING DOOR UNIT IN A FEW HOURS!

JUST 4 EASY STEPS:

1. Assemble header (1) and jambs (2) in opening. Shim jambs to make frame square.
 2. Place roller carriers (3) in grooves of overhead track in header (1).
 3. Wedge doors to adjust (Fig. B); screw to carrier.
 4. Install door guide clip (5) in floor (Fig. C).
- Stock units range from 6' 9½" to 8' high, from 2' to 8' wide. Make a whole storage wall quickly and without straining the pocketbook. Novoply doors cost less than ordinary doors, never bind, and are *guaranteed* against warping in excess of ⅛".

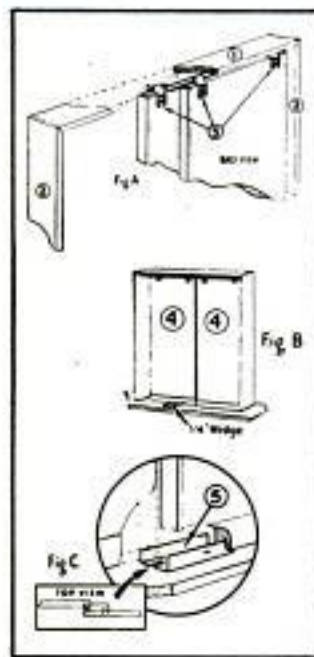

See your lumber dealer or send for **FREE FOLDER**.

Novoply Sliding Door Units by

Weldwood[®]



United States Plywood Corporation
WORLD'S LARGEST PLYWOOD ORGANIZATION

Weldwood Building, 55 W. 44th St., New York 36, N.Y.
and U.S.-Mengel Plywoods, Inc., Louisville, Kentucky
In Canada: Weldwood Plywood, Ltd., Montreal and Toronto

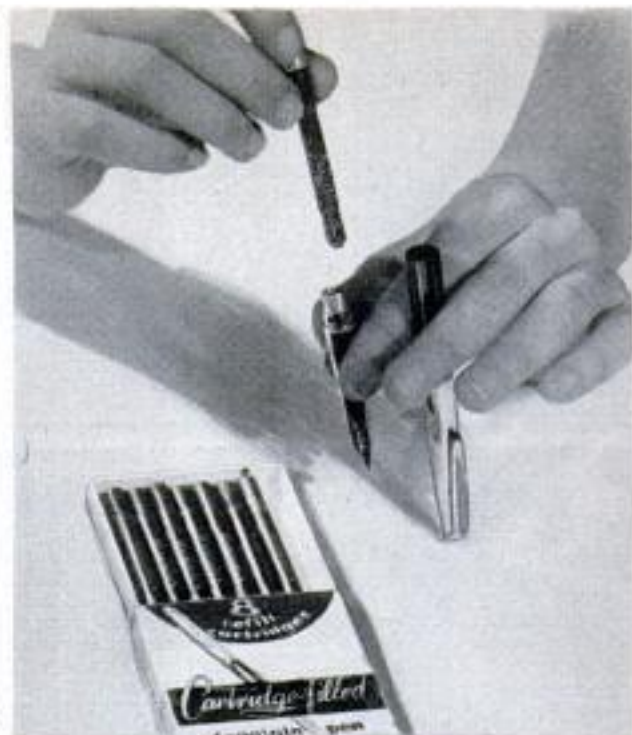

Plastic Ink-Filled Cartridge Supplies Fountain Pen

Cartridges of liquid ink supply a Waterman fountain pen that eliminates the messy ink bottle. In filling, neither the hands nor the pen tip touch ink. Inserting a fresh cartridge in the barrel takes only 10 seconds and, because each cartridge contains much more ink than a standard pen, fillings are less frequent. The unbreakable plastic cartridges are leakproof enough to be carried in the pocket and transparent so that it is possible to see the amount of ink left in the pen. The pen itself has no siphons or sacs.

Buttons Secure Picture Frame

Special hardwood buttons on a new type of picture frame force and hold a close fit at mitered corners

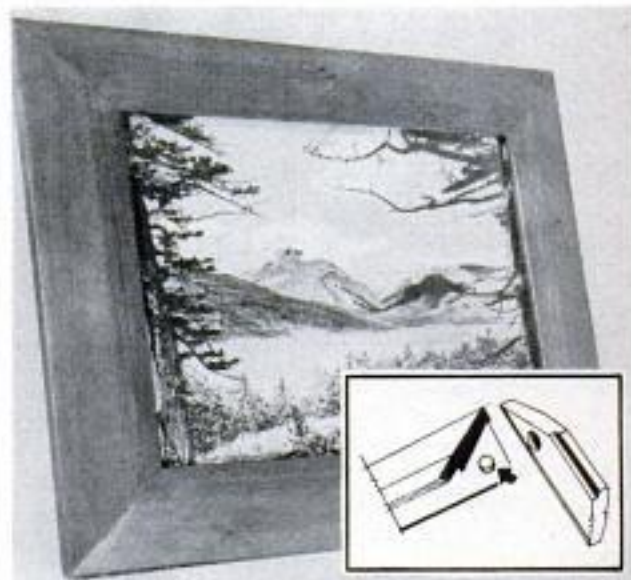

Give Tools FOR Christmas



No. X4
Bench Plane
\$8.50

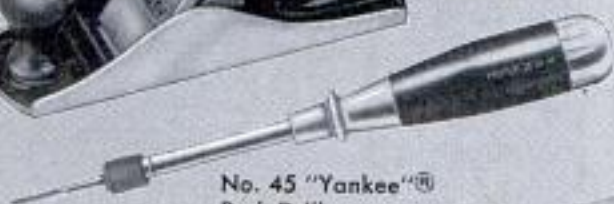

No. 45 "Yankee"
Push Drill
\$5.00



No. X122
Combination
Square — \$2.50

Give the average man a Stanley Tool that welcomes him to craftsmanship.



No. X125A
Power Bit Set
\$4.50



No. X133H
"Yankee-
Handyman"
\$2.98

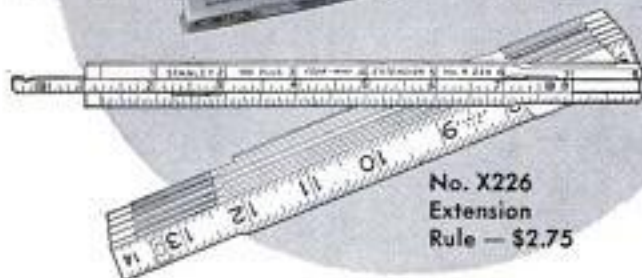

No. X226
Extension
Rule — \$2.75

Give your teen-age son a Stanley Tool that makes for best beginnings.

For every man this gift of tools is the finest kind of giving.

Christmas boxed at your favorite hardware store.



No. X64
Chisel Set
\$11.00



No. X3610W
Pull-Push Rule — \$2.39



No. 130A "Yankee"
Screw Driver
\$7.70

Give your craftsman friend a Stanley Tool that compliments his skill.

THE TOOLBOX OF THE WORLD

STANLEY
Tools

A Division of The Stanley Works, New Britain, Conn.

TOOLS • HARDWARE • ELECTRIC TOOLS • STEEL • STEEL STRAPPING

DECEMBER 1954

247

Copyrighted material



No parking problems!

No traffic tie-ups!

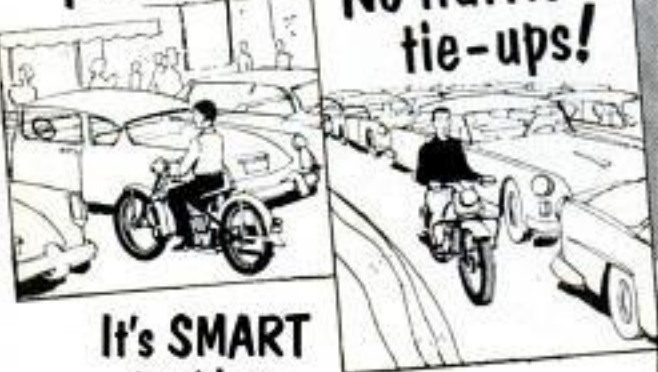

It's SMART to ride a

Harley-Davidson 165

NO PARKING AREA'S SO CROWDED that there's no room for this All-American lightweight. Small and compact, the 165 parks in small spaces anywhere.

NO ROAD'S SO CROWDED that you can't thread through every traffic jam. This peppy two-wheeler is easy to handle . . . safe and economical, too. Small wonder the Harley-Davidson 165 is called the world's most practical transportation.

See the 165 and other Harley-Davidson models at your dealer's. Easy pay plan. Send for **FREE** illustrated literature. Harley-Davidson Motor Company, Department P, Milwaukee 1, Wisconsin.



AVERAGES UP TO

30

Miles per Gallon

SAFE, ECONOMICAL TRANSPORTATION FOR EVERYONE!



Power-Driven Hoe Churns Soil

Flower beds and vegetable gardens are easily cultivated with a new power-driven hoe. A two-horsepower gasoline engine is mounted on the top of the hoe and the entire tool is carried on a sling around the gardener's shoulder. The hoe has four steel blades that churn up the soil to a depth regulated by the speed of the operator's movement across the ground. For deep hoeing a 2½-pound weight is fastened to the tool. The hoe also can be used for digging small trenches and stirring litter in poultry houses.

Smoke Passes But Rain Stops

Complete protection from rain and better dispersal of fumes are the objects of a new top designed for metal chimneys. The staggered baffles that keep water from the flue are so arranged that they do not impede the flow of smoke.

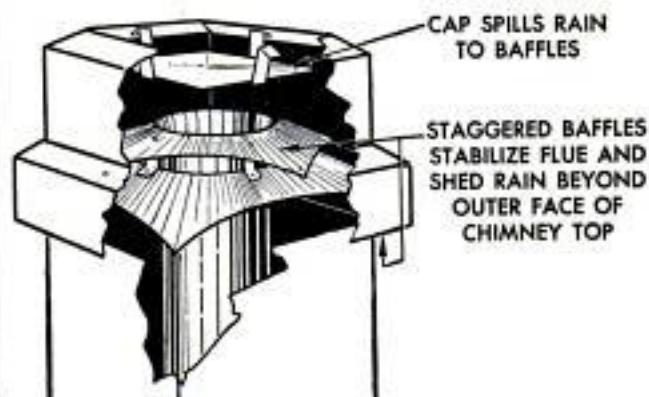

POPULAR MECHANICS

Give a HOBBY for CHRISTMAS

DREMEL Moto-Jig Saw is the Basic Workshop Tool... Used by Thousands Who Enjoy an ALL-FAMILY HOBBY

- The DREMEL is a real production tool, with a built-in ROTARY MOTOR. (Do not confuse with "vibrator" type jig saws.)
- The DREMEL is so powerful, it can cut 1½" wood, ¾" plywood, metals, plastics—even 2 x 4's!
- Only the DREMEL has a 4-way blade holder. It saws in any direction—handles any length stock, cuts even the most intricate scrolls.
- Only DREMEL has Rocker Action that keeps blade under steady tension, lengthens blade life!
- The DREMEL has a 45° tilting table. Also raises and lowers so you can use every tooth in the blade!
- **SAFE FOR CHILDREN.** Foolproof blade guard protects against finger injuries.



ONLY \$23.50

complete with rotary motor

10 Project Plans Furnished FREE

The DREMEL Moto-Jig Saw is America's outstanding tool value. Use it to make hundreds of valuable projects—lawn furniture, valances, cabinets, decorations, toys, etc! Save money by doing your own home repairs. Enjoy a profitable and fascinating hobby you can share with the entire family. The DREMEL is so superior that we challenge you to compare it with other jig saws costing many dollars more. You'll agree it's the greatest value in jig saw history!



FAMOUS GIFT . . . DREMEL TOOL OF 1001 USES!

GRINDS • CARVES • DRILLS • ROUTS • ENGRAVES • SHARPENS

DREMEL MOTO-TOOL is the fastest, most powerful tool in its class—approximately 27,000 R.P.M. It works beautifully in wood, plastics and metal. Unbeatable for home maintenance jobs, model making, a host of money-saving projects. Weighs only 13 oz. Shockproof. 110-120V., A.C.-D.C. motor. Thousands of satisfied users in home and industry.

KIT NO. 1

Includes Model 1 Moto-Tool and 34 Accessories (steel cutters, grinding wheels, polishers, etc.). Packed in attractive steel case. Complete.

\$19.50



KIT NO. 2

Your best buy! Includes Model 2 Moto-Tool and 23 Accessories (high speed steel cutters, grinding wheels, polishers, etc.) Packed in sturdy steel case. Complete.

\$25.95

Moto-Tool No. 2 (with 1 emery wheel point) **\$17.85**



★ SEE YOUR FAVORITE DEALER: Dremel Tools are sold at better dealers everywhere. If yours can't supply you, order direct on a five-day trial, money-back guarantee. Remit in full and we ship post-paid. Or, send only \$2 now, pay postman balance plus postage and C.O.D. fee.

DREMEL MANUFACTURING COMPANY

Dept. 114-M

RACINE, WIS.

BUILD THIS EXTRA ROOM YOURSELF

with Gold Bond Gypsum Wallboard



It's easy to transform a cluttered attic into a snug new room like the one below with Gold Bond Gypsum Wallboard. Gives you durable, fireproof walls and ceilings at low cost...takes any decoration, too!



Application is fast...one panel of Gold Bond Gypsum Wallboard covers up to 48 square feet! Can be sawed like lumber or scored with a knife and snapped off to size. Nail it directly to wood framing or, in remodeling, right over the old walls. Use the Gold Bond Tape Joint Kit to make joints disappear quickly and easily. And for a beautiful decorator finish, paint with Gold Bond Velvet...it dries in an hour.

NATIONAL GYPSUM COMPANY, BUFFALO 2, N. Y.

Write for Gold Bond How-To-Do-It Plan No. 11 with complete instructions for building the room shown above.

MAIL COUPON TODAY

NATIONAL GYPSUM COMPANY
Dept. PM-124, Buffalo 2, N. Y.

Please send me How-To-Do-It Plan No. 11. Enclosed is 10¢ to cover cost of handling.

Name.....

Address.....

City.....County.....State.....



Bowl Attachment for Hose Mixes Fertilizer With Water

Now you can spread fertilizer with a garden hose. A plastic attachment for the hose contains a mixing chamber that is filled with powdered or granular fertilizer. As water rushes through the chamber, it carries the plant food with it and spreads it evenly on the lawn. About one cup of plant food can be spread every 15 minutes.

"Elevator" Empties Barrel

Machine operators save time and eliminate waste motion when parts are loaded in a storage drum equipped with an elevating false bottom. The elevator consists of two separate assemblies. First, the platform and stem are placed in the barrel before the parts are loaded. Then, when the barrel is given to the machine operator, he inserts the hoisting frame inside the stem. As he empties the barrel he raises the parts by moving a lever on the hoisting frame. In this way he never has to reach down inside the barrel. The labor-saving device is made to fit a standard 55-gallon drum.





NO FINER *Gift* FOR MAN OR BOY

Give a gift he can use with pleasure and profit . . . on the job or in his hobby . . . dependable, accurate STARRETT TOOLS.

Starrett TOOLS



 <p>No. 530 Case Tape — 50' No. 500 Pocket Tape — 60'</p>	 <p>Combination Squares Sizes from 4" to 24"</p>	 <p>Satin Chrome Micrometers No. 230F — Friction Thimble No. 436 — Ratchet Stop</p>	 <p>No. 220 MUL-T-ANVIL Micrometer Caliper</p>
 <p>No. 153 Pistol Grip Hacksaw Frame</p>	 <p>No. 815 Toolmaker's Hammer Polished Chrome Finish</p>	 <p>Starrett Book For Student Machinists</p>	 <p>No. 1010 Dial Indicator Pocket Gage</p>
 <p>Satin Chrome Steel Rules No. C309R No. C604RE Also see Nos. 600, 320, 320R and 328</p>	 <p>No. 555 Screw Drivers 6 Blade Sizes</p>	 <p>No. 132 12" Precision Bench Level</p>	 <p>No. 800 Nail Sets Five Point Sizes</p>
 <p>No. 236 Depth and Angle Gage</p>	 <p>No. 86A Hand Vise with Clamp</p>	 <p>Nos. 77, 74, 75 4" Dividers and Calipers</p>	 <p>No. 596 Pencil Dividers</p>
 <p>No. 93 Tap Wrench</p>	 <p>No. 565 Drive Pin Punches</p>	 <p>No. 129 Bench Block</p>	 <p>No. 172A Feeler Gage</p>

Starrett®

BUY THROUGH YOUR
INDUSTRIAL DISTRIBUTOR

3000 GIFT SUGGESTIONS

Choose from the complete Starrett line. See your Starrett Tool Distributor or write for Catalog No. 26-A Address Dept. AP

MECHANICS' HAND MEASURING TOOLS AND PRECISION INSTRUMENTS - DIAL INDICATORS - STEEL TAPES PRECISION GROUND FLAT STOCK - HACKSAWS, BAND SAWS and BAND KNIVES THE L. S. STARRETT COMPANY, ATHOL, MASSACHUSETTS, U. S. A.



Earn More!

get into **BIG PAY**
ARC WELDING

It's EASY
to do
arc weld-
ing!



It costs little
to own one of
these big capac-
ity Hobart
welders

NEW "Husky-Boy"

200 Amp. air-cooled gas engine
arc welder WELDS ANYWHERE!

Equip your lightweight truck with Hobart "Husky-Boy." It's a real money maker on emergency repair jobs. Use it in or out of the shop. Ready on a moment's notice to go to work for you.

BUILD YOUR OWN, with Hobart's "generator only." Simply connect it to a good used auto engine. Make your own portable welder and get in on the extra profits of arc welding.

AC POWER OR AC WELDER. An excellent dual purpose combination. Welds or runs tools, lights, motors independent of power lines. Can be belted or coupled direct to your own gas engine.

TRANSFORMER TYPE AC WELDER. A real welder for production and repair work in shops that have only single phase power available.

300 AMP. ELECTRIC MOTOR DRIVEN portable welder for average welding requirements. Perfect for production, maintenance, repair, tool room work and all general shop welding.

Investigate These Big Money Makers Today!
Mail coupon for complete details.

HOBART BROTHERS CO., BOX M-124
Troy, Ohio, Phone 21223. "One of the
world's largest builders of arc welding
equipment."



Hobart School of Arc Welding
Learn profitable arc welding at
the non-profit Hobart Trade
School. Skilled instructors, G. I.
approved. Low cost.

**CLIP THIS COUPON
and MAIL!**

HOBART BROTHERS CO., BOX M-124, Troy, Ohio
Without obligation, send complete informa-
tion on the items checked below:

Husky Boy Build Your Own AC
Welding—AC Power AC Transformer Type
 300 Amp. Electric Drive Hobart Trade
School Modern Arc Welding Lessons, \$1.00

NAME _____

ADDRESS _____

CITY _____ STATE _____

**MODERN
ARC WELDING
LESSONS**
200 pages, fully
illustrated,
\$1.00



FREE!

Welder's
Vest Pocket
Guide



Build Your Own



AC Power—
AC Welding



AC Transformer



300 Amp.
Electric Drive

Wheel-Mounted Portable Vise Simplifies Field Repair Jobs



Mounted on an old truck wheel, a machinist's vise can be hauled or rolled to the job easily when repairing machinery that has broken down in the field. The vise is fastened to the wheel by a large bolt which screws into a hole in the base of the vise.

A. M. Wettach, Mt. Pleasant, Iowa.

Paper Clip Holds Film Slide On Glass Hood of Camera

A paper clip slipped over the edge of the cover on the ground glass of a press camera provides a convenient place to hold a film slide. For purposes of illustration, a large paper clip is shown in the photograph. A smaller clip should be used to prevent springing the hood or damaging the ground glass of the camera.

Wallace Hanson, Minneapolis, Minn.

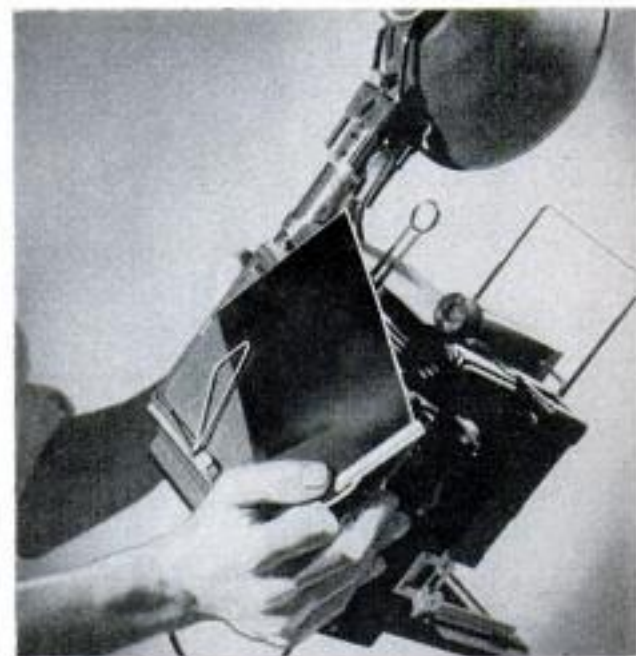

DOES EVERY JIG SAW JOB

- CORNICES
- SCROLL WORK
- CABINETS
- TOYS
- FURNITURE

PATENT PENDING

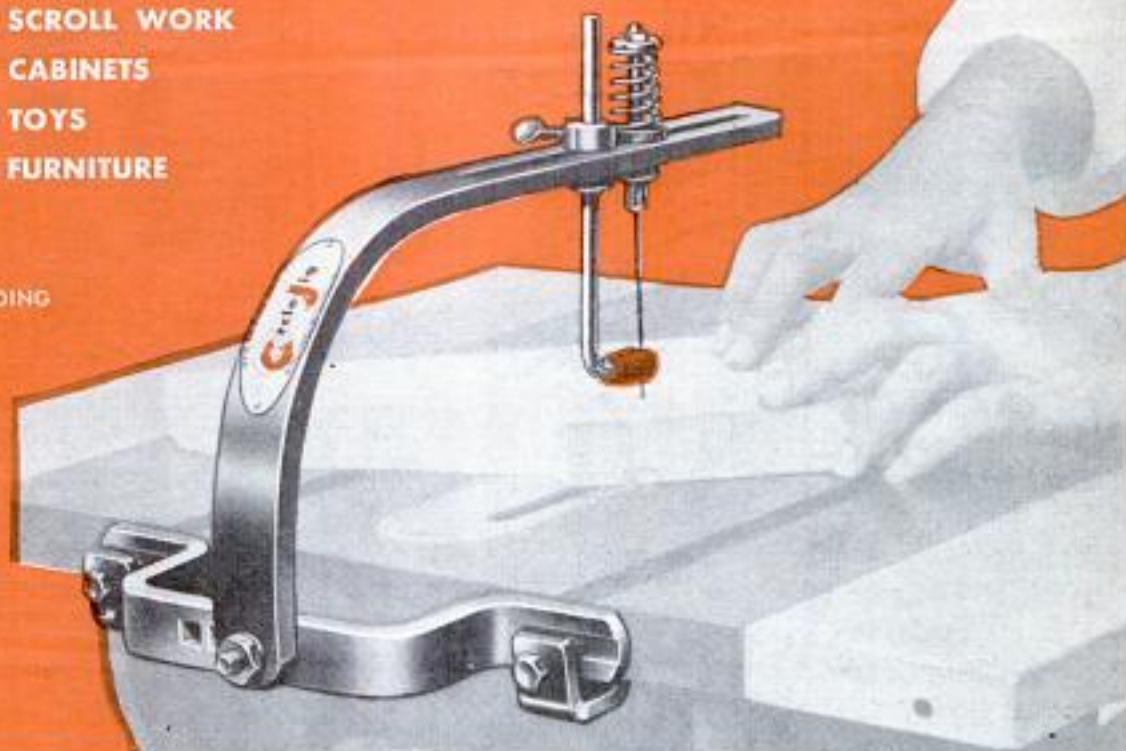

Just \$11⁹⁵ converts your table saw to a big, husky jig saw in 3 minutes

WITH THE AMAZING NEW

Circle Jig
Trade Mark

- No machining—no drilling—no tapping. Simply clamp on with ordinary wrench.
- Cuts to center of 16" to 24" board.
- Cuts 2 $\frac{3}{4}$ "-thick stock.
- Smooth working blade action.
- Uses standard jig saw blades.
- Saves floor space, cuts tool cost.
- Unlimited power at blades! Handles metal, plastics, too.

WHOLESALEERS, DEALERS

Circle Jig is brand new—unavailable as yet in retail store. Write for our distribution offer right now!

Versa-Tool manufacturing company

400 Lake Ave., Racine, Wis.

Yes, now you can have a rugged, big-capacity jig saw simply by mounting Circle Jig on any $\frac{1}{2}$ " or $\frac{5}{8}$ " arbor table saw. Mounts quickly and easily. No special tools required. Compares with any high-priced jig saw—actually out-performs most. Exclusive operating features assure long, trouble-free service.

If Your Favorite Hardware Dealer Cannot Supply You

Order Direct From
Versa Tool Mfg. Co.
400 Lake Ave., Racine, Wis.
\$11.95 Postage Prepaid

Name _____

Address _____

City _____ Zone _____ State _____



GIVE A
PLUMB
TOOL

THE GIFT THAT MAKES
A **PERFECT** HIT

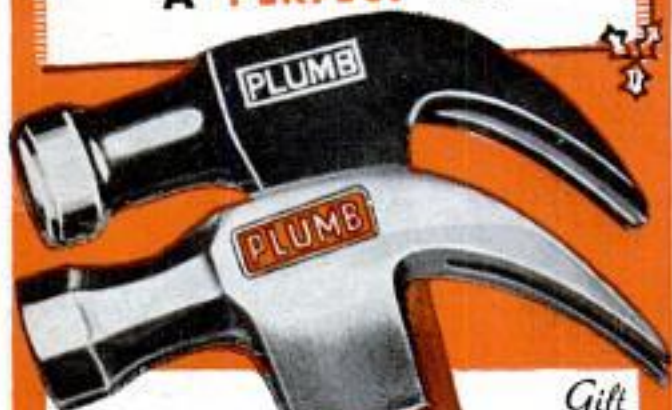

For hobbyist or handyman, the balanced easy swing of a Plumb Tool makes his job twice the fun and gets it done with half the effort.

*Gift
Wrapped
For
Holiday
Giving*



For light Chopping—the Plumb National Axe



All-purpose tool — the Plumb Hatchet

PLUMB®

HAMMERS • HATCHETS • AXES • FILES



Safety Harness Slips Over Seat

Particularly useful for preventing injuries to children in sudden stops or turns, a safety harness simply hooks over the back of the front seat. It can be removed or installed instantly. No bolts or screws are used. It prevents the child from standing or leaning against the door and increases the driver's peace of mind, enabling him to devote more of his attention to driving. Although designed principally for children, the harness will provide some protection for adults in minor impacts. The buckle is released with one hand when desired. There are two models, one for four-door sedans, the other for two-door models.

Miniature Camera

You can take pictures with a new attachment for your glasses. It's a tiny camera that mounts on the rim of any spectacles. Equipped with a frame finder, it uses 16-mm. film, is fitted with an f:5.6 lens and has a shutter speed of $\frac{1}{50}$ second. It is manufactured by a German firm.



GREAT SURPLUS SALE OF HOME, FARM AND FACTORY EQUIPMENT

GROBAN FOUR-WAY OPEN CENTER HYDRAULIC CONTROL VALVE

ITEM #126—Four-way open center control valve with built-in adjustable relief valve factory set at 1000 P.S.I. Spring loaded neutral position. For use with one double acting cylinder. In neutral position cylinder is locked and pump unloaded. Can be used as single unit or mounted in series. Has 3/4" pipe thread inlet and outlet. 1/2" pipe thread cylinder ports. Finger grip handle. Ship. wt. 10 1/2 lbs.

AN OUTSTANDING BUY!
F.O.B. Chicago **21.50**

PESCO GEAR TYPE HYDRAULIC PUMP

Compact — Powerful — Reliable

ITEM #160—Especially designed for belt drive from fan belt, power take-off, drive pulley, electric motor or small gas engine. Equally suitable for direct coupling.

Pedestal type mounting with two bolt holes for 3/4" hold-down bolts. Standard 1/2" pipe thread inlet and outlet ports. Delivers 4.5 GPM at 1000 PSI at 2800 RPM with 4 HP. Hardened steel gears turn in dense oilite bronze bearings. Rotation—clockwise facing shaft. Guaranteed trouble-free service. Ship. wt. 6 lbs. F.O.B. Chicago **22.50**



ITEM #41C1C • 2" Bore • 6" Stroke
• Double Acting • All Steel • 3/8" Pipe thread ports. Lift capacity 3100 lbs. with 1,000 P.S.I. line pressure. Ship. wt. 12 lbs. F.O.B. Chicago. Price ea. **12.50**

ITEM #16-C—1 1/2" bore, 26" stroke. Will lift 1780 lbs. with 1000 lbs. pump pressure. Great for hay loaders, etc. 1" stainless steel piston rod. Postpaid. **16.95**

**TO PLACE PHONE ORDERS
CALL Webster 9-3793**

FREE FALL & WINTER EDITION

1954 CATALOG, 52 PAGES, chock-full of unsurpassed War Surplus Equipment Bargains for farm, home, factory, workshop. Write letter today.

ALL ITEMS BRAND NEW!

A. C. ELECTRIC GENERATOR

7 1/2 K.W. (7500 WATTS) single phase, 110/220 volt output. 3 wire system, 2 bearing construction. 5 groove 6" V belt pulley included. Self-excited. Foot mounted. Drive generator from tractor or stand by engine. Ample power for 6 room house. Dimensions: 34" x 11 1/2". Shipping Wt. 420 lbs. F.O.B. Chicago. **295.00**



GROBAN HYDRAULIC SPEED REDUCER

ITEM #115
7 1/2" x 11 1/2". Gov't acquisition cost \$428.00. Ship. wt. 31 lbs. Complete with 2 qts. of oil and full instructions. F.O.B. Chicago. **54.50**

with FINGERTIP CONTROL

USE FOR: Reamer Drives • Midget Cars • Feed Mills • Canning Machines • Conveyors • Lathes • Milling Machines • Motor Boats • Cream Separators • Garden Tractors • Pumps.

Variable output speeds from 0 to input speed available by moving control handle. Locking handle maintains setting. Use input power of 1/4 to 1 1/2 H.P. Shafts 5/8" diam. Input rotation counter-clockwise facing shaft. Input speed 750 H.P.M. 7 1/2" x 11 1/2" x 11 1/2".



Brand New! 5-TON BLACKHAWK HYDRAULIC LIFT KIT

The Complete Kit **44.45** complete

For — Dumping farm wagons • Adjusting depth of plows • Hydraulic press • Hydraulic jack • Snow plows.

KIT CONSISTS OF:

- 1—Brand new Blackhawk Model P-151—Hydraulic hand pump with built-in oil tank and release valve. Rated from 1200 P.S.I.—to 3400 P.S.I. 2 1/2" handle. Dim. 8" x 6" x 6" Item #82. **22.50**
 - 1—6 Ft. length double wire braid rubber covered hydraulic hose—tested to 20,000 lbs. Item #2784. **3.95**
 - 1—Hydraulic cylinder, 2 1/2" bore, 1 1/2" stroke, 1 1/2" stainless steel shaft, will lift 10,000 lbs. using pump pressure. Standard clevis mounting. May also be used for double action service. Item #355A. **17.00**
 - 2—Qts. non-foaming hydraulic fluid. **1.00**
- All necessary hydraulic fittings. Total ship. wt.—40 lbs. **\$44.45**



COMPLETE KIT PRICE F.O.B. Chicago

ITEM #91 300 AMP. D. C. GENERATORS

IDEAL FOR WELDING GENERATOR
Type R-1, rated 300 Amps.—30 Volts, Mfd. by Jack & Heintz. Government Acquisition Cost \$280.00. Ship. wt. 55 lbs. Dimensions: 16" x 10" x 7". Complete with instructions to connect as Welder. F.O.B. Chicago. **35.00**



PORTABLE ELECTRIC LIGHT PLANT

ITEM #334
Compact Electric Plant suited for small homes, cabins, campers, hunting and fishing camps, trailers and small electrical home appliances. Operating costs: About 5c per hour. Sturdily constructed for dependable service. Net weight only 88 lbs. Can be carried from place to place, or transported in trunk of car. 250-350 Watt—110 Volt—D.C. Model PE-77D. Powered by easy starting 1 Cylinder, 4 Cycle Briggs-Stratton Engine complete with muffler, starting rope and oil bath air cleaner, direct coupled to a 250-350 Watt Generator with twin plug-in outlets. Engine speed 2650 R.P.M. Shipping Wt. 110 lbs. Commercial List Price \$225.00



WAR SURPLUS PRICE
Special Value **75.00** F.O.B. Chicago
At Only **75.00** Chicago
OTHER SIZES IN STOCK
FROM 350 W. TO 25,000 W.

BRAND NEW SELF-PRIMING ALL BRONZE & MONEL GEAR PUMP

ITEM #383 — USE FOR:
• Sprinkling • Irrigation • Insecticide Spraying of 2,4-D, DDT, Chlordane, Sulphur Compounds, etc. • Sump Pump • Fuel Transfer • Home Water Systems • Dewatering • Salt Water, Chemical, Acid Pumping.



FEATURES: • Needle Bearing Construction • 1 1/2" Pipe Thread Inlet, 1 1/4" Hose Outlet • Standard 3/4" Keyed Shaft • All Bronze Body, Monel Shaft • Equipped with Drain Cocks, Grease Cup, Steel Internal Drive Gears for long, trouble free service.

CAPACITY: From 10 to 80 Gal. Per Min. At Speeds from 550 to 2400 Rev. Per Min. Using from 1/2 to 6 Horse Power. For Pressures to 60 lbs. Ship. Wt. 58 lbs. U. S. Navy Cost \$168.00

F.O.B. Chicago. **39.50** ea. Two for **75.00**

**ORDER DIRECT FROM AD
SATISFACTION GUARANTEED**
Send Payment Or
Purchase Order Today

AMERICA'S
FINEST



Preferred everywhere by men who give precision tools the care they deserve. Free Catalog, **GERSTNER TOOL CHESTS**
454 Columbia St., Dayton 7, Ohio

HARDWOOD LEGS FOR "YOU-MAKE-IT" FURNITURE

Solve problem of leg strength!

Laminated to shape—not bent. Take any finish. Easy to make useful, beautiful modern furniture with simple, ordinary tools. 4 sizes for you cut to suit: 1"x16", \$3.36; 2"x16", \$4.96; 2"x30", \$7.52; 3"x10", \$5.52. Send for set of 4 legs today—satisfaction guaranteed. Or get catalog of complete kits of furniture. Prices F.O.B. Send one-half cash or money order—balance C.O.D.

ECONWAY, INC., Dept. M-3, Box 410, Niles, Michigan



More people use

For more than 50 years 3-IN-ONE has been America's most popular household oil. If it works better with oil, it will work best with 3-IN-ONE.



"3-IN-ONE" OIL



NEW from BLACK & DECKER

Christmas Tool Chest for Giving or Getting!

Here's a brand-new B&D Electric Tool Chest in a gift-carrying case. Includes $\frac{1}{4}$ " drill, 7 drill bits, 3 sanding discs and backing pad, polishing bonnet, wire cup brush and paint mixer. Contains everything needed to make home jobs easy! A \$34.25 value! Special Christmas price saves you \$4.30! Order this B&D Chest from your dealer today!

\$29.95

KIT DOES ALL THESE JOBS—AND MORE



DRILLING



REMOVING RUST



SANDING



MIXING PAINT



Bob Davis says: Send 25c in coin for my "Handy Tips" booklet, full of ideas and hints for home jobs. Write: Bob Davis, Home Service Dept. H12M, THE BLACK & DECKER MFG. Co., Towson 4, Md.

FOR INDUSTRY, SHOP, FARM AND HOME



Black & Decker
PORTABLE ELECTRIC TOOLS

Classified Telephone Directory tells where to buy it. For nearest dealer, see "Tools-Electric."



Design Ideas Tested in Flights of Scale-Model Helicopter

Flown by remote control on compressed air, a balsa-wood-and-aluminum scale model of a helicopter is being used in pre-flight tests. A full-scale version is to be completed later this year. Although the model looks like a toy, it has flight characteristics resembling those of full-size aircraft. It is controlled by a flight stick similar to the ones in airplanes and can hover, fly backwards, forwards, up or down. The designer, Igor B. Bensen of Raleigh, N. C., can make it land and take off from a bystander's head or a table in the living room. In flights with the model, Bensen says, he has learned that regular-size craft will fly on one of its two engines, make safe power-on emergency landings.

Communications Zone Indicator

"Jamming" of Voice of America programs and other long-distance broadcasts can be detected by radarlike methods recently perfected. A special signal is sent from the station's own antenna. The beam follows the same path taken by the radio waves, but bounces back to tell where it has been and about how strong the broadcast signals are when they get there. Often it reveals whether it has run into any interference at its destination. Known as COZI (communications zone indicator), the detection equipment may be used by commercial broadcasters and by shipping concerns as a standard accessory in directional broadcasting. It was developed by the Air Force and Raytheon Manufacturing Company. The Air Force plans to use COZI to test the efficiency and reliability of its worldwide communications system.

☐ A 24-mile tunnel to connect the islands of Honshu and Hokkaido is under consideration by the National Railway of Japan.

fully assembled real 1/7 HP. DIESEL ENGINE

OVER 100,000 SOLD AT HIGHER PRICE. NOT A TOY!

DEEZIL is a perfect power plant for planes, boats, race cars and experimenters. (Runs at 7500 R.P.M. Produces 1/7 HP. Weighs only 5 oz.)

DEEZIL is an ultra precision engine as carefully machine-tooled as Giant army engines. Cylinder is honed to .0001 inch and hand fitted to its individual pistons.

DEEZIL is compact, rugged, streamlined. Starts quickly. Simple to install. You get it fully assembled.

**NOW
\$1.95
Plus 5¢
Postage**



ACTUAL SIZE



DEEZIL is test run at the factory to assure perfection. Operating instructions included.

Send \$1.95 plus 5c postage today.

196 Page Book on Model Engines... \$1.00 Postpaid

GOTHAM HOBBY CORP., DEPT. P, 107 EAST 126 ST., NEW YORK 35, N. Y.

64" FLEXIBLE SHAFT WOVEN WIRE CORE

USE AS ELECTRIC DRILL **\$5.95**

REAL BARGAIN — cannot be duplicated for \$15.00. Coupling fits 1/2" or 3/8" motor shaft (state which); other end fits standard chuck. Durable, heavy. Use it for grinding, polishing, buffing, drilling, etc. Chuck for some only. Heavier constr. \$1.25. Send check or money order and we will ship P.P. prepaid or C.O.D. Plus Postage. Money refunded if not satisfied.

L. C. DOWNEY CO. — Dept. M
8004 TRAYMORE AVE., PHILA. 18, PA.

SAY YOU SAW IT IN POPULAR MECHANICS

BUILD FINE GRANDFATHER CLOCK NOW

The simple sensible Rec-i-Kut way as thousands have — SAVE HALF. SHOP TESTED PLANS "SPIRIT OF THE CENTURY". Narrow waist 8 1/2" tall or stately straight side "SPIRIT OF AMERICA." EASY-TO-FOLLOW photostatic PLANS tell all—plus BROCHURE of heavy brass weight Westminster, tube chime, movements, porcelain dials, 3/4" solid mahogany case kits. Send \$1.00 today — Both plans \$1.50 NOW.

KUEMPEL CHIME CLOCK CO., #7 Kuempel Bldg., Minneapolis 16, Minn.

IDEAL LAWNMOWER SHARPENER

BOOST YOUR INCOME

You can earn extra cash with the Model 300 Ideal Lawnmower Sharpener. Used and recommended by leading manufacturers and service shops, the Ideal has everything you need, nothing else to buy. Grinds reel and bed knife, also reconitions. Get started now in this highly profitable business. Write for catalog today.

The Fate-Root-Heath Co.
Dept. PM-12, Plymouth, Ohio



Get This NEW Catalog of WOOD AND WOODWORKING MATERIALS



World's Largest Selection of Finest Domestic and Imported Woods... Mouldings, Hardware, Tools, — ALL AT LOW MONEY SAVING PRICES! Your complete wood buying guide and project book. Craftsman is your best, most complete source of finest kiln-dried domestic and rare imported woods, beautiful wood inlays, colorful bandings, matched plywoods, embossed mouldings, carved ornaments, newest woodworking tools, "hard to find" cabinet hardware and fittings... more than 1,500 items! Packed with newest scroll saw patterns, project ideas & money making plans. Enclose 25c (refunded with first order) to help pay mailing, handling cost. Write now! Craftsman Wood Service Co., Dept. A412 2729 S. Mary Street - Chicago 8, Ill.

148 PAGES Many in full color packed with rare, fancy & imported woods... veneers, plywoods, patterns, tools, ornaments, hardware... everything for the woodworker. MAIL COUPON NOW!

CRAFTSMAN SERVICE CO., Dept. A-412
2729 S. Mary St., Chicago 8, Ill.
Enclosed find 25c. Rush me new Woodworkers' Catalog Handbook.

NAME.....
ADDRESS.....
CITY.....ZONE.....STATE.....

WHAT A MAN'S GIFT!

the WORLD'S
HANDIEST
"DO-IT-YOURSELF"
TOOL!



WISE-GRIP

LOCKS to work with TON-GRIP

Fixin's FUN—home projects EASY with this trim, gleaming Vise-Grip. Is actually a portable vise, super pliers, adjustable end wrench, locking wrench, toggle press. A whole tool kit in one light tool! Does more jobs easier than any other tool made. 7" and 10", cutter optional, only \$1.85 to \$2.60. At your hardware dealer!



MADE ONLY BY

PETERSEN MFG. CO., DEPT. M-12, DeWITT, NEBR.

BE YOUR OWN BOSS! Make UP TO \$50.00 PER WEEK IN YOUR SPARE TIME

Mr. B. of California writes "The lawn mower grinding business, with my Universal Grinder, has been a gold mine these last two years." Mr. J.L.P. of Pennsylvania says "Thank you for getting me started in this wonderful business . . . I averaged \$100.00 per week for the month of May."

ONLY ON THE UNIVERSAL LAWN MOWER GRINDER

. . . can the inside face and edge of the stationary blade, as well as the reel blades, be ground to proper clearance

ALL IN ONE SET-UP

WITHOUT REMOVING ANY BLADE FROM THE MOWER

Users who have tried them all acclaim the UNIVERSAL far above any grinder on the market. Write today for full details of our Proved Success Plan. It's Free.



ROGERS MFG. CO., Dept. M-124, LINDSEY, OHIO

SEND THIS COUPON NOW

ROGERS MFG. CO., Dept. M-124, Lindsey, Ohio
Please send me full details about the profit possibilities of Lawn Mower Sharpening.

NAME _____

ADDRESS _____

CITY _____

STATE _____



Lawn-Sprinkler Pump

To provide water for lawn sprinkling from lakes, ponds, shallow wells or creeks, a small positive-displacement rubber-roller pump has been developed by a Minneapolis manufacturer. Powered by a 1/2-horsepower motor, the pump will supply 30 to 40 pounds of pressure for two sprinklers. Couplings on the pump are for use with lightweight garden hose.

Desk-Top Paper Shredder



Government agencies and businessmen alike can find a use for a desk-top machine that shreds confidential papers. Paper fed into the gravity-feed slot is cut at the rate of 63 feet per minute or about 120 pounds per hour. Rotary cutters shred the paper cleanly and easily cut through staples.



POPULAR MECHANICS

MAKE YOUR BOY'S XMAS IN '54 EXCITING AND EDUCATIONAL



1" x 1 1/2"
x 1 1/2"
high

Your boy will stay home—work on useful projects—learn as he works—if you give Wilson's battery-operated Tiny Atom motors and power accessories this Xmas. Read this list of Wilson's exciting gifts for boys and hobbyists of all ages—and send your order NOW.

- *No. 3-100—Tiny Atom Motor, 1 1/2-V. For higher voltages \$2.00
- No. 5002—2-speed metal motor \$3.00
- No. 96—Open steel frame motor with gear, pinions, pulley and worm \$4.00
- *No. 3113—Tiny Atom motor assembly kit with many accessories \$3.00
- No. 1300—Small accessories kit \$3.00
- No. 3700—Large accessories kit \$3.00
- No. 4000—Deluxe acc. kit with motor \$5.00
- No. 700—Super-Power kit with motor, speed reducer, all accessories \$10.00
- No. 88—Kit of 8 pulleys—2 belts \$2.00
- *No. 3000—Variable speed gear unit \$4.00

* Item is illustrated
All Wilson's motors have Permanent Alstro V Magnets. Catalog FREE on request.

Send with order and see pay postage in U.S.A. No C.O.D. Add 2% Sales Tax for delivery in Ohio. Write Dept. PM.

For quick delivery see your local dealer — or order direct



WILSON'S OF CLEVELAND

425 Lakeside Ave., N.W. • Cleveland 13, Ohio

Give GREAT NEW DRIVING EASE



• HULL AUTO COMPASS—handsome, scientific instrument—is an ideal Christmas gift. Comforting, sure-way motoring guide the year 'round. Hull is the only auto compass, as a stock item, approved and used on combat vehicles in World War II. Write for local dealer's name, free literature.

Beautifully illuminated \$16.95
Non-illuminated \$14.95

MORE HULLS IN USE THAN ALL OTHERS COMBINED

HULL MFG. CO. P. O. Box 246, D-12 WARREN, OHIO

NEW, IMPROVED CALCULATOR FOR WOODWORKERS only 25c



Instantly gives information on lumber, nails, concrete mixes, painting materials, etc. Convenient, simple to read. Just set dial for nail specifications, to convert linear to board feet, find bit sizes for screws, compare characteristics of woods. 6" diameter heavily varnished cardboard. Send 25c, no stamps, please to Greenlee Tool Co., 2112 Columbia Avenue, Rockford, Illinois.

Get Our Big Manual of "HARD-TO-GET" ITEMS

For home craftsmen, wood workers, industrial art departments, furniture repair men, hobbyists, cabinet makers, etc. Send only 50c today for your copy.

A few of the items we sell: Inlays, fancy cabinet wood, lumber, Ebony, Holly, Dimension cut lumber, Bismarck Vase, Carving Blocks, Turning Squares, 120 kinds of veneers. Abrasive papers, archery woods, bill-board clamps, binswings, best fasteners, blueprints, Chair braces, brass chain, brass fencing, Craftsmen books, candlestick holders, candlestick sockets, card table hardware, casters, Chair case, ceramic tiles, clamp nails, crib hardware, Dowels and dowel pins, dowel centers, drawer rollers, felt, Flok finishes, foam rubber, furniture clamps, complete professional finishing materials, Folding tablelegs, hand tools, furniture pulls, modern and period, chest and ornamental hardware, all types of hinges and locks, small box hardware, Inlaid picture kits, Inlaid card table tops, leather working tools, Micarta, revolving Lazy Susans, musical movements, moulded wood carvings, Metalcraft material, Moto Sander, nut bowl hardware, Picture frame moulding, Pre Cut Wood Pix, perforated steel panels, plaster standaris, plastics and plexiglass, internal carving bits, plastic polishing compounds, Electric routers, sanders, foot rheostats, hand drills, sprayers, revolving fixtures for television tables, chairs, etc. Fibre rush, screw hole buttons, spiral saw blades, sliding door track, sharpening stones, home owners specialties, 100 woods, ski woods, platform rocker springs, Table leaf supports, tack rags, thermometer cards, turned furniture legs, typewriter fixtures. Complete upholstery supplies. Veneer presses, wood burning pens, wood working instructions, black and copper wrought iron hardware, silver wire.

Send fifty cents today (refunded on 1st order) for your copy of the Country's leading Catalog, "Constantine Manual for Craftsmen" to:

ALBERT CONSTANTINE & SON, Inc.
Dept. PM-12 797 East 135th St. New York 54, N. Y.



GOSH!
EVERYBODY WANTS

Mall TOOLS

for Christmas

Mall 1000 & 1 DRILL KIT

A complete power tool kit for beginner or expert. See it at your neighborhood MALL Dealer. See the world-famous MALL 149B drill (shown below) . . . the sturdy, steel carrying case . . . and the great many attachments included in this set. Attachments for—



ONLY \$37.95

- Drilling
- Sanding
- Polishing
- Wire Brushing
- Sharpening
- Grinding
- Buffing
- Paint Mixing

Mall MODEL 149B 1/4" DRILL

ONLY \$23.95

It's a lightweight bundle of power with a speed of 2000 rpm. Has many features found only in higher priced drills. It's built to give years of dependable service. Can be purchased as a part of the value-packed 1000 & 1 Drill Kit (above) or as a separate unit at this low, low price. Remember, when you buy a MALL tool, you're buying the brand that's preferred by men who make a living with tools.



POWERS DOZENS OF ATTACHMENTS

#51708 SLITTING SAW



Powered by 149B drill. 5" blade cuts to 1 1/2" depth. Only \$7.95



#51780 JIG SAW. Fits 149B drill. Can cut 2" x 4"—adjusts for cutting angles. Only \$16.50



#52290 BENCH TYPE SAW TABLE enables slitting and jig saws to operate as table saws. Only \$16.50

Send for this Valuable FREE Booklet



MALL TOOL COMPANY

PORTABLE POWER TOOLS
GASOLINE • ELECTRIC • AIR

7805 South Chicago Avenue, Chicago 19, Illinois

Please send me a free copy of the 64 page MALL Booklet of Home Workshop Helps and Projects.

Name _____

Address _____

HU-121

IRWIN add-a-bit set

Gift for the handyman, teenager, professional woodworker

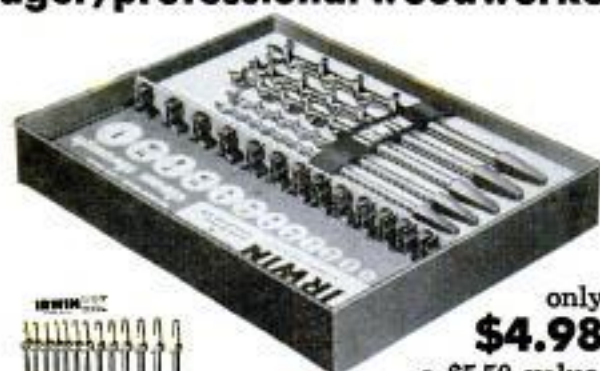

only
\$4.98

a \$5.50 value

Set consists of 5 world-famous Irwin Auger Bits and handy metal storage rack. Rack holds 13 Irwin Auger Bits, sizes 1/4" to 1". Give as a practical starter

set of 5 most-used wood bit sizes. Add other 8 sizes to make complete set of 13 as needed. Ask to see other Irwin gift suggestions when you visit your independent hardware dealer. Irwin — Wilmington, Ohio

IRWIN
Wilmington, Ohio

the original solid
center auger bit
•
screw drivers
screw driver bits



A "must" for your home workshop-



NORTON

Combination Bench Stone

Puts a real edge on workshop and garden tools, scissors, kitchen knives, etc. Fast-cutting CRYSTOLON® Abrasive — coarse on one side, fine on the other. Pre-filled with oil. Handy six-inch size only \$2.04 at your hardware or lumber dealer.

COMPLETE INSTRUCTIONS FOR TOOL SHARPENING

In this 32-page "How to Sharpen" booklet. Send 10¢ to Behr-Manning Corp., Troy, N. Y., Dept. PM-12.



C-21



▲ COATED ABRASIVES ▲ SHARPENING STONES ▲ PRESSURE-SENSITIVE TAPES

Modern Vikings Over the Pole

(Continued from page 103)

instruments, "inch" their way over the top of the world. Knowing the amount of "precession," or drift, due to the rotation of the earth, they direct the pilot to fly an "initial" course that will average out to the "desired grid course" somewhere between the "true" and maximum-error courses. They find this initial course by taking a star shot and resetting the Polar Path every 20 minutes! Thus, the course they fly becomes a series of small circle segments, 20 minutes in length.

SAS's DC-6Bs "top off" at 5500 gallons of fuel, but the planes seldom take off with that much aboard. To satisfy Civil Aeronautics Authority regulations, the pilot takes on enough fuel to reach his destination plus 7½ percent (to allow for fuel-gauge error) plus enough more to reach his first, and then, if necessary, his second alternate airport, plus 7½ percent more, plus enough more to "hold" for two hours for weather.

For the Los Angeles-to-Winnipeg run, a distance of 1434 nautical miles, this comes to about 3500 gallons; for the Winnipeg-to-Bluie West 8 run (1722 n.m.) about 4700 gallons, and from Bluie West 8 to Copenhagen (1929 n.m.) about 5000 gallons. Bluie West 8 is just inside the Arctic Circle on the west coast of Greenland.

Although the planes were originally designed to carry 54 passengers, only 32 climb aboard for each transpolar flight, 24 in the main cabin and eight in the sleeper section.

SAS has found that insulation is adequate to maintain "living room" conditions with the outside temperature 80 below zero. The plane's cabin heaters turn out the equivalent of four home furnaces.

Survival equipment beyond that carried on all North Atlantic flights includes red paint for marking the snow, shovels, rifles, snowshoes, cold-weather rations and individual sleeping bags for each passenger and all nine crewmen.

Food for the in-flight meals on the 23-hour eastbound flight (total elapsed time) is supplied by the Brown Derby Restaurant in Los Angeles; typical fare consists of lobster and champagne.

SAS's problems were tough ones, but the airline has solved them. And, in so doing, it has made the world a smaller place — transpolar flights save five hours between Los Angeles and Copenhagen. As pioneer on the new route, SAS can also claim the honor of opening the Northwest Passage, the "first new trade route in a thousand years."

★ ★ ★



Santa Says:

"A WONDERFUL HOBBY
WORKSHOP GIFT"

JUST DIAL
40 DIFFERENT
WIDTHS ON
ANY SAW!

WITH *Warren* DADO SAWING WASHERS

Cut 40 smooth, accurate, parallel grooves - any angle, with your present saw blade. Dial desired width with Micromatic adjustment. Leave on saw for straight cuts. Sizes to fit your arbor - $\frac{1}{2}$ ", $\frac{3}{8}$ ", $\frac{1}{4}$ ", 1". A perfect gift for woodworkers. See your dealer or write!

ONLY
\$4.95
PER
SET

SEND FOR FREE BOOKLET
WARREN WASHERS COMPANY
DEPT. 32 • BOX 98 • NORTH END STATION • DETROIT, MICH.

SAVE OVER 50% ON **Extruded Aluminum**

STORM WINDOWS AND DOORS

Send for FREE "Do-It-Yourself" Book-PM-1254

U-FAB-IT-URSELF, INC.

Worthington, Ohio

COMBINATION SCREEN-STORM WINDOWS & DOORS • CASEMENT
PICTURE-BASEMENT WINDOWS • SCREEN DOORS & SCREENS



FREE FOLDER "HOW TO SAND"

ADDRESS "Handy" SANDY

CARBORUNDUM®

Niagara Falls, New York

**DOES EVERYTHING A PIPE-
WRENCH WILL DO, AND MORE!**

THE AMAZING
**RATCHETING CHAIN
WRENCH**



Takes the place of 4 pipe wrenches. Gets into tight places where a pipe wrench cannot be used... capacity $\frac{3}{8}$ " to $4\frac{1}{2}$ ". For jobs around the home, garage or service station.

A must for farmers, steam-fitters, plumbers, electricians. Grips anything round or hex, in corners or up against a wall.

EXCELLENT HANDYMAN'S
XMAS GIFT. SEND CHECK OR
MONEY ORDER. NO C.O.D.

\$3.95
POSTPAID

Chain Wrench Co. 1217 HARMON PL.
MINNEAPOLIS 3, MINN.



**OWN
YOUR BUSINESS**

**Start in Spare Time with a
FOLEY SAW FILER**

Here is a steady repeat CASH business you can start at home in your basement or garage, while you are working at your regular job. No experience is necessary to turn out perfect cutting saws - "the first saw I sharpened came out 100%. I think the Foley Saw Filer is a marvel of perfection," writes Clarence E. Parsons. Every saw you sharpen will bring you new customers. You will find you can make up to \$3 to \$5 an hour - \$20 to \$30 a week in your spare time as a starter. With a Foley Saw Filer you can file all hand saws, also band and cross-cut circular saws. It is easy to operate - simple adjustments - no eyestrain. Patented jointing principle evens up all irregular teeth and makes an old saw cut just like new.

**This Free Book
Shows How to Start**

"MONEY MAKING FACTS" shows you how to get plenty of saws to file without canvassing, and how you can develop into a general repair shop that will be your own business. This is a helpful, practical book that tells just what to do - send for your free copy today. No salesman will call.



Send for **FREE BOOK**

**FOLEY MFG. CO., 1216-4 Foley Bldg.
Minneapolis 18, Minn.**

Send me free book "MONEY MAKING FACTS"

Name _____

Address _____

New HEAVY DUTY Tape Rule

makes measurement
easier and faster



LUFKIN WHITE CLAD SUPER MEZURALL

CHECK THESE "SUPER" FEATURES—16-inch centers indicated. Wide $\frac{3}{4}$ " steel line is flexible, yet extends farther unsupported. Long lasting snow-white line has bold, jet black figures. Top edge graduated feet and inches, bottom edge consecutive inches. Long, wide adjustable end hook permits accurate measurement, hooks securely. Feather-weight Magic Metal case is light yet very strong. Packed in beautiful, two-color re-usable plastic box with hinged cover and snap fastener.

A Perfect Gift

for Craftsmen



10 FT. ONLY
\$2.39
12 FT.
\$2.89

BUY **LUFKIN**

334

TAPES • RULES • PRECISION TOOLS
AT YOUR HARDWARE OR TOOL STORE

THE LUFKIN RULE CO., Saginaw, Mich.

POWER HYDRAULICS for SNOW PLOWS

Use on



TRUCKS



JEEPS



TRACTORS

HY-LO-JACK
does
the job
**FASTER-
EASIER**



- Lifts average snow plow in 3 to 10 seconds.
- 1,000 lbs. per square in. pressure
- Quick, easy installation on new or existing equipment.
- Complete kit form, including the pump, tank, hose lines, etc.
- Electric unit also available for 6 or 12 volt systems.

* Write for Circular. See your Road Machinery, Jeep or Farm Equipment dealer.

MONARCH ROAD MACHINERY CO.

Quality Machinery since 1886

1331 Michigan St., N.E., GRAND RAPIDS, MICH.



G E A R S

In Stock - Immediate Delivery

Gears, speed reducers, sprockets, thrust bearings, flexible couplings, pulleys, etc. A complete line is carried in our Chicago stock. Can also quote on special gears of any kind. Send in your blueprints and inquiries.

Send for Complete Catalog No. 10

CHICAGO GEAR WORKS

440-50 N. Oakley Blvd., CHICAGO 12, ILL.

CRESCENT TOOLS

Give Wings to Work

ASK YOUR
HARDWARE
DEALER

18 make-it-at-home ideas 10¢

3 well illustrated folders suggest valuable additions to your home—easily made with standard materials—including valance-bookcase, carport, paneled walls and ceilings, sound-deadening floor, fish or swim pool, hutch cabinet, swing-up garage door, residing, treatment of concrete, roof decking. To secure all 3 folders, please send 10¢ (to cover handling) to:

HOMASOTE CO., Dept. 45A, Trenton 3, N.J.

Say You Saw It in Popular Mechanics

Protect your home against
power interruptions
with an...

ONAN Emergency ELECTRIC PLANT

Provides dependable stand-by electricity for heating system, pumps, freezer, lights, appliances. Keeps home safe, livable. Automatic start and stop. Find out how little it costs!

Write for Folder!

D. W. ONAN & SONS, INC.

8584 University Ave. S. E. • Minneapolis 14, Minnesota

A SIZE FOR EVERY NEED
1,000 to 50,000 watts.
Compact, quiet-running,
easy to install. Gasoline
engine powered.

P & C

Combination Wrenches
are Job Designed
Speed Your Work

Feel right in your hand—work right on every job. Box end for tight places, needs only 15° swing. Open end offset, takes 30°. Tough alloy steel, satin chrome and polished. Ask for P&C combination wrenches. Every P&C tool guaranteed—"the BEST tool money can buy".

Buy your P&C Wrench from this handy display. Send 10c TODAY for big P&C catalog. Over 500 tools fully described.

P & C HAND FORGED TOOL COMPANY

Dept. H-1254, Box 5926
PORTLAND 22, OREGON



BUILD YOUR OWN ELECTRIC HOTBED

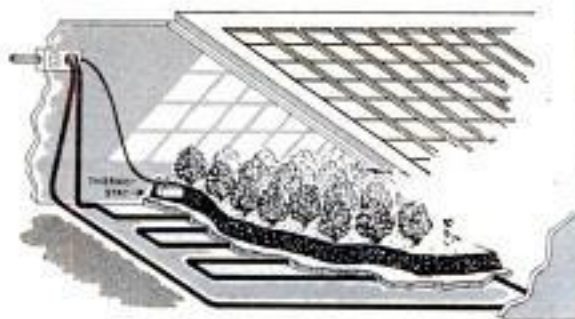

EASY TO INSTALL!

In hotbed or greenhouse, simply bury cable 4 to 6 inches under surface, spacing loops about 7 inches apart, and plug into any electric outlet. One 60-foot cable set heats 36 square feet of soil. In cold frames, lay on surface or bury just below . . . 60-foot cable set will cover 50 square feet. Thermostat can be used to make either type of operation fully automatic. Couple cable sets in parallel for larger areas.

get bigger, healthier plants with G-E Heating Cable Sets

You can speed germination, help start root cuttings, cut growing time, and produce healthier, more uniform plants . . . with the same method that commercial growers have been using for more than fifteen years. G-E heating cable sets supply gentle bottom heat (about 60° F higher than soil temperature) for ideal growing conditions. Inexpensive to use: typical 3' by 6' hotbed sash in northern climate consumes 1 kilowatt-hour per 24 hours of operation. Home gardeners use con-

venient 30- and 60-foot, 110-volt cable sets, or 120-foot, 220-volt sets. G-E heating cable sets are handy, too, for pipe heating and roof de-icing. For details, write Section D142-1272, Construction Materials Division, General Electric Company, Bridgeport 2, Conn.



In 26 days . . . these two celery plants grew from the same seed batch in adjacent flatbeds. Plant at left grew in manure-heated bed; the other in bed equipped with G-E heating cable.

Progress Is Our Most Important Product

GENERAL ELECTRIC

DO MORE PLANING JOBS WITH LOW COST BELSAW

Exclusive MONEY-MAKING Features: • Full 12 1/2" x 6" capacity • Power feeds at 24" a minute • Provides for Grinding Knives in the Cutterhead • Attachments for Jointing, Rabbeting, Tongue, Groove, Matching. Convert low cost rough lumber into high priced cabinet finished stock . . . Easy to make flooring and popular patterns. Send today for free literature and prices.

Belsaw Machinery Co., 1011 Field Bldg., Kansas City II, Mo.

LOW DOWN PAYMENT! EASY TERMS

ALSO CHILD'S 2 PASS. MOTOR CAR

ESHELMAN HOLDS 1 ADULT

AUTO WITH MOTOR

70 Miles Per Gal. Gas
25 Miles Per Hour

Pat. Pend.

Eshelman
DEPT. CM-812
109 Light St.
Baltimore, Md.
333 N. Michigan Ave.
Chicago 1, Ill.
7070 Hollywood Blvd., L. A. 28, Cal.

Write For Free Literature

SURPLUS - NEW CROSLEY

Automotive and industrial 25 HP engines with starter, carburetor, generator, ignition, and transmission, ready to run

\$333.80 F.O.B. SAN DIEGO

GENERAL TRUCK & ENGINE CO.
SAN DIEGO 1, CALIFORNIA

FREE CATALOG of JIG SAWS and SANDERS

Don't Buy Any Till You Get This Catalog!

Powerful NEW JIG SAW cuts 2x4's!

New self-powered SYNCRO 208 cuts 1 1/4" wood—cuts to 30" circle center—safe—motor guaranteed against burnout! Remember . . . more Syncro-made jig saws have been sold than any other self-powered make. Why gamble? Get LOW-PRICED, dependable Syncro!

SANDERS THAT SAVE

(Left) New heavy-duty Syncro "800" with built-in lightsaving lamp removes paint, varnish—has most powerful reciprocating sander motor guaranteed. America's finest sanders for vertical, overhead and finish jobs are No. 504-D DELUXE in metal carry case (right) and No. 504 (not shown). Write for LOW PRICES, Catalog.

QUALITY TOOLS

Authoritative 8-Page Sanding Handbook **FREE!**

SYNCRO CORPORATION
DEPT. 1-94, OXFORD, MICHIGAN, U.S.A.

Send FREE Syncro Saw-Sander Catalog, Low Prices and Informative "Surface Preparation" Sanding Handbook!

NAME _____
ST. & NO. _____
CITY _____ STATE _____

Mail Coupon!

Under the Beauty... STRENGTH OF STEEL



HEAD CAN'T FLY OFF! No more bother with loose or splintered handles. Estwing Unbreakable Tools are forged in one piece from tough tool steel . . . no welds or joints. You'll like the genuine leather grip proven most comfortable and durable.



INDIVIDUALLY GIFT BOXED

Hammer \$3.65
Belt Axe \$4.50

AT ALL LEADING
HARDWARE STORES

Write for FREE catalog

ESTWING MFG. CO. DEPT. NP :-: ROCKFORD, ILL.

more FOR YOUR MONEY!



PRECISION BUILT HOME WORKSHOP LATHE

- Mounts vertically on any floor or bench drill press.
- Mounts horizontally on bench or table, — powered with any 1/4 H.P. motor.
- Centers running in pre-loaded ball bearings.
- Turns wood up to 18" long by 4 1/2" diameter.
- Can also be used for buffing and polishing.

Not a toy, but a smooth-running, high-speed, precision-built lathe, ideal for projects and hobbies. Includes complete machine with vertical-horizontal mounting bracket.

DIRECT FROM FACTORY TO YOU, ONLY \$9.75

AMHERST MFG., CORP. Evans St., Williamsville, N.Y.

Send one complete lathe at \$9.75 plus postage.
Enclosed is check money order

NAME _____

ADDRESS _____

CITY _____ ZONE _____ STATE _____

WONDER SAW BIT



DRILLS OWN
STARTING HOLE



Drills and Saws

IDEAL AS A CHRISTMAS GIFT

New combination bit for electric drills. May be used as a drill, a saw or a reamer. Use for circles, ovals, squares, inside, hard-to-reach work. Works equally well in metal, pipe, wood, plastic, etc. Easy to use. Every carpenter, mechanic, electrician, plumber, hobbyist needs one. Made of abrasive resistant, hi-speed steel. Stands severe, continuous use without breaking. Resharpens free. Use with electric drill, slow drill press, lathe or milling machine. 1/4" diameter, 2" cutting section, total length 3 1/2". Three types—specifically wood, metal or all purpose. Set of 3, \$5.75. Details on request. Dealer inquiries invited. **MONEY BACK GUARANTEE.** Shipped same day. **ORDER NOW!** Send check or money order to:

WONDER DRILL COMPANY

Box 8321, Dept. PMI Kansas City 6, Mo.

NOW

only
\$1.95

Automatic Saw Set...

MAKE EXTRA PROFITS!

Set 400 teeth per minute on hand or band saws, 4 to 16 point, with the BeMaCo Automatic Saw Set. Fast, accurate, true hammer-anvil action sets teeth uniformly, eliminates tooth breakage. Used profitably by saw shops and manufacturers everywhere. Every machine positively guaranteed!

Write for details—today!

Saw
Machine
Division
13-C

BEAVER MFG. CO.

800 ISIS AVENUE • INGLEWOOD, CALIF.

LAWN ORNAMENT-NOVELTY PATTERNS

28 Lawn Ornament Patterns, 25c. Other Patterns: 15-20" high; Dutch Girl, Dutch Boy, Pirate, Bull Terrier, Mexican Girl, Mexican Boy, Dwarf, Penguin, Flower Girl, 15c each. 25 Novelty Patterns, 30c. All 62 Full Size Patterns, \$1.00.
Strother Pattern Service, Dept. DR-8, Box 128, Belington, W. Va.

SAY YOU SAW IT IN POPULAR MECHANICS

AN UNUSUAL OPPORTUNITY!!!!

Famous  German Precision
Calipers & Micrometers
UP TO HALF REGULAR PRICE



30-61 Chrome Steel Caliper .001" & 1/128" . . . \$7.00
with Cam Lock

30-78 Chrome Steel Caliper .001" & 1/128" . . . 6.00
with Set Screw

30-41 Z Micrometer 0 to 1" to read .0001" . . . 9.95
Add 35c for postage—No C.O.D.

MONEY BACK GUARANTEE

Genuine Leather Case for above caliper 75c each

INTER-CONTINENTAL TRADING CORP.

90 WEST STREET

NEW YORK 6, N. Y.

**GIGANTIC
SAVE-TO-70%**

MAIL SALE

**WAR SURPLUS
EXCESS INVENTORY
BANKRUPT STOCK**

SURVEYORS LEVELS—TRANSITS

● Leading make precision level suitable for leveling, contouring, building construction, etc. Fine for builders, farmers, etc.

● Complete with 2-sec. 9' rod, case, instructions. A great buy! **SPECIAL, Prepaid...\$37.95**

● Level-Transit. Combination unit suitable for either leveling or lining up. Finest scope, etc. With 9' rod. **SPECIAL, Prepaid, \$77.50**



ARMY FIRST-AID CHEST

● Complete set of first-aid essentials. Everything for cuts, burns, bruises, bleeding, etc. Full instructions.

● Attractive 10 x 10 x 3 in. metal chest. Can be mounted on wall, in car, etc. Every home and business should have one. Cost over \$12. **SPECIAL, Prepaid...\$56.95**



NEW DELUXE ARMY TOOL CHEST

28" x 38" x 20"

● Wonderful unit. Finest cabinet design. Four lift-out drawers, excellent hardware, etc.

● Ideal for home shops, contractors, tool rooms, etc. Gov't. cost \$59.60. **Sale...\$21.95**



HYDRAULIC SPEED REDUCER

● Amazing Gov't. Speed Reducer unit. Consists of hydraulic pump and motor. Output speed range 0 to 1000 r.p.m. Drive with any AC motor.

● Useful for band saw drives, miniature auto drive, etc. Gov't. cost \$429.50. **SPECIAL, Prepaid...\$33.95**



HYDRAULIC BARGAINS

● Cylinders, Two-way, 2"x10", \$22.85; 2"x24", \$28.90; 3"x24", \$39.90. One-way, 2 1/2"x42", \$36.95.

● Pump, 1000 lb. 12-gal. \$45; Valves, One-way \$18; Two-way \$18; Gauges, 1000, 1500 or 3000 lb. \$3.49.

● Super Special! Cylinder, 1 1/2" bore x 4" stroke, (Precision). Gov't. cost \$87. **SALE, \$1.95 ea.**

ARMY PARTS CLEANER

● Air-turbo solvent cleaner. Makes dirty, greasy parts shiny bright. Wonderful for garages, factories, farms, etc.

● Heavy galv. tank 25"x20"x20". Complete with valve, hose, hydraulic lid lifter. Cost over \$125. **Prepaid, \$29.95**



GIANT LIGHT

110V, 60C



● Amazing 110-Volt unit with intensifier Fresnel. Throws wide beam over large area. Wonderful for parking lots, advertising lite, small airports, etc. Comes in \$30 trunk with extra bulbs. 12 ft. extension tripod, anchors, etc. Gov't. cost over \$200. **SALE, Prepaid...\$49.50**

ARMY AUTOMOTIVE TESTER

● Another four-star buy! Designed for electrical testing of both 6 and 12 volt electrical systems. Fine design, leading make.

● Tests starters, generators, wiring, relays, coils, batteries, etc. Has ohmmeter, voltmeter, current scale. Two separate meters. Many other features. Used, excellent. Cost \$71.50. **SALE...Prepaid, \$14.67**



SPEED TACHOMETER

● Genuine mechanical tachometers. When converted to engine, motors, etc. shows exact speed in r.p.m. Range 0 to 3500 r.p.m. Can be used with any driving cable or by simple insert as hand-held tachometer. Cost \$10.25. **SPECIAL...Prepaid, \$5.95**



AIR COMPRESSORS & TANKS

For painting, cleaning, tires, control terminals. Assemble your own outfit. Lowest prices in U.S.

● Deluxe Kit. Compressor, tank, gauge, regulator, paint gun, fittings. How to build instructions. List \$80. **SALE...Prepaid, \$45.49**

● Deluxe Outfit. Finest ready to use complete air unit on wheels with gun, reg. etc. (Less motor). **SALE...Prepaid, \$69.95**

● Compressor (3-cyl) \$20; 2-cyl \$22; Gov't. Air Tanks \$6.79; Regulators \$2.79; Pop off \$1.95; Pres. gauge \$1.89; Finest paint gun \$9.95; Auto. switch \$4.95. **Prepaid.**

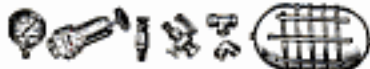

ARMY POWER PLANTS & GENERATORS

● New condition perfect plants. Expensive units less than mfg. cost.

● 3000-4000 watt, 115-v. 60-c. Army's finest unit. 4-cyl. Eng. Push-button start, etc. Cost over \$800. **SALE...Prepaid, \$349.50**

● Generator only—same as above. Full instrument panel. Use your own engine or tractor to drive. Cost over \$350. **SALE...Prepaid, \$169.50**

● Many other AC and DC plants and generators. Low as \$59.50. Write for catalog. We pay all freight!



SPECIAL OF THE MONTH!

ROBOT HYDRAULIC CYLINDER



● Cylinder for automatic pilot system on large planes. Precision construction. Ball bearing swivels on each end. 1.5" bore, 4" stroke, actuating pressures to 700 lbs. Has free wheeling control valves. Two-way type.

● Hundreds applications such as boat steering, small presses, turret lathes, door openers, power auto steering. Drive with small oil gear pump or handpump.

● Can also be used as remote servo using pair of cylinders—one as transmitter, other as receiver. Gov't cost \$87.50 ea. **SALE...Prepaid, \$3.89 each \$6.39 pair**

ELECTRONICS AND MISCELLANEOUS

● Magneto Telephones...\$9.95
● City Telephones...\$4.99
● 200-Amp. Welder Generators...\$29.95
● W. E. Photo Cell (List \$6.50)...49c
● Small Boat Sail and Mast...\$1.95
● Photo Paper and Film (Save 50%)
● Thyatron Trigger Tube (84.05)...98c
● Trip Fire-Burglar Alarm Unit...99c
● Laboratory Micrometer Adjust Relay \$2.97
● Weston 0-300 Amp. DC Meter...\$7.92
● Generator 30-V., 200-Amp., 110-V., 800-C. AC...\$29.48

SELSYN REMOTE CONTROL MOTORS

● War's most amazing invention using pair of units, mechanical motion can be transmitted over wires. Makes fascinating wind direction indicators, antenna rotational controls, burglar alarm, depth reverlers, etc. 110-V. 60-C units. Gov't. cost \$125. **SALE, Ppd...\$12.97, Pr.**

PUMPS — VALVES — SYSTEMS

Irrigate. Do it yourself. Our data shows you how. ● Pumps, Centrifugal 3/4" \$19.99; 1 1/2" \$38.00; Rubber impeller self priming 1 1/2" \$15; Hi-pressure rotary for weed, cattle spraying \$54; ● Water System, Automatic. For lifts to 22 ft. 300 gal. per hr. 40 lbs. 110-V 60-C, 3/4 hp motor, Ppd...\$69.50

AUTOMATIC REMOTE CONTROL SWITCHES

● Amazing electro magnetic switch. Complete with dial. Any circuit from 1 to 100 can be selected simply by dialing the number, uncanny response. Will work over lines up to 20 miles. Used, excellent.

● Fine for inter-coms. Private automatic phone systems, remote control, experimental, etc. New cost over \$200.00. **SALE, Prepaid, \$13.95**

ORDER FROM AD or write us for big FREE CATALOG! 1000s of items! Motors, sporting goods, hand and electric tools, watches, traps, etc., etc. We pay all freight.

BURDEN SALES COMPANY
807 "O" STREET LINCOLN, NEBRASKA

MAGNETS

ASSORTED MAGNETS with big list of handy uses...5 for \$1

POWERFUL POCKET MAGNET ideal for testing metals...\$1

RETRIEVING MAGNET pulls tools, etc., from tank or lake...\$3

HOT PAD MAGNETS to insert in your own hot pads...8 for \$1

BULLETIN BOARD MAGNETS to "pin-up" memos, etc...8 for \$1

SLENDER MAGNETS remove chips from drill holes...2 for \$1

Write for free booklet. 100% satisfaction guaranteed...**POSTPAID**

PARK MAGNETS, PM-12, 1557 GREENBAY RD., HIGHLAND PARK, ILL.

1955 CATALOG — Send 50c

55 Models for '55! See the world's finest line before you buy. Rated tops in design, styling, performance by the experts. '55 catalog plus booklet "Boat Selection, Operation, Maintenance" \$1.00

Custom-Craft

THE ORIGINAL "PACKAGED"

BOAT KITS

BOAT PLANS AND FULL-SIZE PATTERNS

Over 100 Modern plans and full size patterns. Racing classes, cruisers, inboards, outboards, sail boats. By famous designers. 6' to 30' DESIGN CATALOG only 50c. For Design Catalog plus boat building handbook send \$1.00.

CUSTOM-CRAFT (DEPT. A) BUFFALO 7, N. Y.

Red Devil FP-33

Floor Conditioner

Keeps Floors Gleaming

Tackles any job—scrubbing, waxing, polishing, buffing, sanding... any surface. Twin 6" brushes—no bucking, no sideslip.



Red Devil Tools.

Get your FREE copy of "HOW TO MAINTAIN WOOD FLOORS."

MAIL COUPON TODAY

Red Devil Tools. Dept. 151
130 Colt Street, Irvington, N. J.

NAME _____
ADDRESS _____
CITY _____ ZONE _____ STATE _____

2019

Make BIG SAVINGS With FACTORY-DIRECT PRICES!

ELECTRIC LIGHT PLANTS

Why worry about power failure? Buy peace of mind now. It costs less than you think! You get protection for the rest of your life against power failure caused by street storms, hurricanes, floods or disasters. Factory-to-you prices, the lowest ever! Write today for free booklet that outlines size and type of plant needed to do your job!



ELECTRIC WINCHES—Direct-to-you Prices

1/4 HP master gearhead driven winch with drum. Will lift 500 lbs. Pull 1100 lbs. **\$98.00**
 1/2 HP Electric Ball Bearing. Compact gear box. 12 RPM drum speed. **\$165.00**
 3/4 HP, same as above. More lifting power, greater speed. **\$185.00**
 Super-duty 1 HP Ball Bearing, with 24 to 1 worm gear reducer. Length 38", Width 26", Height 17". Pull 3200 lbs. Complete with 100 ft. of aircraft cable, up-and-down buttons **\$245.00**
 (All electric motors Heavy-Duty, Repulsion-Induction, Instant Reverse, 110 V single phase, 3 phase available). Complete Stock of Limit Switches, Magnetic Brakes, Magnetic Reversing Switches, Aircraft Cable.

CABLE 1/4" pre-formed aircraft cable. 17c ft.
 3/16" pre-formed aircraft cable. 12c ft.

BOOSTER FANS

Fit any 8" to 12" furnace pipe. Mounting frame, 7" blade, 110 v motor, 60 cps, 1500 rpm with 6' cord. Silent operation. Easy to install. Warm those rooms with long runs. List \$19.95. Our price . . . **\$6.95**; two for **\$11.95**; three for **\$14.95**. Buy one for each room! REGISTER FAN for hot or cold air with bracket ready to mount; motor, 7" blade, 6' cord ONLY . . . **\$7.00**; two for **\$12.95**; three for **\$16.95**.



Here are only a few big \$ \$ \$ savings! More in our catalog!

Air Compressor	Electric Motors	Hand Truck	Rubber Cable
Air Tank	Electric Switches	Hydraulic	Rubber Wheels
Block & Tackle	Elevator	Cylinder	Saw Tables
Blowers	Drawing	Hydraulic	Shower Sprays
Bomb Trailer	Elevator Incline	Stacker	Starters
Buzz Saw	Fans, Exhaust	1 Beam Trolley	Tools
Compressor	Fans, Heat	Lawn Mower	Transformers
Accessories	Booster	Sulky	Whiting Hoist
Clutches	Gas Engines	Magnetic Starter	Whitton Vise
Conveyors	Generators	Mail Chain Saw	Winch, Electric
Delta Tools	Grinders	Mail Grinder	Winch, Hand
Drop Cords	1 1/2 Ton Wagon	Pumps	Fire Extinguisher
Electric Hoists	Male Fire Pump	Reduction Gear	4 Wheel Trailer

Get this catalog! 88 pages, packed with useful charts, information, plans for dummy & incline elevators, more than 1100 tool and equipment items at money-saving, factory-to-you prices. Send 25c (refund with first order) or write on company letterhead for free copy.

C&H ELECTRIC MACHINE Co. Inc.

434-W W. Juneau Ave., Milwaukee 3, Wisconsin

AUTOMATIC RETOOTHING HAND SAWS

MAKES NEW PROFITS

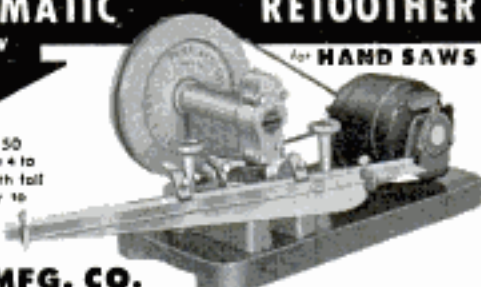

Cuts new teeth in 50 seconds—any size 4 to 16 points. Old teeth fall off as chips. Easy to operate. A perfect job.

BURR MFG. CO.

8933-B VENICE BLVD. LOS ANGELES 34, CALIFORNIA

'55 FORD

... the fine car of its field!

Write TODAY for **FREE PLANS** **SAVE up to \$70!** Build Your Own Big 10-inch Tilt Arbor Saw

Write now for complete FREE Plans and build a Tilt Arbor Saw with the precision performance of \$95 saws. Cuts 3x6's in 2 1/2 seconds. Cuts hard or soft woods up to 3 1/2 inches thick. Rips, bevels, mitres, cuts compound angles, and dados. No special tools needed. Write now!

AMERICAN MACHINE & TOOL CO., Royersford, Penna. Dept. 12

SEND ONLY \$1 for next 6 issues of famous DELTA-GRAM, best home woodworking magazine you ever saw. Packed with shop-tested ideas—12 to 15 in each issue. Send \$1 (no stamps) to: Delta Power Tool Division, Rockwell Mfg. Co., 502M N. Lexington Ave., Pittsburgh 8, Pa.

Porter-Cable

Homemaster Tools

Say You Saw It in Popular Mechanics

AUTO RACING BOOKS AT NEW LOW PRICE

Automobile Racing — Fifth Edition by Ray F. Kuns. This is a book for auto racing fans. It covers construction and specifications of racing cars and tells and shows how you can build your own. It also contains regulations for midget auto racing and describes roadster racing in California. A number of Indianapolis races are described and pictured. Formerly \$1.00 per copy. Now just..... **50c**

Automobile Racing — Fourth Edition by Ray F. Kuns. Includes eight working drawings and complete building instructions for standard midget racers as well as drawings for midget road cars. Miller Ford V8 front-drive racers are illustrated and described and other big-time data given. Large, clear pictures give inside information. Was \$1.00—Now only **50c**

POPULAR MECHANICS PRESS

200 E. Ontario St. Chicago 11, Ill.

BEST-BORE

Wood Boring Bits for your 1/4" electric drill

at really LOW COST **\$2.49**



8 PIECE SET

FAST, ACCURATE, EASY BORING

Best-Bore Bits bore clean, true, 1/4" to 1" holes in a jiffy in wood, plaster or plastic. Bore at an angle, into end grain or for mortising.

Bits—1/4", 3/8", 1/2", 5/8", 3/4", 7/8", 1", and chrome-plated shank. In plastic case, with instruction leaflet and adjusting wrench. At progressive hardware dealers, or send money order for \$2.49.

Buy the **Parker** Line

SNELL DIVISION

PARKER MANUFACTURING CO.

WORCESTER 1, MASS., U. S. A.

SENSATION OF THE NATION

NEVER BEFORE
AT THIS
LOW
PRICE

1/2 HP POWER SAW
3400 RPM

compares to saws
selling up to 49.50
Ideal for HOME-
SHOP

1948
WITH BLADE

NEW

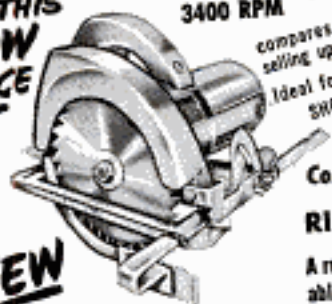

Complete with 5 1/4" Blade
RIPS—CROSSCUTS

A rugged, professional type, adjustable saw. Cut any angle, 0 to 45°. Has adjustable (0 to 6") rip fence. Safety-trigger switch on handle. Full 1/2 HP Universal AC-DC, 110-120 Volt, 60 cycle motor. Weighs only 6 1/2 lbs. A sensational Value—We sold over 700 Saws in Los Angeles in one week's trial.

**CUTS THROUGH A 2 x 4 LIKE
A KNIFE THROUGH BUTTER**

**10 DAY
FREE TRIAL
MONEY BACK
GUARANTEED**

WORLD'S GREATEST DO-IT-YOURSELF TOOL BARGAINS

34 Pc. HOME WORKSHOP

COMPLETE
DRILL • SAND • BUFF GRIND
POLISH • MIX PAINT

Famous Make
**1/4" ELECT. DRILL
WITH JACOBS CHUCK**

Another Palley exclusive. A sturdy, all-purpose drill for all home workshop and "DO-IT-YOURSELF JOBS." 1600 RPM AC-DC motor. Automatic trigger with lock action.



Kit contains: 1/4" Drill with Jacobs chuck, 7 carbon steel drills; 6-piece spindle adaptor; polishing bonnet, sanding discs, grinding & buffing discs, drill stand, etc. Complete in metal case.

COMPLETE KIT **\$16.88 NEW**
24.95 VALUE



**12 Pc. IMPORTED
COMBINATION
KNIFE**
A COMPLETE
CAMP KIT

\$12.95
VALUE

Only
4.95

Eliminates 12 Individual
Items from your Pack or
Tool Kit!

Here is the Perfect, Combination Knife-Tool for every Outdoor Sportsman, Hunter, Camper, Fisherman, Boy Scout, Ranger, Rancher, etc. Think of it! 11, Fine quality Steel Tools, precision made to fold easily into the heavy bone covered body. In one neat, compact unit you have (1) a regular knife, (2) a fork, (3) a spoon, (4) a draw-knife, (5) a bone-saw and fish-scaler, (6) scissors, (7) a can and bottle opener, (8) a cork-screw, (9) awl punch, (10) a screwdriver and (11) a metal file. All this PLUS a genuine leather, belt holster.

NOTE: Orders rec'd by Dec. 15 will be delivered by Xmas.

Palley SUPPLY CO.

2263 E. Vernon Ave., Dept. PM-12
Los Angeles 58, California

Pay by M.O. or check. 1/2 deposit with
C.O.D.'s. Prices F.O.B. Los Angeles.

LARGEST FIRM OF ITS TYPE IN THE WORLD

Also Eshelman SPORT CARS LOWEST PRICE 70 Miles Per Gal. Holds 1 Adult Free Literature	<p>ESHELMAN FOR Better LAWNS And GARDENS</p> <p>WOMEN CAN OPERATE IT. Free Catalog. Write</p> <p>ESHELMAN, Dept. R-512 109 Light St., Baltimore, Md. 333 N. Michigan Ave., Chicago - 3, Ill. 7070 Hollywood Blvd., Los Angeles 28, Cal.</p>
<p>RAKES PLOWES CULTIVATES HARROWS HAULS SPRAYS SAWS DOZER MOWS CUTS ROLLS TILLS SNOW PLOW</p> <p>1 to 8 H.P. Also WALKING TRACTORS Low 49 \$69</p>	

BUILD YOUR OWN ARC-WELDER

We show you how to build NEW powerful welder. No rewinding. Uses most any surplus aircraft generator. Easy to build. 75-300 amps. Complete PLANS 25c. Send today and we'll include FREE our Big War Surplus & Electrical Catalog.

LEJAY MFG. CO., 1247 LEJAY BLDG., MINNEAPOLIS 8, MINN.

SAY YOU SAW IT IN POPULAR MECHANICS

Opportunity for Men with Automotive Background and Executive Ability

Manufacturer and marketer of nationally-advertised line of automotive products now expanding operation here and abroad. Distributors needed to warehouse and administrate to growing dealer network. If you have organizational ability and are financially responsible, write for details.

Your inquiry held in confidence; Write: Box P.M.-12, 10418 Venice Blvd., Culver City, Calif.

New "PULL-GEAR" SPEED-REDUCING PULLEY

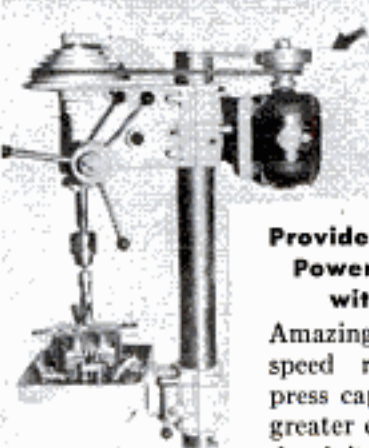

Provides Correct Speed and Power to Drill Up to 1 3/8" with 1/2 H.P. Motor

Amazing new internally geared speed reducer doubles drill press capacity. Greater power, greater efficiency, greater productivity.

Provides the correct speed and power for larger drilling, reaming, tapping and boring on light presses. Easily installed in five minutes. Adaptable to all type machines. Spindle speed range approx. 45 to 3000 RPM. Made in 3 motor shaft sizes: 1/2"-5/8"-3/4". Write for literature.

WRITE FOR LITERATURE

THE PULL-GEAR CO.

25427 Mound Road
Center Line, Mich.

WAR SURPLUS And other Bargains **SAVE UP TO 90%**



SPECIAL ON \$4770 AUXILIARY POWER UNIT

Ideal for your shop, camp, cottage, farm, trailer, home, boat or mines. Makes a terrific welder for any sized job, any time, any place! 2 cylinder, horizontally-mounted air-cooled engine. Complete with AC-DC generator. On DC will supply 200 Amps at 24-28 Volts; on AC will supply 10.5 Amps—1200 Watt at 800 Cycle. The DC Generator rating at normal RPM, 5 KW. Operates on cheap gasoline. Economical. No batteries required. Dual Scintilla magnets. Generator can be removed and engine coupled to other units for other purposes. Mfd by Lawrence Comes complete in fire-proof enclosure which cuts motor noise to a minimum. Shpg. wt. casted, 398 lbs., net wt. 139 lbs. Like NEW. Complete, guaranteed perfect. Govt. Cost \$4770, Special Now—Model D1, 14.5 HP with AC-DC Generator described above—\$137.50; also with 300 Amp Generator—\$167.50. Model C2, with 160 Amp Generator, intermittent 220 Amps, 10.5 HP—\$125.50.

FIELD COOKING UNIT & HEATER

Terrific for hunters, ranch, home, farm, civilian defense, boat, camp, trailer, barbecue, etc. Burns any type gasoline. Burner 10 3/4" dia. Unit approx. 23" x 21" x 10". Has 2 tanks (21 1/2" x 5 3/8") with welded seams, 3 brass valves, 3 air filters, air gauge to 80 lbs. Can use as air tank for compressor or fill with liquid for spraying. NEW Korean war surplus. Wt. 95 lbs., boxed. Approx. GOVT cost \$150. Complete with 2 spare nozzles and orifice cleaner (compare this price!)—\$10.50



SENSITIVE ALTIMETER

In 10 Ft. Increments. NEW! Famous Pioneer! 0 to 35,000 Ft. inches of Mercury. Tested and inspected in our own instrument lab. Guaranteed perfect. Approx. Govt. Cost \$150. NOW ONLY \$12.95 PREPAID!



"HELIOS" ORIGINAL TOOLMAKERS VERNIER CALIPERS

ULTRAPRECISION—Imported. Used by machinists at Lockheed, Douglas, Bendix, GM, RCA, GE. Model 51/2E. Genuine Helios. Hardened lapped precision surfaces. 1/1000" and 1/128" graduations. Handy slide roll and thumb lock. Quick, accurate depth. A \$35 value. Satin finish. ALL NEW. just \$8.50. Leather carrying case, \$1 extra.

MICROMETERS

Chrome plated, precision engineered, carefully toolled to give long life. All new 0-1" cap. \$2.25 ea., 1-2" cap. \$3.50.



PRECISION GROUND SQUARES

Production engineer's Squares. Accuracy guaranteed. Mfd. by Wright & Moore, Sheffield, Eng. Square blades hardened & tempered. Individually packed in wood box. Brand NEW. Fraction of original cost. 2"—\$2.25, 3"—\$2.50, 4"—\$2.75, 5"—\$3, 6"—\$3.25, 9"—\$6.50, 12"—\$8.25.

GEAR HEAD MOTOR

Use to turn antenna, open or close doors and windows, barbecue, displays, etc. Approx. 1 RPM. Set for 140° turning with limit switches that can be removed for full 360° turning. Operates on 24 Volt DC, 1/2" shaft dia. 3" wide, 10" long, Wt. 4 lbs. High speed 7000 RPM, 1/10 HP motor, micro-switches, reduction gears, mounting brackets—a bonanza for hobbyists. Approx. Govt. Cost \$90. In perfect condition, now just \$3.90. Mfd. by Barber-Colman Company.

NEW 1955 CATALOG

Biggest ever... new low prices... need 25c for your copy today.

Prices F.O.B. Culver City unless otherwise stated. Check, money order or cash. 25% deposit for C.O.D.

AIRBORNE SALES CO., INC. DEPT. PM1254
8501 Stellar Drive, Culver City, Calif.

Say You Saw It in Popular Mechanics

FOR YOUR WORKSHOP

Kiln Dried
IDAHO WHITE PINE
PONDEROSA PINE

The perfect lumber that is beautifully white and soft-textured. Ideal for shop and project work. Makes all kinds of toys and furniture and is easily worked for inlays, carving, modeling, whittling, patterns, lathe turning, jig saw work, etc.

SPECIAL SAMPLE PACKAGE OF SHORT BLOCKS, TURNING SQUARES AND BOARDS, BOTH ROUGH AND SURFACED, KD & AD, FOR ONLY \$2.00.

IDAHO WHITE PINE CO., Princeton, Idaho:

Enclosed is \$2.00 for your special sample package of lumber, please ship to:

NAME _____

ADDRESS _____

CITY _____ STATE _____

PUMP WATER FAST!

Drains Wash Tubs, Cellars, Cisterns. Famous #7 pumps 2800 gph. 420 gph. at 75' high or 1600 gph. from 25' well. Sturdy rustproof alloy metal. Six blade impeller. 1/4" inlet, 1/2" outlet. Standard pipe threaded. Uses any 1/2 to 1/2 H.P. Motor. Will not leak or clog. Iron clad guarantee. Send check, M.O., or sent C.O.D. **\$8.95** M.S.

Irrigate, Fill Tanks, Draw Well Water. Heavy duty #8 pumps 7000 gph. —1000 gph. 75' high 3000 gph. from 25' well. Rustproof alloy metal. 8 blade impeller. 1" inlet, 1" outlet. Standard pipe threaded. Will not leak or clog. Iron clad guarantee. Send check, M.O., or sent C.O.D. **\$11.95** M.S.

Free Catalogue—Gear Pumps, Large Centrifugal Pumps, Deep and Shallow Well Pumps, Sump Pumps.

MOORE MANUFACTURING CO.
SWEDESBORO 1, NEW JERSEY

SMALL! POWERFUL!

ECONOMY TRACTOR

Unequaled value! Low price! America's finest tractor. Ruggedly built. Easy to operate. 790 lbs. Borg-Warner clutch, trans. and diff 140 to 1 reduction. 40% more drawbar pull than ordinary tractors 8-1/4 H.P. engine. 20 quick change implements. HOOD, FENDERS.

Thousands In Use Write for complete details.

Engineering Products Co.
915 K 12 Niagara Ct.
Waukesha, Wisconsin

VARIABLE SPEED **HYDRAULIC POWER TRANSMISSION**

It has Infinite Speeds 0 to 550. Reverse. Automatic Overload Protection! Adjustable Torque up to 180 inch pounds. 3/4" Input and Output Shafts. It will handle 1/2 to 1 1/2 H.P. Motor. Case measures 7 1/2" long, 7" high, 6 1/2" wide. VALUE OVER \$300. Shipping Wt. 25#. On C.O.D. Orders we require a 10% only deposit. **\$54.50** Feb. Chicago

DIRZIUS MACHINE SHOP "I" 1423-25 So. 52nd Ave., Cicero 50, Ill.

MACHINE TOOL RECONDITIONING & THE ART OF HAND SCRAPING

— ILLUSTRATED —
SEND TODAY FOR FOLDER DESCRIBING BOOK
MACHINE TOOL PUBLICATIONS, 382 Holly Ave., St. Paul 2, Minn.

Wholesale! TOOLS! GUNS! CAMERAS!

BUY TOOLS, PHOTO EQUIPMENT, SPORTING GOODS, JEWELRY AND THOUSANDS OTHER NATIONALLY ADVERTISED PRODUCTS AT BIG DISCOUNTS. SAVE ON OWN PURCHASES. BIG PROFITS SELLING TO OTHERS. POSTCARD BRINGS FREE COPY "THE WHOLESALE PLAN".

AMERICAN BUYERS SERVICE

629 Linden Ave., Dept. 15, Buffalo 16, N.Y.

Get up to **40% off**

SURPLUS SALE

\$39.50 NEW TOOL POST GRINDERS
REGULAR PRICE \$125.00

1-6 H. P. MOTOR
TAKES WHEELS UP TO 1/2" x 4"
EXTRA GULL EXTERNAL GR
INTERNAL \$79.50

Less Grinding Wheel

EDWARD J. NOLAN, PULASKI, NEW YORK

WELD BRAZE
SOLDER CUT

4WAY
ONLY **\$14.75**
f.o.b. factory

WELDER

Complete with Twin Carbon Arc Torch and accessories... to handle all metal-craft work.

Acclaimed by thousands of Homeowners, Mechanics and Hobbyists as the welder of 1001 uses. Easily operated from properly wired 110 volt AC or DC line. The ideal gift with a life-long use... Order today on 10 day money back guarantee.

FOUR-WAY WELDER CO., Dept. F2-N
1810 S. Federal St. • Chicago 16, Ill.

JOINT AND SHARPEN ALL SAWS

SAVE TIME AND \$\$\$



Sensational new Super Filer No. 11 joints and sharpens both hand and circular saws 6" to 10" with all teeth the correct height, depth, pitch and bevel. Easy to use—when file hits hardened steel roller, teeth are finished. Saw runs true and smooth with no side pull. Complete with special 8" file \$9.95 ppd. **FREE FOLDER.**

"**TRU-CIRCLE**" saw set. Automatically sets teeth at 10° or more \$2.95. **FILE SAWS THE RIGHT WAY**

Guaranteed



SO EASY with this new filing jig and jointer anyone can now sharpen any handsaw like new! When file hits hardened steel rollers teeth are finished and **EXACTLY THE SAME HEIGHT**. All teeth cut and saw runs true and smooth. Jig and instructions \$2.95 postpaid. Free Folder. **A. D. McBURNEY, 5908 Hollywood Blvd., Hollywood 28, Calif., Dept. A-48**

Send Chk. or M.O. No COD's

6 HIGH SPEED STEEL ROTARY FILES



\$11.00 VALUE AT \$4.50
On 3/4" shanks. For grinding or deburring hard metals, wood or plastics. Brand new. **Post-paid**
5 WOODWORKERS DRILLS \$2.95
1/4" to 3/4" on 1/4" shank.

30 ASSORTED DRILLS \$6.00 Value at \$2.75
All new. Mixed high speed, and carbon. Up to 1/4" dia. Set No. 20

SCHUPACK SUPPLY CO. 7331 COTTAGE GROVE, DEPT. M-62 CHICAGO 19, ILL.
New Illustrated Catalog 10c

MAKE BIG MONEY!

Be a floor surfacing contractor and send both new and old floors. Sanders are easy to operate and better still, you're your own boss. Write for latest "hell-ol" booklet entitled "Opportunities in Floor Surfacing", enclosing 25 cents in coin or stamps to cover handling.

AMERICAN

FLOOR SURFACING MACHINE CO.
533 So. St. Clair Street - Toledo 3, Ohio

HASTINGS STEEL-VENT PISTON RINGS

The best money you can spend on your car!

AUTOMATIC LOCKING PLIERS

No adjusting... Just grip on any size work within the 2-wide range made possible by the slip-joint... pressure remains locked. Fingers-operated release trigger provides instant one-hand plier, wrench or clamp action. Forged-heat treated durable 7 1/2" tool. Money-Back Guarantee.



ONLY \$2.25

SARVIE TOOL CO.
Dept. M, Box 164, Alexandria, Minn.

at dealers or postpaid in U.S.A.

CLING-SURFACE V-BELT DRESSING

can SAVE you many dollars in SERVICE BILLS!

★ A few drops of Cling-Surface stops squeaking and slipping belts on washers, driers, refrigerators, water pumps, home power tools, air compressors, power lawn mowers, furnace blowers, garden tractors, etc. If your dealer can't supply you

Send 50¢ to: **CLING-SURFACE CO.**
1047 Niagara St. Buffalo, N. Y.
Canada: send 75¢ to **CLING-SURFACE CO.**
243 College St. Toronto 2, Ont.



HERE'S YOUR COMPLETE POWER TOOL WORKSHOP

FOR ONLY \$7995

FACTORY TO YOU

8" SAW

- TRY SUPERSHOP FREE
- WE PAY FREIGHT
- YOU BE THE JUDGE
- EASY PAY PLAN

Why does Power Tools Inc. make such an unusual offer? Our business is manufacturing and selling power tools direct to people like yourself. We have had experience with hundreds of thousands of people regarding their home workshop requirements. Supershop meets these requirements. This has been proven.

The combination of direct selling, advanced design and efficient manufacturing enables us to give the greatest power tool value in America today. That is why we have the courage to make you this offer.

This free trial is truly free. The machine is prepaid to your door and if it does not satisfy you, you return it at our expense. If you keep Supershop you pay the low factory-to-you cash price — or easy payments to fit your budget.

Write for free information. Mail the handy coupon — or send a postcard. We'll mail you colorful brochures on Supershop — and full details on the FREE TRIAL HOME OFFER. Absolutely no obligation.

POWER TOOLS INC. 166 YATES AVE. BELOIT, WISCONSIN

POWER TOOLS INC. • BELOIT, WIS.

Send me your FREE brochures on Supershop and complete information about the Free Home Trial Plan. I am under no obligation.

NAME _____

ADDRESS _____

CITY _____ STATE _____



1/2" DRILL PRESS



8" SANDER



30" LATHE



8" GRINDER

General SURPLUS SALE!

BUILD YOUR OWN ARC WELDER OR LIGHT PLANT D-C GENERATOR

\$15.50 used good cond. Instruction incl. **\$21.50**
300 Amps, 28 Volts or 200

Stock No. 711 D.C. Generator R-1 Jack & Heintz, 300 Amp, 30 Volts, Gov't, cost \$300.00, For Welder & Light plant, Instructions **\$25.50**

RHEOSTAT #27, Heavy Duty for regulating Voltage on the P-1, R-1 or A.C. **\$6.95**
 D.C. Generators.

CARBON PILE VOLTAGE REGULATOR, For maintaining voltage and check post publication on D.C. Generators. **\$6.95**

115 V. A. C. GENERATOR

Stock No. 511, A.C.-D.C. Generator L.E. Makes ideal A.C. Light Plant & D.C. Battery Charger. Gives 1250 Watts, 800 Cy., 10.9 Amp, 115 V. A.C. & 200 Amps. 30 V. D. C. G. A. #250.00. Instructions. Used, good condition. **\$22.50** NEW **\$32.50**

VALUABLE GEARS BARGAINS, Speed Reducer 5:1 or 10:1 ratio, 20 degree angle, Stated 2 H.P., **\$6.45** Postpaid.

GEAR UNIT, Angle drive type, 1 input & 2 output shafts, Gear ratio 1:1, Rated 10 H.P., size 10"x8"x4", **\$5.50**

RIGHT ANGLE DRIVE, 1:1 ratio through 90 degree bevel gears, Drive & take-off shafts are 3/4" dia, Size 8 1/2"x2 3/4"x1 1/2", **\$3.50** Postpaid

ALUMINUM AIR FILTERS, New 2" thick metallic Mesh in metal frame, Size 16"x 13"x2", Wt. 7 lbs., **\$25.00** value **\$2.95** ea.

SENSATIONAL SELSYNS—Two or more connected together work on 110V. A.C. For controlling distance operation, etc. In-structions incl., **\$7.95** Postage Paid

HYDRAULIC SOLENOID CONTROL VALVES, Bendix #R1560, For remote control & for hydraulic cylinders, For 24V, D.C. & applicable for 110V. A.C. Cap. 1500 P.S.I., \$35.00 value **\$3.95** ea. per instructions incl. **\$7.50**

CUND OIL FILTER, Aircraft type, Filters oil without cartridge replacement, Std. 3/4" inlet & outlet ports, Instructions, **\$4.95** Postpaid, (for trucks & tractors, Purolator Filter type #PR355 1" I.P. ports, **\$5.95** Postpaid)

Send CHECK OR M. ORDER. PRICES F.O.B. KCMO EXCEPT when marked POSTPAID U.S.A.

MAKES IDEAL WINCH HOIST AIRCRAFT STARTING MOTOR

Operates on 12 to 32 volts. Gives high torque, slow speed & tremendous power. Applicable for pulling & moving heavy loads. Best for direct drive. Cost \$300.00. **\$9.95**

BEAM ROTATOR MOTOR, Reversible, geared, 7 R.P.M., for TV, Ham, etc. Lights wt. for 24V. D.C. & applicable for 110V. A.C. Instructions, **\$7.50**

BLACK & DECKER MOTOR & PUMP UNIT, For oil burners, aquarium, fluid metering, coolant, etc. Motor rated 1780 H.P., 1200 R.P.M., Pump rated 2 G.P.H., 1 1/2" ports. For 24V. D.C. & applicable for 110V. A.C. Instructions, **\$8.95**

BOMB INTERVALOMETER, Now. Can be set to release current at fixed time. Size 5" x 9" x 3 1/2". For 24V. D.C. & applicable for 110V. A.C. **\$6.95**

WINCH HOIST, Portable giraffe neck, 1500 lbs. max. Has 2:1 to 1 gear ratio, 10" tube extension with 3" pulley, 12 Ft. of 3/16" cable & handle with ratchet brake. **\$21.50**

PESCO LARGE VOLUME UTILITY PUMP For water, oil, insecticides, etc. 400 G.P.H., 1/2" drive spline 1500 P.S.I., 3/4" ports, **\$7.50**

VICKERS CONSTANT DISPLACEMENT, HYDRAULIC PUMP, New #PP28-2713-20, 400 G.P.H. 3750 R.P.M. 1500 P.S.I., 5/8" Cu. In. Rev., **\$14.50**

ELECTRIC ACTUATOR incl. 1/2 H.P. motor for lifting, lowering, Remote control, etc. Motor drives actuator in 6 1/2" travel. For 24V. D.C. & applicable for 110V. A.C. Rated load 2800 lbs. #AALM Instructions incl., **\$7.50**

ELECTRIC MOTORS, D.C. 1/2 H.P. 27V. D.C. 2500 R.P.M. 22 Amps. Govt. cost \$75.00. New **\$5.95**

1/4 H.P. MOTOR, 28V. D.C. 4000 R.P.M. Applicable 28-32V. A.C. Cost \$82.00. **\$4.50**
1/2 H.P. MOTOR DELCO, 28V. D.C. 4000 R.P.M. Applicable 110V. A.C. **\$3.95**
6 VOLT D.C. DELCO MOTOR, Shaft 1/4" dia. N1 1 1/2" long, 1200-200 R.P.M. **\$3.50** Postpaid
MINIATURE DELCO MOTOR, 27.50 D.C. 120 R.P.M. 8 oz. torque. **\$3.50** Postpaid

STRATOPower CONSTANT DISPLACEMENT PUMP For hydraulic cylinders, tractors, bulldozers, etc. 400 G.P.H. at 3750 R.P.M. 1250 to 1400 P.S.I. & built in relief **\$17.50**
 #37, \$150.00 value

NEW HYDRAULIC CYLINDERS

- No. 11, Double Action, 1 1/2" Bore, Stroke 6", 3/4" dia. shaft, Clevis type, **\$7.95**
- No. 17, Double Action, Bore 1 1/2", Stroke 3 1/2", 3/4" dia. shaft, **\$9.95**
- No. 302, Double Action, 2" Bore, 1 1/2" Stroke, 1 1/2" dia. shaft, **\$12.50**
- No. 512, Double Action, 2 1/2" Bore, 4" Stroke, 3/4" Dia. shaft & built in control valve, Wt. 0 lbs., **\$9.95**
- No. 111, Double Action, 3" Bore, 2 1/2" Stroke, Dia. shaft 1-3/16", Clevis type, 31" length, **\$32.50**
- No. 511, Double Action, 3" Bore, 2 1/2" Stroke, Dia. shaft 1 1/4", Length 30", Clevis mounting, Gov't. cost over \$200.00, **\$39.80**
- No. 12, Double Action, 4" Bore, 10 3/4" Stroke, Dia. shaft 1-5/16", Clevis mt. Gov't. cost over \$200.00, **\$25.50**

HYDRAULIC CONTROL VALVES

- No. 21, FOUR WAY, Off at neutral with built in relief for limit of cylinder stroke & 3 positions, Raise, Lower & Hold, 1/2" Ports, **\$9.95**
- No. 227, FOUR WAY, Poppet type, 1500 P.S.I., 3/4" Ports, **\$7.95**
- No. 324, FOUR WAY SOLENOID VALVE, For 24V. D.C. & applicable for 110 V. A.C. Off in neutral, 1/2" tube ports, **\$9.95**

HYDRAULIC PARTS

- HYDRAULIC PRESSURE GAUGE, 0 to 2000 P.S.I., 1 1/2" Ports, **\$3.50**
- HYDRAULIC AEROFUSE, To protect against loss of fluid, **\$2.50**
- HYDRAULIC GAUGE SHUBBER, To protect Pressure gauge against surges, 1 1/2" Ports, **\$1.25**
- HYDRAULIC PRESSURE SWITCH, For use with Accumulator system, Ports are 1/4", \$25.00 value, **\$5.95**
- PUROLATOR HYDRAULIC FILTER, Permanent type, 3/4" Ports, **\$4.95**
- PUROLATOR HYDRAULIC FILTER with Micronic filter element, 3/4" Ports, **\$4.95**
- HYDRAULIC ACCUMULATOR, Ball type, 2000 P.S.I., 3/4" dia., **\$5.95**
- HYD. ACCUMULATOR, Ball type, 2000 P.S.I., 7/8" Dia., **\$7.95**
- HYD. ACCUMULATOR, Ball type, 2000 P.S.I., 1 1/4" Dia., **\$12.50**
- AIR PRESSURE REGULATOR VALVE for regulating air pressure on the Accumulator, Mfg. by Cromelius, Inlet, 1750 P.S.I., outlet range 50-500 P.S.I., **\$8.95**
- HYDRAULIC FLOW EQUALIZER & PRESSURE BALANCER, For 2 systems or 3 cylinders, 1500 P.S.I., #397-D, \$50.00 value, **\$9.95**

HYDRAULIC PUMP BARGAINS

- WEAVER HYDRAULIC HAND PUMP with built in check & relief, 2000 P.S.I., \$50.00 value **\$8.95**
- PESCO GEAR TYPE HYDRAULIC PUMP, 2 1/2" Cu. In. Rev., 408 G.P.H. 1500 P.S.I., 3/4" Ports, **\$7.00**
- ROMEC POSITIVE DISPLACEMENT, Rotary type pump, Rated 900 G.P.H. at 2500 R.P.M., 4 inches suction & 10 inches discharge (insecure), 3/4" Ports, #RD4420, **\$17.50**

GENERAL SALVAGE CO., 2922 E. 27 St., Dept. 705 Kansas City, Mo.

send for FREE CATALOG

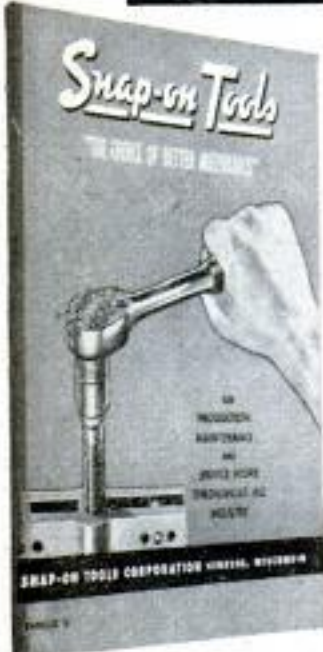

America's Foremost money-making MECHANICS' TOOLS

It's easy to own the same "pay-off" tools used and endorsed by America's top-earning mechanics throughout the automotive, aviation and industrial fields! Snap-on tools help you handle every repair job faster, easier, better. And they LAST... pay for themselves over and over again! Start building your own tool set now with basic Snap-on units—add others any time. Genuine Snap-on tools are never sold in stores—direct to users only. Mail coupon for free catalog.



Snap-on Tools Corporation
 8062-L 28th Ave., Kenosha, Wis.
 Send me free catalog. Occupation _____
 Name _____
 Address _____
 City _____ Zone _____ State _____

DRILL • SAW • REAM • CUT ALL WITH ONE BIT!

BEAVER SPEED SAW DRILL BIT

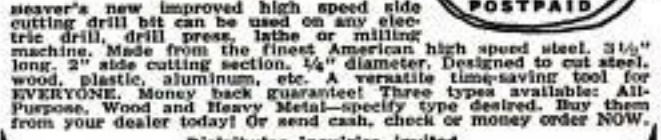

Beaver's new improved high speed side cutting drill bit can be used on any electric drill, drill press, lathe or milling machine. Made from the finest American high speed steel. 3 1/4" long, 2" side cutting section, 1/4" diameter. Designed to cut steel, wood, plastic, aluminum, etc. A versatile time-saving tool for EVERYONE. Money back guarantee! Three types available: All-Purpose, Wood and Heavy Metal—specify type desired. Buy them from your dealer today! Or send cash, check or money order NOW. Distributor inquiries invited.

BEAVER DRILL & TOOL COMPANY, Div. PM-12
 701 East 5th Street • Kansas City 5, Missouri

Big New 24-Page DO-IT-YOURSELF PROJECTS BOOK

Describes after finishing, built-in cabinets, add room, recreation room, kitchen remodeling, summer cottage and lawn projects. Contains helpful information on how to get started, plan, buy, cost estimating, materials purchasing, and proper procedures, also has charts, mounting designs, etc. Send only 25¢ and also receive FREE 32 PAGE POWER TOOL CATALOG

BOICE-CRANE COMPANY
 943 Central Ave., Toledo 6, Ohio

FREIGHT DAMAGED

Cabinets only were slightly scratched in shipment. The microscopes (mechanically and optically) are guaranteed perfect—covered by our money-back guarantee. Once-in-a-lifetime gift values. Instruments available from regular stock or freight special.

NEW QUAD TURRET!

MODEL 500
50-100-300-500 POWER

REGULAR STOCK

\$1995

POSTPAID

FREIGHT SPECIAL

\$1180

POSTPAID

An amazingly versatile instrument with four objective lenses offered here for the first time. Shipped ready to use with slides, cabinet, manual.

MODEL 635

150-300-600 POWER

REGULAR STOCK

\$2995

POSTPAID

FREIGHT SPECIAL

\$1950

POSTPAID

Used throughout the country by schools, colleges, biologists and hobbyists. Shipped with slides, cabinet, manual.

Mechanical Stages—Available for models 635, 800—\$14.95 Postpaid

Cabinets—All microscopes are shipped insured in fitted hardwood cabinets.

Micro-Animal Life—Even with the most inexpensive instruments you can study micro-animal life. See manual.



MODEL 300
100-200-300
POWER

REGULAR STOCK

\$995

POSTPAID

FREIGHT SPECIAL

\$680

POSTPAID

This microscope can show you microscopic animal life.

Triple revolving turret. A wonderful gift. Complete with slides, cabinet, manual.



FREE SLIDES

WONDERFUL SUBJECTS AROUND IN YOUR OWN HOME.



Achromatic condenser, iris. Standard optics throughout. A fine professional instrument. With slides, cabinet, manual.

FREE Micro-manual mentioned above. Shipped on request or included with order.

Send check or money order—1/3 deposit on C.O.D. California residents add 3% state tax.
16 AKRON BLDG., 4379 SUNSET BLVD.
LOS ANGELES 27, CALIF.

the **AKRON**

FIRST AGAIN...

WITH NEW LOW PRICE

now only **\$33⁷⁵**

NEW MODEL "300" Portable Electric Motor Sander



Makes hobby, production and maintenance sanding a breeze. The sturdy new, fine quality electric motor driven Model "300" is built to outlast and outperform more expensive sanders. Provides quick effortless sanding to a smooth "plane" finish on woods, metals, stone, plastics and composition. Has largest surface pad 4 1/2" x 7 1/2". Ball bearing construction, direct drive—no belts or gears to wear, light in weight. Accessories now available for point removal, rubbing and polishing. See it at your tool dealer. "The sander used most extensively by rental services."

Other Electric Products

Model 200 Heavy Duty Sander... \$39.95

Model 505 Flexible Shaft Sander

Write For "Art of Sanding" It's FREE

JUNIOR TOOL COMPANY

Manufacturers of Electric Motor Specialties
975 W. First Street • Azusa, California

Swedish Steel Handsaws



SANDVIK FISH & HOOK



Brand of Quality

Next time you're in a hardware store, ask to try a SANDVIK Handsaw.

Its genuine Swedish Charcoal Steel cuts faster, smoother, and stays sharp longer. Fully taper ground... extra high crown... perfect balance and full size easy grip make a big difference over ordinary saws!

So try it! And when you buy it, you've got yourself a fine tool... for a lifetime!

Write for SANDVIK Folder Dept. PM

Sandvik Saw & Tool

Division of Sandvik Steel, Inc.

47 WARREN ST., NEW YORK 7, N. Y.

Gift Ideas for XMAS

Aladdin 1/4" POWER DRILL TOOL ATTACHMENTS



POWER PLANER

SAVES TIME AND WORK ON MANY JOBS

Ideal for fitting doors, screens, storm windows; smoothing rough edges of lumber; handy in cabinet work. Planes wood up to 2" wide.

Exclusive Attaching Feature gives perfect alignment and holds planer and drill firmly together. Changes on and off quickly. Extra tough, heat-treated spiral rotary cutter 2" wide—cutting depth adjustable. Long wearing sealed gears. Strong alloy die cast frame. A tool you'll enjoy and appreciate.

SANDING ATTACHMENT for Planer and 2 sanding drums, \$1.00 extra.

\$1295 Postpaid

tough, heat-treated spiral rotary cutter 2" wide—cutting depth adjustable. Long wearing sealed gears. Strong alloy die cast frame. A tool you'll enjoy and appreciate.



3-IN-1 SAW A Hack Saw, Jig Saw and Coping Saw

Coping Saw in one easy to use attachment. Cuts metal, wood, plastic, hardboard, etc. Full 9/16" rhp clearance. No gears, no bearings to wear out. Ideal for sawing in hard-to-reach places. Weighs only 11 oz.

\$495 With metal and wood blades (1 ea.). Postpaid

4-HOLE SAW Cut 4 Sizes of Holes Quickly, Perfectly With One Tool

A circular saw blade for each size hole—1", 1 1/2", 2", 2 1/2" diameter, blades slip into grooves of alloy saw body and are firmly held by set screw. A 1/4" drill bit anchored in saw body guides saw blades and prevents tool from "jumping." High carbon steel blades cut wood, plastic and metals.



\$495

Complete with 4 saw blades (8 or 14 tooth) and 1/4" drill bit—Specify for wood or metal cutting when ordering. Postpaid.

Every Aladdin Attachment Tool **GUARANTEED SATISFACTORY** or Money Back. Will ship C.O.D. plus postage. Literature available on all attachments. **DEALER INQUIRIES INVITED.**

ALADDIN MFG. CO. DEPT. PM-4, 3125 HARRISON KANSAS CITY, MISSOURI

LIFE-TIME SECURITY with YOUR OWN BUSINESS

FREE BOOK

TELLS HOW YOU CAN MAKE \$5.00 AN HOUR IN YOUR SPARE TIME! You can easily make up to \$5.00 an hour at home in your own spare time repair service. No expensive equipment to buy. No experience needed. You can quickly build up your own steady repeat cash business. Find out about this spare time hobby that gives you extra Cash Income. Send postcard today for FREE book!

BELSAW MACHINERY CO 551 Field Bldg., Kansas City 11, Mo.

1/3 H.P. Dual Purpose Portable Sprayer: BARGAIN



Regular Value \$95.00

only **\$57.50**

complete as illustrated K.D.

COMPRESSOR ONLY \$20.00

RPM. Positive Piston Type Quincy Compressor 2 x 1 3/4 in. bore & Stroke, Speedy 1 Qt. Pressure Type Spray Gun, handles any type liquids. Unit complete as illustrated: Tank with wheels, 1/3 H.P. Motor, Quincy Comp. all accessories, tire chuck, cord & plug, belt & pulley, hose & Qt. Gun . . . **Knocked Down . . . #KD . . . only \$57.50**

SAME UNIT AS ABOVE fully assembled . . . #AS-3 only \$67.50

C. MARSHALL SALES, 3546 W. Fullerton Av., Dept. P-12, Chicago 47. All prices FOB. Chgo. Write For FREE Catalog: Listing Motors; ALL SIZES: Fans and Air Compressors; ALL SIZES

NEW Govt. Release!

Original Cost **\$444.00**



HOMELITE "Carryable" GENERATING PLANT

1500 WATT 60 CYCLE, **\$18900** fob A.C., Single Phase

Carrying handles for easy portability. Fits easily in car trunk

Fully Guaranteed

Save Hundreds of \$ \$ \$

Ideal as a stand-by emergency power plant to duplicate house current. Plenty of power for lights, refrigerator, deep freeze, oil burner, radio, etc. Pays for itself! Saves time, labor, and money. Provides on-the-spot power for construction, etc. where none is available . . . or expensive to run in. Large enough for Floodlights; Saws; Pumps; and many more labor-saving, heavy-duty machines. Specifications below **CAN'T BE MATCHED** anywhere at this price!

GENERATOR 1500-1700 Watts, 115 Volts, 60 cycle, single phase, AC. Overload capacity well above its rated output. Excellent automatic voltage regulation plus Field Rheostat for even closer adjustment. Built-in Shock-mounted Volt Meter. Oversize brushes.

ENGINE Famous Homelite single cylinder engine. Air cooled; two cycle. Easy rope start. Dust and rain-proof ignition system. Built-in automatic governor. Footproof pressure vapor lubrication system. Adjustable jet-type carburetor.

This Precision power plant has ball and needle bearings throughout and costs only \$c as low to operate. Satisfaction Guaranteed.

SUPPLY LIMITED! IMMEDIATE DELIVERY! ORDER FROM AD

FREE Catalog of Compressors, Motors and Welders

ROBERTS ELECTRIC CO., Dept. P-239, 849 W. Grand, Chicago 22, Ill.

Also Eshelman SPORT CARS LOWEST PRICE

70 Miles Per Gal. Holds 1 Adult. Free Literature.

ESHELMAN CAR SNOW PLOW



Attached to car or truck in 2 minutes without tools. Clears snow 24" deep and full width of car. Lightweight, sturdy. Order Now. Enclose \$10.00 deposit. We pay freight. Balance C.O.D. **ESHELMAN, Dept. SP-512** 109 Light St., Baltimore 2, Md. 333 N. Michigan Ave., Chicago 1, Ill. 7070 Hollywood Blvd., Los Angeles 28, Calif. (Or write for literature)



ELECTRIC WELDER

AC or DC 110 Volts The "Little Marvel" all-metal welder. 5-year written guarantee. Welds 1/8" metal or money back. Repairs tanks, tools, fenders, machine parts, etc. Complete with everything—rods, unit, eye shield, directions.

\$6.45 plus 50c postage. Flame torch accessory for soldering, cutting, brazing \$3.85 complete with carbons, brass rods, flux. \$2.00 deposit on C.O.D. Buy direct and save.

ESSAY MFG. CO., Dept. 51, Quincy 69, Mass.

\$645 Complete

MORE For Your Money in a SHAW DUAL



SHAW MFG. CO. 6680 N. 4th St., Columbus, Ohio

Improved design, better value in 1 1/2, 2 1/2, 3.5 H.P. walking tractors. New, low cost, streamlined 2 1/2, 5, 8 H.P. riding tractor. Inexpensive, new 1 1/2 H.P. tiller that pulverizes up to 12 inch swath 6 inches deep, and less. Automotive gears on heavier models. Prices will please you. **FREE CATALOG**. Write today. 4512 Front St., Galesburg, Kans.

Look At This BARGAIN COUNTER

New GAS ENGINE 1 to 1 1/2 H.P. Power Product 2 cycle—Ball Brg; for tools—grass cutters—air compressors—bikes. Engine, Gas Tank, Muffler. Complete #B-1 . . . only . . . **\$22.50**

1/2 H.P. ELECTRIC MOTOR: Westinghouse Super induction 115 V. 60 cy. 1 ph. 1725 RPM. #B-2 . . . only . . . **\$15.00**

1/3 H.P. DAYTON ELECTRIC MOTOR. Super induction—Hi-Speed for saws, grinders, flexible shafts. 115 V. 60 cy. 1 ph. 3450 RPM. #B-3 . . . only . . . **\$16.50**

3/4 H.P. DAYTON ELECTRIC MOTOR. Capacitor Induction: Hi-Torque, Hi-Speed. 3450 RPM. 115 V. 60 cy. 1 ph. #B-4 . . . only . . . **\$28.00**

3/4 H.P. GENERAL ELECTRIC MOTOR. Capacitor Induction. Ball Brg., Double Shaft. Overload Protected. Hi-Torque. 115 V. 60 cy. 1 ph. 1725 RPM. #B-5 . . . only . . . **\$34.50**

Write For FREE Catalog: Listing Motors; ALL SIZES: Fans and Air Compressors; ALL SIZES

ARMY FIELD PHONES

A private phone or intercom system. Easy to operate. Ideal for use on farms, target range, mountains or forest or any place portable two-way communication is desired. Gives clear reception up to 15 miles. Uses two standard batteries. Set contains ringing generator, leather carrying case and one phone. Several of these phones may be used on one line. Reconditioned and checked out. Price per each phone only **1495**



Price for a system - two sets... **2950**

PORTABLE WINCH HOIST

NEW LIFTS 1500 POUNDS Made for U.S. Navy Bureau of Ordnance as a Bomb Hoist. Has a 21 to 1 gear ratio. 48" tubular arm extension with a 3" pulley on the end. Drum has 12 ft. of 3/16" high tensile strength steel cable. The operating handle has a ratchet brake. Ideal for "swing about", truck or platform loading. **MOQ** A \$125.00 Surplus Value. **2250**

HOIST 2875 WITHOUT MOUNT Ideal for Garages, Machine Shops, Trucks, Boats, etc. Has a 2500 lb. lift capacity through a 24 to 1 gear ratio. A bronze worm gear drive. 18 ft. of high tensile steel cable - 3/16" diameter. **NEW!**

WINCH HOIST - Same as above with a free-spool, pull-out clutch. **2975**

HOIST MOUNTING FRAME Specially designed for above winches. Allows easy universal mounting. Price of Frame Only **450**

RIGHT ANGLE DRIVE

Hog direct 1 to 1 ratio through 90° bevel gears. Drive & take-off shafts are 3/8" diameter. Gears are self-lubricating, hi-speed steel. Ideal for use on power tools, flex drives, etc. Size: 3 1/2" x 2 1/2" x 1 1/2". **225**

6PC. TUBE BENDER SET

For bending copper, aluminum and other thin wall tubing by hand. Of special spring wire coil. Cadmium plated. Set includes sizes for 1/4", 5/16", 3/8", 7/16", 1/2" and 5/8" tubing. A \$5.00 value. **249**

MAGNI-FOCUSER

Has fine ground lenses of optical glass. Neutralizes eye strain from close work. Twin lens, binocular design gives third dimension vision. Allows freedom of both hands. Can be worn over glasses. Ideal for gunsmith, dentist, artist, etc. **MAGNI-FOCUSER SIZES**

focal length	power	price each
20"	15x	1050
14"	11x	
10"	24x	
8"	21x	

MACHETTE

Has 18", Vanadium steel blade. Hardwood handle. Belt sheath. 23" overall. **198**

ARMY PICKMATTOCK NEW

Has 12" steel head with notch on side and pick on other. With belt case & hardwood handle. **129**

PORTABLE SHOVEL NEW

G.I. Surplus. 20" hardwood handle. Blade folds to form pick. Carry in car for emergency in mud or snow. Ideal for camper, etc. **129**

SAVE UP TO 85% ON SPECIAL PALLEY BARGAINS



GIVE THE KIDS A THRILL WITH THIS AMAZING RADIO RECEIVER

Here's a COMPLETE RADIO RECEIVER that picks up STANDARD BROADCAST STATIONS without using batteries or electricity! Just plug in the headset, antenna and ground wires and turn in your favorite program. You'll be amazed at the STRONG, CLEAR SIGNAL. Has a 100KC tuning range. Comes complete with Receiver, Antenna and Ground wires plus a Headset with two 2000 Ohm ear phones. **HOT A TOY - A Gemlike Crystal Receiver!**

WITH HEADSET ONLY **395**



NEW 7x50 BINOCULAR

Here is a Gift anyone will enjoy. All lenses & prisms are made from the finest precision components to give you true image clarity. Air-to-glass optical surfaces are hard coated for increased brilliance and clarity. Lenses are Achromatic, optically ground and color corrected. Made by finest Japanese Optical Works.

7 power 50mm BINOCULARS - Individual focus. Field of view 375 ft. at 1000 yards. \$40.00 value **2495** PLUS 20% TAX

BINOCULAR STEREO MICROSCOPE

Finest Quality Prismatic Binocular Head and Microscope. Micro-engineered and designed for finest stereoscopic (third dimensional) vision. An ideal instrument for industrial quality control, watchmaking, toolmaking, laboratory and hundreds of other uses. Precision adjustment insures perfect micro-focus. Has ground and polished achromatic, 5 power objectives with 10 power eyepieces which give a FULL 50 POWER MAGNIFICATION! Precise prism assembly insures true magnification and stereopsis. Study, solid base. All-metal construction. Comes in hardwood, dovetailed carrying case. **4995**

GENUINE PHILLIPINE MAHOAGNY

Buy Direct from Importer! Prices LESS THAN WHOLESALE (Save 50%!) Our price is LESS than Pine at your local lumber yards. You will be amazed at the rich, golden elegance of this Luan Mahogany Plywood. Weather & Water Resistant. Bonded with the finest resin adhesive. Rotary cut. Face side jointless, both sides sanded. Send for FREE SAMPLE and see for yourself!

3'x6'x3mm	179	4'x8'x1/4"	499
\$5.00 VALUE	FULL SHEET	\$9.00 VALUE	FULL SHEET
Min. order 8 sheets		Min. order 4 sheets	

NEW! SURPLUS TOP QUALITY DRAFTING MACHINE

A precision-built Drafting Machine for draftsmen, Engineers, Artists, Navigators, etc. This fine machine has been precision converted from an Air Corps Navigational Plotting & Drafting Machine. It has a 90° chuck for use with all standard drafting machine scales. Sturdy 18" arms rotate on double-sealed lifetime ball bearings. Graduations on the vernier hub are from 0 to 360° in 1° increments. Locks in any desired position. Bands are of K-Monel metal. Compares to instruments costing to \$130. **4995**

IMPORTED 7PC. DRAW KIT

Only **329**

A bargain for the student, draftsman, architect, etc. Has a 4-1/2" divider, a 4-1/2" compass with pen & pencil parts, a 3-1/2" reverse bow compass for pencil and ink, a 4-1/2" ruling pen, capsule of extra leads. All in a velvet lined case.

PLASTIC ELLIPSE SET

An ideal gift for the artist or draftsman. Permits drawing perfect ellipses every time. Has projections of 20, 30, 45 and 60 degrees. Ellipses will range from 3/8" to 2-3/4" on a major axis. Kit size is 4-3/4" x 9-3/4" . . . **750**

HOLOMETER TEMPLATE

Combines in one template means for measuring sizes and shapes of nuts, bolts, rivets, etc. . . . **135**

CENTRIFUGAL PUMP & MOTOR DELIVERS UP TO 700 G.P.H.

Excellent for draining cellars, rock garden waterfalls, fish ponds, pumps, water circulators, evaporative coolers, etc. Powered by the famous G.E. 110 volt, 60 cycle motor. Has 1 inch standard pipe inlet - 3/4" to 1 inch hose outlet. A Government Surplus Bargain. Completely Reconditioned. Motor rewound and checked for serviceability. Ready to run. Satisfaction guaranteed. A \$20.00 VALUE **995**

LENSATIC OFFICERS COMPASS

A precision, all-purpose instrument for hiker, camper, surveyor, prospector, etc. Use for taking an azimuth reading, as a guide on unfamiliar terrain or map orientation. Has a 360° bezel ring which rotates and is marked in 3° increments. A "Peep" sight with hairline guide for sighting. **NEW** - a \$5.95 value **395**

PALLEY SUPPLY CO 2263 E. VERNON AVE., DEPT. PM-12 LOS ANGELES 58, CALIF

100-200-300 POWER MICROSCOPE

Ideal gift for Student, Amateur Scientist, Botanist, etc. This is NOT A TOY but is a precision instrument comparing to others selling up to \$75. Has a triple, revolving lens turret with 100-200-300 Power, fully ground and polished objective lenses. Adjustable plano sub-stage mirror. Left & right hand focusing. All-metal, inclinable body. Comes in a hardwood case. **999**

30-45-60 POWER POCKET MICROSCOPE

For Botanist, Mineralogist, Prospector, Rockhound, etc. Specially made for and imported by us. Has precision ground and polished lenses. Moisture proof. Magnification 30, 45 & 60 power. **375**

AMAZING NEW MICROSCOPE TELESCOPE

A new optical development. A pocket size Microscope-Telescope. When closed it serves as a 50 POWER Microscope, when opened out it acts as a full 10 POWER Telescope. Only inexpensive Japanese labor can make this price possible. **439**

SHEEPLINED FLYING BOOTS

Fully lined with sheepskin. Soft, warm & comfy. Have genuine leather uppers & rubber lowers. Zipper front closure. Laces up back for snug fit. Sizes: Sm., Med., Lg., X Lg. **1088** NEW

NEW NAVY WADER BOOTS

A Surplus Bargain. Made of top quality, rubberized NYLON - vulcanized to Latex rubber shoe. Shoe is insulated against cold and has grip-tred sole. Boot is 4" high shaft. Order one size larger than shoes. Sizes: 8, 9, 10, 11 and 13. . . . **349**

NAVY WADING SUIT

Makes Surf or Deep Stream Fishing a real pleasure. Also ideal for use whenever it is necessary to protect the body or clothes from mud, silt, moisture, etc. Made to top Government specifications. Originally designed for use as an overboard suit in landing operations. Of heavy duty rubberized canvas with vulcanized seams. Has built-in rubber boots and gloves. Sizes: Medium and large. **3500 VALUE NEW 995**

NAVY WADERS

Made to top Gov't specifications. Of finest quality rubber with worn felt inner lining. Comes up to your chest. Have built-in boots, shoulder straps & vulcanized seams. \$25.00 value. Sizes: Small, Med., Large. **795** NEW

320 PG. CATALOG

Packed with Bargains in GOVERNMENT SURPLUS, FACTORY CLOSE-OUTS, & GENERAL MERCHANDISE. Fully illustrated. Has thousands of items for Hobbyist, Gardener, Mechanic, Sportsman. Send 50¢ to cover our handling & mailing - Refunded on 1st order.

Order from This Ad. Pay by M.O. or check. P.O.'s accepted from D&B firms. W deposit with C.O.D.'s. All Prices FOB Los Angeles.

SAWING IS EASY WITH THESE TWO FAMOUS "DO-IT-YOURSELF" POWER TOOLS



"ARCO-SAW" the only 5" circular saw attachment guaranteed to whiz thru 2x4's in one cut. Has right angle gear drive (no clumsy, dangerous direct drive with drill sideways). No need to pay 3 to 5 times as much for saws that do the same work. Accurate, fast adjusting **Depth, Bevel, Rip Gages** are foolproof. Convert your basement or attic 8-times faster than hand sawing — build kitchen cabinets, book-cases — and save plenty! Simply attach "ARCO-SAW" to any 1/4" electric drill by tightening strong **Safety-Yoke & Clamp** around drill and run this powerful heavy lumber. You'll find "ARCO-SAW" with its tough **BLADES** — 5" Safecut, Rip, Crosscut, or Comb. . . \$1.75

ARCO SAW

No. 455 "ARCO-SAW" \$12.50 with blade

90-DAY FACTORY GUARANTEE



"ARCO JIG-SAW" Does work of Jig, Keyhole, Coping, Rip, Band and Hacksaw! **EXCLUSIVE "AIR-JET" BLOWS AWAY SAWDUST.**

You would expect to pay \$50 or more for a portable jig saw that has the same capacity, cutting speed & precision as "ARCO JIG-SAW." But here, for the first time, is a versatile, rugged saw that attaches in 1 minute to any 1/4" electric drill — eliminates expensive built-in motor — saves you the difference! **Guaranteed** to cut intricate patterns, circumscribed to cut intricate patterns, circles — no matter how large — in eels — no matter how large — in plywood, wallboard, plastics, metals — even lumber up to 2x4's! Cuts openings without starting hole. **Safety-Yoke & Clamp** give you a vibration-free unit. Has wide **Shoe-Plate**. Converts to Table Model with

No. 401 "ARCO STAND" . . . \$2.75
6 Blades for wood, metals, etc. . . \$1.95

No. 500 "ARCO JIG-SAW" \$10.95 with blade.

AT BETTER HARDWARE STORES EVERYWHERE

BUY THE BEST—see your hardware dealer now! If not available, try "ARCO" Tools on our 10-DAY MONEY BACK GUARANTEE. Send us check or M.O. (Postpaid). C.O.D.'s—postage extra.

ARROW METAL PRODUCTS CO. Dept. PM-12, 140 WEST BROADWAY, NEW YORK 13, N. Y.

SHEET METAL BRAKES

Forms angles, locks pans, etc. New eccentric clamps. All steel construction. Size 15"-16 gauge steel. \$21.50; 36"-22 ga., \$33.00; 48"-24 ga., \$48.00. Floor Stand, \$7.50.

IRON BENDER, 10 parts, \$9.50. **FOLDER** 15" 1/4 to 1" 24 ga., \$16.50. **WISE BRAKE** 12" 20 ga., \$12.50. **SHEAR** 7" 16 ga. steel, \$12.50.

(Immediate delivery. Order direct, cash or C.O.D., or send for folder)

VYKE MFG. CO., P-2439 15th St., Denver 11, Colo.

How To . . . BY MASTER

A STRAIGHT LINE WITHOUT PREVIOUS MARKING (Using a 996X Guardsman Extension)



Pull out the metal slide to the measurement you wish to mark. Butt first stick against surface to be marked, allowing metal portion to extend over the edge. Place a pencil at the tip of the rule extension. Draw line as indicated in accompanying sketch.

W. H. Jones, 8412 Dexter, Tampa, Fla. wins an 996X for this fine effort.

THE 996X retails for \$2.00

A sturdy 6 foot wood rule with an extendable 6" solid brass insert, for fractional measurements. To get an exact measurement every time simply expand the 996X to the closest measurement possible, and slide out the insert. Add the reading on the metal slide to the overall reading and you have a truly accurate measurement. Fine spring action joint construction throughout; finest white maple sticks etched figures and graduations on the extension make the 996X a rule you will be proud to own.

WIN A MASTER RULE! If you have a short cut which you feel is worthwhile, send it to us. If we use it in one of our "HOW TO" series, you get as a bonus, your choice of any wood rule or steel tape in the Master line. All entries become the property of the Master Rule Co., and will not be returned.

MASTER
WOOD AND STEEL TAPE RULES

ONE-MAN SAWMILL

LOW \$50.00 DOWN AS . . .



Take BELSAW Portable Sawmill right to the trees—turn out valuable lumber for home and farm—sell to local yards—make up to \$50 a day custom sawing for neighbors. BELSAW lasts a lifetime. No crew needed. Power with tractor or auto engine. Beginners get excellent results. Send today for **FREE BOOK.**

BELSAW MACHINERY CO.
1111 Field Bldg., Kansas City 11, Missouri

WORLD'S BEST SMALL TRENCHERS



Portable DITCH-WITCH digs 2" to 6" clean, even ditches to 36" depth in all types of soil. Complete unit—self propelled—outdigs 8 men. Four rugged models.

Write for illustrated literature.

CHARLES MACHINE WORKS
620 B Street Perry, Oklahoma

MAKE YOUR OWN FOUNTAINS, LAKES, RIVERS, WINDOW DISPLAYS



Get real live action with miniature water pump. Only 4 1/4" high — 3 1/4" wide. Threaded for pipe or uses 3/8" rubber tubing. Sturdy rustproof alloy metal — mounted on rubber. 110 A.C. — 60 cycle, 1/250 H.P. Pumps 50 gal. per hr. Complete — ready to work. Immediate money back guarantee. Send check or M.O. Or send C.O.D., you pay postage. Dealers wanted.

MOORE MANUFACTURING CO.
SWEDSBORO 1, NEW JERSEY

\$9.95 IN U.S.

BARRON Drill Press TOOLS

FOR WORKSHOP AND INDUSTRIAL USES . . .



Over 40 precision built woodworking tools and accessories . . . Hi-Speed Router Bits—Rotary Surface Sanders & Drum Sanders—Safety Shaper Cutters—Dovetail Cutters—Large Auxiliary Metal Tables—All Metal Shaper Fences—Spindle Adapters—Handy Bench Vises. Many other items indispensable for accurate, useful, versatile workshop use. Every tool sold on complete satisfaction or your money back. See your Barron Dealer. Ask for special folder — "24 Extra Uses for Your Drill Press."

ROTARY PLANER
Planes • Rabbits
Tenons • Panels
Routes • Bevels

Only \$8.50 COMPLETE

BARRON TOOL CO. INC.
364 Architects Bldg., Detroit 1, Mich.

FREE Workshop Guide & Catalog

SAVE MIDDLEMAN PROFITS

GIANT 2000-2500 WATT PLANT

110-120 v. 60 cyc. AC. absolutely the best made — exclusive dynamically balanced armature; heavy windings develop up to 2500 watt overload for motor starting. Skid mounted — portable. Powered by 40 easy starting Briggs or Wisconsin 6 HP engine—complete with all accessories; engine easily disconnected for other uses. Big outlet box, voltmeter, no wiring necessary. Ample current for all purposes. Factory warranty. (Item 31) Wt. 210 lb. Reg. price \$585. Special at..... **\$299.50**
Same plant with electric self starter (Item 31a)..... **\$359.50**
Generator only and control box..... **\$169.50**
DUAL VOLTAGE 110-220 available on any of above models for \$28.00 additional.
3000-3500 WATT PLANT (Item 198) 110-220 v. 60 cyc. AC. Belt Drive, Wis. engine Push Button Start. Wt. 370 lbs. Heavy duty..... **\$439.50**
GENERATOR ONLY for belt drive..... **\$239.50**



(Item 31)

HEATING & VENTILATING FAN

(Item 10) Easily installed in furnace pipes. Forces even heat to all rooms. Over range removes kitchen smoke and odors. Powerful, continuous duty motor. 110-120V. AC. Mount in wall or ceiling to ventilate any area. Quiet, super-efficient fan moves huge volume of air. 1400 to 600 CFM.
8" Fan, wt. 5 lb..... **\$6.85**
9" Fan, wt. 6 lb..... **\$7.85**
10" Fan, wt. 7 lb..... **\$8.85**
12" Fan, wt. 8 lb..... **\$9.85**
HEAVY DUTY FAN. Semi-enclosed motor, suitable for spray booths, restaurant exhausts, poultry houses, etc. 10" Fan, wt. 8 lbs. (Item 10E)..... **\$11.95**
12" Fan, wt. 10 lbs. (Item 10D)..... **\$12.95**



CONDITIONAIRE BARN FANS

Save big money installing your own barn ventilating fan. Efficient propeller type blade moves huge volume of air quietly and effortlessly. Heavy welded frame — pre-drilled for easy installation. Just cut opening and bolt in place. Continuous duty motors. Ideal for keeping barns and chicken houses dry and ventilated. Control manually or with thermostat.
Blade Opening CFM Wt. Item
16" 18 1/2" 3025 19 lb. 365a **\$27.95**
18" 19 1/2" 3800 27 lb. 365b **\$31.95**
20" 21 1/2" 4100 30 lb. 365c **\$39.95**
THERMOSTATS: BARN type (range 40-90°). Wt. 2 lbs. **\$6.95**



MASTER GARDENER

SELF-PROPELLED

It's a snow-blower It's a rotary mower
It's a power sickle It's a rotary tiller
It's a cultivator It's a plow

Where can you get a power tool that does so many jobs? Write for your own today. Does terrific job of cleaning snow from walks, drives, etc. without backbreaking work. Also prepares deep mellow seed beds, cuts weeds, lawns, etc. The Master Gardener performs better — does more than tractors cost twice as much. Converts in minutes to Tiller, Power Sickle, etc. Basic self-propelled 2 hp tractor. Briggs or Clinton engine. **\$119.50**
Snow Blower..... **\$39.50** Rotary Tiller..... **\$42.50**
Cultivator..... **\$8.75** Disc Harrow..... **\$18.75**
Furrowing Tool..... **\$6.75** Plow..... **\$15.00**
Rotary Lawn Mower..... **\$42.50**
Sickle Bar Mower..... **\$42.50**
Lawn Mower Hitch..... **\$2.50**
Freight prepaid. Easy payment plan available.

EXTENSION CORD

Very flexible and tough. Neoprene — 3-9' extension cord, complete with plug & outlet. 100 ft. combination. (2-40 ft. and 1-20 ft.) Item 17a. Special **\$6.45**
NEOPRENE CABLE #14-2 (Item 185) Heavy duty, very flexible, 20 year quality. Wt. 9 lbs. 100 ft. Complete with rubber plug and outlet. A terrific buy at only..... **\$8.95**
NO. 12-2 POWER CABLE. Very flexible rubber covered, special outside shield for grounding power tools, etc. 50 ft. (Item 190) Wt. 8 lbs. **\$6.95**. 100 ft. (Item 200)..... **\$12.95**
NO. 10-2 POWER CABLE. Heavy duty, very flexible, rubber covered, 50 ft. with male plug and terminals. (Item 592a)..... **\$10.45**
50 ft. without fittings (Item 592)..... **\$9.95**



get BEDROCK factory prices from MASTER MECHANIC

600-700 WATTS PUSH BUTTON START

115 v. 60 cyc. AC. Powered by a rugged 2 HP easy starting Briggs engine. No wiring necessary; just plug in and operate. Plenty of current for any oil burner, freezer, brooder, emergency lights, etc. which require up to 700 watts. Ideal for television and radios. Complete with Voltmeter and built-in winding to charge 6 v. auto batteries. (Item 24.) Wt. 75 lbs. Easily fits in car trunk. Be prepared if storm knocks out power lines. Reg. \$275 value..... **\$143.50**

1000-1200 Watt Plant (Item 45) same as Item 24 but larger generator and engine

with 50% greater output..... **\$199.50**
LITTLE GIANT—350 WATT (Item 275) 115 v. DC 1 1/2 hp. Briggs engine. Perfect for lights, radios, chain saws and power tools. Wt. 65 lbs..... **\$99.75**

PORTO-POWER 1500-1750 Watt Plant

115/120 v. 60 cyc. AC. Push button start. Powered by a 4.5 HP Briggs engine. Combines compactness and easy portability with higher output for handling heavier starting loads. Ideal for operating oil burners, sump pumps, freezers, television, lights, communication systems, etc. Perfect for contractor's power tools. (Item 20.) Wt. 146 lbs. **\$279.50**

MASTER-LITE 2500 Watt Plant

110/120 v. 60 cyc. AC. A powerful plant, ruggedly constructed and yet designed for easy portability. Can be started by rope or built-in 12 v. electric push button starter. Built-in winding to charge battery. Powered by a big 5.10 HP Briggs engine, complete with all accessories. Includes control box, voltmeter, and handy plug-in power receptacle. An ideal plant for permanent or stand-by service. Wt. 225 lbs. Reg. price \$425.00 (Item 21) Factory Price..... **\$329.50**

Dual Voltage 110/220 available for above plant for \$50.00 additional.

3500 Watt Plant Push Button Start (Item 23) 115 v. 60 cyc. AC. Similar to above, but larger and 33% more capacity. Wt. 270 lbs. Reg. \$760. Factory Price..... **\$379.50**
We make fully automatic controls to operate any of the above light plants. Write for details. We make all sizes up to 25,000 Watts.

MASTER AIR COMPRESSOR

COMPARE! This is the only compressor built with a **NO RUST** stainless steel tank. Safe up to 250 lbs. (Item 209a) High pressure type 14 c.f.m. large volume of air for heavy duty service. For paint spraying, inflating truck & auto tires, greasing, sand blasting, etc. Piston type 2" bore compressor with built-in air filter. Master built with high strength alloys and precision bearings. Tank, 12"x24", 2100 cu. in. cap. Equipped with automatic switch that starts and stops motor to maintain desired pressure (up to 150 lbs.) and check valve, safety valve, gauge, shut-off valve. 20 ft. air hose and tire chuck. Beautifully balanced on ball bearing wheels and rubber tires. Don't take chances with used or surplus equipment. Our compressors are factory new and are guaranteed **SAFE**. Low factory prices. With 1/2 H.P. repulsion-induction 110 v. AC. heavy duty motor. Reg. \$225. (Item 209a). Special Factory Price..... **\$129.50**



Tank Tested up to 500 lbs. per sq. in.

9 TON HYDRAULIC PRESS

A tremendously powerful hydraulic press, capable of exerting 18,000 lbs. pressure. Pays for itself many times over—straightening bent connecting rods, king pins, crank shafts, axles, link pins and bars — or pushing out frozen bearings and bushings. Developed pressure under precise control and visible at all times on accurate gauge. Complete with both large and small anvils and jigs to straighten any kind of curve or bend. (Item 464) Wt. 310 lb. Actual list price \$385. Our special close-out price..... **\$69.50**



LESS THAN WHOLESALE

HI-LINE 6000 WATT PLANT

(Item 182) Push Button Start 115-230 v. 60 cyc. A.O. A brute of a power plant with a rugged 14.0 hp. Wisconsin engine. Plenty of electricity for ranges, water heaters, freezers, pumps, machinery, etc. Affords both 110 and 220 volts. Ideal where heavy current is needed. Wt. 550 lbs. Easily worth \$905. With crank start. **\$585.50**
Same plant, but with self-starter, **\$645.00**
Generator and control box only, belt driven. Use your own engine or tractor. Wt. 240 lbs. (Item 183) Factory price..... **\$345.00**

52 pc. SOCKET SET

Highest quality, guaranteed non-breakable sockets made by Husky. Beautifully matched chrome thin wall alloy absolutely the best. Contains a complete set of 28 sockets in 1/2" drive, 3/4" drive and 1 1/4" drive, plus all necessary extensions, handles, reversible ratchets, etc.; all around, guaranteed against breakage. A beautiful set of tools that will handle any job; in a big doghouse steel box. Wt. 17 lbs. (Item 205) List price \$62.90. Factory special..... **\$27.95**

Variable Speed Selector

Heavy duty, made by B. F. GOODRICH for industrial use. Provides instant speed changes for any drive. For machine tools, dryers, printing, conveyors, production lines, boats—any operation requiring variable speed. Employs reliable "trouble free" planetary system. No hydraulic power losses. Infinite range, smooth operation, easy installation. 3 sizes: 1 1/2 hp. 30 lbs.; 1-2 hp. wt. 35 lbs.; 2-3 hp. wt. 105 lbs.; Reg. list \$228, \$252 and \$352. Our prices **\$79.50, \$89.50 and \$114.50**



JET FLOW BLOWER

Tremendous air movement (1800 CFM) and quiet operation make this double inlet 10" turbine blower unbeatable for heating, cooling, drying and air conditioning. Ideal for attic or barn ventilation, converting gravity heating to forced air; spray booth exhausts, etc. Operates with any 1/2, 3/4 or 1 1/2 HP motor. Oversized, long life bearings. Includes variable speed motor pulley and belt. Dimensions 19" h x 18" x 16 1/2". Outlet opening 13" x 11 1/4". Wt. 45 lbs. Item 245. Reg. \$54.50. **\$27.50**

HEAVY DUTY 1/2 HP motor for above \$16.95

12" TURBINE BLOWER similar to above, but larger with 2400 CFM capacity. Wt. 65 lbs. (Item 245a) Reg. \$70.00. Factory Spec. **\$34.50**

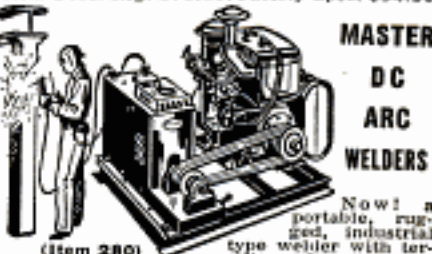

(Item 280)

Now! a portable, rugged, industrial type welder with terrific performance, yet at a price hundreds of dollars less than you'd expect. Senior model made for years of trouble-free, continuous service. High capacity DC welding unit enables you to tackle any job with confidence—easily welds anything up to 2" plate using from 1/16" to 3/4" rods. Built-in stabilizer and cooling system makes arc easy to strike and hold. Dual control rheostat provides low heat soldering, brazing and welding from 30 to 300 amps. Complete with instructions, guarantee and triple V-belt or flat pulley. You can pay more, but you can't buy a better welder.

WELDER ONLY — DUAL CONTROL MODEL.

Same as above, but drive with your tractor, Jeep or gas engine of 14 HP or more. (Item 280a.) Wt. 110 lbs. \$450 value..... **\$119.50**

WELDER ONLY—STANDARD MODEL. Same as above but with single rheostat for heavy metal welding only. (Item 38.)

Wt. 110 lbs. \$400 value. Special..... **\$99.75**

COMPLETE POWER MASTER (Illustrated above) powered by a 14.0 hp., air cooled Wisconsin engine. Wt. 480 lbs. (Item 280c) Compares with welder costing \$1200.

Special for December only..... **\$399.50**

WELDING KIT Two 10 ft. leads, welding helmet, electrode holder, ground clamp. Sold only with welder at.....

\$10.50

Send check or M.O. Prices f.o.b. Factory. 10 day Money back guarantee. SEND 10c for... **BIG 1955 Catalog**

MASTER MECHANIC MFG. CO., DEPT. 201 Burlington, Wis.

MORE ACCURACY • VERSATILITY • DEPENDABILITY FOR YOUR MONEY

SOUTH BEND gives you quality that counts — quality that pays off in better and faster metal working by means of more accuracy, versatility and dependability.

Compare the South Bend 7" Shaper and Pedestal Grinder with any others on this basis. You'll find that their quality actually gives you more value on a dollar-for-dollar basis. The best way to prove this is in your own plant. Let our distributor show you how both of these efficient machine tools can best be used in your production, toolroom or maintenance work.



8" Pedestal Grinder — \$245

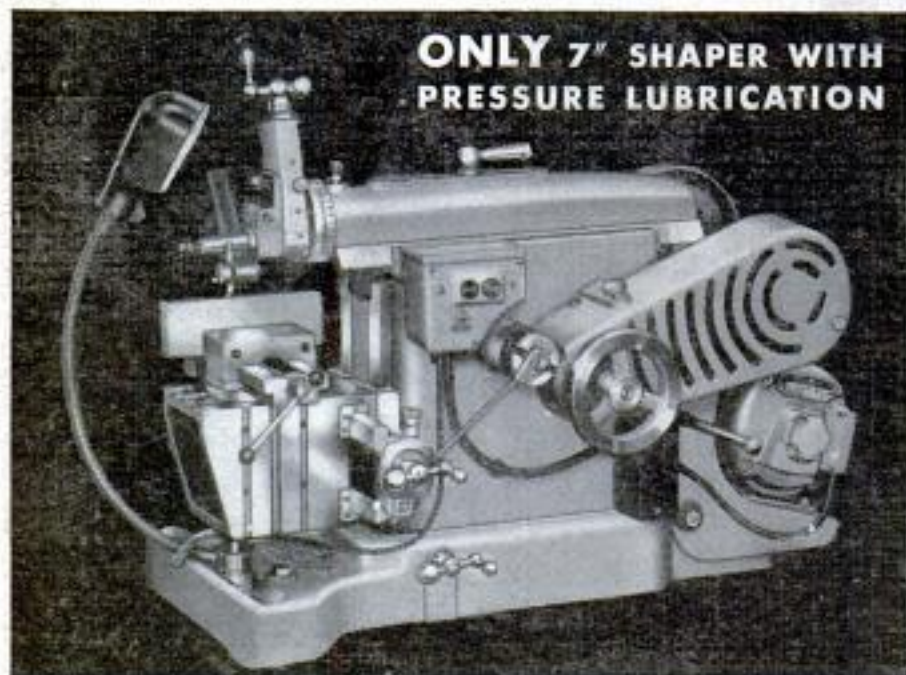

**ONLY 7" SHAPER WITH
PRESSURE LUBRICATION**

7" Precision Bench Shaper — \$551

(Prices f.o.b. factory, less motors)



SEND INFORMATION CHECKED:

9" and 10" BENCH LATHES **10" to 14-24" FLOOR LATHES** **DRILL PRESSES** **TOOL GRINDERS** **1/2" & 1" Collet TURRET LATHES** **7" BENCH SHAPERS**

Name _____ Street _____

City _____ State _____

Building Better Tools Since 1906 • **SOUTH BEND LATHE** • South Bend 22, Indiana



The ONE Camera He Wants Most

**A PACEMAKER
GRAPHIC®**



There are many reasons why most men want to graduate to a Graphic. The big negative, for instance—permits contact prints or big enlargements with equal facility. Use of sheet film offers tough, heavy film base that's easier to handle, permits faster processing, individual handling, is easier to retouch. Plus the unmatched picture-taking versatility of the camera itself. With a Graphic he can solve almost any picture-taking problem!

AS LOW AS \$24 DOWN

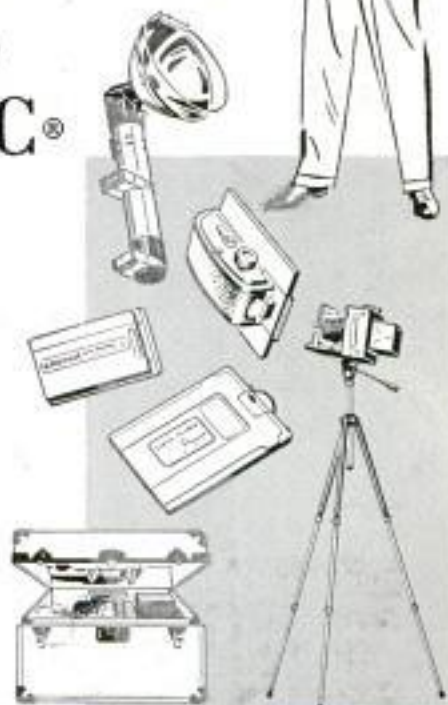

FOR THE MAN WHO WANTS TO

Take 'em & Make 'em



A perfect gift—a camera-enlarger package complete in handy, home storage case. Consists of the famous Century Graphic press-type camera plus cold-light back, stand and baseboard to enable the camera to be used as a precision enlarger. Every basic piece of equipment he needs to take prize-winning pictures and make prize-winning enlargements.



**COMPLETE
FOR ONLY
\$199.50**

GRAFLEX®

Prize-Winning Cameras

Graflex, Inc., Rochester 8, N. Y.

GRAFLEX, INC., Dept. PM-124, Rochester 8, N. Y.

Please send me full information on the Pacemaker Graphic cameras and your "Take 'em, Make 'em" Outfit.

NAME _____

ADDRESS _____

CITY _____ ZONE _____ STATE _____

PRESTONE

BRAND

ANTI-FREEZE

You're
**SET
SAFE
SURE**

NOW

\$2.95

PER GALLON

NEW "PRIME"
GAS LINE ANTI-FREEZE
protects fuel system against
winter cold. Prevents stall-
ing. Only 65¢ a can!



The terms "Prestone", "Eveready" and "Prime" are registered trade-marks of Union Carbide and Carbon Corporation

NATIONAL CARBON COMPANY • A Division of Union Carbide and Carbon Corporation • 30 East 42nd Street, New York 17, N. Y.