

NOVEMBER 1954

35 CENTS

POPULAR MECHANICS

MAGAZINE

WRITTEN SO YOU CAN UNDERSTAND IT

REG. U.S. PAT. OFF. TRADE MARK GREAT BRITAIN NO. 410428

REG. U.S. PAT. OFF.



The '55 Pontiac

1955's New Car Parade Begins—Page 88
Big Christmas Gift Section
How to Upholster With Foam Rubber

DON'T BE PUSHED AROUND THIS WINTER!



Your car will start fast with patented **FIVE-RIB CHAMPION SPARK PLUGS!**

Whatever the weather . . . just touch the starter and your full-firing Champion Spark Plugs go to work!

Champion's exclusive FIVE-RIB insulator design protects you against electrical "flash-over" due to dampness—a major cause of hard starting.

Compare a FIVE-RIB Champion with an ordinary spark plug and you'll see why.

Champion's insulating surface is greater because of its ribbed construction. Exterior electricity is diverted and spent before it can short out a damp plug. Tests prove this gives you as much as forty percent more protection than smooth insulator types under the same conditions.

Get the jump on winter now. Let your Champion dealer install a set of FIVE-RIB Champions when your car has its winter change-over.

You'll get going, and get where you're going, with Champions!

CHAMPION SPARK PLUG COMPANY, TOLEDO 1, OHIO



INSIST ON FIVE-RIB

CHAMPIONS

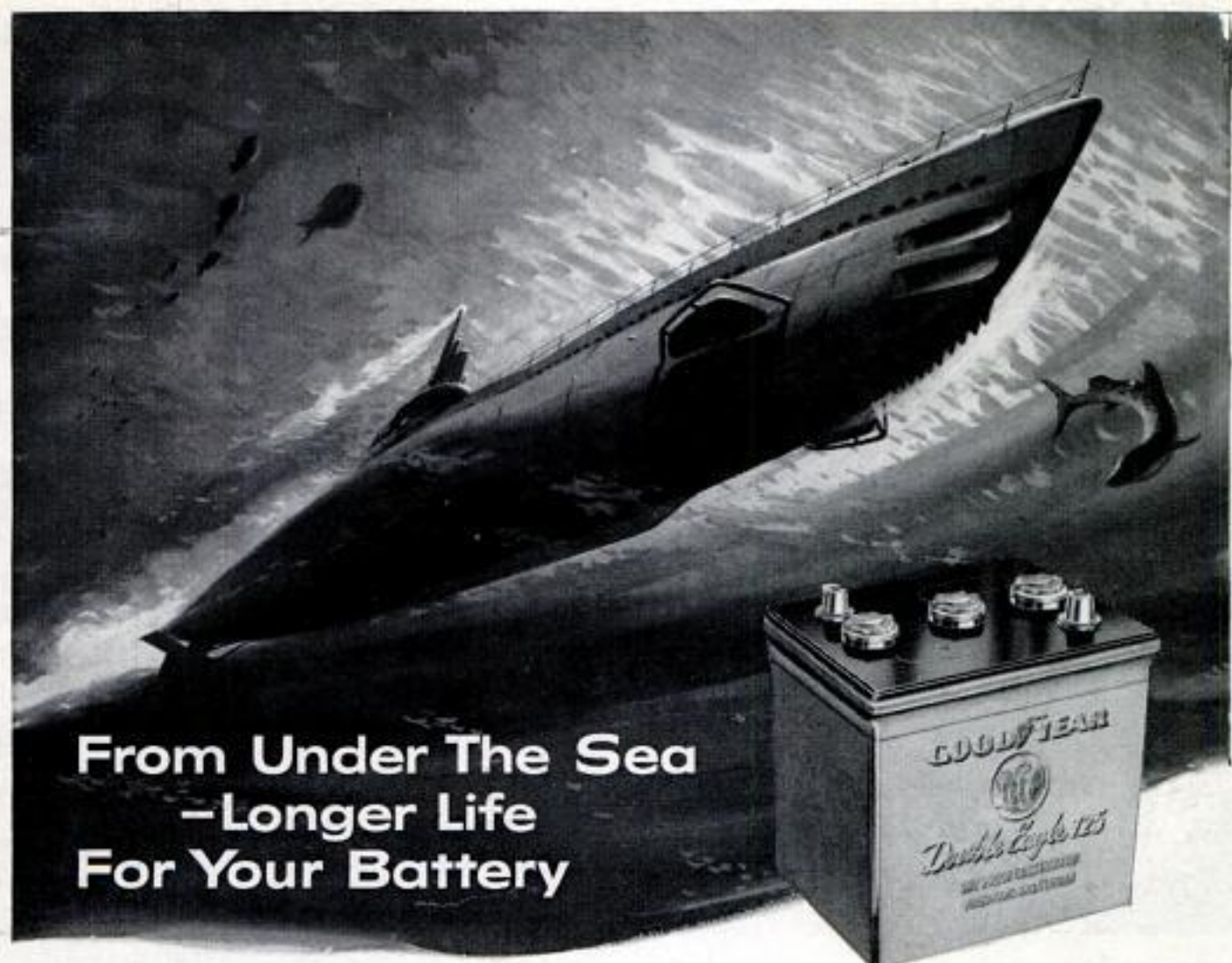

**From Under The Sea
-Longer Life
For Your Battery**

-in the superpowered Double Eagle 125!

Now—Goodyear's completely new Double Eagle 125 battery has the same heat-, acid- and shock-resistant Microporous Rubber Separators as those used in the U. S. Navy's rugged batteries! Together with a special glass fiber insulation, these separators make Double Eagle 125 longer-lived, more efficient, too. In fact, every part of this revolutionary battery is built for heavy

duty: There's 67% more starting stamina than standard equipment batteries — 39% greater power reserve to operate all accessories—and its new blue and yellow Polystyrene case is twice as strong as the finest rubber case!

Ask your Goodyear Dealer about this superpowered Double Eagle 125, soon. Goodyear, Battery Dept., Akron 16, Ohio.

GOODYEAR

DRY PROOF DOUBLE EAGLE BATTERY

Double Eagle—T. M. The Goodyear Tire & Rubber Company - Akron, Ohio

This One



E10B-8HB-LQ7A

NOVEMBER 1954

1

Copyrighted material



Bell's new Telephone Answering Set. In use, the machine tells the caller when to start talking, and when his time—thirty seconds—is up.

He's out...

but he's answering his telephone!

This newly designed Bell Telephone Answering Set makes it possible for you to go out—but leave your voice behind.

Before you leave you twist a knob, dictate a message into your telephone, then switch the machine to "Automatic Answer." When somebody calls, the machine starts up and the caller hears your voice telling who you are, asking his name and telephone number, repeating what you have said. The reply is recorded too. On your return you play back all the calls that have come in, as often as you please.

The new machine features "talking rubber," a Laboratories-developed recording medium of rubber-like plastic and iron oxide which can be used over and over again millions of times. It is another example of how Bell Laboratories research works to help your local Bell Telephone Company serve you in new ways.

**Bell Telephone
Laboratories**



*Improving telephone service for America provides
careers for men in scientific and technical fields*

Popular Mechanics Magazine

Registered in U. S. Patent Office and Canada

H. H. WINDSOR, Founder

H. H. WINDSOR, JR., Editor and Publisher



Next Month

SPECTACULAR is the word for a popular national sport played with motorcycles and steep hills. Every year a large army of riders competes locally for the honor of taking part in the National Championship Hill Climb sanctioned by the American Motorcycle Association. A favorite hill to test the mettle of the best riders is near Muskegon, Mich., is as high as a 30-story building and has a 45-degree grade. Most of the riders build their own souped-up machines for this "sport of spills" in which many compete and few "go over the top." Readers are invited to come along for an exciting ride with the "Mountain Goats on Two Wheels" in December

Information not listed on articles in the index, starting on page 12, frequently is listed in the **WHERE-TO-FIND-IT LIST**, which is available to readers without charge. A copy may be obtained by writing to the Bureau of Information, *Popular Mechanics*, 200 E. Ontario, Chicago 11, Ill.

Published monthly by Popular Mechanics Company, 200 E. Ontario St., Chicago 11, Ill. H. H. Windsor, Jr., president; Wm. Harrison Fearing, exec. vice-pres.; D. F. Windsor, vice-president and secretary-treasurer; H. H. Windsor III, vice-president; Clover L. Perkins, advertising manager; Alan M. Deyoe, circulation manager. Single copy in the United States and Canada, 35 cents; subscription rates in the United States and possessions, Canada, Philippines and countries of the Pan-American Postal Union, 1 year \$3.50; 2 years, \$6.00; 3 years \$8.00. To all other countries add \$1.00 a year over United States prices for overseas postage. If you plan to move, notify us at least 30 days in advance so you will not miss an issue. Give both your old and new addresses. Entered as Second Class Matter, September 15, 1903, at the Post Office at Chicago, Illinois, under Act of March 3, 1879. Entered as Second Class Matter at Post Office Dept., Canada. Registered as Second Class Matter at the Post Office at Mexico, D. F., Mexico, June 20, 1950. Copyright 1954 by Popular Mechanics Company. Copyright under International Copyright Union. Copyright in France. All rights reserved under Pan-American Copyright Union. Printed in the United States of America.

Volume 102 NOVEMBER 1954 Number 5

Address all communications to: 200 E. Ontario St., Chicago 11, Ill.

Managing Editor.....Roderick M. Grant
 Assistant Managing Editor.....Wayne Whittaker
 Shop Notes and Crafts Editor.....James R. Ward
 Radio-Television, Electronics Editor.....Frank L. Brittin
 Associate Editor.....Clifford B. Hicks
 Associate Editor, Automotive.....Arthur R. Railton
 Associate Editor.....George E. Moise
 Associate Editor, Shop Notes and Crafts.....Wayne C. Lecky
 Assistant Editor, Shop Notes.....W. Clyde Lamme
 Assistant Editor, Crafts.....Frank N. Stephany
 Assistant Editor, Makeup.....John C. Dalen
 Automotive Correspondent.....Leo Donovan
 Art Director.....Frank Beatty

Assistant Editors

Leonard F. Hiltz, Jay W. Hedden, Elliott H. McCleary, Emily Mullaney
 Eastern Editor.....Richard F. Dempewolff
 Empire State Bldg., Room 2906, New York City 1
 Western Editor.....Thomas E. Stimson, Jr.
 Suite 1010, 3460 Wilshire Blvd., Los Angeles 5, Calif.
 London Manager.....Douglas W. Wedderspoon
 Eagle House, Jermyn St., London S. W. 1, England
 Director, Bureau of Information.....Allan Carpenter
 200 E. Ontario St., Chicago 11

In This Issue . . .

USS Forrestal—Our Navy's Mightiest Carrier	81
1955's New-Car Parade Begins	88
Christmas Gift Section	100
Fifty Years an Inventor	108
The Owners Report on the Metropolitan	118
How to Make Part-Time Farming Pay	130
Are the V8s All Alike?	140
Taxi Up Misery Mountain	150
Radio, TV and Electronics	157

For the Craftsman . . .

Foam Rubber Simplifies Upholstering	161
Solving Home Problems	170
Say "Merry Christmas" With Plywood Cutouts	174
Cutlery Handles You Can Make	186
Lay Your Own Linoleum Cove Base	193
Darkroom Tricks	202
Circle Tool Does Many Jobs	207
How to Cut Dovetail Joints	212
Shopping for Tools	218

Other items, and manufacturers of available products described, are listed on pages 12, 14 and 16



Do you enter traffic cautiously? It can help you ...

save up to 40% on your auto insurance!

Read why careful drivers get top-notch protection at rock-bottom rates with

STATE FARM MUTUAL

Most car owners who read this are every bit as careful as the driver in our picture.

If you are, you should find it easy to qualify for State Farm Mutual's low-cost "careful driver insurance."

We can cut your auto insurance cost up to 40 per cent because we aim to insure careful drivers only. Careful drivers cost less to insure. We pass the saving right back to State Farm members in the form of *low rates*.

There are other reasons, too, why you should consider State Farm insurance. We insure more than 3 million cars—far more than any other company. We offer the convenience of semi-annual payments at no extra cost. We handle claims in a fast, fair, and friendly manner, through our own organization of 7,000 agents and 700 claim expeditors.

For full details—and the exact amount you can save—call the nearest agent listed under "State Farm Insurance" in the yellow pages of your phone book. Or write: State Farm Mutual, Dept. J-15, Bloomington, Illinois.

Can You Qualify?

State Farm aims to insure careful drivers only. Drivers who can be counted on to:

- Enter traffic cautiously
- Be alert for emergencies
- Make full stop at stop signs
- Obey speed laws
- Always signal stops and turns
- Keep safe distance from car ahead
- Avoid mixing alcohol and gasoline
- Yield pedestrians the right of way

STATE FARM MUTUAL

"the careful driver insurance company"



FREE TO MEMBERS!

Ask your agent for your new State Farm insignia (like above) in bright red headlight-reflecting Scotchlite. Display it proudly on left rear car bumper to identify yourself as "careful driver, soundly insured" ... to provide emergency reflection when parked or if taillight fails.

State Farm Insurance is written only by the
State Farm Mutual Automobile Insurance Co.
and its wholly owned affiliates:
State Farm Life Insurance Company
State Farm Fire and Casualty Company

Home Office: Bloomington, Illinois. Field claim offices in 325 principal cities. 7,000 agents in 40 states, District of Columbia, and Ontario, Canada

Hear "Jack Brickhouse Sports News" Saturdays and "Cecil Brown News Commentaries" Sundays over Mutual Stations. Check local radio listings.

CHANGE for more POWER!



PENNZOIL

THE ONLY
OIL WITH **Z-7**

UNLOCKS HORSEPOWER

- ENDS WINTER SLUDGE PROBLEMS!
- STARTS FAST! PROLONGS BATTERY LIFE!
- STOPS VALVE LIFTER RUSTING!
- ELIMINATES VALVE NOISE!

NO EXTRA COST!

Sound
your **Z**



© 1954, The Pennzoil Co.,
Member Penn. Grade Crude Oil Assn., Permit No. 2

in this corner.....

THE EDITORS



For the USS *Forrestal* story which leads off this month's editorial section on page 81, we commissioned the New York artist, A. Leydenfrost — whose work is familiar to PM readers — to fly to Norfolk, Va., and visit the growing hull of the world's mightiest carrier. There he sketched the two-page drawing giving the first glimpse of the vast interior of the vessel. With him went Dick Dempewolff, our Eastern Editor, to gather facts on the spot for his article.

To the Editor:

When the owner of a new automobile in the early days, 1910-1912, required a license plate for his car he presented the bill of sale or proof of ownership to the city clerk or county recorder. The line number in the record book was his license number.



He had his choice of making a homemade plate of wood or metal, or having the local harness maker turn one out on patent leather with nickel or brass numerals. This was fastened to the car with screw hooks or eyes, most bodies being made of wood.

E. M. Hamm,
Snohomish, Wash.

To the Editor:

The article by Mat Hooper on streamlined cars (*PM*, Aug. 1954) was quite
(Continued to page 8)

This **FREE SAMPLE LESSON** will prove you can become an expert **BOOKKEEPER... ACCOUNTANT** OR **C.P.A.**

This well-paid
LaSalle-trained
Accountant's
success could
be yours.



FREE SAMPLE LESSON

We offer you this free sample lesson so that you can prove to yourself that you CAN master Accountancy—quickly, thoroughly—in spare time at home.

You will see exactly how LaSalle's famous "Problem Method" works... how you are led step-by-step through actual accounting work—learning by doing and not by study of theory alone. First you tackle easy problems, then more difficult ones—until soon you master them all. And at every step you have the close personal guidance of LaSalle's large staff of C.P.A. instructors.

HIGHER ACCOUNTANCY

By the LaSalle Problem Method..

• Practical Accounting

Assignment 1

THE BALANCE SHEET



QUOTING from the "Journal of Accounting," the authoritative organ of the professional accountants of the United States:
"If the accounting profession is probably the best paid in the world, it is because a profession which the average competitor is loath to enter. It is not known to us."
There is need for accountants. There is ample opportunity for accountants. There are prospects that the experts will increase the demand within the lifetime of even the youngest of us."

LaSalle Extension University
A Correspondence Institution
CHICAGO

THIS SAME LESSON HAS STARTED HUNDREDS OF THOUSANDS toward well-paid accounting careers—in business, government, and as C.P.A.'s. Even without previous knowledge, progress is rapid—earning power climbs fast. This sample lesson shows why.

If you have been envying the high incomes and good jobs enjoyed by thousands of men and women Accountants today... incomes ranging from \$4,000 to \$10,000 and more per year... why not launch such a career for yourself?

Do you doubt that you can?

Then let us send you—without cost or obligation—the same Lesson Number One with which LaSalle has started several hundred thousand

men and women toward successful accounting careers. We want you to see for yourself how this remarkable method, originated by LaSalle, makes Accountancy simple, interesting, practical, and certain... how it leads you step-by-step to a complete mastery of Accounting—and on up to the coveted degree of Certified Public Accountant if you so aspire.

It doesn't matter whether you've had previous bookkeeping experience, or whether you don't know a debit from a credit. Whether you wish to qualify as an expert bookkeeper, advanced accountant, cost accountant, auditor, government accountant, income tax specialist, or public accountant... you'll find in LaSalle's Problem Method the exact plan to prepare you rapidly and inexpensively—in spare hours at home—without losing a day from your present job.

So right now, today... if you are an adult, employed, and earnestly ambitious for rapid advancement in this highest-paying of all professions... send your name and address on the coupon below. We'll send the free sample lesson—plus our 48-page book outlining today's career opportunities and how you can qualify for them. A coupon like this has started many thousands toward greater success. It can do the same for you. Mail it today!

Clip Coupon... Mail TODAY!

LaSalle Extension University... A Correspondence Institution
Dept. 1164H, 417 S. Dearborn Street, Chicago 5, Illinois

YES, I want to see how LaSalle's "Problem Method" works... how I can qualify for high-pay Accountancy positions. Send Free Sample Lesson—also your 48-page book, "Accountancy, the Profession That Pays"—all without cost or obligation.

Name..... Age.....

Street Address.....

City, Zone & State.....

Present Position.....



Nearly 10%
of all C.P.A.'s
in the U.S. have
been trained by the
LaSalle Problem
Method

GOOD-PAY JOBS IN 5 BIG FIELDS

If you were an expert accountant right now, chances are you would find yourself among the highest-paid of all professional men and women. Surveys show that accountants earn more than those in other major professions.

There are five big fields of opportunity open to Accountancy-trained men and women... opportunities that are wide open and highly inviting, offering maximum income and job security in good times or bad. And under LaSalle's "Problem Method" you can start earning while still learning—either in spare-time or full-time employment... or in business for yourself with no capital required.

Get the latest information by sending for our 48-page book, "Accountancy, the Profession That Pays"... plus free sample lesson. The coupon at right will bring both to you without cost or obligation. LaSalle Extension, 417 S. Dearborn St., Chicago 5, Ill.

(Continued from page 6)

interesting, especially with regard to the title "One Out of Three Smashes Up."

If these cars were directionally stable, there would be no trouble with cars going out of control, either from the wind or from road disturbances.

The placement of the greater load on the front axle is only one of the requirements for directional stability. The second is that the center of pressure of the air flow forces behind the C.G. [center of gravity].

If these conditions are fulfilled, it is then possible to maintain direction even under the influence of a side wind. In fact, if the center of pressure is located accurately enough, direction can be maintained without any steering correction. With the center of pressure located nearly correct, some small correction is necessary, but the driver then has time, 1 to 2 seconds in which to make the correction, instead of the present 1/10 to 2/10 second.

Theodore R. Gondert,
Lyndhurst, N. J.

☆☆☆

Doing your Christmas shopping early? For some fresh ideas that will please the whole family, turn to our six-page Christmas shopping section on pages 100-105.

To the Editor:

Popular Mechanics' feature story in the September issue regarding hi-fi brings to mind my experience in the sound field some years ago. Since PM readers represent a most intelligent and creative group, I believe my experience may serve as sort of an inspiration for persons with a creative thought to muster greater courage to carry out their convictions in spite of tradition or laws exactly contrary to accepted and recognized procedure.

PM's story brought out the fact that the largest sound companies have today achieved the near ultimate in sound reproduction contrary to the long-accepted principle of recording *only* in cell-like plush-padded studios.

Upon my first venture in the production of a recording many years ago, I struggled, argued and reasoned with almost every sound engineer in sight in an attempt to produce a "live" recording with genuine "presence." My contention had been that for years on end recording companies had been distorting true reproduction by doing "takes" only in studios with sound-absorbing walls. In other words they were making an all-out effort to disguise true fidelity and reproduction through the years due to

(Continued to page 18)

"Here's the new greaseless way to keep your hair neat all day,"

says Arthur Godfrey

Even Mr. G.'s tousled cowlicks stay put after he uses new Vitalis Hair Tonic with V-7. "It works for me even after a shampoo," he says. "That means it'll work for anybody."

V-7, Vitalis' new *greaseless* grooming ingredient, makes even dry, unruly hair easy to manage. Yet it never gives an over-slick, plastered-down look. And Vitalis prevents dryness—maintains hair's natural moisture balance better than any other leading tonic.

Try new Vitalis yourself! And don't miss the new "Arthur Godfrey Digest." CBS Radio Network, Fridays, 8:30-9:30 PM, EST.

**New VITALIS®
Hair Tonic with V-7**

PRODUCT OF BRISTOL-MYERS



How to pass a genius



All of us can't be geniuses. But any ordinarily talented mortal can be a success—and that's more than some geniuses are.

Now, as in Aesop's time, the race doesn't always go to the one who potentially is the swiftest. The *trained* man has no trouble in passing the genius who hasn't improved his talents.

In good times and bad times, in every technical and business field, the *trained* man is worth a dozen untrained ones, no matter how gifted.

The International Correspondence Schools can't make you into a genius. For more than 60 years, however, I. C. S. has been helping its students to become *trained, successful leaders*—and it can do the same for you.

Mark your special interest on the coupon. Don't be like the unsuccessful genius who wastes his life in dreaming of what he intends to do. *Act now!*

3 FREE BOOKS—1. a 36 page pocket-size guide to advancement—a gold mine of tips on "How to Succeed." 2. Big catalog outlining opportunities in your field of interest. 3. Sample I.C.S. lesson text.

For Real Job Security—Get an I. C. S. Diploma!

I. C. S., Scranton 9, Penna.

INTERNATIONAL CORRESPONDENCE SCHOOLS

ICS

BOX 5635-L, SCRANTON 9, PENNA.

(Partial list of 277 courses)

Without cost or obligation, send me "HOW TO SUCCEED" and the opportunity booklet about the field BEFORE which I have marked X (plus sample lesson):

- | | | | | |
|--|--|--|--|--|
| <p>ARCHITECTURE and BUILDING CONSTRUCTION</p> <ul style="list-style-type: none"> <input type="checkbox"/> Air Conditioning—Refrig. <input type="checkbox"/> Architecture <input type="checkbox"/> Building Contractor <input type="checkbox"/> Building Maintenance <input type="checkbox"/> Carpenter and Mill Work <input type="checkbox"/> Estimating <input type="checkbox"/> Heating <input type="checkbox"/> Painting Contractor <input type="checkbox"/> Plumbing <input type="checkbox"/> Reading Arch. Blueprints <input type="checkbox"/> Steamfitting <p>ART</p> <ul style="list-style-type: none"> <input type="checkbox"/> Carboning <input type="checkbox"/> Commercial Art <input type="checkbox"/> Fashion Illustrating <input type="checkbox"/> Magazine Illustrating <input type="checkbox"/> Show Card and Sign Lettering <input type="checkbox"/> Sketching and Painting <p>AUTOMOTIVE</p> <ul style="list-style-type: none"> <input type="checkbox"/> Auto Body Rebuilding <input type="checkbox"/> Auto Elec. Technician <input type="checkbox"/> Auto-Engine Tune Up <input type="checkbox"/> Automobile Mechanic | <p>AVIATION</p> <ul style="list-style-type: none"> <input type="checkbox"/> Aeronautical Engineering Jr. <input type="checkbox"/> Aircraft & Engine Mechanic <p>BUSINESS</p> <ul style="list-style-type: none"> <input type="checkbox"/> Advertising <input type="checkbox"/> Bookkeeping and Accounting <input type="checkbox"/> Business Administration <input type="checkbox"/> Business Correspondence <input type="checkbox"/> Certified Public Accounting <input type="checkbox"/> Creative Salesmanship <input type="checkbox"/> Federal Tax <input type="checkbox"/> Letter-writing Improvement <input type="checkbox"/> Managing Small Business <input type="checkbox"/> Office Management <input type="checkbox"/> Retail Business Management <input type="checkbox"/> Sales Management <input type="checkbox"/> Stenographic-Secretarial <input type="checkbox"/> Traffic Management <p>CHEMISTRY</p> <ul style="list-style-type: none"> <input type="checkbox"/> Analytical Chemistry <input type="checkbox"/> Chemical Engineering <input type="checkbox"/> Chem. Lab. Technician <input type="checkbox"/> General Chemistry <input type="checkbox"/> Natural Gas Prod. & Trans. <input type="checkbox"/> Petroleum Engineering <input type="checkbox"/> Plastics <input type="checkbox"/> Pulp and Paper Making | <p>CIVIL, STRUCTURAL ENGINEERING</p> <ul style="list-style-type: none"> <input type="checkbox"/> Civil Engineering <input type="checkbox"/> Construction Engineering <input type="checkbox"/> Highway Engineering <input type="checkbox"/> Reading Struct. Blueprints <input type="checkbox"/> Sanitary Engineering <input type="checkbox"/> Structural Engineering <input type="checkbox"/> Surveying and Mapping <p>DRAFTING</p> <ul style="list-style-type: none"> <input type="checkbox"/> Aircraft Drafting <input type="checkbox"/> Architectural Drafting <input type="checkbox"/> Electrical Drafting <input type="checkbox"/> Mechanical Drafting <input type="checkbox"/> Mine Surveying and Mapping <input type="checkbox"/> Ship Drafting <input type="checkbox"/> Structural Drafting <p>ELECTRICAL</p> <ul style="list-style-type: none"> <input type="checkbox"/> Electrical Engineering <input type="checkbox"/> Electrical Maintenance <input type="checkbox"/> Electrician □ Contracting <input type="checkbox"/> Lineman <p>HIGH SCHOOL</p> <ul style="list-style-type: none"> <input type="checkbox"/> Commercial <input type="checkbox"/> Good English <input type="checkbox"/> High School Subjects <input type="checkbox"/> Mathematics | <p>LEADERSHIP</p> <ul style="list-style-type: none"> <input type="checkbox"/> Foremanship <input type="checkbox"/> Industrial Supervision <input type="checkbox"/> Leadership and Organization <input type="checkbox"/> Personnel-Labor Relations <p>MECHANICAL AND SHOP</p> <ul style="list-style-type: none"> <input type="checkbox"/> Gas—Electric Welding <input type="checkbox"/> Heat Treatment □ Metallurgy <input type="checkbox"/> Industrial Engineering <input type="checkbox"/> Industrial Instrumentation <input type="checkbox"/> Industrial Supervision <input type="checkbox"/> Machine Design-Drafting <input type="checkbox"/> Machine Shop Inspection <input type="checkbox"/> Machine Shop Practice <input type="checkbox"/> Mechanical Engineering <input type="checkbox"/> Quality Control <input type="checkbox"/> Reading Shop Blueprints <p>Refrigeration</p> <ul style="list-style-type: none"> <input type="checkbox"/> Sheet Metal Worker <input type="checkbox"/> Tool Design □ Toolmaking <p>RADIO, TELEVISION</p> <ul style="list-style-type: none"> <input type="checkbox"/> Electronics <input type="checkbox"/> Practical Radio—TV Eng'ing <input type="checkbox"/> Radio and TV Servicing <input type="checkbox"/> Radio Operating <input type="checkbox"/> Television—Technician | <p>RAILROAD</p> <ul style="list-style-type: none"> <input type="checkbox"/> Air Brakes □ Car Inspector <input type="checkbox"/> Diesel Locomotive <input type="checkbox"/> Locomotive Engineer <input type="checkbox"/> Section Foreman <p>STEAM AND DIESEL POWER</p> <ul style="list-style-type: none"> <input type="checkbox"/> Combustion Engineering <input type="checkbox"/> Diesel—Elec. □ Diesel Eng's <input type="checkbox"/> Electric Light and Power <input type="checkbox"/> Stationary Fireman <input type="checkbox"/> Stationary Steam Engineering <p>TEXTILE</p> <ul style="list-style-type: none"> <input type="checkbox"/> Carding and Spinning <input type="checkbox"/> Cotton, Rayon, Woolen Mfg. <input type="checkbox"/> Finishing and Dyeing <input type="checkbox"/> Loom Fixing <input type="checkbox"/> Textile Designing <input type="checkbox"/> Textile Eng'g □ Throwing <input type="checkbox"/> Warping and Weaving <p>MISCELLANEOUS</p> <ul style="list-style-type: none"> <input type="checkbox"/> Domestic Refrigeration <input type="checkbox"/> Marine Engineering <input type="checkbox"/> Ocean Navigation <input type="checkbox"/> Shipping <input type="checkbox"/> Short Story Writing <input type="checkbox"/> Telephony |
|--|--|--|--|--|

Name _____ Age _____ Home Address _____

City _____ Zone _____ State _____ Working Hours _____ A.M. to P.M. _____

Occupation _____

Canadian residents send coupon to International Correspondence Schools, Canadian, Ltd., Montreal, Canada. . . . Special tuition rates to members of the U. S. Armed Forces.

Our 40th Year

NRI training is thorough, practical, up-to-date. When you enroll with NRI you benefit from our 40 years of successful experience training men at home.

J. E. Smith

President
National Radio Institute
Washington, D. C.



I'll Train You RADIO-

You Practice Broadcasting with Parts I Send

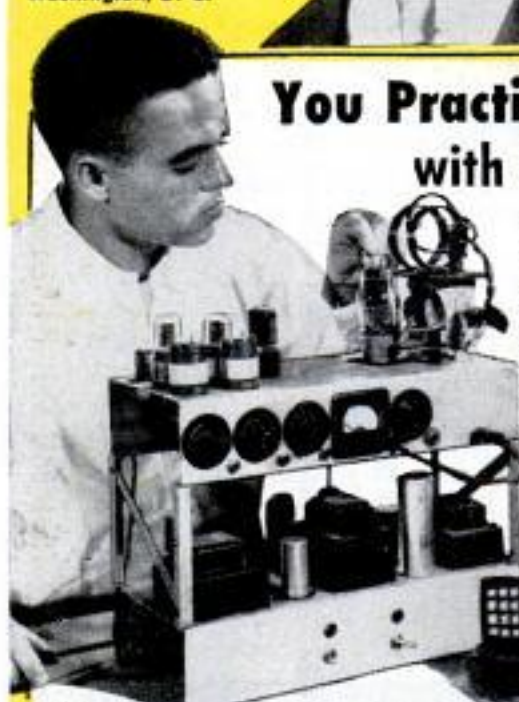

As part of my Communications Course I send you parts to build low-power Broadcasting Transmitter at left, and other equipment. Use it to get practical experience. You put this station "on the air," perform procedures demanded of station operators. An FCC Commercial Operator's License can be your ticket to a bright future. My Course trains you to get your license. Mail Coupon now!

You Practice Servicing with Parts I Send

Nothing takes the place of PRACTICAL EXPERIENCE. NRI training is based on LEARNING BY DOING. You use parts I send to build many circuits common to Radio and TV. You build the modern radio at right. Use Multi-tester you build to make money fixing sets. Many students make \$10, \$15 a week extra fixing neighbors' sets in spare time, starting soon after enrolling. All equipment I send is yours to keep.



Television Is Today's Good Job Maker

Television now reaches from coast-to-coast. More than 25 million Television sets are already in use and require servicing; thousands more sets are being sold every week. About 200 TV stations are now on the air with hundreds more being built. This means new jobs, more jobs, better pay for trained men. The time to act is NOW! Start learning Radio-Television servicing or communications.

Make Extra Money in Spare Time While Learning

Keep your job while training. Many NRI students make \$10, \$15 and more a week extra fixing neighbors' Radios in spare time. The day you enroll I start sending you special booklets that show you how to service sets. Multi-tester you build helps discover and correct Radio troubles, gives PRACTICAL EXPERIENCE on circuits common to radio and TV. Mail coupon today.

I Trained these Men at Home



Laborer
Finds
Success in
Radio-TV

"I was a laborer with no future. Now I have a position that pays well. My spare time servicing pays good money, too. Thanks to NRI."—Robert Ford, Johnstown, Pa.



Switched
to TV
Servicing

"I recently switched from studio work and am now holding a position as TV service technician. Enjoy my work more and more."—Norman Ward, Ridgefield Park, N. J.



Paid for
Course, Car
in Spare
Time

"By the time I graduated I had paid for my course, a car and testing equipment. I can handle any job in Radio-TV."—E. J. Streltenberger, New Boston, Ohio.



\$10 to \$15
Week
Spare Time

"Four months after enrolling, was able to service Radios . . . averaged \$10 to \$15 a week spare time. Now have full time business."—W. Weyde, Brooklyn, N. Y.



Employed as
Transmitter
Operator

"A former employer recommended NRI training to me. Now employed as transmitter operator in Harrisburg."—Albert Herr, New Cumberland, Penna.

AT HOME for Good Jobs in TELEVISION

There is Success-Good Pay-Security for You in America's Fast Growing Industry



NRI Training Leads to These Jobs in RADIO-TELEVISION

BROADCASTING

Chief Technician
Chief Operator
Power Monitor
Recording Operator

SERVICING

Home and Auto Radios
Television Receivers
P.A. Systems

MANUFACTURING

Design Technician
Service Manager
Tester
Research Assistant

SHIP AND HARBOR RADIO

Chief Operator
Radiotelephone Operator
Assistant Operator

GOVERNMENT RADIO

Operator in Army, Navy, Marine Corps
Airways Operator
Forestry Dispatcher

AVIATION RADIO

Transmitter Technician
Airport Transmitter Operator

TELEVISION

Pick-up Operator
Television Technician
Remote Control Operator

Service and Maintenance Technician

POLICE RADIO
Transmitter Operator
Receiver Serviceman

DO YOU want good pay, a job with a bright future, security? Would you like to have a profitable business of your own? If so, find out how you can realize your ambition in the fast-growing RADIO-TELEVISION industry. Even without Television, the industry is bigger than ever before. Just think, over 115 million home and auto Radios, 3000 Radio Broadcasting Stations, plus 25 million Television sets and about 200 Television Broadcasting Stations. Expanding use of Aviation and Police Radio, Micro-wave Relay, Two-way Radio for buses, taxis etc., are making opportunities for Servicing and Communications technicians and FCC Licensed Operators.

My Training Includes Television

You get practical experience by working on circuits common to both Radio and Television. My graduates are filling jobs, making good money in both Radio and Television. Many NRI trained men start their own Radio and Television servicing business with capital earned in spare time. Let me show you how you can be your own boss; earn \$10 to \$15 a week extra even while still learning. Now is the time to get ready for success in Radio-Television. Coupon below brings you Actual Lesson and 64-page book.

Find Out What Radio-Television Offers You

What will YOU be doing one year from today? Decide now that you are going to know more and earn more. ACT NOW. Send the coupon below NOW for my FREE DOUBLE OFFER. You get Actual Servicing Lesson. Also my 64-page Book, "How to Be a Success in Radio-Television." Read what my graduates are doing, earning; see equipment you practice with at home. Mail coupon now. Send in envelope or paste on postal. J. E. SMITH, President, Dept. 4MA, National Radio Institute, Washington 9, D. C. Our 40th Year.

Actual Lesson and 64-page Book BOTH FREE

The ABC's of SERVICING

MAIL THIS NOW!

MR. J. E. SMITH, President, Dept. 4MA
National Radio Institute, Washington 9, D. C.

Mail me Sample Lesson and 64-page Book FREE. (No salesman will call. Please write plainly.)

Name..... Age.....

Address.....

City..... Zone..... State.....

VETS write in date of discharge.....

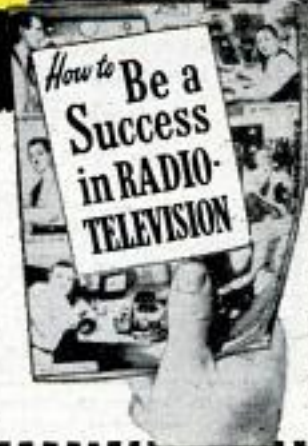

Control Operator, Station WEAN

"Received my License and worked on ships. Now with Station WEAN. NRI Course is as complete as any radio course can be."
—Raymond E. Arnold, Rumford, L. I.

Available to VETERANS under G. I. Bills

NEW!

FOR THE ONE
THAT DIDN'T
GET AWAY!



No. 221A

**Fastens Leaders • Skins Fish
Removes Hooks • Attaches Sinkers
Makes Flies • Repairs Reels, Engines, etc.**

As indispensable as a knife, the new PROTO Fisherman's Plier makes your outdoor sports far more fun. You'll love its extra-heavy chrome-plating for resisting rust; its hardened cutting edges that snip tough leaders with ease; its thin needle nose for repairing tackle and removing hooks; and the attractive fish-knurling on the handles for a sure grip, even with wet hands. A belt sheath of saddle leather keeps the tool instantly available, and a safety flap prevents loss. The Fisherman's Plier is made of special steel and has the same *Professional Quality* for which all PROTO tools are famous. Buy one now from your PROTO dealer. It's the ideal gift for a friend ... or yourself! Send 10¢ for 68-page catalog showing the entire PROTO line to

PLUMB TOOL COMPANY

2255B Santa Fe Ave., Los Angeles 54, Calif.

5497



Eastern Factory and Warehouse—Jamestown, N.Y.
Canadian Factory—London, Ont.

WHERE-TO-BUY-IT INDEX

Source of supply appears after items commercially available

AUTOMOTIVE

Portable lift for autos aids transmissions installation.....	87
(Walker Mfg. Co., of Wis., Racine, Wis.)	
Rubber barricade	98
Automobile turntable at drive-in bank turns them on a dime.....	116
(Macton Machinery Co., Stamford, Conn.)	
Telescoping trailer doubles its size.....	123
Fluorescent tube lights interior of German automobile.....	129
Double-action hydraulic brakes.....	139
(Minnesota Automotive, Inc., 1101 N. Front St., Mankato, Minn.)	
Truck-powered side-wheeler ferries supplies across river.....	145
Tractor rides pickaback on British road roller.....	149
Radioactive-tire test quickly measures wear.....	154
(E. F. Goodrich, Akron, Ohio)	

AVIATION

Airplane stays on ground to teach pilots how to fly.....	115
Electronic tail guns kill in fog and dark.....	116
(General Electric, Schenectady, N. Y.)	
First military transport designed for turboprops.....	120
Flying suit with air supply cools British jet pilots.....	124
Guided missiles ride Navy jet.....	116
Mechanics' tower reaches up 43 feet.....	125
Light bomber packs heavy wallop.....	128
(Glenn L. Martin Co., Baltimore 3, Md.)	
Rugged light plane takes to the air after 30-yard run.....	144
Navy antisub helicopter equipped with sonar.....	148

FARM

Truck-mounted arm loads hay bales.....	93
(Snow Crop, 5002 N. 30th St., Omaha, Neb.)	
Mobile centrifugal irrigation pump.....	99
(Construction Machinery Co., Waterloo, Iowa)	
Three-wheel tractor	145
(Farm-Etic, Mantua, Ohio)	
Meter tells planting date for desired harvest.....	149
(Floyd G. Slantz, Seabrook, N. J.)	

CONSTRUCTION AND INDUSTRY

Lumber lift truck ends hand stacking.....	87
(Townmotor Corp., Cleveland, Ohio)	
Last gasp of the steam locomotive here, but not in Britain... ..	92
Steel fence holds mountain in place during construction.....	129
Giant lathe of 180-inch diameter fills large room.....	134
Aluminum putty	134
(Woodhill Chemical Co., 1391 E. 33rd St., Cleveland 14, Ohio)	
Giant bow saws cut African tree.....	138
89-foot reactor tower erected with tall booms.....	144
Performed church steeple constructed on the ground.....	154
Veneer slats support roof.....	155
(Gamble Bros., Inc., 4601 Almond Ave., Louisville 9, Ky.)	

MISCELLANEOUS

Wheels and skis make many toys.....	87
Inflatable sneakers for mine fields distribute weight safely... ..	92
Drugged pack horses take plane ride.....	93
German soapbox racer.....	96
TV cameras watch prisoners.....	96
Versatile short-wave marine radar can do four different jobs... ..	96
Mock-up watches tell time, date and radioactivity level.... ..	98
Monorail passenger car takes place of elevator.....	99
Paste made from cactus roots cleans books and wallpaper.....	113
(Demco Library Supplies, 2120 Fordem Ave., Madison 1, Wis.)	
Plastic pennants aid sailors.....	113
(Hirschhoff Sailing Instrument Co., 808 Washington Ave., S. E., Minneapolis 14, Minn.)	
Brush chopper cuts big branches.....	115
(Asplundh Chipper Co., 505 York Rd., Jenkintown, Pa.)	
Semiautomatic shotgun with recoil spring in stock holds to target	117
(Winchester Arms Co., East Alton, Ill.)	
Young technicians build accurate models of television equipment	117
Portable icebox carries fish.....	123
Handmade electric "bicycle" aids recovery of polio victim.....	124
Battery-powered clock comes in kit.....	135
(Ralph Colton, 653 N. Fairfax Ave., Los Angeles, Calif.)	
Desk-size press prints 1000 tags on labels per hour.....	135
(American Tag Co., 151 Cortlandt St., Belleville 9, N. J.)	
Seagoing train rides ferry.....	135
Agile wheelchair steps up and over sidewalk curbing.....	139
Flashlight batteries power automatic spit.....	139
(Specialty Co., 6222 San Fernando Rd., Glendale 1, Calif.)	
Mechanical rain guard closes windows automatically.....	143
(Micro-Moisture Controls, Inc., Miami, Fla.)	
Wire-wrapping gun uses no solder.....	148
(Western Electric Co., 195 Broadway, New York 7)	
Fluorescent-lamp dimmer	148
(General Electric, Nela Park, Cleveland 12, Ohio)	
Revolving drum turns canned milk.....	149
Viewers wear polarized glasses to watch 3-D TV in Germany.....	155
Fishing rod rings bell when there's a bite.....	156
Wide ski with a seat permits you to slide sitting down.....	158
(Ski-Sit Co., North Adams, Mass.)	
Past-acting core drill cuts holes in concrete.....	158
Heated tea wagon.....	232

(Continued to page 14)

POPULAR MECHANICS

Copyrighted material

INVENTORS

Learn how to protect your invention. The U. S. Patent Laws provide that any new and useful art, machine, article of manufacture, or composition of matter, or any new and useful improvement thereof, may be patented if the act of invention is involved. Therefore, every inventor with a valuable invention should take advantage of the Patent Laws and proceed for patent protection in order to safeguard his rights.

A patent gives the inventor the exclusive right to prevent others from making, using, or selling the invention claimed in the patent for a period of seventeen years.

The Patent Laws were enacted for the benefit of the inventor to give him protection for the features of his invention which are patentable. These features must be properly and concisely set forth and claimed in a formal application for patent, in order to comply with the requirements of the Patent Laws. For that reason, unless the inventor is familiar with patent matters, he should engage a competent registered patent attorney or agent to represent him. We are registered to practice before the U. S. Patent Office and are prepared to serve you in the handling of your patent matters.

A specially prepared booklet entitled "Patent Guide for the Inventor", containing detailed information with respect to patent protection and procedure, together with a "Record of Invention" form will be promptly forwarded to you without obligation upon request.

CLARENCE A. O'BRIEN & HARVEY JACOBSON

Registered Patent Attorneys

41-L DISTRICT NATIONAL BUILDING

WASHINGTON 5, D. C.

(Continued from page 12)

PHOTOGRAPHY

Photoflash "pin wheel" for rapid-fire shots.....113
 Folding projector table includes outlets, viewer and switch...124
 German microfilm camera shoots both sides of card.....148
 Camera photographs check passers.....154
 Multiple spotlights for color photos.....232

SCIENCE

Portable X-ray unit needs no electricity.....113
 Desk-top "brain" costs \$48,000.....115
 Fast clinical thermometer takes temperature in seconds.....123
 Electrical current protects instruments.....138
 \$100,000 radio telescope aids astronomy students.....138
 Swedish torpedo boat built to resist effects of atom bomb...143
 Radiation slows fungus.....144
 Fuel costs slashed by atomic heater in plutonium-plant buildings145
 Switch aids "brain" memory.....240
 Guided-missile-flight calculator242
 Mechanical arm does heavy work in radioactive areas.....242

Radio-Television, Electronics

Television today (Built-in television units, Hoffman Radio Corp., 3761 S. Hill St., Los Angeles, Calif.; TV-antenna lead-in, Industrial Television, Inc., 359 Lexington Ave., Clifton, N. J.; UHF-TV antenna for indoor use, Channel Master Corp., Ellenville, N. Y.).....157
 DX television-station reception verified with screen photos...158
 Seven-band amateur transmitter kit (E. F. Johnson Company, Waseca, Minn.)160

Craftsman and Shop Notes Index

AUTOMOTIVE

Wrench stored on battery case.....172
 Tire chains quickly put on by using slotted ramp.....206
 Automotive transmissions filled with modified oil measure...216

FARM

Seeder mounted to front of tractor provides accurate control...211
 Liner for watering trough made from sheet aluminum.....217
 Low-bed cart saves labor when lifting milk cans.....220
 Self-filling hog waterer made from oil drum.....220

HOUSEHOLD HINTS

Solving Home Problems—
 To prevent injury of children's fingers.....170
 Metal salt-shaker caps coated to prevent clogging.....170
 Ordinary pliers provide a handy "wrench".....170
 Loose doorknobs tightened with tape.....170
 Small plastic dolls form novelty plant waterers.....170
 Planing the edge of a sticking door.....171
 Two strands of lightweight thread in sewing machine needle171
 Strip of elastic webbing on mop prevents loosening.....171
 Hanging a scrubbing brush from rim of pail.....171
 Hat holders bent from wire.....172
 Tape holds broken parts together when mending chinaware...180
 Bracket on electric phonograph helps child place arm.....182

HOUSE AND HOME

There's a trick to fishing wires through a wall.....173
 Wood screws hold in plaster if lead wool is used.....180
 Economical snow fence provided by discarded lettuce crates...181
 Here's a closet that "grows" with your children.....181
 Paper-tape roll hung on belt frees hands for applying it.....184
 Paint provides vapor barrier beneath unheated attic.....200
 Shim silences rattling latch.....206

(Continued to page 16)

KING KUTTER Saladmaker



Chops
Peels
Waffles
Slices
Crumbs

Grates
Strings
Shreds

**DOES MORE!
COSTS LESS!**

ATTENTION!! We are setting up sub-distributors and dealers. If interested in a distributorship, write for distributor discounts.

There is a tremendous market for a high-quality, medium-priced food-cutting machine. Hundreds of thousands of dollars are being spent each year advertising this new industry. Over a million food-cutters have been sold since Saladmaster introduced their famous machine seven years ago. The market has not been scratched. Everyone is a potential customer for a quality food-cutting machine.

Order your sample and write for distributor discounts today!

VERY NEWEST IN FOOD CUTTERS No Clamps — No Bolts

Complete with Stand and 3 Cutters

Absolutely amazing! Men, women, and children everywhere are proclaiming the marvels of KING KUTTER Saladmaker. Truly a wonder machine. Ideal for the business man whose hobby is cooking. Perfect for the hostess who delights in serving delicate, beautifully cut salads. Cuts paper thin potato chips . . . lacey cole slaw . . . shoestrings and French fries . . . shreds coconut and cheese . . . chops celery . . . apples and nutmeats. Prepares baby foods and vegetable juices. Looks like a jewel and is EASY TO CLEAN! Safe enough for a child to use. Beautifully mirror polished with 3 CHROME PLATED SOLID STEEL BLADES. PLACE KING KUTTER ON YOUR CHRISTMAS OR BUSINESS GIFT LIST — NOW! Postage paid if check with order.

List Price...\$19.95
 Dealer Discount 40%... 7.98
 Sample Price \$11.97
 No C.O.D. Orders Please

Buy Direct & Save! Guaranteed!
TEXAS DISCOUNT HOUSE
 P. O. Box 10144-PM — Dallas, Texas

Send me my sample King Kutter
 Send me Distributor Discounts

NAME _____

ADDRESS _____

CITY _____ STATE _____

**Train QUICK
in Big Coyne
Shops**

GREAT OPPORTUNITY FIELDS!



Instructor helping students check the wiring and trace the circuits of television receivers.

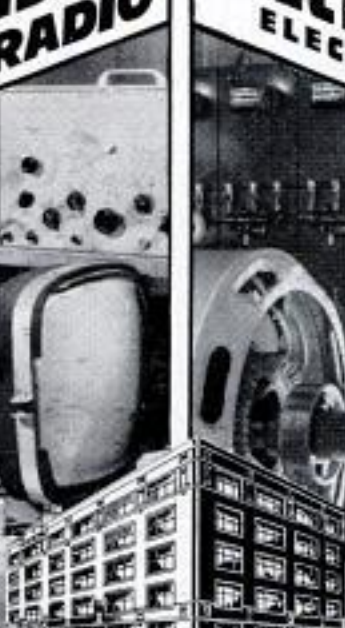

This big fire-proof building is occupied entirely by Coyne.



Instructor explaining operation and testing of a large Motor Generator.

TRAINED YOUNG AND OLDER MEN— URGENTLY NEEDED IN VITAL FIELDS!

ELECTRICITY—RADIO—TELEVISION—ELECTRONICS—VITAL in defense program. Trained men whether 16 or up to 50 needed. TRAIN QUICKLY for better rating if drafted—Vital job in industry if not.

LARGEST, OLDEST, BEST EQUIPPED SCHOOL OF ITS KIND IN THE U.S.

TELEVISION-RADIO ELECTRICITY

Here at COYNE you're retrained for Television, Testing, Trouble-Shooting on Radio, Public Address, F. M. Sound Units, etc. Many Coyne trained men in good jobs or own well paying Television-Radio businesses of their own.

Big future in Power Plant Work, Motors, Industrial Electronics, Armature Winding, Home and Factory Wiring, Appliances, Refrigeration, Maintenance, Illumination, etc. Lifetime job service to Coyne graduates.

WE TRAIN YOU IN CHICAGO

Our famous Practical-Technical method gives you practical experience on a massive outlay of equipment. Actual shop work plus necessary technical training. You are trained right here in the great Coyne shops. Send for BIG FREE BOOK.

**APPROVED
FOR
VETERANS**

START NOW—PAY LATER

Enroll now, pay most of tuition after graduation. Special plan for men of draft age. We'll help you get part-time work, if you need it to help pay living costs while at Coyne.

B. W. COOKE, President

COYNE

A TECHNICAL TRADE INSTITUTE
CHARTERED NOT FOR PROFIT
Established 1899
500 S. Paulina Dept. 84-72H
Chicago 12, Illinois

ELECTRICITY ★ TELEVISION ★ RADIO ★ REFRIGERATION ★ ELECTRONICS



Mail Coupon for Big FREE Book!

Whether you prefer Television-Radio or Electricity, train on actual equipment at Coyne. We will send you a Big, fully Illustrated Book. Indicate below which course interests you most. No salesman will call. Mail coupon TODAY.

B. W. Cooke, President
COYNE SCHOOL, 500 S. Paulina St.
Dept. 84-72H, Chicago 12, Ill.

Send me your Big Free book. I am interested in field checked below. This does not obligate me.

TELEVISION-RADIO ELECTRICITY

NAME.....

ADDRESS.....

CITY.....STATE.....



(Continued from page 14)

MISCELLANEOUS

Dollhouse turntable.....179
 Counter opening for grocery bags permits quick filling.....180
 Detecting leak in sewer pipe.....192
 Auxiliary stop on typewriter aids in aligning paper.....197
 Open padlock for boat chain held by faucet washer.....197
 Canvas tent roof kept taut by compression springs.....200
 Rubber cement painted on easel prevents slipping.....200
 Detergent keeps glass clear.....201
 Improvised dairy thermometer uses empty-bottle float.....211
 Bearings used as bushings.....211

PHOTOGRAPHY

Cutter for photoprint paper made from plywood sheet.....172
 Camera bellows kept soft and pliable by wiping with oil.....173
 Chemical oxidation is retarded by addition of glass marbles.....180
 Soft print made from negative which has too much contrast.....184
 Nails used on print rollers replaced with wood screws.....192
 Photo-negative brush kept soft by natural skin oils.....192
 Mirror helps lecturer view slides projected behind him.....197
 How to check flash-gun synchronization.....201

TOOLS

Barrel-bung wrench improvised from bolt and nuts.....182
 Blocks under stored lawn mower prevent damage to tires.....184
 Length of flooring provides gauge when sharpening saw.....192
 Circular gaskets cut quickly with razor blade in compass.....201
 Jigsaw used to cut asphalt siding.....206
 Belted grinder attached to post takes little shop space.....210
 Calking-gun nozzle cleaned by soaking in thinner.....210
 Notches filed on faceplates assure centering of work.....210
 Taps and button dies held in knurled sleeve on hollow arbor.....211
 Modified implement wheels provide sturdy sawbuck.....216
 Edges of masking tape sealed with stitching tool.....217
 Improved V-block has five working surfaces.....217
 Ax held by C-clamp in vise for sharpening with file.....220

Shopping for Tools—

Chop Saw (Edker Pope Co., 1527 E. 7th St., Los Angeles, 21, Calif.).....218
 Combination vise and drill (American Kayjac Co., Box 666, Saginaw, Mich.).....218
 Disposable tape (Minnesota Mining & Mfg. Co., 900 Farquhar St., St. Paul, Minn.).....218
 Portable workshop (Porter-Cable Machine Co., 31 Exchange St., Syracuse 3, N. Y.).....218
 Combination home-shop power tool (Multicraft Co., P.O. Box 6, Mt. San Antonio College Sta., Walnut, Calif.).....219
 Folding saw (Sweedco, P.O. Box 465, Greenwich, Conn.).....219
 Nylon hammer cap (Lempco Automotive, Inc., Cleveland 27, Ohio).....219
 Sheet-metal saw.....219
 Spindle shaper (Gilliom Power Tools, St. Louis 21, Mo.).....219

WORKSHOP HINTS

Access to trap door provided by vertical folding ladder.....172
 Wire-solder loop holds bottle and prevents spilling liquid.....172
 Holder for hot soldering iron.....181
 Finger of leather glove provides nail-set pocket.....184
 Twine is cut in equal lengths when wrapped around ax.....184
 Stunts with springs.....185
 Empty window-cleaner bottle used to spray fine oil.....197
 Molding contour quickly copied.....197
 Window shade protects clothing.....197
 Crayon lines aid soldering.....210
 Spring on large vise handle prevents pinched fingers.....211
 How to mount heavy shelving above workshop floor.....216
 Soapstone on straightedge improves acetylene cuts.....216
 Graphite aids in removal of soldering-iron tip.....220
 Simple filter for liquids utilizes two bottles.....220

IMPORTANT NOTICE—It is the intention of this magazine to provide its readers with information regarding the latest developments in the mechanical arts. We take no responsibility as to whether the disclosures contained in our articles are covered by patents and advise readers to investigate this subject before making, using, or selling any of the products, machines, or processes described in order to avoid possible liability for patent infringements.

INVENTORS

If you believe that you have an invention, you should find out how to protect it. The first step is to have a search made of the prior pertinent U. S. patents. If a report on this search indicates that the invention appears patentable you can apply for a patent, and the specifications and claims should be prepared.

The firm of McMorrow, Berman & Davidson, with offices in Washington, D. C., is qualified to take the necessary steps for you. We can make a preliminary search on your invention, advise you whether we think it can be patented, and prepare your application for patent.

Unless you are fully familiar with the U. S. Patent Laws, we recommend that you engage the services of a Registered Patent Attorney to protect your interests. The patent laws are *your* laws. A patent gives you the right to prevent others from making, using or selling the invention claimed in your patent for a period of 17 years.

Use these patent laws for your protection. Investigate whether your invention can be patented. If you have what you believe to be an invention, we suggest that you have this firm make a search for you.

Send for a copy of our Patent Booklet entitled "How To Protect Your Invention," containing information about patent protection and patent procedure. Along with this we will also send you an "Invention Record" form, for your use in writing down and sketching details of your invention. We will mail them promptly. No obligation. They are yours for the asking.

McMORROW, BERMAN & DAVIDSON

Registered Patent Attorneys

PATENTS • COPYRIGHTS • PATENTS

1358 VICTOR BUILDING, WASHINGTON 1, D. C.

WHAT SECRET POWER DID THIS MAN POSSESS?



BENJAMIN FRANKLIN
(A Rosicrucian)

WHY was this man great? How does anyone—man or woman—achieve greatness? Is it not by mastery of the powers within ourselves? Know the mysterious world within you! Attune yourself to the wisdom of the ages! Grasp the inner power of your mind! Learn the secrets of a full and peaceful life!

Benjamin Franklin—like many other learned and great men and women—was a Rosicrucian. The Rosicrucians (NOT a religious organization) first came to America in 1694. Today, headquarters of the Rosicrucians send over seven million pieces of mail annually to all parts of the world. Write for YOUR FREE COPY of "The Mastery of Life"—TODAY. No obligation. No salesmen. A non-profit organization. Address: Scribe I.T.Y.

THIS BOOK FREE!



The ROSICRUCIANS

SAN JOSE • (AMORC) • CALIFORNIA

—SEND THIS COUPON—

Scribe I.T.Y.
The ROSICRUCIANS (AMORC)
San Jose, California
Please send me the free book, *The Mastery of Life*, which explains how I may learn to use my faculties and powers of mind.

Name _____

Address _____

City _____

(Continued from page 8)

a principle or "law" laid down during the early introduction of sound recordings to the American public. This law or custom remained unchallenged until in recent years, upon commercial acceptance and public demand it would likewise be contrary to go back to the long-heralded and untouchable procedure employed during the production of an old-fashioned muffled production.

The point or lesson I am bringing out is: If you have a conviction contrary to public or industrial acceptance, *see it through* and you may bring to light a "truth" long hidden due to lack of creative thought or fear of ridicule.

I recall the long, hard fight I had attempting to employ present-day recording techniques some years ago when they would "cork" me up during a wax session. In fear of ridicule and engineering disfavor I finally relented. I let them destroy creative thought to postpone the "live" recording technique for introduction in later years, rather than sticking to my guns. *Don't let it happen to you!*

Herbert Horn,
Chicago

To the Editor:

Referring to the King Midget you write about (PM, July 1954) I have one and it is a dream come true. It has never refused a hill nor even hesitated, and we have some hills in Kansas City. I can go where I want when I want. Carry an extra gallon can of gasoline and can circumnavigate the globe (which statement is only slightly exaggerated). Takes up so little space on the highway. No sir, I would not trade.

Sure wish there were more of them in use for everybody's sake. Thank you for writing about the "imps."

Marie Higinbotham,
City Hall,
Kansas City, Mo.

Editor:

I would like to congratulate you on your article, "The Car That Comes in a Crate," in the July issue. I have one of these fine little King Midget cars, a 1951 model that has been run until the tires are perfectly smooth, which means something like 100,000 miles as near as we can determine.

My car still uses no oil between changes and the upkeep can more easily be compared to a bicycle, than any other automobile. If more people realized the utility and economy of the King Midget most families would want one.

Rod Jonas,
Brunswick, Ga.

Now... In Your Own Home **LEARN** **TELEVISION** **RADIO-ELECTRONICS** THE AMAZINGLY EFFECTIVE **D.T.I. WAY**

NO PREVIOUS TECHNICAL EXPERIENCE NEEDED

NOW... get

EVERYTHING YOU NEED

for real Laboratory-type training
AT HOME

—with the aid of **BOTH HOME LAB EQUIPMENT and HOME MOVIES**

What will mailing the coupon below do for YOU? Just this! You'll find out about one of today's most remarkable... practical ways to prepare to get into America's amazing billion dollar opportunity field of **TELEVISION-RADIO-ELECTRONICS**. You'll see how to get into highly interesting work that pays well... that offers one of America's most promising futures... that enables you to start your own business almost "on a shoe string," if you prefer this to a job opportunity.

And above all, you'll get some **GOOD NEWS** especially welcomed by men anxious to earn **REAL MONEY** in this growing field. For you'll see that **NOW** you can get the kind of practical, laboratory-type training so desirable for making real progress in **Television-Radio-Electronics AND WITHOUT LEAVING HOME**.

You'll see that DeVry Technical Institute sends everything needed to set up your own **HOME LABORATORY**. You get and keep the same type of basic electronic equipment used in our modern Chicago Training Laboratories. You get home training that includes the knowledge and experience gained from training thousands of students first hand in Chicago. And to top it all, you use DTI's amazingly effective and exclusive home training aid—**INSTRUCTIVE MOVIES**. But why not get the complete story? Mail coupon today for complete facts.

1. Build over 300 fascinating experiments from 16 **BIG SHIPMENTS** of Electronic-Radio parts which you **KEEP**.
2. Build valuable commercial-type test equipment—as shown to the left—which you **KEEP**. This includes a quality **5 INCH** oscilloscope and jewel bearing **Multi-Meter**—both highly useful for Television work.
3. Build and keep a big **21 INCH** TV Set. (D.T.I. offers another home training in Television-Radio-Electronics, but without the TV set.)

4. Use a 16 mm. movie projector and new series of highly instructive movies—a wonderful aid to help you grasp important fundamentals faster... easier... better.
5. Enjoy well-illustrated, easy-to-read lessons with handy **FOLD-OUT** diagrams.
6. Get an honest-to-goodness **EMPLOYMENT SERVICE** to help you get a good job after graduation—or assistance in starting your **OWN SALES AND SERVICE BUSINESS**. Mail coupon today for the complete details.

5 INCH "SCOPE"

Oscilloscope

Multi-Meter

21 INCH

Build and keep this **BIG DTI** Engineered TV set—easily converted to U.H.F. (DTI offers another home training, but without the TV set.)

Above: Work over 300 interesting experiments with this equipment

Get this information-packed publication **FREE!**

89 WAYS TO EARN MONEY IN TELEVISION RADIO ELECTRONICS

MODERN LABORATORIES
If you prefer, get all your preparation in our new Chicago Training Laboratories—one of the finest of its kind. Ample instructors, modern equipment. Write for details!

MILITARY SERVICE!
If you're subject to military service, the information we have for you should prove very helpful. Mail coupon today.

"ONE OF AMERICA'S FOREMOST TRAINING CENTERS"

Home Movies

DeVry Technical Institute

4141 BELMONT AVE., CHICAGO 41, ILL. Dept. PM-11-K

I would like your valuable information-packed publication showing how I can get started toward a good job or my own business in Television-Radio-Electronics.

Name _____ Age _____
Street _____ Apt. _____
City _____ Zone _____ State _____

D.T.I.'s Training is available in Canada

DeVry Technical Institute
AFFILIATED WITH
DeForest's Training, Inc.
CHICAGO 41, ILLINOIS

TIME OUT FOR SUCCESS!

He Can't Take the Time to Go to School . . . so He Is Having School Come to Him

There are millions of people, even in America, who say: "There are no opportunities." But this C.T.I. Man (and thousands more like him) says: "Opportunity is here NOW." He is taking time out to get ready for SUCCESS. Yet, in a sense, he isn't out any time at all. His idea is to USE the time other men LOSE. Yes, he USES his spare time, his odd moments, off-days or evenings, to get the Special Knowledge and Skill that a man must have to Get Ahead. For you, too, Opportunity is here NOW. You can USE your spare time to get the Know-How for a Better Job and Bigger Pay. Or you can use this Know-How to build a Business of



SUCCESS COUPON!

**Commercial Trades Institute, Dept. X2-11
1400 Greenleaf Ave., Chicago 26, Ill.**

Here is my Ballot for SUCCESS. Send me your FREE Book with information about Sparetime Home-Training in the field I have checked below.

- | | |
|---|---|
| <input type="checkbox"/> Automotive Mechanics | <input type="checkbox"/> High School Courses |
| <input type="checkbox"/> Auto Body Rebuilding and Refinishing | <input type="checkbox"/> Refrigeration and Air Conditioning |
| <input type="checkbox"/> Building Construction | <input type="checkbox"/> Television & Electronics |
| <input type="checkbox"/> Diesel Mechanics | <input type="checkbox"/> Upholstering |
| <input type="checkbox"/> Drafting (Mechanical) | |

Name _____ Age _____
Address _____
City _____ State _____
County _____

Your Own. Thousands of America's Leaders started just this way. C.T.I. Trained Men are doing it all the time. No need to give up your present job. No need to risk the welfare of family and loved ones. No need to take the time and money to go to School. Instead, let the School, one of America's finest, come right to you. Here is a Coupon. You can shrug it off—or you can use it as a Ballot to cast on the side of SUCCESS. Read it. Then—ACT! COMMERCIAL TRADES INSTITUTE, 1400 Greenleaf Ave., Chicago 26, Ill.

"My selling time actually shows me a profit of

\$20 TO \$25 AN HOUR

with Science's New Midget Miracle, the
PRESTO Fire Extinguisher

says M. R. Stanley of Montana. Many others "cleaning up"—so can YOU!

THIS is an amazing new kind of fire extinguisher. Tiny "Presto" (about the size of a flashlight) does job of bulky extinguishers that cost 4 times as much, and are 8 times as heavy. Ends fires fast as 2 seconds. Fits in palm of hand. Never corrodes. **Guaranteed for 20 years!** Sells for only \$3.98! Almost 2 million already sold!



Science's New Midget Miracle—**"PRESTO"**

Show it to civil defense workers, owners of homes, cars, boats, farms, etc., and to stores for re-sale. Make good income. C. S. Mellous made \$175 in just first 5 days. C. Kama, \$1,000 a month. Write for FREE Sales Kit. No obligation.

(If you want a regular Presto to use as a demonstrator, send \$2.50. Money back if you wish.)

**MERLITE INDUSTRIES, Dept. 511
114 East 32nd St., New York 16, N. Y.**

(In Canada: Mopa Co., Ltd., 371 Dowd St., Montreal 1, P. Q.)



M. R. STANLEY

Build your own JET ENGINE!



Order these plans today
1. JET PROPELLED BICYCLE. Assemble your own. Photo and instructions, \$1.00.
2. HOW TO MAKE EXPERIMENTAL JET ENGINES. Seven sheets drawings with information and instructions \$2.95.
3. BOTH OF ABOVE in one order \$3.75. SEND NO MONEY. Order both at once \$3.75 C.O.D. in USA plus P.O.D. postage. Send check or money order and we pay postage. Get other information too. Rush Order.

J. HOUSTON MAUPIN, Dept. 55, Tipp City, Ohio

TASOPE PHOTO-ENGRAVING PLANTS



Material Cost of This Cut 3/4¢
Selling Price \$1.00 And Up

Establish your own profitable PHOTO-ENGRAVING business. Make cuts for newspapers, printers, and advertisers. Make etched name plates, plaques etc. Instructions furnished, no experience necessary. Sold direct from factory since 1931. First five hundred cuts sold locally or by mail will pay for plant and pay you well for your time. Write for FREE catalog.

TASOPE, DEPT. PM-11, AURORA, MO.

you can be

TALLER

too, in

FREE BOOKLET write

THE ORIGINAL AND GENUINE
ELEVATORS
RIGHT-INCREASING SHOES
"YOUR PERSONAL PEDESTAL"
"MADE IN U.S.A." (U.S. PAT. 2,500,000)

"ELEVATORS" do so many wonderful things for you. You slip on a pair and grow almost 2 inches taller at once. It's amazing . . . because they look and feel just like any other fine quality shoes you've ever worn. 15 styles for street, sport, dress



STONE-TARLOW CO., INC., DEPT. P.M., BROCKTON 68, MASS.

POPULAR MECHANICS

Copyrighted material



"We have been using your book on Auto Repair for the past year and feel like it is a third man around the shop."—F. M. Scott, Stevedore, Wash.



"Fixed motor in 30 minutes another mechanic had worked on half a day."—C. Auberry, Mar/freesboro, Tenn.



"Instructions so clear, have no trouble learning anything about any car. Now working as mechanic in big plant."—S. Ordovez, San Francisco, Calif.



"So easy to understand—have done jobs with Manual I would not have attempted without it."—C. L. Venerstrom, Hazel Park, Mich.



"I have found my MOTOR Manual a wonderful help. It has put me in a position to do every job."—S. L. Sharpless, Los Angeles, Cal.

THOUSANDS OF MEN ARE RAVING ABOUT THIS GIANT GUIDE!

Now YOU Can Be a "Cracker-jack" at Auto Repairs!

Thousands of Easy-to-Follow Step-by-Step Pictures

Easy-Step-by-Step Instructions Show How to do ANY Job on ANY Car—from 1940 through 1954!

BRAND-NEW REVISED EDITION!

THOUSANDS of men are raving about MOTOR'S BIG NEW ILLUSTRATED AUTO REPAIR MANUAL! It enables them to do any job FASTER and better; do MORE jobs; make MORE money!

Whether it's on a 14-year-old "jalopy" or a brand-new 1954 beauty, YOU, too, can "breeze through" any repair job quickly, easily, right! Just look up the make, model, and job in the quick index—and go to it!

Everything You Need to Know to Repair Any Car!

This BIG NEW REVISED edition has MORE REPAIR INFORMATION THAN EVER—right up to the minute! ONE THOUSAND big pages, 2950 "This-Is-How" pictures—clear drawings, diagrams, cut-away photos that lead you every step of the way, 292 "Quick-Check" charts containing 22,598 essential repair specifications. Over 225,000 service and repair facts. Clear, simple directions. You can't go wrong!

Any man—even a green beginner—can do a good job. If you're a top-notch mechanic, you'll find yourself tackling jobs now that you wouldn't touch before!

Earn More Money! Win Greater Prestige!

The editors of MOTOR'S Manual have put together the "Know-How" from over 140 Official Shop Manuals; "boiled it down" into one handy book!

Includes ALL Automatic Transmissions. Covers the newest Carburetors, Engines (including new Buick and Ford V-8s) . . . Chokes . . . Fuel Pumps . . . Oil Filters . . . Starting Motors . . . Generators . . . Distributors . . . Clutches . . . Universals . . . Axles . . . Brakes . . . Power Steering . . . Power Brakes . . . Shock Absorbers, etc. Valuable help in Body Service, Factory Specifications and Adjustment Tables, Tune-up Charts, Tables of Measurements and Clearances, Overhauling and Replacement Facts—AND MUCH, MUCH MORE.

Used by Armed Forces, hundreds of thousands of auto service men! YOU'll want it, too, once you see its 1000 giant pages—almost a foot high!—its 2950 close-up pictures! Try it on the following UNCONDITIONAL GUARANTEE!

Try Book for a Week FREE

Send No Money. Pay nothing to postman. Test book in your own garage or shop. It's GUARANTEED to pay for itself in 7 days. If it doesn't, just return the book, and owe nothing. You don't risk a penny. Rush coupon for your free-trial copy of this great money-saving Manual, MOTOR Book Dept., Desk 11, 250 West 55th St., New York 19, N. Y.

SEND NO MONEY! TRY BOOK FREE! FOR A WEEK!

MOTOR'S AUTO REPAIR MANUAL

COVERS 685 MODELS—ALL THESE MAKES:

Buick
Cadillac
Chevrolet
Chrysler
Crosley
De Soto
Dodge
Frazer
Henry J
Hudson
Kaiser
Lincoln
Mercury
Nash
Oldsmobile
Packard
Plymouth
Pontiac
Studebaker
Willlys

Includes ALL 1954 cars
• New Engines
• Power Steering
• Power Brakes
• Automatic Transmissions
• Much, Much More!

USED BY U.S. ARMED FORCES

Same FREE 7-Day Offer on MOTOR'S TRUCK and TRACTOR REPAIR MANUAL

Covers EVERY job on EVERY popular make truck or farm tractor made from 1946 thru 1954, including Lubrication Systems, Starters, Generators, Clutches, GM and Cummins Diesels! Engines, Fuel Systems, Transmissions, Axles, Brakes, Steering, etc. For FREE TRIAL, check proper box in coupon.

MAIL COUPON NOW FOR 7-DAY FREE TRIAL

MOTOR Book Dept., Desk 11, 250 West 55th Street, New York 19, N. Y.

Rush to me at once: (Check box opposite book you want)
 MOTOR'S New AUTO REPAIR MANUAL. If O.K. I will remit \$2 in 7 days, then \$2 monthly for 2 months, and a final payment of 35c (plus 35c delivery charge) a month later. Otherwise I will return book postpaid in 7 days. (Foreign price, remit \$9 cash with order.)
 MOTOR'S New TRUCK and TRACTOR REPAIR MANUAL. (Described at left.) If O.K. I will remit \$2 in 7 days, and \$2 monthly for 3 months, plus 35c delivery charge with final payment. Otherwise I will return book promptly. (Foreign price, remit \$10 cash with order.)

Print Name Age

Print Address

City & Zone No. State

SAVE 35c delivery charges by enclosing WITH COUPON check or money order for full payment of \$6.35 for Auto Repair Manual (or \$8.60 for Truck and Tractor Manual). Same 7-day return-for-refund privilege applies.

Inventors

The following are the usual preliminary steps to take toward patent protection.

You are advised first, to make a disclosure of your invention. Date, sign and have this document witnessed by two or more persons who are capable of understanding your invention. The "Evidence of Invention" form mentioned below, we offer as a convenience in making your disclosure and in starting action leading toward patent protection.

Mail your disclosure to the registered patent attorney or agent whom you select to assist you, together with a letter authorizing him to conduct a

preliminary search among previously granted U. S. patents for similar types of invention. He then prepares for you a report on the probable patentability of your invention and, if the report is favorable, recommends the further course you should take.

This firm is registered to practice before the U. S. Patent Office and is available to assist you in the preparation and prosecution of patent applications. We shall be glad to send you without obligation, the "Evidence of Invention" disclosure form mentioned above and our instructive booklet, "Patent Protection for Inventors".

VICTOR J. EVANS & Co. *Merlin M. Evans*
REGISTERED PATENT ATTORNEY
930-M MERLIN BUILDING, WASHINGTON 6, D. C.

... TURN CONCRETE INTO GOLD!



MAKE UP TO \$75 A DAY IN YOUR OWN BUSINESS

If you want to have your own business — to start a business on your own — here's your big opportunity! New high speed, low cost General block machine produces up to 1,000 concrete blocks a day. Sell all you make to builders, supply houses, and others for homes, factories, buildings, garages. Cash in on the building boom! You can make profits of 100% to 150% — up to \$75. a day! General block machine equipped with 1/2 h.p. electric motor — or can be supplied with gasoline engine — works anywhere, in little space, indoors or out. Operates from ordinary house light socket. Simple, foolproof 3 step operation — so easy a child can do it. Makes superior 3 core blocks any size from 4" to 12". Also makes chimney, sink, corner and other types. Blocks meet any building code anywhere in the country. Materials — sand, water, cement, available anywhere. Simple illustrated operating instructions and mixing formulae for cement and cinder blocks supplied with each machine. Write for FREE folder with full information.

MOTOR DRIVEN

R. L. T. of New York City reports: "MY GENERAL BLOCK MACHINE PAID FOR ITSELF IN FIRST 2 WEEKS!" Hundreds now in use the world over! Write for FREE details today!

EXTRA Amazing illustrated book gives floor plans for 6 sensational concrete block bungalows. Tells how to lay blocks, lay out building lines, mix concrete, build steps, porch and concrete floors all at great savings. Written by experts. Can save many times the cost of the machine! Get it now! No strings attached. Send \$1.

BOOK SENT FREE IF YOU BUY MACHINE. \$1 REFUNDED IF YOU BUY LATER.

GENERAL ENGINES CO.
DEPT. M-114, 307 HUNTER STREET, GLOUCESTER, N. J.

HOW TO BUILD YOUR OWN CONCRETE BLOCK HOME
Only \$1 Prepaid

SHORTHAND in 6 WEEKS

Famous SPEEDWRITING shorthand. 120 words per minute. No symbols; no machines; uses ABC's. Easiest to learn, write and transcribe. Lowest cost. 250,000 taught by mail. For business and Civil Service. Typing available. 32nd year. Write for FREE booklet to: SCHOOL OF

Speedwriting
Dept. 1511-4, 55 W. 42 St., New York 36

LEARN WATCH REPAIRING

AT HOME Modern, original instruction. Prepare for a position or start in business after completing our course. Write Today!

WISCONSIN SCHOOL OF WATCH REPAIRING
2908 N. 44th St. Dept. M Milwaukee 10, Wis.

WOODWORKING

Low Cost Home Craft Courses Now Available

LEARN The Easy Way!

Make money. Become a skilled woodworker. Interstate's new woodworking course tells and shows how to turn out hundreds of professionally constructed and finished wood projects with hand and power tools. Twenty-two profusely illustrated manuals. Over 1,000 pages. Over 75 projects. Written by expert instructors. The only complete course available today! Get full information without obligation...today.

Write for FREE Booklet

HOW TO BE A SKILLED WOOD WORKER

INTERSTATE TRAINING SERVICE
SCHOOL OF WOODWORKING
DEPT. F-3-M, PORTLAND 13, OREGON

POPULAR MECHANICS

Copyrighted material

GET INTO RADIO-TELEVISION

ELECTRONICS by Shop-Method Home Training

GOOD JOBS AWAIT THE TRAINED RADIO-TV TECHNICIAN

There is a place for you in the great Radio-Television-Electronics industry when you are trained as National Schools will train you at home!

Trained technicians are in growing demand at good pay—in manufacturing, broadcasting, television, communications, radar, research laboratories, home Radio-TV service, and other branches of the field. National Schools Master Shop-Method Home Training, with newly added lessons and equipment, trains you in your spare time, right in your own home, for these fascinating opportunities. OUR METHOD IS PROVED BY THE SUCCESS OF NATIONAL SCHOOLS TRAINED MEN, ALL OVER THE WORLD, SINCE 1905.

EARN WHILE YOU LEARN

Many National students pay for all or part of their training with spare time earnings. We'll show you how you can do the same! Early in your training, you receive "Spare-time Work" Lessons which will enable you to earn extra money servicing neighbors' and friends' Radio and Television receivers, appliances, etc.



Signal Generator

Audio Oscillator

T.R.F. Receiver

National Schools Training is All-Embracing

National Schools prepares you for your choice of many job opportunities. Thousands of home, portable, and auto radios are being sold daily—more than ever before. Television is sweeping the country, too. Co-axial cables are now bringing Television to more cities, towns, and farms every day! National Schools' complete training program qualifies you in all fields. Read this partial list of opportunities for trained technicians:

- Business of Your Own • Broadcasting
- Radio Manufacturing, Sales, Service • Telecasting
- Television Manufacturing, Sales, Service
- Laboratories: Installation, Maintenance of Electronic Equipment
- Electrolysis, Call Systems
- Garages: Auto Radio Sales, Service
- Sound Systems and Telephone Companies, Engineering Firms
- Theatre Sound Systems, Police Radio
- And scores of other good jobs in many related fields.

TELEVISION TRAINING

You get a complete series of up-to-the-minute lessons covering all phases of repairing, servicing and construction. The same lesson texts used by resident students in our modern and complete Television broadcast studios, laboratories and classrooms!



MASTER ALL PHASES!

Get Master Shop-Method Home Training from an Established Practical Resident School with its own Training Shops, Laboratories, Studios — almost 50 Years of Successful Experience in Training Ambitious Men.

We Bring National Schools To You!



You also receive this Multitester

Superheterodyne Receiver

LEARN BY DOING

You receive and keep all the modern equipment shown above, including tubes and valuable, professional quality Multitester. No extra charges.

FREE! RADIO-TV BOOK AND SAMPLE LESSON!

Send today for National Schools' new, illustrated Book of Opportunity in Radio-Television-Electronics, and an actual Sample Lesson. No cost—no obligation. Use the coupon now—we'll answer by return airmail.

APPROVED FOR VETERANS AND NON-VETERANS
Check coupon below

Both Resident and Home Study Courses Offered!

NATIONAL SCHOOLS

Dept. RB-114
4000 S. Figueroa St., Los Angeles 37, Calif. or 323 West Polk St., Chicago 7, Ill.

GET FACTS FASTEST! MAIL TO OFFICE NEAREST YOU!

(mail in envelope or paste on postal card)
NATIONAL SCHOOLS, Dept. RB-114

4000 S. Figueroa Street Los Angeles 37, Calif. or 323 West Polk Street Chicago 7, Ill.

Send FREE Radio-TV Electronics book and FREE sample lesson. No obligation, no salesman will call.

NAME _____ BIRTHDAY _____ 19 _____

ADDRESS _____

CITY _____ ZONE _____ STATE _____

Check here if interested in Resident School Training at Los Angeles. VETERANS: Give Date of Discharge _____



AMAZING XMAS BARGAINS FOR SAVE!



9X AREA
MAGNIFICATION!
SAVE \$7.00

German **POWERHOUSE** Binoculars
give you 20 MILE range!

SPECIAL CUT PRICE
INCLUDING
Genuine LEATHER Case **4.98**
WITH CASE

A lifetime bargain for **POPULAR MECHANICS** readers! **THORESEN**—world's greatest importer of German binoculars—now brings you the renowned **POWERHOUSE** Binoculars at an unbelievably low price! Not 4 . . . 5 . . . 7—but **9X AREA MAGNIFICATION!** It's the pride & joy of every red-blooded hunter, fisherman and sports enthusiast! **Thoresen**—and **ONLY Thoresen**—brings it direct from Western Germany to you for a mere **4.98**. Latest streamlined design, as illustrated in greatly reduced size. A **HINGE** model—you can adjust to the **EXACT** space between your eyes. Aluminum Centerpost focusing gives you clear, sharp viewing—**SEE UP TO 20 MILES AWAY!** **POWERHOUSE** has great structural strength—without tiring weight. (Only 9½ oz. in all.) Modern grained design gives you easy, firm grip . . . high luminosity provides viewing even in moonlight!

Costly, Precision-Ground Lenses for Super Viewing

The **POWERHOUSE LENSES** are the crowning achievement of this 99-year-old German firm—each and every lens is ground & polished to a high tolerance, then carefully checked for accuracy! **NOT** moulded plastic type stamped out by the million. No excessive distortion or "ghosts" found in cheap glasses. Were you to spend \$25, we couldn't give you better lenses! Send coupon **TODAY** and get your **POWERHOUSE** (plus your **FREE Specto-Scopes**) at this low introductory price of **4.98**, tax paid, including handsome **LEATHER** case! Sorry, but limited import supply forces us to restrict orders to **ONE** binocular per reader.

No. 6 . . . **POWERHOUSE BINOCULARS & LEATHER CASE 4.98** tax paid

THORESEN'S, Dept. 6-M, 352 Fourth Ave., New York 10, N. Y.

CANADIANS: Save Tariff. Send orders direct to **THORESEN CO., Dept. 6-M, 45 St. James St. West, Montreal 1, P.Q.**



5 DAY FREE TRIAL-

**3 TURRET
Microscope**

**100X
200X
300X** **9.44**
NO TAX



Imagine! . . . **TRIPLE** revolving turrets . . . **300, 200 or 100** power focusing! Finely ground, polished Achromatic lenses . . . **ALL METAL** construction . . . Precision-tooled threadings. Ideal for lab, school or hobby use. Sturdy wooden case and dustproof plastic cover included. Latest, most attractive design. Extra sturdy & durable for roughest handling. This low, low price of **9.44** may never be repeated again. Send coupon **NOW** and get this **BIG** Microscope bargain **PLUS** a pair of **SPECTO-SCOPES**, free of extra charge!
No. 198 . . . 3-Turret Microscope & Case 9.44 No tax



POPULAR MECHANICS READERS

BUY DIRECT FROM THE IMPORTER!

FREE!

By ordering ANY article of merchandise on these two pages, you receive **FREE OF EXTRA CHARGE** a sparkling new pair of **SPECTO-SCOPES**—the binoculars you wear like eyeglasses! Made in Western Germany by expert optical craftsmen, **SPECTO-SCOPES** give you **CLOSE-UP, MAGNIFIED** viewing all day long—without fatigue. Use them to increase your enjoyment of **SPIRITS, TV, NATURE, MOVIES, PLAYS, PUBLIC EVENTS.** Featherweight (only 1 oz.) in lustrous ebony color. These are the same glasses **NOW** being nationally advertised for \$1.98. To get yours, all you need do is send cash, check or M.O. for ANY item on these 2 pages. You may order in complete confidence—try any article in your own home for **5 FULL DAYS**—then, if not completely delighted, just return the merchandise for **FULL REFUND!**

—MONEY BACK GUARANTEE!

Automatic!

Super Deluxe Model — FULL SWING 17-JEWEL SELF-WINDING AUTOMATIC MEN'S WATCH.

19.95

Just set it . . . then forget it! It winds itself as you wear it. Patented **INCABLOC** 17-Jewel Swiss movement of superb accuracy. Water and shock resistant—you can **DROP IT . . . BANG IT . . .** even **SWIM** with it! 100% Stainless Steel screw back. Gift bands & numerals with **LUMINOUS** markings. Unbreakable Kitecrystal crystal. Hairline Sweep Second hand. Split-second calibrations for precision timing. Metal-Flex expansion band. Handsome thin-styled case. Formerly sold for much **MUCH** more—**NOW 19.95** tax incl. Order **TODAY!** Send coupon with payment and receive also **FREE Specto-Scopes.**



17 JEWEL-SWISS WATER & SHOCK RESISTANT WATCH 9.98

A magnificent Swiss watch engineered to high precision standards with world famed **INCABLOC** protected movement of 17 jewels. Not an ordinary watch—radically different! You can bang it . . . drop it . . . it's **SHOCK RESISTANT!**

Actually Runs UNDER Water!

Try it yourself at **OUR** risk . . . if you drop this watch in a tumbler of water, you can fish it out and find **IT IS STILL RUNNING—KEEPING ACCURATE TIME!** Has deluxe quality features usually found in much, much more expensive watches: Stainless Steel back; Sweep Second hand; 1/5th Second calibrations; Radium-Applique numerals; Unbreakable crystal; **17 JEWEL SWISS MOVEMENT;** Metal-Flex Expansion band; **INCABLOC,** Safeguard Gasket. Send handy coupon **TODAY** and receive this handsome watch at greatly reduced price—**PLUS Specto-Scopes** (free of extra charge.)

No. 224 . . . 17 Jewel Swiss Watch . . . \$9.98 tax incl.



Super Value!

Solingen Steel HUNTING KNIFE

3.95 INCLUDING LEATHER SCABBARD

The famed **BLACK FOREST HUNTING KNIFE** made in Solingen, Western Germany of superfine **Night Rostend** (non-rusting) steel is **NOW** available through **THORESEN'S!** Rugged beauty of this superb knife has already won recognition for design in industrial circles on the Continent—and its utility and value as a hunting & fishing aid has made it a prime favorite with sportsmen all over Europe. Blade is actually sharp enough to shave with; will stand up under most rugged treatment; genuine leather scabbard is metal-tipped. Length, 10 in. Tough, sturdy Solingen Steel assures you years of dependable service.

MAKE THIS TEST!

Place a thick metal disc or medalion on the ground. Plunge the point of the Black Forest knife downward. The knife will completely pierce the thick metal—with **NO** damage to the blade! The sleek, graceful lines of this German import also provide an ideal rec room or den decoration; a dandy gift for men! Send coupon **NOW** with 3.95 for knife & scabbard, tax & postpaid. **SPECTO-SCOPES** included—free of extra charge!

No. 80 . . . Black Forest Knife & Scabbard . . . 3.95 tax paid

Mail!

SAVE MONEY WITH THIS COUPON!

THORESEN'S, Dept. 6-M

352 Fourth Ave., New York 10, N. Y.

RUSH the items checked on 5 Day Free Trial . . . Money Back Guarantee. () Payment enclosed. Send tax & postpaid. () Send C.O.D. plus postal charges.

- No. 6—Powerhouse Binoculars (\$4.98)
- No. 198—3-Turret Microscope (\$9.44)
- No. 238—Automatic Self-Winding Watch (\$19.95)
- No. 224—17 Jewel Shock & Water Resist. Watch (\$9.98)
- No. 80—Black Forest Knife & Scabbard (\$3.95)

NAME _____

ADDRESS _____

CITY _____ ZONE _____ STATE _____

CANADIANS: Save Tariff. Send orders direct to: THORESEN CO., Dept. 6-M, 45 St. James St. W., Montreal 1, P.Q.

WHAT ALL AUTO MECHANICS WANT TO KNOW

1664 PAGES



This Big Practical Book gives full information with working diagrams covering the principles, construction, ignition, service and repair of modern cars, trucks and buses.

Diesel Engines, Hydrumatic & Fluid Drives Fully Explained.

A complete Guide of 1664 pages, with over 1500 illustrations showing inside views of working parts, with instructions for service jobs.

IT PAYS TO KNOW

How to fit pistons—How to locate engine knock. How to fit connecting rod bearings—How to service main bearings—How to recondition valves—How to time valves—How to adjust fan belts—How to adjust carburetors and chokes. How to rebuild a clutch—How to service automatic transmissions—How to service brakes—How to adjust steering gear—How to cope with ignition troubles—How to service distributors—How to time ignition—How to "tune up" an engine.



\$4 COMPLETE • PAY \$1 A MO. TO GET THIS ASSISTANCE FOR YOURSELF SIMPLY FILL IN AND MAIL COUPON TODAY.

Step up your own skill with the facts and figures of your trade. Audels Mechanics Guides contain Practical Inside Trade Information in a Handy Form. Fully illustrated and Easy to Understand. Highly Endorsed. Check the book you want for 7 DAYS FREE EXAMINATION. Send No Money. Nothing to pay postman.

MAIL ORDER



AUDEL, Publishers, 49 W. 23 St., NEW YORK 10, N. Y.

Please send me postpaid for FREE EXAMINATION books marked (X) below. If I decide to keep them I agree to mail \$1 in 7 Days on each book or set ordered and further mail \$1 monthly on each book or set until I have paid price, otherwise I will return them.

- AUTOMOBILE MECHANICS GUIDE, \$4
- TRUCK & TRACTOR GUIDE, 1299 Pages 4
- DIESEL ENGINE MANUAL, 575 Pages 2
- MACHINISTS HANDY BOOK, 1650 Pages 4
- WELDERS GUIDE, 400 Pages 1
- BLUE PRINT READING, 416 Pages 2
- MATHEMATICS & CALCULATIONS, 700 Pages 2
- SHEET METAL PATTERN LAYOUTS, 1100 Pages 4
- SHEET METAL WORKERS HANDY BOOK, 388 Pgs. 1
- MECHANICAL DRAWING GUIDE, 160 Pages 1
- MECHANICAL DRAWING & DESIGN, 480 Pages 2
- AIRCRAFT WORKER, 240 Pages 1
- TELEVISION SERVICE MANUAL, 384 Pages 2
- RADIOMANS GUIDE, 914 Pages 4
- ELECTRONIC DEVICES, 216 Pages 2
- ELECTRIC MOTOR GUIDE, 1000 Pages 4
- ELECTRIC WIRING DIAGRAMS, 272 Pages 1
- ELECTRICIANS EXAMINATIONS, 250 Pages 1
- ELECTRIC POWER CALCULATIONS, 425 Pages 2
- HANDY BOOK OF ELECTRICITY, 1440 Pages 4
- ELECTRIC DICTIONARY, 9000 Terms 2
- ELECTRIC LIBRARY, 7000 Pages (12 Book Set) 18
- MARINE ENGINEERS HANDY BOOK, 1258 Pgs. 4
- SHIPFITTERS HANDY BOOK, 250 Pages 1
- REFRIGERATION & Air Conditioning, 1280 Pgs. 4
- MILLWRIGHTS & MECHANICS GUIDE, 1200 Pgs. 4
- POWER PLANT ENGINEERS GUIDE, 1500 Pages 4
- ENGINEERS & FIREMANS EXAMS, 525 Pages 1
- PUMPS, Hydraulics & Air Compressors, 1658 Pgs. 4
- ENGINEERS LIBRARY (3 Book Set) 9
- MECHANICAL DICTIONARY, 950 Pages 4
- GARDENERS & GROWERS GUIDES (4 Book Set) 6
- CARPENTERS & BUILDERS GUIDES (4 Book Set) 6
- PLUMBERS & Steamfitters Guides (4 Book Set) 6
- MASONS AND BUILDERS GUIDES (4 Book Set) 6
- PAINTERS & DECORATORS MANUAL, 450 Pgs. 2
- HOUSE HEATING GUIDE, 1000 Pages 4
- OIL BURNER GUIDE, 384 Pages 1

Check NOW!

You Can Look Over Any Guide In Your Own Home — Start the Easy Payments If Satisfied

MAIL THIS TODAY



Name _____
 Address _____
 Occupation _____
 Employed by _____

Tells How You Can Learn to MOUNT BIRDS!



FREE BOOK MOUNT BIRDS!

Learn At Home

Men, Boys, Hunters, Fishermen, mount and save your lovely wild-game trophies. Be a Taxidermist. Mount Birds, Animals, Heads, Fish, Tan skins. YOU learn easily, quickly in spare time. Have a grand home-museum. The finest and the greatest hobby known, for sportsmen. Fun, real profits.

FREE BOOK

Yes, FREE. Beautiful strange, valuable Book, telling all about Taxidermy. Contains over 100 beautiful game-pictures. And it's yours FREE, if you rush your request. You can mount all kinds of wild-game, and common specimens too. We can positively TEACH YOU. So GRASP this opportunity. RUSH letter or postal for this amazing FREE BOOK. Don't delay. State your AGE. N. W. SCHOOL OF TAXIDERMY, 2511 Elwood Bldg., Omaha 2, Neb.

AVIATION Pays You More With a Schooling at PARKS

NOW! A&E MECHANIC LICENSE COURSE

45-week course, all phases aircraft & engines. Enrollment Date: Jan. 3, 1955.
FLIGHT COURSES—Private, Commercial, Instrument, Instructor, Multi-Engine.
DEGREE COURSES—B.S. degree in 3 yrs. from Saint Louis University — Aero. Engineering, Maint. Engineering, Aero. Administration.
 All Parks Schooling Approved for Veterans Write Today.

PARKS COLLEGE ARNOLD HALL EAST ST. LOUIS, ILL.

Secrets of VENTRILOQUISM Now Revealed!



Easy to learn in 60 to 90 days with our Home Study Course. RESULTS GUARANTEED. Make Money! Be Popular! Have Fun! Big Opportunity! Radio, Television, Stage Appearance! For FREE information regarding price and terms, WRITE. You must state your age. Dummy Catalog 25c. FRED MAHER SCHOOL OF VENTRILOQUISM Box 36, Studio PM-11 Kensington Station Detroit 24, Michigan

RADIO

Engineering. All phases radio & electronics theory & practice; television; FM; broadcasting; servicing; aviation, marine & police radio. Prepare for high pay; 18-month course. Graduates in demand by major companies. Enter Jan., March, June, Sept. Regular campus life. Write for catalog. VALPARAISO TECHNICAL INSTITUTE, Dept. D, Valparaiso, Ind.

How to Make Money in PHOTOGRAPHY

EARN WHILE YOU LEARN AT HOME! If you are OVER 17—good pay, fascinating work await you in photography! Start making money quickly in sparetime — step into your own studio or exciting job. LEARN-BY-DOING method trains you at home! Write TODAY for FREE catalog. Also Resident Training. 45th Year! GI Approved. NEW YORK INSTITUTE OF PHOTOGRAPHY Dept. 49, 10 W. 33 St., New York 1, N.Y.



TELEPHONES

Desk Stand Style Slightly used but in excellent condition Many Valuable Uses



Inter-House Phones House to Barn, etc. Loud Speakers Microphones Educational Purposes, Toys, etc. Come complete, ready to use with wiring diagrams included. Two complete for only \$5.00 \$2.75 Postpaid in U.S.A. TELEPHONE LAMP KIT — with illustrated instructions for making Desk Telephone Lamp including all parts (sharp, nipples, push switch, cord, plug, etc.) \$6.50 Ppd. (Shade is not included).

MICROPHONE, Dept. X-2002, 1760 W. Lunt Ave., Chicago 26, Ill.

STEP UP YOUR PAY Learn to Fix Appliances

AT HOME IN SPARE TIME

Fast Growing Field for Men Who Know This Profitable Trade

Get into a field where there is important work and the security that comes from knowing a good trade. The electrical appliance repair business offers OPPORTUNITY FOR YOU. Every wired home today has an average of 8 electrical appliances. Up to 10 million new appliances are sold every year. Owners pay well to keep them in repair and enjoy the convenience they provide. Here's your chance to qualify for a better job or be your own boss!

You Learn and Earn With Appliance Tester You Get

This course includes the parts to build a portable, sturdy Appliance Tester that helps you locate electrical defects quickly and easily. You use it to learn and do actual electrical and appliance repair jobs. It helps put you in the professional technician's class. Use it to start making money doing repairs soon after beginning the course.

Pick Up \$3, \$4, \$5 an Hour in Spare Time Starting Soon

Start soon to fix electric toasters, clocks, fans, vacuum cleaners, etc., for neighbors and friends. Work in your basement, garage, or spare room. Earn \$3 to \$5 an hour in your spare time. See how easy it is to increase your earning power—how you can pay for this training many times over with your spare time earnings.

Train Now for Greater Security Low Price—Easy Terms

The day when the tinkerer could do the job is past. Today's automatic electrical appliances need expert servicing. Start now to learn a good trade like appliance repairing. No need to give up your present job while you train. Only \$2.50 starts you, and you pay only \$5.00 a month. A small price to pay for increased earnings, a more secure future. Mail coupon now.



Find Out about Your Opportunities in Electric Appliance Servicing

Actual lesson we send to prove home training is practical. Book tells more about Electric Appliance industry, gives details of our training. Address: Electrical Appliance Training, National Radio Institute, Dept. AM4, Washington 9, D. C.



**FREE LESSON and
BOOK**
—MAIL THIS NOW

NATIONAL RADIO INSTITUTE

Dept. AM4, Washington 9, D. C.

Please send me Electric Appliance Training lesson and book free. (No salesman will call.)

Name _____ Age _____

Address _____

City _____ Zone _____ State _____

FREE! ELIZABETH II EMPIRE STAMPS!



HARD-TO-GET! ALL GENUINE! ALL DIFFERENT!

Rush coupon below at once! We'll send you one of the most exciting offers ever made! Think of it! . . . from the far corners of the British Empire — Falkland Islands, Ceylon, Seychelles, South Africa, Tristan da Cunha, to name just a few — this generous collection of hard-to-get (mint and used) Elizabeth II stamps, Coronation and others. They're all genuine, all different! And now, if you act quickly, you can have them at no cost! But that's not all! Also included is a FREE copy of our popular, helpful illustrated "Stamp Collector's Guide"! PLUS! in handsome color, a beautiful reproduction and the fascinating story of the World's Rarest Stamp! Other valuable offers included for your free inspection. Don't delay — this rare offer may be withdrawn soon! If coupon has been clipped, send direct to: GARCELON STAMP CO., Dept. 11PM0, Calais, Maine. (Enclose 10¢ for postage and handling.)

FREE!

Exclusive with us — handsome new folder and gripping story of the WORLD'S RAREST STAMP worth \$50,000! Perfect for your album or to brighten up your room!



FREE!

Valuable illustrated STAMP COLLECTOR'S GUIDE — tells how to start a collection, how to buy and sell stamps — other helpful hints! Order yours NOW!



GET ALL 3 FREE NOW!

GARCELON STAMP CO., Dept. 11PM0, Calais, Maine
Rush FREE Empire Stamps and other offers. Enclosed is 10c for postage and handling. (PLEASE PRINT.)

NAME _____

ADDRESS _____

CITY _____ ZONE _____ STATE _____

EXPERIENCE IS THE BEST TEACHER—OUR MANY YEARS PROVES YOU CAN'T GET MORE—WHY PAY MORE?
LOW OVERHEAD—LARGE VOLUME SALES & SMALL PROFITS BRING YOU THESE "LOWEST PRICES."

WHAT GOOD IS A TIRE WITHOUT A TUBE? TUBE FREE WITH EVERY TIRE AT NO EXTRA COST



WHY PAY MORE!

21 YEARS AT THIS ADDRESS AN ESTABLISHED POLICY OF CAREFUL SELECTION ASSURES YOU, MANY HAPPY MILES. BE WISE—TRY ONE—YOU'LL BUY MORE! WE WELCOME COMPETITION. NO ONE CAN TOUCH OUR QUALITY & PRICE!

GOOD USED TIRES — NOT RECAPS — NOT RETREADS TAKE THE 10% DISCOUNT WE OFFER & PUT MONEY IN YOUR POCKET!

EVERYBODY MAY TAKE 10% off ON EVERY TIRE

15 MONTHS WRITTEN GUARANTEE

600-16 \$3.52	820-15 \$4.92	600-20 \$7.52	32x6 (8) \$8.72
650-16 4.22	700-15 3.92	650-20 7.62	32x6 (10) 10.72
700-16 4.42	670-15 4.02	700-20 8.82	900-20 13.22
650-15 3.82	710-15 4.32	750-20 8.52	1000-20 14.02
760-15 4.42	550-17 3.72	825-20 14.12	1100-20 16.82

FREE If you buy 2 or 3 PASSENGER, 32 mos. guarantee tires, We GIVE ONE tire FREE. FREE

Specialists in Truck Tires—Selected for Toughest Jobs—Tons in Value

32 MOS. WRITTEN GUARANTEE	34 MOS. WRITTEN GUARANTEE
600-16 \$5.02	475-19 \$5.12
600-16 (6) 6.32	640-15 4.72
650-16 5.52	670-15 5.12
650-16 (6) 7.02	710-15 5.22
700-16 6.12	760-15 5.72
750-16 (6) 8.32	800-15 6.02
850-18 3.92	820-15 6.12
550-17 4.22	670-16 5.02
650-15 5.02	760-16 7.02
700-15 5.12	700-16 (6) 7.12
	32x6 (8) 10.52
	32x6 (10) 12.92
	1100-24 22.92

DeLuxe WHITE WALLS \$1.00 extra

Thousands of tires shipped all over the U.S.A. All tires shipped F.O.B. Phila. Send Check or M.O. with this ad. Dept. 2, No C.O.D.

STANDARD 834 N. Broad St., Philadelphia 30, Pa.

STOPS FOGGY WINDSHIELDS NEW Chemical Mitt



Amazing Discovery! Autoists sold ever new FOG-STOP Windshield Cleaner, Simply glide over windshield chemically-treated Mitt—at once glass sparkles crystal clear. Hazy mist, frost, sleet, snow disappear like magic. Stops fogging. Sells like wild!

SAMPLES FOR AGENTS Sample offer sent immediately to all who send name at once. Hurry, Postcard will do. SEND NO MONEY—just your name. KRISTEE CO., Dept. 679, AKRON 8, OHIO

Learn MECHANICAL DENTISTRY

A profession offering unlimited opportunities. Most modern and complete course embracing every branch from Plate to Porcelain Work, which prepares you to work for Dentists or start your own business. Individual instruction—practical training in day or night school. No books—no classes. Catalog upon request.

McCARRIE SCHOOL OF MECHANICAL DENTISTRY
207 N. Broad Street Dept. 35 Philadelphia 7, Penna.

REAL ESTATE BE A BROKER

PAYS BIG! SEND FOR FREE, BIG, ILLUSTRATED CATALOG NOW! Graduates report making substantial incomes. Start and run your own business quickly. Men, women of all ages, learn easily. Course covers Sales, Property Management, Appraising, Loans, Mortgages, and related subjects. STUDY AT HOME or in classrooms in leading cities. Diploma awarded. Write TODAY for free book! No obligation.

Approved for World War II and Korean Veterans
WEAVER SCHOOL OF REAL ESTATE (Est. 1938)
2020 Grand Dept. PM Kansas City, Mo.

MAKE EXTRA MONEY

PLASTICS

LEARN AT HOME



There are RICH OPPORTUNITIES for MEN and WOMEN with "know-how" in Plastics. Interstate's new Plastics course tells and shows how to make hundreds of fast selling items out of Plastics. Gives complete training in fabrication, casting, lamination, molding, internal carving, etc., in simple, easy, step-by-step language and pictures. Plastics and Fabricating Kits for 23 valuable Plastic items come with training at no extra cost. START A PLASTICS BUSINESS OF YOUR OWN. No other industry holds such promise for the future. You can make big money manufacturing novelties, toys, signs, etc., in your own home in spare or full time. Don't wait! Learn NOW how Interstate's Plastics Training qualifies you for success in the Plastics field.

PLASTICS AND SUPPLIES FURNISHED FOR 23 VALUABLE PROJECTS

INTERSTATE TRAINING SERVICE

Dept. C-3-M Portland 13, Oregon

**It's New! 3 Years in Development
-NOW READY FOR YOU!**



This is the new Sprayberry Training Television Receiver.

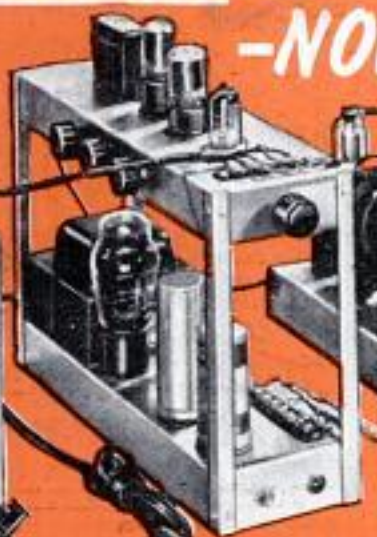

You build the new Sprayberry Tester... 18-range Volt-Ohm-Milliammeter readings.

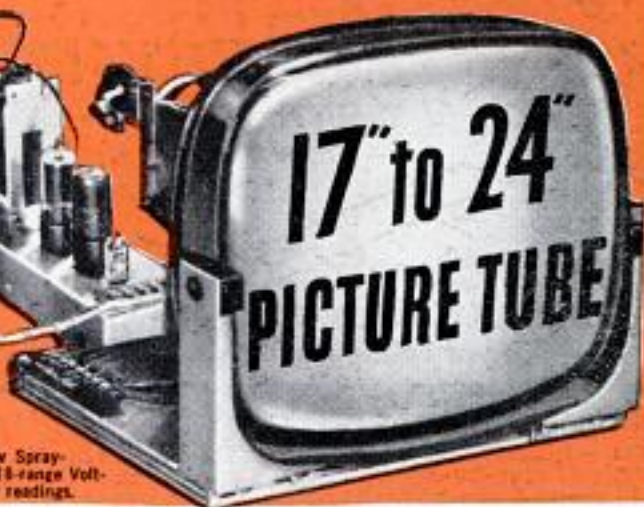

You will build this powerful short wave and broadcast superhet radio receiver.

New Equipment! New Lessons! Enlarged Course!
SPRAYBERRY PRACTICAL TRAINING IN
RADIO-TELEVISION
3 NO OBLIGATION TRAINING PLANS



F. L. SPRAYBERRY
Pres.

You have NO MONTHLY PAYMENT CONTRACT to sign... pay for this outstanding training as you learn!

Mail the coupon at once for my big all-new 56 page FREE CATALOG and FREE Sample Lesson. Get the full story of this remarkable new Training Plan. Read about my 3 NO OBLIGATION PLANS of "packaged unit" instruction. I can prepare you in as little as 10 MONTHS to take your place as a Trained Radio-Television Technician. You take no risk in enrolling for my Training because you DO NOT SIGN A BINDING TIME PAYMENT CONTRACT. I have been training successful Radio-TV technicians for 22 years...I can prepare you, too, to get into your own profitable Service Shop or a good paying job. Full information FREE and without any obligation. No salesman will call.

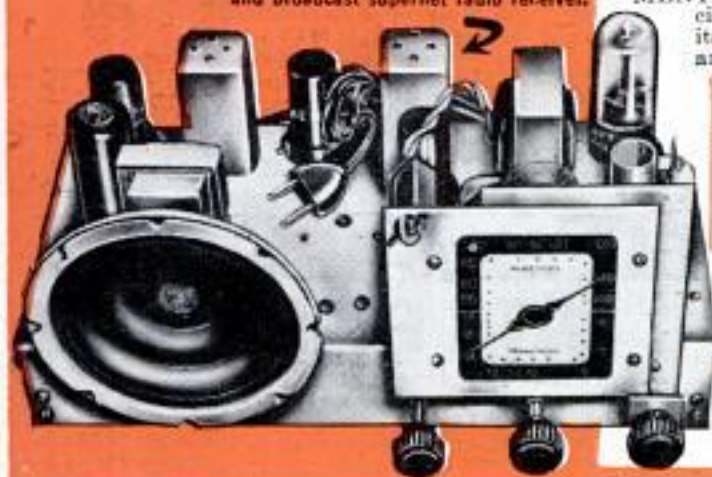

NEWEST DEVELOPMENTS

Your training covers U H F, Color Television, F.M., Oscilloscope Servicing, High Fidelity Sound and Transistors.

PRACTICE AND TRAIN AT HOME WITH 25 NEW KITS of EQUIPMENT

You get valuable practical experience in construction, testing and shop practice. You build a powerful 2 band superhet radio, the all-new 18 range Sprayberry multimeter, the new Sprayberry Training Television receiver, signal tracer and many other projects. All equipment is yours to use and keep. All your training is IN YOUR HOME in spare hours. I help you earn extra spare time money while you learn. Rush coupon below for all the facts—FREE!

SPRAYBERRY ACADEMY OF RADIO

111 NORTH CANAL STREET, DEPT. 10-R
CHICAGO 6, ILLINOIS

SPRAYBERRY ACADEMY OF RADIO MAIL THIS COUPON FOR FREE
Dept. 10-R, 111 N. Canal St., Chicago 6, Ill. FACTS AND SAMPLE LESSON

Please rush New Catalog and Sample Lesson FREE. I understand that no salesman will call.

Name _____ Age _____

Address _____

City _____ Zone _____ State _____

FREE CATALOG AND SAMPLE LESSON

Rush coupon for my catalog "How to Make Money in Radio-Television". PLUS an actual sample Sprayberry Lesson without obligation—ALL FREE. Mail coupon NOW!



DRAFTSMEN



**CASH BIG
PAY CHECKS!**

Train Now for
more success,
greater security

**LEARN AT HOME IN SPARE TIME
(or at college in Chicago)**

Check the want ads in any newspaper—SEE the big-pay opportunities open to you as a draftsman. What's more, you can learn this well-paid, prestige profession at home—quickly, easily! No special talent needed. Get complete, step-by-step Chicago Tech lessons in the mail, spend a few pleasant hours studying each week. In a short time you'll be a well-trained draftsman, ready to take your pick of many good jobs. Act now!



Free Information—Mail Coupon Today!

Get **FREE TRIAL LESSON** plus information about C.T.C. practical training. Learn what successful Chicago Tech graduates say about high pay and opportunities in drafting. No charge, or obligation.

CHICAGO TECHNICAL COLLEGE

P-252 Tech Bldg., 2000 So. Michigan Ave.
Chicago 16, Illinois

Mail me **FREE** lesson with facts about big opportunities
in **DRAFTING**.

Name _____ Age _____

Address _____

City _____ Zone _____ State _____



**ITALIAN ACCORDIONS
AT LOWEST
WHOLESALE
PRICES**

**"PAY AS
YOU PLAY"**

Small Down Payment
As Little As

\$10
per
month

**DIRECT from
Importer to You!**

SATISFACTION GUARANTEED, or your
money back! NOW you can save up to 50%
by direct purchase from America's leading
distributor of famous genuine **ITALIAN
ACCORDIONS TRADE-INS ACCEPTED.**

MAIL COUPON TODAY • World's Largest Selection

**PLEASE
RUSH
FREE
COLOR
CATALOG**

Name _____

Address _____

City _____ Zone _____ State _____

ACCORDION MANUFACTURERS & WHOLESALE OUTLET

2003 West Chicago Ave. Dept. R-114, Chicago 22, Ill.

America's Great Diamond Values

OUT OF PAWN... SAVE UP TO 50% and more

GENUINE DIAMONDS

VALUES FROM \$10 TO \$10,000

TOP QUALITY

Send for Brand New 36 PAGE **FREE ILLUSTRATED CATALOG**

Over 100,000 satisfied customers have bought their diamonds from Berman's.

MONEY-BACK GUARANTEE **ALL DIAMONDS RESET IN BRAND NEW MODERN MOUNTINGS**

Our Reference: Your own bank or any mercantile agency.

Berman's Diamond Loan Bank
Dept. P —BERMAN BLDG., BALTO. 1, MD.

Learn **ACCOUNTING** Business Administration

Bookkeeping, secretarial and allied subjects at home in your spare time or attend nationally approved resident school. Write for **FREE Success Book** giving complete details on courses, plans, rates and employment opportunities. G.I. approved.

Hills BUSINESS UNIVERSITY AND EXTENSION SCHOOL
629 W. MAIN ST. OKLAHOMA CITY 2, OKLAHOMA

LEARN LOCKSMITHING

Learn this fascinating, profitable trade from experts in your spare time at home! Age or physical handicap no disadvantage. Year around, steady income. Full or part time. Practical, illustrated lessons. You can make money even while learning! All materials and special tools supplied without extra charge.

INSTITUTE OF LOCKSMITHING, Dept. P-80
16 PARK AVENUE RUTHERFORD, N. J.
Lic. by N.J. State Board of Education
Approved for Veterans

send for **FREE BOOKLET**

'How to MAKE MONEY with Simple CARTOONS'

A book everyone who likes to draw should have. It is free; no obligation. Simply address **FREE BOOK**

CARTOONISTS' EXCHANGE
Dept. 911D Pleasant Hill, Ohio

EAT ANYTHING WITH FALSE TEETH

If you have trouble with plates that slip, rock and cause sore gums—try **Brimms Plasti-Liner**. One application makes plates fit snugly without powder or paste, because **Brimms Plasti-Liner** hardens permanently to your plate. It relines and refits loose plates in a way no powder or paste can do. Even on old rubber plates you get good results six months to a year or longer. **YOU CAN EAT ANYTHING!** Simply lay soft strip of **Plasti-Liner** on troublesome upper or lower. Bite and it molds perfectly. *Easy to use, tasteless, odorless, harmless to you and your plates. Removable as directed. Money back if not completely satisfied. Ask your druggist!*



BRIMMS PLASTI-LINER
THE PERMANENT DENTURE RELINER

Cylinders
Timing
Overhauls
Pistons
Clutch
Carburetor
Generator
Cooling
Rear end
Alignment
Universal
Ignition
Distributor
All standard and Automatic transmissions, etc.

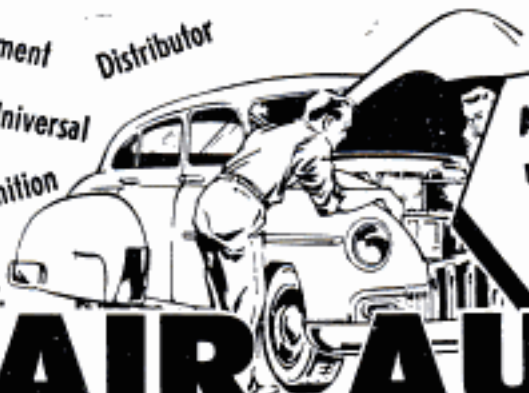

ANY job on ANY car is made so simple it's next to impossible for you to go wrong!

REPAIR AUTOS EASIER AND TWICE AS FAST!

FIX All Cars!

... any make, model or part

With this big "ALL CARS" Chilton Manual, you can fix cars far easier than you may have thought possible. Gives step-by-step procedures for fixing practically EVERY part of EVERY model from 1940 through 1954 of these makes: BUICK, CADILLAC, CHEVROLET, CHRYSLER, DODGE, FORD, FRAZER, HENRY J., HUDSON, KAISER, LINCOLN, MERCURY, NASH, OLDSMOBILE, PACKARD, PLYMOUTH, PONTIAC, STUDEBAKER, WILLYS. 864 pages. Weighs 4 3/4 pounds. Price only \$6.95 on easy terms. 10-DAY FREE EXAMINATION. Use coupon.

Fully revised each year!

FIX Fords!

FIX Plymouths!

FIX Chevrolets!

Save money if you specialize

Only Chilton offers individual low cost manuals on the 3 most popular makes of cars! Each covers complete, accurate, easy-to-understand repair data on EVERY model of that make from 1940 through 1954. Includes latest transmission, steering, overdrive and other developments PLUS specifications. Quick Check and Troubleshooting Charts, hundreds of how-to-fix-it pictures, etc. Only \$2.75 each. Money back if not satisfied. Specify manual of your choice in coupon.

Using these famous manuals is like having 19 of the trade's greatest experts guiding every step of your work—even to showing you what tools to use!

Fixing cars can be much easier than you may think! Just look up the make, model and part you want to fix.

These world-famous Chilton Manuals then tell you how, show you how to handle every step. No guesswork! You work fast . . . and right!

Beginners can easily make repairs they might not have dreamed of tackling. Experienced mechanics use the Manuals to save time and do better, more accurate work.

These Manuals are complete guides to practically ANY job on ANY part of ANY car.

The giant, 4 3/4-pound, 864-page "ALL CARS" Chilton Manual covers over 600 models . . . every model of the 20 leading makes since 1940. It contains data from hundreds of official service manuals . . . 353 Quick Check Data Tables, 58 big Troubleshooting Charts, over 2532 pictures, thousands of specifications, etc.

COMPLETE, EASY-TO-UNDERSTAND REPAIR INSTRUCTIONS

From simple tune-ups to carburetor adjustments . . . from rear end jobs to engine overhauls . . . from windshield wipers to ignition systems . . . or from clutches, rear axles, oil pumps, cooling systems or king pins to the modern automatic transmissions, power brakes and steering, overdrives and dozens more. Chilton books make every step easy to understand.

Remember! For over 25 years, previous Chilton editions have been first choice of students, beginners, garages, schools, and for Army-Navy training because no other books match them for size, completeness or

their ability to make the work clear.

In short, Chilton Car Repair Manuals are the ones the experts use . . . and they're written so you can understand how to do every job, even without previous car repair experience.

Try the manual of your choice for 10 days at our risk. Send coupon to: Chilton Co., 56th & Chestnut Sts., Philadelphia 39, Pa.

PRACTICE 10 DAYS FREE!

MAIL COUPON NOW

THE CHILTON CO.

Dept. PM-114, 56th & Chestnut Sts., Philadelphia 39, Pa.

Please send the following manuals (check the ones you want):

Send the big CHILTON "ALL CARS" REPAIR MANUAL (Price \$6.95) for 10-day FREE EXAMINATION. If I like it, I will promptly remit \$1.95 (plus 35¢ postage); then send \$2.50 monthly for 3 months. Otherwise I will return manual postpaid in 10 days and owe nothing.

Check here for special manuals Chilton "CHEVROLET" Manual, Price \$2.75 Chilton "FORD" Manual, Price \$2.75 Chilton "PLYMOUTH" Manual, Price \$2.75

NOTE: Above special manuals sold for cash with order (we pay postage). Or, we ship C.O.D. and you pay postman for manual plus post office charges. Specify which method. Any manual returnable postpaid in 10 days and we guarantee to refund your \$2.75.

(OUTSIDE U.S.A.—Cash only. "ALL CARS" Manual, \$7.95. Special Manuals, \$3.00 each. Same 10-day return privilege with money refunded.)

Name _____

Address _____

City, Zone, State _____

By The World's Largest Automotive Publishers!

Home of Motor Age and Automotive Industries Magazine, the Flat Rate Book, etc.

BECOME A Mechanical Engineer

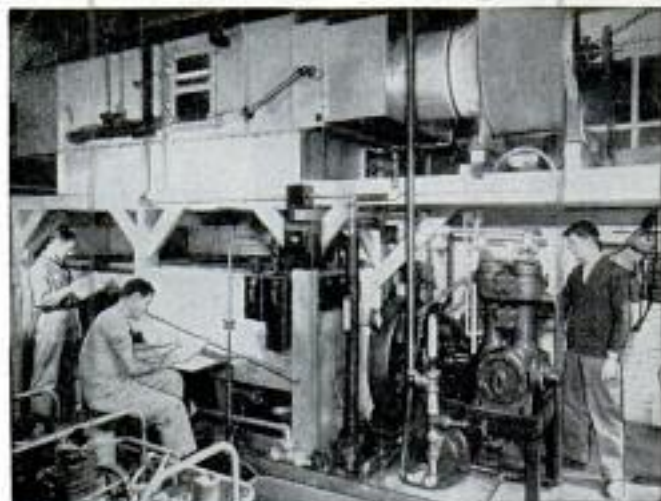

B. S. Degree in 36 months

 Mechanical Engineers hold respected, well-paying, and highly interesting jobs in many fields of industry. You can prepare now . . . for a secure future and a well-paid career as an engineer or engineering technician at the Milwaukee School of Engineering.

Choose from these courses at the Milwaukee School of Engineering

ENGINEERING 36 months, Bachelor of Science Degree

- Mechanical Engineering with a major in Design, Metal Fabrication or Plant Engineering.
- Electrical Engineering with a major in Electronics or Power.

SERVICE 6 to 12 months

- Electricity ● Heating
- Refrigeration ● Welding

TECHNICIAN 12 to 18 months

- Radio and Television
- Electronics
- Electrical Power
- Mechanical Technician
- Air Conditioning
- Welding

General preparatory course — 3 months.

TERMS OPEN JANUARY, APRIL, JULY, SEPTEMBER

Faculty of specialists. Over 50,000 former students. Annual enrollment from 48 states and 23 overseas countries. *Non-profit. 51st year.* Military, Practical or Academic training evaluated for advanced credit. Approved for Veterans Training. Write for details today.

MILWAUKEE SCHOOL OF ENGINEERING

MS-BA

MILWAUKEE SCHOOL OF ENGINEERING
Dept. PM 1154, 1025 N. Milwaukee
Milwaukee 1, Wisconsin

Send free illustrated career booklets Radio-TV
 Mechanical Technology Electrical Technology

I am interested in _____
(name of course)

Name _____ Age _____

Address _____

City _____ Zone _____ State _____

If veteran, indicate date of discharge _____

INVISIBLE REWEAVING

Make Big Money at Home!

BEFORE



AFTER



WOMEN (AND MEN, TOO) FIND FINANCIAL SECURITY—AT HOME!

The demand is endless. Laundries, cleaners, tailors, department stores, homes—everybody needs professional reweaving service sooner or later. And skilled craftsmen are scarce! Learn to make cuts, moth holes, burns, tears DISAPPEAR from coats, suits, dresses, all fabrics almost like magic! AND EARN UP TO \$10 IN AN HOUR AT HOME! The ORIGINAL, Complete Professional Course . . .

You need no special education, experience or ability. Age doesn't matter. Learn all the secrets of this fascinating profession in a few short weeks—start earning at once! **FREE GET THRILLING DETAILS NOW!** Make no mistake! This is a complete, professional course . . . with professional equipment, written by experts. Not a gadget. Not a condensed, unsatisfactory short-cut. FABRICON offers the ORIGINAL home-study course . . . first, best, most-complete in the field. It prepares you for professional work, and for professional earnings. Write TODAY for complete details FREE. FABRICON CO., Dept. 3211, 8342 S. Prairie Ave., Chicago 19, Ill.

MEN! Invisible Reweaving offers as much promise for profit to men, . . . as it does to women. A great number of our successful students are men. Men can learn to do the work as well and as quickly as women. Actually, Invisible Reweaving is the perfect "team" business—for man and wife, . . . or even the entire family! Write!

LOOK!



BUSHNELL Binoculars

A MILLION THRILLS!

High Power
BINOCULARS

30 DAY FREE TRIAL

Finest Precision Optics

Money Back Guarantee

Easy Pay Plan

Free! Catalog & Book

"How to Select Binoculars"

Dept M91 43 E. Green
Pasadena, Calif.

A "GOOD HAND" HELPS YOU SUCCEED!

LEARN TO WRITE WELL

Your Name

Handwriting quickly improves with our easy-to-understand picture lessons! Put your spare time to good use; send today for FREE BOOKLET, "How to Become a Good Penman," or check volumes wanted below at \$1. each: Business Writing Artistic Writing Card Writing Bird & Design Flourishing Engraving Alphabets. COMPLETE SET \$4.50. Ask for price list of penman's supplies.

OUR 53rd YEAR

TAMBLYN SCHOOL OF PENMANSHIP
S.A. Ziller, Pres., 442 Ridge Bldg., Kansas City, Mo., USA

Only 10¢ writing.

Shrinks Hemorrhoids New Way Without Surgery

Science Finds Healing Substance That Relieves Pain—Shrinks Hemorrhoids

For the first time science has found a new healing substance with the astonishing ability to shrink hemorrhoids and to stop bleeding—without surgery.

In case after case, pain was relieved promptly. And, while gently relieving pain, actual reduction (shrinkage) took place.

Most amazing of all—results were so thorough that sufferers made astonishing statements like "Piles have ceased to be a problem!"

The secret is a new healing substance (Bio-Dyne®)—discovery of a world-famous research institute.

Now this new healing substance is offered in ointment form under the name of Preparation H.* Ask for it at all drug stores—money back guarantee.

*Trade Mark



DO IT YOURSELF
THIS NEW BOOK
MAKES EVERY STEP **EASY!**

FIX ELECTRICAL APPLIANCES!

... handle ANY job on ANY make, model or type

By "fixing appliances," we don't mean just simple electrical cord or switch repairs that almost any one can do.

This new 370 page book shows you how to do the toughest jobs as well as the easy ones . . . on practically any home electrical appliance. Clear instructions plus more than 180 how-to-fix-it pictures, diagrams and charts guide you all the way.

ELECTRICAL APPLIANCE SERVICE MANUAL is a real "show-me-how" book . . . not a text book. You don't have to study it. You just look up the appliance you want to repair . . . then go right ahead and fix it.

From complicated thermostat control and timing assemblies to appliances that get too hot, not hot enough or won't heat at all . . . from electric range and automatic washer troubles and adjustments to reducing radio-television interference caused by an appliance . . . from fan oscillating mechanisms to removing a "stuck" washer agitator . . . from automatic washer oil leaks to troubles on electric clocks, electric razors and fluorescent lamps, **ELECTRICAL APPLIANCE SERVICE MANUAL** gets right down to earth in making every job easy.

SAVE SERVICE CHARGES OF UP TO \$10 AN HOUR!

ELECTRICAL APPLIANCE REPAIR book can more than pay for itself in actual money saved the first time you see it.

Just Out!



DON'T THROW THAT BROKEN APPLIANCE AWAY!

Let this book show how to fix it good as new

Troubleshooting Charts guide you right to possible cause of the trouble, show any tests that should be made . . . then tell how to make the needed repairs. Basic electrical principles are explained. Simple appliance test instruments, tools and wiring problems are fully described.

You learn to work safely . . . what dangers and mistakes to avoid.

Specific repair instructions cover **IRONS** (standard, automatic & steam); **ELECTRIC RAZORS**; **CLOCKS**; **FOOD MIXERS**; **HOT PLATES**; **ROASTERS**; **HOT PADS**; **COFFEE MAKERS**; **JUICE EXTRACTORS**; **TOASTERS** (std., automatic & pop-up); **ELECTRIC RANGES**; **WAFFLE IRONS**; **FANS**; **SANDWICH GRILLS**; **IRONERS**; **HAIR DRYERS**; **WASHING MACHINES** (std. & automatic); **CHIMES**; **BOTTLE WARMERS**;

ELECTRIC WATER HEATERS; **FLUORESCENT LAMPS**, etc.

IN ADDITION you get complete details on servicing and repairing all types of appliance motors **PLUS** appliance refinishing methods!

Everything is explained so clearly it's next to impossible to go wrong . . . even if you've never repaired an appliance before. And the price is only \$5.00.

Practice 10 full days **FREE**. If the book is not all you expect, return it and don't owe us a cent. Send coupon to Rinehart & Co., Inc., Dept. PM-114, 232 Madison Ave., New York 16, N. Y.

PRACTICE

MAIL NOW! 10 DAYS FREE!

Dept. PM-114,
RINEHART & CO., INC.,
232 Madison Avenue, New York 16, N. Y.

Send **ELECTRICAL APPLIANCE REPAIR** book for 10 days free examination. If I like book, I will then remit the full price of only \$5.00 (plus a few cents postage). If not, I will return book postpaid and owe you nothing.

Name _____

Address _____

City, Zone, State _____

OUTSIDE U.S.A.—Price \$5.50, cash only. Same 10 day return privilege with money refunded.

MAKE EXTRA MONEY!

Make extra money repairing electrical appliances for friends and neighbors . . . or build a good-paying, full-time repair business of your own. Opportunities everywhere!

Give ME 15 MINUTES A DAY To Prove I Can make YOU a NEW MAN!

That's all I want — just 15 minutes a day to prove I can give you a powerful body of might and muscle — with my quick "Dynamic Tension" method.

Mail coupon below — and I'll send you, absolutely free, my

**CHARLES ATLAS, Dept. 8-L,
115 East 23rd Street, New York 10, N. Y.**

Send me your Free Book which proves how "Dynamic Tension" can make me a NEW MAN.

Name _____ Age _____

Address _____

City _____ State _____

new book, "Everlasting Health and Strength." Reveals secrets that changed me from a 97-pound weakling to winner of title, "World's Most Perfectly Developed Man." Shows how I can build you a champion body the same easy way!

I've taken thousands of flabby men and given them powerful muscles, increased measurements, amazing strength, vitality, pep. My natural "Dynamic Tension" method develops real men!

Send NOW for free copy of my book filled with pictures and body facts. Find out how I can make you the husky, big-muscled NEW MAN you can be! Mail coupon TODAY. **CHARLES ATLAS, Dept. 8-L, 115 East 23 St., N. Y. 10, N. Y.**

CHARLES ATLAS, holder of title, "World's Most Perfectly Developed Man."



Mail Coupon Now For Free Book

PERFECT GIFT!

SIZE
8" x 9 1/2"

GENUINE
HANDTOOLED
COWHIDE

NATURAL
COLOR



IMPORTED
SHOULDER BAG
\$9.98
incl. tax

SOLD BY MAIL ONLY
Guaranteed by BROPAR 1149 Bropar Building
San Antonio 6, Texas



MEN! TRAIN NOW FOR A BIG PAY FUTURE IN DIESEL & SCIENTIFIC MOTOR TUNE-UP

- Diesel Construction
- Diesel Engine Repairman
- Diesel Operator
- Industrial Maintenance
- Auto Engine Rebuilding
- Bus & Truck Maintenance

Be a Trained Diesel Man

Go places with DIESEL! Farms, factories and power plants, trains, ships, trucks, busses all use DIESEL POWER... all need DIESEL-trained men! You can start your DIESEL training at home, in spare time, with tested, proved U E I training. Course includes practical work on Diesel engines under skilled instructors. You learn the operation, maintenance, servicing of all types of Diesel engines, PLUS Scientific Motor Tune-up.

ACT NOW! If you have mechanical ability, you'll like Diesel! High School diploma not necessary. Write now for FREE book, "EARNING POWER IN DIESEL." Act Today!

MAIL NOW FOR FREE BOOK!

**UTILITIES ENGINEERING INSTITUTE, Dept. DC-41
2521 Sheffield Ave., Chicago 14, Ill. (Founded 1907)**

O. K.! Rush, without obligation, FREE Book on DIESEL.

NAME _____

ADDRESS _____

CITY _____ ZONE _____ STATE _____

Check here for information if under 17.

Watch Repairing Pays Big Money Learn at home



Watch repairers in great demand. Train step-by-step in 10 easy lessons. We furnish all tools and 15 jewel watch and practice movement. Turn spare time into cash. A licensed school. Low cost. Send for FREE book today.

ILLINOIS SCHOOL OF WATCH REPAIRING
2870 Elston Ave., Dept. PM-114, Chicago 18, Ill.

THE ABC ACCORDION MANUAL



with 17 full pages and diagrams, explaining hundreds of simplified repairs by one of the country's first manufacturers will save you time and money. Send \$1.00 check or M.O.

ALFRED L. FISCHER
P.O. BOX 402 BELLINGHAM, WASH.

BECOME AN EXPERT IN TRAFFIC

Traffic men earn \$4,000 to \$10,000 and up. Thousands of firms need experts on rates, tariffs, regulations. We train you thoroughly in spare time at home for executive traffic jobs. Personal training under traffic authorities. Placement control and help. Write for free 48-page book "Traffic Management—the Fast Growing Profession."

LASALLE Extension University, 417 So. Dearborn St.
A Correspondence Institution Dept. 1164T Chicago 5, Ill.

Say You Saw It in Popular Mechanics



Sensational Price Reductions ON BRAND NEW—WORLD FAMOUS Firestone TIRES

BRAND NEW — FIRST QUALITY FIRESTONE PASSENGER TIRES			
All Tires	BLACK WALL TIRES	4 PLY FULL PRICE	
Carry	640x15	11.75	
Famous	650x15	14.22	
Firestone	670x15	11.88	
Unconditional Guarantee	710x15	13.11	
	760x15	15.05	
	800x16	10.56	
	850x16	14.01	
BRAND NEW — FIRST QUALITY Heavy Duty Firestone TRUCK TIRES			
Size	Full Price	Size	Full Price
700x15 6 ply	21.04	850x20 8 ply	24.96
700x15 8 ply	23.12	700x20 8 ply	28.01
600x16 6 ply	14.60	700x20 10 ply	34.95
650x16 6 ply	17.63	750x20 8 ply	36.31
700x16 6 ply	21.02	750x20 10 ply	40.28
750x16 8 ply	27.43	825x20 10 ply	49.70
700x17 6 ply	24.26	900x20 10 ply	61.11
700x17 8 ply	26.76	1000x20 12 ply	77.62
	31.25	1000x22 12 ply	81.90
SPECIAL! BRAND NEW WHITEWALL TIRES			
First Line 4 Ply Pass.	600 x 16	12.69	
	670 x 15	14.30	
	710 x 15	18.82	
	760 x 15*	18.41	
	800 x 15*	20.23	
	820 x 15*	21.04	
* (Very Slight Factory Blemish)			

(Order by Mail—Send check or M.O.) • (All prices f.o.b. plant)
Farmers—Full line of tractor tires—Also complete stock of Mud & Snow Tires—Write for Prices.

S & S TIRE CO. 1400 HADDON AVE.
CAMDEN 3, N. J.

Waterproof, Repair and Patch

Practically Anything in the House

With Amazing **LIQUID RUBBER**



DIP • SPRAY • BRUSH

**INSULATES!
SHOCKPROOFS!
RUSTPROOFS!**

GUARANTEE

RUB-R-IZE, the natural liquid rubber, offers this 100% money-back guarantee: If RUB-R-IZE doesn't do everything claimed for it on this page, and MORE; if RUB-R-IZE isn't exactly what we say it is; and IF YOU ARE NOT 100% SATISFIED AFTER A THIRTY DAY TEST THAT RUB-R-IZE HAS DONE A WONDERFUL JOB FOR YOU...then return the unused contents of the can, and we'll refund your money. YOU be the judge; you risk nothing!

freezer or refrigerator—there's no end to its wonderful uses!

SO EASY TO DO SO MUCH!

Not only is RUB-R-IZE amazingly versatile when you want to mend or repair, but you'll be astonished when you discover the number of things you can actually make with it! Just dip, let dry, peel off, and PRESTO!—bathing caps for the entire family! Use several layers of RUB-R-IZE to make as good a shock-proof rubber heel as you'll ever want to have! Rust-proof leaky roofs, gutter runways, and leader pipes...

Yes! From garbage cans to garages; from bathrooms, baskets and balls; from wall-cracks and leaky roofs to sweaty pipes in the cellar...RUB-R-IZE can fix it quickly, easily, and economically!

Rub-R-ize! The Sensational New Liquid Rubber Coating Dries to Real Live Rubber!

HERE IT IS...The brand new "MIRACLE" MATERIAL that will rubberize everything from a pair of pants to an entire roof! SAVES YOU HUNDREDS OF DOLLARS A YEAR! Actually gives you a natural liquid rubber right out of a can! Brush it on like paint—spray it on—dip it!... So easy to handle, even a child can use it! Rubberizes quickly at normal temperatures—just "apply and let dry"! Can be applied to almost anything: paper, wood, fabric, etc.

UNBELIEVABLE VALUE!

Coat your car exhaust and muffler to prevent rusting; weather-proof ignition wires, easily applied to cellar and attic steps to make them permanently non-slip, and prevent dangerous, limb-cracking falls! Put it on the underside of scatter-rugs to stop sliding; use it to prevent condensation on sweating cold water pipes; shockproof your tools with electricity-defying insulation of real, live rubber; insulate all bare wiring with this air-resistant, rubber film.

NO END TO ITS USES!

Because it can withstand up to 220° of heat, and as low as 20° below zero, there's absolutely nothing like RUB-R-IZE for hard use in home or workshop; garden, kitchen, or attic! Waterproof outdoor lights; slam-proof your doors; RUB-R-IZE the inside of your garbage pail to prevent rust, and make it easy to clean; splinter-proof broom and mop handles! Here's the quick, easy and THRIFTY way to patch your convertible car top; make bottle stoppers; waterproof boxes. Patch umbrellas; patch and waterproof all kinds of canvas and awnings; weather-strip your windows and doors; repair the rubber seals on your home

HERE'S PROOF!

Durable! Tests prove how RUB-R-IZE can withstand DESERT HEAT, SALT SPRAY, and even FRIGID TEMPERATURES! A carefully selected jury of householders tested RUB-R-IZE and unanimously vouched for every claim! In addition, a leading testing laboratory proved the value of RUB-R-IZE as for its lasting qualities, its

sturdy flexibility, its astonishing ability to stand up under every rigorous test given! Reported: No change in flexibility after being heated in an oven at 160° for a period of 7 days! Reported: Flexed through a 180° bend 100,000 times, it still showed no change in flexibility! Bend it, stretch it, heat it, freeze it—it's wonderful, it's miraculous, it's sensational! It's RUB-R-IZE!

MAIL ORDERS FILLED! DEALER INQUIRIES INVITED!

RUBBER MAGIC INC., DEPT. B
4312 THIRD AVENUE, Brooklyn 32, N. Y.

Send me the size I have indicated below in the color which I have selected.

- PINT \$2.98 QUART \$3.75
 Large economy size 1 GALLON \$7.95
 Red Green Black
 Grey Transparent

- I will pay postman in full plus postage and C.O.D. charges.
 I am enclosing payment. You pay postage and C.O.D. charges.

MONEY-BACK GUARANTEE

Name
 Address
 City
 Zone State

<p>Patch convertible car tops</p>	<p>Skid-proof rugs, etc.</p>
<p>Roofs, gutters, leaders</p>	<p>Leaky windshields, weather stripping.</p>
<p>Cellar and attic-steps</p>	<p>Sweaty pipes</p>
<p>Waterproof wooden matches, hunting and fishing equipment</p>	<p>Insulate tool handles</p>
<p>Auto ignition wires</p>	<p>Leaky garden hose</p>
<p>Make & patch utility mats</p>	<p>Coat garbage pails</p>

WHICH OF THESE ITEMS IN YOUR HOME NEEDS FIXING RIGHT NOW?

LAMP-STATUE-ASH TRAY BASES • BROKEN TOYS MADE NEW • SPLINTER-PROOFS WOODEN HANDLES • WATERPROOFS WOODEN MATCHES • WATERPROOFING HUNTING EQUIPMENT • INEXPENSIVE WEATHERSTRIPPING • SEALS LEAKY WINDSHIELDS • PROTECTS BATHROOM BASEBOARDS • RENEWS CONVERTIBLE CAR TOPS • RUBBER CAULKING FOR BOATS • MAKES GASKETS, WASHERS • INSULATES WIRE COUPLINGS • RUSTPROOFS CAR EXHAUSTS • PATCHES UMBRELLAS • REVITALIZES SHOWER CURTAINS • MENDS RIPPED FURS • MAKES DOORS SLAM-PROOF • RENOVATES CRACKED LINOLEUM • PERMANENT CAR UNDERCOATING • PROTECTS TV ANTENNAE COUPLINGS



Your Own
Direct Mail
Department
in a
\$19.90
Package

the Heyer dupli-kit

PORTABLE PRINTER and PORTABLE ADDRESSER

Ideal for Club, School, Church Mailings . . . Mail Order and Business Promotions.

Printer performs a multitude of small duplicating jobs—advertising postcards, notices, reminders, inventory and record cards, etc.

Addresser accommodates 250 addresses on a single roll . . . prepare as many rolls as you need. Loads like a camera, addresses fast and easily, prints on anything mailable, on any size piece. Both are constructed for hard usage, trouble-free operation. Both are complete with instructions and supplies.

Write for further information.

Printer or Addresser may be purchased separately at \$10.95 ea. Sold by leading Stationery and Office Equipment Dealers. If your local dealer doesn't stock, send money and order direct to:

THE HEYER CORPORATION 1856 S. Kostner Ave.
Chicago 23, Illinois
FOR CANADIAN PRICES—CONTACT BROWN BROS., LTD., TORONTO

Say You Saw It in Popular Mechanics

FUN AT XMAS

These **GIANT BALLOONS** are a barrel of fun at dances, parties—**TERRIFIC** for high school & college **PROMS**. Great sport in back yards, picnics, etc. Wonderful way to **ATTRACT CROWDS** to new business, to sales, to civic events, conventions, trade shows, exhibitions . . . they're money makers. Surplus U. S. Govt. (new-overage) neoprene weather, target balloons. Approx. inflated sizes:

3 ft. dia., 49c — 6 ft. dia., 99c
13 ft. dia., \$1.59 — 20 ft. dia., \$1.95

• Calif. res. please add sales tax
• Postage paid on prepaid orders

VOLUME SALES CO., War Assets Division
Dept. M-1154 3930 Sunset Blvd. Los Angeles 29, Calif.

STATEMENT REQUIRED BY THE ACT OF AUGUST 24, 1912, AS AMENDED BY THE ACTS OF MARCH 3, 1933, AND JULY 2, 1946 (Title 39, United States Code, Section 233) SHOWING THE OWNERSHIP, MANAGEMENT, AND CIRCULATION of Popular Mechanics Magazine published monthly at Chicago, Ill., for October 1, 1954.

1. The names and addresses of the publisher, editor, managing editor, and business managers are: Publisher, Popular Mechanics Company, 200 E. Ontario St., Chicago 11, Ill.; Editor, H. H. Windsor, Jr., 200 E. Ontario St., Chicago 11, Ill.; Managing editor, R. M. Graig, 200 E. Ontario St., Chicago 11, Ill.; Business manager, W. H. Petridge, 200 E. Ontario St., Chicago 11, Ill. 2. The owner is: (if owned by a corporation, its name and address must be stated and also immediately thereunder the names and addresses of stockholders owning or holding 1 percent or more of total amount of stock. If not owned by a corporation, the names and addresses of the individual owners must be given. If owned by a partnership or other unincorporated firm, its name and address, as well as that of each individual member, must be given.) Popular Mechanics Company, 200 E. Ontario St., Chicago 11, Ill.; H. H. Windsor, Jr., 200 E. Ontario St., Chicago 11, Ill.; H. H. Windsor, Jr., Trustee for H. H. Windsor III and Wm. T. Windsor, 200 E. Ontario St., Chicago 11, Ill. 3. The known bondholders, mortgagees, and other security holders owning or holding 1 percent or more of total amount of bonds, mortgages, or other securities are: (if there are none, so state.) None. 4. Paragraphs 2 and 3 include, in cases where the stockholder or security holder appears upon the books of the company as trustee or in any other fiduciary relation, the name of the person or corporation for whom such trustee is acting; also the statements in the two paragraphs above the affiant's full knowledge and belief as to the circumstances and conditions under which stockholders and security holders who do not appear upon the books of the company as trustees, hold stock and securities in a capacity other than that of a bona fide owner. 5. The average number of copies of each issue of this publication sold or distributed, through the mails or otherwise, to paid subscribers during the 12 months preceding the date shown above was: (This information is required from daily, weekly, semi-weekly, and tri-weekly newspapers only.) Not daily publication. H. H. Windsor, Jr., Editor, publisher, sworn to and subscribed before me this 8th day of September, 1954. Vera L. Freehill, Notary Public. (My commission expires July 17, 1958.)

INVENTORS

PROTECT YOUR INVENTION BY A U. S. PATENT. SEND FOR FREE "INVENTION RECORD" FORM AND "PATENT INFORMATION EVERY INVENTOR SHOULD HAVE".

CARL MILLER
REGISTERED PATENT ATTORNEY

WOOLWORTH BLDG., 35th FLOOR, 114A
NEW YORK CITY

PATENTS

C. A. SNOW & CO.

REGISTERED PATENT ATTORNEYS
WRITE FOR INFORMATION TO
428 SNOW BUILDING, WASHINGTON 1, D. C.

INVENTORS

Send for **REGISTERED PATENT ATTORNEY**
PATENT INFORMATION Book and
INVENTOR'S RECORD ASSOCIATE EXAMINER
without obligation U.S. PAT. OFF. 1922-1929
GUSTAVE MILLER Patent Attorney & Advisor
114-PM WARNER BUILDING U. S. NAVY DEPT. 1930-1947
WASHINGTON 4, D.C. **PATENT LAWYER**

FREE AMAZING NEW BOOK "HOW TO ANSWER ADS"



Never before have you seen anything like this. Tells you in simple language the correct way to answer ads. Gets you quicker replies—better results, and greater satisfaction. Will save you time and money and it's **ABSOLUTELY FREE**. No obligation whatever. Every reader of advertising should have this booklet. Send a postcard for your copy NOW. F. W. Johnson, Popular Mechanics Magazine, Room 600-A, 204 East Ontario Street, Chicago 11, Illinois.

STAMMER?

Get your copy of the new 18th edition of my book, "Stammering, Its Cause and Correction," which describes the Bogue Unit Method for scientific correction of stammering and stuttering. Ask, also, for free **SPEECH CHART!** Benj. N. Bogue, Dept. 543, Circle Tower, Indianapolis 4, Ind.

GET THIS
FREE
BOOK!

INVENTORS

Whether an invention is patentable can be substantially determined by a search of the U. S. Patent records. Without obligation, write for information explaining the steps you should take to secure a patent.

JOHN N. RANDOLPH
Registered Patent Attorney
201 Columbian Building, Washington 1, D. C.

INVENTORS

I shall be pleased to furnish you, upon request, with full information relative to patent procedure—without any obligation on your part.

PATRICK D. BEAVERS
Registered Patent Attorney
934 Columbian Building Washington 1, D. C.

LEARN ELECTRIC APPLIANCE REPAIR IN JUST A FEW WEEKS OF TRAINING AT HOME

Start YOUR OWN BUSINESS

Repair electrical appliances for friends and neighbors. Service electrical equipment in factories, stores, hospitals, etc. Work full or part time! There is a potential market of 50,000,000 customers.

NEW SHOP METHOD HOME TRAINING

Permits you to learn this big money making business at home in your spare time by having you work with your hands testing and repairing. CTS sends you their famous Electronic Trouble Detector, Special Service Kits, together with illustrated Lesson Manuals showing how to easily locate the trouble, quickly repair it, what to charge and how to keep new customers coming to you.

EARN WHILE YOU LEARN

Pay us later with your EARNINGS WHILE LEARNING. Start in the corner of your basement or garage. Earn on the basis of \$5.00 to \$6.00 and more per hour! It's a common practice among repair technicians.

CHRISTY TRADES SCHOOL

4804 N. KEDZIE AVE.

DEPT. D-3603

CHICAGO 25

**RUSH NAME FOR
FREE BOOK
and Special
Pay Later Form**



Finish HIGH SCHOOL AT HOME

Complete 4 Yrs. in 12 Months

Learn More! Earn More! Enter professional or technical schools. Advance Socially. Live a Happier, Fuller Life. Individual Courses or complete schedule. WRITE FOR SCHOOL BULLETIN. **ACADEMY FOR ADULTS**

30 W. Washington, Dept. PM-1104, Chicago, Ill.

CASTING SECRETS REVEALED

Big money! Cast 1000's of plaques, figurines, etc. with X.L. rubber molds. No exper., little capital req. X.L. rubber pts. \$2.50. pts. \$4 (postage extra). Molds, Rubber for 3 molds, \$1.50 ppd. U. S. only. Send 25¢ (refundable) for 40 pp fact catalog.

**HUGE PROFITS!
MORE MONEY!**

PLASTIC ARTS STUDIO, Dept. PM2,
3403 S. Madison St., Muncie, Ind.



Ball-Bearing SPEED WHEELS



JUVENILE WHEELS (No bearing, solid tires)			
5"	45c	6"	65c
7"	75c		
(Semi-pneumatic tire, ball bearing)			
8x1.25	\$1.85	10x1.25	\$2.20
8x1.75	1.95	10x1.75	2.30
8x2	2.20	10x2	2.65
	12x1.75		3.45
INDUSTRIAL WHEELS			
(Low Base, Semi-Pneumatic tire)			
6x2.5W	\$3.45	10x2.00	\$6.10
6x2.00	4.00	10x2.75	5.15
8x2.00	5.20	10x2.75Pneu.	6.90
8x2.50	5.40	12x2.00	6.90
16x4.00	15.15	12x3.00	9.20
(Smooth Base, Pneumatic tire and tube)			
8x3 2 ply			\$10.00
10x3.90 2 ply			10.55
12x4 2 ply			14.41
4.00x8 2 ply			13.10
14x4.50 2 ply			15.96

CASTERS—Now Available
No c.o.d. orders. Prices F.O.B. our plant.
JIM BROWN TOY COMPANY
1095 HOME AVENUE PM-1154 AKRON 10, OHIO

SAY YOU SAW IT IN POPULAR MECHANICS

You Can Play



... even if you don't know
a single note of music now!

IMAGINE! Even if you never dreamed you could play . . . you can soon surprise your friends with your musical ability. No special talent or previous training needed. Spend just a few minutes a day—and only a few cents per lesson. Teach yourself to play piano, guitar, accordion, whatever instrument you choose. Make amazingly rapid progress because you start right out playing real pieces by note. No boring exercises to do. Over 900,000 people have chosen this easy home study method.

SEND FOR FREE BOOK

See actual proof that YOU can play. Mail coupon for 36-page illustrated FREE BOOK. U. S. SCHOOL OF MUSIC, Studio 3011, Port Washington, N. Y. (with SUCCESSFUL YEAR)



U. S. SCHOOL OF MUSIC,
Studio 3011, Port Washington, N. Y.

Please send me valuable illustrated Free Book. No obligation.

I'm interested in playing (name instrument) _____

I do I do NOT—have instrument now.

Name _____ (please print)

Address _____

Sworn statement from Chas. Lemming reads:

"After starting my own business, I've averaged

\$100 A DAY

—most of it clear profit!"



Not everyone does as well . . .

Mr. Lemming owns two machines

• In city of less than 50,000, Mr. Lemming started his own business after filling in coupon like one below. He averaged \$100 a day during first year, some days \$200. Many others have succeeded. For example, Geo. Held grossed \$350 in one week.

• How much you earn depends largely on you. No special skill, no large investment required for our electric upholstery cleaning machine. Can start spare time until full time available. Hire helpers as needed.

No shop necessary. You clean upholstered furniture on customers' premises—homes, hotels, motels, etc. Auto upholstering, too. No hauling; operate from your home. Watch business grow as satisfied customers tell friends. Supplies cost little, profits high.

• If you want to be independent—free of bosses, layoffs—start profitable year-round business of your own. FREE book tells exactly how to do it.

SEND COUPON TODAY FOR FREE BOOK

- VON SCHRADER MFG. CO.
- E10 "D" Pl., Racine, Wisconsin
- Please rush your FREE booklet telling how I can start my own profitable, year-round electric Upholstery-Cleaning business. Request incurs no obligation.
- Name _____
- Address _____
- City _____ Zone _____ State _____

I'll Send You This Handsome SAMPLE CASE—FREE



and Show You How to Make Up to \$30.00 in a Day
 Mail coupon for this Free Tailoring Sample Case packed with 150 beautiful, big-value suit and overcoat fabrics. Take orders from friends, fellow-workers, others, for fine quality, made-to-measure clothes. Pocket big cash profits in advance. Because wearing our suits and overcoats brings more orders, we make it easy for you to get your own clothes without the cost. No experience is needed. **SATISFACTION GUARANTEED.** SEND NO MONEY. Just fill out and mail coupon—today!
W. Z. GIBSON, INC., 500 South Throop Street DEPT. T-516 CHICAGO 7, ILLINOIS

W. Z. GIBSON, INC., Dept. T-516
 500 S. Throop St., Chicago 7, Ill.
 Dear Sir: I WANT A MADE-TO-MEASURE SUIT TO WEAR AND SHOW, without paying 1¢ for it. Rush details and Sample Kit of actual fabrics. **ABSOLUTELY FREE.**

NAME _____ AGE _____
 ADDRESS _____
 CITY _____ STATE _____



"WE FOUND A NEW LIFE IN MOTEL MANAGEMENT"

"Dissatisfied with our routine jobs, we became Motel Managers, thanks to your home study training. Now we earn good pay, work and live in beautiful surroundings." This is typical of the many who have taken the National Motel Training at home, in their spare time. 50,000 Motels offer new opportunities. Write for FREE information today!

NATIONAL MOTEL TRAINING
 404 Lake St., Dept. PM-11, Oak Park, Ill.

FALSE TEETH
KLUTCH holds them tighter

KLUTCH forms a comfort cushion; holds dental plates so much firmer and snugger that one can eat and talk with greater comfort and security; in many cases almost as well as with natural teeth. Klutch lessens the constant fear of a dropping, rocking, chafing plate. 35c and 60c at druggists . . . If your druggist hasn't it, don't waste money on substitutes, but send us 10c and we will mail you a generous trial box.

KLUTCH CO. Box 5493-K ELMIRA, N. Y.

USE THIS PORTABLE SHOWROOM
TO START YOUR OWN BRAND NAME BUSINESS!
 Imprint your own name on this catalog. We'll be your warehouse for 1001 nationally advertised items including APPLIANCES • JEWELRY • RADIOS • CAMERAS • TOYS • ETC. Separate confidential price list. SEND FOR FREE CATALOG TODAY!
O. FAUST, Dept. PM 1154 223 N. 8th St. • PHILA. 6, PA.

WATCHMAKING
 Learn at home • FREE sample lesson • Approved for Vets.
CHICAGO SCHOOL OF WATCHMAKING
 2330 N. MILWAUKEE AVE., DEPT. 1114A, CHICAGO 47, ILL.

BE A COLLECTION EXPERT
EARN \$4000 TO \$20000 YEARLY
 Our correspondence course shows you how! Easy to learn! No waiting . . . you start learning and earning when you receive our detailed instructions. Part-time or full-time, this depression-proof business can earn you steady money all year long. No experience necessary. Money-back agreement. Send now for FREE booklet, "Collect and Grow Rich." Mail card to:
FRANKLIN CREDIT SCHOOL
 DEPT. PM ROANOKE 7, VIRGINIA

Say You Saw It in Popular Mechanics



EARN YOUR OWN KING MIDGET. We want rider agents to demonstrate and sell the World's Lowest Priced Automobile. Fully assembled or bolt together parts. If there is no dealer near you send 25c for detailed literature with agents proposition, or \$1 (refund first order) for this plus actual assembly book and service manual.
MIDGET MOTORS MANUFACTURING CO., ATHENS 1, OHIO

POPULAR MECHANICS

INSURED TIRE SERVICE
POPULAR BRANDS

FREE INSURANCE POLICY given with each used tire sold. We guarantee the amount of service you pay for.

Tube Given Free with Each Used Passenger Tire Upon Request

YOU CAN'T LOSE!!

SPECIAL! Deduct 10% on orders for 2 or more used tires

GOODYEAR SUBURBANITE TYPE SNOW TIRES
New Tire Guarantee—Factory Rebuilt
BEST WINTER TRACTION OF ALL!

670x15	\$8.95	710x15	800x15	850x15	\$9.90
600x16		760x15	820x15	850x15	

Super Quality — Rugged Performance — 15 Months Insured Service

600x16	\$3.65	670x15	\$3.95	700x16	\$4.45	760x16	\$4.75
680x15	3.85	670x16	4.05	710x15	4.35	820x15	4.95
650x16	4.25	700x15	3.95	760x15	4.45	850x17	4.65

Supreme Quality — Nothing Finer — 30 Months Insured Service

600x16	\$5.25	475x19	\$5.45	700x15(6)	\$10.45	700x20	\$12.50
600x16(6)	6.75	640x15	4.95	750x16(8)	15.95	750x20(8)	15.50
680x16	5.75	670x15	5.35	700x17	11.95	750x20(10)	17.50
650x16(6)	7.25	710x15	5.45	750x17	16.45	825x20	21.50
700x16	6.35	760x15	5.95	750x15	10.95	900x20	19.95
750x16(6)	8.45	800x15	6.35	30x5	11.25	1000x20	20.45
550x18	4.95	820x15	6.35	600x20	10.95	1100x20	21.25
880x17	4.75	850x15	5.35	650x20	11.75	1000x22	21.95
650x15	5.25	670x16	5.15	32x6(8)	11.95	1100x22	22.75
700x15	5.35	700x16(6)	10.25	32x6(10)	12.75	1100x24	25.95

Whitewalls \$1.00 extra.

MIDLAND TIRE SALES
Speedy shipments on Mail Orders, F.O.B. Chicago. Insurance policy sent with each order. Deduct 10% on orders for 2 or more used tires. Send CHECK or MONEY ORDER.—No C.O.D.'s.
3701 S. Normal, Dept. PM-28, Chicago 9, Ill.

LEARN TO THROW THE BOOMERANG
A Fascinating Sport and Unique Gift

SEND FOR YOURS TODAY

Flight Tested—Guaranteed to Return Golden Red, Jade Green or Natural with Story and Instructions \$2.00 ea. CARVED by Postpaid

COL. JOHN M. GERRISH
4409-M S.W. Parkview Lane, Portland 1, Ore.

New Way to Improve YOUR ENGLISH

A command of effective English gives you added advantages and better opportunities. Poor English handicaps you more than you will ever realize. You can improve your English through Sherwin Cody's 100% self-correcting invention. If you are embarrassed by mistakes in grammar, spelling, punctuation, or pronunciation, this free book "How You Can Master Good English in 15 Minutes a Day" will prove a revelation to you. Send for it now. It is free. No obligation. No agent will call. Address **SHERWIN CODY COURSE IN ENGLISH, 5811 Central Drive, Fort Washington, N. Y.**

RAISE GIANT FROGS BIG DEMAND

Nuford Giants

MILLIONS USED YEARLY!
Good prices year round! Breeder lays up to 20,000 eggs yearly. Nation-wide markets waiting for all you can ship. Get ready now for next spawn. New book tells how! Small pond starts you. Men and Women send for my illustrated FREE folder today. Do it now!
ALBERT BROEL-7
P.O. Box 506. New Orleans 1, La.

PROFITS FROM SPARE TIME
MAKE BARRON 3-D PLASTIC LETTER SIGNS

Make \$50 daily profit or more making plastic 3-D display signs. Every store, shop, office, and home a prospect. Big Profits! Cost pennies — Sell for Dollars. In your own home, spare or full time. No experience required.

START YOUR OWN BUSINESS WITH ONLY A \$10.00 INVESTMENT
Big starting kit will make nearly \$100.00 worth of signs. Simple, complete instructions and all materials furnished. Send for Starter Kit, \$10 Prepaid (No C.O.D.) or write for complete details.

BIG MONEY NOW - WRITE TODAY!
J. E. BARRON PLASTICS, INC.
807 SYCAMORE ST. Dept. 1 CINCINNATI, OHIO

"HOW I MADE MY HOBBY PAY OFF!"
I've always been interested in cars, then one day I met Joe...

HI, JOE! SINCE WHEN ARE YOU IN THE AUTO REPAIR BUSINESS?

EVER SINCE I STARTED LEARNING AUTO MECHANICS AT HOME. I EARN WHILE I LEARN, THE NATIONAL SCHOOLS WAY!

SOUNDS GREAT! I HEAR THAT TOP MECHANICS MAKE REAL MONEY THESE DAYS!

YOU SAID IT! I MAY EVEN OPEN MY OWN REPAIR SHOP WHEN I GRADUATE.

NATIONAL SCHOOLS SENT ME THIS SWELL AUTOMOTIVE TOOL KIT—IT'S PART OF MY COURSE!

WHAT A DEAL. I'M FINDING OUT ABOUT THIS AUTO MECHANICS COURSE TODAY!

SHOP-TESTED HOME TRAINING
AUTO MECHANICS & DIESEL
NATIONAL SCHOOLS
Technical Trade Training Since 1905
LOS ANGELES 37, CALIFORNIA
In Canada: 811 West Hastings Street, Vancouver, B.C.

APPROVED FOR G.I. TRAINING. Both Home Study and Resident courses offered. Job placement assistance, too! Find out today!

Send for famous illustrated FREE BOOK and FREE LESSON!

YOUR FUTURE IN AUTO MECHANICS

MAIL NOW TO OFFICE NEAREST YOU!
(mail in envelope or paste on postal card)

NATIONAL SCHOOLS, Dept. DB-114

4000 S. FIGUEROA STREET LOS ANGELES 37, CALIF. OR 323 WEST POLK STREET CHICAGO 7, ILL.

Please rush FREE BOOK "Your Future in Auto Mechanics & Diesel," and FREE LESSON. I understand there is no obligation, no salesman will call.

NAME _____ BIRTHDAY _____ 19____

ADDRESS _____

CITY _____ ZONE _____ STATE _____

Check if interested ONLY in Resident Training at Los Angeles.
VETERANS: Give date of discharge _____



You Can Be a Manufacturer of BRIKCRETE

"The World's Most Modern Masonry" is produced in a chain of independently owned local plants. That's why such low prices go

along with such high quality without sacrifice of manufacturing profits. Local materials and local labor cut freight and distribution. Brikcrete brings a super-masonry down to price levels of frame. Gives owners incentive to buy.

Brikcrete has design, size, and color in keeping with the modes of today. Self-contained insulation values—12" long—8" or 4" thick—range of 14 colors. Suited to every kind of construction—residential, commercial, industrial.

Many territories are open for additional local plants. Franchise protection. Equipment available on easy terms, or basic machine can be leased to responsible operators. Write today for interesting Brikcrete Book No. 2.

Brikcrete Associates, Inc.
4679 Division Avenue, S.
Grand Rapids 8, Mich.



*The World's
Most Modern Masonry*

IN CANADA: DUNN MASONRY MACHINERY LIMITED
800 Dundas Highway, Cooksville, Ont.

PUMP WATER FAST!

Drains Wash Tubs, Cellars, Cisterns. Famous #7 pumps 2800 gph. 420 gph. at 75' high or 1600 gph. from 25' well. Sturdy rustproof alloy metal. Six blade impeller. 3/4" inlet, 1/2" outlet. Standard pipe threaded. Uses any 1/2 to 1/2 H.P. Motor. Will not leak or clog. Iron clad guarantee. Send check, M.O., or sent C.O.D. **\$895** inc. s.

Irrigate, Fill Tanks, Draw Well Water. Heavy duty #8 pumps 7000 gph. —1000 gph. 75' high 3000 gph. from 25' well. Rustproof alloy metal. 8 blade impeller. 1" inlet, 1" outlet. Standard pipe threaded. Will not leak or clog. Iron clad guarantee. Send check, M.O., or sent C.O.D. **\$1195** inc. s.

Free Catalogue—Gear Pumps, Large Centrifugal Pumps, Deep and Shallow Well Pumps, Sump Pumps.

MOORE MANUFACTURING CO.
SWEDSBORO 1, NEW JERSEY

GIVE THE GIFT OF LANGUAGE

IT'S FUN TO LEARN

by **LINGUAPHONE**

World's Standard Conversational Method

FRENCH SPANISH GERMAN RUSSIAN
CHINESE ITALIAN MODERN GREEK

Any of 29 languages available

A Linguaphone Language Set is a lasting gift—an invaluable asset in business, travel, school, armed services and social life. With LINGUAPHONE you LISTEN and LEARN another language the same easy, natural way you learned your own—AT HOME you hear native men and women make everyday conversation—you Understand—YOU SPEAK! It's like living in another country. Over a million home-study students of all ages. There's nothing like "The Gift of Language." Write TODAY for FREE Book, "Passport to a New World of Opportunity." Linguaphone Institute, 143-11 RCA Building, New York 20, N. Y.

LINGUAPHONE INSTITUTE,
143-11 RCA Building, New York 20, N. Y.
Please send me your FREE Book.
LANGUAGE INTEREST

NAME _____

ADDRESS _____

CITY _____ ZONE _____ STATE _____

To Worried Smokers:

Doctors prove pipe smokers live longer!
switch to

YELLO-BOLE



\$1 and up

HERE'S A PROFITABLE BUSINESS FREE!

MONEY MAKING OPPORTUNITY FOR YOU WITHOUT INVESTMENT!

No experience needed to act as our Local Dealer for MASTER Work Uniform garments. Every business concern a prospect. Advertising embroidered on garments is a big sales feature. Stores can't compete. You can easily earn up to many thousands of dollars yearly. We supply all Sales Equipment FREE. Write **GEO. MASTER GARMENT DIV.** 280 WATER STREET, LIGONIER, INDIANA



SAVE and EARN BIG MONEY

BUY WHOLESALE DIRECT

APPLIANCES • HARDWARES • JEWELRY • TOOLS • SPORTING GOODS

There's a profit unlimited in a spare or full-time buying service from your own home. Buy for yourself 60-75% less than retail prices. Sell friends, neighbors, etc., at BIG SAVINGS! No experience or investment necessary. We'll show you how to succeed. Big profits with this sales in a permanent paying business.

WRITE TODAY FOR
FREE COPY OF
"WHOLESALE BUY"

NATIONAL BUYERS SERVICE
BOX 426YE, OAKLAND, CALIFORNIA

XMAS MONEY

It's easy with this beautiful all wood 11 in. high SWISS MUSICAL CHURCH. Regular Retailer \$7.50. Complete kit \$3.95. Add 50¢ postage.

PILTZECKER SWISS IMPORTS, Wood-Ridge, N. J.

'How to Make Money with Simple Cartoons'



A book everyone who likes to draw should have. It is free; no obligation. Simply address

FREE BOOK

CARTOONISTS' EXCHANGE
Dept. 911A Pleasant Hill, Ohio

RUPTURE



RELIEF...OR YOUR MONEY BACK
Original, patented Web,
copied but never matched.
Users say it's best ever. Relief
or no cost to you. Write:

WEB TRUSS CO., Dept. M-11 Hagerstown, Md.

Learn BAKING At Home

Baking is one of America's high industries in wages. Nearly DEPRESSION-PROOF. Thorough basic home course lays sound foundation. If you have aptitude, write for FREE Booklet, "Opportunities in Commercial Baking."

NATIONAL BAKING SCHOOL
835 Diversey Pkwy. Dept. 1358 Chicago 14, Ill.



PICK YOUR OWN SUCCESS STORY FROM THIS PAGE

These are the true stories of people who seemed trapped in routine, low-pay shaky jobs. Handicapped by lack of proper training, they couldn't get the things they wanted out of life—more money, a job they liked, security and happiness.

They are a small sample of the thousands of men and women—young and old—who turn to I. C. S. for help. Their will-to-learn plus I. C. S. training have changed the course of their lives.

Are you discouraged with your job and pay and feel you can't improve yourself because of lack of specialized education? Well, these men and women were in the same boat. With I. C. S. training, one of these success stories could be about you.

I. C. S. is the oldest and largest correspondence school. 277 courses. Business, industrial, engineering, academic, high school. One for you. Direct, job-related. Bedrock facts and theory plus practical application. Complete lesson and answer service. No skimping. Diploma to graduates.



Wins \$3000 contest—"After my I. C. S. courses I secured a new position," says Mr. Cecil Rhodes. "My income has more than doubled and I recently won a \$3000 sales contest."



From clerk to Assistant Estimator, thanks to I.C.S. "Any way you look at it," writes Mrs. Edna James, "the time and money one spends for I. C. S. Courses will be repaid a thousandfold."



"As a college graduate, I found I. C. S. very valuable." Robert Lee took the I. C. S. Course in Advertising, is now Promotion Manager for a large corporation. "I. C. S. got me started on the way up," he says.



From \$152 to \$395 a month—"I. C. S. made my engineering work more interesting," Frank Bachtik tells us. "I was a Jr. Draftsman making \$152 a month. My present income is \$395.25 a month."

3 FREE BOOKS—a 36-page pocket-size guide to advancement, a gold mine of tips on "How to Succeed." Also a big catalog outlining opportunities in your field of interest and a sample I. C. S. lesson text.

For Real Job Security—Get an I. C. S. Diploma!

I. C. S., Scranton 9, Penna.

INTERNATIONAL CORRESPONDENCE SCHOOLS

ICS

BOX 5636-L, SCRANTON 9, PENNA.

(Partial list of 277 courses)

Without cost or obligation, send me "HOW TO SUCCEED" and the opportunity booklet about the field

BEFORE which I have marked X (plus sample lesson):

- | | | | | |
|---|---|--|--|--|
| <ul style="list-style-type: none"> <input type="checkbox"/> ACCOUNTING <input type="checkbox"/> Accounting <input type="checkbox"/> Accounting System <input type="checkbox"/> Installation <input type="checkbox"/> Auditing <input type="checkbox"/> Certified Public Accounting <input type="checkbox"/> Cost Accounting <input type="checkbox"/> Federal Tax <input type="checkbox"/> Junior Accounting <input type="checkbox"/> Partnership Accounting <input type="checkbox"/> Practical Accounting <input type="checkbox"/> ADVERTISING <input type="checkbox"/> Adv. Production <input type="checkbox"/> Business Paper Adv. <input type="checkbox"/> Department Store Adv. <input type="checkbox"/> Direct Mail Adv. <input type="checkbox"/> Magazine & Newspaper Adv. <input type="checkbox"/> Mail Order Adv. <input type="checkbox"/> Psychology of Adv. <input type="checkbox"/> Public Relations <input type="checkbox"/> Radio and Television <input type="checkbox"/> Research and Testing <input type="checkbox"/> Retail Adv. <input type="checkbox"/> Visualizing the Layout <input type="checkbox"/> Window, Interior Display <input type="checkbox"/> COMMERCIAL ART <input type="checkbox"/> Adv. Layout, Illustration <input type="checkbox"/> Commercial Cartooning | <ul style="list-style-type: none"> <input type="checkbox"/> Commercial Drawing <input type="checkbox"/> Fashion Illustrating <input type="checkbox"/> Show-Card Lettering <input type="checkbox"/> Sign Lettering <input type="checkbox"/> ENGINEERING <input type="checkbox"/> Aircraft <input type="checkbox"/> Architecture <input type="checkbox"/> Chemical <input type="checkbox"/> Civil <input type="checkbox"/> Electrical <input type="checkbox"/> Industrial <input type="checkbox"/> Mechanical <input type="checkbox"/> Petroleum <input type="checkbox"/> Stationary <input type="checkbox"/> EXECUTIVE MANAGEMENT <input type="checkbox"/> Budgetary Accounting <input type="checkbox"/> Business Administration <input type="checkbox"/> Business Law <input type="checkbox"/> Business Management <input type="checkbox"/> Business Mathematics <input type="checkbox"/> Condensed Business Practice <input type="checkbox"/> Credits and Collections <input type="checkbox"/> Financing <input type="checkbox"/> Insurance <input type="checkbox"/> Interpreting Financial Statements <input type="checkbox"/> Letter Writing Improvement <input type="checkbox"/> Marketing & Production <input type="checkbox"/> Public Relations <input type="checkbox"/> Purchasing <input type="checkbox"/> Quality Control <input type="checkbox"/> Report Writing | <ul style="list-style-type: none"> <input type="checkbox"/> Retail Business Management <input type="checkbox"/> INDUSTRIAL <input type="checkbox"/> Drafting <input type="checkbox"/> Electronics <input type="checkbox"/> Industrial Instrumentation <input type="checkbox"/> Quality Control <input type="checkbox"/> Reading Blueprints <input type="checkbox"/> Shop Practice <input type="checkbox"/> Supervision <input type="checkbox"/> LEADERSHIP <input type="checkbox"/> Foremanship <input type="checkbox"/> Industrial Supervision <input type="checkbox"/> Leadership <input type="checkbox"/> Personnel Management <input type="checkbox"/> OFFICE MANAGEMENT <input type="checkbox"/> Indexing and Filing <input type="checkbox"/> Office Analysis <input type="checkbox"/> Office Communications <input type="checkbox"/> Office Forms <input type="checkbox"/> Office Management <input type="checkbox"/> Office Reproduction <input type="checkbox"/> Personnel Management <input type="checkbox"/> Supervision <input type="checkbox"/> PERSONNEL <input type="checkbox"/> Collective Bargaining <input type="checkbox"/> Employee Relations <input type="checkbox"/> Employment Practices | <ul style="list-style-type: none"> <input type="checkbox"/> Incentive Wage Systems <input type="checkbox"/> Job Analysis & Evaluation <input type="checkbox"/> Labor Relations <input type="checkbox"/> Organized Training <input type="checkbox"/> RETAIL <input type="checkbox"/> Advertising <input type="checkbox"/> Bookkeeping, Business Forms <input type="checkbox"/> Buying, Pricing <input type="checkbox"/> Department Store Operations <input type="checkbox"/> Retail Merchandising <input type="checkbox"/> Retail Salesmanship <input type="checkbox"/> Window, Counter Display <input type="checkbox"/> SALESMANSHIP <input type="checkbox"/> Creative Salesmanship <input type="checkbox"/> Real Estate Salesmanship <input type="checkbox"/> Sales Analysis <input type="checkbox"/> Sales Letters <input type="checkbox"/> Sales Management <input type="checkbox"/> Sales Records and Reports <input type="checkbox"/> Selecting Salesmen <input type="checkbox"/> Supervising Salesmen <input type="checkbox"/> Training Salesmen <input type="checkbox"/> SECRETARIAL-STENOGRAPHIC <input type="checkbox"/> Bookkeeping <input type="checkbox"/> Business Correspondence <input type="checkbox"/> Business English | <ul style="list-style-type: none"> <input type="checkbox"/> High School Subjects <input type="checkbox"/> Secretarial Accounting <input type="checkbox"/> Stenography <input type="checkbox"/> Typewriting <input type="checkbox"/> TRADES AND CRAFTS <input type="checkbox"/> Air Conditioning <input type="checkbox"/> Apprentice Training <input type="checkbox"/> Automotive Repair <input type="checkbox"/> Blue Print Reading <input type="checkbox"/> Building Trades <input type="checkbox"/> Diesel Engines <input type="checkbox"/> Domestic Refrigeration <input type="checkbox"/> Internal Combustion Engines <input type="checkbox"/> Plumbing & Heating <input type="checkbox"/> Radio Servicing <input type="checkbox"/> Railroad <input type="checkbox"/> Sheet Metal <input type="checkbox"/> Television Service <input type="checkbox"/> Textiles <input type="checkbox"/> TRAFFIC MANAGEMENT <input type="checkbox"/> Air Services <input type="checkbox"/> Freight Class. Rates <input type="checkbox"/> Freight Services, Facilities <input type="checkbox"/> Motor Traffic Management <input type="checkbox"/> Regulation of Carriers <input type="checkbox"/> Shipping Documents <input type="checkbox"/> Tracing, Expediting, Claims <input type="checkbox"/> Traffic Control, Management |
|---|---|--|--|--|

Name _____ Age _____ Home Address _____

City _____ Zone _____ State _____ Working Hours _____ A.M. to P.M. _____

Occupation _____

Canadian residents send coupon to International Correspondence Schools, Canadian, Ltd., Montreal, Canada. . . . Special tuition rates to members of the U. S. Armed Forces.

MOST EXPERIMENTS FOR THE MONEY!



CHEMCRAFT

IDEAL CHRISTMAS GIFT

ENDLESS FUN THAT MAY START A CAREER!

Many famous scientists started with CHEMCRAFT, first in its field, first to bring you exciting ATOMIC ENERGY experiments, first with mysterious chemical MAGIC. From 180 to more than 870 experiments including electrochemistry, glass blowing and organic chemistry, plus big instruction manuals. The finest, most complete chemistry outfits to make a young chemist's dream come to life.

MICROCRAFT

MICROSCOPY OUTFITS

Probe the mysterious secrets of the invisible world! The only truly professional type precision microscopes in their field. From 50 to 450 magnification without eyestrain. Splendid assortment of equipment and specimens.

THE PORTER CHEMICAL CO.
42 PROSPECT AVE., HAGERSTOWN, MD.

AT TOY & DEPARTMENT STORES
Send for fascinating FREE BOOK!



"TOOK IN \$217 FIRST 10 DAYS"

Some make more, some less

We help you to start Your Own All-Year Business

Make Big Money! With our easily operated, highly efficient wall washer, Chas. Stelle took in \$217 gross in first ten days. E. L. Goss took in more than \$10,000 in one year. E. C. Taber wrote, "I made \$400 gross in two weeks." And no wonder—this machine washes walls 6 times faster and better than by hand. **Your Money-making Opportunity.** Enjoy independence—freedom from bosses, layoffs. Customers everywhere—homes, offices, schools, etc. Expenses low, profits high. No shop necessary; operate from home. Can start spare time until your full time is available.



Lose no time. Get all facts without obligation

FREE BOOK! MAIL COUPON TODAY!

- VON SCHRADER MFG. CO.
- E10 "W" Pl., Racine, Wisconsin
- Send at once (no obligation) your FREE booklet containing information about your WALL WASHING MACHINE and how I can start my own permanent, profitable business.
- Name _____
- Address _____
- City _____ Zone _____ State _____

BIG BAG of STAMPS



WHAT TREASURES WILL YOU FIND?

Exciting Treasure Hunt! More than 1,000 foreign stamps from over 30 countries in Asia, Africa, Europe, etc., mostly unsorted, unsorted, just as received from foreign missionaries, banks, etc. Nobody knows what's inside! Guaranteed worth over \$10 at Standard Catalog prices or your money back. ONLY \$4. Write today.

Only \$1.00

H. E. HARRIS & COMPANY
772 Transit Bldg., Boston 17, Mass.



FREE-VALUABLE U.S.A. STAMPS!

Scarce genuine postage stamp, as illustrated, picturing first U. S. A. (issued in 1847); PLUS big collection of 30 all-different United States; 19th century, valuable \$5.00 stamp, etc.; PLUS packet beautiful Commemoratives including 1893 Columbian, Boy Scouts, Wild West, many others. Big illustrated U.S. catalog included if you send today! EVERYTHING for 10¢ to cover mailing expenses only! Approvals. Act at once! H. E. HARRIS & CO., 97 Transit Bldg., Boston 17, Mass.

Men's **EGYPTIAN** "Goddess of Luck" RING

Sol With Later, Genuine **2 CARAT ZIRCON**

LOOKS LIKE \$1000.00 GENUINE DIAMOND

PAY ONLY \$4.50

Worn by hundreds with the belief it brings good luck, success, good health. Beautifully designed. Send no money—Pay postage plus 10% Fed. Tax. If not delighted return in 5 days—MONEY-BACK GUARANTEE.

S & K ZIRCON COMPANY
3417 COTTAGE AVENUE, BALTIMORE 15, MARYLAND

Say You Saw It in Popular Mechanics

Write Like This

YOUR penmanship can be improved in 3 hours or corrected to your satisfaction in 10 hours' practice with my DEFINITE HAND CONTROLS. New way!

WRITE OZMENT BOX 668
34-N, ST. LOUIS, MISSOURI

Complete OUTLINE FREE!

YES! SEND



directly to my door every month

I am enclosing

- \$3.50 for 1 year
- \$8.00 for 3 years

name _____

address _____

city _____

zone _____

state _____

Hand this order to your newsdealer or send it to

POPULAR MECHANICS
200 East Ontario St. Chicago 11, Ill.

POPULAR MECHANICS

They
Actually Turn

**Genuine BALL BEARING
JEWELRY for the MAN
in INDUSTRY***

*—and the Ladies he loves!

Moving jewelry that turns conversations your way! Ideal as gifts, premiums, party prizes, etc. Genuine ball bearings, handsomely double-gold plated. Practical, clever and constant reminders of you, your profession and your interests.

- Tie Clasp (reg. or slim).....\$1.95
- Cuff Links, pair..... 3.95
(—for man-tailored blouses, too!)
- Tie Clasp & Links, set..... 5.45
- Earrings, pair..... 2.95
- Money Clip, each..... 2.95

Sorry, no C.O.D.'s, naturally.



THE
MAN'S WORLD



THE MAN'S WORLD
Dept. PM-105
90 WEST STREET
New York 6, N. Y.

... that Women Love!

BUY IT WHOLESALE!

GET
UP TO
40%
OFF

Start a Buying Service at Home,
SPARETIME. GET BIG-NAME MERCHANDISE FOR
YOURSELF AND CLIENTS UP TO 40% LESS THAN REG.
PRICE. SALES EASY, AS YOU CAN GIVE Sizable
DISCOUNTS. STILL MAKE FAT COMMISSIONS.
Post Card brings FREE COPY "The Wholesale Plan".

FREE!
"THE
WHOLESALE
PLAN"

American Buyers Service

• 631-R Linden Ave., Buffalo 16, N. Y. •

DAN LURIE
"America's Most
Muscular Man"
—on television's
"Big Top."

FAMOUS DAN LURIE

BARBELLS

with 4 courses—low factory prices
50 lb. set...\$ 8.48 | 150 lb. set...\$20.48
100 lb. set... 13.98 | 200 lb. set... 25.98

Write for Order by Mail; 50% with order, bal. C.O.D.
Free Catalog Extra wts. 13c per lb., P.O.B. plant

DAN LURIE BARBELL CO.

52-M-11 Bristol St., Dept. 459-L, Brooklyn, N. Y.

SAY YOU SAW IT IN
POPULAR MECHANICS

**REPRODUCE ANY OBJECT
QUICKLY, EASILY**

Now you can easily and quickly make reproductions of any object, in any quantity, right at home, overnight. Make perfect copies of anything of wood, metal, clay, plastic, glass, with new RUBBER MOLD method. No tools or special skills needed. Send for complete kit #100M only \$2.95 postpaid. Brochure M11 gives complete, easy step-by-step instructions only 10c.
SCULPTURE HOUSE, 304 W. 42nd St., New York 36, N. Y.

IS
YOUR **ENGLISH** HOLDING
YOU BACK?

New CAREER INSTITUTE method enables you to stop making mistakes in English, build up your vocabulary, speed up your reading, improve your writing, acquire the "secrets" of fluent conversation. Good English pays off in unexpected ways because words are the tools of thought. The more you learn about words and how to use them to express your ideas, the better your thinking becomes.

FREE BOOKLET

The improvement of your English—and your thinking—can lead quickly to amazing personal achievements. Thousands of men and women use the low-cost CAREER INSTITUTE method. Takes only 15 minutes a day at home. For FREE 32-page booklet send card or letter. No salesman will call—no obligation. CAREER INSTITUTE, Dept. D-1111, 25 E. Jackson, Chicago 4, Ill.

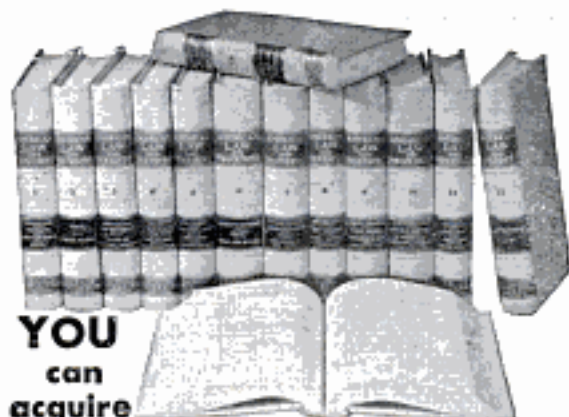

YOU
can
acquire

**LAW NIGHTS AT HOME!
L. L. B. DEGREE**

LaSalle's famous Law Library—used as reference in many Law libraries and Law offices—has enabled thousands to master Law surprisingly fast, in spare hours at home, for business and professional advancement.

These 14 remarkable volumes, compiled by leading professors and lawyers, cover the whole basic field of Law in condensed, orderly, simplified manner.

You advance rapidly with this great library, plus special lectures furnished. We guide you step-by-step with personalized Problem Method of instruction... you learn by doing—handling legal problems—not by memorizing rules.

Send for two FREE 48-page booklets, "Law Training for Leadership," and "Evidence," answering questions about Law and its value to you, and telling how LaSalle Law graduates are winning rapid advancement in business and public life. Mail coupon below. No obligation.

**LA SALLE EXTENSION UNIVERSITY
A Correspondence Institution**

417 S. Dearborn St. Dept. 1164L Chicago 5, Ill.

Send me your two FREE booklets described above, without obligation.

Name.....Age.....

Street.....

City, Zone & State.....

**ENGINEERING DEGREE IN
27 MONTHS**

Big Demand for Graduates

Aeronautical, Chemical, Civil, Electrical, Mechanical and Radio Engineering (inc. TV and Electronics)

Hundreds of young men are earning B. S. ENGINEERING DEGREES annually in this recognized institution — year around operation. New terms start quarterly. Many students earn a major part of their college expenses in this large industrial center.

Low tuition. Competent instruction. Thorough, intense, practical program. Modern, well-equipped laboratories including new physics laboratory and modern wind tunnel. Individualized instruction emphasized.

Government approved for G.I.'s. Engineering preparatory courses. Students from 48 states and 21 foreign countries. Enter December, March, June and September. Send coupon for free catalog and full information. Enroll now.

SEND COUPON TODAY

INDIANA TECHNICAL COLLEGE

5114 E. Washington Boulevard
Fort Wayne 2, Indiana

Please send me free information on B.S. Engineering Degree in 27 months as checked.

- Aeronautical, Chemical, Civil, Electrical,
- Mechanical, Radio-Television

Name.....

Address.....

MECHANICS

—EARN BIG PAY—

Industry needs skilled mechanics. GREER, leader for more than 50 years in the Trade School field, can train you quickly—You "learn by doing," using the finest equipment, under the supervision of expert technicians.

APPROVED FOR CIVILIANS OR GI'S

—CHOOSE YOUR TRADE—

- DIESEL MECHANICS.....20 Weeks
- AUTOMOTIVE MECHANICS.....20 Weeks
- BODY & FENDER REPAIR.....16 1/2 Weeks
- GAS ARC WELDING.....4 to 12 Weeks
- REFRIGERATION.....13 1/2 Weeks
- AIR-CONDITIONING.....8 1/2 Weeks
- MACHINIST TRADE.....30 Weeks
- ADVANCED MACHINIST
(includes tool & die).....32 1/2 Weeks
- PIANO TUNING & REPAIR.....36 Weeks

CHOOSE YOUR ENGINEERING COURSE

- DIESEL AUTOMOTIVE ENGINEERING.....2 Years
- REFRIGERATION & AIR COND. ENGINEERING.....18 Months

FREE EMPLOYMENT HELP.

Start your career with Greer by checking your interest above and mail coupon for complete information at no obligation.

NAME _____ AGE _____

STREET _____

TOWN _____ ZONE _____ STATE _____

Established 1902 — Over 50,000 Graduates.

GREER SHOP TRAINING
2236 S. Michigan Ave.
Chicago 16, Illinois

WANTED MAN WITH CAR

NO TIME LIKE NOW TO
GET IN McNESS BUSINESS

It's no trick to make good money when you use your car as a McNess "Store on Wheels." Farmers buy everything they can from McNess Men because McNess Products are tops in quality, represent extra values. Attractive business-getting prizes and premiums; also money-saving deals to customers make selling McNess daily necessities a snap.



WE SUPPLY CAPITAL—START NOW!

There's no better work anywhere. Pays well, permanent, need no experience to start, and we supply capital to help you get started quick. You begin making money first day. Write at once for McNess Dealer Book. It's FREE. Tells all—no obligation. (15)

THE McNESS CO., 164 Clark St., Freeport, Ill.

BEING PUSHED AROUND??



Why take any more nonsense from bullies, wise guys and other pests? The next time they try to act smart—give them the surprise of their lives! It's easy when you know POLICE JIU JITSU! This complete, fully illustrated course comes to you in one volume. The same as taught to police, marines, "G" men, soldiers, sailors and members of the U. S. Coast Guard. By all means, just pin 21 to this ad and we will send POLICE JIU JITSU to you postpaid FOR RETURN MAIL. Satisfaction guaranteed or your money back.

BOOKS PUBLISHING CO., AMITYVILLE, N. Y.

Say You Saw It in Popular Mechanics

TELEVISION! CAMERAMAN, REPAIRMAN

Learn at home, in spare time. No experience needed. We send you 15' Radio-TV kits including TV receiver. Earn while you learn. Write for free TV Book, free sample lesson, etc. APPROVED FOR VETS. RADIO-TELEVISION TRAINING ASSOCIATION
Dept. M-11 52 East 19th St. New York 3, N. Y.

OIL FILTER REFILLS . . . 10c

Here's News! Ordinary toilet paper makes an ideal oil filter. Laboratory tests prove it cleans oil faster and better than popular makes of filter elements. All you need is a simple set of Retlif Adapter Plates . . . and you can start using toilet paper rolls (costing about 10c) in your present oil filter. For proof and descriptive literature, send name and address to:

RETLIF CORP., Dept. 133, 1239 No. Highland Ave., Los Angeles 38, Calif.

"YOU ARE UNDER ARREST!"

There's a Thrill in Bringing a Crook to Justice Through Scientific

CRIME DETECTION!



We have taught thousands this exciting, profitable, pleasant profession. Let us teach you, too, in your own home. Learn Finger Printing, Fire Arms Identification, Police Photography and Criminal Investigation thoroughly, quickly and at small cost.

Over 800 of All American Bureaus of Identification employ students or graduates of I. A. S. You, too, can fit yourself to fill a responsible crime detection job with good pay and steady employment. But don't delay—get the details now. Let us show you how easily and completely we can prepare you for this fascinating work, during spare time, in your own home. Write today stating age.

INSTITUTE OF APPLIED SCIENCE

(A Correspondence School Since 1910)

1920 Sunnyside Ave., Dept. 1358, Chicago 40, Ill.

Be A
FINGER
PRINT
Expert

FREE!!!
Send for Thrilling
"BLUE BOOK
OF CRIME"

ELECTRICAL WIRING JOBS

Official
CODE RULES
made clear by
PICTURES!

2 GIANT Volumes now made Easier!
3168 Pictures! Surer! SAFER!

Newest idea in ages! Official National Electrical Code rules made crystal-clear by PICTURES! Books contain thousands of pictures explaining every Code rule, parts of rules, exceptions, etc. Based on latest Code . . . shows how to do a right job every time. Saves you time, money, inspection headaches. Pictures are big and clear . . . on 8 1/2 x 11 page size . . . over 1600 pages. Covers things like wiring design and protection, wiring methods, hazardous locations, etc.

ELECTRICAL CODE DIAGRAMS

A few minutes study a day makes you a real Code expert...helps you on the job every day.

- Speeds your electrical planning and installation
- Saves costly errors, expensive violations
- Numbered exactly like Code for quick reference

FREE TRIAL!
EASY TERMS

McGraw-Hill Book Co., Dept. PM-11 (This offer applies to U. S. only)
327 West 41st St., New York 36, N. Y.

Send for 10 days' FREE trial Segall's ELECTRICAL CODE DIAGRAMS, 2 vols. If not satisfied, I will return books. Otherwise I will send \$5.00, plus delivery charges, then \$5.00 a month until \$25.00 is paid. (We pay delivery if you remit with coupon; same return privilege.)

Name _____

Address _____

City & State _____

Employed by _____ PM-11

LEARN MEAT CUTTING AT NATIONAL

Pay After Graduation



The steady dependable trade of Meat Cutting taught easily in 8 short weeks. **YOU LEARN BY DOING** under actual meat market conditions in big modern school at Toledo.

For beginners or men with experience. Get a profitable store of your own. Remember, **PEOPLE MUST EAT!** Big pay jobs. Free employment help. Thousands of successful graduates.

Buying, cutting, percentage, pricing, advertising, selling, etc. A complete retail meat education. National School established over 30 years. Get National training **NOW**. Pay your tuition in easy weekly payments

after you graduate. Send coupon for **FREE** 52 page school catalog — **TODAY**. G.I. approved.

National School of Meat Cutting, Inc., Dept. 50-L, Toledo 4, Ohio

Send me your **FREE** school catalog on National Training at Toledo in Meat Cutting, Meat Merchandising and Self Service Meats. No obligation. No salesman will call.

Name _____ Age _____

Address _____

City _____ State _____

Approved for training Korean Veterans

Broken or Loose FALSE PLATE?



Fix it Yourself **EASILY** in a Few Minutes

Your plates may become broken or loose just when you need them most. With **FIX-IT-KIT** you can repair your own broken plates. Also tightens loose fitting plates, easily. Get permanent comfort with professional material. Complete instructions. Satisfaction guaranteed or your money refunded. **Order Now** at a new low price only **\$2.98** postpaid — or sent C.O.D.

Make Plates Like New

DENT-FIX DENTAL PRODUCTS, Box 674, Dept. PM-11, Kansas City 41, Mo.

Say You Saw It in Popular Mechanics

Learn CARTOONING



at home in spare time . . . the quick easy Landon Picture Chart way. Teaches how to originate—today's big need. Scores of successes. Send 10c for Picture Chart (no test ability) and full details. Please state age.

Landon School of Cartooning, 5411 CT5 Bldg., Cleveland 14, O.

"HOW TO EARN MONEY IN YOUR SPARE TIME"



SENT FREE!
RUSH POST-CARD NOW!

In your own home . . . **PRINT WITHOUT A PRINTING PRESS**. Miracle New Printing Method. Print full color **SIGNS, POSTERS, BANNERS, FABRICS**—anything. Print hundreds at a time (\$100.00 jobs cost you less than \$10). **NO ART** ability necessary. It's easy! We supply everything! **REPRESENTATIVES WANTED**. Unlimited profit opportunities. Help fill **HUGE DEMAND**. Write!

SCREEN-PRINT, Dept. 28, 15130 S. Broadway, Los Angeles 61, Calif.



NEW Crosman

SPORT STYLED AIR RIFLE

Push-button cocking, precision rifled barrel, more hard-hitting power, .22 cal., safety, blued steel finish.

\$14.95

FREE CATALOG

CROSMAN ARMS CO., FAIRPORT, N. Y., Dept. 45

Send for **FREE** 112 page

Illustrated Catalog of Farm, Home, and Workshop Bargains.

Write to **WELLWORTH TRADING COMPANY**

1832 S. WABASH AVE. CHICAGO 16, ILL.

EARN BIG MONEY!

GROW "LIVING" MIDGET TREES!

AT HOME — SPARE TIME — NO EXPERIENCE NEEDED!

It's new! Amazing! At last, the secret of growing miniature (MING) trees can be yours. **FULL GROWN**, dwarf trees—only a few inches high. Beautiful miniature fir, orange, oak, Chinese elm, peach, pine, cypress—any kind! **ALL BLOOM** and even **BEAR FRUIT!** All perfect healthy specimens—but miniature in size! Make costly home decorations and expensive centerpieces. (**SOLD FOR OVER \$1,500 EACH**.) Big demand. Costs only pennies—takes only minutes per week. **IT'S EASY!** Fun! A new fascinating hobby—a new fabulous \$\$\$\$ business. Send for free secret plan details and real seed.

HELP US FILL HUGE DEMAND

These trees are being demanded

- by **STORES** **CLUBS** **HOTELS**
 - FLORISTS**
 - HOUSEWIVES**
 - INTERIOR DECORATORS**
 - COLLECTORS**
 - HOBBYISTS**
- Big Money Opportunity for you.

CYPRESS TREE



JUNIPER TREE



FIR TREE

HOW TO LEARN GROWING SECRETS

\$ BOTH SEED FREE

MAIL TODAY FOR FREE SEED AND PLAN!

NATIONAL NURSERY GARDENS, Dept. M-11
8463 South Van Ness, Inglewood 4, California
Rush me **FREE PLAN** and **SEED** IMMEDIATELY!

Name _____

Address _____ Zone _____

City _____ State _____

FOR YOUR
**TECHNICAL AND VOCATIONAL
TRAINING**

COME TO THE
UNIVERSITY OF HOUSTON
(Located in Fabulous Houston, Texas)

Select from these fascinating fields:

- | | |
|---|---|
| <input type="checkbox"/> Air Conditioning & Refrigeration | <input type="checkbox"/> Drafting |
| <input type="checkbox"/> Auto Body & Paint | <input type="checkbox"/> Electricity |
| <input type="checkbox"/> Auto Mechanics | <input type="checkbox"/> Electronics |
| <input type="checkbox"/> Auto Upholstery & Trim | <input type="checkbox"/> Machine Shop |
| <input type="checkbox"/> Furniture Upholstery | <input type="checkbox"/> Radio Servicing |
| <input type="checkbox"/> Diesel | <input type="checkbox"/> Television Servicing |
| | <input type="checkbox"/> Welding |
| | <input type="checkbox"/> Woodworking |

PREPARE FOR YOUR FUTURE NOW . . . with very latest methods and extensive equipment, at modern U. of Houston College of Technology. Open to high school graduates, or equivalent. Beautiful campus—250 wooded acres in Houston, Texas—city of tomorrow. Air-conditioned classrooms and residence halls. University TV and radio stations. Full college activities, sports, social life. Co-educational. Co-op work-study programs . . . earn part of tuition and expenses with part-time job in your own career field, while you learn. Personal vocational counselling. G.I. approved—V.A. on campus. Job placement assistance. Feb., June, Sept. semesters. Mail ad now for FREE fully-illustrated brochure. No obligation. Mark X before choice of subject. Do it today!



UNIVERSITY OF HOUSTON, COLLEGE OF TECHNOLOGY
Dept. 1B4—HOUSTON 4, TEXAS

**105 POWER
SUPER TELESCOPE**



Everything for the Astronomer, Hobbyist, Student, and Scout in this complete astronomical super value telescope combination. Set comes ready for immediate use, consists of brilliant 33x-65x-105x telescope, 5 foot hardwood Tripod, carrying case for scope, Star Explorer map and 108 page book "Discover the Stars." The 3 foot telescope (closes to 16 inches) is brass bound, has 4 precision lenses that will bring distant objects, people, moon, stars, ships, etc., 105 times closer. All images erect. The sturdily built tripod is equipped with universal mount that has a 360 degree horizontal range and 180 degree vertical range. It locks in any position with one simple adjustment. The Star Explorer map enables you to find any star automatically. This marvelous all purpose instrument is proclaimed by Scientists as a most unusual development. Everyone that has used it is amazed at its performance and value. It will fascinate the entire family. Shipped to you complete, nothing else to buy, at the amazing low price of

\$11.95
POST PAID

Satisfaction guaranteed or money refunded. We pay all delivery charges. Send check or money order to DEPT. PM55

CRITERION CO. 331 CHURCH ST., HARTFORD 1, CONN.

**100 YEAR OLD
U. S. STAMPS**



Believe it or not, but ours is the only firm capable of sending "On Approval" all U. S. stamps, even those over 100 years old, and all foreign too, incl. Roosevelts, Coronations etc. Try it and see! Send 10c for our introductory bargain of 50 diff. U. S. and state whether approvals shall be U. S. foreign or both.

GLOBUS STAMP CO. 268 - 4th Ave., Dept. 213
New York 10, N. Y.

Tiny Telescope
Gives "CLOSE-UPS"
FROM MILES AWAY

ONLY \$3.95 TAX FREE

A Powerful telescope yet the size of your thumb! Completely inside your hand! A revolutionary German made optical achievement. Precision easy-slide operation. Scientifically ground lens provide Brilliant Illumination, sharp detailed images, Lustrous A.I. CHROME with black trim. An all purpose performer . . . Instant focusing from 2 feet to infinity! NOT A TOY! Case 50c extra.

NO RISK TRIAL OFFER. If not 100% satisfied after 10 Day Trial return for full refund. Cash orders \$3.95 postpaid. (C.O.D.'s \$4.51)

UNITED BINOCULAR CO., 9043 S. Western, Dept. PT-8508, Chicago 20.



26" OPERATING SCALE MODEL SUBMARINE
Heavy duty spring motor drives twin propellers, thru sealed gears, running in oil. Water ballast chamber with air valve control for diving or operating submerged. ALUMINUM HULL. BRASS DECK TRIM.
CONSTRUCTION KITS AND ASSEMBLED MODELS
Price Range \$6.50 to \$16.50. Send 3c stamp for detail literature.
WESTLAKE MODEL CO. Dept. P4 Ventura, Calif.

Bar Bells

Buy Direct From Factory **\$8.95** up

Write for free booklet and price list.

INDEPENDENT IRON WORKS
2416 East 23rd Street, Dept. B
Los Angeles 58, Calif.

START OWN BUSINESS ASSEMBLING INSTALLING STORM WINDOWS

Spare Time—No Experience Needed

Big demand today for Buckeye Combination Storm Windows and Doors—glass and screen interchangeable. Both Redwood and aluminum. Build own spare or full time business assembling and installing them. 100% to 200% profit. Each size individually packaged. Sell from sample. No inventory. No special tools needed. Past 20 years many have made big money. We tell you how you can make \$10.00 per hour.

FREE FOLDER — WRITE
Buckeye Screen & Weatherstrip Co.
12801 22nd St., Columbus 7, Ohio

You Pay **\$6.65** You Sell **\$22.00**

BIG PROFIT

The low 100 Redwood 26 1/2" x 24 1/2" window for low price. (Illustration slightly higher.) Make big profit and still beat competition.

**LOOK BETTER!
FEEL BETTER!**

**USE A
Vibrosage
ELECTRIC MASSAGER**

- Professional-Type
- 4 Scientifically Designed Applicators
- Sanitary

A few minutes daily use of VIBROSAGE gives that stimulating, healthful aid to circulation . . . relief from aches and pains. Four applicators assure maximum effectiveness for scalp, face and body. Operates on 110 volt, 60 cycle A.C. Five day trial—money-back guarantee! If your dealer cannot supply you, send \$8.95 check or money order, for pre-paid shipment. Or, send \$2; pay postman balance plus postage and C.O.D. charges.

BEAUTY APPLIANCE CORP., Dept. V524-L, RACINE, WIS.

BREED

• TROPICAL FISH •

EARN \$\$\$\$\$ at HOME DURING SPARE TIME. Wonderful new Home-Business opportunity! HELP US FILL HUGE DEMAND from 20 million hobbyists. Some Rare beautiful multi-colored species sold for \$75 PR. AND MORE. It's easy! It's fun! WE SUPPLY EVERYTHING YOU NEED. Write for FREE plan, reprint, folder and all the details. Please state your age. **TROPICAL FISH BREEDERS OF AMERICA, Dept. DB, 15127 S. Broadway, Los Angeles 61, Calif.**

TOOTHACHE?

Ask your Druggist for **DENT'S TOOTH GUM TOOTH DROPS POULTICE**

SAVE \$65 ON THIS \$100 CONTOUR CHAIR

- Goodyear Air Foam Cushioning
- Duran Upholstery
- Easy to assemble—hammer, screw-driver only.
- Green, Gray, Red, Brown
- Money back Guarantee

Everything needed to put together in one evening
\$34.95

ORDER NOW. \$5 deposit. Balance C.O.D. Or write for literature. **BESTCRAFT CO., Dept. H6, Mathieson Bldg., Baltimore 2, Md.**



The WONDERS of LIQUID PLASTICS

MANUFACTURE WITHOUT TOOLS OR MACHINERY

No previous experience or special ability required! NO TOOLS OR MACHINERY required . . . the entire process is about as easy as pouring water out of a glass! The WONDERS OF LIQUID PLASTICS make all this possible! Many of the products made with our liquid plastics serve so many diverse and useful functions, many can so easily be converted into beautiful and attractive products that thousands of our customers are now actively engaged in a wide variety of proud and profitable businesses established with the aid of our products and instructions!

UNLIMITED POSSIBILITIES

Work with LIQUID IVORY, LIQUID GLASS, LIQUID MARBLE, LIQUID EBONY, LIQUID PORCELAIN, LIQUID WOOD, LIQUID GEMSTONE, and many other LIQUID PLASTICS and in a matter of minutes turn them into an endless and valuable procession of beautiful imbedded jewelry, novelties, ornaments, statuettes, bookends, lamps, pensets, lighters, ashtrays, keychains, figurines, curios, SOUVENIRS, art and gift products, fishing lures, BOATS, GADGETS . . . also e. exquisite GEMS! Make seals, lozels, dies, forms, handles, dials, knobs, MACHINE PARTS, models of inventions, pistol grips . . . the list is endless! The only LIMITATION is your IMAGINATION! Liquid Plastics are the blessing of every creative and ambitious person . . . with these materials ANYONE can create and manufacture by the THOUSANDS and at a tiny fraction of what it would cost by any other method! Just send 25c and we will send you our big combination Instruction-Catalog describing all of the products mentioned above and the methods of use! You'll readily admit it's the most fascinating book of its kind as far as opening new worlds of activity and opportunities for you! Send for it today.

PLASTICAST CO., (Dept. C)

P.O. Box 6737 (Write to) P.O. Box 987
Chicago 80, Ill. (either address) Palo Alto, Calif.

FREE!

This highly instructive book will be sent FREE only to those serious inquiries requesting our Instruction-Catalog (25c). No postcards, please.



PLASTIC LAMINATING

This remarkable Plastic Laminating Machine will earn \$18.00 an hour right in your kitchen! Big profits laminating Business, Social Security, Identification, Credit CARDS of all kinds, photos, passes, clippings, plaques, etc. Prices from \$32.00 and up. Easy terms. Will accept any equipment in trade. Literature free. **PLASTICAST CO.** (See addresses above)



GEARS



FISHING LURES



PEN SETS



HANDLES

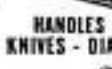

KNIVES - DIALS



STATUES FIGURINES



JEWELRY GEMS



NOVELTIES GADGETS



New Edition!

Catalog of 3200 Novelties, Gadgets, Jokes & Tricks

Send 10c for amazing catalog of novelties, joke articles, funmakers, tricks, gadgets, live animals, scientific supplies, hobbies, planes & boats, unusual seeds, time-savers, cameras, optical goods, projectors, movies, lucky jewelry, religious goods, disguises, masks, musical instruments, stamps, coins, puzzles, fortune tellers, radios, auto & bike accessories, telescopes, magnifiers, compasses, banks, smokers' items, artist supplies, printing sets, engines, motors, shockers, knives, billfolds, guns, rifles, sports, books, games, plants, pennants, emblems, etc. Send name, address and 10c to:

JOHNSON SMITH & CO.
Dept. 909 Detroit 7, Mich.

Here's 10c. Rush me New Catalog!

Johnson Smith & Co., Dept. 909, Detroit 7, Mich.

Name _____

Address _____

PIONEERS IN TECHNICAL TRAINING

TRAINED TELEVISION & ELECTRONIC MEN DESPERATELY NEEDED!

BIG PAY — SECURE FUTURE

Why work for low pay jobs or risk being out of a job. The TELEVISION and ELECTRONIC industry is **BOOMING and NEEDS MEN NOW!** Why waste valuable time poring over books, graphs and charts? We train you in just a few short months, to get in on the ground floor of this Billion dollar industry. You learn immediately by rebuilding, repairing and operating the most recently developed equipment under the guidance of outstanding experienced instructors.

If you want to really learn television and electronics . . . If you really want to get into the big money fast in this gigantic industry . . . it will *pay you* to find out the outstanding advantages of World Famous Bailey School Training. For big pay, act to-day! Mail coupon now for informative school Brochure—it contains complete information and illustrations of equipment and shop training . . . How we help you find part time jobs while in school . . . full time jobs after graduation . . . Success stories of Bailey Students.

BAILEY Technical SCHOOLS
 Veteran Approved
 1634 S. Grand St. Louis 4, Mo. T

NAME.....AGE.....
 STREET.....
 TOWN.....ZONE.....STATE.....

WATCHMAKING

Why spend all your life at dull or backbreaking work? Watchmaking is light, clean, fascinating. Lifelong livelihood. Learn the quick Sweeney way at home or Chicago School. Modern methods, step-by-step. No previous experience needed. Individual training. Start any time. Approved for vets. Send for FREE sample lesson. No obligation. Write today!

CHICAGO SCHOOL OF WATCHMAKING
 2330 N. Milwaukee Ave., Dept. 1114, Chicago 47, Ill. Veteran
 Send me FREE sample lesson Home study Resident school

Name.....
 Address.....
 City.....Zone.....State.....

Say You Saw It in
POPULAR MECHANICS

High School at Home

MANY FINISH IN 2 YEARS

No classes. No time wasted going to and from school. Progress as fast as your time and abilities permit. Standard H. S. texts supplied. Thousands enroll each year in this 57-year-old school. Send for FREE descriptive booklet.

AMERICAN SCHOOL, Dept. H845
 Drexel at 58th St., Chicago 37, Ill.
 Without obligation, please send FREE descriptive booklet.

Name.....
 Address.....
 Canadian Residents: Complete Canadian Course Available.
 Write American School, 1610 Sherbrooke St., West, Montreal.

OWN a Business

\$5 HOURLY Profit . . .
Even If NOW Employed

Alert dealers average 55 hourly profit on own service plus \$3 on EACH serviceman. You can profitably operate part time while building a full time business. We locally train and assist you.

Clean and Mothproof, Rugs and Upholstery
 Duraclean cleans by absorption! No scrubbing, soaking or shrinkage. Dirt, grease and unsightly spots vanish as if by magic . . . matted pile rises . . . colors revive.
 Duraproof protects against moths and carpet-beetle damage. Makes materials resistant to both. Backed by an International Money-Back 6-Year Warranty.

No experience needed. Easy to learn. Quickly established. Nationally advertised Services rendered "In the home." You are trained in your own home town. No Shop Needed. We furnish enough materials to return your TOTAL investment. Territories limited. Write today for FREE booklet explaining details and Easy Terms.

Duraclean Co., 4-16N Duraclean Bldg., Deerfield, Ill.

SKI KIT
\$15.30
SAVE 1/2

IDEAL CHRISTMAS GIFT

Simply assemble and finish our new water ski kit and you have a pair of skis worth twice the price of the kit. Skis are 7 ply moulded plywood, 67 1/2" long, 7" wide, 3/16" thick. Sturdy rubber foot pieces. All parts plus instructions included—\$15.30. Order from your Michigan dealer or MICHIGAN WHEEL CO., Dept. PM-1111, Grand Rapids, Mich. C.O.D. orders accepted.

WHOLESALE Electric Guitars - Parts - Build Your Own
 Accorions, amplifiers, double-necks, triple-necks, pickup mikes, mandolins, non-electric instruments, etc. 1959 Models wholesale. Free Catalog. Free home study course with instruments. Parts and plans available to build your own 6 or 8 string or multi-neck electric guitar. Martin and Fender available at list price.

CARVIN CO., Box 28 PM11, Baldwin Park, Calif.

New Accurate 10" SLIDE Rule

PROFESSIONAL MODEL \$2

For multiplying, proportions, division, extracting roots—difficult calculations at lightning speed without paper or pencil. Easy to learn!—ABC 32 pg. Inst. Book Free sealed A-B-C-D-E-F-G-H-I-J. Lacquer Finish. Leather Case. 82 Plus 25c post. & handling charges. No C.O.D.'s.

UNIVERSAL MAIL MART, Inc., M-11r, 27 E. 22 St., N.Y., N.Y.

Print Your Own

Cards, stationery, circulars, tags, labels, photo and movie titles, advertising, etc. Save money. **Print for Others, Good Profit!** easy rules sent. Raised Printing like Engraving, too. Sold direct from factory only. Write for free catalog of outfits and all details. **KELSEY PRESSES, M-37, Meriden, Conn.**

BENJAMIN SUPER CO2 GAS CARBINE—\$16.50

NEWEST TARGET RIFLE—22 IDEAL FOR SMALL GAME

ECONOMICAL SAFE—NON-TOXIC ACCURATE—CONVENIENT PRACTICAL Easy to operate—No spring recoil—No pumping. Uses low cost Soda Cartridges. Cal. 22 Benjamin H-C Pellets and Darts.

Benjamin CO2 Gas Pistols Also Available

WRITE FOR FREE ILLUSTRATED FOLDER OF ALL MODELS BENJAMIN AIR RIFLES AND BENJAMIN AIR PISTOLS BENJAMIN AIR RIFLE CO.
 896 MARION ST., ST. LOUIS 4, MO. U.S.A.

Don't Neglect Slipping FALSE TEETH

Do false teeth drop, slip or wobble when you talk, eat, laugh or sneeze? Don't be annoyed and embarrassed by such handicaps. **FASTEETH**, an alkaline (non-acid) powder to sprinkle on your plates, keeps false teeth more firmly set. Gives confident feeling of security and added comfort. No gummy, gooey, pasty taste or feeling. Get **FASTEETH** today at any drug counter.

WAR SURPLUS BARGAINS

WAR SURPLUS BARGAINS

\$500,000.00 INVENTORY for QUICK LIQUIDATION

Surplus items—hundreds of them for home, shop, factory, farm and outdoor use. New items, used items, reconditioned items—all at tremendous savings—all priced for quick sale.

Page After Page of Values

This big catalog shows page after page of amazing money saving values. Write for your copy today. Send 10c to cover postage, mailing, etc. Write today! **SEND TODAY FOR YOUR COPY**

10c

STARK'S 212 W. Madison St.
Dept. PM-1154
CHICAGO 6, ILL.

STAMP COLLECTORS ATTENTION

315 DIFFERENT STAMPS 25¢

This imported collection includes an AIRMAIL group: Lundy Island, Croatia airport, San Marino, Iberia Air set, etc. TROPICAL COLLECTION of Animals, U.P.U.'s, United Nations Set, Flowers, Triangles, etc. Altogether 315 all Different Stamps Cataloging over \$6.50—only 25¢ with good-value Approvals.

IDEAL STAMP CO., Dept. 1A, P.O. Box 64
WEST FARMS STATION, NEW YORK 60, N. Y.

LAW FREE BOOK

Write today for FREE book, "THE LAW-TRAINED MAN," which shows how to learn law in spare time through the famous Blackstone home-study course in business and professional law. All instruction material furnished including big 16-vol. law library. Bachelor of Laws (LL.B.) degree awarded. Moderate cost; easy terms. Write today.

Blackstone School of Law, 225 North Michigan Ave.
Founded 1890 Dept. 58, Chicago 1, Ill.

PLEASE SEND ME

POPULAR MECHANICS MAGAZINE

for the time checked.
I am enclosing . . .

1 year \$3.50
 2 years \$6.00

name _____
address _____
city _____ zone _____ state _____

Hand this order to your newsdealer or send it to

POPULAR MECHANICS
200 East Ontario St. Chicago 11, Ill.

Wanted New Writers
of Stories, Mysteries, Articles Plays

FREE Lesson Shows How You Learn at Home for Extra Income or Full-time Career

HAVE you ever had an urge to write? Have you or friends had interesting experiences or ideas about people, places, hobbies, sports, business or social activities, that might make interesting stories, articles or scripts for general magazines, trade and technical journals, fraternal publications, TV-radio stations, etc.?

Editors agree: the demand for new writers is greater than ever, and you don't have to be a genius to make money. Many Palmer beginners earn while learning, receiving small but welcome checks for material that may be turned out quickly once you acquire the technique. And now it's easier to learn than you may imagine, through Palmer's unique method of training—for not just one field of writing, but for all: Fiction, Article, TV-Radio. Endorsed by famous authors—including Rupert Hughes, Katharine Newlin Burt, Keith Monroe, A. E. Van Vogt, and by hundreds of successful graduates.

Learn From Successful Writers

You receive individual coaching by professional writers who go over your writing, giving helpful suggestions and showing you how to capitalize on your good points. Thus, your own individual writing style is created. By learning at home you study fast or slow. Save time, effort and money.

FREE Lesson Shows How

So you can see for yourself how you may cash in on your opportunities as a writer, send coupon or simply write for FREE typical lesson material and 40-page book, "The Art of Writing Salable Stories," explaining the advantages of Palmer's professional home-study instruction. This may well be the important turning point in your life! No obligation. No salesman will call. Send today!

Palmer Institute of Authorship
Since 1917

Member: Nat'l Home Study Council
Desk T-114, 1680 No. Sycamore,
Hollywood 28, Calif.

Approved For Vets

FREE Palmer Institute of Authorship, Since 1917
1680 N. Sycamore Hollywood 28, Calif. Desk T-114

Please send me free typical lesson material and illustrated book explaining how your home-study training helps new writers get started. This is confidential. No salesman will call.

My _____
Mrs. _____
Miss _____
Address _____
City _____ Zone _____ State _____
Please print clearly. Veterans: Check here.

BUILD HELICOPTER GLIDER

The famous GYRO-GLIDER, engine-less helicopter, world's smallest flying machine.

BUILD AND FLY IT YOURSELF.

- Three-View Drawings & Specs—only \$1.00
- Detailed Construction Plans with Building and Flying Instructions—\$10.00
- Raw Materials Kits—\$98.00
- Machined parts and Kits also available. Order yours TODAY.

10-DAY MONEY-BACK GUARANTEE
SENSE AIRCRAFT CORP., Dept. PM9
P. O. Box 2621 Raleigh, N. C.

7 x 50 \$29.95

New, improved, superb, lighter binoculars that are easier to hold, easier to focus, and lower priced. The 7x50, 5 1/2" x 7 1/2" has tremendous light gathering power and provides brilliant, crystal clear images. All binoculars are both water, dust resistant. **UNI-COATED!** Inside surfaces of vital prisms and front and rear Achromatics are COATED for brighter, sharper viewing! Made in Japan by skilled optical craftsmen of precision materials. It explains why prices are so low and quality so high.



WEIGHS ONLY 26 ounces!

6 x 30 I.F.* 4 1/4" x 6" 15 1/2 ounces.....	\$24.95
7 x 35 I.F.* 5 1/4" x 5 1/2" 20 ounces.....	27.95
8 x 28 I.F.* 4 1/2" x 5 1/4" 12 ounces.....	19.95
10x Pocket I.F.* 3" x 3 1/4" 6 1/2 oz.....	19.95
7 x 35 C.F.* Wide Angle 525' field 26 oz.....	49.95
12 x 50 C.F.* 5 1/4" x 7" 27 ounces.....	39.95
15 x 65 C.F.* 8 1/2" x 9" 51 oz. Just Received..	59.50
20x Falcon I.F.* It's New 12 oz.....	39.95

Add \$1.00 for postage and handling. *I.F. are individual and *C.F. are Center Focus. Genuine leather case and straps included. **UNCONDITIONALLY GUARANTEED. USE 30 DAYS AT OUR RISK.** If not fully satisfied return for full refund. C.O.D.'s require \$2.00 deposit. Add new, lower Federal tax only 10%.

UNITED BINOCULAR CO., 9043 S. Western, Dept. ARE-8408, Chicago 20
DEALERS WRITE FOR WHOLESALE CATALOG.

EARN *Big* Money!

in
**TELEVISION · RADIO
ELECTRONICS · RADAR**

The new Christy Shop-Method Home Training makes everything interesting, easy. The only complete Electronics course. Covers Radar, Sonar, Electronics, Radio and Television. No previous knowledge needed. You learn by actually working on equipment you study about. Makes learning fun. Speeds your progress. Helps you understand quicker and remember longer.

19 TRAINING INSTRUMENTS INCLUDED
You build your own Multi-Tester, Oscillator, Signal Tracer, Oscilloscope, Signal Generator, Electronic Timer, Regenerative Radio, Television Receiver (optional), and many other test units. Check circuits, locate and correct troubles, etc. Earn while you learn by repairing television and radio sets for friends and neighbors.

**SEND FOR FREE BOOK and
SAMPLE LESSONS NOW!**
CHRISTY TRADES SCHOOL, INC.,
Dept. T-503
4804 N. Kedzie Ave., Chicago 25, Illinois

LEARN UPHOLSTERY

in your spare time
run your own
business
AT HOME

**FREE BOOK
with
sample
lessons
shows how
YOU MAKE
SLIPPER
CHAIR
CLUB
CHAIR
OTTOMAN**

**WITH
SLIP COVERS
Yours to Keep
or Sell**

BE YOUR OWN BOSS
Earn more from the start! Set up your own profitable business, in your own home, enjoy steady income, independence for life—in the booming field of custom upholstery.
Right off you start learning with tools, complete frames, fabrics and materials, included free with your UTS course. You learn skilled professional custom upholstery, reupholstery, furniture finishing, repair, how to make beautiful slip covers, window cornices, cushions and draperies. **EARN WHILE YOU LEARN**, in your spare time... the UTS easy way.

FREE illustrated book, with sample lessons
Get ready for big pay job, big profits, from steady work, as your own boss, running your own business. Mail coupon NOW!

APPROVED FOR VETERAN TRAINING
UPHOLSTERY TRADES SCHOOL
Dept. CS-310, 721 B'way, N. Y. 3, N. Y.
Send the free book "Your New Way to a Successful Career." No obligation—no salesman will call.
 Check here for special booklet A, if under 18.

Name _____
Address _____
City _____ Zone _____ State _____
 Check if Korean Veteran

SEND FOR
Free Record

**START SPEAKING
FRENCH
OR
SPANISH ALMOST OVERNIGHT!**

HERE'S the easiest way to learn FRENCH, SPANISH, Russian, German, Italian, Japanese or Brazilian. Listen to FREE 2-sided non-breakable record. Let your eyes follow words in FREE sample lesson. Almost at once you'll be chatting in a new language with a perfect accent! That's all you hear! No memorizing needed. Just listen—imitate! It's that easy! Offer may end soon. Rush 25¢ to help cover cost of special packaging, shipping. State language you want. We'll also send free information on full Cortina course. **CORTINA ACADEMY, Dept. 6411, 135 W. 52nd St., New York 19.**

250 POWER

**Complete
Telescope Lens Kit** only **\$3.49** postpaid

Conquer Space. Explore the Universe, Planets, Moon Craters, New Stars, etc. Complete Lens Kit consists of 80 inch focal length ground and polished objective lens, eyepiece lenses for 50 POWER, 100 POWER, 150 POWER, 200 POWER, 250 POWER, and all necessary lens fittings. Easy to make from simple step by step instructions. (Tripod and mount not included.) Money back guarantee.

BUSSE SALES CO., Hartford, Conn., Dept. PM 27

**FREE — Amazing Book on
RHEUMATISM, ARTHRITIS**

If you suffer the aches, pains and discomforts of Rheumatism, as manifested in ARTHRITIS, NEURITIS, SCIATICA or LUMBAGO, send today for the FREE Book. It reveals important facts about why drugs and medicine give only temporary relief without removing cause. Explains fully a proven, specialized system of treatment that may save you years of distress. No obligation. Write for this FREE Book today!

BALL CLINIC, Dept. 756, Excelsior Springs, Mo.

AMERICA'S GREATEST VALUES

FREE CATALOG WATCHES JEWELRY GIFTS TO 60% OFF

MARYLAND DISTRIBUTORS
Dept. 659, 501 E. Baltimore St., Balto. 2, Md.

AIR MAIL XMAS DELIVERY GUARANTEED

LOCKSMITHING & Key Making

PRACTICAL UP-TO-DATE COURSE—ONLY \$4.95

Easy-to-learn modern information for self-instruction. How to work on locks, de-code, make master-keys, repair, install, service, etc. For every handyman, home owner, carpenter, mechanic, service station operator, fix-it shop, hardware dealer, gunsmith, 53 plain illustrated lessons. **FULL PRICE ONLY \$4.95. SEND NO MONEY.** We'll ship postpaid. Satisfaction guaranteed or refund.

NELSON-HALL CO., 210 S. Clinton St., Dept. LW-2, Chicago 6, Ill.

WHEELS WHEELS WHEELS

7" Disc Wheel 3/4" Tire 3/4" sleeve	45c ea.
8" Disc Wheel 1 1/8" Tire 1 1/2" sleeve	70c ea.
7" Disc Wheel 1" Tire 1 1/2" ball bearing	80c ea.
8" Disc Wheel 1 1/4" Tire 1 1/2" ball bearing	\$1.00 ea.
6" Disc Wheel 1.50 semi-pneum. Tire 1 1/2" B.B.	\$1.35 ea.
8" Disc Wheel 2" semi-pneum. T. 1 1/2" B.B.	\$1.50 ea.
10" Disc Wheel 1.75 semi-pneum. T. 1 1/2" B.B.	\$1.50 ea.
10" Disc Wheel 2.75 semi-pneum. Tire 3/4" B.B.	\$3.50 ea.
12" Disc Wheel 1.75 semi-pneum. T. 1 1/2" B.B.	\$1.85 ea.

Above wheel prices includes hub cap. Plus Postage. C.O.D.'s accepted.
AXLES—Sizes 5/16 in., 3/8 in., 1/2 in.—Cut to size—End holes drilled.

UNITED WHEEL STAMPING CO.
12131 S. PEORIA STREET PM-11 CHICAGO 43, ILLINOIS

**TALK — SING — PLAY
OVER YOUR RADIO**

with the real Radio Mike! Attached in a jiffy — full instructions given! Swell for "parties"—"put in" on or "kid" regular network programs or put on your own broadcast! Amaze your friends—real fun. Beautiful Metallic Plastic 6 in. high!

12 RADIO BROADCAST LESSONS GIVEN with each mike

SEND NO MONEY Just pay postman \$3.99 COD plus postage or send \$5.99 and we pay postage! Radio Mike is available only from us by mail—guaranteed.

Midway Co., Dept. MPR-11, Kearney, Nebr.

Wanted! HOME PRODUCERS

BY MANUFACTURERS IN OUR CLEARING HOUSE SERVICE

Become a subcontractor, casting plastic products for important companies. These manufacturers are anxious to place big and small orders for consumer and industrial demand. Thousands of easy-to-make items required now. YOU can make them.

YOU SET YOUR OWN HOURS

Run this profitable business in your home, spare or full time. No previous experience necessary. Here at last is opportunity to have your own successful business. Write today. Information free.



PLASTIC SERVICE ASSOCIATES, DEPT. PA
EAST BOSTON 28, MASS.

STUDY AT HOME

WITH AN EDUCATIONAL INSTITUTION

Courses in **ARTS AND SCIENCES**: Philosophy; Education; Letters; Public Health; Medical Jurisprudence; Psychology; Sociology; Physics; Chemistry; Geology; Pol. Science; Theology; Law; Business and Commerce; Accounting; Mathematics; Statistics; Agriculture. **ENGINEERING**: Electrical, Civil, Mechanical, Drafting, Architectural, Steam, Diesel, Aeronautical, Radio, Structural, Mining, Industrial, Petroleum, Refrigeration, Chemical. Send for free catalog.

McKinley-Roosevelt Incorporated, 4610-K32, Sheridan Rd., Chicago 40, Illinois

FREE

TO NEW MEMBERS OF THE
Around-the-World Shoppers Club



This Exquisite 6-Piece Set
Of Florentine Silver

Send no money now or later for this unusual Florentine Silver Set. It's yours FREE for joining the Around-the-World Shoppers Club. Your Set was hand-made in Florence, Italy, with skilled techniques going back to the time of Michelangelo. Each piece has a different Renaissance design, and handles are tooled in Florentine bas-relief. As a member, each month you will receive a wonderful surprise gift sent to you direct from a different foreign country, *post-paid, duty-free*—accompanied by a colorful brochure describing your gift! Send no money; simply write us and we will enroll you, billing you as follows until you decide to cancel: \$5.00 every 2 months; \$9.00 every 4 months; \$12.00 every 6 months or \$22.00 every 12 months. Be sure to specify plan you choose. Satisfaction guaranteed. Write now while this Florentine Silver Set is FREE for joining.

AROUND-THE-WORLD SHOPPERS CLUB
Dept. 464-F, 71 Concord St., Newark 5, N.J.

Paint STRIPES with New "PAINT PEN"!

Makes Straight, Curved
or Parallel Lines!

Just fill glass vial with any color paint. Use like a fountain pen to stripe furniture, bikes, autos, model planes, toys, linoleum, wall board. Beautiful, clean, crisp results every time, like professional painters. No experience needed to draw straight, curved, circular or evenly spaced parallel lines. Can't clog or smear. May also be used with glue, tempera, textile paint, or ceramic underglazes. Paints on wood, glass, plastics, metal, fabrics and paper. Lasts a lifetime. Only \$1 postpaid, complete with tip for 1/16 inch stripe. C.O.D.'s plus postage. Used by industry. Order your Paint Stripping Tool TODAY!

New! "DOUBLE-STRIPER"
MODEL Only \$2.95

Newest paint stripping invention. Makes DOUBLE stripes—one wide and one narrow or two wide or two narrow at the same time. Or adapt quickly for wide or narrow single stripes. Makes 5 combinations. FREE—Send postcard for complete information... or order now... \$2.95.



\$1.00

DEALERS

Master Paint Stripping Tool packed in Display Cartons of 1 dozen. Fast, profitable seller. Write for discounts!

Attention All Home Craftsmen!

New Paint Stripping Tool gives "professional" results every time, yet simple, easy to use. Send \$1 now.

ATTENTION—MANUFACTURERS!

Write today for information about our industrial and production stripping tools.

WENDELL MFG. CO., Dept. 3-M
4234 Lincoln Ave., Chicago 18, Illinois

6 Other Complete Tools

Complete tools for 1/64, 1/32, 3/64, 5/64, 3/32 or 1/8 inch stripes, \$1.50 each. Extra tips 75c ea. COMPLETE KIT with ALL 7 TIPS, \$5.00. (Also 1/4" tip, only \$1.00). All tips interchangeable.

Learn REFRIGERATION AND AIR CONDITIONING

FREE! PLAN FOR YOUR SUCCESS

EXTRA CASH NOW — Spare time at home — Earn while you learn by doing with Easy Home Course. START YOUR OWN BUSINESS — No Experience Needed. Special tools & equipment furnished. Send for FREE BOOK — TODAY!

MECHANICS TRAINING SCHOOL—Dept. P-5411
7217 South Broadway • Los Angeles 3, California

FREE
BOOK

DRAW The First Day!

NO LESSONS! NO TALENT!

New Amazing Invention—"Magic Art Reproducer." You can draw Your Family, Friends, Anything From REAL LIFE—Like An Artist! Even if You CAN'T DRAW A Straight Line! Anything you want to draw is automatically seen on any sheet of paper thru the "Magic Art Reproducer." Then easily follow the lines of the "picture image" with a pencil for an original "professional looking" drawing. Also reduces or enlarges. SEND NO MONEY! Free Trial! Pay Postman on delivery \$1.98 plus postage. Money Back Guarantee.



10 Day

postage.

NORTON PRODUCTS, Dept. 5811-S, 296 Broadway, N. Y.

SAVE GAS PAY NOTHING

on our TEN DAY FREE TRIAL

Send no money, pay nothing for the new miracle gas savers. Gas costs about 30c a gallon. You can save up to 25% or 2c per gallon on your gas bill. Thousands of satisfied customers have sent their requests for the miracle gas savers. You are under no obligation.

If you are completely satisfied within ten days send us \$1.50 per gas saving needle.

18 cylinder cars take two!

If you are not completely satisfied, return the merchandise.

MEHREN INDUSTRIES

8800 W. PICO, DEPT. PM-11
LOS ANGELES 35, CALIF.



FREE with every request.

See Mehren's 50c Catalog

Book. Safety and economy items

and tips for better driving. Mail

your request today. Specify

year, make, and model of your

car when requesting free trial



C7

Colorcreting Can Be Your Big Opportunity

Local Colorcretors are Needed Everywhere

Colorcreting is a small investment enterprise, rich in sales potentials, high in income possibilities. Work is easy and fascinating. No experience required; we supply complete instructions.

Colorcreting is a building-beautifying process, with Colorcrete being pneumatically applied to new or old masonry surfaces such as concrete or stucco. Lasts indefinitely—25 years or more. Easily cleaned. Gleaming white, or a choice of 30 colors.

Colorcrete equipment is compact and portable. Easy to operate and practically wear-proof. Easy-payment terms when desired. Write at once for Opportunity Book.

COLORCRETE

Colorcrete Industries, Inc.
570 Ottawa Ave., Holland, Michigan

IN CANADA: DUNN MASONRY MACHINERY LIMITED
1020 Dundas Highway, Cooksville, Ont.

OWN Your OWN Radiator Repair Business...



Earn \$6.75 per hour—\$8,000 to \$12,000 a year—servicing auto-truck-tractor radiators! New modern equipment makes work easy, fascinating, insures finest professional workmanship. Only \$995 starts you—\$100 training course included free by world's largest radiator equipment manufacturer. "Pays-for-itself" financing available.

WRITE for free folder "Want a business of your own?"
INLAND MFG. COMPANY Dept. PM11
1108 Jackson St., Omaha 8, Nebr.

P.S.—Training alone also available—only \$100. Ask for training school literature.

MUSIC IN YOUR PALM!



NEW TUBELESS POCKET SIZE RADIO

WEIGHT ONLY TWO OUNCES. BUILT-IN SPEAKER MECHANISM—NO HEADPHONES REQUIRED! NO STATIC! Uses world's finest Signal Detector—Super-Sensitive Germanium Diode Rectifier—Developed for Radar, it performs at high level of volume and efficiency. Nothing to burn out or run down; should last for years. Gets local radio stations with amazing clearness—many users report reception up to several hundred miles. War may stop production or might take entire output for military use, so order today and be prepared in case a national emergency should arise. Over 25,000 sets already ordered and delivered. RADIO COMPLETE ready to play. Rush check, cash or money order. No C.O.D.'s accepted. \$7.95 ea. or 2 for \$15. Scientific Products of Indianapolis, Inc. Dept. PM11, 2450 E. 52nd St., Indianapolis, 5, Ind.

DRAW FOR MONEY—IT'S FUN

Our Simple Method Helps You to be an Artist



Enjoy drawing, painting, advertising art and cartooning at home in your spare time. Earn while learning. Our famous method helps beginners quickly. Low cost. 40th year. Send coupon for free booklet. No salesmen.

- Send free "Art for Pleasure & Profit."
 Tell about trial plan

Name _____
Address _____ Age _____
City, Zone, State _____

Washington School of Art
Studio 1211 N
Washington 5, D.C.

LEARN TV in KC

FAMOUS FOR 24 YEARS

1,000's OF SUCCESSFUL GRADS COAST TO COAST



Easy, quick, fascinating. Learn TELEVISION in 36 short weeks of enjoyable companionship in shop training. Wonderful job opportunities. Graduates have choice of many jobs or can establish their own TV repair shop. YOU CAN START EARNING AS MUCH AS \$150 PER WEEK. NO limit as time goes on. U.T.S. is an old established school (TV exclusive for 24 years) staffed by expert instructors, headed by one of America's first TV broadcasters. Costs so little to prepare yourself for life. No previous experience needed. Fully approved for Korean Veterans. Also fully approved course in color TV (first in U.S.A.). Get the full story today.

FILL OUT COUPON

UNIVERSAL TV SCHOOL
1228M Admiral Boulevard, Kansas City, Missouri
PLEASE SEND ME INFORMATION FREE

Name _____ Age _____
Address _____
City _____ State _____

Check here if Korean Veteran

FREE CATALOG

BE A DETECTIVE

WORK HOME or TRAVEL. Experience unnecessary. DETECTIVE Particulars FREE. Write to GEO. P. M. WAGNER, 125 W. 86th St., N. Y.



You Can Do It at Little Cost!
It's Easy! It's Fun!

Here is the "top" of all home crafts projects. Make a violin—a replica of a famous "Strad"—the original of which sold for \$80,000.00. Joe Reid who has made hundreds of fine violins makes the job so easy—so inexpensive—in his new book "You Can Make a 'Stradivarius' Violin." You don't need any tools. Reid shows you how to make all the tools you need from old table knives, worn out files, sheet metal, etc. Eight full-size plans, 16x23 inches, folded into the book give you every detail in actual size.

Violins Bring High Prices

Make a violin and you probably will never want to sell it. But good tone modern violins bring terrific prices, yet the materials cost comparatively little. With Reid's plans and step-by-step instructions you can make such a violin for yourself. 15 chapters guide you in selection of wood, fashioning the belly, back, sides, mold, lining, neck, scroll, purfling. Other chapters cover varnishing, finishing, stringing. Others show how to make tools and clamps at little or no cost.

Order Book Today.
Money Back if Not Satisfied.

Make your own violin for pleasure or profit. Get book and plans now. Clip this ad and mail with check, money order or cash for only \$3.50 or we will ship C.O.D. Money back in 7 days if not satisfied.

FULL SCALE PLANS INCLUDED
Working plans, drawn to full scale, are included in a special pocket inside the book where they may be withdrawn for quick and easy reference.



Complete Instructions
8 Actual Size Plans
How to Make the Tools You Need
Where to Get the Materials

You trace or work direct from actual size plans. No measurements to translate or confuse you. You see the entire violin in the plans. You read the how-to-do-it instructions in the book.

\$3.50 Cloth Bound
ORDER FORM IN BACK
Dept. 30
200 E. Ontario St., Chicago

POPULAR MECHANICS PRESS

New Optical Radioactivity Detector GEIGERSCOPE

Now you can check minerals for uranium with this amazingly sensitive, inexpensive device. For prospectors, engineers, experimenters, gadgeteers, everyone interested in atomic energy. Now being used in atomic energy laboratories and major universities. Indicates radioactive content with sparkies of light. Sturdy, durable, portable as a pocket watch; needs no power source.



\$1

STANDARD MODEL EACH

MASTER MODEL (20-power magnification) with eye-positioning rubber shield, greater signal strength, usable in bright daylight or lighted room.....\$3

PROFESSIONAL MODEL (30-power magnification) highly-developed instrument, supplied with radioactive standard for exact specimen readings.....\$5

Uranium ore sample, carrying pouch, instructions supplied with all models. **PULL WRITTEN GUARANTEE.** We pay postage.

ATOMIC PROSPECTOR'S HANDBOOK

Valuable data on radioactive ores, field, lab & mill methods, maps, in 54 information-packed pages. Everything you need to know about this vital new field! \$1 postpaid. You can send for Handbook or Geigerscope separately—better yet, order both today! Write to

KEN RESEARCH, INC.

831 Fifth Ave. River Edge 15, N. J.

NO TANKS USED
NEW SIMPLIFIED METHOD

ELECTROPLATE

ANY OBJECT IN HOME, SHOP, GARAGE OR STAIR
YOUR OWN WELL PAYING ELECTROPLATING BUSINESS



NOW, using NEW plating kit.

It's easy to electroplate any object. Complete kit and instructions on plating metal and non-metal objects, with nickel, copper, chrome, gold, etc., plus full data on obtaining all the business you desire and make **BIG MONEY** full or spare time. **ONLY \$2.95. SEND NO MONEY**—everything sent C.O.D. plus postage—OR

send \$2.95 now and receive it postpaid. Money back in 7 days if not satisfied. **M. Z. SALES CO., Dept. PM-7, 113 W. 42 St., New York 36, N. Y.**



DEVELOP A HE-MAN VOICE!

Write for FREE book "How to Strengthen Your Voice for Greater Success" by Eugene Feuchtinger. No obligation. Book will be mailed at once in plain wrapper, postpaid. Just send your name and address. State age. **PREFECT VOICE INSTITUTE, 210 S. Clinton St., Studio LW-2, Chicago 6, Ill.**



**Blast off with DUAL
vacuum AIR HORNS!**

ONLY
\$9.95

•POSTPAID
Money-back Guarantee

Compare with
\$25 to \$100
Air Horns

The voice of authority and commanding warning for safer highway driving. One BLAST and those "Road Hogs" really move over. Installed under the hood or on the front fender. Beautiful lacquer finish. Operates from intake manifold. No tank needed. Only \$9.95 complete with cylinder head bracket, steering column lever, hose, fittings, etc. Send check or money order today. We pay postage. \$1.00 deposit required on all C.O.D. orders.

THE PROTECTURED CO.
Dept. 401, 716 N. E. 17th Rd., Fort Lauderdale, Florida

SAY YOU SAW IT IN
POPULAR MECHANICS

French STYLE DUELING SWORDS SET \$3.98

Once used in deadly combat—now an exciting sport! Learn right at home. Fun—safe—educational. These swords are made of fine blue spring steel, polished metal



guards, turned handles, rubber safety tips. Fencing teaches quick thinking, develops coordination, posture. Since the Middle Ages, Europeans have enjoyed the sport of dueling. *Now advocated by U.S. colleges. Set includes two swords and the booklet, "The Art of Fencing". Special price. **MONEY BACK IF NOT COMPLETELY SATISFIED** At sporting goods dealers or send \$3.98 to **Wham-O Mfg. Co., Box Q 61, Alhambra, Calif.**

I SHOW YOU HOW TO
MAKE MONEY AT ONCE

START YOUR OWN BUSINESS
IN 2 WEEKS—
AT HOME
IN SPARE TIME



METALIZE BABY SHOES

IF YOU ACT NOW, I will show you how to start earning extra money immediately—in spare time or full time. **AND I SHOW YOU HOW** to start your own profitable business. With my complete course and easy-to-understand illustrated instructions containing trade secrets of ALL metalizing processes **PLUS** beautifully processed sample metalized baby shoe **AND** all my tested and proved methods of operating a successful metalizing business. I show you how to start **YOUR OWN** profitable, fascinating business right in **YOUR OWN HOME**. Absolutely no experience needed. For **PROOF** send coupon today for **FREE** details of my **MONEY MAKING PLAN** for you and be convinced.

FREE!

MONEY MAKING PLAN

Full Details Without Obligation

MAIL COUPON TODAY!

KIKTAVI CO., Dept. P-5411
7217 So. Broadway, Los Angeles 3, Calif.
Send me **FREE** details of your **MONEY MAKING PLAN**, without obligation.

NAME _____
STREET _____
CITY _____ ZONE _____ STATE _____

PREPARE FOR THE BEST JOBS

IN INDUSTRY

TRAIN at HOME
IN YOUR SPARE TIME
or at
ALLIED INSTITUTE
in Chicago

- MECH. ENGINEER
- DRAFTSMAN
- TOOL DESIGNER
- TOOL ENGINEER
- TOOL & DIE MAKER
- MASTER MACHINIST

NO RECESSION FOR ALLIED TRAINED MEN

MORE JOBS THAN GRADUATES Shortages of Draftsmen, Designers, Tool Engineers, Machinists, Tool & Die Makers are so widespread that you can pick a highly paid key job and look forward to Achievement and Security.

You can begin your training in Short Courses and continue progressively to a Bachelor Degree in 26 months.

Allied is approved by Industry, Dept. of Education, Office of Public Instruction, State of Illinois, U.S. Veterans Admin., U. S. Dept. of Justice. Accredited: C. S. A.

SEND FOR **FREE BOOKS**

ALLIED SCHOOL OF MECHANICAL TRADES
1338-42 South Michigan Ave. Dept. P-5411 Chicago 5, Illinois

SEND ME WITHOUT OBLIGATION INFO. ON YOUR COURSES:

HOME STUDY RESIDENT VETERAN NON VETERAN

NAME _____

ADDRESS _____ AGE _____

CITY _____ STATE _____

MEN-WOMEN GROW ORCHIDS

IN YOUR LIVING ROOM!

Any Climate - Maine to California

YEAR 'ROUND No Equipment Needed

BIG PROFITS SPARE OR FULL TIME



Fill your home with gorgeous Orchids. Huge purple Cattleyas, exquisite Cymbidiums - dozens of others! Many grow without soil, getting food from the air. White Orchids, yellows, greens, every rainbow color. No equipment needed. Start on table or window ledge.

SUCCESSFUL HOME GROWER SHOWS YOU HOW! Complete instructions show you step-by-step how he and his wife started with a few plants and developed a big-profit home-business - grew an Orchid collection now worth a fortune. Learn how orchids multiply, how one plant may become many, each as valuable as the first. No big investment or overhead. Takes but a few minutes a week.



Orchids have rewarded me richly - thanks to Tropical Flowerland, S. V. SMART-Culcades

Big-profit orders for plants and flowers come from individuals, florists, hotels, clubs, etc. Year 'round gift. Millions sold by Mail-Order.

COMPLETE INSTRUCTIONS AND BLOOMING-SIZE ORCHID PLANT SENT FOR YOU TO EXAMINE AT HOME WITHOUT RISK. Secrets of the experts in simple language, jam-packed with "show-how" drawings, magnificent full-color pictures of Orchids. **Send No Money!** Write NOW for your FREE FACTS that show you how to learn to grow Orchids at home. Airmail is quicker.

TROPICAL FLOWERLAND, Dept. 31B
4622 Wilshire Blvd., Los Angeles 5, Calif.

Take perfect pictures!

USE THE NEW



Instant reading!

No computing needed!

Correct camera settings at-a-glance for all color or black & white photography!

New color styling! In handsome "Sportsman-Gray" with bright metal trim and smart black and red accents. A full size meter, weighs only 4 oz.

Complete with neck cord in "jewel-clear" Gift Box...
Ever-ready Case... \$1.95

\$17.50

New, full size photoelectric exposure meter eliminates tricky computations and guesswork. Has changeable ASA Index Slides that correspond to all popular films—black & white, color, indoor, outdoor. By merely inserting proper slide in meter you read correct camera settings in f/stops from f/2.8 to f/22 and speeds from 1/25 to 1/200. Covers entire color film range in 1/4 f/stops and has special marks for movie settings.

Complete computer dial on back—for special films and light conditions other than normal. Calculates speeds from 1/1000 to full 16 seconds; f/stops from f/1 to f/64; ASA Indexes from .3 to 800.

AT LEADING PHOTO DEALERS EVERYWHERE

SKAN a product of G-M LABORATORIES INC.
4250 N. KNOX AVE., CHICAGO 41

more jobs than graduates

ENGINEERS
Great opportunity! If you are interested in these 12 pay you to write Box D 1 or including a complete history of science and education.

Demand for our engineering graduates exceeds supply. Effective placement! Study in this world-famed college... established 1884. New term starts quarterly. Approved for Korean Vets.

Bach. Sc. degree in 27 months

Bachelor of Science in Mechanical, Civil, Electrical, Chemical, Aeronautical, Radio (Television), Administrative Engineering; Business Administration and Accounting. Also 36-weeks certificate courses in Surveying, Drafting, Secretarial Science. Intensive program; technical fundamentals accented.

Small classes; personalized instruction. For earnest, mature students whose time and budget require accelerated courses and modest costs. Preparatory courses.

Beautiful campus in friendly college town. Well-equipped. new and modernized buildings and labs. Enter Jan., March, June, Sept. Write Jean McCarthy, Director Admissions, for Catalog and View Book.



SAVED FROM FIRE

A few minutes warning can save you and your loved ones from fire. Thousands die in fires every year, while they sleep. With new fire alarm kit you can install a professional fire alarm system in your home at low cost. All parts U.L. Approved. Free booklet tells how. Send for "How to Build a Life-Saving Fire Alarm System".

The GEORGE CO. Box 1068, Minneapolis, Minn.



LEARN MODERN WATCH AND CLOCK REPAIRING

Complete Course—Only \$5.95

At home, spare time. Good field now... security and contentment in future. Start part-time business and EARN while you learn. Horology is precision instrument work... a great and growing field, sensational opportunities. Easy self-instruction course. Full price, only \$5.95. SEND NO MONEY. Just pay postman, plus C.O.D. postage. Or send \$5.95 with order, we'll ship postpaid. Satisfaction guaranteed or refund. NELSON-HALL CO., 210 S. Clinton St., Dept. 31W-2, Chicago 6, Ill.

You're Right!

NOBODY LIKES TO ADD & SUBTRACT FRACTIONS

Get a Fractionator \$1.00 POSTPAID U.S.A.

Direct reading. Answers in Fractions & Decimal Equivalents. 100% Accurate. Handles all Engineering Fractions. Direct Mail Only Refund if not Satisfied

Chas. E. Wells • Box 25-A • Montrose, Calif.

SAY YOU SAW IT IN POPULAR MECHANICS



FINE BOWS and ARROWS
SELECTED RAW MATERIALS

Catalog 5c Send for it
HAND BOOK—Illustrated
Instructions on Making and
Shooting Archery Tackle—75c
L. E. STEMMLER CO.
Manorville (Box 3) L. I. N. Y.

Popular Mechanics Book for Pleasure or Profit 23 BOATS You Can Build

Build the boat you have always wanted. Build it for fun or to sell at a profit. Get Popular Mechanics 23 BOATS YOU CAN BUILD - row boats, canoes, sail boats, power boats and other craft including a 25 foot cabin cruiser. Book includes more than 500 photos, plans, diagrams and working drawings, plus step by step instruction that anyone can follow. Only simple tools needed. Material list of lumber, hardware, fittings, etc., included. Order today under money-back guarantee. Only \$2.00 postpaid. POPULAR MECHANICS PRESS, Dept. PM3, 200 E. Ontario St., Chicago 11

POPULAR MECHANICS

Get into.. PLASTIC LAMINATING AT HOME!



THIS MAN ..
... is taking out of the machine a Plastic Sealing Job—ordered by mail—only 11c in material cost brings back \$2.58 in cash by mail. Capacity of machine: \$25.00 profit per hour of operation.

Get **ORDERS** and **CASH** from your mailman—do work in **SPARE TIME** at home—or expand into **FULL TIME** business. Send coupon for Free facts about the newest and most fascinating of all home operated businesses. For the first time a simplified machine brings the fabulous profits of **Plastic Sealing** and **Plastic Laminating** within the reach of the small operator. Anyone can learn to operate the machine with a few minutes practice—then with our **Magic Mail Plan** can get mail orders pouring in daily with cash in every envelope. **No canvassing—no selling.** We even

**Make \$20 to \$30 a Day by..
MAGIC MAIL PLAN!**

supply the circulars you mail to bring back cash and orders. Don't waste a minute. Rush your name. We'll send you **FREE** and postpaid, pictures, prices, details, and all the facts you need to start. Mail coupon or send name on postcard. No charge. Warner Electric Co., 1512 Jarvis Av., Dept. L-10-M, Chicago 26, Ill.

Make Thousands of Beautiful Art Creations

**COSTUME JEWELRY • CIGARETTE BOXES
TRAYS • CANDLESTICKS • COASTERS
LAMP BASES • BOOK ENDS...ALL IN
SPARKLING COLORED PLASTIC**



**WARNER ELECTRIC CO., 1512 Jarvis Av.
Dept. L-10-M, Chicago 26, Ill.**
At no cost to me, please rush complete details postage prepaid. I am under no obligation.

Name _____
Address _____
City _____ Zone _____ State _____

AMAZING NEW POCKET SIZE RADIO

Really Works—Small as a Pack of Cigarettes!



FITS IN ANY POCKET OR PURSE—GETS LOCAL RADIO STATIONS WITH CLEAR BELL-LIKE TONE—NO STATIC OR INTERFERENCE! NEEDS NO TUBES, BATTERIES OR COMPLICATED HOOKUPS! NO AC PLUG INS! Nothing to wear out. Thousands of users—many report years of service. Uses new crystal diode and Hi-Q coil. SELF-CONTAINED SPEAKER PHONE. Just the tiny radio to take with you ANYWHERE YOU GO—ON TRIPS, VISITING, ETC.—for real fun and enjoyment—ANY TIME. **SEND ONLY \$1.00 (bill, ck., mo.) and pay postman \$3.99 C.O.D. postage of send \$4.99 for u.s. delivery. COMPLETE READY TO LISTEN. MIDWAY CO., Dept. PPM-11, Kearney, Nebr.**

RUPTURED?

Something different. Light. Cool. No leg straps. No elastic. No pressure on hips or spine. Inexpensive. Worn by Mechanics, Farmers, Doctors, etc., everywhere. Guaranteed. Write

HAND-LOCK PRODUCTS EST. 1893 DEPT. PM, PRESTON, ONT., CAN.

STOP THE COLD! DUCK-IT Only



Real comfort in cold climates for sportsmen. Excellent camouflage for stalking ducks, deer, etc. Keeps face, neck, and ears warm during long exposure. Warm over face or under chin. Heavy, durable yet soft and flexible. Fits all head sizes. 100% wool. Send \$1.98 to **WOOLWEAR COMPANY Box 561, Alhambra, Calif.**

SAVE 75% ON



WORK CLOTHES!

**SURPLUS STOCK FROM
MIDWEST SUPPLY FIRM!**
Terrific values you've got to see to believe!

SHIRTS 79c

Made to sell for 2.99! Now Only 4 for \$2.99

What a buy! 4 for the price of one! These shirts, though used, are washed, sterilized and ready for long, tough wear. In blue or tan. Send name, address, neck size.

PANTS to match 99c

Sold for 3.95 now only 4 for \$3.75
Unbelievable Bargains! Send waist measure and inside leg length.

COVERALLS . . . wear 'em used and save plenty! Originally 5.95. Now only \$1.95
Send chest measurement. 3 for \$5.75

SATISFACTION GUARANTEED! Your money back if you can beat these bargains anywhere! You can't lose so order TODAY for immediate delivery! Pay postman or send money with your order and save postage. \$1.00 deposit on C.O.D. orders.

GALCO SALES CO. Dept. 1311
7120 Harvard Ave. • Cleveland 5, Ohio

Say You Saw It in POPULAR MECHANICS

AUTHENTIC BRITISH COMMANDO KNIFE "THE FAIRBAIRN"



\$3.95
EACH POSTPAID
(KNIFE, SHEATH, PHOTOGRAPH)

This is the authentic British Commando knife, which we have purchased from British Ordnance. The last known supply. Used by special Anglo-American commandos and rangers in W.W. II, the favorite knife in Korea, this weapon was developed by the world renowned British officer, Lt. Col. Fairbairn, leading commando trainer, holder of the second degree Black Belt of the Kodokan Judo University, Tokyo. Col. Fairbairn also includes in his military honors the U. S. Legion of Merit for services with the O.S.S.
The "Fairbairn" knife, of finest Sheffield steel is shipped in its original metal tipped leather sheath, designed for both belt and boot. Brand new. 12" overall. Photograph is included. For U.S., APO or FPO air mail, add 80c per knife. Dealers inquire. Calif. residents add 3% state tax. Sorry, no C.O.D.'s.

In Canada: Order from United Surplus Sales,
471 Portage St., Winnipeg, Manitoba.

WITH INSCRIBED PHOTOGRAPH
OF LT. COL. FAIRBAIRN



PASADENA FIREARMS CO.
72 Sports Bldg., 972 East Colorado Street, Pasadena 1, Calif.

FREE TO NEW MEMBERS...

IMPORTS

FROM FOREIGN LANDS

NOW! EASY TO START YOUR OWN
BIG-PROFIT IMPORT-EXPORT
BUSINESS AT HOME!

FREE to new members of the International Traders Guild—many unusual, useful products from France, India, Germany and other foreign lands, and trade bulletins listing hundreds of import bargains. World trade boom offers new, big-money opportunities for men and women! Now you can import at low foreign prices for buyers in your locality at high U. S. prices.

BUY-SELL, WORLD WIDE, WITHOUT CAPITAL Big profits possible, no investment in goods. Operate a world-wide mail-order business from home, spare or full time. Also, for your own use, big savings on clothes, tools, gems, antiques, watches, cameras, china, silk, toys, etc. (see examples at left). No matter where you live World Trade can be carried on—in small towns or large cities, anywhere. World travel opportunities. Established World Trader shows you how. Teaches you quickly at home.

START AT ONCE—IMPORT PROFITABLE ITEMS Complete training includes many exciting imports that come to you from round the world **AT NO EXTRA COST**. Go after big profits NOW—importing and exporting. No previous experience is required. 2000 members in 42 countries. 7th successful year. Free details, write Now. Airmail reaches us overnight.

"We operate a profitable **WORLD TRADE BUSINESS FROM OUR HOME**...Thanks to Mellinger"

Mr. and Mrs. H. F. BEKE, N.Y.

The MELLINGER CO., Exporters-Importers, Dept. A25B 1717 Westwood Blvd., Los Angeles 24, Calif

AIRPLANE WHEEL ASSEMBLIES



These wheel assemblies are all new, and of heavy duty construction. Depending on load desired to carry, they are ideal for House Movers, Farms, Trailers, Carts, Wheelbarrows, etc.

Complete with Wheel, Tire, Tube and Bearings

Size 26:00, 10 ply tire, smooth tread, uses tapered axle size 3 in. x 2 1/4 in. 10 1/2 in. wide. Overall height 26 in. Static Load 9,300 lbs. Weight 54 lbs., Price \$47.80 ea.

Size 24:00 x 4, 8 ply, smooth tread, uses straight 3/4 in. axle. 3 1/4 in. wide. Overall height 13 in. Static Load 1,800 lbs. Weight 8 lbs., Price \$12.50 ea.

Size 8 x 2 1/2, solid rubber tire, heavy duty roller bearing, 6" high, 2 1/2" wide, 1" straight axle, static load 500 lbs. Weight 4 lbs., Price \$3.50 ea.

Size 17:00, 6 ply, smooth tread. Uses tapered axle, size 2 in. x 1 1/2 in. 8 in. wide. Overall height 17 in. Static Load 2,000 lbs. Weight 18 lbs., Price \$17.90 ea.

Size 8:00x4, 4 ply, smooth tread—uses straight 1 1/4 in. axle, 6 in. wide. Overall height 17 in. Static Load 900 lbs. Weight 13 lbs., Price \$27.50 ea.

Size 10 1/2 x 4, 8 ply ribbed tire. Uses straight 5/8 in. axle, 3 1/4 in. wide. Overall height 10 1/2 in. Static Load 1,200 lbs. Weight 8 lbs., Price \$9.95 ea.

Prices F.O.B. Chicago. Include approx. postage on orders valid for in advance. C.O.D. orders enclose 25% balance sent C.O.D.

U. A. S. Corp. Dept. PM 11, 5637 W. 63rd Pl. Chicago 38, Illinois

Malayan THROWING DAGGER

BALANCED TO STICK!

\$1.98

MALAYAN HUNTING KNIFE

used for killing game. Exciting target sport. Easy to learn! Fun indoors or outdoors!

EASY TO THROW!

Learn this Sport! Easy to throw accurately with our clear instructions. Beautiful, heavy-duty 10" knife. Tempered steel. Tough, rawhide-bound handle. Rare souvenir, unusual bargain. At sporting goods dealers or send \$1.98 to

WHOLESALE IMPORT CO. Dept. p. 604 Marengo, Alhambra, Calif.

GOVT. SURPLUS, U. S. STANDARD SHEET METAL GAUGE

(WHOLESALE VALUE—\$4.50)

Precision-made of hardened steel. Measures from 0 to 36 gauge. Decimal equivalents stamped on opposite side. A "must" tool for sheet metal workers and metal-craft hobbyists.

Only \$2.00 each prepaid... 3 for \$5.00

M & N SALES

1555 Lake St., P.O. Box 1351, Ogden, Utah

OWN WORLD'S FINEST CRYSTAL RADIO

Complete Kit Only

\$9.95

Money Back Guarantee

Plays anywhere. Needs no batteries or electric current. Excellent performance guaranteed. Germanium crystal diode can get stations over 500 miles away. Head phones, aerial kit included. Nothing else to buy. Assembled in minutes. Popular 5"x4 1/2"x6 3/4" personal size. Send \$2.00 deposit now, we'll mail C.O.D. plus postage. Satisfaction guaranteed.

IDEAL FOR CHRISTMAS GIFTS!

JAEGER & CO.

P.O. BOX X246 SKOKIE, ILL.

\$\$\$ PUT PROFIT IN YOUR FUTURE... \$\$\$
A diploma from Elgin Watchmakers College can be your passport to independence, give you a good income. Owned by Elgin National Watch Company.

\$\$\$ LEARN WATCHMAKING \$\$\$
Can now accept 50 new students. 15-month training. G. I. Bill. Enroll any month.

Registrar
ELGIN WATCHMAKERS COLLEGE
267 S. Grove Avenue, Box 32
Elgin, Illinois

Send me free booklet giving full details.

Name _____

Address _____

City _____ Zone _____ State _____

275 HOW-TO BOOKS—GIANT CATALOG FREE

How-to-do-it books on hunting, fishing, shop tools, concrete work, welding, plastics, carpentry, photography, boat building, gardening, auto repair, etc., in the new giant 40-page Popular Mechanics Book Catalog. Send postcard for your free copy! Write Dept. CT3.

Popular Mechanics Press, 200 E. Ontario, Chicago 11

Learn PHOTOGRAPHY at Home

Splendid opportunities. Prepare in spare time. Practical basic training. Long-established school. Send for free book, "Opportunities in Photography." No obligation. AMERICAN SCHOOL OF PHOTOGRAPHY, 835 Diversy Pkwy., Dept. 1358, Chicago 14, Ill.

POPULAR MECHANICS

Copyrighted material

NOW READY our big new 1955 wholesale catalog



MAKE EXTRA MONEY—START YOUR OWN BUSINESS

Here's a Golden Opportunity to Own & Operate your Own Business on a Part-Time or Full-Time Basis . . . In the lucrative field of Hardware, Hand Tools, Power Tools, Motors, etc. Or Buy Tools for your Industrial or Institutional Use . . . All without any investment in Inventory—We have a Million Dollar Inventory right at your fingertips. You can buy such tools as STANLEY, MILLERS FALLS, PLUMB, DISSTON, WISS, and other Nationally Advertised Tools at Discounts up to 50%. Remember! YOU DO NOT HAVE TO STOCK ANY MERCHANDISE . . . BUY IT AS YOU NEED IT . . . SAVE . . . MAKE EXTRA MONEY!!!!

SEND \$1. DEPOSIT FOR YOUR DEALER'S CARD, and receive your new 1955 GIANT CATALOG AT NO EXTRA CHARGE. \$1. Refunded on first purchase or returned to you if you are not 100% satisfied.

SILVO HARDWARE CO. DEPT. PM — 108 MARKET ST. PHILA. 6, PENNA.

NEW: Among Our Many Unique Engineering Values!

SLIDE RULE Pencil

Calculate and Write with New Handi-Slide Pen-Cyl

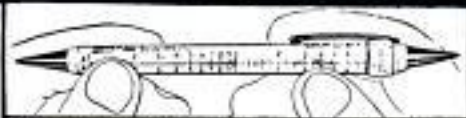

Now you can calculate easily and quickly—anywhere, anytime—with latest DEVCO writing slide-rule. Measures—Calculates—Writes 1 or 2 colors. Clips in pocket like a regular pencil: Lifetime plastic & metal, 6" long, weighs 1 ounce. Permanent, accurate calibrations. A dependable instrument and smart gift. Slide-rule instructions included. Two models: 4 scales, writes one color—\$3.98; 8 scales, writes 2 colors—only \$5.00.

10-day money-back guarantee. Send check or money order. Act now!

DEVICE DEVELOPMENT CO., Dept. D-1, 226 W. 4th St., New York 14, N.Y.

ITALIAN ACCORDIONS



Piano and Chromatic-Vienna & Italian System. Heligons-Irish-Club Models—Hohner & All button type. Also Concertinas & Bandanions. Buy direct from Factory Representative at Lowest Wholesale Prices and Save Money. We take any instrument in trade.

Expert repairing—Write for Free Catalog

ITALIAN ACCORDION MFG. CO.
7600 Cottage Grove Ave., Dept. PM-11, Chicago 19, Illinois

SEA LEGS PRICES from \$39.00

QUALITY BOAT KITS F. O. B. DEFIANCE, OHIO
WRITE FOR FREE LITERATURE
PENNEY WOODCRAFT INDUSTRIES
1301-09 Ottawa Ave., Dept. 11-M Defiance, Ohio

EARN \$60 A DAY!

Now two sensational steam cleaners from Hi-Pure, leading manufacturer of cleaners! NEW! Model 110, entirely automatic—just flip a switch and you're in business! Also famous model 105, lowest-priced high-quality cleaner on the market, with outstanding "jet" steam gun.

Your First 8 Jobs Pay For Your Cleaner!

Write for FREE DETAILS

*FOB Factory; freight prepaid on cash orders
HI-PURE LABORATORIES
EVANSVILLE, INDIANA



Model # 105, \$398.50*
Model # 110, \$449.50*

PLASTICS CATALOG

POLYESTER-FIBERGLAS BOAT AND CAR MATERIALS • PLEXIGLAS • VINYLITE • ACETATE • WHOLESALE-RETAIL PRICES

Whatever you need in plastics, we've got it or we can get it for you cheaper and faster. Our 14 years experience in plastics plus our continuing interest in the fast developing plastics field enables us to supply you with the best materials and advise you on how to use them and get the most for your money. Polyester and Fiberglass for permanent boat coatings and car bodies; Plexiglas, clear and colored, 1/16" to 2" sheets, rods and tubes—Acetate and Vinylite sheet, paper-thin to 3/8"—dyes, cements, supplies, metal findings, books, (including the best book of its kind, "Polyester and Fiberglass," by Maurice Lannon). Our new catalog is crammed with information and facts. It lists prices and tells how to order and how to use all kinds of plastics and materials. We'll mail it first class for 15c—you'll get it in less than a week—send 25c if you want it airmailed. Remember, quality and fast service is our stock in trade. Send for the new catalog today.

GEM-O'-LITE PLASTICS COMPANY

5350C RIVERTON AVENUE NORTH HOLLYWOOD, CALIFORNIA

Say You Saw It in Popular Mechanics

PREPARE FOR BETTER JOB, BIGGER PAY IN SPARE TIME AT HOME

Today, choose the job you want—and prepare for it in time you might otherwise waste. Or if you are already in the work you like best, start training now for quicker promotion and increased pay. During more than 50 years AMERICAN SCHOOL has helped ambitious people to reach higher goals. Check subject that interests you and mail coupon for full information.

AMERICAN SCHOOL, Dept. G845, Drexel at 58th, Chicago 37, Ill.

Without obligation, please send FREE and postpaid, full particulars about the subject checked below.

- | | |
|--------------------------|----------------------|
| Accounting | Plastics Engineering |
| Air Conditioning | Plumbing—Practical |
| Architecture & Building | Private Secretary |
| Automotive Technician | Religion |
| Better Fellowship | Retail Merchandising |
| Bookkeeping | Salesmanship—Outside |
| Business Management | Sheet Metal Work |
| Contracting | Tool Making |
| Diesel Technician | |
| Drafting—Building Trades | |
| Drafting—Machine Trades | |
| Electrical Engineering | |
| Electricity—Practical | |
| Electronics—Industrial | |
| High School Courses | |
| Machine Shop Operations | |
| Mathematics & Slide Rule | |
| Mechanical Engineering | |

NAME..... OCCUPATION.....
HOME ADDRESS..... AGE.....
CITY..... STATE.....
Canadian Residents: Write American School, 1610 Sherbrooke St. West, Montreal

MAIL COUPON NOW



Will you smoke my
new kind
of PIPE . .
30 DAYS AT
MY RISK?



My new pipe is not a new model, not a new gadget, not an improvement on old style pipes. It is the first pipe in the world to use an entirely new principle for giving unadulterated pleasure to pipe smokers.

This patented invention uses four of nature's immutable laws to revolutionize smoking enjoyment. Send name—no money—for astonishing facts and 30 day Free Trial offer.

**E. A. Carey, 1920 Sunnyside Ave.
Dept. 1011 Chicago 40, Illinois**



Free! Scarce AIRMAILS

Spectacular collection of **GENUINE Airmail STAMPS** from all over the world. Includes \$27 China; old German Zeppelin; scarce Hungary diamond; Nicaragua; Colombia; wondrous triangle stamp; many others. **PLUS** new illustrated booklet "Men Against the Sky"—the exciting story of airmail. **EXTRA!** Bargain lists and other unusual offers for your free examination. Send only 10c for mailing expenses.

JAMESTOWN STAMP CO., Dept. 130 Jamestown, N. Y.

Free! ROOSEVELT & DICTATORS

Amazing packet **GENUINE POSTAGE STAMPS** from Uruguay, Monaco, United States, San Marino, etc. honoring F.D.R. **PLUS** big collection of valuable foreign stamps picturing infamous Dictators: Mussolini, Lenin, Hitler, Stalin, and others. **EXTRA!** Free booklet, bargain lists, and interesting offers for your free inspection. Send 10c for mailing expenses.

JAMESTOWN STAMP CO., Dept. 135 Jamestown, N. Y.



**BUILD LUGGAGE AT HOME
WE SELL YOUR PRODUCTS!**

ONLY NEW HOME MONEY-MAKING PLAN IN YEARS!

Make Luggage and cases for traveling, photographers, musicians, salesmen, electronics, tools, portables, 1001 other items. Also repair Luggage. No special equipment needed. **BIG PROFITS.** We supply complete instructions—everything. Write for free details and Business Plan. **ABARSI CASECRAFT, Dept. G-11, 805 W. Sunset Blvd., Los Angeles 12, Calif.**

WORK FOR THE



GOVERNMENT

START AS HIGH AS \$4,205.00 YEAR
Many Appointments To Be Made. Experience Usually Not Required. **MEN-WOMEN.** Mail Coupon Today—Sure.

FRANKLIN INSTITUTE, Dept. W-83, Rochester 4, N. Y.
(Not Government Controlled) Str: Rush FREE:
(1) 26-page book with list of U.S. Gov't Jobs.
(2) Tell me how to get one of these jobs.
Name _____ Age _____
Address _____

ELECTRIFY your **SEWING MACHINE**
NEW LOW PRICE! **\$9.95** 1 YEAR GUARANTEE

Buy direct from manufacturer and save! Kit comes fully wired, installed in a jiffy. Fits all machines! You get **ALL-NEW PARTS**

- Motor & Bracket
- AC-DC 115v 60c
- Multi-speed foot control
- Cord set & block
- Easy instructions
- Steel pulley & belt

FREE . . . reg. \$2.95 chrome SEWLITE given with every kit.

10 DAY FREE TRIAL—ORDER NOW!
Send no money, pay COD or send money order and we'll pay postage. Please state whether wheel on your machine turns toward you or away from you. Shipping wt. 6 lbs.

SENIOR SEWING MACHINE CO.
Box 147 Dept. PM61 Brooklyn 6, N. Y.

Up to 6 MILES MORE per Gal.

Reported by Hundreds Using **MIRACLE ACTION TUR-B-LIZER**

If your car, truck or tractor is a "gas hog," try this simple cure, tested millions of miles experts call best yet. Installed in minutes TUR-B-LIZER simply traps gasoline carburetor wastes. Try it 30 days. Money back guaranteed. If not enthusiastically satisfied, Mail \$3 for the 6-cyl. type, \$4.50 for 8-cyl.

AGENTS WRITE
TUR-B-LIZER CO. 621 E. State St. Milwaukee 2, Wis.

\$3.00 ppd

PORTABLE GARAGE
\$6.75 (Former Price \$10.00)

USE IT ANYWHERE

- Folds compactly
- Keeps rain, snow, dust, salt air, sun away
- Protects your car's finish
- Durable construction of vinyl plastic
- Springlike elasticized bottom, holds securely
- Fits all makes

Direct from MFG. • Enclose payment of \$6.75 plus \$3.25 postage or sent C.O.D. 10-Day Money Back Guarantee.

EXTRA HEAVY GARAGE \$8.95 (Formerly \$12.00)

MARDO SALES CORP.
480 LEXINGTON AVE., DEPT. MG-3, NEW YORK 17, N. Y.

HELPFUL BOOKS

Send post card asking for **FREE catalog**

Popular Mechanics Press, 200 E. Ontario, Dept. 601, Chicago 11

EASY SPARE TIME PROFITS | Start a **VENETIAN BLIND LAUNDRY.** Free book tells how. Profit opportunity for lifetime business. New machine method requires no experience. Begin from home or garage.

W. R. BURTT
101 S. 44th St. Phila. 4, Pa.

Send for Free Book Today

Save Hundreds of Dollars Yearly With **Guide to Home Repairs**

Home Repairs, Modernizing Jobs Made Easy for Home Owners

Beat the high cost of home upkeep. Stop staggering labor costs. Save hundreds of dollars every year on carpentry, electrical, painting, plumbing and other jobs around the house with **Popular Mechanics GUIDE TO HOME REPAIRS.** Simplified how-to-do-it instructions and 646 pictures make all jobs, inside and out, easy. Covers construction, remodeling, modernizing, repairing that you can do yourself at small cost. Repair leaky faucets for pennies; save \$10 to \$15 on new electrical outlets; save hundreds of dollars on new floors, porch repairs, tack pointing, gutter replacements and other improvements. 192 page cloth bound book only \$2.50 postpaid. Get **GUIDE TO HOME REPAIRS** today under our money back guarantee.

POPULAR MECHANICS PRESS, Dept. PM1, 200 E. Ontario St., Chicago 11

POPULAR MECHANICS

CARPENTRY
ELECTRICAL WORK
INSULATION
PLUMBING

Take the Easy Way to Higher Pay

Enjoy
Greater
Security in

TELEVISION

**TRAIN FOR SUCCESS IN YOUR SPARE TIME
AT HOME . . . DO IT THE EASY UT WAY!**

Regardless of work you are now doing, your schooling, or age, PRACTICAL and EASY UT TRAINING can train you for Success . . . help you get a high-pay job where you can be an important person in your community . . . assist you in owning your own business . . . enable you to enjoy the things you now want, and be debt-free!
EASY UT TRAINING opens up the BIG OPPORTUNITY of a lifetime for you. Now is the time to prepare yourself for any of the many important careers offered by the multi-billion dollar TELEVISION and ELECTRONICS Industry. EASY UT TRAINING can make this possible for YOU! GET THE AMAZING DETAILS BY FILLING OUT THE COUPON BELOW AND SENDING IT IN NOW!

NO EXPERIENCE NECESSARY You Are Ready To Train As You Are!

You don't have to know the first thing about Electricity or TV at the start to master EASY UT TRAINING! It's like having your own personal instructor at your side when you use the thousands of step-by-step diagrams, pictures and charts. The professional equipment that you build, the experiments and demonstrations you conduct give you the know-how!
TRAIN AT HOME, the EASY UT WAY! EASY UT Training furnishes you everything you need for SUCCESSFUL, PRACTICAL Home Training, including complete kits of equipment and tools that convert any table or desk in your home into a fascinating experimental laboratory. You set your own pace of learning and do hundreds of thrilling experiments and demonstrations from the many TV and electronic units you build and keep! UT's experienced instructors give you full assistance and guidance so that your training is remarkably easy! When you complete your EASY UT TRAINING at home, you are ready to take your place in the Television and Electronics Industry. Or, at your option . . .

**TAKE ADVANCED TRAINING
AT UT'S BRAND NEW AIR-
CONDITIONED LABORATORIES**

at NO EXTRA TRAINING COST TO YOU! Get 160 hours of intensive TV and ELECTRONICS EXPERIENCE! You get the final PRACTICAL and PROFESSIONAL touch that can make you outstanding in the Industry! Upon graduation, you get expensive wiring diagrams of every set made by nationally-known TV manufacturers . . . AT NO EXTRA COST!

Job Placement and Business Plan

is available to you when you graduate. Excellent record! Find out for yourself!

Own Your Own TV Service Business

No Money Down! . . . Be INDEPENDENT . . . OWN A THRIVING BUSINESS! Get amazing details of UT BUSINESS PLAN! Equipment, stock, parts, tubes and successful business operation know-how included. This is a limited offer . . . FIRST COME—FIRST SERVED . . . even if you are 45 or older, it makes NO difference!

DON'T DELAY - MAIL THIS TODAY

UNITED TELEVISION LABORATORIES, Inc.
Park Drive, Louisville 16, Ky. Dept. M4N
Rush me the big valuable 48-page Book of Opportunities, FREE! I understand I am under no obligation.

Name _____

Address _____

City _____ Zone _____ State _____

_____ Married _____ Single _____ Age _____

I AM INTERESTED IN:

_____ Owning my own business

_____ Getting a HIGH-PAY job in TV



UT has Successfully Trained Thousands!

EASY UT TRAINING has helped these men to higher incomes in better jobs and businesses of their own!



D. J. Schmidt, Iowa, says: "In the past year, my TV sideline has made me around \$3500 extra dollars."

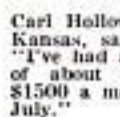

Carl Holloway, Jr., Kansas, says: "I've had a turnover of about \$1200 to \$1500 a month since July."



Lamar E. Williams, Indiana, says: "The training I received at UT has reduced my working hours and doubled my earnings."

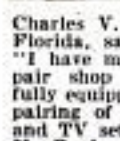

Charles V. Pauley, Florida, says: "I have my own repair shop which is fully equipped for repairing of all Radio and TV sets." Mr. Pauley is 64 years old . . . and owns his own business!

**Color TV INCLUDED AS PART OF
REGULAR TV TRAINING!**

Exciting, profitable COLOR TV is now a commercial REALITY! Network and local color transmission has already started. Trained COLOR TV men will be urgently needed to fill the requirements of this new, amazing Industry! This is YOUR OPPORTUNITY to be on the ground floor, with EASY UT TRAINING! Start your career—SEND COUPON IN NOW!

FREE Exciting, big 48-page book is jam packed with information on how to get HIGH-PAY JOBS in TV; owning your own BUSINESS; how easy it is to train; how to BUILD prestige and income at the same time; how to make the most of your OPPORTUNITIES! SEND FOR IT TODAY . . . NOW!



**UNITED
TELEVISION
LABORATORIES**

PARK DRIVE LOUISVILLE, KY.



MEN - WOMEN! Paint it with Suede

SPRAY ON
RAINBOW COLORS

for PROFIT and Pleasure...



FLOK-KRAFT
A SENSATIONAL NEW HOME BUSINESS!
A NEW INDUSTRY...
A NEW MIRACLE FINISH!!
MAKE \$500 to \$1000 PER HOUR and more!

PROFESSIONAL SECRETS CAN BE YOURS
At last, secrets of this amazing miracle finish can be yours! Huge profits waiting to be tapped in tremendous new field. Flok-Kraft gives a velvety, luxurious surface to radios, lamps, toys, signs, store displays, figurines, auto dash boards—a thousand and one items to be seen on every hand easily and quickly beautified, enriched, increased in value with Flok-Kraft. Make old objects beautiful—saleable, make new things worth much more with this soft, rich covering that can be applied to any surface, even if old or worn.

Read What Others Say About Flok-Kraft

"...pleased with your course and I'm being swamped with work to do." W.F., Pa.

"Got \$52.50 for those 7 trunk interiors for about 4 hours work. \$7.50 per trunk." J.O., Mo.

"Received the flok-kraft outfit and everyone that saw it is very enthused. I only had it about thirty minutes and got an order for a hundred dollar job." Mr. C. H. Maryland.

YOU CAN LEARN IN A FEW DAYS
Make to \$5.00—yes! even \$10.00 and more per hour. Fully detailed Flok-Kraft instructions—complete and easy to understand—every point explained—shows you how to start on the road to big money, full or spare time.

WE FURNISH EVERYTHING YOU NEED TO START
You also get complete Flok-Kraft kit of materials and equipment that enables you to start at once. Add to your income from your regular job or begin to build a successful business of your own and do it all, right in a corner of your basement, garage, service porch, kitchen or living-room.

YOURS TO EXAMINE—WITHOUT RISK!!
Complete instructions, starting kit of materials, equipment—complete, full details on how you can start your own business, spare or full time—EVERYTHING sent you to EXAMINE AT OUR RISK!

GRASP THIS LIFETIME OPPORTUNITY TODAY!
I'll arrange to send you the complete outfit—everything you need to start—for leisurely, no-risk examination right in your own home. You owe it to yourself to investigate. Fill out and mail the coupon below for FREE details. Sample, Plan, etc. Do it today! Everything I send you now is FREE of charge and post-paid. Airmail is faster.

FLOK-KRAFT and DEFENSE
Flok-Kraft offers a way to big extra money, assisting defense manufacturers in many lines as well as filling a big demand as the home front.



COAST INDUSTRIES, Dept. 211
1004 S. Los Angeles St.
Los Angeles 15, Calif.

FREE!
Booklet,
Sample,
Plan!

SEND NO MONEY!
JUST YOUR NAME AND ADDRESS

NAME _____ STREET _____ CITY _____ STATE _____

Quantity: Please rush me FREE details, sample, etc. I understand that everything sent is free and that I'll be under no obligation now or ever.

MAKE YOUR OWN
FOLDING TABLES
IN MINUTES...
AND SAVE MONEY!



WITH TABLECRAFTERS'
TUBULAR STEEL
FOLDING TABLE LEGS

You simply screw leg assemblies to your table top. They're sturdy and rustproof. Won't collapse...yet fold easily for storage. For banquet, buffet, hobby, work and game tables.

COMPLETE KIT \$8.85
FOR ONE TABLE

Send check or money order and we'll pay postage.

ATTENTION!
SHOW THIS AD TO THE COMMITTEE OF YOUR CHURCH, LODGE OR OTHER ORGANIZATIONS. THEY'RE ENTITLED TO SPECIAL DISCOUNTS.

TABLECRAFTERS Dept. A-4
6713 CASTOR AVE., PHILA., PA.

LEARN QUICKLY, EASILY With This MULTI-CIRCUIT RADIO LAB KIT

Designed for those just starting in radio and electronics. With this kit build 6 useful and educational circuits. ± 1 Broadcast Receiver. ± 2 Wireless Home Broadcaster. ± 3 Wireless Code Oscillator. ± 4 Code Signal Light. ± 5 Code Practice Oscillator. ± 6 Signal Tracer. ± 7 Single Side Wave Generator. Simple circuits, can be built by anyone. Low voltages—safe. Complete with Pictorial diagrams and instructions. No previous knowledge necessary. With 6SN7 Radio tube, selenium rect., power trans., all parts, mtbg. board, and inst. less head-phones (also serves as mike), wire and solder. For 110-112 v., 50-60-cy. \$8.95

Headphones, single 1000 ohm... \$1.19

EDUCATIONAL ELECTRONICS
Dept. PM-11, 1771 W. Howard St.
Room 214, Chicago, Ill.



ENGINEERING DEGREE IN 27 MONTHS

INDIANA TECHNICAL COLLEGE

B. S. DEGREE, Aeronautical, Chemical, Civil, Electrical, Mechanical and Radio Engineering, also TV and Electronics. Degree 1-yr. G.I. Gov't. approved. Low rate. Earn board. Large industrial center. Students from 48 states, 21 countries. Demand for graduates. Enter December, March, June, September. Write for catalog, 1611 E. Washington Boulevard, Fort Wayne 2, Indiana.

MASTER MIND!

Learn Short-Cut Mathematics
Juggle figures, do baffling number tricks. Make people gasp at your marvelous lightning-swift mind. Multiply 4 figures by 4 figures without using old-fashioned multiplication! Big cloth-bound volume; fully illustrated course. Sharpen up Your Brain Power

Includes worked out problems, answers, etc. Sensational bargain, only \$2.95, postpaid or COD plus postage. Satisfaction guaranteed or refund. Order this amazing "Short-Cut Mathematics" today!

NELSON-HALL CO., 210 S. Clinton St. \$2.95
DEPT. 2LW-2 CHICAGO 6, ILL. Complete



Say You Saw It in POPULAR MECHANICS

CHEAPER-THAN-WHOLESALE—FAMILY SAFE TIRES

PARTIALLY USED WITH FREE TUBE
FREE This Pictured Tire Ash Tray With Your Name With 2 or More Tires

If you buy a PAIR, you get a SPARE FREE
If you buy THREE, you get a 4th tire FREE
(Pass. Only. Does Not Include Snow Tires)

GOODYEAR, GOODRICH, FIRESTONE, U.S., and others.
Factory adjusted tires, change-offs—one grade only! Not recaps.
FINEST PREMIUM GRADE—34 Mps. Written Guar.—any defective tire replaced free, No Charge, No Delay! Our prices are about 65% off new tire prices!

600-16 \$4.51	650-15 \$4.61	SPECIALIZE IN		650-20 \$8.81
650-16 5.01	700-15 4.71	TRUCK TIRES		700-20 9.71
700-16 5.41	800-15 5.21	600-16(6) \$8.91	750-20 10.21	750-20 10.21
640-15 4.31	820-15 5.21	650-16(6) 8.81	825-20 16.81	825-20 16.81
670-15 4.51	550-17 3.91	700-16(6) 7.21	900-20 15.81	900-20 15.81
710-15 4.51	525-18 3.91	700-15(6) 7.71	1000-20 15.91	1000-20 15.91
760-15 4.87	750-16TK 8.71	700-17 7.61	1100-20 17.81	1100-20 17.81
		750-17 10.31	1000-22 16.81	

RETREADS OR ALMOST NEW SNO-TIRES 24 Mos. guar. \$7 Grade "A" Cold rubber. Any car

MARVIN 6th & Spring Garden Sts. MILITARY MUD-GRIP TIRES
BLATT Philadelphia, Pa. 900-16 \$10.21/900-16 \$12.91
750-20 9.21/750-20 12.87

"27 YEARS OF SINCERITY"

**WORLD'S
BEST
WANT-AD
MEDIUM**

CLASSIFIED ADVERTISEMENTS



Advertisements in this section \$1.00 per word, each insertion, minimum 10 words, payable in advance.

To be inserted under proper classification, copy must be in our office the 20th of the second month preceding date of issue

F. W. Johnson, Manager, Classified Advertising
Popular Mechanics Magazine, 200 East Ontario Street, Chicago 11, Illinois

YOU'LL PROFIT

By reading and answering the classified ads in this section. Hundreds of opportunities for you to make and save money

AUTOMOBILES, MIDGET CARS

WORLD'S Largest supplier hi-mileage speed equipment. Thousands of items to help double the power, mileage, speed of your car. Amazing fuel savers. Complete customizing parts. Thick photo-catalogue 25c. (Literature free.) Write today. Newhouse Automotive Stores, Los Angeles 22.

LOOK! Names of over 2000 American automobiles, who made them, where and when. Only \$2.00. All American Automobile Record, 1016 Sully St., Laramie, Wyo.

NON-Profit organization offers automobile literature—Old, new and foreign; dealer books, service manuals, glossy photographs; free motor magazines. Write today; get on free mailing list. Auto Maniacs, Stockbridge, Mich.

AUTO SUPPLIES AND EQUIPMENT

TCP, Miracle tri-cresyl-phosphate! Add it to gasoline, gives your car up to 25% more power! Pour into gas tank; feel car lunge with new power. Eliminates ping, pre-ignition! Makes premium gas out of regular gas! Saves money! 12 oz. can, treats 100 gallons, \$1 postpaid. Original Chemical Co., Inc., Box 1102-PM, Baltimore 3, Md.

AUTO Accessory and parts catalog. 1955 edition—all new! 148 pages. Save up to 50% over 50,000 items, including Hollywood accessories, hi-speed equipment, rebuilt engines, all parts and accessories for all cars and trucks! Hard-to-get parts! Send 25c (refundable). J. C. Whitney, 1919-PM Archer, Chicago 16, Illinois.

THIEF Chaser—Protect your car, tires and accessories from theft. 20 year guarantee. Free literature. Salesmen wanted. Novak Company, 3131 West 13th, Gary 111, Indiana.

"OVER 200 Miles per gal. gas—your car," claims inventor. Free information. Gane Economy Club, 8664 W. Pico, Dept. PM10, Los Angeles 35, Calif.

BUY Wholesale nationally advertised auto supply, thousands other products at big discount. Free "Wholesale Plan." American Buyers', 629-D Linden, Buffalo 16, New York.

SHOCK Car thieves! Complete circuit, \$1.00. Gaylord, 804 Highland, Fayetteville, Arkansas.

LACHAPPELLE'S Treatment. (Patented.) Puts bearings on the cylinder walls for the pistons to slide on. Only \$3.00 postpaid. Ferns, Box 71827-B, Los Angeles 1, Calif. Free data.

GENUINE Motor treatment, Lachapelle's, (patented). Only \$3.00 delivered. Restores compression, power. Saves gas, oil, repairs. Money back guarantee. You can't lose. Free circular. Write Joe Dillon, Authorized Warehouse and Agents Distributor, Box 323-3, Bridgeport, Ohio. Exclusive distributorships agencies open.

PROTECTO Rod stops rust; removes car radiator scale. Write Godfrey, 1108 Jefferson, Boise 1, Idaho.

SENSATIONAL Free-trial offers at bargain prices! Send no money, pay postman nothing! Try these famous Gale Hall engineering automotive instruments (brand new, original cartons) at our risk for seven full days, then send payment or return merchandise! Testmaster compression tester, formerly \$10.75, only \$3.98! Dual-purpose engine analysis vacuum gauge and fuel pump tester, 5" diameter, usually \$11.70, now \$4.55! 3 1/2" diameter, was \$8.10, now \$3.98! (Free with above instruments, valuable giant wall instruction charts, originally priced \$1-\$1.50 each!) Original motor condition/gasoline economy gauge for permanent dashboard mounting, formerly \$7.50, now only \$2.98—All instructions and accessories free! Famous Mile-O-Meters, standard model, 2 1/2" diameter, slashed from \$9.75 to \$4.55! (Illuminated \$4.98!) Deluxe model 3 1/4" diameter, reduced from \$14.75 to \$6.98! (Illuminated \$7.55!) Order today. Supply limited! (Add 40c to each price for postage.) New England Surplus Sales, Dept. PM-11, Newburyport, Mass.

SUPERLUBE—Restores compression, reduces oil, gas consumption and costly repairs. Moneyback guarantee. Literature free. Power Products, 7522 N. Ashland, Chicago 26.

WOLF Whistle auto horn close out, \$3.25 pre-paid. Charter Oak, 256-145th Ave., St. Petersburg 6, Florida.

CAR Burglar alarm. Works automatically. Easy to install. Protects tires, too. \$4.95 complete. The George Co., Box 1068B, Minneapolis, Minn.

PRESERVE Your car! Drive with safety and comfort! Latest improvements. Catalog free. Bonn, Box 62-A, Jerome Station, New York 68, N. Y.

3-TONE Horn! Play Yoo-hoo, Dragnet, Hello, Woody Woodpecker, Shave and Haircut, etc. Do-it-yourself kit \$4.95 pp. Canyon Company, 6411 Hollywood Blvd., Hollywood 28, Calif.

TAPPET Noises in Fords, Chevrolets and Mercurys stopped with Kaye Tappet Silencers. Free literature. Kaye Products, 2067B S. Layton Blvd., Milwaukee 15, Wis.

NEW And used parts at savings. Complete guaranteed parts service for all models cars and trucks—1924 and later. Largest in the West. Army parts specialists. No catalog, write for quotations. Fast mail order service. Pioneer Auto and Truck Parts Co., 734 W. 13th Avenue, Denver, Colorado.

CUSTOM Accessories headquarters. New summer catalog, just out, most complete ever. Jam-packed with items not in stores. New low prices. 25c. Eastern Auto, 3319-A South Grand, Los Angeles 7, Calif.

ELECTROPLATE Auto parts, novelties, mirrors. Easy, inexpensive home processes. Free booklet. Tyco Metals, Box 13231-BO, Houston 19, Texas.

BRUSH Plating outfits connect to a battery. No tanks or shop required. Free particulars. Gunmetal Co., Ave. J., Decatur, Ill.

CAR Burning oil? Losing compression? Try Clifford's Compression Seal. \$2 postpaid. Clifford's Engineering, 1329 Seventh, Aurora, Illinois.

FORD-T parts—Engine and chassis. Parts for other old models. Special parts made to order. B. S. Wisneski, Milwaukee 7, Wisconsin.

AUTO TRAILERS

ASSEMBLE Yourself kit. Slip-on cabin coach for pickups. Trailer blueprints. Literature 10c. Comstock Trailers, 585-P, Parsons, Kansas.

TRAILER Building. Illustrated circulars 20c. Craftsmann Books, Box 1153, Milwaukee 1, Wis.

BUILD Your own trailer! Plans for all kinds. Illustrated catalog 10c. Jim Dandy, 125-M, Wausau, Wisconsin.

EXCEPTIONAL Expanding eight foot trailer. Accommodates family of five. Build yourself. Literature 10c. Fra-Mar Company, Jones Avenue, Wilmington, Mass.

MOTORCYCLES, BICYCLES, MOTORSCOOTERS AND SUPPLIES

HARLEY-DAVIDSONS—America's best used buys! We pay shipping on motorcycles. Genuine new, used, parts, accessories for current and obsolete models. Send 25c for bulletin, catalog. Knuth's (Harley-Davidson factory dealer), 1753 Muskego, Milwaukee, Wis.

RECONDITIONED Motorcycles and motors. Chromium accessories. Complete stock Indian parts. Expert rebuilding. Fast service. Indian Motorcycle Sales, Kansas City 27, Mo.

"BUZZZZ" The motorcycle magazine. International coverage. Thoroughly illustrated. Yearly \$2.00. Sample 25c. 5424-A Sawyer, Chicago 25.

NSU And BMW motorcycles. 1 1/2 to 35 hp., singles and twins, chaindrive and shaftdrive. Butler & Smith, 160 West 33rd Street, New York 24, N. Y.

1949 SERVICECYCLE \$15. Midget car \$25. Maytag twin engine \$5. Four tires for \$3. Send 25c for new Directory Number 62, just out, listing these and hundreds of other bargains in motorscooters, midget cars, homebuilders parts, plans, engines, etc. (35c by First Class Mail.) Midget Motors Directory, Athens, Ohio.

REBUILT Bicycle or motorscooter engines. \$17.00 up. Send \$1.00 for catalogs. Cauffiel Motors, Temperance, Michigan.

AVIATION

FREE: Monthly aircraft, electronic, gadget list. Dick Rose, Everett, Wash.

SPECIALLY Designed air boat and snow sleigh propellers by the world's oldest manufacturer of aircraft propellers. Free literature. Flottorp Manufacturing Co., Grand Rapids 8, Michigan.

PROPELLERS. Plans, supplies for air boats, snow sleighs. Catalog 10c. Gano Propellers, Box 3284-A, Ft. Worth, Texas.

HELICOPTER—1 Man. Build own. Earn money, fame, Plans—\$3.00. Kerrigan Aircraft, 16525 Bramall, Detroit, Michigan.

AIRCRAFT Engines. all makes 65 to 300 hp. for snow sleds and water boats. Aircraft parts and accessories. Free list. Vestco, Box 5306 T.A., Denver, Colo.

PROPELLERS. Plans, kits for snow sleighs, air boats. Immediate delivery, satisfaction guaranteed. Catalog 25c. Banks-Maxwell, Box 3301E, Ft. Worth, Texas.

BATTERIES, GENERATORS

LONG Life battery—Make your own. Details free. Marbill Products, Ellicott City 3, Md.

EDISON Nickel storage batteries. Any voltage, any amperage. Unconditionally guaranteed. Power plants, generators, motors. Literature. Hawley Smith Co., Croton Falls 1, N. Y.

ELECTRICAL SUPPLIES

ELECTRIC Pencil: Engraves all metals \$1.50. Beyer Mfg., 10511-H Springfield, Chicago 43.

MOTOR Bargains, rewinders supplies, instructions. Modern, Box 4704, Kansas City, Mo.

WORK Light. 25, 50, 100-foot cords. \$2.00, \$2.98, \$3.98 plus postage. Circular free. Nassau Dropcord Co., 364 Chestnut Street, West Hempstead, N. Y.

LAMP Supplies—Wholesale. Any amounts. All parts for repairing and building lamps. Catalogue 15c. Brown Lamp Co., Box 501-Wellston Sta., St. Louis 12, Mo.

LEARN Appliance service. Motors, washers, refrigeration, everything. Booklet. Manager, Box 73136, Los Angeles 3.

LAMPS—25c Brings bargain catalog showing all parts for repairing, building. Contains instructions for electrifying vases, oil lamps, etc. Gyro Lamps, 5402P Clark, Chicago 40.

AIR CONDITIONING

AUTO Air-condition. Learn installation. \$1.50. Vitreno, 4315 W. Martin, San Antonio, Texas.

FILTERS. Air conditioning. Heating. H. K. Arnold, 27 Pelton St., Yonkers 5, New York.

WELDING, SOLDERING, PLATING

ELECTROPLATING Equipment, anodes and solutions for all types of plating. Instructions. Assemble your own plating and save. Free catalog. Ramyr, Dept. E-4, 1624 East First Street, Los Angeles 33, California.

SELF-Training System. Radiator repairing, cleaning, recoring. How to equip small shop at low cost. Supply sources, trade secrets. Instructions. Radiator Service, East Jordan, Mich.

BUILD-Ur-own a.c. welder and a.c. power plant with a good used engine and low cost Hobart generator. Welds anywhere and supplies 5KW stand-by power for any emergency. Write Hobartweld, Box M-1143, Troy, Ohio.

WELDERS. \$29.50, \$54, \$79.50. Morris, 1070 Inner Drive, Schenectady, N. Y.

BUILD Arc welder the easy way using aircraft generator. Plan 10c including catalog welder-kits, hydraulic-kits, etc. Dunbar Mfg., Box 12206-B, Houston 17, Texas.

A.C. Welders, four sizes. Lowest prices. Free literature. Holger's Service, Canton, Kans.

MACHINERY, TOOLS, SUPPLIES

CONCRETE Block machines. Standard sizes. Free catalog. Concrete Machine Company, 5129 South Compton, St. Louis 11, Missouri.

SEND For imported micrometers only \$5.99, vernier calipers scale for 1/128" and 1/10 mm., only \$5.88. Send m.o. or check to Bakalich, 4510 Rodeo Road, Los Angeles 16, Calif.

NEW Hand tool pulls 6000 pounds. Free literature. Multi-Use Puller, Box 971-N, Uptown, Hoboken, New Jersey.

BIG Factory catalog! Buy direct—Save middleman's profits; hundreds of labor saving tools and equipment; tremendous savings. Send 10c. Master Mechanic Mfg., Dept. CL-45, Burlington, Wis.

MAGNETIZED Set 6 quality screwdrivers. Grand gift. Only \$2.00. Tool Sales Co., 441 Ethel Ave., Grand Rapids 6, Mich.

POWER Tools, equipment, wholesale prices. Free bulletin. Homecrafters Cooperative, Grand Rapids 6, Michigan.

CARBIDE Tipped scriber \$1.00 postpaid. Money back guarantee. Box 417, Royal Oak, Mich.

SHEBEL Saw filer files all saws. Circular. A. P. Shebel, 730 So. 2nd St., Milwaukee 4, Wis.

LOOK—New threading tool, for tail-stock of lathe. No setup required. Inexpensive, needed in every shop. Drill grinding jig, used with bench grinder. Free literature. Dealers wanted. Travis Tool & Machine Company, Sidney, Iowa.

ALL Steel woodworking lathe, 5 x 12, \$9.95 prepaid. Circular. Sypher Co., 210 Cherry, Toledo, Ohio.

ALLEN One ton power bench type punch press. \$97.50. Circular. Allen, Dept. PMB, Clinton, Missouri.

NEW Electric drills and saws. 1/4", \$11.75 and \$15.75; 1/2", \$30.75; 3/4" tilting arbor \$39.95. Prepaid. Wilt Surplus, 7829 Racine, Chicago 20.

ENGINES, MOTORS, DYNAMOS

100 WIRE Springs, \$1.25. Spring Distributors, Box 561, Pittsburgh 30, Penna.

NEW Gasoline engines \$29.95. Christmas catalog 10c. Loren, Box 436, Danville, Illinois.

REBUILT 1 1/2 To 3 h.p. engines \$17.00 to \$37.00. Cauffiel Motors, Temperance, Michigan.

WINDING Data. 225 motors, single and three phase, \$1.00. Data Company, Box 7631, Kansas City 28, Mo.

BOATS, OUTBOARD MOTORS

MARINE Conversions for Ford and Jeep engines. Catalog 10c. Lehman Manufacturing Company, 972D Broad Street, Newark 2, New Jersey.

NEW, Used, rebuilt marine motors. Marine conversions, fittings. Free catalog. Stokes Marine Supply, Dept. 24, Coldwater, Michigan.

BUILD Marine engines with Federal conversion kits. Federal Marine Motors, 9011 Cottage Grove Ave., Chicago 19, Illinois.

FREE Catalog! Boat kits, trailers, fiberglass, marine hardware. Luger Industries, Dept. KD, 3207 Fremont South, Minneapolis, Minnesota.

JOHNSON Outboard specialists. Used parts for all models at substantial savings. Prompt quotations. Specify model serial. Crandall-Hicks, 910 Commonwealth, Boston, Mass.

BOAT Covers, custom and ready made. Also tarpaulins, canvas yard goods, life preservers. Free boat cover catalogue. Moran, 16-40R 50th Avenue, Long Island City 1, N. Y.

AIR Boat plans, supplies, catalog 25c. Banks-Maxwell, Box 3301F, Ft. Worth, Texas.

FULL Size, cut-to-shape boat patterns, blueprints, 7 1/2-38 feet. New 1954 illustrated "Build a Boat" catalog of 50 naval architect-designed cruisers, runabouts, sloops, skiffs, outboard boats, sailing, racing, houseboats, 50c. Marine hardware catalog, \$1.50. Bigger, better 1954 "How to Build Boats" book, \$2.50. PolyWog Houseboat Plans, \$12. Cleveland Boat Blueprint Co., Dept. A-66, 9400 Steinway, Cleveland 4, Ohio.

BUY Wholesale nationally advertised outboards, thousands other products at big discount. Free "Wholesale Plan." American Buyers', 628-D Linden, Buffalo 26, New York.

CONVERT Fords and Jeeps to 100% marine engines with Osco's world famous Convo-Kits. Deluxe catalogue 25c (coin). Oscomotors, 3627B Lawrence, Philadelphia 40, Penna.

BOAT Kits. Build your own boat. Easy to follow instructions. Literature free. Paramount Boat Company, 2202 N. Prairie, Joliet, Illinois.

40 DESIGNS, Kits, hardware. Catalog 25c, refundable. Designs only 15c. Marine-crafts, 55-M Sorrento, Allston, Mass.

SIMPLIFIED, Modern boat plans and patterns. Inboards and outboards 12' to 22'. Please specify type. Glen Designs, Box 568, Compton, California.

OUTBOARDER! Explore! Cruise shoals, thin rivers, by reducing draft 50% (cut damage 90%) with new Jackass bracket. Free leaflet. Thos. O. Staley, #1-196, Eagle Point, Oregon.

BOAT Patterns. Literature and illustrated boat construction book \$1.00. German Boat Company, West Saginaw, Mich.

ATHLETIC EQUIPMENT, BODY BUILDING COURSES

BARBELLS. Exercise equipment. Courses. Free booklet. Good Barbell Co., Reading, Penna.

GREAT Strength easily obtained. See page 42, Popular Mechanics, May issue 1954.

SPORTING GOODS, GUNS, FISHING TACKLE, ARCHERY, TRAPPING

5000 BARGAINS, Firearms, binoculars, war relics. Catalog 50c. Smith Firearms, Runnemede, N. J.

180 PROFUSELY Illustrated pages antique pistols, swords, daggers, armor, etc. 50c. Robert Abels, M860 Lexington Ave., New York 21.

CAST Iron molds—For casting fishermen's sinkers. Free illustrated booklet. Reading Instrument Co., Box 76, Reading, Penna.

DIVING Equipment for spear fishermen, skin divers and professional divers. Send 25c for catalog. Desco, 234 N. Broadway, Milwaukee 2, Wis.

MANY Modern, antique guns. List 10c coin. Ed Howe, 52 Main, Coopers Mills, Maine.

GUNS, Reloading supplies, archery supplies, binoculars. Catalogue 10c. Gun Shop, Baker, Oregon.

JAP Rifle altering to 30-06, \$6.00. Jap-shells, \$3.75. Catalog 5c. T. P. Shop, West Branch 11, Mich.

PORTABLE Blinds: For duck, crow, goose shooting. Very light 4 x 5 ft. woven natural Tule mats. Strong. Excellent on duck boats and permanent blinds too! \$3.00 delivered. Peacock Broom Co., 915 Bryant St., San Francisco, Calif.

IMPORTED, Daggers, stilettos, throwing, pocket, hunting knives, etc. Free catalog. J. D. Clinton, 94 Church, Mt. Clemens 2, Michigan.

CALL Elk, deer, coyotes, foxes, etc. Original Animal Calls, Burley, Idaho.

MOLDS For fisherman's sinkers, jigs, squids, casting and spinning lures. Free catalog. Sweet's Molds, Tonawanda 1, New York.

BUY Wholesale nationally advertised sporting goods, thousands other products at big discount. Free "Wholesale Plan." American Buyers', 627-D Linden, Buffalo 16, N. Y.

CAMPING Equipment, tents (direct from manufacturer), sleeping bags, air-mattresses. Low prices. Send 10c for 72 page illustrated tent-camping equipment-tent maintenance catalogue. Mor-San Sales, 16-21R 50th Avenue, Long Island City 1, New York.

FREE Fishing catalog—132 pages. Over 3000 hard to find fishing specialties. Netcraft Company, Dept. PM11, Toledo 13, Ohio.

ANTIQUe Guns, current prices. Books. Free catalog. Pioneer Press, Harriman, Tennessee.

AMERICA'S Best hunting, fishing, trapping stories each month. Newsstands 20c. year \$1.50. Sample 10c. Clip advertisement, attach name, address. Fur-Fish-Game, Columbus 15, Ohio.

BIG Gunsmith catalog. 48 pages just out! 1001 tools make ideal Christmas gifts for amateurs and professionals. Moderate prices. Mail 25c postage today. Frank Mittermeier, Est. 1936, 3577 E. Tremont, Dept. P, Bronx 65, New York.

GUNS! Guns! Guns! New, used hunting bargains, Mausers, Lugers, Kentuckies, Winchester, antique arms, catalog 50c. Ed Agramonte, Yonkers 20, N. Y.

AGENTS: Sell holsters, guns, accessories. Excellent discounts, earn good money. Catalog 25c. Handcraft, 4245 N. Harlem, Chicago 31, Illinois.

BINOCULARS, TELESCOPES, MICROSCOPES, MAGNIFIERS

MICROSCOPES, Prepared slides, biological stains, oculars, illuminators, mechanical stages, objectives, mounting media, parts, specialized equipment. Premium quality merchandise, lowest prices anywhere. Write for free illustrated microscope catalog and price list. Benjamin Miller, 134 W. 32nd St., Rm. 204-A, New York 1, N. Y.

ELBOW Telescopes—8 power, new surplus, extra special \$18.95 prepaid. Buy 2 for \$35.00 with case. Lowest advertised price in country. Government cost \$200.00. Check or money order with order. Coronet Enterprises, Box 564, Rochester, New York.

SPACE-Rover astronomical telescopes, precision made. Rasmussen-Reece, Amsterdam, N. Y.

TELESCOPES—20 Power, new surplus, \$400.00 value, special \$89.50 with free \$50.00 leather carrying case. Shipping weight 40 lbs. Check or money order with order. Coronet Enterprises, Box 564, Rochester, New York.

AMAZING Prices. binoculars, telescopes, microscopes. Free trial. Folder, "Binocular Selecting," catalog free. Dealers wanted. Prentiss Importers, Mercury Bldg., West Los Angeles 25, Calif.

TELESCOPES, Microscopes, binoculars for quarter century. Big bargain scientific catalog 10c. Harry Ross, 70 West Broadway, New York 7, N. Y.

REFLECTING Telescopes, 60X, completely assembled \$29.75. Guaranteed observatory clearness. Free information. Skyscope, 475 Fifth Avenue, New York 17.

MAKE 6" Telescope reflector. Glass, abrasives, instructions—\$10.50. F. Cameron, Box 65, Inwood 96, N. Y.

DYNASCOPE—New sensational reflector telescope 65X-130X-167X; 4 power finder; fully achromatic; hardwood folding tripod, complete ready for use. Send for details. Criterion Manufacturing, Dept. DP6, Hartford, Conn.

IDEAL Christmas gifts. Save 25%! Get interesting facts. Free 52 page binocular telescope catalog. \$3.95 to \$250.00! United, 9043 S. Western, A-7008, Chicago 20. Dealers wanted.

WAR Surplus bargains! Millions of lenses, instruments, telescopes, binoculars, components! World's greatest optical market place! Send only \$1.00 for beginner's 10-lens kit and big instruction booklet Stock CH. Write for catalog CH free! Edmund Scientific Corp., Barrington, New Jersey.

LOWEST Prices all sizes binoculars, telescopes, microscopes. Free catalogue. Joe's Binocular Sales, 4827 Second Blvd., Detroit 1, Michigan.

BINOCULAR Spectacles. Lowest price ever. Enjoy TV and all sports. Focusing, wear like eye glasses \$1.00. Mel-Jo, P.O. Box F, Hillside, N. J.

FREE Literature. Ultra powerful telescopes and telescope makers lens kits. Trifling cost. H. Jamer, Manorville, N. Y.

REFLECTOR Telescope kits from \$6.25. Mirrors and mirror cells, diagonals, focusing mounts, tripods, tubing, oculars. Fully guaranteed. Free illustrated catalog. Visit our store 166 Church St., New York, N. Y. Send orders and inquiries to Esco Products, Dept. PM-11, 1428 Willow Avenue, Hoboken, N. J.

SPECIALISTS, Microscopes and accessories, new and used. Prepared slides, supplies. Biological kits, scientific oddities. Telescopes and equipment. Our 1955 catalog free. Nassau Optical, 9 W. Greenwich, Roosevelt, N. Y.

400X TELESCOPE Makers kit contains focusing tube, erector, 5 lenses and instructions—\$3.75. 100X completely assembled telescope with 5 ft. tripod, \$12.00. Free information. Suffolk Science, Mattituck 3, N. Y.

PETS—DOGS, BIRDS, RABBITS, HAMSTERS, ETC.

CHINCHILLAS—Registered. Guaranteed reproduction. Unbelievable price. Far-West Chinchilla, 1446-A Jones, San Francisco 9, California.

HAMSTERS, Albino and golden. Select breeders. Circle 8 Hamstery, Box 183W, Claymont, Del.

PARAKEETS, Profitable hobby, read Parakeet Newspaper, Box 46, West Bend, Wis., 8 months \$1.00.

HAMSTERS—Retail and wholesale. Prices free. Anderson's Hamstery, 35 Oneida, Pontiac, Michigan.

CHINCHILLAS (No rabbit.) Easily raised anywhere. Profitable. Big future. Terms. Hibner Chinchillas, Ithaca, Mich.

SPORTSMEN: 200 Pointers, Setters, Straight Cooners, combination hunters, rabbit and fox hounds. Reasonable. List free. Ramsey Creek Kennels, Ramsey, Illinois.

RAISE Mink; Free booklet, pen plans, inside secrets, feed care. Mink are money makers. Investigate today. Lawrence Mølgård, Brigham City 12, Utah.

MINK—Easily raised anywhere. Top quality breeders. Free information. Huebl Minkery, LeSueur, Minn.

RAISE Money-making Angora, New Zealand rabbits. Particulars free. White's Rabbitry, Jackson, Mich.

FOR Sale: A few outstanding coon-hounds, beagle, and rabbit-hounds. Prices from \$15.00 to \$40.00. Free literature. Trial. Dures Thomas, Box 268, Albertville, Alabama.

STANDARD Rabbit Journal, Milton 3, Penna. Year \$1.00. Sample dime. Beginners manual 25c.

GROW Mushrooms. Cellar, shed, and outdoors. Spare, full time, year round. We pay \$3.50 lb. We paid Babbitt \$4,165.00 in few weeks. Free book. Washington Mushroom Ind., Dept. 171, 2954 Admiral Way, Seattle, Washington.

MAKE Big money! Raise Chinchilla rabbits. Cash markets supplied. Write today! Rockhill Ranch, Sellersville 15, Penna.

MINK Raising information free. Complete. Lake Superior Mink Farm, Superior, WI, Wisconsin.

RAISE Mink. Get yours free. Wild. We'll teach you. Information free. Wild-mink, Box 324, Superior, Wis.

HAMSTERS—Golden; young, \$4.00 pair, fully developed, \$5.00 pair. Adirondack Hamstery, Prospect 44, New York.

RABBITS, Amazing home enterprise. Booklet free. Tayco Rabbitry, Hapeville, Georgia.

RAISE Rabbits. Let me show you how to succeed. Market information and prices of rabbits sent free. A. Johnson, Box 694, Kansas City 41, Mo.

GUINEA Pigs. Booklet free. Guaranteed markets. Taylors Company, Hapeville, Georgia.

BEAUTIFUL Pure white pedigreed police puppies. Ansonia Kennels, Mose, N. Dak.

MAKE Money raising chinchillas, mink, pigeons, rabbits, cavies for us. Free catalog. Keeney Brothers, New Freedom 2, Penna.

FARMS, FARM LANDS, REAL ESTATE

STROUT Catalog—Mailed free. Farms, homes, businesses, 35 states, coast-to-coast, 3,357 bargains described. World's largest; 54 years' service. Strout Realty, 7-M So. Dearborn St., Chicago 3, Ill.

FLORIDA, Lakefront homesites near Ocala Forest and Saint John's River. Excellent fishing-hunting. \$10.00 monthly without interest. \$295.00-\$895.00. Literature. Write, Parker, Paisley, Florida.

\$5.00 MONTHLY Buys 40 acres productive land, near town; good fishing. Price \$240.00. Box 425-P, Carthage, Mo.

FLORIDA—5 Acres high dry land near beaches, have homesite and garden. Only \$595.00, \$10.00 down, \$10.00 month. Information write G. B. Potterfield, Owner, Union Building, Dept. W, Charleston, West Virginia.

MAKE Money in Texas. Get yourself a fine tract now near Houston for only \$345. Pay \$15 cash and \$15 monthly. Fastest growing city and second largest seaport in the U.S. Huge \$100 million steel plant. World's greatest oil producing, refining, chemical, manufacturing and shipping center. Many are making phenomenal profits here and you can too. These beautiful tracts located in Houston's desirable southside suburbs with all-weather streets, electricity, schools, bus service, etc. Insured title. Write today for maps, pictures, full information free. Bailey Wood, Owner, Box 6804, Houston 5, Texas.

FLORIDA Real estate—80 acres, \$3000. Estate situated at Crystal River. Write J. M. Smith, Jr., Esq., 7 North Main Street, Ocala, Florida.

OZARK Home lands. Reasonable. Listings mailed free. Write Armstrong, Shook, Missouri.

GOVERNMENT Land where and how to buy, 25c. National Tax Service Bureau, 2520A, David Stott Bldg., Detroit, Mich.

FARM And business catalogs free! 4 big editions, Florida, Northeastern States, West's, M-11, Pittsburgh 17, Penna.

RETIREMENT Homes, gardens, nothing down* List free. Ferrys, Briar Hill, Penna.

FLORIDA—Nice homesites near Ocala national forest in Lake county. Best fishing, hunting. Low prices, easy payments. Folder free. Howard Vernor, DeLand, Florida.

FLORIDA—Beautiful retirement homesites near gulf coast. Excellent hunting, fishing in 9 fresh and salt water rivers. 11 bays and gulf. \$250 at \$10 monthly. Free literature. V. M. Mathews, Box 1406, Asheville, N. C.

HOMESITES \$400—Convenient payments. California's finest garden section. On Morro Bay's scenic shores. Wonderful fishing, boating, bathing. Fertile soil, softest water, temperate climate, congenial community. Free literature. Richard Otto, Department M, San Luis Obispo, Calif.

PLANTS, SEEDS, NURSERY AND GARDEN SUPPLIES

CAPERSPURGE—Wonder plant rids lawns and gardens from moles, gophers, rats and mice, send \$1.00 for packet, plants reseed, guaranteed. Lizmart Company, 3404 N. Figueroa, Los Angeles 65, Calif.

TREES And shrubs. Raise your own from seed for shade, windbreak, snow fence, ornament, erosion control, etc. For free planting guide, price list, write Woodlot Seed Company, Norway 9, Michigan.

POULTRY, FARM SUPPLIES

RHODE Island reds, 4 times egg laying contest winners. Great layers. Money makers. Tom Mettler, East Millstone, New Jersey.

POULTRY Farmers, broiler growers, turkey raisers, read the new American Poultry Journal for latest ideas and greater profits. 12 months, 50c. Special offer, 4 years \$1.00. American Poultry Journal, 182 North Wabash, Chicago.

PROFITABLE OCCUPATIONS

SECRET Investigation. Experience unnecessary. Investigators particulars free. George Wagoner, 125 M West 86th, New York 24.

FREE Folio "\$45,000; Unlimited Vacations Plan." No merchandise, equipment. Unknown! Work home—sparetime. Proven successful! Haylings, Carlsbad, Calif.

ALASKAN Jobs! Over 150 new construction projects with names, addresses companies hiring. Thousands needed. Highest wages. Military, private construction, mining, fishing, lumbering, aviation, railroads, homesteading. Skilled, unskilled workers. Salary information. Alaskan map included. Sample application \$1.00 complete. Alaskan Opportunities (PM), Box 362, Kenmore, Washington.

ELECTRONIC Parts distribution offers you a future at top pay. Write Glenn Williams, 6750 S.W. 8th St., Miami, Fla. and enclose \$2.00 for information on this desirable, uncrowded field.

FOREIGN Employment construction work. If interested in foreign projects with high pay write Foreign Service Bureau, Dept. PM, Metuchen, New Jersey.

HOME Workers needed! Spare time, full time. Assemble luggage and cases with our complete illustrated step-by-step instructions. We sell your product—Supply everything. Manufacturing representative needed in your area immediately. Unlimited profits possible. Investigate at our risk. Free details. Cascraft, 807-G10 Sunset, Los Angeles 12, Calif.

MAKE Flexible molds. Cast figurines, plaques. Free sample. Tooker, 630-M Chestnut, Hamilton, Ohio.

EVERYBODY Likes candy. Learn to make professionally. Our 44th year. Ragsdale Candies, D6, East Orange, New Jersey.

GROW Mushrooms. Cellar, shed, and outdoors. Spare, full time, year round. We pay \$3.50 lb. We paid Babbitt \$4,165 in few weeks. Free book. Washington Mushroom Ind., Dept. 99, 2954 Admiral Way, Seattle, Wash.

HELP Wanted, highest salaries. New York City classifieds airmailed—\$1.00. Miller, 24 Whitwell Place, Brooklyn 15, N. Y.

BE The Popular Mechanics representative in your neighborhood and earn big profits in your spare time. Write Popular Mechanics Magazine, Room 408M, 200 E. Ontario St., Chicago, Ill.

FREE Book "505 Odd, Successful Businesses." Work home. Expect something odd! Pacific Ocean, Calif.

AUCTIONEERING—Home study course. Diploma granted. Auction School, Ft. Smith, Ark.

FREE Information now available about foreign and U. S. A. job opportunities paying to \$1500 monthly. Write immediately. Dept. AG, National Employment Information Service, 1020 Broad, Newark, N. J.

MAKE New greaseless doughnuts in kitchen. Sell stores. Free recipes. Michael Ray, 3605 South 15th Ave., Minneapolis 7, Minnesota.

RAISE Pheasants on \$100 week plan. Little capital and space can make you independent. Free details. Great Central System, Columbus 20, Kansas.

WELDING Pays big money. Learn easily at best equipped school in country. Non-profit school with low cost training. G. I. approved. Write Hobart Trade School, Box M-1142, Troy, Ohio.

MAN Wanted—Are you dissatisfied with your work? Would you like a business of your own? If so, write Rawleigh's, Dept. K-QQ-PPM, Freeport, Ill.

WANT A diesel job? New opportunities to increase income. Higher pay. More money. We can help you qualify. Tools. Shop method home training. Write today! Diesel, Tractor, Heavy Equipment Division, Interstate Training Service, Dept. B-3-M, Portland 13, Oregon.

"HOW To Make Money With Simple Cartoons"—A book everyone who likes to draw should have. It is free; no obligation. Simply address Cartoonists' Exchange, Dept. 911CF, Pleasant Hill, Ohio.

FREE! "301 Profitable Small Businesses!" Amazing shoeing plans! Work home! Start sparetime! Deumant Surveys, Kenmore 23-PM, N. Y.

BUY Wholesale thousands nationally advertised products at big discount. Free "Wholesale Plan." American Buyers', 628-P Linden, Buffalo, N. Y.

LEARN Specialized patent drafting \$32.50 complete. International Patent, P.O. Box 134, Dayton 1, Ohio.

FOREIGN-U.S. jobs. South America, Alaska, Spain. Fare paid. 1000's U.S. jobs to \$18,000. Trades, offices, factories. Stamped self addressed envelope brings reply. Job Opportunities, Waseca 1N, Minn.

EXTRA Money every week. I'll send you full-size Blair household products on free trial. Show them to friends and neighbors. You can make big extra profits. Write Blair, Dept. 31MX-2, Lynchburg, Va.

OVER 60? Want employment? (No selling.) Send for free brochure: "400 Salaried Positions and Profitable Occupations for People Over 60." MCB, 405-P Gorman Bldg., Minneapolis 3, Minn.

COMPLETE Merchant Marine employment opportunities, instructions, \$2.00. Worldwide employment guide for skilled, unskilled adventurers and vagabonds, \$1.00. Satisfaction fully guaranteed. Seaways, Box 1231M, Baltimore 3, Maryland.

JOBS On ships. Great Lakes-ocean. Outstanding pay. No experience needed. Full details, \$1.00. Ship Opportunities, Waseca, 1-N, Minn.

OVERSEAS Jobs. Up to \$1400 per month for industrial trades, \$1200 for clerks, laborers. Send \$1 for latest issue Foreign Opportunities Catalog with application forms, today, to Personnel Service Bureau, Stapleton Bldg., Box 72, Billings, Mont. Licensed-bonded.

EARN \$3.50 to \$15.00 per hour in your spare time refinishing and patching furniture. Repair professionally scratches, dents, nicks, cigarette burns, etc. Particulars free. Sunshine City Refinishing Products, M3890 Maple St., Northeast, St. Petersburg, Florida.

EARN \$50.00 Daily making mats, shoes and mud guards from old tires. S and S Patents Inc., 1307 North Clark St., Chicago 10, Ill.

GROW Miniature trees. Fascinating, profitable. Complete instructions, condensed, simplified. Banzal method, supply sources included. \$1.00, returnable. Re-revealer, 1749 Gr. Concourse, New York 53.

ST. Lawrence Seaway starting. Tenders called. Send \$1.00 cash or money order for information and application form. Airmailed 25c extra. Allied Opportunities, Box 10, Station B, Dept. PM-11, Hamilton, Ontario, Canada.

ATTENTION Construction men! Trades, truck drivers, laborers, clerical, engineers, supervisory, many others. Latest copyrighted reports on who to contact to apply for high paying jobs in over 42 countries, including U.S., St. Lawrence Project, Spain, South America, Alaska, Europe, etc. Pay up to \$1500.00 monthly. Usually transportation paid, overtime, other advantages. Included are: best aviation, oil, mining company listings. Year registration and advisory service. Application forms. Unconditional money-back guarantee of satisfaction. Immediate service! All only \$2.00. Airmailed \$2.25. (COD's accepted.) International Reporter, Box 1047-PI, St. Louis 1, Missouri.

MAILORDER Beginners manual, sources, instructions, opportunities, 25c. Carnahan Bros., 5580 Nelson, Cypress, Calif.

BUY Wholesale 450,000 products. Literature free. Carter, Box 6011-B, Chicago 80.

\$1300.00 MONTHLY For truck drivers, \$1400.00 monthly for carpenters, electricians, plumbers, mechanics, \$1200.000 for clerks and laborers. Replacement hiring now being done. Full information and complete foreign listings, with current information on Spain, Korea, Australia, Alaska and Canada, \$1.00. 10,000 men and women needed for new state side project! Complete information and other domestic listings, \$1.00. Dept. 3-K, Opportunities Unlimited, 1110 Commerce Bldg., St. Paul, Minn.

\$15 AN Hour preparing tax returns. Become tax expert. State approved training program. Union Institute, 2-P, Lakewood, N. J.

SELL Popular Mechanics and all other magazine subscriptions. Free catalog, supplies. Subscription Service Company, Dept. B, P.O. Box 2070, Birmingham, Alabama.

JOBS And business opportunities. Los Angeles want ads airmailed \$1.00. Irish, 201 North Euclid Ave., Pasadena, Calif.

MAGAZINE Subscriptions, largest commissions. Bonus. Qualified Publications, 431MA Kingston, Brooklyn 25, N. Y.

LEARN Real estate business for highly profitable lifetime career. Study at home. Newer, quicker, better method. Diploma awarded. Surprisingly low cost. Free literature. Seavy Realty Institute, 1750-B Colorado Blvd., Los Angeles 41, California.

OVERSEAS, Canadian, Latin American, Alaskan employment. Originator 1954 "Foreign Service Directory" gives up-to-minute facts on civilian and military construction, mining, oil companies, steamship lines, aviation. How-when-where to apply with application form. Free, hot list of firms hiring this month. \$1.00. Global Reports, Box 883-P, Hollywood 28, Calif.

UNION Labor leader opportunities. Well paid, satisfying positions. Home or travel expense paid. Details \$1.00. Union Job Guidance Bureau, 103-PM Erie St., Salamanca, N. Y.

EARN Up to \$100.00 weekly just talking on your telephone at home. Easy. For shut-ins, too. Success guaranteed or money refunded, 10 methods complete, \$1.00. Star, 212½-D Fourth, Parkersburg, W. Va.

MUSHROOMS Grown boxes, barrels. Manureless process 50c. Spawn \$1.00. Gordons, 553 William, Winnipeg, Manitoba.

WHOLESALE! 8000 Nationally famous products. 30-80% discounts! Large catalog. Sensational business plans included. Consolidated Distributors, 21-20 Lafayette, Paterson 15, New Jersey.

I Average \$125 weekly selling books by mail! So can you! Start sparetime! Work home! Cooper, 247 Taunton, Buffalo, N. Y.

THIS Is not a pipe dream. I parlayed a fourth grade education into thousands of dollars. So can you. Make me prove it. Information, Spectacular Crafts, Box 5733, Bethesda, Maryland.

EXCLUSIVE Franchise—Business, reality, industrial financing. Capital raised for your business and others. Earn \$100.00 weekly up, \$2.00 full information. SyField, Phoenix Factors, 1008—5th Ave., New York 28.

JOBS That pay to \$1500 monthly! Thousands jobs open. S. America, Europe, Africa, USA, etc. Fare paid when hired. Application forms available. All trades, labor, drivers, clerical, engineers, etc. No employment fees! Free information. Write Dept. 760, National Employment Inform. Serv., 1020 Broad, Newark, N. J.

BOOKS, PERIODICALS, PICTURES, POSTCARDS

AMAZING New book gives instant solutions to 100,000 practical problems. Details free. Columbia Graphs, Columbia, Connecticut.

MAGAZINES! All types and subjects wholesale and retail. National Geographic a specialty. Also large stock of books. Citywide Book & Premium Co., 735 Wythe Ave., Brooklyn, N. Y.

RARE Offers. Illustrated comic booklets, 24 all different \$1. Catalogue 10c. Aladdin Book Co., 210-PM Fifth Avenue, New York 10.

"FEMME Mimics"—Amazing book, containing 375 photographs. About men who wear women's clothing! Free literature. Winco, Dept. PM111, Box 9525, Dallas, Tex.

BOOKHUNTERS! Scarce, unusual, miscellaneous books supplied. Atlantic Book Service, Cedar Street, Charlestown 29, Massachusetts.

SPARETIME Profits taking subscriptions, all magazines. Wholesale catalog free. Cassell Agency, Westfield 2, New Jersey.

NATIONAL Geographic Magazines, 1888-1952. Periodical Service, Box 465-PM, Wilmington, Delaware.

BOOKS Found! Any author, old or new. Rush titles wanted; no obligation. International Bookfinders, Box 3003-PM, Beverly Hills, California.

BOOKHUNTERS! All subjects. Send wants! Jahez Book Service, 620-P East 178 Street, New York 57.

PICTURE Post cards, made from your photograph. 1000, \$11.00. Raum's, 4154 Fifth Street, Philadelphia 40.

BOOKS. Art, hobby, bargain prices. Free catalog. Artercraft, Baldwin, Maryland.

BOOK Catalogue, 1000 bargains, send 10c. Books Publishers, Amityville 3, N. Y.

HANDY-Quick Tolerances, 100 pages pocket size \$1.00. Thousands of tolerances and industrial short cuts. Handy Length Book Co., 3507 17th St. S.W., Canton, Ohio.

ALL Sports bookfinder! Any sport subject. Osmo Tuiskula, Box 482, Worcester 1, Massachusetts.

DEMOCRATIC Digest Magazine, official publication Democratic National Committee, 1 yr. \$3.00. C. M. Marrs, North Tazewell, Va.

BOOKS Government surplus education manuals. Trade and vocational subjects. About one fifth regular price. Free catalog. Long's College Book Co., Dept. PM, Columbus 1, Ohio.

BOOKHUNTERS! All subjects. Send wants! College Book Service, 52 W. Kingsbridge Rd., New York 68, N. Y.

FREE Catalog paper covered books. World Adventure, D237, Ann Arbor, Mich.

LOGIC Mirror-wise. How to count without numbers. 4 page leaflet. Send 15c. W. J. Mallory, 616 N. 34th St., Omaha, Nebr.

BACK Dated magazines. Specific issues and years. Buy-Rite, 57 Whitehall St., New York 4.

GAMES, TOYS, NOVELTIES

PEGLESS Cribbage board. Large numbers. Sliding pointers. Beautiful gift item. \$2.95 prepaid. Curtis Products Co., No. Woodstock, N. H.

AMAZE Your friends! Tell fortunes with cards. Instructions and special cards \$1.98. Send money order or check. Gulf States Distributing Co., 8405 Montridge Drive, Houston 24, Texas.

MAGIC TRICKS, PUZZLES, JOKER NOVELTIES

500 TRICKS, Douglas famous 120-page catalog, only 10c. Fastest service to magicians for 30 years. Send 10c today. Douglas Magician, Dept. 1, Dallas, Texas.

2500 TRICK Catalogue (\$12-pages), pocket, parlor, stage. World's finest magic. Catalogue \$2.00 (dollar trick included free). Kanter's, M-1311 Walnut, Philadelphia 7.

WE Supply every noted magician. Large professional catalog \$1.25. Holden's, 120 Boylston Street, Boston, Mass.

PROFESSIONAL Catalog. 175 pages. 25c. Williams, 900 Plymouth, Ellwood City, Penna.

MAGIC Courses. Catalog with seven lessons free! Success School, Sparta 6, Michigan.

3100 NOVELTIES, Tricks, jokes, gadgets, funmakers, hobbies. Catalog 10c. Johnson-Smith, D852, Detroit 7.

ILLUSTRATED Catalogue 25c, mimeographed catalogue 10c. Joke list 5c. Eagle Magic, Minneapolis 2, Minn.

QUICK, Easy—"Throw Your Voice" instructions, 25c. Ventriloquist, Calallen, Texas.

SENSATIONAL Magician's wand 25c. (Vanishes handkerchief!) Catalog included. Box 1352-PM, Philadelphia 5.

40 JUGGLING Stunts. Easily learned. \$1.00. J. R. Bates, Riverton, Ky.

WOODEN Nickel, catalog, trick, 10c. Fun'n Magic, 423-P North St. Marys, San Antonio 5, Texas.

BAG Chock full of astounding tricks. Send fifty cents to Starling Co., 2206 Starling Ave., New York City 62.

ZANTO'S Dissolve free! Zanto, Waverly, Ohio.

BE A magician. Large professional magic catalog of latest tricks. 35c. Ireland, C-109 North Dearborn, Chicago 2.

BEST Magic. Joker's novelties. Lower prices. Catalog 10c. Top Hat 12, Evanston, Ill.

COINS, TOKENS, CURRENCY

BARGAIN Lists and uncirculated coin 10c. Elliott, 235 Juniper, Coraopolis 6, Penna.

FOREIGN Coins, twenty different each from a different country, \$1.00 postpaid. Webb, 330 Gough, San Francisco 2, Calif.

JAPANESE Invasion notes 1c to \$1000.00 set \$1.00. 100pp. illustrated coin catalogue. 25c. Shultz, Salt Lake City 10, Utah.

FREE! Foreign coin, banknote and coin collectors illustrated catalog to approval service applicants. Send 3c postage. Taham Coinco, Springfield 30, Mass.

INDIAN Cent with bargain lists 10c. Hutchinson, 3463 "I" Street, Philadelphia 34, Penna.

GET Profit and pleasure in collecting old coins. Send 10c for 56-page illustrated coin catalog. You'll be delighted with it. Send for it now. B. Max Mehl, 370 Mehl Building, Fort Worth, Texas. Largest rare coin establishment in U. S. Established 54 years.

CONFEDERATE And Southern bank notes, 3 different, \$2.00. 50 mixed Indian pennies, \$2.00. Ben's Coin Shop, 31 N. Clark, Chicago 2.

WORLD'S Greatest magazine for coin collector's and wooden nickel 10c. Lawrence Brothers, Anamosa, Iowa.

COIN Collector's Magazine. Over 1000 pages per year. Sample copy 30c; \$3.00 per year. Hewitt, 7320-J Milwaukee, Chicago 31.

U. S. Large cent, 2c, 3c all for \$1. Bargain list included. Delmaco, Box 1123, Wilmington, Del.

UNITED States Rare Coin Value Guide, 48 pages 50c. Fortunes in rare coins. Ideal, 4644-P Geary, San Francisco 18, California.

AN 1804 Silver dollar is worth \$12,500! What are your U. S. coins worth? Fell's new 1954 U. S. coin book. Everything on every coin minted—worth, selling, speculating, investment, etc. Clothbound, profusely illustrated. Send no money. Pay postman \$2 (plus postage) or send \$2.00 (postpaid), refundable. Fell Publishers, 386-M-8 4th Ave., New York City 18.

OLD Money wanted. Do you know that coin collectors pay up to \$100 for certain U. S. cents? And high premiums for all rare coins? We buy all kinds. Send 4c for large coin folder. May mean much profit to you. Numismatic Co., Dept. 20, Fort Worth, Texas.

110 DIFFERENT Foreign bills \$1.00. Sayers, 1000 East Unaka, Johnson City, Tennessee.

FORTY Different Liberty Head dimes, \$9.50. Quarterly "Mail Bid" auction lists, 25c. Johnson, 644 E. Valerio, Santa Barbara 3, Calif.

FIVE Page bargain list, Indianhead cent, 10c. Economy Sales, 158 Dean, Mansfield, Mass.

YOUR Foreign coins are worth money! New 1954 Fell's International Coin Book. Tells how to identify, learn exact value, etc., of every coin ever minted whether or not you know country of origin. Also includes selling, speculating, investment, buying, etc. Clothbound, profusely illustrated. Send no money. Pay postman \$2.50 (plus postage) or send \$2.00 (postpaid) refundable. Fell Publishers, 386-M-8 4th Ave., New York City 18.

50 COINS And bills \$1.00. Oddsson, Box 482, St. Louis, Mo.

WE Pay \$5.00 to \$50.00 each for hundreds of old or odd U. S. and foreign coins. Keep all until posted. Send 25c for illustrated coin value book with bargain lists free. 50 years in business. Coin Exchange, Box 2, Le Roy, N. Y.

COIN Collectors 1955 price list. Over 40 pages, many bargains. Send 50c. James, Inc., 300 West Main, Louisville 2, Ky.

WANTED—1894-S dime. Pay \$1,000.00. Certain 1913 nickel \$1,500.00. 1901-S quarter \$30.00 to \$250.00. Hundreds of others. Know their true value. Complete illustrated catalogue 50c. Worthycoin Corporation (D-516), Boston 8, Mass.

APPRAISALS, Certified by expert. Minimum \$1.00 per coin. Special collection fees arranged. Numismatic Appraisal Service, Box 456-P, Encino, California.

FOREIGN Coins, 10 diff. 30c. Foreign bills, 10 diff. 20c. Lists. Oliver Arnold, Macon, Mo.

BEAUTIFUL Slam porcelain coins. 2, \$1.00. Irish set 8 animal coins \$3.00. Elizabeth coronation dollar \$1.85. Giant bargain catalogue 35c. Beber's, 4514 North 30th, Omaha 11, Nebraska.

STAMP COLLECTING

UNITED States price list 100 pages, hundreds of illustrations, stamp identification 10c. Thom, 4808—15 Ave., Minneapolis 17, Minn.

1500 STAMPS \$1.00. Good variety. World wide. Many pictorials. No approvals follow. Satisfaction guaranteed. Whalen, 1516 First Ave., Oakland 6, Calif.

GOYA Nude (2) 5c. Approvals. Hanay's, 310 Quail, Albany 3, N. Y.

AUSTRALIA: 47 Different, 10c. Illustrated lists free. Leslie Anderson, Seaside Heights, N. J.

100 DIFFERENT World 10c gift set. Bellet, Mapledale, Hazel Park, Mich.

WHOLESALE Price lists for dealers. Progressive, 2700 Burkhardt, Cincinnati 15, Ohio.

DIFFERENT, 500, 50c; 1000, \$1.25; 2000, \$2.75; 5000, \$11.00. Approvals. K. S. Holmes, London, Canada.

MINT U. S. approvals free list: singles, blocks, plate blocks. Commemoratives, air mails, regular issues. Select mint copies, guaranteed to please. Fast service, prices you can afford. Special introductory offer: 33 different mint U. S. commemoratives \$1.99 different mint U. S. commemoratives \$5.20 different mint U. S. air post stamps \$3.60 different mint U. S. regular issues \$5.11 different mint comm. plate blocks \$2.50 different mint comm. plate blocks \$9. All select mint. Satisfaction guaranteed. Only 1 of each lot (max. 6) to a customer. Give your age, employment, references and number of mint U. S. in your collection. Approvals accompany. Write today! Now! Russell Patrick, 5550 East 42nd Street, Indianapolis 28, Indiana.

5 MINT Blocks free to approval applicants. A. H., 1207 Northland Ave., Buffalo 15, N. Y.

315 DIFFERENT Foreign stamps including animal, flower and other topicals. Air-mails, coronation and triangle stamps. 25c with approvals. Hathaway, P.O. Box 145PM, Garden City, N. Y.

GERMANY 1947 "Reaching for Peace" issue 3c to approval applicants. Carlson, 8 Esther, Pasadena 3, California.

MACAO Flower set, 10c with approvals. Seminole Stamps, Box 1128-P, Coral Gables 34, Florida.

SEND For illustrated catalog! United States stamps, albums, supplies. Delaney, 44 Bromfield, Boston, Mass.

WONDERFUL Offer. 7 complete mint sets only 10c with approvals. Reich (M26), 1033 Lawrence, Chicago 40.

ALBUM! 32 Pages! Only 10c! Approvals. Hartford Stampart, Hartford 1, Conn.

REQUEST Approvals. Receive Lundy Island sheet free. Elmont Stamp Co., 960 Sixth Avenue, New York 1.

U. S. Illustrated price list free. Lush, 6422 Ellsworth, Detroit 38, Mich.

SHIPS, Planes, trains, plus 200 different foreign, 25c with approvals. Golden West Stamps, Box 245-M, Rivera, Calif.

TERRIFIC Collection, five continents, includes bicolors, triangles, flowers, animals, commemoratives, etc. for 10c with approvals. Richardson Stamp Co., Niagara-on-the-Lake 1, Ontario.

UNITED Nations cover free to applicants of U. S. or British Colonial approvals. A. Taylor, Skyland, N. C.

BARGAINS Galore! Ask for "Stamps of Quality" price list today. Elholms, 821 Hayes, Racine, Wisconsin.

WEST Indies, French Africa, over 100 others, only 10c! Approvals included. Cole, 43-A Rinevalt, Buffalo 21, N. Y.

WORLDWIDE, 50 All different, absolutely free, just to introduce our incomparable approvals. Kent Stamp Company, GPO Box 87, Brooklyn, N. Y.

FREE U. S. illustrated bargain catalogue. Rothberg's, 53 Bromfield, Boston 8, Mass.

TWO \$5.00 U. S. stamps plus 20 different, 10c with U. S. approvals. Irwin Stamp Co., Box 1105, Brooklyn 30, N. Y.

100 DIFFERENT U. S., 40c with U. S. approvals. Faith, 1339½ Westminster, Alhambra, California.

ECONOMICAL 10c-1c-2c-Approvals, 22,000 varieties available. Dresel, Box 270-n, New York 25, N. Y.

FABULOUS Collection—Roosevelt and dictator stamps. Mammoth fascinating collection of Roosevelt and dictators including Stalin, Tito, Franco, Lenin, Hitler and great many others plus free booklet and bargain lists. All for 10c with approvals. Jamestown Stamp, Jamestown, Dept. 413, N. Y.

50 DIFFERENT Bulgaria 10c! Approvals. Ensign Stamp Company, Dept. M, Berdan Avenue, Paterson 2, New Jersey.

NUDES Set: Colorful approvals 10c. Atlas, 2830-M, Eisenhower, Racine, Wis.

EXOTIC Oriental collection, 105 all different stamps from Borneo, Hong Kong, Malaya, Sarawak, Korea, Japan and many other strange countries of the Far East plus free booklet and bargain lists. All for only 10c to new approval customers. Jamestown Stamp Co., Jamestown, Dept. 313, N. Y.

50 DIFF. U. S. commemoratives 25c. Mammoth packet list free. Econopackets, Box 168, Riverside 9, Calif.

UNITED States—58 different including 8 airmails, 15 commemoratives, 10c. Approvals. Sunset, Box 47, South Gate, Calif.

225 STAMPS For only 10c! This mammoth value includes airmails, pictorials; stamps from strange countries cataloguing up to 25c each! Also approvals. Mystic Stamp Company, Camden 80, New York.

HANDSOME New Zealand 1943 Elizabeth and Margaret Rose triangles only 10c to approval applicants. George Richie, 1539 Sixth, Alameda, Calif.

WOW! 153 All different Germany, 10c. Zeppelins, semi-postals, airmails, high values, big bargain lists and approvals included. Jamestown Stamp, Jamestown 512, New York.

STAMPS Wanted. Mint and used, collections, accumulations. Good grades only. Buy outright if bargain. What have you? Write, give details. Vanroy Shirk, Lebanon, Penna.

TRIANGLES, Birds, butterflies, flowers—Big packet 10c with approvals. Southwest Stamps, Box 117, Long Beach 1, Calif.

300 DIFFERENT. Triangle, airmail, pictorials, etc. 25c. 500 mixed U. S. 25c. Carlton's, Tujunga, Calif.

200 DIFFERENT, Including Roosevelt triangle, 10c to approval applicants. M. Avalon Stamp Company, Springfield, Mass.

50 DIFFERENT Argentine 10c. Approvals. Reuter, 611 W. 40th Pl., Los Angeles 37.

AMAZING Offer! 200 United States stamps—including commemoratives, airmails, high denominations to \$1.00. Only 10c to approval applicants! Illustrated bargain lists free. Mystic Stamp Co., Dept. 80, Camden, New York.

100 DIFFERENT Spain 25c. Penny approvals included. Reed, Box 980, Chicago 90, Ill.

OLD Scarce U. S. seconds on approvals. Slight imperfections, lowest prices. Herndon, Clintonhill Sta., Newark 8, N. J.

SPEND Pennies! Not dollars! Thousands of fascinating stamps to choose from our 1c and 2c approvals. No premiums. Just honest value. Pat F. Knowles, Box 2247, Van Nuys, Calif.

OLD U.S. approvals. Low prices. MacG., 2905 Observatory, Cincinnati 8, Ohio.

50 DIFFERENT United States 5c with bargain approvals, lists. Bookman, Manatee 1, Florida.

FREE! 1954 Bargain lists. (Mint stamps of Europe and Africa.) Boger, 3401 Oakmont, Philadelphia 36, Penna.

U.S. Mint 797 SPA sheet, 10c to U.S. approval applicants. M. Haycock, 153M 74th St., Brooklyn 9, N. Y.

25 MULTICOLORED Triangles, only 25c with beginner or advanced approvals. Low prices. Essex, 5946 Arlington, Los Angeles 43, Calif.

FROM Tiny to jumbo ones. Asia, 115 diff. 30c. (China, Hejaz, Israel, Japan, Manchukuo, Siam.) Robert Boger, 3401 Oakmont Ave., Philadelphia 36, Penna.

850 MIXED U.S. old-new 25c. Lists. Weatherby, Medina, Ohio.

25 FRENCH Colonies 3c; approvals sent. Adlez, 367-M Park Ave., Newark 7, New Jersey.

12,000 PENNY Approvals waiting for you. Many from exotic countries, pictorials, airmails, new issues. Tilbury, Box 862, Newark 1, N. J.

FIJI Bicolored health set. 5c. Approvals. Pleasure Stamps, 1865P—52nd, Brooklyn 4, N. Y.

96 PAGE Illustrated U. S. price list. Send 10c, cost of mailing. DeLisle, 69 Plaza Shopping Center, Fresno 1, Calif.

SCOTT'S Modern stamp kit includes looseleaf modern album for stamps of world; 500 different stamps; colored flags, arms, rulers' portraits; toms; hinges; perforation gauge. \$5. Album separately, \$2.50. Scott Publications, 380 Fifth Avenue, New York 36.

FREE: Mint British colonies from Brunel, Papua, New Guinea, Caymans, Gilbert Ellice, Seychelles, Sarawak, Dominica. Free with approvals. Viking, 11-Z Northern Blvd., Great Neck, N. Y.

WEIRD Diamond shape coffee stamp! Lovely flower triangle! First American big commemorative, Greenland idol dancer, etc. Free with approvals. Capital Stamp Co., Little Rock 2, Ark.

HIGHEST Quality stamps available on approval. We specialize in prompt, personalized service, and reasonable prices. Miller, Box 416, Vista, California.

200 DIFFERENT! Plus Macau, Rhodesia, Mauritius, etc. Only 10c to approval applicants. Evden, Box 128, Valley Stream 50, New York.

FREE Stamp collection—100 different stamps from Europe, Africa, Asia, Scandinavia, Balkans, etc. 3c to approval applicants. Tatham Stamp Co., Springfield 30, Massachusetts.

FREE!—107 Iron Curtain stamps—All different—Russia, East Germany, Romania, Poland, sensational Stalin stamp; many smuggled from Communist territory. Free book "How to Recognize Rare Stamps" included. All for 10c. Approvals. Kenmore, Milford OH-433, N. H.

PLEASURE Is yours for pennies when you select from our big books of 1000 stamps. Clean and neatly arranged stamps for your selection. Scott's catalog number and price under each stamp, but large discounts allowed. Write today and watch your collection grow. Wolverine Stamp Service, Dept. A-22, Fruitport, Mich.

FREE Complete set of famous Americans, flags, parks and presidentials to approval buyers. Send 5c for 15 of the above stamps plus full particulars. Triboro Stamp Company, 145 Nassau Street, Dept. 111, New York 38, N. Y.

FREE!—Big United States catalog. Valuable guide and check list. Hundreds of illustrations. Approvals. Harrisco, 468-M Transit Bldg., Boston 17, Mass.

PAYING High prices for approvals? If your collection numbers under 15,000 try our 1c and 2c approvals. In books of 1,000. Special offer to customers. U. S. also available. Clark Stamp Co., Dept. A-42, Muskegon Heights, Mich.

S.P.A. Sheet at face! Mint Smoky Mountain miniature only 10c with U.S. mint approvals. Send dime today. Western, Box 1689P, Salinas, California.

COLONIAL Collection free—Magnificent collection, British, French, American and other colonies. Flowers, animals, commemoratives, triangles, pictorials, high values all free plus Philatelic Magazine. Send 5c for postage. Empire Stamp Company, Dept. PM, Toronto, Canada.

GIANT Approvals, thousands different, one cent each. Wahl's Stamp Exchange, 7006P Farragut, Chicago 31, Ill.

FREE—Valuable British Empire collection! 105 all diff. from Aden to Zanzibar! Includes Cayman, Pitcairn and many other exotic colonies. High catalog value! Sent for 10c mailing expenses. Approvals. Kenmore, Milford 8-T, N. H.

UNITED States, United Nations, Confederate States stamps, at America's lowest prices. Write for free 72 page catalogue with almost 1000 illustrations. Stone's, 192 Washington, Boston 8, Mass.

FINE Approvals. Fast, personal service. What countries do you prefer? I'll send their stamps. Skinner, 438 Locust, Long Beach 12, California.

PICTORIAL. Angola, Mozambique, Hungary, a fine assortment of stamps, 3 different sets depicting wildlife in natural colors, plus 100 attractive stamps. 10c to approval applicants. Modern Stamp Co., Dept. A-6, Ferrysburg, Mich.

HITLER Heads, 27 different from five Nazi-dominated countries. This historically valuable collection only 10c. Approvals accompany. Tristamps, Demarest 4, N. J.

HUNGARIAN Pictorials, 100 large different beauties, \$1.00 with approvals. Hobbycrafts, Bandon, Oregon.

MAMMOTH Collections foreign, wholesale; \$1.00; \$2.00. Approvals. Ehde, Amiret, Minnesota.

JUGOSLAVIA Set 3c approvals. Mrs. Van Housen, RFD-1, Highland Mills, N. Y.

UNITED States sets unused. Famous Americans \$5.50, flags \$5c, national parks \$1.40. Catalog 10c deductible on \$1.00 order. Standard, 10840E Woodview, Parma Hts. 30, Ohio.

500 FINE Mixed U.S. stamps 15c. Wright, 201 Mealey, Hagerstown, Maryland.

FREE U.S.—35 different with superior approvals. Sparta, Box 1082, Rochester 3, N. Y.

UNITED States commemorative price list free. James Cunningham, 101 Terrace, Hasbrouck Heights, N. J.

FIRST U.N. set. Among world's prettiest. Only 10c. Approvals. Welles, Box 1246-R, New York City 8.

FREE Sample! Interesting, illustrated, informative! National Stamp News, Anderson, South Carolina.

FREE United States illustrated catalog. Bailey, 44 Bromfield, Boston, Mass.

TELEVISION Stamp and 50 different 5c with approvals. DeRespinis, G.P.O. Box 771H, New York City.

500 STAMPS \$2.00 plus approvals. Deer Stamps, 914 Balmoral, Detroit 3, Michigan.

DEALERS—Wholesale list. Postage 3c. Frank, 5031 Queensberry, Baltimore 15, Maryland.

LARGE Grabbag 40c. Big lot \$1.00. Persil, 436 New York Ave., Brooklyn 25, N. Y.

FROM Mexico—70 different mint \$1.00. Ralph Ogden, Cuernavaca, Mexico.

SUPERIOR Worldwide mission mixture. Amazing variety! Half pound \$1.50. Baye Nielsen, 4407B Catherine, Montreal 6, Canada.

ISRAEL. Free illustrated pricelist. Levy, 8854—20th Avenue, Brooklyn 14, N. Y.

20,000 DIFFERENT World \$175.00; 10,000 \$47.00; 5000, \$13.00; 3000, \$6.50. Gould's, Box 631, San Francisco 1, Calif.

FREE! Angola elephant, antelope, leopard stamps; Sanmarino triangle sports set; Mozambique butterfly; Monaco ship triangle, sports diamond; Macao flowers; premium coupon, to new approval applicants. Mounblow, Box 278A, East Northport, New York.

65 ALL Different U. S. stamps. Includes 50 year olds, commemoratives, airmails and \$5.00 stamp. Only 15c. Approvals. Willett Co., Box 511-L, Port Chester, New York.

U.S. Mint commemorative plate number blocks. 6 different \$1.00; 24 different \$5.00; 44 different \$10.00. Approvals, price lists. Wm. Kuehl, 3125 East K, Tacoma 4, Wash.

U.S. 1898 Battleship revenues! 13 different, 25c. Free list. Brooks, 2352T East 23rd Street, Brooklyn 29, New York.

LOCOMOTIVES—Honduras 1898, complete set, mint, laid paper, just 10c with approvals. Fred Pittsley, So. Montgomery, Napa, Calif.

NATION-Wide cut-rate sale. Send 10c for giant catalogue of 800 different packets and 2000 sets. Povilauskas, 212 E. 3 St., New York 9, N. Y.

EXCITING Topical collection of seven colorful, all different mint sets. Only 25c with approvals. Firland Stamp Co., Box 493, Seattle 11, Washington.

U.S. Commemoratives, 33 different 10c. Approvals. White, 516A Avenue L, Brooklyn 39, N. Y.

25 DIFFERENT Luxembourg 10 cents, approvals. Waha Company, 178 No. 17th Street, East Orange, New Jersey.

FREE Foreign sets of stamps to approval buyers. Supreme Stamps, 2205 So. Grand, Los Angeles 7, Calif.

LUNDY Island, world's smallest kingdom, 9 beautiful new issues only 15c with approvals. Louis Golden, 6721 Eastwood St., Philadelphia 49, Penna.

BETTER Approvals. Half catalog. Free premium. NorCal Stamps, Box 1041, Walnut Creek, California.

ESTONIA Carrier pigeon set free. Approvals. Canyon Stamps, Box 808, San Fernando, California.

135 DIFFERENT U.S. commemoratives \$1. Request approvals. Harold Holub, 18 East 198th St., New York 68, N. Y.

RUSSIA #596 Mint, catalog 50c. To approval applicants 10c. Reilly's Stamps, Box 323, Compton, Calif.

100 DIFFERENT British colonies, 20c with approvals. Deben, 1059 Dwight, Holyoke, Mass.

U.S. 40 Different commemoratives 25c. No approvals. Seidenberg, Appleton 944, Wis.

APPROVALS By country. Priced right. Chur, Box 117, Williamsville 21, N. Y.

100 DIFFERENT Stamps free with approvals at 60% discount. Martinsen, Box 115, New York 33, N. Y.

15 DIFFERENT Italian commemoratives 10c to approval applicants. Ladue Stamp Co., 9815 Clayton, St. Louis 17, Mo.

50 DIFF. Finland, 10c with approvals. Carroll's, W. 310-A Sprague, Spokane, Wash.

COLORFUL Pictorial set free, with approvals. Variety Stamps, 57-P Circuit, Newton Highlands 61, Mass.

CIPEX Souvenir sheet plus 25 different U.S., 10c. Approvals accompany. Village Stamps, 90-39P 214 St., Queens Village 28, N. Y.

WORLD'S Oldest stamp! 1840 Great Britain 1p. \$9.00 catalogue. Special \$1.00. Approvals. Brooks, 2352X East 23rd Street, Brooklyn 29, New York.

MONACO Nudes complete 10c. Approvals. Royal Stamp Company, Tamaqua, Penna.

TWELVE Beautiful triangles, 10c to approval applicants. Kitchel's, Box 2355, Phoenix, Ariz.

AMAZING Bargain—Five beautiful foreign complete sets only 25c to approval applicants. Wilvanan Stamps, Box 472, Slatersville, R. I.

25 DIFFERENT Dominican Republic 25c. Worldwide approvals. Broad Stamp Co., Box 866, Lexington, Kentucky.

20 DIFFERENT Topicals without approvals 10c. K. Affleck, Vienna 4, Virginia.

BETTER Grade approvals 1/2 Scott. Palmstamp, Box 35211, Los Angeles 35, Calif.

FREE Coronations and triangle packet with approvals. Gilbert, Box 883, Miami Beach 39, Florida.

PACKETS—World, different, 3,000, \$7.00; 5,000, \$19.00; 10,000, \$60.00; 20,000, \$256.00! 30,000, \$600.00. Russell, Box 2011D, Natural Bridge Station, St. Louis 15, Mo.

100 JAPAN 10c. All different, with approvals. Gould's Stamps, Box 631, San Francisco 1, Calif.

APPROVAL Selections that are different. Value, variety, bonuses. LeRoy Stamps, 645 West 2nd, Winston-Salem, N. C.

FREE! \$10,000 Airmail! Canadians! Colonials! Commemoratives! Approvals. Keating, 2320 Boulevard, Jersey City, N. J.

LOOK! 75 U.S., 10c. Includes \$5 stamp, mrs. commemoratives. All different, not a mixture of duplicates. Approvals. Farmer, 4913 Rosewood, Los Angeles 4, Calif.

\$1.94 CATALOGUE Value British Colonies 25c. Obsolete, pictorials, George VI, 18 values. Approvals accompany. Yokum's, Box 1327, San Antonio 6, Texas.

MINT U.S. commemorative, foreign and topical packets. Lists. Hendricks, 505 Bennington, Youngstown 6, Ohio.

\$12.00 VALUE \$1.00. 500 Stamps. Ray, 321 S. Cicero, Chicago 44.

50 U.S. Airmails, commemoratives 25c. Norwood Exchange, 4005 Ivanhoe, Norwood, Ohio.

329 DIFFERENT Worldwide stamps 25c. Including Hitler heads, British colonies, French colonies, rarities, unusuals. Fascinating story approvals. Canada Stamp Company, 1907 Main St., Dept. 118, Niagara Falls, New York.

LOOKING For better U.S. approvals? Write, New-Way Stamp, Lawrence, Mass.

1000 WORLDWIDE Mixed stamps \$1.00; 2000, \$2.00. Postfree from Turks and Caicos. Lewis Bealer, Grandturk, Turks Islands, B.W.I.

78 FREE Sets. Take your pick! Drake, 4415 So. Troy, Chicago 32, Ill.

FREE 105 British colonials, pictorials, Mauritius, Tanganyika, Pakistan, Nigeria, Rhodesia, Singapore. Fascinating story approvals. Send 10c handling, please. Canada Stamp Company, 1907 Main St., Dept. 218, Niagara Falls, New York.

FREE 119 Foreign stamps including Africa, Pakistan, China, India, Russia, Scandinavia. Send 10c handling charge. Free stamp magazine. Approvals. Niagara Stamp Company, St. Catharines 11, Ontario, Can.

SELL Stamps. Extra profitable. Dealer's kits. Wholesale lists free. Big savings. Bryan, 2547 Fourth, San Diego, Calif.

3000 DIFFERENT World \$4.00, 5000 \$9.25, 10,000 mounted \$36.00. F & S, Box 367, Lindenhurst, New York.

UNITED States unused sets presidential rolls 55c, famous Americans \$5.50, flags 185c. Catalog 10c deductible. Standard, 10840E Woodview, Parma Hts. 30, Ohio.

COLLECTIONS All different stamps only 3c each! 25 Japan, 25 Austria, 25 Denmark, 25 Netherlands. Or all 4 packets only 10c! Approvals. Goliath Co., Bethlehem XI, N. H.

101 DIFFERENT World wide stamps including prized Berlin Bear plus free copy "How to Collect Stamps" only 10c with approvals. Littleton Stamp Co., Littleton J1, N. H.

TRIANGLE, Diamond, midjet, giant, Hitler, Stalin, Roosevelt, 100 others—10c! Thrifty Company, Silver Spring, Md.

AFGHANISTAN, Nigeria, North Borneo, African savages, Cameroons—Everything 5c (with approvals) Saxon, Vista, California.

1000 DIFFERENT \$1.00 With approvals. Jacobsen, 4395-C Broadway, New York 40, N. Y.

101 WORLD Wide 10c. with approvals. Box 815, San Francisco 1, Calif.

FREE Sample stamp newspaper, information on collecting, special lists. Approvals. Littleton Stamp Co., Littleton A1, N. H.

BARGAIN Hunters attention! Free stamp magazine, 1000 interesting stamps for your approval inspection. Completely catalogued, substantially reduced. Free tongs and hinges with purchase. Niagara Stamp Company, St. Catharines 31, Ontario, Can.

500 WORLDWIDE All different \$1.00. Free gift. James Kline, Uniontown, Ky.

ANTIQUES, RELICS, INDIAN GOODS, CURIOS

SEND Dollar for full color hand printed picture, Indian Dancer. Free list. Tewa Enterprises, 724 Canyon Road, Santa Fe, New Mexico.

UNITED States silver dollars, \$1.75 each, postpaid. Guaranteed genuine. Liberty head or Peace. Carry one as lucky pocketpiece. Fred Birch, Box 634, Deer Lodge, Montana.

100 SLIGHTLY Damaged arrowheads \$8.30, 4 fine arrowheads \$1.00. List free. Lear's, Glenwood, Arkansas.

DARK Africa genuine native handmade ivory, ebony carvings. Marvellous gifts. Particulars 25c stamp. Vessiere, P.O.B. 2482 Leopoldville, Belgian Congo.

KQUITSchuerbelleracken: Am selling 600 historical firearms, 25,000 pre-historic Indian relics, 20,000 historical cartridges, 10,000 coins, mounted birds, deerheads, bayonets, frontiers, violinwood, Kentucky, Agates, fossils, gold dollars. Profusely illustrated catalog 35c. Heike, Eagleview, Wenona, Ill.

4 SELECTED Arrowheads \$1.00. List 5c. H. Talburt, Calico Rock, Ark.

PRECIOUS STONES, MINERALS

TEN New Mexico minerals \$1.50, six fluorescents \$1.00, fool's gold 25c. Free literature. Minerals, Winston, New Mexico.

GEMCUTTING, Silvercraft authority. Illustrated magazine tells how. Cut rocks, make jewelry. 150 ads illustrating equipment, offering gems for collectors, cutters. Postal brings literature. Lapidary Journal, Drawer B, Palm Desert, Calif.

GEMSTONES, Mineral specimens. Every variety. Lowest prices. Free booklet. Plummer's, 4720 Point Loma Ave., San Diego 7, Calif.

SAPPHIRE, Topaz, tourmaline, garnet, peridot, 5 uncut gem specimens, \$1.00. O'Brien's, 1116M Wilcox, Hollywood 38, Calif.

AGATES, Jade, gems. Free list. North West Gems, 2819 North Warner, Tacoma 7, Washington.

FIND Tungsten, mercury, uranium with Mineralight. Free brochure. Write Dept. PM8, Ultra-Violet Products, South Pasadena, California.

GUARANTEED Genuine rough diamonds. Importer offers one carat \$18.00. Also other sizes. Cresco Trading Company, 522B Fifth Avenue, New York City.

JOIN The thousands whose hobby is gem cutting, jewelry making, mineral collecting. Send only \$3.00 today—for 12 monthly issues of national how-to-do-it magazine. Sample copy 25c. Gems & Minerals, Dept. A-11, Palmdale, California.

HOBBIES AND COLLECTIONS

FOREIGN Medals, clearance catalog 10c; 37 American different emblems \$1.00. Hobbyguild, 550B—5th Ave., New York.

UNUSED Matchbook covers. 100 different \$1.00. 36 page catalog 25c. Match-cover album \$3.00. Charles Edelman, 1311C East 84, Cleveland 3, Ohio.

NAZI Medals, Campaign ribbons, illustrated lists. Big packet, \$1.00. Medcrafts, 1923 34th St. S. W., Calgary 2, Canada.

NEW — 15 Different match covers 10c. Box 202, Rochester 1, N. Y.

INVENTING Can be an interesting and profitable hobby. Write for complete particulars. Institute of American Inventors, Dept. 40-E 631-E St., N.W. Washington 4, D. C.

WORLD'S Smallest Bible 50c. Three, \$1.00. Empires, Box 301, Amesbury 2, Mass.

FREE! "Do-it-yourself" leathercraft catalog. Write Tandy Leather, Box 397-AH, Tulsa, Oklahoma.

PRESERVE Natural color beauty of living flowers indefinitely. Fascinating hobby. Profitable too. Write for interesting free details. Symonds, 636 Broad Street, Meriden, Conn.

MILITARY Miniatures. Illustrated catalog 25c. Bard, Box 1463, Baltimore 3, Maryland.

NAZI-European medals sources Germany, full particulars, addresses, \$1. Kingston, 3224-22 Avenue West, Seattle, Washington.

MEXICO! Ten view cards \$1! Filmer, 910 Marion, Pharr 23, Texas.

CAMERAS, PHOTO SUPPLIES

20 TO 40% Discount. Everything photographic. Dart, 3812E Atlantic Avenue, Brooklyn 24, New York.

DARKROOM Plans, \$1. Industrial Photographic Technicians, Box 2601, University Station, Wichita 14, Kansas.

RANGE Finder lens assemblies, new, government cost \$200.00—\$9.95 while they last, prepaid. Check or money order with order. Coronet Enterprises, Box 564, Rochester, New York.

BASS Says: Quality cameras since 1910. When in Chicago visit the camera cross roads of the world, or write us for your favorite equipment, new or used. Satisfaction guaranteed. Bass Camera Co., Dept. AG, 179 W. Madison St., Chicago 2, Ill.

AERIAL Cameras, K-21, less lens and filters, original government package, \$700.00 value or \$350.00; 3 for \$100.00. Operates automatic or manually. Shipping weight 60 lbs. Check or money order with order. Coronet Enterprises, Box 564, Rochester, New York.

PHOTOGRAPHY For pleasure or profit. Learn at home. Practical basic training. Long established school. Free booklet. American School of Photography, 835 Diversey Parkway, Dept. 3432, Chicago 14.

BUY Wholesale—Photo equipment, appliances. Discounts to 45%. Free catalog. Camera Shoppe, Box 601-M9, Mount Vernon, N. Y.

35MM., 20-Ex. Ansco color, indoor, factory pack, 1953; \$1.00-\$10.50 per dozen. Add postage. Fotoshop, 132 W. 32nd St., New York, N. Y.

BUY Wholesale nationally advertised cameras, photo supplies, thousands other products at big discount. Free "Wholesale Plan." American Buyers, 629-PP Linden, Buffalo 16, N. Y.

100X TELEPHOTO Lens \$1.85 with instructions for mounting. H. Jamer, Manorville, N. Y.

SCENEX Camera takes real action photos, standard 828 film. Camera, leatherette case, 2 rolls film, \$1.98 c.o.d. Speedway, 2320 N. Raynor, Joliet, Ill.

KODAK Film, good, date guaranteed. Kodacolor 620-120 \$1.60. 8mm. roll Kodachrome \$3.00. 8mm. mag. Kodachrome \$3.75. Mel-Jo, P.O. Box F, Hillside, N. J.

2x2 COLOR Slides on highlights of San Francisco, 8 different scenes \$1.50. Printed on genuine Kodachrome. List free. Ideal Service Supply, 4644-PM Geary Blvd., San Francisco 18, California.

DISCOUNTS To 40%—Cameras, projectors, tape recorders, lenses. Write for individual quotations, no catalogs. C & E Camera, D, 249 E. 94 St., Brooklyn 12, N. Y.

"KIKU" Miniature, 1 1/4"x2"x3/4"—Universal focus, adjustable exposure, time stop, leather case, postpaid \$3.45. 6 rolls film, 14mm., \$1.29. Tropical Hobbyland, 1529 Northwest 27th Avenue, Miami.

DISCOUNTS To 40%—Cameras, projectors, tape recorders, lenses. Write for individual quotations, no catalogs. Classified Camera D, 253 E. 94 St., Brooklyn, N. Y.

PHOTO FINISHING

PHOTOS Copied, 20 wallet-size deluxe prints \$1.00. Original picture returned. Send any size photo or negative. Federal Wallet-Size Photo Co., Dept. PM-4, P.O. Box 2448, Kansas City 6, Mo. (No c.o.d.'s please.)

ROLL Developed and 16 prints 40c. Free mailers. Fast service. Mayfair Photos, Box 617-K, Toledo 1, Ohio.

BEAUTIFUL Enlargement from each picture on roll. 8 exposure 35c; 12 exposure 45c. Cut Rate Photos, Dept. B-4, Janesville, Wis.

GUARANTEED Quality. Fast service. Eight jumbos in beautiful super pak plastic ring binder albums only 35c. Send for free mailers and particulars of our complete photo finishing service. Grand Fotos, G.P.O. Box 1410, New York 1, N. Y.

TOP Quality. Fast service. 8 jumbos 35c in beautiful super pak album. 16 contacts 40c. Reprints—Jumbos 4c; contacts 3c. Satisfaction guaranteed. Write for free mailers and circulars. Fast-X-Photo, Box A, Jersey City, N. J.

6 OR 8 Picture roll 35c. 12 or 16 picture roll 55c. Each roll developed and printed in handy album pack. Send coin with roll. No c.o.d.'s. Mailing containers sent free. Deluxe Film Service, Box 1268-A, Shreveport, Louisiana.

TWO Beautiful prints from each picture on roll. 8 exposure 35c. 12 exposure 45c. Thirty-three years of satisfied customers. Quick service. Lens Photos, Dept. J-4, Janesville, Wis.

SENSATIONAL! 8 Jumbos, 25c; 12, 35c. 35mm.-36 exposure, \$1.00. Guaranteed quality. With this ad only. Flash-Photo, Box 36B, Brooklyn 4, N. Y.

ENLARGEMENTS! Eight 5 x 7's or five 8 x 10's, \$1.00. Willart Enlargers, Box 967, Little Rock, Ark.

12 JUMBOS From any size roll developed 25c with this ad only. S. Skrudland, Lake Geneva, Wis.

8 OR 12 Exposure roll custom processed plus 2 jumbo prints from each good negative, plus fresh roll all-weather film, \$1.00. Photo Service, Box 256, Temple, Texas.

5x7 PHOTOCOPY of old photographs \$1.00. Simmons, 1349 West, Berzley, Mich.

WALLET Photos in beautiful sepia-tone made from any photo or snapshot, 20 for \$1.00. Wallet Photos, Box 470, Postoria, Ohio.

JUMBO Prints, 8-exposure roll 30c; 12 exposure, 45c; 16 exposure 55c. Reprints, oversize 4c. Guaranteed quality. Mail Order Photo Service, Box 297, Watertown, Wisconsin.

SEND Negative for photographic Christmas cards. Twelve cards, envelopes, free enlargement \$1.00. R. Morgan, Kuzmik Blvd., Torrington, Conn.

PHOTO Xmas cards 20 for \$1.25. Techni-Photo, Dept. PM, Lorain, Ohio.

SPECIAL Offer—8 Jumbos 25c; 12, 35c, with this ad. Western Photo, PM114, Box 288, San Francisco 1, Calif.

COPY Negatives 30c. Pictures from negatives, five 8x10's \$1.00. Eight 5x7's \$1.00. 20 w.s. \$1.00. Mar-Bro, Box 1503, Fall River, Mass.

MOTION PICTURES AND SOUND EQUIPMENT

TAPE Recorders, tapes, accessories. Unusual values. Dressner, Box 66M, Peter Stuyvesant Station, New York City 9.

3,000 8-16MM. Silent-sound films. International, 2120 Strauss, Brooklyn 12.

MOVIE Camera film: 8mm. roll \$1.50, 16mm. 100' \$3.00. Free processing. Better Films, 742 New Lots, Brooklyn, N. Y.

RECORDERS, Tapes, equipment. Lowest quotations. Boynton Studio, 10 Pennsylvania, Tuckahoe, N. Y.

8 & 16MM. Professional national parks movies in Kodachrome, list 10c Ideal, 4644 W. Geary, San Francisco 18, California.

RCA 16MM. sound projectors \$119. National Cinema, 71 Dey St., New York City.

SAVE 50%! Guaranteed-fresh color, b.&w. movie film! 8mm., 16mm. Free catalog! Eso-R, 47th Holly, Kansas City 12, Missouri.

PINEST 16MM. sound films, lowest rentals. Write Movoco, 14A Leonard St., Springfield 4, Mass.

FREE! Blackhawk's fall sale catalog new and used 16mm., 8mm. films, used 16mm. sound projectors, new 2"x2" color slides. Blackhawk Films, 1035 Eastin, Davenport, Iowa.

WILD Animal and bird movies. 8 mm., or 16 mm. beautiful color or B&W. Also 2x2 color slides. Send for free catalog. Wild Life Films, 3151-A Strohm Ave., N. Hollywood, Calif.

MUSIC AND MUSICAL INSTRUMENTS

SONGS Or song poems needed for commercial recording. Quick action. Celebrated expert offers you free copy of "Secrets of Song Success." Honest deal designed to benefit all concerned. Mail songs or poems now. Rexright Music Co., Dept. A, 5617 Hollywood Blvd., Hollywood 28, Calif.

AMATEUR Songwriters! Top notch Broadway staff offers help and suggestions for improving your song or lyric. Send \$1.00 with each manuscript or recording. Amateur Songwriters Workshop, P.O. Box 359A, Times Sq. Station, New York 35, New York.

WRITE Songs for pay! My new easy method reveals professional secrets of profitable songwriting. Free information. Meadowlark Music School, 300 Sumner Road, Colorado Springs, Colorado.

1954 ACCORDIONS — Wholesale. Free catalog. American Accordion Center, PM-8, 5329 Belmont, Chicago.

WANTED! Poems for musical settings. Write Songwriters' Service, Clifton, N. J.

ACCORDIONS. Wholesale to everyone. Save up to 60%. All national known brands. Free catalogue. Del Principe, 29 South Cicero, Chicago 44.

SONGPOEMS Wanted. Mail to: Tin Pan Alley, Inc., 1650 Broadway, New York 19, N. Y.

FREE Record of your song. Your words, my melody. Free information. Johnny Mack's Melody Mart, 1094 West 39th Street, Dept. A, Los Angeles 37.

SONGWRITERS! Protect your ideas! Hold all songs, poems! Write for safe correct procedure first! Song Service, Dept. P, 333 W. 56th St., New York 19, N. Y.

SONGWRITERS! Send poems, songs. Music Service, 243 West 72nd St., PM, New York 23.

WRITE Songs. Big money and reputation. Write for information. J. Gordon Pub. Co., 4700 South California Avenue, Chicago.

POEMS Wanted for musical setting. Send poems. Free examination. Five Star Music Masters, 630 Beacon Bldg., Boston, Mass.

POEMS Wanted for musical setting. Send poems. Free examination. Crown Music Company, 1476 Broadway, New York City 36.

LP Records—10" 69c, 12" 99c. Guaranteed new. Catalogue 20c. Records, 4710 Caroline, Houston 4, Texas.

SWISS Musical movements \$1.90. Helax, 218 West 72nd Street, New York 23.

SONGWRITERS: Large recording company may record your song. National sales and promotion if selected. No charge for melodies. Send song material to Music Makers, Dept. E-3, Box 2507, Hollywood, California.

SONGWRITERS! Amazing offer. Ray Hibbler, C-5, 6808 Oleander, Chicago 31, Illinois.

PERSONAL Guitar instruction in your home. New, easy, amazing way. Complete beginners course. Low priced. Guaranteed. Midwest Studios, 804m Grand, Kansas City, Mo.

ELECTRIC Guitars, amplifiers. Wholesale. Free catalog. Carvin, P.M., Baldwin Park, California.

ALL Musical instruments, 33% off. Roberts, Box 825, Minneapolis, Minnesota.

STOP Wondering. Have your songs criticized. Frank opinion. \$1.00 each. Gilbert Lassin, Greenville, Michigan.

AFFILIATED Songwriters. Mutual co-operation. Collaboration. Many benefits. Publishing Recording. \$2.00 year. Web, 149 W. 48, New York 36.

SONGPOEMS Wanted. Collaborate with recognized songwriter. Send poems. La Motta Songs, 14 Bogardus Place, New York 40, N. Y.

RADIO AND TELEVISION

FREE List. Builder's pictorial construction plans. Alena, 286 East Broadway, New York 2.

RADIO Diagrams \$1.00, television \$2.00. Give make, model. Diagram Service, 672-PM, Hartford 1, Conn.

MAKE Simple, tubeless, batteryless, distance-getting radio. Genuine Melomite crystal, detector, illustrated instructions. 50c postpaid. Allen, 427-PM5, Clinton, Mo.

RADIO One tube kit. Parts, tube, phone, batteries, instructions, nothing else to buy, \$7.95. Less phone and batteries, \$4.95. Crystal radio kit \$1.50; preassembled \$1.75. Crystal radio plans and germanium diode, \$1.00. Plans and Clearco detector, 50c. Free catalogue. Clearco Crystal Company, Box 1857, Milwaukee, Wis.

FREE 308 Page 1955 television-radio-electronics catalog! World's largest stocks, lowest prices. Complete supplies for builders, experimenters, amateurs, servicemen. Latest builders' kits, TV, Hi-Fi, phonos, records, P.A. Thousands of parts, tubes, test instruments, books, diagrams. Top quality money-saving values. Get your copy now! Allied Radio Corp., 100 N. Western Ave., Dept. 34-L-4, Chicago 80, Ill.

BUILD 15 Radios at home—Only \$19.95 complete. Learn radio construction, theory, trouble-shooting, code, F.C.C. regulations. Complete radio course includes all parts, components, instruction books, etc. Free radio tester and soldering iron. You keep everything. No experience required. Money-back guarantee. Order direct or send for descriptive literature. Valuable radio and TV guide upon request, free of charge, no obligation. Progressive Edu-Kits Inc., 497 Union Ave., Dept. PM23, Brooklyn 11, N. Y.

BUILD A hearing aid battery powered electronic pocket radio. Covers 540 to 1600KC, clear reception. Guaranteed parts, tube, case, photodiagramme furnished. Batteries \$1.15 per set. Aincoc magnet radio earphone (\$2.50 value) only \$1.45. Super deal \$10.00 hearing aid earset only \$4.95. Precision Electronics, Dept. WC, Placerville, Calif.

WHOLESALE Parts flyer free. Wholesale Electronics, 673 Elton Avenue, New York City 51.

BEST Equipment repair. Kit construction. Free information. Bigelow Electronics, Dept. PM, Beulah, Michigan.

REPAIR Your own TV. Instructions compiled exclusively for your set. Simple as replacing light bulb. Send set name, chassis, model number, \$2.95. LB Engineering, Box 4113-PM11, North Hollywood, Calif.

INSTRUCTIONS How to repair radios \$1.00. Slate's Radio Service, Corsicana, Texas.

HIGH Fidelity corner type speaker enclosure suitable for coaxial, standard or dual speaker installation. Precut and ready to assemble. Kit for 12" or 15" speaker \$16.50. Plans only \$1.00. La Garde Mfg. Co., Box 507, Alameda, Texas.

TELEVISION Interference eliminated with effective high-pass filter. Guaranteed \$1.00 postpaid. BMB Co., Box 25, Bethpage, New York.

CRYSTAL Radio experimenters. Write Leslie Hulet, 305 Hope, Lakewood, N. J.

AMAZING Moneysaving values in National Union radio and television tubes. All types, 12 month guarantee. Wonderful offer to dealers. List free. Ideal Service Supply, 4644-PM Geary Blvd., San Francisco 18, California.

COLOR Television! Terrific! Enjoy color today with easily attached non-inflammable Zingo 3 Color Screen. Send \$1 size 10" screen; \$1.10, 12"; \$1.15, 14"; \$1.25, 17"; \$1.50, 20"; \$2.00, 21" \$2.50, 24"; \$3.00, 27". Prompt shipment. Satisfaction guaranteed. Inquiries from dealers and agents welcomed. Zingo Products, Johnstown 77, New York.

BUILD Crystal set, add tubes, speaker. Trowbridge, 312 West 75th, Chicago 21.

EXPERIMENTERS! Beginners! November "Radio Science" 35c. 52½ Backman, Westfield, New York.

BUSINESS OPPORTUNITIES

BUILD Amazing home business supplying multi vitamin-mineral tablets. Whirlwind seller. Great repeater. Profits tremendous. Everything furnished. Free facts. Vitine Company, 208-CK Pacific Building, Miami 32, Florida.

START Home manufacturing business. Make cleaners, soaps, polishes, cosmetics. Free literature. Kemix, Park Ridge, Ill.

OPERATE Profitable mail order business. Splendid opportunity. For details write, S.M.C. Mailing system, P.O. Box 94, Lamoni, Iowa.

AN Important message for you! Is extra money important to you? Would you invest 4 days a week for \$200? Many other smart people are cashing in big in this lucrative repeat business. Captain Payne's booklet reveals hitherto little known secrets of making big money from the products of the sea. Business flourishes in depression, booms in good times, you can't miss. Payne's plan good in both coastal and inland states. Start your own business. Be your own boss. Act now. Send \$2 for booklet to Capt. Fred Payne, P.O. Box 73, Medford, N. Y.

GARDEN Golf. Fascinating entertainment. Popular international sport. Profitable business. S. Brockway, Seaside, Ore.

IMPORT-Export mailorder opportunities! Details. Warner, Box 6, Fort Scott, Kansas.

COMMISSION Circulars—Offering real merchandise. Send for samples and details. Products, Box 23, Boston 17, Mass.

POPCORN And potato chip equipment. Eakins, Box 933-A, Springfield, Ohio.

WOOD Toy wheels. \$1.00 brings 8 finely machined samples. E. L. Overstreet, Route 3, Box 243-A, Lufkin, Texas.

PART Time or full time. Your own business, selling name brands. No inventory required. Manhattan-W, 225 W. 57 St., New York City.

BRONZE Baby shoe mountings, beautiful designs, all-metal astrays, bookends, picture frames, \$2.25 each. Free literature. Bronzecraft Mountings, Greenville Station, Jersey City, New Jersey.

CHRISTMAS Trees bring big profits. Complete "know-how" 25c. Timberline, Box 332, Glenn Falls, New York.

FOR Big money, learn sewing machine repair. Guaranteed plans, assures success. Write Purdy's, Box 207, Weatherford, Texas.

HOME Business pays amazing profits. \$40.00 daily possible, sharpening circular saws. No experience needed. Jobs in your own neighborhood. Free book tells how. Belsaw, 34A Field Bldg., Kansas City 11, Mo.

MONEY For your spare time. Agents needed for leading national magazines. Liberal commissions. Write ATSA, 3132 M St. N.W., Washington 7, D. C.

MAIL Order. Details free. Lexington Mail Service, 5511 Monroe, Chicago 44.

MAKE Flexible molds. Cast figurines, plaques. Free sample. Tooner, 630-R Chestnut, Hamilton, Ohio.

AMAZING Home business plans. Write. Falcon House, Winnebago 2, Illinois.

FORTUNES Made raising crickets and fishworms. Guaranteed raising and marketing instructions, \$1.00. Carter Farms, Plains, Georgia.

NEW-Different home business opportunity! Address-mail literature featuring real merchandise. Everything furnished. Mills, 1752-A, Garden Ave., Lorain, Ohio.

GET \$10.00 Orders by mail! 100% profit! Everything furnished. Terrill, Bogard, Mo.

EXPORT Business easy made! Substantial income from home. No merchandise buying. Full setup service includes everything. Hermes Exports, 152 West 42, New York 18.

METALIZE Baby shoes, jewelry, gifts. Bronze, gold, silver. Free bulletin. Kiktavi, 7217-PY South Broadway, Los Angeles 3.

HAVE Home business mailing postcards offering real merchandise. Big earnings. Write: Mednis, 10 Port Norfolk, Boston 22, Massachusetts.

NATURAL Molding rubber, extra thick. Free sample. Flock, W. Wooley, 113-A Donald, Peoria, Ill.

LIQUID Rubber, make flexible molds. Free sample. Chaney, 1130 E. 16th St., Jacksonville 6, Fla.

MAKE Rubber stamps, repair dolls; learn silk screen printing. Catalogue (60 ideas) free. Universal, Box 1076-A, Peoria, Ill.

MAILORDER—Operate profitable home business using free advertising method. Revealing information free. Seidel, 7070-HF Hollywood, Los Angeles 28.

OVER 700% Profit making finished photos in 2 minutes on the spot in daylight without darkroom. No experience needed. Simple directions teach you quickly. Write P D Q Camera Co., 1161 N. Cleveland Ave., Dept. PM, Chicago 10, Illinois.

ELECTROPLATE Auto parts, novelties, mirrors, baby shoes. Easy, inexpensive home processes. Free booklet. Tyco Metals, Box 13231-MM, Houston 19, Texas.

BOOKKEEPERS. Keep books, small firms spare time. Manual latest technique by C.P.A., \$3.00. Modern Business, Box 406, Youngstown 1, Ohio.

MAKE Money at home—Mail cards, circulars feature real merchandise. Everything furnished. Big earnings. Philip's, Box 3-P, Boston 22, Mass.

RECAST Old batteries into new. Latest achievements. Battery Laboratories, Minneapolis.

START Venetian blind laundry. Profitable lifetime business. New machine. Free booklet. F. C. Co., 442 N. Seneca, Wichita 12, Kansas.

HOW And where to obtain capital. Particulars free. Star Service, Wapakoneta, Ohio.

TO \$40.00 Weekly. Sparetime, home operated mailorder business. Successful beginner's plan. Everything supplied. Lynn, 10420-M National, Los Angeles 34, Calif.

COPUBLISH Mail Sale Advertiser, leading mail order paper. Details, latest copy, dime. Vanroy Shirk, Lebanon, Penna.

EARN Money at home! Homemaker Magazine tells how. Sample, 25c. Sizemore, Box 7, 4917 Kostner, Chicago 30.

SCHEMER Magazine, Canfield 1, Ohio, monthly mailorder ideas, plans. Year \$1.00. Sample 20c.

PLASTERCRAFT Molds, liquid rubber, plasters, flocks, candle supplies. Catalog and manual free. Blue Rapids Supply, Blue Rapids, Kansas.

BUY It wholesale! Manufacturers, distributors offer 850,000 items. Literature free. Olsen, 1231-A East Third St., Duluth 5, Minn.

\$25 WEEKLY Working two hours daily at home. Lycke, Box 3471-A, Cleveland 13, Ohio.

GROW Mushrooms. Cellar, shed, and outdoors. Spare, full time, year round. We pay \$3.50 lb. We paid Babbitt \$4,165.00 in few weeks. Free book. Washington Mushroom Ind., Dept. 172, 2954 Admiral Way, Seattle, Washington.

\$46 FROM Square foot plywood; jigsaw necessary. Write: Woodarts, Bridgewater, Mass.

BREED Rare tropical fish at home. Earn big money! Learn secrets! Help fill huge demand. Amazing opportunity! Free plan. Tropicals, 1008-F Los Angeles St., Los Angeles 15.

INCOME From local information. No selling. Write Neherco, La Verne, Calif.

RESILVERING Mirrors, formula 50c; two-way lookout mirrors. (No one sees you). 50c; coppered mirrors, 50c. All \$1.00. Nelko-Mir, Box 3462-J, Chicago 54.

LIVING Miniature ("Ming") trees only 10 to 20 inches tall. Grow at home. Big profits! Spare time opportunity. Fascinating! Amazing! Write for free seed and plan. National Nursery, Dept. FC, Inglewood 4, California.

MAKE Money spare or full time, casting metal toys and novelties. Big wholesale and chain store demand for autos, soldiers, ashtrays, banks, etc., keeps manufacturers busy. Production moulds furnished for up to 100 and more castings per hour. No experience or special place necessary. Write for information and illustrations of patterns needed. Metal Cast Products Co., Dept. A, 1696 Boston Road, New York 60, N. Y.

OPERATE Profitable mail order business. Write Walter Service, 4159-A East 112th, Cleveland 5, Ohio.

GOOD Paying business silvering mirrors, plating autoparts, reflectors, bicycles, bathroom fixtures, etc., by late method. No tanks or shop required. Outfit furnished. Free booklet. Gunmetal Co., Ave. H, Decatur, Illinois.

MINK Raising information free. Complete. Lake Superior Mink Farm. Superior, WI, Wisconsin.

COLORGLAZED Concrete pottery made without molds. Patented method. Cemetery products, novelties, tiles. Basement leak-sealing. Money-making projects. Booklet, details free. Men only. National Potteries Company, Grand Rapids, Minnesota.

FREE Book "565 Odd, Successful Businesses." Work home. Expect something odd! Pacific, Oceanside, Calif.

FIX Typewriters. Free booklet describes our modern, inexpensive home-study course. Factory methods taught. Write Typewriter, Building 1, Tarentum, Penna.

MONEY In new greasless doughnuts. Start in kitchen. No smoke. Sell stores. Free recipes. M. Ray Company, 3605 South 15th Ave., Minneapolis 7, Minn.

BRONZED Baby shoe supplies, instructions, mountings. Metal bookends. \$1.50 pair. Free catalog. National Bronze Supply, Box 56, Los Angeles 32, Calif.

MAILORDER Home business! Details stamp. Shirley, 20-Raspeburg, Baltimore 6, Maryland.

MILLION Articles wholesale. Supply source directory 10c. Idealer, Park Ridge, Illinois.

MAKE Money at home as renewal headquarters for all magazines. Big Christmas sales profits now. Liberal commissions. Supplies furnished. Write for free catalog. McGregor Magazine Agency, Dept. 500B, Mount Morris, Ill.

VENDING Machines—No selling. Operate a route of coin machines and earn amazing profits. 32-page catalog free. Parkway Machine Corporation, Dept. 72, 715 Ensor St., Baltimore 2, Md.

OPERATE Your own mail order business! Start right! Avoid costly mistakes! "Mail Order Business Manual" shows you how! Price \$1.00. Bud E. Hine, Box 93, Battle Creek, Michigan.

BRONZE Baby shoes. Instructions, equipment and mountings for genuine electroplated process. Free catalog. Hollywood Bronze Supply, Dept. B-3, 1624 East First Street, Los Angeles 33, Calif.

LEARN Exterminating formulas, secrets, charges. Manual tells all. \$1.00 postpaid. Knox, 1208 Walnut, Philadelphia 7.

RAISE Earthworms! Terrific! Get essential information plus story. "An Earthworm Turned His Life." Send dime. Earthmaster System, 8H, El Monte, Calif. Hurry!

FLEXIBLE Rubber molds for plaster and Marble figurines. Sample and large illustrated catalog 25c, refunded on first order. K-C Novelties, Dept. 74, Easthampton, Mass.

UNUSUAL Mail order ideas, sources. Details free. Fax, Box 241, Brownwood, Texas.

MONEY In saw sharpening sparetime at home. Repeat cash business. Experience unnecessary. No selling. Free booklet explains. Victor Foley Company, Columbia Heights, Minnesota.

FREE Kit puts you in business making good money selling world's famous French-type perfumes. Profit packed Christmas sales. Astonishingly low prices. Individually gold boxed \$1 sellers. Costs you \$4 dozen. You make \$8. Mammoth Treasure Royal box—3 thrilling fragrances in one fabulous gold box. \$3 sellers. Costs you \$8 dozen. You make \$28. Huge profits can be yours between now and Christmas. Send for free money making kit. "Husk" O'Hare, 5732 North Kenmore, Chicago 40, Illinois.

MEN Wanted—Build luggage and cases at home. We sell your products, supply complete instructions, materials, everything. No special equipment needed. Free details. Cascraft, 805-G11 Sunset, Los Angeles 12, Calif.

START A buying service, buy wholesale thousands nationally advertised products. Make big profits selling at sizable discounts. Postcard brings details. American Buyers, 827-P Linden, Buffalo, N. Y.

IMPORT-Export Opportunity, profitable, world-wide, mail-order business from home, without capital; or travel abroad. Established world trader ships instructions for no-risk examination. Experience unnecessary. Free details. Mellinger A70B, Los Angeles 24.

NEWEST Spare, full-time home business. \$5 to \$10 hour possible. Paint with suede—The finish with touch and eye-appeal. Beautify auto dashboards, signs, radios, toys, figurines, lamps—1001 others. Complete, step-by-step instructions sent for no-risk examination. Free details. Coast, 1004-NA So. Los Angeles St., Los Angeles 15.

GROW Orchids at home—Profitable, fascinating. Year 'round, Maine to California. No greenhouse. Gorgeous cattleyas, cymbidiums, etc. Successful home grower shows you how. Full details free. Flowerland, 4622-PH Wilshire, Los Angeles 5.

BECOME A game warden, or join forestry, park, lookout, wildlife conservation services. Enjoy outdoor work, good pay, real security. Complete information free! Write Home-Study Institute, 3156NR West Eighth, Los Angeles 5, California.

BE President of your own manufacturing or selling corporation! If you have a sound idea for a product or service and need money or manpower, perhaps we can help. Send self-addressed, stamped envelope and 25c for brief outline of our offer. P. M. Bromley, c/o Wilbourne & Bromley, Engineering Building, Chicago 6, Illinois.

START Your own business on credit. Your own boss. 1661 of our dealers sold \$5,000 to \$28,500 in 1953. We supply stocks, equipment on credit, 200 home necessities. Sales experience unnecessary. Pleasant profitable business backed by world-wide industry. Write Rawleigh's, Dept. K-U-PPM, Freeport, Ill.

COST Of things going up faster than your income? You can make more full or part time as a Rawleigh dealer. Write for full particulars. Rawleigh's, Dept. K-RR-PPM, Freeport, Ill.

WINNING Mail order plans. Details free. Mid-State, Box 214, Syracuse 1, N. Y.

BUY Wholesale direct! Save yourself 66% on 10,000 nationally advertised appliances, sporting goods, watches, furniture, auto parts, toys, giftwares. Sell at tremendous savings to individuals, organizations. Amazing profits! Free "wholesale idea." National Buyers Service, Box 426EA, Oakland, California.

ADVERTISING Book matches—Cash in on big demand; sell union label matches. Cuts for all businesses and political parties. Free powerhouse selling kit, low prices, protection guaranteed on repeat orders. Cash commissions. Superior Match Co., Dept. MX-1154, 7530 Greenwood, Chicago.

LEARN Sewing machine repair, electrify, trade, sell. How to make big money at home sparetime. New zigzag machines, parts, etc., wholesale. Free details. Taylor Service, Hamilton PM-11, Ohio.

COLOR Concrete with chemicals. Marble-glaze cement benches, pottery. Start: home-shop. Hundred beautiful designs: birdbaths to waterfalls. Your chance for fame, fortune. 10c brings sample, pictures. Hollywood Cementcraft, 8527-R Wonderland, Hollywood 46, California.

NEW Money making folios. Low, wholesale catalog 10c. Budget Sales, 2466 Goodson St., Hamtramck 12, Mich.

NOTARY Public information free. Magnolia Press, Box 1272-P, Burbank, Calif.

WELDERS Make ornamental iron railings. Instructions \$1.00. J. O'Connor, Milan, Ohio.

SAVE—Rainproof garments at home. Formula \$1.00. Rainproof Sales, Box 232, Dept. B, Cheswick, Penna.

MAKE Extra money between now and Christmas. Sell subscriptions to all popular magazines. Liberal commissions. For supplies write DeSales Magazine Service, 60 East 42nd St., New York 17, New York.

BOOKKEEPERS. Increase earnings operating sensational bookkeeping service. Kern, 5632 Lankershim, North Hollywood, California.

\$1,000 MONTHLY Possible in collection agency business. Free details. Write Cole Associates, Syracuse 2, N. Y.

BIG Profits owning your own wholesale merchandising business. No investment! America's greatest wholesale appliance, homewares, jewelry, sporting goods catalog in color with your own name. We drop ship. Free brochure. General Wholesalers, Box 1195EG, Chicago; Box 3058EG, San Francisco.

WANTED! Home producers, by manufacturers in our clearing house service. Become subcontractor, casting plastic products for these companies. Thousands of easy-to-make items required for consumer-industrial use. Cash in at home, without previous experience. Plastic Service Associates, Dept. 11-PM, East Boston 28, Mass.

WE Pay \$5.00 for some names. Homework income plan 25c coin. Publisher, Box 73136, Los Angeles 3.

FREE! "301 Profitable Small Businesses!" Amazing shoestring plans! Work home! Start sparetime! Deumant Surveys, Kenmore 23-PM, N. Y.

OPERATE Profitable mail order business. Selling our cartooning courses. Templeton, 1210 Riverview Court, Columbus 1, Ohio.

MAILORDER Magazines, business opportunities, samples, details, 25c. A. W. Vornhede, 11321 East 39th, Terrace, Kansas City 29, Missouri.

THOUSANDS Make good money asking market survey questions spare time. For full details and list 110 top survey firms send \$1.00. Money back guaranteed. Research Service, Dept. J, Box 253, Wilmette, Illinois.

\$500.00 COMMISSION Monthly from one order per day. No investment. No inventory. Richmond Enterprises, Box 1003, Augusta, Georgia.

READ Our amazing offer under Agents Wanted. Fantastic! United Distributors.

AMAZING Opportunity to make money fast selling Motaloy—exclusive, patented metal tabs that actually replat worn engine parts as you drive. Good for cars, trucks, tractors. Simply drop in gas tank. Increases compression and gas, oil mileage. Nationally advertised. Money back guarantee. Get free details on 100% protected territory. Modest investment in stock required. Motaloy Manufacturing Corp., P.M.C. Dept., South Texas Building, San Antonio, Texas.

IT'S Here! 1200% profit! Now, plastic seal photos, cards, licenses, etc. for lifetime protection. No equipment needed. Takes just seconds. Everybody your prospect. Also, sell laminating kits or/and supply other "homeworkers" everywhere. Complete laminating kit \$1, postpaid (seals 10 articles). Wholesale prices, all details. Satisfaction guaranteed. Garen Sales, 1321-M2 Stanberry Ave., Zanesville, Ohio.

WHOLESALE! Buy early large Xmas catalog 50c nationally advertised appliances, jewelry, watches, etc., terrific reductions. International Sales Co., 110 Fifth Ave., New York 10.

FOOD Mailorder business. Home operated. Everything supplied. Successful proven method. Free sample, details. Frasar Foods, Desert Springs 11, Calif.

FREE Catalog. Make rhinestone jewelry. Send \$2.25 for four gross rhinestones, value \$5.00, pin and earring kit \$1.50, value \$3.50. Ebert, Box F183, East Orange, New Jersey.

FREE Lists. Thousands items wholesale. Triple J Industries, 132 Berkshire, Bridgeport 8, Conn.

NEW Exceptionally profitable plans. Ideas for home operated mail business. Rush name. Miller, 1881-P Roxbury Road, East Cleveland 12, Ohio.

EARN \$2.00 Hour! I do, making sandals. Youngs, 1308-PM, South First, Arcadia, California.

UNUSUAL Homework opportunity, spinning Angora sparetime for us. Men, women. Angora House, PM, Springfield, Illinois.

MONEY, Typing—Sewing! Details free. Edwards, 3915-PM, 12th, Des Moines 13, Iowa.

GET Money by mail, quick. Succeedco, P.O. Box 962, Portland 7, Oregon.

FLORIDA Opportunities! Hundreds of jobs, businesses, farms, groves, homes. Free details! Florida Opportunity Journal, Vero Beach 14, Fla.

PROFITABLE Mail-order import business. Send \$1.00 for imported gift worth \$2.00 and free details. Transamerican, Box 815-A, Atlanta 1, Georgia.

ELECTROPLATING Turns spare time into dollars. "Professional Electroplating Technique." Information free. Plater C. Hyde, 327 West 120th Street, Los Angeles 61, California.

FREE Folio up to \$45,000; unlimited vacations. Unknown! No merchandise, equipment. Work home. Proven successful! Haylings, Carlbad, Calif.

\$5000.00 WORKING Ninety days! Become tax consultant. Auditax, 34651CC, Los Angeles 34.

\$70.00 WEEKLY Guaranteed—spare time. Dignified, clerical home business. Immediate income, easy! Auditax, 34651AB, Los Angeles 34.

SELL By mail! "How to Build Your Own Mail Order Business" tells how. Satisfaction guaranteed. Only 25c. La Roche, Merritt Island, Florida.

OPPORTUNITY For your own sparetime business. Be independent. Start right. Booklet and complete plan only 50c. Satisfaction guaranteed. Q. C. Products, Inc., Box 1026, Kokomo, Indiana.

INCREASE Your income. Build your own mail order business. Copyrighted booklet tells how. Only 25c postpaid. Satisfaction guaranteed. Gerwig, 366 South Huron, Columbus 4, Ohio.

BUY Wholesale thousands items. Lists free. Cottage Industries, Omaha 12, Nebr.

SELL Popular Mechanics and all other magazine subscriptions. Free catalog, supplies. Subscription Service Company, Dept. A, P.O. Box 2070, Birmingham, Alabama.

NEWSPAPERS. Turn them into cash. Eighteen methods. Instructions 30c. Charles Company, 12-DCG, Norwood, Ohio.

TRADE Magazines. See late copies through our easy to get acquainted service. Choose from 4367, covering all fields. Current list free. Commercial Engraving Publishing Company, 34C North Ritter, Indianapolis 19, Indiana.

START Venetian blind laundry, patented machine. Free information. Jet Company, 322 N. Rural, Indianapolis 1, Indiana.

WE Love our mailman—He leaves over \$1000.00 monthly in our rural mailbox. My college professor husband drafted a scientific home mailorder method. We bought a Texas ranch, live as we always wanted. Now we sell the Ranch Mailorder Method. Operates anywhere. Inquire: Eveningshade Ranch, Helotes, Texas.

ARE You starting a business? Avoid costly pitfalls. Get inexpensive experienced advice. Write Marchner Consultants, 2053 East Main Street, Rochester 9, N. Y.

START Your own business—Selling vitamins. Small investment, terrific profits. National Health, 83 Barclay St., New York 7.

FREE Details. Profitable home mailorder business. Everything supplied. Holly's, Box 439, Jacksonville, N. C.

EARN Extra Christmas money. Sell beautiful Snow White flocked wreath to neighbors and friends. Flame proof, permanent, can be used for years, 16 inches overall. Sells itself, experience unnecessary. Double your investment easily. Everyone wants a wreath for door or window. This wreath decorated with large red satin bow, and boxed. Don't miss this opportunity to earn extra cash for Christmas. You pay \$1.50 plus few cents parcel post, sell for up to \$4.50. Send money order today for your sample, and start taking orders. No c.o.d. Christmas Wreaths, 339 Howard Street, Evanston, Illinois.

FREE New 280-page book. 2000 businesses, farms, income properties for sale throughout America. Specify type of business desired, and general location. Book No. 76, 5400 Wilshire, Los Angeles, Calif.

REPEATING Mail order sales make good income monthly. Workable full or sparetime. Everything supplied. Dar-Craft, Box 269, Monroe, Washington.

OWN. Operate, route Wishing Wells. Place these new \$8.50 skill games on counters in cafes, luncheonettes, clubs, etc. Collect coins weekly. Write Legalsarr, Box 929, Long Beach 1, California.

UNIVERSAL Sewing machines, portables \$46.50, consoles \$69.95, Zig-Zag portables \$88.25, complete motor kits prepaid \$8.50. 25% deposit, balance c.o.d. Shipped f.o.b. Harrison Wholesale Co., Box 803, Thomasville, N. C.

NEW Mail order business. You mail catalogs. Factory ships orders. Big profits. 33 catalogs \$1. Factory, 41PM Rankin St., Newark 3, N. J.

MAKE Good money in spare time. Mail-order business at home. Complete instructions including 100 page book by experts, \$2.00 moneyorder. James Smithwick, Box 3167, Jackson, Mississippi.

FRANCHISES Make amazing profits! Exclusive distributorships, dealerships, agencies available. Fascinating, nationwide opportunities. Information rushed. National Franchise Reports, 920 North Michigan Avenue, Chicago 11, Illinois.

WHOLESALE! 8,000 Nationally famous products. 30-80% discounts! Large catalog. Sensational business plans included. Consolidated Distributors, 21-11 Lafayette, Paterson 15, New Jersey.

YOUR Own successful, profitable business. Small capital. Why delay? Write today! Details free. Howard Agency, Box 341M, Plymouth, Indiana.

UNUSUAL—Repair pens. Particulars free. Penfix, Box 38, Reading, Penna.

NEW—Profitable home business opportunity! Address mail literature. Get \$10 orders in every mail featuring real merchandise. Everything supplied. Wabash Products, Box 105, Cayuga, Indiana.

INFORMATION Worth dollars. Free details. Wolfe, 8106 So. Park Ave., Chicago 19.

I Average \$125 weekly selling books by mail! So can you! Start sparetime! Work home! Cooper, 246 Taunton, Buffalo, N. Y.

PRINT Without a printing press! Amazing new method! Print colorful signs, banners, cards, posters, glasswear; anything at home. Big profits. Money-making opportunity! We supply everything. Beautiful sample, home-business plan free! Write Screen-Print Company, Los Angeles 15, California.

\$20.00 DAILY Possible. Sharpening barber, beauticians scissors. Details free. Wayne Zell, Summitville 2, Indiana.

\$80.00 WEEKLY. Operate our selective mailorder business in your area, sparetime. Write: House of Plastics, Paramus, N. J.

\$10 DAY Spare time. Costs nothing to try. L. White, 2615 Wilko, Costa Mesa 4, Calif.

\$26,500 SALES In two weeks! Amazing radio-mail order method. Free details. Broadcast Service, 1412-PN Great Northern Building, Chicago 4, Illinois.

MAKE Perfumes, other products. Sell mailorder. Formula catalogue free. International, 6347 Parnell, PM-11, Chicago 21, Illinois.

FREE Gift. With each order featuring real merchandise. 100% profit. Everything furnished. Information free. C. D. Crider, P.O. Box 156, Delhi, La.

STARTING? Inexperienced? "Home-Business Planning" sent free. Farr, Garrettsville, N. Y.

MAGIC Miami, Florida. Fastest growing city. Has marvelous business opportunities to suit your pocket. Will air mail latest list \$1.00. Ardee, Box 2037, Miami, Florida.

GROW Orchids. Beautiful instruction book 50c. Presner, Box 4560-PM, Coral Gables, Florida.

DEALERS Wanted! Sell printed stationery, business cards, labels. Mailorder or locally. Orders filled, wholesale prices. Free samples, plans. Sutton Printing, Box 853-M, Waycross, Georgia.

STAY Home. Sell merchandise by mail! Everything furnished. Orders filled. Big earnings. National, Box 88-A, Dorchester 22, Mass.

MAKE Big money at home! Invisible re-weaving pays up to \$10.00 profit in an hour. Make tears, holes disappear from fabrics. Constant demand from laundries, cleaners, homes, brings steady earnings. Details free. Fabricon, Dept. AE, 8342 S. Prairie, Chicago 19, Illinois.

\$4.00 PER Hour making useful ornamental copper articles. Interesting. Easy. No experience. Sample and instructions \$1.00. Dearing, 235 Monitor Ave., Cincinnati 23, Ohio.

45 MONEYMAKERS 10c! Literature describing mailorder included. Bureau, Box 598, Toronto, Canada.

MOTEL And resort managers needed. Approximately 5000 new motels built each year. This expanding motel business sorely needs competent and trained managers. Ideally suited to couples, 30 to 60. Good pay and secure future. Send \$1 for complete information on motel home training. Mr. L. I. Heater, International Motels, Inc., Millbrae, California.

MINIATURE Trees! Why pay \$2.00-\$10.00 for growing secrets? Free details. Tiny Trees, 5038 N. Winthrop, Chicago 40.

BRONZED Baby shoe mountings, supplies, instructions. Foster, 1520 Ardmore, Chicago 28.

MAKE Durable plastic of waste, easily. Builds attractive flooring, plastering, stuccoing, waterproofing, fireproofing etc., with brush, spray or trowel. Build and repair for half. Bays Laboratories, Oklahoma City 9.

WANTED: Mechanic to represent world's finest sewing machine. Can you sell yourself? Is your wife willing to help? Want to be your own boss? Very few dollars needed to set yourself up in a going business. We'll back right man. See 3-page advertisement in September 27 Life as example of the advertising support you'll get. In East, write: Pfaff American Sales Corp., Dept. PM, 373 Fifth Avenue, New York 16, New York. In West, write: A. C. Weber & Co., Inc., Dept. PM, 216 North Canal Street, Chicago 6, Illinois.

MONEYMAKING OPPORTUNITIES

BOOKKEEPERS! Forget debits, credits, double entry! Govt. investigators want records, not systems. More firms use our simple, inexpensive method than any other. Popular demand. Unlimited earnings. Age no barrier. Live anywhere. Amazing details free. Penna. Business Service, Box 923, York 3, Penna.

EARN \$50.00 Daily making mats, shoes and mud guards from old tires. S and S Patents Inc., 1307 North Clark St., Chicago 10, Ill.

FREE Polio "Startling Unlimited Vacations Plan." No merchandise, equipment. Unknown! Works itself—home! Proven successful. Haylings, Carlsbad, Calif.

LEARN How to make money. Details free! Wrede, Atkinson, N. C.

FOREIGN Employment construction work. If interested in foreign projects with high pay write Foreign Service Bureau, Dept. P.M., Metuchen, New Jersey.

PRINTING And office supplies wholesale. 20,000 items. Literature free. Royal, Box 368-A, Cleveland 27, Ohio.

ATTENTION: Typewriter owners. Make handsome profits. Write today. Groves Company, 682, Hastings 8, Nebraska.

MONEY Troubles? Lick rising costs with little home business. Send 25 cents for new booklet containing dozens of plans and ideas. Atlantic Publications, Box 1103, Riverdale, Maryland.

GENERAL Contest Bulletin. Issued monthly. Sample, 25c. 1609 1/2 East 5th, Duluth, Minn.

NEW Baby items. Agents, salesmen, distributors. Natural for mail order. Write: Liebig Industries, Beaver Dam 5, Wis.

100% PROFIT! Mexican featherbird pictures. Hot sellers! Edmunds, 3009-P Weaver Ave., Baltimore 14, Md.

SELL Books, merchandise by mail. Tremendous profits. We furnish everything. Ship your orders. Write: Tradewinds, Box 8238, Chattanooga, Tenn.

GROW Mushrooms. Cellar, shed, and outdoors. Spare, full time, year round. We pay \$3.50 lb. We paid Babbitt \$4,165.00 in few weeks. Free book. Washington Mushroom Ind., Dept. 173, 2954 Admiral Way, Seattle, Washington.

SPARETIME Profits taking subscriptions, all magazines. Wholesale catalog free. Cassell Agency, Westfield 2, New Jersey.

50,000 ARTICLES Wholesale. Source directory dime. Nelko, Box 3462-DR, Chicago 34.

READ Progressive Mailtrade, the magazine that tells how to make money by mail. Dime brings sample and special offer. Progressive Mailtrade, Box 357, Sheboygan, Wisconsin.

WINNING Prize contests is fabulous, confidential, home opportunity! Send stamp! National Contest Bulletin, Box 2685-P, Miami 16, Florida.

FREE Book "505 Odd, Successful Businesses." Work home. Expect something odd! Pacific, Oceanside, Calif.

MAKE To \$4.50 hour doing common pen lettering. National Artists, 801 1/2-A North Marsalis, Dallas 3, Texas.

BUILD Sales by recruiting productive distributors selling direct or to retail outlets. Secure most concentrated circulation through classified columns of Salesman's Opportunity. Write for facts. Gilbert, Salesman's Opportunity, Room 1700, 28 East Jackson, Chicago 4.

SELL—Buy Titania gems. More brilliant than diamonds. \$9.75 carat wholesale. Free catalogue. Diamonite, 1404-M Mitchell, Oakland 1, California.

SCHOOL Seniors—Sell classmates America's most beautiful graduation name cards. Largest selection. Highest commission. Outsell all others. Free sample kit. Printcraft, Dept. M, 1309 Maple Street, Scranton 5, Penna.

FREE! "301 Profitable Small Businesses!" Amazing shoestring plans! Work home! Start sparetime. Deumant Surveys, Kenmore 23-PM, N. Y.

"HOW To Make Money With Simple Cartoons"—A book everyone who likes to draw should have. It is free; no obligation. Simply address Cartoonists' Exchange, Dept. 911-CM, Pleasant Hill, Ohio.

START A buying service, buy wholesale thousands nationally advertised products. Make big profits selling at sizable discounts. Postcard brings details. American Buyers, 630-P, Linden, Buffalo, N. Y.

INCREASE Your income, turn your spare time into cash—making quick-selling, highly profitable lamps and fiber glass shades. Every home a prospect for one or more. Hundreds already doing it, so can you. No experience needed. No special tools required. Gearon's big, new 72 page 1954 illustrated Catalog No. 8 will show you how, quickly. One special 8-page section shows 6 beautiful lamps in kit form, ready for you to assemble. Another 12-page section shows you how to make stunning, ultra-modern fiber glass shades. Page after page filled with wide variety of other attractive shades, shade frames, figurines, and lamp bases. Also oil lamp converters, boring compound, and all kinds of cords, sockets, pipes, harps, finials, bases, and hundreds of other parts. Everything you need. And you can buy everything wholesale, sell at retail, make big profits, fast. Send only 25c right now for Gearon's big 1954 catalog and wholesale price list. Like hundreds of others, you'll be glad you did. Gearon Co., Dept. 503-B11, 27 S. Desplaines, Chicago 6, Ill.

COLLECTORS Paying up to \$300.00 for old phonograph records, complete listing thousands of records wanted, prices paid (25c coin). Lizmart Company, 3404 No. Figueroa, Los Angeles 65, Calif.

LEARN Technical Metaphysics and insure your future. Easy, inexpensive correspondence course. Simplest method known. Diplomas. Write: Premier College of Technical Metaphysics, 2532 McKenzie St., Vancouver, B.C., Canada.

BUY Wholesale! Nationally advertised merchandise. Catalog, 50c. Levesque, Box 4-B, Atlanta, New York.

AMERICAN Manufactured watches 30% to 60% discount. Includes postage, taxes, insurance. Free circulars. Richmond Enterprises, Box 1003, Augusta, Georgia.

CASH Selling unusual, discarded, old and rare items found around every house, \$1.00 to \$1,000 profit. Informative booklet only \$1.00. Everett Anderson, Box 3, Wheeler, Oregon.

\$10,800 PROFITS! Your own mailorder business! No risk! Success plan free! Treasury, 709 Webster, New Rochelle, PM-25, N. Y.

EARN Money evenings, copying and duplicating comic cartoons for advertisers. Adservice, Argyle 1, Wisconsin.

FUTURE Security! Learn watch, clock repairing at home. Inquire. Modern Technical Supply, 55-PM West 42 St., New York 36.

MAKE Money at home as renewal headquarters for all magazines. Big Christmas sales profits now. Liberal commissions. Supplies furnished. Write for free catalog. McGregor Magazine Agency, Dept. 500C, Mount Morris, Ill.

MONEYMAKING Bargain opportunities, directory 25c. Dellacorte, 2357 Crotona Ave., New York 58.

JIGSAW Bandsaw owners, let your machine bring extra profits, fun. Free details. Nu-Art, Dept. B, Box 2235, Boston, Mass.

\$200 MONTHLY Possible raising earthworms! Backyard, garage, basement. Complete, illustrated booklet explains raising, feeding, packing, marketing. 25c postpaid! Ozark Worm Farm-J, Willow Springs, Mo.

50% PROFIT Selling golden letters kits. Trial 100 imprints 25c. Rochester Novelty, Winton 15, Minnesota.

"MAIL Order Secrets" plus money-making proposition. 3 other offers! Samples! 25c brings packet. Jenkins, 633 South Bradock Avenue, Pittsburgh 21, Penna.

CASH For sparetime. New plan. Free details. Transamerican, Box 815-A, Atlanta 1, Georgia.

PROFIT! Prestige! Publish a magazine under your own name! Only \$3 per month! Same, details 3c! Filmer, 910 Marion, Pharr 22, Texas.

SPECIALTY Farmers can make \$5000 per year on five acres. Free circular. O'Fling, 2313 North 10th, St. Louis 6, Mo.

JUST An honest living. Tested radio-mail order method. Free details. Carter, 114 1/2 W. Washington, Gainesville, Ga.

YOU Can succeed too! This brief simple procedure has helped others to wealth, health, happiness. It can make your success quicker, easier. Complete procedure \$1.00. Money-back guarantee. Get yours now! Litho Publishing Company, 1627 Belmont Avenue, Seattle, Wash.

FREE! Do-it-yourself leathercraft catalog. Write Tandy Leather, Box 397 AM, Tulsa, Oklahoma.

SENSATIONAL—Money maker. No selling. Pix pens. Rush \$1 for kit of parts, instructions, etc. Penfix, Box 38, Reading, Penna.

BE Independent! Fantastic profits! Shoestring investment! Here's how! Write Chemistry, 819 Dufferin, London, Ontario, Canada for free formula worth \$3.00.

SILVER Mirrors. Formula and instructions, \$1.00. Helm Novelty, Box 296, Parker, Indiana.

OPERATE profitable postal box collection agency. Information and sample form \$1.00. Collector, Lake City, Minnesota.

PROFITABLE Sparetime home business or hobby. Complete instructions \$1.00. Harco, Lawrencetown, Nova Scotia, Canada.

NEW 7"x11" Ultra-blue signs, 7c, retail 50c. Sample free! Lowy, 822 Broadway, Dept. 816, New York 3.

WITHOUT Requiring any greater effort than the work you now do for just a mere living. "Beckoning Fortune" takes you along the same path actually trod by every successful man in his rise to wealth and power. It could be your life's turning-point. \$2.00 postpaid. Phillips Company, Box 6817, Towson 4, Maryland.

WHOLESALE! \$800 Nationally famous products. 30-80% discounts! Large catalog. Sensational business plans included. Consolidated Distributors, 21-12 Lafayette, Paterson 15, New Jersey.

BE A director of money-raising drives for churches, hospitals, institutions. Highly paid profession taught at low cost. Backed by thirty-four years experience. William Arbogast, 229 East Mason Avenue, Alexandria, Virginia.

EASY! Two way system home operated business. Profitable. Write, R. Casto, Kenna, West Virginia.

BUY Wholesale! Thousands nationally advertised items. Save—make money! Free details. Durex, Box 672-PM, Chicago 90.

FORMULAS. PLANS. ETC.

300 YEAR Calendar in your head. Know day of week when date's known. Code \$1.00. Krystop, Felton, Calif.

LIFETIME Business! Manufacture extremely profitable products! Lists free! Thermolab, Peoria 4, Ill.

FREE Formula catalog. Anything analyzed \$35.00. Western Chemical, Salem, Oregon.

75 PROVEN Formulas. Easy way to extra cash. \$1.00. Jensen, Lewiston, California.

FORMULAS, 10,000 for \$5.00. Authentic, reliable, practical. Brockway, 1145 High, Topeka 1, Kansas.

MODERN Formulas. Literature free. Jack, Consulting Chemist, 5138 Gainer, Philadelphia 31.

FOR Proof of what you can do in specialty manufacturing get our literature. It's free! Miller, Chemist, 1517-P, Tampa, Florida.

ANY Formula \$3.00. Catalog—Mfg. Treatise 10c. J. Belfort, 192 N. Clark, Chicago 1.

FORMULAS; All kinds. Latest, best. Literature free. Kemixal, Park Ridge, Ill.

REAL Manufacturing formulas. Lists free. Cummings, Chemist, Gordon Ave., Syracuse 4, N. Y.

PRODUCT Analysis, manufacturing formulas, processes developed. Moderate fees. Plastics, Box 1574, Boston 4, Mass.

PLASTICS

PLASTICS Home-craft course for men and women. Tells and shows how to make hundreds of fast selling plastics products. All plastics and materials for 23 projects included in course. No special tools needed. Course pays for itself. Write for free booklet. Interstate Training Service, Dept. D-3-M, Portland 13, Oregon.

PLEXIGLAS, Lucite sq. ft. (12"x12") cost 1/16" \$1.14, 1/8" \$1.50, 3/16" \$1.85, 1/4" \$2.20. Add 10% for postage. Almac Plastics, 600 Broadway, New York 12, N. Y.

CASTING Plastic, crystal like, new formulation, 1 1/2 pounds liquid Numold and complete kit including colors and instructions. Start profitable hobby at home, make your own Christmas gifts. Only \$6.00 postpaid. Information on request. Virginia Research Laboratory, Dept. D-11, Marion, Virginia.

MONEYMAKING Liquid casting plastic. Complete kit \$3.00. Handbook only 50c. Kemnitz Corporation, 2755 N. 5, Milwaukee, Wisconsin.

PLEXIGLAS, Lucite. Square foot cost 1/16" \$1.18; 1/8" \$1.53; 3/16" \$1.88, 1/4" \$2.23, 3/8" \$3.28; 1/2" \$4.38. Colors add 10%. Send 15¢ for postage. Aristocrat Plastics, Inc., 55 Clarkson St., New York City.

PLEXIGLAS Sheets—Cut to size. Clear. All thicknesses. Standard outdoor translucent colors. McClarin Plastics, P.O. Box 168H, Hanover, Penna.

HIGH Profits—Jewelry, gifts, novelties. Free catalog. Pilot Plastics, 67-C Fulton, New York 38.

LAMINATORS Increase sales or if you are entering this field we can help you. Details free. National Association Plastic Laminators, 707 Market St., Knoxville, Tenn.

TUBE For water level. See Hydrolevel ad in "Make It Yourself" classification.

PLASTIC. Sheets, rods, tubes, etc. Free list. Plastic Supply Co., 2901 N. Grand Blvd., St. Louis 7, Mo.

CHEMISTRY

CHEMICALS And apparatus for industrial, analytical, and private laboratories. Catalog 25c. Dept. M-50, Biological Supply Co., 1176 Mt. Hope Ave., Rochester 20, N. Y.

NEW Idea chemical and apparatus outfits for home experimenting. Photo-scales, microscopes, chemicals, biological and laboratory supplies in small quantities. Catalog 25c. Established 1931. John H. Winn, 134A West 23rd Street, New York, N. Y.

ILLUSTRATED Catalog: Chemistry, mineralogy, biology 20c. Tracey Laboratories, Evanston, Illinois.

CHEMICALS, Supplies. Catalog 20c. Laboratory Sales, Box 161-A, Brighton, Mass.

OEIGER Counters, \$29.95 up. Free catalog. Atomic Laboratories, Box 343, Berkeley, California.

BUY IT WHOLESALE

DO Your Christmas shopping, year around buying from your easy chair at big savings. Jewelry, silverware, watches, appliances, toys, power tools. Hundreds of other items. Send 25c for big name brands catalog. Refundable on first purchase. Karlen House, 210 Fifth Avenue, New York 10, New York.

EARLY Christmas shoppers? Wholesale catalog, bonus plan. Complete line nationally advertised merchandise. Pette Company, 1554-PM West 11 Street, Brooklyn 4, New York.

NATIONALLY Advertised merchandise. Rush 50 cents for illustrated catalog showing retail prices to Edward Clemens, 318 W. Bridge St., Morrisville, Penna.

BUY Wholesale direct! Save up to 66% on nationally advertised appliances, home-wares, watches, cameras, sporting goods, toys, giftwares. Free catalog. Wholesalers Mart, Box 6125ER, Houston, Texas.

WHOLESALE Pricelist—Refrigerators, washers, televisions, power tools, typewriters, 25c. Belmont, 861 Dumont Ave., Brooklyn 7, N. Y.

WELL Known brands stainless steel cook ware, appliance, jewelry, radio. We sell 1/2 price. Sale catalog 25 cents. Elbert Pratt, Box 305, Titusville, Penna.

SAVE 50-75% On your Xmas shopping. Free gift with every catalog. Nueblings-M, Sicklerville, New Jersey.

WATCHES! Watches! Tremendous discounts. Particulars free. Econ-O-Mart, Box 535A, Morristown, New Jersey.

AGENTS, Salesmen, buy standard brand merchandise at rockbottom wholesale prices: \$49.50 watches at \$22.95, \$49.50 dinner sets at \$15.60, \$1.00 ladies first quality nylon hose at \$6.50 per dozen. Ladies cleoout \$8-\$10 fall and winter dresses at \$1.50. Other sensational values in clothing, silverware, jewelry and appliances. Minimum order \$10.00. Send \$1.00 for catalog with confidential price list. Refundable first order. Merchandise Dept. P-10, P.O. Box 66, Bronx 59, New York.

WHOLESALE! 8000 Nationally famous products. 30-80% discounts! Large catalog. Sensational business plans included. Consolidated Distributors, 21-14 Lafayette, Paterson 15, New Jersey.

APPLIANCES, Watches, thousands more, catalog 50c (refundable). Buda, Box 124PM1, Oneida, N. Y.

AGENTS WANTED

"FOG-Stop" windshield cloth. Instantly removes blurry mist, frost, sleet, snow. Stops windshield fogging. Samples sent on trial. Kristee 61, Akron, Ohio.

FREE New 1954-55 wholesale catalog free. Appliances, household items, toys, gifts, jewelry, refrigerators, radios, air conditioners, washing machines, freezers. Hundreds of items on which you can make a handsome profit. Space on cover for your own name and address. Write today for big wholesale illustrated catalog free. Halen, Inc., 125 Fifth Ave., Dept. M, New York, N. Y.

EARN \$100 Cash and more by Christmas plus valuable contest prizes! Just take friends' and neighbors' subscription orders for all magazines. Write today for free supplies to J. Foster, Coronet Agency, Dept. M, 488 Madison Ave., New York 22, N. Y.

ADVERTISED Watches, diamonds, pens, wholesale. International. 61R Roberts, Portland 4, Maine.

APPLIANCES, Cameras, watches! Large wholesale catalogue! Cam Company, 6866PM-20th Ave., Brooklyn 4, N. Y.

SELL \$3 Fire extinguisher. Every car owner and household a prospect. A real money maker. Fire Killer Co., 2481 Westport St., Baltimore 30, Md.

EASY Handwork makes fast-selling useful articles. Sample free. Sunmade Company, Brockton 64, Massachusetts.

MUSIC Greeting cards, Christmas specialties. Dorby Publications, Parsonage, Cummington, Mass.

IMMEDIATE Success! Sensational profits! Used suits \$1.75, pants 35c, dresses 20c, shoes 20c. Operate from store, home, car. Free catalog. Superior, 1250-A Jefferson, Chicago 7.

EASY Extra income—Sell sensational new silicone scorch resistant ironing board cover. Good Housekeeping approved. Terrific \$1.98 seller! Send for free complete selling kit. Sample cover \$1.10. Menell Products, Dept. P—P.O. Box 431, Midtown Station, New York 18, N. Y.

HAVE A complete store in your pocket. Buy wholesale and make big profits. Send for free general merchandise catalog now. Jay Norris, Dept. P, 445 Broome St., New York City.

PRINTING, Advertising salesmen—Excellent moneymaking sideline selling decalcomania name plates, small quantities. Automobile initials, sign letters. Free samples. Ralco, XL, Boston 19, Mass.

CALIFORNIA Sweet smelling beads. Sensational sellers. Free particulars. Mission, 2328PM West Pico, Los Angeles 6, Calif.

GOLD Or silver letters, numbers. Windows, doors, trucks. 1" to 6". 500% profits. Free samples. Atlas-T, 544 West 79th, Chicago 20.

\$1.00 PROFIT Selling \$2.95 photo enlargement deal. Allen Studio, Riegler Bldg., Little Rock, Ark.

MAKE Extra money. Sell front door name plates to friends, neighbors. Retail \$1.95; you make \$1.00! Free selling kit. Modern Engraving Co., P.O. Box 194, Boston 14, Mass.

AGENTS—300% Profit selling genuine gold window letters; stores and offices. Free samples. Metallic Sign Letter Co., 431-D North Clark, Chicago.

IT'S So terrific you'll actually sell thousands! Brand new \$2.95 pocket check protector. Sales pouring in. A tremendous deal for you. Get your town today. Federal Products, Evanston 15, Illinois.

BARGAINS, Job lots, close-outs! Save up to 50% on clothing, hosiery, notions, drugs, toiletries, gifts, jewelry, television, etc. 2000 items. 25c brings wholesale bargain catalog with special get acquainted offer which includes free \$1.00 merchandise certificate. Reliable Jobbers, 311-B North Desplains, Chicago.

YOUR Own business—Used suits \$1.50, overcoats 85c, mackinaws 35c, shoes 12 1/2c, ladies coats 30c, dresses 15c. Enormous profits. Catalog free. Moro, 1213AA South Jefferson, Chicago 7.

\$200 WEEKLY, New invention. Amazing 4-second Presto emergency tire chains, fit all modern auto wheels. National advertising building big demand. 3 sales daily to oil stations, dealers, etc. make \$200 or more weekly. Territory going fast. Write Presto Chain Co., Dept. P-30, Des Moines 2, Iowa.

SCHOOL Seniors—Be popular with classmates. Have spending money galore. Details free. Craftcards, Box 235-L, Pittsburgh 19, Pennsylvania.

NATION'S Leading wholesaler offers opportunity to own your own profitable easily operated mail order business. No investment, inventory, experience necessary. We show you how! Sell nationally advertised appliances, home-wares, watches, cameras, giftware, sporting goods, toys! Some 80% less than retail! Catalog, sales plan, and instructions free. United Distributors, 210 Post St., San Francisco.

\$300.00 PER Month selling 4 wheel riding garden tractors, full or part time, exclusive franchise. Anyone owning 1 to 10 acres prospect. \$400 capital required. Tiger Tractor Corp., Box "M," Keyser, West Virginia.

OWN Your own profitable wholesale merchandising business. No investment! Sell nationally advertised appliances, home-wares, jewelry, sporting goods everybody buys. Your own name catalog in color! We drop ship. Free brochure. General Wholesalers, Box 1195EP, Chicago; Box 3058EP, San Francisco.

AGENTS-Salesmen: Sell beautiful hand-colored plastic enlargements and sensational new personalized photo compacts, rings, bracelets, lockets, etc. Experience unnecessary. 40% advance commissions. We deliver, collect. Wonderful sideline—Better full time. Free sample outfit. Novel Portrait Co., 3343 North Ave., Chicago, Ill.

NEW Magic garbage can holder beautifies can, prevents rusting, animals from upsetting. Low priced, sensational seller. Free photos. Kessler Corporation, 11A0, Fremont, Ohio.

SPARE Time money plus new car as encouragement bonus. No house-to-house canvassing required. Amazing 60 gauge nylons. 3 pairs guaranteed 3 months or replaced free. Write Wilknit, 17411 Wash., Greenfield, Ohio.

BUY Wholesale—25,000 items. Catalog 25c. Matthews, 1472-B2 Broadway, New York City 36.

FEATHERBIRD Pictures from Mexico! 100% fast, easy profits. Prompt service. Free details. Jacaman (PM-11), Box 1342, Laredo, Texas.

FREE! Private labels! Exclusive sales! Own a business! Sell radio PI, stores, mailorder. We supply product, plan, literature; you furnish executive management and employ salesmen. VitaMins, 2906PMA Beverly, Los Angeles 57.

BUY Wholesale thousands nationally advertised products at big discount. Free "Wholesale Plan." American Buyers, 629-P Linden, Buffalo, N. Y.

\$15.20 AN Hour is what W. F. Wydallis reports he earns with amazing Presto Fire Extinguisher. Sells itself. No experience needed. Free sales kit. Merlite Industries, Dept. L17, 114 East 32nd St., New York 16.

NEED Extra cash? Get it selling Blair's unusual line of household and food products. Every housewife a prospect. Products sent on free trial. Write Blair, Dept. 31MX-1, Lynchburg, Va.

INCREASE Your income—Personal initialed buckles, belts, cap badges. Free information. Hook-Fast, Box 480 (PM), Roanoke, Va.

PROFITS Unlimited in your own wholesale buying service. Save yourself 66% on 10,000 nationally advertised appliances, homewares, jewelry, sporting goods. Big profits selling others at discount! Free details. National Buyers Service, Box 426EC, Oakland, California.

SHINE Cars without "polish." New invention. Lightning seller. Cars gleam like mirror. Samples sent on trial. Kristee 63, Akron, Ohio.

REVOLUTIONIZES Rubber stamp business. 100% profit. Send 10c for sales plan. Fisher's, Dept. EM11, 4756 So. Central Ave., Los Angeles 11, Calif.

NEW Push button salt-pepper dispenser. Sprays it out! Can't clog. Can't spill. King, 55-P Oleander, West Springfield, Mass.

HIGH Profits in amazing unbreakable plastic housewares, tablecloths, drapes, utility covers. Largest selection, lowest prices! Free catalog. PM411. Acclaim, Box 4, New York 40, N. Y.

ENJOY 3 Color television filter screen now. Send \$2.00 for your screen size. S. George, 5008 Stenton Avenue, Philadelphia 44, Pennsylvania.

BUY Wholesale thousands items. List free. A Sales, 18-PM City Terrace, Newburgh, N. Y.

NATION'S Leading wholesaler offers opportunity to own your own profitable easily operated mail order business! No investment, inventory, experience, necessary. We show you how! Sell nationally advertised appliances, homewares, watches, cameras, giftware, sporting goods, toys! Some 80% less than retail. Catalog, sales plan and instructions; free! United Distributors, 210 Post Street, San Francisco.

FREE Hosiery! Sensational new way to earn to \$3 hour spare time! Introduce amazing hosiery by giving away free pairs to every man and woman, regardless whether or not final purchase is made! Nationally known luxurious nylon stockings guaranteed against runs. New miracle one size two-way stretch nylon socks, fit any size. Never sags or droops. Guaranteed one full year! Buy nothing. Deliver nothing. Advance cash plus huge cash bonus to 40%. Postcard brings you samples of stockings and socks with money-making outfits absolutely free. No obligation. Kendex, Babylon 83, N. Y.

SELL Fishing plugs, made by Wisconsin guide. S. R. Blackstone, 403 Powers Ave., Madison 4, Wis.

BE Our exclusive agent in your community. Every car owner needs our new slip-on safety-belt, especially for his children's protection. Quick seller, 100% profit, no competition. Write for Folder P: Janco, 55 W. 42, New York City.

MAKE Money introducing world's cutest children's dresses. Big selection, adorable styles. Low prices. Complete display free. Rush name. Harford, Dept. M-5341, Cincinnati 25, Ohio.

BEAUTIFUL Feather pictures. 200% profit! Free sample. Apartado 9036, Mexico 1, D.F.

CHAIN Saws. Wheel mounted. Timberbrush cutting. Money makers. Wholesale deal. Farmco-51, Excelsior Springs, Mo.

GOLD Letters, 10c. Signs painted. Frank Watkins Signs, 1241 Overton Park, Memphis, Tenn.

\$9.90 PROFIT Per dozen. Sell magnetic pencils to waitresses. Nicholson Corporation, 3402 Cahuenga, Hollywood 28, Calif.

MAGIC Thread, mends! Without sewing. Terrific seller and repeater, big profits, 30 second convincing demonstration. This amazing invisible liquid repairs, patches any fabrics in seconds. Won't wash off. Send 85c (refundable) for sample or write for more details. Utility Products Co., Niverville, New York.

BIG Profits selling ties (\$2.00 value) \$6.50 dozen. Free catalog. Empire Cravats, 611C Broadway, New York 12.

100% PROFIT, 100% Repeats. Automotive essential. Send \$2.00 for goods, naming territory wanted. Nassau Laboratories, Hackensack, N. J.

I Average \$125 weekly selling books by mail! So can you! Start sparetime! Work home! Cooper, 245 Taunton, Buffalo, N. Y.

TWO New ball point pens, plain and retractable (showing imprinting) with refill problem eliminated. Sample dozen \$2.60 carded, two samples 50c. Nucleus Trading, 2440 Amsterdam Ave., New York City 33.

WHOLESALE! 8000 Nationally famous products. 30-80% discounts! Large catalog. Sensational business plans included. Consolidated Distributors, 21-10 Lafayette, Paterson 15, New Jersey.

\$1.00 WILL Bring you pair of the most wonderful wearing hose, plus our catalog which can help you make up to \$3000 sparetime. Wolfmark, 931 Roosevelt, Chicago.

EXTRA Money. Jewelry, each piece an original. Hand made. Sample \$1.50. Paas Laboratory, 13 Dogwood Road, West Orange, N. J.

JUST Take orders. We deliver. Gadgets. Send 25c. Miss Ann, Jackson Heights 72, New York.

SELL Imported slide rules to students. Hoffman, 682P, Passaic, New Jersey.

60% PROFIT On cosmetics—Famous nationally advertised Hollywood Cosmetics pay 60%! Make \$25 day up! Hire others. For free samples, details, write Studio Girl, Glendale, Calif., Dept. PM-114.

SALESMEN—DISTRIBUTORS

SELL "Dandy"—Fast moving automotive accessory. Dandy, Box 5, Columbus, Ind.

AMAZING New hand cream. Does wonders. Entirely different. Whirlwind seller. Fast repeater. Free moneymaking offer. Sargeant Co., Highland Mills, N. Y.

30,000,000 WOMEN Want amazing new automatic refrigerator defroster. You sell 8 out of 10 on sure-fire free trial. \$250.00 weekly profit not uncommon. Rush postcard for guaranteed plan. D-Frost-O-Matic, Dept. T-102, 173 W. Madison St., Chicago 2, Ill.

DISTRIBUTORS. Large profits. Terrific repeat orders. Unique Italian brooms. Write Peacock, 400 Montgomery Street, San Francisco, California.

NEW Jobs open in selling! Send name, address for five free issues of Opportunity Magazine's money-making guide, listing hundreds of companies who'll pay you well, full or part-time. No experience needed. Opportunity, 28 E. Jackson, Dept. 17, Chicago 4, Ill.

\$6.73 PROFIT On every sale of Lightning portable adding machines, retail \$14.95. Wide market. Full details, actual size color photo free. Lightning Adding Machine Sales Company, Dept. A-147, 234 West 37th Place, Los Angeles 7, Calif.

ANYONE Can sell famous Hoover uniforms for beauty shops, waitresses, nurses, doctors, others. All popular miracle fabrics—Nylon, dacron, orlon. Exclusive styles, top quality. Big cash income now, real future. Equipment free. Hoover, Dept. H-100, New York 11, N. Y.

SALESMEN. \$50.00 In a day definitely assured, selling brand new item going to every type of food and beverage store, factories, laboratories, hospitals, etc. Samples furnished. Utility Durawear, 53 West Jackson Blvd., Dept. PM-11, Chicago 4, Ill.

CALENDARS. Advertising novelties, matches. All styles, including religious, varnished. 12 sheet, girls. Hundreds of advertising novelties, books matches, etc. Fleming Calendar Co., Sales Division, 6539 Cottage Grove, Chicago 37, Ill.

GET New shirt outfit free; make \$90.00 weekly on 5 average orders a day. Famous quality made-to-measure dress and sport shirts at \$3.95 up sell fast to all men. No experience needed. Full or part time. Write: Packard Shirt Co., Dept. 741, Terre Haute, Ind.

MONEY Making opportunity! Take big profit orders for world famous patented varieties fruit trees. Also flowering shrubs, roses, vines. Big sales outfit free. Stark Bro's, Desk 30155, Louisiana, Mo.

AD Matches! Sell amazing designs—10, 20, 30, 40 and 240-light book matches. Bigger spot cash commissions; every business a prospect. Low prices for high quality. Repeats. Start without experience; men, women; full, part time. Buy nothing! Sales kit furnished. Match Corp., Dept. PM-59, Chicago 32, Illinois.

BIG Money-making opportunity. Exclusive line work uniforms. Jackets, pants, shirts, coveralls. Advertising embroidered. Every business prospect. Outfit free. Master Div., 261 Water, Ligonier, Ind.

PLASTIC Signs. New self-adhering interchangeable. Big sales, all type stores. 1208—20th Ave., San Francisco 22.

ADVERTISING Book matches—Cash in on big demand; sell union label matches. Cuts for all businesses and political parties. Free powerhouse selling kit, low prices, protection guaranteed on repeat orders. Cash commissions. Superior Match Co., Dept. M-1154, 7530 Greenwood, Chicago.

BUY Wholesale thousands nationally advertised products at big discount. Free "Wholesale Plan." American Buyers, 630-D Linden, Buffalo, N. Y.

BAR Items and bar gags at wholesale. Resell at 40% profit. Distributors wanted. Collins Products, Box 463, North Hollywood, Calif.

SELL Advertising specialties and executive gifts for old established firm. Good thing for man with wide acquaintance among business firms. Opportunity for hustler who likes to make money and isn't afraid to make calls. Develop your own business with no investment. Leads given after you are established. Best selling season now on. Write today. Newton Mfg. Co., Dept. GT, Newton, Iowa.

SELL Book repair shop service. National chain. Your own business. Professor Martin, Aisen, North Dakota.

ALUMINUM Awning frames—\$9.95. Any width. Saves 50%. Free sample. Smith Agency-PM, Excelsior Springs, Mo.

RURAL Mailbox signal automatically notifies mail arrival. Guaranteed. Demonstrator \$1.50 postpaid. Automatic Devices, 3321 Disston North, St. Petersburg, Florida.

RETRACTABLE Pens, dozen \$3.00, gross \$30.00. Catalog. Arcade, Silver Lake, Ind.

SENSATIONAL Bingo game—Bingo Roll! Sample \$1.00. Lipka Mfg. Co., 617 East 11th Street, New York 9, N. Y.

WRITE For free copy of big magazine listing hundreds of money-making offerings, spare or full time. Specialty Salesman, 307 N. Michigan, Chicago 1, Ill.

HALF Price makes sales easy! Take orders complete Career 30-piece set stainless steel tableware at only \$9.95 (list price \$19.95) yet earn \$4 on each order! We deliver and collect. Beauty of Sterling, yet will never rust, stain or tarnish. Guaranteed 50 years. Rush postcard for complete free outfit or send \$1 for sample four-piece place setting and carrying roll. Topval Corp., Lindenhurst 21, N. Y.

THE Income of an idle millionaire! Yours when you get exclusive Kograt territory. You'll work hard, but not long. Send \$2.00 for goods, name territory wanted. Nassau Laboratories, Hackensack, N. J.

QUALITY Ties—Your profit, 189%. Catalog free. Loren Specialties, 4351-A11 Flournoy, Chicago 24.

NOW Your dreams come true with Pipe Coolers, your latest selling sensation because recent medical smoking reports warn of the need for pipe filters to guard smoker's health. So remember, your future's in easy repeat sales, and dealers are ordering and reordering Pipe Coolers because they're timely demand items. So join the smart money makers. Send now for exciting details to John Lukacs, 138-37 230 Place, Springfield Gardens, New York.

\$2 FIRE Extinguisher, costs you as low as 50 cents. Many other profitable pressurized spray can products. Send name. Strobel Aerosol Co., 2412 Market, Louisville, Ky.

EDUCATIONAL AND INSTRUCTION

SIMPLIFIED Analytics teach algebra clearly, \$1. Another, "Science Magic" proves discoveries plainly, \$4. Both guaranteed. Ziemba, H-6123 Orchard, Dearborn, Michigan.

BE A real estate broker. Study at home. Write for free book today. OI approved. Weaver School of Real Estate, 2020C Grand, Kansas City, Missouri.

LEARN Refrigeration mechanics. Complete illustrated course. Free booklet. Mechanics School, 7217-PM South Broadway, Los Angeles 3.

LEARN Appliance service. Motors, washers, refrigeration, everything. Booklet. President. Box 73136, Los Angeles 3.

NEW. Uncrowded profession, part, full time. Know people. Analyze handwriting, earn big fees. Business men, housewives, doctors, attorneys, teachers use and report success from radio, writing, lecturing, teaching, consultation, court work. Trial lesson free. Give age. Igas, Inc., 414 Wilhoit Building, Springfield, Missouri.

MIDLAND Linotype School. Charles City, Iowa. Civilian and Veteran Courses. Free placement. Established 1909.

MEDICAL Laboratory technique. Learn at home. Catalog free. Century College, 9 East Ohio, Chicago 11, Illinois.

HIGH School diploma at home. Licensed teachers—Approved materials. Southern States Academy, Box 144-MX, Station E, Atlanta, Georgia.

STUDY By correspondence for Doctor's degree in Psychology, Metaphysics and Divinity. College of Divine Metaphysics, Dept. P-M, 2811 North Illinois St., Indianapolis 6, Indiana.

SECRET Investigation. Experience unnecessary. Investigators particulars free. George Wagner, M125 West 85th, New York 24.

PHYSICAL Therapy and massage. We train you at home. Earn big profits from your own private practice or work with hospitals and doctors. Free catalog. National Institute, Desk 4, 4868½ Sheridan Road, Chicago 40, Illinois.

GROW Mushrooms. Cellar, shed, and outdoors. Spare, full time, year round. We pay \$3.50 lb. We paid Babbitt \$4,165.00 in few weeks. Free book. Washington Mushroom Ind., Dept. 174, 2954 Admiral Way, Seattle, Washington.

EARN While you learn. Auto and diesel mechanics master this top paying trade. Many graduates earn \$100 a week and up. Approved for Korean veterans. For free information write Dept. No. 256, Nashville Auto-Diesel College, Nashville 3, Tenn.

BOOKKEEPERS! Increase your earnings! Operate your own simplified "Dollar-A-Week" bookkeeping and tax service. Full or spare time. Details free. No obligation. Ellis, Box 200, Cedar Grove, North Carolina.

MEDICAL Laboratory technicians in great demand. We train you in your own home. Catalogue free. Imperial Technical Institute, Box 973-J, Austin, Texas.

INVESTIGATOR Training. Phillips Secret Service System, 1917-B North Kenneth, Chicago 38.

USED Correspondence courses and books sold and rented. Money back guarantee. Catalog free. (Courses bought.) Lee Mountain, Pisgah, Alabama.

GOVERNMENT Position! Home training for examination, \$9.95. Refunded if don't pass. Write, Ozment Instructions, 34-CS, St. Louis, Mo.

AUCTIONEERING. Be an auctioneer. Earn big money. Term soon. Write for catalog. Kansas City Auction School, Suite 307 Shankman Building, 3119 Troost, Kansas City, Missouri.

UNIVERSITY Degrees by residence and correspondence. Golden State University, Hollywood, Calif.

PIANO Tuning pays. Learn this profitable profession at home easily with patented Tonometer and mechanical aids. No knowledge music necessary. Diploma granted. Write for booklet. Niles Bryant School, 3731 Stockton Blvd., Dept. P, Sacramento 20, California.

"INDUSTRIAL Drafting Opportunities." Free booklet. Write—Industrial Training, 1704-A Frederick, Fort Worth 7, Texas.

COMPLETE Your high school at home in spare time with 57-year-old school. Texts furnished. No classes, Diploma. Information booklet free. American School, Dept. X845, Drexel at 58th, Chicago 37, Illinois.

WANT A diesel job? New opportunities to increase income. Higher pay. More money. We can help you qualify. Tools, Shop method home training. Write today! Diesel, Tractor, Heavy Equipment Division, Interstate Training Service, Dept. B-3-M, Portland 13, Oregon.

INVESTIGATE Accidents—Earn \$750 to \$1000 month. Thousands of insurance companies, airlines, and steamship lines urgently need claim investigators. We train you at home spare time. Placement counsel and help. Free book—now! Universal Schools, Dept. 111, Box 8262, Dallas 5, Tex.

IT'S Fun learning a language by Linguaphone's World Standard Conversational Method. At home, quickly, easily master French, Spanish, German, Russian, Chinese, Modern Greek—29 languages available. Save time, work, money. Send for free book. Linguaphone Institute, 8311 ROA Building, New York 20.

PRACTICAL Nursing—Learn easily at home, spare time. Big demand, good earnings. High school not necessary. Write for free booklet. Wayne School, Dept. PG-25, 2525 Sheffield, Chicago 14, Ill.

"PORTO-Lab"—Portable classroom laboratory. Elementary science equipment. Manual 21 subject sections, 185 experiments. Complete unit \$36.50, f.o.b. New York. Porto-Sales, Dept. 1154, Morrisonville, Illinois.

GET U.S. gov't job! Men-women, 18-55. Start high as \$80.00 week. Qualify now! 23,000 jobs open. Experience often unnecessary. Get free 36-page book showing jobs, salaries, requirements, sample tests. Write: Franklin Institute, Dept. X-24, Rochester, N. Y.

HIGH School—No classes. Study at home. Spare time. Diploma awarded. Write for free catalog HF-49, Wayne School, 2527 N. Sheffield, Chicago 14, Ill.

UNDERSTAND The economy! Analyze prices, unemployment, business cycles, profits, rent, interest, wages. Particulars free. Correspondence Institute of Economics, 508 Lafayette Street, Denver, Colo.

OWN Collection agency office. Pays big! Free details. Franklin Credit, Roanoke 7, Va.

CORRESPONDENCE courses bought, sold, rented, exchanged. Catalog free. Press, Box 1272-P, Burbank, Calif.

LEARN Auctioneering. Term soon. Write for catalog. Missouri Auction School, Box 8425G1, Kansas City, Missouri.

WELDING Training pays at Hobart Welding School, Box M-1141, Troy, Ohio. VA contract. Best equipment. Catalog free.

USED Correspondence courses. Books bought, sold, rented. Educational Exchange, Summerville, Ga.

LEARN Logic and increase speed and accuracy in thinking. Dr. John Henry Melzer, Georgetown, Ky.

BECOME Medical technician. American College, 1410 Central, Kansas City, Mo.

ARTISTS Make money—Booklet free. Drawing, painting, advertising art, cartooning; one enjoyable course; start at home. Write for free illustrated book, "Art for Pleasure and Profit." Our 40th year. Washington School of Art, Studio 4211 N. Washington 5, D. C.

CAMERA Repairmen greatly needed! You can learn manufacturers' service methods at home. In your spare time! Free, big illustrated book tells how; Write today. National Camera Repair School, Dept. FM11, Englewood, Colorado.

MIDWEST Engineering School. Home study opportunity. 10923 Hillcrest, Hickman Mills, Missouri.

SHORTCUT Public bookkeeping guarantees mansized steady income! Simple instructions. Start home, spare time. Auditax, 34651CB, Los Angeles 34.

NEW Changes in 1954 income tax, quarter. Professional School, 1416 P/M Maile, Cleveland 7, Ohio.

BECOME A doctor of psychology or metaphysics. Learn secret of contentment, happiness. Win degree of Ps.D. or Ms.D. Solve mental worries. Free book. College of Universal Truth, 5038-C Broadway, Chicago.

INCREDIBLE! Become mental superman overnight! Free booklet! Bijou, Box 1727-MS, Hollywood 28, California.

OIL Painting course. Dollar brings trial lesson. Prickett, Castine, Maine.

IMPERATIVE! Indispensable! The truth about your ability and importance. Free. Write Applied Christian Psychology, Box 1924-E, Louisville 1, Ky.

FREE! Do-it-yourself leathercraft catalog. Write Tandy Leather, Box 397AE, Tulsa, Oklahoma.

BLUEPRINT Reading for machine and building trades. Train at home. Learn to read blueprints with confidence in 10 easy lessons. Literature free. Belton School, 1059G North Lawndale, Chicago 51, Illinois.

FREE Colleges (residence, correspondence). Free books, other graduating opportunities. Aureas, 156 West 73rd Street, New York City.

PLAYS, STORIES, MANUSCRIPTS

WRITE For pay, new easy way. Based on your daily experiences, thoughts. Free information. Creative Ability Developer, 1819 Gilpin, Denver 18, Colorado.

NO Luck finding a book publisher? Write for free Booklet PM. Vantage Press, 129 W. 31, New York.

BUSINESS SERVICE

500 PENNIPRINT \$5. Drawings, forms, folders, letters reproduced 8½x11. Free estimates. PenniPrint Co., Dept. 10, P.O. Box 1159, Chicago 90.

SPECIAL SERVICES

MIAMI'S Largest Sunday newspaper, 25c. Letters remailed, 25c. Clark, Box 3602, Miami 23, Florida.

AIR Conditioning systems cleaned—vacuum and steam method—commercial and industrial contracting anywhere in U.S.A. A Ventilation Cleaning Service, 469 West Willis, Detroit 1, Michigan.

INFORMATION On anything. Ferguson Research Specialists, 116-14 141 St., So. Ozone Park 36, N. Y.

INVENTION Protection forms free. Write Services, 220 Helm, Williamsville 21, N. Y.

USE Our buying service. We buy and mail promptly to you anything you need. Send your requirements for best prices. Buy-Rite, 57 Whitehall St., New York 4.

CARTOONING, COMMERCIAL ART, SHOWCARD & SIGN PAINTING, TATTOOING

CHALK Talks. Laugh producing program \$1.00. Catalog 10c. Balda The Cartoonist, Oshkosh, Wisconsin.

TATTOOING Course, supply brochures 25c. Zeiss, 728 Lesley, Rockford, Illinois.

"HOW To Make Money With Simple Cartoons"—A book everyone who likes to draw should have. It is free; no obligation. Simply address Cartoonists' Exchange, Dept. 911C, Pleasant Hill, Ohio.

LEARN Sign painting at home. Test lesson free. Ben Kerns, Box 812-PM, Greenville, S. C.

PAINT Signs with master patterns. Set 1¼" to 12" high \$1.00; sample 3c. Eyerly, B-583, Newton, Iowa.

ATTENTION—Sign painters-hobbyists. 14 sets alphabet, monogram, numeral patterns, ½"-4" high, \$1.00 postpaid. Walker Studio, 211-A, 4343 Lindell, St. Louis 8, Mo.

PAINT Signs and show cards. Biggest complete course with 324 illustrations, 18 in colors, \$5 postpaid. Descriptive circular free. E. C. Matthews, 2325 Cass, St. Louis 6, Mo.

ARTISTS' SUPPLIES

IF Interested in artist frames, canvas, canvas boards, Red Sable brushes, etc., be sure to get our money saving price lists before buying. International Sales Co., 414 E. Baltimore St., Baltimore 2, Md.

ADVERTISING AGENCIES, LETTER WRITERS, FOR ADVERTISERS

ADVERTISING—Display, classified. Experts since 1893. Interesting budget brochure free. Newmark's Agency, 217-7th Ave., New York.

MAILING Lists, most any classification. 1000 names \$5.00. 1000 your circulars mailed with ours \$4.00. 5000 your circulars printed and mailed \$12.95. Write Dixie Mailers, King, North Carolina.

ADS Placed in out of town newspapers and magazines. Low rates. Catalogue free. Ideas that pay. Baker Advertising Agency, Successors Ankrum Agency, 189 W. Madison, Chicago 2.

FREE Copy, layout service. Mailorder ad, 1,600,000 nationwide circulation, \$28.70 inch. 24-word classified, 20 big Sunday newspapers, \$30. Advertising ratebook free. Chicago Advertising Agency (Established 1906), Chicago 4.

FREE! 1954 Advertisers Rate and Data Directory, 52 pages! E. H. Brown Advertising Agency, 20 N. Wacker, Chicago 6.

ADVERTISE: 24 Words, 100 Canadian newspapers \$5.50. Lists free. Advertising Bureau, 10511-C Springfield, Chicago 43.

FRESH Mailing lists. Guaranteed. Any classification. Free literature. Trans-American, Box 815-A, Atlanta 1, Ga.

MAILING List, 500 women mail buyers \$2.00. Schultheis, Box 449, Irwin, Penna.

SENSATIONAL Mail order advertising handbook. Methods, tests, publication rates, all the answers. Written by national agency, 25c BT Advertising, 2108 C Payne Avenue, Cleveland 14, Ohio.

RUBBER STAMPS AND OFFICE SUPPLIES

3 LINES, \$1.00. Fast service. Quality printing, reasonable. Samples. Johnson Press, 443 MacDonough, Brooklyn 33, N. Y.

LINE 25c; 2-45c; 3-65c. Stamp Works, Auburn, Nebraska.

RUBBER Stamps by professional craftsmen. 3 lines \$1.00. Price list, South Coast Press, P.O. Box 2074, San Bernardino, Calif.

3 LINE Cushion or pocket stamp \$1.00. We make stamps any size, style or quantity. Also complete printing service. Satisfaction guaranteed or money back. Catalog 10c refunded. Esco 1114 Print, 8 Holt, Dayton 7, Ohio.

TYPEWRITERS, DUPLICATORS, OFFICE DEVICES

POSTCARD Duplicators, automatically feeds 3000 hour, with supplies, \$16.00 postpaid. Larger and color models. Delivered from U.S.A. or Canada. Printing, mimeographing service. W. Cooke, Box 40, Scarboro Junction P.O., Ontario, Canada.

RECONDITIONED Typewriters, duplicating, printing devices, \$25.00 up. Supplies. Appliances. DixieGraph, King, N. C.

PRINTING, MULTIGRAPHING, MIMEOGRAPHING GUMMED LABELS

BUSINESS Printing. Samples, catalog 10c. Howprint, 723-M Eunice, Webster Groves 19, Mo.

150 EACH—Letterheads, envelopes, \$2. Bryan, 2547 Fourth, San Diego, Calif.

SALES And order books, envelopes, statements, E-R Press, New York City 22. Free catalog.

MIMEOGRAPHING. Surprisingly different, colors, samples. Lee, 8 Gables Drive, Hicksville, N. Y.

MIMEOGRAPHING—High quality, reasonable prices. Free samples, pricelists, Mail-Me-Mimeo, 920 Vanburen, Milwaukee 2.

ENVELOPES—#6 $\frac{1}{2}$. Printed, 500, \$2.25; 1000, \$3.75; 2000, \$6.50; f.o.b. Hargraves, Box 517, Corning, N. Y.

100 LETTERHEADS Or envelopes \$1.00. Two colors \$1.50. Broadbrook, Botsford, Connecticut.

1000 RAISED Printing business cards, \$4.00. Samples free. Simon, 1556 Hoe Avenue, New York 60.

100 ENVELOPES. Printed 2-colors \$1.25. Box 523, Rochester 2, N. Y.

MIMEOGRAPHING—Letters, pricelists, formulas, instructions. Lowest prices. Lem's Letter Shop, 5710 Stanton, Detroit 8.

500 $\frac{3}{4}$ x2 $\frac{1}{4}$ FOUR Line gummed stickers 50c. Red border \$1.00. Moritz Printery, Saginaw, Mich.

ATTRACTIVE Labels, stickers. Inexpensive. Samples. Fame, 291 Ellis, San Francisco 2, Calif.

MIMEOGRAPHING Letters, folios, circulars, 100 8 $\frac{1}{2}$ x11 \$1.00. Additional hundreds 50c postpaid. Collander's, Moline, Illinois.

1000 EMBOSSED Cards \$3.95 postpaid. Quick service. Samples. Printing, Box 1272-P, Burbank, Calif.

QUALITY Printing. Booklets, publications, catalogs, stationery. Free catalog. Adams Printers, 30 West Washington, Chicago 2, Illinois.

SAVE 35% On quality, postpaid printing. Request free samples, Lidfin, 3813-B Winslow, Ft. Worth 9, Texas.

PRINTING—Photo-offset, mimeographing. Samples, prices free. Mimeo., Madison, Tennessee.

BUSINESS Cards. Printing. Reasonable. Free samples. Lites, 5352-PM Princeton, Chicago 9.

100 LETTERHEADS And 100 envelopes, \$1.75. Waip, Box 4308-F, Mobile, Alabama.

FREE Catalog, business, personal printing. 500 8 $\frac{1}{2}$ x11 letterheads \$3.50 postpaid. Free copy for approval. D & M Sales Co., Sebastopol, California.

SALESBOOKS. 25, \$2.85 Postpaid. Gropp, 466 Harman St., Brooklyn 37, N. Y.

OFFSET Printing \$6.50—1000, 8 $\frac{1}{2}$ x11, 16 lb. National Letter, 1463 Broadway, New York 36.

1000 BUSINESS Cards \$2.95, raised letters \$3.95, two-color \$4.95, printing catalog. Scull's, Dept. D-4, 121 West 25th Avenue, Wildwood, New Jersey.

TWO Color 8 $\frac{1}{2}$ x11 letterheads, 500, \$4.00. Samples. D'Yarmett Printing, Newark, Ohio.

100 8 $\frac{1}{2}$ x11 HAMMERMILL Letterheads and 100 envelopes postpaid \$1.95. H. Hudson, Centredale, R. 1.

1000 STATEMENTS Or letterheads, 5 $\frac{1}{2}$ x 8 $\frac{1}{2}$, \$5.95 postpaid. Samoset Press, Plymouth, Mass.

1000 BUSINESS Cards \$1.98, 150 each, letterheads, envelopes—\$1.98. Bryan, 2547 Fourth, San Diego, Calif.

1000 2-COLOR Business cards \$3.95 postpaid. Colorprint, 4675 W. Virginia, Denver 19, Colorado.

BUSINESS Cards, 1000—\$2.50. Rush service. Samples. Fuller's, 41 Brewster, Providence 6, Rhode Island.

100 8 $\frac{1}{2}$ x11 LETTERHEADS. Carefully printed, \$1.00 postpaid. Envelopes same. Race Printers, Hudson, New York.

PRINTING OUTFITS AND SUPPLIES

DO Your own printing. Save money. Simple rules. We supply everything. Print for others; good profit. Raised printing like engraving too. Have home shop. Details free. Kelsey Presses, V-11, Meriden, Connecticut.

MAKE Your own line cuts. Waip, Box 4308-M, Mobile, Alabama.

PRINTING Presses, type, supplies. Lists 3c. Turnbaugh Service, Loysville, Penna.

PRESSES, Supplies, paper. Catalog 10c. Custom, Box 211-P, Springfield, Missouri.

MAKE Your own self-molding rubber stamps and printing cuts. Plexirubber, Argyle 1, Wisconsin.

NEW Type 68c up. New cuts 10c. Stamp. John Ryan, 275 Lamartine St., Jamaica Plain 30, Mass.

PRESSES, Type, cabinets, supplies. List for stamp Lincoln Press Company, 220-L Hartwell, Fall River, Mass.

PATENT ATTORNEYS

CANADA—Ramsay Company Registered, 273 Bank Street, Ottawa, Canada.

INVENTION Record form free and "Patent Information Every Inventor Should Have." Carl Miller, Registered Patent Attorney, Woolworth Building, New York.

INVENTORS. Learn how to protect your invention. Unless the inventor is familiar with patent matters, he should engage a competent registered patent attorney or agent to represent him. We are registered to practice before the U.S. Patent Office and prepared to serve you in handling your patent matters. "Patent Guide for the Inventor" containing detailed information concerning patent protection and procedure with "Record of Invention" form will be forwarded to you upon request—without obligation. Clarence A. O'Brien & Harvey Jacobson, Registered Patent Attorneys, 41B-K District National Building, Washington, D. C.

REGISTERED Patent attorney offers services. Sanders, 6430 Evans, Chicago 37, Illinois.

"INVENTOR'S Guide" and "Record of Invention" free on request. Frank P. Ledermann, Registered Patent Attorney, 154 Nassau Street, New York City.

PATENTS—Irving L. McCathran, 315 McLachlen Bldg., Washington 1, D. C. Registered Patent Attorney.

PATENTS. "Proof of Invention" free. E. E. Vrooman, Registered Patent Attorney, 507 McKim Building, Washington 5, D. C.

INVENTORS: When you are satisfied that you have invented something of value write me, without obligation, for information as to what steps you should take to secure a patent. Write Patrick D. Beavers, Registered Patent Atty., 935 Columbian Bldg., Washington 1, D. C.

C. A. Snow & Co.—M427, Snow Building, Washington 1, D. C. Registered Patent Attorneys. Write for information.

INVENTORS: Without obligation, write for information explaining the steps you should take to secure a patent. John Randolph, Registered Patent Attorney, 203 Columbian Bldg., Washington 1, D. C.

INVENTORS—If you have a valuable invention, you are advised to authorize a preliminary search through appropriate classes of United States patents. This firm is registered to practice before the patent office and is available to make such search and report to you concerning the probable patentability of your invention. Instructive booklet with "Evidence of Invention" form sent upon request. Victor J. Evans & Co., 931-M Merlin Building, Washington 6, D. C.

INVENTORS—If you believe you have an invention, you should find out how to protect it. The firm of McMorro, Berman & Davidson with offices in Washington, D. C., is qualified to take the necessary steps for you. Send for copy of our patent booklet "How to Protect Your Invention." We will also send you an "Invention Record" form. No obligation. They are yours for the asking. McMorro, Berman & Davidson, Registered Patent Attorneys, 134-R Victor Building, Washington 1, D. C.

FOR INVENTORS

KNOWLEDGE! Inventor study courses, comprehensive! Ken-Tec, Box 595, Garland, Texas.

INVENTORS—If you believe you have an invention, you should find out how to protect it. The firm of McMorro, Berman & Davidson with offices in Washington, D. C., is qualified to take the necessary steps for you. Send for copy of our patent booklet "How to Protect Your Invention." We will also send you an "Invention Record" form. No obligation. They are yours for the asking. McMorro, Berman & Davidson, Registered Patent Attorneys, 134-S Victor Building, Washington 1, D. C.

INVENTORS—This firm is registered to practice before the United States Patent Office and is available to assist you in the preparation and prosecution of your patent application. "Patent Protection for Inventors" booklet containing detailed information and steps to take toward patent protection will be sent upon request. No obligation. Victor J. Evans & Co., 932-M Merlin Building, Washington 6, D. C.

INVENTORS: Profit from my years of experience in obtaining and promoting 30 U. S. patents. Avoid costly mistakes. \$1.00 may save you hundreds. Send \$1.00 for my booklet "One Inventor's Experience" today. R. E. McLean, 5703 South Benton, Kansas City 30, Missouri.

PATENT Searches, including copies of nearest patents, \$3.00. Reports airmailed within 48 hours. More than 75 registered patent attorneys use my service. For free invention protection forms, write Miss Ann Hastings, P.O. Box 176, Washington 4, D. C.

INVENTORS—Send for free patent information book and inventor's record. Registered Patent Attorney, Associate Examiner, Patent Office 1922-29; Patent Attorney & Advisor, Navy Department 1930-47. Gustave Miller, 114A Warner Building, Washington 4, D. C.

PATENT Searches \$5.00. 48-hour airmail service. Record of invention forms free. Write Patent Engineering Service, 711 14th Street, N. W., Washington 5, D. C.

PROFIT From your invention. The International Inventors Club helps you with patents and sales. Membership only \$15 year. Free information. 6614 Metropolitan Station, Los Angeles 35, California.

PATENT Searches \$5.00. 48-hour service. Free Record of Invention. Write Raymond L. Smith, Patent Searcher, 622 Sheraton Building, Washington 3, D. C.

INVENTORS: Learn how to protect your invention. Unless the inventor is familiar with patent matters, he should engage a competent registered patent attorney or agent to represent him. We are registered to practice before the U.S. Patent Office and prepared to serve you in handling your patent matters. "Patent Guide for the Inventor" containing detailed information concerning patent protection and procedure with "Record of Invention" form will be forwarded to you upon request—without obligation. Clarence A. O'Brien & Harvey Jacobson, Registered Patent Attorneys, 41A-K District National Building, Washington, D. C.

BECOME Patent firm representative. Spare time, mail order. Experience unnecessary. Work done Washington office, you receive sensational income! Industrial Patent Reports, Box 6296, Washington 15, D. C.

IF It can be sold patented, unpatented, we can sell it. Free details. Inventors Research, 1154 North Western, Hollywood 29, Calif.

INVENTION Record form free and "Patent Information Every Inventor Should Have." Carl Miller, Registered Patent Attorney, Woolworth Building, New York.

SEARCHES—Put your patent searches in the hands of a registered patent attorney or agent, as he qualifies to give a worthwhile patentability report. Record of invention form upon request and information on patent protection. Patrick D. Beavers, Registered Patent Attorney, 936 Columbian Bldg., Washington 1, D. C.

INVENTORS: Information on patent procedure furnished on request, without obligation. John Randolph, Registered Patent Attorney, 262 Columbian Building, Washington 1, D. C.

INVENTORS: If you have an invention for sale, patented or unpatented, write Institute of American Inventors, Dept. 40A, 631-E St. N.W., Washington 4, D. C.

"**INVENTOR'S** Guide" and "Record of Invention" free on request. Frank P. Ledermann, 154 Nassau Street, New York 38, N. Y.

CASH For your idea. 280 manufacturers need inventions, patented or unpatented. List free. Invention Bureau, 208M Clinton, Oak Park, Ill.

COMPLETE Services for inventors. "Record of Invention" form free. Write National Inventors Institute, 4097 East 131st St., Cleveland 5, Ohio.

PATENT Searches, \$5.00, including patent copies. Same reliable search as conducted for patent attorneys. Free protection forms. Fast, accurate service. Patent Service Institute, 945-A Pennsylvania Avenue, Washington 4, D. C.

PATENTS FOR SALE

INVENTORS: Test the commercial value of your patented or unpatented inventions, quickly and inexpensively. Write for free information. Institute of American Inventors, Dept. 40-B, 631-E St. N.W., Washington 4, D. C.

INVENTIONS WANTED

WILL Develop and market your invention if acceptable. Steffin's Products, 1099 MacArthur Blvd., San Leandro, Calif.

INVENTORS: If your invention is adaptable to our business we will contract on cash or royalty. If not, we will try to place. Free booklet. Kessler Corporation, 511X, Fremont, Ohio.

INVENTIONS Wanted; patented, unpatented. Foremost promotion service. Full particulars free. Superior, 338-344 North Rodeo, Beverly Hills, Calif.

INVENTORS Don't sell your invention, patented or unpatented, until you receive our offer. Write Cowgill, Box 298, Marion, Ohio.

INVENTIONS Promoted. Patented or unpatented. Established 1911. Write Adam Fisher Company, 3418 Idaho, St. Louis, Mo.

INVENTIONS Wanted. Patented, pending only. Inventors Patent Exchange, Hartford 1, Conn.

INVENTIONS Wanted. Patented; unpatented. Tremendous manufacturers lists. Global Marketing Service, 1404 Mitchell, Oakland 1, California.

INVENTORS: Hundreds of manufacturers have requested our assistance in locating marketable new products. Complete information free. Institute of American Inventors, Dept. 40-D, 631-E St. N.W., Washington 4, D. C.

INVENTIONS Wanted. Patented or patent pending. 23 years experience promoting inventions. National Service Bureau, 3120 Meramec, St. Louis 18, Mo.

CASH Buyers for ideas and inventions. Write National Inventors Institute, 4097 East 131st St., Cleveland 5, Ohio.

BROKERS With complete service for inventors. The Invention Mart, Spring, Tex.

INVENTIONS Promoted since 1931. Jacquelin Harvey, Century Building, Washington 1, D. C.

FROM Center American industry. National Research & Development Corporation seeks patented or unpatented inventions for development or sale. Write for booklet A. Room 324, 11 West 42 Street, New York, N. Y.

INVENTIONS, Ideas wanted for development, manufacture. Write: Wadsworth Manufacturing Co., Wadsworth 9, Ohio.

MANUFACTURING

MODELS—Small lot manufacturing. Metals, plastics, etc. Milburn, Burlington, Kentucky.

WOOD Patterns. Metal castings. Send drawing. Kochan, 4002 E. 54, Cleveland 5, Ohio.

DESIGNING, Development, building. Machinery, inventions, models. Henry, 2136 E. Monmouth, Philadelphia, Penna.

MODELS, MODEL SUPPLIES

POWER Models. Unusual steam, gasoline and traction engines, fittings, metals. Anniversary catalog 50c. Chas. Cole, Ventura, Calif.

SHIP And yacht model fittings; blueprints. Send 25c for illustrated catalog listing hundreds of items. A. J. Fisher, 1002-1 Etowah Ave., Royal Oak, Mich.

SHIP And other scale models. Most complete line in New England. Kits, fittings, plans, books, tools, engines, motors. Illustrated catalog 25c. James Bliss & Co., Inc., Dept. 8M, 342 Atlantic Ave., Boston 10, Mass.

BALSA Wood. Grade AAA. Free sample, price list. Sig Mfg. Co., Montezuma, Iowa.

SHIP Models and yacht supplies. Complete, large 68 page catalogue 50c. Bill Wild's, 510 East 11 St., New York City 9.

FLEISCHMANN Famous German steam engines \$5.95 to \$85.00 and mechanical ships 79c to \$45.00 postpaid. Catalog 50c. Merlo, 50-18 94 Str., Elmhurst 73, N. Y.

1954 CAR Models, 1/25 scale, all metal, chrome trim. Send for catalog. Cars & Hobbies, Dept. PM-20, 2333 Haddon, Chicago.

BALSA Wood! World's finest! For model aircraft, boats, etc. All sizes. Special offer; free price list. Remaco Balsa, 7 Springfield St., Chicopee, Mass.

LIVE Steam castings and supplies. Catalogue 25c. Yankee Shop, Box 275, Danvers, Mass.

HOME CRAFTSMEN

MONEY Maker for home workshop. Handy home shoe shine kit. Plans \$2.00. C. Parsons, 417 Stahl Ave., New Castle, Delaware.

USE Your drill press for precision hand tapping. Tappo chuck wrench eliminates lateral strain, minimizes tap breakage. Free details. Gilbert Manufacturing Co., 139-M Riverview Ave., Elkhart, Indiana.

LIFE Size Santa with pack, 5-ft. pattern. Simple, unique construction directions for achieving life-like appearance. \$1.00 postpaid. Walker Studio, 211-S, 4343 Lindell, St. Louis 8, Mo.

BOXES—Paper and plastic. Small orders welcome. Illustrated list, 25c (refundable). Young's, 10233-A Center Street, Niagara Falls, New York.

JIGSAW Patterns! Large variety for your favorite boy, \$1.00. Pauls, 4633 North 18th, Milwaukee 9, Wis.

GENUINE Leather "do it yourself billfold kit" only \$1.00 postpaid. First hundred customers will receive special surprise gift free. Miles Crafts, 3220-P Fish Avenue, New York 69.

LAMP Size cypress knee with nipple installed \$2.00. Cy Products, Dept. 28, Lafayette, La.

LEATHERCRAFT Pre-cut kits, tools, patterns, instruction books. Stylecraft, Craftool, others. Catalog 10c. Whitman Saddle Mfg. Co., 1725 Powers St., C-11, Cincinnati 23, Ohio.

ALPHABET Patterns. Monograms, numerals. 14 sets 1/2"-4" high. \$1.00 postpaid. Walker Studio, A-211, 4343 Lindell, St. Louis 8, Mo.

BEAUTIFUL Christmas candle holders, make for gifts. Sell poinsettia kits \$2.50 pair. Spencer's, 243 Albion Pl., Cincinnati 19, Ohio.

CHILDREN'S Knockdown platform rocker. Springs, duran, lumber, etc. 100% parts. Make this for Christmas, \$6.75 each. Matching ottoman \$1.00 each p.p. For further information write Carpenter Furniture Co., P.O. Box 1449, Birmingham, Ala.

DOLL House electric light fixtures, inside, outside imported wallpapers. A. Benko, 400 East 66th St., New York 21.

FREE "Do-It-Yourself" leathercraft catalog. Tandy Leather Company, Box 791-Q6, Fort Worth, Texas.

HARDWOOD Play pens. Standard size. Kit form. Send only \$6.95. Freight collect. Peterson's, Box 402, Huntley, Illinois.

BIG Savings leather—Now, for first time, you can buy full sides of top grain cowhide at our special, amazingly low "tannery-to-you" prices. For details, write Dept. 1, W. D. Byron & Sons, Williamsport, Md. Fine cowhide tanners since 1832.

LEATHERCRAFT Supplies at lowest prices. "Craftool" stamps. Catalog 10c. Crown Leather, 22 Spruce Street, New York 38.

METALCRAFT: Complete stock of tools and all the craft metals. Free catalog. Patterson Brothers, 15 Park Row, New York 3, N. Y.

VIOLINMAKERS, Repairers, amateurs, professionals. Fine tone European wood. Materials, tools, patterns, instructions. Illustrated catalogue 10c. Premier Violin Supplies, Division PVM, 430 South Broadway, Los Angeles 13, California.

BUILD The patented Little Mint Paper Baler—Slickest little baler for homes, apartments, schools, churches, offices and small businesses. Makes 50 lb. bale. Easy to build. Plans and instructions plus license and name label to build one baler \$2.00 postpaid. Order today, build one for yourself, build others to sell. L. M. Baler Co., Box 125A, Wausau, Wisconsin.

LEATHER, Tools, lacings, supplies. Free catalog. National Handicraft, 199 William St., New York 7.

129 NEW Full size jigsaw patterns. Unusual novelties, gifts, lawn figures up to 22 inches high, action (merry-go-round) windmill, toys, useful gadgets. Artist drawn. \$1. Craftplans, 1321-A South Michigan, Chicago 5.

STYLECRAFT Sure fire hits. "Pre-traced" leather kits. Handbags, billfolds, filigree belts, over fifty other projects. Patterns on leather. Why trace? Just carve, assemble and lace. Large assortment "precarved" kits also available. Send 25c for catalog, free folder. Refunded first order. Apache Leather Company, 2804 E. Washington St., Phoenix, Arizona.

35 LAWN And garden ornament patterns. Full size, ready cut, colors indicated. Only \$1.00. Lincoln Craft Studio, Columbia, Conn.

KNOCKDOWN Cedar chests. Lumber and veneers. Free price list. Giles & Kendall Company, Huntsville, Ala.

FREE Information. Money-making full size patterns. Professional designs. Furniture, gift shop items. Write Jigsaws, 117 Worth, New York 13.

KNOCKDOWN Cedar chests and lumber. Free price list. Bedford Lumber Company, Shelbyville, Tennessee.

LEATHERCRAFT—The quick, easy way to make extra money. No tools or experience needed with Larson easy-to-assemble beginners kits. Free illustrated instructions included. In minutes, you'll be making belts, billfolds, handbags, gloves, moccasins, woolskin animals, etc. Amaze yourself and friends with your new skill as a leather craftsman! Send 10c today for big new illustrated catalog of ideas, kits, materials and supplies. Act now! J. C. Larson Co., 820 S. Tripp, Dept. 4650, Chicago 24.

BEAUTIFUL Nativity scene. Almost life size patterns of Mary, Christ Child, Joseph, Wisemen, etc. No tracing, just paste, cut out and paint. Plans for stable also included. Only \$2.00. Mastercraft, 118M, 7041 Olcott, Chicago 31, Illinois.

FREE Artcraft catalog. Designs imprinted brass, copper, aluminum for metal pictures; burnt wood etchings; glorified glass, mirrors; pre-sketched paintings. Profitable art hobbies. Dept. PM, Thayer & Chandler, 910 W. VanBuren, Chicago 7, Illinois.

WOODWORKING Course for home craftsmen. Twenty-two manuals. Over 1,000 pages. 73 training projects. Only complete home training program available today. Carefully written, profusely illustrated. Covers everything from wood selection to final finishing. Complete instruction in care and use of all hand and power tools. Prepared by expert manual training instructors. Write for free booklet. Interstate Training Service, Dept. G-3-M, Portland 13, Oregon.

101 FULL Size patterns. Smart, new, gifts, novelties, lawn figures, shelves, action windmills, alphabets. Plus "Make Money Jig Sawing." Only \$1.00. Mastercraft 115M, 7041 Olcott, Chicago 31, Ill.

WEDGES Wooden repair furniture, hand tools, assortment 25c. Wedges, Centerville, Indiana.

16 NEW Lawn chairs, 22 picnic tables, benches, trellises, etc. All 38 plans with necessary full size patterns. \$1.00. Mastercraft 113M, 7041 Olcott, Chicago 31, Ill.

HEATING. Do it yourself. Heat loss, installation plan, specifications, furnace provided. Save 50%. Tomco, 4112 Muskegon, Des Moines, Iowa.

LEATHERCRAFT. Metal tooling, textile painting, beadcraft, shellcraft, many other crafts. Fun, easy, profitable! Free, big, illustrated catalog. Write today. Kit Kraft, Dept. 261, Box 1088, Studio City 1, Calif.

PLASTICS Home-craft course for men and women. Tells and shows how to make hundreds of fast selling plastics products. All plastics and materials for 23 projects included in course. No special tools needed. Course pays for itself. Write for free booklet. Interstate Training Service, Dept. D-3-M, Portland 13, Oregon.

LEATHERCRAFT. Tremendous stock of leather, tools, supplies, and kits. In leather business over forty years. Send 10c for big catalog. Sax Bros., 1111 N. 3rd, Dept. PM11, Milwaukee 3, Wisconsin.

BABY Shoe mountings. America's finest. Plated unbreakable metal and imported onyx. Bookends, ashtrays, desk sets, portrait stands. Low prices. Catalog free. Senti-Metal, 237 E. Capital, Columbus, Ohio.

BIG Full size patterns of Santa, sleigh and reindeer for roof or lawn. Complete directions for making, painting and lighting. \$1.00. Mastercraft, 116M, 7041 Olcott, Chicago 31, Ill.

BUY Wholesale nationally advertised power, hand tools, thousands other products at big discounts. Free "Wholesale Plan." American Buyers', 628-PP Linden, Buffalo 16, N. Y.

JEWELRY Findings, beads, pearls, jewels. It's profitable, fun! Imported beads, all sizes—shapes. Sample pound \$1.50; 5 pounds \$5.00. Deluxe pearls, high luster, assorted \$2.00 pound; 5 pounds \$7.50. Klondike assorted jewelry findings swept from manufacturer's tables. Parts finished and unfinished for bracelets, pins, earrings, necklaces, chains, rings, etc. Sample pound \$2.00; 5 pounds \$7.50. 1,000 jewels for rings, jewelry—all colors, sizes, \$5.00; 100 for \$1.50. For quantity users; 100 pounds, mixed lot \$75.00. No c.o.d.'s. Satisfaction guaranteed! Merchandise Distributing, 19 East 16th Street, Dept. 119, New York City 3.

EASY-To-make lifelike bird and animal models. Authentic colors supplied with complete Ply-Craft kit. Fascinating results. Also makes terrific gift. \$1.25. Helen Miller, 1441 Hemlock Ave., East Meadow, N. Y.

FREE Make-it-yourself craft catalog, low-cost kits and supplies. American Handicrafts, Box 1479-AQ, Fort Worth, Texas.

MAGAZINE Racks. Full size patterns, \$1.00. Helm Novelty, Box 296, Parker, Indiana.

MONEY From scrapwood. Patterns and instructions \$1.00. Jigsaw necessary. Lynds, Medway 9, Mass.

FREE! "Do-it-yourself" leathercraft catalog. Write Tandy Leather, Box 397AC, Tulsa, Oklahoma.

NOW, Interchangeable, sectional jig saw patterns. Lithographed, full size, ornamental, artistic shelves, brackets, novelties, signs. Kit, \$1.00. Winkler, 3167 South Thirteenth, Omaha, Nebraska.

MAKE IT YOURSELF

WOODCRAFTSMEN Genuine African mahogany, oak, walnut, birch, many imported woods pre-cut to your measurements. Write free catalog sheet. House of Wood, 3242 W. George St., Chicago 18, Ill.

CREATE-A-Craft Xmas gifts for fun and profit. Catalog 10c. Gift with order. P.O. Box 86, Richmond Hill 18, N. Y.

BUILD 10 Amazing machinist tools that can't be bought anywhere! Save \$100! Free literature. Progressive Tool Designers, 21610 So. 76th St., Milwaukee 14, Wis.

CLOCK Movements—Gorgeous dials, plans, kits. See ad page 239.

ELECTRIC Drill polishes shoes. Plans \$1.00. Research, 8304 Burley, Chicago 17.

INFLATE Balloons with lighter-than-air gas. Enjoy fascinating new hobby and unusual sport. Build your own apparatus. Send messages hundreds of miles. Use for target practice. Simple, low cost, easy-to-build. Diagrams, formula, complete instructions. Send \$1. Central Machine Works, Dept. PM, Sioux City, Iowa.

LEVEL For foundations, floors, sewers, contour plowing, any distance, based on principle that water seeks its level. Make this accurate level yourself—save time and money. 50 ft. clear tough vinyl tube .287" o.d. and complete illustrated instructions postpaid \$5.95. Moneyback guarantee. Hydrolevel, 53 DeSoto, Ocean Springs, Mississippi.

BUILD Inexpensive concrete blockmaker. Motor-hand. Also mixer. (Both for less than \$10.) Then make blocks for 5 room house for \$95. Write. C. Lee, Mountain View, Oklahoma.

CONCRETE Block homes. 32 page booklet on how to build. \$1.00. H. C. Lightfoot, Civil Engineer, Richboro 1, Penna.

WOODWORKING Supplies, glue, veneers, plywoods. Catalog free! Minnesota Woodworkers Supply, Box 233, Hopkins, Minnesota.

GEIGER Counter and metal detector kits. Inexpensive, educational. Free literature. Electronic Applications, 5024 Lee Highway, Arlington 7, Va.

MAKE IT—Do it yourself. Get chemical story on sugar, sweets and tooth decay. New brochure with know-how and easy to understand methods for better tooth and mouth cleansing. Save money and help prevent decay, discomfort and pain. Simple and easy. Free formula included. All ingredients are available at home. You'll bless the day you saw this. Money back if not satisfied. Postpaid \$1.00. J. W. Brooks, Drug, Chemical, Research Consultant, 137 No. Chatsworth Avenue, Larchmont, New York.

DO IT yourself kit. Knife with one blade and five interchangeable tools. Awl, file, chisel, screwdriver, can opener and cap lifter in billfold size Vinylite case. Handy for sportsmen. Ideal gift. \$2.00 postpaid. No c.o.d. Satisfaction guaranteed. Free circular. Earl B. King, 611 S. Pickwick, Springfield 4, Mo.

BUILD Streamlined plywood kitchen cabinets. Plans, photos, instructions, \$1.00. Playnecabinets, 4617 Johnson, Western Springs, Illinois.

WHY Rent? Build this low cost home! Concrete blocks, beam ceiling. Architect's plans, instructions \$1.00. Budget Homes, 414 Radio Building, Wichita Falls, Texas.

PLANS! Build any size garden tractor. Write Allardco, Eland, Wisconsin.

KITS—Miniature grandfather's clock, etc. Leaflet 10c. Hill, 7224 Favor, Oakland, California.

3 PIECES 3/4" Plywood 10x20, ideal for home workshop use, \$1.50 per package prepaid. Wallace Furniture Inc., Jenkinsburg, Ga.

BUILD 3 Bedroom home \$276.00. Details, plans, pictures 50c. Buildit, Box 322, Arkansas City 1, Kans.

FURNITURE—Wrought iron legs and frames! You assemble. Free catalogue. Phillips Furniture, East Peoria 8, Illinois.

WATCHES, OLD GOLD, JEWELRY

WATCH And clock repairing books for hobbyists. Free information. North American, Dept. 14-K, 2320 N. Milwaukee, Chicago 47, Illinois.

WATCHMAKERS' Tools, materials, supplies, watches. Catalog. Gales, Box 1000, Chicago 90, Ill.

AMATEUR—Professional watchmakers' supplies; correspondence instruction; repairing. Bengale Co., Culver City, Calif.

AMERICAN Manufactured watches 30% to 60% discount. Includes postage, taxes, insurance. Free circulars. Richmond Enterprises, Box 1003, Augusta, Georgia.

RHINESTONES, Jewelry settings, cameos, sequins, beads, hobby kits. Catalog free. J & M Novelties, Dept. CM-3, Griffith, Indiana.

NEW Men's Benrus wrist watches. Retail \$71.50. Selling out \$49.50. Factory guarantee. Leese, 438 South Franklin, Hanover, Penna.

JEWELRY, Top brands, 50% off. Roberts, Box 825, Minneapolis, Minnesota.

WATCHMAKERS' Beginners! Watches, Movements. Descriptive list. Box 150, Chicago 90, Illinois.

WATCHES Overhauled \$4.50. One year's guarantee. Berkowitz, 1150 Castlehill, New York 62.

ANY Watch repaired \$4.00! Eighteen months guarantee. Von Steuben Time, 318 Sinclair Bldg., Steubenville, Ohio.

HIGHEST Prices for gold, silver, platinum, diamonds, watches, gold teeth. Satisfaction assured. Goods returned if offer unsatisfactory. United Smelting Works (Old Reliable), 6-B East Monroe, Chicago 2.

HIGHEST Cash for old gold, broken jewelry, gold teeth, watches, diamonds, silverware, spectacles, platinum. Free information. Satisfaction guaranteed. Rose Refiners, Heyworth Bldg., Chicago 2.

WATCH Materials: I specialize in close outs. Write Fred Harmon, Box 441, Somerset, Ky.

COSTUME Jewelry supplies. Catalog and samples. 35c. Largest line in America. Milady-Fair Co., G.P.O. Box 1328, New York City 1.

MAKE Rhinestone jewelry—No tools needed. Huge profits. Catalog, instructions, sample pin, stones, and color chart of actual rhinestones 50c. Refundable. Bergen Arts, 128M Main, Hackensack, N. J.

FREE Sample pair of earrings shows you how easy it is to make beautiful costume jewelry. Over 5000 styles listed in new catalog, 25c. Barry's, 188 Ardsley Court, Newark, N. J.

UNREDEEMED Diamond, 1-carat, \$295. 30-day refund. Free catalog. Broff's Diamond Loan Association, 411 Smithfield, Pittsburgh, Penna.

TOBACCO, SMOKERS' SUPPLIES

PIPE Smokers! Cigar smokers! Free illustrated catalog offers fabulous savings on choice imported and domestic pipes, cigars, tobaccos, supplies. Write Wally Frank, Dept. 1, 150 Nassau St., New York 38, N. Y.

RAZORS, BLADES, SHARPENING

GET 30 Shaves one blade. Blade Master keeps double edge blades sharp. Ideal gift for service man. Descriptive sheet free. Delano, 31 E. 18th Ave., Denver 2, Colo.

GUARANTEED. 100 Double or single edge blades \$1.00. Pittel, 4640 Jackson, Chicago 44, Illinois.

ELECTRIC Dry shaver guaranteed one year with carrying case, limited offer \$9.95, 1/3 with order, balance c.o.d. Douglas Co., 2905 N. 17 Street, Milwaukee, Wisconsin.

FOR THE HOME

FOAM Rubber furniture cushions. Factory seconds. 50% discount. Free catalog. Perma-Foam, 140-C Main Street, East Orange, New Jersey.

DOORMACK (Pat. applied for) never sold before. Makes your storm door close three times easier by releasing the air that is compressed between the two doors. Also serves as mail door. The perfect gift for the one who has everything. \$4.25. F. W. Cleereman, Newald, Wis.

AUTOMATIC Fire alarm system! Write, Di Medio, 1748 Jarvis Avenue, New York 61.

GUARANTEED Cold wrought iron railing, furniture instructions \$2.00. Clevenger's, Box 1001, Santa Rosa, Calif.

OF INTEREST TO WOMEN

BEAUTIFUL Ribbon remnants, 100 yards, \$1.00. Dollar Doll Club, free information. Peggy's Doll House, Jefferson City 3, Missouri.

PROFITABLE Home business. Make fast-seller chenille monkey trees, dolls, flowers. Terrific holiday demand. Information free. Velva, Bohemia 16, N. Y.

NYLONS 14c. Anklets 6c. socks 9c. print 17c. panties 12c. dresses 50c. slips 47c. undershirts 17c. robes \$1.65. aprons \$2.65. jewelry \$1.25. watches \$3.50. electric razors \$2.00. aspirin \$1.00-1.000. brushes 9c. razor blades 1 1/2c. pens 8c. combs 1 1/2c. Complete stock list, picture catalogue, 25c. Send immediately. Sibert's, Chattanooga 4, Tennessee.

DRESSES, 24c; Shoes 39c; men's suits, \$4.95; trousers, \$1.20. Better used clothing. Free cat. Transworld, 164-AD Christopher, Brooklyn 12, N. Y.

GROW Mushrooms. Cellar, shed, and outdoors. Spare, full time, year round. We pay \$3.50 lb. We paid Babbitt \$4,165.00 in few weeks. Free book, Washington Mushroom Ind., Dept. 175, 2954 Admiral Way, Seattle, Washington.

GOOD Money in weaving. Weave rugs at home for neighbors on \$69.50 Union Loom. Thousands doing it. Booklet free. Union Looms, 153 Post St., Boonville, N. Y.

STRANGE "Dry" window cleaner. Sells like wild. Replaces messy rags, liquids. Simply glide over glass. Samples sent on trial. Kristee 106, Akron, Ohio.

MAGNEPAD—Handy magnetic pot holder stays put; ideal Christmas gift. Sample 35c. information free. Swanson, 3418 East 8th, Kansas City 24, Missouri.

SEWING Supplies wholesale. List, samples, 25c. Refunded first order. Button Shop, Dept. D, 717 W. Roosevelt, Chicago 7, Illinois.

BUTTONHOLE Maker. Fits any sewing machine. Send \$1.00. L. Dentel, Willis, Michigan.

MAKE Big money at home! Invisible reweaving pays up to \$10.00 profit in an hour. Make tears, holes disappear from fabrics. Constant demand from laundries, cleaners, homes brings steady earnings. Details free. Fabricon, Dept. C, 8342 S. Prairie, Chicago 19, Illinois.

FOR SALE—MISCELLANEOUS

OLD Wall telephones. Working order, oak cabinets, hand crank for ringing. \$5.00 each. Telephone Co., Turtle Lake, Wis.

HEARING Aid batteries, wholesale. Free list, Habs, Box 51, York, Penna.

EXPENSIVE 100-Dollar Swiss watches direct from importer for \$30 to \$40. Bachman-Watches, 5120 Randall Ave., Montreal 29.

BANDERA, Texas ranch. One square foot, minerals. Genuine deed in your name. \$1.00. Hilco, Box 71, Kerrville, Texas.

WANTED—MISCELLANEOUS

QUICKSILVER, Sterling, silver solders, precious metals. Wholesale Terminal, Norwood, Massachusetts.

SCRAP Mercury (quicksilver) containers supplied—Tantalum, bismuth, tungsten. Metallurgical Products Company, Established 1909, 35th and Moore Sts., Philadelphia 45, Penna.

BOOKS Wanted! Hard cash paid, J. Williams, Box 673, Hoboken, N. J.

PERSONAL

BORROW By mail from Postal Finance Co. Employed men and women can easily obtain \$50 to \$600 fast, entirely by mail. Repay in small monthly payments. Friends, relatives, employer, tradespeople will not know you are applying for loan. Advise occupation, amount wanted. Postal Finance Co., 200 Keeline Bldg., Dept. 7X, Omaha, Nebraska.

LETTERS Remailed from America's uranium capitol 20c confidential. Furr, Moab, Utah.

LETTERS Remailed 25 cents. Dallas or Ft. Worth. Personal forwarding service. Monthly rates. House of Wright, 120 Casallita Dr., Garland, Texas.

HAIRCUT Facts. Booklet 25c. Mastrolia, 32-20CB 89th Street, Jackson Heights 69, New York.

LETTERS Remailed from the southern most city in the United States. 25c. 5 for \$1.00. Earl Parker, 60 Salt Pond, Key West, Florida.

"FEMME Mimics"—Amazing book, containing 375 photographs. About men who wear women's clothing! Free literature. Winco, Dept. PM112, Box 9525, Dallas, Tex.

INTERESTED, Investigate. New York City help wanted columns air mailed to you—\$1.00. Rudge, P.O. Box 995, New York 7, N. Y.

TAMPA Or Rattlesnake postmark, letters remailed, 25c each. Local information. \$1.00. Receiving, forwarding address, \$5.00 monthly. All services confidential. Bert's Services, P.O. Box 665, Tampa 1, Fla.

LOCKSMITHS. Your card or letterhead brings the Locksmith News, 2703 E. Third Ave., Denver 6, Colorado.

LETTERS Remailed 25c. or have mailing-receiving address in Columbus for \$2.00. McLaughlin, 800 Stewart, Columbus 6, Ohio.

MEXICAN Law. General Practice Attorney, 1203 Arizona St., El Paso, Texas.

RESURRECTION On earth—Not heaven. Free! Write: Harvest, Jefferson City, Mo.

"HOW Can I find out?" You can! Information confidentially developed. Any matter, person, problem. Worldwide. Officially licensed. Established 1922. William Herman, 170 Broadway, New York City.

LETTERS Remailed 25c. Personal forwarding address. Monthly rates. Hicks Service, Box 1547, Washington 13, D. C.

MEXICAN Law office. Bank references. P.O. Box 41, Juarez, Chih., Mexico.

SEATTLE Confidential Remail letters, 25c. C. H. Bell, Box 91, Enumclaw, Wash.

PORTRAIT in oils. Modern-impressionistic, by the renowned E. John Shay, see Fate magazine advertisement for particulars. Send any photograph. \$25.00 prepaid. P. O. Box 4102, Panorama City, California.

CONFIDENTIAL Remail, letters 25c. air mail 35c. pamphlets, circulars rates available. local classifieds airmailed \$1.00. Associated Enterprises, Box 224, Rome, Ill.

HOLLYWOOD Or Pasadena postmark, letters remailed 25c. Box 552E, Pasadena, California.

LETTERS Remailed, Salt Lake, 25c. Lyman, 2234 Lincoln Lane, Murray, Utah.

PERSONAL Name plates—doors, desks. Details free. Advance Products, 31 Radium Street, Pittsburgh 14, Penna.

LETTERS Remailed San Francisco postmark, 25c. Private receiving-forwarding address available. Monthly rates. Memo-Mart, Box 3244, San Francisco 19, Calif.

HOLLYWOOD Remails 25c. Five scenic postcards \$1.00. Confidential receiving-forwarding address. Monthly rates. Any business transacted. California Mailing Service, Box 968, Hollywood 28, California.

LETTERS Remailed 25c each. Confidential. Ace Service, Box 186, Tampa 1, Fla.

LOS Angeles help wanted columns large Sunday editions air-mailed \$1.00. Corbet, 385 Walnut Ave., Long Beach, California.

PRACTICING Psychologist, author, will accept limited number of ambitious men, women for one year course of study by correspondence. Information free. Give age, occupation. Address: HSU., Box 2307NS-PM, Springfield, Missouri.

LOVELAND Remail 25c. B. A. Ogden, P.O. Box 86, Loveland, Ohio.

WORMS, Germany, remailing \$1.00. Glaser, 84 N. Clinton Ave., Trenton, N. J.

BIG Mail! Attractive offers! Magazines, etc.! 6c! Filmer, 9101 Marion, Pharr, Texas.

MISCELLANEOUS

CLOGGED Drains, cesspools and septic tanks cleaned by new powerful chemical. Sursolvent removes grease, soap, tree roots, etc., without expensive digging and electric rodding machines. No pumping necessary. Mix with water and pour down drain. Free details. Electric Drain Cleaning Co., Boston 34, Mass.

NEW! Complete instant coffee sale, with cream and sugar added. Order 1 or more cases at factory prices f.o.b. New York City. 4 oz., 35c—24 to case; 8 oz., 65c—12 to case. 25% deposit required on all orders. Balance c.o.d. Satisfaction guaranteed. Write for circular or order now. A. T. Baron's Coffee Co., 1579 First Ave., New York City.

TREE Ripened best oranges and grapefruit. From tree to you. Five dollars bushel. f.o.b. Vanderforde, RFD, Pharr, Texas.

WRITE For free information. Acreage simplest calculations. Carmean, Hutchinson, Kansas.

FREE. Gadget and home novelty catalog. 180 interesting, useful items. Economy Buyers, 210 Fifth Avenue, New York 10, New York.

"X-Ray Mind." Stupendous mental power. (Details 10c). Krishnar Institute, Box 842-S7, Escondido, Calif.

GOLD, Silver, metal detectors. Geiger counters for uranium. Mineralights. Sensational new fully guaranteed models. None finer. Information free. Detectron Corp., 5420 Vineland Ave., North Hollywood, California.

SELECTIVE Metal and mineral detector. Revolutionary design. Distinguishes metals from black magnetic sands. Readily detects metals under salt water. Also Geiger counters. Free literature. Gardiner Electronics Company, 2018 N. Dayton, Phoenix, Arizona.

RECEIVE Magazines, samples, catalogues. Mails from everywhere. Offers, hundreds. Get listed 25c. Rorick, Box 86, Cincinnati 26, Ohio.

TREASURE Finders for gold, silver and minerals. Money back guarantee, best available. Also Geiger counters for uranium prospectors, free information. Write Goldak Company, 1541 West Glenoaks, Glendale 1, Calif.

GROW Mushrooms. Cellar, shed, and outdoors. Spare, full time, year round. We pay \$3.50 lb. We paid Babbitt \$4,165.00 in few weeks. Free book, Washington Mushroom Ind., Dept. 175, 2954 Admiral Way, Seattle, Washington.

PANNING Gold—Free lesson; catalogue of mining, mineral books, supplies. Old Prospector, Box 729D1, Lodi, Calif.

TREASURE—M-Scope Geiger counters, mineral locators. Why buy something inferior when you can buy the best at a lower price? Backed by years of experience. Fully guaranteed by factory. Detects minerals, metals, gold, silver, coins. Payment plan available. Proven superior performance. Free 16 page illustrated booklet. Fisher Research Lab., Inc., Palo Alto, California.

URANIUM, Gold, silver, treasure. New power-packed, highly sensitive metal detectors and Geiger counters. Kit and factory assembled models from \$34.50. Lightest weight, guaranteed. Free literature. Electronic Applications, 5024 Lee Highway, Arlington 7, Va.

GEIGER Counter tube, gamma, fast-beta. \$7.00 postpaid. Western Radiation Lab., 1107 W. 24th Street, Los Angeles 7, California.

SHOPCOATS, Coveralls, railroad caps with your favorite emblem. Lettering available. Free price list. Southeastern Uniforms, 4108 Park Rd., Charlotte, N. C.

LEATHERCRAFT. Everything needed by beginners, advanced hobbyists and professional leatherworkers. Largest stock of supplies in U.S. Moderate-priced tooling leathers, top quality calfskins, tools, supplies, kits. Send 10c for big catalog. J. C. Larson Co., 820 S. Tripp, Dept. 4261, Chicago 24.

NEW Formula preserves natural beauty of flowers for years. Free information. Write Valentine, Mulino, Ore.

SHRUNKEN Head paperweights. Excellent duplication. \$3.00. Wallace, 614 North 6th Ave., Phoenix, Ariz.

BEAUTIFULLY Boxed exquisite Cameo set with genuine diamond. Necklace, earrings set comes with a good-as-gold written guarantee. \$19.95 value—Christmas special \$6.00! Send payment with order to Fleming's, Box 3223, St. Louis 10, Mo.

BUY Wholesale thousands nationally advertised products at big discount. Free "Wholesale Plan." American Buyers, 631-D Linden, Buffalo, N. Y.

RECEIVE Mail — Samples, magazines, catalogs, 10c. American Directory, Cal-Allen, Texas.

24 FOR \$1.00 — Imported French perfumes! Sortilage, Jealousy, Evening Paris, etc. Amazing offer! Gift catalog free. Geneva House, 670 North Michigan, Chicago 11, Illinois.

NAPIER Multiplier, pocket multiplication aid, 25c. Payne, Box 931, Indianapolis 6, Indiana.

SNOOPER Geiger counter. Only \$29.95 complete. Super-sensitive. Pocket size. Find a fortune in uranium. Order now. Send \$5.00, balance C.O.D. Money back guarantee. Free catalog, scintillator and larger uranium and metal detectors. Precision Radiation Instruments, 2235 CPM So. LaBrea, Los Angeles 16, Calif.

PHOTO Lamp shades. Scenics or your negatives. Write Conaways, Box 7261, San Antonio 10, Texas.

BARGAINS Galore! Gifts-gadgets catalogue 15c. Center Industries, Mt. Auburn, Illinois.

HOW Can I get out of debt? Stop that garnishment? Save my job? You can! Free confidential details. E. Borum, 411 West Walnut Street, Kalamazoo, Michigan.

INCREDIBLE! Become mental superman overnight! Free booklet! Bijou, Box 1727-MS, Hollywood 28, California.

LUMINOUS Reflective paints glow day and night in technicolor! New angle money maker. Assorted color samples 25c. Research, 1842-PM Byron, Chicago 13.

ZODIAC Lucky coins, for pocket, for purse. Beautifully sculptured on genuine goldline metal. Shows your lucky numbers and days, natural abilities. Zodiac lucky coins make wonderful gifts. 50c each, 3 for \$1.00. Give birthday when ordering. Agents wanted. Zodiac Mfg. Co., 1053 Lawrence, Chicago 40.

GERMAN Manufacturer directory! 800 pages. English-Spanish index. \$9.00 postpaid insured. Burke Associates, Manchester, Mass.

SAVE Cash. Swappers read Hoboswap. Rush quarter. Traders, Alger, Mich.

IMPERATIVE! Indispensable! Facts you should know about success and money. Free. write Applied Christian Psychology, Box 1924-M, Louisville 1, Ky.

FREE "Import News Bulletin." gift items. Box 7187H, San Diego 7, Calif.

GEIGERS, Scintillators, several lines new and used, first rental plan catalogues. U.S. wall map uranium deposits postpaid \$1.25. Micromatic Associates, 2322 W. Whittier Blvd., Montebello, California.

RAIN Gauge \$1.00, 3 year chart free. Ablek, 1075 Third Avenue, New York City.

I Average \$125 weekly selling books by mail! So can you! Start sparetime! Work home! Cooper, 248 Taunton, Buffalo, N. Y.

WHOLESALE! 8000 Nationally famous products. 30-80% discounts! Large catalog. Sensational business plans included. Consolidated Distributors, 21-13 Lafayette, Paterson 15, New Jersey.

CIGARETTES—Roll 200 guaranteed to please for 75c. Particulars free. Pete Moberly, Box 782, Owensboro, Ky.

FREE Catalog science, educational materials. World Adventure, D242, Ann Arbor, Michigan.

HEY! Look at this. 3 lbs. delicious roasted coffee sent postpaid \$2.50. No limit. Discounts on larger orders. Hitchcock, Box 113, Olive View, Calif.

New World Adventure Catalog FREE

Things of interest to students, explorers, experimenters, travelers, readers, and those who want to know more about the world around them. Get more fun and adventure from life. For those with intellectual curiosity. Catalog of articles, films, kits, records, educational materials, sets, guides, directories and books. Also helps for vocational guidance, personality aids, intelligence & aptitude tests, consumer buying help, etc. Includes science kits, display sets, nature specimens, travel guides, pictorial wall charts, maps, language records, bird song records, outline guides to almost every subject, experimental sets, unusual records & music helps, models of pre-historic animals, star globes, list of low-priced non-fiction paper covered books, etc., etc. Send name & address with stamp or coin for postage.

WORLD OF ADVENTURE, Dept. 114, Ann Arbor, Michigan

RUPTURED

BE FREE FROM TRUSS SLAVERY

NOW there is a new modern Non-Surgical treatment that permanently corrects rupture. These Non-Surgical treatments are so certain, that a Lifetime Certificate of Assurance is given. Write today for our New FREE Book that gives facts that may save you painful and expensive surgery, and tells how non-surgically you may again work, live, play and love and enjoy life in the manner you desire. There is no obligation. Excelsior Hernia Clinic Dept. 8305 Excelsior Springs, Mo.

Say You Saw It in Popular Mechanics

FREE DO-IT-YOURSELF LEATHERCRAFT CATALOG

THE NATION'S LEADER IN LEATHERCRAFT
TANDY LEATHER CO., BOX 791-LY FT. WORTH, TEX.

NO If They Answer "NO," You Can Make a Sale!

Ask the first 10 . . . or 20 . . . or 50 people (householders, farmers, businessmen) that you meet: "Do you own a personal safe?" 90% will answer "No." Yet every one has valuables and papers that need fire and theft protection. Only SENTRY has what it takes to capture that market—quality, appearance, and a price that opens every pocketbook, yet gives you a healthy profit. Choice, exclusive territories. Drop shipment if desired. Send for full details.



Write to Dept. PM-11, giving address, including county.

BRUSH-PUNNETT CO.
545 WEST AVE., ROCHESTER 11, N. Y.

DO IT YOURSELF KIT FOAM RUBBER SOFA BED \$160 Val. \$59.95

Save over \$100. Sofa by day—single bed by night. Easy assembly; 6' 3" long. "No Sag" springs. Goodyear 4 1/2" Air Foam mattress. Pressure covering. Tan, Gray, Green, Red. Money back guar. Order now. \$10 deposit. Bal. C.O.D. Or write for literature.
BESTCRAFT CO., Dept. 87
Mathieson Bldg., Balto. 2, Md.



Be Independent!

"The World's Best Motorcycle"

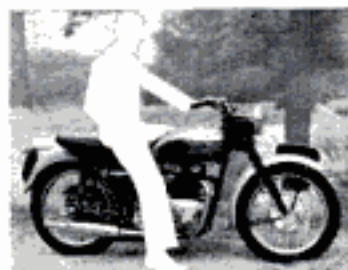

WRITE for FREE catalog and name of Triumph dealer nearest you. Dept. P.

Put YOURSELF on a TRIUMPH

NEW! Unlike clumsy, heavy types. Has no "junk" or useless accessories. Is functional and all motorcycle from head to foot. Beautifully engineered. Triumphs are leading America's trend to two-wheeled transportation. Used by air line pilots, sportsmen, policemen, farmers, business men, service men, etc. Solves traffic problems—easy to ride, safe, maneuverable.

TWELVE MODELS from
\$449.00

West
JOHNSON MOTORS, INC.
267 W. Colorado St.
Pasadena 1, Calif.

TRIUMPH

- "jet wing" double seat
- sparkling colors, with chrome finish
- front and rear springing
- gear position indicator

East
THE TRIUMPH CORPORATION
1727 E. Joppa Rd.
Towson, Baltimore 4, Md.

THIS 39½¢ STORM WINDOW

protects your family all winter!

INSTALL IN 5 MINUTES

SAVE \$100 OR MORE!

JUST PRESS ON—That's All!

• NO NAILS • NO HOOKS • NO SCREWS • NO TOOLS

Imagine a storm window that weighs less than 8 oz.—yet seals out wintry blasts and humidity like magic! **FLEXIBLE**—you can punch it, kick it, even tap it with a hammer and it springs back—never shatters! This amazing new type storm window is as **TRANSPARENT** as **CLEAR GLASS**! Not affected by snow, sleet, rain, dampness, because it is **100% WATERPROOF**.

LOW-COST HEALTH PROTECTION!



You can hardly see this **TRANS-KLEER** storm window—it's wonderfully transparent, yet it protects your loved ones from winter's frigid blasts. And each window costs only 39½ cents each!

Resists climate changes—won't crack even at 25 degrees **BELOW** zero! Will pass any and all Fire Department tests! To install, just press on with dual-purpose Adheso border—no nails, no screws, hooks or tools. Costs you only pennies, yet you can use and re-use it year after year for winter protection and comfort!



TRY ONE AT OUR RISK!

Over 1,000,000 of these new type storm windows were sold last winter alone. We invite you to try one, too, entirely at **OUR RISK**—no obligation whatsoever for you! When you're **TESTED** it—when you see how easily and quickly it goes on, you'll never again use the heavy, bulky, old fashioned kind! No more backbreaking installation! No more broken glass! It's a new, safe, sure way to winter comfort—for only pennies per window. **TRANS-KLEER** comes in rolls 36 inches by 432 inches—**ENOUGH FOR 10 AVERAGE SIZE WINDOWS, AT ONLY 3.95—HARDLY 39½¢ EACH!** In all, you receive **108 SQUARE FEET!**

PROVE IT YOURSELF WITH THIS SIMPLE MATCH TEST!

Try this: on a windy day, hold a lit match just inside a **CLOSED** window. The first strong gust of wind will blow it out. **NOW** put up a **TRANS-KLEER** window . . . you'll find that a lit match will **NOT** blow out **EVEN IF YOU KEEP YOUR REGULAR WINDOW OPEN!** No wonder so many have been sold! No wonder so many home owners, hospitals, farmers, buildings and churches are switching to **TRANS-KLEER!** To avoid disappointment, rush your order **NOW**—while our supply lasts! **SEND NO MONEY.** Simply fill in coupon and mail at once. Pay postman only **3.95** plus a few cents postage. Try a window for 5 days—test it. If not delighted, return the other 9 for **FULL REFUND.** **SPECIAL OFFER FOR BULK BUYERS: 6.90 for 2 full rolls (216 sq. ft.); 18.00 for 6 rolls; 34.00 for 12 rolls. ACT NOW!** Mail the coupon **TODAY!** (**CANADIANS:** avoid tariff. Send direct to Thoresen Co., Dept. 6-M-47, 45 St. James St. W., Montreal 1, P.Q.)

▲ Lift Adheso Border For Airing!

So simple! So quick! Just lift border for airing of rooms. Just **ANOTHER** feature of **TRANS-KLEER** windows—usually **NOT** found in others!

5 WAYS BETTER!

1. Glasslike transparency. Not milky or cloudy.
2. Low conductivity—new Reynalon development.
3. Waterproof and Fire Retardant.
4. Climate resistant—even at 25 below zero.
5. Re-usable year after year.

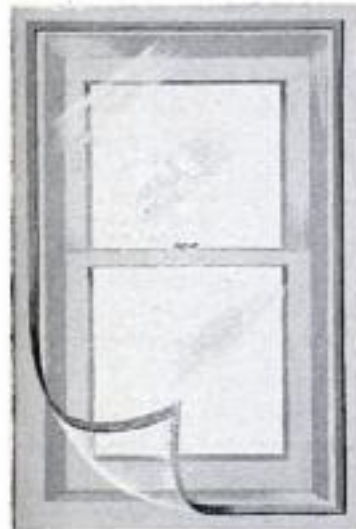

THORESEN'S, Dept. 6-M-47
352 Fourth Ave., New York 10, N. Y.

RUSH _____ rolls **TRANS-KLEER** at **3.95** each. (2 rolls—**6.90**; 6 rolls—**18.00**; 12 rolls—**34.00**). I understand one roll is enough for 10 windows, or 108 sq. ft. I will pay cost plus postage on arrival. I will try one **FREE**. If not delighted, I will return 9 remaining windows for full refund within 5 days. Include Adheso borders at no extra cost.

Name _____

Address _____

City _____

• **SAVE POSTAGE** by sending payment with order. In that case, we pay **ALL POSTAGE** to your door. Same money-back guarantee.



5 TO 12 EXTRA

Miles per gallon

SAVES \$200.00 A YEAR

A million happy users, many reporting 30% increase in gas mileage. AIR-JET automatically rations proper amount of gas and air to engine. Wrong carburetor mixture increases gas consumption. AIR-JET replaces carburetor's present idling screw—installed in 5 minutes . . . no tools needed.

MUST WORK OR MONEY REFUNDED

Don't take our word for it . . . prove it yourself. Test AIR-JET 10 days. If you don't get better mileage, easier starting, faster pickup, return the little sticker to us, we'll refund your money. AIR-JET must work, or it costs you nothing. Fair enough?

IMPORTANT: HOW TO ORDER
Send name, address, make of car, year; make, model number of carburetor (if known). Enclose \$2.00 for each AIR-JET. (8 cylinder car requires two, 6 cylinder, one AIR-JET). Sorry, no C.O.D.'s.

AUTOMOTIVE RESEARCH, Box 1001, Milwaukee, Wis.



New!

for only **\$32.95**
\$25.95 west of Rockies

ALL YOU WANT IN 12 ga. REPEATING SHOTGUN

C-LECT-CHOKE changes pattern instantly—cushion rubber recoil pad—ventilated barrel—thumb-operated safety. Other 3-shot Mossberg C-LECT-CHOKE repeaters in 16, 20 and 410 gauges. See them at your Mossberg dealer's.

O. F. MOSSBERG & SONS, INC. *Send for illustrated folder*
49711 St. John St., New Haven 5, Conn.

FREE BOAT KIT CATALOG

12 ft. Runabout Pictured.

- Assemble your own boat
- No experience necessary
- Save 1/2 to 2/3 "factory built" prices
- Prices include freight and paint

8' to 14' Models from \$39.25



Marine Hardware, Fiberglass & Trailers

LUGER INDUSTRIES Kit Division 3207 FREMONT AVE. SO. MINNEAPOLIS 8, MINN.



GROW MINIATURE TREES

Grow authentic, LIVE dwarf trees! Fascinating hobby! Fabulous profit!

SEND FOR FREE SEED & INSTRUCTIONS!

MINIATURE NURSERY CLUB

Dept. J-11, Box 8794, Los Angeles 8, Calif.

HELPFUL BOOKS

Send post card asking for **FREE** catalog

Popular Mechanics Press, 200 E. Ontario, Dept. 601, Chicago 11

NOW! USE YOUR WILLYS OR DODGE AS BOTH A 2 and 4 WHEEL DRIVE



Enjoy 2-wheel drive pep, speed, extra mileage, performance—keep 4-wheel drive power and traction with WARN HUBS. Change 4-wheel to 2-wheel or back in seconds with fingertip control. Front end assembly stands still in 2-wheel drive—ends drag, stops shimmy, cuts front tire wear, increases gas mileage to 4 m.p.g. For Willys \$69.00, Dodge \$74.00 pr.; also Standard Hub for Willys \$20.00, Dodge \$23.00, Land Rover \$24.00 pr.; Automatic Hub for Willys \$120.00 pr., all incl. Money back guarantee. Dealers or direct. Write for folder.

WARN MFG. CO., RIVERTON Box 6064-A3, Seattle 88, Wash.

Koenig ALL-STEEL CABS for JEEPS

SAFETY FOR PASSENGERS AND CARGO

- ★ PROTECTION—from weather and burglary.
- ★ SAFETY—All-steel, welded construction. No rivets. Safety glass used throughout.
- ★ COMFORT—Full air-spaced head lining and door lining. No vibration.
- ★ CONVENIENCE—Roll-down windows, full opening. Available in full cabs (cover entire body), and half-cabs (cover front passenger compartment).



KING POWER WINCHES

For all Willys Jeeps, 4 W. D. Trucks and 4 W. D. Station Wagons, and all other make trucks.

Gets you out of mud, sand, snow—out of ditches or gullies, and up hills. Moves machinery, logs and heavy objects. Makes hoisting or clearing jobs easier, safer.

KOENIG CABS and KING WINCHES available through KAISER-WILLYS Distributors and Dealers.

KING GALVANIZED HAND WINCHES

Tested over 1000 lbs. Capacity 100' 1/4" cable. All-steel construction with bronze bearings. Mounts horizontally or vertically. Right or left hand. Adjustable handle lever. Positive ratchet, either direction.

Koenig *Free*

Write for descriptive literature.

IRON WORKS

Dept. M. 2214 Washington Ave.

HOUSTON 10, TEXAS

FREE 1955 WORLD RADIO LABORATORIES

"The World's Largest Distributor of Amateur Radio Transmitting Equipment."

Jam packed with bargains—everything in Radio, TV, and Hi-Fi—for Handyman, Ham, Experimenter or Serviceman!

- Pay Only 10% Down
- Easy Terms
- Liberal Trade-Ins
- Save Over 50% on Used Equipment
- Over 600 guaranteed reconditioned items.



WORLD RADIO LABORATORIES
3415 W. Broadway—Council Bluffs, Iowa

Leo I. Meyerson

PERSONALIZED SERVICE

MAIL HANDY COUPON

WORLD RADIO LABORATORIES, INC. Dept. PM-11
3415 W. Broadway—Council Bluffs, Iowa 3'x4' U.S.

Free 1955 Catalog Used Eq't List Radio Map 25c

NAME _____

ADDRESS _____

CITY _____ STATE _____

Build it Yourself! Furniture • Furnishings • Work Benches • Children's Toys • Shelves • Boat • Cupola • Weathervane • With

Popular Mechanics
NEW

FULL SIZE PATTERNS

Authentic Designs by Professional Designer
Trace Patterns on Wood and Follow Simple Guides
Every Step Made Easy for Building at Home.

Now you can make modern furniture, a fine work bench, toys for the children, fancy shelves, even a 12-foot motor boat and other things you want and need. But best of all, you can save money and turn out articles with that sought-after professional look. Popular Mechanics presents the first group of many new full size patterns for home craftsmen. They are the designs of John Bergen, noted furniture designer, working with the craft editors of Popular Mechanics—the big name in home shop and craft projects.

So easy to use, these full size patterns make play of most wood-working jobs.



Modern Step Table

No. 104. New and original design to match cocktail table Number 103. 28 x 18 inches. Upper step 24 inches high. A modern and stylish addition to any living room. 1 pattern. 50 cents



Decorative Wall Shelves

No. 110. Two attractive, distinctive wall shelves you can build to beautify your home. You can choose either modern or traditional styling. Modern shelf with metal trim is 28 x 16 x 8 inches. Traditional design is 29 1/2 x 16 x 8 inches and includes attractive fret work. Drawers can be eliminated if desired. 2 shelves in one pattern. 50 cents



Modern Cocktail Table

No. 103. Beautiful new and original design with plank top and metal grill inserts in sides. 40 x 19 inches. 15 1/2 inches high. Fun to make and a joy to own. 1 pattern. 50 cents



Modern Tub Chair

TV Chair



No. 112. A real all-out lounging chair in attractive modern design. Seat is 22 inches deep, 24 inches wide. Overall, 28 x 27 inches. 27 inches high. Simple foam rubber upholstery over Sagless type wire springs. Your choice of cover. 2 plans. \$1.00



Personal Work Bench

No. 108. Here's a compact, sturdy workbench designed to stand up under frequent use and provide a maximum amount of work space in a small area. Top is 44 x 20 inches. 35 inches high. Drawer and sliding doors. Completely enclosed, it provides a large amount of storage space for tools, materials, etc. 2 patterns. \$1.00

Juvenile Chest Robe



No. 106. A good-to-look-at and convenient-to-use wardrobe for the little folks room. 30 inches wide. 16 inches deep. 39 inches high. Has two drawers, shelf and hanging storage space. Cabinet and drawer construction simplified. 2 patterns. \$1.00

No. 111. Beauty and comfort are well combined in this TV Chair. Seat 22 inches deep, 24 inches wide. Overall, 27 1/2 x 32 1/2 inches. 26 1/2 inches high. Uses simple Sagless type wire springs. Instructions included for easy-to-do upholstery with new foam rubber method. 2 patterns. \$1.00



Trundle Beds

No. 102. Space-saving, safer beds for young people. No ladder to climb. Easier to make up. One bed tucks away under the other. Size 90 x 45 1/2 inches. Top bed 40 inches high. Lower bed 23 inches high. Storage cabinet in head. Springs included in patterns. Uses standard size mattress. 3 patterns in set. \$1.50

A Genuine Professional-Like Job With Any Pattern You Choose

FULL PURCHASE PRICE REFUNDED ON ANY PATTERN THAT DOES NOT PLEASE YOU

Each pattern lists the materials needed and shows you what type and size of lumber to choose. Then you lay the patterns on this lumber, trace, saw, smooth edges and put the pieces together. It's as easy as that, for every nail, screw, bolt, dowel and joint to be glued, is located for you on the pattern. You can't go wrong. You can't make a mistake.

If you can use a hammer and a saw and other simple tools, you can do a genuine professional-like job with any pattern you choose. What's more you'll get a lot of fun and personal satisfaction making good-to-look-at and useful things and save more money than you spend.



Love Seat

No. 114. Beautify your home with this smartly designed, comfortable love seat. A truly fine piece of furniture you can be proud to own. Modernized Lawson style goes well with either modern or traditional furnishings. 48 inches between arms. 21 inches deep. Overall, 55½ x 29 inches. Upholstery is new Sagless type wire springs with foam rubber padding. Your choice of covering material. 3 patterns in set. **\$1.50**

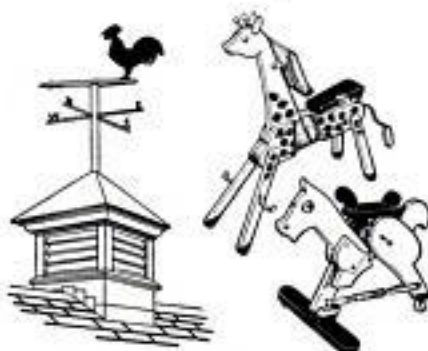

Cupola and Weathervane

No. 107. Design and style that invites use on home in town, on farm, or on garage or other smaller building. Cupola is 24 x 24 inches. 34 inches high plus height of weathervane, which can be made of metal or tempered hardboard. 1 pattern. **50 cents**



Sofa Bed

No. 113. A full size sofa by day and a comfortable bed for one by night. Sagless type wire springs built-in. Uses standard size 4½ inch, foam rubber or other mattress. Removable bolster. Overall size 78¼ x 29¼ inches. Height 33 inches. 3 patterns in set. **\$1.50**



Valances and Trims

No. 109. Add charm and beauty to your home quickly and inexpensively with these drapery valance designs and other attractive designs for interior use around windows, cabinets, between wall cabinets in kitchen, etc. and for exterior use on porches, gables, etc. Merely trace patterns on the wood, saw to traced lines and then assemble. Finishing suggestions are included. Adjustable for various widths and lengths. 12 designs on 1 pattern. **50 cents**

Toys for the Children

No. 105. The "Giraffe Drawing Board" with board mounted on the long neck and adjustable seat. "Bucking Bronco" the riding toy with delightful action. Patterns include assembly instructions and painting suggestions. Both on one pattern. Build these for your children today. **50 cents**

Order by Number or Use the Coupon

Select from this listing of the first 14 sets of Popular Mechanics full size patterns. Every article shown has actually been built from one of the patterns. Every pattern has been proven for design, correct fit of parts and construction details and is guaranteed to please you or the full purchase price will be refunded. Order on handy coupon.

Order Blank for Popular Mechanics Patterns

Popular Mechanics Press • 200 E. Ontario St. • Chicago 11

Send at once, Popular Mechanics Full Size Patterns as indicated below. Remittance for \$_____ enclosed. Send postpaid. I understand that any pattern which does not please me may be returned within 7 days for full refund of purchase price.

___Crusette, Utility Outboard (101)	\$2.00	___Personal Work Bench (108)	\$1.00
___Trundle Beds (102)	1.50	___Valances and Trims (109)	50c
___Modern Cocktail Table (103)	50c	___Decorative Wall Shelves (110)	50c
___Modern Step Table (104)	50c	___TV Chair (111)	1.00
___Toys for Children (105)	50c	___Modern Tub Chair (112)	1.00
___Juvenile Chest Robe (106)	1.00	___Sofa Bed (113)	1.50
___Cupola and Weathervane (107)	50c	___Love Seat (114)	1.50



CRUSETTE

12 Foot Utility Outboard

No. 101. Build this sturdy 12-foot utility outboard at amazing savings using only ordinary hand tools. Previous experience is not necessary. A fine seaworthy craft, ideal for fishing, family outings and other general utility uses. Length 12 feet. Beam 4½ feet. Complete material list and step-by-step instructions included. 4 patterns in set. **\$2.00**

Name _____

Address _____

City _____ State _____

ARE YOU DRIVING *Holes* IN YOUR CAR?



A cupful of anti-freeze escaping into your engine can cause serious damage. Don't let this happen to you! Bar's Leaks, containing Rhizex, will STOP WATER LOSS AND DANGEROUS ANTI-FREEZE SEEPAGE!

Bar's Leaks contains tiny soft particles which fill any minute holes or cracks and anneal in the heat of the engine, thus forming a permanent seal. A combination of oil and fine non-abrasive particles, resists rust chemically and inhibits scale mechanically. Bar's Leaks scrubs away damaging deposits and maintains a stable lubricative coolant which prolongs the life of your water pump.

Your car needs a Bar's Leaks PREVENTATIVE MAINTENANCE TREATMENT every 5000 miles.

Approved and used by world's largest automobile manufacturers

\$1.00 IN U.S.A. and CANADA

FREE: Write for new brochure, "Truth and Consequences"

BAR'S LEAKS

BAR'S PRODUCTS SUPPLY, INC.
5871 S. Telegraph Rd., Dearborn, Mich.

AT LAST! SIMPLIFIED TRIGONOMETRY NO SQUARE ROOT—38 LESS FORMULAS

Color diagrams clarify, by separating known and unknown dimensions. Eight triangle sides named. Pocket size plastic dial chart. \$1.00 plus 3c stamp. No C.O.D.'s. TRIG-AID SALES, Dept. PM-11, 4133 Marwick, Long Beach 8, Calif.



The MODERN
SAFE
FIRE
EXTINGUISHER

2 for
\$3.00
POSTPAID

STOP FIRES!

AMAZINGLY SIMPLE, EASY TO USE!
X-Fire Extinguisher puts out fires scientifically by blowing a cloud of dry chemical into the flame, producing carbon dioxide which smothers fire instantly, before it has a chance to spread. For use on any small fire in your home, car or garage. Safe to use by anyone, anywhere. Comes in a handy squeeze plastic container 6 inches high. Instructions included. Help save your worldly possessions for the small investment of \$3.00 for two Fire Extinguishers, or \$5.00 for four. Laboratory tested. Order today—we pay the postage. No C. O. D.'s.

NEW IDEAS, INC., DEPT. 404
300 N. Jefferson St., Chicago 6, Illinois

find URANIUM with ATOMS



Gun Type

SCINTILLATION COUNTERS
100-times more sensitive than a Geiger Counter. Currently used by Atomic Energy Commission for Uranium prospecting. Excellent for airborne, mobile or foot prospecting. From \$299.50 up.



Prospector

\$84.50

The "PROSPECTOR", Model GC-238—a portable, light (2 1/2 lbs.) ultra-sensitive Geiger Counter for radio-active ore prospecting. The first to utilize a patented Printed Circuit. Uses low voltage batteries. 3 methods of indication—flashing neon light, earphone & meter with 3 ranges of sensitivity. \$84.50 complete. RADIAC CO., INC., 489 Fifth Ave., Dept. PM-11, N.Y. 17, N.Y.



BIG
REPEAT
PROFITS

FREE OPPORTUNITY BOOK

- Have a business of your own! Make \$100.00 a week with no investment, no stock to carry.
- Thousands now earning lifetime incomes!
- Send for FREE Opportunity Book at no obligation.

HARRY COHON & SONS, Inc.
1067A Utica Ave., Brooklyn, N. Y.

"TRADE WITH THE HOUSE THAT HELPS YOU SUCCEED"

HELPFUL BOOKS

Send post card asking for FREE catalog

Popular Mechanics Press, 200 E. Ontario, Dept. 601, Chicago 11

Save on all PLUMBING JOBS

When You Build · When Making
Improvements · Repairs · Maintenance



Get
POPULAR MECHANICS
Home Plumbing
Guide



How to plan
plumbing in-
stallations, se-
lect materials
and fixtures.

How to save money on all plumbing jobs using approved methods.

Easy to Do Professional-Like Jobs
and Save Over One-Half

Get the Popular Mechanics HOME PLUMBING GUIDE. It shows how you can do every kind of plumbing job yourself and save from a few to hundreds of dollars. Covers plans, layouts, installation, maintenance and repair. Shows what materials to get and use, where to get them and how to do a proper job with approved methods. Few, other than the simplest tools are required and some of these can be rented. Don't pay high prices for work you can do yourself. Get the HOME PLUMBING GUIDE for only \$3.50. You will be amazed how jobs you thought difficult are simplified.

Clip This Ad and Mail. Money
Back if Not Pleased

Invest only \$3.50. Use the book for 7 days. Then if you are not satisfied return it for full refund of your money. Sent C.O.D. (U.S.A. only) if you prefer.

- 15 Ways to Save Money
All about modern home plumbing
How to use plumbing tools
Getting acquainted with pipe
Planning home plumbing systems
Installing and maintaining home drainage systems
Private sewage disposal systems
Causes and cures of drainage troubles
Installing home water lines
Private water supply systems
Water Heaters
Water Conditioning
Water system troubles and cures
Installing and caring for fixtures
What to do with valves and faucets

Over 500
How-to-do-it
Pictures Guide You



POPULAR MECHANICS PRESS, Dept. HP6-10, 200 E. Ontario St., Chicago 11



Whatever your hobby

Model building, whittling, Indiancrafts, leather, plastics or any other creative handicraft

x-acto knives, tools & sets

designed by craftsmen and precision-made for fine craftsmanship

will help you do a better job

and get more fun and satisfaction from your hobby.

Send for 16 page booklet "Helpful Hints" on use of modeling tools—FREE.

X-acto 28 page catalog—20¢



dept. M-11

x-acto, Inc.

48-41 Van Dam Street
Long Island City 1, N. Y.

make your hands more creative with x-acto

INSTANT Dual Sighting

Enjoy better shooting with this popular new sighting combination. Scope and Foolproof (or open sight)—simultaneously used—provide the most positive sighting possible under ALL conditions.

WILLIAMS

Nothing to obscure or detract from shooter's view!

The "Foolproof" is free from knobs and other obstructions that impair shooter's vision. Internal micrometer adjustments. 28 models available. The Williams offset is mounted slightly off center and low (see above) for greater strength and easier sight alignment. Available for a wide variety of guns.

Write for free mount folder or send 25c for complete Shooter's Catalog #5.

WILLIAMS GUN SIGHT CO.

7211 Lapeer Rd., Davison 23, Michigan

Super All Channel TV RECEPTION Powerful IN ALL DIRECTIONS

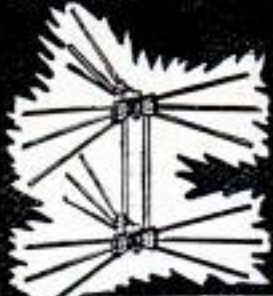

Rocket DIRECTRONIC MOTORLESS TV ANTENNA

- 360° Electronically Switched Beam
- No Motors
- No Roof
- Orientation
- No Electric Power
- No Ghosts
- Flick of Switch Clears Picture Instantly

In the city or in an ultra-fringe area, the Directronic will outperform ordinary antennas. Only the Motorless 360° Directronic TV Antenna offers "around the compass" reception WITHOUT Rotors. Clarity of picture will amaze, it's so bright, so sharply defined. AX-599 "Serviceman's Array" contains Hi-Fac molded insulator of extremely high tensile strength, 14 hi-tensile aluminum alloy elements, 1 set of connecting stubs (3), Universal U-Clamps for masts to 1 1/2", Directronic Beam Selector, 75 feet of Tri-X Cable.

Do not remit more than complete purchase price. 25% deposit on C.O.D. orders, please. Money-back guarantee.

NATIONAL ELECTRONICS OF CLEVELAND
311 DELCO BLDG. CLEVELAND 3, OHIO



FINISH TO LOOK LIKE WROUGHT IRON

Make Personalized HOUSE, LAWN Signs

18 artist designed scenes. Simply trace onto plywood and cut out—then follow special finishing directions. (Gives sign appearance of expensive wrought-iron.) 18 full size patterns plus two complete alphabets and numerals. All for \$1.00 postpaid.

WALKER STUDIO H-211, 4343 Lindell, St. Louis 8, Mo.

SAY YOU SAW IT IN POPULAR MECHANICS

SEND ME



every month so I am sure to see each new issue. Here's

- \$3.50 for 1 year
 \$8.00 for 3 years

name _____

address _____

city _____

zone _____

state _____

B-114

Hand this order to your newsdealer or send it to

POPULAR MECHANICS
200 East Ontario St. Chicago 11, Ill.

Sensational SPY Camera

Smallest in the World

Hide It in the
Palm of Your Hand
MAKE SECRET SNAPS
Only \$3.98



Exact copy of camera used by spies during World War II for making secret photographs of documents and other under-cover pictures. Not a toy—even though it's smaller than a matchbox and weighs less than 3/4 oz.! Actually a fine example of German precision craftsmanship—including a genuine German f4.5 lens. Optical view finder, 1/30 second shutter and exposure counter window make it easy to get clear, crystal-sharp pictures—8 to a roll. (Film price, 3 rolls for \$7c). Sensational value at \$3.98. Get several to give for Christmas. Order today. Immediate delivery. Guaranteed. (No C. O. D.s please, at this low price.)

AMERICAN HOMECRAFT CO. 3702 MILWAUKEE AVENUE
Dept. C-1411, CHICAGO 41, ILL.

WHAM-O SPORTSMAN

\$1.50
PER SET

35-LB.
PULL!

HITS LIKE A RIFLE—
KILLS RABBITS, SQUIRRELS.
Powerful, silent, accurate.
For hunting, target,
routing pests.
Sportsman's choice
sold world
over!



HUNTING SLINGSHOT

Heavy duty 7" ash stock.

40 steel balls, extra rubber target.

GUARANTEED. *Professional model
of Nat'l Slingshot Assn. If your sporting
goods dealer can't supply you, send \$1.50 to

Wham-O Mfg. Co. Box 61 J, Alhambra, Calif



WORLD'S LOWEST PRICED ADDING MACHINE

IDEAL FOR BUSINESS AND PERSONAL USE—GUARANTEED ACCURATE. Not a toy. Operates with only a finger flick. Adds, subtracts, multiplies, divides. Counts up to one billion. Pays for itself over and over. Ideal Gift—for Business, Income Tax and School use. MONEY BACK GUARANTEE. Send name and address. Pay postman only \$2.95 plus postage. (Send full cash if outside U.S.) Beautiful rich-looking Leatherette Case included at no extra cost. Money back in 10 days if not delighted. AGENTS WANTED.

CALCULATOR MACHINE CO., (Mfgs.)
Box 35 Glenview, Illinois

Vest Pocket Size
FREE TRIAL
\$2.95

only
TOTAL COST
SEND NO
MONEY

HELPFUL BOOKS

Send post card asking for FREE catalog

Popular Mechanics Press, 200 E. Ontario, Dept. 601, Chicago 11

FREE URANIUM ORE

SOURCE OF ATOMIC POWER

You've heard about it! You've read about it!
Now you can get it! FREE!

Uranium may be in your back yard. Tremendous rewards for you from Uncle Sam. To help recognize it when you see it, a sample rock containing Uranium and full details will be sent to you absolutely FREE.

Write to: OURAY URANIUM MINES, Box 847, Ojus, Fla.

To cover cost of handling and postage enclose 25c in coin.

MAKE IT YOURSELF... PLATFORM ROCKER FOR KIDDIES

Perfect for Christmas Gifts! Kit is complete including Duran upholstery, belts, dowels, etc. This is a genuine 12.95 retailer. Send check or money order... satisfaction guaranteed. Matching Ottoman 1.00 more.

\$6.75
Postpaid



CARPENTER JUVENILE FURNITURE

P.O. BOX 1449

Dept. A

BIRMINGHAM, ALA.

Build it YOURSELF

Heathkit

BROADCAST BAND RECEIVER KIT



Have you ever experienced the thrill of building your own radio? Invest a few of your dollars—a few hours of your time, and build a truly worthwhile broadcast band receiver. Transformer operation eliminates potential shock hazard characteristic of "economy" AC-DC sets. Operates as radio, phono, amplifier, or tuner. Fine tone quality, excellent sensitivity. Simplified Construction Manual outlines basic theory of radio principles. Actually a radio course in itself. Price includes tubes—speaker—chassis, etc. Every part you need! Order your Heathkit Radio Kit today.

MODEL BR-2
\$17.50

SHPG. WT. 10 LBS.
(LESS CABINET)

OTHER "BUILD IT YOURSELF" Heathkits

Oscilloscope
Vacuum Tube Voltmeter
Signal Generator
Amateur Transmitter
Communications Receiver

Multimeter
Handitester
Hi-Fi Amplifier
Hi-Fi Pre-amplifier
Battery Eliminator
Signal Tracer
Tube Checker
(And many others)

WRITE FOR
Free
CATALOG

Complete description
of all Heathkits

HEATH COMPANY

BENTON HARBOR 17,
MICHIGAN

Get this NEW 1955 Catalog of AUTO PARTS AND Accessories

Includes World's Largest
Selection—50,000 Items!

SAVES YOU UP TO 50%

Ready now... complete automotive buying guide... everything for your car, truck, custom-styled car, or hot rod... all at rock-bottom lowest prices! Hard-to-find equipment, parts for cars from 1920 to 1955 models! New HOLLYWOOD ACCESSORIES; HIGH-SPEED PARTS; CUSTOM-STYLING EQUIPMENT!

FREE...valuable Safety Chart showing how you can know if your car is safe—sent free if you mail coupon for catalog TODAY with 25c to help pay postage and handling. We credit the 25c on your first \$5-or-more order, so Catalog will then be FREE TO YOU. Fill in and mail Coupon NOW!

J. C. WHITNEY & CO., 1917 P11 Archer Ave., Chicago 16, Ill.

J. C. WHITNEY & CO.

1917 P11 Archer Ave., Chicago 16, Ill.

Rush giant 1955 Catalog of auto parts and accessories at lowest prices. I enclose 25c to cover part of cost, which will be credited to me on my first \$5.00-or-more order.

Name.....
Address.....
City.....State.....



148 Pages packed
with items like
these... all at
Lowest Prices!

Auto radios — Mufflers,
pumps — Engines, parts —
Transmissions — Tires,
tubes — Tools — Springs,
shocks — Ignition parts

Now...dependable engine overhauls at LOW COST!

Perfect Circle

power service



Performance assured with:

- 2-in-1 CHROME PISTON RINGS.** Both TOP ring and OIL ring are plated with thick, solid chrome, giving wear protection where heat is highest, pressure greatest, lubrication poorest!
- NURLIZING.** Restores pistons to correct fit quickly, accurately and permanently, at a fraction of new piston cost.
- STEEL TOP RING GROOVE SPACER.** Precision-made to compensate for increased groove width and to retard top ring and ring groove side wear.
- MANULATHE.** Accurately and quickly regrooves worn top ring grooves. Gives new top rings a break...not breakage!
- PLASTIGAGE.** Bearing clearances are quickly and accurately checked, in as little as one third the time required by older methods!
- TAPER SHIM BEARING ADJUSTERS.** Custom-made to correct excessive clearance in main and connecting rod bearings.

If your car needs an engine overhaul, here is the safe, sure way to stretch dollars and miles!

Perfect Circle *low cost* Power Service will assure satisfaction and give you thousands of *extra* miles of *sustained* power and *positive* oil control!

Perfect Circle Corporation,
Hagerstown, Indiana;
The Perfect Circle Co.,
Ltd., Toronto, Ontario.



See Your Doctor of Motors, your favorite mechanic, for better and lower cost engine overhauls with Perfect Circle Power Service!



Perfect Circle PISTON RINGS

The Standard of Comparison

POPULAR NOVEMBER 1954 MECHANICS

WRITTEN SO YOU CAN UNDERSTAND IT
VOL 102 NO 5

Our Navy's Mightiest Carrier

USS FORRESTAL

By
Richard F. Dempewolff

BESIDE a yawning concrete abyss three city blocks long, six stories deep and twice as wide, giant cranes rear against Virginia's coastal skies like monsters from the Age of Reptiles. Towering booms reach down like dinosaur necks. Powerful jaws grab and lift the last few 75-ton, house-size assemblies that remain to be placed on the most fantastic honeycomb of seagoing steel ever put in one pile by mankind.

Right now, that mammoth pile at the Newport News Shipbuilding and Drydock Company is a bedlam of sound and confusion. A walk through its endless maze of dimly lit caverns compares with a stroll through the Maginot Line under bombardment. A deafening clatter of riveters and chippers batters your eardrums, over the nerve-shattering background of a thousand electric grinding wheels bur-nishing steel plates. On every side, the smoky haze, laden with smells of strange gas and hot metal, is pierced by the sudden, blinding glare of blue light from hissing torches that shoot cascades of molten steel high in the air just like

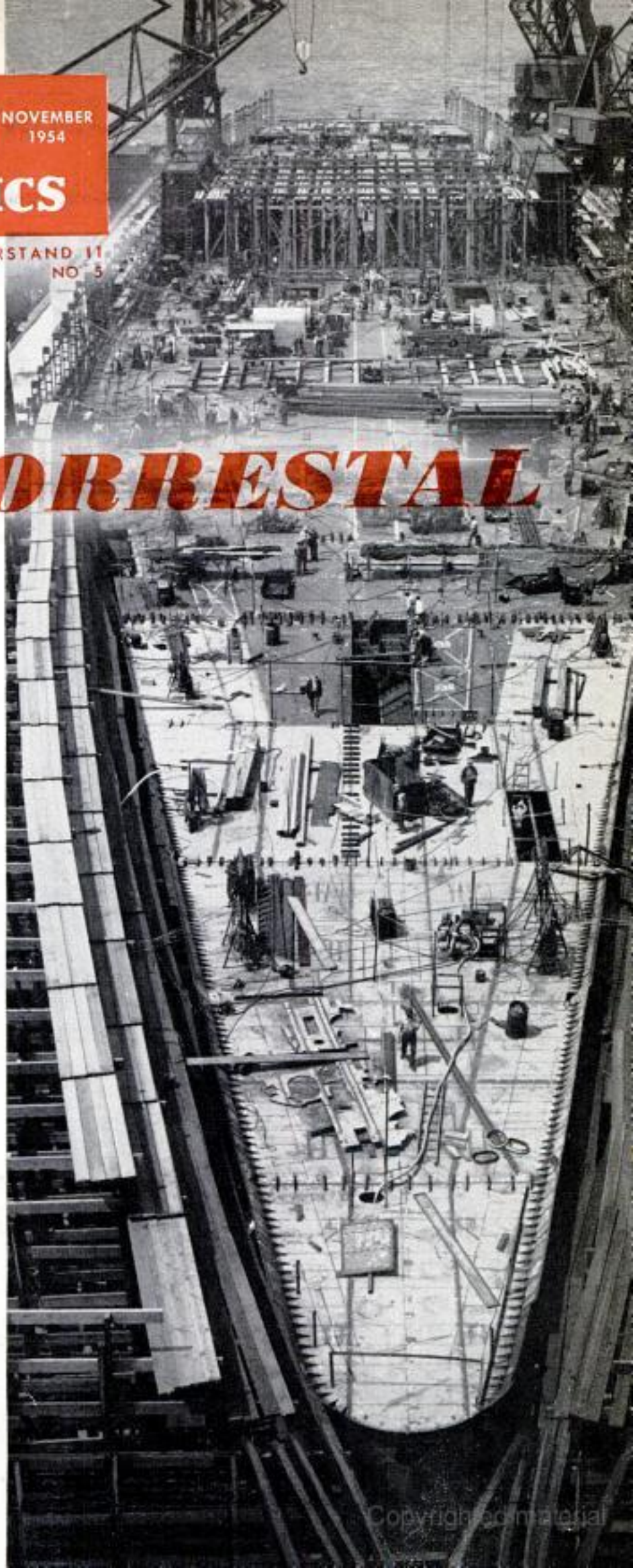

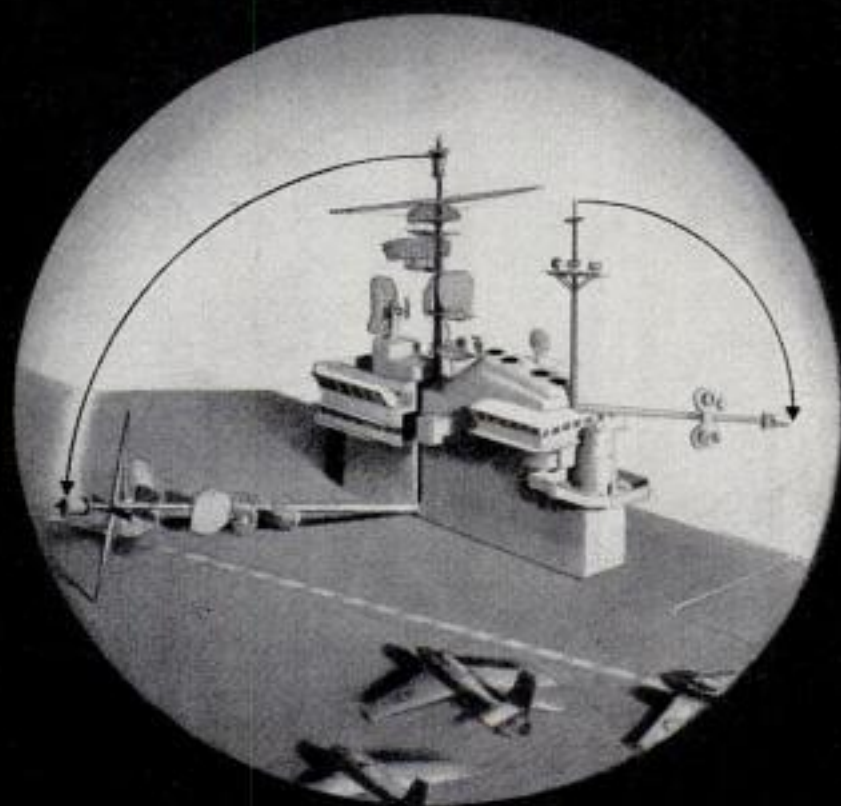
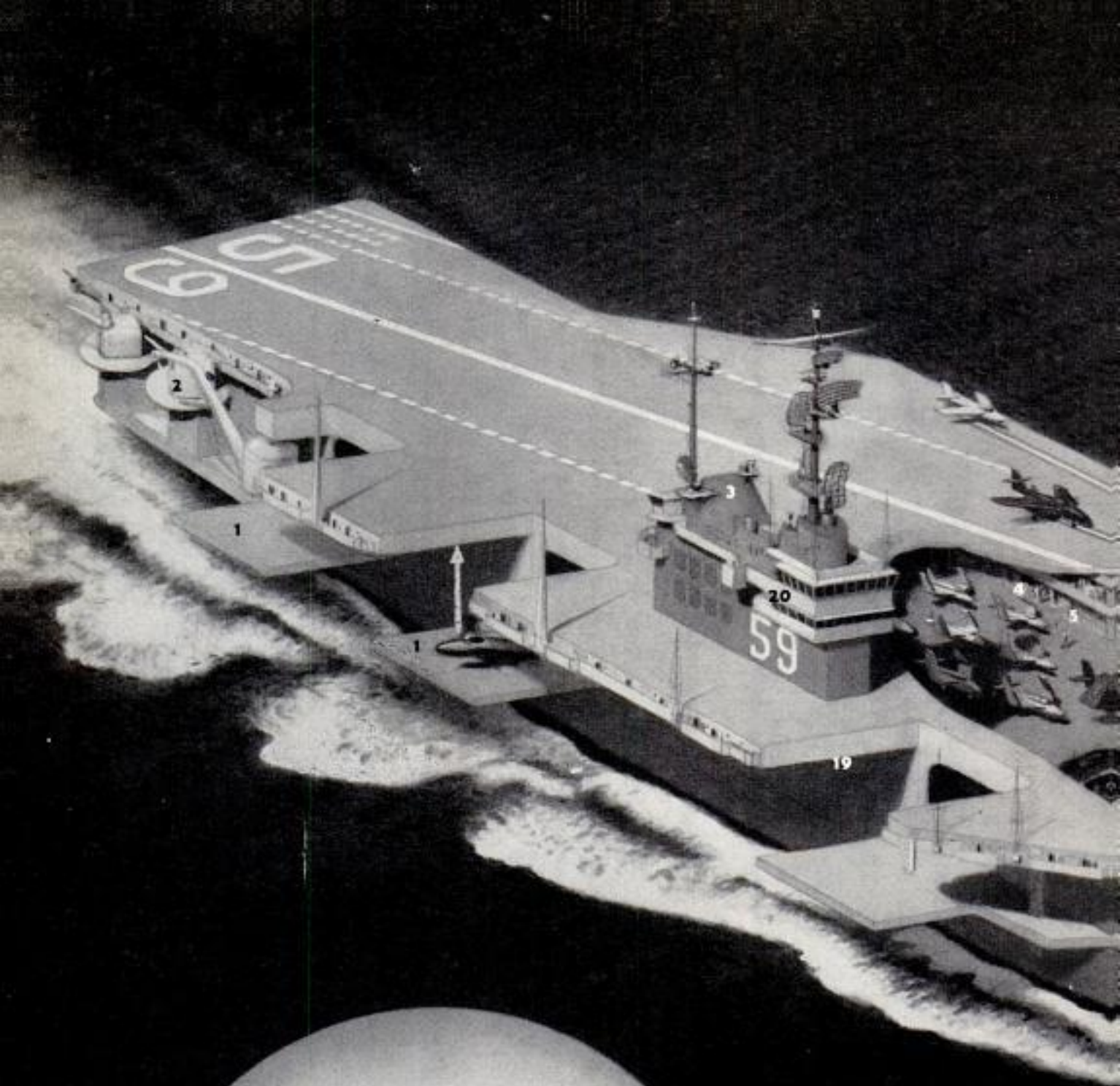

**MASTS TIP LIKE DERRICK BOOMS TO PERMIT
SHIP TO CLEAR THE BROOKLYN BRIDGE**

Copyrighted material

1—Starboard elevators lift 75,000 pounds each. 2—Five-inch gun battery mounted on each quarter. 3—Sloped stack. 4—Machine shops. 5—Escalator from ready room. 6—Flight offices. 7—Officers quarters. 8—File rooms. 9—Port catapults. 10—Storage space. 11—Hospital. 12—Operating room and laboratory. 13—Corpsmens quarters. 14—Dispensary. 15—Machinery and storage. 16—Forward catapults. 17—Elevator shafts. 18—Machinery spaces. 19—Flight deck overhangs 60 feet on each side. 20—Island conning bridge. 21—Hangar deck which is served by the elevators

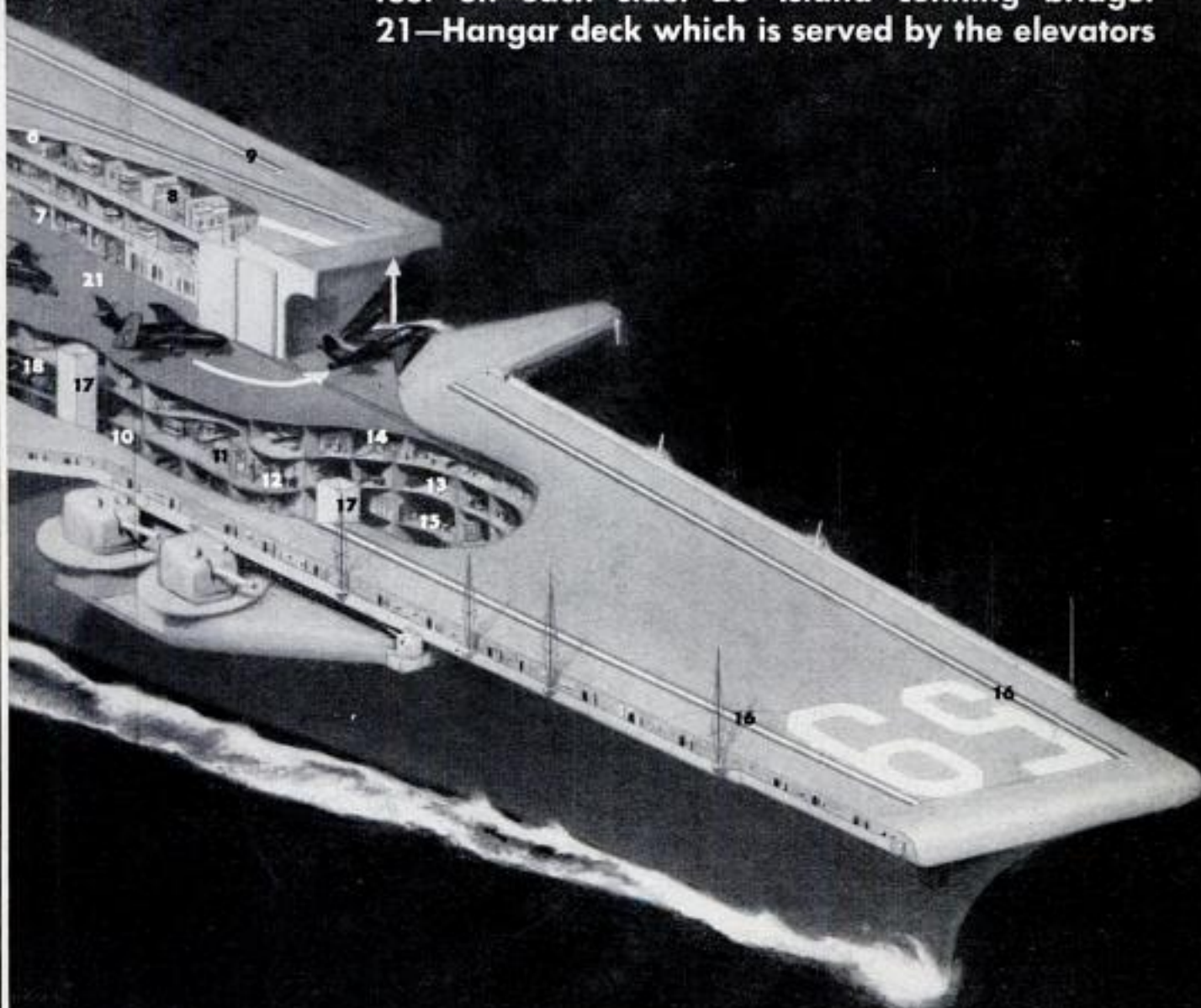

A. Leydenfrost

Copyrighted material

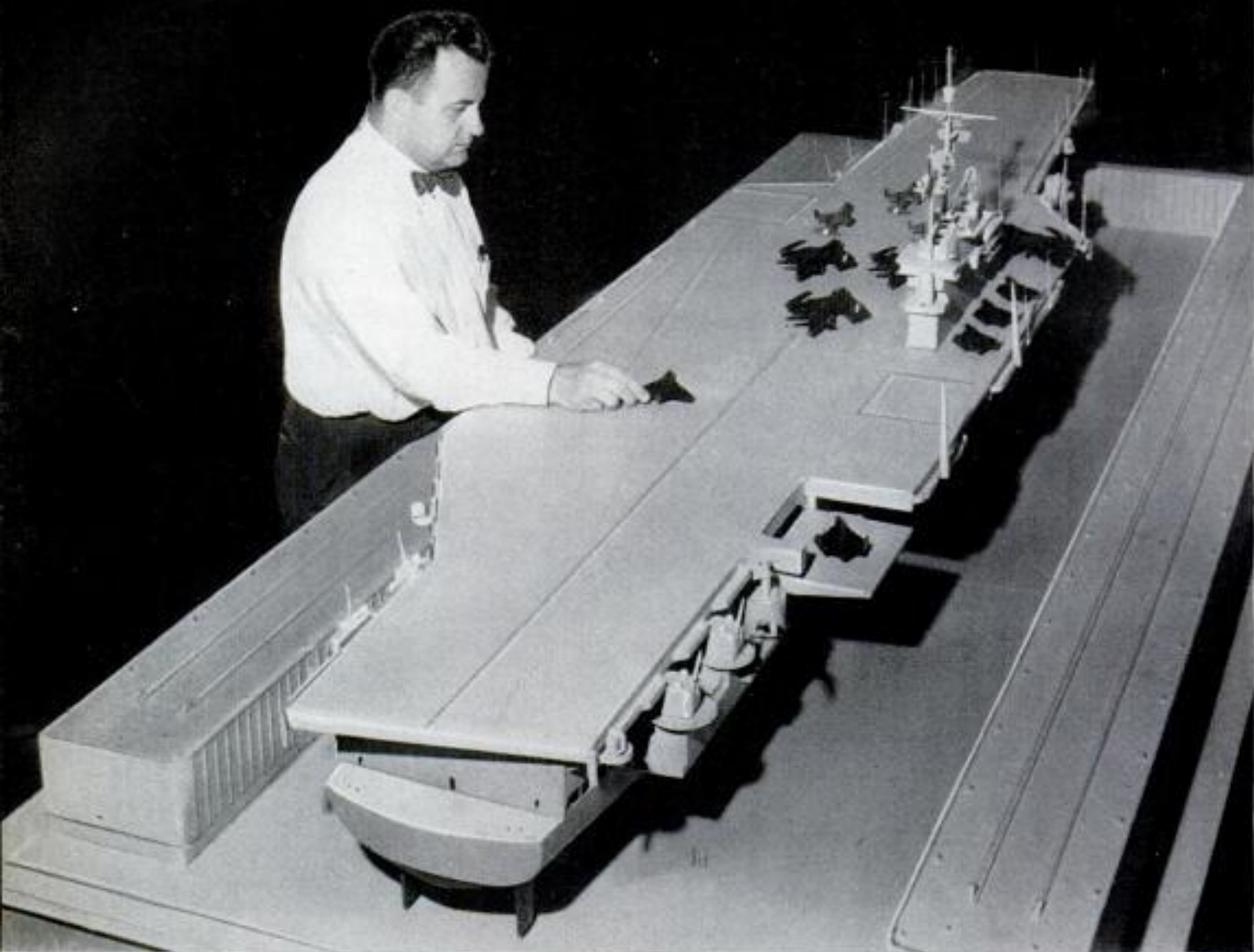

Stern view of *Forrestal* model shows canted rear lip of flight deck. Pilots land planes in slanting line

fireworks. Over all, as you stumble through forests of massive shoring timbers, is the rolling thunder of multiton steel plates dropping into position up above, and the rumble of the traveling giant cranes.

But before next month is out, the bedlam will subside to a hush. Some lady of note will smash a bottle of perfectly good champagne on a bow plate, and the 60,000-ton mammoth will become the USS *Forrestal*, CVA 59 (CVA stands for Carrier Vessel—Attack). She'll be floated into the James River to join the Navy as first in a new class of atom-age carriers—the biggest, most unique and expensive (\$218,000,000) in the world.

The immense size of the *Forrestal* is a strain on the wildest imagination. From end to end, her three-acre flight deck lacks only 284 feet of being a quarter of a mile long. Stand her on end and she'd line up with the tower base atop the Empire State Building. A walk across the flight deck at its widest point equals one city block—252 feet, or as wide as an old four-stacker destroyer is long. That's wide enough so you could sit both the SS *United States* and the SS *America* side by side atop the *Forrestal*,

and no part of either would overhang the flight-deck boundaries.

In his office at the yard, Capt. A. L. Dunning, USN, supervisor of shipbuilding for the Navy, can stagger you with superlatives. "Her four props—two four-bladed and two five-bladed—are 22 feet across," he points out. "They'd top the roof-tree of a two-story home. The biggest of her three vast rudders weighs about 45 tons and equals the floor area of a two-bedroom house. Her seven air conditioners, each 500 tons capacity, produce 600 tons more than the entire air-conditioning system of Radio City Music Hall. "They could cool both National Conventions with several degrees left over."

Because of her size, the *Forrestal* will never squeeze through the Panama Canal; she'll detour around Cape Horn. Since the 187 feet from water line to the tip of her 19-story radar and radio masts is just 60 feet too many to clear Brooklyn Bridge (under which she must pass to get to Brooklyn Navy Yard), engineers employed a neat trick. The towering masts are collapsible. They are raised or lowered by cablelike derrick booms.

Stand on the towering island overlooking the expanse of flight deck and, as the officials in charge of the project reel off graphic descriptions, the welders and riveters fade away. The deck comes alive with big delta and swept-wing sonic jets. You see this massive ship as she will appear in operation—utilizing tricks and devices that make her the most fantastic fortress yet conceived by engineers for an era of push-button war.

Older carriers with wood or jointed-steel decks were fine for propeller-driven fighter planes with low landing speeds and short take-off runs. But the *Forrestal's* six-squadron complement, totaling 80 to 100 planes, presents hair-raising problems. Her fire-shooting F3H Demon fighters and F4D Skyray interceptors blur in at speeds over 100 miles per hour. So do the Banshees and twin-finned Cutlasses that may streak across her deck. Her A3D jet attack planes can carry an A-bomb load nearly the weight of a fully equipped World War II carrier plane according to reports of aviation specialists. No ordinary wires, barriers or deck plates can contain these firebirds. "That," Navy officials explain, "is one reason the *Forrestal's* deck is one solid sheet of welded steel. Jet afterburners can actually kick chunks from a concrete runway."

At first, the towering five-story island from which skipper and flight officer control operations above the flight deck was to have been retractable. During operations, just push a button and it would lower into the ship's bowels like an elevator, to give speeding jets a clear landing field with no obstructions. A tricky TV system would have given the skipper, below, a picture of activity on the flight deck, plus a full view of the other side of the ship.

Stacks had to fold sideways, and the nightmare of communications lines made the job too complicated. So the British idea of a canted, or angled deck was adopted.

To get the full impact of how the unique deck and other innovations on the *Forrestal* work, try to imagine her majestic bow plunging through white spume on an actual mission, operations aboard in full swing.

The three-acre deck is aswarm with activity. The roar of jets warming up is enough to lift the scalp off your head. It actually causes bodily discomfort. The men you see scooting around on

buglike tractors spotting sleek jets on the deck, wear earplugs and muffs to keep from becoming shuddering wrecks. They're spelled off frequently because of the damaging noise level. Flight officers on the island bridge conduct operations by remote communication, for they are completely encased in a cabin with protective glass and soundproofing.

Incoming Skyray interceptors barrel in from a mission, streaking down the deck in succession, to be pulled up short as tail hooks snag arresting wires. On the *Forrestal*, they will not wham into barriers, flip over and wind up smoking or flaming wrecks amid planes parked on the bow if hooks miss the last wire. That used to happen occasionally. Nor are they likely to veer into the island if they get a "wave off" for poor approach—as sometimes happened on older carriers. And the reason for this? Canted deck.

Instead of landing straight in, *Forrestal* planes will land at a 10.5 degree angle from the starboard quarter of the ship's odd transom stern. That stern, incidentally, looks just like the rear end of a mammoth rowboat. Roaring in across the slanted lip of the flight deck, the jet pilot rockets toward the ship's bow—but 'way off to the left. He'll pass the island with more than 100 feet of clearance. A "wave off" will send him gunning straight ahead over blue water, far off the *Forrestal's* port bow, clear of the ship and parked planes.

To angle the "alley" required space—and is one reason the *Forrestal* is the widest

(Continued to page 262)

Side view of model shows 60-foot overhang of the flight deck. Planes land on the port side of angled deck and island side is for parking

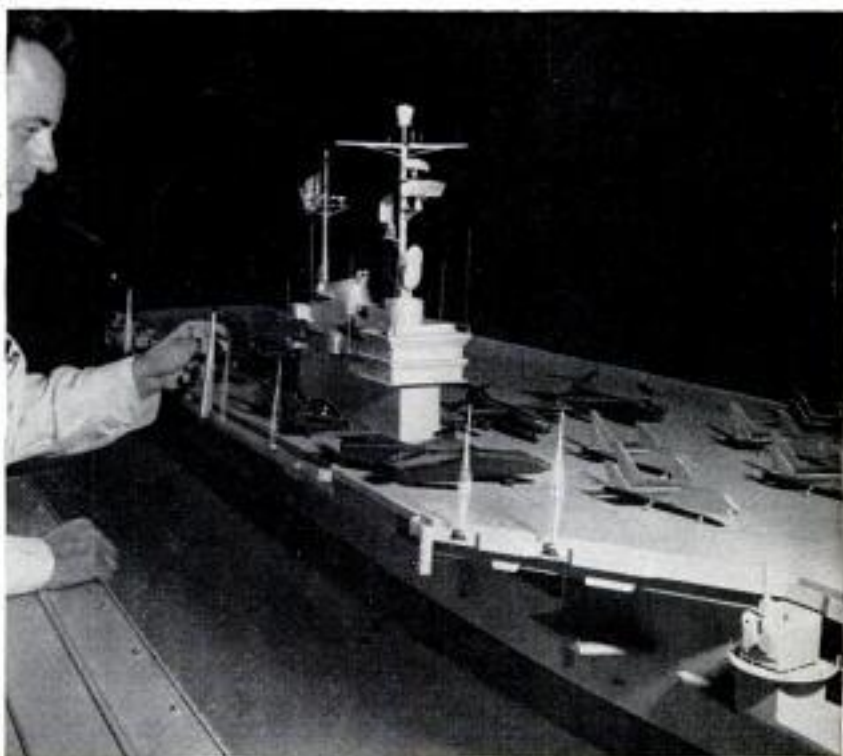

Detroit Listening Post



By Leo Donovan

YOU'VE SEEN the first three—what do you think so far? The three cars introduced in this issue (page 88 and following) set the mood of the season. That mood is power!

High as they are, power ratings are only a base. You don't have to stop there. Companies (like Chevrolet) will offer special speed kits of four-barrel carburetors, dual exhausts and maybe superchargers to bring horsepower of the "small" cars far above what big cars boasted about a few years ago. In 1950, the highest advertised horsepower was 160 in the Cadillac and Packard. Today you buy a stock Chevrolet with 162 horsepower or, with optional extras, 180 horsepower!

By Thanksgiving Day, all but a few of the 1955 models will be in showrooms. Hudson dealers will be selling Nash Ramblers and Metropolitans under Hudson emblems before December 1. Engineering delays will probably keep the 1955 Hudson Hornet and Wasp from coming out until after the Nash Statesman and Ambassador in February. No official indications yet as to what will happen to the Jet.

Corvette Versus Thunderbird

An interesting conflict is taking place between the Ford Thunderbird and the Chevrolet Corvette. For 1955, the Corvette is expected to produce 185 horsepower in a V8 engine that will, it is hoped, inject life into lagging sales. Stories of being able to buy Corvettes at a discount are common.

Ford has been keeping some specifications on the Thunderbird under wraps despite much publicity and advertising.

The engine, adapted from the yet-to-be-announced 1955 Mercury, is a 292-cubic-inch V8 of about 185 horsepower (by coincidence, just what the Corvette is said to have). It has an 8.1:1 compression ratio and a top speed of 117 miles per hour.

Production is slow with about 150 Thunderbirds having been handmade by mid-October. These were not for sale, being spread around to key personnel.

The standard model will have the much-described removable plastic roof. You pay extra for a hand-operated cloth top that folds behind the seat and does not interfere with installation of the plastic hardtop.

Is the Six Done?

With the introduction of four new V8 engines this year, the six-cylinder engine becomes a rare bird indeed.

Asked about this trend, Paul Hoffman of Studebaker (it still makes the Champion L-head six) suggested that simple and easy-to-work-on engines like the Champion's may soon be worth a premium on the used-car lot. He wonders if used-car buyers want the added cost of keeping a more complex V8 engine running economically. If second-hand buyers retreat from the big V8 cars, depreciation costs on such cars will rise, he said, and this will make the six a better new-car buy also.

Two-tone paint jobs will be out-dazzled by the three-tone paint job, being introduced for 1955 on several makes. Stylists foresee a widespread use of color combinations with perhaps textile patterns in paint, Roman stripes and even polka dots decorating cars in a few years.

Headlight Development

The Automobile Manufacturers Association announces a new design for sealed-beam units that gives a longer light projection on the low beam, especially on the right side of the road. It is very effective in rain, snow or fog when the high beam often is useless. It presents less glare to oncoming drivers.

Vital to the design is a small metal cap over the filament or bulb (depending on the manufacturing system used). If the 48 states agree, there will be a midseason change-over to the light by car makers.

Although the tubeless tire has taken over for 1955, researchers say it is only the first of some startling new tire developments. Not far distant, they say, is a practically indestructible tire to last the life of the car. When that comes, the spare tire may be as unnecessary as a spare fuel pump.

Stylists love to pick an item that is accepted as fixed and make it fresh—like the shift quadrant on the steering column. In 1954, the indicator was moved into the dashboard. In 1955 the whole thing, indicator and lever both, will be in the dashboard. The taillight is also in for a freshening. It took years to blend it into the fender and now along comes a fresh look that puts it saucily atop the fender all by itself. Another styling trick for '55 is side-mounted running lights about half way back on the body—like lights on a boat or a truck.

Lumber Lift Truck Ends Hand Stacking

Chain-driven, hydraulically powered rollers mounted on the forks of a lift truck enable a load to be shifted to either side as far as desired. In lumber warehouses, where lumber is stacked with the ends facing the aisles, the equipment saves valuable time. The load is lifted the height of the stack and shoved inward by the rollers. Previously, workers had to take the boards off the lift piece by piece and finish the stacking by hand.



Portable Lift for Autos Aids Transmission Installation

One man can remove or install automatic transmissions efficiently with a hydraulic lift that has pin-point hydraulic controls. The controls permit the "inching" of the transmission into place. The lift tilts the transmission through a 98-degree arc and rotates the unit completely on its axis. It has a lifting range of from 48 to 76 $\frac{5}{8}$ inches and will not tip over even when the transmission is tilted to the fullest extent possible. The unit has a steel-tube quadruple leg base that assures maximum stability at full height under load but leaves the working area free. The unit rolls on swivel-type wheels.

Wheels and Skis Make Many Toys

Youngsters can use a new German toy as several different vehicles including a sled, scooter, wheelbarrow and ski scooter. The various parts are assembled with easy-to-remove bolts. In addition to a tubular framework, the parts include four wheels and two ski runners.

Experiments at an Army and Navy Hospital indicate very-high-frequency sound waves may reduce pain and relax arthritis patients.



Hardtop models are long, low and colorful (see cover). Scoops over the headlights are not functional



1955

1955 PONTIAC V8 SPECIFICATIONS

Wheelbase	Chieftain 122 in.
	Star Chief 124 in.
Over-all length	Chieftain 203 in.
	Star Chief 210 in.
Over-all width	75.4 in.
Over-all height (unloaded)	62.5 in.
Steering ratio	25:1
Turning diameter	Chieftain 42.6 ft.
	Star Chief 43.0 ft.
Bore and stroke	3.75x3.25
Displacement	287.2 cu. in.
Compression ratio	8.0:1
Horsepower	180 at 4000 r.p.m.
Torque	264 at 2400 r.p.m.

EVEN THE INDIAN HEAD had to go! All new, the 1955 Pontiac replaced its famed Indian-head hood ornament with a flying V, marking the end of the straight eight. (You can still get a lighted Indian ornament, but it's an extra-cost item.)

Under the V ornament is the most important of many changes: The overhead-valve V8 with a 180-horsepower kick.

The body is all new, too. Only the Silver Streaks remain and these are modified. Two rows of them run down the lowered hood (3.7 inches under '54) from the base of the big wrap-around windshield to the bold front grille. In the rear, the streaks appear in shortened form atop each fender.

The new engine has a staggered-block design. The right-hand bank of cylinders is cast slightly forward of the left-hand bank, permitting the fuel pump to fit at the left front where it is

From the rear, it has a wider look. Note the Silver Streaks atop the fenders



Right, the new V8. Its 180 horsepower will accelerate a Chieftain from 0 to 60 in 12.65 seconds, say Pontiac engineers

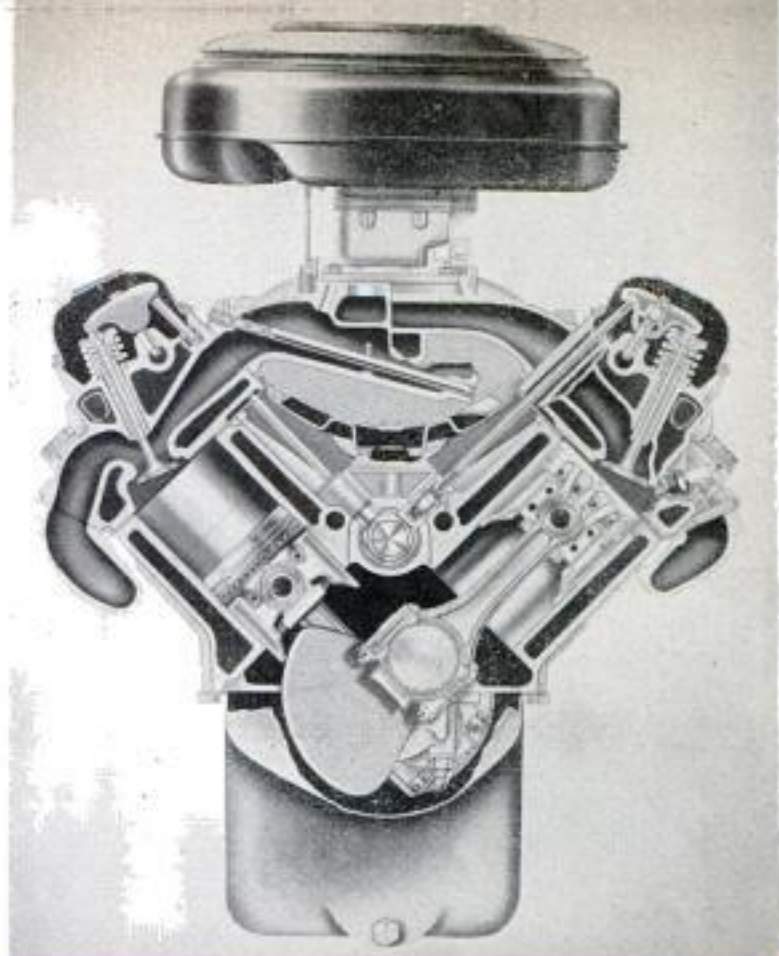
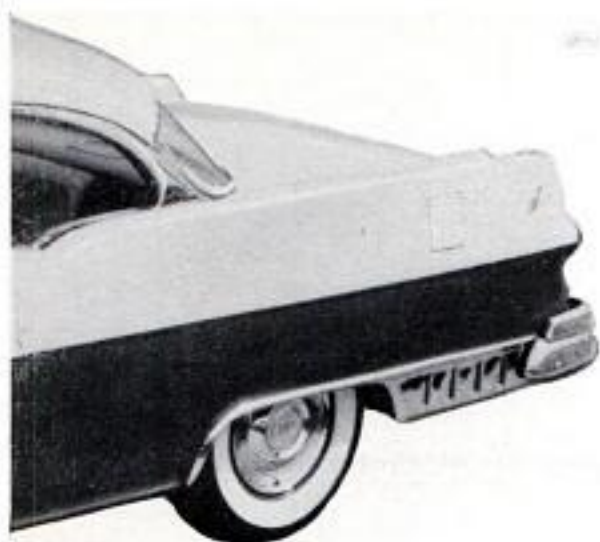

Pontiac is all New

cooled by the fan to prevent vapor lock. Other features are ball-pivot valve-rocker arms that eliminate rocker-arm shafts. Each arm sits atop a pedestal and, according to Pontiac, no tappet adjustments are required—there being a built-in automatic take-up. Hydraulic valve lifters, plus a large quench area in the combustion chambers, are said to make the engine extremely quiet. A novel oil system provides pressure lubrication at both ends of valve push-rods. Two oil-filler-and-vent caps (one atop

each bank) give full crankcase ventilation.

Bodies are nearly three inches lower than last year (station wagons are 7½ inches lower and have wrap-around rear windows).

The speedometer has no needle. As speed increases, a continuous red curve moves around the dial. The more speed, the more red shows. The glove compartment is in the center of the dash and its door, when open, has two recesses stamped in it to hold cups or pop bottles safely upright.★★★

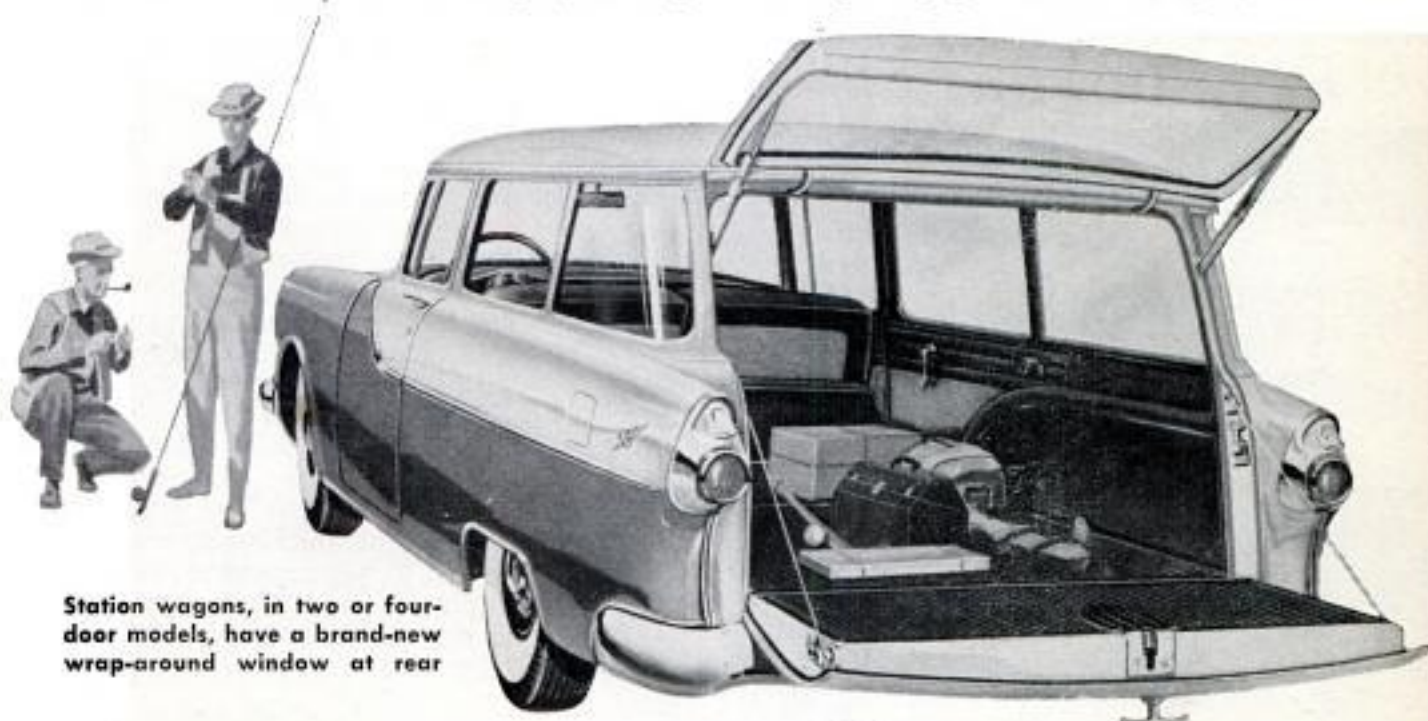

Station wagons, in two or four-door models, have a brand-new wrap-around window at rear

Simple lines feature the front-end styling of the Chevrolet. Barely visible on the cowl is the wide air intake for heater



1955 CHEVROLET SPECIFICATIONS

Wheelbase	115 in.
Estimated weight	3125 lb.
Over-all length	195.6 in.
Over-all width	74 in.
Over-all height (unloaded).....	62.1 in.
Steering ratio	25.7:1
Turning diameter	38 ft.

V8 ENGINE

Bore and stroke	3.75 x 3.00
Displacement	265 cu. in.
Compression ratio	8:1
Horsepower	162 at 4400 r.p.m.
Torque	257 at 2200 r.p.m.

6-CYLINDER ENGINES

Bore and stroke	3.56 x 3.94
Displacement	235.5 cu. in.
Compression ratio	7.5:1
Horsepower, standard	123 at 3800 r.p.m.
Powerglide	136 at 4200 r.p.m.
Torque, standard	207 at 2000 r.p.m.
Powerglide	209 at 2200 r.p.m.

New V8

Below are three models of Chevrolet's luxury line, the Bel Air

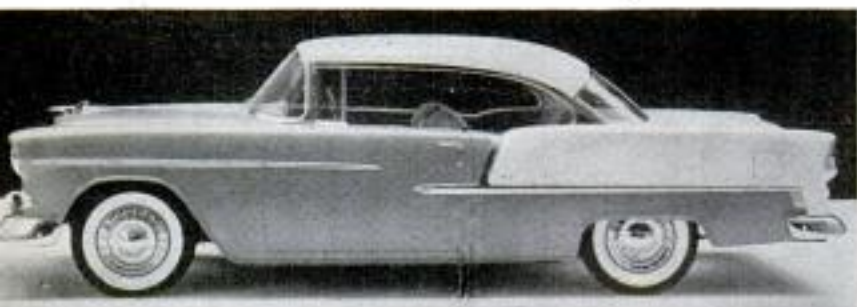

Above, the Bel Air sport coupe. Below, the Bel Air convertible

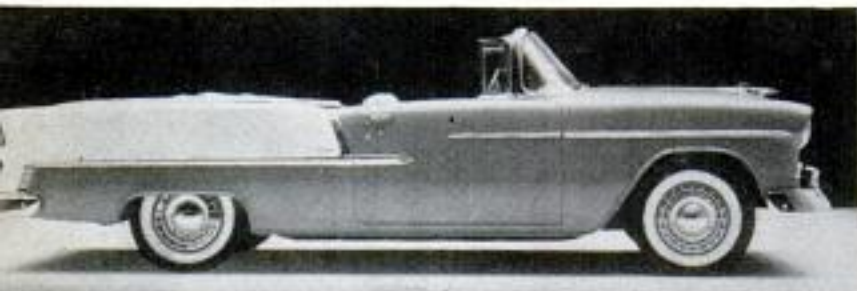

Station wagon, two or four-door, has wrap-around rear windows



POWER PLUS is what Chevrolet offers for 1955. The power is its 162-horsepower V8 engine. The plus is its optional, extra-cost, speed kit (dual exhausts and four-barrel carburetor) that boosts the V8 to 180 horsepower!

But power isn't all. Bodies are all new, too. No longer than in 1954, they look longer because of the lower styling. Wheelbase is unchanged.

Roofs have been lowered as have hoods and belt lines. Sedans are 2½ inches lower, station wagons 6 inches.

Strength has been added by a stiffer, more twist-resistant frame. Front suspension is of ball-joint design which reduces lubrication points from 16 to 4. Lengthened rear leaf springs are now outside the frame to increase stability.

Most obvious styling features are the wrap-around windshield, the simple, Ferrari-type front grille, hooded headlights.

Mechanically, Chevrolet has much to talk about. Its new V8 engine, with one of the shortest strokes in the industry (3 inches), means low piston travel per mile, an important factor in engine life and economy. Crankshafts are balanced after assembly right in the engine. So

PAY TOLL HERE



Long and sleek is the Two Ten four-door sedan. You have a choice of three engines and three transmissions

Sparks 1955 Chevrolet

compact is the new V8 design that it takes only four quarts of oil to fill the crankcase.

Smoother power application results from replacement of the old torque-tube drive by the Hotchkiss system in which engine torque is cushioned by the rear springs.

For the first time, Chevrolet offers an optional overdrive that reduces engine speed 22 percent for added quiet and economy.

Horsepower of the six-cylinder engines is up also. The handshift model has 123 horsepower; Powerglide has 136.

Other features of all models include a 12-volt electrical system, tubeless tires, improved steering, center glove compartment, suspended brake, clutch pedals. ★ ★ ★

Right, the V8 engine. Below, rear styling of hardtop





Studebaker Adds New Line

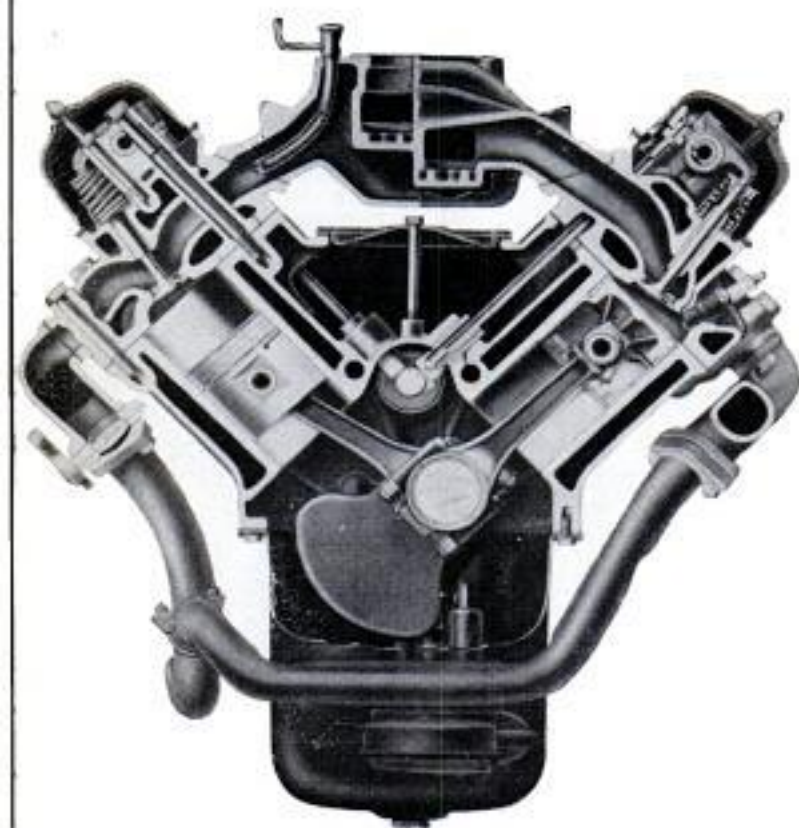

Top of page is the President hardtop. Below it is the 175-horsepower V8 that is under its hood. Below, coupe models have a new armrest in the rear seat. It folds down flush with the cushion when not in use, as at left

MECHANICAL CHANGES are the big story at Studebaker along with the re-introduction of the President line.

This new President has a 175-horsepower V8 which is not, as has been rumored, adapted from the Packard V8. It is Studebaker's own.

The 1955 Commander has the industry's shortest-stroke V8, it being only 2.813 inches (the 1954 Commander had a 3.25-inch stroke). It now develops 140 horsepower.

Still retaining the L-head inline six, the Champion has had a horsepower jump to 101. Stroke is increased to 4.375 inches (in 1954 it was 4 inches).

Stylewise, Studebaker has been face-lifted with a new front-end treatment, chrome trim and taillights.

Low-gear starts in all Automatic Drive models now assure faster get-aways. Gears shift automatically and lock into economical direct drive. President models have four-barrel carburetors.

Price cuts on all models have been announced, bringing the Commander into the range of such low-price V8s as Ford, Chevrolet and Plymouth. ★ ★ ★

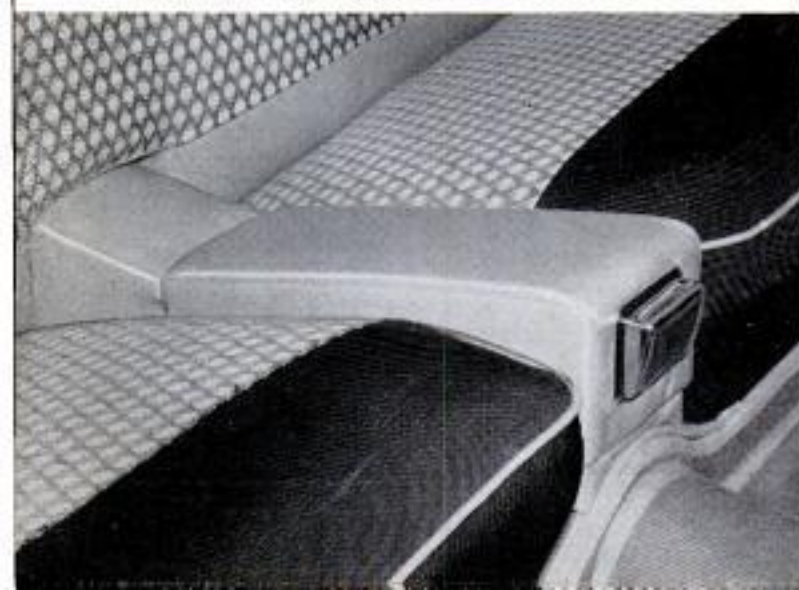

"Flying Bedstead" Goes Straight Up

There are no wings on the "Flying Bedstead," an experimental aircraft made in Britain. Designed for vertical take-off, it consists of two turbojet engines mounted on a tubular-steel frame. The pilot sits in the middle of the framework, above the engines, and directs his craft by directing air streams from the jets. Most vertical take-off designs leave the ground with the pilot's feet above his head, but in this he remains in a normal seated position at all times.

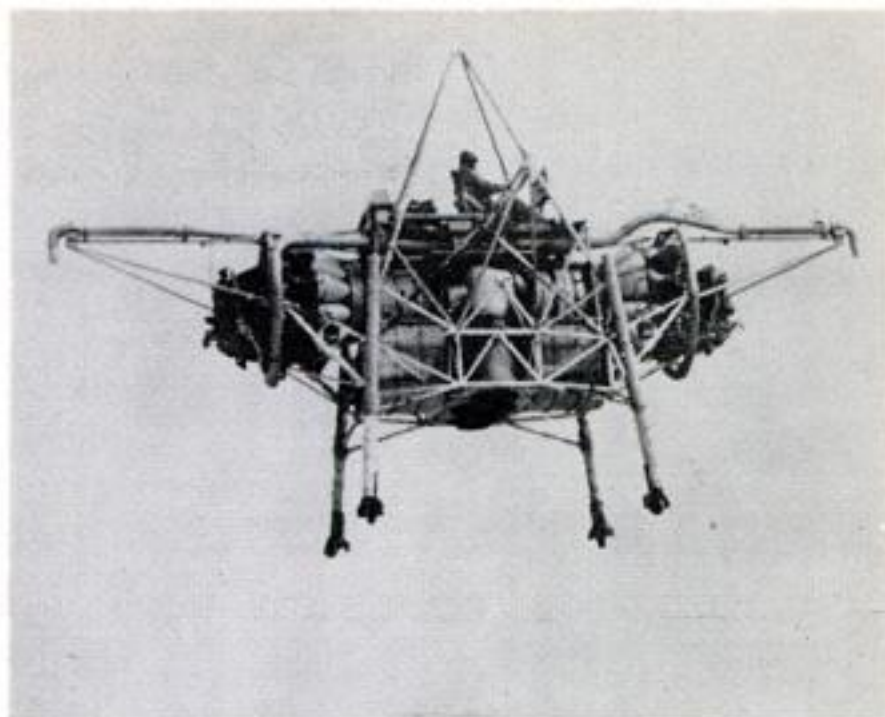

Powered Decoys Swim and Dive Around Hunter's Blind to Fool Ducks

Duck hunters and ducks don't always get together, frequently because the hunter's motionless decoys don't fool the wily birds. Thomas Paladino of Conway, Ark., tried pulling decoys with strings and powering them with rubber bands. Finally he came to the conclusion that a self-powered decoy was the only kind that would fool a duck. The result is two new decoys, one

that paddles around the blind and another that actually lifts its tail and ducks for the ducks. The swimming model is powered by a motor operated by two flashlight batteries. The motor turns a propeller which moves the decoy through the water for 1½ hours before the batteries have to be replaced. The decoy is tied to a weight with fishing line and swims in a circle. A switch on the tail, operated by another length of line, permits the hunter to start and stop the motor. A de luxe model is operated by a six-volt battery, with an extension cord running from the blind to the decoy. The ducking decoy has no motor, but is operated by a line which runs from the decoy's bill through a stabilizer weight beneath the water, over a pulley near the hunter and into the blind. The stabilizer is anchored to the bottom of the river or pond. When the hunter pulls the line, the decoy ducks.

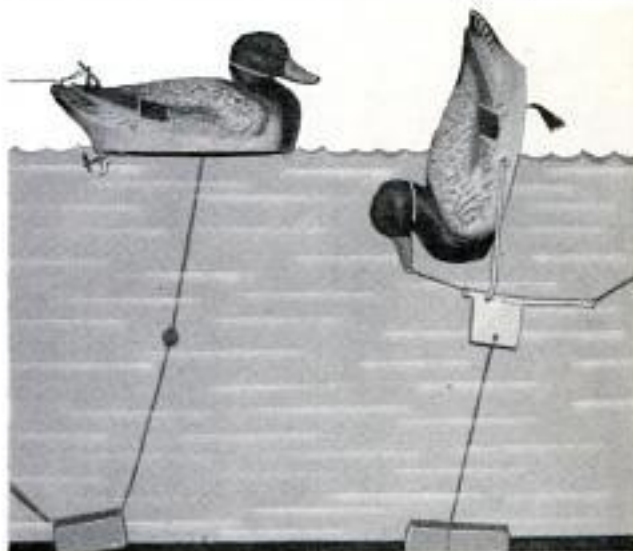
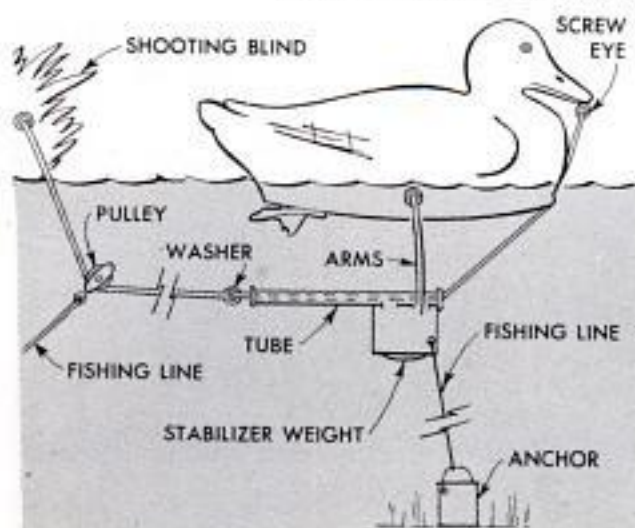
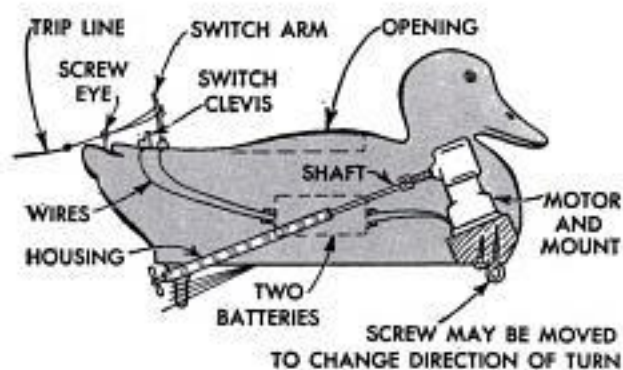



Each of the bales at left, not much larger than a bale of hay, represents a scrapped car pounded by the press

ONE-TWO-THREE

By Gerald R. Hunter

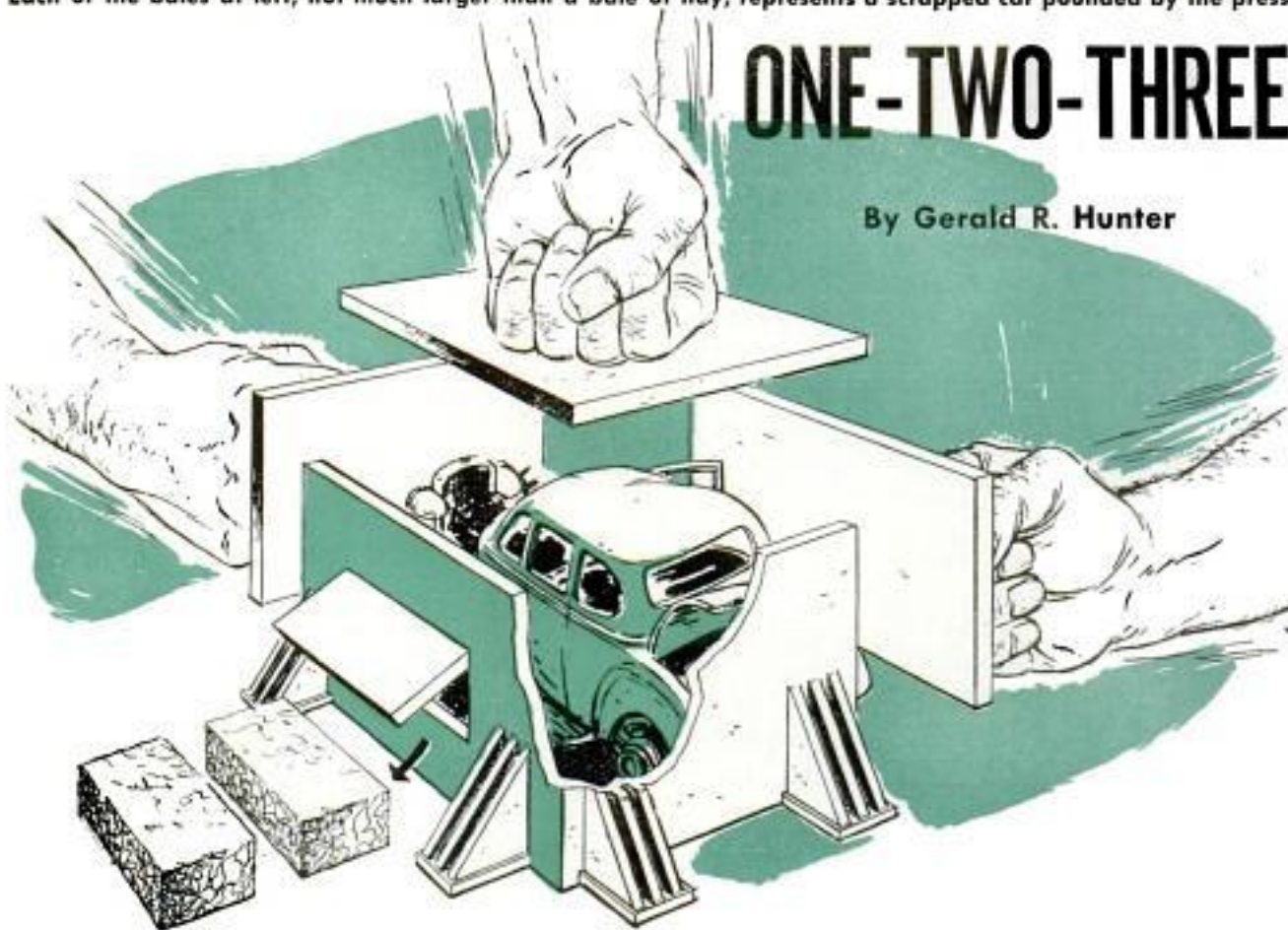

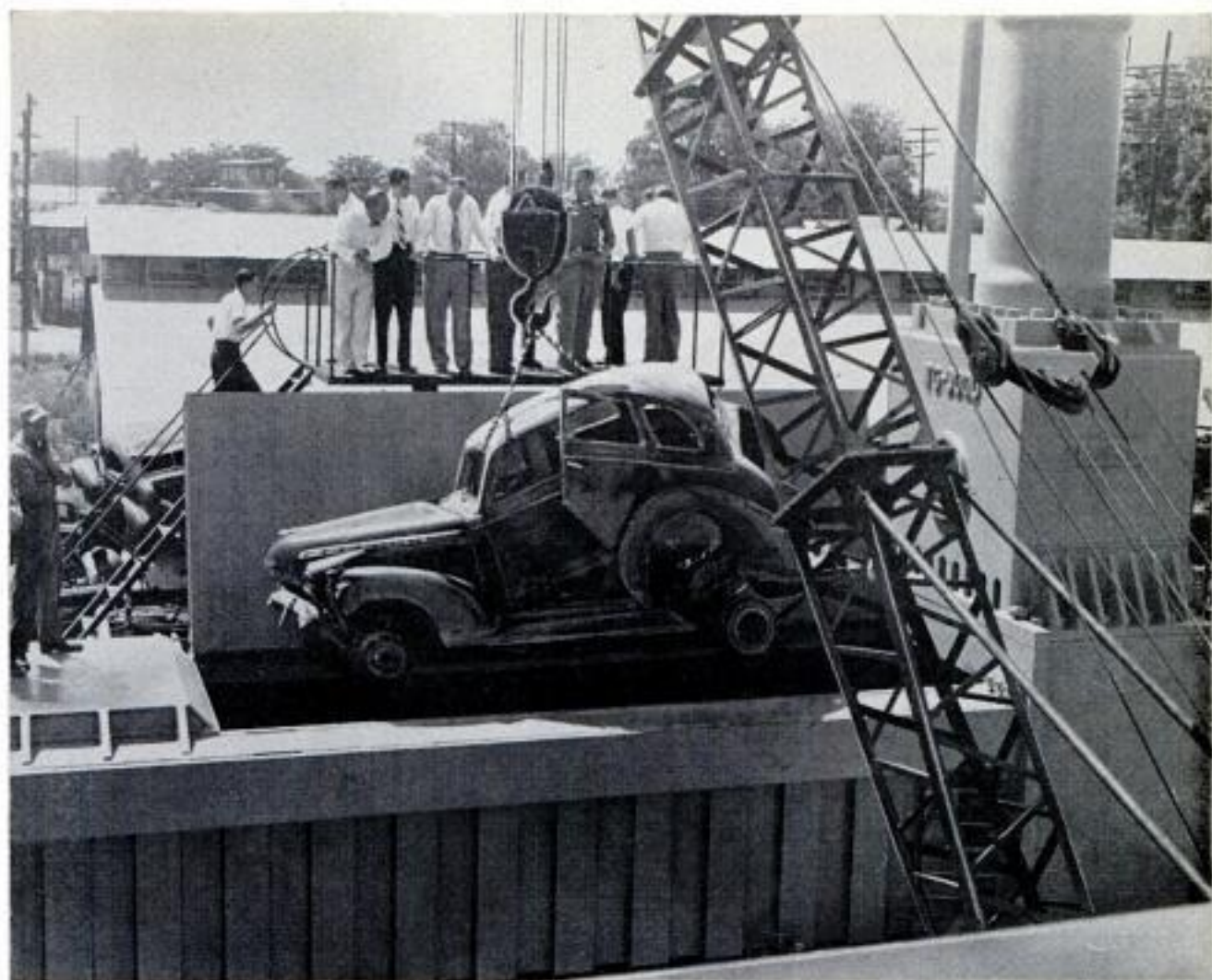

Old auto, engine and all, is dropped into the maw of the press. In seconds it will emerge as a little bale

PUNCH REDUCES AUTOS TO BALES

A MONSTER so powerful that it gives even its hardened operators the creeps now is punching scrapped autos into bales.

The machine, in three, simple, horrifying strokes reduces an entire automobile or truck—engine included—into a 2500-pound chunk of steel about the size of a street-corner mailbox.

The press weighs 675,000 pounds and will wad up 45 tons per hour of autos, tricycles, dull lawnmowers or old razor blades. The Chicago Auto Wrecking Corporation, which bought the prototype, is using it only to massacre old cars. The press was built by the Harris Foundry & Machine Company.

Five 100-horsepower motors, each designed to deliver a peak load of 160 horsepower, give the press its tremendous punch. They actuate 10 pumps, each of which delivers 55 gallons of hydraulic fluid per minute at 2000 pounds per square inch.

Spectators gasp when a scrapped automobile is dropped into the maw of the huge

press. Without apparent effort the first compression, or gatherer, ram pushes the whole automobile up under the vertical compression, or tramper, ram in such a way that the car is reduced in length from about 20 feet to 5 feet. The car collapses like a concertina. Then while the compression ram holds the shortened vehicle in position, the tramper ram comes down and flattens it to a height of 24 inches. And with both compression and tramper rams extended, the ejector ram slams in for the third and final punch that squeezes the bale into its final size of about 60 by 24 by 24 inches. A separate stroke of the ejector ram knocks the little 2500-pound bale from the press.

The size of the finished bale depends somewhat upon the size of the original car; a big, heavy car makes a bale slightly larger than a light car.

It's quite possible that your 1956 model car, stove, refrigerator or other steel product will have its start in the crunching maw of the big press. ★ ★ ★



TV Cameras Watch Prisoners

Television cameras replace guards in the Redlands, Calif., jail. Three receivers before the desk sergeant show what's happening in the group cell, assembly room and cell block. Another set is in the police chief's office. Each camera is operated remotely and can cover an entire area. The



group-cell camera has a wide-angle lens, while the other two swivel to pan 360 degrees horizontally, 45 degrees downward.

Versatile Short-Wave Marine Radar Can Do Four Different Jobs

Four different jobs are done by a new short-range sound radar system, designed to supplement long-range equipment and for use by boatowners without conventional radar. At one selector-switch setting a high-pitched tone is sent out which echoes or reflects from obstructions in its path up to one third of a mile. The distance of the object is indicated by the time lapse

between the sending and receiving. When at the "talk listen" setting, the loudspeaker becomes a sensitive microphone which picks up sounds seven times farther away than can be heard by the unaided ear. By pressing a switch on the microphone and using a normal voice, the speaker will greatly magnify the sound. Final switch position activates whistle or foghorn.



German Soapbox Racer Has Plastic Body

Clear plastic forms the body of a soapbox racer built by a German firm. Displayed at an international fair at Frankfurt, it is powered by foot pedals. Steered like a full-size automobile and equipped with a hand brake, the little racing car sells for about \$45.

British scientists report an experiment in which they froze hamsters to 23 degrees below zero for 40 minutes, and in less than two hours the animals were walking again.

Helicopter Gets Power Boost From Rockets

TINY ROCKET ENGINES mounted on the rotor tips and using hydrogen peroxide as fuel give the Marine Corps' HRS-2 helicopter enough take-off power to double its payload under certain conditions. The rocket engines themselves weigh only about one pound each, and the entire system, including the dome-shaped fuel tank mounted on the rotor, fuel lines and controls, weighs but 67 pounds. Since the fuel capacity of the tank allows a maximum of but seven minutes' operation, the rocket assist is designed primarily to give the helicopter a power boost at the moment of take-off, although it can be used to increase hovering ability or gliding distance in the event of failure of the main power plant.

The rocket-assist system is particularly valuable at higher altitudes. A helicopter capable of evacuating six men at sea level normally could pick up only three at 5000 feet. With added rocket power, it can lift its sea-level load at the higher altitude. Although the system was designed for the Sikorsky HRS-2, its maker, Reaction Motors, Inc., say that it can be adapted to any helicopter in operation with a minimum of change.

Dome-shaped tank on rotor holds special rocket fuel



Except for pilot's controls, mechanism is mounted entirely on rotor (diagram, right). The small rocket engine rides inside streamlined rotor-tip fairing (above). Rocket exhaust, which provides thrust, is practically invisible and almost silent

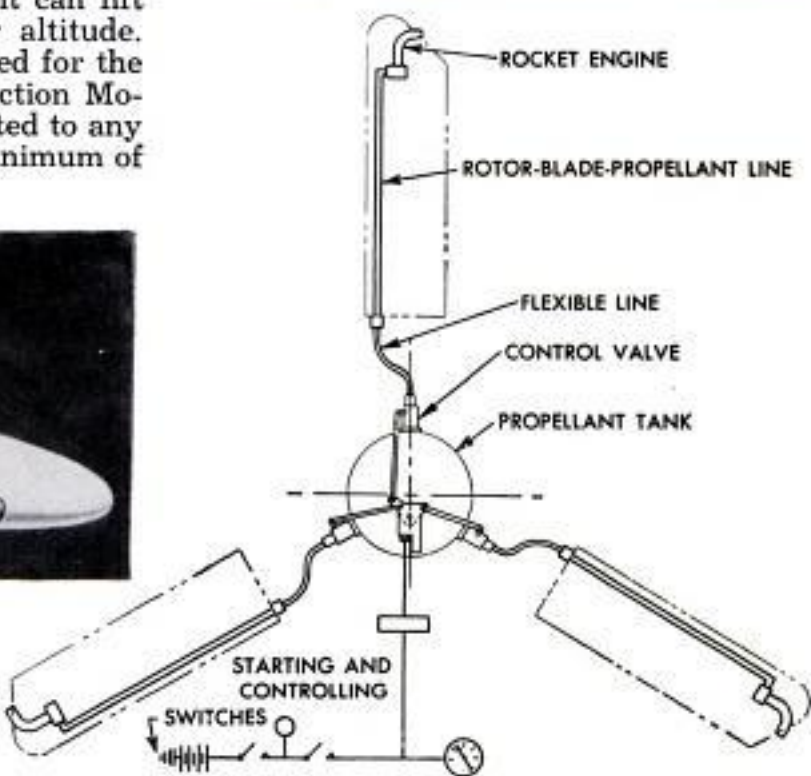

Mock-Up Watches Tell Time, Date and Radioactivity Level



Spectrum dial on "atomic" watch would indicate the radioactivity of area. Wrist piece also mounts a standard watch and a calendar. Below, FM wrist radio would receive time signals at five-second intervals



Rotating disks may replace hour and minute hands. The time on this watch is 6:12. Direct-reading watch below has smaller windows but white dials outlined in black are easier to see and give precise time



Following Detroit's lead, one watch company is exhibiting its own futuristic dream models. Like most dream cars, these "watches of the future" are not for production and do not actually work. One warns the wearer against radioactivity, in addition



to telling the time and date. Others have circling disks which show the time through a small window in the face. One is a transistorized wrist radio which would receive time signals broadcast by special FM stations.

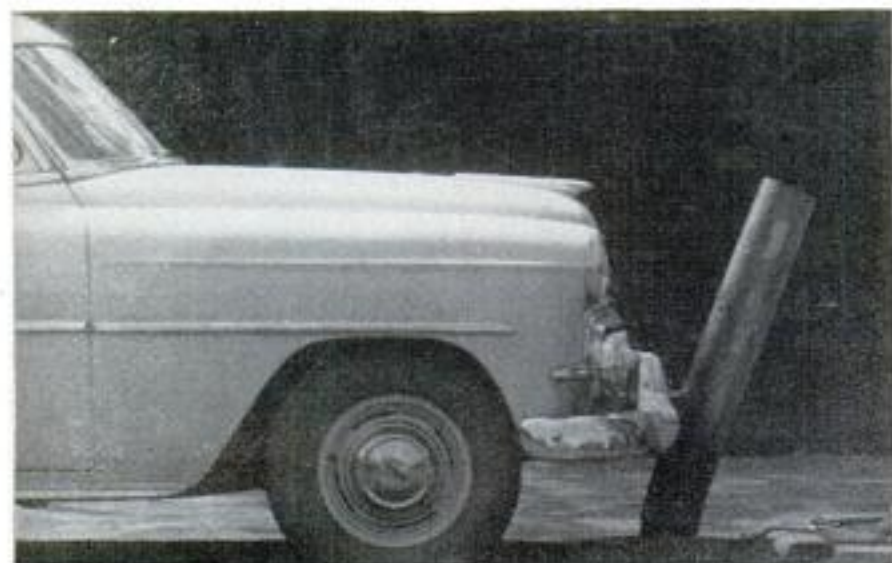

Rubber Barricade

Rubber traffic markers have proved to be life-savers on a boulevard in Cuyahoga Falls, Ohio. Steel rail sections formerly used to protect the park strip and designate traffic lanes caused fatal auto accidents. Recently the rails were replaced with large rubber pipe sections set in concrete. Since then, the posts have been hit many times, but no accidents or car damage have been reported.

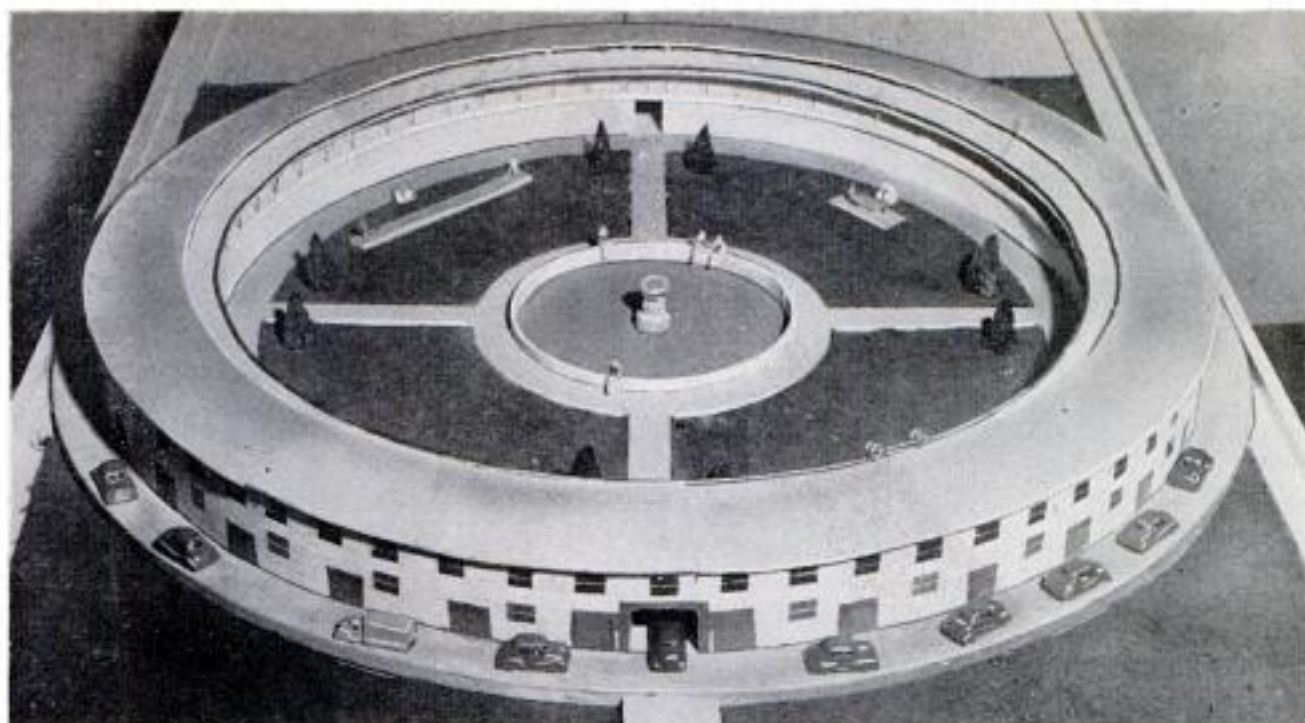

Large inner court with swimming pool in center will be feature of circular building, here shown in a model

Monorail Passenger Car Takes Place of Elevator

Instead of an elevator, a two-story circular building to be erected in Miami will have a "circulator." This will be a modified monorail car which will travel around the second-floor balcony on the inner side of the building. Push buttons will control the electrically driven car so that it can be returned to any point in the circle. An automobile chassis will be used to make the car, which will have rubber-tired wheels, two running on the rail and two against the wall of the building. The building, which will house an optical school and a scientific club, will have an outer circumference of 1000 feet and an open court in the center.

Crude model of monorail car shows its basic design, with two wheels on rail, two riding against the wall

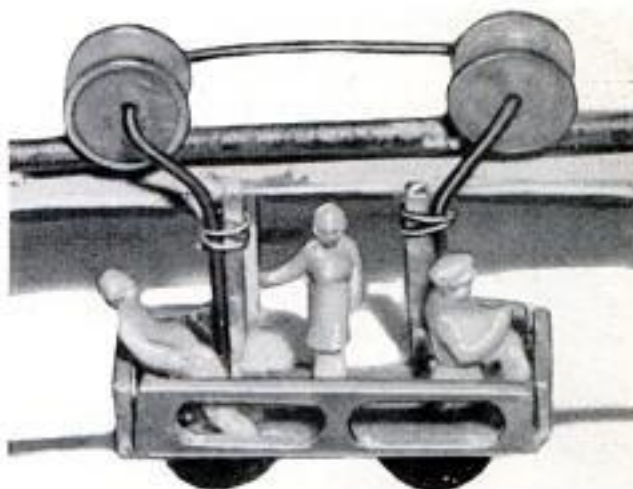

Mobile Centrifugal Irrigation Pump

Crops and pastures are irrigated with a four-inch centrifugal pump that is pulled behind a tractor and driven by the power take-off. The mobile pump, rolling on rubber tires, comes as a complete unit ready to run. The pump can be used with any 20 to 30-horsepower tractor and delivers one inch of water to an acre in an hour. It is equipped with a built-in speed increase and a hand-operated priming pump.



DASH LIGHT appears to be a telephone receiver, is actually a handy flashlight that plugs into cigar lighter. It serves as a trouble light or as a baby spotlight.
Richter Co., 800 E. 10th St., Los Angeles 12, Calif.



DO YOUR CHRISTMAS SHOPPING HERE-DO



STEREO CAMERA features low cost, four shutter speeds, automatic exposure adjustments, distance indicator and spirit level. It is loaded with a film magazine
Eastman Kodak Co., Rochester 4, N. Y.

BARBECUER portable enough to be taken on camping trips gives smoky flavor to meats and offers positive smoke and fire control. The barbecue uses little charcoal
Old Smokey Mfg. Co., 3023 Tilden St., Houston, Tex.

JUICER supplies glassful of vegetable or fruit juice in only a few seconds. Juice contains no pulp. Cut fruit and vegetables are dropped in, automatic feed does rest
Sweden Freezer Sales Corp., Juicer Division, Seattle 99, Wash.





WALLET that fits on car sun visor has big Zipper pocket for maps and papers, a case for sunglasses and a notebook for addresses and mileage reports

Pam Sales Co., 8905 Lake Ave., Cleveland 2, Ohio

ELECTRIC WHEEL CHAIR can turn sharply, go anywhere. One lever operates all controls. Batteries are charged by plugging unit into electrical outlet

Sears, Roebuck and Co., 925 S. Wabash Ave., Chicago 7



YOUR CHRISTMAS SHOPPING HERE-DO YOU

HAND STAMP ONLY
PRINTED MATTER
PARCEL POST
AIR PARCEL POST

SPECIAL DELIVERY
FIRST CLASS MAIL
REGISTERED
VIA AIR MAIL

FOR DEPOSIT ONLY
PLEASE BEND
DO NOT BEND
SPECIAL HANDLING



RUBBER STAMP mounts the 12 most-used markings for packages. A twist of key puts right stamp in position. Imprints are 1/4 in. high, 1 1/2 in. wide

Postal Press, 8646 West Pico Blvd., Los Angeles 35, Calif.



CLOTHES ROD can be hung in seconds from hooks in car. It telescopes for installation or removal. Clothes can be carried to and from car in position

Ventura Enterprises, 3676 Paloma Drive, Ventura, Calif.

BASEBALL GAME has plunger-operated pitching device that throws curves or straight balls. Balls are batted into squares marked for hits, outs and fouls

Barrett Gameboard Co., Evanston, Ill.





CAMPER'S RANGE fueled with gasoline fits into any car trunk, has two burners and contains cooking and serving utensils for four diners. Weight is below 34 pounds

Flinson Co., 706-K E. 19th St., Kansas City 8, Mo.

STEREO CAMERA for amateurs has a fixed focus, single speed, is loaded with a film magazine. Camera comes in kit with shoulder strap, carrying case and viewer
Linux Div. of Lionel Corp., 15 E. 26th St., New York

DO YOUR CHRISTMAS SHOPPING HERE-DO



FEED STATION for birds attaches to window sill without use of tools, allows you to watch and feed birds easily. Unit has perches, drinking and feeding cups

Dunecraft, Dunn Bldg., Penacook, N. H.

CAMERA that delivers a finished print in 60 seconds is smaller and less costly than its predecessor. Wallet-size photos from it cost less than standard pictures

Polaroid Corp., Cambridge 39, Mass.

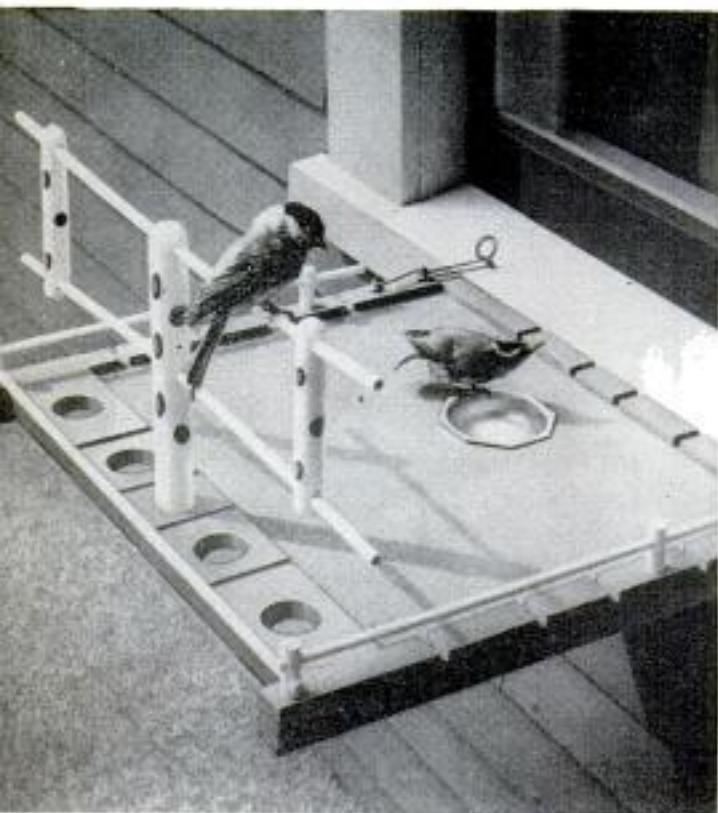



PICNIC SET allows you to carry in one hand a full meal for six or eight. Five aluminum pans filled with food, tableware and paper plates lock into each other to become one package. Bottom pan is a skillet
 Buckeye Aluminum Co., Wooster, Ohio

TOY TUBA made of lightweight plastic plays real music, is easy to blow and withstands rough handling by youngsters. Push buttons control eight hand-tuned valves. Instrument is three feet high, golden plated
 Emenee Industries, Inc., 200 Fifth Ave., New York 10

YOUR CHRISTMAS SHOP



TOOL CART for transporting lawn and garden equipment holds rakes, hoes, shovels, small tools
 Gem Toys, Inc., 702 Todd St., Azusa, Calif.

FISH SCALER is part of a power-tool kit for cleaning and sharpening fishing gear
 C-D Products, Inc., 3946 Willow Rd., Schiller Park, Ill.

CABINET for small objects has clear-plastic drawers that swing out

Akro-Mills, Inc., 820 E. Market St., Akron 9, Ohio



NOVEMBER 1954



103



BRUSHES of water-color set have reservoirs in handles, do not require messy dipping. Water and a coloring tablet in each handle combine to produce paint. Pictures to be painted go with set

Kenner Products Co., 912 Sycamore St., Cincinnati 2, Ohio

STAR PROJECTOR turns a small room into a planetarium. Light in globe shines through holes in shell, casting "stars" on wall or ceiling. The easily adjusted toy duplicates 40 constellations

Harmonic Reed Corp., Rosemont, Pa.

DO YOUR CHRISTMAS SHOPPING HERE-DO



MONORAIL toy train zips along single track. Flashlight batteries and an electric motor power the plastic, streamlined car. Nonpowered cars and additional tower and track can be added

Northrop Products, Inc., 915 Meridian, South Pasadena, Calif.



SHOCK ABSORBER for bicycle prevents any jarring action from being transmitted to frame and handle bars

Evans Products Co.,
Plymouth, Mich.

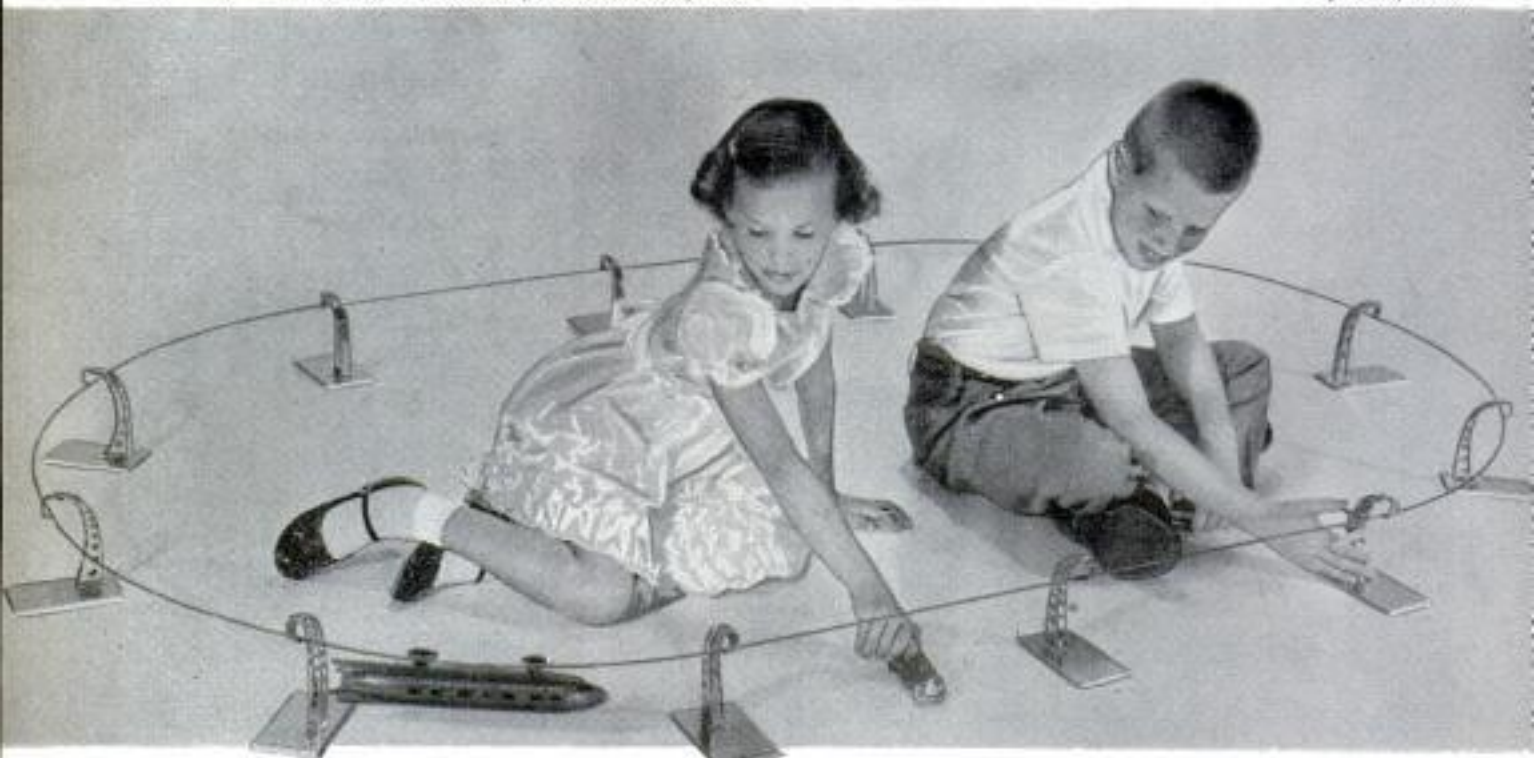



RERAILER for model trains simplifies the task of placing cars on tracks when setting up or after derailment. It lies on tracks, acts as chute
 General Machining Works, 214 W. Grand Ave., Chicago 10

CLOTHES HANGER shaped like a dog is made of perforated hardboard, with leather ears and tail and a plastic eye. Hooks fit perforations
 Robert J. Bender, 419 S. Jefferson St., Chicago 7



YOUR CHRISTMAS SHOPPING HERE-DO YOU

"RADIO" set transmits voice and code over two telephones up to a half mile away, has a toy station with signal searchlight
 Bemco Industries, Inc., Newark, N. J.



SWING in the form of a hobby horse is safe for small children. Rowing motion by child sends swing up into air. The seat is always level; swing hangs from three chains
 E. Burke Co., Van Dyne Rd., Fond du Lac, Wis.



TV EARPHONES let children listen to noisy programs parents don't hear. Headset has antenna and 12-foot cord
 Hoffman Radio Corp., 820 Atlantic, Kansas City, Mo.





Inflatable Sneakers for Mine Fields Distribute Weight Safely

Members of the British Royal Engineers are experimenting with inflatable sneakers for use in mine fields. The huge supports are inflated like toy balloons by the wearer.

When he's sweeping for land mines, they distribute his weight over such a large area that he won't trip a land mine even if he steps on one—it's hoped.

Last Gasp of the Steam Locomotive Here, But Not in Britain

Steam locomotives may have reached the end of the line in the United States, but not in Britain. The first of 20 new steam-powered freight locomotives has been delivered to the British Railways. They will be used primarily for mining hauls. The

coupled wheels are five feet in diameter and locomotive and tender measure 55 feet 11 inches long. Boiler pressure is 250 pounds per square inch. In 1953, for the first time in 125 years, not one U.S. railroad ordered a steam locomotive.

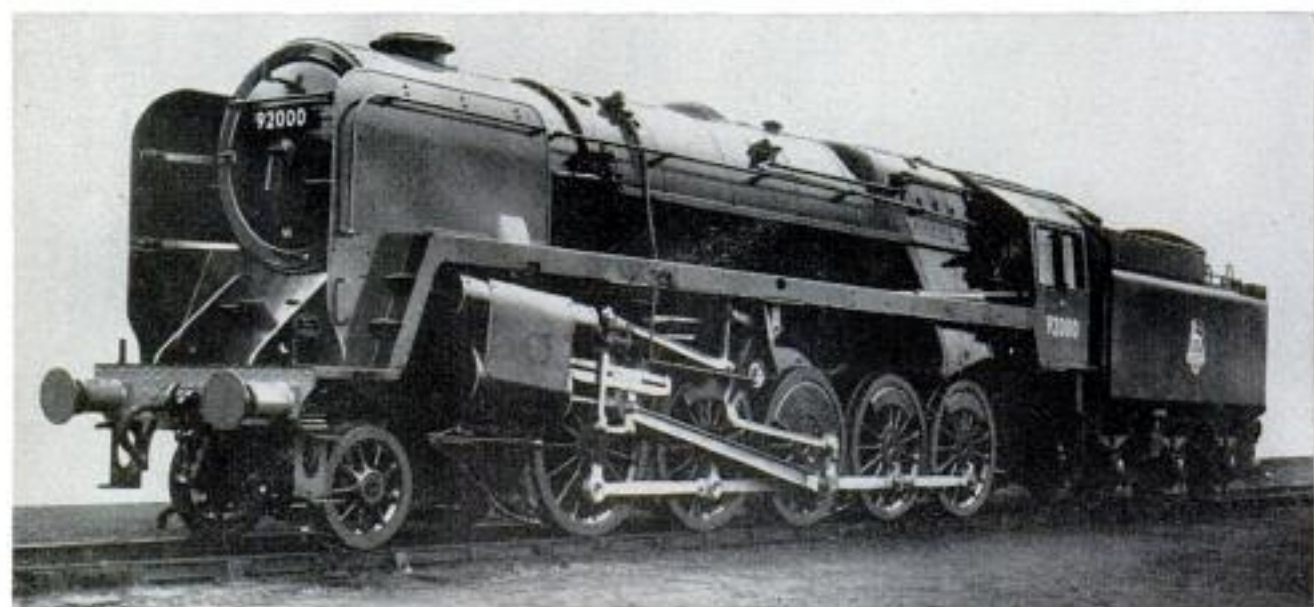



Drugged Pack Horses Take Plane Ride

Even pack horses are riding airplanes these days. Recently the Montana Fish and Game Department flew three of them over the Continental Divide to a remote wilderness lake. The horses were needed to carry out spawn of the black-spot native trout, but it would have taken many days to trail them in. An ancient Ford tri-motor plane was used, for it was the only craft that could carry a load over the Divide and land safely on the tiny U.S. Forest Service landing strip provided. The horses were "knocked out" with intravenous injections of chloral hydrate, rolled in canvas and swung into the plane for the 60-mile trip. Two trips were made. One of the horses came out from under the anesthetic during the first trip and a wild



scramble ensued. The cabin was not big enough for the frightened pony to stand in and the 25-year-old plane was seriously endangered. After the horses were landed, they were placed in the propeller wash from the airplane and quickly revived.



Truck-Mounted Arm Loads Hay Bales

Attached to the side of a truck or wagon, a mechanical arm picks up hay bales, swings them in a big arc and drops them gently in the bed of the vehicle. No source of power is required to operate the implement, as it works off a power wheel rolling along the ground. As the loader approaches the bale, a guide on a small caster wheel turns the bale into line so it will slide into the rear pick-up fork. The front fork then descends to clamp the bale securely, and the lifting arm hoists it through the air to the truck bed, where it is released. The arm then returns to the ground, ready to receive another bale. The loader is attached by dropping a bolt into a clevis welded to the truck or wagon. It can be operated in gullies, irrigation ditches and on hillsides.

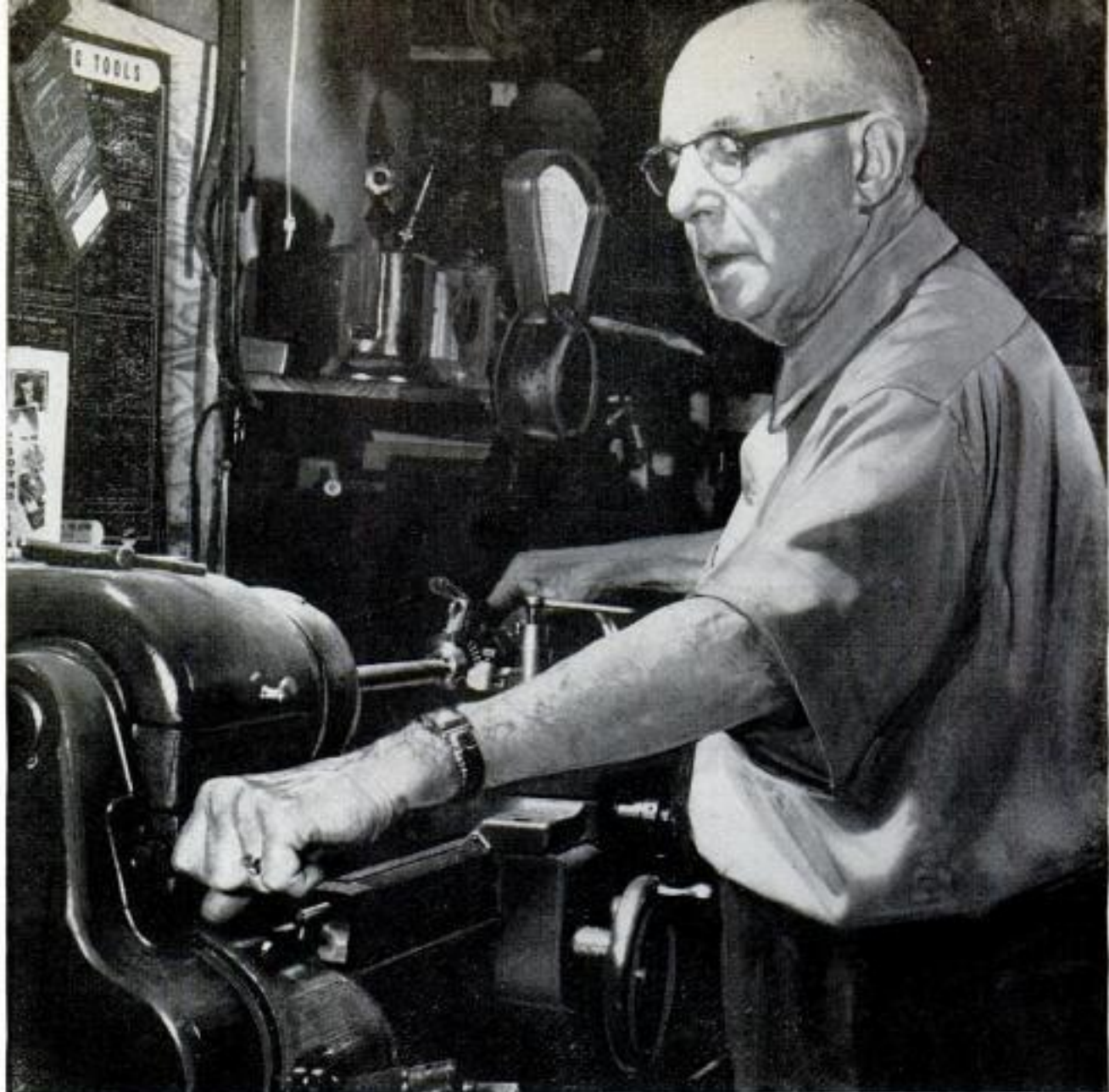

Although Copeman has made over \$1,000,000 on a single invention, he still likes to putter in his workshop

FIFTY YEARS AN INVENTOR

His name may be less renowned than Edison, but millions of housewives and their husbands thank Lloyd Copeman for a lifetime of ideas

By Anita K. Clever

THE MAN worried the heel of one glazed rubber boot with the toe of the other. Wherever the toe pressed, thin ice cracked and flipped to the ground.

Thus was born to Lloyd Groff Copeman a million-dollar brainchild, the rubber ice-cube tray for refrigerators. Copeman had been gathering sap "just for the fun of it," and slush collected and gradually froze on his boots. When he returned from the jaunt he sat down and dreamily regarded his footwear, an act of contemplation which led to the ice-cube-tray idea. It was one of many to be conceived by Copeman which would ease the daily burdens of the housewife and others.

This is the story behind the important

inventions of a man who admits "some of my neighbors are certain I'm balmy." A distinguished-looking, white-haired man from Metamora, Mich., Copeman's memory at 71 is one of his outstanding traits.

Immediately after the tray idea came to him, Copeman told his attorney to prepare patent applications for three types of rubber trays—one for a complete rubber tray, one for a tray with just rubber section separators and one with individual, removable cube holders. That night Copeman traveled to New York City on other business, and asked the use of his hotel's refrigerator in which he put small rubber caps filled with water. Next morning, after amusing himself by flipping the cubes out of them,



he elatedly wired his attorney to submit the application for the all-rubber tray.

The nation's ice-cube consumers avidly accepted Copeman's tray idea and the invention proceeded to gross more than a million dollars in royalties.

Copeman's inventions range from items as indispensable to the modern housewife as the electric stove to a process used throughout the world for greasing automobile bearings.

The electric stove evolved from a thermostat he had invented which provided automatic warning when transformer stations for high-tension wires were about to burn out.

In those days of 1906, some women practiced the art of cooking in what was known as a "fireless cooker." This was an awkward wooden box which enclosed heated soapstones over which pans of food were placed. Copeman applied the idea of his transformer thermostat to a fireless cooker and substituted electrical units for the soapstones.

A few years later, Copeman and the late J. D. Dort, automotive pioneer, established in Flint, Mich., the Copeman Electric Stove Company. It began in 1912 with 22 stockholders and was a \$500,000 enterprise.

Residents of the carriage-manufacturing town of Flint may have been favorably impressed with Copeman's stove—not so the rest of the country. The electric range, unlike the rubber tray, was not swiftly fastened upon by the housewife.

One day he sat glumly alone in a booth at a Philadelphia convention where various manufacturers were demonstrating their products before potential distributors. He had been undisturbed all day by a single distributor. But now, approaching before his almost unbelieving eyes, was a handsome, elderly gentleman, who stopped and expressed interest in Copeman's stove.

"And how are you doing with your product, young man?" the gentleman inquired of the inventor.

"Well, we've got a good product, but darned poor sales organization—that's me," Copeman said.

"We have a good sales organization and no likely cooking product," the man replied. He was president of Westinghouse Electric Corporation.

In a few days, a deal was made in which



Copeman got the idea for the rubber ice-cube tray from a rubber boot which easily shed ice coating

A recent invention is this hood for paint cans that catches drippings and keeps rims clean for resealing



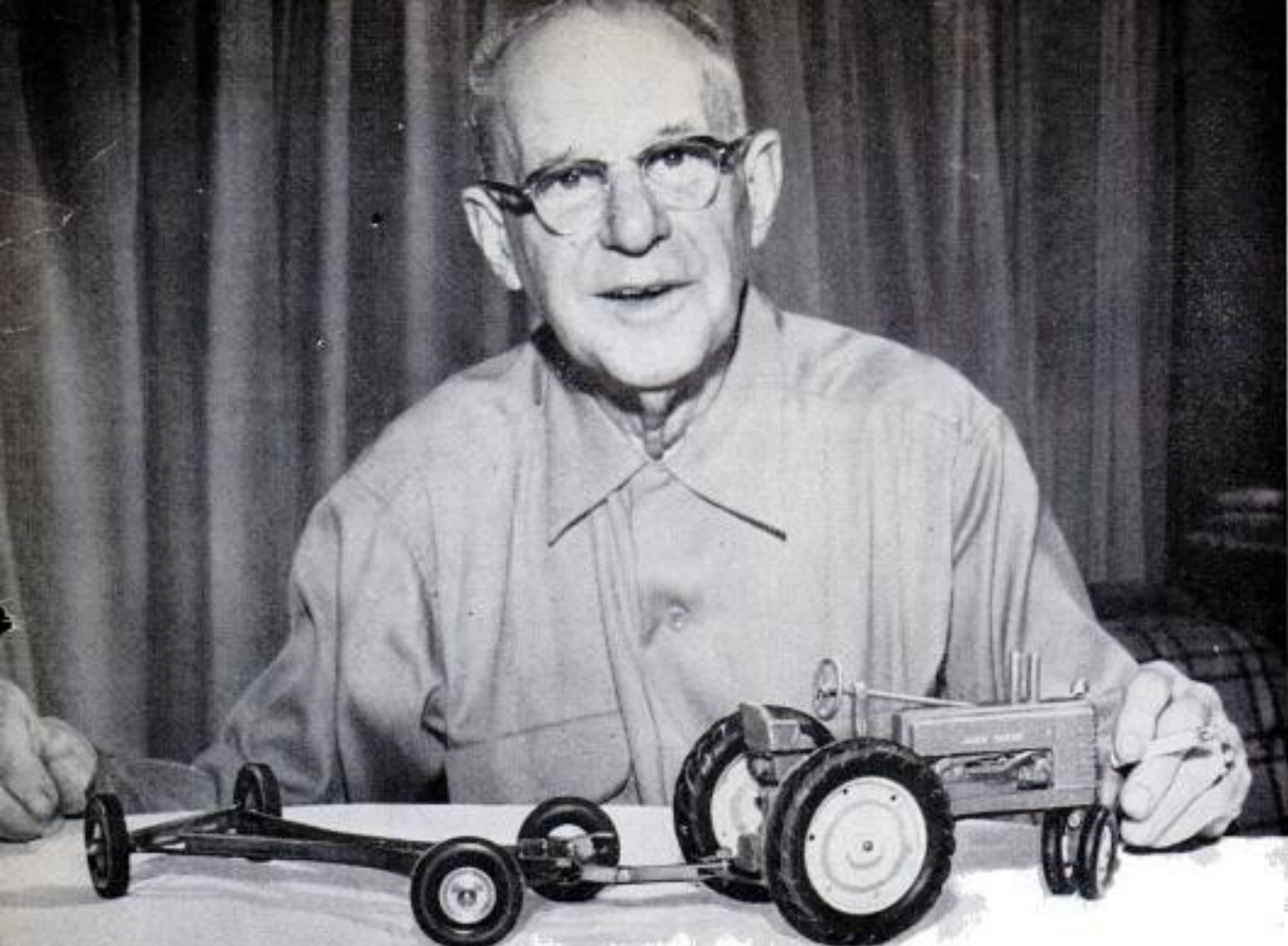

Special gear for trailer permits rear wheels to turn for balanced carriage of load; it locks for normal use

the Copeman stove company was absorbed by Westinghouse. The year was 1918.

One of the inventor's first money-making products was developed in 1900. It was a cauterizing instrument for surgery. Another invention which never amounted to much financially, but which certainly has a practical value, is his flexible-rubber clothesline for indoors. The clothesline is about a foot long and is of three strands of braided tube rubber. This stretches to eight feet and articles of clothing are clamped between the strands until they dry.

A number of his inventions were born as a result of his having spent most of his life in one of the biggest centers of automobile production in the world. Some of them died there, too. One which thrived and is used today throughout the world is a high-pressure system for forcing grease into automobile bearings. This idea was sold in its infancy for \$178,800.

Another ingenious and work-saving device that Copeman invented was the result of an idea born, quite naturally, with the help of his wife. The two were window shopping and she spotted a toaster.

"Why don't you invent a toaster that turns the toast automatically?" she asked casually.

So he did. He employed a knob and rack

device which turned the bread without making it necessary to touch it. This was the first automatic toaster, forerunner of the pop-up toaster of today.

One of Copeman's ideas, which has been extremely valuable to his fellowmen and is used in countless ways, is his application of latex, as acquired in its liquid form from trees. Copeman discovered that this product, when applied to paper, forms a cold, strong adhesive which sticks to itself but to nothing else.

Copeman is presently awaiting word on the value of latex as used in a possible tamperproof envelope for the government. The envelope cannot be opened without tearing the message. Another use of latex is a protective paper covering for auto parts in shipment.

Among his other patented inventions is a refrigeration process used by meat delivery trucks. In this, Dry Ice is melted in a nonfreezing-liquid bath and the resulting gas forces the chilled liquid through tubes in the truck. He also dreamed up a paint-can hood to keep the top of the can clean so the cover can be fastened tightly after using only part of the paint. This one is not yet in production.

Copeman has many more inventions up his ingenious sleeves. After all, he figures, you can't let the neighbors down. ★ ★ ★

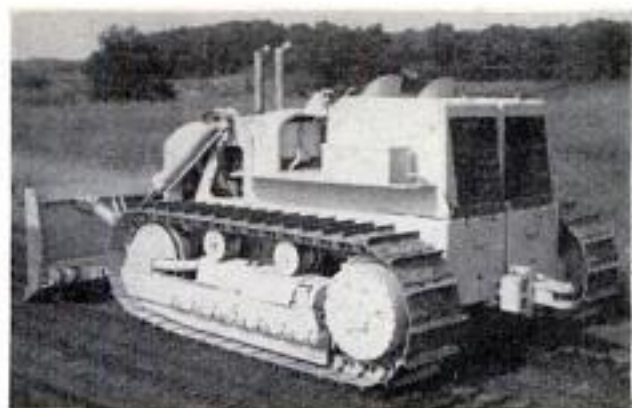

Separate Engines Power Left and Right Tracks of Tractor

Each track of a new crawler-type tractor is powered by its own diesel engine. The engines are mounted side by side in front of the operator, with their radiators located in the rear to minimize dust and heat around the driver's seat. Each of the 190-horsepower engines transmits power to its

own track through a torque-converter transmission. All shifting is accomplished under full power, and the tractor can be shifted from one speed range to another without loss of motion. The top speed is eight miles per hour. The tractor is steered by varying the speeds of the two engines.



Proposed Television Sets Would Feature Thin Screens

Your TV-picture screen in 1964 may be so thin that it can be hung like a painting on the wall or mounted like a vanity mirror in a table model. That's the prediction of General Electric scientists. The circuitry would be built into the picture frame and would use printed wiring and miniature components. Closely spaced wire grids would luminesce at their intersections to reproduce the transmitted picture. The futuristic TV set was suggested by work on an aircraft plotting system that will automatically transfer radar information to a picture screen.

Home Battery Charger Serves Double Purpose

Auto and marine batteries are kept at top efficiency by a charger that delivers six amperes until the full charge is reached. Then it automatically switches over to a low-charging "battery saver" circuit that maintains a full charge over weeks or months. One plug of the charger connects to a standard electrical outlet while another plug fits into the cigar lighter on the car's dashboard. The compact charger is easily carried and is simple and economical to operate. A single push button begins the charge. The rest is automatic.

☐ Nearly 700 diesel-powered taxicabs went into service in London during the first half of 1954.





The A-shaped net not only catches the smelt when properly cast, but provides a storage pouch at one end

Tricky A-Nets Land Surf Smelt

ALONG THE COAST extending from southern Alaska to northern California an unusual brand of smelt is caught in an unusual manner. The surf smelt, which has the unique habit of spawning in the surf in small coves, is captured in large quantities in A-nets. These nets are in the shape of an A with a crossbar to complete the letter. A thin-meshed, baggy net is attached and the net is dipped into the surf large end down. The fisherman wields the net with one hand on the crossbar and the other on the pointed end.

There is a definite knack required to make a good catch. If the fisherman does not meet the wave as it breaks and rolls

Fishermen must lift A-nets quickly after dipping into the surf or the elusive smelt will get away

over the beach, the fish move in, spawn in an instant and are going out to deep water again. The experienced netter learns a few practical tricks such as dipping his net at just the right moment, then lifting it quickly into the air above the water. If he lands any surf smelt—one dip usually yields from two or three to a dozen—the fisherman works the catch down to the small end of the net, forming a little bag over which he closes his hand. This enables him to keep his catch until he has enough to take ashore and put into a bucket. The spawning season is from early summer to late fall, but the elusive smelt come and go in their own mysterious way.

Green and silver smelt average six inches in length and are very tasty. Coast limit is 25 pounds a day





Paste Made From Cactus Roots Cleans Books and Wallpaper

Ground cactus roots make up a new detergent that cleans book pages without causing them to stick together. It's also a fast-acting cleanser for Venetian blinds, wallpaper, mirrors and furniture. Harmless to the hands, it contains a powder base and is supplied in the form of a paste which is diluted with eight parts of water for normal use.

Photoflash "Pin Wheel" For Rapid-Fire Shots

Photographers can shoot five flash shots in a hurry when their cameras are equipped with a turret-type flash gun. A revolving magazine holds up to five bayonet-base bulbs. After each shot, the photographer merely turns a fresh bulb upright. Or, if he wants a trick effect, he can spin the magazine with the shutter open for a multiple exposure. The unit fits any camera equipped with a synchronized shutter and uses a 22½-volt battery, firing through a condenser. Extra "pin wheel" magazines can be bought separately so you can load several of them in advance for rapid shooting, if you wish.

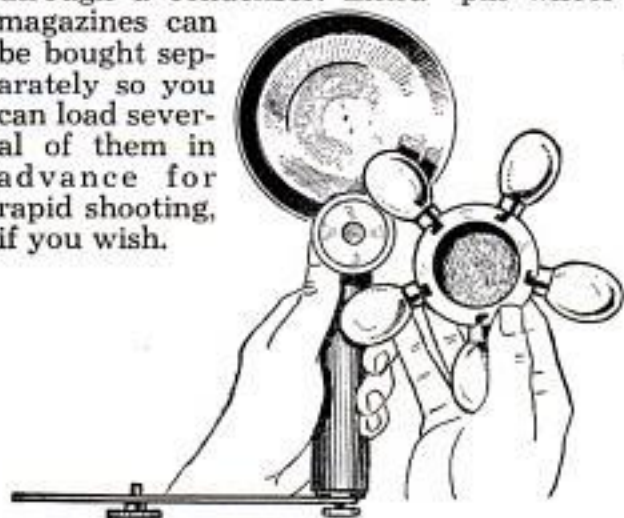

NOVEMBER 1954



Portable X-Ray Unit Needs No Electricity

Only \$40 worth of materials was required to make a little X-ray unit that produces rays comparable to those of a 100,000-volt X-ray machine. The simple, portable device contains radioactive thulium and does not require electricity. Developed by the Atomic Energy Commission's Argonne Laboratory, it may be used for X-ray photography in industry, for medical purposes in remote areas and in Army field hospitals.

Plastic Pennants Aid Sailors

Plastic pennants for sailboats make it easy for amateur yachtsmen to keep their craft in the "wind's eye." A one-ounce lead weight on each pennant staff keeps it always perpendicular, no matter how high the boat is heeling. Used in pairs, the sensitive wind indicators are fastened to the mast at right angles to the centerline.

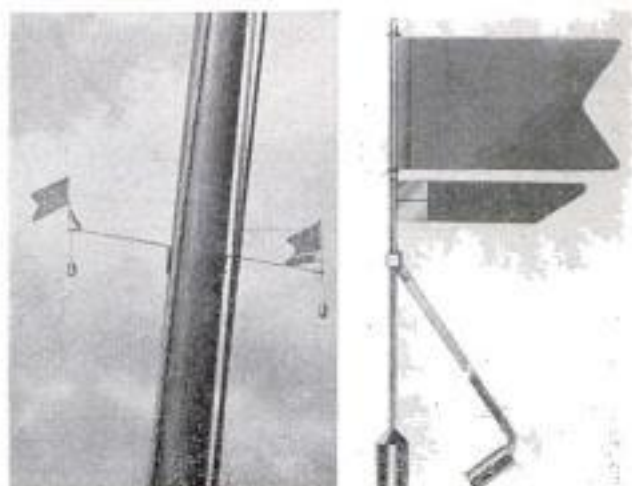

113

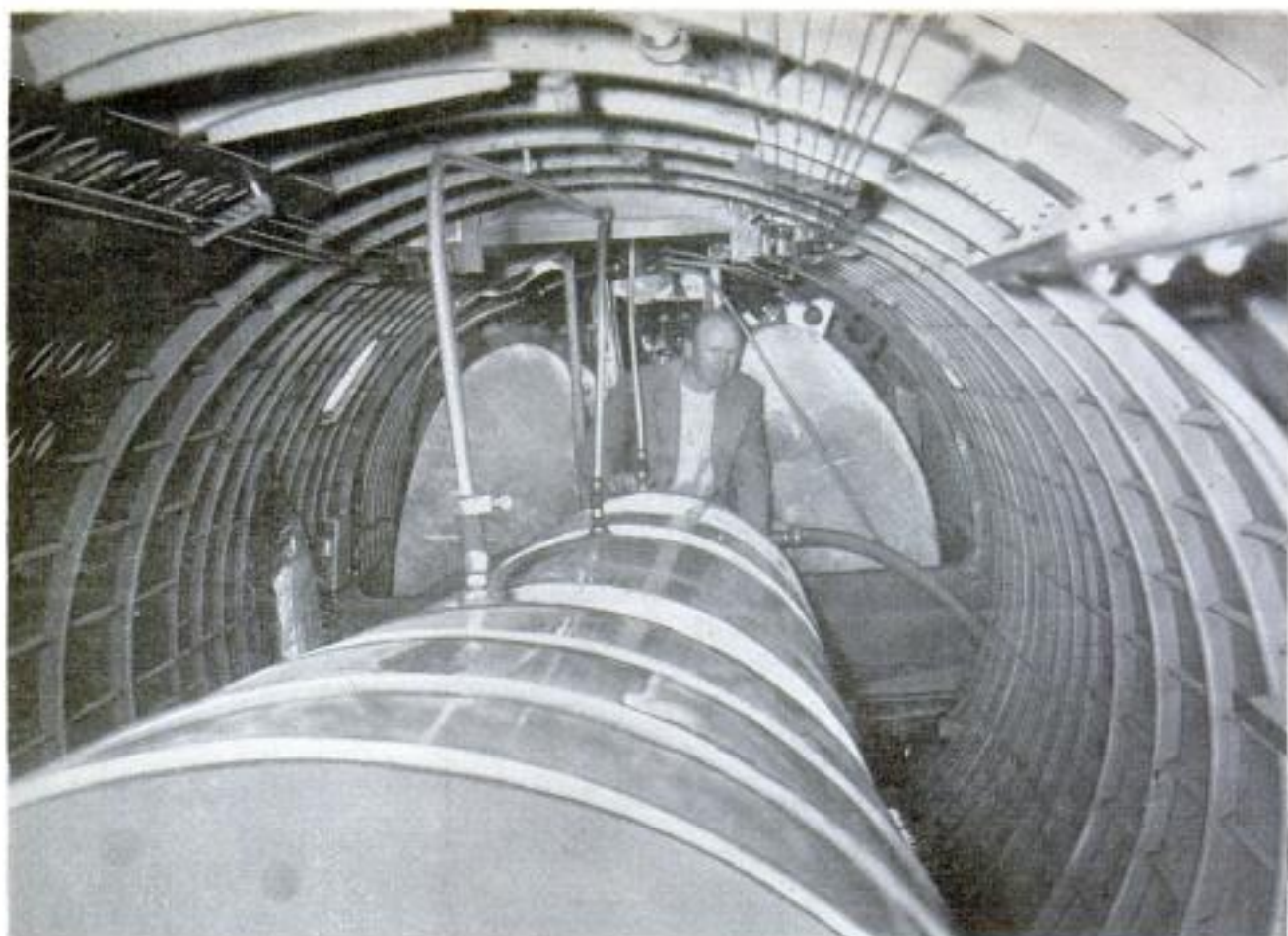

Built to carry bombs, the B-17's fuselage is almost filled by the eight interconnected insecticide tanks



In addition to the huge tanks inside the plane, there are two F-94 jet wing tanks suspended under the fuselage. Between them can be seen the center spray bar. Below, there is also a spray bar under each wing. Propeller wash helps spread insecticide



Bomber Battles Bugs

SPRAYING 150 ACRES of land per minute, a huge four-engine B-17 is said to be the world's largest insect-spray plane. At the end of World War II, the plane ended up in a Stuttgart, Ark., park as a war memorial. Bought by two brothers, Max and John Biegert of Shickley, Neb., the B-17 was completely refitted. The change-over from bombing in war to "bug bombing" in peace took 13 months and \$80,000. The Biegerts are no novices at the business as they have been spraying from airplanes for eight years. Heretofore, however, they have always used the conventional, small single-engine plane. Three spray bars release a 500-foot swath of spray. With four engines whipping the spray, the plane lays down a mist upon 150 acres per minute. Two tanks under the fuselage and eight more inside the plane provide space for hauling 3000 gallons of insecticide. In operation, the plane flies at 150 feet altitude and 160 miles per hour.

Desk-Top "Brain" Costs \$48,000

For just \$48,000 you can buy a desk-top electronic computer that stores 2048 words in its magnetic-drum memory. Data are fed to the "thinking machine" by as many as 10 electric typewriters at a time, or by perforated tape. The computer has a host of uses. According to the manufacturer, the machine does the work of a million-dollar computer and is worth installing in any office employing 500 people or more.



Brush Chopper Cuts Big Branches

Tree trimmers of a Florida power company feed brush into a machine that chops it up and blows it into a truck. The barrel-type cutter, with a single blade, takes a one-inch chip off butts of branches up to four inches in diameter. The brush is reduced to an easily handled silagelike mass, to be hauled away for dumping or pulp tests.

Airplane Stays on Ground to Teach Pilots How to Fly

Flying students don't wear parachutes while learning to fly in a combination automobile and airplane. Invented by an Italian, the trainer has the conventional controls of an airplane. As the car is driven along the highway, the air currents passing over the wing surfaces of the plane, attached by a swivel to the car, cause the aircraft to respond to the controls as though airborne.

☛ Birds are repelled by a substance that is sprayed on roosting places with an aerosol bomb, and is effective for over a year.

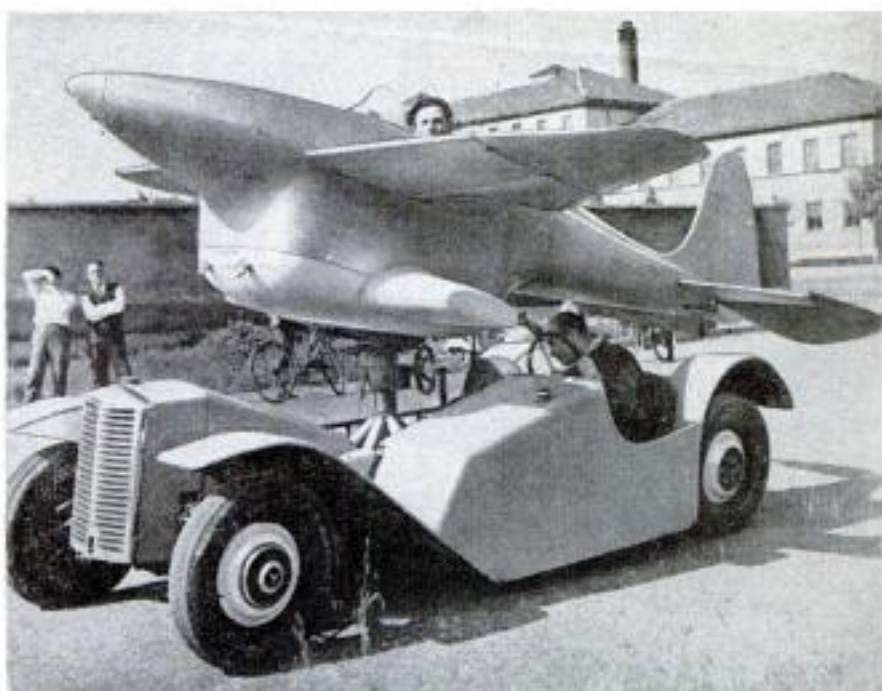



Electronic Tail Guns Kill in Fog and Dark

Protecting the Air Force's Boeing B-47E Stratojet bombers are electronically controlled tail turrets that can see and shoot down enemy interceptors in the night or fog. The turret mounts two 20-mm. cannon. In a danger area, the turret's radar is turned to "search." If the radar picks up an attacking plane a "pip" appears on the screen. When the target is centered in the cross hairs, the "electric brain" tracks it automatically, computes the firing information and fires the guns when the attacking plane comes into range. The turret was designed by General Electric especially for high-speed-jet operations.

Guided Missiles Ride Navy Jet

Four Sperry Sparrow guided missiles hang from racks beneath the wings of the Navy's twin-jet night fighter, the Douglas F3D Sky-night. These launched missiles travel at supersonic speeds and are directed by the fighter pilot as they rush toward their targets.



Automobile Turntable at Drive-In Bank Turns Them on a Dime

Motorists using the drive-in service of a Waterbury, Conn., bank can negotiate a sharp U-turn in the bank's narrow lot with the help of an electrically driven turntable.

As a car drives onto the turntable, it breaks an electronic beam that is directed at a photoelectric eye, and a yellow caution light flashes on. A second beam is inter-

sected when the car is fully on the turntable, a red light warns the motorist to stop, and the table revolves to face the car in the direction of the teller's window. A third beam situated between the turntable and the teller's window stops the turntable if cars are lined up in the drive. The new feature is used once every two minutes during the average day.



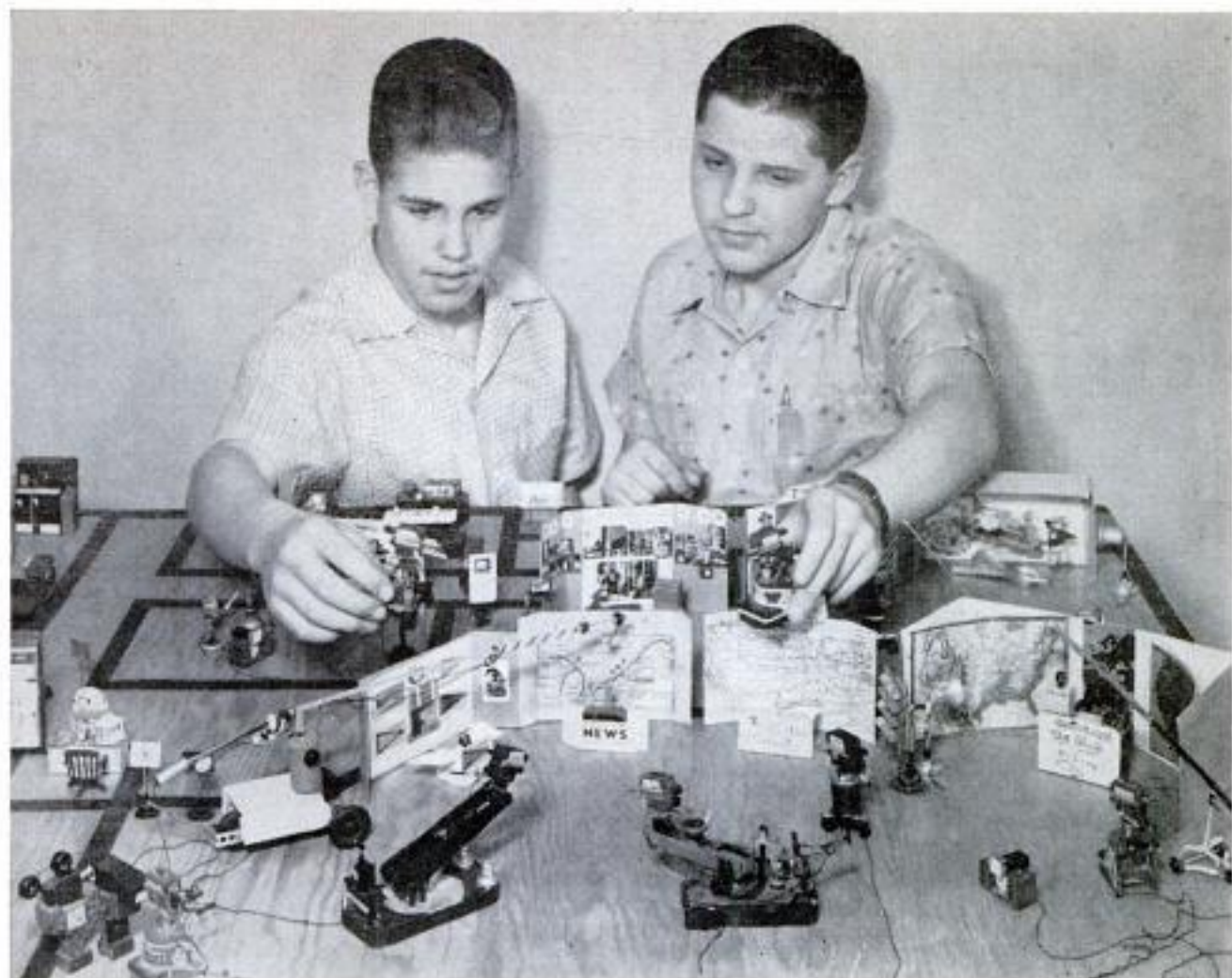

Jeff Howard, 12, and Donald Wasserman, 15, pooled skill and knowledge to build this model TV-station layout

Young Technicians Build Accurate Models of Television Equipment

At an age when most youngsters simply watch TV, Donald Wasserman, 15, and Jeff Howard, 12, of New Haven, Conn., are building accurate replicas of television broadcasting equipment. Their biggest project has been a complete layout of a TV station, which they've exhibited on three television programs and at the local do-it-yourself show. They have also built a model of a transmission station, a mobile unit and a home containing a tiny receiver.

Cameras, booms, cable and other gear are made from pieces of wood, pins, matchsticks and thread. Donald, an amateur student of TV since he was eight years old, supplies most of the technical knowledge and Jeff contributes his skill in draftsmanship to sketch and build models. The Allen B. DuMont Laboratories gave the boys technical information with which to build further models and presented them with a valuable used image-orthicon tube.



Semiautomatic Shotgun With Recoil Spring in Stock Holds to Target

Equipped with a nonrecoiling barrel and a recoil spring built within the stock, the new Model 50 Winchester shotgun is said to have very little tendency to stray from the target as shot after shot is fired. The semiautomatic shotgun has an independent

chamber that moves less than $\frac{1}{10}$ inch to actuate the breech bolt and start the cycle of unlocking, extraction, reloading and locking. An inertia rod, working against the spring in the stock, absorbs the recoil to make the gun "softer" on the shoulder.

OWNERS REPORT:



Its good points:

"I drive 500 miles a week, mostly in city, and save \$4 a week on gas. It's paying for itself."

Michigan insurance adjuster

"At 73 miles per hour, it handles as good as at 40. With it, my parking problems are gone."

Indiana animal welfare worker

Its weak points:

"Needs no-draft vents on windows. Also there should be a cover on the glove compartment."

New Jersey engineer

"Accelerator is a poor design. No foot rest."

Massachusetts insurance man

Is such a small car worth-while?

"Half the bulk of a big car is wasted. The less horsepower, the more careful a driver is."

Mississippi branch manager

"Cars are too big because we try to keep up with the Joneses. Only big families need big cars."

Massachusetts salesman

"With fuel costs going up, big cars are unwise."

New York flight engineer

"I do a lot of city driving. With my big car I was always tired, even with automatic shift. Now I shift and end up fresher and money ahead."

Michigan sales manager

METROPOLITAN IS A GOOD THING IN A SMALL PACKAGE, SAY OWNERS

By Metropolitan Owners

THE NASH METROPOLITAN is like one of the family—you love it despite its faults. And it does have faults, owners agree, but its good points are so good, its faults are unimportant.

The car's smallness is its strongest point—and its weakest one simultaneously. Owners with no previous experience in small-car driving are amazed to find it so enjoyable, yet want more rear-seat room.

"Aside from the fact that occasionally I would like passenger room in back, I have never driven a car I liked more."—Marcellus, N. Y., secretary.

"I bought this car after one ride around the block. Since then I have learned I have a real car, not just a cute plaything. I buy a new car every year, but haven't liked owning anything so much since I bought my first bicycle. I now take long rides on side roads and even wash the car myself. I haven't driven a sports car, but this car is so good it makes me believe American cars are not all they could be."—Lincoln, Neb., plant manager.

That seems to be typical. The owners are amazed that a car can be so easy to drive, comfortable, economical and yet so small.

Handling Is Best Feature

By far the best-liked feature (see percentages on page 121) is its handling and maneuverability.

CLYMER ROAD TESTS THE METROPOLITAN

By Floyd Clymer

I ABUSED this little car for 376 miles and got the surprise of my life. Performance was far better than I expected from the tiny, economical 73-cubic-inch engine (less than one third the size of a Ford or Chevrolet). The engine is a British Austin A-40 overhead-valve, 42-horsepower, 4-cylinder job.

With a rear-axle ratio of 4.6:1, the car cruises nicely at 60 to 65 miles per hour. Top speed was 78 on the speedometer.

(Continued to page 248)

"I feel superior when driving. I'm driving the car, it's not driving me."—Fair Lawn, N. J., clerk.

"Easiest car I ever owned to park or get around in. Handles as good at 70 as at 40."—Richmond, Ind., owner.

"An almost perfect performer, a pleasure to drive and a joy to own, not to mention the startling decrease in operating costs over 'standard' cars."—Dover, Mass., insurance man.

"Extremely responsive to steering on winding roads. Does not roll on turns, but will skid in wet weather and on sand."—Newtown, Conn., attorney.

Next in the owners' favor is economy.

"I save \$5 a week on gasoline alone."—Bayside, N. Y., salesman.

"My weekly expense for this car is about \$1. It will pay for itself in savings of the difference over my previous car costs."—Hammonton, N. J., technician.

"Never been so pleased with any car in my life. I drive 500 miles a week, mostly in city. This is a businessman's dream. I save \$4 a week on gas. The car is paying for itself."—Detroit, Mich., adjuster.

"I drive about 600 miles a week in city traffic and haven't had a thing done to anything. Change oil every 1500 miles. Never down a drop. Wind up with four times as much money in my pocket as with big car."—Detroit, Mich., sales manager.





Starter is operated by pull-type switch. The small glove compartment is doorless and the owners object

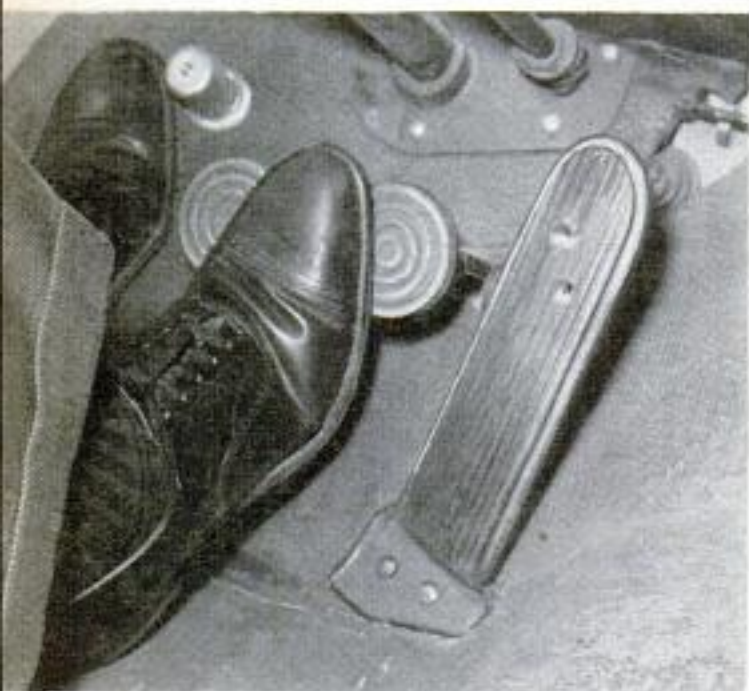

Brake and clutch pedals are too small, too crowded, says Clymer. That is the modified accelerator pedal

Owners object to lack of outside opening in trunk. To load it, you have to pull down the rear-seat back



Here Are Some Complaints

As mentioned above, Metropolitan owners do not hesitate to point out their cars' weaknesses. It is obvious that they believe so strongly in its good points, the weak points are not something to hide. Most frequent complaint was the awkward and uncomfortable accelerator pedal.

"Gas pedal works with very little pressure and leg gets tired on long drive. Should get away from Nash front-fender styling to give shorter turning radius."—Decatur, Ill., manager.

"Accelerator pedal is uncomfortably located even with their makeshift modification."—Bradley, Ill., electrician.

Originally, the Metropolitan had a roller-type gas pedal. Later models have a conventional organ-type slab pedal.

Water and dust leaks were second on the list of owners' complaints.

"Rubber strips around doors too narrow and don't seal. Water comes in freely in the rain."—Skokie, Ill., businessman.

"Water leaks in and the floor mats smell awful when wet. Don't like windshield wipers. Too noisy."—Boonville, N. Y., distributor.

Another frequent complaint was the lack of exterior trunk lid. To get into the trunk, you have to fold down the back of the rear jump seat.

"Trunk is inaccessible and the rear seat is of no value. Therefore if the rear seat could be pushed back and made more comfortable the car would be more desirable."—Milton, Mass., engineer.

"Don't like no outside access to trunk. After being used to garage-door trunk lids on large cars, it is unhandy to say the least. However, I seldom use this space."—Biloxi, Miss., manager.

Are Small Cars Practical?

We asked the owners of the Metropolitan to comment on their experiences with this smallest of American cars.

"My husband and I purchased this car for a second car, but now we would like to dispose of our large car and get another Metropolitan."—Logan, W. Va., housewife.

"I am six feet tall, weigh 260 pounds, yet I drive this car without being cramped. I use it in preference to my 1953 four-door V8 except when late or when more than one grown person besides myself is going along."—Hillsboro, N. H., lawyer.

"After driving a small car, big cars seem like arks. Too much car for the job."—Brimfield, Mass., nurse.

"We have a larger car. Do not use it as much for pleasure as we do the Metropolitan."—Littleton, Mass., secretary.

"Just returned from a 1700-mile trip.



Percentages from PM Poll of Nash Owners

Owners in 29 states
took part in survey

Average mileage reported by Metropolitan owners: 3292 miles

Average miles per gallon

Everyday driving 32 m.p.g.
Long trips 37 m.p.g.

Owners adding oil during 1000
miles 25%

Owners rate roadability

Excellent 66%
Good 34%
Poor 0%

Owners rate handling

Excellent 86%
Good 14%
Poor 0%

Owners rate structural rigidity

Excellent 51%
Good 46%
Poor 3%

Average speed driven

Normal driving 52 m.p.h.
Top speed 75.4 m.p.h.

Owners rate engine

Powerful enough 95%
Not powerful enough 5%

Owners rate car's size

Satisfactory 96%
Too small 4%

OVER-ALL RATING OF METROPOLITAN

Excellent 65%
Good 31%
Fair 3%
Poor 1%

Owners say trend to large cars

Is wise 3%
Is unwise 97%

Does small car feel safe?

Yes 100%
No 0%

Owners rate brakes

Excellent 70%
Average 28%
Poor 2%

Owners rate visibility

Excellent 87%
Average 12%
Poor 1%

Owners rate driver's seat

Comfortable 92%
Uncomfortable 8%

Owners rate passenger's seat

Comfortable 94%
Uncomfortable 6%

Only car in family?

Yes, only car 67%
No, second car 33%

Would buy another Metro?

Yes 67%
Might 30%
No 3%

Another car this small?

Might 46%
Yes 30%
No 24%

Owners rate dealer service

Excellent 40%
Good 25%
Fair 18%
Poor 17%

BEST-LIKED FEATURES

Handling, maneuverability 65%
Economy of operation 58%
Parking ease 34%
Styling 26%
Performance 16%

MOST-FREQUENT COMPLAINTS

Foot-throttle position 18%
Water and dust leaks 15%
Inside trunk door 13%
Dealer service 12%
Open glove compartment 10%
No no-draft vents 9%

Owners with no complaints, 15%

You can buy a Metropolitan in
either hardtop or convertible
models. It takes only a minute
for one person to put up top



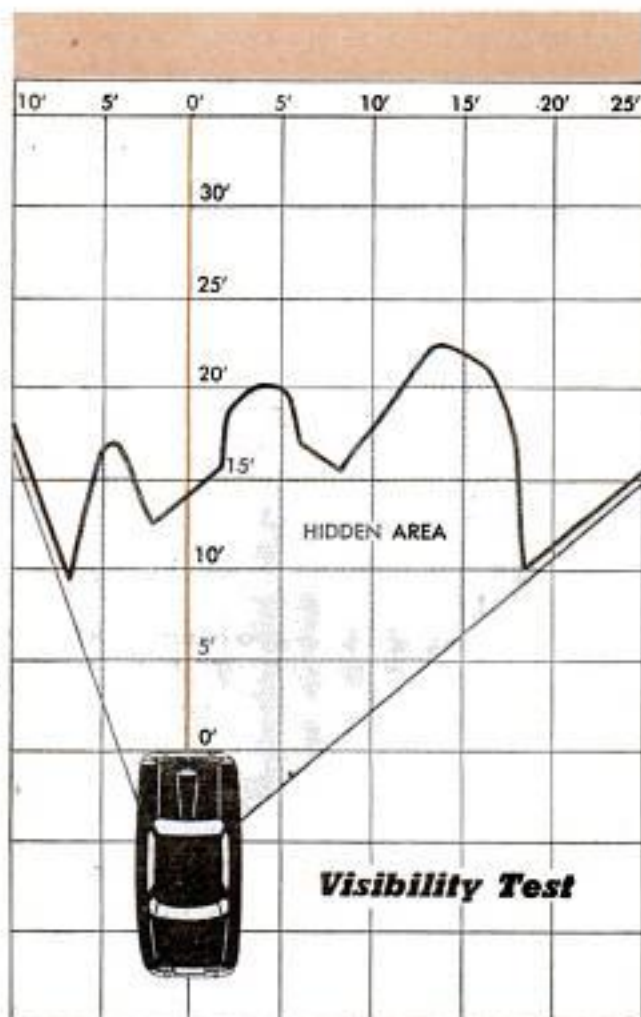

Acceleration Test

NASH METROPOLITAN HARDTOP

1/4 mile from zero	24.1 seconds
1/2 mile from zero	49.8 seconds
0 to 30 miles per hour	5.9 seconds
0 to 60 miles per hour	22.2 seconds
Top speed by speedometer	76-78 miles per hour
Actual top speed about	74 miles per hour

Economy Test

Constant-Speed Mileage

At constant 30 miles per hour	39.1 miles per gallon
At constant 50 miles per hour	25.1 miles per gallon
At constant 65 miles per hour	29.4 miles per gallon

Cross-Country Mileage

Los Angeles to Bakersfield (via Ventura)	considerable traffic	31.1 miles per gallon
Bakersfield to Carstow	(via Mojave Desert)	36.6 miles per gallon
Carstow to Los Angeles (via Angeles Crest Mountain Highway)		33.8 miles per gallon

*Regular gasoline used in all tests!

✱ Each month PM surveys owners from coast to coast to find out what they think of their cars. The results are carefully reported in this series of Owners Reports. In addition, Floyd Clymer tests the cars for performance data shown above. By these two methods, the Owners Report and the Clymer Test, we accurately report the good and bad about each car

Had plenty of baggage space and were comfortable. Two grown-ups and two children. Drove 850 miles in 17 hours, averaged 50 miles per hour and 30.7 miles on a gallon."—South Bend, Ind., salesman.

"Have a wife and baby. We make back seat into bed for baby."—Detroit, Mich., crane operator.

"Many people go too deeply in debt for cars. They buy to satisfy their ego, not their real needs. Even a teacher can afford this car."—Bernardsville, N. J., teacher.

Are Small Cars Safe?

"It gives a sense of speed when on the road which you do not have in the big car. Consequently we drive slower."—Normal, Ill., businessman.

"There would be fewer mishaps and deaths caused by reckless driving if all cars were Metropolitan."—Newburgh, N. Y., machine operator.

"I feel completely safe except when big trucks follow too close behind."—Franklin Square, N. Y., clerk.

"I notice that large cars tend to cut me off. I have to watch every one that passes so they don't cut into me too soon."—Amityville, N. Y., aircraft engineer.

"Very safe, because of fast reaction to steering."—New Orleans, La., traffic manager.

Other Best-Liked Features

"Large part of big-city parking problems can be solved with small car."—Chicago engineer.

"I park on the streets of New York City and many times have found a parking place the ordinary car would not fit. Commuting is now as cheap as a bus, cheaper than a train, more convenient than either."—Old Tappan, N. J., bank teller.

"Uses little garage space."—Cedar Rapids, Iowa, engineer.

(Continued to page 244)

Engine is so tiny that it is hard to believe it will move the car so easily at 60 miles per hour or more



Fast Clinical Thermometer Takes Temperature in Seconds

You don't have to shake down a clinical thermometer that tells a patient's temperature in five to seven seconds. A stainless-steel probe that goes in the patient's mouth contains a tiny Carboloy thermistor that resists heat and translates this resistance into degrees on a hand-held meter. A flexible cord connects the probe with the meter, which is contained in a plastic hand-piece and is powered by a mercury-cell battery. Tests showed the new thermometer takes daily ward temperatures in a fraction of the time usually required.

Portable Icebox Carries Fish

Fresh fish are kept that way by a refrigerated container that is shipped directly to its destination. The conventional method is to transfer the fish from a refrigerated railroad car to cold storage before delivery to buyers. The insulated aluminum container, which holds 150 pounds of fish, is kept at 29 degrees for 100 hours by a mixture of sodium sulphate and water sealed in rubber plaques.

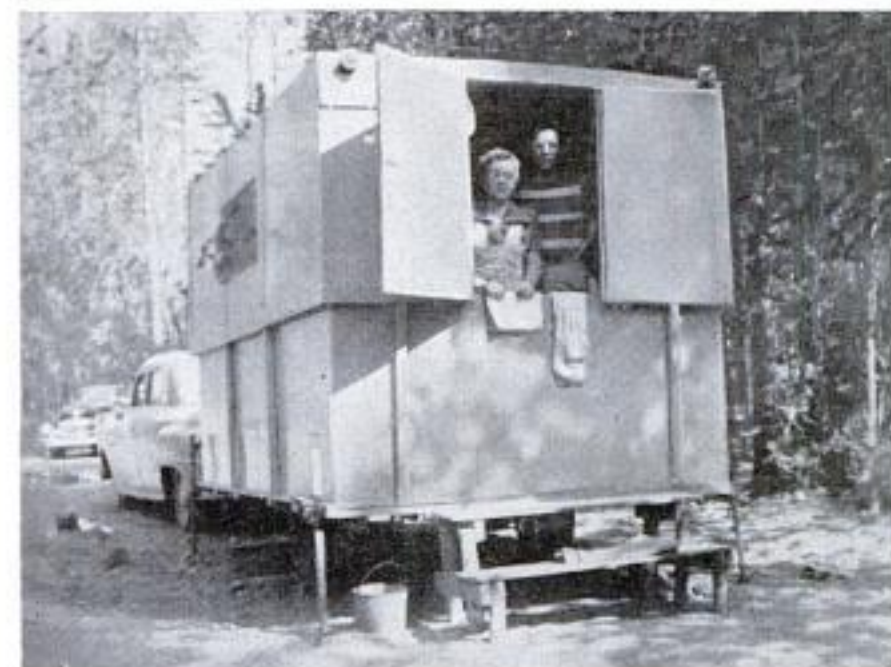
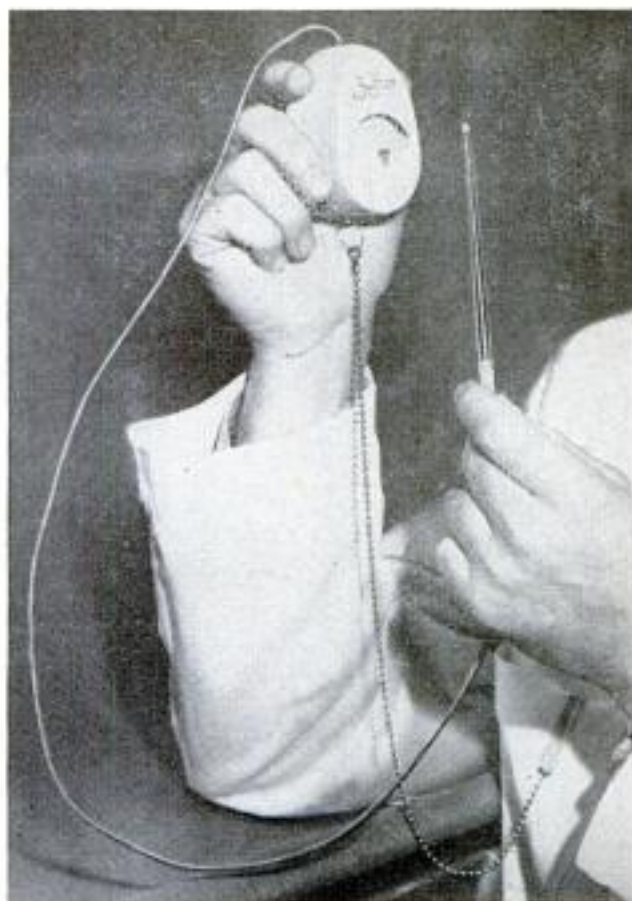

Telescoping Trailer Doubles Its Size

When it's on the road, a two-wheel cabin trailer built by A. B. Walfrid of Minneapolis is collapsed for easy traveling. The top half of the cabin, which is 47 inches high, drops down over a 42-inch-high bottom section. When it's time to stop for the night, Walfrid quickly raises the upper section with a winch. Light and air are supplied by three screened windows in the outer shell. The top rear doors swing out on both sides and, since they are wider than the lower door, permit access to the trailer even when it is collapsed. Walfrid, starting with an ordinary 44-inch by 72-inch two-wheel trailer, built a cabin of tempered hardboard supported by pine bracing. It is 6 feet, 8 inches wide, and 11 feet, 8 inches long. Cost of conversion was \$250.



British Information Services photo

Flying Suit With Air Supply Cools British Jet Pilots

Designed to keep pilots cool at very high speeds and extreme altitudes, a new British flying suit is plugged into an air supply that is distributed through vein-like tubes to about 100 parts of the body. It is worn beneath the pilot's pressure suit and other safety equipment.

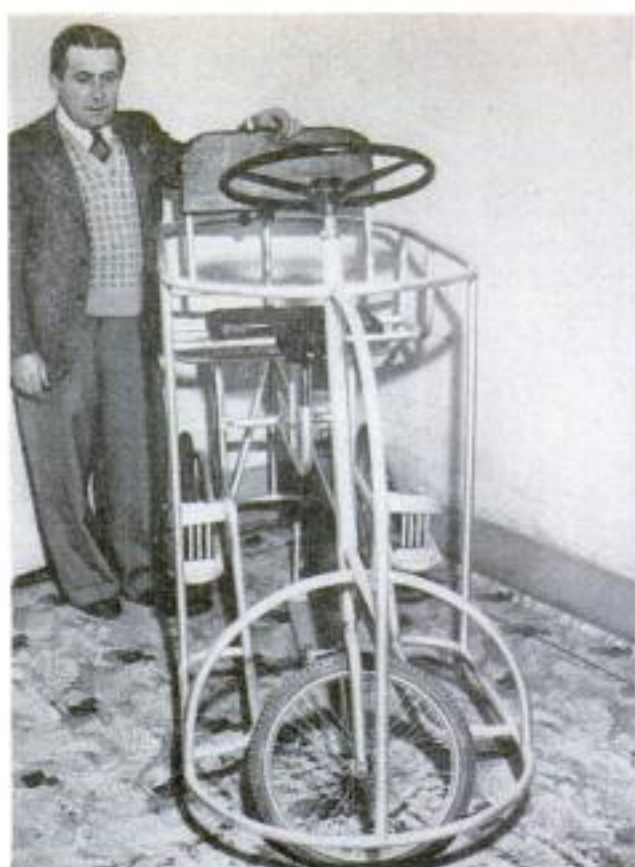

Handmade Electric "Bicycle" Aids Recovery of Polio Victim

Using a specially designed electric bicycle has hastened the recovery of an Australian polio patient. The handmade machine was built by Ronald Ashcroft of Sydney for his younger brother. Built-in shoes attached to the pedals drag the patient's feet with them slowly when the power is turned on. Later he works the pedals himself.

Folding Projector Table Includes Outlets, Viewer and Switch



Easy storage is only one feature of a folding table for slide and movie projectors. Others include a built-in switch, two outlets, an illuminated viewer and a 15-foot electric cord. The viewer permits a preview of the slides before projection; in addition it casts a soft glow of light under the table. The switch turns on one outlet while turning the other off, so that it is possible to switch on the projector and simultaneously turn off room illumination. The table top tilts to the proper projecting angle. Construction is of steel.

Information not listed on articles in the index, starting on page 12, frequently is listed in the WHERE-TO-FIND-IT LIST, which is available to readers without charge. A copy of this list may be obtained simply by sending a postcard to the Bureau of Information, *Popular Mechanics Magazine*, 200 East Ontario Street, Chicago 11, Illinois

Mechanics' Tower Reaches Up 43 Feet

MECHANICS checking B-52 Stratofortresses at Boeing Field in Seattle use a giant workstand owned by the Air Force. The stand, which is hydraulically and electrically operated, extends to a height of 43 feet. That's just five feet short of the tip of the bomber's tail.



Worlds You Can See Through



Geographer points to markings inside a transparent-plastic globe which can never be worn off by handling

DID YOU EVER WONDER what is on the other side of the world from the place where you stand? Is it ocean depths or mountains, desert or the site of some strange city? Globe makers in Philadelphia are answering these questions by making worlds that you can literally see through.

These worlds are made of transparent plastic and have diameters of six inches to three feet. They offer a "fourth dimension" where in the past man has had to be satisfied with a 3-D view.

In addition to making terrestrial globes that you can see through, the Farquhar Transparent Globe Company also makes transparent structures of the universe itself. These globes enclose spheres of the earth in such a way that the relative position of any point on earth may be determined in regard to the sun, moon or any



Globe can be turned on mount equipped with rollers or lifted out for a better look through the world. Right, holding celestial globe aloft. This globe shows stars and heavenly bodies used in navigation





Geographer's layout of a hemisphere is transferred to flat sheet of plastic by a silk-screen process



Air pressure forms softened plastic sheet into a hemisphere with electric eye controlling air valve

celestial body. This globe-within-a-globe arrangement has an outer hemisphere containing azimuth information and a small rotating "sun."

Making globes of transparent plastic is a delicate process controlled by electric eye and air pressure. The globes are made in two sections, north and south hemispheres, which are carefully joined. Markings that identify continents and oceans are inside the globe and thus do not wear away with constant handling. The student or armchair strategist can map out global campaigns with a grease pencil, or make any notes he desires, and then wipe the globe clean when he is through. The globe makers have only one concern—the political boundaries they fix so carefully within the plastic globe are probably more permanent than they are in reality.

Globe-within-a-globe (right) includes earth and celestial globe capped by outer hemisphere which contains azimuth data and "sun"



Difficult task for geographer is to compensate on flat surface for map to be "blown up" as hemisphere

Edge of hemisphere for large-size globe is neatly trimmed by machine before it joins the other half



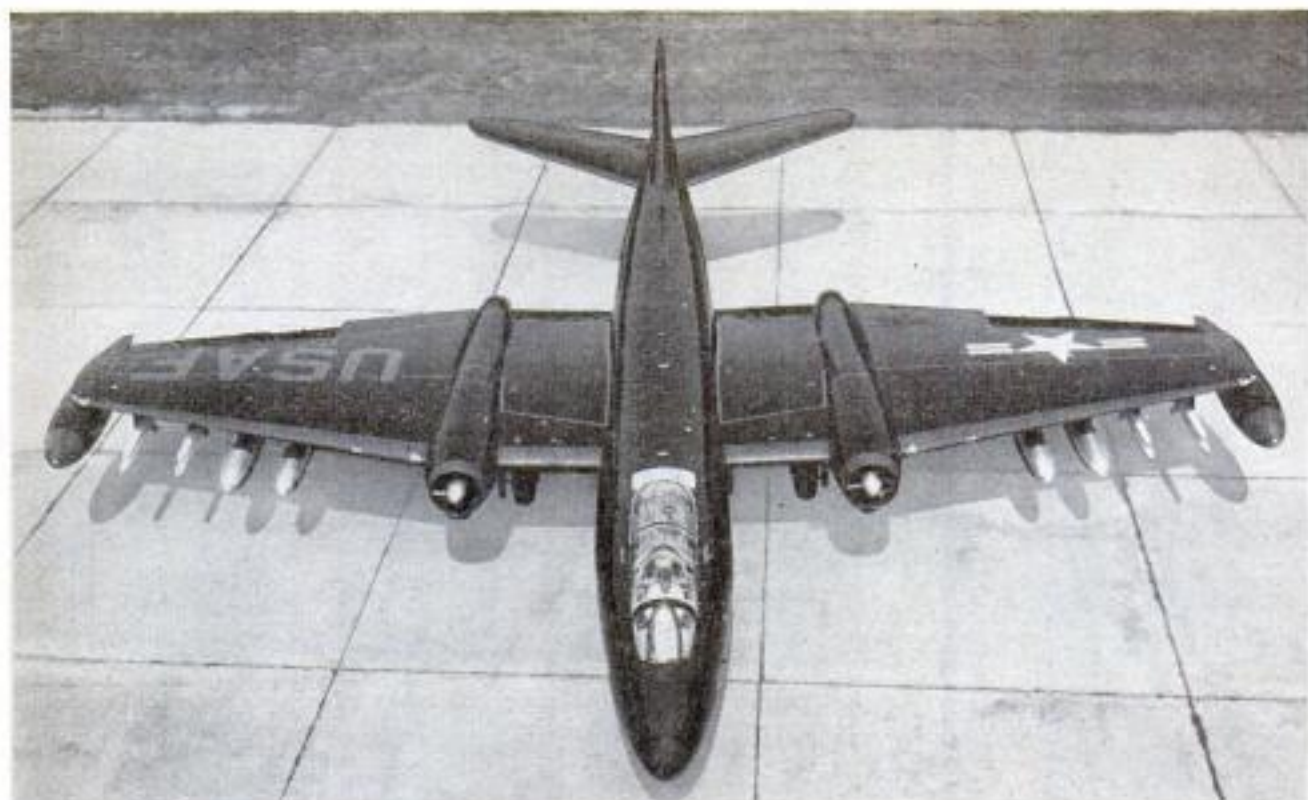

Light Bomber Packs Heavy Wallop

Newest American version of Britain's record-breaking Canberra light jet bomber, termed the B-57B by the U. S. Air Force, has been unveiled by the Glenn L. Martin Co. Improvements in the B-57B include a tandem cockpit rather than the earlier side-by-side arrangement, fuselage speed brakes and a Martin-developed ro-

tary bomb door. Replacing clamshell bomb openings, the new door forms part of the fuselage until it is rotated 180 degrees to bring the bombs into dropping position. Armaments, other than bombs, varies, but the first B-57B mounted four napalm tanks and eight high-velocity rockets under the wings, plus eight 50-caliber machine guns.

First Military Transport Designed for Turbo Props

First U. S. military transport built around turboprop engines — jet power plants driving propellers — the new Lockheed YC-130 is designed to fly faster and higher than any other aircraft of its type. In the tradition of troop-and-cargo carriers, the big-bellied YC-130 appears ungainly on

the ground, but its four 3750-horsepower Allison T-56 engines give it high air speed. Mounted on a tandem landing gear, the giant plane has a fuselage floor no higher than a truck bed, and the high tail permits easy loading from the rear. The YC-130 carries up to 20 tons of equipment.





Steel Fence Holds Mountain in Place During Construction

Commonly used to restrain movement of men and animals, chain-link fencing imprisons a mountainside of loose rock at the site of Idaho's new Palisades Dam on the Snake River. When repeated sealing operations failed to halt the fall of rock dur-

ing intake-tunnel construction, engineers found a high-tensile-strength retaining mat in 20,000 square feet of steel fence. The mat is attached, top and bottom, to cables strung through five-inch steel anchor posts. The mat could be used in road construction.

Fluorescent Tube Lights Interior of German Automobiles

Using less electricity but providing more illumination, a small fluorescent tube is now used in Germany as an automobile dome light. It is said to illuminate the car interior like daylight, providing enough light for comfortable reading. It draws only 12 watts and has a working life of about

7500 hours. The tube is instant starting and does not flicker. A vibrator is used in the circuit. There is also a built-in socket for plugging in 110-volt electric razors. The unit can be supplied for either 6 or 12-volt systems and uses so little current it can be left on all night when parked on street.

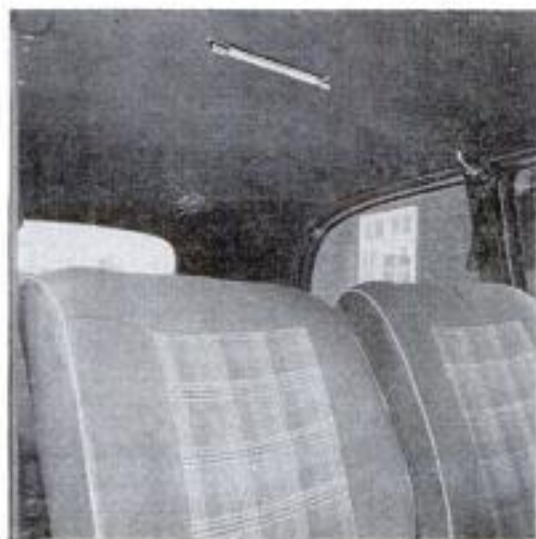

HOW TO MAKE PART-TIME FARMING PAY



Laying cages may boost profits, but the farmer must keep accurate records

By A. B. Kennerly

IF YOU'RE DREAMING of retiring on a small farm or if you plan to go into part-time farming, you'll find that your best farm hands are the new labor-saving machines developed to take the backaches out of doing the chores.

Futhermore you will be following a definite trend. Thirty years ago one farmer in 10 was considered a part-time farmer. Today one of every four makes a part of his living from the farm, the other part coming from off-the-farm employment. But if you're planning to join the ranks of these part-time farmers, the very machines that will remove the backaches may give you plenty of headaches. When you sit down to dollar out your costs, you may find you could have bought your eggs, onions, milk and chickens

The author has had 30 years' experience in agriculture and his farm articles have appeared in national magazines for the last 10 years. Kennerly now is associated with the agricultural information center at Texas A. & M. College

Single cow with her calf may help the family budget, but a herd of 20 is a minimum if you expect a decent profit from dairying



Garden tractors take drudgery out of truck farming, but it takes a lot of vegetables to pay for equipment

cheaper at the grocer's than they cost to produce them yourself.

Take a simple enterprise like raising chickens. Poultry specialists such as those at Texas A. & M. who check costs and production on all size flocks quote two sets of figures: 25 hens or 300. What they mean is that if you want to keep a few hens strictly for your own use, keep no more than 25 hens. If you are thinking of selling eggs, don't keep less than 300 hens.

You're interested in selling chickens and eggs? Fine. It's a good business if you keep in mind some hard facts. Experimental results show that automatic feeders and waterers will save three fourths of your labor. That means if you're competing by hand with poultry growers who have this equipment you will work four times as long as they do for about the same money.

Three hundred hens will be required to justify an investment in laborsaving equipment, but 1000 or more is better. The cost of the automatic equipment for 1000 birds will be about \$600. The cost of electricity to operate the feeder may average no more than 30 cents per month.

The days when chickens could run the range and show a nice profit have passed. Greater profits come from flocks that are

confined in laying houses, and plans for houses suitable for your climate can be obtained from your local county agent. But don't figure on overcrowding the houses. It's going to take every bit of three to four square feet for each laying hen confined in the house.

What happens if the house is overcrowded? Lower production and more stained and dirty eggs are the result.

The big trend now, especially in the southern part of the country, is toward caged hens. By this method hens are kept

Farmer helps establish brand name and regular market by prepackaging vegetables in transparent bags



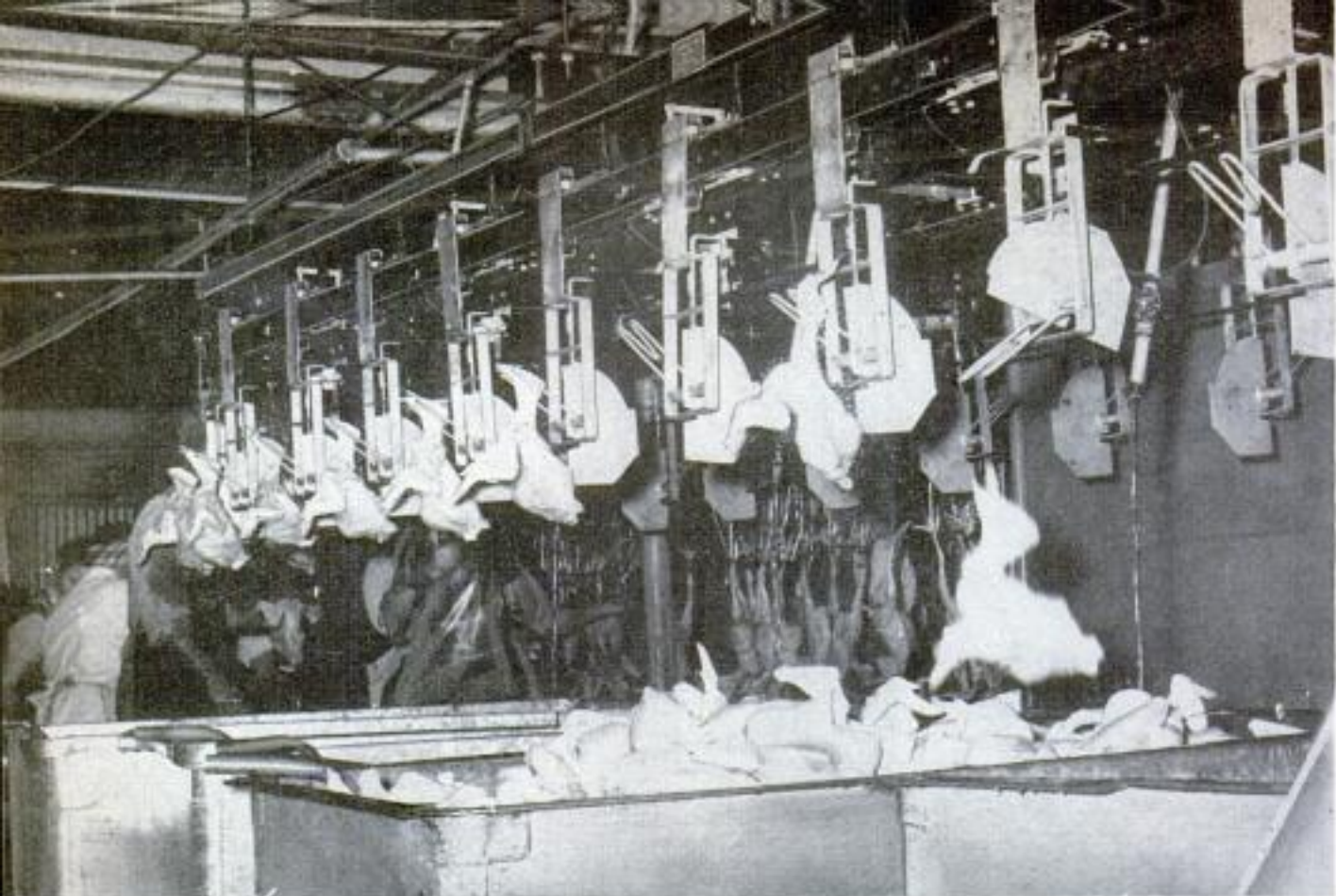

Part-time farmer may have trouble competing with big broiler raisers who operate with assembly-line equipment. Below, automatic feeders save labor and reduce the part-time farmer's cost of producing eggs



Varieties of vegetables are important. Type at left may yield five times as much as one on the right



in individual cages from the time they start laying until they die or their production falls below a profitable figure.

The investment required for the laying-cage method is about \$5 a hen for the equipment and the cost of bringing the hens into production. But the profits are high. Some producers are making \$4 a hen per year from caged layers as against a dollar or two from layers on the floor. This profit has boomed the cage-laying industry and has cut the profits of poultrymen who must depend on the floor method. So competitive has the business become that in some parts of the country poultry authorities are advising back-yard and small-flock producers to get out of the business entirely. One producer in Texas is planning a poultry plant with 200,000 cages. Beginners can get by with 500 cages, but 1000 is a better figure profitwise.

Laying-cage systems, to be successful, must be run with clocklike precision. Let one operation fail or fall below par and the whole assembly line is affected. This precision involves feeding, watering, air circulation, cleaning, culling, replacement and checking up on your own technique.

The beginner should be careful in selecting a location. Examine zoning and health-department regulations. Locate the plant far enough from neighbors so they will not be bothered by the two difficulties of the caged system: flies and odors. Locate near enough to egg-marketing facilities, feed sources and shopping centers to operate and market eggs efficiently.

You can build laying cages yourself or buy them ready for installation. Hang the cages in relation to your own height so you won't have to stoop or reach up when gathering eggs and tending the birds.

Culling can make or break this system of producing eggs. To be successful, the system calls for ruthless culling. The cost of raising pullets, the price of eggs and the market price for culled birds will determine the rate at which hens should be culled. To know when to cull you must know your cost of growing a replacement pullet and the price you will receive for the culled hen. When these two figures are about the same, the rate of culling should be high. For example, each week you may remove and sell any hen that has failed to lay 10 eggs in the past 14 days. You can be more lenient if the price of eggs is high and if the cost of replacements is higher than culled hens are bringing.

Records on some laying-cage operations prove that with good management, breeding, feeding and disease control, an average of 240 eggs per cage per year can be maintained by culling about eight percent each month.

Accurate records can be kept with the cage system since eggs are gathered from individual hens. The simplest systems of keeping records include washers on a wire,

clothespins on cage wires, or pegs in holes that are used to record a 7 to 14-day laying period. More complete records can be kept with an individual card for each hen recording the date she was hatched, breeding information, date she started laying, number of broken and soft-shell eggs and any other needed information.

If you're figuring on broilers, you will need to think in terms of at least 3000 birds. Some houses run to 6000 birds and some operators take care of several houses. An authority at Texas A. & M. says, "If extra help is available during the first week when the very young chicks must be fed and watered by hand, one man can easily attend to 40,000 to 60,000 broilers." This requires automatic watering and feeding equipment.

If you're near a good retail outlet, battery brooding may be profitable, although it is not practiced extensively. Batteries usually are placed in rooms supplied with extra heat in the fall and winter. With this system, broilers go through three stages of production in different buildings or rooms. The first stage is the starting battery where all chicks of the same age are brooded until they are three weeks old. For the growing stage, from three to six weeks, they are put in larger batteries in

(Continued to page 228)

Automatic milkers and a well-planned layout may enable a family to milk from 20 to 30 cows without hired help

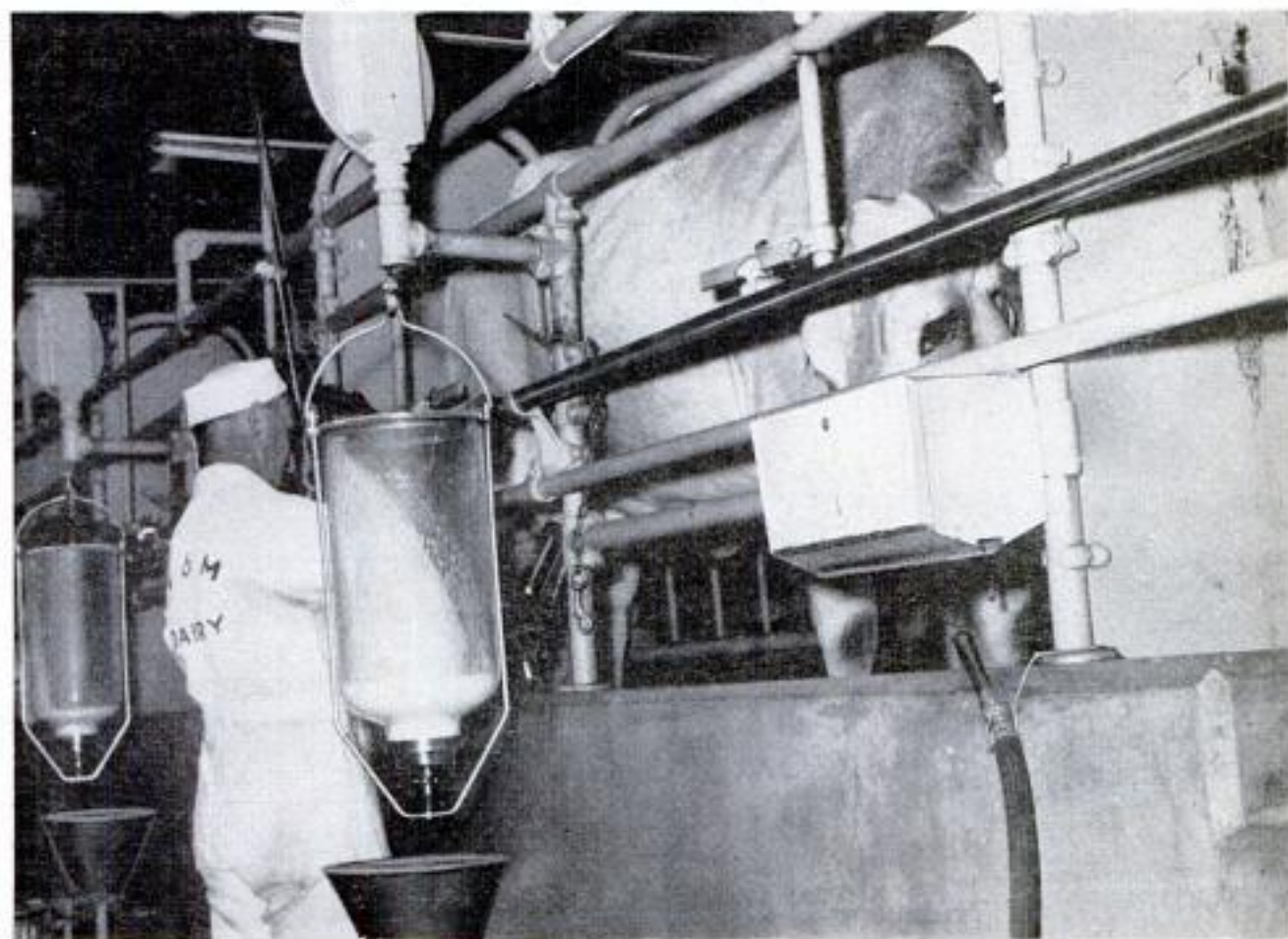

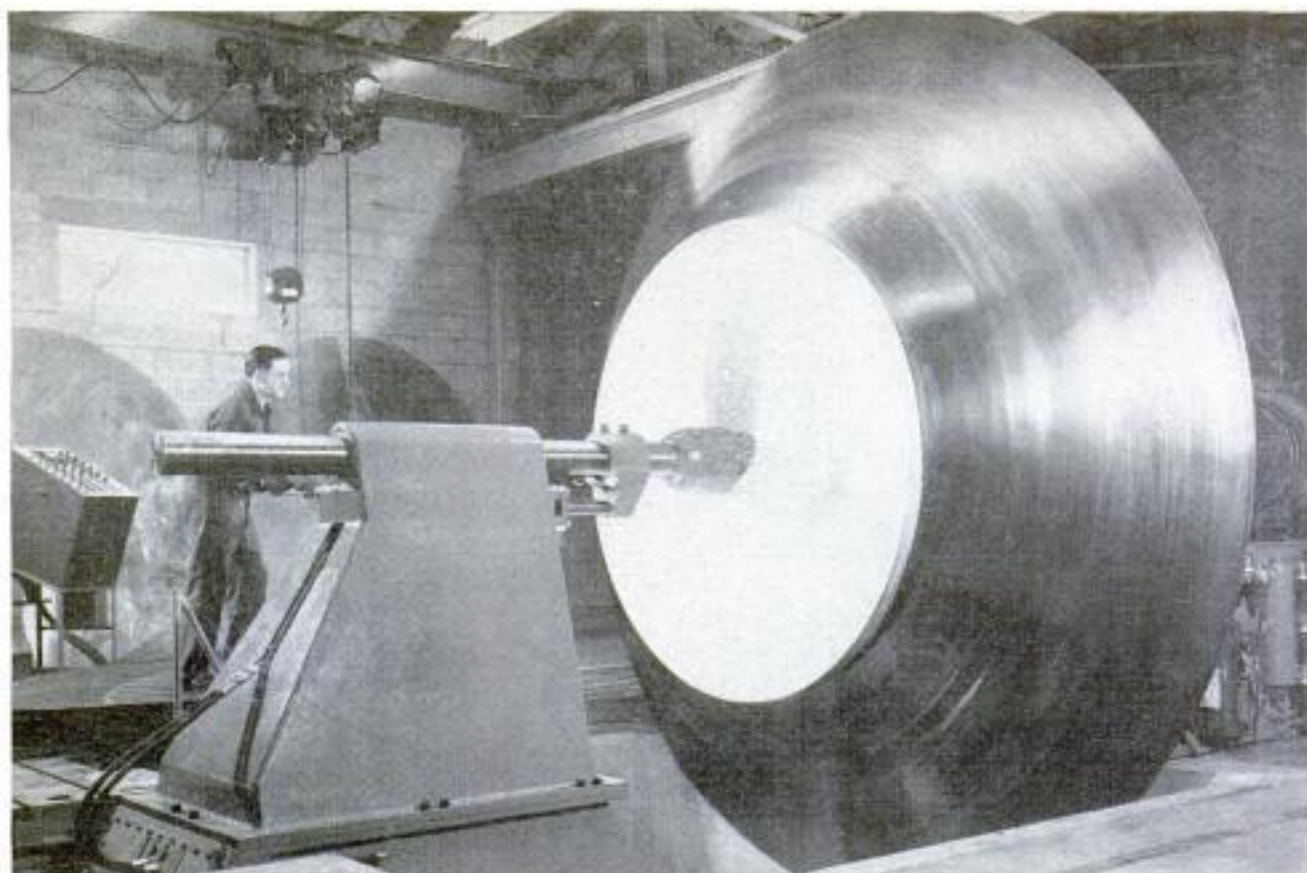

Giant Lathe of 180-Inch Diameter Fills Large Room

So big that no commercial lathe builder would tackle the job of building it, a giant 180-inch-diameter swing metal-spinning lathe fills a huge room by itself. Designed to meet the demand for larger spun shapes in atomic-energy plants and industrial air-conditioning equipment, the lathe is

powered by a 50-horsepower drive system. Spinning tools are hydraulically actuated and pressures needed for hot-spinning can be built up to a point never before reached. One example of the lathe's capacity is the spinning of a 14-foot dome for an air-conditioning installation.



Light-Metal Shakes Save Rebuilding Time

Resembling wooden shakes, insulated aluminum shingles can be applied to exterior walls in one third the time required for ordinary shingling

Aluminum Putty

Aluminum in putty form now makes all sorts of handicraft possible. Applied with a spatula or brush, it bonds to practically any surface and dries metal-hard in several hours. No special tools, heat or flame are necessary and the material can be filed, sanded, burnished, drilled or tapped. The putty can be used to bond aluminum to aluminum, to give hardware an antique or otherwise unusual appearance, to create a metal inlay in leather or wood, or metalize baby shoes. You can also make your own "leaded" glass windows with it as well as auto, shop and boat repairs.

Seagoing Train Rides Ferry

Passengers on a new German train which shuttles between Copenhagen and Hamburg get a boat ride as well as a train ride. The three-car diesel train rolls right onto a ferry, which then carries it across the Baltic Sea. The train has seats for 224 passengers and makes the trip between the two cities in about seven hours. The boat ride shortens the run considerably.



Desk-Size Electric Press Prints 1000 Tags or Labels Per Hour

Up to 1000 cards, tags or labels can be printed per hour with a desk-size electric press suited for many jobs. A companion to the printer is a case which holds 42 sep-

arate characters in indexed rows. A wide variety of type styles and sizes is available. Trademarks can also be used. Type is picked out of the case with a type fork and slipped into a grooved printing plate which is inserted in the press. The press prints with the aid of a ribbon, like a typewriter. Eleven lines of copy can be printed at once. The material to be printed is fed into the press one piece at a time. The piece itself is the trigger which causes the press to print automatically as it is placed in the jaws.

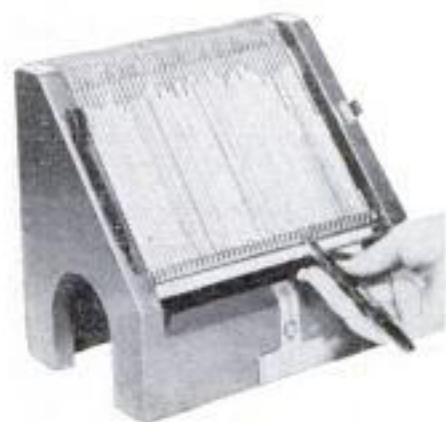

Battery-Powered Clock Comes in Kit

Electric clocks powered by batteries may be placed anywhere or hung on any wall without the usual trailing wires. They can be made from kits now available. The kit consists of a 2½-inch-diameter clock movement, a pair of clock hands and a set of hour markers. The only additional material required is a slab of hardwood or other material that serves as the clock face and a 4½-volt dry cell. Because current is used only intermittently, one cell runs the clock for approximately a year. The clock movement has three jewels and weighs less than eight ounces. The same kit may be used as a replacement for an unsatisfactory automobile clock.

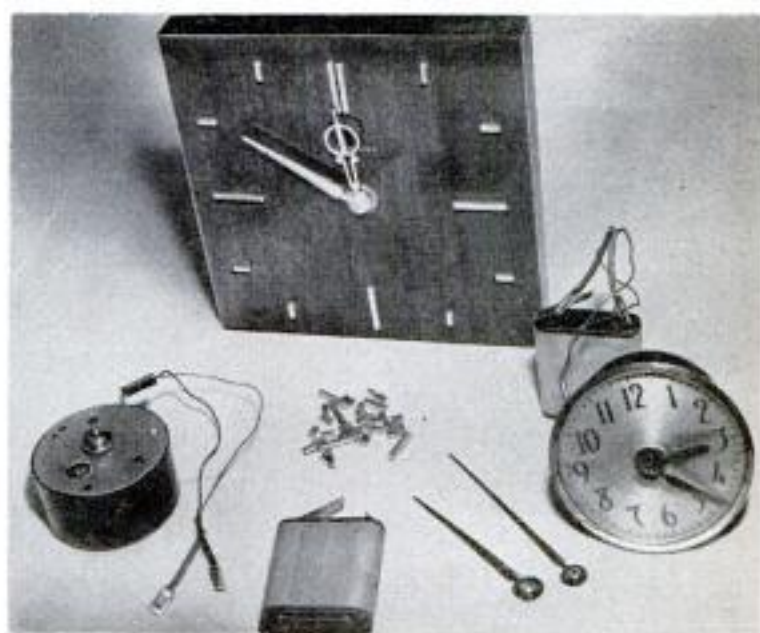

Completed battery-powered clock is in the background, with the kit units in the left foreground. Clock movement and battery are shown at the right assembled as an auto-clock replacement.

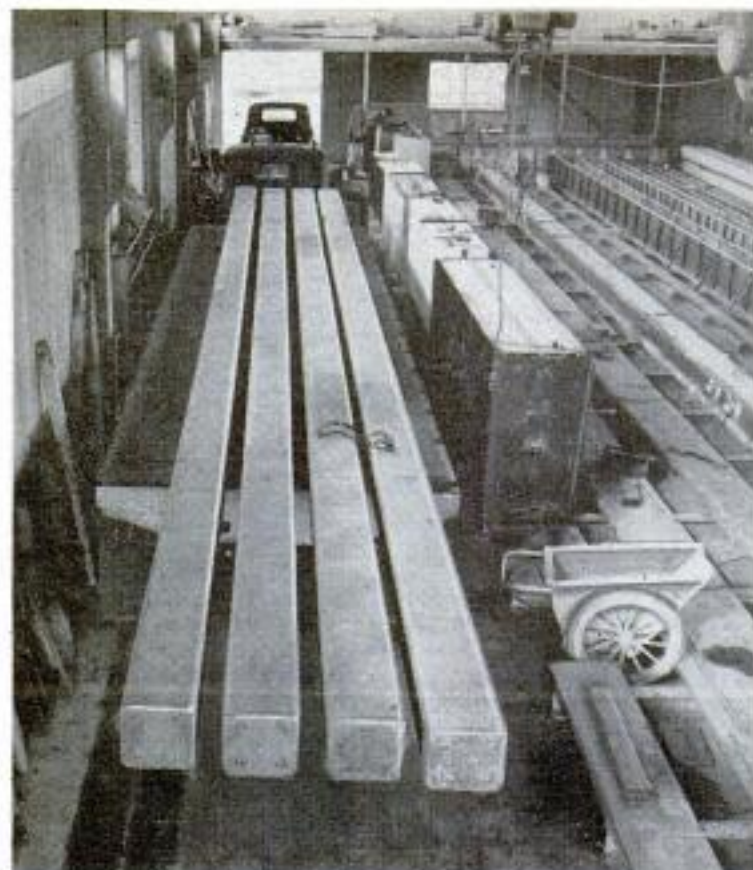

Four 50-foot lengths of piling made of prestressed concrete are shipped by truck, like other materials, to building site

ONE OF THE NEWEST construction techniques is the use of prestressed concrete, sometimes called "rubber concrete" or "concrete with muscles." Now two ingenious brothers have succeeded in prefabricating this remarkable material into girders, beams, pilings and planks. They make these items in specified types and sizes, then ship them by truck or rail to the job site. The result is that "muscular concrete" now is ordered and handled just like steel or wood construction members.

Tom and Arthur Anderson of Tacoma, Wash., figured that prestressed concrete could be prefabricated for the builder the same as his other materials. Before setting up their plant they made an inspection trip to Europe where prestressed concrete has been in production for some time. They were particularly impressed with certain production techniques in Sweden. Back home, they devoted endless hours to planning, engineering, inventing and testing.

The "muscles" of prestressed

PRESTRESSED CONCRETE FROM THE FACTORY

Concrete girders for this building were delivered 24 hours after dry-mix concrete had been placed in forms

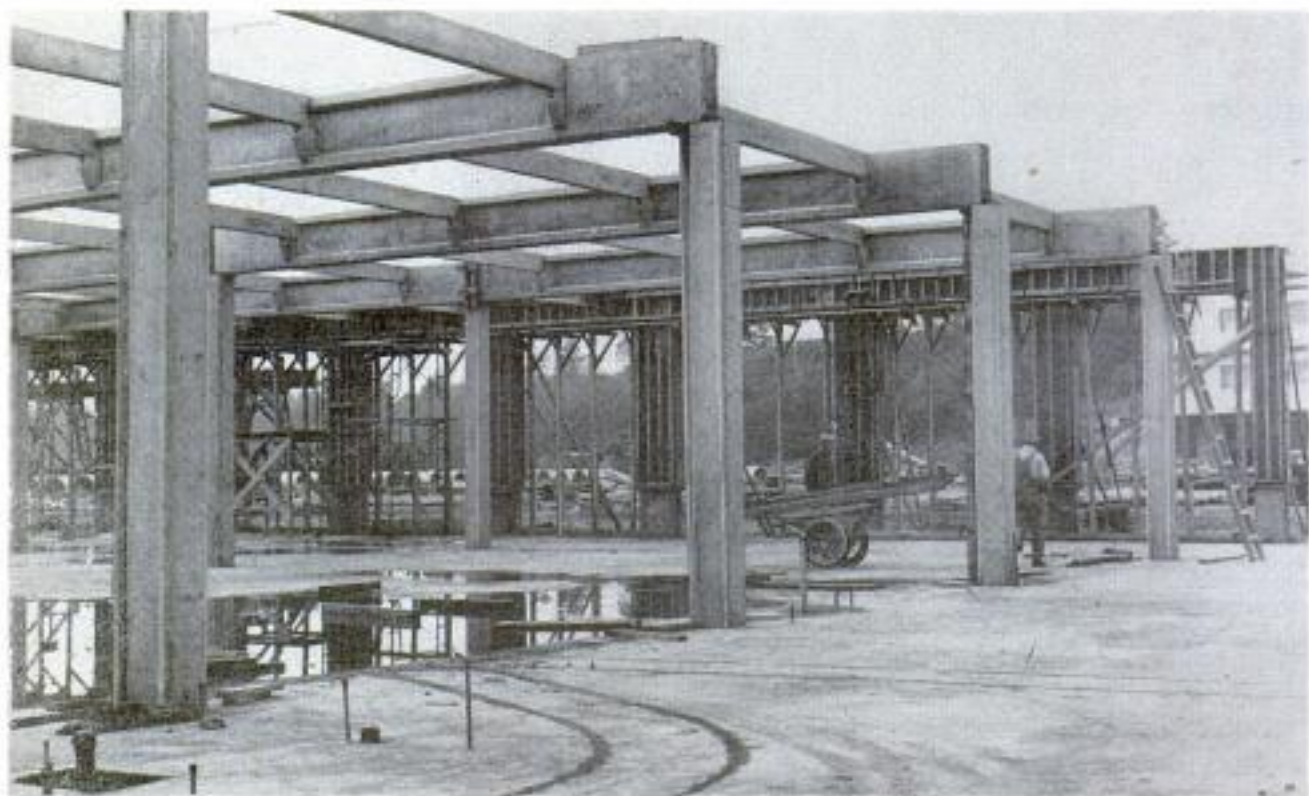

concrete are provided by wires which are stretched through the form. When the concrete hardens, the wires tend to contract, providing a built-in tension that makes the concrete far stronger than ordinary poured concrete.

In a test made last year on an Anderson 40-foot concrete girder, a load of about 40 tons, placed near the middle, caused the girder to deflect four inches. When the load was removed, the girder returned like a giant spring to its original position. With an ordinary section of concrete of this size, conventionally strengthened with reinforcing rods, the deformation would be devastating—about the same as a 40-ton Army tank crushing your sidewalk.

The problem of the two brothers was to work out a system that would produce the strongest possible girders and other construction members. Here's the method they finally decided to use:

Custom-made, stranded wires $\frac{5}{16}$ inch in diameter are anchored at the end of a steel form in which the girder will be poured. The number of wires used in the form depends upon the size of the girder and the load it must bear. Then, with special hydraulic jacks, the wires are put under extreme tension. The pulling force is so great that the length of the wire is increased 10 inches.

An exceptionally dry-mix concrete is placed in the forms and vibrated with electric "shakers" clamped to the forms. Thus agitated, the dry-mix concrete flows, as Tom Anderson says, "like melted butter in a hot skillet."

When the concrete has cured a sufficient time, the hydraulic jacks are backed off. The tension on the wires is maintained by the bonding action between the concrete and the wires. The result is that the girder has a built-in compression.

The Anderson brothers not only had to whip the problem of producing the prestressed beams and girders, but also of convincing contractors that they were stronger than many conventional building materials. Most building codes make no mention of prestressed concrete, and certainly nothing about the prefabricated stuff.

Gradually, though, the brothers have overcome the doubts of construction engineers as well as sidewalk superintendents. They recently worked out building-code requirements for prestressed concrete which were accepted with minor revisions by the City of Tacoma. As a result, the Andersons' factory-made girders and beams are being used on building projects throughout the city, and the brothers have firmly established prefabricated, prestressed concrete as a modern building material. ★ ★ ★

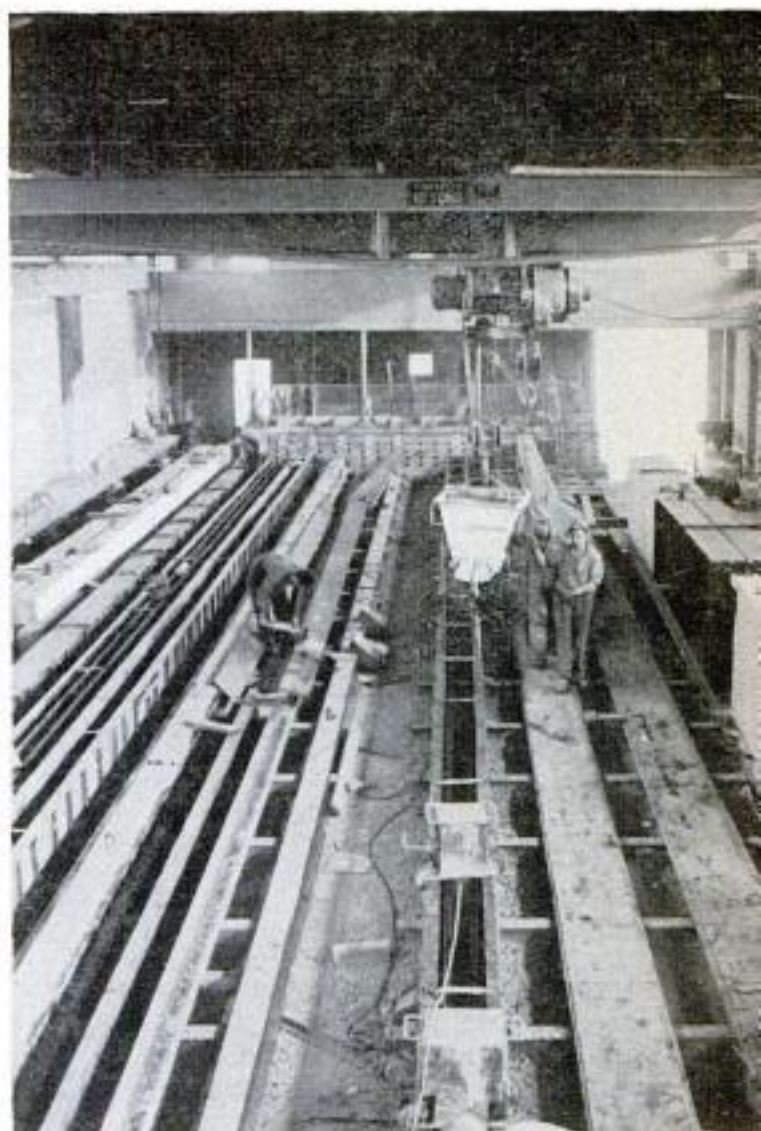

Concrete from traveling bucket is dropped into the form. Wires in form have already been placed under extreme tension. Below, girders ready for erection

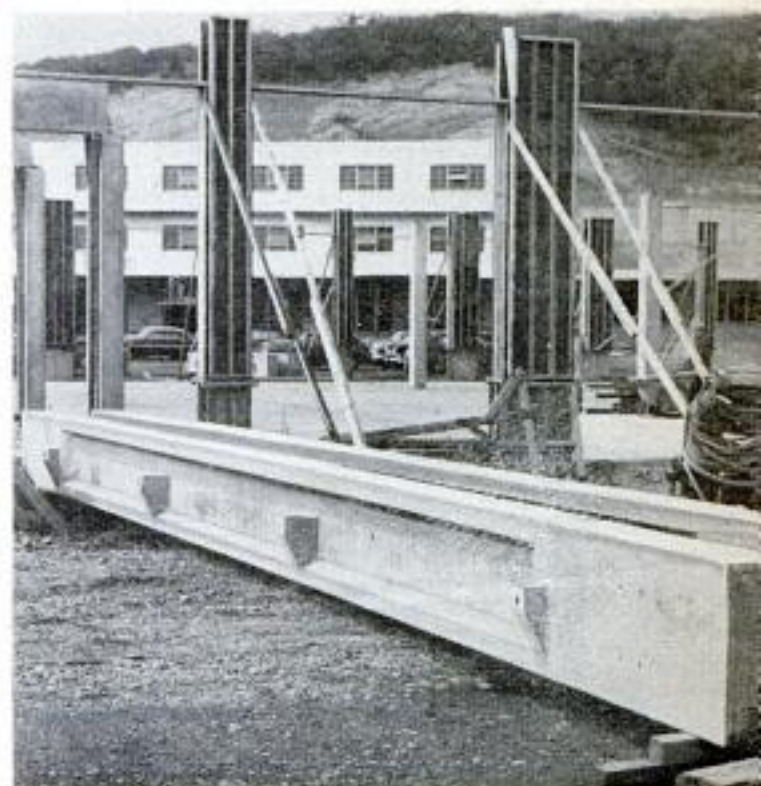



Electrical Current Protects Instruments

Delicate surgical instruments can now be sterilized in boiling water without blunting their sharp edges. In a new sterilizer, an instrument is attached to the negative terminal of a battery, another piece of metal to the positive terminal. Electrical current passing through the water from the instrument to the other metal prevents electrochemical corrosion of the instrument. Neither boiling the instruments nor immersing them in a chemical solution (which does not completely destroy bacteria) has been satisfactory in the past.

\$100,000 Radio Telescope Aids Astronomy Students

It took \$100,000 to build the radio telescope with which Edward Lilley and David Heesch worked to secure doctorates in radio astronomy at Harvard. This will be the first time that such degrees have been awarded anywhere in the world. The wire-mesh parabolic antenna of their radio telescope is 24 feet in diameter and is mounted on a small building. The instrument traps radio waves originating in distant constellations.

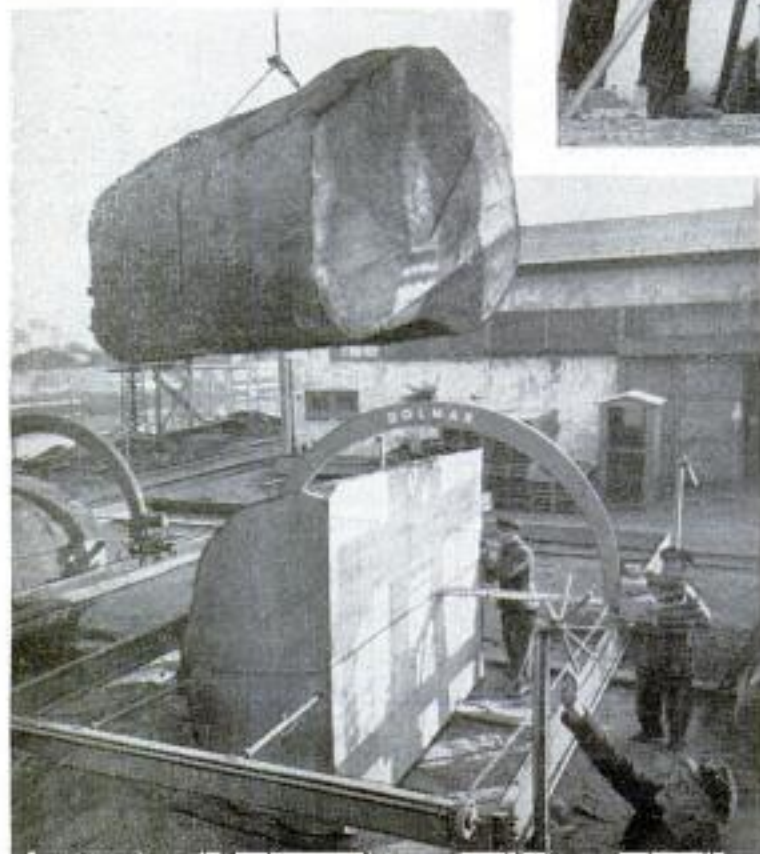

Giant Bow Saws Cut African Tree

Workmen in Hamburg, Germany, used huge chain bow saws to cut apart the trunk of a giant African pear tree. The trunk, which weighed 60 tons and was 7½ feet in diameter, furnished enough lumber for 6000 cabinets.

☐ Pigeon races are so popular in Britain that in one region British Railways carries an estimated 25,000,000 homing pigeons to and from races each year.



Agile Wheelchair Steps Up and Over Sidewalk Curbing

Chair-ridden patients appear to lift themselves over curbs by pulling on their own bootstraps when using a wheelchair developed at New York University. Nine inches longer than a conventional chair, the curb-climbing model has two sets of steel legs that lift the chair up when two hand cranks are turned. The patient simply rides up to the curb, rotates the operating handles three times, pushing down two front legs. By the end of the third turn of

the handles the front wheels are safely up on the curb. He then propels the chair forward slightly until the rear wheels touch the curb. Rotating the handles in the opposite direction extends two rear legs, raising the rear wheels onto the sidewalk. It takes no greater effort to accomplish the lift than it does to propel a wheelchair along a level stretch of sidewalk. The complete operation of climbing a curb takes less than a minute.

Flashlight Batteries Power Automatic Spit

Two flashlight batteries power a portable spit that slowly rotates a chicken or other meat over the coals of a campfire. The unit also may be attached to an ordinary back-yard barbecue brazier. Two flashlight cells operate the unit for 20 to 30 hours.

Double-Action Hydraulic Brakes

Developing twice the braking pressure of conventional systems, a two-stage master cylinder is said to provide "power" brakes without air or vacuum assist. The basis of the system is a master cylinder that switches automatically from low pressure to high pressure, doubling the braking power. The system has been used for some time on trucks and is now being made for passenger cars. Easy to install, it costs less than usual power-assist brakes.



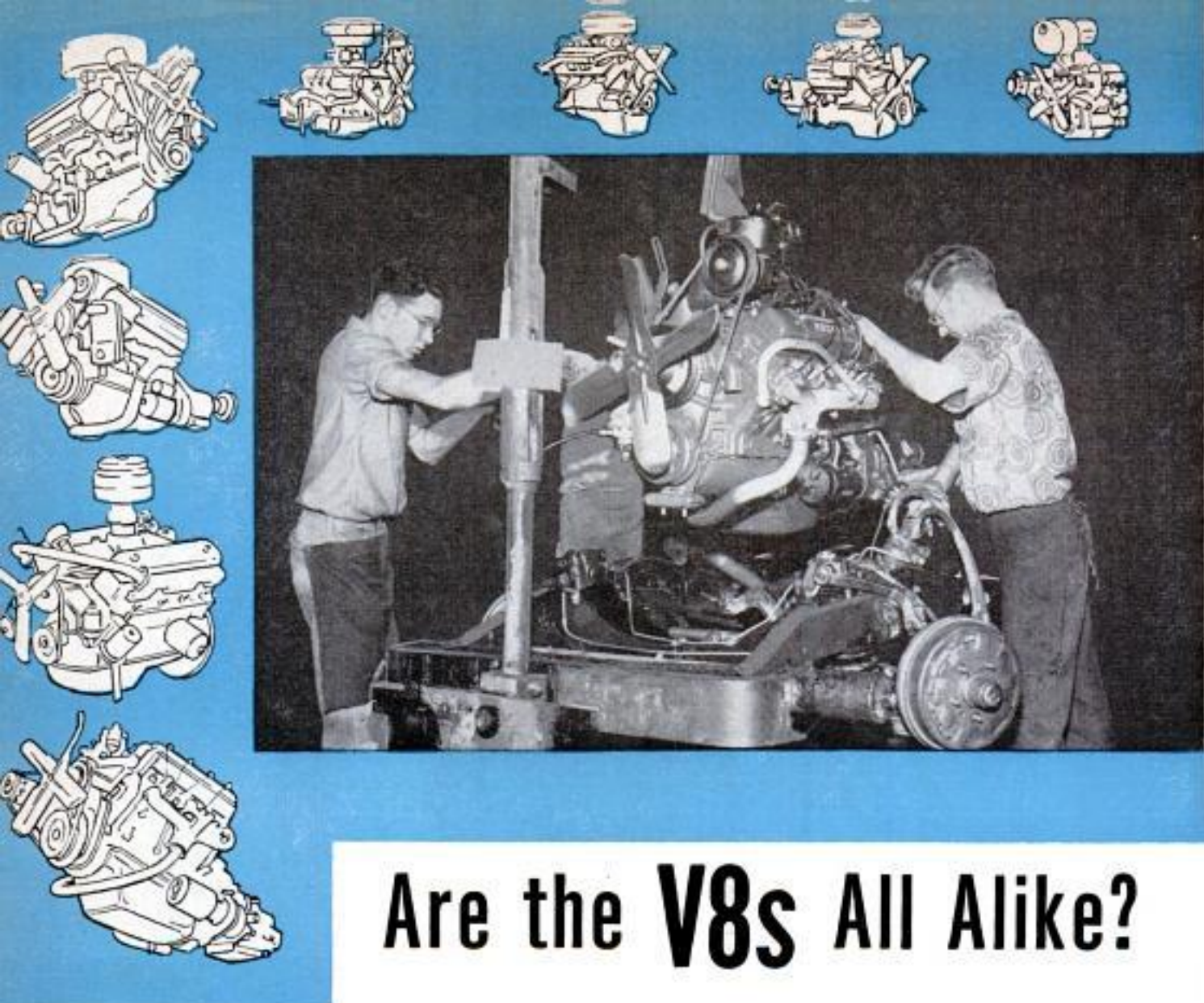

Are the V8s All Alike?

By Roger Huntington

Member, Society of Automotive Engineers

CAN THE DESIGN of a machine ever become so highly developed—such an exact science — that there is only one “right” way to do it?

John Q. Public could very easily get that idea about the design of automobile engines. With a couple of exceptions, every basically new engine to come out of the American auto industry since World War II has been a V8 with push-rod-operated overhead valves, stroke shorter than the bore and five main bearings.

But are these new V8 engines really alike? The eye of the engineer detects some interesting and significant differences not apparent to the layman.

Combustion Chambers

Engineers never have been able to agree on just how we should burn the gasoline in an internal-combustion engine. They all know that for maximum smoothness and resistance to “ping” the rise in pressure in the cylinder during combustion should be gradual and peak pressure should not be too high. But this can also cause a drop in maximum horsepower and torque. Com-

bustion therefore must be a compromise.

There are three schools of thought in the industry today: Cadillac, Oldsmobile, Studebaker and all the Ford divisions use a compact wedge-shaped combustion chamber, with valves in the top at a slight angle and the spark plug set in one corner. This layout gives a lot of turbulence, or swirling motion in the gas mixture to promote smooth, rapid combustion. Yet the chamber walls are not wide open around the plug, so peak pressure is moderate.

Chrysler engineering—and this includes DeSoto and Dodge—doesn’t see it this way. Chrysler soft-pedals combustion control and gambles everything on brute horsepower. They place the valves at a steep angle on opposite sides of a “hemispherical” combustion chamber with the spark plug at the top of the dome. They realize that this shape of chamber doesn’t give a lot of turbulence, so it can’t handle as much compression without knocking as the small wedge-type and it might even be a bit rougher. But the beauty of it is that you can crowd huge valves into the dome area,

even bigger than they're using now! This means freer "breathing" and gobs of power. Because of this extra valve area and improved porting layout, the other V8s will never be able to touch the Chrysler products on horsepower per cubic inch of piston displacement. Chrysler thinks performance is the key to the future.

Buick is in a category by itself. They use a "pentroof" shape of combustion chamber (an inverted V) with the valves on one side and the plug in the top. This doesn't leave room for very big valves, but Buick engineers figure by building up the top of the piston in the proper shape they can get a compact chamber that will give very smooth combustion and good knock resistance. They proved the courage of their convictions by using a compression ratio of 8.5:1! Results have been so-so. Combustion is quite smooth, but knock resistance is only fair and moderate valve area limits the power potential of the design.

Anyway, you can see that our new V8 engines are far from being alike.

Manifolding

There are interesting differences in the layout of manifold tubes and ports that deliver mixture in and out of the cylinders on the new V8s.

Consider the intake side. The problem here is to get equal mixtures of fuel and air to each cylinder with a minimum of breathing restriction. It's a headache, believe me. You can't possibly get all the liquid gasoline to vaporize in the manifold and what doesn't has a way of ducking into the wrong cylinder, making some run rich and others lean. Some engineers think that by directing the mixture from the carburetor up against a more or less dead end in the manifold passages before it branches off to the various cylinders, the resulting turbulence will mix the fuel and air and improve the distribution. All the Chrysler divisions, Ford divisions, and Buick go for this idea. Cadillac, Oldsmobile and Studebaker see it just the opposite! They don't think the "buffer end" does a lot for distribution, and certainly short, smooth passages from carburetor

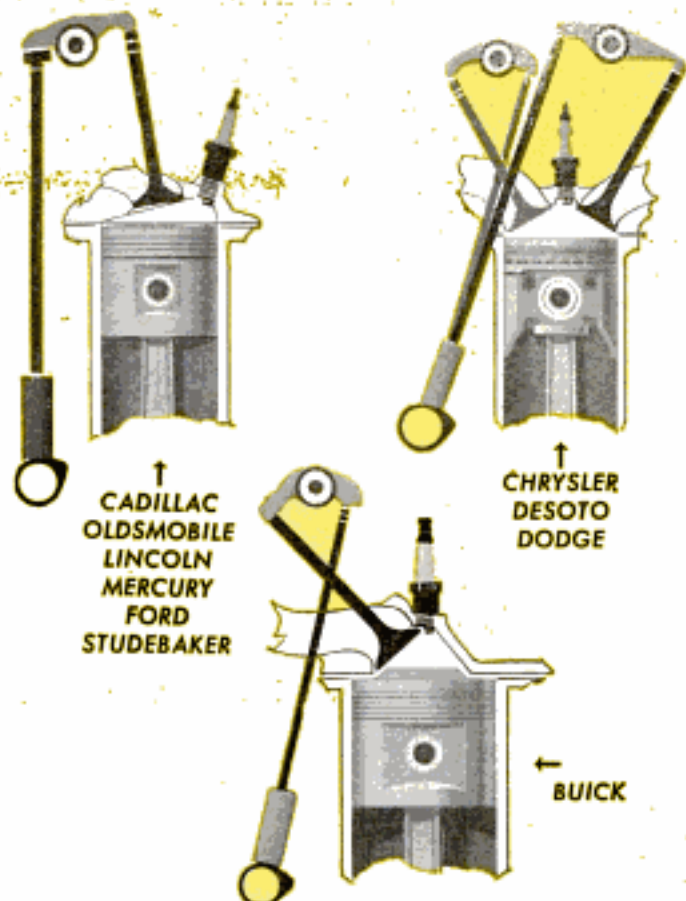

COMBUSTION CHAMBERS AND VALVES

Above are the three types of combustion-chamber design. They are (1) the wedge-shaped (like Cadillac), (2) the hemispheric (like Chrysler) and (3) the inverted V (like Buick). Note Chrysler has two rocker-arm shafts

Below are the two basic exhaust-manifold designs. One has four individual ports on each bank (like Buick). The other combines the two center ports (Studebaker)

EXHAUST MANIFOLDING

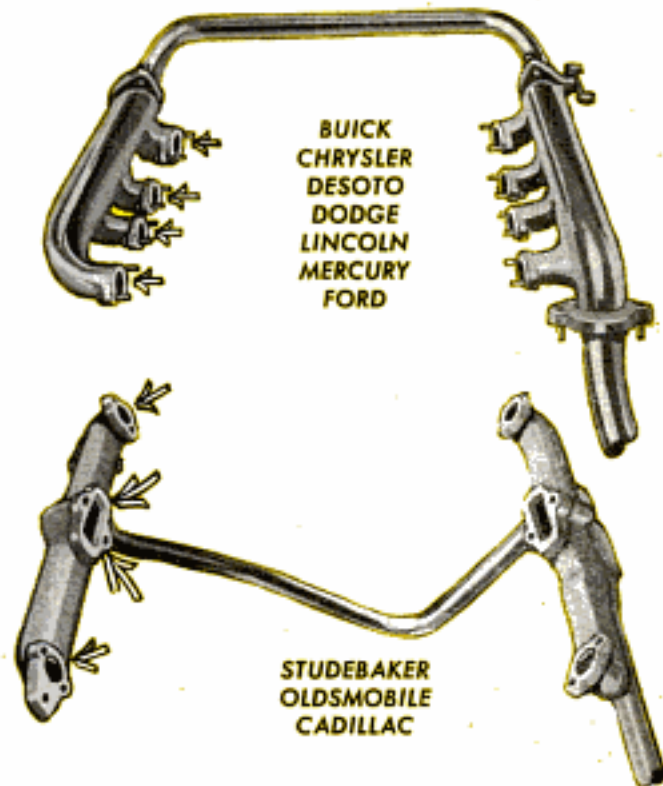

INTAKE MANIFOLDING

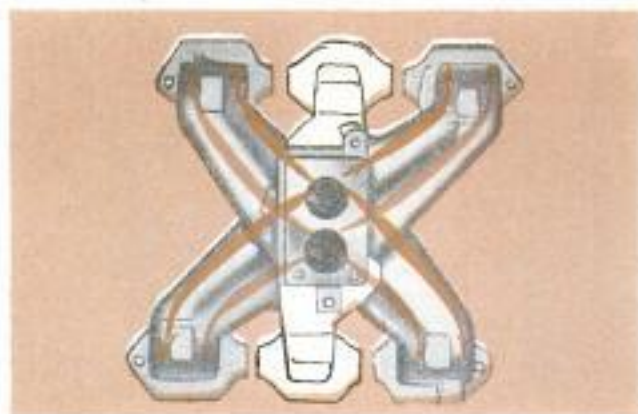

Studebaker's intake manifold is a straight-line X. Passages from carburetor to ports are very direct

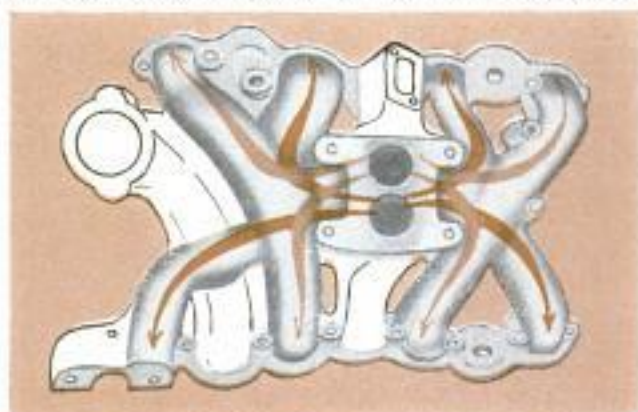

Chrysler divisions and Buick use a dead-end type of passage, creating turbulence that mixes fuel and air

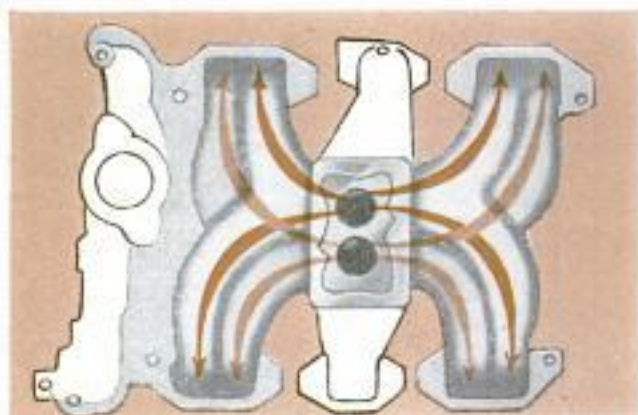

Cadillac and Oldsmobile go in for smooth curves in their manifolding. They see no need for turbulence

All Ford Motor manifolds have an over-and-under design to make passages the same length for even flow

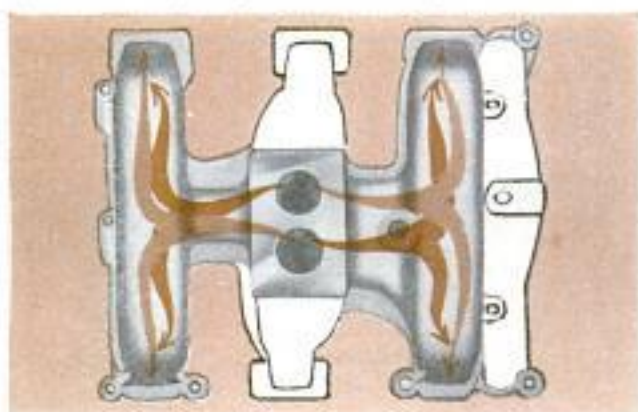

to cylinder-head ports should be better from the breathing angle. Studebaker uses straight lines from carburetor to ports, with a general X-shape manifold. Oldsmobile and Cadillac use smooth curves.

Exhaust porting is no cut-and-dried deal, either. Cadillac, Oldsmobile and Studebaker have a single "Siamese" port for the two center cylinders on each bank. None of the others would be caught dead with a Siamese port! Also, Cadillac and some Chrysler models have separate exhaust-outlet lines for each bank . . . a la hot rods.

Crankshafts

All V8 crankshafts probably look alike to you. Actually there's an interesting behind-the-scenes difference here. All manufacturers except Ford (with Mercury and Lincoln) forge their crankshafts. Because of certain mass-production economics much too complicated to go into here, it is not practical to provide counterweights for the center main bearing of a five-bearing V8 shaft when you forge it. Ford casts its crankshafts. There are no limitations here and Ford, Mercury and Lincoln shafts are fully counterbalanced at the center main, which makes possible somewhat closer control of over-all engine balance.

Valve Trains

Detroit is in trouble with excessive valve-train wear on some of the new V8s. Terrific rubbing and impact forces between the camshaft lobe and valve-lifter face, necessary because of ever-higher speeds and higher valve lift, are chewing up parts like taffy. One dealer said he was replacing lifters regularly at anywhere from 1000 to 7500 miles on his new models; another found some cam lobes worn away at 95 miles!

Engineers are knocking themselves out to find the answer. All makers except Buick cast their camshafts; Buick forges theirs. Many "soup up" specialists around the country have found that the stock cast shafts absolutely will not stand up under high valve loadings and always replace them with forged billet cams on hot engines. There may be something here. Or maybe the material and surface treatment of the lifters are the key. Some makers use steel, some cast iron or chilled iron. (And, as far as that goes, some engineers think that oil additives may be a factor.)

The question of whether to use more costly hydraulic lifters to take up valve-train clearances and quiet valve action is unsettled. Chrysler, DeSoto, Dodge, Cadillac, Oldsmobile, Lincoln and Buick think hydraulic lifters worth the cost. Others claim you can't tell if an engine has solid or hydraulic lifters after it's partly warmed

(Continued to page 252)



Swedish Torpedo Boat Built to Resist Effects of Atom Bomb

First of its kind is the Swedish Navy's *Plejad* motor torpedo boat, said to be the only ship ever designed to resist the effects

of an atomic bomb. Five such vessels are planned. The *Plejad* has a displacement of 150 tons and a top speed of about 40 knots.



Mechanical Rain Guard Closes Windows Automatically

In Florida, where sudden squalls are frequent during the rainy season, one company makes an automatic system to close your windows when it rains. A unit containing a sensitive moisture grid is installed on each side of the house. When rain touches the grid, a relay closes and starts small motors which close the windows on one side of the house. When the grid dries, it starts the motors again, which open the jalousie windows. All windows can be operated from a master switch.

Moisture grid, left, below window starts the mechanism. Below, master switch also controls windows

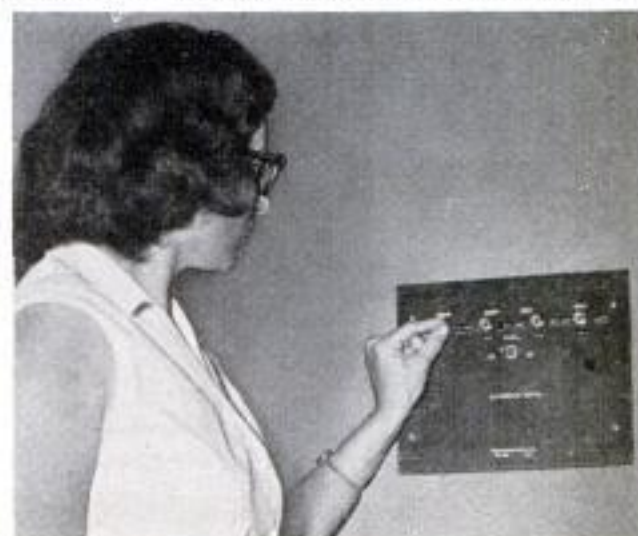



Rugged Light Plane Takes to the Air After 30-Yard Run

You can fly as slow as 27 miles per hour or take to the air after a 30-yard run with a new plane designed for the amateur pilot. It won't stall or spin, according to the manufacturer, and is equipped with cross-wind landing gear for safety. It can land into a 10-mile-per-hour wind at a ground speed of 17 miles per hour and by safe braking can come to a dead stop in less than 50 feet. Because the plane requires

only a short landing strip, it can replace helicopters for certain uses. At the same time, it has the cruising speed, useful load and range of the conventional light plane. The front wheels are placed well forward to prevent "nosing over" upon landing. Sharp banks and turns are possible with safety. Simplified controls make it easy to operate. The "Courier" is made by Helio Aircraft.

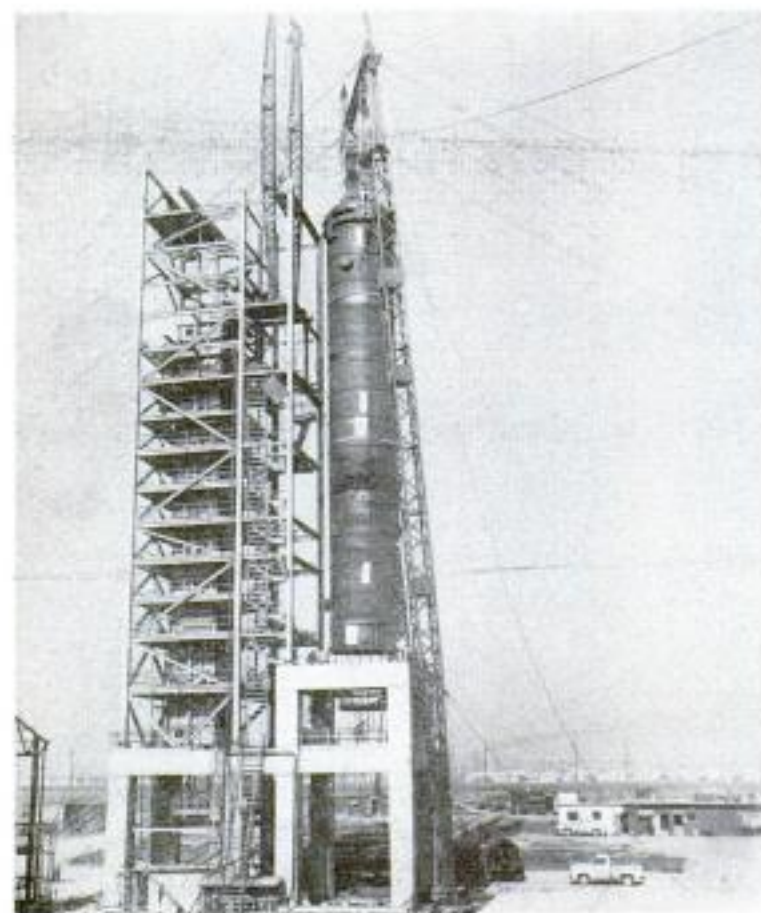

89-Foot Reactor Tower Erected With Tall Booms

Riggers used 175-foot booms to drop an 89-foot reactor tower onto its 44-foot base at a Torrance, Calif., refinery. The 190-ton steel tube, 13½ feet in diameter, settled into place without bending a single one of the bolts encircling its base flange. The tower is a key section of a catalytic reformer unit that will produce about 15,000 barrels per day of high-quality gasoline-blending stock for the General Petroleum Corporation.

Radiation Slows Fungus

Atomic radiation increases the resistance of plants to a fungus disease, recent experiments show. Small dosages of radiation applied to plants made them 50 percent more resistant to Fusarium wilt, a common plant disease in New England. Radiation strong enough to kill the fungus completely stunted the growth of the plants.

Truck-Powered Side-Wheeler Transports Supplies Across River

Men of the United States Coast Guard stationed on the Philippine island of Palawan ferry their supply truck across a near-by jungle river on a unique side-wheeler. The rear wheels of the truck rest on rollers mounted in the gasoline-drum craft. On each end of one of the rollers is a paddle wheel with shallow, lightweight blades which revolves as the wheels spin the rollers.



Three-Wheel Tractor

Sharp, quick turns are possible with a three-wheeled garden tractor that has rear steering controlled by handle bars. A two-horsepower engine coupled with the single front-drive wheel provides power for a reverse speed or a three-mile-per-hour forward speed. A drawbar midway between front and rear of the tractor handles cultivating and light disking equipment. Maintenance equipment attaches to a rear drawbar, while the 30-inch reel mower, sickle bar, snowplow, sprayer and compressor are front-mounted. The compact, rugged unit has ample crop clearance.

Fuel Costs Slashed by Atomic Heater in Plutonium-Plant Buildings

Atomic reactor heat will be used in new buildings at the Hanford plutonium plant near Richland, Wash. Water from the Columbia River will be pumped through a reactor to absorb the tremendous heat produced when uranium atoms become atoms of plutonium. Part of the water will then go through a heat exchanger, where it will heat water for an air-conditioner-type heating unit for the buildings. Air warmed by the water will then be conducted into the buildings. Water from the reactor can't be piped directly into the air conditioner because dissolved minerals become slightly radioactive in the reactor and a leak in the coils would allow this

water to get into the air going into the buildings. The heating system, designed by engineers for General Electric, is expected to make possible an estimated yearly fuel saving of \$59,000.

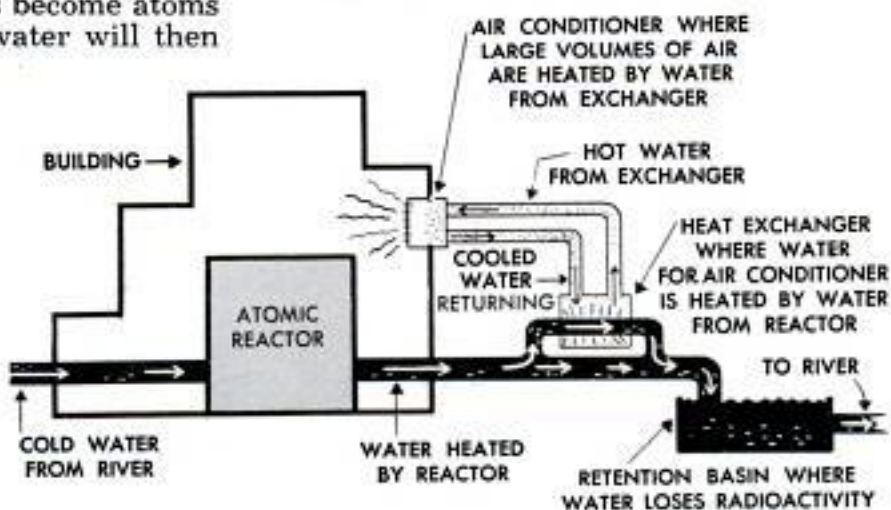



The metal is heated in this furnace, at White Oak Naval Ordnance Laboratory where Thermenol was developed

Tough Alloy for Hot Jobs

From a Naval Laboratory comes the new recipe for Thermenol—a metal combination that may be a substitute for stainless steel in jet planes

STAINLESS STEEL now has a competitor that can do many of the same jobs but is low in cost and formed of easy-to-get materials.

Known as Thermenol, it is an alloy of iron, aluminum and vanadium or molybdenum. It may be a substitute for some of the high-temperature alloys now used in jet engines. Experts describe it as a "natural" for such things as airplane, truck and automobile exhaust systems where hot, corrosive gases must be handled.

Because the metal uses no critically

scarce materials, it promises to conserve supplies of nickel, cobalt and chromium.

Birthplace of the metal is the Naval Ordnance Laboratory at White Oak, Md. Scientists there were working with 16-alphenol, a rock-hard magnetic metal composed of 84 percent iron and 16 percent aluminum. The alloy was lighter than stainless steel and was almost impossible to burn up. But it had no strength at high temperatures and was therefore useless in jet engines.

The scientists tried adding noncritical al-

Thermenol is composed of 80 percent iron (pile at left, 15 percent aluminum and 5 percent molybdenum





Laboratory worker pours molten Thermenol into mold. Metal is hot rolled and later rolled under moderate heat

loying materials. One of these was molybdenum. Results were spectacular.

The new metal, which they named Thermenol, had all the advantages of 16-alfenol, but with a high-temperature strength 100 times greater. The metal measured up to some specifications for stainless steel and surpassed others. While it cannot replace the "superalloys" needed for extremely hot applications, it is good enough to substitute for sheet stainless steel in jet tail cones, exhaust systems and many others.

From 20 to 25 percent lighter than ordinary stainless steel, it could lessen the weight of existing aircraft. It is very hard and has a high tensile strength. It resists corrosion and oxidation, takes a high polish

and holds it. Thus, it may someday serve as a bright, permanent trim for automobiles.

The metal resists electricity 50 percent more than does chrome-nickel wire, the material now used in the heating elements of electric toasters, annealing furnaces and similar applications. Because it is lower in cost and produces more heat, volume for volume, than chrome-nickel wire, it may see wide use in this field.

Less than 50 pounds of the new metal has been produced. But, according to a Laboratory spokesman, large-scale production is probable. When that happens, he says, "stainless steel will not be able to compete with it because of Thermenol's low-cost, noncritical components." ★ ★ ★

After a week in a beaker of nitric acid, Thermenol, at right, was undamaged. Sample of iron in the same test was badly corroded. Metal would keep its shine when used as trim for autos





Navy Antisub Helicopter Equipped With Sonar

Another weapon against submarines is a new helicopter that detects them with sonar equipment. Sonar gear hung from a cable is lowered into the ocean by the hovering copter. The crew can then listen for the echoes of submerged submarines. The helicopter is the Navy's new Sikorsky XHSS-1, recently exhibited in a public demonstration for the first time. The helicopter could patrol large areas from a cargo ship.

Wire-Wrapping Gun Uses No Solder

Without the use of solder, a new wire-wrapping tool produces a tight joint between a terminal lug and its connecting wire in the assembly of electric and electronic equipment. The tool is a hand-held gun that wraps the bare wire tightly around the terminal. The wire is inserted in an opening in the hollow gun tip, which then is placed over the terminal. When the tip rotates, it virtually shoots the wire around the terminal in a strong metal-to-metal joint. The gun can be operated either by air or electricity.

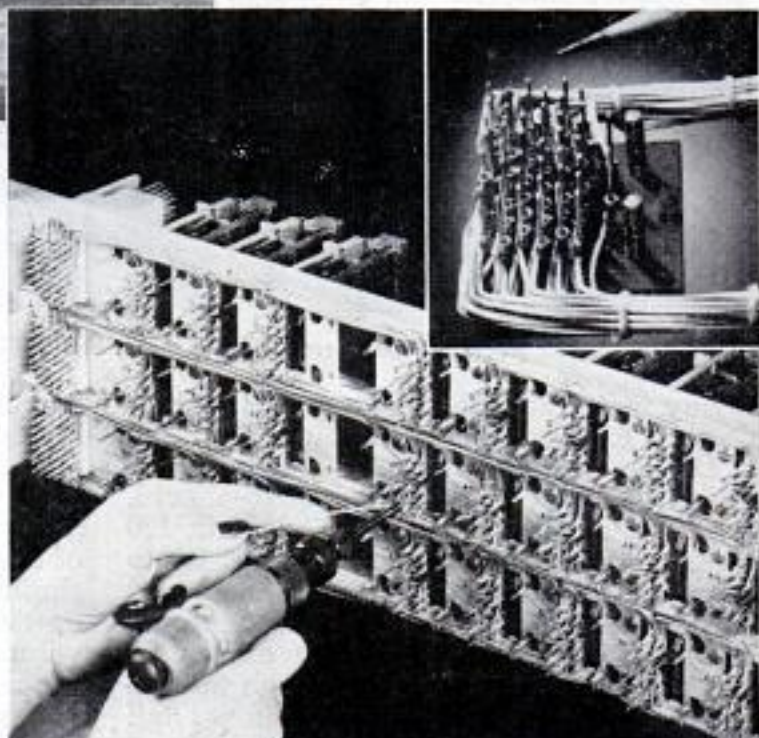

American ~~German~~ Microfilm Camera Shoots Both Sides of Card

Fronts and backs of filing cards are photographed simultaneously as they roll through a microfilming machine. The device was exhibited at Düsseldorf, Germany. It is priced at 24,000 marks — approximately ~~\$5710~~ **3500.**

Fluorescent-Lamp Dimmer

Fluorescent lamps may be dimmed or brightened by a simplified low-cost control developed by General Electric. The dimmer will control light output of up to twenty 40-watt bulbs. It employs a control of the type used for dimming incandescent lamps in combination with a special rapid-start ballast.

Revolving Drum Turns Canned Milk

Milk turning used to be quite a job at the Naval Supply Depot in San Diego, Calif., until someone mechanized the process. Condensed milk in storage tends to separate like paint, so each carton was turned over by hand at least once a month. Now 36 cases at a time are hoisted by a fork lift and placed inside a mechanical turner. Another pallet is placed atop the cases. Wheel rims ride on revolving trucks in the base of the device as the entire load is turned by hand in a half circle. The upside-down cases are then removed from the opposite side by another fork lift and stacked in storage. Almost two thousand cases can be turned per hour.

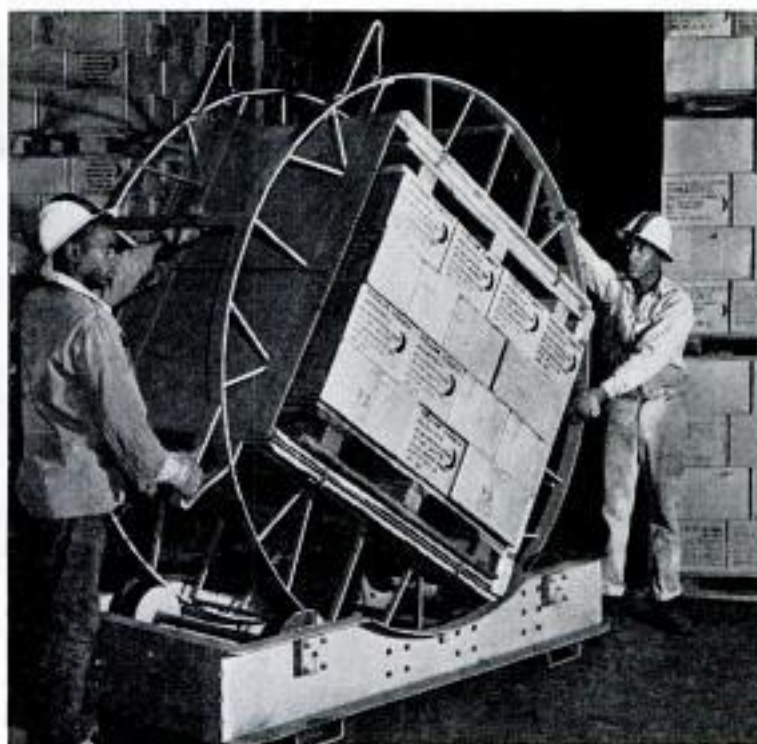

Meter Tells Planting Date For Desired Harvest

Slide-rule techniques now have been put to work for the gardener. A new Cropmeter which is actually a slide rule in dial form tells the gardener when to plant hundreds of species of vegetables so he can harvest them on the dates he desires. This enables him to raise an even flow throughout the season without periods of overproduction or scarcity. In the instruction book is a map dividing the country into 10 growth zones. When the gardener has found the proper zone for his location, he can set the date he wishes to harvest a particular vegetable on the meter, and then calculate the proper planting date. The figures are based on average climatic conditions for each zone.

Tractor Rides Pickaback On British Road Roller

Power and weight for a British road roller are provided by a farm tractor that rides pickaback. The tractor is backed up a portable ramp onto its carrying frame, then lifts its rear wheels clear by its own hydraulic implement linkage. The chain drive to the rear rollers is from a sprocket bolted to the hub of each wheel. A steering wheel is linked to the front roller.

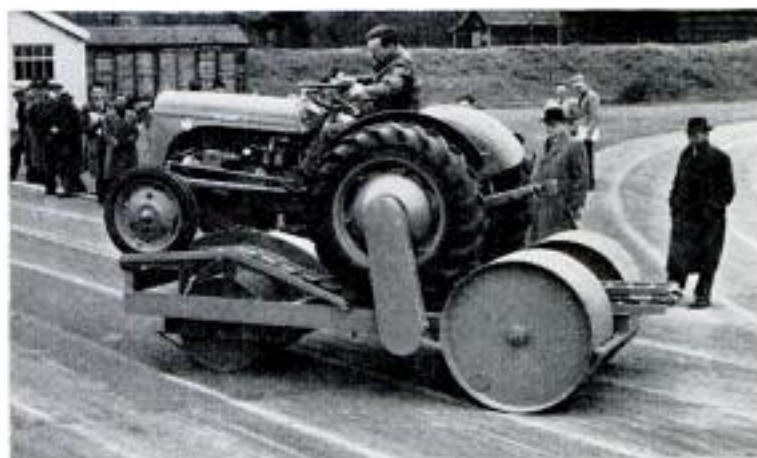

TAXI UP MISERY MOUNTAIN



Cabbie Labbe checks in after stormy ride down the mountain in a Sno-Cat. Weasel driven by assistant, below, is faster



IT IS RECOMMENDED
THAT CARS WITH
AUTOMATIC TRANSMISSIONS
NOT CLIMB
MT. WASHINGTON



A Sno-Cat picks its way down the Winter Cutoff, a risky short cut that skirts the edge of the Great Gulf

IF YOU dislike winter driving, you won't envy Phil Labbe. Labbe runs a year-round taxi service up to the top of Mount Washington, a stormy peak in New Hampshire that has the wildest winter weather in America.

It has been found to be a perfect spot for the testing of jet-aircraft engines. Arctic experts say it has the fog and wind of the Aleutians with the snow and cold of Labrador.

Labbe's route up to the jet-engine testers and scientists on top rises almost a mile in altitude as it twists and turns over eight miles of snow and icy rock. To fight the mountain, Phil has courage, skill and a choice of three types of weapon: Weasel, Sno-Cat and bulldozer. But often, when a "taxi" breaks down or a man is lost in a swirling blizzard, Labbe must supplement his mechanical

By
William Gilman



Labbe keeps a 'dozer on top of mountain in case vehicles can't get through from below. Keeping the road clear is constant job

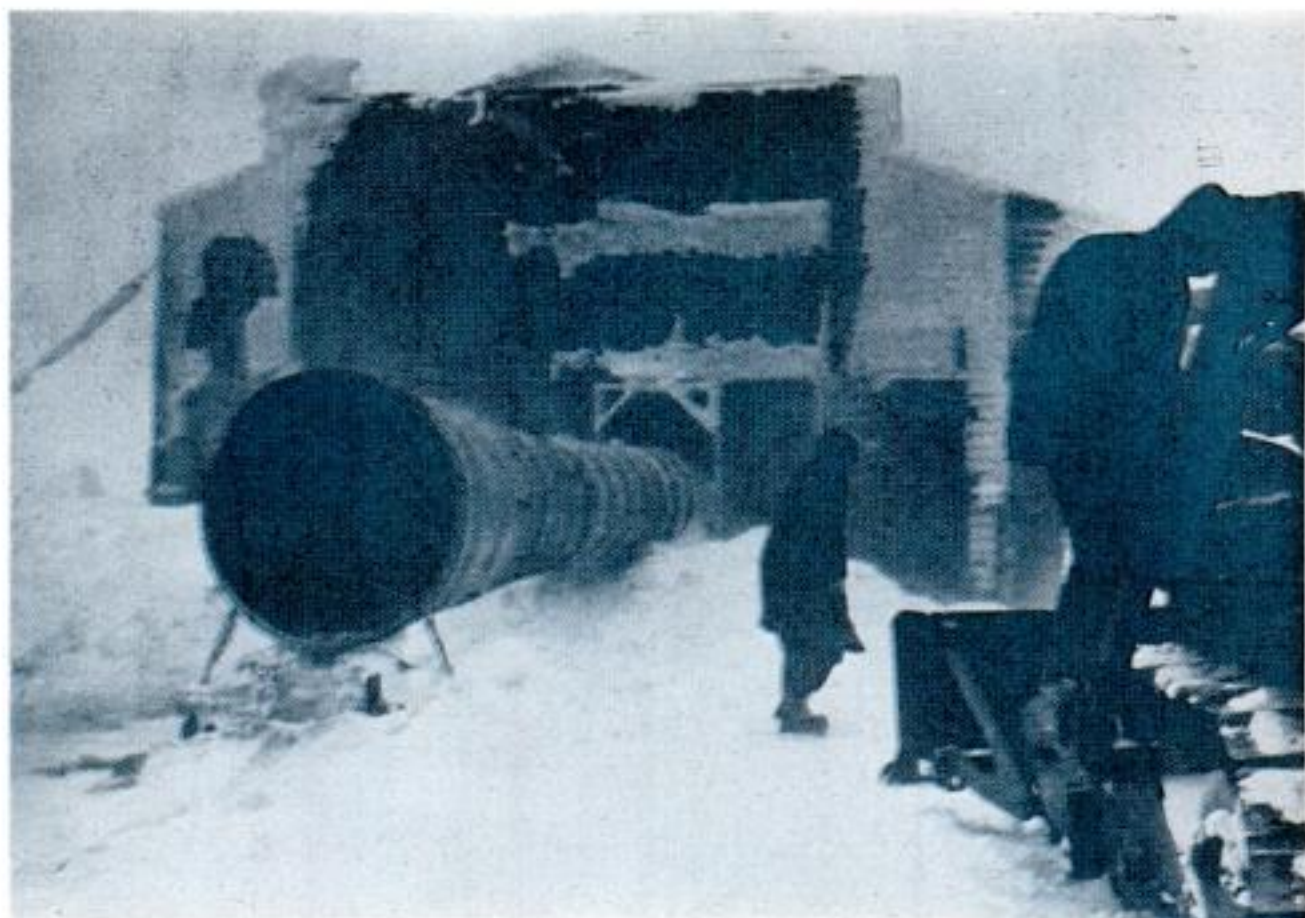

Exit end of wind tunnel juts from icing-research hangar at summit. Savage weather is ideal for test purposes



and driving skills with his own two legs. In summer Phil carries up supplies and men in a Jeep or a truck. Tourists journey up the old graveled "Carriage Road" to view what P. T. Barnum called "the second greatest show on earth." Others ascend the other, western side of the mountain

Below timber line, left, weather is calmer. Radio and telephone, below, link summit and base of mountain





Labbe's Sno-Cat "taxi" hugs the edge of the Great Gulf, a 1500-foot drop. A bulldozer cleared the way

on the freak Cog Railway now owned by Dartmouth College.

In New England's tourist weather, the mountain is usually safe enough for people who follow instructions. For others, especially in winter, it can be a trap that shuts fast. Thirty-eight people have perished on its slopes, most of them from ex-

icing conditions at top of mountain built up a huge mass of frost rime around single upright two-by-four



NOVEMBER 1954

posure or from injuries received in falls.

Last winter a pair of would-be arctic explorers from Harvard University camped in Tuckerman Ravine, a great bowl that fills up with 90 feet of snow and is famed for its spring skiing that lasts into June. They died there. One was killed in his igloo by an avalanche; the other perished from exposure while trying to flee to safety.

During its long winters, Washington is known as "Misery Mountain." It is then that the arctic vehicles supplied by Labbe's employer come in handy. Phil is hired by the Mount Washington Laboratory, an Armed Forces project under Army Capt. John Hitchcock and operated by the icing-research experts of Smith, Hinchman and Grylls, Inc.

Phil, who used to drive a bulldozer for a logging outfit, is "at home" on crawlers.

But Misery Mountain knows some tricks, too. Up above timber line—in the three miles between the "Horn" and the "Home-stretch"—a traveler caught in fog or storm can easily wander off the road, despite the stone cairns which have been placed along the way to guide him.

Even in quiet weather the area can be treacherous. There are places which become ice traps with glacierlike accumulations of snow and rain. Soft new snow atop this can both hide and lubricate the trap.

Four years ago, the first winter with a

(Continued to page 234)



Radioactive-Tire Test Quickly Measures Wear

"Hot" tires—manufactured with radioactive phosphor in the treads—are giving wear-test data in days instead of the months required by a standard road test. One method employs a Geiger counter, mounted on a small cart behind the rear wheel, which scans the track of the tire as it rolls along. A radiation meter in the cab tells how much tire tread is wearing off onto the road. To measure the amount of rubber particles blown into the air, an air scoop feeds the particles into a vacuum-cleaner hose where they are trapped by a paper filter.

Camera Photographs Check Passers

Check passers and their checks are photographed by a device that holds a two-lens 35-mm. camera and 6000 feet of film. A vertical lens makes a picture of the check passer's check and identification card while a horizontal lens takes a picture of him. Both pictures are recorded on the same frame.



Preformed Church Steeple Constructed on the Ground

At first glance it appeared to be a powerful rocket ready for launching—but residents of Wausau, Wis., knew that the strange, needle-nosed object was actually the steeple of the new church being erected. To bypass special scaffolding, the 50-foot wooden steeple was built on the ground in an upright position, then finished to a point that could easily be reached by workmen on the roof. Cement building blocks in the base and guy wires kept the steeple upright as it was raised into position by a crane.

More aluminum was produced in the United States during 1953 than in any previous year—a total of about 1,250,000 tons of primary (new) metal.

Viewers Wear Polarized Glasses to Watch 3-D TV in Germany

Three-dimensional television recently was transmitted by a station in Berlin. Two different images were transmitted, as in any true three-dimensional effect, and picked up on standard receivers during the test. Viewers wore polarized glasses to obtain the three-dimensional effect. A mask which separated the two images was placed in front of the receiving screen to produce a picture with clear-cut edges. The 3-D picture, of course, was only half as large as the receiving screen, dividing it into two vertical pictures.

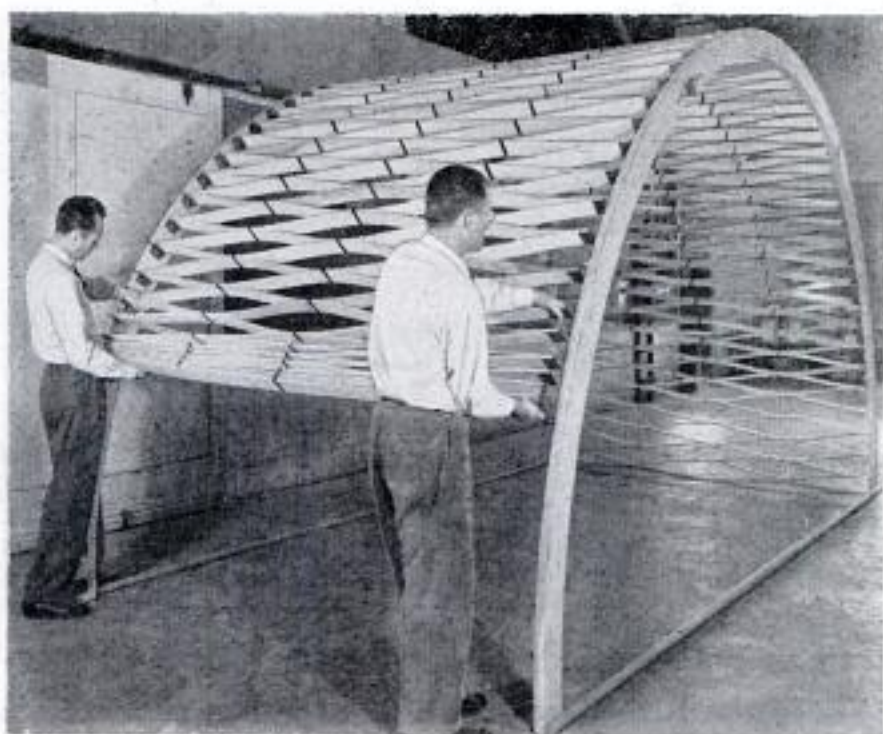
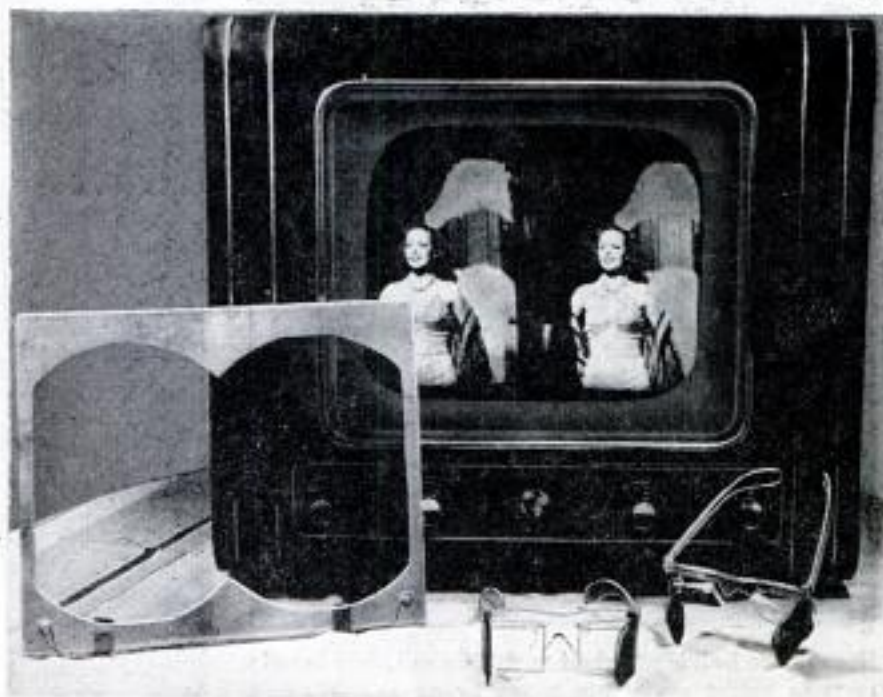

Veneer Slats Support Roof

Lightweight roofing, such as plastic, plywood and thin metal, is supported uniformly by a lattice of wood slats. The slats, which are fastened together by metal strips, are supported by metal slots on each side. Smaller framing members can be used because the weight of the roof is distributed uniformly. The slats, which come in packages eight feet long and nine inches thick, are expanded as they are applied. One unit, containing 32 slats, covers 64 square feet. The slats are made of three-ply oak veneer, are about three inches deep and $\frac{3}{16}$ inch thick. The underside of the slats may be left unfinished to provide a decorative surface, or covered to furnish a dead-air space for insulation. Because the material conforms to curves, it can be used in a wide variety of structures, such as warehouses, farm buildings, carports, and porches. It is quickly installed.

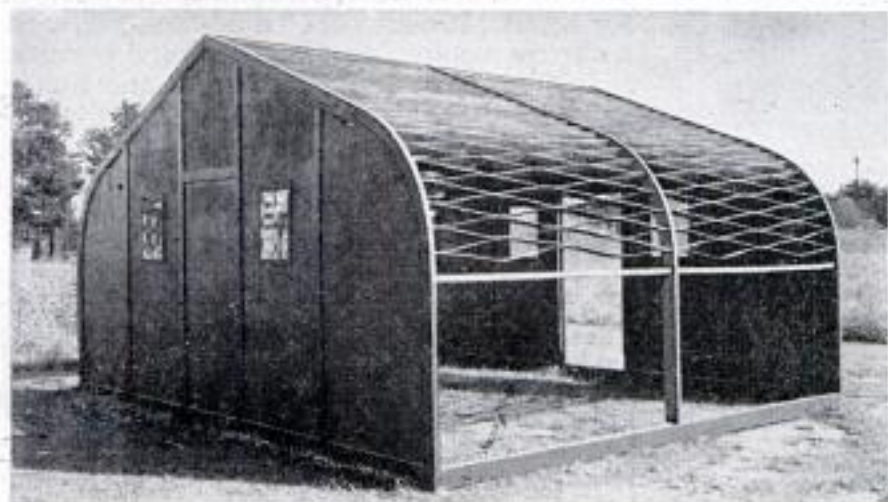

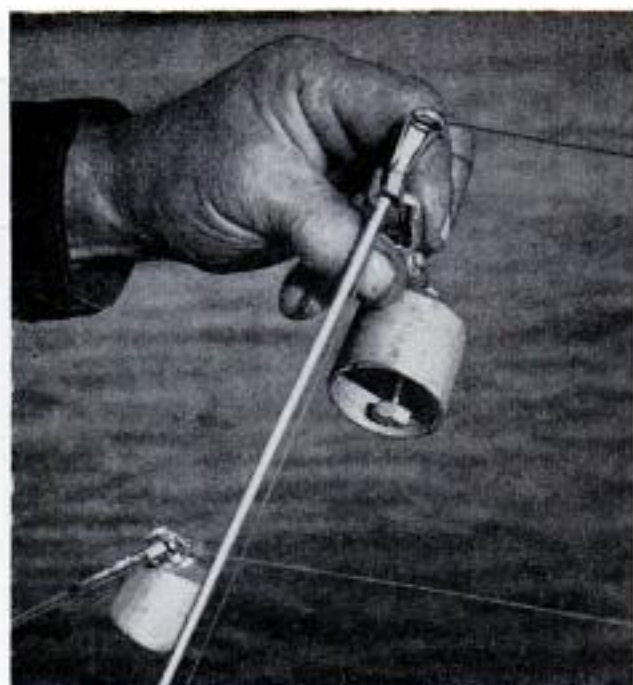

Homemade bell is attached to fishing rod. Rod handle rests in holder stuck into plank or ground. Waiting for fish, lower right, Evanoff catches up on reading



Fishing Rod Rings Bell When There's a Bite

When Ben Evanoff of Detroit, Mich., goes fishing, he can safely read the paper while waiting for the fish to bite. Evanoff has designed a rod holder to free his hands and an alarm that signals a bite. The holder consists of two rings cut from an old auto steering column and welded to a heavy steel wire. The handle of the fishing rod is inserted through the rings and the wire shoved into the ground. The alarm is a little homemade bell which clamps on the rod. When the bell rings, Evanoff drops his reading matter, grabs the rod and reels in the fish.



Wide Ski With a Seat Permits You to Slide Sitting Down



You can ski down a slope sitting down with a ski that mounts a seat. Large enough for adults, it consists of a 54-inch ski with a sturdy wooden post supporting a wooden seat. The seat contains thumb-and-finger grips to allow a good grasp during the descent. Steering and braking are done with the feet. The sit-down ski is intended primarily for use on small slopes or hills, away from regular skiing areas.

Sources of available products described in this issue are listed on pages 12, 14 and 16. Sources of further information on other articles are listed in our free WHERE-TO-FIND-IT LIST. For your copy just write to the Bureau of Information, *Popular Mechanics*, 200 East Ontario Street, Chicago 11, Illinois

Radio Television Electronics

TELEVISION TODAY

THE TREND in home decor toward built-in-furniture units has just found a new friend in a West Coast TV manufacturer who recently announced three new built-in-television units for installation in walls. On a roller-and-track system for easy servicing, as illustrated in photo A, each unit is actually two units. The chassis and picture tube, safety glass and controls are packaged together, with the shadow box and front molding. The sound systems, each with their own moldings are separate, permitting installation anywhere in the room for maximum reception. One high-fidelity sound-system unit includes two 10-in. woofers, a tweeter with diffusion horn, crossover network and 10 watts of push-pull audio amplification with bass and treble controls.

The "girl in the iron mask," photo B, is a trained technician, shielded by a welding mask, expertly joining the faceplate section of an RCA tricolor television-picture tube to the main cone of the tube. The welding operation provides a rugged airtight seal.

The Phantom Feed-Thru is the trade name for the gadget shown in photo C which permits the TV antenna to be brought through the glass. This eliminates drilling through the window frame or wall which involves defacing the house. It is claimed that no signal loss results.

A decorative touch in indoor antennas appears in photo D. Called the Wonder Bow, this TV antenna is claimed to provide ideal reception in city areas on all television channels including VHF and UHF.

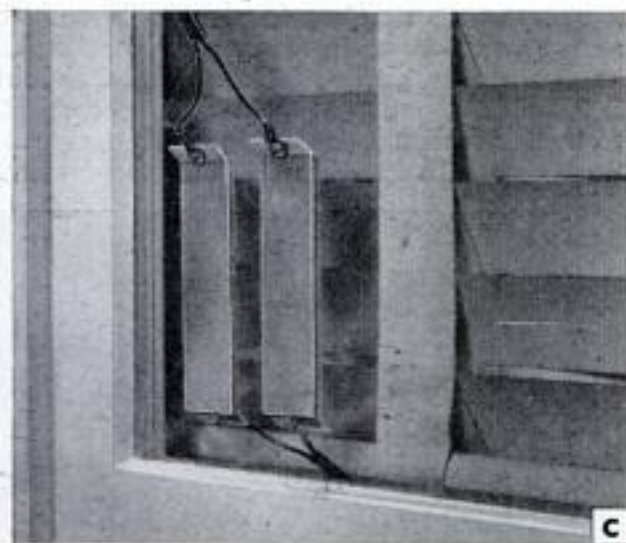
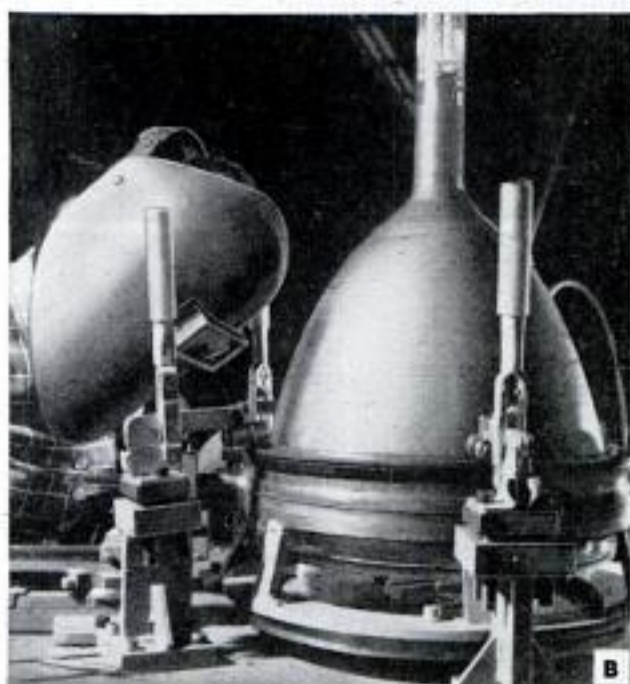

DX TELEVISION-STATION RECEPTION

By Max Tharpe

VERIFIED RECEPTION of distant (DX) television stations may well be the beginning of a new hobby "TV-DX." It not only presents problems of TV-antenna selection, but it also offers an interesting study of weather conditions, sun-spot activity and atmospheric conditions which are favorable to distant TV reception.

Radio hams and short-wave listeners often take advantage of these freak conditions to log DX radio stations on the very-high-frequency (VHF) bands that are normally not considered good for distance. During these periods of freak reception, TV signals from many hundreds of miles can be pulled out of the sky by any good TV receiver that is tuned to the right channel at the correct time. When such conditions have been favorable, the writer has been receiving clear pictures and sound in Statesville, North Carolina, from as far away as Denver, Colorado, a distance of about 1350 miles. As atmospheric conditions varied TV pictures and sound from many other points were tuned in clearly. Sometimes it is possible to enjoy reception for several hours from even the most distant stations. The real thrill is in the satisfaction of seeing big clear call letters at station-break time from some distant station. Then, with camera ready as in photo A, you get your own verification on film.

To add to the suspense, an unidentified station may be loud and clear up until just before the station break—then fade out completely before it is identified. Often a station after coming in clear for some time may become lost in a scramble of stations as the freak conditions affect more stations on the same channel.

The verification screen photos shown are as follows: Photo B, Denver, Colorado; C, Wichita Falls, Texas; D, Montreal, Canada; E, Dallas, Texas; F, Santiago, Cuba; H, Temple, Texas; I, St. Joseph, Missouri; J, Savannah, Georgia; and K, Winston-Salem,



VERIFIED WITH SCREEN PHOTOS



North Carolina. However, there are many others in the writer's collection. The latest improvement in my TV-antenna array is shown in photo G; the rotor motor appears just below the peak of the roof. This rather elaborate array now also includes a stacked UHF reflector on top.

By combining a sensitive 1954 TV receiver with this rotary all-channel TV antenna, it is possible to select programs from 10 clear stations almost every night in the year. The rotator makes it possible to turn the entire antenna array in any direction by means of a remote-control unit at the receiver. In many cases this helps to clear up the distant signals. Although special antenna arrays and TV boosters are a great help in bringing in a large number of stations, a simple TV antenna at the proper height will often bring clear pictures and sound from distant points when freak conditions are active.

A tip for the TV-DXer is when viewers complain about distant TV stations interfering with their reception. This disturbance pattern is a guide as to when distant stations are coming through. Since the TV signal does not bend with the curvature of the earth, its reception usually fades out at a distance of 100 to 200 miles from the transmitting station. Normally the VHF TV sky wave travels on into space as the low angle of reflection from the Heaviside layer is not sufficient to bring it back to earth. The Heaviside layer, or ionosphere, acts as a mirror in the upper atmosphere above a height of about 60 miles, see Fig. 1. These ionized layers are subject to continuous change and sometimes the angle of refraction is changed so that the signals are reflected back to earth again and can be picked up in the area where they strike; this is the freak condition referred to.

When photographing the screen of the TV set, an exposure of $\frac{1}{3}$ second at f:5.6 should make a good picture if you use a tripod. Do not use a flash, as the brilliant light will wash out the picture. ★ ★ ★



SEVEN-BAND CW AND PHONE TRANSMITTER IN KIT FORM



PLANNED for easy assembly, this versatile and compact kit transmitter is specially designed for the advancing novice or experienced amateur. It is a complete self-contained 75-watt input CW and 65-watt phone transmitter with built-in variable-frequency oscillator (VFO). The use of crystal control is also conveniently provided for if desired.

It is interesting to note in photo A that this ultra-compact transmitter, being operated by John E. Magnusson WØAGD, is smaller than the communications receiver at his left. An important feature is efficient television-interference suppression, provided by complete shielding and filtering; the unit can also be used as a flexible exciter rig without modification. The r.f. and audio sections may be used separately to drive larger amplifiers. For example, the 6146 final can be used to excite a high-power r.f. amplifier, while the speech amplifier and modulator section provide the necessary audio gain and power output to drive the grids of a high-power Class B modulator. The Novice Band operator, looking forward to getting his higher-grade license, will appreciate the fact that he has a complete foundation for a much larger rig.

Operating on 160-80-40-20-15-11 and 10 meters, VFO or crystal, it is easy to tune as the basic tuning controls are located on the VFO dial escutcheon. A block diagram of the transmitter is shown in Fig. 1. The built-in VFO in this Viking Ranger transmitter is patterned after the well-known

(Continued to page 256)

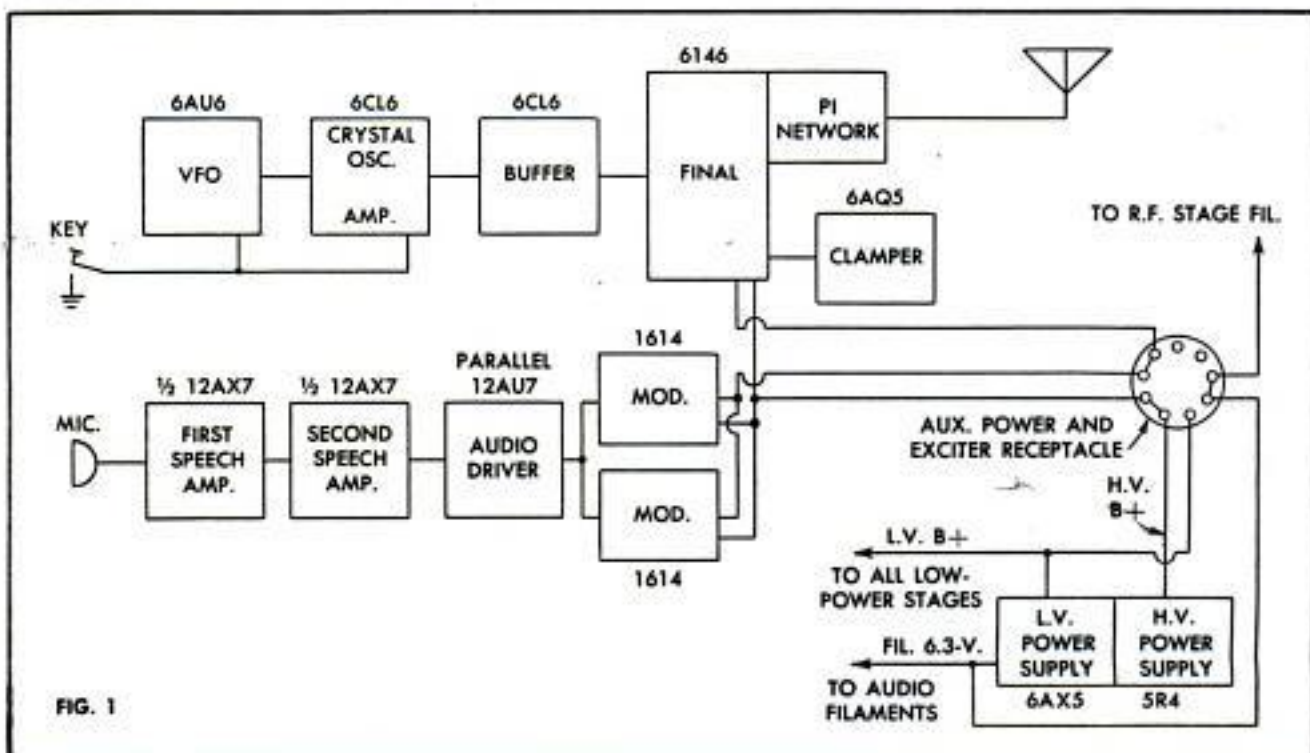
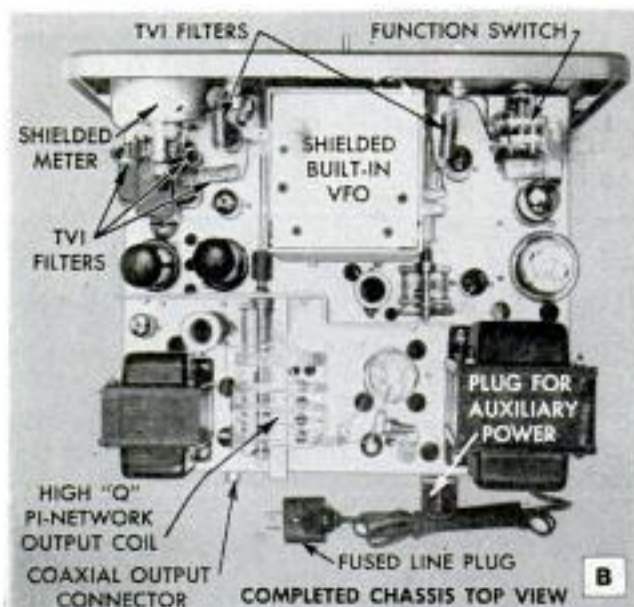

FIG. 1

the

POPULAR
MECHANICS

CRAFTSMAN

FOAM RUBBER Simplifies Upholstering

Have you a piece of furniture that needs upholstering but are afraid to tackle the job yourself? Foam rubber and sagless-type springs now make upholstering at home easy



STRIPPING a sagging, overstuffed chair down to the frame is easy for anyone but building it back up again is a job not many care to undertake. The task of tying countless springs together and the work of adding cotton and hair padding are complicated steps that make upholstering difficult for the novice to master.

However, what was once a trying job is now actually fun. New sagless-type springs, which are merely hooked to the frame with special clips, do away with tedious tying, and resilient foam rubber, which is cemented in position, takes the place of padding without the drawbacks of matting and shifting.

On this and the following eight pages, John Bergen, in cooperation with the U. S.





**TABLE FOR DETERMINING
NUMBER OF SAGLESS STRANDS, PROPER
SPACING OF CLIPS AND CORRECT SIZE OF SEAT
HELICALS, EXTENSION SPRINGS FOR CHAIR AND SOFA SEATS**

Distance Between Arms Along Front Rail	Number of Sagless Strand	Center- to-Center Spacing For Clips	Center Spacing of Two Outside Clips From Inside Arm Posts	Seat, Helical and Extension Spring Size
21" Chair	5	4 $\frac{1}{4}$ "	2"	2"
22" Chair	5	4 $\frac{1}{2}$ "	2"	2"
23" Chair	5	4 $\frac{3}{4}$ "	2"	3"
24" Chair	5	5"	2"	3"
24" Chair	6	4"	2"	2"
25" Chair	6	4 $\frac{1}{4}$ "	1 $\frac{7}{8}$ "	2"
58" Sofa	12	5"	1 $\frac{1}{2}$ "	3"
59" Sofa	12	5"	2"	3"
60" Sofa	13	4 $\frac{3}{4}$ "	1 $\frac{1}{2}$ "	3"
61" Sofa	13	4 $\frac{3}{4}$ "	2"	3"
62" Sofa	13	4 $\frac{3}{4}$ "	2 $\frac{1}{2}$ "	3"
63" Sofa	13	5"	1 $\frac{1}{2}$ "	3"
63" Sofa	14	4 $\frac{1}{2}$ "	2 $\frac{1}{4}$ "	2"
64" Sofa	14	4 $\frac{1}{2}$ "	2 $\frac{3}{4}$ "	2"
65" Sofa	14	4 $\frac{3}{4}$ "	1 $\frac{5}{8}$ "	3"
66" Sofa	14	4 $\frac{3}{4}$ "	2 $\frac{1}{8}$ "	3"
67" Sofa	15	4 $\frac{1}{2}$ "	2"	2"

Where distance between arms is in half inches use table for next smaller or larger size and set each outside clip $\frac{1}{4}$ " farther away from arm post (if table for smaller size is used) or $\frac{1}{4}$ " closer to arm post (if table for larger size is used).

Rubber Co. and the No-Sag Spring Co., shows how simple it is to upholster both old and new furniture using these two new products. Full-size plans, plus material lists, are available for constructing the frames for the new pieces of furniture which are pictured on the first three pages.

This new-type spring is sold under the trade names of No-Sag and Zigger Wire and is manufactured in strip form from spring-steel wire which is bent in a zigzag pattern. The wire does not actually become a spring until it is uncoiled and stretched and anchored at each end to the seat or back frame. Sagless-type springs are sold both in ready-cut lengths and in coils up to 160 ft. long. Springs of No. 8 to 11-ga. wire are recommended for seats, while springs from No. 10 $\frac{1}{2}$ to 12 $\frac{1}{2}$ ga. are best for backs.

Measuring springs for length: The comfort and resiliency of sagless-type springs will depend entirely on the correct arc, gauge of the wire and length of the springs. The greater the arc, the more resilient the seat. Never make the arc greater than 2

**TABLE OF GAUGES AND SIZES
OF SAGLESS-TYPE SPRINGS FOR SEATS**

Inside-Seat Dimension	Gauge	1 1/4" Arc	1 1/2" Arc	1 3/4" Arc	2" Arc
12"	11	11 3/4"	12"	12 1/2"	
13"	11	12 3/4"	13"	13 1/2"	
14"	10 1/2	13 3/4"	14"	14 1/2"	
15"	10 1/2	14 3/4"	15"	15 1/4"	
16"	10	15 3/4"	16"	16 1/4"	
17"	10	16 1/4"	16 1/2"	16 3/4"	
18"	9 1/2	17"	17 1/2"	18"	
19"	9 1/2	18 1/4"	18 1/2"	18 3/4"	
20"	9	19"	19 1/2"	19 3/4"	20"
21"	9	20"	20 1/2"	20 3/4"	21"
22"	8 1/2	21"	21 1/4"	21 3/4"	22"
23"	8 1/2	22"	22 1/2"	22 3/4"	23"
24"	8 1/2	23"	23 1/4"	23 1/2"	24"
25"	8	24"	24 1/4"	24 1/2"	25"
26"	8	25"	25 1/4"	25 1/2"	26"
27"	8	26"	26 1/4"	26 1/2"	27"

Inside-seat dimension is the distance between the inside of the front and back rails. Sagless springs cut to this exact length will give you the normal arc. It varies from 1 1/4" to 2" increasing with the length of the spring as shown above. When clip is not attached to inside edges of frame, clip-to-clip dimensions can be used instead of inside dimensions.

in. high without using a hinge link, which is a U-shape wire connector applied to the end of the spring at the back seat rail. To measure sagless-type springs for length, hold one end of the uncoiled spring on one end of a yardstick. Then roll back the other end of the spring until it lies flat on the yardstick. The distance between the extreme outside edges of the bent ends is the correct length of the spring. Avoid measuring with a flexible-steel tape around the curve shape of the spring as this will give an incorrect measurement. Springs that are sold already cut are measured by the yardstick method.

Cutting and bending ends of springs: When the spring wire is purchased in coils, it must be cut into individual springs of the proper length, after which the ends must be bent back slightly. The wire can be cut either with a file or fine-tooth hacksaw blade. With a file, a notch is made in

Above, attractive sofa bed is practical answer to small quarters of studio apartment or den. Dual-purpose feature provides roomy couch by day and with bolster removed, a comfortable bed by night

Below, another example of how foam-rubber padding gives neat tailored look to this Davenette. Author John Bergen has prepared full-size plans for the frame of this piece as well as the others shown above





Threadbare occasional chair, above, becomes like new with foam-rubber padding and red plastic upholstery



A little redesigning, the magic of foam rubber and re-covering with new fabric revived the castoff easy chair pictured above. The slat bench in playroom, below, is upholstered with foam rubber and plastic



the wire while it is clamped in a vise and then the wire is bent back sharply to snap it off. Bending back of the ends is done by clamping the spring in a vise and hammering the end back. Bending the ends back is necessary to prevent the springs from slipping out of the clips which are used to anchor them to the wooden frame. When the springs are purchased ready-cut to length, they come with the ends already bent.

How springs are installed: The special metal clips which hold the spring ends securely to the frame are nailed in place first. The chart given on page 162 recommends the number of springs needed in the seats and backs of certain size frames and also gives the correct spacing of the clips. Mark the location of the clips on the rails of the frame. When the seat tapers to the back, the outside clips on the back rail should be placed the same distance in from the sides as they are placed at the front. The other clips for the back seat rail are spaced evenly between the outside clips. On large seats, the second clip from the outside on the back seat rail is spaced evenly between the outside clip and the normal position of the third clip. The springs are always installed between the front and the back seat rails in the case of the seat, and from the top rail to the back liner when springing the back of a chair. The only exception is when the seat and the back are upholstered together in one continuous form. Then the springs are installed between the side seat rails and between the back posts.

When nailing the clips in place, be sure each clip overhangs the inside edge of the frame at least $\frac{1}{8}$ in. This allows the spring to swivel freely inside the clip and prevents noise that might otherwise result from restricted spring movement. It is best to install all clips in their respective positions with one nail before hooking the springs in place. In placing the springs, it is important to alternate the direction of

Sagless-type springs are installed in back by nailing lower clips closed and drawing springs upward



First step is to nail spring clips to frame. Note wire hinge links along back rail. Links plus clips are used at rear rail when greater spring arc is desired

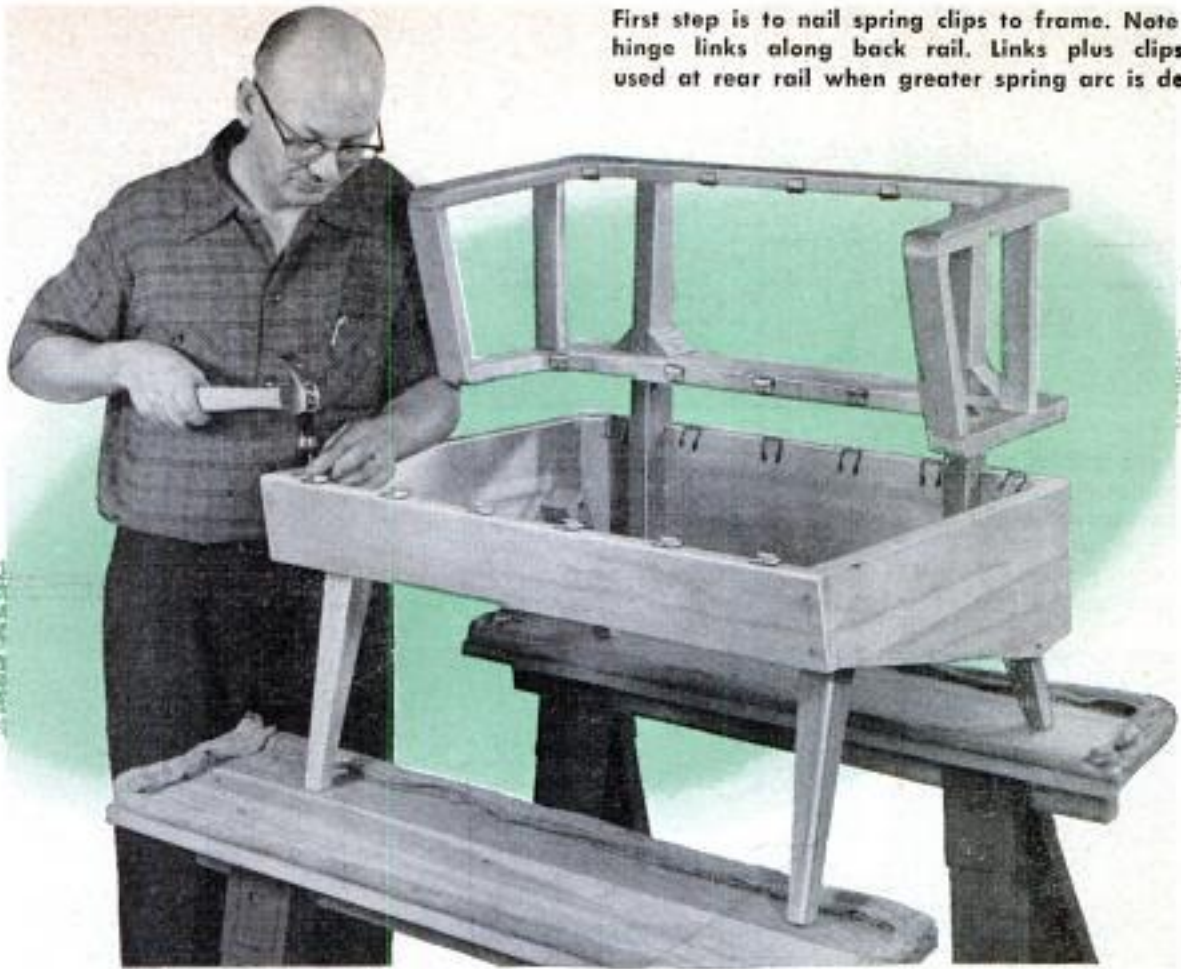

the bent ends. For example, if the bent end of the first spring points to the right, the bent end of the adjacent spring should point to the left. Alternating the direction of the bent ends of the springs brings closed loops opposite each other, thus permitting helical and retainer springs to be applied to the sagless-type springs in a straight line. Alternating the bent ends of the springs also is necessary to permit installing edge springs.

Installing springs in seat: When all the clips have been nailed to the frame, you are ready to install the springs. To determine the gauge and length of the springs needed for the particular frame at hand,

measure the frame from the inside of the front rail to the inside of the back rail. Then consult the chart on page 163 to find the length and the gauge of the springs needed. Keep the arc about 2 in. high. This will make the most resilient seat.

Each spring is installed individually by first hooking it in the open clip at the back seat rail and then nailing the clip shut. After this the spring is pulled forward, hooked in the clip at the front rail and the clip is nailed shut as before. As sagless-type springs are quite stiff and thus require a good deal of pull to stretch them, you should make sure that the clips are well nailed and that you have a good hold

Next, the springs are covered with burlap. Long running stitches are used in sewing it to the springs

Tacking strips of muslin, cemented to edges of foam-rubber pad, serve to secure rubber in place on seat





Above, small helical springs tie sagless-type springs together crosswise in both seat and back. Below, foam rubber, covering arms of chair, is cemented at seams



Above, chair arms are covered on inside with furniture webbing. Back and seat have already been covered with burlap. Below, photo shows chair padded with foam rubber and ready for fabric cover. Cotton is used to pad arms on outside



Below, fabric cover is applied to outside face of arms last. First, welting is tacked all around outer edge of arm. Then fabric is blind-tacked along top edge by tacking through cardboard strip and rear side of fabric. Cardboard is concealed when fabric is pulled down



on the spring. One of the best ways to stretch the springs is to grip the free end with the claw of a hammer. With the hammer held in the right hand, left hand is used to press downward on the crown of the spring as it is pulled forward and hooked in the clip. As each spring is stretched in place, remember to alternate the direction of the bent ends.

Helical springs installed next: Helical springs are used to connect the sagless-type springs together crosswise so they will function as a unit and spread the seating load evenly over all the springs. When installing the helical springs, be sure the open hook of the coil is placed downward so that the hook will not snag the burlap covering and foam-rubber padding. At least two rows of helical springs should be used, three are better. These are anchored to the side seat rails with retainer plates which are sheet-metal hooks that are nailed vertically to the outside face of the rails. The plates should be spaced evenly three or four spring loops apart along each rail, and should be nailed at a height on the rail that will permit a straight sideward pull against the outside row of sagless-type springs.

Applying springs in the back is done practically the same as described in springing the chair seat. Here, the



After foam rubber is applied to bolster, the rubber is cut with scissors all the way through to burlap. This allows the bolster to be deeply tufted when it is covered



Above, wooden frame to which sagless springs are applied and then covered with burlap, is designed to take standard, cored foam-rubber mattress. Below, helical springs are added to sagless springs of bolster

springs are stretched from the back liner (lower crossrail) of the frame to the top rail. Two or three rows of helical springs are installed across the back as was done in the seat. However, the springs at the ends of the rows are held to the frame with staples instead of retainer plates. After all the springs are installed in both the back and seat, the springs are covered with burlap which is drawn taut and tacked to

Below, bolster is "wrapped" with fabric which is brought around and tacked to ends of frame. Separate plywood panels, covered with fabric, cap each end



Below, before foam rubber is applied, edge roll is tacked all around each end of bolster to soften the hard edges of frame and produce recess for end panels





Above, this photo of the Davenette shows it ready for the foam-rubber padding. Note the spring edge wire that is required across front of T-type seat

the top edges of the wooden chair frame. **Adding foam-rubber padding:** Padding the springs with foam rubber is much simpler than padding them with loose stuffing, as the rubber is of uniform thickness and density. Foam rubber comes in cored and plain slab stock of various densities. Rubber of extra-soft density is recommended as a topping over back springs. Rubber of medium density is best for soft seats, with or without springs. Rubber of soft density is used for both back and seat padding. Plain slab stock (not cored) of

UPHOLSTERY ALLOWANCE	
0 to 6"—Allow $\frac{1}{4}$ " over-all	36 to 48"—Allow $1\frac{1}{2}$ " over-all
6 to 12"—Allow $\frac{1}{2}$ " over-all	48 to 60"—Allow $1\frac{1}{2}$ " over-all
12 to 24"—Allow 1" over-all	60 to 72"—Allow 2" over-all

These allowances can be varied slightly when extra soft or very firm foam rubber or rubberized fiber is used. When using extra-soft stock add more to these allowances and when using very firm stock less allowance can be made.

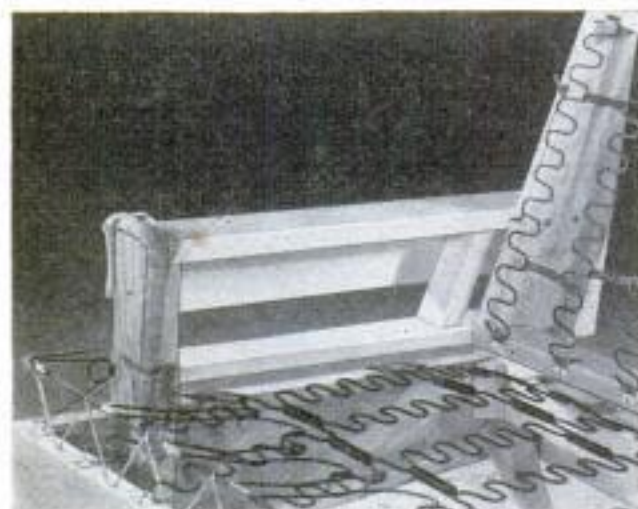

Above, edge roll is tacked around the front of each arm to soften hard edge and prevent excessive cover wear. Notice torsion spring and how edge wire is tied

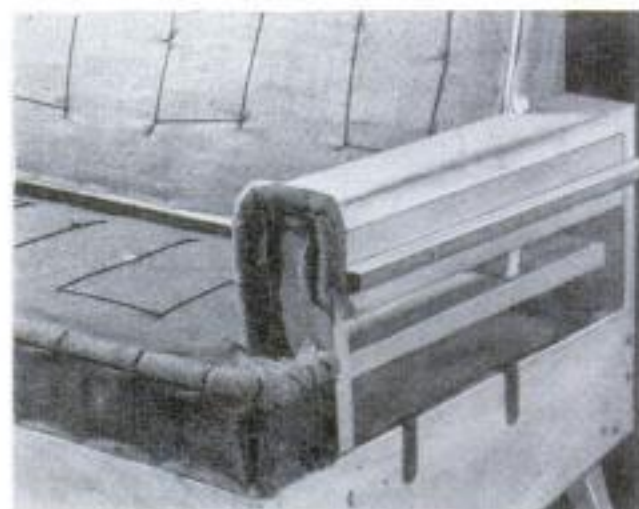

Above, close-up view of arm and corner of seat show how edge roll should look. Roll is tacked to arm and sewed to seat. Long stitches fasten burlap to springs



Here Davenette is fully padded with foam rubber. Notice muslin tacking strip across the front edge

medium density is used for padding the top and inside surfaces of arms, slip seats, benches, shaped seats and thinly padded chair backs.

A paper pattern should be made of all parts that are to be padded with foam rubber. To assure that the fabric cover will fit snugly, the foam rubber should be cut slightly larger than the pattern. Consult the chart on page 168 for proper allowance. The pattern can be traced on the foam rubber with an indelible pencil, ball-point pen or colored pencil. A few pins will hold the pattern in place while tracing. Any thickness of solid-slab foam rubber can be cut completely through with scissors. The same applies to cored stock up to 2 in. thick. In the case of heavier stock, it is best to make the first cut through the smooth top surface deep enough to sever the top of each core. Then cut through each core well. The scissors should be dipped in water frequently to lubricate them and make cutting easier.

Cementing foam rubber: Foam rubber is cemented to the burlap over the springs to hold it in place. Both the burlap and foam rubber is given a coat of special cement made for the purpose and allowed to become tacky before placing the foam-rubber slab in position. In the case of cored stock, the cores should first be dusted with talcum powder to prevent any cement from sticking that might run down inside the cores. Slabs of foam rubber may be cemented together edgewise in the same way when building up several pieces for width. After several hours, the bonded seams will be stronger than the foam rubber itself.

Applying tacking tape: Foam rubber is held to the frame with tacking tape. This is a strip of muslin which is cemented to the outer edges of the foam-rubber slab and tacked to the frame. It also helps to reinforce the edges of the rubber. The tape is applied by coating the edges of the foam rubber and the tape, a distance of 1 in. along the edge with cement, and sticking the two coated surfaces together after they have dried a minute or two.

From here on the job is completed in the normal way, pulling the fabric cover on over the foam rubber and tacking it to the frame. As a rule, a conventional muslin cover is not required over foam rubber, except where the cover is a pile fabric like cut velour.

While the steps described here have been presented briefly due to limited space, a much more detailed explanation of working with sagless-type springs and foam rubber may be found in a book written by the author, John Bergen, which covers the subject completely. ★ ★ ★

NOVEMBER 1954

Making a Foam-Rubber Cushion

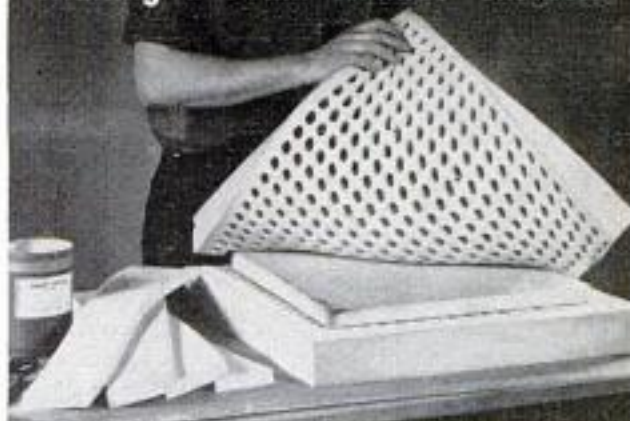

Above, solid slab stock is sandwiched between two cored slabs and then all three are cemented together



Above, strips of solid slab rubber are cemented to edges and at four corners of built-up center portion

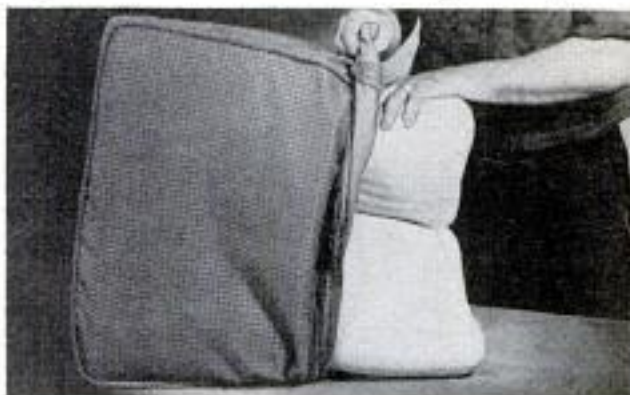

Above, built-up foam-rubber pad is inserted in a stitched-fabric cover and then open side of cover is hand-sewn shut along welt edge of the cushion

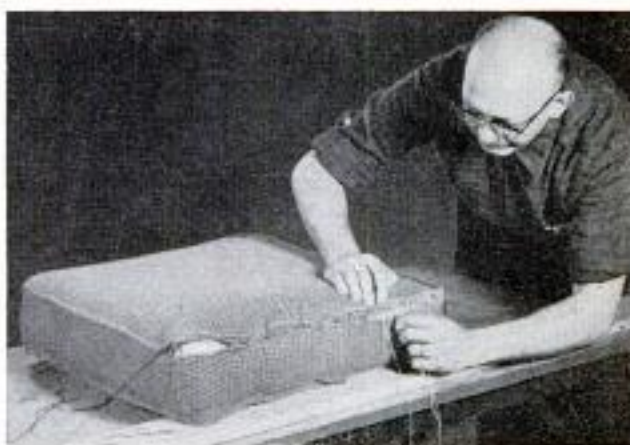

169

Solving HOME PROBLEMS

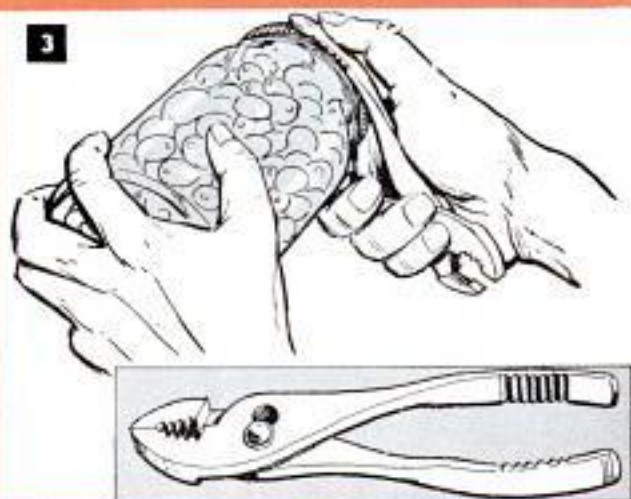
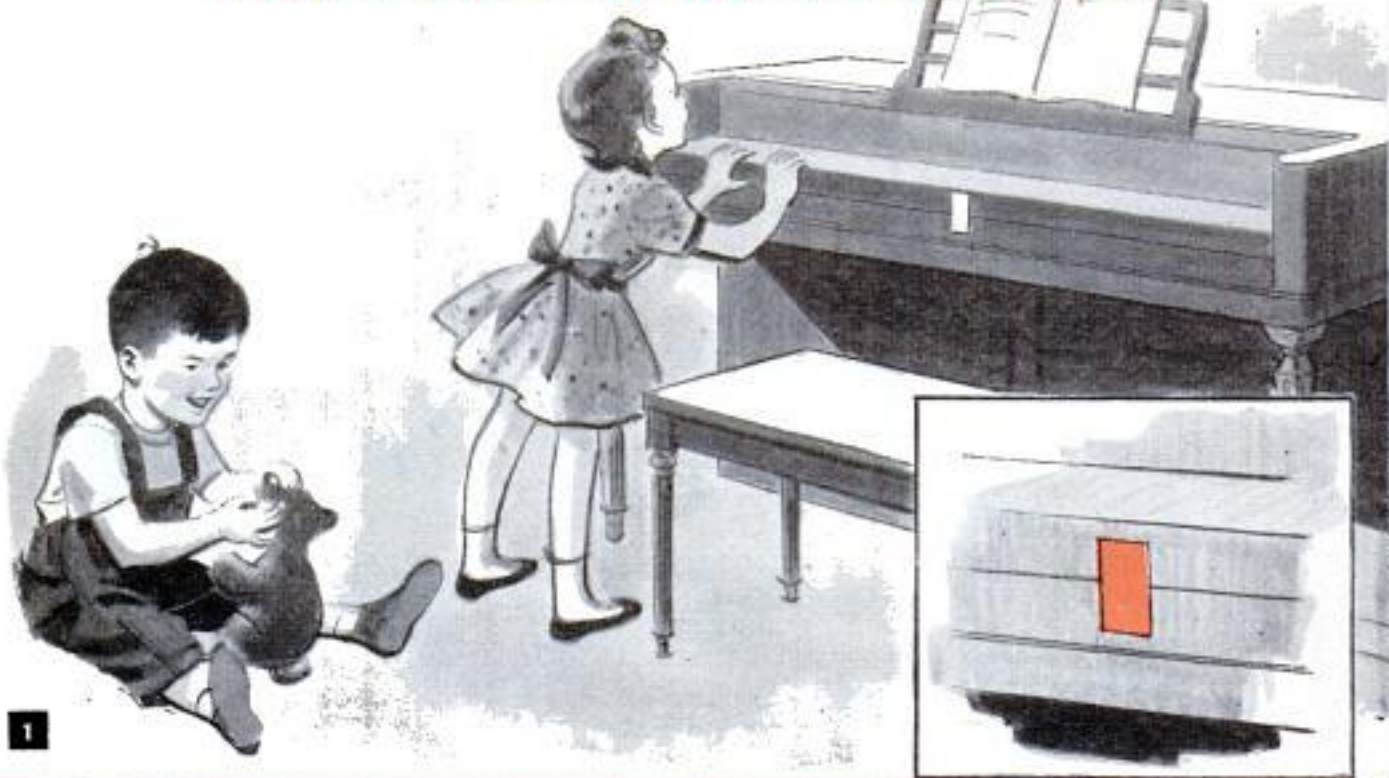

1 **TO PREVENT INJURY** of children's fingers by the lid of a piano keyboard, tape the lid in the closed position whenever children are likely to play in the room. Either cellulose or masking tape may be used without marring finish of the piano

2 **METAL SALT-SHAKER CAPS** have a tendency to rust and become clogged readily during damp weather. This problem can be solved easily by coating inside of salt-shaker cap with fingernail polish, punching out holes with a pin or needle

3 **ORDINARY PLIERS** provide a handy "wrench" for opening fruit-jar lids. A row of shallow notches filed on the inside of each handle engages serrations on the side of the jar lid. This gives the handles of the pliers a good nonslip grip

4 **LOOSE DOORKNOBS** due to worn threads on a square split shaft may be tightened by sandwiching masking tape between the two parts of the shaft. Use one or more layers of tape to build up shaft thickness so threads will engage knob

5 **SMALL PLASTIC DOLLS** of type sold at candy counters form novelty plant waterers. Doll should have holes in the top and bottom so it may be filled with water after being set in planter and slowly water plant. Drill holes if necessary

6 **BEFORE YOU PLANE** the edge of a sticking door check it with carbon paper to find which portion needs planing. Close the door over the paper repeatedly, moving the paper each time. Carbon smudges on edge of door indicate need for planing

7 **TWO STRANDS** of lightweight thread used simultaneously through the needle of your sewing machine will do the trick in the absence of heavy thread. Length of spindle can be increased to hold two spools by slipping a soda straw over spindle

8 **A STRIP OF ELASTIC WEBBING** will keep dust-mop head from falling off the handle when you are shaking the mop. Simply sew the webbing across open side of the mop to keep the eyes in mop wire from spreading too far apart when mop is shaken

9 **HANGING A SCRUBBING BRUSH** from rim of pail saves time and trouble. Easiest way to do this is to make a hanger by fastening a shade-roller bracket to top of brush with wood screws. Locate bracket so it won't interfere when grasping brush

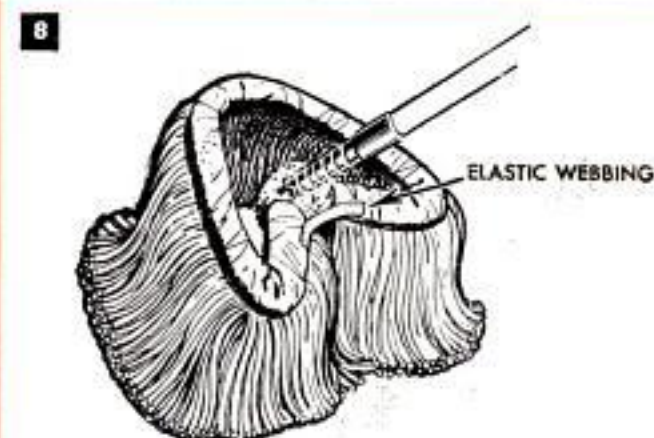
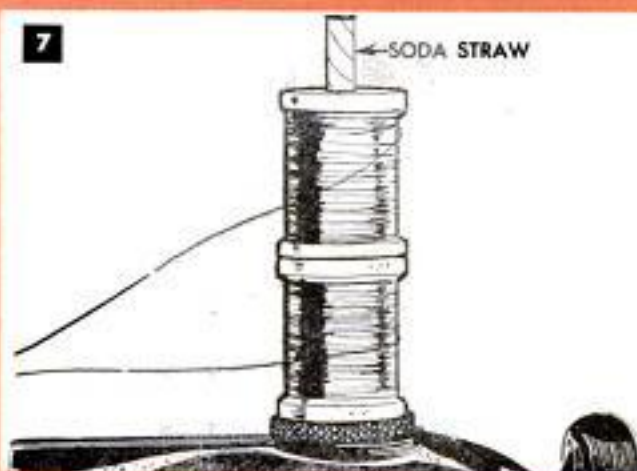

Access to Trap Door Provided By Vertical Folding Ladder

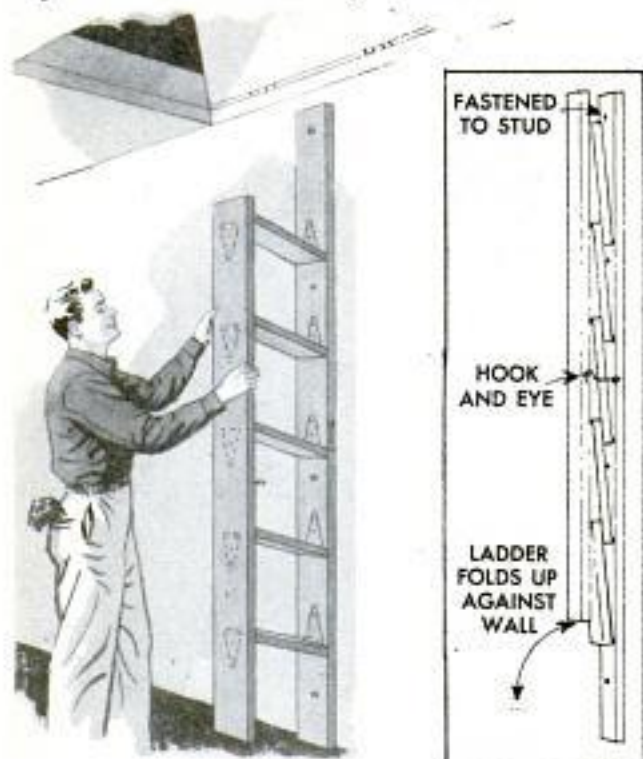

In a barn, garage or workshop which has only a trap-door entrance to a loft, and no room for a stairway, a vertical folding ladder will provide ready access. The ladder is made of 1-in. stock, hinged as shown in the detail, and one side is screwed to a wall stud with lag screws. A hook and eye holds the folded ladder flat against the wall. The dimensions, of course, will vary with the ceiling height and the most convenient tread width.

Wire-Solder Loop Holds Bottle And Prevents Spilling Liquid



The next time you have a hurry-up job at your workbench that involves an open bottle of cement, soldering acid or other liquid, use a spool of wire solder to assure that the bottle is not accidentally tipped over. Simply unroll a length of solder to wrap around the bottle, as shown in the sketch.—G. E. Hendrickson, Argyle, Wis.

Wrench Stored on Battery Case

Should the danger exist of an electrical short circuit setting fire to a car, it is advisable to keep an open-end wrench of the proper size within easy reach for quick-

ly disconnecting one of the battery cables. One way of storing the wrench is to tie it to the battery case with a piece of string that will break when the wrench is jerked free.—Charles H. Coleman, Aurora, Ill.

Hat Holders Bent From Wire

Women's hat holders that clip to a shelf and are adaptable to any size or shape of hat can be bent from a length of No. 12-gauge wire. The wire first is bent double to form a long U-shape about 1 in. across. The parallel lengths then are twisted together for about 6 in. near the center. Next, the circle for the top end is formed and the ends twisted together and taped to cover any sharp edges. The shelf clip is shaped last and bent to fit the particular shelf on which the holders are to be used. Several holders usually can be clipped to one shelf.



Cutter for Photoprint Paper Made From Plywood Sheet

Limiting the number of various sizes of photographic printing papers, to prevent some from becoming overage, can be done by buying only the larger-size stock and cutting it to the desired smaller sizes. A simple cutter can be made by using a small sheet of plywood or hardboard. First a strip of plywood is nailed and glued to one edge of the plywood sheet. Then blocks are fastened to opposite edges and positioned so that when a steel rule is placed against them, as shown in the photograph, the desired size can be cut along the rule. A razor blade in a holder is used to cut the paper.

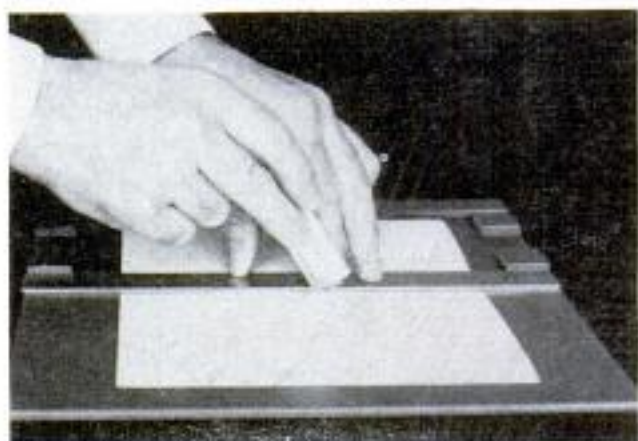

There's a Trick to Fishing Wires Through a Wall

When installing electrical wiring in an old house, the problem of fishing cables through the walls can be simplified if you know a few tricks. First, if a long bit, such as an electrician's extension bit, is used, the least amount of damage will be done to the wall. Start drilling just above the baseboard as shown at the right, holding the bit at an angle that will permit it to penetrate the sole plate and, if desired, the top plate of the lower partition.

Furnace chain is ideal as a lead for pulling the cable through a wall because of its flexibility, strength and ease of handling. Two tools that are useful for cable fishing are a wire guide and a long "fish" wire. The guide is bent as shown in the detail directly below, and is used to push the chain through the walls. The fish wire, shown in the right-hand detail, is a long wire with a hook formed in one end and an eye in the other. The hook is used to pull the chain through. One method of splicing cable to the chain is shown below.

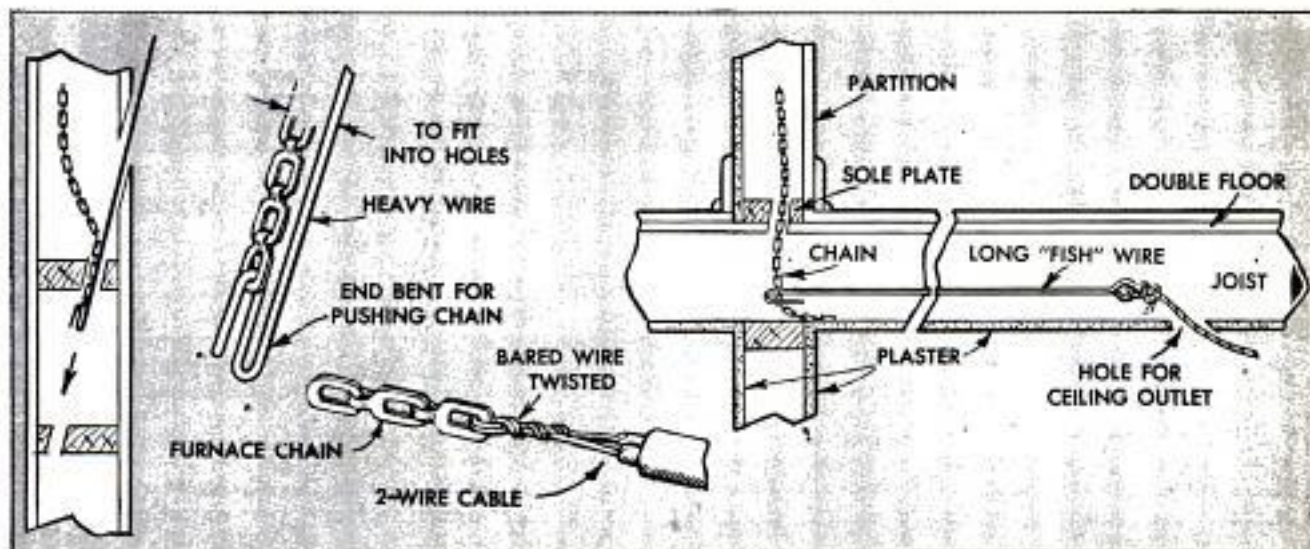

Camera Bellows Kept Soft and Pliable by Wiping With Oil

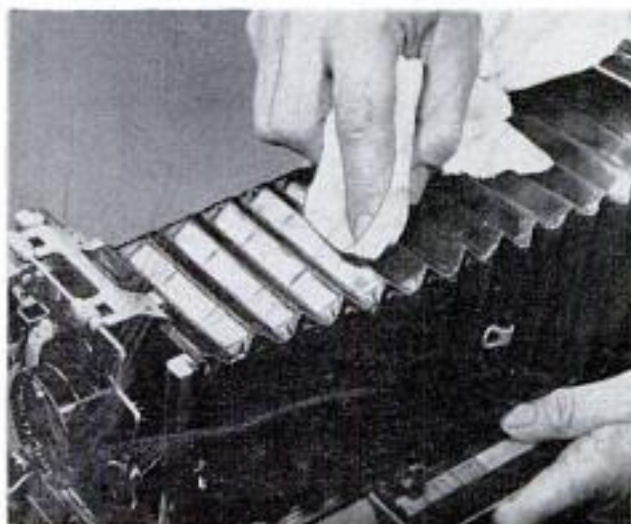

Camera bellows which have become dry and stiff, presenting the possibility of light leaks from breaks in the folds, can be softened by wiping with castor or olive oil or a good leather dressing. One treatment a day, for several days, may be required to soften a bellows that has become badly dried. A bellows that is soft, pliable and in good condition can be kept that way with an occasional application of one of the dressings mentioned.

☞ To keep the interior of a fishing-tackle box in good condition, line the compartments with rubber cut from an inner tube, cementing it in place with tire-patching or gasket cement.



Designs by Pat and Jerry Gropp, Seattle, Wash.

SAY "MERRY CHRISTMAS"

With Plywood Cutouts

FOR AN EXTRA-SPECIAL Christmas display this year, train your outdoor spotlights on one or more of these cutout lawn figures. By following the plans prepared by the Douglas Fir Plywood Association, you will not only come up with some eye-catching outdoor decorations but you will truly enjoy making them. The eight designs presented in this story offer

a wide selection of displays and, if you and your neighbors usually cooperate on Christmas decorations, you can utilize the designs for an outstanding block display.

All of the designs are simple to cut out, the larger ones from $\frac{1}{2}$ -in. and the smaller ones from $\frac{3}{8}$ -in. exterior-grade fir plywood. If you want to decorate only one side of the cutout, the Plypanel-grading

The snowman cutout, upper left, may be used alone or in combination with the Christmas-tree cutouts. The carolers, upper right, or the choir boys, below, are excellent near the front door or under a window

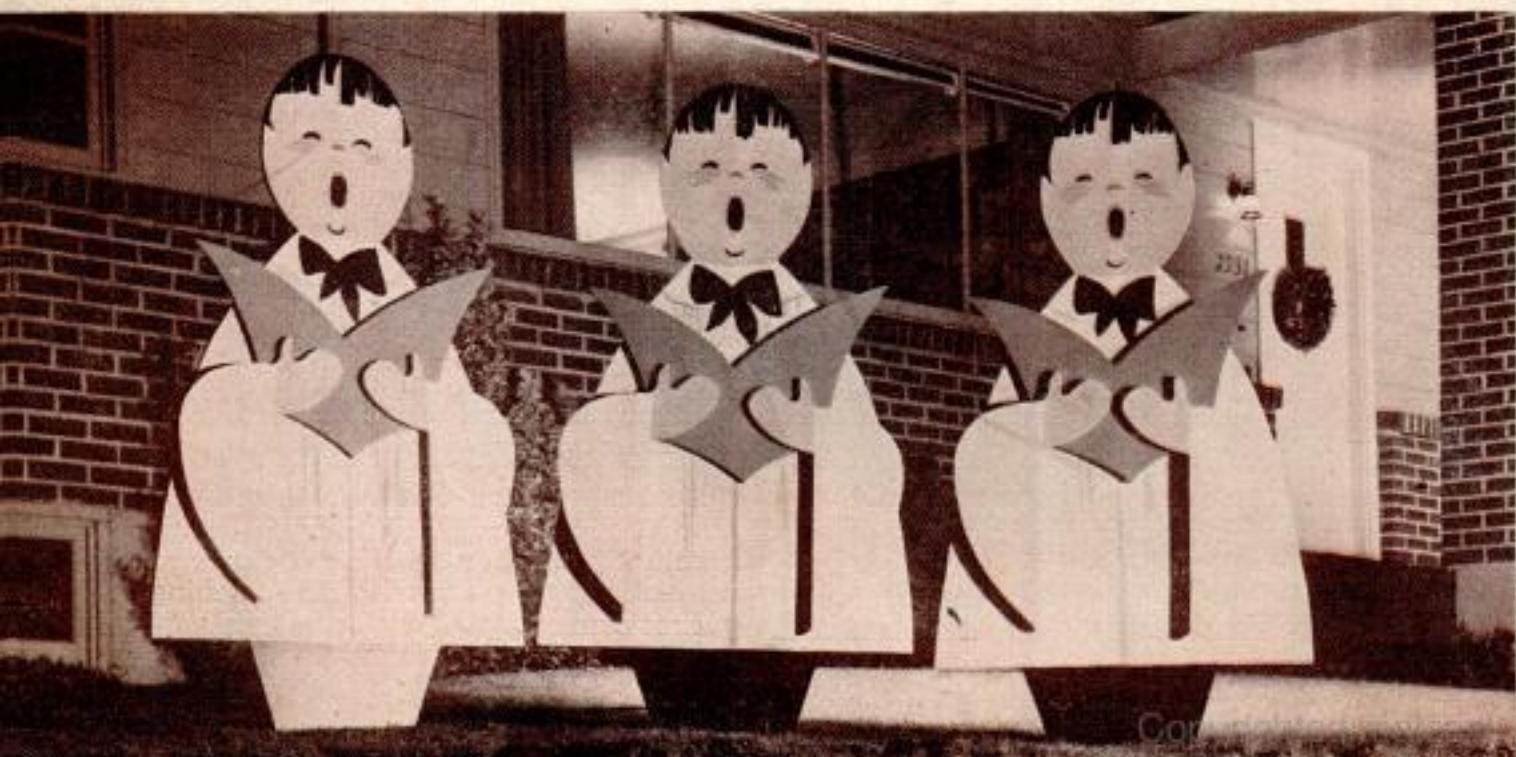

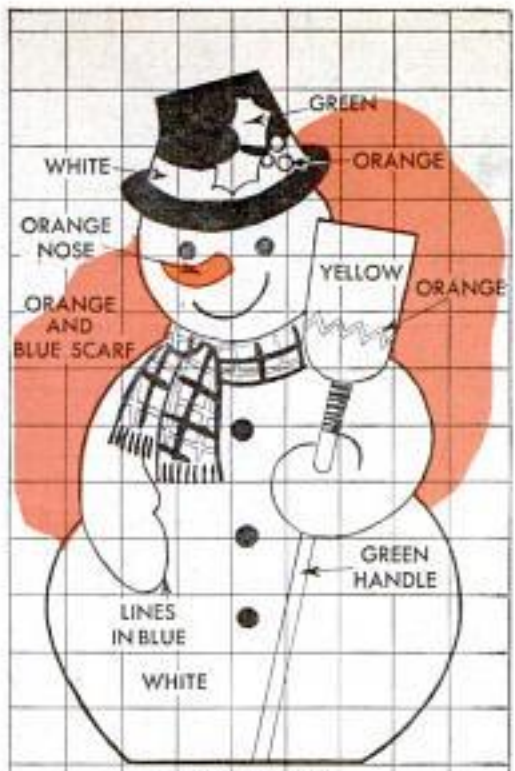

SNOW MAN

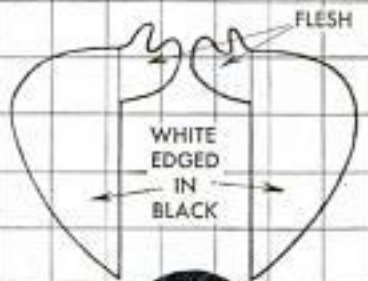

CHOIRBOY



4" SQS.

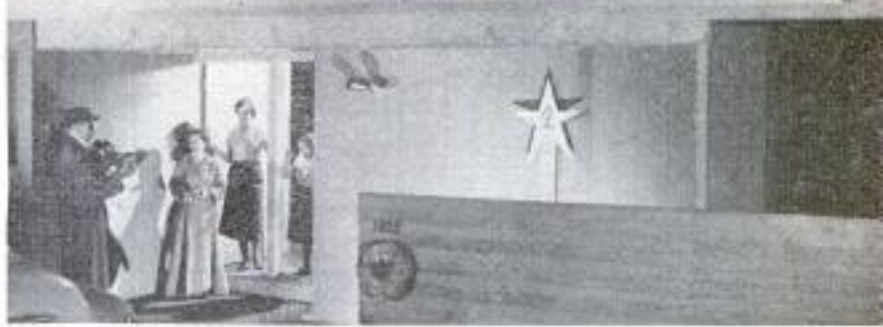

Here, Old Saint Nick and his trusty reindeer actually seem to prance across the roof tops to the delight of the youngsters



Christmas trees, above, are ideal for flanking the walk or front stoop. Lights can be added behind foam-plastic ornaments. Santa Claus, below, looks especially fine spotlighted on roof top



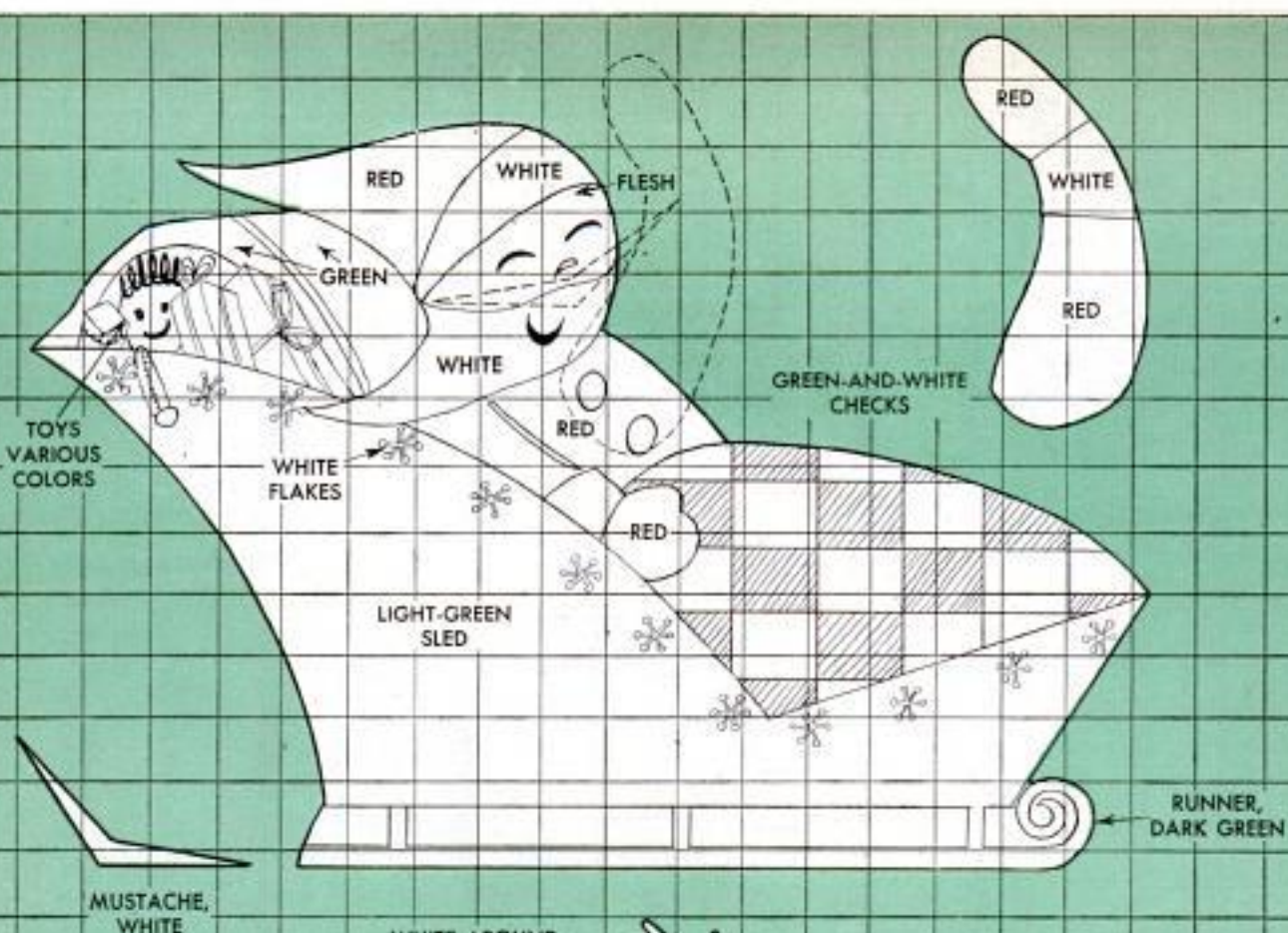

SLEIGH AND REINDEER

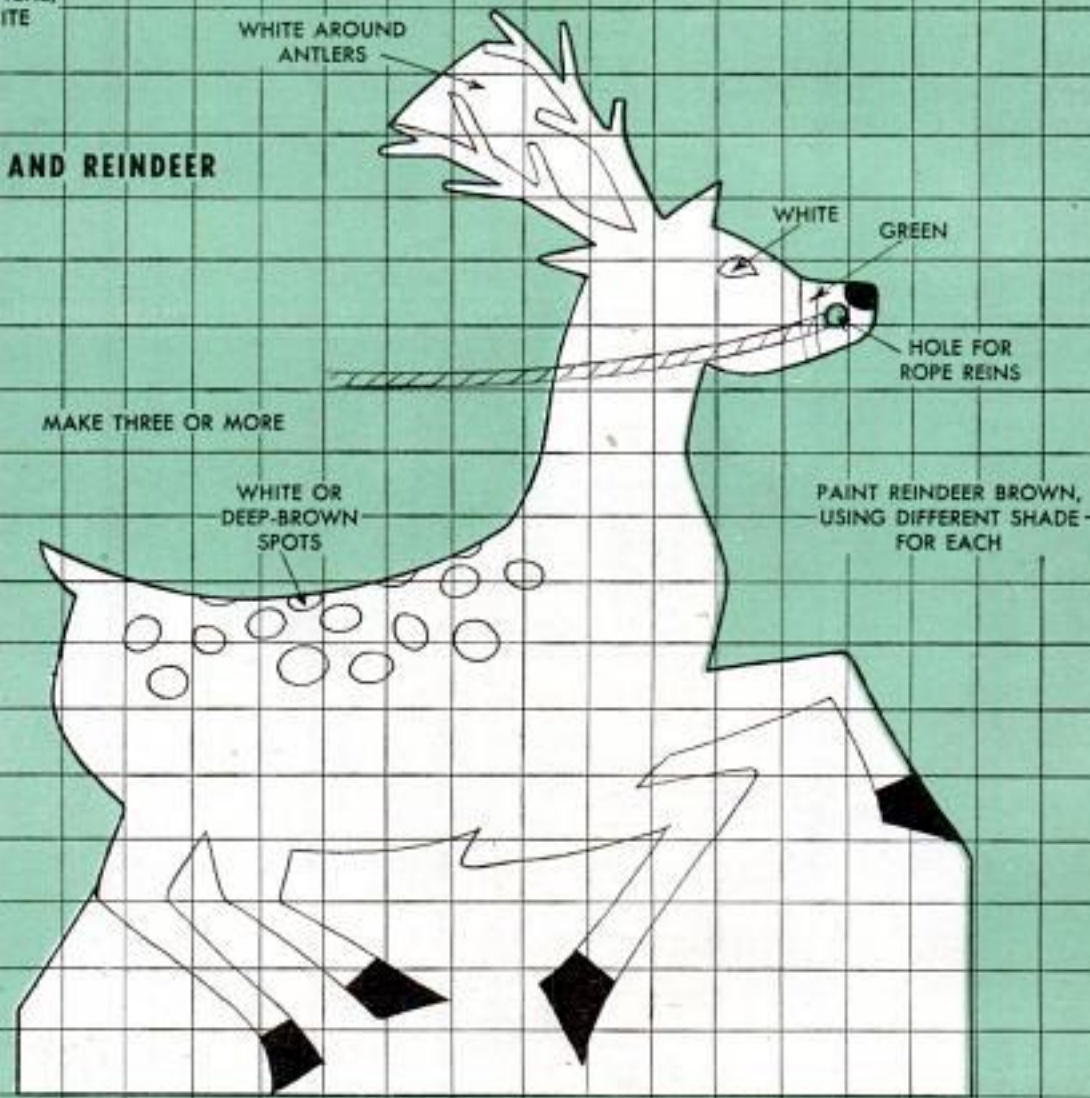

2 1/4" SQS.

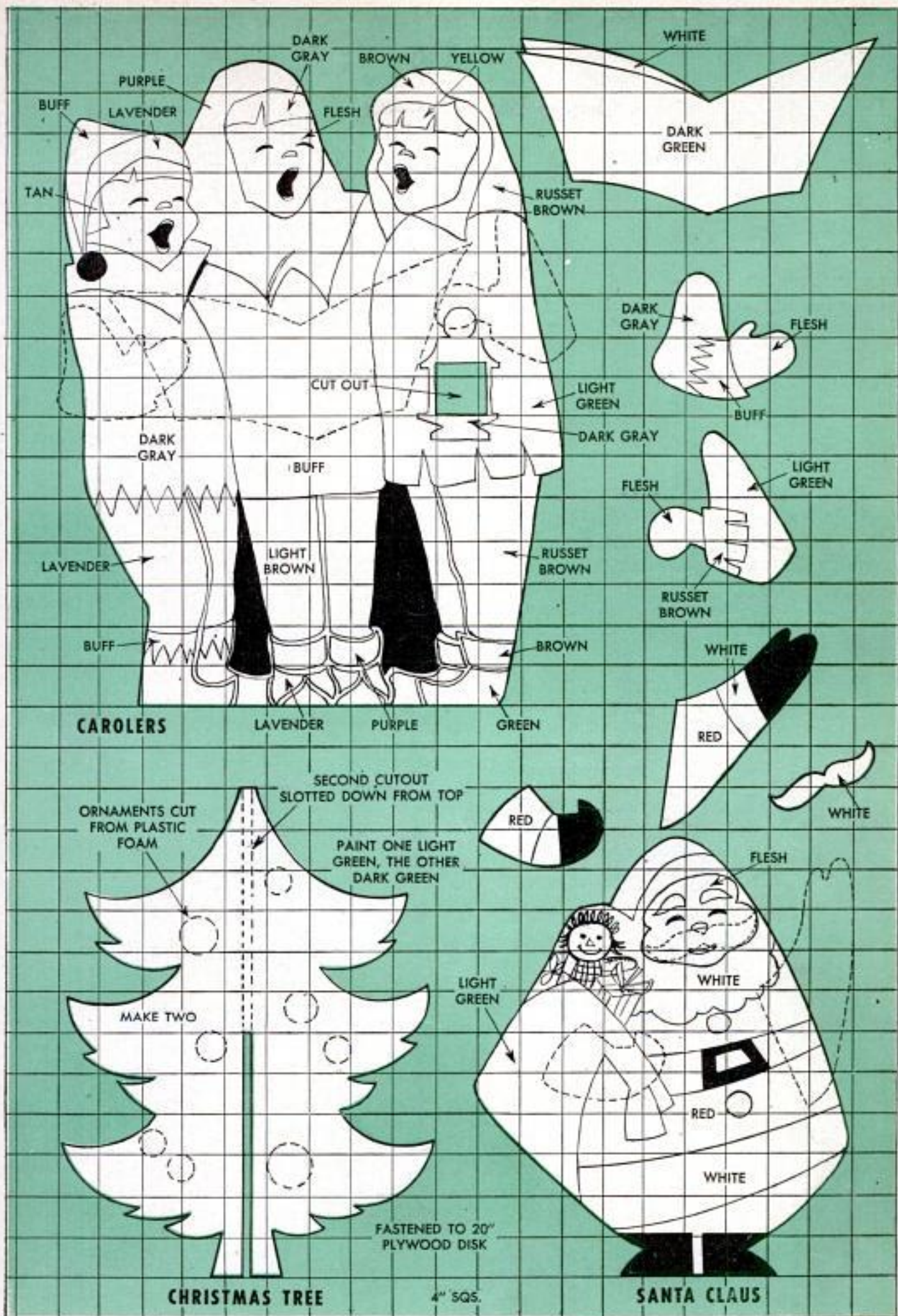



Pair of colorful candles, over 5 ft. tall, makes striking bay or picture-window decoration. They're fine, too, for sides of the doorway

plywood is the type suggested. This has one face of top-quality veneer, which would be used for the front of the cutout, and the other face of a lower-quality veneer. Should you prefer to decorate both sides of the cutout, obtain Exterior A-A plywood.

Enlarging the figures from the squared patterns and bandsawing them to shape is no problem. For best results in painting, fill in any gaps in the edges of the plywood with wood putty and then prime face, back and edges of the panels with exterior-enamel undercoat. Finally, add the exterior-enamel finish coat. ★ ★ ★

Same candles shown above are used with angel cutout in setup below. Either one or two candles and angel form attractive decoration

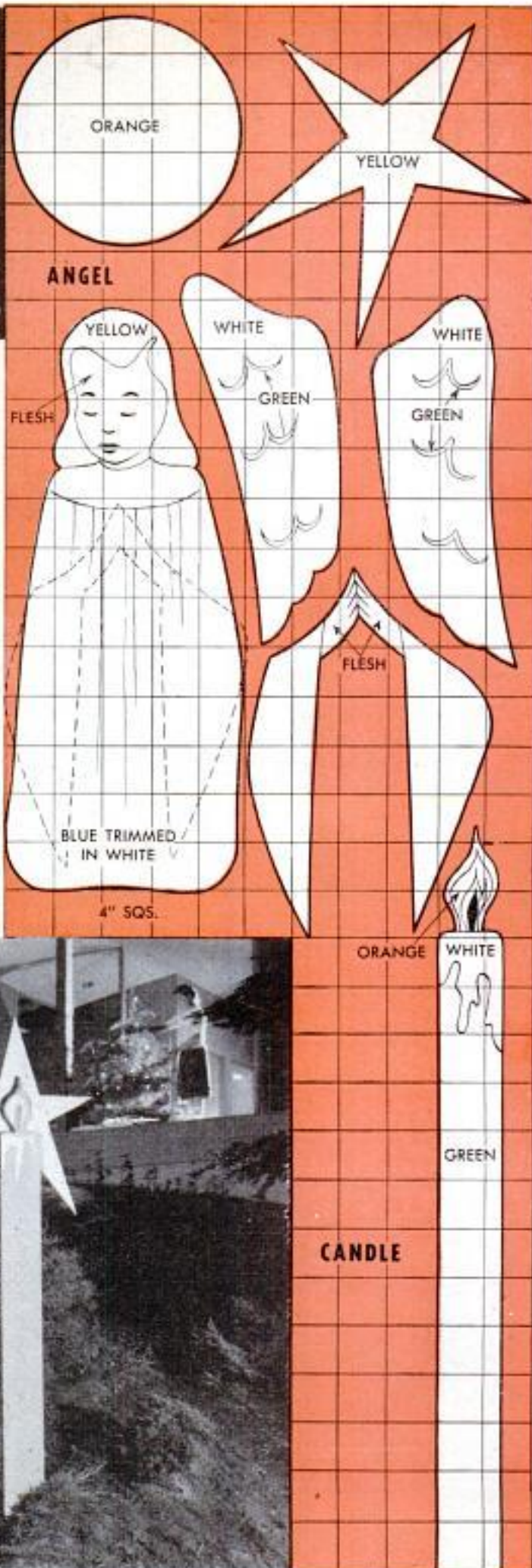

DOLLHOUSE TURNTABLE

By Stanley Roberts

PLAYING with a dollhouse can be a lot more fun for a little girl if she has this turntable on which the house can be set. It's at the right height for play and can be turned as she likes without fear of scratching floors or a good table. Fir plywood is used for both the table top and the rotating turntable. The table top should be made from $\frac{3}{4}$ -in. plywood, while the turntable is best cut out of $\frac{1}{2}$ -in. material. Dimensions may be varied to suit the dollhouse. The frame is made of $1\frac{3}{8}$ -in. pine. Miter the corners as indicated in the detail and drill holes for the screws. Finally, assemble it with wood screws and glue.

The legs are cut from $1\frac{1}{8}$ -in. pine. Notch the top end to fit into the corners and to overlap the frame, as shown in the detail. Chamfer the bottoms of the legs so that they will not split while in use. Then join the legs to the underframe with wood screws and glue. The center disk and the bearing ring of the turntable are cut from



$\frac{1}{4}$ -in. birch plywood, and attached to the table top with glue and brads.

The turntable is framed with $\frac{1}{2}$ x $\frac{1}{2}$ -in. pine. The hole in the center of both the table and the turntable is $\frac{3}{8}$ in. counterbored to take a $\frac{3}{8}$ x 2-in. stove bolt. To finish, paint all surfaces with dark-brown, semigloss oil paint. Coat the top surface of the center disk and the ring bearing with paraffin for smooth turning.

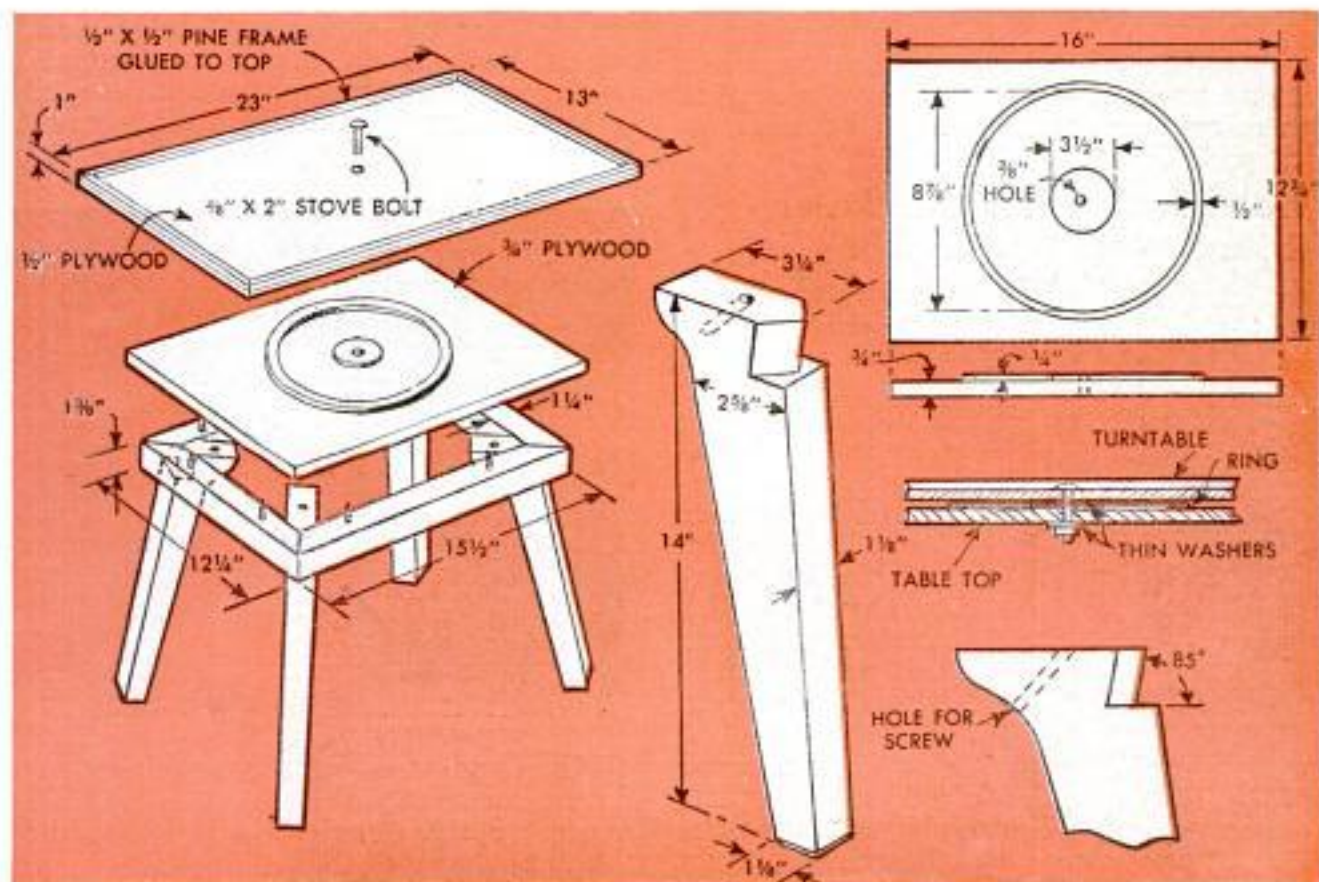



Counter Opening for Grocery Bags Permits Quick Filling

Filling large bags with groceries can be done much more quickly if the bags are at a lower level than the counter on which the groceries are piled. Instead of using an aisle-blocking bench or stool to hold the bags, cut out a section of the counter and build a platform beneath it. The size of the opening should be $8\frac{1}{2} \times 16\frac{1}{2}$ in., and the shelf should be 17 in. below the counter. The shelf and opening will accommodate a No. 50 paper bag. In stores where business is heavy enough, several of these counter openings might be used.

Wood Screws Hold in Plaster If Lead Wool Is Used

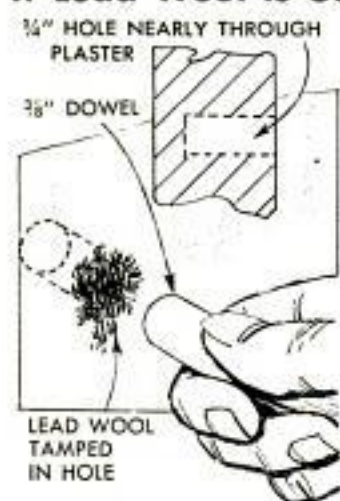

screw then can be driven into the lead, which expands uniformly against the plaster. Under normal use, the screw will not loosen or break the plaster.

Chemical Oxidation Is Retarded By Addition of Glass Marbles

The oxidation which occurs in some photographic chemicals can be retarded by using clean glass marbles to exhaust the air from the bottle in which the chemical is contained. The marbles are dropped into the bottle as the chemical is used, thus raising the level of the liquid and keeping the volume of the damaging air at a minimum. The marbles also could be used to raise the level of paint thinner in a bottle in which small brushes are cleaned.



George W. Crotts, Fayetteville, N. C.

Tape Holds Broken Parts Together When Mending Chinaware

Masking tape can be used to hold the broken pieces in alignment when mending chinaware because the tape will fit over any type contour, and can be removed later without leaving a mark. Rubber bands which, if used alone, would slip to a smaller section or force the parts out of line, can be used to apply pressure after the parts have been taped in position.



When working on a stucco or frame house, one workman avoids leaving ladder marks on the exterior walls by padding the upper ends of the ladder with several pairs of old woolen socks.

Here's a Closet That "Grows" With Your Children

If you provide your small fry with a clothes pole they can reach, you can teach them to hang up their clothes. And if the clothes pole in their closet can be adjusted, it can be raised as they sprout up—thus making a closet that "grows" right with them.

The adjustable feature is provided by the use of metal hanger tracks, such as are used in making adjustable bookshelves. One pair of tracks, spaced 8 in. on centers, is fastened to each side of the closet with $\frac{3}{4}$ -in. screws. It is best to have the tracks extend to within 10 in. of the ceiling. If you install shelves as well as a clothes pole, be sure the rear track is no more than 2 in. from the rear wall for a 12-in. shelf.

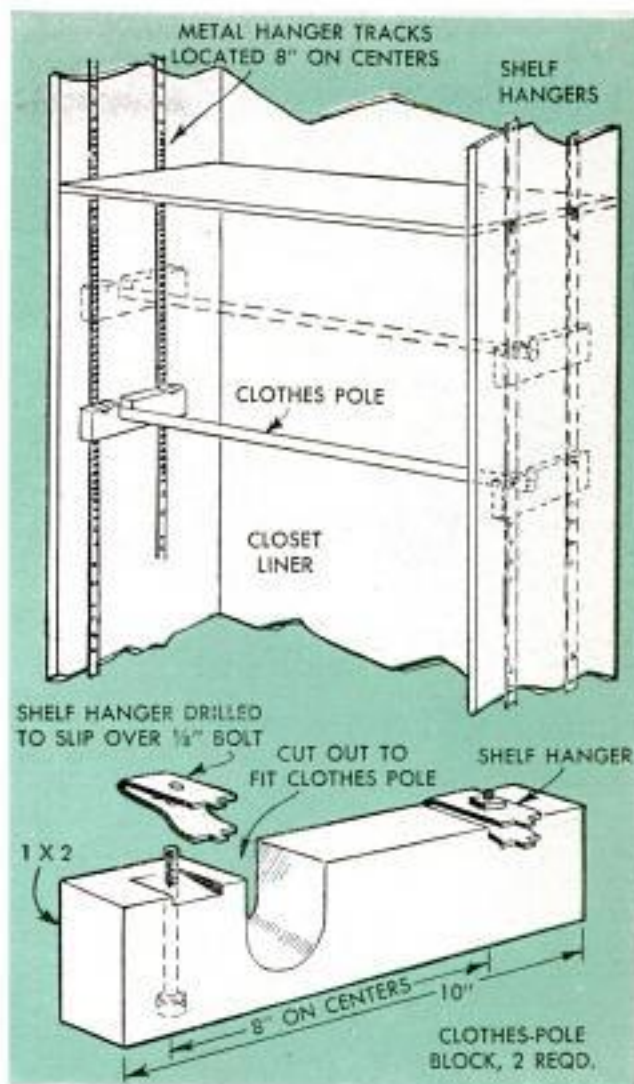
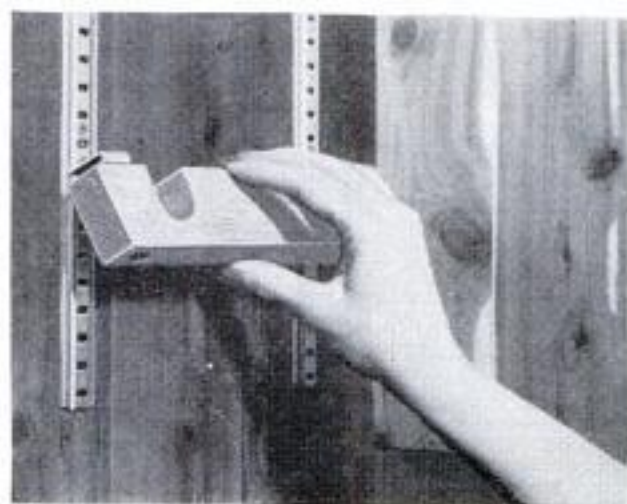

Economical Snow Fence Provided by Discarded Lettuce Crates

Properly placed, a snow fence will eliminate a lot of snow shoveling around garage and other exposed doorways, especially if winds have a tendency to drift even the slightest snowfall. The wire-bound sides of discarded lettuce crates can be used to

make an efficient and economical snow fence for this purpose. The ends of the crates are removed and the sides spread out and wired to stakes driven into the ground. The work of driving the stakes will be greatly simplified if the fence is installed before the ground freezes.

G. E. Hendrickson, Argyle, Wis.



Holder for Hot Soldering Iron

When a regular holder for a soldering iron is not available, an emergency holder can be made by driving two nails into a block of wood or into the bench top. As shown in the photograph, the hot tip of the iron rests on the fork of the crossed nails and is clear of the workbench.



WTM 56

Circus-Wagon

TOY CHEST

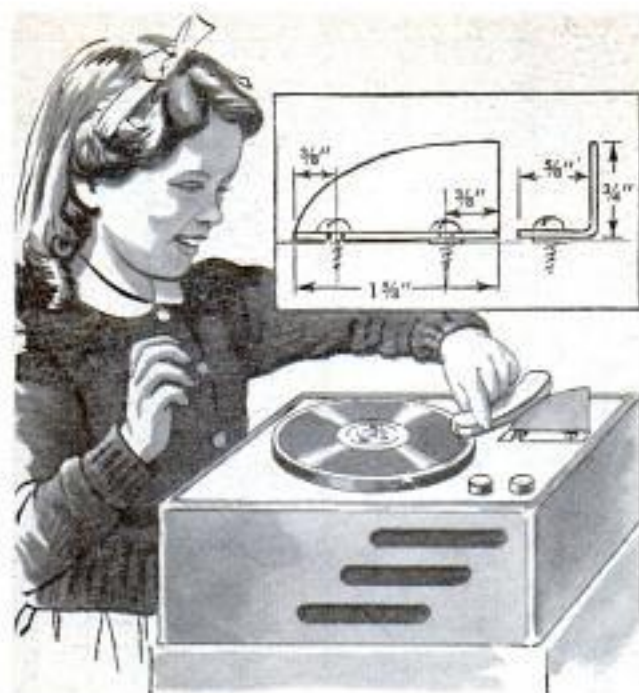

Bracket on Electric Phonograph Helps Child Place Arm

Although very young children can be taught to start a manually operated record player and to control speaker volume, they will have trouble locating the needle in the starting groove of the record. To overcome this problem, screw a curved sheet-metal bracket to the player so it will guide the tone arm to the starting groove. Cut and shape the bracket to the dimensions given in the detail above. Next locate the bracket by first placing the needle in the groove of a child's record. Then hold the bracket so it just touches the arm at a point well clear of the turntable. Mark and drill the two screw holes and use a washer under the one screw, as shown. This permits the bracket to swing out of the way when not in use.

Basil Jackson, Toronto, Ontario, Can.

Barrel-Bung Wrench Improvised From Bolt and Nuts

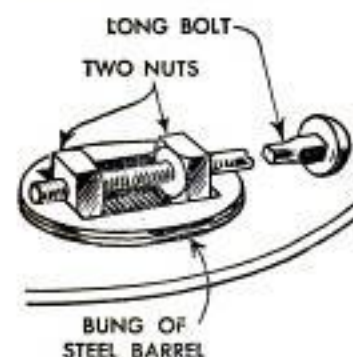

If a wrench is not available, the bung of a steel barrel can be opened by using a $\frac{1}{2}$ -in. or $\frac{3}{8}$ -in. bolt about 10 in. long, and two square nuts to fit. Turn the nuts onto the bolt and space them to fit snugly

inside the recessed surface of the bung. Hold the nuts down with a block of wood while applying turning pressure.

RESEMBLING A TOY itself, this novel toy box on wheels can be pulled along like a wagon when picking up after busy small fry. Its lively circus motif will add a colorful touch to any nursery. The "cage" can be made to look even more realistic by applying an animal decal to the side panel behind the dowel bars. The scrolled roof of the wagon is hinged along one side.

Start by assembling two $14\frac{1}{2} \times 25\frac{1}{2}$ -in. frames from $\frac{3}{4} \times 1$ -in. white pine. These provide the top and bottom members of the box itself. The underside of the bottom frame is covered with $\frac{1}{4}$ -in. hardboard, flush with the outside edges. Registering holes for the $\frac{3}{8}$ -in. dowels that are placed across the front of the wagon, are bored by clamping the two frames together and drilling both at one time. The holes are spaced 2 in. apart and are centered on a line $\frac{1}{2}$ in. from the front edge. The frames are joined at the corners with built-up posts, $12\frac{3}{4}$ in. long. Each one consists of two pieces of white pine, one measuring $\frac{3}{4} \times 1\frac{1}{2}$ in. and the other $\frac{3}{4} \times \frac{3}{4}$ in. The two are nailed together to form an angle and, when installed, they provide an inside nailing surface for the hardboard side and end panels. The posts are set in $\frac{1}{4}$ in. at the corners to bring them flush with the inside edges of the two frames.

Bolsters for the front and rear axles are cut from $\frac{3}{4}$ -in. pine according to the squared drawing and fastened to the underside of the wagon box with screws driven through the hardboard bottom. Hardwood dowels provide axles for the $3\frac{1}{2}$ -in. wooden wheels which are cross-pinned to the axles with short $\frac{1}{4}$ -in. dowels. The drawing of the under-carriage assembly shows how the handle is attached to the lower half of the front bolster ★ ★ ★

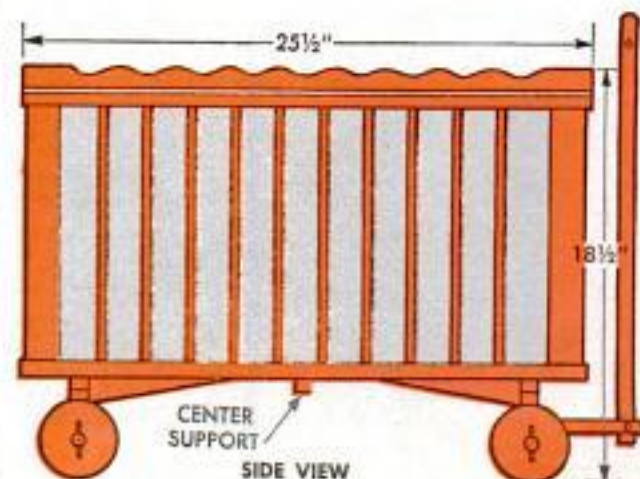

POPULAR MECHANICS

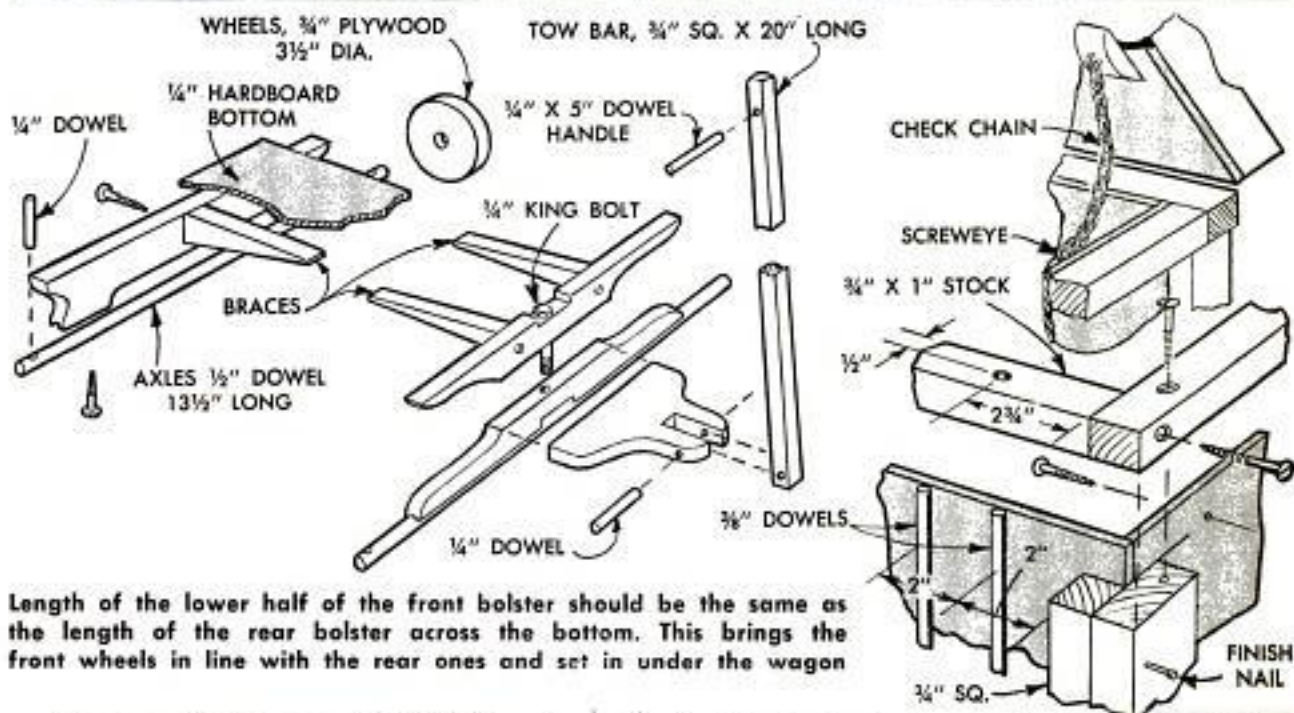

Length of the lower half of the front bolster should be the same as the length of the rear bolster across the bottom. This brings the front wheels in line with the rear ones and set in under the wagon

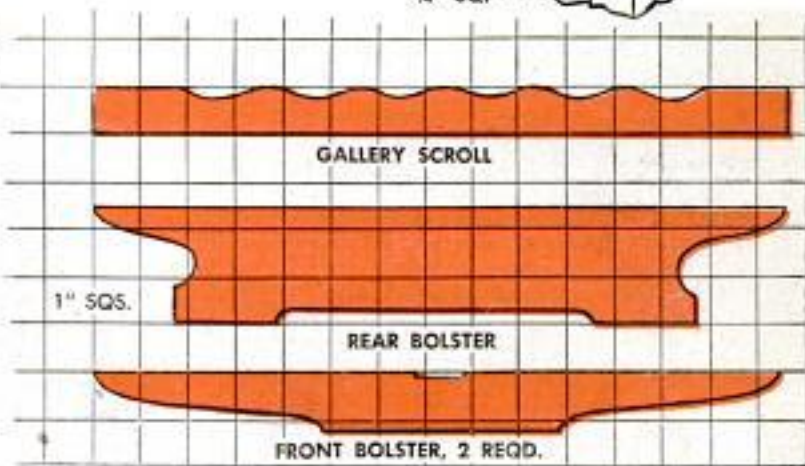
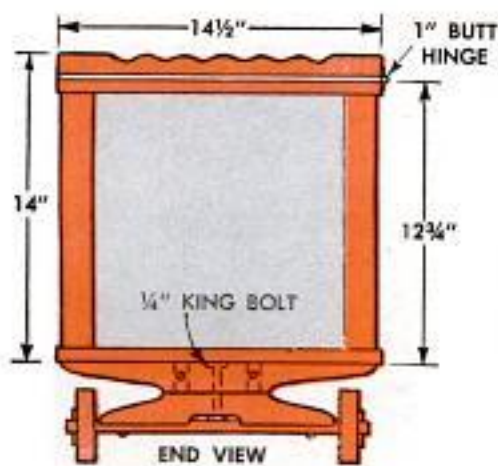

Paper-Tape Roll Hung on Belt Frees Hands for Applying It

See
1671-6



Keeping both hands free when applying tape to plasterboard joints can be done by hanging the roll of tape from your belt. Slip the roll onto a loop of light wire or heavy cord and tie it to your belt. Make the loop loose enough so the tape can be pulled easily from the roll as it is applied. This same stunt also can be applied to rolls of friction and rubber tape used on wiring.

Stanley J. Pollard, Georgetown, La.

Finger of Leather Glove Provides Nail-Set Pocket

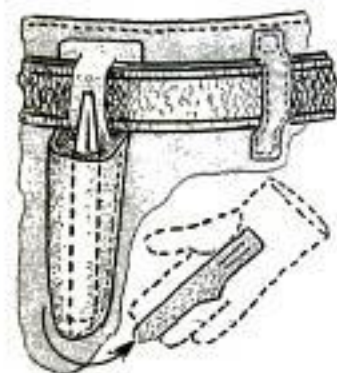

The problem of fishing among the nails in a nail apron to find a nail set can be overcome by making a pocket to carry it on a belt. The finger and part of the back of a glove are cut, as shown, and the back is slit to form a loop.

Soft Print Made From Negative Which Has Too Much Contrast

If a negative has too much contrast when printed on even the softest paper, there is a method that can be used to provide a softer print without reducing the negative. First, make a print in the usual way on

the softest paper available. Next, immerse the print in a solution of one percent potassium bichromate for about one minute. Agitate the print thoroughly, remove it from the solution and wash off all traces of the bichromate with water. Then put the print in the developer and develop in the usual way. It will be necessary to adjust the exposure time to obtain the desired results and, of course, all the work should be done in the darkroom under safelights.

Twine Is Cut in Equal Lengths When Wrapped Around Ax

When a number of pieces of twine of the same length are needed, such as when tying feed sacks, an ax or hatchet may be used to cut them. The required number of turns are made on the ax head, and a quick blow on the edge cuts the twine.

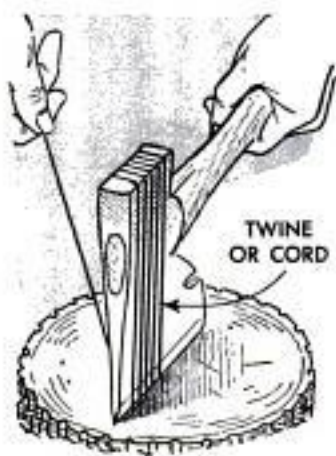

Blocks Under Stored Lawn Mower Prevent Damage to Tires

Two blocks of wood, placed under the axle of a power lawn mower when it is stored for the winter, will prevent the rubber tires from becoming flattened in one spot by the weight of the machine. Also, the blocks will keep the tires clear of oil or dampness on the garage or basement floor which could cause the rubber to deteriorate.—R. Hanscom, Elmhurst, Ill.

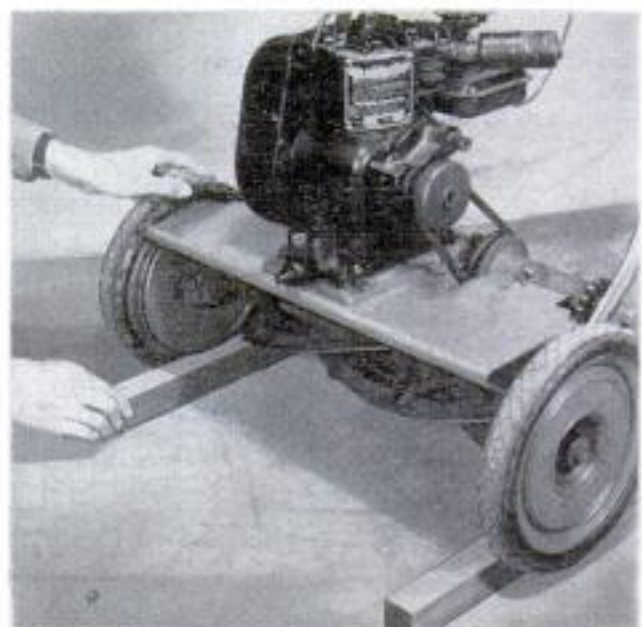

Stunts with SPRINGS

By Sidney V. Worth

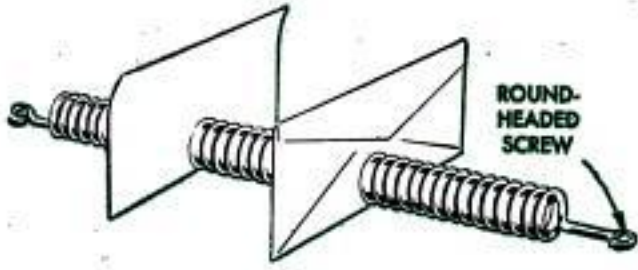

Form eyes in both ends of a length of coil spring, stretch it slightly and fasten to the bench top with round-headed wood screws. Cards, letters and other papers are held by coils

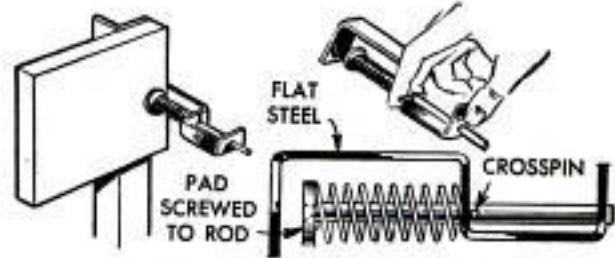

A handy tension clamp for holding light work is made by bending flat steel to a squared-S shape, drilling it to receive a length of rod fitted with pad. A crosspin in the rod provides a fingerhold for opening clamp

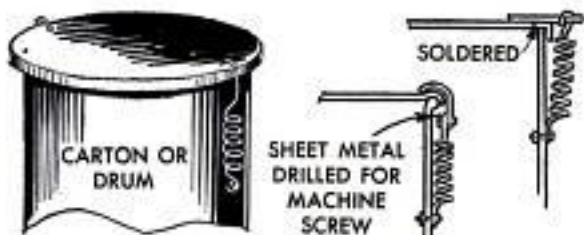

The lids on cartons, drums and garbage cans will be held on tightly if springs are used in one of the three ways shown in detail above. Place the springs under just enough tension to hold the lids firmly

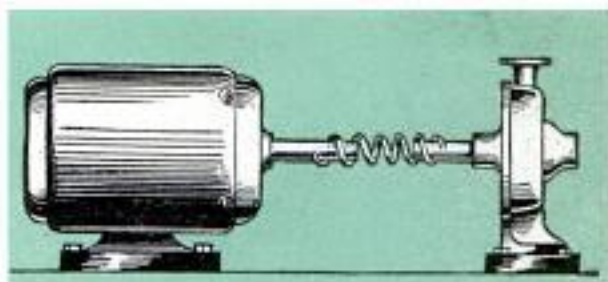

A temporary shock-absorbing coupling between electric motor and pump or other machine can be made from heavy spring of same or slightly smaller diameter than the shafts

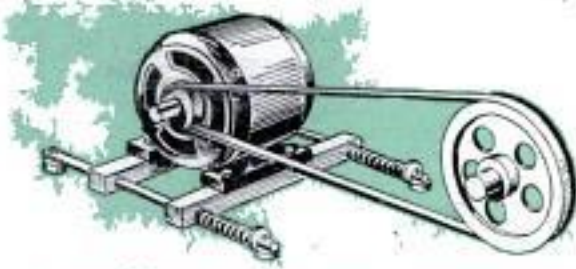

Compression springs provide constant tension on belt between motor and pulley. Simple mount consists of lengths of wood to which motor is bolted. Mount slides on two rods

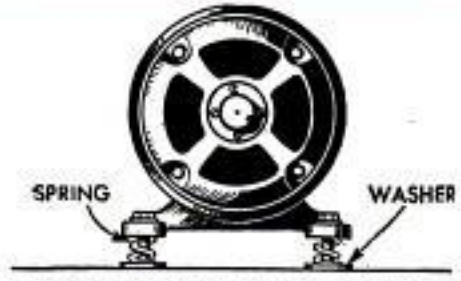

Springs under electric motor assure quiet, vibration-free running. Adjusting length of each bolt against spring tension provides means of aligning shafts

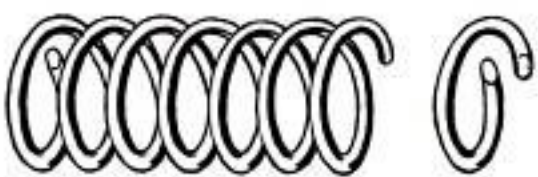

Next time you can't find a lock washer of a particular size, look through your stock of coil springs. Cut the coils so ends overlap, then file to meet smoothly as do regular lock washers. The spring should be a fairly stiff compression type, although in an emergency a tension spring can be stretched and cut



Bending tubing without kinking can be done by using a length of coil spring that fits snugly over tubing. Center the spring on point of bend, shape with thumbs placed as shown

W T M 56

Cutlery handles you can make

By Lee Woods

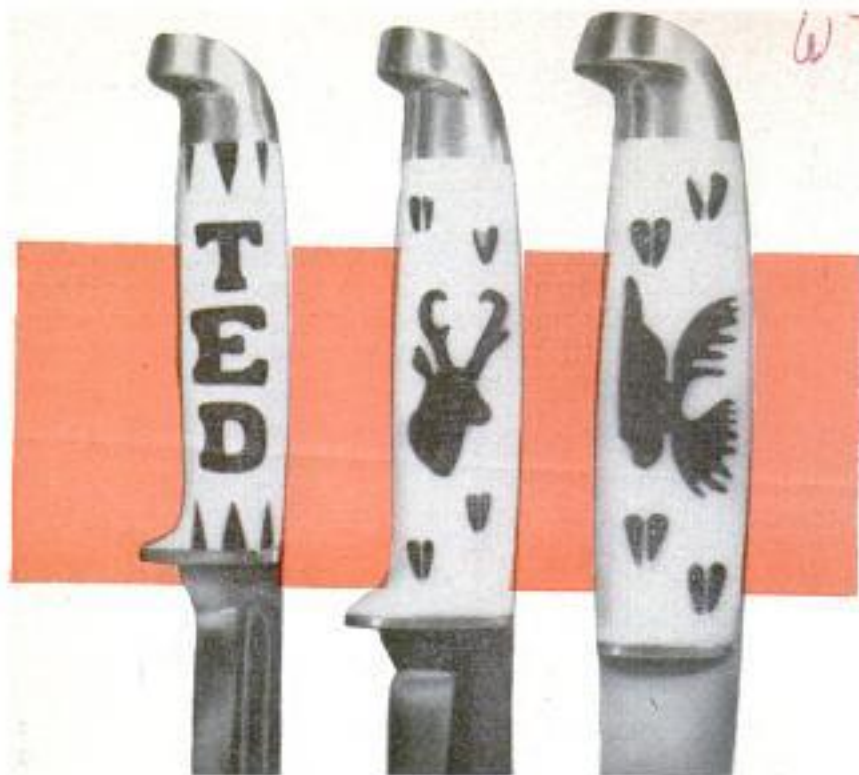

DRESSING UP your sporting knives and fine kitchen cutlery with custom-designed plastic handles is easy, and the results are sure to bring the admiration of your friends. These serviceable handles can be made as fancy as you like, as the molded plastic permits an endless selection of colors and patterns.

To make the handles, you'll need liquid casting plastic and catalyst, dye of the desired color, one or more soap-rubber erasers and some rubber-mold compound. The other items, like aluminum foil, razor blade and masking tape, you'll probably have around the house.

The first step is to cover the blade and metal tip of the handle, if any, with masking tape. Then remove the old handle from the blade, cutting or sawing as necessary but being especially careful not to mar metal surfaces that will be exposed when the work is finished.

Making the patterns for the inlays comes next. Be sure to keep the inlay small enough so that it will be at least $\frac{1}{8}$ in. from the sides of the finished handle when installed. Then trace or draw the design of the inlay on a soap-rubber eraser, using a pencil first and then going over the pattern with drawing ink. Then cut out the pattern, Fig. 1, with a single-edge razor blade or a coping-saw blade,



Pattern for plastic-inlay design is traced on soap-rubber eraser and cut out, as above. Sides of cutout pattern must be perpendicular. Below, pattern is placed in bottom of aluminum-foil trough and rubber-mold material is poured over it



being careful to keep the sides of the pattern perpendicular to the face. Cementing strips of fine sandpaper to the sides of toothpicks will give you a supply of tiny cutting tools for the hard-to-reach corners of the eraser pattern.

Then make a trough from aluminum foil. This should be large enough to allow $\frac{1}{4}$ to $\frac{1}{2}$ in. of rubber-mold material to be poured over the top of the pattern and $\frac{1}{2}$ in. of the material on all sides. Place the pattern in the bottom of the trough, heat the rubber-mold material and pour it over the pattern, Fig. 2. After allowing the mold to cool, remove the foil and take the eraser pattern out of the mold. Fig. 3 shows several rubber molds ready for use.

Now mix the liquid plastic. As procedure will vary slightly depending on the manufacturer of the material, follow his directions carefully when adding the catalyst and dye. Stir the plastic slowly to avoid air bubbles and allow any bubbles that may form to rise to the surface before pouring. Then pour the mixed plastic slowly into the mold, Fig. 4. If the plastic requires heat-hardening, be careful not to overheat it, as overheating is likely to cause the casting to crack. Should the mold become too hot, place it immediately in the refrigerator or in a shallow pan of cold water. Castings weighing 2 oz. or more should be allowed to stand overnight at room temperature before heating.

When the casting has cooled and hardened, remove it from the mold. Then clean the mold and cast a duplicate inlay so you will have one for each side of the handle.

When the inlay pieces have hardened, arrange them on the knife-handle tang and cement in place as in Fig. 5. Then allow the cement to dry thoroughly. Make a second aluminum-foil trough which will accommodate the entire handle, as pictured in Fig. 6. The trough should be $\frac{1}{4}$ in. larger all around than the size of the finished handle. This eliminates depressions in the finished handle which otherwise might be caused by bubbles forming near the foil mold.

Place the handle tang with inlays — or without inlays if the handle is to be plain — in the



When material has cooled, remove foil trough and eraser pattern from rubber mold. Note various mold designs shown above

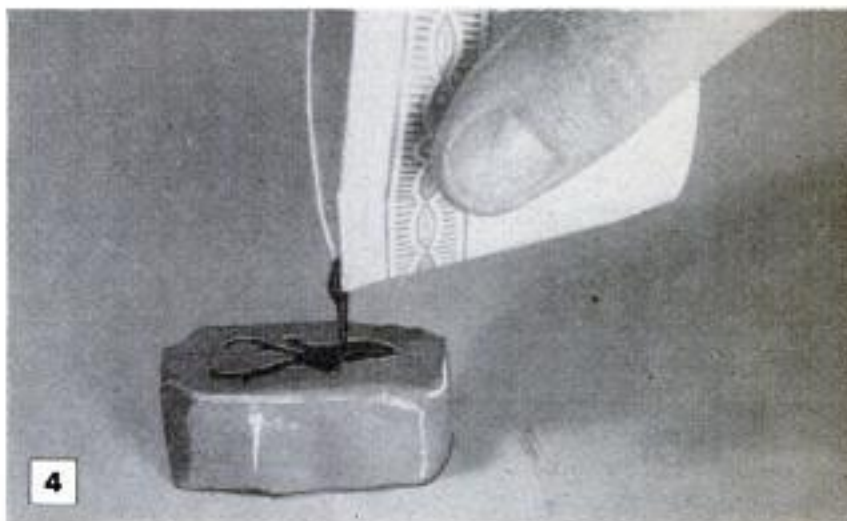

Liquid-plastic solution is mixed with catalyst and dye and then poured slowly into rubber mold, above. After hardening and cooling, inlays are cemented to handle tang, below



A second aluminum-foil trough is made, this time to enclose the entire knife handle. Holes and joints of trough must be sealed carefully and plastic poured in slowly, as shown below

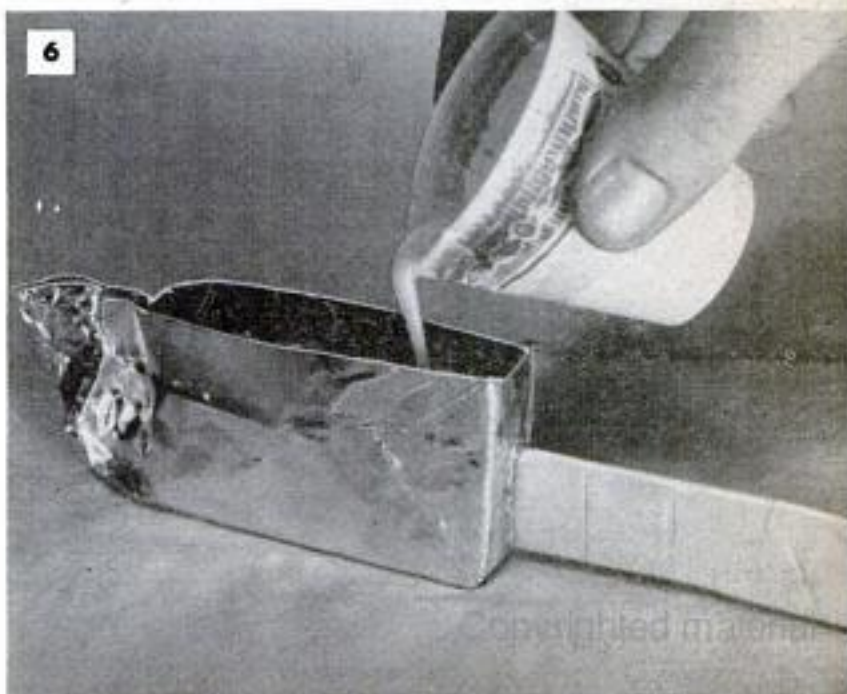

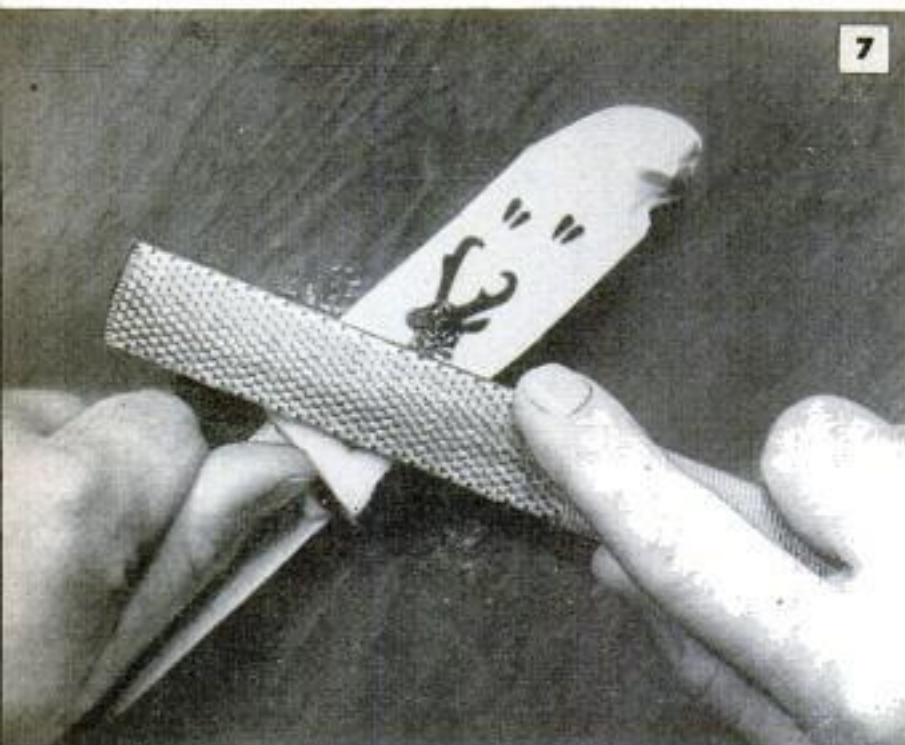

Plastic handle is a crude block when foil is removed from it. This is roughed to shape with wood rasp or coarse sandpaper

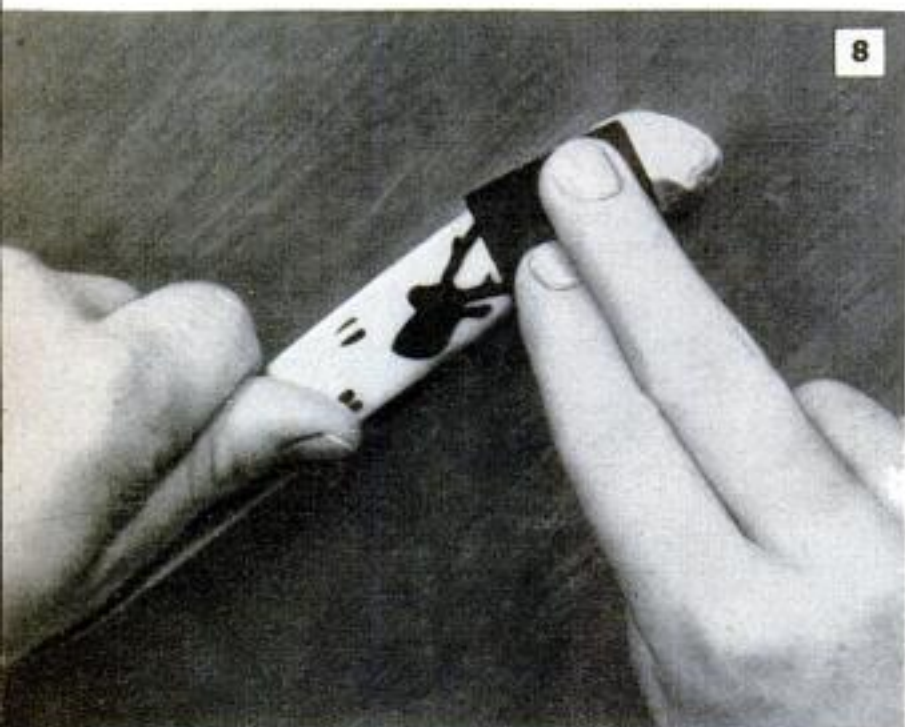

Roughly shaped handle is given a secondary sanding with 180-grit paper and then a final sanding with 320-grit paper, as above, both sandpapers being used wet. After sanding has resulted in desired shape, handle is given final polishing with cloth

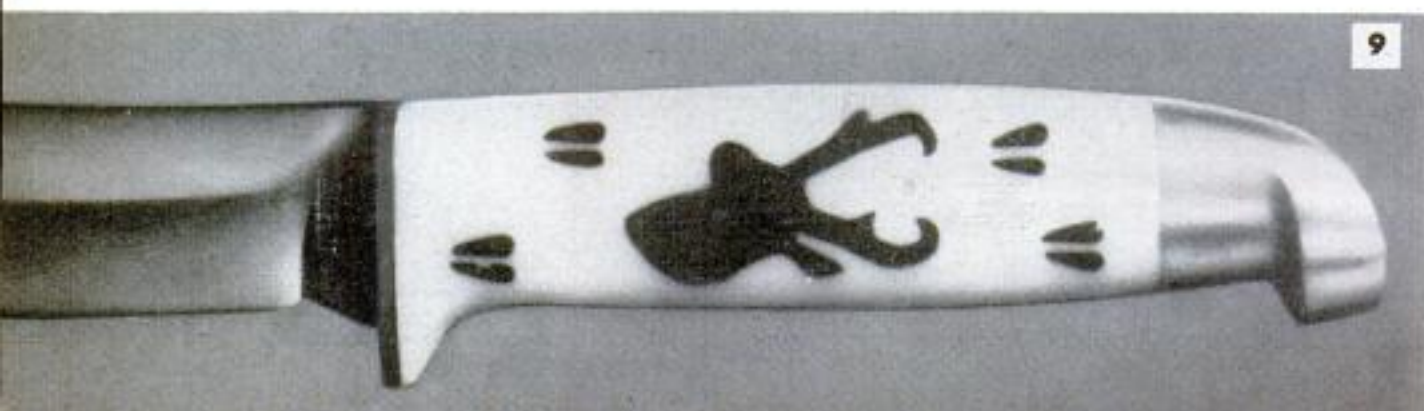

trough. Seal off all holes in the trough with cellulose tape and cement joints of the trough, as it is important that the trough be leakproof when the plastic is poured into it.

Check to see that the foil trough has not been dented to the point where it will leave an impression in the plastic. Then mix the plastic and pour it slowly into the trough as shown in Fig. 6. The plastic should cover the handle tang to a depth of $\frac{1}{4}$ in. over its top. This plastic, of course, will be of a contrasting color to that used for the inlays.

The hardening of the handle casting is considerably more critical than that of the inlays. After the plastic has jelled, it is best to leave it at room temperature overnight before heating. Then be careful that you do not heat the casting excessively. When the plastic has hardened and cooled, remove the foil trough.

The handle at this point is a rough plastic casting. Begin working it to shape with a wood rasp, Fig. 7, or coarse sandpaper. When the handle is slightly larger than finished size, begin smoothing the surface with 180-grit wet sandpaper. Then follow with a finer, 320-grit wet paper, as in Fig. 8. Give the handle a final polishing with a soft cloth. When the masking tape is removed from the blade and handle tip, your knife handle will look much like the one pictured in Fig. 9, and it will be as rugged and durable as it is good looking.

If an air bubble should leave a depression in the plastic surface that can't be sanded out, you can patch it with plastic of a matching color. Sand with 320-grit wet sandpaper and polish to blend in the patch with the rest of the handle. ★ ★ ★

Plumb Bob on Long Straightedge Permits Use As Level

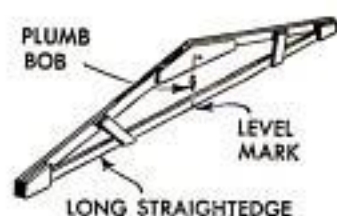

An exceptionally long straightedge, which is cross braced to assure that the edge remains accurate, can also be utilized as a level. A plumb bob is suspended from the center of the cross brace, the straightedge is set level and the location of the plumb is marked on the straightedge. In use thereafter, locating the plumb on the mark will show when the straightedge is level.

Handle of Boat Hook Grooved To Indicate Hook Position

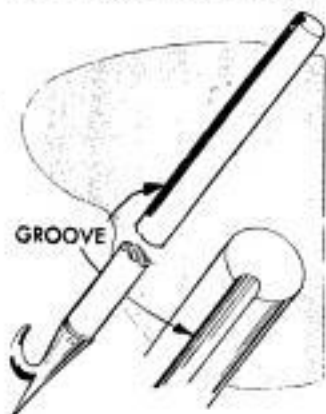

In order to tell which way the hook end of a long-handled boat hook or gaff is facing when you use it in deep water or at night, cut a shallow groove along the handle on the same side as the hook. Then, when using the hook, you can tell which way it is facing by the feel of the handle in the palm of your hand.

J. H. Muscat, Saint Julians Bay, Malta.



Magnifying Glass Held Steady By Simple Wooden Standard

When a magnifying glass is used for long periods of time, a simple wooden standard may be used to hold the glass steady and at the right distance from the surface being examined. The standard is a length of broomstick fitted in a hole drilled in a plywood base. The magnifying glass is moved up and down the broomstick until the focal point is determined, then a hole is drilled in the broomstick to receive the handle of the glass. The plywood base is cut out, as shown in the photograph, so the work to be examined is exposed.

Adjustable Plywood Bookholder Ideal Gift for Bedridden

This adjustable bookholder, which makes an ideal gift for a bedridden friend or anyone who likes to read in bed, is an easy one-evening project. The two leaves of the holder are $\frac{1}{4}$ -in. plywood, 10 x 12 in., with a $\frac{3}{4}$ x 1-in. strip fastened to the long side of one piece. A pair of $1\frac{1}{4}$ -in. butt hinges is mounted on the strip, being mortised so that the folded hinge is flush with the surface. The hinges are then attached to the other leaf of the bookholder with wood screws that go through the plywood and into a narrow strip that forms a ledge for the book. The edge on which the book rests is a $\frac{1}{2}$ x $\frac{3}{4}$ -in. strip. The adjustable bracket is the type used on storm sash, a thumbnut

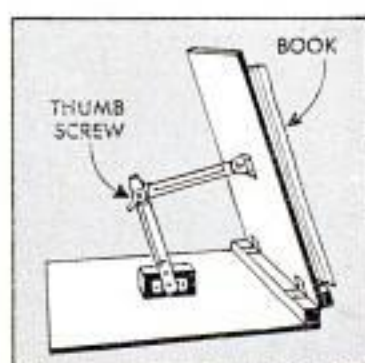

being provided in place of the hex nut for tightening. The lower end of the bracket is fastened to a $\frac{1}{2}$ x $\frac{3}{4}$ x $2\frac{1}{2}$ -in. block of wood, which is screwed to the base leaf of the holder.—John Strickler, Detroit, Mich.



INDOOR SHOOTING GALLERY

By Webster P. Taylor

THAT YOUNG SPORTSMAN in your home can practice his air-rifle marksmanship safely if you install a shooting gallery like this one in your basement. It has both still and moving targets just like the large ones at penny arcades.

The frame is made of $\frac{3}{4}$ -in.-sq. stock, the beds for the moving and stationary targets are hardboard and the backstops are heavy-gauge sheet metal. The drums which turn the belt carrying the moving targets are beverage cans, the ends of which are center drilled so the cans turn freely on $\frac{1}{4}$ or $\frac{3}{8}$ -in. axles. The belt is driven by a small electric motor hooked to a gear reducer taken from a toy construction set. The reducer is fitted with a

flat pulley which drives one drum through a flat belt. Fine sandpaper is cemented to the drums to provide a grip for the leather or canvas belt. The bases of the moving targets are riveted to the belt, and each target is bent slightly forward so that vibration and the movement of the belt will not tip it back. The coat-hanger-wire loop which straightens the targets as they pass around the drum, will require some adjusting to do its job properly.

The lights and buzzer are operated from an electric-train transformer; the lights are regular Christmas-tree lights wired in parallel. Drops of solder added to the counterweights of the swinging targets adjusts them to tip with slight pressure. ★ ★ ★

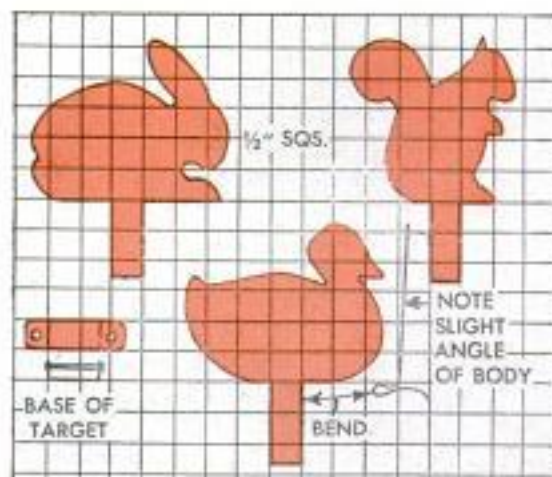
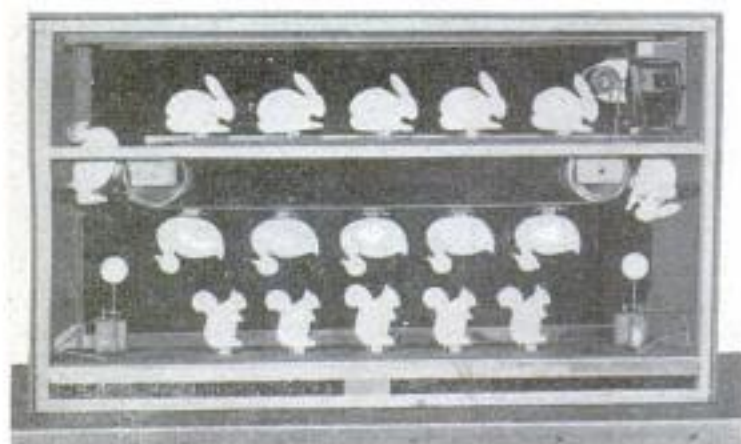

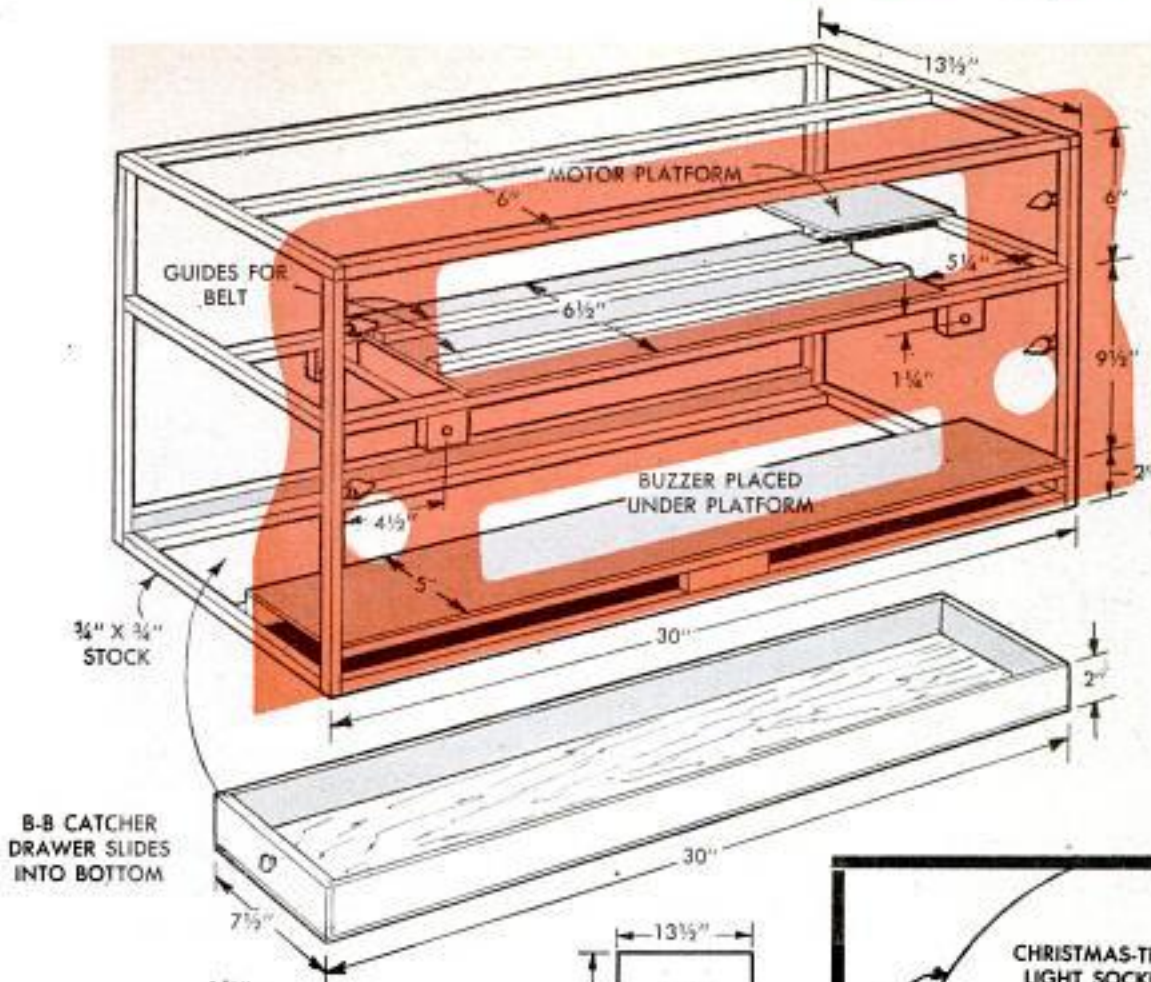

B-B CATCHER DRAWER SLIDES INTO BOTTOM

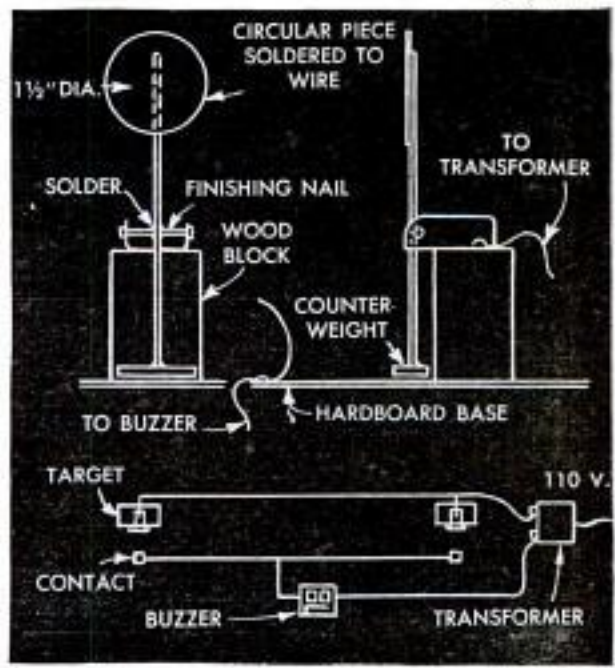
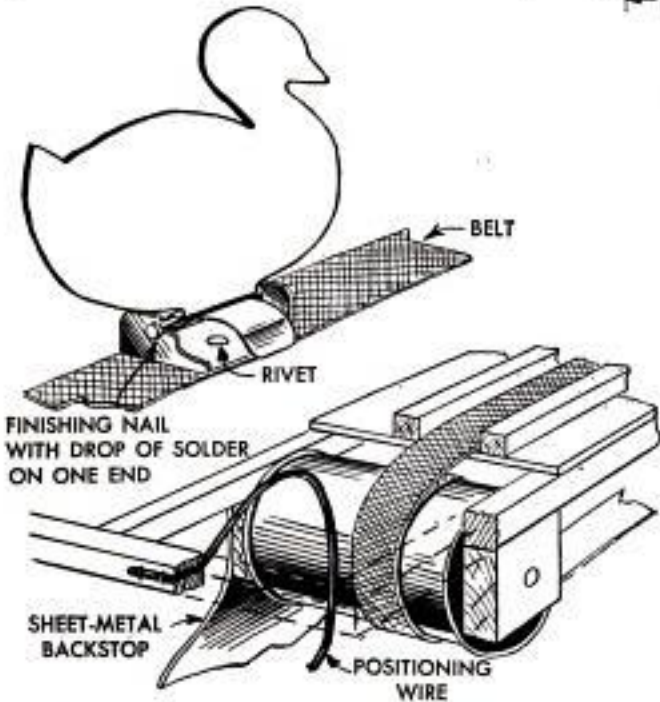
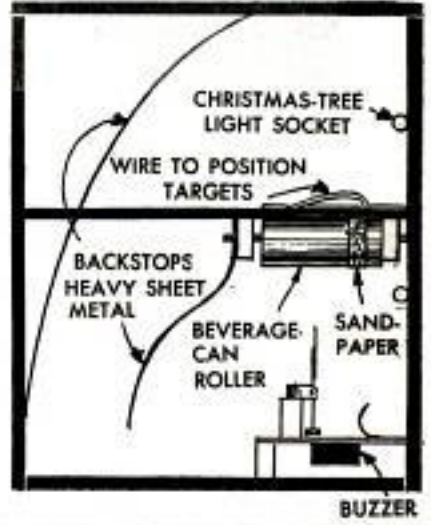
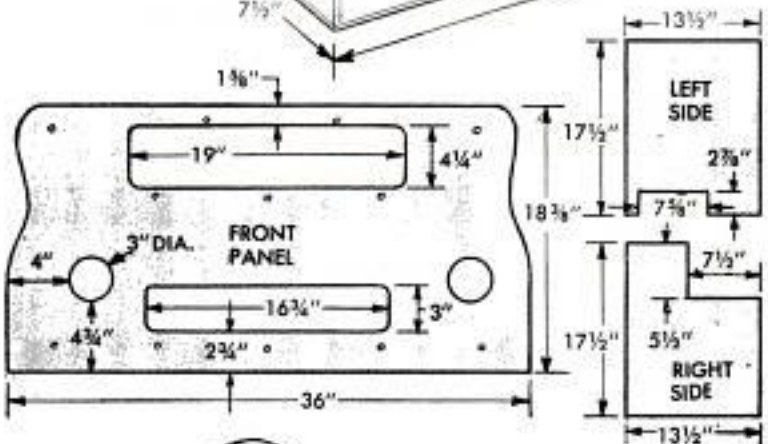

Photo-Negative Brush Kept Soft By Natural Skin Oils



A soft camel's-hair brush, which is ideal for removing dust from negatives, will dry out in time and shed bristles onto the film. To prevent this, occasionally wipe the brush across your forehead to absorb some of the natural skin oils from your face. The oil is so fine that it will leave no marks on the negative to be picked up in printing. To clean the brush when it becomes dirty, wash it gently in a coconut-oil hair shampoo. When it is dry, reapply skin oil from your forehead.

Robert C. Florian, Chicago.

Stopper for Open Water Pipe Improvised From Rubber Ball

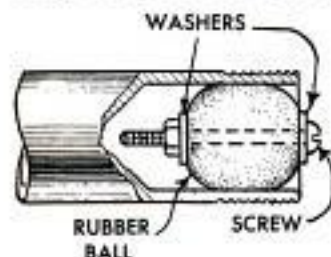

If you keep two or three solid-rubber balls of different sizes in your toolbox, a stopper for an unfinished water line can be improvised if you do not have pipe fittings at hand to close the pipe. A hole to receive a screw is drilled through each ball by using a sharp-edged metal tube lubricated with water. A washer is fitted under the head of the screw and under the nut so that when the screw is tightened the ball will expand inside the pipe. The ball should be just slightly smaller than the inside diameter of the pipe in which it is used.

Detecting Leak in Sewer Pipe

During a long dry spell it sometimes is possible to tell whether or not there is a leak in an outdoor water pipe or sewer by

inspecting the ground above the pipe. Grass or flowers directly above the leak will appear fresh and green in contrast to the brownish, faded appearance of the rest of the lawn and garden.

Ted Otsu, Vancouver, B. C., Can.

Length of Flooring Provides Gauge When Sharpening Saw

A short length of tongue-and-groove flooring can be used to provide a gauge for setting a handsaw at a uniform depth in a vise. With the teeth of the blade projecting the same amount for the full length of the blade it is easier to file the teeth to a uniform depth and angle. In use, the strip of flooring is placed over the blade, groove side down, and the blade is lowered into the vise until the wood just contacts the jaws.



Nails Used on Print Rollers Replaced With Wood Screws

The short nails which are used as axles or spindles on some print rollers become loosened after a comparatively short period of use. To correct this, remove the nails and replace them with screws driven into the roller in their place. Use screws of a size that fit loosely in the holes in the handle, so that the roller turns freely. Avoid oiling the spindles as any excess oil is likely to soil the prints.

O. A. Nelson, Seattle, Wash.

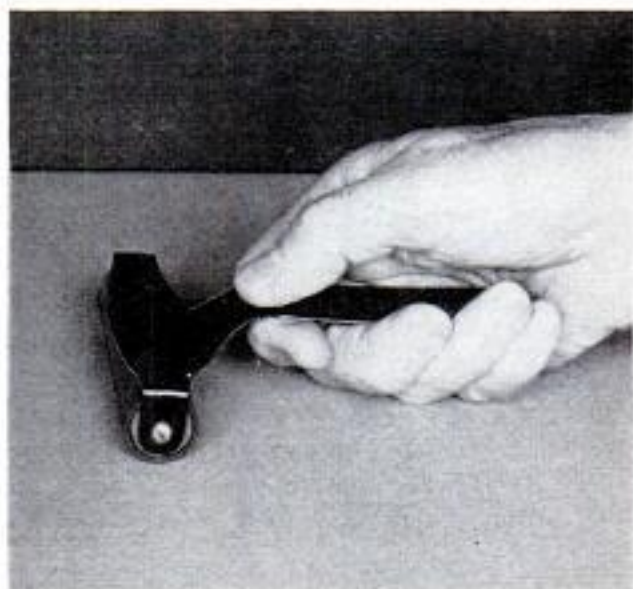

POPULAR MECHANICS

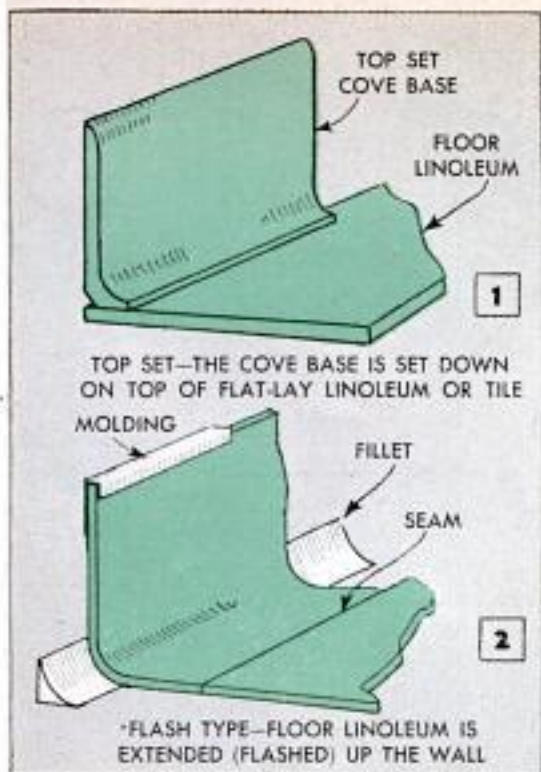

Lay Your Own LINOLEUM COVE BASE

By Sam Brown

EXTREMELY NEAT and colorful, the cove-base linoleum floor has the added advantage of forming a smooth, easily cleaned joint between floor and walls, an especially desirable feature in kitchens, laundry and utility rooms. Although the simplest installation is top set, Fig. 1, the true cove base is the style in which the floor material is extended (flushed) up the wall. Flashed cove base can be installed in a variety of decorative schemes, the plainest design being the same color and pattern as the floor material, Fig. 3. More often, the cove base is a solid color repeating the predominant shade of the floor pattern. A distinctive separation line between the cove base and the floor (or field) linoleum often is provided by using a feature strip, Fig. 14, of a contrasting color.

Fittings: Two essential items for flashed cove base are the cap molding and the fillet. The cap molding is a metal or plastic shape which provides a trim and stop on the top edge of the cove, and is nailed 4 to 6 in. above the floor. The fillet is a cove molding, Fig. 2, which is available in plastic

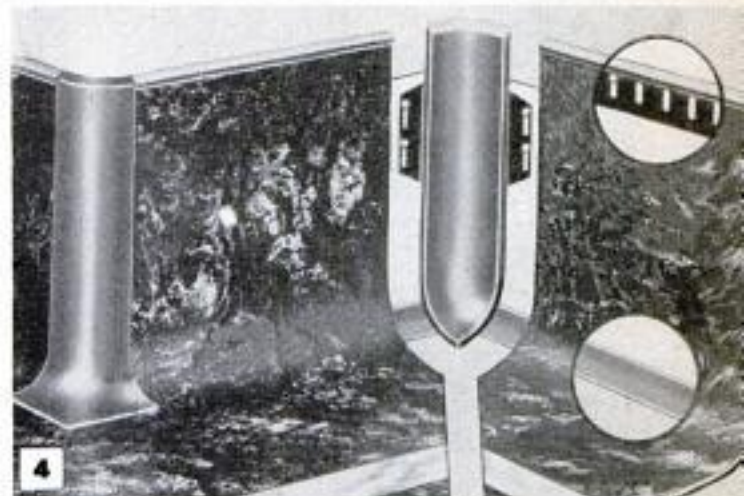

Above, simplest installation of cove base uses same color and pattern of linoleum as the floor, or field

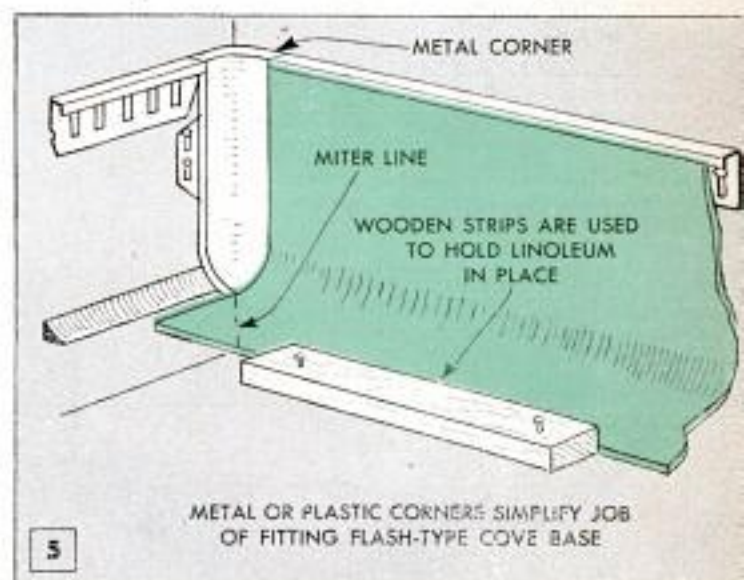

Figs. 4 and 5 show method of using metal or plastic inside and outside corners to fit flash-type cove base

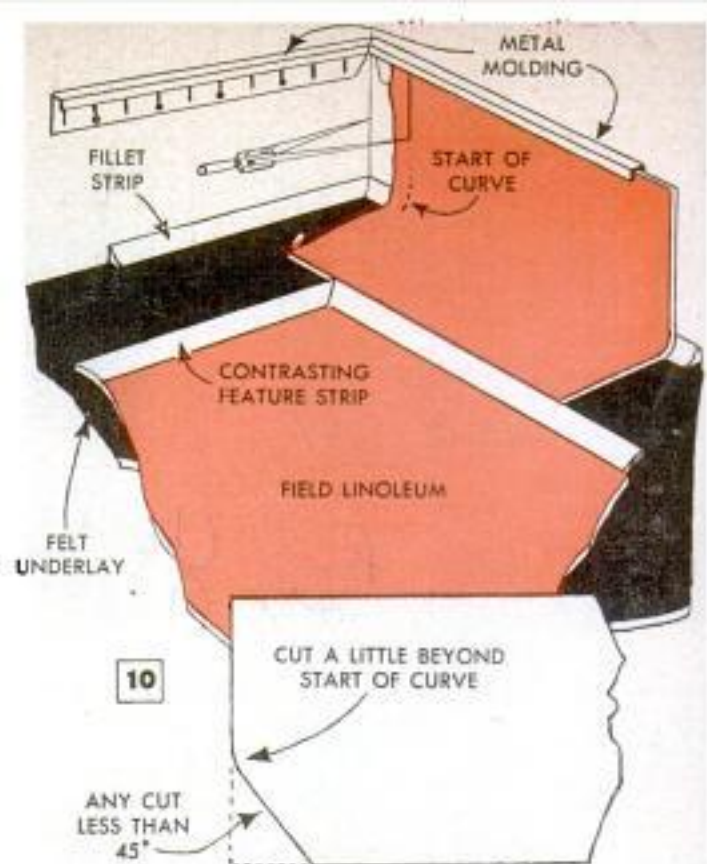
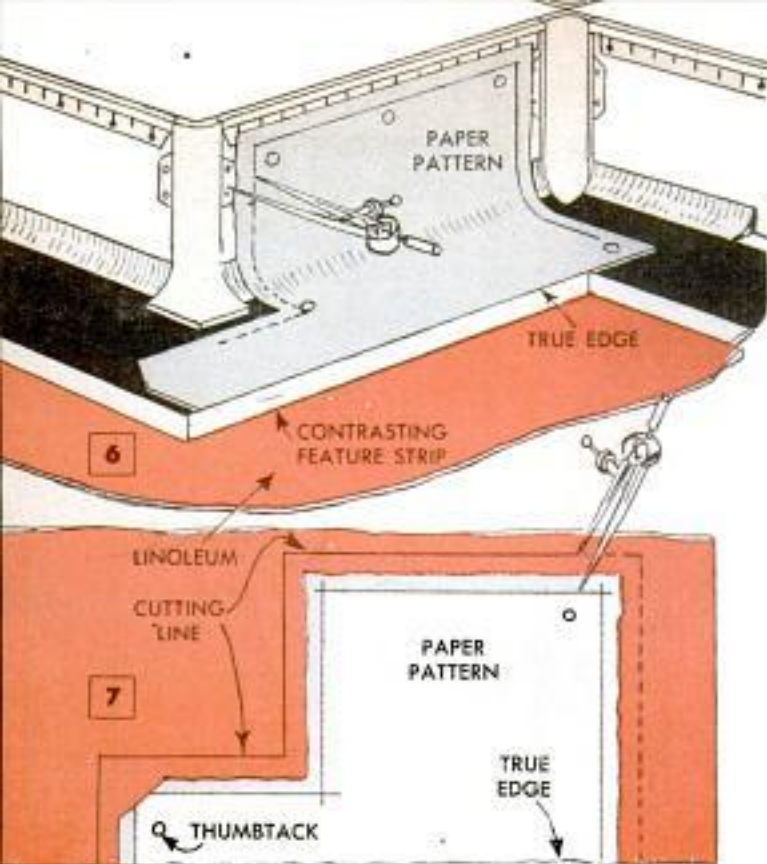

Figs. 11 and 12 show how an inside corner is cut and fitted when metal or plastic corners are not used



Above, when patterns are used to cut cove, allowance must be made for fitting under cap molding and corners

Below are shown tools that can be purchased or made which aid fitting and shaping cove base in corners

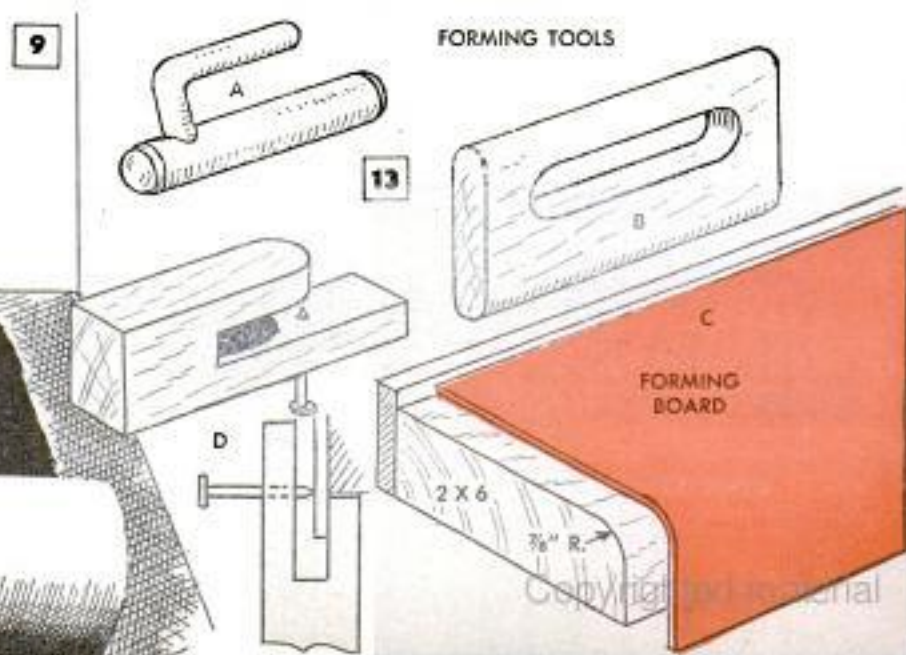

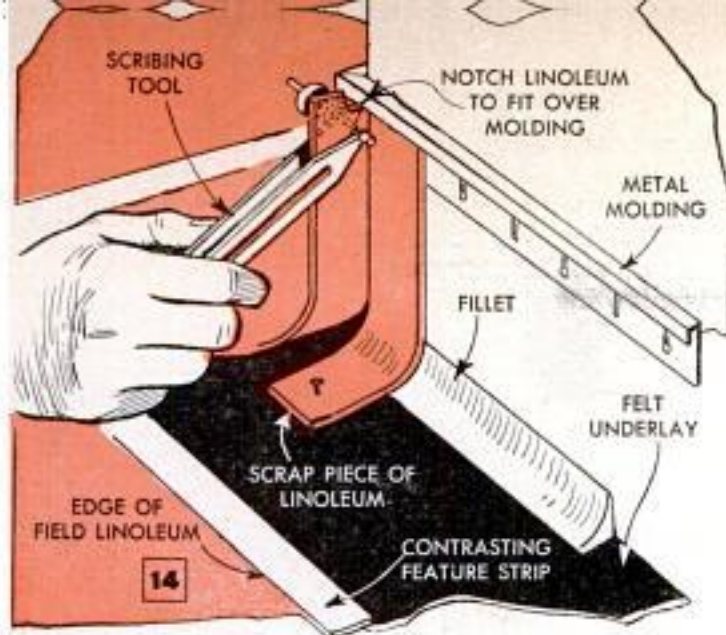

and other flexible materials. It is nailed or cemented in the corner between wall and floor over the usual felt underlay. Ordinary wood-cove molding, $\frac{7}{8}$ in. on the sides and with a $\frac{7}{8}$ -in. radius also can be used. Other fittings which may be used if desired, are outside and inside corners, Fig. 4, and right and left-hand end stops. They are available in either metal or plastic, $4\frac{1}{2}$ or 6 in. high. In all cases, when installing cove-base floor, the conventional wood baseboard and base shoe, if present, are removed.

Installation with corner pieces: As with a flat-lay floor, either border or field can be laid first. Fig. 9 shows the field laid first, while Fig. 5 shows the cove border laid first. Wood strips nailed to the floor are used to crowd the cove strip against the fillet while the cement dries. The cove base itself is simply a strip of border-strip linoleum trimmed to the desired width and shaped to fit into the corner. The miter line on the floor in the corner can be cut singly as each piece is applied, Fig. 5, or the two corner pieces can be overlapped and cut together.

Either direct or pattern scribing can be used to determine the shape of the linoleum. If a paper pattern is used, Fig. 6, it should be fitted snugly in place without wrinkles. Felt underlay and lining paper make excellent pattern materials. Note that in scribing to the metal cap molding and corners that the dividers ride against the edges. Since the linoleum is to fit under the edge of both cap and corner, the dividers must be opened an additional $\frac{1}{8}$ in. when transferring this line to the linoleum, Figs. 6, 7 and 8.

Self corners: This style of corner takes more skill and patience, but since no corner pieces are used, the cove base can be flashed any distance up the wall, and the cove molding located accordingly. Self corners are usually scribed directly onto the linoleum itself. The first strip for the

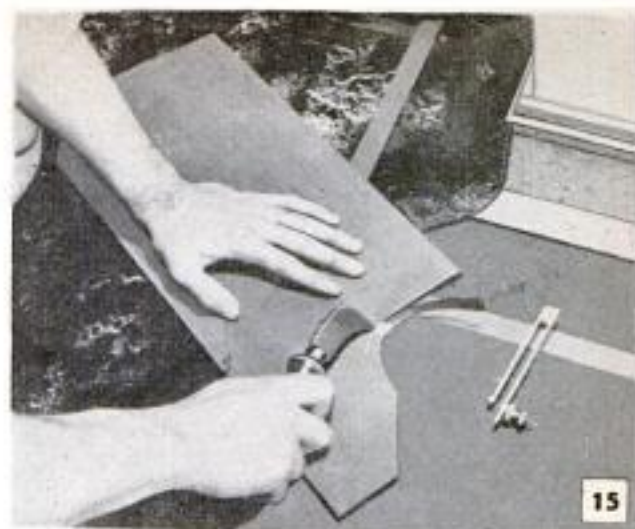

Above, linoleum on self corner is cut at 45-deg. angle down to middle of fillet on outside corners

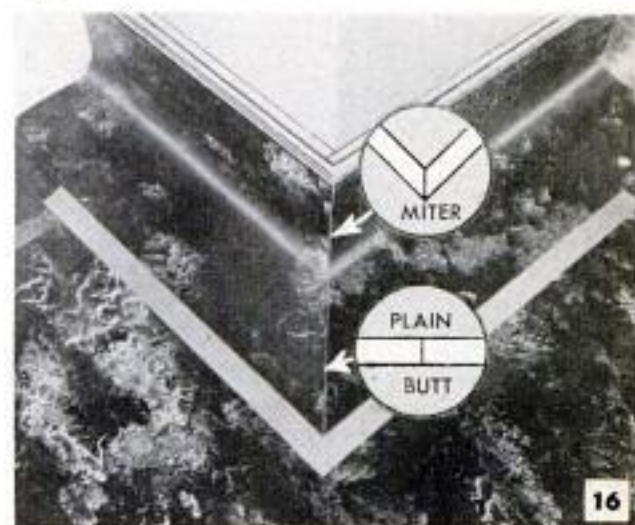

Above, from center of fillet to corner of field linoleum edge is cut at right angle to form plain butt

corner is pressed into place and scribed from the top down to about halfway across the fillet, Fig. 10. The second strip then is pushed into position, Fig. 11, and scribed and cut in the same manner. Both strips are cemented in place, then the cut is continued down across the fillet and out to the corner of the floor linoleum. After double-cutting in this manner, the top piece of linoleum is lifted slightly to permit removal of the waste end of the underpiece. Fig. 12 shows the finished inside corner.

To fit an outside corner, the first strip is pressed into place and underscribed along a scrap piece of linoleum fitted against the adjacent surface, Fig. 14. After it is marked the corner is cut down to about halfway across the fillet, the cut being a 45-deg. miter, as shown in Figs. 15 and 16. After the linoleum is cemented in place, the cut is continued across the fillet to the corner of the floor linoleum. Note here, Fig. 16, that the cut edge is a 45-deg. miter down to the fillet, then gradually changes

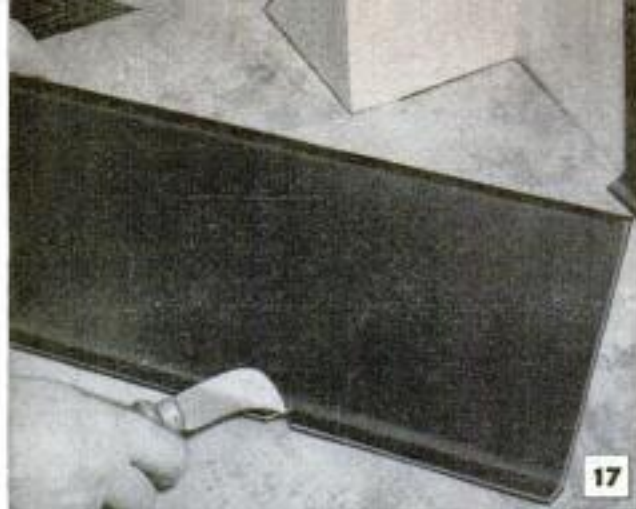

Above, asphalt tile used for top-set cove is notched, heated and bent to form inside corner as shown below

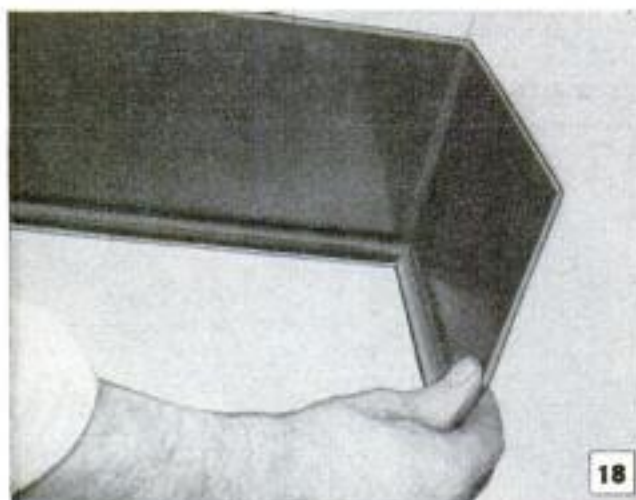

Below, score back of asphalt tile and heat to form outside corner. Also cut slit in the surface on floor

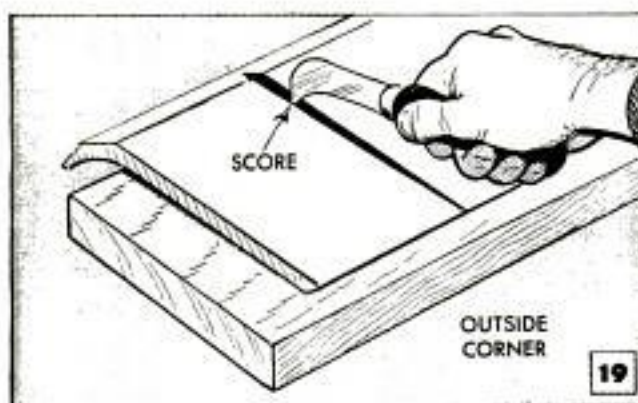

Below, close-coupled inside and outside corners present neat appearance when shaped from one piece

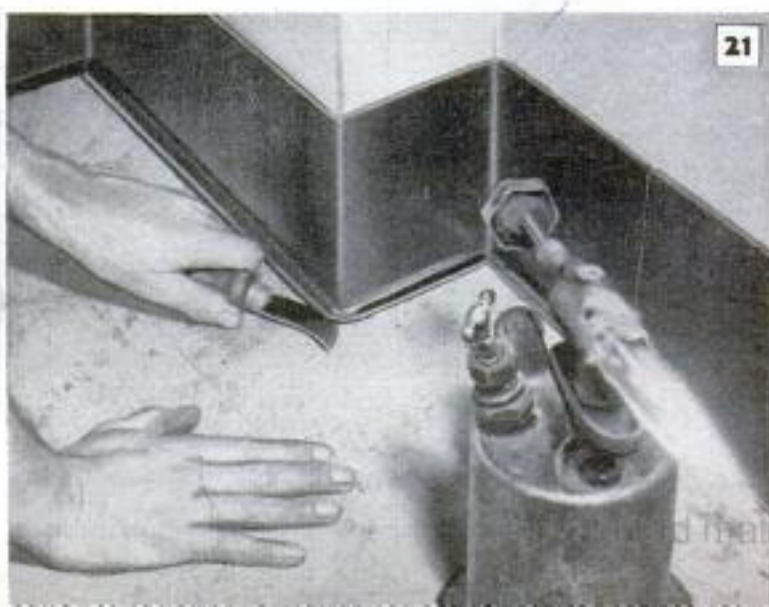

across the fillet to become a right-angle cut to form a plain butt the rest of the way across the cove.

Whether you use metal or self corners, the most difficult part of laying a base cove is shaping the linoleum to the required bend. The linoleum must be warm. If the room is cool, use a heat lamp to warm the linoleum before bending it. Form the bend as well as possible by hand before fitting. A better method is to use a forming board, shown in detail C, Fig. 13. Be sure the linoleum fits snugly against the fillet before scribing it. Also, double-check your cementing job; a few sandbags will help keep the linoleum in place while the cement is drying. Detail A in Fig. 13 shows a manufactured metal tool that is used to press the linoleum firmly against the fillet strip. Detail B is an easily made wooden tool used for the same job. Detail D shows a simple scribing tool that can be made if you do not have a regular one.

Top-set cove base: This style is easy to lay, being the same as the flashed type, except that the cove base is merely set on top of the floor covering, Fig. 1. If an asphalt material is used, corners are made by heating the spot with a blowtorch or heat lamp. To make an inside corner, notch the front of the molding, Fig. 17, apply heat and bend, Fig. 18. For an outside corner, score the back, heat and bend, Figs. 19 and 20. If the corner breaks slightly when bent, apply heat and mold shut with a hot knife, Fig. 21. Dust scraped from a scrap piece of asphalt can be used to fill in and "weld" a wider gap.

Rubber cove base must be cut and fitted the same as linoleum. Rubber does not cut as easily as linoleum and is usually fitted by using a special deep miter box and a fine-toothed saw. Some types of rubber tile are obtainable in preformed inside and outside corners, thus eliminating the problems of mitering. Preformed corners are cemented in place first and base strips are installed and fitted between them. ★ ★ ★

Scrap piece of asphalt tile is welded into opening left when outside corner is bent. Hot knife is used

Auxiliary Stop on Typewriter Aids in Aligning Paper

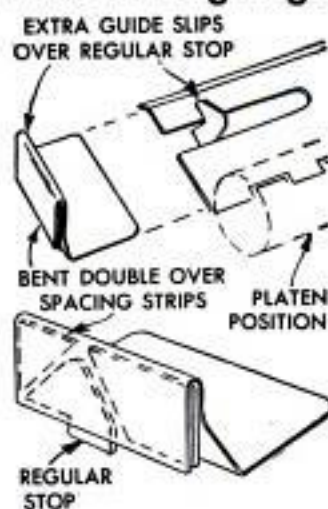

The paper stop, which on some typewriters is so small that it does not effectively align the paper fed into the machine, can be fitted with an auxiliary stop to correct this trouble. A piece of light sheet metal—the metal from an ordinary tin can will do—is cut and shaped as shown in the detail, so

it will fit over the original stop. Two spacers cut from the sheet metal are fitted inside the fold of the auxiliary stop to hold it in place. To keep the spacers locked in, hold the stop on a flat surface and lightly center punch it over the spacers, or solder the assembly.

Molding Contour Quickly Copied



In an emergency, a molding contour may be copied quickly by using one or two decks of playing cards and a C-clamp. The ends of the cards are pushed firmly against the mold-

ing to copy the contour, then clamped. A small piece of plywood or hardboard should be placed on either side of the deck to provide a better grip for the clamp.

B. McClure, Los Angeles, Calif.

Empty Window-Cleaner Bottle Used to Spray Fine Oil



Don't discard the empty spray bottle that has contained a glass-cleaning liquid. Fill the bottle with a light oil and use the plunger pump to spray a fine mist of lubricant for rust-proofing tools.—W. H. Bradley, Point Reyes Station, Calif.

NOVEMBER 1954



Mirror Helps Lecturer View Slides Projected Behind Him

To eliminate the inconvenience of having to turn around in order to view slides being projected on a screen while he was speaking, one lecturer mounted a concave mirror in front of him. Thus as he talked he could look directly at the audience, and a glance at the mirror would tell him which of the slides was being projected at the moment. Interruptions are eliminated.

Victor Lamoy, Upper Jay, N. J.

Window Shade Protects Clothing

One car owner found that an old window shade provides a practical mat for preventing his clothes from being soiled when working on the car or repairing a flat tire. When rolled, the shade takes very little space in the car trunk.

Open Padlock for Boat Chain Held by Faucet Washer

The loss of an open padlock from the anchor chain of a rowboat may be prevented by forcing a rubber faucet washer over the shackle of the lock to hold it in place. If the original hole in the washer is too small and must be enlarged, use a drill or punch slightly smaller than the diameter of the shackle, so the washer won't work loose.—G. E. Hendrickson, Argyle, Wis.



197

Ignition-Distributor Lubrication Adds Power and Performance

By Ed Packer

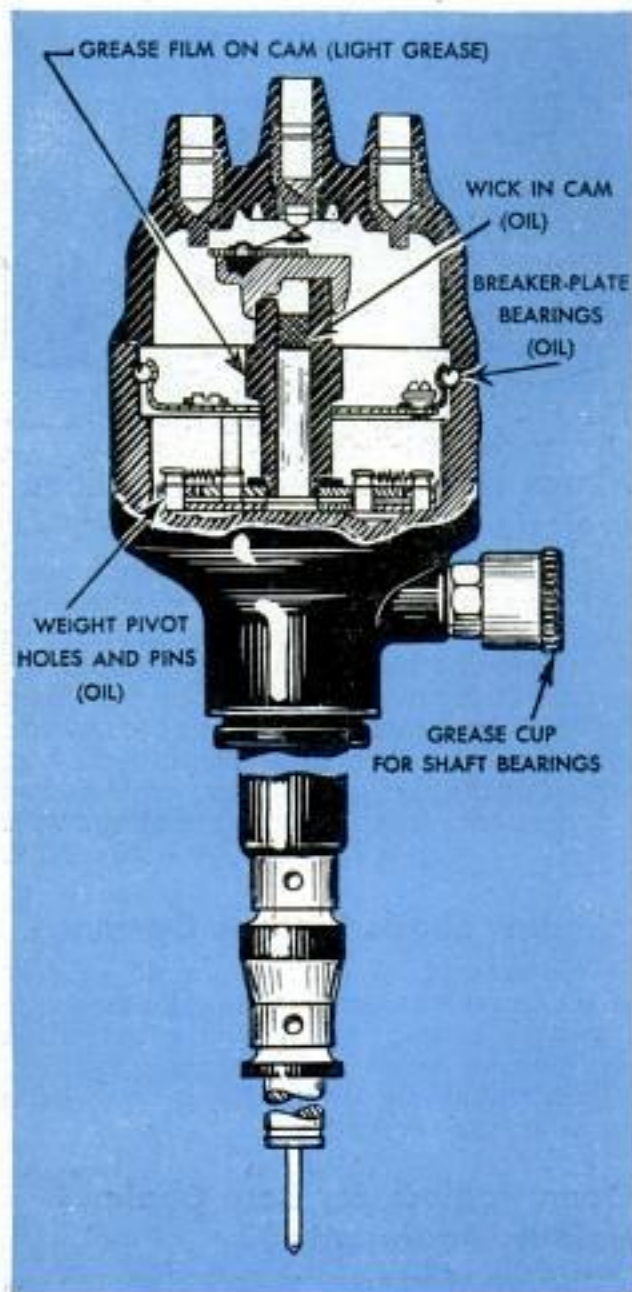

WHEN WAS THE IGNITION distributor on your car last lubricated? If the car has been driven more than five or six thousand miles, the distributor should be checked for lubrication. It is a precision instrument and, as such, needs correct care. Even a well-tuned engine cannot function correctly with a worn distributor. There are five places on a distributor that require lubrication, detail at left: The wick on top of the cam shaft, the cam lobes, plate bearings, counterweight pivots and the shaft bearings.

Do not overdo the job; too much lubricant is worse than none at all and can stop the engine completely. Just a slight amount of oil or grease will insulate the breaker points and prevent a hot spark passing between them, or it may cause excessive arcing, which will pit the points in a short time.

The shaft bearings of the distributor are lubricated by either a grease or oil cup located under the main body of the distributor housing. When the grease cup is full, a turn or two every few thousand miles generally is all that is required. If an oil cup is used, just a few drops of oil are needed at similar intervals. It is best to check in your owner's manual, or ask a competent mechanic to learn the recommended number of miles for your particular car.

Do not overlubricate the shaft bearings. It is possible for the engine heat to vaporize excess oil or grease and force the fumes up the shaft into the distributor housing. The cooler air in the distributor will condense the vapor and a film of oil or grease will settle on all parts of the distributor. This condition often is encountered in older cars where the distributor-shaft bearings have become badly worn, and

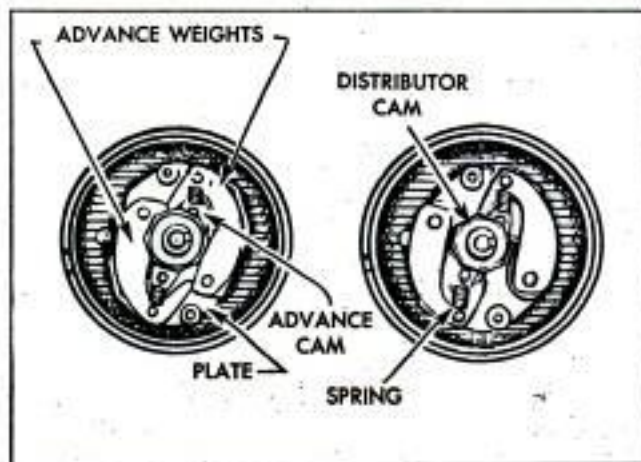
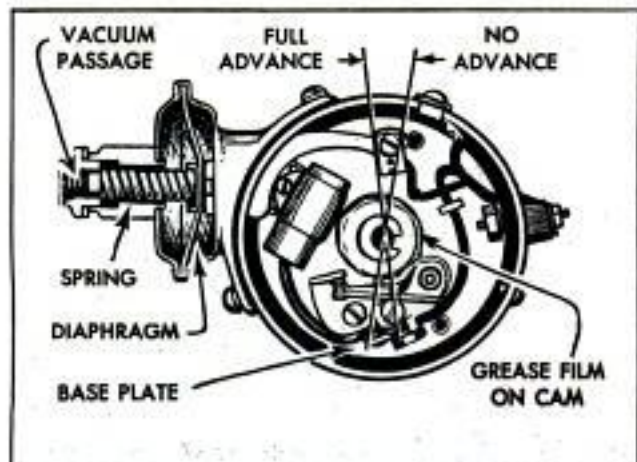

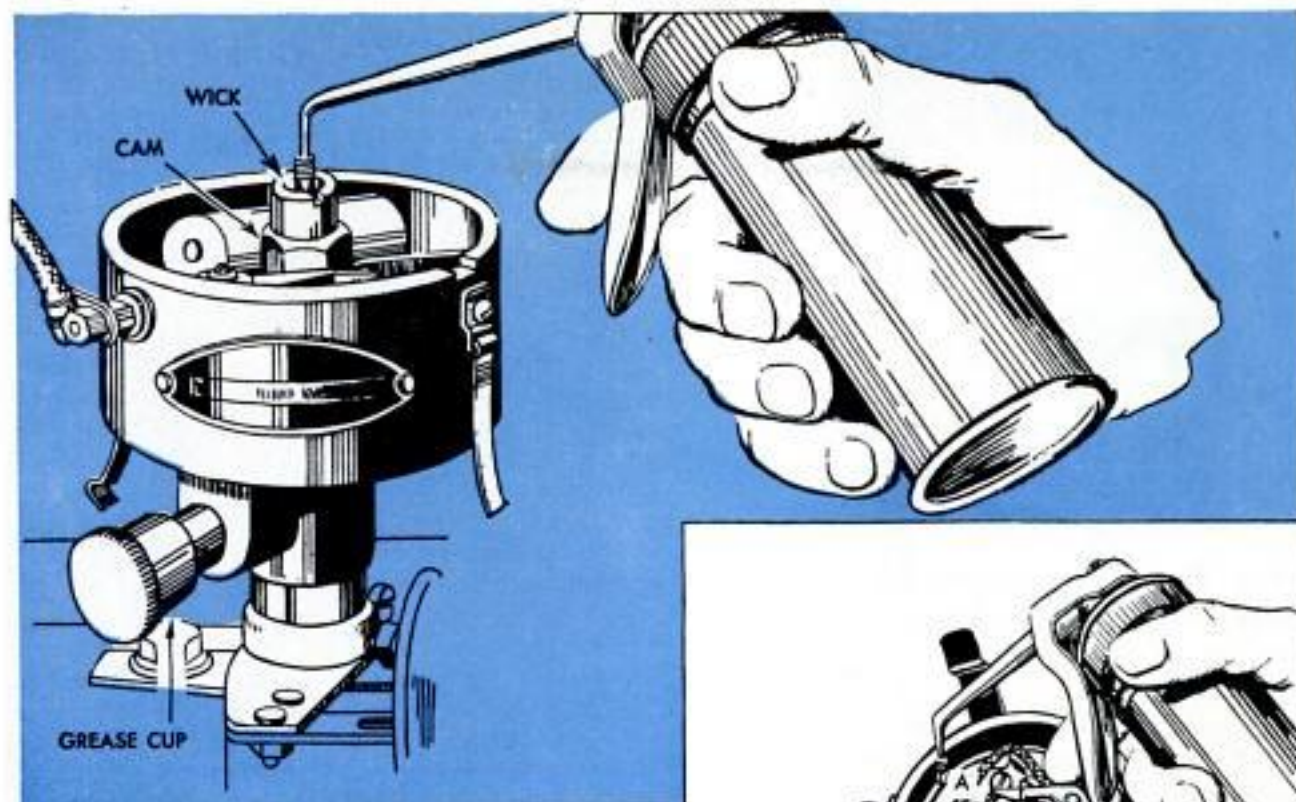

even fumes from the engine crankcase can pass up the shaft.

When you remove the distributor cap and take out the rotor, you will notice a wick under it that requires two or three drops of oil about every 5000 miles. The wick lubricates the upper end of the short camshaft, which is moved slightly on the main distributor shaft by counterweights to automatically advance or retard the spark according to engine speed.

If the distributor is of the type shown in the right-hand drawing on this page, a drop of light oil should be placed on each of the ball bearings on which the distributor plate rides, points A in the drawing. On later models of this type of distributor, an oiled felt pad under the plate lubricates three plastic buttons on which the plate turns. The pad is oiled through a hole in the plate, point B in the right-hand drawing. Should the plate be removed from a distributor of the type which has three ball bearings riding in a groove machined in the housing, care must be taken not to lose the balls and to replace them properly when reassembling the distributor. The distributor plate is turned on the bearings or plastic buttons by a diaphragm in a vacuum chamber connected to the distributor. This is shown in the lower left-hand drawing, page 198. The diaphragm is actuated by changes in the intake-manifold vacuum. Manifold vacuum varies with the load on the engine, rather than the speed.

The machined faces of the cam lobes on the distributor shaft require a very fine film of hard grease. This film prevents too-



rapid wear of the fiber block on the pivoted arm of the ignition points. If this block—which may be under 18 to 20 oz. of pressure and struck by the cam as much as 1500 times a minute at 60 m.p.h.—should wear down too much, the points will not open at all and the engine will not run.

The counterweights beneath the distributor plate should be oiled or packed with grease about every 5000 miles. Unless you are familiar with an ignition distributor, do not remove the plate to get at the weights. Leave this for an ignition specialist. If you do remove the plate, you will see the counterweights as the lower right-hand drawing on page 198. The detail on the left shows the position of the counterweights when there is no advance, while the detail on the right shows full advance. The places requiring lubrication are, of course, the pins on which the weights pivot. Some distributors require only a drop of oil on each of these pins, others must be packed with light grease. It can be seen that if too much grease were used, the weights would not be able to move outward to function properly. The same is true, of course, if the pivots are dry and rusty. ★★ ★



Paint Provides Vapor Barrier Beneath Unheated Attic

The problem of excess humidity in an unheated attic space, caused by moist air passing through the plaster and loose insulation in the ceiling, can be solved by using a good grade of moistureproof paint on the ceiling. Oil, aluminum and rubber-base paints, as well as spar varnish can be used. Apply the paint with a brush or roller, thoroughly covering all cracks and irregularities. Two or three coats will assure more effective protection. After the paint has completely dried, the ceiling can be wallpapered, if desired. Outside walls which do not have a vapor barrier also can be protected with paint in the same manner before they are covered with wallpaper.

Improvised Stencil Knife

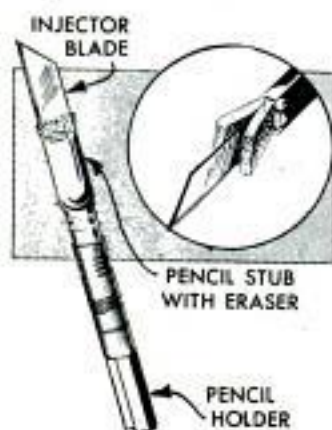

While doing some art work I misplaced my stencil knife and, needing one immediately, improvised the one illustrated. A pencil stub, with the flat-type eraser shown in the detail, was screwed into a pencil holder. The eraser was slit part

Automatic Clothes Driers . . .

Whether you now own a clothes drier or are just thinking about buying one, you certainly want to know as much as possible about them. What different types are available. How they work. What to do about lint. How a drier should be vented. The answers to these questions and many others will be waiting for you when you read next month's informative roundup story on clothes driers

way down and an injector-type razor blade, the end of which was ground to a bevel, was inserted in the rubber. Whenever the blade becomes dull it is a simple matter to replace it with a new one.

Earle Engdahl, Oakland, Calif.

Tent Roof Kept Taut By Springs

A canvas-tent roof can be kept taut even though the canvas becomes stretched, by using a compression-type coil spring to keep the ridgepole under tension. Steel pins are driven into the upper ends of the ridge-support poles, which are wound with wire

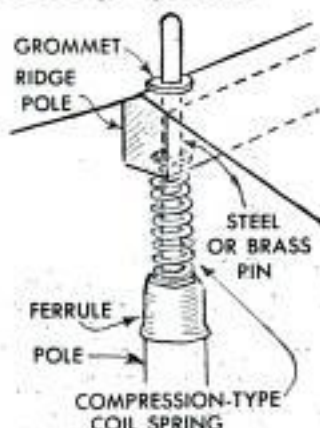

or fitted with ferrules to prevent splitting. The pins fit into holes drilled through the ridgepole and extend through holes punched and grommeted in the canvas roof. Washers are used on each end of the springs, which are slipped over the pins and placed under tension by drawing down tightly on the tent-roof lines.

Rubber Cement Painted on Easel Prevents Slipping

If the enlarging easel slips so easily on the baseboard of an enlarger that there is a chance of moving it when inserting the paper after the picture is composed, coat the bottom of the easel with rubber cement. When the cement dries it will leave a thin film of rubber which will effectively prevent the easel from sliding, yet permit it to be moved easily when necessary.

Virginia Hanson, Los Angeles, Calif.

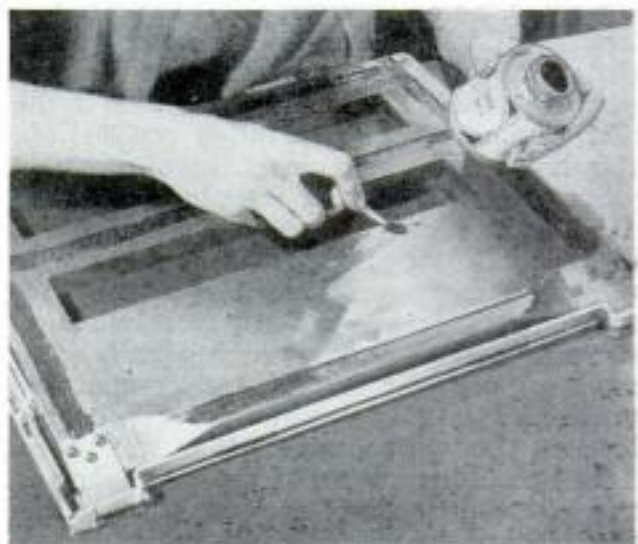

How to Check Flash-Gun Synchronization

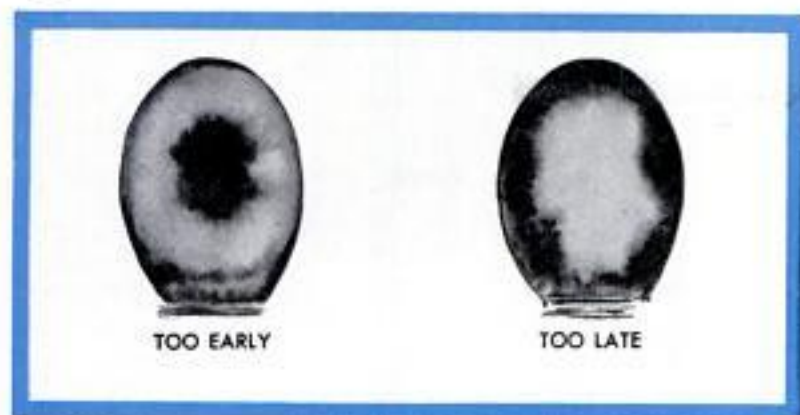

Any variation from full intensity in photoflash synchronization can affect your flash pictures through a considerable exposure range. A simple check quickly reveals any discrepancy. Stand your flash gun in front of the camera, as pictured above, and focus on the flash bulb. Make sure that all electrical connections are tight, and remove any near-by objects that might throw sharp reflections, either into the lens or onto the flash unit. Open the lens to full aperture, then shoot, using two or more speeds, and develop the film. If the flash is too early you will get an image similar to

that shown at the left above. Too late, the image will appear something like that indicated at the right. If the flash is "right on the nose," the image will be all black, or very nearly so, with possibly a slight halation at the edges. Phosphorescent paper can be used to make the check instead of film. It is used in the same manner as film but does not require developing. After exposure, the phosphorescent paper is simply viewed in a darkened room.

Circular Gaskets Cut Quickly With Razor Blade in Compass

A section of discarded razor blade, fastened to the pencil side of a compass speeds the cutting of circular gaskets. By using the compass you can cut them directly

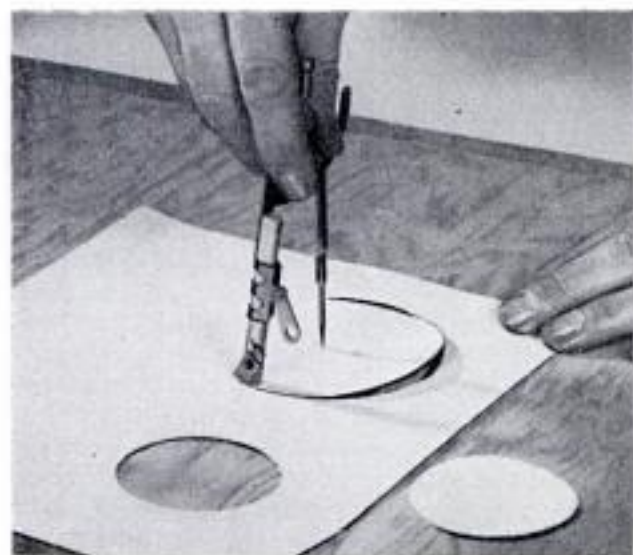

from the gasket material, eliminating the need for drawing a circle and then cutting with a knife or scissors. A single-edged razor blade with a hole near each end is the type most readily adapted to this purpose. Hold the blade in a vise or pliers and snap off the blade close to one of the holes, so that a length of blade about $\frac{1}{2}$ in. long remains. Next, replace the pencil with a short length of dowel. File a flat near the end of the dowel, shaping it so the shoulder of the flat is at a slight angle, as shown in the photo. A small wood screw is used to hold the blade against the flat of the dowel.

Detergent Keeps Glass Clear

An application of a liquid detergent to eyeglasses, mirrors, windshields and other glass surfaces will prevent moisture condensation, or "steaming." Apply the detergent with an atomizer or a small wad of cotton and then polish with a clean cloth.



Multiple prints must be worked out in detail. Select negatives that will print on the same grade of enlarging paper. Make sketch like that above to determine placement of negatives. When printing, vignette each image with masks like those below

By John I. Fish

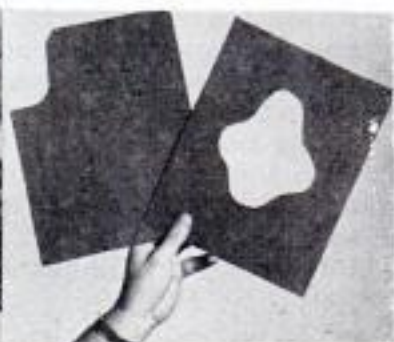

MULTIPLE-PICTURE TRICKS

A SMALL FILE of your favorite negatives, plus a measure of creative handling in the darkroom, can give you photoprints that portray qualities of spontaneity and appeal in striking combinations. As an example, five separate negatives were used in making the appealing multiple portrait reproduced above. Note how the photographer has achieved the effect of a single print by using the simple process known in the darkroom as vignetting. In this the individual images are projected through cutouts made in pieces of cardboard, as in the small photo at the right. Each cutout is held about halfway between the enlarger lens and the paper and kept in motion throughout the exposure.

The steps in making a multiple portrait

must be carried out in detail. Select negatives that will all print on the same grade of enlarging paper. Make test exposures of the enlarging paper that is to be used and process identically. This is important as all exposures will be printed on the same sheet of paper, and any variations in developing will cause the pictures in the multiple print to vary in density. Make simple sketches of that portion of each image that is to be used so you can determine the area it is to occupy in the multiple print. Note how this has been done in the detail at the right of the photo above. Then print the separate negatives onto the proper areas of the enlarging paper. As each successive exposure is made, use the vignetting cardboard cutout to prevent light from



Printing through fabric or open mesh gives striking effects. Care must be taken in selection of negative

reaching any other area of the paper except that which is being exposed. Keep the mask in motion to blend the edges of each image. Develop precisely the same as the test exposures. To avoid errors in placement, mark the top of the enlarging paper on the back.

You can have a lot of fun by simply placing objects on top of a sheet of photographic paper and exposing to light. For best re-

Unusual photoprints are made by simply placing various objects on paper and exposing as shown below

sults, use the enlarger as in the lower left-hand photo. The photo at the lower right is a good example of what you'll get. Almost any common object can be used, either opaque or partially translucent. This includes glassware, plastic containers and utensils, tree leaves, blades of grass, heads of bearded wheat or barley, fern leaves and so on. Other variations can be carried out with unusual results. For example,

This picture is an example of what you can expect. Opaque and translucent objects make best pictures





These two prints were combined to make the striking picture on the opposite page. The lighthouse negative is used as the base negative and the cloud negative is printed in by masking out the foreground



place several small seeds, feathers or insects in the negative carrier of the enlarger. Photograms made in this way are similar to those taken through a microscope. To do this work in enlargers that do not have glass negative carriers, clear the emulsion from two sheets of film by washing in a fixing bath and use these as a carrier.

Other interesting multiple-print tricks include printing the image through a fabric

Negative printing can give you such unusual pictures as this one. Fine for wall decoration when framed



or open-mesh netting. Photos at the lower right and at the top of the preceding page are good examples of the variations and novel effects possible.

Another stunt that gives you really striking results is negative printing. The first step is to make a print from the chosen negative on commercial sheet film rather than paper. In other words, you make a film positive by printing the negative onto commercial film. The positive should be

An example of an exposure made through fairly fine-mesh fabric. Correct exposure is determined by test



Compare this photo with that at the upper left on opposite page. Clouds printed in by a second exposure give a feeling of completeness to the scene. After first exposure foreground is masked out with mask shown below, second exposure is made

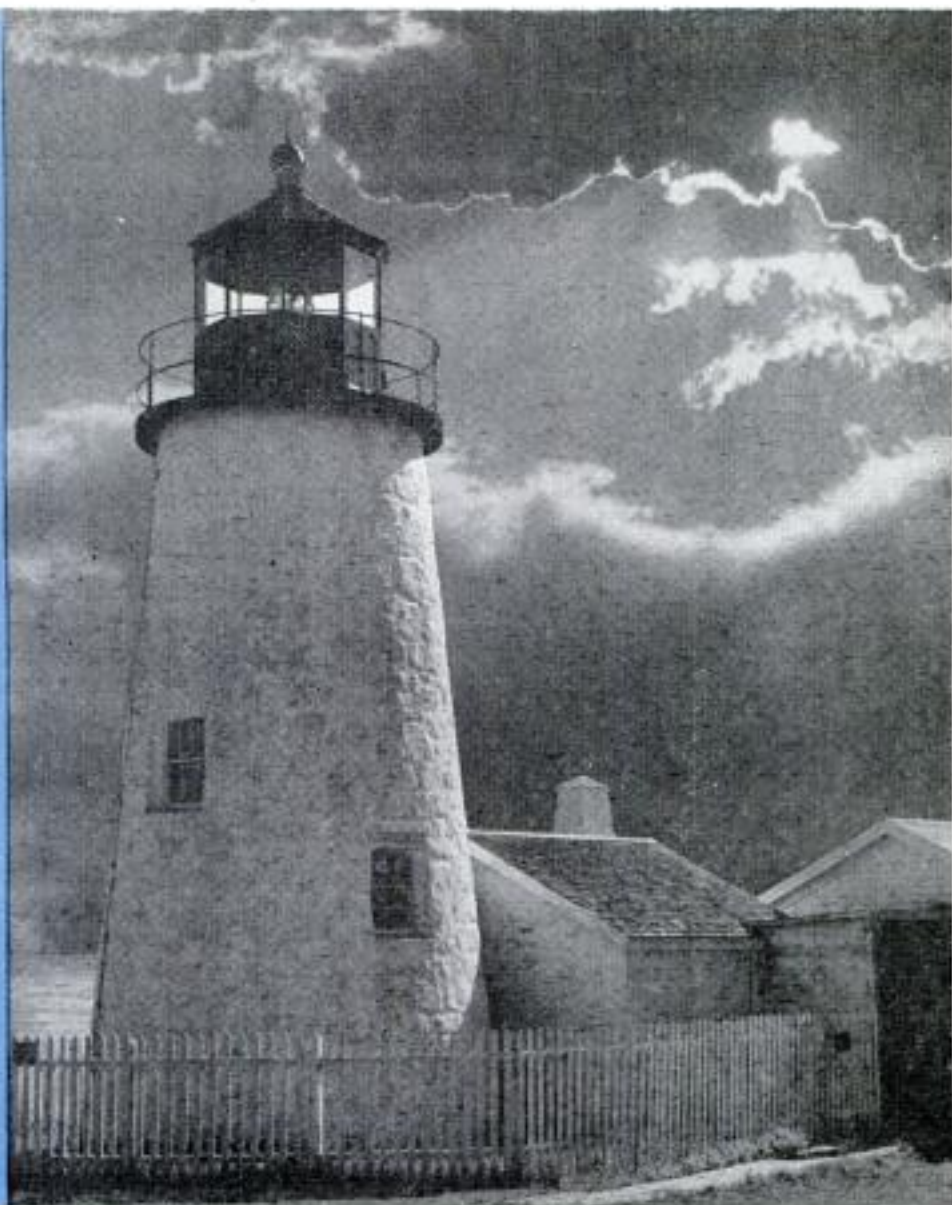

the same size as the negative carrier or, if you prefer, you can make the positive full picture size and make contact prints from it. First, run a test strip, just as you would when making prints on paper, to get an exposure range suitable for that particular negative. Develop the film in a soft-working developer. The time will vary, depending on the contrast in the negative, but about 7 minutes at 68 deg. F. should provide a reasonably accurate guide. In the exposure tests, aim for a positive that will print on grade-2 paper. This will give you several grades on each side of the normal, should the negative in hand require this variation. When the positive turns out satisfactorily, print the film on paper just as you would a regular negative. The lower left-hand photo on the opposite page is a good example of what you can expect.

Printing in clouds can bring life and feeling to a plain, uninteresting picture. Note the blank-sky print at the upper left on the opposite page and contrast with the one above with a cloud sky printed in. As

the first step, place in the easel a sheet of opaque (black) paper of the same size as the enlarging paper to be used. Project the original negative and outline all details and areas in the foreground with a pencil. Then cut carefully along this line to produce a mask which will be used to prevent the cloud negative from printing in areas below the horizon line and over any objects in the foreground, such as the lighthouse in the photos above and at the upper left on the opposite page. Note the mask at the left of the photo above. Determine the correct exposures for both the original negative and the cloud negative by running separate test strips for each one. Be sure to mark the back of the enlarging paper so that you can replace it in exactly the same position for the second exposure. Precise alignment is of the greatest importance. With most work of this kind the trick is in cutting and placing the mask accurately. Be sure to place the paper in a light-safe cabinet or box between exposures. ★ ★ ★

Tire Chains Quickly Put on By Using Slotted Ramp



1" SLOTS IN 2" X 8" PLANK

Most of the problems ordinarily associated with putting tire chains on a car can be eliminated by using a ramp consisting of a 3-ft. length of slotted 2 x 8-in. lumber. The slots are 1 x 1 in. and are spaced to fit the cross links of the chain. One end of the plank is beveled to provide an approach and a stop block is spiked to the other end. In use, the chain is placed in the slots, the

car is backed onto the ramp until the tire contacts the stop and the chain then is pulled up around the wheel. The ramp also could be made by nailing blocks to a plank.—Karl Schoeller, Oswego, N. Y.

Jigsaw Used to Cut Asphalt Siding

For cutting odd shapes and angles when applying asphalt siding, a saber or jigsaw is an excellent tool. The tarry underlayer and gritty outer surface will quickly dull a saw blade, so it is suggested that you use an old, discarded blade.

Ralph Hitner, Philadelphia, Pa.

Shim Silences Rattling Latch

A door that rattles in a draft because of a loose latch can often be quieted by fastening a thin wood or cardboard shim to the hinge edge of the door. The shim should be slightly thicker than the clearance between the door and the jamb so that when the door is closed it is forced toward the striker plate on the jamb. The latch thus is held tightly against the striker plate and cannot rattle.

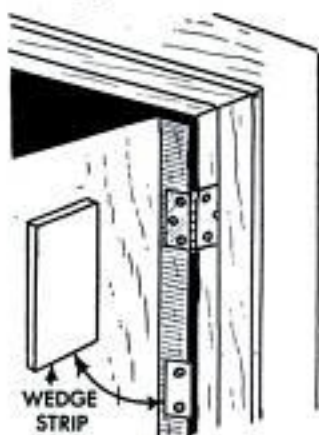

Popular Mechanics Bookshop



Remodel Your Home

Now's the time to get started on home-remodeling projects. *How to Remodel Your Home* gives you 160 pages of remodeling know-how. Whether your home is old or brand new—whether you want to add a porch, modernize a kitchen, add new closets, build a basement playroom, convert attic space into living quarters or any one of 101 projects, you'll find complete step-by-step instructions. \$3.50



Build Your Own Furniture

Here's a profitable way to spend cold winter evenings! Build beautiful furniture for every room of your home at really worth-while savings. Select from 100 pieces. Choose complete suites or occasional pieces. You'll find step-by-step directions together with photographs and diagrams. Send for *100 Beautiful Pieces of Furniture You Can Build* today. \$3.00



Take Care of Your Home

If you have some last-minute fall repairs, this is the book you'll need. *Guide to Home Repairs* can easily save you as much as \$100 a year. You can easily correct leaky faucets, sticking doors, squeaking floors, leaking gutters and hundreds of other annoying and expensive household defects simply by following the easy-to-use instructions in the book. \$2.50

All books available from Popular Mechanics Book Dept., 208 E. Ontario St., Chicago 11, Ill.



SHOP NOTES

CIRCLE TOOL DOES MANY JOBS

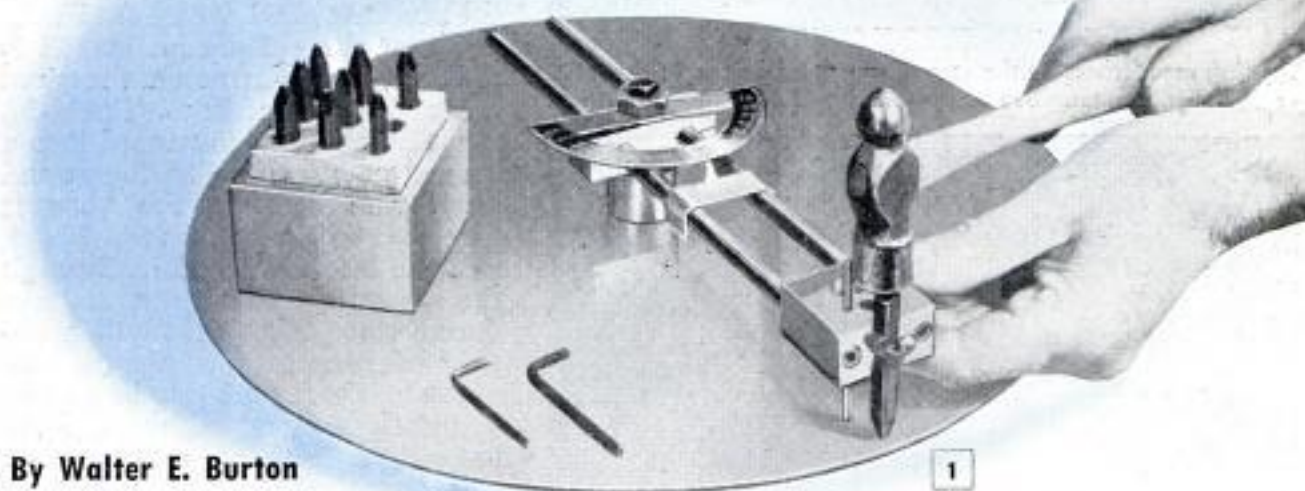

By Walter E. Burton

BASICALLY, THIS UNIT is a type of trammel, or compass, having an adjustable head for mounting various cutting and embossing tools. It has a wide application in craftwork. Dimensions of the unit detailed provide a capacity ranging from $1\frac{3}{4}$ to 20 in. in dia. This range can be increased somewhat without the use of heavier material. The unit consists of a sliding head which holds the cutting tool, two

round slides and a swiveling base attached to the work or the bench top as required, Figs. 6 and 7.

The sliding head, Fig. 10, is made from a piece of mild steel (you can use oil-hardening steel) $\frac{3}{4}$ in. thick and $1\frac{1}{2}$ in. square. This block is drilled, tapped and slotted as indicated in the details. Begin by squaring the block, either by milling or filing by hand. Note in the detail that the block is

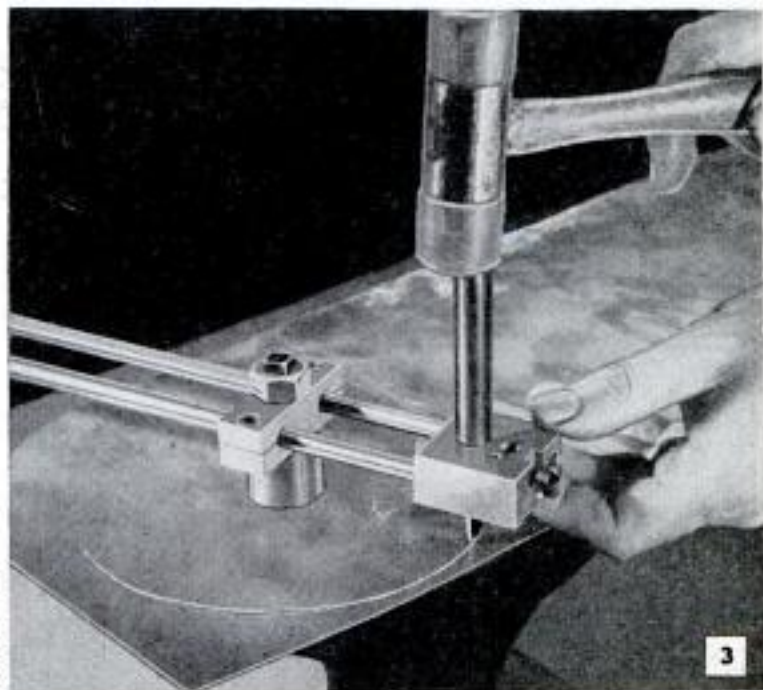
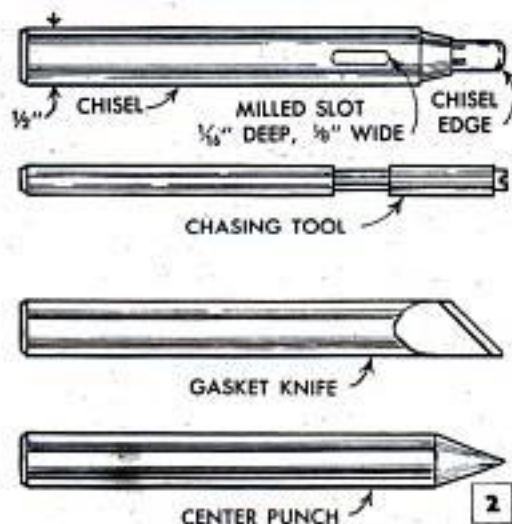

Various types of chasing tools, chisels and punches can be used in the circle tool. Photos above and at the right picture manner of using unit on circular work. It can be attached to the bench or work

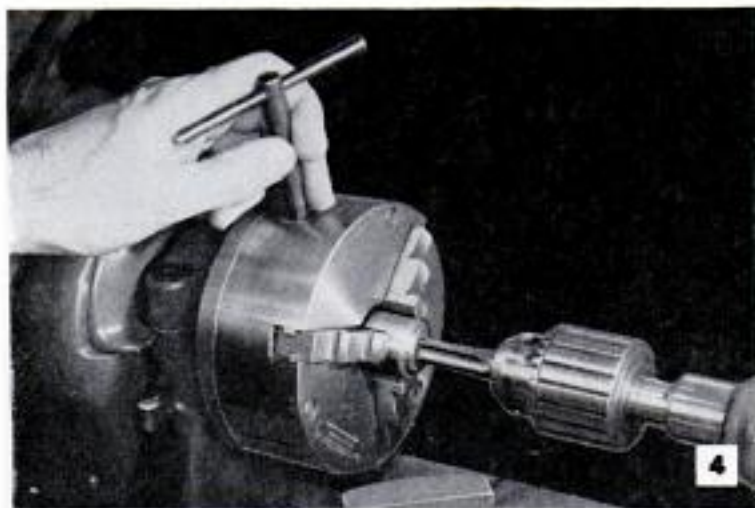

Tapping counterbore in the round base can be done in the lathe or in a drill press. Use a bottom tap for full-depth thread

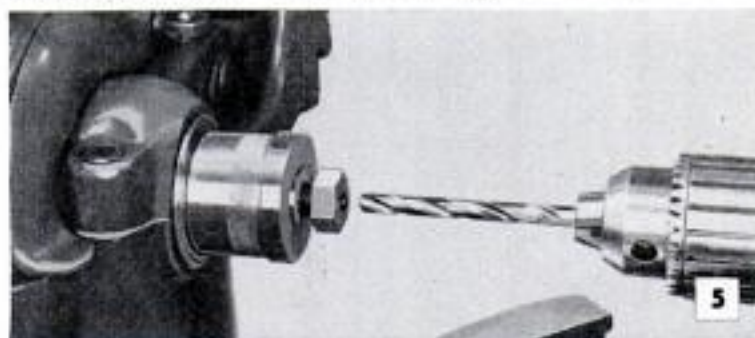

Drilling the pivot bolt axially also can be done in the lathe or drill press. Hole is for insertion of $\frac{1}{4}$ -in. attachment bolt

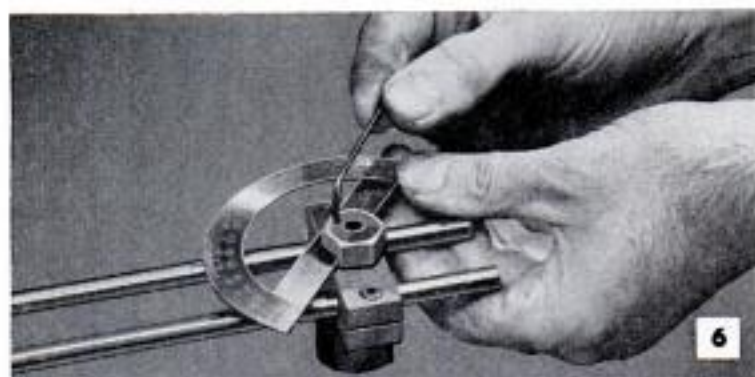

Above, a protractor is fitted into a slot cut in the head of the pivot bolt as in detail on opposite page. Protractor is held in place with setscrew. Below, circle tool can be attached to work or bench top. Works on full circle or any size segment

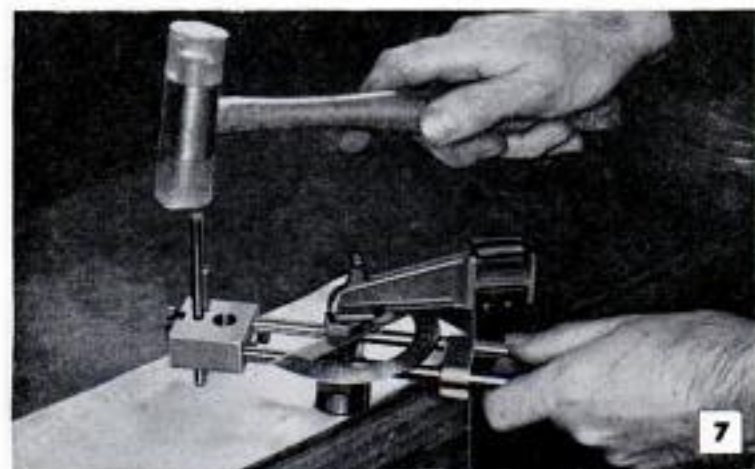

slotted across one edge, the slot forming a slide for the tool, which is held in place by a flat spring as indicated. The spring is attached to the block with an 8-32 screw, Fig. 10. The finished head, with the parts in relative positions, is shown in Fig. 8. Note in Fig. 10 that the head is supported in the horizontal position by a $\frac{1}{8}$ -in. pin. The center-to-center distance of the holes for the rods should be $1\frac{1}{16}$ in., although the dimension is not critical.

The base consists of three parts, the pivoting head, which is similar to the tool head except that it is of $\frac{3}{4} \times \frac{3}{4} \times 2\frac{1}{4}$ -in. stock, the pivot bolt and the round base. The $\frac{1}{2}$ -in. pivot bolt, Fig. 9, is turned into a tapped counterbore in the round base. The hole in the base is threaded with a bottom tap, Fig. 4, and the bolt is turned in through the swiveling head as in the sectional view, Fig. 9. It will probably be necessary to file the end of the bolt to permit it to be turned in tightly and yet allow the head to swivel without undue play. Note that the bolt is drilled lengthwise as in Fig. 5 to permit insertion of a $\frac{1}{4}$ -in. bolt for attaching to the work. Slot the head of the pivot bolt for the protractor, which is held in place with an 8-32 setscrew as in the left-hand detail, Fig. 9, also Fig. 6. Some protractors of the type used will require notching as indicated by the dotted lines. A snap band of sheet metal cut with an indicating point on one edge, is bent to a friction fit over the two rods in the position shown in Figs. 9, 10 and 11. An index mark is made on the indicator point as in Fig. 9. Note how the swiveling block is slotted in from both ends, forming clamps that are tightened with setscrews to hold the rods in the desired position. The screw holes are counterbored, the counterbore for the head and body of the screw being made in one jaw of each clamp.

Figs. 2 and 3 show the various tools and how they are used in the unit. Tools with $\frac{1}{2}$ -in. round shanks are held in the round hole of the same size drilled in the head, Fig. 3. Square-shanked tools are held in the groove in the head as in Fig. 1. Figs. 1 and 7 show the unit clamped to the work and to the bench top. ★ ★ ★

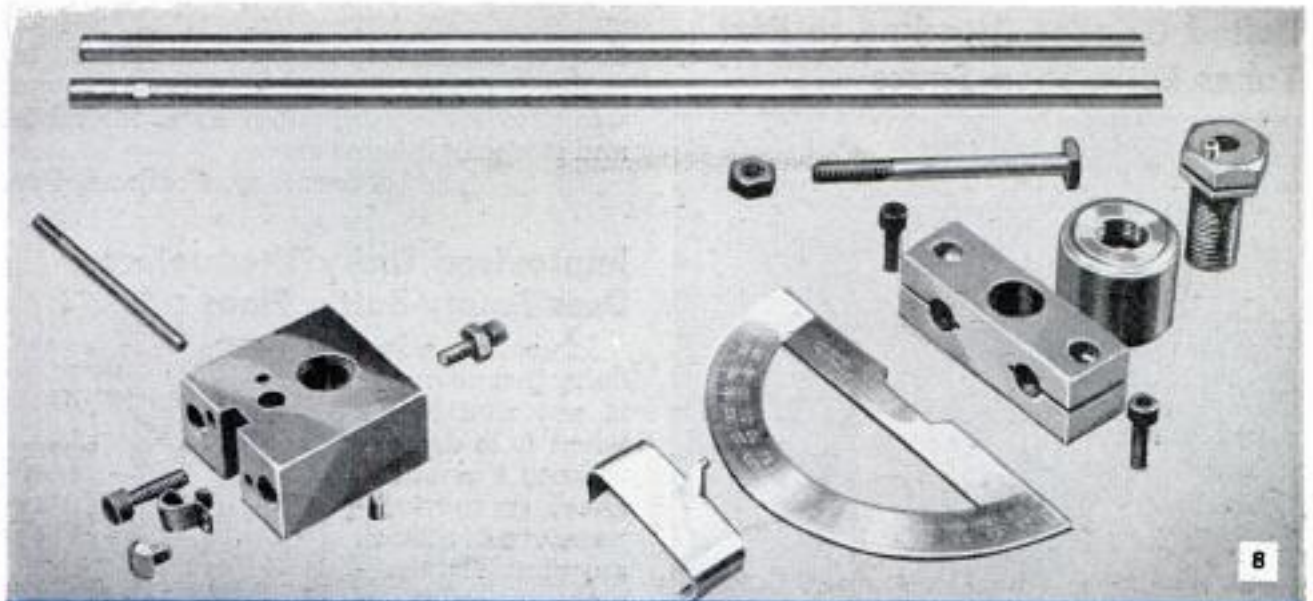

8

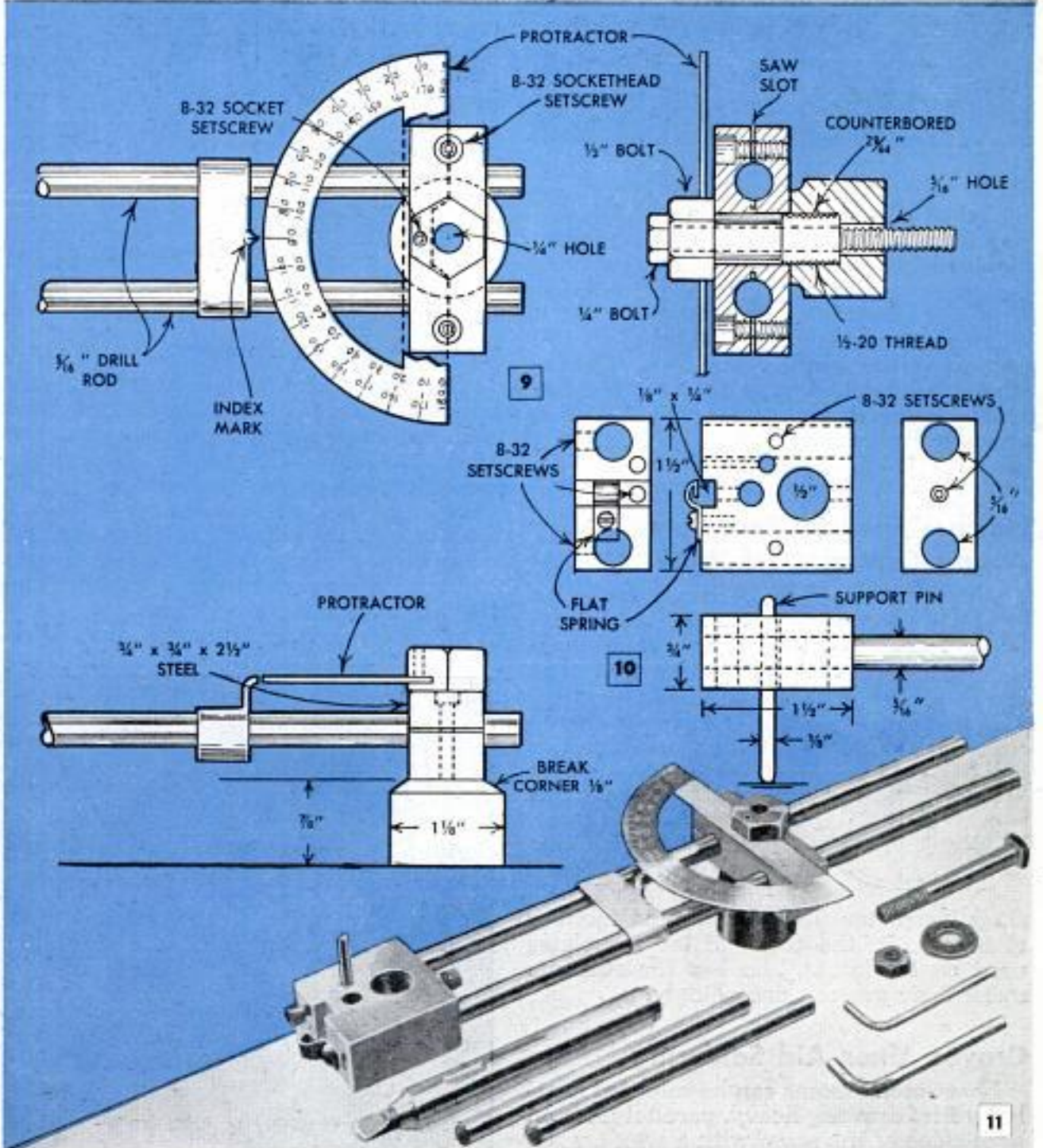

11

Belted Grinder Attached to Post Takes Little Shop Space

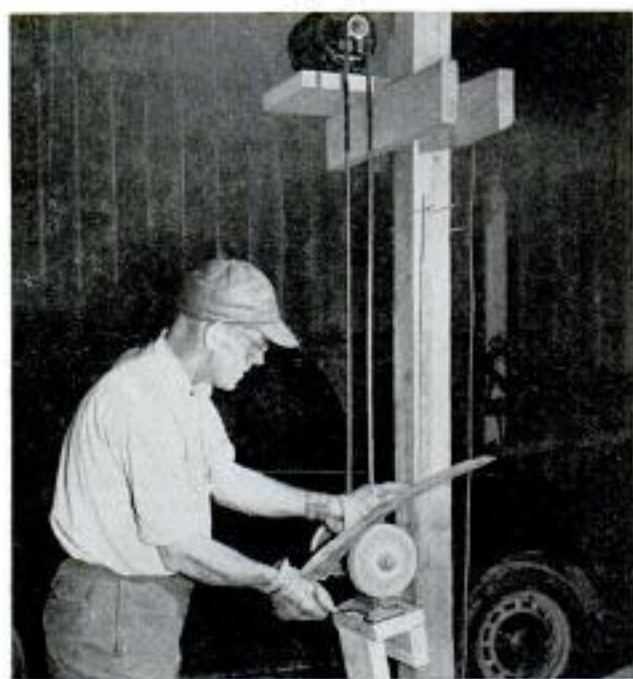

Mounted on scrap lengths of 2-in. stock nailed to a post as shown, a grinder will require a minimum amount of space when installed convenient to a work area in a garage or tool shed. The electric motor is kept free of grinding dust by mounting it on crosspieces attached to the beam several feet above the grinder. The grinder never should be installed in an area where flammable materials near by, or on the floor, create a fire hazard.

G. E. McVickar, Bethesda, Md.

Notches Filed on Faceplates Assure Centering of Work

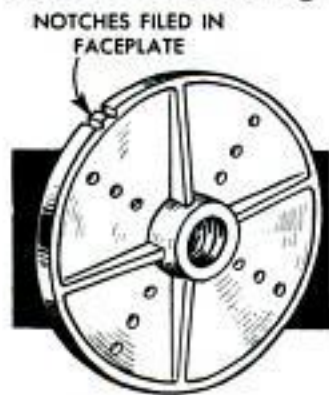

Because the screw holes in various lathe faceplates are not drilled in identical locations, changing work from one plate to another will throw the work off center. To overcome this problem, one woodworking-shop instructor filed a different number of notches in the edges of the faceplates used on his lathes, and has the students mark their projects accordingly.

Crayon Lines Aid Soldering

Sheet-metal seams can be soldered neatly by first drawing heavy, parallel lines on both sides of the seam with a wax crayon

and ruler. The wax usually will check the flow of the solder and, in the event the solder does overflow onto the lines, the wax will prevent it from adhering to the metal and simplify later removal.

Tom Riley, Portland, Ore.

Improvised Dairy Thermometer Uses Empty-Bottle Float

If a regular dairy thermometer is not available when it is desired to keep a constant check on the temperature of a fluid, any standard thermometer, plus an empty bottle, may be used as a substitute. The thermometer is fastened to the bottle with rubber bands

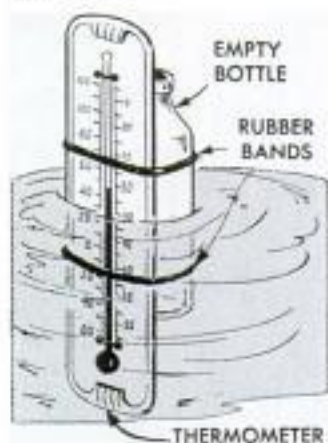

and can be adjusted to float at any depth by pouring a small amount of water into the bottle as ballast.

G. E. Hendrickson, Argyle, Wis.

Calking-Gun Nozzle Cleaned By Soaking in Thinner

The clogged nozzle of a calking gun, which usually is cleaned by boiling in an alkali solution, can be cleaned in a fraction of the time by soaking it in lacquer thinner. Simply pour a small amount of the thinner into a glass jar and drop the nozzle into it. A few hours of soaking will completely clean a badly clogged nozzle. *Caution:* Lacquer thinner is highly flammable. Keep away from flame.

Ken Murray, Colon, Mich.



Taps and Button Dies Held in Knurled Sleeve on Hollow Arbor

Sliding on a hollow arbor held in the tailstock, a knurled sleeve will permit controlled threading and tapping in a lathe with regular taps and button dies. The end of the sleeve is machined to receive bushings with various inside diameters to accommodate several sizes of dies and taps. A setscrew in the sleeve locks the tap or die in place. In use, the work to be threaded is turned by the headstock, and the tailstock wheel is used to bring the tap or die against the work. Holding the knurled sleeve allows the work to be threaded, and releasing the sleeve allows it to turn freely on the hollow arbor. The lathe then is stopped, reversed and the sleeve is held to permit

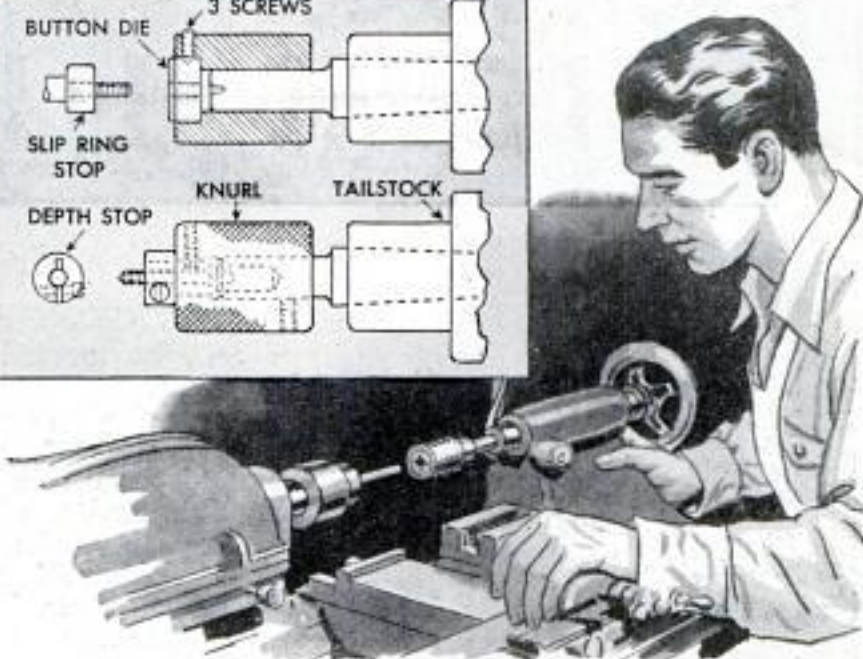
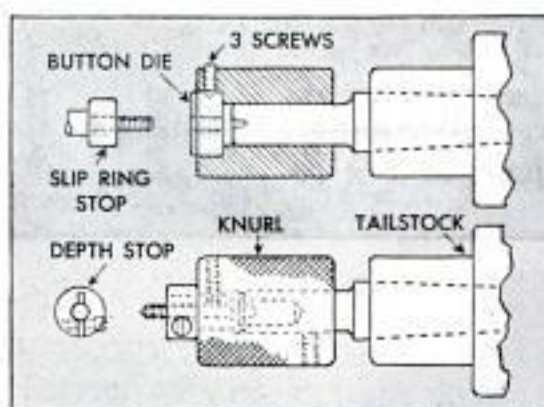

the tap or die to be withdrawn. A depth or slip-ring stop may also be used.

W. C. Betz, New Britain, Conn.

Seeder Mounted to Front of Tractor Provides Accurate Control

An endgate seeder mounted on the front of the tractor provides more accurate and flexible control than a towed wagon, when used in small or irregularly shaped fields or meadows. The seeder is supported by

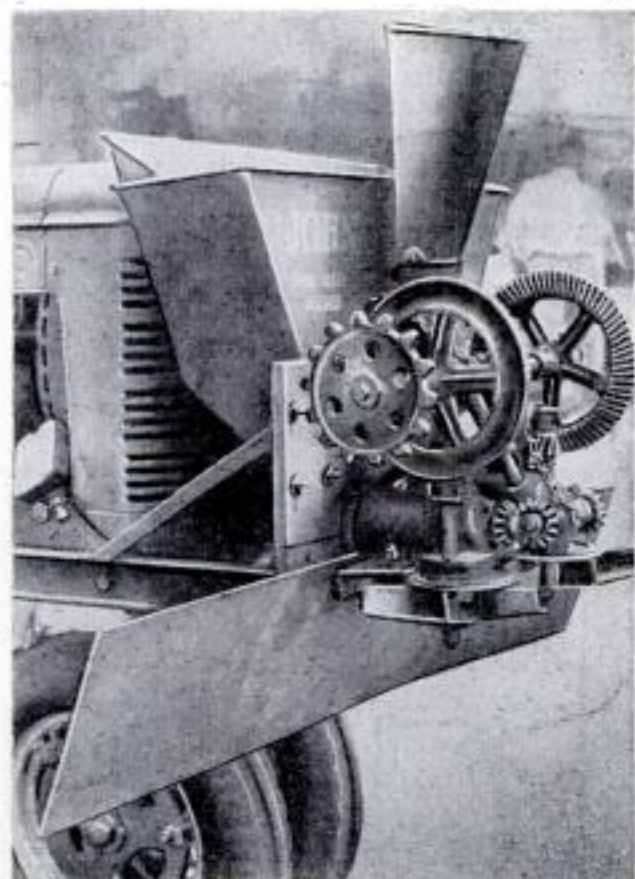

two steel channels, 3 x 24 in., bolted to the tractor frame, and is driven by a sprocket mounted on the belt pulley. A flat-link chain runs from the powered sprocket to the sprocket on the seeder. Various-sized sprockets will have to be tried, until a combination gives the right speed to the seeder when the tractor is run in high gear. A piece of sheet steel, 11 x 60 in., is mounted across the front of the tractor to act as a seed deflector.

A. M. Wettach, Mt. Pleasant, Iowa.

Spring on Large Vise Handle Prevents Pinched Fingers

A short length of coil spring can be used to overcome the finger-pinching tendencies of the sliding handle of a large machinist's vise. As shown in the sketch, the spring is stretched tightly around the handle and the end of the vise screw, and then the ends of the spring are hooked together. The handle will stay put in any position and yet can be moved easily.—Andrew Vena, Philadelphia, Pa.

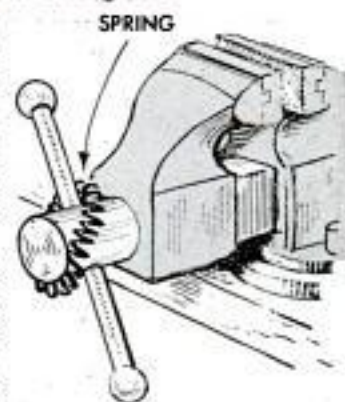

HOW TO CUT DOVETAIL JOINTS

By Sam Brown

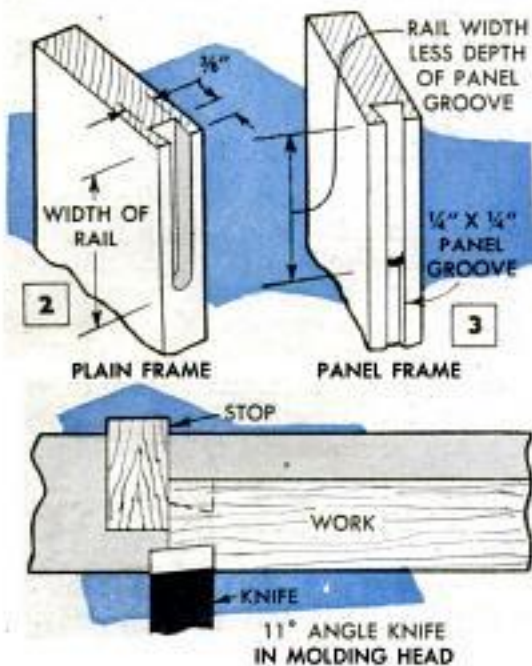
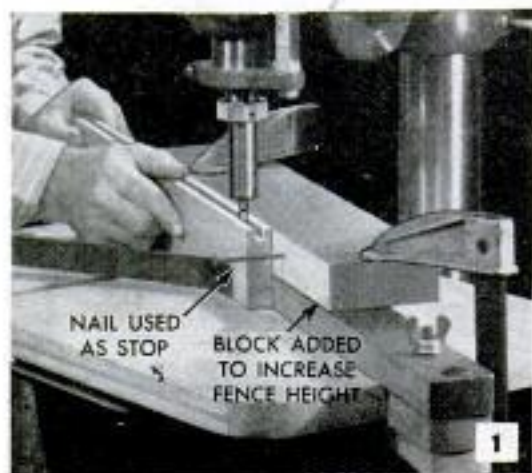

SELF-LOCKING and as strong as the wood itself, the dovetail joint is one of the oldest and best methods of wood joinery. Most familiar is the multiple-dovetail joint used in drawer construction in all the better-grade cabinets, but the single dovetail also has many applications. Both single and multiple dovetails are made in a variety of sizes. Dovetails cut on an 11-deg. angle are almost universally used in present-day joinery. In modern dovetail cutting the sockets and pins are spaced uniformly, but in older types of joinery the pins varied in relation to the spacing. In some cases only one or two pins were used, even on wide boards.

Dovetail grooving: Figs. 1 to 14 inclusive picture and detail methods of cutting dovetail grooves and matching dovetail tenons on the circular saw and drill press. When making a frame, Figs. 1 to 5, the groove is first cut with a router bit on the drill press as in Fig. 1. Note that a high fence must be used to support the work adequately. Note also in Figs. 2 and 3 that this type joint can be used when joining either a plain frame or a paneled frame. The matching dovetail tenon is cut on the circular saw as in Figs. 4 and 5, using a molding head on the saw arbor. After the first pass the work is turned over and the second pass made. The resulting tenon should be a sliding fit in the dovetail groove. As shown in Fig. 6, an allowance must be made in the depth of the groove to provide clearance for the end of the dovetail.

A similar procedure is used when joining rails to square legs, or curved legs to a single round column as in Figs. 7 to 14 inclusive. When routing

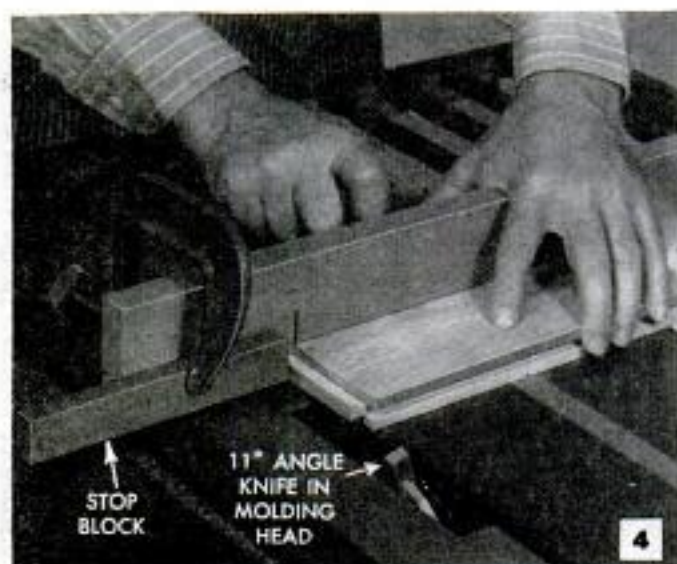

Details and photos at left and below show how to cut dovetail grooves and matching dovetail tenons. Joint is used when framing either plywood or raised panels. Groove is cut on drill press

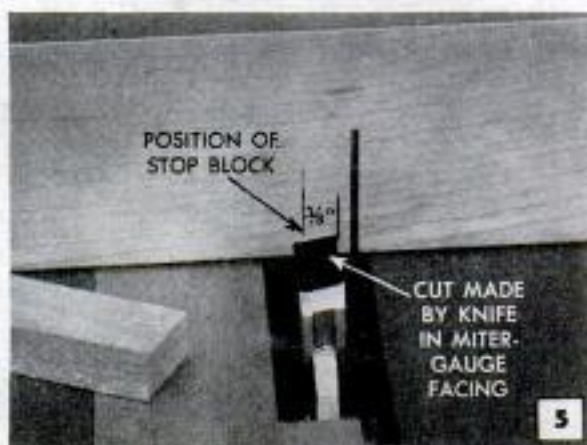

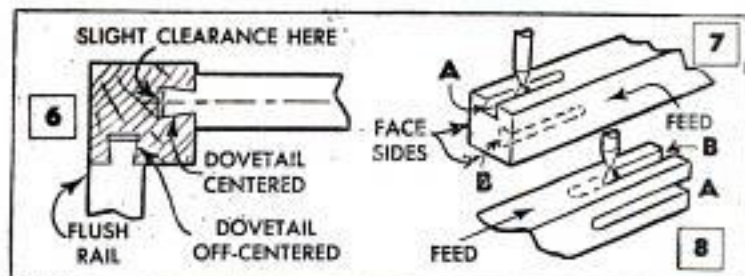

grooves on adjacent sides of the leg care must be taken to keep the proper sequence of operations so that the parts will assemble correctly. This is indicated in details A and B in Figs. 7 and 8. The grooves are run first with a straight router bit, then finished with the dovetail bit. Note in Fig. 6 how the tenon is offset when the construction calls for a flush rail.

Dovetail grooves in round work: When cutting dovetail grooves 120 deg. apart, Fig. 11, the work can be mounted between

indexing centers as in Fig. 12. When there are four legs the surface is sometimes squared with a router bit as in Fig. 12, this being the first operation after turning. Dovetail tenons are cut on the curved legs as in Fig. 14. Note in Fig. 11 that the dovetail shoulders, or cheeks, are curved slightly so that they join accurately to the curved surface of the column. This can be done by bandsawing to the correct contour.

Dovetail dados and sockets: Dovetail dado cuts are made in a manner similar to

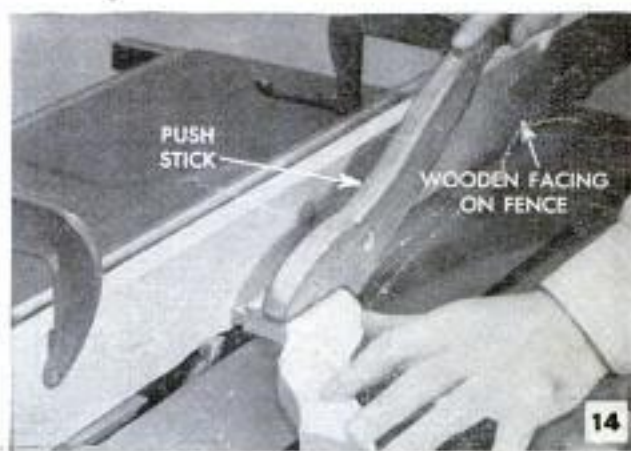
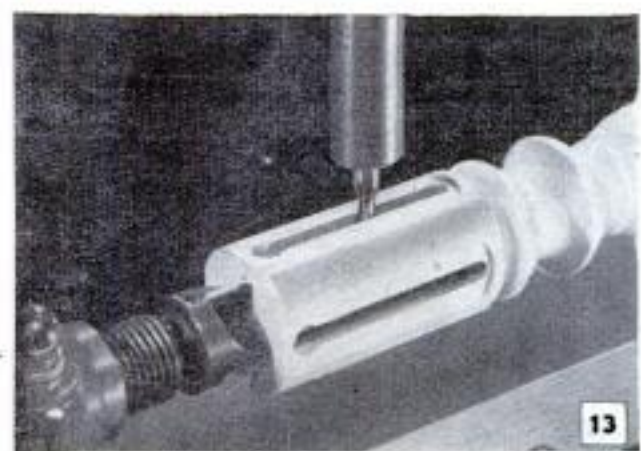
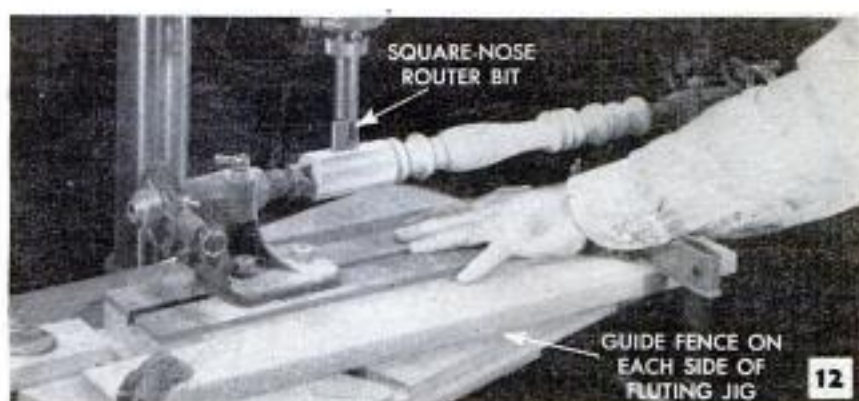
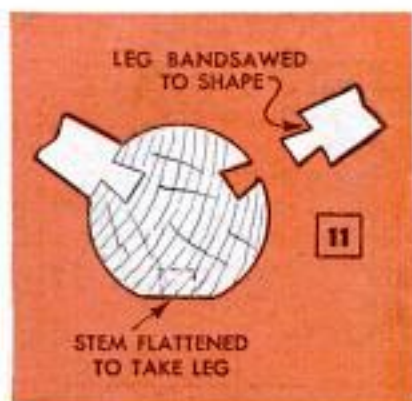

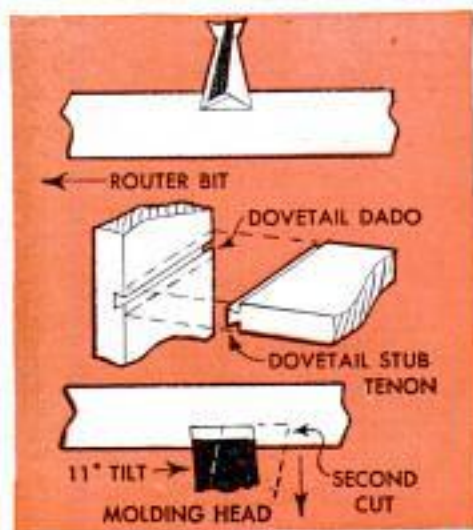
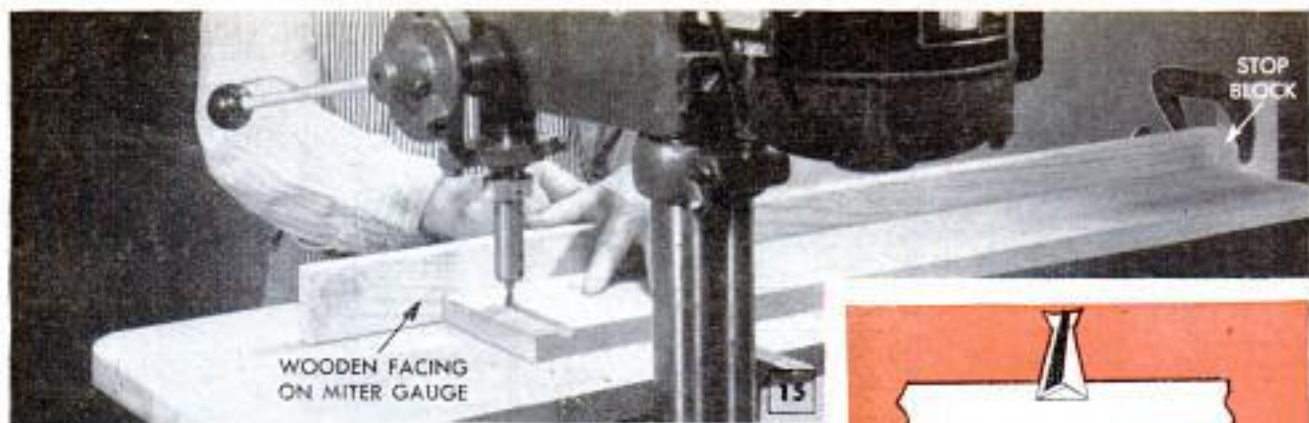

dovetail grooves except that the cut is made across the grain as in Fig. 15, using the drill-press setup pictured. Here a special table is bolted to the regular machine table and grooved for the miter gauge which is taken from the saw table to serve this purpose. A long wooden facing, carrying a stop, is screwed to the miter gauge. The dovetail tenon is cut as in Fig. 4. Another method of cutting the dovetail

is shown in Fig. 16, using the molding head tilted 11 deg. as in the detail at the right of Fig. 16. Although the molding-head setup is much the faster of the two methods, it is subject to possible error as the stock must be reversed for the second cut. Accuracy requires that the edges of the stock be parallel.

Single dovetail joint: Sometimes referred to as a pocket dovetail, this joint is often

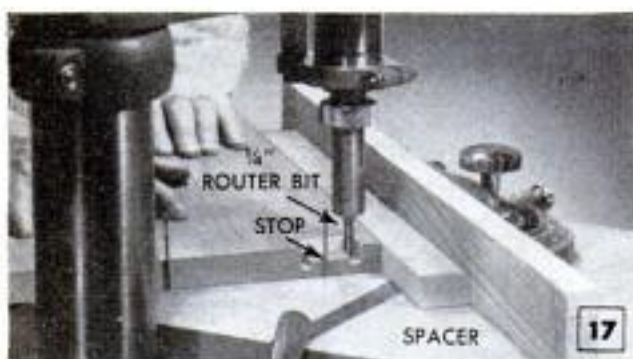

Above, first cut in making a pocket is made with a straight router bit in the drill press. Note spacer strip. Below, single matching dovetail is made with molding head as in Fig. 4, except that stock is on edge

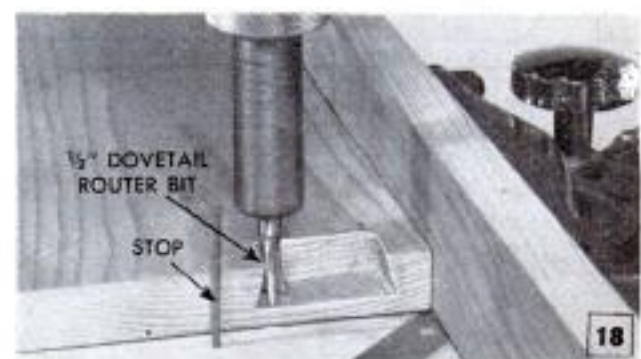

Above, after cutting pocket with straight router bit, job is finished with 1/2-in. dovetail router bit. Nail is used as stop in both operations. Below, in the finished joint dovetail should be snug fit in the pocket

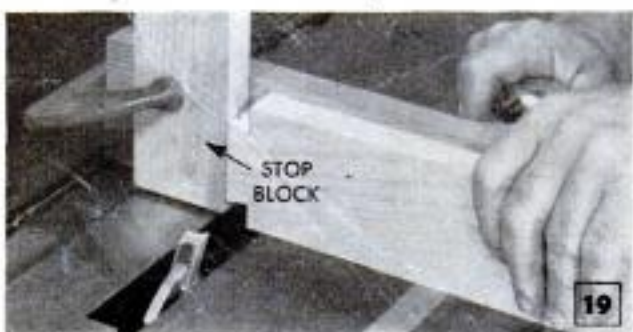

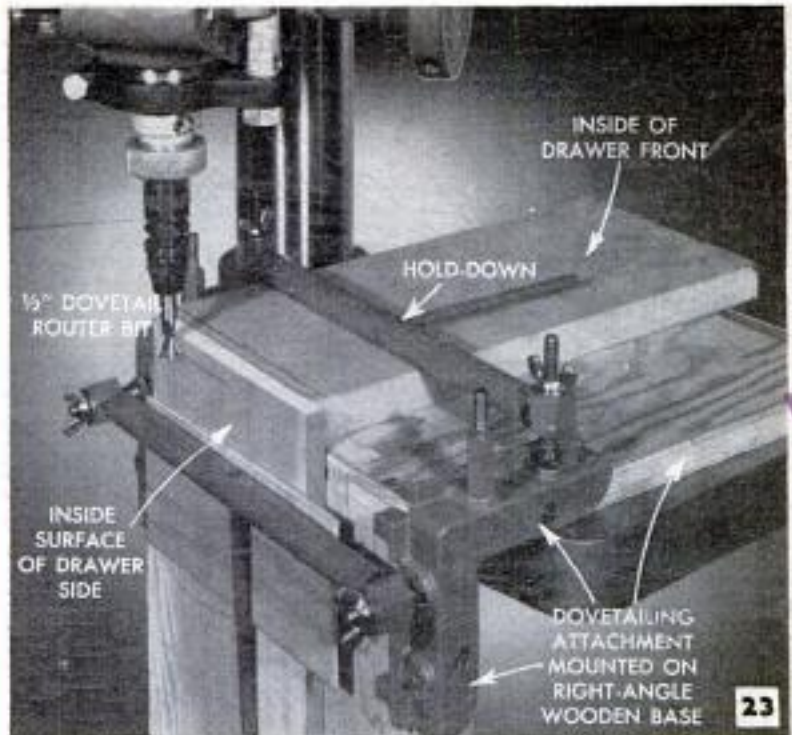
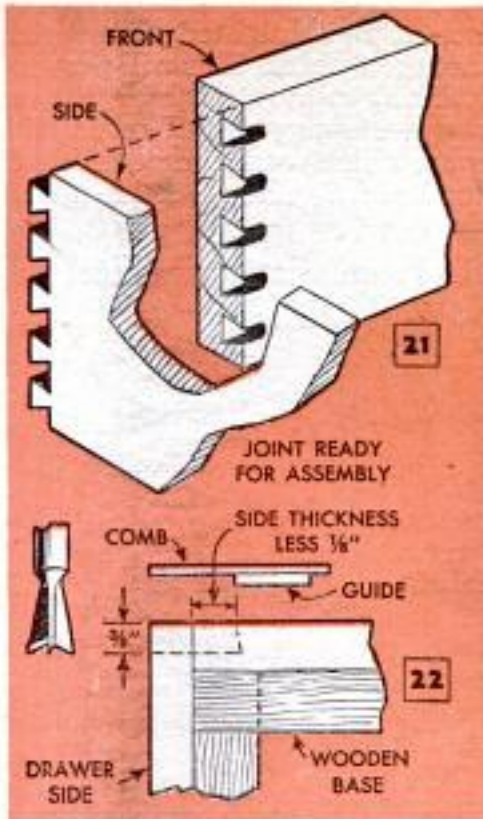

Multiple dovetails, such as used in drawer construction are the easiest of all to cut with the aid of the dovetailing jig shown

used to join top rails to legs or panels in cabinet construction. This type of joinery was much favored by older cabinetmakers. Fig. 20 pictures a typical example. Usually it is best to cut the socket, or pocket, first. This is first cut square as in Fig. 17, using a $\frac{1}{4}$ -in. square-nosed router bit. Use a spacer strip for the run-in cuts. The width of the spacer should be equal to the width of the pocket minus $\frac{1}{4}$ in. Then, using the same setup, a $\frac{1}{2}$ -in. dovetail bit will make the angular side cuts as in Fig. 18. The matching dovetail pin is made with the setup shown in Fig. 19. It is the same as that in Fig. 4, except that the cuts are made with the work on edge. Care must be taken to make an accurate layout.

Dovetail drawer joints: These are the easiest of all to cut as you use the dovetail jig pictured in Figs. 23, 24 and 25. When correctly set up this unit cuts the sockets and pins in one pass, a finger template, or comb, Fig. 22, guiding the bit for each cut. When the cuts are finished the parts join as in Fig. 21. No glue is used in the joint. Care must be taken when making the setup, Fig. 23. A weight, Fig. 24, helps to steady the sliding jig. Fig. 25 shows the completed cuts. ★ ★ ★

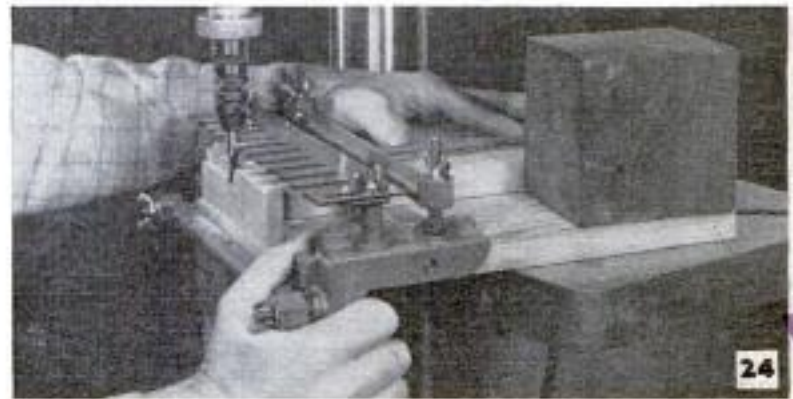

This is the jig assembled with two pieces of stock in place. In some cases a weight is needed to steady the sliding jig

The cut partially completed. Photo shows finger template which guides the dovetail bit. Joint is finished in one pass

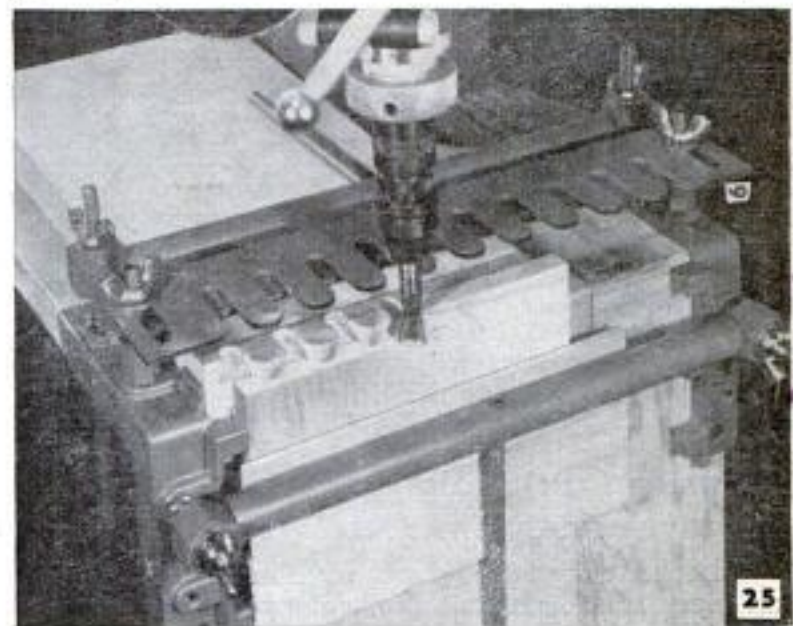

Leans, Rabush & Company

How to Mount Heavy Shelving Above Workshop Floor

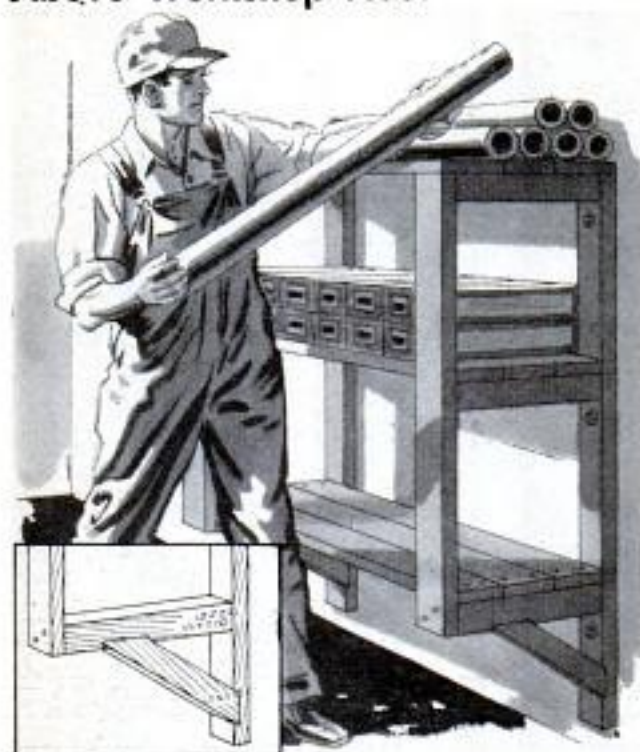

In a garage or workshop where the floor is frequently swept or washed, a 45-degree angle brace can be used to provide simple framing for heavy-duty shelving. As shown in the detail, the ends of the braces are mortised into both the vertical and horizontal pieces and fastened with lag screws. The vertical piece of the framing is lag-screwed to the wall studding. For most shelving, the braces should be spaced no more than 4 ft. apart.

Modified Implement Wheels Provide Sturdy Sawbuck



Two implement wheels, plus an axle or length of steel pipe, will provide a strong and easily made sawbuck. Cut off the rims and all but four of the spokes of each wheel as shown in the detail. Welding the pipe or axle to the hubs will make the sawbuck more rigid.

Soapstone on Straightedge Improves Acetylene Cuts

When cutting small parts by hand with an acetylene torch, using a straightedge as a guide, rub a heavy coating of soapstone

over the face of the straightedge on which the tip of the torch glides. This will prevent slag from sticking to the straightedge, thus avoiding work stoppages and increasing the speed with which work can be finished.

Claudie H. Sanders, Portland, Ore.

Automatic Transmissions Filled With Modified Oil Measure

A regular 1-qt. oil measure can be modified to overcome the difficulty of reaching the filler tube on automatic transmissions, which on most cars is located down low and to the rear of the engine compartment. Braze or solder a pipe nipple to the spout of the oil measure, first grinding the pipe to a size that will slip inside an 18-in. length of $\frac{3}{4}$ -in. o.d. rubber hose. Fasten the hose to the nipple with a regular automobile-heater-hose clamp.



Phil McCafferty, Fort Bliss, Tex.

Bearings Used as Bushings

Bronze electric-motor bearings make ideal reducing bushings for adapting pulleys with a large i.d. to fit a smaller shaft. The bushings have various wall thicknesses, such as $\frac{1}{2} \times \frac{5}{8}$ in. and $\frac{1}{2} \times \frac{3}{4}$ in., allowing a considerable range of sizes. By lining up the oil slot with the setscrew on the pulley, a tight, positive fit is assured.—Ralph E. Moore, Wenatchee, Wash.

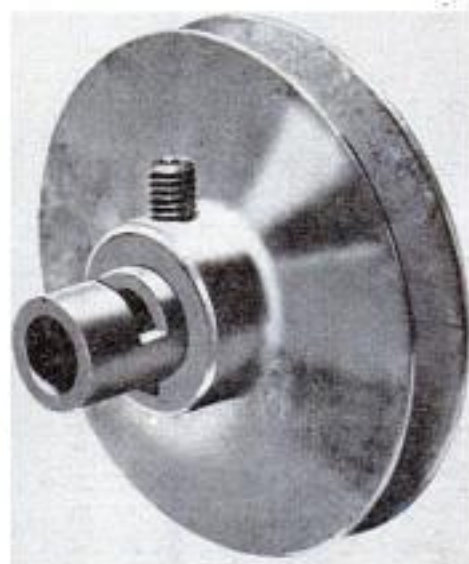

Improved V-Block Has Five Working Surfaces

By Paul R. Dube

Ordinary V-blocks used by machinists and toolmakers are limited in machineable and surface-plate applications due to the external clamp. At most, only three surfaces are usable, the bottom and the two ends. The clamp prevents use of the block on either of the two sides. The V-block detailed at the right provides five working surfaces, all square with those adjacent. The opposite sides and ends are ground parallel. A special clamp slides internally, the two arms fitting into parallel slots milled one on each side of the vee and equidistant from the center line of the block. The slots are made by drilling holes through the block lengthwise, then milling grooves to the holes. The arms of the clamp are shaped as indicated with rounded ends milled and ground to a true radius and sized to fit in the slots with sufficient clearance for easy insertion and removal. Dimensions of the block can be altered to suit individual requirements but proportions should be kept reasonably close to those indicated. An oil-hardening steel is used for the block. After the machining is done the block is hardened, quenched in oil and the temper drawn to a blue color. After hardening, all dimensions must be checked and the block re-ground if necessary. The clamp can be made deeper if desired. Some machinists prefer to break all corners on the block $\frac{1}{2}$ in. for ease in handling. This prevents chipping and avoids any possibility of hand injury due to the sharp corners. Note that there is a $\frac{3}{16}$ -in. chip-clearance groove milled in the bottom of the vee.

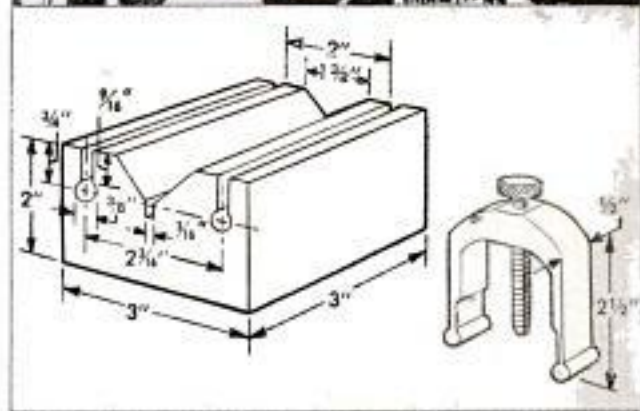
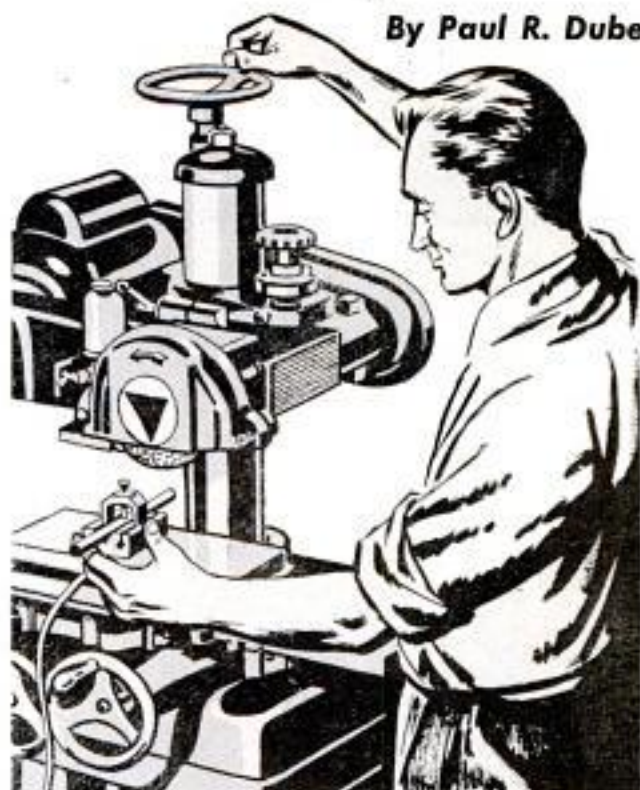

Liner for Watering Trough Made From Sheet Aluminum

For an easily cleaned liner in a watering or feeding trough, use sheet aluminum, which will never rust, rot, mildew or de-



teriorate from exposure to weather. Supplied in several gauges and patterns, the metal can be worked easily with hand tools and is available now at most hardware stores. Be careful to see that the aluminum does not come in contact with steel at any point, as an electrolytic action will result, which destroys the aluminum in the area of contact. Use aluminum nails or screws to fasten sheet aluminum in place.

Edges of Masking Tape Sealed With Stitching Tool

To prevent paint from creeping under the edge of masking tape, due to the fact that the edges of the tape are not firmly in contact with the surface, use a vulcanizer's stitching tool or a wallpaper seam-roller along the edge of the tape. The tool will press edges of the tape down tightly.

SHOPPING FOR TOOLS



1. PORTABLE WORKSHOP consists of a stationary table and five portable power tools, each of which can be detached and used individually. Table provides space for mounting such portable electric tools as a drill, sander, circular saw, grinder and a router-shaper
Porter-Cable Machine Co., 31 Exchange St., Syracuse 3, N. Y.

2. COMBINATION VISE AND DRILL is arranged to attach to a truck bed or a bench with one bolt. Vise swivels through 360 deg. and can be detached from anvil base. Drill is clamped in vise jaws as pictured. Swings 11 in., is hand operated with pressure screw
American Knut'ac Co., Box 600, Saginaw, Mich.

3. DISPOSABLE TAPE is marked on 16-in. centers so that when placed on the plate or sill, studs, joists and rafters are quickly and accurately spaced for nailing. Can be applied by hand or with the special dispenser pictured to effect an added saving in time
Minnesota Mining & Mfg. Co., 900 Parkview St., St. Paul 6, Minn.

4. CHOP SAW saves time when cutting a quantity of material to length, either square off or at an angle. Designed to mount an 8-in. electric handsaw with a special attachment for lifting the blade guard on the downstroke and lowering it on the upstroke
Edker Pope Co., 1527 E. 7th St., Los Angeles 21, Calif.

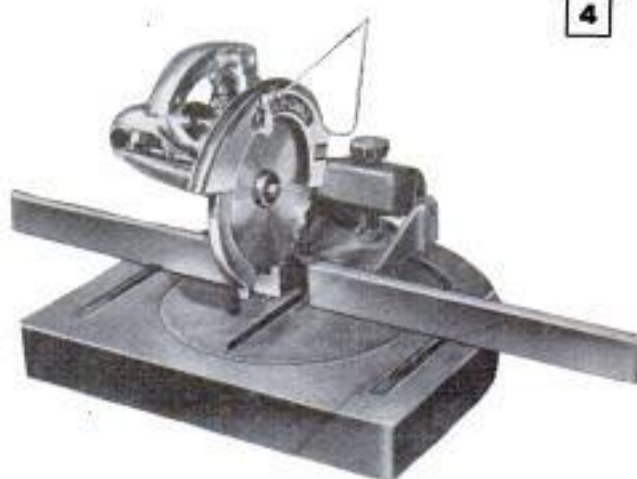
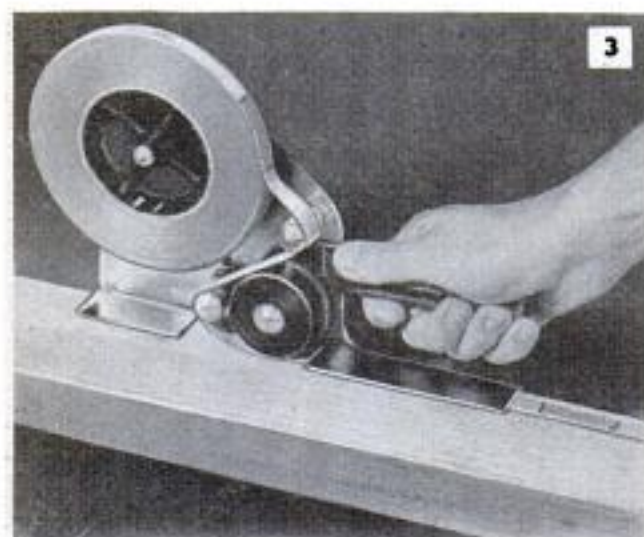

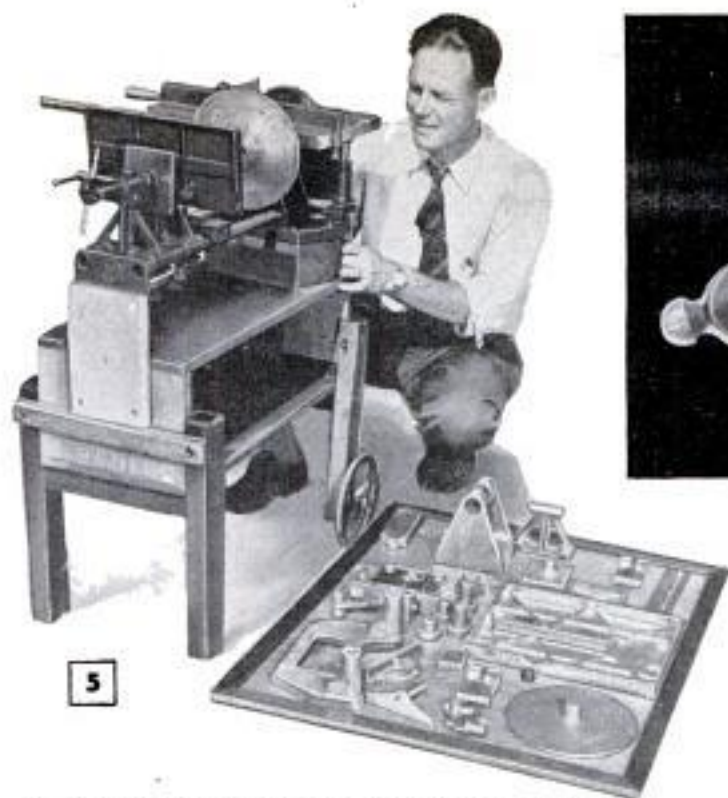

5

5. COMBINATION HOME-SHOP POWER TOOL can be built from the castings pictured. Assembled unit consists of saw, lathe, drill press, sander and grinder. Aluminum-castings kit comes complete with blueprints
 Multicraft Co., P.O. Box 6, Mt. San Antonio College Sta., Walnut, Calif.

6. NYLON HAMMER CAP fits standard ball-peen and claw hammers, making a "soft" hammer of either type for use on parts which must not be marred or broken by hammer blows. Available in five sizes
 Lemco Automotive, Inc., Cleveland 27, Ohio

7. SHEET-METAL SAW is made like an ordinary carpenter's handsaw, except that it uses a standard narrow hacksaw blade with 32 teeth per in. for cutting thin sheet metal without buckling or binding
 James Neill & Co. (Sheffield), Ltd., Napier Street, Sheffield 11, England

8. FOLDING SAW for campers and woodsmen has a pivoted blade that folds into the wooden handle for carrying. Blade has 6 teeth to the inch. Unit is only 10 in. long when folded. Tang has eye for belt loop
 Swedco, P.O. Box 465, Greenwich, Conn.

9. SPINDLE SHAPER in build-it-yourself kit comes with ball-bearing spindle mechanism assembled ready to mount under a wooden table. Kit includes shaper fence, screws and bolts and complete instructions
 Gilliom Power Tools, St. Louis 21, Mo.

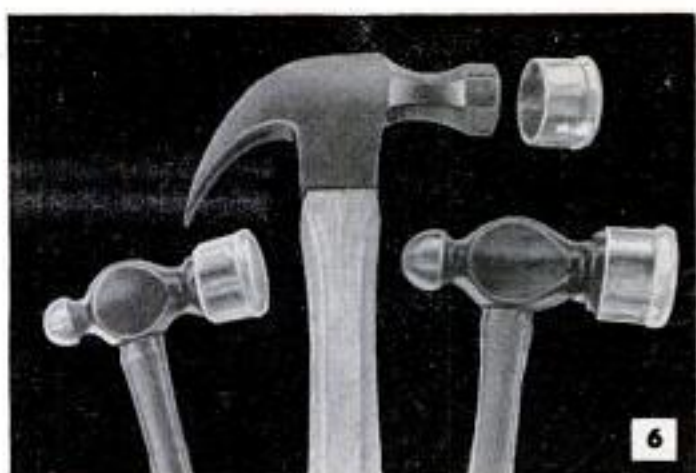

6



7



8



9

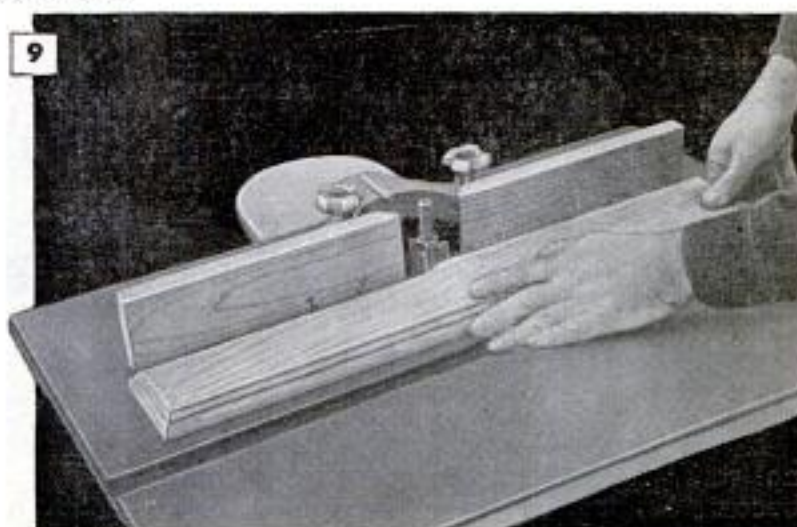

Low-Bed Cart Saves Labor When Lifting Milk Cans



To save labor in handling milk cans around his dairy barns, one farmer uses this three-wheel cart. Its low bed eases the labor of lifting filled cans, and the single rear wheel permits making sharp turns. Rubber tires allow the cart to roll over rough floors or ground with ease and reduce noise to a minimum.

John Krill, North Lima, Ohio.

Simple Filter for Liquids Utilizes Two Bottles



Ordinary drain oil will be filtered clean enough to be used to rustproof tools.

W. F. Schaphorst, Newark, N. J.

Graphite Aids in Removal Of Soldering-Iron Tip

If the tip of an electric soldering iron is not removed occasionally, the threads will become oxidized and eventually seize. This makes removal difficult and, in some cases,

makes drilling of the tip necessary. Seizing of the tip can be prevented by rubbing a little powdered graphite into the threads before replacing it.

Harry J. Miller, Sarasota, Fla.

Ax Held by C-Clamp in Vise For Sharpening With File

To use a file effectively to sharpen an ax or hatchet, the blade should be held in a horizontal position. It can be done easily by using a C-clamp held in a vise, as shown. File against the edge of the blade to prevent a burr. — R. W. De Cesare, Vallejo, Calif.

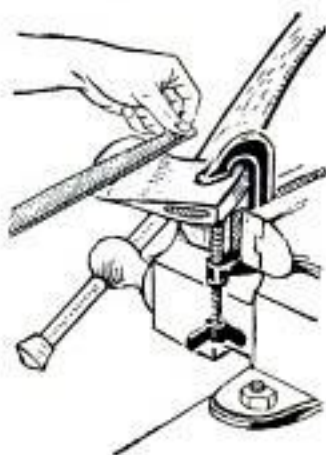

Self-Filling Hog Waterer Made From Oil Drum

The hog waterer shown in the illustration was made by cutting an opening in the side of a 50-gal. oil drum. A float valve then was installed in the drum and a board placed in front of it to protect it. The hole in the drum is large enough to allow hogs to drink, but small enough to keep them from sticking their feet into the water.



☞ Silk lamp shades should be cleaned with dough wallpaper cleaner instead of a brush.

Get Prize-Winning Pictures and Enlargements

WITH THIS BRAND NEW GRAPHIC-GRAFLARGER

TAKE 'EM, MAKE 'EM OUTFIT!



ONLY \$199.50
Complete in Home Storage Case

Camera fans! Here's an outfit that will enable you to take and make the best pictures you ever had! Think of it . . . you get a real press-type Century Graphic camera and a true precision enlarger for little more than you'd pay for the camera alone!

Your Century Graphic with the famous Grafmatic Sheet Film Holder, has the amazing versatility to conquer almost any photographic problem. The Graflarger, with its cold light illumination, sturdy, precision stand and handsome baseboard, is just what you need to make superb enlargements (up to 11 x 14) from your negatives. Here's a combination—at a price—that can't be beat! See your dealer today!

GET ALL THIS FOR AS LOW AS \$19.95 DOWN

1. CENTURY GRAPHIC 23 with 103 mm., Graftor f/4.5 coated lens in Century synchronized shutter.
2. GRAFMATIC SHEET FILM HOLDER
3. GRAFLARGER COLD LIGHT BACK converts Century Graphic to a precision enlarger.
4. GRAFLARGER STAND holds combination rigidly, yet is easily adjusted.
5. Rigid, moisture-proofed, 18" x 30" baseboard.

DO IT YOURSELF

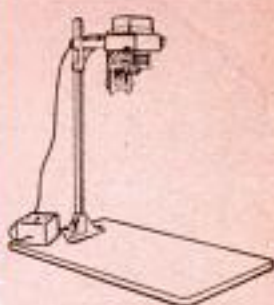

Used vertically, your Century Graphic-Graflarger gives enlargements up to 11" x 14".

HAVE MORE FUN

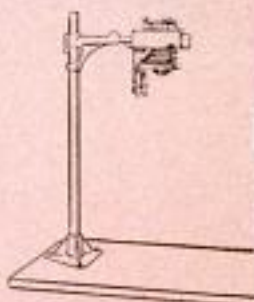

The Graflarger makes an excellent copying stand for the Century Graphic. Long bellows extension permits 1:1 copying.

SAVE MONEY!

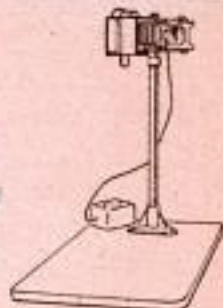

Used horizontally, your Century Graphic-Graflarger may be used for making big enlargements or murals.

FOR FULL INFORMATION

MAIL THIS COUPON



GRAFLEX®

Prize-Winning Cameras

Graflex, Inc., Rochester 8, N. Y.



GRAFLEX, INC., Dept. PM-19, Rochester 8, N. Y.

Please send me full information on your new "take 'em and make 'em" outfit.

NAME _____

ADDRESS _____

CITY _____ ZONE _____ STATE _____



Million-dollar thrill for as little as **\$5²⁵**

—watching your first photo
appear out of nowhere

**Now it's so easy to print your own snapshots!
You can do it with the room lights on!**

Watch a picture you've taken appear as if by magic on a blank sheet of paper in the developing tray. We wager you'll get the thrill of a lifetime!

It's all so easy with the Kodak Velite Paper that's included in Kodacraft Outfits. You can print a picture in daylight or under any type of electric light ordinarily used in your home.

The pictures below show how really simple it all is. *As little as \$5.25 can start you off.* Your best friend to see is your Kodak dealer.



Kodacraft Photo Developing and Printing Outfits

are designed for ease of use, contain all basic equipment. Kodacraft Printing Kit, \$5.25; Kodacraft Photo-Lab Outfit (illustrated), \$9.75; Kodacraft Advanced Photo-Lab, \$14.95.



Expose 20 secs. Place negative and Velite Paper in printing frame and expose with 100-watt bulb in reflector of gooseneck desk lamp at 8 inches.



Develop 60 secs. Remove Velite Paper and place in developer. Rock tray gently. Picture will appear in about 60 seconds. You'll scarcely believe your eyes.



Use stop bath 15 secs. Next drop into stop bath and agitate 15 secs. (Isn't this an easy way to make extra prints for friends—or personal photogreeting cards.)



Place in fixer. Take print from stop bath and place in fixing bath. Soak for 5-10 minutes. Wash in running water—then dry in blotter.

No elaborate equipment needed to become expert at this hobby

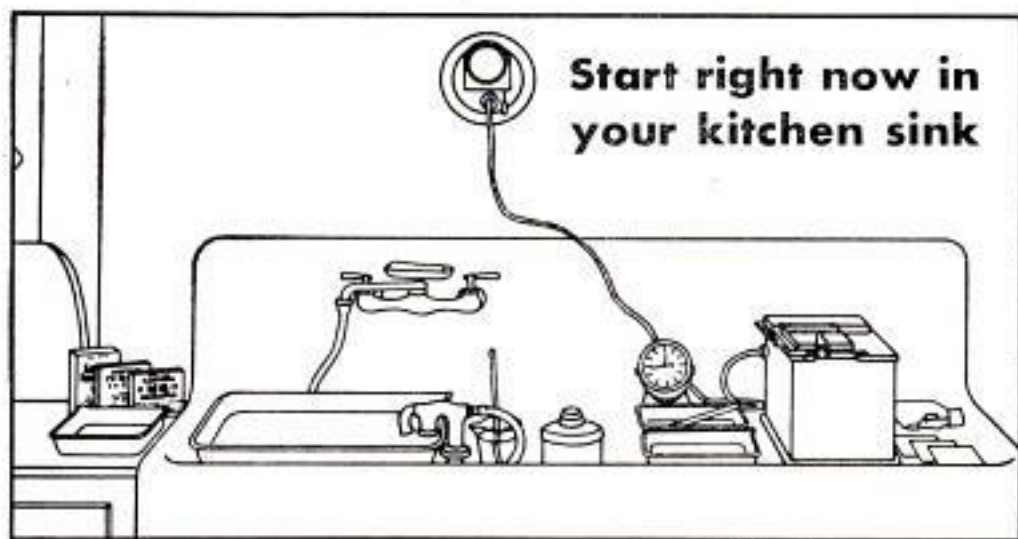

Once you've enjoyed the thrill of printing your own photos and gained some experience, you'll want to develop your own film—and eventually make big, dramatic *enlargements*.

The modestly priced Kodacraft Photo-Lab Outfits have everything you need to start off. Later on, as you advance, you'll want to add such pieces of Kodak equipment as are shown below. Equipment arrangement should allow a smooth flow of work from printing frame through de-

veloper, stop bath, fixing, and washing with everything compactly grouped so operations can be performed with a minimum of steps. If there's no lamp socket over the sink, safelight can be placed on extension cord.

Your Kodak dealer can give you valuable help on this project. Among the literature available is the booklet, "Developing, Printing and Enlarging," which you'll find extremely useful. Why not see him before the weekend?



Time-saving print dryer. Kodak Photo Blotter Roll prevents prints from curling. \$2.88



Handy combination funnel. Kodak Combination Funnel provides 3 sizes of funnels. \$.85



Low-cost timer. Kodak Timer (with split-second hands) can be restarted without resetting. \$7.95



Automatic print-washing. Kodak Automatic Tray Siphon attaches to water faucet. \$4.50



2-way safelamp. For enlarging, black-out kitchen window—use Kodak 2-way Safelamp. \$4.50

Popular-priced enlarger complete with lens. Kodak Hobbyist takes negatives up to 2 1/4 x 3 1/4 inches. "Cold-light" protects negatives. New-type, easy loading. \$57.50

Prices are subject to change without notice



Eastman Kodak Company
Rochester 4, N. Y.

Kodak
TRADE-MARK

Care and Feeding of Engines



BY
S. P. CORP

SPARK PLUG CARE

When tuning up, be sure to sand-blast electrodes and porcelain on all plugs, to remove metallic oxide coating. Then inspect threads to make sure they are sharp and not rounded off. Rounded threads will not form a good seal with threads of the cylinder head, and will cause loss of power. Take an old plug, with good sharp threads, and cut a groove through the threads with a 3-cornered file. Use this plug as a die to cut the carbon from the threads in the cylinder head. Then remove plug and clean cylinder head threads with compressed air before installing new plug. Such carbon causes poor plug performance by restricting heat transfer, and can cause a compression leak.



FILE NOTCH
IN THREADS



HOT PLUG LONG INSULATOR
COLD PLUG SHORT INSULATOR

Individual engines operate under varying conditions. If an engine runs cool, a hotter plug will increase operating efficiency. Such a plug has a longer white insulator and retains heat to burn oil vapor that may get past valve guides, in worn engines. Do not use a hot plug in an engine with good compression. Cool plugs, with very short insulators, should be used only if engine operates under very hot running conditions. Be sure your new plugs have sharp threads to make a good seal in the cylinder head.

DOES YOUR STARTER JAM?

Then get a starter wrench. Remove live wire from battery, hot wire from starter, and use starter wrench to remove starter from engine. Clean screw drive and pinion with kerosene (not gasoline!) and check pinion spring for possible damage. Lubricate drive screw and pinion with engine oil. Make sure armature shaft is not bent; see that drive spring screws are tight. Then remove any burrs from teeth of starter ring gear, as these could cause starter pinion to jam.

VALUABLE MANUAL FREE!



When you re-ring, give your engine the heat-fighting, friction-fighting endurance of the finest in chrome rings—KromeX Ring Sets! Millions of road miles have proved their superiority. Write for the free illustrated manual, "MORE POWER, Less Gas, Less Oil," which may save you a lot of money. Address SealedPower, Dept. G-11, Muskegon, Michigan.

Sealed Power

PISTON RINGS

Clinic for Homemakers



As a service to our readers in solving the hundreds of problems pertaining to a home—inside or out—the editors of *Popular Mechanics* invite you to present your problems to The Clinic Editor for help and advice. Address your questions to The Clinic Editor, *Popular Mechanics Magazine*, 200 East Ontario Street, Chicago 11, Ill.

Damp Basement



Q—My problem is a damp basement. The walls are of poured concrete. The house is about two years old. There are drops of water on the walls nearly all the time. I thought this was condensation, but I have noticed that it seems to be a continuing condition regardless of temperature changes. What is the cause?

—M.R., N. Y.

A—Your description would indicate that the trouble is caused by a static head of water rather than condensation. Also it would indicate that the wall was not properly waterproofed at the time the house was built, as otherwise water would not pass through the wall from the outside. Sometimes an underground spring is the cause but more often it is due to water flowing from a higher to a lower level where it collects in quantity below grade. Under these conditions the water becomes trapped somewhere at a lower level and considerable hydrostatic pressure is built up, especially where poor-drainage conditions exist. This may happen only occasionally as there may be sufficient drainage to carry away the water over a period of time. It is possible that coating the inside surface of the walls with a masonry waterproofer would turn the trick, but we are inclined to be rather doubtful. However, a trial would not be expensive. We'd recommend it as the first step. If it proves unsuccessful, then the only alternatives are laying a drain tile or digging down along the walls to the footings and waterproofing the walls with hot asphalt.

Finish Bleeds



Q—The woodwork in my home was originally stained a dark color, what I presume was called mission oak. Recently I sanded the woodwork and applied a light-green semigloss finish to match the walls. Only a part of the woodwork is finished and I have lately noticed that the stain seems to be bleeding through in spots. Is there anything I can do to prevent this?—B.E., Iowa

(Continued to page 226)

Texaco



Tips on car care



How to keep your windshield from freezing over

Freezing rain, sleet or snow on your windshield is one of winter's worst driving hazards and can cause serious accidents. Good way to prevent freezing is to rub a *thin* film of glycerin on the windshield with a cloth. Be sure to wash off the glycerin film after the storm because it tends to collect road dirt.

How to get that "cushiony" ride

Turn all your driving miles into pleasure miles. Keep your car's chassis protected with *Marfak*. This tough, elastic lubricant clings to vital points of friction longer (note the "collar" of *Marfak* guarding the universal joint). *Marfak* resists squeeze-out, jar-out and wash-out, too. In your car, this means one thousand miles or more of *cushiony*, smooth riding. Drive in for longer lasting *Marfak* lubrication. See your Texaco Dealer . . . the best friend your car has ever had.



THAT "CUSHIONY" FEELING LASTS LONGER WITH



THE TEXAS COMPANY
TEXACO DEALERS
IN ALL 48 STATES

Texaco Products are also distributed in Canada and in Latin America
TUNE IN...TEXACO STAR THEATER starring JIMMY DURANTE or DONALD O'CONNOR on Television...Saturday nights, NBC.

Make your home look like new INSIDE and OUT with low-cost* Weldtex

Easy to apply...deep-grooved surface hides joints and nails.



BEAUTIFUL Weldtex panels on 8' x 12' wall with real wood for only \$27*. Put easy-to-handle 4' x 8' sheets right over old wall. Stain it, paint it or finish it natural.



GIVE CEILINGS, walls new and dramatic beauty with Weldtex squares. Cover a 12' x 15' ceiling with 12" or 16" pre-cut squares for approximately \$50*.



EASILY APPLIED Weldtex exterior paneling harmonizes with any architectural design, takes stain or paint beautifully. Panels 4' x 8' cost 33¢* a sq. ft.

*Prices vary slightly in different areas

SEE YOUR LUMBER DEALER

for literature, displays and prices



Weldwood®

REAL WOOD PANELING

United States Plywood Corporation

WORLD'S LARGEST PLYWOOD ORGANIZATION

Weldwood Building, 55 W. 44th St., New York 36, N. Y.
and U. S.-Mengel Plywoods, Inc., Louisville, Kentucky

(Continued from page 224)

A—You did not say whether or not you applied an undercoater under the new finish. This is usually recommended when painting or enameling old woodwork, especially that which has been finished in a dark color. As a rule you can rely on the undercoater to prevent bleeding of the darker color. Sometimes it is necessary or advisable to remove the old finish back to the bare wood. In your case, we would suggest that you select a door or window trim in an inconspicuous place, apply an undercoater and a coat of top finish in the color desired and note the results before going any further with finishing the remainder of the woodwork. If no discoloration shows after a week or so it probably is safe to proceed. On the woodwork already finished and which is showing discoloration, it likely is best to remove the defective finish with a paint remover and begin over again, using an undercoater as the first application. However, we would await results of the test before going ahead with the job. It is likely you will experience no further trouble after using the undercoat.



Seep Drains

Q—I'm having trouble with the drainage field from a septic tank. Apparently the difficulty is simply the lack of ample drainage area within the boundaries of my property as the natural drainage should be reasonably good. Would the installation of dry wells solve the problem? Or can you suggest any other method or type of installation?—F.D., Ill.

A—Assuming that you have rightly stated the cause of the trouble and that the tank itself is of the recommended size and construction, it is just possible that the installation of dry wells would remedy the condition. Without knowing more about the possible causes of the condition as it now exists it would be impossible to say definitely. The wells might effect a temporary cure but we are inclined to be doubtful if it would be permanent as it is possible that the dry wells would not handle the effluent in sufficient volume after a time as they tend to fill with soil and sand. There is one other possible solution, the use of metal seepage wells. These can be installed singly or in a series along one drain tile, and are said to be quite effective on systems installed where drainage conditions are inadequate. The wells are of metal, asphalt-coated and perforated. They are rectangular in shape, are closed on the four sides and the top and come in two sizes. The units are installed below grade in large holes and the inlet and outlet tiles enter holes in the sides near the top of each unit. After installing the unit, the space around each unit is filled with medium to coarse gravel.

Repairing Concrete Step

Q—I want to repair a concrete step which has chipped to a depth of about 1 1/4 in. The loose portion is about 12 in. long and can be lifted out, leaving a shallow depression. Is there any material, cement or other adhesive, which can be used to reinstall this piece? If not, what other method should I use?—V.J., Calif.

A—We could not recommend that you attempt to replace the damaged portion as you suggest. Such a repair is rarely satisfactory or reliable over a period of time. We think it better to remove the loose concrete, then cut down to a depth of about 1 in. at the feathered edges of the depression, using a cold chisel. This will form a rectangular recess with square edges. You did not say, but we assume the break extends to the edge of the step. This being the case, it will be necessary to place a retaining board, or form board, along the rise of the step, its top edge flush with the top of the step. Fill the recess with a cement-sand mixture and trowel smooth. After the mixture sets, remove the form board and cover with a dampened burlap bag or other coarse fabric. Keep the cover damp for at least a week.

For the first time!
**a modern
 power tool**
 as simple to run as a
modern appliance

Just Plug It In!

SHOPMASTER

presents its Amazing New

TILTING ARBOR

**8" CIRCLE
 8" SAW**

with Built-in Motor and Table Extensions



As simple to run
 as a toaster!

What rugged
 construction!

Look at the big
 Control Panel

Now for the first time a power tool as simple to run as a modern appliance. Just plug it in! No motors to buy or mount! No V-belts or pulleys to worry about. Now, the most important tool for your home workshop is also the easiest to operate. Shopmaster's handy floor model 8" tilting arbor Circle Saw features a one-piece all-metal stand; has a specially built nationally famous motor that develops up to 3/4 h.p. torque—direct drive motor... Operates with no power loss! Note newly designed master view indicator with finger-tip control. Blade cuts 2 1/2" depth and tilts to a full 45°. Table size with extensions is 16" x 30". Comes complete with stand, saw, built-in motor, cord, mitre gauge, stop rods, rip fence, 8" Roc-edge blade, side extensions and plastic guard—nothing else to buy!

99⁵⁰

Newly designed
TABLE MODEL

**8" TILTING
 ARBOR
 CIRCLE
 SAW**



Newly designed table model tilting arbor circle saw. Ruggedly constructed. Has new easy-to-view finger tip controls for precision work. Without motor, only

\$54⁵⁰

**MAIL
 COUPON
 TODAY**



BUILT-IN-MOTOR

**NO MOTOR TO BUY!
 NO V BELT TO BUY!
 NO PULLEYS TO BUY!
 NO STAND TO BUILD!**
It's Complete

SHOPMASTER, Inc. Rm 10R
 1214 S. 3rd St., Minneapolis, Minn.

Please send me your booklet on Shopmaster tools.

Name _____

Address _____

City _____ State _____

WORLD'S STRONGEST PADLOCK

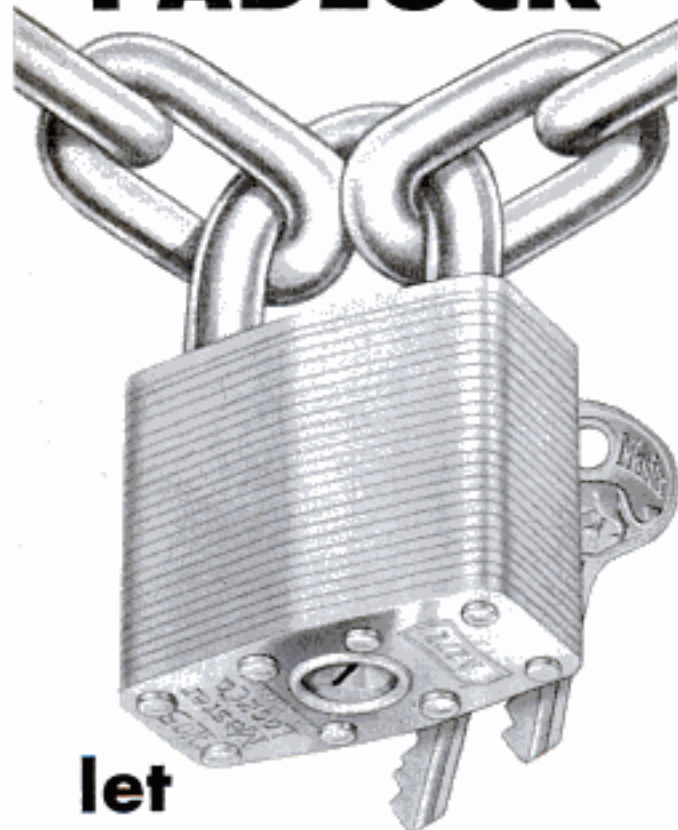

let Master Padlocks

SAFEGUARD YOUR PROPERTY!

When it comes to providing padlock protection for your valuables — don't be satisfied with less than the best! Buy **MASTER PADLOCKS** — the world's strongest . . . laminated like a bank vault door — with genuine pin tumbler security. Available in keyed-alike sets.



*At hardware
stores everywhere...
25c to \$3.00*

Master Padlocks
WORLD'S STRONGEST

MASTER LOCK CO. Milwaukee 45, Wisconsin

How to Make Part-Time Farming Pay

(Continued from page 133)

a different room or another building. After they are six weeks old they are moved to the finishing batteries in another room or building where they are kept until ready for market. Keeping the different-age birds in separate rooms cuts the danger of respiratory diseases.

Almost any kind of building is suitable provided at least 10 feet of head room is available. In some cases old factory buildings, barns, garages and sheds have done as well as new buildings. Here are some of the advantages of the battery-brooder system over the floor method: A definite number of finished birds can be ready for market each week, heavier weights come more quickly, feed costs are slightly lower and, since from three to five times as many birds can be produced per square foot of floor space, the system is practical if the price of land is high or if the space available is limited.

There are these disadvantages: The investment per bird is higher; battery broilers must be slaughtered soon after removal from the battery (being soft-meated they shrink too much if shipped alive); there is a bigger danger of respiratory disease, disposal of droppings may be a problem and labor costs are higher since hand feeding must be used.

It is desirable to have a preferred retail market near by for birds weighing 2 to 2½ pounds that will absorb your weekly supply. Birds of this weight can be produced in eight or nine weeks, thus giving a faster turnover.

Another farm enterprise that has undergone drastic changes in the past few years is dairying. It is another instance where you don't *grow* into the business—you *buy* into it. Unless you are raising a house full of robust, milk-drinking youngsters it's quite likely you can buy your dairy products for less money than you can produce them for home consumption.

To make dairying as easy and as pleasant as possible, plan to use laborsaving equipment. It is doubtful if a 12 or 15-cow herd can be an efficient operation. Think in terms of 20 or 40—at least 20 cows for the family operation or 40 if additional labor is to be employed.

At present costs you can figure your total investment in cows, buildings, fencing and milking equipment (not including land) at about \$610 per cow. For a 20-cow dairy this would total about \$12,200. For

(Continued to page 230)

THE GREATEST INVENTION SINCE THE HAND SAW . . .

New **Amf** DeWalt "Power Shop" brings out the expert in you!

Today, AMF DeWalt® "Power Shop" is everywhere known and accepted as the one really safe, accurate, easy-to-use machine. It's so designed that even the inexperienced can *expertly* do everything in home woodworking.

Whether you're modernizing, decorating or repairing your home, AMF DeWalt is your best investment. See it demonstrated today. At your DeWalt Dealer's or fine hardware and department stores.



\$229 delivered (saw blade and custom-built 1/2 H. P. motor included). **EASY TERMS.**

All these exclusive extra-value advantages!



TOP-SIDE CUTTING! No guesswork—no mistakes. You always see the cut because layout marks are visible and easy to follow.



PROFESSIONAL ACCURACY! Calibrated scales for miter, bevel and rip are visible above table. Instantaneous settings!



EASY TO USE! You control ball-bearing travel head in radial arm. Moves smoothly, precisely. All cuts perfect—no spoilage.

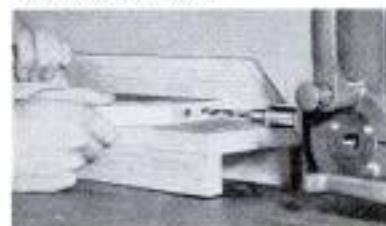

COMPLETE VERSATILITY! One powerful direct-drive motor accommodates any circular tool—gives full home workshop flexibility.



NO FLOOR SPACE NEEDED! Builds into your workbench! When not in use radial arm swings conveniently out of way, freeing work area.



HOME SAFETY FEATURES! "Stop" red controls, UL*-approved motor, safety key switch, auto-float safety guard (optional).

*Underwriters' Laboratories, Inc.



PLUS BIG CAPACITY and many more extra-value features—all explained in new **FREE 20-PAGE COLOR BOOKLET!**

Another **Amf** Product

DEWALT

POWER TOOLS

DeWalt Inc. • Lancaster, Penna., U.S.A.
IN CANADA: DeWalt Canada Ltd., Guelph, Ontario

Send this coupon today!
AMF DeWalt, Dept. PM-54-11, Lancaster, Penna.

Please send me free illustrated booklet "The Greatest Invention Since The Hand Saw" showing how your Power Shop makes me a woodworking expert, saves money in my home.

Please send me free blueprint "Building A Home Workbench."

Name.....

Address.....

City.....Zone.....State.....

Flow on wall paint in an even coat...



Pointers on painting interior walls: wash old paint with detergent, wipe clean, let it dry thoroughly. Paint with sweeping, fanning strokes (a 4-inch brush is the most popular size). Paint in narrow strips from ceiling to baseboard. Work back towards wet areas to avoid lap marks. And always . . .

Use brushes with bristles of Du Pont **TYNEX** nylon

You'll do faster, better-looking work inside or outside your home when you use brushes with "Tynex" bristles.

See how Du Pont "Tynex" nylon bristles flow on a smooth coat of any type paint . . . spread it evenly over the surface. "Tynex" nylon bristles can be easily cleaned in any commercial cleaner . . . and last up to five times longer than other types of bristles.

FOR FREE BOOKLET "How to Choose and Use a Paintbrush Bristled with Du Pont 'Tynex' Nylon," write E. I. du Pont de Nemours & Co. (Inc.), Polychemicals Dept., PM-11, Wilmington 98, Del.

"TYNEX" is the trade-mark for genuine
Du Pont nylon bristles

Look for **TYNEX** nylon bristles
when you buy brushes



Better Things for Better Living
... through Chemistry

land requirements, figure on one acre per cow for grazing on planted pasture and another acre in permanent pasture. You will need to raise or buy six tons of silage and two tons of hay per cow.

Roughly, you can figure cows at \$300 each, Grade A milking barn at \$1500, feeding barns, sheds and feed storage \$2500, fencing \$500, water system \$550 and equipment for dairy barn and milk room \$1200.

A new trend in dairying is pickup by insulated milk tank trucks. This eliminates the milk can and saves labor. Milk is piped directly from the milking machine into the cold-wall tank which holds the milk at low temperature until the truck picks it up.

Small fruit farms can be profitable where spray machinery, tractors and orchard cultivators have reduced the cost of growing fruit. For most efficient use of this equipment there are minimum acreages that will justify the investment. Harry Morris, working with peaches for the Texas Agricultural Experiment Station says that 30 acres is about the minimum for a peach orchard mechanized for most operations.

Vegetable growing is becoming more highly mechanized every year. It is the one farm enterprise in which you can start small and grow as big as you wish. Small garden tractors mechanize truck farming even on a part of an acre. The kind of truck crops you grow may determine the size of operations. An acre of pole beans, for example, will require as much cultural labor as five acres of cabbage.

The competition is keen when you go to market with your produce, but if you have a good retail outlet your chances of success are good. Some areas of the country blessed with mild climate, fertile soil and cheap labor can grow vegetables and flood the market with produce cheaper than it can be produced anywhere else. Onions at 50 cents for a 50-pound bag, cabbage at \$12 a ton, and tomatoes at \$30 a ton point up the periodic marketing problems in some of these areas. The small, part-time grower must have a select market for extra-quality produce to compete with them.

Spraying and dusting equipment are musts for the truck grower. Make them power-driven to save labor, but remember it takes more acres to support the overhead. More consumers want their vegetables prepackaged and this may involve an additional outlay.

There are still many part-time farmers who do all of their chores by hand, chores that can be done at a mighty cheap price by electricity and gasoline engines. Human muscles can't compete with them. But it takes a lot of volume to make machines pay off.

★ ★ ★

MORE REAL R.R. ACTION!

Diesel Switcher with powerful worm-drive motor, *Magne-Traction*, knuckle couplers on both ends. For busy switch-yard action! Length 11 $\frac{5}{8}$ ".

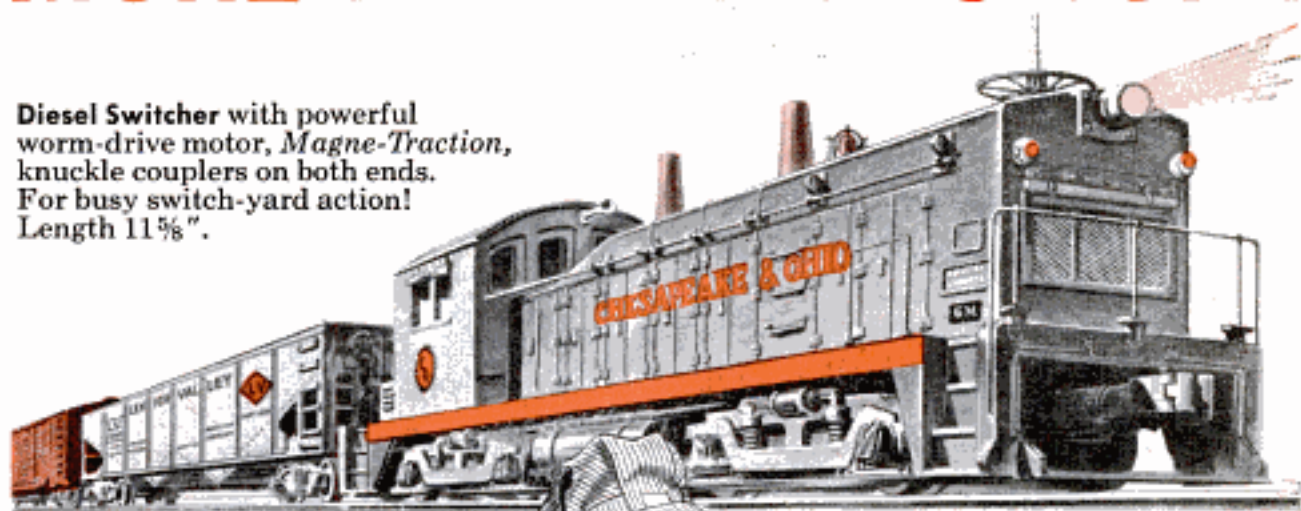

LIONEL TRAINS



WITH MAGNE-TRACTION

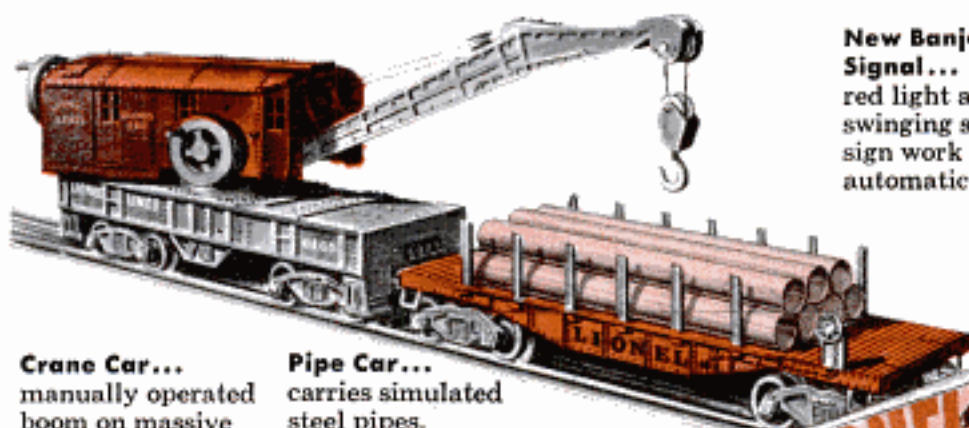

Crane Car... manually operated boom on massive die-cast frame. Length 7 $\frac{3}{8}$ ".

Pipe Car... carries simulated steel pipes. Removable car stakes. Realistic. Length 11".

New Banjo Signal... red light and swinging stop sign work automatically.



*Special
Coupon Offer*

Get more action, more thrills with new Lionel rolling stock and accessories. New, mighty Diesel and steam locomotives... with exclusive *Magne-Traction* for more power, more climb, more control. Colorful new freight cars... bigger, scale-detailed. Real R. R. remote-control Knuckle Couplers on *all* Lionel cars! Amazing new accessories including Portal Gantry Crane with 3 remote control operations. Build a bigger, better Railroad... see your Lionel Dealer!



* Plays on all 78 RPM phonographs except some spindle or automatic changers.

LIONEL TRAINS, P.O. Box 9, Dept. Y, N.Y. 46, N.Y.

I enclose 25¢. Please send me special Lionel Train catalog offer, postage prepaid.

1. The new 44-page full-color Lionel catalog.
2. The new 5 $\frac{1}{2}$ " double-faced record of whistles, bells, railroad sound effects and Diesel horns.*
3. Lionel's special "Pop Persuader."

Name _____

Address _____

City _____ Zone _____ State _____

Weatherstrip with your fingertip

THE EASY

Mortite WAY!



ELIMINATE UNHEALTHY, fuel-wasting drafts—Mortite your windows *now!* Weather-proofs a window *in seconds* at so little cost! Self-adheres—no tacks or tools—just press in place!



SOFT, ROPE-LIKE STRANDS. ($\frac{1}{4}$ " diameter), unroll like ribbon, mould into place like modeling clay. Use inside or out—no need to go out in cold to apply. Won't crack, chip or peel. Use over and over—in Spring, hold one end, pull right off. 1,001 other uses! Ideal as gasket, caulker, base for flower stems. Perfect plugger-upper for variety of uses in, around home all year long!



**KEEP
Mortite
HANDY**

Available At All Leading Stores.
Send For Your **FREE** Circular
Showing Mortite Uses In,
Around Home!

29¢ · 98¢ · \$1.25

**JW Mortell
COMPANY**

Serving The Home and Industry Since 1895

522 Burch St.

KANKAKEE, ILL.



Multiple Spotlights For Color Photos

Six spotlights mounted in a single housing and operated through a transformer permit taking color pictures indoors at $\frac{1}{40}$ second at apertures as small as $f:22$. The unit draws 16 amperes and may be used with ordinary household fuses, yet produces the equal of 7000 watts of ordinary studio illumination.

Heated Tea Wagon

You can cook a meal and heat a room with a German teacart that is plugged into the nearest electrical outlet. The warming cabinet, open at top and bottom, contains an electric grill on which food and beverages can be heated.





Santa Says:

**"A WONDERFUL HOBBY
WORKSHOP GIFT"**

**JUST DIAL
40 DIFFERENT
WIDTHS ON
ANY SAW!**

WITH Warren SAWING WASHERS

Cut 40 smooth, accurate, parallel grooves - any angle, with your present saw blade. Dial desired width with Micromatic adjustment. Leave on saw for straight cuts. Sizes to fit your arbor - $\frac{1}{2}$ ", $\frac{3}{4}$ ", $\frac{3}{8}$ ", 1". A perfect gift for woodworkers. See your dealer or write!

**ONLY
\$4.95
PER
SET**

SEND FOR FREE BOOKLET

WARREN WASHERS COMPANY

DEPT. 31 • BOX 98 • NORTH END STATION • DETROIT, MICH.



AMAZING, PERMANENT MAGNETS—WILL NOT WEAKEN! NON-ELECTRIC

Retrieve guns, tackle, tools and other steel items from lake, river, plating tanks, drains or other hard-to-reach spots. Recover drills, taps, etc. from sweeping. Clear alloy of harmful tacks, nails. Many other uses. Pays for itself quickly. GUARANTEED. Try any magnet one week. Money refunded if you are not well pleased.

No. M-725 (Weights 54 oz.) Has pull of 225 lbs. on steel block. \$15.00

No. M-875 (Weights 48 oz.) Has pull of 175 lbs. on steel block. \$10.50

No. M-625 (Weights 70 oz.) Has pull of 125 lbs. on steel block. \$ 8.50

No. M-575 (Weights 18 oz.) Has pull of 75 lbs. on steel block. \$ 6.00

No. M-500 (Weights 15 oz.) Has pull of 50 lbs. on steel block. \$ 4.00

No. M-30 Hobbyist assortment of six small magnets. \$ 1.50

Send Money Order or Check. We pay postage. No C.O.D.'s.

MIAMI MAGNET COMPANY, 3240 N. W. 27th Ave., Miami 42, Fla.

MONEY FOR MEN ALL DATA FREE

THE PLASTEX Industry needs manufacturers on small scale and for big production of Lamp and Clock Stands, Art Goods and Novelties in Plastic and Marble imitation. Experience unnecessary. 1/2c material makes regular 10c store sellers. Rubber moulds furnished for speed production. Small investment brings good returns. We are now placing big Chain Store Orders with manufacturers. Ambitious men have chance for real prosperity. Our Free booklet will interest and benefit you.

PLASTEX INDUSTRIES, Dept. A
3400 Third Ave. New York 56, N. Y.

MODERN LAWN MOWER SHARPENER

Service departments of leading Lawn Mower manufacturers use the Modern Lawn Mower Sharpener. One lever moves lawn mower into grinding position. Gasoline and oil remain in engine while sharpening, no dismantling of wheels, roller or handle. The Modern is a precision bed knife grinder—no extra grinder to buy. Imitated but never equalled—Compare before you buy. If it isn't a Modern it can't be Modern (Prices subject to change without notice)

MODERN MFG. CO.
160 N. Fair Oaks - Pasadena 1, Calif.

\$263.00
with motor
F.O.B. PASADENA

WRITE FOR FREE BOOKLET 100

NOVEMBER 1954

233

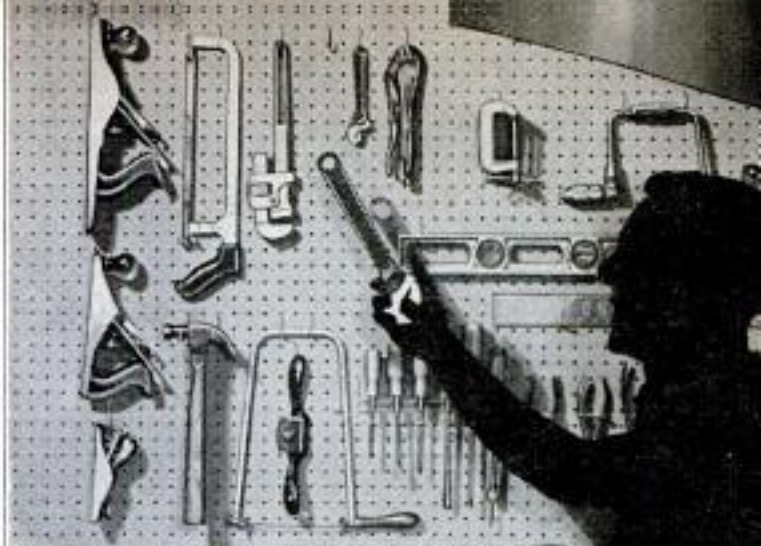

**Your tools
are handier and
so are you...**

when you hang 'em on

**USG*
PERFORATED
HARDBOARD**

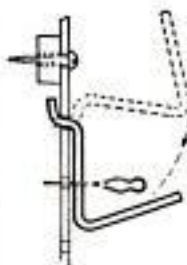

Fixtures slide easily into the $\frac{3}{16}$ " perforations

You'll be a better craftsman with your tools neatly arranged and ready to use, hanging on USG Perforated Hardboard right over your work bench. This precision-perforated, smooth-both-sides board goes up in minutes with nails or screws, giving you storage exactly suited to your needs.

You'll find dozens of uses for this premium USG DURON® hardboard product. Attached to any wall, door or framing member, it makes worlds of new storage space—ideal for garden tools, shoes, brooms, pans, hats, a hundred things.

USG Perforated Hardboard is a DURON Hardboard product manufactured by U. S. Gypsum.

FREE PLAN BOOK

12 pages of easy-to-follow plans for making useful things with regular DURON hardboard. Ask your U.S.G. dealer or write Dept. PM-11, 300 W. Adams, Chicago 6.



*T. M. Reg. U. S. Pat. Off



UNITED STATES GYPSUM

The Greatest Name in Building

NAIL this WEATHERSTRIP

on the bottom of your overhead-type garage door

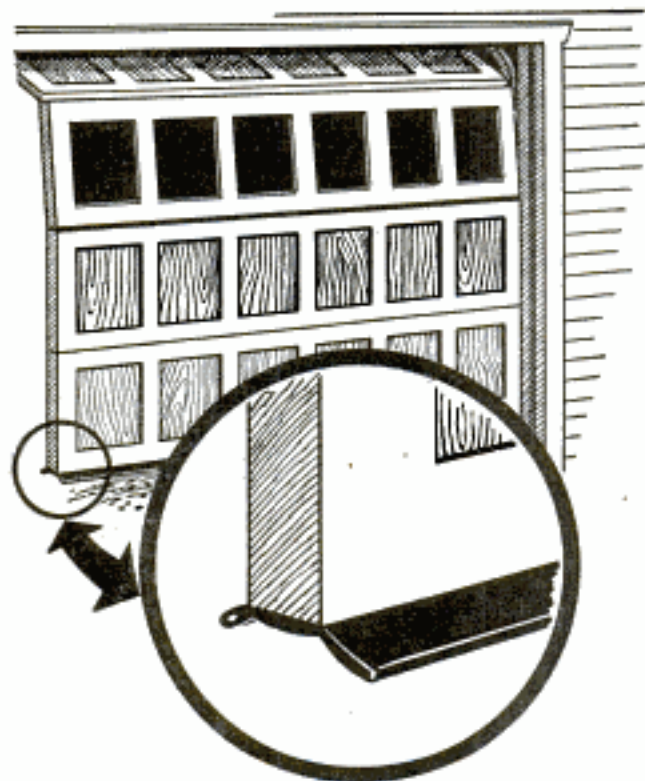

- Seals out rain, snow, dust and drafts.
- Seals in heat. Pays for itself quickly.
- Cushions door closing.
- Protects door bottom against rotting.
- Prevents splintering and glass breakage.

StanStrip* is a durable, live-rubber weatherstrip, easily installed by nailing to the bottom of your present overhead-type garage door. Proved effective for years on thousands of garages. Or if your plans include a new garage, ask the builder to install StanStrip. *Trademark



SOLD IN LEADING HARDWARE STORES EVERYWHERE. If unavailable, use coupon below. Postage prepaid with check or money order. Sorry, no c.o.d.'s.

THE STANDARD PRODUCTS CO.

Dept. "M", Box 1092, Cleveland 2, Ohio

Enclosed is \$ _____ for StanStrip as checked below.

8 Ft. \$2.95 9 Ft. \$3.29 16 Ft. \$5.90
(Other lengths to 20 Ft., 37¢ per Ft.)

Name _____

Address _____

City & State _____

Taxi Up Misery Mountain

(Continued from page 153)

Sno-Cat, Phil fell into a sideslip at the vicious Cragway turn. The 'Cat was an improved model that had been tried out in Alaska, disassembled and flown to New Hampshire. But all four of its crawler "pontoons" were helpless as Phil tried feverishly to get some grip that would stop the 3½ tons in its sideways slide down the mountain.

Finally, after 150 feet, the ground leveled off slightly and a bumper of snow packed against boulders brought the crawler to a stop. Phil continued to drive the 12-passenger 'Cat, but never again under such breath-taking circumstances. Since then, using his welding ability, he's tacked in bars that tighten the tracks. He's rebuilt the fifth wheels in the pontoons so that they can take more punishment when they slam down on the rocks.

Although heavy freight is usually trucked up the mountain before winter sets in, special deliveries are sometimes necessary. Once a two-ton jet had to be rushed up for icing tests. Phil delivered it on a sled he built and skidded up the curving road behind his bulldozer.

His transport system has no regular timetable because so much depends upon the weather and his sound judgment.

It was an almost balmy day down below the morning I rode with him on the Sno-Cat. But we learned from a telephone call to Walter J. Wallis, the company's resident engineer, that the temperature at the top was 10 degrees below zero and the wind was 65 miles per hour.

Phil figured it would be an unpleasant but not dangerous journey. As usual, he was right, and we made the eight miles in two hours. That's about par for a Sno-Cat.

A Weasel is faster, but can't always be used. Smaller than a Sno-Cat, it has just one pair of tracks and can scoot up the mountain like a souped-up crawler tractor in 50 minutes. That's only twice the time taken by a Jeep. The Weasel prefers running over packed snow, and stays home when snow is too deep or the winter route is too icy or steep.

Even the Sno-Cat, which can handle moderate side slants and with which we went up 32-degree grades, has its limits.

That's when Phil goes back to bulldozing. Rocking a 'dozer back and forth, he can crush ice and pack snowdrifts. Heavy drifts that slant across the road are chopped down and leveled so that the Sno-Cat can get through. Together with his assistant,

(Continued to page 236)

The CHRISTMAS GIFT

that has everything any
homecraftsman or
hobbyist needs

FOR SCORES OF
MONEY-SAVING
JOBS

Perfect gift to give or receive . . .
useful all year 'round. Each kit includes:

- Weller 8250A Soldering Gun—
250 watts
- Famous Kester Solder—general
purpose spool
- Soldering Tip—for all kinds of
soldering
- Smoothing Tip—for mending
and sealing
- Cutting Tip—for plastic tile, etc.
- Wrench—for tip interchange
- Instruction Booklets—handy
soldering and homecraft hints
- Metal Case—for storage and carrying

Nothing else to buy for soldering, sealing, cutting, mending,
joining and smoothing. Makes professional results easy.



only \$14.95

MODEL 8250AK

NEW WELLER GUNS AND KITS ARE AVAILABLE AT HARDWARE DEALERS

Junior SOLDERING GUN

- New, Compact Design
 - Heats in 5 Seconds
- Over 100 Watts
 - Trigger Switch Control
 - Dual Spotlights

The ideal homecrafters' soldering tool.
No other soldering gun or iron offers the
professional quality, practical features and
low price of the Weller JUNIOR.



Weller

THE FINEST TOOLS FOR THE FINEST CRAFTSMEN
ELECTRIC CORPORATION
816 Packer St., Easton, Pa.

SOLDERING GUNS • SOLDERING KITS • POWER SANDERS

Fred A. Short, service station proprietor of Los Angeles, Cal., says: "If your oil filter's clogged, put in a Purolator Refill right away!"



"Right here, in the book that came with your car,* it says—

Change your Oil Filter every 5,000 miles"

*17 out of 18 leading car makers recommend oil filter changes at least every 5,000 miles, on the average, depending on driving conditions.

Grit and sludge in the oil stream can damage delicate engine parts . . . run up expensive repair bills. Protect your engine by putting in new Purolator Oil Filter Refills regularly.

If you've driven 5,000 miles since changing your oil filter, it's probably clogged. Install a new Purolator Micronic Refill—right away! Costs as little as \$1.60. More car makers specify Purolator than any other oil filter.

PurOlator

World's finest OIL FILTER



"Purolator," "Micronic" Reg. U.S. Pat. Off.
Purolator Products, Inc., Rahway, N. J.; Toronto, Canada.

Morris Parent, Phil not only has to drive the road, but keep it open too.

The end of the route is at the very top of the mountain, where the laboratory's headquarters for the activities of about 40 men is located. Here also is the transmitting station of WMTW, a newly opened TV station that covers much of New England.

Next door is the famed Mount Washington Observatory building where about four men keep track of the wild weather. It's here that a record 231-mile-per-hour wind was noted. Winds of 75 miles per hour are ordinary, since they occur on an average of every other day through four months of the year. The general rule up top is that at 80 miles per hour you don't trust your feet, but crawl. At over 125 miles per hour, you stay indoors.

Misery Mountain's breeziness causes Phil to warn new passengers getting out of a Sno-Cat: "Hold onto the door—with both hands."

With Parent, he has to clear the road and service vehicles that include three 'dozers, four Weasels and two Sno-Cats. Up top, he has another assistant, Martin Landry, who helps with maintenance jobs, like heating buildings and running the four diesel power generators. Like the 'dozers, they feed on kerosene hauled up in summer. The lighter fuel is preferred because of the intense cold.

One of Phil's more rugged jobs is to build and repair the telephone line down the mountain. That's part of his job of linking the men perched on top with civilization.

Three years ago Phil started using what's called the Winter Cutoff route. It's a short cut one mile long that leaves the section known as The Horn, which is 4½ miles up, and rejoins it at Mile 6¼. Thus, it saves almost a mile, but its main advantage is that it bypasses some devilish icing and drifting spots on the main road.

But a journey on the cutoff isn't exactly a pleasure trip. It means Phil has to teeter along the edge of the Great Gulf, a 1500-foot chasm that's a mile wide and two miles long. The first winter when a Sno-Cat was being tried here by someone else, its four clawing pontoons lost their grip and it went into a 200-foot slide. Luckily, it was head-on down the route, and not sideways into the Gulf.

Another winter, five years ago, Phil went down into the Gulf, but on foot. It was a dirty March day. George Nichols, one of the crew at the summit, had received word of his father's death, and left immediately on foot, expecting that Phil would come along in his Weasel soon and pick him up.

Phil left the summit five minutes later.

(Continued to page 238)

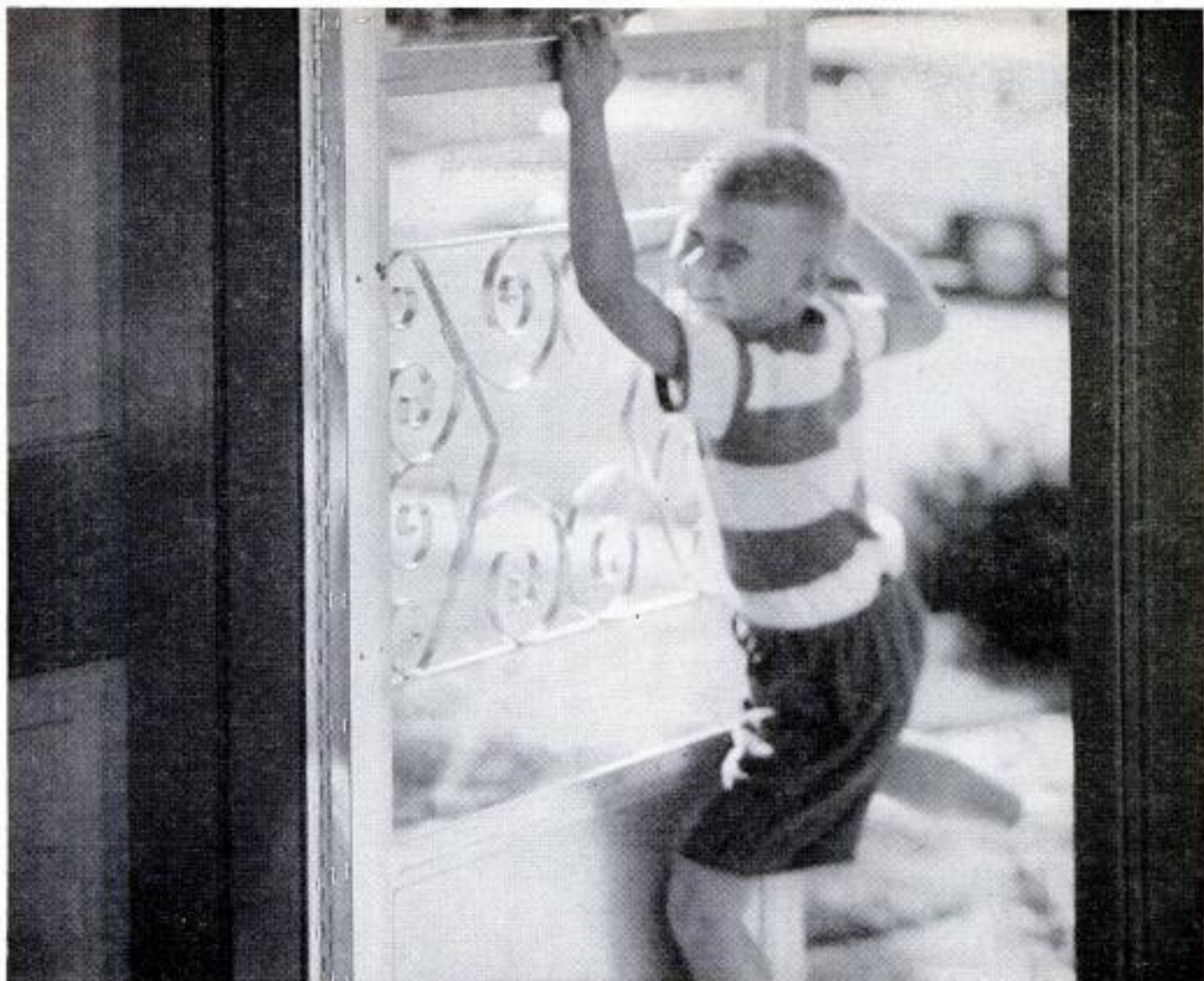

STAPLING SAVES 66%, STOPS SAG! You're looking at a big-selling feature of a well-known storm-and-screen door. It's the strong, continuous hinge secured by *staples* to aluminum frames. Until recently, self-tapping screws held three 3-inch hinges. In time, screws worked loose. Doors sagged.

A Bostitch Economy Man saw a way to improve this method—using metal-piercing, rust-proofed staples and longer, stronger hinges. Now, Bostitch Metal Stitching saves manufacturer *two-thirds* in fastening costs, offsets extra cost of better hinge. The improved doors work better, sell faster, last longer.

How much can you save by swinging over to Bostitch stapling?

Your Bostitch Economy Man can tell you—objectively and honestly. He's one of 350 trained fastening specialists working out of 123 cities in the U. S. and Canada. There are over 800 kinds of Bostitch staplers in his cost-cutting repertoire. Look up "Bostitch" in your telephone directory or check the coupon.

Fasten it better and faster with

BOSTITCH, Inc., 551 Mechanic St., Westerly, R. I.

I'd like to know exactly how stapling can cut costs in our fastening operations. I'm particularly interested in the applications checked below:

HI-SPEED PRODUCTION FASTENING

- stapling vs. riveting
- stapling vs. spot welding
- stapling vs. screws or bolts
- stapling vs. glue or cement
- stapling vs. tape
- stapling vs. tacks or nails
- stapling vs. solder
- stapling vs. wire or string

PACKAGING and CARDING

- sealing bags (cloth, paper or plastic)
- mounting products on display cards
- fastening items to individual cards

SHIPPING ROOM ECONOMIES

- preparing cartons for filling
- sealing filled cartons
- lining or padding crates
- applying shipping bills or tags

BUILDING APPLICATIONS

- applying asphalt roofing
- laying underfelt
- installing ceiling tile
- applying insulation
- installing low-voltage wiring
- applying shake shingle siding

OFFICE EFFICIENCIES

- filing
- routing
- posting
- binding folders and reports
- preparing advertising dummies

BOSTITCH®
STAPLERS AND STAPLES

Name _____ Position _____

Company _____

Address _____

City _____ Zone _____ State _____

ASK HIM TO BRING YOU ONE OR ALL OF THESE



FLAT SIDE



SINGLE CUT

ROUND SIDE



DOUBLE CUT

Two dandies for the handy man

Novelty and versatility go hand in hand with these multi-purpose items of the famous Nicholson and Black Diamond file brands.

4-IN-HAND (upper) is a file-rasp that gives you a choice of four different material-removing faces: Half Round file and Half Round rasp on one side, Flat file and Flat rasp on the other. For wood, metal, leather, plastics, etc.

HANDY FILE (lower) is double-cut on one side, single-cut on the other—for both roughing down and smoothing. Also wonderful for sharpening edges of many kinds of cutting tools. Forged-on handle with handy hang-up hole.

Amateur and professional craftsmen who pride themselves on a representative collection of fine tools invariably prefer Nicholson or Black Diamond when it comes to files. *Hardware dealers are equally proud to sell them.*

Two "musts" for the make-it-yourself hobbyist



ROTASET with either 18 assorted power-driven Rotary files or Ground burs (or 9 Rotary files and 9 Ground burs) in high-speed steel with $\frac{3}{8}$ " shank.

ROKIT in similar 10-item assortments with $\frac{3}{8}$ " shank.

X.F. SWISS PATTERN files—craftsmen's delight! They're Round-handle Needle files in 12 assorted shapes for fine work on small, accurate parts, dies, instruments, etc. Choice of 3 lengths and 4 degrees of cut. Handsome 2-color plastic case with bottom stand.



NICHOLSON FILE CO., 22 Acorn St., Providence 1, R. I.
(In Canada: Nicholson File Company of Canada Ltd., Port Hope, Ontario)



The fog was so thick that he couldn't see ahead. He had to open his door and look straight down for previous tracks to follow. After a half mile, he gave up and went on by foot.

A mile farther, at Telegraph Hill's hair-pin turn, he saw Nichols' tracks take off to the left. Phil hoped it was just a short cut over what later became the Winter Cutoff. He kept on down to Halfway House, a relay point which is four miles up the mountain. It's just below the timber line.

He asked anxiously about Nichols. He hadn't come in. Phil phoned back to the summit for two rugged men to meet him at Mile 6½, and started back up the mountain with bare necessities stuffed in his back pack for men up at the summit—their mail and a case of canned milk.

He cached these when he met the other two men and they started trailing Nichols. Soon they were in snow up to their hips and the fog changed to drenching rain. To make it worse, the lost man had begun to circle as he dropped deeper into the chasm. At another spot, a bear's trail crossed his tracks.

It was seven hours before they found him floundering in the soaking, deep snow.

Going back would be impossible, so Phil led the party through the Gulf and six hours later had them safely at the Glen House below.

Even the Winter Cutoff can fill up as fast as bulldozers work to keep it open. On my trip up with Phil, I saw him peer ahead through wind-whipped snow, then mutter, "Talking of bad spots, here's one coming."

Rains had washed a wide gully in the mountainside at the spot we had to cross. The road had drifted deep.

Phil eased his 'Cat ahead, gently feeling his way. But snow piled ahead of him and he couldn't risk going into a skid. He rolled back, felt his way up the gully in a wide arc that brought him gently back to where the roadway should be, and clawed up the rise that took him out.

A few minutes later the rising wind was whipping fine snow into a blinding curtain ahead of us. Phil was driving with his door open so that he could follow his previous tracks.

"Suppose," I asked, "you can't see ahead and your tracks are too badly covered to see them?"

Phil chewed on that a second, then replied, "That's time to stay home."

When he looms in out of the storm up top, he's Mr. Popularity himself. Besides bringing mail, special parcels and equipment, he hauls up visitors and replacement

(Continued to page 240)

**RELIEVES
HEADACHE
NEURALGIA
NEURITIS PAIN**

FAST



Here's Why...

Anacin® is like a doctor's prescription. That is, Anacin contains not one but a combination of medically proved active ingredients. Anacin is specially compounded to give **FAST, LONG LASTING** relief. Don't wait. Buy Anacin today.

**GET THIS STRAIGHT you can't beat
an EMPIRE LEVEL**



For improved accuracy, better visibility, less breakage, use the new Empire 9" aluminum Torpedo pocket level with machined bottom groove and protected, easy-reading vials. See your dealer today for all-purpose Empire Levels.

EMPIRE

LEVEL MFG. CO. | 10930 W. Potter Rd., Dept. PM
Milwaukee 13, Wisconsin



BUILD FINE GRANDFATHER CLOCK NOW

The simple, beautiful Red-Kut way as thousands have — **SAVE HALF. SHOP TESTED PLANS "SPIRIT OF THE CENTURY"**. Narrow waist 83" tall or stately straight side **"SPIRIT OF AMERICA," EASY-TO-FOLLOW** (photograph) PLANS left all—plus **BROCHURE** of heavy brass weight Westminster, tube chime, movements, gorgeous dials, 34" solid mahogany case. **Send \$1.00 today — Both plans \$1.50 NOW.**

KUEMPEL CHIME CLOCK CO., 27 Kuempel Bldg., Minneapolis 16, Minn.

*Protect your home against
power interruptions
with an...*

**ONAN Emergency
ELECTRIC PLANT**

Provides dependable stand-by electricity for heating system, pumps, freezer, lights, appliances. Keeps home safe, livable. Automatic start and stop. *Find out how little it costs!*

Write for Folder!

D. W. ONAN & SONS, INC.
8583 University Ave. S. E. • Minneapolis 14, Minnesota

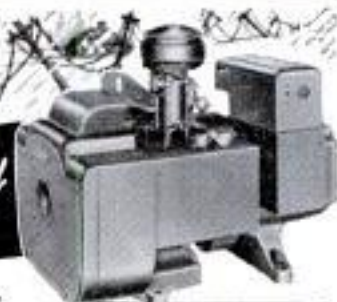

A SIZE FOR EVERY NEED
1,000 to 50,000 watts.
Compact, quiet-running,
easy to install. Gasoline
engine powered.

FREE

SEND FOR THE

1955

308-PAGE



value-packed **ALLIED**
TV & RADIO CATALOG
world's most complete
ELECTRONIC SUPPLY GUIDE

Everything for Experimenters,
Builders, Amateurs, Servicemen,
Engineers & Hi-Fi Specialists

Get ALLIED's big 308-page Catalog featuring the world's largest selections of latest top-quality electronic equipment at lowest, money-saving prices. See the newest in custom TV chassis, antennas and accessories; FM and AM tuners; High Fidelity systems and components; recorders and phono equipment; Amateur supplies; test instruments; builders' kits; industrial electronic supplies — plus thousands of parts, tubes, tools and books. Get everything, get more for your money—send today for your **FREE 1955 ALLIED Catalog!**

**SAVE ON
EVERYTHING**



**WORLD'S
LARGEST
STOCKS**

Ultra-modern facilities to
SERVE YOU BEST

Send
for **FREE**
Catalog

ALLIED RADIO

ALLIED RADIO CORP., Dept. 5-LL-4
100 N. Western Ave., Chicago 80, Illinois

Rush **FREE 1955 ALLIED 308-Page Catalog.**

Name _____

Address _____

City _____ Zone _____ State _____



TEENUTS

steel threads in wood

TEENUTS mount flush without counter-boring. Excellent for new work or repairs . . . wood to wood, wood to metal . . . and where old screw holes have worn out. Simply drill hole for TEENUT barrel, hammer home TEENUT and its steel prongs provide rigid, permanent anchorage. Same size hole for bolt. Sizes to fit standard bolts: 6-32, 8-32, 10-24, 10-32 (4 per card), 1/4-20 (3 per card), 5/16-18, 3/8-16 (2 per card).

AT HARDWARE COUNTERS
EVERYWHERE 15¢
per card

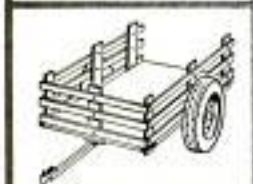

3229 South Ashland Ave., Chicago 8,
Illinois

THE **DOT** LINE



send for **FREE CATALOG**



America's Foremost
money-making
**MECHANICS'
TOOLS**

It's easy to own the same "pay-off" tools used and endorsed by America's top-earning mechanics throughout the automotive, aviation and industrial fields! Snap-on tools help you handle every repair job faster, easier, better. And they LAST . . . pay for themselves over and over again! Start building your own tool set now with basic Snap-on units—add others any time. Genuine Snap-on tools are never sold in stores—direct to users only. Mail coupon for free catalog.

Snap-on Tools
THE CHOICE OF BETTER MECHANICS

Snap-on Tools Corporation
8062-K 28th Ave., Kenosha, Wis.

Send me free catalog. Occupation _____

Name _____

Address _____

City _____ Zone _____ State _____

personnel. Big Brass from Washington and leading scientists come to see the station. Relief crews are especially welcome. In winter, the men's schedule is 10 days on the mountain and 20 days off.

Getting off Misery Mountain is understandable. Why should anyone want to be on, anyway?

Its altitude—6288 feet—makes it the highest peak north of North Carolina and east of the Mississippi, but that alone is not why it's so rugged.

This barren summit is wide open to two great weather tracks—one swooping in from the St. Lawrence, the other up our East Coast. The result is Misery's turbulent refrigeration, and its weathermen have learned to expect 340 foggy days a year, with some frost and snow every month.

This makes it rugged for Phil Labbe, but just dandy for engineers trying to find cures for the icing that can crash a jet or vibrate a helicopter to pieces. On Mt. Washington, they can try out jet motors and captive helicopters under the dirtiest flying conditions, but with comparative safety and convenience.

Eventually all research will be housed in one building on which construction is well underway. It's a three-story affair of steel and concrete anchored deep into rock.

Sometimes in their bull sessions up top, the isolated engineers dream about a vehicular tunnel that would run up the mountain. Inside it, a conveyor system could haul freight and passengers. Some even envision it big enough to accommodate Jeeps.

But in the meantime, nobody's missing any rides with Phil's taxi service. And Phil isn't worrying about traffic cops or traffic congestion. The road's all his, when he can find it. ★ ★ ★

Switch Aids "Brain" Memory

Electronic brains are prevented from "forgetting" by a silicon-alloy junction diode that permits electricity to flow in only one direction. The tiny switch passes a minute charge of electricity to the plates of a condenser, where the stored charge represents one bit of information. By preventing the current from leaking backward, the diode prevents memory lapses. Tests have shown the leak through ordinary vacuum tube rectifiers to be up to 1000 times as great. An outgrowth of transistor research, the diode requires no warm-up time and will last indefinitely. It is about the size of a match head, and works thousands of times faster than its best mechanical counterparts.

No wonder it's called
"Miracle Vinyl-Flooring"!

MATICO ARISTOFLEX

RESISTS GREASE, ACID, ALKALI AND GRIME!



You'll call it "miracle flooring," too, when you see for yourself how rugged, durable MATICO Aristoflex shrugs off household acid, alkali and grease... stays new and sparkling looking with easy damp moppings. Biggest miracle of all is the price! Produced especially to meet the needs of homeowners everywhere, MATICO

Aristoflex is low in cost... gives you more for your money. And you can install economical Aristoflex in every room in your home... from basement to attic. See Aristoflex in 12 rich, clear colors at your MATICO dealer soon. You'll find him listed in your classified telephone directory.



MASTIC TILE CORPORATION OF AMERICA

Joliet, Ill. • Long Beach, Calif. • Newburgh, N. Y.

Manufacturers of:

Aristoflex • Confetti • Parquetry • Asphalt Tile • Cork Tile • Plastic Wall Tile

INSTALL IT YOURSELF AND SAVE!

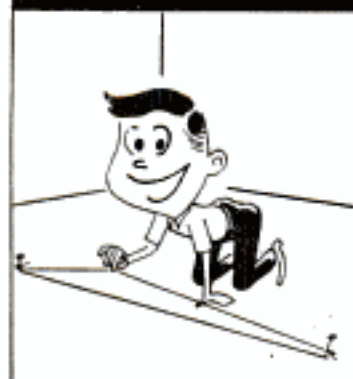

It's easy! Just mark a straight line through the center of your room in both directions, using a chalk and line. Be careful not to cover up your guide lines.



With a notched trowel, spread adhesive over one-half of your room at a time. Leave only a thin coat of adhesive on the floor.

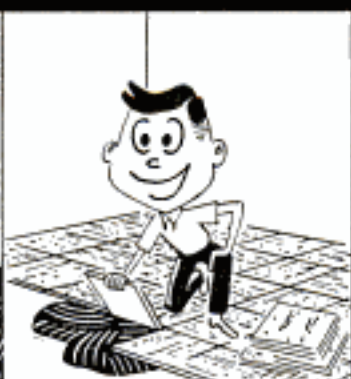

After adhesive becomes tacky, snap the tiles into place. Do not slide tiles or adhesive will push up between the tiles.



Here's the best part! Show your wife your handiwork. (Don't tell her what a cinch it is with MATICO's easy-to-follow instructions).

Simplify your work with these

GOOD SHORT-CUTS

from

"Handy" SANDY



Need a disc sander? Your circular saw makes a dandy . . . if you substitute a disc cut from tempered hardboard for the saw blade, and attach one of my HANDY-SANDY Discs to it with a "peel-it-off" cement.

Or, if you have a wood lathe, the 6" face plate will work as a disc sander. Attach a 6 x 0 HANDY-SANDY Disc with pressure-sensitive adhesive or rubber cement. Turn the face plate at 500 to 1500 rpm for best results. Top-quality HANDY-SANDY Discs are available from your hardware or lumber dealer in four grit sizes: Fine, Medium, Coarse and Extra Coarse. Pays to keep an assortment on hand.

When repairing splintered or broken furniture, woodwork, etc., use FLEXBAC® Masking Tape by CARBORUNDUM to hold the pieces in place after gluing. When the glue has set, just peel the tape off.

Ever get a splinter when reaching in a drawer or pulling out a table leaf? You can avoid them by covering such "rough spots" with strips of FLEXBAC Masking Tape . . . it works better than any other type of tape because its made to hold fast to wood. Yet it peels off quickly, cleanly—whenever you want it to.

Plastic storm windows are easier to install, easier to remove—and stay weathertight longer—if you use FLEXBAC Masking Tape. Cut the plastic to size, run strips of tape along each edge, overlapping at the corners (let about two-thirds the width of the tape overhang the edge of the plastic on all sides). Then just press the storm window in place. No tacking . . . no cardboard strips necessary. Works on both wood and metal window frames. Buy FLEXBAC® Masking Tape by CARBORUNDUM from your favorite hardware dealer or lumber yard.

Strips of Flint Paper, glued grit side out to bottles containing anything "dangerous when taken internally" will alert you . . . specially when you're still half asleep, looking for a remedy in the middle of the night!

Remove soiled spots from anything with a natural wood finish by dipping a small sheet of Fine or Extra Fine Flint Paper by CARBORUNDUM in linseed oil (or a mixture of half linseed oil, half turpentine). Rub the soiled spot lightly until clean . . . won't injure the finish at all!

Write for free folder, "HOW TO SAND".

Address postcard to me—

"Handy" SANDY

CARBORUNDUM

Niagara Falls, New York

"CARBORUNDUM", "HANDY-SANDY" AND "FLEXBAC" ARE TRADEMARKS OF THE CARBORUNDUM COMPANY, NIAGARA FALLS, NEW YORK

00-442

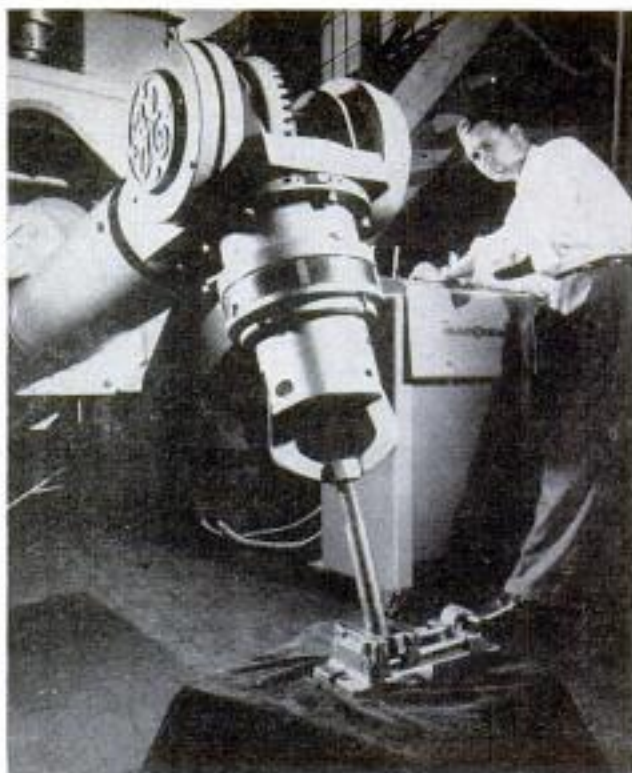

Mechanical Arm Does Heavy Work In Radioactive Areas

Steel claws of the "world's largest mechanical arm" can thread a nut on a bolt or twist a heavy iron bar into the shape of a pretzel. The giant arm can operate drills, hammers and wrenches, assemble or disassemble machinery, lift 3000 pounds off the floor or carry 1000 pounds while extended horizontally. It can also pick up an egg or a laboratory beaker without cracking it. General Electric built the giant robot to substitute for human brawn in radioactive areas where men could not survive. It is remotely controlled from an instrument panel.

Guided-Missile-Flight Calculator

Musical messages from guided-missile instruments are radioed to earth and translated into charts and figures with equipment developed by Lockheed Aircraft. Transmitters squeezed into the missile broadcast messages fed to them by scores of delicate test instruments. Each instrument's reading is radioed as a sound closely resembling a violin note. Variations in pitch mean changes in instrument readings. From a master-recording tape, an electronic machine transposes high As into speed readings and F-sharps into heat, stress, steering information, engine performance or whatever the F-sharp represents. Readings come out as punched cards which are fed into an automatic plotter that charts the data as curves on a graph.

FRAMED IN FAME—
Safety-Engineered
UTILITY AXLES



MODEL 1-UCO, shown, features 1½" square axle of solid steel; 2500 lb. capacity. Comes completely equipped, except for tires. List price \$65.29, Fed. Ex. Tax included, F.O.B. Wausau. Other models to 5000 lb. capacity. We manufacture a complete line of trailer axles, couplers and jacks. Write for Brochure 13-K

HAMMER BLOW TOOL CO.

"As old as the Industry!"
WAUSAU, WISCONSIN



CUT BUILDING COSTS 2/3!
Make Your Own Concrete
BLOCKS and BRICKS
To Use or Sell

New superior moulds make absolutely square, true, easy-to-lay blocks which will pass any building code. Production is fast... easy. One durable \$30 machine will make four 5"x8"x12" blocks per minute—1,000 a day. Pays for itself in one day! Sell blocks for big profit... or save 2/3 building cost for yourself. POST CARD BRINGS FREE FOLDER.

ECONOMY MFG. CO.
DEPT. P STONE MOUNTAIN, GA.

THE BEST IN PLIERS?

CHAN NEL LOCK

CHAMPION DEPARTMENT TOOL CO., MEADVILLE, PA.

SET-UP—KNOCKDOWN SAWHORSE with *Jiffy* BRACKETS



No nails or bolts... use 2x4's for legs. 2x4 or wider for crossbar. Rugged, sturdy, easy to move, saves storage space. Sold by hardware and building material dealers, or order direct.

GRAND HAVEN STAMPED PRODUCTS CO., Grand Haven, Mich.



The Modern PLASTIC
for lasting Home Repairs

PERMANENTLY mends cracks or holes in wood, tile, stone or plaster. Sticks and stays put—Does not chip, shrink or fall out. Easy to use. Economical. Mold it, chisel it, polish or paint it. The big 4-lb. can is obtainable from your lumber, paint or hardware dealer at \$1.25; or will be shipped direct postpaid (in U. S.) for \$1.50. Complete satisfaction guaranteed or your money refunded.

DONALD DURHAM CO.
Box 804-T Des Moines, Iowa

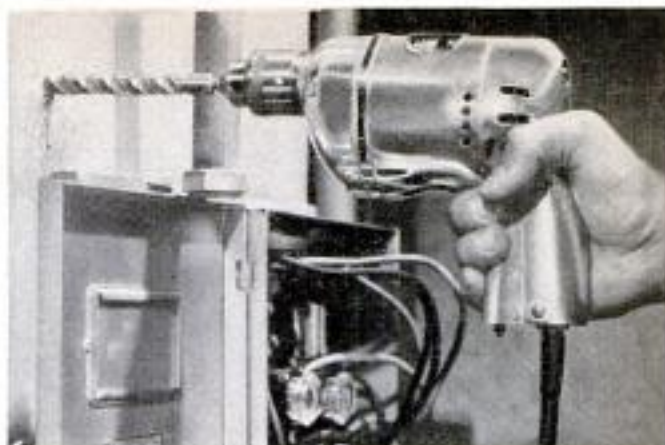

Now—for tougher drilling jobs
NEW B&D 3/8" Utility Drill!



Only **\$38.95**

Here's a new drill, specially geared and powered for tougher-than-ordinary jobs! Its powerful B&D-built universal motor drives up to 3/8" diam. twist drills, 3/4" wood bits, 1/2" masonry bits, and 1 1/4" Hole Saws. Perfect for advanced craftsmen and light installation and service work. See your B&D dealer today!



Get this Complete 3/8" Utility Drill Kit—only \$64.95

Includes 3/8" Drill, 3 Hole Saws, 3 masonry bits, 3 wood augers and 8 twist drills in steel box with ample space for other items. Ideal for electricians, plumbers, carpenters, etc.

Bob Davis says: Send 25c in coin for my "Handy Tip" booklet, full of ideas and hints for home jobs. Write: Bob Davis, Home Service Dept. M-114, THE BLACK & DECKER MFG. CO., Towson 4, Maryland.



FOR INDUSTRY, SHOP, FARM AND HOME

Black & Decker
PORTABLE ELECTRIC TOOLS



Classified Telephone Directory tells where to buy it. For nearest dealer, look under "Tools-Electric"

Save Money!

SAVE YOUR BRUSHES!



Now it's easy
to clean brushes

PAINT TRAP

Reconditions old hard brushes
Thoroughly cleans after using

• Place brush in can of PAINT TRAP and work back and forth on the "Stay-Clean" Paint Trap. Emulsifying action washes away any paint, varnish or shellac. Old paint settles in paint trap—liquid can be used over and over. It's safe for all bristles. No fire hazard. Buy PAINT TRAP Brush Cleaner where you buy paint, or write:



The Klean-Strip Co., Inc.
2340 S. Lauderdale, Memphis 6, Tenn.

BEST WINTER PROTECTION

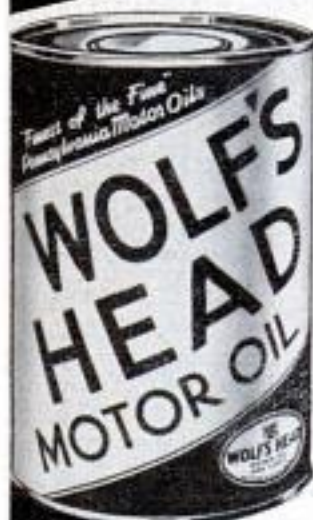

WOLF'S HEAD Motor Oil—100% Pure Pennsylvania—is specially refined from nature's finest crude. It provides rich, tough, long lasting lubrication in severe winter driving conditions. Scientifically fortified, it cleans as it lubricates . . . protects against sludge, rust, deposits. Be particular—change now to winter grade WOLF'S HEAD!

45¢
A QUART

Write for free
Weather Guide folder.

WOLF'S HEAD OIL REFINING CO., INC.
OIL CITY, PA.
GLENDALE 27, NEW YORK

Metropolitan Is a Good Thing In a Small Package, Say Owners

(Continued from page 122)

"I bought the car solely because of its eye appeal. It 'fits' me and suits my aesthetic taste."—Newburgh, N. Y., teacher.

"Rivals expensive sports cars for looks."—Myrtle Creek, Ore., department head.

"Bought it to travel back and forth to work, but found it rides so well now use it for all things."—West Hempstead, N. Y., foreman.

1954 NASH METROPOLITAN SPECIFICATIONS

ENGINE

Type 4-cyl., in-line, OHV
Bore and stroke 2.578 x 3.5 in.
Piston displacement 73.2 cu. in.
Brake horsepower 42 @ 4500 r.p.m.
Torque 62 @ 2400 r.p.m.
Compression ratio 7.2 to 1
Transmission Three-speed conventional

GENERAL

Steering ratio (over-all) 21:1
Steering wheel, lock-to-lock, 2 3/4 turns
Turn-circle diameter 40 feet
Brakes Hydraulic
Tire size 5.20 x 13
Recommended tire pressure, 24 lb. front, 22 lb. rear
Shipping weight (hardtop unladen) 1825 lb.
Wheelbase 85 in.
Tread, front 45 5/16 in.
Tread, rear 44 13/16 in.
Height, over-all 54 1/2 in.
Width, over-all 61 1/2 in.
Length, over-all 149 1/2 in.
Road clearance 6 3/4 in.

CAPACITIES

Oil 4 qt.
Water 7 1/2 qt.
Gasoline 10 1/2 gal.

INTERIOR DIMENSIONS

Front-seat width 49 3/4 in.
Front headroom 35 1/2 in.
Front legroom 43 1/4 in.

"A pleasure to just joy ride again."—Portland, Ore., supervisor.

"Back seat excellent for my grandchildren. Seat is right height. Their feet touch floor and they can see out."—Scarsdale, N. Y., housewife.

Other Complaints of Owners

"Bad service. Dealers don't know how to fix things on this new design and don't like to work on it."—Chicago policeman.

"Lack of parts available. Windshield wipers poor. Ash tray too small."—Highland Park, Ill., broker.

"Would like larger, closed glove compartment or a side pocket in door."—N. Massapequa, N. Y., housewife.

"No cover on glove compartment. Can't remove ash tray to clean it."—Bayside, N. Y., advertising man.

"My wife is short and she has to look under steering-wheel rim. Seat too low."—Lacon, Ill., manager.

(Continued to page 246)



NEW MOPAR ANTIFREEZE

*OFFERS COMPLETE WINTER PROTECTION...
WITHOUT RUST, CORROSION, "GUMMING"!*

New MoPar All-Weather Antifreeze, made with special Chrysler Corporation formula, offers you these advantages:

1. Prevents decay of cooling system rubber parts.
2. Guards against rust which causes radiator clogging, pinhole leaks.
3. Minimizes "gum" deposits which can cause engine overheating.
4. Protects against corrosion of cooling system metals.

One filling (it won't boil off!)

assures worry-free driving all winter

New MoPar All-Weather Antifreeze gives 100% protection against freeze-ups—and will not boil off, foam off, or evaporate. And new MoPar All-Weather Antifreeze helps preserve top engine performance because it helps protect your cooling system against rust, corrosion, rubber decay, and "gum" deposits.

MoPar All-Weather Antifreeze is economical, too—it costs no more than ordinary permanent-type antifreeze. Get new MoPar All-Weather Antifreeze today from your nearby Plymouth, Dodge, De Soto, or Chrysler dealer, or from better service and repair shops everywhere.

MOPAR

... is more than just the name of top-quality antifreeze. It is the identifying name of thousands of genuine parts and accessories designed and built especially for your Plymouth, Dodge, De Soto, or Chrysler car, or Dodge "Job-Rated" truck.

PARTS DIVISION • CHRYSLER CORPORATION

NOW! SLASH HEAT BILLS



with Amazing new Gold Bond TWINSULATION

You cut your heating bills immediately when you insulate your attic with new Gold Bond Twinsulation! In fact, Twinsulation soon pays back its cost in fuel savings. More than that, you collect these savings every year. And your home is so much more comfortable... warmer in winter, up to 15° cooler in summer. Remember, too, only Gold Bond Twinsulation gives you fireproof rock wool with an aluminum heat-reflective covering on both sides—double insulating action. Twinsulation is easy to install—anyone can do it. Enjoy this extra year 'round comfort that actually pays for itself.

NATIONAL GYPSUM CO., BUFFALO 2, N. Y.

Send for complete How-To-Do-It Booklet on insulating your home... then see your Gold Bond dealer!

NATIONAL GYPSUM COMPANY
Dept. PM-114, Buffalo 2, N. Y.
I enclose 25¢ for "Home Insulation" booklet.

Name

Address

City.....County.....State.....



"No power. No pickup. All you have is gas mileage."—Niagara Falls, N. Y., draftsman.

"Would like split windows with no-draft vents. Gets awfully windy at 60 with windows down."—Berwyn, Ill., accountant.

"Gearshift sometimes locks in third."—Nashville, Tenn., owner.

"Windshield wipers too noisy. Motor is under dash, should be in engine compartment."—Aberdeen, Wash., cook.

"Folding top could be improved. Boot does not fit right."—Buffalo, N. Y., photographer.

"Panel light reflects on windshield."—Revere, Mass., schoolteacher.

"Can't lock both doors from inside."—Tonawanda, N. Y., accountant.

"Tread should be two inches wider. Can't drive on usual hoists for service. Have to go where they have fork-type lift."—Villa Park, Ill., salesman.

"Rattle in steering column somewhere. All of them have this."—Shreveport, La., contractor.

"Too rough riding on city streets."—Springfield, Mass., salesman.

"Both doors should have a key lock."—Reno, Nev., telephone operator.

"No room in rear seat with top down."—Staten Island, N. Y., cashier.

"Back window slants too soon so an adult can't sit in back."—Vineland, N. J., electrician.

Is Trend to Bigger Cars Wise?

"There is no need for 100 horsepower and over to transport one or two persons."—Bayville, N. Y., estimator.

"Trend to larger, more powerful and complex automobiles is wasteful of resources, it aggravates overcrowded highways and increases danger of fatal accidents."—Concord, Mass., engineer.

"Too many large cars are 'driving' the people."—Stormville, N. Y., public-relations man.

"Too much size and power gives driver too much confidence; omnipotent feeling. Makes showoffs speed-happy as well as reckless."—Clayton, Mo., engineer.

How Would They Change Metro?

We asked the owners what one change they would make on their cars.

"Remove rear passenger seat and make trunk accessible from outside."—West Patterson, N. J., superintendent.

"Make top slightly higher and longer so adults could sit in back."—New Orleans, La., physicist.

"Make back seat roomier or eliminate it."—Newfield, N. Y., technician.

(Continued to page 248)

Ask for a ROCKWELL-BUILT
DELTA SHOP

for a Christmas of a Lifetime....



**...So easy to get
 "A-Tool-At-A-Time"**

Here's the "do-it-yourself" power tool most men really want—the Rockwell-built DELTASHOP—the only combination tool made up of full-size power tools and arranged in the natural woodworking sequence—the only one motor combination tool you can buy either complete (as shown at left) or through the sensible "Tool-At-A-Time" Plan.

Here's How Easy **DELTA SHOP**
 "Tool-At-A-Time" Plan Works

1 Start with the precision-built Homecraft 8" Circular Saw—

PACKAGE #1 (Homecraft 8" Tilting Arbor Circular Saw and Stand)** Only \$109.80*



2 Next add the Homecraft 4" Jointer—

PACKAGE #2 (Homecraft 4" Jointer) Only \$49.15*



3 Then add the Homecraft 11" Drill Press—

PACKAGE #3 (Homecraft 11" Drill Press) Only \$57.50*



4 Now, get the Homecraft Disk Sander—

PACKAGE #4 (Homecraft Disk Sander) Only \$17.55*



5 Finally, the new Homecraft Saber Saw for cutting intricate curves—

PACKAGE #5 (Homecraft Saber Saw) Only \$14.95



Other Delta Gifts from 50¢ to \$200

There's a complete line of individual Delta Tools—all of them ideal Christmas gifts. You could ask for a circular saw, jointer, drill press, sander, band saw, scroll saw, shaper or lathe.

Or—ask for the Delta accessory you've been wanting for the Delta Tool you already own. See your Delta Dealer (he's listed in the classified pages of your phone book under "TOOLS" or "MACHINERY"), or write for catalog to: Delta Power Tool Division, Rockwell Manufacturing Company, 502-L North Lexington Avenue, Pittsburgh 8, Pa.

DELTA ROCKWELL DELTA QUALITY MAKES THE DIFFERENCE
 *prices slightly higher in western region **motor extra

DELTA QUALITY POWER TOOLS
 Another Product by
Rockwell

Make Big Money Arc Welding

with these
**LOW COST
HOBART
WELDERS**



New AC Welder has Remote Control

The new 300 Amp. AC Transformer welder lets you handle the profitable jobs. Easy to operate and ideal for production or all types of general repair work. New convenience features plus finger-tip Remote Control, at no extra cost. **Generator only for "Building Your Own" portable gasoline engine driven unit that gets**



Generator for "Building-Your-Own"



"Bantam Champ"

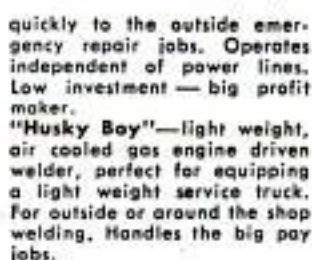

"Husky Boy"

quickly to the outside emergency repair jobs. Operates independent of power lines. Low investment — big profit maker. "Husky Boy"—light weight, air cooled gas engine driven welder, perfect for equipping a light weight service truck. For outside or around the shop welding. Handles the big pay jobs.

Let HOBART HELP YOU EARN MORE!

Hobart welders will help you earn more—start you in a profitable business of your own—built to give longer, more dependable service at low initial cost. Check the coupon for information that will start you on your way to earning more money.



HOBART trains you quickly!

You can learn arc welding quickly by actual on the job experience at the non-profit Hobart Trade School. Complete or partial courses. G.I. approved. Check coupon for free booklet.

HOBART BROTHERS CO., BOX M-114

TROY, OHIO, Phone 21223

"One of the world's largest builders of arc welding equipment"

Clip this Coupon!

MODERN ARC WELDING LESSONS
200 pages, fully illustrated. \$1.00



HOBART BROTHERS CO., BOX M-114, Troy, Ohio

Without obligation send information or items checked below:

AC Welder "Build-Your-Own" Generator Welder's Vest Pocket Guide
 "Bantam Champ" "Husky Boy" Hobart Trade School Welding Lessons, \$1

NAME _____

ADDRESS _____

CITY _____

STATE _____

"Should have overdrive."—Issaquah, Wash., engineer.

"Needs fourth speed forward. Can't get in trunk with top down."—Mt. Vernon, N. Y., attorney.

Of the mechanical troubles that the owners mentioned in their responses to the questionnaire, the most frequent was windshield-wiper trouble. Then came brake trouble, especially complaints about squealing. Other complaints concerned the carburetor, oil and grease leaks, inoperative turn signals and shift linkage sticking.

But despite complaints, owners were enthusiastic about their cars. Never have we received such a large percentage of returns on the questionnaires. Never have we had so many comments written on the blanks. In other words, the Metropolitan owners know their cars and they love this tiny import bearing the Nash nameplate.

Turn back to page 119 for Floyd Clymer's road test of the Metropolitan. ★ ★ ★

Clymer Road Tests The Metropolitan

(Continued from page 119)

Roadability is surprising and after a few miles you seem to forget you are driving a small car. There is some bottoming on hard bumps and some noise from the shock absorbers, but the ride is excellent. Quick-action steering (2-2/3 turns lock to lock) and the short wheelbase makes the car easy to corner. The narrow tread and overall length makes it desirable for congested traffic and small parking spaces.

For an 85-inch-wheelbase car, it has an amazing amount of leg and head room. Three persons can ride in the front seat, although somewhat crowded. The back seat is narrow and fine for small children, but is not comfortable for adults.

The Metro will cover about the same distance on one fill of its 10½-gallon gasoline tank as larger cars with double the tank capacity. Regular gas is satisfactory.

Styling is pleasing from front to rear and the hood has an air-scoop decoration that is not functional. The instrument panel is plain but practical. Warning lights indicate low oil pressure or a noncharging generator. The electrical system is 12-volt, an excellent feature that is becoming more common on American cars.

Fuel gauge and speedometer (the only dials on the dash) are easy to read with no horn ring to obstruct vision. Speaking of horns, the Metro has one that sounds more like a five-ton truck than a light car. Directional signals are controlled by a switch

(Continued to page 250)

THIS CAR HAS **WIPER SLOW-DOWN**

...WHEN YOU  CLIMB HILLS...  OR STEP ON THE GAS



THIS CAR HAS AN **AC BOOSTER PUMP!**

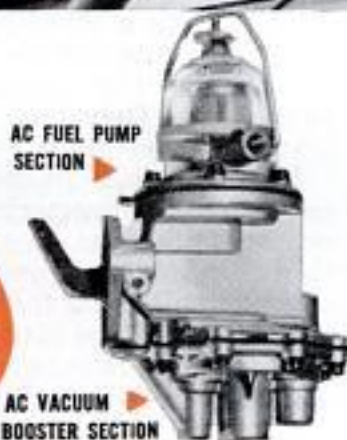
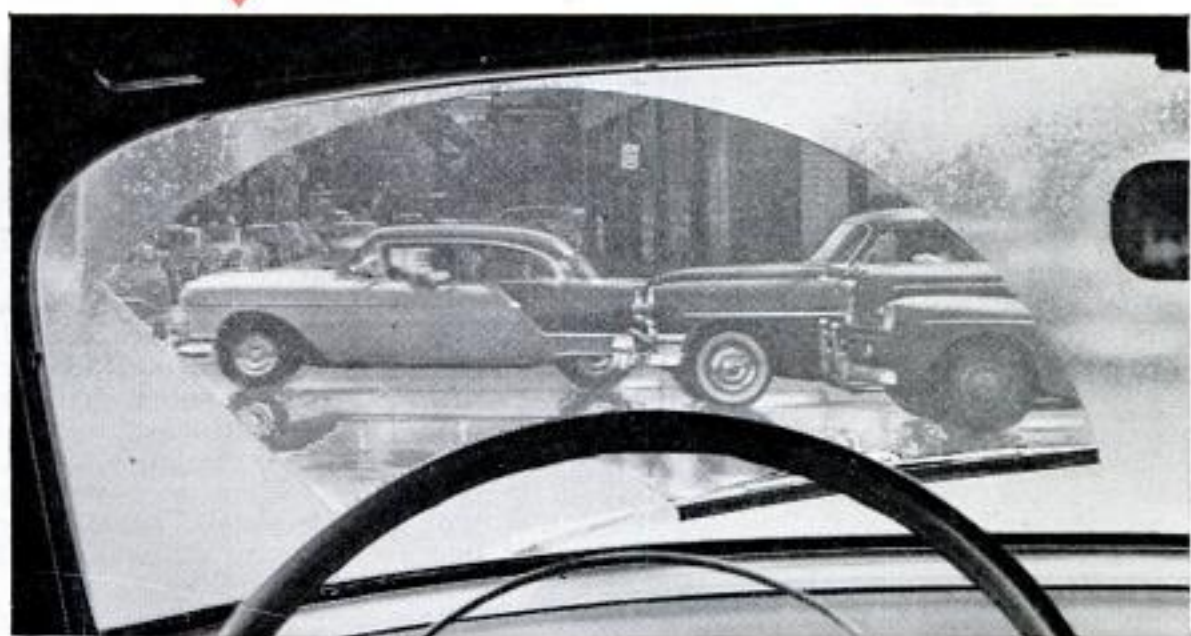

Accelerate, climb hills, pass other cars on the road—wiper slow-down is no problem when you have an AC combination Fuel and Vacuum Booster Pump! This hazard of the road need be a hazard no longer.

Insist on an AC combination Fuel and Vacuum Booster Pump on any new car or truck you buy—or have one installed on the one you are now driving.



AC SPARK PLUG DIVISION • GENERAL MOTORS CORPORATION

FREE PLAN

Tells How to Start
Your Own Business

FILING SAWS

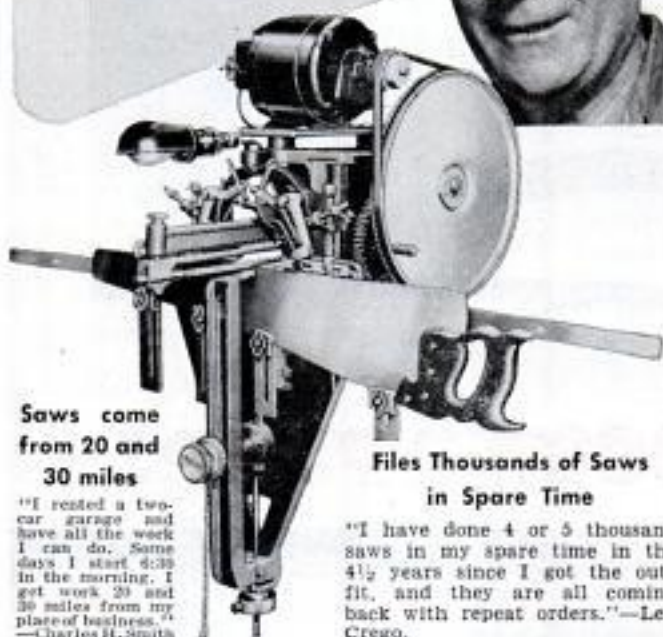

Saws come
from 20 and
30 miles

"I rented a two-car garage and have all the work I can do. Some days I start 6:30 in the morning. I get work 20 and 30 miles from my place of business."
—Charles H. Smith

Files Thousands of Saws
in Spare Time

"I have done 4 or 5 thousand saws in my spare time in the 4½ years since I got the outfit, and they are all coming back with repeat orders."—Len Crego.

FOLEY FILED SAWS BRING NEW CUSTOMERS

Here is a steady repeat CASH business that pays up to \$3 to \$5 an hour, and you can start in your own basement or garage in your spare time. Every saw you sharpen with the machine accuracy of the Foley Saw Filer is an ad that brings more customers. S. M. Hollingshead wrote to us: "I am doing very well with my Foley Filer, and I am glad I invested in your machinery. It is very satisfactory and works very well in the small community in which I live."

You can file all hand saws, also band and crosscut circular saws on the Foley Saw Filer. The adjustments are simple—there is no eyestrain—and you can start right away to turn out perfect cutting saws. "The first saw I sharpened with my Foley Saw Filer came out 100%. I think it is a marvel of perfection."—writes Clarence E. Parsons.

"**MONEY MAKING FACTS**" explains how you can get business from hardware stores, home owners, farmers, carpenters, schools, mills, factories, etc. Just think—with a modest investment, no overhead, no stock of goods to carry, you can start right in on a cash business that will help pay the rent, buy groceries, or a new car. Get the facts—send coupon today for this practical, money-making plan. No salesman will call.



Send for **FREE BOOK**

FOLEY MFG. CO., 1116-4 Foley Bldg.,
Minneapolis 18, Minn.

Send me free book "**MONEY MAKING FACTS**"

Name _____

Address _____

on top of the horn button. A temperature gauge would be worth-while—there is none. The pull-type starter switch, ignition key and light control are all operated by the right hand. The ash tray is on top of the instrument panel. Radio speaker is in the center. The radio is below average. The glove compartment has no lid and is about big enough for a good-size pair of gloves. The rear-view mirror is well located, although the glass seemed to be of poor quality, distorting rear vision.

The front-seat cushion is foam rubber with leather and nylon upholstery. Vinyl plastic is used for door trim, side panels and rear-seat upholstery. A rear tire mount carries the spare outside the trunk as there is no exterior opening into the luggage compartment. Luggage must be loaded from inside the car. Most owners would prefer a luggage compartment operating from outside and so would I.

Vision is exceptionally good, front and rear. All four fender tips are easily seen by the driver. Three and a half turns of the crank open the windows. Doors open and close easily. Only the right door can be locked from the outside. This is bad because in a parking lot another car may drive so close that it is difficult to use the right door.

The brakes are hydraulic, internal-operating Girling (an excellent British make). There are several other British characteristics about the car as it is built in England for Nash.

The brake-pedal pressure is rather hard, but I found no evidence of fading even when abusing the car around winding mountain roads and turns. The pedal, however, is too small and is located too close to the clutch pedal and accelerator. The accelerator is an odd-shaped curved lever with a roller for the foot to press. It is not good as there is too much travel and Nash is already adding a conventional organ-type throttle pedal. This still does little to improve the arrangement because of the awkward foot angle.

The body and chassis are welded as a unit, a feature of all Nash cars. This does help eliminate rattles and squeaks and I found none in the test car which was waterproof also. There is a feeling of solidity about the well-built body.

I felt very safe in the car. Once one gets used to its characteristics, a small car is not so dangerous as some people seem to think. In fact, all owners answering our questionnaire said they felt safe in the car.

It may well be that Nash has started a new trend in American motoring. Perhaps the public is now getting ready to accept a small car—Nash is betting that it is. ★ ★ ★

GIVE A DREMEL STRAIGHT-LINE ACTION SANDER!

The PERFECT GIFT...
for PERFECT FINISHES!

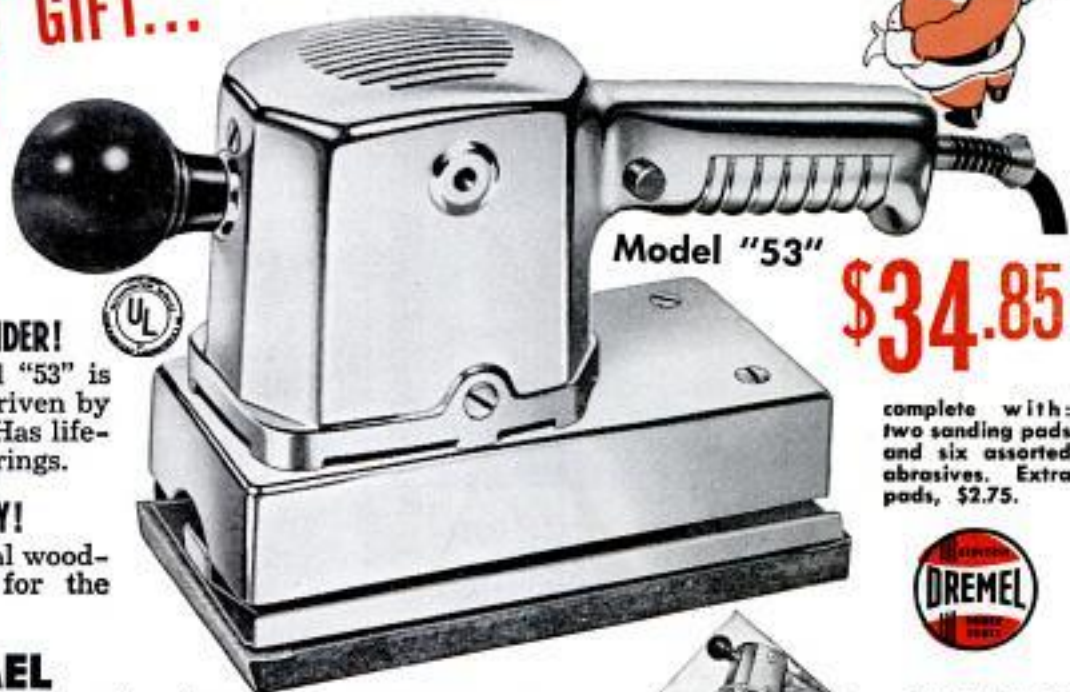

● SENSATIONAL NEW SANDER!

The DREMEL Model "53" is a real powerhouse, driven by a real rotary motor! Has life-time sealed ball bearings.

● HEAVY DUTY CAPACITY!

Built for the industrial wood-worker yet priced for the handyman!

● ONLY DREMEL

offers you straight-line action in a big capacity, motor-powered sander. That's why the "53" is the choice of craftsmen in home and industry. The "53" has a big 24 sq. in. sanding pad, yet weighs but 5 1/4 lbs. Delivers 6,000 strokes per minute. Has no gears, belts, brushes or commutator to wear out. Use it for WET or DRY, coarse, medium or fine sanding. You'll get results impossible with other sanders costing many dollars more!

EXCLUSIVE!

DREMEL Model "53" has a quick-action detachable sanding pad. Extra pad furnished free.



complete with:
two sanding pads
and six assorted
abrasives. Extra
pads, \$2.75.



Easy on! Easy off!
Only DREMEL
has it!

Hobbyists . . . Craftsmen . . . Housewives . . . All Need a DREMEL Sander!

Did you know there are 4 different sanding actions? When choosing a power sander—it's the type of action that counts. To do the job right, you must sand with-the-wood grain. Sanding across-the-grain with a circular or orbital motion leaves scratches and swirl marks which show up after varnishing. Always remember — only DREMEL STRAIGHT-LINE ACTION will sand with-the-grain.

Proof that DREMEL Action Can't Scratch!

Of the four common sanding actions, only DREMEL sands 100% with-the-grain—the only guaranteed scratch-free action approved by finishing experts.

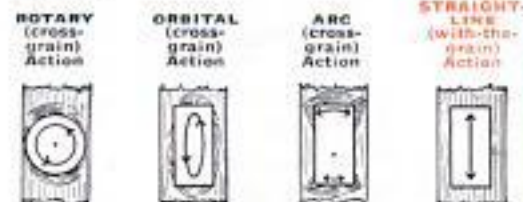

SEE YOUR FAVORITE DEALER: Dremel Tools are sold at better dealers everywhere! If your dealer can't supply, order direct on a five-day trial, money-back guarantee. Remit in full, and we will ship postpaid. Or, send only \$2.00 now, pay postman balance plus postage and C.O.D. fee.

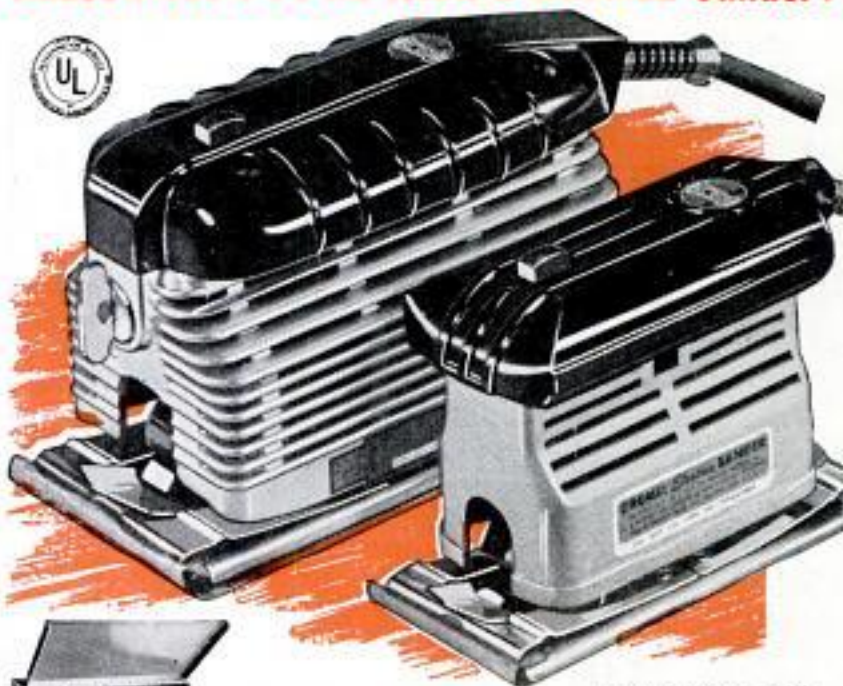

DREMEL MODEL "2000" SANDER-POLISHER

Perfect for small shop use, home repair, and workshop projects. Choice of craftsmen for fine finishing operations. Features Dremel "Straight-Line Action"! 14,000 strokes per min.; 5 lb. wt.; 21 sq. in. (3 1/2" x 7") sanding surface. Model "2000" Sander-Polisher, 25 asst'd. abrasives, 1 polish pad in sturdy steel carrying case **\$24.50**

DREMEL MODEL "A" SANDER-POLISHER-MASSAGER

Lighter capacity model, a favorite for general home maintenance, hobbycraft, furniture polishing, etc. Effective body massager. Features Dremel "Straight-Line Action." Wt. 2 1/2 lbs.; 12 sq. in. (2 1/2" x 5 1/2") sanding surface. Model "A" Sander-Polisher-Massager, 6 abrasives, 1 polish pad, 1 massage pad **\$14.85**



DREMEL MANUFACTURING COMPANY, Dept. 114-L, Racine, Wisconsin



Piston rings wear out, too!

You can't see the wear on your piston rings. But you can feel it—in your engine's loss of power—and in your pocketbook.

At the first symptom of power drop-off or oil-pumping, you should go to your motor specialist for a ring check-up.

Wasted oil costs money. Needless repairs cost more. Both can be avoided by replacing the piston rings at the first symptom of ring wear.

Hastings rings are especially designed for replacement service. They deliver the lubrication that older motors must have—but always with complete oil control.

Don't gamble with the power that is built into your engine. Restore it, keep it, enjoy it.

If your motor specialist recommends new rings, ask him to install a Hastings Steel-Vent replacement set. Truly the best money you can spend on your car!

HASTINGS MANUFACTURING CO. • HASTINGS, MICHIGAN
HASTINGS LTD., TORONTO
Piston Rings, Casite, Oil Filters, Spark Plugs

HASTINGS

STEEL-VENT PISTON RINGS

Regular or Chrome



TOUGH on Oil-Pumping
GENTLE on Cylinder walls

Are the V8s All Alike?

(Continued from page 142)

up. Studebaker, Ford and Mercury are doing very well with solids.

At the other end of the valve train there are some interesting features. For instance, Ford Motor Company V8s (Ford, Mercury and Lincoln) have special features to prolong valve life. Low-friction valve-spring retainers are used that permit the valves to rotate freely as they move up and down; this greatly reduces seat deposits and wear. Furthermore, to promote valve cooling, they don't use separate guide bushings; the valves run directly in the iron cylinder heads—and this reduces valve-head temperatures over 200 degrees Fahrenheit. All the other V8 builders use conventional "solid" valve retainers and separate guides.

Ignition and Carburetion

Ford has done some pioneering in spark-advance control, too. All the other makers use a combination of manifold vacuum and engine speed to control the spark advance on the road; a linkage operated by centrifugal flyweights in the distributor advances the spark as the engine speed increases, and a diaphragm connected to the manifold operates another linkage to advance or retard the timing according to the load on the engine. Works good.

Ford has apparently found a simpler and less expensive way to do it. On the new Ford, Mercury and Lincoln V8s there is just a diaphragm linkage, and this is connected to the manifold vacuum and the carburetor throat (venturi). Manifold vacuum is proportional to load and venturi vacuum depends more or less on revolutions per minute; the combination of the two is put to work to handle spark advance over the full operating range. What could be simpler?

Whether to use a two or four-barrel carburetor is pretty much a question of your performance requirements. The hotter jobs—the large Chrysler, Oldsmobile, Buick, the big Studebaker, Cadillac, Lincoln and Mercury—use the big \$65 quads. DeSoto, Dodge, small Buicks, Ford and Studebaker Commander use the two-barrel carburetors. Any of these latter engines, however, could jump 10 percent in horsepower overnight with a quad installation.

To me, one of the most interesting features about the four-barrel carburetors is a special gimmick to control the two secondary barrels (used only by Buick). All the other engines open the secondary barrels according to manifold vacuum or throttle position. When you floor the throttle

(Continued to page 254)



\$35,000 REWARD FOR URANIUM

Here's your chance to "cash in!" Over \$2,500,000 in Government Bonuses have been paid for URANIUM discoveries in the past 2 years. Currently \$150,000 a month is paid to people just like you.

Precision Geiger Counters and Scintillators are the finest instruments made for URANIUM prospecting. These highly sensitive instruments are compact, lightweight and ruggedly built for field use. Prices start at \$29.95.

CONTACT YOUR NEAREST DEALER or write direct to factory for FREE 12-PAGE CATALOG, describing URANIUM and Metal detectors.



PRECISION RADIATION INSTRUMENTS, INC.
2235PM S. La Brea, Los Angeles 16, California

WORLD'S LARGEST MANUFACTURER OF PORTABLE RADIATION INSTRUMENTS

AT ALL HARDWARE STORES

FULLER'S "SCREW HOLDER"

SCREW DRIVERS

NOW! do the job at HALF THE COST!

- Spring Clip holds and sets screws tightly!
- Reaches those "out of the way" spots!
- In 3 1/2", 4 1/2", 6" and 8" lengths — **ONLY 30c**
- Also 4" Phillips type!
- Hi Carbon Blades! • Unbreakable Amber Handles! (3 1/2" x 1/2" blade)

FULLER TOOL CO., Inc. 3522 Webster Ave., N. Y. 67
Export Sales Dept., John H. Graham Co., 105 Duane St. • New York, U. S. A.

LAWN ORNAMENT-NOVELTY PATTERNS

28 Lawn Ornament Patterns, 25c. Other Patterns: 15-20" high: Dutch Girl, Dutch Boy, Pirate, Bull Terrier, Mexican Girl, Mexican Boy, Dwarf, Penguin, Flower Girl, 15c each. 25 Novelty Patterns, 30c. All 62 Full Size Patterns, \$1.00.

Strother Pattern Service, Dept. DR-8, Box 128, Belington, W. Va.

HARDWOOD LEGS FOR "YOU-MAKE-IT" FURNITURE

Solve problem of leg strength!

Laminated to shape—not bent. Take any finish. Easy to make useful, beautiful modern furniture with simple, ordinary tools. 4 sizes for you cut to suit: 1"x4", \$3.39; 2"x4", \$4.99; 2"x6", \$7.52; 3"x6", \$7.88. Send for set of 4 legs today—satisfaction guaranteed. Or get catalog of complete kits of furniture. Prices F.O.B. Send one-half cash or money order—balance C.O.D.

ECONOWAY, INC., Dept. M-2, Box 410, Niles, Michigan

BUILD your own SMITH AIR COMPRESSOR

Operates spray guns, rock drills, tampers, paving breakers, sandblasting . . . Uses only 1 gallon of gas an hour! Famous the world over! Capacity 60 cu. ft.; pressure up to 100 lbs. per sq. inch. Just order the Smith Compressor Head and Accessories with complete instructions for assembling. All you need is a Ford Motor and shop facilities. Head equipped with high speed compressor valves; automatic unloading and idling.

Write for complete information!

GORDON SMITH & COMPANY, Inc.
410 College Street • Bowling Green, Ky.



WARNING!

Insure now against Anti-freeze loss and engine overheating

1. CLEAN OUT RUST AND SCALE WITH NEW IMPROVED DU PONT COOLING SYSTEM CLEANSER

To prevent costly spill-over and boil-away, clean out your radiator *before* adding anti-freeze. Du Pont Cooling System Cleanser gets rid of rust, scale and grease quickly, safely, surely. No reverse flushing necessary.



2. PREVENT LEAKS AND SEEPAGE WITH DU PONT COOLING SYSTEM SEALER

Your cooling system may *seem* watertight, yet still have tiny pinholes through which permanent anti-freeze can "creep." To eliminate the threat of this wasteful seepage, simply pour Du Pont Cooling System Sealer into your radiator. It finds and closes the holes . . . can't clog or harm hose or metal parts.



ASK ABOUT THE COMPLETE DU PONT PRE-ANTI-FREEZE SERVICE at your service station or car dealer today and assure trouble-free driving this winter.

DU PONT NO. 7. PRODUCTS
From Chemical Research . . . For Easier Car Care



BETTER THINGS FOR BETTER LIVING . . . THROUGH CHEMISTRY

Radioactive
Tracer Tests
Prove . . .



PYROIL "A"

reduces top cylinder wear **40%**

These results were achieved by one of America's most reputable independent oil laboratories using the most modern radioactive scientific instruments in a series of tests which compared wear on top piston rings with and without Pyroil "A" added to *premium grade gasoline* . . . Pyroil "A" in a *continuous* test reduced wear 40%. In normal stop and go driving the value of Pyroil "A" as a *top engine* lubricant would be even more evident!

HERE'S WHY!

Pyroil "A" contains an agent possessing a high polar attraction for metal, so it clings strongly to all metal surfaces. Pyroil is also strongly attracted to oil which means that it actually *holds* oil to the metal. Thus when two metal surfaces slide together the oil is not squeezed out nor will it drain or wash off.

Pyroil "A" lubricates valve stems and upper engine parts not properly lubricated by crankcase oil. Rust proofs entire exhaust system.



PYROIL "B" Crankcase Additive
Reduces Wear 17% when used
with premium or heavy duty oils

Another test by a petroleum laboratory shows a 17% reduction in engine wear when Pyroil "B" is added to one of the top grade heavy duty oils, due again to its polar attraction creating a thin film of an extreme oiliness nature which will not drain off, wash off or squeeze off. Keeps hydraulic valve lifters free—makes starting easier!

The Perfect Pair for Motor Care

Pyroil "A" complete upper engine lubrication only 25¢

Pyroil "B" complete crankcase treatment only 79¢

IT PAYS TO PYROILIZE

NEW
40°
Below
Zero
Protection



PYROIL frostfree "A"
— Gasoline Anti-Freeze
plus top engine lubrication
8 oz. only 50¢

PYROIL frostfree "B"
— Winter Crankcase Ad-
ditive plus condensation
protection 12 oz. only 79¢

Sold by leading gasoline stations, garages and automotive stores in Canada, Cuba and most foreign countries. Write for descriptive literature.

PYROIL COMPANY, INC., 279 PYROIL BLDG., LACROSSE, WISCONSIN

at very low speed all four barrels pop open and you've got too much carburetor capacity; mixture distribution gets sluggish and the torque output may be less than with only two barrels. On the Buick carburetors a special valve system keeps the rear barrels closed off, even with full throttle, until the engine air-flow demand actually exceeds the capacity of the primary barrels—something around 1500 revolutions per minute. Throttle response at low speed is improved. It's the only logical way to regulate a four-barrel carburetor.

Well, anyway, I think you'll agree that, even though our new V8s may look pretty much alike from the outside, you've really got plenty to choose among. Which will it be for you? ★ ★ ★



Fast-Acting Core Drill Cuts Holes in Concrete

Water and a cutting compound are used in a vertical drill that cuts through concrete, stone or glass. Speedy, quiet and dustless, it can be used in occupied buildings to cut holes for conduit, water and service lines, and for anchoring machinery of any size. When the drill gets dull, it isn't sharpened on a grinding wheel—a common hacksaw regrooves it in three minutes. A new drill costs about one tenth as much as the usual carbide-tipped drill. The machine drills a core of one to six inches in diameter at the rate of 1/4 to 3/4 inch per minute. No experience is required to operate it. Maximum depth of the hole is 18 inches.

POWER HYDRAULICS for SNOW PLOWS

Use on



TRUCKS



JEEPS



TRACTORS

HY-LO-JACK
does
the job
**FASTER-
EASIER**

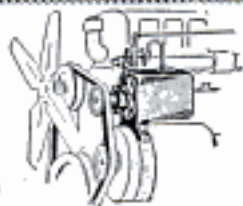

- Lifts average snow plow in 3 to 10 seconds.
- 1,000 lbs. per square in. pressure
- Quick, easy installation on new or existing equipment.
- Complete kit form, including the pump, tank, hose lines, etc.
- Electric unit also available for 6 or 12 volt systems.

* Write for Circular. See your Road Machinery, Jeep or Farm Equipment dealer.

MONARCH ROAD MACHINERY CO.
Quality Machinery since 1856
1331 Michigan St., N.E., GRAND RAPIDS, MICH.



Buy the things you
want with the money
you save using this...

New

Porter-Cable

Homemaster

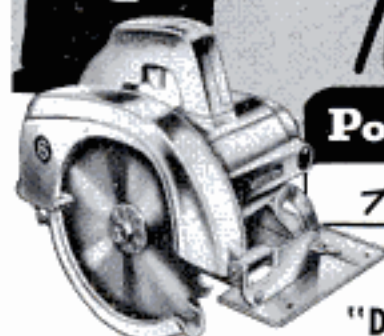

"DO-IT-YOURSELF"

ELECTRIC SAW

Convert your attic yourself and save up to \$500!
Build a basement gameroom and save as much as \$400. Save around \$50 on wooden lawn furniture!

Men whose tool experience is limited to screwdrivers and hammers find this an extremely easy saw to use. It was built for amateurs — but built in such a way they'll still be using it when they're "experts."

First and foremost, it's safe. The Kick-Proof Clutch (only one of its kind) prevents the blade from kicking out of the cut when you hit hard knots. And the protective telescoping guard always covers the exposed teeth, whether the blade is whirling or at rest.

It's a powerful saw with a big 9 amp. motor. Comes with a 6" combination blade that makes any cut you want — long rips, fast cross-cuts, shallow or deep grooves, narrow or wide angles, tricky bevels. Has ball bearings throughout. Installs on a saw table (accessory) for double usefulness. Fully guaranteed by manufacturer.

Remember, the money you'll save
with this saw will pay for the things
you thought you couldn't afford!

Only **49⁵⁰**

- Mail coupon for specifications, pictures, etc.

PORTER-CABLE Machine Co.
2451 N. Salina St., Syracuse 8, N. Y.
In Canada: Strongridge, Ltd., London, Ont.
Send illustrated literature on Model 125 "Do-It-Yourself" Electric Saw . . . also address of store where I can examine one.

Name.....

Address.....

City.....Zone.....State.....

Makers of Speedmatic & Guild Electric Tools Since 1906

SAVE OVER 50% ON Extruded Aluminum

STORM WINDOWS AND DOORS

Send for FREE "Do-It-Yourself" Book-PM-1154

U-FAB-IT-URSELF, INC.

Worthington, Ohio

COMBINATION SCREEN-STORM WINDOWS & DOORS • CASEMENT PICTURE-BASEMENT WINDOWS • SCREEN DOORS & SCREENS



NEW, IMPROVED CALCULATOR FOR WOODWORKERS only 25c

Instantly gives information on lumber, nails, concrete mixes, painting materials, etc. Convenient, simple to read. Just set dial for nail specifications, to convert linear to board feet, find bit sizes for screws, compare characteristics of woods. 6" diameter heavily varnished cardboard. Send 25c, no stamps, please to Greenlee Tool Co., 2111 Columbia Avenue, Rockford, Illinois.

Holds Tight

ask your dealer for

Red Devil
triangle points



Red Devil Tools.

Get your FREE copy of "HOW TO CUT GLASS."

MAIL COUPON TODAY

Red Devil Tools. Dept. 150
130 Coit Street, Irvington, N. J.

NAME.....

ADDRESS.....

CITY.....ZONE.....STATE.....

BEST-BORE Wood Boring Bits for your $\frac{1}{4}$ " electric drill at really low cost

\$2.49



FAST, ACCURATE, EASY BORING

You'll be amazed at the ease of boring holes from $\frac{1}{4}$ " to 1" in wood, panel board, plaster, plastic or composition—to say nothing of the price. Best-Bore Bits make clean, true holes—at an angle, into end grain or for mortising. Also ideal for hard to reach places and for boring overhead.

Bits — $\frac{1}{4}$ ", $\frac{3}{8}$ ", $\frac{1}{2}$ ", $\frac{5}{8}$ ", $\frac{3}{4}$ ", $\frac{7}{8}$ ", 1", chrome-plated shank packed in handy plastic case, complete with instruction leaflet and tightening wrench. Your hardware dealer can supply, or send money order for \$2.49.



Buy the **Parker Line**
SNELL DIVISION
PARKER MANUFACTURING CO.
WORCESTER 1, MASS., U. S. A.

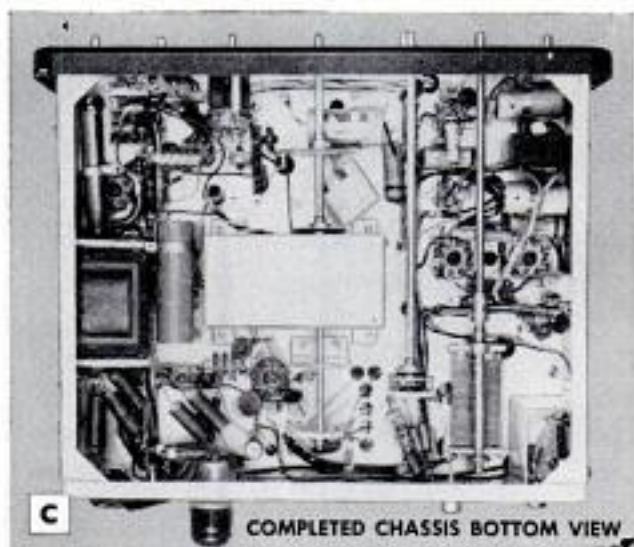

COMPLETED CHASSIS BOTTOM VIEW

CW and Phone Transmitter Kit

(Continued from page 160)

Johnson model 122 VFO kit, and it is extremely stable. The separately calibrated bandspread-dial scales for each of the seven bands, and the efficient 6 to 1 planetary-dial mechanism, provided exceptional tuning accuracy with smooth control when tested under actual operating conditions. The 65-watt phone with 100 percent modulation and pi-network antenna load matching from 50 to 500 ohms will please any ham. Excellent break-in keying stability for CW is accomplished by light loading, voltage regulation and careful circuit design. The kit is available from all radio-parts houses.

Photos B and C show top and bottom views of the completed chassis. Wiring harness, which greatly simplifies assembly, is supplied. All parts, hardware and connectors, are furnished in the kit which includes the chassis base, cabinet and all shields which are formed and punched. No drilling or other metal work is necessary. The 18-gauge steel cabinet measures 15" x 11 $\frac{5}{16}$ " x 9". Photo D shows a view of the meter-shield and TVI-filter assembly.



SHOP by MAIL and SAVE at GROBAN'S

SURPLUS SALE

ALL ITEMS Brand New!

BRAND NEW - MULTI PURPOSE HYDRAULIC PUMP OR MOTOR

NEW MANUFACTURE
ITEM #55 Silent, High efficiency, Helical Gear Type Ball Bearing, Hydraulic Pump or Motor. Rated 8 Gal. Per Min. At 1500 R.P.M.—Delivers — 1000 P.S.I.—Reversible Rotation — 3/4" Pipe Thread Inlet and Outlet Ports—1/4" Drain Port—3/8" shaft with keyway and flat for either direct or pulley drive. Dimensions—5 3/4" high 7 1/4" long, 3 1/4" wide. Shipping weight 18 lbs.
P.O.B. Chicago. 45.50

DOUBLE ACTION HYDRAULIC CYLINDER

ITEM #31C—3 1/2" bore, 11" stroke. Alloy steel cylinder wall. Micro-Honed and all steel 1 1/4" diameter piston rod. 191 1/2" overall length closed. Clevis mounting at base and shaft. Will lift 9625 lbs. with 1000 P.S.I. Pressure. Uses 3/8" tubing fittings. Fittings to pipe thread: two 3/8" MPT & 3/8" A \$102.00 value. Shipping weight 11 lbs. **P.O.B. Chicago. 25.00**

SELF-PRIMING HAND FLUID PUMP WITH STRAINER

ITEM #129—Type D-2—May be used as a boat bailing pump, sump pump, barrel pump, fuel transfer pump, for water, oil, gasoline, insecticides, etc. Bronze and aluminum construction, 3/4" in. pipe thread ports. Fine general utility hand pump. Capacity—300 Gal. per hr. **Ship. wt. 6 lbs. P.O.B. Chicago. 11.95**

CENTRIFUGAL PUMP

Brand New
ITEM #130
200 GALLONS Per Minute
 • For Draining Basements • Fire Fighting
 • Irrigation • Fuel Transfer • Swimming Pools
 • Home Water Systems • Dewatering
 For high volume commercial, home and industrial use. Standard 2 1/2" pipe thread inlet, twin 1 1/4" pipe thread outlets. Ball bearing supported 3/4" shaft. Easy priming. Rotation, counter-clockwise facing shaft. Gov't. aq. cost \$145.00. Complete with full instructions. **Ship. wt. 35 lbs. P.O.B. Chicago. 39.50**
 Will deliver 200 gals. per min. against 65 ft. head using 5.2 H.P. at 3500 R.P.M.

GROBAN HYDRAULIC SPEED REDUCER

with FINGERTIP CONTROL
USE FOR: • Reamer Drives • Midget Cars • Feed Mills • Canning Machines • Conveyors • Lathes • Milling Machines • Motor Boats • Cream Separators • Garden Tractors • Pumps.
OUTPUT SHAFT
 Variable output speeds from 0 to input speed available by moving control handle. Locking handle maintains setting. Use input power of 3/4 to 1 1/2 H.P. Shafts 3/8" diam. Input rotation counter-clockwise facing shaft. Input speed 750 R.P.M. 7 1/2" x 3 1/2" x 1 1/2". Gov't acquisition cost \$428.00. **Ship. wt. 31 lbs. Complete with 2 qts. of oil and full instructions. P.O.B. Chicago. 54.50**

Brand New! 5-TON BLACKHAWK HYDRAULIC LIFT KIT

The Complete Kit NOW ONLY 44.45 complete
Item No. 116
 For — • Dumping farm wagons • Adjusting depth of plows • Hydraulic press • Hydraulic jack • Snow plows.
KIT CONSISTS OF:
 1—Brand new Blackhawk Model P-151—Hydraulic hand pump with built-in oil tank and release valve. Rated from 1200 P.S.I.—to 8000 P.S.I. 20" handle. Dim. 6" x 6" x 6"
Item #42. 22.50
 1—6 Ft. length double wire braid rubber covered hydraulic hose—tested to 20,000 lbs.!
Item #2784. 3.95
 1—Hydraulic cylinder. 2 1/2" bore, 7 1/2" stroke. 1 1/2" stainless steel shaft. Will lift 10,000 lbs. using pump pressure. Standard clevis mounting. May also be used for double action service.
Item #355A. 17.00
 2-Qts. non-foaming hydraulic fluid. 1.00
 All necessary hydraulic fittings. Total ship. wt.—40 lbs.
COMPLETE KIT PRICE. \$44.45
ALL OF ABOVE INCLUDED P.O.B. Chicago

A. C. ELECTRIC GENERATOR

ITEM #G-75-D
 —7 1/2 K.W. single phase, 110/220 volt output. 3 wire 333-tem, 2 bearing construction, 5 groove 6" V belt pulley included. Self-excited. Foot mounted. Drive generator from tractor or stand by engine. Ample power for 6 room house. Dimensions: 34" x 11 1/2". Shipping Wt. 420 lbs.
P.O.B. Chicago 295.00

RUGGED!! 25 TON MASSIVE!! CAPACITY HYDRAULIC CYLINDER

ITEM #1815
 • ALL STEEL CONSTRUCTION
 • 8" BORE—15" STROKE
 • DOUBLE ACTION
 • 50,000 LBS. PRESSURE WITH 1000 P.S.I. PUMP OUTPUT.
 • UP TO 70,000 LBS.—CAPACITY ON INTERMITTENT SERVICE.
 • SOLID STEEL 2 1/2" PISTON ROD
 • 1" PORTS
 • OVERALL DIAMETER—10 1/2"
 • DISTANCE BETWEEN CENTERS—28 1/4" CLOSED—43 1/4" OPEN.
IDEAL FOR:
 • HYDRAULIC PRESSES • DUMP TRUCK HOISTS • TD-18, TD-24 INTERNATIONAL HARVESTER DOZERS AND GRADERS • LEVELING RAMPS • INDUSTRIAL MACHINERY • ROAD MACHINERY • FARM MACHINERY • HYDRAULIC TAIL GATES
 Replacement cost—\$300.00. Shipping Wt.—185 lbs.
SPECIAL PRICE P.O.B. Chicago. 95.00

GENERAL MOTORS -ALLISON

200 GALLONS Per Minute
 • For Draining Basements • Fire Fighting
 • Irrigation • Fuel Transfer • Swimming Pools
 • Home Water Systems • Dewatering
 For high volume commercial, home and industrial use. Standard 2 1/2" pipe thread inlet, twin 1 1/4" pipe thread outlets. Ball bearing supported 3/4" shaft. Easy priming. Rotation, counter-clockwise facing shaft. Gov't. aq. cost \$145.00. Complete with full instructions. **Ship. wt. 35 lbs. P.O.B. Chicago. 39.50**
 Will deliver 200 gals. per min. against 65 ft. head using 5.2 H.P. at 3500 R.P.M.

GROBAN FOUR-WAY OPEN CENTER HYDRAULIC CONTROL VALVE

ITEM #126—Four-way open center control valve, with built-in adjustable relief valve factory set at 1000 P.S.I. Spring loaded neutral position. For use with one double acting cylinder. In neutral position cylinder is locked and pump unloaded. Can be used as single unit or mounted in series. Has 3/4" pipe thread inlet and outlet. 1/2" pipe thread cylinder ports. Finger grip handle. **Ship. wt. 10 1/2 lbs.**
AN OUTSTANDING BUY! P.O.B. Chicago 21.50

FREE FALL & WINTER EDITION
 1954-55 CATALOG, 52 PAGES, check-full of unsurpassed War Surplus Equipment Bargains for farm, home, factory, workshop. Write letter today.

To place phone orders call Webster 9-3793
GROBAN SUPPLY CO. Dept. PM-11
 1139 S. WABASH AVE., CHICAGO 5, ILL.

ORDER DIRECT FROM AD SATISFACTION GUARANTEED
 Send Payment Or Purchase Order Today

NOW! A BIG Drill Press Vise
 A quality tool. Dense grain semi-steel jaws; 3/4" machined screw; lies on either side as well as upright. Send cash, check, money order. Money refunded if not satisfied. **\$9.95**
GORDON & MORGAN MACHINE CO.
 3725 Touzalin Ave., Lincoln, Nebraska

MAGNETS
ASSORTED MAGNETS with big list of handy uses. 5 for \$1
POWERFUL POCKET MAGNET ideal for testing metals. \$1
RETRIEVING MAGNET pulls tools, etc., from tank or lake. \$3
HOT PAD MAGNETS to insert in your own hot pads. 8 for \$1
BULLETIN BOARD MAGNETS to "pin-up" memos, etc. 8 for \$1
SLENDER MAGNETS remove chips from drill holes. 2 for \$1
WE REFUND EVERY PENNY IF NOT 100% PLEASD POSTPAID
PARK MAGNETS, PM-11, 1557 GREENBAY RD., HIGHLAND PARK, ILL.

IDEAL LAWNMOWER SHARPENER
BOOST YOUR INCOME
 You can earn extra cash with the Model 300 Ideal Lawnmower Sharpener. Used and recommended by leading manufacturers and service shops, the Ideal has everything you need, nothing else to buy. Grinds reel and bed knife, also reconditions. Get started now in this highly profitable business. Write for catalog today.
The Fate-Root-Heath Co.
 Dept. PM-11, Plymouth, Ohio

Look at these

CRAFTSMAN

REG. TRADE MARK

Carbide Tipped Saws

Now Save Up to
\$262 until
 Dec. 31st

ONE OF THESE SAWS

—a 10-inch blade in actual service—sawed more than 27 miles of 3-in. laminated Masonite without resharpening, until damaged by a steel object!

8-inch
 Was \$8.75

\$7.77

Compare these LOW LOW Sale Prices

Sears introduced this special design saw less than 3 years ago. Since then we have consistently sold these top quality blades at prices lower than any other saw blade manufacturer. Now, during this sale, until December 31, we are again cutting our regular low price.

Tungsten carbide tipped—hardest metal known! Special steel saw blade is heat treated. Teeth are ground with diamond wheels to exacting tolerances to give faster, smoother, more efficient cutting; less vibration; less noise. Needs less resharpening. Rips, cross-cuts, miters. Cuts all woods, plastics, Formica, aluminum, abrasive building materials, wallboard, etc. NOT for masonry, steel or other ferrous metal.

Prices reduced at your nearest Sears Retail Store!

Diam.	Arbor Hole	Fits These Saws	Price
5 ⁷ / ₈ in.	13/16 in. diamond	6-in. Skil-saw elec. hand saw...	6.66
6 in.	1/2 in. square	Mall; DUNLAP elec. hand saw...	6.66
6 in.	5/8 to 1/2 in. round bushed arbor	Porter-Cable electric hand saw; bench saws	6.66
6 1/8 in.	1 1/8 in. round	6-in. Black and Decker	6.66
6 1/2 in.	1/2 in. round	CRAFTSMAN 6 1/2-in. electric hand saw; bench saws	6.66
7 in.	5/8 to 1/2 in. round bushed arbor	Bench saws	7.33
7 in.	13/16 in. diamond	Skil-saw and Sears former 02186 electric hand saw	7.33
7 in.	1/2 in. square	Mall electric hand saw	7.33
8 in.	5/8 to 1/2 in. round bushed arbor	CRAFTSMAN 8-in. electric hand saw; bench saws	7.77
8 in.	13/16 in. square	Mall electric hand saw	7.77
8 in.	13/16 in. diamond	Skil-saw electric hand saw	7.77
8 in.	1 3/8 in. round	Black & Decker elec. hand saw	7.77
10 in.	1-3/4-5/8 in. round bushed	Bench, builders', radial, and swing saws	8.88
12 in.	1-3/4 in. round bushed arbor	Radial saws, swing saws, and bench saws	14.88



1/2 or 13/16 in. square 1, 1 1/8, 1 3/8 in. round 1/2, 5/8, 3/4 in. round 13/16 in. diamond

Big Price Cuts!

CRAFTSMAN

REG. TRADE MARK

Molding Cutter Set

Separate Prices
Total \$19.95

\$9.95

SEARS
ROEBUCK AND CO.



Plastic Storage Box included with each set. Has six compartments for cutter bits . . . compartment for molding head

You get Molding Cutter Head and 6 Cutter Bits Sets Shown. Seventeen cutter bit sets available at Sears stores

Convert your Bench Saw to a Jointer-Planer and Shaper

We want you to share with us the tremendous savings offered in this molding cutter set. By special arrangement with our manufacturer we can again offer this amazing Molding Cutter Set at our **LOW SALE PRICE** during the months of November and December. We know of no comparable set selling at anywhere near this low price. Go to your nearest Sears Retail Store and see it for yourself. It saves lumber costs, and it saves time. Sale priced until December 31, 1954.

Number of Designs are Unlimited! You are actually limited only by your imagination. Cutter bits are made from special heat-treated tool steel; 1 inch wide. Vertical slot in back of blade assures alignment in molding head. Six different cutter bit sets included as shown above: (A) 3 Bead ($\frac{1}{4}$ in.) cutter; (B) 1-in. Planer and Jointer; (C) Glue Joint Cutter; (D) $\frac{1}{4}$ and $\frac{1}{2}$ in. Quarter Round Cutter; (E) Quarter Round and Cove Cutter; (F) Base Mold Cutter. In plastic box, with wrench, space washer and bushings.

CRAFTSMAN Hand and Power Tools by **SEARS, ROEBUCK and CO.**
Famous for fine quality . . . precision performance . . . low price!

New Christmas
Tool Gift Guide

FREE



Santa urges you to send for Syncro's FREE Gift Guide of new Electric Do-It-Yourself jig saws and sanders! Get or give dependable Syncro performance, quality, durability at rock-bottom cost. Mail coupon for Free Guide, Low Prices!

NEW JIG SAW

Yes... it cuts 2x4's

Basic homeshop tool . . . for making home repairs, lawn furniture, valances, toys, intricate designs, etc. New Syncro 208 is the only self-powered jig saw to offer YOU all this: (1) cuts 1 3/4" wood; (2) cuts to center of 30" circle; (3) 100 sq. in. working surface; (4) Safe for all the family; (5) Motor guaranteed against burnout; (6) Cuts smooth edge—no splintering; (7) same blade cuts wood, plastic, metal, lime-um, leather, etc.

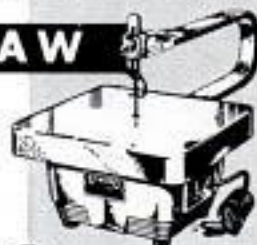

LOW PRICED

Powerful NEW SANDERS

No. 900 HEAVY DUTY SANDER! It is revolutionizing portable sanding! Removes paint, varnish—outlasts all other portables—running 1,500 hours without breakdown in laboratory tests. Easiest to use. Most powerful reciprocating sander motor (patented). Get the facts now.



LOW PRICED

No. 504-D DELUXE and 504 are America's finest light-duty sanders, dollar for dollar, for vertical, overhead jobs and finishing! 504-D in high-lustre plated casing comes in sturdy metal carry case—504 has same power, plain finish—costs even less. Ideal gifts!



LOW PRICED

FREE—Authoritative 8-Page Handbook tells best methods of surface preparation, sanding techniques. Valuable, money-saving facts. Richly illustrated. **FREE** with Syncro Tool Gift Guide!

SYNGRO
QUALITY TOOLS

Mail Coupon
for SANDER CATALOG
and NEW HANDBOOK
Both FREE!

SYNGRO CORPORATION
DEPT. 1-84, OXFORD, MICHIGAN

Please send **FREE** Syncro Saw-and-Sander Gift Guide, surprising **LOW PRICES**, **FREE** 8-Page **SANDING HANDBOOK!**

NAME _____

ST. & NO. _____

CITY _____

STATE _____

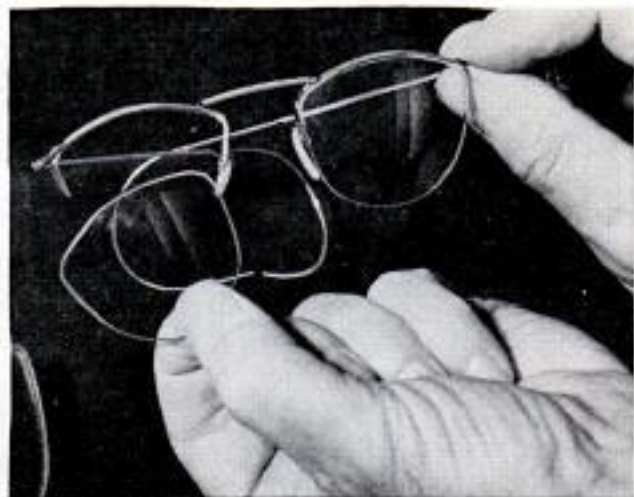

Grooved Wire Holds Lenses In Place Without Drilling

Snap-on half-rims that hold eyeglass lenses firmly in place without screws which pierce the glass have been developed by a Geneva, N. Y., optical manufacturer. The lenses are held in place by plastic-lined, deeply grooved wires on either side of the top sections. Spring action of a crossbar just behind each lens top provides necessary tension to grip the lenses.

"Hedgehog" for Kitchen Sink Removes Stains From Cups

Bristling like a porcupine, a new kitchen aid has rubber spikes that remove lipstick, stains and grease from coffee cups. The cup washer, developed in England, consists of seven brushes covered with rubber bristles. A suction cup attaches it to the sink, which is filled with soapy water to the tops of the brushes. The cup then is inverted over the center brush and moved up and down to remove all dirt and stains.

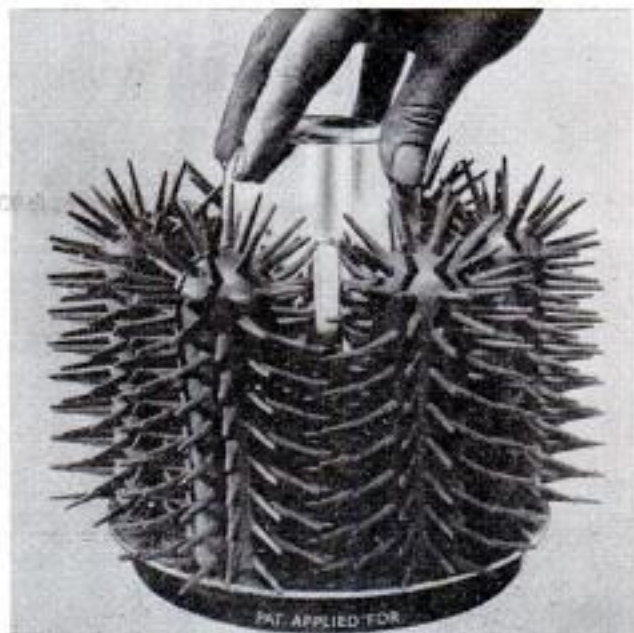

Just dropping a hint to Ford owners

FALLING LEAVES are rustling out the message that *right now* is the time to have your Ford "winterized." Then you'll know it's ready to take on winter's roughest weather.

For one thing, you'll want your ignition system gone over . . . and, if new spark plugs or battery will step up its performance, insist on Genuine Ford Spark Plugs and Battery. You'll also want to have your cooling system protected with Genuine Ford Anti-freeze, permanent or regular.

When your oil is changed, a new Genuine Ford Oil Filter Element will keep it clean under winter conditions.

Always remember that you can depend on Genuine Ford Parts because they're made to specifications set by the same men who originally built your Ford.

WHEREVER YOU GO, INSIST ON



HOW TO QUIET YOUR CAR

—and do "1001" jobs around the house



FREE "Tips to the Handyman" folder shows over 40 ways you can use L·O·F Super·Fine.

This handy free folder shows you how to do a variety of jobs around the house with fine-fibered, easy-to-apply Super·Fine Fiber·Glass. A few of the suggested uses include: **Hot-water tank wrap • Garage-wall insulation • Milk-box liner • Comforter padding • Shrubbery wrap • Auto tool wrap.**

Buy Super·Fine from your local hardware, lumber, or building supply dealer.



FIBER·GLASS

Libbey-Owens-Ford Glass Company
Fiber-Glass Division
48-114 Wayne Building
Toledo 3, Ohio

Please send me, FREE "Tips to the Handyman" folder, showing how to quiet my car and make over 40 household improvements with Super·Fine Fiber·Glass.

Name _____

Address _____

City _____ Zone _____ State _____

Our Navy's Mightiest Carrier— USS Forrestal

(Continued from page 85)

ship afloat. "Her flight deck overhangs the hull 60 feet on each side," engineers point out. "She's the only ship on which crewmen can come aboard under cover when it rains. It's like walking in under a theater marquee."

The extra width has other advantages. Look down from the outboard side of the island and you'll see flight crews spotting landed planes on a wide strip of deck well out of harm's way. No other carrier has deck space big enough to take planes behind the island. From here, tractors haul them on broad aprons back to the bow for relaunching, or to one of the ship's four monster elevators, capable of lifting 70,000 pounds each.

All this while, on the bow, Demon fighters have been rocketing into the air—tossed skyward by revolutionary catapults that can ram the biggest jets into the air at well over 100 miles per hour. As each plane roars down the slot, it is followed by a small geyser of hissing steam, for these are steam "cats"—another British brainstorm (*Popular Mechanics*, March 1953). Here's how they work: Steam from the ship's boiler expands behind a huge piston in the "cat," and sends it slamming down a cylinder the length of a football field. The plane, attached to the piston by means of a bridle that pokes up through a slot in the cylinder wall, goes with it. A tricky "Zipper" valve, extending the length of the slot, lets the bridle slip down the slot, but closes up behind it to keep the high-pressure steam from escaping. By the time it hits the end of the cylinder, that piston—and the plane—are moving at incredible speed. The piston is braked abruptly in a long tube of water at the cylinder's end, while the plane soars away at flying speed up above. So powerful are these "cats" that jets can be launched when the *Forrestal* is dead in the water—or even downwind. The ship has four of them—two off the bow and two on the port side, amidship.

The jets with folded wings that you see disappearing below the flight deck on the big outboard elevators are being wheeled out, below, into a hangar deck reminiscent of Mammoth Cave. Twenty-five feet high and running the entire length of the ship, it is a tumultuous melee of engines and planes undergoing repair and maintenance, tractors wheeling here and there towing folded-wing jets to tie-down position. Here, men work at the largest fuel-blending

(Continued to page 264)



Do-It-Yourself . . . Do More . . . Do Better

with **STANLEY TOOLS**

Take this folding rule. Only the inches are like other rules. Even these last longer. The sticks are extra thick and plastic coating protects the markings against wear. 8 in. brass slide extends 6 inches either end, or may be removed to measure where rule won't fit. Rule opens to even numbers . . . folds to convenient marking gauge for even inches from 2 to 12. Ask for Stanley "100 PLUS" No. X226. \$2.75.

Try this nail hammer. Stanley solves the problem of hitting 'em where you ain't . . . at least where you can't reach to hold and hit — over your head. The claw grips the nail, the slot seats the head . . . you reach over your head and start the nail. Then finish the job with the business end of the hammer. Ask for Stanley NAILMASTER No. 51½. \$3.35.

Inspect this screw driver. Here's a tool that deserves inspection . . . that'll stand it. This is a professional tool, used for years by craftsmen in industry, in the home shop. It does more than drive screws. With this "Yankee" you drive and draw one hand, thanks to ratchet action and quick-return handle. It's fast and easy. Ask for "Yankee" Spiral Ratchet Screw Driver No. 130A. \$7.70 (Includes three different size bits).

Look for Stanley and "Yankee" when you look for fine tools. Use coupon for free catalog.

THE TOOLBOX OF THE WORLD

STANLEY Tools

A Division of The Stanley Works

Stanley Tools, 314 Elm St., New Britain, Conn., or
Stanley Tool Co. of Canada, 314 Stanley St., Roxton Pond, Que.

Yes, I want a copy of Tool Catalog No. 54.

Name _____

Address _____

City _____ Zone _____ State _____

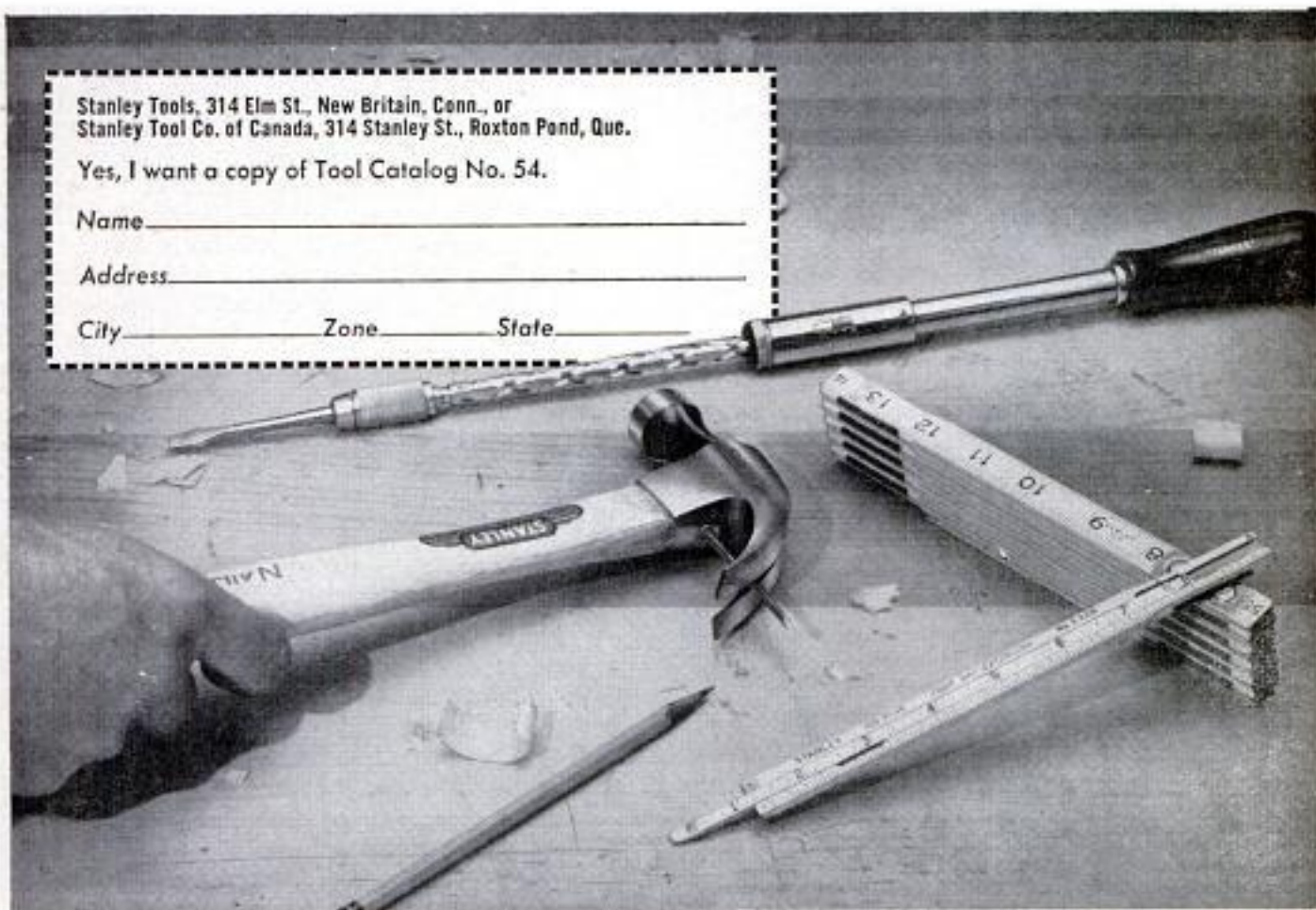

TOOLS • ELECTRIC TOOLS • HARDWARE • STEEL • STEEL STRAPPING

**Richer, Creamier,
AERO SHAVE
Saves 20¢ a Can!**

Just Push Valve
...Out Comes
Lather!



- Richer, Creamier Lather
- Quicker, Slicker Shaves
- No Brush Needed
- No Greasy Cream
- 3 Beard Softeners
- Contains Lanolin
- Turret Top Won't Leak

Not 79¢... Not 69¢ Only **59¢**

AERO SHAVE Lather Bomb

Also economical King Size—12 oz. only 98¢

YOU CAN START A

**\$40 A DAY
BUSINESS
IN YOUR SPARE TIME**

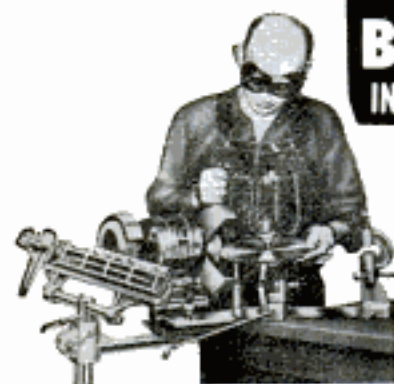

Andy Phillips says:
"MyBELSAW Sharp
Smith gives me big
profits at low ex-
pense — I can run
35 to 40 circular
saws in an 8-hour
day — that makes
me \$40 cash."

"I also get BIG EXTRA PROFITS... up to \$4 an hour... by grinding planer and jointer knives — there's always a demand for this kind of work."

You can start this REPEAT CASH business in your own home or garage while you are working at your regular job. Easy to operate, no experience needed. "Pays for itself from just 65 jobs." — Harvey Jensen

For as little as \$15 down payment, you can get your BELSAW SHARP SMITH rushed to you.

FREE book tells how

YOU can start making money the very day your BELSAW SHARP SMITH arrives. Earns \$4 to \$5 an hour in your SPARE TIME, sharpening and setting circular saws for builders, lumber yards, factories... Plus BIG EXTRA CASH, precision grinding planer and jointer knives, plane irons, wood chisels and drill bits. Hundreds of jobs in your own neighborhood. No extra equipment needed, no canvassing. Send today for your Free copy of "Life-Time Security."



BELSAW MACHINERY CO

3706 Field Building

Kansas City 11, Mo.

machine on any carrier — mixing gasoline with oil to produce the cheaper concoction that jet engines gulp at a prodigious rate 3 to 10 times greater than World War II fighters used. There may be a crew of men at the vast quarter-deck opening—bigger than the foundation hole of a three-bedroom house—grouped around a boa constrictor of a refueling hose stretched across water to a heaving tanker alongside. The *Forrestal* can refuel from either side.

The heads and shoulders of goggled, space-suited men you see gliding upward behind the hangar-deck bulkhead are no hallucination. They are jet pilots heading for the flight deck via escalators—an innovation on carriers, and not just to pamper the pilots. "The ready rooms," say Navy experts, "where pilots sit in leather chairs for briefing—under red light for night missions or white light for daytime sorties—are at hangar-deck level. When he leaves for his plane, the average jet pilot is lugging nearly 100 pounds of gear. If he were to double-time up four flights of steps, he'd be soaked with perspiration—all set to court pneumonia at the rarefied sub-zero temperatures to which his jet will carry him in a few minutes."

Actually, no ship ever had such facilities and comforts as the *Forrestal's* 3500-man crew will enjoy. You see sailors descending broad stairways to air-conditioned quarters. Each has an individual Pullman-type bunk with reading lamp and air-conditioning ventilator. Those bunks in the gallery-deck areas even have foam-rubber mattresses. The men in skivvies, with towels over their arms, have no obstacle hike to the showers because every berthing area has its own—just as each has its own mess and recreation room, with easy chairs and writing tables all done in soft color schemes. "These are not just luxury either," Navy engineers point out. "Men get lethargic when they work in a hot steel box all day. Experts have found that air conditioning and good recreation and sleeping quarters makes for greater efficiency—and that pays off."

The gallery deck on a carrier is the space between the hangar-deck overhead and the flight deck. It's a tricky structure on the *Forrestal*, for besides housing officers and berthing areas, it holds the ship together. On most flat tops, the flight deck is merely an appendage laid atop the ship itself. Under the *Forrestal's* flat top a row of 10-foot-high steel beams spans the ship like a row of joists in a flat-roofed house. The hangar-deck's steel overhead is a complete "gallery deck" hung on the underside of

(Continued to page 266)

clean *PENTA*-treated wood won't rot!

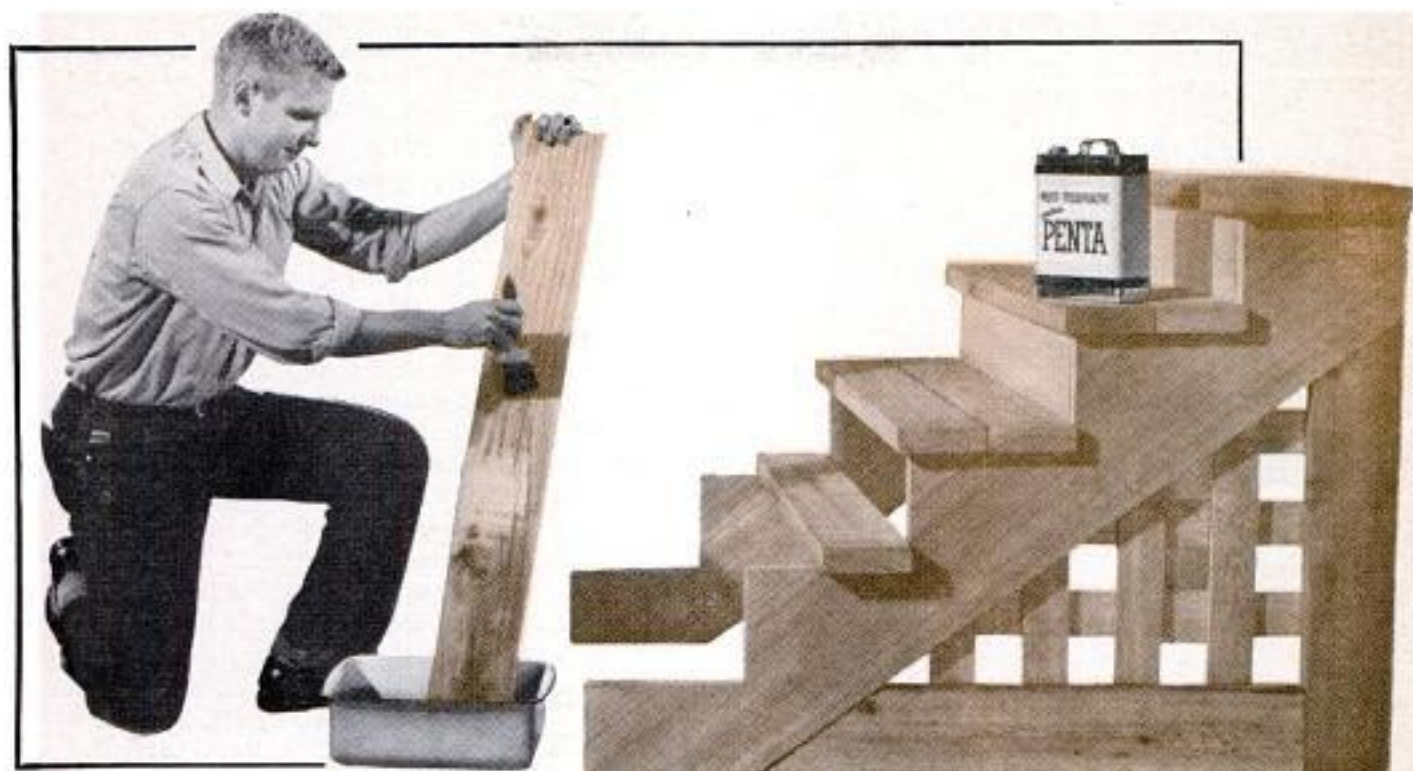

ADD YEARS OF LIFE TO HOME REPAIRS

Give your home repair projects, or anything you build with wood, the same *protection* against destructive rot and termites that big builders and architects favor. Clean PENTA* preservatives penetrate deep into wood, bringing longer-lasting resistance to decay and insects to save you costly replacement or repairs.

PENTA applies easily: just flood solution on surfaces with a broad brush, or dip each piece before assembling. PENTA-treated wood is clean, pleasant to handle or work, can be painted over if desired.

Ask your local hardware or lumber dealer for a brand-name wood preservative containing *PENTACHLOROPHENOL in either a water-repellent or regular type. And for money-saving suggestions on how to use PENTA wood preservatives to best effect, mail coupon today for your free copy of Dow's helpful "Handyman's Guide to Home Wood Preservation." THE DOW CHEMICAL COMPANY, Midland, Michigan.



Replace rotted steps with clean PENTA-treated wood; its long-lived resistance to decay and termites insures family safety.



THE DOW CHEMICAL COMPANY
Dept. PE 768N
Midland, Michigan

- Please send me FREE BOOKLET, "Handyman's Guide to Home Wood Preservation."
 Send the name of my nearest PENTA dealer.

Name _____

Address _____

City _____ Zone _____ State _____

you can depend on DOW CHEMICALS





STOP

sway, sag and dip!



No more dangerous swaying on curves or deep dipping on hard stops. No more unsightly sagging due to weakened springs. Amazing, low cost AIR LIFT units make old springs ride like new — smooth bumps, cushion spring action against curves and stops, ease steering, save tires and avoid repairs. Super-simple to install and factory guaranteed. At car dealers and repair shops or write direct. Be sure to specify make and model of your car. Write Department 411.



FREE — Send for HOW TO STOP FRONT END TROUBLES booklet, Dept. 411.

AIR LIFT COMPANY

2330 W. Main Street, Lansing, Michigan

Build Your Own ICE FISHING SHELTER



with

MASONITE PRESWOOD

Windtight, portable shelter, 4' wide, 5'9" long, 6' high; easy to take apart for storage. Masonite Tempered Preswood® resists cold and wet. Lasts indefinitely. Send for your plan and Masonite Idea Book. Get 33 types and thicknesses of Preswood from building materials dealers.



NATURALLY STRONGER WITH LIGNIN

MASONITE
CORPORATION

Dept. PM-11, Box 777, Chicago 90, Ill.

Please send me plan No. AE-299 for ice fishing shelter and your "Idea Book."

Name.....

Address.....

Town.....Zone.....

County.....State.....

"Masonite" signifies that Masonite Corporation is the source of the product

these big girders. The flight-deck plates sit on top of them. *Forrestal* crew members will live and work in the spaces between the girders like mice scurrying around the ceiling spaces of a house.

The rooms you see with nozzles jutting from the overhead are "drenching rooms." Every damage-control area has one for prompt scrub-down of personnel in case of atomic attack. If you have any doubts about the atom-age features of this push-button ship, they're soon settled by the spaghetti-like nightmare of conduits, cables and pipes you see weaving down the passageways in a vast incomprehensible tangle. Some of the gadgets they serve would put Buck Rogers in the gaslight era.

No naked eye can see the signals the *Forrestal* flashes from the big lamps on her signal bridge. Their infrared light is invisible and can only be picked up with special equipment. Automatic features in her engine spaces are so complete that engines can actually run themselves for hours in case men are forced out by high temperatures or smoke during action. "Boilers and blowers," engineers will tell you, "operate without being touched by human hands."

Although it would take a still uninvented supertorpedo to penetrate the *Forrestal's* top-secret hull structure (so designed that torpedo shock is dissipated and can't inflict inside damage), the ship is back-stopped by the most streamlined damage-control system afloat.

Imagine yourself in the weird damage-control center deep in the ship's bowels. It's a room lined with tiny lights that stud the bulkheads like plugs in a switchboard. Suddenly the carrier shudders under the impact of a hit. Here's what happens—faster than you can follow. A tiny red light flashes red on the big board, indicating exact location of the emergency. Via intercom, the operator quickly learns from men in the area just what the damage is. Flipping his rotary switchboard, he alerts the damage-control crew in that area. Within seconds, men swarm in to handle the damage. During battle, this may happen in a dozen places at once, but terse messages flying in and out of damage-control keep everything moving like clockwork.

Even more fantastic are the five-inch-gun emplacements on each quarter of the ship. Their Mark 56 directors do everything but bury the victim. "Suppose," says one Navy expert, "ship's radar picks up an enemy plane. Immediately the bridge alerts fire-control crews on the guns. They turn Mark 56's search radar on target location, flip a switch and that's that—scratch one plane."

The incredible Mark 56 brain, with its

(Continued to page 268)

DRILL SAW REAM CUT

INTERNATIONAL
HI-SPEED COPE SAW DRILL BIT



IDEAL AS A CHRISTMAS GIFT

DRILL, SAW, REAM . . . metal, pipe, wood, plastic, Transite, etc. Use with any electric drill, slow drill press, lathe or milling machine. Drills own starting hole—upper part of bit is used to cut, saw or ream circles, ovals, squares or scrolls. Easy to operate. Ideal for carpenters, mechanics, electricians, plumbers, hobbyists, many others. Abrasive resistant, high speed steel. Flutes ground from solid. Will withstand severe continuous use without breaking. Resharp-ened at no charge. Takes place of up to 350 in tools. 1/4" diameter, 2" cutting sections, total length 3 1/2". Available in three types—All Purpose, Wood, Heavy Metal. Specify type needed. Set of 3, \$11.50. Details on request. Shipped same day. Money-back guarantee. Dealer inquiries invited. **ORDER NOW! SEND CASH, CHECK OR MONEY ORDER.**

only
\$3.95
POST PAID

Manufactured and distributed by
INTERNATIONAL TWIST DRILL CORP.
618 Wyandotte, Rm. 631, Kansas City 5, Mo.

PUMP WATER FAST!

Drains Wash Tubs, Cellars, Cisterns. Famous #7 pumps 2600 gph. 420 gph. at 75' high or 1600 gph. from 25' well. Sturdy rustproof alloy metal. Six blade impeller. 3/4" inlet, 1/2" outlet. Standard pipe threaded. Uses any 1/4 to 1/2 H.P. Motor. Will not leak or clog. Iron clad guarantee. Send check, M.O., or sent C.O.D. **\$8.95** M.S.S.

Irrigate, Fill Tanks, Draw Well Water. Heavy duty #8 pumps 7000 gph. 1000 gph. 75' high 3000 gph. from 25' well. Rustproof alloy metal. 8 blade impeller. 1" inlet, 1" outlet. Standard pipe threaded. Will not leak or clog. Iron clad guarantee. Send check, M.O., or sent C.O.D. **\$11.95** M.S.S.

Free Catalogue—Gear Pumps, Large Centrifugal Pumps, Deep and Shallow Well Pumps, Sump Pumps.

MOORE MANUFACTURING CO.
SWEDSBORO 1, NEW JERSEY

MORE For Your Money in a SHAW 'DU-ALL'

New Low Prices
Walking Tractors \$29.00 up
Riding Tractors \$29.50 up



Improved design, better value in 1 1/4, 2 1/4, 3, 5 H.P. walking tractors. New, low cost, streamlined 2 1/4, 5, 8 H.P. riding tractor. Inexpensive, new 1 1/2 H.P. tiller that pulverizes up to 12 inch swath 6 inches deep, and less. Automotive gears on heavier models. Prices will please you. **FREE CATALOG.** Write today.

SHAW MFG. CO. 66RG N. 4th St., Columbus, Ohio

Big New 24-Page
profusely Illustrated
DO-IT-YOURSELF
PROJECTS BOOK



Describes attic finishing, built-in cabinets, add a room, recreation room, kitchen remodeling, summer cottage and farm projects. Contains helpful information on how to get started, planing, cost estimating, materials purchasing, and proper procedures, also nail charts, moulding designs, etc. Send only 25¢ and also receive **FREE 52 PAGE POWER TOOL CATALOG**

BOICE-CRANE COMPANY

943 Central Ave., Toledo 6, Ohio

Mallory
MAGSPARK
TRANSFORMER



YOU WILL BE AMAZED AT THE PERFORMANCE WHEN YOU INSTALL THE MAGSPARK TRANSFORMER ON YOUR CAR . . . You can install the Mallory Distributor to function with the Magspark Transformer, or you can install in your OWN distributor, the Magspark Dual-Point Plate, especially designed to function with the Magspark Transformer . . . Write today for name of dealer nearest you.



MAGSPARK DUAL-POINT PLATE



MALLORY DISTRIBUTOR

Proven by 30 Years Experience Building MALLORY Ignition

MALLORY ELECTRIC CORPORATION
12416 Cloverdale Ave. • Detroit 4, Mich.

MOTOR TIPS

for the Handyman

This **FREE** motor guide tells how to . . .

- Choose the **RIGHT** motor for any application.
- Select proper accessories and pulleys.
- Make your motor portable to handle a 1001 jobs.
- Make your motor last longer — with minimum care.



REMODELING—for better living all the family will appreciate.



REPAIRS—Dad wants to enjoy making while he saves money.



NEW FURNITURE—Mom wants to beautify and dress up her home.



JUVENILE FURNITURE—that spells play fun for Junior and Sis.

Versatile Westinghouse Handy-Craft® motors make all these projects easy—more fun. Your Handy-Craft dealer displays the decal at right. See him for a motor guide, or use coupon below.

J-21855

YOU CAN BE **SURE**...IF IT'S
Westinghouse



WESTINGHOUSE ELECTRIC CORPORATION
Handy-Craft Motors, P. O. Box 5151, Cleveland 1, Ohio
Please send me a copy of your **FREE** Handy-Craft motor guide.

I would like complete drawings and instructions for constructing the Handy-Crafter coffee table.

Name _____

Address _____

City _____ Zone _____ State _____

PM 11-54

glowing tubes, humming condensers and clucking relays, pin-points the target via its search radar's electronic eye, which can pierce the blackest, foggiest night. In split seconds, electron beams flash signals through the nightmarish equipment. Automatically wind, lead, ship's degree of roll are calculated and fed into the machine's maw by itself. Gun directors whir and big barrels swing skyward automatically, eerily tracking the invisible target across the sky. When the target is within range, the brain knows it. It waits until the ship rolls into proper position—and then lets go! Missiles with electronic fuses fly upward to demolish the victim with almost foolproof accuracy. That's not all. The guns then automatically eject their empty shell, automatically load themselves and automatically track and fire at other targets they have automatically discovered, while the crew sits back and fans itself. "Though we don't do it," the Navy admits, "it's possible to operate these turrets without men in them."

It takes plenty of ingenuity to build a ship like the *Forrestal*, and men at the Newport News Yard can set your head reeling as they recount some of the problems they faced and solved.

Gordon Donnan, of the steel-hull division, will show you how the giant cranes are being forced to back off toward the bow as the flight-deck overhang goes on. "Those 60-foot sponsons come out over crane tracks and everything," he points out. "That means we had to install everything—shafting, propellers and heavy machinery—before we could move forward. Once the overhang is up those cranes can never go back again."

Special hot shops had to be built on the piers to work her oversize plates. Welders wore special asbestos shoes to work on her plates while they were still hot—because of her new steel alloys requiring new welding techniques.

Though the yard's massive cranes can lift 75 tons with controls so fine that a full load can be raised or lowered a fraction of an inch, they couldn't heft the *Forrestal*'s mighty 166-ton elevators. So these were built in a near-by shipway for "launching" into position, where combinations of barge cranes could hoist them into place. Huge sponsons for the ship's mushrooming flight deck had to be fabricated right alongside the place they were going. They were too heavy to move around.

Weight of the *Forrestal*'s mighty chunks are a standing joke among the men, and many a piece the size of a city apartment

(Continued to page 270)

POPULAR MECHANICS



AIR COMPRESSOR

SURPLUS! NEW Gov. Release!
Original Gov. Cost \$350.00

The Finest 2-H.P. **\$129.00** f.o.b.
TWIN CYLINDER Industrial Unit
Ever Built! Fully Guaranteed
200 lb. PRESSURE

5.3 C.F.M.

Maintains 40 to 65 lb. pressure for **CONTINUOUS** spraying (no waiting 'til tank keeps building up)

Made by **BENDIX WESTINGHOUSE** to rigid specifications. A BUY for Contractor, Factory, Garage, Service Station, Shop, **FARM! PORTABLE!** Two independent air outlets—one for high pressure (up to 200 lbs.)—the other controlled by regulator from 0 to max. Large face gauge. Adjustable safety valve. Automatic unloader (adjustable up to 200 lbs.) keeps pressure constant without stopping engine. Welded hollow frame acts as air reservoir . . . assuring large supply of **OIL-FREE** air with **ABSOLUTELY NO PULSATION!** Sprays with material tanks of any size. *Unexcelled for:* Spraying; Greasing; Tire inflation; Blowing out heating and refrigeration lines; Small pneumatic tool operation; Insecticide dusting and spraying; Flocking; Undercoating!

SPECIFICATIONS BELOW

- | | |
|--|--|
| <p>—COMPRESSOR—</p> <ul style="list-style-type: none"> • Mfg. by BENDIX WESTINGHOUSE • Twin cylinder • 4 Rings on each piston for added compression—capable of pumping 1100 lbs. p.s.i. • Forced pressure lubrication assures oil to every moving part • Ball bearing construction • Capacity 5.3 cu. ft. | <p>—ENGINE—</p> <ul style="list-style-type: none"> • Mfg. by BILGGS & STRATTON • Kick or type start • 2 H.P., 4 cycle air cooled • Splash lubrication system • 2-qt. gas tank • Float feed carburetor with adjustable idle speed and automatic governor • 3 Piston rings |
|--|--|

ALSO AVAILABLE! Same unit with 1 H.P. Electric Motor, **\$129.00** f.o.b.
Single-phase, 110-220 volts, 60 cy.

IMMEDIATE DELIVERY! SUPPLY LIMITED! ORDER FROM AD
FREE Catalog of Motors and Electrical Equipment
ROBERTS ELECTRIC CO., Dept. P-229, 849 W. Grand, Chicago 22, Ill.

NEW! The Do-It-Yourself Saw For Aluminum Cutting!

ATKINS No. AL-4



Cuts Bars, Flats, Rods, Tubing—
Mitres Straight, Clean and Easy!

At Your Hardware Stores Everywhere



ATKINS SAW DIVISION

Borg-Warner Corporation

Indianapolis 9, Indiana



HELPFUL BOOKS

Send post card asking for **FREE** catalog
Popular Mechanics Press, 200 E. Ontario, Dept. 601, Chicago 11

BUILD YOUR OWN ARC WELDER OR LIGHT PLANT D-C GENERATOR

\$15.50 used good condition. Instructions incl. to convert to 200 amp. welder & 5000 Watt Light plant. **NEW . . . \$21.50**

Stock No. 711 D.C. Generator R-1 Jack & Heintz, 300 Amp. 30 Volts, Gov't. cost \$300.00. For Welder & Light plant. Instructions **\$25.50**

RHEOSTAT R-27, Heavy duty for regulating voltage on the P-1, R-1 or A.C.— **\$6.95** post D.C. Generators

115 V. A. C. GENERATOR
Stock No. 511 Makes Ideal A.C. Light Plant & D.C. Battery Charger. Mfg. By G.E. Rated 1250 Watts, 300 Cy., 10.9 Amps, 115V. A.C. & 200 Amps. 30V. D.C. Gov't. cost \$300.00. Instructions incl. Wt. 50 lbs. Used, good cond. . . . **\$22.50** **NEW \$32.50**

MAKES IDEAL WINCH HOIST **AIRCRAFT STARTING MOTOR**
Operates on 12 to 24 volts. Gives high torque slow speed & tremendous power. Applicable for moving heavy loads. Belt or direct drive. O. Cost over \$300.00 ±110. **\$9.95**

Send check or M. Order. Prices f.o.b. RCMo Except when marked postpaid U.S.A.

GENERAL SALVAGE CO., Dept. 704, 2922 E. 27 St., Kansas City, Mo.

WINCH HOIST.

Navy type Mark 7 portable giraffe neck. 1500 lbs. max. lift. Max 21 to 1 gear ratio. 40" tube extension with 3" pulley incl. 12 ft. of 3/16" steel cable & handle with ratchet brake . . . **\$24.50**

VICKERS HYDRAULIC PUMP.

New # PF 28-2713-25-2E 400 G.P.H. 3750 R.P.M. 1500 P.S.I. .507 Cu. In. Rev. . . . **\$14.50**

SENSATIONAL SELSYNS

Two or more connected together work on 110V. A.C. For controlling distance operation, etc. Instructions Post Paid incl. . . . **\$8.95**

Get This NEW 1955 Craftsman Catalog of

WOOD AND WOODWORKING TOOLS AND EQUIPMENT

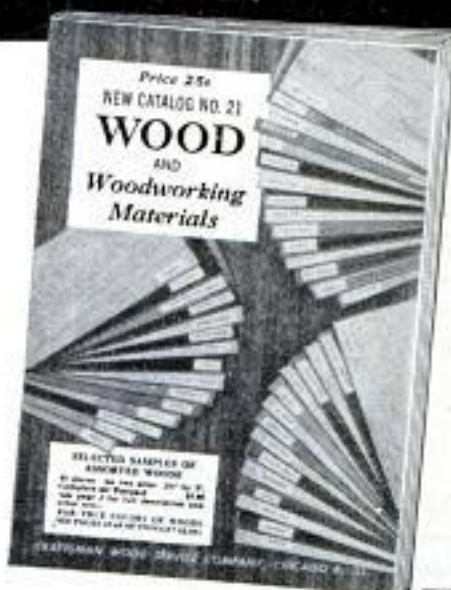

Everything for the Woodworker and His Shop!

World's Largest Selection of **Finest Domestic and Imported Woods . . . Mouldings, Hardware, Tools . . . ALL AT LOW MONEY SAVING PRICES! . . .**

Your complete wood buying guide and project book. Craftsman is your best, most complete source of finest kiln-dried domestic and rare imported woods, beautiful wood inlays, colorful bandings, matched plywoods, embossed mouldings, carved ornaments, newest woodworking tools, "hard to find" cabinet hardware and fittings . . . more than 1,500 items! Packed with newest scroll saw patterns, project ideas and money making plans. Enclose 25c (refunded with first order) to help pay mailing and handling cost. **WRITE TODAY!**

148 PAGES

Many in Full Color packed with rare, fancy & imported woods . . . veneers, plywoods, patterns, tools, ornaments, hardware . . . everything for the woodworker.

MAIL COUPON NOW!

Craftsman Wood Service Co., Dept. A-411
2729 S. Mary Street • Chicago 8, Ill.

CRAFTSMAN WOOD SERVICE CO., Dept. A-411
2729 S. Mary St., Chicago 8, Ill.

Enclosed find 25c. Rush me new **WOODWORKERS' CATALOG HANDBOOK.**

NAME _____
ADDRESS _____
CITY _____ ZONE _____ STATE _____

Faster, Easier Gluing



with new squeeze bottle

Here's a ready-to-use glue that's strong enough for practically all your light, woodwork projects and repair jobs. It's quick setting, dries clear . . . glues wood, paper, cloth and all porous materials. Try Elmer's Glue-All in the new, handy, plastic applicator bottle . . . get the large 8-oz. workshop size at leading hardware stores. Write for folder: The Borden Company, Chemical Division, Dept. PM-114, 350 Madison Avenue, New York 17, N. Y.



ELMER'S[®] GLUE-ALL



Make your own
**HUTCH
CABINET**
— a piece to
show and own
with pride

Standing 6' high, this cabinet is 43½" wide, 17½" deep—offers ample storage and display space. A break-front display of china—with linen or silver in the drawers and cabinet below. Or—in the den—shelves and storage for books, records, etc. *You build without blueprints!* Our Simplified Easi-Build* Pattern #270 shows how to cut and assemble your cabinet—specifies all materials. The Pennsylvania Dutch decorating design is included in the pattern. *You save up to two-thirds of the usual cost!*

The major material used is Homasote, Type RD—one of the strongest building boards you'll ever use—distributed by dealers throughout the United States and in Canada.

NEW! Three illustrated folders—suggesting 18 practical *make-it-at-home* projects, from a new room in the attic to a swimming pool. Clip or copy the coupon—mail today for pattern and/or folders. *T. M. Reg. Easi-Build Pattern Company

MAKE it at home . . . with HOMASOTE

HOMASOTE CO., Dept. 35A, Trenton 3, N. J.

I enclose: 75¢ for pattern #270 10¢ for 3 folders

NAME

ADDRESS

CITY.....STATE.....

My lumber dealer is.....

house bore a sign that quipped: "Not to be moved by hand."

Plenty of odd things can happen on a ship the size of the *Forrestal*. Walter Deal of the yard's steel-hull division recounts with gusto how one welder went down in the endless maze of chambers in the *Forrestal's* underbottom to check a tank and got lost. "When the welder turned up missing at time-card check that night, we sent a search party through the underbottom," Deal explains. "They found the man all right. He'd beaten his flashlight to pieces, pounding the bulkheads trying to make enough noise to attract attention."

With all the problems, the mighty *Forrestal* is on schedule—and that's some achievement when you know that nearly 2000 railroad cars of materials from every corner of the country had to be carefully fitted in just the right place; that 50,000 tons of steel went into her; that four miles of blueprints a day for 20 months were required in her plans; that her 14,000 working drawings kept 700 draftsmen busy for three solid years.

But things learned the hard way on our new atom-age carrier will help pave the way for a whole fleet of floating monsters. Already the *Forrestal's* sisters are in the making. The *Saratoga*, same size and shape, is due off the Brooklyn Navy Yard ways next year. And in 1956 the third CVA, *Ranger*, will float out of the same graving dock as the *Forrestal*. Right now, the *Ranger's* hull plates are going down in a dock beside her eldest sister. The dock is much too small for her, but construction is timed so that when the *Forrestal* is launched this month, *Ranger* will be far enough along to be floated out of her crib and into a grown-up bed that will take her growing hulk. ★ ★ ★

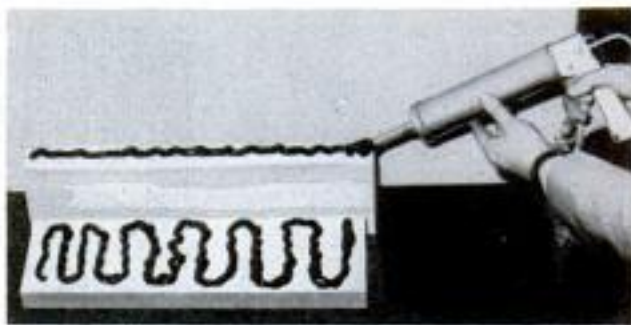

Sticky Paste Repels Birds

Adhesive paste is now used to prevent birds from roosting where they shouldn't. Ribbons of the sticky substance are applied to ledges with a caulking gun. Birds won't alight on the treated areas, it's said. The treatment lasts for a year.

STOP CHANGING MOTOR OIL!

End this needless expense forever with

RECLAIMO Today's most advanced OIL RE-REFINING filter FOR CARS, TRUCKS, TRACTORS.

Continuously cleans and RE-REFINES motor oil as you drive by utilizing motor heat — keeps oil in high grade lubricating condition at all times.

"RECLAIMO"

- REMOVES SOLIDS (by filtration)
- REMOVES WATER (by distillation)
- PREVENTS Excess fuel dilution
- PREVENTS Acid and Sludge Formation
- ADDS Thousands of Miles to Engine Life

MAINTAINS Stable Viscosity **ELIMINATES** All Oil Changes
 FREE 32-page book "OIL FACTS" with bonafide \$1,000.00 offer on page 30. Gives you the complete "Reclaimo" story and details of our extraordinary 90-DAY NO-RISK TRIAL OFFER. Write for your copy today!

RECLAIMO MFG. CO.

5083 Elston Ave., Dept. M-11, Chicago 30, Ill.
 Wm. Schwalge, U.S. Pat. 1757223, 1834654, 2068473.

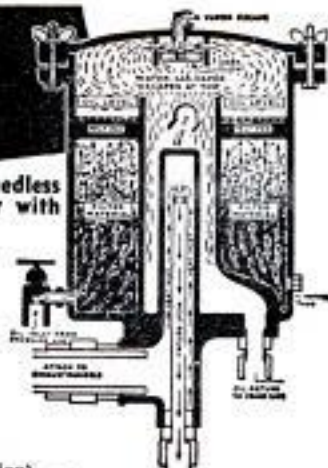

DEALERS WANTED

U. S. BUREAU OF STANDARDS, Bul. 86 States, "Oil does not wear out mechanically."

In the kitchen

A few drops of highly penetrating 3-IN-ONE make appliances run better. It never gums up the way many oils do.



"3-IN-ONE" OIL

SHEET METAL BRAKES

New eccentric clamps. Forms angles, locks, pans, etc. Mount on bench, truck or floor stand. All steel construction.
 Size 15"x16 gauge, 40 lbs.
 \$21.50; 16"x20 ga., 65 lbs.
 \$28.50; 16"x22 ga., 80 lbs.
 \$31.00; 18"x24 ga., 110 lbs.
 \$48.00; 10"x28 ga., 260 lbs., \$115.00. Floor stand, 22 lbs. \$7.00. Shipped Collect.



24" Scurring and slitting shear cuts sheet metal, plastic and cardboard. For bench mounting \$38.00. Floor stands \$7.00. Express Collect. Shears 7" by 16 gauge, straight or curved, any length cuts 1/8" aluminum bars. \$12.50 collect. \$14.00 postpaid.

ORDER DIRECT OR SEND FOR CATALOGUE.

VYKE MFG. CO., P-2439 15th St., Denver 2, Colo.

Under the Beauty... STRENGTH OF STEEL



HEAD CAN'T FLY OFF! No more bother with loose or splintered handles. Estwing Unbreakable Tools are forged in one piece from tough tool steel . . . no welds or joints. You'll like the genuine leather grip proven most comfortable and durable.



INDIVIDUALLY GIFT BOXED

Hammer \$3.65
 Belt Axe \$4.50

AT ALL LEADING HARDWARE STORES

Write for FREE catalog

ESTWING MFG. CO. DEPT. NP -- ROCKFORD, ILL.

ALSO CHILD'S 2 PASS. MOTOR CAR Write For Free Literature

ESHELMAN HOLDS 1 ADULT

AUTO WITH MOTOR

LOWEST PRICE
 70 Miles Per Gal. Gas
 25 Miles Per Hour

Eshelman

DEPT. CM-811
 109 Light St.
 Balto 2, Md.
 353 N. Michigan Ave.
 Chicago 1, Ill.



7070 Hollywood Blvd., L. A. 28, Cal. Free Literature

FULLY ASSEMBLED REAL 1/7 H.P. DIESEL ENGINE Over 100,000 sold at higher price. Not a Toy!

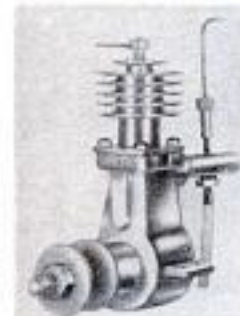

DEEZEL is a perfect power plant for planes, boats, race cars and experiments. (Runs at 7500 R.P.M. Produces 1/7 HP. Weighs only 5 oz.)

DEEZEL is an ultra precision engine as carefully machine-tooled as Giant army engines. Cylinder is honed to .0001 inch and hand fitted to its individual pistons.

DEEZEL is compact, rugged, streamlined. Starts quickly. Simple to install. You get it fully assembled.

DEEZEL is test run at the factory to assure perfection. Operating instructions included.

Send \$1.95 plus 5c postage today.

196 Page Book on Model Engines . . . \$1.00 Postpaid

GOTHAM HOBBY CORP., DEPT. P, 107 East 126 St., New York 35, N. Y.



OUR 783RD ADVERTISEMENT

BUILD YOUR OWN POWER TOOLS - GIL-BILT WITH PARTS KITS

Exclusive GIL-BILT Build-It-Yourself Features

- No machining—build easily with hand tools only
- No blueprint reading — step-by-step pictorial plans, full scale patterns, actual photographs
- Sturdy wood, aluminum and steel construction
- Capacity and performance of commercial saws
- Selling for \$60 and up
- Proved performance. Nationally advertised and sold for 7 years. Satisfied customers around the world

GIL-BILT 10-in. TILT/ARBOR SAW



- 27x28 in. table, 13 1/2 in. capacity in front of blade
- 10 in. blade cuts 3 1/4 in. deep, tilts full 45 degrees
- Floor model 34 1/2" high, table always stays level
- New Departure ball bearing arbor, 3/4" precision shaft turned down for 3/4" bore blades, elim. housing, shipped ready to run
- Jackscrew and 4 1/2 in. dia. handwheel lowers and raises blade
- Cast aluminum miter gauge and self-aligning rip fence guide

GIL-BILT Metal Parts Kit includes Plans, ball bearing arbor, miter gauge and bar, rip fence guide, dado insert, lock knobs, jackscrew mechanism and handwheel, and all other metal parts (less blade).....\$22.95
Same Kit with 10" Combination Blade \$25.90
Same Kit with 8" Combination Blade \$24.90

GIL-BILT 12-INCH BAND SAW



- Cuts to center of 24 inch circle
- Handles stock up to 6 inches thick
- 18x18 inch table tilts 45 degrees
- Lower wheel and drive pulley runs on sealed New Departure Ball Bearings! Upper wheel runs on two 3/4" bore Gilite Bronze bearings
- Upper wheel tension and tilt mechanism of cast aluminum, completely assembled
- Upper and lower blade guides, Each has ball thrust bearing, self-lub bronze jaws
- Rigid cast aluminum wheels fully machined ready-to-install. Heavy rubber tires
- Uses standard 78 inch blades up to 3/4 in. wide
- Fully enclosed mechanism for utmost safety

GIL-BILT Metal Parts Kit includes Plans, rubber tires, aluminum wheels, 3/4 in. blade, ball bearing spindle, tilt mechanism, blade guides, table tilt segments, and all other metal parts.....\$23.95
Return Kits in 10 days for refund if not satisfied. For shipments up to 600 miles, add 5%; over 600 add 10%.

Amount in excess of actual postage will be refunded.

Order Kit now, or order Plans at \$1.00 each and Kit later less cost of plans. Write for FREE Catalog

ALSO AVAILABLE Plans & Parts Kits for 18-in. Band Saw, Belt Sander, Spindle Shaper, 8-in. Tilt/Table Saw

GILLIOM POWER TOOLS P. O. Box 1-PL, Lambert Field St. Louis 21, Missouri

BACK AGAIN!

4 TOOLS IN 1

Bigger! Improved!

the complete Metal Work Shop

**FORMS
SHEARS
PUNCHES
RIVETS**



Patent No. 2053309

ONLY **9.95**

Postage Paid

Send check with order. Satisfaction guaranteed or full refund. No. C.O.D.'s.

Now this one compact unit offers more than ever before. Five punch sizes bigger handles larger stock simplified operation does more. The perfect all-purpose tool for hobbyists, craftsmen, radio repair, metal shops, model manufacturers, experimental laboratories, etc.

SPECIAL — Threading dies for 1/8", 5/32", and 3/16" stock included for only \$1.00 extra.
EXTRA punches available in square, rectangular and hexagon shapes. Only 40c each.

SAVE! BUY AT WHOLESALE! Send 50c in coin or stamps for 64 page Catalog of Name Brand items you can buy at wholesale.

ALBERT J. TATU, INC.
85 COLUMBIA DRIVE, DEPT. PM-11
WILLIAMSVILLE, N. Y.

... make hard jobs easy!

HUNT UP HUNTER

Smitty DRIVER FOR ALLEN HEADS

AVOID SCATTERING and LOSING SOCKET WRENCHES

Complete set of socket head wrenches in jack-knife type handle—avoid scattering and losing. Greater leverage at any angle. Handle will not break or bend... special heat treated keys. Satisfaction or refund.

\$1.50 Postpaid

<p>Magic-Tip SCREWDRIVER 7 1/2" Long</p> <p>\$1.98 postpaid</p>	<p>Magnetic RE-CHUT (retrieves position nails)</p> <p>\$1.00 postpaid</p>	<p>Magnetic BRAD PUSHER</p> <p>\$1.90 Postpaid</p>
--	--	---

at your Hardware Dealer or
HUNTER TOOLS Write for FREE CATALOG
HUNTER TOOLS Box 564M11 • Whittier, California

Treasure - Minerals - COINS

Easily located with new Light-weight M-Scope Detector. Superior performance, lowest price, monthly payment plan.

FREE LITERATURE
FISHER RESEARCH LAB., INC.
PALO ALTO CALIF.

CASH FILING SAWS

Start saw filing shop spare time in basement or garage. Earn up to \$2 or \$5 an hour. No selling—no experience needed. FREE PLAN tells how. Send postcard today.

FOLEY MFG. CO.
Dept. P.M. 11-4 Minneapolis 18, Minn.

SURPLUS SALE

\$39.50 NEW TOOL POST GRINDERS
REGULAR PRICE \$125.00

1-6 H. P. MOTOR
TAKES WHEELS UP TO 12" x 4"
EXTRA GRILL EXTERNAL OR INTERNAL \$19.50
MONEY BACK GUARANTEE

EDWARD J. NOLAN, PULASKI, NEW YORK

HELPFUL BOOKS

Send post card asking for FREE catalog

Popular Mechanics Press, 200 E. Ontario, Dept. 601, Chicago 11

Enjoy the Fascinating Story of the Horseless Carriage in

Popular Mechanics **166** Illustrations

AUTO ALBUM

The most intriguing book about the automobile ever printed. It's thrilling, fascinating and informative. From the very first gasoline-propelled buggy to the cars of today and the atomic auto of the future. The first cars — the men who made them — the scrambled start and the development of the fabulous auto industry—the story of auto racing—the growth of the Nation's highways. 166 thrilling action pictures—old-time cars—racing cars—early auto advertising—automotive oddities. Roll call of names of more than 2000 autos made in the U.S. included. Ideal gift book. Cloth bound, only \$3.00 by mail. Money back if not pleased. Paper covered edition \$1.00 at newsstands.

POPULAR MECHANICS PRESS, Dept. PM14
200 East Ontario Street Chicago 11, Illinois

Amazing NEW INVENTION

MAKE \$20.00 AN HOUR

Big Demand for
Serrated Knives



Puts Serrated Edges on Steak & Table Knives in 20 Seconds. Also Sharpens Kitchen Knives.

SAW-KEEN

Lightweight, Portable, Easy to Operate Electric (Plugs in Anywhere) Knife Serrator & Sharpener

This Profitable, "On-the-Spot" Business of your own returns investment of \$98.50 for machine in just a few hours. Every Private Home, Restaurant, Night Club, Cafeteria, Drive-In, Hotel, Hospital, Institution, etc. A Steady & Repeat Customer.

Make \$100.00 or more for a day's work with SAW-KEEN. Be your own Boss. Work as much or as little as you like. A simple demonstration gets the job and repeat orders. YOU CAN DO EXPERT & PROFESSIONAL KNIFE SHARPENING & SERRATING. SAW-KEEN is guaranteed to do precision work or money refunded. WRITE TODAY for full details plus our Guaranteed-Proven Method of getting Profit Making Jobs Daily.

CUTTER CRAFT MFG. CO., Dept. M
1000 E. GREEN ST. PASADENA, CALIF.

SURPLUS GIGANTIC SALE SAVE UP TO 85%

IMPORTED PRECISION SQUARES		NEW HI-SPEED DRILLS	
Accuracy Blades—Tempered Precision Ground		10 ea. 1/50" to 1/4" \$3.50	
2" \$1.50	6" \$2.30	10 ea. 1/4" to 1/2" \$3.50	(Assorted Sizes)
3" 1.70	8" 2.80	D.C. GENERATORS	
4" 1.90	10" 3.80	For Welding	
5" 2.10	12" 4.80	P.I. 24V. 200 Amp. \$12.50	
Cat. 15c or Free with Order		R.I. 30V. 300 Amp. 21.50	
Check or M.O. 25% dep. on		Guaranteed Perfect	
C.O.D. — F.O.B. L.A.		1507 S. La Cienega	
METRO PRECISION TOOL CO.		Los Angeles 35, Cal., Dept. M11	

POWER HACKSAW \$55.75
LESS MOTOR
F.O.B. Benton Harbor

● Rugged cast iron construction. Wt. 56 lbs., bronze bearings. Draw cut. Auto. return lift. Auto. shut-off. Vise swivels 45°. Cap. 4"x4".

Send for full details and name of nearest dealer.

EXCEL MACHINE TOOLS Dept. PM-114
BENTON HARBOR, MICHIGAN

Say You Saw It in Popular Mechanics

BUILD 15 RADIOS
AT HOME WITH THE NEW IMPROVED
1955 PROGRESSIVE RADIO "EDU-KIT"

ONLY **\$19.95** COMPLETE

Now Includes High Fidelity Signal Tracer & Code Oscillator
All Parts, Instructions, Soldering Iron, Tester Included. Money Back Guarantee.

PROGRESSIVE "EDU-KITS" INC.
Dept. PM-523, 497 Union Ave., Bklyn. 11, N. Y.

PROGRESSIVE "EDU-KITS" INC.
Dept. PM-523, 497 Union Ave., Brooklyn 11, N. Y.

RUSH ME THE FOLLOWING:
 Free Descriptive Literature—No Obligation.
 Free Valuable Radio and TV Guides—No Obligation.

Name _____
Address _____
City _____ Zone _____ State _____

Make BIG SAVINGS with FACTORY-DIRECT PRICES!

47 BRAND NEW AIR COMPRESSORS — SURPLUS

1/2 HP—\$80	3 HP, 3 phase, 60 gal. tank—\$395.
3/4 HP—\$160	5 HP, 3 phase, 80 gal. tank—\$395.
1 HP—\$180	7 1/2 HP, 80 gal. tank—\$705.
2 HP 3 phase—\$275	10 HP, 80 gal. tank, 3 phase—\$805.
	15 HP, 120 gal. tank, 3 phase—\$1200.
	20 HP, 120 gal. tank, 3 phase—\$1300.



All voltages and phases available. Write for particulars. GENERAL SPECIFICATIONS: (COMPRESSOR) Timken main bearing; semi-steel pistons; cushioned steel valve. (TYPE) Two stages, 200 lb. PSI (TANK) built ASME specification for 200 lb. working pressure; tested to 300 lbs.; test certificate furnished (MOTOR) Standard make, 1750 RPM (STANDARD EQUIPMENT) Pressure switch; air gauge; safety valve; tank drain; shut-off valve.

ELECTRIC WINCHES—Direct-to-you Prices
1/2 HP motor gearhead driven winch with drum, with lift 600 lbs. Pull 1100 lbs. \$95.00
3/4 HP, same as above. More lifting power, greater speed. \$185.00
Super-duty 3/4 HP Ball Bearing, with 24 to 1 worm gear reducer. Length 30", Width 26", Height 17". Pull 3500 lbs. Complete with 100 ft. of aircraft cable, up-and-down buttons. . . . \$245.00
(All electric motors Heavy-Duty, Repulsion-Induction, Instant Reverse, 110 V single phase, 3 phase available.)
Complete Stock of Limit Switches, Magnetic Brakes, Magnetic Reversing Switches, Aircraft Cable

CABLE 1/4" pre-formed aircraft cable. 17c ft.
3/16" pre-formed aircraft cable. 12c ft.

NEW SPEED REDUCERS — FOOTE BROS.
5 to 1, 6 H.P. Regular \$118. Only \$65
SHIELDED WIRE A.W.G. No. 12, 14, 18. \$30 per 1,000 ft.

CUTLER-HAMMER HEAVY-DUTY PUSH BUTTONS
Dustproof, waterproof, shockproof. "Start and Stop"
Regular \$21. Only \$9.95
"Up and Down" or "Forward and Reverse" Regular \$21. Only \$5.95

Here are only a few big \$ \$ \$ savings! More in our catalog!

Air Compressor	Electric Motors	Hand Truck	Rubber Cable
Air Tank	Electric Switches	Hydraulic	Rubber Wheels
Block & Tackle	Elevator	Cylinder	Saw Tables
Blowers	Drawing	Hydraulic	Shower Sprays
Bomb Trailer	Elevator Incline	Stacker	Starters
Buzz Saw	Fans, Exhaust	1 Beam Trolley	Tools
Compressor	Fans, Heat	Lawn Mower	Transformers
Accessories	Booster	Sulky	Whiting Hoist
Clutches	Gas Engines	Magnetic Starter	Wilton Vise
Conveyors	Generators	Mail Chain Saw	Winch, Electric
Delta Tools	Grinders	Mail Grinder	Winch, Hand
Drop Cords	1/2 Ton Wagon	Pumps	Fire Extinguisher
Electric Hoists	Hale Fire Pump	Reduction Gear	4 Wheel Trailer

Get this catalog! 88 pages, packed with useful charts, information, plans for dummies & incline elevators, more than 1100 tool and equipment items at money-saving, factory-to-you prices. Send 25c (refund with first order) or write on company letterhead for free copy.

C&H ELECTRIC MACHINE CO. Inc.
434 W. Juneau Ave., Milwaukee 3, Wisconsin

WORKING IN METAL IS AS EASY AS WORKING IN WOOD WITH..

"SELFWELD"
new weld-it-yourself method

SIMPLE AS SNAPPING A SWITCH—With Lincoln "Selfweld" you can weld at home now. There's no need for taking time to learn welding as with other equipment on the market today. All you do is touch "Selfweld" to the work and press a switch. Your weld is strong, good looking.

The handy "Selfweld" Kit includes: "Lincwelder 100", welding shield, cable, electrode holder and "Selfweld" electrodes.

Priced only \$99.00 F. O. B., Cleveland, O.

Order Your "SELFWELD" KIT NOW!

The Lincoln Electric Company, Dept. 2903
Cleveland 17, Ohio

Name _____
Address _____
City _____ State _____

Send me the Lincoln Selfweld Kit enclosed is check money order for \$ _____
 Send Selfweld Bulletin giving more information on home welding.

8-INCH TILT ARBOR SAW

\$24⁹⁵

Factory
to You



826.95 West
of Mississippi

Extensions,
guard,
blade extra

PRECISION GROUND CAST IRON TABLE

Miter Gauge and rip fence included — standard equipment.

Rips, Miters, Bevels, Dados, Makes Mouldings.

Patented blade tilt mechanism and patented ball bearing motor mount.

BIG CAPACITY — CUTS 2 x 4's AT 45°

TIME PAY PLAN

YOURS FREE for the asking—amazing free trial plan and full information. Send postcard.

15 DAY
FREE
TRIAL

POWER TOOLS INC.

165A Yates Ave.
Beloit, Wisconsin

save

UP TO 20% ON FUEL!

BUY *Bridgeport*
INNER-SEAL
WEATHER STRIPPING



Homeowners from coast to coast keep fuel bills low with INNER-SEAL, the flexible, easy-to-install weather stripping. INNER-SEAL's exclusive patented construction makes a pressure-tight seal that keeps heat IN, keeps cold OUT. Neoprene coated INNER-SEAL is waterproof, abrasive-resistant, durable. Fits perfectly even on warped doors, windows and frames . . . lasts for years.



Available in handy "do-it-yourself" Queen B and B Paks — in the lengths you need to weather-strip doors, windows and storm windows! Complete instructions printed inside every pak.

FREE copies of "Why & How To Weather-Strip" booklet — available where you buy your hardware or building supplies.

OR, WRITE: DEPT. PM11, _____



BRIDGEPORT FABRICS, INC., BRIDGEPORT 1, CONN.



Seat Mounted in Inner Tube Permits Deep-Water Fishing

You can fish in shallow or deep water by using a canvas seat that fits into a truck-tire inner tube. It's said to give the fisherman stability in the water yet hold him high and dry with both arms free for casting. With little practice, the user can move about by paddling his feet.

Pull-Out "Wire" Wheels

Held to the rim of the wheel by five spring clips mounted in rubber, a wire wheel attachment snaps out when you want to clean behind it. The spring clips also end rattles, says the manufacturer. The clips are easily inserted without damaging the wheel's paint or without deflating the tire. The new wheel attachment with the snap-out clips is available in chrome or white enamel. An extra set of clips is provided for permanent attachment to the spare wheel, permitting immediate transfer of the wire-wheel unit in case of a flat tire.



POPULAR MECHANICS

SLIGHT IMPERFECTIONS

GUARANTEED OPTICALLY, MECHANICALLY PERFECT—our fall inventory has shown that we have on hand a fairly large number of our nationally sold and advertised microscopes which did not pass inspection. These imperfections are such things as finish defects, small pit in one of the frame castings, etc. All imperfect lenses or focusing mechanism parts are replaced and made perfect. We extend our regular 10-day money-back guarantee to all these instruments from the standpoint of perfect function and use.

Model 635
150-300-600 POWER

REG. \$2995
\$47 ON HAND AT
\$1995

each postpaid

This is the most popular all-around instrument in the country capable of 600 power.

Used universally by schools, colleges, biologists and hobbyists. Additional eyepieces are available. See accompanying catalog.

(Comes equipped with 15X eyepiece.)



Model 300P

100-200-300 POWER

REG. \$995

\$52 ON HAND AT
\$695

each postpaid

This is the most popular microscope ever made. Used in many schools for teaching elementary biology. Sold in department stores all over the country. Triple objective, excellent focusing.



Model 800

20-600 POWER

REG. \$3995

\$61 ON HAND AT
\$2995

each postpaid

Purchase price above includes 15X eyepiece. 5X, 10X, 30X & 45X objectives. See accompanying catalog for additional eyepieces. Achromatic condenser, iris. Premium construction metal head. Standard optics throughout. A handsome professional instrument.



Model 300PL

70-100-200-300 POWER

REGULARLY

\$1695

\$208 ON HAND AT

\$995

each postpaid

This is the fast quadruple turret hobby microscope ever made. All modern features, inclined eyepiece, "L" design.



CABINETS

All microscopes shown are shipped insured in their original fitted hardwood cabinets.



MICRO-ANIMAL LIFE

Even with the most inexpensive instrument shown you can see and study microscopic animal life in a drop of stagnant water—such as the Volvox (Lily Animal).



EXECUTIVE INTERCOM SYSTEM

IMMEDIATE SHIPMENT

\$1995 postpaid

TWO ULTRA-MODERN FRENCH PHONES with desk cradles. An Akron country wide service, the greatest intercom value ever offered anywhere!

Handsome contemporary design. Solid lifetime construction. Built-in double buzzer system. Operated anywhere with ordinary flashlight batteries. (Two concealed in each cradle). EXCELLENT VOLUME, FIDELITY, RANGE, CLARITY.

Use interoffice, store-home, home-garage, outside, inside. Black satin finish. 2 phones and cradles, 4 batteries inc., postpaid \$1995. Double wire, postpaid 4c per foot.

SEND CHECK OR MONEY ORDER 1/2 deposit on C.O.D. Call, read, add 20 state tax. Return any item within 30 days for full refund. Items manufactured to our rigid specifications by selected Japanese firms. Electronics are standard U.S. manufacture.



MECHANICAL STAGES

Mechanical stages are \$14.95 extra (over standard price) and are available only when shown on instruments above. Your instrument will be equipped with standard clip slide holders if mechanical stage is not ordered. A few blank slides are included with each instrument.



FREE WITH ORDER

Our big 64 Pg. catalog of microscopes from \$9.95 to \$200, including accessories, telescopes, binoculars. Plus extra micro-manual that tells how to use. Both included free with any order or mailed for 20c postage & handling.

Sensational Level-X 3 Purpose Car Instrument



Patents Pending

- Accurate Compass
- Level Gauge
- Acceleration Guide

Fits any car. Compass easy to compensate. Shows grades up or down to 20 degrees. Rugged construction. Ideal for cars, trucks, tractors. 10 day money-back guarantee. Send for yours today!

LEVEL-X, INC.
Suite (M-111) 627 Salem Ave.
Dayton 6, Ohio

Ohio residents add 15c Sales Tax

ONLY \$495
POSTPAID IN U.S.A.

Distributors Wanted

READY CUT HOMES

\$2150 AND UP DIRECT FROM MILL

YOU SAVE the items which help make today's building cost expensive: high labor cost, contractor's profit and overhead, insurance, architect's fees. Cut-to-Fit eliminates usual lumber and material waste, also costly mistakes. Anyone can assemble. Simple, easy-to-follow plans furnished and each part numbered. Complete with all lumber, roofing, nails, glass, hardware, paint, doors, windows. Freight paid. Low-cost building plans sold separately if desired. 57 Homes and Floor Plans.



5 EASY PAY PLANS
COLOR CATALOG



INTERNATIONAL MILL & TIMBER CO.
Dept. P.M. 114 Bay City, Mich.

NOVEMBER 1954

BE YOUR OWN BOSS! Make UP TO \$50.00 PER WEEK IN YOUR SPARE TIME

Mr. B. of California writes "The lawn mower grinding business, with my Universal Grinder, has been a gold mine these last two years." Mr. J.L.P. of Pennsylvania says "Thank you for getting me started in this wonderful business . . . I averaged \$100.00 per week for the month of May."

ONLY ON THE UNIVERSAL LAWN GRINDER

. . . can the inside face and edge of the stationary blade, as well as the reel blades, be ground to proper clearance

ALL IN ONE SET-UP

WITHOUT REMOVING ANY BLADE FROM THE MOWER

Users who have tried them all acclaim the UNIVERSAL for above any grinder on the market. Write today for full details of our Proved Success Plan. It's Free.

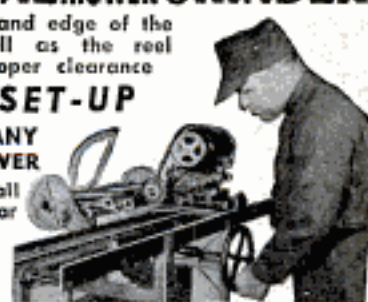

ROGERS MFG. CO., Dept. M-114, LINDSEY, OHIO

SEND THIS COUPON NOW

ROGERS MFG. CO., Dept. M-114, Lindsey, Ohio
Please send me full details about the profit possibilities of Lawn Mower Sharpening.

NAME _____
ADDRESS _____
CITY _____ STATE _____

WHEN IT COMES TO WOOD
FILLERS THERE'S NO
SUBSTITUTE FOR PLASTIC WOOD!



Plastic Wood is stronger—resists weather. Sands down to a smooth, hard finish. Professional craftsmen have preferred Plastic Wood for more than 50 years because it takes paint, varnish and other finishes best. Will not chip, crack or peel . . . won't pull away! In cans and tubes.

In Natural and 8 wood colors!

"PLASTIC WOOD"®

**The New Improved Model 38-98
DYNAMIC POWER TOOL
COMBINATION**



INCLUDES: Cummins 1/4" Pistol-Grip Electric Drill; Cummins Saw Attachment; Combination Saw Blade; Set of Drills; Lambs Wool Bonnet; 13 Sanding Discs; Steel Arbor and Attachments; Cloth Buffing Wheel; Grinding Wheel; Wire Wheel Brush; Steel Paint Mixer; Steel Bench Stand; Portable Steel Carrying Case.

Price of Dynamic Power Tool Combination complete is \$29.95

**SHIPPED ON APPROVAL
No Money With Order — No C.O.D.**

Try it ten days before you buy. If completely satisfied then send \$4.95 and pay balance at rate of \$5.00 per month for 5 months — No Interest or Carrying Charges Added. If not completely satisfied, return to us, no explanation necessary.

KAPNER HARDWARE, INC.

Dept. A-119, 2248 Second Ave., New York 29, N. Y.

Please rush 1 Dynamic Power Tool Combination. I agree to pay \$4.95 within 10 days after receipt and \$5.00 per month thereafter.

Name _____
Address _____
City _____ Zone _____ State _____

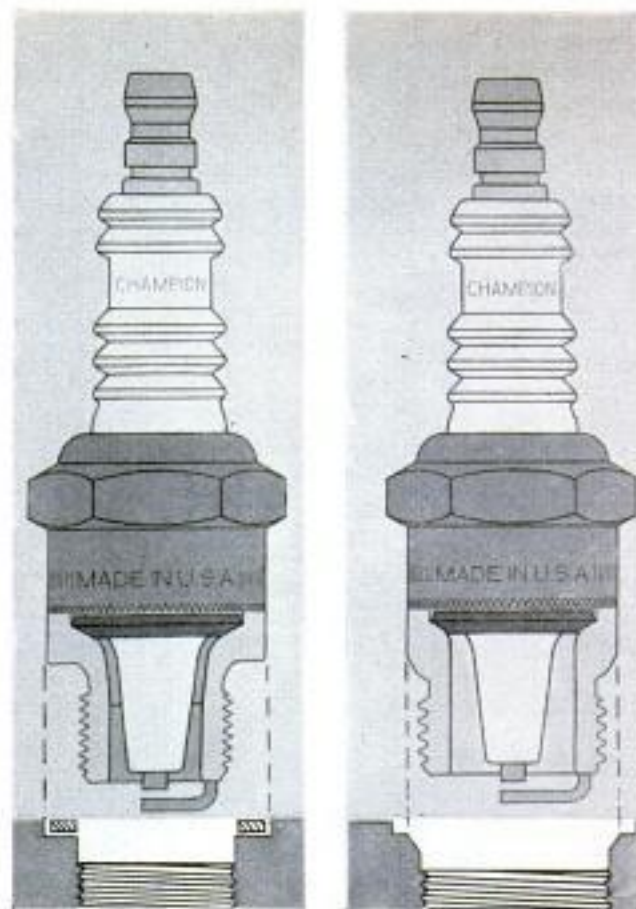

OLD

NEW

Seal is formed by tapered shoulder, right, eliminating need for gasket, left, and space-wasting shoulder

Spark Plug Uses No Gasket

Tightening into a taper in the cylinder head, a new spark plug eliminates any need for a gasket. Because no square shoulder is needed to seat a gasket, the base of the plug can be larger, increasing clearance around the insulator. This added clearance gives the plug a much wider heat range. It minimizes fouling during low-speed driving and yet has a heat range adequate to avoid preignition during high-speed conditions. Developed by Champion, the plug is being used on Ford Thunderbirds.

Chemical May Kill Red Tide

Airplanes may dust the ocean along the west coast of Florida with activated charcoal to destroy the red tide. The red tide is caused by thousands of one-celled organisms which color the water, cluster together in massive red-tinged "blooms" and create a poison which litters the beaches with thousands of dead and dying fish. The activated charcoal, it is believed by University of Florida researchers, would absorb the hormones and vitamins needed by the organisms for their life processes. The cost would be considerably below the copper sulphate now being used effectively.

WALDEN

Soft-Faced HAMMERHEADS

CONVERT YOUR STEEL HAMMER EASILY AND QUICKLY!

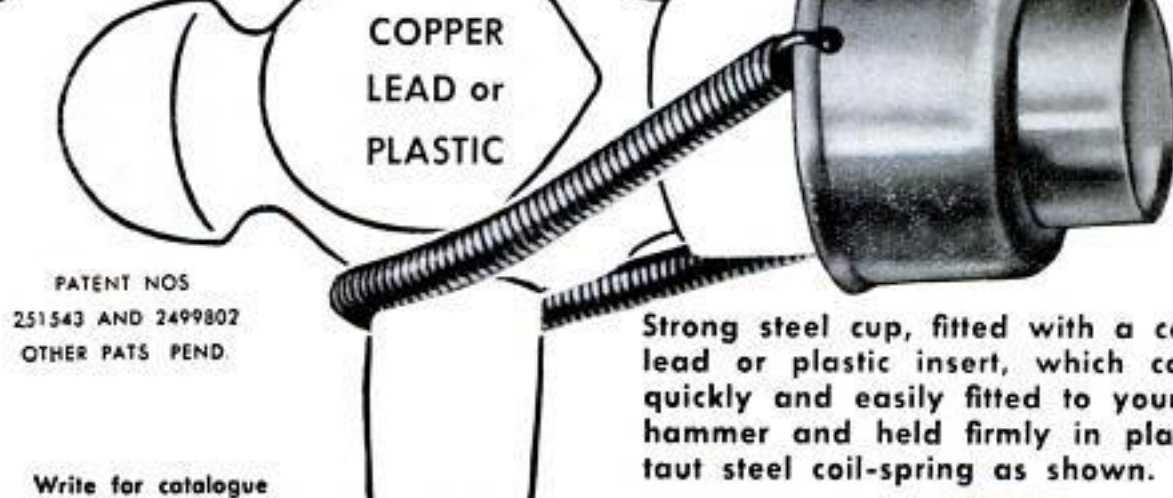

PATENT NOS
251543 AND 2499802
OTHER PATS PEND.

Strong steel cup, fitted with a copper, lead or plastic insert, which can be quickly and easily fitted to your own hammer and held firmly in place by taut steel coil-spring as shown.

Write for catalogue

STEVENS WALDEN Inc.

480 SHREWSBURY STREET — WORCESTER, MASSACHUSETTS

MAKERS OF
WORLD-FAMOUS HAND TOOLS
FOR OVER 50 YEARS

4-403

DO MORE PLANING JOBS WITH LOW COST BELSAW



Exclusive MONEY-MAKING Features: • Full 12 3/4" x 6" capacity • Power feeds at 24" a minute • Provides for Grinding Knives in the Cutterhead • Attachments for Jointing, Rabbeting, Tongue, Groove, Matching. Convert low cost rough lumber into high priced cabinet finished stock... Easy to make flooring and popular patterns. Send today for free literature and prices.

Belshaw Machinery Co., 1011 Field Bldg., Kansas City II, Mo.

LOW DOWN
PAYMENT
EASY
TERMS

6 DRAINS cellars, cisterns, wash tubs; IRRIGATES - CIRCULATES - SPRAYS



1,001 USES—HOUSE, GARDEN, FARM
Original All-Purpose Pump has 2400 GPH capacity, 360 GPH 7 1/2" high; or 1500 GPH from 2 1/2" well. Use any 1/40 to 3/4 HP motor. Stainless steel shaft, 1" inlet, 3/4" outlet. Motor coupling included.

DOES NOT CLOG OR RUST!
Postpaid if cash with order. (West of Miss. add 50c.) MONEY BACK GUARANTEE. Larger Centrifugal Pumps, and Gear Pumps in all sizes. LABAWCO PUMPS, Belle Mead 7, N. J.

DRILL • SAW • REAM • CUT ALL WITH ONE BIT! BEAVER SPEED SAW DRILL BIT



ONLY
\$2.45 each
3 for \$7.00
POSTPAID

Beaver's new improved high speed side cutting drill bit can be used on any electric drill, drill press, lathe or milling machine. Made from the finest American high speed steel. 3 1/2" long, 2" side cutting section, 1/4" diameter. Designed to cut steel, wood, plastic, aluminum, etc. A versatile time-saving tool for EVERYONE. Money back guarantee! Three types available: All-Purpose, Wood and Heavy Metal—specify type desired. Buy them from your dealer today! Or send cash, check or money order NOW.

Distributor inquiries invited.

BEAVER DRILL & TOOL COMPANY, Div. PM-11
701 East 5th Street • Kansas City 5, Missouri

Say "MERRY CHRISTMAS" to the "do-it-yourself" fan with this new ROTARY STORAGE STAND



ONLY \$15.50

Complete
3-Tray Unit No. 8116-C

1. Stores 2 to 4 times as many different items (nails, screws, washers, etc.) as with drawers or boxes.
2. Prevents rust, dust, damage and corrosion.
3. Items instantly visible through the combination of glass jars and rotary action.
4. Eliminates mixing of small parts.
5. Accessibility through easily removed jars.
6. Includes ten 4-ounce, eight 8-ounce and six 16-ounce glass storage containers.
7. Assembles to a sturdy, compact height of 13 3/4 inches.
8. Ideal for handy, time-saving use in workshop, den, lab, toolroom, office or kitchen.
9. Priced right—at only \$15.50.

Immediate
Delivery!
ORDER
TODAY
From This Ad!

The Union Metal Manufacturing Co.,
Canton 5, Ohio

10-day money-back guarantee if not satisfied!

Please send me, shipment prepaid, the 3-tray Vu-O-Matic Rotary Stand No. 8116-C. Enclosed is my check (or money order) for \$15.50... or

Send C.O.D., freight charges collect.

Name _____

Address _____

City _____ Zone _____ State _____

LOCK UP FOR WINTER



with **CORBIN**
**PIN-TUMBLER
PADLOCKS**

Storage buildings, outbuildings, summer camps, sports equipment, garden and farm tools, boats . . . all these and many other things should be put under lock and key NOW. Do it right with Corbin Pin-Tumbler Padlocks! You get real security and economy, too. In every size . . . for every purpose . . . in every price range. At better stores IF IT'S WORTH LOCKING, IT'S WORTH A CORBIN PIN-TUMBLER PADLOCK!

CORBIN CABINET LOCK Division

The American Hardware Corporation
New Britain, Conn.

how much are
'throw-aways'
costing you?

replace with

Alum-Aire
permanent type
FILTERS



Engineered to last a lifetime in your warm air heating system!

for greater economy and efficiency

Here's the filter that's sure to save you money! Eliminate discards forever, improve heating efficiency, cut redecorating costs. Keeps air clean for better health. Check or money order. Shipped prepaid promptly.



Easiest cleaned filter on the market - simply flush with water and replace. No messy oils or adhesives. Absolutely rustproof and fireproof.

Size	1"	2"
10" x 20"	\$7.50	\$8.50
15" x 20"	8.50	9.50
16" x 20"	8.50	9.50
16" x 25"	9.50	10.50
20" x 20"	9.50	10.50
20" x 25"	10.50	11.50

Prices other popular sizes on request.
(Ohio residents add 3% State Sales Tax)

Carey Metal Wool Division
ELECTRONIC ENGINEERING CO.
Dept. PM-3 Springfield, Ohio

NOW! A New, Rugged Portable Jig Saw with a PISTOL GRIP HANDLE!

Provides Cooler Handling, Greater Sawing Accuracy Through Its Easier Operation and Control.

NEW **DALTON** Portable ★ Electric **JIG SAW**

Does the work of a Rip, Crosscut, Coping, Scroll, Jig, Band and Keyhole saw.

IT CUTS—

Circles, straight lines, intricate designs in Wood, Plastics, Metals, Composition Boards, Hard Rubber and others.

Excellent Xmas Gift!

Other features:

● Specially built motor insures fast feeding speeds, no jumping or chattering ● Oilite bearings, hardened steel gears ● Makes own starting hole for inside cuts ● Air stream blows sawdust off guide line ● Quick, easy blade changing ● Even cuts a 2x4!

If Dealer Can't Supply You, Write Direct to Us.

DALTON MFG. CO., 20-C So. Central, St. Louis 5, Mo.



Model D-500

Complete with 5 Different Blades

\$48.00

At Hdw., Bldg. Supply Stores Everywhere

OUT-PERFORMS ANY SAW IN ITS PRICE CLASS!

20 UNUSUAL, PRACTICAL, DO-IT-YOURSELF FURNITURE PLANS

Build distinctive furniture of custom quality ATLAS Plan Book No 1 shows exactly what to do . . . large diagrams, clear instructions 20 projects by top designers Send 50c (65c outside U.S.A.) to ATLAS PRESS CO., 1124 N. Pitcher, Kalamazoo, Mich.



Say You Saw It in Popular Mechanics



STATICmaster

THE TRIED AND PROVEN TOOL THAT ELIMINATES SURFACE STATIC ELECTRICITY

- For cleaning slides before mounting
- For cleaning negatives before printing
- For cleaning Readymounts for projection

Buy Staticmasters at your local photographic store or order direct . . . postpaid if cash with order

NUCLEAR PRODUCTS CO.

Dept. 65-10175 E. RUSH ST., EL MONTE, CALIF.

NEW SHOP WITH has capacity-PLUS!

• Beats any power tool at any price. Powerful 3/4-hp. motor. Big all-purpose 9" circular saw. Lathe 16 1/2" swing. 12" sanding disc with 14" x 18 3/4" table. Drill press to center of 16 1/2" circle. Horizontal drilling unlimited. Price complete, \$269.50. Write for catalog. **MAGNA ENGINEERING CORP.**, Dept. 278-B, 12318 Coit Rd., Cleveland 8, Ohio, or Menlo Park, Calif.

MAKE UP TO \$5 AN HOUR WITH

EASISHARP



MONEY MAKING SALES PLAN FREE

Big profits in your spare time sharpening scissors. We show you how to start making money immediately. This is your chance now to have your own business and a steady income. Sharpen a pair of scissors in less than two minutes! A child can operate it. Weighs only 10 lbs. Every home, barber, tailor, dressmaker—everybody uses scissors and all need sharpening two to four times a year. Don't let some one else beat you to this opportunity. Write immediately to **SERR-EDGE MACHINE CO., 9731 Lorain Ave., Cleveland, Ohio**

**GIGANTIC
SAVE-TO-70%**

MAIL SALE

**WAR SURPLUS
EXCESS INVENTORY
BANKRUPT STOCK**

ELECTRONIC AUTOMATIC TIMER

● Genuine Telechron 115-volt, 60-cycle Clock Timer in beautiful red onyx case. Will handle 1000-watt load. Set for any time 0 to 15 Minutes. Turns power off at proper time. Has pilot light and alarm buzzer.
● Many experimental and laboratory uses. Use for photography, sun lamps, timing studies. List \$19.95 Sale \$4.95 Prepaid



AIR COMPRESSOR BARGAINS

For painting, cleaning, tires, control terminals. Assemble your own outfit. Lowest prices in U.S.
● Deluxe Kit, Compressor, tank, gauge, regulator, paint gun, fittings. How to build instructions. List \$80. Sale \$45.49
● Deluxe Outfit. Finest ready to use complete air unit on wheels with gun, reg. etc. (Less motor) \$89.95
● Compressor (1-cyl) \$20; 2-cyl \$52; Govt. Air Tanks \$6.79; Regulators \$2.79; Pop off \$1.95; Pres. gauge \$1.89; Finest paint gun \$9.95; Auto. switch \$4.95.

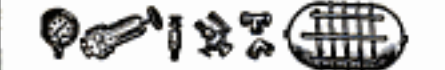

SELSYN REMOTE CONTROL MOTORS

● The war's most amazing invention. Self-synchronous motors enable the transmission of mechanical movement via electric wires over any distance. Hundreds of fascinating experimental applications. Remote wind direction and velocity indicators, positive controls, antenna rotational units, theft alarms, remote depth indicators.
● Genuine new precision G.E. and Bendix ball bearing units. Silver slip rings and brushes. Built like a fine watch.
● To use simply connect each unit to nearest 115-volt AC line. Then, connect two selysyns together using three wires. Any movement of shaft of Selysyn No. 1 causes identical movement of shaft of Selysyn No. 2. Full experimental instructions furnished. Cost \$125.00. Sale \$12.97 per pair prepaid.

ELECTRICAL KIT

● 50-piece war surplus new electronic apparatus. Includes capacitors, photo cell, thyatron trigger tube, rectifiers, resistors, sockets, switches, burglar alarm, ultra-black light tube, and many other valuable items. Full experimental manual and instructions furnished.
● Perform hundreds fascinating experiments in home laboratory. Very educational. Worth \$19. SALE \$4.99 ppd.



GIANT AIR CORPS LIGHT

● Amazing 110-Volt unit with intensifier fresnel. Throws wide beam over large area. Wonderful for parking lots, advertising lite, small airports, etc. Comes in \$30 trunk with extra bulbs, 12 ft. extension tripod, anchors, etc. Govt. cost over \$200. Sale \$49.50 Prepaid.



WORLD'S LARGEST LIGHT

● Make \$50 nightly renting Army 20-mi. beam, 800,000,000 candle power search-light to stores, fairs, night ball games, etc. Service easy to sell.
● Complete new condition light, 18,000 watt, 115-volt DC power plant and carbons furnished. Govt. cost \$38,600 Sale \$895 FOB Lincoln



ARMY PARTS CLEANER

● Air-turbo solvent cleaner. Makes dirty, greasy parts shiny bright. Wonderful for garages, factories, farms, etc.
● Heavy galv. tank 25"x20"x20". Complete with valve, hose, hydraulic lid lifter. Cost over \$125. Prepaid, \$29.95



ARMY POWER PLANTS

New condition. Full guarantee. Perfect plants. Latest models. Shipped prepaid to you.
● Plants 2000-W, 115-V. 60C.
● Plants 1000-W, 115-V. 60-C. \$189
● Generators 7500-W 115-V. 60-C. \$235
● Generators 3000-W 115-V. 60-C. with instr. panel \$169.50
● Generator 3000-W 115-V. D.C. Fine for portable AC-DC tools. Govt. cost over \$195 \$58

HYDRAULIC SPECIALS

Save to 80%. Build loaders, lifts, etc.
● Cylinder Buy! Finest leading make. 3" bore, 8" stroke, one way. Fine for plow lifts, etc. List \$25.50. Sale \$11.95
● Cylinders. Two-way. 2"x10" \$22.85; 2"x24" \$28.90; 3"x24" \$39.90. One-way. 2 1/2"x42" \$36.95.
● Pump. 1000 lb. 12 gal. \$45; Valves. One-way \$18; Two-way \$18; Gauges, 1000, 1500, or 3000 lb. \$3.49.
● Super Special. Cylinder. 1 1/2" bore x 4" stroke. (Precision). Govt. cost \$87. Sale \$1.95 ea.

PHOTO PAPER AND FILM

Eastman Kodak film and paper purchased from the Govt. Outdated but guaranteed good. Save to 70%. Write for bargain sheet on surplus paper and film prepaid to you.
SHEET FILM — SAVE TO 70%
11 x 14—Super Pan-Press Sports Type—10 sheets per box \$3.15
11 x 14—Super Pan-Press Type B—10 sheets per box \$3.21
8 x 10—Reproliith Ortho—25 sheets per box \$2.95
11 x 14—Super Ortho Press—10 sheets per box \$3.09
PHOTO PAPER
13" x 13"—Contact paper sing. wt. glossy 250 sheets per box contrast 1, 2 or 3 \$9.07
10" x 10"—Enlarging paper S W 100 sheets per box contrast 1, 2, 3 or 4 \$3.49

SUPER SPECIAL!

**Carload Sale — 3000-4000 Watt
115-Volt 60-Cycle Plants**



● Marvellous new condition Hercules-Hobart units. Gas engine is famous 4-cylinder ZXB Hercules. Generator ball bearing Hobart. Finest instrument panel, controls, etc. Push button start. Weather-proof housing.

● Excellent full time or emergency unit. Easily connected to your wiring system. Generate your own power when disaster strikes. Unit guaranteed new condition, perfect. Buy now while Govt. surplus is still available. Govt. cost over \$800. Prepaid price \$349.50
● Available also 115/230 volt model, slightly higher. Also automatic-start model, write-in comparing prices, we pay all freight, we guarantee complete satisfaction or money back. 30 years in business.

PUMPS — VALVES — SYSTEMS

Irrigate. Do it yourself. Our data shows you how. ● Pumps. Centrifugal 8 1/2" \$19.95; 1 1/2" \$38.60; Rubber impeller self priming 1/2" \$15; Hi-pressure rotary for weed, cattle spraying \$54; ● Water System, Automatic. For lifts to 22 ft. 300 gal. per hr. 40 lbs. 110-V 60-C. 3/4 hp. motor. \$69.50

NEW DELUXE ARMY TOOL CHEST

28" x 38" x 20"
● Wonderful unit. Finest cabinet design. Four lift-out drawers. Excellent hardware, etc.
● Ideal for home shops, contractors, tool rooms, etc. Govt. cost, \$59.60. Sale \$21.95

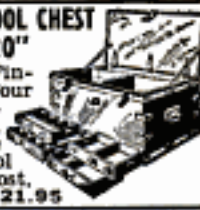

AUTOMATIC REMOTE CONTROL SWITCHES

● Amazing electro magnetic switch. Complete with dial. Any circuit from 1 to 100 can be selected simply by dialing the number, unanny response. Will work over lines up to 20 miles. Used, excellent.
● Fine for inter-coms. Private automatic phone systems, remote control, experimental, etc. New Cost Over \$200.00. Sale \$13.95 Prepaid.



ELECTRONICS AND MISCELLANEOUS

Interested in electronics? Write for bulletin "E-1." Some of our many bargains:
● Surveyors Level & Tripod \$37.95
● \$36,000 Arc Searchlight (FOH) \$895.00
● Farm Telephones \$9.95
● Generators—200 amp. DC-AC \$29.95
● W.E. Photo Cell (List \$8.50) \$4.95
● Black Light Tube—4 Watt \$4.85
● Thyatron Trigger Tube (List \$4.95) \$9.85
● Army Hip Waders \$36.97

ORDER FROM AD or write us for big FREE CATALOG! 1000s of Itemal Motors, sporting goods, hand and electric tools, watches, lamps, etc., etc.

BURDEN SALES COMPANY
806 "O" STREET LINCOLN, NEBRASKA

Say You Saw It in Popular Mechanics

WISE-GRIP SAVES A FULL DAY'S FISHING FOR ANXIOUS MINNESOTA ANGLERS!



"Early one morning last summer a stranger approached my boat dock complaining that his motor's starting cord had pulled out of his motor. Another man joined us whose motor's boat-clamp had been bent on route. I got my Wise-Grip, fixed both motors in jig-time. No other tool could have done the work so fast!" — A.N.



WISE-GRIP WRENCH

DOES MORE JOBS EASIER THAN ANY OTHER TOOL!

True stories like this show why Wise-Grip is the HANDIEST tool of all! A squeeze of the hand locks these powerful jaws onto work with Ton-Grip. Pulls, bends, turns, twists, ratchets, cuts — WON'T SLIP. A whole tool kit in one trim tool! At your dealer.

7W, 7" \$2.25
10W, 10" 2.40

Made only by PETERSEN MFG. CO., DEPT. M-11, DE WITT, NEBR.

Floor Surfacing Contractors NEEDED!



- ★ BIG PAY
 - ★ FULL or PART TIME
 - ★ AGE No Barrier
 - ★ Minimum Investment
- ### BE YOUR OWN BOSS

Highly respected profession offers you unusual opportunity to *be your own boss!* Thousands of men from 18 to 80 have found financial security and happiness in this phase of building and remodeling. Pay scale is high—many earn \$50 a day and more. Men even with physical handicaps enjoy this pleasant year 'round work. No schooling or special skill required. Only small investment in sander gets you started. Send for booklet "Opportunities in Floor Surfacing", enclosing 25c in coin or stamps to cover handling.

AMERICAN FLOOR SURFACING MACHINE CO.
535 So. St. Clair St., Toledo 3, O.

SEND..



give them a
FISTFUL
of
POWER!



NEW SpeedDrill has 1/2" capacity in steel, 1/2" in wood. Geared chuck with key. HEAVY DUTY RADIAL AND END THRUST BALL BEARING ON SPINDLE. Beautiful hi-polish natural aluminum finish. Helical cut steel gears. Real quality built-in for years of professional punishment. UL Approved. **\$25.00**

SpeedDrill Kit (as illustrated) 33 pieces—for sanding, buffing, grinding, polishing, etc. Includes: steel case; 7 chrome alloy bits (1/8" to 1/4"); bench stand; polishing bonnet; abrasive discs; wire brush; grinding wheel; linen buffer; polishing compound; etc., etc.

Only **\$35.00**

complete
write for **FREE**

Do-It-Yourself Booklet

SpeedWay manufacturing co.
a division of Thor Power Tool Company

1863 South 52nd Avenue • Cicero 50, Illinois

Thor
SpeedTools

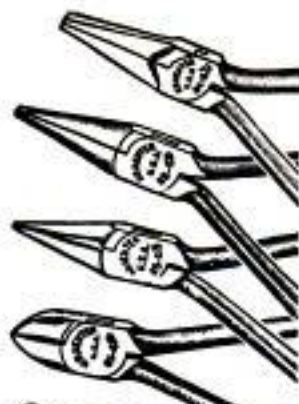

PRECISION PLIERS

• For accurate, exacting work use the fine, small pliers jewelers and watchmakers use — Kraeuter's Precision Pliers. Matched in size and handle shape, drop forged from selected tool steel, machined and heat treated to exacting specifications. For hobby crafters, model builders, TV and radio technicians.

Buy wherever fine tools are sold in U. S. and Canada.



KRAEUTER



TRANSFORMER WELDER \$19.95 FOR QUINCY

Complete with everything. Ready to plug in. 110 volts AC. 15-30 Amps. 3 heats. Welds metal from 1/16" to 1/2" using 1/16" to 3/32" standard rods. Guaranteed unconditionally. 10-day trial. \$5.00 deposit on C.O.D. Does everything welders costing up to \$75.00 do. Buy direct and save.

ESSAY MFG. CO., INC., Dept. 51, Quincy 69, Mass.

FIND \$\$\$\$

NEW U-238 geiger counter—world's smallest, most sensitive uranium locator. Ideal for prospecting even on hunting, fishing trips! (Full line of mineral and metal locators, too.)



FREE booklets on request. (Dealer inquiries welcome.)

GOLDAK COMPANY 1542 W. Glenoaks Blvd., Glendale, Calif.

WOODWORKERS! With beautiful veneers you can use the world's choicest woods in your own home projects. We specialize in highest quality veneers and inlays for the home craftsman. Send \$1.00 for samples of 14 exotic woods. Price list and "Tips on Veneering" free.

SOUTHERN CRAFTSMEN

Dept. P

P.O. Box 1644

Louisville, Ky.

make your own Gems 29.50 FOR 60

The Gem Maker comes complete with all necessary equipment, including a super-charged diamond blade for sawing, and all wheels for grinding, shaping and polishing; also complete instructions. The complete equipment as shown, less motor and belt, for only \$29.50, f.o.b., Burlington, Wisconsin. Write today for information and literature.

B&I MANUFACTURING CO.
Dept. S Burlington, Wis.



BRONZE FOUNDRY

Schools and Home Workshops

Make your own castings of aluminum, copper, bronze, silver. Foundry sets are available in three sizes including 2400 Deg. F. blast Furnaces. \$22.50; \$29.50; and \$42.00. f.o.b. Kansas City. Free Circular.

KANSAS CITY SPECIALTIES CO. P. O. Box 6022, Dept. P-11
KANSAS CITY, MO.

Guide to
HOME REPAIRS

Pays for Itself 100 Times Over

Beat the high cost of home upkeep. Save hundreds of dollars every year on carpentry, electrical, painting, plumbing and other jobs around the house with **Popular Mechanics GUIDE TO HOME REPAIRS**. Simplified how-to-do-it instruction and 646 pictures make all jobs, inside and out, easy. Covers construction, remodeling, modernizing, repairing that you can do yourself at small cost. 192 page cloth bound book only \$2.50 postpaid. Order today under our money back guarantee.

POPULAR MECHANICS PRESS, Dept. PM16
200 EAST ONTARIO STREET CHICAGO 11, ILLINOIS

New HANDY WrapLock
Best ALL PURPOSE CLAMP EVER MADE!



SAVE MONEY ON REPAIRS!
Do It Yourself—at Low Cost

Easy to use anywhere, clamps anything to anything, any size or shape, 1001 uses, for Hose clamps, pipes, TV antennas, Marine & Auto work, fences, etc. **LOCKS TIGHT. CANNOT COME APART OR LOOSEN. RUSTPROOF. Fearproof. Vibration Proof.** Can be re-used. Used by Air Force, Navy, R. C. A., Inventors, etc. (Tensile Strength over 64,000 psi.). **EASY TO FOLLOW DIRECTIONS.**

3 HANDY, COMPLETE LOW COST KITS

"KIT A"—100 FT. (Elec. Galvanized) Non-chipping, heavy gauge steel strap 1/2" wide, 100 Clamp Buckles, Ratchet Wrench, etc.—ONLY \$6.45 POSTPAID.

"KIT B"—50 FT. (Stainless) steel strap 1/2" wide, 50 Stainless Steel Clamp Buckles, Ratchet Wrench, etc. ONLY \$7.85 POSTPAID.

"KIT C"—100 FT. (Stainless) steel strap 1/2" wide, 100 Stainless Steel Clamp Buckles, Ratchet Wrench, etc. ONLY \$11.85 POSTPAID. (Deduct 10% on any 3 or more ordered.)

Send check or money order today. \$1 deposit on C. O. D. SATISFACTION GUARANTEED OR MONEY REFUNDED

DOMBERT CO., Box 23M Gedney Sta., White Plains, N. Y.

NEW LOW-PRICED QUALITY TOOLS!

This durable PORTABLE HACK SAW ATTACHMENT easily saws metal, wood, and plastics. Fast action, simple to use. All around tool gives years of service. Housing of aluminum alloy casting. Complete with 2 blades. Satisfaction guaranteed. Order today! Send check or money order. Immediate shipment, postage paid.



\$15.95

DURA-TOOL

Write today for Free Catalog on entire line of tools!

CLIZBE BROS. MFG. CO., PLYMOUTH, INDIANA

SILVER SOLDER TORCH & KIT \$7.95
 JOINS ALL METALS PERMANENTLY
 Do your own repairing. KIT includes one tube silver solder paste and 12 5-in. lengths silver solder alloy. **Hottest ALCOHOL TORCH** known. 2700° F. flame. Operates in any position, indoors or out. Pint of special fuel included. Complete outfit ready for use \$7.95 postpaid. TORCH alone with pint of special fuel \$6.85. KIT alone \$1.65. Instructions included.
AMERICAN PRODUCTS CORP., 422 S. Dearborn, Dept. 3-K, Chicago

WORLD'S BEST SMALL TRENCHERS



Portable DITCH-WITCH digs 2" to 6" clean, even ditches to 36" depth in all types of soil. Complete unit—self propelled—outdigs 8 men. Four rugged models.

Write for illustrated literature. **CHARLES MACHINE WORKS**
 620 B Street Perry, Oklahoma

Say You Saw It in Popular Mechanics

1955 CATALOG — Send 50c

55 Models for '55! See the world's finest line before you buy. Rated tops in design, styling, performance by the experts. '55 catalog plus booklet "Boat Selection, Operation, Maintenance" \$1.00

Custom-Craft
 THE ORIGINAL "PACKAGED"
BOAT KITS

BOAT PLANS AND FULL-SIZE PATTERNS

Over 100 Modern plans and full size patterns. Racing classes, cruisers, inboards, outboards, sail boats. By famous designers. 6' to 30' DESIGN CATALOG only 50c. For Design Catalog plus boat building handbook send \$1.00.

CUSTOM-CRAFT (DEPT. A) BUFFALO 7, N. Y.

WAR SURPLUS AND OTHER BARGAINS SAVE UP TO 90%



SENSATIONAL GENERATOR BUY!!

Famous Navy NEA-5 Generator Combination AC-DC Type. AC voltage—115 V. 10.5 Amps. 1200 Watt. DC voltage—24 V. 200 Amps. 2 complete generators in 1... 2 separate fields and 2 separate armatures on same shaft yet no larger than regular aircraft generator. Ideal for home, farm and shop lighting plants by hooking wires to AC side. DC side can be used for welding and operating war surplus low voltage hobby motors and equipment. Weight 54 lbs. NEW. Approx. GOVT. COST \$350. NEW \$27.50. Used Perfect \$18.00.



SPECIAL CARBON PILE TYPE VOLTAGE REGULATOR

To go with above generator. Incl. mounting base and completely enclosed in steel mesh box. Helps maintain constant current and prevents pulsation. Ideal for installation with above generator for lighting plant. Wt. 5 lbs. Complete NEW. Approx. GOVT. COST \$90. Now only \$7.95

BUY 'EM BOTH—SAVE \$5.45! Generator & Regulator together \$30



NEW P1 GENERATORS

Electric Auto-Lite, 200 Amps. 24 Volt. 4400 RPM. Dandy arc welder. Wt. 33 lbs. Approx. GOVT. cost \$450. Like NEW. \$11.50 incl. easy diagram.

SENSITIVE ALTIMETER IN 10 FT. INCREMENTS 0 to 35,000 ft. (inches of Mercury). Tested and inspected in our own instrument lab. Guaranteed perfect. Ready to install. \$12.95. PREPAID!



NEW IMPROVED MODEL MAUSER-TYPE PRECISION 1/1000" VERNIER CALIPERS

Quick, handy, accurate. 6" Vernier Calipers. Glass hardened, lapped measuring surfaces. Fine engraved scales—1/1000" & 1/10 mm for inside, outside & depth measurements. Friction thumb release. Larger capacity. 2 gib adjustments. Reg. \$25. Now only \$6.95. Leather case \$1 extra.

MICROMETERS Chrome plated, precision engineered, carefully tooled to give long life. All new 0-1" cap. \$2.25 ea., 1-2" cap. \$3.50.



PRECISION GROUND SQUARES

Production engineer's Squares. Accuracy guaranteed. Mfd. by Wright & Moore, Sheffield, Eng. Square blades hardened & tempered. Individually packed in wood box. Brand NEW. Fraction of original cost. 2"—\$2.25, 3"—\$2.50, 4"—\$2.75, 5"—\$3, 6"—\$3.25, 8"—\$4.25, 10"—\$6.25, 12"—\$8.25

LOW VOLTAGE CIRCUIT TESTER

Made for U.S. Ordnance. Self-contained device makes complete & rapid check of generator battery circuit. Will check out any 6 or 12 volt system. Garages, mechanics, truck fleet owners, boat & marine mechanics. Guaranteed perfect. Shpg. Wt. 20 lbs. Approx. GOVT. COST \$175. NEW, complete with steel carrying case & instruction book. WHILE THEY LAST—\$29.75



INTERIOR COMMUNICATION GONG BAR CHIME

Single stroke chime bar with sound well that gives clear resonated tone. Ideal for use indoors or out, for ranch or home, schools, plants, stores, etc. as signal system. Mfd. by Federal and Edwards & Co. Water tight construction. 115 Volt AC, 50 or 60 cycle, .18 Amps. Buy in single or multiple units. Wall mounting type complete with mounting bracket. Wt. 4 lbs. Approx. Govt. Cost \$37.50. NEW. Closeout at \$3.50 (not incl.)

NEW 1955 CATALOG Biggest ever... new low prices... Send 25c for your copy today.

Prices F.O.B. Culver City unless otherwise stated. Check, money order or cash, 25¢ deposit for C.O.D.

AIRBORNE SALES CO INC. DEPT. PM1154
 8501 Stellar Drive, Culver City, Calif.

earn BIG PROFITS
Sharpening Hand Saws

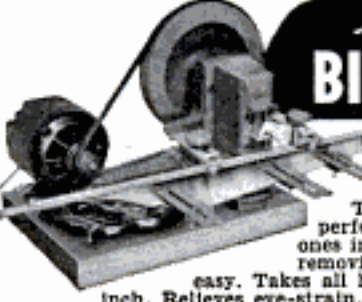

The Foley Saw Retooler cuts perfect new teeth right over old ones in less than 1 minute, without removing saw handle. Makes filing easy. Takes all hand saws 4 to 16 points per inch. Relieves eye-strain. No experience needed.

FREE Foley Price Guide of saw sharpening charges. A valuable chart of actual prices. Send coupon today. No salesman will call.

FOLEY MFG. CO. 1170-4 Foley Bldg. Minneapolis 10, Minn.
 Send FREE Price Guide and Foley Retooler circular.

Name _____
 Address _____

BUILD IT OF PLYWOOD!

Save
up to \$75

Make your own **10 INCH
TILT ARBOR SAW**

Complete KIT

\$19⁹⁵

less guard
and blade

Prepaid.



Money back
guarantee.

Write for
**FREE
PLANS**

You get all machined metal parts, all necessary screws, nuts, bolts, and washers, plus **FREE PLANS** that are simple as a-b-c! All you need are a few pieces of inexpensive 3/8-inch plywood to build a Tilt Arbor Saw with the precision performance of saws costing up to \$95! Blade tilts to 45° angle, table always remains level. Cuts hard or soft woods up to 3-5/8 inches thick. Cuts 2x6s in 2 1/2 seconds. Makes frames, joints, slots, etc. Rips wide or narrow panels. Cuts joists, sidings, rafters. Bevels, mitres, cuts compound angles, and dados. Plana Centric Suspension adjusts blade instantly for height and tilt, locks rigidly. Trans-Axial Motor Drive keeps belt always tight and untwisted. Self-Adjusting Rip Fence stays parallel

AMERICAN MACHINE & TOOL CO.
Dept. B.P. Royersford, Pennsylvania

**MACHINE TOOL RECONDITIONING
& THE ART OF HAND SCRAPING**

— ILLUSTRATED —

SEND TODAY FOR FOLDER DESCRIBING BOOK

MACHINE TOOL PUBLICATIONS, 382 Holly Ave., St. Paul 2, Minn.

NEW Govt. Release!

Original
Cost
\$444.00

**HOMELITE "Carryable"
GENERATING PLANT**

1500 WATT
60 CYCLE, **\$189⁰⁰** fob

A.C.,
Single Phase



Carrying handles for
easy portability. Fits
easily in car trunk

Fully
Guaranteed

Save Hundreds of \$ \$ \$

Ideal as a stand-by emergency power plant to duplicate house current. Plenty of power for lights, refrigerator, deep freeze, oil burner, radio, etc. Pays for itself! Saves time, labor, and money. Provides on-the-spot power for construction, etc. where none is available . . . or expensive to run in. Large enough for Floodlights; Saws; Pumps; and many more labor-saving, heavy-duty machines. Specifications below **CAN'T BE MATCHED** anywhere at this price!

GENERATOR 1500-1700 Watts, 115 Volts, 60 cycle, single phase, A.C. Overload capacity well above its rated output. Excellent automatic voltage regulation plus Field Rheostat for even closer adjustment. Built-in Volt Meter. Oversize brushes easily replaceable.

ENGINE Famous Homelite single cylinder engine. Air cooled; two cycle. Easy rope start. Dust and rain-proof ignition system. Built-in automatic governor. Foolproof pressure vapor lubrication system. Adjustable jet-type carburetor.

This Precision power plant has ball and needle bearings throughout and costs only \$c an hour to operate. Satisfaction Guaranteed.

**SUPPLY LIMITED! IMMEDIATE DELIVERY! ORDER FROM AD
FREE Catalog of Compressors, Motors and Welders**

ROBERTS ELECTRIC CO., Dept. P-231, 849W. Grand, Chicago 22, Ill.

*Now You Can Upholster
Any Piece of Furniture!*

**Upholster—Restyle Any
Piece of Furniture Yourself**

John Bergen, custom furniture designer, tells and shows you how to transform old out-of-date furniture into brand new smart-looking comfortable furniture in his new book **ALL ABOUT UPHOLSTERING**.

No Experience Needed

Bergen tells you every step to follow in amazingly clear easy-to-understand step-by-step instructions and then shows you how in hundreds of big, clear drawings and photos. You read and see how to strip the old frame, install new webbing and springs, apply burlap, install stuffing and padding, fit the muslin cover and the final fabric and install trim.

Use New Materials—Methods

Now you can have furniture upholstered with foam rubber, sagless springs and other new materials that add so much to comfort and durability and are so costly when included in new furniture.

Save 50% of Usual Cost

Don't pay a small fortune for new furniture when you can make your old furniture better than new! Why pay high prices to have someone else upholster and restyle your old furniture when you can do it yourself for cost of materials alone? It's easy and it's fun.

Special Chapter on Slipcovers

Learn how to make custom-made slipcovers with professional look and fit. Find out how you can realize tremendous savings by investing a few spare-time hours and the cost of a few yards of fabrics.

7-Day Money Back Guarantee

Send for your copy of **ALL ABOUT UPHOLSTERING** today. Read and use it for 7 days. If it isn't entirely satisfactory return it for a full refund.

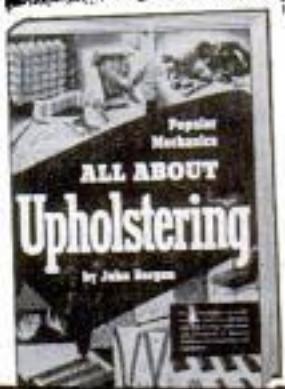

USE THIS HANDY ORDER COUPON

**POPULAR MECHANICS PRESS, Dept. AAU
200 E. Ontario St., Chicago 11, Illinois**

Gentlemen:

Please send my copy of **ALL ABOUT UPHOLSTERING**. Enclosed is my remittance of \$3.50. If I am not completely satisfied with the book I will return it for a full refund after 7 days.

Name _____

Address _____

City _____ Zone _____ State _____

DOES EVERYTHING A PIPE- WRENCH WILL DO, AND MORE!

THE AMAZING RATCHETING CHAIN WRENCH



Takes the place of 4 pipe wrenches. Gets into tight places where a pipe wrench cannot be used... capacity $\frac{3}{8}$ " to $4\frac{1}{2}$ ". For jobs around the home, garage or service station.

A must for farmers, steam-fitters, plumbers, electricians. Grips anything round or hex, in corners or up against a wall.

EXCELLENT HANDYMAN'S XMAS GIFT. SEND CHECK OR MONEY ORDER. NO C.O.D.

\$3.95
POSTPAID

Chain Wrench Co. 1217 HARMON PL. MINNEAPOLIS 3, MINN.

WELD **BRAZE**
SOLDER **CUT**



Acclaimed by thousands of Homeowners, Mechanics and Hobbyists as the welder of 1001 uses. Easily operated from properly wired 110 volt AC or DC line. The ideal gift with a life-long use... Order today on 10 day money back guarantee.

FOUR-WAY WELDER CO., Dept. F2-M
1810 S. Federal St. • Chicago 16, Ill.

ONE-MAN SAWMILL LOW AS... **\$50.00** DOWN



Take BELSAW Portable Sawmill right to the trees—turn out valuable lumber for home and farm—sell to local yards—make up to \$50 a day custom sawing for neighbors. BELSAW lasts a lifetime. No crew needed. Power with tractor or auto engine. Beginners get excellent results. Send today for FREE BOOK.

BELSAW MACHINERY CO
P.O. 8119 Field Bldg. Kansas City 11, Missouri

Say You Saw It in
POPULAR MECHANICS



MINIATURE ENGINES
GASOLINE — STEAM

BUILD THEM YOURSELF—IN YOUR OWN SHOP WITH YOUR OWN TOOLS
Anyone with a 6" or 10" lathe and a drill press can make them.

Send 20c For Illustrated Catalog of Miniature Engine Castings and Drawings
OPTURA MODELS
P.O. BOX 536-E PARK RIDGE, ILL.

WAR SURPLUS BARGAINS

SEND FOR
1954-55
SAVE UP TO 80%
OVER 200 Big Values

FREE Catalog

SIoux FALLS SURPLUS STORE
SIoux FALLS S. DAK.

Dear Family



This is a "what I want for Christmas" letter with pictures from my favorite power tool catalog.

I could do more of the jobs you ask me to do if I had any one of these Stanley electric tools. So you see, I'm really not asking for myself.

With this swell drill kit, built around the $\frac{1}{2}$ " drill, I could do lots of things faster and easier. Look at all that's in it.

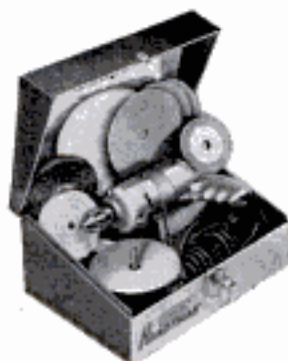

H21 Drill Kit—
\$44.95

Fred says I can use this Stanley router in 90% of my woodworking. I could really use it to help make your new cabinets, Mom.



H15 Router
\$39.95



H65 Saw—\$67.50

You may get a kick out of seeing the old man working a hand saw down a long cut, but this power saw would really save our time and my temper.

(Hint) I got my catalog of Stanley Electric Tools by sending a postcard to 314 Myrtle Street, New Britain, Conn.



STANLEY Electric Tools

A Division of The Stanley Works

TOOLS • ELECTRIC TOOLS • HARDWARE • STEEL • STEEL STRAPPING

FREE! for every
**Household
Handy man!**

**101
ILLUSTRATIONS
AND INSTRUCTIONS**



Anything made of wood—and this folder illustrates 101 items—should have the water repellency, resistance against warping, swelling and shrinking—and immunity against termites and decay—made possible with Woodlife.

WOODLIFE is the original water repellent wood preservative that should be on every handyman's work shelf—along with this folder which shows how to apply Woodlife to 101 household wood-working projects.

Ask your lumber, paint or hardware dealer for Woodlife and for your copy of this informative "do it yourself" folder! or write,



Protection Products MANUFACTURING COMPANY
Dept. O Kalamazoo, Michigan
When you repair, remodel or build, ALWAYS ask for Woodlife treated lumber!

LOOK FOR
THE NAME

UTICA®

**ADJUSTABLE WRENCHES
THAT LAST UP TO
10 TIMES LONGER**



Ordinary adjustable wrenches, subject to hard usage, burr over at the jaw edges. UTICA® wrenches have jaw surfaces extra-hardened by electronic induction (see diagram at left). Tests show they last up to 10 times as long as ordinary adjustable wrenches.



Jaw surfaces induction hardened for longer wear.

Your hardware dealer has UTICA® adjustable wrenches or can get them for you. Sizes 4" to 18".

U T I C A
DROP FORGE & TOOL CORP.
Utica 4, N. Y.

A REAL MONEY MAKER!

THE NEW ALL-IN-ONE SHARPENER



Precision Made
Ball Bearing-

**SHARPENS
PINKING
SHEARS
ALL MAKES
ALL MODELS**

ORDER TODAY

\$69.50 F.O.B.
Factory
(Less Motor)

Does perfect job on all size Scissors and Knives—the machine of many uses.

Write for details on how you can make \$75 a week and up, full or part time, in your home or shop.

TURPIN-JONES CO. P.O. BOX 1109, Dept. OPM
Manufacturers and Distributors Pasadena 1, Calif.

AMAZING NEW KIT OF HARD TO GET BRASS FITTINGS! A \$17.50 Value for Only \$5.95



Keep it running with **MUELLER BRASS FITTINGS REPAIR KIT.**

Kit contains over a hundred brass fittings—fittings for maintenance of all types of Air Craft, Automobiles, Diesel, Gasoline, Oil and Steam Engines, Farm Equipment, Tractors, Trailers, Motor Boats, Pumps, Oil Burners, Refrigeration, Plumbing, Heating, etc. (These fittings can be used on all types of tubing.) Complete kit only \$5.95 prepaid. Mail check to—**MUELLER SALES, 5157 W. Montrose Ave., Chicago 41, Ill., Dept. PM-11.**

VARIABLE SPEED HYDRAULIC POWER TRANSMISSION



It has Infinite Speeds 0 to 550, Reverse, Automatic Overload Protection; Adjustable Torque up to 180 inch pounds. $\frac{3}{8}$ " Input and Output Shafts. It will handle $\frac{1}{4}$ to $1\frac{1}{2}$ H.P. motor. Case measures $7\frac{1}{2}$ " long, 7" high, $6\frac{1}{2}$ " wide. VALUE OVER \$300. Shipping Wt. 25#. On C.O.D. orders we require a 10% deposit. **\$54.50** only
Fab. Chicago

DIRZIUS MACHINE SHOP "H" 1423-25 So. 52nd Ave., Cicero 50, Ill.



STARRETT "Tools and Rules" BOOK

Describes and illustrates the precision methods skilled mechanics use. Only one dime. Write Dept. AP.

THE L. S. STARRETT CO., Athol, Mass., U. S. A.



PUNCH PRESS

**1 Ton Power Bench Type
Make Your Shop Complete
Powerful — Dependable — Economical**

Easily make your own dies for light stampings, forming, riveting etc. Ideal for production or experimental work. Replaces more expensive presses. Uses $\frac{1}{4}$ to $\frac{1}{2}$ H.P. motor. Weighs 105 lbs. Fully guaranteed. Only \$97.50 less motor. Write for free circular.

ALVA F. ALLEN
Dept. PM, Clinton, Missouri

Do a Real Professional-Like Job
Yourself and SAVE

HOW to PAINT With Brush and Spray

Covers All Painting Methods and Materials

You can do professional-like painting and finishing jobs yourself and save about two-thirds of the cost. Sam Brown, noted craft authority, makes it so easy for you in his book, **HOW TO PAINT WITH BRUSH AND SPRAY.** Order your copy now and enjoy this tremendous saving. It covers exterior painting, wall and interior decorating, furniture finishing, concrete painting — every type of painting with brush, spray gun, roller and other methods. Tells what finish is best; what materials to use, etc. No previous experience needed. Fully illustrated. Order by mail. Only \$2.50. Money back if not pleased.

POPULAR MECHANICS PRESS, Dept. PM18
200 E. ONTARIO ST., CHICAGO 11, ILL.



BUILD IT **FIX IT** with **AMBROID**



- Ready-to-use
- Fast drying
- High tensile strength
- Transparent
- Waterproof

IT STAYS STUCK

Dries entirely by evaporation of the solvent. Quick setting—no distortion. Ideal for assembling, repairing, home crafts, electrical work, factory, workshop or household use. Send postcard for free literature.

EIE Try Ambroid in your business, too. For over 40 years recognized as the leading industrial adhesive of its type.

Art galleries, museums, and leading industrial concerns, rely on AMBROID

TRY A TUBE TODAY—At most hardware stores and hobby shops. If your dealer cannot supply you, send 30¢ for big 2 oz. tube, postpaid. Money back guarantee.

AMBROID WEYMOUTH 88, MASS.

INSULATE YOUR HOME

For As Low As

\$67.60*



"I did it myself in an afternoon"

Yes, you can insulate your home yourself and save \$50-\$100 installation costs. Zonolite vermiculite Insulating Fill easily pours from the bag between attic joists and sidewall studs—flows snugly around pipes, wiring, braces, eliminates money-draining heat leaks—keeps winter heat IN... summer heat OUT! Saves up to 40% on fuel. It's fireproof—snuffs out flame—termiteproof, rotproof, rodent-proof—permanent. Mail coupon today for **FREE BOOKLET!**

**(cost of insulating attic in average home)*



ZONOLITE COMPANY, Dept. PM-114
135 S. LaSalle St., Chicago 3, Ill.

Gentlemen: Please send me, free-of-charge, booklet III-47, "Safety, Comfort, Savings in Your Home."

Name.....
Address.....
City.....Zone.....State.....

SEE YOUR LUMBER OR BUILDING SUPPLY DEALER

GRAVELY Snowblower
BLOW YOUR SNOW TROUBLES AWAY!

5 HP

Snow Blower attachment for powerful 5-Horsepower Gravely Tractor moves deep, dangerous snow swiftly and easily. 20 other attachments for every lawn, garden, field job. All-gear drive, reverse. Postcard brings complete story of "Power vs. Drudgery."

FREE! Write Today!

GRAVELY TRACTORS, INC.
BOX 1163 DUNBAR, WEST VA.

ENJOY TRAVELING WITH AMERICA'S FINEST AUTO COMPASSES



GUIDEWAY
Only \$4.49

TRAVELITE
Illuminated
Only \$5.49

ONLY COMPASS APPROVED BY AUTO MAKERS

DINSMORE...

Shows you the right way—the short cuts. Always accurate and dependable anywhere. Fits all cars. Send for free folder—"Pants, Knives and Compasses" and name of nearest dealer.

DINSMORE INSTRUMENT CO., 1802-41 Kelso St., Flint, Mich.

CAR BURGLAR ALARM

"Devil-Dog" automatically sounds alarm when your car is tampered with. Complete. Easy to install yourself. Nothing to wear out. Protects tires, too. Be the first to get one. Sorry, no C.O.D.

4.95
Post-paid

The GEORGE CO. Box 1068, Minneapolis, Minn.



Start a NEW BUSINESS!

or Add to your present Repair Business
SHARPEN DULL PIPE WRENCHES
PIPE TAPS & DIES
"GUM" CIRCULAR SAWS
Also MOTOR DRIVEN ROTARY HONE
Write for Information

J. C. MOORE INDUSTRIES
BOX M 276 FREDONIA, PA.

• WELDS, CUTS, HEATS •

No Attachments Needed

PREST-O-LITE Oxy-Acetylene Outfit

Trade-Mark

- Slices through heavy steel; welds sheet and light plate. No limit to the repairs you can make or useful things you can build. **Only \$76.50.**
- Oxygen and acetylene in cylinders sized to meet your needs.

Write today for free descriptive booklet.

LINDE AIR PRODUCTS COMPANY

A Division of Union Carbide and Carbon Corporation
30 East 42nd Street **UIC** New York 17, N. Y.

JOINT AND SHARPEN ALL SAWS

SAVE TIME AND \$\$\$



Sensational new Super Filer No. 11 joints and sharpens both hand and circular saws 6" to 10" with all teeth the correct height, depth, pitch and bevel. Easy to use—when file hits hardened steel roller, teeth are finished. Saw runs true and smooth with no side pull. Complete with special 8" file \$9.95 ppd. **FREE FOLDER.**

"**TRU-CIRCLE**" saw set. Automatically sets teeth at 10° or more \$2.95. **FILE SAWS THE RIGHT WAY**



SO EASY with this new filing jig and jointer anyone can now sharpen any hand saw like new! When file hits hardened steel rollers teeth are finished and EXACTLY THE SAME HEIGHT. All teeth cut and saw runs true and smooth. Jig and instructions \$2.95 postpaid. Free Folder.

SUPER DRILL GRINDER

Sharpens round shank drills from 3/32" to 1/2" in diameter, up to 6" long. Grinds old drills like new in 4 different point angles, using hand or power grinding wheels. \$2.95

ROBI

Reversible DOVETAIL SAW

A quality tool for fine cabinet work and easier dovetailing. Special blade and handle permits left or right handed sawing. **ABSOLUTELY FLAT.** Reversible blade pivoted at center of back—locks immediately in either position. \$3.95 ppd.

A. D. MCBURNEY, 5908 Hollywood Blvd., Hollywood 28, Calif. Dept. A-47

DON'T DIG 'TIL YOU KNOW WHERE



ONLY \$2.98

The most amazing instrument you've ever seen! New MAGNA PROBE traces water, gas, and metal or tile sewer lines. Saves hours of unnecessary digging. Finds hidden springs and underground streams. Just as efficient over concrete as bare ground. Sensitive to depth of 30 ft. Works indoors or outdoors. MAGNA PROBE works by scientific principle of dissimilar metals and elements attracting and opposing one another like magnetic electricity. So simple—a child can use it. **GUARANTEED TO WORK!**

Complete with easy-to-use instructions TODAY! Send check or money order (no C.O.D.'s) to:

THE MAGNA PROBE CO.
6022 Mayfield Road Cleveland 24, Ohio

BATTERIES!—START

—a factory at home and re-cast junk batteries into new; latest achievement. We supply complete instructions and everything needed. Large daily profits!

BATTERY LABORATORIES, Dept. PM, Minneapolis 4, Minn.

Wholesale! TOOLS! GUNS! CAMERAS!

BUY TOOLS, PHOTO EQUIPMENT, SPORTING GOODS, JEWELRY AND THOUSANDS OTHER. **NATIONALLY ADVERTISED PRODUCTS AT BIG DISCOUNTS. SAVE ON OWN PURCHASES. BIG PROFITS SELLING TO OTHERS. POSTCARD BRINGS FREE COPY "THE WHOLESALE PLAN."**

Get up to **40% off**

AMERICAN BUYERS SERVICE
629 Linden Ave., Dept. 15, Buffalo 16, N.Y.

NOW FINISH LEATHER like an EXPERT with

Fielsing's DYEING and REFINISHING KIT

Create your own fine leather gifts. Add a rich lustrous professional finish with Fielsing's Leather Refinishing Kit. Contains 9 basic preparations—everything you need for a complete job. Order Now—make your own gifts for Christmas. Complete Kit \$3.50 Postpaid

FREE FIELSING'S Handbook on How to DYE and REFINISH LEATHER

ASK YOUR DEALER or write direct **FIELSING CHEMICAL CO.**
516 South 2nd St. • Milwaukee 4, Wisconsin

HERE'S YOUR COMPLETE POWER TOOL WORKSHOP

FOR ONLY \$7995

FACTORY TO YOU

8" SAW

- TRY SUPERSHOP FREE
- WE PAY FREIGHT
- YOU BE THE JUDGE
- EASY PAY PLAN

Why does Power Tools Inc. make such an unusual offer? Our business is manufacturing and selling power tools direct to people like yourself. We have had experience with hundreds of thousands of people regarding their home workshop requirements. Supershop meets these requirements. This has been proven.

The combination of direct selling, advanced design and efficient manufacturing enables us to give the greatest power tool value in America today. That is why we have the courage to make you this offer.

This free trial is truly free. The machine is prepaid to your door and if it does not satisfy you, you return it at our expense. If you keep Supershop you pay the low factory-to-you cash price—or easy payments to fit your budget.

Write for free information. Mail the handy coupon—or send a postcard. We'll mail you colorful brochures on Supershop—and full details on the FREE TRIAL HOME OFFER. Absolutely no obligation.

POWER TOOLS INC. 165 YATES AVE. BELOIT, WISCONSIN

POWER TOOLS INC • BELOIT, WIS.

Send me your FREE brochures on Supershop and complete information about the Free Home Trial Plan. I am under no obligation.

NAME _____

ADDRESS _____

CITY _____ STATE _____



1/2" DRILL PRESS



8" SANDER



30" LATHE



8" GRINDER

Gift Ideas for XMAS

Aladdin 1/4" POWER DRILL TOOL ATTACHMENTS



POWER PLANER

SAVES TIME AND WORK ON MANY JOBS

Ideal for fitting doors, screens, storm windows; smoothing rough edges of lumber; handy in cabinet work. Planes wood up to 2" wide.

Exclusive Attaching Feature gives perfect alignment and holds planer and drill firmly together. Changes on and off quickly. Extra tough, heat-treated spiral rotary cutter 2" wide—cutting depth adjustable. Long wearing sealed gears. Strong alloy die cast frame. A tool you'll enjoy and appreciate.

SANDING ATTACHMENT for Planer and 2 sanding drums, \$1.00 extra.

\$12.95

Postpaid

tough, heat-treated spiral rotary cutter 2" wide—cutting depth adjustable. Long wearing sealed gears. Strong alloy die cast frame. A tool you'll enjoy and appreciate.



3-IN-1 SAW A Hack Saw, Jig Saw and Coping Saw

In one easy to use attachment. Cuts metal, wood, plastic, hardboard, etc. Full 9/16" chip clearance. No gears, no bearings to wear out. Ideal for sawing in hard-to-reach places. Weighs only 11 oz.

\$4.95 With metal and wood blades (1 ea.). Postpaid

4-HOLE SAW Cut 4 Sizes of Holes Quickly, Perfectly With One Tool

A circular saw blade for each size hole—1", 1 1/2", 2", 2 1/2" diameter, blades slip into grooves of alloy saw body and are firmly held by set screw. A 3/4" drill bit anchored in saw body guides saw blades and prevents tool from "jumping." High carbon steel blades cut wood, plastic and metals.



Complete with 4 saw blades (8 or 14 tooth) and 1/4" drill bit—Specify for wood or metal cutting when ordering. Postpaid.

\$4.95

Every Aladdin Attachment Tool **GUARANTEED SATISFACTORY** or Money Back. Will ship C.O.D. plus postage. Literature available on all attachments. **DEALER INQUIRIES INVITED.**

ALADDIN MFG. CO. DEPT. PM-3, 3125 HARRISON KANSAS CITY, MISSOURI

Also Eshelman SPORT CARS LOWEST PRICE

70 Miles Per Gal. Holds 1 Adult. Free Literature.

ESHELMAN CAR SNOW PLOW CLEARS ROADS & DRIVEWAYS



Attached to car or truck in 2 minutes without tools. Clears snow 24" deep and full width of car. Lightweight, sturdy. Order Now. Enclose \$10.00 Deposit. We pay freight. Balance C.O.D.

ESHELMAN, Dept. SP-511
109 Light St., Baltimore 2, Md.
333 N. Michigan Ave., Chicago 1, Ill.
7070 Hollywood Blvd., Los Angeles 28, Calif.
(Or write for literature)

1/3 H.P. Dual Purpose Portable Sprayer: BARGAIN



only **\$57.50**

complete as illustrated K.D.

COMPRESSOR ONLY \$20.00

Regular Value \$95.00

RPM. Positive Piston Type Quincy Compressor 2 x 1 1/4 in. bore & Stroke, Speedy 1 Qt. Pressure Type Spray Gun, handles any type liquids. Unit complete as illustrated: Tank with wheels, 1/2 H.P. Motor, Quincy Comp, all accessories, tire chuck, cord & plug, belt & pulley, hose & Qt. Gun . . . Knocked Down . . . #KD . . . only \$57.50

SAME UNIT AS ABOVE fully assembled . . . #AS-3 only \$67.50

C. MARSHALL SALES, 3546 W. Fullerton Av., Dept. P-11, Chicago 47. All prices F.O.B. Chgo. Write For FREE Catalog: Listing Motors; ALL SIZES: Fans and Air Compressors; ALL SIZES

DRIVE 500,000 MILES

Without Need of A Major Overhaul

Engineers have shown that the combustion process produces over a gallon of water in vapor or steam for every gallon of fuel burned. Some of these vapors enter crank case causing rust, varnish, acids and sludge.

INSTALL POWER VENTILATION and increase the efficiency of your car with amazing Moto-Vent. Positive Power Ventilation removes water vapors, sulphur and other corrosive materials that enter crank case. Not a "gimmick" or "gadget" but a precision engineered instrument designed to give better engine performance, up to 2 or 3 more miles per gallon and cut engine wear up to 40%.

EASY TO INSTALL Moto-Vent between oil breather and intake manifold in less than half hour. Fits all cars, trucks, tractors. **FREE 30 DAY TRIAL OFFER.** Moto-Vent complete with all fittings and installation chart only \$4.95 postpaid, or, C.O.D. plus charges. Try for 30 days. If not completely satisfied, return for refund. Order or write for FREE particulars today! **PRECISION PROD. CO., Dept. 28, Harvard, Ill.**

SMALL! POWERFUL!

ECONOMY TRACTOR

Unequaled value! Low price!
America's finest tractor. Ruggedly built. Easy to operate. 790 lbs. Borg-Warner clutch, trans, and diff 140 to 1 reduction. 40% more drawbar pull than ordinary tractors 8-1/4 H.P. engine. 20 quick change implements. HOOD, FENDERS.

Thousands In Use Write for complete details.
Engineering Products Co.
915 K 11 Niagara Ct.
Waukesha, Wisconsin

HELPFUL BOOKS

Send post card asking for **FREE** catalog

Popular Mechanics Press, 200 E. Ontario, Dept. 601, Chicago 11

CRESCENT TOOLS

Give Wings to Work

ASK YOUR HARDWARE DEALER

BUILD YOUR OWN

ARC-WELDER

We show you how to build NEW powerful welder. No rewinding. Uses most any surplus aircraft generator. Easy to build. 75-300 amps. Complete **PLANS 25c.** Send today and we'll include **FREE** our Big War Surplus & Electrical Catalog.

LEJAY MFG. CO., 1247 LEJAY BLDG., MINNEAPOLIS 8, MINN.

2-WAY BENCH AND HAND VISE

HOME and SHOP USE—complete with base and handle. Especially designed for model hobbyists, radio and TV technicians, jewelers, tool and die makers. 3 in. high bench mounted. 6 1/2 in. long with handle attached. Has hardened steel screw and turning. V-notched to hold pins.

Opens to 1/2 in. We pay postage in U.S.A. **\$2.49**

MONEY BACK GUARANTEE

VERNON GREEN
806 Paris Ave. Rockford, Ill.

Look At This BARGAIN COUNTER

New GAS ENGINE 1 to 1 1/2 H.P. Power Product 2 cycle—Ball Brg; for tools—grass cutters— air compressors—bikes. Engine, Gas Tank, Muffler. Complete #B-1 . . . only **\$22.50**

1/2 H.P. ELECTRIC MOTOR; Westinghouse Super induction 115 V. 60 cy. 1 ph. 1725 RPM. #B-2 . . . only **\$15.00**

1/2 H.P. DAYTON ELECTRIC MOTOR. Super induction—Hi-Speed for saws, grinders, flexible shafts. 115 V. 60 cy. 1 ph. 3450 RPM. #B-3 . . . only **\$16.50**

3/4 H.P. DAYTON ELECTRIC MOTOR. Capacitor Induction—Hi-Torque, Hi-Speed. 3450 RPM. 115 V. 60 cy. 1 ph. #B-4 . . . only **\$28.00**

3/4 H.P. GENERAL ELECTRIC MOTOR. Capacitor Induction. Ball Brg., Double Shaft. Overload Protected. Hi-Torque. 115 V. 60 cy. 1 ph. 1725 RPM. #B-5 . . . only **\$34.50**

NOW! A LOW COST PUNCH PRESS



CUTS CLEAN, ACCURATE SHAPES IN METAL WITH HAM-R-PRESS

Up to 1 1/4" — and up to 14 gauge metal. Punching is simple — accurate. Punch slips on bottom of Ram. Die is locked in Work Table. The Work is placed between, and Ram is struck by Hammer — completing the cut. Up to 15 tons pressure obtainable. Punches are precision machined, heat-treated tool steel. Many sizes and shapes stocked. Average Punch and Die cost — only \$1.95 per set.

HAM-R-PRESS is built of light weight Aircraft Alloy Aluminum (stronger than cast iron). **TWO SIZES:** 7 1/2" depth throat — \$24.95. Wt. 10 lbs. 12" throat — \$32.95. Wt. 12 lbs.

ORDER FROM YOUR JOBBER, or FROM US (at above delivered prices)
CHASE MANUFACTURING CO.
5008 W. Jefferson Blvd., Los Angeles 6, Calif.



HULL AUTO COMPASSES ALSO SAVE THE DAY IN STRANGE CITY TRAFFIC

Watching for road signs in city traffic calls for an extra pair of eyes . . . and every intersection is an opportunity to make a wrong turn. Here, as on the open road, Hull Auto Compass drivers sail confidently through.

WRITE FOR LOCAL DEALER'S NAME, FREE LITERATURE



Beaconlite \$6.95
Illuminated
SIRENAIR \$4.95
non-illuminated

HULL MFG. CO. P.O. Box 246-011
WARREN, OHIO



TERRIFIC VALUES
"DO-IT-YOURSELF" TOOL KITS
ON SALE AT YOUR LOCAL DEALER
The RUGOL CO., New York 13, N. Y.

NOW — THE QUICK-WAY TO SHARPEN ALL CIRCULAR SAWS

Model PG-12 Complete No extras to buy. **\$16.50** Postage Paid

Model PG-12 sharpens joints, gums, and retools all cross cut, rip, combination, miter, and planer blades up to 12" in diameter. Two precision index plates give versatile, accurate sharpening. Guarantees precise spacing of teeth.

New safety rest prevents tilting and gouging of blade.

Save time and money. Special \$5.00 grinding wheel also included for use on your own power table.

Order today. Send check, cash, or money order. We pay postage.

QUICK-WAY SAW CO.
101 Herby Drive, Painted Post, N. Y.

Say You Saw It in Popular Mechanics

BARRON Drill Press TOOLS



ROTARY PLANER

Planes • Rabbits
Tenons • Panels
Routs • Bevels

Only \$8.50 COMPLETE

BARRON TOOL CO. INC.
364 Architects Bldg., Detroit 1, Mich.

FOR WORKSHOP AND INDUSTRIAL USES . . .

Over 40 precision built woodworking tools and accessories . . . Hi-Speed Router Bits — Rotary Surface Sanders & Drum Sanders — Safety Shaper Cutters — Dovetail Cutters — Large Auxiliary Metal Tables — All Metal Shaper Fences — Spindle Adapters — Handy Bench Vises. Many other items indispensable for accurate, useful, versatile workshop use. Every tool sold on complete satisfaction or your money back. See your Barron Dealer. Ask for special folder — "24 Extra Uses for Your Drill Press."

FREE
Workshop
Guide &
Catalog

12 PIECE IMPORTED SPORTSMAN'S COMBINATION KNIFE



COMPLETE CAMP KIT ONLY \$9.95
INCLUDING BELT HOLSTER

The perfect GIFT for Sportsmen, Campers, Boy Scouts, etc. Never before sold at our Special Low Xmas Price. Ruggedly made to last a lifetime. Top quality carbon steel. Handsome Bone type handle. Has 12 everyday and outdoor tools. Carry your Knife, Fork & Spoon plus every tool you need in one compact case. Fits securely in genuine cowhide belt holster. Size closed: 4-5/8" long.

22 CAL. AIR RIFLE

Made in Belgium for famous My-Score. No pumping necessary — just cock and fire. Has ALL-STEEL, fully rifled barrel, 17 1/2" long. A beautiful, natural finished hardwood stock. Shoots .22 cal. Pellets or Darts. An excellent training rifle. Ideal for indoor or outdoor use. Wt. 5 lbs. Length 40 1/2".

FAMOUS HANNA OFFICIAL BASEBALL BATS
Made for Armed Services by the countries leading bat mfr. These are regulation size, rugged, straight grain hardwood — made to take it! Available in either hardball or softball bats. Weight 3 lbs. Please include postage.

AN-630 AVIATORS GOGGLES
Rubber covered metal frames, lined with a soft chamolite. Has built-in breathers to keep lenses clear. Your choice of interchangeable lenses in clear, amber green. A \$5.00 value . . .

SURPLUS WIRE SCREEN CLOTH

Super fine quality at LESS THAN MFR'S COST. Ideal for fine strainer work. Absolutely insect proof. Quantities limited.

BRONZE CLOTH SCREEN
32 mesh, .007 gauge, 42" wide. Minimum order 10 lineal feet. Per lineal ft. (2 1/2 sq. ft.) Value 65¢ ft. 2 1/2' — 100 lineal ft. roll \$23.50

200 PSI OIL PRESSURE GAUGE
Made by Marshalltown Mfg. Reads 0 to 200 PSI. Has a 3-1/2" white face. Has 28" hose with fittings. Steel case. **2.95**

100 PSI STEAM PRESSURE GAUGE
New Ashcroft gauge. Reads from 0 to 100 lbs. of steam pressure in 1 lb. increments. 9 1/2" face. Rear mounting plate with 1/4" holes. 1/8" standard pipe port. **6.95**

ARMY PICKMATTOK
Small, easy to use Has 12" steel head with notched one side pick on other. Has hardwood handle & case. **1.29**

VARIABLE SHOVEL
New G.I. Surplus. 20" Hardwood handle. Blade folds to form pick. Carry in car for emergency in snow or mud. **1.29**

BOLO KNIFE AND CASE
Made of top quality steel. 15" long. Ideal for clearing brush, etc. Comes complete with sturdy belt sheath. **1.98**

DEPTH GAUGE
Depth Gauge & Protractor. Made of finest quality steel. Has double-face, 6" scale in 32's and 64's. Has thumbscrew lock on head. Increments and numbers are engraved. Made by Millers-Falls or Union. A \$4.00 VALUE. **1.89**

FUEL PRESSURE GAUGES
Reads from 0 to 10 lbs. fuel pressure. Has 2" diam. face with luminous markings. **1.50**

FUEL PRESSURE GAUGE
Reads 0 to 25 pounds. Mfd. by Auto-Lite. Has a 2" diam. face with luminous markings. **ONLY 1.75**

10 PC. HOBBY MIX
A set for Hobbyist, Model Maker, etc. Consists of (1) Blisclair Scalpel Knife, 3pc. Offset Scriber, (1) Jeweler's Hammer, (1) Inspection Mirror, (1) Hemostat Clamp and 5 assorted shaping tools. Entire 10 piece set for **4.99**

320 PAGE CATALOG
Packed with Bargains in GOVERNMENT SURPLUS FACTORY CLOSE-OUTS & GEN. MERCHANDISE — Fully illustrated. Items for Hobbyist, Mechanic, Gadgeteer, Sportsman, etc. Send 50¢ TODAY to cover cost of handling & mailing — this 50¢ credited to YOUR FIRST ORDER. . . .

Order From This Ad. Pay by M.O. or check. P.O.'s accept. from D&S firms. 1/2 deposit with C.O.D.'s. All Prices FOB Los Angeles.

PALLEY SUPPLY CO 2363 E. VERNON AVE. DEPT. PM-11
LOS ANGELES 38, CALIF.

Schupack's Amazing Tool Bargains! All Brand New! Save up to 100%!

75 MOUNTED WHEELS AND MINIATURE CUTTERS

For cutting and grinding on wood, metal or plastic. Includes 26 mtd. wheels and points on 3/32" shanks; 24 miniature cutters on 3/32" shanks; 25 short shank min. cutters. Will fit all electric drills and hand grinders.

Regular \$11.00 Value
\$4.50 Post-Paid

FLEXIBLE SHAFT — ONLY \$4.95

Fits all electric drills & hand power tools. 35 3/4" long. Durable bearings. Core of specially wound, high carbon steel wire in flexible steel casing. Will accommodate tool shafts up to 1/4" dia. For latches, electric drills, etc.

2 DRUM SANDERS \$1.50 Post-Paid
With 12 Bands in Assorted Grits— 1/2" dia. x 1" long on 1/4" arbor with 12 bands

ONE DRUM, 1" DIA. x 1" LONG ON 1/4" ARBOR WITH 6 EXTRA SLEEVES \$1.00 Post-Paid

NEW ILLUSTRATED CATALOG 10c

10 Hi-Speed Steel & Carbon Drills, \$1.30 for \$2.75

Most popular sizes up to 1/4".

5 Hi-speed steel Drills 1/4" to 1/2" Dia. \$1.95

15 Assorted Drills From 1/16" to 1/2" High speed steel and carbon. \$3.95

12 Assorted Drills High speed & carbon steel, from 1/8" to 1/2". Post. \$3.60

5 Woodworkers Drills From 1/4" to 3/4" on 1/4" shank. \$2.95

5 Larger Drills From 1/2" to 1-1/8" High speed steel, and carb. \$7.50

12 MOUNTED WHEELS and points on 1/4" Shank. \$2.95 Post-Paid

For grinding on plastic, wood, soft and hard metal. Regular List Value \$8.40.

18 MOUNTED POINTS ON 3/32" SHANK. \$2.50

12 MTD. WHEELS ON 1/4" SHANK \$3.60

18 ROTARY CUTTERS \$13.50 Value \$5.85 Post-Paid
Illustrated 1/2" actual size

Assorted sizes cutter on 1/4" or 3/32" shank. Will fit all hand grinders. Ideal for cutting wood, metal, or plastic. Brand new.

ADAPTER CHUCK \$1.50 Post-Paid
With 2 interchangeable collets, opening from 3/32" to 0. on 3/4" mandrel. Price each only.

SCHUPACK SUPPLY CO., 7331 COTTAGE GROVE AVE., DEPT. M-67 CHICAGO 19, ILL. SEND CHECKS OR M. O. NO COD'S PLEASE

The little saw with the big capacity

JEFFERSON "601" Power Hack Saw

Cuts steel, brass and aluminum bars, rounds and pipe up to 3 1/2" x 3 1/2". An ideal heavy duty saw for industrial shop work or home hobby shop. Swivel vise for nitro cuts up to 45° and handy gauge bar controls uniform stock cutting. Make your workshop complete. Truly a bargain at only \$54 (less motor), \$71.50 (including motor).

Immediate shipment F.O.B. Eau Claire, Wisconsin

SALES SERVICE MACHINE TOOL CO.

2363 University Ave., Dept. P, St. Paul 4, Minnesota

7150 F.O.B. Eau Claire, Wis.

Write for free catalog

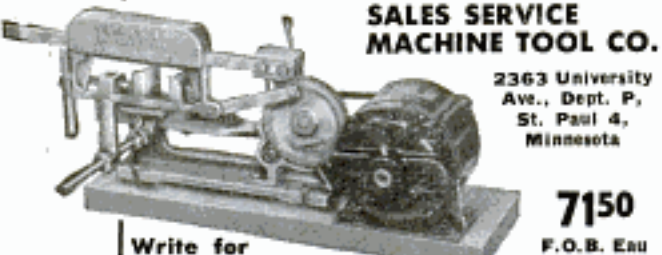

MAKE YOUR OWN FOUNTAINS, LAKES, RIVERS, WINDOW DISPLAYS

Get real live action with miniature water pump. Only 4 1/2" high — 3 1/2" wide. Threaded for pipe or uses 3/4" rubber tubing. Sturdy rustproof alloy metal — mounted on rubber. 110 A.C. — 60 cycle. 1/250 H.P. Pumps 50 gal. per hr. Complete — ready to work. Immediate money back guarantee. Send check or M.O. Or send C.O.D., you pay postage. Dealers wanted.

\$9.95 IN U.S.

MOORE MANUFACTURING CO.
SWEDSBORO 1, NEW JERSEY



Run your power tools from ONE MOTOR

CLUTCH PULLEY and LINE SHAFT SET

FLIP LEVER to engage or disengage belts. Complete set includes 40" See shaft and 3 mounts with 2 1/2" clutch pulleys for only \$14.95 (F.O.B. Los Angeles). Extra clutch pulley set, \$4.95. Order by mail.

A. J. VOS MFG. CO. 431 W. 120TH STREET LOS ANGELES 44, CALIF.



Say You Saw It in Popular Mechanics

AUTOMATIC RETOOTHER

MAKES NEW PROFITS

Cuts new teeth in 50 seconds — any size 4 to 16 pairs. Old teeth fall off as chips. Easy to operate. A perfect job.

BURR MFG. CO.
8933-A VENICE BLVD. LOS ANGELES 34, CALIFORNIA

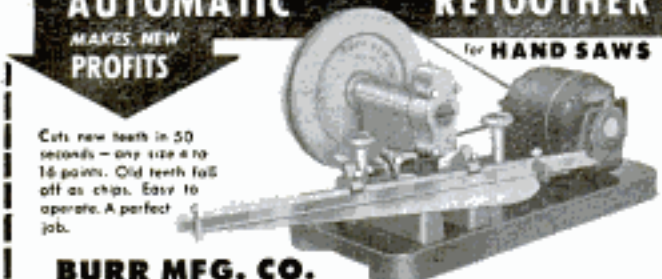

129 FULL SIZE PATTERNS \$1.00

EASY-TO-USE PATTERNS (just trace on wood, cut out, paint) on 129 Unusual Novelties, Gifts, Lawn Figures, up to 22 in., Action (Merry-go-round, Windmill), Toys, Useful Gadgets, etc. Artistic drawing. Money back guarantee. Clip this ad and mail with \$1.00 bill TODAY. CRAFTPLANS Dept. A-248 1321 S. Michigan, Chicago 9.

NOW! STOP BATTERY CORROSION GET FULL POWER WITH Sheeld

For the first time since Korea you can get amazing liquid Sheeld for your battery. Stops all power leaks and loss due to corrosion of terminals, cables, carriers, hold-downs. Used by fleet owners. Simple to apply. Fully guaranteed. 4-oz. supply lasts life of your car.

ORDER Sheeld TODAY — only \$2.00 Postpaid U.S.A.
MONEY BACK GUARANTEE — NO C.O.D.'S

SHEELD, INC., DEPT. B . . . 2523 CARLISLE . . DALLAS 4, TEXAS



The Chief WORK BENCH

Built to Last a Lifetime!

With Bottom Shelf and 18" Sq. Drawer. 2"x6", Solid Plank, Grooved and Dado-tailed Top and 1"x8" Back Rail, Shelloaked to a Smooth, Satiny Finish.

MOHAWK LUMBER CO. Dept. 33 14525 W. Chicago Blvd. Detroit 27, Mich.

Enclosed Check Money Order for \$
Ship CHIEF WORK BENCHES at Quantity

\$19.95 each, F.O.B. Detroit, Mich.
 Send C.O.D., \$5 Deposit Enclosed.

NAME
ADDRESS
CITY STATE

• 6 Ft. Long • 34" High • 26" Deep. Shipped Knock-down, with Bolts, Nuts and Screws and ABC Chart for Quick, Simple Assembly.

Prompt Delivery

MOHAWK LUMBER CO.
14525 W. Chicago Boulevard
DETROIT 27, MICHIGAN

\$19.95 F.O.B. DETROIT

Send Check or Money Order, or Will Ship C. O. D. (\$5 Deposit)



SAVE MIDDLEMAN PROFITS

GIANT 2000-2500 WATT PLANT

110-120 v. 60 cyc. AC. Absolutely the best made — exclusive dynamically balanced armature; heavy windings develop up to 3000 watt overload for motor starting. Skid mounted — portable. Powered by an easy starting Briggs or Wisconsin 6 HP engine—complete with all accessories; engine easily disconnected for other uses. Big outlet box, voltmeter, no wiring necessary. Ample current for all purposes. Factory warranty. (Item 31) Wt. 210 lb. Reg. price \$585. Special at \$299.50
Same plant with electric self starter (Item 31a) \$359.50
Generator only and control box . . . \$169.50
DUAL VOLTAGE 110-220 available on any of above models for \$28.00 additional.
3000-3500 WATT PLANT (Item 198) 110-220 v. 60 cyc. AC Belt Drive. Wis. engine Push Button Start. Wt. 370 lbs. \$439.50
Heavy duty \$439.50
GENERATOR ONLY for belt drive. \$239.50



(Item 31)

BUY at factory prices direct from MASTER MECHANIC



(Item 24)

600-700 WATTS PUSH BUTTON START

115 v. 60 cyc. AC. Powered by a rugged 3 HP easy starting Briggs engine. No wiring necessary; just plug in and operate. Plenty of current for any oil burner, freezer, brooder, emergency lights, etc. which require radios. Complete with Voltmeter and built-in winding to charge 6 v. auto batteries. (Item 24.) Wt. 75 lbs. Easily fits in car trunk. He prepared if storm knocks out power lines. Reg. \$275 value. . . . \$143.50
1000-1200 Watt Plant (Item 45) same as Item 24 but larger generator and engine \$199.50 with 50% greater output.
LITTLE GIANT—350 WATT (Item 273) 115 v. DC 1 1/2 hp. Briggs engine. Perfect for lights, radios, chain saws and power tools. Wt. 45 lbs. \$99.75

PORTO-POWER 1500-1750 Watt Plant 115/130 v. 60 cyc. AC. Push button start. Powered by a 4.5 HP Briggs engine. Combines compactness and easy portability with higher output for handling heavier starting loads. Ideal for operating oil burners, sump pumps, freezers, television, lights, communication systems, etc. Perfect for contractor's power tools. (Item 20.) Wt. 145 lbs. \$279.50
Factory Special Price \$279.50
MASTER-LITE 2500 Watt Plant 110/130 v. 60 cyc. AC. A powerful plant, ruggedly constructed and yet designed for easy portability. Can be started by rope or built-in 12 v. electric push button starter. Built-in winding to charge battery. Powered by a big 5.10 HP Briggs engine, complete with all accessories. Includes control box, voltmeter, and handy plug-in power receptacle. An ideal plant for permanent or stand-by service. Wt. 225 lb. Reg. price \$645.00 \$329.50
(Item 21) Factory Price \$329.50
3500 Watt Plant Push Button Start (Item 23) 115 v. 60 cyc. AC. Similar to above, but larger and 33% more capacity. Wt. 270 lbs. Reg. \$760. Factory Price \$379.50
We make fully automatic controls to operate any of the above light plants. Write for details. We make all sizes up to 25,000 Watts.



(Item 20)



(Item 21)

LESS THAN WHOLESALE

HI-LINE 6000 WATT PLANT

(Item 162) Push Button Start 115-230 v. 60 cyc. A.C. A brute of a power plant with a rugged 14 hp. Wisconsin engine. Plenty of electricity for ranges, water heaters, freezers, pumps, machinery, etc. Affords both 110 and 220 volts. Ideal where heavy current is needed. Wt. 590 lbs. Easily worth \$995. With crank start. \$585.50
Factory price \$645.00
Same plant, but with self-starter, generator and control box only, belt driven. Use your own engine or tractor. Wt. 240 lbs. (Item 163) Factory price. . . . \$345.00

JET FLOW BLOWER

Tremendous air movement (1800 CFM) and quiet operation make this double inlet 10" turbine blower unbeatable for heating, cooling, drying and air conditioning. Ideal for attic or barn ventilation, converting gravity heating to forced air; spray booth exhausts, etc. Operates with any 1/4, 1/2 or 3/4 HP motor. Oversized, long life bearings. Includes variable speed motor pulley and belt. Dimensions 19" hi x 18" x 16 1/2". Output opening 13" x 11 1/4". Wt. 45 lbs. Item 245. Reg. \$34.50. \$27.50
Factory Special \$27.50
HEAVY DUTY 1/4 HP motor for above \$16.95
12" TURBINE BLOWER Similar to above, but larger with 2400 CFM capacity. Wt. 65 lbs. (Item 245a) Reg. \$70.00. Factory Spec. \$34.50

CONDITIONAIRE BARN FANS

Save big money installing your own barn ventilating fan. Efficient propeller type blade moves huge volume of air quietly and effortlessly. Heavy welded frame—pre-drilled for easy installation. Just cut opening and bolt in place. Continuous duty motors. Ideal for keeping barns and chicken houses dry and ventilated. Control manually or with thermostat.
Blade Opening CFM Wt. Item
16" 1850 2925 19 lb. 385a \$27.95
18" 1950 3600 27 lb. 385b \$31.95
20" 2150 4100 30 lb. 385c \$39.95
THERMOSTATS: BAHN type (range 40°-60°). Wt. 2 lbs. \$6.95.



HEATING & VENTILATING FAN

(Item 10) Easily installed in furnace pipes. Forces even heat to all rooms. Over range removes kitchen smoke and odors. Powerful, continuous duty motor, 110-120V. AC. Mount in wall or ceiling to ventilate any area. Quiet, super-efficient fan moves huge volume of air. (800 to 600 CFM).
8" Fan, wt. 5 lb. \$6.85
9" Fan, wt. 6 lb. \$7.85
10" Fan, wt. 7 lb. \$8.85
12" Fan, wt. 8 lb. \$9.85
HEAVY DUTY FAN. Semi-enclosed motor, suitable for spray booths, restaurant exhausts, poultry houses, etc. 10" Fan, wt. 8 lbs. (Item 10E) \$11.95
12" Fan, wt. 10 lbs. (Item 10D) \$12.95



HI-FLO Centrifugal PUMP

Completely self-priming! No foot valve required. Tremendous capacity—100 gal. per min. 1" Special impeller enables pump to handle muddy or sandy water. Simple to operate—simply start engine and watch the water go. Powered by a rugged, easy-starting 2 HP Briggs engine. Pre-lubricated sealed bearings for years of heavy low-cost service. Big 1 1/2" Model. Item 502. Wt. 70 lbs. \$134.50
Factory price \$134.50
2" Model (150 gal. per min.) with 2 1/2 HP engine. Item 502a. 90 lbs. Fact. Spec. \$154.50



9 TON HYDRAULIC PRESS

A tremendously powerful hydraulic press, capable of exerting 18,000 lbs. pressure. Pays for itself many times over—straightening bent connecting rods, link pins, crankshafts, axles, link pins and bars—or pushing out frozen bearings and bushings. Developed pressure under precise control and visible at all times on accurate gauge. Complete with both large and small anvils and lugs to straighten any kind of curve or bend. (Item 464) Wt. 110 lb. Actual list price \$365. Our special list price close-out price. . . . \$69.50

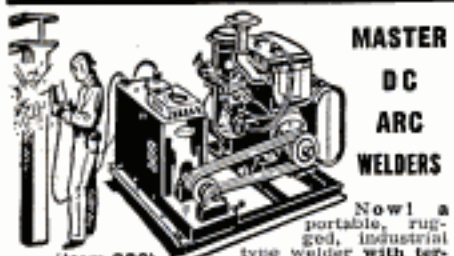

MASTER DC ARC WELDERS

Now! a portable, rugged, industrial type welder with terrific performance, yet at a price hundreds of dollars less than you'd expect. Senior model made for years of trouble-free, continuous service. High capacity DC welding unit enables you to tackle any job with confidence—easily welds anything up to 2" plate using from 1/16" to 1/4" rods. Built-in stabilizer and cooling system makes arc easy to strike and hold. Dual control rheostat provides low heat soldering, brazing and welding from 30 to 300 amps. Complete with instructions guarantee and triple V-belt or flat pulley. You can pay more, but you can't buy a better welder.
WELDER ONLY—DUAL CONTROL MODEL. Same as above, but drive with your tractor, jeep or gas engine of 14 HP or more. (Item 280.) Wt. 119 lbs. \$450 value. \$119.50
WELDER ONLY—STANDARD MODEL. Same as above but with single rheostat for heavy metal welding only. (Item 38.) \$99.75
Wt. 110 lbs. \$400 value. Special. . . . \$99.75
COMPLETE POWER MASTER (Illustrated above) powered by a 14 hp., air cooled Wisconsin engine. Wt. 480 lbs. (Item 280) Complete with welder costing \$1200. . . . \$399.50
Special for November only \$399.50
WELDING KIT, Two 10 ft. leads, welding helmet, electrode holder, ground clamp. Sold only with welder. . . . \$10.50

EXTENSION CORD

Very flexible and tough! Neoprene #16-2 conductor cord, ideal for lawn mowers, hedge trimmers and power tools. U.L. approved. Complete with heavy rubber plug and outlet, 40 ft. cord (Item 17a) Wt. 2 1/2 lbs. regularly \$4.95—SPECIAL. . . \$2.95
100 ft. combination (2-40 ft. and 1-20 ft.) Item 17N. factory price. . . \$6.45
NEOPRENE CABLE #14-2 (Item 185) Heavy duty, very flexible, 20 year quality. Wt. 9 lbs. 100 ft. Complete with rubber plug and outlet. A terrific buy at only . . . \$8.95
NO. 12-2 POWER CABLE. Very flexible rubber covered special outside shield for grounding power tools, etc. 50 ft. (Item 199) wt. 8 lbs. \$6.95. 100 ft. (Item 200) \$12.95
NO. 10-2 POWER CABLE. Heavy duty, very flexible, rubber covered, 50 ft. with male plug and terminals. (Item 502a) \$10.45
50 ft. without fittings (Item 502) . . . \$9.95



JET STEAM MASTER

Now, a new super-efficient portable steam generator that provides live steam at 100 lbs. pressure in 60 seconds from a cold start! The first quality steam blaster ever offered at this low price. Instantly cleans, sticky grease, dirt, rust, old paint, etc. off motors—farm implements and road machinery. Pays for itself in a few weeks. Sterilizes as it cleans—milk equipment, etc. Fully automatic—oil fired with built-in water circulating pump. Draws water from faucet or bucket. Simple and safe: anyone can use it—built-in safety valve. New triple efficiency jet steam gun automatically mixes in soap or detergent if desired. Wt. 250 lbs. Item 463. Special Factory Price. . . . \$298.00



MASTER SHOP COMPRESSOR

Big and rugged. This stationary compressor provides 8 C.F.M.—plenty of air for industrial uses, powered by heavy duty repulsion induction 3/4 HP, 115/230 v. motor. Factory type twin cylinder compressor designed for continuous operation. Mounted on heavy 22 gal. steel tank. Complete with unloader type automatic switch, pressure relief valve, check valve, gauge, shut-off valve, and 20 ft. heavy duty air hose. (Item 209h) Regular retail \$119.50. Factory price. . . \$174.50



52 pc. SOCKET SET

Highest quality, guaranteed non-breakable sockets made by Husky. Beautifully matched chrome thin wall alloy absolutely the best. Contains a complete set of 26 sockets in 1/2" drive, 3/4" drive and 1 1/4" drive, plus all necessary extensions, handles, speeders, reversible ratchets, etc.; all uncond. guaranteed against breakage. A beautiful set of tools that will handle any job in a big doghouse steel box. Wt. 17 lbs. (Item 205) List price \$62.90. Factory special. . . \$27.95

44 Pc. SOCKET SET (Item 206) Same unconditionally guaranteed, non-breakable sockets as above. Complete range of 21 sockets from 1/4" thru 7/16" (1/4" drive) & 7/16" thru 1-1/16" (1/2" drive). Two extensions, reversible 1/2" ratchet, 3 drift punches, sliding "T" head, all angle coupling, 1/2" speeder, 1/2" breaker, 5 pc. high chrome alloy combination wrench set and 8 pc. offset wrench set in big doghouse tool box with ample room for other tools. Reg. \$49.50. Wt. 16 lb. \$21.95

M.O. Prices f.o.b. Factory. 10 day Money back guarantee. SEND 10c for . . . **BIG 1955 Catalog**

Send check or **MASTER MECHANIC MFG. CO., DEPT. 100 Burlington, Wis.**



KEEP CLOSE-TOLERANCE MACHINING EFFICIENT!

South Bend PRECISION TURRET LATHES

South Bend 2-H Precision Turret Lathe—1" collet capacity, 16 $\frac{1}{4}$ " swing, 96 power turret feeds, 48 cross slide feeds, 48 carriage feeds, 48 thread cutting feeds.

Base Price \$3190

South Bend Precision Turret Lathes keep efficient the machining of small duplicate parts. Their remarkable accuracy and positive controls simplify the holding of close tolerances with only normal machine handling care. Finishes are commonly produced that otherwise would require additional operations. Simplicity of tooling makes job changes quick and economical. Wide ranges of power feeds and thread cutting feeds assure maximum efficiency on every job. They are particularly suited for second operations. Available in 3 sizes: 1" collet—16" swing; 1" collet—10" swing; $\frac{1}{2}$ " collet—9" swing.

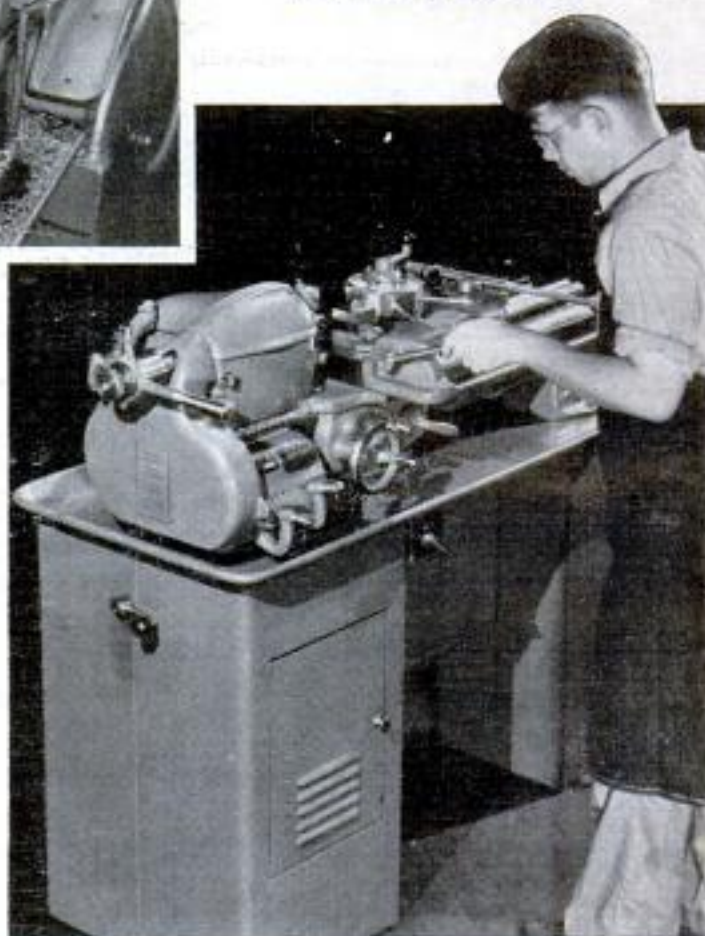

South Bend CL930Z Precision Turret Lathe — $\frac{1}{2}$ " collet capacity, 9 $\frac{1}{4}$ " swing. Base price \$975.

Compared with our costs
OUR PRICES ARE LOWER
than they were back in 1941



Prices are closely tied to costs. Costs are still rising. Buy now before increased costs necessitate higher prices.

SEND INFORMATION CHECKED:

- | | | | | | |
|---|---|--|---|--|--|
| <input checked="" type="checkbox"/>  9" and 10" BENCH LATHES | <input type="checkbox"/>  10" to 16-24" FLOOR LATHES | <input type="checkbox"/>  DRILL PRESSES | <input type="checkbox"/>  TOOL GRINDERS | <input type="checkbox"/>  $\frac{1}{2}$ " & 1" Collet TURRET LATHES | <input type="checkbox"/>  BENCH SHAPERS |
|---|---|--|---|--|--|

Name _____ Street _____
City _____ State _____

Building Better Tools Since 1906 • SOUTH BEND LATHE • South Bend 22, Indiana



How Researchers Solved Detroit's Biggest Problem

...their ingenuity may make your present engine last years longer and save you hundreds of dollars in repairs.

THEORETICALLY, YOUR ENGINE should never wear out, because the moving parts never touch each other. They're always separated by a thin film of oil. The problem is to keep abrasive particles out of that thin film of oil. That problem has become tougher every year since the Model T, as engine clearances have become finer and speeds higher.

Today, abrasive particles comparable to the thickness of the ink on this page may do hundreds of dollars of damage to your engine!

Because hot oil, under pressure, often forces "channels" in rag or paper filter packs, these abrasives get through. That's why a team of researchers developed a new material for oil filters: porous bronze.

This new filter material is made of millions of microscopic balls fused together. No amount of oil can force a channel in it. No dangerous abrasive particles can get through. It doesn't soak up valuable oil additives as absorbent filters do. *And you never change it!* You simply rinse it in gasoline and keep on using it for 10,000, 100,000 and more miles of driving. It's called the Life-Time filter.



The cost? About the same as a couple of throwaway filter packs. In addition to saving the cost of filter pack replacement, you save the quart of oil soaked up and thrown away with ordinary filter packs and — most important — you save money on engine repairs by filtering out dangerous abrasives.

OPPORTUNITY FOR DEALERS AND DISTRIBUTORS

A dealer and distributor network is now being formed to handle demand generated by advertising and editorial features in national magazines. If you can qualify, you can be first with the most exciting automotive product of this decade, to win new customers and build a substantial business. These valued franchises are not being sold; they are awarded on the basis of ability to grow with us. For complete details, write or wire: Continental Manufacturing Corporation, Dept. FPM-11, Washington Blvd. & Motor Avenue, Culver City, Calif.

Evolution of Bronze Filter Design

1. "Tin Can"



2. Rigid Cone



1. First crude attempts to design a bronze filter simply imitated the shape of the ordinary throwaway pack. Because of its basic structural weakness and the danger that sediment packing between the element and the case might critically reduce oil pressure, all attempts to "improve" this design were abandoned, even though it was relatively cheap to manufacture.

2. After considering almost every geometric shape, the cone was selected as the most rigid and was used for the Life-Time filter. This design also allows the sediment to drop to the bottom of the case, clear of the element. It has withstood the ultra-sonic vibration test and the 100G shock test. Only the Life-Time filter uses this exclusive cone design; it is fully protected by patents.

HOW TO GET A LIFETIME FILTER FOR YOUR CAR

Try the Lifetime filter on your car for 2 weeks: if it isn't all I say, you get your money back; if you keep it, you're through buying filter packs—the Lifetime filter is guaranteed for 10 years, actually will last many times that long.

For complete unit, including case (fits any car), send make, year and model of your car and \$12.95 (we pay shipping).

Conversion kit, which replaces your present filter pack with Life-Time bronze, is \$6.95 for most cars (send make and number of present filter when ordering). Conversion kits for Buicks with hydraulic lifters and for cars with full flow systems: \$13.95.

Or send \$2 deposit, pay C.O.D. charges on arrival. But do it today—don't waste another cent on filter pack replacements!



Complete Lifetime Filter; fits any car.



Lifetime Conversion Kit; replaces ordinary packs with permanent bronze element.

© 1954

Permanent Filter Division, Dept. FPM-11
CONTINENTAL MANUFACTURING CORP.
Washington Blvd. at Motor Ave., Culver City, Calif.

Ship complete unit for _____
make, model, year of car

conversion kit for _____
make and number of present filter

I enclose \$12.95 for complete unit (\$18.95—chrome)
 \$6.95 for conversion kit (full-flow, \$13.95)
 \$2.00 deposit; send C.O.D.

Name _____

Address _____

City _____ Zone _____ State _____

There's only one...

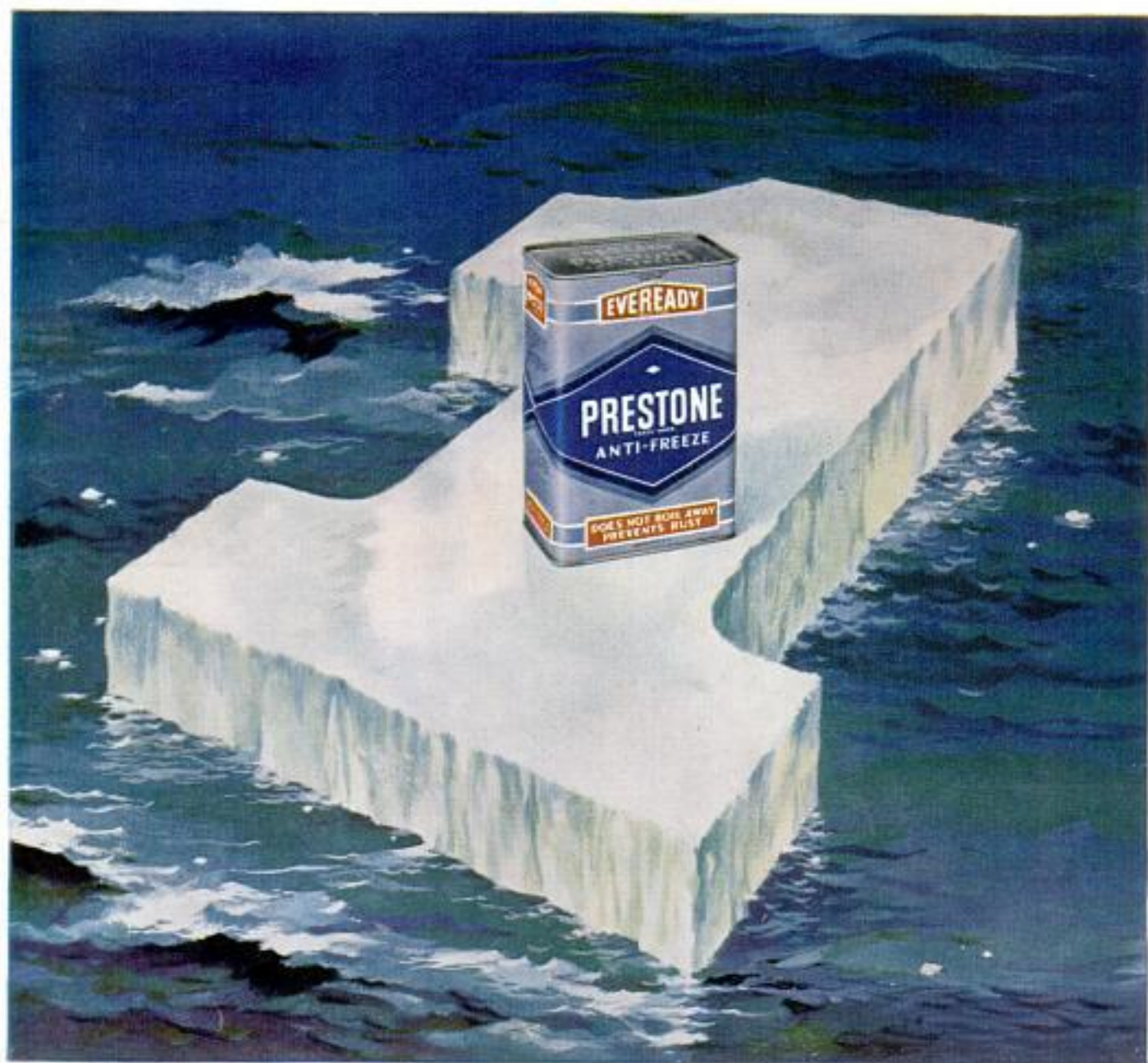

"PRESTONE" BRAND ANTI-FREEZE

ask for it by name...make sure you get it

NEW LOW PRICE **\$2.95** 80¢ in quart cans
PER GAL. WAS \$3.75

YOU'RE SET • YOU'RE SAFE • YOU'RE SURE • WITH "PRESTONE" ANTI-FREEZE



NEW "PRIME"
GAS LINE ANTI-FREEZE
protects fuel system
against winter cold.
Prevents stalling.
Only 65¢ a can.

The terms "Prestone", "Eveready" and "Prime" are registered trade-marks of Union Carbide and Carbon Corporation
NATIONAL CARBON COMPANY • A Division of Union Carbide and Carbon Corporation • 30 East 42nd Street, New York 17, N.Y.

Copyrighted material