

SEPTEMBER 1954

35 CENTS

POPULAR MECHANICS

MAGAZINE

WRITTEN SO YOU CAN UNDERSTAND

Hi-Fi Is Sweeping the Country!
What's It All About?
—Page 106

Report on the
CADILLAC

HOW TO SHOOT
OVER DECOYS



**"Sports Car Racing or
Everyday Driving . . .**



**I use CHAMPION Spark Plugs because
they make any engine perform better!"**

—says *James H. Kimberly*

top sports car competition driver
(above) with Marshall Lewis, his
chief mechanic, and (right) with his
personal car and 4.5 FERRARI.



**Here's Why Champion 5-Rib Insulators
Give You Faster All-Weather Starting!**



Champion's 5-rib insulator resists
"shorting" up to 40% more than
smooth insulator plugs because of
the longer path any "flashover" is
forced to take between the plug
terminal and shell.

Each time Jim Kimberly hurries the
twelve-cylinder, 331-h.p. FERRARI
through a tight corner, decelerating,
then roaring out at full-throttle, the
spark plugs are subjected to an almost
unbelievable amount of heat and
pressure.

This takes place hundreds of times in
every sports car race. And, each time,
the Champion Spark Plugs in this
great engine demonstrate their amaz-
ing ability to resist compression leak-
age and misfiring under these extreme
conditions.

Because all Champions are manufac-
tured to one high standard of quality,
this is additional proof that Champions
—engineered especially for your car—
will assure you an extra margin of
dependable performance in town or
on the open road.

Champion Spark Plug Company, Toledo 1, Ohio



Dependable

CHAMPIONS

FOR ANY MAKE OR YEAR OF ENGINE

67% MORE

Starting punch

**with this great
new super-powered
Double Eagle battery**



You'll get faster, surer starts with Goodyear's super battery—the new Double Eagle 125. That's because it has 67% more starting stamina than other batteries of its type.

But that's not all. The tremendous reserve power of the Double Eagle Dry-Proof Battery is even more than you need to supply heater, radio and a whole carload of accessories. And its superior plate insulation is highly resistant to acid, heat and pressure.

You'll recognize the super-powered Double Eagle by its double strength blue and yellow Polystyrene case. Ask your dealer about this modern battery today.

Goodyear, Battery Dept., Akron 16, Ohio

GOODYEAR

DRY-PROOF DOUBLE EAGLE BATTERY

Double Eagle—T. M. The Goodyear Tire & Rubber Company, Akron, Ohio

This One

SEPTEMBER 1954



L1GN-PSN-E97J

1

ated material

The
pole
that
need
not
be
climbed

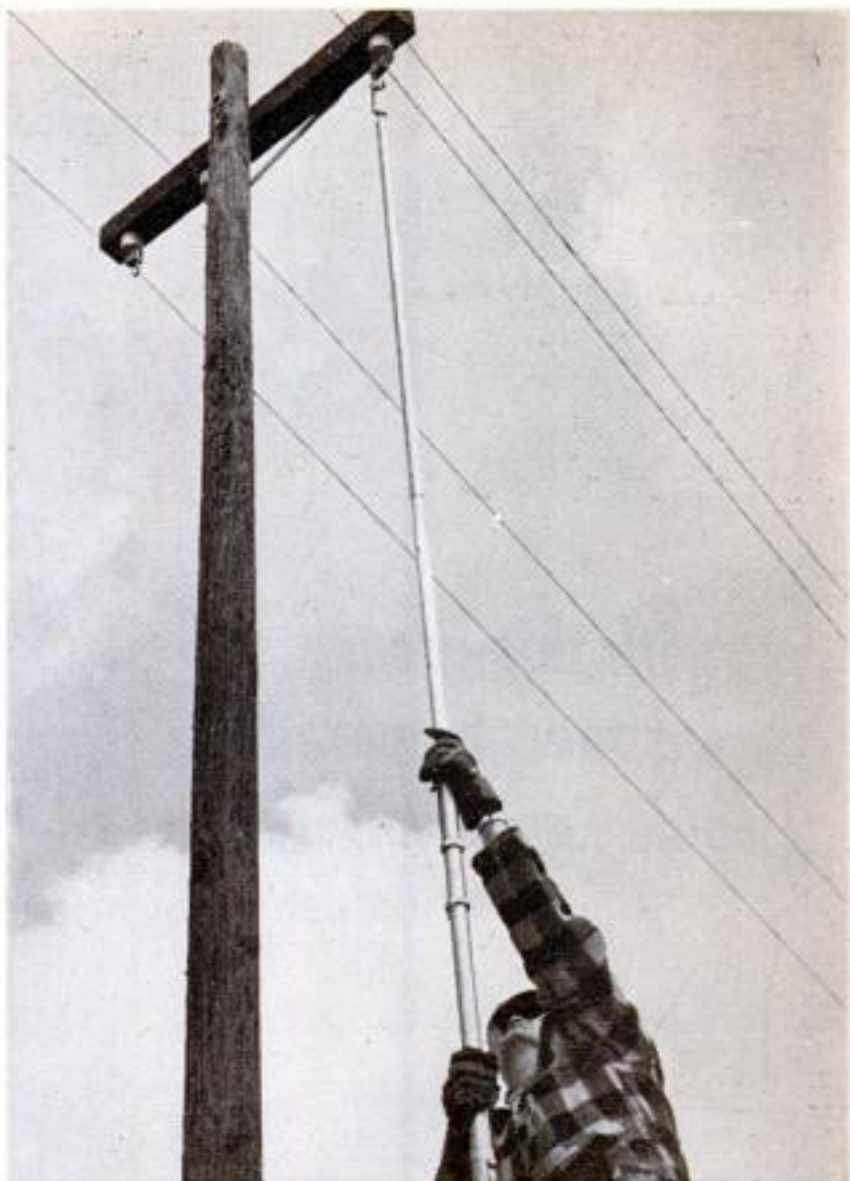

Fastening wires with new tool.

Since telephony began, there has been just one way to install telephone wires on poles: have a trained man climb up and fasten them there. Now Bell Telephone Laboratories engineers have developed a special pole line for rural areas. The entire line can be erected without climbing a pole.

The whole job is done from the ground. Light-weight poles are

quickly and easily erected. Newly created tools enable men to fasten wires to crossarms 10 to 25 feet over their heads.

This inexpensive line promises more service in sparsely populated places. From original design to testing, it exemplifies a Bell Telephone Laboratories team operation in widening telephone service and keeping costs down.



Key to the new "climbless" pole is this insulator. Ground crews use long-handled tools to place the wire in position and then lock it fast.

BELL TELEPHONE LABORATORIES

Improving telephone service for America provides careers for creative men in scientific and technical fields



Popular Mechanics Magazine

Registered in U. S. Patent Office and Canada

H. H. WINDSOR, *Founder*

H. H. WINDSOR, JR., *Editor and Publisher*



Volume 102 SEPTEMBER 1954 Number 3

Address all communications to: 200 E. Ontario St., Chicago 11, Ill.

Managing Editor.....Roderick M. Grant
 Assistant Managing Editor.....Wayne Whittaker
 Shop Notes and Crafts Editor.....James R. Ward
 Radio-Television, Electronics Editor.....Frank L. Brittin
 Associate Editor.....Clifford B. Hicks
 Associate Editor, Automotive.....Arthur R. Railton
 Associate Editor, Shop Notes and Crafts.....Wayne C. Leckey
 Assistant Editor, Shop Notes.....W. Clyde Lammey
 Assistant Editor, Crafts.....Frank N. Stephany
 Assistant Editor, Makeup.....John C. Dalen
 Automotive Correspondent.....Leo Donovan
 Art Director.....Frank Beatty
 Assistant Editors: Leonard F. Hills, Jay W. Hedden, Elliott H. McCleary
 Eastern Editor.....Richard F. Dempewolf
 Empire State Bldg., Room 2906, New York City 1
 Western Editor.....Thomas E. Stimson, Jr.
 Suite 1010, 3460 Wilshire Blvd., Los Angeles 5, Calif.
 London Manager.....Douglas W. Wedderspoon
 Eagle House, Jermyn St., London S. W. 1, England
 Director, Bureau of Information.....Allan Carpenter
 200 E. Ontario St., Chicago 11

this month's cover

THAT MUSIC-MINDED gal on our cover is being very careful about where she places the speaker, for it must balance the one installed in the door across the room. New record players, amplifiers and speakers make possible the faithful reproduction of sound. But what's all this talk about woofers and tweeters and cross-over networks? What's behind those arguments over the exact placement of speakers and the design of their enclosures? Just what is hi-fi, anyway? An authoritative feature starting on page 106 unravels the mysteries of this new family pastime. Whether your tastes run to jazz or opera, here's a story that can be your key to countless hours of pleasure

Information not listed on articles in the index, starting on page 12, frequently is listed in the WHERE-TO-FIND-IT LIST, which is available to readers without charge. A copy may be obtained by writing to the Bureau of Information, Popular Mechanics, 200 E. Ontario, Chicago 11, Ill.

In This Issue . . .

After Disaster, the Trouble Shooter - - -	81
Built for Modern Living - A House of Magic	90
What's All This Talk About Hi-Fi? - - -	106
Animals Are Like Other People - - -	113
The Owners Report on the '54 Cadillac - -	122
What's New for Your Home - - -	130
Fast Horses and Short Ropes - - -	133
Big Guns in Miniature - - -	141
TV From a Mountaintop - - -	156
Radio, TV and Electronics - - -	161

For the Craftsman . . .

Custom-Build Your Own Dining Booth - -	165
Solving Home Problems - - -	178
How to Shoot Over Decoys - - -	185
Build This Model Jaguar SS-100 Sports Car	195
How to Make Cabinet Doors - - -	202
Drilling in a Lathe - - -	205
New Uses for Electric Saws - - -	210
Portable Welding Screen - - -	214
Shopping for Tools - - -	218

Other items, and manufacturers of available products described, are listed on pages 12, 14 and 16

Published monthly by Popular Mechanics Company, 200 E. Ontario St., Chicago 11, Ill. H. H. Windsor, Jr., president; Wm. Harrison Petridge, exec. vice-pres.; D. F. Windsor, vice-president and secretary-treasurer; H. H. Windsor III, vice-president; Clover L. Perkins, advertising manager; Alvin M. Deyoe, circulation manager. Single copy in the United States and Canada, 35 cents; subscription rates in the United States and possessions, Canada, Philippines and countries of the Pan-American Postal Union, 1 year \$3.50; 2 years, \$6.00; 3 years \$8.00. To all other countries add \$1.00 a year over United States prices for overseas postage. If you plan to move, notify us at least 30 days in advance so you will not miss an issue. Give both your old and new addresses. Entered as Second Class Matter, September 15, 1903, at the Post Office at Chicago, Illinois, under Act of March 3, 1879. Entered as Second Class Matter at Post Office Dept., Canada. Registered as Second Class Matter at the Post Office at Mexico, D. F., Mexico, June 20, 1950. Copyright 1954 by Popular Mechanics Company. Copyright under International Copyright Union. Copyright in France. All rights reserved under Pan-American Copyright Union. Printed in the United States of America.

SEPTEMBER 1954

Learn how homeowners everywhere
save money by installing their own

MATICO TILE FLOORING



*MATICO's New Improved
Install-It-Yourself System
Makes It Easy!*



1—Mark straight lines through the center of the room in both directions, using a chalk and line.

2—With a notched trowel, spread adhesive evenly over floor and allow to "set."



3—Press tiles into position. You can walk on MATICO as soon as floor is in place.



Yes, you can enjoy colorful, durable MATICO Asphalt Tile Flooring in your home at amazing low cost by installing MATICO yourself. You can't buy a more economical type of luxury flooring than MATICO. It lasts for years... is easy to keep sparkling clean and comes in 32 striking decorator colors that can't wear off because colors and marbleization go clear through the tile.

It's a cinch to install, too, with MATICO's tested install-it-yourself instruction booklet... tile calculator... and special tool kit. Why, you can finish a room in just a few hours.

Why put up with a dingy, worn-out floor when it costs so little to install a MATICO tile floor yourself.

See your classified telephone directory for the name of your MATICO dealer.



MASTIC TILE CORPORATION OF AMERICA

Joliet, Ill. • Long Beach, Calif. • Newburgh, N. Y.

Manufacturers of:

Aristoflex • Confetti • Parquetry • Asphalt Tile • Cork Tile • Plastic Wall Tile

MASTIC TILE CORPORATION OF AMERICA
Dept. M2-9, P. O. Box 986, Newburgh, N. Y.

Please send me MATICO's money-saving install-it-yourself instruction kit and complete color chart.

Name

Address

City..... Zone..... State.....

4C151

Texaco



Tips on car care

How to achieve greater parking safety

Many serious accidents occur at night as motorists get out of cars parked on the street. A good safety precaution against this danger is placing a strip of red reflector tape on your car doors (see illustration). This flashes a warning to approaching cars as soon as the door is opened.



How to get smoother engine performance



Today's high-compression engines out-distanced Nature's best motor oil. A better motor oil had to be made—and Texaco engineers did it! They developed *Advanced Custom-Made Havoline*. This great new motor oil, with its *Balanced-Additive* formula, helps keep those extremely close valve lifter clearances properly lubricated and quiet (see cutaway model at left). The new Havoline helps your engine stay clean, free from sludge, carbon and bearing-eating acids . . . actually wear-proofs your engine for the life of your car. Get *Advanced Custom-Made Havoline* today! See your Texaco Dealer . . . the best friend your car has ever had.

Change to *Advanced* CUSTOM-MADE HAVOLINE

. . . the best motor oil your money can buy.

THE TEXAS COMPANY
TEXACO DEALERS
in all 48 states

Texaco Products are also distributed in Canada and in Latin America



Get into RADIO-TELEVISION ELECTRONICS by Shop-Method Home Training



GOOD JOBS AWAIT THE TRAINED RADIO-TV TECHNICIAN!
Business of Your Own • Broadcasting • Radio Manufacturing, Sales, Service • Telecasting • Television Manufacturing, Sales, Service • Laboratories: Installation, Maintenance of Electronic Equipment • Electrolysis, Call Systems • Theatre Sound Systems, Police Radio • Garages: Auto Radio Sales, Service • Sound Systems, Telephone Companies, Engineering Firms, etc.

WE BRING NATIONAL SCHOOLS TO YOU! There is a place for you in the great Radio-Television-Electronics industry when you are trained as National Schools will train you at home! **OUR METHOD IS PROVED BY THE SUCCESS OF OUR GRADUATES SINCE 1905.**

YOU RECEIVE PARTS for Signal Generator, T.R.F. Receiver, Audio Oscillator and Superheterodyne Receiver, plus professional Multitester shown above. *No extra charges.*
EARN WHILE YOU LEARN—we show you how!



APPROVED FOR G. I. TRAINING

**FREE
RADIO-TV
BOOK &
SAMPLE
LESSON!**

MASTER ALL PHASES! Get Master Shop-Method Home Training from an Established Resident Technical Trade School with its own Training Shops, Laboratories, Studios—almost 50 Years of Successful Experience in Training Ambitious Men.

NATIONAL SCHOOLS

Technical Trade Training Since 1905

LOS ANGELES 37, CALIF.

In Canada: 811 West Hastings Street, Vancouver, B. C.

BOTH HOME STUDY AND RESIDENT COURSES OFFERED

MAIL NOW TO OFFICE NEAREST YOU!

(mail in envelope or paste on postal card)

NATIONAL SCHOOLS, Dept. RB-94

4000 S. FIGUEROA STREET
LOS ANGELES 37, CALIF.

OR

323 W. POLK STREET
CHICAGO 7, ILL.

Please rush **FREE RADIO-TELEVISION BOOK & FREE LESSON.** No obligation, no salesman will call.

NAME _____ BIRTHDAY _____ 19 _____

ADDRESS _____

CITY _____ ZONE _____ STATE _____

Check if interested **ONLY** in Resident training at Los Angeles.
VETERANS: Give date of discharge _____

in this corner.....
**THE
EDITORS**



Popular Mechanics is "at home" to Californians in a new branch office opened recently in the spanking new Tishman Building, 3460 Wilshire Blvd., Los Angeles 6.



Conveniently located close to the downtown business district on famous Wilshire Boulevard, the office is headquarters for Thomas E. Stimson, Jr., Western Editor, and an advertising sales staff of three headed by Max Hunter. The telephone, if you care to make a note of it, is DUNKIRK 2-8458.

Next Month . . .

Next month we distribute another big bonus to the home lover—and who isn't?

Most of our readers own their own homes. Whether you own or rent, the October issue will inspire a million of you to plan your new home or the remodeling that will bring it up to the minute in modern style and comfort.

Our first special section devoted to homes was published a year ago. In this second event of the kind we will present 50 pages of houses and remodeling ideas, hints on planning and heating, air conditioning and lighting. Highlight of the issue will be the four-color feature presenting "The Home You Asked For"—a house especially planned for us by a noted architect from the specifications of you, the readers, outlined in answer to 1000 questionnaires mailed to subscribers. It conforms to the price, size and style you dictated and promises to be a sensation. Thousands will want to build it from the plans which will be made available by the architect.

Other titles in the home section are "Is

(Continued to page 8)

5 reasons why ACCOUNTANCY



offers you **MORE MONEY . . . and SUCCESS!**

REASON #1. If you were an expert accountant right now, chances are you would find yourself among the highest-paid of all professional men and women. Even back in "depression years," surveys showed that accountants earned more on the average than men in other major professions.

REASON #2. The demand for accountants is great—everywhere. All businesses must have trained accountants to cope with ever-growing requirements. It's a profession offering wide opportunity—always—to the man who knows.

REASON #3. You can fit into any business, anywhere in the country—because accounting principles are universal. Think what this means in terms of security and independence!

REASON #4. Accountancy is open to all. Any man or woman of good intelligence, who enjoys figure work and is willing to follow LaSalle's systematic "problem method" plan, can rapidly qualify for a highly profitable, enjoyable life-time career . . . and he doesn't have to finish his training before beginning to "cash in."

REASON #5. Without losing a day from your present work, you can prepare in spare hours at home, at low cost, under LaSalle's step-by-step "Problem Method" of "learning by doing." This famous plan accounts for LaSalle's remarkable record of having trained nearly 10 per cent of all Certified Public Accountants in the U. S. . . . and of having put many thousands of others into high-paying careers.

Send today for Free Sample Lesson and "Accountancy, the Profession That Pays." Learn about the five great fields of opportunity . . . and LaSalle's time-tested plan for helping men and women to rapid advancement, higher income, greater prestige and professional standing. The coupon below will bring this information to you—without cost or obligation.

MAIL THE COUPON—NOW

→ **GET FREE SAMPLE LESSON** ←



LASALLE
417 S. Dearborn St.,
CHICAGO 5, ILL.

LaSalle Extension University
— A Correspondence Institution —
Dept. 964H, 417 S. Dearborn St., Chicago 5, Ill.

Please send me, free of all cost or obligation, a sample lesson in Accounting . . . also, your 48-page illustrated book, "Accountancy, the Profession That Pays."

Name.....Age.....
Address.....
City, Zone, State.....

FIX CARS!

EASIER, TWICE AS FAST!



Any Make, Model or Part

Fix cars easier than you may have thought possible . . . even without previous training!

Just look up in this giant, 4 1/2-pound, 864-page Chilton "ALL CARS" Manual the make, model and part you want to fix. The manual shows you what to do . . . exactly how to do it. Covers step-by-step details on specific jobs in a way you can't fail to understand. Largest book of its kind. First choice of garages, schools and for Army-Navy training. Tops for beginners. Helps experienced mechanics work faster, more profitably.

NEW 1954 EDITION

Contains complete service data on EVERY model from 1940 through 1954: **BUICK, CADILLAC, CHEVROLET, CHRYSLER, DeSOTO, DODGE, FORD, FRAZER, HENRY J., HUDSON, KAISER, LINCOLN, MERCURY, NASH, OLDSMOBILE, PACKARD, PLYMOUTH, PONTIAC, STUDEBAKER, WILLYS.** 353 Quick Check Trouble Tables, 2532 pictures, etc., explain things at a glance. Contains over 47,000 specifications. Check "ALL CARS" Manual in coupon for FREE TRIAL.

By the world's largest automotive publishers

FIX Chevrolets!

This brand new, 144-page Manual makes it easy to repair ANY Chevrolet! Covers EVERY "Chevie" model from 1940 through 1954 . . . specifications, wiring diagrams and COMPLETE repair data on practically every part. Over 550 pictures. Order Chevrolet Manual in coupon. **Only \$2.75** Money back guarantee.

FIX Fords!

Now, even beginners can handle Ford repair jobs fast and r-i-g-h-t! Contains 144-pages; over 500 pictures; Quick Check Trouble Tables, etc. Covers all models, specifications and complete service details, 1940 through 1954. Specify Ford Manual in coupon. **Only \$2.75**

FIX Plymouths!

Here's your master guide to fast, easy repairs on every Plymouth model from 1940 through 1954. 128-pages; over 500 pictures; Quick Check Trouble Tables; hundreds of specifications and full service details. Order Plymouth Manual in coupon. **Only \$2.75**

PRACTICE 10 DAYS FREE!

THE CHILTON CO., Dept. PM-94
56th & Chestnut Sts., Philadelphia 39, Pa.

Please send the following manuals (check the ones you want):

Send the big CHILTON "ALL CARS" REPAIR MANUAL (Price \$4.95) for 10-day FREE EXAMINATION. If I like it, I will promptly remit \$1.95 (plus 35c postage); then send \$2.50 monthly for 2 months. Otherwise, I will return manual postpaid in 10 days and owe nothing.

Check here for special manuals: Chilton "CHEVROLET" Manual, Price \$2.75
 Chilton "FORD" Manual, Price \$2.75
 Chilton "PLYMOUTH" Manual, Price \$2.75

NOTE: Above special manuals sold for cash with order (we pay postage). Or, we ship C.O.D. and you pay postman for manual plus post office charges. Specify which method. Any manual returnable postpaid in 10 days and we guarantee to refund your \$2.75.

(OUTSIDE U.S.A.—Cash only. "ALL CARS" Manual, \$7.95. Special Manuals, \$2.00 each. Same 10-day return privilege with money refunded.)

Name _____

Address _____

City, Zone, State _____

(Continued from page 6)

the Old Homestead Worth Remodeling?" "New Faces for Old Houses," "At Home, 2004 A.D.," and one feature pictures a variety of new houses from \$7,250 to \$15,000 to please every taste.

Don't miss the October home section!

To the Editor:

When Paris was liberated in August of 1944, the American army took over the Eiffel Tower and installed at the tower's top, where the Germans previously had a radio station, the terminals for several very-high-frequency radiotelephone and telegraph circuits directed to Cherbourg, to England and forward to the armies. These radio terminals were connected by wire lines to the American Signal Center on the Avenue Kleber, near the Etoile. To bring these wires from the ground to the top of the tower, regular telephone twisted-pair wires, of the kind normally used between house and



pole, were hung from the tower's frame. These wires swung in the wind, were quickly frayed and were continually having to be replaced. To eliminate these troubles, it was decided to place a cable between the radio station on the tower's top and the ground. The job was assigned to a young Signal Corps captain.

The captain spent the evening with the handbooks and a slide rule investigating cable weights and tensile strengths and finally went to bed with a rather dim view of his assignment. Early the next morning,

(Continued to page 10)

How I foxed the Navy

by Arthur Godfrey



The Navy almost scuttled me. I shudder to think of it. My crazy career could have ended right there. Who knows, I might still be bumming Chesterfields instead of selling them.

To be scuttled by the Navy you've either got to do something wrong or neglect to do something right. They've got you both ways. For my part, I neglected to finish high school.

Ordinarily, a man can get along without a high school diploma. Plenty of men have. But not in the Navy. At least not in the U. S. Navy Materiel School at Bellevue, D. C., back in 1929. In those days a bluejacket had to have a mind like Einstein's. And I didn't.

"Godfrey," said the lieutenant a few days after I'd checked in, "either you learn mathematics and learn it fast or out you go. I'll give you six weeks." This, I figured, was it. For a guy who had to take off his shoes to count

above ten, it was an impossible assignment.

I was ready to turn in my bell-bottoms. But an ad in a magazine stopped me. Here, it said, is your chance to get special training in almost any subject—mathematics included. I hopped on it. Within a week I was enrolled with the International Correspondence Schools studying algebra, geometry and trig for all I was worth.

Came week-end liberty, I studied. Came a holiday, I studied. Came the end of the six weeks, I was top man in the class. Within six weeks I had mastered two years of high school math, thanks to the training I'd gotten.

I.C.S. made the impossible—easy!

GET EXPERT GUIDANCE 2 FREE BOOKS Free, illustrated catalog on career that interests you. Also 36-page, pocket-size guide to advancement, "How to Succeed." Just mail the coupon!

For Real Job Security—Get an I. C. S. Diploma!

I. C. S., Scranton 9, Penna.

INTERNATIONAL CORRESPONDENCE SCHOOLS

ICS

BOX 5630-L, SCRANTON 9, PENNA.

(Partial list of 277 courses)

Without cost or obligation, send me "HOW TO SUCCEED" and the opportunity booklet about the field BEFORE which I have marked X:

- | | | | | |
|---|--|---|--|--|
| <p>ARCHITECTURE and BUILDING CONSTRUCTION</p> <ul style="list-style-type: none"> <input type="checkbox"/> Air Conditioning—Refrig. <input type="checkbox"/> Architecture <input type="checkbox"/> Building Contractor <input type="checkbox"/> Building Maintenance <input type="checkbox"/> Carpenter and Mill Work <input type="checkbox"/> Estimating <input type="checkbox"/> Heating <input type="checkbox"/> Painting Contractor <input type="checkbox"/> Plumbing <input type="checkbox"/> Reading Arch. Blueprints <input type="checkbox"/> Steamfitting <p>ART</p> <ul style="list-style-type: none"> <input type="checkbox"/> Cartooning <input type="checkbox"/> Commercial Art <input type="checkbox"/> Fashion Illustrating <input type="checkbox"/> Magazine Illustrating <input type="checkbox"/> Show Card and Sign Lettering <input type="checkbox"/> Sketching and Painting <p>AUTOMOTIVE</p> <ul style="list-style-type: none"> <input type="checkbox"/> Auto Body Rebuilding <input type="checkbox"/> Auto Elec. Technician <input type="checkbox"/> Auto-Engine Tune Up <input type="checkbox"/> Automobile Mechanic | <p>AVIATION</p> <ul style="list-style-type: none"> <input type="checkbox"/> Aeronautical Engineering Jr. <input type="checkbox"/> Aircraft & Engine Mechanic <p>BUSINESS</p> <ul style="list-style-type: none"> <input type="checkbox"/> Advertising <input type="checkbox"/> Bookkeeping and Accounting <input type="checkbox"/> Business Administration <input type="checkbox"/> Business Correspondence <input type="checkbox"/> Certified Public Accounting <input type="checkbox"/> Creative Salesmanship <input type="checkbox"/> Federal Tax <input type="checkbox"/> Letter-writing Improvement <input type="checkbox"/> Managing Small Business <input type="checkbox"/> Office Management <input type="checkbox"/> Retail Business Management <input type="checkbox"/> Sales Management <input type="checkbox"/> Stenographic-Secretarial <input type="checkbox"/> Traffic Management <p>CHEMISTRY</p> <ul style="list-style-type: none"> <input type="checkbox"/> Analytical Chemistry <input type="checkbox"/> Chemical Engineering <input type="checkbox"/> Chem. Lab. Technician <input type="checkbox"/> General Chemistry <input type="checkbox"/> Natural Gas Prod. & Trans. <input type="checkbox"/> Petroleum Engineering <input type="checkbox"/> Plastics <input type="checkbox"/> Pulp and Paper Making | <p>CIVIL, STRUCTURAL ENGINEERING</p> <ul style="list-style-type: none"> <input type="checkbox"/> Civil Engineering <input type="checkbox"/> Construction Engineering <input type="checkbox"/> Highway Engineering <input type="checkbox"/> Reading Struct. Blueprints <input type="checkbox"/> Sanitary Engineering <input type="checkbox"/> Structural Engineering <input type="checkbox"/> Surveying and Mapping <p>DRAFTING</p> <ul style="list-style-type: none"> <input type="checkbox"/> Aircraft Drafting <input type="checkbox"/> Architectural Drafting <input type="checkbox"/> Electrical Drafting <input type="checkbox"/> Mechanical Drafting <input type="checkbox"/> Mine Surveying and Mapping <input type="checkbox"/> Ship Drafting <input type="checkbox"/> Structural Drafting <p>ELECTRICAL</p> <ul style="list-style-type: none"> <input type="checkbox"/> Electrical Engineering <input type="checkbox"/> Electrical Maintenance <input type="checkbox"/> Electrician <input type="checkbox"/> Contracting <input type="checkbox"/> Lineman <p>HIGH SCHOOL</p> <ul style="list-style-type: none"> <input type="checkbox"/> Commercial <input type="checkbox"/> Good English <input type="checkbox"/> High School Subjects <input type="checkbox"/> Mathematics | <p>LEADERSHIP</p> <ul style="list-style-type: none"> <input type="checkbox"/> Foremanship <input type="checkbox"/> Industrial Supervision <input type="checkbox"/> Leadership and Organization <input type="checkbox"/> Personnel-Labor Relations <p>MECHANICAL AND SHOP</p> <ul style="list-style-type: none"> <input type="checkbox"/> Gas—Electric Welding <input type="checkbox"/> Heat Treatment <input type="checkbox"/> Metallurgy <input type="checkbox"/> Industrial Engineering <input type="checkbox"/> Industrial Instrumentation <input type="checkbox"/> Industrial Supervision <input type="checkbox"/> Machine Design—Drafting <input type="checkbox"/> Machine Shop Inspection <input type="checkbox"/> Machine Shop Practice <input type="checkbox"/> Mechanical Engineering <input type="checkbox"/> Quality Control <input type="checkbox"/> Reading Shop Blueprints <input type="checkbox"/> Refrigeration <input type="checkbox"/> Sheet Metal Worker <input type="checkbox"/> Tool Design <input type="checkbox"/> Toolmaking <p>RADIO, TELEVISION</p> <ul style="list-style-type: none"> <input type="checkbox"/> Electronics <input type="checkbox"/> Practical Radio—TV Eng'ng <input type="checkbox"/> Radio and TV Servicing <input type="checkbox"/> Radio Operating <input type="checkbox"/> Television—Technician | <p>RAILROAD</p> <ul style="list-style-type: none"> <input type="checkbox"/> Air Brakes <input type="checkbox"/> Car Inspector <input type="checkbox"/> Diesel Locomotive <input type="checkbox"/> Locomotive Engineer <input type="checkbox"/> Section Foreman <p>STEAM AND DIESEL POWER</p> <ul style="list-style-type: none"> <input type="checkbox"/> Combustion Engineering <input type="checkbox"/> Diesel—Elec. <input type="checkbox"/> Diesel Eng's <input type="checkbox"/> Electric Light and Power <input type="checkbox"/> Stationary Fireman <input type="checkbox"/> Stationary Steam Engineering <p>TEXTILE</p> <ul style="list-style-type: none"> <input type="checkbox"/> Carding and Spinning <input type="checkbox"/> Cotton, Rayon, Woolen Mfg. <input type="checkbox"/> Finishing and Dyeing <input type="checkbox"/> Loom Fixing <input type="checkbox"/> Textile Designing <input type="checkbox"/> Textile Eng'g <input type="checkbox"/> Throwing <input type="checkbox"/> Warping and Weaving <p>MISCELLANEOUS</p> <ul style="list-style-type: none"> <input type="checkbox"/> Domestic Refrigeration <input type="checkbox"/> Marine Engineering <input type="checkbox"/> Ocean Navigation <input type="checkbox"/> Shipfitting <input type="checkbox"/> Short Story Writing <input type="checkbox"/> Telephony |
|---|--|---|--|--|

Name _____ Age _____ Home Address _____

City _____ Zone _____ State _____ Working Hours _____ A.M. to P.M. _____

Occupation _____ Canadian residents send coupon to International Correspondence Schools, Canadian, Ltd., Montreal, Canada. . . . Special tuition rates to members of the U. S. Armed Forces.

WHAT SECRET POWER DID THIS MAN POSSESS?



BENJAMIN FRANKLIN
(A Rosicrucian)

WHY was this man great? How does anyone—man or woman—achieve greatness? Is it not by mastery of the powers within ourselves? Know the mysterious world within you! Attune yourself to the wisdom of the ages! Grasp the inner power of your mind! Learn the secrets of a full and peaceful life!

Benjamin Franklin—like many other learned and great men and women—was a Rosicrucian. The Rosicrucians (NOT a religious organization) first came to America in 1694. Today, headquarters of the Rosicrucians send over seven million pieces of mail annually to all parts of the world. Write for YOUR FREE COPY of "The Mastery of Life"—TODAY. No obligation. No salesmen. A non-profit organization. Address: Scribe H.V.X.

**THIS BOOK
FREE!**



The ROSICRUCIANS
SAN JOSE • (AMORC) • CALIFORNIA

—SEND THIS COUPON—

Scribe H.V.X.
The ROSICRUCIANS (AMORC)
San Jose, California
Please send me the free book, *The Mastery of Life*, which explains how I may learn to use my faculties and powers of mind.

Name _____

Address _____

City _____

(Continued from page 8)

he hunted up the superintendent of the tower—a French government employee—who told him the Germans had tried three times to install such a cable and had failed each time. They had first carried a reel of cable to the top of the tower, installed massive brakes and had started to unreel the cable and let it down from the top. On two tries the cable pulled itself apart from its own weight before it was halfway down. Then they set up a reel on the ground at the foot of the tower and tried to hoist the free end of the cable with hoisting tackle; again the cable was pulled in two. Here the Germans gave up.

The American captain accomplished his purpose, however, in a simple, common sense and speedy way. He had several hundred galvanized-iron clamps made by a near-by machine shop; put a reel of cable on the tower elevator and, taking the elevator up about two or three feet at a time, clamped the cable to the tower frame every two or three feet on the way up; a completely professional way of accomplishing his mission.

Carroll O. Bickelhaupt,
Washington Depot, Conn.

Serious Homework

It will not surprise us if David Bay Chalmers, Jr., of Oklahoma City, turns out to be a mechanical genius. When most of his



chums were taking their midday siesta, David was applying himself seriously to the study of his favorite magazine. Certainly, at seven months, he can claim to be one of our youngest readers.

You Practice **SERVICING** with Kits I Send You

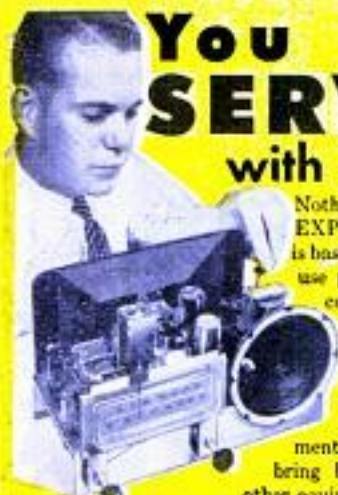

Nothing takes the place of PRACTICAL EXPERIENCE. That's why NRI training is based on LEARNING BY DOING. You use parts I send to build many circuits common to Radio and Television. With my Servicing Course you build the modern Radio shown at left. You build a Multitester and use it to help make \$10, \$15 a week fixing sets in spare time while training. All equipment is yours to keep. Coupon below will bring book of important facts. It shows other equipment you build.

You Practice **BROADCASTING** with Kits I Send You



As part of my Communications Course I send you parts to build low-power Broadcasting Transmitter at left. Use it to get practical experience. You put this station "on the air" . . . perform procedures demanded of broadcasting station operators. An FCC Commercial Operator's License can be your ticket to a bright future. My Communications Course trains you to get your license. Mail coupon. Book shows other equipment you build for practical experience.

I Will Train You at Home in Spare Time to be a **RADIO-TELEVISION** Technician



TELEVISION Making Jobs, Prosperity

25 million homes have Television sets now. Thousands more sold every week. Trained men needed to make, install, service TV sets. About 200 television stations on the air. Hundreds more being built. Good job opportunities here for qualified technicians, operators, etc.



J. E. SMITH, President
National Radio Institute
Washington, D. C.
Our 40th Year

America's Fast Growing Industry Offers You Good Pay, Success

Training PLUS opportunity is the PERFECT COMBINATION for job security, advancement. When times are good, the trained man makes the BETTER PAY, gets PROMOTED. When jobs are scarce, the trained man enjoys GREATER SECURITY. NRI training can help assure you and your family more of the better things of life. Radio is bigger than ever with over 3,000 broadcasting stations and more than 115 MILLION sets in use, and Television is moving ahead fast.

N.R.I. Training Leads to Good Jobs Like These

I TRAINED THESE MEN

"Am transmitter-studio operator at KPAT. Most important day of my life was when I enrolled with NRI."—Elmer Frewaldt, Madison, S. Dakota.

"Made my first \$100 from spare time work before I finished my course. Now I average better than \$10 a week, spare time."—Frank Rorer, Lorain, Ohio.

"I've come a long way in Radio and Television since graduating. Have my own business on Main Street."—Joe Travers, Asbury Park, New Jersey.

"I didn't know a thing about Radio. Now have a good job as Studio Engineer at KMMJ."—Bill Delsell, Central City, Nebraska.



BROADCASTING: Chief Technician, Chief Operator, Power Monitor, Recording Operator,

Remote Control Operator. **SERVICING:** Home and Auto Radios, Television Receivers, FM Radios, P. A. Systems. **IN RADIO PLANTS:** Design Assistant, Technician, Tester, Serviceman, Service Manager. **SHIP AND HARBOR RADIO:** Chief Operator, Radio-Telephone Operator. **GOVERNMENT RADIO:** Operator in Army, Navy, Marine Corps, Forestry Service Dispatcher, Airways Radio Operator. **AVIATION RADIO:** Transmitter Technician, Receiver Technician, Airport Transmitter Operator. **TELEVISION:** Pick-up Operator, Television Technician, Remote Control Operator.



Start Soon to Make \$10, \$15 a Week Extra Fixing Sets

My training is practical, complete; is backed by 40 years of success training men at home. My well-illustrated lessons give you basic principles you need and my skillfully developed kits of parts "bring to life" things you learn from the lessons. I start sending you special booklets that show you how to fix sets the day you enroll. Multitester you build with my parts helps you discover and correct set troubles, helps you make money fixing neighbors' sets in spare time while training. Many make \$10, \$15 a week extra this way.

Mail Coupon—Find Out What Radio-Television Offer You

Act now to get more of the good things of life. I send actual lesson to prove NRI home training is practical, thorough. My 64-page book "How to be a Success in Radio-Television" shows what my graduates are doing and earning. It gives important facts about your opportunities in Radio-Television. Take NRI training for as little as \$5 a month. Many graduates make more than the total cost of my training in two weeks. Mail coupon now to: J. E. SMITH, President, Dept. 4JA, National Radio Institute, Washington 9, D. C. Our 40th year.

AVAILABLE to all qualified VETERANS UNDER G. I. BILLS

Good for Both—FREE

MR. J. E. SMITH, President, Dept. 4JA
National Radio Institute, Washington 9, D. C.
Mail me Sample Lesson and 64-page Book, FREE.
(No salesman will call. Please write plainly.)

Name Age
Address
City Zone State

VETS write in date of discharge



Mail Today—Tested Way to Better Pay



PUZZLE:
Which Man Owns the **NEW PROTO**
Mechanics Standard Tool Set?

How would you like more leisure, easier work and more money? PROTO's new Mechanics Standard Tool Set No. 9908 can help you achieve them because it is designed to do your work faster and easier. To reduce your investment, tools with the greatest use are included. Their professional quality, user-tested designs, proper forging and heat-treating, and special alloy steels give you the best tool values ever. Start enjoying greater earnings and easier work. Buy the No. 9908 set from your PROTO dealer. Send 10¢ for 68-page catalog to

PLUMB TOOL COMPANY

2255V Santa Fe Ave., Los Angeles 54, Calif.

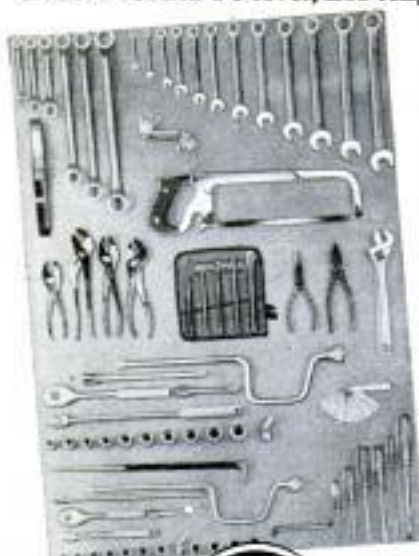

No. 9908

High-utility, 76-item set, containing socket sets, 4 types of wrenches, pliers, hacksaw, screwdrivers, punch and chisel set, gauge sets, bar, and carbon scraper. Also available with tool box as set No. 9909

5491



Eastern
Factory—
Jamestown,
N.Y.
Canadian
Factory—
London,
Ont.

WHERE-TO-BUY-IT INDEX

Source of supply appears after items commercially available

AUTOMOTIVE

Plastic car from Argentina.....138
Plastic sportster.....138
Propeller drives car.....138
Inflatable top.....139
Motorcycle canopy.....139
Three-wheel "family car".....139
Jet-age custom car.....145
Windshield has viewing slit.....148
Periscope built into car roof has 140-degree rear vision.....154
Tire-truing machine (Paul's Mfg. Co., 13 N. Western, Oklahoma City, Okla.).....250
Pooch is up to his neck in automobile.....256

AVIATION

Predict short design life for supersonic planes of the future.....154
Lights reflected in mirror aid landings on carrier.....155
Aircraft industry tops automotive.....238

CONSTRUCTION

"Pigs" root through pipe under pressure to remove corrosion.....159
Stone-restoration method "face lifts" old buildings (Nicholson & Galloway, Inc., 426-428 E. 110th St., New York City 29).....160

FARM

Tractor mounted on "stilts" is used to dust and detassel corn (Mechanical Farm Equip. Distr., Inc., P.O. Box 848, San Jose, Calif.).....121
Turn-on-a-dime tractor (Tucker Sno-Cat Corp., Medford, Ore.).....140
Generator on side of tractor produces electricity anywhere on farm (International Harvester, 180 N. Michigan Ave., Chicago 1).....154

HOUSE AND HOME

What's New for Your Home
Freezer for small apartments (Revco, Inc., Deerfield, Mich.).....130
Control switches (Fisher-Pierce Co., Inc., 71 Pearl St., So. Braintree, Boston 85, Mass.).....130
Rocker spring for crib (Jason Lee Industries, Masonic Bldg., Salem, Ore.).....130
Water purifier (Pro-Tech Corp., 1613 Burbank Blvd., Burbank, Calif.).....131
Air Cleaner (Raytheon Mfg. Co., Waltham 54, Mass.).....131
Dimmer replaces wall switch (Superior Electric Co., Bristol, Conn.).....131
Convertible bed (Castro Convertible Corp., Danbury, Conn.).....131
Weed killer aids soil (American Cyanamid Co., 30 Rockefeller Plaza, New York City 20).....137
White house is home for martins with presidential ambitions.....148

MISCELLANEOUS

Gas-cartridge tourniquet.....18
Liquid added to can of paint prevents formation of skin (Ames Laboratories, Inc., 132 Water St., So. Norwalk, Conn.).....121
Motion of boat operates automatic bailer (Brinktum, Inc., 2502 N. 2nd St., Minneapolis, Minn.).....121
Floating mower cuts canal weeds.....127
Silage blower vacuums golf greens covered with layer of silt.....127
Photographic "north light" uses 140 automobile headlight bulbs (Natural Lighting Corp., 612 W. Elk, Glendale, Calif.).....132
Bag protects camera for underwater shots.....137
Small electroplating tool (Frank Best & Co., Inc., 9 Rockefeller Plaza, New York City 20).....148
Homemade shaping tools put inventor in business (Perrine Products, Box 27, Lawrenceburg, Ind.).....149
Amphibious boat.....155
Logs "shoot the chute" to bypass high dam.....160
Shingle repels water (Kearbey & Mathison Co., Ambler, Pa.).....230
Curled strips bind notebook.....236
TV aids elevator starter.....236

SCIENCE

Electric wind tunnel speeds tests of airplane wings.....120
Surveyors who pin-point land areas have a "flare" for their jobs.....120
Lifeboat engine runs under water (Norse Electric Mfg. Co., Inc., 35 Water, New York City).....127
Trailers packed with radios aid civil defense in Los Angeles.....132
12-ton window stops atomic rays.....137
Inflated plastic suit shields worker in atomic laboratory.....145
Robot watchman protects pump engines at untended oil wells.....145
Extend col life.....236

Radio-Television, Electronics

TV "service saver" (Raytheon Mfg. Co., 5921 W. Dickens Ave., Chicago 39).....161
Color TV receiver (Motorola, Inc., 4545 W. Augusta Blvd., Chicago 51).....161
Decorator sleeves for TV receiver (Raytheon Mfg. Co., 5921 W. Dickens Ave., Chicago 39).....161

(Continued to page 14)

INVENTORS

Learn how to protect your invention. The U. S. Patent Laws provide that any new and useful art, machine, article of manufacture, or composition of matter, or any new and useful improvement thereof, may be patented if the act of invention is involved. Therefore, every inventor with a valuable invention should take advantage of the Patent Laws and proceed for patent protection in order to safeguard his rights.

A patent gives the inventor the exclusive right to prevent others from making, using, or selling the invention claimed in the patent for a period of seventeen years.

The Patent Laws were enacted for the benefit of the inventor to give him protection for the features of his invention which are patentable. These features must be properly and concisely set forth and claimed in a formal application for patent, in order to comply with the requirements of the Patent Laws. For that reason, unless the inventor is familiar with patent matters, he should engage a competent registered patent attorney or agent to represent him. We are registered to practice before the U. S. Patent Office and are prepared to serve you in the handling of your patent matters.

A specially prepared booklet entitled "Patent Guide for the Inventor", containing detailed information with respect to patent protection and procedure, together with a "Record of Invention" form will be promptly forwarded to you without obligation upon request.

CLARENCE A. O'BRIEN & HARVEY JACOBSON

Registered Patent Attorneys

41-J DISTRICT NATIONAL BUILDING

WASHINGTON 5, D. C.

Build a Fine **BIG MONEY**



Jacket and Shoe Business!

TOP MEN
MAKE
\$5 to \$10
AN HOUR
YOU DON'T
INVEST
A CENT
SALES OUTFIT
FREE!

REAL SHEEPSKIN LINING! DOUBLE PROFITS WITH SPECIAL 2-IN-1 COMBINATION SALES!

Start a big money business without investing a cent! Make up to \$84 extra a week on just 3 sales a day in spare time—much more for full time! Take orders for fast-selling leather jackets and popular Velvet-eex Air-Cushioned shoes that are Nationally-famous for special comfort features. Make two sales at one time by showing these special combinations: **rugged jacket of Horsehide leather lined with wooly fleece**, and to match: **top quality work shoes also lined with real Sheepskin**. Show such extra features as Air-Cushion innersoles that let you "walk on air"—Neoprene oil-resisting soles. Think of all the people in town who will buy these from you!

NOT SOLD IN STORES—Our shoes and jackets are not sold in stores. People must buy from YOU. Start by selling to friends, relatives, people where you work. Outdoor workers around home will stuff your pockets with cash. Complete line includes jackets of Horsehide leather, fine Capeskin leather, soft Suede, take orders for Nylon, Gabardine, Wool jackets, raincoats, too! Special features include fleece, quilted, rayon linings—non-scuff leathers—fur collars. And look at the "shoe store" business you'll have! You offer 160 different styles for men, women; dress, sport, work shoes. **You actually feature more shoes in a greater range of widths and sizes than any store in your town!** No need to substitute—customers get the exact style, size, width they order. No wonder ambitious men earn up to \$200 and more EXTRA cash a month! **\$20,000 EXTRA in Prizes!** Do a good job this year (our 50th), win exciting Bonus gifts: Florida Trip, Tappan Range, Diamond Rings, many more! Even beginners win! So start now. Send coupon today! I'll rush your powerful Free Selling Outfit with everything you need to start making BIG MONEY the first hour! **MASON SHOE MFG. CO., Dept. MA 364, Chippewa Falls, Wis.**

Send for FREE Outfit!

MR. NED MASON, Dept. MA 364
MASON SHOE MFG. CO., Chippewa Falls, Wis.

You bet I want to build a fine BIG MONEY Jacket and Shoe Business! Please rush my Free Selling Outfit so I can start earning cash profits from the first hour! Also send details on how I can win Valuable Bonus Prizes!

NAME.....
ADDRESS.....
TOWN..... STATE.....

(Continued from page 12)

TV color cameras for local programming (RCA Victor, Camden, N. J.).....	161
How to transmit phono music on a light beam.....	162
Quick-Set elevator tripod (Quick-Set, Inc., 8121 Central Park Ave., Skokie, Ill.).....	163

Craftsman and Shop Notes Index

AUTOMOTIVE

Build your own rear-window defroster.....	181
Fuse clips hold air gauge on barrel of tire pump.....	212
Adjusting car horn noiselessly.....	216

FARM

Extension perch removes fowl from trees on open range.....	209
Portable hog-ringing crate has adjustable stanchions.....	209
Piston welded in cylinder aids removing sleeve.....	212
Poultry-yard water supply furnished by steel drum.....	212
Barbed wire wrapped on posts keeps cattle away from cable.....	216
Posts easily pulled by chain wrapped around tractor tire.....	216
Altered tractor-gearshift lever more easily reached.....	216

HOUSE AND HOME

Small barrel provides rack for storing garden hose.....	172
Picture or mirror conceals television set in living-room wall.....	175
New faces for old doors.....	176
Door framed in scrolled garland brightens drab entrance.....	177
Rubber hose protects shins against bruising on ladder.....	180
Rubber pad keeps pastry board in place on counter top.....	180
Coin caddy for door.....	184
Freeze paint roller between jobs.....	190
Protector for backyard light made from gallon can.....	190
Valve turned with rubber grip.....	190
Tongue-and-groove cabinet doors.....	202
Solving Home Problems—	
Portable drying rack.....	178
Sparkling silver nut cups for party.....	178
Rubber gloves will have longer life.....	178
Level a wobbly chair.....	179
The problem of clothesline props that slip.....	179
Window shade without pull string.....	179
A handy mop.....	179
Hand discomfort caused by string handles.....	179

MISCELLANEOUS

Bank made from plaster figure by cutting slot in top.....	172
Blackboard on bins and shelves keeps stock up-to-date.....	172
Tire irons lashed to long pole retrieve knife from lake.....	180
Volume of irregular object measured by water displacement.....	180
Portable bookcase doubles as shipping box.....	185
Suction cups provide vanishing points for perspective drawing.....	212

PHOTOGRAPHY

Curled photographs flattened between curved blocks.....	177
Locking reflectors to stands.....	184
Wetting agent flattens and cleans curled photo negatives.....	184
Filaments of flash bulbs tested with dry cell and earphones.....	185
Electric "hot plate" warms photo developer.....	191
Photo-solution trays warmed by strip-type heaters.....	192
Cause of scratched film removed by polishing camera interior.....	194
Tap used as screw extractor when no tool is available.....	184
Template with dowel "comb" eases job of cutting hedge.....	190
Arrow on valve handle helps adjust blower.....	192
Modified combination-type drill used for roundheaded screws.....	194
"V-block" for large work.....	212
Round-pin "dovetails" made with cutter.....	214
Shopping for Tools—	

Drill extension (Pitman Corp., 183 New York Ave., Huntington, N. Y.).....	218
Portable bandsaw (Porter-Cable Machine Co., Syracuse 8, N. Y.).....	218
Paint Mixer (Conn and Co., 11 S. Madison St., Warner, Pa.).....	218
Portable-saw guide (Radial See-Saw, 4140 Syracuse, Dearborn, Mich.).....	218
Center-punch duplicator (Hemiga Tool Co., P. O. Box 656, Terre Haute, Ind.).....	219
Miniature Torque wrench (P. A. Sturtevant Co., Addison, Ill.).....	219
T-handled screwdriver (J. & L. Tool Co., P. O. Box 82, Three Rivers, Mich.).....	219
Hardness tester (Kurt Orban Co., Inc., 205 E. 42nd St., New York City 17).....	219
Metal-cutting bandsaw (Tester Mfg. Co., Iron River, Wis.).....	219
Cushioned file holders (Milwaukee File Co., Milwaukee 4, Wis.).....	220
Welder's turntable (Superior Welding Co., 3416 E. 14th St., Los Angeles 23).....	220
Fuse puller (Star Fuse Co., Inc., 235 Canal St., New York City 13).....	220
Nail driver (Safety Nail Driver Corp., 70 Rosalie Ave., Clifton, N. Y.).....	220
Leather-lacing cutter (Carvir Co., 322 31st St., Hermosa Beach, Calif.).....	220

(Continued to page 16)

IMPORTANT NOTICE—It is the intention of this magazine to provide its readers with information regarding the latest developments in the mechanical arts. We take no responsibility as to whether the disclosures contained in our articles are covered by patents and advise readers to investigate this subject before making, using, or selling any of the products, machines, or processes described in order to avoid possible liability for patent infringements.

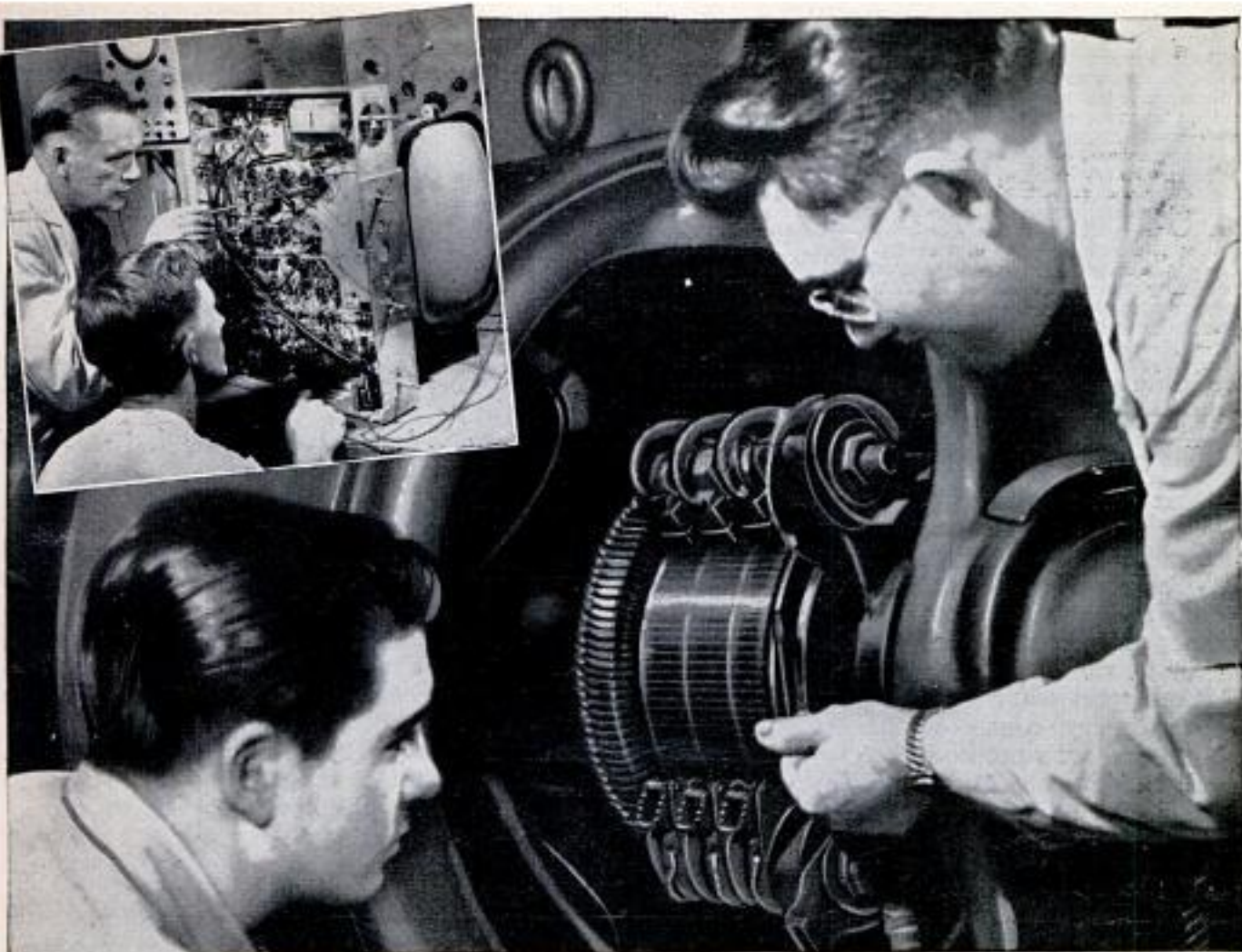

TRAIN FOR A FUTURE IN Electricity or Television-Radio

IT'S THE ACTUAL SHOP TRAINING AT
COYNE THAT MAKES THE DIFFERENCE!

Prepare quickly at Coyne for a career with a future!
Trained men are vitally needed now whether 17 or up to 45. Get a better rating, if drafted—an essential job in industry, if not in A FIELD THAT OFFERS A REAL FUTURE.

**APPROVED
FOR
VETERANS**

Mail Coupon
Today for
**BIG FREE
BOOK**



Check whether interested in
ELECTRICITY or TELEVISION-
RADIO or both.

WE TRAIN YOU IN CHICAGO
Learn the easier, practical way at Coyne, on real, full size equipment. No advanced education or previous experience needed. You learn better the Coyne way.

Train in the shops of Coyne—where thousands of successful men have trained for over 55 years—Coyne is the largest, oldest, best equipped school of its kind—established in Chicago in 1899.

FINANCE PLAN Enroll now. You may pay most of tuition later. We have a special plan for men of draft age.

CLIP COUPON NOW for big new illustrated Coyne book. No obligation; no salesman will call. Get vital facts now!

B. W. COOKE, President
COYNE ELECTRICAL SCHOOL
500 S. Paulina St., Chicago 12, Ill., Dept. 64-72H

Send **BIG FREE** book and details of your training offer. This does not obligate me and no salesman will call. I am interested in:

ELECTRICITY TELEVISION-RADIO

Name.....

Address.....

City..... State.....

B.W. COOKE President **COYNE** FOUNDED 1899
ELECTRICAL SCHOOL
A TECHNICAL TRADE INSTITUTE CHARTERED NOT FOR PROFIT
500 S. PAULINA, CHICAGO, Dept. 64-72H
ELECTRICITY ★ RADIO ★ TELEVISION ★ REFRIGERATION ★ ELECTRONICS

(Continued from page 14)

WORKSHOP HINTS

Belt-clip prevents misplacing of measuring tape.....	172
Wedge assures tight joint when regluing chair leg.....	172
Fishing spear has barbs forged from carriage bolts.....	175
Rubber brush for soldering acid made in a few moments.....	175
Emergency reflector for light made from large funnel.....	177
Salvaging clogged sander belts.....	177
Oak strips on folding table lock legs in place.....	184
Nail set used at right angles prevents damage to flooring.....	190
Plastic sheet under tissue roll permits it to turn easily.....	192
Pull-out trash bin under bench easily removed for emptying.....	192
Ammonia helps remove tip of soldering iron.....	193
Turned cigarette box has monogrammed lid.....	193
Step ladder provides sawhorse.....	194
Spring tension holds chocks against casters on power tool.....	209
Drop-front cabinet for parts storage.....	213
Spring clamp wired to cord prevents pulling plug.....	216
Blower fan on router bit keeps work cleaned.....	217
Spring clamps used in shop to hold small gluing jobs.....	217

Hot Problem in Atomic Energy

How can we safely dispose of the waste fission products of atomic energy? This is one of the knottiest problems facing atomic physicists today. W. A. Roger of Argonne National Laboratory estimates that by the end of this century there will be about three tons of "hot" waste to be disposed of each day. Diluted with water, this amount would soon poison every ocean in the world. Rogers points out that methods are under development to concentrate the wastes into solids in a form suitable for burial. The problem here is to prevent water from leaching them out and menacing the earth for decades to come. It may be possible, he says, to deposit the

wastes on clay or glass-forming materials and vitrify them so they won't be affected by water. They then might be buried in pyramids or radio-active "tombs" in remote areas.

Gas-Cartridge Tourniquet

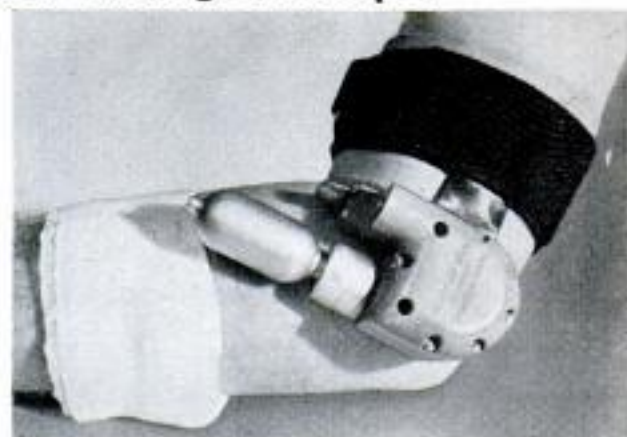

Bleeding from wounds is instantly slowed with a tourniquet equipped with a carbon-dioxide-gas cartridge. Turning the case of the cartridge releases gas to inflate the tourniquet and exert the proper pressure on blood vessels and veins without injury to cell tissue. The tourniquet, which weighs 15 ounces, can be self-applied between the wound and the heart. Pressure can be released and reapplied if necessary.

NEW GREASELESS WAY TO KEEP YOUR HAIR NEAT ALL DAY



New Vitalis with V-7 makes even dry, unruly hair easy to manage

V-7, the *greaseless* grooming discovery now in Vitalis, outdates messy oils. Keeps your hair neat, yet you never have an over-slick, plastered-down look.

Vitalis gives extraordinary protection against "summer dryness"—dull, brittle hair, parched scalp. Also, it maintains hair's natural moisture balance better than any other leading tonic.

VITALIS®
HAIR TONIC
WITH V-7



TV announcer Joel Aldred protects his hair from "summer dryness" with *greaseless* Vitalis.

PRODUCT OF BRISTOL-MYERS

INVENTORS

If you believe that you have an invention, you should find out how to protect it. The first step is to have a search made of the prior pertinent U. S. patents. If a report on this search indicates that the invention appears patentable you can apply for a patent, and the specifications and claims should be prepared.

The firm of McMorrow, Berman & Davidson, with offices in Washington, D. C., is qualified to take the necessary steps for you. We can make a preliminary search on your invention, advise you whether we think it can be patented, and prepare your application for patent.

Unless you are fully familiar with the U. S. Patent Laws, we recommend that you engage the services of a Registered Patent Attorney to protect your interests. The patent laws are *your* laws. A patent gives you the right to prevent others from making, using or selling the invention claimed in your patent for a period of 17 years.

Use these patent laws for your protection. Investigate whether your invention can be patented. If you have what you believe to be an invention, we suggest that you have this firm make a search for you.

Send for a copy of our Patent Booklet entitled "How To Protect Your Invention," containing information about patent protection and patent procedure. Along with this we will also send you an "Invention Record" form, for your use in writing down and sketching details of your invention. We will mail them promptly. No obligation. They are yours for the asking.

McMORROW, BERMAN & DAVIDSON

Registered Patent Attorneys

PATENTS

• **COPYRIGHTS**

• **PATENTS**

1356 VICTOR BUILDING, WASHINGTON 1, D. C.

Genuine DIAMONDS Direct from N. Y. Leading Pawnbroker



In Latest Style Mountings From \$25 to \$5,000 Remarkable Savings

Diamonds never get old! Kaskel's, New York's leading pawnbroker since 1882, have originated a novel plan for you to enjoy great savings on diamonds reset in brand new 14 Kt. gold or platinum mountings. Kaskel's plan is simple. They fine-comb the many outlets where diamonds can be secured at much lower than regular wholesale prices. These markets uncover first grade diamonds at amazingly low bargain prices. Kaskel's resets them into beautiful diamond rings, diamond bracelets, diamond pins, diamond earrings, diamond watches . . . AND . . . Kaskel's grades them for you according to nationally accepted standards. These unusual beauties are yours for a fraction of the usual market cost. You take no risk. You are 100% protected by a written band and a money back guarantee. You can see your selection before you buy. Any size genuine diamond can be yours on a pay as you like lay-away plan. There are no extra charges. Kaskel even pays the excise tax.

FREE BIG CATALOG Diamond Advice FREE!

Send today for the big illustrated catalog just off the press. It illustrates many wonderful diamond bargains. All in most fashionable, up to the minute mountings, of 14 Kt. gold or platinum. You also get important advice about diamonds that is in itself a diamond buying safe-guard and education. Send coupon below for your copy today and learn all the facts which includes Kaskel's special pay as you like lay-away plan. There's no obligation. SEND COUPON TODAY.

References: Dun & Bradstreet, Jewelers Board of Trade, or your own bank.

KASKEL'S, Dept. 407-J (Diamond
41 West 57th St. Specialists
New York 19, New York since 1882)
Send FREE CATALOG and advice about DIAMONDS
without obligation.

Name _____
Address _____
City _____ State _____



BRAND NEW! Firestone TIRES

**SAVE
UP TO 50%**

SEND FOR FREE CATALOG

BRAND NEW—FIRST QUALITY—HEAVY DUTY
FIRST QUALITY—SENSATIONAL VALUES

TRUCK TIRES		PASSENGER TIRES	
Size	Full Price	Size	Full Price
700x15 6 ply	25.79	750x20 10 ply	50.42
600x16 6 ply	17.78	825x20 10 ply	58.50
650x16 6 ply	21.58	825x20 12 ply	69.73
700x17 6 ply	30.75	900x20 10 ply	70.55
600x20 6 ply	24.31	900x20 12 ply	83.84
650x20 8 ply	31.47	1000x20 12 ply	89.27
700x20 8 ply	35.45	1100x20 12 ply	104.78
700x20 10 ply	42.48	1000x22 12 ply	94.08
750x20 8 ply	45.15	1100x22 12 ply	110.75
		1100x24 12 ply	115.40

BRAND NEW—FIRST QUALITY
FIRESTONE PASSENGER TIRES

All Tires Carry Famous Firestone Unconditional Guarantee	BLACK WALL TIRES 4 PLY FULL PRICE
	640 x 15 11.82
	650 x 15 14.29
	670 x 15 12.50
	710 x 15 13.88
	760 x 15 15.12
	800 x 16 11.12
	850 x 16 14.73

SPECIAL! BRAND NEW WHITEWALL TIRES (Factory Blomish)
First Line 4 ply Pass. 670 x 15 15.24
710 x 15 16.83
760 x 15 18.41
800 x 15 20.23
820 x 15 21.04

SUPER SPECIAL!
1st. Qual. Armstrong 670 x 15 11.91

(Order by Mail—Send check or M.O.) • (all prices f.o.b. plant)
Farmers—Full line of tractor tires—Write for Prices

S&S TIRE CO. 1400 HADDON AVE.
CAMDEN 3, N. J.

How to Hold FALSE TEETH More Firmly in Place

Do your false teeth annoy and embarrass by slipping, dropping or wobbling when you eat, laugh or talk? Just sprinkle a little **FASTEETH** on your plates. This **alkaline** (non-acid) powder holds false teeth more firmly and more comfortably. No gummy, gooey, pasty taste or feeling. Does not sour. Checks "plate odor" (denture breath). Get **FASTEETH** today at any drug counter.

Write Like This

YOUR penmanship can be improved in 3 hours or corrected to your satisfaction in 10 hours' practice with my **DEFINITE HAND CONTROLS**. New way!

WRITE **OZMENT** BOX 605
34-N, ST. LOUIS, MISSOURI

**Complete
OUTLINE
FREE!**



GROW MINIATURE TREES

Grow authentic, LIVE dwarf trees!
Fascinating hobby! Fabulous profit!

SEND FOR FREE SEED & INSTRUCTIONS!

MINIATURE NURSERY CLUB
Dept. J-9, Box 8794,
Los Angeles 8, Calif.

MAKE EXTRA MONEY

LEARN HOW TO MAKE fast-selling PLASTIC NOVELTIES FURNITURE JEWELRY SIGNS TOYS LAMPS

PLASTICS

LEARN AT HOME

There are RICH OPPORTUNITIES for MEN and WOMEN with "know-how" in Plastics. Interstate's new Plastics course tells and shows how to make hundreds of fast selling items out of Plastics. Gives complete training in fabrication, casting, lamination, molding, internal carving, etc., in simple, easy, step-by-step language and pictures. Plastics and Fabricating Kits for 23 valuable Plastic items come with training at no extra cost. **START A PLASTICS BUSINESS OF YOUR OWN.** No other industry holds such promise for the future. You can make big money manufacturing novelties, toys, signs, etc., in your own home in spare or full time. Don't wait! Learn NOW how Interstate's Plastics Training qualifies you for success in the Plastics field.

PLASTICS AND SUPPLIES FURNISHED FOR 23 VALUABLE PROJECTS

INTERSTATE TRAINING SERVICE
Dept. C-3-J Portland 13, Oregon

All Electronic Parts
YOURS TO KEEP!

Now!
Work over
300
practical projects
WITH THESE
PARTS...



MULTIMETER



.... TO
HELP YOU LEARN

TELEVISION

RADIO-ELECTRONICS Now... at home in spare time you can get BOTH the very training and subsequent Employment Service you need to help you start earning real money in America's thrilling, multi-billion dollar opportunity field of Television-Radio-Electronics. Now that Television is coming to almost every community, here is a chance of a lifetime to prepare to cash in on one of Television's great expansions.

D.T.I.'s amazingly practical home method enables you to set up your own HOME LABORATORY. You get many Electronic parts which you mount on individual bases with spring clip connectors. Taps for experimenting! Add or remove parts in a jiffy. No wasted hours of soldering and unsoldering for each project. You spend minimum time to get maximum knowledge of important circuits that really work. In fact, you get exactly the same type of basic training equipment used in our Chicago training laboratory—one of the nation's finest.

Build and KEEP This VALUABLE TEST EQUIPMENT

Your home laboratory projects also include building and keeping a versatile 5 inch Oscilloscope and precision Jewel Bearing Multi-Meter. These quality commercial test instruments help you EARN WHILE YOU LEARN and will prove mighty valuable, should you later decide to start your own full time TV-Radio service business. You also build and keep a quality 21 inch TV SET.

D.T.I. Provides EVERYTHING YOU NEED to master TELEVISION

In addition to your home laboratory and easy-to-read lessons, you even use HOME MOVIES—a wonderfully effective and exclusive D.T.I. training advantage. You watch hidden actions... see electrons on the march. Important fundamentals... become "movie clear," helping you learn faster... easier... better. Full time Residential training in D.T.I.'s great Chicago laboratories also available. MAIL COUPON TODAY for all facts. (If subject to Military Service, you'll especially welcome the information we have for you.)

D.T.I.'s Training is available in Canada



89 WAYS TO EARN MONEY

MAIL COUPON TODAY!

21 INCH

Build and keep this BIG DTI Engineered TV set—easily converted to U.H.F. (DTI offers another home training, but without the TV set.)

"ONE OF AMERICA'S FOREMOST TELEVISION TRAINING CENTERS"



DeVRY TECHNICAL INSTITUTE

AFFILIATED WITH
DeFOREST'S TRAINING, INC.
CHICAGO 41, ILLINOIS

DeVRY TECHNICAL INSTITUTE
4141 BELMONT AVE., CHICAGO 41, ILL.

Dept. PM-9-II

I would like your valuable information-packed publication showing how I can get started toward a good job or my own business in Television-Radio-Electronics.

Name _____ Age _____

Street _____ Apt. _____

City _____ Zone _____ State _____

DRAFTSMEN



**CASH BIG
PAY CHECKS!**

**Train Now for
more success,
greater security**

**LEARN AT HOME IN SPARE TIME
(or at college in Chicago)**

Check the want ads in any newspaper—SEE the big-pay opportunities open to you as a draftsman. What's more, you can learn this well-paid, prestige profession at home—quickly, easily! No special talent needed. Get complete, step-by-step Chicago Tech lessons in the mail, spend a few pleasant hours studying each week. In a short time you'll be a well-trained draftsman, ready to take your pick of many good jobs. Act now!



Free Information—Mail Coupon Today!

Get **FREE TRIAL LESSON** plus information about C.T.C. practical training. Learn what successful Chicago Tech graduates say about high pay and opportunities in drafting. No charge, or obligation.

CHICAGO TECHNICAL COLLEGE

M-252 Tech Bldg., 2000 So. Michigan Ave.
Chicago 16, Illinois

Mail me **FREE** lesson with facts about big opportunities in **DRAFTING**.

Name _____ Age _____

Address _____

City _____ Zone _____ State _____

**LOOK BETTER!
FEEL BETTER!**

USE A
Vibrosage
ELECTRIC MASSAGER

- Professional-Type
- 4 Scientifically Designed Applicators
- Sanitary

A few minutes daily use of **VIBROSAGE** gives that stimulating, healthful aid to circulation... relief from aches and pains. Four applicators assure maximum effectiveness for scalp, face and body. Operates on 110 volt, 60 cycle A.C. **Five day trial—money-back guarantee!** If your dealer cannot supply you, send \$8.50 check or money order, for pre-paid shipment. Or, send \$2; pay postman balance plus postage and C.O.D. charges.

BEAUTY APPLIANCE CORP., Dept. V524-J, RACINE, WIS.

"YOU ARE UNDER ARREST!"



There's a Thrill in Bringing a Crook to Justice Through Scientific

CRIME DETECTION!

We have taught thousands this exciting, profitable, pleasant profession. Let us teach you, too, in your own home. Learn Finger Printing, Fire Arms Identification, Police Photography and Criminal Investigation thoroughly, quickly and at small cost.

Over 800 of All American Bureaus of Identification employ students or graduates of I. A. S. You, too, can fit yourself to fill a responsible crime detection job with good pay and steady employment. But don't delay—get the details now. Let us show you how easily and completely we can prepare you for this fascinating work, during spare time, in your own home. Write today stating age.

**Be A
FINGER
PRINT
Expert**

FREE!!!
Send for Thrilling
"BLUE BOOK
OF CRIME"

INSTITUTE OF APPLIED SCIENCE

(A Correspondence School Since 1916)

1920 Sunnyside Ave., Dept. 1356, Chicago 40, Ill.

SHINE WITHOUT 'POLISH'

New Invention! • Sells Like Wild



Replaces messy pastes, liquids. Simply glide over shoes—and presto! —you have a lustrous, long-lasting shine. No mess, no fuss. Shoes gleam like mirrors. For Men's, Women's, Children's Shoes. Take orders! Earn money!

SAMPLES FOR TRIAL

Sample offer sent to all who send name at once. Postcard will do. **SEND NO MONEY—just your name.** KRISTEE CO., Dept. 676, AKRON 8, OHIO



send for
**FREE
BOOKLET**

LEARN LOCKSMITHING

Learn this fascinating, profitable trade from experts in your spare time at home! Age or physical handicap no disadvantage. Year around, steady income. Full or part time. Practical, illustrated lessons. You can make money even while learning! All materials and special tools supplied without extra charge.

INSTITUTE OF LOCKSMITHING, Dept. P-58
15 PARK AVENUE RUTHERFORD, N. J.
Lic. by N.J. State Board of Education
Approved for Veterans



MECHANICAL DENTISTRY

A profession offering unlimited opportunities. Most modern and complete course embracing every branch from Plate to Porcelain Work, which prepares you to work for Dentists or start your own business. Individual instruction—practical training in day or night school. No books—no classes. Catalog upon request.

McCARRIE SCHOOL OF MECHANICAL DENTISTRY
207 N. Broad Street Dept. 33 Philadelphia 7, Penna.

BECOME AN EXPERT IN TRAFFIC

Traffic men earn \$4,000 to \$10,000 and up. Thousands of firms need experts on rules, tariffs, regulations. We train you thoroughly in spare time at home for executive traffic jobs. Personal training under traffic authorities. Placement counsel and help. Write for free 68-page book "Traffic Management—the Fast Growing Profession."

LASALLE Extension University, 417 So. Dearborn St.
A Correspondence Institution Dept. 964T Chicago 5, Ill.



EXTRA MONEY
Selling **EXCLUSIVE
PARAGON Cushion Shoes**

Even If Now Employed

Enjoy your own lifetime, secure, independent shoe business—without investment. Steady demand and repeats. Up to \$4.00 pair advance commissions. Big bonus. Latest smart styles, top quality, heel-to-toe cushion. Complete line. It's easy to start. Write for **FREE OUTFIT** today!

Happy
No. 537
Brown Calf
Leather Lined

PARAGON SHOE COMPANY
79 Sudbury St., Dept. 20, Boston 14, Mass.

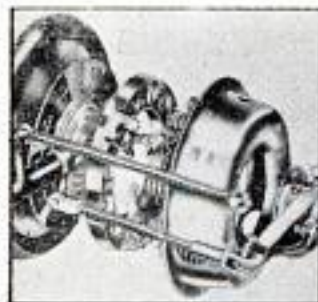

2950 photos and diagrams, plus crystal-clear directions, make every operation easy as A-B-C.

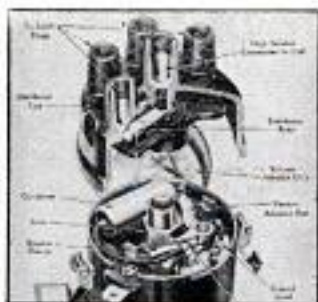

Diagrams, tables and text take the "mystery" out of all ignition systems.

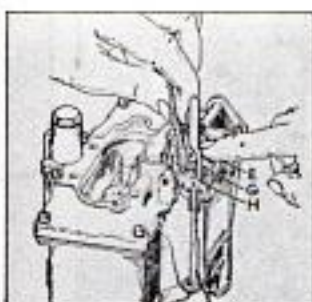

You get illustrated repair procedures for all types of carburetors.

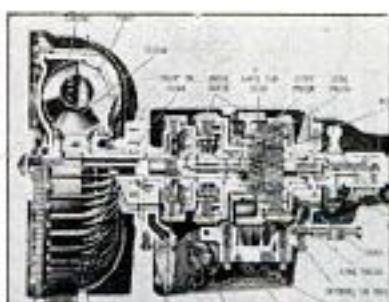

ALL AUTOMATIC TRANSMISSIONS are fully covered in special big section. (NOTE: All pictures shown here are greatly reduced in size. Actually, this giant book is almost a foot high!)

Here's the EASY Step-by-Step Way to FIX ANY CAR IN A JIFFY!



Fuel pumps can cause trouble. Pictures show exactly how to take them apart, fix them.

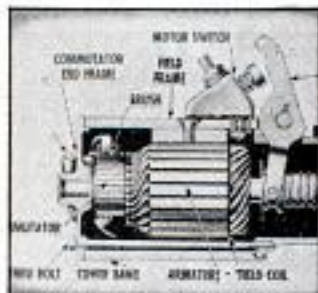

No guesswork. Clear pictures show how to fix starting motor, generator, brakes, chokes, etc.

Just 2 of the Many Letters of Praise
Does Every Job. "My MOTOR Manual is a wonderful help. It has put me in a position to do every job." — S. L. Sharpless, Los Angeles, Calif.
Amazed Self and Friends. "I amazed myself and my friends, too. Now do jobs that stumped me before." — Michael Baliccky, Newark, N. J.

Now—Whether You're a Beginner or Expert Mechanic—You Can "Lick" Any Repair Job On Any Car Built From 1940 Thru 1954

NOW you can tackle any repair job, and do it quickly, easily, right—the first time! MOTOR'S BRAND-NEW AUTO REPAIR MANUAL shows you how—with crystal-clear pictures and step-by-step directions you can easily follow.

No guesswork. This giant guide tells you where to start; what tools to use. Leads you easily and quickly through the entire operation. Covers everything from a simple carburetor adjustment to a complete overhaul.

Everything You Need to Know

BIG, NEW REVISED Edition has MORE REPAIR INFORMATION THAN EVER! ONE THOUSAND giant pages, 2,950 "This-Is-How" pictures—clear drawings, diagrams, cut-away photos—make every step EASY; Over 290 "Quick Check" charts—more than 22,500 essential repair specifications. Over 225,000 service and repair facts. Instructions and pictures so COMPLETE, so CLEAR—you CAN'T go wrong!

Even a green beginner can do a good job. If you're a top mechanic, you'll be amazed at the time-saving procedures.

The "Meat" of Over 140 Official Shop Manuals

The editors have put together the "Know-How" from over 140 Official Shop Manuals: "botted it down" into one handy indexed book.

- Includes ALL Automatic Transmissions (including new PowerFlite). Covers the newest Carburetors, Engines (including new Buick & Ford V-8s) ... Chokes ... Fuel Pumps ... Oil Filters ... Starting Motors ... Generators ... Distributors ... Clutches ... Universals

- ... Axles ... Brakes ... Power Steering ... Shock Absorbers, etc.

Factory Specifications and Adjustment Tables. Tune-up Charts. Tables of Measurements and Clearances. Overhauling and Replacement Facts—AND MUCH MORE.

Used by Armed Forces, hundreds of thousands of auto service men! YOU'LL want to try it, too—on the following UNCONDITIONAL GUARANTEE:

Try Book for a Week FREE

SEND NO MONEY. Pay nothing to postman. Test book in your own garage or shop. It's GUARANTEED to pay for itself in 7 days. If it doesn't just return the book, and owe nothing. Rush coupon for your free-trial copy of this great money-saving Manual. MOTOR Book Dept., Desk 1J, 250 West 55th St., New York 19, N. Y.

USED BY U.S. ARMY NAVY MARINES



MAIL COUPON NOW FOR 7-DAY FREE TRIAL

MOTOR Book Dept., Desk 1J, 250 West 55th Street, New York 19, N. Y.

Rush to me at once: (Check box opposite book you want).
 MOTOR'S New AUTO REPAIR MANUAL. If okay, I'll remit just \$2.00 in seven days, then \$2.00 monthly for two months and a final payment of 95c (plus 35c delivery charge) one month after that. Otherwise, I'll return the book postpaid in seven days. (Foreign price: Remit \$9.00 cash with order.)
 MOTOR'S New TRUCK and TRACTOR REPAIR MANUAL. (Described at left.) If okay I will remit \$2.00 in seven days, and \$2.00 monthly for three months, plus 35c delivery charge with final payment. Otherwise, I will return book promptly. (Foreign price: Remit \$10.00 cash with order.)

Print Name.....Age.....
Print Address.....
City & Zone No.....State.....

SAVE 35c delivery charge by enclosing WITH COUPON check or money order for full payment of \$6.95 for Auto Repair Manual for \$8.00 for Truck and Tractor Manual.) Same 7-day return-for-refund privilege applies.

Some FREE 7-Day Offer on MOTOR'S TRUCK and TRACTOR REPAIR MANUAL
Covers EVERY job on EVERY gasoline-powered truck and farm tractor made from 1946 thru 1954. 2,200 pictures, 850 big 8 1/2 x 11 inch pages. 300,000 facts. Check proper box in coupon for free trial.

COVERS 685 MODELS— ALL THESE MAKES

Buick	Ford	Nash
Cadillac	Frazer	Oldsmobile
Chevrolet	Henry J	Packard
Chrysler	Hudson	Plymouth
Crosley	Kaiser	Pontiac
De Soto	Lincoln	Studebaker
Dodge	Mercury	Willys

1,886,000 COPIES IN USE!

BECOME A Mechanical Engineer

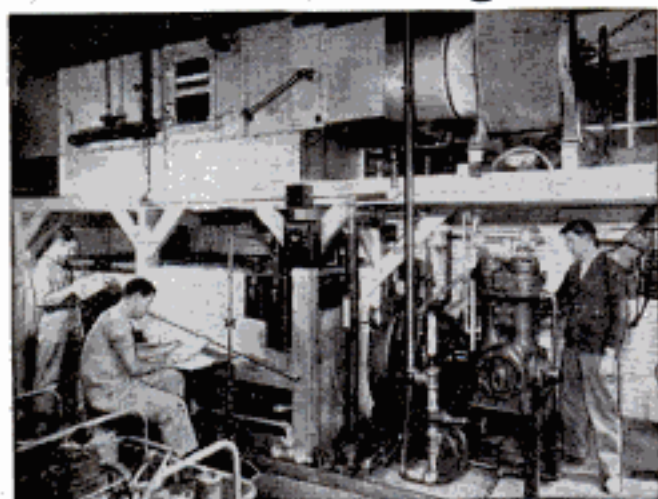

B. S. Degree in 36 months

 Mechanical Engineers hold respected, well-paying, and highly interesting jobs in many fields of industry. You can prepare now... for a secure future and a well-paid career as an engineer or engineering technician at the Milwaukee School of Engineering.

Choose from these courses at the Milwaukee School of Engineering

ENGINEERING 36 months, Bachelor of Science Degree

- Mechanical Engineering with a major in Design, Metal Fabrication or Plant Engineering.
- Electrical Engineering with a major in Electronics or Power.

SERVICE 6 to 12 months

- Electricity ● Heating
- Refrigeration ● Welding

TECHNICIAN 12 to 18 months

- Radio and Television
- Electronics
- Electrical Power
- Mechanical Technician
- Air Conditioning
- Welding

General preparatory course — 3 months.

TERMS OPEN SEPTEMBER, JANUARY, APRIL, JULY
Faculty of specialists. Over 50,000 former students. Annual enrollment from 48 states and 23 overseas countries. Non-profit. 51st year. Military, Practical or Academic training evaluated for advanced credit. Approved for Veterans Training. Write for details today.

MILWAUKEE SCHOOL OF ENGINEERING

MS-2A

MILWAUKEE SCHOOL OF ENGINEERING
Dept. P.M.-954, 1025 N. Milwaukee
Milwaukee 1, Wisconsin

Send free illustrated career booklets Radio-TV
 Mechanical Technology Electrical Technology

I am interested in _____
(name of course)

Name _____ Age _____

Address _____

City _____ Zone _____ State _____

If veteran, indicate date of discharge _____

Shrinks Hemorrhoids Without Surgery

Science Finds Healing Substance That Relieves Pain—Shrinks Hemorrhoids

Science has found a healing substance that shrinks hemorrhoids, stops pain promptly, ends bleeding — without surgery. Doctors report actual shrinking of hemorrhoids. Sufferers say, "Hemorrhoids have ceased to be a problem." The secret is Bio-Dyne® — already widely used for healing injured tissue. This substance is now available in a hemorrhoid ointment called Preparation H*. Ask your druggist for Preparation H. Money back guarantee.

*Trade Mark

AVIATION Pays You More With a Schooling at PARKS

NOW! A&E MECHANIC LICENSE COURSE

45-week course, all phases aircraft & engine. Enrollment Dates: Sept. 1-2, 1954, Jan. 3, 1955

FLIGHT COURSES—Private, Commercial, Instrument, Instructor, Multi-Engine.

DEGREE COURSES—B.S. degree in 3 yrs. from Saint Louis University — Aero. Engineering, Maint. Engineering, Aero. Administration.

All Parks Schooling Approved for Veterans Write Today.

PARKS COLLEGE ARNOLD HALL EAST ST. LOUIS, ILL.

LEARN WATCH REPAIRING

AT HOME Modern, original instruction. Prepare for a position or start in business after completing our course. Write Today!
WISCONSIN SCHOOL OF WATCH REPAIRING
759 N. Milwaukee St. Dept. M Milwaukee 2, Wis.



SEND FOR THIS FREE!

Make money. Know how to break and train horses. Write today for this book FREE, together with special offer of a course in Animal Breeding. If you are interested in Gaiting and Riding the saddle horse, check here () Do it today—now.

BEERY SCHOOL OF HORSEMANSHIP
Dept. 1109 Pleasant Hill, Ohio

Ball-Bearing SPEED WHEELS

JUVENILE WHEELS (No bearing, solid tires)
5" 45¢ 6" 65¢
7" 75¢

(Semi-pneumatic tire, ball bearing)
8x1.25 \$1.85 10x1.25 \$2.20
8x1.75 1.95 10x1.75 2.30
8x2 2.20 10x2 2.65

12x1.75 3.45
INDUSTRIAL WHEELS
(Lug Base, Semi-Pneumatic tire)
6x2 SW \$3.45 10x2.00 \$6.10
6x2.00 4.00 10x2.75 5.15
8x2.00 5.20 10x2.75^{neu} 6.90
8x2.50 5.40 12x2.00 6.90
16x4.00 15.15 12x3.00 9.20
(Smooth Base, Pneumatic tire and tube)
8x3 2 ply \$10.00
10x3.50 2 ply 10.55
12x4 2 ply 14.41
4.00x8 2 ply 13.10
14x4.50 2 ply 15.96



CASTERS—Now Available Write for circulars on all wheels.
No c.o.d. orders. Prices F.O.B. our plant.
JIM BROWN TOY COMPANY
1095 HOME AVENUE PM-954 AKRON 10, OHIO

Want to make \$125 or so Extra every month in your spare time?

**Then Let Me Show You How to Do It.
No Experience Needed. And You
Don't Invest a Single Penny!**

Making the ends meet is getting harder all the time. That's why so many people are glad of a chance to have some extra money coming in each month. You know how it is, when you go to the grocery store. The price tags on the shelves are enough to scare a person. And it's not only high prices for everything we buy. On the top of that, the government takes a big part for taxes and social security out of each paycheck even before we get it!

So I feel pretty good about being in a position to help folks get the extra money they need.

Now this is not a plan to get some of your money out of you. It's just like I said above. I have a plan that makes it easy to earn extra money every month. And the way this Plan works, I even send you a money-making outfit free without any charge and without any deposit of any kind. I believe that shows there are no strings attached to the offer and that I mean exactly what I say.

We both know there are a lot of ways to make extra money. But many of them have certain drawbacks. For example, a good many people don't like the idea of house-to-house selling. With my Plan this is not necessary. Then, with some companies, you are required to make a considerable investment in merchandise before any money starts coming back. I do not ask you to do this and you can start making money the very same day you start using my Plan.

Before I tell you my Plan, let me tell you something about our Stainless Steel Cookware. It is made of the very same kind of Stainless Steel we have been selling for years to the country's leading Hotels, Restaurants, Hospitals and Institutions. So you know our utensils are the finest it is possible to produce.



F. W. STRONG
Director,
**EXTRA MONEY
PLAN**

Stainless Steel Cookware is becoming more popular every day. The demand for it is greater than it has ever been. That's because more and more people have heard about the advantages and benefits of Stainless Steel "Waterless Cooking." This is the method that retains more of the natural vitamins and minerals and makes food more nutritious and makes it taste a lot better, too. (I'll tell you more about this when I write.) But better food is only one of the features of Stainless Steel Cookware. Stainless Steel cleans easily — washes as easily as a piece of china. No scouring or scrubbing is necessary in order to keep it mirror-bright. Then, of course, Stainless Steel cannot rust, corrode or stain. Buy it once and you'll never have to replace it. Do you know why? It's because Stainless Steel is stainless all the way through. It can't chip, crack or peel. You can use it the rest of your life and then pass it along to your children! *It never wears out!*

Is it any wonder that so many people are turning to Stainless Steel in preference to any other kind of cookware? Is it any wonder it's so easy to get orders for cookware like this? But let me tell you something else. When your first customer gets her Carlton Cookware, it's the start of an endless chain of orders. She's so enthusiastic about it she can't wait to tell her friends. These, in turn, tell their friends and before you know it you'll be getting orders from folks you never heard of. It's one of those fantastic money-making ideas that just keeps growing and growing. That's why I say it's easy to make at least \$125 extra money every month because you have to deliver only ten sets to make that much. And if you don't think that's easy, take the case of Mrs. William Hanchow. She writes, "Got my set Saturday — already have 17 customers." Mrs. Montell took orders for \$1400 worth of Carlton Ware the first month!

But here's the big thing about it. We make Stainless Steel Cookware in such big quantities that our manufacturing costs are very, very low. Our costs are so low that we can sell our Stainless Steel for less than half what most other companies charge.

With prices so low, I figured that every family could now afford to own a set of our Stainless Steel Cookware. And, if you have some friends who haven't got all the money handy, you can offer them a Time Payment Plan on which the monthly payment is only \$5.00.

If you have read this much of my announcement, I feel safe in assuming that you are one who would be happy to make some extra money every month. So I suggest that you get in touch with me right away so that I can give you full and complete details about my Plan. I'll be happy to send everything you need free of charge. At the same time, I'll also send you a complete order-taking outfit to show your friends and neighbors.

It is understood, of course, that I will include instructions that make it very easy to write up orders. And I will show you how to start making money immediately without any house-to-house calls on strangers.

There is no charge for these things — now or any other time. When I say everything I send you now is free, I mean FREE. And here's the best part. When you qualify, I'll even furnish you with a complete 15-piece set of Stainless Steel Carlton Ware that you can use in your own kitchen and show it to your friends. This is an extra bonus and all 15 pieces will be shipped to you free.

There is just one thing for you to do and I hope you will do it right away. Just write your name and address in the coupon and get the coupon in the mail at once. I do not say this to hurry you, but this announcement may not appear in this magazine again, and I don't want to see you miss this wonderful opportunity to make enough extra money for practically anything you want to buy.

So send the coupon now — or just send your name on a postcard and drop it in the nearest mailbox. Simply write "Send everything free" and I'll see that it goes out to you by return mail. No salesman will call on you and you won't be under the slightest obligation.

F. W. Strong

**Director, Extra Money Plan
3349 High Street, Carrollton, Ohio**

The 15 utensils and covers that make up the Carlton Set are all interchangeable. They fit into each other so as to make up 23 different cooking combinations for "Waterless Cooking," that cover 99% of all cooking needs.



**F. W. STRONG, Director, EXTRA MONEY PLAN
3349 High St., Carrollton, Ohio**

Dear Mr. Strong: Please send me free and without any obligation whatever a complete order-taking outfit with exact instructions for making an extra \$125.00 a month. I don't want to do any house-to-house selling, but I will show your products to my friends and give them the advantage of the low price.

Name.....

Address.....

City.....Zone.....State.....

I am already selling cookware and am interested in getting a line that can be sold at a lower price. Please send me your Distributor's proposition.

AMAZING BARGAINS FOR SAVE!



9X AREA
MAGNIFICATION!
SAVE \$7.00

**German POWERHOUSE Binoculars
give you 20 MILE range!**

SPECIAL CUT PRICE
INCLUDING
Genuine LEATHER Case **4.98**
WITH CASE

A lifetime bargain for **POPULAR MECHANICS** readers! **THORESEN**—world's greatest importer of German binoculars—now brings you the renowned **POWERHOUSE** Binoculars at an unbelievably low price! Not 4 . . . 5 . . . 7—but **9X AREA MAGNIFICATION!** It's the pride & joy of every red-blooded hunter, fisherman and sports enthusiast! **Thoresen**—and **ONLY Thoresen**—brings it direct from Western Germany to you for a mere **4.98**. Latest streamlined design, as illustrated in greatly reduced size. A **HINGE** model—you can adjust to the **EXACT** space between your eyes. Aluminum Centerpost focusing gives you clear, sharp viewing—**SEE UP TO 20 MILES AWAY!** **POWERHOUSE** has great structural strength—without tiring weight. (Only 9 1/2 oz. in all.) Modern grained design gives you easy, firm grip . . . high luminosity provides viewing even in moonlight!

Costly, Precision-Ground Lenses for Super Viewing

The **POWERHOUSE LENSES** are the crowning achievement of this 99-year-old German firm—each and every lens is ground & polished to a high tolerance, then carefully checked for accuracy! **NOT** moulded plastic type stamped out by the million. No excessive distortion or "ghosts" found in cheap glasses. Were you to spend \$25, we couldn't give you better lenses! Send coupon **TODAY** and get your **POWERHOUSE** (plus your **FREE Specto-Scopes**) at this low introductory price of **4.98**, tax paid, including handsome **LEATHER** case! Sorry, but limited import supply forces us to restrict orders to **ONE** binocular per reader.

No. 6 . . . **POWERHOUSE BINOCULARS & LEATHER CASE 4.98** tax paid

THORESEN'S, Dept. 6-K, 352 Fourth Ave., New York 10, N. Y.

CANADIANS: Save Tariff. Send orders direct to **THORESEN CO., Dept. 6-K, 45 St. James St. West, Montreal 1, P.Q.**



**5 DAY FREE TRIAL-
3 TURRET**

Microscope

**100X
200X
300X** **9.44**
NO TAX



Imagine! . . . **TRIPLE** revolving turrets . . . **300, 200 or 100** power focusing! Finely ground, gold-plated Achromatic lenses . . . **ALL METAL** construction . . . Precision-tooled threadings. Ideal for lab, school or hobby use. Sturdy wooden case and dustproof plastic cover included. Latest, most attractive design. Extra sturdy & durable for roughest handling. This low, low price of **9.44** may never be repeated again. Send coupon **NOW** and get this **BIG** Microscope bargain **PLUS** a pair of **SPECTO-SCOPES**, free of extra charge!
No. 198 . . . **3-Turret Microscope & Case 9.44** No tax



POPULAR MECHANICS READERS

BUY DIRECT FROM THE IMPORTER!

FREE!

By ordering ANY article of merchandise on these two pages, you receive **FREE OF EXTRA CHARGE** a sparkling new pair of **SPECTO-SCOPES**—the binoculars you wear like eyeglasses! Made in Western Germany by expert optical craftsmen, **SPECTO-SCOPES** give you **CLOSE-UP, MAGNIFIED** viewing all day long—without fatigue. Use them to increase your enjoyment of **SPORTS, TV, NATURE, MOVIES, PLAYS, PUBLIC EVENTS**. Featherweight (only 1 oz.) in lustrous ebony color. These are the same glasses **NOW** being nationally advertised for **\$1.95**. To get yours, all you need do is send cash, check or M.O. for **ANY** item on these 2 pages. You may order in complete confidence—try any article in your own home for **5 FULL DAYS**—then, if not completely delighted, just return the merchandise for **FULL REFUND!**

—MONEY BACK GUARANTEE!

Automatic!

19.95

Super Deluxe Model—FULL SWING 17-JEWEL SELF-WINDING AUTOMATIC MEN'S WATCH.

Just set it . . . then forget it! It winds itself as you wear it. Patented **INCABLOC** 17-Jewel Swiss movement of superb accuracy. Water and shock resistant—you can **DROP IT . . . BANG IT . . .** even **SWIM** with it!

100% Stainless Steel screw back. Gift bands & numerals with **LUMINOUS** markings. Unbreakable Kiverrite crystal. Hairline Sweep Second hand. Split-second calibrations for precision timing. Metal-Flex expansion band. Handsome thin-styled case. Formerly sold for much, **MUCH** more—**NOW \$19.95** tax incl. Order **TODAY!** Send coupon with payment and receive also **FREE Specto-Scopes**.

No. 238 . . . Automatic Self-winding Watch \$19.95 tax incl.



17 JEWEL-SWISS WATER & SHOCK RESISTANT WATCH

9.98

A magnificent Swiss watch engineered to high precision standards with world famed **INCABLOC** protected movement of **17 jewels**. Not an ordinary watch—radically different! You can bang it . . . drop it . . . it's **SHOCK RESISTANT!**

Actually Runs UNDER Water!

Try it yourself at **OUR** risk . . . if you drop this watch in a tumbler of water, you can fish it out and find **IT IS STILL RUNNING—KEEPING ACCURATE TIME!** Has deluxe quality features usually found in much, much more expensive watches: Stainless Steel back; Sweep Second hand; 1/5th Second calibrations; Radium-Applique numerals; Unbreakable crystal; **17 JEWEL SWISS MOVEMENT**; Metal-Flex Expansion band; **INCABLOC**, Safeguard Gasket. Send handy coupon **TODAY** and receive this handsome watch at greatly reduced price—**PLUS Specto-Scopes** (free of extra charge.)

No. 224 . . . 17 Jewel Swiss Watch \$9.98 tax incl.



Super Value!

Solingen Steel HUNTING KNIFE

3.95 INCLUDING LEATHER SCABBARD

The famed **BLACK FOREST HUNTING KNIFE** made in Solingen, Western Germany of superfine **Nicht Rostend** (non-rusting) steel is **NOW** available through **THORESEN'S!** Rugged beauty of this superb knife has already won recognition for design in industrial circles on the Continent—and its utility and value as a hunting & fishing aid has made it a prime favorite with sportsmen all over Europe. Blade is actually sharp enough to **thrust** with; will stand up under most rugged treatment; genuine leather scabbard is metal-tipped. Length, 10 in. Tough, sturdy Solingen Steel assures you years of dependable service.

MAKE THIS TEST!

Place a thick metal disc or medalion on the ground. Plunge the point of the **Black Forest** knife downward. The knife will completely pierce the thick metal—with **NO** damage to the blade! The sleek, graceful lines of this German import also provide an ideal res room or den decoration; a dandy gift for men! Send coupon **NOW** with 3.95 for knife & scabbard, tax & postpaid. **SPECTO-SCOPES** included—free of extra charge!

No. 80 . . . Black Forest Knife & Scabbard . . . 3.95 tax paid

Mail!

SAVE MONEY WITH THIS COUPON!

THORESEN'S, Dept. 6-K
352 Fourth Ave., New York 10, N. Y.

RUSH the items checked on 5 Day Free Trial . . . Money Back Guarantee. () Payment enclosed. Send tax & postpaid. () Send C.O.D. plus postal charges.

- No. 6—Powerhouse Binoculars (\$4.98)
- No. 198—3-Turret Microscope (\$9.44)
- No. 238—Automatic Self-Winding Watch (\$19.95)
- No. 224—17 Jewel Shock & Water Resist. Watch (\$9.98)
- No. 80—Black Forest Knife & Scabbard (\$6.95)

NAME _____

ADDRESS _____

CITY _____ ZONE _____ STATE _____

CANADIANS: Save Tariff. Send orders direct to **THORESEN CO., Dept. 6-K, 45 St. James St. W., Montreal 1, P.Q.**

Learn **ELECTRIC APPLIANCE REPAIR** IN YOUR SPARE TIME AT HOME



START YOUR OWN BUSINESS

WITH A POTENTIAL MARKET OF 50,000,000 CUSTOMERS

New shop-method, home-training system gives you electrical know-how that used to take years to learn. Learn at home by building valuable testing kits, repairing your own and neighbors' appliances. It is not unusual for appliance repairmen to charge on the basis of \$5.00-\$6.00 an hour.

FREE ILLUSTRATED BOOK
Shows you how you learn every phase of electrical appliance. How to make money while you learn. Write today for your FREE copy.

CHRISTY TRADES SCHOOL
Dept. D-3403
4804 North Kedzie Ave., Chicago 25

ONE BUSINESS THAT IS NOT AFFECTED BY STRIKES, DEPRESSIONS OR POLITICS

TRAINED MEN NEEDED

BIG PAY—GOOD FUTURE

- | | |
|-------------------------------------|--------------------------------------|
| <input type="checkbox"/> TELEVISION | <input type="checkbox"/> ELECTRONICS |
| <input type="checkbox"/> DIESEL | <input type="checkbox"/> AUTO |

WHY WORK FOR LOW PAY or risk being out of a job??? Usually the properly trained man has a steady job... through good times or bad. Even back during DEPRESSION there was a big demand for Bailey Trained men.

In only 5½ to 6 months we can train YOU to enter one of the big pay fields!

No previous experience or special education necessary. With our method of training you do not spend years pouring over books, figures, charts and graphs. You learn by rebuilding, repairing, testing and operating the most modern equipment, under the guidance of experienced, courteous and friendly instructors. This method of training gives you the experience and confidence required to step right into the big pay jobs without spending years as a mechanic's helper.

It's EASIER and COSTS LESS than you may think to get this residence shop training... we help you find part-time jobs while in school—full-time jobs after graduation. Check subject above in which you are interested and mail for complete information.

BAILEY Technical SCHOOLS

Veteran Approved

1634 S. Grand St. Louis 4, Mo.

NAME.....AGE.....
STREET.....
TOWN.....ZONE.....STATE.....

EASY WAY to EXTRA MONEY



be a GREETINGS GET-TOGETHER Hostess!

GREETINGS UNLIMITED really puts you in business with this exciting Party Plan. In a few hours, in your own home, show friends and neighbors the smartest Greeting Card assortments, plus hundreds of other unusual gifts and gadgets. QUICK CASH for the hostess! Send today for colorful FREE 68-PAGE CATALOG and full details. Write to Party Director, Dept. PM-2.

GREETINGS UNLIMITED PARK SQUARE ST. PAUL, MINN.

Wanted New Writers of Stories, Mysteries, Articles Plays

Would you be willing to spend a few hours a week learning to write so you may earn \$200-\$1200 a year part-time? Or many thousands full-time? FREE book, "Art of Writing Salable Stories," tells how to get started writing short stories, radio-TV scripts, articles, business items. Many students earn while learning (Graham Dour sold one story to Post, CBS Radio and NBC-TV). Endorsed by famous authors, scores of successful graduates; approved for veterans. Send today for FREE book (no salesman will call).

PALMER INSTITUTE OF AUTHORSHIP, Since 1917
1680 N. Sycamore Hollywood 28, Calif. Desk T-94

Build your own JET ENGINE!



Order these plans today

1. JET PROPELLED BICYCLE. Assemble your own. Photo and instructions, \$1.00.
2. HOW TO MAKE EXPERIMENTAL JET ENGINES. Seven sheets drawings with information and instructions \$2.50.
3. BOTH OF ABOVE in one order \$3.75. SEND NO MONEY. Order both at once \$5.75 C.O.D. in USA plus c.o.d. postage. Send check or money order and we pay postage. Get other information too. Rush Order.

J. HOUSTON MAUPIN, Dept. 55, Tipp City, Ohio

Become a MENTAL SUPERMAN

OVERNIGHT! Floor everybody! Revolutionary "MEMO-PROP" does all your thinking! It's uncanny! Unprecedented! FREE LITERATURE! BIJOU STUDIO, BOX 1727MR, HOLLYWOOD 28, CAL.

Learn ACCOUNTING Business Administration

Bookkeeping, secretarial and allied subjects at home in your spare time or attend nationally approved resident school. Write for FREE Success Book giving complete details on courses, plans, rates and employment opportunities. G.I. approved.

Hills BUSINESS UNIVERSITY AND EXTENSION SCHOOL
619 W. MAIN ST. OKLAHOMA CITY 2, OKLAHOMA

Make Big Money At Home



PAYS UP TO \$10.00 IN AN HOUR!

Here's your chance for lifetime financial security! Be THE expert INVISIBLE REWEAVING in your own community. Make cuts, burns, moth holes, tears in dresses, suits, all fabrics DISAPPEAR! Do it at home—in spare time. Constant demand from tailors, cleaners, dept. stores, laundries, individuals—and reweavers are scarce! Profits up to \$10.00 for a single hour's work! Quick, easy to learn with complete professional home-study course—first in the field! Write for FREE details TODAY! FABRICON CO., 8342 S. Prairie Ave., Dept. 329, Chicago 19, Ill.



Yours for the asking— No charge—no obligation “How to Become a Mail Order Millionaire”

Read how Gilbert on a “peanut” investment built up to \$350.00 A DAY. Learn how Zimmerman started a mail order business on a buck private’s pay and spiraled \$16.80 into a big yearly income. See how a Chicago clerk quit a \$75.00 job and now makes \$22,000 a year in his own Mail Order business. Read how a southern boy made a fortune selling war-surplus parachutes which he bought as he went along. All Free! Send name on coupon for a copy of this fascinating reprint of “How to Become a Mail Order Millionaire” from *Mechanix Illustrated* plus details on the L.W. Mail Order Survey.

Start on a SHOESTRING!

The real-life stories of success in Mail Order read like fairy tales. If I had not personally known these people their stories would be hard to believe. Yet they are not only true, but they represent just a few of the hundreds of “little operators” who have been swept into big money by Mail Order.

GAINES. I personally guided his start when he invented an automatic post presser. He started with one little ad in one magazine. Four years later he retired with enough real estate to keep him in cash income the rest of his life.

VAN MARK. I worked with him for six years. I met him when he was a wagon man for a tea and coffee house, knocking on doors. He went into Mail Order as a hobby—made money from the start—ended up six years later with savings of \$50,000 and an income of \$5000.00 a year for life without further work.

DUGGAN. A few years ago he was a truck driver. Started fooling with Mail Order in a spare room in his spare time. Last year he said, “I don’t know how much I’m worth—after you get the first million you quit keeping track.”

MRS. NIXON. Started a small Mail Order business at home—just to keep occupied. It looked good and she came to me for advice. I showed her how to expand. In two years the business got so big her husband resigned his job to help manage it.

FOXMAN. Foxman worked as a hack writer at \$70 a week. He had idle time in the evenings—ran an ad offering something he didn’t have—got so many orders he had to find a source of supply. He made \$18,000 the first year. He gives me credit for “showing the way.”

JORGENSEN. Consulted me about a specialty product. On my advice he ran one ad to “test” its saleability. That ad brought sales of \$50,000. In his first year he did a business of nearly a half million dollars. His original investment was less than a thousand.

These things I have seen. These people I have helped to the realization of their dreams—these and hundreds of others. My own fortune was made in Mail Order. And now my secrets can be yours.

L. W.

Have you ever thought of running a profitable little sideline right from your home? Has it occurred to you that you are just as capable as anyone else of making money on a product or service that can be sold by mail? Have you ever looked into the Mail Order business as it’s run (on tiny investments) by innumerable small operators?

Forget about Sears and Ward’s! Read about the “little fellows” . . . clerks, teachers, vets, mechanics, salesmen and others . . . who are packing Mail Order items in bedrooms, spare rooms, attics, garages, cellars . . . dumping them in the Post Office . . . and quietly banking the fistful of Money Orders, cash and checks delivered to them daily by the mailman.

An annual business of almost a billion dollars is done by “little fellows” who advertise and sell just one item! The Department of Commerce of the United States says, “A number of the most successful obtain incomes as high as \$40,000 to \$50,000.00.”

It’s an incredible story . . . a story of a business that’s wide-open for newcomers . . . with opportunities for income far-and-away greater than you can ordinarily hope to attain by holding down a job. And in Mail Order you can stay as small as you wish—run your deal as a \$50 or \$75 weekly sideline—or consider jacking it up into really big figures as a full time operation.

Glance at the examples at left. These true stories are far from unusual. Multiply them by the hundreds and you begin to get an idea of what can be done . . . what is being done . . . in the phenomenal Mail Order field.

Yet, if you were to jump blindly into Mail Order your chances would be slim. A peculiar brand of “know-how” is vital in this little-known, little-understood business. This is fortunate for you. If any Tom, Dick, or Harry would “click” in Mail Order, the field would have been overloaded years ago.

But now you have the opportunity to learn the authentic secrets of successful Mail Order operation. They are revealed for the first time, step by step, in an extraordinary new Survey . . . the L.W. Confidential Mail Order Letters.

This Survey is not a course—not a book—not a group of lessons. It is a simple guide that anyone can follow. It shows you how to pick the right product for Mail Order. It shows you exactly how to start a profitable business fast, with cash or Money Orders in the envelopes you receive. It shows how to buy your product out of the very money you get in the mail, so you don’t have to tie up cash in large supplies of your product. It gives you actual examples of ads and letters, analyzed to show how and why they make money. It demonstrates the months to start, the time to expand, the best way to get prospects’ names. It reveals from A to Z the confidential facts that have made fortunes for Mail Order operators who use them.

Mail the coupon today, or simply send your name and address on a postcard. No salesman will call. We will mail, postage prepaid, a Free copy of “How to Become a Mail Order Millionaire” and along with it will give you complete facts about the L.W. Mail Order Survey. Read the facts. Then decide whether you would like to spend spare time or full time in a profitable, fascinating Mail Order enterprise. If you think you would like to follow the footsteps of hundreds of others who are now making good money in this way, you can get your L.W. Survey and begin at once.

Please don’t decide to write us “a little later.” Send your name now, before you forget. This one little act might be the first step to a future of independence and wealth.

The L. W. MAIL ORDER SURVEY, Dept. 19
805 LARRABEE ST., LOS ANGELES 46, CALIF.

The L. W. MAIL ORDER SURVEY, Dept. 19
805 Larrabee St., Los Angeles 46, Calif.
Mail me a free copy of “How to Become a Mail Order Millionaire” and details about the L. W. SURVEY. It is understood there is no charge at any time, and that I am not under the slightest obligation. After reading, I will decide whether I want to use the L. W. Confidential Letters to help me start a Mail Order business at home.

NAME _____

ADDRESS _____

CITY _____ Zone _____ STATE _____

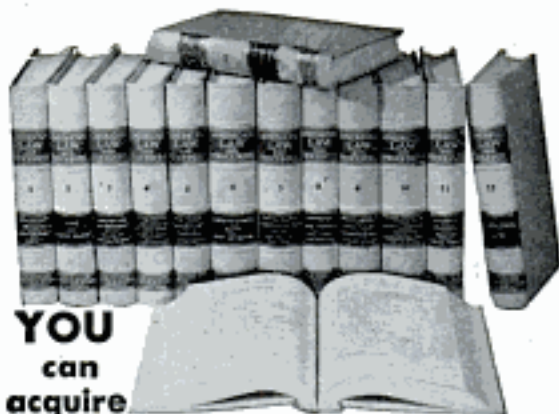

**YOU
can
acquire**

LAW NIGHTS AT HOME! L. L. B. DEGREE

LaSalle's famous Law Library—used as reference in many Law libraries and Law offices—has enabled thousands to master Law surprisingly fast, in spare hours at home, for business and professional advancement.

These 14 remarkable volumes, compiled by leading professors and lawyers, cover the whole basic field of Law in condensed, orderly, simplified manner.

You advance rapidly with this great library, plus special lectures furnished. We guide you step-by-step with personalized Problem Method of instruction . . . you learn by doing—handling legal problems—not by memorizing rules.

Send for two FREE 48-page booklets, "Law Training for Leadership," and "Evidence," answering questions about Law and its value to you, and telling how LaSalle Law graduates are winning rapid advancement in business and public life. Mail coupon below. No obligation.

LA SALLE EXTENSION UNIVERSITY A Correspondence Institution

417 S. Dearborn St. Dept. 964L Chicago 5, ILL.

Send me your two FREE booklets described above, without obligation.

Name.....Age.....

Street.....

City, Zone & State.....

ENGINEERING DEGREE IN 27 MONTHS

Big Demand for Graduates

Aeronautical, Chemical, Civil, Electrical, Mechanical and Radio Engineering (inc. TV and Electronics)

Hundreds of young men are earning B. S. ENGINEERING DEGREES annually in this recognized institution — year around operation. New terms start quarterly. Many students earn a major part of their college expenses in this large industrial center.

Low tuition. Competent instruction. Thorough, intense, practical program. Modern, well-equipped laboratories including new physics laboratory and modern wind tunnel. Individualized instruction emphasized.

Government approved for G.I.'s. Engineering preparatory courses. Students from 48 states and 21 foreign countries. Enter September, December, March, June. Send coupon for free catalog and full information. Enroll now.

SEND COUPON TODAY

INDIANA TECHNICAL COLLEGE

594 E. Washington Boulevard
Fort Wayne 2, Indiana

Please send me free information on B.S. Engineering Degree in 27 months as checked.

Aeronautical, Chemical, Civil, Electrical,
 Mechanical, Radio-Television

Name.....

Address.....

OWN your OWN Radiator Repair Business

\$995.00 Starts You . . . Equips You

Many cities offer exclusive opportunity for business minded men in fast growing auto radiator repair service. New Modern Equipment brings in good profits and makes work easy and interesting. For \$995.00 (financing available) you can own a rewarding business.

You will be trained by the world's largest radiator equipment manufacturer free in their own plant, or if you want training alone the cost is \$100.00. Specify interest in training alone.

Inland Mfg. Co. Dept. PM-9 1108 Jackson St.
Omaha 8, Nebraska

FALSE TEETH

KLUTCH holds them tighter

KLUTCH forms a comfort cushion; holds dental plates so much firmer and snugger that one can eat and talk with greater comfort and security; in many cases almost as well as with natural teeth. Klutch lessens the constant fear of a dropping, rocking, chafing plate. 35c and 60c at drugists . . . If your druggist hasn't it, don't waste money on substitutes, but send us 10c and we will mail you a generous trial box.

KLUTCH CO. Box 5493-1 ELMIRA, N. Y.

A "GOOD HAND" HELPS YOU SUCCEED!
LEARN TO WRITE WELL

Handwriting quickly improves with our easy-to-understand picture lessons! Put your spare time to good use; send today for FREE BOOKLET, "How to Become a Good Penman," or check volumes wanted below at \$1 each: Business Writing Artistic Writing Card Writing, Bird & Design Flourishing Engraving Alphabets. COMPLETE SET \$4.50. Ask for price list of penman's supplies.

Your Name beautifully written, plus special pen-point for shaded writing. **Only 10c** OUR 53rd YEAR

TAMBLYN SCHOOL of PENMANSHIP
S.A. Ziller, Pres., 442 Ridge Bldg., Kansas City, Mo., USA

BUY IT WHOLESALE! FREE THE WHOLE SALES PLAN!

GET UP TO 40% OFF! START A BUYING SERVICE AT HOME, SPARETIME. GET BIG NAME MERCHANDISE FOR SELF AND CLIENTS UP TO 40% LESS THAN REG. PRICE. SALES EASY AS YOU CAN GIVE SIZEABLE DISCOUNTS. STILL MAKE FAT COMMISSIONS. Post Card Brings Free Copy

AMERICAN BUYERS SERVICE

631-R Linden Ave., Buffalo 16, N. Y.

TASOPE PHOTO-ENGRAVING PLANTS



Material Cost of This Cut 34c
Selling Price \$1.00 And Up

Establish your own profitable PHOTO-ENGRAVING business. Make cuts for newspapers, printers, and advertisers. Make etched name plates, plaques etc. Instructions furnished, no experience necessary. Sold direct from factory since 1931. First five hundred cuts sold locally or by mail will pay for plant and pay you well for your time. Write for FREE catalog.

TASOPE, DEPT. PM-9, AURORA, MO.

New Way to Improve YOUR ENGLISH



A command of effective English gives you added advantages and better opportunities. Poor English handicaps you more than you will ever realize. You can improve your English through Sherwin Cody's 100% self-correcting invention. If you are embarrassed by mistakes in grammar, spelling, punctuation, or pronunciation, this free book "How You Can Master Good English in 15 Minutes a Day" will prove a revelation to you. Send for it now. It is free. No obligation. No agent will call. Address **SHERWIN CODY COURSE IN ENGLISH, 589 Central Drive, Port Washington, N. Y.**

Thrilling Work COLORING PHOTOS

Fascinating vacation learned at home by those with aptitude. Thrilling pastime. National method brings out life-like colors. Free booklet.

NATIONAL PHOTO COLORING SCHOOL
835 Diversey Pkwy., Dept. 1356, Chicago 14

**MAKE MORE MONEY FASTER
IN BUILDING TRADES**



EXAMINE THESE SIX BUILDING SKILL BOOKS

AT OUR RISK!

**ACT NOW...SEND NO MONEY
GET ONE BONUS BOOK FREE**

We urge you to accept our liberal offer to send these 6 basic self-training books for 10 days of thoughtful inspection. Check through the more than 2400 pages of easy-to-understand instruction and the more than 1600 informative illustrations, all relating to the many building fundamentals from excavating to finishing the building. See how thoroughly the many pay-raising subjects are covered—how they can help you to become a more skilled worker and qualify for better jobs in building trades. They can help you to start a contracting business of your own. You'll be surprised how quickly they will help you solve many, many problems. Just fill in and mail the coupon now. Send no money. We will send the set of 6 big volumes, plus the bonus book (illustrated above) which is our gift to you, as stated in the coupon. Mail it at once.

(A year's consulting privileges with our staff given with these books at no extra cost.)

This 182-page idea and fact book, containing 200 pictures and plans, is your **FREE** bonus book. See offer at right and in coupon.

AMERICAN TECHNICAL SOCIETY — Publishers Since 1898
Dept. G619, Drexel Ave. at 58th St., Chicago 37, Illinois

I would like to examine your 6-Volume Set of Building Skill Books. I will pay delivery charges only, but if I choose I may return them express collect. If after 10 days I prefer to keep them I will send you \$4 plus postage and pay the balance at the rate of only \$3 a month until \$38.65 has been paid. The **FREE** Bonus Book is to be my property whether I keep or return the 6-Volume Set.

Name _____

Address _____

City & Zone _____

Please attach letter giving employer's name and address. If self employed, give business man's name as reference. Men in service please give home address.

FREE! SEND FOR MY
NEW PLAN FOR A
BUSINESS OF YOUR OWN!



METALIZE BABY SHOES

Add to your present income or have a full-time business. Fill huge demand for most precious keepsakes. Start at once—no big investment. Complete instructions include all processing methods. It's fun and very profitable. Start now — **SEND NO MONEY** — just name and address.
KIKTAVI CO., Dept. PM-549, 7217 S. Broadway, Los Angeles 3, Cal.

*Instructions
Include
Complete
Kit of
Supplies
& Beautiful
**BRONZED
BABY SHOE**

SAY YOU SAW IT IN POPULAR MECHANICS



**ITALIAN ACCORDIONS
AT LOWEST
WHOLESALE
PRICES**

**DIRECT from
Importer to You!**

SATISFACTION GUARANTEED, or your money back! NOW you can save up to 50% by direct purchase from America's leading distributor of famous genuine **ITALIAN ACCORDIONS**. TRADE-INS ACCEPTED
Send for **FREE** Illustrated Catalog!

ACCORDION MANUFACTURERS & WHOLESALE OUTLET

2003 West Chicago Ave. Dept. R94, Chicago 22, Ill.

**GROW Living
MIDGET TREES!**

**EARN \$1000
PER HOUR!**

- AT HOME
- IN SPARE TIME
- NO EXPERIENCE NEEDED



It's new! Amazing! At last, the secret of growing miniature (MING) trees can be yours. FULL GROWN, dwarf trees — only a few inches high. Beautiful miniature fir, orange, oak, Chinese elm, peach, pine, cypress—any kind! ALL BLOOM and even BEAR FRUIT. All perfect healthy specimens—but miniature in size! Make costly home decorations and expensive centerpieces. (SOLD FOR OVER \$1,500 EACH) Big demand. Costs only pennies — takes only minutes per week. IT'S EASY! Fun! A new fascinating hobby—a new fabulous \$\$\$\$ business. Send for free secret plan details and real seed.

HELP US FILL HUGE DEMAND!

These trees are being demanded by STORES
CLUBS • HOTELS • FLORISTS • HOUSEWIVES • INTERIOR
DECORATORS • COLLECTORS • HOBBYISTS — A Big Money
Opportunity FOR YOU.

FREE! GENUINE SEED AND PLAN!

NATIONAL NURSERY GARDENS, Dept. M-9
8463 South Van Ness
Inglewood 4, Calif.
Rush me **FREE** plan and seed **IMMEDIATELY!**

Name _____
Address _____ Zone _____
City _____ State _____



Check the Kind of Body You Want



Charles Atlas

... and I'll Prove How EASILY You Can Have It!

Just tell me, in coupon below, the kind of body you want—and I'll give it to you SO FAST your friends will be amazed! "Dynamic Tension," my easy, 15-minutes-a-day method, will make your chest and shoulders bulge... arms and legs surge with power... your whole body feel "alive!"

FREE BOOK 32 pages on how "Dynamic Tension" changed me from a 97-pound weakling into "World's Most Perfectly Developed Man"—and how I'll prove it can change YOU too. Mail coupon NOW!

CHARLES ATLAS, Dept. 8J,
115 East 23rd St., New York 10, N. Y.

Dear Charles Atlas: Here's the Kind of Body I want:
(Check as many as you like)

- | | |
|--|--|
| <input type="checkbox"/> More Weight—Solid—in The Right Places | <input type="checkbox"/> Powerful Arms, Legs, Grip |
| <input type="checkbox"/> Broader Chest, Shoulders | <input type="checkbox"/> Slimmer Waist, Hips |
| | <input type="checkbox"/> Better Sleep, More Energy |

Send me absolutely FREE a copy of your famous book "Everlasting Health and Strength"—32 pages, crammed with photographs, answers to vital questions, and valuable advice. No obligation.

NAME _____ AGE _____
(please print or write plainly)

ADDRESS _____

CITY _____ STATE _____

I'll Send You This Handsome SAMPLE CASE—FREE!



Make up to \$30.00 in a Day!

Your Own Tailored Suits Without 1¢ Cost

If you want to make more money, spare time or full time, rush the coupon below today for this big, valuable tailoring Sample Case packed with 150 beautiful, big-value suit and overcoat samples. Just show the samples and last-minute styles to friends, fellow-workers, others. Take their orders for fine made-to-measure clothes—and pocket BIG CASH PROFITS in advance. No experience, no tailoring knowledge needed—and no money needed, ever. WE SUPPLY EVERYTHING FREE... sample case, sample suitings, equipment, complete instructions. Start making money first day!

Use Spare Evenings... Weekends... Make Money... Get Suits!

It's easy to make money taking orders in just spare time—lunch-time, evenings, weekends. When men see the fine fit, quality and value of our suits—THEY ORDER! So we make it easy for you to get your own personal suits and overcoats without paying even one penny. Don't wait! Rush coupon with your name, address, and age for FREE Sample Case.

STONE-FIELD CORP., Dept. R-816
532 SOUTH THROOP STREET, CHICAGO 7, ILLINOIS

STONE-FIELD CORP., Dept. R-816

532 S. Throop St., Chicago 7, Ill.

Please rush ABSOLUTELY FREE the valuable Sample Case with suit fabrics and style display. Include instructions, money-making plans and details for getting my own suits without paying one cent.

Name _____ Age _____
Address _____
City _____ State _____

"HOW TO EARN MONEY IN YOUR SPARE TIME"



SENT FREE!
RUSH POST-CARD NOW!



In your own home... PRINT WITHOUT A PRINTING PRESS. Miracle New Printing Method. Print full color SIGNS, POSTERS, BANNERS, FABRICS—anything. Print hundreds at a time (\$100.00 jobs cost you less than \$10). NO ART ability necessary. It's easy! We supply everything! REPRESENTATIVES WANTED. Unlimited profit opportunities. Help fill HUGE DEMAND. Write!

SCREEN-PRINT, Dept. 29, 15129 S. Broadway, Los Angeles 61, Calif.

OWN a Business



If employed, start part time. Alert dealers can gross \$5 hourly profit on own service plus \$3 on EACH serviceman. Clean, revive, moth-proof rugs & upholstery on location. No shop needed. Services nationally advertised. Repeat customers. Easy to learn. We locally train and assist you. Quickly established. Easy terms. Send today for FREE booklet. No obligation.

DURACLEAN CO., 4-169 Duraclean Bldg., Deerfield, Ill.

'How to MAKE MONEY with Simple CARTOONS'



A book everyone who likes to draw should have. It is free; no obligation. Simply address

FREE BOOK

CARTOONISTS' EXCHANGE
Dept. 99D Pleasant Hill, Ohio

I HAVE BEEN AVERAGING \$25,771.16 gross in cash monthly (Dec. \$31,362.14) for two years in mail order business started very limited capital 1950. Because I can't cover even 1% of the market, I can supply you with merchandise, mailing lists, sales letters, advice based on experience. Can be operated on small scale by man or woman. Began in my home, now employ 23. Send one dollar which will be credited to you. My firm belongs to Chamber of Commerce, well rated financially. Not a crazy scheme but a legitimate business. No special education, training required. One dollar brings story. Mail order P.O. Box 1715-D-2, Dallas, Texas.

Catalog of 3000 Novelties 10c

Send 10c for amazing catalog of novelties, live animals, scientific supplies, hobbies, funmakers, planes & boats, looms, magic tricks, joke articles, unusual seeds, gadget time-savers, cameras, optical goods, projectors, movies, lucky jewelry, religious novelties, diaguines, musical instruments, stamps, coins, puzzles, fortune tellers, radios, auto & bike accessories, telescopes, magnifiers, compasses, banks, smokers' gadgets, artists' supplies, printing sets, engines, motors, shockers, knives, billboards, guns, rifles, sports, books, games, plants, etc. Send 10c (3 for 25c—get for friends!).

JOHNSON SMITH & CO., Dept. 828, Detroit 7, Michigan

Say You Saw It in Popular Mechanics

Better Than Your Own

SHOE STORE AT HOME



Two-Eyelet Hit With Cushioned Comfort

No investment, no experience needed. Just show magic cushion comfort to friends, neighbors, co-workers. Advance commissions to \$4.00 a pair, plus Cash Bonus, Paid Vacation, \$25.00 Reward Offer. Outstanding values for men, women, children. Money back guarantee. Shoe samples supplied without cost. Write TODAY for FREE new 76 page catalog and full details.

TANNERS SHOE CO., 485 Brockton, Mass.

**USE THIS
FREE KIT**

**MAKE UP TO
\$1000⁰⁰ a Month!**

Everything You Need to Make Big Money
with New "Midget Miracle" PRESTO
Over 2 MILLION Already Sold!

FREE—everything you need to cash in on
this amazing new kind of fire extinguisher.
Tiny "Presto" (about the size
of a flashlight) does job of
bulky extinguishers that cost
4 times as much and are 2
times as heavy. Ends fires fast
as 2 seconds. Fits in palm of
hand. Never corrodes. Guar-
anteed for 20 years! A tremen-
dous money-making bargain—
sells for only \$3.98!



Advertised
in LIFE
Magazine

On this offer you get complete
Sales Kit FREE. Everything you
need to "wrap up" sales to civil
defense workers, owners of
homes, cars, boats, farms, etc.,
and to stores for re-sale—make
big income. C. B. Melious made
\$175 in just 5 days. M. R. Stanley \$100 a day.
C. Kama \$1,000 a month. Write for your FREE Sales
Kit. No risk. No obligation. (If you want a regular
Presto to use as a demonstrator, send only \$2.50.
Money back if you wish.) REALITE INDUSTRIES,
Dept. 59, 114 East 32nd St., New York 16, N. Y.

IN CANADA: Mops Co., Ltd., 271 Doved St., Montreal 1, P. Q.

OVER \$1,000
A MONTH



Charles Kama
"I'm making
more than
\$1,000.00 a
month—and I
haven't touched
bottom yet."

**Electrical Appliance
Repairs MADE EASY**

**New Repair Manual Covers EVERY
Repair on ALL Home Appliances**

NO repair job is too tough with the help
of this big new Guide. TELLS and
SHOWS how to service ALL home appli-
ances. SAVE MONEY keeping your own
appliances like new—or MAKE MONEY
with a home repair shop of your own...
full or spare time.

OVER 850 "how-to-do-it" pages,
packed with pictures, drawings, dia-
grams. Sectional charts locate
"trouble spots" in a jiffy... make
it easy to dismantle and reassemble
appliances correctly. A-B-C directions
tell "why" as well as "how". Book
covers fundamentals of electricity for
beginners. Over 150 manufacturers
supplied the servicing and repair
data.

FREE 10-DAY EXAMINATION—Cou-
pon will bring you "Electrical Ap-
pliance Servicing" to examine FREE
—without obligation. Mail it NOW!

FREE
10-Day
Trial

Electrical
Appliance

**Covers ANY Service
or Repair on:**
Irons • Toasters •
Heaters • Vacuum
Cleaners • Sewing
and Washing Ma-
chines • Refrigerators
• Air-Conditioners • Fans •
and much more.

McGraw-Hill Book Co., Inc., Dept. PM-9
327 West 41st St., New York 36, N. Y.

Send Crouse's Electrical Appliance Servicing for 10-DAY
FREE EXAMINATION. If not satisfied I will return it—pay
nothing. Otherwise, I will keep it—send only \$3 (plus small
delivery charge) then—and \$3.00 a month for 2 months to
complete payment.

Name _____
Address _____ PM-9
Employed by _____
City _____ Zone No. _____ State _____
City _____ (if any) _____

WE'LL PAY DELIVERY if you remit (check or M.O.) WITH
coupon. Same Refund Privilege. (Offer applies to U. S. only).

**more jobs
than graduates**

ENGINEERS

Demand for our engineering graduates
exceeds supply. Effective placement! Study
in this world-famed college... established
1884. New term starts quarterly. Approved for
Korean Vets.

Bach. Sc. degree in 27 months

Bachelor of Science in Mechanical, Civil, Electrical, Chemical,
Aeronautical, Radio (Television), Administrative Engineering,
Business Administration and Accounting. Also 36-weeks certifi-
cate courses in Surveying, Drafting, Secretarial Science. Inter-
sive program: technical fundamentals accentuated.

Small classes: personalized instruction. For earnest, mature
students whose time and budget require accelerated courses and
modest costs. Preparatory courses.

Beautiful campus in friendly college town. Well
equipped, new and modernized buildings and labs.
Enter Sept., Jan., March, June. Write Jean McCarthy,
Director Admissions, for Catalog and View Book



TRI-STATE COLLEGE

494 College Avenue

Angola, Indiana

**SHORTHAND in
6
WEEKS**

Famous SPEEDWRITING shorthand. 120 words
per minute. No symbols; no machines; uses
ABC's. Easiest to learn, write and transcribe.
Lowest cost. 250,000 taught by mail. For business
and Civil Service. Typing available. 31st
year. Write for FREE booklet to: SCHOOL OF

Speedwriting
Dept. 1509-4, 55 W. 42 St., New York 36 (R)

RUPTURED

BE FREE FROM TRUSS SLAVERY

NOW there is a new modern Non-Surgical treatment
that permanently corrects rupture. These Non-Sur-
gical treatments are so certain, that a Lifetime Certi-
ficate of Assurance is given. Write today for our New
FREE Book that gives facts that may save you pain-
ful and expensive surgery, and tells how non-surgi-
cally you may again work, live, play and love and en-
joy life in the manner you desire. There is no obligation.
Excelsior Hernia Clinic Dept. 8305 Excelsior Springs, Mo.

**STUDY
AT HOME LAW FREE
BOOK!**

PREPARE FOR THE BAR

Write today for your copy of our FREE book, "THE LAW-TRAINED
MAN," which describes the famous Blackstone home-study course
in bar and business law. All needed instruction material furnished
including big 16-volume law library. Bachelor of Laws (LL.B.)
degree awarded. Moderate tuition/easy monthly terms. Write today.
Blackstone School of Law 225 N. Michigan Ave.
Founded 1890 Dept. 56, Chicago 1, Illinois

**BUILD LUGGAGE AT HOME
WE SELL YOUR PRODUCTS!**

ONLY NEW HOME MONEY-MAKING PLAN IN YEARS!
Make Luggage and cases for traveling, photographers, musi-
cians, salesmen, electronics, tools, portables, 1001 other items.
Also repair Luggage. No special equipment needed. BIG Profits.
We supply complete instructions—everything. Write for free
details and Business Plan. **ABARSI CASECRAFT, Dept. G-9,**
305 W. Sunset Blvd., Los Angeles 12, Calif.

Learn BAKING At Home

Baking is one of America's high industries in wages.
Nearly depression-proof. Thorough basic home course
lays sound foundation. If you have aptitude, write for
FREE BOOKLET, "Opportunities in Commercial Baking."
NATIONAL BAKING SCHOOL
835 Diversey Pkwy. Dept. 1356 Chicago 14



If YOU have hidden talent, your future is secure!

Now: America's 12 Most Famous Artists

TEST YOUR ART TALENT!



Yours FREE if you act today! Thousands paid \$1.00 to take this revealing test. Now, to meet the ever-increasing demand for artists needed for higher-paying jobs, this same Talent Test is yours without charge or obligation. Here's your chance-of-a-lifetime to find out if you have that real, hidden talent which can open up an exciting, glamorous, well-paying career in magazine illustration and advertising art. This is one field with no age limits, seniority, or prejudices, nothing to hold you back, when you are a talented artist. If you like to draw, you owe it to your future to take this Talent Test now.

Quantity limited. Write today!



FREE!

This exciting test, printed on 8 large pages of drawing paper, has over 50 illustrations. It tests you seven ways to show your sense of design, composition, form, observation, imagination, originality and picture sense. Yours if you act today!

FAMOUS ARTISTS COURSE

Studio 6-K, Westport, Conn.

Send me with no obligation the Famous Artists Talent Test

Mr. _____
 Mrs. _____ Age _____
 Miss _____ (please print)
 Address _____
 City _____ Zone _____ State _____

- Norman Rockwell
- Jon Whitcomb
- Stevan Dohanos
- Harold Von Schmidt
- Peter Helck
- Fred Ludkens
- Al Parker
- Ben Stahl
- Robert Fawcett
- Austin Briggs
- Doug Kingman
- Albert Dorne

High Power BINOCULARS

FREE 14-PAGE BOOK & CHART

Know the facts! Learn meaning of Power, Field, Coating. Latest data. 33 Models sold on

30 DAY FREE TRIAL



BUSHNELL'S, 185 Bushnell Bldg., Pasadena, Calif.

THROWING-KNIFE



BALANCED for ACCURACY

Be an expert knife thrower. Exciting sport. Carry knife for sport and protection. Knife made in England of finest tempered Sheffield steel. 3 1/2 in. mirror polished blade. 7 in. overall. Handle grip of Xylo. With leather sheath. Satisfaction guaranteed. Only \$1.50 postpaid.

SPORTSMAN SUPPLY, Dept. 4, Box 6016, Kansas City 10, Mo.

Tells How You Can Learn to



Learn At Home

Men, Boys, Hunters, Fishermen, mount and save your lovely wild-game trophies. Be a Taxidermist. Mount Birds, Animals, Heads, Fish, Tan skins. YOU learn easily, quickly in spare time. Have a grand home-museum. The finest and the greatest hobby known, for sportsmen. Fun, real profits.

FREE BOOK

Yes, FREE. Beautiful strange, valuable book, telling all about Taxidermy. Contains over 100 beautiful game-pictures. And it's yours FREE, if you rush your request. You can mount all kinds of wild-game, and common specimens too. We can positively TEACH YOU. So GRASP this opportunity. RUSH letter or postal for this amazing FREE BOOK. Don't delay. State your AGE. N. W. SCHOOL OF TAXIDERMY, 2509 Elwood Bldg., Omaha 2, Neb.

and SCIENTIFIC MOTOR TUNE-UP
 —One of America's Fastest-Growing Big-Pay Industries!

Get ready now . . . Make a place for yourself in the mighty Diesel industry. Be there to take advantage of the opportunities ahead. The U.E.I. Plan for learning Diesel is simple, practical and is based upon the principle of learning-to-do-by-doing. Includes Auto Engine Tune-Up. You get fundamentals through spare-time home-study, followed by actual shop practice on modern Diesel engines. Experienced instructors guide you step-by-step — you learn the HOW and WHY of Diesel operation, service and maintenance. Get all the facts—mail the coupon and we'll send you a free copy of "Earning Power in Diesel." Mail coupon today!



UTILITIES ENGINEERING INSTITUTE

Dept. DC-40, (Founded 1927) Chicago 14, Ill.

UTILITIES ENGINEERING INSTITUTE, Dept. DC-40
 2521 Sheffield Ave., Chicago 14, Illinois

Please send me, without obligation, your free book, "Earning Power in Diesel."

NAME (print).....AGE.....
 ADDRESS

CITY..... Zone..... State.....

Check here for information if you are under 17

SEND FOR Free Record

START SPEAKING SPANISH or FRENCH



ALMOST OVERNIGHT!



MORE MONEY



NEW CAREER



TRAVEL FUN

HERE'S the easiest way to learn a new language. Listen to **FREE** 2-sided non-breakable record. Let your eyes follow words in **FREE** sample lesson. Almost at once you'll be chatting whole sentences in your new language with a perfect accent! There are no "strings" to offer. But it may end soon. Rush name, address with 25c to help cover cost of special packaging, shipping of free record, lesson. State language you want. We'll also send free information on full Cortina course. No obligation.

CORTINA ACADEMY

"Originators of the Phonograph Method"

Dept. 643, 136 W. 52nd St., New York 19, N. Y.

Also:
GERMAN
ITALIAN
RUSSIAN
JAPANESE
BRAZILIAN

WATCHMAKING

Learn at home • **FREE** sample lesson • Approved for Vets.
CHICAGO SCHOOL OF WATCHMAKING
2330 N. MILWAUKEE AVE., DEPT. 194A, CHICAGO 47, ILL.

"Building Beautifiers" Can Earn High Incomes

Colorcrete, a cementitious plastic, gives lifetime beauty and protection to drab, dirty masonry — concrete, stucco, etc. — on all kinds of buildings. Tough, tenacious, enduring. Easily cleaned. Helps to daylight dark interiors. Choice of gleaming white or 30 colors. Applied under pneumatic pressure to form an inseparable bond.



More Colorcreters are needed to supply the ever-increasing demand. Low investment appeals to men of limited capital. Work is easy, fascinating, highly profitable. Broad opportunity to develop a lifetime business. No special ability or experience needed because we supply full instructions and sales cooperation. Colorcrete machine is simple to operate, easy to move around. Write today for Opportunity Book.

Colorcrete Industries, Inc. **COLORCRETE**
570 Ottawa Av., Holland, Mich.

IN CANADA: DUNN MASONRY MACHINERY LIMITED
1020 Dundas Highway, Cooksville, Ont.

LOW OVERHEAD-LARGE VOLUME SALES & SMALL PROFITS
BRING YOU THESE "LOWEST PRICES"
WHAT GOOD IS A TIRE WITHOUT A TUBE?
TUBE FREE WITH EVERY TIRE AT NO EXTRA COST



WHY PAY MORE!

AN ESTABLISHED POLICY OF CAREFUL SELECTION ASSURES YOU, MANY HAPPY MILES, BE WISE—TRY ONE—YOU'LL BUY MORE! WE WELCOME COMPETITION. NO ONE CAN TOUCH OUR QUALITY & PRICE!

GOOD USED TIRES — NOT RECAPS — NOT RETREADS
TAKE THE 10% DISCOUNT WE OFFER & PUT MONEY IN YOUR POCKET!
EVERYBODY MAY TAKE **10% off** ON EVERY TIRE

15 MONTHS WRITTEN GUARANTEE

600-16 \$3.52	820-15 \$4.92	600-20 \$7.52	32x6-10 \$8.72
650-16 4.22	700-15 3.82	650-20 7.62	32x6-10 10.72
700-16 4.42	670-15 4.02	700-20 8.82	900-20 13.22
650-15 3.82	710-15 4.32	750-20 8.52	1000-20 14.02
760-15 4.42	860-17 3.72	825-20 14.12	1100-20 16.82

FREE If you buy 3 PASSENGER, 30 mos. guarantee tires. We GIVE the 4th tire FREE. **FREE**

Specialists in Truck Tires—Selected for Toughest Jobs—Tops in Value
30 MOS. WRITTEN GUARANTEE 32 MOS. WRITTEN GUARANTEE

600-16 \$5.02	475-15 \$5.12	700-15(8) \$8.42	700-20 \$10.62
600-16(8) 6.32	640-15 4.72	750-16(8) 8.42	750-20(10) 13.02
650-16 5.52	670-15 5.12	700-17 8.72	750-20(8) 12.72
650-16(6) 7.02	710-15 5.22	750-17 10.52	825-20 17.52
700-16 6.12	760-15 5.72	750-15 10.42	900-20 17.62
750-16(6) 8.32	800-15 6.02	825-15 10.92	1000-20 16.52
550-18 3.92	820-15 6.12	600-20 8.72	1100-20 17.02
550-17 4.22	670-16 5.02	650-20 9.52	1100-22 17.92
650-15 5.02	760-16 7.02	32x6-10 10.52	1000-22 17.92
700-15 5.12	700-16(6) 7.12	32x6-10 12.92	1100-24 22.92

ALL WHITE WALLS \$1.00 extra (Military treads)—750x20—\$14.02

Thousands of tires shipped all over the U.S.A. All tires shipped F.O.B. Phila. Send Check or M.O. with this ad. Dept. 2, No C.O.D.

STANDARD 834 N. Broad St., Philadelphia 30, Pa.

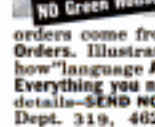

GROW ORCHIDS AT HOME
BIG PROFITS!! SPARE—FULL TIME

World's most thrilling hobby—profitable home business. Single Orchid plant may multiply into many — each as valuable as the first. Successful home grower shows you how! Raise gorgeous Cattleyas, Cymbidiums, Epidendrums, on living-room table. Big-profit orders come from friends, neighbors, florists, etc.—also Mail Orders. Illustrated secrets of the experts in simple "show-how" language AND blooming-size orchid plants sent at NO RISK. Everything you need to start — for pleasure or profit. **FREE** — full details—SEND NO MONEY. Write today. TROPICAL FLOWERLAND, Dept. 319, 4622 Wilshire Blvd., Los Angeles 5, California

Broken or Loose FALSE PLATE?



Fix it Yourself **EASILY** in a Few Minutes

Your plates may become broken or loose just when you need them most. With **FIX-IT-KIT** you can repair your own broken plates. Also tightens loose fitting plates, easily. Get permanent comfort with professional material. Complete instructions. Satisfaction guaranteed or your money refunded. **Order Now** at a new low price only **\$2.98** postpaid — or sent C.O.D.

DENT-FIX DENTAL PRODUCTS, Box 674, Dept. PM-9, Kansas City 41, Mo.

BEING PUSHED AROUND??



Why take any more nonsense from bullies, wise guys and other pests? The next time they try to act smart—give them the surprise of their lives! It's easy when you know **POLICE JIU JITSU!** This complete, fully illustrated course comes to you in one volume. The same as taught to police, marines, "G" men, soldiers, sailors and members of the U. S. Coast Guard. By all means, put pin 81 to this ad and we will send **POLICE JIU JITSU** to you postpaid by return mail. Satisfaction guaranteed or your money back.

BOOKS PUBLISHING CO., AMITYVILLE, N. Y.

REAL ESTATE BE A BROKER

PAYS BIG! SEND FOR FREE, BIG, ILLUSTRATED CATALOG NOW! Graduates report making substantial incomes. Start and run your own business quickly. Men, women of all ages, learn easily. Course covers Sales, Property Management, Appraising, Loans, Mortgages, and related subjects. **STUDY AT HOME** or in classrooms in leading cities. Diploma awarded. Write TODAY for free book! No obligation.

Approved for World War II and Korean Veterans
WEAVER SCHOOL OF REAL ESTATE (Est. 1930)
2020 Grand Dept. PM Kansas City, Mo.

Learn PHOTOGRAPHY at Home

Splendid opportunities. Prepare in spare time. Practical basic training. Long-established school. Send for free book, "Opportunities in Photography." No obligation.
AMERICAN SCHOOL OF PHOTOGRAPHY, 835 Diverser Pkwy., Dept. 1358, Chicago 14, Ill.

**It's New! 3 Years in Development
-NOW READY FOR YOU!**

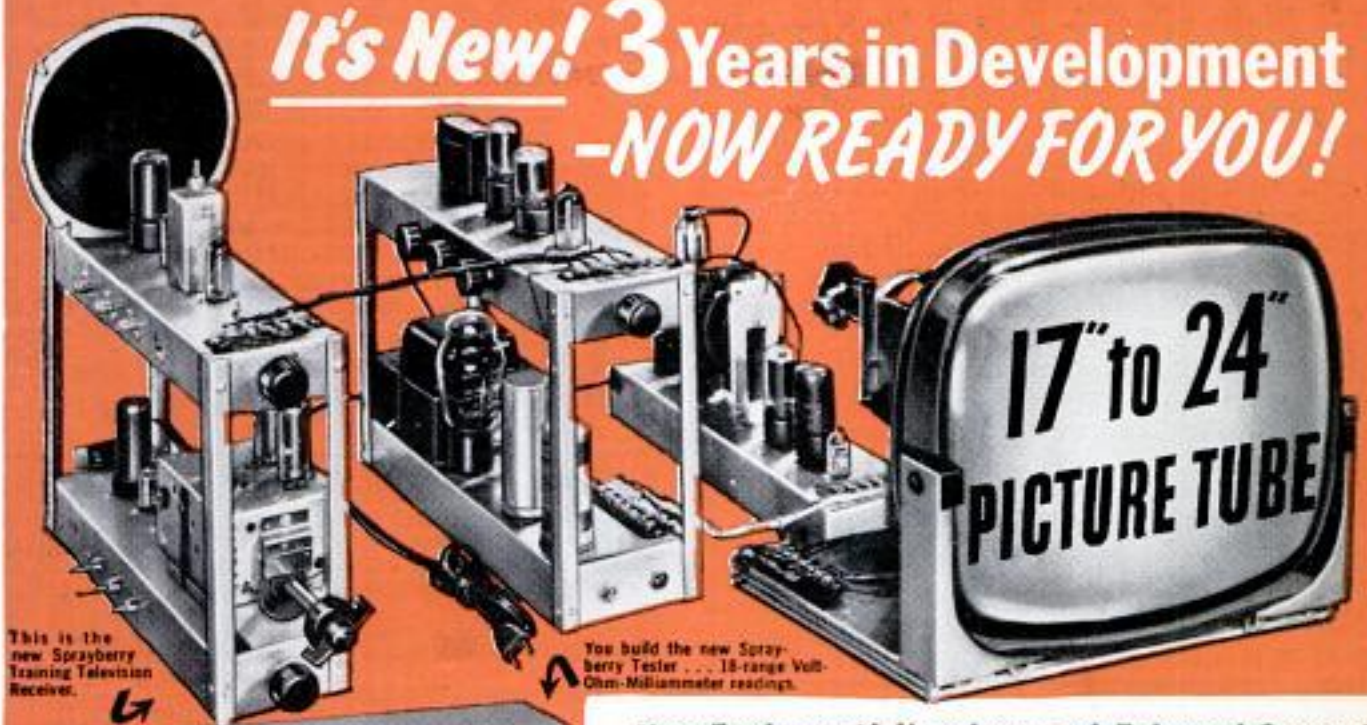

This is the new Sprayberry Training Television Receiver.

You build the new Sprayberry Tester... 18-range Volt-Ohm-Milliammeter readings.

**17" to 24"
PICTURE TUBE**



You will build this powerful short wave and broadcast superhet radio receiver.

New Equipment! New Lessons! Enlarged Course!
SPRAYBERRY PRACTICAL TRAINING IN
RADIO-TELEVISION
3 NO OBLIGATION TRAINING PLANS



F. L. SPRAYBERRY
Pres.

You have NO MONTHLY PAYMENT CONTRACT to sign... pay for this outstanding training as you learn!

Mail the coupon at once for my big all-new 56 page **FREE CATALOG** and **FREE Sample Lesson**. Get the full story of this remarkable new Training Plan. Read about my **3 NO OBLIGATION PLANS** of "packaged unit" instruction. I can prepare you in as little as **10 MONTHS** to take your place as a **Trained Radio-Television Technician**. You take no risk in enrolling for my Training because you **DO NOT SIGN A BINDING TIME PAYMENT CONTRACT**. I have been training successful Radio-TV technicians for 22 years...I can prepare you, too, to get into your own profitable Service Shop or a good paying job. Full information **FREE** and without any obligation. No salesman will call.

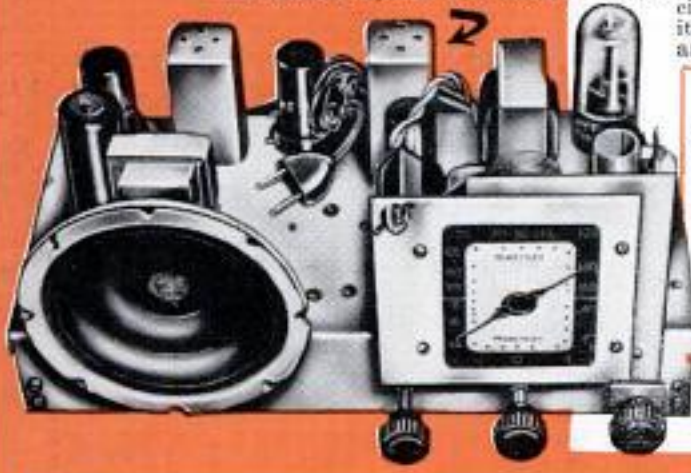

NEWEST DEVELOPMENTS

Your training covers **U H F, Color Television, F.M., Oscilloscope Servicing, High Fidelity Sound and Transistors.**

PRACTICE AND TRAIN AT HOME WITH 25 NEW KITS of EQUIPMENT

You get valuable practical experience in construction, testing and shop practice. You build a powerful 2 band superhet radio, the all-new 18 range Sprayberry multimeter, the new Sprayberry Training Television receiver, signal tracer and many other projects. All equipment is yours to use and keep. All your training is **IN YOUR HOME** in spare hours. I help you earn extra spare time money while you learn. Rush coupon below for all the facts—**FREE!**

SPRAYBERRY ACADEMY OF RADIO

**111 NORTH CANAL STREET, DEPT. 10-N
CHICAGO 6, ILLINOIS**



FREE CATALOG AND SAMPLE LESSON

Rush coupon for my catalog "How to Make Money in Radio-Television". **PLUS** an actual sample Sprayberry Lesson without obligation—**ALL FREE**. Mail coupon **NOW!**

SPRAYBERRY ACADEMY OF RADIO MAIL THIS COUPON FOR **FREE** Dept. 10-N, 111 N. Canal St., Chicago 6, Ill. **FACTS AND SAMPLE LESSON**
Please rush New Catalog and Sample Lesson **FREE**. I understand that no salesman will call.

Name _____ Age _____
 Address _____
 City _____ Zone _____ State _____

Inventors

The following are the usual preliminary steps to take toward patent protection.

Make a disclosure of your invention; sign, date and have this document witnessed by two or more people who understand your invention; authorize your registered patent attorney or agent to conduct a preliminary search among previously granted U. S. patents for similar types of invention; secure a report on the probable patentability of your invention and a recommendation of the further course to take.

We shall be glad to send you without obligation our instructive booklet, "Patent Protection for Inventors" and our "Evidence of Invention" disclosure form.

VICTOR J. EVANS & Co. *Merlin M. Evans*
REGISTERED PATENT ATTORNEY
930-K MERLIN BUILDING, WASHINGTON 6, D. C.

MAKE UP TO \$5 AN HOUR WITH



EASISHARP

Big profits in your spare time sharpening scissors. We show you how to start making money immediately. This is your chance now to have your own business with Easisharp. Sharpens a pair of scissors in less than two minutes! A child can operate it. Weighs only 10 lbs. Every home, barber, tailor, dressmaker—everybody uses scissors and all need sharpening two to four times a year. Don't let some one else get ahead of you. Write immediately to

MONEY MAKING SALES PLAN FREE

—everybody uses scissors and all need sharpening two to four times a year. Don't let some one else get ahead of you. Write immediately to

SERR-EDGE MACHINE CO., 9731 Lorain Ave., Cleveland, Ohio

HOBBIES

For FUN and PROFIT! Everything under the sun that's new, fascinating, different! Send only 25c for our big new Catalog No. 20 and receive an exciting GIFT KIT FREE!

PLASTICAST CO., (DEPT. C)
P.O. Box 6737 Chicago 80, Ill. (Write to either address) P.O. Box 987 Palo Alto, Calif.

EARN BIG MONEY

BE YOUR OWN BOSS • GET A BETTER JOB

IN CUSTOM FURNITURE UPHOLSTERY

EARN WHILE YOU LEARN

AT HOME prepare for big opportunity upholstery field with practical N. Y. State approved UTS Course. Be your own boss, get big pay job. Pay for training with spare time earnings while learning professional custom furniture, upholstery, reupholstery, slipcovers, furniture finishing and repairs, window cornice, cushion and drapery making.

FREE with Course: ALL tools, frames, materials and fabrics you use to make 3 beautiful pieces of upholstered furniture with slip covers—yours to keep or sell. You learn How to Start Your Own Upholstery Business and are entitled to Wholesale Supply Service privileges.

FREE illustrated book "Your New Way to a Successful Career," gives full details. Write today. Training in N. Y. School also available.

Approved for Veteran Training.



E. Weber, former foundry worker says: "Now I'm boss in my own successful custom furniture upholstery business."

UPHOLSTERY TRADES SCHOOL
Dept. CO-307, 721 B'way, N. Y. 3, N. Y.

Send me FREE book on:

Home Study In N. Y. School Training

Name _____

Address _____

City _____ Zone _____ State _____

Check if Korean Veteran

SEND FOR BIG FREE BOOK

INVENTORS

PROTECT YOUR INVENTION BY A U. S. PATENT. SEND FOR FREE "INVENTION RECORD" FORM AND "PATENT INFORMATION EVERY INVENTOR SHOULD HAVE."

CARL MILLER
REGISTERED PATENT ATTORNEY

WOOLWORTH BLDG., 35th FLOOR, 94A
NEW YORK CITY



PATENTS
C.A. SNOW & CO.
REGISTERED PATENT ATTORNEYS
WRITE FOR INFORMATION TO
428 SNOW BUILDING, WASHINGTON 1, D. C.

INVENTORS

Send for PATENT INFORMATION Book and INVENTOR'S RECORD without obligation
GUSTAVE MILLER
94-PM WARNER BUILDING
WASHINGTON 4, D. C.

REGISTERED PATENT ATTORNEY
ASSOCIATE EXAMINER
U.S. PAT. OFF. 1922-1929
Patent Attorney & Advisor
U. S. NAVY DEPT. 1930-1947
PATENT LAWYER

INVENTIONS WANTED

If you want to market, or sell, your invention for cash or royalties, Write for our Free Booklet. Send no drawings. We also welcome hearing from firms, or private capital, wishing to review inventions in any field. We will be glad to send notice of our clients' inventions.

GLOBAL MARKETING SERVICE
1404 Mitchell Street Dept. PD Oakland 1, Calif.



YOU CAN BUILD A VIOLIN FOR PLEASURE OR PROFIT

Now you can build a rich toned mellow violin modeled after a famous "Strad." YOU CAN MAKE A STRADIVARIUS VIOLIN contains 8 full scale plans plus complete instructions. You work directly from the plans with no confusing scale of dimensions to translate. Detailed instructions for each step including varnishing and stringing—even shows how to build your own tools. Cloth bound. Order today from

POPULAR MECHANICS PRESS . . . \$3.50
200 EAST ONTARIO STREET, CHICAGO 11, ILLINOIS

INVENTORS

Whether an invention is patentable can be substantially determined by a search of the U. S. Patent records. Without obligation, write for information explaining the steps you should take to secure a patent.

JOHN N. RANDOLPH

Registered Patent Attorney
201 Columbian Building, Washington 1, D. C.

INVENTORS

I shall be pleased to furnish you, upon request, with full information relative to patent procedure—without any obligation on your part.

PATRICK D. BEAVERS

Registered Patent Attorney
934 Columbian Building Washington 1, D. C.

100 YEAR OLD U.S. STAMPS



Believe it or not, but ours is the only firm capable of sending "On Approval" all U. S. stamps, even those over 100 years old, and all foreigns too, incl. Roosevelts, Coronations etc. Try it and see! Send 10c for our introductory bargain of 50 diff. U. S. and state whether approvals shall be U. S., foreign or both.

GLOBUS STAMP CO. 268 - 4th Ave., Dept. 213
New York 10, N. Y.

Learn BUILDING TRADES

Act Now to Earn Big Money
Send for Free Information Today
Home Training Program Sent

Building trades need men qualified to hold good paying positions as contractors, sub-contractors, estimators, supervisors, and in real estate sales. Are you letting biggest opportunity of our time to make money fast get away? Write for free facts today!

COMMERCIAL TRADES INSTITUTE, Dept. HB2-9
1400 Greenleaf Avenue Chicago 26, Ill.

DR. GRABOW PIPES

COOLER... Milder!
BECAUSE THEY'RE PRE-SMOKED

\$1.50 TO \$5.00

GREENSBORO, N. C.

RUPTURED?

Something different. Light. Cool. No leg straps. No elastic. No pressure on hips or spine. Inexpensive. Worn by Mechanics, Farmers, Doctors, etc., everywhere. Guaranteed. Write

HAND-LOCK PRODUCTS EST. 1893 DEPT. PW, PRESTON, ONT., CAN.

STUDY AT HOME

WITH AN EDUCATIONAL INSTITUTION

Courses in **ARTS AND SCIENCES:** Philosophy; Education; Letters; Public Health; Medical Jurisprudence; Psychology; Sociology; Physics; Chemistry; Geology; Pol. Science; Theology; Law; Business and Commerce; Accounting; Mathematics; Statistics; Agriculture. **ENGINEERING:** Electrical, Civil, Mechanical, Drafting, Architectural, Steam, Diesel, Aeronautical, Radio, Structural, Mining, Industrial, Petroleum, Refrigeration, Chemical. Send for free catalog.

McKinley-Roosevelt Incorporated, 4610-K32, Sheridan Rd., Chicago 40, Illinois

RAISE GIANT FROGS

Big Demand

MILLIONS USED YEARLY!
Good prices year round! Breeder lays up to 20,000 eggs yearly. Nation-wide markets waiting for all you can ship. Get ready now for next spawn. New book tells how! Small pond starts you. Men and Women send for my illustrated FREE folder today. Do it now!

ALBERT BROEL-7
P.O. Box 506, New Orleans, La.

250 POWER

Complete Telescope Lens Kit only **\$3.49** postpaid

Conquer Space, Explore the Universe, Planets, Moon Craters, New Stars, etc. Complete Lens Kit consists of 80 inch focal length ground and polished objective lens, eyepiece lenses for 50 POWER, 100 POWER, 150 POWER, 200 POWER, 250 POWER, and all necessary lens fittings. Easy to make from simple step by step instructions. (Tripod and mount not included.) Money back guarantee.

BUSSE SALES CO., Hartford, Conn., Dept. PM 25

THOUSANDS NOW PLAY

who never thought they could!



Delighted with Piano Course

Mildred Cade of Texas, right, and her friends are so delighted with our easy way to learn piano, they've all taken it up. Another student, Mrs. Phyllis Jones, Utah, calls it "easy as falling off a log."



"Opened Door to Popularity"

"I was able to play many pieces in a short time. Family and friends certainly surprised. Course opened door to popularity, wider circle of friends."—Peter H. Kozyra, Manitoba, Canada.



"Can't Thank Your School Enough"

"Never studied music before. Your method is easy; being your own teacher is best. After 4 lessons I could play a few pieces. Now play any piece I like. Can't thank you enough."—Rose Boyer, Blackwell, Mo.

You, too, can play any instrument by this **EASY A-B-C METHOD**

YOU think it's difficult to learn music? That's what thousands of others have thought! Just like you, they longed to play some instrument. But they denied themselves the pleasure—because they thought it took months and years of tedious study to learn.

And then they made an amazing discovery! They learned about a wonderful way to learn music at home—without a private teacher—without tedious study—and in a surprisingly short time. They wrote to the U. S. School of Music about this remarkable short cut method.

The result? Over 900,000 people have studied music at home this simple, A-B-C way. They have found the key to good times, popularity and profit. And that's what you can do right now.

Mail Coupon for FREE Book

Simply mail the coupon. Get the proof that you, too, can learn to play your favorite instrument—quickly, easily, in spare time at home. Just read the fascinating 36-page illustrated book. Tear out the coupon now, before you turn the page. Instruments supplied when needed, cash or credit. **U. S. SCHOOL OF MUSIC, Studio 309, Port Washington, N. Y.** 56th successful year. (Established 1898.)

U. S. SCHOOL OF MUSIC,
Studio 309, Port Washington, N. Y.

Send me your 36-page illustrated Free Book. No salesman is to call upon me. I'm interested in playing (name instrument) _____

I do I do NOT—have an instrument now.

Name _____ (please print)

Address _____

FOR YOUR VOCATIONAL TRAINING

COME TO THE COLLEGE OF TECHNOLOGY UNIVERSITY OF HOUSTON

(LOCATED IN FABULOUS HOUSTON, TEXAS)

FOR SUCCESS . . . Select one of these fascinating vocational fields:

- Automotive Mechanics Automotive Body and Paint
 Automotive Upholstery and Trim Furniture Upholstery
 Machine Shop Radio Servicing Television Servicing
 Welding Woodworking

TRAIN NOW for the job you want . . . a job with a good income and security. Train at the University's College of Technology . . . rated one of the best in the country.

- Beautiful 250 acre campus
- Air conditioned classrooms and residence halls
- Graduate placement
- University television and radio station
- Modern, extensive equipment
- Part-time job while in school
- Co-educational
- G.I. approved—V.A. on campus
- Open to high school graduates or equivalent
- Aptitude testing and vocational guidance
- Sept., Feb., June semesters

SEND FOR FREE illustrated brochure now. Mark X before your choice of subject.

UNIVERSITY OF HOUSTON—COLLEGE OF TECHNOLOGY
 DEPT. 194 — HOUSTON 4, TEXAS

FREE 1955 CATALOG

WORLD RADIO LABORATORIES

"The World's Largest Distributor of Amateur Radio Transmitting Equipment."

Jam packed with bargains—everything in Radio, TV, and Hi-Fi—for Handyman, Ham, Experimenter or Serviceman!

- Pay Only 10% Down
- Easy Terms
- Liberal Trade-Ins
- Save Over 50% on Used Equipment
- Over 600 guaranteed reconditioned items.



WORLD RADIO LABORATORIES
 3415 W. Broadway — Council Bluffs, Iowa
 Leo I. Meyerson **PERSONALIZED SERVICE**

MAIL HANDY COUPON

WORLD RADIO LABORATORIES, INC. Dept. PW-9
 3415 W. Broadway — Council Bluffs, Iowa 3'x4' U.S.
 Free 1955 Catalog Used Eqp't List Radio Map 25c

NAME _____
 ADDRESS _____
 CITY _____ STATE _____



20 POWER BINOCULAR

\$39⁹⁵

12 OUNCES

USE 30 DAYS AT OUR RISK! If dissatisfied, return for immediate refund.

It is now possible to secure a guaranteed 20 POWER, prismatic binocular that weighs only 12 ounces! At the amazing price of only \$39.95! The first time since Carl Zeiss invented the prism binocular over 100 years ago! Tremendous Power—Easy to Hold and Focus! Handsome durable crackle finish with lustrous chrome trim. Individual focus. Removable, screw-in, protective dust caps! Lens are color corrected AND interior surfaces of vital front rear Achromatics have been COATED for sharper, crisper images at all distances! EXCLUSIVELY MADE TO RIGID UNITED REQUIREMENTS in Japan which explains why the price is so low and the quality so high. Fine leather case and straps included! Cash orders postpaid. C.O.D.'s require \$2.00 deposit. Add 10% Federal Tax. **DEALERS WANTED.**

UNITED BINOCULAR CO.
 9043 S. Western Dept. ARF-8108 Chicago 20

BLOOD PRESSURE GAUGE \$5.98

for home use



Apparatus comes complete with instruction manual telling what blood pressure reading actually is, what it means to you and what you can do for it. Anyone can operate the dependable Mercury type gauge without assistance. You will be able to check your condition daily and in the privacy of your own home! You can count on years of dependable service from your apparatus and remember, two pressure readings alone are worth the cost of the entire outfit. Everything you will need is sent prepaid for just \$5.98 or C.O.D. plus charges. Free circular sent on request.

JOY SPECIALTY COMPANY
 2320-A West Hubbard St. Chicago 12, Ill.

Popular Mechanics Book for Pleasure or Profit

23 BOATS You Can Build

Build the boat you have always wanted. Build it for fun or to sell at a profit. Get Popular Mechanics 23 BOATS YOU CAN BUILD — row boats, canoes, sail boats, power boats and other craft including a 25 foot cabin cruiser. Book includes more than 500 photos, plans, diagrams and working drawings, plus step by step instruction that anyone can follow. Only simple tools needed. Material list of lumber, hardware, fittings, etc., included. Order today under money-back guarantee. Only \$2.00 postpaid. **POPULAR MECHANICS PRESS, Dept. PM3, 200 E. Ontario St., Chicago 11**

YES! SEND



directly to my door every month

I am enclosing

\$3.50 for 1 year

\$8.00 for 3 years

name _____

address _____

city _____ zone _____ state _____ A-94

Hand this order to your newsdealer or send it to

POPULAR MECHANICS
 200 East Ontario St. Chicago 11, Ill.

LINGUAPHONE

MAKES IT EASY TO LISTEN and LEARN to

Speak

**SPANISH • FRENCH • ITALIAN
GERMAN • RUSSIAN • JAPANESE
MODERN GREEK—29 languages available**

With LINGUAPHONE—World's Standard Conversational Method—You can Start to SPEAK another language TOMORROW! For just 20 Minutes a Day you listen to Linguaphone's MODERN Recordings. They make it easy—AND FUN—to learn another language AT HOME—the same natural way you learned to speak before you went to school.

You Listen, You Understand, You SPEAK

It's like living in a foreign land, you hear native men and women converse about everyday matters with a 1954 vocabulary. You acquire a true accent no textbook can teach.

Exciting Business, Travel Opportunities here and abroad, Linguaphone Method is used the world over by schools, colleges, governments, large business firms. Over 1,000,000 home study students.

Stop Wishing—Start Talking! **WRITE FOR FREE BOOK**, "Passport to a New World of Opportunity." Linguaphone Institute, 143-09 RCA Building, New York 20, New York.



GIANT BALLOONS

Surplus U. S. Gov't. (new—overage) NEOPHENE weather, target balloons. For FUN or PROFIT. Great sport in the backyard; or for parties, picnics, dances, fairs. **MONEY-MAKERS.** Use these balloons to attract crowds to civic events, conventions, exhibitions, trade shows. **TERRIFIC** for high school and college PROMS. All sizes are approx. inflated size. We pay postage on prepaid orders.

3 ft. dia. 49¢ — 6 ft. dia. 99¢
13 ft. dia. \$1.59 — 20 ft. dia. \$1.95
* Calif. residents please add sales tax.

WAR ASSETS DIV. VOLUME SALES CO.
Dept. M-954 3930 Sunset Blvd. Los Angeles 29, Calif.

How to Make Money in PHOTOGRAPHY

EARN WHILE YOU LEARN AT HOME!

If you are OVER 17—good pay, fascinating work await you in photography! Start making money quickly in sparetime—step into your own studio or exciting job. **LEARN-BY-DOING** method trains you at home! Write TODAY for FREE catalog. Also Resident Training. 45th Year! GI Approved.

NEW YORK INSTITUTE OF PHOTOGRAPHY
Dept. 49, 10 W. 33 St., New York 1, N.Y.

Send for FREE BOOK

BE A LANDSCAPE CONTRACTOR

Make \$20 to \$60 a day. Millions of new and old homes, estates, etc., need modern landscaping. Easy-to-follow Home Study Course. Hundreds of successful graduates. Write for FREE BOOK.

NATIONAL LANDSCAPE INSTITUTE
310 S. Robertson Dept. P-9 Los Angeles 48, California

FAMOUS DAN LURIE

BARBELLS

with 4 courses—low factory prices
50 lb. set...\$ 8.48 | 150 lb. set...\$20.48
100 lb. set... 13.98 | 200 lb. set... 25.98

Write for Order by Mail; 50% with order, bal. C.O.D. Free Catalog Extra wts. 13c per lb., F.O.B. plant

DAN LURIE BARBELL CO.
52-M-9 Bristol St., Dept. 459-J, Brooklyn, N. Y.



HERE'S A PROFITABLE BUSINESS FREE!

MONEY MAKING OPPORTUNITY FOR YOU WITHOUT INVESTMENT!

No experience needed to act as our Local Dealer for **MASTERS** Work Uniform garments. Every business concern a prospect. Advertising embroidered on garments is a big sales feature. Stores can't compete. You can easily earn up to many thousands of dollars yearly. We supply all Sales Equipment FREE. Write **GEO. MASTER GARMENT DIV.** 278 WATER STREET, LIGONIER, INDIANA



WHAT ALL AUTO MECHANICS WANT TO KNOW

1664 PAGES

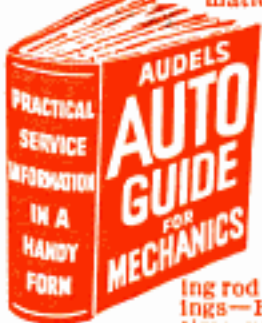

This Big Practical Book gives full information with working diagrams covering the principles, construction, ignition, service and repair of modern cars, trucks and buses.

Diesel Engines, Hydramatic & Fluid Drives Fully Explained.

A complete Guide of 1664 pages, with over 1500 illustrations showing inside views of working parts, with instructions for service jobs.

IT PAYS TO KNOW

How to fit pistons—How to locate engine knocks. How to fit connecting rod bearings—How to service main bearings—How to recondition valves—How to time valves—How to adjust fan belts—How to adjust carburetors and chokes. How to rebuild a clutch—How to service automatic transmissions—How to service brakes—How to adjust steering gear—How to cope with ignition troubles—How to service distributors—How to time ignition—How to "tune up" an engine.



\$4 COMPLETE • PAY \$1 A MO. TO GET THIS ASSISTANCE FOR YOURSELF SIMPLY FILL IN AND MAIL COUPON TODAY.

Step up your own skill with the facts and figures of your trade. Audels Mechanics Guides contain Practical Inside Trade Information in a Handy Form. Fully illustrated and Easy to Understand. Highly Endorsed. Check the book you want for 7 DAYS FREE EXAMINATION. Send No Money. Nothing to pay postman.

MAIL ORDER

AUDEL, Publishers, 49 W. 23 St., NEW YORK 10, N. Y.



Check NOW!

You Can Look Over Any Guide In Your Own Home — Start the Easy Payments If Satisfied

Please send me postpaid for FREE EXAMINATION books marked (X) below. If I decide to keep them I agree to mail \$1 in 7 Days on each book or set ordered and further mail \$1 monthly on each book or set until I have paid price, otherwise I will return them.

- AUTOMOBILE MECHANICS GUIDE, \$4
- TRUCK & TRACTOR GUIDE, 1299 Pages . . . 4
- DIESEL ENGINE MANUAL, 575 Pages . . . 2
- MACHINISTS HANDY BOOK, 1650 Pages . . . 4
- WELDERS GUIDE, 400 Pages . . . 1
- BLUE PRINT READING, 416 Pages . . . 2
- MATHEMATICS & CALCULATIONS, 700 Pages. 2
- SHEET METAL PATTERN LAYOUTS, 1100 Pages 4
- SHEET METAL WORKERS HANDY BOOK, 388 Pgs. 1
- MECHANICAL DRAWING GUIDE, 160 Pages . . 1
- MECHANICAL DRAWING & DESIGN, 480 Pages 2
- AIRCRAFT WORKER, 240 Pages . . . 1
- TELEVISION SERVICE MANUAL, 384 Pages . . 2
- RADIODIAGNOSIS GUIDE, 914 Pages . . . 4
- ELECTRONIC DEVICES, 216 Pages . . . 2
- ELECTRIC MOTOR GUIDE, 1000 Pages . . . 4
- ELECTRIC WIRING DIAGRAMS, 272 Pages . . . 1
- ELECTRICIANS EXAMINATIONS, 250 Pages . . 1
- ELECTRIC POWER CALCULATIONS, 425 Pages. 2
- HANDY BOOK OF ELECTRICITY, 1440 Pages. . 4
- ELECTRIC DICTIONARY, 9000 Terms . . . 2
- ELECTRIC LIBRARY, 7000 Pages (12 Book Set) 18
- MARINE ENGINEERS HANDY BOOK, 1258 Pgs. 4
- SHIPFITTERS HANDY BOOK, 250 Pages . . . 1
- REFRIGERATION & Air Conditioning, 1280 Pgs. 4
- MILLWRIGHTS & MECHANICS GUIDE, 1200 Pgs. 4
- POWER PLANT ENGINEERS GUIDE, 1500 Pages 4
- ENGINEERS & FIREMANS EXAMS, 525 Pages . 1
- PUMPS, Hydraulics & Air Compressors, 1658 Pgs. 4
- ENGINEERS LIBRARY (3 Book Set) . . . 9
- MECHANICAL DICTIONARY, 950 Pages . . . 4
- GARDENERS & GROWERS GUIDES (4 Book Set) 6
- CARPENTERS & BUILDERS GUIDES (4 Book Set) 6
- PLUMBERS & Steamfitters Guides (4 Book Set) 6
- MASONS AND BUILDERS GUIDES (4 Book Set) 6
- PAINTERS & DECORATORS MANUAL, 450 Pgs. 2
- HOUSE HEATING GUIDE, 1000 Pages . . . 4
- OIL BURNER GUIDE, 384 Pages . . . 1

MAIL THIS TODAY

Name _____
Address _____
Occupation _____
Employed by _____ P-9



The World's
Most Modern
Masonry



Opportunities Open for Local Manufacturing

From local plants dotting the country has come the Brikrete used to erect many thousands of buildings—homes, apartments, motels, stores, shopping centers—practically every type of residential, commercial and industrial construction. Why?

Because Brikrete has more quality features than any other fine masonry—design, size, light weight, insulation properties, range of 14 colors. And a price competitive to lumber! It's an outstanding business opportunity.

High Income Potentials

Freight and distribution costs are by-passed in the manufacture of Brikrete. By using local aggregates and local labor it's a "direct to user" business. Production economies enable low prices to consumers and generous profit margins to manufacturers.

More plants are needed to operate in protected territories under franchise privileges. Basic machine available on lease or purchase. Write for Brikrete Book No. 2.

Brikrete Associates, Inc.
4679 Division Ave., So.
Grand Rapids 8, Mich.

BRIKRETE

IN CANADA: DUNN MASONRY MACHINERY LIMITED
800 Dundas Highway, Cooksville, Ont.

Paint STRIPES with New "PAINT PEN"!

Makes Straight, Curved or Parallel Lines!

Just fill glass vial with any color paint. Use like a fountain pen to stripe furniture, bikes, autos, model planes, toys, linoleum, wall board. Beautiful, clean, crisp results every time, like professional painters. No experience needed to draw straight, curved, circular or evenly spaced parallel lines. Can't clog or smear. May also be used with glue, tempera, textile paint, or ceramic underglazes. Paints on wood, glass, plastics, metal, fabrics and paper. Lasts a lifetime. Only \$1 postpaid, complete with tip for 1/16 inch stripe. C.O.D.'s plus postage. Used by industry. Order your Paint Striping Tool TODAY!

New! "DOUBLE-STRIPER"
MODEL Only \$2.95

Newest paint striping invention. Makes DOUBLE stripes—one wide and one narrow or two wide or two narrow at the same time. Or adapt quickly for wide or narrow single stripe. Makes 6 combinations. FREE—Send postcard for complete information... or order now... \$2.95.



\$1.00

DEALERS

Master Paint Striping Tool packed in Display Cartons of 1 dozen. Fast, profitable seller. Write for discounts.

Attention All Home Craftsmen!

New Paint Striping Tool gives "professional" results every time, yet simple and easy to use as a fountain pen. Adjustable guide keeps lines straight as an arrow. Just as easy to make curves or freehand designs. Adds new beauty, finished look to everything you paint. Send \$1 now.

WENDELL MFG. CO., Dept. 3-K
4234 Lincoln Ave., Chicago 18, Illinois

6 Other Complete Tools

Complete tools for 1/64, 1/32, 3/64, 5/64, 3/32 or 1/8 inch stripes, \$1.50 each. Extra tips 75c ea. COMPLETE KIT with ALL TIPS, \$5.00. (Also 1/4" tip, only \$1.00). All tips interchangeable.

WATCHMAKING

Why spend all your life at dull or backbreaking work? Watchmaking is light, clean, fascinating. Lifelong livelihood. Learn the quick Sweezer way at home or Chicago School. Modern methods, step-by-step. No previous experience needed. Individual training. Start any time. Approved for vets. Send for FREE sample lesson. No obligation. Write today!

CHICAGO SCHOOL OF WATCHMAKING

2330 N. Milwaukee Ave., Dept. 194, Chicago 47, Ill. Veteran

Send me FREE sample lesson Home study Resident school

Name _____

Address _____

City _____ Zone _____ State _____

NEW! SUPER POWERFUL

All Channel VHF-UHF TV RECEPTION IN ALL DIRECTIONS

ONLY **23.50**
Model AX-524

Rocket Directronic Motorless
TV Antenna 360° Electronically
Switched Beam



In the fringe or ultra-fringe, the NEW 1954 Motorless Directronic will outperform any ordinary antennas. This sensational new 360° UHF-VHF TV Antenna offers "around the compass" reception WITHOUT Rotors. Provides superb ghost-free picture clarity. Model AX-524 "Service-man's Array" contains Hi-Pac Molded Insulator of Extreme tensile strength, 24 hi-tensile aluminum elements, including 6 Multi-purpose Reflector-directors, 1 set matched tie rods, Universal Mast Clamps, 6-position Beam Selector Switch, 75' Low-loss UHF-VHF Tubular TRI-X Cable. 25% DEPOSIT ON C.O.D. ORDERS. ALL PRICES F.O.B. CLEVELAND. YOU PAY POSTAGE.

NATIONAL ELECTRONICS OF CLEVELAND
309 Delco Bldg. Cleveland 3, Ohio

\$2850 BUILDS INCOME DUPLEX

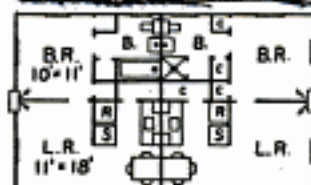

Build your own duplex from our full size plans. Choice of frame, brick veneer, or concrete block. Features include awning windows, slab and asphalt tile floors, factory cabinets, rock wool insulation and soundproofing. Each side contains livingroom, dining area, kitchenette, bedroom, bath, four closets, wall furnace and one-half ton air conditioner. You receive two sheets genuine blueprints showing floor plan, foundation, wall section, front and side views and large two dimensional cutaway drawing of entire framework, also material list and proven cost estimate (cost above for brick) \$2.95 Ppd. Unconditional money-back guarantee.

BAILEY BUILDERS, 915 Pyramid Bldg., Little Rock, Ark.

BENJAMIN SUPER CO₂ GAS CARBINE-\$16.50

NEWEST TARGET

RIFLE-22

IDEAL

FOR

SMALL

GAME



ECONOMICAL

SAFE-NON-TOXIC

ACCURATE-CONVENIENT

PRACTICAL. Easy to operate—No spring

recoil—No pumping. Uses low cost Soda Cartridges

Cal. 22 Benjamin H-C Pellets and Darts.

Benjamin CO₂
Gas Pistols
Also Available

WRITE FOR FREE ILLUSTRATED FOLDER OF ALL MODELS

BENJAMIN AIR RIFLES AND BENJAMIN AIR PISTOLS

BENJAMIN AIR RIFLE CO.

896 MARION ST., ST. LOUIS 4, MO. U.S.A.

\$2.95 OR 2 FOR \$5.00!

Complete tested and guaranteed with inter-com instructions, 50 ft. of wire and roll of tape (Offer good for this month only). Write for free list of telephones. All shipments FOB Simpson, Pa.

TELEPHONE ENGINEERING CO.
Dept. 984 Simpson, Pa.

Say You Saw It in Popular Mechanics

Buy Nationally Known Brands WHOLESALE! DIRECT! SAVE to 66 2/3%!

- APPLIANCES
 - WATCHES
 - CAMERAS
 - SPORTING GOODS
 - AUTO SUPPLIES
- OWN YOUR OWN BUSINESS!
● No Investment!
● No Inventory!
- Write for FREE Brochure

NATIONAL BUYERS SERVICE, P.O. 426, OAKLAND, CALIF.

Enjoy the Fascinating Story of the Horseless Carriage in

It's thrilling, fascinating, informative. From the very first gasoline-propelled buggy to the cars of today and the atomic auto of the future. The first cars—the men who made them—the scrambled start and development of the fabulous auto industry—the story of auto racing. 166 thrilling action pictures—old-time cars—racing cars—early auto advertising—automotive oddities. Listing of 2000 U. S. autos included. Ideal gift book. Cloth bound, only \$5.00 by mail. Money back if not pleased. Paper covered edition \$1.00 at newsstands.



POPULAR MECHANICS PRESS, Dept. PM15, 200 E. Ontario St., Chicago 11

FOR REAL JOB SECURITY -GET I.C.S. DIPLOMA



"You can stop worrying, Jane. My job's secure now! And here's the insurance policy to prove it—my I.C.S. diploma!"

This feeling of security is probably typical of every I.C.S. graduate. Because—as the job situation gets tighter, the man with I.C.S. training has the advantage.

Why? Your I.C.S. diploma tells your present employer three important things: (1) You want to make the most of your present job.

(2) You have the training you need for advancement. (3) You look for better ways of doing things on your own.

What you do about your future is up to you. Do nothing and stay at your present job at the same old pay. Or earn an I.C.S. diploma in your spare time for security, promotions, more pay! Your first step is to mark the course that interests you in the coupon below, and mail it to us.

Free books

We'll send you two interesting books. The first, "How to Succeed," is a gold mine of helpful tips. Points out many small things in your personality and behavior that can make the difference between success and failure. The second book tells you about the opportunities in the field of your choice.

Costs pennies a day

Many an I.C.S. student has made up the cost of his course in one month with the salary increase his I.C.S. training earned for him. By studying at home in your spare time, you pay yourself many times an hour more than you're now making. (One student reports—"My I.C.S. course was worth \$95 an hour to me.")

The security of your present job—or the success in finding the new job you've always wanted—is in your hands. Move ahead with I. C. S. training while others stay behind on the routine, small-pay jobs. Remember, your first step to security and success is to mail this coupon. Take a few minutes and do it now. If you put it off, it can cost you your future.

For Real Job Security—Get an I. C. S. Diploma!

I. C. S., Scranton 9, Penna.

INTERNATIONAL CORRESPONDENCE SCHOOLS

ICS

BOX 5631-L, SCRANTON 9, PENNA.

(Partial list of 277 courses)

Without cost or obligation, send me "HOW TO SUCCEED" and the opportunity booklet about the field BEFORE which I have marked X (plus sample lesson):

- | | | | | |
|--|--|---|--|---|
| <input type="checkbox"/> ACCOUNTING | <input type="checkbox"/> Commercial Drawing | <input type="checkbox"/> Retail Business Management | <input type="checkbox"/> Incentive Wage Systems | <input type="checkbox"/> High School Subjects |
| <input type="checkbox"/> Accounting | <input type="checkbox"/> Fashion Illustrating | <input type="checkbox"/> INDUSTRIAL | <input type="checkbox"/> Job Analysis & Evaluation | <input type="checkbox"/> Secretarial Accounting |
| <input type="checkbox"/> Accounting System | <input type="checkbox"/> Show-Card Lettering | <input type="checkbox"/> Drafting | <input type="checkbox"/> Labor Relations | <input type="checkbox"/> Stenography |
| <input type="checkbox"/> Installation | <input type="checkbox"/> Sign Lettering | <input type="checkbox"/> Industrial Instrumentation | <input type="checkbox"/> Organized Training | <input type="checkbox"/> Typewriting |
| <input type="checkbox"/> Auditing | ENGINEERING | <input type="checkbox"/> Quality Control | RETAIL | TRADES AND CRAFTS |
| <input type="checkbox"/> Certified Public Accounting | <input type="checkbox"/> Aircraft | <input type="checkbox"/> Reading Blueprints | <input type="checkbox"/> Advertising | <input type="checkbox"/> Air Conditioning |
| <input type="checkbox"/> Cost Accounting | <input type="checkbox"/> Architecture | <input type="checkbox"/> Shop Practice | <input type="checkbox"/> Bookkeeping, Business Forms | <input type="checkbox"/> Apprenticeship Training |
| <input type="checkbox"/> Federal Tax | <input type="checkbox"/> Chemical | <input type="checkbox"/> Supervision | <input type="checkbox"/> Buying, Pricing | <input type="checkbox"/> Automotive Repair |
| <input type="checkbox"/> Junior Accounting | <input type="checkbox"/> Civil | LEADERSHIP | <input type="checkbox"/> Department Store Operations | <input type="checkbox"/> Blue Print Reading |
| <input type="checkbox"/> Partnership Accounting | <input type="checkbox"/> Electrical | <input type="checkbox"/> Foremanship | <input type="checkbox"/> Retail Merchandising | <input type="checkbox"/> Building Trades |
| <input type="checkbox"/> Practical Accounting | <input type="checkbox"/> Industrial | <input type="checkbox"/> Industrial Supervision | <input type="checkbox"/> Retail Salesmanship | <input type="checkbox"/> Diesel Engines |
| <input type="checkbox"/> Stationary | <input type="checkbox"/> Mechanical | <input type="checkbox"/> Leadership | <input type="checkbox"/> Window, Counter Display | <input type="checkbox"/> Domestic Refrigeration |
| ADVERTISING | <input type="checkbox"/> Petroleum | <input type="checkbox"/> Personnel Management | <input type="checkbox"/> Retail Salesmanship | <input type="checkbox"/> Internal Combustion Engines |
| <input type="checkbox"/> Adv. Production | EXECUTIVE MANAGEMENT | <input type="checkbox"/> Office Management | <input type="checkbox"/> Creative Salesmanship | <input type="checkbox"/> Plumbing & Heating |
| <input type="checkbox"/> Business Paper Adv. | <input type="checkbox"/> Budgetary Accounting | <input type="checkbox"/> Indexing and Filing | <input type="checkbox"/> Real Estate Salesmanship | <input type="checkbox"/> Radio Servicing |
| <input type="checkbox"/> Department Store Adv. | <input type="checkbox"/> Business Administration | <input type="checkbox"/> Office Analysis | <input type="checkbox"/> Sales Analysis | <input type="checkbox"/> Railroad |
| <input type="checkbox"/> Direct Mail Adv. | <input type="checkbox"/> Business Law | <input type="checkbox"/> Office Communications | <input type="checkbox"/> Sales Letters | <input type="checkbox"/> Sheet Metal |
| <input type="checkbox"/> Magazine & Newspaper Adv. | <input type="checkbox"/> Business Management | <input type="checkbox"/> Office Forms | <input type="checkbox"/> Sales Management | <input type="checkbox"/> Television Servicing |
| <input type="checkbox"/> Mail Order Adv. | <input type="checkbox"/> Business Mathematics | <input type="checkbox"/> Office Management | <input type="checkbox"/> Sales Records and Reports | TRAFFIC MANAGEMENT |
| <input type="checkbox"/> Psychology of Adv. | <input type="checkbox"/> Condensed Business Practice | <input type="checkbox"/> Office Reproduction | <input type="checkbox"/> Selecting Salesmen | <input type="checkbox"/> Air Services |
| <input type="checkbox"/> Public Relations | <input type="checkbox"/> Credits and Collections | <input type="checkbox"/> Personnel Management | <input type="checkbox"/> Supervising Salesmen | <input type="checkbox"/> Freight Class, Rules |
| <input type="checkbox"/> Radio and Television | <input type="checkbox"/> Financing | <input type="checkbox"/> Supervision | <input type="checkbox"/> Training Salesmen | <input type="checkbox"/> Freight Services, Facilities |
| <input type="checkbox"/> Research and Testing | <input type="checkbox"/> Interpreting Financial Statements | PERSONNEL | <input type="checkbox"/> SECRETARIAL-STENOGRAPHIC | <input type="checkbox"/> Motor Traffic Management |
| <input type="checkbox"/> Retail Adv. | <input type="checkbox"/> Letter Writing Improvement | <input type="checkbox"/> Collective Bargaining | <input type="checkbox"/> Bookkeeping | <input type="checkbox"/> Regulation of Carriers |
| <input type="checkbox"/> Visualizing the Layout | <input type="checkbox"/> Marketing & Production | <input type="checkbox"/> Employee Relations | <input type="checkbox"/> Business Correspondence | <input type="checkbox"/> Shipping Documents |
| <input type="checkbox"/> Window, Interior Display | <input type="checkbox"/> Public Relations | <input type="checkbox"/> Employment Practices | <input type="checkbox"/> Business English | <input type="checkbox"/> Tracing, Expediting, Claims |
| COMMERCIAL ART | <input type="checkbox"/> Quality Control | | | <input type="checkbox"/> Traffic Control, Management |
| <input type="checkbox"/> Adv. Layout, Illustration | <input type="checkbox"/> Report Writing | | | |
| <input type="checkbox"/> Commercial Cartooning | | | | |

Name _____ Age _____ Home Address _____

City _____ Zone _____ State _____ Working Hours _____ A.M. to P.M. _____

Occupation _____

Canadian residents send coupon to International Correspondence Schools, Canadian, Ltd., Montreal, Canada. . . . Special tuition rates to members of the U. S. Armed Forces.

BUILD your own TV Set

YES, actually build a valuable TV Set right at home. At the same time learn all about installing, repairing, servicing—and get ready for a Big-Pay Job in America's fastest-growing, most exciting industry. The CTI TV Train-at-Home Plan is preparing hundreds for bigger pay TODAY—and a brighter Future TOMORROW. No experience needed. We supply easy-to-understand instructions—made clear with hundreds of charts, diagrams, photos—plus TWENTY KITS of Parts, Professional Equipment and Tools. Get a TV Set to ENJOY. Get set to ENJOY a TV Future. Make money in spare time while taking Course. THOUSANDS SUCCEEDING! So can You. Send today for big FREE Book, "You Can Succeed in Television."

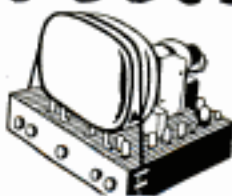

COMMERCIAL TRADES INSTITUTE
Dept. T2-9, 1400 Greenleaf Ave., Chicago 26, Ill.

\$1 Sensational TIRE Special \$1

THINK OF IT! Just \$1.00 buys an extra, SUPER MILEAGE passenger tire (any size) when you order 2 SUPER MILEAGE pass. tires (any size) at only \$5 each. Limited offer! Act quickly!

Finest used tires! Goodyear, Firestone, U. S., Goodrich, etc.
FREE TUBE WITH EACH TIRE! EVERY TIRE FULLY GUARANTEED!
GOLDEN RULE 32 MONTH GUARANTEE BOND WITH EVERY TIRE!

SUPER MILEAGE TRUCK TIRE BARGAINS!

700-15(6)	\$8.00	050-20	\$10.62	1000-20	\$18.42
750-16(8)	9.00	700-20(10)	11.95	1100-20	19.12
700-17	9.00	750-20(8)	12.80	1200-20	27.02
750-17	10.70	750-20(10)	13.25	1000-22	19.72
825-15	23.72	825-20	18.50	1100-22	20.42
600-20	8.90	900-20	17.92	1100-24	23.22

Military Mud-Sno Treads—Super Mileage Specials!
Std. Genr. 16 Mos. 750-20 Std. \$12.55 | 900-16 Std. \$12.95
Rugged Genr. 30 Mos. 750-20 Rg. 14.95 | 900-16 Rg. 14.00

FOR RUSH SHIPMENT send check or Money Order!

JAYDEE TIRE CO. 2236 N. FRANKLIN STREET,
PHILA 33, PA. (Dept. PM)

PREPARE FOR THE BEST JOBS IN INDUSTRY

TRAIN at HOME
IN YOUR SPARE TIME
or at
ALLIED INSTITUTE
in Chicago

- MECH. ENGINEER
- DRAFTSMAN
- TOOL DESIGNER
- TOOL ENGINEER
- TOOL & DIE MAKER
- MASTER MACHINIST

NO RECESSION FOR ALLIED TRAINED MEN

MORE JOBS THAN GRADUATES Shortages of Draftsmen, Designers, Tool Engineers, Machinists, Tool & Die Makers are so widespread that you can pick a highly paid key job and look forward to Achievement and Security.

You can begin your training in Short Courses and continue progressively to a Bachelor Degree in 26 months.

Allied is approved by Industry, Dept. of Education, Office of Public Instruction, State of Illinois, U. S. Veterans Admin., U. S. Dept. of Justice. Accredited: C. S. A.

SEND FOR
FREE
BOOKS

ALLIED SCHOOL of MECHANICAL TRADES
1338-42 South Michigan Ave. Dept. PM-9 Chicago 5, Illinois

SEND ME WITHOUT OBLIGATION INFO. ON YOUR COURSES:

HOME STUDY RESIDENT VETERAN NON VETERAN

NAME _____

ADDRESS _____

CITY _____ STATE _____

23 BOATS YOU CAN BUILD



You Can Build These Boats Without Experience With Few Tools, and Little Time to Spare!

And the best part is that after you have completed your boat, you will know it is seaworthy as well as eye-worthy. This book, a few tools, and some time each day in your garage or basement, is all you'll need to complete the boat of your dreams. Nothing is left to the imagination. Everything is planned for you before you turn back the cover of the book. All you do is follow simple step-by-step instructions and show how photos and drawings.

Building and Service Hints Provided

You'll learn how to build your boat right the first time. Success in building a boat depends on two things. Knowing beforehand exactly what type boat you want to build and then getting started correctly on the construction. With this book it's simple. Material lists are supplied where essential, listing lumber required, hardware, sailcloth, fittings, etc. Also included are hundreds of hints for building your boat right, the best boat for beginners, and tips on servicing boats after they are built.

Special Chapter on Boats for Sportsmen

If you are a sportsman, hunter, fisherman, trapper, or just plan to use your boat for pleasure, this chapter contains ideal craft for your use. Perhaps you have a canoe in mind, or a rowboat that can be carried on your auto. Maybe you have always wanted a duckboat but have been reluctant to purchase one because of the expense. All these boats plus a 3-second

rowboat, and 12-foot plywood outboard, are available in this one chapter alone. All are easy to construct, and beautiful to own. Step-by-step instructions, photographs and illustrations, plus important material lists carry you right through from the forming of the keel to the last coat of paint and varnish.

Half a Million Persons Build Their Own

There are more than half a million persons in the United States who regularly build boats for pleasure or for profit. They form a cross section of American life. And theirs is a double reward—the fun of building the boat, and the thrill of using it when it is finished.

Partial Listing of Boats

Think of being able to build and own the following boats: "Su-Lu" the PT-type Plywood Dinghy, 11-ft. Skiff, "Sport" a V-Bottom Inboard, "Tramp" a 15-ft. Sailing Knockabout, "Sea Craft" a 25-ft. Cabin Cruiser, "Zephyr" a 14-ft Sailing Dinghy, "Arrowhead" a 21-ft. Sloop, a bicycle Boat, Motor-driven Paddle Board, "Skimmer" a Sturdy Plywood Kayak, "Skip" a Pram-Type Dinghy, "Tiny" a 6-ft. Training Ship, and many more, from large to small and at a fraction of the purchase cost!

7-Day Money Back Guarantee

Send for your copy of 23 BOATS YOU CAN BUILD today. Read and use it for 7 days. If it isn't entirely satisfactory return it for a full refund.

Use This Handy Order Coupon

POPULAR MECHANICS PRESS
200 E. Ontario St., Chicago 11, Illinois

Gentlemen:

Please send my copy of 23 BOATS YOU CAN BUILD. Enclosed is my remittance of \$2.00. If I am not completely satisfied with the book I will return it for a full refund after 7 days.

Name _____

Address _____

City _____ Zone _____ State _____

EARN \$60 A DAY!

The famous Hi-Pure Model 105, lowest-priced high-quality steam cleaner on the market, combines every engineering advance.

Your First 8 Jobs Pay For Your Cleaner

Owning your own high-profit business is easy with a Hi-Pure Steam Cleaner. Write for FREE details.

*FOB shipping point. Freight prepaid on cash orders.



*\$398.50 MODEL 105, COMPLETE

HI-PURE LABORATORIES, Evansville, Indiana

MAIL ORDER BUSINESS

Your Big Opportunity!

34-lesson course on proved, up-to-date, profitable methods. Amazing treasure-house of the best mail order plans and practices. How to start your own mail order business on a small one-man scale... how to keep it growing more and more profitable month after month. Money-making FACTS. Full price only \$8.95, postpaid—no COD plus postage. Nothing more to pay. Satisfaction guaranteed or refund. Order "Mail Order Course" today! NELSON-HALL CO., 210 S. Clinton St., Dept. JW-2, Chicago 6, Ill.



MAKE YOUR OWN POGO STICK

Comparable to any \$8. Pogo Stick. ALL METAL... SIMPLY AND QUICKLY ASSEMBLED.

Complete kit—Finest Materials—Painted—ready to assemble. Up to 100 lbs. \$1.50. Over 100 lbs. \$4.50 ppd. Specify weight.

PAR SALES CO., 6912 Hollywood Blvd., Hollywood 28, Calif. Dept. PH-94

XMAS MONEY

It's easy with this beautiful all wood 11 in. high SWISS MUSICAL CHURCH. Regular Retailer \$7.50. Complete kit \$3.95. Add 50c postage.

PILTZECKER SWISS IMPORTS, Wood-Ridge, N. J.

TRICK BASEBALL 75¢

YOU GET 2 FOR \$1.00 POSTPAID: A real screwball in this baseball that's as full of tricks as a practical joker. Even a Major Leaguer couldn't pitch a straight ball with it! It dips. It curves. It bounces crazily. It rolls in circles. Write for FREE Novelty Catalogue.

NOVELTY MART, 59 E. 8th Street, New York 3, N.Y., Dept. 315

LUFTWAFFE DRESS DAGGER
(AIR CORPS) OF THE GERMAN REICH \$5.95 POSTPAID EACH INCLUDES SHEATH

Special — limited supply. Ceremonial Weapon of W.W. II German Luftwaffe (air force). The dress dagger that is the most rare and highly prized war souvenir. Polished 10" Solingen blade, overall 15½". Ivory-like handle, silver cord wrapped. Equipped with black German custom leather sheath. A must for every den and wall collection. As new. Send check, cash or M. O. For U.S., APO and FPO airmail, add 80c per knife. Sorry, no COD'S. Calif. resid. add 3% state tax.

GOLDEN STATE ARMS CORPORATION
20 BOWLING BLDG., 972 E. COLORADO ST., PASADENA 1, CALIF.

The WONDERS of LIQUID PLASTICS

MANUFACTURE WITHOUT TOOLS OR MACHINERY

No previous experience or special ability required! NO TOOLS OR MACHINERY required... the entire process is about as easy as pouring water out of a glass! The WONDERS OF LIQUID PLASTICS make all this possible! Many of the products made with our liquid plastics serve so many diverse and useful functions, many can so easily be converted into beautiful and attractive products that thousands of our customers are now actively engaged in a wide variety of proud and profitable businesses established with the aid of our products and instructions!

UNLIMITED POSSIBILITIES

Work with LIQUID IVORY, LIQUID GLASS, LIQUID MARBLE, LIQUID EBONY, LIQUID PORCELAIN, LIQUID WOOD, LIQUID GEMSTONE, and many other LIQUID PLASTICS and in a matter of minutes turn them into an endless and valuable procession of beautiful imbedded jewelry, novelties, ornaments, statuettes, bookends, lamps, pensets, lighters, ashtrays, keychains, figurines, curios, SOUVENIRS, art and gift products, fishing lures, BOATS, GADGETS galore, exquisite GEMS! Make gears, tools, dies, forms, handles, dials, knobs, MACHINE PARTS, models of inventions, pistol grips... the list is endless! The only LIMITATION is your IMAGINATION! Liquid Plastics are the blessing of every creative and ambitious person... with these materials ANYONE can create and manufacture for the THOUSANDS and at a tiny fraction of what it would cost by any other method! Just send 25c and we will send you our big combination Instruction-Catalog describing all of the products mentioned above and the methods of use! You'll readily admit it's the most fascinating book of its kind as far as opening new worlds of activity and opportunities for you! Send for it today.

PLASTICAST CO., (Dept. C)

P.O. Box 6737 (Write to P.O. Box 987 Chicago 80, Ill. either address) Palo Alto, Calif.

FREE!

This highly instructive book will be sent FREE only to those serious inquiries requesting our Instruction-Catalog (25c). No postcards, please.



PLASTIC LAMINATING

This remarkable Plastic Laminating Machine will save \$18.00 an hour right in your kitchen! Big profits laminating Business, Social Security, Identification, Credit CARDS of all kinds, photos, passes, clippings, plaques, etc. Prices from \$85.00 and up. Easy terms. Will accept any equipment in trade. Literature free.

PLASTICAST CO.
(See addresses above)



**SAVE 75%
ON**



WORK CLOTHES!

**SURPLUS STOCK FROM
MIDWEST SUPPLY FIRM!**
Terrific values you've got to see to believe!

SHIRTS 79c

Made to sell for 2.99! Now Only 4 for \$2.99

What a buy! 4 for the price of one! These shirts, though used, are washed, sterilized and ready for long, tough wear. In blue or tan. Send name, address, neck size.

PANTS to match

Sold for 3.95 now only **99c**
Unbelievable Bargains! Send waist measure and inside leg length.

COVERALLS ... wear 'em used and save plenty! Originally 5.95. Now only **\$1.95**
Send chest measurement. 3 for \$5.75

SATISFACTION GUARANTEED! Your money back if you can beat these bargains anywhere! You can't lose so order TODAY for immediate delivery! Pay postman or send money with your order and save postage. \$1.00 deposit on C.O.D. orders.

GALCO SALES CO. Dept. 139
7120 Harvard Ave. • Cleveland 5, Ohio

Make UP TO \$10.00 an Hour, Spare Time!
Assemble and Install **BUCKEYE**
Combination Storm Windows

EQUIP YOUR OWN HOME. THEN EASILY SELL FRIENDS, NEIGHBORS
No inventory or special tools to buy! All sizes, redwood or aluminum, shipped knocked down, factory to you, as you fill orders. Top quality windows; screen and glass panels easily changed from indoors! A sound profit opportunity, proved by thousands of sales over 20 years. You can also arrange to offer low, easy FHA terms, through your local bank.
WRITE FOR DETAILS TODAY!



Your Cost Only \$6.65*
You Sell For \$22.00
*for 28 1/2" x 26" window, plus screen cloth and glass you buy locally. Other sizes and aluminum slightly higher.

BUCKEYE SCREEN & WEATHERSTRIP CO.
1380 S. 22nd Street, Columbus, Ohio

WHEELS WHEELS WHEELS

- 7" Disc Wheel 3/4" Tire 3/4" sleeve 45c ea.
 - 8" Disc Wheel 1 1/8" Tire 1 1/8" sleeve 70c ea.
 - 7" Disc Wheel 1" Tire 1 1/2" ball bearing 80c ea.
 - 8" Disc Wheel 1 1/4" Tire 1 1/2" ball bearing \$1.00 ea.
 - 6" Disc Wheel 1.50 semi-pneum. Tire 1/2" B.B. \$1.35 ea.
 - 8" Disc Wheel 2" semi-pneum. T. 1/2" B.B. \$1.50 ea.
 - 10" Disc Wheel 1.75 semi-pneum. T. 1/2" B.B. \$1.50 ea.
 - 10" Disc Wheel 2.75 semi-pneum. Tire 5/8" B.B. \$2.50 ea.
 - 12" Disc Wheel 1.75 semi-pneum. T. 1/2" B.B. \$1.85 ea.
- Above wheel prices include hub cap. Plus Postage, C.O.D.'s accepted. AXLES—Size 5/16 in., 3/4 in., 1/2 in.—Cut to size—End holes drilled.

UNITED WHEEL STAMPING CO.
12131 S. PEORIA STREET PM-9 CHICAGO 43, ILLINOIS

PUMP WATER FAST!



DRAIN WASH TUBS, CELLARS, CISTERNS. Famous #7 pumps 2800 GPH. 420 GPH at 75' high or 1600 GPH from 25' well. Sturdy, rustproof Alloy Metal. Six Blade impeller. Uses any 1/4 to 1/2 H.P. Motor. Will not leak or clog. Fits any garden hose.

Immediate money back guarantee. Send Check, Money Order, or C.O.D. **\$8.95**

IRRIGATE, FILL TANKS, DRAW WELL WATER. Heavy duty #8 Pumps 7000 GPH. 1000 GPH 75' high — 3000 GPH from 25' well. Rust-proof Alloy Metal. 8 blade impeller. 1" inlet — 1" outlet. Standard Pipe Threaded. Money back guarantee. Send check, **\$11.95** Money Order, or C.O.D.

Free Catalogue — Gear Pumps — Deep and Shallow Well Pumps.
MOORE MANUFACTURING CO.
SWEDESBORO 1A NEW JERSEY

Send for **FREE** 112 page
Illustrated Catalog of Farm, Home,
and Workshop Bargains.

Write to **WELLWORTH TRADING COMPANY**
Dept. D9
1832 S. WABASH AVE. CHICAGO 16, ILL.

STRENGTHEN DEVELOP A HE-MAN VOICE!
...TRAIN YOUR VOICE
Write for FREE book "How to Strengthen Your Voice for Greater Success" by Eugene Fruchtinger. No obligation. Book will be mailed at once in plain wrapper, postpaid. Just send your name and address. State age. **PREFECT VOICE INSTITUTE, 210 S. Clinton St., Studio JW-2, Chicago 6, Ill.**

Up to 6 MILES MORE per Gal.

Reported by Hundreds Using
MIRACLE ACTION TUR-B-LIZER

Carburetor specialists say Tur-B-lizer is best patented improvement they have seen. Tested in millions of miles of driving in cars, trucks and tractors. Easily installed. Send \$3.00 for six cylinder type, \$4.50 for eight cylinder type. Try Tur-B-lizer for 30 days. If you are not enthusiastically satisfied as claimed by hundreds of users, your money will be promptly refunded.

UNIVERSAL TUR-B-LIZER CO. 621 E. STATE ST. MILWAUKEE 2, WISC.
(Excellent item for radio, TV, mail order)

START ART ON TRIAL PLAN

SEE HOW EASY IT IS Step by Step!



Enjoy drawing, painting, advertising art and cartooning at home in your spare time. Earn while learning. Step-by-step method helps beginners quickly. Low tuition. 40th year. Send coupon for free booklet. No salesmen.

Send free "Art for Pleasure & Profit."
 Tell about trial plan

Name _____
Address _____ Age _____
City, Zone, State _____

Washington School of Art
Studio 129 N
Washington 5, D.C.

Say You Saw It in Popular Mechanics

ENGINEERING DEGREE IN 27 MONTHS

INDIANA TECHNICAL COLLEGE
B. S. DEGREE, Aeronautical, Chemical, Civil, Electrical, Mechanical and Radio Engineering (inc. TV and Electronics). Drafting, 1-yr. G.I. Gov't. approved. Low rate. Earn board. Large industrial center. Students from 48 states, 21 countries. Demand for graduates. Enter September, December, March, June. Write for catalog, 1694 E. Washington Boulevard, Fort Wayne 2, Indiana.

Do a Real Professional-Like Job Yourself and SAVE

HOW to PAINT
With Brush and Spray

Covers All Painting Methods and Materials

You can do professional-like painting and finishing jobs yourself and save about two-thirds of the cost. Sam Brown, noted craft authority, makes it so easy for you in his book, **HOW TO PAINT WITH BRUSH AND SPRAY**. Order your copy now and enjoy this tremendous saving. It covers exterior painting, wall and interior decorating, furniture finishing, concrete painting — every type of painting with brush, spray gun, roller and other methods. Tells what finish is best; what materials to use, etc. No previous experience needed. Fully illustrated. Order by mail. Only \$2.50. Money back if not pleased.

POPULAR MECHANICS PRESS, Dept. PM18
200 E. ONTARIO ST., CHICAGO 11, ILL.





Chippendale
Coffee Table
(Adapted from
the English But-
ler's Tray circa
1770)

19.95

Express Collect
Send check
or M.O.

make antique reproductions in your own home workshop

Now! Reproduce in finest kiln-dried Honduras mahogany this authentic masterpiece at a fraction of its worth.

We supply the plans, wood, finishes—everything.

Now you can reproduce priceless early American furniture treasures in your own home workshop. We send you the plan made from the original, detail for detail; we send you 19 pieces of the finest select kiln-dried Honduras mahogany, the kind used by only the finest cabinetmakers. We send you the hardware and the specially prepared professional finishes. This is not knockdown furniture. It's easy to make. You won't believe your eyes when you realize you've reproduced this magnificent full size 19" x 27" authentic Chippendale Coffee Table for only \$19.95. Money back guarantee.

Send for free catalogue of Traditional and Modern American Home Craft Kits.

AMERICAN HOME CRAFT SUPPLY
GLENDSIDE dept. 20, PENNSYLVANIA



FINE BOWS and ARROWS
SELECTED RAW MATERIALS

Catalog 5c Send for it
HAND BOOK—illustrated
Instructions on Making and
Shooting Archery Tackle—75c
L. E. STEMLER CO.
Manorville (Box 3) L. I. N. Y.

EARN Big Money!



**TELEVISION
ELECTRONICS
RADIO-RADAR**

Learn TV, Radio Servicing, Radar, Sonar, Electronics at home in your spare time by Christy Shop-Method Home Training. Covers all subjects. The only complete course. Repair television and radio sets of friends and neighbors. Service electronic equipment in factories, stores, hospitals. Earnings made while learning can pay for your training. **19 TRAINING INSTRUMENTS INCLUDED!** Learn by Doing. Rush name for FREE Book and FREE Sample Lessons.

CHRISTY TRADES SCHOOL

Dept. T-403

4804 N. Kedzie, Chicago 25

Finish HIGH SCHOOL AT HOME

Complete 4 Yrs. in 12 Months

Learn More! Earn More! Enter professional or technical schools. Advance Socially. Live a Happier, Fuller Life. Individual Courses or complete schedule. **WRITE FOR SCHOOL BULLETIN.**

ACADEMY FOR ADULTS

30 W. Washington, Dept. PM-904, Chicago, Ill.

WHOLESALE Electric Guitars - Parts - Build Your Own

Accordions, amplifiers, double-necks, triple-necks, pickup mikes, mandolins, non-electric instruments, etc. 1954 Models wholesale. Free Catalog. Free home study course with instruments. Parts and plans available to build your own 6 or 8 string or multi-neck electric guitar. Martin and Fender available at list price.

CARVIN CO., Box 28 PM-9, Baldwin Park Calif.

RUPTURE



RELIEF...OR YOUR MONEY BACK
Original, patented Web,
copied but never matched.
Users say it's best ever. Relief
or no cost to you. Write:

WEB TRUSS CO., Dept. M-9, Hagerstown, Md.



Tiny Telescope
Gives "CLOSE-UPS"
FROM MILES AWAY

**ONLY
\$3.95
TAX FREE**

NO RISK TRIAL OFFER. If not 100% satisfied after 10 Day Trial return for full refund. Cash orders \$3.95 postpaid. (C.O.D.'s \$4.50) **UNITED BINOCULAR CO., 9043 S. Western, Dept. PT-8008, Chicago 20.**

A Powerful telescope yet the size of your thumb! Conceals completely inside palm of hand! A revolutionary German made optical achievement. Precision easy-slide operation. Scientifically ground lens provide brilliant illumination, sharp detailed images. Lustrous ALL CHROME with black trim. An all purpose performer... instant focusing from 2 feet to infinity! **NOT A TOY! Case 50c extra.**

Learn the Secrets

BREED RARE

tropical fish

KISSING FISH



Proof of tremendous profits!

KIND OF FISH	EGGS OR YOUNG PRODUCED AT ONE BIRTH	APPROX. RETAIL PRICE OF FULL-GROWN FISH
Swordtail	20 to 100	\$2.00 to \$4.00 Pr.
Red Betta	70 to 200	3.00 to 4.00 Pr.
	100 to 150	8.00 to 11.00 Pr.

... IN YOUR HOME... SPARE ROOM, BASEMENT, GARAGE... ANYWHERE!

EARN BIG MONEY—SPARE TIME

New "Chance of Lifetime" opportunity! Start your own spare or full time business once you know the revealing breeding secrets. It's fascinating! It's Fun! Breed EXOTIC and graceful "Angel Fish", BEAUTIFUL "Gourami" that are 12 DIFFERENT COLORS, "Fighting Fish" THAT FIGHT UNTIL DEATH; "Danio" that are STRIPED LIKE A ZEBRA; TRANSPARENT FISH—hundreds of expensive varieties. Some fish lay 300 to 600 eggs at one time. (Some very rare fish have sold for over \$75 a pair.) Get into PARTNERSHIP WITH NATURE and let nature multiply your profits for you. **NO EXPENSIVE EQUIPMENT—NO EXPERIENCE NECESSARY. WE SUPPLY EVERYTHING YOU NEED. HELP FILL HUGE DEMAND** from stores, offices, theaters, hotels, etc. New plan lets **YOUR MAILMAN BRING YOU ORDERS.** Investigate TODAY.

FREE! Colorful "How To Do It" success BOOK-LET, REPRINTS, breeding BROCHURE and ALL DETAILS. Rush coupon today!

RUSH this Coupon TODAY!

Tropical Fish Breeders of
America, Dept. D-9
15127 S. Broadway St.,
Los Angeles 61, California

Dear Sir:
Please rush me all Free Details.

Name

Address

City

State

Your Age



MECHANICS

—EARN BIG PAY—

Industry needs skilled mechanics. GREER, leader for more than 50 years in the Trade School field, can train you quickly—You "learn by doing," using the finest equipment, under the supervision of expert technicians.

APPROVED FOR CIVILIANS OR GI'S

—CHOOSE YOUR TRADE—

- DIESEL MECHANICS.....20 Weeks
- AUTOMOTIVE MECHANICS.....20 Weeks
- BODY & FENDER REPAIR.....16½ Weeks
- GAS ARC WELDING.....4 to 12 Weeks
- REFRIGERATION.....13½ Weeks
- AIR-CONDITIONING.....8½ Weeks
- MACHINIST TRADE.....30 Weeks
- ADVANCED MACHINIST
(includes tool & die).....32½ Weeks
- PIANO TUNING & REPAIR.....36 Weeks

CHOOSE YOUR ENGINEERING COURSE

- DIESEL AUTOMOTIVE ENGINEERING.....2 Years
- REFRIGERATION & AIR COND. ENGINEERING.....18 Months

FREE EMPLOYMENT HELP.

Start your career with Greer by checking your interest above and mail coupon for complete information at no obligation.

NAME _____ AGE _____

STREET _____

TOWN _____ ZONE _____ STATE _____

Established 1902 — Over 50,000 Graduates.

GREER SHOP TRAINING
2236 S. Michigan Ave.
Chicago 16, Illinois

HELPFUL BOOKS

Send post card asking for FREE catalog
Popular Mechanics Press, 200 E. Ontario, Dept. 601, Chicago 11

start a big profit business
with a small investment
**EARN UP TO
\$200 a DAY**

Manufacturing Exciting New

RAINBOW ROCK

Concrete Slump Brick
in your back yard

Earn big building boom profits with Rainbow Rock, the colorful new building brick that's taking the country by storm. Sell all you can make to contractors, builders, building supply houses. RAINBOW ROCK CUTS LABOR COSTS BY 1/3! Amazing low cost machine makes modern slump brick 24" long (3 times the length of ordinary brick) in a variety of widths and pastel colors . . . up to 1500 bricks a day! NEEDS NO SPECIAL SKILL. Operates indoors or out. Full instructions and valuable mixing formulae supplied. YOU CAN START EARNING BIG MONEY NOW. PAY AS YOU PROFIT! A limited number of machines available on easy payment terms. NOW is the time to start. Write today for free literature and full information.

GENERAL ENGINES CO., INC.
Dept. MR-94 —307 Hunter Street
Gloucester, N.J. - Gloucester 6-1337



STEEL PIER SENSATION
Luxurious RAINBOW ROCK fireplace wall in living room of the "Home of the Century" in Atlantic City, N. J.'s Steel Pier... acclaimed by over 500,000 Summer, 1953 visitors as the most beautiful they'd ever seen! Endorsed by the Pier's famous architect, William F. B. Koelle.



Makes beautiful, decorative fences, garden walls, garages, outside walls, room separators, etc.

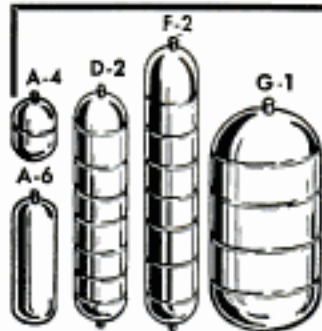

STEEL AIR TANKS

Steel pressure tanks suitable for compressors, pneumatic units, gases, hydraulics, and liquids. Rated at 500 lbs. per square inch pressure. 1/2" standard pipe thread openings on tank ends as shown.

	Size	Wt. Lbs.	Volume	Price
A-4A Carbon Steel —New	7 1/2"x5 1/4"	11 1/2	104 cu. in.	\$1.50
A-4 Stainless Steel —New	7 1/2"x5 1/4"	11 1/2	104 cu. in.	2.50
A-6 Carbon Steel —New	14 1/2"x5 1/2"	3 1/4	280 cu. in.	3.50
D-2A Carbon Steel —New	24"x6"	5	500 cu. in.	4.50
D-2 Stainless Steel —New	24"x6"	5	500 cu. in.	7.50
F-2A Carbon Steel —New	45"x6"	11	1000 cu. in.	8.50
F-2 Stainless Steel —New	45"x6"	11	1000 cu. in.	9.50
F-1 Stainless Steel —New	18"x10"	12	1000 cu. in.	9.50
G-1 Stainless Steel —New	24"x12"	18	2100 cu. in.	12.50

Prices F.O.B. Chicago. Include approx. postage on orders paid for in advance. C.O.D. orders enclose 25% balance sent C.O.D.

U. A. S. Corp.

Dept. PM-9, 5637 W. 63rd Pl.
Chicago 38, Illinois

SAY YOU SAW IT IN
POPULAR MECHANICS

HOW TO RUN A RESTAURANT

Get into a Good MONEY-MAKING BUSINESS of Your Own!



Virtually a complete self-instruction course on starting and operating profitable lunchettes, cafeterias, diners, tea rooms, etc. Teaches you the all-important facts about leases, licenses, equipment, furnishings, decorating, kitchen arrangement, menu-planning, etc. How to make money! FULL PRICE, Only \$4.95, Postpaid. This could be your BIG chance! Satisfaction guaranteed or money back. Order "How to Run a Restaurant," Only \$4.95 postpaid—or C.O.D. plus postage. WELSON-HALL CO., 210 S. Clinton St., Dept. 3JW-2, Chicago 6, Ill.

PLEASE
SEND ME



for the
time checked.
I am enclosing . . .

- 1 year \$3.50
- 2 years \$6.00

name _____

address _____

city _____

zone _____

state _____

Hand this order to your newsdealer or send it to

POPULAR MECHANICS
200 East Ontario St. Chicago 11, Ill.

PROOF! Toilet Tissue Makes Ideal Oil Filter Refill... Costs Only

10c

Install Retlif Adapter Plates in your car oil filter and you can use ordinary toilet paper roll for the filter element! Laboratory tests, thousands of motorists, proved conclusively that toilet paper cleans dirty motor oil faster and better than popular makes of filter elements! And costs only 10c! Now get these advantages with Retlif Adapter Plates. Easily installed. Write today for facts, proof, descriptive literature.

RETLIF CORPORATION, Dept. 127
915 N. Highland Ave., Los Angeles 38, Calif.



SAVE \$65 ON THIS \$100 CONTOUR CHAIR

- Goodyear Air Foam Cushioning
- Duram Upholstery
- Easy to assemble—hammer, screw-driver only.
- Green, Gray, Red, Brown
- Money back Guarantee

Everything Complete Kit Only needed to put together in one eve. **\$34.95**

ORDER NOW. \$5 deposit. Balance C.O.D. Or write for literature. **BESTCRAFT CO., Dept. 78, Mathison Bldg., Baltimore 2, Md.**



TELEVISION! CAMERAMAN. REPAIRMAN.

Learn at home, in spare time. No experience needed. We send you 15 Radio-TV kits including TV receiver. Earn while you learn. Write for free TV Book, free sample lesson, etc. **RADIO-TELEVISION TRAINING ASSOCIATION, Dept. M-9, 52 East 19th St., New York 3, N. Y.**

HELPFUL BOOKS

Send post card asking for **FREE** catalog
Popular Mechanics Press, 200 E. Ontario, Dept. 601, Chicago 11

200 MILE PER GAL. GAS FUEL SYSTEM DEVELOPED!

Says Inventor-Engineer, "Over 200 MPG obtained with amazing new fuel system on '49 Ford!" Plans being completed to manufacture new fuel system in L.A. Designed for all cars—will reportedly sell for under \$100! **FACTORY OUTPUT RESERVED FOR OVER 500,000 GANE CLUB MEMBERS.** Write today for **FREE** DATA and **FREE** membership application!
GREAT NATIONAL GANE ECONOMY CLUB, Dept. PM-9, 6610 S. Vermont Ave., L. A. 44, Calif.

TELEPHONES



Desk Stand Style
Slightly used but in excellent condition
Many Valuable Uses
Inter-House Phones House to Barn, etc.
Loud Speakers Microphones
Educational Purposes, Toys, etc.
Come complete, ready to use with wiring diagrams included. **\$2.75** Postpaid in U.S.A.
Two complete for only **\$5.00**
TELEPHONE LAMP KIT—with illustrated instructions for making Desk Telephone Lamp including all parts (harp, nipples, push switch, cord, plug, etc.) ... \$6.50 Ppd. (Shade is not included).

MICROPHONE, Dept. X-1802, 1760 W. Lunt Ave., Chicago 26, Ill.



"SEE-THRU" CABINETS

- A** See what's in each 5 1/2" x 2 3/4" x 1-7/16" drawer
- B** Drawers can't fall out or spill contents
- C** Label slot on face of each drawer
- D** 7 different ways to make drawer compartments

Stop frantic searching for small items... here's perfect storage for every small article up to 6" long for hobby bench, office, or sewing... nuts, bolts, fishing lures, stamps, threads, pins, cosmetics, jewelry, etc. Crystal-clear transparent plastic drawers for quick picking—can not spill—yet instantly removable. Welded, silver-gray, all steel cabinet with rubber feet.

As Many as 144 Separate Compartments

- No. 36—36-compartment, 12-drawer, 6 1/2" x 12 1/2" x 6", **\$5.95**
- No. 60—60-compartment, 20-drawer, 10 1/2" x 12 1/2" x 6", **\$7.95**
- No. 96—96-compartment, 32-drawer, 15 1/4" x 12 1/2" x 6", **\$12.95**
- No. 144—144-compartment, 48-drawer, 22 1/2" x 12 1/2" x 6", **\$20.95**

BUY "SEE-THRU" DIRECT BY MAIL—Send check or money order today! We pay postage. Money back if not delighted.

AMERICAN HOMECRAFT CO., Dept. 14-K
3710 MILWAUKEE AVENUE - CHICAGO 41, ILLINOIS



... LIFE OF THE PARTY!

There's nothing like a set of drums in your house to bring the gang together! Whether artist or amateurs, you and your friends will have great times and loads of fun.

BUY SLINGERLAND—the make that KRUPA uses.

Send for **FREE** catalog!

SLINGERLAND DRUM COMPANY

1325 Belden Ave. Chicago, Illinois

free!

308 VALUE-PACKED PAGES

308



1955 ALLIED

TV & RADIO CATALOG

SAVE ON EVERYTHING IN ELECTRONICS

World's Largest Stocks... Everything for Experimenters, Builders, Amateurs, Servicemen, Engineers & High Fidelity Specialists.

Send for ALLIED's big 308-page value-packed buying guide to *everything* in TV, Radio and Electronics! Largest selections of custom TV chassis, antennas and accessories; FM and AM tuners; High Fidelity systems and components; Amateur supplies; recorders and phono equipment; test instruments; builders' kits; industrial electronic supplies—plus the world's largest stocks of electronic parts, tubes, tools and books. Get *everything*—get *more* for your money—send today for your FREE 1955 ALLIED Electronic Supply Catalog.



ultra-modern facilities

TO SERVE YOU BEST!

Send for
FREE
Catalog

ALLIED RADIO

ALLIED RADIO CORP., Dept. 5-J-4
100 N. Western Ave., Chicago 80, Ill.

Rush FREE 1955 ALLIED 308-Page Catalog

Name _____

Address _____

City _____ Zone _____ State _____

Now You Can Upholster Any Piece of Furniture!

Upholster—Restyle Any Piece of Furniture Yourself

John Bergen, custom furniture designer, tells and shows you how to transform old out-of-date furniture into brand new smart-looking comfortable furniture in his new book **ALL ABOUT UPHOLSTERING**.

No Experience Needed

Bergen tells you every step to follow in amazingly clear easy-to-understand step-by-step instructions and then shows you how in hundreds of big, clear drawings and photos. You read and see how to strip the old frame, install new webbing and springs, apply burlap, install stuffing and padding, fit the muslin cover and the final fabric and install trim.

Use New Materials—Methods

Now you can have furniture upholstered with foam rubber, sagless springs and other new materials that add so much to comfort and durability and are so costly when included in new furniture.

Save 50% of Usual Cost

Don't pay a small fortune for new furniture when you can make your old furniture better than new! Why pay high prices to have someone else upholster and restyle your old furniture when you can do it yourself for cost of materials alone? It's easy and it's fun.

Special Chapter on Slipcovers

Learn how to make custom-made slipcovers with professional look and fit. Find out how you can realize tremendous savings by investing a few spare-time hours and the cost of a few yards of fabrics.

7-Day Money Back Guarantee

Send for your copy of **ALL ABOUT UPHOLSTERING** today. Read and use it for 7 days. If it isn't entirely satisfactory return it for a full refund.

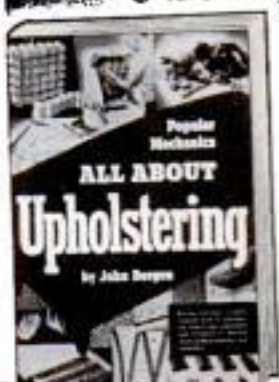

USE THIS HANDY ORDER COUPON

POPULAR MECHANICS PRESS, Dept. AAU
200 E. Ontario St., Chicago 11, Illinois

Gentlemen:

Please send my copy of **ALL ABOUT UPHOLSTERING**. Enclosed is my remittance of \$3.50. If I am not completely satisfied with the book I will return it for a full refund after 7 days.

Name _____

Address _____

City _____ Zone _____ State _____

WAR SURPLUS BARGAINS

\$500,000.00 INVENTORY for QUICK LIQUIDATION

Surplus items—hundreds of them for home, shop, factory, farm and outdoor use. New items, used items, reconditioned items—all at tremendous savings—all priced for quick sale.

Page After Page of Values

This big catalog shows page after page of amazing money saving values. Write for your copy today. Send 10c to cover postage, mailing, etc. Write today! **SEND TODAY FOR YOUR COPY**

10c

STARK'S 509 So. State St.
Dept. PM-954
CHICAGO 5, ILL.

Save Hundreds of Dollars Yearly With

Guide to Home Repairs

Home Repairs, Modernizing Jobs Made Easy for Home Owners

Beat the high cost of home upkeep. Stop staggering labor costs. Save hundreds of dollars every year on carpentry, electrical, painting, plumbing and other jobs around the house with **POPULAR MECHANICS GUIDE TO HOME REPAIRS**. Simplified how-to-do-it instructions and 646 pictures make all jobs, inside and out, easy. Covers construction, remodeling, modernizing, repairing, that you can do yourself at small cost. Repair leaky fixtures for pennies! Save \$10 to \$15 on new electrical outlets; save hundreds of dollars on new floors, porch repairs, tuck pointing, gutter replacements and other improvements. 112 page cloth bound book only \$2.50 postpaid. **GET GUIDE TO HOME REPAIRS** today under our money back guarantee.

POPULAR MECHANICS PRESS, Dept. PM1, 200 E. Ontario St., Chicago 11

BE YOUR OWN BOSS

Make Hundreds of \$ Spare or Full Time Work

NO EXPERIENCE NEEDED

Here is the ideal business with no previous experience or large investment required and no high-priced equipment to buy. A business that will return dollars for the pennies you invest.

YOU CAN CAST ANYTHING

With *Flexible Mold Making and Ornamental Casting*, an amazing fact-packed book, you learn how you can cast practically any article in concrete, plaster, imitation marble or any other casting material using a marvelous new process. You can make ash trays, novelties, garden and lawn ornaments and hundreds of other highly profitable items that cost you but a few cents and sell for as much as \$5.00 and more. Why you can even make true-to-life full-sized busts of your neighbors and friends.

NO EXPENSIVE MOLDS TO BUY

Why buy high-priced molds from others? Learn how you can make your own molds quickly, easily and inexpensively with materials that can be used over and over. You get copyrighted formulas, complete instructions and detailed how-to-do-it photographs as well as complete sources of supply for the few inexpensive materials you need. This is the only book printed in America today that contains instructions for making profitable papier-mache casts.

MONEY BACK GUARANTEE

Start on your road to extra income and independence today. Send only \$3.00 for your copy of *Flexible Mold Making and Ornamental Casting*. Complete satisfaction guaranteed or your money refunded within seven days.

POPULAR MECHANICS PRESS, Dept. 46
200 E. ONTARIO ST., CHICAGO 11, ILL.

CARPENTRY
ELECTRICAL WORK
INSULATION
PLUMBING

BUSTS
GARDEN URNS
NOVELTIES
TILE
STATUARY

PREPARE FOR BETTER JOB, BIGGER PAY IN SPARE TIME AT HOME

Today, choose the job you want—and prepare for it in time you might otherwise waste. Or if you are already in the work you like best, start training now for quicker promotion and increased pay. During more than 50 years **AMERICAN SCHOOL** has helped ambitious people to reach higher goals. Check subject that interests you and mail coupon for full information.

AMERICAN SCHOOL, Dept. G645, Drexel at 58th, Chicago 37, Ill.

Without obligation, please send **FREE** and postpaid, full particulars about the subject checked below.

<input type="checkbox"/> Accounting	<input type="checkbox"/> Drafting—Building Trades	<input type="checkbox"/> Physics Engineering
<input type="checkbox"/> Air Conditioning	<input type="checkbox"/> Drafting—Machine Trades	<input type="checkbox"/> Plumbing—Practical
<input type="checkbox"/> Architecture & Building	<input type="checkbox"/> Electrical Engineering	<input type="checkbox"/> Private Secretary
<input type="checkbox"/> Automotive Technician	<input type="checkbox"/> Electricity—Practical	<input type="checkbox"/> Refrigeration
<input type="checkbox"/> Better Foremanship	<input type="checkbox"/> Electronics—Industrial	<input type="checkbox"/> Retail Merchandising
<input type="checkbox"/> Bookkeeping	<input type="checkbox"/> High School Courses	<input type="checkbox"/> Salesmanship—Outside
<input type="checkbox"/> Business Management	<input type="checkbox"/> Machine Shop Operations	<input type="checkbox"/> Sheet Metal Work
<input type="checkbox"/> Contracting	<input type="checkbox"/> Mathematics & Slide Rule	<input type="checkbox"/> Tool Making
<input type="checkbox"/> Diesel Technician	<input type="checkbox"/> Mechanical Engineering	

NAME..... OCCUPATION.....
 Hours Available..... Age.....
 City..... STATE.....
 Canadian Residents: Write American School, 1610 Shrevebroke St. West, Montreal

Prints Postal Cards!

FREE Use on 30 Day Trial! Send name today for facts and **FREE** Illustrated Book of unique advertising plans and money-making ideas for your business. Learn how others are boosting sales with post card ads... easy with Cardmaster.

Cardmaster Co., 1920 Sunnyside, Dept. 1348, Chicago 40, Ill.

AMAZING NEW POCKET SIZE RADIO

Really Works — Small as a Pack of Cigarettes!

Fits in ANY POCKET OR PURSE—GETS LOCAL RADIO STATIONS WITH CLEAR BELL-LIKE TONE—NO STATIC OR INTERFERENCE! NEEDS NO TUBES, BATTERIES OR COMPLICATED HOOKUPS! NO AC PLUG INGS! Nothing to wear out. Thousands of users—many report years of service. Use new crystal block and 31-64 coil. SELF-CONTAINED SPEAKER PHONE. Just the tiny radio to take with you ANYWHERE YOU GO—ON TRIPS, VISITING, ETC.—for real fun and enjoyment—ANYTIME. **SEND ONLY \$1.00**

(Ill. ex. inc.) and pay postman \$3.00 C.O.D. postage or send \$4.99 for D.S. delivery. COMPLETE! READY TO LISTEN. MIDWAY CO., Dept. PPR-9, Kearney, Nebr.

Want a Government Job?

START AS HIGH AS \$4,205.00 A YEAR

MEN—WOMEN Prepare NOW for next exams
Thousands of appointments being made. 36-page Book **FREE**.

FRANKLIN INSTITUTE (Not Gov't Controlled)
Dept. S-83, Rochester 4, N. Y.
Sirs: Rush **FREE**: (1) 36-page book with list of U. S. Gov't. Jobs; (2) Tell me how to qualify.

Mail Coupon Today. **SURE.** Name..... Age.....
Address.....

Get the Practical Help You Need With These

POPULAR MECHANICS BOOKS

Use Them to
Save Time and Money
Make Extra Money
Enjoy Hobbies and Pastimes
Build Your Own Home
Improve Farm Income
Get the Most Out of Your Home Workshop
Enjoy Better Living



HOME SHOP

SIXTY POWER TOOLS AND HOW TO BUILD THEM (1) How to turn scrap and discarded materials into power tools at little cost. \$2.50

POWER TOOLS AND HOW TO USE THEM (2) Expert advice on selection and use of power tools for the home shop. \$2.50



PLANNING YOUR HOME WORKSHOP (3) The six basic power tools, floor plans, layouts, etc. \$2.50

PORTABLE POWER TOOLS (4) Practical information on the selection, care and use of portable power tools. \$2.00

WELDING, BRAZING AND SOLDERING (5) All the tricks and know-how of pool soldering, welding, etc. \$1.75



HOMES • BUILDING

YOUR HOME AND HOW TO BUILD IT YOURSELF (6) Hundreds of amateur builders have built this six room house themselves. \$3.00

CONCRETE BLOCK HOUSE (7) Built in many communities for less than \$4,000. \$2.00

RANCH HOUSE BOOK (Build It Yourself) (8) Exciting new ranch type home with five or six rooms you can build yourself. \$3.50

ROOF FRAMING (9) The Paulsen method. Roof framing in one-fifth the time. \$3.00

GUIDE TO HOME REPAIRS (10) Money and time saving information for home owners. \$2.50

HOW TO BUILD YOUR OWN GARAGE (11) Popular Mechanics own collection of designs, plans and building information for amateur builders. \$3.50

HOME PLUMBING GUIDE (12) Approved methods, materials and how-to-do-it instructions. \$3.50

LAWNS AND GARDENS (13) How to grow the best lawns and gardens in any neighborhood. \$2.00

HOW TO PAINT WITH BRUSH AND SPRAY (14) Includes interior and exterior painting, walls, woodwork and furniture finishing. \$2.50

AUTO BOOKS

AUTO OWNERS MANUALS By C. E. Packer. Cover all models from 1940 to 1953.

MANUAL FOR PLYMOUTH OWNERS. (15) \$3.50

MANUAL FOR CHEVROLET OWNERS. (16) \$3.50

MANUAL FOR FORD OWNERS. (17) \$3.50

You may examine any books that interest you. Full purchase price refunded on books returned in 7 days. Order by number in coupon below. All books are cloth bound and fully illustrated with photos, drawings, plans and working diagrams. Some in colors. Only Popular Mechanics with 51 years of publishing experience and tremendous facilities can give you such practical and helpful how-to-do-it books so moderately priced. Order today. Prompt shipment and guaranteed delivery. Order by number in coupon below

MOTORISTS FIX-IT BOOK (18) How to avert auto troubles; make simple repairs, do auto servicing at home. \$2.00

POPULAR MECHANICS AUTO ALBUM (19) Most fascinating of all auto books. From the first cars to the cars of tomorrow. \$3.00

SAVE WITH THESE

ALL ABOUT TELEVISION (20) A new and timely money-saving book for the TV set owner. \$3.00

RADIO, TV AND ELECTRONICS HANDBOOK (21) Ideal book for the student, beginner and experimenter. \$2.50

ALL ABOUT UPHOLSTERY (22) How to do all types of upholstery and save 50% of the cost. \$3.50

ELECTRICAL FIX-IT BOOK (23) How to repair and service all types of electrical appliances. \$2.00

WHAT TO MAKE

WHAT TO MAKE AND HOW TO MAKE IT Volumes 1 to 12. Average 175 projects in volume. Each. Give volume number with prefix (WMI) \$1.75

12 Volume set (24) There are over 2,000 projects in this 12 volume set. Complete instructions for each. \$18.00

1952 Volume. (25) \$2.00

1953 Volume. (26) \$2.00

WHAT TO MAKE FOR CHILDREN (27) 175 projects—things to make from discarded and inexpensive materials. \$2.00

100 BEST WOODWORKING PROJECTS (28) Cream-of-the-crop projects. Selected by Popular Mechanics editors for their popularity. \$2.00

100 BEAUTIFUL PIECES OF FURNITURE YOU CAN MAKE (29) Real furniture projects for the craftsman with few tools. \$3.00

23 BOATS YOU CAN BUILD (30) Build a boat for pleasure or profit — row boat, sail boat, power craft. \$2.00

YOU CAN MAKE A STRADIVARIUS VIOLIN (31) Full set of actual size plans in pocket in the cover. \$3.50

WHAT TO MAKE WITH CONCRETE (32) Covers walks, walls, pools, fireplaces and ornamental garden pottery. \$2.00



OUTDOORS • SPORTS

OUTDOOR SPORTS MANUAL (33) 200 helpful articles for hunters, fishermen, trappers, etc. Hundreds of ideas on fishing tackle, guns, traps, boats, motors, etc. \$2.00

HOW TO TEMPT A FISH (34) By Joe Godfrey, Jr. Complete fisherman's guide. Covers all types of fishing equipment and lures. Tells where and when to fish. \$2.00

GUIDE TO GOOD HUNTING AND TRAPPING (35) How, where and when to hunt all game animals. Special section on birds, guns and hunting dogs. \$3.00

FOR GIFTS • FOR BETTER LIVING

HOW TO BUILD AND ENJOY YOUR OWN OUTDOOR KITCHEN (36) How to build and use outdoor living facilities. \$2.00

FOOD FOR HOME USE (40) How to produce and conserve food from farms and home gardens. \$3.00

FIFTY YEARS OF POPULAR MECHANICS (41) The fascinating story of invention, scientific discoveries and mechanical developments from the pages of

Popular Mechanics during its first 50 years. \$5.00

ALBUM OF AVIATION (42) A history of famous flights and flyers commemorating the anniversary of 50 years of powered flight. Hundreds of thrilling photographs and drawings. \$3.00

PICTORIAL HISTORY OF AMERICAN TRANSPORTATION (43) Fascinating gift book featuring 50 years of an America on the move. \$5.00



FOR CHILDREN

MR. WIZARD'S SCIENCE SECRETS (44) By TV's famous Don Herbert. Collection of safe, simple experiments children can make at home. \$2.95

BOY MECHANIC (45) New edition with all new material. Hundreds of things a boy can easily make at home. \$2.95

YOUNG CRAFTSMAN (46) The book of useful pastimes — things to do and make for boys of all ages. \$2.00

FOR FARMERS

HOG PROFITS FOR FARMERS (47) A "must" book for every hog producer. \$3.00

FARM MANUAL (48) A book every farm home should have. More than 150,000 sold to date. \$3.00

VETERINARY GUIDE FOR FARMERS (49) Enables farmers to perform most veterinary tasks. \$3.95



USE THIS MONEY BACK ORDER COUPON

POPULAR MECHANICS PRESS,
200 E. Ontario St., Chicago 11, Ill.

Send Popular Mechanics books as indicated by numbers.

Number

Number

Remittance for \$_____ enclosed. Send postpaid.
 Send C.O.D. I will pay postum for books and delivery.
I understand I may return book within 7 days and you will refund the full purchase price. Attach extra sheet to coupon if more space is needed.

Name

Address

City Zone State

Take your Short Cut to HIGH-PAY JOBS or BE YOUR OWN BOSS IN Television

TRAIN FOR SUCCESS AS A TV TECHNICIAN IN YOUR SPARE TIME AT HOME—EARN WHILE YOU LEARN!

Are you looking for employment opportunities with a FUTURE? What are your chances for promotions or raises in your present job? BETTER YOURSELF... train NOW for profitable jobs in the booming Television Industry. Thousands of top jobs are awaiting the Trained TV Technician. HERE IS YOUR BIG OPPORTUNITY IF YOU ACT NOW!

MANY UTL TRAINEES MAKE \$25 A WEEK IN SPARE TIME, while still in training. The money and radios for neighbors... assisting service shops and distributors, more than paid for the training, and permitted them to enjoy many of the luxuries in life. UTL SHOWS YOU HOW!

NO EXPERIENCE NECESSARY YOU ARE READY TO TRAIN AS YOU ARE!

You don't have to know the first thing about electricity or television at the start, to master UTL Training. Step-by-step instructions TELL you how—thousands of pictures, diagrams and charts SHOW you how! The finest equipment GIVES you the Know-how! Age or experience is not important... just your AMBITION.

Be Your Own Boss No Money Down!

Start your own profitable service business immediately after graduation, without putting one cent down for equipment, stock, parts, and tubes. Get the amazing details! ACT NOW... OFFER LIMITED TO FIRST COME, FIRST SERVED.

NOTE TO MEN PAST 40:

If you find it difficult to get ahead, here is your opportunity to be independent and have your own thriving business.



ALL PROFESSIONAL TOOLS AND EQUIPMENT FURNISHED, COMPLETE!

UTL sends you everything you need for successful Home Training. These BIG KITS, which you keep, convert any table into a fascinating experimental laboratory. Enjoy doing hundreds of thrilling experiments and interesting demonstrations. Build professional equipment to use in your career, including a volt-ohm-milliammeter, a complete superheterodyne receiver, a cathode-ray oscilloscope and other valuable units. Practice servicing on TV receiver units!



UTL has Successfully Trained Thousands

Amazing Training Program has caused graduates to say UTL training was responsible for their getting ahead so fast... trainees report UTL training is the easiest thing they have ever done! Training is professional and efficient... you are treated as a person, on an individual basis.

TRAIN AT HOME... set your own pace. Practice with parts and equipment sent you. UTL instructors give you full assistance. Your training is remarkably EASY. Upon completion, you...

TRAIN IN UTL LAB. for 160 hours of INTENSIVE, ADVANCED TV EXPERIENCE! You operate modern equipment found only in a lab; do interesting trouble-shooting assignments; get the professional touch by knowing accepted TV circuits, equipment and standards!

JOB PLACEMENT SERVICE and BUSINESS PLAN IS AVAILABLE when you complete your training. Excellent record. Find out for yourself!

COLOR TV TRAINING INCLUDED!

Exciting, profitable COLOR TV is now a commercial REALITY! Industry leaders predict that in years to come, COLOR TV WILL PRACTICALLY REPLACE BLACK AND WHITE TV! UTL training prepares YOU to take full advantage of the HUGE field of black and white TV NOW... as well as putting you in position to EXPAND WITH THE RAPID GROWTH OF COLOR TV!

This means ADDED OPPORTUNITIES FOR YOU with UTL TRAINING. ACT NOW... get in on the ground floor of COLOR TV!

FREE FREE FREE!

Exciting big 48-page book is jam-packed with information on how to get high pay jobs in TV; how easy it is to train; how to build up prestige and income at the same time; how to take advantage of your opportunities.



DON'T DELAY-MAIL THIS TODAY

UNITED TELEVISION LABORATORIES, Inc., Dept. M545
19th and Main Streets, Louisville 3, Kentucky

Send me the big, valuable 48-page book of Opportunities, FREE! I understand I am under no obligation.

Name _____
Address _____
City _____ Zone _____ State _____
Married _____ Single _____ Age _____

PLEASE SEND DETAILED INFORMATION ON:

- TV Technical Training
- Owning my own business
- Television Studio Techniques
- How to get a high-pay job in TV

UNITED TELEVISION LABORATORIES
19th & MAIN • LOUISVILLE, KENTUCKY

IMPORT PAYS BIG!

B. E. MELLINGER
Exporter-Importer

NEW WORLD TRADE BOOM OFFERS BIG PROFIT OPPORTUNITY to ambitious Men and Women everywhere. I'll show you how you may Import Thousands of desirable products at low foreign prices for buyers in your locality at high U.S. Prices—how you can operate a world-wide mail-order Import-Export business from home whether you live in a big city, or small town.

B. E. Mellinger

HERE'S PROOF!

As startling first-hand proof I will send you an actual import from overseas, **AT MY COST**—something to see and use. Just mail me 25¢ in coin and I will rush you this Imported Melson Automatic cigarette lighter—made to retail in the U.S. at \$2. This magnificent import will convince you of the tremendous profits being made in World Trade.

START AT ONCE WITHOUT CAPITAL or previous experience. Fantastic profits are possible. My training also includes shipment to you of many sample imports from 'round the world.

GRASP THIS OPPORTUNITY TODAY!

Send for your Melson Automatic cigarette lighter now and I will include full details that show you how to learn my Big Profit secrets of Import-Export—complete instructions that will put you on the road to a profitable business of your own. Opportunity to travel abroad for profit and pleasure. I'll also show you how you can save many dollars on your own purchases of Clothes, Tools, Gems, Antiques, Watches, Cameras, China, Silks, Toys, etc. You can have the complete details FREE without ordering the lighter if you wish, but I would like to send you the Melson lighter as an actual demonstration of Import Values. Either way, mail coupon now. Airmail reaches me overnight.

The Mellinger Co., Dept. A-259, 1717 Westwood, Los Angeles, 24, Calif.

HERE'S MORE PROOF!

"We operate a profitable World Trade Business from our home... Thanks to MELLINGER."

Mr. and Mrs. Beke, N.Y.

MAIL COUPON NOW!

The Mellinger Co., Dept. A-259
1717 Westwood, Los Angeles 24, Calif.

Mr. Mellinger: Show me the big profits to be made through World Trade. I enclose 25¢ in coin. Send me one Melson Cigarette Lighter and your plan that shows me how to learn the secrets of World Trade. [No lighter without a coupon. Only one to a person.]
 Just send your FREE World Trade Plan.

Name _____ Age _____
Street _____
Town _____ Zone _____ State _____



**SELL JUST ONE
SENTRY SAFE A DAY
AND YOU CAN EARN
\$8,000 A YEAR!**

ONLY 5% of the people own a personal safe to protect their valuables from fire, theft and loss! Cash in on this untapped market with SENTRY—the world's finest small safe. Prospects everywhere—householders, professional men, farmers, small businessmen. Set your own price, take a big mark-up, and still undersell all competition. Just one SENTRY sale a day can bring you \$8,000 a year. Choice, exclusive territory. Drop shipment if desired. Send for full details. Write Dept. PM-9, giving address, including county.



BRUSH-PUNNETT CO.
345 WEST AVE., ROCHESTER 11, N. Y.

NO TANKS USED
NEW SIMPLIFIED METHOD
SUCCESS IN THE
ELECTROPLATING
BUSINESS



ELECTROPLATE

ANY OBJECT IN HOME, SHOP, GARAGE OR STABLE
YOUR OWN WELL PAYING ELECTROPLATING BUSINESS

NOW, using NEW plating kit.

It's easy to electroplate any object. Complete kit and instructions on plating metal and non-metal objects, with nickel, copper, chrome, gold, etc., plus full data on obtaining all the business you desire and make BIG MONEY full or spare time. ONLY \$5.95. SEND NO MONEY—everything sent C.O.D. plus postage—OR send \$5.95 now and receive it postpaid. Money back in 7 days if not satisfied.

M. Z. SALES CO., Dept. P28-3, 113 W. 42 St., New York 36, N. Y.

RADIO

Engineering. All phases radio & electronics theory & practice; television; FM; broadcasting; servicing; aviation, marine & police radio. Prepare for high pay; 18-month course. Graduates in demand by major companies. Enter Jan., March, June, Sept. Regular campus life. Write for catalog. VALPARAISO TECHNICAL INSTITUTE, Dept. D, Valparaiso, Ind.



Earn BIG STEADY MONEY SELL WORK UNIFORMS!

It's easy with TOPPS' great "Panoramic" line that spreads out over 8 feet wide! Swatches are king size! Style figures are big, full color—they almost pop off the page! Prospects are everywhere—garages, service stations, factories, etc. Profits are big—one man made \$900 on a single sale! Selection of sizes, fabrics (including DuPont's miracle ORLON), colors, embroidery is unlimited. Start spare time... you'll make it a career! Get the "Panoramic" line FREE. Write TODAY.

TOPPS Dept. 619 - Rochester, Indiana

Powerful GIANT TELESCOPE SEES THINGS MILES AWAY!

Ready for use. Steel telescope tube 38 in. long, 30X, 50X and 100 power eyepieces giving clear erect images. Heavy 5 lb. tripod with aluminum head assembly provides rigid mount. Guaranteed to bring all distant objects 100 times nearer, 10,000 times larger. \$12.00 FOB factory. COD orders require a \$5.00 deposit.

SUFFOLK SCIENCE SERVICE
Dept. GTM-9 Mattituck, N. Y.

\$12.00 COMPLETE

PLYWOOD BOAT KITS

12 FT. \$97.00
14 FT. \$129.00
Freight Included



Send for free folders on all models as low as \$39.00 freight included

TAFT MARINE WOODCRAFT
Dept. PM8, 636 39th Ave. N.E., Minneapolis 21, Minn.

WORLD'S
BEST
WANT-AD
MEDIUM

CLASSIFIED ADVERTISEMENTS



Advertisements in this section \$1.00 per word, each insertion, minimum 10 words, payable in advance.

To be inserted under proper classification, copy must be in our office the
20th of the second month preceding date of issue
F. W. Johnson, Manager, Classified Advertising
Popular Mechanics Magazine, 200 East Ontario Street, Chicago 11, Illinois

YOU'LL PROFIT

By reading and answering the classified ads in this section. Hundreds of opportunities for you to make and save money

AUTOMOBILES, MIDGET CARS

HI-Mileage speed equipment from the world's largest supplier. Dual manifolds, finned heads, electric doors, lowering sets, fuel savers, thousands of items for all cars. Huge catalog, 25c. (Illustrated literature free). Wholesale to garages. Newhouse Automotive Industries, Los Angeles 22.

FIBERGLAS Automobile bodies. Build your own. Lowest prices. 14 years plastic experience reflected in complete information catalog—10c. Gem-O-Lite. Box 6681A, North Hollywood, California.

AUTO Owners law book \$1.00. Richmond Enterprises, Box 1003, Augusta, Georgia.

NON-Profit organization offers automobile literature—Old, new and foreign; dealer books, service manuals, glossy photographs; free motor magazines. Write today; get on free mailing list. Auto Maniacs, Stockbridge, Mich.

ANTIQU Automobile color slides, 2x2. Illustrated catalog free. Universal Slide Company, Box 779A, Beverly Hills, Calif.

SPORTS Car enthusiasts—Join the International Sports Car Club. \$25.00 annual dues. International Sports Car Club, Inc., New York Telephone Building, Glen Cove, Long Island, New York.

AUTO SUPPLIES AND EQUIPMENT

PRECISION Du-All meter saves gas; indicates engine performance; 5 minute installation! Free utility box and manual. Money-back guarantee! Rush \$4.98 to: H. J. Pope Co., 18529 Detroit, Cleveland, Ohio.

CADILLAC, Buicks, Olds, Pontiacs, Spark-O-Liner makes precision ignition, stops that skip, develops full smooth power. 3 1/2 million sold. Fits all through '54. Write Hove for free literature. 5605 Clinton, Minneapolis 18, Minn.

AUTO Radios wholesale. Send year and make car. Free literature, prices. Genuine Buick radios \$49.95. Cherry Radio Co., 1438 Belfield, Philadelphia 40, Penna.

SENSATIONAL Free trial offers! Surplus stock of famous Gale Hall automotive instruments, brand new, original cartons! Try at our risk for seven days—then return merchandise or send payment! Professional compression testers, originally \$10.75, now \$2.98! Terrific value—Combination vacuum gauge/fuel pump testers, originally \$8.10, now only \$3.09! Original Gale Hall motor condition/gasoline economy gauges for permanent dashboard mounting—Standard originally \$7.50, now \$2.98; Deluxe all-chrome custom foreign model, originally \$14.95, now only \$4.98! (Add 40c to each price for postage.) Order now! New England Surplus Sales, Dept. PM-9, Newburyport, Mass.

NO More flat tires for you! Puncture-proof your tires in 5 minutes. Write for free offer. Spadco, 412-K Portland, Rochester 5, New York.

HYDRAMATIC Owners prior to '52 models, added control available similar to dual-range. Select third speed at will. Price \$13.95. Third Speed Selectors, 1680 North Western Ave., Los Angeles 27, Calif.

ORDER By mail. Speed equipment, convertible tops, U. S. tires, rear tire mounts. Geo. Eberhardt, 4651 W. Madison, Chicago 44. Write for prices.

THIEF Chaser. 10 days free trial! Protect your car, tires and accessories from theft. Guaranteed for 30 years. Salesmen wanted. Free sample. Free literature. Novak Company, 3131 West 13th, Gary 91, Indiana.

VISION Clear? Manual inside windshield wiper, \$1.00. Autos, trucks, boats. Free literature, Strong's, 4217 E. 14th, Oakland, California.

FORD Brake power doubled! Easily installed energizer kits. All Fords '26-'34, \$6.00 ppd. '35-'38., \$7.50 ppd. Everything included. Barlec's, 4311 Airport Station, Los Angeles 45, California.

BUY Wholesale nationally advertised auto supply, thousands other products at big discount. Free "Wholesale Plan." American Buyers', 629-D Linden, Buffalo 16, New York.

TAPPET Noises on Fords, Chevrolets and Mercury's stopped with Kaye Tappet Silencers. Free literature. Kaye Products, 2067B So. Layton Blvd., Milwaukee 7, Wis.

GENUINE Motor treatment, Lachapelle's, (patented). Only \$3.00 delivered. Restores compression, power. Saves gas, oil, repairs. Money back guarantee. You can't lose. Free circular. Write Joe Dillon, Authorized Warehouse and Agents Distributor, Box 323-1, Bridgeport, Ohio. Exclusive distributorships agencies open.

FIBERGLASS Repair kits \$1.00 (75 sq. in.). For customizing, dechroming, repairing rusted parts; eliminates body solder, car building supplies. Ace Plastics, Box #204, Lockland, Ohio.

CRANKSHAFT Grinder, hand operated. Makes bearings fit without taking engine apart, \$3.75. Literature. L. D. McGee, 719 Cascade St., Wenatchee, Wash.

CUSTOM Accessories headquarters. New summer catalog, just out, most complete ever. Jam-packed with items not in stores. New low prices, 25c. Eastern Auto, 3319-A South Grand, Los Angeles 7, Calif.

QUICK Release safety belts \$5.95, shoulder harness \$3.95 postpaid. Ort. Dept. 99, Thomasville, Penna.

PREVENT Auto horn from blowing when parked. Complete unit \$2.00. Potential Radio, 446 Crown Street, Brooklyn, New York.

FOR A better motor for \$3.00. Use Lachapelle's Treatment, it puts bearings in the motor for the pistons to slide on. Write. Ferns Products, 8120-B Walnut Dr., Los Angeles 1, Calif., for free information.

STOP Flats! Approved-American Testing Laboratories, \$7.92 punctureproofs car, \$1.98 punctureproofs bicycle. Write SG, 1704 Monmouth Blvd., Belmar, N. J.

END Oil changing! Refine your oil as you drive! Refinol antiquates all other oil filters. Free booklet on saving your car or tractor motor. International Refinol Company, 8848 W. 47th, Brookfield, Ill. "Chicago's technical suburb."

NEW And used parts at savings. Complete guaranteed parts service for all models cars and trucks, late or old. Largest in the west. Army parts specialists. No catalog—Write for quotations. Past mail order service. Pioneer Auto and Truck Parts Co., 734 W. 13th Avenue, Denver, Colorado.

NOW Enjoy strainless driving with Lazy Leg left foot accelerator designed for your driving comfort. Relieves leg and back-aches. Easily installed in a few minutes on automatic or clutch shift cars. No interference with right foot accelerator. No alterations required. Transferable from car to car. A very useful accessory. Satisfaction guaranteed. \$3.98 plus 25c postage. Harris and Company, 249 Pequot Avenue, New London, Connecticut.

ELECTROPLATE Auto parts, novelties, mirrors. Easy, inexpensive home processes. Free booklet. Tyco Metals, Box 13231-BG, Houston 19, Texas.

BRUSH Plating outfits connect to a battery. No tanks or shop required. Free particulars. Gunmetal Co., Ave. J., Decatur, Ill.

CAR Burning oil? Losing compression? Try Clifford's Compression Seal, \$2 postpaid. Clifford's Engineering, 1329 Seventh, Aurora, Illinois.

FORD-T parts—Engine and chassis. Parts for other old models. Special parts made to order. B. S. Wisneski, Milwaukee 7, Wisconsin.

AUTO TRAILERS

TRAILERS. Pick-up coach. Kits or blueprints. Literature 10c. Comstock Trailers, 585-P, Parsons, Kansas.

EXCEPTIONAL Expanding eight foot trailer. Accommodates family of five. Build yourself. Literature 10c. Fra-Mar Company, Jones Avenue, Wilmington, Mass.

TRAILER Building, illustrated, 20c. Craftsman Books, Box 1153, Milwaukee 1, Wis.

MOTORCYCLES, BICYCLES, MOTORSCOOTERS AND SUPPLIES

WHIZZER Motor \$10; midget car \$45; Cushman Eagle 895; Cushman Jess motor \$25. Four airplane tires \$3. (Mailorder only). Send 25c for Directory Number 61, just out listing these and hundreds of other bargains in motorscooters, midget cars, parts, plans for homebuilders, etc. (35c by first class mail). Midget Motors Directory, Athens, Ohio.

PARTS. Pistons, new, used. Harley, Indian, Henderson. list 10c. Ballak, 811 N. 9th, St. Louis 1, Missouri.

"BUZZZZ" The motorcycle magazine. International coverage. Thoroughly illustrated. Yearly \$2.00. Sample 25c. 5424-A Sawyer, Chicago 25.

REBUILT Wasp 4 cycle bicycle engine kits. Cauffiel Motor Industries, Temperance, Michigan.

AMAZING "Mobylette" with automatic clutch lightweight motorbike. \$179.50 retail including federal tax. New in U.S.A. Exclusive territories—Salesmen, agents, dealers, distributors. Write P.O. Box 128, Hammel Station, Rockaway Beach, N. Y.

WHIZZER Motorscooter \$20.00; two-speed Cushman motorscooter \$20.00; Indian Scout motorcycle \$40.00; midget car \$15.00; homemade motorscooter \$6.00. Send 25c (35c first class mail) for catalog #26 jammed with sensational bargains in wheels, motors, motorscooters, midget cars, motorbikes, construction plans, etc. Qail, 1313 Jefferson, Toledo, Ohio.

HARLEY-Davidsons—America's best used buys! We pay shipping on motorcycles. Genuine new, used, parts, accessories for current and obsolete models. Send 25c for bulletin, catalog. Knuth's (Harley-Davidson factory dealer), 1753 Muskego, Milwaukee, Wis.

SMITH Motorwheel \$15. Maytag twin engine \$3, garden tractor \$10, Check motorcycle \$35, Servicycle \$35. (Mailorder only.) Send 25c for Directory Number 60, just out, listing these and hundreds of other bargains in new and used midget cars, motorscooters, engines, parts, plans for homebuilders, etc., (35c by first class mail.) Midget Motors Directory, Athens, Ohio.

AVIATION

AIRCRAFT Engines, all makes 65 to 300 hp, for snow sleds and water boats. Aircraft parts and accessories. Free list. Vestco, Box 3306 T.A., Denver, Colo.

BUILD A helicopter jet engine yourself! "Practical Ram Jet Design"—\$1.00. Decker Engine Works, Dept. PM, Plasterco, Virginia.

FLY As a steward-purser. Work but 35 hours a month, starting salary \$235 up. O. I. approved, free catalogue. Air-Purser School, Room P, 1030 Nicollet, Minneapolis, Minnesota.

PROPELLERS, Plans, kits for snow sleighs, air boats. Immediate delivery, satisfaction guaranteed. Catalog 25c. Banks-Maxwell, Box 3301E, Ft. Worth, Texas.

BUILD A helicopter jet engine yourself! "Practical Ram Jet Design"—\$1.00. Decker Engine Works, Dept. PM, Plasterco, Va.

LIGHTPLANE Circular, illustrated, 20c. Craftsman Books, Box 1153, Milwaukee 1, Wisconsin.

PROPELLERS, Plans, supplies for air boats, snow sleighs. Literature, Gano Propeller, Box 3284A, Ft. Worth, Texas.

FREE: Monthly aircraft, electronic, gadget list. Dick Rose, Everett, Wash.

BATTERIES, GENERATORS

EDISON Nickel storage batteries. Any voltage, any amperage. Unconditionally guaranteed. Power plants, generators, motors. Literature, Hawley Smith Co., Croton Falls 1, N. Y.

ELECTRICAL SUPPLIES

MAGNET Wire, varnish, insulation. Electric Motor Service, 308 Delaware, Mason City, Iowa.

LAMP Supplies—Wholesale. Any amounts. All parts for repairing and building lamps. Catalogue 15c. Brown Lamp Co., Box 501-Wellston Sta., St. Louis 12, Mo.

LAMPS—25c Brings bargain catalog showing all parts for repairing, building. Contains instructions for electrifying vases, oil lamps, etc. Gyro Lamps, 5462P Clark, Chicago 40.

ELECTRIC Pencil: Engraves all metals \$1.50. Beyer Mfg., 10511-H Springfield, Chicago 43.

REWINDERS, Supplies, motors, instructions, plans, Modern, Box 4704, Kansas City 9, Mo.

WELDING, SOLDERING, PLATING

ELECTRO Plating equipment—New and used. Complete assemblies. All sizes for all types of plating. Baby shoe, metallizing sets. Mounts, supplies, instructions. Free catalog. Hollywood Bronze Supply, 1624-C E. First Street, Los Angeles 33, Calif.

WELDERS, \$29.50, \$54, \$79.50. Absolute guarantee. Morris, 1070 Inner Drive, Schenectady, N. Y.

ELECTROPLATING Equipment, anodes and solutions for all types of plating. Instructions. Assemble your own plater and save. Free catalog. Ramy, Dept. E-4, 1624 East First Street, Los Angeles 33, California.

"BUILD-UR-OWN" a.c. welder and a.c. power plant with a good used engine and low cost Hobart generator. Welds anywhere and supplies 5kw stand-by power for any emergency. Write Hobartweld, Box M-943, Troy, Ohio.

ACETYLENE Welding outfits, new \$49.00; used \$29.00. Arcwelders \$49.50. Eagle Welding, Dept. PM, 5085 Broadway, Chicago 40, Ill.

A.C. Welders, four sizes. Lowest prices. Free literature. Holgerson's Service, Canton, Kans.

MACHINERY, TOOLS, SUPPLIES

ALLEN One ton power bench type punch press. \$97.50. Circular, Allen, Dept. PMB, Clinton, Missouri.

SHEBEL Saw filer. Files all saws. Circular, A. P. Shebel, 730 S. 2nd St., Milwaukee 4, Wis.

NEW Electric drills and saws. 1 1/2", \$11.75 and \$15.75; 1/2", \$30.75; 6 1/2" tilting arbor \$39.95. Prepaid. Will Surplus, 7829 Racine, Chicago 20.

LUPKIN Steel tapes—100-ft. \$4.95; 50-ft. \$2.75. Lowest price anywhere! Connecticut Yankee Bargain Buyers, 84 Brightwood, Torrington, Conn.

SENSATIONAL New all steel wood working lathe, 4 1/2" swing, 122 centers, \$9.95 prepaid. Circular, Sypher Co., 208 Cherry, Toledo, Ohio.

TRUE Lathe chucks easy way. Send \$1.00. S. V. Height, Spring Lake, N. J.

ATTENTION Toolmakers. New simple method for turning or grinding tapers or angles to perfection on any machine. No special equipment. Complete instruction \$1.00. Bazar, 4603 West-Vanbeck, Milwaukee.

REVOLUTIONARY Hand tool. Increases pulling power 31 times. Free literature. Multi-Use Puller, Box 971-M, Uptown, Hoboken, New Jersey.

NEW Drill grinding jig, used with bench grinder. Circular free. Dealers wanted. Travis Tool & Machine Company, Sidney, Iowa.

NEW, Bench milling machine. \$59.50. Money back guarantee. Southern Machine Tool Co., Conyers, Georgia.

BIG Factory catalog! Buy direct—Save middleman's profits; hundreds of labor saving tools and equipment; tremendous savings. Send 10c. Master Mechanic Mfg., Dept. CL-32, Burlington, Wis.

ENGINES, MOTORS, DYNAMOS

WINDING Data, 225 motors, single and three phase, \$1.00. Data Company, Box 7631, Kansas City 26, Mo.

2-H.P. Gas engine, Briggs, 4 cycle. Kick or rope start. Regular \$68.00. New Government release. Special, \$37.50. Money back guarantee. Roberts, 449 Grand, Dept. C20, Chicago 22.

A.C. Generators, 750 watt \$38.50. Twin cylinder compressors with 1/2 horse \$22.50. Motors, 1 horse \$37.50. Butler, 1885 Milwaukee, Chicago 47.

REBUILT 1 1/2 To 3 h.p. engines \$17.00 to \$37.00. Cauffiel Motor Industries, Temperance, Michigan.

BOATS, OUTBOARD MOTORS

FIBERGLASS Repair kits \$1.00 (75 sq. in.). Repairs wood, Fiberglass boats. Boat covering kits from \$9.95. Free estimate for your boat. Ace Plastics, Box #204, Lockland, Ohio.

CONVERT Fords and Jeeps to 100" marine engines with Osco's world famous Convo-Kits. Deluxe catalogue 25c (coin). Oscomotors, 3627B Lawrence, Philadelphia 40, Penna.

BUY Wholesale nationally advertised outboards, thousands other products at big discount. Free "Wholesale Plan." American Buyers, 628-D Linden, Buffalo 26, New York.

SIMPLIFIED Boat plans for amateur builders. Inboards, outboards, runabouts, cruisers. Please state type. Glen Designs, Box 568, Compton, California.

SECRETS Of Outboard Motorboat Racing. Valuable book for every outboard driver, \$3.00 postpaid. Van Pelt Boat Company, Spring Lake 4, Michigan.

BOAT Covers, custom and ready made. Also tarpaulins, canvas yard goods, life preservers. Free boat cover catalogue. Morsan, 10-40R 50th Avenue, Long Island City 1, N. Y.

BOAT Kits. Build your own boat. Easy to follow instructions. Literature free. Paramount Boat Company, 2202 N. Prairie, Joliet, Illinois.

AIR Boat plans, supplies, catalog 25c. Banks-Maxwell, Box 3301F, Ft. Worth, Texas.

FIBERGLAS Permanent boat coating. Lowest prices. 14 years plastic experience reflected in complete information catalog—10c. Gem-O-Lite, Box 6861B, North Hollywood, California.

FULL Size, cut-to-shape boat patterns, blueprints, 7 1/2-38 feet. New 1954 illustrated "Build a Boat" catalog of 50 naval architect-designed cruisers, runabouts, sloops, skiffs, outboard boats, sailing, racing, houseboats, 50c. Marine hardware catalog, \$1.50. Bigger, better 1954 "How to Build Boats" book, \$2.50. PolyWog Houseboat Plans, \$12. Cleveland Boat Blueprint Co., Dept. A-66, 9400 Steinway, Cleveland 4, Ohio.

FIBERGLAS Your boat for permanent waterproofing. Easily applied. Complete instructions. Guaranteed materials. Wholesale prices. Complete kits \$12.60 up. Free lists. Ajax Plastics, Dept. PM, P.O. Box 1323, Ft. Worth, Texas.

MARINE Conversions for Ford and Jeep engines. Catalog 10c. Lehman Manufacturing Company, 972D Broad Street, Newark 2, New Jersey.

NEW, Used, rebuilt marine motors. Marine conversions, fittings. Free catalog. Stokes Marine Supply, Dept. 24, Coldwater, Michigan.

BUILD Marine engines with Federal conversion kits. Federal Marine Motors, 9011 Cottage Grove Ave., Chicago 19, Illinois.

FREE Catalog! Boat kits, trailers, fiberglass, marine hardware. Luger Industries, Dept. KD, 3207 Fremont South, Minneapolis, Minnesota.

JOHNSON Outboard specialists. Used parts for all models at substantial savings. Prompt quotations. Specify model serial. Crandall-Hicks, 910 Commonwealth, Boston, Mass.

SPORTING GOODS, GUNS, FISHING TACKLE, ARCHERY, TRAPPING

SAVE 50%. Finest bows, arrows, complete bowhunting outfits, etc. Free catalog and "How to Select Bow" booklet. Write: (Send 25c for "How to Bowhunt" booklet if desired). Malibu Archery, Los Angeles 5, California.

CALL Elk, deer, coyotes, foxes, etc. Original Animal Calls, Burley, Idaho.

CATALOG On government surplus from country's largest surplus organization specializing in outdoor, sporting goods, clothing, camping equipment. Hundreds of items including tents, rubber boats, tarpaulins, swim fins. Only 10c! Rockaway Sales Co., Dept. PM, Route 46, Rockaway, New Jersey.

MOLDS For fisherman's sinkers, jigs, squids, casting and spinning lures. Free catalog. Sweet's Molds, Tonawanda 1, New York.

HOLLOWGLASS Fishing rods. Save over half. Buy complete kits. Casting, spinning, fly and boat. \$4.95 to \$7.95. Assemble yourself. Full instructions. Makit Rod Company, Dept. PM, 429 Fulton, Ft. Worth, Texas.

5000 BARGAINS, Firearms, binoculars, war relics. Catalog 50c. Smith Firearms, Runnemed, N. J.

180 PROFUSELY illustrated pages antique pistols, swords, daggers, armor, etc. 50c. Robert Abels, M860 Lexington Ave., New York 21.

CAST Iron molds—For casting fishermen's sinkers. Free illustrated booklet. Reading Instrument Co., Box 78, Reading, Penna.

DIVING Equipment for spear fishermen, skin divers and professional divers. Send 25c for catalog. Desco, 234 N. Broadway, Milwaukee 2, Wis.

TENTS (Direct from manufacturer), camping equipment, sleeping bags, air mattresses. Low prices. Send 10c for 72 page illustrated tent-camping equipment-tent maintenance catalogue. Mor-San Sales, 10-21R 50th Avenue, Long Island City 1, New York.

TWENTY Imported fishing flies \$2.00. Miller, Box 10104, Tampa 9, Florida.

FREE Fishing catalog—132 pages. Over 3000 hard to find fishing specialties. Net-craft Company, Dept. PM9, Toledo 13, Ohio.

CATCH Fish galore. Amazing bait makes fish come to you. Simply astounding. Free facts, 1000 Islands Enterprises, Clayton 33, New York.

SEMIFINISHED Osage, bamboo, lemon-wood bows; arrow supplies; redwood burrs; hardwoods; catalog. Jim Deeds Archery, 5151 Branciforte Drive, Santa Cruz, Calif.

MANY Modern, antique guns. List 10c coin. Ed Howe, 52 Main, Coopers Mills, Maine.

GUNS, Reloading supplies, archery supplies, binoculars. Catalogue 10c. Gun Shop, Baker, Oregon.

JAP Rifle altering to 30-06, \$6.00. Jap-shells, \$3.75. Catalog 5c. T. P. Shop, West Branch 11, Mich.

PORTABLE Blinds: For duck, crow, goose shooting. Very light 4 x 5 ft. woven natural Tule mats. Strong. Excellent on duck boats and permanent blinds too! \$3.00 delivered. Peacock Broom Co., 915 Bryant St., San Francisco, Calif.

BUY Wholesale nationally advertised sporting goods, thousands other products at big discount. Free "Wholesale Plan." American Buyers, 427-D Linden, Buffalo 16, N. Y.

BIG Fish small Quick-Catch bait from distance! You hook 'em fast! Bait easily made! Scientific directions, \$1. Star, 405 Madison, Fort Wayne, Indiana.

JAP and Mauser military guns make fine hunting rifles. Do it yourself in your spare time. Save money. Send for complete easy to follow instructions. Free. Fajen's, Warsaw, Missouri.

BINOCULARS, TELESCOPES, MICROSCOPES, MAGNIFIERS

AMAZING Prices, binoculars, telescopes, microscopes. Free trial. Folder, "Binocular Selecting," catalog free. Dealers wanted. Prentiss Importers, Mercury Bldg., West Los Angeles 25, Calif.

SAVE 25%! Get interesting facts. Free \$2 page binocular, telescope catalog. \$3.95 to \$250.00! United, 9043 S. Western, A-7008, Chicago 20. Dealers wanted.

LOWEST Prices, all sizes binoculars, telescopes, microscopes. \$X30 \$32.00. Free catalogue. Joe's Binocular Sales, 4827 Second Blvd., Detroit 1, Michigan.

TELESCOPES, Microscopes, binoculars for quarter century. Big bargain scientific catalog 10c. Harry Ross, 70 West Broadway, New York 7, N. Y.

REFLECTING Telescopes, 60X, completely assembled \$29.75. Guaranteed observatory clearness. Free information. Skyscope, 475 Fifth Avenue, New York 17.

MAKE 6" Telescope reflector. Glass, abrasives, instructions—\$19.50. F. Cameron, Box 65, Inwood 96, N. Y.

BINOCULARS, Telescopes, microscopes. Terrific values, \$3.98 up. Request free money saving catalog. Criterion, P25, Hartford, Conn.

FULL Size 6x7 in. field glasses 3-power \$3.95 postpaid. Richmond Enterprises, Dept. PM11, Box 1003, Augusta, Georgia.

GIANT 100X Telescope completely assembled with two eyepieces, helioscope instructions and extra heavy tripod. Steel and brass tube construction. Regularly \$7.95 now \$7.50. 400X telescope makers kit contains focusing tube, erector, 5 lenses and instructions—\$3.75. Suffolk Science, Mattituck 3, N. Y.

FREE Literature, 100X giant metal telescope with very heavy tripod \$7.95 f.o.b. Manorville, 400X telescope makers lens kit \$3.95 postpaid. We originate. Others imitate. Established 25 years. Carl Jamer, Manorville 1, N. Y.

DYNASCOPE—New sensational reflector telescope 65X-130X-167X, 4 power finder, fully achromatic hardwood folding tripod, complete ready for use. Send for details. Criterion Manufacturing, Dept. DP4, Hartford, Conn.

SPACE-Rover astronomical telescopes, precision made. Rasmussen-Reece, Amsterdam, N. Y.

REFLECTOR Telescope kits from \$6.25. All parts designed and built at our Hoboken factory. Mirror cells, diagonals, focusing mounts, tripods, tubing, oculars. Fully guaranteed. Free illustrated catalog. Easy time payments and lay-away plan available. Send orders and inquiries to Esco Products, Dept. PM-4, 1428 Willow Avenue, Hoboken, N. J.

WAR Surplus bargains! Millions of lenses, instruments, telescopes, binoculars, components! World's greatest optical market place! Send only \$1.00 for beginner's 10-Lens kit and big instruction booklet, Stock CH. Write for catalog CH free! Edmund Scientific Corp., Barrington, New Jersey.

PETS—DOGS, BIRDS, RABBITS, HAMSTERS, ETC.

RAISE Rabbits. Cash markets. Booklet free. Tayco Rabbitry, Hapeville, Georgia.

FOR Sale: A few outstanding coon-hounds, beagle, and rabbithounds. Prices from \$15.00 to \$40.00. Free literature. Trial. Dures Thomas, Box 268, Albertville, Alabama.

HAMSTERS—Golden; young, \$4.00 pair, fully developed, \$5.00 pair. Adirondack Hamstery, Prospect 34, New York.

GUINEA Pigs. Money makers. Booklet free. Taylors Company, Hapeville, Georgia.

CHINCHILLAS Book, breeding and care \$2.00. Ludwig Ranch, Mohnton 10, Penna.

RAISE Squabs. Demand exceeds supply. Profits unlimited. Details 10c. Text-Kings, Box 193, Grand Prairie, Texas.

AMAZING Profits raising chinchillas, pigeons, rabbits or cavy for us. Information 25c. Keeney Brothers, New Freedom 2, Penna.

HAMSTERS—Rare Albinos; young, pair \$7.00. I. C. Gengler, Caledonia, Minn.

BEAUTIFUL Pure white pedigreed police puppies. Ansonia Kennels, M.se, N. Dak.

ST. Bernard puppies. Details free. Mrs. Dorothy Poling, R2, Elida, Ohio.

RAISE Mink: Free booklet, pen plans, inside secrets, feed care. Mink are money makers. Investigate today. Lawrence Mould, Brigham City 12, Utah.

HAMSTERS—Retail and wholesale. Prices free. Anderson's Hamstery, 35 Oneida, Pontiac, Michigan.

MINK, \$20.00 Up. Darks, pastels, sapphires. Satisfaction guaranteed. Blue Sky Mink Ranch, Box 332, Henry, Ill.

CHINCHILLAS. Profitable business operated in cellar or spare room. Quality registered stock. Guaranteed. Delivered personally. Full care instruction. Stewart Chinchilla Ranch, Washingtonville, N. Y.

CHINCHILLAS—Registered. Guaranteed reproduction. Unbelievable price. Par-West Chinchilla, 1448-A Jones, San Francisco 9, California.

CHINCHILLA Raising pays amazing profits! Our plan makes it easy. Our guarantee protects you. Free booklet explains all. Wiltner Chinchilla Ranch, Dover 5, New Hampshire.

MINK—Easily raised anywhere. Top quality breeders. Free information. Huebl Minkery, LeSueur, Minn.

RAISE Money-making Angora. New Zealand rabbits, Particulars free. White's Rabbitry, Jackson, Mich.

STANDARD Rabbit Journal, Milton 3, Penna. Year \$1.00. Sample dime. Beginners manual 25c.

GROW Mushrooms. Cellar, shed, and outdoors. Spare, full time, year round. We pay \$3.50 lb. We paid Babbitt \$4,165.00 in few weeks. Free book. Washington Mushroom Ind., Dept. 171, 2954 Admiral Way, Seattle, Washington.

MAKE Big money! Raise Chinchilla rabbits. Cash markets supplied. Write today! Rockhill Ranch, Sellersville 15, Penna.

MINK Raising information free. Complete. Lake Superior Mink Farm, Superior, Eel, Wisconsin.

FARMS, FARM LANDS, REAL ESTATE

HOMESITES \$400—Convenient payments. California's finest garden section. On Morro Bay's scenic shores. Wonderful fishing, boating, bathing. Fertile soil, softest water, temperate climate, congenial community. Free literature, Richard Otto, Department M, San Luis Obispo, Calif.

GIANT Listings free. Timber, grazing, retirement, etc. Address—Armstrong, Shook, Missouri.

NEW Strout catalog, just out! Mailed free! Farms, homes, businesses, 35 states, coast-to-coast, over 3000 bargains described. World's largest; 34 years service. Strout Realty, 7-M So. Dearborn St., Chicago 3, Ill.

\$5.00 MONTHLY Buys 40 acres productive land; near town. Price \$240.00. Free list. Box 425-P, Carthage, Mo.

MAKE Big money in marvelous Houston. America's fastest growing city. Buy guaranteed homesites in beautiful suburb. Special price \$345. Terms. Fine investment. Booklet free. Preston Wood, Box 413, Houston, Texas.

MAKE Money in Texas. Get yourself a fine tract now near Houston for only \$345. Pay \$15 cash and \$15 monthly. Fastest growing city and second largest seaport in the U. S. Huge \$100 million steel plant. World's greatest oil producing, refining, chemical, manufacturing and shipping center. Many are making phenomenal profits here and you can too. These beautiful tracts located in Houston's desirable southside suburbs with all-weather streets, electricity, schools, bus service, etc. Insured title. Write today for maps, pictures, full information free. Wood, Owner, Box 6804, Houston 5, Texas.

FARM And business catalogs free! 4 big editions, Florida, northeastern states. West's, M-8, Pittsburgh 17, Penna.

PLANTS, SEEDS, NURSERY AND GARDEN SUPPLIES

GINSENG, Goldenseal roots bring \$2-\$12 pound. Full information. M. Collins, Viola, Iowa.

GROW Miniature trees. "Banzai" method exposed. Complete simplified instructions \$1.00. Returnable. Revealer, 1749 Gr. Concourse, New York 53.

COBRA Orchid, Carnivorous—Eats insects. Free details. Bell, Box 314, Vincennes, Indiana.

AMAZING New Zoysia Japonica lawn seed mixture. Heat, drought resistant. Green spring until winter. \$1.00 test packet plants 50 sq. ft. Dougherty, 4643, Baltimore 12, Maryland.

PROFITABLE OCCUPATIONS

MAKE Flexible molds. Cast figurines, plaques. Free sample. Tooker, 630-M Chestnut, Hamilton, Ohio.

MERCHANT Marine opportunities! Complete information and employment instructions \$1.98. Satisfaction guaranteed. Seaways, Box 1231M, Baltimore 3, Md.

EVERYBODY Likes candy. Learn to make professionally. Our 44th year. Regs-dale Candies, D6, East Orange, New Jersey.

FOREIGN, Latin American, domestic employment. 1954 "Foreign Service Directory" originator of job news by copyright, gives up-to-minute facts on military and civilian construction; Canadian, Alaska construction; major oil companies; aviation; manufacturers; steamship lines; mining; importers-exporters; how-when-where to apply with application form. Free—Hot list firms hiring. \$1.00 postpaid. Global Reports, Box 882-P, Hollywood 28, Calif.

GROW Mushrooms. Cellar, shed, and outdoors. Spare, full time, year round. We pay \$3.50 lb. We paid Babbitt \$4,165 in few weeks. Free book. Washington Mushroom Ind., Dept. 99, 2954 Admiral Way, Seattle, Wash.

BE The Popular Mechanics representative in your neighborhood and earn big profits in your spare time. Write Popular Mechanics Magazine, Room 408M, 200 E. Ontario St., Chicago, Ill.

FREE Book "505 Odd, Successful Businesses." Work home. Expect something odd! Pacific, Oceanside, Calif.

EARN \$3.50 To \$15.00 per hour in your spare time refinishing and patching furniture. Repair professionally scratches, dents, nicks, cigarette burns, etc. Particulars free. Sunshine City Refinishing Products, 3800 Maple St., Northeast, St. Petersburg, Florida.

HOMEWORKERS, Men, women. Hand lace moccasins. Easy—profitable. California Handicrafts, Dept. 61, Hollywood 46, California.

MAN Wanted—Are you dissatisfied with your work? Would you like a business of your own? If so, write Rawleigh's, Dept. I-GG-PPM, Freeport, Ill.

"HOW To Make Money With Simple Cartoons"—A book everyone who likes to draw should have. It is free; no obligation. Simply address Cartoonists' Exchange, Dept. 99CP, Pleasant Hill, Ohio.

FOREIGN-U.S. Jobs. South America, Alaska, Spain. Fare paid. 1000's U. S. jobs to \$18,000. Trades, office, factories. Stamped self addressed env. brings reply. Job Opportunities, Waseca 18, Minn.

FREE! "301 Profitable Small Businesses!" Amazing shoestring plans! Work home! Start sparetime! Deamant Surveys, Kenmore 23-PM, N. Y.

HOME Mailorder beginners. Sources, methods, opportunities, instructions. Details free. Carnahan Bros., 5583-G Nelson, Cypress, Calif.

"LATEST Copyrighted Reports!" Who to contact for highest paying jobs in over 38 countries, including U. S., Spain, South America, Alaska, Europe, Africa, Canada, etc. Listings of employers with contracts who hire skilled, unskilled, professional, supervisory, clerical, trades, laborers, many others. Pay up to \$1550 monthly. Also best oil, aviation, mining opportunities. Only \$2. Airmail \$2.25. (C.O.D.'s accepted). Includes one year registration and advisory service. Application forms. We can help you find employment. Only service with unconditional guarantee of satisfaction or money back. Immediate service. International Reporter, Box 1047-PO, St. Louis 1, Missouri.

SELL Popular Mechanics and all other magazine subscriptions. Free catalog, supplies. Subscription Service Company, Dept. B, P.O. Box 2070, Birmingham, Alabama.

EXTRA Money every week. I'll send you full-size Blair household products on free trial. Show them to friends and neighbors. You can make big extra profits. Write Blair, Dept. 31MS-2, Lynchburg, Va.

WELDING Pays big money. Learn easily at best equipped school in country. Non-profit school with low cost training. G. I. approved. Write Hobart Trade School, Box M-942, Troy, Ohio.

WANT A diesel job? New opportunities to increase income. Higher pay. More money. We can help you qualify. Tools. Shop method home training. Write today! Diesel, Tractor, Heavy Equipment Division, Interstate Training Service, Dept. B-3-J, Portland 13, Oregon.

BIG Construction projects now under way in Canada and abroad. Outstanding pay. Complete information for only \$1.00 to Service Bureau, Box 116 Stn. B, Hamilton, Ontario.

CALIFORNIA Opportunities. Men, women job information. Enjoy life, work and live better. Write, Information Service, Box 927, Santa Monica, Calif.

\$1300.00 MONTHLY For truck drivers, \$1400.00 monthly for carpenters, electricians, plumbers, mechanics, \$1200.00 for clerks and laborers. Replacement hiring now being done. Full information and complete foreign listings, with current information on Spain, Korea, Australia, Alaska and Canada, \$1.00. 10,000 men and women needed for new stateside project! Complete information and other domestic listings, \$1.00. Dept. 3-1, Opportunities Unlimited, 1110 Commerce Bldg., St. Paul, Minn.

HOME Workers needed! Spare time, full time. Assemble luggage and cases with our complete illustrated step-by-step instructions. We sell your products—Supply everything. Become our manufacturer's representative in your area. Help fill huge demand. Unlimited profits possible. Investigate at our risk. Free details. Casecraft, 807-G Sunset, Los Angeles 12, Calif.

FREE Polio "\$45,000: Unlimited Vacations Plan." No canvassing, mailorder, merchandising, equipment. Unknown. Works itself—home! Keep job. Haylings, Carlsbad, Calif.

SAN Fernando Valley, world's fastest growing area! Information supplied regarding job and business opportunities, vacation spots, real estate, homes, schools, living conditions. Job application forms included. Will assist you in getting settled. \$1.00. Ronne, Box 44B, Canoga Park, Calif.

TYPISTS—Profitable home business. Complete copyrighted information, 50c. Gaunt, 827 Irving, Chicago 13.

AUCTIONEERING—Home study course. Diploma granted. Auction School, Ft. Smith, Ark.

FREE Information now available about foreign and U. S. A. job opportunities paying to \$1500 monthly. Write immediately, Dept. AG, National Employment Information Service, 1020 Broad, Newark, N. J.

MAKE New greaseless doughnuts in kitchen. Sell stores. Free recipes. Michael Ray, 3605 South 15th Ave., Minneapolis 7, Minnesota.

MAGAZINE Subscriptions—Biggest commissions, bonus. Qualified Publications, 451-AL Kingston, Brooklyn 25, N. Y.

RAISE Pheasants on \$100 week plan. Little capital and space can make you independent. Free details. Great Central System, Columbus 20, Kansas.

BUY Wholesale thousands nationally advertised products at big discount. Free "Wholesale Plan," American Buyers', 628-P Linden, Buffalo, N. Y.

MUSHROOMS Grown boxes, barrels. Manureless process 50c. Spawn \$1.00. Gordons, 553 William, Winnipeg, Manitoba.

BOOKS, PERIODICALS, PICTURES, POSTCARDS

SPARETIME Profits taking subscriptions, all magazines. Wholesale catalog free. Cassell Agency, Westfield 2, New Jersey.

NATIONAL Geographic Magazines, 1888-1932. Periodical Service, Box 465-PM, Wilmington, Delaware.

BOOKS Found! Any author, old or new. Rush titles wanted; no obligation. International Bookfinders, Box 3063-PM, Beverly Hills, California.

BOOKHUNTERS! All subjects. Send wants! Jaher Book Service, 620-P East 178 Street, New York 57.

20 ASSORTED Natural color postcards of New York City \$1.00. Rubie Studios, 254 West 31st Street, New York City.

"FEMME Mimics"—Amazing book, containing 375 photographs. About men who wear women's clothing! Free literature. Winco, Dept. PM91, Box 9325, Dallas, Tex.

BOOKS Galore. Illustrated comic booklets, 24 all different \$1. Catalogue 10c. Aladdin Book Co., 210-PM Fifth Avenue, New York 10.

BOOKS Government surplus. Career, text and instructional. Bargain prices. Free catalog. Also 50 other free catalogs on separate subjects. Long's College Book Co., Dept. PM, Columbus 1, Ohio.

BOOK Catalogue, 1000 bargains, send 10c. Books Publishers, Amityville 3, N. Y.

FREE Catalog paper covered books. World Adventure, B438B, Ann Arbor, Mich.

MAGIC TRICKS, PUZZLES, JOKER NOVELTIES

VENTRILOQUIAL Dummies, courses, scripts, monologues, etc. Catalogue and illustrations \$1. (Deductible first order). Gough, 218 N. Jefferson, Hartford City, Ind.

FREE Bag full of amazing tricks. Send dime for handling. Starling Co., 2206M Starling Ave., New York City 62.

WE Supply every noted magician. Large professional catalog \$1.25. Holden's, 120 Boylston Street, Boston, Mass.

500 TRICKS, Douglas famous 120-page catalog, only 10c. Fastest service to magicians for 30 years. Send 10c today. Douglas Magicland, Dept. 1, Dallas, Texas.

2500 TRICK Catalogue (512-pages), pocket, parlor, stage. World's finest magic. Catalogue \$2.00 (dollar trick included free). Kanter's, M-1311 Walnut, Philadelphia 7.

PROFESSIONAL Catalog, 175 pages, 25c. Williams, 900 Plymouth, Ellwood City, Penna.

VENTRILOQUISM Easy to learn in 60 to 90 days! Home study course! Results guaranteed. For free information write stating your age. Dummy catalog 25c. Fred Maher School of Ventriloquism, Box 36, Studio PM-9, Kensington Station, Detroit 24, Michigan.

FREE Magic and novelty catalog, includes 14 wonderful magic tricks fully illustrated and described. Read all about our free gift offer. Chicago Magic Center, PM-9, 19 W. Randolph St., Chicago 1, Ill.

"VENTRILOQUISM Selftaught"—Complete book 25c. Greenview, Box 61-BH, Whitestone 57, New York.

FREE Catalog. Best magic. Practical jokes. Top Hat Magic, Evanston, Illinois.

128 PAGES Of coin tricks \$1.00. D. Clayton, Conover, Ohio.

MAGIC Courses. Catalog with seven lessons free! Success School, Sparta 6, Michigan.

3100 NOVELTIES, Tricks, jokes, gadgets, funmakers, hobbies. Catalog 10c. Johnson-Smith, D852, Detroit 7.

SENSATIONAL Magician's wand 25c. (Vanishes handkerchief!) Catalog included. Box 1352-PM, Philadelphia 5.

COINS, TOKENS, CURRENCY

FOREIGN Coins, twenty different each from a different country, \$1.00 postpaid. Webb, 330 Gough, San Francisco 2, Calif.

JAPANESE Invasion notes 1c to \$1000.00 set \$1.00. 100pp. illustrated coin catalogue, 25c. Shultz, Salt Lake City 10, Utah.

FREE! Foreign coin, banknote and coin collectors illustrated catalog to approval service applicants. Send 3c postage. Tatham Coinco, Springfield 30, Mass.

INDIAN Cent with bargain lists 10c. Hutchinson, 3463 "I" Street, Philadelphia 34, Penna.

GET Profit and pleasure in collecting old coins. Send 10c for 56-page illustrated coin catalog. You'll be delighted with it. Send for it now. B. Max Mehl, 370 Mehl Building, Fort Worth, Texas. Largest rare coin establishment in U. S. Established 34 years.

CONFEDERATE And Southern bank notes, 3 different, \$2.00. 50 mixed Indian pennies, \$2.00. Ben's Coin Shop, 31 N. Clark, Chicago 2.

WORLD'S Greatest magazine for coin collector's and wooden nickel 10c. Lawrence Brothers, Anamosa, Iowa.

COIN Collector's Magazine. Over 1000 pages per year. Sample copy 30c; \$3.00 per year. Hewitt, 7320-J Milwaukee, Chicago 31.

U.S. Large cent, 2c, 3c all for \$1. Bargain list included. Delmaco, Box 1123, Wilmington, Del.

UNITED States Rare Coin Value Guide, 48 pages 50c. Fortunes in rare coins. Ideal, 4644-P Geary, San Francisco 18, California.

AN 1894 Silver dollar is worth \$12,500! What are your U. S. coins worth? Fell's new 1954 U. S. coin book. Everything on every coin minted—worth, selling, speculating, investment, etc. Clothbound, profusely illustrated. Send no money. Pay postman \$2 (plus postage) or send \$2.00 (postpaid), refundable. Fell Publishers, 386-M-6 4th Ave., New York City 16.

OLD Money wanted. Will pay \$100.00 for 1894 dime, S. mint. \$50.00 for 1913 Liberty head nickel (not buffalo). Big premiums paid for all rare coins. Send 4c for large coin folder. May mean much profit for you. Numismatic Co., Dept. 20, Fort Worth, Texas.

GENUINE Wooden nickels! Free sample and price list. E. P. Ross, 620 W. Duffy La., Savannah, Ga.

FOR Sale—Half-guinea, 1788. R. T. Cox, Glanville, Sask, Canada.

FIFTEEN Different Indian cents \$1.00. Sayers, 1000 East Unaka, Johnson City, Tennessee.

35 DIFFERENT Foreign coins, \$1.00. Claud Denney, 3633 Colonial, Dallas 15, Texas.

FOREIGN Coins, 10 diff. 30c. Foreign bills, 10 diff. 20c. Indian cents, 15 diff. \$1.00. Lists. Oliver Arnold, Macon, Mo.

COIN Collectors; \$1.00 brings year's subscription, copy 10c. Coin Collectors News, Haleyville, Alabama.

40 DIFFERENT Selected coins \$1.00. Oddehon, Box 482, St. Louis, Mo.

5 DIFFERENT Foreign coins—10c. Jolie, Box 19C, Brooklyn 3, N. Y.

LARGE \$1.00 Bill \$2.50; new \$3.95. Vatican Holy Year set 4, \$1.25. Tahiti set 4, \$1.00. 256 page guidebook \$1.75; handbook \$1.00; our giant bargain catalogue 35c. Fast service. Bebee's, 4514 North 30th, Omaha 11, Nebraska.

1954 UNITED States proof set \$3.00. Libya (new country) set (5) \$1.00. 256 page guidebook \$1.75; buying handbook \$1.00. Giant bargain coin catalogue 35c. Fast service. Bebee's, 4514 North 30th, Omaha 11, Nebraska.

WANTED—1894-S dime pay \$500.00. Certain 1913 nickel \$1,000.00. 1901-S quarter \$20.00 to \$150.00. Hundreds of others. Know their true value. Complete illustrated catalogue 25c. Worthycoin Corporation, (D-325), Boston 8, Mass.

BARGAIN Lists, 10 good different Indianhead cents, 50c. Economy Sales, 156-C Dean, Mansfield, Mass.

STAMP COLLECTING

BARGAINS Galore! Ask for "Stamps of Quality" price list today. Elholms, 621 Hayes, Racine, Wisconsin.

WEST Indies, French Africa, over 100 others, only 10c! Approvals included. Cole, 43-A Rinehart, Buffalo 21, N. Y.

WORLDWIDE, 50 All different, absolutely free, just to introduce our incomparable approvals. Kent Stamp Company, GPO Box 57, Brooklyn, N. Y.

FREE U. S. illustrated bargain catalogue. Rothbers's, 53 Bromfield, Boston 8, Mass.

FREE 105 Different stamps to approval applicants. Supreme Stamp Service, 2205 So. Grand Ave., Los Angeles 7, Calif.

TWO \$5.00 U. S. stamps plus 20 different, 10c with U. S. approvals. Irwin Stamp Co., Box 1105, Brooklyn 30, N. Y.

UNITED Nations cover free to applicants of U. S. or British Colonial approvals. A. Taylor, Skyland, N. C.

100 DIFFERENT U. S., 40c with U. S. approvals. Faith, 1339 1/2 Westminster, Alhambra, California.

POLAR Bear triangle, giant George Washington, six colored Ecuador, Arctic triangle, first American commemorative, Corisca, Devils Island, others. Everything free with approvals. Capital Stamps, Little Rock 2, Ark.

ECONOMICAL 1/2c-1c-2c-Approvals, 22,000 varieties available. Dresel, Box 270-n, New York 25, N. Y.

FABULOUS Collection—Roosevelt and dictator stamps. Mammoth fascinating collection of Roosevelt and dictators including Stalin, Tito, Franco, Lenin, Hitler and great many others plus free booklet and bargain lists. All for 10c with approvals. Jamestown Stamp, Jamestown, Dept. 413, N. Y.

50 DIFFERENT Bulgaria 10c! Approvals. Ensign Stamp Company, Dept. M, Berdan Avenue, Paterson 2, New Jersey.

EXOTIC Oriental collection, 105 all different stamps from Borneo, Hong Kong, Malaya, Sarawak, Korea, Japan and many other strange countries of the Far East plus free booklet and bargain lists. All for only 10c to new approval customers. Jamestown Stamp Co., Jamestown, Dept. 313, N. Y.

90,000 STAMPS: Grabbag 40c. Big lot, better stamps, \$1. Extra special, \$2. Giant assortment, \$5. Pervis, 436 New York Ave., Brooklyn 25, N. Y.

15 DIFFERENT United States stamps over 50 years old. Entire collection only 10c. Approvals accompany. Tristamps, Democrat 4, N. J.

50 DIFF. U. S. commemoratives 25c. Mammoth packet list free. Econopackets, Box 168, Riverside 9, Calif.

NUDES Set: Colorful approvals 10c. Atlas, 2830-M, Eisenhower, Racine, Wis.

329 DIFFERENT Worldwide stamps 25c including Hitler heads, British colonies, French colonies, rarities, unusuals. Everything complete 25c to adults requesting approvals. Canada Stamp Co., 1907 Main St., Dept. 118, Niagara Falls, N. Y.

UNITED STATES—58 different including 8 airmails, 15 commemoratives, 10c. Approvals. Sunset, Box 47, South Gate, Calif.

FREE—50 Different, with approvals. Fahsting, Dept. PM, Alhambra, California.

65 ALL Different U. S. stamps. Includes 50 year olds, commemoratives, airmails and \$5.00 stamp. Only 10c. Approvals. Willett Co., Box 511-L, Port Chester, New York.

225 STAMPS For only 10c! This mammoth value includes airmails, pictorials; stamps from strange countries cataloguing up to 25c each! Also approvals. Mystic Stamp Company, Camden 80, New York.

FREE—Valuable illustrated catalog. Over 1100 special offers, attractive bargains! Approvals. Kenmore, Milford 8-C, N. H.

ANIMALS. Birds, triangles, flowers, butterflies, fish, ships, locomotives, kings, dictators, multicolored, historical, geographical, musical, battles, giants, midgets and over 100 others—only 25c with approvals. Adults please. Canada Stamp Co., 1907 Main St., Dept. 318, Niagara Falls, N. Y.

HANDSOME New Zealand 1943 Elizabeth and Margaret Rose triangles only 10c to approval applicants. George Richie, 1539 Sixth, Alameda, Calif.

WOW! 153 All different Germany, 10c. Zeppelins, semi-postals, airmails, high values, big bargain lists and approvals included. Jamestown Stamp, Jamestown 512, New York.

STAMP'S Wanted. Min. and used, collections, accumulations. Good grades only. Buy outright if bargain. What have you? Write, give details. Vanroy Shirk, Lebanon, Penna.

TRIANGLES. Birds, butterflies, flowers—Big packet 10c with approvals. South-west Stamps, Box 117, Long Beach 1, Calif.

300 DIFFERENT. Triangle, airmail, pictorials, etc. 25c. 500 mixed U. S. 25c. Carlton's, Tujunga, Calif.

200 DIFFERENT. Including Roosevelt triangle. 10c to approval applicants. M. Avalon Stamp Company, Springfield, Mass.

327 DIFFERENT Stamps 25c! Including early Canada, Newfoundland, British Colonies, Vatican, Red Russia, Hitler heads, Indian states, animals, airmails, French Colonies, rarities, unusuals. Every stamp different. Rare bargain with approvals. Money back guarantee. Niagara Stamp Co., Niagara-on-the-Lake 61, Canada.

50 DIFFERENT Argentine 10c. Approvals. Reuter, 611 W. 40th Pl., Los Angeles 37.

FREE 119 Foreign stamps including Africa, Australia, Pakistan, China, India, Russia and Scandinavia. Send 10c for postage and handling. With approvals. Niagara Stamp Co., Niagara-on-the-Lake 81, Canada.

AMAZING Offer! 200 United States stamps—including commemoratives, airmails, high denominations to \$1.00. Only 10c to approval applicants! Illustrated bargain lists free. Mystic Stamp Co., Dept. 80, Camden, New York.

100 DIFFERENT Spain 25c. Penny approvals included. Reed, Box 980, Chicago 90, Ill.

OLD Scarce U. S. seconds on approvals. Slight imperfections, lowest prices, Herndon, Clintonhill Sta., Newark 8, N. J.

WORLD'S Largest stamp (7 1/2 x 14 inches). A real curiosity! Retail for 50c, only 2c to approval applicants. Tatham Stamp Co., Springfield 30, Mass.

SPEND Pennies! Not dollars! Thousands of fascinating stamps to choose from our 1c and 2c approvals. No premiums. Just honest value. Pat F. Knowles, Box 2247, Van Nuys, Calif.

COLOSSAL Stamp zoo free! Jungle beasts, wildlife, domestic animals—Fifteen different, including rhinoceros, elephant, snake, tiger, zebu, kangaroo, koalabear, emu, kookaburra, bull, horse. Extraordinary accompanying approvals. Send 10c for postage and handling. Niagara Stamp Co., Niagara-on-the-Lake 51, Canada.

OLD U. S. approvals. Low prices. MacG., 2905 Observatory, Cincinnati 8, Ohio.

50 DIFFERENT United States 5c with bargain approvals, lists: Bookman, Manatee 1, Florida.

SENSATIONAL Illustrated United States, United Nations, Confederate states catalogue free. Stone's, 45 Bromfield, Boston 8, Mass.

LOOKING For bargains? Try our 1c and 2c approvals mounted in books of 1,000. We believe in both quantity and quality. First try will satisfy. Clark Stamp Co., Dept. A-44, Muskegon Heights, Mich.

"VALUE Packed" mixture. Half pound large U. S. commemoratives \$3.75. Satisfaction guaranteed. Wiggins, Box 72-A, Guild, N. H.

FINE Approvals. Fast, personal service. What countries do you prefer? I'll send their stamps. Skinner, 438 Locust, Long Beach 12, California.

FIRST U. N. set. Among world's prettiest. Only 10c. Approvals. Welles, Box 1248-R, New York City 8.

VATICAN City airmail set of 3 only 3c. Approvals. Goliath Co., Bethlehem Y1, N. H.

ZOO Parade 10 different bi-colored stamps depicting queer Civet from Liberia, Bay-thighed Diana monkey, Sudan camel, Hedge-hog, rabbit, squirrel, fox, finch, Gouza, Gullitun including big triangles, regular \$1.00 value only 10c to approval applicants. Roseland Stamp Co., Dept. A-34, Spring Lake, Mich.

1,000 STAMPS For you to look at. Big, attractive approval books of beautiful stamps. Pick and choose to suit yourself, at 1c to 5c each! Let us show you the economical way to a large, worthwhile collection. Wolverine Stamp Service, Dept. A-34, Fruitport, Mich.

FREE Complete set of famous Americans, flags, parks and presidentials to approval buyers. Send 5c for 15 of the above stamps plus full particulars. Triboro Stamp Company, 145 Nassau Street, Dept. 109, New York 38, N. Y.

TOPS! Free book "How To Collect Stamps." Send for your copy today! Approvals. Littleton Stamp Company, Littleton E1, N. H.

80 DIFFERENT 10c With approvals. Guy Stamp, 5165—5th Ave., Rosemont, Montreal, Canada.

COLONIAL Collection free—Magnificent collection, British, French, American and other colonies. Flowers, animals, commemoratives, triangles, pictorials, high values all free plus Philatopic Magazine. Send 5c for postage. Empire Stamp Company, Dept. PM, Toronto, Canada.

FREE! 1954 Bargain lists. (Mint stamps of Europe and Africa.) Boger, 3401 Oakmont, Philadelphia 36, Penna.

DEALERS. Wholesale list. Postage 3c. Frank, 5031 Queensberry, Baltimore 15, Maryland.

212 AUSTRIA \$1.00. With approvals. Guy Stamp, 5165—5th Ave., Rosemont, Montreal, P.Q., Canada.

ROOSEVELT Greece, Pope triangle, Greenland, Israel, 51 others, 5c. Approvals. Longhorn, Box 3068-M, Lubbock, Texas.

FREE—105 Different British Colonies, Aden to Zanzibar! High catalog; pictorials. Approvals. Send 10c for mailing. Kenmore, Milford 8T, N. H.

FREE!—Big United States catalog. Valuable guide and check list. Hundreds of illustrations. Approvals. Harrisco, 468-J Transit Bldg., Boston 17, Mass.

U. S. Mint 197 SPA sheet, 10c to U. S. approval applicants. M. Haycock, 153M 74th St., Brooklyn 9, N. Y.

MONACO Nudes complete 10c. Approvals. Royal Stamp Company, Tamaqua, Penna.

ESTONIA Carrier pigeon set free to approval applicants. Canyon Stamps, Box 808, San Fernando, California.

25 MULTICOLORED Triangles, only 25c with beginner or advanced approvals. Low prices. Essex, 5946 Arlington, Los Angeles 43, Calif.

FREE Sample—Interesting, illustrated. National Stamp News, Anderson, 696, South Carolina.

U. S. 40 Different commemoratives 25c. No approvals. Seidenberg, Appleton 944, Wis.

EXCEPTIONAL. 125 Different cataloging \$3.00 with triangles, commemoratives, 10c. approvals. Reeves, Box 597P, Miami 37, Florida.

51 DIFFERENT North America. From tropics to frozen north, 10c with approvals. Richardson Stamp Co., Niagara-on-the-Lake 4, Ontario.

51 DIFFERENT from 51 countries 10c. Schmidlin, Dept. P.M., Russiaville, Ind.

JAPAN—100 Different. Clockfull of commemoratives, high values, pictorials. Exceptional value, just 10c. Appealing approvals accompany. Viking, 11-Z Northern Blvd., Great Neck, N. Y.

10 CORONATION Sets 25c; Queen Elizabeth mint, \$1.00 value; 25c with United States or foreign approvals. Ocean Stamp Co., Box 64-PM, Brooklyn 29, New York.

FROM Tiny to jumbo ones. Asia, 115 diff. 30c. (China, Hejaz, Israel, Japan, Manchukuo, Siam.) Robert Boger, 3401 Oakmont Ave., Philadelphia 36, Penna.

LUCKY Star pkt, 10c. Better than average approvals. Low prices. Sohn, Route 1, Box 357A, Mt. Prospect, Ill.

VATICAN Airmail mint, three values free, with depression priced approvals. Goble Approvals, 931 Emwell, Ferndale 20, Mich.

U. S. Mint specials! Flag set, \$1.00; national parks 2 740-49, \$1.50. Free price list. Brooks, 2324 East 23rd Street, Brooklyn 29, New York.

DIFFERENT. 500, 50c; 1000, \$1.25; 2000, \$2.75; 5000, \$11.00. Approvals. K. S. Holmes, London, Canada.

3 RHODESIA; 10 Mexico; 20 Swiss; 20 U. S.; 25c. Approvals. S. Penniston, Norborne, Mo.

OLTRE Giuba—7 different commemoratives 20c. Approvals. WBO, Box 758, Wilkes-Barre, Penna.

3 RHODESIA; 10 Mexico; 20 Swiss; 20 U. S.; 25c. Approvals. S. Penniston, Norborne, Mo.

OLTRE Giuba—7 different commemoratives 20c. Approvals. WBO, Box 758, Wilkes-Barre, Penna.

FREE \$3.00 Catalog value, over 50 different stamps. Limited get acquainted offer with our beautiful approvals. Hall of Stamps, 4327 Marr, Centerline, Mich.

TERRIFIC! 100 Different including 10 triangles 10c with approvals. Free souvenir. GAM, Box 108, Brooklyn 29, N. Y.

100 JAPAN 10c. All different, with approvals. Gould's Stamps, Box 631, San Francisco 1, Calif.

U.S. Commemoratives. 33 different 10c. Approvals. White, 516 Avenue L, Brooklyn 30, New York.

MEDITERRANEAN Bonanza — Ships, planes, bi-colorfuls, all pictorial, only 10c to approval applicants. Comanche, Box 7817, Lakewood, Colorado.

850 MIXED U.S. old-new 25c. Lists. Weatherby, Medina, Ohio.

125 DIFFERENT 10c With approvals. Pylon, Box 740, Bellport, New York.

U.S. Mint 21 famous Americans \$1.00. Dolin, 31 Parkrow, New York City 38.

5 QUEENS 10c With approvals. NorCal Stamps, Box 1041, Walnut Creek, Calif.

CIPEX Souvenir sheet plus 25 different U.S. 10c. Approvals accompany. Village Stamps, 90-39P 214 St., Queens Village 28, N. Y.

EXCHANGE. Send 200 different and 25c. Receive 250 different. Hartwell Knight, 1438 Blue Hill Avenue, Mattapan 26, Mass.

BARGAINS Galore. Low priced approvals. Schur, Box 117, Williamsville 21, N. Y.

25 FRENCH Colonies 5c; approvals sent. Adlex, 367-M Park Ave., Newark 7, New Jersey.

12,000 PENNY Approvals waiting for you. Many from exotic countries, pictorials, airmails, new issues. Tilbury, Box 662, Newark 1, N. J.

BREAKING Up a collection at 1/3 catalog. I send the album sheets on approval. Ayot, 175 Galley, Toronto, Canada.

VATICAN, 25 Diff. 25c. Approvals. Luxor, 115-C Montague, Brooklyn 1, N. Y.

ZEPPELIN Set free, with approvals. Variety Stamp Service, 57-P Circuit Avenue, Newton Highlands 61, Mass.

FREE! Big illustrated catalog! Send today! "Stamps By Mail," 2133 Lunt, Chicago 45.

FREE! 125 Different foreign, including Malaya, Siam, Burma, triangles, pictorials, etc., all for 3c postage. Approvals. Kensington Stamp Company, Buffalo 15, N. Y.

25 PHILIPPINES 10c. Pictorial approvals. Moffat's, 921 College, Rock Hill, 12, South Carolina.

FIJI Bicolored health set. 5c. Approvals. Pleasure Stamps, 1865P-52nd, Brooklyn 4, N. Y.

LOOK! Ten different foreign sets, 10c. Approvals. Farmer, 4913 Rosewood, Los Angeles 4, Calif.

1/2c APPROVALS. Povilauskas, 212 E. 3rd St., New York 9, N. Y.

VATICAN Or Israel, 25 different, 25c with approvals. Excello Stamp Company, Box 489, Red Bank, N. J.

LATIN America, 200 different, \$1.00. Lists free. Horovitz, Sunnyvale, California.

96 PAGE Illustrated U. S. price list. Send 10c, cost of mailing. DeLisle, 69 Plaza Shopping Center, Fresno 1, Calif.

ANTIQUES, RELICS, INDIAN GOODS, CURIOS

SEND Dollar for full color hand printed picture, Indian Dancer. Free list. Tewa Enterprises, 724 Canyon Road, Santa Fe, New Mexico.

8 GEM Arrowheads \$2.00. 4 fine arrowheads \$1.00. Notched tomahawk \$1.00. List free. Lear's, Glenwood, Arkansas.

ANTIQUA Firearms, swords. Illustrated booklet 25c. Westbrook, 738 Royal Street, New Orleans, La.

4 SELECTED Arrowheads \$1.00. List 3c. H. Talburt, Calico Rock, Ark.

PRECIOUS STONES, MINERALS

GEMCUTTING. Silvercraft authority. Illustrated magazine tells how. Cut rocks, make jewelry. 150 ads illustrating equipment, offering gems for collectors, cutters. Postal brings literature. Lapidary Journal, Drawer B, Palm Desert, Calif.

GEMSTONES, Mineral specimens. Every variety. Lowest prices. Free booklet. Plummer's, 4720 Point Loma Ave., San Diego 7, Calif.

SAPPHIRE, Topaz, tourmaline, garnet, peridot. 5 uncut gem specimens, \$1.00. O'Brien's, 1116M Wilcox, Hollywood 38, Calif.

JOIN The thousands whose hobby is gem cutting, jewelry making, mineral collecting. Send only \$3.00 today—for 12 monthly issues of national how-to-do-it magazine. Sample copy 25c. Gems & Minerals, Dept. A-9, Palmdale, California.

TEN New Mexico minerals \$1.30. six fluorescents \$1.00, fool's gold 25c. Free literature. Minerals, Winston, New Mexico.

AGATES, Jade, gems. Free list. North West Gems, 2819 North Warner, Tacoma 7, Washington.

HOBBIES AND COLLECTIONS

UNUSED Matchbook covers, 100 different \$1.00, 36 page catalog 25c. Match-cover album \$3.00. Charles Edelman, 1311C East 84, Cleveland 3, Ohio.

ANTIQUA Posters — Circus, minstrel, drama, gay nineties, etc., \$1 each. List for stamp. Central Show Printing Co., Box P-617, Mason City, Iowa.

NAZI Medals. Campaign ribbons, illustrated lists. Big packet. \$1.00. Medcrafts, 1923 34th St. S. W., Calgary 2, Canada.

NEW — 15 Different match covers 10c. Box 202, Rochester 1, N. Y.

INVENTING Can be an interesting and profitable hobby. Write for complete particulars. Institute of American Inventors, Dept. 40-E 631-E St., N.W. Washington 4, D. C.

MILITARY Miniatures: U. S. Marines, American Revolution, Civil War, Custer's Cavalry. Illustrated catalog 25c. Bussler Miniatures, 59 Russell Park, Quincy 69, Mass. Dept. B.

LUGGAGE Labels, hotels, cities, 10c each. Mampa, 818 Dakin, Chicago 13, Ill.

WORLD'S Smallest Bible 50c. Three, \$1.00. Empires, Box 301, Amesbury 2, Mass.

FREE! Leathercraft catalog. Do-it-yourself! Write Tandy Leather, Box 397A, Tulsa, Okla.

CIRCUS Wagons, railroad cars. Enclose stamp. Box 181, Omaha 7, Nebr.

COLLECTORS Cards, 28 exclusive designs \$2.00 a set including air postage. Reply Collector, Box 34, Moorabbin, 820, Victoria, Australia.

ASSORTED Shells. Sea horse pack \$1. Box 716, Manhattan Beach, Calif.

CAMERAS, PHOTO SUPPLIES

FREE Bargain book packed with hundreds of fine photographic values. Write Central Camera Co. (Photographic headquarters since 1899). Dept. 9H, 230 S. Wabash Ave., Chicago 4, Ill.

BASS Says: Quality cameras since 1910. When in Chicago visit the camera cross roads of the world, or write us for your favorite equipment, new or used. Satisfaction guaranteed. Bass Camera Co., Dept. AG, 179 W. Madison St., Chicago 2, Ill.

DISCOUNTS To 40% — Cameras, projectors, tape recorders, lenses. Write for individual quotations, no catalogs. Classified Camera D, 253 E. 94 St., Brooklyn, N. Y.

OIL Coloring photographs — A fascinating hobby or profitable sideline for those with artistic talent. Learn at home. Easy simplified method. Free booklet. National Photo Coloring School, 835 Diversey Parkway, Dept. 343C, Chicago 14.

PHOTOGRAPHY For pleasure or profit. Learn at home. Practical basic training. Long established school. Free booklet. American School of Photography, 835 Diversey Parkway, Dept. 3432, Chicago 14.

BUY Wholesale nationally advertised cameras, photo supplies, thousands other products at big discount. Free "Wholesale Plan." American Buyers, 629-PP Linden, Buffalo 16, N. Y.

PHOTO FINISHING

ROLLS, Reprints, Jumbos in albums. 8-30c; 12-40c; 16-30c. Bob's Photo, Box 23, Fairmont, W. Va.

TWO Beautiful prints from each picture on roll. 8 exposure 35c, 12 exposure 45c. Thirty-three years of satisfied customers. Quick service. Lens Photos, Dept. J-4, Janesville, Wis.

SENSATIONAL! 8 Jumbos, 25c; 12, 35c, 35mm.-36 exposure, \$1.00. Guaranteed quality. With this ad only. Flash-Photo, Box 36B, Brooklyn 4, N. Y.

FAST, Same day service! 8 oversized prints only 35c; 12-50c, 16-65c. Satisfaction guaranteed. This ad worth 10c toward first roll. Trial offer only! PicSure, Box 899-B, Philadelphia 5, Penna.

BEAUTIFUL Enlargement from each picture on roll. 8 exposure 35c; 12 exposure 45c. Cut Rate Photos, Dept. B-4, Janesville, Wis.

GUARANTEED Quality. Fast service. Eight jumbos in beautiful super pak plastic ring binder albums only 35c. Send for free mailers and particulars of our complete photo finishing service. Grand Fotos, G.P.O. Box 1410, New York 1, N. Y.

TOP Quality. Fast service. 8 jumbos 35c in beautiful super pak album, 16 contacts 40c. Reprints—Jumbos 4c; contacts 2c. Satisfaction guaranteed. Write for free mailers and circulars. Fast-X-Photo, Box A, Jersey City, N. J.

6 OR 8 Picture roll 35c, 12 or 16 picture roll 55c. Each roll developed and printed in handy album pack. Send coin with roll. No e.o.d.'s. Mailing containers sent free. Deluxe Film Service, Box 1268-A, Shreveport, Louisiana.

ENLARGEMENTS! Eight 5 x 7's or five 8 x 10's, \$1.00. Wilart Enlargers, Box 967, Little Rock, Ark.

8 JUMBO Prints in album 30c; 12 exp. 45c; 20 exp. 85c; 36 exp. \$1.25. Free mailer. Mel's Photo, Box 106F, Brooklyn 20, N. Y.

JUMBO Prints, 8 exposure roll 30; 12 exposure 45c; 16 exposure 55c; reprints jumbo 4c. Guaranteed quality since 1915. Mail order Photo Service, Box 297, Watertown, Wisconsin.

SPECIAL Offer—8 jumbos 25c; 12, 35c, with this ad. Western Photo, PM94, Box 298, San Francisco 1, Calif.

KING Size enlargements. Dramatically beautiful. Panoramic movie screen scope. Cut rate prices. Free details. Wall Photos, Byars, Oklahoma.

HAND Colored 5x7 enlargement from your negative or photograph, one dollar. State colors. Snapshot Photo Service, 309 Citizens, Aberdeen, South Dakota. "Near as your mail box."

MAGNIFICENT Jumbo oversize finishing at low prices. Latest equipment. Superior quality work. 8-exp. roll, deluxe finish, only 40c. 12-exp. 35c. 16-exp. 70c. 36-exp. \$1.50. Oversize reprints 5c each. Free mailers. Send us your next order. Century Photo Service, Box 5208, Chicago 80, Ill.

PROFESSIONAL Goldtone enlargements — Three 5x7, plus three wallet size, \$1.00. Sudway, 3708m Broadway, Kansas City, Missouri.

12 JUMBOS From any size roll developed 25c with this ad only. S. Skrudland, Lake Geneva, Wis.

MOTION PICTURES AND SOUND EQUIPMENT

TAPE Recorders, tapes, accessories. Unusual values. Dressner, Box 66M, Peter Stuyvesant Station, New York City 9.

5,000 8-16MM. Silent-sound films. International, 2120 Strauss, Brooklyn 12.

MOVIE Camera film: 8mm. roll \$1.50, 16mm. 100' \$3.00. Free processing. Better Films, 742 New Lots, Brooklyn, N. Y.

GUARANTEED Fresh 8mm. roll, magazine; 16mm. roll, magazine movie films. Color, b&w. Free catalog. ESO-R, 47th Holly, Kansas City 2, Missouri.

8MM. And 16mm. professional national parks movies in Kodachrome, list 10c. Ideal Service Supply, Suite 506, 20 West Jackson Blvd., Chicago 4, Illinois.

RECORDERS. Tapes, equipment. Lowest quotations. Boynton Studio, 10 Pennsylvania, Tuckahoe, N. Y.

RENT 16MM. Sound feature pictures—\$3.95, three days, including delivery, return postage. 25-minute short subject programs. \$2.49. Big catalog free. Eastin Pictures, 100 Eastin Bldg., Davenport, Iowa.

FREE! Blackhawk's sale catalog new and used 16mm., 8mm. films, used 16mm. sound projectors, new 2"x2" color slides. Blackhawk Films, 1247 Eastin, Davenport, Iowa.

WILD Animal and bird films. Beautiful color and b. and w. 2" x 2" slides and 8mm or 16mm movies. Write for free literature. Wild Life Films, 5151AJ Strohm Ave., North Hollywood, Calif.

MUSIC AND MUSICAL INSTRUMENTS

WANTED! Poems for musical settings. Send poems now! Songwriting Service, 2859 Division, Chicago 22.

1954 ACCORDIONS—Wholesale. Free catalog. American Accordion Center, PM-8, 3329 Belmont, Chicago.

NEW Songwriters can now sell their songs! My new, easy method reveals professional secrets of profitable songwriting. Free details. Meadowlark Music School, 300 Sumner Road, Colorado Springs, Colo.

WANTED! Poems for musical settings. Write Songwriters' Service, Clifton, N. J.

ACCORDIONS, Wholesale to everyone. Save up to 60%. All national known brands. Free catalogue, Del Principe, 29 South Cicero, Chicago 44.

SONGPOEMS Wanted. Mail to: Tin Pan Alley, Inc., 1650 Broadway, New York 19, N. Y.

FREE Record of your song. Your words, my melody. Free information. Johnny Mack's Melody Mart, 1094 West 39th Street, Dept. A, Los Angeles 37.

SONGWRITERS! Protect your ideas! Hold all songs, poems! Write for safe correct procedure first! Song Service, Dept. P, 333 W. 56th St., New York 19, N. Y.

POPULAR Songs. How to write and sell them. Write for free booklet Successful Songwriting. Gateway Songs, Box 2470, Hollywood 28, Calif.

SONGWRITERS! Send poems, songs. Music Service, 243 West 72nd St., PM, New York 23.

WRITE Songs. Big money and reputation. Write for information, J. Gordon Pub. Co., 4700 South California Avenue, Chicago.

HONEST Deal, music to poems, audition records made. Gregory, 1693 Broadway, New York 19.

POEMS Wanted for musical setting. Send poems. Free examination. Five Star Music Masters, 630 Beacon Bldg., Boston, Mass.

LEARN To play piano at home. Complete course illustrated. Send \$1.00. Tracy Music, 619 East Baltimore Street, Baltimore #2, Maryland.

SONGWRITERS: Large recording company may record your song. National sales and promotion if selected. No charge for melodies. Send song material to Music Makers, Dept. E, Box 2507, Hollywood, Calif.

POEMS Wanted for musical setting. Send poems. Free examination. Crown Music Company, 1476 Broadway, New York City 36.

RADIO AND TELEVISION

MAKE Simple, tubeless, batteryless, distance-setting radio. Genuine Melomite crystal, detector, illustrated instructions. 50c postpaid. Allen, 427-PM5, Clinton, Mo.

COLOR Television! Enjoy low cost 3 color television screen now. Easily attached. Free descriptive circular. Zingo Products, Johnstown 77, New York.

RADIO TUBES, all types, guaranteed. Ideal Service, 4644 Geary, San Francisco 18, California.

CRYSTAL Radio experimenters. Write Leslie Hulet, R4, Lakewood, New Jersey.

BUILD 15-Radios at home—Only \$19.95 complete. Learn radio construction, theory, trouble-shooting, code, F.C.C. regulations. Complete radio course includes all parts, components, instruction books, etc. Free radio tester and soldering iron. You keep everything. No experience required. Money-back guarantee. Order direct or send for descriptive literature. Valuable radio and TV guide upon request, free of charge, no obligation. Progressive Edu-Kits Inc., 497 Union Ave., Dept. PM21, Brooklyn 11, N. Y.

REPAIR Your own TV. Instructions compiled exclusively for your set. Simple as replacing light bulb. Send set name, chassis, model number, \$1.95. LS Engineering, Box 4113-I North Hollywood, California.

FLASHLIGHT Battery radio—Instructions, 50c. Boscia, 152 Whittington Road, Rochester 9, N. Y.

TEST Equipment repair—Kit construction. Free information. Bigelow Electronics, Dept. PM, Beulah, Michigan.

EXPERIMENTERS. An amazing sensitive, selective crystal radio receiver, 50c for copyright plans to Cotter, Box 60, Boston, Mass.

FREE 308 Page 1955 television-radio-electronics catalog! World's largest stocks, lowest prices. Complete supplies for builders, experimenters, amateurs, servicemen. Latest builders' kits, TV, Hi-Fi, phonos, records, P.A. Thousands of parts, tubes, test instruments, books, diagrams. Top quality money-saving values. Get your copy now! Allied Radio Corp., 100 N. Western Ave., Dept. 34-J-4, Chicago 80, Ill.

RADIO One tube kit. Parts, tube, phone, batteries, instructions, nothing else to buy, \$7.95. Less phone and batteries, \$4.95. Crystal radio kit \$1.50; preassembled \$1.75. Crystal radio plans and germanium diode, \$1.00. Plans and Clearco detector, 50c. Free catalogue. Clearco Crystal Company, Box 1857, Milwaukee, Wis.

REPAIR Your own TV. Prepared exclusively for your model. Plus introductory bonus. Send make, model, \$1.00. Personal TV, Box 66A, Little Neck, N. Y.

FREE List. Builder's pictorial construction plans. Alena, 286 East Broadway, New York 2.

BUILD Your own top quality TV set. We supply complete equipment, tools, instructions as part of America's finest home-study TV course. Be a high-paid TV technician. Install, repair, service all makes of sets. Many excellent jobs now open. Or start your own business. Get full facts free. Write: Commercial Trades Institute, Dept. CT-2-9, 1400 Greenleaf Ave., Chicago 26, Ill.

BUSINESS OPPORTUNITIES

DISPLAYS—Make turn tables and motorized displays your shop. Plans and motors. Complete details on request. Motorized Display Service, 139 East Second, Reno, Nevada.

MAKE Best doughnuts, yeast raised. Start in kitchen. Sell retail and wholesale. I sell no material or equipment. Write Lyon, 1695 W. 17th St., Davenport, Iowa.

MAKE Flexible molds. Cast figurines, plaques. Free sample. Tooker, 630-R Chestnut, Hamilton, Ohio.

AMAZING Home business plans. Write Falcon House, Winnebago 2, Illinois.

YOUR Own bronzed baby-shoe business. Famous Alice Ames plan. Shoes and mounts made in largest and best bronzing plant in country. Give your customers the best. Write Alice Ames, Dept. 1, Boston 36, Mass.

\$40.00 DAILY With \$86.00 sawshop equipment. Zapart, 586-PM Manhattan, Brooklyn 22, N. Y.

MAKE Perfume. 59 formulas \$1.00. Billows, 110-65 37 Ave., Corona 68, N. Y.

FORTUNES Made raising crickets and fishworms. Guaranteed raising and marketing instructions, \$1.00. Carter Farms, Plains, Georgia.

LEARN Invisible reweaving! Harris Reweavers, P. O. Box 7112, New Orleans, La.

NEW—Different home business opportunity! Address-mail literature featuring real merchandise. Everything furnished. Mills, 1752-A, Garden Ave., Lorain, Ohio.

GET \$10.00 Orders by mail! 100% profit! Everything furnished. Terrill, Bogard, Mo.

EXPORT Business easy made! Substantial income from home. No merchandise buying. Full setup service includes everything. Hermes Exports, 152 West 42, New York 18.

LEARN Sewing machine repair, guaranteed plans, assures success. Write Purdy's, Box 207, Weatherford, Texas.

METALIZE Baby shoes, jewelry, gifts. Bronze, gold, silver. Free bulletin, Kiklavi, 7217-PY South Broadway, Los Angeles 3.

MONEY Getters club! Receive 1,000 or more different money-making propositions. Year's membership now only 25c. Satisfaction guaranteed or money back. Storm-Associates, Cedarville, New Jersey.

HAVE Home business mailing postcards offering real merchandise. Big earnings. Write: Mednis, 10 Port Norfolk, Boston 22, Massachusetts.

NATURAL Molding rubber, extra thick. Free sample. Flock, W. Wooley, 115-A Donald, Peoria, Ill.

MAKE Rubber stamps, repair dolls; learn silk screen printing. Catalogue (60 ideas) free. Universal, Box 1076-A, Peoria, Ill.

OPPORTUNITY Seekers write James Leigh, 537 Chester Street, Oakland 20, California.

LIQUID Rubber, make flexible molds. Free sample. Chaney, 1130 E. 16th St., Jacksonville 6, Fla.

MAILORDER—Operate profitable home business using free advertising method. Revealing information free. Seidel, 7076-HF Hollywood, Los Angeles 28.

HOME Business—Mailing literature to new mothers. Details free. K & M Products, 3634-A Homewood, Toledo 12, Ohio.

SELL Name brands—No inventory. Manhattan, 225 W. 57 St., New York City.

\$900 A Year sparetime sharpening saws at home. No selling. Hardware stores get saws on commission basis. Free booklet tells how. Victor Foley Company, Columbia Heights, Minnesota.

OVER 700? Profit making finished photos in 2 minutes on the spot in daylight without darkroom. No experience needed. Simple directions teach you quickly. Write P D Q Camera Co., 1161 N. Cleveland Ave., Dept. PM, Chicago 10, Illinois.

ELECTROPLATE Auto parts, novelties, mirrors, baby shoes. Easy, inexpensive home process. Free booklet. Tyco Metals, Box 13231-MM, Houston 19, Texas.

BOOKKEEPERS. Keep books, small firms spare time. Manual latest technique by C.P.A., \$3.00. Modern Business, Box 406, Youngstown 1, Ohio.

MAKE Money at home—Mail cards, circulars feature real merchandise. Everything furnished. Big earnings. Phillip's, Box 3-P, Boston 22, Mass.

RECAST Old batteries into new. Latest achievements. Battery Laboratories, Minneapolis.

START Venetian blind laundry. Profitable lifetime business. New machine. Free booklet. F. C. Co., 442 N. Seneca, Wichita 12, Kansas.

WHOLESALE Of sensational nationally advertised appliances, silverware, watches, cameras, etc. Start your own business. Full details. Send 50c for catalogue. International Sales Co., 175 Fifth Ave., New York 10, N. Y.

UNUSUAL Homework opportunity, spinning Angora sparetime for us. Men, women. Angora House, PM, Springfield, Illinois.

HOW And where to obtain capital. Particulars free. Star Service, Wapakoneta, Ohio.

TO \$40.00 Weekly. Sparetime, home operated mailorder business. Successful beginner's plan. Everything supplied. Lynn, 10420-M National, Los Angeles 34, Calif.

COPUBLISH Mail Sale Advertiser, leading mail order paper. Details, latest copy, dime. Vanroy Shirk, Lebanon, Penna.

EARN Money at home! Homemaker Magazine tells how. Sample, 25c. Sizemore, Box 7, 4917 Kosner, Chicago 30.

SCHEMER Magazine, Canfield 1, Ohio, monthly mailorder ideas, plans. Year \$1.00, Sample 20c.

PLASTERCRAFT Molds, liquid rubber, plasters, flocks, candle supplies. Catalog and manual free. Blue Rapids Supply, Blue Rapids, Kansas.

BUY It wholesale! Manufacturers, distributors offer 850,000 items. Literature free. Olsen, 1231-A East Third St., Duluth 5, Minn.

GROW Mushrooms, Cellar, shed, and outdoors. Spare, full time, year round. We pay \$3.50 lb. We paid Babbitt \$4,165.00 in few weeks. Free book. Washington Mushroom Ind., Dept. 172, 2954 Admiral Way, Seattle, Washington.

POPCORN And potato chip equipment. Leeco, Box 933-A, Springfield, Ohio.

\$46 FROM Square foot plywood; gigsaw necessary. Write: Woodarts, Bridgewater, Mass.

\$25 WEEKLY Working two hours daily at home. Lycke, Box 2471-A, Cleveland 12, Ohio.

BREED Rare tropical fish at home. Earn big money! Learn secrets! Help fill huge demand. Amazing opportunity! Free plan. Tropicals, 1008-F Los Angeles St., Los Angeles 15.

INCOME From local information. No selling. Write Neherco, La Verne, Calif.

RESILVERING Mirrors, formula 50c; two-way lookout mirrors. (No one sees you). 50c; coppered mirrors. 50c. All \$1.00. Nelko-Mir, Box 3482-J, Chicago 54.

LIVING Miniature ("Ming") trees only 10 to 20 inches tall. Grow at home. Big profits! Spare time opportunity. Fascinating! Amazing! Write for free seed and plan. National Nursery, Dept. FC, Inglewood 4, California.

MAKE Money spare or full time, casting metal toys and novelties. Big wholesale and chain store demand for autos, soldiers, ashtrays, banks, etc., keeps manufacturers busy. Production moulds furnished for up to 100 and more castings per hour. No experience or special place necessary. Write for information and illustrations of patterns needed. Metal Cast Products Co., Dept. A, 1696 Boston Road, New York 60, N. Y.

OPERATE Profitable mail order business. Write Walter Service, 4159-A East 112th, Cleveland 5, Ohio.

GOOD Paying business silvering mirrors, plating autoparts, reflectors, bicycles, bathroom fixtures, etc., by late method. No tanks or shop required. Outfit furnished. Free booklet. Gunmetal Co., Ave. H, Decatur, Illinois.

MINK Raising information free. Complete. Lake Superior Mink Farm. Superior. EE1, Wisconsin.

COLORGLAZED Concrete pottery made without molds. Patented method. Cemetery products, novelties, tiles. Basement leak-sealing. Money-making projects. Booklet, details free. Men only. National Potteries Company, Grand Rapids, Minnesota.

FREE Book "505 Odd, Successful Businesses." Work home. Expect something odd! Pacific, Oceanside, Calif.

PIX Typewriters. Free booklet describes our modern, inexpensive home-study course. Factory methods taught. Write Typewriter, Building 1, Tarentum, Penna.

MONEY In new greaseless doughnuts. Start in kitchen. No smoke. Sell stores. Free recipes. M. Ray Company, 3605 South 15th Ave., Minneapolis 7, Minn.

BRONZED Baby shoe supplies, instructions, mountings. Metal bookends, \$1.50 pair. Free catalog. National Bronze Supply, Box 56, Los Angeles 32, Calif.

FORM A buyers or consumers group. My plan successful. Excellent money-making opportunity. Free details. Putnams, Box 14A, Columbus Grove, Ohio.

MAILORDER Home business! Details stamp. Shirley, 20-Raspeburg, Baltimore 6, Maryland.

MILLION Articles wholesale. Supply source directory 10c. Idealer, Park Ridge, Illinois.

SELL Books, merchandise by mail. Good profits. We furnish circulars, names—Ship your orders. National, Box 88, Dorchester, 22G, Mass.

BUY Wholesale! 30-80% discounts! Free! Large catalog of nationally advertised appliances, gifts, watches, jewelry, cameras, typewriters, tools, kitchenware, etc. Start your own fully self-operating mail order business without capital! No experience necessary. Wholesale starting kits furnished. Outline of unique automatic sales plan included. Consolidated Distributors, Division 119, 21 Lafayette, Paterson 15, New Jersey.

ADVERTISING Book matches—Cash in on big demand; sell union label matches. Cuts for all businesses and political parties. Free powerhouse selling kit, low prices, protection guaranteed on repeat orders. Cash commissions. Superior Match Co., Dept. MX-954, 7330 Greenwood, Chicago.

BUILD Amazing home business supplying multi vitamin-mineral tablets. Whirlwind seller. Great repeater. Profits tremendous. Everything furnished. Free facts. Vitine Company, 208-CJ Pacific Building, Miami 32, Florida.

START Your own business on credit. Your own boss. 1661 of our dealers sold \$5,000 to \$28,500 in 1953. We supply stocks, equipment on credit. 200 home necessities. Sales experience unnecessary. Pleasant profitable business backed by world-wide industry. Write Rawleigh's, Dept. I-U-PPM, Freeport, Ill.

MAKE Big money at home! Invisible re-weaving pays up to \$10.00 profit in an hour. Make tears, holes disappear from fabrics. Constant demand from laundries, cleaners, home brings steady earnings. Details free. Fabricon, Dept. AE, 8342 S. Prairie, Chicago 19, Illinois.

IMPORT-EXPORT: Opportunity, profitable, world-wide, mail-order business from home, without capital; or travel abroad. Established world trader ships instructions for no-risk examination. Experience unnecessary. Free details. Mellinger A709, Los Angeles 24.

MONEYMAKING Mailorder business plan, free! Write, George Lenhoff, Lincoln 8, Nebraska.

FREE! "301 Profitable Small Businesses!" Amazing shoeing plans! Work home! Start sparetime! Deumant Surveys, Kenmore 23-PM, N. Y.

LEARN Sewing machine repair, electrify, trade, sell. How to make big money at home sparetime. New zigzag machines, parts, etc., wholesale. Free details. Taylor Service, Hamilton PM-9, Ohio.

OPERATE Profitable mail order business—Selling cartooning courses. Write Templeton, 1210 Riverview Court, Columbus 1, Ohio.

BE Your own boss, 301 plans. Free details. Smith, 525 Auditorium, Daytona Beach, Florida.

BECOME A game warden, or join forestry, park, lookout, wildlife conservation services. Enjoy outdoor work, good pay, real security. Complete information free! Write Home-Study Institute, 31568R West Eighth, Los Angeles 5, California.

FULL Or part time business at home. Earnings \$200.00 weekly possible. Columbia, 1249 Ferguson, Newport News, Va.

BOOKKEEPERS, Increase earnings operating sensational bookkeeping service. Kern, 4942 Vineland, North Hollywood, California.

GARDEN Golf. Fascinating entertainment. Popular international sport. Profitable business. S. Brockway, Seaside, Ore.

MAKE Extra money between now and Christmas. Sell subscriptions to all popular magazines. Liberal commissions. For supplies write DeSales Magazine Service, 60 East 42nd St., New York 17, N. Y.

MAKE Money at home as renewal headquarters for all magazines. Big Christmas sales profits now. Liberal commissions. Supplies furnished. Write for free catalog. McGregor Magazine Agency, Dept. 500B, Mount Morris, Ill.

VENDING Machines—No selling. Operate a route of coin machines and earn amazing profits. 32-page catalog free. Parkway Machine Corporation, Dept. 72, 715 Ensor St., Baltimore 2, Md.

IMPORT, Export! Profitable details free. Warner's, Box 6, Fort Scott, Kansas.

COST Of things going up faster than your income? You can make more full or part time as a Rawleigh dealer. Write for full particulars. Rawleigh's, Dept. I-RR-PPM, Freeport, Ill.

BUY Wholesale thousands items. Lists free. Cottage Industries, Omaha 12, Nebr.

CAPITAL Available. All you need. Consider any business. Complete manual tells how and where to get it fast. Rush \$2.00. Satisfaction guaranteed. Colburn, 429-P So. Wetherly, Beverly Hills, California.

FRANCHISES Make amazing profits! Exclusive distributorships, dealerships, agencies available. Fascinating, nationwide opportunities. Information rushed. National Franchise Reports, 920 North Michigan Avenue, Chicago 11, Illinois.

SELL By mail! "How to Build Your Own Mail Order Business" tells how. Satisfaction guaranteed. Only 25c. Fred La Roche, Merritt Island 3, Florida.

\$500,000.00 LIFETIME Earnings? Dignified administrative profession. Immediate income—Easy! Inspirational booklet: Auditax, 34631A, Los Angeles 34.

START A buying service, buy wholesale thousands nationally advertised products. Make big profits selling at sizable discounts. Postcard brings details. American Buyers, 627-P Linden, Buffalo, N. Y.

NEWEST Spare, full-time home business, \$5 to \$10 hour possible. Paint with suede—The finish with touch and eye-appeal. Beautify auto dashboards, signs, radios, toys, figurines, lamps—1001 others. Complete, step-by-step instructions sent for no-risk examination. Free details. Coast, 1004-MY So. Los Angeles St., Los Angeles 15.

GROW Orchids at home—Profitable, fascinating. Year 'round, Maine to California. No greenhouse. Gorgeous cactuses, cymbidiums, etc. Successful home grower shows you how. Full details free. Flowerland, 4622-PF Wilshire, Los Angeles 5.

WE Love our mailman—He leaves over \$1,000.00 monthly in our rural mailbox. My college professor husband drafted a scientific home mailorder method. We bought a Texas ranch, live as we always wanted. Now we sell the Ranch Mailorder Method. Operates anywhere. Inquire: Eveningshade Ranch, Helotes, Texas.

3,658 GOVERNMENT Inventions, free use. Information, 20c. Box 122, Allenhurst, N. J.

SAWDUST. Turn it into cash. Twenty methods. Instructions 50c. Charles Company, 12-DCE, Norwood, Ohio.

BOOKKEEPERS. Keep books, small firms. Spare time. Heffernan, 37-06 Jerusalem Avenue, Wantagh, New York.

MAKE Rhinestone jewelry. Send \$1.25 for four gross rhinestones, value \$5. Free catalog. Ebert, Box P183, East Orange, New Jersey.

ANSWER Advertisements easier! 500 name-address labels \$1.00 postpaid. Miles Crafts, 3220-P Fish Avenue, New York 69.

START Home mailorder. Details. Gimbert, 1454 W. Washington, Petersburg, Virginia.

\$26,500 SALES In two weeks! Amazing radio-mail order method. Free details. Broadcast Service, 1412-PS Great Northern Building, Chicago 4, Illinois.

MAKE Attractive building plastic. Easily. Build and repair better for half. Bays Laboratories, Oklahoma City 9.

LOWER Priced metal baby shoe mountings. Posters, 1520 Ardmore, Chicago 26.

MINIATURE Trees. Why pay \$2.00-\$10.00 for growing secrets? Free details. Tiny Trees, 5038 N. Winthrop, Chicago 40.

\$5,000.00 WORKING Ninety days! Become tax consultant. Auditax, 34651C, Los Angeles 34.

\$15 HOUR Preparing tax returns. Become tax expert. Write Union Institute, 2-N, Lakewood, N. J.

PROFITS Unlimited in your own wholesale buying service. Buy 66% less than retail famous appliances, homewares, jewelry, sporting goods. Free details. National Buyers Service, Box 426EC, Oakland, California.

AN Important message for you! Is extra money important to you? Would you invest 4 days a week for \$200? Many other smart people are cashing in big in this lucrative repeat business. Captain Payne's booklet reveals hitherto little known secrets of making big money from the products of the sea. Business flourishes in depression, booms in good times, you can't miss. Payne's plan good in both coastal and inland states. Start your own business. Be your own boss. Act now. Send \$2 for booklet to Capt. Fred Payne, P. O. Box 73, Medford, N. Y.

BIG Profits in your own wholesale merchandising business. No investment. America's greatest wholesale appliance, homewares, jewelry catalog in color with your own name. We drop ship. Write General Wholesalers, Box 1195EG, Chicago, or Box 3058EG, San Francisco.

WE Pay \$5.00 for some names. Homework income plan 25c coin. Publisher, Box 73136, Los Angeles 3.

PROFITABLE, Selected mailorder ideas, books, products. Complete list \$1.00. Richards, 182-25 Wexford, Jamaica 32, New York.

MAKE - Ur - Own aluminum awnings, Saves 50%. Any width. Beautiful. Approval offer. Smith Agency-PM, Excelsior Springs, Missouri.

BOOKLET "Your Business at Home." \$1.00. Home Industries Association, Dept. PS, 1727 K Street N. W., Washington 6, D. C.

MAKE Perfumes, other products. Sell mailorder. Formula catalogue free. International, 6347 Parnell, PM-9, Chicago 21, Illinois.

CHAIN Saws. Self-propelled. Money makers. Fall-winter. Power mowers—wholesale. Terms. Farmco 51, Excelsior Springs, Mo.

MAKE Perfumes, other profitable products. Carelabs, 1914-PM Chouteau, St. Louis 3, Missouri.

BUY Wholesale. Thousands items. Lists 10c. Triple J Industries, 132 Berkshire, Bridgeport 8, Conn.

OPERATE "Escalator" mailorder system, selling our products or any products. Fastest, most revolutionary mailorder system known. Write: Selbyco, Decatur 258, Illinois.

FISHWORM Breeder's Manual—\$1.00. Postpaid. Literature free. Dixdok, Kent, Ohio.

NEW Exceptionally profitable plans, ideas for home operated mail business. Rush name. Miller, 1772-P Carlyon Road, East Cleveland 12, Ohio.

ARE You ready for sales at a profit by mail? A new folio, "Basic Requirements for Success," can help you find the right answer. 25c coin or stamps. Lawson A. Wood, 20 East Delaware, Chicago 11, Ill.

SELL Popular Mechanics and all other magazine subscriptions. Free catalog, supplies. Subscription Service Company, Dept. A, P.O. Box 2070, Birmingham, Alabama.

MAILORDER Business! Your own! Write: Solleau, 515 Stagg, Ville Platte, Louisiana.

SELL Mail order items by radio! Several hundred radio stations, specializing in mail order sales, will advertise worthwhile products and services, accepting commission per sale as payment for radio time. For station list and complete information send \$2.00 to Cyril Kilb, 210-A Fifth Avenue, New York 10, N. Y.

OPERATE Your own mail order business! Start right! Avoid costly mistakes! "Mail Order Business Manual" shows you how! Price \$1.00. Bud E. Hine, Box 93, Battle Creek, Michigan.

EXCLUSIVE Distributor! Terrific profits; appoint salesmen to hardware, paint, lumber dealers, homes, contractors. Startling invention! Amazing redwood cedar powder! Makes cedar closets, chests, drawers. Add water, painted on. Attractive bags, low cost; protected territory. Write Plant 91, Summit Ave., Brookline, Mass.

MEN Wanted—Build luggage and cases at home. We sell your products, supply complete instructions, materials, everything. No special equipment needed. Free details. Cascraft, 805-G9 Sunset, Los Angeles 12, Calif.

BRONZE Baby shoes. Instructions, equipment and mountings for genuine electroplated process. Free catalog. Hollywood Bronze Supply, Dept. B-3, 1624 East First Street, Los Angeles 33, Calif.

\$1,000 MONTHLY Possible in collection agency business. Free details. Write Cole Associates, Syracuse 2, N. Y.

WANTED! Home producers, by manufacturers in our clearing house service. Become subcontractor, casting plastic products for these companies. Thousands of easy-to-make items required for consumer-industrial use. Cash in at home, without previous experience. Plastic Service Associates, Dept. 9-PM, East Boston 28, Mass.

OWN Your business, mailorder or local, envelopes, tags, bags. No investment. You carry no stock. Tremendous demand, good repeat profits. Complete set-up including best prospects, samples, sales plans, etc. based on our 23 years experience, \$1.00 postpaid. Satisfaction or your \$1.00 refunded. Omaha Envelope Service, Dept. 10, 4721 California, Omaha 3, Nebr. Established 1930.

MONEY, Typing-sewing! Details free. Edwards, 3915-PM, 12th, Des Moines 13, Iowa.

LEARN Exterminating formulas, secrets, charges. Manual tells all. \$1.00 postpaid. Knox, 1208 Walnut, Philadelphia 7.

A Business of your own financed entirely by mail. Can be started during spare time. McCann, 1612 Johnson, Amarillo, Texas.

BUY Wholesale thousands name brand products. Catalog 50c. P.O. Box 124, Oneida, New York.

OWN, Operate, route Wishing Wells. Place these new \$8.50 skill games on counters in cafes, luncheonettes, clubs, etc. Collect coins weekly. Write Legalsharr, Box 929, Long Beach 1, California.

RAISE Earthworms! Terrific! Get essential information plus story. "An Earthworm Turned His Life." Send dime. Earthmaster System, 8H, El Monte, Calif. Hurry!

EARN \$50.00 Daily making mats, shoes and mud guards from old tires. S and S Patents Inc., 1307 North Clark St., Chicago 10, Ill.

EARN \$2.50 To \$6.00 per hour plating auto parts, baby shoes, etc. Part or full time. Free information, trade secrets. Plater B. Hyde, 327 West 120th Street, Los Angeles 61, California.

\$200 WEEKLY Reported! No selling. Free booklet. T. J. Surface, Roanoke 4, Virginia.

TRADE Magazines. See late copies through our easy to get acquainted service. Choose from 4,387, covering all fields. Current list free. Commercial Engraving Publishing Company, 34C North Ritter, Indianapolis 19, Indiana.

BUY Wholesale thousands items. Lists free. Cottage Industries, Omaha 12, Nebr.

FREE Folio "445,000 Unlimited Vacations Plan." No canvassing, mailorder, merchandise, equipment. Unknown, Works itself—home! Keep job. Haylings, Carlsbad, Calif.

EARN \$2.00 Hour! I do—making sandals. Youngs, 1308-PM, South First, Arcadia, California.

FLEXIBLE Rubber molds for plaster and Marbleite figurines. Sample and large illustrated catalog 25c, refunded on first order. K-C Novelties, Dept. 74, Easthampton, Mass.

UNUSUAL Mail order ideas, sources. Details free. Fax, Box 241, Brownwood, Texas.

IMPORT—No risk plan offers big profits. Sparetime. Selling Mexican hand tooled leather hand bags, hand painted skirts. Frontier Imports, Box 3032, Sta. A, El Paso, Texas.

OIL Portraits. Fabulous profits. This is really different. Represent our famous workmanship in your town. Carlan, 574 Clinton Avenue, Newark, New Jersey.

MONEYMAKING OPPORTUNITIES

KEY Making small investment—Big profits. Everything needed to start. Key machines. Complete setups from \$94.50. Send for free literature. Hugo Solomon & Son, 70 East Warren, Detroit 1, Michigan.

GENERAL Contest Bulletin. Issued monthly. Sample, 25c. 1609½ East 5th, Duluth, Minn.

\$3 HOURLY, Camera necessary, guaranteed instructions \$1. Jon's, Whittharral, Texas.

NEW Baby items. Agents, salesmen, distributors. Natural for mail order. Write: Liebig Industries, Beaver Dam 5, Wis.

100% PROFIT! Mexican featherbird pictures. Hot sellers! Edmunds, 3009-P Weaver Ave., Baltimore 14, Md.

SELL Books, merchandise by mail. Tremendous profits. We furnish everything. Ship your orders. Write: Tradewinds, Box 8238, Chattanooga, Tenn.

MAIL Letters featuring real merchandise. Get \$10 orders in every mail. 100% profit. Everything furnished. Products, Box 23, Boston 17, Mass.

GROW Mushrooms. Cellar, shed, and outdoors. Spare, full time, year round. We pay \$3.50 lb. We paid Babbit \$4,165.00 in few weeks. Free book. Washington Mushroom Ind., Dept. 173, 2954 Admiral Way, Seattle, Washington.

SPARETIME Profits taking subscriptions, all magazines. Wholesale catalog free. Cassell Agency, Westfield 2, New Jersey.

50,000 ARTICLES Wholesale. Source directory, dime. Nelko, Box 3462-DR, Chicago 54.

READ Progressive Mailtrade, the magazine that tells how to make money by mail. Dime brings sample and special offer. Progressive Mailtrade, Box 357, Sheboygan, Wisconsin.

FREE Book "505 Odd, Successful Businesses." Work home. Expect something odd! Pacific, Oceanside, Calif.

PUBLISH Your own magazine. Hand-some 52 page format, well edited, illustrated. Cost low as \$1.00 month. Brings you prestige, profits, 25c brings sample, details. National, Ord, Nebr.

MAKE To \$4.50 hour doing common pen lettering. National Artists, 801½-A North Marsalis, Dallas 3, Texas.

300% PROFIT Making and selling seamless wallets. Only scissors needed. Send \$1.00 for pattern. Barcklow, King St., Woodbury, N. J.

FREE Literature describing moneymaking mailorder plans. Lewis Barlett, Richland, Georgia.

WINNING Prize contests is fabulous, confidential, home opportunity! Send stamp! National Contest Bulletin, Box 2685-P, Miami 16, Florida.

BUILD Sales by recruiting productive distributors selling direct or to retail outlets. Secure most concentrated circulation through classified columns of Salesman's Opportunity. Write for facts. Gilbert, Salesman's Opportunity, Room 1700, 28 East Jackson, Chicago 4.

MAKE Money at home as renewal headquarters for all magazines. Big Christmas sales profits now. Liberal commissions. Supplies furnished. Write for free catalog. McGregor Magazine Agency, Dept. 300C, Mount Morris, Ill.

INCREASE Your income, turn your spare time into cash—Making quick-selling, highly profitable lamps and fiber glass shades. Every home a prospect for one or more. Hundreds already doing it, so can you. No experience needed. No special tools required. Gearon's big, new 72 page 1954 illustrated Catalog No. 8 will show you how, quickly. One special 8-page section shows 6 beautiful lamps in kit form, ready for you to assemble. Another 12-page section shows you how to make stunning, ultra-modern fiber glass shades. Page after page filled with wide variety of other attractive shades, shade frames, figurines, and lamp bases. Also oil lamp converters, boring compound, and all kinds of cords, sockets, pipes, harps, finials, bases, and hundreds of other parts. Everything you need. And you can buy everything wholesale, sell at retail, make big profits, fast. Send only 25c right now for Gearon's big 1954 catalog and wholesale price list. Like hundreds of others, you'll be glad you did. Gearon Co., Dept. 503-B9, 27 S. Desplaines, Chicago 6, Ill.

BUY Wholesale! 30-80% discounts! Free! Large catalog of nationally advertised appliances, gifts, watches, jewelry, cameras, typewriters, tools, kitchenware, etc. Start your own fully self-operating mail order business without capital! No experience necessary. Wholesale starting kits furnished. Outline of unique automatic sales plan included. Consolidated Distributors, Division 118, 21 Lafayette, Paterson 13, New Jersey.

WHY Work for others when others will work for you? 50c brings facts in dollar tips. Vernon Glover, 900 Pleasant Valley Ave., Dayton 4, Ohio.

SELL—Buy Titania gems. More brilliant than diamonds. \$9.75 carat wholesale. Free catalogue. Diamonite, 1404-M Mitchell, Oakland 1, California.

FREE! "301 Profitable Small Businesses!" Amazing shoestring plans! Work home! Start sparetime. Deumant Surveys, Kenmore 23-PM, N. Y.

OPERATE Profitable mail order business. Roblin Sales, 1001 Curtiss, Downers Grove, Ill.

FREE! Get ahead 36 ways! Boyer, 65 Uptown, Hoboken, N. J.

NEW 7"x11" Ultra-blue signs. 7c, retail 50c. Sample free! Lowy, 812 Broadway, Dept. 811, New York 3.

FREE "Import News Bulletin" gift items. Box 7187P, San Diego 7, California.

HOME Electroplating units. Free details. Reed Engineering, 620 S. Inglewood, Inglewood, Calif.

NEED Money? Sell the sensational BM game. Sample and plan \$1.00. Deming Products Co., 841 Bennett St., Jackson, Michigan.

MAKE Money at home doing easy pleasant work. Everything furnished. Good earnings. Write today. West Distributor, 7 South Harlem St., Worcester 4, Mass.

MANUFACTURER Wants reliable men, women part time selling, distinctive marble figurines. Sample, price, details. Unique Gifts, Box 566, Freemansburg, Penna.

NEW! Make—sell plastic plants at home. Look, feel real. Sample, details, 20 cents. Mario Studios, 1157 Belmont, Chicago 13.

START Own profitable home business. Big earnings. Merit-P, Box 1984, Jacksonville 1, Fla.

EARN Money evenings, copying and duplicating comic cartoons for advertisers. Adservice, Argyle 1, Wisconsin.

FISHWORM Raising turns spare time into money. Instructions free. Robert E. Gilbert, Tallulah, Louisiana.

PRESERVE Color, beauty of living flowers indefinitely. Tremendous profits, fascinating work! Maxson, Falls Church 18, Virginia.

CHINCHILLAS: Profitable. Raise in spare room, cellar. Terms. Ross Chinchilla Ranch, 749 Rincon, El Sobrante 11, California.

TYPISTS: Profitable home projects. Complete folio 50c. Carter, Box 6011-TM, Chicago 80.

\$200 MONTHLY Possible raising earthworms! Backyard, garage, basement. Complete, illustrated booklet explains raising, feeding, packing, marketing. 25c postpaid! Ozark Worm Farm-J, Willow Springs, Mo.

FREE Folio "\$45,000; Unlimited Vacations Plan." No canvassing, mailorder, merchandise, equipment. Unknown. Works itself—home! Keep job. Haylings, Carlsbad, Calif.

TESTED Plans for home operated business. Free details. Gilchrist Sales Company, 13 Brown, Cortland, New York.

START A profitable subscription business in spare time! We need men and women (young or old) as representatives for all leading national magazines. Liberal commissions paid for new and renewal subscriptions. Start earning money in this pleasant work at once! Clip this ad and send with your name and address to: Agency Bureau, Dept. PM, Hearst Magazines, 250 West 55th St., New York 19, N. Y.

BECOME Patent firm representative. Spare time, mail order. Experience unnecessary. Work done Washington office. you receive sensational income! Industrial Patent Reports, Box 6296, Washington 15, D. C.

EARN Money at home serving as magazine representative. No experience. No investment. Write for free catalog and supplies. Hanson Bennett Magazine Agency, Desk P1, 180 N. Wabash Ave., Chicago 1, Ill.

NEED Money? Raise earthworms. Complete information 10c. Earthworm Gardens, 43 Peacock Bldg., El Monte, Calif.

START A buying service, buy wholesale thousands nationally advertised products. Make big profits selling at sizable discounts. Postcard brings details. American Buyers, 630-P, Linden, Buffalo, N. Y.

SPARETIME Profits. Make genuine leather handbags, moccasins, billfolds, belts, novelties, for gifts or to sell. Miles Crafts, 3220-P Fish Avenue, New York 69.

LEARN How to make money by mail! Free details. Write: Bruce, Box 2551, Salt Lake City, Utah.

SCHOOL Seniors—Sell classmates America's most beautiful graduation name cards. Largest selection. Highest commission. Outsell all others. Free sample kit. Printcraft, Dept. M, 1509 Maple Street, Scranton 5, Penna.

BUY Wholesale nationally advertised watches, jewelry, appliances. Sell from new 1955 catalog. Invest no money. Earn \$50.00 daily during Xmas season. Louis Perloff, Dept. PM, 733 Walnut St., Philadelphia, Pennsylvania.

NEED Extra money? New plan. No investment. Sparetime. Sample, details free. Transamerican, Box 815-A, Atlanta 1, Ga.

FUTURE Security! Learn watch-clock repairing at home. Inquire. Modern Technical Supply, 55-PM West 42nd St., New York 36.

FORMULAS, PLANS, ETC.

FOR Proof of what you can do in specialty manufacturing get our literature. It's free! Miller, Chemist, 1517-P, Tampa, Florida.

ANY Formula \$3.00. Catalog—Mig. Treatise 10c. J. Belfort, 192 N. Clark, Chicago 1.

FORMULAS; All kinds. Latest, best. Literature free. Kemikal, Park Ridge, Ill.

REAL Manufacturing formulas. Lists free. Cummings, Chemist, Gordon Ave., Syracuse 4, N. Y.

PRODUCT Analysis, manufacturing formulas, processes developed. Moderate fees. Plastics, Box 1574, Boston 4, Mass.

MAKE Big profits manufacturing perfumes. Introductory manual \$1. Fragrance Research Foundation, 1513 Oxford Way, Oklahoma City 14, Oklahoma.

FREE Formula catalog. Anything analyzed \$35. Western Chemical, Salem, Ore.

PLASTICS

PLEXIGLAS. Fiberglass, polyester, acetate, vinylite. Casting, coating plastics. Fast service, wholesale - retail prices. Catalog 10c. Gem-O-Lite, Box 6861P, North Hollywood, California.

PLASTIC. Sheets, rods, tubes, etc. Free list. Plastic Supply Co., 2901 N. Grand Blvd., St. Louis 7, Mo.

PLEXIGLAS. Lucite. Any size sheets. Square foot (12 x 12) cost, 1/16" \$1.18; 1/8" \$1.55; 3/16" \$1.90; 1/4" \$2.25. Add 15% for postage. Minimum order \$3.00. Almac Plastics, 605 Broadway, New York City.

PLEXIGLAS Sheets—Cut to size. Clear. All thicknesses. Standard outdoor translucent colors. McClarin Plastics, P.O. Box 168H, Hanover, Penna.

PLASTICS Home-craft course for men and women. Tells and shows how to make hundreds of fast selling plastics products. All plastics and materials for 23 projects included in course. No special tools needed. Course pays for itself. Write for free booklet. Interstate Training Service, Dept. D-3-J, Portland 13, Oregon.

INTERESTING Plastic kits, circular. Science Now Co., R. D. 2, Catskill, New York.

PLEXIGLAS. Lucite. Square foot cost 1/16"-\$1.16, 1/8"-\$1.53, 3/16"-\$1.88, 1/4"-\$2.23, 3/8"-\$3.28, 1/2"-\$4.38. Colors add 10%. Send 10% for postage. Aristocrat Plastics, Inc., 55 Clarkson St., New York City.

CHEMISTRY

CHEMICALS, Supplies. Catalog, 20c. Laboratory Sales, Box 161-A, Brighton, Massachusetts.

LABORATORY Pyrotechnics manual, interesting and thorough. Contains complete formulas, set-ups, instructions, on spectacular chemical experiments, thermites, fulminates, acetylides, nitrogen iodides, explosive powders, etc. Easily modified. Still \$1.00 postpaid. Chemi-Technix Labs., 368DA Riley, Buffalo 8, New York.

SPOT Tests for quick chemical analysis \$3.00. J. Tate, 1056 W. Berwyn, Chicago 40, Illinois.

NEW Idea chemical and apparatus outfits for home experimenting. Photo-scales, microscopes, chemicals, biological and laboratory supplies in small quantities. Catalog 25c. Established 1931. John H. Winn, 124A West 23rd Street, New York, N. Y.

CHEMICALS And apparatus for industrial, analytical, and private laboratories. Catalog 25c. Dept. M-50, Biological Supply Co., 1176 Mt. Hope Ave., Rochester 20, N. Y.

ILLUSTRATED Catalog: Chemistry, mineralogy, biology 20c. Tracey Laboratories, Evanston, Illinois.

BUY IT WHOLESALE

BUY Wholesale! 30-80% discounts! Free! Large catalog of nationally advertised appliances, gifts, watches, jewelry, cameras, typewriters, tools, kitchenware, etc. Start your own fully self-operating mail order business without capital! No experience necessary. Wholesale starting kits furnished. Outline of unique automatic sales plan included. Consolidated Distributors, Division 142, 21 Lafayette, Paterson 15, New Jersey.

BONAFIDE Wholesale catalog offering nationally advertised utility and luxury merchandise at tremendous discounts. 50c. Paul Howe, 503 South 15th Street, Esterville, Iowa.

EARLY Christmas shoppers? Wholesale catalog, bonus plan. Complete line nationally advertised merchandise. Petite Company, 1554-PM West 11 Street, Brooklyn 4, New York.

WHOLESALE: Sell retail, tremendous profits. Nationally advertised products. Individual purchases. Catalog \$1.00. Day, Mount Morris 12, New York.

NATIONALLY Advertised merchandise. Rush 50 cents for illustrated catalog showing retail prices to Edward Clemens, 318 W. Bridge St., Morrisville, Penna.

BUY Wholesale direct. Save yourself up to 66% on 10,000 nationally advertised appliances, homewares, jewelry, sporting goods, toys. Make big money selling others. Free details. National Buyers Service, Box 426EA, Oakland, California.

WHOLESALE Name brand merchandise. Big discounts. Individuals buy one or 1,000 items. Catalog \$1.00 refundable first order. Transamerican, Box 815-A, Atlanta 1, Ga.

MILLION Products wholesale. List of sources 50c. Fitzpatrick, 1842 Jeanette, Abilene, Texas.

AGENTS WANTED

GIVE Your customers the best. Famous Alice Ames bronzed baby-shoes made in the biggest and best plant devoted exclusively to bronzed baby shoes. Not available in stores. For details, write to Alice Ames, Dept. 2, Boston 36, Mass.

APPLIANCES, Cameras, watches! Large coded wholesale catalogue! Cam Company, 6806PM-20th Ave., Brooklyn 4, N. Y.

IMMEDIATE Success! Sensational profits! Used suits \$1.75, pants 35c, dresses 20c, shoes 20c. Operate from store, home, car. Free catalog. Superior, 1250-A Jefferson, Chicago 7.

EASY Extra income—Sell sensational new silicone scorch resistant ironing board cover. Good Housekeeping approved. Terrific \$1.98 seller! Send for free complete selling kit. Sample cover \$1.10. Menell Products, Dept. P—P.O. Box 431, Midtown Station, New York 18, N. Y.

HAVE A complete store in your pocket. Buy wholesale and make big profits. Send for free general merchandise catalog now. Jay Norris, Dept. P, 445 Broome St., New York City.

PRINTING. Advertising salesmen—Excellent moneymaking sideline selling decalcomania name plates, small quantities. Automobile initials, sign letters. Free samples. Balco, XL, Boston 19, Mass.

CALIFORNIA Sweet smelling beads. Sensational sellers. Free particulars. Mission, 2328PM West Pico, Los Angeles 6, Calif.

GOLD Or silver letters, numbers. Windows, doors, trucks. 1" to 6". 500¢ profits. Free samples. Atlas-T, 544 West 79th, Chicago 20.

\$1.00 PROFIT Selling \$2.95 photo enlargement deal. Allen Studio, Riegler Bldg., Little Rock, Ark.

MAKE Extra money. Sell front door name plates to friends, neighbors. Retail \$1.98; you make \$1.00! Free selling kit. Modern Engraving Co., P.O. Box 194, Boston 14, Mass.

AGENTS—300% Profit selling genuine gold window letters; stores and offices. Free samples. Metallic Sign Letter Co., 431-D North Clark, Chicago.

IT'S So terrific you'll actually sell thousands! Brand new \$2.95 pocket check protector. Sales pouring in. A tremendous deal for you. Get your town today. Federal Products, Evanston 15, Illinois.

EASY Handwork makes fast-selling useful articles. Sample free. Sunmade Company, Brockton 64, Massachusetts.

RUN Spare-time greeting card and gift shop at home. Show friends samples of our new 1954 Christmas and all-occasion greeting cards and gifts. Take their orders and earn to 100% profit. No experience necessary. Costs nothing to try. Write today for samples on approval. Regal Greetings, Dept. 188, Ferndale, Michigan.

BARGAINS. Job lots, close-outs! Save up to 50% on clothing, hosiery, notions, drugs, toiletries, gifts, jewelry, television, etc. 2000 items. 25c brings wholesale bargain catalog with special get acquainted offer which includes free \$1.00 merchandise certificate. Reliable Jobbers, 311-B North Desplaines, Chicago.

AMAZING Profits for you selling Sunshine quality Christmas cards. No investment or experience necessary. Nationally famous 21 cards for \$1.00. Sells on sight! Imprints. Currier-Ives, religious, gift wraps, many others. Samples on approval, write: Sunshine Art Studios, Inc., Dept. PM-9, Springfield 1, Mass., Pasadena 3, Calif. (Note: East of Rockies address Springfield office.)

NEED Money? \$50.00 yours, sell only 100 boxes new Christmas cards. Other amazing offers. Free samples imprinted cards. Feature box assortments on approval; free catalogue. 100 profitable items. Work with a national leader. Write today. Pen 'N' Brush, Dept. PM-9, 139 Duane St., New York City 13.

AGENTS—Salesmen: Sell beautiful hand-colored plastic enlargements and sensational new personalized photo compacts, rings, bracelets, lockets, etc. Experience unnecessary. 40% advance commissions. We deliver, collect. Wonderful sideline—Better full time. Free sample outfit. Novel Portrait Co., 3343 North Ave., Chicago, Ill.

BIGGER Profits selling greeting cards. Get list of sensational factory surplus bargains. \$1.25 boxes for 50c, \$1 boxes for 35c—while they last! Big line new 1954 Christmas cards, stationery, gifts. Assortments on approval, personalized samples free! Midwest Cards, 1113 Washington, Dept. J-135, St. Louis, Mo.

AT Last! Something new and sensational in Christmas cards. Make extra money fast! Show satins, velours, metallics. Gets easy orders. Pays up to 100% cash profit. 30 free samples. With name 50 for \$1.50. Big line. Amazing new glitter-brite ornaments, napkins, gifts, stationery. Several \$1.00 boxes on approval. Puro Greetings, 2801 Locust, Dept. 440-L, St. Louis, Mo.

BUY Wholesale! 30-80% discounts! Free! Large catalog of nationally advertised appliances, gifts, watches, jewelry, cameras, typewriters, tools, kitchenware, etc. Start your own fully self-operating mail order business without capital! No experience necessary. Wholesale starting kits furnished. Outline of unique automatic sales plan included. Consolidated Distributors, Division 101, 21 Lafayette, Paterson 15, New Jersey.

SHINE Cars without "polish." New invention. Lightning seller. Cars gleam like mirror. Samples sent on trial. Kristee 60, Akron, Ohio.

SEND Postcard for free money-making kit guaranteed direct-from-mill nylons, lingerie, blouses, men's and children's wear. American Mills, Dept. 433, Indianapolis.

MONEY For Xmas! Make \$50 and more during spare time. Friends, neighbors—everyone buys from Elmira's exquisite new sparkling line. Imprinted Christmas cards for as little as 3c. Personalized stationery, napkins, large gift wrappings with free accessories, ribbon ties—All fine quality money saving values. No experience needed. Send name and address for free portfolios, catalog, assortments on approval. Bonus plan. Elmira's "portable gift shop" makes money first day. Write today. Elmire Greeting Card Co., Dept. C-200, Elmira, N. Y.

YOUR Own business—Used suits \$1.50, overcoats 65c, mackinaws 35c, shoes 12 $\frac{1}{2}$ c, ladies coats 30c, dresses 15c. Enormous profits. Catalog free. Moro, 1218AA South Jefferson, Chicago 7.

CASH Commissions, up to \$10 per hour. Sell new and exclusive Ortho-Vent "Spring-Step" cushion shoes. Call on business places, industries and individuals offering them America's most comfortable shoe. High commissions, cash bonuses and exclusive repeats build you profitable business guaranteeing security. Free sales kit. No experience or investment needed. Write now. Ortho-Vent Shoe Co., Inc., Dept. PM-954, Salem, Virginia.

MAKE Money selling ties. Buy direct from manufacturer. Write to Phillip's Neckwear, 20 West 22nd, Dept. 332, New York.

BIG Income, full, part time. Qualify as advertising match book man your area. Big cash commissions. Steady repeats. No investment or experience. Exclusive cover designs. Write in detail about yourself, territory desired. Maryland Match Co., Dept. M-3, 1100 South Eutaw, Baltimore, Maryland.

FREE Full color catalog of 160 different ways to make extra money! Sell new type Christmas, birthday, get well cards, wrappings, gifts. Big profits, plus extra cash bonus. Write for feature assortments on approval, free samples personal Christmas cards, stationery. New England Art Publishers, North Abington, 933-C, Mass.

AGENTS Wanted full or part time. Free catalog appliances, watches, etc. Box #4, Limestone, Maine.

SELL Foam, All purpose cleaner. Du-mont Products, 53 Duckett Ave., Lawrence, Mass.

FREE—Big new wholesale catalog! Up to 50% saving for you, family, friends on nationally-known gifts, mdse.: hosiery, appliances, cards, etc. Also make money selling part time! Write today. Evergreen Studios, Box 846-AC, Chicago 42, Ill.

MAKE Money fast for yourself, church, organization selling friends, neighbors big value \$1.00 and \$1.25 Christmas and all occasion greeting cards. Leading 21 card boxes, religious and novelty assortments. Gift wrappings, stationery, children's items, gifts, gadgets. Deluxe imprinted Christmas cards. Over 200 items—profits to 100%. Experience unnecessary. Free gift for promptness. Bonus. Free selling plan! Samples on approval. Hedenkamp, 361 Broadway, Dept. PM-34, New York.

MAN To earn \$150 up per week. Long needed invention. Advertised worldwide. Prospects everywhere. Full or part time. Exclusive. No investment. Free use of samples. Write Red Comet, Inc., Dept. 374-M, Littleton, Colorado.

MAKE Money introducing world's cutest children's dresses. Big selection, adorable styles. Low prices. Complete display free. Rush name. Harford, Dept. M-3341, Cincinnati 25, Ohio.

SPARE Time money plus new car as encouragement bonus. Amazing 60 gauge nylons 3 pairs guaranteed 3 months. Write Wilknit, 1749 Wash., Greenfield, Ohio.

RETRACTABLE Pens. Free selling plan. Ameco, 2013 Boston Rd., New York 60, N.Y.

SELL Highly profitable French imported perfumes. Write Al Kravitz, 5524 N. Campbell Ave., Chicago 25, Ill.

"CUT-Own" hair trimmer \$2.00 prepaid. Electric \$12.95. Lifesize photo free. Mitchell Manufacturers, Aurora, Illinois.

BEAUTIFUL Feather pictures. 200% profit! Free sample. Apartado 9036, Mexico 1, D. F.

NEED Extra cash? Get it selling Blair's unusual line of household and food products. Every housewife a prospect. Products sent on free trial. Write Blair, Dept. 31MS-1, Lynchburg, Va.

FEATHERBIRD Pictures from Mexico! 100% fast, easy profits. Prompt service. Free details. Jacaman (PM-9), Box 1342, Laredo, Texas.

NEW Hand plane for wood and plastic. M. A. Tool Co., 2900 W. Davison, Detroit 6, Michigan.

FREE! Private labels! Exclusive sales! Own a business! Sell radio PL stores, mail-order. We supply product, plan, literature; you furnish executive management and employ salesmen. VitaMins, 2908PMA Beverly, Los Angeles 57.

BUY Wholesale 450,000 products. Literature free. Carter, Box 6011-F, Chicago 80.

NEW Plan pays up to \$25.00 an afternoon or evening at home. Write Harford Frocks, Dept. M-335, Cincinnati 25, Ohio.

FREE Hosiery! Sensational new way to earn to \$3 hour spare time! Introduce amazing hosiery by giving away free pairs to every man and woman, regardless whether or not final purchase is made! Nationally known luxurious nylon stockings guaranteed against runs. New miracle one size two-way stretch nylon socks, fit any size. Never sags or droops. Guaranteed one full year! Buy nothing. Deliver nothing. Advance cash plus huge cash bonus to 40%. Additional hose and gifts extra bonus. Postcard brings you samples of stockings and socks with money-making outfits absolutely free. No obligation. Kendex, Babylon 63, N. Y.

NEW Bathroom deodorizer. Hangs on wall. Banishes odors bathroom, kitchen. Lightning seller. Samples sent on trial. Kristee, 58, Akron, Ohio.

BUY Wholesale—Thousands items. List free. A Sales, 18PM City Terrace, Newburgh, N. Y.

CASH In on tremendous demand for new low-priced burglar alarm for cars, homes and farm buildings. Nothing like it. Everybody wants one. 286% profit. Unique sample offer. Northwest Electric Co., 131 Main, Mitchell, S. Dak.

\$200 WEEKLY. New invention. Amazing 4-second Presto emergency tire chains, fit all modern auto wheels. National advertising building big demand. 3 sales daily to oil stations, dealers, etc. make \$200 or more weekly. Territory going fast. Write Presto Chain Co., Dept. P-30, Des Moines 2, Iowa.

BUY Wholesale thousands nationally advertised products at big discount. Free "Wholesale Plan." American Buyers, 629-P Linden, Buffalo, N. Y.

SCHOOL Seniors—Be popular with classmates. Have spending money galore. Details free. Craftcards, Box 235-L, Pittsburgh 19, Pennsylvania.

TWO New ball point pens, retractable and plain, with a written guarantee to write a lifetime. Refill problem eliminated. Sample dozen \$2.60 carded, two samples 50c. Nucleus Trading, 2440 Amsterdam Ave., Dept. M-9, New York City 33.

BUY Wholesale direct. Save yourself up to 66% on 10,000 nationally advertised appliances, homewares, jewelry, sporting goods, toys. Make big money selling others. Free details. National Buyers Service, Box 426EA, Oakland, California.

SCHOOL Seniors—Earn sensational profits selling classmates America's most beautiful graduation name cards. Largest selection. Outsell all others. Free sample kit. Printcraft, Dept. M, 1509 Maple Street, Scranton 5, Penna.

MULTIPOP Twelve bowl corn popper \$11.95 sensation. Associated Sales, 6 Superior, Toledo 4, Ohio.

NATIONALLY Advertised. Appliances, cookware, diamonds, typewriters, watches, etc. Wholesale catalog 50c. J. J. Davis Co., 30 E. Englewood Ave., Englewood, New Jersey.

AMAZINGLY Different name and address Christmas card. Terrific seller. Big profits. Free sample outfit. Printer, 1223 Spring Garden, Pittsburgh 13, Penna.

OWN Your own profitable wholesale merchandising business. No investment. Sell nationally advertised appliances, homewares, jewelry, sporting goods everybody buys. Your own name wholesale catalog in color. We drop ship. Write General Wholesalers, Box 1195EF, Chicago, or Box 3058EP, San Francisco.

FREE Directory listing. Register name, address. Receive agency offers automatically. Save time, postage. No obligation. Transamerican, Box 813-A, Atlanta 1, Ga.

ALL the King's men are making money selling advertising specialties, business builders, industrial gifts, calendars. Be a Kingsman. Write fully to: King Industries, 2970 West Grand Boulevard, Detroit 2, Michigan.

SALESMEN—DISTRIBUTORS

LEARN Where millions in profits from Bible sales have gone! Receive free proven sales course and whole story of how you can get these profits! Also free catalogue of six of the world's finest Morocco grain genuine leather covered Bibles and related items! Joseph W. Cain, Wholesaler, Box 5065E, San Antonio 1, Texas.

MAKE Money with fast-selling Bostonian shirts. Spare time, full time. Sales kit, actual sample fabrics, free. Bostonian, 89 Bickford, Dept. F-10, Boston 30, Mass.

PRINTING—Sales and order books, envelopes, statements, business forms with or without carbon. Erscow, Bronx 72, N. Y. Free catalog.

FORTY-Niner sourdough starter. Healthfoods, pancakes, breads. \$1.00 package with recipes, territory. William G. Withrow Co., 2805 W. Colorado Blvd., Los Angeles 41, Calif.

\$10,000 PROFIT Selling printing, matches, specialties! Arrow dealer tells how he did it in giant free sales outfit. You can do it too—without experience. Write Arrow Press, 515-K Fourth Ave. So., Minneapolis, Minn.

AMAZING invention stops slamming, banging doors! Big profits easy with lowest priced hydraulic door check for all type doors! 10-second demonstration sells it! Kant-Slam, Dept. M-11, Bloomfield, Ind.

GOOD Man can make \$3,000 next 90 days. Every house in town wants amazing NiLite glowing curbside numbers. Automatic free trial plan pays profits day after day. Write for free details. NiLite, 173 W. Madison, Dept. 312, Chicago 2, Ill.

30,000,000 WOMEN Want amazing new automatic refrigerator defroster. You sell 8 out of 10 on sure-fire free trial. \$250.00 weekly profit not uncommon. Rush postcard for guaranteed plan. D-Frost-O-Matic, Dept. T-102, 173 W. Madison St., Chicago 2, Ill.

ADVERTISING Book matches—Cash in on big demand; sell union label matches. Cuts for all businesses and political parties. Free powerhouse selling kit, low prices, protection guaranteed on repeat orders. Cash commissions. Superior Match Co., Dept. M-954, 7330 Greenwood, Chicago.

GET New shirt outfit free; make \$90.00 weekly on 5 average orders a day. Famous quality made-to-measure dress and sport shirts at \$3.95 up sell fast to all men. No experience needed. Full or part time. Write: Puckard Shirt Co., Dept. 739, Terre Haute, Ind.

BIG Money-making opportunity. Exclusive line work uniforms. Jackets, pants, shirts, coveralls. Advertising embroidered. Every business prospect. Outfit free. Master Div., 259 Water, Ligonier, Ind.

ANYONE Can sell famous Hoover uniforms for beauty shops, waitresses, nurses, doctors, others. All popular miracle fabrics—Nylon, dacron, orlon. Exclusive styles, top quality. Big cash income now, real future. Equipment free. Hoover, Dept. F-100, New York 11, N. Y.

AD Matches! Sell amazing designs—20, 30, 40 and 240-light book matches. Bigger spot cash commissions; every business a prospect. Low prices for high quality. Repeats. Start without experience; men, women; full, part time. Buy nothing! Sales kit furnished. Match Corp., Dept. PM-57, Chicago 2, Illinois.

DISTRIBUTORS. Large profits. Terrific repeat orders. Unique Italian brooms. Write Peacock, 400 Montgomery Street, San Francisco, California.

BRAND New patented clip on ashtray. Housewives delight. 100% profits for agents, distributors and jobbers. E-Z-Por Manufacturing Co., 4514 N. Broadway, Chicago, Ill.

NEW Jobs open in selling! Send name, address for five free issues of Opportunity Magazine's money-making guide, listing hundreds of companies who'll pay you well, full or part-time. No experience needed. Opportunity, 28 E. Jackson, Dept. 17, Chicago 4, Ill.

NEW Business stimulator. \$4.55 profit. Sample 25c. Weiland, Graham, Florida.

SALESMEN. \$50.00 In a day definitely assured, selling brand new item going to every type of food and beverage store, factories, laboratories, hospitals, etc. Samples furnished. Utility Durawear, 53 West Jackson Blvd., Dept. PM-9, Chicago 4, Ill.

MAKE Big money selling industrial brush line to gas stations, stores, factories. Joe Usber, Ill., made \$996.61 in month. Protected territory; full commissions on repeat orders. No experience needed. Sample offer sales guaranteed. Write Harper Brush, 509 Third, Fairfield, Iowa.

100% PROFIT. Fast money for you! Take orders for Sweet Georgia Brown cosmetics. Colored people buy quick. Free sample. Write Valmor, 2451JX Michigan, Chicago 16.

SELL Advertising specialties and executive gifts for old established firm. Good thing for man with wide acquaintance among business firms. Opportunity for hustler who likes to make money and isn't afraid to make calls. Develop your own business with no investment. Leads given after you are established. Best selling season now on. Write today. Newton Mfg. Co., Dept. GR, Newton, Iowa.

NEW Chemical discovery. Pro auto wax, easy way to car beauty. Free sample, information. Amazing profits. Burford Auto Finishes, 1660-20th Street, Santa Monica, California.

CALENDARS. Advertising novelties, matches. All styles, including religious, varnished, 12 sheet, girls. Hundreds of advertising novelties, book matches, etc. Fleming Calendar Co., Sales Division, 6539 Cottage Grove, Chicago 37, Ill.

WE Start you in jacket business! Complete line of fast-selling warm leather, wool, gabardine, nylon jackets. Air cushion shoes, too! No investment, no experience. Rush postcard for free money-making sales kit. Mason Shoe, Dept. MC32, Chippewa Falls, Wis.

\$2 FIRE Extinguisher, costs you as low as 50 cents. Many other profitable pressurized spray can products. Send name. Strobel Aerosol Co., 2412 Market, Louisville, Ky.

LUTHY Aero triple electrode spark plugs outlast ordinary plugs 3 to 1. Sensational invention increases gas mileage, etc. Every car owner a prospect. Big profits for salesmen, distributors. Write Luthy Aeronautical, Dept. 449, Jackson, Mich.

BUY Wholesale thousands nationally advertised products at big discount. Free "Wholesale Plan." American Buyers, 630-D Linden, Buffalo, N. Y.

EDUCATIONAL AND INSTRUCTION

MIDLAND Linotype School. Charles City, Iowa. Civilian and Veteran Courses. Free placement. Established 1909.

MEDICAL Laboratory technique. Learn at home. Catalog free. Century College, 9 East Ohio, Chicago 11, Illinois.

CORRESPONDENCE Courses, educational books bought, sold, rented. Catalog free. Willard Bayles, 211 Essex, Hackensack, New Jersey.

HIGH School diploma at home. Licensed teachers—Approved materials. Southern States Academy, Box 144-MX, Station E, Atlanta, Georgia.

STUDY By correspondence for Doctor's degree in Psychology, Metaphysics and Divinity. College of Divine Metaphysics, Dept. P-M, 2811 North Illinois St., Indianapolis 8, Indiana.

PHYSICAL Therapy and massage. We train you at home. Earn big profits from your own private practice or work with hospitals and doctors. Free catalog. National Institute, Desk 4, 466 $\frac{1}{2}$ Sheridan Road, Chicago 40, Illinois.

SECRET Investigation. Experience unnecessary. Investigators particulars free. George Wagner, M125 West 86th, New York 24.

GROW Mushrooms. Cellar, shed, and outdoors. Spare, full time, year round. We pay \$3.50 lb. We paid Babbitt \$4,163.00 in few weeks. Free book. Washington Mushroom Ind., Dept. 174, 2954 Admiral Way, Seattle, Washington.

EARN While you learn. Auto and diesel mechanics master this top paying trade. Many graduates earn \$100 a week and up. Approved for Korean veterans. For free information write Dept. No. 256, Nashville Auto-Diesel College, Nashville 3, Tenn.

BOOKKEEPERS! Increase your earnings! Operate your own simplified "Dollar-A-Week" bookkeeping and tax service. Full or spare time. Details free. No obligation. Ellis, Box 200, Cedar Grove, North Carolina.

MEDICAL Laboratory technicians in great demand. We train you in your own home. Catalogue free. Imperial Technical Institute, Box 973-J, Austin, Texas.

INVESTIGATOR Training. Phillips Secret Service System, 1917-B North Kennebec, Chicago 39.

USED Correspondence courses and books sold and rented. Money back guarantee. Catalog free. (Courses bought.) Lee Mountain, Pisgah, Alabama.

UNIVERSITY Degrees by residence and correspondence. Golden State University, Hollywood, Calif.

GOVERNMENT Position! Home training for examination, \$9.95. Refunded if don't pass. Write, Ozment Instructions, 34-CS, St. Louis, Mo.

AUCTIONEERING. Be an auctioneer. Earn big money. Term soon. Write for catalog. Kansas City Auction School, Suite 307 Shankman Building, 3119 Troost, Kansas City, Missouri.

PRACTICAL Nursing—Learn easily at home; spare time. Big demand, good earnings. High school not necessary. Write for free facts, Wayne School, Dept. FG-23, 2525 Sheffield, Chicago 14, Ill.

COMPLETE Your high school at home in spare time with 57-year-old school. Texts furnished. No classes. Diploma. Information booklet free. American School, Dept. X645, Drexel at 58th, Chicago 37, Illinois.

BLUEPRINT Reading for machine and building trades. Train at home. Learn to read blueprints with confidence in 10 easy lessons. Literature free. Belton School, 1059A North Lawndale, Chicago 31, Illinois.

EARN Money in photography! America's oldest and largest photo school trains you at home. Low cost, earn while you learn! You can quickly qualify for well-paid job or your own business. Veteran approved. Send for free book. New York Institute of Photography, Dept. C-49, 10 West 33 St., New York 1.

LEARN Priceless secrets of Technical Metaphysics. Easy to learn. Only school of its kind. Write: Premier College of Technical Metaphysics, 2532 McKenzie St., Vancouver, B. C., Canada.

HIGH School—No classes. Study at home. Spare time. Diploma awarded. Write for free catalog HF-47. Wayne School, 2527 N. Sheffield, Chicago 14, Ill.

BECOME A doctor of psychology or metaphysics. Learn secret of contentment, happiness. Win degree of Ps.D. or MsD. Solve mental worries. Free book. College of Universal Truth, 5038-C Broadway, Chicago.

UPHOLSTERY. Become professional at home. Big earnings. Free book. Write Upholstery Trades School, Dept. CO-1402, 721 Broadway, New York 3.

BE Smart. Study at home. College. Write. Speier, Box 101, Carson City, Nev.

ENGINEERING. College-level, home study, catalog free. Midwest Engineering School, 19923 Hillcrest, Hickman Mills, Mo.

WELDING Training pays at Hobart Welding School, Box M-941, Troy, Ohio. VA contract. Best equipment. Catalog free.

WANT A diesel job? New opportunities to increase income. Higher pay. More money. We can help you qualify. Tools. Shop method home training. Write today! Diesel, Tractor, Heavy Equipment Division, Interstate Training Service, Dept. B-3-J, Portland 13, Oregon.

FREE Bible correspondence course. Worldwide. Harmer, Missionary Institute, Wildwood, Georgia.

INVESTIGATE Accidents—Earn \$750 to \$1000 month. Thousands of insurance companies, airlines, and steamship lines urgently need claim investigators. We train you at home spare time. Placement counsel and help. Free book—Now! Universal Schools, Dept. 109, Box 8292, Dallas 5, Tex.

METALLURGY Easily learned at home. Prepare now for this big income field. Write Fran Council, Box 150, Wildwood, New Jersey.

PIANO Tuning pays. Learn this profitable profession at home easily with patented Tonometer and mechanical aids. No knowledge music necessary. Diploma granted. Write for booklet. Niles Bryant School, 3731 Stockton Blvd., Dept. P, Sacramento 20, California.

CAMERA Repairmen greatly needed! You can learn manufacturers' service methods at home, in your spare time! Free, big illustrated book tells how! Write today. National Camera Repair School, Dept. FMB, Englewood, Colorado.

BOOKKEEPERS! Discovered! Shortcut public bookkeeping. Thousand simplifications. Streamlined systems. Clients unlimited. \$6.50 hourly. Auditax, 34651B, Los Angeles 34.

"INDUSTRIAL Drafting Opportunities." Free booklet. Write—Industrial Training, 1704-A Frederick, Fort Worth 7, Texas.

U. S. Civil service jobs! Men-women, 18-55. Qualify now! Start high as \$80.00 week. 23,000 jobs open. Experience often unnecessary. Get free 36-page book showing jobs, salaries, requirements, sample tests. Write: Franklin Institute, Dept. T-24, Rochester, New York.

AFRAID To talk? Lack confidence in the sound of your own voice? Amazing home training plan quickly gives you strong, confident voice. Free booklet gives facts. Write Perfect Voice Institute, 210 South Clinton, Studio 2/JW-2, Chicago 6.

BE A real estate broker. Study at home. Write for free book today. GI approved. Weaver School of Real Estate, 2023 Grand, Kansas City, Mo.

INCREDIBLE! Become mental superman overnight! Free booklet! Bijou, Box 1727-MP, Hollywood 28, California.

PLAYS, STORIES, MANUSCRIPTS

NO Luck finding a book publisher? Write for free Booklet PM. Vantage Press, 120 W. 31, New York.

BOOK Manuscripts invited—Cooperative publishers since 1925. Meador Press, 324 Newbury St., Boston 15, Mass.

HAVE Your book published by Nelson-Hall, 204 South Clinton, Chicago 6. (Founded 1909). Free details.

BUSINESS SERVICE

YOUR Ideas and inventions developed. Details free. Le Roi Engineering, Box 251, Elmhurst, Illinois.

SPECIAL SERVICES

REMAINS New York City 25c each. Other cities 30c. Foreign \$1.00. Make our address yours, monthly rates. Prompt, reliable, confidential. Ardell, 251 W. 15 St., New York 11, N. Y.

HELP Wanted ads New York City 50c, letters remailed 15c. Bouris, 146-42 61 Road, Flushing, N. Y.

AIRMAILED Remails Arabia or Lebanon, \$1.00 each. Staat, Box 2635, Dhahran, Saudi Arabia.

CARTOONING, COMMERCIAL ART, SHOWCARD & SIGN PAINTING, TATTOOING

TATTOOING Course, supply brochures 25c. Zeiss, 723 Lesley, Rockford, Illinois.

"HOW To Make Money With Simple Cartoons"—A book everyone who likes to draw should have. It is free; no obligation. Simply address Cartoonists' Exchange, Dept. 89C, Pleasant Hill, Ohio.

MAKE Money with trade secrets of experienced cartoonist \$1.00. J. Kirsch, 3333 N. Marshfield Ave., Chicago.

ATTENTION—Sign painters-hobbyists, 14 sets alphabet, monogram, numeral patterns. 1 $\frac{1}{2}$ "-4" high. \$1.00 postpaid. Walker Studio, 29-A, 4343 Lindell, St. Louis 8, Mo.

FUN With drawing. A wonderful gift. Copy anything or enlarge. Highly satisfactory. Complete set, \$1.25 postpaid. Sketchograph, P.O. Box 606, Martinez, California.

ADVERTISING AGENCIES, LETTER WRITERS, FOR ADVERTISERS

MAILING Lists, most any classification. 1000 names \$5.00. 1000 your circulars mailed with ours \$4.00. 5000 your circulars printed and mailed \$12.95. Write Dixie Mailers, King, North Carolina.

ADS Placed in out of town newspapers and magazines. Low rates. Catalogue free. Ideas that pay. Baker Advertising Agency, Successors Ankrum Agency, 189 W. Madison, Chicago 2.

SENSATIONAL Mail order advertising handbook. Methods, tests, publication rates, all the answers. Written by national agency. 25c. BT Advertising, 2108 A Payne Avenue, Cleveland 14, Ohio.

FREE Copy, layout service. Mailorder ad, 1,600,000 nationwide circulation, \$28.70 inch. 24-word classified, 20 big Sunday newspapers, \$30. Advertising ratebook free. Chicago Advertising Agency (Established 1900), Chicago 4.

FREE! 1964 Advertisers Rate and Data Directory. 52 pages! E. H. Brown Advertising Agency, 20 N. Wacker, Chicago 6.

ELECTRONIC Games skill, chance, window display gadgets, designed, built to order. Confidential. Give details. Engineer, 5208-1 Onacrest, Los Angeles 43.

SALES At a profit letters for mail order dealers. \$3.00. Satisfaction guaranteed. Tom Wood, 20 East Delaware, Chicago 11, Illinois.

ADVERTISE: 24 Words, 100 Canadian newspapers \$5.50. Lists free. Advertising Bureau, 10511-C Springfield, Chicago 43.

FRESH Mailing lists. Guaranteed. Opportunity seekers, mail buyers agents, births. Many other classifications. Free literature. Transamerican, Box 815-A, Atlanta 1, Georgia.

RUBBER STAMPS AND OFFICE SUPPLIES

STOCK Stamps 25c each. 3 for \$1.00, 3 line cushion or pocket stamp 75c. Gummed stickers 300-50c. Any size gummed labels or stickers made to order. 100% guarantee. Catalog 10c refunded. Esco 194 Print, 8 Holt, Dayton 7, Ohio.

3 LINES \$1.00. Prompt, accurate. Graphic, P.O. Box 852, Oakland 4, Calif.

TREMENDOUS, Unequaled stamp values. 60c for 3 or 4 line cushioned, indexed rubber stamp. Any two stamps \$1.00. Nickel steel case pocket stamp, cushioned, self-inking, 3 lines \$1.00. 23 different standard rubber stamps, any 5, \$1.00 all postage paid. Handy Stamps, Box 11691, Dallas, Texas.

3 LINES, \$1.00. Past service. Quality printing, reasonable. Samples. Johnson Press, 443 MacDonough, Brooklyn 33, N. Y.

RUBBER Stamps by professional craftsmen. 3 lines \$1.00. Price list. South Coast Press, P.O. Box 2074, San Bernardino, Calif.

MAKE Your own rubber stamps! New miracle self vulcanizing rubber stamp discovery! Complete kit and instructions \$1.98 includes enough formula for over 100 rubber stamps. Amazing possibilities. Results guaranteed. No c.o.d.'s. Quick-Stamp, Juniper Road, Scarsdale, New York.

TYPEWRITERS, DUPLICATORS, OFFICE DEVICES

RECONDITIONED Typewriters, duplicating, printing devices, \$25.00 up. Supplies. Appliances. DixieGraph, King, N. C.

PRINTING, MULTIGRAPHING, MIMEOGRAPHING, GUMMED LABELS

LETTERHEADS 8 1/2 x 11, 6 3/4 Envelopes, 250 each. \$3.00 postpaid. Coenen, Roseville, Calif.

ILLUSTRATED Business letterheads. Catalog 10c. Howprint, 723-M Eunice, Webster Groves 18, Mo.

500 8 1/2 x 11 LETTERHEADS \$3.50 postpaid. Samples free. Gillingham P, Milford, Conn.

MIMEOGRAPHING — Surprisingly different, colors, samples. Lee, 8 Gables Drive, Hicksville, New York.

JOB Printing, letterheads, envelopes, circulars. Printing, 21-M Barclay, Portsmouth, Va.

ENVELOPES — #6 3/4 Printed, 500, \$2.25; 1000, \$3.75; 2000, \$6.50; f.o.b. Hargraves, Box 517, Corning, N. Y.

OFFSET Printing \$6.50—1000, 8 1/2 x 11, 16 lb. National Letter, 1463 Broadway, New York 36.

500 6 3/4 ENVELOPES Printed \$4.95. Winprint, Box 636, Windsor, Vermont.

FREE Samples, airmailed. Letterpress, color litho, raised printing. Postpaid. Fast service. D & M Sales Co., Sebastopol, Calif.

100 PRINTED Cards or stationery \$1.00. Postpaid for cash. Gpc., 270 Sixth Street, San Francisco 3, Calif.

100 ENVELOPES \$1.00; 250, \$2.00. #10's, \$1.25, \$2.40 Postpaid. Graphic, 556 Beacon, Manchester, New Hampshire.

100 8 1/2 x 11 LETTERHEADS. Carefully printed. \$1.00 postpaid. Envelopes same. Race Printers, Hudson, New York.

MIMEOGRAPHING. Printing, office supplies. Samples free. Robert Bailey, Monterey, Tenn.

500 STANDARD Letterheads or envelopes \$5.00, 1,000 business cards \$3.99, postpaid. Free catalog. Arthur Steinbergen, 1274-B Stebbins, New York City 59.

BUSINESS Cards. Printing. Reasonable. Free samples. Lites, 5352-PM Princeton, Chicago 9.

1000 BUSINESS Cards \$2.50. Rush service. Samples free. Fuller's, 41 Brewster, Providence 6, R. I.

EMBOSS (Imitation engraved) business cards \$3.99 thousand. Free samples, style chart. Meder, 350-A Fifth Avenue, New York 36.

COLOR Duplicating — Sensational new silk screen process. Samples. Quantities reasonable. Gatewayad, 219 Empire Building, Pittsburgh 22, Penna.

PRINTING. 100 Letterheads with envelopes \$2.50. Prompt service. The Pike County Dispatch, Winslow, Indiana.

PHOTO-Offset printing, free price list. 1,000 8 1/2 x 11 \$9.70 postpaid. Newman, 3539 Hartford, St. Louis 18, Mo.

100 LETTERHEADS Or envelopes \$1.00. Two colors \$1.50. Broadbrook, Botsford, Connecticut.

SUPERIOR Printing. Low prices. Prompt service. Free price list, samples. Southern Printing, Alma, Georgia.

1000 RAISED Printing business cards. \$4.00. Samples free. Simon, 1556 Hoe Avenue, New York 60.

100 ENVELOPES. Printed 2-colors \$1.25. Box 523, Rochester 2, N. Y.

MIMEOGRAPHING — Letters, pricelists, formulas, instructions. Lowest prices. Lem's Letter Shop, 5710 Stanton, Detroit 8.

500 2 1/2 x 3 1/2 POUR Line gummed stickers 50c. Red border \$1.00. Moritz Printery, Saginaw, Mich.

ATTRACTIVE Labels, stickers. Inexpensive. Samples. Fame, 291 Ellis, San Francisco 2, Calif.

PRINTING OUTFITS AND SUPPLIES

MAKE Your own line cuts. Walp, Box 4308-M, Mobile, Alabama.

FREE Membership "Amateur Printers Society," 1221 E. 59th Street, Brooklyn 34, N. Y.

MAKE Your own self-molding rubber stamps and printing cuts. Flexirubber, Argyle 1, Wisconsin.

PRESSES, Type, cabinets, supplies. List for stamp. Lincoln Press Company, 220-J Hartwell, Fall River, Mass.

DO Your own printing. Save money. Simple rules. We supply everything. Print for others; good profit. Raised printing like engraving too. Have home shop. Details free. Kelsey Presses, V-11, Meriden, Connecticut.

PRINTING Presses, type, supplies. Lists 3c. Turnbaugh Service, Loysville, Penna.

PATENT ATTORNEYS

INVENTION Record form free and "Patent Information Every Inventor Should Have." Carl Miller, Registered Patent Attorney, Woolworth Building, New York.

REGISTERED Patent attorney offers services. Sanders, 6430 Evans, Chicago 37, Illinois.

"INVENTOR'S Guide" and "Record of Invention" free on request. Frank P. Ledermann, Registered Patent Attorney, 154 Nassau Street, New York City.

PATENTS — Irving L. McCathran, 315 McLachlen Bldg., Washington 1, D. C. Registered Patent Attorney.

INVENTORS: Learn how to protect your invention. Special booklet "Patent Guide for the Inventor" containing detailed information concerning patent protection and procedure together with "Record of Invention" form will be promptly forwarded to you upon request—without obligation. We are registered to practice before the U. S. Patent Office and prepared to serve you in the handling of your patent matters. Clarence A. O'Brien & Harvey Jacobson, Registered Patent Attorneys, 41B-G District National Building, Washington, D. C.

PATENTS. "Proof of Invention" free. E. E. Vrooman, Registered Patent Attorney, 507 McKim Building, Washington 5, D. C.

INVENTORS: When you are satisfied that you have invented something of value write me, without obligation, for information as to what steps you should take to secure a patent. Write Patrick D. Beavers, Registered Patent Atty., 935 Columbian Bldg., Washington 1, D. C.

C. A. Snow & Co.—M427, Snow Building, Washington 1, D. C. Registered Patent Attorneys. Write for information.

INVENTORS: Without obligation, write for information explaining the steps you should take to secure a patent. John Randolph, Registered Patent Attorney, 203 Columbian Bldg., Washington 1, D. C.

CANADA—Ramsay Company Registered, 273 Bank Street, Ottawa, Canada.

INVENTORS—If you believe you have an invention, you should find out how to protect it. The firm of McMorro, Berman & Davidson with offices in Washington, D. C., is qualified to take the necessary steps for you. Send for copy of our patent booklet "How to Protect Your Invention." We will also send you an "Invention Record" form. No obligation. They are yours for the asking. McMorro, Berman & Davidson, Registered Patent Attorneys, 134-L Victor Building, Washington 1, D. C.

INVENTORS—If you have a valuable invention, you are advised to authorize a preliminary search through appropriate classes of United States patents. This firm is registered to practice before the patent office and is available to make such search and report to you concerning the probable patentability of your invention. Instructive booklet with "Evidence of Invention" form sent upon request. Victor J. Evans & Co., 931-K Merlin Building, Washington 6, D. C.

FOR INVENTORS

"AN Inventor's Story" 60c. Eye-opening details. Inquire. Demitz, Box 9641, Norfolk 5, Virginia.

INVENTION Record form free and "Patent Information Every Inventor Should Have." Carl Miller, Registered Patent Attorney, Woolworth Building, New York.

INVENTORS: Learn how to protect your invention. Special booklet "Patent Guide for the Inventor" containing detailed information concerning patent protection and procedure together with "Record of Invention" form will be promptly forwarded to you upon request—without obligation. We are registered to practice before the U. S. Patent Office and prepared to serve you in the handling of your patent matters. Clarence A. O'Brien & Harvey Jacobson, Registered Patent Attorneys, 41-A-G District National Building, Washington, D. C.

SEARCHES—Put your patent searches in the hands of a registered patent attorney or agent, as he qualifies to give a worthwhile patentability report. Record of invention form upon request and information on patent protection. Patrick D. Beavers, Registered Patent Attorney, 935 Columbian Bldg., Washington 1, D. C.

INVENTORS: Information on patent procedure furnished on request, without obligation. John Randolph, Registered Patent Attorney, 203 Columbian Building, Washington 1, D. C.

INVENTORS: If you have an invention for sale, patented or unpatented, write Institute of American Inventors, Dept. 40A, 631-E St. N.W., Washington 4, D. C.

"INVENTOR'S Guide" and "Record of Invention" free on request. Frank P. Ledermann, 154 Nassau Street, New York 38, N. Y.

CASH For your idea. 280 manufacturers need inventions, patented or unpatented. List free. Invention Bureau, 208M Clinton, Oak Park, Ill.

INVENTORS—This firm is registered to practice before the United States Patent Office and is available to assist you in the preparation and prosecution of your patent application. "Patent Protection for Inventors" booklet containing detailed information and steps to take toward patent protection will be sent upon request. No obligation. Victor J. Evans & Co., 932-K Merlin Building, Washington 6, D. C.

PATENT SERVICES, \$5, including patent copies, 48-hour air mail service. Invention protection forms free. Patent drawings prepared. Edward Abbey, Warner Bldg., Washington 4, D. C.

INVENTORS: Do not spend money until you have read my valuable booklet "One Inventor's Experience." Avoid costly mistakes. Postpaid \$1. R. E. McLean, 3703 South Benton, Kansas City 30, Mo.

COMPLETE SERVICES for inventors. "Record of Invention" form free. Write National Inventors Institute, 4097 East 131st St., Cleveland 5, Ohio.

HELP YOURSELF! Booklets. Write Gordon MacAdams, Box 565, Garland, Texas.

INVENTORS—If you believe you have an invention, you should find out how to protect it. The firm of McMorror, Berman & Davidson with offices in Washington, D. C., is qualified to take the necessary steps for you. Send for copy of our patent booklet "How to Protect Your Invention." We will also send you an "Invention Record" form. No obligation. They are yours for the asking. McMorror, Berman & Davidson, Registered Patent Attorneys, 134-K Victor Building, Washington 1, D. C.

PATENT SEARCHES \$5.00. 48-hour airmail service. Record of invention forms free. Write Patent Engineering Service, 711 14th Street, N. W., Washington 5, D. C.

PATENT SEARCHES, \$5.00, including patent copies. Same reliable search as conducted for patent attorneys. Free protection forms. Fast, accurate service. Patent Service Institute, 945-A Pennsylvania Avenue, Washington 4, D. C.

SPECIALIST in financing, developing, and promoting unpatented ideas. Inventors Research, 1154 North Western, Hollywood 29, Calif.

PATENT SEARCHES, including copies of nearest patents, \$5.00. Reports airmailed within 48 hours. More than 75 registered patent attorneys use my service. For free invention protection forms, write Miss Ann Hastings, P. O. Box 176, Washington 4, D. C.

PATENT SEARCHES, including copies and analysis, by Registered Patent Agent: D. Smith, 100 East Braddock Road, Alexandria, Virginia.

PROFITING from your invention? The International Inventors Club helps you with patents and sales. Membership only \$15 year. Free information. 6614 Metropolitan Station, Los Angeles 55, California.

PATENT SEARCHES \$5.00. 48-hour service. Free record of invention. Write Raymond L. Smith, Patent Searcher, 622 Sheraton Building, Washington 5, D. C.

WANTED Plastic Inventors: Manufacturer selling national variety, drug, department and supermarket chains, will manufacture and sell your item. E-Z-For Corporation, 4314 N. Broadway, Chicago 40, Illinois.

INVENTORS—Send for free patent information book and inventor's record. Registered Patent Attorney, Associate Examiner, Patent Office 1922-29; Patent Attorney & Advisor, Navy Department 1930-47. Gustave Miller, 94A Warner Building, Washington 4, D. C.

INVENTIONS WANTED

INVENTORS Don't sell your invention, patented or unpatented, until you receive our offer. Write Cowgill, Box 298, Marion, Ohio.

INVENTIONS Promoted. Patented or unpatented. Established 1911. Write Adam Fisher Company, 5418 Idaho, St. Louis, Mo.

INVENTIONS Wanted. Patented, pending only. Inventors Patent Exchange, Hartford 1, Conn.

INVENTIONS Wanted. Patented; unpatented. Tremendous manufacturers lists. Global Marketing Service, 1404 Mitchell, Oakland 1, California.

INVENTORS: Hundreds of manufacturers have requested our assistance in locating marketable new products. Complete information free. Institute of American Inventors, Dept. 40-D, 631-E St. N.W., Washington 4, D. C.

INVENTIONS Wanted. Patented or patent pending. 23 years experience promoting inventions. National Service Bureau, 3120 Meramec, St. Louis 18, Mo.

NEW PRODUCTS or processes bought, sold licensed, U.S. and abroad. For details write New Products Institute, Irvington, N. Y.

CASH BUYERS for ideas and inventions. Write National Inventors Institute, 4097 East 131st St., Cleveland 5, Ohio.

INVENTORS: If your invention is adaptable to our business we will contract on cash or royalty. If not, we will try to place. Free booklet, Kessler Sales Corporation, 39A, Fremont, Ohio.

BROKERS With complete service for inventors. The Invention Mart, Spring, Tex.

ATTENTION INVENTORS! Sell your invention to manufacturers, investors, through the pages of: "Gadgets Patents & Invention News." Write Inventors' Service Bureau, 847 W. Roscoe, Chicago 13, Illinois.

PATENTED. Unpatented inventions wanted. Foremost promotion service. Full particulars free. Superior, 338-344 North Rodeo, Beverly Hills, Calif.

INVENTIONS, Ideas wanted for development, manufacture. Write: Wadsworth Manufacturing Co., Wadsworth 9, Ohio.

PATENTS FOR SALE

INVENTORS: Test the commercial value of your patented or unpatented inventions, quickly and inexpensively. Write for free information. Institute of American Inventors, Dept. 40-B, 631-E St. N.W., Washington 4, D. C.

PARALLEL Jaw pliers. Nothing like this. Newly patented. Would like same manufactured on royalty. Spikings, 2424 River Road, River Grove, Ill.

FLUSH By-passing sliding door hardware. Patent pending. Simple positive mechanism. McCall, 1611 Shawnee, Columbus 3, Ohio.

MANUFACTURING

MODELS — Small lot manufacturing. Metals, plastics, etc. Milburn, Burlington, Kentucky.

WE Design, develop, build. Machinery, inventions, models. Henry, 2815 Blvd., Jersey City 6, New Jersey.

MODELS, MODEL SUPPLIES

BUILD Miniature passenger hauling live steam locomotive with file and drillpress. We do machine work, you bolt it together. Catalog 50c. Little Engines, Wilmington, California.

SHIP And yacht model fittings; blueprints. Send 25c for illustrated catalog listing hundreds of items. A. J. Fisher, 1602-1 Etowah Ave., Royal Oak, Mich.

SHIP And other scale models. Most complete line in New England. Kits, fittings, plans, books, tools, engines, motors. Illustrated catalog 25c. James Bliss & Co., Inc., Dept. SM, 342 Atlantic Ave., Boston 10, Mass.

BALSA Wood, Grade AAA. Free sample, price list. Sig Mfg. Co., Montezuma, Iowa.

FLEISCHMANN Famous German steam engines \$5.95 to \$85.00 and mechanical ships 79c to \$45.00 postpaid. Catalog 35c. Merlo, 50-18 94 Str., Elmhurst 73, N. Y.

10 MICROMODELS \$1.00. List for stamp. Jenid, 558 Loring Station, Minneapolis 3, Minnesota.

1954 CAR Models, 1/25 scale, all metal, chrome trim. Send for catalog. Cars & Hobbies, Dept. PM-18, 2333 Haddon, Chicago.

POWER Models. Unusual steam, gasoline and traction engines, fittings, metals. Anniversary catalog 50c. Chas. Cole, Ventura, Calif.

SHIP Models and yacht supplies. Complete, large 68 page catalogue 50c. Bill Wild's, 510 East 11 St., New York City 9.

BALSA Wood! Top quality! For model aircraft, boats, etc. All sizes. Special offer; free price list. Write: Remaco Balsa, 7 Springfield St., Chicopee, Mass.

HOME CRAFTSMEN

BEAUTIFUL Nativity scene. Almost life size patterns of Mary, Christ Child, Joseph, Wisemen, etc. No tracing, just paste, cut out and paint. Plans for stable also included. Only \$2.00. Mastercraft, 98M, 7041 Olcott, Chicago 31, Illinois.

METALCRAFT: Complete stock of tools and all the craft metals. Free catalog. Patterson Brothers, 15 Park Row, New York 3, N. Y.

LEATHERCRAFT. Tremendous stock of leather, tools, supplies, and kits. In leather business over forty years. Send 10c for big catalog. Sax Bros., 1111 No. 3rd, Dept. PM9, Milwaukee 3, Wisconsin.

59 FULL Size jig saw patterns of beautiful shelves, ornaments, toys, novelties. Plus "How, Where to Sell." Only \$1.00. Mastercraft 94M, 7041 Olcott, Chicago 31, Illinois.

LEATHERCRAFT. Metal tooling, textile painting, bendcraft, shellcraft, many other crafts. Fun, easy, profitable! Free, big, illustrated catalog. Write today. Kit Kraft, Dept. 259, Hollywood 46, Calif.

101 FULL Size patterns. Smart, new, gifts, novelties, lawn figures, shelves, action windmills, alphabets. Plus "Make Money Jig Sawing." Only \$1.00. Mastercraft 95M, 7041 Olcott, Chicago 31, Illinois.

PLASTICS Home-craft course for men and women. Tells and shows how to make hundreds of fast selling plastics products. All plastics and materials for 23 projects included in course. No special tools needed. Course pays for itself. Write for free booklet. Interstate Training Service, Dept. D-3-J, Portland 13, Oregon.

WOODWORKING Course for home craftsmen. Twenty-two manuals. Over 1,000 pages. 75 training projects. Only complete home training program available today. Carefully written, profusely illustrated. Covers everything from wood selection to final finishing. Complete instruction in care and use of all hand and power tools. Prepared by expert manual training instructors. Write for free booklet. Interstate Training Service, Dept. G-3-J, Portland 13, Oregon.

BIG Full size patterns of Santa, sleigh and reindeer for roof or lawn. Complete directions for making, painting and lighting. \$1.00. Mastercraft, 96M, 7041 Olcott, Chicago 31, Illinois.

LEATHERCRAFT Items at big savings. Make billfolds, belts, gloves, handbags, moccasins, woolskin animals, etc. Sell, use or give as wanted gifts. Start now making quality leather specialties with Larson easy-to-assemble beginners kits. No tools or experience needed. Illustrated instructions. Attention professionals, hobbyists and crafts classes! Careful grading assures a uniform selection of tooling and carving leathers, fine calfskins, kits and projects. Quality guaranteed. Complete stock of accessories, tools, supplies. Orders shipped same day received. Send 10c today for big, new illustrated catalog for beginners and advanced hobbyists. J. C. Larson Co., 820 S. Tripp, Dept. 4450, Chicago 24.

PLYWOOD Panels — Mahogany, cedar, oak, maple, cherry, walnut, pine, birch, Korina. For the first time, direct from manufacturer and priced for "do-it-yourself" or commercial users—5 ply furniture grade, A-A Marine grade, Formica, large or small sizes, 1/4" to 1/2" thick, any quantity. Motor freight delivery to your door. Write for descriptive folder and price list. Southern Plywood Corporation, Dept. M, High Point, N. C.

LAMP Size cypress knee, nipple installed \$2.00. Cy Products, Dept. 2 N, Lafayette, La.

ALPHABET Patterns. Monograms, numerals. 14 sets 1/2"-4" high. \$1.00 postpaid. Walker Studio, 29-A1, 4343 Lindell, St. Louis 8, Mo.

CRAFT Supplies—Metals, plastic, tools. Helpful catalog. Kale Craft, 2250 Milwaukee, Chicago 47.

JEWELRY Findings, beads, pearls, jewels! It's profitable, fun! Imported beads, all sizes—shapes. Sample pound \$1.50; 5 pounds \$5.00. Deluxe pearls, high luster, assorted \$2.00 pound; 5 pounds \$7.50. Klondike assorted jewelry findings swept from manufacturer's tables. Parts finished and unfinished for bracelets, pins, earrings, necklaces, chains, rings, etc. Sample pound \$2.00; 5 pounds \$7.50. 1,000 jewels for rings, jewelry—All colors, sizes, \$5.00; 100 for \$1.50. No c.o.d.'s. Satisfaction guaranteed! Merchandise Distributing, 19 East 16th Street, Dept. 100, New York City 3.

ELECTRIC Kiln and complete kit for making porcelain jewelry. Amazing low price—\$6.95. Details free. Lea's, Box 582-B SLI, Lafayette, Louisiana.

VIOLINMAKERS, Repairers, amateurs, professionals. Fine tone European wood. Materials, tools, patterns, instructions. Illustrated catalogue 10c. Premier Violin Supplies, Division PVM, 430 South Broadway, Los Angeles 13, California.

FINISH Plywood to resemble expensive wrought-iron. Directions plus 18 full size personalized house, lawn sign patterns—complete alphabet, numerals. \$1.00 postpaid. Walker Studio, 29-H, 4343 Lindell, St. Louis 8, Mo.

BABY Shoe mountings, America's finest. Plated unbreakable metal and imported onyx. Bookends, ashtrays, desk sets, portrait stands. Low prices. Catalog free. Senti-Metal, 235 E. Capital, Columbus, Ohio.

LEATHERCRAFT For pleasure and profit. Big new illustrated catalog of leathers, easy-to-make projects, tools accessories, supplies. Send 10 cents today. Tanart Leathercraft Co., Dept. PM, 149 N. 3rd Street, Philadelphia 6, Penna.

LEATHERCRAFT For pleasure or profit. Make easy to assemble purses, moccasins, keychains. Send for new catalog. Hinckley Leather Company, Dept. PM, 2824 Commerce, Dallas 26, Texas.

BUY Wholesale nationally advertised power, hand tools, thousands other products at big discounts. Free "Wholesale Plan." American Buyers', 628-PP Linden, Buffalo 16, N. Y.

LEATHERCRAFTERS: Everything you need. Catalog 10c. Art Leather, 411 Joseph Ave., Rochester 5, N. Y.

BUILD The patented Little Mint Paper Baler—Slickest little baler for homes, apartments, schools, churches, offices and small businesses. Makes 50 lb. bale. Easy to build. Plans and instructions plus license and name label to build one baler \$2.00 postpaid. Order today, build one for yourself, build others to sell. L. M. Baler Co., Box 125A, Wausau, Wisconsin.

LEATHERCRAFT Pre-cut kits, tools, patterns, instruction books. Stylecraft, Craftool, others. Catalog 10c. Whitman Saddle Mfg. Co., 1725 Powers St., C9 Cincinnati 23, Ohio.

INTRODUCTORY—2 Kits for only \$1! Special offer—2 kits only \$1.00 postpaid! 1 moonstone earring kit; 2 gorgeous, genuine rhodium silver pin and earring kit with imported Austrian rhinestones. Also including large, colorful, illustrated catalog which tells how to make earrings, pins, bracelets, necklaces, cuff links, tie bars, barrettes, etc., with imported rhinestones, pearls, and moonstones. Money-back guarantee. Catalog alone, 25c. Address Dept. E-29, Don-Bar Novelty Company, 3511 W. Armitage Ave., Chicago 47, Ill.

MAKE Your own toys, novelties with beautiful colored pipe cleaners. Bundl-O-Fun Jr. kit. 38 cleaners 9" long, assorted colors, only 30c postpaid. Economy kit contains 36—9" and 50—6" cleaners for 50c. Illustrated instructions. Send coins today. No c.o.d. or stamps. Satisfaction guaranteed. Rochester-Livingstone, Dept. B, 81 Charlotte St., Rochester 7, N. Y.

VENEERS .010" Thick. Glueable without press. Mahogany, birch, others. Free samples. Write Miles Goff, North Girard, Penna.

FREE "Do-It-Yourself" leathercraft catalog. Tandy Leather Company, Box 791-D5, Fort Worth, Texas.

129 NEW Full size jigsaw patterns. Unusual novelties, gifts, lawn figures up to 22 inches high, action (merry-go-round) windmill, toys, useful gadgets. Artist drawn. \$1. Craftplans, 1321-A South Michigan, Chicago 5.

LEATHER, Tools, lacings, supplies. Free catalog. National Handicraft, 199 William St., New York 7.

STYLECRAFT Sure fire hits. "Pre-traced" leather kits. Handbags, billfolds, filigree belts, over fifty other projects. Patterns on leather. Why trace? Just carve, assemble and lace. Large assortment "precarved" kits also available. Send 25c for catalog, free folder. Refunded first order. Apache Leather Company, 2804 E. Washington St., Phoenix, Arizona.

35 LAWN And garden ornament patterns. Full size, ready cut, colors indicated. Only \$1.00. Lincoln Craft Studio, Columbia, Conn.

KNOCKDOWN Cedar chests. Lumber and veneers. Free price list. Giles & Kendall Company, Huntsville, Ala.

FREE Information. Money-making full size patterns. Professional designs. Furniture, gift shop items. Write Jigsawers, 117 Worth, New York 13.

"TOPS" In everything for leathercraft. Lowest prices. Genuine "Craftool" stamps. Catalog 10c. Crown Leather Company, 22 Spruce Street, New York 38.

KNOCKDOWN Cedar chests and lumber. Free price list. Bedford Lumber Company, Shelbyville, Tennessee.

MAKE IT YOURSELF

AWNINGS—All-aluminum. Make your own! Assemble America's most beautiful aluminum door canopies and window awnings. The sides are pre-assembled. Save 50%. Factory to you. Free measuring chart and literature. Herbert's Aluminum Awnings, Dept. 1, 8974 St. Charles Rd., St. Louis 14, Mo.

WOODWORKING Supplies, glue, veneers, plywoods. Catalog free! Minnesota Woodworkers Supply, Box 233; Hopkins, Minnesota.

MOTORIZED Wheelbarrow, three wheels, self-dumping, use lawnmower engine. Complete plans \$1.00. Bennett, 2461 Lucas Drive, Beaumont, Texas.

GEIGER Counter and metal detector kits. Inexpensive, educational. Free literature. Electronic Applications, 5024 Lee Highway, Arlington 7, Va.

DINING Room table. Attach our 29" V-type wrought iron legs. \$7.95 freight paid, to any flush door. Wrought iron chair frame to match \$3.95. Dealers wanted. Wrought Craft, Box 502, Hialeah, Florida.

GRANDFATHER Clock easily built. Big savings. See ad on page 241.

HOME Freezer—Build from old refrigerator. Plans \$1.00. Cryder Refrigeration, 31c Mix Ave., Columbus 4, Ohio.

HOW To have power when and where you want and save 30%. Now you can have electricity anywhere you need it and save up to 30% of the cost. How? With a dependable Winco "Make-It-Yourself" Engine-Generator. Just mail us your name and address with 25c and we'll send you complete plans for assembling and mounting a Winco "Make-It-Yourself" Engine-Generator. Write today to: Wincharger Corp., Sioux City 2, Iowa.

UPHOLSTERED Chair. Easy to build. NoSag springs. Foam rubber. Costs \$19.50 plus lumber. Sells \$69.50. Complete plans and materials list, \$1.00. Decorator Angle, 4601 W. North Ave., Milwaukee 8, Wis.

AIR Conditioners—Home or automobile. See Seeley ad, page 248.

WATCHES, OLD GOLD, JEWELRY

HIGHEST Cash for old gold, broken jewelry, gold teeth, watches, diamonds, silverware, spectacles, platinum. Free information. Satisfaction guaranteed. Rose Refiners, Heyworth Bldg., Chicago 2.

WATCHES Overhauled \$4.50. One year's guarantee. Berkowitz, 1150 Castiehill, New York 61.

JEWELRY Making can be a profitable hobby—Send 20c for our latest illustrated catalog. Milady-Fair Co., G.P.O. Box 1328, New York City.

ORUEN Watches. Small down payment. Armstrongs, 6 Rockland, Melrose, Mass.

FREE Sample pair of earrings shows you how easy it is to make beautiful costume jewelry. Over 5000 styles listed in new catalog, 25c. Barry's, 188 Ardsley Court, Newark, N. J.

HIGHEST Prices for gold, silver, platinum, diamonds, watches, gold teeth. Satisfaction assured. Goods returned if offer unsatisfactory. United Smelting Works, Old Reliable, 6-B East Monroe, Chicago 3.

MAKE Rhinestone jewelry—No tools needed. Huge profits. Catalog, instructions, sample pin, stones, and color chart of actual rhinestones 50c. Refundable. Bergen Arts, 128M Main, Hackensack, N. J.

WATCHES, Buy wholesale; savings to 65% famous brand, wide selection; free illustrated catalog. Sidney Sachs, 159 East 96 St., Brooklyn 12, N. Y.

UNREDEEMED Diamond, 1-carat, \$295, 30-day refund. Free catalog. Broff's Diamond Loan Association, 411 Smithfield, Pittsburgh, Penna.

WATCH And clock repairing books for hobbyists. Free information. North American, Dept. 14-1, 2320 N. Milwaukee, Chicago 47, Illinois.

WATCHMAKERS'—Jewelers' complete informative catalogue 20c. Bengale Company, Culver City, California.

RHINESTONES, Jewelry settings, cameo, sequins, beads, hobby kits. Send 10c for illustrated catalog. J & M Novelties, Dept. CK-3, Griffith, Indiana.

WATCHMAKERS' Tools, materials, supplies, watches. Catalog. Gales, Box 1000, Chicago 90, Ill.

TOBACCO, SMOKERS' SUPPLIES

FREE Booklet, "How to Blend Pipe Tobaccos." Tobacco Blending, Box 1171, Louisville 1, Ky.

PIPE Smokers! Cigar smokers! Free illustrated catalog offers fabulous savings on choice imported and domestic pipes, cigars, tobaccos, supplies. Write Wally Frank, Dept. 1, 150 Nassau St., New York 38, N. Y.

RAZORS, BLADES, SHARPENING

EASIEST Shaves with "Perfect" double-edge blades—100 for \$1.00. Handy knife included free. Artsons Co., 255 W. 34 Street, New York 1.

FOR THE HOME

FOAM Rubber furniture cushions. Factory seconds. 50% discount. Free catalog. Perma-Foam, 140-C Main Street, East Orange, New Jersey.

CESSPOOLS! Outdoor toilets. Clean yours without digging. Use amazing Rid-X. Money saving details free. Wilco, Dept. A, Box 294, Danville, Ill.

CLEAN Your coal furnace with hinged radiator rake. \$2.00 postpaid. Midway Products, Box 223, Pocatello, Idaho.

OF INTEREST TO WOMEN

PROFITABLE Home business. Make fast-seller chenille monkey trees, dolls, flowers. Terrific holiday demand. Information free. Velva, Bohemia 16, N. Y.

NYLONS 14c, Anklets 6c, socks 9c, print 17c, panties 12c, dresses 50c, slips 47c, undershirts 17c, robes \$1.65, spreads \$2.65, jewelry \$1.25, watches \$3.50, electric razors \$2.00, aspirin \$1.00—1,000, brushes 9c, razor blades 1 1/2c, pens 8c, combs 1 1/2c. Complete stock list, picture catalogue, 25c. Send immediately. Sibert's, Chattanooga 4, Tennessee.

DRESSES, 24c; Shoes 39c; men's suits, \$4.95; trousers, \$1.20. Better used clothing. Free cat. Transworld, 164-AD Christopher, Brooklyn 12, N. Y.

GROW Mushrooms. Cellar, shed, and outdoors. Spare, full time, year round. We pay \$3.50 lb. We paid Babbitt \$4,165.00 in few weeks. Free book. Washington Mushroom Ind., Dept. 178, 2954 Admiral Way, Seattle, Washington.

FREE Clothes pins with clothes line tightener only \$1.00. Mah Company, 3066 Arcadia, Omaha 11, Nebraska.

MAKE Big money at home! Invisible reweaving pays up to \$10.00 profit in an hour. Make tears, holes disappear from fabrics. Constant demand from laundries, cleaners, homes brings steady earnings. Details free. Fabricon, Dept. C, 8342 S. Prairie, Chicago 19, Illinois.

EMBROIDER Stamped linens. Buy direct from manufacturer and save. Send for free catalog. Merrilee, Dept. 598, 22 West 21st Street, New York 10, N. Y.

SEWING Supplies wholesale. Free price list. Button Shop, Dept. D, 717 W. Roosevelt, Chicago 7, Illinois.

AMAZING Sewing shears. Magnetic points pick up pins. Ruler blade measures as you cut. Samples sent on trial. Kristee 104, Akron, Ohio.

PROFITABLE Home business from wood fiber flowers made with magic box. Beginner's kit \$1.50. Robbins, 3714 E. 25th, Indianapolis 18, Ind.

FOR SALE—MISCELLANEOUS

HEARING Aid batteries, wholesale. Free list. Habs, Box 51, York, Penna.

MAP Measure and compass, precision built \$1.00 ppd. duty free. A. G. Kohler, Berlin W. 15, Germany.

THREE Retractable ball points or five refills for any retractable, \$1.00. Thomas Pens, Box 3, Brooklyn 11, New York.

WANTED—MISCELLANEOUS

QUICKSILVER, Sterling, silver solders, precious metals. Wholesale Terminal, Norwood, Massachusetts.

WATCHES, Old gold, silver, jewelry. Write Southern Watches, Gray, Georgia.

SCRAP Mercury (quicksilver) containers supplied—Tantalum, bismuth, tungsten. Metallurgical Products Company, Established 1909, 35th and Moore Sts., Philadelphia 45, Penna.

PERSONAL

"HOW Can I find out?" You can! Information confidentially developed. Any matter, person, problem. Worldwide. Officially licensed. Established 1922. William Herman, 170 Broadway, New York City.

LETTERS Remailed 25c. Personal forwarding address. Monthly rates. Hicks Service, Box 1547, Washington 13, D. C.

MEXICAN Law office. Bank references. P.O. Box 41, Juarez, Chih., Mexico.

WHAT Is your "I.Q."? Take an excellent adult intelligence test in home privacy! Recognized by civil service. Send only \$2.00 to: Desk C, University Test Bureau, Box 401, Palo Alto, California. Confidential report.

MEXICAN Law. General Practice Attorney, 1203 Arizona St., El Paso, Texas.

NORWAY Remail 25c. Reairmail 50c. 10 beautiful viewcards midnight sun, etc. \$1.00. Digerud, Brettevillestg., 24, Oslo.

SEATTLE Confidential Remail letters, 25c. C. H. Bell, Box 91, Enumclaw, Wash.

REPORTS Prepared by specialists. Free details. Lee Library Research Service, Box 86, Hammel Station 83, N. Y.

"FEMME Mimics"—Amazing book, containing 375 photographs. About men who wear women's clothing! Free literature. Winco, Dept. PM92, Box 9525, Dallas, Tex.

PORTRAIT In oils. Modern-impresionistic, by the renowned E. John Shay, see Fate magazine advertisement for particulars. Send any photograph, \$25.00 prepaid. P. O. Box 4102, Panorama City, California.

CANADA St. Lawrence seaway site job ads \$1.00. Remails 25c. 5 scenic postcards \$1.00. Box 1025, Cornwall 2, Ontario.

IRELAND Or Germany. Letters remailed, \$1. Cogavin, 85 Middle Abbey Street, Dublin, Ireland.

HOLLYWOOD Remails 25c. Want ads airmailed \$1.00. California Mailing Service, Box 968, Hollywood 28, California.

JOBS New York City classifieds airmailed \$1.00. Ardell (See Special Services column).

LETTERS Remailed—St. Petersburg or Tampa, Florida, 35c. Local classified pages airmailed \$1.00. Box 2741, Tampa, Florida.

ALL States and foreign remailing. Business and personal address, details 10c. Chicago postmark 25c. Macks Mailorder, 5636 No. Hermitage, Chicago 26-Y, Ill.

RESURRECT And expand the magic powers of your inner intelligence. Demonstrate success, happiness and abundance. Write: Psychography, Box 27683A, Hollywood, California.

ATLANTA Address. Business, personal. Monthly rates. Atlanta remails 25c; any U. S. city 35c. Foreign rates available. Confidential. Free details. Transamerican, Box 815-A, Atlanta 1, Georgia.

MISCELLANEOUS

"X-Ray Mind." Stupendous mental power. (Details 10c). Krishnar Institute, Box 842-ST, Escondido, Calif.

CLOGGED Drains opened by new powerful chemical called Sursolvent. Removes grease, soap, tree roots, etc., without expensive digging and electric rodding machines. Simple to use. Mix with water and pour down sink. Postal brings free details. Electric Sewer Cleaning Co., Allston 34, Mass.

GOLD, Silver, metal detectors. Geiger counters for uranium. Mineralights. Sensational new fully guaranteed models. None finer. Information free. Detecron Corp., 5420 Vineland Ave., North Hollywood, California.

RECEIVE Magazines, samples, catalogues. Mails from everywhere. Offers, hundreds. Get listed 25c. Rorick, Box 86, Cincinnati 26, Ohio.

TREASURE Finders for gold, silver and minerals. Money back guarantee, best available. Also Geiger counters for uranium prospectors, free information. Write Goldak Company, 1541 West Glenoaks, Glendale 1, Calif.

GROW Mushrooms. Cellar, shed, and outdoors. Spare, full time, year round. We pay \$3.50 lb. We paid Babbit \$4,165.00 in few weeks. Free book. Washington Mushroom Ind., Dept. 175, 2954 Admiral Way, Seattle, Washington.

PANNING Gold—Free lesson; catalogue of mining, mineral books, supplies. Old Prospector, Box 729D1, Lodi, Calif.

SELECTIVE Metal and mineral detector. Revolutionary design. Distinguishes metals from black magnetic sands. Readily detects metals under salt water. Also Geiger counters. Free literature. Gardiner Electronics Company, 2018 N. Dayton, Phoenix, Arizona.

TREASURE—M-Scope Geiger counters, mineral locators. Why buy something inferior when you can buy the best at a lower price? Backed by years of experience. Fully guaranteed by factory. Detects minerals, metals, gold, silver, coins. Payment plan available. Proven superior performance. Free 16 page illustrated booklet. Fisher Research Lab., Inc., Palo Alto, California.

TANNED Hereford unborn calf hides and tanned sheepskin for dens walls, throw rugs, etc. \$5.00 each. Postage paid if payment with order. Satisfaction or money refunded. Texas Skin Processing Co., 1126 W. Malone Ave., San Antonio, Texas.

BUY Wholesale! 30-80% discounts! Free! Large catalog of nationally advertised appliances, gifts, watches, jewelry, cameras, typewriters, tools, kitchenware, etc. Start your own fully self-operating mail order business without capital! No experience necessary. Wholesale starting kits furnished. Outline of unique automatic sales plan included. Consolidated Distributors, Division 120, 21 Lafayette, Paterson 15, New Jersey.

UNBELIEVABLY Simple calculating land measuring wheel. Write Carmean, Hutchinson, Kansas.

SCOTTISH Imported ties. Pure wool, all clans. \$3.50 each postpaid. Send m.o. Ties, Box 1009, Long Beach 1, Calif.

RECEIVE Mails, magazines, samples. Your name in numerous mailing lists 25c. Greenwood, Box 1116-W, New York 8.

3-D Writing. Raised letters just like engraving. Make your own invitations, greeting cards etc. \$1.00 for complete kit and instructions. gold, silver and colors. Guaranteed. Hawkins, Box 328, San Pedro, California.

URANIUM, Gold, silver, treasure. New power-packed, highly sensitive metal detectors and Geiger counters. Kit and factory assembled models from \$34.50. Lightest weight, guaranteed. Free literature. Electronic Applications, 5024 Lee Highway, Arlington 7, Va.

LEATHERCRAFT—The quick, easy way to make extra money. No tools or experience needed with Larson easy-to-assemble beginners kits. Free illustrated instructions included. In minutes, you'll be making belts, billfolds, handbags, gloves, moccasins, wooskin animals, etc. Amaze yourself and friends with your new skill as a leather craftsman! Send 10c today for big new illustrated catalog of ideas, kits, materials and supplies. Act now! J. C. Larson Company, 820 S. Tripp, Dept. 4051, Chicago 24.

GERMAN Address lists. Anything manufactured \$1.00. Burke Associates, Manchester 1, Mass.

SAVE Up to 50%. Jewelry, radio, television, furniture, pianos, appliances, sporting goods. Free information. Merchandise Buying Service, 8251 Buffalo Ave., Chicago 17, Illinois.

STRONG! Brass key chain, 18" overall. Leather belt loop one end. Key ring other end. 50c postpaid. Satisfaction guaranteed. Wilco, Box 294, Danville, Ill.

GEIGER Counter tube, gamma, fast-beta. \$7.00 postpaid. Western Radiation Lab., 1107 W. 24th Street, Los Angeles 7, California.

HOBOSWAP List. Thousand offers. Dollars saved. Rush quarter. USA Traders, Alger, Mich.

URANIUM Prospectors headquarters. Geiger counters \$29.95-\$300. Scintillators locators catalog. Micromatic, 2322 W. Whittier, Montebello, California.

BUY Wholesale thousands nationally advertised products at big discount. Free "Wholesale Plan." American Buyers, 631-D Linden, Buffalo, N. Y.

PAINT—10,000 Gallons battleship grey exterior paint, suitable for metal or wood, perfect condition, packed in 5 gallon steel cans. Cancellation on large marine order. Price \$1.00 per gallon, check with order, f.o.b. Rahway, N. J. Commercial Chemical Co., Rahway, New Jersey.

PHOTO Lamp shades. Scenics or your negatives, for full particulars, write Conways, Box 7261, San Antonio 10, Texas.

GEIGER Counters, metal detectors, ultra-violet mineralights—From \$29.50 up. Write for full information. The Radiac Co., Inc., 489 Fifth Ave., Dept. PM-9, New York 17, N. Y.

FIND Tungsten, mercury, uranium with Mineralight. Free brochure. Write Dept. PM6, Ultra-Violet Products, South Pasadena, California.

MAKE Your own will—in private. Save money! We send will form, complete instructions, legal seals. Valid in all states. Complete, only \$1.00. 3 for \$2.00. Valley Research, P. O. Box 2502, Phoenix, Ariz.

FIX False teeth yourself. Tighten loose plates. Free information. Pioneer, 104, Harriman, Tennessee.

FREE Catalog science, educational materials. World Adventure, B438C, Ann Arbor, Michigan.

URANIUM. Latest information on new location deposits. High profits. Write, P.O. Box 64393, W. Los Angeles 64.

INCREDIBLE! Become mental superman overnight! Free booklet! Bijou, Box 1727-MP, Hollywood 28, California.

REFLECTIVE Tape prevents accidents. For bumpers, bicycles, driveways. \$1.00 delivers. Electronic, Box 1142, Lancaster, Penna.

Train at Home for Good Job or Own Business in
REFRIGERATION
Information Free
Now is the time to get into this long established, rapidly growing industry. Learn at home—no previous experience needed. Free details explain how quickly you can be ready to install, service, maintain, repair home and industrial equipment. Free information about how to start your own business and job opportunities. Send name and address today.
COMMERCIAL TRADES INSTITUTE, Dept. A2-9
1400 Greenleaf Ave. Chicago 26, Ill.

All New Supermatic
RETRACTABLE PEN
New 4" Cartridge
Press Here To Write
Press Here To Retract Point
Red, Blue or Green Ink
Larger Quantity & Imprint Prices On Request
ONLY
3 for \$1 postpaid
12 for \$3.50
50 for \$14.00
100 for \$27.00

REFILLS TO FIT PAPER-MATE & EVERGLIDE PENS
Only 6 for \$1 postpaid
Choice of Red, Blue or Green Ink
Instant drying. Won't leak, smear or transfer. Send check or money order. Money back guarantee.
Barclay Distributors, Dept. 1-P
P.O. Box 45, Forest Hills, N. Y.

LEARN MEAT CUTTING AT NATIONAL

Pay After Graduation



The steady dependable trade of Meat Cutting taught easily in 8 short weeks. **YOU LEARN BY DOING** under actual meat market conditions in big modern school at Toledo.

For beginners or men with experience. Get a profitable store of your own. Remember, **PEOPLE MUST EAT!** Big pay jobs. Free employment help. Thousands of successful graduates.

Buying, cutting, percentage, pricing, advertising, selling, etc. A complete retail meat education. National School established over 30 years. Get National training **NOW**. Pay your tuition in easy weekly payments

after you graduate. Send coupon for **FREE** 52 page school catalog — **TODAY**. G.I. approved.

National School of Meat Cutting, Inc., Dept. 50-J, Toledo 4, Ohio

Send me your **FREE** school catalog on National Training at Toledo in Meat Cutting, Meat Merchandising and Self Service Meats. No obligation. No salesman will call.

Name _____ Age _____

Address _____

City _____ State _____

Approved for training Korean Veterans

FORTUNES IN EXPIRED PATENTS

1037 Patents Now Legally Available for Your Own Use!

- Revealing Formulas
- Many New Inspirations
- Manufacturing Means
- Improvements & Perfections for Your Own Ideas

Yes, Bulletin of Expired Patents is a Mine of Unclaimed Fortunes! Men with vision, who look to the future, plan ahead through the Bulletin of Expired Patents.

Only \$2.00. Send for Your Copy Today to:

NEW YORK RESEARCH BUREAU

220 Cabrini Blvd. New York 33, N. Y.

Famous AUTO-LOADING JOHNSON 30/06 RIFLES

4 Models • \$68.50 up

BEST FOR BIG GAME!

Lightning-fast action, superb balance, accuracy. National Rifle Association Tested! Dealer Inquiries Invited

FREE! ILLUSTR. FACTS. (encl. 10¢ for handling)

WINFIELD ARMS CORP., Dept. P9, 409 E. PICO BLVD., L.A. 15, CALIFORNIA

SAY YOU SAW IT IN POPULAR MECHANICS

HANDS TIED?

—because you lack a **HIGH SCHOOL DIPLOMA**

• You can qualify for an American School Diploma *in spare time at home!* If you have left school, write or mail coupon for **FREE** booklet that tells how. No obligation of any kind.

OUR 57TH YEAR

AMERICAN SCHOOL, Dept. V645
Drexel at 58th, Chicago 37, Illinois

Please send **FREE** High School booklet.

Name _____

Address _____

City & State _____

Canadian Residents: Complete Canadian Course Available. Write American School, 1010 Sherbrooke St. West, Montreal.

Get info.. PLASTIC LAMINATING AT HOME!



THIS MAN ..
... is taking out of the machine a Plastic Sealing Job — ordered by mail — only 11¢ in material cost brings back \$2.58 in cash by mail. Capacity of machine: **\$25.00 profit per hour of operation.**

Get **ORDERS** and **CASH** from your mailman—do work in **SPARE TIME** at home —or expand into **FULL TIME** business.

Send coupon for Free facts about the newest and most fascinating of all home operated businesses. For the first time a simplified machine brings the fabulous profits of **Plastic Sealing** and **Plastic Laminating** within the reach of the small operator. Anyone can learn to operate the machine with a few minutes practice—then with our **Magic Mail Plan** can get mail orders pouring in daily with cash in every envelope. **No canvassing—no selling.** We even

Make \$20 to \$30 a Day by.. MAGIC MAIL PLAN!

supply the circulars you mail to bring back cash and orders. Don't waste a minute. Rush your name. We'll send you **FREE** and postpaid, pictures, prices, details, and all the facts you need to start. Mail coupon or send name on postcard. No charge. Warner Electric Co., 1512 Jarvis Av., Dept. L-10-K, Chicago 26, Ill.

Make Thousands of Beautiful Art Creations

- COSTUME JEWELRY • CIGARETTE BOXES TRAYS • CANDLESTICKS • COASTERS LAMP BASES • BOOK ENDS...ALL IN SPARKLING COLORED PLASTIC**



WARNER ELECTRIC CO., 1512 Jarvis Av. Dept. L-10-K, Chicago 26, Ill.

At no cost to me, please rush complete details postage prepaid. I am under no obligation.

Name _____

Address _____

City _____ Zone _____ State _____

SUDDENLY...

your whitewalls look new again... and easily too. Read on. You'll find why.



Whitewalls come clean in a hurry with LILY WHITE—one of the many Hollingshead automotive products included in the Service Center pictured above. This Service Center identifies the stations that really know how to take care of your car.



R. M. *Hollingshead* CORPORATION
Camden 2, New Jersey

SEND ONLY \$1 for next 6 issues of famous DELTA-GRAM, best home woodworking magazine you ever saw. Packed with shop-tested ideas—12 to 15 in each issue. Send \$1 (no stamps) to: Delta Power Tool Division, Rockwell Mfg. Co., 502J N. Lexington Ave., Pittsburgh 8, Pa.

The New Improved Model 38-98J DYNAMIC POWER TOOL COMBINATION

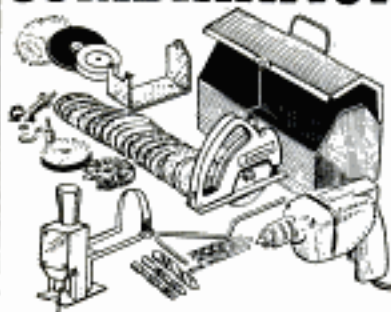

INCLUDES: Cummins 1/2" Pistol-Grip Electric Drill; Cummins Saw Attachment; Combination Saw Blade; Set of Drills; Lamb Wool Sander; 13 Sanding Discs; Steel Arbor and Attachments; Cloth Buffing Wheel; Grinding Wheel; Wire Wheel Brush; Steel Paint Mixer; Steel Bench Stand; Portable Steel Carrying Case; also Arc Jig Saw Attachment which does the work of a Jig, Coping, Keyhole and Hacksaw. Cuts circles and intricate patterns, making its own starting hole.

Includes seven blades for wood, metal, plastic, wellboard, etc. Built-in air blower removes sawdust as you go.

Price of Model 38-98J complete is \$42.85.

SHIPPED ON APPROVAL
No Money With Order — No C.O.D.

Try it ten days before you buy. If completely satisfied then send \$12.85 and pay balance at rate of \$7.50 per month for 4 months — No Interest or Carrying Charges Added. If not completely satisfied, return to us, no explanation necessary.

KAPNER HARDWARE, INC.
Dept. A-112 224E Second Ave., N. Y. 29, N. Y.
Please rush 1 Dynamic Power Tool Combination. I agree to pay \$12.85 within 10 days after receipt and \$7.50 per month thereafter.

Name _____
Address _____
City _____ Zone _____ State _____

START YOUR OWN BUSINESS

OR ADD TO YOUR PRESENT ONE

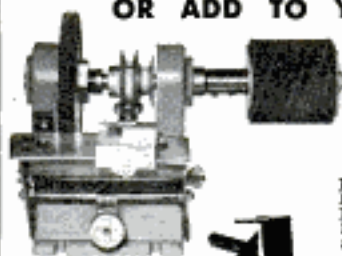

BRAND NEW ALL-IN-ONE SHARPENER
Precision Made Ball Bearings

Does perfect job on Scissors, Knives, ADJUSTABLE POPULAR MAKES PINKING SHEARS, etc. No other sharpener offers such accuracy and easy operation.

ORDER TODAY **\$69.50** F.O.B. Factory

WILL PROVIDE STEADY, IMMEDIATE, YEAR ROUND INCOME, \$75-\$125 a week. No skill required. Complete instructions supplied. For use on truck, workbench, door to door; establish routes among butcher shops, barber shops, beauty salons, etc. BE FIRST in your town—you can make a fine living. Write for folder.

TURPIN-JONES CO., P.O. BOX 1109, PASADENA 1, CALIFORNIA



HAVE A BIGGER — MORE EFFICIENT HOME WORKSHOP

Popular Mechanics PLANNING YOUR HOME WORKSHOP shows you how to make use of every inch of space in your workshop; detailed floor plans, wiring layouts and power tool hookups plus actual photographs of famous home workshops you can use as models. Save money by building your own shop furniture. Special Where-to-Buy-It Guide, 400 Illustrations, Cloth Bound. Working Diagrams. Order your **\$2.50** copy today from

POPULAR MECHANICS PRESS
200 E. Ontario Street Chicago 11

HELPFUL BOOKS

Send post card asking for FREE catalog

Popular Mechanics Press, 200 E. Ontario, Dept. 601, Chicago 11

200 ONE-EVENING PROJECTS

Start and Finish Any One of These Projects in One Evening!

The editors of Popular Mechanics have assembled 200 projects, any one of which you can start and complete in a single evening. In a few hours' time, using only simple hand tools, you can build a coffee table, magazine rack, end table or scores of other useful projects. There are projects for the entire family. Best of all, any one may be built in just a few hours. No special skills are needed. Even if you have never built anything before, you can build the 200 projects in this big new book!

Step-by-Step Instructions, Show-How Photos, Drawings

First you read how to do it in famous Popular Mechanics step-by-step instructions and then actual photos, drawings and diagrams show you how it is done.

Each Project Costs Just 1c

Just imagine! Each project costs you only 1c. Where else today can you get so much for so little? Fill out and mail the coupon now. Full money-back guarantee, of course.



POPULAR MECHANICS PRESS, Dept. EP-1
200 E. Ontario St., Chicago 11, Ill.

Gentlemen:

Remittance for \$2.00 enclosed. Rush postpaid my copy of 200 ONE-EVENING PROJECTS. Unless it is entirely satisfactory I may return it in seven days for a full refund.

NAME _____

ADDRESS _____

CITY _____ ZONE _____ STATE _____

Send C.O.D. (U.S.A. only). Postage extra.

POPULAR MECHANICS

Copyrighted material

STOP CHANGING MOTOR OIL!

End this needless expense forever with

RECLAIMO Today's most advanced OIL RE-REFINING filter FOR CARS, TRUCKS, TRACTORS.

Continuously cleans and RE-REFINES motor oil as you drive by utilizing motor heat — keeps oil in high grade lubricating condition at all times.

"RECLAIMO"

- REMOVES SOLIDS (by filtration)
- REMOVES WATER (by distillation)
- PREVENTS Excess fuel dilution
- PREVENTS Acid and Sludge Formation
- ADDS Thousands of Miles to Engine Life

MAINTAINS Stable Viscosity **ELIMINATES** All Oil Changes
FREE 32-page book "OIL FACTS" with bonafide \$1,000.00 offer on page 30. Gives you the complete "Reclaimo" story and details of our extraordinary 90-DAY NO-RISK TRIAL OFFER. Write for your copy today!

RECLAIMO MFG. CO.

5083 Elston Ave., Dept. M-9, Chicago 30, Ill.
 Wm. Schwelge, U.S. Pat. 1,757,221, 1,834,654, 2,008,473.



DEALERS WANTED

U. S. BUREAU OF STANDARDS, Bul. 86
 States, "Oil does not wear out mechanically."

Guide to HOME REPAIRS



Pays for Itself 100 Times Over

Beat the high cost of home upkeep. Save hundreds of dollars every year on carpentry, electrical, painting, plumbing and other jobs around the house with **Popular Mechanics GUIDE TO HOME REPAIRS**. Simplified how-to-do-it instructions and 640 pictures make all jobs, inside and out, easy. Covers construction, remodeling, modernizing, repairing that you can do yourself at small cost. 192 page cloth bound book only \$2.50 postpaid. Order today under our money back guarantee.

POPULAR MECHANICS PRESS, Dept. PM16
 200 EAST ONTARIO STREET CHICAGO 11, ILLINOIS

FURNITURE for YOUR BEDROOM



SAVE MONEY, be the envy of your neighbors by making this beautiful bedroom suite yourself! Only a power saw and jointer are needed to turn out this smart suite, featuring bed with storage space, three-piece vanity with cosmetic compartment and makeup mirror, Mr. and Mrs. dresser, and twin night stands with drawers. Letters demanding detailed plans poured in after this furniture was pictured in *Popular Mechanics Magazine*. Now the 4 plans are ready—easy-to-follow scale drawings—and they're yours for only \$2.00! Send for a complete set today.

POPULAR MECHANICS PRESS
 200 EAST ONTARIO STREET, CHICAGO 11, ILL.

Send for **FREE** Literature on the New 1955 **MIDWEST TELEVISION and RADIO Line**

Featuring 21" and 27" TV Receivers



NEW LOW FACTORY PRICES

30 DAYS TRIAL EASY TERMS

TABLE MODELS • CONSOLES • CHASSIS

For its 35th Anniversary Year Midwest offers sensational values in big-picture VHF or All-Channel TV receivers in your choice of mahogany, walnut, or blond finishes with new performance features and long-distance reception. Also new 1955 Midwest 5-band Series 16 radios and radio-phonographs. Buy your new Television or Radio receiver direct from the Midwest Factory on 30 Days Trial... Easy Terms... and at **LOW FACTORY PRICES!**

SEND THIS COUPON ON 2¢ POST CARD FOR NEW 1955 FREE MIDWEST LITERATURE	MIDWEST RADIO & TELEVISION CORP.	
	Dept. 252, 909 Broadway,	Cincinnati 2, Ohio
	NAME _____	ADDRESS _____
	CITY _____	ZONE _____ STATE _____

Say You Saw It in *Popular Mechanics*

ADDING MACHINE DIALS like a PHONE

- Fast • Accurate • Dials the Answer • Adds and Subtracts Up to a Million • A Ruler • Flat
- No Moving Parts • Fits into Pocket or Purse • Fully Guaranteed • Nothing to Learn • Start Using Right Away! \$1.00 plus 25c post and handling charge.

M-9m **UNIVERSAL MAIL MART, Inc.**
 27 East 22 St., New York, N. Y.



LOUDSPEAKER Intercom

OFFICE, HOME, FARM, DEN, GARAGE, HOBBY ROOM
TWO LOUDSPEAKERS, desk type with power to hear plainly all over the average room! **TWO INTERCOM MICROPHONES** (see illus.) with simple pushbutton operation! No plug-in necessary. Four standard flashlight batteries (concealed) power this sleek, handsome system — including mikes and full 4" Alnico V speakers. All you do is connect it up!

FULL GUARANTEE — return in two weeks for full refund if not perfectly satisfied. Purchase price includes: 2 desk loudspeakers & cabinets, 2 mikes, 4 batteries, 25' wire. Send check, cash or money order (\$3 deposit for COD). California residents add 3% state tax.

SAVES STEPS SAVES TIME



\$9.95

23 CRAFT BLDG., 5864 HOLLYWOOD BLVD., HOLLYWOOD 28, CALIF. POSTPAID



Cadmus Industries

Don't hide the grain!

INSIST ON



RESIN FREE
(ALL OIL BASE)
Liquid Raw-Hide
FINISHES for
REDWOOD

CEDAR, MAHOGANY,
CYPRESS, FIR, ETC.

Even long lasting Redwood needs surface protection. The Original Resin Free Liquid Raw-Hide Redwood Finishes are now available in: Natural Clear-Gloss or Dull; Redwood Color Stain & Sealer #3, \$1.75 Qt., \$5.30 Gal. Also Redwood Color Preservative #4, a penetrating stain drying within rather than on the wood, \$1.40 Qt., \$4.40 Gal. Prepaid. Guaranteed. Complete Redwood Finishing Instructions with every order or free on request

LINSEED OIL PRODUCTS CO.
1122K SO. FREMONT AVE. ALHAMBRA, CALIF.

"Specialists in Resin Free Finishes"

Extra-hardened at points of extreme wear. Last longer.



WHEN YOU DO IT YOURSELF

USE GOOD TOOLS

For those 101 jobs around the house, the auto and the yard, good tools get the work done faster and easier.

UTICA® pliers and adjustable wrenches are good tools, skillfully forged for rugged strength. And UTICA extra-hardens jaw surfaces and cutters for longer wear.

Your dealer has UTICA TOOLS® or can get them for you. It will pay to remember the name—UTICA.

U T I C A

DROP FORGE & TOOL CORP.

Utica 4, N. Y.

SAVE HUNDREDS OF DOLLARS with HOME-A-MINUTE "KIT"

This is not something to fool around with. It is a hard hitting he man system of saving big money when you build or remodel



Design and build your New Home, Attic Flat, Extra Bedrooms or Remodeling—IN MINUTES—with over 100 transparent plastic partitions, Doors, Windows, Kitchen Cabinets, made to

scale same as blueprint. THEN, BELIEVE IT OR NOT, YOU, THE LAYMAN, who knows nothing about building, can estimate your own costs — IN MINUTES — after you adjust charts to local prices. Don't build anything until you get this "KIT" if you want to save money. Handbook tells you how. This information should not pass you by. Complete "KIT" \$5.95 ppd., or COD plus postage. \$1 deposit required on COD orders. Handbook without "KIT" \$1.95 or free literature. Money back guarantee. Return in 10 days. Dealer inquiries invited.

R. J. HALL & CO.

3824 W. ROOSEVELT DR.
MILWAUKEE 16, WIS.

SHOPMASTER'S

NEWEST SENSATION

COMBINATION POWER TOOL



It's... One Saw, Drill Press, Sander, Router, Shaper, Lathe All in One

For Complete Information Write Dept. 10N
1214 S. 3rd St., Minneapolis, Minn.

SHOPMASTER, INC.

MACHINE TOOL RECONDITIONING

& THE ART OF HAND SCRAPING

— ILLUSTRATED —

SEND TODAY FOR FOLDER DESCRIBING BOOK

MACHINE TOOL PUBLICATIONS, 382 Holly Ave., St. Paul 2, Minn.

WAR SURPLUS BARGAINS

SEND FOR

1954-55

SAVE UP TO 80%

OVER 200 Big Values

FREE Catalog

SIoux FALLS SURPLUS STORE
SIoux FALLS S. DAK.

Say You Saw It in Popular Mechanics

DRIVE 500,000 MILES

Without Need Of A Major Overhaul ENGINEERS HAVE PROVEN THIS POSSIBLE. They have shown that the combustion process produces more than a gallon of water in vapor or steam for every gallon of fuel burned. Some of these vapors enter crank case causing rust, varnish, acids and sludge.

INSTALL POWER VENTILATION— GET UP TO 2 or 3 MORE MILES PER GALLON— CUT ENGINE WEAR UP TO 40%—

Increase the overall operating efficiency of your car with amazing Moto-Vent. Positive Power Ventilation removes water vapors, sulphur and other corrosive materials that enter crank case. Not a "gimmick" or "swagel" but a precision engineered instrument designed to give better engine performance, up to 2 or 3 more miles per gallon and cut engine wear up to 40%. Oil and water vapors are fed back into the combustion chambers where they give you water injection and overhead lubrication. No extra oils or additives needed.

EASY TO INSTALL—DO IT YOURSELF. Fits all cars, trucks, tractors—old or new. Install Moto-Vent between oil breather and intake manifold in less than half hour. Will soon pay for itself.



FREE 30 DAY TRIAL OFFER. Moto-Vent complete with all fittings and easy to follow installation chart only \$4.95 postpaid, or, C.O.D. plus charges. Try for 30 days. If you are not completely satisfied, return for full refund. Send order or write for further FREE particulars, today!

PRECISION PRODUCTS CO.,

Dept. 22

Harvard, Ill.

POPULAR MECHANICS

Copyrighted material

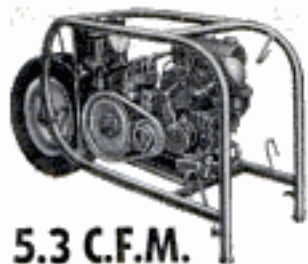

AIR COMPRESSOR

SURPLUS! NEW Gov. Release!
Original Gov. Cost \$350.00

The Finest 2-H.P. TWIN CYLINDER Industrial Unit Ever Built! Fully Guaranteed
\$129.00 f.o.b.
200 lb. PRESSURE

5.3 C.F.M.

Maintains 40 to 65 lb. pressure for **CONTINUOUS** spraying (no waiting 'til tank keeps building up)

Made by **BENDIX WESTINGHOUSE** to rigid specifications. A BUY for Contractor; Factory; Garage; Service Station; Shop; **FARM! PORTABLE!** Two independent air outlets—one for high pressure (up to 200 lbs.)—the other controlled by regulator from 0 to max. Large face gauge. Adjustable safety valve. Automatic unloader (adjustable up to 200 lbs.) keeps pressure constant without stopping engine. Welded hollow frame acts as air reservoir... assuring large supply of **OIL-FREE** air with **ABSOLUTELY NO PULSATION!** Sprays with material of any size. **Facilities for:** Spraying; Greasing; Tire inflation; Blowing out heating and refrigeration lines; Small pneumatic tool operation; Insecticide dusting and spraying; Flocking; Undercoating! **SPECIFICATIONS BELOW:**

—COMPRESSOR—

- Mfg. by **BENDIX WESTINGHOUSE**
- Twin cylinder
- 4 rings on each piston for added compression—variable of pumping 1100 lbs. p.s.i.
- Forced pressure lubrication assures oil to every moving part
- Ball bearing construction
- Capacity 5.3 cu. ft.

—ENGINE—

- Mfg. by **HIGGINS & STRATTON**
- Kick or rope start
- 2 H.P., 4 cycle air cooled
- Splash lubrication system
- 2-qt. gas tank
- Final fuel carburetor with adjustable idle speed and automatic governor
- 3 Piston rings

ALSO AVAILABLE! Same unit with 1 H.P. Electric Motor. **\$129.00** f.o.b.

IMMEDIATE DELIVERY! SUPPLY LIMITED! ORDER FROM AD FREE Catalog of Motors and Electrical Equipment
ROBERTS ELECTRIC CO., Dept. P-212, 849 W. Grand, Chicago 22, Ill.

SURPLUS GIGANTIC SALE SAVE UP TO 85%

New Hi-Speed Drills
"O" ca. 1/50"-1/4" \$3.50
10 ca. 1/4"-1/2" \$3.50
(Assorted sizes)

IMPORTED PRECISION SQUARES

Accuracy Blades—Tempered Precision Ground

2" 1.50	6" 2.30	Mfr.
3" 1.70	8" 2.80	Guar.
4" 1.90	10" 3.80	Cert.
5" 2.10	12" 4.80	Incl.

8 pc. Comb. Set 2" to 12" 19.95

METRO PRECISION TOOL CO.

D.C. GENERATORS For Welding
P.I. 24V, 200 Amp. \$12.50, M.I. 30V, 300 Amp. \$21.50, P.I. (New) 200 Amp. \$22.50. In- Guaranteed including Diagram.

ALTIMETER SALE
(New) 0-20,000 Increment 200 ft. \$4.50. Sens. Perf. (New) 0-35,000 Increment 20 ft. **\$9.95**

Cal. 15c or Free with Order
Check or M.O. 25% dep. on C.O.D. — F.O.R. L.A.
1507 S. La Cienega
Los Angeles 35, Cal., Dept. M9
Phone: BRadshaw 2-2528

HELPFUL BOOKS

Send post card asking for **FREE** catalog
Popular Mechanics Press, 200 E. Ontario, Dept. 601, Chicago 11

DO IT YOURSELF KIT FOAM RUBBER SOFA BED \$160 Val.

Save over \$100. Sofa by day—single bed by night. Easy assembly. 6' 3" long. "No Nail" springs. Goodyear 3 1/2" Air Foam mattress. Presewn covering. Tan, Gray, Green, Red, Money back guar. Order now. \$10 deposit. Bul. C.O.D. Or write for literature.
BESTCRAFT CO., Dept. 79
Mathison Bldg., Balto. 2, Md.



ENJOY YOUR OWN BUSINESS

Start earning at once—No special experience required
STAND-ALL Model 7
10-in-one Automatic Saw Sharpener
A shop in itself.

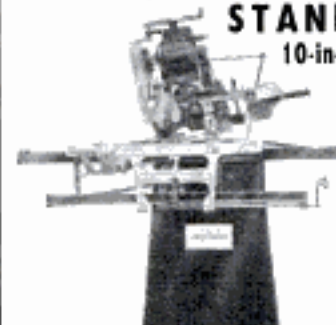

Reboots and sharpens 10 types of saws—hand rip, hand cross cut, nail, mitre, pruning, docking, back, metal cutting band, wood and metal cutting circle saws. Chart settings make operation positive and accurate! Simple adjustments give any shape tooth desired. Small down payment. Balance low monthly payments from earnings.

WRITE, PHONE, OR WIRE FOR DETAILS TODAY!

SMITH-NIELSEN EQUIPMENT CO., MFR. OF SAW GRINDERS
902 NORTH NORMANDIE SPOKANE, WASHINGTON
Teletype SP13 Phone Madison 2161

Koenig ALL-STEEL CABS for JEEPS SAFETY FOR PASSENGERS AND CARGO

- ★ **PROTECTION**—from weather and burglary.
- ★ **SAFETY**—All-steel, welded construction. No rivets. Safety glass used throughout.
- ★ **COMFORT**—Full air-spaced head lining and door lining. No vibration.
- ★ **CONVENIENCE**—Roll-down windows, full opening.

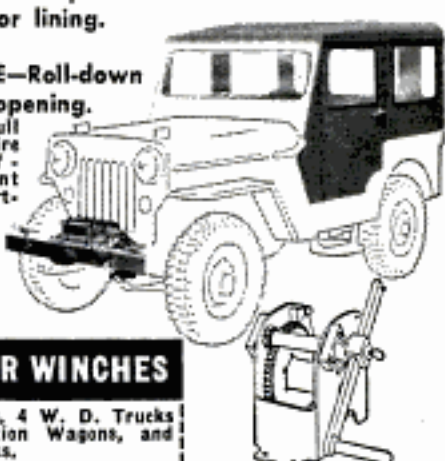

KING POWER WINCHES

For all Willys Jeeps, 4 W. D. Trucks and 4 W. D. Station Wagons, and all other make trucks.
Gets you out of mud, sand, snow—out of ditches or gullies, and up hills. Moves machinery, logs and heavy objects. Makes hoisting or clearing jobs easier, safer.
KOENIG CABS AND KING WINCHES available through **KAISER-WILLYS** Distributors and Dealers.

KING GALVANIZED HAND WINCHES
Tested over 1000 lbs. Capacity 100' 1/4" cable. All-steel construction with bronze bearings. Mounts horizontally or vertically. Right or left hand. Adjustable handle lever. Positive ratchet, either direction.

Koenig Free Write for descriptive literature.
IRON WORKS
Dept. M. 2214 Washington Ave. HOUSTON 10, TEXAS



45c
A QUART

GREATEST PROTECTION for engines!

- Richer, tougher lubrication for your engine because it's 100% Pure Pennsylvania... specially refined from nature's finest Pennsylvania crude.
- Complete protection for your engine because it's scientifically fortified... guards against sludge, corrosive acids and rusting.

BE PARTICULAR! INSIST ON WOLF'S HEAD!

WOLF'S HEAD OIL REFINING CO., INC.
OIL CITY, PA.
GLENDALE 27, NEW YORK

Opportunity for Men with Automotive Background and Executive Ability

Manufacturer and marketer of nationally-advertised line of automotive products now expanding operation here and abroad. Distributors needed to warehouse and administrate to growing dealer network. If you have organizational ability and are financially responsible, write for details.

Your inquiry held in confidence; Write: Box P.M.-9, 10418 Venice Blvd., Culver City, Calif.

DO MORE PLANING JOBS WITH LOW COST BELSAW



Exclusive MONEY-MAKING Features: • Full 12 1/2" x 6" capacity • Power feeds at 24" a minute • Provides for Grinding Knives in the Cutterhead • Attachments for Jointing, Rabbling, Tongue, Groove, Matching. Convert low cost rough lumber into high priced cabinet finished stock... Easy to make flooring and popular patterns. Send today for free literature and prices.

Belsaw Machinery Co., 1011 Field Bldg., Kansas City II, Mo

LOW DOWN
PAYMENT
EASY
TERMS



Treasure - Minerals - COINS

Easily located with new Light-weight M-Scope Detector. Superior performance, lowest price, monthly payment plan.

FREE LITERATURE
FISHER RESEARCH LAB., INC.
PALO ALTO CALIF.

NEW UHF CONVERTER-\$7.50

It's new! It's guaranteed! A converter you can install! Use on any set having either fine tuning control or a continuous tuner.
THE PHILDYNE CO., Box 273, Berkeley 21, Mo.

MORE For Your Money in a SHAW "DU-ALL"



Improved design, better value in 1 1/2, 2 1/4, 3, 5 H.P. walking tractors. New, low cost, streamlined 2 1/4, 5, 8 H.P. riding tractor. Inexpensive, new 1 1/4 H. P. tiller that pulverizes up to 12 inch swath 6 inches deep, and less. Automotive gears on heavier models. Prices will please you. FREE CATALOG. Write today: 4509 Front St., Galesburg, Kans.

SHAW MFG. CO. 6880 N. 4th St., Columbus, Ohio

Say You Saw It in Popular Mechanics



SURPLUS SALE

\$39.50 NEW TOOL POST GRINDERS REGULAR PRICE \$125.00

1-6 H. P. MOTOR
TAKES WHEELS UP TO 1/2" x 4"
EXTRA QUIET INTERNAL OR INTERNAL \$19.50
MONEY BACK GUARANTEE
EDWARD J. NOLAN, PULASKI, NEW YORK

FREE AMAZING NEW BOOK "HOW TO ANSWER ADS"



Never before have you seen anything like this. Tells you in simple language the correct way to answer ads. Gets you quicker replies—better results, and greater satisfaction. Will save you time and money and it's ABSOLUTELY FREE. No obligation whatever. Every reader of advertising should have this booklet. Send a postcard for your copy NOW. F. W. JOHNSON, Popular Mechanics Magazine, Room 600-A, 204 East Ontario Street, Chicago 11, Ill.

Now first time offered direct "factory-to-you"

Alum-Aire
permanent type
FILTERS

Engineered to last a lifetime in your air-conditioning or warm air heating system

Revolutionary new permanent-type filters for top economy and efficiency in cleaning air safely and completely. Approved by industry and U.S. Govt. agencies. Send check or money order with size required. Shipped prepaid.



Easiest cleaned filter on the market — simply flush with water and replace. No messy oils or adhesives. Absolutely rustproof and fireproof.

Size	1"	2"
10" x 20"	\$7.50	\$8.50
15" x 20"	8.50	9.50
16" x 20"	8.50	9.50
16" x 25"	9.50	10.50
20" x 20"	9.50	10.50
20" x 25"	10.50	11.50

Prices other popular sizes on request
(All products add 3% State Sales Tax)

Carey Metal Wool Division
ELECTRONIC ENGINEERING CO.
Dept. PM-1 Springfield, Ohio

DO-IT-YOURSELF!



Modernize with prefinished MARLITE PLANK & BLOCK

A hammer, saw, and level are all you need for beautiful walls, quickly installed. Planks (16" x 8") and Blocks (16" square) with exclusive tongue and groove joint are easily applied over old or new walls. Soilproof baked finish fused to a tempered hardboard never needs painting, cleans with a damp cloth. Ten "Companion Colors," plus 4 distinctive wood patterns, practical for every home interior.

Write for free folder and do-it-yourself instructions, or see your lumber dealer. Marsh Wall Products, Inc., Dept. 942, Dover, Ohio. Subsidiary of Masonite Corp.

Marlite
REFINISHED
WALL and CEILING PANELING

Marlite Plank and Block
Patent Applied For

Made with genuine Masonite® Tempered Duolux®

FOR THE JOB ON YOUR HANDS . . . There's A WOLVERINE GLOVE TO FIT!



GREATER COMFORT for you in Wolverine work and utility gloves. Tough, long-wearing pigskins, horsehide and deerskin—triple tanned by Wolverine's secret process—stay soft, even dry out soft. 117 styles. Choose the Wolverine for your job at your local dealer.

Special Get Acquainted Offer!

5-PIECE RATCHET SCREW DRIVER KIT

\$1.98 VALUE FOR ONLY **\$1.00**

Kit consists of a lock-tight, shock-proof ratchet handle and 4 different screwdrivers (3 regular and 1 Phillips style). Bits are made of tool steel. Packed in handy packette. Unconditionally guaranteed. This special "get acquainted" offer is made so that you will think of WOLVERINE when you need work gloves. Send only \$1.00 to: Wolverine Screwdriver Kit, 310 W. Washington Blvd., Chicago 6, Ill. (Please print name and address plainly...allow 2 weeks for delivery.)



WOLVERINE SHOE & TANNING CORP. ROCKFORD, MICHIGAN

TOUCH UP nicks, scratches, bruises with "MATCH-IT" spray bomb lacquer mixed-to-match YOUR CAR'S COLOR!

\$3.00
12 oz.

WE GUARANTEE to match any original finish on any model from 1940 on!

Now with MATCH-IT, the amazing new, matching spray lacquer, you can remove unsightly stone bruises, door nicks, scratches and other finish blemishes . . . or paint fender skirts, sun visors and similar accessories in a matter of minutes—with no fuss! no fuss! **YOU JUST PUSH A BUTTON** and the MATCH-IT can's fine mist nozzle applies a beautiful high gloss lacquer that dries in minutes to a gleaming luster without rubbing . . . giving you the equal of an expensive, professional job. **CUSTOM MATCHING** to your car's finish. The makers of MATCH-IT use the same mixture and paints as were specified by the manufacturer in the original finish on your car. MATCH-IT is guaranteed to match within one percent of original factory color! **CAUTION!** MATCH-IT is mixed to match original factory finishes only—not repaints. (NOTE: Where primer is needed, order MATCH-IT automotive primer, 6 oz. can, \$2.00, 12 oz. can, \$3.00.)

YOU SAVE THE COST OF A COMMERCIAL JOB by doing it yourself. Refinishing a scratched area on your car costs only pennies instead of dollars. MATCH-IT's new self pressurized paint and spray head enables you to spray paint on like a professional . . . Anyone—even a child can do it!

REFRIGERATORS, WASHERS, KITCHEN CABINETS can also be spray painted with MATCH-IT's beautiful, long-wearing Appliance White. Also available in modern Wrought-Iron, Flat Black.

PREVENT destructive rust and corrosion in the winter months ahead. Just write the make, year and original paint color of your car on a piece of paper, and enclose it with check or M.O. for \$3.00 in an envelope addressed to:

MILWAUKEE paint products co., inc.
Dept. M-1, 2600 W. North Ave., Milwaukee 5, Wis.

DRILL • SAW • REAM • CUT ALL WITH ONE BIT!

BEAVER SPEED SAW DRILL BIT



ONLY **\$2.45** each
3 for \$7.00
POSTPAID

Beaver's new improved high speed side cutting drill bit can be used on any electric drill, drill press, lathe or milling machine. Made from the finest American high speed steel. 3 1/2" long, 2" side cutting section, 1/4" diameter. Designed to cut steel, wood, plastic, aluminum, etc. A versatile time-saving tool for EVERYONE. Money back guarantee! Three types available: All-Purpose, Wood and Heavy Metal—specify type desired. Buy them from your dealer today! Or send cash, check or money order NOW.

Distributor inquiries invited.

BEAVER DRILL & TOOL COMPANY, Div. PM-9
701 East 5th Street • Kansas City 5, Missouri

SAVE MONEY on SURPLUS PARTS for MILITARY TYPE TRUCKS & JEEPS

4 & 6 wheel drive. FREE catalog. State make of truck or Jeep. (New Jeep Tops, steel or canvas for all models). **AMERICAN AUTO PARTS CO., Inc.**, 1830 Locust, Kansas City, Mo.

SAY YOU SAW IT IN POPULAR MECHANICS

NOW! . . . A COMPLETE, PORTABLE OXY-ACETYLENE WELDING & CUTTING OUTFIT



WEIGHS ONLY 65 LBS. COMES IN A STURDY, COMPACT CARRYING CASE WITH HANDLE. Ideal for: Machine Shops, Garages, Wreckers, Farmers, Metal Workers, others. Does the job *instantly* where and when you need it. Includes two sets of double dial regulators, filled tanks, Benz-O-Matic Torch, goggles, M. S. welding rod, hose and necessary components. Pays for itself quickly. Nothing like it anywhere! Complete . . . \$129.95. Write for detailed folder.

A. AGUADO TRDG. CO., Box 4525 Plaza Sta., St. Louis, Mo.

SEND ME



every month so I am sure to see each new issue. Here's

- \$3.50 for 1 year
 \$8.00 for 3 years

name _____

address _____

city _____

zone _____

state _____

Hand this order to your newsdealer or send it to

POPULAR MECHANICS
200 East Ontario St. Chicago 11, Ill.



SAVE \$15 to \$35

Assemble It Yourself!
**BIG 10 INCH
 POWER SAW
 KIT \$14⁹⁵**
 BUDGET TERMS

\$5 Down
 \$5 Monthly

Why spend \$29 to \$49 for a power saw when you can easily build one yourself with a few pieces of inexpensive lumber and this kit. You get all machined metal parts plus all the screws, nuts, bolts, and washers you need and complete detailed assembly instructions. Make a complete he-man saw that cuts hard or soft woods up to a full 3 1/2 inches thick . . . cuts 2x6s in 2 1/2 seconds. Makes frames, joints, slots, etc. Rips wide or narrow panels, cuts any angle. Cuts joists, siding, rafter. Build and repair furniture and equipment for your home, farm, shop, or office. Table measures 24"x20" and tilts to 45° angle. *Only \$14.95 with blade, postage prepaid.* Money back guarantee. Write for complete details.

Yolanda Precision Tool Co. PM 954, 20 Baylston St., Boston, Mass.

URANIUM - SCOPE

Here is a precision built optical instrument used to detect radioactivity from Uranium Ores. This is one of the most sensitive detectors of natural radioactivity, without investing in costly electronic equipment. This instrument is made of sturdy, protected aluminum, with precision optical parts, to give it unlimited durability in the field and laboratory use. URANIUM-SCOPE is furnished with Uranium ore sample and packed in attractive box.

Send Check or Money Order — No C.O.D.'s
KOSCO, INC. OF CALIFORNIA
 Dept. 17N11 Suite 910 Tishman Bldg., 2460 Wilshire Blvd.
 Los Angeles 5, Calif.
 *Dealing and Agents Wanted



ONLY
\$3⁹⁵

POST
 PAID

See the
 Bombardment
 of the Atom!
 A
 Scientific
 and
 Educational
 Gift
 for All.

"HANDY TIPS FOR HANDY MEN"

BOOK OF HINTS to make home repairs and hobby projects easier. Send 25 cents in coin to: THE BLACK & DECKER MFG. Co., Dept. H9M, Towson 4, Maryland.

New Accurate 10" SLIDE Rule

Plus 25c Handling

\$1



For multiplying, proportions, division, extracting roots—difficult calculations at lightning speed without paper or pencil. Easy to learn!—ABC 312 page Instruction Book FREE. \$1.00. Professional Model: \$2.00

M-9r UNIVERSAL MAIL MART, Inc., 27 E. 22 St., N. Y., N. Y.

SAY YOU SAW IT IN POPULAR MECHANICS

PRECISION PLIERS

• For accurate, exacting work use the fine, small pliers jewelers and watchmakers use — Kraeuter's Precision Pliers. Matched in size and handle shape, drop forged from selected tool steel, machined and heat treated to exacting specifications. For hobby crafters, model builders, TV and radio technicians.

Buy wherever fine tools are sold in U. S. and Canada.

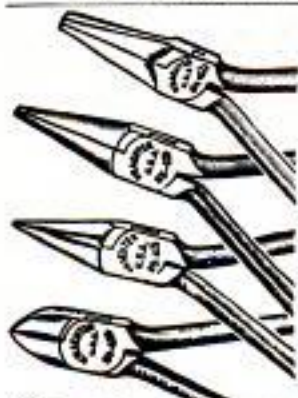

KRAEUTER

Your Car's Water Pump needs Lubrication, too!



The heart of your car's cooling system is the pump that circulates the water. Completely enclosed, your pump never derives benefit from the lubrication applied regularly to other parts of the car, yet it operates continuously while the engine is running.

Permatex Water Pump Lubricant provides the internal lubrication that every water pump should have. It mixes perfectly with cooling system water and anti-freeze to thoroughly penetrate the moving parts of the pump. It prolongs pump life—prevents wear and squeaking. Contains Anti-Rust to keep the radiator water supply crystal clear. Prevents rust for entire season.

Install one can of Permatex Water Pump Lubricant now. Available at garages and service stations everywhere. The distinctive Permatex label has been a guarantee of quality for over 45 years. Permatex Company, Inc., Brooklyn 35, N. Y.

PERMATEX Water Pump Lubricant and Radiator Anti-Rust

Over Fifty Chemical Products for Better Automotive Maintenance

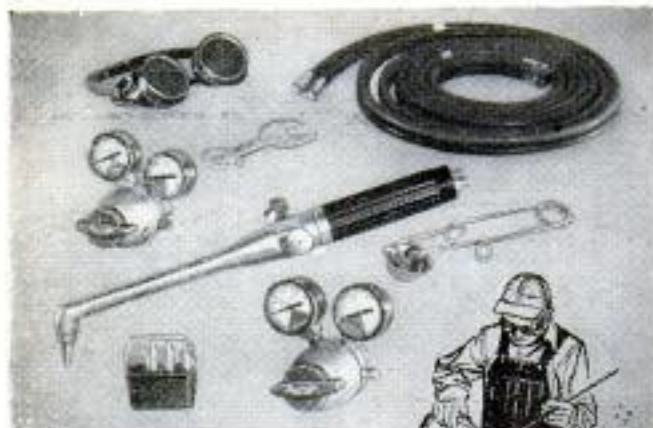

WELDS, CUTS, HEATS

No attachments needed

PREST-O-LITE Oxy-Acetylene Outfit

Trade-Mark

Change tips—in seconds—to switch from welding to cutting. It's easy. No attachments needed; no time lost changing over.

Slices through heavy steel; welds sheet metal and light plate. There's no limit to the repairs you can make or the useful things you can build. Only \$76.50, as illustrated.

Oxygen and acetylene immediately available in cylinders sized to meet your needs.

Write today for free descriptive booklet.

"Prest-O-Lite" is a trade-mark of UCC

LINDE AIR PRODUCTS COMPANY

A Division of Union Carbide and Carbon Corporation
30 East 42nd Street  New York 17, N. Y.

Take perfect pictures!

USE THE NEW



SKAN

Quick Exposure Meter

Instant reading!

No computing needed!



Correct camera settings at-a-glance for all color or black & white photography!

New color styling! In handsome "Sportsman-Gray" with bright metal trim and smart black and red accents. A full size meter, weighs only 4 oz.

Complete with neck cord in "jewel-clear" Gift Box...
\$17.50
Ever-ready Case...\$1.95

New, full size photoelectric exposure meter eliminates tricky computations and guesswork. Has changeable ASA Index Slides that correspond to all popular films—black & white, color, indoor, outdoor. By merely inserting proper slide in meter you read correct camera settings in 1/stops from 1/2, 8 to 1/22 and speeds from 1/25 to 1/200. Covers entire color film range in 1/3 stops and has special marks for movie settings.



Complete computer dial on back—for special films and light conditions other than normal. Calculates speeds from 1/1000 to full 16 seconds; 1/stops from 1/1 to 1/64; ASA Indexes from .3 to 800.

AT LEADING PHOTO DEALERS EVERYWHERE

SKAN a product of **G-M LABORATORIES INC.**
4230 N. KNOX AVE., CHICAGO 41

NOW AVAILABLE! NEW LEVEL-X Auto Compass



- IT'S A COMPASS
- IT'S A LEVEL GAUGE
- IT'S AN ACCELERATION GUIDE

Patents Pending

Fits any car. Compass easy to compensate with permanent magnet mechanism. Level Gauge shows

20 degrees either side of level, equivalent to a 36% grade. Use it as an acceleration guide for fast starts. Rugged Construction. 10 day money back guarantee. Send for yours now!

Distributors Wanted

Write for details

LEVEL-X, INC.

Suite M-8
627 Salem Avenue
Dayton 6, Ohio

ONLY \$495

POSTPAID IN U.S.A.

Ohio Residents add 15c sales tax



This fine 22 caliber, 7-shot, bolt action carbine, Model 142, weighs only 5 lbs. but packs full power and accuracy. Forend hinged for hand grip or ground support. Peep Sight or Open Sights—your choice. Also in automatic, Model 152 at \$29.95*. See them at your Mossberg dealer's — or send for literature.

ONLY \$23.95*

O. F. MOSSBERG & SONS, INC.

*Slightly higher west of Rockies

49709 St. John St., New Haven 5, Conn.



MINIATURE ENGINES

GASOLINE — STEAM

BUILD THEM YOURSELF — IN YOUR OWN SHOP WITH YOUR OWN TOOLS

Anyone with a 6" or 10" lathe and a drill press can make them.

SEND 10c FOR ILLUSTRATED CATALOG OF MINIATURE ENGINE CASTINGS AND DRAWINGS

OPTURA MODELS
P.O. BOX 536-C PARK RIDGE, ILL.

EARN \$300. BONUS

We will pay up to \$300.00 for information concerning new sources of scrap magnesium which we can buy on a contract basis. Any type of scrap magnesium—borings, shavings, cuttings—scrap magnesium in any form. Many plants today use magnesium and then throw the scrap away. Maybe yours does. Investigate and write today and you may qualify for a bonus of up to \$300.00.

STANDARD MAGNESIUM CORP.

8950 East 41st Street • Tulsa, Oklahoma

Say You Saw It in Popular Mechanics

CUT BUILDING COSTS 2/3!
Make Your Own Concrete BLOCKS and BRICKS To Use or Sell



New superior moulds make absolutely square, true, easy-to-lay blocks which will pass any building code. Production is fast... easy. One durable \$30 machine will make four 5"x8"x12" blocks per minute—1,000 a day. Pays for itself in one day! Sell blocks for big profit... or save 2/3 building cost for yourself. POST CARD BRINGS FREE FOLDER.

ECONOMY MFG. CO.
DEPT. P STONE MOUNTAIN, GA

POPULAR MECHANICS

PENTA-treated wood won't rot!

Dow

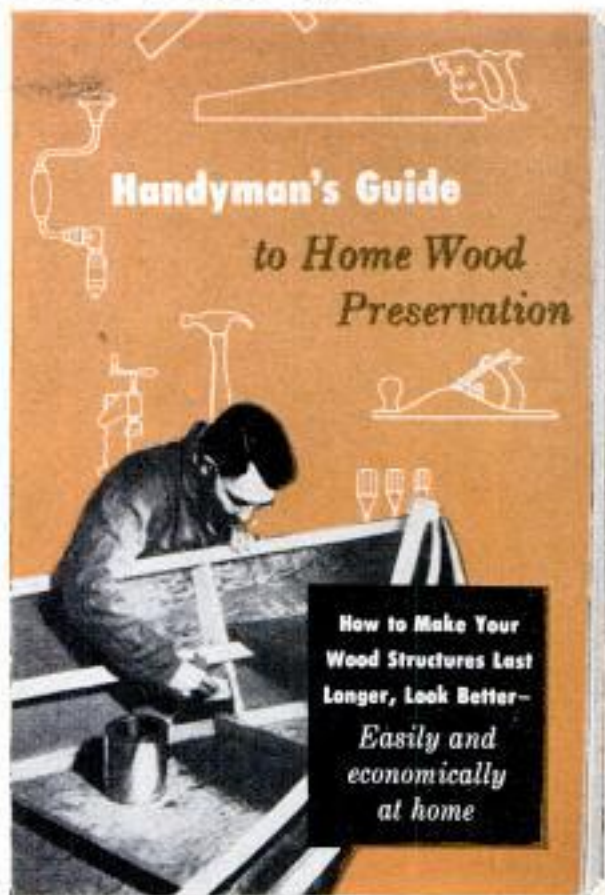

SEND FOR FREE DOW "HANDYMAN'S GUIDE"

Free booklet tells how to stop wood decay and termites with clean, easy-to-apply PENTA

THE DOW CHEMICAL COMPANY
Dept. PE 767N, Midland, Michigan

Please send me FREE BOOK-
LET, "Handyman's Guide to
Home Wood Preservation".

Send the name of my nearest
PENTA dealer.



Name _____

Address _____

City _____ Zone _____

State _____

Whatever your interest—pride in woodworking *craftsmanship*, an eye for money-saving *home maintenance*—Dow's "Handyman's Guide to Home Wood Preservation" belongs on your workbench.

This comprehensive booklet tells how to end rot and termite destruction with a clean water-repellent wood preservative containing PENTA*. It suggests how to enjoy your home and handiwork years longer, without the heavy money losses decay brings.

Wood's natural enemies are catalogued—illustrations show how to recognize them. You'll find full instructions on how to apply PENTA by brushing, spraying and dipping.

Ask your lumber or hardware retailer for a brand-name wood preservative containing *PENTACHLOROPHENOL. When the name PENTA is on the container, you can be sure of making all the things you build with wood last longer . . . *far* longer. THE DOW CHEMICAL COMPANY, Midland, Michigan.

you can depend on DOW CHEMICALS

DOW

DO IT YOURSELF AND SAVE



Cut your heating costs with good insulation. Do a professional job yourself with Bostitch H2B Stapling Hammer. Four times faster, less awkward than nails. Free hand holds work.

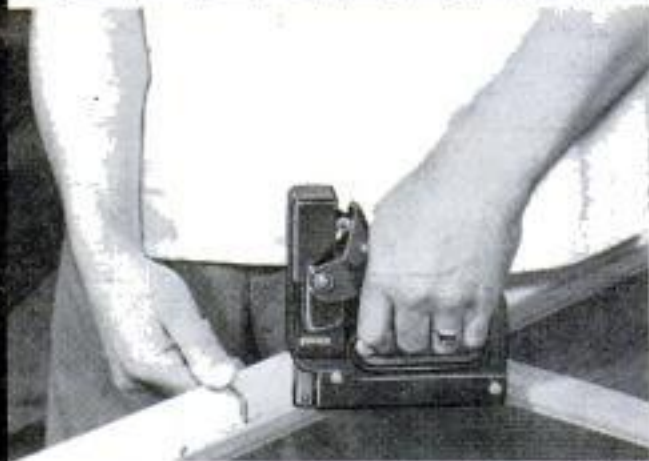

Make drum-tight, wrinkle-proof screens yourself. It's easy when you staple the screening with a Bostitch T5 Tacker. Ask your building supply dealer for easy instructions.



Lay asphalt shingles yourself—or re-shingle sound roofing with old shingles removed. Bostitch H4 Stapling Hammer is twice as fast as nailing, secure against windstorm. Free hand lines up shingles.



Install ceiling tiles and wall planking (tongue and groove). Do it yourself, as professionals do, with Bostitch T5 Tacker. No hammer dents, no dirty finger marks (wear gloves), no messy glue.

Millions of Americans are helping themselves to more enjoyable living with "do-it-yourself" projects that take only a few hours of spare time. *Building Supply Dealers* are glad to help by giving you simple instructions, recommending the right materials, and furnishing these Bostitch fastening tools. If your dealer cannot supply you, send for **FREE** folder No. 282 and give us his name.

Fasten it better and faster with

BOSTITCH[®]
STAPLERS AND STAPLES

BOSTITCH, 549 Mechanic Street, Westerly, R. I.

Please send folder No. 282.

Name _____

Address _____

City _____

Zone _____

State _____

Favorite Dealer _____

POPULAR SEPTEMBER 1954 MECHANICS

WRITTEN SO YOU CAN UNDERSTAND IT
VOL. 102 NO. 3



*Telephone and power lines lie broken
and snarled in the wake of flood, fire,
ice storm and twister*

After Disaster, The Trouble Shooter...

By Richard F. Dempewolff

THE AIR WAS DEAD as the inside of a tomb. Al Sadowski, operator at a substation of the Cleveland Electric Illuminating Company, was shutting the windows against smothering humidity when suddenly his lights flickered. The next thing he knew, his entire station was dead. So were the telephones.

Al didn't know it then, but less than a block away a dirty black funnel, reaching from the eerie overcast, was thundering across town with the roar of a diesel loco-

motive. Hit-skipping its way, the whirling maelstrom was overturning busses, flinging people, bricks, beds, automobiles and entire houses into the air like scraps of paper. One second the brick telephone building stood like a bulwark in the path of the oncoming monster. Then it was minus its roof and a wall.

In ten minutes the tornado had cut a 20-mile swath. Some 200 power and telephone poles were down. Twenty-eight miles of crackling, flashing wire had



grounded or been damaged. Sixty-four transformers were wrecked. Desperate hands reached for telephones only to find them dead. It looked like a total blackout of power and communications with weeks of staggering repairs.

A few years ago it might have been, but not today.

Before the twister hit, Cleveland utility officials readied a disaster plan. When the funnel roared in, 10 two-way radio cars were already feeling their way through sheets of rain to key points of the blueprint. More than 40 crews of linemen, summoned from home, stood beside their squat line trucks. As reports of damage came in from the radio trouble cars, they roared away.

High-speed mobile cranes lifted new poles into holes that had been dug seconds before by giant augers spinning off the tailboards of line trucks. Odd-looking side-armed clamshells carved trenches for new cable as fast as men could walk beside them. Mammoth Bushwackers slammed



Northwestern Bell Co. photo

Long before the 1952 Mississippi flood subsided, linemen were out in rowboats, rigging special lines to service emergency telephones along the levees

through tangled woodland clearing new line cuts. Six-inch trees tumbled before them, crunched in each machine's maw and spewed out behind in a blanket of chips. Double-jointed Skylift trucks hoisted men in steel baskets to hard-to-reach trouble spots between poles.

Fifty-four hours from the time the tornado struck, Cleveland's power was restored and phones were ringing again. Weary men rumbled homeward on their clanking monsters. Many had worked straight through without letup.

In tornadoes, hurricanes, fires, floods and earthquakes, power and communications often are among the first things hit. Keeping telephone lines open and power flowing to hospitals and disaster centers is a vital business in such emergencies. In spite of all the new gadgets that speed things along, the bulk of the job falls on the "infantry" of the telephone and power companies—the line crews. For them, every big emergency is packed with potential dynamite.

When New York was hit by an ice storm in 1953, trees crashed by the thousands, taking telephone and power lines with them across hundreds of square miles.

The night was split by vivid blue flashes and pistol-shot cracks as "hot" lines grounded against wet trees. Line crews of the Consolidated Edison Company waded into a sea of free electricity leaking across wet, icy surfaces, to cut down broken trees

Power lineman has rubber gloves and sleeves, safety belt, climbing irons, tools hung from body belt

Philadelphia Electric Co. photo



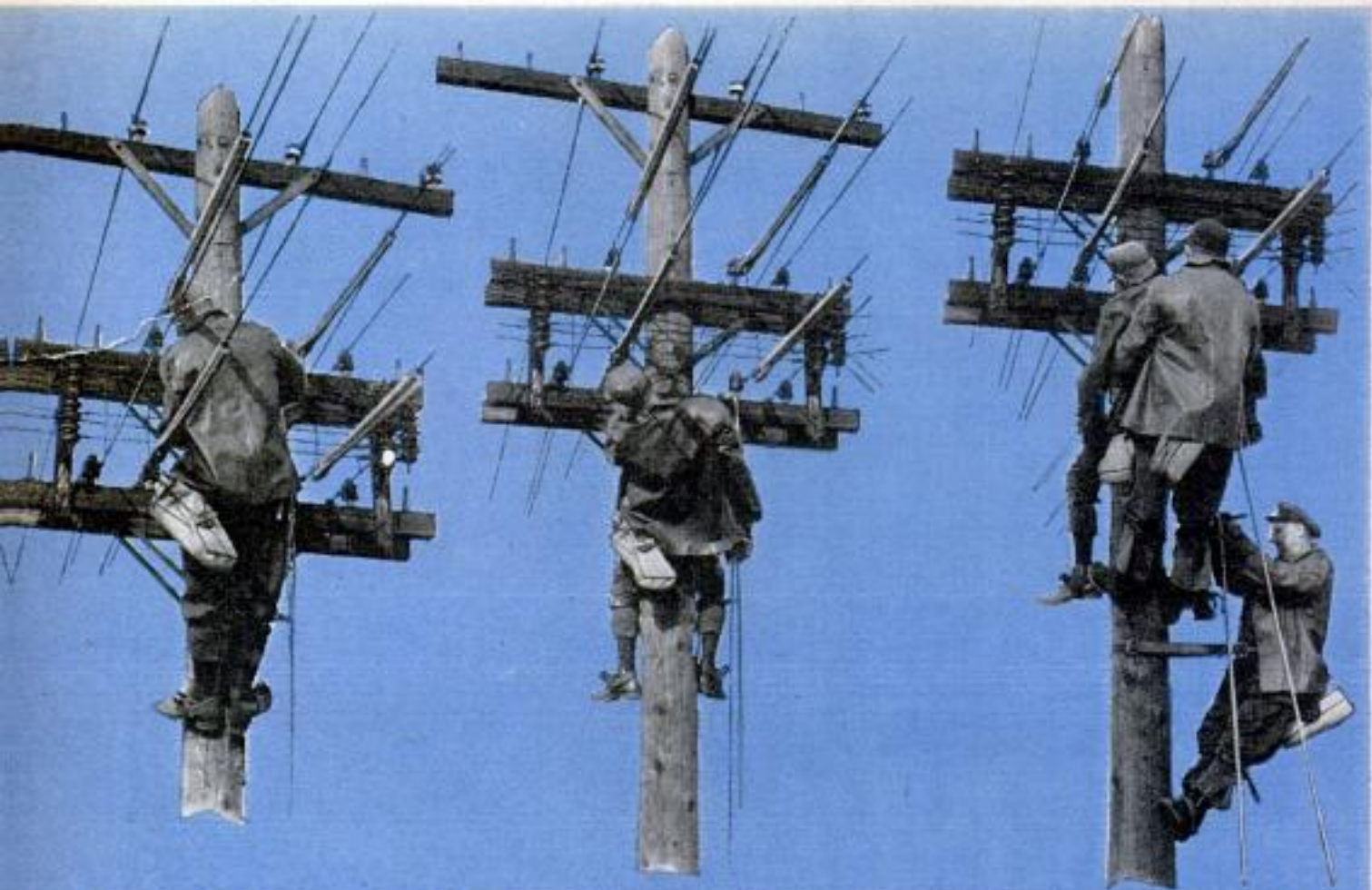

Trouble men of Philadelphia Electric carry out a mock pole-top rescue. Rubber guards placed over line have slipped back, exposing "hot" wire. Worker brushes his head against wire and is knocked unconscious. He falls back against his safety belt and fellow workers rush up pole. One unfastens the victim's safety belt while the other throws a line under his arms and over the crossarm on the pole. Victim is gently lowered to the ground and co-workers administer artificial respiration



and poles festooned with ice-coated wires. But before a line was cut, the men had to be sure trees draped over it didn't fall on houses, cars, people, or produce "hot crosses" with energized lines still carrying power. Yet, within 72 hours, these men had restored 6300 telephones to service, replaced 14 poles and 136 miles of line without a fatality.

In a similar three-day battle, telephone linemen using trucks and rowboats battled a horrendous Mississippi flood two years ago. Thirty-five miles of fast-strung line and 61 outdoor-telephone shelters erected along dikes and levees enabled sand-bag crews to coordinate activities fast enough to raise the dikes and save St. Paul and Minneapolis from the worst Mississippi flood in recorded history.

Besides this, the line crews moved and saved 15,000 phones and 25 PBX systems from flooded towns. They installed tielines, teletypewriter and other emergency communications wherever needed, and filled underground cables with pressurized gas to keep water out. Their fast work enabled disaster units to place 50 percent more long-distance calls than normal in the area, although flood waters had destroyed 236 regular long-distance circuits.

Men who make up line crews are a well-trained, rough-and-ready breed whose job requires brain as well as brawn. Line Foreman Joe Bain and his crew at the Philadelphia Electric Co. are typical of thousands of such outfits.

Their truck has a built-in swivel ladder like the one on a modern hook-and-ladder



Cleveland Electric Illuminating Co. photo

Electric pole stuck into roof top by tornado posed problem for Cleveland crew. Some wires remained hot

Bushwacker used in Cleveland chews up brush and large trees, spits them out the back as fine mulch of chips

Cleveland Electric Co. photo

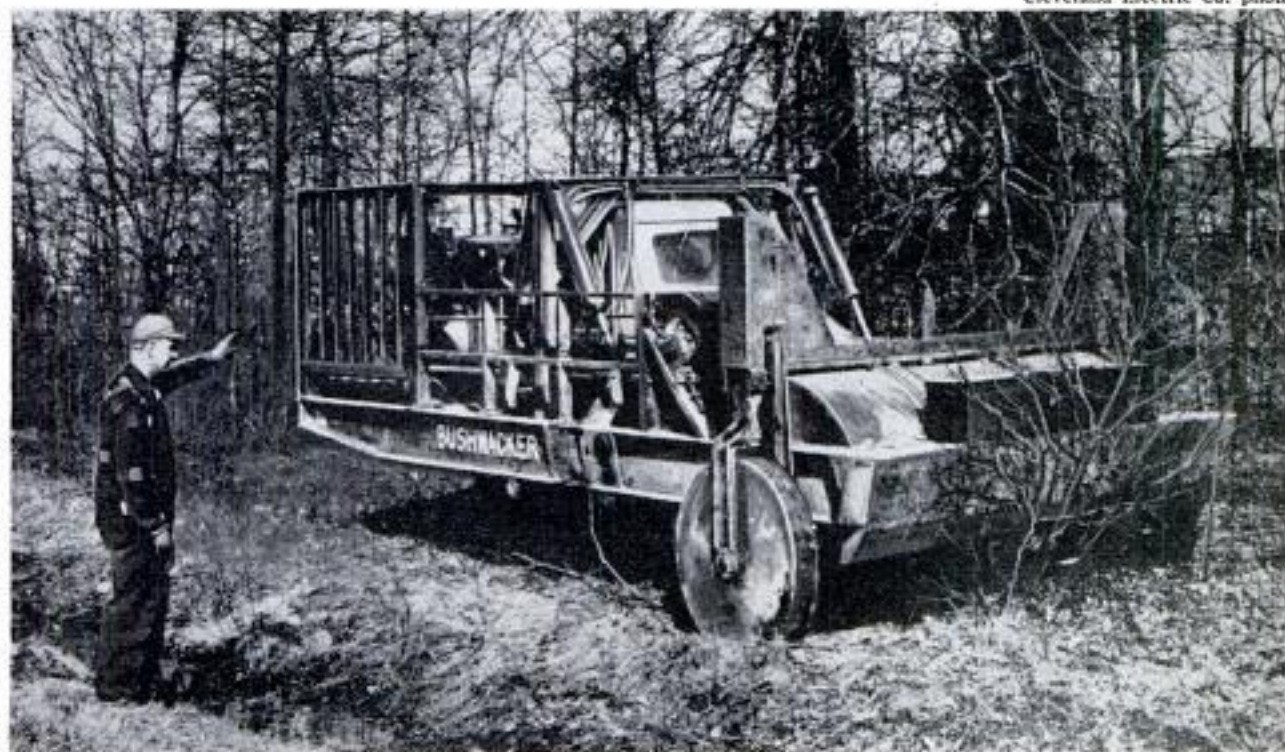



Philadelphia Electric Co. photo

This trouble-shooting truck for power lines mounts a swiveling extension ladder. Side compartments contain assortment of spare parts and equipment. Lineman, below, slips rubber "snakes" over hot wires before he starts work. "Boots" cover joints



fire truck, only smaller. Actually the truck's a rolling electrical shop carrying a full store of wire, insulators, splicing gear, fuses, disconnects, a transformer, rubber blankets and hose for covering hot pole-top equipment, plus a vast assortment of odd-looking nuts and bolts stowed in drawers and compartments inside and out.

Here's how the crew would work if you lived in Philadelphia, your lights went out in a storm and you rushed to call the utility:

Your call would come in to one of 12 operators at six switchboards "which," explains John Zimmerman, chief supervisor, "are all lit up like Christmas when a big 'outage' hits." The message is flashed instantly by Tel-Autograph to the load dispatcher's office, where load checks would quickly show any circuits in trouble.

One of a battery of complaint takers would then write your name on a card and drop it on a moving belt that would carry it to the "trouble desk." Here, one of four trouble dispatchers handling about 500 complaints a day (twice as many in storms), would telephone for a one-man trouble car to go out. Meantime your neighbors are calling, too. A check on the wall map shows a whole neighborhood circuit may have tripped. The trouble dispatcher plugs in his radio and goes on the air to the moving car: "Outage from 2800 to 3100 block. Check transformer at 39th Street." He orders a second car, just in case.

Perhaps the cars report two crossarms down—struck by lightning. Hot lines drag the streets. The trouble men, wearing rubber coats and gloves, probably have shinnied up the poles, cut the broken lines and rerouted the circuits. But chances are that any lines clear of street and pedestrians are still hot, because any utility tries hard to keep service going to its customers. And here's where Joe Bain and his linemen get into the act. Their job is to put the "tripped" circuit back in service.

A unique array of equipment and techniques helps them perform what otherwise would be an impossibly dangerous job, because there's often enough current floating around the top of a pole to

(Continued to page 266)

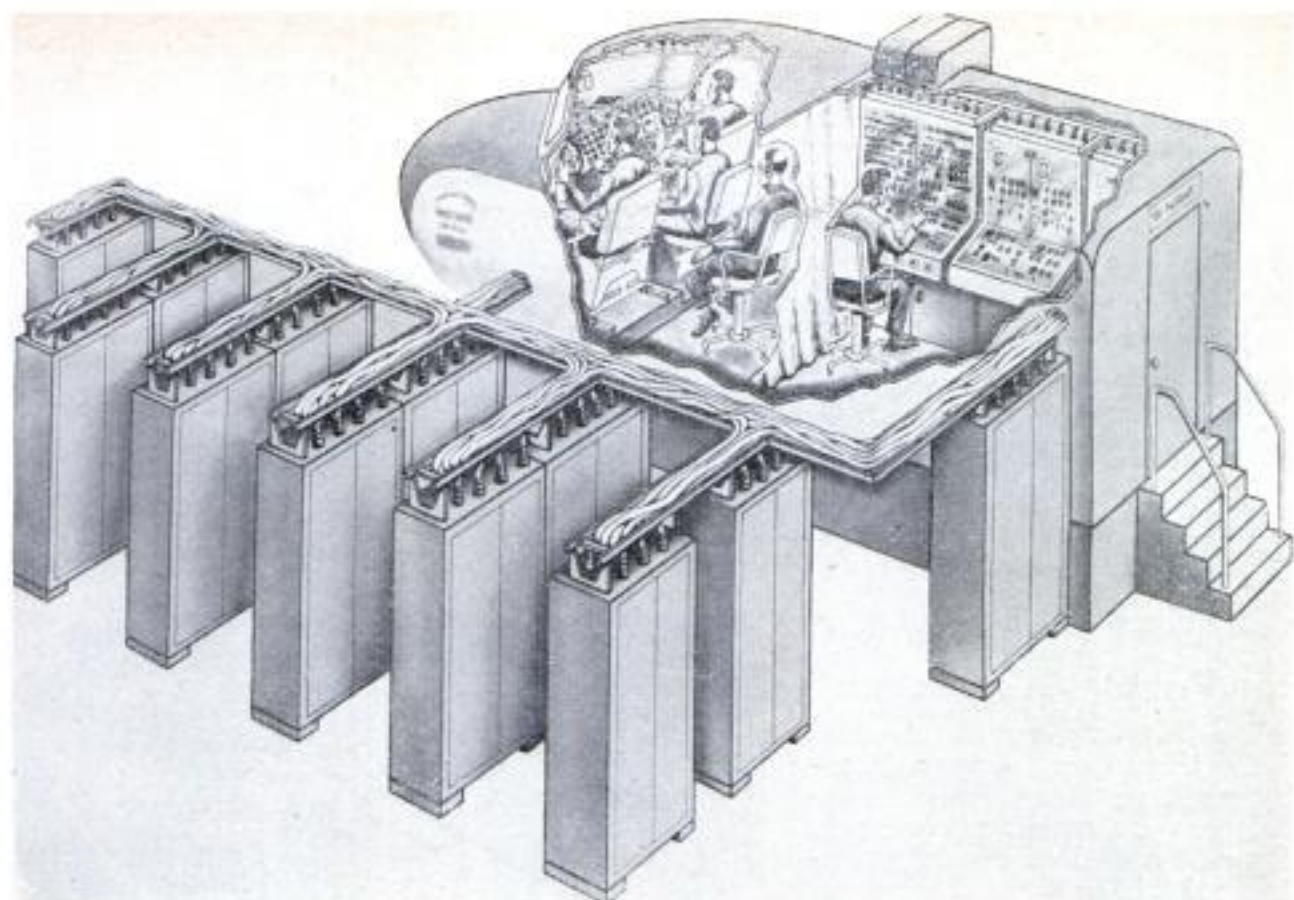

Airline Pilots Fly Anywhere in World—Without Leaving the Ground

Airline pilots now can take off or land at any airport in the world—while sitting on the ground! United Air Lines, at a cost of more than \$3,000,000, has purchased four flight simulators for pilot training. The simulators, built by Curtiss-Wright, actually are huge "electronic brains" capable of reproducing any airplane flight with great realism. Attached to the simulator is the nose of a real plane, complete with all the flight instruments. The instructor sits at an instrument board behind the crew, and by manipulating the instruments

he can feed any type of information into the simulator, which transmits it to the flight instruments. As the pilot takes action to correct any condition, the simulator automatically trims the plane, dumps the fuel or feathers the propeller—all on the pilot's instruments, of course. Noises such as the sound of the engines and the screech of tires on the runway make the "flight" even more realistic. The simulator is so accurate that it has been used to check the performance of an aircraft before the plane even left the ground.

Car-Window Screen Keeps Out Sun

Motorists can protect themselves from the direct rays of the sun without blocking vision or ventilation by a Venetian-blind screen that fits into the window opening. The screen keeps out the sun just as a Venetian blind does because the horizontal wires are flattened and tilted to face the sun. It is held in place by the window glass. Extension arms permit the screen to be tilted if desired.



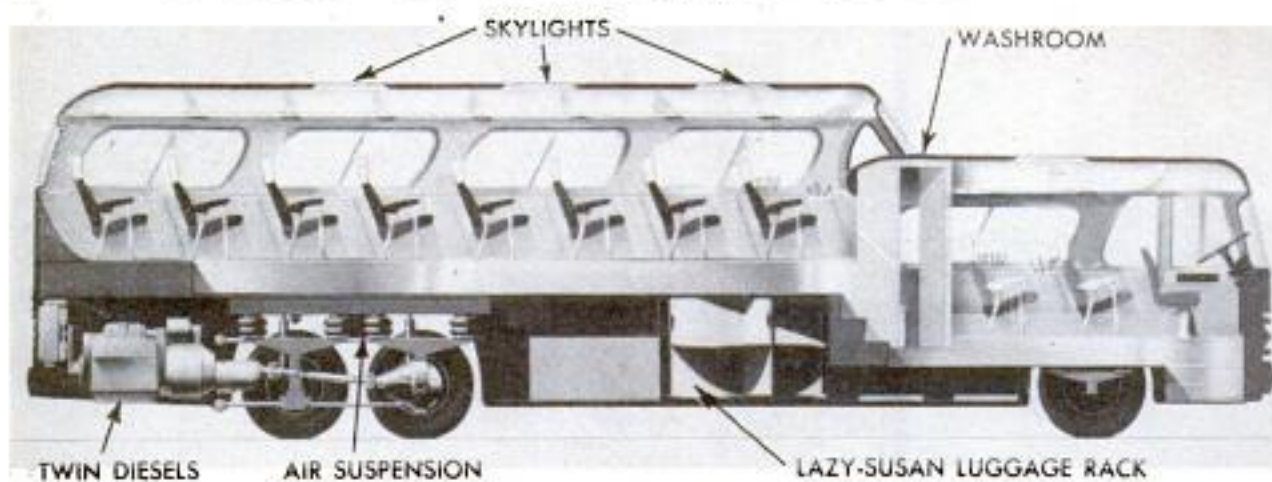

Two-Level Highway Bus Has Private Washroom

Five feet longer and one foot higher than a conventional intercity bus, a new Greyhound Scenicruiser seats most of its passengers high on a rear deck providing unhindered vision in all directions. The extra five feet of length provides additional legroom between seats and space for a complete toilet and washroom. Three steps lead to the upper deck. The driver and 10 passengers ride on the lower level while 33 more passengers sit upstairs. Tinted skylight windows in the roof provide upward vision in mountainous country. These \$49,000 highway cruisers are powered by two four-cylinder diesel engines, each producing 150 horsepower. Either engine can move the bus alone if necessary in case of breakdown.



The busses are completely air conditioned and individual smoke vents enable passengers to smoke without annoying others. Built by GMC Truck and Coach Division, the bus also features air suspension which eliminates metal leaf springs. Another feature is a Lazy Susan luggage compartment.



Dotted line is where usual blade stops. New type wiper 5½ inches more

Wiper Goes Around Wrap-Around Glass

Windshield-wiper engineers have come up with a blade that reduces the blind spot on wrap-around windshields by 60 square inches. The blade travels 5½ inches farther into the blind corner of these extra-large windshields and does it without scratching. The new blade permits the pressure to be increased to 11 or 12 ounces (conventional blade pressures are from 6 to 8 ounces). The blade is held erect at all times and wipes without chatter.

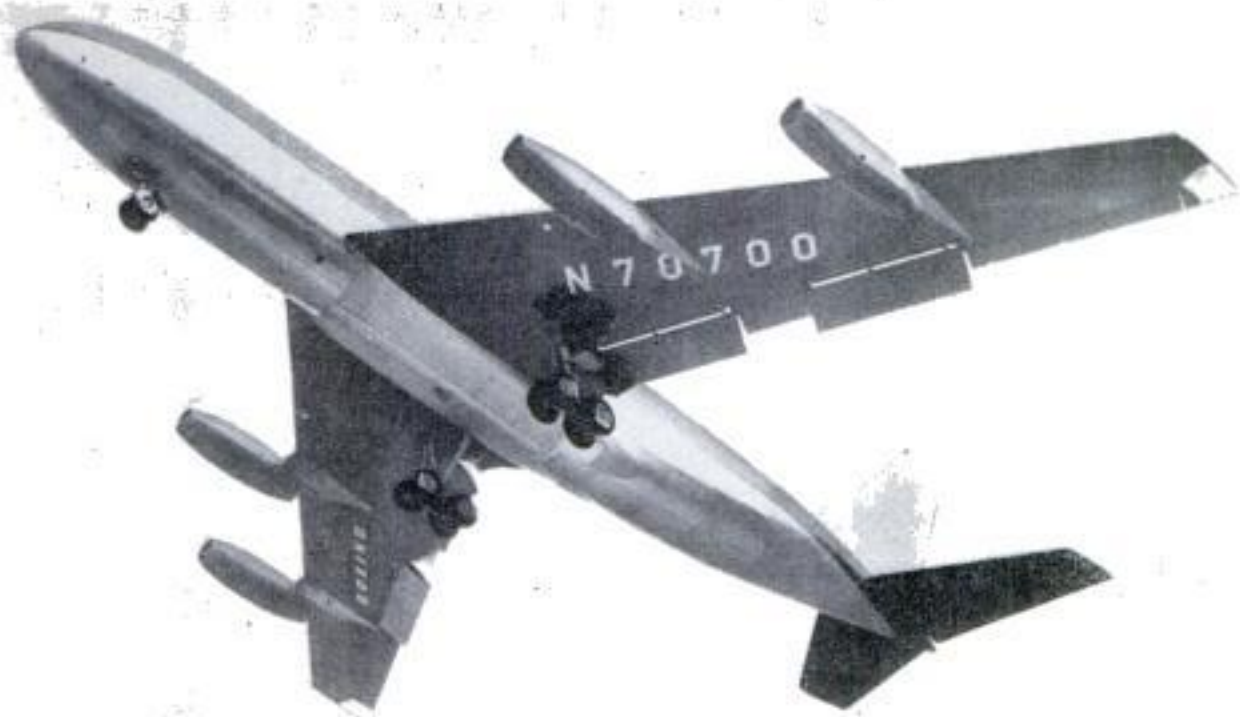

Boeing's Jet Transport Flies to 42,000 Feet in First Tests

Test flights of Boeing's new jet-transport prototype (see "America's First Jetliner," *PM* Aug.) have already carried it above 42,000 feet and over 550 miles per hour. The prototype, which is America's first entry into the jet-transport field, will be followed by production models scheduled for completion in the fall of 1956. The military version of the plane, the Stratotanker, will be able to refuel military jet aircraft at high altitudes and high speeds. The commercial version, the Stratoliner, will carry from 80 to 130 passengers, whisk-

ing them across the Atlantic in seven hours or across the continent in less than five hours. Britain's ill-fated Comet carried only 48 passengers. In the tests, the Boeing 707 climbed at maximum rate and, with wing flaps lowered and landing gear down, descended at a mile a minute. It was deliberately stalled to test flying characteristics and control. It was banked again and again at all speeds to test lateral control. All reported tests of the \$15,000,000 plane were successful. The huge craft is 128 feet long and has a 130-foot wingspan.

Two Auto Hoods Make Boat

Scrapped automobile hoods looked like the "makings" of a boat to Elroy Joellenbeck of Okawville, Ill. He obtained two 1940 Ford hoods and welded them together to form a seaworthy little craft for less than \$10. Joellenbeck brazed a small fin-type stabilizer to one end of the boat.

During the 17-month period from Jan. 1, 1953, to June 1, 1954, Military Air Transport Service (MATS) airlifted more than 731,000 passengers without a single fatality.



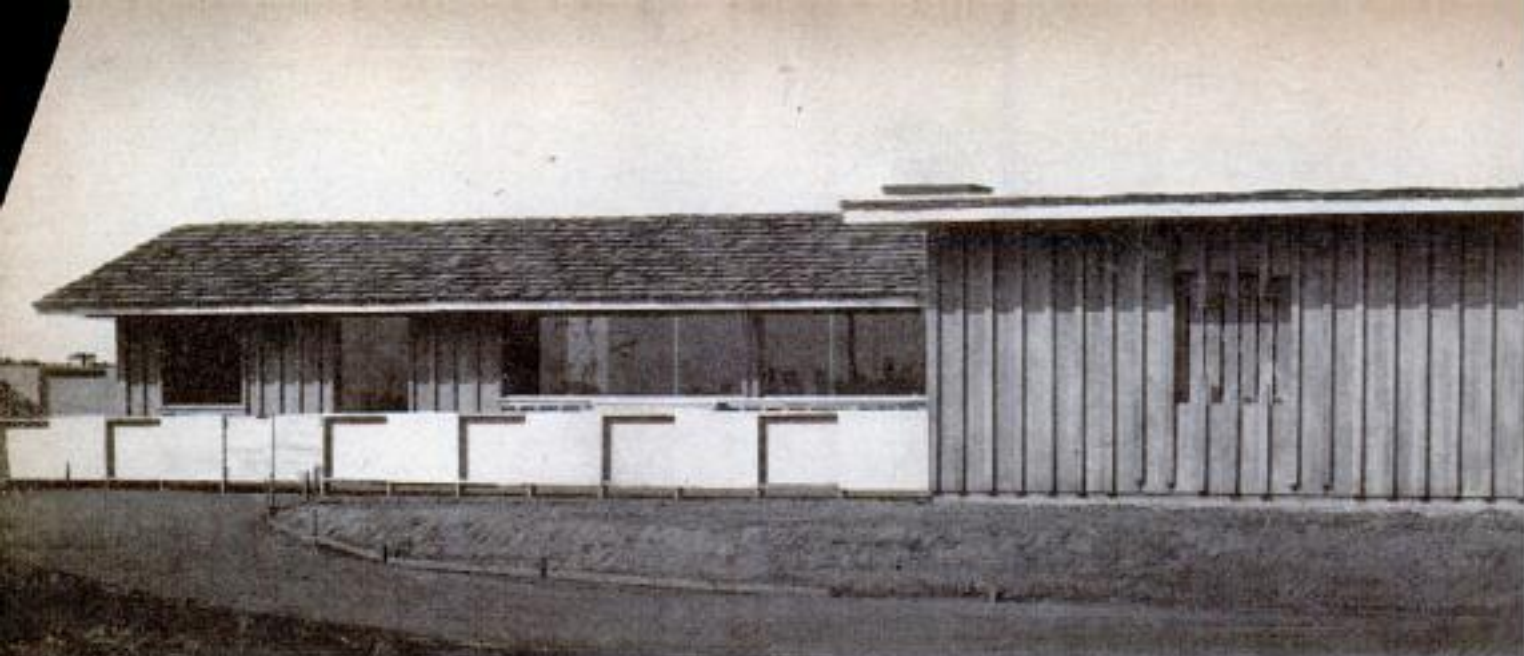

"House of the 21st Century" has rustic shake roof and board-and-bat siding. Makeshift fence is only temporary

Built for Modern Living

A HOUSE OF MAGIC

By Thomas E. Stimson, Jr.

IN JACK FLETCHER'S new home, the windows close themselves whenever the wind blows hard for more than 15 seconds. They close automatically, too, when a rainstorm starts or when the outside temperature drops too low for comfort.

Guests never trip over the wires to a floor lamp in Fletcher's living room. The floor lamps in this "House of the 21st Century" have no electric cords. Their fluorescent tubes, in fact, could be burned out and still operate perfectly when placed over certain spots on the living-room floor.

Mrs. Fletcher's stove has an attractive hardwood top and she does her cooking over the stove, not on it. A concealed electromagnetic cooking element not only heats the pans but keeps them suspended in the air while the meal is cooking. There's no need for an "old fashioned" metal stove top.

If the children start quarreling in their play yard, Mrs. Fletcher can admonish them at once from the house via a loud-speaker attached to the play-yard wall. She sees the youngsters by means of a television camera that scans the yard area and is linked to TV receivers in the kitchen, living room and master bedroom. These picture tubes also receive standard TV programs.

In the Fletcher house you don't need to press a wall switch to turn on the room lights; they turn on automatically as you

enter a room, then switch themselves off when the last person leaves. This "walk-a-light" switching system likewise rings the doorbell when a visitor approaches and serves as an alarm against prowlers.

To phone his office or various friends Fletcher presses a button opposite the name he desires, then lifts the receiver when a signal lamp shows the connection has been made. The actual dialing of the number is performed by a concealed rotary switch.

One of the fantastic features of Fletcher's

"Window brain" with rain troughs, weather vane and wind gauge, shuts windows exposed to bad weather



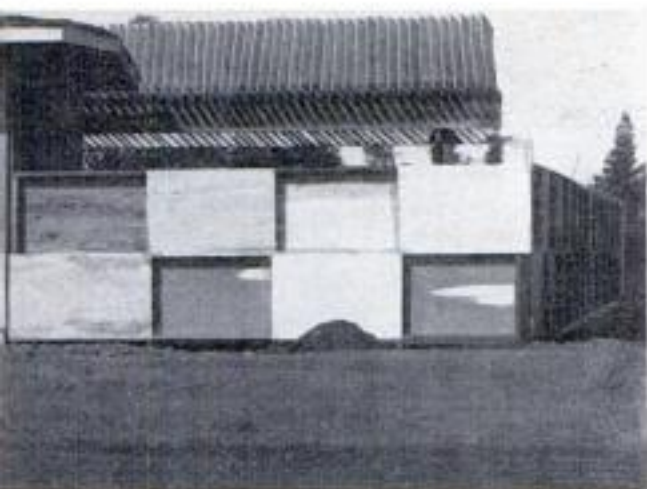

Right, pan floating above radical range is heated and repelled by coils under range top

house is that its fireplaces have no chimneys. The secret is that the flue doubles back down from above the fireplace opening, then runs under the floor to a central chimney in the middle of the house. It's an old Chinese principle, so ancient that it seems brand new when put to use.

When 23-year-old Jack Fletcher, ex hot-rod and custom-car enthusiast, got ready to build a house for his growing family he decided to make science go to work for him. A lot of well-known scientific principles, he reasoned, can be put to everyday use.

Together with his father, Frank Fletcher, one of the heads of Fletcher Aviation, and with John Scott Campbell of CalTech he set up a laboratory to turn his ideas into realities and to build the equipment for his new house which is in West Covina, Calif.

Electrical gadgets aren't the only innovations in the house. The Fletchers drew on their aircraft and engineering experience to work out some new basic construction techniques. The result is that Jack Fletcher's new home is an example of quality construction at relatively low cost.

The house includes three bedrooms and two baths and has a total of 1905 square feet of heated area. Heating is of the electrical radiant type, there being chrome-nickel wire buried in the concrete slab floor. Constructionwise, the house uses a post-and-beam structural system to support the roof. All walls and partitions

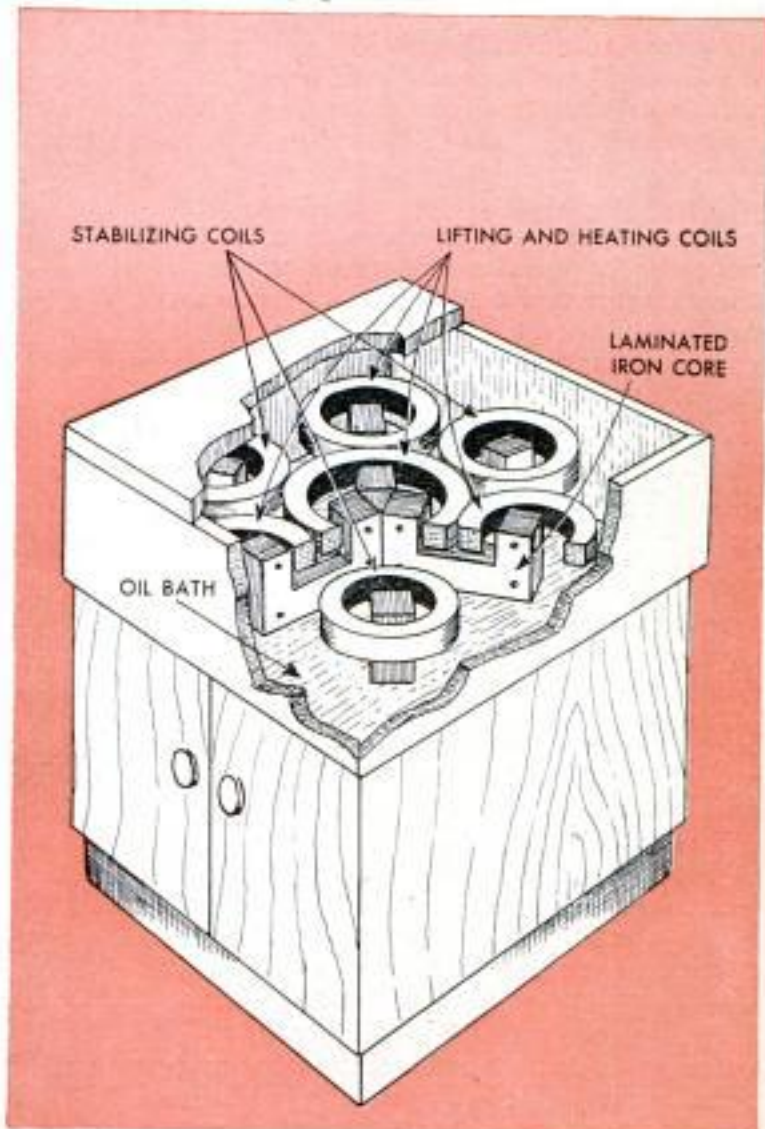



Bedroom wall consists of slab doors permanently set at a stagger. Movable glass panes will be between

thus can be simple nonload-bearing curtain walls built up from short inexpensive lengths of material. The wall panels, in fact, were assembled at a temporary factory instead of on the job. They consist of one-by-six-inch vertical stiffeners nailed to two-by-four horizontal spacers. There are no vertical studs in the ordinary sense. Any scrap lengths of wood as short as 29 inches can be used.

This wall core is erected, then building paper and insulation are added, and finally the exterior and interior wall surfaces are applied. In Fletcher's home the exterior consists of redwood boards and bats. Wall-board paneling is used in the interior.

Steel-pipe columns support the roof beams. The beams are hollow and are built in accordance with aircraft design. A typical beam may consist of a two-by-six on top, a three-by-six on the bottom with 16-inch-deep walls of one-half-inch plywood and with an internal wood stiffener every eight feet. One of these beams will support a 25-foot span and can be nailed and glued together "by the mile" at less cost than solid timbers. For some shorter spans two-by-fours are used for the top and bottom of the beam.

To provide privacy, light and ventilation in his bedroom Fletcher used slab doors for one exterior wall, the doors being staggered to create a louvered effect. The space between each pair of door panels contains a narrow pane of glass for ventilation.

Patio areas outside the house have louvered roofs that screen out the sun and yet permit air to circulate. The patio-roof boards are set on edge, in slots, and may be

removed when winter sunlight is desired.

Fletcher's self-closing windows are actuated by a "window brain" located on the roof. The brain is actually a metal box with rain-catching channels on each side and with a weather vane and anemometer on top. Inside the box is a bimetallic thermometer. When bad weather strikes, the instruments actuate an electric circuit. Solenoids beneath the windows trip locks to release springs which close the windows.

Mrs. Fletcher's mysterious stove operates by electromagnetic repulsion. Be-

Wood louver roof over patio provides shade in summer, may be lifted out for additional sunlight in winter



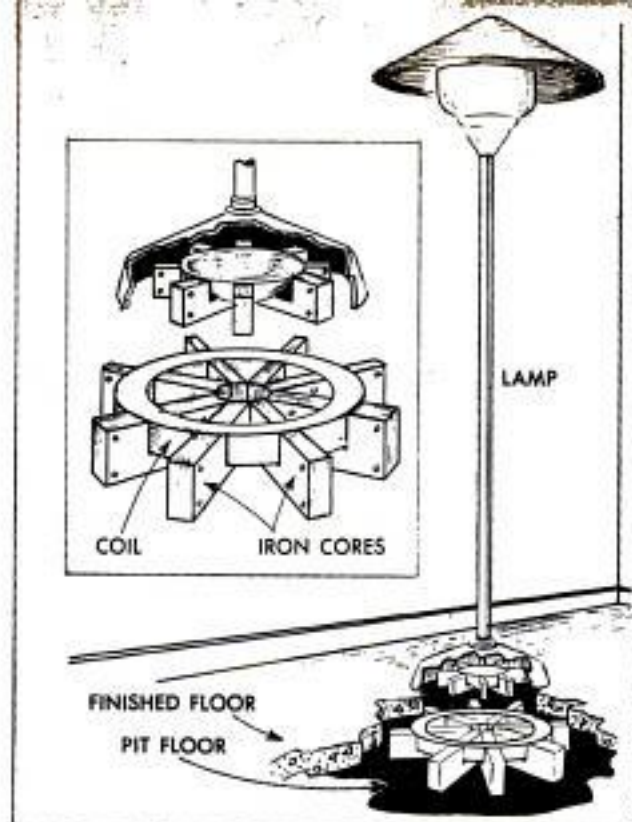

Cordless floor lamp relies upon induction coil buried in concrete slab floor, secondary coil in lamp base

neath the hardwood stove top are four main lifting coils that also heat the metal pan floating above it. Three adjustable stabilizing coils steady the pan.

To operate his cordless floor lamps, Fletcher buried induction coils at various points in his living-room floor. Contained in the base of each floor lamp is a secondary coil. The current flowing between the coils provides enough wattage to fluoresce the gases in the fluorescent tube at the top.

The walk-a-light switching system throughout the house operates on the capacity principle. The presence of a person's body changes the capacity of a plate



John Campbell shows that fluorescent tube of lamp glows brightly even when lamp is lifted from floor

connected to a vacuum-tube circuit. A relay then switches on the lights. The same capacity effect operates the doorbell when a person walks onto the porch. It is used outside the house to operate lights and on a burglar-alarm system.

By the time you read this, Fletcher may have added some other improvements to his house. He and John Campbell are studying the feasibility of an outdoor air conditioner that would keep the large patio areas at comfortable temperatures even on the hottest days. And they are thinking about an invisible ultrasonic screen that would keep flies away. ★ ★ ★

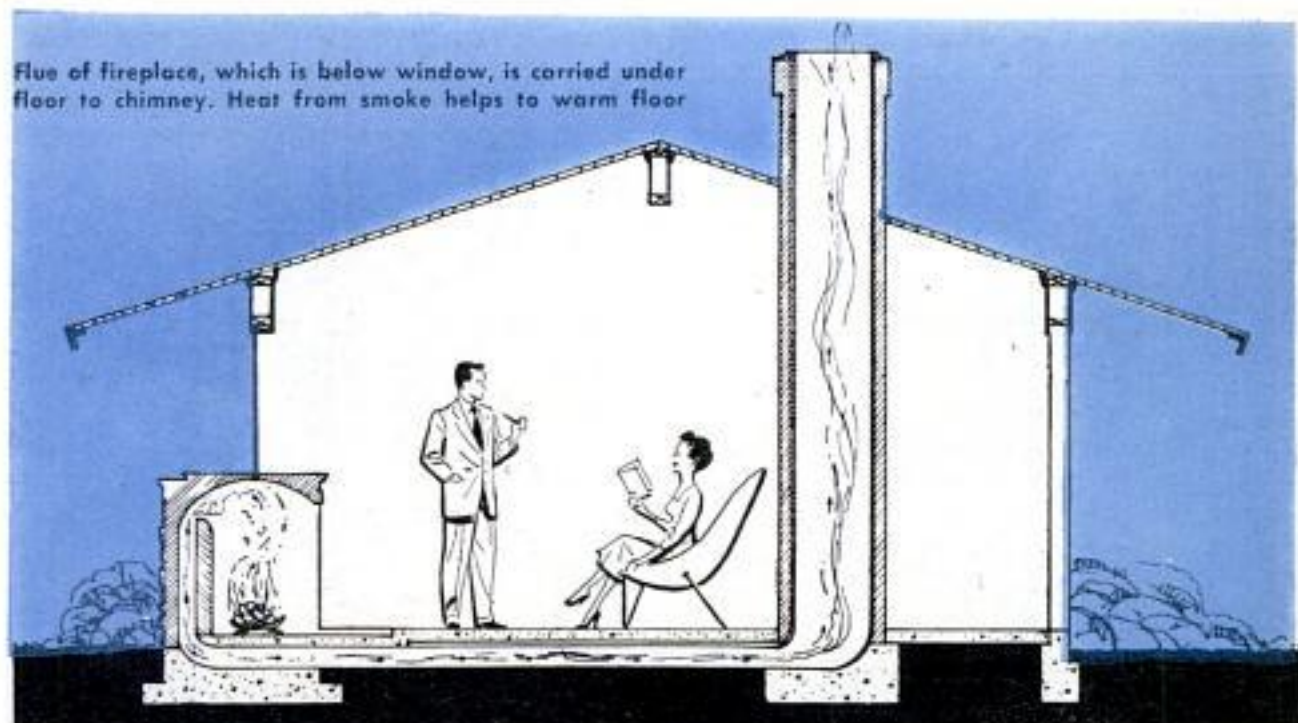

Flue of fireplace, which is below window, is carried under floor to chimney. Heat from smoke helps to warm floor

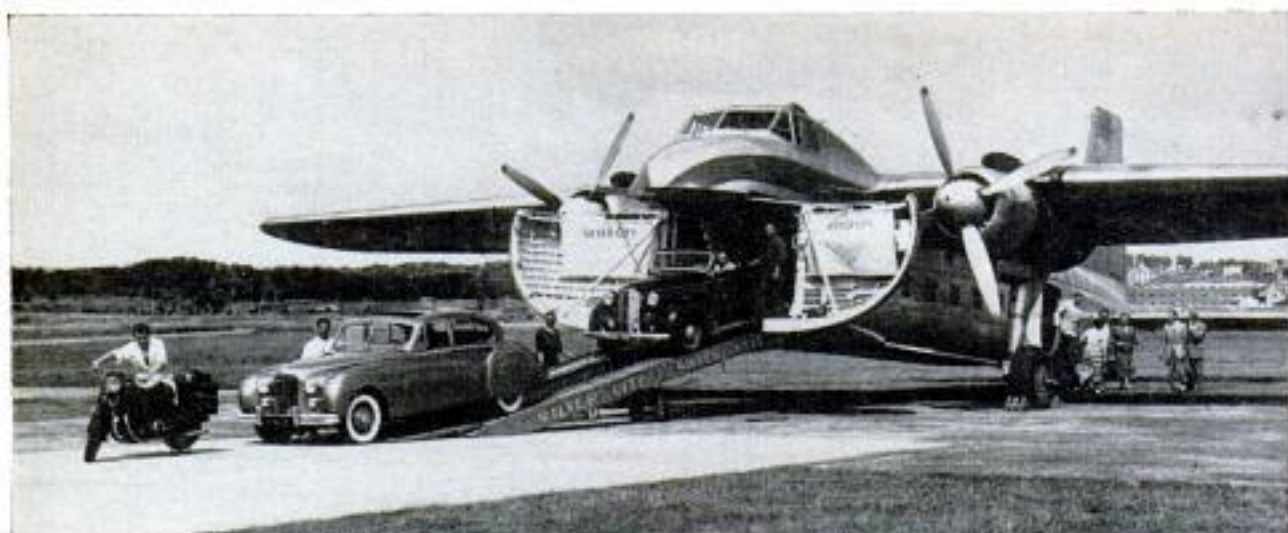

Plane carries two large or three small cars. Air lift is popular with tourists who take their cars with them

British Air Ferry Takes Automobiles Across English Channel

Flying two or three automobiles and up to 20 passengers at a time, Bristol Superfreighters have ferried more than 25,000 cars from England to the Continent since early 1953. Cost for a car on the 20-minute cross-channel hop is about the same as the boat fare. By moving a wooden partition, space can be made for either three 14-foot cars and 20 passengers, or two of the largest American makes and 12 passengers.

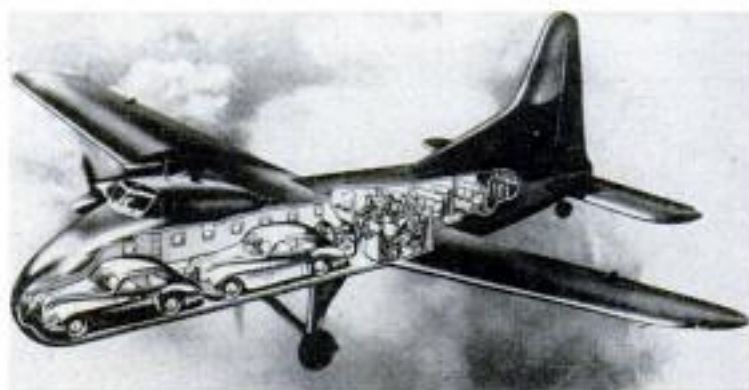

Key Card Inserted in Slot Opens Gate of Automatic Parking Lot

Inserting a key card in the slot of an electronic control device opens the gate of an unattended parking lot. As the car enters the lot, the wheels depress a treadle which automatically closes the gate. Exit is made in a similar manner. The card

contains bits of metal arranged in a coded pattern. A magnetic scanner in the control device "reads" the pattern and actuates the gates. New cards may be issued and the mechanism adjusted to the new code at the start of each rental period.





Truck dumps remains of radioactive building in 600-foot-long "grave" a safe distance from the laboratory

"Hot" Building at Los Alamos Gets a Careful Burial

WITH GREAT CARE and ceremony, a historic frame building at Los Alamos, N. Mex., has been torn down and buried. It is the building in which the nuclear parts of the first atom bomb were born. But the ceremonial burial is not the result of any historian's sentimentality. It's because some room surfaces of the famous building became contaminated with alpha-particle emitting material. These alpha particles travel only an inch or so in air and are stopped by paper or a coat of paint, yet are dangerous to humans. For safety during use, it was only necessary to cover the walls periodically with fresh wallboard or paint. But in tearing the building down, such protective shields are broken, endangering the workmen. The sections were painted as soon as they were torn down and then trucked to the "cemetery." Cars with air samplers followed the trucks like mourners in a funeral procession to make sure no dangerous particles escaped. Dumped into a "grave," the materials were buried under 20 feet of earth.



Los Alamos Scientific Lab photo

Radiation safety monitor checks roof-mounted exhaust fan for possible radioactivity. Below, workmen wear protective clothing to guard against radioactive dust



AIR CURTAIN FENCES BLAST



A WALL OF AIR BUBBLES prevented the knockout of a Canadian power station recently, as engineers touched off 12,000 pounds of high explosives in nearby rock. The project took place at the huge Ontario hydroelectric-power installation at Niagara Falls. Water had to be channeled from the forebay of an old powerhouse to the forebay of a newly completed generating plant. Separating the two reservoirs were 12,000 cubic yards of hard rock. The rock plug was only 160 feet away from the screen house of the old generating station, and a blast sufficient to dislodge the plug would have damaged the building severely. Shock waves carried through the water would have rocked the structure. Piece-meal blasting would waste time.

A Canadian explosives engineer, "Lap" LaPrairie, suggested the unique solution. The plug could be removed with a blast, he believed, if an air buffer was inserted between the screen house of the generating station and the plug to be blasted. This could be done, he suggested, by forcing compressed air through pipes laid down at a strategic point in the forebay. LaPrairie had never tested his idea, nor heard of its use. First the theory had to be tested.

A tank was built in a Toronto laboratory and perforated pipes laid in its bottom. Compressed air was forced through the perforated pipe to create a wall of air bubbles across the middle of the tank. Blasting caps were set off in the water at one end of the tank while instruments fastened at the other end gauged the intensity of the shock. Weeks of tests proved the idea sound.

At Niagara Falls, a central pipe was laid in the bed of the forebay between the rock plug and the generating plant with four lengths of perforated hose running parallel to the main pipe. When compressed air at 90 pounds pressure was forced through the 250-foot lengths, the water "boiled." Water level immediately above the pipes was raised almost four feet.

Nitron explosive was placed in the rock plug and detonated. The blast sent a huge wave traveling down the eight-mile power canal. The rock plug was completely shattered, but the power station was undamaged. Shock waves reaching the building were cut 98 percent by the air curtain.

Project engineers predict that the technique will be used to save time and money in other blasting work. ★ ★ ★



Rock plug separating forebays was loaded with 12,000 pounds of explosives. Power station was 160 ft. distant



Huge wave was created by blast, but air curtain absorbed shock waves. Only a tremor was felt at powerhouse. Below, rock barrier was completely shattered by massive charge of explosives. Cost of project was \$2000



Detroit Listening Post



By Leo Donovan

THE SPOTLIGHTS OF 1955 will shine on Chevrolet, Ford and Plymouth as they battle for the lion's share of the low-price market. But don't lose sight of another vigorous struggle at the opposite end of the price scale. Cadillac, Lincoln and Chrysler will be swinging hard for leadership in the prestige field. And Packard, the independents' candidate, won't be holding back either.

Cadillac, long dominant in this market, may become a victim of its own success. As more and more of any product is sold, the prestige value of each diminishes under the simple law of abundance.

It is this possibility that Chrysler hopes to capitalize on with its 1955 entry, the Imperial. Advance rumors are that it will be completely new. No longer will it be the Chrysler Imperial—it will simply be the Imperial, a separate, exclusive name plate. It will have a V8 engine capable of higher speed than any in mass production, an improved transmission, better springing and more luxurious appointments than ever. It will have its own styling, distinct from Chrysler.

Lincoln, which gained in sales position this year, may have its own transmission (replacing Hydra-Matic) and a more powerful engine. It is expected to make major face-lift changes. Eventually, Lincoln may be a separate division with the revived Lincoln Continental becoming the swankiest vehicle in the Ford family. However, the first of a very limited production of the Continental is not expected until late 1955.

Packard's Plans for 1955

Packard, surviving economic pressures better than most independents, has big plans for 1955. Its new V8 engine and body styling probably won't be announced until early in January. This year the Packard Clipper becomes simply the Clipper with distinctive styling of its own—another move to recapture prestige for the big Packards.

Studebaker will have engine surprises to offer as well as a completely new line.

Chevrolet, Ford and Plymouth all will boast entirely new bodies and new V8 engines (Ford's will be adapted from the 1954 Mercury). Pontiac and Mercury will be new, too. And a V8 will probably show up in the Nash family. Word is out that Nash is buying the new Packard V8 engine.

Both Ford and Chevrolet are expected to announce in October or by mid-November, to be followed by Plymouth and perhaps the whole Chrysler lineup before December first. Pontiac will be out late in October, with the rest of GM following.

Mercury is expected to boost horsepower to 175, as Ford moves up to 160.

At Chrysler Corporation everybody's as excited as an expectant father—and also as apprehensive! It is an important year as stylist Virgil Exner's new look makes its debut. Early plans called for a tooling program of \$130,000,000 and guesses are that even more than that was spent.

Plymouth, the bread-and-butter winner of the Corporation, is the car to watch. With its V8 engine and Exner styling, it is new all the way through. You won't see any more references to that "compact design" or the "smaller on the outside" feature—the Plymouths are expected to be long, low and luxurious. And Dodge even more so.

But Small Cars Still Sell

While other cars keep getting longer, Nash says its small cars, the Rambler and Metropolitan, are selling well with Metropolitan sales surprising even the optimists. Don't expect any change in this tiny import for 1955, but there may be a welcome difference in the Rambler. The story is that the full-skirted front fenders are gone. With full front-wheel cutouts, the popular Rambler will become as maneuverable as a small car should be.

The Statesman and Ambassador may be late getting out because of styling changes. Rumor is that they will get wrap-around windshields. Incidentally, the wrap-around glass has taken over the industry. All but two or three makes will have it in 1955.

Hudson is expected to be late coming out as it probably will adapt its new styling to the Nash body shell. This may mean the end of Hudson's step-down design.

It can now be foretold that Reo Motors may soon introduce a plastic-bodied truck—opening a new field for plastics.

Speaking of plastics, Chevrolet cut Corvette production from 1000 to 300 a month as sales lagged. Now Ford's Thunderbird, its steel body even more suitable for mass production, will be out in October. Is there a market for such sportsters? Some say it's a limited fad that imports can best satisfy. They see more future in a low-silhouette station wagon.

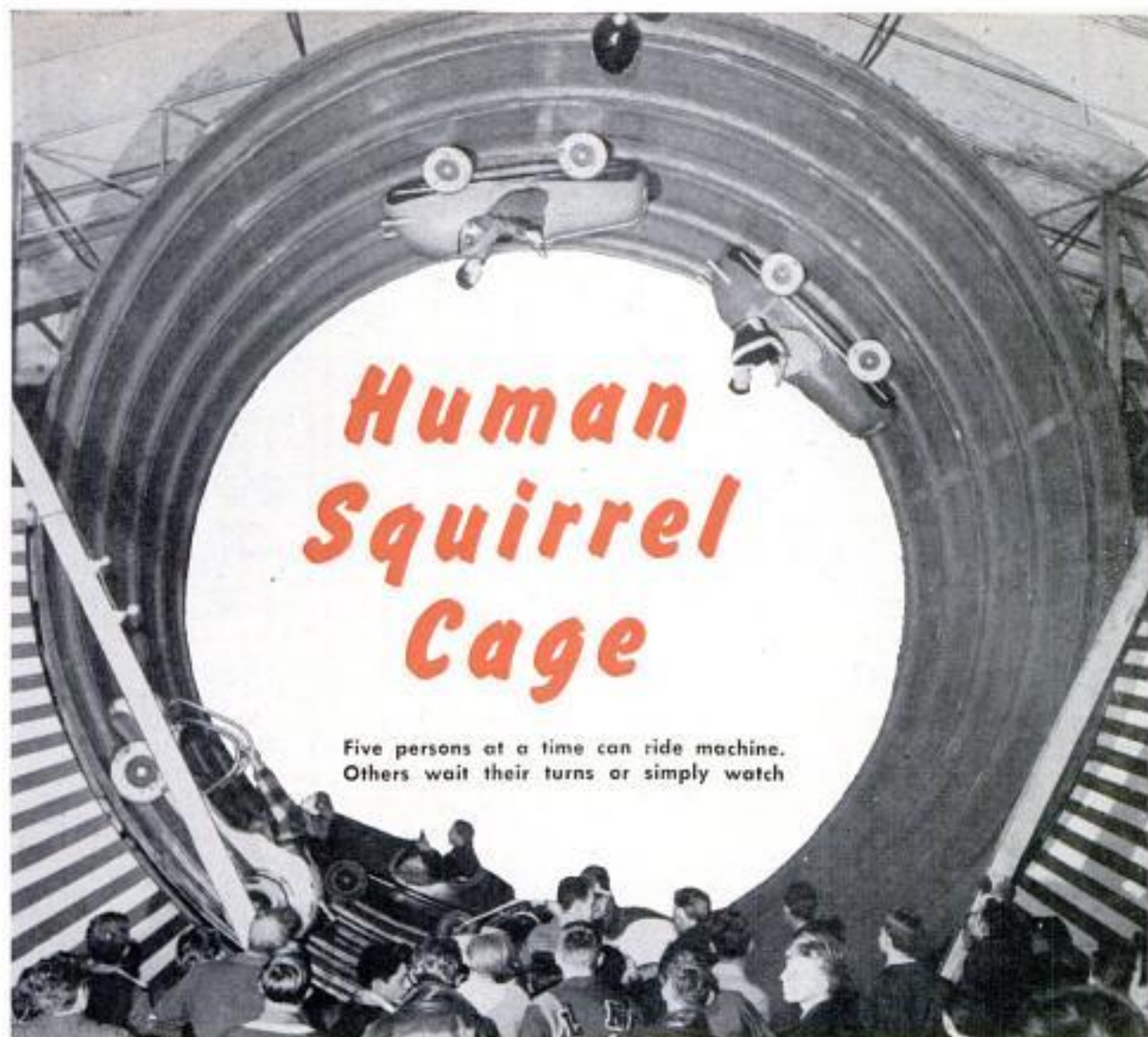

Human Squirrel Cage

Five persons at a time can ride machine.
Others wait their turns or simply watch

THRILL ADDICTS registered their screaming approval of a German-made fun machine introduced at Chicago's Riverview Amusement Park this summer. Little cars circle a drum 27 feet in diameter which supports five circular tracks. The cars are loosely attached to the tracks and, by oper-

After a round or two, fright wears off and riders begin to enjoy it. Lap strap is a safety measure

ating a foot pedal, the rider can lock his car to the track. As the drum revolves at about 15 miles per hour, the cars go around with it. Timid riders can release the brake pedal and their cars merely rock back and forth. But braver souls press the pedals and make like squirrels in a squirrel cage.

Brake linings are replaced every day or two. Young riders must be capable of reaching the brake pedals



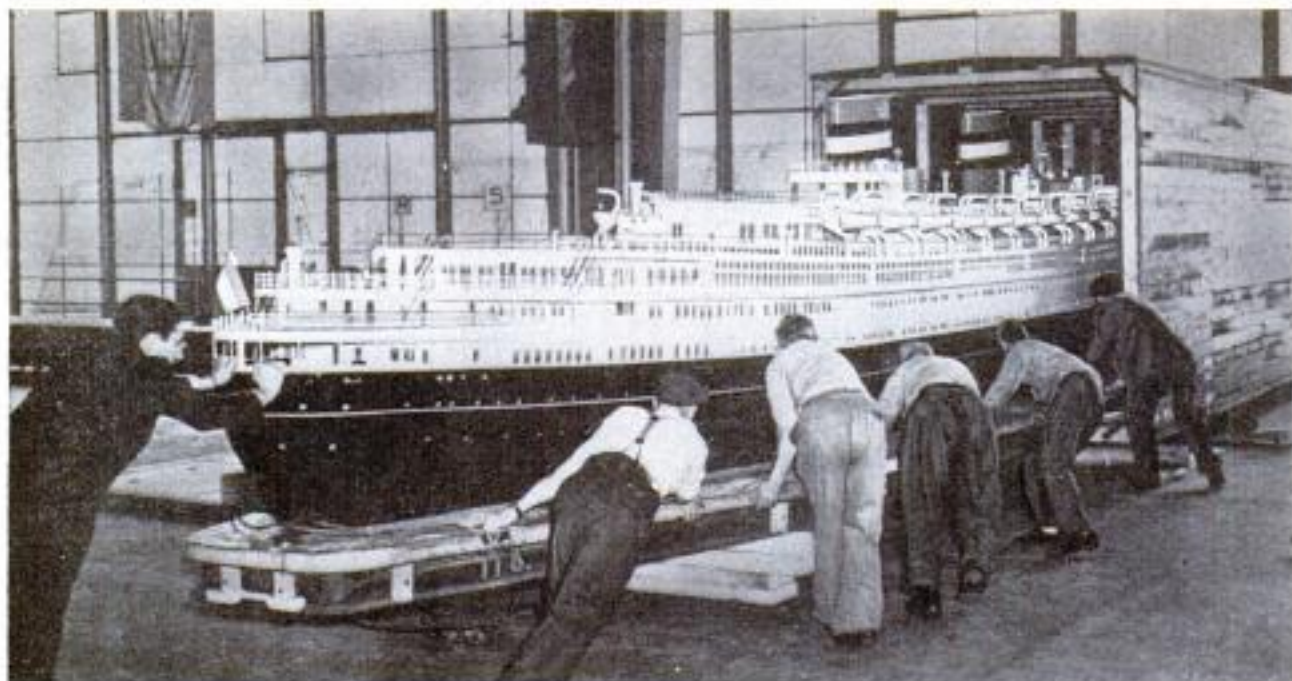

Ship Model Tours Country for Display at Boat Shows

Probably the largest ship model ever built has been sent to this country from The Netherlands for display at boat shows. The model is 40 feet long and weighs 1½

tons. It is a 1/50 size reproduction, complete to the last porthole and lifeboat, of the SS *Nieuw Amsterdam*, flagship of the Holland America Line fleet.

Boat Hanger Keeps Them Dry

Boats are lashed high and dry at Pittwater, a suburb of Sydney, Australia. When not in use, the boats are pulled up out of the water and hung from a high, narrow pier. A winch mounted on a traveling cart is used to elevate the boats. The method protects the boats from damage caused by storms which chop up the water, and makes sure that water doesn't splash into the boats and necessitate bailing. It also helps to protect the boats' hulls against water.

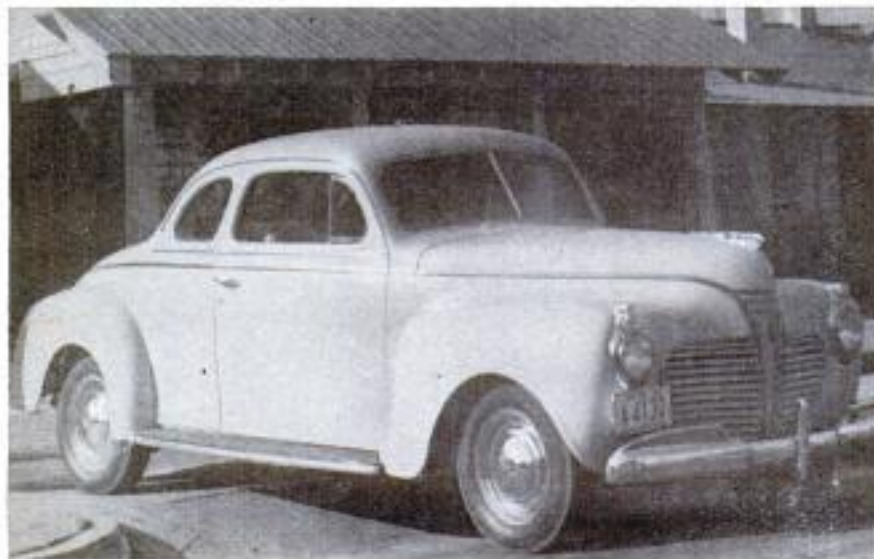

Builds New '41 Car

When Fred Schults of Phoenix, Ariz., got a new car he did it the hard way. He found an unused frame, axles and wheels for a 1941 Plymouth in a warehouse. Then he began writing letters. He finally rounded up the parts needed to make a brand-new car—about a dozen years late! Total cost for parts: \$650. Counting his time, the total bill for the car would be about \$1000.

**Next
Month
You'll
See**



Our Big 1954 Special Section ON HOMES

Including

THE HOUSE OUR READERS ASKED FOR

**3561 PM READERS HELPED PLAN IT BY ANSWERING OUR QUESTIONNAIRES.
A NOTED ARCHITECT DESIGNED IT THE WAY YOU WANT IT BUILT**

50 PAGES OF FEATURES:

- An Album of Homes, \$7,000 to \$15,000
- How to Know Whether to Remodel
- Space Savers for Heating and Cooling
- New Faces for Old Houses
- Tips on Lumber, Lighting, Doors
- How Much Will It Cost?
- Three Men Who Built Their Own Homes Say "We'd Do It Again!"

SEPTEMBER 1954

101

Copyrighted material

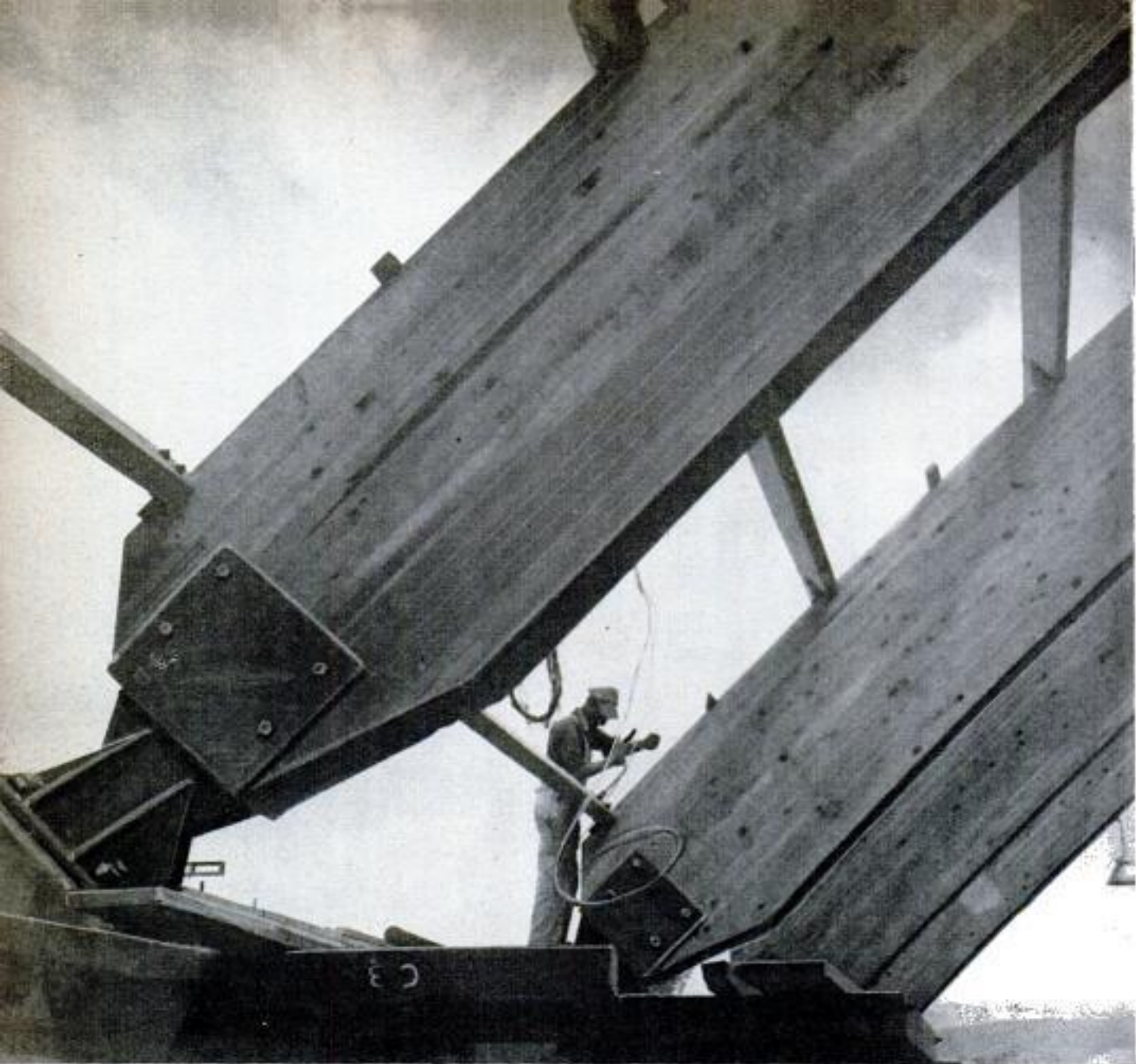

You get an idea of the huge size of these timber arches from this picture of a man working on the footings

Nature needs man's help to "grow"

200-FOOT TIMBER ARCHES

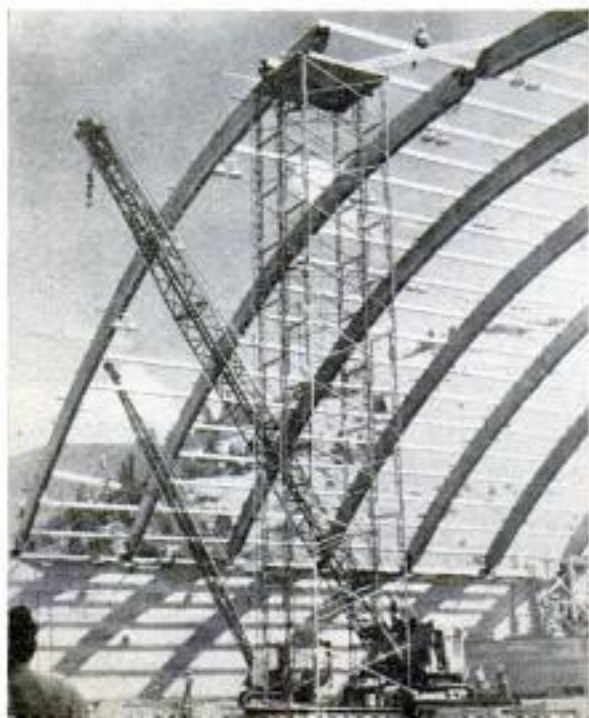

TREES JUST DON'T grow big enough to suit Timber Structures, Inc., so the company "grows" its own timbers, some of which arch 200 feet like giant wooden rainbows.

Outstanding example of the use of such giant timbers is the new field house of Montana State University. The wooden arches that support the roof of the 200-foot structure were virtually "factory grown" to size.

Many layers of planed and seasoned lumber are combined to create the structural units. Special machinery applies glue to both sides of the lumber, creating a permanent bond which is even stronger than the wood itself. With the glue applied, the planks are laid into

Too long to move in one piece, the arches were shipped in two halves which are being joined here on the site

jigs and bent to follow the contour of a full-size pattern of the desired arch timber. Tremendous pressure is required to curve the layers of planks around the jig.

When the glue has set, the jigs are removed and the timber arch is ready for finishing. As with structural steel members, each arch timber is cut and drilled in the factory and shipped to the site ready to be erected. Each is tailor-made for the project.

Giant arches such as those in the Montana field house were so large that they had to be shipped in two sections, each consisting of a half-arch. Said to be the largest timber arches ever made, they are dimensionally stable and less expensive than steel construction.

The cost of the completed structure, according to the architects, will be about \$12,000 lower than if steel timbers had been used.

An additional saving will be made each year as a result of the lower fire-insurance rates earned by the superior fire-resistant properties of heavy-timber construction. This apparent contradiction is due to the tendency of steel to deform under extreme heat while heavy timbers such as these arches maintain their shape and sustain weight longer, even though the wood itself is combustible. ★ ★ ★

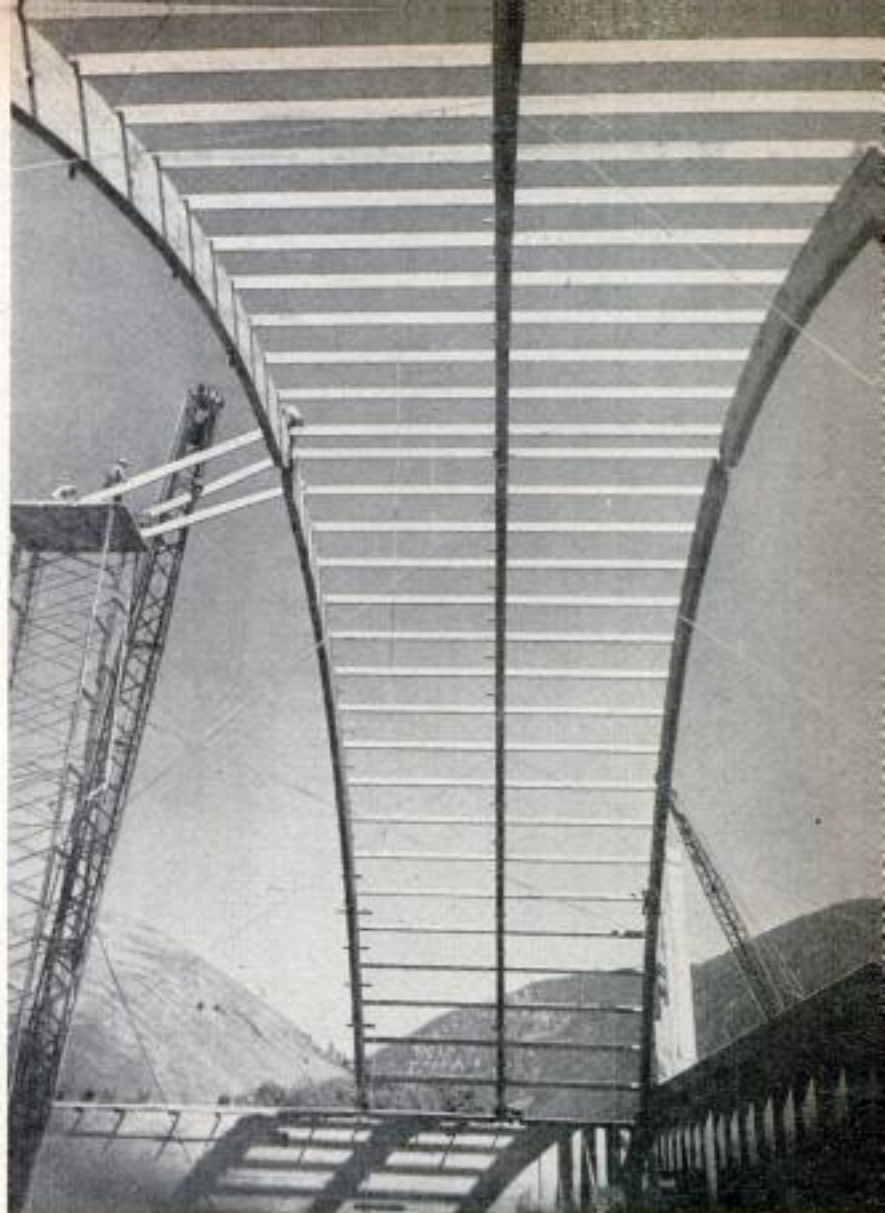

Like a suspension bridge between Montana hills, the roof takes shape. These are said to be the largest such arches ever made

Glued-up timbers are also used as vertical supports on each end of the vast roof which is 200 feet long





Kodak's Extra-Fast Film Permits Indoor Action Shots Without Flash

You won't need a costly f:1 lens to take indoor action shots without flash when you use Kodak's Royal Pan film. It has a daylight A.S.A. exposure index of 200, tungsten 160. Exposure for this shot: 1/200 at f:4.7

Air Force Puts Supersonic XF-104 Fighter Through Its Paces

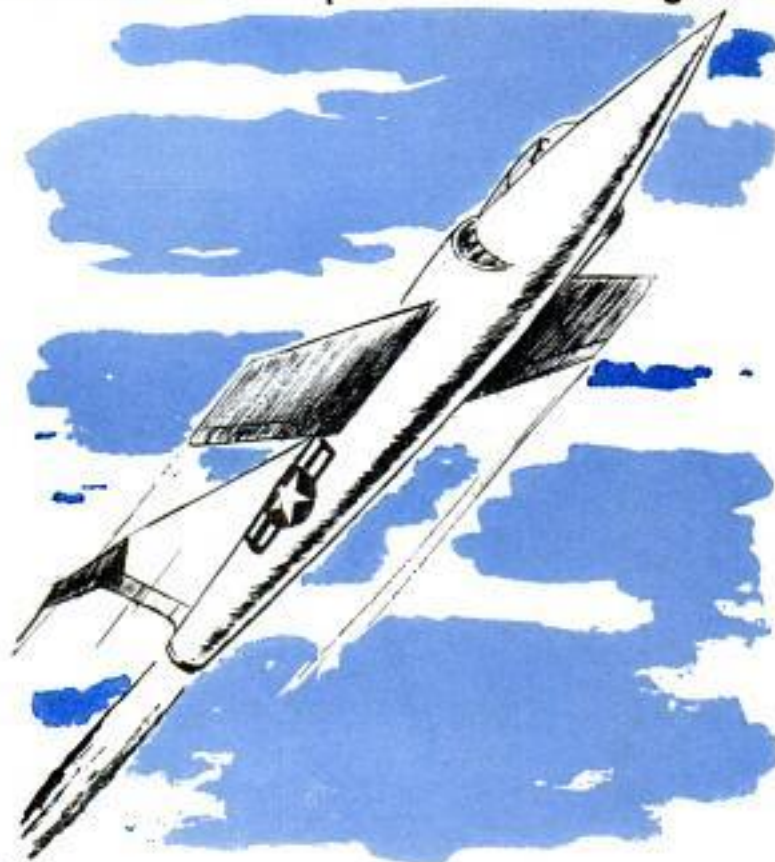

Under flight test at the Edwards Air Force Base is the supersonic XF-104 day fighter. This is not a stripped-down experimental craft, but a fast, highly maneuverable fighter that can climb with amazing speed. The Air Force has not released photographs of the plane. This drawing is an artist's conception based on information which has been published about the "aluminum sliver." Top speed of the plane in level flight is estimated to be about 1000 miles per hour. The slender fuselage has two large air scoops for the Curtiss-Wright J-65 jet engine. Exceptionally short wings measuring only about 28 feet from tip to tip are installed amidship. The tail is set high.

☛ Designed especially for duck hunters, a three-horsepower outboard motor has no highly polished surfaces and is the color of dead marsh grass.

Construction "Pistol" Penetrates Steel Plates

You can drive heavy-shank fasteners into concrete or inch-thick structural-steel plates with a new tool using a gunpowder charge. Pins and studs driven into steel with the gun are said to hold 25 percent better than fasteners seated by other heavy-duty tools. The gun weighs less than eight pounds, can be operated by one hand and drives at the rate of one stud or pin per minute. It uses one of four different powder loads, depending on the job, and is safe to operate.

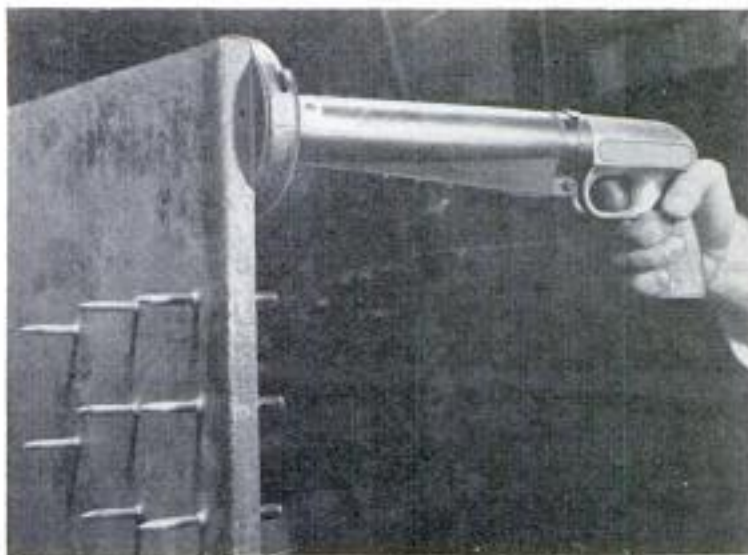

Rocket-Powered "Pinwheel" Points to "Back Pack" Unit

Something new in simplified air travel was exhibited by the Navy at Glendale, Calif. The "Pinwheel" Rotor-Craft RH-1. The tiny rocket motors built into tips of its rotor blades are fed by flameless liquid-chemical fuel which is transformed into superheated gas. The jets whirl the blades to flying speed in less than 10 seconds. The craft is controlled by a single motorcycle-grip hand throttle. Previously rockets had only two power settings. The objective of the design is to study the possibilities of "back pack" whirlybirds.



One-Man Navy Helicopter → Tests Stabilizing Controls

It's no good in a rainstorm, but the Navy's Kellett KH-15 helicopter isn't designed for pleasure. The one-man, fresh-air craft is used for studying gyrostabilizing controls for copters. It is rocket powered and has new controls which provide great stability.

Rubber Mixed With Cement Makes Resilient Concrete

Natural rubber latex has been combined with cement to make a new structural product. The material is resilient like rubber and resists corrosion and abrasion, yet has many of the structural qualities of concrete. It can be applied directly to wet or dry surfaces and sticks to plastic, tile, and steel, as well as concrete.



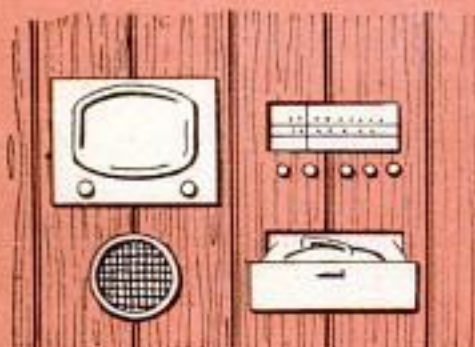

What's All This Talk About

HI-FI?

By Robert Gorman

THAT BIG SOUND sweeping the country is high fidelity—complete with words and music. The music is sweet when you hear it, but some of the words drown out the tune. Everywhere people are talking a gobbledygook language of decibels, inter-modulation distortion, pickup compliance, woofers, tweeters, bass and treble boost.

One of the most startling developments in hi-fi

Lafayette Radio sketches
Electronic Workshop photo



is one that now gives "canned" sound its natural third dimension—space. Already such sound systems are in thousands of homes. A binaural recording uses two tracks, one aimed at your left ear and one at your right. The recording is on twin-track tapes or on records that are played through dual amplifiers and speakers in different parts of the room. A few radio stations broadcast binaurally, using two microphones and transmitters. One mike feeds an FM channel, the other pipes sound to a standard AM outlet. Home listeners using two radios can hear the location of each instrument.

But one ear or two, fidelity is the thing in sound today. Recording artists and engineers pay attention to "room tone"—echoes that give listeners a feeling of space. Padded sound studios are being replaced by "live" halls in which sound bounces around. Other effects that separate and focus individual instruments are added by spotting extra microphones in strategic locations, mixing sounds and by electronic hocus-pocus. At Columbia Records' building in New York, people ride elevators whether they want to or not. Signs on the stair doors read: "Do Not Use Stairway! Reserved as Echo Chamber." RCA Victor engineers have discovered that the tiled men's room of one of their recording halls gives excellent sound bounce.

Skillfully used, such methods add some of the magic of 3-D to canned music, giving it sparkle and realism that old records rarely had. It's all part of a snowballing campaign.

What's all the hi-fi business about? Do you have to learn a new language before you can listen to it? Some of the details are technical but they boil down to this: More and better sound is being broadcast and recorded. It is cleaner, crisper, smoother, more natural and it has an exciting

new third dimension that makes listening more fun. Today's music sounds better on any equipment; it sounds best on hi-fi. Just what is hi-fi?

A high-fidelity system is an arrangement of electronic and mechanical parts that converts electric signals to sound. It starts with a radio tuner or record player—one receives, the other generates signals. The middle section is an amplifier; it soups up the signals and gives them enough "muscle" to operate a loudspeaker. The speaker changes electric impulses to sound waves.

Does the list sound familiar? You find exactly the same parts in every radio-phonograph. The different thing about hi-fi is its quality—achieved by the way it nurses signals and sounds through a series of important changes. To understand this you should know a few simple facts about sound.

Sound waves are vibrations of air that can be measured in frequency, or cycles per second. The ones we hear fall roughly in the band from 50 to 15,000 cycles. Before they are recorded or broadcast, these air vibrations are translated by a microphone into electrical signals. Records are simply sound waves converted to a vibration track on a disk, or magnetic impulses on tape. When played back, the process is reversed from "squiggles" to voltage and, finally, to sound.

A real high-fidelity system must handle the playback without adding to, changing or taking away any important part of the original sound.

That original sound, however, is no simple thing. Every musical note is a cluster of frequencies that includes a pure tone, or fundamental, and an assortment of related frequencies called harmonics or overtones. Harmonics make the difference between a note struck on a piano and the same note "sawed out" on a fiddle. They are sounds

Here are some installation ideas for the hi-fi fan. End table can be fitted with components of his choice





BY RADIO

Two mikes transmit different signals which reach two speakers



THREE-DIMENSIONAL SOUND

Dual arms pick up two different tracks of the record simultaneously. Signals go through an amplifier to speakers on opposite sides of room



BY RECORDING



that give life and individuality to music. Since many of them are in the upper part of the frequency band, one key essential of a hi-fi system is its ability to reproduce the higher frequencies.

By itself, however, the best high-frequency reproduction can be unpleasant. It sounds shrill and harsh unless it is balanced at the other end by low-frequency tones. Hi-fi, therefore, must cover the full range of audible sounds, from the lowest bass to the highest treble overtone.

The weakest link in any sound-reproducing chain is the loudspeaker—the bridge between electricity and sound. To recreate vibrations of air, the diaphragm of the speaker must move in response to the signals it receives. A good speaker has to handle many different sounds at one time without jumbling them together, changing their frequencies or relative loudness, or producing unwanted vibrations. It has to respond to crashing peaks without going into a tailspin and slurring over the next few notes; it must boom like a bass drum and tinkle like a triangle; it must do this smoothly and without noticeable effort.

This is a big assignment for any mechanical device. It takes the most careful design and construction. And even after a speaker has done its job properly, the beautiful sound waves it makes can backfire.

For instance, low-frequency waves fan out. Part of their energy sneaks behind the speaker's cone and cancels new sound-producing vibrations that follow. That's why a speaker needs a "baffle" or enclosure that will prevent back waves from interfering with front ones. If the enclosure isn't large enough, air trapped inside may stiffen the speaker cone and choke off some of the sound.

This affects only the low notes. High-pitched tones create another kind of problem. They beam out so straight that what you hear may depend upon where you sit. A speaker that is hi-fi in front may have poor fidelity when heard from the left or right side.

For a long time this complex speaker problem bottlenecked high fidelity. Old-time fans solved the problem by rigging a room full of speaker boxes. Some purists claim that big boxes are still essential, but others insist that speaker and enclosure developments of the last year or two have revolutionized hi-fi for the average home. Some of today's little boxes give wonderful sound quality. Baffle arrangements with two or more speakers are part of the story. Another part is the speakers themselves. They are more efficient, cleaner sounding. And

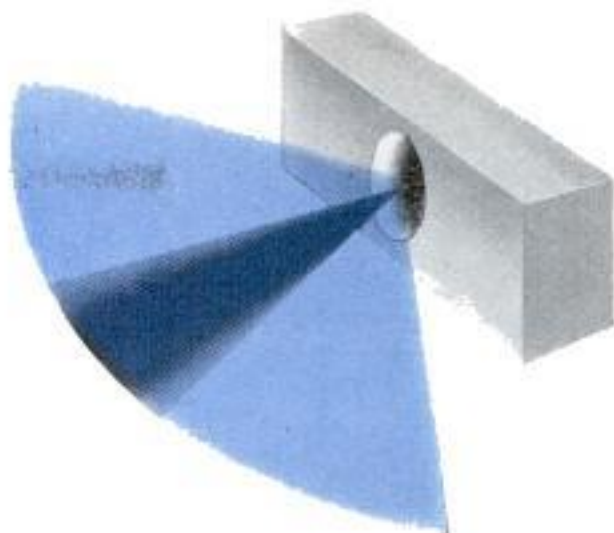

Speaker tends to beam high-frequency sounds straight out in narrow band. Bass sounds spread more evenly

there's a whole batch of new design tricks that make those higher frequencies spread out. One new speaker appears to have warts. Little cones pressed into the big one deflect treble tones and diffuse them over a wider area. Other high-frequency speakers have metal diffusion rings or specially shaped horns that serve the same purpose.

Speaker improvements have been more than matched by improvements in other parts of the sound chain—radio tuners, record players and amplifiers—so it is finally possible to assemble components that are hi-fi from beginning to end. In fact, one of the most difficult problems facing the

New RCA speaker has "acoustic domes" which deflect treble tones from tweeter in center





Modern open cabinet holds record player and preamplifier while cabinet at right holds amplifier and speaker

beginner is that of just too much goodness.

If you are in the market for new equipment, your first job is to balance quality against cost. The greatest pitfall facing the average consumer is the tendency to overbuy one part—such as an amplifier—that is too good for the system as a whole. It is possible to buy refinements you can't hear and some that aren't pleasant to your ear.

What kind of sound do you want? How much do you plan to spend? How much quality can you hear? How much is each improvement worth? These are questions only you can answer, but it may help to examine the parts of a high-fidelity system and the way they relate to each other.

Speakers—High-fidelity speakers range in price from about \$20 to well over \$600. Since this is the part you hear, it is a good idea to select it first. Check with a good

dealer for what your installation will need in the way of angle of sound diffusion, frequency range, uniformity of response (the ability to deliver all frequencies with equal energy) and distortion (a tendency to combine sounds or produce harmonics instead of the frequencies called for).

But bear in mind that it is sound, not statistics, that counts. If you possibly can, listen to several speakers before you buy. Make sure that the speakers you are judging are housed in identical boxes or the comparison will tell you little.

Some speakers are built to reproduce all or most of the audible frequencies. It is usually possible to get smoother sound by parceling out the work, using a combination of speakers—a large cone (this is a woofer) to handle the low frequencies plus

(Continued to page 258)

Photo-diagram shows elements of a hi-fi system. Preamplifier may be separate or built into another unit

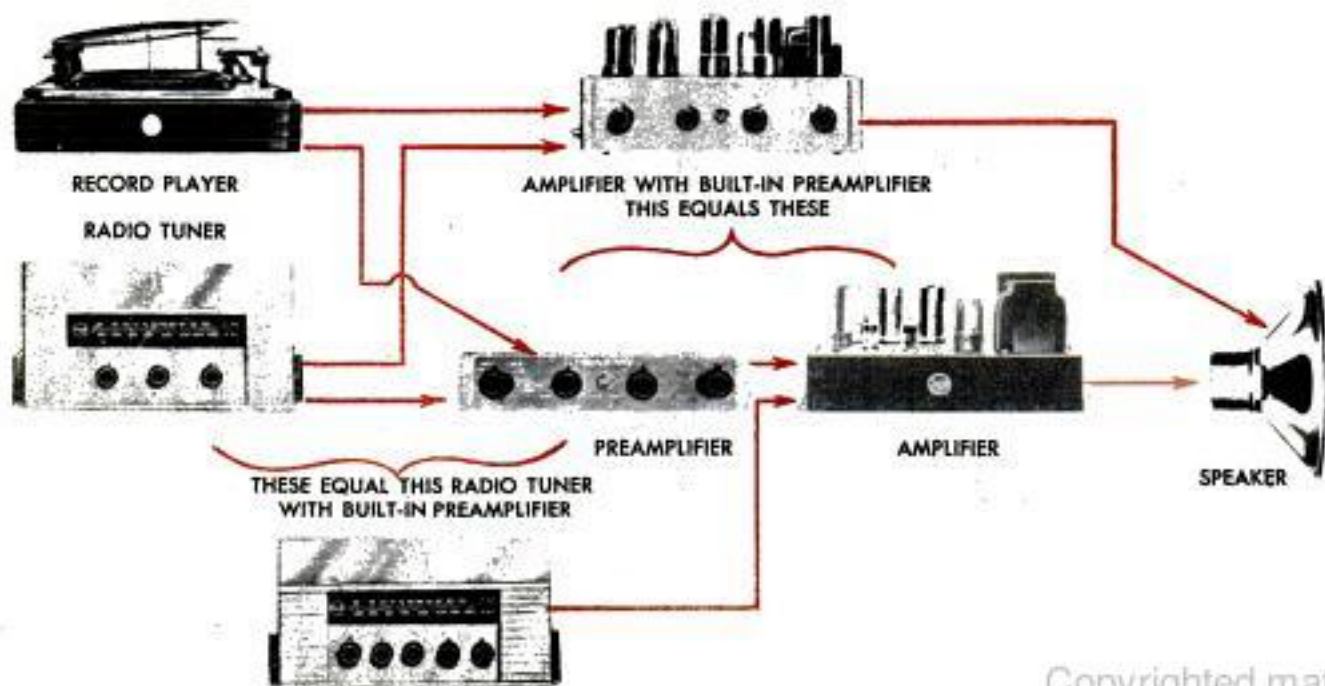



Monster's engine, taken from a fighter plane, is mounted behind driver. Car has a wheelbase of 17 feet

Fastest Drag Racer?

A STRANGE CAR that seems to be all wheels and power plant roared down a section of highway near Akron, Ohio, a few weeks ago to set what is believed to be a new world's drag-race record. From a standing start, the hot rod accelerated to 145.16 miles per hour in a run of $\frac{1}{4}$ mile.

Parts from airplanes, Army tanks and automobiles went into the 20-foot-long car named "Green Monster No. 2." It was built by Arthur and Walter Arfons.

The power plant, mounted behind the driver, is an Allison V12 engine from a P-51 fighter plane. The Arfons brothers estimate it develops 2000 horsepower at the 4000-r.p.m. rate at which they run it. The power is transmitted through a hydraulically operated clutch taken from a 30-ton tank, and a chain drive to two rear axles mounting four drive wheels. The brothers use the unusual tandem-wheel drive for better traction. They estimate the top speed of the car at 270 miles per hour, but in recent runs the tires began to smoke as the speed approached 150 miles per hour. Acceleration has been estimated at 0 to 140 miles per hour in eight seconds.



Projecting from the Monster's savage mouth is an air-speed indicator tube. It takes the place of an ordinary speedometer



Tandem-wheel drive increases the traction and minimizes the tendency to "fishtail." Car has a clutch from a 30-ton tank

Monster recently accelerated to 145.16 miles per hour in $\frac{1}{4}$ -mile run. Top speed may be 270 miles per hour

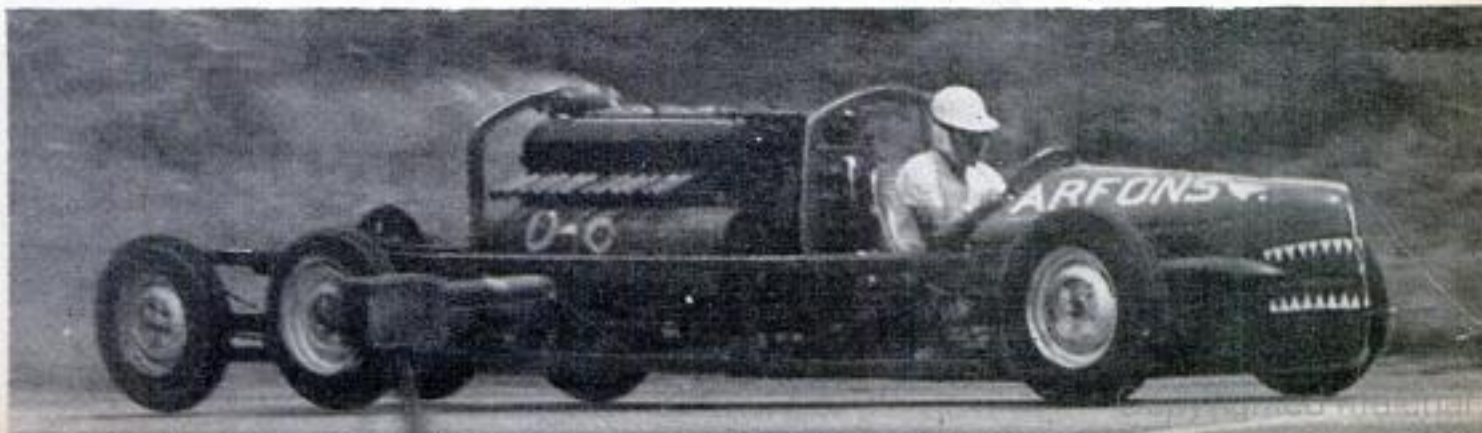

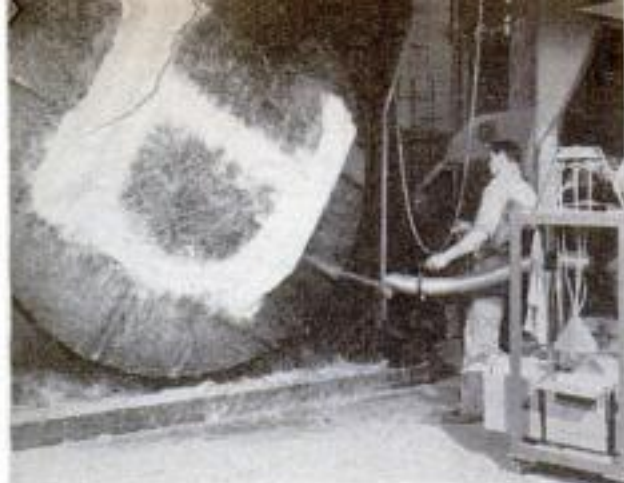

Glass fiber is sprayed over perforated screen as it rotates. Suction from back holds fibers in position



When removed from screen, preform resembles fluffy blanket. But fender and headlight bulges are evident

GLASS BLANKETS BECOME A CORVETTE BODY



Preform is placed between dies in press, saturated with resinous liquid and stamped under pressure

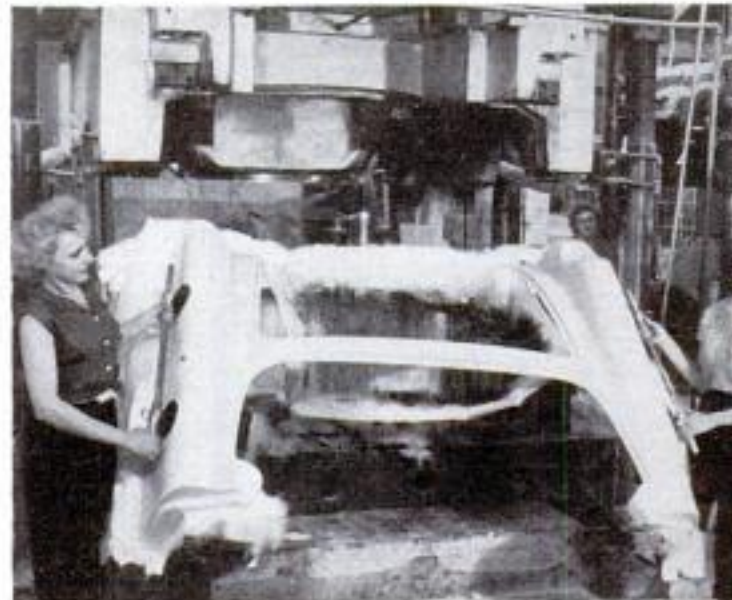

Stamped part is removed from press after two-to-seven-minute application of steam heat and pressure

WHEN THE FIRST Corvettes were being made, curing major sections of the glass-fiber body took up to 24 hours. Now it's done in a few minutes by improved, mass-production techniques. Birthplace of a Corvette body section is a circular metal screen that carries a mold of the part. As the screen rotates, a worker funnels chopped glass fiber in the direction of the mold. A powerful suction behind the screen draws and holds the fibers in place while a light spray of resin adds a bond. When the "preform," as it's called, is complete, a shield is lowered over the screen and heat stiffens the resin-coated mass. The preform is placed between the dies in a press and the fibers saturated with a resinous liquid. To give a smooth finish, a veil of finely woven fiber glass is superimposed and the part compressed under 120 pounds per square inch. Steam is forced through the hollow dies to raise their temperature to 220 degrees. After a curing time of from two to seven minutes, the now-rigid form is removed from the press and excess fiber cut away. Later it is joined to other body parts by welding or riveting.

Large piece in foreground is front-fender section that was formed in the four steps shown above. It has been trimmed and the cowl added. Seen here are main body parts





Graceful leap of the cougar is stopped in mid-air by the cameraman to show muscles of its powerful body

Walt Disney's cameramen spent months filming wildlife on the Western plains for the new film, *The Vanishing Prairie*. Here is the story of one of the Disney crew:



A prairie dog signals "all clear" after danger passes

ANIMALS ARE LIKE OTHER PEOPLE

By Tom McHugh

NO HOLLYWOOD STAR could be as temperamental, as hilarious, as touching or as frightening as some of the actors that have performed their roles before my camera.

As a member of the Walt Disney wildlife camera crew, I spent two seasons filming the spectacular true-life adventure, *The Vanishing Prairie*. We followed and found our animal and bird actors in remote sections of the West—in the last retreats of the native wildlife of the Great Plains.

This was my greatest camera adventure.

My "actors" were unpredictable. They misbehaved continually. Small ones disappeared down burrows just when I was ready to start my camera. Of course they ran from me whenever I inadvertently revealed myself. They hid from me much more easily than I from them. Larger ones often charged me angrily when I got too close.

Yet all this was to be expected.

The story for this film was their story—the everyday adventures of the animals and birds of the vast American prairie. They wrote the script with nature as their director. My camera was merely the "invisible" intruder.

In spite of the fact that the "actors" were animals, Disney



demanding that this feature have many of the qualities of other features. There had to be humor, emotion, drama and struggles.

The big difference from most movies, however, was that all these animal adventures were truth and not fiction. Yet truth in the animal world is as fascinating and entertaining as any fiction. *The Vanishing Prairie* tells the problems of the animal actors as they perform naturally on this prairie stage. It is much more than a disjointed assembly of beautiful wildlife pictures.

For example, prairie dogs fight ceaselessly against their unwanted neighbors. First a pair of burrowing owls usurps a section of the dog's burrow to raise a family. Then a badger disrupts life by chasing the dog into his burrow and trying to dig him out. The dog outsmarts the badger by moving through his underground home and emerging from another entrance to watch the badger dig.

But this dog becomes so intent upon watching the badger that he fails to see a coyote stalking from behind. When the coyote corners him he puts up such a bewildering defense of tooth and claw that the coyote hesitates. And the coyote who hesitates loses his prairie dog.

The mesh of life in a prairie-dog town continues. Animals that first looked like unwanted visitors soon appear in a different light when a rattlesnake in-

Spectacular film sequence shows falcon "dive bombing" a prairie dog. Drawing shows how cameras were set up to shoot every angle

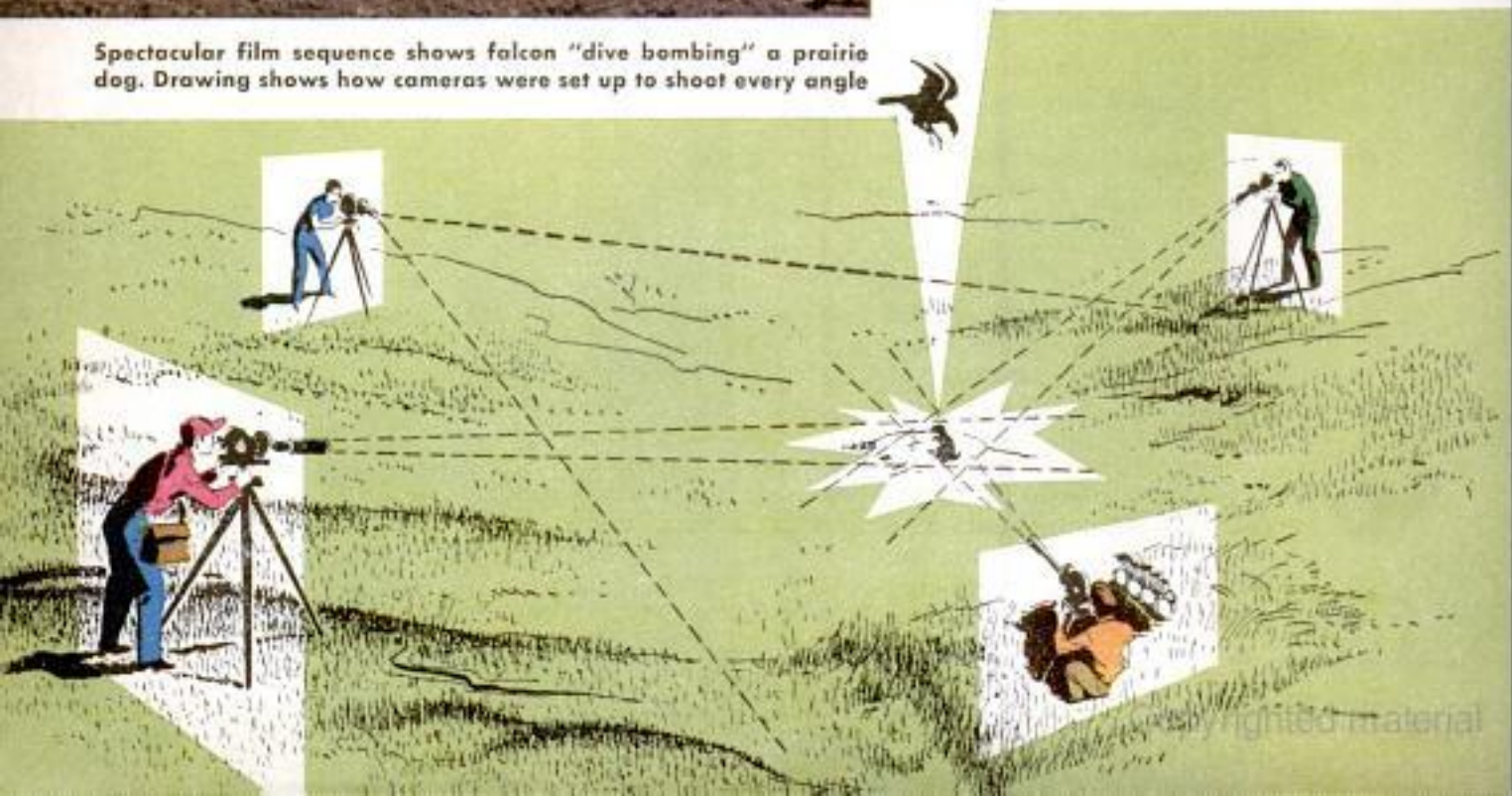



Little snowplow carried author McHugh, right, and cameraman James Simon into snowbound Yellowstone

vades the prairie-dog area. The owls bluff it away and the coyote moves in to kill it.

Many intimate close-ups help carry a story like this. These are the most difficult parts of wildlife photography. To get them I used 16-power telephoto lenses, stalked creatures by creeping along on hands and knees under cover of low foliage, built blinds to camouflage myself and my camera and used remote camera control by electric wires or radio.

Intimate close-ups bring out the personality in animals. When you compare their personalities with those of people you know, you understand and sympathize with their problems better. Animals with human traits, such as anger or foolishness, are amusing.

A group of prairie dogs has as great a range of personality as any group of humans. There is the fat dog that can't stand up on its hind legs without tipping over backwards. There is the vain dog who constantly takes dust baths to spruce up her fur. There is the tough-looking, battle-scarred man of the home and his harem of coy wives.

The most dramatic angle for photographing these animal personalities is to substitute the camera in place of one animal. The camera sees another prairie dog or a buffalo just as a prairie dog sees it—from a height of six inches



After penetrating the depths of Yellowstone in winter, the cameramen photographed buffalo standing almost belly-deep in the snow. Below, in one film sequence a prairie dog wanders too far from his burrow and has to defend himself with teeth and claw against a coyote. Eventually the coyote backed away





Clever photographers managed to film a cutaway view of the life inside an underground prairie-dog town

above the ground. An attacking prairie falcon—and the camera—sees his prey while swooshing toward it just above the ground.

The camera itself can be adjusted mechanically to best portray other sequences. Speed up the camera to 64 or 128 frames per second for a slow-motion effect. This is good for animals with unusual or irregular patterns of action. It gives a speed analysis of the graceful leap of a cougar, the hops and bounces of a jack rabbit, the booming air sacs of a sage cock or the pro-

gression of the shock wave through the bodies of colliding bighorn rams.

Slow down the camera to create just the opposite effect. By taking only one frame every few seconds, you speed action considerably on the screen. Static scenes spring to life. The clouds of a sunset bubble about and then darken in seconds on the screen. Or a prairie thundercloud explodes in moments.

Cameras should be used only during the brightest sunlight of the day according to the color-film manufacturers. Yet wildlife



Cameraman-author McHugh, camouflaged under a real buffalo robe, attempts to sidle slowly up to a wary buffalo



Like humans, prairie dogs work and play well together, but occasionally get into a rather serious scrap

doesn't always heed this rule. In fact, early morning and late evening are periods of greater activity.

The Vanishing Prairie contains many shots taken under such extreme conditions. There is even a scene of a cluster of sage grouse on their booming ground taken just before dawn with the moon in the picture. Such shots have a reddish or bluish cast due to the off-color light at these odd hours. These hues add a wonderful mood which ordinary bright daylight lacks.

Prairie chickens tested our use of weak light beyond the limit, however. They danced their best courtship displays before the light was bright enough for pictures, all the while uttering an eerie, booming sound. Activity dropped off when the sun came

up. Somehow, we would have to tempt them to dance in light that was bright enough for the cameras.

A portable phonograph solved this problem. As the sounds of booming prairie chickens streamed forth from our blind one bright morning, the birds began to cock their heads. Perhaps they thought, "Listen! Other chickens are dancing and booming—why shouldn't we start again?" And they did, to give us some wonderful shots in good sunlight.

The prairie chickens were guinea pigs for other experiments. On some mornings the best activity was too far from the blind for good pictures. That indicated a need for a "blind sneak." Cameras were first hung from hooks on the roof of the blind.

Where's the photographer? Cameramen found they virtually had to live with the herd to get top-notch films





Young owl, raised in a prairie-dog home which his mother usurped, tries to bluff away the former homeowner



Camouflaged camera was placed in path of buffalo stampede and touched off by radio. Below, in another setup, lead buffalo broke string to start camera

I then lifted the blind slowly from the ground and began walking with it to the center of action, being careful all the time to avoid bumping into birds. The cocks were so engrossed in their dancing that they seldom flushed when the blind crept past them!

Luck is a wonderful thing in wildlife photography. I only regret that it doesn't occur as often as most observers think.

Many people remarked after viewing *The Vanishing Prairie*, "Wasn't that cameraman lucky to get that comical shot of a newborn buffalo doing a backward somersault!"

In a way, it was luck—luck that I found a cow with a newborn calf. But that's where the luck ended. The key to this shot was *anticipation*. I expected that the new calf would make a spectacle of standing up for the first time. I held the camera on that calf continually, changing focus and lens

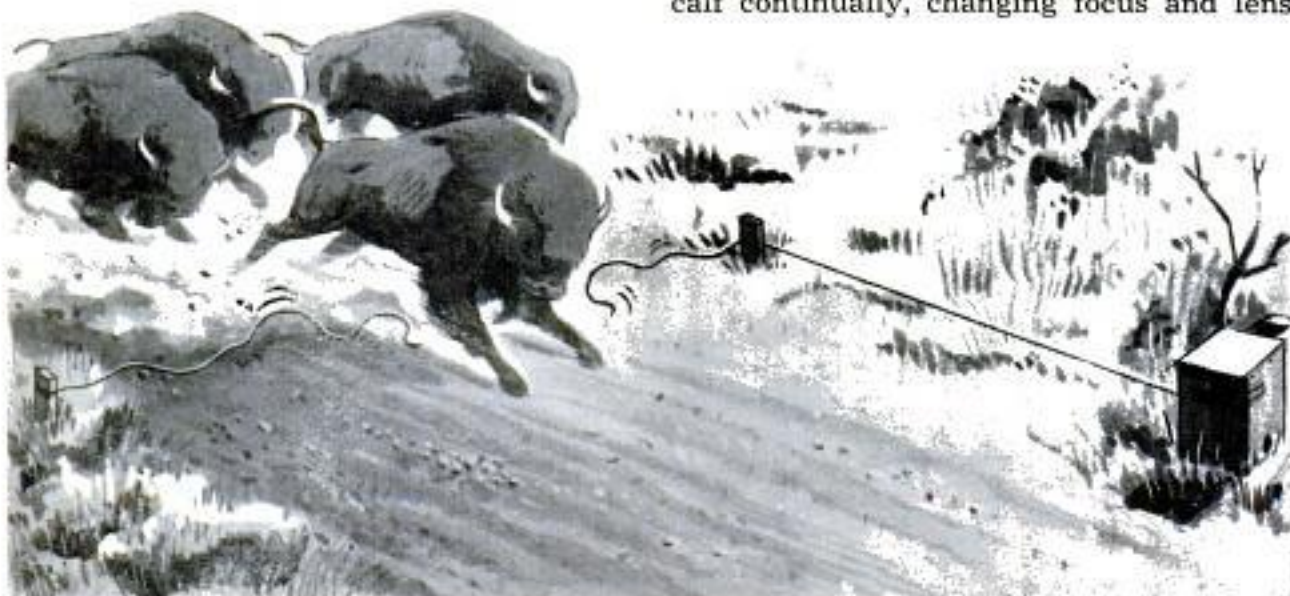



Photographer creeps up on grouse and prairie chicken under cover of a "sneak blind." Right, sage grouse cock inflates air sacs to show off for his girl friends

opening when necessary. My arm began to get tired and my eyes were straining through the viewer but I still kept the camera glued to the calf. When the big moment came, I was completely ready. A push of the shutter release and the scene was mine.

Anticipation sometimes devours film very rapidly. Prairie dogs gave little warning when they were going to "salaam" as an all-clear signal after a falcon raid. Yet we had to have this action for the film. The only solution was to start the camera when there were indications of such actions happening. And the unexpected or unpredictable did happen at some times when the camera was running.

One result of this was a great surplus of film, more than 70 times as much as could be used in the final picture. Such a surplus allowed the Disney staff to choose only the gems of action.

The Vanishing Prairie closely merges unusual wildlife with the most romantic era in American history, the settlement of the West. To get some of these animal shots we also had to pioneer expeditions into wilderness areas.

For winter scenes of buffalo, Jim Simon and I organized an expedition of two snowplanes — little propeller-driven vehicles that scoot along the snow on skis—to explore snowbound Yellowstone Park. Veteran pilots Harry Brown and Holly Leek



moved their planes to the park for this trip.

There were too many times on this jaunt when it looked as though we were doomed to walk out on snowshoes without any pictures at all.

Take the first day, for example. The 40-mile trip from West Yellowstone to Canyon was supposed to take less than two hours, until we discovered the effect of Yellowstone's thermal areas. The park is noted for its numerous geysers, but "hot spots" which melted the snow from the road were equally abundant. Our ski planes ground to a stop on these areas of bare pavement—skis were about as useful here as a motorboat on land. We then had to lift up each ski, put a caster underneath and slowly maneuver the plane across the bare spot.

We also ran into sticky snow on hills. Harry gunned the motor but the plane wouldn't budge. In this emergency we had

(Continued to page 232)

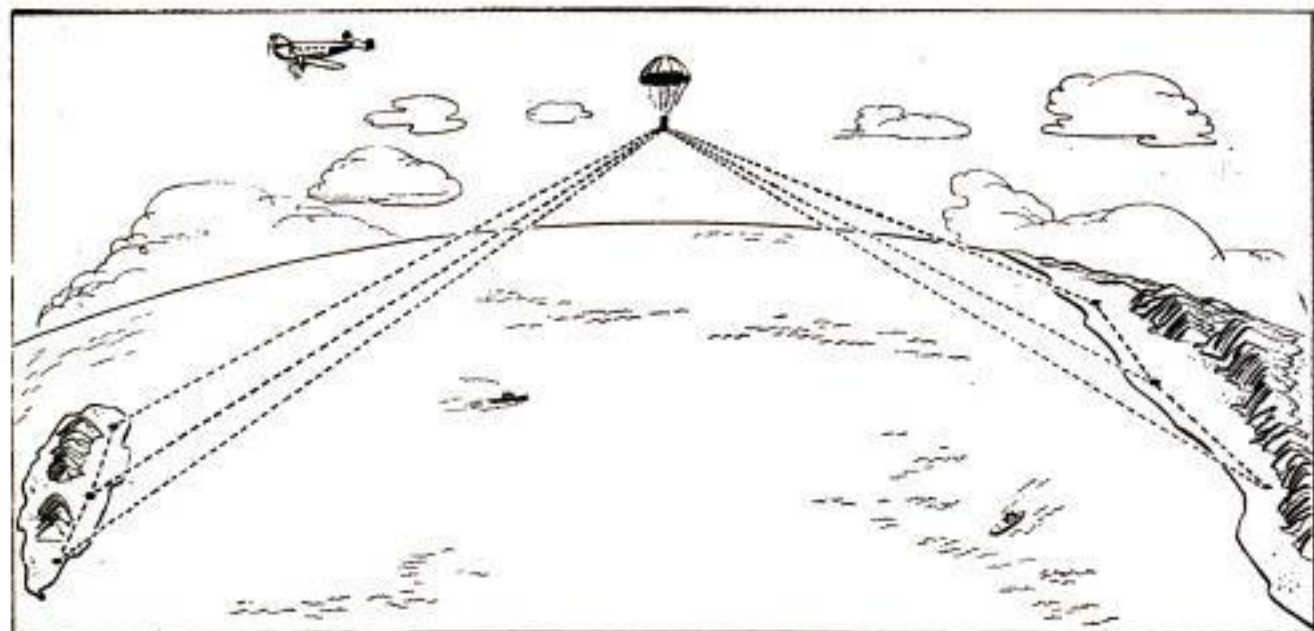

Surveyors Who Pin-Point Land Areas Have a "Flare" for Their Jobs

Geodetic surveyors have a bright new tool to measure the world. These men who make the surveys that accurately locate states, countries, islands and continents, now are using aerial flares to pin-point areas never before accessible.

The surveyors work at night. Two or more groups set up highly precise transits called theodolites at key points of an area to be measured. The instruments may be as much as 50 miles apart with any kind of terrain—ocean, desert, icecap or jungle—between them. An airplane flies to a central point and drops a brilliant parachute flare, one of at least a million candlepower. As the flare slowly descends, a man in the plane alerts the surveyors by radio to train the telescopes of their instruments on what to them is a distant tiny light. The man in the plane then pushes a button on the trans-

mitter. That's all there is to the process.

Each of the theodolites on the ground contains a robot camera that records on film the exact angle of each surveyor's sighting on the flare. All the cameras record their readings at the same instant. The final calculations, as in all geodetic surveying, are done in an office where other factors such as the varying curvature of the earth at different latitudes can also be considered. The precision of the process is so great that the final angles recorded by the instruments are obtained by viewing the film through a laboratory microscope equipped with a micrometer.

The method can be used to locate an island that is over the horizon from the shore. Previously such a measurement could be made only roughly with devices similar to a ship's navigating instruments.

Electric Wind Tunnel Speeds Tests of Airplane Wings

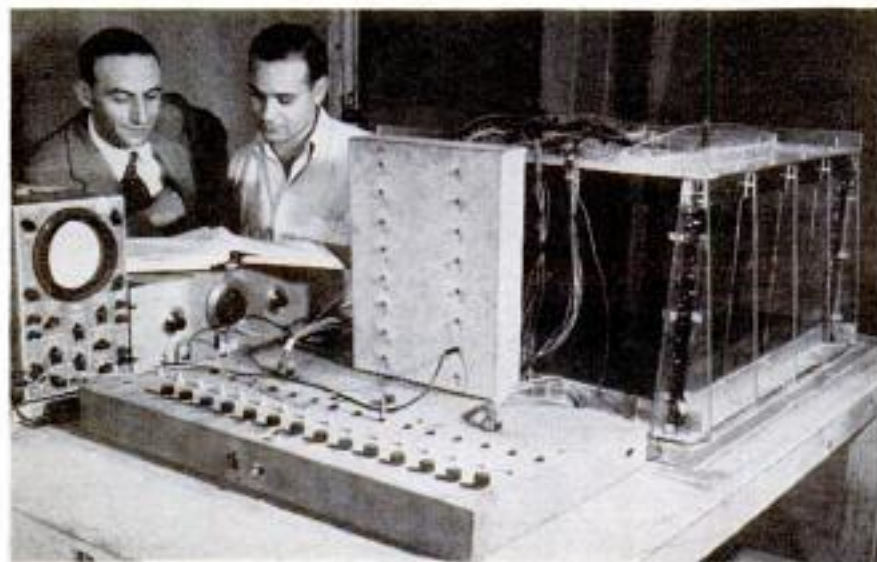

Cornell University photo

By means of an "electric wind tunnel," researchers can now determine how forces act on an airplane wing in a fraction of the time it takes in a conventional wind tunnel or by computational methods. Built at Cornell University, the new device simulates the flow of air by passing electricity through liquid. It can quickly provide engineers with an extremely accurate lift pattern for any wing shape and any sub-sonic speed.

Tractor Mounted on "Stilts" Is Used to Dust and Detassel Corn

Moving slowly through the sweet-corn fields of California is a weird tractor on stilts. The tractor is used to dust and detassel the high corn. The builder started with a 21-horsepower crawler tractor. He raised the tractor chassis including the motor and transmission so there would be 78 inches of clearance beneath it. Side frames—the "stilts"—support the tractor in this position. Additional sprockets and links of track were installed on each side. The result is a tractor that rolls through the high corn, dusting and detasseling it even during wet weather when rubber-tired tractors bog down in the mud. It has 6½ feet clearance and straddles two rows of corn while dusting 12. A framework across the back holds the dusting equipment. During detasseling, men ride on hangers dropped down between the rows alongside the tractor.

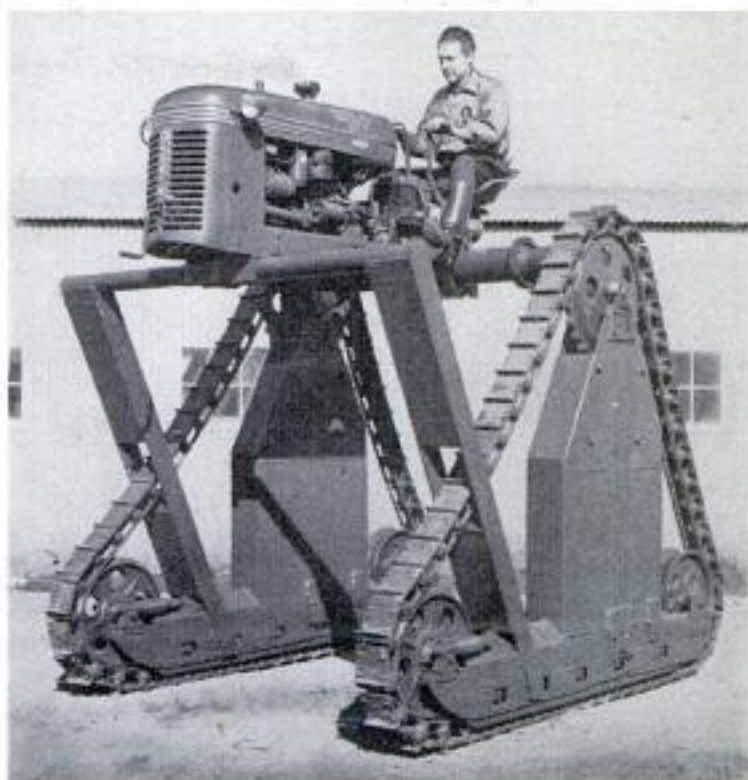

Motion of Boat Operates Automatic Bailer

As long as a boat is in motion a new bailer keeps it dry. The automatic bailer is a tube which operates on the Venturi principle to suck the water out of the boat. The tube clamps to the boat, with one end in the water and the other in the bottom of the craft. Whenever the boat is in motion, any water in the bottom moves up the tube and over the side. Another tube attached to the bailer brings fresh water from the lake or river into the minnow pail to keep bait alive longer.

Liquid Added to Can of Paint Prevents Formation of Skin

One tablespoonful of a colorless liquid in a quart of paint prevents the formation of skin and lumps during storage. By halting the oxidation and consequent drying of important oils, the chemical maintains the quality of the paint. It also retards the settling of pigments; thus paint for touch-ups retains its original color. The chemical, which in addition can be used to keep putty and calking compounds smooth and ready for use, evaporates when the paint is applied and leaves no residue.

Information not listed on articles in the index frequently is listed in the WHERE-TO-FIND-IT LIST, free to readers from the Bureau of Information, *Popular Mechanics*, 200 E. Ontario St., Chicago 11

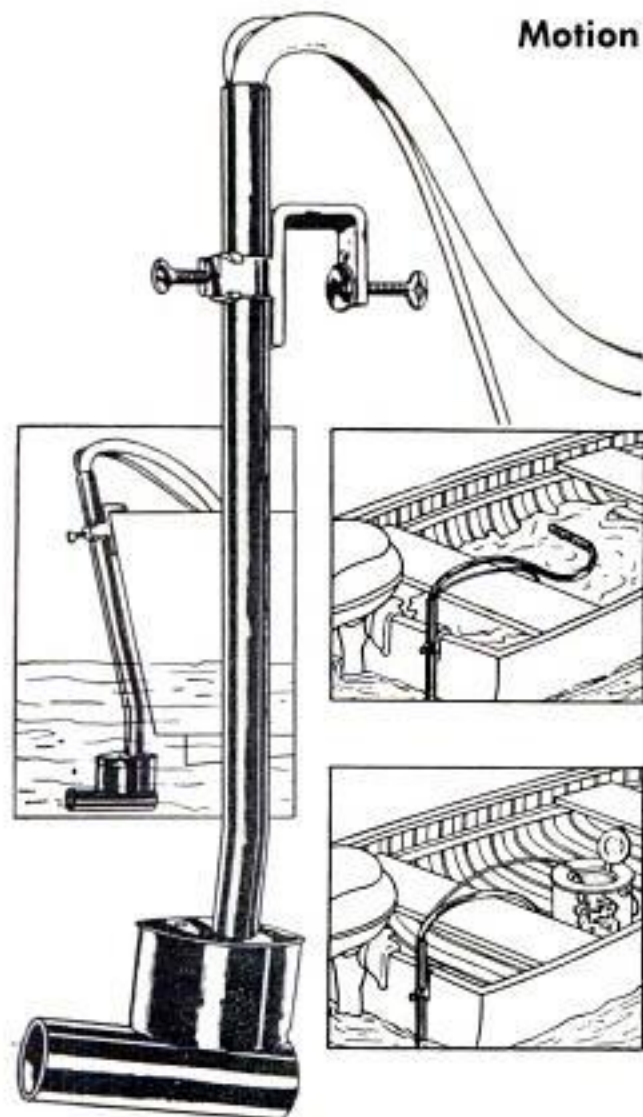

The OWNERS REPORT:



Owners are the real test drivers. They know the good and the bad features of their cars. We asked 1000 Cadillac owners to tell you about the 1954 models. Here is their story

WHY DID THEY BUY A CADILLAC?

"Economical on gas and repairs."

*Provo, Utah,
professor*



"High resale value and economical operation."

*Laramie, Wyo.,
attorney*



"My wife wanted a Cadillac."

*Crescent City, Calif.,
merchant*



"I always hoped to own one. My greatest ambition."

*La Crosse, Wis.,
business man*



"Better performance."

*Pelham, N. Y.,
salesman*



"Wonderfully low depreciation."

*Newbury, Ohio,
consultant*



"Just like to impress people."

*Oakwood, Va.,
businessman*



"Prestige and to show off."

*Daly City, Calif.,
investor*



Copyrighted material

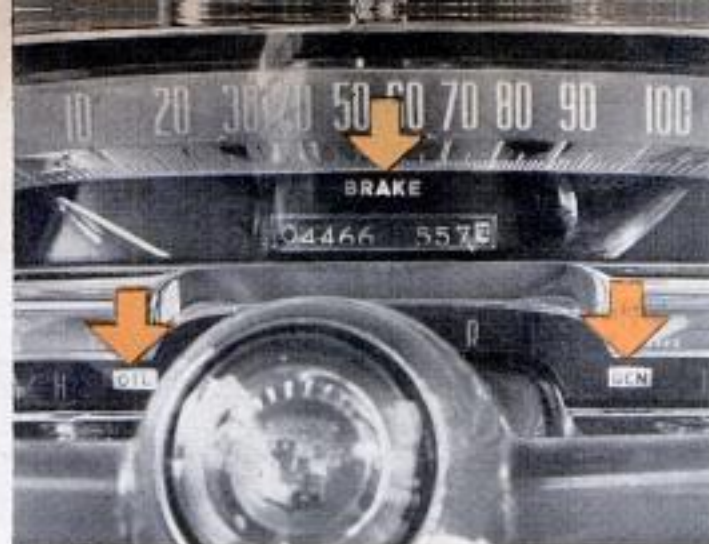

Lights indicate oil pressure and amperes. The word "brake" warns driver he has not released hand brake



White card in front of radiator is a Cadillac "extra." On it is printed name and address of the car's owner

OWNERS SAY THEY LIKE CADILLAC'S COMFORT, POWER AND PRESTIGE

By Cadillac Owners

WHAT'S THE MAGIC of Cadillac? Why is it the prestige car it is? A thousand Cadillac owners were asked to explain.

But even owners could come to no definite conclusion. Owners are aware of the prestige value of their cars, but none could explain it. Price alone is not the answer because other cars cost as much or more.

"It carries a lot of prestige to own a new Cadillac each year."—Daly City, Calif., investor.

"I always hoped to own one. My greatest ambition."—La Crosse, Wis., businessman.

"I bought Cadillac because of the name."

—Chicago, Ill., certified public accountant.
"I just like to impress people."—Oakwood, Va., businessman.

"Every Tom, Dick and Harry hasn't got one."—Mason, Mich., factory mechanic.

Even those owners who have had trouble with their Cadillacs still maintain a great admiration for the car.

"I realize from all viewpoints, it is the finest for the money. Thus far, I had my hood, rear door, trunk lid and front fender refinished. Have had trouble getting engine to start. Steering gear had to be gone over."—Chicago, Ill., warehouseman.

Strangely enough, economy is mentioned

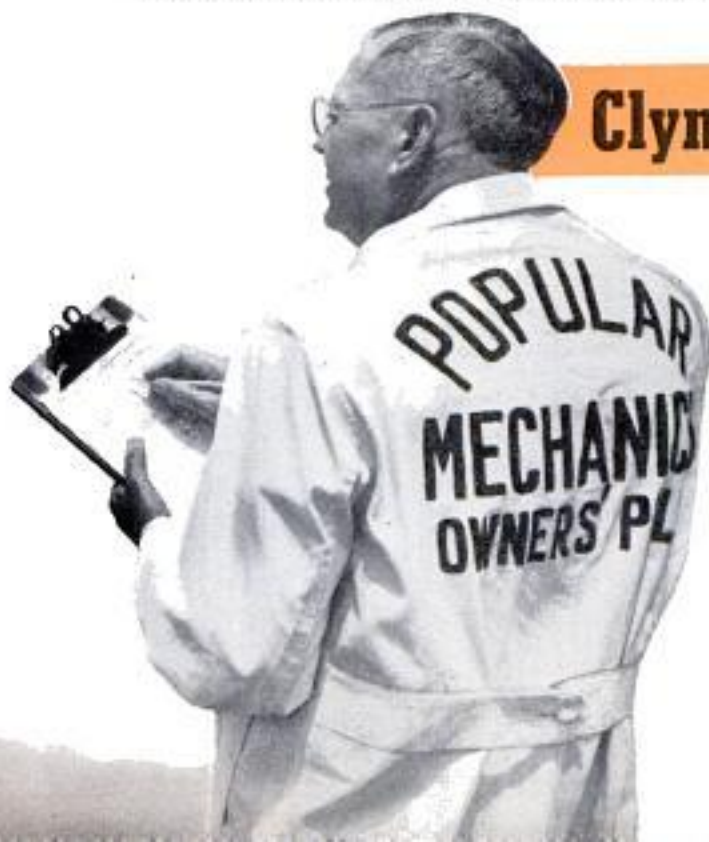

Clymer Tests the Cadillac

By Floyd Clymer

MY ROAD TEST covered about 340 miles in the Rockies around Denver and about 220 miles in Southern California—a total of 560 miles. Two Series 62 sedans were put through tests under conditions ranging from high altitudes of the Rockies to the heat of the Mojave Desert.

The 1954 Cadillac is improved over the previous models and, for a big car, handling qualities are excellent.

Cadillac has been noted for economy despite its size and the 1954 model is no exception. The overhead-valve V8 engine provides smooth, effortless power at all

(Continued to page 234)

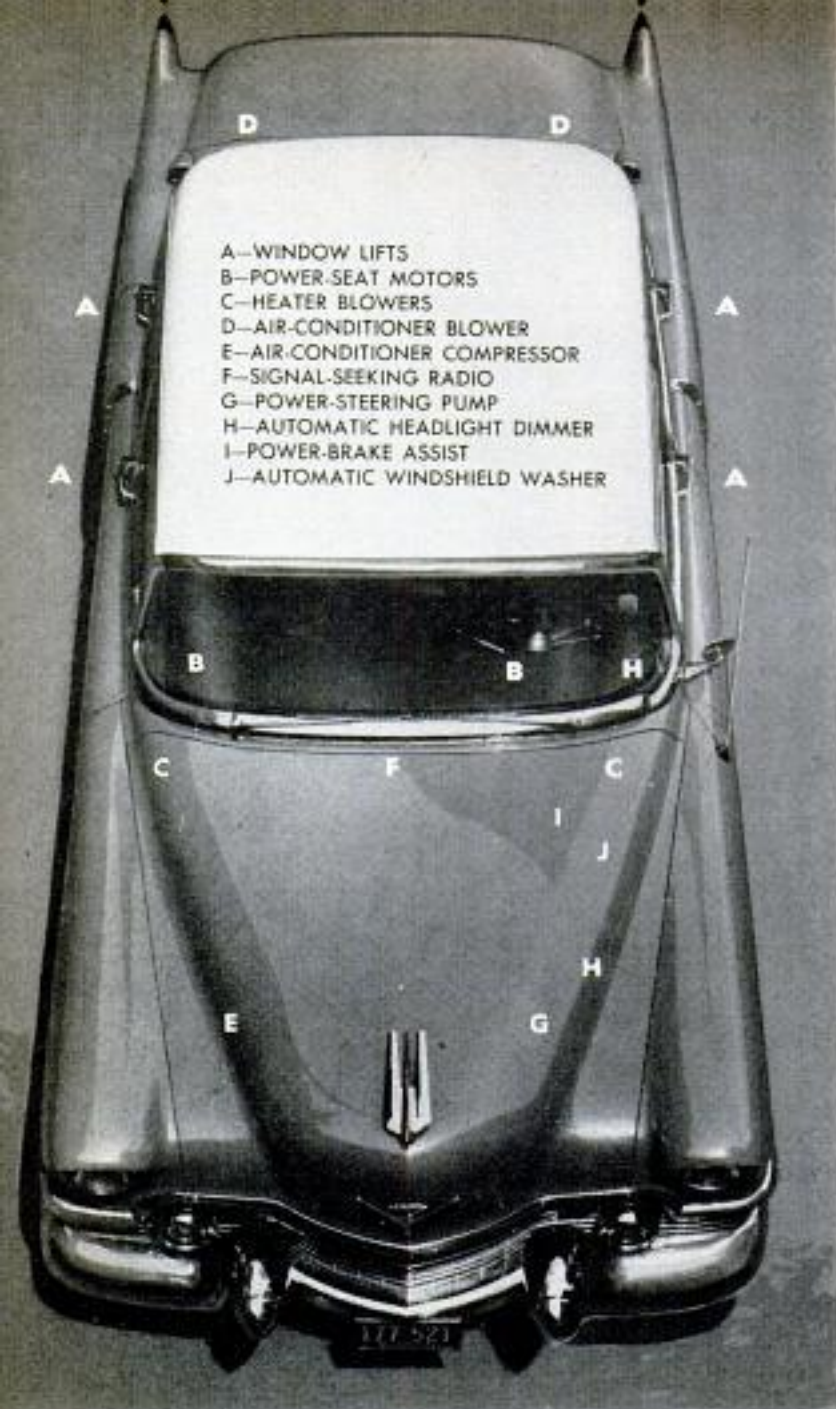

- A—WINDOW LIFTS
- B—POWER SEAT MOTORS
- C—HEATER BLOWERS
- D—AIR-CONDITIONER BLOWER
- E—AIR-CONDITIONER COMPRESSOR
- F—SIGNAL-SEEKING RADIO
- G—POWER-STEERING PUMP
- H—AUTOMATIC HEADLIGHT DIMMER
- I—POWER-BRAKE ASSIST
- J—AUTOMATIC WINDSHIELD WASHER

For a price, these magical "gremlins" will take the work and discomfort out of driving. Power steering is now standard

Cadillac pipes heated air into the rear seat via a duct in each front door. When the door is closed, the outlet is behind the front seat. Sketch at right shows details of system



as one reason why owners think so highly of their Cadillacs.

"Cheapest over-all operation."—Greenville, Ill., owner.

"It is economical for gas and repairs."—Provo, Utah, professor.

"High resale value."—Laramie, Wyo., attorney.

Probably the following owner came closest to describing the Cadillac appeal:

"You are satisfied when you drive the Cadillac."—Portland, Ore., manufacturer.

Best-Liked Features

Riding comfort is the best-liked feature of the 1954 Cadillac, according to owners. Performance and power are right behind.

"Easy riding qualities. Excellent for trips, a fine family car."—Oxnard, Calif., chiropractor.

"It rides like floating on air."—Chicago, Ill., businessman.

"I like the higher seating which gives me better visibility. The ease of all controls. The power steering and brakes."—New Brunswick, N. J., merchant.

"Riding qualities are wonderful."—Buffalo, N. Y., business executive.

"Engine is economical as well as powerful."—Antioch, Calif., plant manager.

"This car can really go in fine shape for mile after mile with a minimum of repair. A great performer!"—Minneapolis, Minn., salesman.

Third among the best-liked features was the ease of handling. All Cadillacs for 1954 have power steering as standard equipment and this makes steering effortless. Fourth in popularity was Cadillac's styling and appearance.



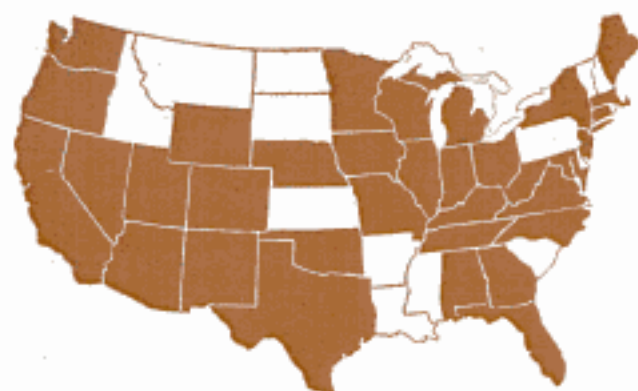

Cadillac owners from 34 states (shown in color on the map) tell you about their cars in the PM poll

Percentages from PM Poll of 1954 Cadillac Owners

OVER-ALL RATING OF THE CADILLAC

Excellent	71%
Good	21%
Fair	5%
Poor	3%

Previous Cadillac owners.....83%
 Owners of 5 or more Cadillacs previously.....30%

Owners who have 2 or more cars.....69%

Make of the "second" car:
 Cadillac26%
 Ford15%
 Chevrolet14%
 Oldsmobile11%
 Others34%

Owners' rate dealer service:
 Excellent45%
 Good26%
 Fair19%
 Poor10%

Would buy another Cadillac?
 Yes85%
 Might12%
 No3%

Tried other makes before buying Cadillac:
 Did try other makes.....45%
 Did not try other makes.....49%
 No comment.....6%

Owners' opinion of engine:
 Excellent89%
 Good11%
 Poor0%

Owners' opinion of wrap-around windshield:
 Excellent73%
 Good22%
 Poor5%

Owners' opinion of rear fender fins:
 Like90%
 Dislike7%
 No comment.....3%

Owners' opinion of front grille unit:
 Like65%
 Dislike28%
 No comment.....7%

Owners' opinion of overall length:
 Like88%
 Dislike11%
 No comment.....1%

Owners' opinion of body styling:
 Like90%
 Dislike6%
 No comment.....4%

Average miles per gallon
 City driving.....13.9 m.p.g.
 Country driving.....16.7 m.p.g.

Roadability
 Excellent82%
 Good16%
 Poor2%

Handling
 Excellent88%
 Good12%
 Poor0%

Structural rigidity
 Excellent62%
 Good28%
 Poor10%

Acceleration from zero
 Excellent72%
 Good24%
 Poor4%

Acceleration from 50 m.p.h.
 Excellent73%
 Good26%
 Poor1%

Who are the Cadillac owners?
 Owners of a business.....33%
 Business executives.....20%
 Professional persons.....14%
 Salesmen7%
 Retired6%
 Not given.....6%
 Miscellaneous14%

BEST-LIKED FEATURES
 Riding comfort.....35%
 Performance and power.....31%
 Handling ease*.....27%
 Styling24%
 Economy of operation.....11%
 * Power steering standard on all 1954 Cadillacs

MOST-FREQUENT COMPLAINTS
 Poor assembly work.....19%
 Rattles and squeaks.....18%
 Gasoline fumes inside car.. 9%
 Poor paint job.....7%
 Excessive wind noise.....6%

Owners with no complaints at all.....33%

"I like best the ease of handling on the road which does not tire you on long trips."
 —Omaha, Neb., broker.

"Distinctive, smart styling. Modern yet not overdone. Plenty of legroom."
 —Somerset, Ky., photographer.

"Beautiful lines with no danger of it being 'dated' by the next model."
 —Chippewa Falls, Wis., businessman.

However, some owners disagree with the 24 percent who said styling was among the best-liked features.

"Bulky and unattractive." — Chevy Chase, Md., executive.

"Too much gingerbread on front grille. Too much overhang beyond rear wheels."
 —Chicago executive.

Cadillac Owners Complain Also

Although most are convinced they drive the prestige car, Cadillac owners have complaints just like all owners.

By a wide margin, the two most frequent complaints were (1) poor assembly work at

the factory, and (2) rattles and squeaks.

"Factory inspection very bad. Had paint bubbles, unfinished in spots. Directional signals faulty. Odometer not accurate. Steering wheel not properly lined up. However, dealer is gradually getting everything in order."
 —Fair Haven, N. J., executive.

"Sloppy job of inspection. Upholstery not good for a custom car. Bad paint job. Car was repainted at 2000 miles."
 —Glen-coe, Ill., executive.

"Quality-control inspection poor. Chrome not too good. Back bumper had to be changed. Paint applied too sloppy."
 —Panama City, Fla., Air Force officer.

"Too little time given to details or inspection. At 600 miles speedometer failed. At 1000 miles Hydra-Matic had to be replaced. At 3000 miles generator went bad and had to be replaced."
 —Peekskill, N. Y., dentist.

"Doors on my convertible are terrible. Either rattle or won't open."
 —Richmond, Va., scientist.

"Body rattles very bad. Leaks around

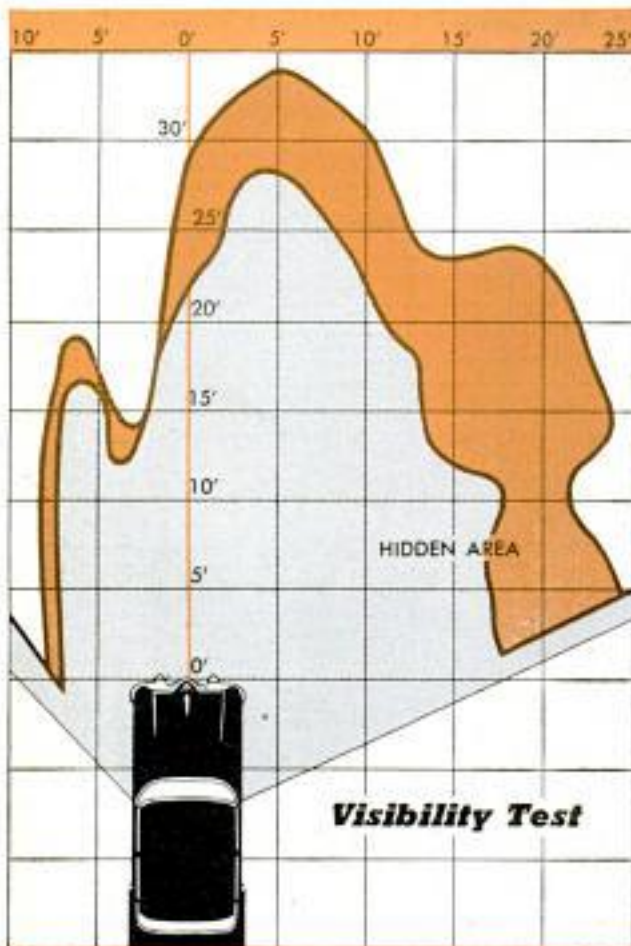

With four-way front seat in highest position, driver can't see gray area. With seat all the way down, yellow area is also invisible to him

Acceleration Test

1954 CADILLAC 62 FOUR-DOOR SEDAN
with Hydra-Matic

¼ mile from zero

½ mile from zero

0 to 30 m.p.h.

0 to 60 m.p.h.

Top speed by speedometer.....115 m.p.h.
Actual top speed about 5% less

Economy Test

MILES PER GALLON
Constant-Speed Mileage

At constant 30 m.p.h.	22.2
At constant 50 m.p.h.	18.1
At constant 60 m.p.h.	15.9
At constant 75 m.p.h.	11.8

Cross-Country Mileage

Denver to Estes Park and Grand Lake, returning by Lookout Mountain (altitudes from 5280 ft. to 13,000 ft.)	13.2
Denver to Cheyenne, Wyo., returning via Jules- burg, Colo., (open spaces, little traffic)	17.4
Los Angeles to Barstow and return via Mojave Desert	17.1

(Premium gasoline used)

doors so bad you have to keep rubber sheeting on seat. Dealer very cooperative."—Lewiston, Me., accountant.

"Doors fit badly. Rattle. I have had to have rubber in both doors to prevent noise."—Lincoln, Me., physician.

Also mentioned by the owners is an annoying odor of gasoline inside the car.

"Raw gas smell. Many other annoyances; Radio stopped four times; taillight out three times; directional lights failed two times."—Hartsdale, N. Y., housewife.

"New car had one bad bug: Gas tank was not properly vented and gas fumes got into car. Has been fixed."—Galesburg, Ill., executive.

"Some gasoline fumes leak into inside of car through space where filler neck passes through trunk."—Houston, Tex., rancher.

Another complaint, although not so frequently mentioned, was wind noise at high speeds.

"Windshield causes wind noise at 50 miles per hour on my Coupe de Ville."—Birmingham, Ala., executive.

Reputation for Economy

Cadillac has built up a reputation for economy of operation and, as previously mentioned, some owners list this as the reason why they bought the car. However, there seems to be some dissension among owners about this fact.

"I have often wondered where the Cadillacs are that get such good gas mileage. I have never gotten more than 12.5 miles per gallon around town and 16.5 on the road, driving fairly conservatively, too."—Atlanta, Ga., real-estate owner.

"I get 10 miles per gallon in city and 12 miles per gallon in country driving. My 1949 Cadillac provided superior economy."—Reynolds, N. C., retired owner.

Cadillacs have had a very low annual depreciation since the war, another economy factor. There is some indication that this is changing.

"We traded a 1950 for a 1951 for about \$500 depreciation. Each year it has cost me more to trade. My last trade was a '53 for this '54, same model and same equipment. Cost me about \$1600."—Somerville, Tenn., merchant.

But there can be no doubt but that Cadillac owners believe they drive the outstanding automobile. Nearly half of them (49 percent) admitted that they did not even try any other make before buying Cadillac. And these owners could buy any make as they don't have to limit their choice to any price class for economy reasons.

One third of them (33 percent) did not list a single complaint.

Who are the Cadillac owners? More than

(Continued to page 240)

Silage Blower Vacuums Golf Greens Covered With Layer of Silt

Ingenuity and a vacuum silage blower solved the problem of removing a heavy layer of silt that threatened to kill the grass on the greens of the Garden City, Kans., Country Club. A severe storm deposited the silt, inches deep, on the greens. A vacuum silage blower was borrowed from a local farm and two nine-horsepower motors rigged to it. The large-scale vacuuming was done as the silt was sucked up through its flexible pipe and then exhausted.

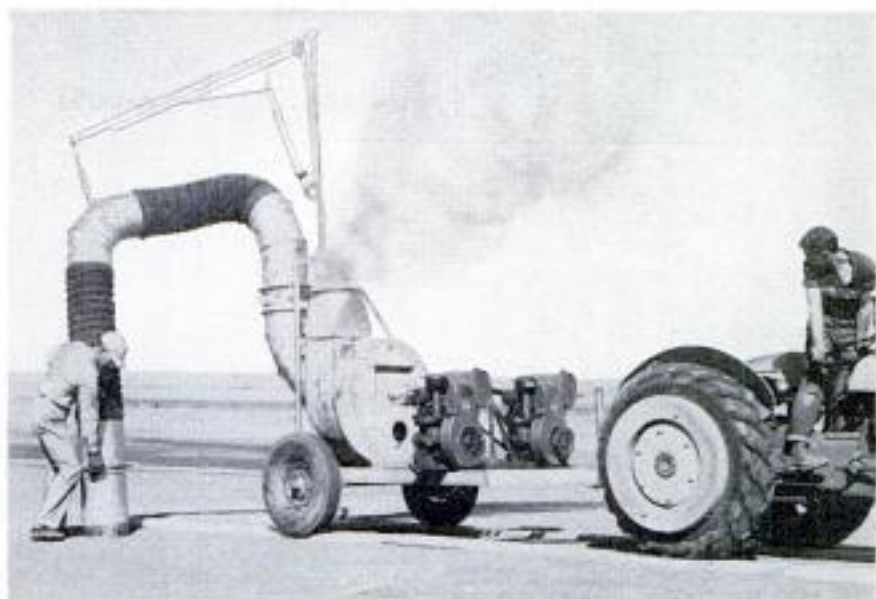

Lifeboat Engine Runs Under Water

Even when it's covered with water, a new lifeboat engine keeps chugging. The diesel engine is also its own bailer and can be started or stopped while submerged. It was recently demonstrated in New York. The waterproof engine is only the latest in a long list of products designed for lifeboat use. These include radios, water distillers and fishing equipment.



Floating Mower Cuts Canal Weeds

Weeds and water plants which slow navigation in the canals of Holland are cut by a boat-mounted mower. The rig has two cutting bars, one at the bow to make an initial cut in dense growth, the other at the stern. Both are driven by a motor. Weeds are mowed down as the boat moves along.

Should a ship's aerial be shot away, disconnected or otherwise damaged, the transmitter of a new type of ship's radio-telephone developed in England remains unaffected.



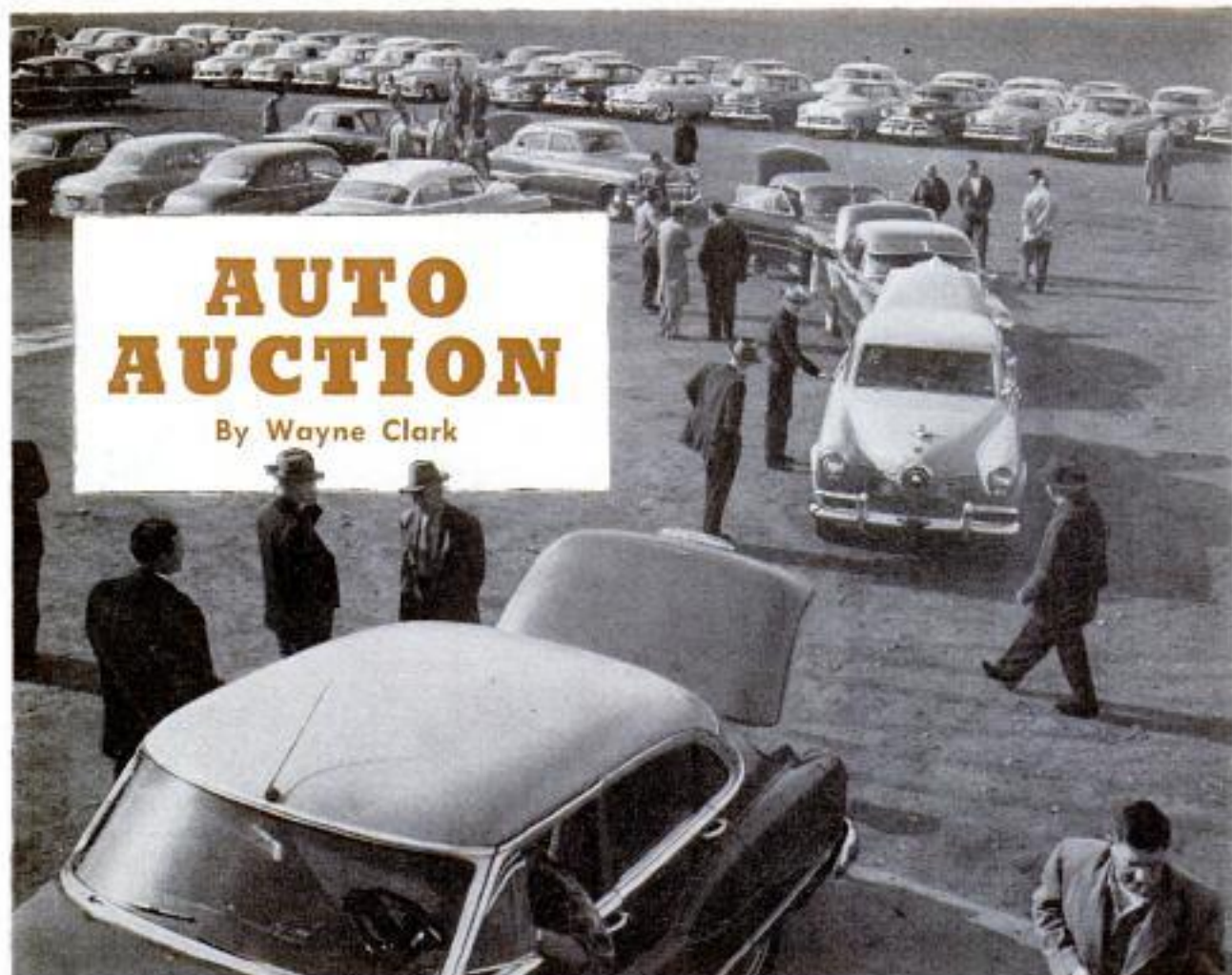

AUTO AUCTION

By Wayne Clark

Cars move into the auction hall as prospective buyers take a final look before going in for the bidding

AUCTIONEERS SOUND the same whether they're selling tobacco or automobiles. Little known by the public, auto auctions all over the nation are setting prices of used cars—determining in large measure what your family "hack" is worth.

The automobile auction gives the new-car dealer a chance to get rid of surplus trade-ins or, in some cases, to get rid of surplus new cars (an activity frowned on as "bootlegging"). It enables the used-car dealer to get cars that he knows he can sell. At the auction he selects the makes and models that are wanted by his customers.

When a car comes in for auction, it is first registered and then parked with other cars of the same year and make. The title is held in trust by the auction house until the sale. Titles are guaranteed and have to be checked to make certain the car has not been stolen.

Only dealers can bid, although they may bring guests. Used-car buyers are shrewd. They have to be or they will soon go broke. A few bad buys and the year's profits are wiped out. The buyers inspect the cars, checking everything. In the lot before the car goes on the block is where the buyer makes up his mind. He checks the trunk

to make sure there are no telltale holes where a taxicab radio might have been. He starts the engine, backs the car up. He lifts the hood to be certain an oversize generator doesn't give away a record as a police car.

If his inspection convinces him it's a car he wants, he jots down the registration number that's on the windshield and puts down what he thinks is the top price he should bid when the car comes up.

Should he make the top bid on the car, some auctions permit him to test drive the car briefly. Most auctions guarantee the cars they sell if they go for more than a certain minimum price. The guarantee states that the rear end, transmission and block are in good condition. It lasts only until the dealer gets the car to his lot—from then on it's his worry.

Cars go on the block in order of age—the oldest cars first. As the car is driven in, the trunk is opened to show how clean it is and what the spare tire looks like. Doors and hood are opened. But the buyers do little inspecting now—they have done all of it earlier out in the parking lot.

The auctioneer begins his sing-song. Pit men "drum up" the bids and relay them to the auctioneer, slapping fenders, opening



Photos courtesy Dyer, Int., Auto Auction

Buyers cluster around as the auctioneer keeps bidding going. It is fast, taking about two minutes per car

and closing doors to punctuate their activities. The dealer who is selling the car is permitted to enter the bidding to protect his interest. If he thinks the bid is too low, he buys the car himself.

Prices for any given year and make may vary as much as \$300, depending upon the

condition of the car. To describe that condition, the trade has its own set of adjectives. From top quality on down, they are as follows: New, sharp, good, fair and rough. New means just what it says—never been used. And, as the buyers know, rough is really rough! ★ ★ ★

Three used-car dealers look over a 1952 Plymouth. Buyers go over each car carefully before it goes on block



WHAT'S NEW FOR Your Home



1

1. FREEZER for small apartments is also a drop-leaf kitchen table. Unit has six-cubic-foot capacity, pedal opener, swing door and smooth-rolling food file drawers

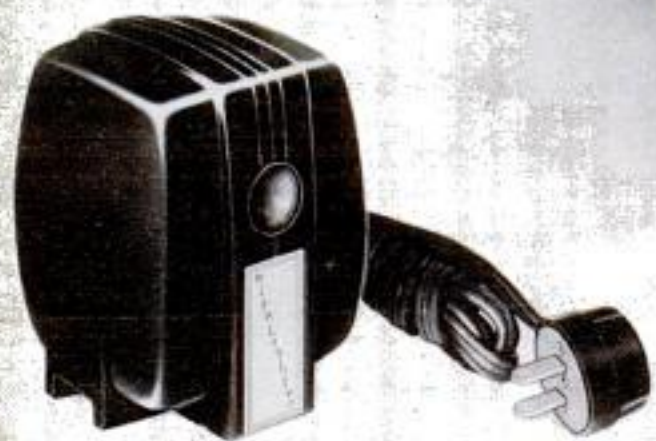

2

2. CONTROL switches house lights on when darkness comes, fools burglars. Lamp to be controlled is plugged into the photoelectric unit, which is placed or mounted by window

3. ROCKER SPRINGS for crib take place of casters, turn bed into cradle. Electric motor (inset) automatically rocks crib. Timer shuts off the rocker at a predetermined time



3





4

4. WATER PURIFIER attached to plumbing is designed to make any water safe and pleasant to drink. Chemical cartridge is replaced twice yearly. Unit removes dirt, bad tastes, bacteria



5

5. AIR CLEANER filters with electrically charged plates. Dust, smoke, pollen and lint are removed as the air rushes through. Unit, designed for home use, aids allergy sufferers

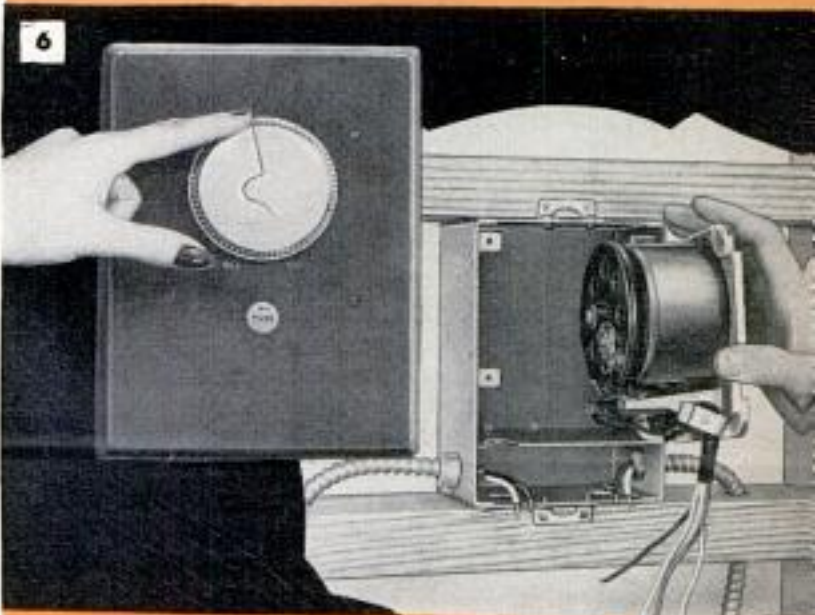

6

6. DIMMER replaces wall switch, provides an infinite range of light from blackout to full illumination. Transformer unit lets you select best light for reading, conversation or TV

7. CONVERTIBLE BED folds into a compact seat for daytime use. Bed, which measures 31 by 76 inches, has full innerspring mattress. Decorative cover conceals folded bed by day



7



Trailer is towed to safe site and radio antennas erected. Transmitters then relay civil-defense messages

Trailers Packed With Radios Aid Civil Defense in Los Angeles

Los Angeles now has three truck trailers packed with radios and other communication equipment. The units, costing \$40,000 each, serve as mobile communication centers for the city's civil-defense system. In each trailer are six receiving and transmitting sets, plus a master communication set. They provide contact with 36 fixed communication centers. In an emergency, the trailers can be hauled to any location and antennas for the equipment set up quickly. Any one of the trailers can function as the base unit.



Photographic "North Light" Uses 140 Automobile Headlight Bulbs



Artificial "north light" for taking photographs with faint shadows consists of 140 old-style six-volt automobile headlamp bulbs mounted on a rectangular panel. The lamps are wired in seven parallel lines of 20 bulbs each, thus operating directly on 120-volt house current. Color temperature of the lights is controlled by a set-up transformer.

☐ In its first year of operation, the MATS Pacific Airlift ferried some 91,500 passengers and more than 20,600 tons of cargo from America to the Far East.



FAST HORSES AND

SHORT ROPES

By Willard H. Porter

THE BAY HORSE Jess, one of the best mounts on the rodeo circuit, quivered, his muscles hard and knotted, as his rider backed him into the starting box beside the chute. Then the cowboy, rope held ready in his right hand, nodded to the man at the chute gate. The gate opened and a fast Brahman calf bolted into the arena. On a cue from his rider the bay horse broke from the box like a spring. With terrific speed he overtook the calf.

Hushed and expectant, the big Fort Worth rodeo crowd watched Gene Rambo, great all-around cowboy of Shandon, Calif., ride to his last calf. He was in a good position to win the two-calf-average prize money if he could tie this one in 18.3 seconds or better.

Rambo threw his rope like a rock. As the loop settled neatly over the calf's head the horse jabbed all four legs into the arena turf and stopped. Rambo dismounted on the run and quickly threw the calf. He jerked the piggin' string from between his teeth and popped it around a foreleg. He gathered the kicking calf's two hind legs over one foreleg. His hands blurred as he speed-tied. Three wraps and a half hitch! His arms slashed upwards to signal he was through.

No one said a word. It had been good time, all right.

Add a cowboy's skill and you have the formula for a big business, Western style—calf roping



Here's the champion of all roping horses, Baldy, now retired



Copyright by Matt Colley

Perfect loop tossed by roper Asbury Schell drops over the calf's head. As soon as Schell tightens the loop, his horse will dig in for a lightning stop

But just how good? Then the loudspeaker blared.

"Gene Rambo's time on his second and last calf," the announcer said, pausing for effect, "was 16.4 seconds." For his half-minute's work—he secured his first calf in 13.8 — Rambo won Fort Worth's 1950 calf-roping championship plus a check for \$2500.

Watching top-drawer ropers perform like this is fun. I have seen them all—the make-believe, the good and, like Rambo, the really outstanding.

To me, professional calf roping is one of the most spectacular sports in the world. The men who make a living at it are the greatest athletes in the West. They have to be for, of all the rodeo events, roping calves is the most popular and competitive. Four years ago at Fort Worth, when Rambo won, 110 ropers had each paid an entrance fee

Practice can cut a split second off a roper's time. Here Del Haverly rehearses every move while he pins the calf with his knees. Three legs of the calf must be tied with the rope



copyrighted material

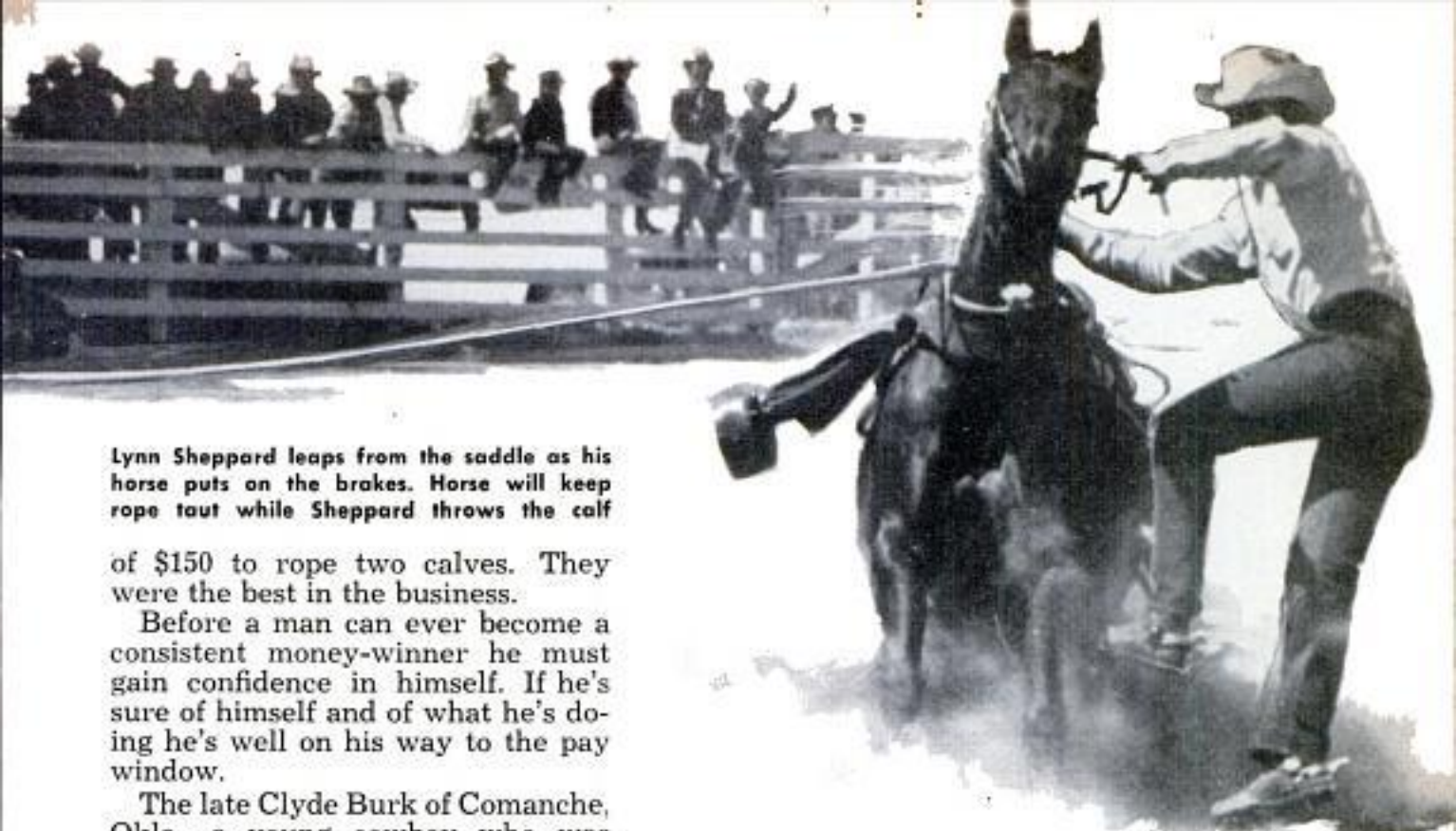

Lynn Sheppard leaps from the saddle as his horse puts on the brakes. Horse will keep rope taut while Sheppard throws the calf

of \$150 to rope two calves. They were the best in the business.

Before a man can ever become a consistent money-winner he must gain confidence in himself. If he's sure of himself and of what he's doing he's well on his way to the pay window.

The late Clyde Burk of Comanche, Okla., a young cowboy who was killed hazing a bulldogging steer at Denver in 1945, was extremely self-confident, a factor which contributed greatly to his financial success as a roper. Once at an Oklahoma rodeo Burk's turn in the calf roping was delayed for minor chute repairs. As he waited for his calf, walking his horse up and down in front of the box, a friend called, "Hey, Clyde, you nervous?"

"No," Burk answered quietly, "I'm not. But you see them fellers sittin' down there along the fence? The ones that's got calves tied in 13 and 14? They're the ones that are nervous!"

A few minutes later Burk backed into the box. Out he came, riding like a blue norther, and when he was finished he had tied a calf in 12.4 to win the roping.

Calf roping has been a favorite rodeo event for about 35 years. Last year some 500 rodeos, approved by the Rodeo Cowboys' Association, were staged in more than half the states in this country and Canada. Each rodeo had calf roping.

The rules are much the same now as when cowboys first gathered to rope against time. The calf is put in a chute. In another similar chute or box wait the roper and his horse. When the calf is released and crosses a designated line, the horse and rider start after the calf and the timers start their stop watches. When the calf is caught and tied by any three legs, a judge in the arena flags the tie, signaling the timers to stop the watches. He then inspects the tie to make sure it conforms to the rules.

Tying really "fast" calves is an art attained only after years of constant practice. A split second here or there can mean the difference between a fat check or no

check. So most ropers try to perfect their groundwork — handling stock and wrapping it up. More is needed here than skill; a man has to be strong and smart.

Head and shoulders above everyone else in the roping world at throwing and tying bone-busting calves is "Toots" Mansfield of Big Spring, Tex. Mansfield, a loose-jointed, limber-bodied cowboy of 39, has been roping professionally for 18 years and has unquestionably pocketed more money than any other roper. In 1948, at the height of his career, he paid an income tax on \$29,647—all earned with his loop-slinging right arm.

Weighing 185 pounds and standing a stingy six feet, two inches, Mansfield goes after calves as if he were getting ready to barbecue them for supper. He can slam

Most ropers leave the chute with two nooses and several tying ropes





Here's the great Baldy in action under Jack Skipworth. This horse stopped so fast he sometimes threw rider

them to the ground from either side and tie them with amazing speed. He's a fierce competitor and is very seldom rattled by an audience.

About the only major changes in modern roping have been in the stock—the horses and calves. Today's horses are real speed merchants, trained with painstaking care especially for the job of catching and holding a calf. The calves are smaller, in general, and are mostly Brahms weighing 250 to 300 pounds.

Rope horses play such a vital role in calf

roping that it is not unusual for some of the best ones to change hands for \$5000 or more. And when a cowboy gets a top horse that suits him, he is reluctant to sell him at any price. A level-headed, even-tempered mount with the heart to go all out is wanted.

Because of their build—short, compact and heavily muscled—most rope horses are of the quarter-horse breed. In action, a roping quarter horse is backed into the box, where he stands quietly without rearing or pawing until the calf is turned out. Then the horse breaks from the box, getting into high gear from a flat-footed jump in a few short strides. He must overtake the calf as quickly as possible and then rate his own speed to that of the calf. When the roper catches and bails out of the saddle, the horse is expected to stop fast and back up a few steps. As the roper throws and ties the calf, the horse must keep the rope taut enough to help the roper in his groundwork but not tight enough to choke the calf.

Probably the greatest money-grabbing rope mount of all time was Baldy, now retired on Troy Fort's Lovington, N. Mex., ranch. The bald-faced sorrel's career is particularly interesting because he nearly burned to death when he was four.

Ike Rude and Junior Caldwell, two rodeo riders, were traveling with Rude's horse, Baldy, in a trailer behind the car. Suddenly the car began to sway from side to side.

"We got a flat?" asked Caldwell.

Rude looked in the rear-view mirror and slammed on the brakes, yelling "We're afire!"

A cigarette, tossed carelessly from the moving car, had ignited the loose straw on the trailer floor and the

(Continued to page 252)

Clark McEntire is one of the fastest tiers. It's three wraps and a half hitch, then up go the hands to signal a completed tie

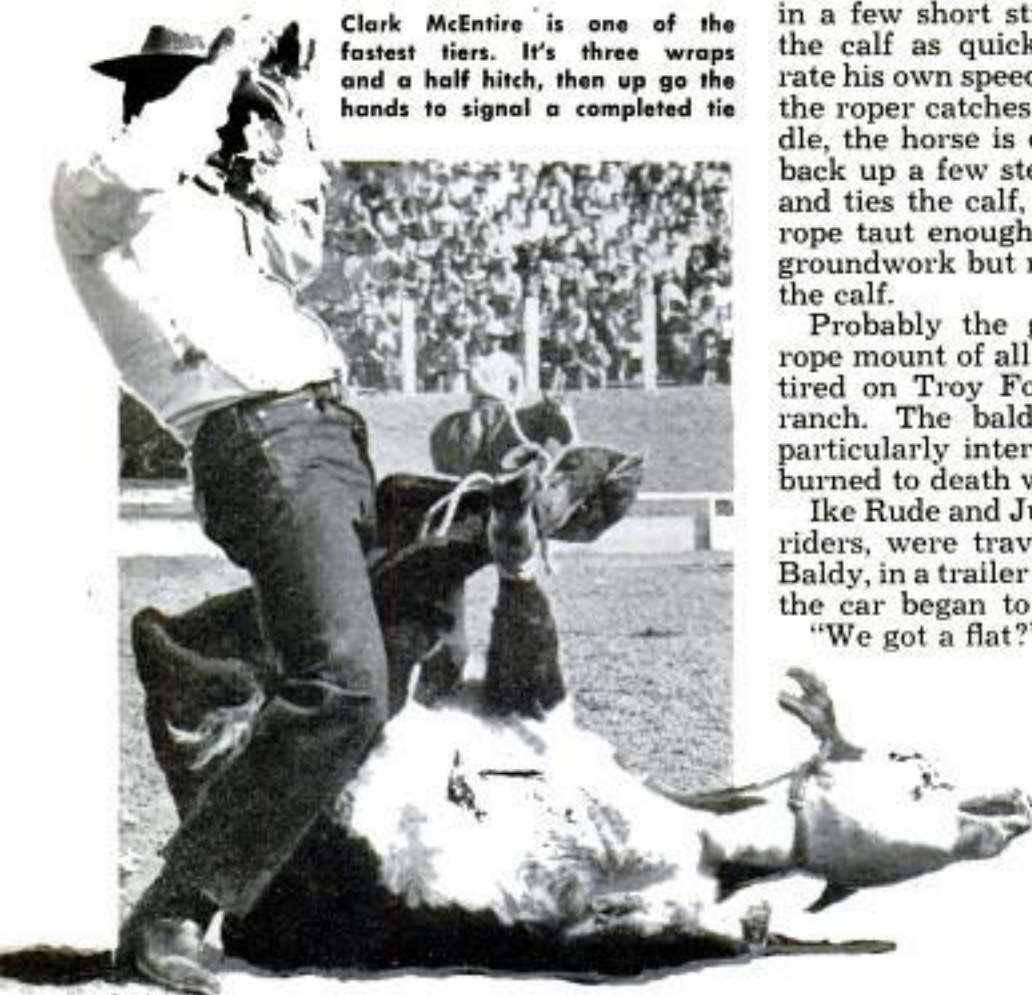

Bag Protects Camera For Underwater Shots

No box or rigid case is required to protect the camera in a new system of underwater photography developed in France. The camera is installed in a plastic bag with the lens behind a glass window. A rubber glove is clamped in a collar at one end of the bag. Air is then blown through a valve to inflate the bag. The photographer slips his hand into the glove to operate the camera.



Weed Killer Aids Soil

Double-acting calcium cyanamide, a chemical which kills weed seeds and fertilizes the soil, is now available to home lawn-and-garden owners. For about three weeks after it is applied, the dry, granular material kills weed seeds. Then it undergoes a rapid chemical change to supply lime and nitrogen to the soil.

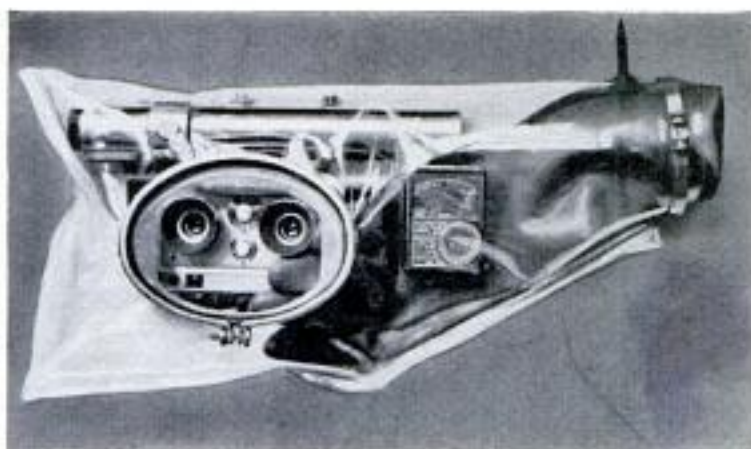

"Crow's Nest" on Cycle Serves as Hunting Perch

German hunters sit up to shoot—up on a telescoping "crow's nest" mounted on their motorcycles. Tripod legs provide stability

12-Ton Window Stops Atomic Rays

Heavy glass windows, some of which are six inches thick, six by eight feet in size and weigh as much as 12 tons, will protect the workers from atomic radiation during the research and development of an atomic-powered airplane. Employees using manipulators will be able to perform their experiments in safety while looking through the heavy windows. The windows are made up of a number of pieces of glass stacked together in a steel frame. Three different densities of glass are used, including glass with a density of 6.2, one of the densest glasses ever melted. It is six times as heavy as water, or almost as dense as steel. The other two types of glass have densities of 3.2 and 2.7. Corning Glass Works made the windows for the National Reactor Testing Station in Idaho.

Take Your Choice: Open-Road Speedsters—



Plastic Sportster

Molded in a single piece of glass-fiber plastic, a new sports-car body is designed to mount on a standard Ford chassis from the years 1949 through 1951. Actually, there is room in the engine compartment for any of the stock V8 engines available today. There is also enough room under the hood to move the Ford engine back more than a foot, if desired. The plastic body is produced by a company in Houston, Tex.

Propeller Drives Car

Eliminating transmission, differential and other heavy components, a propeller-driven automobile built in Argentina will go 165 miles per hour when powered with a conventional Chevrolet engine. It accelerates from zero to 60 miles per hour in less than 10 seconds. The engine is mounted in the rear, driving the propeller with motorcycle chains.



Plastic Car From Argentina

Powered by an air-cooled four-cylinder engine, a plastic sports car, the Justicialista, is being mass-produced in Argentina. The first automobile mass-produced in that country, the car can attain a top speed of 92 miles per hour and go 24 miles per gallon. The body is of reinforced plastic and has a removable top. Weight of the car is only 1600 pounds; horsepower is 55.

or Traffic-Dodging Gasoline Misers

Three-Wheel "Family Car"

It may be a little crowded, but it certainly is economical to take the family for a ride in a three-wheeled Austrian convertible. The single rear wheel is driven by a one-cylinder, two-stroke, nine-horsepower engine through a four-speed gearbox. Top speed is 50 miles per hour and the tiny car will travel 100 miles on a gallon of gasoline. Empty, it weighs only 420 pounds.



Motorcycle Canopy

Rain, wind and snow don't bother motorcyclists enclosed in a new canvas-and-plastic cabin. It shelters two passengers and can also be used as a pup tent when camping. It was shown at the recent Motorcycle and Bicycle Exhibition in Nuremberg, Germany.

Inflatable Top

If it starts to rain while you're driving around in a German motor scooter, you pull a plastic top out of its carrying bag, blow it up and snap it in place. Longitudinal air cells stiffen the top so it is self-supporting, eliminating the need for a conventional framework. The three-wheeled scooter, incidentally, has a $4\frac{1}{2}$ -horsepower engine and runs along easily at about 40 miles per hour.



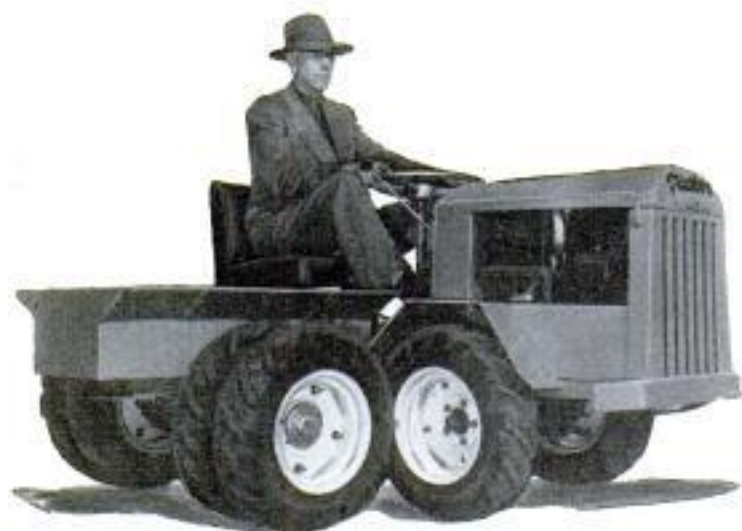

JOINED in the middle, a new tractor has an inside-turning radius of only $10\frac{1}{2}$ inches. The tractor has a four-wheel drive but, due to the design, any number of additional power wheels can be installed. This makes it possible to design special tractors for swampy areas or steep slopes. The models now in production are rated at 25 and 100 horsepower. Most of the implements, including cultivators and sickle bars, are pushed instead of pulled, giving the operator a good view of his work.

Turn-on-a-Dime Tractor

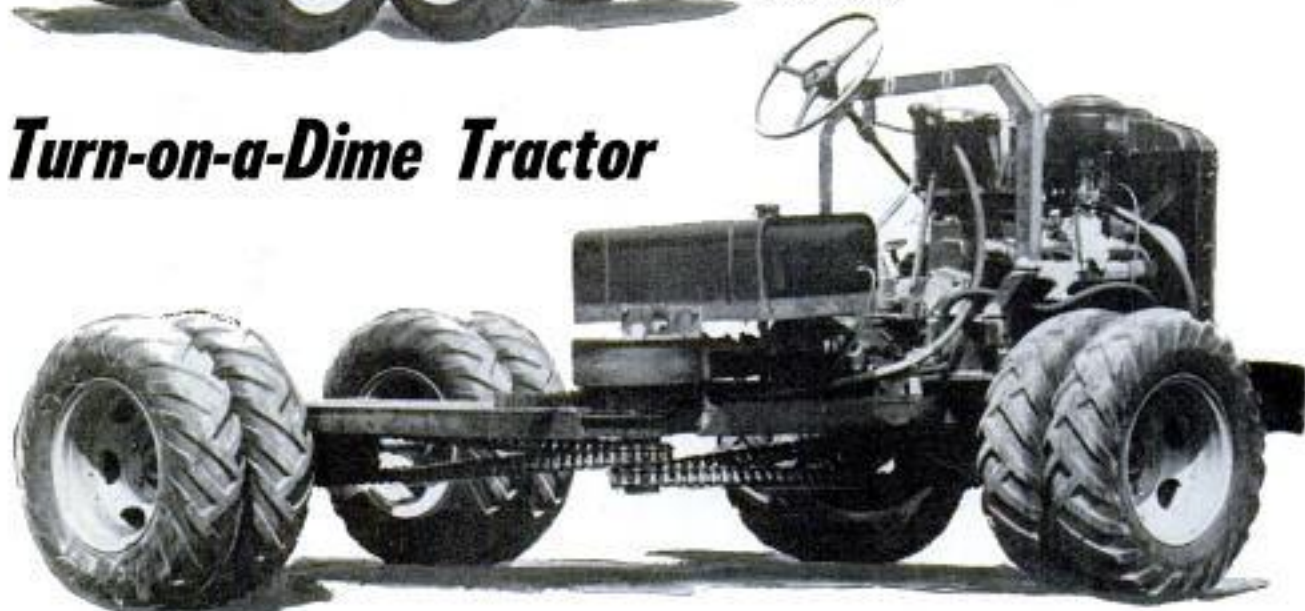

Machine is made in two four-wheel-drive models, both joined in the middle to shorten the turning radius

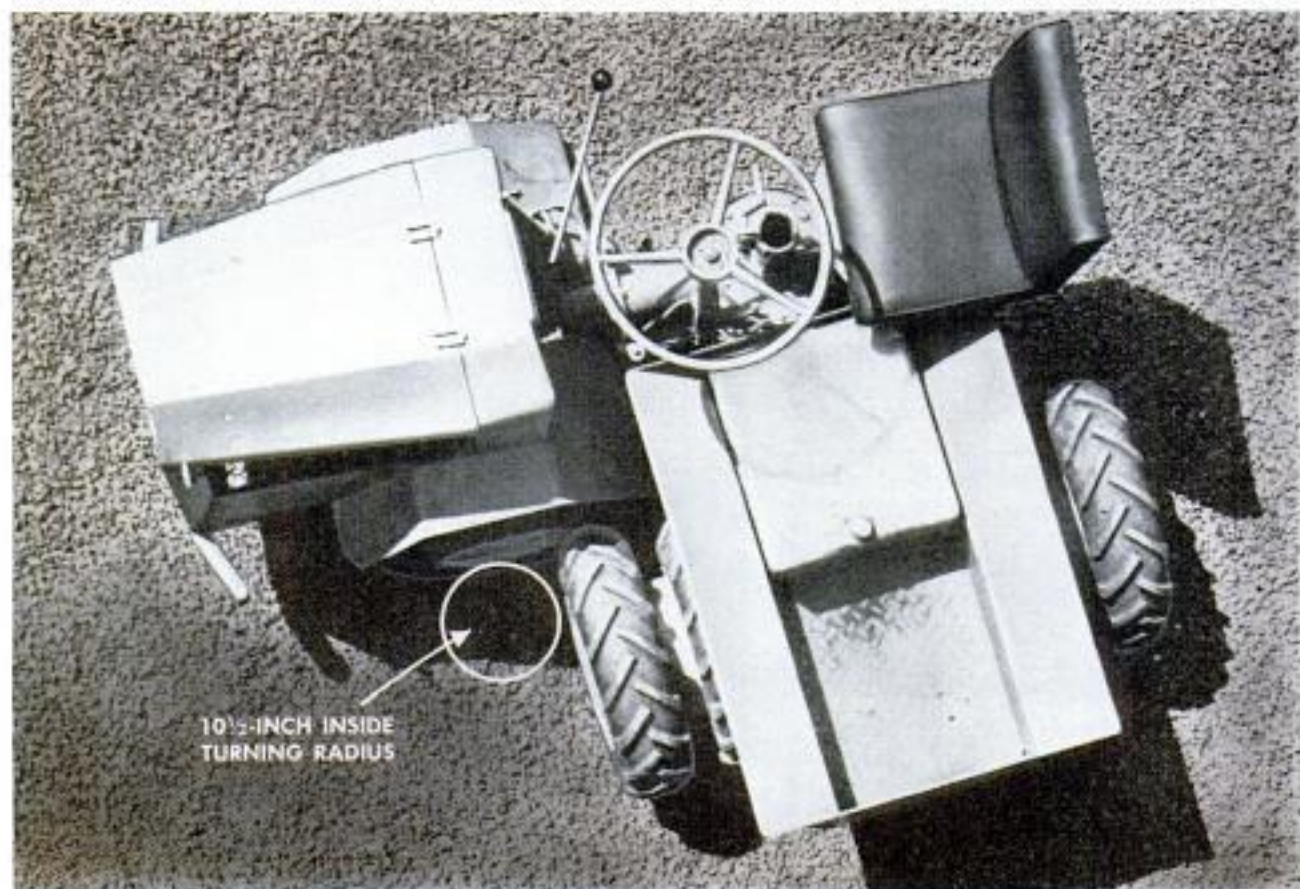

$10\frac{1}{2}$ -INCH INSIDE
TURNING RADIUS

Hobby With a Bang— BIG GUNS IN MINIATURE



Engineer Herd and son flinch at the instant of firing as a 1650 model field cannon goes off with a bang

By Jack B. Kemmerer and Douglas N. Rhodes

A QUIET MAN most of the time, Harold H. Herd uses his hobby to relax with a bang—literally and loudly.

Herd, a California engineer, builds and fires some of the world's smallest real cannon. His working scale models of historic military ordnance range from 14th Century French bombards and Italian cerbotana to Rodman siege guns, the heavy artillery of the Civil War.

The little big guns are complete to the tiniest detail in appearance and can be loaded, primed and fired exactly like the originals. Their accuracy at hitting long-range targets amazes champion rifle marksmen. On the office walls of his instrument-and-optical factory, Herd displays punctured targets that are a tribute to his ability as a gun craftsman—one-inch bull's-eyes perforated by .50-caliber shot fired from tiny cannon at 200 yards. Some of the guns, he declares, could kill a rabbit at 2000 yards—if he could ever hit such an

elusive, hopping target at that long range.

The bearded engineer's interest in historic cannon was sparked in 1949 when his son, Howard, then five years old, became fascinated by an ancient fieldpiece on display at the Los Angeles County Museum.

"He talked of nothing else for weeks,"

Building a scale model that works requires lots of painstaking research. Herd checks the barrel of a Civil War trench mortar





Son Howard drills a gun barrel with his Dad's help



Howard, who pestered his Dad into making his first cannon, rams home powder, wadding and cannon ball



Next, Herd drills holes in the barrel for inserting the trunnions, the pins on which the barrel pivots

Herd prepares to fire "Bambi," his favorite cannon, a half-size model of a 1400 Tower of London piece





With the trunnions inserted in the holes, the barrel is heated in an oven to assure a good bond of solder

Herd explained, "and pestered me to build him a toy cannon like the big one in the museum. Finally, I went back and measured the gun. Later I studied ordnance design in a borrowed library book.

"Soon I was as interested as Howard and began to work on a model—a quarter-inch-to-the-foot miniature. After a lot of trial and error I completed the gun and was proud of the job. I showed it to my son. He looked at it and said: 'Okay, Daddy, now let's shoot it.'

"It didn't take long to discover that my cannon might make a good ornament, but it was no working model. The thing was just too small to fire black powder and ball. I decided to start over and do it right."

Herd made another model of the same gun, this time on a half-inch-to-the-foot scale. He found that it worked perfectly and fired a little molded cannon ball with fine accuracy and excellent sound effects.

In the past five years, Herd has built several hundred cannon. His personal collection now numbers about 20 pieces in varying scales from one half inch to one inch to the foot. There are a few cannon that are even larger. All are actual working models.

Herd's favorite is a strange weapon he's nicknamed "Bambi"—a one-half-size copy of a small-caliber cannon built in 1400 to guard the Tower of London. This odd gun was so small it could be carried around by one man. It is easily recognized by its earlike handgrips for controlled trajectory and sweep.

"There is no other cannon like it in the world," Herd explains. "It was nearly 500 years ahead of its time in efficient artillery design, but it resembles a spread-legged deer more than it does a cannon. That's why I call it 'Bambi.'"

Herd had a problem finding a suitable place to test-fire his guns. The local police frowned on cannon shooting within the city limits. He finally found a remote canyon in the San Gabriel Mountains to the north of town. He was blasting away happily one day when a deputy sheriff appeared.

"What's all the shooting about?" he demanded of the engineer.

"I'm test-firing my cannon, officer," Herd



All the kids in the neighborhood must be envious of Howard Herd and his cannon firing. The tiny but precise models fire a small cannon ball with the accuracy of a rifle—and with a bigger bang



Once the tiny gun is aimed at the target, all the cannoneer has to do is light the priming fuse with some Chinese punk or a lighted cigarette

replied. "I didn't think anybody would mind out here. Not a soul around for miles. Is it against the law?"

The deputy scratched his head, looked at the arsenal of tiny pieces lined up on the ground and said hesitatingly: "I just don't know—never had a case of cannon firing before. I guess it's all right. Say, I'd like to come back when I'm off duty and fire one of those things, if you don't mind."

Herd now uses a rifle range operated by the San Gabriel Valley Gun Club in Azusa, a few miles from his home. His cannons are the principal object of attention whenever

When the powder charge goes off, there's a loud report and the ball hits the bull's-eye with great accuracy even at a distance of 200 yards

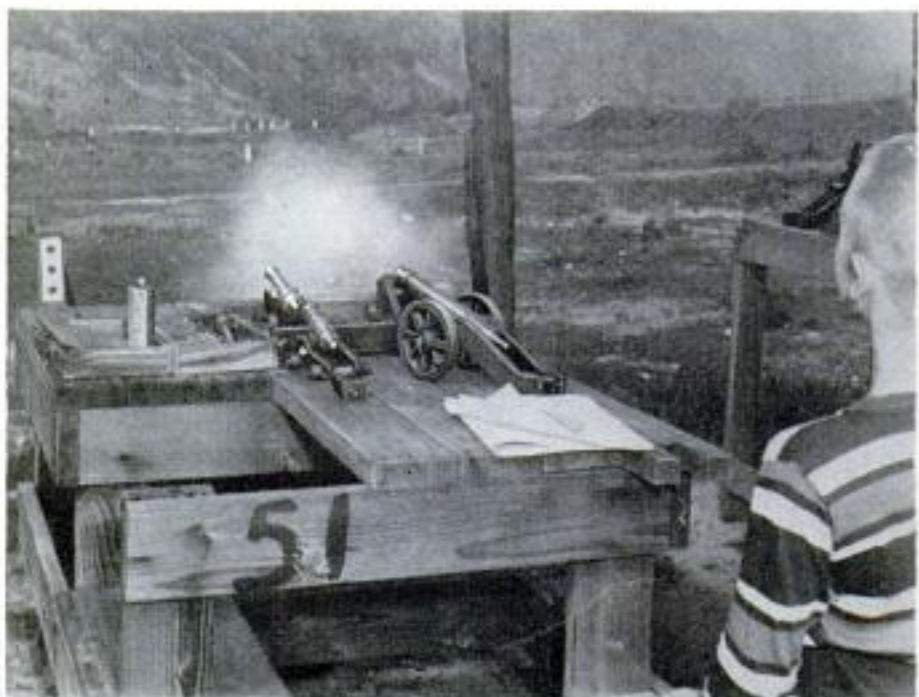

he sets them up for target practice. In fact, so great has been the interest that Herd has a growing side line, manufacturing and selling the model cannon in kit form.

Beginning with a modest production schedule, Herd's "Bit-of-History Cannon" are now sold in hobby shops in the area. They are also in demand by interior decorators as mantel ornaments. Kit prices range from \$20 up to \$50 for the largest working models.

The materials used are free-machining brass or steel bar stock for the barrels, trunnions and some other

metal parts. Carriages and wheels are carved and turned on a lathe from hardwood. Brass, copper or iron fittings are attached after the model is assembled.

Ordinary black powder serves as the charge. Miniature cannon balls of required caliber are made by melting scrap lead on a kitchen stove and pouring it into simple molds.

To fire one of the guns, the cannoneer charges it with a carefully measured amount of black powder. Then he adds a small paper wad and after this he inserts the tiny cannon ball itself.

The whole load is then ramrodded into place and the gun is ready to be fired. The priming fuse is ignited with a lighted cigarette or a smoldering piece of Chinese punk and in a second or so the gun goes off with a bang. This procedure is the same as the one used by cannoneers in centuries past as they loaded and fired the full-size originals of Herd's models.

Cost of firing even the largest model is estimated by Herd at about one-half cent a shot.

"And that's, to use a current Army slogan," Herd says, "a lot of bang for a buck!" ★★



Jet-Age Custom Car

No flames spout from the tail pipes of a custom-built three-wheeled car, but that is about the only difference between it and a space ship! The engine is a 60-horsepower V8 mounted in the rear. A single front wheel is suspended on a motorcycle fork. The sheet-metal body is welded to the frame. Air scoops on each side of the body ventilate the engine. The 10 tail pipes permit the hot



air from the engine to escape. The unusual car was built by Stanley M. Eakin of Grove City, Ohio. It took six years of his spare time. Top speed is about 90 miles per hour.

Robot Watchman Protects Pump Engines at Untended Oil Wells

Pump engines at untended oil wells are protected from damage by a new control that shuts off an engine when trouble develops. The device keeps tab of engine vacuum. When the engine speeds up or

slows down, the change of vacuum actuates a switch that stops the engine. An indicator needle registers slight changes that warn of future trouble. Bryan Thomas, at Oil Center, Okla., developed the control.

Inflated Plastic Suit Shields Worker in Atomic Laboratory

Radioactive dust doesn't bother a worker at the General Electric plutonium plant in Richland, Wash., who walks around in a plastic balloon. The suit provides a protective barrier against radiation in "hot" areas, permitting checking for contamination, clean-up and maintenance work. A flexible plastic tunnel at the rear of the suit connects to a port in the wall, provides air and serves as an entrance and exit passage. An air mask is worn ready for use in case the suit develops a leak. The suit and tunnel remain inflated because air inside the contaminated room is at a lower pressure than air on the outside. Any flow of air is into the contaminated area rather than out.

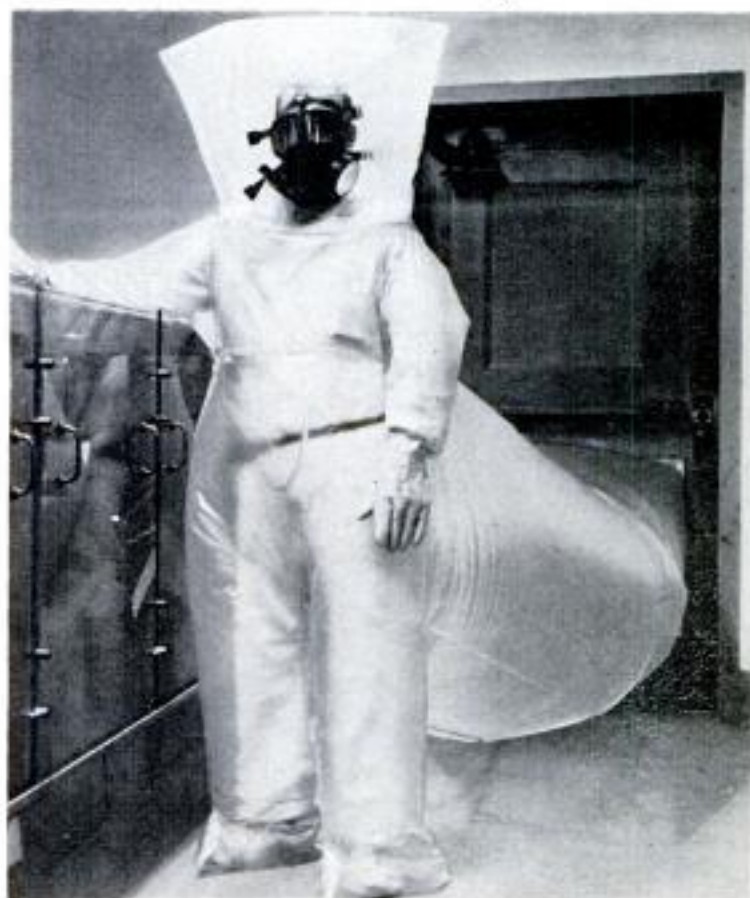

Information not listed on articles in the index frequently is listed in the WHERE-TO-FIND-IT LIST, which is available to readers without charge from Bureau of Information, Popular Mechanics, 200 East Ontario Street, Chicago 11

RUBBER BUTTERFLIES

By Walter E. Burton

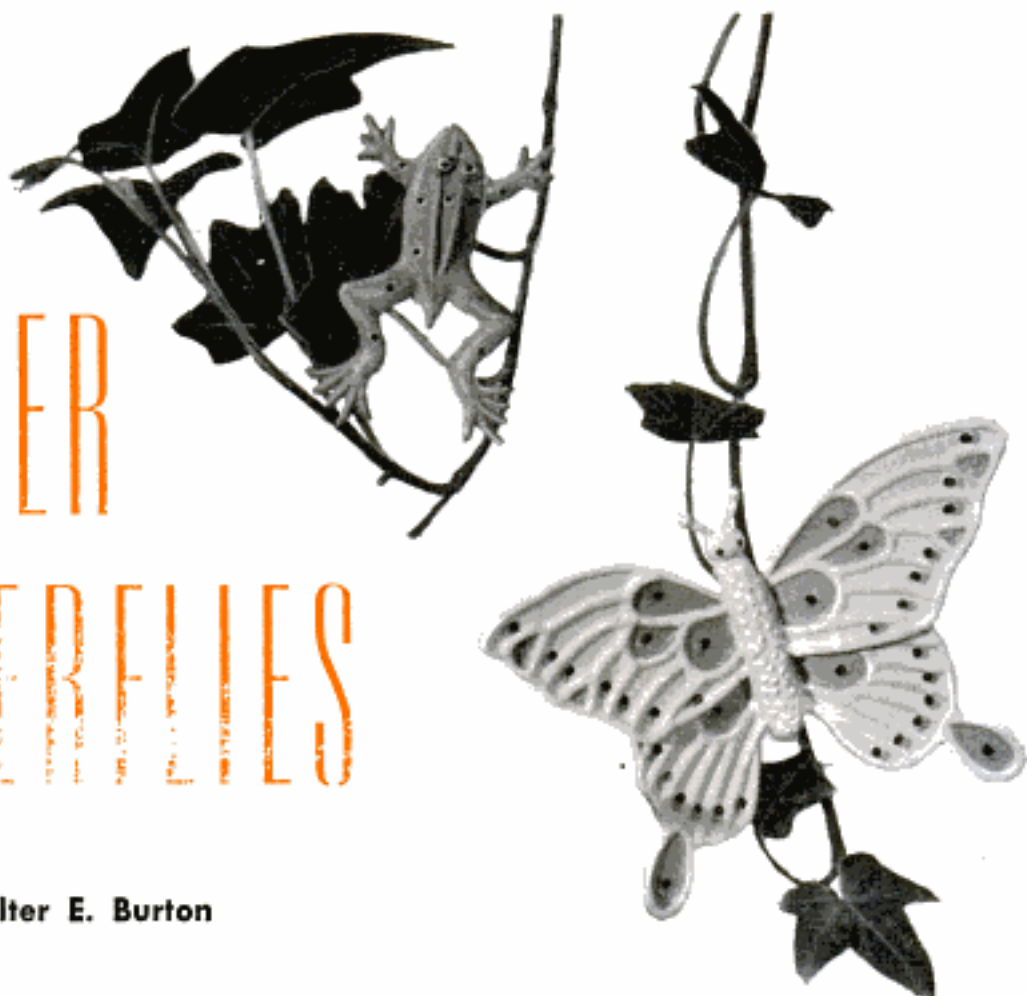

A BUTTERFLY that glided past his porch launched George Riddell, of Cuyahoga Falls, Ohio, on a new hobby.

Riddell, 68, began making molded-rubber fish baits several years ago as a hobby-business. His baits consisted of lifelike replicas of frogs, crawfish and other things attractive to fish. From the start, he had little difficulty selling enough, at good prices, to make his bait business—which was primarily a hobby—self-supporting. But when some large companies entered the bait field on a quantity-production basis, Riddell found it difficult to compete. His hobby was becoming a burden.

One day, while he and his wife were sitting on their porch, a butterfly winged by. Suddenly Mrs. Riddell said, "How about butterflies? You could make them of rubber, just as you do your fish baits."

This was as good an idea as any to date, so Riddell hurried to his basement workroom, got out a block of plaster, and began sketching on it a pattern for a mold. But it was six months before he could mold a satisfactory butterfly. He found that the insects are not the easiest things to copy in rubber. For one thing, any genuine butterfly would be a poor pattern even if a plaster cast could be made of it easily. For technical reasons, in creating a rubber replica of an insect, certain departures from nature

usually are necessary. Nevertheless, the butterflies and other creatures Riddell now makes are surprisingly realistic.

When he finally succeeded in molding a satisfactory butterfly, he gave it to his wife. She wore it like a brooch. Other women saw it and wanted copies, and Riddell found himself in the butterfly-making business.

The hobby launched by that first butterfly grew until Riddell's line now includes several sizes of butterflies, a wise-looking owl and two other birds, and a frog that looks real enough to jump. He sells these directly and by mail, but never through retail stores. Many of his items were brought out as a result of popular demand. One of these is a series of kits for people who want to make their own butterflies.

The molds he uses and those he sells to other hobbyists are made of plaster. A plaster mold, largely because of its porosity, imparts to the rubber a texture that is remarkably real looking. He uses compounds of various colors, and makes little attempt to follow nature's color schemes. Colored details such as dots on butterfly wings are made with colored rubber; no paints, lacquers or similar pigmented materials are used. Consequently the colors will stretch with the rest of the rubber, cannot flake or rub off, are washable and will last as long as the rubber itself. ★ ★ ★

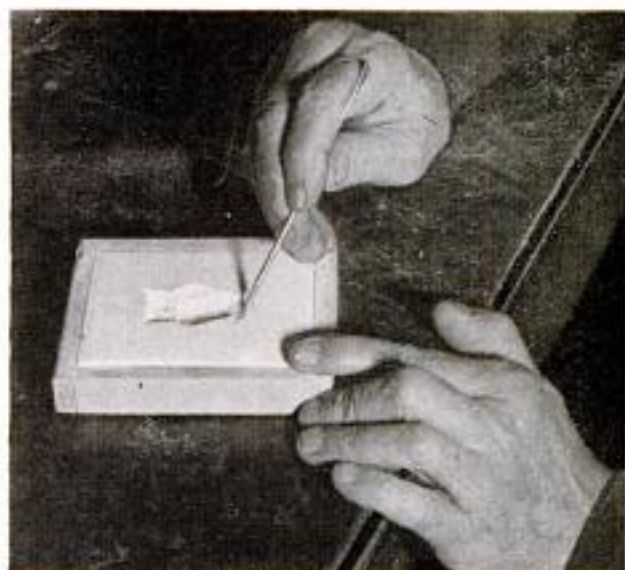
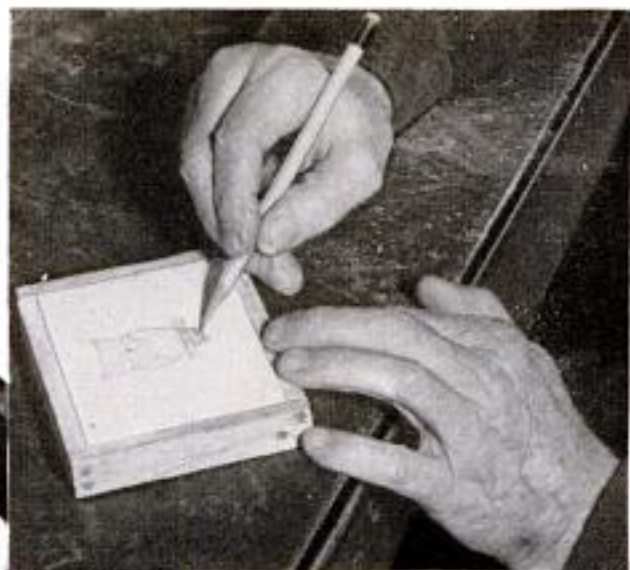

First step in making original cast is to pencil outline of figure on block of plaster. Homemade engraving tool is used to dig cavity out of block. Finished articles add humor to clothes, house plants, flower arrangements

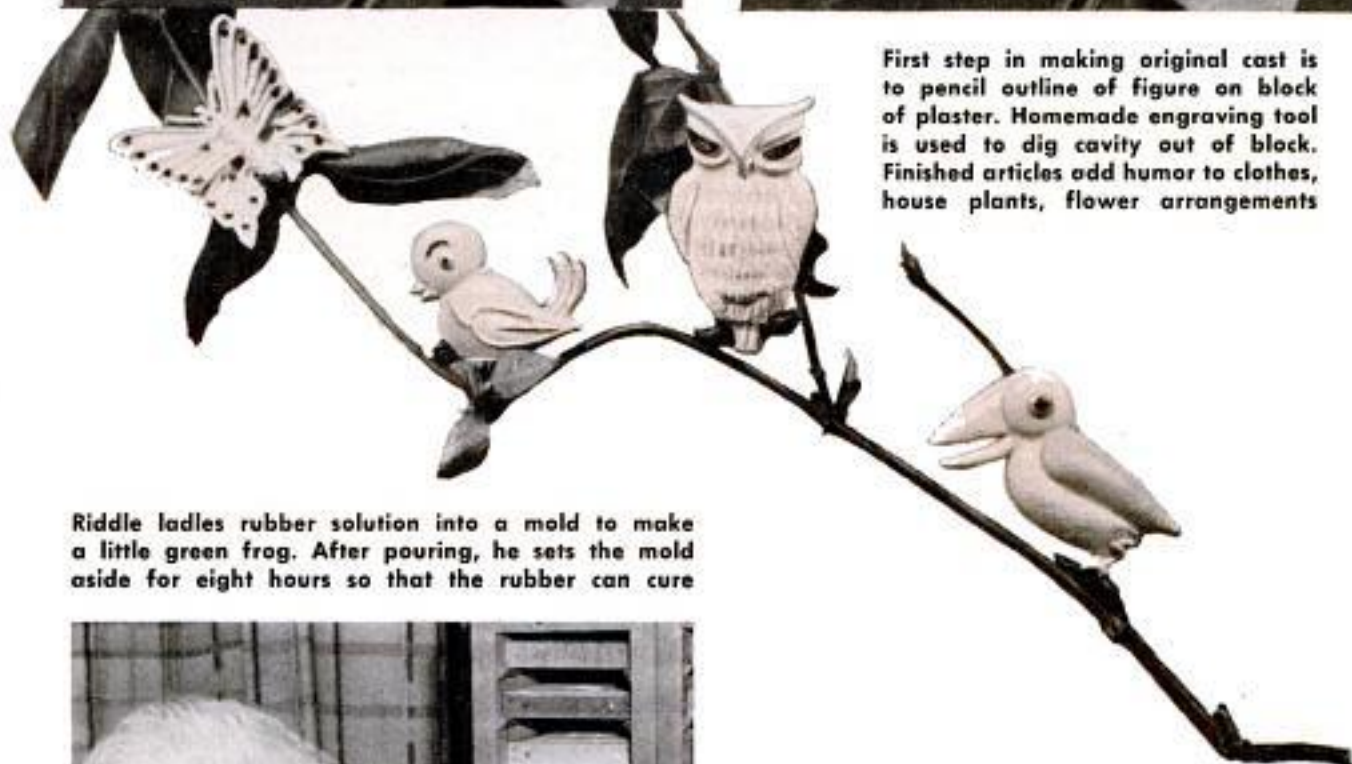

Riddle ladles rubber solution into a mold to make a little green frog. After pouring, he sets the mold aside for eight hours so that the rubber can cure



Block holds butterfly in proper position as parts are cemented together and dots of color are added



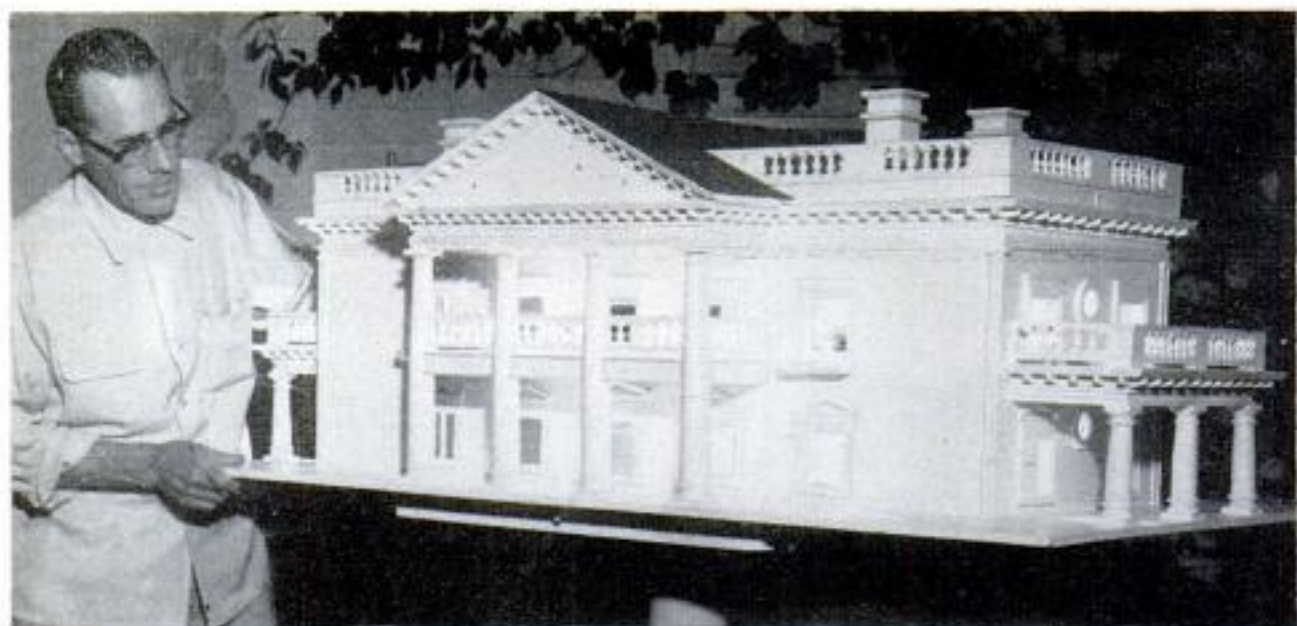

White House Is Home for Martins With Presidential Ambitions

Martins with presidential aspirations can live in a "White House"—or at least a martin-size copy of the presidential mansion. Dr. Charles C. McGuire of Minneapolis, Minn., built a 28-room martin house that has cross ventilation in every room.

The differences in the martin house over the real thing are for the martins' convenience. The second-story porches are not "genuine," but give the birds a place to stand outside the upstairs entrances. The inside lifts out for cleaning.

Small Electroplating Tool

Hobbyists can electroplate jewelry, hardware, silverware, chrome appliances and even the trim on automobiles with a small tool that contains two miniature batteries. On one end of the tool is a brush for applying the metal solution. At the other end is a short cable that fastens to the object to be plated. Each kit comes with brush and a bottled solution of gold, silver, copper, a chromelike finish or rhodium.



Windshield Has Viewing Slit

Rain or snow doesn't block vision through a plastic motorcycle windshield that has a slit for the driver to look through. The top portion of the shield, the part above the slot, is mounted at an angle to deflect insects, raindrops and other airborne materials over the driver's head. The screen is a big help at night because it eliminates the glare that usually results from scratched plastic windshields. The windshield is made in Germany.



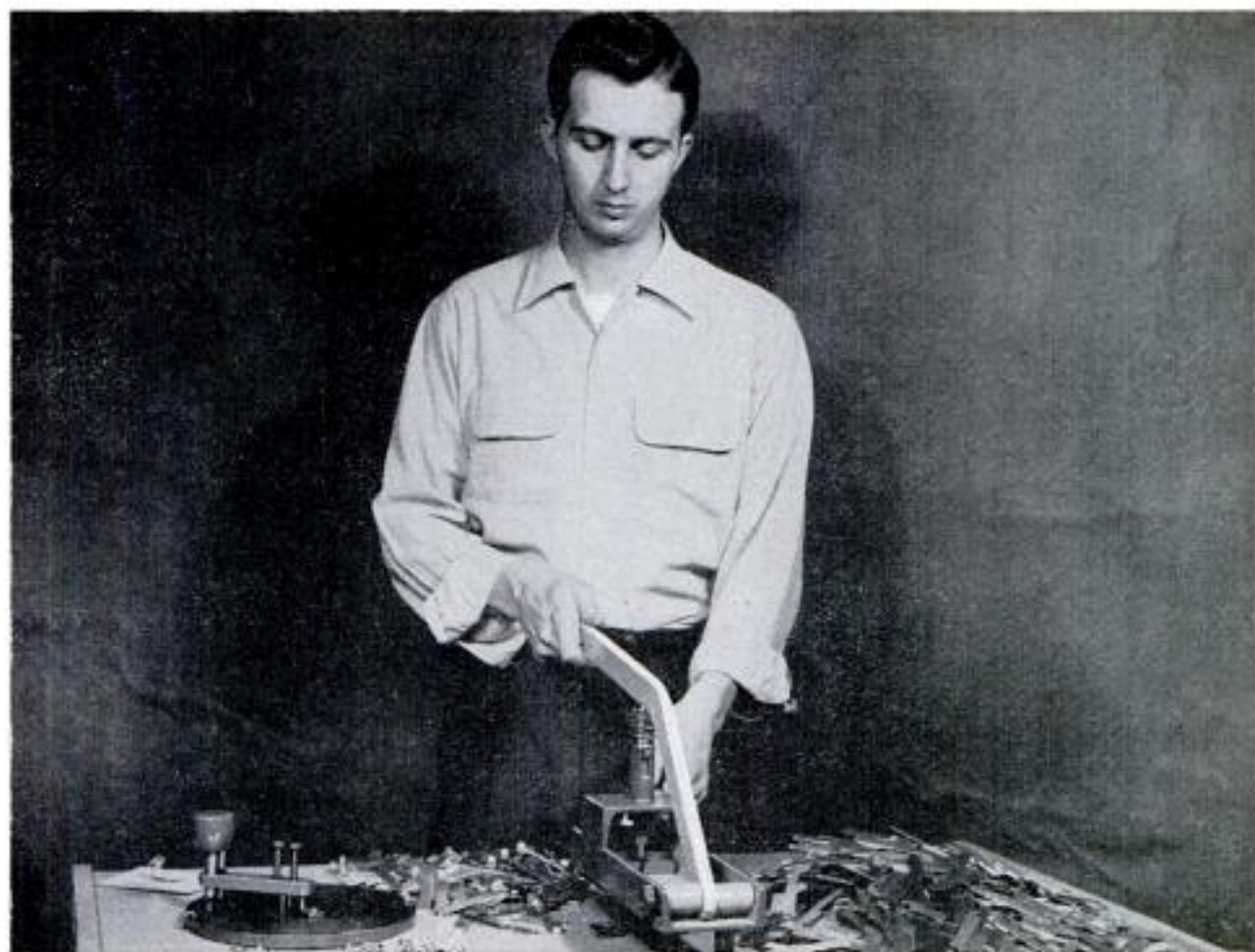

Perrine notches sheared strips in last step of punching process. Finished strips at left are ready for bending

Homemade Shaping Tools Put Inventor in Business

PAUL PERRINE, of Lawrenceburg, Ind., thought his new invention would appeal to thousands of housewives. The only trouble was that the manufacturing dies needed to make the simple device—a metal spoon holder—would cost \$1000. Perrine didn't have that kind of money. So he enrolled in a machine-shop course at the local high school and learned enough about mechanics to build his own manufacturing tools. Cost: \$25. Now he can turn out 100 to 150 holders per hour with his table-top setup.

His equipment consists of a punch press and a bender tool, both operated by hand. Three different punches, with corresponding die plates beneath, are used in the shearing process. A shear punch cuts aluminum strips to the proper length. The next punch puts a bend in one end of the strip. A third puts a small notch in the end opposite the bend. Perrine puts the necessary curves in a sheared piece by revolving the arm of the bender tool and another holder is completed.

The 24-year-old inventor is sure that other persons, using similar homemade tools, could transform their pet schemes into salable products with little expense.



Last step is to curve strips with bending tool. The holder secures spoon on edge of pot, keeps it cool



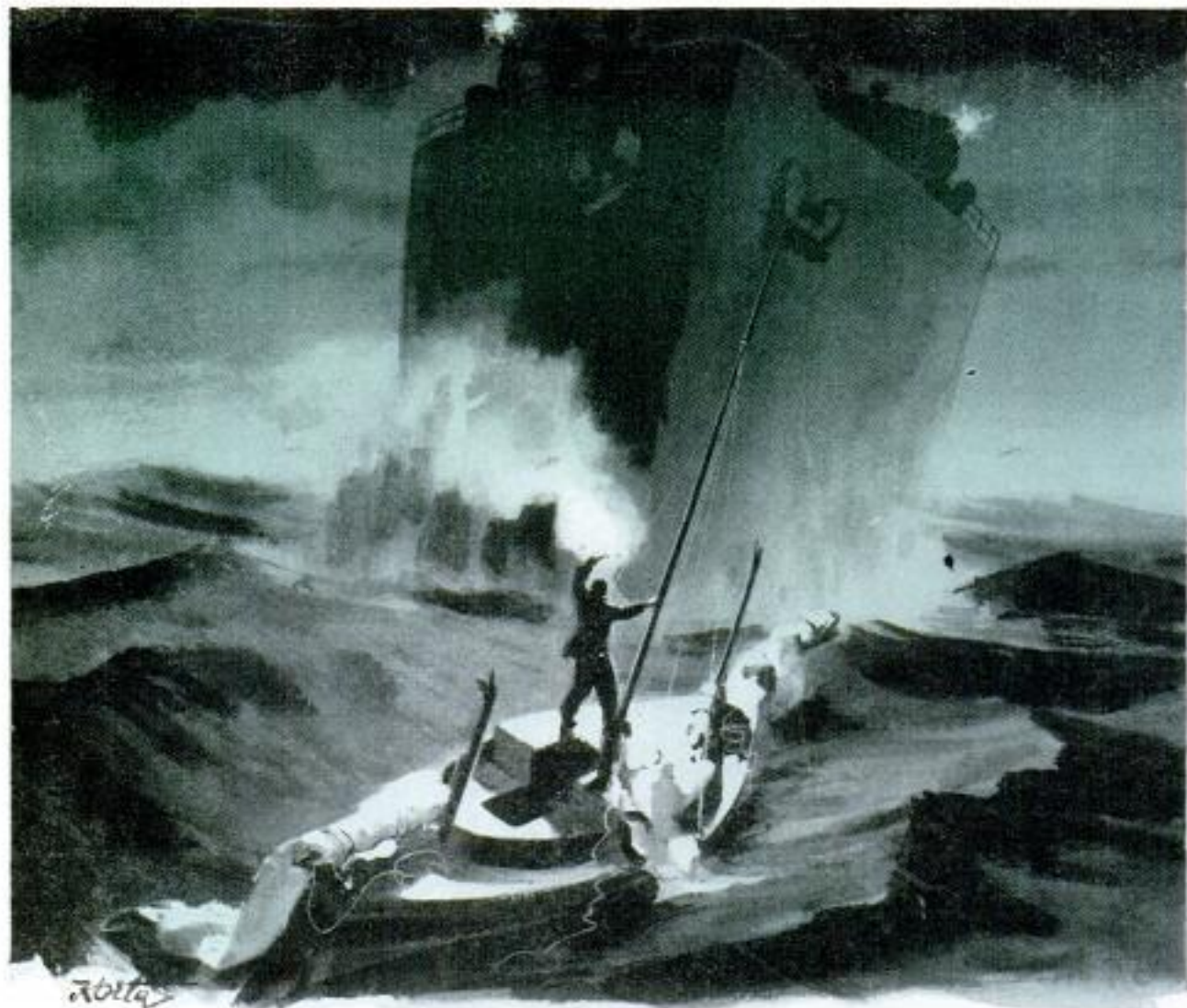

Voss awoke to see a steamer's lights bearing down on his drifting boat. Frantically, he waved a burning rag

**An almost forgotten Odyssey—
40,000 MILES
in an INDIAN DUGOUT**

Already 50 years old, the dugout canoe looked like this when Voss found it on the Beach at Victoria harbor



Although Voss didn't sail around the world, he did travel 40,000 miles in his 38-foot dugout canoe

By Francis Dickie

FIFTY YEARS AGO this month, a tiny sailboat, its hull a hollowed-out cedar log, dropped anchor in an English harbor, marking the end of an amazing 40,000-mile voyage.

The skipper was Capt. J. C. Voss, a 43-year-old Canadian. For more than three years, he sailed the oceans in his 38-foot craft as it meandered from Victoria, Canada, to London, England.

The hull was a cedar dugout canoe bought from an Indian for \$75 and strengthened with an oak frame. A 300-pound keel and 1000 pounds of ballast were added.

Inside the hull, Voss built a 5-by-8-foot cabin, his home for three years. There were three small masts supporting four sails. One man could set and take in all the canvas from the cockpit. The boat had no engine to depend on in emergency.

Voss named his strange craft *Tilikum*—a Chinook word meaning friend.

Voss and his partner, a writer named Norman Luxton, left Victoria on May 27, 1901, for Suva. After a series of violent storms, the boat finally made Suva and Luxton decided he'd had enough. Voss took on Louis Begent as seaman, the second of nine companions on the long trip.

At night, six days later, running ahead of a furious sea, Begent carelessly let go of the tiller momentarily, letting the boat swing far around into the wind. A huge wave poured over the craft hurling Begent into the sea. Voss was unable to save him.

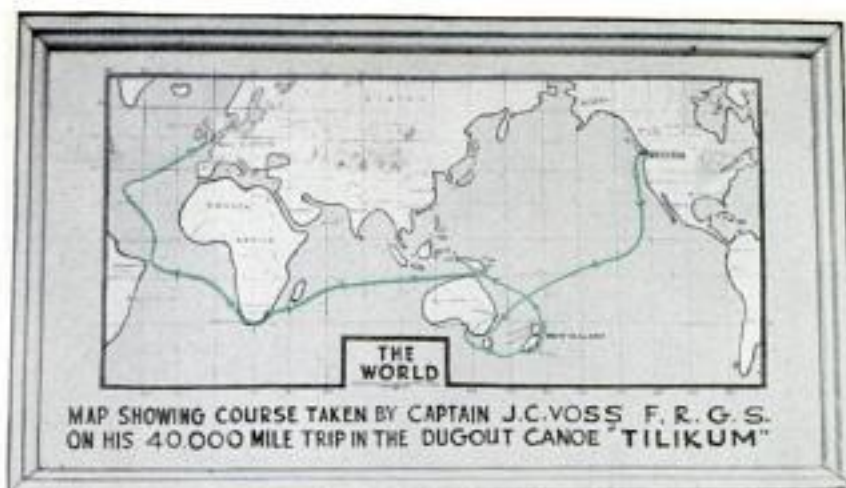

The Canadian sailed on toward Sydney alone and without a compass, it having gone over the side when the luckless seaman was washed overboard.

As the sea calmed slightly, Voss put out his huge sea anchor and lay down to rest, letting the boat drift. He awoke in the darkness to see the lights of a steamer bearing down on him. He lighted a kerosene-soaked rag and waved it frantically. The steamer altered course just in time, passing by the battered *Tilikum*.

At Sydney, Voss renewed his finances by putting the strange craft on display. The crowds were so large that he stayed two months and decided to combine showmanship with sailing. He showed his boat in Tasmania, New Zealand, South Africa, South America and some of the European islands. He hauled the boat inland to show it to persons who had never even seen the sea.

On September 2, 1904, the *Tilikum* arrived in England, three years, three months and 12 days after it left Canada. The boat was brought back to Victoria and placed on permanent display in 1930. ★ ★ ★

Abandoned by Voss in London, the *Tilikum* was returned to Victoria years later and put on permanent display

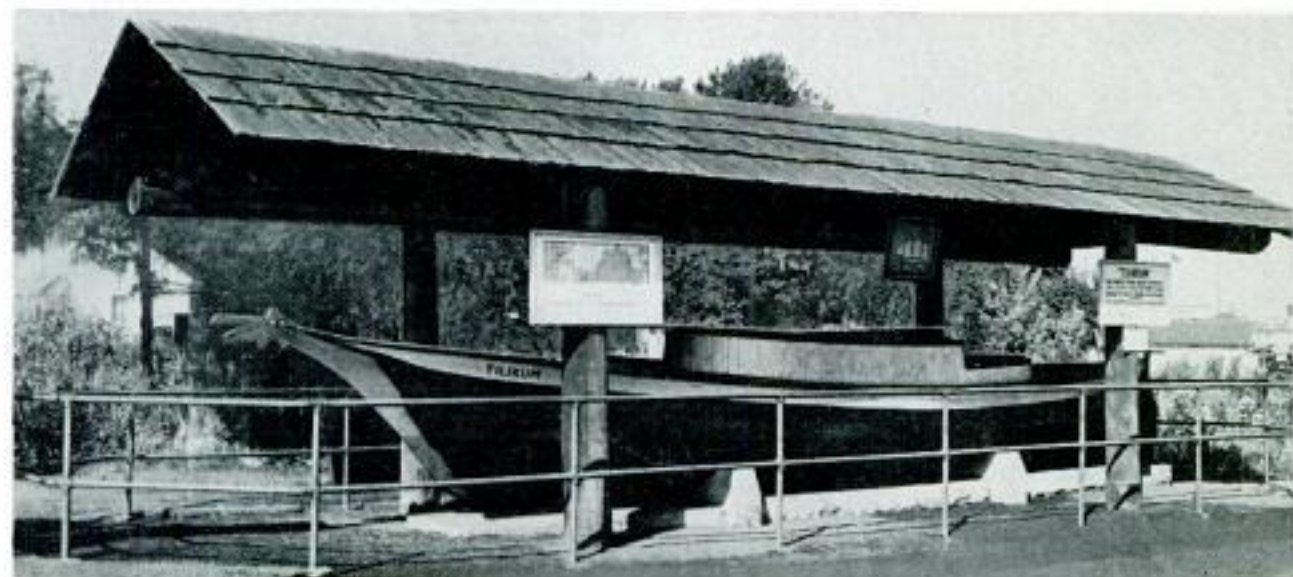

Live Steam on Four Rails

By Harry De Lasaux

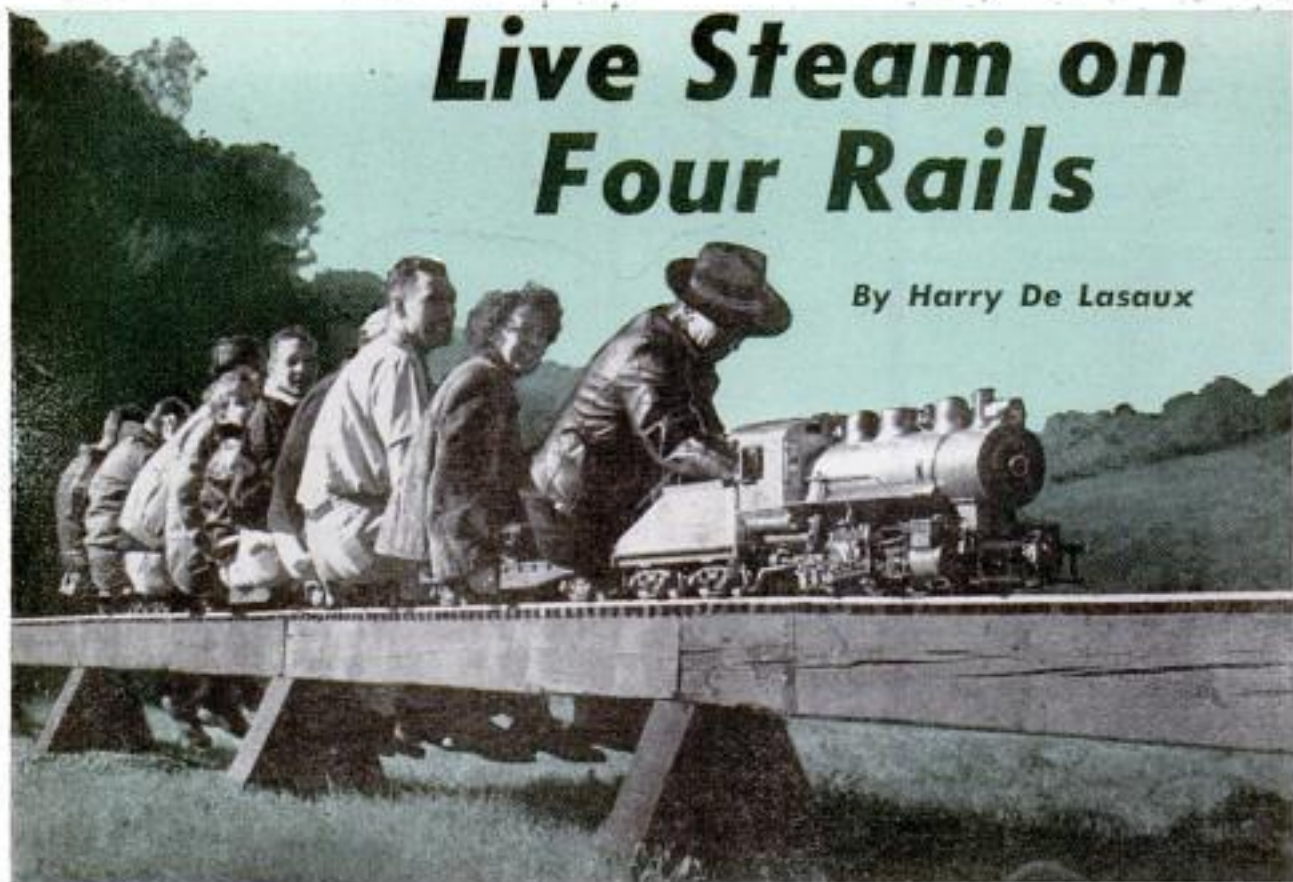

It's a long uphill pull with a full load of 10 passengers, but the steam switcher makes it without strain

EVERYBODY GETS a free ride Sundays on the Golden Gate Live Steamers Railroad. Owned and operated by hobbyists who shun such contradictions as the electric-powered "steam" locomotives common on most model railroads, the layout includes 1300 feet of track in Redwood Regional Park east of Oakland, Calif.

The tracks are on a trestle 30 inches

aboveground. Passengers ride sidesaddle on padded flatcars behind engines that puff realistically.

Four tracks provide three gauges simultaneously. The gauges are 2.75 inches, 3.75 inches and 4.50 inches. All flatcars run on the broadest gauge, using the two outer rails, to insure stability under heavy loads.

The first part of the run is the easiest,

In the layout are 1300 feet of track. Train riding appeals to adults as well as to youngsters as you can see





Note that this Pacific-type, alcohol-burning 4-6-2 locomotive runs on a narrower gauge than the flatcars do

being slightly downhill for about 300 feet. After a curve and a broad circle, the right of way takes a sharp uphill grade. The writer watched with amazement as an 0-6-0 switcher hauled 10 persons up this grade without stalling.

Club members consider live-steam railroading the highest form of scale-model activity. They build their own locomotives, machining nuts and bolts, wheels, pistons

and other parts. Blueprints of full-scale locomotives are followed.

With steam chuffing from stacks and cylinders, the engines provide the ultimate in realism. And there's no disputing their pulling power as they haul passengers around curves and upgrades. Nor is there any disputing a quite different sort of pull they have on both young and old every Sunday afternoon. ★ ★ ★

Realism in design and operation is a must on live-steam models. Drive system functions like the real thing

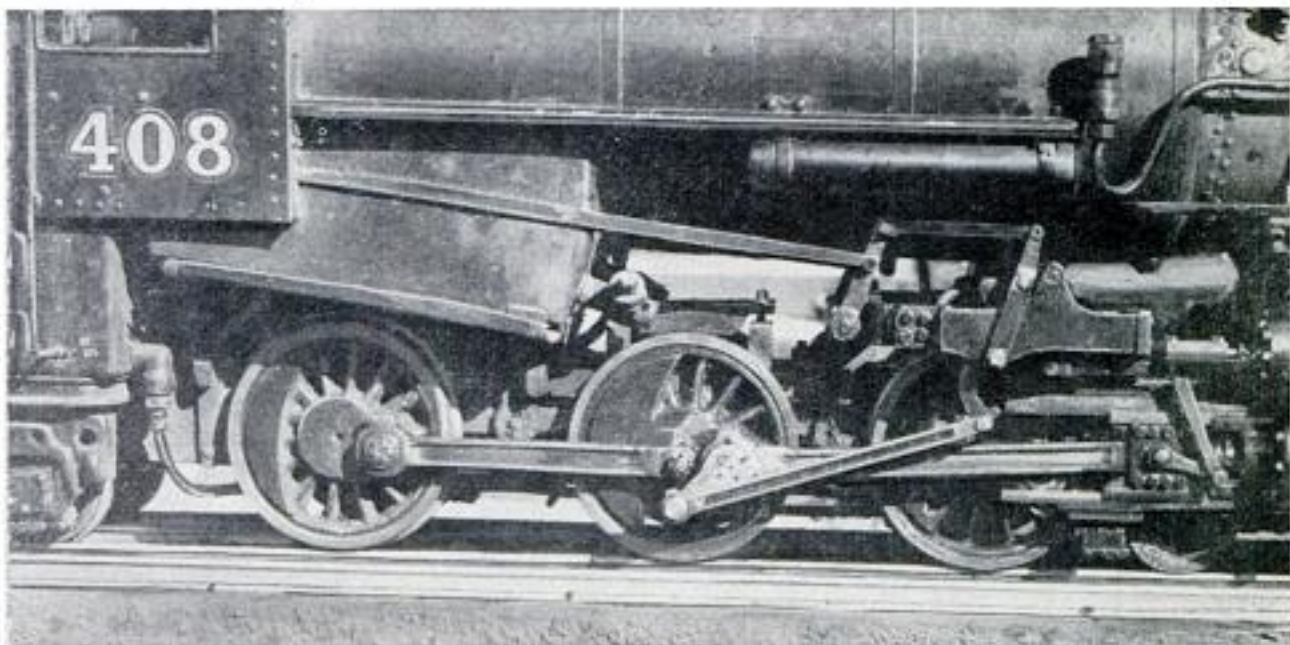

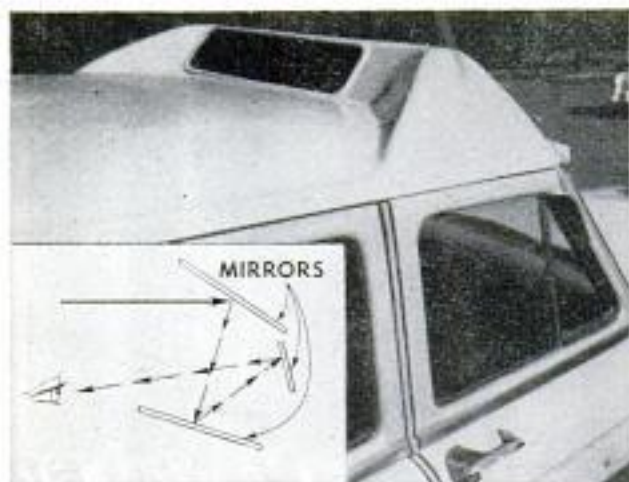

Mounted in a built-up roof, the rear-vision system has three mirrors and provides 140-degree rear view



Photo of driver's view in periscope. Car overtaking him is in view until it comes even with rear bumper

Periscope Built Into Car Roof Provides 140-Degree Rear Vision

Anxious to solve the problem of the rear-view mirror that is plaguing the auto industry, Daniel Stocker of Hammond, Ind., designed and built a periscope into the roof of his station wagon. There are three mirrors in the periscope and the driver can see the full width of the road directly behind his car. Passengers or bundles inside

the car don't interfere with the view. The periscope is molded into the roof of the station wagon and the front portion of it extends over the windshield as a visor. An adjustment of the mirror system sets the view to fit the individual driver. Stocker has patented the invention and has also designed a similar periscope for airplanes.

Predict Short Design Life for Supersonic Planes of the Future

Supersonic jet planes of the future may be designed to last only a limited time, according to Dr. George Gerard of New York University. Friction with the air would heat the metal of the plane to several hundred degrees, thus weakening it and reducing its life span. Aircraft strong enough

to withstand such temperatures would have to be much heavier and less maneuverable. At five times the speed of sound a supersonic aircraft would encounter temperatures as high as 1600 degrees Fahrenheit. Present engineering practices call for building planes for long durability.

Generator on Side of Tractor Produces Electricity Anywhere on Farm

Farm tractors, which now provide the farmer with mechanical and hydraulic power, may soon furnish him with portable

electric power. Under development by International Harvester is an electric generator that can be installed on the right side of larger tractor models. Power from the tractor engine is transmitted through gears and a pulley to a V-belt which turns the generator. The resulting electric power can be used either to run motors on attached implements or to operate portable tools or lights anywhere on the farm. The generating system also can be installed in the body of some truck models. Development of the system is still a research project and the generator unit is not yet available to farmers.



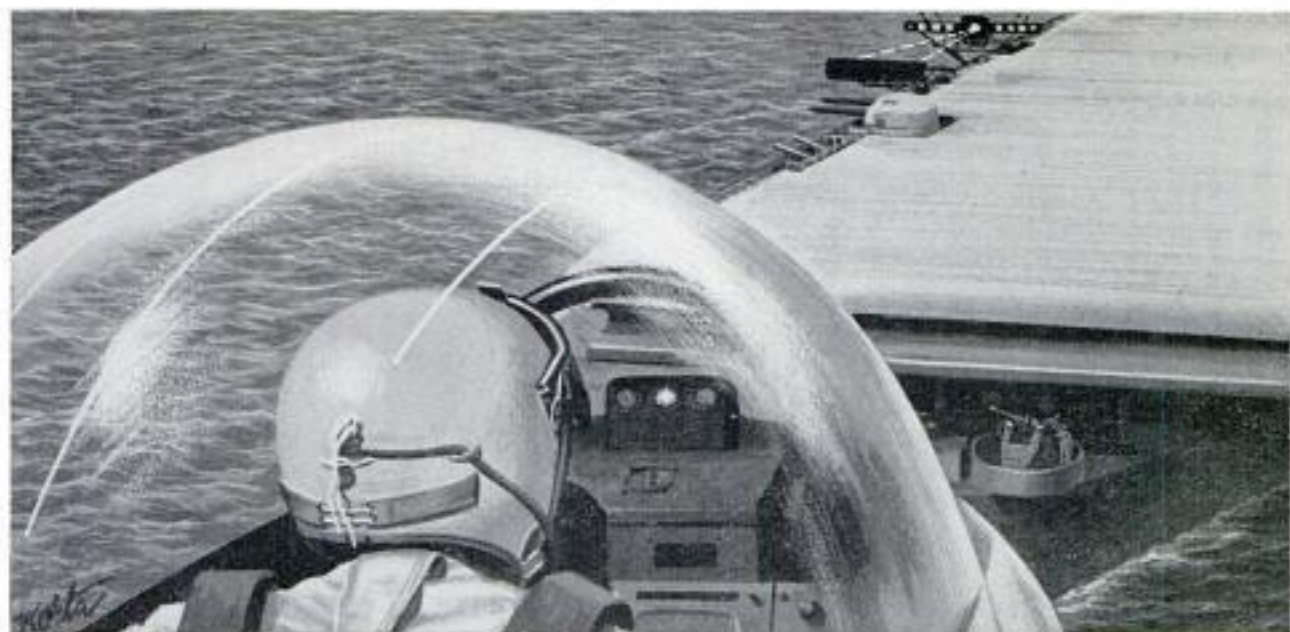

Lights Reflected in Mirror Aid Landings on Carrier

Big curved mirrors and lights will soon replace signalmen as aids to landing jets on British aircraft carriers. The new landing system incorporates a large curved mirror which the pilot watches as he approaches the carrier from astern. It has a gyro-operated mounting which keeps it at the proper level even in rough seas. Two lines of colored lights flank the mirror and, from the aft part of the ship, light is beamed into the mirror. The pilot knows that his angle of approach is correct as long as he keeps the reflected light from the mirror in line with the colored lights flanking the mirror.

Since the pilot must keep his eyes straight ahead on the lights, he can't look



British Information Service photo

down at the instruments to check his approach speed. Instead, colored lights attached to his air-speed indicator reflect in his windshield to tell him if he is flying too fast, too slow or just right. Night and day tests have been made.

Amphibious Boat

American oil hunters in the swamps and mud flats of Venezuela are using a boat that travels on land or water. At its stern are two paddle wheels that push the boat along in the water or pull it on land. A 3½-horsepower motor powers the unit, which will carry several hundred pounds of supplies and equipment.

☐ Nuclear bombardment of seed oats at Brookhaven National Laboratory has resulted in a mutated strain resistant to rust disease.



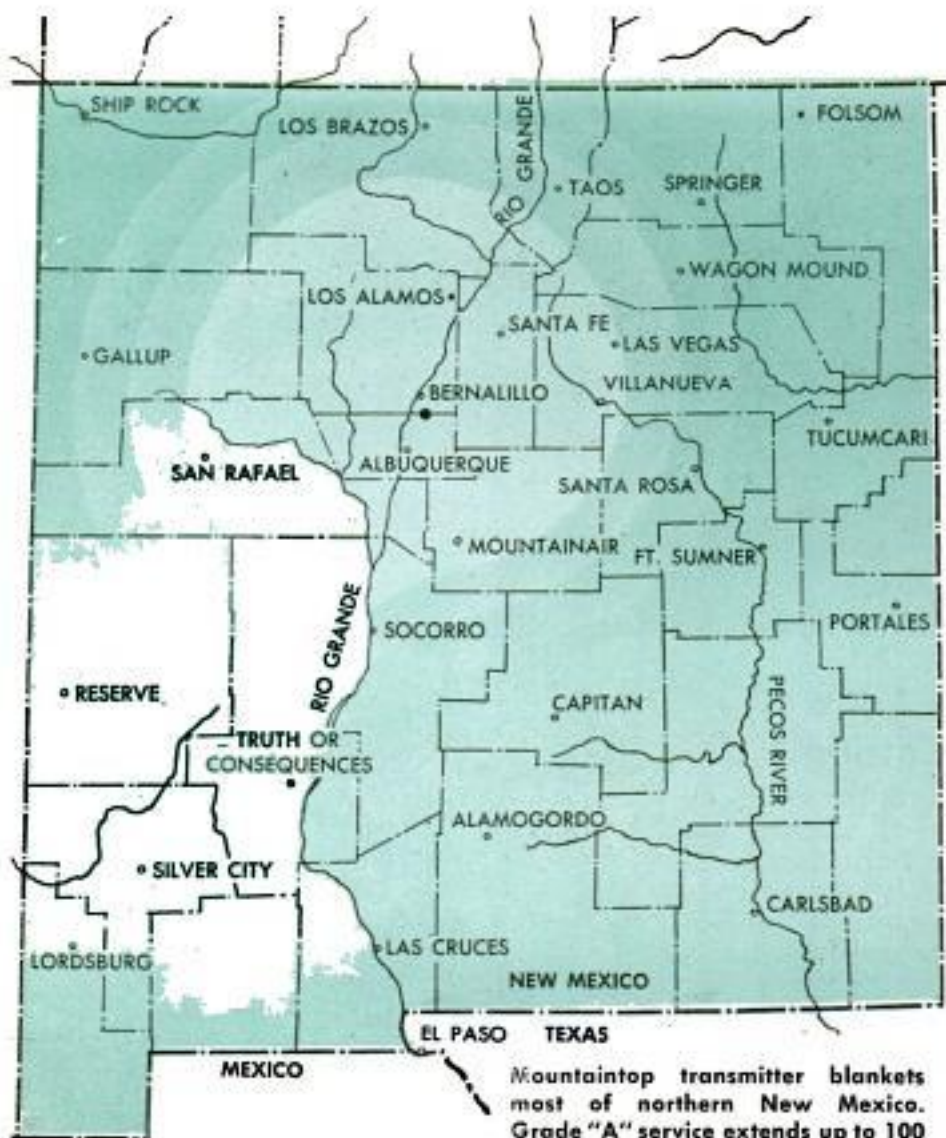

Mountaintop transmitter blankets most of northern New Mexico. Grade "A" service extends up to 100 miles. Outer ring gets "B" service



TV FROM A MOUNTAINTOP

By George Gregg

TALK WITH the engineers of almost any television station and they'll readily admit that their greatest problem is sending their pictures far enough to reach their audience.

Down in the middle of New Mexico a couple of stations have almost the opposite problem—they are apt to send their signals winging far over the heads of their choicest target, somewhat like a hunter shooting downhill with the bullet soaring 10 feet above the deer.

KOB-TV and KGGM-TV have boldly planted their transmitters high atop a two-mile mountain near Albuquerque. The installation is easily the highest in the nation; staff members can claim kinship with the relative handful of humans who work, eat, sleep and live above 10,000 feet elevation. The lofty site gives assured coverage of a

large part of New Mexico and "freak" reception has been reported from South Carolina, Minnesota and Oregon.

The location is so high above Albuquerque, the principal target, that the signals must actually be bent *downward* to reach the city. Even so, houses along the very base of the mountain get almost no reception though they are less than two direct miles from the transmitters.

The site might have been made to order. The east side of the Sandia mountain range, the side facing Texas and away from Albuquerque, slopes in normal mountain fashion. But the side which towers above the city is sliced off like an anthill cut through the center. From the 10,679-foot crest to the 5000-foot flat mesa and Rio Grande Valley the drop is almost sheer, nothing but precipitous cliffs, jutting crags

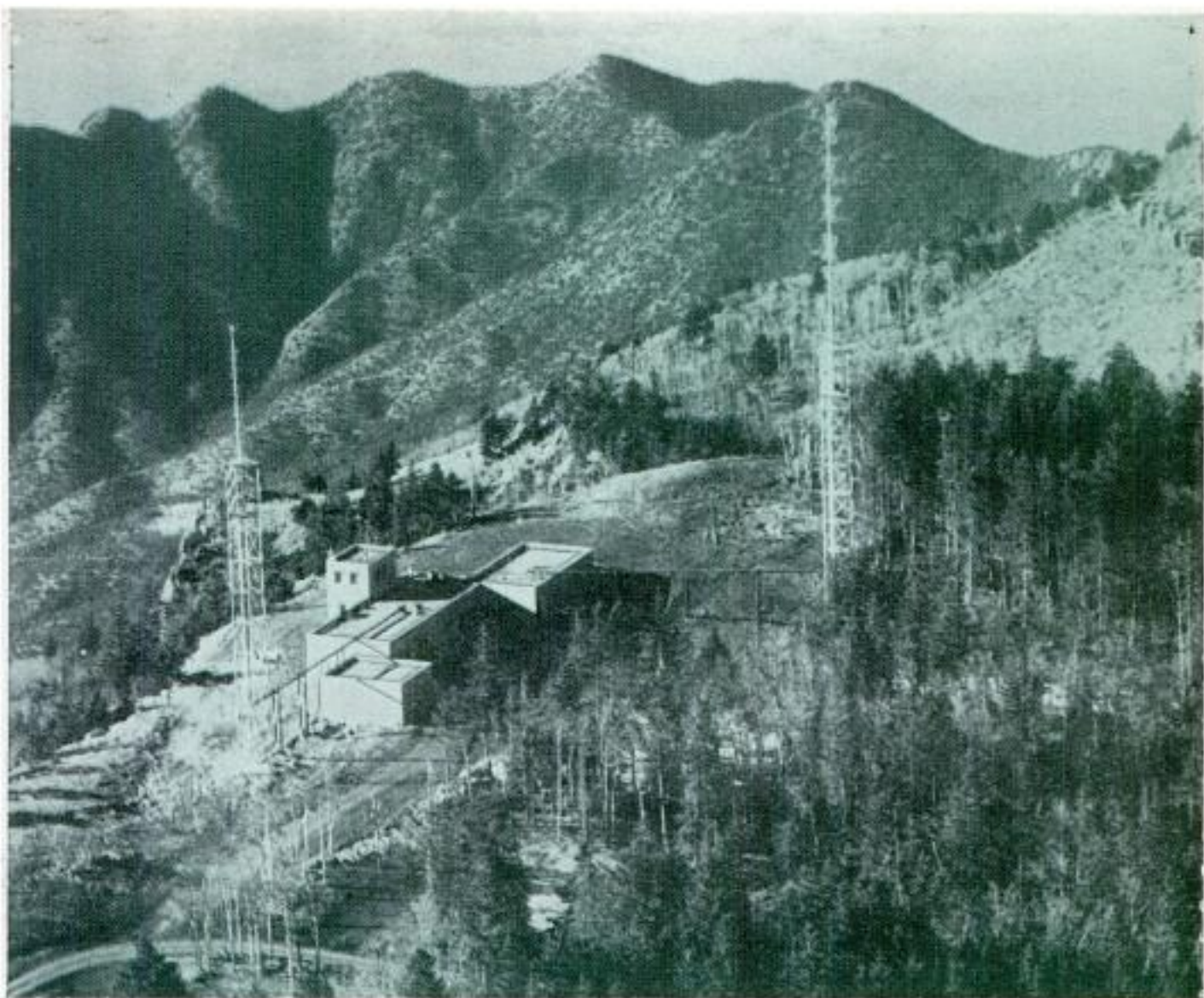

Highest transmitter in the nation is shared by two stations. Ridge in background is 2000 feet lower

and narrow ledges that even the native goats and pines can barely cling to.

When eastern TV engineers saw the possibilities of the site they chortled with glee. Their enthusiasm increased upon learning that a road existed to the highest pinnacle, where a fire lookout was maintained during the summer. But a trip up the road made the prospect less appealing. Although the peak is only about 10 miles from Albuquerque for an eagle, it is 35 miles for a good car—22 miles of hard-surfaced highway and 13 miles of fantastically twisting, looping, hairpinning dirt-and-rock road. From November to April the last 10 miles of rock is usually covered with snow and ice.

No one had ever spent a winter on top and the few parties that had climbed the mountain during the cold season brought back tales of deep snow, extreme cold and raging windstorms. Even the U. S. Weather Bureau couldn't tell them exactly what to expect at 11,000 feet. Winter snows at similar locations in the state were estimated at about 300 inches, and at slightly lower

locations temperatures as low as 50 degrees below zero had been recorded.

The natural difficulties were too much for one station and one purse, but when the big TV freeze ended in 1952 KGGM-TV and KOB-TV decided they could swing it together. The combination proved highly successful.

Construction began in the spring of 1953 and the first pattern was telecast September 30, a near record in view of the special problems posed by the location. Trucks hauling heavy equipment from eastern manufacturers had to be unloaded at the foot of the mountain and repacked with only about half their normal load. Even so, they wheezed and puffed up the steep grades. Holes for pilings and for power-line poles had to be blasted from solid rock with dynamite. Hauling ready-mix concrete to the site was out of the question, so all sand, gravel and water was carted up the mountain and mixed on the spot. Dump trucks carrying the aggregate could be only half loaded, else they didn't get there.



Workmen install antenna of KGGM-TV on edge of mountain. Mesa 5000 feet below is at the Albuquerque level

The building unit evolved as three separate structures nestled into the mountain-side. The power room, containing three generators and fuel and water-storage tanks, was housed in one building, transmitters and living quarters in the central and largest structure and the third was designed for vehicle storage. Sound insulation was the reason for the separation, with fire protection as an added bonus.

A squat story-and-a-half tower was attached to the Albuquerque side of the main unit, vented with large square ports covered by plywood shutters. In this tower are located the parabolic "dishes" which receive the microwave signals from the studios and feed them to the transmitters. Almost no weakening of the signals is suffered by reception through the unpainted plywood panels, though engineers say definite loss is sustained when the signals must be transmitted through masonry or glass. Even the tiny metallic fragments in the pigment of ordinary paint are enough to disturb the sensitive signals.

The antenna towers and transmitting bays were designed to withstand tremendous ice and wind loads. Since wind speeds in the free air at this level often reach 50

to 75 miles per hour, it was thought advisable to use 135 miles per hour as a design figure, since the speed can almost be doubled by Venturi effects as the air is forced over the mountain. Figures for icing rates at such a location were practically nonexistent, but the engineers eventually settled for a maximum figure of three inches (diameter) of ice in combination with the 135-mile wind.

So far, the highest sustained winds have been less than 100 miles per hour, but on one memorable night a full six inches of ice coated the towers between sign off and sunrise. Fortunately, the ice that night formed with relatively light winds, so no damage was caused. But it took two full days to melt the accretion off, even with maximum use of the integral defrosters.

The high-level location had been eyed by weather experts long before the television age. Such high points are valuable in basic and applied weather research. From an 11,000-foot observation point, measurements can be made with little time, expense and chance for error. Weather Bureau officials were quick to see the possibilities of getting a costly weather station

(Continued to page 230)



Pipe-line workers use "pigs" of various sizes and shapes. Some have cutting blades, others wire brushes

"Pigs" Root Through Pipe Under Pressure to Remove Corrosion

ROOTING THROUGH oil lines to scrape wax and corrosion off pipe walls are "pigs" that are made in a variety of shapes and sizes. The pigs squeal and grunt their way through pipe lines under water or oil pressures up to 1000 pounds. They push ahead

of them rust, rock, wrenches and anything else that happens to get into the pipe. The pigs vary in size from those for two-inch pipe up to the giants—taller than a man—which scrape out 30-inch pipe. They have a variety of cutting blades and brushes.

Pig is inserted in pipe and will be driven through under pressure. Some are more than six feet long

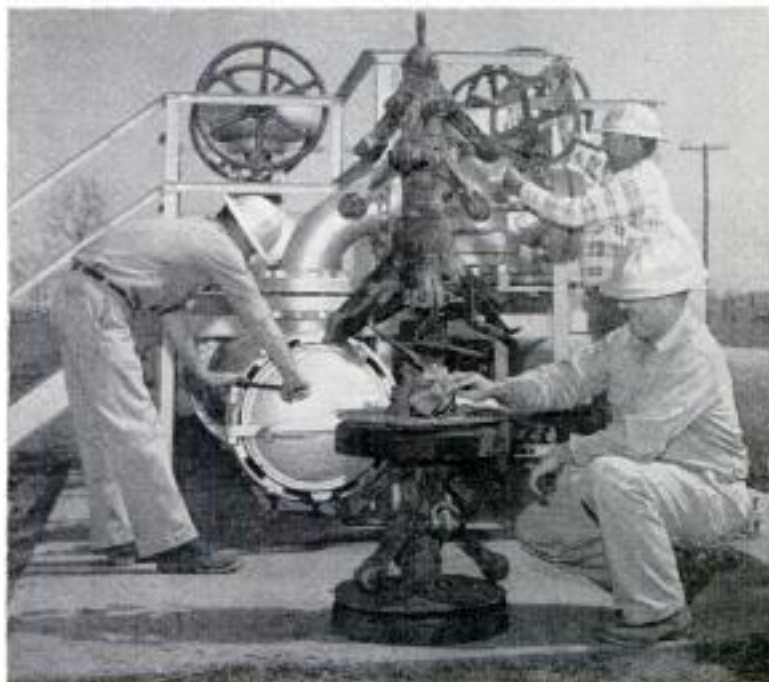

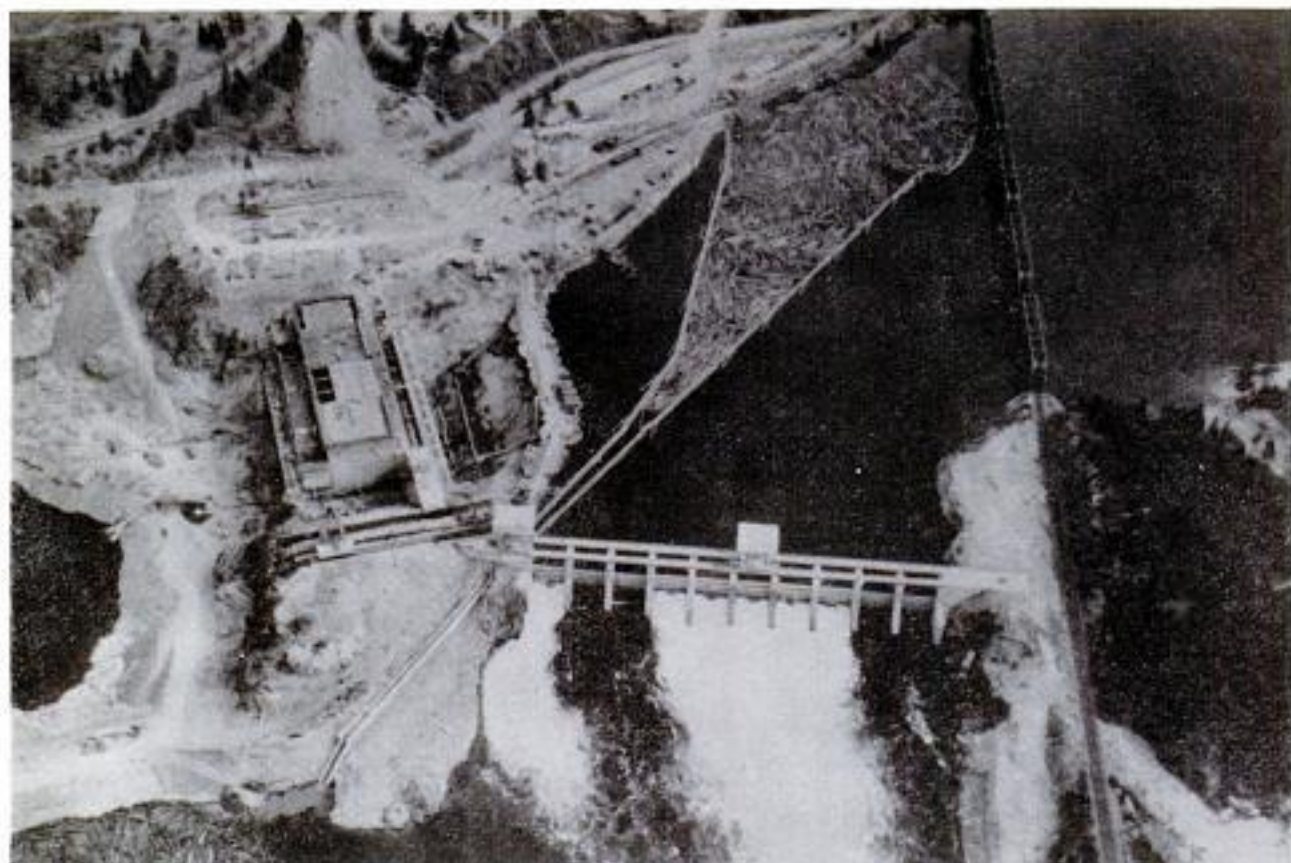

Logs "Shoot the Chute" To Bypass High Dam

Millions of feet of logs floated down the Pend Oreille River in Idaho are shunted around a high dam at Albeni Falls through a tunnel and chute. Ordinarily, such a dam would prevent passage. Rafted logs destined for mills at Newport, Wash., are towed across Lake Pend Oreille and down a 28-mile stretch of the Pend Oreille River to the dam's forebay. The logs are herded two or three abreast into a concrete trough 450 feet long, 6 feet wide and 10 feet deep. Gates at the upper and lower ends of the trough govern the elevation and velocity of water passing through the chute and tunnel. The logs, after a wild ride, come to rest in a quiet eddy below the dam.

Stone-Restoration Method "Face Lifts" Old Buildings

Stone buildings that have started to decay are made to appear like new by a restoration method imported from Europe. The stone of which the structure was originally built is broken up or crushed and mixed with a special paste, in the ratio of 85 percent stone to 15 percent paste. The mixture is applied in layers to the broken surface; deep cavities are filled with lumps of stone bedded in paste. The new surface can be worked and carved like quarried stone, looks like the original stone, and weathers the same way.

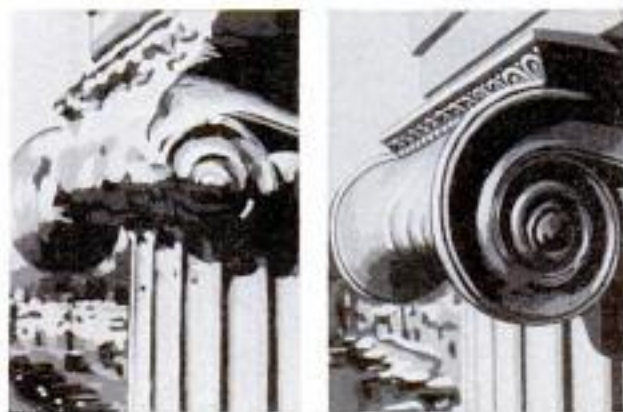

RADIO *Television* ELECTRONICS

TELEVISION TODAY

TV "SERVICE-SAVER" is the title of the booklet held by the young lady using the telephone in photo A. Recently issued by the Raytheon Manufacturing Company, this booklet contains numbered pictures of faulty TV reception. It is a timesaver for TV-set owners and repairmen. The housewife matches the picture on the screen with a similar one in the book. She then reads the number over the phone to give the repairman a good idea of what is wrong before he leaves the shop.

Intense activity in color TV continues in various manufacturer's laboratories. Photo B shows engineer Donald Perry in the service department of Motorola Inc., checking out the composite color-bar signal which appears on the oscilloscope and on the face of the color tube.

The TV set illustrated in photo C is a portable model available with either 17 or 21-in. screen. This decorator's model has control knobs on top, and a choice of "sleeves" in a variety of modern colors and durable fabrics that can be changed quickly.

The first compatible color-TV cameras to come off the television industry's commercial production lines are the two units illustrated in photo D. These RCA units were recently shipped to the National Broadcasting Company and the Columbia Broadcasting System respectively.

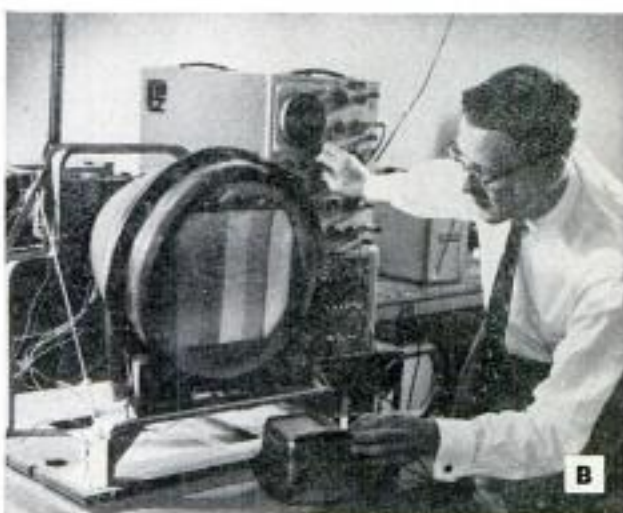

How to Transmit Phono

By Dr. Richard C. Hitchcock
and Frank L. Brittin, W9DCX

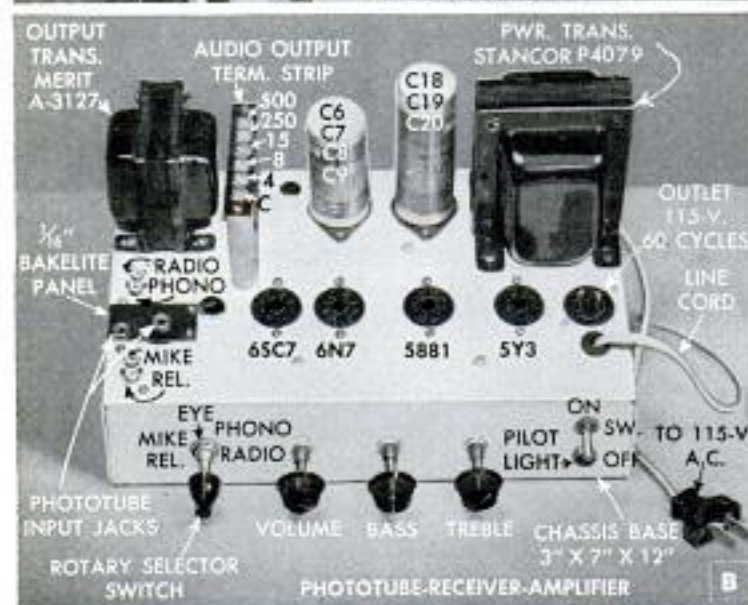
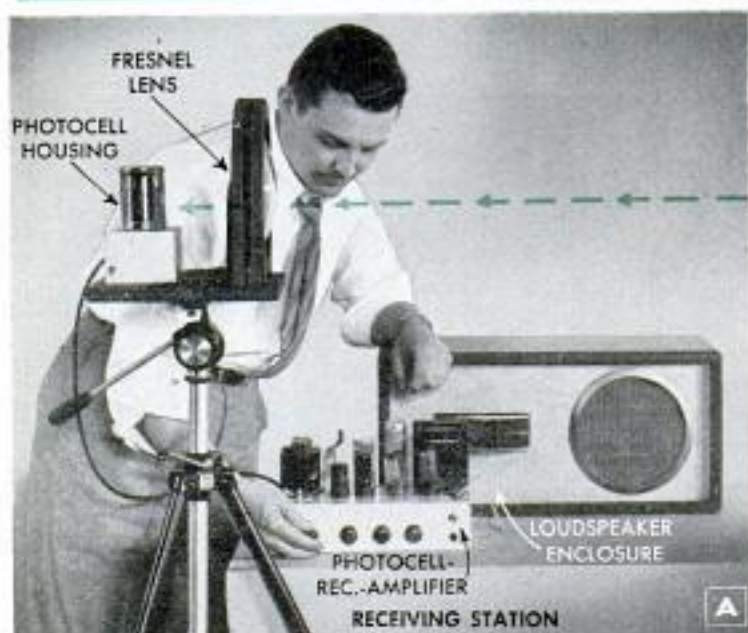

THIS EXPERIMENTAL two-unit system is a lot of fun to operate. The idea is not new to electronic laboratory technicians, but no peace-time applications for it have been suggested. Perhaps you can figure out some practical use.

One unit consists of a simple transmitter with provision for phono or microphone input. Most radio "hams" have many of the necessary parts in their junk boxes. The audio input at the transmitting end is amplified and sent as a carefully directed pencil-like beam of modulated light across space. At the receiving end it is converted into electricity, by means of a phototube, and the amplified output is then fed to a loudspeaker. In other words, it is a light-beam transmitter and an electric-eye audio-amplifier-receiver, with high-quality output.

The complete assembly for the receiving and transmitting stations is illustrated in photos A and D. In the transmitter, the plate of the output 6V6-GT tube is in series with a Sylvania model R-1131-C crater-type neon-glow lamp. Lamps of this type are available from radio-parts houses, and are used in facsimile transmitting systems. Due to the cost of this lamp, a d.c. milliammeter is always set at 20 ma. to protect it from overload. The beam can be projected from 5 to 30 or 40 feet to the receiving phototube with the lenses used. This beam can be intercepted at any point along the path; you can literally "stop the music" by placing your hand or anything opaque in the beam. The input at the transmitting end can be either a crystal phonograph pickup, output 1 volt, or a high-impedance microphone. If the crystal phonograph pickup has low output, less than 1/4 volt, connect it to the "mike" jack.

Music on a Light Beam

Photos E, F and H show various views of the beam transmitter and its associated crater-lamp housing.

The schematic circuit diagram appears in Fig. 1 on page 164, together with a sketch of the crater-lamp housing, Fig. 1-A.

An electric eye (phototube) is only one of five inputs possible with the receiver-amplifier unit, Fig. 2. You can use this amplifier for other useful purposes such as radio, reluctance (magnetic) pickup, crystal microphone, or crystal phono pickup. This unit and the phototube housing, with the mounted Fresnel lens, are illustrated in photos B, C, G and the detailed sketch (Fig. 3). Cable connections to the phototube are shown with the tube base symbol (bottom view) in Fig. 2-A. These connections are, of course, reversed in the top view of the socket. The interior of the "shaker" can is painted flat black.

If you are an electronic experimenter, the only unfamiliar items in the entire system will be the lens systems needed to focus the transmitted light into a concentrated beam, and then to bring this beam into the 1/4-in. hole in the aluminum shaker can that houses the phototube, at the receiving station. Both the phototube-receiver housing and the transmitter-lamp housing must be securely fastened to prevent motion once the beam is properly focused. Sturdy Quick-Set elevator tripods were used for this purpose, as shown in photos A and D. To line up the transmitting and receiving stations at a distance with the least trouble, do it at night, with practically no other lights around. Once lined up, all other lights can be turned on, and, of course, it works fine in daylight.

(Text continued to page 274)

(Circuit diagrams shown on page 164)

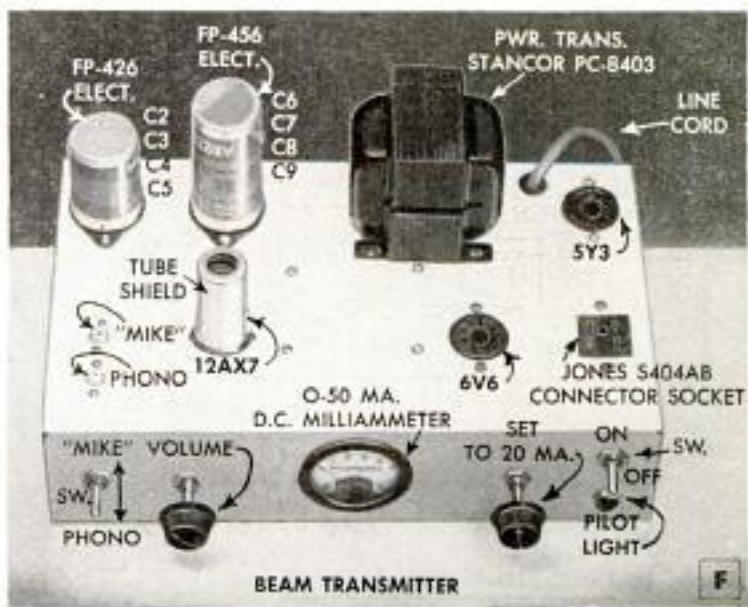
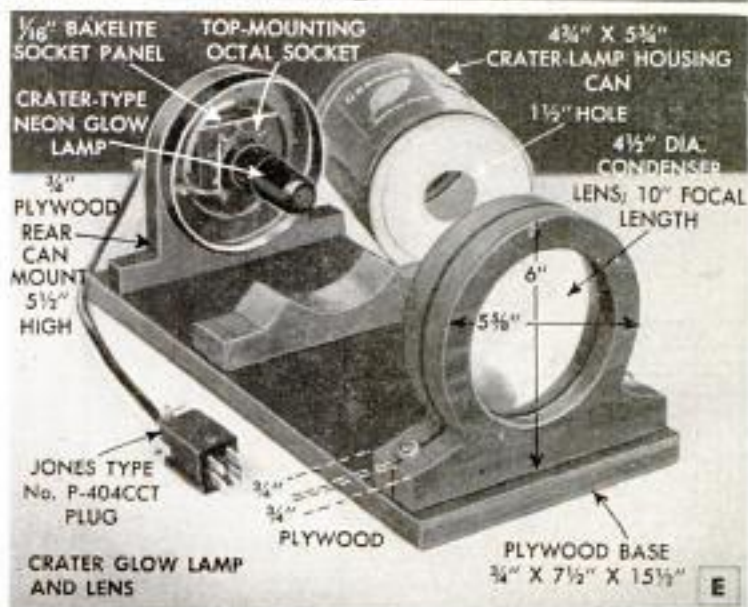
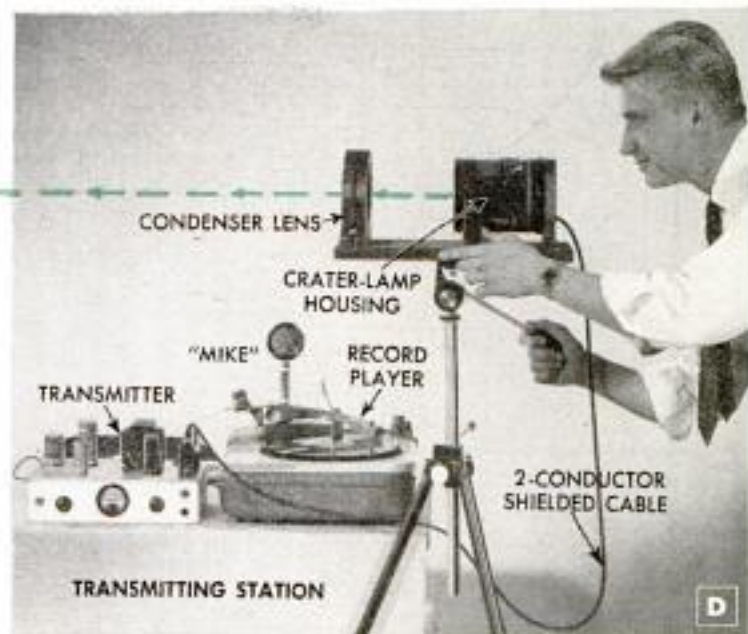

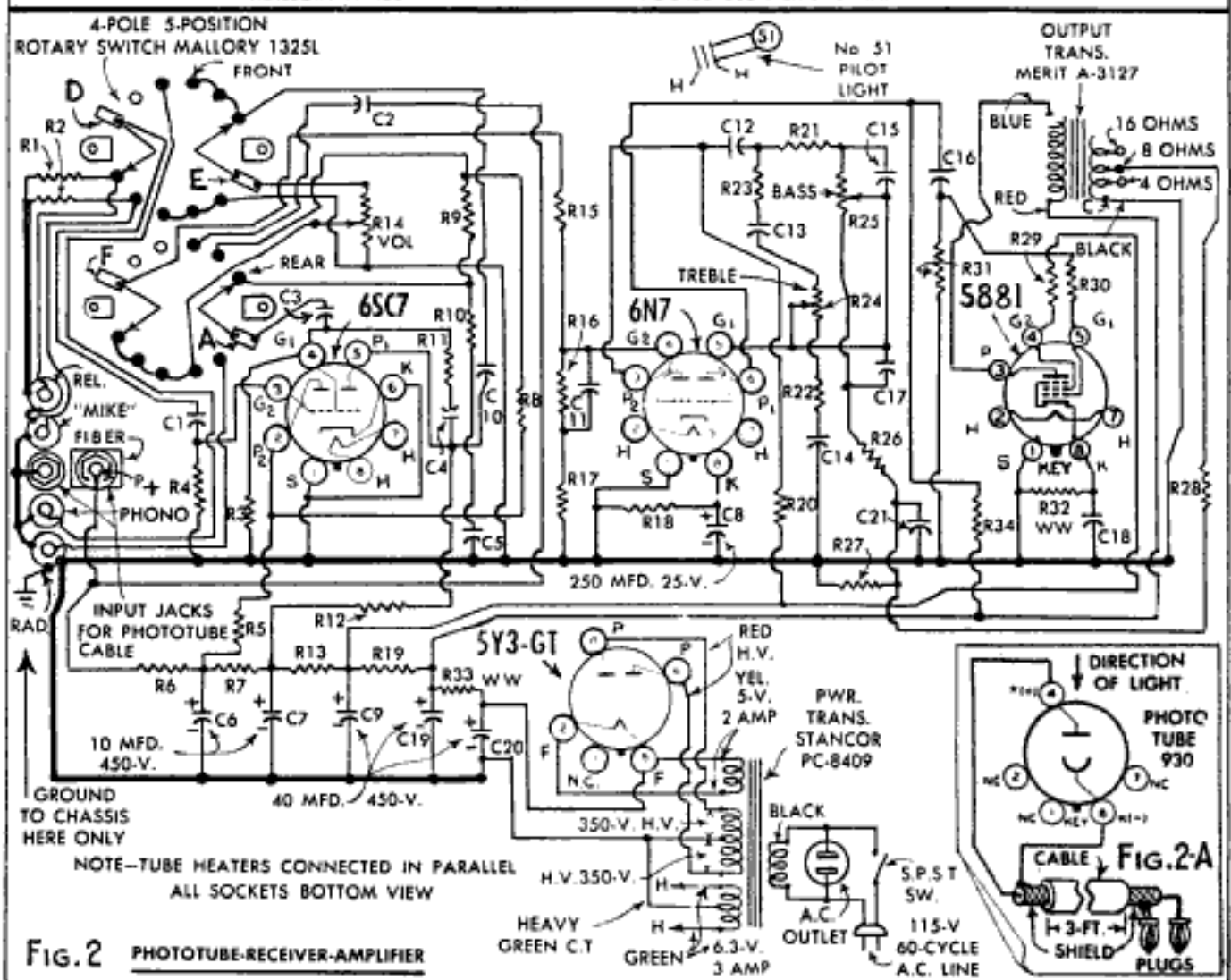
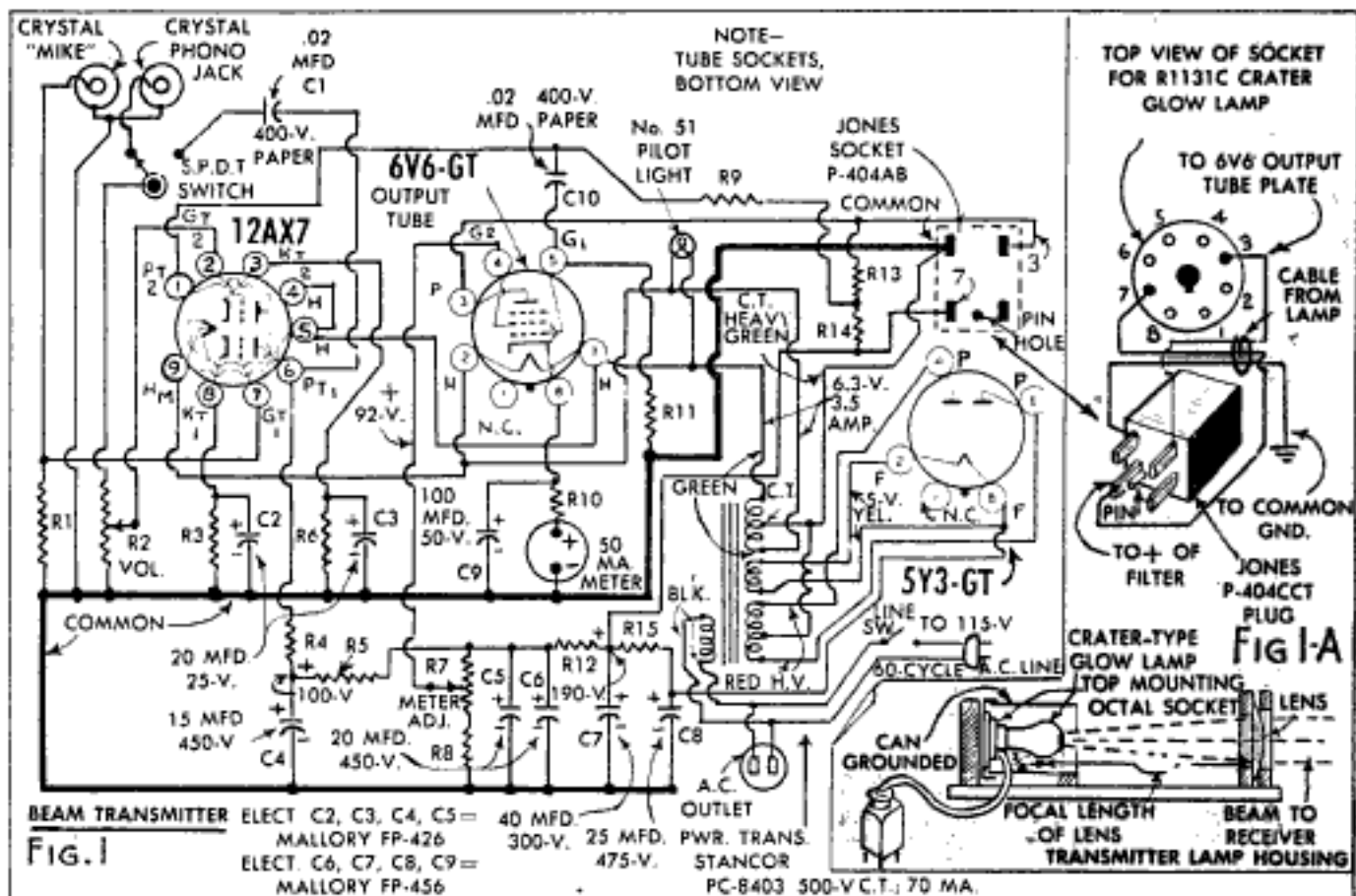

the

POPULAR
MECHANICS

X223A CRAFTSMAN

WTM 56 + Modern Furniture

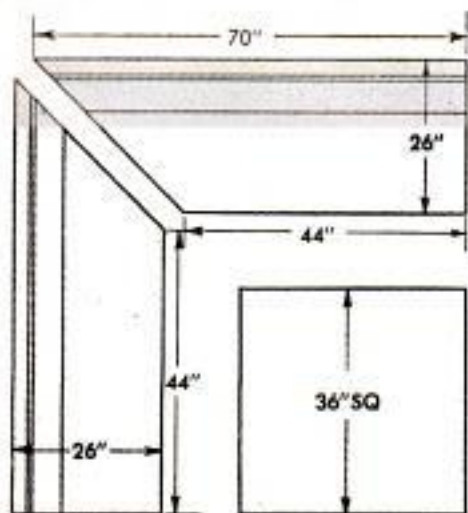

*Custom-Build
Your Own*
DINING BOOTH

By John Bergen

COLORFUL UPHOLSTERED booths lend atmosphere and utility to the dining area or recreation room, but the cost of custom-built booths places them beyond reach of most people. Now, however, you can stay within your budget and still have all the advantages of a good-looking dining booth by building one of the three styles detailed in this story. They are all roomy,

comfortable and covered with easy-to-clean plastic fabric. Suggested over-all dimensions are given in the arrangement plan accompanying each illustration and construction of the tables is detailed in Fig. 8.

Framing of the booth seats is detailed in Fig. 1. The center section of each seat is basic, the 45-deg. corner sections being added as needed. The plan for the center

Booth seats are built from a basic plan 26 in. wide by 44 in. long. This provides the center section to which are added triangular-shaped corner sections as needed. Two 45-deg. corners are set together to form right angle

Longest of the booth units, which is detailed below, consists of a center section with a 45-deg. section at each end. This normally would be used to form the rear seat of U-shaped booth

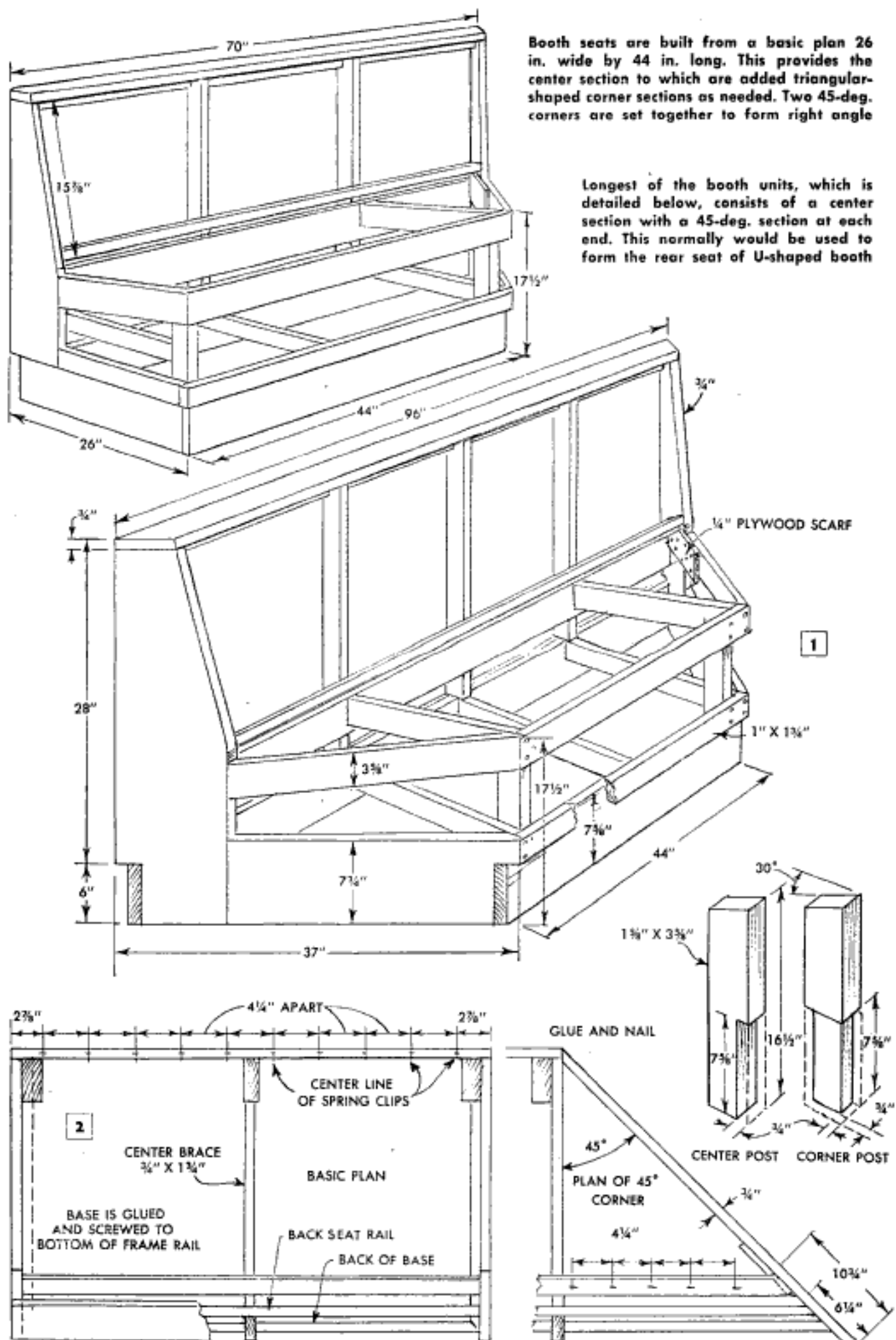

and corner sections is given in Fig. 2. Assembly details of the frames are shown in the perspective views in Fig. 1, while location and dimensions of the various parts are given more completely in the sectional view, Fig. 5. The center and corner posts are cut as in the detail to the right of Fig. 2.

Dimensions for the back post, used when the end of the seat is square, are given in Fig. 5, and the back post for the 45-deg. corner is detailed in Fig. 3. The plywood overlay dimensioned in Fig. 3 is used in applying fabric to the exposed back posts. An overlay is needed for the square ends only, as the 45-deg. ends will be butted against each other. The seat portion of the 45-deg. end section is covered with a piece of 1/4-in. plywood which is cut as in the upper detail in Fig. 5. When this is covered with two triangular-shaped pieces of foam rubber, as in Fig. 4, a satisfactory cushion is provided without the need for springing.

The seat and back frames of the center section are fitted with no-sag type springs spaced at 4 1/4-in. intervals as in Figs. 2 and 6. Use 11-ga. spring for the back and heavier 9 ga. for the seat, adding the necessary number of springs to the back for the 45-deg. corners.

Note the length of the springs given in Fig. 5. It is important to cut all the springs for either the seat or back to the same length so the resiliency will be the same throughout the length of the unit. Measure the springs by uncoiling them flat along a yardstick. Then

The U-shaped booth pictured below is ideal for the basement recreation room or for the larger breakfast nook. It consists of right and left-hand side units and rear unit as at the right

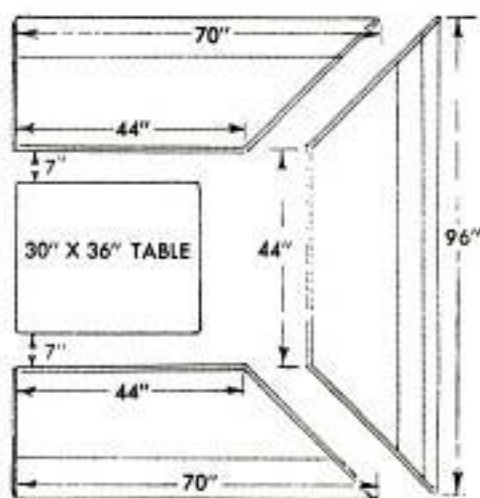
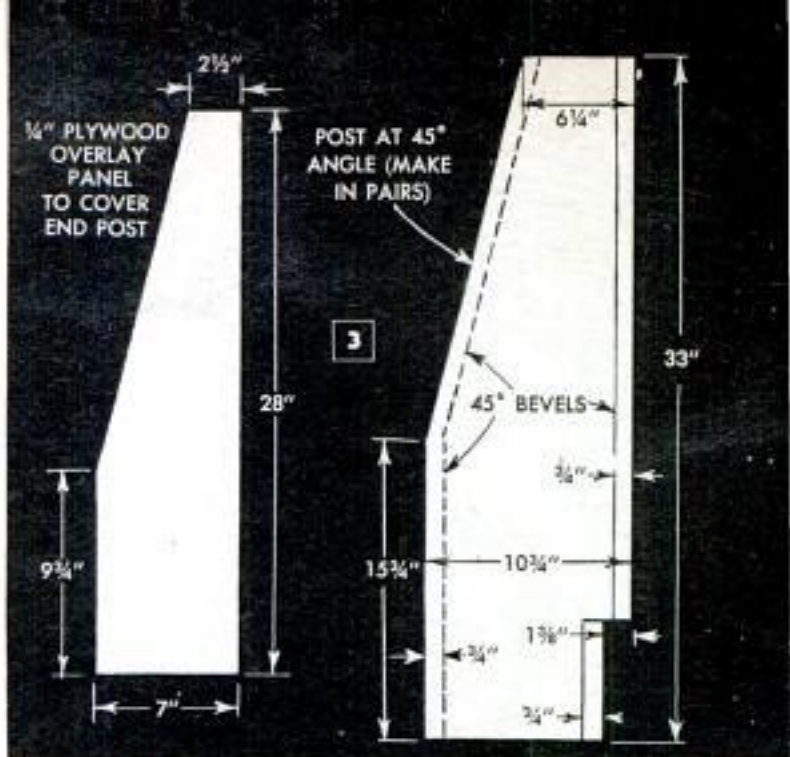

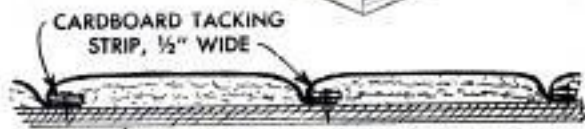
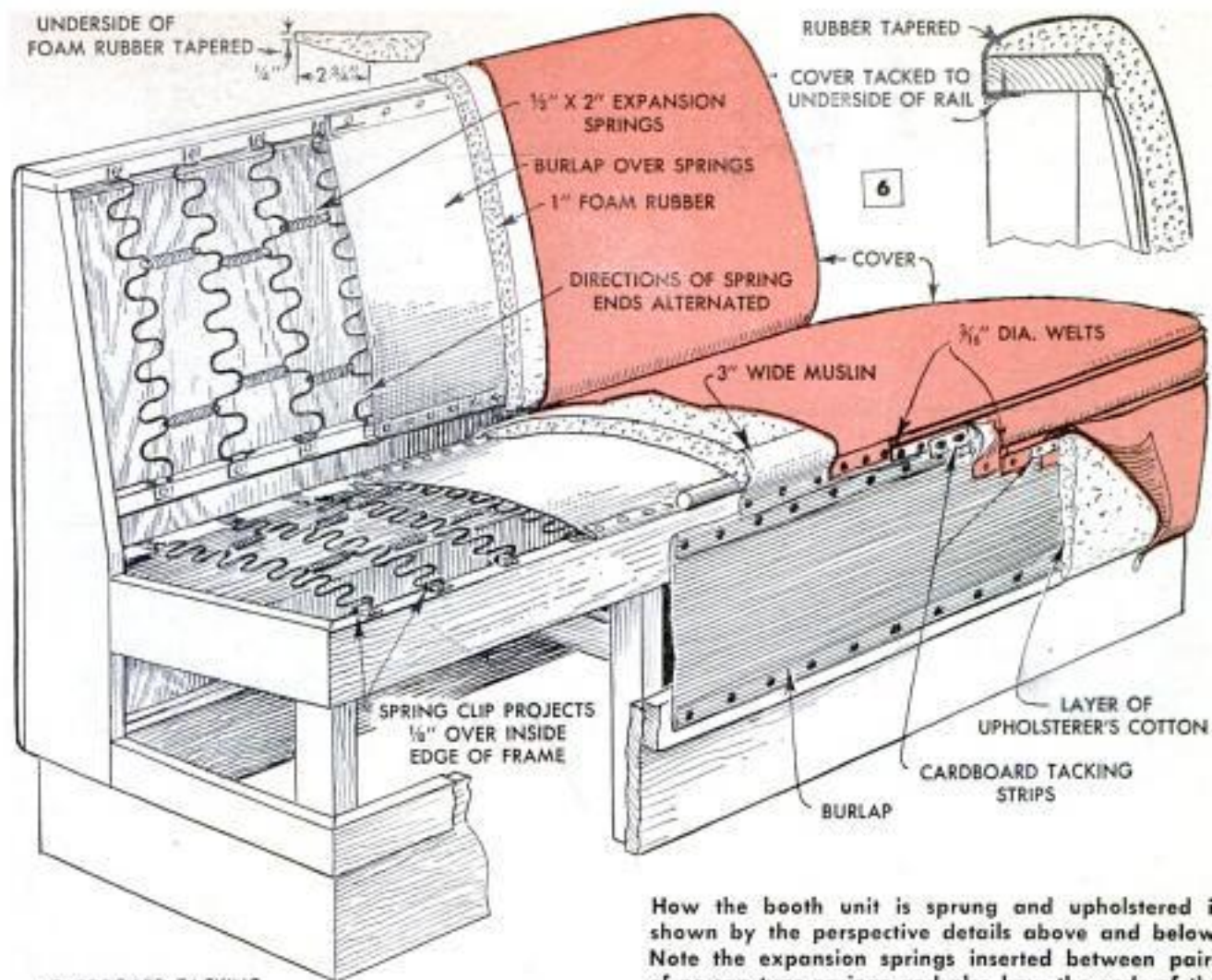

How the booth unit is sprung and upholstered is shown by the perspective details above and below. Note the expansion springs inserted between pairs of no-sag-type springs and also how the ends of the latter face in opposite directions. The burlap facing on the front and ends provides a backing for the upholsterer's cotton. When cutting finish cover to size, be sure to allow enough overhang for tacking

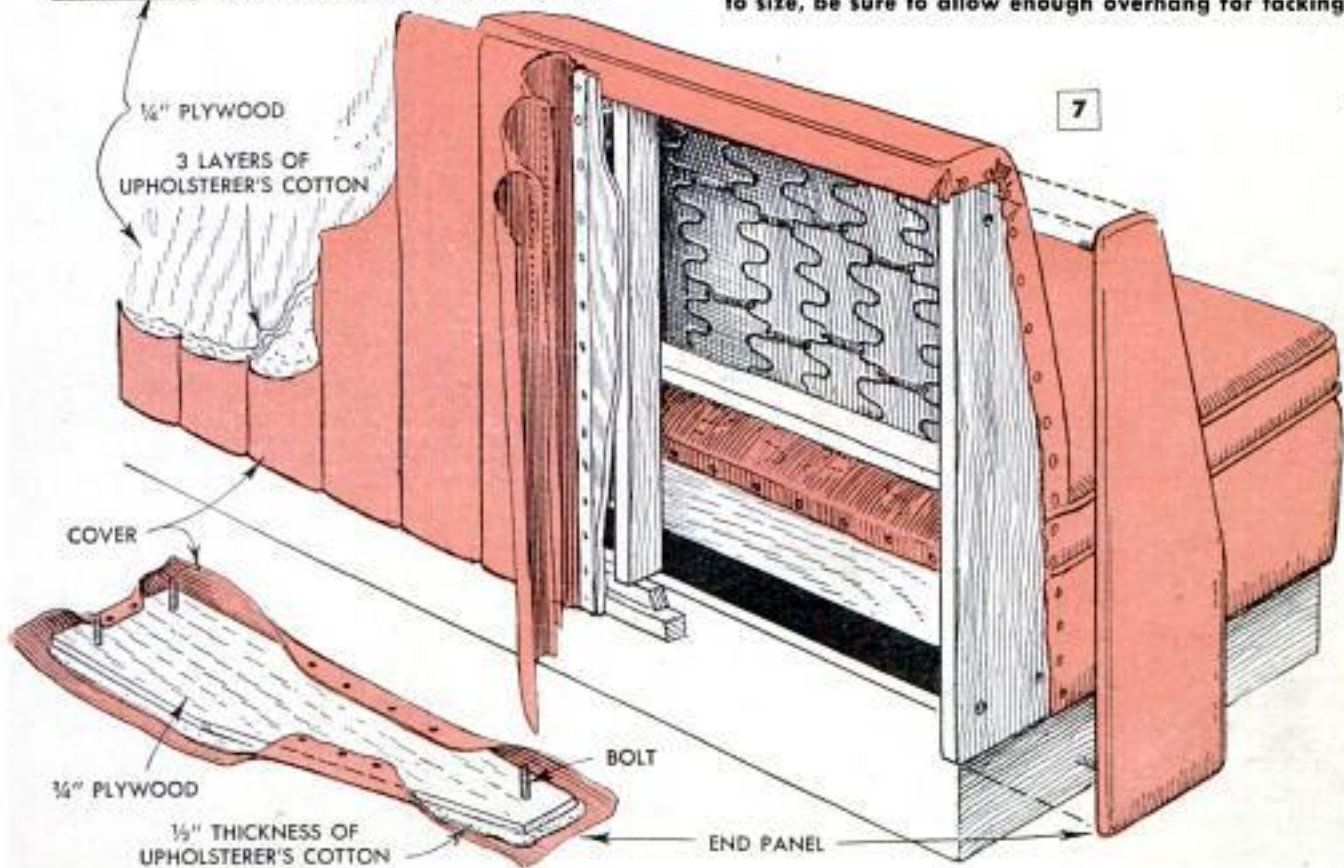

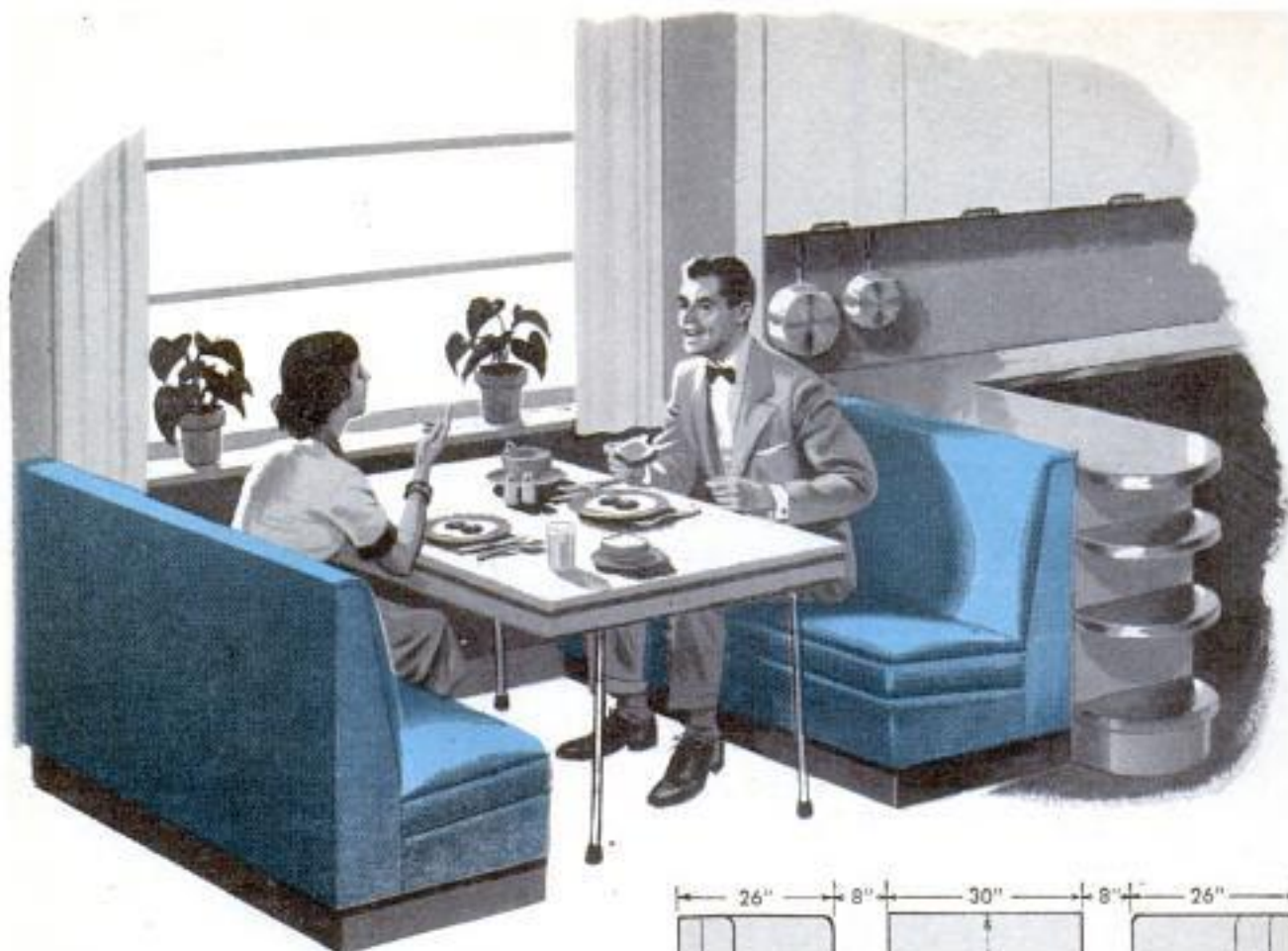

The breakfast-nook booth above consists simply of two 44-in. center sections and a 30 x 44-in. table. This provides comfortable seating for four persons

seat springs. After the no-sag-type springs are installed, hook $\frac{1}{2}$ x 2-in. expansion springs between them as in Fig. 6. These springs should be installed so that the ends of the hook point inward, away from the burlap and foam-rubber padding.

The burlap is tacked over the springs and to the front and ends of the unit as in Fig. 6. Then a $\frac{3}{4}$ -in.-dia. edge roll is nailed all the way around the seat rails, Figs. 5 and 6. You can make an edge roll by wrapping burlap around a firm hair or moss filler or you can buy one ready-made.

The next step is the application of the foam-rubber padding to the seat and back. Each pad should be cut 1 in. longer and $\frac{1}{2}$ in. wider than the section it is to cover. You might find it necessary to use two or more pieces of foam rubber for each of the pads. In this case, simply butt the pieces of foam rubber together and apply rubber cement to the butting edge of each piece. Allow the cement to become tacky (3 to 5 min.) and press the pieces together. Do not attempt to assemble the cemented pieces for several hours.

As the foam rubber cannot be tacked in place, it is held in position by means of muslin tacking strips, which are cemented to the rubber. These strips are about 3 in.

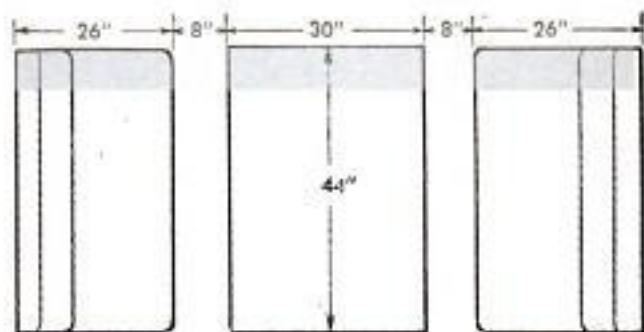

wide and run the full length of the rubber.

After applying the foam rubber, cut and fit the seat and back covers. The seat cover is tacked to the front and rear seat rails and the back cover to the top and bottom back rails. The ends of both covers are tacked to the end seat rails and back end panels. Where the ends of the unit are exposed, an upholstered end panel is made and bolted to the unit, as in the lower left-hand detail of Fig. 7. When the back of the seat is not set against a wall, it can be covered attractively with a padded channel treatment, as in Fig. 7. The channels may vary from 4 to 10 in. in width, the important point being to lay out the $\frac{1}{4}$ -in. plywood backing so all the channels will be of the same width. When estimating the size to which the fabric is to be cut, add $1\frac{3}{4}$ in. to the width of each channel, and allow an extra $2\frac{1}{2}$ in. for the length of the channels.

Fig. 8 details an attractive table designed especially for these booths. The table, which is extremely simple to build, can be made in a variety of sizes to suit the booth

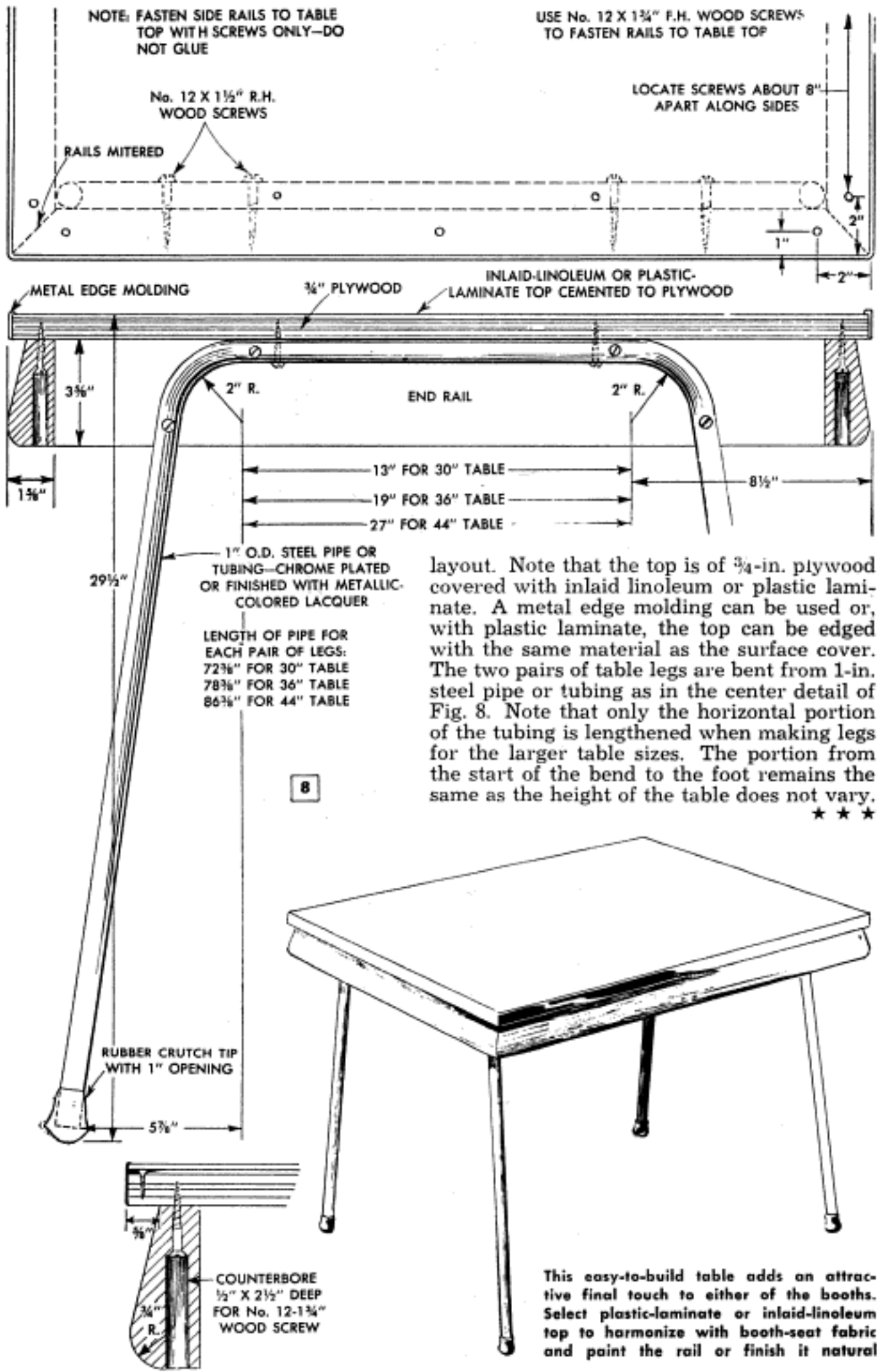

layout. Note that the top is of 3/4-in. plywood covered with inlaid linoleum or plastic laminate. A metal edge molding can be used or, with plastic laminate, the top can be edged with the same material as the surface cover. The two pairs of table legs are bent from 1-in. steel pipe or tubing as in the center detail of Fig. 8. Note that only the horizontal portion of the tubing is lengthened when making legs for the larger table sizes. The portion from the start of the bend to the foot remains the same as the height of the table does not vary.

★ ★ ★

This easy-to-build table adds an attractive final touch to either of the booths. Select plastic-laminate or inlaid-linoleum top to harmonize with booth-seat fabric and paint the rail or finish it natural

Blackboard on Bins and Shelves Keeps Stock Up-to-Date



By providing small blackboards on the front of his bins and shelves, one parts manager has found it easy to keep a perpetual inventory of parts on hand. Blackboard paint is applied to the front of the bin or shelf. Whenever a part is taken out or replaced, the number on the blackboard is changed, so that the actual number of parts in stock always can be seen easily. When compiling an order for a salesman, all the manager need do is walk past the shelves and note those numbers that are low.

Small Barrel Provides Rack For Storing Garden Hose



A small barrel or nail keg, because of its relatively large radius, can be used to provide a simple rack for storing garden hose. The barrel is slotted, as shown in the detail, and two lengths of 2 x 4 are bolted together to form a bracket on the wall. In the example illustrated, the bracket also was bolted to the studs of the garage wall.

Bank Made From Plaster Figure By Cutting Slot in Top

The hollow plaster animals and figurines given as prizes at carnivals and fairs are easily converted into coin banks. Pencil the outline of the coin slot at the top of the figure, then cut it out with a pocket knife or small sharp chisel. Coat the raw edges of the slot with several coats of lacquer or shellac to prevent further powder-

ing as the coins enter it. To permit emptying of the bank, cut a hole 1 in. in dia. in the bottom of the figure and plug with a cork.—E. Jenicek, Chicago.

Wedge Assures Tight Joint When Regluing Chair Leg

When refastening a loose leg in the blind hole in a chair bottom, use a wedge to assure a tight fit. Saw a kerf in the leg, so that it is at right angles to the grain of the wood in the seat. Then cut a wedge, the wide end of which is about twice the width of the kerf. Apply glue to the wedge, kerf and the end of the leg. With the wedge just started in the kerf, slip the leg into place. Invert the chair, support the top on a workbench or other solid surface and drive the leg into place.

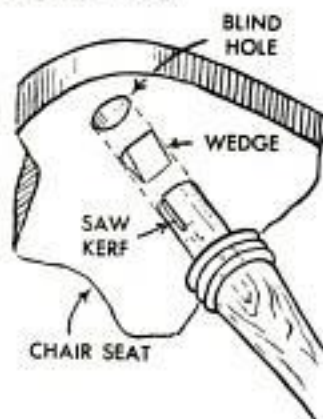

Belt-Clip Prevents Misplacing Of Measuring Tape

A definite aid to prevent mislaying your steel measuring tape is this spring-clip that permits carrying it on your belt within easy reach. The clip is a narrow strip cut from spring-brass or steel, folded in half and shaped to clip over a man's belt. It may be necessary to drill or punch a hole to clear the rivet that projects from the center of the measuring-tape case. The rule should be removed from the case, if possible, when soldering on the clip.

Ken Murray, Colon, Mich.

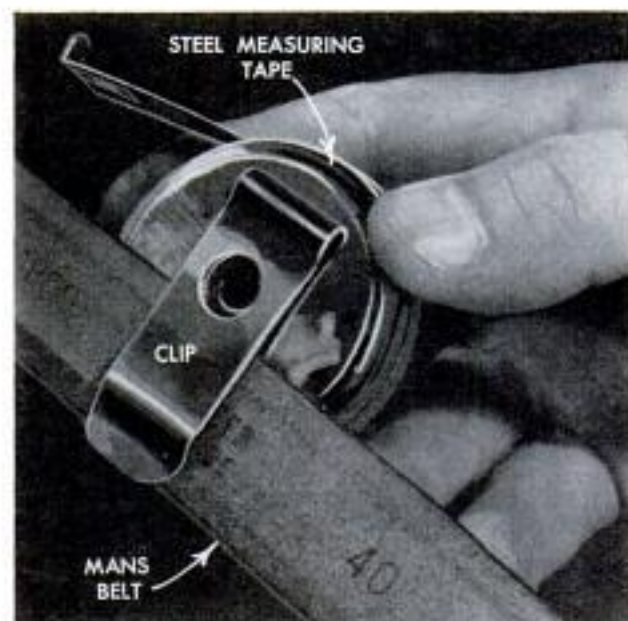

FREE HEAT FOR YOUR BASEMENT

Increase the heating capacity of your present furnace without burning more fuel. The secret is to utilize the wasted heat which normally is lost up the chimney



Above, the Free Heater can be installed in fairly limited space, either horizontally or vertically. Below, typical installation showing Free Heater, blower and thermostatic control for motor

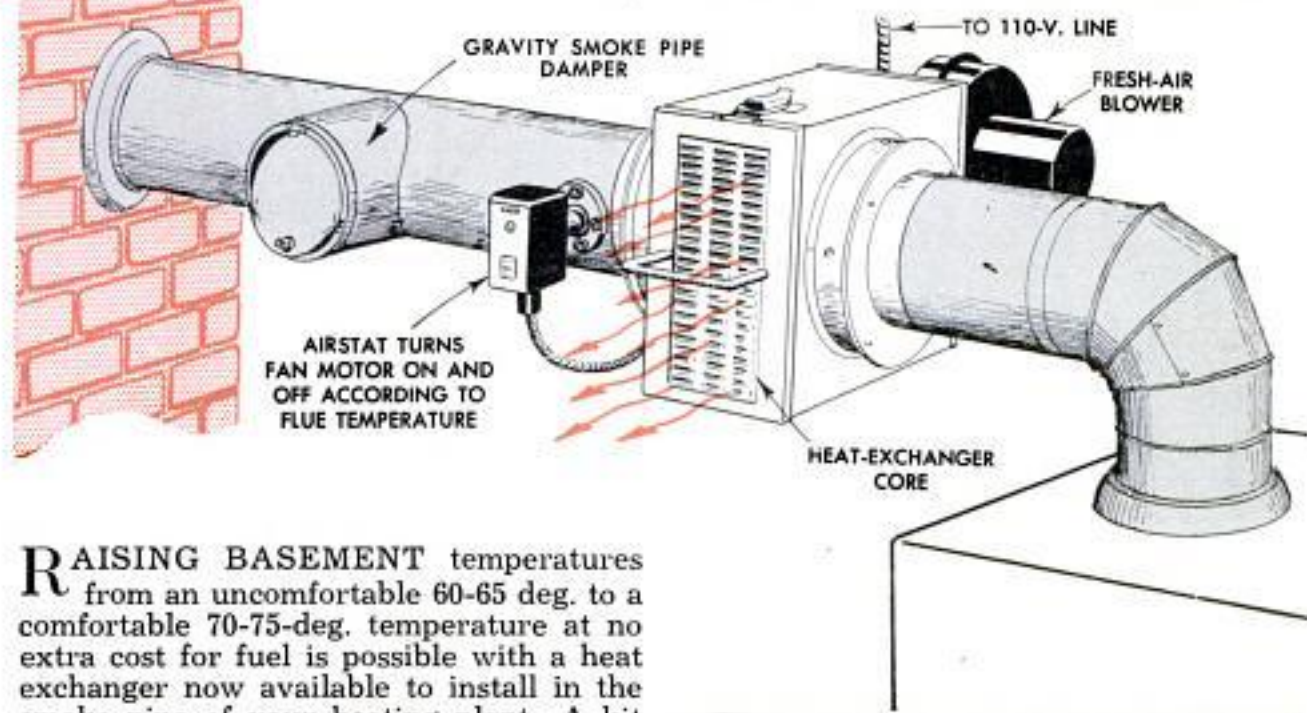

RAISING BASEMENT temperatures from an uncomfortable 60-65 deg. to a comfortable 70-75-deg. temperature at no extra cost for fuel is possible with a heat exchanger now available to install in the smoke pipe of your heating plant. A kit also is available to adapt the unit for a 4-in. round sheet-metal pipe to carry heat to an attic, a workshop, enclosed breezeway, attached garage or even to supply auxiliary heat to a room that is hard to heat.

Called a Free Heater because it utilizes only waste heat headed for the chimney, the exchanger works best on oil-fired heating plants where smoke-pipe temperatures are high. It will, however, work on stoker-fired plants if the stack temperatures are 450 deg. or higher—the higher the better.

In one test case, a standard oil-burning furnace of 80,000-B.T.U. capacity showed a stack-temperature drop across the heat exchanger from 750 to 360 deg. The air forced

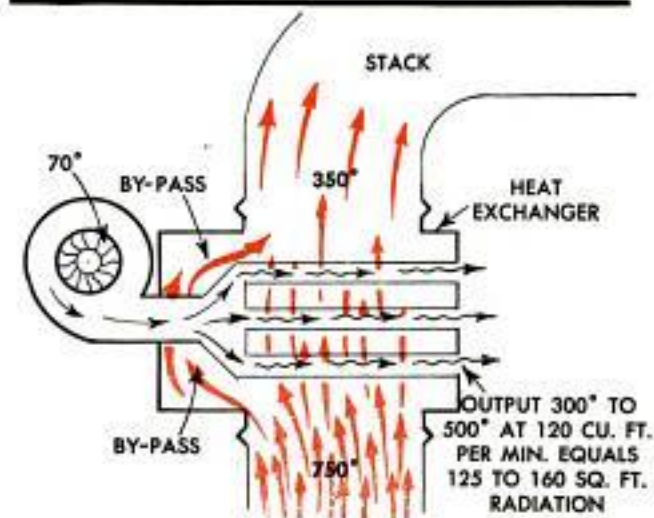

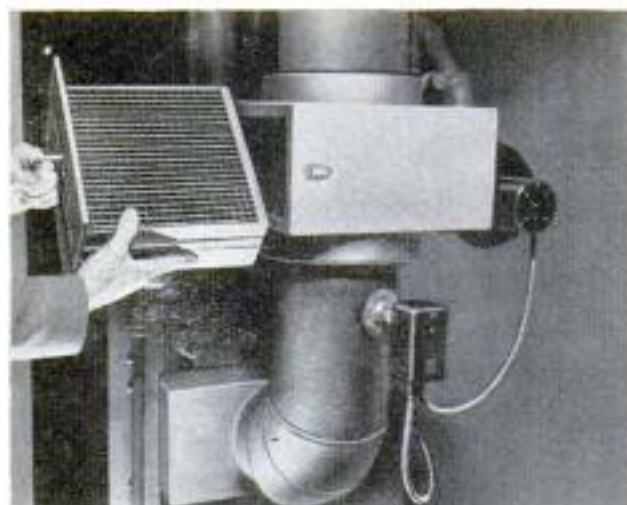

Heat-exchanger core is removed from Free Heater by simply releasing spring catch and pulling out drawer

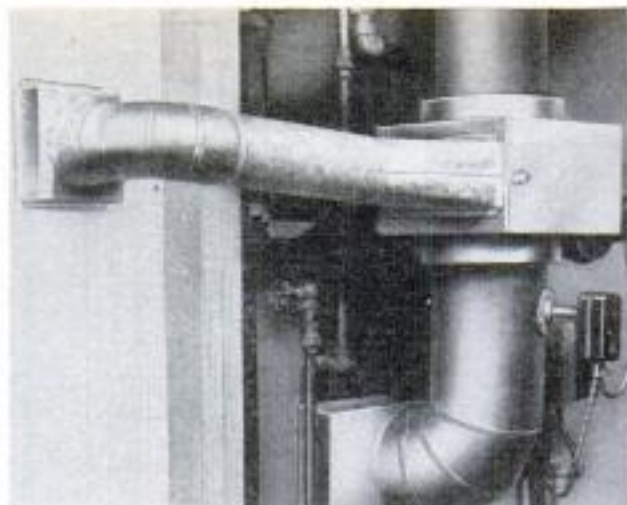

Adapter kit permits use of standard furnace ducts to run heat from exchanger to other parts of house

into the basement was 460 deg. as it left the exchanger. Basement temperature, including the air entering the blower, was 68 deg.

The heater should not be used where there is a possibility of lowering the stack temperature at the chimney below an amount suitable to maintain the required draft on the heating plant, which usually is a minimum of 350 to 400 deg. F.

The exchanger consists of a core of steel tubes encased in a heavy-gauge sheet-metal housing and a small 150 c.f.m. fan. When it is installed in the smoke pipe by removing a section of the latter, hot gases from the heating plant pass over the tubes of the exchanger heating the air which is blown through the inside of the tubes. A thermostatic control starts the blower in the exchanger whenever the stack temperature rises above 350 deg. Normally, the control

is installed in the pipe between the exchanger and the furnace. If lack of space makes it necessary to place the control between the exchanger and the chimney, a lower setting is used.

A safety device built into the exchanger is a bypass that allows the furnace gases to pass around the exchanger and directly into the chimney if the tubes should become clogged with soot.

Maintenance of the Free Heater is a simple job. The steel tubes are specially brazed to withstand temperatures up to 2000 deg., far above the temperatures in a home-furnace chimney. To clean the exchanger, simply pull out the core as you would a drawer and use a garden hose to wash away the soot collected between the tubes. Under normal conditions the exchanger need be cleaned only once or twice a season.★★★

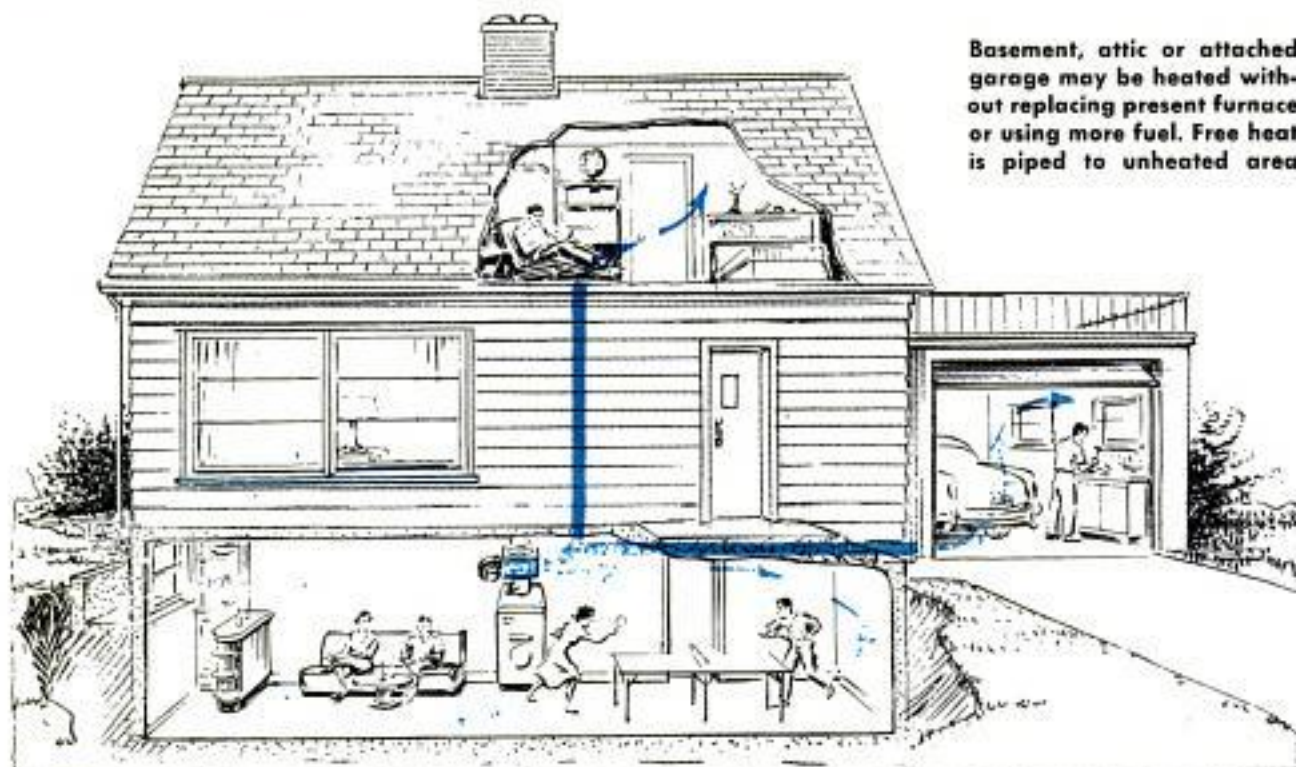

Basement, attic or attached garage may be heated without replacing present furnace or using more fuel. Free heat is piped to unheated area

Fishing Spear Has Barbs Hand-Forged From Carriage Bolts

Not being able to purchase a fishing spear in his locality, one sportsman made his own by using carriage bolts and a discarded rake handle. As shown in the detail, a length of flat steel was drilled to receive a number of carriage bolts which were forged into barbed spears. The head of each bolt was cut off, leaving the square shoulder. This was hammered to a rough shape, which then was ground to a finished point. The bolts can be worked cold, but heating the ends red hot would make the job of shaping with a hammer considerably easier. The finished barbs were then bolted to the drilled flat

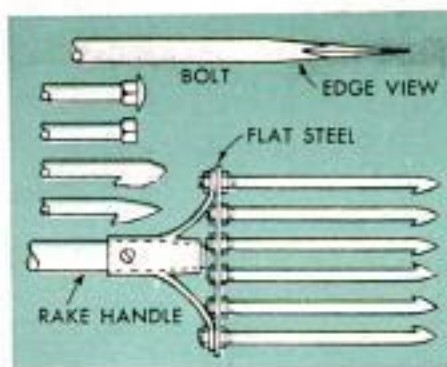

steel and assembled on the rake handle. If a heavier handle is desired, pipe or tubing can be substituted for the rake handle.

Jack Voegler, Muskegon, Mich.

Picture or Mirror Conceals Television Set in Living-Room Wall

One method of gaining more floor space in the living room is to install the TV set in the wall. A large picture or wood-backed mirror then can be hinged to cover the set when it is not in use, thus maintaining the effects of your interior decorating. An installation of this kind will require that there be a closet or other room not affected by the set projecting through

the wall. The studs of the wall are cut and double headers nailed in place, as would be the case when installing a window. A sturdy, well-braced shelf is built to hold the set, so that the TV screen and controls are nearly flush with the living-room wall. Ample ventilation must be assured, to carry away the heat generated by the set. For purposes of repair there should be easy access to the back of the set.

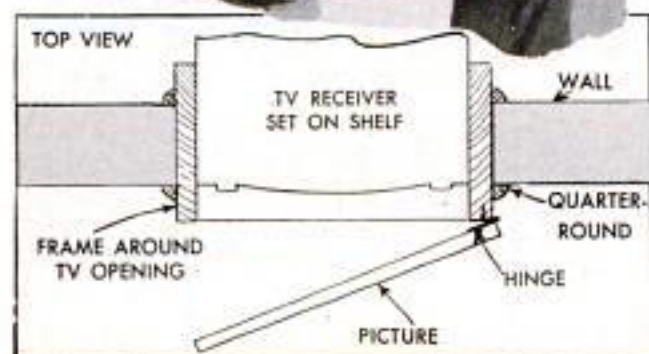
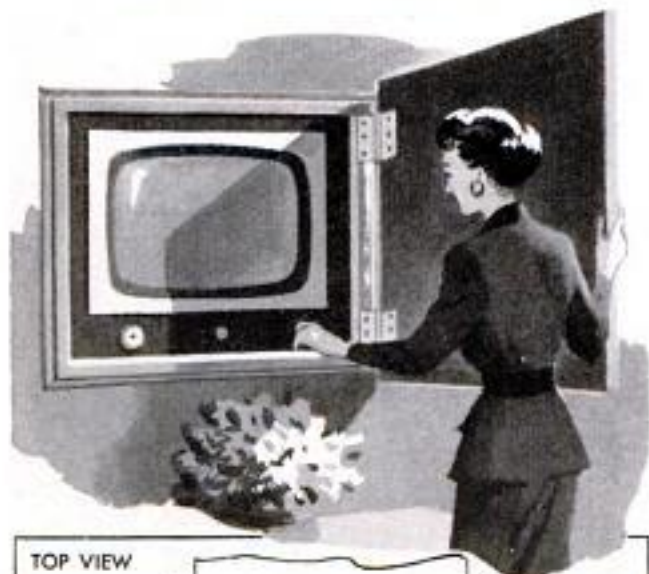

Rubber Brush for Soldering Acid Made in a Few Moments

An all-rubber brush for applying soldering acid can be made in a few moments from a short length of thick-wall rubber tubing and some small rubber bands. Rubber cement is smeared inside the end of the tubing and also



over the rubber bands, which are hooked over a bent piece of wire, as shown. The rubber bands are stretched taut and then pulled into the tubing with the hooked wire. When the tension is released, the tubing becomes slightly distended as the bands expand. This pressure, plus the cement, holds the bands firmly in the tube. Cut the doubled ends of the bands off with a shears at the desired length.

NEW FACES FOR OLD DOORS

By Henry and Vera Bradshaw

AN OLD-FASHIONED glass-paneled entrance door that gives no privacy and is a constant decorating problem, can be remodeled into a modern panel door at moderate cost in a couple of hours. Unless new hinges are used which require being mortised into the edge of the door, no refitting is necessary. To remodel the door, first remove the glass and molding. Next, nail filler strips around the inside edge of the opening so that $\frac{1}{4}$ -in. plywood panels will come flush with the surface of the door. Measure the opening and cut a plywood panel for each side. The window is located by first temporarily fitting one of the panels in place and marking off the center line of the door. Then the window opening is laid out and the openings are cut in both panels at one time. Filler strips are added around the edges of the cutouts and the panels are glued and nailed into place. The glass for the window is held in place with L-shaped molding. The door is finished by filling in all joints with wood putty.

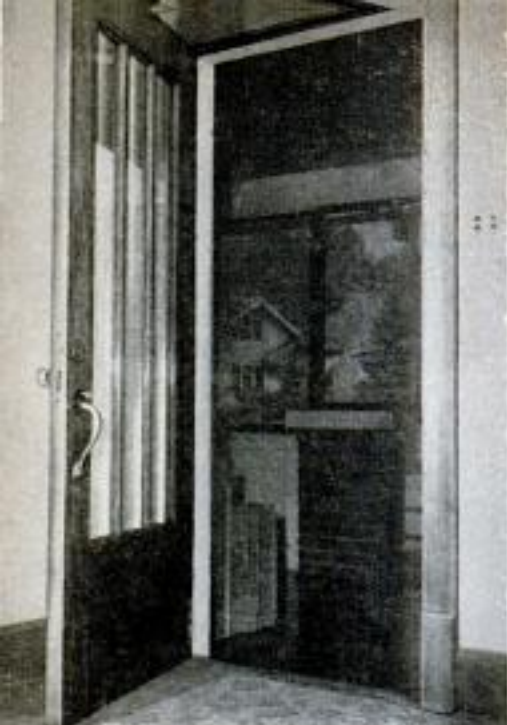

Above, old-fashioned glass-paneled door before remodeling job



Above, assembly before refinishing. Below, door is filled, sanded, painted white

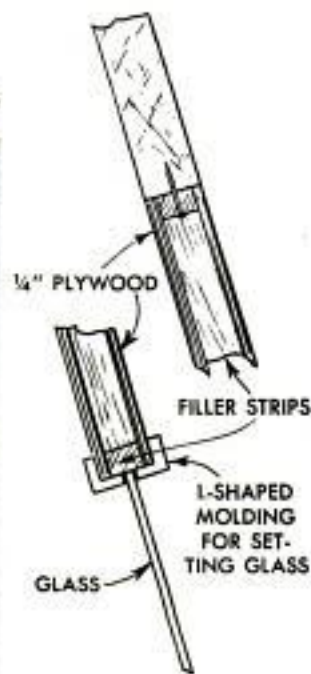
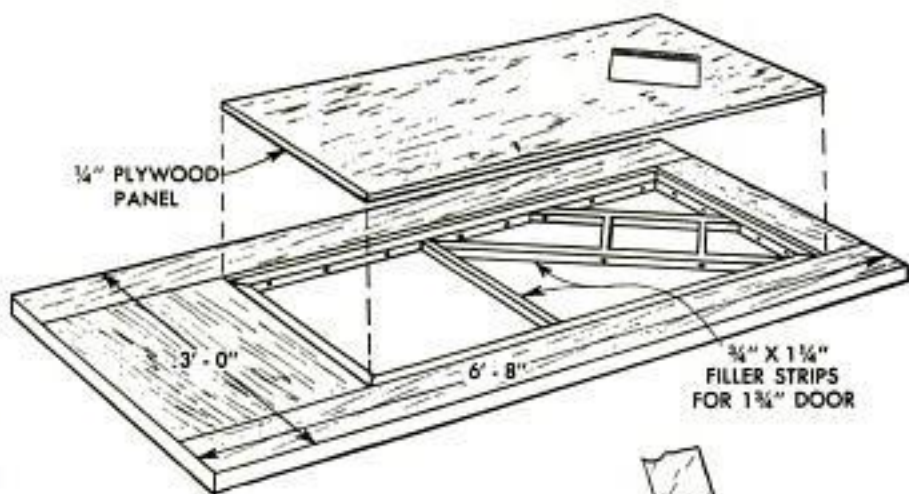
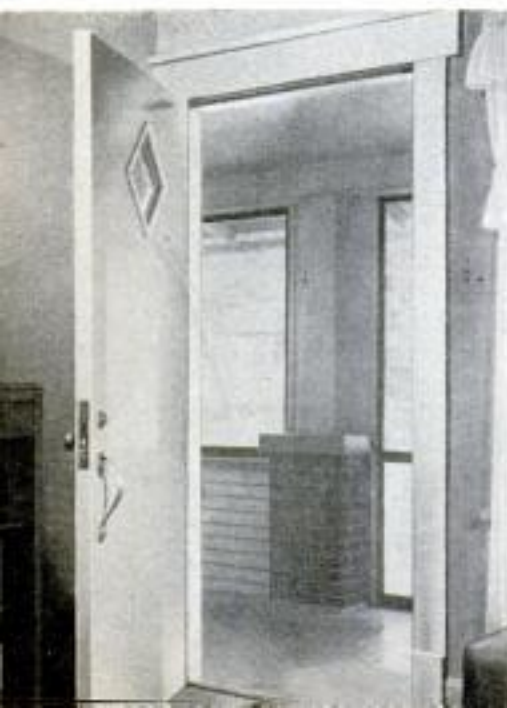

Emergency Reflector for Light Made From Large Funnel



One homeowner used a large funnel as a shade on an improvised light over the workbench in his basement. As an emergency measure, until he found time to install proper lighting over the bench, he used a standard trouble light suspended

from a hook. By pulling a loop of the cord through the funnel as shown, he was able to use the funnel as a shade without taking off either the receptacle or the plug of the cord. As a safety precaution, he lined the funnel with electrical tape to prevent contact between the two metal surfaces.

Curled Photographs Flattened Between Curved Blocks

Snapshots that have become curled to the extent that they are difficult to handle and file, can be flattened by pressing them between two curved blocks to reverse the curl.

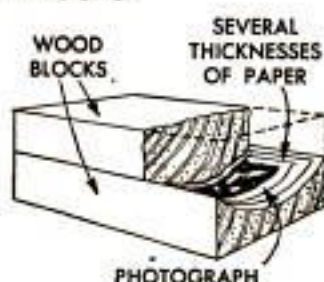

The two blocks are bandsawed from one piece of solid stock and the curved faces sanded smooth and covered with several thicknesses of paper to protect the photos. Place a weight on the top block or snap heavy rubber bands around both blocks to hold them together.

Salvaging Clogged Sander Belts

Instead of discarding a sander belt that has become clogged with resin, varnish, paint or glue, rinse it lightly in lacquer thinner. Then go over the belt with a wire brush to finish the job.

Henry Josephs, Gardenville, Pa.

Door Framed in Scrolled Garland Brightens Drab Entrance

To highlight the drab-looking entrance to his house, one homeowner replaced the old door with a new flush-panel, and then framed it with a scrollsawed garland of leaves, as pictured. The leaves, cut from $\frac{1}{4}$ -in. exterior plywood, are nailed directly to the frame and painted a light-green color, to contrast with the dark green of the house. He also made the flush-panel door himself. The door consists of plywood panels glued and nailed to a frame of $\frac{3}{4}$ x $2\frac{1}{2}$ -in. stock. Upper and lower portions of the frame are strengthened with X-braces. The outside panel is of $\frac{1}{2}$ -in. plywood, while $\frac{3}{4}$ -in. plywood is used for the inside panel. When figuring the dimensions of the door, allowance should be made

for $\frac{1}{2}$ -in. cover strips at the top and sides. It is best to use exterior-grade plywood for both panels. The garland of leaves can also be used around the windows or on the house eaves.—Hi Sibley, Nuevo, Calif.

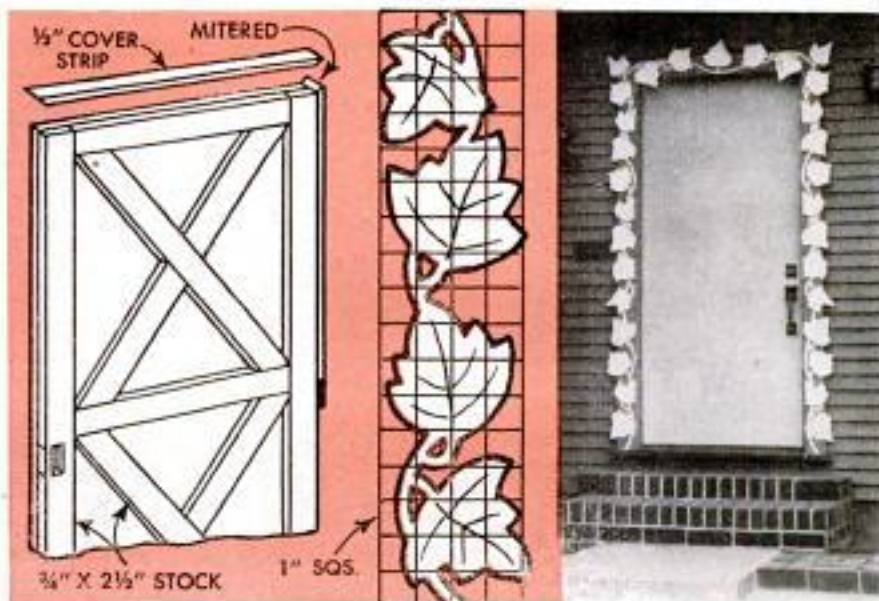

Solving

HOME PROBLEMS



① **PORTABLE DRYING RACK** for drying small articles of clothing over register or radiator is provided by folding screen fitted with removable dowels. Screw hooks are driven into ends of dowels which are hooked into screw eyes in edges of screen

② **SPARKLING-SILVER NUT CUPS** for party place settings can be made easily by hand-forming aluminum foil over bottom of a small glass jar or tumbler. Shape the foil carefully so it does not tear, remove it from the glass form and trim edge with scissors

③ **RUBBER GLOVES** will have a longer useful life if tips of the fingers are protected from sharp fingernails. Simply place a small pod of cotton inside the tip of each finger so that the soft rubber will be protected when the gloves are pulled on tightly

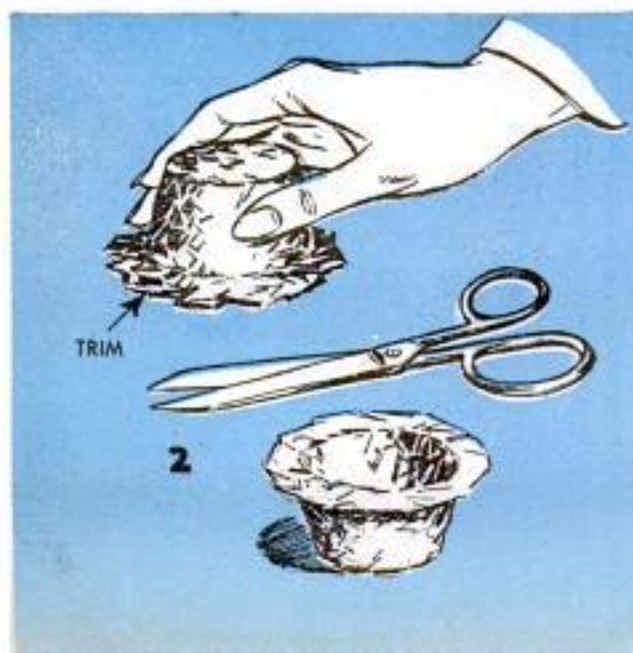

- 4 LEVEL A WOBBLY CHAIR by sticking wood putty on the short leg. Clean and sand bottom of leg and place chair on level surface with waxed paper under leg. Put wad of putty under leg and weight chair until all four legs contact floor evenly. Trim off excess putty and sand it when dry.

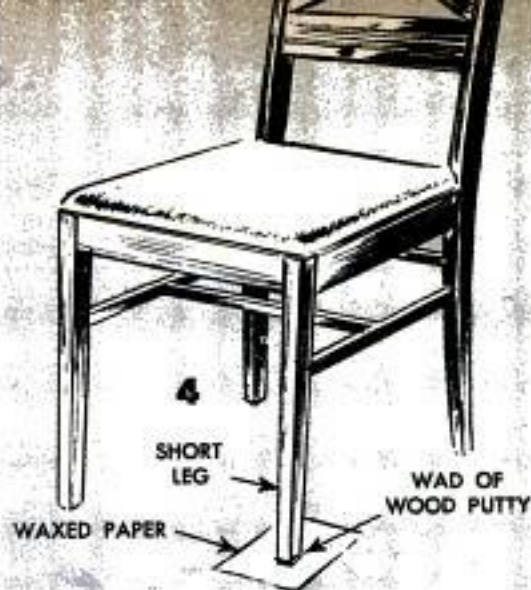

- 5 THE PROBLEM OF clothesline props that slip on the line and allow the clothes to drag on the ground can be solved by slotting the end of the pole like a clothespin and fitting it with a carriage bolt and wing nut. The hole for the bolt is drilled near the bottom of the slot.

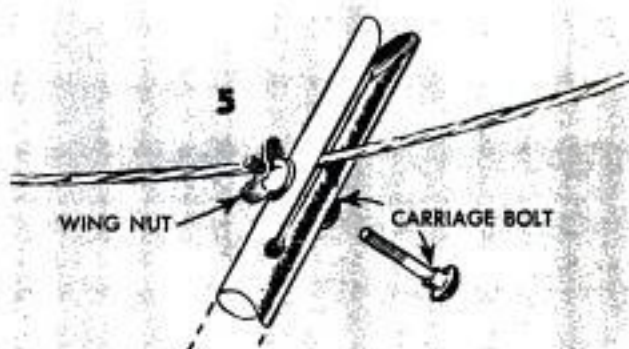

- 6 IF THE WINDOW SHADE in the kitchen or bathroom is not fitted with a pull string or tab, you can improvise one by taping a large pearl button to the edge with cellulose tape. The button provides a comfortable finger grip and the cellulose tape prevents soiling from wet fingers.

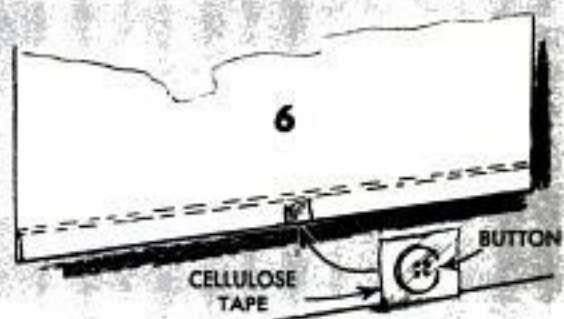

- 7 A HANDY MOP for wiping up small puddles of spilled liquids is made by nailing a cellulose sponge to a discarded mop or broom handle; use a leather washer under the head of the nail. The sponge readily washes clean and will not drip if it is not wrung out immediately after use.

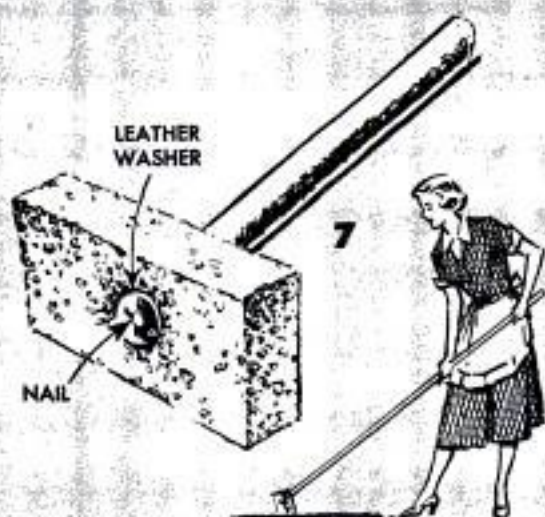

- 8 HAND DISCOMFORT caused by the string handles of heavily loaded shopping bags can be eliminated by using a 5-in. length of broomstick as a handle. A groove is cut around the stick near each end to receive the string. When not in use, the handle can be carried in pocket.



Rubber Hose Protects Shins Against Bruising on Ladder



Painters, paperhangers and others who do much of their work from a stepladder, can prevent bruising their shins by padding the steps of the ladder. The padding consists of a length of garden hose which is split and slipped over the edge of the step as shown in the illustration. Tacks or small nails can be used to hold the hose in place. The hose will not interfere with the normal use of the ladder and will give an added safety factor by making the steps slipproof.

Volume of an Irregular Object Measured by Water Displacement

WATER
DISPLACEMENT
BY
IRREGULAR
OBJECT

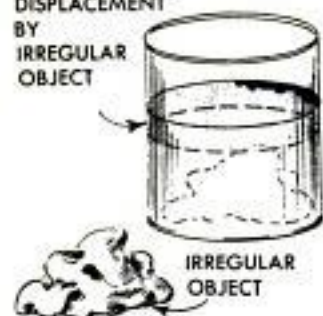

cu. in.) into a container which has straight vertical sides. Measure the height of the water with a rule graduated in tenths of an inch. Next, place the object to be measured alongside the container and add enough water to bring the level above the object, to assure there will be sufficient water to cover it. Add enough water so the total height will be an even number. Example: If the pint of water measured 3

in. and the object was slightly more than 2 in. higher, add 3 in. of water. Thus, the total volume of water is now two pints or 2×28.875 . Now place the object in the water and measure the final height of the liquid. Suppose it measured 10 in.; then the ratio of the volume of the object is to 10 in. as 2×28.875 is to 6 in. Another way to figure it would be to consider that the additional 4 in. is $\frac{2}{3}$ of 6 in. (or 2×28.875 .)

Rubber Pad Keeps Pastry Board In Place on Counter Top

Many modern kitchen counter tops and tables have a hard, smooth surface that permits a pastry board to slide around when it is used for rolling pie crust. To overcome this, place a sheet of sponge rubber or a section of inner tube under the board.



Tire Irons Lashed to Long Pole Retrieve Knife From Lake



When one fisherman dropped a knife over the side of a boat, he recovered it by using a tool consisting of two tire irons lashed to the end of a pole. The irons were tied so the slight bend at the end of each iron faced out, thus creating a "jaw." The clear water of the lake permitted slipping the jaw over the knife and the natural spring of the irons clamped it tightly, permitting it to be drawn to the surface.

Harold L. Monroe, Lomita, Calif.

❑ Freezing fruit juice in the refrigerator tray will provide ice cubes that can be used in the juice without diluting it.

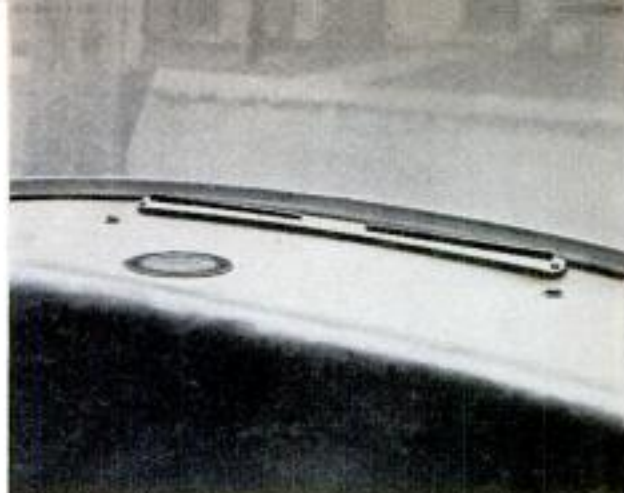
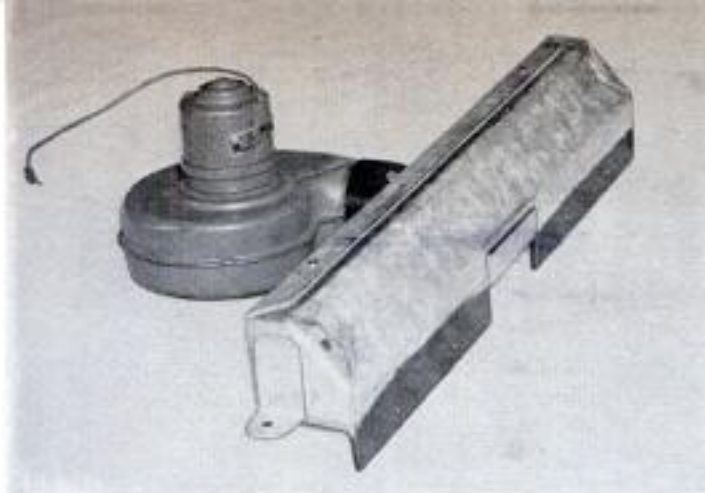

Above left, defroster before installation. Above right, finished job as it looks from passenger compartment

Build Your Own REAR-WINDOW DEFROSTER

A FOGGED OR FROSTED rear window—a common problem in modern automobiles with their large areas of glass—can be completely eliminated by this inexpensive defroster. Air from the passenger compartment is recirculated and forced across the full width of the window. The size of the defroster duct, which is formed from light sheet metal, will depend on the space available under the “package shelf” in the trunk. After the blower “Y” is shortened as indicated and soldered into the opening in the duct, the blower is fastened to the Y with sheet-metal screws to permit easy removal. An angle bracket at each end of the duct permits the assembly to be bolted to the package shelf. A screen-wire cover is fitted over the blower intake and a slotted strip of wood fits over the exhaust vents. Besides clearing the back window, the defroster assures better distribution of heated air in the car.

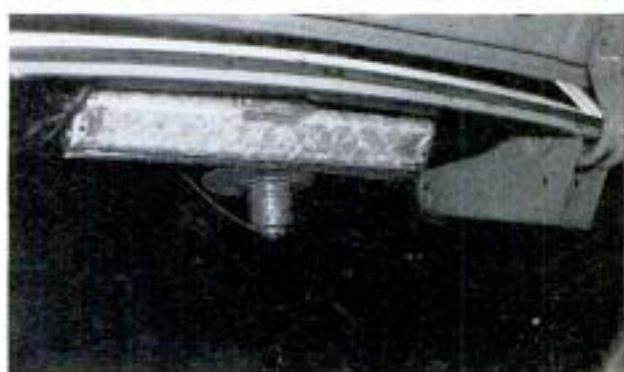

Above, installed duct and defroster seen from trunk

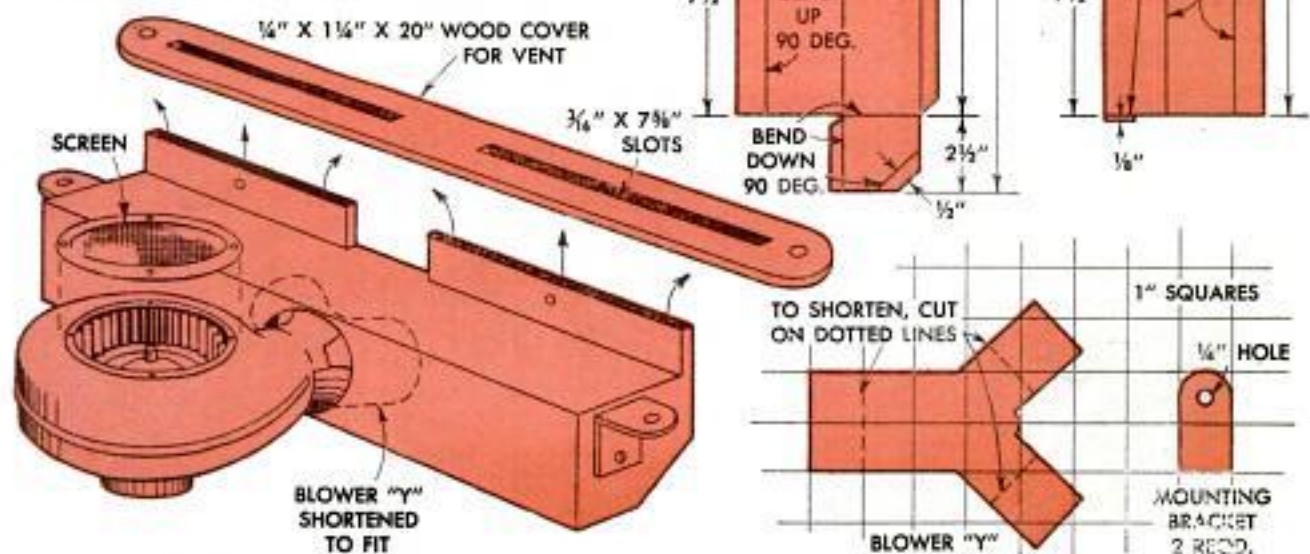

...Kitchen Accessories

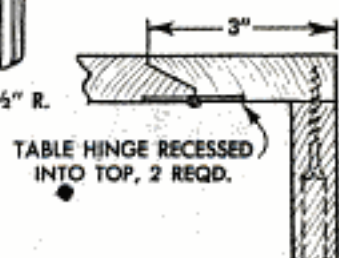
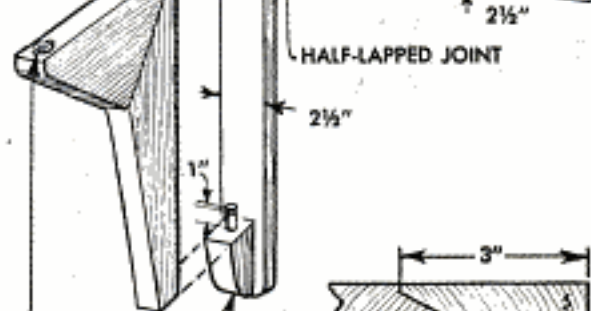
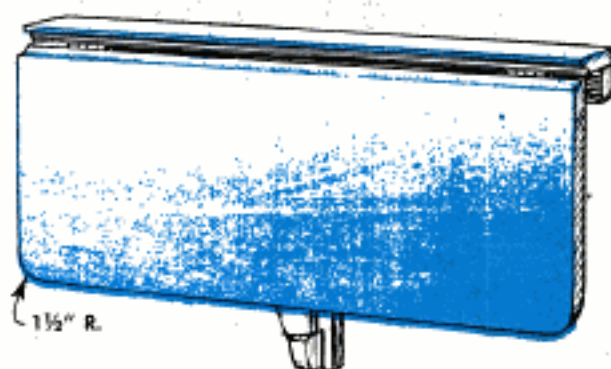
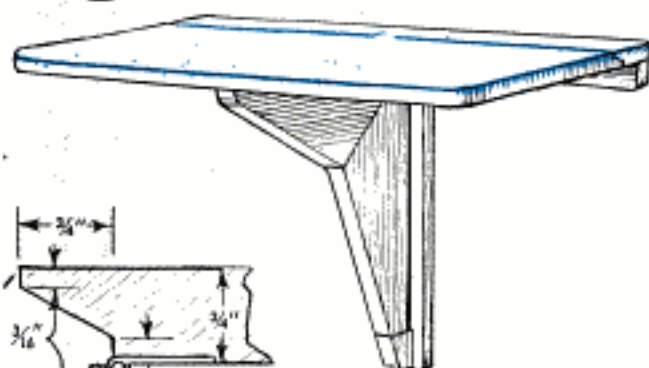

MATERIAL LIST

Canister Cabinet

Lumber

- 1 pc.— $3/4$ " x $63/4$ " x $20 1/2$ "—Top
- 1 pc.— $3/4$ " x $63/4$ " x $19 1/2$ "—Bottom
- 2 pcs.— $3/4$ " x $63/4$ " x $11 1/2$ "—Ends
- 3 pcs.— $3/4$ " x $6 1/2$ " x $10 1/2$ "—Partitions
- 1 pc.— $3/4$ " x $6 1/2$ " x $4 1/2$ "—Partition
- 2 pcs.— $1/2$ " x 2 " x $23 1/4$ "—Spice-rack ends
- 3 pcs.— $3/4$ " x $4-9/16$ " x $10 3/4$ "—Bin fronts
- 2 pcs.— $3/4$ " x $4-11/16$ " x $5-5/16$ "—Drawer fronts
- 3 pcs.— $3/4$ " x $3-11/16$ " x $5-15/16$ "—Bin bottoms
- 2 pcs.— $3/4$ " x $3-7/16$ " x $5-15/16$ "—Drawer bottoms
- 3 pcs.— $3/4$ " x $3-11/16$ " x $8 1/4$ "—Bin backs
- 2 pcs.— $3/4$ " x $3-7/16$ " x $4-9/16$ "—Drawer backs

Plywood or hardboard

- 1 pc.— $1/4$ " x 2 " x $18 1/2$ "—Spice-rack back
- 1 pc.— $1/4$ " x $10 3/4$ " x $19 3/4$ "—Back
- 6 pcs.— $1/4$ " x $6-7/16$ " x $9-15/16$ "—Bin sides
- 4 pcs.— $1/4$ " x $6-7/16$ " x $4-9/16$ "—Bin sides

Hardware

- 3— $1 1/8$ "-dia. knobs
- 2— $3/4$ "-dia. knobs
- 1 pc.—Stainless steel or aluminum— $1/16$ " x $5 3/8$ "

Folding Service Shelf

Plywood

- 1 pc.— $3/4$ " x $15 3/4$ " x 44 "—Drop leaf
- 1 pc.— $3/4$ " x 3 " x 44 "—Top
- 1 pc.— $1/4$ " x 2 " x $8 1/2$ "—Spline

Lumber

- 1 pc.— $3/4$ " x $2 1/2$ " x 44 "—Top support
- 1 pc.— $3/4$ " x $2 1/2$ " x $19 1/4$ "—Wall support
- 1 pc.— $1 1/8$ " x $5 3/8$ " x $19 1/4$ "—Hinged support, lower half
- 1 pc.— $1 1/8$ " x $5 3/8$ " x 15 "—Hinged support, upper half

Hardware

- 2—Table hinges
- 1—Bullet catch and striker

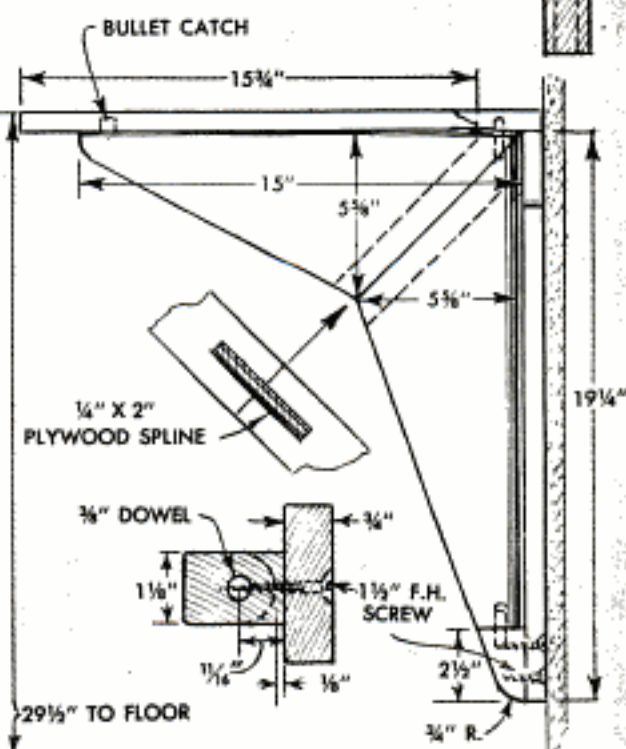

Oak Strips on Folding Table Lock Legs in Place

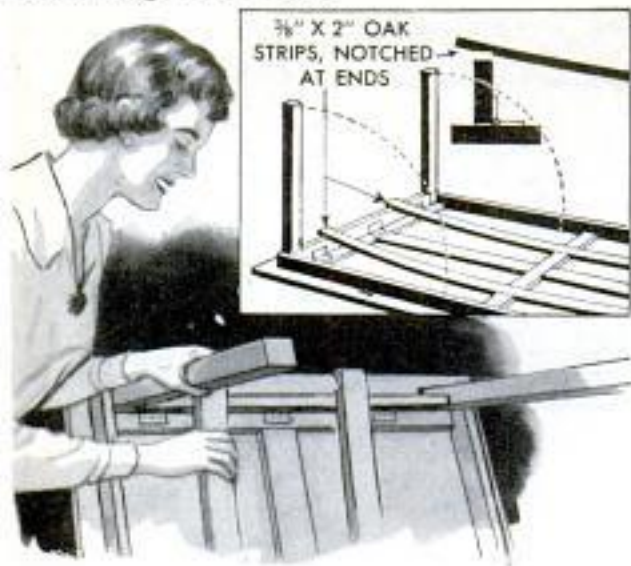

A simple yet positive device for locking the legs of a folding table in the vertical position utilizes two oak strips, $\frac{3}{8}$ x 2 in. The strips are cut long enough to extend beyond the table apron on two sides, and the center of each strip is screwed to the crosspiece under the table. Each set of two legs and apron is made as a unit and hinged to the table top. As shown in the detail, notches are cut in the strips to engage the apron when the legs are at right angles to the table top. The natural spring of the wood will hold the legs and apron in position. A slight pull on the strips will release the apron to permit folding the legs.

Coin Caddy for Door



For those people who leave money between their storm or screen and inner door to pay the milkman or paper boy, this coin caddy is recommended. It consists of

an ordinary steel crescent drawer pull mounted upside down, either on the door itself or on the doorframe. Change can be removed easily from the holder because of its cup shape and convenient width.

Thomas P. Ramirez, Fond du Lac, Wis.

Wetting Agent Flattens and Cleans Curled Photo Negatives

A drop of concentrated wetting agent applied to both sides of a curled negative just before prints or enlargements are made will flatten it out, eliminate any brit-

tleness, and clean it all in one operation. There are a number of such wetting agents available from photo-supply houses. After applying the liquid, rub lightly with a lens tissue to eliminate any streaks. The coating will not register when the photo is printed.—Robert C. Florian, Chicago.

Tap Used as Screw Extractor When No Tool Is Available

When no screw extractor of the proper size is available to remove the broken-off portion of a small screw, a discarded small-size tap can be used to do the job. The tap is ground to a triangular point, then driven lightly into a hole drilled in the broken screw.

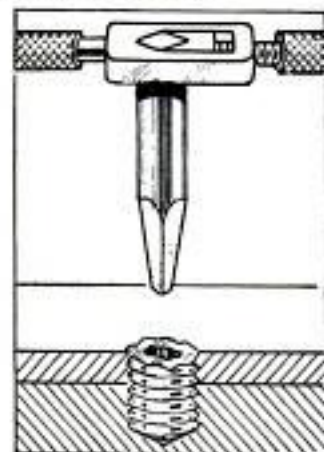

A tap wrench placed on the tap is used to back out the screw.

E. J. Gilkerson, Columbus, Ohio.

Locking Reflectors to Stands

No doubt every photographer who works with spot and photoflood reflectors has experienced the nuisance of lifting the reflector in moving a light about, only to have the stand drop off due to loose thumbscrews. To overcome this trouble, I drilled an oversize registering hole in the upper end of each stand to take the end of the thumbscrew. Thus, even if the thumbscrews should work loose, they will still engage the stands and keep them from dropping off accidentally.



Portable Bookcase Doubles as Shipping Box

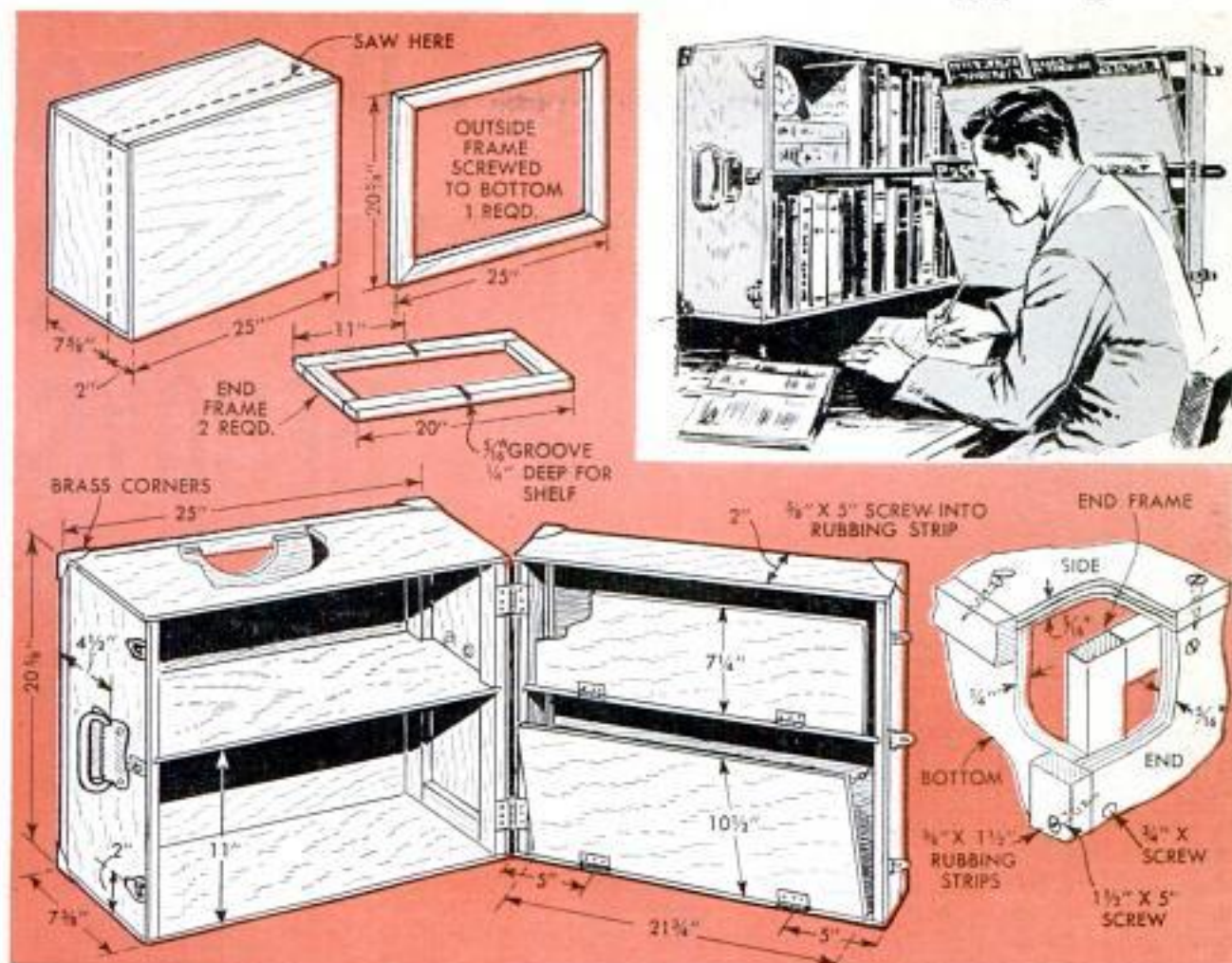

Students and others who find that packing books in a suitcase is very unsatisfactory will appreciate this traveling bookcase. With the lid closed, it is an ideal shipping crate for about 35 books. With the lid open, the case can be set on a table, where it becomes a bookcase and magazine rack. To begin construction, make the box shown in the upper corner of the detail and saw the top off. Then the inside and outside of the box are braced with the frames shown.

Before installing, the inside end frames are grooved to take a shelf. They are installed first, and then the bottom frame is put on the outside. Screws are driven through it into the end frames. Screws also are driven into it at an angle through the box sides. The lid is braced with two 2-in. boards which also are grooved for a shelf. Partitions are hinged to the lid, as shown, and then the lid is attached to the box.

John C. Wilson, Ottawa, Ont., Can.

Filaments of Flash Bulbs Tested With Dry Cell and Earphones

If there is any question as to the age and condition of photoflash bulbs, the filaments can be tested by using a single dry cell borrowed from the camera's flash gun and a single or double set of radio earphones. Clip one of the earphone leads to a contact on the dry-cell case and touch the other lead to the metal base of the bulb as the bulb is held in contact with the terminal of the dry cell. An audible click in the earphones indicates that the filament is unbroken and will fire. No sound indicates that the filament is broken and the bulb is defective. — Robert Hertzberg, Jackson Heights, New York.



HOW TO SHOOT OVER DECOYS

By Shep Shepherd

A FLOCK OF DUCKS or geese swinging in to the decoys is a sight to delight the eye of any wildfowler. On marginal feeding grounds near big flyways and in marshes, ponds and lakes, birds usually must be decoyed within range for consistent shooting. Jump and pass shooting, although preferred by some wildfowl hunters purely because of the skills involved, do not always produce satisfying bags, except for those exceptionally skilled in shotgun handling.

Most wildfowlers put out at least a dozen duck decoys unless shooting over a very small marsh or pond where a big flight would not ordinarily land. In making duck-decoy sets always keep in mind that for the surface feeders such as mallard, pintail, teal and others, the decoys should be placed so that the birds can swing in and land outside the set.

Decoys for geese should be of the full-bodied type with detachable heads which can be placed in any one of several positions so that the individuals in the set appear to be feeding in a natural manner. Make set in stubble or grain fields near resting grounds birds are known to frequent

A typical decoy set for geese with individuals in natural poses and some distance from traveled roads and fences. All feeding flocks are watched over by a sentinel. Don't forget the sentinel when putting out the decoy set. Locate this individual at some distance from flock, on a rise if possible





A typical duck-decoy set with live birds coming in for a landing. Note especially position of individuals

The divers, which include upwards of a dozen species, usually come directly in to the decoy set and for this reason it's a good idea to keep the individual decoys more widely separated. The decoy set for the divers also should be placed over deeper water than that for the surface feeders, or puddlers.

Another thing to avoid is regularity in the set formation. This can be done by changing the anchor point on several of the individual decoys so that they will ride quartering or side to the wind. This arrangement will make the set appear more natural. When coming in to the decoys, ducks usually will land directly into the wind or quartering it. They rarely come in without circling the set at least once, even in rough weather, more often two or three times. Pick your shooting position with this in mind. Generally the best shots

are afforded when the decoy set and shooting position are arranged so that ducks coming in to the decoys will pass in front of the blind, quartering across the line of vision from the right or left. However, selection of the shooting position is more or less a matter of individual preference and, of course, is determined to some extent by the nature of the shooting grounds.

If there has been much shooting in the locality, leaders of the flocks will be unusually wary. When this is the case there are several simple tricks that will often bring them in. Four to six individual decoys grouped a short distance from the main set may

Below, left, pebbles thrown into quiet water will form ripples like those made by feeding ducks. Right, body-form decoys of the type which can be nested for convenience in transporting



Copyrighted

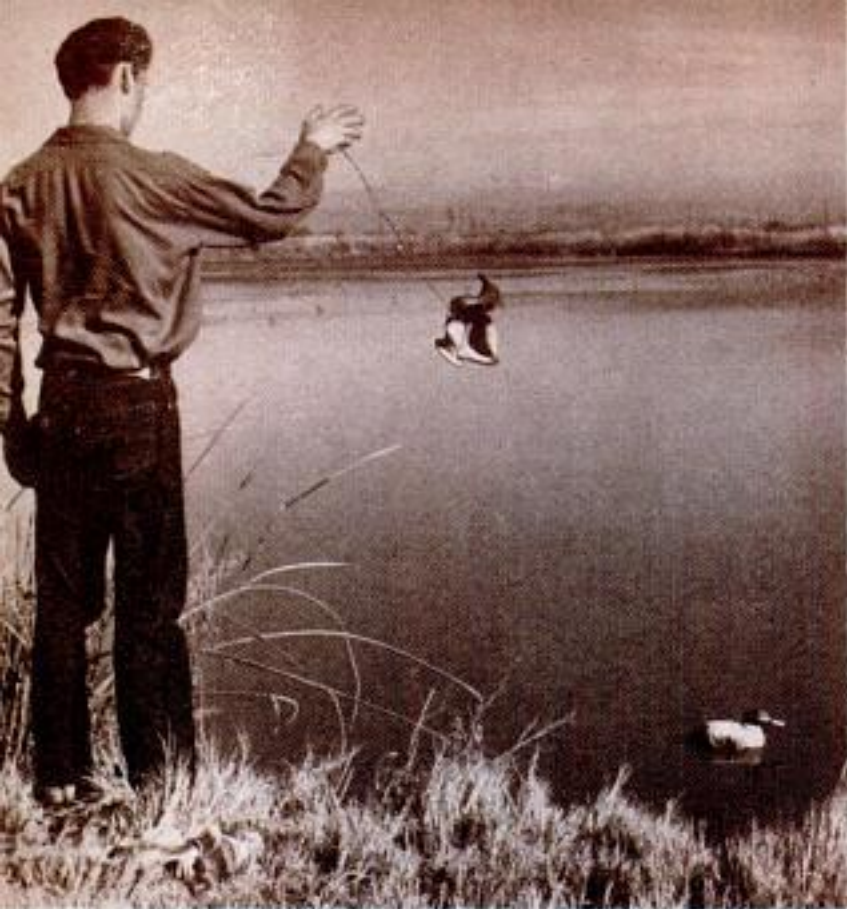

Self-inflating rubber decoys are set simply by tossing into the air over water. Colors are impregnated and won't wear off



Above, large paper napkins make good decoys for snow geese. Twist one corner for head and neck and tuck two opposite corners under small stones. Below, a well-arranged decoy set appears remarkably realistic when viewed from near-by blind

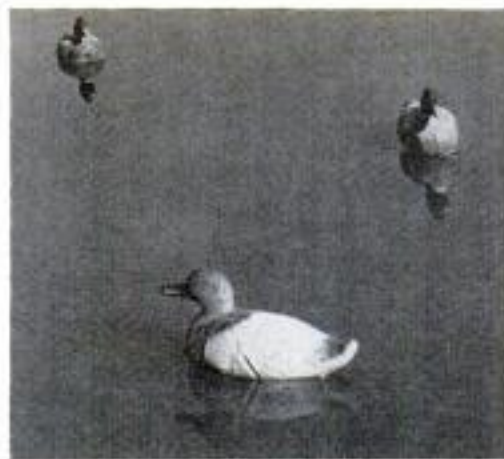

Change anchor points on several decoys to make them head in different directions

fool them. These individuals should all be of one species and should face the set. When there are no wind ripples on the water to give the decoys the appearance of motion, a wise old leader may become suspicious. Frequently you can deceive him by tossing several small pebbles into the set. These will cause ripples in the smooth water like those made by feeding ducks.

Use a duck call sparingly and then only to attract flights passing at some distance. If they swing to the call, stop calling as soon as you know they have located your decoy set. Should they waver and draw away you may be able to bring them in again with the call. You must remain well hidden in the blind while a flock is circling the set. If they suddenly tower and swing away, you can be sure the leader has spotted you. Repeated calling is not likely to bring him in again.

The best decoys for geese are the full-bodied type with detachable heads and necks which can be turned into any one of several natural positions. A typical set made near the feeding ground is pictured in one of the photos. Geese always feed into the wind or slightly quartering and there is always a sentinel on guard. Usually he will be some distance from the feeding flock and on a rise of ground. Don't forget to include the sentinel in your decoy set. When possible the set should be made in an open field, away from roads and fences. Make the set early, before daylight if possible. In some localities, shooters make decoys for snow geese from large



Close-up of paper-napkin decoys. Note realism when viewed from near by. Sentinel decoy in foreground

white paper napkins. Tuck the opposite corners under small stones and then twist one corner to resemble the head and neck. These decoys are pictured in accompanying photos and are rated quite effective by experienced hunters. As a rule it's better to move the decoys to a different feeding ground after a day's shooting. How far or where depends on the nature of the feeding grounds. Your best procedure is to



Wooden decoys should be packed individually in heavy paper bags for transport. Bags keep them clean

study the feeding habits of the birds in a given locality beforehand. Then you will be able to plan decoy sets and the necessary blinds or pits with a minimum loss of time. Provisions for adequate cover are important. The blind or pit must be so constructed as to enable you to remain concealed for long periods of time. Once geese start moving to the feeding grounds shooters must remain hidden. ★ ★ ★

Under some conditions, artificial camouflage is effective, especially when nothing is at hand for suitable blind

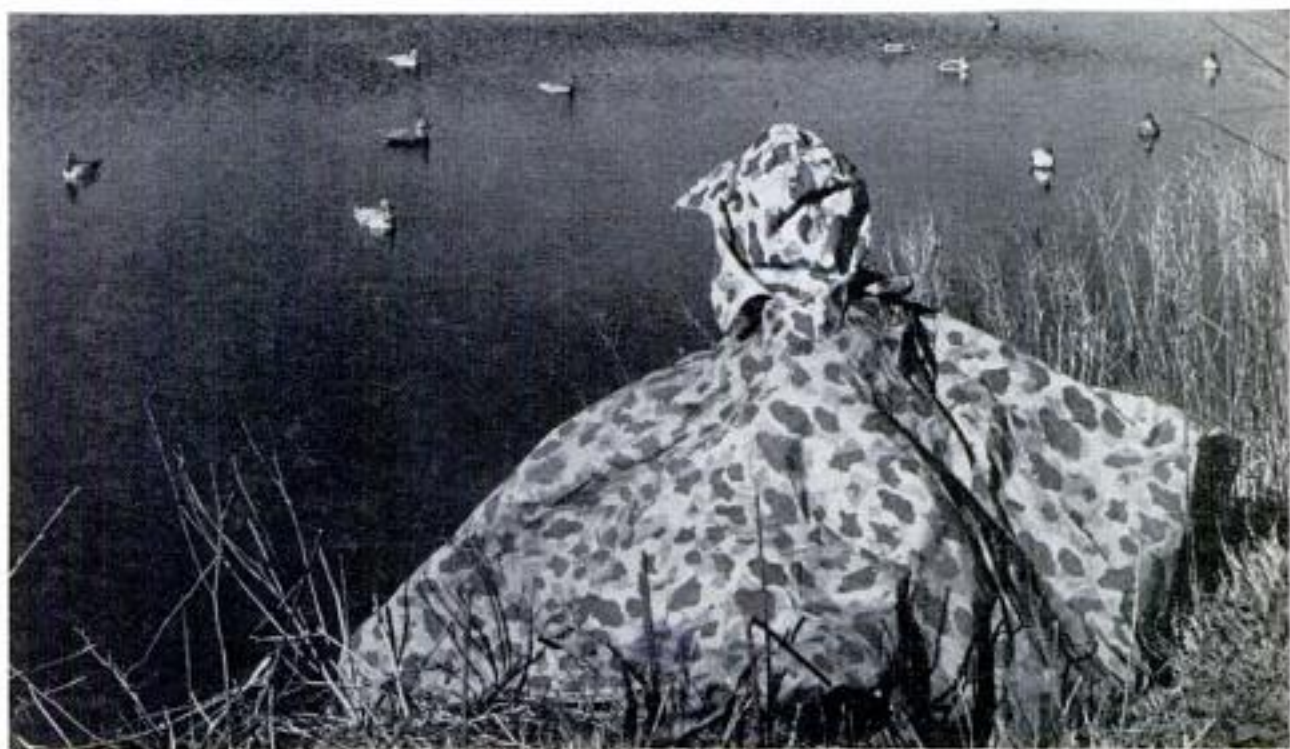

Template With Dowel "Comb" Eases Job of Cutting Hedge



The job of trimming a hedge can be made much less tedious by the use of a plywood template. A piece of 1/2-in. plywood is fitted with 1/2-in. dowels, as shown in the detail, to provide a "comb" which holds the leaves and branches ahead of the template. The two outside dowels are set at a slight angle to help pull in stray branches. The hedge is clipped even with the top of the dowels. A piece of hardboard nailed at right angles to the adjacent edge of the plywood aids in keeping the comb in line, and permits the template to be tipped on edge to aid cutting the sides of the hedge. Drawer pulls can be screwed to the plywood for easier handling.

Valve Turned With Rubber Grip

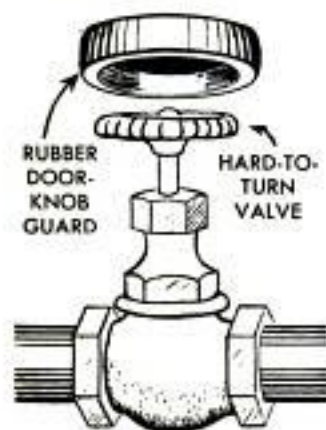

Water valves which are not often operated become difficult to open and close, and it can be painful to grip the valve handle tightly enough to turn it. A rubber doorknob guard, slipped over the handle, will overcome this problem.

Freeze Paint Roller Between Jobs

A paint roller that has been used to apply water-mixed paints can be prevented from hardening between jobs if you keep it in the freezing compartment of your refrigerator. Rinse as much of the paint as possible from the roller, wrap it in wax

paper, and freeze it. To get it ready for use again, drop it in a pan of hot water for several minutes to thaw the paint.

F. S. Tobey, Sharon, Mass.

Nail Set Used at Right Angles Prevents Damage to Flooring

A trick used by some professionals will help you speed up the job of laying tongue-and-groove flooring and reduce the chance of damage caused by the nail set slipping off the nails. First, the round-shank nail set used must be of fairly small diameter. The nails are driven and set



as far as is possible without risking damage to the wood. Then the set is placed lengthwise across the nail head in the angle of the tongue and edge of the floor. A few sharp blows on the set will drive the several minutes to thaw the paint.

Witten V. Bradly, Spokane, Wash.

Protector for Back-Yard Light Made From Gallon Can

A protector for a back-yard light that will also act as a reflector can be made from a 1-gal. can. Cut the sides of the can with a tin snips so that 1/2 to 2/3 of it will cover the light, after first removing the top with a rotary can opener. A hole is cut in the bottom of the can large enough to permit passage of the wires. Then the socket is mounted over the bottom of the can, as shown, so that the screws which hold the socket in place also hold the can.

Don Honick, Chicago.

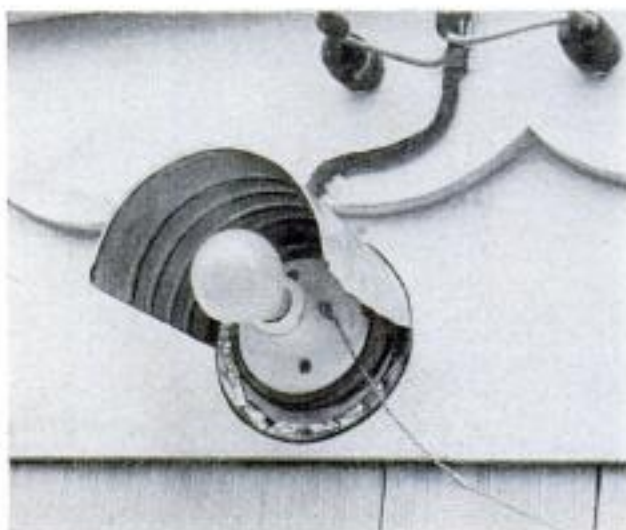

Electric "Hot Plate" Warms Photo Developer

By Walter B. Ford

THIS IMPROVED electric heater solves the problem of maintaining developing solutions at a uniform temperature in the home darkroom. An adjustable thermostat provides a range of temperature controls to meet varying conditions. The detail below shows how to build the box-type frame and line it with sheet asbestos. Porcelain lamp sockets are mounted on a length of flat iron bent and screwed to the ends of the box as shown. The thermostat is built as in the detail at the right, using a bi-metallic strip and silver contacts. The fixed thermostat contact is soldered to a screw fitted with a slotted fiber cap which is adjusted through an access hole drilled in the sheet-metal cover. A condenser and a single-pole toggle switch are provided. Drill a 1¼-in. hole in the side of the frame to permit air circulation.

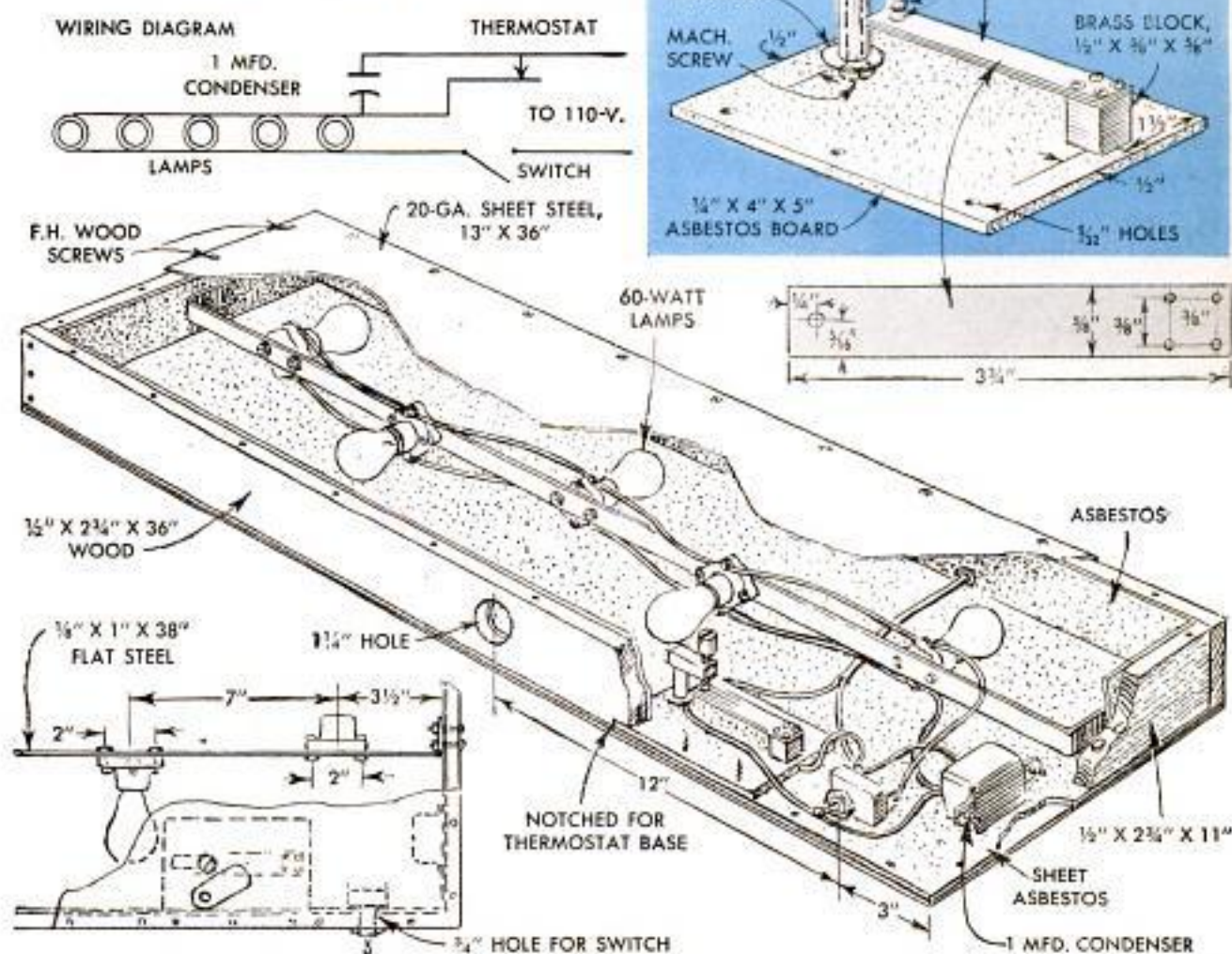
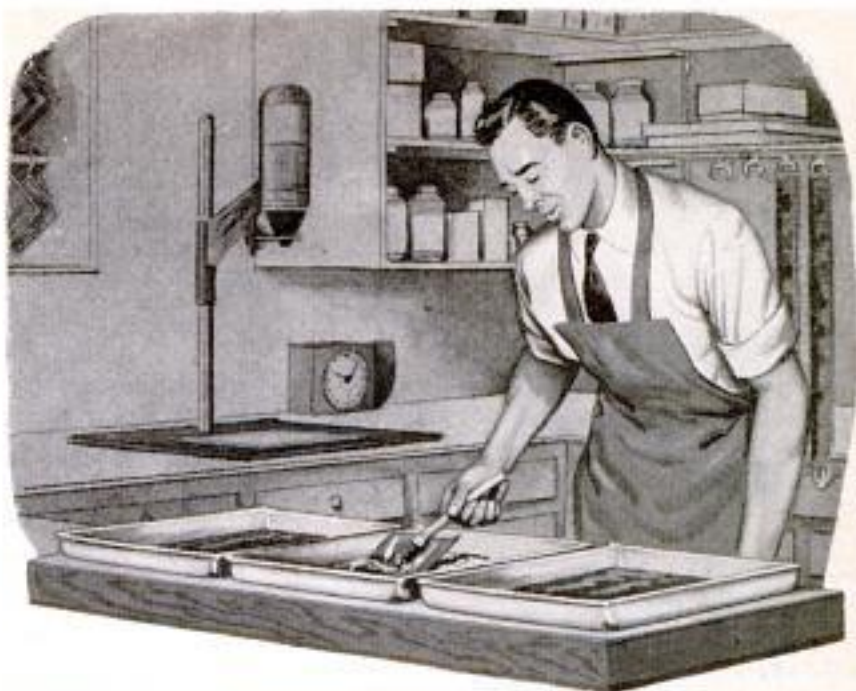

Pull-Out Trash Bin Under Bench Easily Removed for Emptying



A trash bin that pulls out from under the workbench to receive shavings and other debris from the bench top can be made easily from $\frac{1}{4}$ -in. plywood. After the bin is assembled, following the lines in the drawing and made for the individual bench, it is hinge-supported at the bottom by means of a 1-in. dowel inserted through the bottom of the box. The ends of the dowel rest in notched blocks that are nailed to the floor, allowing the box to be lifted out.

Photo-Solution Trays Warmed By Strip-Type Heaters



When a dark-room is so cool that a tray of developer must be heated to bring it to correct temperature, it is advisable that all processing solutions be warmed to the

same degree to prevent reticulation, the webbing or wrinkling of the emulsion, caused by sudden temperature changes.

Ventilation for the Kitchen . . .

Cooking odors and smoke from frying will be a thing of the past in your kitchen after a kitchen vent fan is installed. And the kitchen will be more comfortable in the summer months, when the fan will remove the excess heat. Learn all about kitchen ventilating fans—from the advantages of each different type to how to install one—in the story to be featured in next month's issue

Three or four trays, or tanks, can be heated at one time by merely resting them on a strip-type electric brooder heater. The heater strips come in lengths of 23 in. and are available in 100, 200 and 300-watt ratings. The cost is less than a dollar for each unit.

Plastic Sheet Under Tissue Roll Permits It to Turn Easily

When a sand-finish or other rough-surfaced wall behind a roll of tissue does not permit the roll to turn properly, a small sheet of clear plastic attached to the wall will provide a smooth and inconspicuous surface on which it will turn easily.



The plastic should be slightly wider than the roll and should extend to a point just below where the roll contacts the wall. To attach the plastic to the wall, loosen the screws of the roller bracket, insert the plastic under the base, and then tighten the screws.

Arrow on Valve Handle Helps Adjust Blowtorch

A small arrow or other mark painted on the valve handle of a blowtorch will aid in preventing damage to the needle valve. Besides indicating when the valve is almost shut, the mark also will act as an indicator when adjusting the flame. The arrow should point straight up when the valve is closed.—Richard Hanscom, Elmhurst, Ill.



Turned Cigarette Box Has Monogrammed Lid

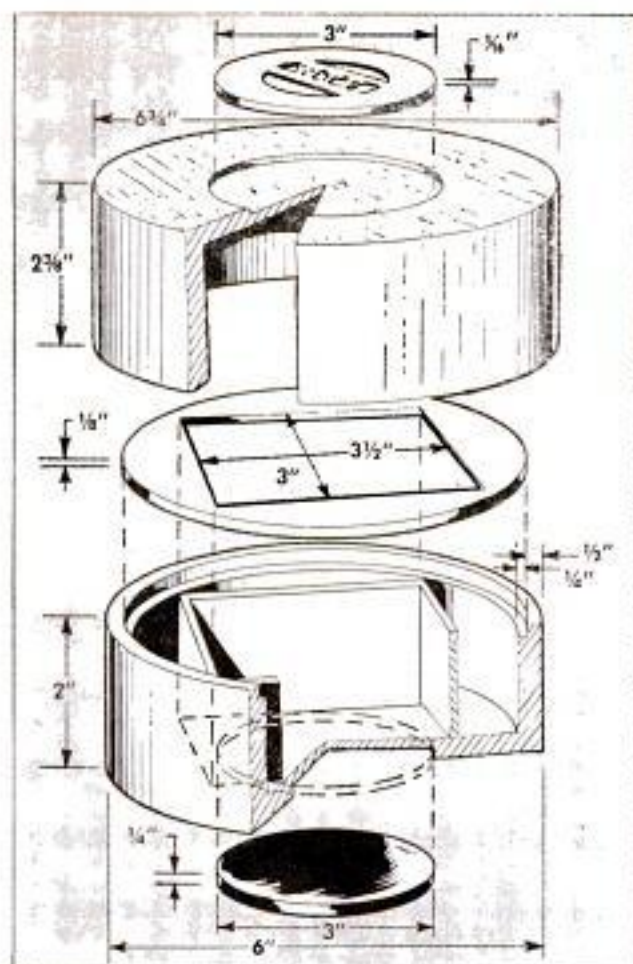

By R. J. DeCristoforo

Consisting primarily of two "pillbox" wood turnings, this attractive cigarette box is a fairly simple project that can be completed over a week end or in a few nights in the workshop. The cover and the body of the box are turned from maple, while the inner box that actually holds the cigarettes is made of walnut or mahogany for contrast. The block for the body is mounted on a faceplate and turned to size, then recessed $\frac{1}{4} \times 3$ in. on the bottom to receive a disk of sheet lead which is used to weight the body and keep it from lifting when the cover is removed. After the recess is made, the body is removed from the faceplate and held in a wooden chuck for turning out the inside and forming the $\frac{1}{8} \times \frac{1}{4}$ -in. rabbet around the edge. Next, the cover of the box is turned to size and hollowed out. If the fit between the body and the cover is snug enough, the body now can be used as a chuck to hold the cover while the recess for the metal inlay is turned in the top. When the cover is completed, both it and the body are sanded until they are a good sliding fit with each other. The inner cigarette box is formed of $\frac{1}{8}$ -in. stock butt-jointed and glued together, after which it



Below, recess is turned in the bottom for a lead weight which is tacked in place and covered with felt



is glued inside the base. The frame of the inner box, which is a disk with a rectangular opening cut from the center, may be shaped on a jigsaw, then sanded or filed to fit snugly into the rabbet in the body. The metal inlay for the top of the cover may be of aluminum, brass or copper. A disk of the metal is cut to provide a press fit in the recess of the cover, then a suitable monogram or design is scribed on it. The design is cut out with a jeweler's saw or jigsaw and the inlay is fastened to the cover, either by simply cementing it or riveting it through the cover with soft rivets. Fill in the fretwork of the inlay with wood putty, allow it to dry, then sand it flush. As shown, the lead weight on the bottom of the body is tacked in place.

Ammonia Helps Remove Tip Of Soldering Iron

Until recently I have spent considerable time in removing the copper tip of my soldering iron when it was necessary to replace it. Then I discovered that by putting a small quantity of household ammonia around the tip and in the recess, I could remove the tip in just a few seconds.—Arthur M. Greshemer, Sr., Columbus, Ohio.

Stepladder Provides Sawhorse When None Is Available



When you need a sawhorse and none is available, an open stepladder laid on its side will serve as a substitute. Though it is not as high as a horse and will be a little less convenient to work with, it will be a help when sanding, sawing or painting. It is especially useful on jobs where you need both a ladder and a sawhorse.

Cause of Scratched Film Removed By Polishing Camera Interior

If developed films are consistently returned from the photofinishers with scratches on them, check the inside of your camera for rough spots that are causing the trouble. First, examine the negatives under a bright light to determine whether the front or back of the film is being scratched. If the scratches are very fine, drag a needle point gently across the negative; the tiny irregularities can be felt. After determining which side is being

scratched, examine that side of the inside of your camera with a magnifying glass, going carefully over every point which the film strip contacts as it is wound in the camera. Wherever rough spots or burrs are seen, rub them down with crocus cloth and polish with jewelers' rouge. Cover the lens with tissue as protection against the abrasive. Also, if the black paint is rubbed off, repaint it.

Philip E. McCafferty, Fort Bliss, Tex.

Modified Combination-Type Drill Used for Roundheaded Screws

The combination-type drill that bores, in one operation, a pilot and shank hole, plus a countersink, for a flat-headed screw, can easily be adapted to drill holes for round-headed screws. Cut a leather washer and slot it, as shown in the detail, to slip over the bit and under the shoulder of the drill. The leather should be just thick enough to cover the blades of the countersink, thus permitting the drill to bore a hole of full depth.—Andy Vena, Philadelphia, Pa.



Friction tape will unroll more easily if an X is cut lightly with a razor blade on both sides of the roll to sever any strings stuck together along the edges of the roll.

Walter M. Shutok, Uniontown, Pa.

Popular Mechanics Bookshop



Electric Fix-It Book

There are scores of hints and kinks that will aid you in repair of electric outlets and home wiring in this book. There are instructions for lighting up your back yard and a number of special ways to make useful items around the home. In cloth binding only \$2.00.



Planning Your Home Workshop

Here is a book that shows you just how to set up a shop on a limited budget, how and where to get the tools you will need and want, explains the basic big six power tools, gives floor plans and layouts to suit your space requirements. Over 160 pages 250 photos only \$2.50.

All books available from Popular Mechanics Book Dept., 208 E. Ontario St., Chicago 11, Ill.

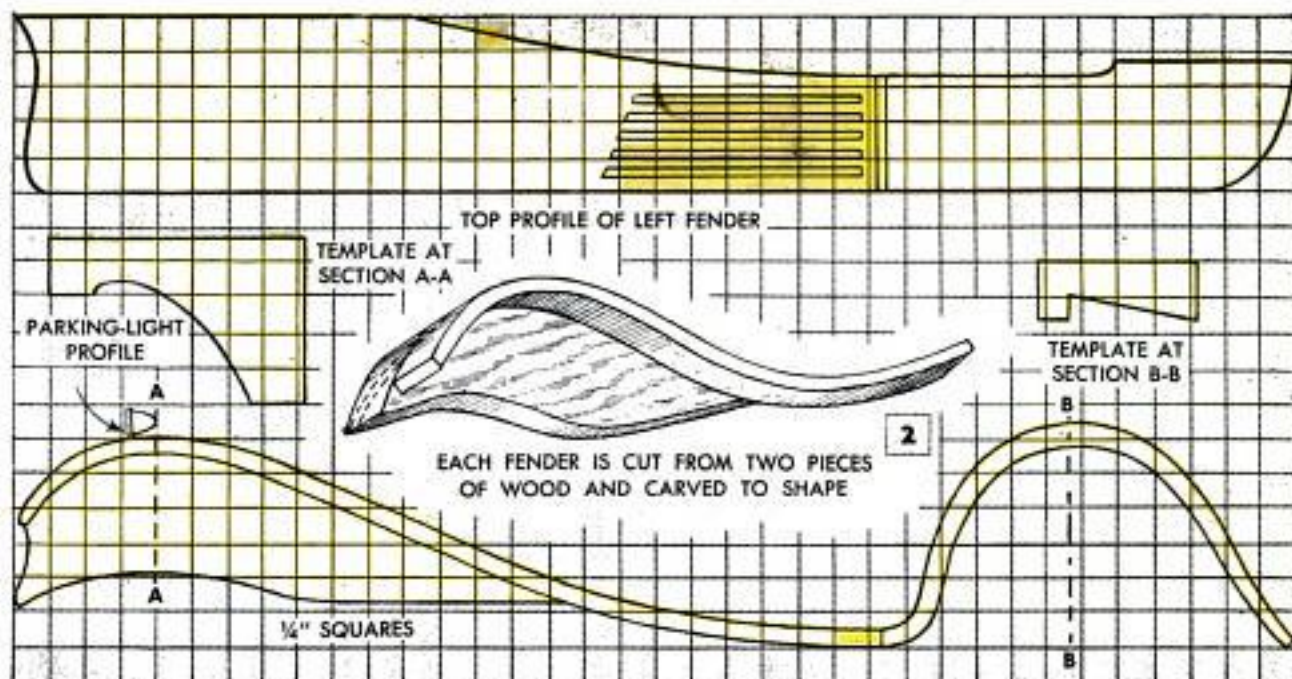

as the floor board and measure $\frac{7}{8}$ in. wide and $1\frac{3}{4}$ in. long. In referring to the profile view, Fig. 3, notice that these supports are curved to match the curvature of the fenders, and are soldered to the side of the rails at a point even with the leading edge of the floor board. Holes in the running-board supports provide a strong bond in cementing them to the fenders. The two supports for the fender shields are formed from .015 sheet brass. Each one is bent to an L-shape from a $\frac{1}{4} \times 1\frac{1}{16}$ -in. strip by bending it down the center to produce a $\frac{1}{8}$ -in. angle. A V-gusset is made in the top of each angle to make it conform to the shape of the side rails. These are soldered in place $\frac{7}{16}$ in. forward of the floor board and flush with the top of the side rails.

The top leaf of each front spring is made from .015 sheet brass, $\frac{1}{8}$ in. wide and $2\frac{1}{4}$ in. long. One end of each leaf is rolled to form a small eye to hook over the ends of the tubular cross member. Four more leaves of varying lengths are soldered to the top leaf, after which each complete spring is fastened to the side rail by sweat-soldering it to a tiny L-shaped bracket, $\frac{5}{32} \times \frac{1}{4}$ in. This, in turn, is soldered to the rail. The front splash pan is cut and bent from sheet brass, $1\frac{1}{2} \times 2\frac{1}{2}$ in. A full-size pattern should be made for this by enlarging the squared drawing given. Three sides of the pan are bent upward on the dotted lines, while the front edge is bent downward somewhat to form a slight lip for hooking over the tubular cross member. Simulated louvers in the bot-

tom of the pan are formed by embossing the metal from the underside with the end of a hardwood stick. The pan fits between the side rails flush with the top where it is sweat-soldered in place. Two short lengths of brass tubing, $\frac{3}{32}$ in. in dia. and $\frac{1}{4}$ in. long, are soldered vertically to the sides of the pan, one on each side, to provide sockets for the headlight brackets, detailed in Fig. 8. The rear-axle mounting brackets are shaped from .053 brass and measure $\frac{1}{4}$ in. wide and $\frac{9}{16}$ in. long. Holes are drilled in the rounded ends for the $\frac{1}{8}$ -in. rear axle, detailed in Fig. 5. The brackets are sweat-soldered to the outside of the rails, centering them on a line $1\frac{1}{2}$ in. from the end of the chassis. This leaves fitting the rear tubular cross member, which is $\frac{1}{8}$ in. in dia. and 2 in. long, in the holes previously made in the side rails, and soldering the wire gearshift and hand brake to the floor board.

Figs. 4 and 5 detail the front and rear axles and brake drums. In the case of the rear axle, a 4-40 thread is run back $\frac{5}{16}$ in.

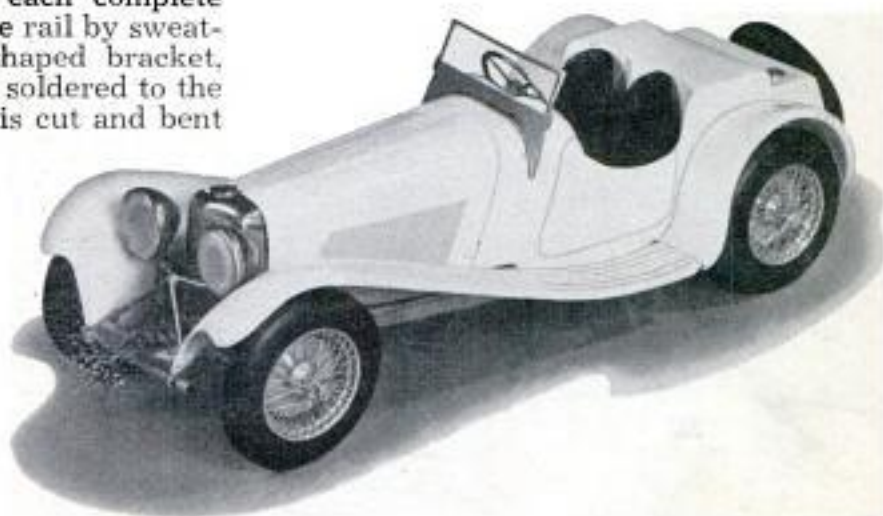

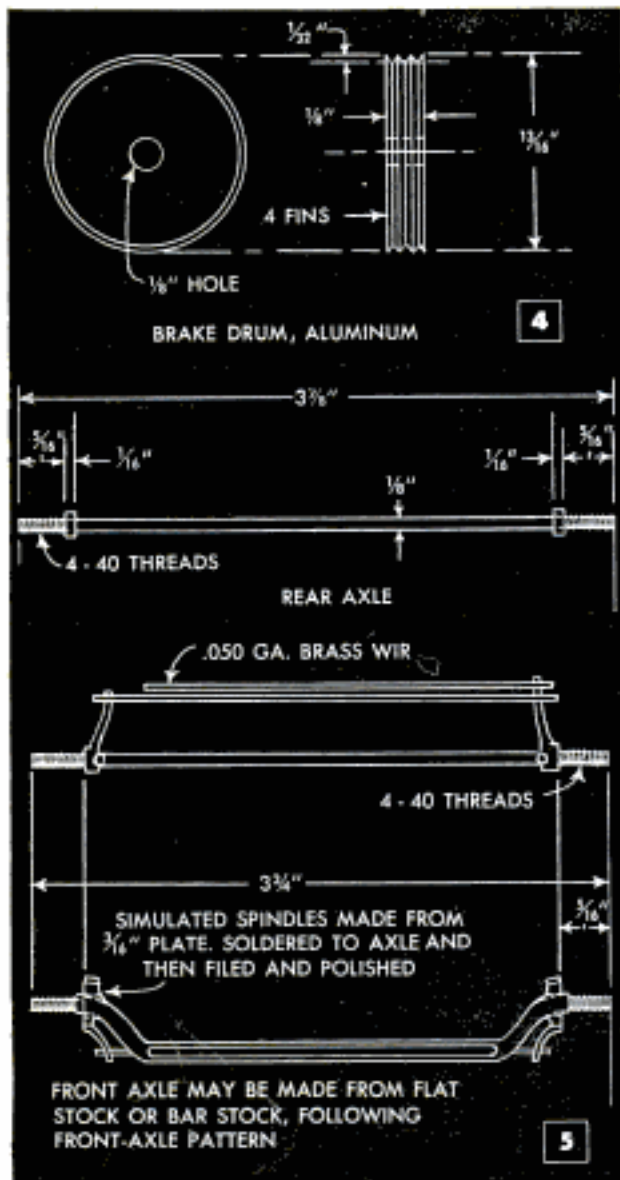
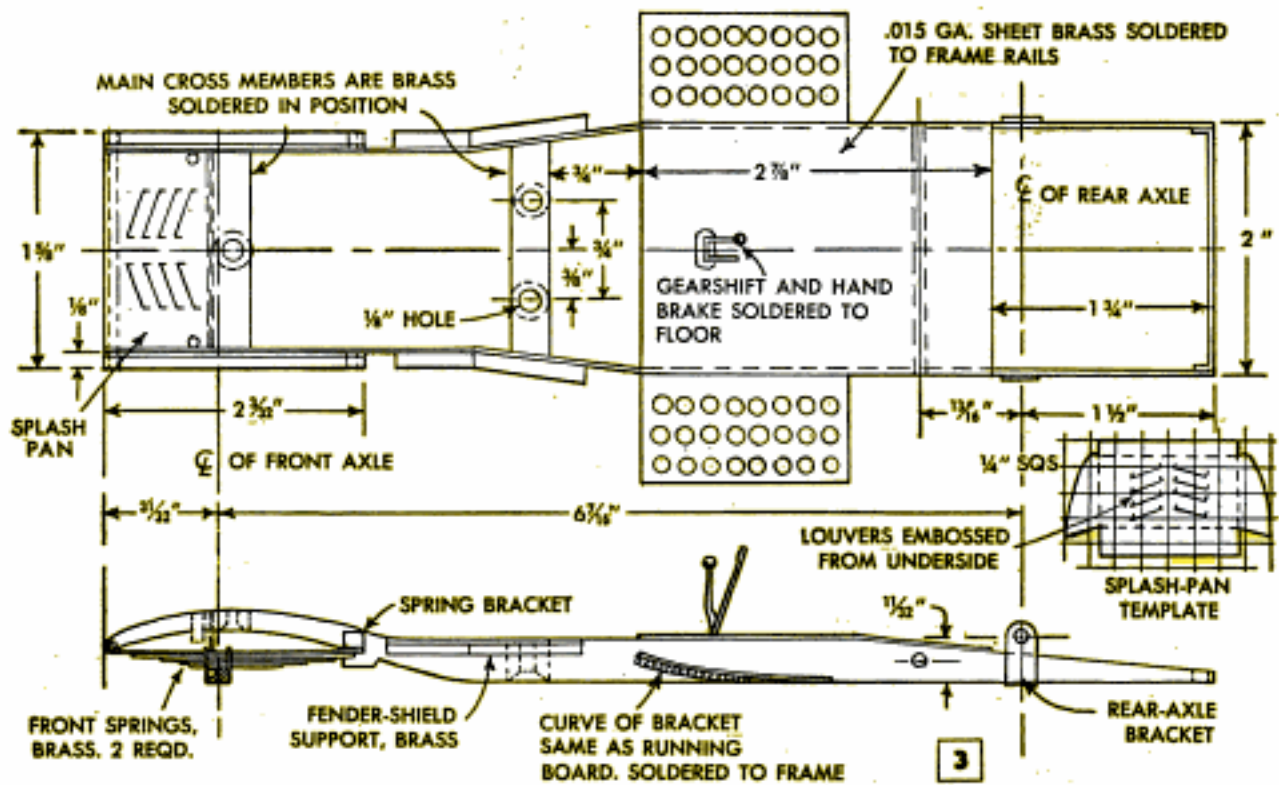

from each end of a 1/8-in. brass rod. The brake-drum stops, or collars, which are drilled to slip over the ends of the axle, are sliced from 3/16-in. brass rod into tiny disks 1/16 in. thick. These are drilled and spot-soldered at the ends of the threaded sections after the axle is installed. The front axle consists of an "I" beam shaped from 3/16-in. brass rod approximately 4 in. long. This is chucked in a lathe and each end is turned to a .115-in. dia. for a distance of 5/16 in. The turned portion at each end is then threaded with a 4-40 thread as was done on the rear axle. The brass rod is now annealed to permit it to be bent to the shape shown. To anneal brass, heat it to a cherry red and then quench it immediately in water. Steering knuckles and brake-drum stops are shaped from 1/8 x 1/4 x 1/2-in. pieces of brass plate. Steering arms, drag link and tie rod are all formed from .050 brass wire and soldered in their respective positions. The completed front-axle assembly is wired and soldered to the center of each front spring, the brass wire representing shackle bolts. The four aluminum brake drums may be turned from 1/8-in. flat stock or from 7/8-in.-dia. bar stock. Four tiny grooves are turned in the edges of the drums to represent cooling fins, and a 1/8-in. hole is bored centrally through each drum to slip over the threaded ends of the axles.

The radiator body is cut, filed and polished to the shape indicated in Fig. 7 from a block of soft brass, 5/8 x 1 1/16 x 1 3/8 in. Various holes indicated are drilled in the block, one in the top for the radiator cap,

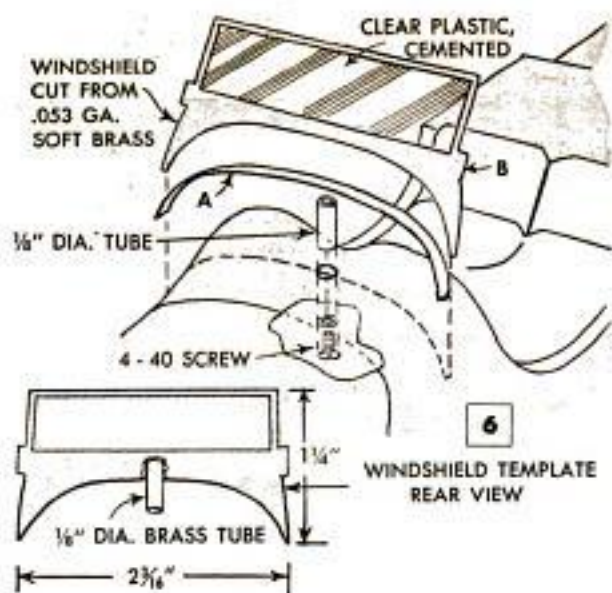

a tapped hole up from the bottom for bolting the radiator to the chassis and two holes through the body for fastening the screen plate to the face of the radiator. The screen plate is cut from .015 sheet brass, $\frac{7}{8} \times 1\frac{3}{16}$ in., and is bent down the center at a 20-deg. angle. Two short lengths of brass tubing, $\frac{1}{8}$ in. in dia. and $\frac{7}{16}$ in. long, tapped internally with a 4-40 thread, are soldered to the rear side of the screen plate to register with the two holes in the radiator. Two 4-40 x $\frac{1}{4}$ -in. brass screws are turned into the brass tubes to anchor the screen plate to the radiator. Finally, a section of tea-strainer screening, shaped the same size as the screen plate, is spot-soldered to the face of the latter. The completed radiator is nickel plated.

Fig. 8 details making of the headlights and taillight. The headlights are turned from $\frac{3}{4}$ -in.-dia. brass bar and recessed to take press-fit plastic lenses. The supporting framework for the headlights consists of short lengths of .050 brass wire, inserted in holes in the headlights and soldered to the splash pan.

The body of the car is built-up from five separate blocks; a right and a left-hand side, the hood, the cowl and the gas tank. All are glued into one unit after being shaped. The right and left-hand pieces, or sides of the body, are cut from blocks 1 $\frac{3}{16}$ in. thick, 1 $\frac{3}{4}$ in. wide and 6 $\frac{1}{2}$ in. long. The final glue joint of the two blocks form the centerline of the body. Full-size paper patterns of the top and profile views, Fig. 1, should be made for tracing on your wood. Actually, only a half pattern of the body need be made as it is a duplicate on each side. The cockpit of the car is formed by sawing away a portion of both blocks at the center, following the dotted lines extending under the hood. The rear of the cockpit, as well as the sides, flares outward. This can be duplicated with a coarse file.



The hood is shaped from a block $\frac{1}{2}$ in. thick, 2 in. wide and 2 $\frac{7}{8}$ in. long. The cowl adjoining the top of the hood is shaped from a separate block. You'll notice a distinct tumble home in the lines of the cowl which is a feature of sports cars of this type. After the hood is glued in place, the top and sides of it are covered with four pieces

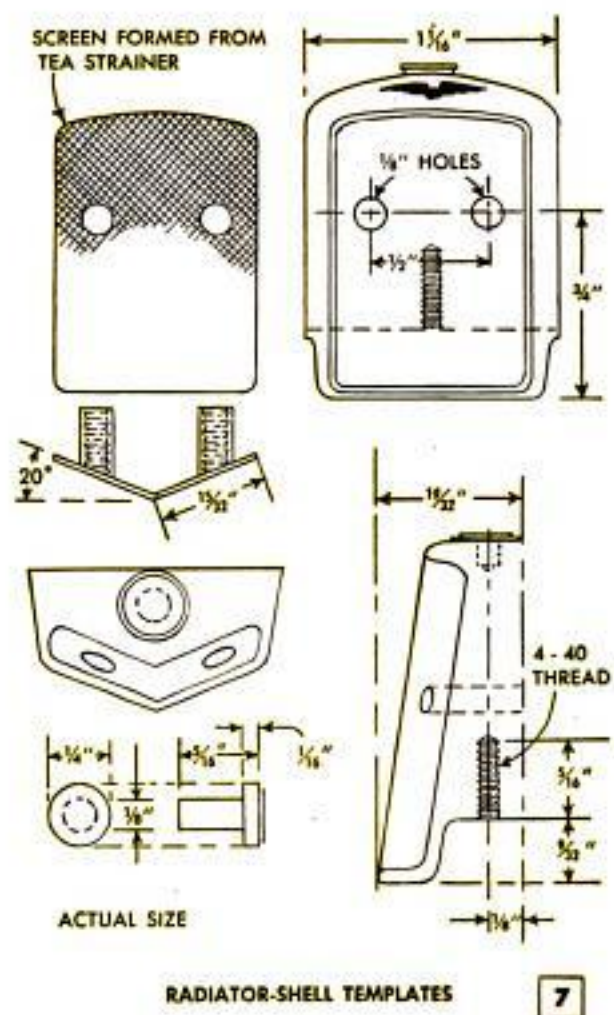

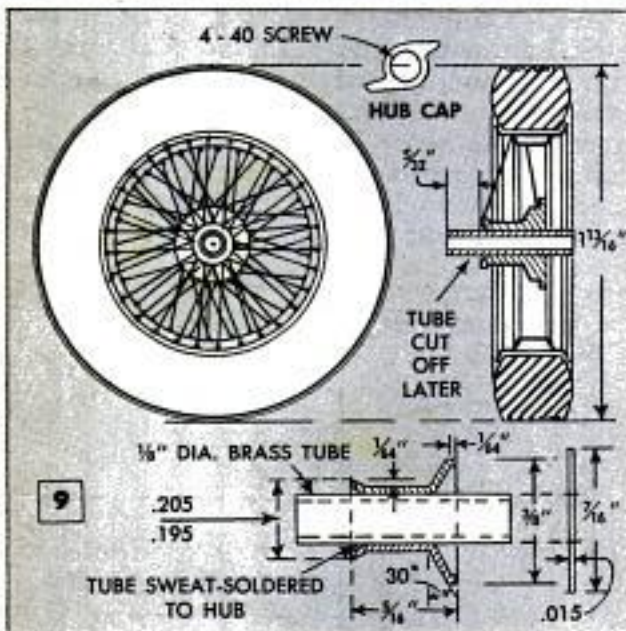
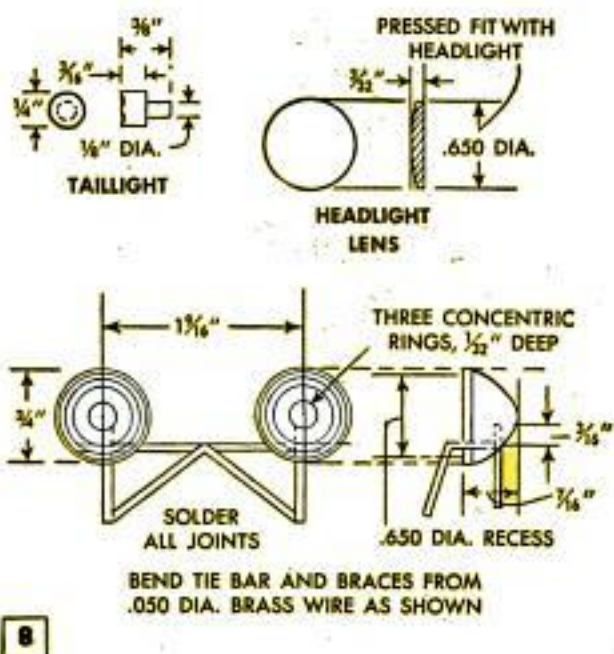

Upper left, authentic copies of Rudge Whitworth wire wheels add remarkable realism to the finished model

of .015 sheet brass in which louvers are first stamped from the underside. The sides of the hood require pieces $\frac{3}{4} \times 2\frac{1}{4}$ in., while the top of the hood takes two $\frac{1}{2} \times 2\frac{1}{4}$ -in. pieces. When the brass covering is cemented in place, the edges of the metal are carefully feathered out with a file to blend it into the rest of the body. Outlines of the doors are merely scribed in the body by drawing around a cardboard template with a pointed tool. The gas tank is cut from a $1\frac{1}{4} \times 1\frac{1}{2} \times 2\frac{1}{4}$ -in. block of wood. Before this is glued to the body, wells are cut $\frac{1}{4}$ in. deep in the sides of the body to provide clearance for the rear wheels. The windshield and the bucket seats are detailed in Figs. 6 and 11 respectively.

Fig. 2 gives the profile and plan patterns for the running boards and fenders which should be enlarged full size for tracing on your wood. The running board is a part of the sweeping front fender, both being shaped from two glued-up members, the inner one, or shield as it is called, being $\frac{3}{4}$ in. thick. The running board butts against the rear fender which is made separately and glued to the body. Ribbing on the running boards is simulated with strips of

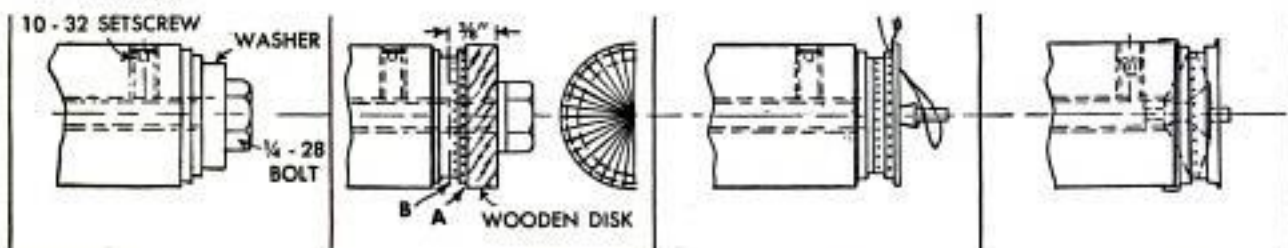
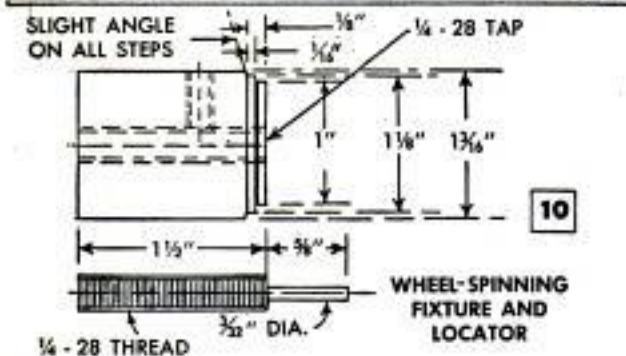

The wire wheels are spun and laced on a turned fixture that is chucked in the lathe. Rim flanges are spun from disks of aluminum, then two half rims are soldered together, edge to edge, to make one complete rim. Locator rod inserted in center of fixture to hold hub, makes lacing of spokes in rim comparatively simple

cardboard glued in place. The original model was finished with seven coats of white lacquer, each carefully sanded.

The wire wheels, detailed in Figs. 9 and 10, are spun and laced on a special fixture which is turned from brass following the dimensions given in Fig. 10. The rim of each wheel consists of two half rims which are spun to conform to the stepped form of the fixture and then soldered together, edge to edge. Thus, the five wheels require 10 disks of .015 brass, $1\frac{5}{8}$ in. in dia. Each blank disk is first annealed, then locked on the spinning fixture and spun to shape with the edge of a hardwood stick. The spun part of the rim is cut off from the rest of the blank at the very edge of the first step of the form. After a pair of half rims are soldered together, the complete rim is replaced on the spinning fixture and a back-up turning of hardwood, stepped to match the inner shape of the rim, is pressed into the outer half of the rim and held with the locking bolt. Next, rim A is indexed for 36 holes spaced 10 deg. apart and a scriber, or other sharp-pointed tool, is used to punch a tiny hole at each point. Then 36 more holes are laid out around rim B, staggering them between the holes in rim A and punching through into the back-up block as before. The punching produces a realistic spoke nipple on the inside of the rim. When all the holes are made as explained, gently work loose the back-up block from the rim.

Next, five wheel hubs are turned from $\frac{3}{8}$ -in.-dia. brass rod, following the details in Fig. 9. Each tube is sweat-soldered to a $\frac{1}{8}$ -in. brass tube, $\frac{3}{4}$ in. long, which is later tapped internally with a 4-40 thread after the wheel is laced and the excess tube cut off. The locking bolt is now removed from the spinning fixture and replaced with a locator rod, Fig. 10, on which the hub is placed. The wheel rim is temporarily spot-soldered to the fixture at three or four points to hold it in place for the lacing operation. The solder will be turned off later. Using .011 brass wire, start lacing by tying a knot in the end of the wire and pull it taut through a hole in rim A. Next, loop the wire around the end of the locator and press the looped wire into the recess in the hub. Bring the wire up through the next hole in the rim, pull taut and anchor with a drop of solder applied to the top of the rim. Continue lacing in this same manner all around the rim, then flow solder over the wire in the hub recess. To lace the inner row of holes, B, the rim is cut free, reversed on the fixture and resoldered. This requires first counterboring the end of the fixture to clear the laced hub. Lacing the inner row of holes is done the same as before, and after soldering the wires at the

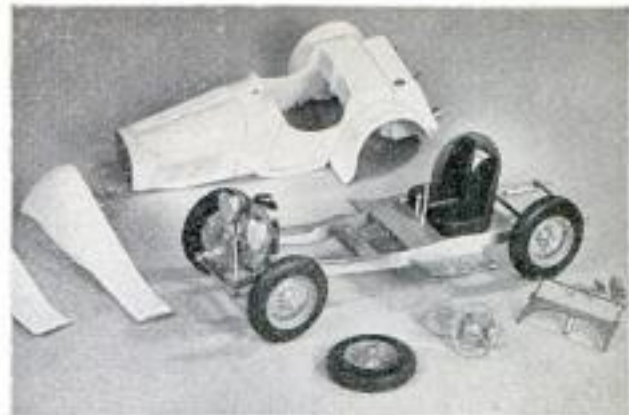

hub, a $\frac{3}{16}$ -in. brass disk is sweat-soldered over the face of the hub to finish it off. Finally, the excess tubing is cut off and the wheel is ready to be nickel plated.

Tires are turned from rubber desk-leg cushions sold at hardware stores. To make a tire, screw a rubber block to a wooden block attached to the lathe faceplate and turn the outside diameter of the tire, including the treads, with a sharp chisel. Then remove the work and turn a recess in the wooden faceplate block so the rubber turning can be wedged snugly in the recess for boring the inside diameter. This should be of a size to provide a light push fit over the rim. Each side of the tire is shaped by reversing it in the recess. Use sandpaper to finish the rubber smoothly and paint the finished tire black. As the wheels are designed to thread onto the threaded axles, they thus remain fixed and are kept from backing off with racing-style hub caps, Fig. 9. These are shaped from .031 sheet brass, $\frac{3}{16}$ in. wide and $\frac{7}{16}$ in. long. A 4-40 x $\frac{1}{4}$ -in. flat-headed, brass machine screw is sweat-soldered to the back of each hub cap. Like the wheels, the hub caps also are nickel plated. ★ ★ ★

BUCKET SEATS MADE FROM TWO BLOCKS OF PINE GLUED TOGETHER. MARK OFF PLEATS AND CARVE ACCORDING TO SECTION A-A

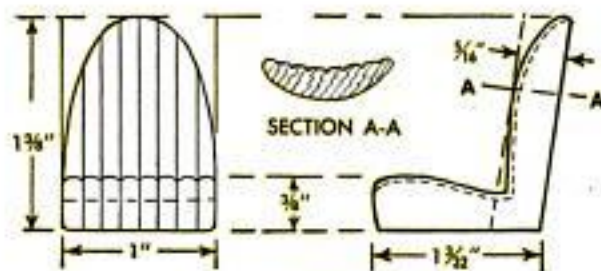
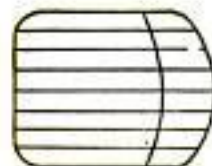

BUCKET SEATS, 2 REQD.

11



HERE ARE A FEW tricks to help you make neater, more professional-looking cabinet doors from tongue-and-groove lumber. Such doors are especially attractive in paneled rooms, where it is desirable to have cabinet doors that match the rest of the wall. The doors shown in the photographs were made of wormy chestnut.

One trick, to eliminate the heavy Z-framing so often used for such doors, is to use two lengths of angle steel across the ends of the boards to hold them together. The ends of the boards are rabbeted to receive the angle, and the angle is fastened to the boards with roundheaded screws driven through slots. The slots are cut to allow the wood to expand during damp weather without warping. An alternate method would

A length of angle steel is fitted into the rabbeted door and fastened with roundheaded screws through slots

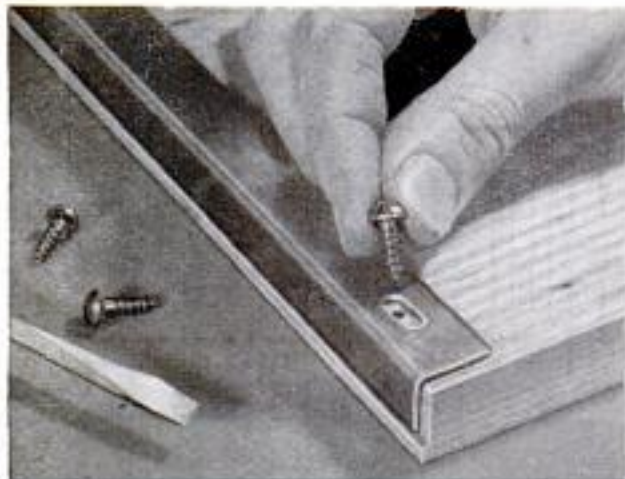

be to assemble the boards with a spacing between them at the joints.

Another method of achieving a professional look is to have the door fitted with handmade hardware. This is done by converting inexpensive iron strap hinges into handmade ones by hammering all the visible surfaces with a ball-peen hammer. Hammer some distortion into the edges to kill that machine-made look. As peening will warp the hinge leaf, turn it over several times and hit it to straighten it.

If the doors are hung in dry weather, a $\frac{1}{4}$ -in. allowance should be left between them for expansion. During warm moist weather the doors can be installed with a tight fit. Shrinkage and expansion are mostly in a cross-grain direction.

"Antiqued" hinges can be made by hammering regular strap hinges to eliminate the machine-made look



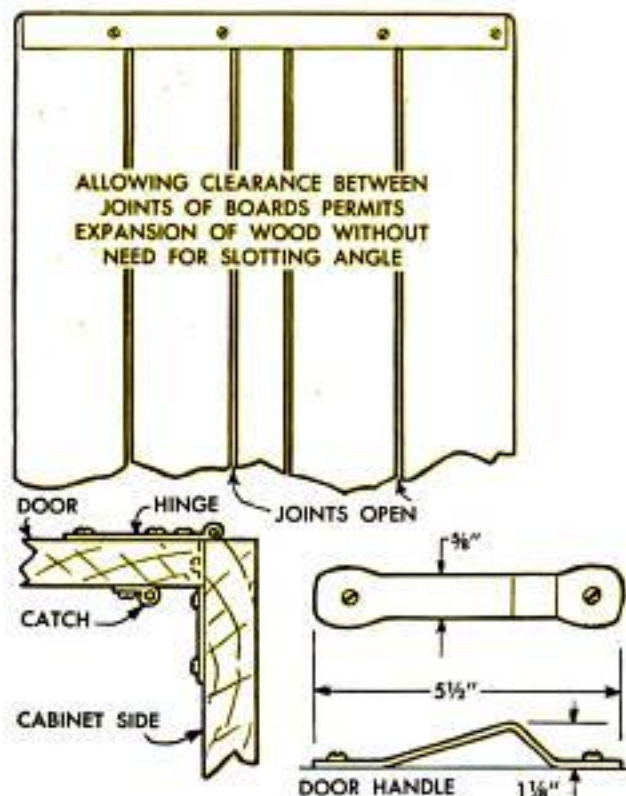
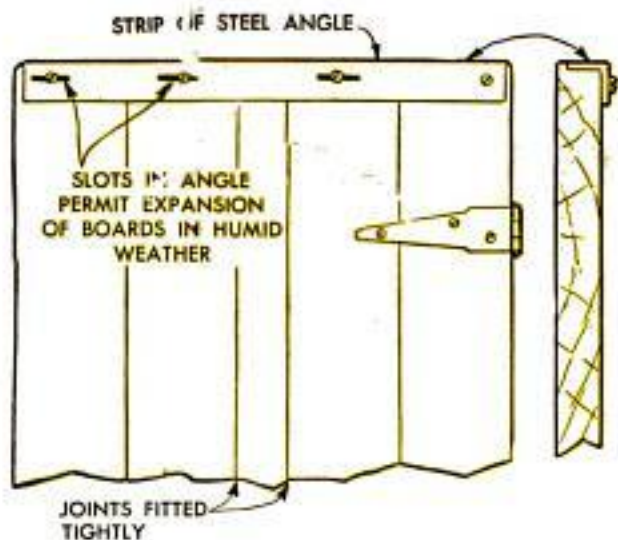

Below, when a hinge has been textured with a hammer, give it a heat-coloring treatment. Polish the surface with steel wool, then heat slowly until color changes. Remove heat when desired color appears

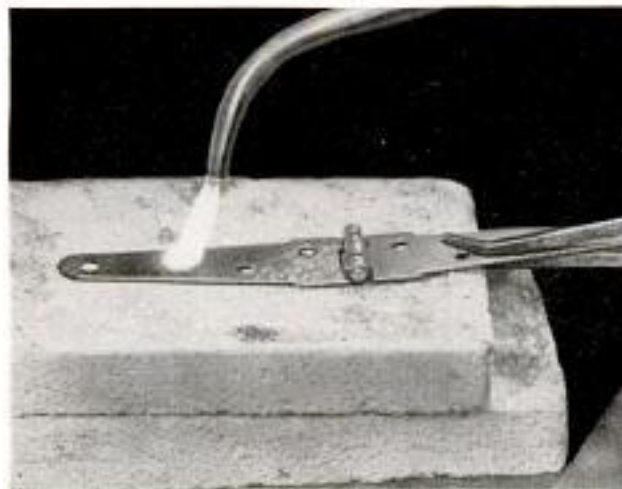

Above, the textured leaf of the hinge is mounted in the conventional way on the front surface, and the edge of the wood is notched so that when the other leaf is swung back at right angles it will be flush



Above, handles to match the hinges can be bent from iron strips and textured to match hinges. Below, the screws should also be textured to match. They should be hammered and colored as the hinges were

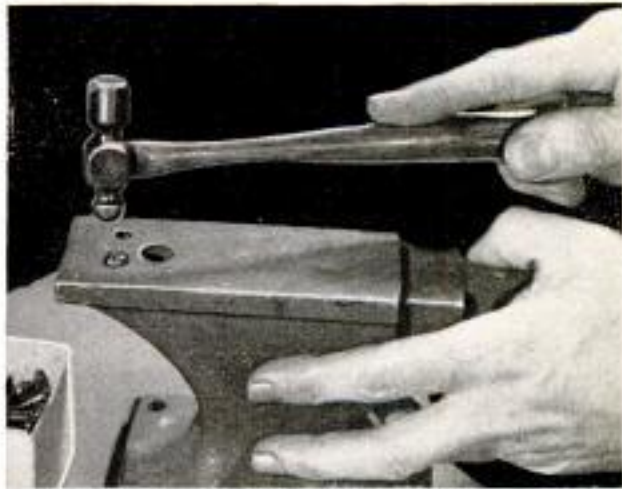

Leaf From Broken Auto Spring Used to Remove Shingles



The job of removing shingles from a house; preparatory to reshingling, can be made easier by using a tool made from one leaf of a broken automobile spring. To serve as a handle, one end of the leaf is taped, while the other end is beveled to allow it to slide under the shingles easily. The tool is long enough to give good leverage, and the natural spring action of the leaf permits the shingles to be pried off with a minimum of effort.

R. M. Woodbury, Natick, Mass.

Screw Eye Driven Into Slot Locks Handle in Brush



If the handle of a floor brush becomes loose and pulls out of the brush, the trouble can be overcome by driving a screw eye into a slot cut in the end of the handle. The slot is sawed 2 or 3 in. deep and the handle is pushed back

into the hole in the brush. A screw eye then is driven into the slot where it acts as a wedge to spread the end of the handle and lock it tightly in the hole.

Tip for Squirrel Hunting

If you have ever hunted squirrel alone, you know that once a squirrel is aware of your presence he keeps moving to the opposite side of the tree, preventing you from taking a shot. One hunter, to make the squirrel come to his side of the tree, carries a 100-ft. length of cord with him which he

ties to a bush 30 or 40 ft. from the tree in which the squirrel is sitting. He then walks to the opposite side of the tree and makes a noise by pulling the cord and shaking the bush. Disturbed by the sound, the squirrel goes to the other side of the tree, giving the hunter a clear shot.

M. C. Hosmer, McCalla, Ala.

Adjustable Low-Level Tripod Improvised From Ash Tray

An adjustable low-level tripod, which is sometimes necessary for extreme-angle and other process shots, may be improvised from a metal ash tray, of the type shown in the illustration. Drill a hole in the center of the inverted ash tray and fit it with a $\frac{1}{4}$ -in. bolt, held in place with a nut and lockwasher. The small tilting top from a standard tripod will fit over the projecting bolt and can be locked with the thumbscrew.



Stamp-Pad Cover Shielded Against Corrosion

The hinges of a stamp-pad cover usually will corrode because of chemicals in the ink, making the cover difficult to open. But if a narrow strip of sheet metal is forced between the pad and the hinge, as shown, the ink will be confined to the pad. The hinges then can be lightly oiled, and will open easily throughout the lifetime of the pad. Thin sheet aluminum would be best for this purpose, since it is nonrusting, but other metals could also be used.

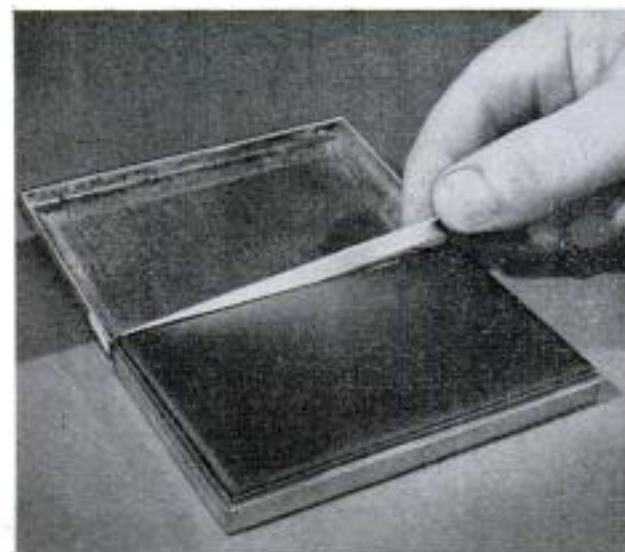

SN 56



DRILLING IN THE LATHE

By Sam Brown

DRILLING IN THE metal or wood-turning lathe can be done with the drill rotating and the work held stationary, or with the drill held stationary and the work rotating. Machinists refer to the rotating drill bit as "live" and the stationary drill bit as "dead." In live drilling the bit is held in a chuck and driven by the headstock spindle. Large drill bits with tapered shanks are inserted in the tapered spindle and driven direct by the spindle itself without any support other than a dog applied as a precaution to prevent the drill shank from scoring the spindle sleeve should it suddenly "freeze" in the nonrotating work. Live drilling is applicable to a wide range of work because of the variation in speeds available at the metal-lathe headstock. However, drilling from the tailstock has a wide application because of the delicate feed and positive control possible by tailstock feeding.

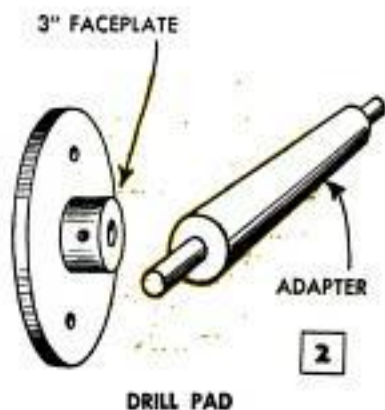
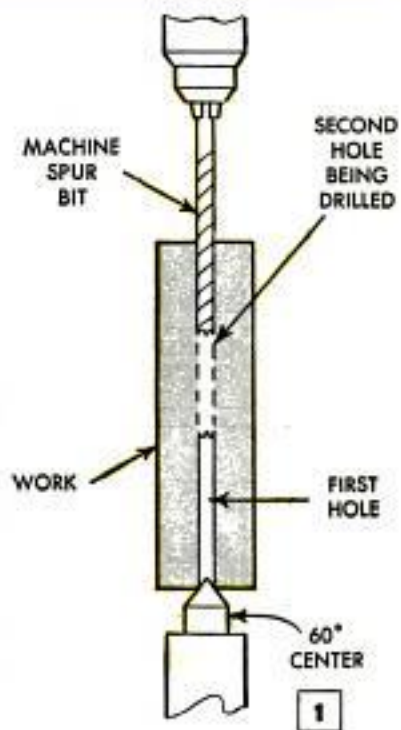

In live drilling, pictured in the photos above and below, the drill usually is held in a geared chuck and driven by the lathe headstock. Flat work is supported by a pad as in the lower views. Note wooden facing



Live Drill Is Driven by the Lathe Spindle

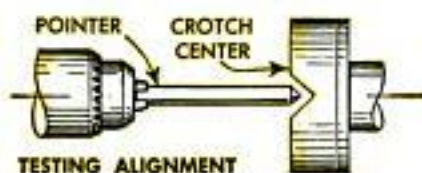
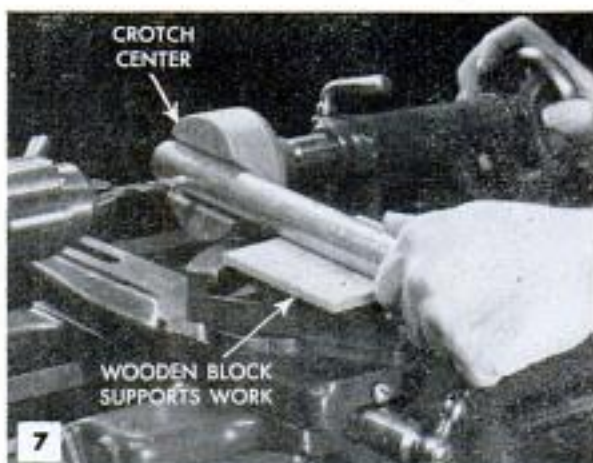
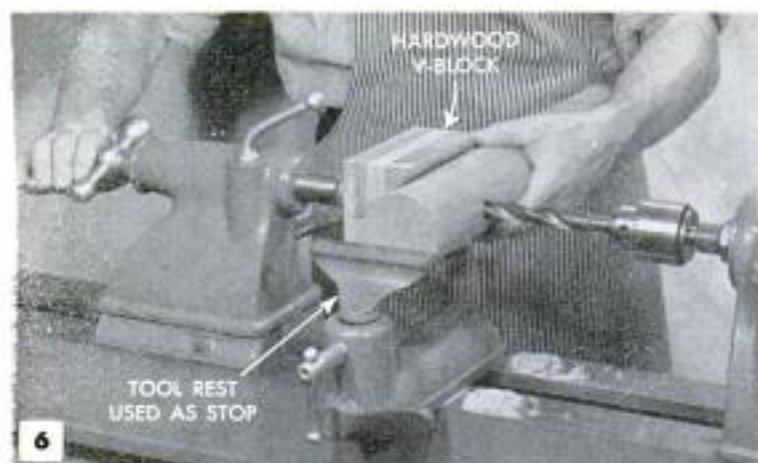

TESTING ALIGNMENT

A V-BLOCK OR A CROTCH CENTER must be used when cross-drilling round work in metal or wood-turning lathe. A hardwood V-block is easily made for drilling operations on wood as in left-hand view above. A round V-block or a crotch center of hardwood is suitable for certain drilling operations on metal. Work must be correctly aligned

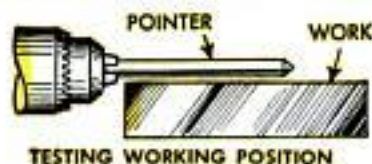
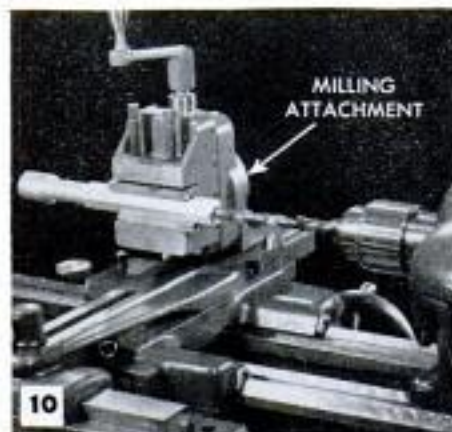
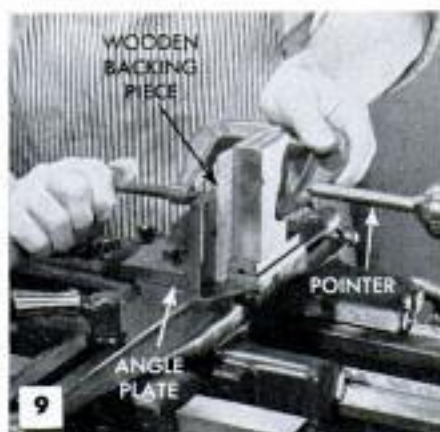

TESTING WORKING POSITION

POWER FEED can be used when work is mounted on lathe carriage, using either the boring table, angle plate or milling attachment. Boring table can serve for indexing circular work. A pointer must be used to align the work before drilling. When centers have been located, pointer is replaced by drill bit, as in right-hand view

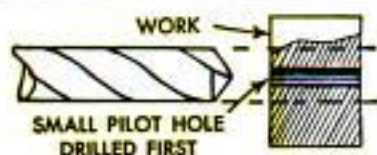

LARGE DRILL BITS should be driven by a lathe dog. This will prevent any possibility of the drill turning in the spindle sleeve and scoring it. When using large-diameter drills it is always best to drill a pilot hole first, as in the detail at the left. This will aid in starting larger drill bit, result in cleaner hole and prevent breakage

Dead Drill Is Stationary, Work Rotates



DRILL MOUNTED IN TAILSTOCK gives hand control of the rate of feed which is important on certain types of very fine work, using small drill bits. When work tends to pull sidewise apply side pressure with end of tool-holder or supporting fork made as in detail at the left. Apply a lubricant to prevent scoring the work. Be sure drill bit is correctly ground

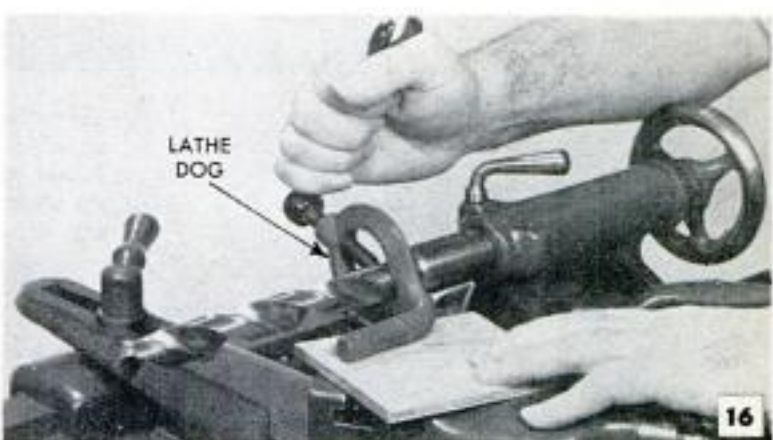

SIDE PRESSURE applied to the drill bit often is necessary in order to start it correctly. However, pressure should be very light, just enough to steady the drill until it is cutting the full diameter. Large drill bits with tapered shanks should be supported with a lathe dog. This will prevent the drill turning in the tailstock sleeve and possibly scoring the sleeve or the spindle

Chucking: Figs. 1 to 12 inclusive picture live-drilling setups which are typical of those commonly used in both wood and metal lathes. Figs. 1, 3, 4 and 5 show setups for drilling work longitudinally and also drilling from one face against a pad, Figs. 4 and 5. Note that in all instances, Figs. 1 to 10, the drill bit is held in a screw-on chuck driven by the lathe spindle. In Figs. 8 and 9, the work is located by using a pointer. After work is located, the pointer is replaced by the drill bit as in Fig. 10. In Figs. 11 and 12 the drill bit is of the type having a tapered shank. It is inserted in the tapered spindle sleeve and driven by a dog as shown. Another example of how work may be fed by the tailstock against a live drill is shown in Fig. 3. Here work to be mounted between centers in the lathe

is center-drilled by using the combination drill and countersink shown in the insert. The operation is similar to that in Fig. 1, except that in the latter case the work is drilled through from both ends, the drill being run in to the halfway point and the work reversed and supported at the tailstock end on a 60-deg. center. If you have no drill pad and the amount of work does not warrant the purchase of this accessory, you can easily improvise a suitable pad as in Fig. 2.

Work support: When the drill is driven by the headstock, either the tailstock or the lathe carriage becomes the logical work support. Both provide a means of advancing the work to the drill. If the drilled hole is small it generally is quite safe to hold the work by hand, Fig. 4, but it usually

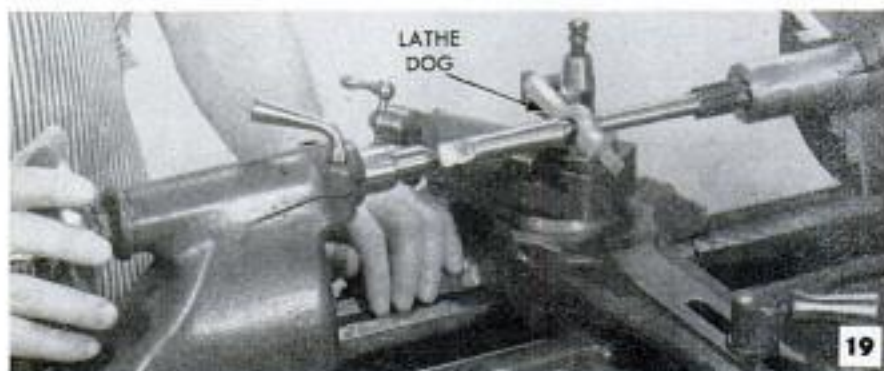
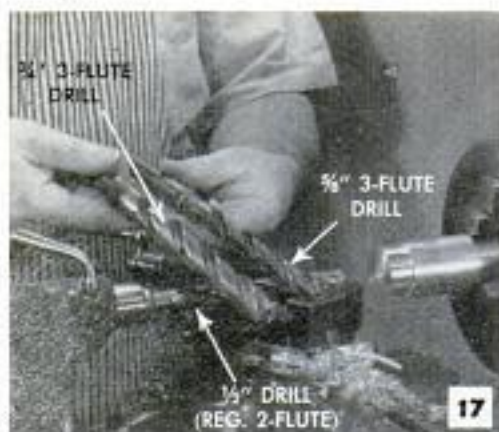

Accurate cross drilling can be done with flexible shaft held in milling attachment. Locate centers accurately

is best to clamp it in position with a wooden facing on the drill pad as in Fig. 5. Still another method is to provide a stop or support as in Figs. 6 and 7. In Fig. 6 wood is being drilled and in Fig. 7 a steel shaft is being drilled transversely, supported in a crotch center of hardwood. Various setups also can be made on the lathe carriage, using a boring table, an angle plate or a milling attachment for holding the work as in Figs. 8, 9 and 10. Avoid overloading in these setups as breakage may result. A small lathe and accessories will handle drill bits up to $\frac{3}{4}$ in. in mild steel and cast iron. Speeds for the larger drill bits should not exceed 350 r.p.m. with 250 r.p.m. a good average speed.

Drilling from tailstock: In dead drilling, the drill bit generally is held in a geared chuck as in Figs. 13, 14 and 15. This method is suitable for drill bits up to $\frac{1}{2}$ in. Larger

Three-flute drill bits, Fig. 17 are smooth cutting, suitable for enlarging holes. Steady rest, Fig. 18, is not necessary for drilling but is included in setup when machining is to be done. In straight reaming, Fig. 19, reamer is carried on a 60-deg. center

bits with tapered shanks, Fig. 17, are inserted in the tailstock sleeve, or quill, as in Figs. 16, 17 and 18. The lathe steady rest, Fig. 18, normally is not needed for the drilling operation, but is always included in the setup if drilling is to be followed by any turning operation on long stock held in a three-jaw chuck. Large drill bits are supported by a lathe dog as in Fig. 16. The tail of the dog bears on a block of thin wood to prevent it from marring the surface of the compound. In some instances when drilling from the tailstock the drill or the work may tend to draw off-center as the drill engages it. This can be corrected by applying side pressure as in Figs. 14 and 15.

Reaming: A typical setup for reaming a drilled hole is shown in Fig. 19, using a straight reamer carried on a 60-deg. center in the tailstock. Note the use of a lathe dog to prevent the reamer from turning. In holes up to 1 in. in dia. the reamer should never remove more than .006 if smooth work is to be produced. Use a lubricant.

Cross drilling: Very accurate cross, or transverse, drilling is possible with the setup pictured in Fig. 20, using small drill bits. The hand piece of the flexible shaft is clamped in the vise of the milling attachment and centered vertically on the work. Then the drill is fed into the work with the lathe-carriage cross-feed. ★ ★ ★

Spring Tension Holds Chocks Against Casters on Power Tool

One shop owner who utilized roller-skate wheels as heavy-duty casters on one of his power tools, installed two wooden chocks under spring tension to lock the wheels. The chocks are lengths of 2 x 2 or 2 x 4, beveled on the inside edge. Screw eyes are screwed into the lower inside edge and screen-door springs are hooked into the eyes and used to hold the chocks together and against the wheels. When the wheels are released, the chocks are slipped up out of the way and held against the legs by the springs. A pair of roller-skate wheels on half a skate frame is used under each leg of the machine.

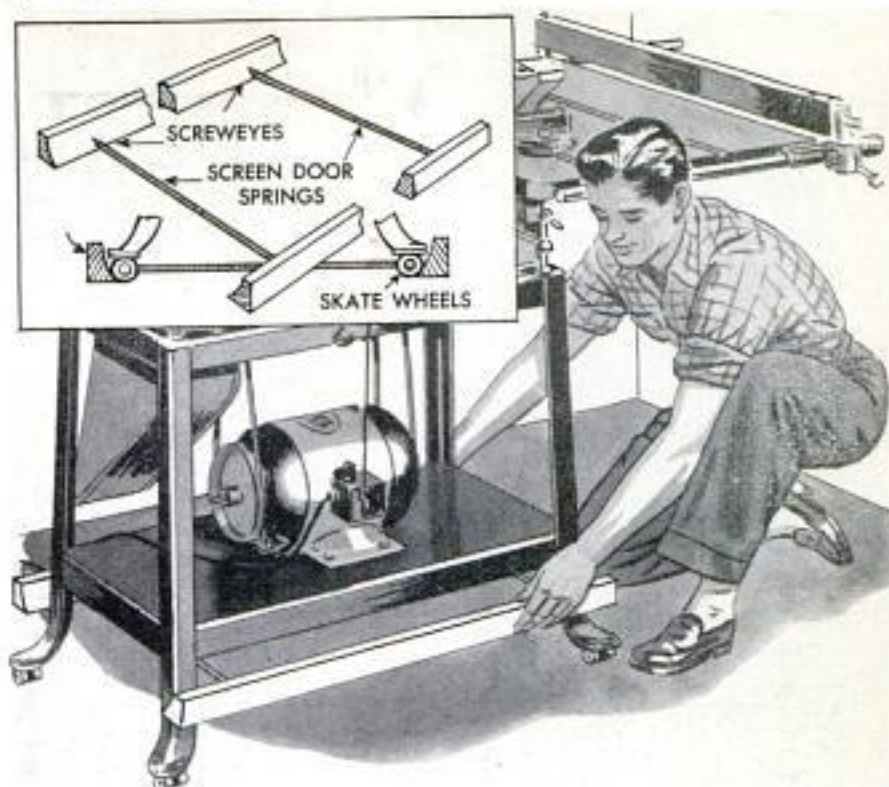

Portable Hog-Ringing Crate Has Adjustable Stanchion

Merely moving a few steel pins to different holes allows the stanchion opening on this portable hog-ringing crate to be adjusted to fit any size animal. The crate, which measures 20 x 40 x 60 in. inside, has a gate at the front and back. The front

gate, which is the stanchion, is fitted with steel angles welded to the hinges to prevent it from being lifted. Each of the steel pins, which fit into conveniently spaced holes for the various adjustments, has a small crossbar welded to one end. When the pins are in place, they are turned so the cross-bars fit behind short lugs welded to the steel angles.

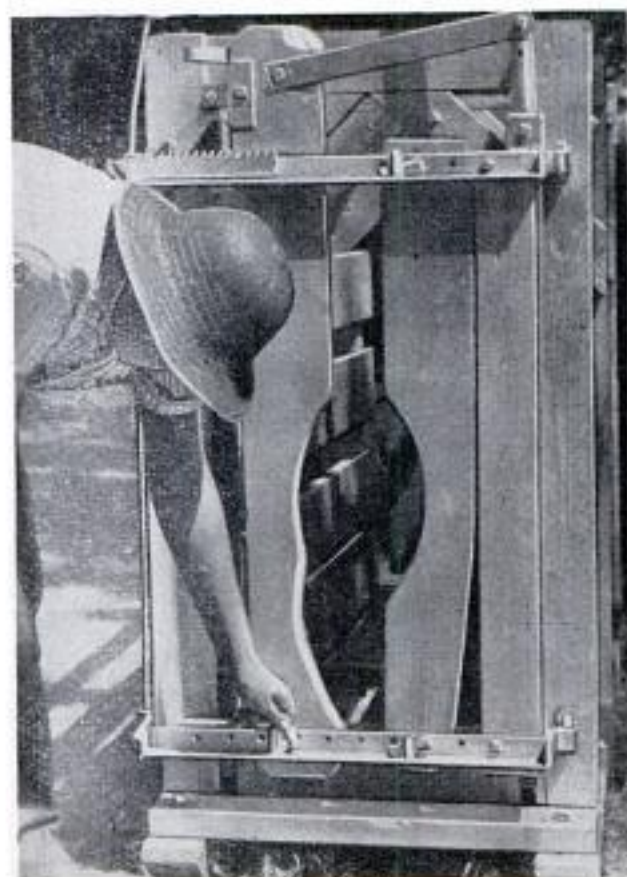

Extension Perch Removes Fowl From Trees on Open Range

Fowl running on open range often get into the habit of roosting in trees rather than returning to the poultry house at night. To discourage this habit, which exposes the birds to night-prowling predators, one farmer removes the birds by using a perch nailed to the end of a long stick. The perch is pushed against the roosting bird's breast, which makes it automatically step forward onto the perch so it can be lowered and transferred to the protection and safety of the poultry house.



G. E. Hendrickson, Argyle, Wis.

SN 56

NEW USES for PORTABLE SAW

YOUR PORTABLE electric saw is designed to cut almost anything—wood, metal, stone, concrete, glass fiber, hardboard, softboard and composition materials of various kinds. The table on the opposite page gives complete cutting instructions and tells you the kind of blades and abrasive disks to use for different materials. The photos picture typical operations on wood, concrete, tile and metal. The saw requires no alteration other than changing the blade or disk to one suitable for use on the material to be cut. No special techniques are required. Most operations are one-handed, the same as in cutting wood. When saw is used on a vertical surface, or overhead, use both hands to hold it properly. Also when making exceptionally deep cuts, or when cutting metals, the saw should be held in both hands as in the right-hand photos on the opposite page. Operator should wear goggles when cutting with abrasives. ★ ★ ★



Above, note similarity of operations of cutting wood and clay tile. Saw is held in same manner. Woodcutting blade is replaced by abrasive disk for cutting tile. Right and below, saw squares up broken pieces of hollow tile and concrete for re-use



Right, saw cutting a length of steel shafting, using an aluminum-oxide abrasive disk in place of a toothed blade. Lower right, cutting a stone lintel with abrasive disk. Wear goggles on abrasive-cutting operations

Lower left, opening old mortar joints preparatory to repointing is job for portable saw with abrasive disk. Disk is set to take shallow cut to avoid damaging bricks when cleaning vertical joints. Center, cutting cast-iron soil pipe with a portable saw



Photos and technical information courtesy Skill Corp.

CUTTING INSTRUCTIONS FOR VARIOUS MATERIALS

Type of Cut	Type of Blade	WOOD	
Ripping or rough cutting	Rip or combination	Keep blades sharp. On resinous or wet woods put extra set in teeth.	
Crosscut	Combination or crosscut	Crosscut blade for smooth cut on hardwood. Combination blade for rough cut.	
Finishing or mitering	Miter or fine tooth	Miter blade for trim. Fine-tooth for veneer. Feed slowly.	
Plywood	Fine tooth, miter, cross-cut or carbide tipped	Fine-tooth blade for 1/4-in. or thinner panels; miter blade for thicker sheets. Carbide-tipped blade on exterior plywood.	
FERROUS MATERIALS			
Cast iron, cast soil pipe	Flexible or cutoff wheel	Flexible wheel for continuous cutting; cutoff wheel for occasional work.	
Sheet steel	Friction or flexible wheel	Friction blade up to 16 ga.; flexible wheel for heavier gauges.	
Stainless steel	Friction or flexible wheel	Friction blade up to 16 ga.; flexible wheel for heavier gauges.	
Aluminum	Metal-slitting, miter or cutoff blade	Metal slitting for light gauge. Miter or cutoff blade for infrequent cutting. Use lubricant.	
Brass, copper	Metal-slitting or flexible cutoff wheel	Flexible wheel for hard alloys or thick sections. Slow speed for copper 1/2 in. or thicker. Use lubricant to cool blade.	
Lead	Floor blade	Use lubricant. Large saw and undersized blade minimize load.	
ASBESTOS AND GYPSUM PRODUCTS			
Combination materials	Carbide-tipped, diamond-grit or flexible cutoff wheel	Carbide tipped for production; diamond grit for extremely hard materials; flexible wheel for occasional work. Water attachment must be used with diamond grit.	
Plasterboard, gypsum plank	Carbide-tipped, cutoff or flexible wheel	Carbide tipped for production; cutoff or flexible wheel on metal-bound or wire-reinforced board only.	
MASONRY, TILE, CONCRETE			
Marble, slate, stone	Flexible, cutoff or diamond grit	Diamond grit for hard materials (hard tile or firebrick). Feed slowly. Support brittle stone (slate) at cut. Use water-feed attachment with diamond grit.	
Tile, brick	Flexible, cutoff or diamond grit	Diamond grit for hard materials (hard tile or firebrick). Feed slowly. Support brittle stone (slate) at cut. Use water-feed attachment with diamond grit.	
Concrete	Flexible, cutoff or diamond grit	Diamond grit on hard concrete; flexible wheel for reinforced concrete. Water attachment with diamond grit.	
SPECIAL COMPOSITIONS, LAMINATIONS, WALLBOARDS			
Metal and wood laminations	Metal-slitting blade	Metal-slitting blade for steel-laminated wood; also for zinc or aluminum laminated. Cut with face side down.	
Wallboard	Fine-tooth blade	Carbide tipped for asphalt-coated board. Support well during cut. Cut with face side down.	
Aggregate coated board	Carbide-tipped blade	Wipe blade occasionally with kerosene to remove asphalt build-up. Cut with face side down.	
Fiberglass, laminates	Flexible or cutoff wheel	Use water-feed attachment to keep dust down. Lower foot for smoother cut.	

Suction Cups Provide Vanishing Points for Perspective Drawing



Large rubber suction cups of the type fitted with a screw can be used to provide the vanishing points of a perspective drawing when the points must be located outside the board. Place the board on a large table or desk and locate the cups at the desired positions on the table. Hold a yardstick or other straightedge against the screw and strike off the perspective lines. An alternate method is to use a yardstick fitted with a screw eye, as shown in the detail. The screw eye is driven into the end of the yardstick so the edge of the stick aligns with the screw. The screw eye should be a snug fit on the screw.

Fuse Clips Hold Air Gauge On Barrel of Tire Pump

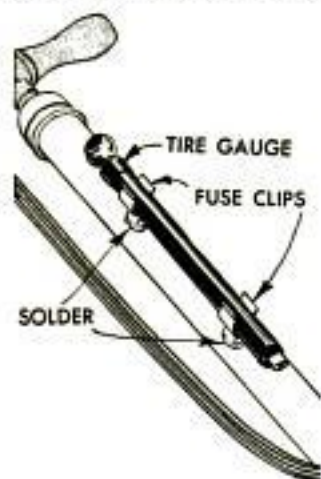

One way of insuring that the air gauge is always kept with the tire pump is to fasten it to the barrel of the pump with two fuse clips. Two cartridge-fuse clips of about 40-amp. size, properly spaced, are soldered to the barrel of the pump. —Albert P. Zanelli, Tampa, Fla.

Piston Welded in Cylinder Aids Removing Sleeve

When he had difficulty removing the worn sleeves from a tractor engine, one farmer inverted a discarded piston in the cylinder and welded it solidly to the sleeve with a bead around the skirt. A length of

lumber then was inserted from the bottom of the cylinder, held against the piston and used to drive out the welded sleeve-and-piston assembly. — W. J. S. McLaughlin, Christchurch, New Zealand.

"V-Block" for Large Work

Large-diameter work can easily be accommodated in an adjustable "V-block," consisting of two lengths of steel T-bar and two lengths of steel round stock. A number of equally spaced holes are drilled in the vertical web of both T-bars to allow the steel rounds to be used as cross members of the V-block. The various holes in the T-members permit adjustment in width, while the use of longer or shorter lengths of round stock permits lengthwise adjustment. —C. W. Woodson, Chicago.

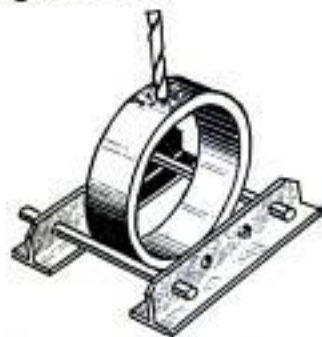

Poultry-Yard Water Supply Furnished by Steel Drum

Fitted with a float-type watering cup, as shown in the photograph, a 55-gal. steel drum will provide a generous supply of water for the poultry yard. Because the float regulates the supply, there is seldom any overflow of water to cause a mudhole and the steel drum will not dry out in the sun, as will a wooden barrel. The drum head is not cut out, thus the drum is sealed so the birds cannot get into the water to dirty it. A hose is used to fill the drum through one of the threaded bungs.

A. M. Wettach, Mt. Pleasant, Iowa.



When assembling handles and ferrules on tools, coat the parts with lacquer. When wet, the lacquer provides lubrication for assembly and, when dry, has the same holding power as a waterproof cement.

SN 56

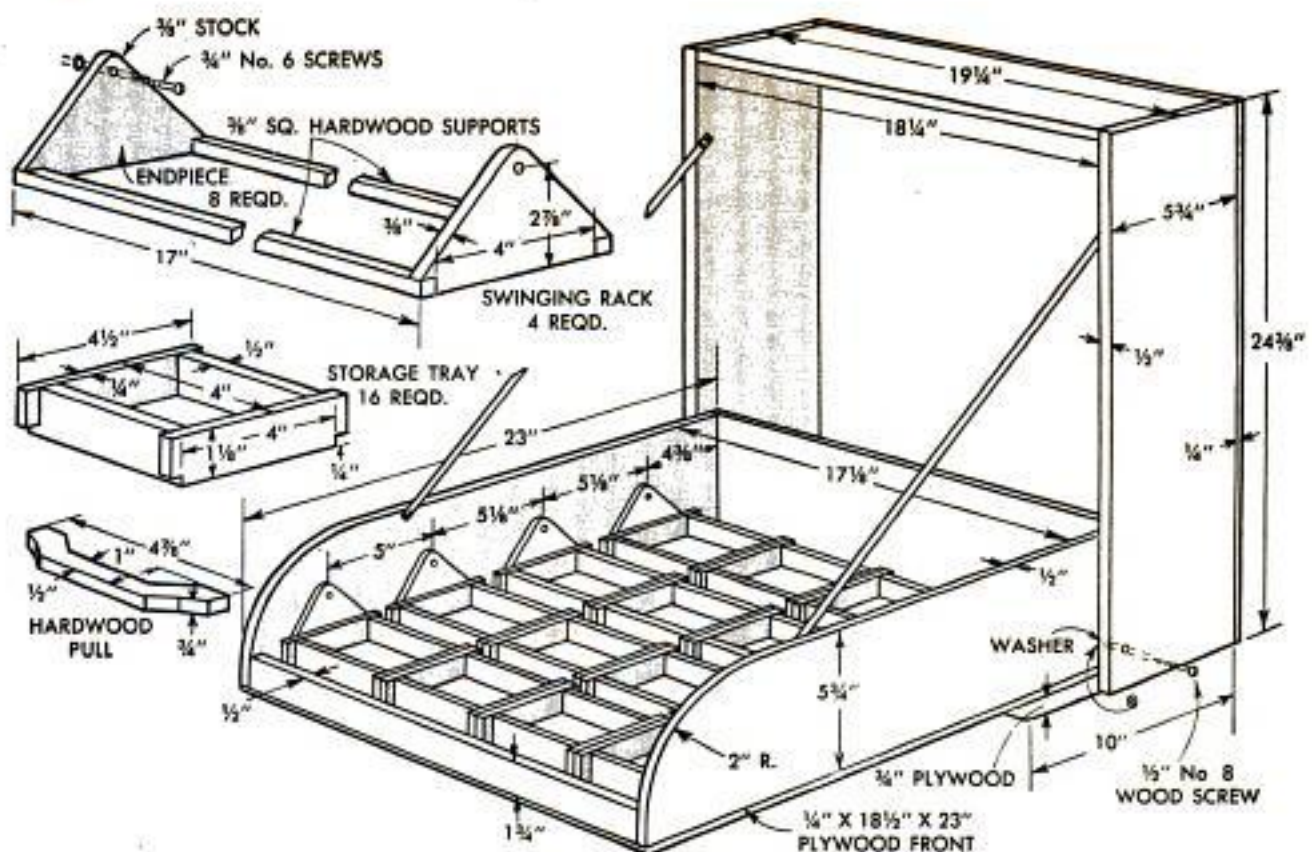

Drop-Front Cabinet

FOR PARTS STORAGE

By Dick Hutchinson

SWINGING STORAGE RACKS in this drop-front cabinet are always level and the individual trays, four to each rack, are purposely made shallow so that assorted small parts in the trays are readily accessible. Individual trays can be lifted out for closer inspection of the contents. Trays and supporting racks are made from hardwood, such as oak or maple. The trays are fitted with 1/16 or 1/8-in.-plywood bottoms. The cabinet is a simple box with a plywood back. The corners are butt jointed with screws and glue. The lower endpiece, or bottom, of the cabinet is 10 in. wide and extends to form a shelf when the drop front is closed, as in the center view at the right. Four trays are made to the dimensions given in the upper left-hand detail and pivoted in the drop front. The racks should be 1 in. from the plywood front piece so that they will clear when the front is closed and they swing to the level position. Add chains or tapes to support the drop front when lowered as in the photo.

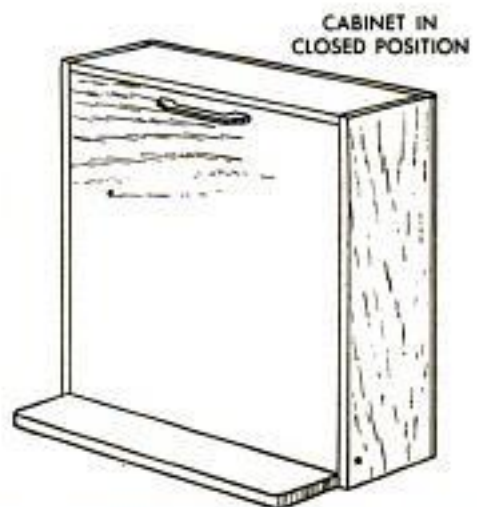

SN 56

PORTABLE WELDING SCREEN

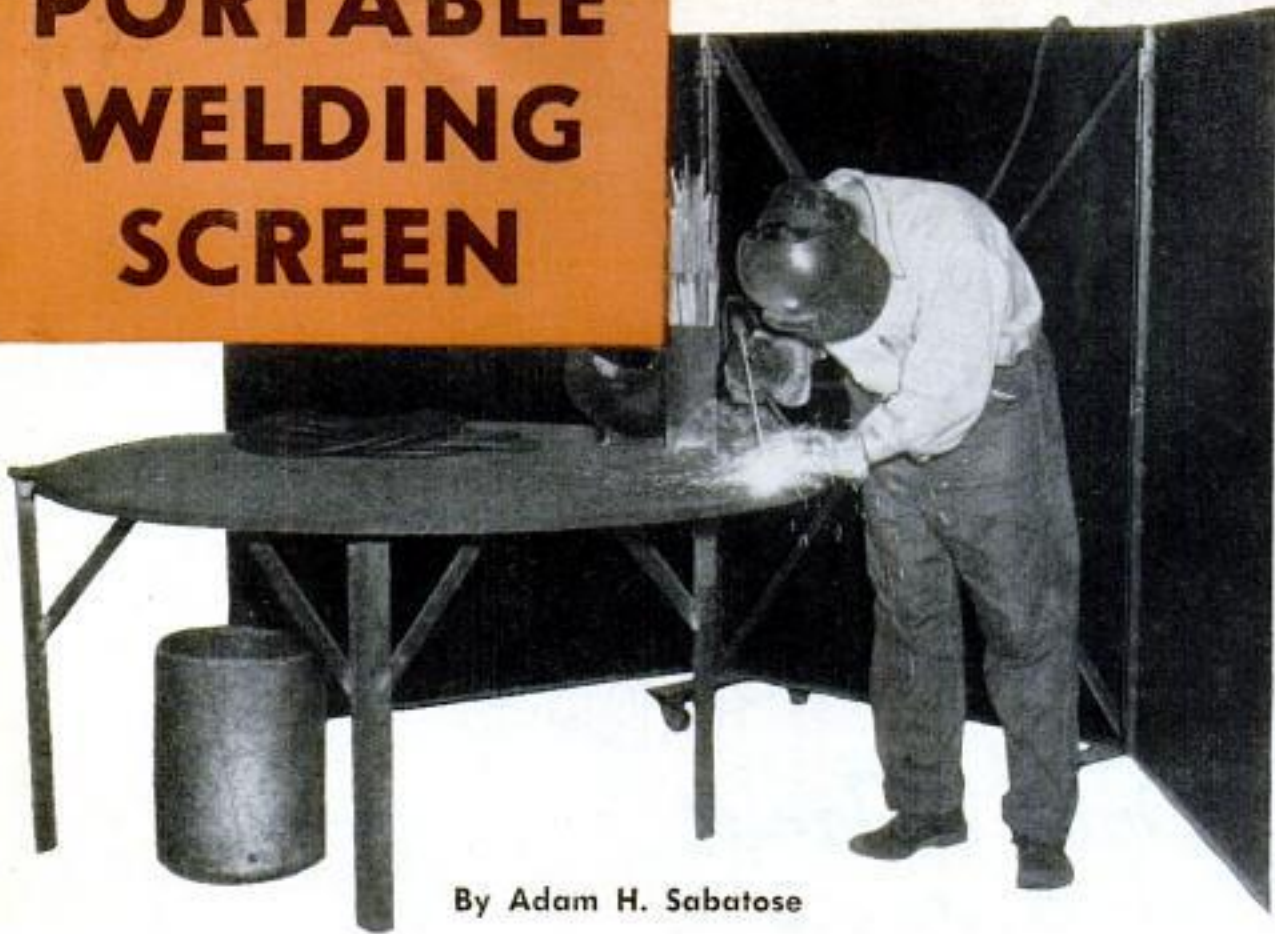

By Adam H. Sabatose

WELDERS WORKING IN small shops where space is limited, or on assembly floors where others near by need protection, usually improvise a screen which confines torch and arc glare and also restricts any possible fire hazard to the im-

mediate area in which the work is being carried out.

Rather than improvise for each special job one welder designed and built this portable screen. It is made by welding heavy sheet-steel panels into angle-steel

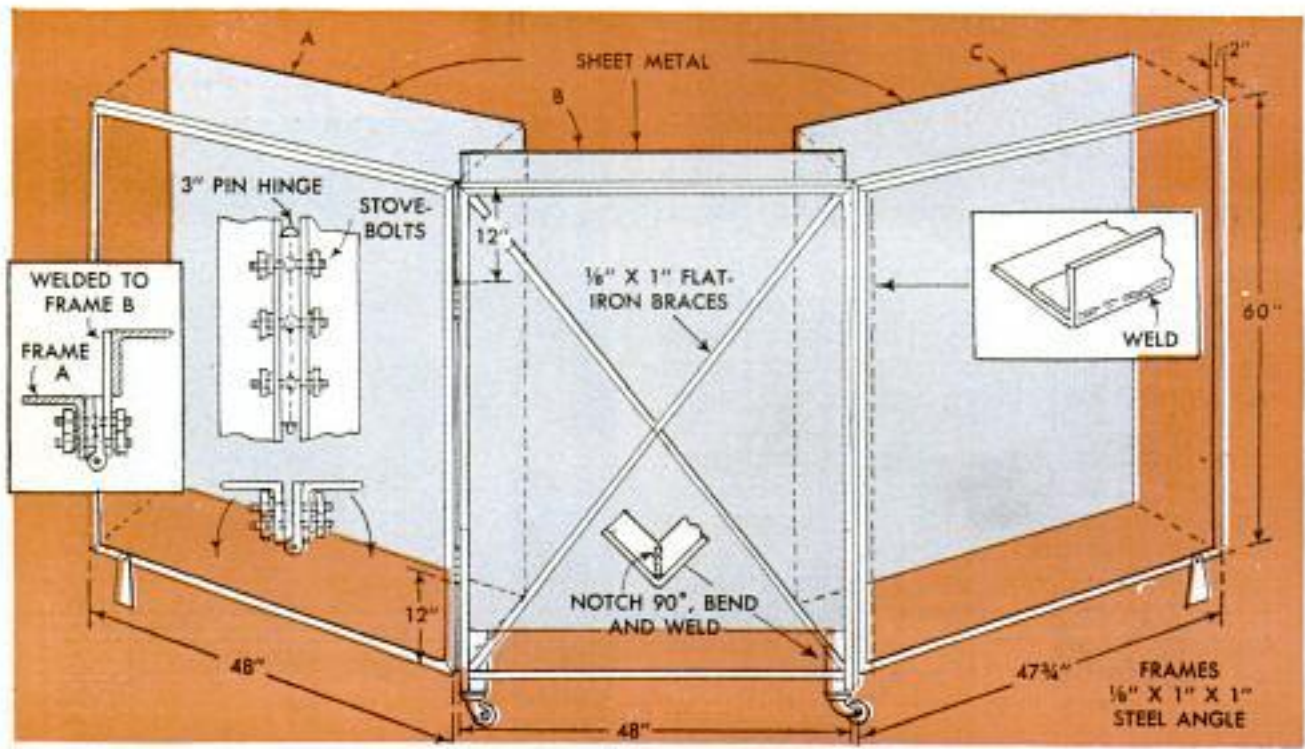

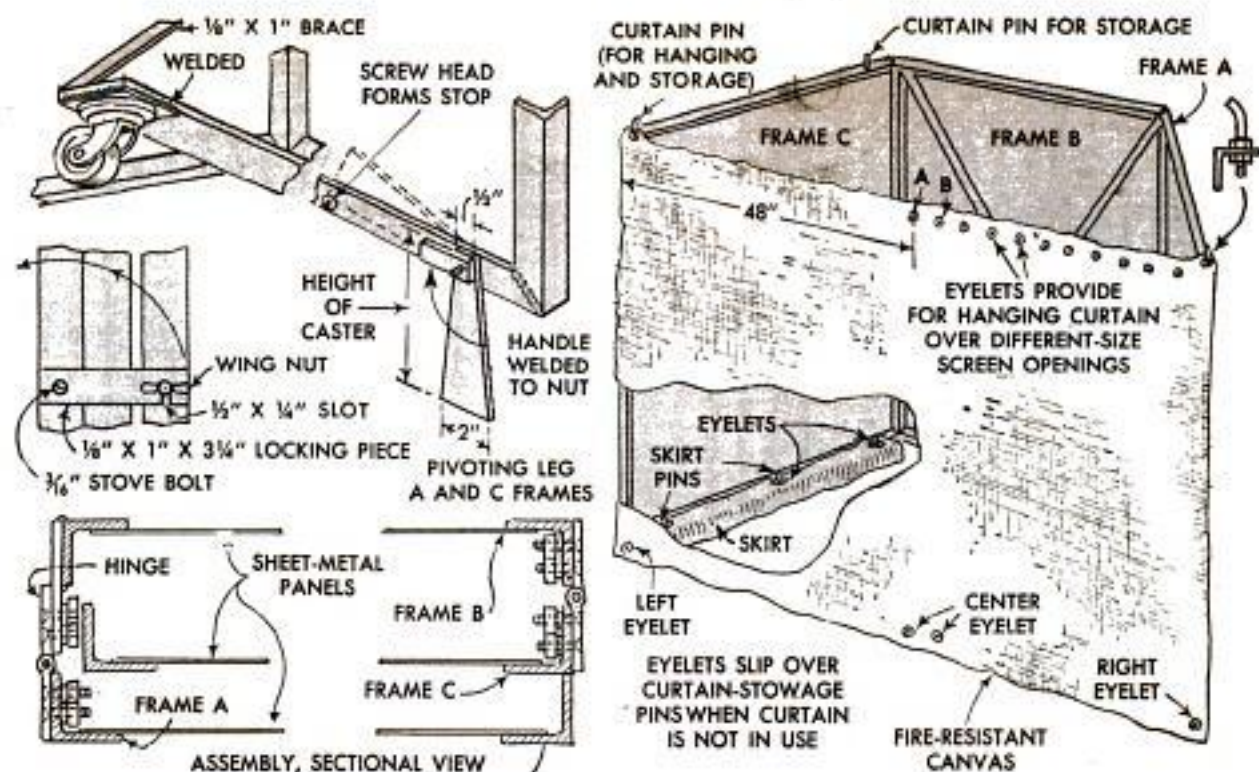

frames, two of which are hinged to fold flat for transport from one point to another. When folded, the unit rolls easily on heavy casters. The dimensions given are those of the original screen and can be changed within reasonable limits to suit any special purpose. The detail on the opposite page shows the position of the parts and the methods of assembling the frames. All joining parts are welded. When opened, the wings are supported on short folding legs as detailed above and on the opposite page. Before cutting parts, note in the sectional assembly view above how the panels A, B and C are hinged. Braces to the caster

frames, shown in the photo below, are on one side only.

When welders must work screened on all sides a fire-resistant canvas curtain and skirt can be attached permanently to the screen as in the right-hand detail above. Curtain pins, for hanging and storage, are made from steel rod, cut into short lengths and threaded and bent as indicated. Rows of eyelets in the curtain provide a means of hanging it over screen openings of varying size. Note that the handle is designed to slide back under the frame when not in use. The free end is supported by an eye made from 1/4-in. steel rod. ★ ★ ★

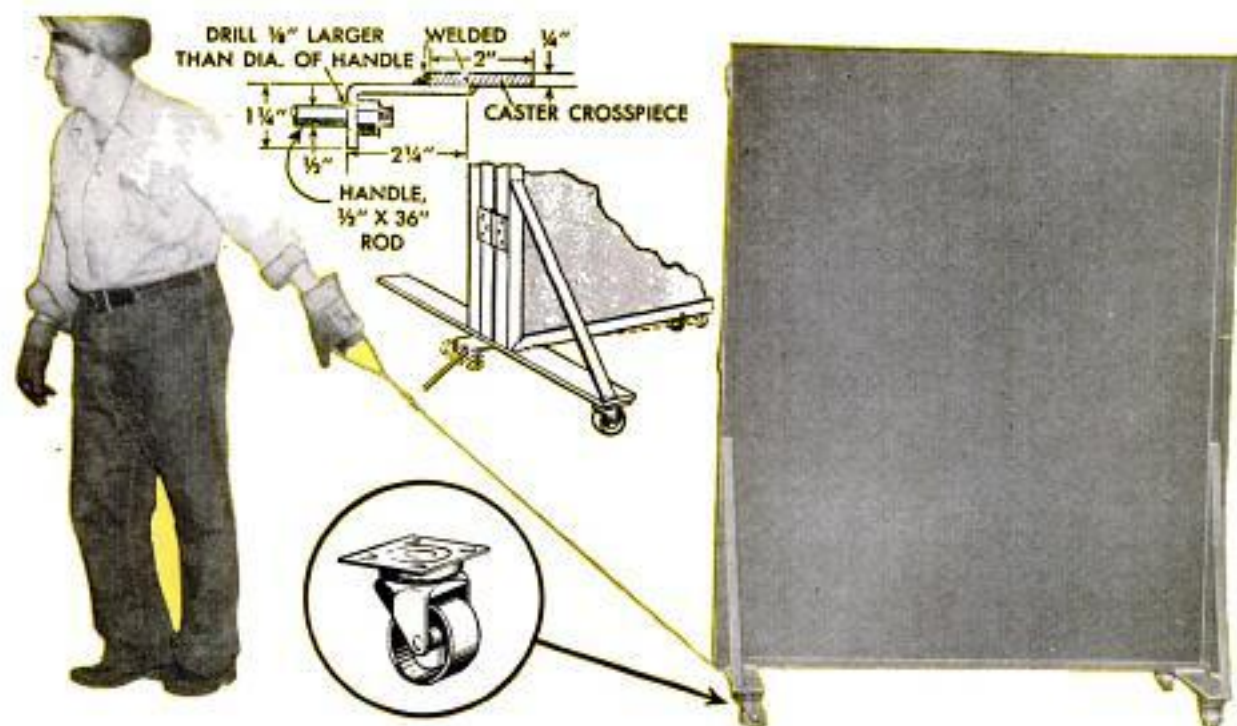

Posts Easily Pulled by Chain Wrapped Around Tractor Tire

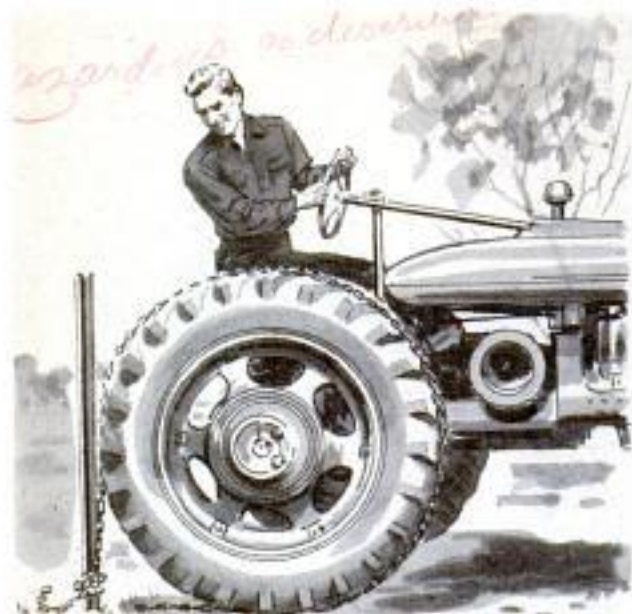

A quick and easy method of pulling steel fence posts is to use a length of chain wrapped around the rear tire of a tractor. The chain is stretched out on the ground, leading away from the post, and the tractor wheel is backed over it. The forward end of the chain then is passed up and around the tire and tied to the post, close to the ground. The chain will lift the post as the tractor is driven forward.

Edwin W. Saeger, Rock Rapids, Iowa.

Spring Clamp Wired to Cord Prevents Pulling Plug



The problem of overreaching the length of a drill or extension cord and pulling the plug out of the receptacle can be overcome by using a spring clamp of the type shown. The clamp is taped or wired to the cord at a point several inches from the plug and is snapped onto a wood screw driven into the wall adjacent to the receptacle. When the limit of the cord is reached, the clamp and screw absorb the pull, rather than the plug.

Marion L. Rhodes, Knightstown, Ind.

Adjusting Car Horn Noiselessly

To make adjustments on the horn ring or steering column of a car without sounding the horn, which may be annoying to persons near by, connect a 6-volt bulb into one of the horn wires in series. The bulb

will light up when current is passing through the horn but will not pass enough current to sound the horn. Thus, the horn circuit can be tested silently.

Walter H. Smarook, Somerville, N. J.

Barbed Wire Wrapped on Posts Keeps Cattle Away From Cable

Cattle scratching themselves on the anchor cable of a transformer pole, which carried high-voltage lines, caused the wires to sway so violently that there was danger of the uninsulated wires being broken and falling to the ground. Two fence posts, wrapped with barbed wire as shown, eliminated the hazard. The posts were set in line with the cable and the pole, one on each side of the cable. The barbed wire then was wrapped between the posts at a height above the shoulders of the animals, to effectively discourage them from approaching the cable.—Henry Josephs, Gardenville, Pa.

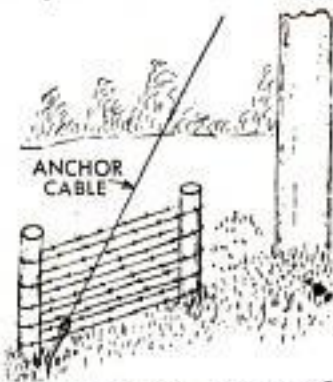

Altered Tractor-Gearshift Lever More Easily Reached

Easier tractor operation was the result of bending and lengthening the gearshift lever. It formerly was a short, straight lever under the steering wheel that was awkward to reach. Another factory-built lever was purchased, the top cut off and the lever bent as shown. Then the old lever was cut off and welded to it.

A. M. Wettach, Mt. Pleasant, Iowa.

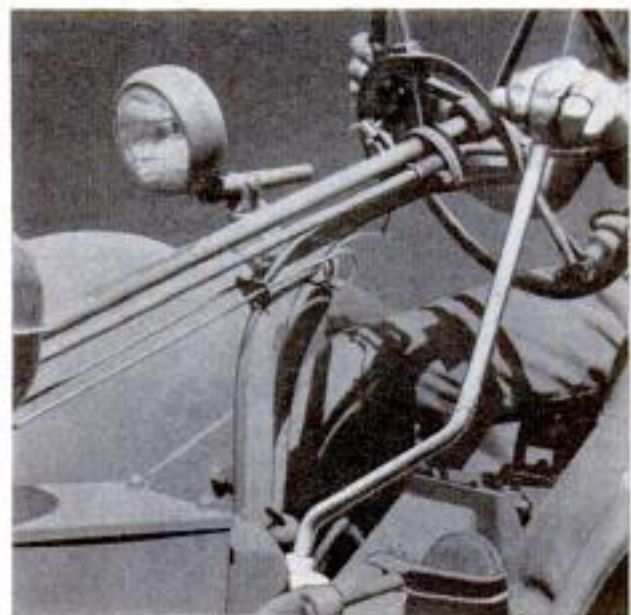

Round-Pin "Dovetails" Made With Plug Cutter

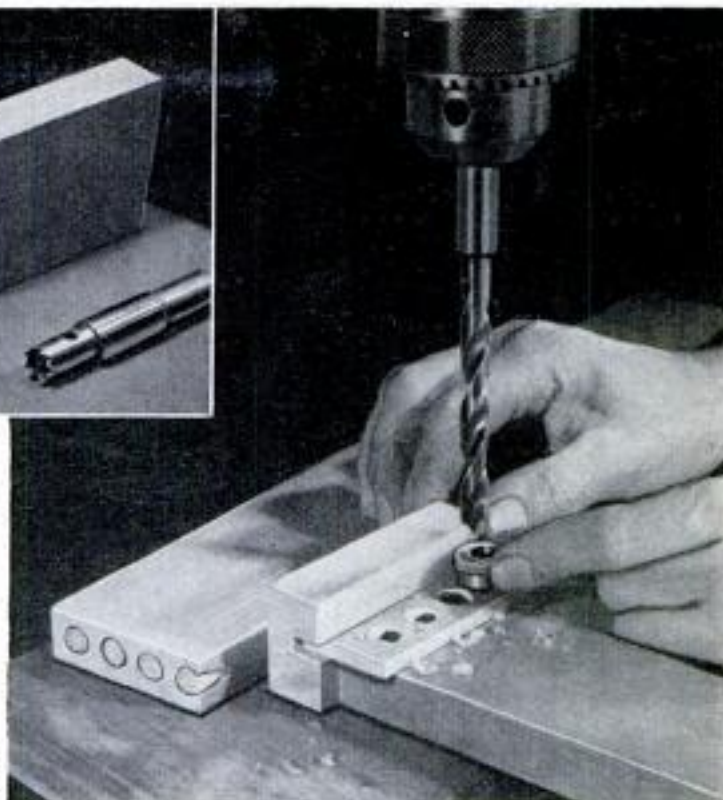
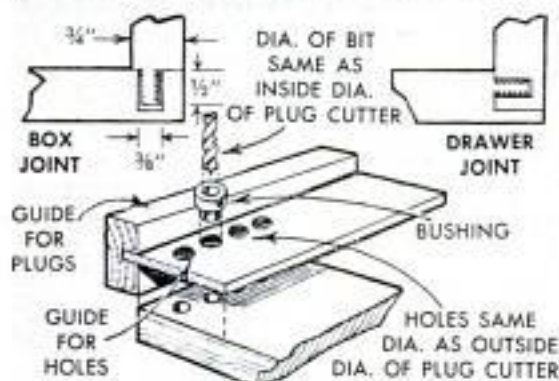
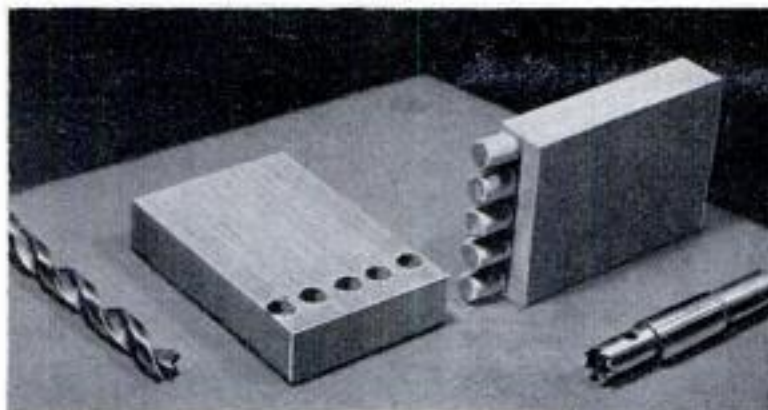

Using a plug cutter and a bit to drill matching holes, you can make corner joints which are the equal of the dovetail joint in strength. The plug cutter forms round projections in an offset position on the end of one of the joining members. Spaced holes are then drilled across one face of the second member as in the photos. To insure an accurate fit the holes must be drilled with a jig which utilizes a shouldered bushing as a guide for the bit. No dimensions are given as the jig must be made up to suit

the work at hand. Any number of holes and pins may be used, but they must be carefully spaced so that the holes do not cut out at either edge of the stock. The set-up for drilling the holes accurately is pictured in the photo and also shown in the detail. Note the variation in the box and drawer joints. If the holes for the drawer joint are drilled clear through and the pins made correspondingly longer, the joint that results is similar to the "round pin" drawer joint used by early cabinetmakers.

Blower Fan on Router Bit Keeps Work Cleared

To keep the work free of chips when routing with a drill press, slip a blower fan over the router bit. The fan is a 2-in.-dia. disk of cardboard, slit at several points around the edge to form a number of vanes which are twisted slightly to provide a pitch.—H. Hanscom, Elmhurst, Ill.

Spring Clamps Used in Shop To Hold Small Gluing Jobs

Ordinary stationer's spring clamps can be used to hold many small gluing jobs around the shop, in modelmaking and wherever pressure is needed while the glue dries. They come in a variety of sizes, are inexpensive and the pressure exerted by the bowed steel in the closed end of the clamp is considerable.

Art Frank Williams, Wood-Ridge, N. J.

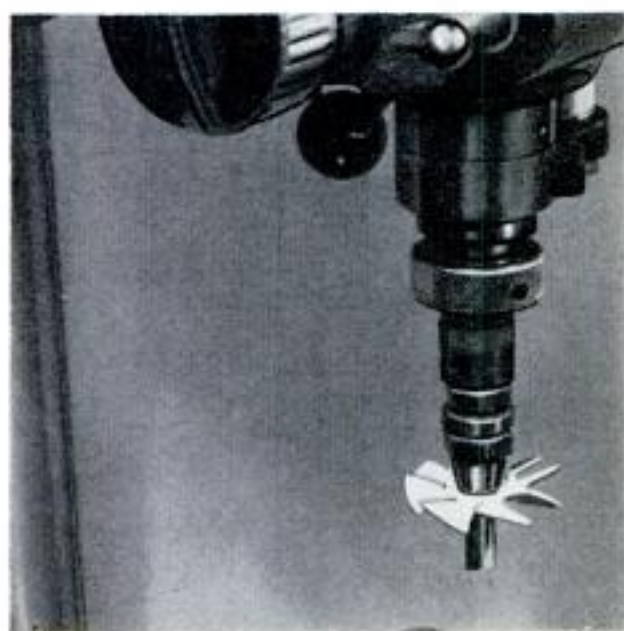

SHOPPING FOR TOOLS

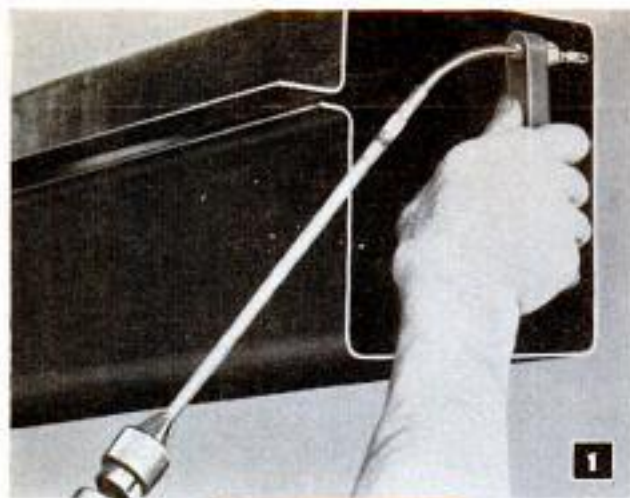

1

1. DRILL EXTENSION designed for use with portable electric drills consists of a flexible coupling, an extension shaft and a handle. The flexible coupling takes a standard 1/4-in.-drill chuck. The handle, made from very hard wood, provides a means of guiding the drill and at the same time serves as a bearing back of the drill chuck on the extension as pictured

Hilmar Corporation, 183 New York Ave., Huntington, N. Y.



2

2. PORTABLE BANDSAW for cutting metal weighs only 16 lb., making it light enough to be used freehand in any ordinary work position. Cuts stock up to 3 1/4 x 4 1/4-in. sectional size in ferrous and nonferrous metals and other problem materials. Speed of the saw band is 240 s.f.m. under full load. Bands are available in sizes ranging from 6 to 32 teeth per inch

Porter-Cable Machine Co., Syracuse 8, N. Y.

3. PAINT MIXER can be operated with any portable electric drill or driven by a drill press as pictured. Designed for mixing paint, enamels and lacquers in gallon, quart and pint cans, the mixer head does a thorough job without lifting the liquid over the rim of the container. Head is self-cleaning; does not accumulate paint pigments while in operation

Corn and Co., 11 S. Marion St., Warren, Pa.

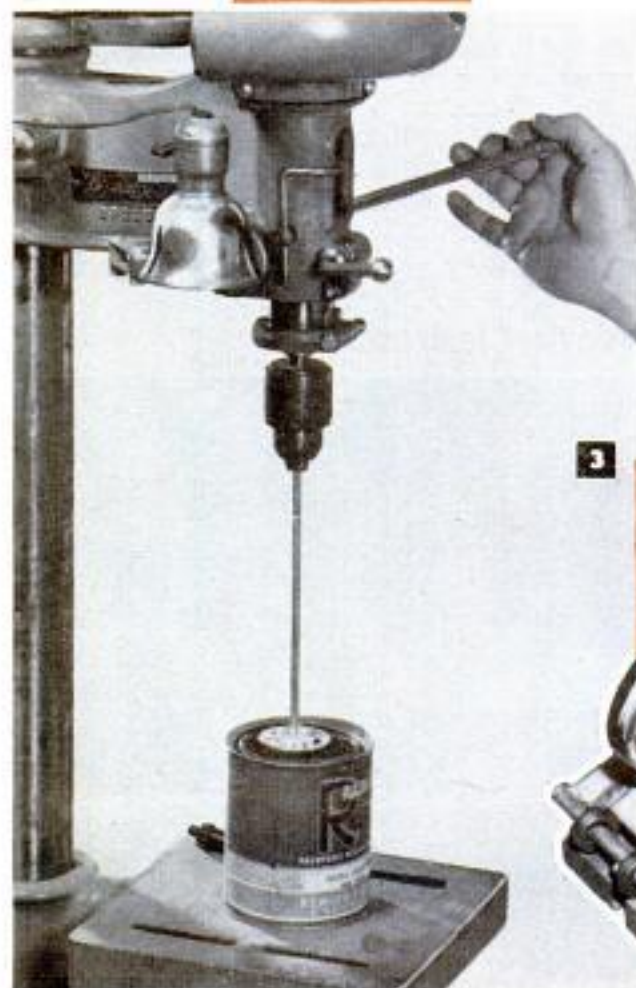

3

4. PORTABLE-SAW GUIDE tilts from the horizontal work position when saw is retracted, allowing ample clearance for placement of stock for mitering or cutting to length. Pivots for angle sawing and is fitted with a positive lock. Guide can be raised or lowered to accommodate stock of varying thickness and is adjustable to fit base plates of different-make saws

Radial Saw-Box, 4140, Syracuse, Dearborn, Mich.

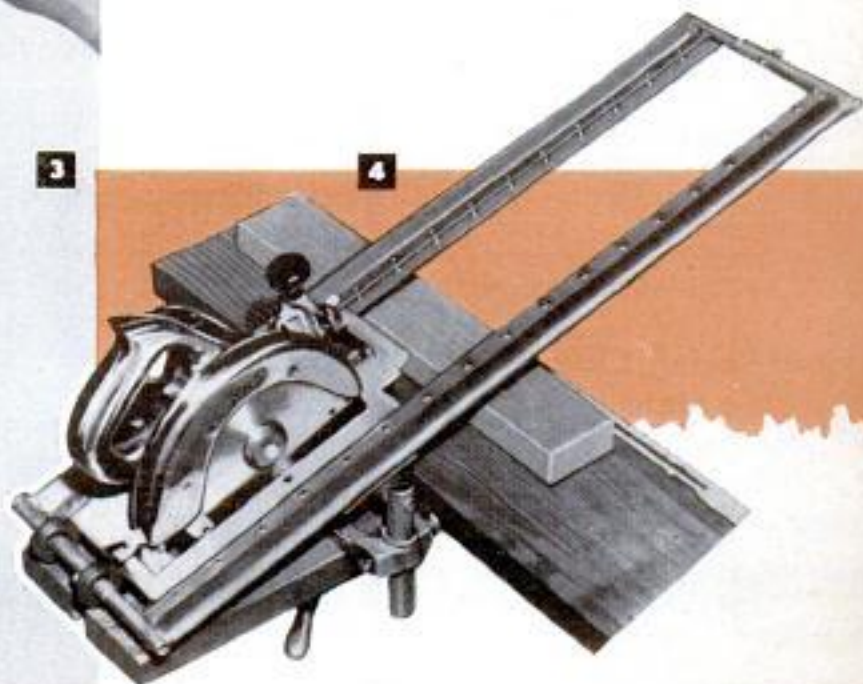

4

5. CENTER-PUNCH DUPLICATOR has been designed to eliminate the necessity of scribing a number of lines to locate holes or points on surface of work. Sliding stops are set to required measurements on scale arms. Unit is then placed in position with stops against sides. Striking spring-loaded center punch in guide gives accurate indentation at point desired

Hemiga Tool Co., P.O. Box 656, Terre Haute, Ind.



6. MINIATURE TORQUE WRENCH for assembling electronic devices, instruments and other delicate units has torque gauge registering in inch-grams and inch-ounces. Tool is available with scale marked in either calibration. A pull chain replaces the ordinary solid handle. The chain prevents inaccuracies and twisting which might damage tiny bolts or screws

P. A. Sturtevant Co., Addison, Ill.

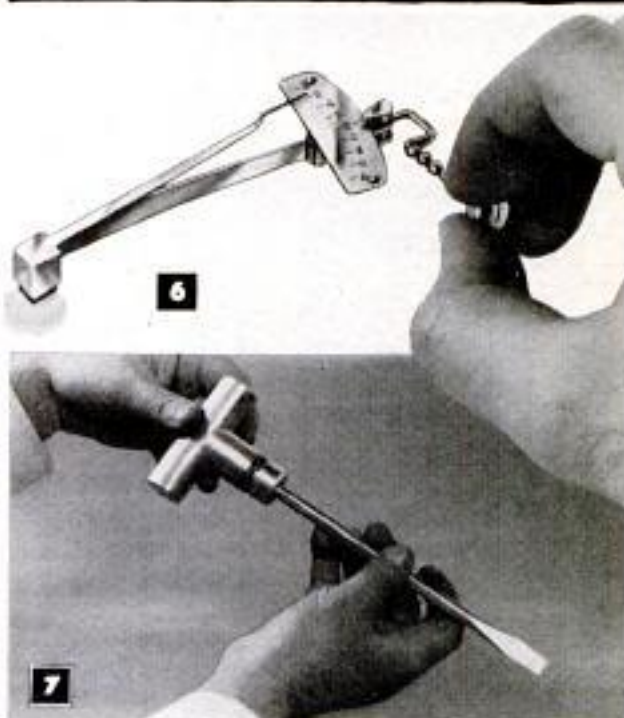

7. T-HANDLED SCREW DRIVER has efficient non-ratchet drive, enabling operator to apply considerably more torque, or twist, when tightening screws under difficult conditions. T-handle is of aluminum, correctly shaped for easy handgrip. Jaw-type clutch gives positive engagement and drives in either direction. Handle is spring-loaded to release clutch automatically

J & L Tool Co., P.O. Box 82, Three Rivers, Mich.

8. HARDNESS TESTER is pocket size, operates on the rebound principle and combines low cost with accuracy. In use, ball-pointed rebounding bar is raised and released by means of a catch. Bar then falls and rebounds to point on scale corresponding to hardness of object. Accuracy readings to 1 point Rockwell C are consistent. Conversion tables are available

Kurt Orban Co., Inc., 205 E. 42nd St., New York City 17

9. METAL-CUTTING BANDSAW has 6-in. throat capacity and 9-in. clearance under the guide. Cuts at any angle up to 45 deg. Saw band runs on 10-in.-dia. wheels. Auxiliary table is provided so that machine can be used in vertical position for cutting metal or wood. Machine is adjustable right or left for positioning cut. Wheeled truck is regular equipment

Tester Mfg. Co., Iron River, Wis.

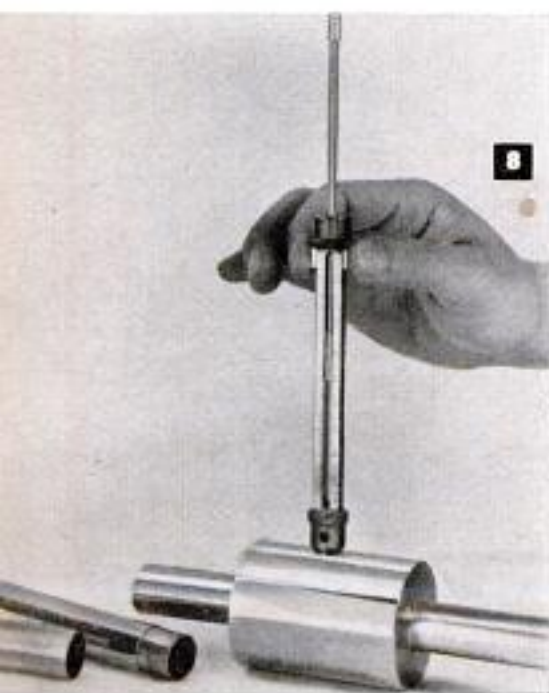

SHOPPING FOR TOOLS

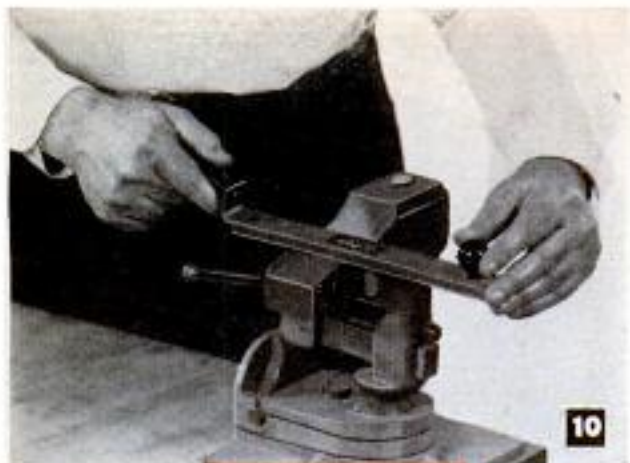

10

10. CUSHIONED FILE HOLDERS are available in several sizes and types for holding special files and also abrasives for sanding and polishing on flat and curved surfaces. Sponge-rubber facings permit abrasive to follow contours with equal pressure. The files are fitted with handles for two-handed operation

Milwaukee File Co., Milwaukee 4, Wis.

11. WELDER'S TURNTABLE permits precision placement of small parts and holding in either a vertical or horizontal position, or at any angle. Takes 100-lb. load. Turntable, or platen, is motor driven and is controlled by means of a foot switch. Built-in ground provides resistance-free return of welding current

Superior Welding Co., 3410 E. 14th St., Los Angeles 23



11

12. FUSE PULLER is double-ended with handles hinged to give the action of a toggle on both sets of jaws. Small jaws take cartridge fuses up to 30 amp. Large jaws handle fuses to 100-amp. size. Made from tough plastic to protect user from possible shock. Toggle grip prevents fuse from slipping out of the jaws

Star Fuse Co. Inc., 215 Canal Street, New York City 13



12

13. NAIL DRIVER eliminates possibility of injury when setting masonry nails. Nail is inserted in safety sleeve where head is held securely by magnet. Driver then is placed over mark where nail is to be driven, the outer sleeve pressed in and struck with hammer to start nail. Takes all common sizes of masonry nails

Safety Nail Driver Corp., 70 Rosalie Ave., Clifton, N. J.



13

14. LEATHER-LACING CUTTER cuts lace to any desired width from leather of varying kinds and thicknesses. Sharp cutter slices clean, is adjustable to cut any width up to 3 in. from the guide. This makes it possible to use the tool for cutting straps and single-leather belts. Leather skiver also is available

Carver Company, 322 31st St., Hermosa Beach, Calif.



14

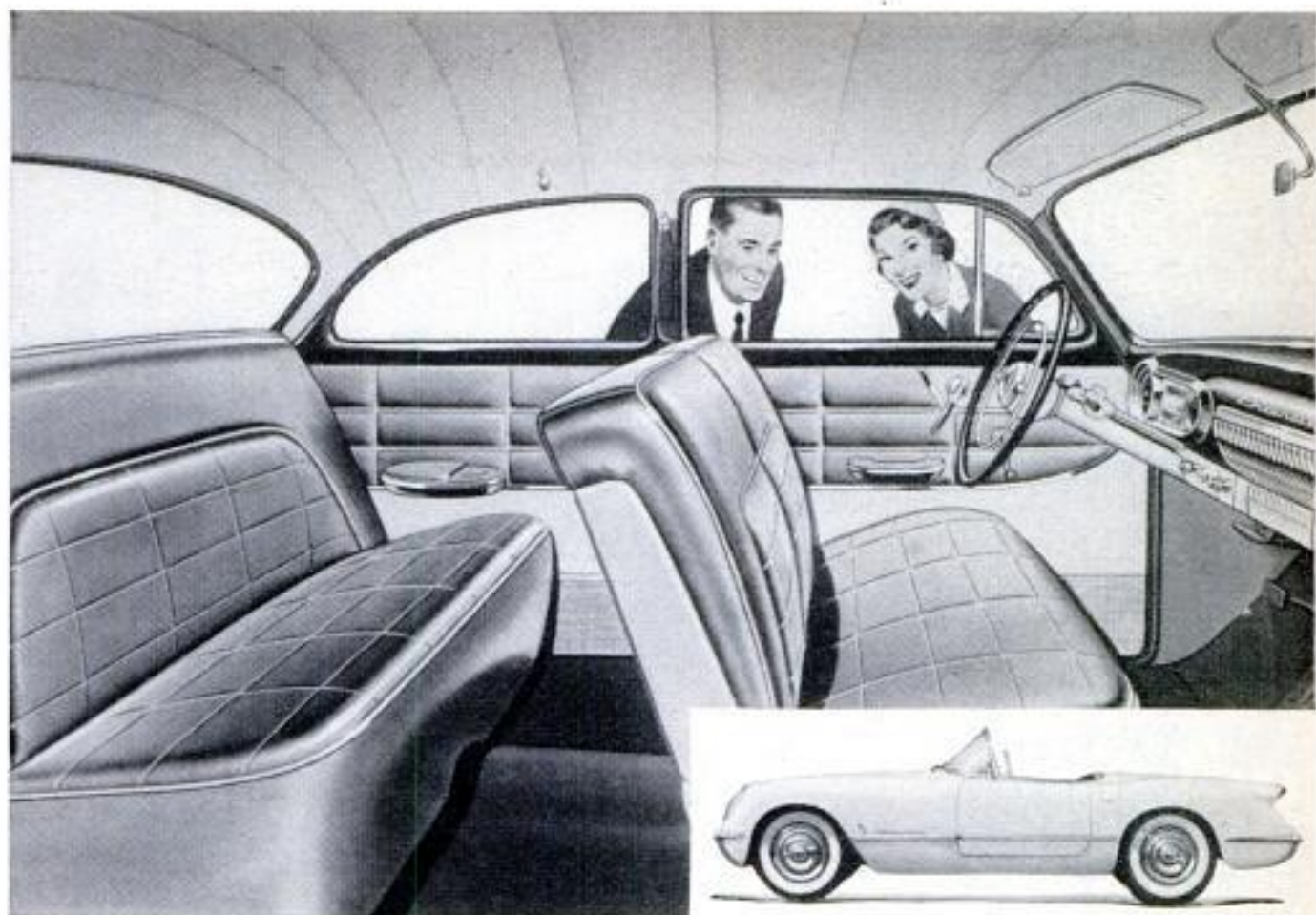

Advanced Chevrolet Engineering brings
PROGRESS IN PLASTICS
for greater beauty and durability in bodies

In the new Chevrolet, dozens of body and assembly parts are now made of durable plastic materials. You see it in the three-dimensional beauty of the hood, trunk and wheel emblems. You welcome it in the extra protection a plastic bond gives Chevrolet safety plate glass windshields. And you feel its soft-textured smoothness as soon as you slide into the all-plastic interior of a Convertible, Station Wagon or Delray Club Coupe (shown above).

In these Chevrolet models you're completely surrounded by colorful, comfortable vinyl plastic. Good looking, sure; but that's only one advantage. Plastic, you know, not only lasts and lasts, but is easily cleaned if stained. Dirt usually wipes right off. The comfortable vinyl seats, practically friction free, have the smart appearance of genuine leather.

Another advantage: Soft, flexible plastics can be finished in all kinds of designs and colors. That's why these Chevrolet interiors are so inviting just to look at!

Now the Chevrolet Corvette is a story in itself . . . and an excellent example of plastic durability. The first American sports car to reach volume production, the Corvette features a body of plastic reinforced with glass fibre. Half of the plastic body shell is light enough to be lifted above your head with one hand, yet strong enough to withstand, and not even show, repeated blows from a hammer.

Your Chevrolet dealer will be glad to show you many examples of advanced Chevrolet engineering—in plastics and in other ways important to you. . . Chevrolet Division of General Motors, Detroit 2, Michigan.

EVER FINER ENGINEERING

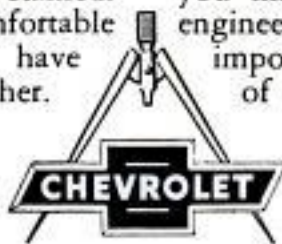

EVER FINER CHEVROLETS



Constant alertness saves lives. It can also help you...

save up to 40% on your auto insurance!

Read how careful drivers get top-notch protection at rock-bottom rates with

STATE FARM MUTUAL

If you're a careful, wide-awake driver (like the man in the picture), you *avoid* auto accidents.

Why should you pay as much for your auto insurance as careless, reckless drivers who are likely to *cause* accidents?

At State Farm Mutual, we deliberately aim to insure *careful drivers only*. Careful, accident-free driving by State Farm members saves money. We pass the saving directly back in the form of *low rates*. Rates as much as 40 percent *lower* than the cost of equivalent protection with other good companies.

You get this saving *plus* convenience and service. Our 3 million members (more than any other company insures) pay for their insurance semi-annually. They are served—in

case of accident — by our own 7000 agents and 700 claim expeditors.

To find the agent who lives nearest you, look under "State Farm Insurance" in the yellow pages of your phone book. Or write: State Farm Mutual, Dept. J-10, Bloomington, Ill.

Can You Qualify?

State Farm aims to insure careful drivers only.

Drivers who can be counted on to:

- Be alert for emergencies
- Make full stop at stop signs
- Heed crossing signals
- Obey speed laws
- Be extra careful on slick pavements
- Avoid passing on hills or curves
- Avoid mixing alcohol and gasoline
- Yield pedestrians the right of way

STATE FARM MUTUAL



"the careful driver insurance company"

*State Farm Insurance is written only by the
State Farm Mutual Automobile Insurance Co.
and its wholly owned affiliates:*

**State Farm Life Insurance Company
State Farm Fire and Casualty Company**

FREE TO MEMBERS!

Ask your agent for your new State Farm insignia (like above) in bright red headlight-reflecting Scotchlite. Display it proudly on left rear car bumper to identify yourself as "careful driver, soundly insured"... to provide emergency reflection when parked or if taillight fails.

Home Office: Bloomington, Illinois. Field claim offices in 325 principal cities. 7,000 agents in 40 states, District of Columbia, and Ontario, Canada

Hear "Jack Brickhouse Sports News" Saturdays and "Cecil Brown News Commentaries" Sundays over Mutual Stations. Check local radio listings.

Care and Feeding of Engines



BY
S. P. CORP

WHEN THERMOSTATS DON'T WORK

If your radiator has ever boiled dry, your thermostat may have been damaged. This would make your engine run too cool, wasting oil and gas. To test thermostat, place a .003" feeler ribbon $\frac{1}{8}$ " under lip of valve and submerge it in a container of water, 1" from bottom. Hang a thermometer in the water so the bulb is same height as thermostat. Heat slowly and stir to equalize temperature.

If thermostat drops off ribbon upon immersion, or if it opens 5° too soon or too late, you need a new thermostat.

Standard thermostats should start to open at 148° to 155° and be fully open at 175°. High-opening thermostats should start at 178° to 185°, and be wide open at 211°. When installing a new thermostat, use new gaskets and be sure side openings are placed to let water flow.

CAR RADIO STATIC

If your car radio clicks annoyingly, even when tuned between stations, it may be due to static caused by tires on certain kinds of pavement. Apply brakes lightly. If static decreases, it's tire static, and you should have static collectors on front wheels checked to see if they are greasy, or incorrectly installed. You may have to use a special static-eliminator powder, available at your parts supplier.

GET THIS FREE MANUAL

Worn piston rings are the most serious cause of wasted oil, wasted gas, and lost power. Re-ring with Sealed Power KromeX Ring Sets for immediate oil control, easy starting, and better than double normal ring mileage! Chrome-faced top compression ring and chrome faces on side rails of MD-50 Steel Oil Ring protect each KromeX Ring Set against heat, friction, abrasion and corrosion. To get your free copy of the valuable illustrated manual, "MORE POWER, Less Gas, Less Oil," address a card to Sealed Power, Dept. G-9, Muskegon, Mich.



Sealed Power

PISTON RINGS

Clinic for Homemakers



As a service to our readers in solving the hundreds of problems pertaining to a home—inside or out—the editors of *Popular Mechanics* invite you to present your problems to The Clinic Editor for help and advice. Address your questions to The Clinic Editor, *Popular Mechanics Magazine*, 200 East Ontario Street, Chicago 11, Ill.

Wallpaper peels

Q—We are having trouble with the wallpaper peeling from the walls in several of the rooms in our new home. We took off the old paper and applied new, but now that is peeling in nearly all the rooms. The paper also is discolored in spots. What is the cause of the peeling and discolorations and what can I do to prevent it?

—Y.A., Ont., Can.



A—You do not say but we are assuming that the walls are plastered. Peeling of any wall covering, including paint, is a common trouble when the materials are applied before the plastered walls are thoroughly dry. Newly plastered walls should dry from two to six months before any covering is applied. Of course, this time can be greatly shortened by artificial drying but this process is seldom practical for the homeowner to carry out. Probably in your case the best thing to do is to remove the damaged paper and wash the paste residue off the walls. Then leave the walls bare for at least a couple of months during the heating season. Shut off the furnace humidifier to lower the moisture content of the air in the rooms. Then size the walls and repaper.

Moisture Problem

Q—Moisture collects on the inner side of my storm sash and freezes to a coating of ice in cold weather. When the temperature rises, the ice melts and forms a pool of water between the inner and outer sash. In an attempt to cure the trouble, I sealed the storm sash with caulking compound all the way around the window frames, but this seems to do no good as ice forms on the glass the same as before. What can I do?

—T. F., N. J.



A—Moisture-laden air is leaking through the inner sash into the space between the two units. When it reaches the outer pane the moisture condenses on the surface for the same reason that it collects on the outer surface of a tumblerful of cold

(Continued to page 226)

JOBS ARE EASIER WITH THE
Westinghouse
HANDY-CRAFT
Motor

for HOMES
FARMS
SHOPS

IN THE HOME

ON THE FARM

Free Westinghouse motor guide saves you money 4 ways!

Are odd jobs around the home and farm stealing a big hunk of your time, pleasure and budget? Your free copy of the Westinghouse motor guide will show you how a versatile Westinghouse Handy-Craft® motor can make those "fix-it" jobs and chores easier, more fun—while it saves you money. Check with your Westinghouse Handy-Craft motor dealer (local hardware, automotive or electrical appliance store) or use coupon below.

J-21856

- Helps you choose the *right* motor for any application.
- Guides you in the selection of proper accessories and pulleys.
- Shows you how to make your motor portable to handle a 1001 jobs.
- Tells you how you can make your motor last longer—with minimum care.

Look for this decal. It will identify your local Westinghouse Handy-Craft motor dealer.



YOU CAN BE **SURE**... IF IT'S
Westinghouse



SEND THIS COUPON TODAY!

WESTINGHOUSE ELECTRIC CORPORATION
Handy-Craft Motors, P. O. Box 5151, Cleveland 1, Ohio

Please send me a copy of your **FREE** Handy-Craft motor guide.

I would like complete drawings and instructions for constructing the Handy-Crafter coffee table.

Name _____

Address _____

City _____ Zone _____ State _____

PM-9-54

TIME SAVING TIPS

ALL YOU NEED IS A TUBE OF

DU PONT DUCO CEMENT

REG. U. S. PAT. OFF.



SCREWS HOLD FAST in plaster walls when they're coated with easy-to-apply Du Pont "Duco" Cement.



THREAD ON THE RUN stops short when a dab of transparent Du Pont "Duco" Cement is applied.



SCUFFED SHOES, leather heels and inner soles can be repaired in a wink with Du Pont "Duco" Cement.



MEND BELTS TO LAST. When two layers of leather come apart, use "Duco" Cement. It's flexible and tough.



WOBBLY PICTURE FRAMES can be quickly reinforced with strong "Duco" Cement. Mends broken frames, too.



BROKEN RULE back in service in minutes. "Duco" Cement joins pieces quickly, neatly—almost invisibly.



HOBBYIST? It doesn't take a master craftsman to cement parts neatly with Du Pont "Duco" Cement.



GOING TRAVELING? Repair torn and scuffed leather luggage with strong Du Pont "Duco" Cement.



(Continued from page 224)

water on a warm summer day. The surface of the glass is much colder than the air. Likewise the surface of the glass in the storm sash is much colder than the air adjacent to it. Probably the surest remedy is to weatherstrip the inner sash. Of course, this takes time and may run into considerable money even though you do the job yourself. A temporary preventive is to seal the inner sash with strips of adhesive tape. Sometimes the leaks are in the lower sash only, due to a loose fit of the sash between the stops. In this case, resetting the stops may cure the trouble.



Paint Failure

Q—I painted my home less than a year ago. I applied two coats but the old paint was still in quite good condition. Now the surface of the new paint is broken into a series of fine cracks. Looks just like checked varnish. However, the checked paint is hard and is not peeling from the wood. What happened?—N. T., Del.

A—We don't know for sure but we'd suspect right away that you did not allow sufficient time for the first coat to dry thoroughly. That's a common cause of the paint failure you describe, especially if the first coat is laid on fairly heavy. Unfortunately there is no simple remedy for the condition that results. The alternatives are either to take the paint off to the bare wood with a prepared remover, or sand down the surface so that the checks are less prominent after repainting. Either method will involve considerable labor and time. In most cases we would recommend sanding, which can be done either by hand or by machine. It's a disagreeable job, but it is quite effective. Wear a respirator to prevent inhalation of the dust.

Bracing Old Buildings

Q—I have an old building on my property which not only leans a few inches out of plumb, probably due to windstorm damage, but also the ridge sags considerably, causing the sides of the building to bow outward at the eaves. Is there any way to straighten it without rebuilding?—O. P., Ind.

A—Your question is so very similar to one previously answered in this column that we are republishing our answer to the former question. Ordinarily, a building in the condition you describe is plumbed at the corners first. This usually can be done by placing long timbers, 4 x 4s or 4 x 6s, diagonally against the leaning corners and then forcing the corners back with jackscrews placed diagonally under the lower ends of the timbers. Leave these timbers in position. Now, pass a short length of chain around each plate at the center and hook a tackle block to the chains so that you can exert inward pressure on the plates. Place two uprights, 4 x 4s or 4 x 6s, four to six ft. apart with their upper ends bearing against the ridge board. Place a jackscrew under the lower end of each upright. Take up the slack in the tackle block and have a helper raise the jackscrews simultaneously one or two turns. Continue this procedure by stages, keeping tension on the tackle block, until the ridge and plates have been brought back to the original position. Leave the tackle block and uprights in place and under tension. Tie the structure at the plates with 2 x 6s or 2 x 8s spiked or bolted to the rafters at a point just above the plate. In some cases it is more practical to install X-braces on the rafters. In X-bracing, a common method is to spike or bolt each brace to the rafter at a point just above the plate, the other end of the brace being attached to the companion rafter about a ft. or so above the midpoint. The second brace of the pair is installed in the same manner except that it is run in the opposite direction. Install a spacer block and bolt the braces together at the point where they cross. Next, nail diagonal braces in each corner of the building, each brace extending from the plate to the floor, or sills, at the midpoint of the ends and sidewalls of the building.

"Sure, I'm Confident!"

"I have the tools to do the job!"

Start a project feeling like this — and, brother! — you'll do a wonderful job! And you *can* start with that kind of confidence. How? *Tool up with Stanley!* They're the finest tools you can put in your hands.

"YANKEE"[®] SPIRAL RATCHET SCREW DRIVER

Can be used with one hand

Just push the handle — the tool does the work! Drives or draws. No need to use both hands — amazing, quick-return spring brings handle back automatically after each stroke. This big, rugged, professional screw driver, with 3 most-used bits, \$7.70.

No. 130A



No. 11½

FINEST HAMMER! Drive the nail in straighter with the famous Stanley "100 Plus"! Extra power in every stroke — more accuracy, too — thanks to Stanley's balanced 2° toe-in design. Choice of curved or ripping claw. \$3.50* (16 oz.)

*Western prices slightly higher.



No. X 226

FINEST RULE! Take direct readings of inside measurements with the Stanley "100 Plus" Zig Zag Extension Rule. Slide and rule reading centered at one point. 6' rule, 8" slide. \$2.75 wherever fine tools are sold.

THE TOOL BOX OF THE WORLD

STANLEY Tools

HARDWARE • ELECTRIC TOOLS • STEEL STRAPPING • STEEL



USE COUPON for copy of STANLEY TOOL GUIDE and free literature about Stanley and "Yankee" Tools.

STANLEY TOOLS, 394 Elm Street, New Britain, Conn. or
STANLEY TOOL CO. of CANADA, 394 Stanley Street, Roxton Pond, Quebec

- Please send me STANLEY TOOL GUIDE for which I enclose 25¢.
- Please send me FREE STANLEY DOWELING JIG FOLDER P51A.
- Please send me FREE "YANKEE" TOOL BOOK Y41.

Name _____

Address _____

City _____ Zone _____ State _____

WORKING WITH DOWELS?

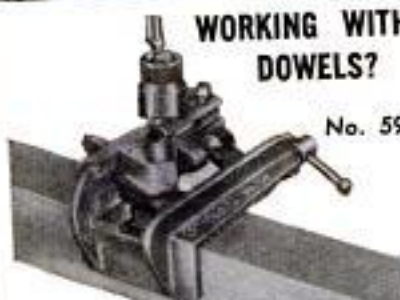

No. 59

Do doweled joints or dowel holes give you trouble? Try the Stanley Doweling Jig. You'll bore holes of exact accuracy in edge, end or surface of work. You can't go wrong (see illustration). \$5.75* with 6 different sized guides, wherever fine tools are sold.

Do-it-yourself America!



**FOR ONLY
\$39.95**

No. 0888 — same but without
chuck or accessories . . . \$29.95

BUILT FOR PERFORMANCE

In every detail, this great new tool is designed to give you outstanding performance. For instance, all attachments are driven directly from the spindle (the chuck is used for drilling only). Thus the load is kept close to the bearings — wear and vibration are minimized. Other features include: Rugged, Universal motor with full 4.0 amp. rating . . . N.L. Speed of 3200 r.p.m. . . . drilling capacity $\frac{3}{8}$ " in metal — 1" in wood . . . trigger switch with lock and automatic release. See for yourself the hundreds of ways this powerful new Millers Falls tool can save you time, work and money. Buy the 888 at your hardware dealer's. If he does not have it in stock, send us his name and we will gladly see that you are supplied.



FREE at your hardware store — Special Catalog on the 888 Power Unit and all its attachments. Or available direct on request.

MILLERS FALLS COMPANY
Dept. PM-3
Greenfield, Mass.



Complete with . . .

- $\frac{3}{8}$ -inch Jacobs Geared Key Chuck
- 6-inch Rubber Pad with Conical Lock Nut
- Three 6-inch Sanding Discs
- 6-inch Lamb's Wool Polishing Bonnet
- Spindle Arbor for use with buffing, grinding and wire brush wheels with $\frac{1}{2}$ " holes
- Reversible Side Handle

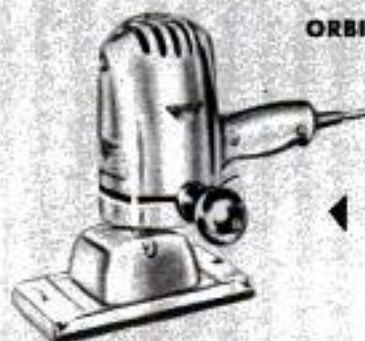

ORBITAL SANDER

A must for fine finishing. Mounts directly on the 888 Power Unit's Spindle and Spindle Housing. Uses standard abrasive sheets cut in thirds — produces "mirror" finish equal to finest cabinet work. No. 882 Orbital Sander \$15.50

6-INCH PORTABLE SAW

Powered by the 888, this becomes a really fine portable saw. Cut is adjustable from 0" to $1\frac{7}{8}$ " deep. Built-in angle adjustment. Ripping guide. Telescoping saw guard. No. 8811 Portable Saw with 6" combination blade \$15.95



New MILLERS FALLS 888 Power Unit

.. the start of a complete power workshop for only **\$39⁹⁵**

Greatest time and work saver ever developed! That's what you'll say when you realize how many projects become quick and easy with this new Millers Falls 888 Power Unit and its amazing assortment of beautifully engineered attachments. Just as it comes, the 888 is three tools in one — a powerful (4.0 amps.) $\frac{3}{8}$ " drill — a 6" disc sander — and a 6" polisher. Add its attachments, and you

have all the power tools shown here. Yet you pay only a fraction of what it would cost to buy individually powered tools for the same work. The 888 and its attachments are expertly designed and built to do a real man-sized job. See and try them at your dealer's. Their fine performance will more than meet your expectations. Millers Falls Company, Dept. PM-3, Greenfield, Mass.

To complete your shop just add these inexpensive attachments as you need them

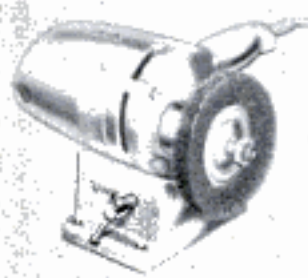

BENCH STAND
Changes the 888 from a portable to a fixed bench power unit. Used with Bench Sander, Bench Grinder, and Bench Jig Saw shown below and at right. Also ideal for use with buffing and wire brush wheels. No. 881 Bench Stand . . . **\$2.95**

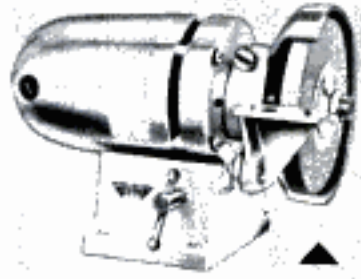

4-INCH BENCH GRINDER
Converts the 888 Power Unit, mounted on the 881 Stand, into a smooth-operating grinder. Adjustable work rest, 4" wheel and wheel arbor. No. 8810 Bench Grinder . . . **\$5.95**

6-INCH DISC BENCH SANDER
For accurate sanding and metal polishing at angles and even at compound angles. Table— $5\frac{3}{8}$ " x 8"—tilts to 45°. Disc attaches direct to the 888 spindle. Frame bolts to 881 Stand. Complete with angle gauge and abrasive disc. No. 889 Disc Sander . . . **\$7.95**

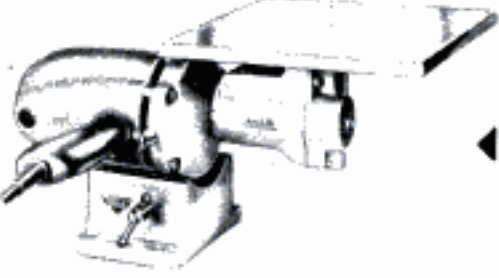
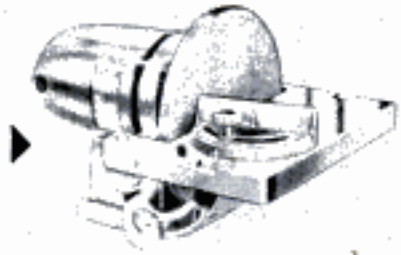

6-INCH BENCH SAW
Driven by the powerful 888 Power Unit, this saw makes cuts up to $1\frac{5}{8}$ " deep. Table top is $12\frac{1}{4}$ " x 13". Complete with cut-off and mitering gauge, rip fence, combination saw blade. No. 883 — Bench Saw . . . **\$22.95**
No. 884 — Table Extensions, each 3" wide . . . **\$4.95** per pair
No. 885 — Saw Guard . . . **\$2.45**

BENCH JIG SAW
For cutting curves and scroll work. This saw is made up of a heavy steel table 8" x 8" which clamps onto the shoe of the 886 Jig Saw. The 888 Power Unit and 881 Stand complete the assembly. No. 887 Jig Saw Table only . **\$1.75**

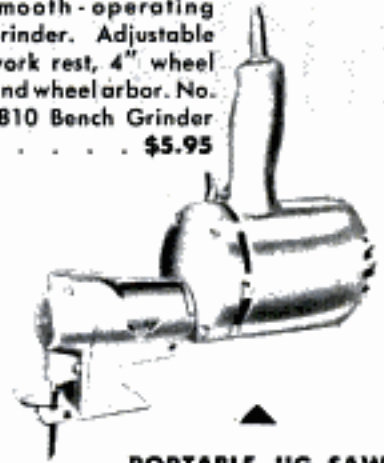
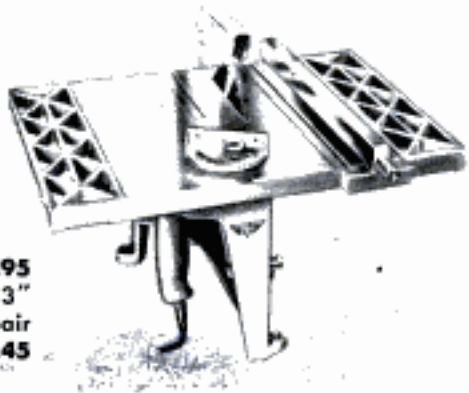

PORTABLE JIG SAW
Attached to the 888 Power Unit, this versatile tool saws curves in $\frac{3}{4}$ " wood or $\frac{1}{8}$ " metal. Cuts its own starting hole in wood. No. 886 Jig Saw with 4 blades . **\$9.95**



The Mark of Superiority

NOW! An *auto compass*

WITH THE SUPERIOR, SUPER-POWER
ALNICO 5 MAGNET



The
NEW

Airguide AUTO COMPASS



... leads the field with Alnico 5, the mighty magnet that has 10 times the coercive force and 3 times the residual induction of a steel magnet... far outlasts and outperforms steel... gives faster, steadier readings.



... uses an 8 magnet system of aircraft type compensators which has proven most effective in offsetting surrounding metal and electrical current. Adjusts easily and quickly to finest accuracy.



... offers greatest visibility from all angles with the distinct VISI-DOME dial. Clean white details on jet black dome, calibrated to 5°.



... mounts on windshield molding with a double ball and socket bracket which permits complete flexibility of adjustment for convenient reading while driving. Easily installed. Fits all cars.



... harmonizes perfectly with today's modern car interiors. Choice of two beautiful colors, soft gray or tan.



... available with or without light. Lighted model has a warm green indirect glow. With light (suitable for either 6 or 12 volt systems), \$6.95. Without light, \$5.95.

AT
LEADING
STORES

... makes driving more care-free and more fun.

Made and Guaranteed by

AIRGUIDE INSTRUMENT CO., P-4, CHICAGO 47

TV From A Mountaintop

(Continued from page 158)

at a bargain price. Since the mountain dwellers have an intense interest in weather, both present and future, an agreement was quickly reached. The Bureau furnished and installed valuable meteorological equipment without charge in return for observations taken by the resident TV engineers. Six observations are taken per day and immediately transmitted to the forecast center in Albuquerque by radio and telephone. Forecast service is available to the engineers at all times.

Ironically, the only damage to exposed equipment yet sustained was suffered by the weather equipment. The roof-top anemometer was mounted one evening just prior to a heavy storm. Midway of the blow, the anemometer abruptly stopped measuring wind speeds. Next morning the reason was apparent. The cups had been solidly encased and locked with ice and the wind had then unscrewed the instrument from its socket. A member of the staff estimated the wind that night, "At least 70 miles per hour—with ice." Later the equipment was reinstalled, more securely, but no subsequent storm has brought such violent conditions... yet.

The more severe storms cause some discomfort to personnel and some damage to electronic equipment, though no insurmountable problems have arisen. Staff members say that during periods of exceptionally heavy snow, and when winds are in excess of 50 miles per hour, they experience a feeling of lethargy and lassitude and can barely force themselves to perform the most essential tasks. One particular tube in the transmitters shows an alarming tendency to fail during the same type of weather. Since each replacement for this tube costs \$50 and since there are twelve of them in the circuit, one storm could cause \$600 in blown tubes—an item not to be taken lightly by the most affluent broadcasting company.

But civilization has definitely come to the mountain to stay, despite small reverses. They say the Sandia bears and goats are shopping for another home—they have been dispossessed by TV. ★★★

Shingle Repels Water

Water and water-borne dirt are repelled by an asbestos-cement siding shingle that is treated with a silicon coating. The coating has high resistance to sunlight, industrial fumes, ice, snow and below-freezing temperatures. No painting is ever necessary, according to the manufacturer.

.22 CAL. RIFLE

**over
and
under**

.410 GA. SHOTGUN

*The famous
all-purpose*

gun! **24**

SAVAGE MODEL

\$36⁹⁵

The choice of *either* an accurate .22 cal. rifle or a dependable .410 gauge shotgun is yours—*instantly*—when you're afield with the Savage Model 24 over-and-under.

It's the most versatile gun on the market today—ideal for fun, fur or feathers. Use the accurate .22 cal. *upper* barrel for plinking, informal target shooting or small furred game. Then, with a flick of the thumb, the dependable .410 ga. *lower* barrel is ready for flying pests, game or targets.

The Savage Model 24 "over-and-under" is as compact, lightweight, streamlined and good looking as it is practical—the perfect many-purpose gun for use on the farm, at camp, or for all-around utility. See it at your dealer's. Write for catalog of Savage, Stevens and Fox shotguns and rifles.

SAVAGE ARMS CORPORATION
Firearms Division Chicopee Falls, Mass.



Savage
TRADE MARK

SAVAGE · STEVENS · FOX Firearms



A lightweight, rugged, many-purpose over-and-under gun. Upper barrel shoots all .22 cal. rimfire cartridges; lower barrel, .410 shot shells. Single trigger. Single sighting plane. Selector button permits instant choice of either barrel. Two-way top opening lever. Walnut stock. Takedown.



First in the Field

Hints on How to Refinish Furniture

Step 1. Remove old finish—quickly, easily, with fast-acting Strypeeze. Brush on, let it set . . . off comes the old finish. (hint: sprinkle sawdust over Strypeeze. "Roll off" sawdust, Strypeeze and old finish.)



Step 2. Fill all holes, nicks — permanently and simply with Savogran Wood Putty. Tools easily, won't shrink. Now, sand entire surface with 6/0 sandpaper. (For cracks in plaster, use Savogran Crack Filler. It's the original patented quick-hardening water putty.)

Step 3. Refinish—before you start, be sure brush is clean. Savogran Kwikzee really cleans varnish brushes. Leaves no specks of old varnish, dirt in brush to mar finish. Apply stain, thinned shellac seal, then spar varnish or dull "rubbed effect" varnish in finishing.



SAVOGRAN

PRODUCTS . . . at better paint & hardware stores

Write for **FREE** helpful literature

LAN CO., Dept. 54, 25 Huntington Ave., Boston 16, Mass.

Animals Are Like Other People

(Continued from page 119)

to lighten the planes by dumping out all possible ballast — including me. Both drivers walked alongside to push the planes up the hill.

The end of that day arrived with gloom. We had gotten little more than halfway to our goal. Our food had run out. The gas supply was dangerously low. There was a strong possibility we might end up walking out on snowshoes.

Suddenly Holly shouted, "If Colter made it through here in winter with only a rifle and snowshoes, we sure can with these planes!" And we did! The first night was rough, but the next day we moved on to pick up emergency gas and food supplies. And the next day we also got our first shots of buffalo plodding through snow that reached a foot above their bellies.

The reaction of our horses to buffalo or grizzlies was critical. If they shied from them our trip would be a failure. The test came the first evening when two grizzlies started to hunt down the meadow toward our horses. The bears reared up on their hind legs and looked over the horses. I also reared up and looked more closely—this display could cost us \$150, the value of the two horses. Suddenly one horse decided the bears had moved close enough into his meadow. In one charge he made the bewildered bear beat a hasty retreat.

Buffalo gave us some more anxious moments while we were photographing their battles during the mating season. One ornery bull almost wiped out both of us and both horses because we inadvertently stood in the fresh trail that he was following. Other buffalo charged angrily toward me when I was on the treeless meadows. Retreating under such conditions would be foolish—the buffalo could easily outrun any human. Furthermore, they're more apt to chase you when you retreat. With my heart in my mouth, I stood still and watched each animal thunder toward me. And my bluff worked! Each one stopped about 20 feet away and paused long enough to let me retreat slowly backwards while still facing it.

Charging buffalo, striking rattlesnakes, prairie fires, prairie floods, snowplane trips—these were the more spectacular moments during the filming of *The Vanishing Prairie*. There were other less dramatic yet just as fascinating moments. They were characterized by one quality—*patience*. More than anything else, this film required an endless amount of patient spying on all prairie creatures to film their lives as they lived them. ★ ★ ★

The NEWEST and FINEST: Buck's 400 Series

CHROME EDGE CHISELS

You get: ★ The Finest Cutting Edges
★ Tough Tenite II Handles
with Inserted Steel Caps
★ Rust Proof Tools



Plastic pocket Kit—
4 Sizes \$9.40

Most complete line of Chisels,
Gauges and Carving Tools
CATALOG AVAILABLE!

BUCK BROS. INC.
RIVERLIN WORKS MILLBURY, MASS.

1" — \$2.60
¾" — \$2.40
½" — \$2.30
¼" — \$2.10

WHAT'S NEW ABOUT NEW



Everything! It's even more accurate, more versatile, easier to operate! See it at your dealer's now. For big, new, free booklet with 20 pages of pictures, data, drop a card to: SHOPSMTIH, Dept. 267-B, 12819 Coit Rd., Cleveland 8, Ohio



Start a NEW BUSINESS!

or Add to your present
Repair Business
SHARPEN DULL PIPE WRENCHES
PIPE TAPS & DIES
"GUM" CIRCULAR SAWS
Also MOTOR DRIVEN ROTARY HONE
Write for Information

J. C. MOORE INDUSTRIES
BOX # 276 FREDONIA, PA.



PRICES
from **\$39.00**

SEA LEGS
QUALITY BOAT KITS F.O.B. DEFIANCE, OHIO
WRITE FOR FREE LITERATURE
PENNEY WOODCRAFT INDUSTRIES
1301-09 Ottawa Ave., Dept. 9-M Defiance, Ohio



NEW WAY TO CUT PERFECT GROOVES WITH CIRCLE SAW!

Just dial any of 40 cuts. Parallel, clean, no sanding! Only
Leave on saw for regular cuts. For ½, ¾, ¾ and **\$4.95**
1" arbors. At dealer's or order direct! per set
Send for free booklet

WARREN DADO WASHERS CO.

Dept. #29 P.O. Box 98, Detroit 2, Mich.

GET THIS STRAIGHT you can't beat an EMPIRE LEVEL



For improved accuracy, better visibility, less breakage, use the new Empire 9" aluminum Torpedo pocket level with machined bottom groove and protected, easy-reading vials. See your dealer today for all-purpose Empire Levels.

EMPIRE
LEVEL MFG. CO. | 10930 W. Potter Rd., Dept. PM
Milwaukee 13, Wisconsin

FREE

SEND FOR THE

1955

308-PAGE

value-packed **ALLIED**
TV & RADIO CATALOG
world's most complete
ELECTRONIC SUPPLY GUIDE



Everything for Experimenters,
Builders, Amateurs, Servicemen,
Engineers & Hi-Fi Specialists

Get ALLIED's big 308-page Catalog featuring the world's largest selections of latest top-quality electronic equipment at lowest, money-saving prices. See the newest in custom TV chassis, antennas and accessories; FM and AM tuners; High Fidelity systems and components; recorders and phono equipment; Amateur supplies; test instruments; builders' kits; industrial electronic supplies — plus thousands of parts, tubes, tools and books. Get *everything*, get *more* for your money—send today for your FREE 1955 ALLIED Catalog!

SAVE ON
EVERYTHING



WORLD'S
LARGEST
STOCKS

Ultra-modern facilities to
SERVE YOU BEST

Send
for FREE
Catalog

ALLIED RADIO

ALLIED RADIO CORP., Dept. 5-JJ-4
100 N. Western Ave., Chicago 80, Illinois

Rush FREE 1955 ALLIED 308-Page Catalog.

Name _____

Address _____

City _____ Zone _____ State _____



Painting's a

SNAP

with

DURAVAL

A TEXOLITE® PAINT PRODUCT

- 23 ready-to-use colors; over 100 decorator blends; many more you can create yourself from just two colors.
- It's rubberized—it's scrubberized.
- Dust-free in just 20 minutes...leaves no "painty" odor; minimizes brush marks.
- Thrifty—one gallon covers up to 450 sq. feet. Brushes or rollers come clean in ordinary water.

For further information see your TEXOLITE paint dealer, or write Dept. PM 9, 300 West Adams Street, Chicago 6, Illinois.

*T. M. Reg. U.S. Pat. Off.

U.S. O.

UNITED STATES GYPSUM

UNITED STATES GYPSUM

the greatest name in building

Clymer Tests the Cadillac

(Continued from page 123)

speeds with no evidence of vibration. It develops a maximum of 230-horsepower with an 8.25 compression ratio and 331-cubic-inch displacement.

According to the factory, no basic change was made to get the additional 20 horsepower over the 1953 rating of 210 at 4000 revolutions per minute. But the 1954 engine gets its advertised 230 horsepower at the higher engine speed of 4400 revolutions per minute. It has the same compression ratio, same internal dimensions, same four-barrel carburetor and dual exhaust system. New are a 12-volt ignition system and electrical components.

Cadillac is a fast road car. The speedometer needle pushed above the maximum 110 mile-per-hour mark on the dial during long, straight stretches. The speedometer is fast by about five percent.

The 1954 brakes have 12-inch ribbed, cast-iron drums and 211.55 square inches of effective lining area. Although this area is considerably less than the 1953 version (258.5 square inches), the cutting of a ½-inch groove in the primary lining (reducing total area) has provided more even heat distribution and therefore more effective braking. The brakes showed no evidence of fading.

Both test cars were loaded with all the electrical accessories available. With this heavy load, the 12-volt system is a definite improvement over the 6-volt system.

The four-speed Hydra-Matic permits rear-axle ratios of 3.07 (standard) and 3.36 (in air-conditioned cars), both being excellent for gasoline economy.

Cadillac's all-new styling gives an unusually low appearance and it grows on a person the longer he drives the car, especially the wrap-around windshield. There is a sturdy feeling about the doors, hood and other body parts. Doors open and close easily. No rattles, squeaks or leaks developed during my tests. The new frame with its double-cross bracing eliminates twist and makes body and chassis more rigid.

Though the hood is long, wide and high, vision directly in front of the wheels is good. The wrap-around windshield and the large window area afford better-than-ever vision.

The front grille is large and massive. I do not like the two bullet-shaped projections at the front of the bumper. In pushing another car or in parking, these projections do not always line up with the opposing bumper. I cannot see that they

(Continued to page 238)

MAKE BIG MONEY

Sharpening Lawn Mowers...

SPARE OR FULL TIME

Mr. C. E. Hardy of Missouri says, "I am doing a fine business with the Universal Grinder. One Customer sends another. I spent 40c for a newspaper ad and have done nearly \$500 worth of business." G.E. of Ark. says, "I have had my Universal Grinder 2 months and made a net profit of \$227."



ONLY ON THE UNIVERSAL LAWN MOWER GRINDER

... can the inside face and edge of the stationary blade, as well as the reel blades, be ground to proper clearance ALL IN ONE SET-UP, without removing any blade from either hand or power mower. Send Today for Free Details. **ROGERS MFG. CO.** Dept. M-94 LINDSEY, OHIO

Find HIDDEN TREASURES

GEIGER COUNTERS (as shown) for Uranium Detection. **TREASURE DETECTORS** for gold, silver, etc. Lightweight, ultra sensitive. **Nada finder.** Also Mineralights for Tungsten.

• INFORMATION FREE •

Detectron Co.
5420 Vineland, North Hollywood, Calif

Kar-Lite
lights your way
when you
park in the dark!

Time Switch turns headlights off automatically after you leave your car. Easy to install. At automotive supply stores, or write for nearest dealer.

\$595

M. H. RHODES, INC.
HARTFORD 6, CONNECTICUT

REAL PROTECTION

Designed and built to give lasting protection to your fine tools. Free Catalog.

GERSTNER TOOL CHESTS
454 Columbia St., Dayton 7, Ohio

WORLD'S BEST SMALL TRENCHERS

Portable **DITCH-WITCH** digs 2" to 6" clean, even ditches to 36" depth in all types of soil. Complete unit—self propelled—outdigs 8 men. Four rugged models.

Write for illustrated literature.
THE CHARLES MACHINE WORKS
620 B Street Perry, Oklahoma

Build this 14-foot FIBERGLAS PLASTIC BOAT

only **\$197.50**

No experience needed; can be assembled in 12 hours with ordinary household tools. Simple 1-2-3 instructions make assembly a snap. 52" beam, 16" depth. Kit complete except paint. Cross members and seats of highest quality hardwood. Constructed of pressure molded plastic sheets. **DENTPROOF . . . ROTPROOF . . . NO MAINTENANCE.** Write for illustrated folder. Available assembled only \$295.00.

Plastic sheets for boat parts also available. Write . . .

UTILITY PLASTICS CO.
1544 E. 6th Dept. P.M. Tulsa, Okla.



Free Power Tool Book

60 PAGES OF POWER TOOLS and accessories for the beginner, advanced hobbyist and production shop. Portable electric tools, wood and metal working equipment, welders, motors, etc. Wards Power-Kraft tools plus other famous name equipment including: Mall, Shopsmith, Beaver, Skilsaw, Stanley, Black & Decker, Logan and Westinghouse. Helpful "Buying Guides" on most major power tools plus photos showing the tools in action make it a valuable reference book.



Circular Saw Set . . . Only \$2.00

Special Offer! We'd like you to get acquainted with Wards Power Tool Book. That's why we're offering this handy Circular Saw Set for only \$2 Postpaid, if you request our free catalog before Oct. 15. Quickly and accurately sets crosscut, rip and combination blades up to 10 in. diam. All metal body, tool steel anvil and punch. Complete instructions are included.

Montgomery Ward

Chicago 7, Ill. • Baltimore 32, Md. • Albany 1, N. Y.
St. Paul 1, Minn. • Denver 17, Colo.
Kansas City 11, Mo. • Portland 10, Ore.
Oakland 16, Cal. • Ft. Worth 1, Tex.

Clip and mail to nearest city above—NOW!

MONTGOMERY WARD, Dept. WT-7M9

Please send Wards free Power Tool Book.

Enclosed find \$2. Send me Circular Saw Set and Wards Free Power Tool Book.

Name.....
(Please PRINT Plainly)

Street Address or
Route and Box No.....

Post Office.....State.....

The easy way to paint!

Speedy Sprayer



Favorite of home owners and craftsmen for 20 years! SPEEDY SPRAYER gives your work that professional paint finish everyone admires. Sprays paint, enamel, varnish, lacquer, etc. . . . 4 to 7 times faster than hand brushing! Lightweight, portable, uses any 1/4 H.P. motor. Improved diaphragm principle assures clean, oil-free air. You'll find dozens of time and money saving uses for SPEEDY SPRAYER, including spraying insecticides 2-4-D and DDT. Complete outfit, without motor, only \$36.50.

At leading hardware, lumber, and auto supply dealers. FREE—write for handy booklet "How to Spray."

W. R. BROWN CORPORATION
2635 N. Normandy • Chicago 35, Ill.

ONLY **\$36.50**
LESS MOTOR

For work-free masonry drilling



Use new
CARBOLOY
"LIVE-SPIRAL"
Masonry Drill

Even drills concrete like wood!

Now . . . rotary drill any masonry in your home with ease! New Carboly "Live-Spiral" Masonry Drills bite cleanly through brick, slate, tile, concrete or cast stone. Won't stick, stall, bind.

Super-hard carbide tip gives extra-long use. Lets you drill holes at any angle . . . to bolt down washer, dryer, tubs . . . fasten hooks, screens, awnings, trellises . . . attach bath, kitchen fixtures, partitions, furring strips, etc.

Get "Handy-Man" Kit today. Contains 3 "Live-Spiral" Drills; 1/4", 3/8", 1/2". Fit 1/4" chucks. \$6.65 per kit. Send coupon, or see your hardware dealer.

"Carboly" and "Live-Spiral" are registered trademarks of the Carboly Department of General Electric Company



MAIL THIS COUPON TODAY

CARBOLOY

DEPARTMENT OF GENERAL ELECTRIC COMPANY

11185 E. 8 Mile Blvd., Detroit 32, Michigan

Send me Handy-Man Kits at \$6.65 per kit, postpaid. Enclosed is check or money order for _____ Send C.O.D. Send me free folder.

Name _____

Address _____

City _____ Zone _____ State _____



Chicago Daily News photo

TV Aids Elevator Starter

Closed-circuit TV in Chicago's Merchandise Mart lets the elevator starter gauge the traffic on the second floor as well as the first. Since the building has entrances on both levels, traffic is equally divided. A camera on the second floor relays a picture to a 21-inch receiver before the starter on the first floor. He looks up at his screen, watches a crowd gather before the second-floor elevators and knows just when to send up a car.

Extend Oil Life

Longer life for the oil in your car is predicted by the Canadian National Research Council. Experiments show that the addition of lithium, potassium, magnesium or their salts or oxides, in certain quantities, has the effect of braking the oxidation that gradually destroys the properties of ordinary motor oil. A piece of protective metal could be built into the oil filter.

Curled Strips Bind Notebook



Curled ends of plastic binding strips for a notebook make the addition or withdrawal of pages an easy task. The sturdy strips hold the binder together firmly. The new twist in plastic is from France.

Clean both sides INDOORS!

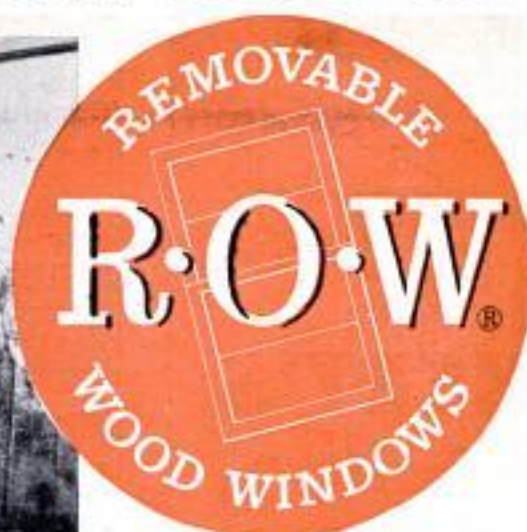

You can clean or paint both sides of a removable R.O.W. window from *inside* the house—no need for ladders or sitting on sills.

See your local lumber dealer or write for free folders.

R.O.W. SALES CO.

1338-80 ACADEMY AVENUE • FERNDALE 20, MICHIGAN

Please send me, without obligation, your free folders.

Name _____

Address _____

City _____ Zone _____ State _____

R.O.W. is the registered trade-mark of the R.O.W. Sales Co.

SET-UP - KNOCKDOWN SAWHORSE with *Jiffy* BRACKETS



No nails or bolts... use 2x4's for legs, 2x4 or wider for crossbar. Rugged, sturdy, easy to move, saves storage space. Sold by hardware and building material dealers, or order direct

GRAND HAVEN STAMPED PRODUCTS CO., Grand Haven, Mich.

make your own *Gems* 29⁵⁰ F.O.B.

The Gem Maker comes complete with all necessary equipment, including a super-charged diamond blade for sawing, and all wheels for grinding, shaping and polishing; also complete instructions. The complete equipment as shown, less motor and belt, for only \$29.50, f.o.b., Burlington, Wisconsin. Write today for information and literature.

B & I MANUFACTURING CO.
Dept. 5 Burlington, Wis.

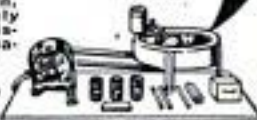

REMOVING PAINT?

Do it the easy way with

WONDER-PASTE

Wonder-Paste makes paint, varnish, enamel come off easily—not coat by coat, but all in one scraping. Clings to upright surfaces. Use it on furniture, trim, floors, etc. At paint and hardware stores.

Write for leaflet and advice on your removing problem

Wilson-Imperial Co., 119 Chestnut St., Newark 5, N. J.

send for FREE CATALOG



America's Foremost money-making MECHANICS' TOOLS

It's easy to own the same "pay-off" tools used and endorsed by America's top-earning mechanics throughout the automotive, aviation and industrial fields! Snap-on tools help you handle every repair job faster, easier, better. And they LAST... pay for themselves over and over again! Start building your own tool set now with basic Snap-on units—add others any time. Genuine Snap-on tools are never sold in stores—direct to users only. Mail coupon for free catalog.

Snap-on Tools
THE CHOICE OF BETTER MECHANICS

Snap-on Tools Corporation
8062-1 28th Ave., Kenosha, Wis.

Send me free catalog. Occupation _____

Name _____

Address _____

City _____ Zone _____ State _____

CUT FUEL BILLS

UP TO
40%
with

TORIDHEET'S

Direct Heating Action



Unlike conventional heating units TORIDHEET'S flames actually contact the walls of the combustion chamber, communicating their tremendous heat directly to the surfaces which heat the water or air.

This direct heating action insures the maximum efficiency from your fuel. Think what this means to you—in dollars and cents.

COMPARATIVE EFFICIENCY TABLES

Conventional Coal Furnace	Oil in Ordinary Burner	Oil in Toridheet Burner
Heat	Heat	Heat
Wasted Gases	Wasted Gases	Heat
Soot and Carbon	Carbon	Wasted Gases
Ashes and Cinders		

Complete furnaces or conversion burners—oil or gas

For Fuel Savings up to **40%**
MAIL THIS COUPON TODAY!

TORIDHEET DIVISION

Cleveland Steel Products Corporation
16027 Brookpark Rd. • Cleveland 11, Ohio

Please send me complete facts on the TORIDHEET Wall Flame burner with direct heating action.

Name _____

Address _____

City _____ Zone _____ State _____

serve any purpose other than ornamental. They are certainly not practical and should be eliminated in favor of a bumper that would offer more front-end protection.

The trunk is large and the self-locking lid is easy to open and close. Dual mufflers are standard. Twin exhaust pipes extend through each end of the rear bumper. This adds to appearance and the dual exhaust does improve performance somewhat.

The instrument panel is massive and its top is covered with a fabric to eliminate sun glare. The edge, although rather sharp, is cushioned with sponge rubber to afford some protection in case of impact. I don't like the red warning light that indicates battery discharge. Needle gauges are better.

My test models were equipped with the Autronic Eye headlight-dimming unit. While this is convenient at times, it occasionally operates unnecessarily and is annoying. I found that the brilliant lights of service stations would sometimes cause dimming of lights.

GM's air-conditioning system is somewhat complicated. The body seems to be honeycombed with ducts, scoops and vents, but the unit itself is highly efficient and simple to operate. An evaporator and two blowers are located in the trunk and there is a fresh-air intake on each side of the body near the rear window. A control switch puts the air conditioner in operation within 3 to 5 minutes. Two blowers, one for each side of the passenger compartment, control the amount of cool air. It is a little noisy when the blowers are on high.

The car took the bumps with a feeling of security and the ride is certainly an easy one. The front end is still somewhat soft for the driver who likes to corner fast. The car "floats" over the rough spots with no tendency to hop around on corners or over sharp bumps.

I like the power-steering unit as there is always a slight pressure on the wheel. This long-and-low car, with its large body, is easier to handle and park than you might expect. Power steering is standard on all Cadillacs this year. The steering ratio of four turns from lock to lock is satisfactory and steering is almost effortless. ★ ★ ★

Aircraft Industry Tops Automotive

Top employer of manufacturing workers in the United States is now the aircraft industry, with 823,000 on the payrolls. The automobile industry, which formerly led, employs 786,000. Once before, during World War II, the aircraft industry ranked first. But it fell to 16th place in 1946.

**RELIEVES
HEADACHE
NEURALGIA
NEURITIS PAIN**

FAST



Here's Why...

Anacin® is like a doctor's prescription. That is, Anacin contains not one but a combination of medically proved active ingredients. Anacin is specially compounded to give **FAST, LONG LASTING** relief. Don't wait. Buy Anacin today.



MAGNETS 225 lb. PULL
GENUINE ALNICO—NEVER WEAKENS

AMAZING, PERMANENT MAGNETS—WILL NOT WEAKEN! NON-ELECTRIC

Retrieve guns, tackle, tools and other steel items from lake, river, piling banks, drains or other hard-to-reach spots. Recover drills, taps, etc. from sawdust. Clear alley of harmful ticks, nails. Many other uses. Pays for itself quickly. **GUARANTEED.** Try any magnet one week. Money refunded if you are not well pleased.

No. M-725 (Weights 54 oz.) Has pull of 225 lbs. on steel block. \$15.00
No. M-675 (Weights 49 oz.) Has pull of 175 lbs. on steel block. \$10.50
No. M-550 (Weights 41 oz.) Has pull of 150 lbs. on steel block. \$ 8.50
No. M-500 (Weights 15 oz.) Has pull of 50 lbs. on steel block. \$ 4.00
No. M-30 Hobbyist assortment of six small magnets. \$ 1.50
Send Money Order or Check. We pay postage. No C.O.D.'s.

MIAMI MAGNET COMPANY, 3240 N. W. 27th Ave., Miami 42, Fla.

COLOR PRINTS 32¢—big, brilliant Kodacolor Prints, 3½x5 inches, from 2x2 slides—only 32 cents each, plus 30 cents for negative from each slide from which prints are to be made. Minimum charge, \$1. Order from your dealer.

Eastman Kodak Company, Rochester 4, N. Y.

**MODERN
LAWN MOWER
SHARPENER**

Service departments of leading Lawn Mower manufacturers use the Modern Lawn Mower Sharpener. One lever moves lawn mower into grinding position. Gasoline and oil remain in engine while sharpening, no dismantling of wheels, roller or handle. The Modern is a precision bed knife grinder—no extra grinder to buy. Imitated but never equaled—Compare before you buy. If it isn't a Modern it can't be Modern.

(Prices subject to change without notice)

MODERN MFG. CO.

160 N. Fair Oaks - Pasadena 1, Calif.



WRITE FOR
FREE BOOKLET
10¢

\$263.00
with motor
F.O.B.
PASADENA

here's why
Master Padlocks
are the **WORLD'S
STRONGEST**

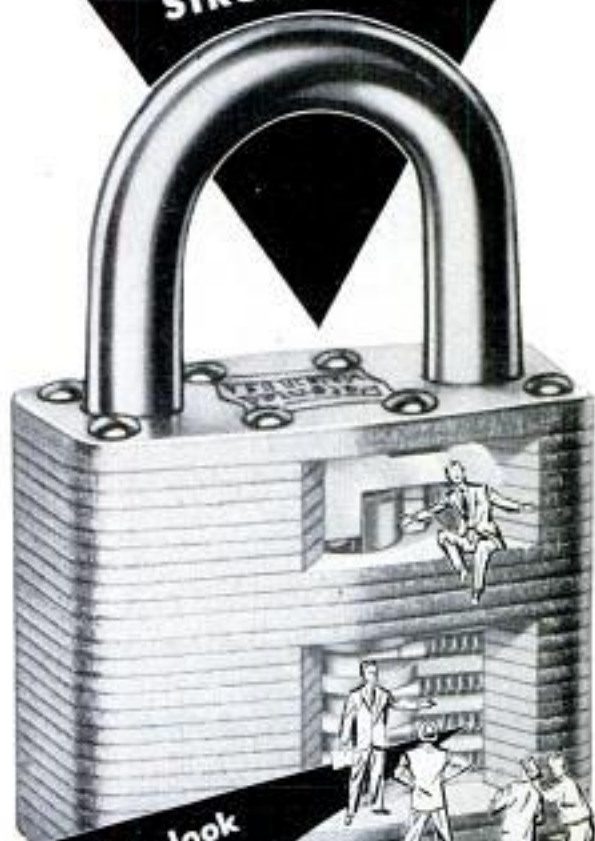

take a look
INSIDE!

- Laminated steel case for maximum strength!
- Genuine pin tumbler security!
- Precision-built patented features!
- Available keyed-alike for all your padlock needs!

The best padlock protection you can buy comes in a laminated steel case with genuine pin tumbler mechanism — and that's **MASTER Padlocks**, proved the world's strongest, the world over!

MASTER PADLOCKS — 25¢ to \$3.00
at hardware stores everywhere.

Master Padlocks
WORLD'S STRONGEST



MASTER LOCK CO. Milwaukee 45, Wisconsin

**Richer, Creamier,
AERO SHAVE
Saves 20¢ a Can!**

**Just Push Valve
...Out Comes
Lather!**



- Richer, Creamier Lather
- Quicker, Slicker Shaves
- No Brush Needed
- No Greasy Cream
- 3 Beard Softeners
- Contains Lanolin
- Turret Top Won't Leak

Not 79¢... Not 69¢ Only **59¢**

AERO SHAVE Lather Bomb

Also economical King Size—12 oz. only 98¢

NOW—build this practical
**SWING-UP
GARAGE
DOOR**
at a
major
saving

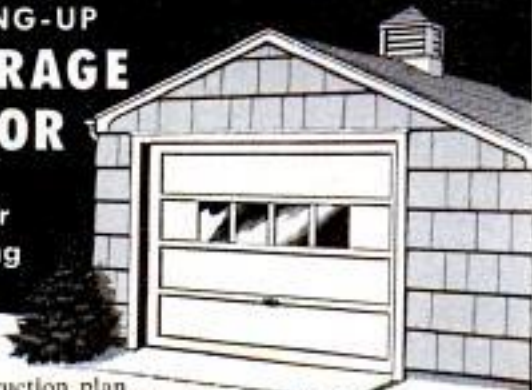

The construction plan for this door is adaptable to openings of many sizes. Light and easy to operate, the door swings up on standard overhead garage door hardware. *You build without blueprints!* Our simplified Easi-Bild* Pattern No. 86 shows you how to cut each piece to exact size—specifies all materials required—shows how to assemble and install the finished door.

You save up to two-thirds of the usual cost!

The major material used is Homasote—the oldest and strongest insulating-building board on the market—sold by dealers throughout the United States and Canada.

NEW! Three illustrated folders suggesting 18 practical *make-it-at-home* projects ranging from the attic to the cellar. Clip or copy the coupon—mail today for pattern and/or folders. *T. M. Reg. Easi-Bild Pattern Company

MAKE it at home...with HOMASOTE

HOMASOTE CO., Dept. 83, Trenton 3, N. J.

I enclose: 10¢ for three folders 50¢ for Pattern #86

NAME.....

ADDRESS.....

CITY.....STATE.....

My lumber dealer is.....



Cadillac's air conditioner introduces cooled air into body through four outlets similar to those on planes

Owners Report on the Cadillac

(Continued from page 126)

half are businessmen (33 percent owning their own business and 20 percent being executives in a business). Professional men (doctors, lawyers, dentists) make up another 14 percent of the owners. Salesmen account for 7 percent and retired owners for another 6 percent. Included among the miscellaneous occupations was one mechanic in an automobile factory, the only factory worker in the survey.

Most of the owners have two or more cars in the family, 69 percent to be exact. The most popular second car is another Cadillac with 26 percent owning two of them. Ford was next with 15 percent, Chevrolet third with 14 percent and Oldsmobile fourth with 11 percent. A tiny percentage own a sports model as the second car.

When asked what they use the second car for, owners gave a variety of answers.

(Continued to page 242)

Apparently Cadillac owners do wash their own cars. Many said the "waffle" grille is too hard to clean



**PICTURED PERFECTION —
BULLDOG
TRAILER PARKING JACKS!**

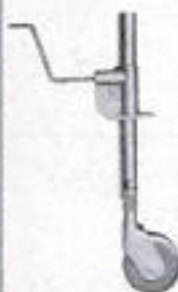

MODEL 50-P makes hitching or parking trailers an easy, one-man job. Rides flush. Easily installed. \$15.37 complete, Fed. Ex. Tax included, F. O. B. Wausau.

Manufacturers of a complete line of trailer axles, couplers and jacks. Write for Brochure 13-1

HAMMER BLOW TOOL COMPANY
"As old as the Industry!"
WAUSAU, WISCONSIN

**New Easy Way to
DRY CLEAN RUGS**



**Only AMERICAN
has it!**

... Earn Big Money!

New wonder-way to dry clean rugs can start you earning *big money* every day! Full or part time. Homes, stores, offices are prospects! Amazing American ALM-13 machine with exclusive new Float-Action Whirling Brush does the work—so easy a child can operate it! Just spread dry-cleaning material on rug . . . then guide machine while brush whirls this material thoroughly into fibers of rug. Out comes grease, grime and deep-down dirt! Pick up with vacuum. Rug can be used immediately. Clean rugs on location. No hand scrubbing. Does professional job in a jiffy . . . makes rugs new-looking! Minimum investment. Write today for details!

Make extra profits—use same machine to clean floors, too! Easy-to-use ALM-13 does five floor jobs with no-tool attachments . . . scrubbing, steel wooling, buffing, polishing, waxing . . . wood, rubber, asphalt, linoleum . . . make money on *all* floors!



BIG PAY SANDING FLOORS

Get ahead in fast-growing building field! Be a floor surfacing contractor and sand both new and old floors. No experience needed. High earnings, steady work with a future! Write for booklet "Opportunities in Floor Surfacing," enclosing 25 cents in coin or stamps to cover handling.

**AMERICAN
FLOOR MACHINES**

SEND!

The American Floor Surfacing Machine Co.
535 So. St. Clair St., Toledo 3, Ohio

- Send full details on new easy way to Dry Clean Rugs and make money!
- Here is 25c in stamps or coin for booklet "Opportunities in Floor Surfacing," telling me how I can start my own floor sanding business.

Name _____

Street _____

City _____ State _____

EASY MONEY FOR YOU!
Sell the Wheelhorse.
Dealerships open! Write today

Wheelhorse

Makes gardening easier — adds to your leisure!

FREE Catalog! Send Postcard today!

Only **\$149.50**
2 h.p. model

You'll buy a Wheelhorse when you compare price . . . construction . . . design and ease of handling! Easy to change attachments help you plow, cultivate, harrow, haul, spray, mow, saw, cut, roll, plow snow. Guaranteed! 2, 2½, 3 and 3½ h.p. models. Write!

POND COMPANY

2643-P9 Dixie Way North, South Bend 17, Ind.



HOW TO QUIET YOUR CAR

—and do "1001" jobs around the house



FREE "Tips to the Handyman" folder shows over 40 ways you can use L·O·F Super·Fine.

This handy free folder shows you how to do a variety of jobs around the house with fine-fibered, easy-to-apply Super·Fine Fiber·Glass. A few of the suggested uses include: **Hot-water tank wrap** • **Garage-wall insulation** • **Milk-box liner** • **Comforter padding** • **Shrubby wrap** • **Auto tool wrap**.

Buy Super·Fine from your local hardware, lumber, or building supply dealer.



FIBER·GLASS

Libbey-Owens-Ford Glass Company
Fiber-Glass Division
48-94 Wayne Building
Toledo 3, Ohio

Please send me, FREE "Tips to the Handyman" folder, showing how to quiet my car and make over 40 household improvements with Super·Fine Fiber·Glass.

Name _____
Address _____
City _____ Zone _____ State _____

Here are a few answers taken at random: "Pleasure." "Business and sport trips." "Fishing and hunting." "Running errands."

Owners Like the Cad's Fins

By an outstanding margin, Cadillac owners expressed a liking of the car's "trademark," its tail fins. A mere 7 percent did not like them, but many of this minority found fault only with the 1954 version, not

1954 CADILLAC Specifications

ENGINE

Type 8-cyl., V-type, OHV
Bore and stroke 3.8125 x 3.625 in.
Piston displacement... 331 cu. in.
Compression ratio... 8.25:1
Brake horsepower.... 230 at 4400 r.p.m.
Transmission Hydra-Matic, Dual-Range

CAPACITIES

Oil 5 qt.
Water (with heater)... 22 qt.
Gasoline 20 gal.

GENERAL

	Series 62	Series 60 Special
Steering ratio (over-all)	21.3:1 (power steering std.)	
Steering wheel, lock-to-lock	4 turns	
Turning diameter (curb to curb).....	45.1 ft.	46.3 ft.
Brakes	conventional hydraulic	
Tire size.....	8.00 x 15	
Recommended pressures	24 lb. front and rear	
Shipping weight (4-dr.)	4330 lb.	4490 lb.
Wheelbase	129 in.	133 in.
Tread, front.....	60 in.	
Tread, rear.....	63.1 in.	
Height, over-all (4-dr. unladen).....	64.1 in.	
Width, over-all (4-dr.).....	80.0 in.	
Length, over-all (4-dr.).....	216.4 in.	227.4
Rear clearance.....	6.15 in.	

INTERIOR DIMENSIONS

Front-seat width.....	63.9 in.	64.2
Rear-seat width.....	65.2 in.	
Headroom, front.....	35.8 in.	
Headroom, rear.....	35.6 in.	
Legroom, front.....	43.2 in.	
Legroom, rear.....	45.8 in.	

the tail-fin idea. It is looked upon as a distinctive mark by most owners. This year's design also has a functional purpose in that both fins can be seen by the driver when backing up.

"It is easy to tell exactly where your rear end is when backing up."—Kansas City, Mo., advertising man.

"Distinctive in appearance."—Perth Amboy, N. J., doctor.

Here are some of the objectors:

"Fins too big this year. Looked better on 1953 models."—Portland, Ore., dentist.

"Easily bumped when parking."—Cleveland, Ohio, salesman.

"Too ostentatious."—Worcester, Mass., consulting engineer.

(Continued to page 244)

DRILL SAW INTERNATIONAL REAM CUT

HI SPEED COPE SAW DRILL BIT



DRILL, SAW, REAM . . . metal, pipe, wood, plastic, Transite, etc. Use with any electric drill, slow drill press, lathe or milling machine. Drills own starting hole—upper part of bit is used to cut, saw or ream circles, ovals, squares or scrolls. Easy to operate. Ideal for carpenters, mechanics, electricians, plumbers, hobbyists, many others. Abrasive resistant, high speed steel. Flutes ground from solid. Will withstand severe continuous use without breaking. Resharp-ened at no charge. Takes place of up to \$50 in tools. 1/4" diameter, 2" cutting sections, total length 3 1/2". Available in three types—All Purpose, Wood, Heavy Metal. Specify type needed. Set of 3, \$11.50. Details on request. Shipped same day. Money-back guarantee. Dealer inquiries invited. **ORDER NOW! SEND CASH, CHECK OR MONEY ORDER.**

only \$3.95 POST PAID

Manufactured and distributed by **INTERNATIONAL TWIST DRILL CORP.** 618 Wyandotte, Rm. 630, Kansas City 5, Mo.

MONEY for MEN ALL DATA FREE

THE PLASTEX Industry needs manufacturers on small scale and for big production of Lamp and Clock Stands, Art Goods and Novelties in Plastex and Marble imitation. Experience unnecessary. The material makes regular 10¢ store sellers. Rubber moulds furnished for speed production. Small investment brings good returns. We are now placing big Chain Store Orders with manufacturers. Ambitious men have chance for real prosperity. Our Free booklet will interest and benefit you.

PLASTEX INDUSTRIES, Dept. A
3400 Third Ave. New York 56, N. Y.

STARRETT "Tools and Rules" BOOK

Describes and illustrates the precision methods skilled mechanics use. Only one dime. Write Dept. AP.

THE L. S. STARRETT CO., Athol, Mass., U. S. A.

"SNOOPER" GEIGER COUNTER

Super-sensitive! Only 1 1/4 lbs! Fits pocket—uses flashlight battery. Find a fortune in uranium. Order Now! Send \$5.00, balance C.O.D. **MONEY BACK GUARANTEE. FREE CATALOG**—scintillator and larger uranium and metal detectors **DEALERS WANTED.**

PRECISION RADIATION INSTRUMENTS
2235 PM S. LA BREA, LOS ANGELES 16, CALIF.

2995 COMPLETE

Say You Saw It in Popular Mechanics

KING MIDGET AUTOMOBILE



EARN YOUR OWN KING MIDGET. We want rider agents to demonstrate and sell the World's Lowest Priced Automobile. Fully assembled or bolt together parts. If there is no dealer near you send 25¢ for detailed literature with agents proposition, or \$1 (refund first order) for this plus actual assembly book and service manual. **MIDGET MOTORS MANUFACTURING CO., ATHENS 1, OHIO**



World's #1 Brush Gun . . . **MARLIN .35 CAL.**

Now Only \$68.95*

Tremendous Demand . . . Expanded Production . . . Permit \$10 Reduction on Three Marlin Cal. .35 Rem. Models!

HERE's the only gun in this brush-blasting caliber that provides the split-second speed of lever action.

A terrific value . . . a tremendous favorite . . . at its original price of \$78.95! Practically a "steal" now—at only \$68.95*!

Available in carbine, rifle and deluxe rifle models—the carbine with regular pistol grip . . . or "Texan" style, with straight grip.

See your Marlin dealer now (name of one nearest you available on request). Many Marlin dealers have a layaway plan. Ask your dealer about it. Marlin Guns are also sold in Canada.

Model 336—.35 Rem. Carbine—full magazine holding 8 shots. Reduced to **\$68.95***

*Prices slightly higher west of Rockies.

THE NAME FOR GAME **Marlin** FINE GUNS SINCE 1870

VALUABLE COUPON—MAIL TODAY!

The Marlin Firearms Co., Dept. 9-PM, New Haven, Conn. Send me catalogue with information and photo-illustrations of Marlin Guns, plus new cartoon booklet, "More Fun with Your .22 Rifle." Also send me a pack of (check preference) single or double edge Marlin Razor Blades. I enclose 10¢ for handling.

Name _____
Street _____
City _____ Zone _____
County _____ State _____



TEENUTS

steel threads in wood

TEENUTS mount flush without counter-boring. Excellent for new work or repairs . . . wood to wood, wood to metal . . . and where old screw holes have worn out. Simply drill hole for TEENUT barrel, hammer home TEENUT and its steel prongs provide rigid, permanent anchorage. Same size hole for bolt. Sizes to fit standard bolts: 6-32, 8-32, 10-24, 10-32 (4 per card), 1/4-20 (3 per card), 5/16-18, 3/8-16 (2 per card).

AT HARDWARE COUNTERS EVERYWHERE 15¢

per card

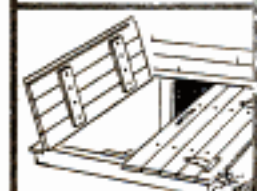
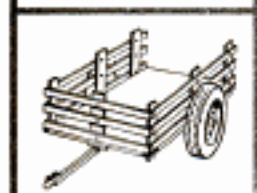

3229 South Ashland Ave., Chicago 8, Illinois

THE **DOT** LINE

FREE! for every Household Handy man!

101 ILLUSTRATIONS AND INSTRUCTIONS



Anything made of wood—and this folder illustrates 101 items—should have the water repellency, resistance against warping, swelling and shrinking—and immunity against termites and decay—made possible with Woodlife.

WOODLIFE is the original water repellent wood preservative that should be on every handyman's work shelf—along with this folder which shows how to apply Woodlife to 101 household wood-working projects.

Ask your lumber, paint or hardware dealer for Woodlife and for your copy of this informative "do it yourself" folder! or write,



Protection Products MANUFACTURING COMPANY
Dept. O Kalamazoo, Michigan
When you repair, remodel or build, ALWAYS ask for Woodlife treated lumber!

Always good for a laugh is the joke about "times getting so tough that owners have to wash their own Cadillacs." Well, apparently that isn't so funny as it appears. Cadillac owners do wash their own cars, the survey shows. When asked about the new and unusual front grille and bumper, some Cadillac owners complained that the grille was too difficult to wash.

"Too complicated and hard to clean."—Crescent City, Calif., merchant.

"Grille mesh is so small it is difficult to keep clean."—Mt. Prospect, Ill., paving contractor.

A fairly large percentage of owners did not like the grille: 28 percent. Other reasons for this include the following:

"Bumper doesn't protect lower part of the grille."—Pomona, Calif., real-estate broker.

"Grille too fragile."—Walled Lake, Mich., resort owner.

But the majority likes the grille and bumper. Included is a Galesburg, Ill., doctor who wrote the design "creates an illusion of massiveness."

"The front bumper is very pretty, but the two bulbs sticking out in front are very dangerous and could easily kill someone. The car cannot bump another car without damage to these and they are expensive to replace."—Chicago, Ill., merchant.

Miscellaneous Comments

Cadillac owners make many interesting comments that, while not always typical, are worth repeating.

"I don't like the floor covering. The odor inside for a month or two was sickening."—E. Brewster, Mass., housewife.

"Very unpleasant sounding, blarey horns."—Saugerties, N. Y., manufacturer.

"Controls for window lifts are very poorly located and not convenient to operate."—Brooklyn, N. Y., businessman.

"Heater is definitely bad. Drafty. Too hot or too cold."—Decatur, Ala., realtor.

"General Motors should give the owners a better deal. I like my Cadillac but you have to order one year in advance and take what the dealer wants to sell you. He loads it with all kinds of extras and won't handle your old car. The price is out of line."—Beckley, W. Va., owner.

"Windshield wipers don't wipe as much area of wrap-around windshield as they might."—Weldon, N. C., superintendent.

"Rear exhaust extensions do not allow the Caddy to be pushed easily."—Pelham, N. Y., wholesale salesman.

"Ash tray not convenient for driver. Mud drains from front fenders down over bumpers."—Charleston, W. Va., owner.

(Continued to page 250)

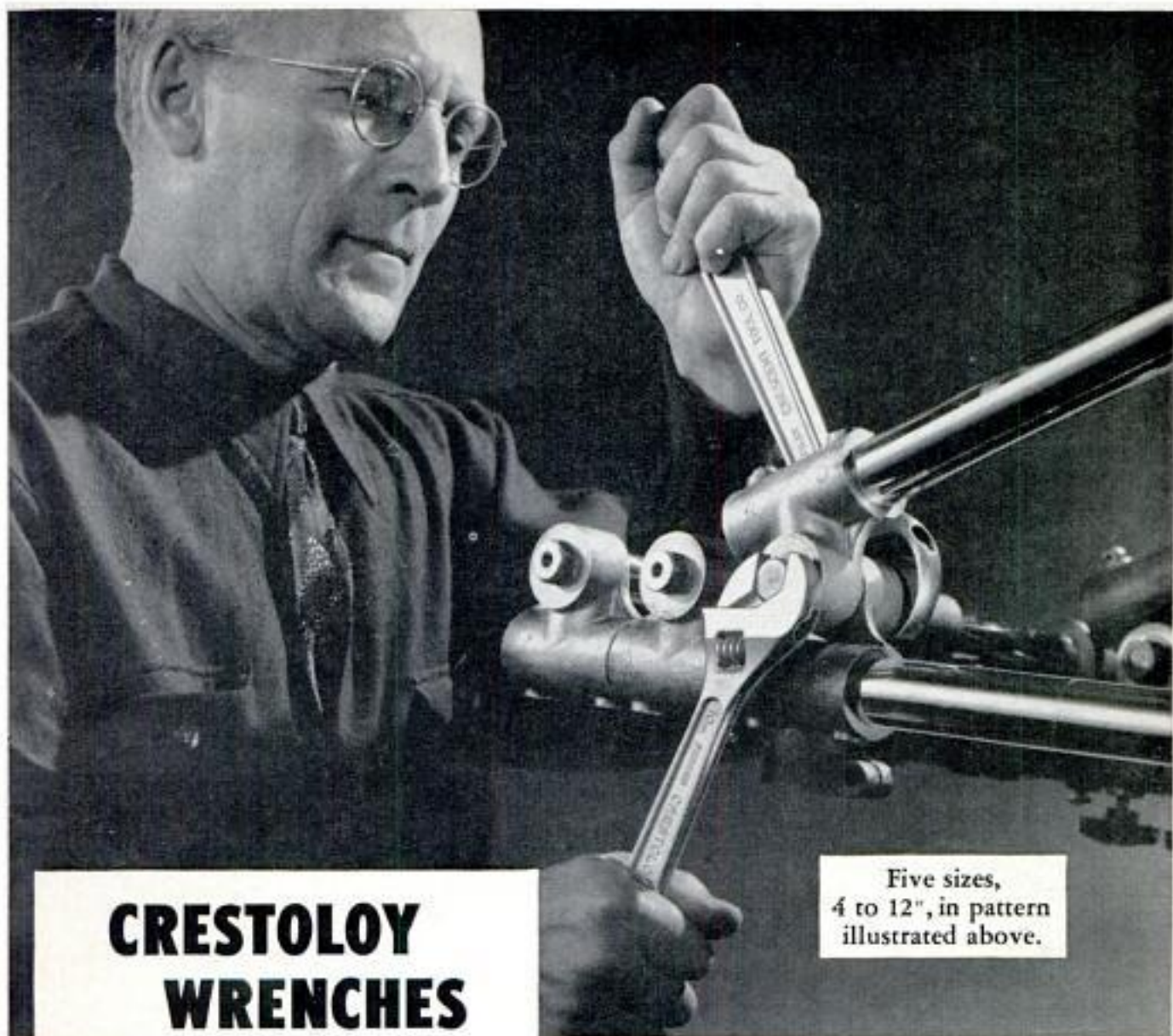

CRESTOLOY WRENCHES

Five sizes,
4 to 12", in pattern
illustrated above.

Forged from Crescent's own CRESTOLOY Steel, these fine wrenches are 200% stronger and 30% thinner than conventional adjustable wrenches. They are hardened by a selective induction process which guarantees longer life through a combination of surface hardness and interior toughness. Chrome plate finish. Sold by Industrial Distributors and Hardware Dealers everywhere.

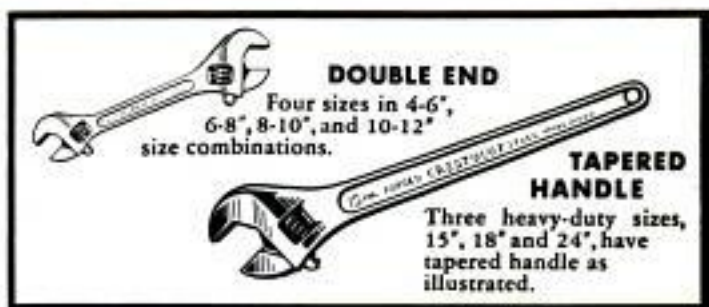

CRESCENT TOOLS

Give Wings to Work

*Sign of the Artisan
Symbol of Excellence*



Crescent is our trade-mark, registered in the United States and abroad, for wrenches and other tools. Sold by leading distributors and retailers everywhere and made only by
CRESCENT TOOL COMPANY, JAMESTOWN, NEW YORK



1

Replace thermostat every year for maximum heater efficiency and better cooling system performance. Quality built original equipment replacement. Rust-proof. Easy to install. Either Alcohol type or Permanent Anti-freeze type for all popular cars from.....\$1.28 to \$2.10



2

Wizard fuel pumps, guaranteed for long, dependable service. Original equipment replacement. Diecast body; precision machined surfaces and parts; fully tested for correct pressure. Diaphragm of extra high quality for longer life, top performance. For all popular cars (887201)\$1.75



3

"Minit-On" Tire Chains—so revolutionary you can put them on in just *one* minute. Install anywhere—in snow, on ice, or on a hill. Not "snap-ons", but complete, patented chains with adjusters. Tough, wear-resisting links. Plastic coat sleeve protectors included. Pair from \$13.95



New Power...New Beauty..

Over 45 Years...Headquarters



7

Don't be stranded by a worn-out fan belt. Replace now with a Western Auto extra-quality fan belt. Inner core of endless cable cords. Tough rubber cushion reduces heat, assures long life, cooler-running performance. Can't warp, slip, or stretch. Guaranteed fit. (189165).....98¢



8

Easy to change tires at night, spot street signs, house numbers with this all-purpose spotlight. Plugs into lighter socket, or dash socket which is included. Beautiful die-cast chrome-trimmed handle and rim with blue enamel back. On-off switch, GE bulb, 10' cord. 6-volt. (215116)\$5.19

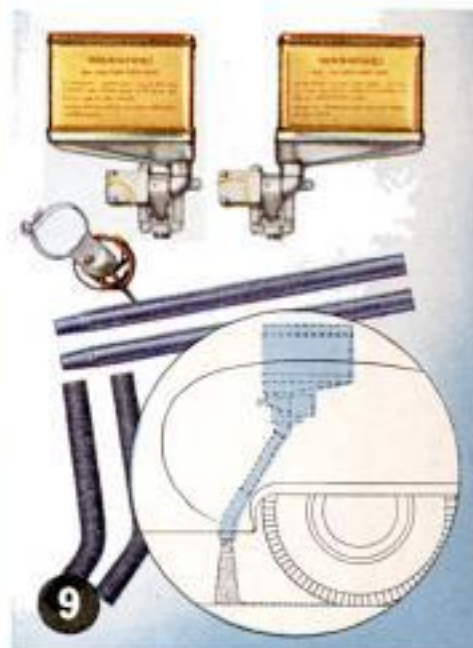

9

"Grip King" Electric Road Sander mounts in car trunk. At touch of electronic control switch on the steering post, instantly discharges grit in front of rear wheels for non-slip starting, stopping on icy hills, packed snow, slick curves. Easy to install. Less grit. \$23.95 Non-freezing grit. 50 lbs. \$1.59

FREE: Mail post card today for folder explaining how to get more horsepower

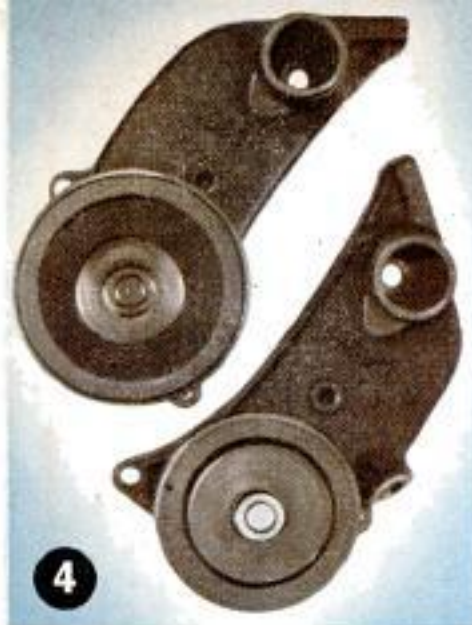

4

Guaranteed Wizard water pump—original equipment replacement types. All new material. Made of gray cast iron, accurately machined. Shaft, impellers, bearings precision fitted to assure long, trouble-free service and top performance under all conditions. For most cars, from\$4.65



5

Guaranteed to fire in oil. Aldor spark plugs have bi-metallic thermostat control that keeps spark plug always at peak efficiency for smoother running, easier starting. Adjusts to any heat range requirement automatically. Special non-burning electrodes. In sets (131280-8).....95¢ (ea.)



6

Add new beauty and style to your car's interior, and protect your floor mat from excessive wear with these handy rubber utility Mats. Also has many uses around the house. Easy to clean. Yellow, green, red, blue and black. 17" x 17" (291105-9).....Ea. 89¢
17" x 20" (291110-14).....Ea. \$1.19

New Safety For Your Car At **Western Auto**

STORES AND ASSOCIATE STORES

NOTE: Western Auto Associate Dealers own their stores and set their own prices, terms and conditions. Prices may vary due to difference in local conditions. (PM 34)

For Top Quality Auto Supplies.



10

Add new beauty to your car with these top quality Wizard Country Club Plastic Seat Covers. Beautiful Saran plastic panels with harmonizing trim, top cap, sides and back. Stay lovelier longer. Wide choice of patterns and colors sure to please. All car sizes, from (36429-89).....\$26.95



11

Cozy "living-room" warmth! Supreme EA Double-Flow Heater with 7½" dual fan delivers 250 cu. ft. of air per minute. Heavy-duty motor. Illuminated variable speed switch. Original equipment styling. (Defroster kit available.) With fittings, (21134).....\$32.95
Deluxe EA Hot Wave (21132) \$21.95



12

Complete Wizard Tune-Up Kit saves gas, gives your car easier starting, smoother running, better performance all season. Easy to install yourself. Contains all ignition parts needed for complete tune-up: heavy duty points, condenser, rotor. Complete, easy instructions. Chev. 1933-52 (158815-61) \$1.05

from your car. Write Western Auto, Dept. 200 I, 2107 Grand, Kansas City, Mo.

Copyrighted material

POPULAR MECHANICS

75c

WHAT to MAKE

AND HOW TO MAKE IT



NOVEL PLANTERS



NOW ON SALE AT YOUR NEWSSTAND

BUY YOUR COPY TODAY ONLY 75¢



PHONOGRAPH



CAMPER'S CAR-TOP SLEEPER



SEWING CABINETS



SURFBOARD

170 Build-It-Yourself Plans



PERIOD TABLES



LAZY SUSAN



SCALE-MODEL RAILROAD

MODERN FURNITURE
FARM SHELTERS
GARDEN ORNAMENTS
CAMP EQUIPMENT
TOYS AND GAMES
HOLIDAY NOVELTIES
HOME REMODELING
KITCHEN AIDS
METAL PROJECTS
SPORT OUTFITS
MODEL SHIPS
TRAVEL LUGGAGE

Kortz

FOR STREAK-FREE RESULTS

USE THE FINEST BRUSH

FREE BOOK — "How to Do a Good Paint Job!"
Send card (and name of your retailer, if you wish) to Baker Brush Co., Inc., 83 Grand St., New York City 13

Brushes by Baker

AMERICA'S FINEST PAINTING TOOLS

VARIABLE SPEED HYDRAULIC POWER TRANSMISSION



It has Infinite Speeds 0 to 550. Reverse, Automatic Overload Protection; Adjustable Torque up to 180 inch pounds. 5/8" Input and Output Shafts. It will handle 1/2 to 1 1/2 H.P. Motor. Case measures 7 1/2" long, 7" high, 6 1/2" wide. **VALUE OVER \$300.** Shipping Wt. **\$54.50** 25¢. On C.O.D. Orders we require a 10% only. **Feb. Chicago**

DIRZIUS MACHINE SHOP "F" 1423-25 So. 52nd Ave., Cicero 50, Ill.

LAWN ORNAMENT-NOVELTY PATTERNS

28 Lawn Ornament Patterns, 25¢. Other Patterns: 15-20" high; Dutch Girl, Dutch Boy, Pirate, Bull Terrier, Mexican Girl, Mexican Boy, Dwarf, Penguin, Flower Girl, 15¢ each. 25 Novelty Patterns, 30¢. All 62 Full Size Patterns, \$1.00. Strother Pattern Service, Dept. DR-8, Box 128, Belington, W. Va.

BUILD YOUR OWN AIR CONDITIONERS

AND DEHUMIDIFIERS — For Home or Automobile FROM JUNKED REFRIGERATORS — FOR \$15

Instruction books □ for Home—75¢ □ for Car—75¢, both for \$1.00 **COMPLETE "Install-It-Yourself" KIT for Auto — ONLY \$164.70** This kit contains everything you need to install an air conditioner in your car that is equal to capacity and performance of units costing \$600 or more. Save hundreds of dollars. Send for instruction books or further information to

SEELEY PRODUCTS CO., Dept. 519, 3716 Belmont, Chicago 18, Ill.

Protect your home against power interruptions with an...

ONAN Emergency ELECTRIC PLANT

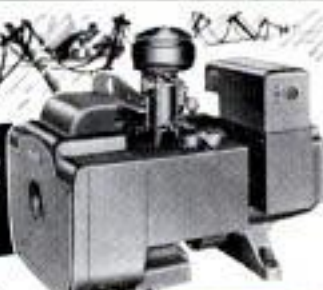

Provides dependable stand-by electricity for heating system, pumps, freezer, lights, appliances. Keeps home safe, livable. Automatic start and stop. Find out how little it costs!

A SIZE FOR EVERY NEED
1,000 to 50,000 watts. Compact, quiet-running, easy to install. Gasoline engine powered.

Write for Folder!
D. W. ONAN & SONS, INC.
8581 University Ave. S. E. • Minneapolis 14, Minnesota

New LUFKIN Micrometers have 18% Bigger Barrels

For Faster, Easier, More Accurate Measurements



1 Choice of Friction Thimble or Ratchet Cap. Friction Thimble (illustrated below) has mechanism built right into the Thimble that automatically stops



further pressure on the measuring faces when correct reading is obtained.

The easy-to-reach Ratchet Cap (illustrated above) permits you to take repeated "one-hand" measurements with exactly the same pressure on measuring faces.

2 Widely spaced markings on bigger barrel are easier to read and show up better on non-glare Satin-Chrome finish . . . wider spacings also make it easier to estimate tenths of thousandths.

3 Choice of new Slip-Proof Black Crackle finish or Satin-Chrome finish on frame. Black Crackle frame makes the micrometer easiest to handle when hands are oily . . . note that new tapered frame and extended anvil permit measurements in places inaccessible to other micrometers.

There's A New Lufkin Big Barrel Micrometer To Fit Your Needs Exactly . . . Write For Free New Tools Booklet Today.

BUY LUFKIN TAPES — RULES — PRECISION TOOLS AT YOUR HARDWARE OR TOOL STORE

Send for Free Booklet

THE LUFKIN RULE CO. — Dept. PM, Saginaw, Mich.
Please send me your free New Tools booklet.

318 NAME _____
ADDRESS _____
CITY _____ STATE _____

YOU NEED THIS POWERFUL NEW JIG-SAW.

for
DO-IT-YOURSELF JOBS
Valances, Lawn Furniture,
Intricate Designs, Toys



**SAFE
FOR ALL
AGES**

No. 208

Before you buy ANY self-powered jigsaw, remember this: more Syncro-Made jig saws have been sold than any other self-powered make! Why gamble? Buy now Syncro 208—get *PROVEN* performance, durability, quality, lasting economy!

**NEW 208 CUTS MORE
MATERIALS FASTER
THAN ANY OTHER
Self-Powered JIG SAW!**



HOME REPAIRS



VALANCES



LAWN FURNITURE



**TOYS
INTRICATE DESIGNS**

Yes ...it cuts 2x4's

The new Syncro #208 is the only self powered jig saw to offer you *ALL* these important features—1. Cuts 1 3/4" wood. 2. Cuts to center of 30" circle. 3. 100 square inches of working surface. 4. Safe for every member of the family. 5. Motor guaranteed against burnout. 6. Cuts smooth edge—No splintering—No sanding needed. 7. Cuts with same blade: Wood, plastic, metal, linoleum, leather, etc.

**SEND POSTAL NOW
FOR LOW PRICE AND
FREE CATALOG!**



SYNGRO
SELF-POWERED
JIG-SAWS

MADE ONLY BY

SYNGRO CORPORATION Dept. 1-64
OXFORD, MICHIGAN

"I get good service at reasonable prices at Cadillac agencies, but other service stations seem to tack on a little extra because I drive a Cad."—Pomona, Calif., fruit grower.

Over-All Rating High

Altogether the Cadillac owners rate their new cars highly with 71 percent describing them as excellent, 21 percent as good, 5 percent as fair and 3 percent as poor. Asked if they would buy another Cadillac, 85 percent of the owners replied that they definitely would, 12 percent said they might and only 3 percent said they would not.

Dealer-service ratings were just average with 45 percent saying their dealers were excellent, 26 percent good, 19 percent fair and 10 percent poor.

For Floyd Clymer's road test of the 1954 Cadillac, turn back to page 123. ★ ★ ★

Tire-Truing Machine

You probably think that automobile tires are round—and to anyone but a perfectionist they are. However, even when brand-new they are slightly out of round and during the first 2000 miles of wear they stretch somewhat, causing high spots and dished areas on the tread. An automatic truing machine trims tires to within .003 inch of true roundness, handling tires of all sizes from the smallest passenger-car tire to big truck tires.

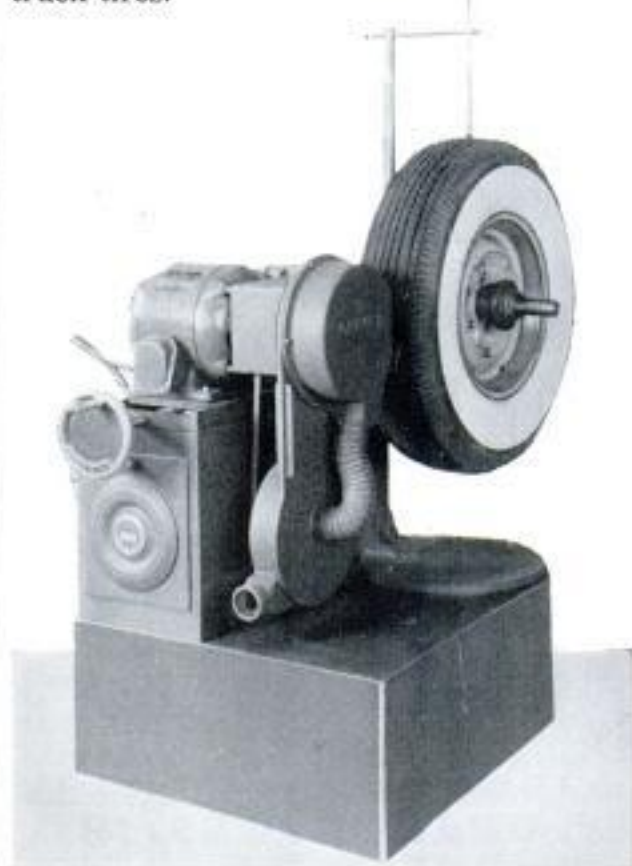



**Make sure you
put the right parts
into your FORD**

Parts may fit into your Ford but still not give the performance you have the right to expect. Make sure you get parts you know are made right for Fords—Genuine Ford Parts!

Genuine Ford Parts are the ones to rely on when your Ford needs replacement parts. They're made to the *exact* specifications set by the same men who originally built your Ford. And they're all tested thoroughly before approved for manufacture—so you can be sure they're made right to fit right to last longer in your Ford. *When your Ford needs new parts, go where you know you can get Genuine Ford Parts!*



"TRADE" WHERE YOU SEE THIS SIGN

This Year!

Thousands Are Accepting Startling NEW FREE BOOKLET OFFER,

Revealing how 33,432 pictures make
Encyclopaedia reference as fascinating
as the latest picture magazine.

The New 24-volume edition is called the
Greatest Treasure a Family Can Possess!



Outlining Sensational

ENCYCLOPAEDIA BRITANNICA

Book a Month PAYMENT PLAN

The new edition of Britannica is the greatest treasure of knowledge ever published, the work of 4,479 of the world's best minds. It is the final authority on factual knowledge, and a constant inspiration that will continuously enrich the lives of yourself and your family.

See the new pictorial method portrayed in the free preview booklet. Mail the coupon today! We are sure you'll be glad to help spread the news by showing your copy to one other family. Fill in and mail the coupon now!

So fascinating, so different, so unlike the average person's idea of an encyclopaedia... Yes, this new Britannica depends vastly on pictures—33,432 of them, over 1,300 pictures average per volume.

That is why we are now prepared to send valuable 32-page preview booklets, containing beautiful, large-size, full-color pictures, to a number of people.

These booklets are sent free and without any obligation except that, because of the high cost of printing, we ask you to show the booklet to one other family, friends or neighbors. That is all you have to do to acquire free this gorgeous and valuable booklet.

EXTRA! FREE! beautiful booklet sent
if you agree to show it
to a
neighbor



NAME _____
ADDRESS _____
CITY _____ STATE _____

IN CANADA, WRITE E.B. LTD. TERMINAL BLDG., TORONTO, ONT.

ENCYCLOPAEDIA
BRITANNICA, INC.
DEPT. 12-B
475 N. Michigan Ave.,
Chicago 11, Ill.

Please let us have the FREE PREVIEW
BOOKLET and complete details about the
Book a Month Payment Plan. I agree to show
BOOKLET to a neighbor. There is no other obligation.

Fast Horses and Short Ropes

(Continued from page 136)

wind had quickly fanned the blaze. By the time Rude and Caldwell got the trailer gate open a wild-eyed horse was frantically trying to side-step flames that were flickering over his left foreleg from shoulder to hoof. He jumped free when the tail gate crashed down, the flesh of his leg scorched and sizzling. But he recovered to become a famous rope horse.

For the three men who roped off him during the 1947 rodeo season—Fort, Jack Skipworth and Cotton Lee—Baldy won \$43,000. In the first two months of 1949 he won Fort and Skipworth an amazing \$10,000 in only four rodeos. At Tucson, Ariz., that year his two riders tied for first place in the two-calf-average roping by securing their stock in identical times—35.3 seconds.

Like the ropers themselves, the best of horses occasionally foul up. To the Madison Square Garden rodeo in the early 1930s came Jake McClure and his wonderful sorrel gelding, Silver. Both McClure and a friend, Richard Merchant, were roping off the horse.

Preliminary to Merchant's run, the announcer started praising Silver. He couldn't say enough glowing words about the great little horse that once had been awarded the Prince of Wales Trophy as the best rope horse at the Calgary Stampede in Alberta, Canada. He was without doubt "the best... the greatest... the most well-mannered..." Then Merchant came out after his calf.

He missed his first loop, but caught with a second rope. The first rope, trailing from the saddle, scared Silver (McClure very seldom missed his first loop) so much that he bucked Merchant off and ran for the exit gate, pulling the calf behind him. Of course, Merchant received "no time."

When Silver was hit and killed by a car in 1937, McClure was heartbroken. McClure's own life was prematurely snuffed out in 1940 when he roped a steer on his ranch to look at the brand. The steer jerked McClure's horse over on top of him and he never regained consciousness. He will long be remembered for his ability to catch calves with a small loop—the one Will Rogers called the "wedding-ring loop of rodeo."

Luck plays a large part in roping. The roper who draws one or two slow calves in a calf-roping event will win. Although rodeo-stock contractors do their best to cull weak, slow calves from the roping herd, a couple of soft calves will always turn up out of a 100-head herd.

Thus professional calf ropers recognize

(Continued to page 254)

WIN this Beautiful PALACE 45' "RANCHOME"*



Seal applies to all Palace Trailers — not to furnishings, equipment and tires.

ENTER PALACE'S

\$10,000.00 CONTEST TODAY!

Here's your opportunity to win one of the finest quality mobile homes built in America today — and the only one carrying the Good Housekeeping Seal of Approval — a beautiful 45-foot Palace "Ranchome"! All you have to do is go to your nearest Palace Dealer . . . inspect a Palace Ranchome . . . get an entry blank . . . and fill in the following sentence, "The feature of the 1954 Palace Ranchome I like best is _____ because _____ (25 words or less) _____". That's all there is to it! If your entry is first choice of the judges, you'll win the marvelous 45-ft. Palace Ranchome pictured above at absolutely NO COST TO YOU! If your entry is judged one of the first ten runner-ups, you'll win one of the amazing miniature Palace "Ranchomes" . . . and make your kiddie the envy of the neighborhood! So don't delay! Go to your Palace Dealer now! Get your entry in! If there's no Palace Dealer in your city, send in the coupon below and an entry blank will be mailed to you directly from the factory.

PALACE CORPORATION
3321 S. DORT HIGHWAY
FLINT, MICHIGAN

UNITED MANUFACTURERS
Williamston, Michigan

PALACE HOMES, INC.
Newport, Arkansas

PRIZES INCLUDE

10 MINIATURE 6' TOY

PALACE

"RANCHOMES"

WORTH

\$500.00 EACH!

ATTENTION DEALERS:

Your Territory May Be Open—
Write!

*Plus a \$1,000.00 cash bonus and full cash refund if you've purchased a new Palace "Ranchome" during the contest period.

MAIL THIS COUPON TODAY

For Complete Information and Entry Blank to the \$10,000.00 Palace Contest

Gentlemen:
Please send me an entry blank for your \$10,000.00 contest . . . also give me the name of my nearest Palace "Ranchome" Dealer.

NAME _____

ADDRESS _____

CITY _____ ZONE _____ STATE _____

PALACE CORPORATION • FLINT, MICHIGAN

Your engine's life depends on a film of oil 14 times thinner than an apple skin!



High speeds, high temperatures—and clearances down to 1/1000th of an inch! That's why you need an oil that gives a tough, free-flowing film!

Use high-quality Quaker State for the rich super film that reduces engine wear

IT'S A SUPER FILM! And only Quaker State Motor Oil gives you this wonderful film—so rich, so full bodied, so enduring, that it assures your car of less engine wear! Every drop of this superb oil is refined from 100% Pure Pennsylvania Grade Crude Oil, nature's best. It is the product of over 50 years of specialization in automobile lubrication. Quaker State gives modern engines complete protection. Economical in use—every quart goes farther!

Quaker State Motor Oil is made in new streamlined grades to suit the requirements of all makes of cars and for every type of service. Ask your dealer.

ASK FOR . . .



QUAKER STATE OIL REFINING CORPORATION, OIL CITY, PA.
Member Pennsylvania Grade Crude Oil Association

no world's records for fast times. Variations in arena size and the breeds of calves also automatically prohibit national records, although individual arena records are kept.

However, here are a few fast times: Buckshot Sorrells at Crystal City, Tex., in 11.2; Cotton Lee at Plainview, Tex., in 10.4; Jim Bob Altizer at Rosenberg, Tex., in 9.9 and Jack Saunders at Euless, Tex., in 9.8.

Because of the shorter start given the calves, times at indoor shows are generally faster than those at outdoor shows. Twenty years ago at Tucson the calves got an 80-foot start, and any tie under 25 seconds was really "hustlin'."

Calf roping is becoming more appealing; Texas high schools send a representative boy each year to Hallettsville to compete in a championship rodeo. The Intercollegiate Rodeo Association boasts a top array of roping talent from Texas, New Mexico, Arizona, California and Colorado colleges. Some of the roping students make a career of it. F. C. Stover, paid his way through college with his money-winning loop.

A red piggin' string in the corral doesn't mean a calf has kicked a cowboy in the mouth. It's lipstick! Even the girls are organized—the Girls Rodeo Association is 15 years old and some of the members are real hands.

Twenty-two-year-old Wanda Harper, of Mason, Tex., has been roping calves over half her life. Once at Laramie, Wyo., during the girl's calf-roping contest, Wanda roped a calf that went through the fence just after the loop tightened around its neck. Wanda didn't hesitate a second. Off her horse she sprang and scrambled through the fence.

"Little old fence like that wasn't about to stop me," said Wanda after she had tied the calf and remounted her horse.

The two current calf-roping champions of the two rodeo associations are B. J. Pierce of Clovis, N. Mex., and Don McLaughlin of Smithfield, Tex. A bespectacled college graduate who looks more like a schoolteacher than a roper, Pierce is the International Rodeo Association's champ. His best performance of the past season was in November at San Francisco's Cow Palace rodeo. After missing his first go-round calf, Pierce won the second and third go-rounds by tying calves in 12.6 and 12.5 seconds to win \$1565.86.

McLaughlin, a former trick roper and fancy rope spinner, is one of the toughest competitors on the circuit. Last year he won about \$20,000. Rough calves often throw this slight roper for a loss, but on small calves he has a lightning tie.

I think a big change has come in public

(Continued to page 256)

**New Optical
Radioactivity Detector
GEIGERSCOPE**

Now you don't need expensive equipment to check mineral specimens for uranium! This remarkably sensitive device for



prospectors, engineers, experimenters, gadgeteers, everyone interested in atomic energy, indicates radioactive content with sparkles of light. Now being used in major universities and atomic energy laboratories. Sturdy, durable, portable as a pocket watch; needs no power source. Supplied complete with sample of uranium ore, carrying pouch, full directions. Full written guarantee. **\$1**

ATOMIC PROSPECTOR'S HANDBOOK EACH **\$1**
Postpaid
Just off the press! Valuable data and descriptions of radioactive ores, field, lab & mill methods, maps, in 54 information-packed pages! Everything you need to know to give you a thorough grounding in this vital, new field. You can get the Geigerscope or Handbook separately—better yet send \$2 for both today! Write to

KEN RESEARCH, INC.

831 Fifth Ave.

River Edge 15, N. J.

SAVE OVER 50% ON Extruded Aluminum

STORM WINDOWS AND DOORS

Send for FREE "Do-It-Yourself" Book-PM954

U-FAB-IT-URSELF, INC.

Worthington, Ohio

COMBINATION SCREEN-STORM WINDOWS & DOORS • CASEMENT
PICTURE-BASEMENT WINDOWS • SCREEN DOORS & SCREENS

**Do It Yourself
with DREMEL
Straight-Line-Action
SANDERS!**



Send for free catalog of Dremel power tools.

DREMEL MFG. CO., Dept. 114-J, Racine, Wis.

FREE BOAT KIT CATALOG

12 ft. Runabout Pictured.

- Assemble your own boat
- No experience necessary
- Save 1/2 to 2/3 "factory built" prices
- Prices include freight and paint



Marine Hardware, Fiberglass & Trailers

8' to 14' Models from \$39.25

LUGER INDUSTRIES Kit Division 3207 FREMONT AVE. SO. MINNEAPOLIS 8, MINN.

SHEET METAL BRAKES

New eccentric clamps. Forms angles, locks, pans, etc. Mount on bench, truck or floor stand. All steel construction. Size 15"x16 gauge, 40 lbs. \$21.50; 30"x20 ga., 65 lbs. \$24.50; 36"x22 ga., 80 lbs. \$33.00; 48"x24 ga., 110 lbs. \$48.00; 100"x28 ga., 260 lbs., \$115.00. Floor stand, 22 lbs. \$7.00. Shipped Collect.



24" Squaring and slitting shear cuts sheet metal, plastic and cardboard. For bench mounting \$38.00. Floor stands \$7.00. Express Collect. Shears 7" by 16 gauge, straight or curved, any length cuts 1/2" aluminum bars. \$12.50 collect. \$14.00 postpaid.



ORDER DIRECT, OR SEND FOR CATALOGUE.

VYKE MFG. CO., P-2439 15th St., Denver 2, Colo.

**Last Year's Profit
\$3,000!**



with a

**FOLEY automatic
SAW FILER**

"Last year's profit amounted to \$3,000. Not so bad for a one-man outfit" — from Chas. C. Hough. James B. Williams wrote us—"I made \$765 last year filing saws, and it sure comes in handy. I do this work in my spare time." Men in communities of all sizes make up to \$3 or \$4 an hour with the Foley Saw Filer working full time or part time.

It's no trick to take care of the saw filing for your neighborhood hardware or lumber dealer — plus looking after the saws for farmers, townspeople, manual training departments and factories. The Foley files all hand saws, also band and cross-cut circular saws. It's a repeat cash business, no canvassing, no eyestrain and no experience needed.

**FREE BOOK
Shows How to Start**

"MONEY MAKING FACTS" shows just how you can start at home in your spare time working in your basement or garage. It's an immediate cash business that can develop into a full-time repair shop. Send coupon today — no salesman will call.



Send Coupon for **FREE BOOK**

FOLEY MFG. CO., 916-4 Foley Bldg. Minneapolis 18, Minn.

Send me free book "MONEY MAKING FACTS"

Name _____

Address _____

New pep·performance·
speed·gas mileage to 6mp.g.
for **4 WHEEL DRIVES!**

2 OR 4 WHEEL DRIVE IN SECONDS FOR WILLYS, DODGE



PATENTED

WARN HUBS

STOP FRONT END DRAG

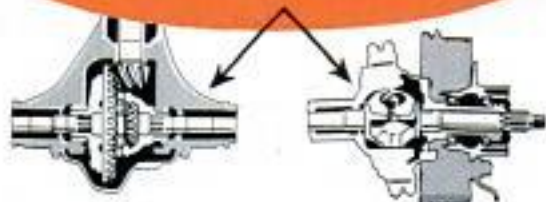

"What a difference Warn Hubs make!" say over 40,000 enthusiastic users. Warn Hubs disengage the front axle assembly for 2-wheel drive use; give your 4-wheel drive amazing pep, getaway, speed, gas mileage, easier steering! They save gears, tires, repairs; also stop front end shimmy. But—you still have 4-wheel drive power and traction when you want it, automatically or with manual control! No interference with low power range or 8 speeds. **MONEY BACK GUARANTEE** on material, workmanship and performance. 10-day return privilege! **CHOOSE FROM 3 MODELS—AT DEALERS OR DIRECT**

AUTOMATIC



Automatic Conversion as you shift gears!
For Willys only,
pair, ppd. \$120

LOCKING



Selective Fingertip Manual Control!
Willys, pr. ppd. \$69
Dodge, pr. ppd. \$74

STANDARD



Fixed Conversion to 2-wheel drive!
Willys, pr. ppd. \$20
Dodge, pr. ppd. \$23

DEALERS! Get special offer now!

WARN MFG. CO.

Riverton Box 5064-A5
Seattle 88, Washington

attitude toward roping and other rodeo events. The ropers, too, look on rodeo now as more of a money-making business than a rip-roaring pastime. But only a few years ago rodeo ropers were called "carnival boys." They were talked about disparagingly and regarded with a dim view, a justifiable outlook since many of them were real bums, cashing in on rodeo in any way they could.

It's different now. The men of rodeo are a sincere bunch. They are professional athletes, regardless of what names press agents care to call them. They win only what they get by beating their roping opponents; most of them rope for a livelihood. Some, like Pierce and Stover, are college graduates; others have been sports stars in high school or college.

Still others are Easterners gone Western in a complete way, for calf roping is no longer a cowboy's game. Anyone who is coordinated, can ride a horse and is not afraid to practice, can learn to rope calves well. One of the good ropers, Lex Connelly, now of Fresno, Calif., was born and reared in Bryn Mawr, Pa.

Like other spectator sports, roping calves against time has taken on a standard of competitive excellence that is hard to beat. Ropers have developed themselves and their mounts into slick, smooth-working teams that are a downright pleasure to watch. ★★★

Pooch Is Up to His Neck In Automobile

European cars are small and have no room for large dogs, so an ingenious dog lover has converted the trunk into a roomy traveling kennel. A hole cut in the trunk lid permits the dog to get air and, if he desires, to see where he has been, at least.



WALDEN

Soft-Faced HAMMERHEADS

CONVERT YOUR STEEL HAMMER EASILY AND QUICKLY!

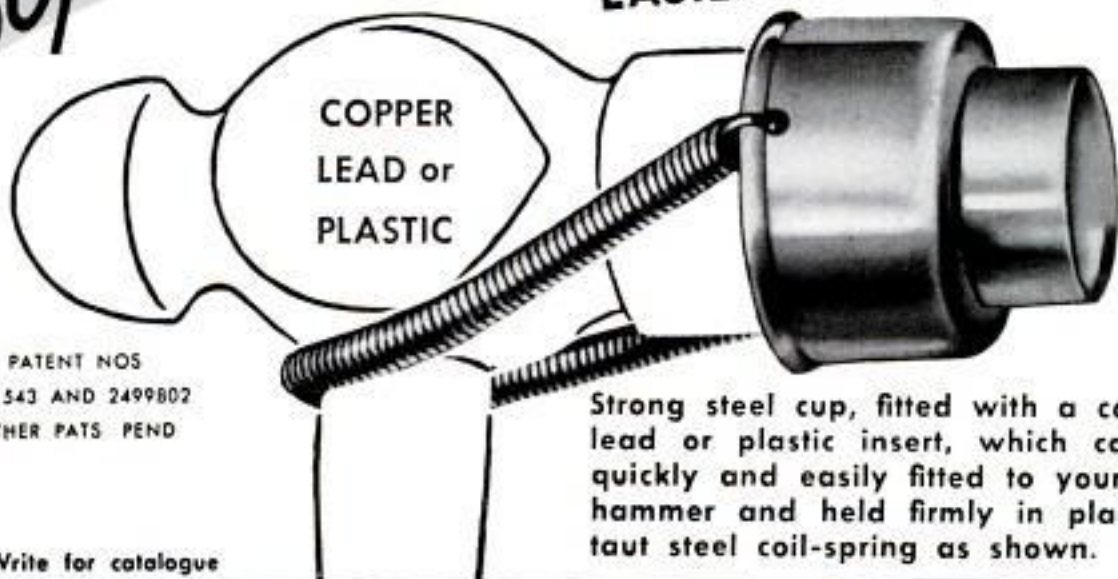

PATENT NOS
251543 AND 2499802
OTHER PATS PENDING

Strong steel cup, fitted with a copper, lead or plastic insert, which can be quickly and easily fitted to your own hammer and held firmly in place by taut steel coil-spring as shown.

Write for catalogue

STEVENS WALDEN Inc.

480 SHREWSBURY STREET — WORCESTER, MASSACHUSETTS

MAKERS OF
WORLD-FAMOUS HAND TOOLS
FOR OVER 50 YEARS

204 4



PUNCH PRESS

**1 Ton Power Bench Type
Make Your Shop Complete
Powerful — Dependable — Economical**
Easily make your own dies for light stamping, forming, riveting, etc. Ideal for production or experimental work. Replaces more expensive presses. Uses 1 1/2 to 1 1/2 H.P. motor. Weight 105 lbs. Fully guaranteed. Only \$97.50 less motor. Write for free circular.
ALVA F. ALLEN
Dept. PM, Clinton, Missouri

REVIVE YOUR OLD PAINT BRUSHES

RESTORE NEGLECTED BRUSHES. Use BRISSEL-TONE to clean them easily. Simply soak brushes in BRISSEL-TONE and wash old dried paint away with WATER. Re-use BRISSEL-TONE many times. Speedy, thorough, economical. Send \$1.00 plus 25c postage for BRISSEL-TONE Brush-Cleaning Kit TODAY. MONEY BACK GUARANTEE.
MONTGOMERY CHEMICAL COMPANY
P.O. Box 187-A, Jenkintown, Pennsylvania



IDEAL LAWNMOWER SHARPENER



BOOST YOUR INCOME

You can earn extra cash with the Model 300 Ideal Lawnmower Sharpener. Used and recommended by leading manufacturers and service shops, the Ideal has everything you need, nothing else to buy. Grinds reel and bed knife, also reconditions. Get started now in this highly profitable business. Write for catalog today.

The Fate-Root-Heath Co.
Dept. PM-9, Plymouth, Ohio

HAVE FUN!

SAVE MONEY

TRY SUPERSHOP FREE
Factory To You — \$79.95

Think of the fun you'll have and the money you'll save with your own big capacity workshop. Picture yourself saving with the 8" ball bearing saw. Or drilling in steel with the vertical drill press. You bore with the horizontal drill — exclusive with SUPERSHOP. You sand with the 8" disc sander. You turn with the 30" lathe. You sharpen tools on the 5" grinder.



VERTICAL DRILL PRESS

You are invited to TRY SUPERSHOP FREE. We will pay all shipping expense. Write for full details of this amazing FREE TRIAL PLAN. Mail postcard now.

POWER TOOLS INC.

163 Yates Ave.
Beloit, Wisc.

Lighten your "load" with these



GOOD SHORT-CUTS from "Handy" SANDY

Make your own cylindrical sanders — any size you want — for use with your drill press. Just cut a slot $\frac{1}{2}$ " deep in one end of a suitable hardwood dowel. Insert a strip of ALOXITE® aluminum oxide Cabinet or Finishing Paper in the slot, and wind it around the dowel. Fasten the end with cement . . . a rubber band will hold it 'til the cement dries.

A strip of Emery Cloth by CARBORUNDUM, tacked or glued to your work-bench (or your desk or drawing board) lets you sharpen drawing pencils, touch up knives or other cutting tools in jig time!

Clean auto distributor contacts and other hard-to-reach electrical contacts with a $\frac{1}{8}$ " dowel, with a small disc of Fine Emery Cloth glued to the end. Just twirl the dowel between the palms of your hands.

Hard wood is easier to plane if you dampen the surface first. Be sure you wipe the plane dry afterwards, though; otherwise you'll have to buy some more Emery Cloth to remove the rust!

You can keep knobs from loosening on your dresser drawers and other furniture this way: Cut small "washers" from a sheet of Medium Flint Paper by CARBORUNDUM. Insert them between the knob and drawer, grain side out. Then tighten the screw that holds the knob. The Flint "bites" into the base of the knob—keeps it from turning.

Asphalt tile floors with cracks or chips can be temporarily repaired with sealing wax. Melt enough wax over the spot so it fills the break or hole—plus a little extra. Let it cool, then sand it down to floor level with a small sheet of Fine Flint Paper.

It's easy to remove burrs from metal edges. Clamp the metal to your bench, or in your vise. Tear a 1" strip from a sheet of Fine or Medium Emery Cloth by CARBORUNDUM. Grip one end in each hand and sand the edge in "shoe-shine" fashion.

There's no such thing as "sandpaper" anymore! And you can be mighty glad about it, for CARBORUNDUM Brand Flint Paper, Garnet Paper, Emery Cloth, and ALOXITE® aluminum oxide Paper and Cloth are so far superior to old-fashioned "sandpapers" it isn't funny! Your hardware or lumber dealer will help you choose the right product for each job. Just insist on the CARBORUNDUM Brand name on every sheet you buy.

Write for free folder, "HOW TO SAND".



"Handy" SANDY
CARBORUNDUM
Niagara Falls, New York

"CARBORUNDUM" AND "ALOXITE" ARE REGISTERED TRADEMARKS OF
THE CARBORUNDUM COMPANY, NIAGARA FALLS, NEW YORK

90-4101

What's All This Talk About Hi-Fi?

(Continued from page 110)

a small cone (tweeter) for the highs, and even a third speaker for the midrange. A "coaxial" speaker has a tweeter built into the center of the woofer. A "cross-over network" should be used to separate the signals and feed each speaker the ones it can handle best.

Many hi-fi fans start on a small budget and improve their systems from time to time. Instead of buying separate speakers or a coaxial, you could begin with a single "extended range" unit. Later you may want to add a tweeter and a cross-over network which will turn your old speaker into a woofer. If you choose this course, make sure that matched, add-on components are available for your speaker. There are a number of progressive systems on the market that help put hi-fi on a pay-as-you-go basis.

If you ear-test woofer-tweeter combinations, beware of a trick your ear may want to play. Adding a tweeter increases treble sound but sometimes makes it seem as if the bass tones had been chopped off. Tone controls are included in some cross-over networks to permit you to restore an ear-pleasing balance.

Power, in watts, tells you how much volume a speaker can handle. Normal listening level is only about one watt, but a hefty reserve of power is by no means wasted. Sharp peaks and loud passages occur very often in music. If they overload the speaker—even for an instant—they will mush up the sound and may eventually damage the speaker. Your speaker system should be able to handle at least the output power of the amplifier it will be used with, and preferably a good bit more.

Amplifiers—An amplifier receives feeble signals from a phono pickup or radio tuner and gives them the power they need to pump a speaker. Even very modest ones are more faithful to the signal than the best speakers. You will want at least 10 watts of output power (like the speaker's, it is for reserve rather than use). Catalog figures on distortion should be well below that of the speaker, and you should not be able to hear hum at any volume setting.

It is wise to get an amplifier that has a "flat response" from below 50 cycles to 15,000 or above. This means that within this range it amplifies signals uniformly.

[ED. NOTE: In sales literature this is indicated as a line on a graph, or abbreviated "50 to 15,000 cps ± 2 db." The last part means "cycles per second, plus-or-minus 2 decibels (a unit of sound change). A small

(Continued to page 260)

Wherever
you need
a
Bearing
Mounting



Now
Available
at
New
Low
Cost

**USE
Precision Ball Bearing
PILLOW BLOCK**

Send
Check or Money Order

Give Shaft size	Postpaid
3/4" shaft each	\$3.75
7/8"-1 1/16"-1" each	4.00
1 1/8"-1 3/16"-1 1/2" each	4.75

A complete economy unit, including two-piece pressed steel housing, wide inner ring type bearing with self locking collar and seals. Self aligning. Impervious to dust and moisture. Prepacked with grease. Easy to install. N O W — use ball bearings everywhere a shaft turns! All makes of ball and roller bearings at a big saving. Inquiries invited—including dealers.

ASSOCIATED BEARINGS CO., 2918 McGee, Kansas City, Mo.

FIND \$\$\$\$

NEW U-238 geiger counter—world's smallest, most sensitive uranium locator. Ideal for prospecting even on hunting, fishing trips! (Full line of mineral and metal locators, too.)

FREE booklets on request. (Dealer inquiries welcome.)

GOLDAK COMPANY 1542 W. Glenoaks Blvd., Glendale, Calif.

Wholesale! TOOLS! GUNS! CAMERAS!

BUY TOOLS, PHOTO EQUIPMENT, SPORTING GOODS, JEWELRY AND THOUSANDS OTHER NATIONALLY ADVERTISED PRODUCTS AT BIG DISCOUNTS. SAVE ON OWN PURCHASES. BIG PROFITS SELLING TO OTHERS. POSTCARD BRINGS FREE COPY "THE WHOLESALE PLAN".

AMERICAN BUYERS SERVICE

Get up to **40% off**

629 Linden Ave., Dept. 15, Buffalo 16, N.Y.

THE BEST IN PLIERS? CHAN NEL LOCK

CHAMPION DEARMENT TOOL CO., MEADVILLE, PA.

TRANSFORMER WELDER \$19.95 FOR QUINCY

Complete with everything. Ready to plug in. 110 volts AC. 15-30 Amps. 3 heats. Welds metal from 1/16" to 3/4" using 1/16" to 3/32" standard rods. Guaranteed unconditionally. 10-day trial. No C.O.D. Does everything welders costing up to \$75.00 do. Buy direct and save.

ESSAY MFG. CO., INC., Dept. 51, Quincy 69, Mass.

Distributed by Eugene Dietzgen Co. Stores

ALL POCKET SIZE

EASY TRIGONOMETRY CHARTS

COMPLETE SET 3 CHARTS ILLUSTRATED BOOK 168 PAGES POSTPAID \$3.00

AN EASY METHOD TO SOLVE SPHERICAL, PLANE & COMPOUND ANGLES. USED BY TOOL, DIE & JIG MAKERS, DRAFTSMEN, MACHINISTS SINCE 1942. PREVIOUS TRAINING NOT NEEDED. SEND FOR YOUR SET NOW. MONEY BACK GUARANTEE.

FREE CIRCULAR ON REQUEST

USE TRIG-EASY

E. H. Needham Box 587 Dept. A Culver City, Calif.



SURFWOOD comes in 4' x 8' panels, 3/16" thick. Open and sound knotholes add to its picturesque, weathered appearance.

Beautiful new wall paneling looks like weathered driftwood—install it yourself at low cost*!



PANEL YOUR DEN with the clean-swept look of the sea! With Surfwood, you can transform a whole room or make a good-looking hobby nook in your living room or bedroom. Surfwood's large panels go up easily right over existing walls. Nail holes are hidden by Surfwood's irregular surface.

SURFWOOD texture is produced by special process that etches away the soft wood tissues between the hard grain.

SURFWOOD can be finished to give a wonderful variety of effects: it can be stained any color, finished natural with Satinlac, pickled with white Firzite, or even rubbed with dry pigment to give a modern two-tone look.

SEE SURFWOOD at your lumber dealer's or at any one of the 73 United States Plywood or U.S.-Mengel Plywoods showrooms located in principal cities.

*An 8' x 12' wall costs only \$23; prices vary slightly in different areas.

SEE YOUR LUMBER DEALER **Weldwood®**

REAL WOOD PANELING
United States Plywood Corporation
WORLD'S LARGEST PLYWOOD ORGANIZATION
Weldwood Building, 55 W. 44th St., New York 36, N. Y.
and U. S.-Mengel Plywoods, Inc., Louisville, Kentucky



**This oil-pumper needs
Tough-but-oh-so-gentle
piston rings***

Wasted motor oil is one of the most expensive things you buy. Just to keep the oil-level up, soon runs into a lot of money—even worse, it soon runs into a big repair bill, too.

Every extra quart you buy is a danger signal, a symptom of worn-out piston rings. One sure way to check this wear is to install Hastings Rings—the rings that are designed for replacement service.

As your engine gets older, it runs hotter because of accumulations in the cooling system. The cylinders wear tapered and out-of-round—need more oil on the walls.

It requires a special type of rings—*replacement* rings to deliver extra oil, under full control, without waste.

Hastings pioneered in the development of steel oil-control rings and set new high standards in replacement ring service. Hastings makes replacement rings exclusively, devotes all its research to the particular replacement problems of each make and type of engine.

That's why Hastings Rings *stop* oil-pumping, *check* cylinder wear, *restore* engine performance—in re-ring, re-bore and re-sleeve installations.

So go to your motor specialist at the first sign of oil-pumping or performance drop-off. If rings are the trouble, ask him to install a Hastings Steel-Vent replacement set. Truly the best money you can spend on your car!

HASTINGS MANUFACTURING COMPANY • HASTINGS, MICH.
HASTINGS LTD., TORONTO

Piston Rings, Casite, Caslube, Drout, Oil Filters, Spark Plugs

HASTINGS
STEEL-VENT PISTON RINGS

Regular or Chrome



TOUGH on Oil-Pumping
GENTLE on Cylinder walls

variation of 2 db or less over the whole frequency band should be satisfactory, since 3 db is about the lowest level of sound change the ear can hear.]

Some amplifiers range to 100,000 cycles or more. You can't hear such ultrasonics, but the electronic refinements of these amplifiers push distortion and hum below the vanishing point. They are expensive.

In the old days an amplifier was all you needed between a phonograph pickup and a loudspeaker. Today's high-fidelity pickups have added a new element—the pre-amplifier. The preamp is required by today's variable-reluctance magnetic cartridges, which are extremely sensitive but produce signals that need more amplification than the amplifier alone provides. Sometimes the preamp and amplifier are built in one, or the preamp may be part of a radio tuner.

Good tone controls are usually worth having. They let you balance the sound to your own taste or to the acoustics of your home. The better outfits have separate controls for bass and treble, but some very satisfactory controls adjust both high and low tones at the same time. One mark of a good control is that it doesn't change the over-all volume.

Record Players—Like speakers, the turntables and pickups that play your records are chiefly mechanical devices. Shortly after the war, General Electric introduced the low-priced variable-reluctance magnetic pickup. Its needle or stylus was able to follow the record groove accurately and freely. This pickup has since been improved; so have other types of magnetic, crystal, ceramic and capacitive cartridges. You can get hi-fi from a well-made unit of any type but the variable-reluctance magnetic group is by far the most popular.

Whether you start with it or not, you may want to switch to one later on. To allow for this possibility the phonograph motor you buy must be of the four-pole type. A less expensive two-pole motor has a magnetic field which will induce hum.

Medium-priced turntables or record changers are probably good enough for most nonprofessional installations. High-priced tables are excellent, but it's doubtful whether they can improve sound enough for you to hear.

In the long run the pickup arm that carries the cartridge is likely to be more important than the motor and turntable. The arm must be critically balanced so the stylus will follow the groove at present flyspeck pressures. The arm mustn't bounce and it must hold the stylus at the correct angle from the outside groove to

(Continued to page 262)

JOINT AND SHARPEN ALL SAWS

SAVE TIME AND \$\$\$



Sensational new Super Filer joints and sharpens both hand and circular saws 6" to 10" with all teeth the correct height, depth, pitch and bevel. Easy to use—when file hits hardened steel roller, teeth are finished. Saw runs true and smooth with no side pull. Complete with special 8" file \$9.95 ppd. FREE FOLDER.

"TRU-CIRCLE" saw set. Automatically sets teeth at 10" or more \$2.95. FILE SAWS THE RIGHT WAY



SO EASY with this new filing jig and jointer anyone can now sharpen any handsaw like new! When file hits hardened steel rollers teeth are finished and EXACTLY THE SAME HEIGHT. All teeth cut and saw runs true and smooth. Jig and instructions \$2.95 postpaid. Free Folder.

SUPER DRILL GRINDER

Sharpens round shank drills from 3/32" to 1/2" in diameter, up to 6" long. Grinds oil drills like new in 4 different point angles, using hand or power grinding wheels. \$2.95



SUPER DOWEL CENTERS

Points are concentric. These centers take all sizes of dowels from 1/8" to the largest made. Drill all your holes at the same time. You'll only need these 4, why buy more. 4 Centers \$1.00 postpaid.



A. D. McBURNEY, 5908 Hollywood Blvd., Hollywood 28, Calif. Dept. A-45

AT ALL HARDWARE STORES

FULLER'S "SCREW HOLDER" SCREW DRIVERS



NOW! do the job at HALF THE COST!

- Spring clip holds and sets screws tightly!
- Reaches those "out of the way" spots!
- In 3 1/2", 4 1/2", 6" and 8" lengths — ONLY 30c
- Also 4" Phillips type!
- Hi Carbon Blades! • Unbreakable Amber Handles! (3 1/2" x 1 1/2" blade)

FULLER TOOL CO., Inc. 3522 Webster Ave., N. Y. 67
Export Sales Dept., John H. Graham Co., 105 Duane St. • New York, U. S. A.

Print Your Own

Cards, stationery, circulars, tags, labels, photo and movie titles, advertising, etc. Save money. **Print for Others, Good Profits!** Easy rules sent. Raised Printing like Engraving, too. Sold direct from factory only. Write for free catalog of outfits and all details. KELSEY PRESSES, M-37, Meriden, Conn.

\$6.95 DRAINS cellars, cisterns, wash tubs; IRRIGATES - CIRCULATES - SPRAYS



1,001 USES—HOUSE, GARDEN, FARM
Original All-Purpose Pump has 2400 GPH capacity, 100 GPH 7 1/2" high or 1500 GPH from 2 1/2" well. Use any 1/40 to 3/4 HP motor. Stainless steel shaft, 1" inlet, 3/4" outlet. Motor coupling included.
DOES NOT CLOG OR RUST!
Postpaid if cash with order. (West of Miss., add 50c.) MONEY BACK GUARANTEE. Larger Centrifugal Pumps, and Gear Pumps in all sizes.
LABAWCO PUMPS, Belle Mead 7, N. J.



The Modern PLASTIC for lasting Home Repairs

PERMANENTLY mends cracks or holes in wood, tile, stone or plaster. Sticks and stays put—Does not chip, shrink or fall out. Easy to use. Economical. Mold it, chisel it, polish or paint it. The big 4-lb. can is obtainable from your lumber, paint or hardware dealer at \$1.25; or will be shipped direct postpaid (in U. S.) for \$1.50. Complete satisfaction guaranteed or your money refunded.

DONALD DURHAM CO.
Box 804-T Des Moines, Iowa

How to Make 4 Decorative Cuts

with the new Stanley Handyman Router

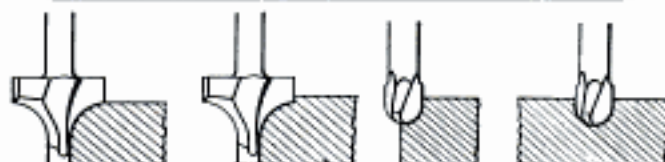
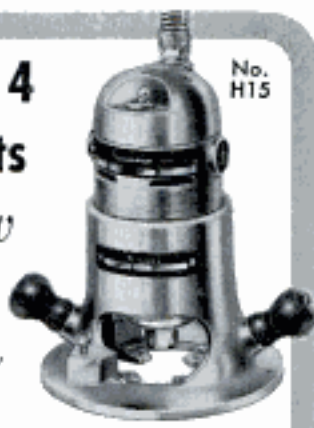

1. ROUNDING-OVER 2. HALF BEAD 3. COVE 4. CORE BOX

1. To cut a rounded-over edge, use Stanley Bit No. H508. The pilot on this bit serves as a guide on the work.

2. To cut a beaded edge use the same bit, simply raising the base of the Handyman Router, thus lowering the bit.

3. To cut a cove, use No. H408 and guide Handyman Router along the edge of the work.

4. To cut a core box, use same bit but guide Handyman Router across surface. For accurate guiding use Gauge No. GA-H39.

This is No. 3 in a series of "how-to-hints" by Stanley. Watch for them.

RECOMMENDED TOOLS

Stanley No. H15 Handyman Router—High Speed (27,000 r.p.m.) router, complete—\$39.95

Stanley Handyman GA-H39 Straight and Circular Gauge—\$3.75

The Stanley Handyman H27 "Hi-Hone" Bit Assortment, 6 high speed steel bits selected for maximum versatility with the Handyman Router—\$12.80 the set. Both bits shown here included.

STANLEY Electric Tools

A Division of the Stanley Works

HARDWARE • TOOLS • STEEL STRAPPING • STEEL

Expert craftsman or woodworking beginner! Stanley's new Router Book E12 is filled with lots more "how-to-do-it" know-how. Over 100 illustrations. Only 50c. Use the convenient coupon.



STANLEY ELECTRIC TOOLS, 629 Myrtle Street, New Britain, Connecticut

Please send me free literature describing the new Stanley Handyman Router and Handyman accessories.

Please send me new Router Book (I enclose 50c).

Name _____

Address _____

City _____ Zone _____ State _____

WAR SURPLUS AND OTHER **SAVING** **SAVE UP TO 90%**

PIONEER MAGNETIC COMPASS
 For boats, trucks, cars. By Pioneer Instrument Co., Div. of Bendix, No. 1829-2A. Contains screw-type heading compensator, removable drawer-type compensator, screw-type horizontal compensator and spider-type compensator. All devices for elimination of errors caused by effects of magnetism. Has constant deviation corrector and course setter. Notable dial engraved with compass card graduations. Complete with book of instructions, light and mounting screws and shock mounts. Shpg. Wt. 10 lbs. Approx. GOVT cost \$400. NEW. \$23.95 incl. in U. S.



FIELD COOKING UNIT & HEATER
 Terrific for hunters, ranch, home, farm, civilian defense, boat, camp, trailer, barbecue, etc. Burns any type gasoline. Burner 10 3/4" dia. Unit approx. 23" x 21" x 10". Has 2 tanks (21 1/4" x 5 3/4") with welded seams, 3 brass valves, 3 air filters, air gauge to 80 lbs. Can use as air tank for compressor or fill with liquid for spraying. NEW Korean war surplus. Wt. 95 lbs., boxed. Approx. GOVT cost \$150. Complete with 2 spare energizers and orifice cleaner (compare this price) — \$10.50



SENSITIVE ALTIMETER in 10 Ft. Increments. NEW! Famous Pioneer! 0 to 35,000 Ft. (inches of Mercury). Tested and inspected in our own instrument lab. Guaranteed perfect. Approx. Govt. Cost \$150. NOW ONLY \$12.95 PREPAID!



NEW P1 GENERATORS
 Electric Auto-Lite. 200 Amps. 24 Volt. 2500 RPM. Dandy arc welder. Wt. 53 lbs. Approx. GOVT cost \$450. Like NEW. \$11.50 incl. easy diagram.



MICROMETERS Chrome plated, precision engineered, carefully toned to give long life. All new 0-1" cap. \$2.25 ea., 1-2" cap. \$3.50.



Send 25¢ for big catalog. Bargains for everyone. Check, Money Order or Cash. 25% deposit on C.O.D. orders. Prices F.O.B. Culver City, Calif. Unless otherwise stated.

AIRBORNE SALES CO., INC. DEPT. PM954
 8501 Stellar Drive, Culver City, Calif.

Protect that gun!
 3-IN-ONE oils your gun and prevents rust—never gums up the way many oils do! Ideal for fishing tackle too!



"3-IN-ONE" OIL

WELD BRAZE
SOLDER CUT
4WAY
ONLY \$14.75
 f.o.b. factory
WELDER
 Complete with Twin Carbon Arc Torch and accessories... to handle all metal-craft work.



PUMP WATER FAST!
 DRAIN WASH TUBS, CELLARS, CISTERNS. Famous #7 pumps 2000 GPH. 420 GPH at 75' high or 1600 GPH from 25' well. Sturdy, rustproof Alloy Metal. Six Blade impeller. Uses any 1/2 to 1/2 H.P. Motor. Will not leak or clog. Fits any garden hose. Immediate money back guarantee. Send Check, Money \$8.95 Order, or C.O.D. **\$8.95** U.S.
 IRRIGATE, FILL TANKS, DRAW WELL WATER. Heavy duty #8 Pumps 7000 GPH. 1000 GPH 75' high — 3000 GPH from 25' well. Rust-proof Alloy Metal. 8 blade impeller. 1" inlet — 1" outlet. Standard Pipe Threaded. Money back guarantee. Send check, \$11.95 Money Order, or C.O.D. **\$11.95** U.S.
 Free Catalogue — Gear Pumps — Deep and Shallow Well Pumps.
MOORE MANUFACTURING CO.
 SWEDSBORO 1A NEW JERSEY



NEW ROOM
ONLY \$16* A MONTH
 with triple value
Gold Bond Insulation Board



Add a new attic room like this with easy-to-handle Gold Bond Insulation Board on walls and ceiling. It decorates, insulates and sound-conditions!

Gold Bond Insulation Plank and Tile are pre-finished and give smart good looks in combinations of ivory or pastel colors. Sturdy, made from "live" southern pine fibres, they keep furnace heat in, and summer heat out! Easily applied with a stapling gun... available at your Gold Bond dealer's. Send for complete plans on how to build this room or one similar—then see your Gold Bond dealer.

**Based on cost of materials spread over 24 months. Prices vary slightly in some localities.*

NATIONAL GYPSUM CO.
 BUFFALO 2, N. Y.



SEND 10¢ FOR PLAN

NATIONAL GYPSUM COMPANY
 Dept. PM-94, Buffalo 2, N. Y.

Enclosed is 10¢ for Gold Bond How-To-Do-It Plan No. 14 for building this attractive room in our attic.

Name.....
 Address.....
 City..... Zone..... County..... State.....

CRAFTSMAN Circular Saw Blades

SEARS HAS 51 DIFFERENT TOP QUALITY BLADES . . .

Tungsten-carbide tipped. Saws wood, metal, plastic, plywood, etc.

CRAFTSMAN
Safe Saw

\$7.75
6½-inch

CRAFTSMAN
Chisel-Tooth

\$1.69
6-inch

CRAFTSMAN Carbide-tipped Blades

Out-perform similar blades selling for much higher prices! Teeth are tipped with tungsten carbide . . . cutting edges last 20 times longer than ordinary all-steel blades. Safer 8-tooth design . . . each tooth projects only .020 in. above non-cutting edge. Saw can't grab . . . protects you from kickbacks. Cuts faster, easier . . . uses less power . . . needs less resharpening. Special steel saw blade is heat treated. Rips, cross-cuts, miters. Cuts woods, plastics, plywood, Formica, Masonite, Presdwood, Transite, laminates, asbestos, roofing, aluminum, etc. (NOT for masonry, steel, iron or other ferrous metals.) See this sensational blade at your nearest Sears Retail Store.

Diam.	Arbor Hole	Fits These Saws	Each
5½ in.	13/16 in. diamond	6-in. electric Skil-saw . . .	\$ 7.75
6 in.	*5/8-1/2 in. round	Porter-Cable electric hand saws; bench saws . . .	7.75
6 in.	1/2 in. square . . .	Mall, PET, DUNLAP electric hand saws . . .	7.75
6½ in.	1¼ in. round . . .	6-in. Black & Decker . . .	7.75
6½ in.	1/2 in. round . . .	CRAFTSMAN 6½-in. elec. hand saw; bench saws . . .	7.75
7 in.	*5/8-1/2 in. round	Bench saws . . .	8.25
7 in.	13/16 in. diamond	Skil-saw; also Sears former No. 2186 electric hand saw . . .	8.25
7 in.	1/2 in. square . . .	Mall electric hand saw . . .	8.25
8 in.	*5/8-1/2 in. round	CRAFTSMAN 8-in. elec. hand saw; bench saws . . .	8.75
8 in.	13/16 in. diamond	Skil-saw elec. hand saw . . .	8.75
8 in.	13/16 in. square	Mall electric hand saw . . .	8.75
8 in.	1¾ in. round . . .	Black & Decker electric hand saw . . .	8.75
10 in.	*1-3/8-3/4 in. round . . .	Bench, builders', radial, swing saws . . .	10.95
†12 in.	*1-5/8 in. round . . .	Bench, builders', radial, swing saws . . .	17.50

* Arbor bushed to accommodate either size arbor shown.
† 12 teeth.

CRAFTSMAN Chisel-tooth Blades

Bevel-filled, chisel-shaped tooth has greater hook angle . . . provides a stronger, faster-cutting blade. Cuts up to 30% longer before resharpening or resetting than standard or fancy-tooth combination blades. Reduces vibration . . . easy to sharpen and reset. Combination type . . . for ripping and crosscutting. Made by new automatic machine methods that eliminate costly hand processes. Chrome-nickel-molybdenum steel . . . scientifically heat treated and hardened. Far superior to high carbon steel used in most circular saws. Evenly tensioned to run true and cut straight. Deep gullets to clear out sawdust. Now available at your nearest Sears Retail Store.

Teeth	Diam.	Arbor Hole	Fits These Saws	Each
16	5¾ in.	13/16 in. diamond	Skil-saw electric hand saw . . .	\$1.69
16	6 in.	1/2 in. square . . .	Mall, PET, DUNLAP elec. hand saws . . .	1.69
16	6 in.	*5/8-1/2 in. round	Bench saws . . .	1.69
16	6½ in.	1¼ in. round . . .	Black and Decker elec. hand saw . . .	1.69
16	6½ in.	1/2 in. square	PET, DUNLAP electric hand saws . . .	1.69
16	6½ in.	1/2 in. round	CRAFTSMAN 6½-in. electric hand saw . . .	1.69
18	7 in.	*5/8-1/2 in. round	Bench saws . . .	1.89
18	7 in.	1/2 in. square . . .	Mall electric saw . . .	1.89
18	7¼ in.	13/16 in. diamond	Skil-saw, Sears former No. 2186 . . .	1.89
20	8 in.	*5/8-1/2 in. round	CRAFTSMAN 8-in. electric hand saw; bench saws . . .	1.98
20	8¼ in.	13/16 in. diamond	Skil-saw elec. saw . . .	1.98
20	8¼ in.	1¾ in. round . . .	Black & Decker saw . . .	1.98
20	8¼ in.	13/16 in. square	Mall electric saw . . .	1.98
24	10 in.	*3/8-3/4 in. round	Bench saws . . .	2.98
24	12 in.	*1-3/8 in. round . . .	Radial, swing, and commercial saws . . .	4.29

* Arbors bushed to fit either size arbor indicated.

Solve Your Cutting Problems!

SIZES AND TYPES TO FIT ALMOST EVERY POWER SAW



A \$1.69
6-inch

B \$1.69
6-inch

C \$1.69
6-inch

D \$2.69
6-inch

CRAFTSMAN Crosscut, Rip and Combination type Blades

Professional quality . . . made by improved machine methods that eliminate many costly hand processes. You pay LESS for a MORE accurate saw! Electrically controlled furnaces hold saws flat, temper them under pressure . . . give blades toughness, long-lasting edges. Chrome-nickel-molybdenum steel; heat treated; evenly tensioned to run true. Accurately ground for better balance and surface finish; pitch and gum are less likely to stick. Will stand up under hardest production use.

For fine woodworking—ripping, crosscutting or mitering—use CRAFTSMAN Hollow-ground Combination Blades. 3-gauge taper grinding gives free, easy cutting. The gradual taper means greater strength . . . allows saw to run without set . . . won't bind. Cuts smoothly enough to glue work without sanding. Cuts slightly slower than flat-ground saw blade.

No matter which type of saw you own—bench, electric hand, radial, swing, builders', or floor model—there's a CRAFTSMAN Blade designed to fit. At your nearest Sears Retail Store.

(A) (B) CRAFTSMAN Flat-ground Crosscut and Rip Saw Blades

Diameter	Center Hole	R.P.M.	(A) Crosscut	(B) Rip
6 inches	$\frac{3}{8}$ - $\frac{1}{2}$ in.	5080 to 7640	\$1.69	\$1.69
7 inches	$\frac{3}{8}$ - $\frac{1}{2}$ in.	4350 to 6550	1.89	1.89
8 inches	$\frac{3}{8}$ - $\frac{1}{2}$ in.	3820 to 5730	1.98	1.98
10 inches	$\frac{3}{8}$ - $\frac{3}{8}$ in.	3050 to 4580	2.98	2.98
12 inches	$\frac{1}{2}$ - $\frac{3}{4}$ in.	2540 to 3820	4.29	4.29

(C) CRAFTSMAN Flat-ground Combination Saw Blades

Diameter	Center Hole	R.P.M.	Each
6 inches	$\frac{3}{8}$ - $\frac{1}{2}$ in.	5080 to 7640	\$1.69
7 inches	$\frac{3}{8}$ - $\frac{1}{2}$ in.	4350 to 6550	1.89
8 inches	$\frac{3}{8}$ - $\frac{1}{2}$ in.	3820 to 5730	1.98
10 inches	$\frac{3}{8}$ - $\frac{3}{8}$ in.	3050 to 4580	2.98
12 inches	$\frac{1}{2}$ - $\frac{3}{4}$ in.	2540 to 3820	4.29

(D) CRAFTSMAN Hollow-ground Combination Saw Blades

Diameter	Gauge Taper	Center Hole	R.P.M.	Each
6 inches	15 to 18	$\frac{3}{8}$ - $\frac{1}{2}$ in.	5080 to 7640	\$2.69
7 inches	15 to 18	$\frac{3}{8}$ - $\frac{1}{2}$ in.	4350 to 6550	2.98
8 inches	15 to 18	$\frac{3}{8}$ - $\frac{1}{2}$ in.	3820 to 5730	3.89
10 inches	14 to 17	$\frac{3}{8}$ - $\frac{3}{8}$ in.	3050 to 4580	7.25
10 inches	14 to 17	1 in.	3050 to 4580	7.25

* Arbors bushed to fit either size arbor indicated.



CRAFTSMAN 6-in. Dado Set. Converts your bench saw, radial saw or swing saw for dadoing, grooving, rabbeting, etc. Made of tempered high quality steel. Each complete set includes: two $\frac{1}{8}$ -in. thick outside saws and five chipers (four $\frac{1}{8}$ in. thick, and one $\frac{1}{16}$ in. thick). Precision ground. With $\frac{1}{2}$ or $\frac{3}{8}$ -in. arbor hole. At your nearest Sears store . . . Set **\$8.75**

CRAFTSMAN 8-inch Dado Set. Heavy duty . . . for dado work with your bench saw, radial saw, or swing saw. Each set includes two outside saws (each cuts $\frac{1}{8}$ -in. groove), six $\frac{1}{8}$ -in. inside cutters, and paper washers for $\frac{1}{16}$ -in. width adjustments. Available with 1-in. or $\frac{3}{4}$ -in. arbor hole. ($\frac{3}{4}$ -in. size includes bushings to fit $\frac{5}{8}$ -in. arbors.) At your nearest Sears store . . . Set **\$14.95**



Other special-purpose blades — including Nail-cutting, Plywood-cutting, and Fine-tooth Finish Blades — also available at your nearest Sears Store.

CRAFTSMAN Hand and Power Tools by **SEARS, ROEBUCK and CO.**
Famous for fine quality . . . precision performance . . . low price!

I'VE TRIED THEM ALL—
THERE'S NOTHING THAT
DOES THE JOB LIKE
PLASTIC WOOD!



Plastic Wood is stronger—resists weather. Sands down to a smooth, hard finish. Professional craftsmen have preferred Plastic Wood for more than 50 years because it takes paint, varnish and other finishes best. Will not chip, crack or peel . . . won't pull away! In cans and tubes.

In natural, white and 8 wood colors.

"PLASTIC WOOD"®

LOCK UP FOR WINTER



with **CORBIN**®
**PIN-TUMBLER
PADLOCKS**

Storage buildings, outbuildings, summer camps, sports equipment, garden and farm tools, boats . . . all these and many other things should be put under lock and key NOW. Do it right with Corbin Pin-Tumbler Padlocks! You get real security and economy, too. In every size . . . for every purpose . . . in every price range. At better stores. IF IT'S WORTH LOCKING, IT'S WORTH A CORBIN PIN-TUMBLER PADLOCK!

CORBIN CABINET LOCK Division

The American Hardware Corporation
New Britain, Conn.

After Disaster, The Trouble Shooter . . .

(Continued from page 86)

electrocute a whole company of men. Spurs strapped to knees and ankles, permit the men to clamber up bare poles. Safety belts support them once they're there. With their thick rubber gloves, arm guards and jackets they'll handle hot lines surging with up to 4000 volts of current. Anything higher is worked with long sticks or else the line is de-energized. This doesn't mean they get careless. "A man can be killed just as dead by the 120 volts in a light socket as he can by 60,000 on a pole top," Joe Bain explains.

Joe, a square, solid-looking man who has spent some 20 years around power-pole crossarms, can cite plenty of cases to prove his point. Most spectacular was the time when he and his crew buddies were called out in a bitter winter ice storm to hoist live 120,000-volt transmission cables back on the steel towers from which they'd been ripped by the ice and wind. "We'd gotten one back," he recalls. "The other was swinging in the wind, just clear of the ground, when a man came down to our tower and sat on a steel platform to rest. All of a sudden he got up and climbed the tower ladder for no special reason. A second later the wind caught that swinging cable and whammed it against the exact spot where the man had been. There was a crack like a cannon when those 120,000 volts grounded out. A fire ball five feet around lit up the scene. Cable, steel and everything within several feet just melted and disappeared. Don't know where that man is today, but I'll bet he's mighty careful where he sits."

Before he starts work, a lineman shinnies up the pole and slips a rubber line hose, which he calls a "snake," or "eel," over each hot line on both sides of the crossarm. Rubber "boots" cover insulators. A thick rubber blanket is thrown over transformers and other equipment.

All this, when properly fixed, should allow a man to work safely in a high-voltage area, but no good lineman takes anything for granted. "Electricity is tricky stuff," says Jim Mather, one of John Zimmerman's boys. "You get up on those crossarms in rainy weather when the current is leaking here and there and you can feel it tickle your back, or your arm, or your shoulder even though you may not be touching anything hot."

Mather knows just how tricky it is. He got the full wallop one day when his hand

(Continued to page 268)

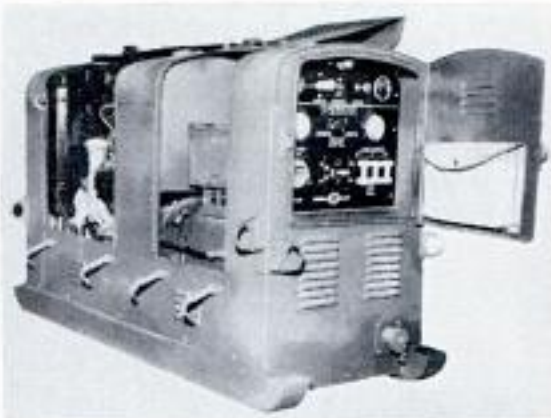

U. S. GOVERNMENT SURPLUS 3 KVA AC ALL PURPOSE GASOLINE POWERED GENERATOR

3 Phase — can be used single phase

only
\$295⁰⁰

LIKE NEW — \$1,000.00 value. Ideal for contractors, farmers, resorts, carnivals, oil fields, anywhere permanent or temporary power is needed. All units tested before shipment. 4 cylinder ZXB Hercules gas engine 115/120 volt 50/60 cycle, push-button electric starter and generator, full control panel.

**HEAVY DUTY OR
EMERGENCY STAND-BY POWER**

NEW ● **NEW** ● **NEW**
GOVT. COST **\$6,000.00**
GENERATOR OUR PRICE **\$695⁰⁰**

16.5 KW DC 160 amp at 1200 RPM, full panel board JXD 6 cylinder Hercules engine mounted on wheels. Portable. Tires \$75.00 extra. Oil fields, contractors, carnivals, circuses.

SUPERIOR TRAILER MFG. CORP.
P.O. Box 1516 • INDIANAPOLIS, INDIANA • Cable Address: INDMAC

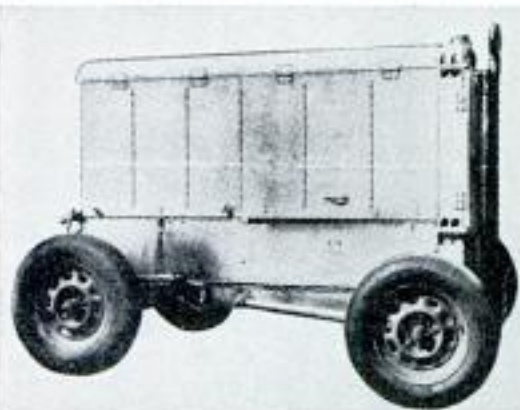

Our 763rd Advertisement
REAL DIESEL ENGINE
\$1.95

- for planes, boats, midget cars
- 7500 RPM: 1/7 HP; ht. 3 1/2" wt. 5 oz.
- precision machined for smooth operation

You just can't beat this price for a precision diesel engine! Streamlined, compact, easy to install. Thousands of satisfied users all over the world. Fast delivery if you ORDER TODAY! Send \$1.95 plus 5c postage.

GOTHAM HOBBY CORP. Dept. P, 107 E. 126th St. New York 35, N. Y.

Say You Saw It in Popular Mechanics

WELD IT YOURSELF! IN A JIFFY!

**Weld, Cut, Braze, Solder
IRON, STEEL, BRONZE, BRASS,
ALUMINUM & OTHER METALS**

Tool and Equipment breakdowns are always annoying and costly. Don't let them bother you. Get a Dynamic Arc Welder. You can do expert work on your very first job. Welders operate from any properly wired 110 V. AC line. Also make your own wrought iron furniture, railings, fences & knick-knacks. Repair fenders, & bodys, etc. with the handiest "tool" in your workshop. A Dynamic Welder will pay for its low cost of \$38.50 F.O.B. in both time and money.

DYNAMIC INDUSTRIAL type transformer Arc Welder 75 amp. output for industrial or Workshop use.

**DYNAMIC
WELDER CO.**

Dept. D2-J, 1808 S. Federal
Chicago 16, Ill.



**EASY
PAY PLAN**

Low down payment. Pay as you weld. Sold on money-back guarantee. Send for details. Complete outfit only

\$38.50

f.o.b. factory

Free Details and "How to Weld"



**Darra-James
POWER TOOLS**



**Better
Than
Ever**

8" and 9"
Tilt Arbor
SAWS

More For Your Money!

Better in every way . . . larger work tables . . . sturdier frames . . . newest mechanical improvements. Darr-James engineering department is constantly working to give you more for your money.

WRITE FOR CATALOGS

TOOLKRAFT CORP., SPRINGFIELD 1, MASS.



**SHE cleans the easy way . . .
but HOW DO YOU SAW?**

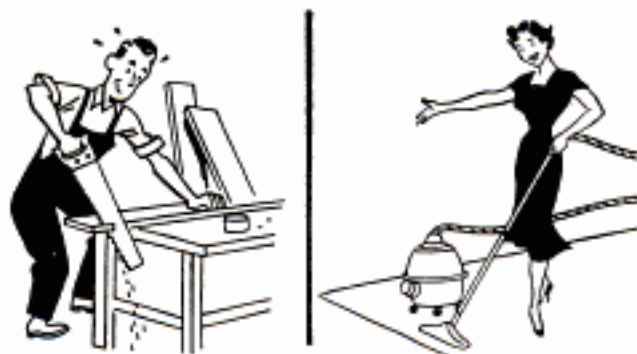

Here's how to eliminate exhausting hand-sawing forever
..for less than the cost of your wife's vacuum cleaner!

Get this **NEW 6-inch**

Porter-Cable

Homemaster

**ELECTRIC
SAW**

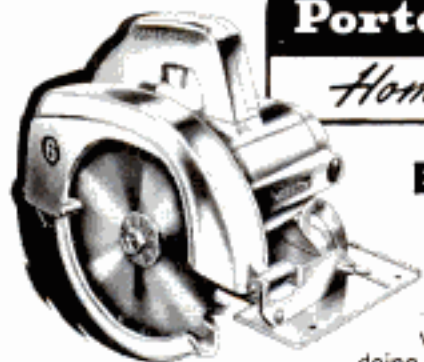

When it comes to doing things the easy way, Mister, your wife's way out in front! She takes advantage of modern labor-saving devices. Isn't it about time you caught up?

Take sawing. Why do it the slow, tiresome way? For only \$49.50 you can get this Homemaster Portable Electric Saw that rips . . . cross cuts . . . angle-cuts . . . bevels . . . notches . . . ten times faster and a hundred times easier!

There must be dozens of things you've always wanted to build—but avoided because of the backbreaking hand-sawing involved. Now, do them with this saw! And without the aches and pains.

Compare these features: kick-proof clutch (exclusive), big 8 amp motor, depth and angle adjustments, 6" combination blade, ball bearings, telescoping guard, fully guaranteed. Converts to saw table. An outstanding "Do It Yourself" tool!

**ONLY
\$49.50**
Easy Payments

**WANT MORE FACTS?
Fill out coupon and mail
this evening**

PORTER-CABLE MACHINE CO.
2449 N. Salina St., Syracuse 8, N. Y.
(In Canada: Strongridge, Ltd., London, Ont.)
Tell me all about your low-priced Model 125
Homemaster Saw . . . and where I can get hold of
one for a demonstration.

Name.....
Address.....
City.....Zone.....State.....

Makers of SPEEDMATIC and GUILD Electric Tools Since 1906

brushed a protruding line (which shouldn't have been there) from a connection box. The shock knocked him out and he fell back against his safety belt. His crew buddies hauled him down, revived him and he's good as new today except for the scar on one hand and foot. "It burns the point of contact and the place where you ground it out," he explains. "That's why a badly burned lineman may lose a hand and foot. If he touches the line with a hand or arm, the current grounds out in the pole where his spikes are dug in. If he brushes the line with his head, his neck and shoulders may get it."

Odd things happen to a burn victim. "I tasted copper in my mouth for five weeks after it happened," Mather reveals. In most cases, the shock paralyzes diaphragm muscles, so all linemen must know how to use artificial respiration effectively. In many line-crew headquarters, you'll find sawed-off poles where men practice rescuing each other with rope slung over crossarms. One man goes up and fastens the line to the shock victim. Another clammers up and releases the victim's safety belt while the first lowers him. On the floor, they both take turns pumping air into him by artificial respiration.

Since telephone linemen often find their companies' equipment on the same poles with local power lines, they are also trained in similar techniques. You'll find them driving and using much the same kind of pole equipment. Frequently telephone men may be called on to save lives of power linemen, and vice versa. A few years ago in Winona, Miss., telephone man Luther Lamb was led by an excited fellow to a spot down the road from his job. A power lineman atop a 35-foot pole had been burned by a 13,000-volt line and was dangling, unconscious, on his body belt, clothes and hair afire. Lamb shinnied up and beat out the flames with his bare hands. Though working close to the hot lines, he managed to sling a rope around the victim, toss one end over a crossarm so men below could lower him to the ground, where Lamb then rendered first aid until an ambulance came.

Short circuits do start pole-top fires on rare occasions—but probably nothing as spectacular as the one that nearly got a phone-company splicer and his helper in Syracuse, N. Y. The splicer was under one of those platform tents linemen use on pole tops in bad weather, soldering a connection with a gas torch. Suddenly a paraffined wire flared up, burned the gas hose and enveloped him in flame. Bob Case, his helper, was down below and heard the cry of "fire!" He looked up to see a holocaust.

(Continued to page 270)



RESCUE

your car with...

The fellow you see staring at you from this page is the new AC Sludgehound . . . symbol of the tremendously important "rescue work" which is the daily job of AC Oil Filters everywhere.

Each year AC Filters literally rescue millions of cars from the damage that can be done by carbon, grit, dirt and sludge. AC Oil Filters have actually filtered out as much as 1 1/4 pounds of injurious matter in 5,000 miles. So you see, *regular changing of your AC Oil Filter saves you repair bills, keeps your oil clean all of the time, keeps your engine quiet, keeps it easy on gas and oil.*

Remember the Sludgehound's friendly advice. Ask your Registered AC Dealer to check your oil filter each time he changes your oil . . . and change the filter every 5,000 miles. There's an AC Oil Filter for nearly every make of car and truck.

You get **10** times the filtering area with AC accordion fold



More than **90** sludge-trapping pockets are formed by this fold



Standard or Optional Factory Equipment on Cadillac, Buick, Oldsmobile, Chevrolet, GMC

Ask any Registered AC Dealer to attach an AC metal tag to your dipstick; then he can tell you at once when oil and oil filter should be changed to give your engine the proper protection.

AC SPARK PLUG DIVISION • GENERAL MOTORS CORPORATION





New Mending Tool

Build and repair with this handy workshop helper. New polyvinyl acetate adhesive is ready to use, forms strong, long-lasting bond on wood and other porous materials. Sets fast. Dries clear. New squeeze bottle makes gluing faster, cleaner, easier. Get the large 8-oz. workshop size. \$1.00 at leading hardware stores. Write for folder. The Borden Company, Chemical Division, Dept. PM-94, 350 Madison Avenue, New York 17, N. Y.



© T. B. C.

ELMER'S[®] GLUE-ALL

Get This **NEW**
Catalog of
WOOD
AND
WOODWORKING
MATERIALS



World's Largest Selection
of Finest Domestic and Imported
Woods... Mouldings, Hardware, Tools,
—ALL AT LOW MONEY SAVING PRICES!

Your complete wood buying guide and project book. Craftsman is your best, most complete source of finest kiln-dried domestic and rare imported woods, beautiful wood inlays, colorful handings, matched plywoods, embossed mouldings, carved ornaments, newest woodworking tools, "hard to find" cabinet hardware and fittings... more than 1,500 items! Packed with newest scroll saw patterns, project ideas & money making plans. Enclose 15c (refunded with first order) to help pay mailing, handling cost. Write now! Craftsman Wood Service Co., Dept. A-49, 2727 S. Mary Street - Chicago 8, Ill.

148 PAGES

Many in full color

packed with rare, fancy & imported woods... veneers, plywoods, patterns, tools, ornaments, hardware... everything for the woodworker.

MAIL COUPON NOW!

CRAFTSMAN SERVICE CO., Dept. A-49,
2727 S. Mary St., Chicago 8, Ill.

Enclosed find 15c. Rush me new Woodworkers' Catalog Handbook.

NAME.....

ADDRESS.....

CITY.....ZONE.....STATE.....

Racing up the pole, he slashed the tent with a knife, reached inside and grabbed his co-worker by the clothing. With a superhuman effort, he dragged the man out and helped him to the ground. A second later, blazing lines burned through, dumping gas tank, tools, burning platform and tent to the ground.

Case was awarded a silver medal and \$500 for that lifesaving job. The Bell Telephone Company makes a practice of recognizing both individual and group heroics among its employees, with gold, silver or bronze medals (and cash as well) from the Theodore N. Vail memorial fund which was set up for the purpose. Many a telephone lineman's name is on that roll of honor—sometimes for heroics not strictly in the line of duty.

When the Contoocook River flooded an entire New Hampshire village, lineman Michael O'Connor heard that several boats had capsized in the raging torrent, and two exhausted victims were clinging to the top of a telephone pole above water too fast for anyone to get through. O'Connor took a boat out as far as he could. Carrying a cable car and 150 feet of rope, he climbed a swaying pole and rode the strand the remaining distance to the pole to which the victims clung. He sent one man to safety on the cable car, which jammed on the return trip. Then he rode along that line on his safety belt, retrieved the car, tied victim number two on it, and hauled him all the way to safety.

In this age of mechanical perfection you'd think that jobs for the power and telephone linemen should be dwindling. In many ways the young "lightning jerkers" have it easier, according to fellows like Zimmerman and Bain, who remember the days when the only Bushwacker was an ax, and the only Skylift was a man's own leg beef—or a swift kick from his crew chief. But actually, as long as wires come out of the ground and ride overhead, line crews will have work to do.

Why? Storms, earthquakes, fires, floods—and animals. Recently in Northern Michigan a beaver successfully gnawed through a pole butt, brought it crashing down in a tangle of wire and knocked out 11 phone and power circuits.

Linemen tracking down a short circuit in Montana found the cause after days of search—a dead catfish! It was draped across two lines, where it had probably been dropped by a fish hawk. Fish hawks are a menace to line crews—especially on Long Island, where they insist on building their king-size nests on pole crossarms. Bits of wire and metal they use for building

(Continued to page 272)

DOUBLE ACTION HYDRAULIC CYLINDER
 ITEM #31C—3½" bore, 11" stroke. Alloy steel cylinder wall. Micro-Housed and all steel 1½" diameter piston rod. 19½" overall length closed. Clevis mounting at base and shaft. Will lift 9625 lbs. with 1000 P.S.I. Pump Pressure. Uses ¾" tubing fittings. (Fittings to pipe thread: two ¾" MPT & 3/8" A) \$102.00



value. Shipping weight 11 lbs. F.O.B. Chicago. **25.00**

BRONZE & MONEL BALL BEARING GEAR PUMPS



ITEM #204 For—
 • Insecticide Pumping and Spraying of D.D.T., 2-4D, Chlorodane, etc. • Self-Priming—use as Shallow Well Pump • For Sprinklers • Home Water Systems • For Sump Pump • For P.T.O., Direct or Pulley Drive • Rated—6 G.P.M. at 600 R.P.M.—18 G.P.M. at 1800 R.P.M., 36 G.P.M. at 3600 R.P.M. • Pressure to 250 P.S.I. • Use ½ to 5 H.P. • 1" Pipe thread inlet 1" hose outlet • Shipping Wt.—15 lbs. F.O.B. Chicago. **24.50**

WELDING GENERATOR



ITEM #90—When connected as a welder, this unit will deliver 200 amps for a sustained period and 250 amps for intermittent service. This generator is widely used for shop-built portable welders. Rated 200 amps, 28 volts, 2500 R.P.M., using 10 H.P. Dimensions: 15" L. x 6" W. x 8½" H. Spooled drive shaft. Gov't. Acq. cost \$300.00. Ship. Wt. 51 lbs. F.O.B. Chicago. **22.50**

High Pressure GLOBE VALVE



ITEM #380—Designed for 3000 P.S.I. aircraft hydraulic systems • ¾" pipe thread ports • Aluminum alloy body • Alloy steel shaft • Hardened bronze valve seat. Dimensions: W 3½" x H 5½" x D 2". Shipping Wt. 1½ lbs. F.O.B. Chicago. **5.95**

FREE FALL & WINTER EDITION

1954 CATALOG, 52 PAGES, check-full of unsurpassed War Surplus Equipment Bargains for farms, home, factory, workshop. Write letter today.

BRAND NEW!
WAR SURPLUS
 Released Since
KOREAN TRUCE

BERRY — HEAVY DUTY HYDRAULIC PUMP or MOTOR

ITEM #166—use on road machinery, vibrators, paper mills, wire reels, hydraulic presses, speed control units. Ball bearing construction, balanced cam design assures high efficiency performance. When used as a pump delivers 8 G.P.M., 1000 P.S.I., 8 H.P. At 1200 R.P.M. as a HYDRAULIC MOTOR: Rated up to 12 H.P., up to 2400 R.P.M. Standard ¾" pipe thread ports. ¾" shaft with keyway. Dimensions: 14½" x 8" x 7". Weight 63 lbs. Regularly \$212.00. **OUR SPECIAL PRICE 2 for 110.00** **59.50** F.O.B. Chicago

GROBAN FOUR-WAY OPEN CENTER HYDRAULIC CONTROL VALVE

ITEM #126—Four-way open center control valve, with built-in adjustable relief valve factory set at 1000 P.S.I. Spring loaded neutral position. For use with one double acting cylinder. In neutral position cylinder is locked and pump unloaded. Can be used as single unit or mounted in series. Has ¾" pipe thread inlet and outlet. ½" pipe thread cylinder ports. Finger grip handle. Ship. wt. 10½ lbs. **AN OUTSTANDING BUY!** F.O.B. Chicago **21.50**

GROBAN HYDRAULIC SPEED REDUCER

With **FINGERTIP CONTROL**
 USE FOR: • Reamer Drives • Midget Cars • Feed Mills • Canning Machines • Conveyors • Lathes • Milling Machines • Motor Boats • Cream Separators • Garden Tractors • Pumps.

Variable output speeds from 0 to input speed available by moving control handle. Locking handle maintains setting. Use input power of ¼ to 1½ H.P. Shafts ¾" diam. Input rotation counter-clockwise facing shaft. Input speed 750 R.P.M. 7½" x 7½" x 11½". Gov't acquisition cost \$428.00. Ship. wt. 31 lbs. Complete with 2 qts. of oil and full instructions. F.O.B. Chicago. **54.50**



GROBAN SUPPLY CO., Dept. PM-9
 1139 S. WABASH AVE., CHICAGO 5, ILL.

A. C. ELECTRIC GENERATOR
 ITEM #G-75-D



—7½ K.W. single phase. 110/220 volt output. 3 wire system, 2 bearing construction. 5 groove 6" V belt pulley included. Self-excited. Foot mounted. Drive generator from tractor or stand by engine. Ample power for 6 room house. Dimensions: 34" x 11½". Shipping Wt. 420 lbs. F.O.B. Chicago. **295.00**

PORTABLE ELECTRIC LIGHT PLANT



ITEM #334 Compact Electric Plant suited for small homes, cabins, campers, hunting and fishing camps, trailers and small electrical home appliances. Operating costs: About 5c per hour. Sturdily constructed for dependable service. Net weight only 88 lbs. Can be carried from place to place, or transported in trunk of car. 250-350 Watt—110 Volt—D.C. Model PE-77D. Powered by easy starting 1 Cylinder, 4 Cycle Briggs-Stratton Engine complete with muffler, starting rope and oil bath air cleaner, direct coupled to a 250-350 Watt Generator with twin plug-in outlets. Engine speed 2650 R.P.M. Shipping Wt. 110 lbs. Commercial List Price \$225.00

WAR SURPLUS PRICE
 Special Value . . . **75.00** F.O.B. Chicago

OTHER SIZES IN STOCK
 FROM 350 W. TO 25,000 W.

ORDER DIRECT FROM AD
SATISFACTION GUARANTEED
 Send Payment Or
 Purchase Order Today

TO PLACE, PHONE ORDERS
 CALL WEbster 9-3793

BUILD YOUR OWN ARC-WELDER
 We show you how to build NEW powerful welder. No rewinding. Uses most any surplus aircraft generator. Easy to build. 75-300 amps. Complete **PLANE 25c**. Send today and we'll include **FREE** our Big War Surplus & Electrical Catalog.
 LEJAY MFG. CO., 1247 LEJAY BLDG., MINNEAPOLIS 8, MINN.



Red Devil Tools.
 Get your **FREE** copy of "HOW TO PREPARE FOR PAINTING."
MAIL COUPON TODAY
Red Devil Tools. Dept. 148
 130 Coit Street, Irvington, N. J.
 NAME _____
 ADDRESS _____
 CITY _____ ZONE _____ STATE _____

Say You Saw It in Popular Mechanics

SAVE UP TO 50%

	ALUMINUM VENETIAN BLIND KITS	
	ALUMINUM STORM WINDOW & DOOR KITS	
	ALUMINUM AWNING KITS	
	ALUMINUM JALOUSIE & LUGGAGE KITS	

FLEXOLITE MANUFACTURING AND SUPPLY COMPANY
 369 Wilson Avenue, Dept. 1-A, Brooklyn 21, N. Y.

FREE CATALOG Name _____
 Address _____
 City _____ Zone _____ State _____

Salesmen & Dealers Invited



Last gasp
for
your old Screens?

Replace 'em for good with non-staining Alcoa Aluminum screening

Now is the time to fix your worn-out screens for keeps. Replace with screening woven from genuine Alcoa® Alclad Aluminum Wire and relax. It *won't* stain your sills and siding. It *will* last for years.

Hardware stores and building supply yards carry Alcoa Aluminum screening. Look for the Alcoa label. Write for folder that tells easy ways to replace screening.

ALCOA 
ALUMINUM

ALUMINUM COMPANY OF AMERICA

ALUMINUM COMPANY OF AMERICA
1931-J Alcoa Building, Pittsburgh 19, Pa.

Please send a copy of your booklet that tells how to install Alcoa Aluminum screening.

Name _____
(Please print plainly)

Address _____

City _____ Zone _____ State _____

material continually short out the lines and start grass fires as well. This may burn pole butts for miles around. Phone company linemen think they've finally solved the problem by erecting "bird nest" platforms on special poles to lure the creatures away from the high lines.

Bears, it is said, sometimes hear the lines humming, think it's a swarm of bees, climb a pole and then smash all the crossarms to bits when they discover they've been tricked.

Not long ago, telephone linemen in Kingston, N. Y., were puzzled because they couldn't find where a rural line was grounded out, causing failures on a whole string of subscribers' phones. Then one day a repairman noticed a little knoll where the line dipped within reach of the ground on its way through a farm. There, tethered by a chain to the handy telephone line, stood a nanny goat peacefully grazing—and grounding out the circuit.

Most of the time, however, it's the elements and not two-legged or four-legged creatures who make it necessary for rugged line crews to buck a dozen hazards as they cling to precarious perches in bitter-cold blizzards, buffeted by wind and rain, so you'll have light and phone service. Even the inside of a sturdy line truck isn't always so cozy. F. J. Smith, for instance, a telephone repairman in Port Huron, Mich., was sitting out a storm in such a truck, when a tornado came roaring up the street and took him—truck and all—on a 200-foot unscheduled flight. "I saw poles tumbling and a building came flying toward me," he recalls. "I remember seeing it flatten the car next to me. Next thing I remember the truck was on its side the next street up the block."

In the same storm, another line crew holed up in a truck, suddenly saw poles collapse in front of and behind them, draping 40,000-volt conductors over the truck cab. Knowing their tires would protect them, they sat deathly still for three hours, after their foreman, Norm Schneider, took a long chance, leaped clear and went for help.

In spite of it all, few linemen would swap jobs with anyone. And next time your lights go out and your phone goes dead, you may be sure that the John Zimmermans, Joe Bains and Jim Mathers of your community are out in the dirty weather getting things fixed up as fast as they can.

★ ★ ★

☛ Jupiter's atmosphere is mostly hydrogen and helium, not methane and ammonia, according to a report by the Carnegie Institution of Washington.

WORLD'S MOST POPULAR HOBBY MICROSCOPES

150-300-600 POWER

Model 635 Triple objective microscope, all accessories available including interchangeable eyepieces. Excellent optics, 6-aperture diaphragm, fixed condenser, plano-concave mirror. Shipped insured in fitted hard-wood cabinet.

\$29⁹⁵

POSTPAID



100-200-300 POWER

Model 300 Triple revolving turret microscope — capable of seeing and studying microscopic animal life. Shipped insured in hard-wood cabinet.

\$9⁹⁵

POSTPAID



BACK-TO-SCHOOL SPECIAL!

August and September, 1954 only. This quality dissecting kit, regularly listed in our catalog for \$4.95 will be included with every microscope order for \$1.00 additional!

\$1.00



AS ADVERTISED IN SATURDAY EVENING **POST**

FREE

44 Page Catalog Plus Extra Micro-Manual mailed on request or included in your order. Microscopes up to 2000X research instruments. Slide making materials, optics of all kinds. Don't miss these two fascinating books.

20 TO 600 POWER **\$39⁹⁵**

POSTPAID

Model 800 Quadruple objective. Consultation swirl lens. Designed as an inexpensive instrument for the professional microscopist. Purchase price includes 15X eyepiece, 5X, 10X, 20X & 40X objectives. All accessories available. Shipped insured in fitted hard-wood cabinet.



EXECUTIVE INTERCOM SYSTEM

IMMEDIATE SHIPMENT **\$19⁹⁵** POSTPAID



TWO ULTRAMODERN FRENCH PHONES with desk cradles, completely self contained. Handsome contemporary design. Solid lifetime construction. Built-in double buzzer system. Operated anywhere on ordinary flashlight batteries (two in each cradle). Excellent fidelity, range, clarity. Use inter-office, store-home, home-barn, home-garage, outside, inside. Black satin finish. Additional batteries recommended for over 100 yards. Two phones and cradles, 4 batteries inc. postpaid \$19.95. Double wire, postpaid 4c per foot.

MONEY BACK GUARANTEE! Return any item within 10 days for full refund. To order: Send check or money order, 1/3 deposit on C.O.D. Calif. resid. add 3% state tax. Items manufactured to our rigid specifications by selected Japanese firms. Electronics are standard U.S. manufacture. DEALERS, SCHOOLS INQUIRE.

the **AKRON**

112 AKRON BLDG. 4379 SUNSET BLVD.
LOS ANGELES 27, CALIFORNIA

ACE TOOLS

No. 8-A SET

Be permanently toolled-up for every operation on your Metal Cutting Lathe.

No. 8-A Ace Tool Set for 9" and 10" Swing Lathes—fits shank size 3/8" x 3/4". Includes Turning, Cutting-off, Boring, Knurling and Threading Tools with high speed cutters, blades and wrenches. 8 complete tools in fitted steel case—nothing else to buy. See your local dealer or order direct.

ARMSTRONG BROS. TOOL CO.
5268 W. Armstrong Ave., Chicago 30, Ill.

\$26⁹⁵



WOODWORKERS! With beautiful veneers you can use the world's choicest woods in your own home projects. We specialize in highest quality veneers and inlays for the home craftsman. Send \$1.00 for samples of 14 exotic woods. Price list and "Tips on Veneering" free.

SOUTHERN CRAFTSMAN
P.O. Box 1644

Louisville, Ky.

Dept. P

Only **HOLD-E-ZEE** The Original AUTOMATIC GRIP **SCREWDRIVERS**

PROVIDE THESE FEATURES:

- **LOK-BLOK** that makes blade twist and impact proof.
- **GRIPPER** that snaps back—recedes deep into handle, giving full blade use.
- **HAND GROUND BITS**—chrome vanadium, chrome plated blades.

YET COST NO MORE THAN ORDINARY SCREWDRIVERS



At Leading Dealers
Everywhere!

UPSON BROS., INC., ROCHESTER 14 N. Y.



Quick way to a keen edge ...use a **NORTON** INDIA--

Combination Stone, made of almost diamond-hard grit, and factory oil-filled. The oil you apply in sharpening does not soak in, but remains on the surface, increasing the "bite" of the stone and flushing off the fine steel chips which quickly clog stones not so protected. Use PIKE® Oil, specially prepared for the job. Get this combination of 6 in. stone and oil at your local hardware store, or send us \$2.46, which includes 32¢ for the PIKE Oil, and a copy of the "How to Sharpen" Book.

Or send us 10¢ for the book only, telling how the experts sharpen, with many illustrations. Address Behr-Manning, Troy, N. Y., Dept. PM-9.

C-20



BEHR-MANNING

division of NORTON Company

▲ COATED ABRASIVES ▲ SHARPENING STONES ▲ PRESSURE-SENSITIVE TAPES

SEPTEMBER 1954

273

NAIL this WEATHERSTRIP on the bottom of your overhead-type garage door

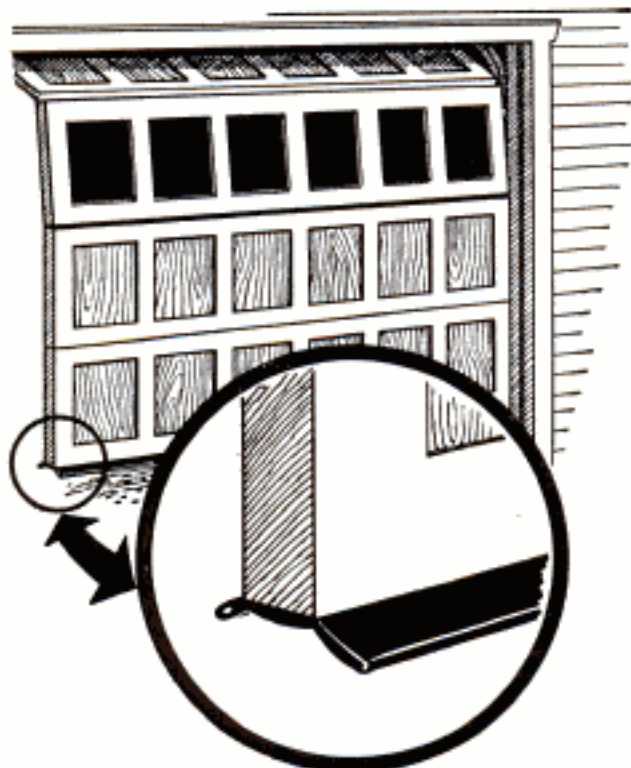

- Seals out rain, snow, dust and drafts.
- Seals in heat. Pays for itself quickly.
- Cushions door closing.
- Protects door bottom against rotting.
- Prevents splintering and glass breakage.

StanStrip* is a durable, live-rubber weatherstrip, easily installed by nailing to the bottom of your present overhead-type garage door. Proved effective for years on thousands of garages. Or if your plans include a new garage, ask the builder to install StanStrip. *Trademark



SOLD IN LEADING HARDWARE STORES EVERYWHERE. If unavailable, use coupon below. Postage prepaid with check or money order. Sorry, no c.o.d.'s.

THE STANDARD PRODUCTS CO.
Dept. "M", Box 1092, Cleveland 2, Ohio

Enclosed is \$ _____ for StanStrip as checked below.
 8 Ft. \$2.95 9 Ft. \$3.29 16 Ft. \$5.90
 (Other lengths to 20 Ft., 37¢ per Ft.)

Name _____
 Address _____
 City & State _____

Phono Music on a Light Beam

(Continued from page 164)

BEAM TRANSMITTER RESISTORS

Note—K=1000; all carbon 10%

R1=100 K ohms, ½-watt carbon	R8=15 K ohms, 2-watt carbon
R2=½ megohm (log. taper) pot. volume control	R10=500 ohms, wirewound, 10 watt
R3 & R6=2.2 K ohms, ½-watt carbon	R11=470 K ohms, ½-watt carbon
R4 & R9=220 K ohms, ½-watt carbon	R13=47 K ohms, 1-watt carbon
R5 & R12=10 K ohms, ½-watt carbon	R14=4.7 K ohms, ½-watt carbon
R7=10 K ohms, pot. (meter control)	R15=5 K ohms, wirewound, 10 watt

BEAM TRANSMITTER CAPACITORS

C1 & C10=.02 mfd. 400-V., paper type

C2=20 mfd. 25-V.	} Mallory Elect. FP-426
C3=20 mfd. 25-V.	
C4=15 mfd. 450-V.	
C5=20 mfd. 450-V.	
C6=20 mfd. 450-V.	} Mallory Elect. FP-456
C7=40 mfd. 300-V.	
C8=25 mfd. 475-V.	
C9=100 mfd. 50-V.	

The 4½-in. plano-convex lens (flat on one side, bulged on the other) at the transmitter has a focal length of 10 inches. This condenser lens is a type used for arc-lamp projection systems. The one used is No. 85655D, from Central Scientific Co., 1700 Irving Park Rd., Chicago 13, Ill. It is also available as No. 892 from Kliegl Bros., 321 W. 50th Street, New York 19, N. Y.

The Fresnel "step" lens at the receiver is an inexpensive 8-in.-dia. variety having a focal length of 12 in.; available from Kliegl Bros. Their catalog number is 2072. It is also available from many theater-supply houses. The receiving-lens mounting details are shown in Fig. 3. See Fig. 1-A for mounting the lens at the beam transmitter. Note that the focal-length setting is figured from the back of the lens to a

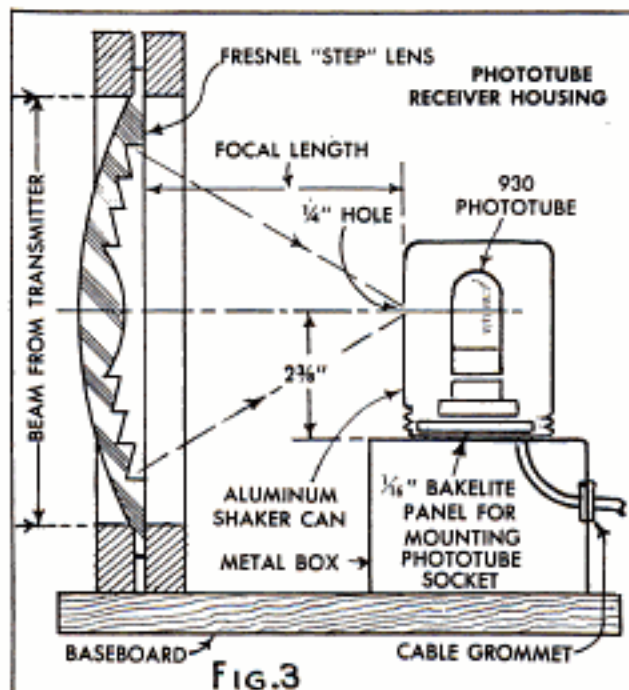

FIG. 3
(Continued to page 276)

GIGANTIC MAIL SALE

WAR SURPLUS
EXCESS INVENTORY
BANKRUPT STOCK

ARMY POWER PLANTS

New condition. Full guarantee. Perfect plants. Latest models. Shipped prepaid to you.

- Plants 3000-4000-W, 115/230 V, 60-C. Push-button start \$351.00
- Plants 2000-W, 115-V 60-C \$289
- Plants 1000-W, 115-V 60-C \$189
- Generators 7500-W, 115-V, 60-C... \$235
- Generators 3000-W, 115-V, 60-C... \$149
- Generator 3000-W, 115-V-DC. Fine for portable AC-DC tools. Govt. cost over \$105... \$58



G. E. MOTOR — 3 HP — SAVE 50%

Brand new General Electric's finest heavy duty motor. Ideal for farm or business. 115-V, 60-C. Sing. phase. Capacitor type. Purchased from Army in org. crates. (List \$220.50) Prepaid to you... \$119



ARMY PHONE & TEST UNIT

Consist combined field phone and test unit. Talk, ring or test. Range 20 miles on iron wire lines. Set also useful for testing elec. appliances, motors, etc. Cost over \$150. Sale... \$24.95



GIANT AIR CORPS LIGHT

Amazing 110-Volt unit with intensifier fresnel light. Throws wide beam over large area. Wonderful for parking lots, advertising lite, small airports, etc. Comes in \$30 trunk with extra bulbs, 12 ft. extension tripod, anchors, etc. Govt. cost over \$200. Sale... \$49.50



FREE CATALOG!

Thousands of items. Tools, electronics, watches, transistors, tarpes, microscopes, weed spray units, etc. Get finest Govt. items at fraction of original cost.

BURDEN PAYS ALL SHIPPING CHARGES

AIR COMPRESSOR BARGAINS

For painting, cleaning, tires, control termite. Assemble your own outfit. Lowest prices in U.S.

- DeLuxe Kit. Compressor, tank, gauge, regulator, paint gun, fittings. How to build instructions. List \$80. Sale... \$45.49
- DeLuxe Outfit. Finest ready to use complete air unit on wheels with gun, reg. etc. (Less motor) \$80.95
- Compressor (1-cyl) \$20; 2-cyl \$52; Govt Air Tanks \$6.79; Regulators \$2.79; Pop off \$1.95; Pres. gauge \$1.89; Finest paint gun \$9.95; Auto. switch \$4.95.

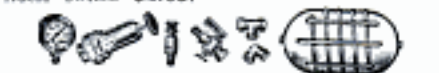

HYDRAULIC SPECIALS

Save to 80%. Build loaders, lifts, etc.

- Cylinder Buy! Finest landing make, 3" bore, 8" stroke, one way. Fine for plow lifts, etc. List \$25.50... \$11.95
- Cylinders. Two-way, 2"x10" \$22.85; 2"x24" \$28.90; 3"x24" \$39.90. One-way, 2 1/2"x42" \$36.95.
- Pump, 1000 lb, 12 gal \$45; Valves. One-way \$18; Two-way \$18; Gauges, 1000, 1500, or 3000 lb, \$3.49.
- Super Special Cylinder, V 1 1/2" bore x 4" stroke. (Precision). Govt. cost \$87... Sale \$1.95 ea.



PUMPS — VALVES — SYSTEMS

Investigate. Do it yourself. Our data shows you how.

- Pumps. Centrifugal 1/2" \$19.95; 1 1/2" \$36.60; Rubber impeller self priming 1/2" \$15; Hi-pressure rotary for weed, cattle spraying \$54; Water System, Automatic. For lifts to 22 ft. 300 gal. per hr. 40 lbs. 110-V 60-C, 1/4 hp. motor... \$69.50

SPEED REDUCERS—Winches—Hoists

Speed Reducers. Brand new. Worm gear. Frode, 6 hp. 1 to 5 ratio. Input shaft 1 1/2"; Output 1 1/2" \$69.50. Winches. Hand 1000 lb. \$21.69. Winches. Hand 2000 lb. \$31.90. Hoists. 3000 lb. chain... \$21.95



SPECIAL OF THE MONTH

AUTOMATIC CLOCK SWITCH

Marvelous Westinghouse 110-V 60-C. Telechron. Automatically turns on radios, stoves, furnaces, fans, TV, etc. Anytime —day or nite. Set up your favorite programs hours ahead. Dual switch handles loads to 2000 watts. (Only 200 available) List \$16.50... Sale... \$7.95



ELECTRONICS and MISCELLANEOUS

Interested in electronics? Write for bulletin "E-1". Some of our many bargains!

- Surveyors Level & Tripod... \$37.95
- \$30,000 Arc Searchlight (FOB)... \$850.00
- Farm Telephones... \$9.95
- Generators—200 amp. DC-AC... \$29.95
- W.E. Photo Cell (List \$6.50)... \$4.9c
- Black Light Tube—4 Watt... \$8c
- Fluorotron Trigger Tube (List \$4.95)... \$8c

ARMY HIP WADERS

Brand new. Perfect. Leading makes. Durable. Finest rubber. Only 1,000 pairs. Ideal for sportsmen, contractors, farmers, etc. Less than wholesale (List cost \$15.95)... Sale \$8.65

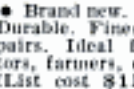

HOME APPLIANCE TESTER

Expensive direct num reading. Weston 8" precision tester. Enables anyone to check motors, appliances, radios, etc. Troubleshooting instructions turn. free. Only 90 available. (List \$51.50)... Sale \$12.95



ARMY PARTS CLEANER

Air-turbo solvent cleaner. Makes dirty, greasy parts shiny bright. Wonderful for garages, factories, farms, etc.

- Heavy galv. tank 25"x20"x20". Complete with valve, hose, hydraulic lid lifter. Cost over \$125... \$29.95

We pay all shipping charges. Send for Free Catalog

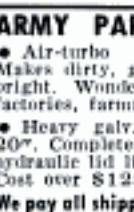

BURDEN SALES COMPANY

804 140" STREET LINCOLN, NEBRASKA

SAVE OVER 50% on NEW TOOLS

Ignition wrench set—8 sizes. These are Proto tools forged from alloy steel \$3.00 value for \$1.00 set. Henry Disston #4 back saws 16" blade \$9.25 value for \$3.50 ea. Geo. H. Bishop spring steel mitre box saws, 26" blade—\$16.00 value for only \$6.50 ea. All tools are new—we pay all postage.

Send cash, check or money order to

ARMY SURPLUS SALES

1820 TULARE ST. FRESNO, CALIF.

ALSO CHILD'S 2 PASS. MOTOR CAR Write For Free Literature

ESHELMAN HOLDS 1 ADULT

AUTO WITH MOTOR

LOWEST PRICE
70 Miles Per Gal. Gas
25 Miles Per Hour

Eshelman

DEPT. CM-89
109 Light St.
Baltimore, Md.
333 N. Michigan Ave.
Chicago 1, Ill.
7070 Hollywood Blvd., L. A. 28, Cal.



Write For Free Literature

SAWING IS EASY WITH THESE TWO FAMOUS "DO-IT-YOURSELF" POWER TOOLS

"ARCO-SAW" the only circular saw attachment guaranteed to whiz thru 2x4's in one cut or your money back! No need to pay 3 to 5 times as much for saws that do the same work. Accurate, fast adjusting Depth, Bevel, Rip Gages are foolproof—give your projects professional-looking results. Convert your basement or attic 8-times faster than hand sawing—build modern kitchen cabinets, bookcases—and save plenty! Simply attach "ARCO-SAW" to any 1/4" electric drill by tightening strong Safety-Yoke & clamp around drill and run its tough steel gears practically indestructible. BLADES—5" Safcut, Rip, Crosscut, or Comb... \$1.75

No. 455 "ARCO-SAW" with Blade \$12.50

90-DAY FACTORY GUARANTEE

BUY THE BEST—see your hardware dealer now! If not available, try "ARCO" Tools on our 10-DAY MONEY BACK GUARANTEE. Send us check or M.O. (Postpaid). C.O.D.'s—postage extra.

ARROW METAL PRODUCTS CO. Dept. PM-9, 140 WEST BROADWAY, NEW YORK 13, N. Y.

"ARCO JIG-SAW" Does work of Jig, Keyhole, Coping, Rip, Band and Hack Saw! EXCLUSIVE "AIR-JET" BLOWS AWAY SAWDUST.

You would expect to pay \$50 or more for a portable jig saw that has the same capacity, cutting speed & precision as "ARCO JIG-SAW." But here, for the first time, is a versatile, rugged saw that attaches in 1 minute to any 1/4" electric drill—eliminates expensive built-in motor—saves you the difference! Guaranteed to cut intricate patterns, circles—no matter how large—in dies—plywood, wallboard, plaster, metals—even lumber up to 2x4's! Cuts safely—without starting hole. Safety-Yoke & Clamp give you a vibration-free unit. Has wide Shoe-Plate. Converts to Table Model with

No. 401 "ARCO STAND"... \$2.75
6 Blades for wood, metals, etc.... \$1.95

No. 500 "ARCO JIG-SAW" with blade. \$10.95

AT BETTER HARDWARE STORES EVERYWHERE

BUY THE BEST—see your hardware dealer now! If not available, try "ARCO" Tools on our 10-DAY MONEY BACK GUARANTEE. Send us check or M.O. (Postpaid). C.O.D.'s—postage extra.

this **ONE** GOVERNOR

fits ALL popular
farm & industrial
gasoline engines



PIERCE LONG RANGE Universal Governor

Instant variable speed selection and accurate engine control at any speed setting within 1600 to 2600 RPM. Higher and lower ranges obtainable by simple change of pulley. Also "constant speed" operation.

Accurate, dependable speed control for engines operating corn shellers, drag lines, hoists, arc welders, trucks and tractors with power take-offs, etc.

Write for Complete Information.

DEALERSHIPS
AVAILABLE

"World's Most
Experienced Governor
Manufacturer"

ONLY
\$39⁵⁰

Pulley extra
Send Check or
Money Order.
State Make,
Model of engine.

**THE PIERCE
GOVERNOR CO., Inc.**
1652 Ohio Avenue, Box 1000
Anderson, Indiana, U. S. A.

Bring
life
into
your
attic
with



MASONITE PRESDWOOD

Put that unused space to work—for children, relatives or for income. Handy panels of strong, grainless Masonite Presdwood and Plan AE-297 make it easier. See your building materials dealer for 33 types and thicknesses of Presdwood®.

Send for "Idea Book." Lists other plans, too.

NATURALLY STRONGER WITH LIGNIN



MASONITE
CORPORATION

Dept. PM-9, Box 777, Chicago 90, Ill.

Please send me your "Idea Book."

Name.....

Address.....

Town..... Zone.....

County..... State.....

"Masonite" signifies that Masonite Corporation is the source of the product

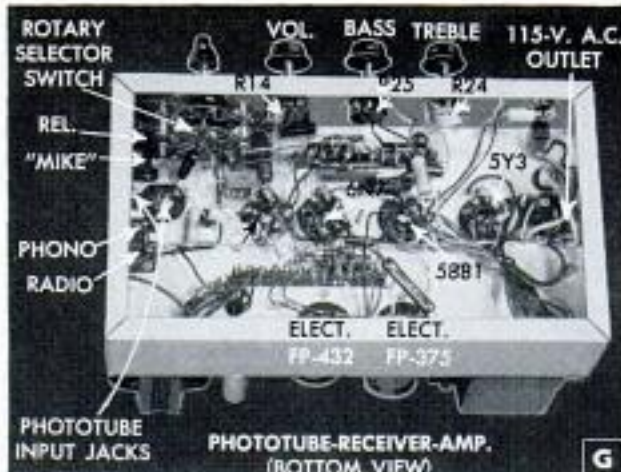

PHOTOTUBE AMPLIFIER RESISTORS

Note—K=1000; all carbon 10%

R1=6.8 K ohms, 1/2-watt carbon	R17 & R23=47 K ohms, 1/2-watt carbon
R2 & R28=15 K ohms, 1/2-watt carbon	R18 & R22=2.2 K ohms, 1/2-watt carbon
R3=10 megohms, 1-watt (low noise) carbon*	R19 & R34=100 K ohms, 1-watt carbon
R4=3.8 megohms, 1/2-watt carbon	R20 & R21=100 K ohms, 1/2-watt carbon
R5 & R7=68 K ohms, 1/2-watt carbon	R24=1/2 megohm, (log. taper) treble control pot.
R6=5-megohms (low noise) carbon*	R25=(same as R24) bass control
R8, R9, R13 & R15=100 K ohms, 1/2-watt carbon	R26=10 K ohms, 1/2-watt carbon
R10=27 K ohms, 1/2-watt carbon	R27 & R30=1 K ohms, 1/2-watt carbon
R11=51 K ohms, 1/2-watt carbon	R29=470 ohms, 1/2-watt carbon
R12=33 K ohms, 1/2-watt carbon	R32=300 ohms, wirewound, 5 watts
R14=1/2 megohm (log. taper) pot. volume control	R33=750 ohms, wirewound, 10 watts
R16 & R31=470 K ohms, 1/2-watt carbon	

*Continental carbon X-type

PHOTOTUBE AMPLIFIER CAPACITORS

C1, C3, C10, C11, C12 & C17=.05 mfd. 400-V. paper type
C2 & C13=.001 mfd. 400-V. paper type
C4=.0002 mfd. mica type
C5, C14 & C21=.01 mfd. 400-V., paper type
C6=10 mfd. 450-V. } Mallory Elect. FP-432
C7=10 mfd. 450-V. }
C8=250 mfd. 25-V. }
C9=40 mfd. 450-V. }
C15=.005 mfd. mica disk cap type
C16=.02 mfd. 400-V. paper type
C18=100 mfd. 400-V. } Mallory Elect. FP-375
C19=40 mfd. 450-V. }
C20=40 mfd. 450-V. }

point 3/8 of an inch back from the front end of the crater glow lamp. Detailed student material list R-427 is available from Popular Mechanics Radio-TV and Electronics department upon receipt of ordinary letter postage. ★ ★ ★

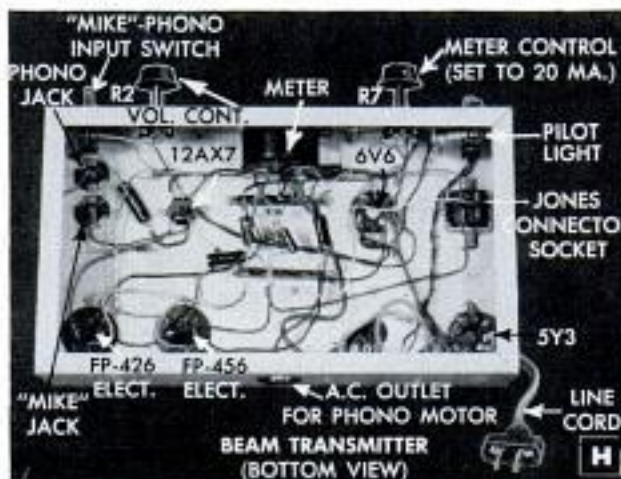

AUTOMATIC AIR COMPRESSOR



1/2 H.P.
\$79.00
FREE
\$12.00
QUART
GUN

1/2 HP heavy duty
R.I. or Cap. motor,
115-V, 60 Cy. AC
\$23.50
X2 Quincy 3 CFM,
100-150 lb. com-
pressor . . . \$20.50
Automatic adjusta-
ble pressure switch
. . . \$6.50
Tank 8x26, rubber
tired wheels and
handle . . . \$17.00
Adjustable pressure regu-
lator and gauge . . . \$6.00
Moisture filter—\$3.25 V-
belt drive . . . \$2.75
Hose and tire chuck \$2.50
Safety valve . . . \$1.50
Check valve & copper tub-
ing . . . \$3.75
Small parts shipped
parcel post prepaid at above
prices.

Complete 1/2 HP unit as-
sembled, ready to use—
Plus Special FREE \$12.00
value Quart External
Atomizing Spray Gun with
SA-5, \$89.00 FOB Chicago
down, you assemble, free
spray gun, \$12.00 value. \$5.50
\$95.00 — 1 HP Motor 15x30 Tank Twin Cylinder 9 CFM Com-
pressor, All Access. You assemble. Free Gun . . . \$169.50 FOB
Write for CIRCULAR: Listing Motors; ALL SIZES; Fans and Air
Compressors—ALL SIZES.

C. MARSHALL SALES

3546 W. Fullerton Ave. Dept. P-9 Chicago 47



x-acto

KNIVES • TOOLS
HANDICRAFT KITS



NO. 82
KNIFE SET
\$4.20

X-ACTO, INC.
48-41 Van Dam St.
Long Island City,
N. Y.

Send 20¢ for 28-page Catalog

CASH IN YOUR SPARE TIME

UP TO \$40 A DAY IN YOUR OWN BUSINESS. Easy to start repeat cash business at home with the New BELSAW... sharpening and setting circular saws, grinding planer and jointer knives. Low Cost, only \$15 down... Start to work the day your BELSAW arrives. No experience needed. Hundreds of jobs in your neighborhood. Send Today for Free Book, "Lifetime Security".



BELSAW MACHINERY CO.
3706 Field Bldg., Kansas City 11, Mo.

FREE BOOK
TELLS HOW

HOBBYISTS! SHOPMEN! Special ONLY \$54.50

PALMGREN "HOBB-E" Rotary, Index, Milling Table
Ideal for Model Parts or Shop Work

Mill-Grind-Drill-Index-Rout curved or straight-Rabbit and Mortise on drill press or lathe. 8" Table, 4" Cross Feed, 360° Rotation. Accurately Graduated. Holds to Table. Order NOW! SAVE \$100. Only \$54.50. Less Rotary Feed \$39.75. Write for "HOBB-E" Tool Circular.

CHICAGO TOOL and ENGINEERING CO.
8355 South Chicago Ave. Chicago 17, Ill.



Say You Saw It in Popular Mechanics

PREPO CORPORATION EDGERTON, WISCONSIN



**ATKINS
CHAMFER CHAIN**
for all chain saws
© 1954

ATKINS SAW DIVISION
BORG-WARNER CORPORATION
INDIANAPOLIS 9, INDIANA

All the Facts You Need About PORTABLE ELECTRIC TOOLS!

New CATALOG! Hundreds of time and money-saving ideas for hobbyists, builders, professional woodworkers! New 28-page catalog describes latest portable electric tools—how they work—what they do—where they save. Explains features and uses of electric saws, belt sanders, orbital sanders, disc

grinder-sander-polisher, routers, planes, shapers, drills, bench grinders, chain saws, hedge trimmers—tool accessories. Shows what to look for when buying electric tools—how to get most value. Write today. Send 10¢ to cover postage and handling. Send for your copy NOW!

PORTER-CABLE MACHINE CO., 2669 N. Salina St., Syracuse 8, N. Y.

ONLY
10¢

Earn Big Money with this NEW air-cooled arc welder

Check this ad and mail TODAY!

Cash in on the big demand for dependable arc welders. Set up your own shop—full or part time—with a Hobart. Earn hundreds of extra dollars. New air-cooled gas drive "Husky Boy" welds anywhere... ideal for use on truck for emergency calls. Earns bigger profits... saves an initial cost!

HOBART BROTHERS CO., BOX M-94 TROY, OHIO, U.S.A.

NEW
air-cooled
gas drive
WELDS
ANYWHERE



Check and mail with your name and address, today!

- Husky Boy
 Hobart Trade School.
 FREE—Welder's Vest
Pocket Guide

Phone 21223

ONE SURE
WAY TO
KNOW

YOU ARE
BUYING A FINE
POWER DRILL

For top performance, choose the power drill equipped with a Supreme Chuck. Or replace your old style chuck with a Supreme. See your hardware dealer.

Supreme Chucks
BRAND



SUPREME PRODUCTS, INC., 2222 S. CALUMET, CHICAGO 16

SAVE UP TO 85% ON GOVT SURPLUS



GENUINE AN-4539 AVIATORS GOGGLES
Have rubber covered metal frames, lined with soft chamolite. Has built-in breathers to keep lenses clear. Your choice of interchangeable lenses in clear, amber or green.

A \$5.00 Value for only **2.79**
EXTRA LENSES—Choice of colors listed above. Price per pair **1.39**



LENTICULAR OFFICER'S COMPASS
All-purpose precision instrument. Ideal for hunter, hiker, boy scout, surveyor, etc. Has bezel ring marked in 3 degree notches—will rotate through 360°. Also has special "peep" sight & hair-line sighting guide for taking bearings. A surplus \$5.95 value.



NEW NAVY WADING SUITS

Will make surf or deep stream fishing a pleasure. Also used by duck hunters to protect body and clothes from mud, water, silt, etc. Made to finest Government specifications. Originally used as an Overboard Suit in landing operations. Made of heavy duty rubberized canvas. Has fully vulcanized seams and built-in rubber boots and gloves. **NEW and Ready to Use. ONLY... 10.95**

ORDER FROM THIS AD—Pay by Money Order or Check, P.O.'s accepted from D&B firms. 1/2 deposit with C.O.D.'s. Prices FOB Los Angeles.

WORLD'S MOST AMAZING BARGAIN CATALOG

320 PAGES FULLY ILLUSTRATED
Packed with **SENSATIONAL VALUES** in **WAR SURPLUS, FACTORY CLOSE-OUTS** and **GENERAL MERCHANDISE!**

Thousands of items for the **HOBBYIST, GADGETEER**, etc. Includes **Hand & Power Tools, Microscopes, Binoculars, Precision Instruments, Outdoor & Sport Equipment, Photo Supplies & Cameras, Hardware, Foam Rubber, Industrial Tools, Aircraft Supplies** such as—over 20,000 Hydraulic Cylinders in 61 sizes & types, also Hydraulic motors, pumps, fittings, tubing, valves, etc. Also hundreds of War Surplus Gadgets and parts.



SEND 50¢ to cover the cost of **HANDLING & MAILING**—**REFUNDED** with your first order!

PALLEY SUPPLY CO

2263 E. VERNON AVE. DEPT. PM-9
LOS ANGELES 58, CALIF.

BUILD YOUR OWN POWER TOOLS—TILT/ARBOR SAW



TILT/ARBOR SAW
● 27 x 28 in. table stays level. Blade tilts full 45 degrees. ● 10 in. blade cuts 3 3/4 in. deep ● Jackscrew depth adjustment. ● Floor model, 34 in. table height. ● New Departure ball bearing arbor, 3/4 in. precision shaft, ready to run, 5/8 in. bore blades. ● Quick positioning, self-aligning rip fence guide. ● Sturdy wood, steel and aluminum construction. ● No machining—build easily with hand tools only. ● Capacity and performance of floor saws selling for \$150.00 and up!

GIL-BILT Metal Parts Kit, includes Plans, ball-bearing arbor, cast aluminum miter gauge and bar, rip fence guide, machined lock knobs, jackscrew mechanism with 4 1/2 in. handwheel, and all other metal parts (less blade)..... \$22.95
Same Kit with 10" combination blade..... \$25.90
Same Kit with 8" combination blade..... \$24.90
If not satisfied, return Kits in 10 days for refund of purchase price.

For shipments up to 600 miles, add 2%; over 600 add 10%. Amount in excess of actual postage will be refunded. GIL-BILT Step-by-Step pictorial plans (No blue-print reading required), full-scale patterns—actual photographs for the material. ● TILT/ARBOR SAW, 6" TILT/TABLE SAW, 12" BAND SAW, 18" BAND SAW, BELT SANDER, SPINDLE SHAPER, \$1.00 each postpaid anywhere in the world or WRITE FOR FREE descriptive catalog.

COMPLETE PLANS only \$1.00 EACH

GILLIOM POWER TOOLS P. O. Box 1-PJ, Lambert Field, St. Louis 21, Missouri

Only HULL AUTO COMPASSES



Give You This
Patented compensators make the Hull Auto Compass the easiest to adjust on the market. Even a child can obtain pin-point accuracy—quickly, surely. Why accept less? Write for local dealer's name, free literature.

MORE HULLS IN USE THAN ALL OTHERS COMBINED

HULL MFG. CO. P.O. Box 246, D-9 Warren, Ohio

Beaconite '63
SURTANINE '14.95

BRONZE FOUNDRY



Schools and Home Workshops
Make your own castings of aluminum, copper, bronze, silver. Foundry sets are available in three sizes including 2400 Deg. F. blast Furnaces. \$22.50; \$29.50; and \$42.00. f.o.b. Kansas City. Free Circular.

KANSAS CITY SPECIALTIES CO. P. O. Box 8022, Dept. P-9 KANSAS CITY, MO.



MAKE YOUR OWN FOUNTAINS, LAKES, RIVERS, WINDOW DISPLAYS

Get real live action with miniature water pump. Only 4 3/4" high—3 1/4" wide. Threaded for pipe or uses 3/4" rubber tubing. Sturdy rustproof alloy metal—mounted on rubber. 110 A.C.—60 cycle. 1/250 H.P. Pumps 50 gal. per hr. Complete—ready to work. Immediate money back guarantee. Send check or M.O. or send C.O.D., you pay postage. Dealers wanted.

MOORE MANUFACTURING CO. SWEDSBORO 18 NEW JERSEY **\$9.95 IN U.S.**

AMAZING TOOL BARGAINS!

FLEXIBLE SHAFT — ONLY \$4.95



Post-paid Fits all electric drills & hand power tools. 35 3/4" long. Oilite bearings. Core of specially wound, high carbon steel wire in flexible steel casing. Will accommodate tool shafts up to 3/8" dia. For lathes, electric drills, etc.

12 MINIATURE CUTTERS \$1.00



Post-paid For Cutting Wood, Plastic, or Metal. Actual size. Assorted shapes on 3/32" shank. For die makers, home workshops, etc.

30 SHORT SHANK MINIATURE CUTTERS \$1.00

30 ASSORTED STEEL DRILLS .. \$2.75

High Speed, and Carbon Steel Assort. sizes up to 1/4", only—**SCHUPACK SUPPLY CO.,** 7331 Cottage Grove, Dept. M-58 Chicago 19, Ill. NEW Illustrated Catalog 10c

TERRIFIC VALUES

GIANT 2000-2500 WATT PLANT

110-120 v. 60 cyc. AC. absolutely best made — exclusive, dynamically balanced armature; heavy windings develop up to 5000 watt overload for motor starting. Skid mounted — portable. Powered by an easy starting Briggs & Stratton Wisconsin engine—complete with all accessories; engine easily disconnected for other uses. Big outlet box, voltmeter, no wiring necessary. Ample current for all purposes. Factory warranty. (Item 31) Wt. 210 lb. Reg. price \$580. Special at. . . . **\$299.50**
Same plant with electric self starter (Item 31A). . . . **\$359.50**
Generator only and control box. . . . **\$169.50**
DUAL VOLTAGE 110-220 available on any of above models for \$28.00 additional.



(Item 31)

CONDITIONAIRE ATTIC FANS

Now, at new low cost, you can relax . . . live and sleep in cool comfort. Master Mechanic's attic fans exhaust stale, hot humid air . . . pull in fresh cool air. High contour blade design and venturi shaped frame move large volume of air—cool the entire house in a few minutes at quiet low speed. Dynamically balanced blades, rubber mounted shaft and motor, assure smooth quiet operation. Pre-drilled frame is easily mounted in a few minutes, just cut opening and bolt in place. Complete with heavy duty 1/4 or 1/2 hp. electric motor. Conditionaire fans are built in our factory—you buy them at low factory prices.

Blade Opening	Rooms	Wt.	Item	Price	
24"	28 x 28	5	75 lb.	555	\$66.50
30"	34 x 34	7	90 lb.	555A	\$74.50
36"	40 x 40	9	105 lb.	555B	\$82.50
42"	46 x 46	11	150 lb.	555C	\$93.50

Add \$6.00 to above prices for horizontal mounting.



HEATING & VENTILATING FAN

(Item 10) Easily installed in furnace pipes. Forces even heat to all rooms. Over range removes kitchen smoke and odors. Powerful, continuous duty motor, 110-120v. AC. Mount in wall or ceiling to ventilate any area. Quiet, super-efficient fan moves huge volume of air. (400 to 600 CFM).

8" Fan, wt. 5 lb.	56.85
9" Fan, wt. 6 lb.	57.85
10" Fan, wt. 7 lb.	58.85
12" Fan, wt. 8 lb.	59.85

HEAVY DUTY FAN. Semi-enclosed motor, suitable for spray booths, restaurant exhausts, poultry houses, etc. 10" Fan, wt. 8 lbs. (Item 10E). . . . **\$11.95**
12" Fan, wt. 10 lbs. (Item 10D). . . . **\$12.95**



CONDITIONAIRE VENTILATING FANS

Save big money installing your own exhaust fan. Efficient propeller type blade moves huge volume of air quietly and effortlessly. Heavy welded frame—pre-drilled for easy installation. Just cut opening and bolt in place. Continuous duty motors. Ideal for attics, restaurants, garages, bars, chicken houses, etc. Control manually or with thermostat.

Blade Opening CFM	Wt.	Item	Price
10" 184.4"	2925	19 lb.	365a \$27.95
18" 195.4"	3690	27 lb.	365b \$31.95
20" 216.4"	4100	30 lb.	365c \$39.95

THERMOSTATS: BARN type (range 40-90°), Wt. 2 lbs. **\$6.95.** ATTIC type (50-90°), Wt. 2 lbs. **\$11.95**



JET STEAM MASTER

Now, a new super-efficient portable steam generator that provides live steam at 100 lbs. pressure in 60 seconds from a cold start! The first quality steam blaster ever offered at this low price. Instantly cleans, sticky grease, dirt, rust, old paint, etc. off motors—farm implements and road building machinery. Puffs for itself in a few weeks. Sterilizes as it cleans—milk equipment, etc. Fully automatic—oil fired with built-in water circulating pump. Draws water from faucet or bucket. Simple and safe; anyone can use it—built-in safety valve. New triple efficiency jet steam gun automatically mixes in soap and detergent if desired. Wt. 250 lbs. Item 445. . . . **\$298.00**
Special factory price. . . . **\$298.00**



at MASTER MECHANIC'S

Direct from Factory Prices

PORTABLE LIGHT PLANTS

Ideal for your camp, cottage, trailer or boat!

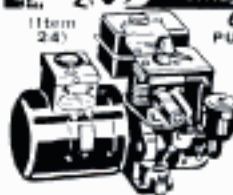

600-700 WATTS PUSH BUTTON START 115 v. 60 cyc. AC. Powered by a rugged 2 HP easy starting Briggs engine. No wiring necessary! Just plug in and operate. Plenty of current for any oil burner, freezer, brooder, emergency lights, etc. which require up to 200 watts. Ideal for Civil Defense and Fire Dept. Complete with Voltmeter and built-in Whistling to charge 6 V. auto batteries. (Item 24.) Wt. 75 lbs. Easily fits in car trunk. Be prepared if storms knock out power lines. Item #275 value. . . . **\$143.50**
1000-1200 Watt Plant (Item 45) same as Item 24 but larger generator and engine **\$199.50**
1500-1700 Watt Plant (Item 20) similar to Item 24, but has three times more capacity **\$279.50**
LITTLE GIANT—350 WATT (Item 273) 115 v. DC 1 1/2 hp. Briggs engine. Perfect for lights, radios, small power tools. . . . **\$99.75**
Wt. 65 lbs. Factory price.

MASTER-LITE 2500 Watt Plant 110/120 v. 60 cyc. AC. A powerful plant, ruggedly constructed and yet designed for easy portability. Can be started by rope or built-in 12 v. electric push button starter. Built in whistling to charge battery. Powered by a big 5.80 HP Briggs engine, complete with all accessories. Includes control box, voltmeter, and handy plug-in power receptacles. An ideal plant for permanent or standby service. Wt. 225 lb. Reg. price \$645.00. **\$329.50** (Item 21) Factory Price. . . .

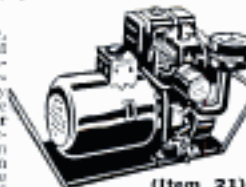

(Item 21)

3500 Watt Plant Push Button Start (Item 23) 115 v. 60 cyc. AC. Similar to above, but larger and 35% more capacity. Wt. 270 lbs. Reg. \$760. Factory Price. . . . **\$379.50**
We make fully automatic controls to operate any of the above light plants. Write for details. We make all sizes up to 25,000 Watts.

52 pc. SOCKET SET

Highest quality, guaranteed non-breakable sockets made by Husky. Beautifully matched chrome trim wall also absolutely the best. Contains a complete set of 28 sockets in 1/2" drive, 3/4" drive and 1 1/4" drive, plus all necessary extensions, handles, sockets, reversible ratchets, etc.: all uncond. guaranteed against breakage. A beautiful set of tools that will handle any job; in a big doghouse steel box. Wt. 17 lbs. (Item 205) . . . **\$27.95**
List price \$62.00. Factory special.

EXTENSION CORD

Very flexible and tough; Neoprene is 16-2 conductor for cork, ideal for lawn mowers, hedge trimmers and power tools. U.L. approved. Complete with heavy rubber plug and outlet. 40 ft. cord (Item 170) Wt. 23 1/2 lbs. regularly \$4.95—SPECIAL. . . **\$2.95**
100 ft. combination (2-40 ft. and 1-20 ft.) Item 17N. factory price. . . **\$6.45**
NEOPRENE CABLE is 14-2 (Item 185) heavy duty, very flexible, 20 year quality. Wt. 9 lbs. 100 ft. Complete with rubber plug and outlet. 1 handle for use. . . . **\$8.95**
NO. 12-2 POWER CABLE. Very flexible rubber covered. Complete with heavy rubber plug and outlet. 50 ft. (Item 199) Wt. 8 lbs. **\$6.95.** 100 ft. (Item 200) **\$12.95**

HI-FLO Centrifugal PUMP

Completely self-priming! No foot valve required. Tremendous capacity—100 gal. per min. . . . Special impeller enables pump to handle muddy or sandy water. Simple to operate—simply start engine and watch the water go. Powered by a rugged, easy-starting 2 HP Briggs engine. Pre-lubricated sealed bearings for years of heavy low-cost service.
Big 1 1/2" Model. Item 502. **\$134.50**
Wt. 70 lbs. Factory price. . . .
2" Model 1 1/2 gal. per min. with 2 1/2 HP engine. Item 502A. 90 lbs. Fact. Spec. **\$154.50**



SAVE UP TO 85%

HI-LINE 6000 WATT PLANT

Push Button Start 115-230 v. 60 cyc. A.C. A brute of a power plant with a rugged 14 hp. Wisconsin engine. Plenty of electricity for ranges, water heaters, freezers, pumps, machinery, etc. Affords both 110 and 220 volts. Ideal where heavy current is needed. Wt. 500 lbs. Easily worth \$995. With self-starter. . . . **\$645.00**
Factory price . . . **\$585.50**
Same plant, but with crank start, generator and control box only, belt driven. Use your own engine or tractor. Wt. 240 lbs. (Item 163) Factory price. **\$345.00**

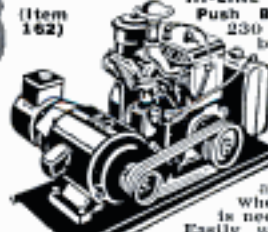

AUTOMATIC 6 VOLT COMPRESSOR

The ideal compressor for operating load blast air horns on cars or boats, and for use as tire inflating equipment on service trucks or jeeps. Inflates tires in seconds. Compact! Can be installed in small space under hood, in trunk, etc. High air output 14 CFM. Operates on standard 6 or 12 volt storage battery current. Built-in 1/2 hp. electric motor, solenoid switch, 4"x24" air tank, pressure gauge, safety valve, shut-off valve, automatic on and off switch. Runs only when air is needed. 1 Wt. 39 lbs. Item 353. Regularly \$129.50. Our special. . . . **\$54.50**



Variable Speed Selector

Heavy duty, made by B. F. GOODRICH for industrial use. Provides instant speed changes for any drive. For machine tools, dryers, printing, conveyors, production lines, hoists—any operation requiring variable speed. Employs reliable "trouble free" planetary system. No hydraulic power losses. Infinite range, smooth operation, easy installation. 3 sizes: 1/2 hp., 3/4 hp., 1-2 hp. wt. 7.5 lbs.; 2-3 hp. wt. 105 lbs.; Reg. list \$228, \$252 and \$352. Our prices **\$79.50, \$89.50 and \$114.50**



9 TON HYDRAULIC PRESS

A tremendous power hydraulic press, capable of exerting 18,000 lbs. pressure. Pays for itself many times over—straightening bent connecting rods, king pins, crank shafts, axles, link pins and bars—or pushing out frozen bearings and bushings. Developed pressure under precise control and visible at all times on accurate gauge. Complete with both large and small anvils and jigs to straighten any kind of curve or bend. (Item 464) Wt. 110 lb. Actual list price \$365. Our special close-out price. . . . **\$69.50**



POWER MASTER DC ARC WELDERS

Now! a portable, rugged, industrial type welder with terrific performance, yet at a price hundreds of dollars less than you'd expect. Senior model made for years of trouble-free, continuous service. High capacity DC welding unit enables you to tackle any job with confidence—easily welds anything up to 2" plate using from 1/16" to 1/4" rods. Built-in stabilizer and roofing system makes arc easy to strike and hold. Dual control rheostat provides low heat soldering, brazing and welding from 30 to 300 amps. Complete with instructions, guarantee and triple V-belt or flat pulley. You can pay more, but you can't buy a better welder.
COMPLETE POWER MASTER (Illustrated above) powered by a 14 hp., air cooled Wisconsin engine. Wt. 480 lbs. (Item 280) Compares with welder costing **\$449.50**
WELDER ONLY—DUAL CONTROL MODEL. Same as above, but drive with your tractor, jeep or gas engine of 14 HP or more. (Item 280A.) Wt. 110 lbs. \$450 value. . . . **\$119.50**
WELDER ONLY—STANDARD MODEL. Same as above but with single rheostat for heavy metal welding only. (Item 38.) Wt. 110 lbs. \$400 value. Special. . . . **\$99.75**
WELDING KIT Two 10 ft. leads, welding helmet, electrode holder, ground clamp. Sold only with welder at. . . **\$10.50**

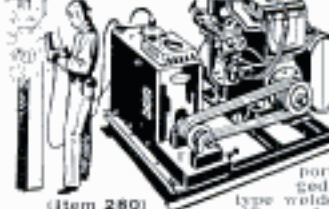

Send check or M.O. Prices f.o.b. Factory. 10 Day Money back guarantee. SEND 10c for . . . **Big 1954 Catalog**

MASTER MECHANIC MFG. CO., DEPT. 333

Burlington, Wis.

SOUTH BEND 9" LATHES



HEADSTOCK

Bearings are line bored and bearingized for precision fit. Ample lubrication from oil reservoirs. Spindle is carburized, hardened, and ground; with bearing surfaces super-finished to .000005" rms.

Base price
\$385
Other models
from **\$211**

BELT RELEASE

Instant release of belt tension for speed changes. Proper tension of headstock spindle drive belt is easily adjusted.

TAILSTOCK

Has set-over for taper turning. Graduated spindle has witness mark for aligning cutter bit. Hardened center self-ejecting.

BED

Three V-ways and one flat-way are hand-scraped entire length for precision alignment of headstock, tailstock, and carriage.

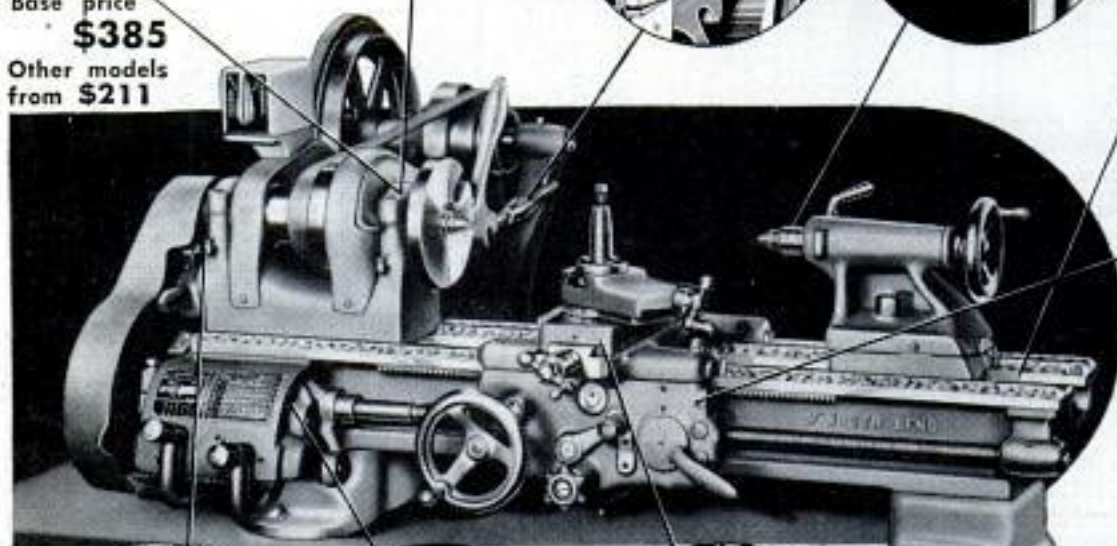

APRON

Has powerful friction clutch and large half-nuts. Safety interlock prevents engaging opposing feeds. All gears machine cut.



REVERSE GEARS

Easily shifted for reversing lead screw rotation and feeds, positive lock. All the gears used in this lathe are machine cut.



GEAR BOX

Screw threads and power feeds selected by shifting two tumblers as indicated on index chart. All gears machine cut steel.



CARRIAGE

V-ways and dovetails hand-scraped. Engine divided micrometer collars on feed screws. Compound Rest base graduated 180 degrees.

Send for this
New
Catalog

56 pages showing the complete line of South Bend Machine Tools. Mailed on request to any address.



Time Payment Terms

You can purchase any South Bend Machine Tool complete with attachments and accessories, paying as little as 10% down and balance in 12 or 18 monthly payments. Write for information.

Compared with our costs
OUR PRICES ARE LOWER
than they were back in 1941



Prices are closely tied to costs. Costs are still rising. Buy now before increased costs necessitate higher prices.

SEND INFORMATION CHECKED:



9" and 10" BENCH LATHES



10" to 14-24" FLOOR LATHES



DRILL PRESSES

TOOL GRINDERS

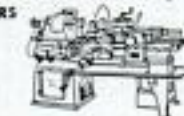

1/2" & 1" Collar TURRET LATHES



7" BENCH SHAPERS

Name _____ Street _____

City _____ State _____

Building Better Tools Since 1906 • SOUTH BEND LATHE • South Bend 22, Indiana



PRINTED IN U.S.A.

THIS COMPLETE, SIMPLE, PRACTICAL COURSE FOR SELF-INSTRUCTION WILL QUICKLY GIVE YOU

a complete mastery of
MATHEMATICS



The Essential Knowledge For the Better Jobs IN ALL BUSINESS AND INDUSTRY

GET a better job—learn mathematics! Mathematics is the basic requirement of all mechanical and scientific work, and of all business and industry based on science. Without this essential knowledge, even the most capable man is left behind while others forge ahead to bigger contracts, more money, better jobs.

You need mathematics to improve, speed up, and check on your work and the work of others. Such basic training is quickly recognized today and gladly paid for. It singles you out from the crowd and gives you an advantage whether it is a matter of a job, a promotion or a contract.

MATHEMATICS For Self Study

By J. E. Thompson, B.S. in E.E., A.M., Dept. of Mathematics, Pratt Institute
A COMPLETE COURSE AND REFERENCE LIBRARY

Now, if you will devote only 10 minutes each day to this easy home-study course, you can gain all the benefits of a complete training in mathematics. With this practical course, you start right from the beginning with a review of arithmetic that gives you all the special shortcuts that save countless hours of your time. Then, step-by-step, you go into the higher mathematics and learn how simple it all can be when an expert explains it to you. Every minute you spend on this course will pay you big dividends.

An Expert Gives You His Simplified Methods

Mr. Thompson, the author of these books, presents each practical method and problem in the clearest and simplest way possible. He gets right down to the kind of information you need in your daily work.

Here Are but a Few of the Hundreds of Subjects Explained in this Complete Self-study Course:

ARITHMETIC: Starting with a quick review of principles, this book gives you the special calculation methods used in business and industry that are rarely given in ordinary arithmetic books. Above all else this volume shows you how to attain speed and accuracy with fractions and decimals, ratio and proportion, powers and roots, etc. Fundamentals in all computations in engineering and the essential methods for rapid calculation, such as is needed in setting lathes, etc., are made clear and simple. Important business subjects made easy in this book include bank interest, discount, income on securities, payment on mortgages, insurance plans, etc.

other subjects, this book teaches you all about logarithms—the method of computation that engineers use to save time. It also shows you how to solve problems relating to machines, engines, ships, autos, planes, etc.

GEOMETRY: This book gives you the practical, common-sense method for solving all problems in both plane and solid geometry—problems ranging from the simplest distance problems to the geometry of spheres which has applications ranging all the way from the atom to the earth itself. Here you will find all the facts you need to deal with angles, triangles, circles, and the many other geometric figures that are basic to engineering design.

TRIGONOMETRY: Practically every problem in machine work, surveying, mechanics, astronomy and navigation is

solved by methods of trigonometry, and this interesting volume makes the methods of solving them clear and easy. The great range of problems in this volume includes those arising in the work of the civil engineer, whether he is surveying land, laying out a road or railroad track or "leveling off" a lawn or tennis court.

CALCULUS: This branch of mathematics deals with rate problems and is essential in computation involving objects moving with varying rates of speed. It also enables us to find the most efficient design for any kind of mechanism, engine, or moving vehicle. The practical application of calculus forms much of the foundation for our present world of engineering and mechanics. In each chapter, the author shows you, step by step how to work out practical problems that occur in business and industry.



5 VOLUMES
1,598 Pages
Illustrated

NEW EDITION
Revised for present-day needs. More useful, more practical than ever before!

ALGEBRA: This book makes algebra a live interesting subject. The author starts with simple problems from everyday life that can be solved by arithmetic and algebraic methods. Among

Thousands of Jobs Are Waiting for Trained Men

RIGHT now, today, trained mechanics and technicians are in urgent demand . . . and in practically ALL OF THESE JOBS a knowledge of mathematics is required.

Remember, mathematics is the foundation of all technical work. Prepare now for one of these better jobs—Learn mathematics by this easy, practical method.

SEND NO MONEY

Examine These Great Home-Study Books for 10 Days FREE

Send me money now, not a penny! The coupon at right will bring you the complete course in book form for 10 days' trial. Unless you are convinced that it is exactly what you need you may return the books and owe nothing or you may keep them by sending us only \$1.85 down, balance in four monthly payments of \$2.00 each. Take advantage of this opportunity to acquire a complete training in mathematics this simple, inexpensive way.

MAIL THIS COUPON

D. Van Nostrand Company, Inc., 250 Fourth Ave., New York 3, N. Y.
Send me MATHEMATICS FOR SELF STUDY in 5 volumes. Within 10 days I will either return the books or send you \$1.85 as first payment and \$2.00 per month for four months until the total price of \$9.85, plus a few cents postage, is paid.
(If you send \$9.85 with this coupon, we will pay the postage. Return privilege and refund guaranteed.)

Name.....

Address.....

City.....Zone.....State.....

In Canada: Order from D. Van Nostrand Company, Ltd., 25 Hollinger Road, Toronto, Canada PA-9-54

How MILD can a cigarette be?

These CAMEL smokers have known for 35-40 years!

When you've enjoyed Camels for 30 years or 30 days... you know why they're now more than ever America's most popular cigarette!



JOHN W. FINCHER, Cairo, Ga. "For 35 years, I've gotten more pleasure out of Camels than any other brand!"



A. R. SCHNEIDEWIND, Upper Montclair, N. J. "In 37 years of smoking Camels, you get to know how well they agree with you!"



W. C. FOWLER, Dallas, Tex. "Forty years I've enjoyed Camels. They suit my taste—agree with me best!"

MRS. KATHARINE B. COELSCH, The Dalles, Ore. "Camels were my choice 35 years ago. They're really mild!"

MRS. B. COLLINS EDGAR, Look-out Mountain, Tenn. "I've enjoyed Camels' mild smoothness for 35 years!"



From the great Camel file of unsolicited letters from Camel smokers.

R. J. Reynolds Tobacco Co., Winston-Salem, N. C.



**For Mildness,
For Flavor...**



I'M A NEWCOMER TO SMOKING AND 30 DAYS WITH CAMELS' FLAVORFUL MILDNESS HAVE MADE THEM MY BRAND!

Evelyn Terjesen, N. Y. City, Secretary

**Make your own 30-day
Camel Mildness Test!**

Yes, try Camels *yourself!* Make the famed 30-day Camel mildness test. See what you've been missing in true mildness, richer flavor and more pure pleasure!

CAMELS AGREE WITH MORE PEOPLE THAN ANY OTHER CIGARETTE

Copyrighted material