

AUGUST 1954

35 CENTS

POPULAR MECHANICS

MAGAZINE

WRITTEN SO YOU CAN UNDERSTAND IT

GREAT BRITAIN, NO. 60426

REG. U.S. PAT. OFF.



Florida's "Blow Boat" Derby
—Page 93

Report on the
OLDSMOBILE

HOW TO PAINT
HOUSE EXTERIORS

Kosta



Touch up scratches in seconds with new MoPar paint applicator— only \$100*

STOP RUST BEFORE IT STARTS

You can cover up unsightly scratches in your car's finish in a hurry. It's easy with this handy, new MoPar fountain-brush touch-up applicator. Each applicator comes complete with a self-storing brush and a generous supply of X-Act Match paint . . . factory checked to *match the color* of your Plymouth, Dodge, De Soto, or Chrysler car.



AS EASY TO USE AS A FOUNTAIN PEN

Just shake, and a built-in metal agitator mixes the paint thoroughly. Remove cap, and brush springs out, pre-dipped and ready to go. No mess or fuss. A few quick strokes and the job's done. Paint dries evenly and quickly.



ASK FOR THE NEW TOUCH-UP APPLICATOR

at your Plymouth, Dodge, De Soto, or Chrysler dealer's, and keep it in your glove compartment. And look for the MoPar label whenever you want *official* Chrysler Corporation parts and accessories, made to *fit right, work right, last longer.*

MoPar is more than just the name for a paint applicator.

It is the identifying name of thousands of parts and accessories designed and built especially for your Plymouth, Dodge, De Soto, or Chrysler car or Dodge "Job-Rated" truck.

*Manufacturer's suggested retail price.

**"I WENT OVER TO BORROW A CUP OF SUGAR
—and came away with a great idea!"**



IT was Saturday morning, and I wanted to surprise Joe with a fresh apple pie—but discovered I was short on sugar. So I ran across to the Jones' to borrow some.

But I came away with more than the sugar!

Bill Jones was busy at work—installing a beautiful new floor. And he told me *it would never need waxing* because it's factory pre-polished!

I got so intrigued, it was almost lunchtime when I got home. My poor Joe never got his pie that day. Instead, he had to listen to me tell him all about the stunning Goodyear All-Vinyl Flooring that smart Bill Jones was installing himself!

That afternoon, Joe went across to the Jones'—then he was gone for a while down to the shopping center.

Next thing I knew he was home—ready to do battle with *our* old kitchen floor! He went to work like a professional—armed with beautiful Goodyear All-Vinyl Tiles, and the handy self-installation kit which provides all the necessary tools.

Our new Goodyear All-Vinyl Floor was in before the weekend was over—and Monday night my Joe not only got the finest apple pie a proud wife could bake, but roast beef with all the trimmings!

SEND FOR FREE GOODYEAR "Self-Installation" BOOKLET—address post card to: Goodyear, Flooring Dept. T-8318, Akron 16, Ohio.

**Never
needs
waxing!**



FLOR-MASTER INSTALLATION KIT provides all the tools and instructions to do a professional job in jig time. Available at better dealers', where Goodyear All-Vinyl Flooring is a featured item.

Flor-Master—T. M. The Goodyear
Tire & Rubber Company, Akron, Ohio

GOODYEAR  **All-Vinyl Flooring**

FOR FLOORS • WALLS • COUNTER TOPS—BY THE TILE OR YARD

AUGUST 1954

Copyrighted material ¹

**YOU
CAN'T
BEAT**

CHAMPIONS...

FOR ECONOMY!
WESTERN UNION

<small>Check your car's spark plugs and have them replaced if necessary.</small>	
PLUGS	REPLACED
DATE	BY

<small>Check your car's spark plugs and have them replaced if necessary.</small>	
PLUGS	REPLACED
DATE	BY

NAME	ADDRESS	CITY	STATE	ZIP

CHAMPION SPARK PLUG COMPANY
TOLEDO, OHIO

APRIL 20, 1954

SPLENDID PERFORMANCE OF REGULAR STOCK CHAMPION SPARK PLUGS HELPED STUDEBAKER CARS SWEEP TOP HONORS IN MOBILGAS ECONOMY RUN. SCORING HIGHEST ACTUAL MILES PER GALLON AND TON MPG IN EVERY CLASS ENTERED PLUS THE GRAND SWEEPSTAKES WIN CONFIRMS OUR LONG TIME JUDGMENT IN FACTORY-EQUIPPING ALL STUDEBAKERS WITH DEPENDABLE CHAMPIONS.



C.K. WHITTAKER,
EXECUTIVE VICE PRESIDENT
THE STUDEBAKER CORPORATION OF AMERICA



FOR PERFORMANCE!
WESTERN UNION

<small>Check your car's spark plugs and have them replaced if necessary.</small>	
PLUGS	REPLACED
DATE	BY

<small>Check your car's spark plugs and have them replaced if necessary.</small>	
PLUGS	REPLACED
DATE	BY

NAME	ADDRESS	CITY	STATE	ZIP

CHAMPION SPARK PLUG COMPANY

MAY 31, 1954

TOLEDO, OHIO

FOR THE SECOND STRAIGHT YEAR I HAVE DRIVEN CHAMPION SPARK PLUGS TO VICTORY IN THE INDIANAPOLIS 500 MILE RACE. AVERAGE SPEED OF 130.840 MILES PER HOUR SETS NEW RACE RECORD. THANKS FOR A GREAT PRODUCT.

BILL VUKOVICH



ASK FOR

CHAMPION

SPARK PLUGS

WITH THE EXCLUSIVE 5-RIB INSULATOR

Here's a real performance record! In their 24th Indianapolis victory Champions were the choice for every one of the 33 starting cars. And here's how they came through—
NOT ONE CHAMPION SPARK PLUG WAS REPLACED DURING THE ENTIRE RACE!

Whatever the year or model of your car, better install Champions for better performance and longer engine life.

CHAMPION SPARK PLUG COMPANY, TOLEDO 1, OHIO

Popular Mechanics Magazine

Registered in U. S. Patent Office and Canada

H. H. WINDSOR, Founder

H. H. WINDSOR, JR., Editor and Publisher



Volume 102 AUGUST 1954 Number 2

Address all communications to: 200 E. Ontario St., Chicago 11, Ill.

Managing Editor.....	Roderick M. Grant
Assistant Managing Editor.....	Wayne Whittaker
Shop Notes and Crafts Editor.....	James R. Ward
Radio-Television, Electronics Editor.....	Frank L. Brittin
Associate Editor.....	Clifford B. Hicks
Associate Editor, Automotive.....	Arthur R. Railton
Associate Editor, Shop Notes and Crafts.....	Wayne C. Lecky
Assistant Editor, Shop Notes.....	W. Clyde Lamney
Assistant Editor, Crafts.....	Frank N. Stephany
Assistant Editor, Makeup.....	John C. Dalen
Automotive Correspondent.....	Leo Donovan
Art Director.....	Frank Beatty
Assistant Editors: Leonard F. Hilts, Jay W. Hedden, Elliott H. McCleary	
Eastern Editor.....	Richard F. Dempewolf
Empire State Bldg., Room 2906, New York City 1	
Western Editor.....	Thomas E. Stimson, Jr.
Suite 1010, 3460 Wilshire Blvd., Los Angeles 5, Calif.	
London Manager.....	Douglas W. Wedderspoon
Eagle House, Jermyn St., London S. W. 1, England	
Director, Bureau of Information.....	Allan Carpenter
200 E. Ontario St., Chicago 11	

this month's cover

SHOOTING ACROSS the calm surface of Biscayne Bay off Florida's southeast coast are three of the world's strangest craft. Half boat and half airplane, they are blown over the water by aircraft engines and propellers mounted in their sterns. Spills are frequent in the unique race as the top-heavy craft roar around turns and zoom over the placid bay at speeds approaching 60 miles per hour. But most of the time the homemade boats are used to take frogging expeditions deep into the tangled Everglades swamp, to carry supplies, and to rescue downed aviators and stranded fishermen. You'll be able to read more about Florida's "blow boats" in a feature article beginning on page 93

Information not listed on articles in the index, starting on page 12, frequently is listed in the WHERE-TO-FIND-IT LIST, which is available to readers without charge. A copy may be obtained by writing to the Bureau of Information, Popular Mechanics, 200 E. Ontario, Chicago 11, Ill.

In This Issue . . .

"One Out of Three Smashes Up" - - - -	65
Twelve Hours on the Test Track - - - -	76
On Trial - America's First Jetliner - - - -	84
Florida's Blow-Boat Derby - - - -	93
Thomas Jefferson Lives Here - - - -	97
The Owners Report on the '54 Olds - - - -	106
I've Looked Inside a Tornado - - - -	116
Good-by to the In-Line Flat Head - - - -	122
Nylon Reaches Sweet Sixteen - - - -	127
They Fool Ducks by the Hundreds - - - -	134
Bugs for Sale - - - -	140
Radio, TV and Electronics - - - -	145

For the Craftsman . . .

Fluting and Etching Sheet Metal - - - -	149
Solving Home Problems - - - -	154
Assemble Your Own Attic Fan - - - -	159
Safe Sewage Disposal - - - -	166
Plan of the Month—Tackle Box and Rod Cabinet	174
When Water's Too Soft - - - -	177
Better Results in Outdoor Painting - - - -	182
Movie Titles From Souvenir Decals - - - -	188
Versatile Welding Table - - - -	193
Lathe Bench Built in Three Stages - - - -	199
Shopping for Tools - - - -	202

Other items, and manufacturers of available products described, are listed on pages 12, 14 and 16

Published monthly by Popular Mechanics Company, 200 E. Ontario St., Chicago 11, Ill. H. H. Windsor, Jr., president; Wm. Harrison Furrage, exec. vice-pres.; D. F. Windsor, vice-president and secretary-treasurer; H. H. Windsor III, vice-president; Clover L. Perkins, advertising manager; Alan M. Dwyer, circulation manager. Single copy in the United States and Canada, 35 cents; subscription rates in the United States and possessions, Canada, Philippines and countries of the Pan-American Postal Union, 1 year \$3.50; 2 years, \$6.00; 3 years \$8.00. To all other countries add \$1.00 a year over United States prices for overseas postage. If you plan to move, notify us at least 30 days in advance so you will not miss an issue. Give both your old and new addresses. Entered as Second Class Matter, September 15, 1903, at the Post Office at Chicago, Illinois, under Act of March 3, 1879. Entered as Second Class Matter at Post Office Dept., Canada, Registered as Second Class Matter at the Post Office at Mexico, D. F., Mexico, June 20, 1950. Copyright 1954 by Popular Mechanics Company. Copyright under International Copyright Union. Copyright in France. All rights reserved under Pan-American Copyright Union. Printed in the United States of America.

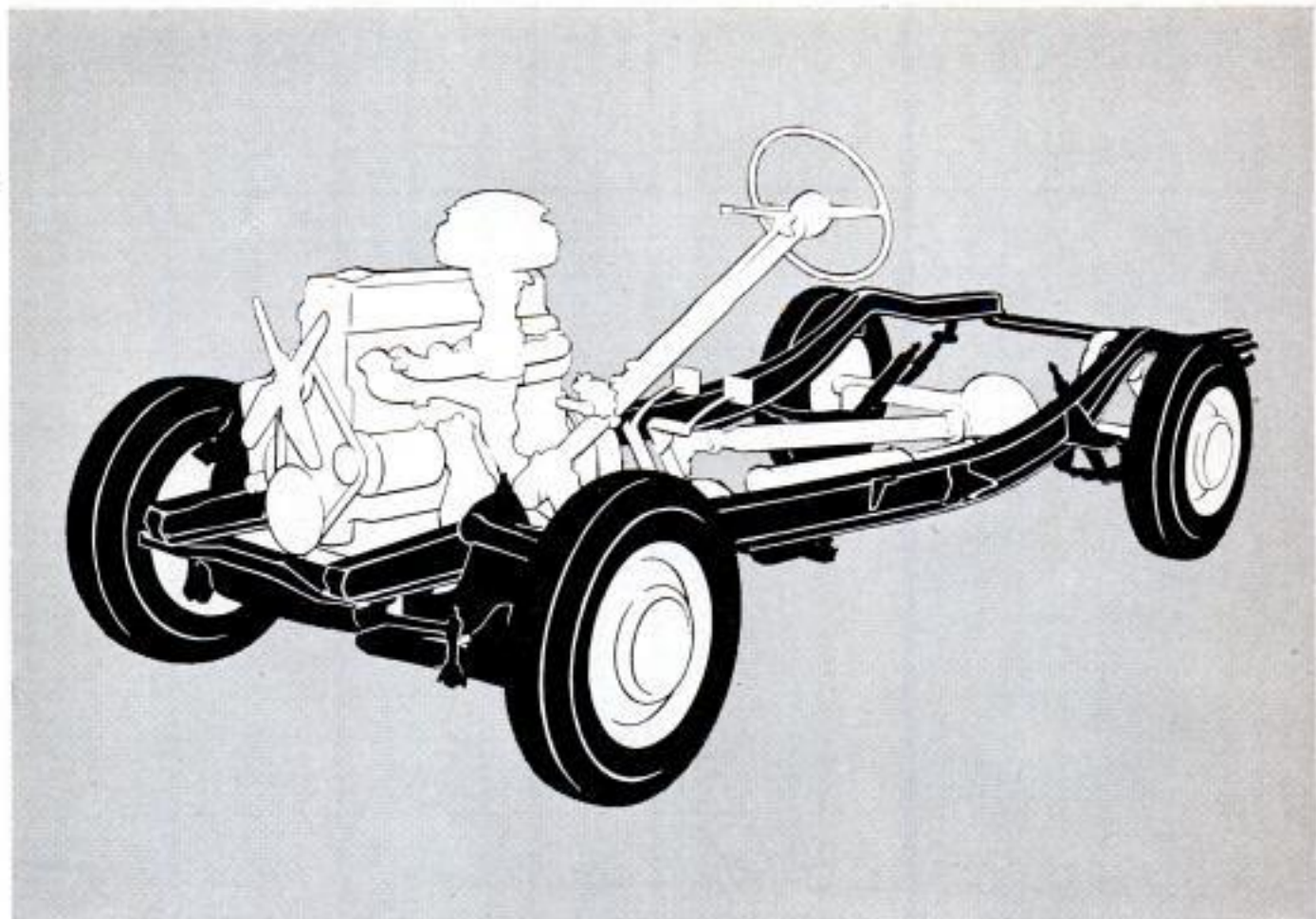

Advanced Chevrolet Engineering brings
BALANCED CAR SUSPENSION
 for greater riding comfort

Behind Chevrolet's big-car riding ability is a lot more than just a suspension system. Actually it's a balanced combination of size, weight, weight distribution, tires *and* suspension system design that gives you that smooth ride you *expect* of a Chevrolet.

First of all, Chevrolet offers plenty of room in its wide, comfortable seats, cradled between front and rear wheels where they're least affected by road bumps. Chevrolet is a heavy-weight in its field, and the pounds are nearly equally distributed on all four wheels for greater stability.

Then in the suspension system itself: Famous Unitized Knee-Action, exclu-

sive with Chevrolet in its field. A front ride stabilizer that reacts against any body roll tendency. Long, resilient rear springs that, leaf by leaf, diminish road vibrations. Tension type shackle hangers that regulate rear spring deflection rate and provide for a uniform ride regardless of the number of passengers. And, double-acting airplane type shock absorbers that not only cushion spring action but stabilize roll and body sway as well. See your Chevrolet dealer and try out a new Chevrolet. See if *Balanced Suspension* doesn't give you a much smoother ride. . . .

Chevrolet Division of General Motors, Detroit 2, Michigan.

EVER FINER ENGINEERING

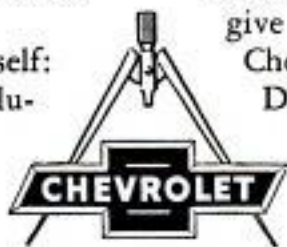

EVER FINER CHEVROLETS



Dejected is Dunkle -
 it is his dreadful loss
 That he gets nothing more
 from car polish - but gloss.

So when it starts blowing,
 he puts on a duster
 And reclines on the hood
 to keep dust off the lustre.



How different, Stan Stauncher!
 His enlightened selection
 Is an easy-on wax that
 gives rock-hard protection!

For Bodygard forms
 such a shield against scratches
 That his car is as safe
 as if stowed under hatches!

(He feels extra breezy, 'cause the job is so easy.)

MORAL: Use New Liquid Bodygard -
 the first, easy wipe-on wax that
 protects your car with this
 rock-hard finish. Protects 9 times
 longer than skimpy-shine polishes.

YOU CAN'T SHINE DIRT,
 SO CLEAN YOUR CAR FIRST.

Every car must be cleaned before it's waxed.
 Simoniz Liquid Kleener cleans better, faster.

Copyright 1954 by Simoniz Company



True Simoniz Quality in
 a Liquid Car Wax. Only 98¢



"HOW I MADE MY HOBBY PAY OFF!"

I've always been interested in cars, then one day I met Joe..."

HI, JOE! SINCE WHEN ARE YOU IN THE AUTO REPAIR BUSINESS?

EVER SINCE I STARTED LEARNING AUTO MECHANICS AT HOME. I EARN WHILE I LEARN, THE NATIONAL SCHOOLS WAY!

SOUNDS GREAT! I HEAR THAT TOP MECHANICS MAKE REAL MONEY THESE DAYS!

YOU SAID IT! I MAY EVEN OPEN MY OWN REPAIR SHOP WHEN I GRADUATE.

NATIONAL SCHOOLS SENT ME THIS SWELL AUTOMOTIVE TOOL KIT—IT'S PART OF MY COURSE!

WHAT A DEAL. I'M FINDING OUT ABOUT THIS AUTO MECHANICS COURSE TODAY!

SHOP-TESTED HOME TRAINING AUTO MECHANICS & DIESEL NATIONAL SCHOOLS

Technical Trade Training Since 1905
LOS ANGELES 37, CALIFORNIA

In Canada: 811 West Hastings Street, Vancouver, B.C.

APPROVED FOR G.I. TRAINING. Both Home Study and Resident courses offered. Job placement assistance, too! Find out today!

MAIL NOW TO OFFICE NEAREST YOU!

(mail in envelope or paste on postal card)

NATIONAL SCHOOLS, Dept. DB-84

4000 S. FIGUEROA STREET
LOS ANGELES 37, CALIF.

323 WEST POLK STREET
CHICAGO 7, ILL.

Please rush FREE BOOK "Your Future in Auto Mechanics & Diesel," and FREE LESSON. I understand there is no obligation, no salesman will call.

NAME _____ BIRTHDAY _____ 19__

ADDRESS _____

CITY _____ ZONE _____ STATE _____

Check if interested ONLY in Resident Training at Los Angeles.

VETERANS: Give date of discharge.

in this corner.....

THE EDITORS



In the vivid story beginning on page 116, Roy F. Hall, former Army captain and now a Weather Bureau observer in Texas, tells of his tornado studies after surviving a twister that wrecked his home. In a subsequent letter Captain Hall describes his home experiments in reproducing tornado phenomena in a glass jar:

The trouble with tornado research has been that those pursuing it have dwelt too much on theory, while the means of simple experiments were right at hand. Wish you could have witnessed my glass-jug experiment, wherein I determined the rotational velocity necessary to force air out into a vacuum. I used up three glass gallon jugs

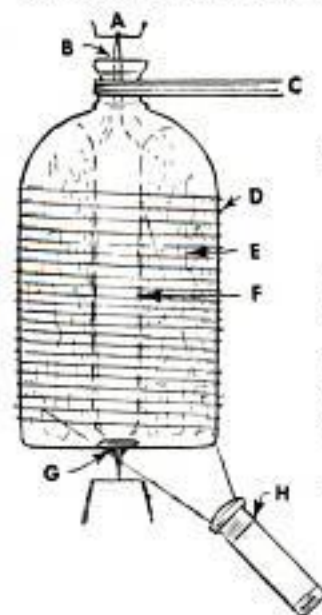

- A—Needle-point bearings.
- B—Axle cemented in with iron cement after an inch of powdered Dry Ice was placed in jug. Jug was kept in freezer until cement hardened.
- C—Belt to motor.
- D—Copper wire, 8-gauge, wound one half inch apart top to bottom of jug.
- E—Dry Ice fumes.
- F—Vacuum funnel formed at 1400 f.p.s.
- G—Axle cemented in hole with iron cement in bottom of jug.
- H—Flashlight.

in doing this before I eventually found that the jug had to be reinforced with several wrappings of heavy copper wire to prevent it flying to pieces. Balancing them true to the nth degree on the axle was something to bring on nightmares.

I used reducing pulleys in order to have the jug rotate at about 800 feet per second. With the motor turning at 1725 r.p.m., the jug flew to pieces and small particles of glass buried themselves in my barn 75 feet away. I wrapped the next with several turns of copper wire, but it was slightly out of plumb and blew up like a shotgun blast. The third did the business. It was wrapped from top to bottom with the wire and, being perfectly balanced, lasted throughout my tests, even up to a rotational velocity of 1000 m.p.h.

(Continued to page 8)

This **FREE SAMPLE LESSON** will prove you can become an expert **BOOKKEEPER... ACCOUNTANT** OR **C.P.A.**



This well-paid LaSalle-trained Accountant's success could be yours.

FREE SAMPLE LESSON

We offer you this free sample lesson so that you can prove to yourself that you CAN master Accountancy—quickly, thoroughly—in spare time at home.

You will see exactly how LaSalle's famous "Problem Method" works... how you are led step-by-step through actual accounting work—learning by doing and not by study of theory alone. First you tackle easy problems, then more difficult ones—until soon you master them all. And at every step you have the close personal guidance of LaSalle's large staff of C.P.A. instructors.

HIGHER ACCOUNTANCY

By the LaSalle Problem Method..

• Practical Accounting

Assignment 1

THE BALANCE SHEET



LOOKING for the "Secret of Accountancy," the mysterious means of the professional accountants of the United States?
"The accounting profession is probably the best paid in the world. If there were a profession in which the average man could be successful, it is well known to us.
"There is need for accountants. There is ample opportunity for advancement. There is no prospect but the really well equipped the demand which the demand of even the youngest of us."

LaSalle Extension University
A Correspondence Institution
CHICAGO

THIS SAME LESSON HAS STARTED HUNDREDS OF THOUSANDS toward well-paid accounting careers—in business, government, and as C.P.A.'s. Even without previous knowledge, progress is rapid—earning power climbs fast. This sample lesson shows why.

**Nearly 10%
of all C.P.A.'s
in the U.S. have
been trained by the
LaSalle Problem
Method**

GOOD-PAY JOBS IN 5 BIG FIELDS

If you were an expert accountant right now, chances are you would find yourself among the highest-paid of all professional men and women. Surveys show that accountants earn more than those in other major professions.

There are five big fields of opportunity open to Accountancy-trained men and women... opportunities that are wide open and highly inviting, offering maximum income and job security in good times or bad. And under LaSalle's "Problem Method" you can start earning while still learning—in spare-time or full-time employment... or in business for yourself with no capital required.

Get the latest information by sending for our 48-page book, "Accountancy, the Profession That Pays"... plus free sample lesson. The coupon at right will bring both to you without cost or obligation. LaSalle Extension, 417 S. Dearborn St., Chicago 5, Ill.

If you have been envying the high incomes and good jobs enjoyed by thousands of men and women Accountants today... incomes ranging from \$4,000 to \$10,000 and more per year... why not launch such a career for yourself?

Do you doubt that you can?

Then let us send you—without cost or obligation—the same Lesson Number One with which LaSalle

has started several hundred thousand men and women toward successful accounting careers. We want you to see for yourself how this remarkable method, originated by LaSalle, makes Accountancy simple, interesting, practical, and certain... how it leads you step-by-step to a complete mastery of Accounting—and on up to the coveted degree of Certified Public Accountant if you so aspire.

It doesn't matter whether you've had previous bookkeeping experience, or whether you don't know a debit from a credit. Whether you wish to qualify as an expert bookkeeper, advanced accountant, cost accountant, auditor, government accountant, income tax specialist, or public accountant... you'll find in LaSalle's Problem Method the exact plan to prepare you rapidly and inexpensively—in spare hours at home—without losing a day from your present job.

So right now, today... if you are an adult, employed, and earnestly ambitious for rapid advancement in this highest-paying of all professions... send your name and address on the coupon below. We'll send the free sample lesson—plus our 48-page book outlining today's career opportunities and how you can qualify for them. A coupon like this has started many thousands toward greater success. It can do the same for you. Mail it today!

Clip Coupon... Mail TODAY!

LaSalle Extension University... A Correspondence Institution
Dept. 864H, 417 S. Dearborn Street, Chicago 5, Illinois

YES, I want to see how LaSalle's "Problem Method" works... how I can qualify for high-pay Accountancy positions. Send Free Sample Lesson—also your 48-page book, "Accountancy, the Profession That Pays"... all without cost or obligation.

Name..... Age.....

Street Address.....

City, Zone & State.....

Present Position.....

This One



BDWE-D14-30FP



AUDELS Carpenters and Builders Guides

4 vols. \$6



Inside Trade Information for Carpenters, Builders, Joiners, Building Mechanics and all Woodworkers. These Guides give you the short-cut instructions that you want—including new methods, ideas, solutions, plans, systems and money saving suggestions. An easy progressive course for the apprentice and student. A practical daily helper and Quick Reference for the master worker. Carpenters everywhere are using these Guides as a *Helping Hand to Easier Work, Better Work and Better Pay.* To get this assistance for yourself, simply fill in and mail **FREE COUPON** below.

Inside Trade Information On:

How to use the steel square—How to file and set saws—How to build furniture—How to use a mitre box—How to use the chalk line—How to use rules and scales—How to make joints—Carpenters arithmetic—Solving mensuration problems—Estimating strength of timbers—How to set girders and sills—How to frame houses and roofs—How to estimate costs—How to build houses, barns, garages, bungalows, etc.—How to read and draw plans—Drawing up specifications—How to excavate—How to use settings 12, 13 and 17 on the steel square—How to build hoists and scaffolds—skylights—How to build stairs—How to put on interior trim—How to hang doors—How to lath—lay floors—How to paint.



Step up your own skill with the facts and figures of your trade. Audels Mechanics Guides contain Practical Inside Trade Information in a handy form, Fully illustrated and Easy to Understand, Highly Endorsed. Check the book you want for **7 DAYS FREE EXAMINATION.** Send No Money, Nothing to pay Postman.

MAIL ORDER



Check NOW!

You Can Look Over Any Guide In Your Own Home — Start the Easy Payments If Satisfied

MAIL THIS TODAY



AUDELS, Publishers, 49 W. 23 St., NEW YORK 10, N. Y.

Please send me postpaid for **FREE EXAMINATION** books marked as below. If I decide to keep them I agree to mail \$1 in 7 Days on each book or set ordered and further mail \$1 monthly on each book or set until I have paid price, otherwise I will return them.

- AUTOMOBILE MECHANICS GUIDE, 1800 Pages \$ 4
- TRUCK & TRACTOR GUIDE, 1299 Pages . . . 4
- DIESEL ENGINE MANUAL, 575 Pages . . . 2
- MACHINISTS HANDY BOOK, 1650 Pages . . . 4
- WELDERS GUIDE, 400 Pages . . . 1
- BLUE PRINT READING, 416 Pages . . . 2
- MATHEMATICS & CALCULATIONS, 700 Pages. 2
- SHEET METAL PATTERN LAYOUTS, 1100 Pages. 4
- SHEET METAL WORKERS HANDY BOOK, 388 Pgs. 1
- MECHANICAL DRAWING GUIDE, 160 Pages . . 1
- MECHANICAL DRAWING & DESIGN, 480 Pages. 2
- AIRCRAFT WORKER, 240 Pages . . . 1
- TELEVISION SERVICE MANUAL, 384 Pages. . 2
- RADIONANS GUIDE, 914 Pages 4
- ELECTRONIC DEVICES, 216 Pages 2
- ELECTRIC MOTOR GUIDE, 1000 Pages 4
- ELECTRIC WIRING DIAGRAMS, 272 Pages . . . 1
- ELECTRICIANS EXAMINATIONS, 250 Pages. . . 1
- ELECTRIC POWER CALCULATIONS, 425 Pages. 2
- HANDY BOOK OF ELECTRICITY, 1440 Pages. . 4
- ELECTRIC DICTIONARY, 9000 Terms 2
- ELECTRIC LIBRARY, 7000 Pages (12 Book Set) 18
- MARINE ENGINEERS HANDY BOOK, 1258 Pgs. 4
- SHIPFITTERS HANDY BOOK, 250 Pages 1
- REFRIGERATION & Air Conditioning, 1280 Pgs. 4
- MILLWRIGHTS & MECHANICS GUIDE, 1200 Pgs. 4
- POWER PLANT ENGINEERS GUIDE, 1500 Pages 4
- ENGINEERS & FIREMANS EXAMS, 525 Pages . 1
- PUMPS, Hydraulics & Air Compressors, 1658 Pgs. 4
- ENGINEERS LIBRARY (3 Book Set) 9
- MECHANICAL DICTIONARY, 950 Pages 4
- GARDENERS & GROWERS GUIDES (4 Book Set) 6
- CARPENTERS & BUILDERS GUIDES (4 Book Set) 6
- PLUMBERS & Steamfitters Guides (4 Book Set) 6
- MASONS AND BUILDERS GUIDES (4 Book Set) 6
- PAINTERS & DECORATORS MANUAL, 450 Pgs. 2
- HOUSE HEATING GUIDE, 1000 Pages 4
- OIL BURNER GUIDE, 384 Pages 1

Name.....
 Address.....
 Occupation.....
 Employed by..... PG

(Continued from page 6)

The experiment had to be conducted after dark, as nothing could be seen inside the jug at high-rotational velocity in daytime. At night, by directing a flashlight beam upward, the hollow vacuum in the center looked like a rigid, hollow glass tube, at speeds of 1400 f.p.s. and above. The higher the velocity, the larger the vacuum.

The jug merely proved my figures on 1400 f.p.s. as the velocity required to form a tornado vacuum, or funnel. The walls of the jug, of course, would not expand as would air at sea-level pressure, but this was compensated for by the cooling of the air within the jug by the carbon-dioxide fumes.

Roy F. Hall

To the Editor:

I have been able to build a working model of a 4-6-0-type locomotive with tender and a coach from memory, without consulting any blueprint. The model was made

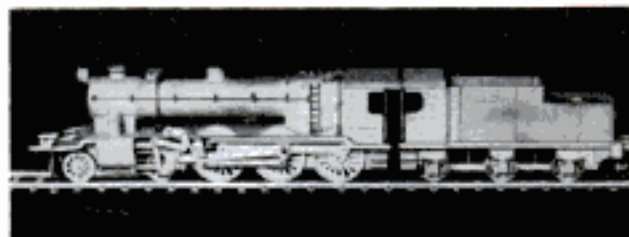

out of cigarette packets, odd bits of cardboard, bamboo, wire and springs. Motion pins, crank pins and axles are made of bamboo. Rubber bands supply the power.

S. N. Guha,
Calcutta, India

To the Editor:

Thought you might be interested in hearing from one of your subscribers who, without previous experience, undertook building the intercom in your March issue.

Using only the schematic diagram plus the photos and text, a bill of materials was drawn, parts ordered and, in less than a week after receiving the parts, the work had progressed to the point where the system could be tested.

Much to my amazement, it worked and, having a well-equipped woodworking shop, I made my own cabinets for the master and two substations. As permanently installed,

(Continued to page 10)

For real job security...

FILL THE GAPS IN YOUR

TRAINING

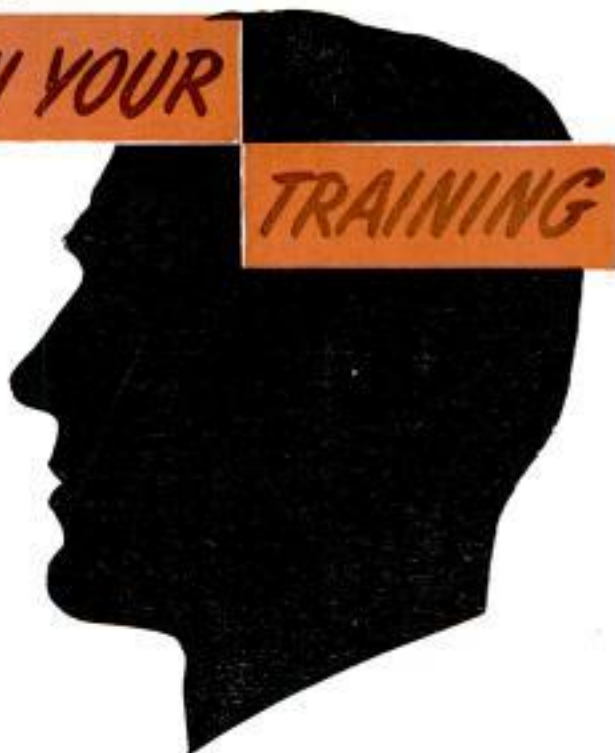

THE pressure is mounting. Competition for jobs is growing fast. Business and industry are tightening up. Every man or woman holding a good job is now, in effect, "on probation."

Are there "weak spots" in your training? Now's the time to get after them! Six months from now may be too late.

How can you *fill the gaps*—quickly? International Correspondence Schools can help you! There's no faster, surer way to get *exactly* the training you need!

You have 277 famous, spare-time I. C. S. Courses to choose from: trade, industrial engineering, office, executive, high school. Or you can arrange for "refresher" courses, advanced training or special instruction combining two or more specific business or technical subjects.

I. C. S. has the most complete line-up of job-related instruction you can find anywhere. Courses are tailored to fit *your* needs. This means you waste no time on subjects you can't use. You lose no time traveling back and forth to classes. You set your own schedule—no interference with business or social activities.

Find out for yourself how quickly, how thoroughly I. C. S. can fill the gaps in *your* training! No obligation. Just mark and mail the coupon!

2 FREE BOOKS

32-page, pocket-size gold mine of facts, "How to Succeed," plus catalog outlining opportunities in field that interests you!

For Real Job Security—Get an I. C. S. Diploma!

I. C. S., Scranton 9, Penna.

INTERNATIONAL CORRESPONDENCE SCHOOLS			ICS	
BOX 5627-L, SCRANTON 9, PENNA.		(Partial list of 277 courses)		
Without cost or obligation, send me "HOW TO SUCCEED" and the opportunity booklet about the field BEFORE which I have marked X:				
ARCHITECTURE and BUILDING CONSTRUCTION <input type="checkbox"/> Air Conditioning—Refrig. <input type="checkbox"/> Architects <input type="checkbox"/> Building Contractor <input type="checkbox"/> Building Maintenance <input type="checkbox"/> Carpenter and Mill Work <input type="checkbox"/> Estimating <input type="checkbox"/> Heating <input type="checkbox"/> Painting Contractor <input type="checkbox"/> Plumbing <input type="checkbox"/> Reading Arch. Blueprints <input type="checkbox"/> Steamfitting ART <input type="checkbox"/> Cartooning <input type="checkbox"/> Commercial Art <input type="checkbox"/> Fashion Illustrating <input type="checkbox"/> Magazine Illustrating <input type="checkbox"/> Show Cards and Sign Lettering <input type="checkbox"/> Sketching and Painting AUTOMOTIVE <input type="checkbox"/> Auto Body Rebuilding <input type="checkbox"/> Auto Elec. Technician <input type="checkbox"/> Auto-Engine Tune Up <input type="checkbox"/> Automobile Mechanic	AVIATION <input type="checkbox"/> Aeronautical Engineering Jr. <input type="checkbox"/> Aircraft & Engine Mechanic BUSINESS <input type="checkbox"/> Advertising <input type="checkbox"/> Bookkeeping and Accounting <input type="checkbox"/> Business Administration <input type="checkbox"/> Business Correspondence <input type="checkbox"/> Certified Public Accounting <input type="checkbox"/> Creative Salesmanship <input type="checkbox"/> Federal Tax <input type="checkbox"/> Letter-writing Improvement <input type="checkbox"/> Managing Small Business <input type="checkbox"/> Office Management <input type="checkbox"/> Retail Business Management <input type="checkbox"/> Sales Management <input type="checkbox"/> Stenographic-Secretarial <input type="checkbox"/> Traffic Management CHEMISTRY <input type="checkbox"/> Analytical Chemistry <input type="checkbox"/> Chemical Engineering <input type="checkbox"/> Chem. Lab. Technician <input type="checkbox"/> General Chemistry <input type="checkbox"/> Natural Gas Prod. & Trans. <input type="checkbox"/> Petroleum Engineering <input type="checkbox"/> Plastics <input type="checkbox"/> Pulp and Paper Making	CIVIL, STRUCTURAL ENGINEERING <input type="checkbox"/> Civil Engineering <input type="checkbox"/> Construction Engineering <input type="checkbox"/> Highway Engineering <input type="checkbox"/> Reading Struct. Blueprints <input type="checkbox"/> Sanitary Engineering <input type="checkbox"/> Structural Engineering <input type="checkbox"/> Surveying and Mapping DRAFTING <input type="checkbox"/> Aircraft Drafting <input type="checkbox"/> Architectural Drafting <input type="checkbox"/> Electrical Drafting <input type="checkbox"/> Mechanical Drafting <input type="checkbox"/> Mine Surveying and Mapping <input type="checkbox"/> Ship Drafting <input type="checkbox"/> Structural Drafting ELECTRICAL <input type="checkbox"/> Electrical Engineering <input type="checkbox"/> Electrical Maintenance <input type="checkbox"/> Electrician <input type="checkbox"/> Contracting <input type="checkbox"/> Lineman HIGH SCHOOL <input type="checkbox"/> Commercial <input type="checkbox"/> Good English <input type="checkbox"/> High School Subjects <input type="checkbox"/> Mathematics	LEADERSHIP <input type="checkbox"/> Foremanship <input type="checkbox"/> Industrial Supervision <input type="checkbox"/> Leadership and Organization <input type="checkbox"/> Personnel-Labor Relations MECHANICAL AND SHOP <input type="checkbox"/> Gas—Electric Welding <input type="checkbox"/> Heat Treatment <input type="checkbox"/> Metallurgy <input type="checkbox"/> Industrial Engineering <input type="checkbox"/> Industrial Instrumentation <input type="checkbox"/> Industrial Supervision <input type="checkbox"/> Machine Design-Drafting <input type="checkbox"/> Machine Shop Inspection <input type="checkbox"/> Machine Shop Practice <input type="checkbox"/> Mechanical Engineering <input type="checkbox"/> Quality Control <input type="checkbox"/> Reading Shop Blueprints <input type="checkbox"/> Refrigeration <input type="checkbox"/> Steel Metal Worker <input type="checkbox"/> Tool Design <input type="checkbox"/> Toolmaking RADIO, TELEVISION <input type="checkbox"/> Electronics <input type="checkbox"/> Practical Radio—TV Eng'ing <input type="checkbox"/> Radio and TV Servicing <input type="checkbox"/> Radio Operating <input type="checkbox"/> Television—Technician	RAILROAD <input type="checkbox"/> Air Brakes <input type="checkbox"/> Car Inspector <input type="checkbox"/> Diesel Locomotive <input type="checkbox"/> Locomotive Engineer <input type="checkbox"/> Section Foreman STEAM AND DIESEL POWER <input type="checkbox"/> Combustion Engineering <input type="checkbox"/> Diesel—Elec. <input type="checkbox"/> Diesel Eng'g <input type="checkbox"/> Electric Light and Power <input type="checkbox"/> Stationary Fireman <input type="checkbox"/> Stationary Steam Engineering TEXTILE <input type="checkbox"/> Carding and Spinning <input type="checkbox"/> Cotton, Rayon, Woolen Mfg. <input type="checkbox"/> Finishing and Dyeing <input type="checkbox"/> Loom Fixing <input type="checkbox"/> Textile Designing <input type="checkbox"/> Textile Eng'g <input type="checkbox"/> Throwing <input type="checkbox"/> Warping and Weaving MISCELLANEOUS <input type="checkbox"/> Domestic Refrigeration <input type="checkbox"/> Marine Engineering <input type="checkbox"/> Ocean Navigation <input type="checkbox"/> Shipping <input type="checkbox"/> Short Story Writing <input type="checkbox"/> Telephony
Name _____	Age _____	Home Address _____		
City _____	Zone _____	State _____	Working Hours _____	A.M. to P.M. _____
Occupation _____				
Canadian residents send coupon to International Correspondence Schools, Canadian, Ltd., Montreal, Canada. . . . Special tuition rates to members of the U. S. Armed Forces.				

NEW BODIES

FOR OLD!

**I've Made New Men Out of
Thousands of Other Fellows...**

**"Here's what I did for
THOMAS MANFRE...and
what I can do for you!"**

—Charles Atlas



GIVE me a skinny, second-rate body — and I'll cram it so full of handsome, bulging new muscle that your friends will grow bug-eyed! . . . I'll wake up that sleeping energy of yours and make it hum like a high-powered motor! Man, you'll feel and look different! You'll begin to LIVE!

**Let Me Make YOU a NEW MAN—
IN JUST 15 MINUTES A DAY**

You wouldn't believe it, but I myself used to be a 97-lb. weakling. Fellows called me "Skinny." Girls made fun of me behind my back. THEN I discovered—"Dynamic Tension." And it turned me into such a complete specimen of MANHOOD that today I hold the title "THE WORLD'S MOST PERFECTLY DEVELOPED MAN."

My Secret — "Dynamic Tension"

When you look in the mirror and see a healthy, strapping fellow smiling back at you—then you'll realize how fast "Dynamic Tension" GETS RESULTS!

"Dynamic Tension" is the easy, NATURAL method you can practice in the privacy of your room—JUST 15 MINUTES EACH DAY — while your chest and shoulder muscles begin to swell, ripple . . . those arms and legs of yours bulge . . . and your whole body starts to feel full of zip and get! And you'll be using the method which many great athletes use for keeping in condition—prize fighters, wrestlers, baseball and football players, etc.

FREE My 32-page Book—Not \$1. or 10c — But FREE

Send NOW for my famous book, "Everlasting Health and Strength," 32 pages, crammed with photographs, valuable advice, answers to many vital questions.

This book is a real prize for any fellow who wants a better build. Yet I'll send you a copy absolutely FREE.

It may mean the turning point in your whole life! Rush the coupon to me personally! **CHARLES ATLAS, Dept. 8-H, 115 East 23rd St., New York 10, N.Y.**



**CHARLES ATLAS, Dept. 8-H
115 East 23rd St., New York 10, N. Y.**

Send me—absolutely FREE—a copy of your famous book, "Everlasting Health and Strength"—32 pages, crammed with actual photos, advice. I understand this book is mine to keep, and sending for it does not obligate me in any way.

Name _____ Age _____
(Please print or write plainly)
Address _____
City _____ State _____

(Continued from page 8)

the system works fine and it is to your credit that your article was so clearly presented that such an inexperienced person as I could successfully build one.

Walter W. Weil,
Hammond, Ind.

Wooden Road

Ending service of 34 years is a 14-mile road built entirely of planks and logs on Graham Island off British Columbia. The



road was built in 1920 to connect two frontier villages separated by treacherous muskeg. Whole logs were cut about three times the length of railroad ties and used to support the two-inch-thick planks which formed the roadway. As a result, the wooden road actually floated on top of the bog.

To the Editor:

This is a picture of my car which my dad and I built from an old lawn mower and transmission. It will go 25 miles per hour. It has three speeds forward and a reverse. It cost about \$90 to make. The car is 6 feet long, 2 feet high and 3 feet wide. There is enough room for my two brothers, age 7 and 5, and myself, age 11, to ride.

Robert Scott Mefford,
Virginia, Ill.





I Will Send You BOTH FREE

J. E. SMITH, President
National Radio Institute
Washington 9, D. C.

ACTUAL
LESSON

The ABC's of
SERVICING

How to be a SUCCESS
in
RADIO-TELEVISION

64
PAGE
BOOK

See How I Train You at Home in Spare Time for Good Pay Jobs in RADIO-TELEVISION

You Practice Broadcasting with Equipment I Send

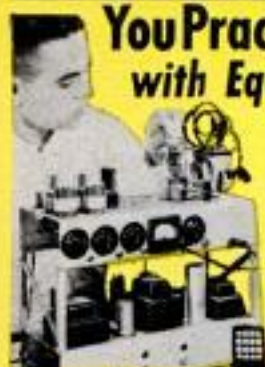

As part of my Communications Course I send you kits of parts to build the low-power Broadcasting Transmitter shown at left. You use it to get practical experience putting this station "on the air," to perform procedures required of broadcasting station operators. An FCC Commercial Operator's license can be your ticket to a better job and a bright future. My course gives you the training you need to get your license. Mail coupon below. See in my book other valuable equipment you build and keep.

TRAINING plus OPPORTUNITY is the PERFECT combination. The sample lesson I send will prove to you that it is practical to keep your job while TRAINING right in your own home for better pay and a brighter future. My 64-page book should convince you that Radio-Television is truly today's field of OPPORTUNITY.

TELEVISION MAKING JOBS, PROSPERITY

Radio, even without Television, is bigger than ever. 115 million home and auto Radios create steady demand for service. 3000 Radio stations give interesting, good pay jobs to operators, technicians. NOW ADD TELEVISION. 25 million Television homes and the total growing rapidly. 200 Television stations on the air and hundreds more under construction. Color Television soon to be a reality. Government, Aviation, Police, Ship, Micro-wave Relay, Two-way Communications for bases, taxis, trucks, railroads are growing fields providing good jobs for men who know Radio-Television. All this adds up to good pay now, a bright future later for men who qualify.

START SOON TO MAKE \$10, \$15 A WEEK EXTRA

An important benefit of Radio-Television training is that you can start to cash in fast. Many men I train fix neighbors' sets, make extra money, starting soon after they enroll. Multitester built with parts I send helps locate and correct set troubles. Read at left how you build actual equipment that gives you practical experience, brings to life what you learn from my lessons.



You Practice Servicing with Equipment I Send

Nothing takes the place of PRACTICAL EXPERIENCE. That's why NRI training is based on LEARNING BY DOING. You use kits of parts I furnish to build many circuits common to both Radio and Television. With my Servicing Course you build the modern receiver shown at right. You also build an Electronic Multitester which you can use to help fix sets while training at home. Many students make \$10, \$15 a week extra fixing neighbors' sets in spare time, starting soon after enrolling. I send you special booklets that show you how to fix sets. Mail coupon for 64-page book and actual Servicing Lesson, both FREE.



MEN OF ACTION NEEDED MAIL COUPON TODAY

Act now to enjoy more good things of life. Get the benefit of my 40 years' experience training men at home. Take NRI training for as little as \$5 a month. Many NRI graduates (some with only a grammar school education) make more in two weeks than the total cost of training. Find out about this tested way to better pay. Mail coupon below today for Actual Lesson and 64-page Book — BOTH FREE. J. E. SMITH, President, National Radio Institute, Dept. 4HA, Washington 9, D. C. OUR 40TH YEAR.

I TRAINED THESE MEN AT HOME

 "Started repairing Radios six months after enrolling. Earned \$12 to \$15 a week, spare time." — ADAM KRAMLIK, JR., Sunnyside, Pennsylvania.

 "I've come a long way in Radio and Television since graduating. Have my own business on Main Street." — JOE TRAVERS, Asbury Park, New Jersey.

 "Answered ad for Radio and Phone Servicing. Got the job. Within a year my pay increased 50%." — CHURCHILL CARTER, San Bernardino, California.

 "Am with WCOC. NRI course can't be beat. Passed exam for first class Radiophone license with no trouble at all." — JESSE W. PARKER, Meridian, Miss.

 "Am with WNBT as video control engineer on RCA color project. Owe a lot of my success to your textbooks." — WARREN DEEM, Malverne, N. Y.

AVAILABLE TO VETERANS UNDER GI BILLS

Good for Both — FREE

Mr. J. E. SMITH, President, Dept. 4HA
National Radio Institute, Washington 9, D. C.

Mail me Sample Lesson and 64-page Book, FREE. (No salesman will call. Please write plainly.)

Name _____ Age _____

Address _____

City _____ Zone _____ State _____

VETS write in date of discharge



WHAT SECRET POWER DID THIS MAN POSSESS?



BENJAMIN FRANKLIN
(A Rosicrucian)

WHY was this man great? How does anyone—man or woman—achieve greatness? Is it not by mastery of the powers within ourselves? Know the mysterious world within you! Attune yourself to the wisdom of the ages! Grasp the inner power of your mind! Learn the secrets of a full and peaceful life!

Benjamin Franklin—like many other learned and great men and women—was a Rosicrucian. The Rosicrucians (NOT a religious organization) first came to America in 1694. Today, headquarters of the Rosicrucians send over seven million pieces of mail annually to all parts of the world. Write for YOUR FREE COPY of "The Mastery of Life"—TODAY. No obligation. No salesmen. A non-profit organization. Address: Scribe H.F.B.

THIS BOOK FREE!



The ROSICRUCIANS
SAN JOSE • (AMORC) • CALIFORNIA

—SEND THIS COUPON—

Scribe H.F.B.
The ROSICRUCIANS (AMORC)
San Jose, California
Please send me the free book, *The Mastery of Life*, which explains how I may learn to use my faculties and powers of mind.

Name _____
Address _____
City _____

WHERE-TO-BUY-IT INDEX

Source of supply appears after items commercially available

AUTOMOTIVE

Lightweight "stretcher" straightens body wrinkles.....	74
Detroit Listening Post.....	82
Lavatory complete with running water attaches to side of car.....	105
Full-length cot rests on top of automobile seats.....	112
Floating automobile trailer cruises lake under own power.....	138
Flat-bed truck tilts like a dump truck for loading or unloading.....	144
Screened observation platform of trailer folds for transit (Prairie Schooner, Inc., Elkhart, Ind.).....	144
There's everything in this car—even the kitchen sink.....	144

AVIATION

Pilotless bomber packed in crates.....	90
Assault transport plane lands troops on enemy beach.....	96
Smallest jet fighter carries atom bomb.....	96
British braking parachute for airplanes folds itself after use.....	96
Lightweight helicopter glider built for less than \$100.....	103
Turbojet engine produces more than 25,000 horsepower (Pratt & Whitney Aircraft, East Hartford & Conn.).....	104
Brightly colored "fish" fly high over Mexico's sand dunes (Ryan Aeronautical Co., San Diego 12, Calif.).....	105
Single turboprop can power bomber.....	112
Twin-turborotor helicopter (Kaman Aircraft Corp., Bloomfield, Conn.).....	139
Electron tube for airplanes functions over 1000 hours.....	228

CONSTRUCTION

Tampa Bay crossing spans 14 miles of tidewater.....	72
Dome-shaped aluminum auditorium needs no interior supports.....	91
Arched troughs form roof and sides of simple steel building.....	92
Running model of St. Lawrence River helps engineers plan seaway.....	92
Irrigation dam made from vinyl (Nebraska Plastics, Inc., Cozad, Neb.).....	112
Road-patching outfit heats mix and dries hole at same time (Buhl Machine Works, Buhl, Idaho).....	126
Line clip aids bricklayer (Mason's Twig Sales Co., 1629 Dierks Bldg., Kansas City 6, Mo.).....	133

FISHING

Aluminum tube holds fish (Dooley Dunker Co., P. O. Box 2011, Dallas, Tex.).....	71
Quick-change spinning reel switches spools in a matter of seconds (Spool-Change Co., 185 N. Wabash Ave., Chicago 1).....	74
Salmon-egg dispenser fits on fishing rod (Mark Weaver, Box 1130, Santa Monica, Calif.).....	120

HOUSE AND HOME

Steel cellar door swings open like hood of automobile (Heat-lator, Inc., Syracuse 5, N. Y.).....	74
What's New for Your Home—	
Contour-bed mechanism (Sleeper Lounge Co., 3279 Wilshire Blvd., Los Angeles 5).....	86
Weather stripping for casement windows (Mackinburg-Duncan Co., Box 1197, Oklahoma City, Okla.).....	86
"Snow-ice" sealed in plastic bag (The Cupples Co., 401 S. 7th St., St. Louis, Mo.).....	86
Crushed ice slips out of new ice-cube tray (Fireside Shop, 916 Wayne St., South Bend 17, Ind.).....	87
Squeeze cleaner for mirrors and windows (M. Merle Yoder, Goodrich Road, Clarence Center 30, N. Y.).....	87
Clothes drier attaches to door of automatic washer (Turo Dryer Corp., 3 Washington Pl., New York City 3).....	87
Portable electric outlet (Marcon Products Co., 400 N. Wells St., Chicago 10).....	87
Sprinkler system (Hi-Spra Sprinkler Corp., 1457 S. Concord St., Los Angeles 23).....	87
Precut packaged fence allows you to build variety of patterns (Cascade Pacific Lumber Co., 319 Pacific Bldg., Portland 4, Ore.).....	125
Attachments convert lawn mower into mobile home workshop (Rocklin Mfg. Co., Grand Ave. at Jennings St., Sioux City 2, Iowa).....	131
Swinging door for pets (Warner Products Co., Baldwinville, N. Y.).....	133
Roof-sprinkling hose (Sibert & Co., 41 Rankin St., Newark 3, N. J.).....	143
Sponge evaporator cools fan's breezes (Ajax Mfg. Co., 331 Southwest Blvd., Kansas City, Mo.).....	143

LAWN AND GARDEN

Weed topper on power mower (Moto-Mower Co., 4607 Woodward Ave., Detroit 1, Mich.).....	111
Garden-hose attachment anchored in turf forms portable shower.....	113
Portable barbecue oven with heat controls holds 15 steaks (R. D. Fageol Co., 5725 Mt. Elliot, Detroit, Mich.).....	125
Floral Ferris wheel made from pipe puts petunias on display.....	126
Screen frame fits garden cart to break up lumps in topsoil (Niagara Garden Sifter Co., 1006-10 Prudential Bldg., Buffalo 2, N. Y.).....	133

MISCELLANEOUS

Flashlight changes color (Walter F. Martini, 2-4 Stone St., New York City 4).....	71
Infrared lamps heat patrons of sidewalk cafe in Brussels.....	83
Meter tests hardness by touch metal.....	83
Compact golf-ball gauge indicates imperfections.....	103

(Continued to page 14)



INVENTORS

Learn how to protect your invention. The U. S. Patent Laws provide that any new and useful art, machine, article of manufacture, or composition of matter, or any new and useful improvement thereof, may be patented if the act of invention is involved. Therefore, every inventor with a valuable invention should take advantage of the Patent Laws and proceed for patent protection in order to safeguard his rights.

A patent gives the inventor the exclusive right to prevent others from making, using, or selling the invention claimed in the patent for a period of seventeen years.

The Patent Laws were enacted for the benefit of the inventor to give him protection for the features of his invention which are patentable. These features must be properly and concisely set forth and claimed in a formal application for patent, in order to comply with the requirements of the Patent Laws. For that reason, unless the inventor is familiar with patent matters, he should engage a competent, registered patent attorney or agent to represent him. We are registered to practice before the U. S. Patent Office and are prepared to serve you in the handling of your patent matters.

A specially prepared booklet entitled "Patent Guide for the Inventor", containing detailed information with respect to patent protection and procedure, together with a "Record of Invention" form will be promptly forwarded to you without obligation upon request.

CLARENCE A. O'BRIEN & HARVEY JACOBSON

Registered Patent Attorneys

41-H DISTRICT NATIONAL BUILDING

WASHINGTON 5, D. C.

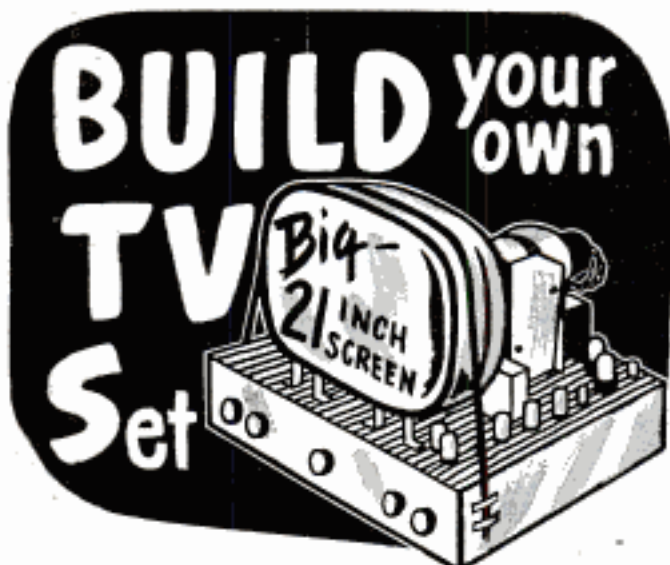

ALSO GET READY for a Big Pay Job
or a Business of YOUR OWN

in TELEVISION

Get the Best in TV Training

NOW you can BUILD YOUR OWN TV SET and at the same time train at home for a BIG-PAY job as a TV Technician. Or start a Business of YOUR OWN. We supply Twenty-TWENTY-Kits of Fine Tools, Quality Parts and Professional Equipment for your own Home TV Service Shop. All these advantages and MANY MORE come to you as part of America's finest Home-Study TV Training Plan. TELEVISION—Today's fastest growing Industry, has a place for YOU. Thousands of Job Opportunities now open. Or BE YOUR OWN BOSS and HAVE YOUR OWN BUSINESS as many other CTI Men are doing. Absolutely no previous experience in radio or TV needed. We train you in TV from A to Z. Big new FREE Book brings you FACTS and PROOF. Rush Coupon TODAY!

20 We send you
Valuable Kits

Hundreds of Parts, Tools, Equipment come with course. FREE BOOK Shows These and MUCH MORE.



**Big FREE BOOK
SHOWS YOU HOW!**

Send today for new TV Book, "YOU and TELEVISION." Gives you latest facts and figures. Also shows twenty big Kits of Parts, including everything to make your own 21 inch screen TV Set. Book is FREE. Send Coupon TODAY.

MAIL COUPON
TODAY

- EXTRA CASH
Make Money in Spare Time. We show you how.
- COLOR TV
coming soon. We supply special instructions without extra cost.
- JOB HELP
Take your pick of Jobs.
- HAVE A BUSINESS
We show you how to start.

COMMERCIAL TRADES INSTITUTE
Dept. T2-B, 1400 Greenleaf Ave.
Chicago 26, Ill.

Send big FREE Book telling how I can Train at Home and Make Big Money in Television.

Name _____ Age _____

Address _____

City _____ State _____

County _____

(Continued from page 12)

- Alarm sounds if child or pet falls into unguarded swimming pool (Modern Design Engineers, 3617 S. Avalon, Los Angeles).....104
- Invisible sentinel times operation of automatic-elevator doors (Westinghouse Electric Corp., Merchandise Mart, Chicago 54).....104
- Wonder oil ignores cold.....105
- Plastic beads popped like corn permit molding of foam plastic (Koppers Co., Inc., Pittsburgh 19, Pa.).....111
- Unsafe water purified (A. F. Schneider Co., Altadena, Calif.).....111
- Noisy padlock (Master Lock Co., 2600 N. 32nd St., Milwaukee, Wis.).....120
- Unfolded golf-cart handle becomes comfortable seat (Cart Seat Co., 3338 S.E. 17th Ave., Portland, Ore.).....120
- Pressurized gasoline can mounts vanishing hose (Alva T. Smith Co., Milwaukee 12, Wis.).....121
- Tent made of fiberboard may shelter troops in Arctic (Gaylord Container Corp., 111 N. 4th St., St. Louis, Mo.).....121
- Recorded bird shrieks free towns of starlings.....125
- Today's known oil reserve greater than year ago.....130
- Dispatcher 200 miles away lights burners under railroad tracks.....131
- Sports clothes made of treated cloth serve as life preserver.....131
- Multipurpose plastic (Borg-Warner Corp., 310 S. Michigan Ave., Chicago 4).....132
- Surplus life raft doubles as crib.....132
- Tweezers with battery and bulb in handle furnishes own light (Top Line, Inc., P.O. Box 297-M, 2124 E. Colorado St., Pasadena, Calif.).....138
- Air-filled hoses are ribs of roomy German sleeping tent.....139
- Leakproof battery stops flashlight corrosion (National Carbon Co., 30 E. 42nd St., New York City).....143
- Spider folding "fireplace" easy to carry and store (Sewards Mfg. Co., 1513 E. Blaine St., Springfield, Mo.).....143

PHOTOGRAPHY

- Former antiaircraft gun serves as mast for long-range camera 83
- Underwater motion-picture camera takes movies at 100 feet.....113
- Two cameras in sealed case take underwater photographs.....120

SCIENCE

- Easy-to-use resuscitator operates aloft or on ground..... 71
- Hypodermic gun "fires" liquid injection.....113
- Scientist takes pulse of earth daily.....125
- Ultraviolet picture tube for radar may be used in television sets (Radio Corporation of America, 30 Rockefeller Plaza, New York City 20).....126
- Discover oldest plants.....132
- "Packaged radioactivity" treats tissue and makes X-ray photos.....132
- Experimental phone booth leaves both hands free.....138

TOOLS

- Lathe roller flows metal into conical shapes..... 75
- Grubbing tongs attached to tractor chain uproot stubborn brush (Re-Bo Mfg. Co., 331 Madison Ave., New York City 14) 91
- Portable earth borer works by vibration (Mall Tool Co., 4740 S. Chicago Ave., Chicago 25).....121

Radio-Television, Electronics

- Sight-and-sound news (A) RCA Building, New York City 20, (B) Heath Co., Benton Harbor, Mich. (C) Hallcrafters Co., 4401 W. Fifth Ave., Chicago 24 (D) Reeves Soundcraft Corp., 10 E. 52nd St., New York City 22.....145
- How to build a low-cost Conelrad alarm monitor.....146
- Radio Electronics Today (A) Purple Co., Hermansville, Mich. (B) General Electric Co., Syracuse, N. Y. (C) Continental Electronics & Sound Co., 711 Liscom Dr., Dayton 7, Ohio. (D) (E) General Electric Co., Syracuse, N. Y.148

Craftsman and Shop Notes Index

AUTOMOTIVE

- Tissue box taped to sun visor aids cleaning windshield.....165
- Tire pressure marked on gauge.....176
- Method for cleaning steamed windows of car while driving.....197
- Handy wall hangers in garage are discarded auto valves.....198
- Hot-weather driving kink.....198

FARM

- Motorized wheelbarrow.....181
- Horse-drawn plow converted for use with tractor.....198
- Poultry fountains kept clean.....198

FISHING

- A nibble is a catch with tandem fishhooks.....153
- Burlap sack laced to wheel rim keeps newly caught fish alive.....176
- Bent fishhooks taped to pole make efficient line guides.....180
- Sand spike made of steel rod acts as equipment rack.....187

HOUSE AND HOME

- Dustpan fitted with handle provides child's shovel.....152
- Stamps removed from envelope by reversing usual method.....152
- Solving Home Problems—
Toddlers can't open drawers of sewing-machine cabinet.....154
- Soaking wallpaper before removing.....154
- Wooden drawer knobs will stay tight.....154
- Rubber hose makes shelf guards.....154

(Continued to page 16)

WANTED!

Only men with training

Are you looking for a better job . . . where you work or elsewhere? . . . discouraged because you don't seem to "fit" the better jobs your company offers or in help wanted ads?

Do you realize that there are many jobs—good jobs—open *right now!* At this very minute industry is looking for *trained men*. Men with specific skills and knowledge get the best jobs, hold them through good times and bad.

Experience isn't enough. There are two types of experience. One comes from adding up the years. The other comes from adding years *plus* knowledge.

"One out of every four men is being laid off in the plant where I work," says I. C. S. student V. R. Robuccio. "I am not one of them. My I. C. S. training assured me my job!"

Experience plus training means something. When competition for jobs is tough, the man with special skill has the edge.

YOU can offer that extra something. For pennies each day, using an hour or two of your free time without interference with business or social life, you can prepare yourself in the field of your choice. *Not* just for a job. But for "the job you've always wanted." One with a future. One with responsibilities.

I. C. S. has helped millions. You're not alone. Millions of people have turned to I. C. S. — in good times and bad. They've put their free time to work. Take W. K. Watson of Lakewood, Ohio. "Took I. C. S. Accounting Course. Got two other jobs . . . each paying better than the previous. Would have been impossible without I. C. S. training."

From California—"I was a farm laborer when I enrolled for Analytical Chemistry," says Dr. S. Carl Traedge. "I continued with Advanced Organic and Physical Chemistry. This enabled me to advance to Senior Research Chemist."



3 FREE BOOKS Send the coupon below with the subject of your choice checked. I. C. S. will send you, FREE, three books that might change the course of your life. The first is the eye-opening book, "How to Succeed," which tells how you can discover hidden talents in yourself. The second book outlines the opportunities in the field you check. The third is a sample I. C. S. lesson. Absolutely no obligation.

For Real Job Security—Get an I. C. S. Diploma!

I. C. S., Scranton 9, Penna.

INTERNATIONAL CORRESPONDENCE SCHOOLS

ICS

BOX 5628-L, SCRANTON 9, PENNA.

(Partial list of 277 courses)

Without cost or obligation, send me "HOW TO SUCCEED" and the opportunity booklet about the field BEFORE which I have marked X (plus sample lesson):

- | | | | | |
|---|--|---|---|--|
| <p>ARCHITECTURE and BUILDING CONSTRUCTION</p> <ul style="list-style-type: none"> <input type="checkbox"/> Air Conditioning—Refrig. <input type="checkbox"/> Architecture <input type="checkbox"/> Building Contractor <input type="checkbox"/> Building Maintenance <input type="checkbox"/> Carpenter and Mill Work <input type="checkbox"/> Estimating <input type="checkbox"/> Heating <input type="checkbox"/> Painting Contractor <input type="checkbox"/> Plumbing <input type="checkbox"/> Reading Arch. Blueprints <input type="checkbox"/> Steamfitting <p>ART</p> <ul style="list-style-type: none"> <input type="checkbox"/> Cartooning <input type="checkbox"/> Commercial Art <input type="checkbox"/> Fashion Illustrating <input type="checkbox"/> Magazine Illustrating <input type="checkbox"/> Show Card and Sign Lettering <input type="checkbox"/> Sketching and Painting <p>AUTOMOTIVE</p> <ul style="list-style-type: none"> <input type="checkbox"/> Auto Body Rebuilding <input type="checkbox"/> Auto Elec. Technician <input type="checkbox"/> Auto-Engine Tune Up <input type="checkbox"/> Automobile Mechanic | <p>AVIATION</p> <ul style="list-style-type: none"> <input type="checkbox"/> Aeronautical Engineering Jr. <input type="checkbox"/> Aircraft & Engine Mechanic <p>BUSINESS</p> <ul style="list-style-type: none"> <input type="checkbox"/> Advertising <input type="checkbox"/> Bookkeeping and Accounting <input type="checkbox"/> Business Administration <input type="checkbox"/> Business Correspondence <input type="checkbox"/> Certified Public Accounting <input type="checkbox"/> Creative Salesmanship <input type="checkbox"/> Federal Tax <input type="checkbox"/> Letter-writing Improvement <input type="checkbox"/> Managing Small Business <input type="checkbox"/> Office Management <input type="checkbox"/> Retail Business Management <input type="checkbox"/> Sales Management <input type="checkbox"/> Stenographic-Secretarial <input type="checkbox"/> Traffic Management <p>CHEMISTRY</p> <ul style="list-style-type: none"> <input type="checkbox"/> Analytical Chemistry <input type="checkbox"/> Chemical Engineering <input type="checkbox"/> Chem. Lab. Technician <input type="checkbox"/> General Chemistry <input type="checkbox"/> Natural Gas Prod. & Trans. <input type="checkbox"/> Petroleum Engineering <input type="checkbox"/> Plastics <input type="checkbox"/> Pulp and Paper Making | <p>CIVIL, STRUCTURAL ENGINEERING</p> <ul style="list-style-type: none"> <input type="checkbox"/> Civil Engineering <input type="checkbox"/> Construction Engineering <input type="checkbox"/> Highway Engineering <input type="checkbox"/> Reading Struct. Blueprints <input type="checkbox"/> Sanitary Engineering <input type="checkbox"/> Structural Engineering <input type="checkbox"/> Surveying and Mapping <p>DRAFTING</p> <ul style="list-style-type: none"> <input type="checkbox"/> Aircraft Drafting <input type="checkbox"/> Architectural Drafting <input type="checkbox"/> Electrical Drafting <input type="checkbox"/> Mechanical Drafting <input type="checkbox"/> Mine Surveying and Mapping <input type="checkbox"/> Ship Drafting <input type="checkbox"/> Structural Drafting <p>ELECTRICAL</p> <ul style="list-style-type: none"> <input type="checkbox"/> Electrical Engineering <input type="checkbox"/> Electrical Maintenance <input type="checkbox"/> Electrician <input type="checkbox"/> Contracting <input type="checkbox"/> Lineman <p>HIGH SCHOOL</p> <ul style="list-style-type: none"> <input type="checkbox"/> Commercial <input type="checkbox"/> Good English <input type="checkbox"/> High School Subjects <input type="checkbox"/> Mathematics | <p>LEADERSHIP</p> <ul style="list-style-type: none"> <input type="checkbox"/> Foremanship <input type="checkbox"/> Industrial Supervision <input type="checkbox"/> Leadership and Organization <input type="checkbox"/> Personnel-Labor Relations <p>MECHANICAL AND SHOP</p> <ul style="list-style-type: none"> <input type="checkbox"/> Gas—Electric Welding <input type="checkbox"/> Heat Treatment <input type="checkbox"/> Metallurgy <input type="checkbox"/> Industrial Engineering <input type="checkbox"/> Industrial Instrumentation <input type="checkbox"/> Industrial Supervision <input type="checkbox"/> Machine Design-Drafting <input type="checkbox"/> Machine Shop Inspection <input type="checkbox"/> Machine Shop Practice <input type="checkbox"/> Mechanical Engineering <input type="checkbox"/> Quality Control <input type="checkbox"/> Reading Shop Blueprints <input type="checkbox"/> Refrigeration <input type="checkbox"/> Sheet Metal Worker <input type="checkbox"/> Tool Design <input type="checkbox"/> Toolmaking <p>RADIO, TELEVISION</p> <ul style="list-style-type: none"> <input type="checkbox"/> Electronics <input type="checkbox"/> Practical Radio—TV Eng'ing <input type="checkbox"/> Radio and TV Servicing <input type="checkbox"/> Radio Operating <input type="checkbox"/> Television—Technician | <p>RAILROAD</p> <ul style="list-style-type: none"> <input type="checkbox"/> Air Brakes <input type="checkbox"/> Car Inspector <input type="checkbox"/> Diesel Locomotive <input type="checkbox"/> Locomotive Engineer <input type="checkbox"/> Section Foreman <p>STEAM AND DIESEL POWER</p> <ul style="list-style-type: none"> <input type="checkbox"/> Combustion Engineering <input type="checkbox"/> Diesel—Elec. <input type="checkbox"/> Diesel Eng't <input type="checkbox"/> Electric Light and Power <input type="checkbox"/> Stationary Fireman <input type="checkbox"/> Stationary Steam Engineering <p>TEXTILE</p> <ul style="list-style-type: none"> <input type="checkbox"/> Carding and Spinning <input type="checkbox"/> Cotton, Rayon, Woolen Mfg. <input type="checkbox"/> Finishing and Dyeing <input type="checkbox"/> Loom Fixing <input type="checkbox"/> Textile Designing <input type="checkbox"/> Textile Eng'g <input type="checkbox"/> Throwing <input type="checkbox"/> Warping and Weaving <p>MISCELLANEOUS</p> <ul style="list-style-type: none"> <input type="checkbox"/> Domestic Refrigeration <input type="checkbox"/> Marine Engineering <input type="checkbox"/> Ocean Navigation <input type="checkbox"/> Shipfitting <input type="checkbox"/> Short Story Writing <input type="checkbox"/> Telephony |
|---|--|---|---|--|

Name _____ Age _____ Home Address _____

City _____ Zone _____ State _____ Working Hours _____ A.M. to P.M. _____

Occupation _____

Canadian residents send coupon to International Correspondence Schools, Canadian, Ltd., Montreal, Canada. . . . Special tuition rates to members of the U. S. Armed Forces.

Get into RADIO-TELEVISION ELECTRONICS by Shop-Method Home Training



GOOD JOBS AWAIT THE TRAINED RADIO-TV TECHNICIAN!
Business of Your Own • Broadcasting • Radio Manufacturing, Sales, Service • Telecasting • Television Manufacturing, Sales, Service • Laboratories: Installation, Maintenance of Electronic Equipment • Electrolysis, Call Systems • Theatre Sound Systems, Police Radio • Garages: Auto Radio Sales, Service • Sound Systems, Telephone Companies, Engineering Firms, etc.

WE BRING NATIONAL SCHOOLS TO YOU! There is a place for you in the great Radio-Television-Electronics industry when you are trained as National Schools will train you at home! **OUR METHOD IS PROVED BY THE SUCCESS OF OUR GRADUATES SINCE 1905.**

YOU RECEIVE PARTS for Signal Generator, T.R.F. Receiver, Audio Oscillator and Superheterodyne Receiver, plus professional Multitester shown above. **No extra charges. EARN WHILE YOU LEARN—we show you how!**

APPROVED FOR G. I. TRAINING

**FREE
RADIO-TV
BOOK &
SAMPLE
LESSON!**

MASTER ALL PHASES! Get Master Shop-Method Home Training from an Established Resident Technical Trade School with its own Training Shops, Laboratories, Studios—almost 50 Years of Successful Experience in Training Ambitious Men.

NATIONAL SCHOOLS

Technical Trade Training Since 1905

LOS ANGELES 37, CALIFORNIA

In Canada: 811 West Hastings Street, Vancouver, B. C.

BOTH HOME STUDY AND RESIDENT COURSES OFFERED

MAIL NOW TO OFFICE NEAREST YOU!

(mail in envelope or paste on postal card)

NATIONAL SCHOOLS, Dept. RB-84

4000 S. FIGUEROA STREET OR 323 W. POLK STREET
LOS ANGELES 37, CALIF. CHICAGO 7, ILL.

Please rush **FREE RADIO-TELEVISION BOOK & FREE LESSON.** No obligation, no salesman will call.

NAME _____ BIRTHDAY _____ 19 _____

ADDRESS _____

CITY _____ ZONE _____ STATE _____

Check if interested **ONLY** in Resident training at Los Angeles.

VETERANS: Give date of discharge _____

(Continued from page 14)

Rubber shield for broom handle.....	155
Shoe-polishing cloths.....	155
Spring-type clothespin holds curtain rod.....	155
Chair-back pocket for home hair dressing.....	155
Leather table tops can be repaired with melted wax.....	155
Rug nap raised by steam iron.....	157
Half-lapping adds rigidity to latticework.....	157
Kettle lid on fishbowl.....	158
Decals applied to sheet plastic provide attractive plaques.....	158
Putty knife protects woodwork when pulling nails.....	158
Refrigerator frozen-food space increased by insulated box.....	162
Corn-on-the-cob holders turned from hardwood.....	172
Stop strip on bookcase shelf keeps volumes aligned.....	172
Folding door saves needed floor space in small room.....	173
Salt removes soot from carpet without smearing.....	176
Rubber cot protects finger when filling plaster cracks.....	176
Flush-tank handle kept tight with copper-wire shim.....	180
Guide rollers at corners of house reduce garden-hose wear.....	181
Large plants on movable platforms shifted easily during cleaning.....	191
Pot holder used as "cushion" for baby's safety pins.....	191
Strawberry runners placed in cans to aid transplanting.....	191
Compact writing desk built in unused corner.....	197

MISCELLANEOUS

Self-propelled toy "tank" made of empty spool.....	153
Bobby-pin "clamps" suspend brushes at desired depth in solvent.....	153
Freezing pipe in emergency shuts off water.....	156
Razor blade used as stencil.....	156
Lighter fluid added to polish improves shoe shine.....	157
Breaking in new penpoint.....	162
Typewriter noise reduced with acoustical tile.....	162
Paper matchbook cover doubles as emergency shoehorn.....	165
Space-saving portable picnic table is easily disassembled.....	165
Mirror mounted in wood jig reverses artist's copy.....	180
Hand-truck capacity increased by removable extensions.....	201
Water content of gasoline barrels easily checked.....	201

PHOTOGRAPHY

Rubber-cup camera "tripod" attaches to car body.....	156
Holder for ferrotype plates.....	158
Masking arms of photo easel squared on ruled card.....	180
Syringe keeps lenses mildew-free.....	187

TOOLS

Drill bit used as center punch aligns hinge screw holes.....	162
Jig holds mitered corners when gluing and nailing.....	191
Holes in top tread of ladder prevent dropping tools.....	192
Tape holds screw on driver in restricted location.....	192
Emergency coil spring wound in vise-held jig.....	197
Tape provides correct angle when grinding small drills.....	198
Grip on jointer push stick is electric-iron handle.....	201
Shopping for Tools—	
Bolt-and-nut gauge (Quality Products, P. O. Box 1186, Gering, Neb.).....	202
Tap wrench (Gilbert Mfg. Co., 139 Riverview Ave., Elkhart, Ind.).....	202
Wire splicer (Aircraft-Marine Prod., Inc., Harrisburg, Pa.).....	202
Dovetail saw (X-acto, Inc., 4841 Van Dam St., Long Island City 1, N. Y.).....	203
Plastic screwdriver handle (Upson Bros., Inc., Rochester 14, N. Y.).....	203
Sheet-metal brake fits ordinary vise (Lund Mfg. Co., Biddeford, Me.).....	203
Special clips hold cans for small parts (Hiarings, 614 N.E. 3rd, Madison, S.D.).....	203
Tooling clamp (Holdwell Tool Co., 606 S. Hill St., Los Angeles 14).....	203
Magnetic parts retriever (General Scientific Equip. Co., 2700 W. Huntingdon St., Philadelphia 32, Pa.).....	204
Rotary plane (Honeycutt Mfg. Co., Inc., 2715 Oak St., Kansas City 8, Mo.).....	204
Router-mortiser (J. D. Wallace & Co., 134 California Ave., Chicago 12).....	204
Saber-saw accessory (American Machine & Foundry Co., 511 Fifth Ave., New York 17).....	204

WORKSHOP HINTS

Use center punch to lock nut.....	152
Small parts sorted quickly on shower-curtain rings.....	152
Steel angles on miter box allow sawing heavy stock.....	153
Properly opened chain links are easily retightened.....	156
Sawhorse for use on uneven floor built with just three legs.....	156
Screen wire cleans files.....	156
Prevent opening of door with outside hinges.....	158
Elastic tape sewed to pocket prevents loss of rule.....	162
Fast method of striking ellipse on layout of doorway arch.....	164
Wood installed on concrete sill without using screw anchors.....	185
Shelves and partitions supported by basement-column brackets.....	172
Small-parts cabinet for shop assembled from precut pieces.....	173
"Locking" small screws.....	176
Screen molding mitered easily while tacked in place.....	176
Broken stud quickly removed with discarded tap.....	187
Friction-tape life prolonged by rubber-cement coating.....	187
Raw potato provides "heat dam" when annealing metal strip.....	187
Disk taped to bottom of jug acts as shock absorber.....	198
Wooden plugs in masonry walls held tightly with wedges.....	201

IMPORTANT NOTICE—It is the intention of this magazine to provide its readers with information regarding the latest developments in the mechanical arts. We take no responsibility as to whether the disclosures contained in our articles are covered by patents and advise readers to investigate this subject before making, using, or selling any of the products, machines, or processes described in order to avoid possible liability for patent infringements.

INVENTORS

If you believe that you have an invention, you should find out how to protect it. The first step is to have a search made of the prior pertinent U. S. patents. If a report on this search indicates that the invention appears patentable you can apply for a patent, and the specifications and claims should be prepared.

The firm of McMorrow, Berman & Davidson, with offices in Washington, D. C., is qualified to take the necessary steps for you. We can make a preliminary search on your invention, advise you whether we think it can be patented, and prepare your application for patent.

Unless you are fully familiar with the U. S. Patent Laws, we recommend that you engage the services of a Registered Patent Attorney to protect your interests. The patent laws are *your* laws. A patent gives you the right to prevent others from making, using or selling the invention claimed in your patent for a period of 17 years.

Use these patent laws for your protection. Investigate whether your invention can be patented. If you have what you believe to be an invention, we suggest that you have this firm make a search for you.

Send for a copy of our Patent Booklet entitled "How To Protect Your Invention," containing information about patent protection and patent procedure. Along with this we will also send you an "Invention Record" form, for your use in writing down and sketching details of your invention. We will mail them promptly. No obligation. They are yours for the asking.

McMORROW, BERMAN & DAVIDSON

Registered Patent Attorneys

PATENTS • COPYRIGHTS • PATENTS

1355 VICTOR BUILDING, WASHINGTON 1, D. C.

DRAFTSMEN



**CASH BIG
PAY CHECKS!**

**Train Now for
more success,
greater security**

**LEARN AT HOME IN SPARE TIME
(or at college in Chicago)**

Check the want ads in any newspaper—SEE the big-pay opportunities open to you as a draftsman. What's more, you can learn this well-paid, prestige profession at home—quickly, easily! No special talent needed. Get complete, step-by-step Chicago Tech lessons in the mail, spend a few pleasant hours studying each week. In a short time you'll be a well-trained draftsman, ready to take your pick of many good jobs. Act now!



Free Information—Mail Coupon Today!

Get **FREE TRIAL LESSON** plus information about C.T.C. practical training. Learn what successful Chicago Tech graduates say about high pay and opportunities in drafting. No charge, or obligation.

CHICAGO TECHNICAL COLLEGE

K-252 Tech Bldg., 2000 So. Michigan Ave.
Chicago 16, Illinois

Mail me **FREE** lesson with facts about big opportunities in **DRAFTING**.

Name _____ Age _____

Address _____

City _____ Zone _____ State _____

FREE!

GET ALL THESE
**5 PICTURE-PACKED
COURSES**
Plus "Amazing Secrets"
PHOTO BOOK
If you mail coupon NOW!
Millions have been sold
at \$1.



**JIM
NORMAN**
AFTER
He
Mailed
Coupon

Quit being a **BAG of BONES**
Weakling Like I Was →
**IN 10 MINUTES OF
FUN A DAY**
YOU CAN DO ALL I did!

I gained 25 Terrific Lbs. of
**HANDSOME POWER-PACKED
MUSCLES** all over!

I Improved My **HE-MAN**
Looks 1000%.

I Won **NEW STRENGTH-POPULARITY**
NO! I don't care how skinny or flabby you
are. I'll make you **OVER** by the **SAME**
method I turned myself from a wreck to
the strongest of the strong. **DEVELOP YOUR
520 MUSCLES.**

YES! You'll see **INCHES** of
mighty muscles added.
From head to heels you'll
gain **SIZE, POWER, SPEED.**

**NOW YOU CAN WIN A BIG
15" TALL SILVER CUP and \$100 as I just did**

LAST CHANCE COUPON — 5 COURSES FREE!
SHIPPED INSTANTLY, MAIL, P.M.—48
500 Fifth Avenue, New York 11, N.Y.
Dear Gents: Please mail to me **SHIPPED FREE** **IMMEDIATE** Photo
Book of **Strong Men, 5 Mighty Men, 50 of 2 Mighty Building**
Courses, "How to Become a Mighty He-Man." **ENCLOSED FIND ONE** for
strength and building the C.T.C. V.

Name _____ (Please print name, include zone number)
Address _____
City _____ Zone & State _____

EASY WAY to EXTRA MONEY



**be a GREETINGS GET-
TOGETHER Hostess!**

GREETINGS UNLIMITED really puts you in business with this exciting Party Plan. In a few hours, in your own home, show friends and neighbors the smartest Greeting Card assortments, plus hundreds of other unusual gifts and gadgets. **QUICK CASH** for the hostess! Send today for colorful **FREE 68-PAGE CATALOG** and full details. Write to Party Director, Dept. PM-1.

GREETINGS UNLIMITED PARK SQUARE
ST. PAUL, MINN.

AVIATION Pays You More With a Schooling at PARKS

NOW! A&E MECHANIC LICENSE COURSE

45-week course, all phases aircraft & engines.

Enrollment Dates: Sept. 1-2, 1954, Jan. 3, 1955

FLIGHT COURSES—Private, Commercial, Instrument, Instructor, Multi-Engine.

DEGREE COURSES—B.S. degree in 3 yrs. from Saint Louis University — Aero. Engineering, Maint. Engineering, Aero. Administration.

All Parks Schooling Approved for Veterans

Write Today.

PARKS COLLEGE ARNOLD HALL
EAST ST. LOUIS, ILL.

Write Like This **Complete
OUTLINE
FREE!**

YOUR penmanship can be improved in 3 hours or corrected to your satisfaction in 10 hours' practice with my **DEFINITE HAND CONTROLS**. New way!

WRITE OZMENT BOX 665
34-N, ST. LOUIS, MISSOURI



LEARN LOCKSMITHING

Learn this fascinating, profitable trade from experts in your spare time at home! Age or physical handicap no disadvantage. Year around, steady income. Full or part time. Practical, illustrated lessons. You can make money even while learning! All materials and special tools supplied without extra charge.

INSTITUTE OF LOCKSMITHING, Dept. P-57
15 PARK AVENUE RUTHERFORD, N. J.
Lic. by N.J. State Board of Education
Approved for Veterans

Learn **ACCOUNTING**
Business Administration

Bookkeeping, secretarial and allied subjects at home in your spare time or attend nationally approved resident school. Write for **FREE Success Book** giving complete details on courses, plans, rates and employment opportunities. **G.I. approved.**

Hills **BUSINESS UNIVERSITY AND
EXTENSION SCHOOL**
619 W. MAIN ST. OKLAHOMA CITY 2, OKLAHOMA

TELEPHONES

Desk Stand Style
Slightly used but in excellent condition
Many Valuable Uses
Inter-House Phones House to Barn, etc.
Loud Speakers Microphones
Educational Purposes, Toys, etc.

Come complete, ready to use with wiring diagrams included. **\$2.75** Postpaid in U.S.A.
Two complete for only **\$5.00**

TELEPHONE LAMP KIT—with illustrated instructions for making Desk Telephone Lamp including all parts (barn, nipples, push switch, cord, plug, etc.)
\$6.50 Ppd. (Shade is not included).

MICROPHONE, Dept. X-1702, 1760 W. Lunt Ave., Chicago 26, Ill.

**Train QUICK
in Big Coyne
Shops**

GREAT OPPORTUNITY FIELDS!



Instructor helping students check the wiring and trace the circuits of television receivers.



This big fire-proof building is occupied entirely by Coyne.



Instructor explaining operation and testing of a large Motor Generator.

TRAINED YOUNG AND OLDER MEN— URGENTLY NEEDED IN VITAL FIELDS!

ELECTRICITY—RADIO—TELEVISION—ELECTRONICS—VITAL in defense program. Trained men whether 16 or up to 50 needed. TRAIN QUICKLY for better rating if drafted—Vital job in industry if not.

TELEVISION-RADIO ELECTRICITY

Here at COYNE you're retrained for Television, Testing, Trouble-Shooting on Radio, Public Address, F. M. Sound Units, etc. Many Coyne trained men in good jobs or own well paying Television-Radio businesses of their own.

Big future in Power Plant Work, Motors, Industrial Electronics, Armature Winding, Home and Factory Wiring, Appliances, Refrigeration, Maintenance, Illumination, etc. Lifetime job service to Coyne graduates.

WE TRAIN YOU IN CHICAGO

Our famous Practical-Technical method gives you practical experience on a massive outlay of equipment. Actual shop work plus necessary technical training. You are trained right here in the great Coyne shops. Send for BIG FREE BOOK.

**APPROVED
FOR
VETERANS**

START NOW—PAY LATER

Enroll now, pay most of tuition after graduation. Special plan for men of draft age. We'll help you get part-time work, if you need it to help pay living costs while at Coyne.

B. W. COOKE, President

COYNE

SCHOOL

A TECHNICAL TRADE INSTITUTE
CHARTERED NOT FOR PROFIT
Established 1899
500 S. Paulina Dept. C4-72H
Chicago 12, Illinois

ELECTRICITY ★ TELEVISION ★ RADIO ★ REFRIGERATION ★ ELECTRONICS

LARGEST, OLDEST, BEST EQUIPPED SCHOOL OF ITS KIND IN THE U.S.

Mail Coupon for Big FREE Book!



Whether you prefer Television-Radio or Electricity, train on actual equipment at Coyne. We will send you a Big, fully illustrated Book. Indicate below which course interests you most. No salesman will call. Mail coupon TODAY.

B. W. Cooke, President
COYNE SCHOOL, 500 S. Paulina St.
Dept. C4-72H, Chicago 12, Ill.

Send me your Big Free book. I am interested in field checked below. This does not obligate me.

TELEVISION-RADIO ELECTRICITY

NAME.....

ADDRESS.....

CITY.....STATE.....



**YOU
can
acquire**

**LAW NIGHTS AT HOME!
L.L.B. DEGREE**

LaSalle's famous Law Library—used as reference in many Law libraries and Law offices—has enabled thousands to master Law surprisingly fast, in spare hours at home, for business and professional advancement.

These 14 remarkable volumes, compiled by leading professors and lawyers, cover the whole basic field of Law in condensed, orderly, simplified manner.

You advance rapidly with this great library, plus special lectures furnished. We guide you step-by-step with personalized Problem Method of instruction . . . you learn by doing—handling legal problems—not by memorizing rules.

Send for two FREE 48-page booklets, "Law Training for Leadership," and "Evidence," answering questions about Law and its value to you, and telling how LaSalle Law graduates are winning rapid advancement in business and public life. Mail coupon below. No obligation.

**LA SALLE EXTENSION UNIVERSITY
A Correspondence Institution**

417 5. Dearborn St. Dept. 864L Chicago 5, ILL.

Send me your two FREE booklets described above, without obligation.

Name.....Age.....

Street.....

City, Zone & State.....

**Shrinks Hemorrhoids
Without Surgery**

**Science Finds Healing Substance That
Relieves Pain—Shrinks Hemorrhoids**

Science has found a healing substance that shrinks hemorrhoids, stops pain promptly, ends bleeding—without surgery. Doctors report actual shrinking of hemorrhoids. Sufferers say, "Hemorrhoids have ceased to be a problem." The secret is Bio-Dyne® — already widely used for healing injured tissue. This substance is now available in a hemorrhoid ointment called Preparation H*. Ask your druggist for Preparation H. Money back guarantee. *Trade Mark

SHORTHAND in

**6
WEEKS**

Famous SPEEDWRITING shorthand, 120 words per minute. No symbols; no machines; uses ABC's. Easiest to learn, write and transcribe. Lowest cost. 250,000 taught by mail. For business and Civil Service. Typing available. 31st year. Write for FREE booklet to: SCHOOL OF

Speedwriting
Dept. 1508-4, 55 W. 42 St., New York 36 (R)

OWN a Business

If employed, start part time. Alert dealers can gross \$5 hourly profit on own service plus \$3 on EACH serviceman. Clean, revive, moth-proof rugs & upholstery on location. No shop needed. Services nationally advertised. Repeat customers. Easy to learn. We locally train and assist you. Quickly established. Easy terms. Send today for FREE booklet. No obligation.

DURACLEAN CO., 4-188 Duraclean Bldg., Deerfield, Ill.

MAKE TREMENDOUS PROFITS

Have fun! Earn Big Money! Cast plastic figurines, book ends, plaques, novelties at home in your spare time with X.L. rubber mold! NO EXPERIENCE NEEDED! Models and rubber for 3 molds, only \$1.50 each. Start your business now! Send 25c for 40 page catalog.

PLASTIC ARTS STUDIO 3403 SO. MADISON, DEPT. PM2 MUNCIE, INDIANA

EARN WHILE YOU LEARN AT HOME

MAKE MONEY 90 WAYS IN PHOTOGRAPHY

If you are OVER 17—good pay, fascinating work await you in photography. Start earning at once as you learn to make money 90 ways with your camera. Our famous, low-cost LEARN-BY-DOING method and INDIVIDUAL guidance train you quickly at home! Write TODAY for FREE catalog. Also Resident Training. 4th Year. GI Approved.

NEW YORK INSTITUTE OF PHOTOGRAPHY
Dept. 49, 10 W. 33 Street New York 1, New York

Send for FREE BOOK

FOR BIG MEN ONLY!

Sizes 10 to 16 Widths AAA to EEE

We SPECIALIZE in large sizes only — sizes 10 to 16; widths AAA to EEE. Loungers; Dress Oxfords; Moccasins; Cushion Crepe; High and Low Work Shoes; Slippers; Rubbers; Over-shoes; Sox. Enjoy the finest in fit, comfort, style at amazingly low cost. Sold by mail only. Write for FREE Style Book TODAY!

KING-SIZE, Inc., 469, Brockton, Mass.

SEND FOR FREE CATALOG



**BIG PROFIT making
Concrete Drain Tile**

Millions of dollars' worth of drain tile are used every year for farm drainage, building construction, reclamation projects, highways, and other purposes. And the big swing is to concrete tile because it's better and costs less. Sales potentials are BIG.

Concrete drain tile is locally manufactured of local materials, for direct selling to local users or contractors. Useless costs—freight, distribution, breakage—are eliminated. While worth more than clay tile, concrete tile can sell for less and still earn a handsome profit.

Tile made on the Champion Machine are strong and uniform. Truly round. All sizes up to 12" diameter. Easy to make because the Champion is simple to operate.

Get The Champion Facts

Write for the Champion book. Tells about concrete drain tile as an outstanding manufacturing opportunity. Describes the machine and outlines liberal payment terms.

CONCRETE EQUIPMENT CO.
522 Ottawa Ave., Holland, Mich.



Now IN YOUR OWN HOME Learn

TELEVISION RADIO ELECTRONICS

the Amazingly Effective

D. T. I. WAY

—with the aid of BOTH
HOME EQUIPMENT
and HOME MOVIES



NO PREVIOUS EXPERIENCE NEEDED

NOW... get
**EVERYTHING
YOU NEED**

Laboratory-
type training
AT HOME



5 INCH
"SCOPE"

Oscilloscope



Multi-Meter



21 INCH

Build and keep this BIG DTI
Engineered TV set—easily
converted to U.H.F. (DTI offers
another home training, but
without the TV set.)

1. Build over 300 fascinating experiments from 16 BIG SHIPMENTS of Electronic-Radio parts which you KEEP.

2. Build valuable commercial-type test equipment—as shown to the left—which you KEEP. This includes a quality 5 INCH oscilloscope and jewel bearing Multi-Meter—both highly useful for Television work.

3. Build and keep a big 21 INCH TV Set. (D.T.I. offers another home training in Television-Radio-Electronics, but without the TV set.)

4. Use a 16 mm. movie projector and new series of highly instructive movies—a wonderful aid to help you grasp important fundamentals faster... easier... better.

5. Enjoy well-illustrated, easy-to-read lessons with handy FOLD-OUT diagrams.

6. Get an honest-to-goodness EMPLOYMENT SERVICE to help you get a good job after graduating—or assistance in starting your OWN SALES AND SERVICE BUSINESS. Mail coupon today for the complete details.

D.T.I.'s Training is available in Canada

Above:
Work over
300
fascinating
experiments
with this
equipment

What will mailing the coupon below do for YOU? Just this! You'll find out about one of today's most remarkable... practical ways to prepare to get into America's amazing billion dollar opportunity field of TELEVISION-RADIO-ELECTRONICS. You'll see how to get into fascinating work that pays well... that offers one of America's most promising futures... that enables you to start your own business almost "on a shoe string," if you prefer this to a job opportunity.

And above all, you'll get some GOOD NEWS especially welcomed by men anxious to earn REAL MONEY in this thrilling field. For you'll see that NOW you can get the kind of practical, laboratory-type training so desirable for making real progress in Television-Radio-Electronics AND WITHOUT LEAVING HOME.

You'll see that DeVry Technical Institute sends everything needed to set up your own HOME LABORATORY.

You get and keep the same type of basic electronic equipment used in our modern Chicago Training Laboratories. You get home training that includes the knowledge and experience gained from training thousands of students first hand in Chicago.

And to top it all, you use DTI's amazingly effective and exclusive home training aid—INSTRUCTIVE MOVIES. But why not get the complete story? Mail coupon today for information-packed literature.

MODERN LABORATORIES

If you prefer, get all your preparation in our new Chicago Training Laboratories—one of the finest of its kind. Ample instructors, modern equipment. Write for details!

MILITARY SERVICE!

If you're subject to military service, the information we have for you should prove very helpful. Mail coupon today.

Get this
information-
packed
publication

FREE!

Mail Coupon Today

**89 WAYS
TO
EARN
MONEY
IN TELEVISION
RADIO ELECTRONICS**

DEVRY TECHNICAL INSTITUTE, Dept. PM-B-K
4141 BELMONT AVE., CHICAGO 41, ILL.

I would like your valuable information-packed publication showing how I can get started toward a good job or my own business in Television-Radio-Electronics.

Name..... Age.....
Street..... Apt.....
City..... Zone..... State.....

DEVRY TECHNICAL INSTITUTE

AFFILIATED WITH
DEFORREST'S TRAINING, INC.
CHICAGO 41, ILLINOIS

**BIG VALUES IN
ALLIED'S
LATEST TV-RADIO
SUPPLEMENT**



FREE send for it
*Everything for Experimenters, Builders,
Amateurs, Servicemen, Hi-Fi Fans*



Send for our latest bargain-packed Supplement listing big values and new releases in TV accessories, custom chassis, High Fidelity systems and components, P.A. systems, recorders, FM and AM radios, Amateur supplies, test instruments, builders' kits, electronic parts, tubes, tools and books. Make your selections from the world's largest stocks of electronic supplies at lowest, money-saving prices!

ALLIED RADIO

100 N. Western Ave., Dept. 5-H-4
Chicago 80, Illinois

Send for Supplement **FREE**

ALLIED RADIO

FOR YOUR

TECHNICAL EDUCATION

COME TO

THE UNIVERSITY OF HOUSTON

(LOCATED IN FABULOUS HOUSTON, TEXAS)

For **SUCCESS** . . . Select one of these fascinating technical fields:

- Air Conditioning and Refrigeration Technology
- Diesel Technology
- Drafting Technology
- Electrical Technology
- Electronic Technology

Train NOW for the job you want . . . a job with a good income and security. Train at the University's College of Technology . . . rated one of the best in the country:

- Beautiful 250 acre campus
- Air conditioned classrooms and Residence Halls
- Graduate placement
- Short or longer programs
- University television and radio station
- Opportunity to extend your education and earn a college degree
- Accredited curricula
- Modern, extensive equipment
- Part-time job while in school
- Co-educational
- G.I. approved—V.A. on campus
- Open to high school graduates or equivalent
- Aptitude testing and vocational guidance
- Sept., Feb., June semesters.

Send for **FREE** illustrated brochure Now.

Mark X before your choice of subject.

UNIVERSITY OF HOUSTON—COLLEGE OF TECHNOLOGY
DEPT. 184 — HOUSTON 4, TEXAS

BE YOUR OWN BOSS

If you have \$3,000 to \$3,500 and would like to be in business for yourself, write, wire or call Tastee-Freeze. **OVER 1000 SUCCESSFUL STORES** now in operation. **EARNINGS LARGE.**



Tastee-Freeze is a reg. trade mark
TASTE-FREEZE CORP. of AMERICA
2518 W. Montrose, Dept. F, Chicago 18, Ill.

GIANT BALLOONS



Surplus U. S. Gov't. (new—average) NEOPRENE weather, target balloons. For FUN or PROFIT. Great sport in the backyard; or for parties, picnics, dances, fairs, MONEY-MAKING. Use these balloons to attract crowds to civic events, conventions, exhibitions, trade shows, TERRIFIC for high school and college PROMS. All sizes are approx. Inflated size. Postage prepaid on prepaid orders.
3 ft. dia. 49c — 6 ft. dia. 99c
13 ft. dia. \$1.59 — 20 ft. dia. \$1.95
• Calif. residents please add sales tax.

WAR ASSETS DIV. VOLUME SALES CO.
Dept. M-854 3930 Sunset Blvd. Los Angeles 29, Calif.

'How to Make Money with Simple Cartoons'



A book everyone who likes to draw should have. It is free; no obligation. Simply address **FREE BOOK**

CARTOONISTS' EXCHANGE
Dept. 98D Pleasant Hill, Ohio

Become a Doctor of PSYCHOLOGY

Win the degree of Ps.D. Learn the secret of contentment, happiness. Solve mental worries. Experience the revelation of truth. Chartered college. Individual help. Write for **FREE** book. **COLLEGE OF UNIVERSAL TRUTH, 5038-B Broadway, Chicago.**

LEARN WATCH REPAIRING

AT HOME Modern, original instruction. Prepare for a position or start in business after completing our course. Write Today!
WISCONSIN SCHOOL OF WATCH REPAIRING
759 N. Milwaukee St. Dept. M Milwaukee 2, Wis.

HOT! TIRED! FEET?

ROLL YOUR FEET TO HEALTH!

A few minutes exercise with **DAVID'S MAGIC FOOT COMFORTER** followed by lathering in **DAVID'S MAGIC FOOT COMFORTER SOLUTION** is guaranteed to give absolute relief from hot, tired aching feet!

Both only \$3.00 postpaid
ORDER TODAY
DAVID'S MAGIC FOOT COMFORTER
Dept. M, P.O. Box 5597 Fenkell Station
Detroit 38, Mich.



SHINE WITHOUT 'POLISH'



Cars Glean Like Mirror

NEW
MEN! WOMEN! So easy a child can do it! Amazing "Dry" Polisher puts mirror-like shine on car **WITHOUT 'POLISH'**. No messy pastes, liquids, sprays. Simply glide over car. **PRESTO!** Leaves hard, lustrous, long-lasting protective Wax Coating. **Take orders! Earn money!**

SAMPLES FOR TRIAL

Sample offer sent immediately to all who send forms at once. Just a postcard will do. **SEND NO MONEY**—just your name.
KRISTEE CO., Dept. 677. Akron 8, Ohio

QUICK EASY!

HOW TO FIX

Brakes, Clutches, Transmissions, Rear Ends, Carburetors—Yes,

ANY PART OF ANY CAR

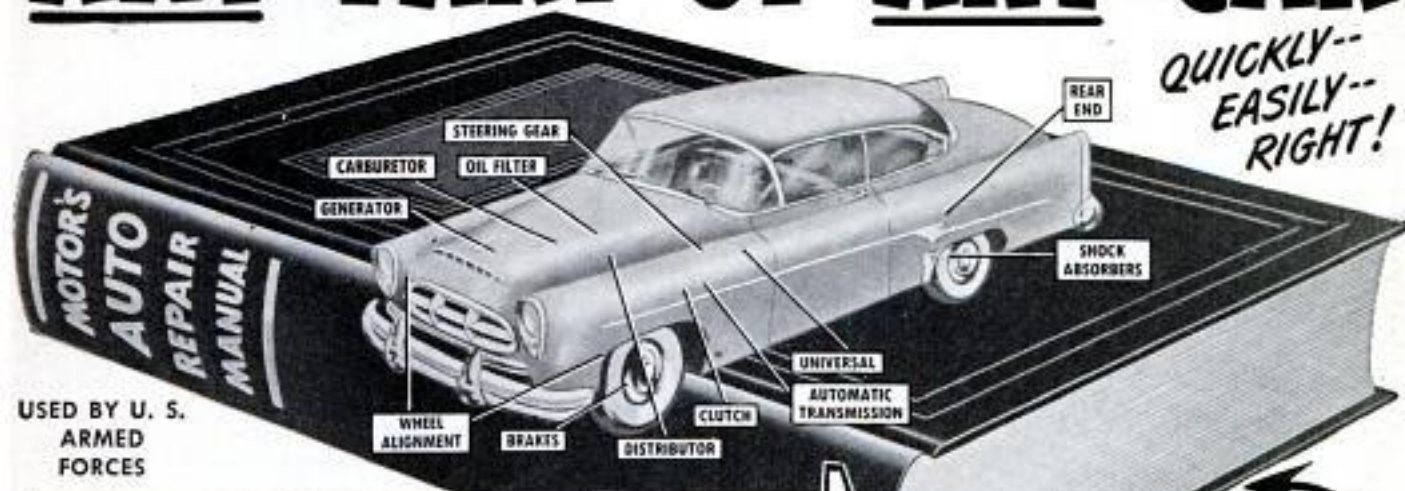

USED BY U. S.
ARMED
FORCES

NOW—Whether You're a Beginner or an Expert Mechanic—You Can "Breeze Through" ANY AUTO REPAIR JOB! MOTOR'S BIG BRAND-NEW AUTO REPAIR MANUAL Shows You HOW — With 2950 PICTURES AND SIMPLE STEP-BY-STEP INSTRUCTIONS.

Free 7-DAY TRIAL
Return and Pay Nothing
If Not Satisfied

COVERS EVERY JOB ON EVERY CAR BUILT FROM 1940 THRU 1954

YES, it's easy as A-B-C to do any "fix-it" job on any car whether it's a simple carburetor adjustment or a complete overhaul. Just look up the job in the index of **MOTOR'S New AUTO REPAIR MANUAL**. Turn to pages covering job. Follow the clear, illustrated step-by-step instructions. Presto—the job is done!

No guesswork! **MOTOR'S Manual** takes nothing for granted. Tells you where to start. What tools to use. Then it leads you easily and quickly through the entire operation!

Same FREE Offer On MOTOR'S Truck and Tractor Manual

Covers EVERY job on EVERY popular make gasoline truck, tractor made from 1946 thru 1954. FREE 7-Day Trial. Check proper box in coupon.

cuts that will amaze you. No wonder this guide is used by the U. S. Army and Navy! No wonder hundreds of thousands of men call it the "Auto Repair Man's Bible"!

Meat of Over 140 Official Shop Manuals

Engineers from every automobile plant in America worked out these time-saving procedures for their own motor car line. Now the editors of **MOTOR** have gathered together this wealth of "Know-How" from over 140 Official Shop Manuals, "boiled it down" into crystal-clear terms in one handy indexed book!

Covers 685 Models—All These Makes

Buick	Ford	Nash
Cadillac	Frazer	Oldsmobile
Chevrolet	Henry J	Packard
Chrysler	Hudson	Plymouth
Crosley	Kaiser	Pontiac
De Soto	Lincoln	Studebaker
Dodge	Mercury	Willys



Many Letters of Praise from Users
"MOTOR'S Manual paid for itself on the first 2 jobs, and saved me valuable time by eliminating guesswork."
—W. SCHROP, Ohio

He Does Job in 30 Min.—Fixed motor another mechanic had worked on half a day. With your Manual I did it in 30 minutes.
—C. AUBERRY, Tenn.



Over 2,950 Pictures! So Complete, So Simple, You CAN'T Go Wrong!

BIG BRAND-NEW REVISED Edition. Covers everything you need to know to repair over 685 chassis models—including ALL 1954 CARS. ONE THOUSAND giant pages, 2,950 "This-Is-How" pictures. Over 290 "Quick-Check" charts — more than 22,598 essential repair specifications. Over 225,000 service and repair facts. Instructions and pictures are so clear you can't go wrong!

Even a green beginner mechanic can do a good job. And if you're a topnotch mechanic, you'll find short-

Try Book FREE 7 Days

SEND NO MONEY! Just mail coupon! When the postman brings book, pay him nothing. First, make it show you what it's got! Unless you agree this is the greatest time-saver and work-saver you've ever seen —return book in 7 days and pay nothing. Mail coupon today! Address: **MOTOR Book Dept., Desk 1H, 250 West 55th St., New York 19, N. Y.**

MAIL COUPON NOW FOR 7-DAY FREE TRIAL

MOTOR BOOK DEPT.
Desk 1H, 250 W. 55th St., New York 19, N. Y.

Rush to me at once (check box opposite book you want):

MOTOR'S New AUTO REPAIR MANUAL. If O.K., I will remit \$2 in 7 days, \$2 monthly for 2 months and a final payment of 96c (plus 35c delivery charges) one month after that. Otherwise I will return the book postpaid in 7 days. (Foreign price, remit \$9 cash with order.)

MOTOR'S New TRUCK & TRACTOR REPAIR MANUAL. If O.K., I will remit \$2 in 7 days, and \$2 monthly for 2 months, plus 35c delivery charges with final payment. Otherwise I will return book postpaid in 7 days. (Foreign price, remit \$10 cash with order.)

Print Name.....Age.....

Address.....

City.....State.....

Check box and save 35c shipping charge by enclosing WITH coupon entire payment of \$6.95 for Auto Repair Manual (or \$8 for Truck and Tractor Repair Manual). Same 7-day return-refund privilege applies.

PROFESSIONAL-TYPE ELECTRIC
HAIR CLIPPER

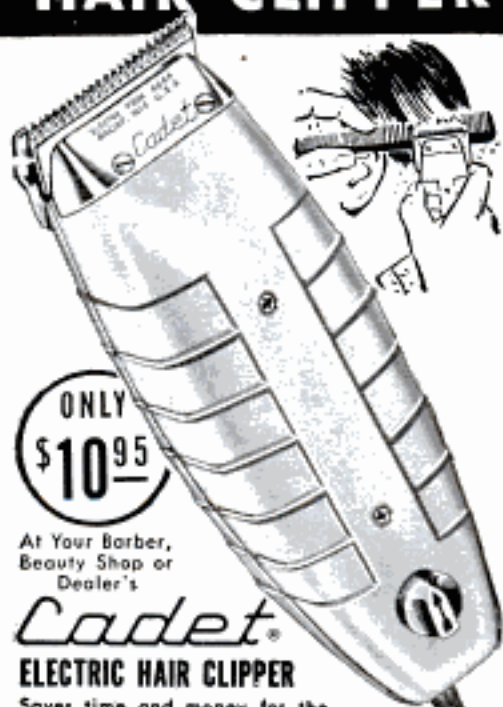

ONLY
\$10.95

At Your Barber,
Beauty Shop or
Dealer's

Cadet

ELECTRIC HAIR CLIPPER

Saves time and money for the whole family! Has cool-running magnetic motor; fine-tooth blade for close cutting; streamlined plastic case. 110v 60 cycle AC; fully tested by UL. If your barber, beauty shop or dealer cannot supply you, order direct on 10-day money-back guarantee.

ELECTRO TOOL CORPORATION
DEPT. C524-H • RACINE, WISCONSIN

own your own business! earn up to
\$75 A DAY CLEAR PROFIT
in your back yard or basement!

**MAKE CONCRETE BLOCKS With Amazing New
LOW PRICED GENERAL BLOCK MACHINE**

NOW! Big Building Boom

Profits Within Your Reach
You don't need much cash to cash in on the building boom! New high speed, low cost General Block Machine produces up to 1,000 concrete blocks a day for homes, factories, buildings, garages. Your profit mark-up is 100% to 150%! Fool-proof, easily operated, sturdy steel machine can make any size from 4" to 12". These superior 3-core blocks meet all building code requirements for foundation, chimney, corner, sash and many other types of blocks. Works indoors or out. Sand, cement and water available anywhere! Simple operating instructions and mixing formulae for cement and cinder blocks supplied FREE. Get full details, no obligation!

EXTRA!

Amazing illustrated book gives floor plans for 6 sensational concrete block bungalows. Tells how to lay blocks, lay out building lines, mix concrete, build steps, porch and concrete floors all at great savings. Written by experts. Can save many times the cost of the machine! Get it now! No strings attached.

R.L.T. of
New York
City Reports:
"My General
Block Machine
PAID FOR ITSELF IN FIRST
2 WEEKS!"

HOW TO
BUILD
YOUR OWN
CONCRETE
BLOCK
HOME
Only 1/3 priced

Thousands now in use
the world over!
Write for FREE details
TODAY

Book sent free if you buy
machine. \$1 refunded if
you buy later.

GENERAL ENGINES COMPANY

Dept. M-84, 307 HUNTER STREET, GLOUCESTER, N. J.

more jobs
than graduates

ENGINEERS
An interesting opportunity! If you are interested in writing to Box D 3, we will pay you to write a complete history of science and education.

Demand for our engineering graduates exceeds supply. Effective placement! Study in this world-famed college... established 1884. New term starts quarterly. Approved for Korean Vets.

Bach. Sc. degree in 27 months

Bachelor of Science in Mechanical, Civil, Electrical, Chemical, Aeronautical, Radio (Television), Administrative Engineering; Business Administration and Accounting. Also 36-weeks certificate courses in Surveying, Drafting, Secretarial Science. Intensive program: technical fundamentals accelerated.

Small classes; personalized instruction. For earnest, mature students whose time and budget require accelerated courses and modest costs. Preparatory courses.

Beautiful campus in friendly college town. Well-equipped, new and modernized buildings and labs. Enter Sept., Jan., March, June. Write Jean McCarthy, Director Admissions, for Catalog and View Book.



TRI-STATE COLLEGE

484 College Avenue

Angola, Indiana

Secrets of VENTRILOQUISM
Now Revealed!



Easy to learn in 60 to 90 days with our Home Study Course. RESULTS GUARANTEED. Make Money! Be Popular! Have Fun! Big Opportunity! Reading, Television, Stage Appearances! For FREE information regarding price and terms, WRITE. You must state your age. Dummy Catalog 25c. FRED MAHER SCHOOL OF VENTRILOQUISM Box 36, Studio H Kensington Station Detroit 24, Michigan



MECHANICAL DENTISTRY

To make Crowns, Plates, Bridgework, etc., for Dentists. Easy practical way to learn mechanical dentistry at home in spare time. FULL EQUIPMENT OF TOOLS AND MATERIALS INCLUDED WITH COURSE. Low tuition. Easy terms. Write for FREE BOOK about this money-making profession that is not affected by machine age.

McCARRIE SCHOOL OF MECHANICAL DENTISTRY
207 N. Broad St., Dept. 32, Philadelphia 7, Pa.

BUILD LUGGAGE AT HOME
WE SELL YOUR PRODUCTS!

ONLY NEW HOME MONEY-MAKING PLAN IN YEARS!

Make Luggage and cases for traveling, photographers, musicians, salesmen, electronics, tools, portables, 1001 other items. Also repair Luggage. No special equipment needed. BIG Profits. We supply complete instructions—everything. Write for free details and Business Plan. ABARSI CASECRAFT, Dept. G-8, 805 W. Sunset Blvd., Los Angeles 12, Calif.

STUDY **LAW** FREE
AT HOME **BOOK!**

PREPARE FOR THE BAR



Write today for your copy of our FREE book, "THE LAW-TRAINED MAN," which describes the famous Blackstone home-study course in bar and business law. All needed instruction material furnished including big 16-volume law library. Bachelor of Laws (LL.B.) degree awarded. Moderate tuition; easy monthly terms. Write today. Blackstone School of Law 225 N. Michigan Ave. Founded 1890 Dept. 50-C, Chicago 1, Illinois

REAL ESTATE
BE A BROKER

PAYS BIG! SEND FOR FREE, BIG, ILLUSTRATED CATALOG NOW! Graduates report own business quickly. Men, women of all ages, learn easily. Course covers Sales, Property Management, Appraising, Loans, Mortgages, and related subjects. STUDY AT HOME or in class-rooms in leading cities. Diploma awarded. Write TODAY for free book! No obligation. Approved for World War II and Korean Veterans

WEAVER SCHOOL OF REAL ESTATE (Est. 1936)
Suite 300 Law Bldg. Dept. P38 Kansas City, Mo.

Learn **PHOTOGRAPHY** at Home

Splendid opportunities. Prepare in spare time. Practical basic training. Long-established school. Send for free book. "Opportunities in Photography." No obligation. AMERICAN SCHOOL OF PHOTOGRAPHY, 625 Diversy Pkwy., Dept. 135C, Chicago 14, Ill.

FIX TV AND RADIO SETS RIGHT AWAY



—even if you never fixed a lamp or doorbell before!

McGraw-Hill's Amazing New Low-Cost
Instruction Manual Skips Hard-to-Understand
"Theories" and "Formulas." Tells How-to-do-it in PLAIN ENGLISH!

WHY hasn't somebody done this BEFORE? That's what you'll exclaim the minute you start browsing through this amazing new one-volume instruction manual in TV and radio repair.

For here at last a well-known EXPERT has found a way to tell you in PLAIN ENGLISH how to fix almost ANY radio or television set. (And he even tells you where you can go to have the extra-tough jobs done FOR you . . . at reduced professional rates.) Right from the very first chapters you can start doing simple repairs . . . and before you're HALF way through the manual, you can fix HALF the television and radio sets that you encounter. In just a few weeks you can start fixing your own and friends' sets . . . get a service shop job . . . even start your own money-making business at home.

Why It's So EASY to Understand

You get no complicated formulas, algebra, laboratory experiments. Instead you deal *only* with the parts that go wrong in sets—how to recognize the trouble—and what to do about it. "Easy as A-B-C" directions and 700 clear photos, diagrams, and drawings show you exactly WHAT and HOW to fix, step-by-step.

Tells HOW To "Cash In" ON THE BIG DEMAND FOR RADIO-TV REPAIRMEN

Over 25 million TV sets . . . over 100 million radios! Make nice extra money just fixing sets for friends and neighbors in your spare time . . . or start your own full-time repair business. Book tells exactly how to get started; which tubes to stock; how to make a service call. Actually start fixing sets and making money before you're half-way through book.



Save Money on Your Own Set

Save \$50 to \$100 a year just in installing, repairing, and servicing your own TV set. Book tells which controls to adjust or tubes to replace if picture is entirely dark — blurred — split — distorted — off center — tilted — wiggles and weaves — low gain — too black — jitters — snow effects — drifts — etc., etc.

The author is Associate Editor of *Electronics Magazine*. He spent FOUR years making this one-volume manual practical and easy-to-understand—even for an "un-handy" beginner.

Here's everything you need to know about *where* and *how* to buy tubes and parts, where and how to get an official circuit diagram for any receiver; how to choose and use basic tools; how to test tubes WITHOUT a tube tester; how to use 58 common TV controls; how to "diagnose" and "cure" common radio and TV troubles; how to fix loudspeakers, phono pickups; how to install and check antennas; and much, much more.

SEND NO MONEY

Examine this book for 10 days BEFORE you decide if you wish to own it. Try it out FREE on your own or a neighbor's set. See how simple and easy it makes nearly every repair job. Make it pay for itself in 10 days or don't keep it! Mail coupon to: McGraw-Hill Book Co., Inc., Dept. PM-8, 327 West 41st St., New York 36, N. Y.

TELEVISION
AND RADIO
REPAIRING

TRY IT
FREE
ON YOUR OWN SET
FOR 10 DAYS

PARTIAL CONTENTS

How to Remove and Replace Tubes
• Testing Tubes without a Tester
• Using a Tube Tester • Power-Supply Troubles • How to Test and Replace Resistors, Controls, Switches, Condensers, Coils, Transformers • Loudspeakers • Phono Pickups and Needles • Antennas . . . MUCH MORE.

"Written as simply and clearly as possible. A natural for the beginner."
—Radio & TV News
"Prepared for people who know absolutely nothing about radio or use of tools."
—Radio Electronics
"Unique in its ability to explain something in easy-to-understand terms."
—Electrical South

FREE 10-DAY TRIAL COUPON

McGraw-Hill Book Co., Inc., Dept. PM-8,
327 West 41st St., New York 36, N. Y.

Please send me, for 10 days' FREE EXAMINATION, your one-volume "Television and Radio Repairing," by John Markus. If not delighted, I may return book, pay nothing. Otherwise, I will send only \$1.05 plus few cents delivery; then 3 monthly installments of \$2.00 each.

Name _____

Address _____

City _____ Zone _____ State _____

SAVE MONEY. Check here if enclosing full price of \$7.95 with coupon. Then WE will pay for delivery. Same 10-day return privilege. (Offer good in U.S.A. only.)

105 POWER SUPER TELESCOPE



Everything for the Astronomer, Hobbyist, Student, and Scout in this complete astronomical super value telescope combination. Set comes ready for immediate use, consists of brilliant 33x-65x-105x telescope, 5 foot hardwood Tripod, carrying case for scope, Star Explorer map and 108 page book "Discover the Stars." The 3 foot telescope (glasses to 16 inches) is brass bound, has 4 precision lenses that will bring distant objects, people, moon, stars, ships, etc., 105 times closer. All images erect. The sturdily built tripod is equipped with universal mount that has a 360 degree horizontal range and 180 degree vertical range. It locks in any position with one simple adjustment. The Star Explorer map enables you to find any star automatically. This marvelous all purpose instrument is proclaimed by Scientists as a most unusual development. Everyone that has used it is amazed at its performance and value. It will fascinate the entire family. Shipped to you complete, nothing else to buy, at the amazing low price of

\$11.95
POST PAID

Satisfaction guaranteed or money refunded. We pay all delivery charges. Send check or money order to DEPT. PMS 3

CRITERION CO. 331 CHURCH ST., HARTFORD 1, CONN.

"NOW I'M MY OWN BOSS at Double My Former Salary"



Paul M. De Vita, Former Low Paid Auto Mechanic Steps-Up Earnings to Over \$100 a Week

As A CUSTOM UPHOLSTERER

"I can hardly believe how quickly I've gotten ahead in this interesting and profitable trade. I was a mechanic making \$55 a week. Now I operate my own shop and make more than \$100 a week doing mostly contract work. UTS training has been invaluable."

WHAT DO YOU WANT? Your Own Profitable Business—A Steady Job—Substantial Sparetime Earnings—A More Secure Future?—They're all waiting for YOU in the Big-Opportunity Field of Custom Furniture Upholstery.

The big nationwide home and institutional building boom has created a great demand for trained upholsterers. Prepare for this big-money trade just as hundreds of UTS graduates have done—easily, quickly. You can earn as you learn to make good money all year 'round at home, in your own shop, or in a well-paid job. The practical N. Y. State-approved UTS Course teaches you professional custom furniture upholstery, reupholstery, slipcovers, furniture finishing, window cornice, cushion, and drapery making. You get—FREE—ALL tools, frames and materials you use.



Our FREE book, "YOUR NEW WAY TO A SUCCESSFUL CAREER" tells you all about this fascinating, big pay, big opportunity trade. WRITE TODAY! Training in N. Y. School also available. UPHOLSTERY TRADES SCHOOL, Dept. CM-305, 721 Broadway, N. Y. 3.

SEND FOR BIG FREE BOOK

UPHOLSTERY TRADES SCHOOL, Dept. CM-305
721 Broadway, New York 3, N. Y.
Send me FREE book on:
 Home Study In N. Y. School Training
Name _____
Address _____
City _____ Zone _____ State _____
 Check here if Korean Veteran

"HOW TO EARN MONEY IN YOUR SPARE TIME"



SENT FREE!
RUSH POST-CARD NOW!

In your own home... PRINT WITHOUT A PRINTING PRESS. Miracle New Printing Method. Print full color SIGNS, POSTERS, BANNERS, FABRICS—anything. Print hundreds at a time (\$100.00 jobs cost you less than \$10). NO ART ability necessary. It's easy! We supply everything! REPRESENTATIVES WANTED. Unlimited profit opportunities. Help fill HUGE DEMAND. Write!

SCREEN-PRINT, DEPT. 28, 1010 S. LOS ANGELES ST., LOS ANGELES 15, CALIF.



FAMOUS DAN LURIE BARBELLS

with 4 courses—low factory prices
50 lb. set... \$ 8.48 | 150 lb. set... \$20.48
100 lb. set... 13.98 | 200 lb. set... 25.98

Write for Order by Mail; 50% with order, bal. C.O.D. Free Catalog Extra wts. 13c per lb., F.O.B. plant

DAN LURIE BARBELL CO.
52-M-8 Bristol St., Dept. 459-M, Brooklyn, N. Y.



GROW ORCHIDS AT HOME

BIG PROFITS
SPARE OR
FULL TIME

World's most thrilling hobby—profitable home business. Single Orchid plant may multiply into many—each as valuable as the first. Successful home grower shows you how! Raise gorgeous Cattleyas, Cymbidiums, Epidendrums, on living-room table. Big-profit orders come from friends, neighbors, florists, etc.—also Mail Orders. Illustrated secrets of the experts in simple "show-how" language AND blooming-size Orchid plants sent at NO RISK. Everything you need to start—for pleasure or profit. FREE—full details—SEND NO MONEY. Write today. TROPICAL FLOWERLAND, Dept. 318, 4622 Wilshire, Los Angeles 5, Calif.

PLEASE SEND ME



for the time checked.
I am enclosing . . .

- 1 year \$3.50
- 2 years \$6.00

name _____
address _____
city _____ zone _____ state _____ C-84

Hand this order to your newsdealer or send it to
POPULAR MECHANICS
200 East Ontario St. Chicago 11, Ill.

LOW OVERHEAD-LARGE VOLUME SALES & SMALL PROFITS
BRING YOU THESE "LOWEST PRICES."
WHAT GOOD IS A TIRE WITHOUT A TUBE?
TUBE FREE WITH EVERY TIRE AT NO EXTRA COST

WHY PAY MORE!



21 YEARS AT THIS ADDRESS
AN ESTABLISHED POLICY OF CAREFUL SELECTION ASSURES YOU, MANY HAPPY MILES. BE WISE—TRY ONE—YOU'LL BUY MORE! WE WELCOME COMPETITION. NO ONE CAN TOUCH OUR QUALITY & PRICE!

YOU GET WHAT WE ADVERTISE

GOOD USED TIRES — NOT RECAPS — NOT RETREADS
TAKE THE 10% DISCOUNT WE OFFER & PUT MONEY IN YOUR POCKET!
EVERYBODY MAY TAKE **10% off** ON EVERY TIRE



20 MONTHS WRITTEN GUARANTEE			
600-16 \$3.82	820-15 \$4.92	600-20 \$7.52	32x6-8 \$8.72
650-16 4.22	700-15 3.92	650-20 7.62	32x6-10 10.72
700-16 4.42	670-15 4.02	700-20 8.82	900-20 13.22
650-15 3.82	710-15 4.32	750-20 8.52	1000-20 14.02
760-15 4.42	550-17 3.72	825-20 14.12	1100-20 16.82

FREE If you buy 2 Passenger tires, we GIVE the 4th tire FREE with 32 mos. guarantee **FREE**

Specialists in Truck Tires—Selected for Toughest Jobs—Tops in Value		34 MOS. WRITTEN GUARANTEE	
600-16 \$5.02	475-19 \$5.12	700-15(6) \$8.42	700-20 \$10.62
600-16(6) 5.32	640-15 4.72	750-16(8) 8.42	750-20(10) 13.02
650-16 5.52	670-15 5.12	700-17 8.72	750-20(8) 12.72
650-16(6) 7.02	710-15 5.22	750-17 10.52	825-20 17.52
700-16 6.12	760-15 5.72	750-15 10.42	900-20 17.62
750-16(6) 8.32	800-15 6.02	825-15 10.92	1000-20 16.52
550-18 3.92	820-15 6.12	600-20 8.72	1100-20 17.02
550-17 4.22	670-16 5.02	650-20 9.52	1100-22 17.92
650-15 5.02	760-16 7.02	32x6-8 10.52	1000-22 17.92
700-15 5.12	700-16(1) 7.12	32x6-10 12.92	1100-24 22.92
ALL WHITE WALLS \$1.00 extra (Military treads)—750x20—\$14.02			

Thousands of tires shipped all over the U.S.A. All tires shipped F.O.B. Phila. Send Check or M.O. with this ad. Dept. 2. No C.O.D.

STANDARD 834 N. Broad St., Philadelphia 30, Pa.

LEARN TO MOUNT BIRDS



ANIMALS, FISH, PETS

Be a Taxidermist. Save your hunting TROPHIES. Have a fine home-museum. Hunters, save and MOUNT your beautiful DUCKS, QUAIL, DEER, TAN skins, FURS. Great Fun. Spare-time PROFITS. Tells ALL about it. 100 fine wild-game pictures, 48 pages. SEND TODAY, don't delay. Get this WONDERFUL FREE BOOK, MEN AND BOYS. Learn Taxidermy. Double your hunting pleasure. Rush letter or POSTAL today. STATE YOUR AGE. N. W. SCHOOL OF TAXIDERM, Dept. 2508 Omaha, Neb.

SAVE ARCHERS!
50%

BOWHUNTER'S OUTFITS \$16.95 up
Includes laminated bow, matched arrows, quivers, etc. Amazing FREE TRIAL PLAN! Investigate TODAY!
FREE! "How to Choose Bow" Booklet and Catalog. Send 25c for "How to Hunt With Bow" Booklet, if desired.

MALIBU ARCHERY CO., Dept. B-8, 3156 W. 8th, Los Angeles 5, California

STAMP COLLECTORS! 317 STAMPS - 25c plus FREE Stamp Encyclopedia



Special imported collection includes **STALIN DEATH STAMP**; New Zealand **QUEEN VICTORIA 98-year-old** proof (sold \$5 at auction); plus hundreds more from all over the world! 317 different stamps—reg. \$3.50 value—all yours for 25c with Bargain Approvals. Fascinating book included, free.
SEND 25c TODAY ASK FOR LOT FO-18
ZENITH CO., 81 Willoughby St., Brooklyn 1, N.Y.

AQUA-LUNGS FROGMEN SUITS SPEAR GUNS

SELF-CONTAINED DIVING—A comprehensive diving digest reviewing various types of equipment and a thorough study of underwater pressure and its effects. Includes a decompression table showing how much time can be safely spent at various depths. Send more 60c in coin to receive this 65c booklet.
DIVING GEAR—A 16 page beautifully illustrated catalogue showing the latest available foreign and domestic diving equipment: frogman suits, masks, spear guns, snorkel tubes, swim fins and "Aqua-Lungs." Send only 15c in coin.
SEND FOR THESE VALUABLE BOOKLETS TODAY
U. S. DIVERS CORP., 1045 Broxton Ave., W. Los Angeles 24, Cal.

BECOME AN Electrical Engineer



● Major in Electronics or Power
● Earn B. S. Degree in 36 Months
Over 50% of the nation's industrial leaders began their careers with engineering training. Prepare now for a rewarding future as an Electrical Engineer or Engineering Technician. Enroll at the Milwaukee School of Engineering.

Plan Your Career — Eight Courses Give You Wide Range of Study

ENGINEERING COURSES	
Electrical Engineering—Bachelor of Science Degree	Save a valuable year through optional year 'round study.
Electronics major	36 months
Power major	36 months
TECHNICIAN COURSES	
Electra Technician	12 months
Electronic Technician	12 months
Radio Technician	12 months
Radio and Television Technician	18 months
SERVICE COURSES	
Electrical Service	6 months
Radio and Television Service	12 months

Terms open September, January, April, July
Approved for veterans. Prior Military, Practical or Academic training evaluated for advanced credit. Faculty of specialists. 50,000 former students. Annual enrollment from 48 states and 23 overseas countries. 51st year. Non-profit. Residence courses only. Send handy coupon today.

MECHANICAL TECHNOLOGY COURSES — Also available, Service and Technician courses 6 to 18 months — Heating, Refrigeration, Welding, Air Conditioning and Mechanical — B.S. Degree in Mechanical Engineering with a major in Design, Metal Fabrication, or Plant Engineering. Also, general 3-month preparatory course.

MILWAUKEE SCHOOL OF ENGINEERING

MILWAUKEE SCHOOL OF ENGINEERING
Dept. PM-854, 1025 N. Milwaukee St., Milwaukee, Wis.
Send free illustrated career booklets Electrical Technology Mechanical Technology Radio-Television.
I am interested in _____ (name of course)
Name _____ Age _____
Address _____
City _____ Zone _____ State _____
If veteran, indicate date of discharge _____

**USE THIS
FREE KIT**



**MAKE UP TO
\$1000⁰⁰ a Month!**

Everything You Need to Make Big Money
with New "Midget Miracle" PRESTO
Over 2 MILLION Already Sold!

FREE—everything you need to cash in on this amazing new kind of fire extinguisher. Tiny "Presto" (about the size of a flashlight) does job of bulky extinguishers that cost 4 times as much and are 4 times as heavy. Ends fires fast as 2 seconds. Fits in palm of hand. Never corrodes. Guaranteed for 20 years! A tremendous money-making buy—sells for only \$2.95!



Advertised
in LIFE
Magazine

On this offer you get complete Sales Kit FREE. Everything you need to "wrap up" sales to civil defense workers, owners of homes, cars, boats, farms, etc. and to stores for resale—make big income. C. S. Mellous made \$175 in just 3 days. M. B. Stanley \$100 a day. C. Kama \$1,000 a month. Write for your FREE Sales Kit. No risk. No obligation. If you want a regular Presto to use as a demonstrator, send only \$2.50. Money back if you wish. MERLITE INDUSTRIES, Dept. 58, 114 East 32nd St., New York 16, N. Y.

IN CANADA: Mogo Co., Ltd., 212 Dorset St., Montreal 1, P. Q.

OVER \$1,000
A MONTH



Charles Kama

"I'm making more than \$1,000.00 a month—and I haven't touched bottom yet."

GREER SHOP TRAINING
2230 So. Michigan Blvd.
Chicago 16, Illinois

**Leader in Practical
Training for 50 Years**

Gain success by learning a trade offering security and high pay—go into business for yourself.

Get the "Know-how" at Greer

You learn in our new, large, modern shops by working with latest tools and equipment of the trade—tear down, inspect, repair and rebuild... under supervision of experts. Greer founded 1902. Over 51,000 successful grads. Part time, full time, day and evening. E-Z terms. Mail coupon today.

CLIP COUPON... MAIL TODAY
Greer Shop Training—2230 South Michigan
Chicago 16, Illinois Desk 213

Please send information about trade checked:
In our Chicago Shops: Auto Mechanics
 Body, Fender Repair Diesel Mechanics
 Welding—Arc, gas Tool & Die
 Refrigeration & Air-conditioning
 Machinist Piano tuning
 (check which)

APPROVED FOR CIVILIANS and G.I.'s
ATTENTION: HIGH SCHOOL GRADUATES.
Write for information on 2 year DIESEL-AUTOMOTIVE ENGINEERING COURSES.

Name _____
Address _____
City _____
State _____ Age _____



**START YOUR OWN
ELECTRICAL APPLIANCE
REPAIR BUSINESS**



Repair electrical appliances of friends and neighbors. Service electrical equipment in factories, stores, etc. Work full or part time! New Shop Method home-training system. Rush name today for **FREE BOOK** and special form for getting Electric Kit. Valuable Heating Element Kits, Advisory Service and Illustrated Instructions on new 12-3-payment plan. Pay later from **EARNINGS WHILE LEARNING**. Rush name today.
CHRISTY TRADES SCHOOL
4804 N. Kedzie, Dept. D-3303, Chicago 29

FALL 1954



L.L. BEAN & CO.

**Free Fall
Catalog**

Ready August 5

Fully illustrated, 104 pages, showing Hunting Footwear, Clothing, and one hundred and twenty other leather and canvas specialties of our own manufacture for campers and hunters.

L. L. Bean, Inc.

112 Main St.

Freeport, Maine



SAVE UP TO 50%
ON FAMOUS ITALIAN
ACCORDIONS

Buy direct from America's leading distributor. Offers Students, Teachers and Professionals SPECIAL DISCOUNTS. Send now for FREE literature and lowest prices. Easy Terms. Trade-ins accepted. Write today.
ACCORDION MANUFACTURERS & WHOLESALE OUTLET
DEPT. R-84 2003 W. CHICAGO AVE., CHICAGO 22, ILL.



RUPTURED?

Something different. Light. Cool. No leg straps. No elastic. No pressure on hips or spine. Inexpensive. Worn by Mechanics, Farmers, Doctors, etc., everywhere. Guaranteed. Write

HAND-LOCK PRODUCTS DEPT. PM, PRESTON, ONT., CAN.

STAMP COLLECTORS ATTENTION
315 DIFFERENT STAMPS 25¢

This imported collection includes an AIRMAIL group: Lundy Island, Croatia airport, San Marino, Iberia Air set, etc. TOPICAL COLLECTION of Animals, G.P.U.'s, United Nations Set, Flowers, Triangles, etc. Altogether 315 all Different Stamps Cataloging over \$6.00—only 25¢ with good-value Approvals.

IDEAL STAMP CO., Dept. 1A, P.O. Box 64
WEST FARMS STATION, NEW YORK 60, N. Y.

I HAVE BEEN AVERAGING \$25,771.16 gross in cash monthly (Dec. \$31,362.14) for two years in mail order business started very limited capital 1950. Because I can't cover even 1% of the market. I can supply you with merchandise, mailing lists, sales letters, advice based on experience. Can be operated on small scale by man or woman. Began in my home, now employ 23. Send one dollar which will be credited to you. My firm belongs to Chamber of Commerce, well rated financially. Not a crazy scheme but a legitimate business. No special education, training required. One dollar brings story. Mail order P.O. Box 1715-D-1, Dallas, Texas.

**Learn
Public
Speaking**

Learn theory and fundamentals at home—in spare time. Then acquire actual experience and practice. Send for FREE booklet "Power of Effective Speech."

North American School, Dept. 135C
835 Diversy Pkwy., Chicago 14, Illinois

DRAW BOB HOPE!

WE'LL AWARD A COMPLETE \$295.00 2-YEAR ART SCHOLARSHIP—INCLUDING DRAWING OUTFIT—FOR THE BEST AMATEUR DRAWING!

Imagine how you'll feel, one day soon, if you get a telegram reading "Congratulations. Your drawing wins you complete 2-year home study art course!"

It could happen! You've a chance to win free art training from Art Instruction, Inc., world's greatest home study art school, in this contest. All you have to do is draw Bob Hope's head, five inches high. It's an easy way to find out if you've money-making art talent, and it may start you on an exciting career! You've nothing to lose—everything to gain. Mail your drawing today!

Amateurs Only! Our students not eligible. Make copy of Bob Hope 5 ins. high. Pencil or pen only. Omit lettering. All drawings must be received by Sept. 30, 1954. None returned. Winners notified.



BOB HOPE, currently appearing in "Casanova's Big Night," a Paramount picture, color by Technicolor.

ART INSTRUCTION, INC. STUDIO 8134
500 South 4th Street, Minneapolis 15, Minnesota

Please enter my attached drawing in your Bob Hope contest.
(PLEASE PRINT)

Name _____ Age _____
Address _____ Phone _____
City _____ Zone _____ County _____
State _____ Occupation _____

A POSTCARD PUTS YOU IN BUSINESS!

Earn \$84.00 EXTRA a Month on just 5 Sales a Week!

Go into business without spending a cent! My powerful FREE Sales Kit makes it easy to take orders for Mason's fast-selling line of leather jackets. Your friends, relatives, outdoor workers will grab these from you, paying you Big Profits on each order! Just sell 5 of our popular Fleece-lined Leather jackets a week, to make \$84 extra income a month! Besides jackets of Hoeschlide, Capeskin leather, Suede, Nylon, Gabardine, Wool... take orders for 174 fine shoe styles for men, women, including popular Air-Cushioned work shoes. People MUST buy from you, because we do not sell through stores! To start at once, rush postcard for your free money-making Sales Kit!



FREE KIT!

MASON SHOE MFG. CO., Dept. MA-363 Chippewa Falls, Wisconsin

Learn TELEVISION-ELECTRONICS RADIO

2 Big Books FREE

Train at Home—Get Big Kits of Radio Parts! Prepare now in spare time. Practical instruction. Write for details and 2 Radio Books—ALL FREE! Rush name today! SPRAYBERRY ACADEMY OF RADIO Dept. 10-M 111 No. Canal Chicago 6, Illinois

MAKE EXTRA MONEY PLASTICS LEARN AT HOME



There are RICH OPPORTUNITIES for MEN and WOMEN with "know-how" in Plastics. Interstate's new Plastics course tells and shows how to make hundreds of fast selling items out of Plastics. Gives complete training in fabrication, casting, lamination, molding, internal carving, etc., in simple, easy, step-by-step language and pictures. Plastics and Fabricating Kits for 23 valuable Plastic items come with training at no extra cost. START A PLASTICS BUSINESS OF YOUR OWN. No other industry holds such promise for the future. You can make big money manufacturing novelties, toys, signs, etc., in your own home in spare or full time. Don't wait! Learn NOW how Interstate's Plastics Training qualifies you for success in the Plastics field.

PLASTICS AND SUPPLIES FURNISHED FOR 23 VALUABLE PROJECTS

INTERSTATE TRAINING SERVICE
Dept. C-3-H Portland 13, Oregon

GROW Living MIDGET TREES!

EARN \$10.00 PER HOUR!

- AT HOME
- IN SPARE TIME
- NO EXPERIENCE NEEDED



It's new! Amazing! At last, the secret of growing miniature (MING) trees can be yours. FULL GROWN, dwarf trees—only a few inches high. Beautiful miniature fir, orange, oak, Chinese elm, peach, pine, cypress—any kind! ALL BLOOM and even BEAR FRUIT. All perfect healthy specimens—but miniature in size! Make costly home decorations and expensive centerpieces. (SOLD FOR OVER \$1,500 EACH) Big demand. Costs only pennies—takes only minutes per week. IT'S EASY! Fun! A new fascinating hobby—a new fabulous \$\$\$\$ business. Send for free secret plan details and real seed.

HELP US FILL HUGE DEMAND!

These trees are being demanded by STORES CLUBS • HOTELS • FLORISTS • HOUSEWIVES • INTERIOR DECORATORS • COLLECTORS • HOBBYISTS—A Big Money Opportunity FOR YOU.

FREE! GENUINE SEED AND PLAN!

NATIONAL NURSERY GARDENS, Dept. M-8
8463 South Van Ness
Inglewood 4, Calif.
Rush me FREE plan and seed IMMEDIATELY!

Name _____
Address _____ Zone _____
City _____ State _____



● **NEW PROFIT MAKING MACHINE FOR YOUR PRESENT OR NEW BUSINESS AND FOR ALL WHO SELL MILK SHAKES**

MILLSHAKE

Makes 25¢ Shake for less than 7¢!

Combines freezing, flavors and blending in one efficient unit!

Saves labor—Convenient—Fast!

Completely automatic, serves shakes in seconds!

A sensational customer attraction!



Millshake is new and different—a complete milk shake production machine including insulated refrigerated mix supply and flavor compartment. Operation is fully automatic so even young inexperienced help can serve fresh-made, wholesome shakes and malts like an expert. Making a shake is as quick and easy as 1, 2, 3. Merely open draw-off gate for basic vanilla shake, add flavor and use built-in shielded blender. Complete shake is ready in less than 10 seconds. Gone forever is back-breaking, money-wasting, time-consuming scooping of hard ice cream, handling of milk and flavors. One low-cost mix replaces ice cream and milk handling and storage. Everything is right at hand—a finished shake without moving!

Besides saving time, labor and material costs, the Millshake has proven itself to be a sensational traffic builder wherever installed! Its modern, gleaming white finish with blue hood and tray are without comparison for beauty and quality. Get the facts on Millshake—world's newest and finest money-making shake machine. Write for Brochure 954 now! Mills Distributors cover the nation—Coast to Coast.

MILLS INDUSTRIES, INC.

4114 FULLERTON AVENUE • CHICAGO 39, ILLINOIS

PUMP WATER FAST!

DRAIN WASH TUBS, CELLARS, CISTERNS. Famous #7 pumps 2800 GPH. 420 GPH at 75' high or 1600 GPH from 25' well. Sturdy, rustproof Alloy Metal. Six Blade Impeller. Uses any 1/2 to 1/2 H.P. Motor. Will not leak or clog. Fits any garden hose. Immediate money back guarantee. Send Check, Money \$8.95 Order, or C.O.D. **8 m.s.**

IRRIGATE, FILL TANKS, DRAW WELL WATER. Heavy duty #8 Pumps 7000 GPH. 1000 GPH 75' high — 3000 GPH from 25' well. Rustproof Alloy Metal. 8 blade impeller. 1" inlet—1" outlet. Standard Pipe Threaded. Money back guarantee. Send check, \$11.95 Money Order, or C.O.D. **11 m.s.**

Free Catalogue — Gear Pumps — Deep and Shallow Well Pumps.

MOORE MANUFACTURING CO.
SWEDISSBORO 6 NEW JERSEY

GO PLACES

LEARN ANOTHER LANGUAGE

EASILY — QUICKLY

by **LINGUAPHONE**

20

MINUTES
A DAY

World's-Standard CONVERSATIONAL METHOD

FRENCH Are interesting job, travel, cultural, armed services' opportunities passing you by because you speak only one tongue? Learn another language **AT HOME** the same, natural, easy way you learned English long before you went to school. **YOU LISTEN**—you hear native men and women speak—you understand—**YOU SPEAK.** Worldwide educational endorsement; over a million home-study students of all ages. **FREE BOOK**, "Passport to a New World of Opportunity," gives fascinating facts. **WRITE TODAY!**

LINGUAPHONE INSTITUTE, 143-08 RCA Building, N. Y. 20, N. Y.

Send me your FREE book. I want to learn _____ language.

Name _____

Address _____

City, Zone & State _____

MAKE MORE MONEY SELLING ORTHO-VENT "SPRING-STEP" CUSHION SHOES!



- Amazing, new "Spring-Step" cushion design creates exclusive repeats.
- Customers are biggest boosters. One try and they're sold for life.
- Over 160 different styles make everyone a prospect. Sales Easy.

Genuine Shell Cordovan

Sell exclusive new Ortho-Vent "Spring-Step" cushion shoes, FULL OR PART TIME. High commissions, big cash bonuses and Ortho-Vent's exclusive repeats build you a thriving, highly profitable business. Always a demand for exclusive Ortho-Vent "Spring-Step" cushion, the world's most comfortable, flexible, lightest weight shoe. Complete sales kit, including cut-aways and catalogue, furnished. No experience or investment needed. This is an opportunity to build your future SECURITY with the finest, most complete shoe line in America. Write today!

Free
A BONUS PAIR OF SHOES!

ORTHO-VENT SHOE COMPANY, Dept. PM-854, Salem, Va.

NEW! CHEAP! OIL BURNER

AMAZING HEAT INVENTION

\$14.75 for Stoves

\$29.50 for Furnaces

FITS IN ANY COAL STOVE, RANGE, BOILER OR FURNACE. No more shovelling Coal or Ashes. This Universal Unit makes one of the quickest, hottest, cheapest fires known. Sold on a 60 day Money-Back Guarantee. Send No Money. You will receive Agents Prices and full details by sending your name to

NORTHWEST MFG. CO., 10-K Main, Mitchell, South Dakota

BECOME AN EXPERT IN TRAFFIC

Traffic men earn \$4,000 to \$10,000 and up. Thousands of firms need experts on rates, tariffs, regulations. We train you thoroughly in spare time at home for executive traffic jobs. Personal training under traffic authorities. Placement counsel and help. Write for free 48-page book "Traffic Management—the Fast Growing Profession."

LASALLE Extension University, 417 So. Dearborn St.
A Correspondence Institution Dept. 8647 Chicago 5, Ill.

BUILD YOUR OWN SMALL HOME—\$750

Save rent, mortgage payments; own your own home. Takes 14 days to build. FREE EXPANSION PLANS. Four complete rooms & bath. Stucco block construction. Plans, drawings, instructions \$1.00. Free money-back guarantee. *Modern Building Designers, 49 W. 44th St., Dept. A, N.Y.C. 36.

SCIENTIFIC CRIME DETECTION

IT'S EASY TO LEARN

Let us teach you in your own home. Learn Finger Printing, Firearms Identification, Police Photography, Criminal Investigation Methods thoroughly quickly, at small cost. Over 800 of all U. S. Bureaus of Identification employ I. A. S. students or graduates. Write today, stating age.

INSTITUTE OF APPLIED SCIENCE, 1920 Sunnyside Ave., Dept. 135-C
(A Correspondence School Since 1916) Chicago 48, Ill.

Say You Saw It in Popular Mechanics

Catalog of 3000 Novelties 10c

Send 10c for amazing catalog of novelties, live animals, scientific supplies, hobbies, funmakers, planes & boats, looms, magic tricks, joke articles, unusual seeds, gady get time-savers, cameras, optical goods, projectors, movies, lucky jewelry, religious novelties, disguises, musical instruments, stamps, coins, puzzles, fortune tellers, radios, auto & bike accessories, telescopes, magnifiers, compasses, banks, smokers' gadgets, artists' supplies, printing sets, eye gins, motors, shockers, knives, billfolds, guns, rifles, sports, books, games, plants, etc. Send 10c (3 for 25c—get for friends!).

JOHNSON SMITH & CO., Dept. 827, Detroit 7, Michigan

Thrilling Work COLORING PHOTOS

EASY TO LEARN

Fascinating vocation learned at home by those with aptitude. Thrilling pastime. National method brings out life-like colors. Free booklet.

NATIONAL PHOTO COLORING SCHOOL
835 Diversey Pkwy., Dept. 186C, Chicago 14, Ill.

LEFAX POCKET SIZE TECHNICAL DATA BOOKS



Printed on loose leaf, six hole, 6 3/4" x 3 3/4" bond paper, each book contains about 140 pages of technical data, presenting condensed, accurate and essential data for the student, engineer, technical worker and business man.

- | | | |
|--|---|---|
| Architecture
Home Heating
Illumination
Electrician's Data
Builder's Data
Lumber Data
Air Conditioning
General Math.
Math. Tables
Physics
Chemical Tables
Mechanics of Materials
Power Trans. Mach'y.
Thermodynamic
Tables & Charts | Phys. & Thermodyn.
Data
Phys. & Org.
Chemistry
Metals
General
Chemistry
Reinforced Concrete
Building Constr.
Radio
Television & FM
Electricity, AC
Electricity, DC
AC Motors and
Generators | Transformers,
Relays, Meters
Hydraulics
Surveying
Mechanical Drawing
Machine Design
Machinists' Data
Piping Data
Surveying Tables
Trig-Log Tables
Metallurgy
Analytic
Chemistry
Highway
Engineering |
|--|---|---|

Write for FREE catalogs (over 2000 listings). See for yourself how helpful LEFAX can be to you. Send \$1.25 for each book (or \$6 for any five books listed above), to

LEFAX Dept. PM-5 PHILADELPHIA 7, PA.

RUPTURED

BE FREE FROM TRUSS SLAVERY

NOW there is a new modern Non-Surgical treatment that permanently corrects rupture. These Non-Surgical treatments are so certain, that a Lifetime Certificate of Assurance is given. Write today for our New FREE Book that gives facts that may save you painful and expensive surgery, and tells how non-surgically you may again work, live, play and love and enjoy life in the manner you desire. There is no obligation. Excelsior Hernia Clinic Dept. 8305 Excelsior Springs, Mo.

RADIO

Engineering. All phases radio & electronics theory & practice; television; FM; broadcasting; servicing; aviation, marine & police radio. Prepare for high pay; 18-month course. Graduates in demand by major companies. Enter Jan., March, June, Sept. Regular campus life. Write for catalog. VALPARAISO TECHNICAL INSTITUTE, Dept. D, Valparaiso, Ind.

A "GOOD HAND" HELPS YOU SUCCEED!
LEARN TO WRITE WELL

Handwriting quickly improves with our easy-to-understand picture lessons! Put your spare time to good use; send today for FREE BOOKLET "How to Become a Good Penman," or check volumes wanted below at \$1 each: Business Writing Artistic Writing Card Writing, Bird & Design Flourishing Engraving Alphabets. COMPLETE SET \$4.50. Ask for price list of penman's supplies.

TAMBLYN SCHOOL of PENMANSHIP
S.A. Ziller, Pres., 442 Ridge Bldg., Kansas City, Mo., USA

Our 53rd Year

Only 10¢

SAY YOU SAW IT IN POPULAR MECHANICS

BIG BAG OF 1,000 UNSORTED STAMPS



Here's a giant bargain—to introduce services of world's largest stamp firm! This big cloth bag is jam-packed with more than 1,000 genuine foreign stamps from over 30 countries in Asia, Europe, Africa, Australia, Latin America, etc. Weighed out in bulk, unpicked, unsorted, mostly still on paper, just as received from foreign banks, missions, etc. Nobody knows what treasures are inside! Stamps are guaranteed worth \$10.00 or more at Standard Catalog prices—you may find rare, valuable varieties! In any case, you're sure to get a wonderful lot of stamps to begin or add to your collection.

Only \$1.00 Postpaid

FREE! "HOW TO COLLECT STAMPS" BOOKLET & POWERFUL STAMP MAGNIFIER

Send \$1.00 for Big Bag of Stamps TODAY! We'll include FREE a valuable illustrated Book on Collecting plus a powerful Stamp Magnifier. If not completely satisfied with Bag of Stamps, return it and we'll refund every cent you paid—but keep the Book and Magnifier for your trouble! Act NOW!

H. E. HARRIS & CO., 490 Transit Bldg., Boston 17, Mass.
THE WORLD'S LARGEST STAMP FIRM

Build your own JET ENGINE!

Order these plans today

1. JET PROPELLED BICYCLE. Assemble your own. Photo and instructions. \$1.95.
2. HOW TO MAKE EXPERIMENTAL JET ENGINES. Seven sheets drawings with information and instructions \$2.95.
3. BOTH OF ABOVE in one order \$3.75. SEND NO MONEY. Order both at once \$3.75 C.O.D. in USA plus e.o.d. postage. Send check or money order and we pay postage. Get other information too. Rush Order.

SEND NO MONEY

J. HOUSTON MAUPIN, Dept. 55, Tipp City, Ohio

LEARN MEAT CUTTING AT NATIONAL

Pay After Graduation



The steady dependable trade of Meat Cutting taught easily in 8 short weeks. YOU LEARN BY DOING under actual meat market conditions in big modern school at Toledo.

For beginners or men with experience. Get a profitable store of your own. Remember, PEOPLE MUST EAT! Big pay jobs. Free employment help. Thousands of successful graduates.

Buying, cutting, percentage, pricing, advertising, selling, etc. A complete retail meat education. National School established over 30 years. Get National training NOW. Pay your tuition in easy weekly payments

after you graduate. Send coupon for FREE 52 page school catalog — TODAY. G.I. approved.

National School of Meat Cutting, Inc., Dept. 50-H, Toledo 4, Ohio

Send me your FREE school catalog on National Training at Toledo in Meat Cutting, Meat Merchandising and Self Service Meats. No obligation. No salesman will call.

Name _____ Age _____

Address _____

City _____ State _____

Approved for training Korean Veterans



See How Easy Music Can Be!

NOW it's easy to learn to play ANY instrument. You start right out playing real pieces—properly, by note. Our famous print-and-picture method leads you step by step. No previous musical knowledge needed. No boring exercises to do. Only a few cents a lesson. **WRITE FOR FREE 36-PAGE ILLUSTRATED BOOK.** Just mail postcard to **U. S. SCHOOL OF MUSIC, Studio 308, Port Washington, N. Y.** (900,000 students. 56th successful year.) No obligation; no salesman will call.



U. S. SCHOOL OF MUSIC
Studio 308, Port Washington, N. Y.
Please send me your Free 36-page Illustrated Book.

I'm interested in playing (name instrument) _____
 I do I do NOT—have instrument now,

Name _____ (please print)

Address _____

TRAINED MEN NEEDED

BIG PAY—GOOD FUTURE

- | | |
|-------------------------------------|--------------------------------------|
| <input type="checkbox"/> TELEVISION | <input type="checkbox"/> ELECTRONICS |
| <input type="checkbox"/> DIESEL | <input type="checkbox"/> AUTO |

WHY WORK FOR LOW PAY or risk being out of a job??? Usually the properly trained man has a steady job... through good times or bad. Even back during DEPRESSION there was a big demand for Bailey Trained men.

In only 5½ to 6 months we can train YOU to enter one of the big pay fields!

No previous experience or special education necessary. With our method of training you do not spend years pouring over books, figures, charts and graphs. You learn by rebuilding, repairing, testing and operating the most modern equipment, under the guidance of experienced, courteous and friendly instructors. This method of training gives you the experience and confidence required to step right into the big pay jobs without spending years as a mechanic's helper.

It's EASIER and COSTS LESS than you may think to get this residence shop training... we help you find part-time jobs while in school—full-time jobs after graduation. Check subject above in which you are interested and mail for complete information.

BAILEY Technical SCHOOLS

Veteran Approved

1634 S. Grand St. Louis 4, Mo.

NAME.....AGE.....
 STREET.....
 TOWN.....ZONE.....STATE.....

Make UP TO \$10.00 an Hour, Spare Time! Assemble and Install BUCKEYE Combination Storm Windows

EQUIP YOUR OWN HOME, THEN EASILY SELL FRIENDS, NEIGHBORS

No inventory or special tools to buy! All sizes, redwood or aluminum, shipped knocked down, factory to you, as you fill orders. Top quality windows; screen and glass panels easily changed from indoors! A sound profit opportunity, proved by thousands of sales over 20 years. You can also arrange to offer low, easy FHA terms, through your local bank.

WRITE FOR DETAILS TODAY!

Your Cost Only \$6.65*
 You Sell For \$22.00

*for 28½" x 20" window, plus screen cloth and glass you buy locally. Other sizes and aluminum slightly higher.

BUCKEYE SCREEN & WEATHERSTRIP CO.
 1380 S. 22nd Street, Columbus, Ohio

BENJAMIN SUPER CO₂ GAS CARBINE—\$16.50

NEWEST TARGET

RIFLE—22
 IDEAL FOR SMALL GAME



ECONOMICAL
 SAFE—NON-TOXIC

ACCURATE—CONVENIENT

PRACTICAL. Easy to operate—No spring
 recoil—No pumping. Uses low cost Soda Cartridges
 Cal. 22 Benjamin H-C Pellets and Darts.

Benjamin CO₂
 Gas Pistols
 Also Available

WRITE FOR FREE ILLUSTRATED FOLDER OF ALL MODELS
 BENJAMIN AIR RIFLES AND BENJAMIN AIR PISTOLS
 BENJAMIN AIR RIFLE CO.

806 MARION ST., ST. LOUIS 4, MO. U.S.A.

WATCHMAKING

FREE SAMPLE LESSON Cash in on growing opportunities. Study at home or in person with Chicago School of Watchmaking. Approved for veterans.

CHICAGO SCHOOL OF WATCHMAKING

2330 Milwaukee Ave., Dept. 184, Chicago 47, Ill. Veteran

BUY IT GET UP TO 40% OFF

WHOLESALE! FREE THE WHOLESALER'S PLAN!

Start a Buying Service at Home, SPARETIME. GET BIG-NAME MERCHANDISE FOR SELF AND CLIENTS UP TO 40% LESS THAN REG. PRICE. SALES EASY, AS YOU CAN GIVE Sizable DISCOUNTS. STILL MAKE FAT COMMISSIONS. Post Card Buys Free Copy.

AMERICAN BUYERS SERVICE

631-R Linden Ave., Buffalo 16, N. Y.

FREE AMAZING NEW BOOK "HOW TO ANSWER ADS"



Never before have you seen anything like this. Tells you in simple language the correct way to answer ads. Gets you quicker replies—better results, and greater satisfaction. Will save you time and money and it's ABSOLUTELY FREE. No obligation whatever. Every reader of advertising should have this booklet. Send a postcard for your copy NOW. Advertising Department, Popular Mechanics Magazine, Room 600-A, 204 East Ontario Street, Chicago 11, Ill.

BEING PUSHED AROUND??



Why take any more nonsense from bullies, wise guys and other pests? The next time they try to act smart—give them the surprise of their lives! It's easy when you know POLICE JIU JITSU! This complete, fully illustrated course comes to you in one volume. The same as taught to police, marines, "G" men, soldiers, sailors and members of the U. S. Coast Guard. By all means, just pin \$1 to this ad and we will send POLICE JIU JITSU to you postpaid by return mail. Satisfaction guaranteed or your money back.

BOOKS PUBLISHING CO., AMITYVILLE, N. Y.

250 POWER.....



Complete Telescope Lens Kit only \$3.49 postpaid

Conquer Space. Explore the Universe, Planets, Moon Craters, New Stars, etc. Complete Lens Kit consists of 80 inch focal length ground and polished objective lens, eyepiece lenses for 50 POWER, 100 POWER, 150 POWER, 200 POWER, 250 POWER, and all necessary lens fittings. Easy to make from simple step by step instructions. (Tripod and mount not included.) Money back guarantee.

BUSSE SALES CO., Hartford, Conn., Dept. PM 24

ENJOY ALL SPORTS THIS NEW WAY!



IMPORTER'S
BARGAIN
OFFER

88¢

PLUS TAX
BELOW
WHOLESALE
PRICE!

Over 500,000 people paid up to \$2.98 for these powerful BINOULAR-SPECTACLES. This amazing CUT-PRICE offer is made to win more satisfied customers. Now you, too, can enjoy the viewing thrills of famous Telekular-Spectoscopes and SAVE \$2 or more! You actually pay LESS than the WHOLESALE PRICE! Limit: Only TWO per customer.

NOW Get Close-Ups ALL DAY Without Fatigue!

At this SLASHED PRICE, Western Germany's famed binocular-spectacles are the optical BARGAIN OF THE YEAR! Wear 'em like ordinary eye glasses—hour after hour—without fatigue! Use them to watch BASEBALL, RACING, BOXING, PLAYS, TV, MOVIES! You get CLEAR, CLOSEUP, MAGNIFIED VIEWING at all times! Featherweight—only 1 oz.—hardly feel you have 'em on!

See Better Get Extra Thrills!
Telekular-Spectoscopes are a new, truly powerful optical design that gives you greater range than many expensive opera or field glasses and a far greater field of view than some selling for many times more. INDIVIDUAL focusing for each eye—for close-up OR distant viewing!

Try at Our Risk!
Enjoy at our risk for 5 days. You MUST

be delighted! Otherwise your money will be refunded with no questions asked! Send check, cash or m.o. for 88c plus 12c for tax and delivery (Total 1.00). PROMPT DELIVERY. Send TODAY to:

THORESEN'S, Dept. 6-H-90
352 Fourth Ave., New York 10, N. Y.
(Canadians: Send orders direct to:
THORESEN CO., Dept. 6-H-90, 45 St. James St., West Montreal 1, P.Q.)

WHEELS WHEELS WHEELS

7" Disc Wheel 3/4" Tire 3/4" sleeve	45c ea.
8" Disc Wheel 1 1/8" Tire 1 1/2" sleeve	70c ea.
7" Disc Wheel 1 1/8" Tire 1 1/2" ball bearing	80c ea.
8" Disc Wheel 1 1/8" Tire 1 1/2" ball bearing	\$1.00 ea.
9" Disc Wheel 1.50 semi-pneum. Tire 1 1/2" B.B.	\$1.35 ea.
8" Disc Wheel 2" semi-pneum. T. 1 1/2" B.B.	\$1.50 ea.
10" Disc Wheel 1.75 semi-pneum. T. 1 1/2" B.B.	\$1.50 ea.
12" Disc Wheel 1.75 semi-pneum. T. 1 1/2" B.B.	\$1.85 ea.

Above wheel prices includes hub cap. Plus Postage. C.O.D.'s accepted.
AXLES—Sizes 5/16 in., 3/8 in., 1/2 in.—Cut to size—End holes drilled.

UNITED WHEEL STAMPING CO.
12131 S. PEORIA STREET PM-8 CHICAGO 43, ILLINOIS



TRICK
BASEBALL
75¢

YOU GET 2 FOR \$1.00 POSTPAID! A real screwball is this baseball that's as full of tricks as a practical joker. Even a Major League couldn't pitch a straight ball with it! It dips. It curves. It bounces crazily. It rolls in circles. Write for FREE Novelty Catalogue.
NOVELTY MART, 59 E. 8th Street, New York 3, N. Y., Dept. 277

Tool and Die Design Training

\$8,000 to \$15,000 YEARLY INCOME!

ACME training has been fully proved in practice through its fine resident schools. Acme graduates report outstanding promotions, resulting in higher salaries. Progress is sure and easy through Acme's famous "COPE" System. Prepare yourself IN YOUR SPARE TIME for a secure position of responsibility and high earnings, and qualify at a time when you will have every opportunity to rise to a position in the \$8-15,000 per year salary bracket. Be successful — Go Farther Faster!

Approved Under PL550 for Korean Veterans Training

ACME SCHOOL OF DIE DESIGN

Write Correspondence Div., "M," for Information
8 N. JEFFERSON STREET DAYTON 2, OHIO

A complete
Spin Fish-
ing Outfit,
only \$9.95!

GLASS SPINNING ROD and SPIN REEL

Positively no backlash with UNITED'S quality spin outfit. Offer includes a sturdy, featherweight aluminum reel, synchro meshed for smoothest performance, 3.22 gear ratio! Full ball pickup. Unbreakable spool (250 yd. capacity). AND a 6 1/2 ft., 2 piece spinning rod, of precision laser-ground laminated glass fibre. Case included. Exclusive construction features assure championship performance. A bargain buy!

USE 10 DAYS. If not satisfied return for refund. Cash orders prepaid. C.O.D.'s require \$2.00 deposit. UNITED PRODUCTS, 9043 S. Western, Dept. RS-208, Chicago 20



\$9.95



HANDS TIED?

—because you lack a
HIGH SCHOOL DIPLOMA

• You can qualify for an American School Diploma in spare time at home! If you have left school, write or mail coupon for FREE booklet that tells how. No obligation of any kind.

OUR 57TH YEAR

AMERICAN SCHOOL, Dept. VC45
Drexel at 58th, Chicago 37, Illinois

Please send FREE High School booklet.

Name.....

Address.....

City & State.....

Canadian Residents: Complete Canadian Course Available.
Write American School, 1610 Sherbrooke St. West, Montreal.

**CAN YOU
GIVE AWAY**

**FREE
HOSIERY?**

Sensational new way to make up to \$3 an hour in your spare time! Introduce amazing hosiery by giving away free pairs to every man and woman (regardless whether or not final purchase is made) just to prove how good they are! Wonderful luxurious nylon stockings, guaranteed against runs, wear and even snags, nationally known and sold coast to coast. New miracle one size two-way stretch men's nylon hose, contains no elastic, yet fits every size foot from 9 to 14! Never sags or droops—clings to foot like a second skin—Outlasts several pairs of ordinary hose and guaranteed for **ONE FULL YEAR!** You need no money or experience. You buy nothing. Deliver nothing. Advance cash plus huge cash bonus to 40%, and your own hose as extra bonus. What man or woman will refuse a free gift pair to try? Nothing like this ever offered before. **FREE SAMPLES OF STOCKINGS AND MIRACLE SOCKS** with complete money-making outfits free and

**FREE
SAMPLES**

prepaid. Nothing to pay now or later. Absolutely no obligation. Hurry! Mail postcard today with your name and address

KENDEX CORP.
Babylon 146, N. Y.

**FREE!
ELIZABETH II
EMPIRE
STAMPS**
and illustrated
booklet



We'll send generous collection of hard-to-get (mint and used) Elizabeth stamps, Coronation and others — Falkland Islands, Ceylon, Seychelles, South Africa, Tristan da Cunha — many others. **PLUS! FREE** copy "Stamp Collectors Guide"! — **FREE** color copy World's Rarest Stamp! Other offers for your free inspection. Rush name, 10¢ for postage and handling — *limited time offer!* GARCELON Stamp Co., Dept. 8TMO, Calais, Maine.



**You Can Be a
Manufacturer
of BRIKRETE**

"The World's Most Modern Masonry" is produced in a chain of independently owned local plants. That's why such low prices go along with such high quality without sacrifice of manufacturing profits. Local materials and local labor cut freight and distribution. Brikrete brings a super-masonry down to price levels of frame. Gives owners incentive to buy.

Brikrete has design, size, and color in keeping with the modes of today. Self-contained insulation values—12" long—8" or 4" thick—range of 14 colors. Suited to every kind of construction—residential, commercial, industrial.

Many territories are open for additional local plants. Franchise protection. Equipment available on easy terms, or basic machine can be leased to responsible operators. Write today for interesting Brikrete Book No. 2.

Brikrete Associates, Inc.
4679 Division Avenue, S.
Grand Rapids 8, Mich.



*The World's
Most Modern Masonry*

This **FREE** Catalog
Brings You
**\$60.00
A WEEK**
for just 3 orders a day!



No investment, no experience needed. Just show amazing cash-in comfort features to friends, co-workers, neighbors in spare time. Advance commissions to \$4.00 a pair. 110 styles for dress, work, sport. Amazing values for men, women, children. Satisfaction guaranteed. Shoe samples supplied without cost. Write **TODAY** for **FREE** new 76 page Catalog and full details.
Tanners Shoe Co., 467 Brockton, Mass.

- * Plus Extra Cash Bonus
- * Plus Paid Vacation
- * Plus \$25.00 Reward Offer

**ENGINEERING DEGREE IN
27 MONTHS**

**INDIANA
TECHNICAL
COLLEGE**

B. S. DEGREE, Aeronautical, Chemical, Civil, Electrical, Mechanical and Radio Engineering (Inc. TV and Electronics), Drafting, 1-yr. U.I. Gov't. approved. Low rate. Earn board. Large industrial center. Students from 48 states, 21 countries. Demand for graduates. Enter September, December, March, June. Write for catalog, 1684 E. Washington Boulevard, Fort Wayne 2, Indiana.

Say You Saw It in Popular Mechanics

DR GRABOW PIPES



SEND ME



every month so I am sure to see each new issue. Here's

- \$3.50 for 1 year
- \$8.00 for 3 years

name _____

address _____

city _____

zone _____

state _____

Hand this order to your newsdealer or send it to **B-84**

POPULAR MECHANICS
200 East Ontario St. Chicago 11, Ill.

Success Requires Training! **LEARN** AIR CONDITIONING and REFRIGERATION

This great, modern industry is alive with opportunities for trained men. Installation, maintenance and servicing of home and industrial equipment is a well-established, paying trade and business. Now mechanically inclined men can get practical instruction in spare time at home, plus quick shop practice at U. E. I. (founded 1927).

IMPORTANT FACTS FREE — Write today
Find out all about these interesting opportunities without obligation. Send a postcard or short note right now.
UTILITIES ENGINEERING INSTITUTE, Dept. C-10
2525 SHEFFIELD AVENUE CHICAGO 14, ILLINOIS

LOOK!



A MILLION THRILLS!

**High Power
BINOCULARS**

30 DAY FREE TRIAL
Finest Precision Optics
Money Back Guarantee
Easy Pay Plan

Free! Catalog & Book
"How to Select Binoculars"

Dept. M88 43 E. Green
Pasadena, Calif.

BUSHNELL Binoculars

33 Models
\$9.95
UP

Finish HIGH SCHOOL AT HOME

Complete 4 Yrs. in 12 Months

Learn More! Earn More! Enter professional or technical schools. Advance Socially. Live a Happier, Fuller Life. Individual Courses or complete schedule. **WRITE FOR SCHOOL BULLETIN.**

ACADEMY FOR ADULTS

30 W. Washington, Dept. PM-804, Chicago, Ill.

Say You Saw It in Popular Mechanics

STARTING YOUR OWN BUSINESS?

Look before you leap! Get outline of my experience. May save you hundreds of dollars and many headaches. Applies to any business. Send One Dollar with name and address. Money back if not satisfied.
R. S. STOTT, 60 Blakeslee Ave., North Haven, Conn.



SAMSON FIBER-GLASS BOWS
THEY DON'T BREAK
THE WHOLE FAMILY
CAN USE THE SAME BOW

CATALOG - Fine Bows Arrows Materials 3c
HANDBOOK - Illustrated Instructions on Making & Shooting Arrows 7c

L. E. STEMMLER CO., Box 3
HANDSVILLE, L. I., NEW YORK
Making Bows & Arrows for over 40 years

Have a Motorized Shop at **Low Cost**
Make Your Own **POWER TOOLS**

Popular Mechanics Book Shows How to Make 60 Machines from Scrap and Discarded Materials
Get **SIXTY POWER TOOLS AND HOW TO BUILD THEM**, the sensational new Popular Mechanics book. Build your own lathe, drill press, sander, circular and band saw and other power tools at a cost of only a few dollars each. Use old auto parts, pipe and wood and odds and ends that cost little or nothing. Every detail of construction is given in plain language you can understand and follow. Hundreds of pictures and plans show every step to follow in making the power tools you want. Clip this ad and mail with name, address and only \$2.50, or we will send C.O.D. (U.S.A.). You'll be amazed with the fine, practical tools you can make and how little they cost. Your money back if you return the book in 7 days. Order today.



Over 250 Pictures

POPULAR MECHANICS PRESS, Dept. PT-1, 200 E. Ontario St., Chicago 11

FREE
A NEW HOME INDUSTRY



OPPORTUNITIES UNLIMITED!
Let us show you how extremely easy and PROFITABLE it is to make beautiful and useful things out of LIQUID PLASTICS, LIQUID MARBLE, LIQUID IVORY, LIQUID GLASS, CERAMICS, ETC. . . as easy as pouring water out of a glass! Make novelties, jewelry, gifts, artware, toys, tools, dials, gauges, ceramics . . . a million useful things! We supply everything—**MATERIALS** and **INSTRUCTIONS!** Send only 25c for big 64 page catalog of exciting materials, molds and accessories and we will include free of extra cost a remarkable book, "THE WONDERS OF LIQUID PLASTICS" . . . that will open your eyes to wonders you never dreamed of! Send 25c today—this may be the lucky coin that will start the most fascinating and profitable phase of your life!

PLASTICAST COMPANY, (Dept. C)
P.O. Box 6737 (Write to either address) P.O. Box 987
Chicago 80, Ill. Palo Alto, Calif.



PLASTIC LAMINATING

This remarkable Plastic Laminating Machine will earn \$18.00 an hour right in your kitchen! Big profits laminating Business, Social Security, Identification, Credit CARDS of all kinds, photos, passes, clippings, etc. Price complete (including) \$35.00 plus postage. Others higher. Literature free.
PLASTICAST CO.
(Address in ad above)



CURE SELF-CONSCIOUSNESS!

How to develop a strong, positive personality—get rid of timidity, bashfulness, shyness and fear. Successful self-instruction lessons based on new principles of practical psychology. Healthy self-confidence can be yours! Complete course of 22 home-study lessons, NOT a book. Full price only 86.95 postpaid, or COD plus postage.



Mailed sealed in plain wrapper. Satisfaction guaranteed or refund. Order "Curing Self-Consciousness Course" today. **Nelson-Hall Co., 210 S. Clinton St., Dept. 2HW-2, Chicago 6, Ill.**

Want a Government Job?

START AS HIGH AS \$4,205.00 A YEAR

MEN—WOMEN Prepare NOW for next exams
Thousands appointments being made. 36-page book FREE.
FRANKLIN INSTITUTE (Not Gov't Controlled), Dept. R-83, Rochester 4, N. Y.

First Rush FREE: (1) 36-page book with list of U. S. Gov't. Jobs; (2) Tell me how to qualify.

Mail Coupon Today, SURE. Name _____ Age _____ Address _____

START ART ON TRIAL PLAN

SEE HOW EASY IT IS
Step by Step!



Enjoy drawing, painting, advertising art and cartooning at home in your spare time. Earn while learning. Step-by-step method helps beginners quickly. Low tuition. 40th year. Send coupon for free booklet. No salesmen.

Send free "Art for Pleasure & Profit."
 Tell about trial plan

Washington School of Art
Studio 128 N
Washington 5, D.C.

Name _____
Address _____ Age _____
City, Zone, State _____

Inventors

The following are the usual preliminary steps to take toward patent protection.

Make a disclosure of your invention; sign, date and have this document witnessed by two or more people who understand your invention; authorize your registered patent attorney or agent to conduct a preliminary search among previously granted U. S. patents for similar types of invention; secure a report on the probable patentability of your invention and a recommendation of the further course to take.

We shall be glad to send you without obligation our instructive booklet, "Patent Protection for Inventors" and our "Evidence of Invention" disclosure form.

VICTOR J. EVANS & Co. *Merlin M. Evans*
REGISTERED PATENT ATTORNEY
930-J MERLIN BUILDING, WASHINGTON 6, D. C.

7 x 50 \$29.95

New, improved, superb, lighter binoculars that are easier to hold, easier to focus, and lower priced. The 7x50, 5 1/2" x 7 1/2" has tremendous light gathering power and provides brilliant, crystal clear images. ALL binoculars are both water, dust resistant. **UNI-COATED!** Inside surfaces of vital prisms and front and rear achromatics are COATED for brighter, sharper viewing! Made in Japan by skilled optical craftsmen of precision materials. It explains why prices are so low and quality so high.



WEIGHS ONLY 26 ounces!

6 x 30 I.F.*	4 1/2" x 6"	15 1/2	ounces.....	\$24.95
7 x 35 I.F.*	5 1/4" x 5 5/8"	20	ounces.....	27.95
8 x 25 I.F.*	4" x 5 1/4"	12	ounces.....	19.95
12 x 50 C.F.*	5 1/4" x 8"	27	ounces.....	39.95
15 x 65 C.F.*	8 1/2" x 9"	51	ounces.....	59.50
7 x 35 C.F.*	Wide Angle	525' field	26 oz.....	49.95

Add \$1.00 for postage and handling. *I.F. are individual and *C.F. are Center Focus. Genuine leather case and straps included. **UNCONDITIONALLY GUARANTEED. USE 30 DAYS AT OUR RISK.** If not fully satisfied return for full refund. C.O.D.'s require \$2.00 deposit. Add new, lower Federal tax only 10%. **UNITED BINOCULAR CO., 9043 S. Western, Dept. ARF-7908, Chicago 20**
DEALERS WANTED

ENGINEERING DEGREE IN 27 MONTHS

Big Demand for Graduates

Aeronautical, Chemical, Civil, Electrical, Mechanical and Radio Engineering (inc. TV and Electronics)

Hundreds of young men are earning B. S. ENGINEERING DEGREES annually in this recognized institution — year around operation. New terms start quarterly. Many students earn a major part of their college expenses in this large industrial center.

Low tuition. Competent instruction. Thorough, intense, practical program. Modern, well-equipped laboratories including new physics laboratory and modern wind tunnel. Individualized instruction emphasized.

Government approved for G.I.'s. Engineering preparatory courses. Students from 48 states and 21 foreign countries. Enter September, December, March, June. Send coupon for free catalog and full information. Enroll now.

SEND COUPON TODAY -

INDIANA TECHNICAL COLLEGE

584 E. Washington Boulevard
Fort Wayne 2, Indiana

Please send me free information on B.S. Engineering Degree in 27 months as checked.

Aeronautical, Chemical, Civil, Electrical,
 Mechanical, Radio-Television

Name _____

Address _____

INVENTORS

PROTECT YOUR INVENTION BY A U. S. PATENT. SEND FOR FREE "INVENTION RECORD" FORM AND "PATENT INFORMATION EVERY INVENTOR SHOULD HAVE."

CARL MILLER
REGISTERED PATENT ATTORNEY

WOOLWORTH BLDG., 35th FLOOR, 84A
NEW YORK CITY

PATENTS

C. A. SNOW & CO.

REGISTERED PATENT ATTORNEYS
WRITE FOR INFORMATION TO
428 SNOW BUILDING, WASHINGTON 1, D. C.

INVENTORS

Send for **REGISTERED PATENT**
PATENT INFORMATION **ATTORNEY**
Book and **ASSOCIATE EXAMINER**
INVENTOR'S RECORD U.S. PAT. OFF. 1922-1929
without obligation
GUSTAVE MILLER Patent Attorney & Advisor
84-PM WARNER BUILDING U. S. NAVY DEPT. 1930-1947
WASHINGTON 4, D.C. **PATENT LAWYER**

INVENTIONS For Sale

Our clients have excellent inventions in many fields to be manufactured and marketed on a cash, royalty or license basis. Full description of clients' inventions will be sent if you state your field of interest. **INVENTORS!** We also want inventions of every type. Write for details.

GLOBAL MARKETING SERVICE
1404 Mitchell Street Dept. M5 Oakland 1, Calif.

YOU CAN BUILD A VIOLIN FOR PLEASURE OR PROFIT

Now you can build a rich toned mellow violin modeled after a famous "Strad." YOU CAN MAKE A STRADIVARIUS VIOLIN contains 8 full scale plans plus complete instructions. You work directly from the plans with no confusing scale of dimensions to translate. Detailed instructions for each step including varnishing and stringing—even shows how to build your own tools. Cloth bound. Order today from

POPULAR MECHANICS PRESS . . . \$3.50
200 EAST ONTARIO STREET, CHICAGO 11, ILLINOIS

INVENTORS

Whether an invention is patentable can be substantially determined by a search of the U. S. Patent records. Without obligation, write for information explaining the steps you should take to secure a patent.

JOHN N. RANDOLPH

Registered Patent Attorney
201 Columbian Building, Washington 1, D. C.

INVENTORS

I shall be pleased to furnish you, upon request, with full information relative to patent procedure—without any obligation on your part.

PATRICK D. BEAVERS

Registered Patent Attorney
934 Columbian Building Washington 1, D. C.



FULLY GUARANTEED TIRES COST LESS!

Nationally famous FIRESTONE, GOODRICH, U. S. ROYAL, GOODYEAR, and other makes. Every tire selected and inspected for your safety.

FREE TUBE ON REQUEST WITH PASSENGER TIRES

WHITE WALL TIRES \$1 EXTRA

HIGH GRADE TIRES GUARANTEED 12 MONTHS

600x16	4.14	700x16	5.14	32x6(8)	8.84	825x20	14.24
650x16	4.84	670x16	4.74	32x6(10)	10.84	900x20	13.34
650x18	4.34	850x20	7.84	750x20(8)	8.54	1000x20	14.14
700x18	4.64	700x20(8)	8.94	750x20(10)	9.94	1100x20	16.14

AAA PREMIUM GRADE GUARANTEED 18 MONTHS

550x15	5.48	700x15	5.98	760x15	5.58	750x20(10)	14.98
600x16	5.28	700x16	6.78	550x17	5.48	825x20	18.68
600x18(6)	5.58	700x16(6)	7.98	600x20	9.78	900x20	18.98
640x15	5.68	750x16(6)	8.98	650x20	10.88	1000x20	19.98
650x16	5.78	800x15	6.88	700x20	12.88	1000x22	21.98
650x18(6)	6.98	820x15	7.48	32x6(8)	10.48	1100x20	20.98
650x15	5.98	710x15	6.08	32x6(10)	12.48	1100x22	21.98
670x16	6.18	850x18	8.98	750x20(8)	12.98	1100x24	23.98

MILITARY SPECIAL

AAA Guaranteed 12 Months—	NEW TREAD GUAR.	
900x16 10.69	1000x20 19.98	600x16 8.98
750x20 10.98	1100x20 21.98	600x18(6) 9.98
AAA GUARANTEED 18 MONTHS	700x15(6) 15.95	700x18(6) 15.95
900x16 14.98	750x20 16.48	750x20(8) 24.98

Largest stock of used tires in the East. Thousands of satisfied customers. Write for Free Catalogue. MONEY ORDER OR CHECK WITH ORDER. NO C.O.D.'s

PYRAMID TIRE CO.
1333-35 North 5th St.
Dept. M., Phila. 22, Pa.

NO TANKS USED
NEW SIMPLIFIED METHOD



ELECTROPLATE

ANY OBJECT IN HOME, SHOP, GARAGE OR STAY
YOUR OWN WELL PAYING ELECTROPLATING BUSINESS

NOW, using NEW plating kit. It's easy to electroplate any object. Complete kit and instructions on plating metal and non-metal objects, with nickel, copper, chrome, gold, etc., plus full data on obtaining all the business you desire and make BIG MONEY full or spare time. ONLY \$5.95. SEND NO MONEY—everything sent C.O.D. plus postage—OR

send \$5.95 now and receive it postpaid. Money back in 7 days if not satisfied. M. Z. SALES CO., Dept. PM-4, 113 W. 42 St., New York 36, N. Y.

STUDY INDUSTRIAL DESIGN

You can train at Art Center School in California with practicing-professionals for upper-level jobs in INDUSTRIAL DESIGN. Recent graduates have been added to the staff at General Motors, Chrysler, Raymond Loewy, Henry Dreyfus, etc. Majors in transportation, general product design, structures, community development, furniture design, packaging, display, 4-year degree courses. Learn to combine imaginative design with technical proficiency, coordinate utility and beauty. Stimulating environment. Field trips. Advantages of mild Southern California climate and nearby holiday spots. Coed. Placement service. Write for catalog.

ART CENTER SCHOOL, Edward M. Adams, Director
5353 WEST THIRD STREET, LOS ANGELES 5, CALIFORNIA

Become a MENTAL SUPERMAN

OVERNIGHT! Floor everybody! Revolutionary "MEMO-PROP" does all your thinking! It's amazing! Unprecedented! FREE LITERATURE! BIJOU STUDIO, BOX 1727MP, HOLLYWOOD 28, CAL.

Saludos Amigos
IT'S EASY to speak Spanish my way!
Learn at home by famous RATIONAL system.
Send for FREE BOOKLET
NORTH AMERICAN SCHOOL
Dept. PM-3, Box 27606, Hollywood 27, Calif.

POWER MOWERS & KITS

LOW FACTORY PRICES DIRECT TO YOU

Build your own quality mowers with our LOW COST KITS. Parts, Engines, Free Plans guide you. 3 and 4 Wheel Kits, complete. Parts precision finished, ready to use. Write TODAY for Free Plans, Low Prices, Parts List and Guarantee.

FREE PLANS

3 & 4 Wheel Model
4 Wheel Direct Drive
3-WHEEL KIT NO. T-800

America's Finest Power Mowers completely assembled in 3 and 4 wheel models. Belt or direct drive. 18" and 20" sizes. Nationally known make engine. Latest improved features, sturdy construction and money back guarantee fully described in color folder. Write today.
▲TRIANGLE MANUFACTURING CO., Box M-33, Fort Scott, Kansas

STOP BURNING OIL!

LOSING POWER WASTING \$\$\$

When your car "eats-up" oil, loses that get-up-and-go power, has poor gas mileage, it's a sure sign that you have worn rings, pistons, and cylinder walls in your engine. This is robbing you of driving pleasure and valuable \$\$\$ to the tune of \$250 every 10,000 miles in oil, gas, and repair bills.

WHAT CAN YOU DO ABOUT IT?
You can either have an expensive overhaul job done or offset this wear with a

RING-RE-NU MOTOR RECONDITIONER KIT

It's the inexpensive, proven answer to a worn engine. This terrific 1-2 combination restores power and zip to your car without expensive repair work, reduces oil burning, slashes gas consumption, brings back that "new car" performance to your car.

HERE'S HOW THIS DOUBLE VALUE KIT PERFORMS!

- 1. PVR COMPOUND**—is a hard hitting engine reconditioner that removes sludge, tars, sticky greases from a tired, worn engine. Pour in carburetor, idle engine. Leaves rings, valves, pistons whistle clean, ready for . . .
 - 2. RING-RE-NU**—this amazing compound when squeezed by tube on pistons forms a tough, pliable, self-expanding seal on rings and pistons to compensate for wear.
- RESULT!**—You get power-packed, economical driving pleasure. Good for 10,000 plus miles. Adds years to the life of your car. Guaranteed not to harm the finest engine. Takes only 30 minutes to install.

PROVEN SUCCESSFUL! Over 100,000 customers

acclaim results! —

You risk no money!—Ring-Re-Nu must reduce oil burning—improve compression in your car. Try it for 400 miles — if results aren't favorable—return empty tube and can — full purchase price refunded!
1 tube kit \$4.95 post. treats all cars except large 8 cyl. autos which require 2 tube kit at \$8.95 post. sold with money back guarantee. (C.O.D.'s accepted. \$1 deposit required, bal. and postage on arrival.)
FREE with your order from this ad — one "Micro-Moly" crankcase treatment worth \$1.50!
RUSH ORDER TO:

RICHIE DISTRIBUTING, INC.
11916 MADISON AVE. • DEPT. MB • CLEVELAND 7, OHIO

SAY YOU SAW IT IN POPULAR MECHANICS

Paint STRIPES with New "PAINT PEN"!

Makes Straight, Curved or Parallel Lines!

Just fill glass vial with any color paint. Use like a fountain pen to stripe furniture, bikes, autos, model planes, toys, linoleum, wall board. Beautiful, clean, crisp results every time, like professional painters. No experience needed to draw straight, curved, circular or evenly spaced parallel lines. Can't clog or smear. May also be used with glue, tempera, textile paint, or ceramic underglazes. Paints on wood, glass, plastic, metal, fabrics and paper. Lasts a lifetime. Only \$1 postpaid, complete with tip for 1/16 inch stripe. C.O.D.'s plus postage. Used by industry. Order your Paint Striping Tool TODAY!

New! "DOUBLE-STRIPER" MODEL Only \$2.95

Newest paint striping invention. Makes DOUBLE stripes — one wide and one narrow or two wide or two narrow at the same time. Or adapt quickly for wide or narrow single stripe. Makes 5 combinations. FREE—Send postcard for complete information... or order now... \$2.95.

\$1.00 DEALERS

Master Paint Striping Tool packed in Display Cartons of 1 dozen. Fast, profitable seller. Write for discounts.

Attention All Home Craftsmen!
New Paint Striping Tool gives "professional" results every time, yet simple and easy to use as a fountain pen. Adjustable guide keeps lines straight as an arrow. Just as easy to make curves or free hand designs. Adds new beauty, finished look to everything you paint. Send \$1 now.

WENDELL MFG. CO., Dept. 3-J
4234 Lincoln Ave., Chicago 18, Illinois

6 Other Complete Tools
Complete tools for 1/64, 1/32, 3/64, 5/64, 3/32 or 1/8 inch stripes. \$1.50 each. Extra tips 75c ea. COMPLETE KIT with ALL 7 TIPS, \$5.00. (Also 1/4" tip, only \$1.00). All tips interchangeable.

PREPARE FOR THE BEST JOBS

TRAIN at HOME
IN YOUR SPARE TIME
or at
ALLIED INSTITUTE
in Chicago

- MECH. ENGINEER
- DRAFTSMAN
- TOOL DESIGNER
- TOOL ENGINEER
- TOOL & DIE MAKER
- MASTER MACHINIST

NO RECESSION FOR ALLIED TRAINED MEN

MORE JOBS THAN GRADUATES Shortages of Draftsmen, Designers, Tool Engineers, Machinists, Tool & Die Makers are so widespread that you can pick a highly paid key job and look forward to Achievement and Security.

You can begin your training in Short Courses and continue progressively to a Bachelor Degree in 26 months.

Allied is approved by Industry, Dept. of Education, Office of Public Instruction, State of Illinois, U.S. Veterans Admin., U.S. Dept. of Justice, Accredited: C. S. A.

SEND FOR
FREE BOOKS

ALLIED SCHOOL of MECHANICAL TRADES
1338-42 South Michigan Ave. Dept. PM-8 Chicago 5, Illinois

SEND ME WITHOUT OBLIGATION INFO. ON YOUR COURSES:

HOME STUDY RESIDENT VETERAN NON VETERAN

NAME _____

ADDRESS _____ AGE _____

CITY _____ STATE _____

Say You Saw It in
POPULAR MECHANICS



WAR SURPLUS BARGAINS
STARK'S

WAR SURPLUS BARGAINS

\$500,000.00 INVENTORY for QUICK LIQUIDATION

Surplus items—hundreds of them for home, shop, factory, farm and outdoor use. New items, used items, reconditioned items—all at tremendous savings—all priced for quick sale.

Page After Page of Values

This big catalog shows page after page of amazing money saving values. Write for your copy today. Send 10c to cover postage, mailing, etc. Write today! **SEND TODAY FOR YOUR COPY**

10c

FIELD TELEGRAPH TRANSMITTER & RECEIVER SET

Complete. Includes transmitter with pair of hand phones, sending telegraph key, buzzer, double throw switch. Original cost of this instrument to English government well over \$100.00. Ship. wt. 20 lbs. each. Allow sufficient postage or will be shipped express charges collect. Two 4 1/2 volt C batteries needed in each set. Batteries 45c each extra. Wire needed to connect for operation. No. 43R. Complete set of two... **\$15.00**
One set **\$7.95**

STARK'S 509 So. State St.
Dept. PM-54R, Chicago 5, Ill.

IT'S DANGEROUS (VERY DANGEROUS) TO PAY LESS For "Family-Safe" Fine Used Tires

Year after year, Popular Mechanics brings us to you



FREE THIS PICTURED TIRE ASB TRAY WITH YOUR NAME WITH TWO OR MORE TIRES

These are not recaps. "Standard" grade used tires..... **\$2.75**



GOODYEAR, FIRESTONE U.S. & others **Free Tube** with tire

world's finest quality... grade AAA
AMERICA'S MOST RESPECTED WRITTEN "UNLIMITED" GUARANTEE

Not Just 18, 24, or 34 months—We will adjust, regardless of time or Mileage, Any Tire That Ever Fails For Any Reason For the Life of Tire. You Can't Lose.

IF YOU BUY "3" CAR TIRES, YOU GET A "4th" TIRE FREE					
600-16	\$4.30	670-15	\$4.70	600-16TK	\$5.60
650-16	5.00	710-15	4.90	650-16TK	6.30
700-16	5.50	760-15	5.20	700-16TK	6.50
640-15	4.30	800-15	5.50	750-16TK	7.50
650-15	4.50	820-15	5.60	700-15TK	7.60
		700-15	4.80	700-17TK	8.40
				1000-20TK	9.90
				1000-22TK	12.20

MILITARY MUD-GRIP TREAD

750-20	Super 20 Mos.	\$10.20
	Rugged 34 Mos.	\$12.50
900-16	Super 20 Mos.	\$10.20
	Rugged 34 Mos.	\$13.20

I have personally inspected every tire, as if our very future depended on it. Not 1 tire, I wouldn't use myself.

"I ask one chance to treat you right." Mort Blatt Mgr.; Faithfully serving motorists, hospitals, schools & churches since 1917.

BLATT PHILA., PA., 11th & SPRING GARDEN ST. Send ck. or M.O. and this ad.
MIAMI, FLA., 2827 N.W. 7th AVE. and this ad.
—Thousands of shipments RUSHED all over the world.

I'll Send You This Handsome SAMPLE CASE—FREE



and Show You How to Make Up to \$30.00 in a Day

WRITE for this FREE Tailoring Sample Case packed with 150 beautiful, big-name suit and overcoat fabrics. Take orders from friends, fellow-workers, others, for fine quality, made-to-measure clothes. Pocket big cash profits in advance.

Because wearing our suits and overcoats brings more orders, we make it easy for you to get your own clothes without cost. No experience is needed. **SATISFACTION GUARANTEED. SEND NO MONEY.** Rush your name, address, and age—today!

PIONEER TAILORING CO., Congress & Throop Sts. DEPT. P-1116 CHICAGO 7, ILLINOIS

WHAT'S MY NAME? FREE PRIZE for Answer!

I've been nicknamed the "Australian Teddy-Bear". What's my real name? (Clue: it begins with the letter K)... Send answer with your name and address for Free Australian Packet of 25 bird, animal and commemorative stamps including new Coronation. Also, big illustrated U.S. Catalog. All FREE for 2c stamp to cover postage. Approvals.

H. E. HARRIS & CO., 721 Transit Bldg., Boston 17, Mass.



HOW TO RUN A RESTAURANT

Get into a Good MONEY-MAKING BUSINESS of Your Own!

Virtually a complete self-instruction course on starting and operating profitable luncheonettes, cafeterias, diners, tea rooms, etc. Teaches you the all-important facts about licenses, licenses, equipment, furnishings, decorating, kitchen arrangement, menu-planning, etc. How to make money! **FULL PRICE, Only \$4.95, Postpaid.** This could be your BIG chance! Satisfaction guaranteed or money back. Order "How to Run a Restaurant" Only \$4.95 postpaid—COD plus postage. **NELSON-HALL CO., 210 S. Clinton St., Dept. 3HW-2, Chicago 6, Ill.**

FREE! IMPORTS

To New Members

FROM FOREIGN LANDS



Free to new members of the International Traders Guild—many unusual, useful products from France, Japan, Germany and other foreign lands, and trade bulletins listing hundreds of import bargains to sell at high U. S. prices. Also requests from overseas buyers for U. S. exports. Opportunity, men—women, profitable, world-wide, mail order business at home; or travel abroad; no capital needed. 2,000 members in 42 countries. 7th successful year. **FREE details.** Mellinger Co., Dept. A258, 1717 Westwood, Los Angeles 24, Calif.



Take your Short Cut to HIGH-PAY JOBS or BE YOUR OWN BOSS IN Television

TRAIN FOR SUCCESS AS A TV TECHNICIAN IN YOUR SPARE TIME AT HOME—EARN WHILE YOU LEARN!

Are you looking for employment opportunities with a FUTURE? What are your chances for promotions or raises in your present job? BETTER YOURSELF... train NOW for profitable jobs in the booming Television Industry. Thousands of top jobs are awaiting the Trained TV Technician. HERE IS YOUR BIG OPPORTUNITY IF YOU ACT NOW!

MANY UTL TRAINEES MAKE \$25 A WEEK IN SPARE TIME, while still in training. The money they earn for repairing TV sets and radios for neighbors... assisting service shops and distributors, more than paid for the training, and permitted them to enjoy many of the luxuries in life. UTL SHOWS YOU HOW!

NO EXPERIENCE NECESSARY YOU ARE READY TO TRAIN AS YOU ARE!

You don't have to know the first thing about electricity or television at the start, to master UTL Training. Step-by-step instructions TELL you how—thousands of pictures, diagrams and charts SHOW you how! The finest equipment GIVES you the Know-how! Age or experience is not important... just your AMBITION.

Be Your Own Boss No Money Down!

Start your own profitable service business immediately after graduation, without putting one cent down for equipment, stock, parts, and tubes. Get the amazing details! ACT NOW... OFFER LIMITED TO FIRST COME, FIRST SERVED.

NOTE TO MEN PAST 40:

If you find it difficult to get ahead, here is your opportunity to be independent and have your own thriving business.



ALL PROFESSIONAL TOOLS AND EQUIPMENT FURNISHED, COMPLETE!

UTL sends you everything you need for successful Home Training. These BIG KITS, which you keep, convert any table into a fascinating experimental laboratory. Enjoy doing hundreds of thrilling experiments and interesting demonstrations. Build professional equipment to use in your career, including a volt-ohm-milliammeter, a complete superheterodyne receiver, a cathode-ray oscilloscope and other valuable units. Practice servicing on TV receiver units!

UTL has Successfully Trained Thousands

Amazing Training Program has caused graduates to say UTL training was responsible for their getting ahead so fast... trainees report UTL training is the easiest thing they have ever done! Training is professional and efficient... you are treated as a person, on an individual basis.

TRAIN AT HOME set your own pace. Practice with parts and equipment sent you. UTL instructors give you full assistance. Your training is remarkably EASY. Upon completion, you...

TRAIN IN UTL LAB, for 160 hours of INTENSIVE, ADVANCED TV EXPERIENCE! You operate modern equipment found only in a lab; do interesting trouble-shooting assignments; get the professional touch by knowing accepted TV circuits, equipment and standards!

JOB PLACEMENT SERVICE and BUSINESS PLAN IS AVAILABLE when you complete your training. Excellent record. Find out for yourself!

COLOR TV TRAINING INCLUDED!

Exciting, profitable COLOR TV is now a commercial REALITY! Industry leaders predict that in years to come, COLOR TV WILL PRACTICALLY REPLACE BLACK AND WHITE TV! UTL training prepares YOU to take full advantage of the HUGE field of black and white TV NOW... as well as putting you in position to EXPAND WITH THE RAPID GROWTH OF COLOR TV!

This means ADDED OPPORTUNITIES FOR YOU with UTL TRAINING. ACT NOW... get in on the ground floor of COLOR TV!

FREE FREE FREE!

Exciting big 48-page book is jam-packed with information on how to get high pay jobs in TV; how easy it is to train; how to build up prestige and income at the same time; how to take advantage of your opportunities.



DON'T DELAY-MAIL THIS TODAY

UNITED TELEVISION LABORATORIES, Inc., Dept. M54A
19th and Main Streets, Louisville 3, Kentucky
Send me the big, valuable 48-page book of Opportunities, FREE! I understand I am under no obligation.

Name _____
Address _____
City _____ Zone _____ State _____
Married _____ Single _____ Age _____

PLEASE SEND DETAILED INFORMATION ON:

- TV Technical Training
- Owning my own business
- Television Studio Techniques
- How to get a high-pay job in TV

UNITED TELEVISION LABORATORIES
19th & MAIN • LOUISVILLE, KENTUCKY



Amazing Offer for POPULAR MECHANICS Readers!

9X AREA MAGNIFICATION!



**Genuine
COATED LENSES**

This is what
you see with
the naked eye



This is what
you see with
the POWERHOUSE

FREE FINE LEATHER CASE

**OF
EXTRA
COST**

This magnificent case is truly an achievement of the leather-crafter's art. Made entirely of Supple-Soft genuine leather. Beautifully finished in a golden tan with harmonizing stitching and snap closure. Protects your POWERHOUSE binoculars against rain, dust, grime. Yours **ABSOLUTELY FREE** of extra cost with your order for the new POWERHOUSE Binoculars with coated lenses!

SAVE \$7.00

**DIRECT FROM
IMPORTER
TO YOU**

4 98
WITH
LEATHER
CASE
•
F.T.I.

SEE UP TO TWENTY MILES AWAY!

Lifetime bargain for readers of Popular Mechanics! **THORESEN**—world's greatest importer of German binoculars—brings you famous, nationally advertised **POWERHOUSE** Binoculars at an unbelievably low price! **NOT** another crude Jap model! **NOT** a toy! **NOT** 4... 5... 7... but **9X AREA MAGNIFICATION!** It's the pride and joy of every red blooded sports enthusiast! Thoresen and only Thoresen brings it direct to you for a mere **4.98**.

TRIUMPH OF GERMAN OPTICAL INDUSTRY

The **POWERHOUSE** is made in Western Germany—world's outstanding producers of quality optics—the finest Cameras, Telescopes, Microscopes and Binoculars. German know-how and superb workmanship are reflected in the many features of the famous **POWERHOUSE**. Here are a few: 1. Great Structural Strength without tiring weight. Only 9 1/4 ounces in all! 2. Aluminum centre-post focusing gives you over 25 steady positions for sharp viewing. 3. Easy adjustment for close-up or far-apart eyes. 4. Crisp, modern design gives you easy, firm grip. 5. New streamlined model as illustrated in reduced size above. 6. Jumbo center wheel gives effortless focusing. 7. High luminosity gives you viewing even in moonlight.

Coated, Precision-Ground Lenses for Superb Viewing

The powerful lenses are the crowning achievement of the 99 year old firm. Far different, indeed, from the moulded plastic kind stamped

out by the million. Each and every lens is ground and polished to high tolerances, then skillfully **COATED!** This takes much longer, costs 20 to 30 times more! But it's worth it! You get **CRYSTAL-CLEAR** viewing. Your eyes don't suffer the strain of excessive distortion and ghost images so common in cheap binoculars. Were you to spend \$25.00, we could not give you better quality lenses!

Magic of American Dollar Makes This Value Possible

In less than 18 months **THORESEN** has sold close to 500,000 binoculars—making it the greatest importer of German binoculars in the world! This immense volume, plus the magic of the American dollar, enables us to buy at far less—sell for less! Get your **POWERHOUSE** now at our low introductory price of **4.98**, tax paid, including handsome leather case.

SEEING IS BELIEVING!

Try **Powerhouse** at **OUR** risk! One look thru the **POWERHOUSE** will convince you of its superb quality. That's why we want to send one to you on **FREE TRIAL** for 5 days. Use it on hunting or fishing trips. Use it at races—on trips—for bird watching. Always have a ringside seat at boxing matches! Then—if you don't think this is the **GREATEST** binocular value of the last 10 years, return it for full refund—no questions asked!

LIMITED OFFER! Order at once Only about 100,000 **POWERHOUSES** can be produced this year, due to the high manu-

facturing standards. To be fair to all, we are forced to place a limit of **ONE** binocular per reader. Send coupon today to ensure yours!

THORESEN'S

352 Fourth Avenue, Dept. 6-H-6, New York 10, N. Y. **CANADIANS:** Order direct from our Montreal plant: **THORESEN CO., 45 St. James St., West, Dept. 6-H-6, Montreal 1, Que.** Same price and guarantee. (No extra for Tariff.)

THORESEN'S, Dept. 6-H-6
352 Fourth Avenue, New York 10, N.Y.

RUSH 1 POWERHOUSE with leather case for 4.98, on 5 Day FREE Trial—Money Back guarantee.

4.98 enclosed. Send all charges prepaid.

Send C. O. D. plus postal charges

Name _____

Address _____

Town _____

State _____

CANADIANS: Save Tariff. Send orders to **THORESEN CO., 45 St. James St., West, Dept. 6-H-6, Montreal 1, Que.**

**WORLD'S
BEST
WANT AD
MEDIUM**

CLASSIFIED Advertisements



Advertisements in this section \$1.00 per word, each insertion, minimum 10 words, payable in advance.

To be inserted under proper classification, copy must be in our office the

20th of the second month preceding date of issue

F. W. Johnson, Manager, Classified Advertising

Popular Mechanics Magazine, 200 East Ontario Street, Chicago 11, Illinois

YOU'LL PROFIT

By reading and answering the classified ads in this section. Hundreds of opportunities for you to make and save money

AUTOMOBILES. MIDGET CARS

AUTO Owners law book \$1.00. Richmond Enterprises, Box 1003, Augusta, Ga.

SEND For your copy of Popular Mechanics How to Restore Antique and Classic Cars \$2.95 today! Learn the short cuts in automobile restoration with hundreds of photographs to help you. Book also contains interesting stories of old cars, etc. Send to Popular Mechanics Press, 200 E. Ontario Street, Chicago 11, Illinois.

FIBERGLAS Automobile bodies. Build your own. Lowest prices. 14 years plastic experience reflected in complete information catalog—10c. Gem-O-Lite, Box 6861A, North Hollywood, California.

FREE Motor magazines; automobile literature, old, new and foreign; glossy photos, dealer books, shop manuals—Offered with non-profit organization. Write today. Get on free mailing list. Auto Maniacs, Stockbridge, Mich.

HELP Send American built road racing cars to Europe. The A.R.R.A. will sponsor the construction of Grand Prix and competition sports cars to be run in major events in Europe, U. S., and Mexico. Just send \$1.00 for a comprehensive brochure outlining the program to establish American prestige in this field of sport. American Road Racing Assn., 1881-A Laurel Canyon Blvd., Hollywood 46, Calif.

200 MILES Oallon, average car. Make your own carburetor. Complete patent details plus comments. 29 page booklet \$2. Behling, Box 955, Dept. 1A, Inglewood, Calif.

HI-Mileage speed equipment from the world's largest supplier. Dual manifolds, finned heads, electric doors, lowering sets, fuel savers, thousands of items for all cars. Huge catalog, 25c. (Illustrated literature free). Wholesale to garages. Newhouse Automotive Industries, Los Angeles 22.

AUTO SUPPLIES AND EQUIPMENT

NEW And used parts at savings. Complete guaranteed parts service for all models cars and trucks, late or old. Largest in the west. Army parts specialists. No catalog—Write for quotations. Past mail order service. Pioneer Auto and Truck Parts Co., 734 W. 13th Avenue, Denver, Colorado.

NOW Enjoy strainless driving with Lazy Leg left foot accelerator designed for your driving comfort. Relieves leg and backaches. Easily installed in a few minutes on automatic or clutch shift cars. No interference with right foot accelerator. No alterations required. Transferable from car to car. A very useful accessory. Satisfaction guaranteed. \$3.95 plus 25c postage. Harris and Company, 249 Pequot Avenue, New London, Connecticut.

THIEF Chaser, 10 days free trial! Protect your car, tires and accessories from theft. Guaranteed for 20 years. Free literature. Novak Company, 3131 West 13th, Gary 81, Indiana.

AUTO Emblems, Masonic, many others, solid aluminum \$5.00 doz. Mail \$1.00 for (2) postpaid. Car burglar alarms \$24 doz. Sample \$2.00. Sales circular. High Ram Emblem Company, Box 335, Mission, Kans.

200 MILES Per gallon carburetor. Proven practical. Patented. Patent drawings and test data \$2.00. John Andre, Rocky Mountain House, Alta., Canada.

CARBURETORS — Fords, Chevrolets. Guaranteed. \$5.95 outright. Carbo. 10452 Magnolia, No. Hollywood, Calif.

SENSATIONAL Free trial offers! Surplus stock of famous Gale Hall automotive instruments, brand new, original cartons! Try at our risk for seven days, then return merchandise or send payment! Professional compression testers, originally \$10.75, now \$2.98! Terrific value—Combination vacuum gauge/fuel pump testers, originally \$8.10, now only \$3.09! Original Gale Hall motor condition/gasoline economy gauges for permanent dashboard mounting—Standard originally \$7.50, now \$2.98! Deluxe all-chrome custom foreign model, originally \$14.95, now only \$4.98! (Add 40c to each price for postage.) Order now! New England Surplus Sales, Dept. PM-8, Newburyport, Mass.

MAKE 500% Selling new 50c miles-per-gallon calculators. Introductory special 10 for \$1.00. Mrmco, 812 S. Ada St., Chicago 7, Ill.

3½ MILLION Cadillacs, Buicks, Olds, Pontiacs 1936 to 1950 use Spark-O-Liner to get new car smoothness, power, gas mileage. Only \$1.50 at all ignition jobbers. Free factory ignition bulletin shows how to install. Write Hove, 5606 Clinton, Minneapolis 19, Minn.

LACHAPPELLE'S 100,000 Miles treatment. For \$3.00, makes any gasoline better. Ferns Products, 8120-B Walnut Dr., Los Angeles 1, Calif. Free data.

POWERFUL, Compact gas turbine. See details under Engines, Motors, Dynamos.

DISTRIBUTOR'S Improvement increases engine performance. Literature. Centson's, 3333 Neenah, Chicago 34.

NEW Accessory stops headlight glare. Extra helpful in rain. Money back guarantee. Only \$2.95. Free literature. Olocar Light Controls Company, 126 N. Kensington, La Grange, Illinois.

CUSTOM Accessories headquarters. New summer catalog, just out, most complete ever. Jam-packed with items not in stores. New low prices. 25c. Eastern Auto, 3319-C South Grand, Los Angeles 7, Calif.

MOTORIST Save gasoline vacuumating overrich mixtures. For free particulars, how you install on your car for introducing, write Vacuumatic, Dept. 2084, Wauwatosa, Wis. Salesmen wanted.

BUY Wholesale nationally advertised auto supply, thousands other products at big discount. Free "Wholesale Plan." American Buyers', 629-DD Linden, Buffalo 16, New York.

DRIVE If ignition fails. Attach in minute. Easy, inexpensive. Plan 25c. Box 157, Goshen, Indiana.

NO More flat tires for you! Puncture-proof your tires in 5 minutes. Write: Spandco, 412-G Portland, Rochester 5, New York.

THOUSANDS Of readers have asked for it! Here is Build Your Own Garage. \$3.50 by Wayne C. Leckey. Choose from 25 different designs and build attractive and sturdy garage. Step-by-step instructions, photographs and drawings help. Order from Popular Mechanics Press, 200 E. Ontario, Chicago 11, Illinois.

"WHAMEE"—Just like a chamomile. New miracle non-woven fabric for automobile and household cleaning. 18x18. \$1.00 postpaid. "Whamee." Box 111, Cincinnati 25, Ohio.

BUY Wholesale direct. Nationally advertised auto supplies, 10,000 other items. Free "Wholesale Idea." National Buyers Service, Box 426ED, Oakland, California.

SPEED Equipment—Any car. Write Power, 327 W. 117th, Hawthorne, Calif.

END Oil changing! Refine your oil as you drive! Refinol antiquates all other oil filters. Free booklet on saving your car or tractor motor. International Refinol Company, 8848 W. 47th, Brookfield, Ill. "Chicago's technical suburb."

"OVER 200 Miles per gallon gas your car," claims inventor. Free information. Gane Economy Club, 8664 West Pico, Department PM7, Los Angeles 35, California.

SAVE Your life with amazing new "Torsion-Flex" Sway-Bilizers! Stops sway, skid, slide. Postal brings free illustrated literature, gift offer. Sway-Bilizer, 5434-A Higgins, Chicago 30.

AUTOMOBILE Accessories, for free trial! Write Neher Industries, LaVerne, Calif.

ELECTROPLATE Auto parts, novelties, mirrors. Easy, inexpensive home processes. Free booklet. Tyco Metals, Box 13231-BG, Houston 19, Texas.

BRUSH Plating outfits connect to a battery. No tanks or shop required. Free particulars. Gunmetal Co., Ave. J, Decatur, Ill.

CAR Burning oil? Losing compression? Try Clifford's Compression Seal. \$2 postpaid. Clifford's Engineering, 1329 Seventh, Aurora, Illinois.

FORD-T parts — Engine and chassis. Parts for other old models. Special parts made to order. B. S. Wisneski, Milwaukee 7, Wisconsin.

AUTO TRAILERS

BUILD Your own trailer! Plans for all kinds. Illustrated catalog 10c. Jim Dandy, 125-M, Wausau, Wisconsin.

ASSEMBLE Yourself. Trailer kits. Pick-up coach kit. Blueprints. Literature 10c. Comstock Trailers, 585-K, Parsons, Kansas.

EXCEPTIONAL Expanding eight foot trailer. Accommodates family of five. Build yourself. Literature 10c. Fra-Mar Company, Jones Avenue, Wilmington, Mass.

TRAILER Building. Illustrated, 20c. Craftsmann Books, Box 1153, Milwaukee 1, Wis.

MOTORCYCLES. BICYCLES. MOTORSCOOTERS AND SUPPLIES

SIDEWALK Automobile \$25.00; Cushman motorscooter \$25.00; Whizzer motorbike \$25.00; 1954 motorscooter \$40.00. Rush 25c (35c first class mail) for new catalog #956 listing many other amazing bargains in motors, midget cars, motorscooters, motorbikes, construction plans. Associated, Box 534, Toledo, Ohio.

HARLEY-DAVIDSONS — America's best used buys! We pay shipping on motorcycles. Genuine new, used, parts, accessories for current and obsolete models. Send 25c for bulletin, catalog. Knuth's (Harley-Davidson factory dealer), 1753 Muskego, Milwaukee, Wis.

RECONDITIONED Motorcycles and motors. Chrom. m. acc. stores. Complete stock Indian parts. E. part rebuilding. Fast service. Indian Motorcycle Sales, Kansas City 27, Mo.

SMITH Motorwheel \$15. Maytag twin engine \$5, garden tractor \$10. Check motorcycle \$35. Service \$35. (Mailorder only.) Send 25c for Directory Number 60, just out, listing these and hundreds of other bargains in new and used midget cars, motorscooters, engines, parts, plans for homebuilders, etc. (35c by first class mail.) Midget Motors Directory, Athens, Ohio.

AVIATION

FLY As a steward-purser. Work but 85 hours a month, starting salary \$235 up. G. I. approved, free catalogue, Air-Purser School, Room L, 1030 Nicollet, Minneapolis, Minnesota.

PROPELLERS, Plans, kits for snow sleighs, air boats. Immediate delivery, satisfaction guaranteed. Catalog 25c. Banks-Maxwell, Box 3301E, Ft. Worth, Texas.

BUILD A helicopter jet engine yourself! "Practical Ram Jet Design"—\$1.00. Decker Engine Works, Dept. PM, Plasterco, Va.

LIGHTPLANE Circular, illustrated, 20c. Craftsmann Books, Box 1153, Milwaukee 1, Wisconsin.

PROPELLERS, Plans, supplies for air boats, snow sleighs. Literature, Gano Propeller, Box 3284A, Ft. Worth, Texas.

FREE: Monthly aircraft, electronic, gadget list. Dick Rose, Everett, Wash.

BATTERIES, GENERATORS

EDISON Nickel odorless storage batteries 12 to 600 ampere hour. Any voltage. Long guarantee. Literature, Hawley Smith Co., Croton Falls 1, N. Y.

ELECTRICAL SUPPLIES

MAGNET Wire, varnish, insulation. Electric Motor Service, 308 Delaware, Mason City, Iowa.

LAMP Supplies — Wholesale. Any amounts. All parts for repairing and building lamps. Catalogue 15c. Brown Lamp Co., Box 501-Wellston Sta., St. Louis 12, Mo.

LAMPS—25c Brings bargain catalog showing all parts for repairing, building. Contains instructions for electrifying vases, oil lamps, etc. Gyro Lamps, 5402P Clark, Chicago 49.

WELDING, SOLDERING, PLATING

"BUILD-UR-OWN" a.c. welder and a.c. power plant with a good used engine and low cost Hobart generator. Welds anywhere and supplies 5kw stand-by power for any emergency. Write Hobartweld, Box M-843, Troy, Ohio.

A.C. Welders, four sizes. Lowest prices. Free literature. Holgeron's Service, Canton, Kans.

ACETYLENE Welding outfits, new \$49.00; used \$39.00. Arcwelders \$49.50. Eagle Welding, Dept. PM, 5085 Broadway, Chicago 40, Ill.

ELECTRO Plating equipment—New and used. Complete assemblies. All sizes for all types of plating. Baby shoe metalizing sets. Mounts, supplies, instructions. Free catalog. Hollywood Bronze Supply, 1624-C E. First Street, Los Angeles 33, Calif.

MACHINERY, TOOLS, SUPPLIES

STARTLING Discovery reveals traditional illusion. Now machinists chase perfect fitting threads without trying on copposites. Geometrically illustrated booklet, two dollars. Address Threads Formula, Orrville, Ohio.

BIG Factory catalog! Buy direct—Save middleman's profits; hundreds of labor saving tools and equipment; tremendous savings. Send 10c. Master Mechanic Mfg., Dept. CL-29, Burlington, Wis.

SENSATIONAL New all steel wood-working lathe, 3" swing, 12" centers, \$9.95 prepaid. Circular, B. M. Sypher Co., 210 Cherry, Toledo, Ohio.

NEW Electric drills and saws. 1/4", \$11.75 and \$15.75; 1/2", \$30.75; 6 1/4" tilting arbor \$39.95. Prepaid. Wilt Surplus, 7829 Racine, Chicago 20.

ALLEN One ton power bench type punch press. \$97.50. Circular, Allen, Dept. PMB, Clinton, Missouri.

SHEBEL Saw filler. Files all saws. Circular, A. P. Shebel, 730 S. 2nd St., Milwaukee 4, Wis.

ENGINES, MOTORS, DYNAMOS

WINDING Data, 225 motors, single and three phase, \$1.00. Data Company, Box 7631, Kansas City 26, Mo.

INVALUABLE Motor winders handbook, simplifies complicated reconnecting. \$4.98. Jeonak, Clinton, Penna.

REBUILT Gasoline engines \$17.00 to \$27.00. Cauffield Motor Industries, Temperance, Michigan.

GAS Turbine — Ideal for boats, sports cars, or any other application where a high h.p. to weight ratio is desired. This engine is of the axial flow type, the same as used in the world's fastest aircraft. All excessive bulk and weight has been eliminated. Components have been engineered, so that the engine may be built entirely in the home work shop. Specifications: 50 h.p. @ 6800 r.p.m., turbine to output ratio 4:1, 3/4" diameter output shaft, maximum diameter 1 1/2", length 20", weight 40 pounds. For a complete set of tenzloy castings, plus complete assembly and detailed drawings, send \$16.50. Treco Products, 1364 Woodland Hills Dr., Atlanta 5, Ga.

A.C. Generators, 750 watt \$38.50. Twin cylinder compressors with 1/2 horse \$22.50. Motors, 1 horse \$37.50. Butler, 1885 Milwaukee, Chicago 47.

BOATS, OUTBOARD MOTORS

SEA Legs boat kits, prices from \$39.00. Complete kits, including brass wood screws, precut parts, pre-assembled frames, fool-proof illustrated instructions. Write for free literature, Penney Woodcraft Industries, Dept. C-21, Defiance, Ohio.

CONVERT Fords and Jeeps to 100% marine engines with Osco's world famous Convo-Kits, Deluxe catalogue 50c (coin). Oscomotors, 3627B Lawrence, Philadelphia 40, Penna.

BOAT Patterns. Literature and illustrated boat construction book 50c. German Boat Company, West Saginaw, Mich.

BOAT Kits. Build your own boat. Easy to follow instructions. Literature free. Paramount Boat Company, 2202 N. Prairie, Joliet, Illinois.

SIMPLIFIED Boat plans for amateurs. Outboards-inboards, 12'-22'. New 19' outboard cruiser sleeps four. Glen Designs, Box 568, Compton, California.

OUTBOARD Motor, 4 h.p., \$99.50. Chain saw, complete kit, \$169.50 guaranteed. 3 h.p. 20" chain. Assemble yourself. Save. Preston Trail Blazer Products, Box 5142, Grosse Pointe, Michigan.

AIR Boat plans, supplies, catalog 25c. Banks-Maxwell, Box 3301F, Ft. Worth, Texas.

BUY Wholesale nationally advertised outboards, thousands other products at big discount. Free "Wholesale Plan." American Buyers', 628-DD Linden, Buffalo 26, N. Y.

FIBERGLAS Permanent boat coating. Lowest prices. 14 years plastic experience reflected in complete information catalog—10c. Gem-O-Lite, Box 6861B, North Hollywood, California.

FULL Size, cut-to-shape boat patterns, blueprints, 7 1/2-38 feet. New 1954 illustrated "Build a Boat" catalog of 50 naval architect-designed cruisers, runabouts, sloops, skiffs, outboard boats, sailing, racing, houseboats. 50c. Marine hardware catalog \$1.50. Bigger, better 1954 "How to Build Boats" book, \$2.50. PolyWog Houseboat Plans, \$12. Cleveland Boat Blueprint Co., Dept. A-66, 9400 Steinway, Cleveland 4, Ohio.

FIBERGLAS Your boat for permanent waterproofing. Easily applied. Complete instructions. Guaranteed materials. Wholesale prices. Complete kits \$12.60 up. Free lists. Ajax Plastics, Dept. PM, P.O. Box 1323, Ft. Worth, Texas.

MARINE Conversions for Ford and Jeep engines. Catalog 10c. Lehman Manufacturing Company, 972D Broad Street, Newark 2, New Jersey.

NEW, Used, rebuilt marine motors. Marine conversions, fittings. Free catalog. Stokes Marine Supply, Dept. 24, Coldwater, Michigan.

BUILD Marine engines with Federal conversion kits. Federal Marine Motors, 9011 Cottage Grove Ave., Chicago 19, Illinois.

FREE Catalog! Boat kits, trailers, fiberglass, marine hardware. Lager Industries, Dept. KD, 3207 Fremont South, Minneapolis, Minnesota.

JOHNSON Outboard specialists. Used parts for all models at substantial savings. Prompt quotations. Specify model serial. Crandall-Hicks, 910 Commonwealth, Boston, Mass.

ATHLETIC EQUIPMENT, BODY BUILDING COURSES

FRENCH Briefs, Zebra or leopard. \$3.00. Maribill, Box 32, Garland 6, Texas.

GREAT Strength easily obtained. See page 42, Popular Mechanics, May issue 1954.

SPORTING GOODS, GUNS, FISHING TACKLE, ARCHERY, TRAPPING

AIR Mattresses, sleeping bags, tents (direct from manufacturer), camping equipment. Low prices. Send 10c for 72 page illustrated tent-camping equipment-tent maintenance catalogue. Mor-San Sales, 10-21R 50th Avenue, Long Island City 1, New York.

IMPORTED, Daggers, stilettos, throwing, pocket, hunting knives, etc. Free catalog. J. D. Clinton, 94 Church, Mt. Clemens 2, Michigan.

ELECTRIC Prod; 110v. electrode brings nitracrawlers to surface without digging. \$2.00 postpaid. Instructions included. Sportshop, Osage, Iowa.

FREE Fishing catalog—132 pages. Over 3000 hard to find fishing specialties. Netcraft Company, Dept. PMS, Toledo 13, Ohio.

STOP Rust — Famous "Dichanite" now available. Simply sprinkle in gun cabinets, tackle boxes, lockers. Details free. Foley Engineering, Box 348, Montclair, N. J.

SAVE 50%. Finest bows, arrows, complete bowhunting outfits, etc. Free catalog and "How to Select Bow" booklet. Write: (Send 25c for "How to Bowhunt" booklet if desired). Malibu Archery, Los Angeles 5, California.

SPRAY Ground, pick up worms. Instructions plus 100 assorted books. \$1.00. Box 271, Ballston Spa, N. Y.

SEMI-Finished bows, lemonwood, bamboo-backed osage, laminated bamboo; target and hunting arrows; catalog. Jim Deeds Archery, 5151 Branciforte Drive, Santa Cruz, California.

SWIMMERS! Send \$3.95 for imported French mask. Skin divers' catalog 25c. Aquafun 7, Davenport, Iowa.

CALL Elk, deer, coyotes, foxes, etc. Original Animal Calls, Burley, Idaho.

BUY Wholesale nationally advertised sporting goods, thousands other products at big discount. Free "Wholesale Plan." American Buyers', 627-DD Linden, Buffalo 16, N. Y.

RIFLES Built to order. Your action or mine. Prices. Illustrations. Kenneth Clark, Madera, California.

CATCH Plenty fish! Newly discovered formula works wonders! Details 50c. Returnable. Revealer, 1749 Gr. Concourse, New York 53.

HELPFUL Hints for fishermen, hunters, campers, trappers, archers and boatmen, with Outdoor Sports Manual. Published by Popular Mechanics Press, \$2.00. Send for your copy today! Popular Mechanics Press, 200 E. Ontario St., Chicago 11, Ill.

CATALOG On government surplus from country's largest surplus organization specializing in outdoor, sporting goods, clothing, camping equipment. Hundreds of items including tents, rubber boats, tarpaulins, swim fins. Only 10c! Rockaway Sales Co., Dept. PM, Route 46, Rockaway, New Jersey.

JAP And Mauser military guns make fine hunting rifles. Do it yourself in your spare time. Save money. Complete easy to follow instructions only 10c. Fajen's, Warsaw, Missouri.

MOLDS For fisherman's sinkers, jigs, squids, casting and spinning lures. Free catalog. Sweet's Molds, Tonawanda 1, New York.

HOLLOWGLASS Fishing rods. Save over half. Buy complete kits. Casting, spinning, fly and boat. \$4.95 to \$7.95. Assemble yourself. Full instructions. Makit Rod Company, Dept. PM, 429 Fulton, Ft. Worth, Texas.

JAP Rifle altering to 30-06, \$6.00. Catalog 5c. T. P. Shop, West Branch 11, Mich.

5000 BARGAINS. Firearms, binoculars, war relics. Catalog 50c. Smith Firearms, Rummelme, N. J.

180 PROFUSELY Illustrated pages antique pistols, swords, daggers, armor, etc. 50c. Robert Abels, M860 Lexington Ave., New York 21.

CAST Iron molds—For casting fishermen's sinkers. Free illustrated booklet. Reading Instrument Co., Box 78, Reading, Penna.

DIVING Equipment for spear fishermen, skin divers and professional divers. Send 25c for catalog. Desco, 234 N. Broadway, Milwaukee 2, Wis.

BINOCULARS, TELESCOPES, MICROSCOPES, MAGNIFIERS

GIANT 100X completely assembled day and night telescope. Steel and brass tubing construction. Heavy hardwood tripod. Two eyepieces. Helioscope instructions. \$7.95 f.o.b. factory. We originate. Others copy. Established 25 years. 400X telescope makers lens kit \$3.95 postpaid. Free literature. Carl Jamer, Manorville 1, N. Y.

AMAZING Prices, binoculars, telescopes, microscopes. Free trial. Folder, "Binocular Selecting," catalog free. Dealers wanted. Rentiss Importers, Mercury Bldg., West Los Angeles 25, Calif.

DYNASCOPE—New sensational reflector telescope 65X-130X-167X, 4 power finder, fully achromatic, 5 foot tripod. Complete ready for use. Send for details. Criterion Mfg., Hartford, Conn., Dept. DP3.

WAR Surplus bargains! Millions of lenses, instruments, telescopes, binoculars, components! World's greatest optical market place! Send only \$1.00 for beginner's 10-lens kit and big instruction booklet, stock CH. Write for catalog CH free! Edmund Scientific Corp., Barrington, New Jersey.

SPECIALISTS. Used, new microscopes. Prepared slides. Supplies. Free catalog. Nassau Optical, 9 W. Greenwich, Roosevelt, New York.

GIANT 100X telescope completely assembled with two eyepieces and extra heavy tripod. Steel and brass construction, \$7.50. Other telescopes at \$12.00 and \$16.00. Free information. 400X telescope makers kit contains brass focusing tube, erector, 5 lenses and instructions. \$3.75. Suffolk Science, Mattituck 3, N. Y.

BINOCULARS. Telescopes, microscopes. Terrific values \$3.98 up. Request free money saving catalog. Criterion, Hartford, Conn., Dept. P24.

REFLECTOR Telescope kits from \$6.25. All parts designed and built at our Hoboken factory. Mirror cells, diagonals, focusing mounts, tripods, tubing, oculars. Fully guaranteed. Free illustrated catalog. Easy time payments and lay-away plan available. Send orders and inquiries to Esco Products, Dept. PM-2, 1428 Willow Avenue, Hoboken, N. J.

SAVE 25%! Get interesting facts. Free 52 page binocular, telescope catalog. \$3.95 to \$250.00! United, 9043 S. Western, A-7008, Chicago 20. Dealers wanted.

LOWEST Prices, all sizes binoculars, telescopes, microscopes, EX30 \$32.00. Free catalogue. Joe's Binocular Sales, 4827 Second Blvd., Detroit 1, Michigan.

TELESCOPES, Microscopes, binoculars for quarter century. Big bargain scientific catalog 10c. Harry Ross, 70 West Broadway, New York 7, N. Y.

SPECIALIST. Used, new microscopes. Prepared slides. Supplies. Telescopes. Free illustrated catalog. Nassau Optical, 9 W. Greenwich, Roosevelt, New York.

REFLECTING Telescopes, 60X, completely assembled \$29.75. Guaranteed observatory clearness. Free information. Skyscope, 475 Fifth Avenue, New York 17.

MAKE 6" Telescope reflector. Glass, abrasives, instructions—\$10.50. F. Cameron, Box 65, Inwood 96, N. Y.

PETS—DOGS, BIRDS, RABBITS, HAMSTERS, ETC.

MAKE Money raising chinchillas, cavies, rabbits for us. Free information. Keeney Brothers, New Freedom 2, Penna.

GUINEA Pigs. Marketing agreement. Booklet free. Taylors, 426A, Hapeville, Georgia.

CHINCHILLAS. Profitable business operated in cellar or spare room. Quality registered stock. Guaranteed. Delivered personally. Full care instruction. Stewart Chinchilla Ranch, Washingtonville, N. Y.

HAMSTERS—Golden; young, \$4.00 pair, fully developed, \$5.00 pair. Adirondack Hamstery, Prospect 28, New York.

CHINCHILLAS—Registered. Guaranteed reproduction. Unbelievable price. Par-West Chinchilla, 1446-A Jones, San Francisco 9, California.

CHINCHILLAS Prove delightful way for extra income. Healthy registered stock available. Reasonable prices. Tashmoo Farm, Vineyard Haven, Massachusetts.

FOR Sale, 30 graded chinchilla. Best offer accepted. Box 1316, Southampton, L. I., N. Y.

GOLDFISH Die? Stop replacing them. Scientific routine with complete instructions in manual "Keep Your Goldfish for Years"—\$1. James Trebel, 653 Wrightwood, Chicago, Illinois.

CHINCHILLA Raising pays amazing profits! Our plan makes it easy. Our guarantee protects you. Free booklet explains all. Witsner Chinchilla Ranch, Dover 3, New Hampshire.

RAISE Rabbits. Cash income. Booklet free. Tayco Rabbitry, Hapeville, Georgia.

HAMSTERS—Breeding, pets. Golden \$4 pair, albinos \$17.50 pair. Combs, Rural Hall, N. C.

WILD Animals, birds, reptiles. Mowrer's, 1421 St. Louis, Springfield, Missouri.

ANGORAS, Chinchillas, White Giants. World's most profitable rabbits! Catalog free. Grinstead's, Edwardsville, Illinois.

HAMSTERS — Retail and wholesale. Prices free. Anderson's Hamstery, 35 Oneida, Pontiac, Michigan.

BEAUTIFUL Pure white pedigreed police puppies. Ansonia Kennels, Mose, N. Dak.

MINK — Easily raised anywhere. Top quality breeders. Free information. Huebl Minkery, LeSueur, Minn.

RAISE Moneymaking Angora, New Zealand rabbits. Particulars free. White's Rabbitry, Jackson, Mich.

STANDARD Rabbit Journal, Milton 3, Penna. Year \$1.00. Sample dime. Beginners manual 25c.

GROW Mushrooms. Cellar, shed, and outdoors. Spare, full time, year round. We pay \$3.50 lb. We paid Babbitt \$4,165.00 in few weeks. Free book. Washington Mushroom Ind., Dept. 171, 2954 Admiral Way, Seattle, Washington.

MAKE Big money! Raise Chinchilla rabbits. Cash markets supplied. Write today! Rockhill Ranch, Sellersville 15, Penna.

MINK Raising information free. Complete. Lake Superior Mink Farm, Superior, E.E.I. Wisconsin.

CHINCHILLAS (No rabbit.) Easily raised anywhere. Profitable. Big future. Terms. Hibner Chinchillas, Ithaca, Mich.

FARMS, FARM LANDS, REAL ESTATE

MAKE Big money in marvelous Houston, America's fastest growing city. Buy guaranteed homesites in beautiful suburb. Special price \$345. Terms. Fine investment. Booklet free. Preston Wood, Box 413, Houston, Texas.

FARM And business catalog free! Big edition. Hundreds of bargains from \$1000 up. Maine to Florida. West's, M-8, Pittsburgh 17, Penna.

COLONIAL Home, 10 rms., in town, \$8,000.00. Sam L. Bigford, Earville, N. Y.

STROUT Realty catalog mailed free! Farms, homes, businesses, 34 states, coast-to-coast, 3240 bargains described. World's largest; 54 years service. Strout Realty, 7-M So. Dearborn St., Chicago 3, Ill.

\$5.00 MONTHLY Buys 40 acres productive land; near town. Price \$240.00. Free list. Box 425-P, Carthage, Mo.

FARM-Ranch opportunities. Favorable conditions. Washington, Minnesota, Montana, Idaho, Oregon, North Dakota. Literature, farm descriptions. Specify which state. J. W. Haw, 119 Northern Pacific Ry., St. Paul 1, Minn.

HOMESITES \$400 — Convenient payments. California's finest garden section. On Morro Bay's scenic shores. Wonderful fishing, boating, bathing. Fertile soil, softest water, temperate climate, congenial community. Free literature. Richard Otto, Department M, San Luis Obispo, Calif.

GIANT Listings free. Timber, grazing, retirement, etc. Address — Armstrong, Shock, Missouri.

FREE California ranch land catalog. \$10 to \$25 acre. Easy terms. Write Pacific Lands, 1621BW, Cahuenga, Hollywood 28, Calif.

PLANTS, SEEDS, NURSERY AND GARDEN SUPPLIES

GROW Miniature trees. "Banza" method exposed. Complete simplified instructions \$1.00. Returnable. Refeater, 1749 Gr. Concourse, New York 33.

PROFITABLE OCCUPATIONS

WANT A diesel job? New opportunities to increase income? Higher pay. More money. We can help you qualify. Tools. Shop method home training. Write today! Diesel, Tractor, Heavy Equipment Division, Interstate Training Service, Dept. B3H, Portland 13, Oregon.

FREE! "301 Profitable Small Businesses!" Amazing shoestring plans! Work home! Start sparetime! Deumant Surveys, Kenmore 23-R, N. Y.

MAKE Flexible molds. Cast figurines, plaques. Free sample. Tooker, 630-M Chestnut, Hamilton, Ohio.

CANADA. Big projects now underway. For information send \$1.00 to Box 116, Station B, Hamilton 1, Ontario, Canada.

"LATEST Copyrighted Reports!" Who to contact for highest paying jobs in over 38 countries, including U. S., Spain, South America, Alaska, Europe, Africa, Canada, etc. Listings of employers with contracts who hire skilled, unskilled, professional, supervisory, clerical, trades, laborers, many others. Pay up to \$1550 monthly. Also best oil, aviation, mining opportunities. Only \$2. Airmail \$2.25. (C.O.D.'s accepted). Includes one year registration and advisory service. Application forms. We can help you find employment. Only service with unconditional guarantee of satisfaction or money back. Immediate service. International Reporter, Box 1047-PF, St. Louis 1, Missouri.

SELL Popular Mechanics and all other magazine subscriptions. Free catalog, supplies. Subscription Service Company, Dept. B, P.O. Box 2070, Birmingham, Alabama.

MAN Wanted—Are you dissatisfied with your work? Would you like a business of your own? If so, write Rawleigh's, Dept. H-GG-PPM, Freeport, Ill.

PROFITABLE Hobby-books. List free. Shonback, 2737 Clement, San Francisco 21, California.

MERCHANT Marine opportunities! Complete information and employment guaranteed. Instructions \$1.98. Satisfaction guaranteed. Seaways, Box 1231M, Baltimore 3, Md.

HOME Mailorder beginners. Sources, methods, instructions. Details free. Carnahan Bros., 5582-A Nelson, Cypress, Calif.

WELDING Pays big money. Learn easily at best equipped school in country. Non-profit school with low cost training. G. I. approved. Write Hobart Trade School, Box M-842, Troy, Ohio.

FOREIGN-U.S. Jobs. So. America, Alaska, Spain. Fare paid. 1000's U.S. jobs to \$18,000. Trades, office, factories. Send stamped self-addressed env. Job Opportunities, Waseca, IG, Minn.

"HOW To Make Money With Simple Cartoon"—A book everyone who likes to draw should have. It is free; no obligation. Simply address Cartoonists' Exchange, Dept. 98CP, Pleasant Hill, Ohio.

CATERING Course. 20 lessons. \$5 a lesson. Parks Catering, 1618 Rhode Island Ave. N.W., Washington 6, D. C.

\$1300.00 MONTHLY For truck drivers, \$1400.00 monthly for carpenters, electricians, plumbers, mechanics, \$1200.00 for clerks and laborers. Replacement hiring now being done. Full information and complete foreign listings, with current information on Spain, Korea, Australia, Alaska and Canada. \$1.00. 10,000 men and women needed for new stateside project! Complete information and other domestic listings, \$1.00. Dept. 3-H, Opportunities Unlimited, 1110 Commerce Bldg., St. Paul, Minn.

BUY Wholesale thousands nationally advertised products at big discount. Free "Wholesale Plan." American Buyers', 628-R Linden, Buffalo, N. Y.

LATEST Employment information Greenland. Interest rehers. Spain, Alaska many others listed. \$1.00. Foreign Job Information Service, Box 657, Minneapolis, Minnesota.

TRADE Publications offer biggest profits. Also R.F.D. deals. Trade Press, 3119 Troost, Kansas City 9, Missouri.

MAGAZINE Subscriptions. Highest commission, bonus. Qualified Publications, 451-GL Kingston, Brooklyn 25, N. Y.

START Your own wholesale business with name brand appliances, watches, giftware. No investment. Big profits. Free "Wholesale Buying." National Buyers Service, Box 428EA, Oakland, California.

EVERYBODY Likes candy. Learn to make professionally. Our 44th year. Ragsdale Candies, D6, East Orange, New Jersey.

MEN Wanted now for foreign construction employment on American bases in Europe, South America, Far North and other countries. Truck drivers, \$3.55 hour. Clerks, \$3.00 hour. Carpenters, \$3.70 hour. Laborers, \$3.00 hour. Many other trades wanted with wage rate accordingly. Up to 70 hour week with time and one half for all over 40 hours. Transportation paid. \$ to 24 month contract. Also jobs with ship, oil, mining, aviation firms and construction jobs in U.S.A. with wage rate in 71 of the larger cities. Full information of all firms hiring, jobs open, wage rate, sample contract, medical examination, application form, etc., air mailed to you for only \$2.00. Foreign Construction Bulletin, P.O. Box 393, Dept. 20, Dallas, Texas.

SIGN Painting pays amazing profits. You do professional work using "All-In-One" master letter patterns. Windows, buildings, trucks, banners, cards, cutout letters. Complete set 1 1/2" to 12" with instructions \$1.00 prepaid. Eyerly Co., B-583, Newton, Iowa.

FREE Folio describing "\$45,000; Unlimited Vacations Plan." No canvassing, mail-order, merchandise, equipment. Unknown. Works itself—home! Keep job. Haylings, Carlsbad, Calif.

RAISE Pheasants on \$100 week plan. Little capital and space can make you independent. Free details. Great Central System, Columbus 1, Kansas.

FOREIGN, Latin American, domestic employment. 1954 "Foreign Service Directory" originator of job news by copyright, gives up-to-minute facts on military and civilian construction; Canadian, Alaska construction; major oil companies; aviation; manufacturers; steamship lines; mining; importers-exporters; how-when-where to apply with application form. Free—Hot list firms hiring. \$1.00 postpaid. Global Reports, Box 883-P, Hollywood 28, Calif.

GROW Mushrooms. Cellar, shed, and outdoors. Spare, full time, year round. We pay \$3.50 lb. We paid Babbitt \$4,185 in few weeks. Free book. Washington Mushroom Ind., Dept. 99, 2954 Admiral Way, Seattle, Wash.

BE The Popular Mechanics representative in your neighborhood and earn big profits in your spare time. Write Popular Mechanics Magazine, Room 408M, 200 E. Ontario St., Chicago, Ill.

FREE Book "505 Odd, Successful Businesses." Work home. Expect something odd! Pacific, Oceanside, Calif.

BOOKS, PERIODICALS, PICTURES, POSTCARDS

BIBLES. King James, revised. Douay, 100 styles and bindings. Bible Store, 299 Central, Yonkers, N. Y.

TWENTY Cards beautiful Washington thirty cents. Guy Hornsby, Box 123, Washington 4, D. C.

"FEMME Mimics"—Amazing book, containing 375 photographs. About men who wear women's clothing! Free literature. Winco, Dept. PM81, Box 9525, Dallas, Tex.

BOOK Catalogue, 1000 bargains, send 10c. Books Publishers, Amityville 3, N. Y.

FREE Giant Popular Mechanics 32 page book catalog! Many books to choose from. Send name and address to Popular Mechanics Press, 200 E. Ontario, Chicago 11, Ill.

WORLD'S Smallest Bible 50c, 3 for \$1.00, 224 pages. Anderson, 327 Devon St., Kearny, New Jersey.

ILLUSTRATED Comics, 24 all different \$1. Terrific illustrated stunts and tricks 50c. Aladdin Book Co., 210-PM Fifth Avenue, New York 10.

SPARETIME Profits taking subscriptions, all magazines. Wholesale catalog free. Cassell Agency, Westfield 2, New Jersey.

NATIONAL Geographic Magazines, 1888-1952. Periodical Service, Box 465-PM, Wilmington, Delaware.

BOOKS Found! Any author, old or new. Rush titles wanted; no obligation. International Bookfinders, Box 3003-PM, Beverly Hills, California.

BOOKHUNTERS! All subjects. Send wants! Jaher Book Service, 620-P East 178 Street, New York 57.

MAGIC TRICKS, PUZZLES, JOKER NOVELTIES

VENTRILLOQUISM Easy to learn in 60 to 90 days! Home study course! Results guaranteed. For free information write stating your age. Dummy catalog 25c. Fred Mahler School of Ventriloquism, Box 36, Studio PM-8, Kensington Station, Detroit 24, Michigan.

FREE Magic and novelty catalog, includes 14 wonderful magic tricks fully illustrated and described. Read all about our free gift offer. Chicago Magic Center, PM-8, 19 W. Randolph St., Chicago 1, Ill.

VENTRILLOQUIAL Dummies, courses, scripts, monologues, etc. Catalogue and illustrations \$1. (Deductible first order). Gough, 218 N. Jefferson, Hartford City, Ind.

E-Z Magic catalog with surprise gift 25c. Eastern, P.O. Box 63, No. Westport, Mass.

LEARN Ventriloquism. 3c stamp brings particulars. Smith, 801 Bigelow, Peoria 5, Ill.

FREE Catalog. Best magic. Practical jokes. Top Hat Magic, Evanston, Illinois.

FREE Lists, magic tricks, novelties. Marean Magic Shop, Hopewell 3, Va.

FREE Bag full of amazing tricks. Send dime for handling. Starling Co., 2206M Starling Ave., New York City 62.

NEW Illustrated catalogue of new club, parlor, pocket and stage tricks 25c. Mimeographed catalogue 10c. New joke lists 5c. Eagle Magic, Minneapolis 2, Minn.

WE Supply every noted magician. Large professional catalog \$1.25. Holden's, 120 Boylston Street, Boston, Mass.

500 TRICKS, Douglas famous 120-page catalog, only 10c. Fastest service to magicians for 30 years. Send 10c today. Douglas Magician, Dept. 1, Dallas, Texas.

2500 TRICK Catalogue (512-pages), pocket, parlor, stage. World's finest magic. Catalogue \$2.00 (dollar trick included free). Kanter's, M-1311 Walnut, Philadelphia 1.

PROFESSIONAL Catalog, 175 pages, 25c. Williams, 900 Plymouth, Ellwood City, Penna.

COINS, TOKENS, CURRENCY

OLD Money wanted. Do you know that coin collectors pay up to \$100 for certain U. S. cents? And high premiums for all rare coins? We buy all kinds. Send 4c for large coin folder. May mean much profit to you. Numismatic Co., Dept. 20, Fort Worth, Texas.

LARGE \$1 Bill \$2.50; new \$3.95. Beautiful Pony Express medal 75c. Giant bargain catalogue 25c. Bebee's, 4514 Noth 30th, Omaha 11, Nebraska.

FOREIGN Coins, twenty different each from a different country, \$1.00 postpaid. Webb, 330 Gough, San Francisco 2, Calif.

AN 1804 Silver dollar is worth \$12,500! What are your U. S. coins worth? Fell's new 1954 U. S. coin book. Everything on every coin minted—worth, selling, speculating, investment, etc. Clothbound, profusely illustrated. Send no money. Pay postman \$2 (plus postage) or send \$2.00 (postpaid), refundable. Fell Publishers, 386-M-5 4th Ave., New York City 16.

100 DIFFERENT Bills \$1.00. Grady Berry, 1705 Cobb Street, Columbia 4, S. C.

JAPANESE Invasion notes 1c to \$1000.00 set \$1.00. 100pp. illustrated coin catalogue, 25c. Shultz, Salt Lake City 10, Utah.

FREE! Foreign coin, banknote and coin collectors illustrated catalog to approval service applicants. Send 3c postage. Tatham Coinco, Springfield 30, Mass.

INDIAN Cent with bargain lists 10c. Hutchinson, 3483 "T" Street, Philadelphia 34, Penna.

GET Profit and pleasure in collecting old coins. Send 10c for 56-page illustrated coin catalog. You'll be delighted with it. Send for it now. B. Max Mehl, 370 Mehl Building, Fort Worth, Texas. Largest rare coin establishment in U. S. Established 54 years.

CONFEDERATE And Southern bank notes, 3 different, \$2.00, 50 mixed Indian pennies, \$2.00. Ben's Coin Shop, 31 N. Clark, Chicago 2.

WORLD'S Greatest magazine for coin collector's and wooden nickel 10c. Lawrence Brothers, Anamosa, Iowa.

COIN Collector's Magazine. Over 1000 pages per year. Sample copy 30c; \$3.00 per year. Hewitt, 7320-J Milwaukee, Chicago 31.

U.S. Large cent, 2c, 3c all for \$1. Bargain list included. Delmaco, Box 1123, Wilmington, Del.

UNITED States Rare Coin Value Guide, 48 pages 50c. Fortunes in rare coins. Ideal, 4644-P Geary, San Francisco 18, California.

STAMP COLLECTING

UNITED States introductory special, all for \$1.00. Superb mint, complete flags, Roosevelt, Cipex sheet. Adults only. Give age, employment. Approvals accompany. Merritt Brundige, Cambridge, N. Y.

WONDERFUL! Numerous flowers, birds, fishes, butterflies, 200 stamps, triangles, etc. Everything 10c with approvals. H. Howard, 5400 7th St. N.W., Washington 11, D. C.

SENSATIONAL! Set each Honduras, Martinique, Guadeloupe, Guiana, also \$2.-000.00 stamp. Brunel, over 100 different others. Everything 10c with approvals. Whitehead, 315P South 5th Ave., Canton, Illinois.

BARGAINS Galore! Ask for "Stamps of Quality" price list today. Elholms, 821 Hayes, Racine, Wisconsin.

U. S. Illustrated price list free. Lush, 6422 Ellsworth, Detroit 38, Mich.

100 JAPAN 10c. All different, with approvals. Gould's Stamps, Box 631, San Francisco 1, California.

WEST Indies, French Africa, over 100 others, only 10c! Approvals included. Cole, 43-A Rinewalt, Buffalo 21, N. Y.

LEOPARD, Antelope, eland, plus worldwide packet, free to approval buyers. Conquistador, 2627B Troy Road, Schenectady 9, N. Y.

96 PAGE Illustrated United States price list, 10c mailing cost. DeLisle, #69 Plaza Shopping Center, Fresno 1, Calif.

CHRISTOPHER Columbus mint bi-colors. Be first to get this beautiful set honoring the discoverer of America. This plus another navigator set of mint multi-color stamps from St. Thomas and Principe for only 10c to approval applicants, U. S. or foreign. Clark Stamp Co., Dept. A-43, Muskegon Heights, Mich.

GREATEST Free offer—Croatia exile government air set; gorgeous birds, natural colored triangles. Also albums, supplies. All to our approval buyers. Bell Stamp Service, Dept. S-5, Bell, California.

FREE!—Big United States catalog. Valuable guide and check list. Hundreds of illustrations. Approvals. Harriaco, 468-G Transit Bldg., Boston 17, Mass.

GIGANTIC Collection free. Includes triangles, early United States, animals, commemoratives, British Colonies, high value pictorials, etc. Complete collection plus big illustrated magazine all free. Send 5c for postage. Gray Stamp Company, Dept. PM, Toronto, Canada.

100 DIFFERENT United States 50c. Approvals. Utechs, 1143D North Keeler, Chicago 51.

FREE Complete set of famous Americans, flags, parks and presidentials to approval buyers. Send 5c for 15 of the above stamps plus full particulars. Triboro Stamp Company, 145 Nassau Street, Dept. 108, New York 38, N. Y.

WANT More for your dollar? Try our low priced, neat, attractive approvals. Books of 500 and 1,000 U. S. or foreign. We also have a premium card which will earn you free albums. Write today. Roseland Stamp Co., Dept. A-33, Spring Lake, Mich.

FREE. Scott's International Album. Other premiums. Particulars with approvals. Raymax, 35-Z Maiden Lane, New York 38.

THOUSANDS Of stamps can be added to your collection at 1 and 2c each. Ask to see our big approval books of attractive, low priced approvals. Everything catalogued according to Scott's. Large discounts. Modern Stamp Co., Dept. A-7, Ferrysburg, Mich.

NORWAY 1946 Charity complete (72c value) only 25c with approvals. Walter Torgesen, Cornelia, Georgia.

FREE—Valuable British Empire collection! 105 all diff. from Aden to Zanzibar! Includes Cayman, Pitcairn and many other exotic colonies. High catalog value! Sent for 10c mailing expenses. Approvals. Kenmore, Milford 8-T, N. H.

SENSATIONAL Illustrated United States, United Nations, Confederate states, catalogue free. Stone's, 45 Bromfield, Boston 8, Mass.

FINE Approvals. Past, personal service. What countries do you prefer? I'll send their stamps. Skinner, 438 Locust, Long Beach 12, California.

FREE: Mint British Colonies from Brunel, Papua, New Guinea, Caymans, Gilbert Ellice, Seychelles, Sarawak, Dominica—free with approvals. Viking, 11-M Northern Blvd., Great Neck, N. Y.

WORLDWIDE. 50 All different, absolutely free, just to introduce our incomparable approvals. Kent Stamp Company, GPO Box 57, Brooklyn, N. Y.

SHIPS, Planes, trains, plus 200 different foreign, 25c with approvals. Golden West Stamps, Box 245-M, Rivera, Calif.

FIRST U.N. set. Among world's prettiest. Only 10c. Approvals. Welles, Box 1246-R, New York City 8.

GUATEMALA-Nicaragua collection: Scarce triangles, bisects, flags, pictorials, etc., from war-threatened "Banana Republics." Big catalog included. All for only 10c. Approvals. Kenmore, Milford GC 410, N. H.

LOOK! Ten different foreign sets, 10c. Approvals. Farmer, 4913 Rosewood, Los Angeles 4, Calif.

FREE U. S. illustrated bargain catalogue. Rothberg's, 53 Bromfield, Boston 8, Mass.

FREE 105 Different stamps to approval applicants. Supreme Stamp Service, 2205 So. Grand Ave., Los Angeles 7, Calif.

COLLECTIONS All different stamps only 3c each! 25 Japan, 25 Austria, 25 Denmark, 25 Netherlands. Or all 4 packets only 10c! Approvals. Goliath Co., Bethlehem XI, New Hampshire.

BEAUTIFUL Pictorial sets, 25c with approvals. J. J. Tighe, 306 Cravens, San Antonio, Texas.

ARMENIA Pictorials, value 65c, free with approvals. Exotic, Box 755, Miami Beach 39, Florida.

U. S. Approvals, mint, used! Square Deal Teal, 663 Beach, Rochester 12, N. Y.

TWO \$5.00 U. S. stamps plus 20 different, 10c with U. S. approvals. Irwin Stamp Co., Box 1105, Brooklyn 30, N. Y.

20 PHILIPPINES 10c. Pictorial approvals. Moffat's, 921 College, Rock Hill 11, South Carolina.

1/2-1-2c APPROVALS. Povilauskas, 212 E. 3 St., New York 9, N. Y.

UNITED Nations cover free to applicants of U. S. or British Colonial approvals. A. Taylor, Skyland, N. C.

SAUDI Arabia—3 unused Arabian stamps airmailed from Saudi Arabia. \$1.00. Thompson, 1103 E. 71st Street, Long Beach 5, California.

FREE Sample stamp newspaper, valuable information on collecting, special lists. Approvals. Littleton Stamp Co., Littleton A1, New Hampshire.

51 DIFFERENT North America. From tropics to frozen north. 10c with our approvals. Richardson Stamp Co., Dept. 4, Niagara-on-the-Lake, Ontario.

CIPEX Souvenir sheet plus 25 different U. S., 10c. Approvals accompany. Village Stamps, 90-39P 214 St., Queens Village 28, New York.

FREE! Dandy packet with economical approvals. William Monjar, Cincinnati 14, Ohio.

FREE! Price list of 250 different collector's supplies, albums. Approvals. Littleton Stamp Co., Littleton O1, N. H.

100 DIFFERENT U. S., 46c with U. S. approvals. Faith, 1339 1/2 Westminster, Alhambra, California.

EDUCATIONAL Approvals. (Pictures on stamps described.) Stampore, Box 1062, Sherman Oaks, Calif.

POLAR Bear triangle, giant George Washington, six colored Ecuador, Arctic triangle, first American commemorative, Corsica, Devils Island, others. Everything free with approvals. Capital Stamps, Little Rock 2, Ark.

ECONOMICAL 1/2c-1c-2c-Approvals, 22,000 varieties available. Dresel, Box 270-n, New York 25, N. Y.

PABULOUS Collection—Roosevelt and Africa stamps. Mammoth fascinating collection of Roosevelt and dictators including Stalin, Tito, Franco, Lenin, Hitler and great many others plus free booklet and bargain lists. All for 10c with approvals. Jamestown Stamp, Jamestown, Dept. 413, N. Y.

50 DIFFERENT Bulgaria 10c! Approvals. Ensign Stamp Company, Dept. M, Berdan Avenue, Paterson 2, New Jersey.

TELEVISION Stamp and 50 different 5c with approvals. DeRespina, G.P.O. Box 771 A, New York City.

EXOTIC Oriental collection. 105 all different stamps from Borneo, Hong Kong, Malaya, Sarawak, Korea, Japan and many other strange countries of the Far East plus free booklet and bargain lists. All for only 10c to new approval customers. Jamestown Stamp Co., Jamestown, Dept. 313, N. Y.

START Your own stamp business. Send 10c for wholesale catalog. Shepard, Box 1147, Chicago.

90,000 STAMPS: Grabbag 40c. Big lot, better stamps, \$1. Extra special, \$2. Giant assortment, \$5. Perisil, 436 New York Ave., Brooklyn 25, N. Y.

15 DIFFERENT United States stamps over 50 years old. Entire collection only 10c. Approvals accompany. Tristamps, Demarest 4, N. J.

50 DIFF. U. S. commemoratives 25c. Mammoth packet list free. Econopackets, Box 168, Riverside 9, Calif.

NUDES Set: Colorful approvals 10c. Atlas, 2830-M, Eisenhower, Racine, Wis.

329 DIFFERENT Worldwide stamps 25c including Hitler heads, British colonies, French colonies, rarities, unusuals. Everything complete 25c to adults requesting approvals. Canada Stamp Co., 1907 Main St., Dept. 118, Niagara Falls, N. Y.

UNITED States—68 different including 8 airmails, 15 commemoratives, 10c. Approvals. Sunset, Box 47, South Gate, Calif.

UNITED States. 75 different, 10c. Approvals. Farmer, 4913 Rosewood, Los Angeles 4, Calif.

FREE—50 Different, with approvals. Fahsing, Dept. PM, Atascadero, California.

65 ALL Different U. S. stamps. Includes 50 year olds, commemoratives, airmails and \$5.00 stamp. Only 10c. Approvals. Willett Co., Box 511-L, Port Chester, New York.

225 STAMPS For only 10c! This mammoth value includes airmails, pictorials; stamps from strange countries cataloguing up to 25c each! Also approvals. Mystic Stamp Company, Camden 80, New York.

FREE—Valuable illustrated catalog. Over 1100 special offers, attractive bargains! Approvals. Kenmore, Milford 8-C, N. H.

ANIMALS, Birds, triangles, flowers, butterflies, fish, ships, locomotives, kings, dictators, multicolored, historical, geographical, musical, battles, giants, midgets and over 100 others—only 25c with approvals. Adults please. Canada Stamp Co., 1907 Main St., Dept. 318, Niagara Falls, N. Y.

HANDSOME New Zealand 1943 Elizabeth and Margaret Rose triangles only 10c to approval applicants. George Richie, 1539 Sixth, Alameda, Calif.

WOW! 153 All different Germany, 10c. Zeppelins, semi-postals, airmails, high values, big bargain lists and approvals included. Jamestown Stamp, Jamestown 512, New York.

STAMPS Wanted. Mint and used, collections, accumulations. Good grades only. Buy outright if bargain. What have you? Write, give details. Vanroy Shirk, Lebanon, Penna.

TRIANGLES, Birds, butterflies, flowers—Big packet 10c with approvals. Southwest Stamps, Box 117, Long Beach 1, Calif.

300 DIFFERENT. Triangle, airmail, pictorials, etc. 25c. 500 mixed U. S. 25c. Carlton's, Tujunga, Calif.

200 DIFFERENT, Including Roosevelt triangle, 10c to approval applicants. M. Avalon Stamp Company, Springfield, Mass.

327 DIFFERENT Stamps 25c! Including early Canada, Newfoundland, British Colonies, Vatican, Red Russia, Hitler heads, Indian states, animals, airmails, French Colonies, rarities, unusuals. Every stamp different. Rare bargain with approvals. Money back guarantee. Niagara Stamp Co., Niagara-on-the-Lake 61, Canada.

50 DIFFERENT Argentine 10c. Approvals. Reuter, 611 W. 40th Pl., Los Angeles 37.

FREE 119 Foreign stamps including Africa, Australia, Pakistan, China, India, Russia and Scandinavia. Send 10c for postage and handling. With approvals. Niagara Stamp Co., Niagara-on-the-Lake 81, Canada.

AMAZING Offer! 200 United States stamps—including commemoratives, airmails, high denominations to \$1.00. Only 10c to approval applicants! Illustrated bargain lists free. Mystic Stamp Co., Dept. 80, Camden, New York.

100 DIFFERENT Spain 25c. Penny approvals included. Reed, Box 980, Chicago 90, Ill.

OLD Scarce U.S. seconds on approvals. Slight imperfections, lowest prices. Hernefield, Clintonhill Sta., Newark 8, N. J.

WORLD'S Largest stamp (7 1/2"x14 inches). A real curiosity! Retail for 50c, only 3c to approval applicants. Tatham Stamp Co., Springfield 30, Mass.

SPEND Pennies! Not dollars! Thousands of fascinating stamps to choose from our 1c and 2c approvals. No premiums. Just honest value. Pat F. Knowles, Box 2247, Van Nuys, Calif.

COLOSSAL Stamp zoo free! Jungle beasts, wildlife, domestic animals—Fifteen different, including rhinoceros, elephant, snake, tiger, zebu, kangaroo, koalabear, emu, kookaburra, bull, horse. Extraordinary accompanying approvals. Send 10c for postage and handling. Niagara Stamp Co., Niagara-on-the-Lake 81, Canada.

35 MULTICOLORED Triangles, only 25c with beginner or advanced approvals. Low prices. Essex, 5946 Arlington, Los Angeles 43, Calif.

FREE Sample—interesting, informative, illustrated! National Stamp News, Anderson, South Carolina.

OLD U.S. approvals. Low prices. MacG., 2905 Observatory, Cincinnati 8, Ohio.

50 DIFFERENT United States 5c with bargain approvals, lists. Bookman, Manatee 1, Florida.

ANTIQUES, RELICS, INDIAN GOODS, CURIOS

SEND Dollar for full color hand printed picture, Indian Dancer. Free list. Tewa Enterprises, 724 Canyon Road, Santa Fe, New Mexico.

6 GEM Arrowheads \$2.00, 4 fine arrowheads \$1.00. Notched tomahawk \$1.00. List free. Lear's, Glenwood, Arkansas.

ANTIQUA Firearms, swords, illustrated booklet 25c. Westbrook, 738 Royal Street, New Orleans, La.

4 SELECTED Arrowheads \$1.00. List 5c. H. Talburt, Calico Rock, Ark.

PRECIOUS STONES, MINERALS

JOIN The thousands whose hobby is gem cutting, jewelry making, mineral collecting. Send only \$3.00 today—for 12 monthly issues of national how-to-do-it magazine. Sample copy 25c. Gems & Minerals, Dept. A-6, Palmdale, California.

ROCKS, Ores, minerals precisely analyzed \$5. Absolute spectrographic detection of 45 elements including uranium. Free information. Keldon Research, Box 2555P, Los Angeles 54, Calif.

METAL Detectors. Free details. Reed Engineering, 620 S. Inglewood, Inglewood, Calif.

GEMCUTTING, Silvercraft authority. Illustrated magazine tells how. Cut rocks, make jewelry. 150 ads illustrating equipment, offering gems for collectors, cutters. Postal brings literature. Lapidary Journal, Drawer B, Palm Desert, Calif.

GEMSTONES, Mineral specimens. Every variety. Lowest prices. Free booklet. Plummer's, 4720 Point Loma Ave., San Diego 7, Calif.

SAPPHIRE, Topaz, tourmaline, garnet, peridot. 5 uncut gem specimens, \$1.00. O'Brien's, 1116M Wilcox, Hollywood 38, Calif.

LAPIDARY—Four square inches native Texas stones slabbed 3/16" thick. \$1.00 to Rocks, Box 6617, Houston 5, Texas.

HOBBIES AND COLLECTIONS

UNUSED Matchbook covers, 100 different \$1.00. 36 page catalog 25c. Match-cover album \$3.00. Charles Edelman, 1311C East 84, Cleveland 3, Ohio.

ANTIQUA Posters—Circus, minstrel, drama, gay nineties, etc., \$1 each. List for stamp. Central Show Printing Co., Box P-617, Mason City, Iowa.

NAZI Medals, Campaign ribbons, illustrated lists. Big packet, \$1.00. Medcrafts, 1923 34th St. S. W., Calgary 2, Canada.

50 DIFFERENT Army embroidered patches \$1. Other bargains. Insignia Mart, 703A Broadway, New York 3, N. Y.

NEW—15 Different match covers 10c. Box 202, Rochester 1, N. Y.

WANTED Cigarette, tobacco, cards. Write Charles Bray, East Bangor, Penna.

HOBBIES. Make-em, sell-em, buy-em, sell-em. Write George Riddell, 2355 3rd Street, Cuyahoga Falls, Ohio.

ROCK Collectors: Send \$1.00 to Norton Pike, Littleton, New Hampshire for four 1 1/2" square pieces New Hampshire granite polished on one surface. Granite brochure included.

INVENTING Can be an interesting and profitable hobby. Write for complete particulars. Institute of American Inventors, Dept. 40-E 631-E St. N.W. Washington 4, D. C.

CAMERAS, PHOTO SUPPLIES

WILD Animal and bird films in beautiful color or b. and w. 2" x 2" slides and 8mm or 16mm movies. Write for free literature. Wild Life Films, 5151 AH Strohm Ave., North Hollywood, Calif.

BUY Wholesale nationally advertised cameras, photo supplies, thousands other products at big discount. Free "Wholesale Plan." American Buyers, 629-RR Linden, Buffalo 16, N. Y.

20 to 40% Discount. Everything photographic. Dart, 3812E Atlantic Avenue, Brooklyn 24, New York.

FREE Bargain book packed with hundreds of fine photographic values. Write Central Camera Co. (Photographic headquarters since 1899), Dept. 9H, 230 S. Wabash Ave., Chicago 4, Ill.

BUY Wholesale—Photographic equipment, appliances. Popular brands. Free catalog. Camera Shoppe, Box 601-M8, Mount Vernon, New York.

OIL Coloring photographs—A fascinating hobby or profitable sideline for those with artistic talent. Learn at home. Easy simplified method. Free booklet. National Photo Coloring School, 835 Diversey Parkway, Dept. 343C, Chicago 14.

WHOLESALE Photographic supplies. Cameras, films, projectors, enlargers. Write for free catalog. Capitol Photo Supplies, 2428 Guadalupe, Austin, Texas.

BASS Says: Quality cameras since 1910. When in Chicago visit the camera cross roads of the world, or write us for your favorite equipment, new or used. Satisfaction guaranteed. Bass Camera Co., Dept. AG, 179 W. Madison St., Chicago 2, Ill.

DISCOUNTS To 40%—Cameras, projectors, tape recorders, lenses. Write for individual quotations, no catalogs. Classified Camera D, 253 E. 94 St., Brooklyn, N. Y.

PHOTO FINISHING

YOUR Films are valuable—Don't take chances on prints. Let Whitehall skilled finishers with years of experience, most modern equipment, highest quality materials, photo-finish your films for very best results. Satisfaction guaranteed or money back. Only \$1.00 for oversize prints of any 8 or 12-exposure film plus new, freshly-dated Kodak film. 24-hour service. Free catalog of photo novelties and portfolio of Christmas photo greetings. Whitehall Studios, Inc., Dept. 17, Elmira, N. Y.

FREE 5 x 7 Enlargement with each roll. 6, 8, exposures 35c; 12s, 16s, 50c. Big jumbo wallet album prints. Finest work, service. Free mailers. Dean Smith Photos, Box 511-3, Marshall, Texas.

BEAUTIFUL Results at low cost. Jumbo oversize finishing. Quality workmanship. 8-exp. roll superline finish only 40c. 12-exp. 55c. 16-exp. 70c. 36-exp. \$1.50. Oversize reprints 3c each. Send us your order. Free mailers. Mailbag Film Service, Box 5440A, Chicago 80, Ill.

SPECIAL Offer—8 jumbos 25c; 12, 35c, with this ad. Western Photo, PM84, Box 298, San Francisco 1, Calif.

SIXTEEN Deckled billfold photos \$1.00. Send photo or negative. Conaways, Box 7261, San Antonio 10, Texas.

QUALITY Color enlargements from your transparencies! 2 1/4 x 3 1/4 22c each, 9 for \$1.39. 3 1/4 x 4 43c each, 6 for \$2.35. 4 x 5 50c each, 4 for \$1.90. 5 x 7 85c each, 3 for \$2.40. 8 x 10 \$1.89 each, 3 for \$5.35. Minimum order \$1.00. No c.o.d.'s. Panoramic Film Labs., Dept. M, 1190 6th Ave., New York 36.

KING-Size prints from your roll film, less than 4c each, (if you return this ad) developing included. Finest-quality, fast service from photo capital of the world. Over 200,000 satisfied customers. 8 exposure roll 25c; 12, 50c; 16, 85c; 20, \$1.40. Money-back guarantee. Send for free mailing bag and complete price list. Rochester Laboratory, Rochester 1, New York.

WALLET Photos, double weight silk finish, for gifts, applications, made from any picture of you, your baby, wedding, etc., 20 for \$1. Money back guarantee. Send picture (returned unharmed) and \$1. Delco, Box 362, Upper Darby, Penna.

SPECIAL Trial offer. Mail us 4 negatives with 10c coin and you will receive 4 modern beauty enlargements with information on our new different photo finishing at amazingly low costs. Modern Film Service, Box 3957 PM, Cleveland 20, Ohio.

YOUR B&W roll and \$1 brings 12 jumbo album prints and fresh roll Verichrome film plus gift enlargement coupon. B&B Photos, Box 379B, Hillisboro, Illinois.

JUMBO Prints, 8-exposure roll 30c; 12 exposure, 45c; 16 exposure 55c. Reprints, oversize 4c. Guaranteed quality, Mail Order Photo Service, Box 297, Watertown, Wisconsin.

ROLLS, Reprints, jumbos in albums, 8-20c; 12-40c; 16-50c. Bob's Photo, Box 23, Fairmont, W. Va.

SENSATIONAL! 8 Jumbos, 25c; 12, 35c. 35mm.-36 exposure, \$1.00. Guaranteed quality. With this ad only. Flash-Photo, Box 36B, Brooklyn 4, N. Y.

THE Photo Mill. Immediate service. Eight exposure roll developed and one print each good negative 30c; two, 40c; one jumbo each 35c; two 65c. Write for complete prices and mailers. The Photo Mill, Dept. K, 1511 Hennepin, Minneapolis, Minn.

TWO Beautiful prints from each picture on roll, 8 exposure 35c; 12 exposure 45c. Thirty-three years of satisfied customers. Quick service. Lens Photos, Dept. J-4, Janesville, Wis.

FAST. Same day service! 8 oversized prints only 35c; 12-50c, 16-65c. Satisfaction guaranteed. This ad worth 10c toward first roll. Trial offer only! PicSure, Box 899-B, Philadelphia 5, Penna.

BEAUTIFUL Enlargement from each picture on roll, 8 exposure 35c; 12 exposure 45c. Cut Rate Photos, Dept. B-4, Janesville, Wis.

GUARANTEED Quality. Fast service. Eight jumbos in beautiful super pak plastic ring binder albums only 35c. Send for free mailers and particulars of our complete photo finishing service. Grand Fotos, G.P.O. Box 1410, New York 1, N. Y.

TWO Prints each good negative, 8 exposures, 35c; 12 exposures, 50c; reprints, 4c. Mayfair Photo Service, Box 617-K, Toledo 1, Ohio.

TOP Quality. Fast service. 8 jumbos 35c in beautiful super pak album. 16 contacts 40c. Reprints—Jumbos 4c; contacts 3c. Satisfaction guaranteed. Write for free mailers and circulars. Fast-X-Photo, Box A, Jersey City, N. J.

6 OR 8 Picture roll 25c. 12 or 16 picture roll 55c. Each roll developed and printed in handy album pack. Send coin with roll. No c.o.d.'s. Mailing containers sent free. Deluxe Film Service, Box 1268-A, Shreveport, Louisiana.

ENLARGEMENTS! Eight 5 x 7's or five 8 x 10's, \$1.00. Wilart Enlargers, Box 967, Little Rock, Ark.

12 JUMBOS From any size roll developed 35c with this ad only. S. Skrudland, Lake Geneva, Wis.

8 JUMBO Prints in album 30c; 12 exp. 45c; 20 exp. 85c; 36 exp. \$1.25. Free mailer. Mel's Photo, Box 106F, Brooklyn 20, N. Y.

MOTION PICTURES AND SOUND EQUIPMENT

NOW! H. bomb movie release. 8 mm, 16 mm Kodachrome. Ideal Service, 4644-H Geary, San Francisco 18, California.

"ENTIRE Life Story of Christ." 8mm., 16mm., sound and silent, purchase or rent. state projector. Hemenway Film, 31P Church St., Boston 16, Mass.

FREE Movies! Hundreds of reels free! Charlie Poorman, Pottsville, Penna.

TAPE Recorders, tapes, accessories. Unusual values. Dressner, Box 66M, Peter Stuyvesant Station, New York City 9.

8MM. And 16mm. professional national parks movies in Kodachrome, list 10c. Ideal Service Supply, Suite 508, 20 West Jackson Blvd., Chicago 4, Illinois.

FREE! Blackhawk's summer sale catalog new and used 16mm., 8mm. films, used 16mm. sound projectors, new 2" x 2" color slides. Blackhawk Films, 1246 Eastin, Davenport, Iowa.

WILD Animal and bird films in beautiful color and b. and w. 2" x 2" slides and 8mm or 16mm movies. Write for free literature. Wild Life Films, 5151 AH Strohm Ave., North Hollywood, Calif.

RECORDERS, Equipment. Reasonable. Fine recordings, Boynton Studio, 10 Pennsylvania, Tuckahoe, N. Y.

5,000 8-16MM. Silent-sound films. International, 2120 Strauss, Brooklyn 12.

MOVIE Camera film: 8mm. roll \$1.50, 16mm. 100' \$3.00. Free processing. Better Films, 742 New Lots, Brooklyn, N. Y.

GUARANTEED Fresh 8mm. roll, magazine; 16mm. roll, magazine movie films. Color, b&w. Free catalog. ESO-R, 47th Holly, Kansas City 2, Missouri.

MUSIC AND MUSICAL INSTRUMENTS

WANTED! Poems for musical settings. Send poems now! Songwriting Service, 2959 Division, Chicago 32.

1954 ACCORDIONS—Wholesale. Free catalog. American Accordion Center, PM-8, 5329 Belmont, Chicago.

COLLABORATION Offer. Newark Pubs, Box 1226, Syracuse, N. Y.

MUSIC Arranged. Songs printed. Frank Wildt, Music Publisher, Lancaster, Penna.

NEW Songwriters can now sell their songs! My new, easy method reveals professional secrets of profitable songwriting. Free details. Meadowlark Music School, 300 Summer Road, Colorado Springs, Colo.

POEMS Wanted for musical setting. Send poems. Free examination. Five Star Music Masters, 630 Beacon Bldg., Boston, Mass.

AMATEUR Songwriters! Top-notch Broadway staff offers expert professional opinion-suggestions for improving your song or lyric. Enclose \$1.00 with each manuscript or recording. Amateur Songwriters Workshop, P.O. Box 359A, Times Square Station, New York 36, New York.

WANTED! Poems for musical settings. Write Songwriters' Service, Clifton, N. J.

ACCORDIONS, Wholesale to everyone. Save up to 60%. All national known brands. Free catalogue. Del Principe, 29 South Cicero, Chicago 44.

SONGPOEMS Wanted. Mail to: Tin Pan Alley, Inc., 1650 Broadway, New York 19, N. Y.

FREE Record of your song. Your words, my melody. Free information. Johnny Mack's Melody Mart, 1094 West 39th Street, Dept. A, Los Angeles 37.

SONGWRITERS! Protect your ideas! Hold all songs, poems! Write for safe correct procedure first! Song Service, Dept. P, 333 W. 56th St., New York 19, N. Y.

POPULAR Songs. How to write and sell them. Write for free booklet Successful Songwriting. Gateway Songs, Box 2470, Hollywood 28, Calif.

SONGWRITERS! Send poems, songs. Music Service, 243 West 72nd St., PM, New York 23.

WRITE Songs. Big money and reputation. Write for information. J. Gordon Pub. Co., 4700 South California Avenue, Chicago.

RADIO AND TELEVISION

TELEVISION-Radio offers world of opportunities for good job or own business, full or part time. Write for free information on amazingly low cost home training offered by Coyne, old established school. Write Coyne School, Dept. C4-HT2, Chicago 12, Illinois.

NEW TV catalog free. Loaded with bargains for TV servicemen, technicians, installers. Finest new TV antennas, motorless directronics, multi-channel yags, UHF antennas, converters, motors, boosters, parts, instruments, hundreds of quality accessories at money-saving prices. Get your catalog now! National Electronics, 3068 Delco Bldg., Cleveland 3, Ohio.

FREE List. Builder's pictorial construction plans. Alera, 286 East Broadway, New York 2.

BUILD 15 Radios at home—Only \$19.95 complete. Learn radio construction, theory, trouble-shooting, code, F.C.C. regulations. Complete radio course includes all parts, components, instruction books, etc. Free radio tester and soldering iron. You keep everything. No experience required. Money-back guarantee. Order direct or send for descriptive literature. Valuable radio and TV guide upon request, free of charge, no obligation. Progressive Edu-Kits Inc., 497 Union Ave., Dept. PM20, Brooklyn 11, N. Y.

REPAIR Your own TV. Prepared exclusively for your model. Plus introductory bonus. Send make and model, \$1.00. Personal TV, Box 66, Little Neck, N. Y.

TV For everybody: Experts, radio and TV men, beginners and hobbyists. Non-technical trouble shooting guide and reference with examples and explanations. Memorized as guide to making TV calls as start in TV or passing license test. Charts of step by step methods from antenna to picture tube, all theory discarded. \$1.50. Bursha, 918 Bath St., Ann Arbor, Mich.

COLOR Television! Enjoy low cost 3 color television screen now. Easily attached. Free descriptive circular. Zingo Products, Johnstown 77, New York.

RADIO Hobbyists! August "Radio Science" 25c. 52½ Backman, Westfield, New York.

MAKE Simple, tubeless, batteryless, distance-getting radio. Genuine Melomite crystal, detector, illustrated instructions. 50c postpaid. Allen, 427-PM5, Clinton, Mo.

24 PAGE Plans "18 Long Distance Crystal Sets" 25c, including "Radiobuilder," catalog. Laboratories, 328-C Fuller, Redwood City, California.

REPAIR Your own TV. Instructions compiled exclusively for your set. Simple as replacing light bulb. Send set name, chassis, model number, \$1.95. LS Engineering, Box 4113-H, North Hollywood, California.

RADIO TUBES, all types, guaranteed. Ideal Service, 4644 Geary, San Francisco 18, California.

CRYSTAL Radio experimenters. Write Leslie Hulet, R4, Lakewood, New Jersey.

BUSINESS OPPORTUNITIES

IMPORT-Export: Opportunity, profitable, world-wide, mail-order business from home, without capital; or travel abroad. Established world trader ships instructions for no-risk examination. Experience unnecessary. Free details. Mellinger A708, Los Angeles 24.

GROW Orchids at home—Profitable, fascinating. Year 'round, Maine to California. No greenhouse. Gorgeous cactuses, cymbidiums, etc. Successful home grower shows you how. Full details free. Flowerland, 4622-PD Wilshire, Los Angeles 5.

DISPLAYS—Make turn tables and motorized displays your shop. Plans and motors. Complete details on request. Motorized Display Service, 139 East Second, Reno, Nevada.

MAKE Best doughnuts, yeast raised. Start in kitchen. Sell retail and wholesale. I sell no material or equipment. Write Lyon, 1605 W. 17th St., Davenport, Iowa.

DEALER Franchises for states and counties open for Franklin Thrift factory built homes. Requirements: honest effort, some business ability, sample home eventually. Small contractors, planing mills, home builders, land owners and developers make ideal set up. Write Franklin Thrift Homes, Inc., Box 631, State College, Penna.

MAKE Flexible molds, Cast figurines, plaques. Free sample. Tooker, 630-R Chestnut, Hamilton, Ohio.

TRADE Magazines. See current copies through our easy to get acquainted service. Choose from 4,387, covering all fields. Current list free. Commercial Engraving Publishing Company, 34C North Ritter, Indianapolis 19, Indiana.

NEWEST Spare, full-time home business. \$5 to \$10 hour possible. Paint with suede—The finish with touch and eye-appeal. Beautify auto dashboards, signs, radios, toys, figurines, lamps—1001 others. Complete, step-by-step instructions sent for no-risk examination. Free details. Coast, 1004-MX So. Los Angeles St., Los Angeles 15.

BUY Wholesale direct 10,000 nationally advertised appliances, sporting goods, watches, furniture, auto parts, toys, gift-wares. Sell at tremendous savings to individuals, organizations. Amazing profits! Free "Wholesale Idea." National Buyers Service, Box 426EB, Oakland, California.

ALUMINUM Awnings, baked enamel colors! Factory prices! Any size. Write All Weather Comfort, Box 10254, Tampa, Fla.

BECOME A game warden, or join forestry, park, lookout, wildlife conservation services. Enjoy outdoor work, good pay, real security. Complete information free! Write Home-Study Institute, 3156AT West Eighth, Los Angeles 5, California.

FREE! "301 Profitable Small Businesses!" Amazing shoestring plans! Work home! Start sparetime! Deumant Surveys, Kenmore 23-R, N. Y.

LEARN Sewing machine repair, electrify, trade, sell. How to make big money at home sparetime. New zigzag machines, parts, etc., wholesale. Free details. Taylor Service, Hamilton PM-8, Ohio.

AMAZING Home business plans. Write Falcon House, Winnebago 2, Illinois.

GUATEMALAN Typical handmade products: Leather bags, belts, skirts, etc. Mail orders filled. Dealers inquiries invited. Free catalog. Maplion, Box 268, Guatemala, C.A.

BIG Money easy breeding parakeets at home! Free plan. Parakeets, Box 2127-C, Inglewood 4, Calif.

START Your own business on credit. Your own boss. 1658 of our dealers sold \$5,000 to \$27,500 in 1953. We supply stocks, equipment on credit. 200 home necessities. Sales experience unnecessary. Pleasant profitable business backed by world-wide industry. Write Rawleigh's, Dept. H-U-PPM, Freeport, Ill.

\$1,000 MONTHLY Possible from your own easily learned office business. Write Cole Associates, Syracuse 2, N. Y.

YOUR Own bronzed baby-shoe business. Famous Alice Ames plan. Shoes and mounts made in largest and best bronzing plant in country. Give your customers the best. Write Alice Ames, Dept. 1, Boston 36, Mass.

\$40.00 DAILY With \$86.00 sawshop equipment. Zapart, 586-PM Manhattan, Brooklyn 22, N. Y.

100 IMPORT-Export opportunities \$1.00. Sample opportunities bulletin 25c. Warner's, Box 6, Fort Scott, Kansas.

MAKE Perfume, 59 formulas \$1.00. Bil-lows, 110-05 37 Ave., Corona 68, N. Y.

GARDEN Golf. Fascinating entertainment. Popular international sport. Profitable business. S. Brockway, Seaside, Ore.

BOOKKEEPERS! Keep books. Small firms. Spare time. Heffernan, 37-06 Jerusalem Avenue, Wantagh, New York.

FORTUNES Made raising crickets and fishworms. Guaranteed raising and marketing instructions. \$1.00. Carter Farms, Plains, Georgia.

ADVERTISING Book matches—Cash in on big demand; sell union label matches. Cuts for all businesses and political parties. Free powerhouse selling kit, low prices, protection guaranteed on repeat orders. Cash commissions. Superior Match Co., Dept. MX-834, 7530 Greenwood, Chicago.

KNOCK-Knock! Who's there? Opportunity: Your chance for prosperity. Waldak-Wayson(S), P. O. 2624, Phoenix, Ariz.

MONTHLY Repeat business which you can operate in your own community. For free details write Grasak, 321-28th St., McKeesport, Penna.

LEARN Invisible reweaving! Harris Re-weavers, P. O. Box 7112, New Orleans, La.

SELL Popular Mechanics and all other magazine subscriptions. Free catalog, supplies. Subscription Service Company, Dept. A, P. O. Box 2070, Birmingham, Alabama.

WANTED! Home producers, by manufacturers in our clearing house service. Become subcontractor, casting plastic products for these companies. Thousands of easy-to-make items required for consumer-industrial use. Cash in at home, without previous experience. Plastic Service Associates, Dept. 8-PM, East Boston 28, Mass.

\$200 WEEKLY Reported! No selling. Free booklet. T. J. Surface, Roanoke 4, Virginia.

NEWSPAPERS. Turn them into cash. Eighteen methods. Instructions 50c. Charles Company, 13-DCB, Norwood, Ohio.

EARN \$2.00 Hour! I do—Making sandals. Youngs, 1308-PM, South First, Arcadia, California.

MONEY, Typing—Sewing! Details free. Edwards, 3915-PM, 12th, Des Moines 13, Iowa.

COST OF things going up faster than your income? You can make more full or part time as a Rawleigh dealer. Write for full particulars. Rawleigh's, Dept. H-RR-PPM, Freeport, Ill.

NEW-Different home business opportunity! Address-mail literature featuring real merchandise. Everything furnished. Mills, 1752-A, Garden Ave., Lorain, Ohio.

GET \$10.00 Orders by mail! 100% profit! Everything furnished. Terrill, Bogard, Mo.

TRY It. Send 10c for details of new mail-order business to Heriff, 5317½ McCorkle Ave., Charleston, W. Va.

LETTERS Remailed. Kester, 1028 Lancaster Ave., Bryn Mawr, Penna.

START A lettershop on a shoestring! Sales \$56,000. Started \$36.00. Information? Merritt, Box 13, Basking Ridge, N. J.

BUY Wholesale! 30-80% discounts! Free! Large catalog of nationally advertised appliances, gifts, watches, jewelry, cameras, typewriters, tools, kitchenware, etc. Start your own fully self-operating mail order business without capital! Wholesale starting kits furnished. No experience necessary. Outline of unique automatic sales plan included. Consolidated Distributors, Division 119, Box 1537, Paterson 15, New Jersey.

EARN Extra money during your spare time. Sell subscriptions for popular magazines. Liberal commissions. Send for supplies, etc. DeSales Magazine Service, 60 East 42nd St., New York 17, N. Y.

FRANCHISE Opportunities nationwide. Fascinating, profitable business affiliations. Request information immediately. National Franchise Reports, 920 North Michigan Avenue, Chicago 11, Illinois.

MAKE Perfumes, other products. Sell mailorder. Formula catalogue free. International, 6347 Parnell, PM-8, Chicago 21, Illinois.

MAKE Attractive building plastic, easily. Build and repair better for half. Bays Laboratories, Oklahoma City 9.

\$200 WEEKLY. New invention. Amazing 4-second Presto emergency tire chains. Fit all modern auto wheels. National advertising building big demand. 3 sales daily to oil stations, dealers, etc. make \$200 or more weekly. Territory going fast. Write Presto Chain Co., Dept. P-30, Des Moines 2, Iowa.

\$15 HOUR Preparing income tax returns. Experience unnecessary. Details free. Union Institute, Lakewood 1-M, N. J.

START A buying service, buy wholesale thousands nationally advertised products. Make big profits selling at sizable discounts. Postcard brings details. American Buyers, 627-R Linden, Buffalo, N. Y.

EXPORT Business easy made! Substantial income from home. No merchandise buying. Full setup service includes everything. Hermes Exports, 152 West 42, New York 18.

SELLING Out! \$3.95 mailorder course; now \$1.00! Girard, Coventry, R. I.

OPERATE A sharpening shop. \$100 per week (\$5000 per year) not uncommon. We can completely equip your shop and give bank terms on approval of credit. Makers of famous Acme saw sharpeners; agents for Modern lawn mower sharpeners. Be-MaCo rapid saw sets and Burr retouchers. Send for free literature. Max Mfg. Co., San Jose 26, Calif.

SELL To women by mail from your home—Repeat order merchandise. Everything furnished. Big profits. Mohawk, 37A, Second, Amsterdam, N. Y.

MEN, Start a successful business of your own. No investment required. Part or full time. Earnings unlimited. Act now for territory of your choice. Write Gilmer Monument Works, Inc., Howard Lake, Minn.

SIMPLIFIED Advertising methods sell 39 profitable mailorder-local repeat items. List \$1.00. Richard, 182-25 Wexford Terrace, Jamaica 32, N. Y.

FREE Literature. Fishworm Breeder's Manual—\$1.00. Postpaid. Dixdok, Kent, Ohio.

PROVEN Best stucco paint. Joints, cracks, spackling, patching. Big success. Free information. Write Larson, 3419-9-East, Salt Lake City 6, Utah.

MAKE Money writing household hints, recipes, poems, etc. Gibson, Hudson, South Dakota.

FREE Sample offer, catalog. Make and sell rhinestone jewelry. Ebert, Box P183, East Orange, New Jersey.

LEARN Sewing machine repair, guaranteed plans, assures success. Write Purdy's, Box 207, Weatherford, Texas.

METALIZE Baby shoes, jewelry, gifts. Bronze, gold, silver. Free bulletin. Kiktavi, 7217-PY South Broadway, Los Angeles 3.

MONEY Getters club! Receive 1,000 or more different money-making propositions. Year's membership now only 25c. Satisfaction guaranteed or money back. Storm-Associates, Cedarville, New Jersey.

HAVE Home business mailing postcards offering real merchandise. Big earnings. Write: Mednis, 10 Port Norfolk, Boston 22, Massachusetts.

NATURAL Molding rubber, extra thick. Free sample. Flock, W. Wooley, 115-A Donald, Peoria, Ill.

BIG Money selling and installing this new, low-priced burglar alarm. Real protection for homes, shops, stores, etc. Write for details. Protect-O-Larm, 6012 Irving Park Road, Chicago 34.

MAKE Rubber stamps, repair dolls; learn silk screen printing. Catalogue (60 ideas) free. Universal, Box 1076-A, Peoria, Ill.

OPPORTUNITY Seekers write James Leigh, 537 Chester Street, Oakland 20, California.

PROFITS At home molding jungle masks, wall plaques, etc. Instructions and sample to copy. \$1.00. Cera-Masques, Box 481, Fontana, California.

LIQUID Rubber, make flexible molds. Free sample. Chaney, 1130 E. 16th St., Jacksonville 6, Fla.

LIST Your name in "Big Mail." Get many offers. 25c coin. Refundable. Walter Rix, Box 6521-A, Cleveland 1, Ohio.

EARN Extra money, spare time, from typewriter or sewing machine. Free details. McKinley Home Enterprises, 817-A Park S.W., Canton, Ohio.

MAILORDER—Operate profitable home business using free advertising method. Revealing information free. Seidel, 7070-HF Hollywood, Los Angeles 28.

HOME Business—Mailing literature to new mothers. Details free. K & M Products, 3634-A Homewood, Toledo 12, Ohio.

RAISE Earthworms! Easy! Profitable! Dime brings information plus unusual true story. "An Earthworm Turned His Life." Earthmaster System, 8E, El Monte, Calif.

FREE Folio describing "445,000 Unlimited Vacations Plan." No canvassing, mail-order, merchandise, equipment. Unknown. Works itself—home! Keep job. Haylings, Carlsbad, Calif.

SELL Name brands—No inventory. Manhattan, 225 W. 57 St., New York City.

MEN Wanted—Build luggage and cases at home. We sell your products, supply complete instructions, materials, everything. No special equipment needed. Free details. Casecraft, 805-G7 Sunset, Los Angeles 12, Calif.

PRINT Without a printing press! Amazing new method! Print colorful signs, banners, cards, posters, glassware; anything at home. Big profits. Money-making opportunity! We supply everything. Beautiful sample, home-business plan free! Write Screen-Print Company, Los Angeles 15, California.

\$900 A Year sparetime sharpening saws at home. No selling. Hardware stores get saws on commission basis. Free booklet tells how. Victor Foley Company, Columbia Heights, Minnesota.

MAKE Money at home as renewal headquarters for all magazines. Liberal commissions. No experience. No capital needed. Supplies furnished. Write for free catalog. McGregor Magazine Agency, Dept. 500B, Mount Morris, Ill.

OVER 700% Profit making finished photos in 2 minutes on the spot in daylight without darkroom. No experience needed. Simple directions teach you quickly. Write P D Q Camera Co., 1161 N. Cleveland Ave., Dept. PM, Chicago 10, Illinois.

ELECTROPLATE Auto parts, novelties, mirrors, baby shoes. Easy, inexpensive home processes. Free booklet. Tyco Metals, Box 13231-MM, Houston 19, Texas.

BOOKKEEPERS. Keep books, small firms spare time. Manual latest technique by C.P.A., \$3.00. Modern Business, Box 406, Youngstown 1, Ohio.

MAKE Money at home—Mail cards, circulars feature real merchandise. Everything furnished. Big earnings. Phillip's, Box 3-P, Boston 22, Mass.

UNUSUAL Mail order ideas, sources. Details free. Fax, Box 341, Brownwood, Texas.

RECAST Old batteries into new. Latest achievements. Battery Laboratories, Minneapolis.

LEARN Metalizing baby shoes, gifts, etc. Bronze, gold, silver. Folio free. Kiklavi, 7217-PM South Broadway, Los Angeles 3.

WHOLESALE Of sensational nationally advertised appliances, silverware, watches, cameras, etc. Start your own business. Full details. Send 50c for catalogue. International Sales Co., 175 Fifth Ave., New York 10, N. Y.

START Venetian blind laundry. Profitable lifetime business. New machine. Free booklet. F. C. Co., 442 N. Seneca, Wichita 12, Kansas.

UNUSUAL Homework opportunity, spinning Angora sparetime for us. Men, women. Angora House, PM, Springfield, Illinois.

HOW And where to obtain capital. Particulars free. Star Service, Wapakoneta, Ohio.

TO \$40.00 Weekly. Sparetime, home operated mailorder business. Successful beginner's plan. Everything supplied. Lynn, 10420-M National, Los Angeles 34, Calif.

COPUBLISH Mail Sale Advertiser, leading mail order paper. Details, latest copy, dime. Vanroy Shirk, Lebanon, Penna.

EARN Money at home! Homemaker Magazine tells how. Sample, 25c. Sizemore, Box 7, 4917 Kostner, Chicago 30.

DOLLARS in personalized baby record books. Sell by mail. Eleven thousand new prospects daily. Use same literature we do. No-Co-Ro, Oakland 6, California.

SCHEMER Magazine, Canfield 1, Ohio, monthly mailorder ideas, plans. Year \$1.00. Sample 20c.

PLASTERCRAFT Molds, liquid rubber, plasters, flocks, candle supplies. Catalog and manual free. Blue Rapids Supply, Blue Rapids, Kansas.

BUY It wholesale! Manufacturers, distributors offer 850,000 items. Literature free. Olsen, 1231-A East Third St., Duluth 5, Minn.

GROW Mushrooms. Cellar, shed, and outdoors. Spare, full time, year round. We pay \$3.50 lb. We paid Babbitt \$4,163.00 in few weeks. Free book. Washington Mushroom Ind., Dept. 172, 2954 Admiral Way, Seattle, Washington.

POPCORN And potato chip equipment. Leeco, Box 933-A, Springfield, Ohio.

\$46 FROM Square foot plywood; jigsaw necessary. Write: Woodarts, Bridgewater, Mass.

\$25 WEEKLY Working two hours daily at home. Lycke, Box 2471-A, Cleveland 12, Ohio.

BREED Rare tropical fish at home. Earn big money! Learn secrets! Help fill huge demand. Amazing opportunity! Free plan. Tropicals, 1008-F Los Angeles St., Los Angeles 15.

INCOME From local information. No selling. Write Neherco, La Verne, Calif.

RESILVERING Mirrors, formula 50c; two-way lookout mirrors. (No one sees you). 50c; coppered mirrors, 50c. All \$1.00. Nelko-Mir, Box 3462-J, Chicago 54.

LIVING Miniature ("Ming") trees only 10 to 20 inches tall. Grow at home. Big profits! Spare time opportunity. Fascinating! Amazing! Write for free seed and plan. National Nursery, Dept. FC, Inglewood 4, California.

MAKE Money spare or full time, casting metal toys and novelties. Big wholesale and chain store demand for autos, soldiers, ashtrays, banks, etc. keeps manufacturers busy. Production moulds furnished for up to 100 and more castings per hour. No experience or special place necessary. Write for information and illustrations of patterns needed. Metal Cast Products Co., Dept. A, 1696 Boston Road, New York 60, N. Y.

OPERATE Profitable mail order business. Write Walter Service, 4159-A East 112th, Cleveland 5, Ohio.

GOOD Paying business silvering mirrors, plating autoparts, reflectors, bicycles, bathroom fixtures, etc., by late method. No tanks or shop required. Outfit furnished. Free booklet. Gunmetal Co., Ave. H, Decatur, Illinois.

MINK Raising information free. Complete. Lake Superior Mink Farm. Superior, EE1, Wisconsin.

COLORGLAZED Concrete pottery made without molds. Patented method. Cemetery products, novelties, tiles. Basement leak-sealing. Money-making projects. Booklet, details free. Men only. National Potteries Company, Grand Rapids, Minnesota.

FREE Book "505 Odd, Successful Businesses." Work home. Expect something odd! Pacific, Oceanside, Calif.

FIX Typewriters. Free booklet describes our modern, inexpensive home-study course. Factory methods taught. Write Typewriter, Building 1, Tarentum, Penna.

MONEY in new greaseless doughnuts. Start in kitchen. No smoke. Sell stores. Free recipes. M. Ray Company, 3605 South 15th Ave., Minneapolis 7, Minn.

BRONZED Baby shoe supplies, instructions, mountings. Metal bookends, \$1.50 pair. Free catalog. National Bronze Supply, Box 56, Los Angeles 32, Calif.

FORM A buyers or consumers group. My plan successful. Excellent moneymaking opportunity. Free details. Putnams, Box 74A, Columbus Grove, Ohio.

START Your own mail order business. "Mail Order Business Manual" reveals proven methods. No crackpot schemes. Bud E. Hine, Box 93, Battle Creek, Mich.

MAILORDER Home business! Details stamp. Shirley, 20-Raspeburg, Baltimore 6, Maryland.

MILLION Articles wholesale. Supply source directory 10c. Idealer, Park Ridge, Illinois.

SELL Books, merchandise by mail. Good profits. We furnish circulars, names—Ship your orders. National, Box 88, Dorchester, 22G, Mass.

BIG Money. Home plastics business. Free catalog. Bing Products, PM-854, Watertown 72, Mass.

MONEYMAKING OPPORTUNITIES

INCREASE Your income, turn your spare time into cash—Making quick-selling, highly profitable lamps and fiber glass shades. Every home a prospect for one or more. Hundreds already doing it, so can you. No experience needed. No special tools required. Gearon's big, new 72 page 1954 illustrated Catalog No. 8 will show you how, quickly. One special 8-page section shows 6 beautiful lamps in kit form, ready for you to assemble. Another 12-page section shows you how to make stunning, ultra-modern fiber glass shades. Page after page filled with wide variety of other attractive shades, shade frames, figurines, and lamp bases. Also oil lamp converters, boring compound, and all kinds of cords, sockets, pipes, harps, finials, bases, and hundreds of other parts. Everything you need. And you can buy everything wholesale, sell at retail, make big profits, fast. Send only 25c right now for Gearon's big 1954 catalog and wholesale price list. Like hundreds of others, you'll be glad you did. Gearon Co., Dept. 503-B8, 27 S. Desplaines, Chicago 6, Ill.

MONEY Making plans and manuals. Literature free. Kaiser, 136B Gamewell, Hackensack, New Jersey.

START A profitable subscription business in spare time! We need men and women (young or old) as representatives for all leading national magazines. Liberal commissions paid for new and renewal subscriptions. Start earning money in this pleasant work at once! Clip this ad and send with your name and address to: International Circulation Distributors, Dept. PM, Hearst Magazines, 250 W. 53th St., New York 19, N. Y.

PRESERVE Color-beauty of living flowers indefinitely. Tremendous profits, fascinating work! Maxson, Falls Church 18, Virginia.

GENERAL Contest Bulletin. Issued monthly. Sample, 25c. 1609½ East 5th, Duluth, Minn.

ALASKAN Government land obtained now offers fabulous profits upon statehood. Information \$1. McGurrin, 12 Lorton, Burlingame, California.

MAKE Extra money! Learn mailorder. Free details. Write Bruce, Box 2551, Salt Lake City, Utah.

\$200 MONTHLY Possible raising earthworms! Backyard, garage, basement. Complete, illustrated booklet explains raising, feeding, packing, marketing. 25c postpaid! Ozark Worm Farm-J, Willow Springs, Missouri.

FREE! "301 Profitable Small Businesses!" Amazing shoeing plans! Work home! Start sparetime. Deumant Surveys, Kenmore 23-R, N. Y.

TELEVISION Antennas. Big profits rebuilding. Dimensions, instructions, \$1.00. Electronics, 29-D Clymer, Burlington, Vt.

KEY Making small investment—Big profits. Everything needed to start. Key machines. Complete setups from \$94.50. Send for free literature. Hugo Solomon & Son, 70 East Warren, Detroit 1, Michigan.

START Profitable spare time home business. Amazing opportunities. Particulars free. Merit-P, Box 1984, Jacksonville 1, Fla.

\$3 HOURLY, Camera necessary, guaranteed instructions \$1. Jon's, Whitharral, Texas.

STEADY Customers! Show mothers how keep children quiet, hours. Details, dime. Controller, 1009 S. First, Champaign, Ill.

PLASTIC Laminating equipment (nationally advertised, Warner). Information free. Dundon, 1310 Clinton, Kalamazoo, Mich.

NEW 7"x11" Ultra-blue signs, 7c, retail 50c. Sample free! Lowy, 812 Broadway, Dept. 806, New York 3.

SELL-Paint figurines, plaques, Circular 10c. Novelties, 105F Parkway, Tiffin, Ohio.

SELL Books, merchandise by mail. Tremendous profits. We furnish everything. Ship your orders. Write: Tradewinds, Box 8238, Chattanooga, Tenn.

BUY Wholesale! 30-80% discounts! Free! Large catalog of nationally advertised appliances, gifts, watches, jewelry, cameras, typewriters, tools, kitchenware, etc. Start your own fully self-operating mail order business without capital! Wholesale starting kits furnished. No experience necessary. Outline of unique automatic sales plan included. Consolidated Distributors, Division 118, Box 1337, Paterson 15, New Jersey.

ATTENTION: Typewriter owners. Make handsome profits. Write today, Groves Company, 682, Hastings 8, Nebraska.

START A buying service, buy wholesale thousands nationally advertised products. Make big profits selling at sizable discounts. Postcard brings details. American Buyers, 630-R, Linden, Buffalo, N. Y.

EARN Money evenings, copying and duplicating comic cartoons for advertisers. Adservice, Argyle 1, Wisconsin.

FREE! Complete mailorder business! Terrific profits! Everything furnished. Veejay Vitamins, 18707 Cimsta, Los Angeles 18, California.

AMAZINGLY Different home money-making plans—25c. Sales Co., 67 Brinkerhoff, Jersey City 4, N. J.

DOLLARS in Tiny-Tot booties. Literature 25c. Brittingham, Atlantic Highlands, New Jersey.

TESTED Plans for home operated business. Free details. Gilchrist Sales Company, 13 Brown Avenue, Cortland, New York.

NEW Baby Items. Agents, salesmen, distributors. Natural for mail order. Write: Liebig Industries, Beaver Dam 5, Wis.

100% PROFIT! Mexican featherbird pictures. Hot sellers! Edmunds, 3009-P Weaver Ave., Baltimore 14, Md.

FREE Folio describing "845,000; Unlimited Vacations Plan". No canvassing, mail-order, merchandise, equipment. Unknown. Works itself—home! Keep job. Haylings, Carlsbad, Calif.

NEW: Make-sell plastic plants. Look, feel real. Kit \$2.00. Mario Studios, 1157 Belmont, Chicago 13.

GET Free copy of "Opportunity", the magazine that shows you the way to unlimited profit possibilities. Gilbert, Room 1700, 28 East Jackson, Chicago 4.

MAIL Letters featuring real merchandise. Get \$10 orders in every mail, 100% profit. Everything furnished. Products, Box 23, Boston 17, Mass.

GROW Mushrooms. Cellar, shed, and outdoors. Spare, full time, year round. We pay \$3.50 lb. We paid Habbitt \$4,165.00 in few weeks. Free book. Washington Mushroom Ind., Dept. 173, 2954 Admiral Way, Seattle, Washington.

SPARETIME Profits taking subscriptions, all magazines. Wholesale catalog free. Cassell Agency, Westfield 2, New Jersey.

SELL Titania gems; \$9.75 carat wholesale. More brilliant than diamonds. Free catalogue. Diamonite, 1404-M Mitchell, Oakland 1, California.

50,000 ARTICLES Wholesale. Source directory, dime. Nelko, Box 3462-DR, Chicago 54.

READ Progressive Mailtrade, the magazine that tells how to make money by mail. Dime brings sample and special offer. Progressive Mailtrade, Box 357, Sheboygan, Wisconsin.

FREE Book "505 Odd, Successful Businesses". Work home. Expect something odd! Pacific, Oceanside, Calif.

PUBLISH Your own magazine. Handsome 52 page format, well edited, illustrated. Cost low as \$1.00 month. Brings you prestige, profits. 25c brings sample. Details. National Ord. Nebr.

MAKE To \$4.50 hour doing common pen lettering. National Artists, 801½-A North Marsalis, Dallas 3, Texas.

300% PROFIT Making and selling seamless wallets. Only scissors needed. Send \$1.00 for pattern. Barcklow, King St., Woodbury, N. J.

FREE Literature describing moneymaking mailorder plans. Lewis Barlett, Richmond, Georgia.

WINNING Prize contests is fabulous, confidential, home opportunity! Send stamp! National Contest Bulletin, Box 2635-P, Miami 16, Florida.

FORMULAS, PLANS, ETC.

TERRIFIC Savings—Profitable, complete plans and specifications for building water softeners. \$2.00. Morrison Engineering Co., 3955 Hope St., San Diego 15, Calif.

FOR Proof of what you can do in specialty manufacturing get our literature. It's free! Miller, Chemist, 1517-P, Tampa, Florida.

ANY Formula \$3.00. Catalog—Mfg. Treatise 10c. J. Belfort, 192 N. Clark, Chicago 1.

FORMULAS; All kinds. Latest, best. Literature free. Kemikal, Park Ridge, Ill.

REAL Manufacturing formulas. Lists free. Cummings, Chemist, Gordon Ave., Syracuse 4, N. Y.

PLASTICS

INSTRUCTIVE, Entertaining plastic kits, details. Science Now Company, R.D. 2, Catskill, New York.

PLASTICS Home-craft course for men and women. Tells and shows how to make hundreds of fast selling plastics products. All plastics and materials for 23 projects included in course. No special tools needed. Course pays for itself. Write for free booklet. Interstate Training Service, Dept. D-3-H, Portland 13, Oregon.

PLEXIGLAS, Fiberglass, polyester, acetate, vinylite. Casting, coating plastics. Fast service, wholesale - retail prices. Catalog 10c. Gem-O-Lite, Box 6861P, North Hollywood, California.

PLASTIC, Sheets, rods, tubes, etc. Free list. Plastic Supply Co., 2901 N. Grand Blvd., St. Louis 7, Mo.

PLEXIGLAS Sheets—Cut to size. Clear. All thicknesses. Standard outdoor translucent colors. McClarin Plastics, P.O. Box 168H, Hanover, Penna.

PLEXIGLAS, Lucite. Any size sheets. Square foot (12 x 12) cost, 1/16", \$1.18; 1/8", \$1.55; 3/16", \$1.90; 1/4", \$2.25. Add 15% for postage. Minimum order \$3.00. Almac Plastics, 600 Broadway, New York City.

CHEMISTRY

"SPECTACULAR Chemical Experiments" manual, covers laboratory pyrotechnics. Interesting and thorough. Contains complete formulas, set-ups, instructions, special data, on thermites, fulminates, acetylides, nitrogen iodide, explosive powders, etc. Only \$1.00 postpaid. Chemi-Technix Laboratories, 568CY Riley, Buffalo 8, New York.

NEW Idea chemical and apparatus outfits for home experimenting. Photo-scales, microscopes, chemicals, biological and laboratory supplies in small quantities. Catalog 25c. Established 1931. John H. Winn, 1244 West 23rd Street, New York, N. Y.

CHEMICALS And apparatus for industrial, analytical, and private laboratories. Catalog 25c. Dept. M-50. Biological Supply Co., 1176 Mt. Hope Ave., Rochester 20, N. Y.

ILLUSTRATED Catalog: Chemistry, mineralogy, biology 20c. Tracey Laboratories, Evanston, Illinois.

BUY IT WHOLESALE

BARGAINS, Job lots, close-outs! Save up to 50% on clothing, hosiery, notions, drugs, toiletries, gifts, jewelry, television, etc. 2000 items. 25c brings wholesale bargain catalog with special get acquainted offer which includes free \$1.00 merchandise certificate. Reliable Jobbers, 311-B North Desplines, Chicago.

WHOLESALE: Individual purchases, nationally advertised products, tremendous discounts. Catalog \$1.00. Day, Mount Morris 12, New York.

BONAFIDE Wholesale catalogue offering highest quality utility and luxury products at lowest prices, 25c. Paul House, Estherville, Iowa.

BUY Wholesale! 30-80% discounts! Free! Large catalog of nationally advertised appliances, gifts, watches, jewelry, cameras, typewriters, tools, kitchenware, etc. Start your own fully self-operating mail order business without capital! No experience necessary. Wholesale starting kits furnished. Outline of unique automatic sales plan included. Consolidated Distributors, Division 142, 21 Lafayette, Paterson 15, New Jersey.

BUY Wholesale direct 10,000 nationally advertised products. Save yourself 50%. Make big money selling others. Free "Wholesale Idea." National Buyers Service, Box 426EC, Oakland, California.

AGENTS WANTED

\$9.90 PROFIT Dozen. Magnetic pencils for waitresses, nurses. Nicholson Corporation, 3403 Cahuenga, Hollywood 48, Calif.

NEW Hand plane for wood and plastic. M. A. Tool Co., 2980 W. Davison, Detroit 6, Michigan.

BRAND New patented clip on ashtray. Housewives delight. 100% profits for agents, distributors and jobbers. E-Z-For Manufacturing Co., 4314 N. Broadway, Chicago, Ill.

ENJOY 3 Color television filter screen now easily attached. Send \$2.00 for your screen size. Satisfaction guaranteed. S. George, 5008 Stenton Avenue, Philadelphia 44, Pennsylvania.

MONEY For Xmas! Make \$50 and more during spare time. Friends, neighbors—everyone buys from Elmira's exquisite new sparkling line. Imprinted Christmas cards for as little as 3c. Personalized stationery, napkins, large gift wrappings with free accessories, ribbon ties—All fine quality money saving values. No experience needed. Send name and address for free portfolios, catalog, assortments on approval. Bonus plan. Elmira's "portable gift shop" makes money first day. Write today. Elmira Greeting Card Co., Dept. C-199, Elmira, N. Y.

MAKE Money at home as renewal headquarters for all magazines. Liberal commissions. No experience, no capital needed. Supplies furnished. Write for free catalog. McGregor Magazine Agency, Dept. 500A, Mount Morris, Ill.

GIVE Your customers the best. Famous Alice Ames bronzed baby-shoes made in the biggest and best plant devoted exclusively to bronzed baby shoes. Not available in stores. For details, write to Alice Ames, Dept. 2, Boston 36, Mass.

BEAUTIFUL Feather pictures. 200% profit! Free sample. Apartado 9036, Mexico 1, D. F.

BIG Profits: Sell 2 blade haircutting comb. Felice Pala, 420 Union St., Farrell, Penna.

AT LAST! Something new and sensational in Christmas cards. Make extra money fast! Show satins, velours, metallics. Get easy orders. Pays up to 100% cash profit. 30 free samples. With name 50 for \$1.50. Big line. Amazing new Glitter-Brite ornaments, napkins, gifts, stationery. Several \$1.00 boxes on approval. Puro Greetings, 2801 Locust, Dept. 440-K, St. Louis, Mo.

CHRISTMAS Cards pay 75c profit on \$1.25 assortment. Exclusive 40 for \$1 name imprints; gift wraps by-the-yard; 200 new fast-sellers. Cash bonus, 5 assortments on approval. Cardinal, 1400 State, Dept. 79-L, Cincinnati 14.

MAKE \$50, \$75, \$100 Again and again! Extra money selling "lifelike" Christmas, all occasion greeting cards. Big profits, plus extra cash bonus. Write for feature assortments on approval, free samples name imprinted Christmas cards, stationery, free color catalog, selling guide. New England Art Publishers, North Abington 833-A, Mass.

SEND Postcard for free money-making kit guaranteed direct-from-mill nylons, lingerie, blouses, men's and children's wear. American Mills, Dept. 430, Indianapolis.

MAKE Money introducing world's cutest children's dresses. Big selection, adorable styles. Low prices. Complete display free. Rush name. Harford, Dept. M-2341, Cincinnati 25, Ohio.

MAKE Money fast—For yourself, church, organization. Selling friends, neighbors big value \$1.00 and \$1.25 Christmas and all occasion greeting cards. Leading 21 card boxes, religious and novelty assortments. Gift wrappings, stationery, children's items, gifts, gadgets. Deluxe imprinted Christmas cards. Over 200 items, profits to 100%. Experience unnecessary. Free gift for promptness. Bonus. Free selling plan! Samples on approval. Hedenkamp, 361 Broadway, Dept. PM-33, New York.

SHINE Shoes without "polish." New invention. Lightning seller. Shoes gleam like mirror. Samples sent on trial. Kristee 59, Akron, Ohio.

RUN Spare-time greeting card and gift shop at home. Show friends samples of our new 1954 Christmas and all-occasion greeting cards and gifts. Take their orders and earn to 100% profit. No experience necessary. Costs nothing to try. Write today for samples on approval. Regal Greetings, Dept. 104, Ferndale, Mich.gnn.

BIGGER Profits selling greeting cards. Get list of sensational factory surplus bargains. \$1.25 boxes for 50c, \$1 boxes for 35c—While they last! Big line new 1954 Christmas cards, stationery, gifts. Assortments on approval. Personalized samples free! Midwest Cards, 1113 Washington, Dept. H-135, St. Louis, Mo.

BIALEK'S Famous liniment. Sells and repeats fast. Sample \$1.00. Dozen \$6.00. Frank Bialek, Junction City, Wis.

SELL The Guarunan Angel Bible for \$2.95, sample \$2.00. Modern Enterprises, Cynthia 1, Kentucky.

400% PROFIT For selling amazing new skin cream for skin disorders. Used by millions. State, county, foreign territories available. Send for free literature. Wiley Products Inc., P.O. Box 46, Chicago 17, Ill.

GET Into toys! Show sensational toy flannel-back tablecloth. Free toy gift line. Take orders. Juicy profits. Styleco, Dept. T450, Cincinnati 10, Ohio.

GET New shirt outfit free; make \$90.00 weekly on 5 average orders a day. Famous quality made-to-measure dress and sport shirts at \$3.95 up sell fast to all men. No experience needed. Full or part time. Write: Packard Shirt Co., Dept. 706, Terre Haute, Ind.

NEED Money? \$50.00 yours, sell only 100 boxes new Christmas cards. Other amazing offers. Free samples imprinted cards. Feature box assortments on approval; free catalogue, 100 profitable items. Work with a national leader. Write today. Pen 'N' Brush, Dept. PM-8, 139 Duane St., New York City 13.

IMMEDIATE Success! Sensational profits! Used suits \$1.75, pants 35c, dresses 20c, shoes 20c. Operate from store, home, car. Free catalog. Superior, 1250-A Jefferson, Chicago 7.

BUY Wholesale! 30-80% discounts! Free! Large catalog of nationally advertised appliances, gifts, watches, jewelry, cameras, typewriters, tools, kitchenware, etc. Start your own fully self-operating mail order business without capital! Wholesale starting kits furnished. No experience necessary. Outline of unique automatic sales plan included. Consolidated Distributors, Division 101, Box 1537, Paterson 15, New Jersey.

MEN-Women: 100% profit, taking orders for Sweet Georgia Brown beauty products. Colored people buy on sight. Sample offer. Valmor, 2451-HY6 Michigan, Chicago 16.

NEED Extra cash? Get it selling Blair's unusual line of household and food products. Every housewife a prospect. Products sent on free trial. Write Blair, Dept. 31ML, Lynchburg, Va.

REVOLUTIONARY! Exclusive! New, economical safety auto accessory. Instant seller. Giant profit plan. No competition. Territories open. Parnat Machine Works, 1816 Vyse Avenue, Dept. PM-15, New York 60, N. Y.

BUY Wholesale thousands nationally advertised products at big discount. Free "Wholesale Plan." American Buyers, 629-R Linden, Buffalo, N. Y.

BIG Profits. Razor blades, other items. Free sample, lists. Hansen Sales, 4908-P Ohio, Chicago 44.

A Dress-lingerie shop in your home. No investment. Good commissions. Write for sample book. Modern Manner, 250PA Fifth Avenue, New York.

DIRECT Salesmen—Mail order dealers: Here's quick profits! Unbelievable sales being made! Amazing new "Clean House" fumigation cones, burn like incense, kill small flying and exposed soft or hard shelled insects within two hours. Effective up to six weeks. Safe—No flame, no sparks. Guaranteed. 14 cones, boxed, sell for \$1.100% profit. One sales company sold 28,000 boxes in 60 days! Test mail order returns overwhelming! A proved "natural"; needed in every home; year around profits just waiting for you. Introductory salesmen's offer: Dozen boxes, \$5.00 prepaid. White Company, 1593A Crossroads, Los Angeles 28, Calif.

AMAZING Profits for you selling Sunshine quality Christmas cards. No investment or experience necessary. Nationally famous 21 cards for \$1.00. Sells on sight! Imprints, Currier-Ives, religious, gift wraps, many others. Samples on approval, write: Sunshine Art Studios, Inc., Dept. PM-8, Springfield 1, Mass. Pasadena 3, Calif. (Note: East of Rockies address Springfield office.)

OWN Your own profitable wholesale merchandising business. Investment, experience unnecessary. Sell 5,000 famous nationally advertised products everybody buys. Your own name catalog. We drop ship orders. Free details. General Wholesalers, Box 1195EF, Chicago, or Box 3058EF, San Francisco.

START Your own money making discount business. Buy wholesale nationally advertised appliances, watches, giftware. Experience, investment unnecessary. Sales unlimited. Free "Wholesale Idea." National Buyers Service, Box 426EM, Oakland, California.

EXTRA Money. Amazing profits. Selling sensational new patented double-edge razor blades. Finest Swedish steel. World famous genuine German Solingen brand. Outstanding quality, highest precision, extremely smooth cut, longer lasting. Outperforming everything on market. Steady satisfied customers all year round, try yourself and see. Buy direct from exclusive importer at original lowest factory cost. \$1 brings 5 dozen samples and details. B. & C. Imports, Inc., 220 Broadway, New York 38, N. Y.

NEW Plastic mending tape. Just press on! Repairs clothing instantly. Lightning seller. Samples sent on trial. Kristee, 57, Akron, Ohio.

APPLIANCES, Cameras, watches! Large coded wholesale catalogue! Cam Company, 6806PM-20th Ave., Brooklyn 4, N. Y.

EASY Extra income—Sell sensational new silicone scorch resistant ironing board cover. Good Housekeeping approved. Terrific \$1.98 seller! Send for free complete selling kit. Sample cover \$1.10. Menell Products, Dept. P—P.O. Box 431, Midtown Station, New York 18, N. Y.

YOUR Own business—Used suits \$1.50, overcoats 65c, mackinaws 35c, shoes 12½c, ladies coats 30c, dresses 15c. Enormous profits. Catalog free. Moro, 1218 South Jefferson, Chicago 7.

HAVE A complete store in your pocket. Buy wholesale and make big profits. Send for free general merchandise catalog now. Jay Norris, Dept. P, 445 Broome St., New York City.

PRINTING, Advertising salesmen—Excellent moneymaking sideline selling decalcomania name plates, small quantities. Automobile initials, sign letters. Free samples. Ralco, XL Boston 19, Mass.

CALIFORNIA Sweet smelling beads. Sensational sellers. Free particulars. Mission, 2328PM West Pico, Los Angeles 6, Calif.

WINDOW Sign letters. Samples free. West Coast Sign Letter Service, P.O. Box 697, Escalon, Calif.

GOLD Or silver letters, numbers. Windows, doors, trucks. 1" to 6". 500% profits. Free samples. Atlas-T, 544 West 76th, Chicago 20.

\$1.00 PROFIT Selling \$2.95 photo enlargement deal. Allen Studio, Riegler Bldg., Little Rock, Ark.

MAKE Extra money. Sell front door name plates to friends, neighbors. Retail \$1.98; you make \$1.00! Free selling kit. Modern Engraving Co., P.O. Box 194, Boston 14, Mass.

AGENTS—300% Profit selling genuine gold window letters; stores and offices. Free samples. Metallic Sign Letter Co., 431-D North Clark, Chicago.

IT'S So terrific you'll actually sell thousands! Brand new \$2.95 pocket check protector. Sales pouring in. A tremendous deal for you. Get your town today. Federal Products, Evanston 15, Illinois.

EASY Handwork makes fast-selling useful articles. Sample free. Sunmade Company, Brockton 64, Massachusetts.

SALESMEN—DISTRIBUTORS

MORE Money with the best in automatic fire protection. 60% profit. Everything furnished. Leading national manufacturer. Red Ball Inc., Box 1562, Salt Lake City, Utah.

LEARN Where millions in profits from Bible sales have gone! Receive free proven sales course and whole story of how you can get these profits! Also free catalogue of six of the world's finest Morocco grain genuine leather covered Bibles and related items! Joseph W. Cain, Wholesaler, Box 3065P, San Antonio 1, Texas.

SPECIALIZED Hand tools for industry and home. Free catalog. Tools, Box 564, Whittier, California.

\$10,000 PROFIT Selling printing, matches, specialties! Arrow dealer tells how he did it in giant free sales outfit. You can do it too—without experience. Write Arrow Press, 515-J Fourth Ave. So., Minneapolis, Minn.

ANYONE Can sell famous Hoover uniforms for beauty shops, waitresses, nurses, doctors, others. All popular miracle fabrics—Nylon, dacron, orlon. Exclusive styles, top quality. Big cash income now, real future. Equipment free. Hoover, Dept. E-109, New York 11, N. Y.

AD Matches! Sell amazing designs—20, 30, 40 and 240-light book matches. Bigger spot cash commissions; every business a prospect. Low prices for high quality. Repeats. Start without experience; men, women; full, part time. Buy nothing! Sales kit furnished. Match Corp., Dept. PM-56, Chicago 2, Illinois.

HOUSEWIFE'S Delight. Apron with two matching potholders. Terrific sales appeal. Details-sample 70c. Step Saver Mfg. Co., 1671 Milwaukee Ave., Chicago 47, Ill.

CANVASSERS. Easy to sell. Patented pen. Guaranteed, 100% profits. Box 1240, G.P.O., New York City.

BIG Money-making opportunity. Exclusive line work uniforms. Jackets, pants, shirts, coveralls. Advertising embroidered. Every business prospect. Outfit free. Master Div., 258 Water, Ligonier, Ind.

ADVERTISING Book matches—Cash in on big demand; sell union label matches. Cuts for all businesses and political parties. Free powerhouse selling kit, low prices, protection guaranteed on repeat orders. Cash commissions. Superior Match Co., Dept. M-854, 7530 Greenwood, Chicago.

SALESMEN—\$50.00 in a day definitely assured, selling brand new item going to every type of food and beverage store, factories, laboratories, hospitals, etc. Samples furnished. Utility Durawear, 53 West Jackson Blvd., Dept. PM-8, Chicago, Illinois.

MAKE Money with fast-selling Bostonian shirts. Spare time, full time. Sales kit, actual sample fabrics, free. Bostonian, 89 Bickford, Dept. F-10, Boston 30, Mass.

PRINTING—Sales and order books, envelopes, statements, business forms with or without carbon. Erco, Bronx 72, N. Y. Free catalog.

NEW Chemical discovery. Pro Auto Wax, easy way to car beauty. Free sample, information. Amazing profits. Burford Auto Finishes, 1660—20th Street, Santa Monica, Calif.

A Postcard can put you in a fine business! Complete line. Leather jackets, 160 shoe styles. Big commissions. No experience, no investment. Send postcard for free outfit. Mason Shoe, Dept. MC31, Chippewa Falls, Wis.

BUY Wholesale thousands nationally advertised products at big discount. Free "Wholesale Plan." American Buyers, 630-DD Linden, Buffalo, N. Y.

FULL Or part time. Sell Clinton engine rotary power mowers. Only five sales per week makes you \$150.00. Initial investment \$47.17 secured by inventory. W. Earl Starbuck, Pittsboro, Indiana.

BONAFIDE Specialties needed by all retailers, car dealers, realtors. Big commissions. Box 3678, San Francisco 19.

DISTRICT Agency. Chain saws. Wheel mounted. Power mowers. Sales-service. Exclusive. Farmco-PM, Excelsior Springs, Mo.

SELL "Dandy" profitable fast moving automotive accessory. Dandy, Box 5, Columbus, Ind.

FORTY - Niner sourdough starter. Healthfoods, pancakes, breads. \$1.00 package with recipes, territory. William G. Withrow Co., 2805 W. Colorado Blvd., Los Angeles 41, Calif.

LEARN Where millions in profits from Bible sales have gone! Receive free proven sales course and whole story of how you can get these profits! Also free catalogue of six of the world's finest Morocco grain genuine leather covered Bibles and related items! Joseph W. Cain, Wholesaler, Box 5065P, San Antonio 1, Texas.

IS \$210 A week worth a postcard to you? Then rush card with name and address for special free trial plan that sells amazing new automatic refrigerator defroster like hot cakes! Write to Mr. Lewis, D-Frost-O-Matic Corp., Dept. P-102, 173 W. Madison, Chicago 2, Illinois.

GOOD Man can make \$3,000 next 90 days. Every house in town wants amazing NiLite glowing curbside numbers. Automatic free trial plan pays profits day after day. Write for free details. NiLite, 173 W. Madison, Dept. 301, Chicago 2, Ill.

EDUCATIONAL AND INSTRUCTION

IT'S Quick, easy fun to learn a language by Linguaphone. At home, in leisure time, quickly, easily master French, Spanish, German, Russian, Japanese—29 languages by Linguaphone World's Standard Conversational Method. You listen, you hear men and women speak, you understand, you speak. Save time, money. Gain job, school, travel, cultural opportunities. Write for free book. Linguaphone Institute, 8308 RCA Building, New York 20.

OWN Collection agency office. Pays big! Free details. Franklin Credit, Roanoke 7, Va.

BLUEPRINT Reading for machine and building trades. Train at home. Learn to read blueprints with confidence in 10 easy lessons. Literature free. Belton School, 1059G North Lawndale, Chicago 51, Illinois.

COMPLETE Your high school at home in spare time with 57-year-old school. Texts furnished. No classes. Diploma. Information booklet free. American School, Dept. XC45, Drexel at 58th, Chicago 37, Illinois.

WANT A diesel job? New opportunities to increase income. Higher pay. More money. We can help you qualify. Tools. Shop method home training. Write today! Diesel, Tractor, Heavy Equipment Division, Interstate Training Service, Dept. B3-H, Portland 13, Oregon.

U. S. Gov't jobs! Men-women, 18-55. Start high as \$350.00 month. Qualify now! 23,000 jobs open. Experience often unnecessary. Get free 36-page book showing jobs, salaries, requirements, sample tests. Write: Franklin Institute, Dept. S-24, Rochester, N. Y.

LEARN Priceless secrets of technical metaphysics. Easy to learn. Only school of its kind. Write: Premier College of Technical Metaphysics, 2532 McKenzie St., Vancouver, B. C., Canada.

WELDING Training pays at Hobart Welding School, Box M-841, Troy, Ohio. VA contract. Best equipment. Catalog free.

HIGH School—No classes. Study at home. Spare time. Diploma awarded. Write for free catalog HP-46, Wayne School, 2527 N. Sheffield, Chicago 14, Ill.

COMPLETE Conversational tape and text courses, French, German, Russian, \$15.00. Also taperecording courses. Shakespeare Tape Library, 1818 M Street, Washington 6, D. C.

INCREDIBLE! Become mental superman overnight! Free booklet! Bijou, Box 1727-MO, Hollywood 28, California.

USED Correspondence courses and educational books bought, sold, rented. Catalog free. Educational Exchange, Summer-ville, Ga.

MIDLAND Linotype School, Charles City, Iowa. Civilian and Veteran Courses. Free placement. Established 1909.

CAMERA Repairmen greatly needed! You can learn manufacturers' service methods at home, in your spare time! Free, big illustrated book tells how! Write today. National Camera Repair School, Dept. P.M.B., Englewood, Colorado.

AFRAID To talk? Lack confidence in the sound of your own voice? Amazing home training plan quickly gives you strong, confident voice. Free booklet gives facts. Write Perfect Voice Institute, 210 South Clinton, Studio 2HW-2, Chicago 6.

GENEALOGY Research course (tracing families). Circular free. Outlet, 2455 Clement, San Francisco 21, Calif.

METALLURGY Easily learned at home. Prepare now for this big income field. Write Fran Council, Box 150, Wildwood, New Jersey.

SMASH Worries, fears and problems with our life-changing "Thought and Behavior Control" method. Many helped. Write today for free eye-opening lecture. Applied Christian Psychology, Inc., Box 1924-E, Louisville 1, Ky.

MAKE Good money in camera repairing and servicing. Learn how. Ed. Valera, 4202 N. Wolcott, Chicago 13, Ill.

MEDICAL Laboratory technique. Learn at home. Catalog free. Century College, 9 East Ohio, Chicago 11, Illinois.

CORRESPONDENCE Courses, educational books bought, sold, rented. Catalog free. Willard Bayles, 211 Essex, Hackensack, New Jersey.

HIGH School diploma at home. Licensed teachers—Approved materials. Southern States Academy, Box 144-MX, Station E, Atlanta, Georgia.

STUDY By correspondence for Doctor's degree in Psychology, Metaphysics and Divinity. College of Divine Metaphysics, Dept. P-M, 2811 North Illinois St., Indianapolis 8, Indiana.

PHYSICAL Therapy and massage. We train you at home. Earn big profits from your own private practice or work with hospitals and doctors. Free catalog. National Institute, Desk 4, 4868 1/2 Sheridan Road, Chicago 40, Illinois.

BE A real estate broker. Study at home. Write for free book today. G.I. approved. Weaver School of Real Estate, 304 Law Bldg., Kansas City, Missouri.

SECRET Investigation. Experience unnecessary. Investigators particulars free. George Wagner, M125 West 86th, New York 24.

GROW Mushrooms. Cellar, shed, and outdoors. Spare, full time, year round. We pay \$3.50 lb. We paid Babbitt \$4,165.00 in few weeks. Free book. Washington Mushroom Ind., Dept. 174, 2954 Admiral Way, Seattle, Washington.

EARN While you learn. Auto and diesel mechanics master this top paying trade. Many graduates earn \$100 a week and up. Approved for Korean veterans. For free information write Dept. No. 256, Nashville Auto-Diesel College, Nashville 3, Tenn.

BOOKKEEPERS! Increase your earnings! Operate your own simplified "Dollar-A-Week" bookkeeping and tax service. Full or spare time. Details free. No obligation. Ellis, Box 200, Cedar Grove, North Carolina.

MEDICAL Laboratory technicians in great demand. We train you in your own home. Catalogue free. Imperial Technical Institute, Box 973-J, Austin, Texas.

INVESTIGATOR Training. Phillips Secret Service System, 1917-B North Kenneth, Chicago 39.

USED Correspondence courses and books sold and rented. Money back guarantee. Catalog free. (Courses bought.) Lee Mountain, Pisgah, Alabama.

AUCTIONEERING—Be an auctioneer. Earn big money. Term soon. Write for catalog. Kansas City Auction School, Suite 307 Shankman Building, 3119 Troost, Kansas City, Missouri.

UNIVERSITY Degrees by residence and correspondence. Golden State University, Hollywood, Calif.

PIANO Tuning pays. Learn this profitable profession at home easily with patented Tunometer and mechanical aids. No knowledge music necessary. Diploma granted. Veteran approved. Write for booklet. Niles Bryant School, 3731 Stockton Blvd., Dept. P, Sacramento 20, Calif.

"INDUSTRIAL Drafting Opportunities." Free booklet. Write—Industrial Training, 1704-A Frederick, Fort Worth 7, Texas.

GOVERNMENT Position! Home training for examination. \$9.95. Refunded if don't pass. Write, Ozment Instructions, 34-CS, St. Louis, Mo.

EARN Big pay. Become criminal investigator. Wonderful field to work in. Train at home. Very easily mastered. Details free. C I & I Academy, 257 South Spring Street, Los Angeles 12, California.

PLAYS, STORIES, MANUSCRIPTS

NO Luck finding a book publisher? Write for free Booklet PM. Vantage Press, 120 W. 31, New York.

BOOK Manuscripts invited—Cooperative publishers since 1925. Meador Press, 324 Newbury St., Boston 15, Mass.

BUSINESS SERVICE

BUSINESS Cards \$3.95, 1000. Information, samples free. Lydamore, Mineola, N. Y.

TROUBLE Getting capital? Concerned about marketing plans? For tried and proven method enabling effective presentation of your enterprise obtain "Basic Fundamentals of New Enterprise." Postpaid \$2. Rover Research, 650 South Grand, Los Angeles 17, California.

300 PENNI-Prints \$5. Your ideas, testimonial letters, diagrams, clippings reproduced 8 1/2 x 11. Free estimates. Penniprint Co., Dept. 10, Box 1159, Chicago 90.

SPECIAL SERVICES

LETTERS Remailed 25c. 6 picture postals \$1.00. Banas, 602 Onondaga Ave., Syracuse 7, N. Y.

RESEARCH. Speeches, articles written, graduate engineer. Factual questions answered \$2. Jewett, 611 Sycamore, Decatur, Georgia.

AIRMAILED Remails Arabia or Lebanon. \$1.00 each. Staast, Box 2635, Dhahran, Saudi Arabia.

HELP Wanted ads from Cincinnati air mailed \$1.00. L&M, 3136 Portsmouth, Cincinnati, Ohio.

CARTOONING, COMMERCIAL ART, SHOWCARD & SIGN PAINTING, TATTOOING

CARTOONISTS: Prepare for animation. Write Vera Coleman, Lincoln Bldg., New York, N. Y.

CARTOONING Self taught, complete course only \$1.00. Cummings Studio, 2009 Utah Street, St. Louis 4, Missouri.

9 ALPHABET, 3 Numeral pattern sets and raised wood letter catalog, \$1.00. Sign Letter Distributors, P.O. Box 101, Mineola, N. Y.

"HOW To Make Money With Simple Cartoons"—A book everyone who likes to draw should have. It is free; no obligation. Simply address Cartoonists' Exchange, Dept. 98C, Pleasant Hill, Ohio.

TATTOOING Course, supply brochures 25c. Zeiss, 728 Lesley, Rockford, Illinois.

ADVERTISING AGENCIES, LETTER WRITERS, FOR ADVERTISERS

MAILING List—Our own cash buyers. Trial 100 names \$1.00, 1000 names \$5.00. Richmond Enterprises, Box 1093, Augusta, Georgia.

WANT More business? Here's an amazing opportunity to increase your sales. Talk to thousands of interested readers of "Mechanica Popular." Our Spanish Edition covers the Latin American countries like a blanket. They're real mailorder buyers. Classified rate 75c per word. Try an ad in our next issue. Classified Advertising Department, Popular Mechanics Magazine, 200 East Ontario Street, Chicago 11, Ill.

MAILING Lists, most any classification. 1000 names \$5.00, 1000 your circulars mailed with ours \$4.00, 5000 your circulars printed and mailed \$12.95. Write Dixie Mailers, King, North Carolina.

ADS Placed in out of town newspapers and magazines. Low rates. Catalogue free. Ideas that pay. Baker Advertising Agency, Successors Ankrum Agency, 189 W. Madison, Chicago 2.

BEFORE Advertising get instructive Ad-Guide and Ratebook, 10c. Ideas developed. Advertisements prepared free. Chicago Advertising Agency (Established 1900), Chicago 4.

RUBBER STAMPS AND OFFICE SUPPLIES

STOCK Stamps 35c each, 7 for \$2.00, 3 line cushion or pocket stamp 75c. Gummed stickers 500—50c. Labels and stamps all kinds. 100% guarantee. Catalog 10c refunded. Esco 184 Print, 8 Holt, Dayton 7, Ohio.

RUBBER Stamps by professional craftsmen. 3 lines \$1.00. Price list, South Coast Press, P.O. Box 2074, San Bernardino, Calif.

3 LINES \$1.00 Additional lines 25c. Free
—pad or airmail stamp. Expert craftsmen.
Printex. Roanoke, Virginia.

TYPEWRITERS, DUPLICATORS, OFFICE DEVICES

RECONDITIONED Typewriters, dupli-
cating, printing devices. \$35.00 up. Sup-
plies. Appliances. DixieGraph, King, N. C.

PRINTING, MULTIGRAPHING, MIMEOGRAPHING GUMMED LABELS

PRINTING. 100 Letterheads with envel-
opes \$2.50. Prompt service. The Pike Coun-
ty Dispatch, Winslow, Indiana.

PHOTO-Offset printing, free price list.
1,000 8 $\frac{1}{2}$ x 11 \$9.70 postpaid. Newman,
3539 Hartford, St. Louis 18, Mo.

LETTERHEADS, Envelopes, cards, any
amount, finest workmanship, guaranteed.
Free samples. Maywood Industries, Box 6,
Riveredge, New Jersey.

ENVELOPES—#6 $\frac{3}{4}$ Printed, 500, \$2.25;
1000, \$3.75; 2000, \$6.50; f.o.b. Hargraves,
Box 517, Corning, N. Y.

100 LETTERHEADS Or envelopes \$1.00.
Two colors \$1.50. Broadbrook, Botaford,
Connecticut.

BETTER Printing—Reasonable prices.
Free estimates. Samples. Reporter, Chelsea,
Oklahoma.

FREE Samples, airmailed. Printing ac-
curacy guaranteed. Fast service. Postpaid.
U. S. D & M Sales Co., Sebastopol, Calif.

CIRCULAR Printing: 5,000 3 x 6 \$7.95
postpaid. Samples 3c. Transworld, Harlan,
Kentucky.

500 STANDARD Letterheads or envel-
opes. \$3.00 postpaid. Expert m.o. printers.
Free catalog. Arthur Steinbergen, 1274-B
Stebbins, New York City 59.

BUSINESS Cards. Finest vellum. 1000,
\$3.50; 500, \$2.00. Free type-chart. Quality
Products, Box 145, Madison, Ohio.

MIMEOGRAPHING. 500 White 8 $\frac{1}{2}$ x 11"
\$5.00 postpaid. 400 words maximum. Over-
night service, colors. Lee, 8 Gables Drive,
Hicksville, N. Y.

BUSINESS Cards 1000—\$2.50. Free sam-
ples, styles. Fuller's, 41 Brewster, Provi-
dence 6, R. I.

SUPERIOR Printing. Low prices. Prompt
service. Free price list, samples. Southern
Printing, Alma, Georgia.

MIMEOGRAPHING. Printing, office
supplies. Free samples. Robert Bailey,
Monterey, Tenn.

EXTRA Fine quality embossed cards.
Adds prestige to business or personal use.
Price—exceedingly low. Prepaid delivery.
Free samples. M-P Distributing Co., 130-P
Sutphen St., Santa Cruz, Calif.

1000 RAISED Printing business cards.
\$4.00. Samples free. Simon, 1556 Hoe
Avenue, New York 60.

OFFSET Printing \$6.50—1000, 8 $\frac{1}{2}$ x11,
16 lb. National Letter, 1463 Broadway,
New York 36.

100 8 $\frac{1}{2}$ x11 HAMMERMILL Letterheads
and 100 envelopes \$1.95 postpaid. H. Hud-
son, Centredale, R. I.

100 ENVELOPES. Printed 2-colors \$1.25.
Box 523, Rochester 2, N. Y.

MIMEOGRAPHING—Letters, pricelists,
formulas, instructions. Lowest prices.
Lem's Letter Shop, 5710 Stanton, Detroit 8.

500 3 $\frac{1}{2}$ x2 $\frac{1}{4}$ FOUR Line gummed stickers
50c. Red border \$1.00. Moritz Printery,
Saginaw, Mich.

ATTRACTIVE Labels, stickers. Inexpen-
sive. Samples. Fame, 291 Ellis, San Fran-
cisco 2, Calif.

JOB Printing, letterheads, envelopes,
circulars. Printing, 21 Barclay, Ports-
mouth, Virginia.

PRINTING OUTFITS AND SUPPLIES

PRESSES, Type, cabinets, supplies. List
for stamp. Lincoln Press Company, 220-H
Hartwell, Fall River, Mass.

MAKE Your own self-molding rubber
stamps and printing cuts. Flexirubber,
Argyle 1, Wisconsin.

DO Your own printing. Save money.
Simple rules. We supply everything. Print
for others; good profit. Raised printing
like engraving too. Have home shop. De-
tails free. Kelsey Presses, V-11, Meriden,
Connecticut.

PRINTING Presses, type, supplies.
List 3c. Turnbaugh Service, Loysville,
Penna.

FREE Booklet, "Make Your Own Cuts."
Amazing new process. Walp, Box 4308-M,
Mobile, Ala.

PATENT ATTORNEYS

REGISTERED Patent attorney offers
services. Sanders, 6430 Evans, Chicago 37,
Illinois.

INVENTORS. If you believe you have an
invention, you should find out how to pro-
tect it. The firm of McMorro, Berman &
Davidson with offices in Washington,
D. C., is qualified to take the necessary
steps for you. Send for copy of our patent
booklet "How to Protect Your Invention."
We will also send you an "Invention Rec-
ord" form. No obligation. They are yours
for the asking. McMorro, Berman &
Davidson, Registered Patent Attorneys,
134-G Victor Building, Washington 1, D. C.

INVENTORS—If you have a valuable in-
vention, you are advised to authorize a
preliminary search through appropriate
classes of United States patents. This
firm is registered to practice before the
patent office and is available to make such
search and report to you concerning the
probable patentability of your invention.
Instructive booklet with "Evidence of In-
vention" form sent upon request. Victor J.
Evans & Co., 931-J Merlin Building,
Washington 6, D. C.

INVENTION Record form free and "Pat-
ent Information Every Inventor Should
Have." Carl Miller, Registered Patent At-
torney, Woolworth Building, New York.

INVENTORS: Learn how to protect your
invention. Special booklet "Patent Guide
for the Inventor" containing detailed in-
formation concerning patent protection
and procedure together with "Record of
Invention" form will be promptly forward-
ed to you upon request—without obliga-
tion. We are registered to practice before
the U. S. Patent Office and prepared to
serve you in the handling of your patent
matters. Clarence A. O'Brien & Harvey
Jacobson, Registered Patent Attorneys,
41B-G District National Building, Wash-
ington, D. C.

CANADA—Ramsay Company Registered,
273 Bank Street, Ottawa, Canada.

"INVENTOR'S Guide" and "Record of
Invention" free on request. Frank P.
Ledermann, Registered Patent Attorney,
154 Nassau Street, New York City.

PATENTS. "Proof of Invention" free.
E. E. Vrooman, Registered Patent Attor-
ney, 507 McKim Building, Washington 5,
D. C.

PATENTS—Irving L. McCathran, 315
McLachlen Bldg., Washington 1, D. C.
Registered Patent Attorney.

INVENTORS: When you are satisfied
that you have invented something of
value write me, without obligation, for
information as to what steps you should
take to secure a patent. Write Patrick D.
Beavers, Registered Patent Atty., 935 Co-
lumbian Bldg., Washington 1, D. C.

C. A. Snow & Co.—M427, Snow Build-
ing, Washington 1, D. C. Registered Pat-
ent Attorneys. Write for information.

INVENTORS: Without obligation, write
for information explaining the steps you
should take to secure a patent. John Ran-
dolph, Registered Patent Attorney, 203 Co-
lumbian Bldg., Washington 1, D. C.

FOR INVENTORS

INVENTORS—This firm is registered to
practice before the United States Patent
Office and is available to assist you in the
preparation and prosecution of your pat-
ent application. "Patent Protection for
Inventors" booklet containing detailed in-
formation and steps to take toward pat-
ent protection will be sent upon request.
No obligation. Victor J. Evans & Co.,
932-J Merlin Building, Washington 6, D. C.

MANUFACTURER, Dun & Bradstreet
rating B-1, facilities and know how for de-
veloping, fabrication and assembly of non-
precision products, seeks other lines. Buy
outright or royalty. No brokers. Box 3003,
Linden Hills Station, Minneapolis, Minn.

INVENTORS—Send for free patent in-
formation book and inventor's record. Re-
gistered Patent Attorney. Associate Exam-
iner. Patent Office 1922-29; Patent Attor-
ney & Advisor, Navy Department 1930-47.
Gustave Miller, 84A Warner Building,
Washington 4, D. C.

"AN Inventor's Story" 60c. Eye-opening
details. Inquire. Demitz, Box 9641, Nor-
folk 5, Virginia.

INVENTORS—If you believe you have an
invention, you should find out how to
protect it. The firm of McMorro, Berman
& Davidson with offices in Washington,
D. C., is qualified to take the necessary
steps for you. Send for copy of our patent
booklet "How to Protect Your Invention."
We will also send you an "Invention Rec-
ord" form. No obligation. They are yours
for the asking. McMorro, Berman & David-
son, Registered Patent Attorneys, 134-H
Victor Building, Washington 1, D. C.

PROFIT From your invention. The In-
ternational Inventors Club helps you with
patents and sales. Membership only \$15
year. Free information. 6614 Metropolitan
Station, Los Angeles 55, California.

INVENTORS: Do not spend money until
you have read my valuable booklet "One
Inventor's Experience." Avoid costly mis-
takes. Postpaid \$1. R. E. McLean, 5793
South Benton, Kansas City 30, Mo.

PATENT Searches \$5.00. 48-hour airmail
service. Record of invention forms free.
Write Patent Engineering Service, 711 14th
Street, N. W., Washington 5, D. C.

PATENT Searches \$5.00. 48-hour service.
Free record of invention. Write Raymond
L. Smith, Patent Searcher, 622 Sberaton
Building, Washington 5, D. C.

PATENT Searches, including copies of
nearest patents, \$5.00. Reports airmailed
within 48 hours. More than 75 registered
patent attorneys use my service. For free
invention protection forms, write Miss Ann
Hastings, P. O. Box 176, Washington 4,
D. C.

INVENTION Record form free and "Pat-
ent Information Every Inventor Should
Have." Carl Miller, Registered Patent At-
torney, Woolworth Building, New York.

MY Invention paid \$750,000.00. Book
"What Inventors Should Know" tells all!
\$1.00 refunded if unsatisfactory. Invention
record free! Inventor, Box 5 B, Omaha,
Nebraska.

MOST Complete inventors promotion and
marketing service in the world. Inventors
Research, 1154 N. Western, Hollywood 29,
California.

PATENT Searches, including copies and
analysis, by registered patent agent: D.
Smith, 100 East Braddock Road, Alexan-
dria, Virginia.

INVENTORS: Learn how to protect your
invention. Special booklet "Patent Guide
for the Inventor" containing detailed in-
formation concerning patent protection
and procedure together with "Record of
Invention" form will be promptly forward-
ed to you upon request—without obliga-
tion. We are registered to practice be-
fore the U. S. Patent Office and prepared
to serve you in the handling of your patent
matters. Clarence A. O'Brien & Harvey
Jacobson, Registered Patent Attorneys,
41-A-G District National Building, Wash-
ington, D. C.

SEARCHES—Put your patent searches
in the hands of a registered patent attor-
ney or agent, as he qualifies to give a
worthwhile patentability report. Record
of invention form upon request and in-
formation on patent protection. Patrick D.
Beavers, Registered Patent Attorney, 936
Columbian Bldg., Washington 1, D. C.

INVENTORS: Information on patent
procedure furnished on request, without
obligation. John Randolph, Registered
Patent Attorney, 202 Columbian Building,
Washington 1, D. C.

I Sell patents. Established 1900. Charles
A. Scott, 735PM Garson Avenue, Rochester
9, N. Y.

INVENTORS: If you have an invention
for sale, patented or unpatented, write
Institute of American Inventors, Dept.
40A, 631-E St. N.W., Washington 4, D. C.

"INVENTOR'S Guide" and "Record of
Invention" free on request. Frank P.
Ledermann, 154 Nassau Street, New York
38, N. Y.

CASH For your idea. 280 manufacturers
need inventions, patented or unpatented.
List free. Invention Bureau, 208M Clinton,
Oak Park, Ill.

INVENTIONS WANTED

PATENTED, Unpatented inventions.
Complete promotion service. Free particu-
lars, expert advice and invention recording.
Superior, 338-344 North Rodeo, Beverly
Hills, Calif.

INVENTORS: If your invention is adapt-
able to our business we will contract on
cash or royalty. If not, we will try to place.
Free booklet. Kessler Sales Corporation,
58A, Fremont Ohio.

INVENTORS don't sell your invention, patented or unpatented, until you receive our offer. Write Cowgill, Box 296, Marion, Ohio.

INVENTIONS Promoted. Patented or unpatented. Established 1911. Write Adam Fisher Company, 5418 Idaho, St. Louis, Mo.

INVENTIONS Wanted. Patented, pending only. Inventors Patent Exchange, Hartford 1, Conn.

INVENTORS: Hundreds of manufacturers have requested our assistance in locating marketable new products. Complete information free. Institute of American Inventors, Dept. 40-D, 631-E St. N.W., Washington 4, D. C.

INVENTIONS Wanted. Patented; unpatented. Tremendous manufacturers lists. Global Marketing Service, 1404 Mitchell, Oakland 1, California.

INVENTIONS Wanted. Patented or patented pending. 23 years experience promoting inventions. National Service Bureau, 3120 Meramec, St. Louis 18, Mo.

PATENTS FOR SALE

PAT. #2,683,196 Clearance indicator for vehicles. M. S. Hunter, 9 Third Street, Manning, S. C.

INTERCHANGEABLE Storage battery for manufacturing on royalty terms requires no tools, cells automatically connect, and a complete change in 10 minutes. John Anderson, 3215 N. Keating, Chicago, Ill.

INVENTORS: Test the commercial value of your patented or unpatented inventions, quickly and inexpensively. Write for free information. Institute of American Inventors, Dept. 40-B, 631-E St. N.W., Washington 4, D. C.

MANUFACTURING

SMALL Lot manufacturing. Wood, metal, plastics. McKinney, Route 3, Box 144A, Wichita 15, Kansas.

WE Design, develop, build, inventions, machinery, appliances. Henry, 2815 Blvd., Jersey City 6, N. J.

MODELS — Small lot manufacturing. Metals, plastics, etc. Milburn, Burlington, Kentucky.

MODELS, MODEL SUPPLIES

1954 CAR Models. 1/25 scale, all metal, chrome trim. Send for catalog. Cars & Hobbies, Dept. PM-21, 2333 Haddon, Chicago.

GEARS And model supplies for the inventors. Send 10c for catalog. Pierce Model Works, Tinley Park, Ill.

FLEISCHMAN Famous German steam engines \$5.95 to \$85.00 and mechanical ships 79c to \$45.00 postpaid. Catalog 35c. Merlo, 50-18 94 Str., Elmhurst 73, N. Y.

BUILD Miniature passenger hauling live steam locomotive with file and drillpress. We do machine work, you bolt it together. Catalog 50c. Little Engines, Wilmington, California.

MODEL Railroaders: Amazing giant \$8 page "0" gauge catalog. Scale toy-train combined. Hundreds of car kits, steam locomotives, diesels, specialty items, parts galore. Catalog 75c (refundable). All-Nation Hobby Shop, 182-A North LaSalle, Chicago 1, Ill.

SHIP And yacht model fittings: blueprints. Send 25c for illustrated catalog listing hundreds of items. A. J. Fisher, 1002-1 Etowah Ave., Royal Oak, Mich.

SHIP And other scale models. Most complete line in New England. Kits, fittings, plans, books, tools, engines, motors. Illustrated catalog 25c. James Bliss & Co., Inc., Dept. SM, 342 Atlantic Ave., Boston 10, Mass.

BALSA Wood. Grade AAA. Free sample, price list. Sig Mfg. Co., Montezuma, Iowa.

HOME CRAFTSMEN

89 FULL Size jig saw patterns of beautiful shelves, ornaments, toys, novelties. Plus "How, Where to Sell." Only \$1.00. Mastercraft 84M, 7041 Olcott, Chicago 31, Illinois.

90 ALL New, full size lawn ornament and novelty patterns, up to 20" high. Only \$1.00. Mastercraft 82M, 7041 Olcott, Chicago 31, Illinois.

LEATHERCRAFT. Tremendous stock of leather, tools, supplies, and kits. In leather business over forty years. Send 10c for big catalog. Sax Bros., 1111 No. 3rd, Dept. PM6, Milwaukee 3, Wisconsin.

LEATHERCRAFT Of highest quality for advanced hobbyists, professionals and crafts classes. Careful grading assures a uniform selection of tooling and carving leathers, fine calfskins, kits and projects. Quality guaranteed. Complete stock of accessories, tools, supplies. Save time by using this one source for all your leathercraft requirements. All orders shipped same day received. Send 10c today for big, new illustrated catalog. Act now! J. C. Larson Co., 820 S. Tripp, Dept. 4350, Chicago 24.

WOODWORKING Course for home craftsmen. Twenty-two manuals. Over 1,000 pages. 75 training projects. Only complete home training program available today. Carefully written, profusely illustrated. Covers everything from wood selection to final finishing. Complete instruction in care and use of all hand and power tools. Prepared by expert manual training instructors. Write for free booklet. Interstate Training Service, Dept. G-3-H, Portland 13, Oregon.

101 FULL Size patterns. Smart, new, gifts, novelties, lawn figures, shelves, action windmills, alphabets. Plus "Make Money Jig Sawing." Only \$1.00. Mastercraft 83M, 7041 Olcott, Chicago 31, Illinois.

LEATHERCRAFT. Metal tooling, textile painting, beadcraft, shellcraft, many other crafts. Fun, easy, profitable! Free, big, illustrated catalog. Write today. Kit Kraft, Dept. 258, Hollywood 46, Calif.

PLASTICS Home-craft course for men and women. Tells and shows how to make hundreds of fast selling plastics products. All plastics and materials for 23 projects included in course. No special tools needed. Course pays for itself. Write for free booklet. Interstate Training Service, Dept. D-3-H, Portland 13, Oregon.

16 NEW Lawn chairs, 22 picnic tables, benches, trellises, etc. All 33 plans with necessary full size patterns, \$1.00. Mastercraft 83M, 7041 Olcott, Chicago 31, Illinois.

BUY Wholesale nationally advertised power, hand tools, thousands other products at big discounts. Free "Wholesale Plan." American Buyers', 628-RR Linden, Buffalo 16, N. Y.

LAMP Size cypress knee, nipple installed, \$2.00. Cy Products, Dept. 2M, Lafayette, Louisiana.

GET Professional results every time by learning how from easy-to-understand Popular Mechanics Press title "How to Paint with Brush and Spray." \$2.50. Write Popular Mechanics Press, 200 E. Ontario St., Chicago 11, Ill.

FREE! LeatherKraft catalog free! Write Box 397A. (Use little 2c postcard!) Tandy Leather, Tulsa, Oklahoma.

EXOTIC Veneers for home craftsmen. "Veneering Tips," price list free. Veneers, Box 1644, Louisville, Ky.

VEENEERS .010" Thick. Glueable without press. Mahogany, birch, others. Free samples. Write Miles Goff, North Girard, Penna.

FREE "Do-It-Yourself" leathercraft catalog. Tandy Leather Company, Box 791-D6, Fort Worth, Texas.

129 NEW Full size jigsaw patterns. Unusual novelties, gifts, lawn figures up to 22 inches high, action (merry-go-round) windmill, toys, useful gadgets. Artist drawn \$1. Craftplans, 1321-A South Michigan, Chicago 5.

LEATHER. Tools, lacings, supplies. Free catalog. National Handicraft, 199 William St., New York 7.

STYLECRAFT Sure fire hits. "Pre-traced" leather kits. Handbags, billfolds, filigree belts, over fifty other projects. Patterns on leather. Why trace? Just carve, assemble and lace. Large assortment "precarved" kits also available. Send 25c for catalog, free folder. Refunded first order. Apache Leather Company, 2804 E. Washington St., Phoenix, Arizona.

35 LAWN And garden ornament patterns. Full size, ready cut, colors indicated. Only \$1.00. Lincoln Craft Studio, Columbia, Conn.

KNOCKDOWN Cedar chests. Lumber and veneers. Free price list. Giles & Kendall Company, Huntsville, Ala.

FREE Information. Money-making full size patterns. Professional designs. Furniture, gift shop items. Write Jigsaws, 117 Worth, New York 13.

"TOPS" In everything for leathercraft. Lowest prices. Genuine "Craftool" stamps. Catalog 10c. Crown Leather Company, 22 Source Street, New York 33.

KNOCKDOWN Cedar chests and lumber. Free price list. Bedford Lumber Company, Shelbyville, Tennessee.

MAKE IT YOURSELF

MOTORIZED Wheelbarrow, three wheels, self-dumping, use lawnmower engine. Complete plans \$1.00. Bennett, 2461 Lucas Drive, Beaumont, Texas.

CHEAP Geiger counter! Plans \$1.00. Esco, 2718 W. 8th, Los Angeles 6.

BUILD Inexpensive concrete blockmaker. Motor-hand. Also mixer. (Both for less than \$10.) Then make blocks for 5 room house for \$95. Write. C. Lee, Mountain View, Oklahoma.

MAKE Your own fluorescent fixtures. Instructions 25c. R. G. Taborsky, 12008 Holborn, Cleveland 5, Ohio.

GRANDFATHER Clock easily built. Big savings. See ad on page 219.

300 PROJECTS You can make in Popular Mechanics 32-page blueprint catalog. Send 3c stamp for copy. Popular Mechanics, 200 E. Ontario St., Chicago 11, Illinois.

AIR Conditioners—Home or automobile. See Seeley ad, page 251.

GEIGER Counter and metal detector kits. Inexpensive, educational. Free literature. Electronic Applications, Box 4973, Washington 8, D. C.

POWER Mower kits, tree plans, instructions, parts list. Temco Mowers, Springfield 1, Missouri.

BUILD Permanent awnings, patios, jalousie porch, bathtub and shower enclosures. Aluminum prefabricated frames. Assemble yourself and save. Close-out prices. Russ Smith, 1335 Ridgewood, Cleveland 7, Ohio.

INFLATE Balloons with lighter-than-air gas. Enjoy fascinating new hobby and unusual sport. Build your own apparatus. Send messages hundreds of miles. Use for target practice. Simple, low cost, easy-to-build. Diagrams, formula, complete instructions. Send \$1. Central Machine Works, Dept. PM, Sioux City, Iowa.

AWNINGS—All-aluminum. Make your own! Assemble America's most beautiful aluminum door canopies and window awnings. The sides are pre-assembled. Save 50%. Factory to you. Free measuring chart and literature. Herbert's Aluminum Awnings, Dept. 1, 8974 St. Charles Rd., St. Louis 14, Mo.

WATCHES, OLD GOLD, JEWELRY

HIGHEST Cash for old gold, broken jewelry, gold teeth, watches, diamonds, silverware, spectacles, platinum. Free information. Satisfaction guaranteed. Rose Refiners, Heyworth Bldg., Chicago 2.

RHINESTONES. Jewelry settings, cameos, sequins, beads, hobby kits. Send 10c for illustrated catalog. J & M Novelties, Dept. CJ-3, Griffith, Indiana.

WATCHMAKERS' Journal contains instructive articles for watchmakers and beginners. Sample copy 20c. Dean Co., Box 3218-M, Daytona Beach, Fla.

WATCH And clock repairing books for hobbyists. Free information. North American, Dept. 14-H, 2320 N. Milwaukee, Chicago 47, Illinois.

GRUEN Watches, small down payment. Armstrong's, 6 Rockland, Melrose, Mass.

MAKE Rhinestone jewelry—No tools needed. Huge profits. Catalog, instructions, sample pin, stones, and color chart of actual rhinestones 50c. Refundable. Bergen Arts, 128M Main, Hackensack, N. J.

WATCHES Overhauled \$4.50. One year's guarantee. Berkowitz, 1150 Castlehill, New York 61.

FREE Sample pair of earrings shows you how easy it is to make beautiful costume jewelry. Over 5000 styles listed in new catalog. 25c. Barry's, 178 Ardsley Court, Newark, N. J.

JEWELRY Making can be a profitable hobby—Send 20c for our latest illustrated catalog. Milady-Fair Co., G.P.O. Box 1328, New York City.

TOBACCO, SMOKERS' SUPPLIES

PIPE Smokers! Cigar smokers! Free illustrated catalog offers fabulous savings on choice imported and domestic pipes, cigars, tobaccos, supplies. Write Wally Frank, Dept. 1, 150 Nassau St., New York 38, N. Y.

BEAUTIFUL Pocket lighter \$2.23! New fully automatic. Looks, works and made like expensive lighters selling from \$6 to \$10. Unconditional guarantee. Van Wart, Box 168, Riverside 9, Calif.

FOR THE HOME

FOAM Rubber furniture cushions. Factory seconds. 50% discount. Free catalog. Perma-Foam, 140-C Main Street, East Orange, New Jersey.

OF INTEREST TO WOMEN

NEW Plastic mending tape. Just press on! Repairs clothing instantly. Lightning seller. Samples sent on trial. Kristee 103, Akron, Ohio.

DRESSMAKERS, Sewers, wholesale lists. Dress, suitings, formal fabrics. Box 863, Norwalk, Conn.

BEAUTIFUL Ribbon remnants. 100 yards, \$1.00. Peggy's Doll House, Jefferson City 5, Missouri.

EMBROIDER Stamped linens. Buy direct from manufacturer and save. Send for free catalog. Merrilee, Dept. 595, 22 West 21st Street, New York 10, N. Y.

DRESSES, 24c; Shoes 39c; men's suits, \$4.95; trousers, \$1.20. Better used clothing. Free cat. Transworld, 164-AD Christopher, Brooklyn 12, N. Y.

GROW Mushrooms. Cellar, shed, and outdoors. Spare, full time, year round. We pay \$3.50 lb. We paid Babbitt \$4,165.00 in few weeks. Free book. Washington Mushroom Ind., Dept. 176, 2954 Admiral Way, Seattle, Washington.

NYLONS 14c, Anklets 6c, socks 9c, print 17c, panties 12c, dresses 50c, slips 47c, undershirts 17c, robes \$1.65, spreads \$2.65, jewelry \$1.25, watches \$3.50, electric razors \$2.00, aspirin \$1.00—1,000, brushes 9c, razor blades 15c, pens 8c, combs 15c. Complete stock list, picture catalogue, 25c. Send immediately. Sibert's, Chattanooga 4, Tennessee.

PROFITABLE Home business. Make fast-seller chenille monkey trees, dolls, flowers. Terrific holiday demand. Information free. Veiva, Bohemia 16, N. Y.

FOR SALE—MISCELLANEOUS

FLOCK, Rayon—cotton. All colors. Parker Industries, Inc., Constantine, Mich.

HEARING Aid batteries, wholesale. Free list. Habs, Box 51, York, Penna.

WANTED—MISCELLANEOUS

CIVIL War land scrip certificates purchased. Eugene Lederer, State College, Pennsylvania.

SCRAP Mercury (quicksilver) containers supplied—Tantalum, bismuth, tungsten. Metallurgical Products Company. Established 1909, 35th and Moore Sts., Philadelphia 45, Penna.

QUICKSILVER, Platinum, silver, diamonds, indium. Write. Wholesale Terminal, Norwood, Massachusetts.

PERSONAL

MEXICO Remails 25c, airmail 30c. Thill, 2508 5th Ave., San Diego 3, Calif.

WHAT Is your "I.Q."? Take an excellent adult intelligence test in home privacy! Recognized by civil service. Send only \$2.00 to: Deak C, University Test Bureau, Box 401, Palo Alto, California. Confidential report.

LETTERS Remailed, Albany, N. Y., 25c. Local information \$1.00. Hale, Box 1, Glenmont, N. Y.

ROMANTIC Postmark! Romeo, Mich., remails 25c. Also Detroit, Pritchard, 15335 Artesian, Detroit 23, Mich.

LETTERS Remailed from Oklahoma City, 25c each, 7 for \$1. Vaughn Knott, 421 So. Harrison, Enid, Oklahoma.

ADOPTION Results in the adult under review at the Life History Study Center, 222 N. Hicks St., Philadelphia 3, Penna. Send 25c for leaflet.

LETTERS Remailed 25c. Any business transacted. Trove, Box 462, Vancouver, Canada.

FLORIDA Remails 25c. Confidential forwarding service. Monthly rates. Carver, Box 2309, Lakeland, Florida.

RESURRECTION On earth—Not heaven. Free! Write: Harvest, Jefferson City, Mo.

LOCKSMITHS. Your card or letterhead brings the Locksmith News, 2701 East Third Ave., Denver 6, Colorado.

SEATTLE Confidential Remail letters, 25c. C. H. Bell, Box 91, Enumclaw, Wash.

CHRISTIAN People, send name for free subscription "Security Here and Hereafter." No obligation. Christian Bookstore, McMinnville, Tenn.

"FEMME Mimics"—Amazing book, containing 375 photographs. About men who wear women's clothing! Free literature. Winco, Dept. PM82, Box 9525, Dallas, Tex.

NEW False plate for old in 24 hours! Low as only \$15.95! Enjoy comfortable, attractive false teeth. Made of lustrous Dupont beauty-pink plastic. Amazing savings. Free details. West Dental Laboratory, Dept. 500, 127 N. Dearborn, Chicago 2, Ill.

CANADA St. Lawrence seaway site job ads \$1.00. Remails 25c. 5 scenic postcards \$1.00. Box 1025, Cornwall 1, Ontario.

CHICAGO Confidential remailing 20c. Oppenheimer, 2430 Lakeview Avenue, Chicago 14.

MEXICAN Law. General Practice Attorney, 1203 Arizona St., El Paso, Texas.

AIR Letters remailed \$1. Krueger Agency, Box 54, Auckland, New Zealand.

PARIS, France, remailing or personal questions answered. \$1.00. Ernest, 769 Floyd, Louisville, Ky.

MIAMI Or Hollywood, Florida. Letters remailed. 25c. Classified \$1.00. Hopes, Box 126, Hollywood, Florida.

LETTERS Remailed from Cincinnati, Ohio, 25c each, 5 for \$1.00. L&M, 3136 Portsmouth, Cincinnati, Ohio.

"HOW Can I find out?" You can! Information confidentially developed. Any matter, person, problem. Worldwide. Officially licensed. Established 1923. William Herman, 170 Broadway, New York City.

LETTERS Remailed 25c. Personal forwarding address. Monthly rates. Hicks Service, Box 1547, Washington 13, D. C.

MEXICAN Law office. Bank references. P.O. Box 41, Juarez, Chih., Mexico.

MISCELLANEOUS

IMPORTED Handwoven Mexican sarapes. Sample 10c. Box 7187D, San Diego 7, Calif.

BUY Wholesale cameras, appliances, gift ware. Catalogue 50c (refundable). Dart, 3812 E. Atlantic Avenue, Brooklyn 24, N. Y.

GERMAN Address lists! Anything manufactured 50c. Burke Associates, Manchester 1, Mass.

BUY Wholesale 450,000 products. Literature free. Carter, Box 6011-S, Chicago 80.

"X-Ray Mind." Stupendous mental power. (Details 10c). Krishnar Institute, Box 842-87, Escondido, Calif.

SEPTIC Tanks, outdoor toilets reconditioned, deodorized without digging, pumping. Easy, guaranteed do-it-yourself method free. Write Granite State Industries, Box 507D, Manchester, N. H.

INCREDIBLE! Become mental superman overnight! Free booklet! Bijou, Box 1727-MO, Hollywood 28, California.

BUY Wholesale thousands nationally advertised products at big discount. Free "Wholesale Plan." American Buyers, 631-DD Linden, Buffalo, N. Y.

LATE Newspapers from all large cities \$1.50. McLaughlin, 378 Baldwin Ave., Jersey City 6, N. J.

BUY Wholesale! 30-80% discounts! Free! Large catalog of nationally advertised appliances, gifts, watches, jewelry, cameras, typewriters, tools, kitchenware, etc. Start your own fully self-operating mail order business without capital! Wholesale starting kits furnished. No experience necessary. Outline of unique automatic sales plan included. Consolidated Distributors, Division 120, Box 1537, Paterson 15, New Jersey.

CHARCOAL Grilled hot dogs! Easier with new rotisserie grill. Portable, small, inside or outside. \$3.95 postpaid. Circular free. Lawnlite Co., Litchfield, Ill.

YOU Can build your own home for \$4500 to \$7046. Books that take you through every step. Popular Mechanics famous Concrete Block House, \$2.00; Your Home and How to Build It Yourself, \$3.00; Ranch-Type House You Can Build, \$3.50. Full-sized plans available. Popular Mechanics Press, 300 E. Ontario, Chicago 11, Illinois.

FIND Out how easy it is to remodel your home. Get Popular Mechanics How to Remodel Your Home \$2.95. Covers everything possible in the field of remodeling. Write Popular Mechanics Press, 300 E. Ontario, Chicago 11, Ill., today for your copy!

POEMS Wanted for free publication. Write for free facts. Dept. C. Poetry Publishers, 446 Pearl Street, New York 38.

URANIUM, Gold, silver, treasure. New power-packed, highly sensitive metal detectors and Geiger counters. Kit and factory assembled models from \$34.50. Lightest weight, guaranteed. Free literature. Electronic Applications, Box 4975, Washington 8, D. C.

GET The opportunity packet for the latest and best money-making offers in mail-order. Everything for 25c. Redmon, Capitol Heights 1, Maryland.

CLOGGED Drains opened by new powerful chemical called Sursolvent. Removes grease, soap, tree roots, etc., without expensive digging and electric rodding machines. Simple to use. Mix with water and pour down sink. Postal brings free details. Electric Sewer Cleaning Co., Aliston 34, Mass.

GOLD, Silver, metal detectors. Geiger counters for uranium. Mineralights. Sensational new fully guaranteed models. None finer. Information free. Detectron Corp., 5420 Vineland Ave., North Hollywood, California.

RECEIVE Magazines, samples, catalogues. Mails from everywhere. Offers, hundreds. Get listed 25c. Rorick, Box 86, Cincinnati 28, Ohio.

TREASURE Finders for gold, silver and minerals. Money back guarantee, best available. Also Geiger counters for uranium prospectors, free information. Write Goldak Company, 1541 West Glenoaks, Glendale 1, Calif.

GROW Mushrooms. Cellar, shed, and outdoors. Spare, full time, year round. We pay \$3.50 lb. We paid Babbitt \$4,165.00 in few weeks. Free book. Washington Mushroom Ind., Dept. 175, 2954 Admiral Way, Seattle, Washington.

PANNING Gold—Free lesson; catalogue of mining, mineral books, supplies. Old Prospector, Box 729D1, Lodi, Calif.

SELECTIVE Metal and mineral detector. Revolutionary design. Distinguishes metals from black magnetic sands. Readily detects metals under salt water. Also Geiger counters. Free literature. Gardiner Electronics Company, 2018 N. Dayton, Phoenix, Arizona.

TREASURE—M-Scope Geiger counters, mineral locators. Why buy something inferior when you can buy the best at a lower price? Backed by years of experience. Fully guaranteed by factory. Detects minerals, metals, gold, silver, coins. Payment plan available. Proven superior performance. Free 16 page illustrated booklet. Fisher Research Lab., Inc., Palo Alto, California.

EARN \$300. BONUS

We will pay up to \$300.00 for information concerning new sources of scrap magnesium which we can buy on a contract basis. Any type of scrap magnesium—borings, shavings, cuttings—scrap magnesium in any form. Many plants today use magnesium and then throw the scrap away. Maybe yours does. Investigate and write today and you may qualify for a bonus of up to \$300.00.

STANDARD MAGNESIUM CORP.
6950 East 41st Street • Tulsa, Oklahoma

Learn LANDSCAPE GARDENING

A thorough, interesting home study course for those who wish to become LANDSCAPERS, GARDENERS, DESIGNERS, etc., for profit or pleasure. Write today for FREE INFORMATION to:
NATIONAL LANDSCAPE INSTITUTE
Dept. P-B, 310 So. Robertson Blvd., Los Angeles 48, Calif.

Learn BAKING At Home

Baking is one of America's high industries in wages. Nearly depression-proof. Thorough basic home course lays sound foundation. If you have aptitude, write for FREE BOOKLET, "Opportunities in Commercial Baking."
NATIONAL BAKING SCHOOL
Dept. 135C Chicago 14, Ill.



POPULAR MECHANICS

Copyrighted material

Get info.. PLASTIC LAMINATING AT HOME!



THIS MAN ..
... is taking out of the machine a Plastic Sealing Job—ordered by mail—only 11c in material cost brings back \$2.58 in cash by mail. Capacity of machine: **\$25.00 profit per hour of operation.**

Get **ORDERS** and **CASH** from your mailman—do work in **SPARE TIME** at home—or expand into **FULL TIME** business. Send coupon for **Free** facts about the newest and most fascinating of all home operated businesses. For the first time a simplified machine brings the fabulous profits of **Plastic Sealing** and **Plastic Laminating** within the reach of the small operator. Anyone can learn to operate the machine with a few minutes practice—then with our **Magic Mail Plan** can get mail orders pouring in daily with cash in every envelope. **No canvassing—no selling.** We even

Make \$20 to \$30 a Day by.. MAGIC MAIL PLAN!

supply the circulars you mail to bring back cash and orders. Don't waste a minute. Rush your name. We'll send you **FREE** and postpaid, pictures, prices, details, and all the facts you need to start. Mail coupon or send name on postcard. No charge. Warner Electric Co., 1512 Jarvis Av., Dept. L-10-J, Chicago 26, Ill.

Make Thousands of Beautiful Art Creations

COSTUME JEWELRY • CIGARETTE BOXES TRAYS • CANDLESTICKS • COASTERS LAMP BASES • BOOK ENDS...ALL IN SPARKLE COLORED PLASTIC



WARNER ELECTRIC CO., 1512 Jarvis Av.

Dept. L-10-J, Chicago 26, Ill.

At no cost to me, please rush complete details postage prepaid. I am under no obligation.

Name _____

Address _____

City _____ Zone _____ State _____

FREE BOAT KIT CATALOG

- Assemble your own boat
- No experience necessary
- Save 1/2 to 2/3 "factory built" prices
- Prices include freight and paint

8' to 14' Models from \$39.25



12 ft. Runabout Pictured.

Marine Hardware, Fiberglass & Trailers

Kit Division 3707 FREMONT AVE. SO. **LUGER INDUSTRIES** MINNEAPOLIS 8, MINN.



DEVELOP A HE-MAN VOICE!

Write for **FREE** book "How to Strengthen Your Voice for Greater Success" by Eugene Feuchtinger. No obligation. Book will be mailed in plain wrapper, postpaid. Just send your name and address. State age. **PERFECT VOICE INSTITUTE, 210 S. Clinton St., Studio HW-2, Chicago 6, Ill.**

WARNING! VETERANS DISCHARGED BEFORE AUG. 20, 1952, must be **IN TRAINING** by Aug. 20, 1954, or lose G.I. rights to free education under **NEW G.I. bill**. Train at home to become a **TV Technician!** Time is short. Send for **FREE LITERATURE**. (Non-vets too!) **RADIO-TELEVISION TRAINING ASSOCIATION, Dept. M-8B, 52 E. 19th St., N. Y. 3, N. Y.**

TASOPE PHOTO-ENGRAVING PLANTS



Material Cost of This Cut 34c Selling Price \$1.00 And Up

Establish your own profitable **PHOTO-ENGRAVING** business. Make cuts for newspapers, printers, and advertisers. Make etched name plates, plaques etc. Instructions furnished, no experience necessary. Sold direct from factory since 1931. First five hundred cuts sold locally or by mail will pay for plant and pay you well for your time. Write for **FREE** catalog.

TASOPE, DEPT. PM-8, AURORA, MO.

INSURED TIRE SERVICE POPULAR BRANDS

FREE INSURANCE POLICY given with each used tire sold. We guarantee the amount of service you pay for. Tube Given Free with Each Used Passenger Tire Upon Request

SPECIAL! Deduct 10% on orders for Two or More used tires

YOU CAN'T LOSE!!

Super Quality — Rugged Performance — 15 Months Insured Service	
600x16 \$3.65 670x15 \$3.95 700x16 \$4.45 760x16 \$4.75	
650x16 3.85 670x16 4.05 710x15 4.35 820x15 4.95	
650x16 4.25 700x15 3.95 760x15 4.45 850x17 4.65	
Supreme Quality — Nothing Finer — 30 Months Insured Service	
600x16 \$5.25 475x19 \$5.45 700x15 (6) \$10.45 700x20 \$12.50	
600x16 (6) 6.75 640x15 4.95 750x16 (8) 15.95 750x20 (8) 15.50	
650x16 5.75 670x15 5.35 700x17 11.95 750x20 (10) 17.50	
650x16 (6) 7.25 710x15 5.45 750x16 16.45 825x20 21.50	
700x16 6.35 760x15 5.95 750x15 10.95 900x20 19.95	
750x16 (6) 8.45 800x15 6.35 30x5 11.25 1000x20 20.45	
550x18 4.95 820x15 6.35 600x20 10.95 1100x20 21.25	
550x17 4.75 550x15 5.35 650x20 11.75 1000x22 21.95	
650x15 5.25 670x16 5.15 32x6 (8) 11.95 1100x22 22.75	
700x15 5.35 700x16 (6) 10.25 32x6 (10) 12.75 1100x24 25.95	

Whitewalls \$1.00 extra.

MIDLAND TIRE SALES

Speedy shipments on Mail Orders. F.O.B. Chicago. Insurance policy sent with each order. Deduct 10% on orders for 2 or more used tires. Send **CHECK** or **MONEY ORDER**—No C.O.D.'s. **3701 S. Normal, Dept. PM-25, Chicago 9, Ill.**

AMAZING NEW POCKET RADIO

Really Works—Small as a Pack of Cigarettes!



FITS IN ANY POCKET OR PURSE—GETS LOCAL RADIO STATIONS WITH CLEAR BELL-LIKE TONE—NO STATIC OR INTERFERENCE! NEEDS NO TUBES, BATTERIES OR COMPLICATED HOOKUPS! NO AC PLUG INS! Nothing to wear out. Thousands of users—many report years of service. Uses new crystal diode and HI-Q coil. SELF-CONTAINED SPEAKER PHONE. Just the tiny radio to take with you ANYWHERE YOU GO—ON TRIPS, VISITING, ETC.—for real fun and enjoyment—ANYTIME. **SEND ONLY \$1.00 (bill, ck., mo.) and pay postman \$3.00 C.O.D. postage or send \$4.99 for p.p. delivery. **COMPLETE READY TO LISTEN. MIDWAY CO., Dept. PPM-8, Kearney, Nebr.****

SAY YOU SAW IT IN POPULAR MECHANICS

PREPARE FOR BETTER JOB, BIGGER PAY IN SPARE TIME AT HOME

Today, choose the job you want—and prepare for it in time you might otherwise waste. Or if you are already in the work you like best, start training now for quicker promotion and increased pay. During more than 50 years **AMERICAN SCHOOL** has helped ambitious people to reach higher goals. Check subject that interests you and mail coupon for full information.

AMERICAN SCHOOL, Dept. GC45, Drexel at 58th, Chicago 37, Ill.

Without obligation, please send **FREE** and postpaid, full particulars about the subject checked below.

Drafting—Building Trades
 Drafting—Machine Trades
 Electrical Engineering
 Electricity—Practical
 Electronics—Industrial
 High School Courses
 Machine Shop Operations
 Mathematics & Slide Rule
 Mechanical Engineering
 Plastics Engineering
 Plumbing—Practical
 Private Secretary
 Refrigeration
 Retail Merchandising
 Salesmanship—Outside
 Sheet Metal Work
 Tool Making

Accounting
 Air-Conditioning
 Architecture & Building
 Automotive Technician
 Better Foremanship
 Bookkeeping
 Business Management
 Contracting
 Diesel Technician

NAME OCCUPATION
 HOME ADDRESS APT.
 CITY STATE
 Canadian Residents: Write American School, 1610 Sherbrooke St. West, Montreal

MAIL COUPON NOW



Lt. Wt. Aluminum PIANO HINGE

Length 72
inches,
thickness
.040—width
1 3/4"—

Operating
radius 27 1/2
degrees. Made of
aluminum alloy,
sold in 3 foot
lengths only—
per length... **\$1.15**

HEAVY DUTY STEEL PIANO HINGE

Length 56"—Thickness 3/32"—
Width (open) 3-5/16"—Operating
radius 330 degrees—Made
of heavy duty steel—Drilled
ready for use. Ideal for drop
tables, heavy tool boxes, heavy
doors, and many other uses
where heavy hinges are re-
quired. Sold in 56" lengths only.
Ship. Wt. 7 lbs. At a
fraction of original cost **\$1.45**

Prices F.O.B. Chicago. Include approx. postage on orders paid for
in advance. C.O.D. orders enclose 25% balance sent C.O.D.

U. A. S. Corp. Dept. PM-8 5637 W. 63rd Pl.
Chicago, Ill.

LIVE RUBBER SHOCK CORD

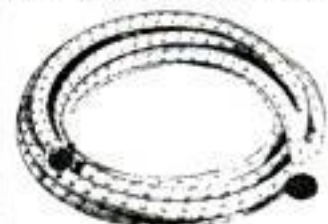

Made in accordance with rigid army
specifications. Clean fresh stock. 1 1/2
contains approx. 40 strands of live
rubber, 3/8" approx. 100 strands, 1/2"
approx. 500 strands, etc. Sold in 25
ft. lengths or more. At about 20% of
original cost. Excellent for marine
and boat supplies, for trampolines,
for tying down tarpaulins, etc.

DIAM.	PRICE (per 25')	SHIP.	WT.
1/4"	\$2.00	2 lbs.	
3/8"	\$2.75	3 lbs.	
1/2"	\$3.25	4 lbs.	
5/8"	\$4.50	5 lbs.	
3/4"	\$5.75	6 lbs.	

Quantity price on application.

3-FT. PLAY BALL

Fun for **\$1**

This Jumbo Live-Rubber Play Ball is **QUARANTEED 100% AGAINST BREAKAGE!** A barrel of fun for tot and pop at beach, backyard, pools, picnics, gyms, etc. No vacation complete without one. Multi-color, gay design. Inflates easy by mouth or pump, patented blow-up feature can't leak. One-piece, seamless construction. **PERFECT YEAR AROUND GIFT.** Only \$1 ppd... Order now.

SPORTS DIV., VOLUME SALES CO.
Dept. PM-8, 3930 Sunset Blvd., Los Angeles 29, Calif.

FREE-VALUABLE U.S.A. STAMPS!

Rare genuine postage stamp, as illustrated, picturing first U. S. A. (issued in 1847!); PLUS big collection of 30 all-different United States: 19th century, valuable \$5.00 stamp, etc.; PLUS packet beautiful **Commemoratives** including 1893 Columbian Exposition, Boy Scouts, Wild West, many others. Big illustrated U.S. catalog included if you send today! **EVERYTHING for 10c to cover mailing expenses only!** Act at once! **H.E. HARRIS & CO., 50 Transit Bldg., Boston 17, Mass.**

Prints Postal Cards!

FREE Use on 30 Day Trial! Send name today for facts and **FREE** Illustrated Book of unique advertising plans and money-making ideas for your business. Learn how others are boosting sales with post card ads... easy with Cardmaster.

Cardmaster Co., 1920 Sunnyside, Dept. 1348, Chicago 40, Ill.

Tiny Telescope

Gives "CLOSE-UPS" FROM MILES AWAY

ONLY **\$3.95**
TAX FREE

NO RISK TRIAL OFFER. If not 100% satisfied after 10 Day Trial return for full refund. Cash orders \$3.95 postpaid. (C.O.D.'s \$4.51) **UNITED BINOCULAR CO., 9043 S. Western, Dept. PT-7808, Chicago 20.**

Save on all PLUMBING JOBS

When You Build - When Making Improvements - Repairs - Maintenance

Get **POPULAR MECHANICS Home Plumbing Guide**



How to plan plumbing installations, select materials and fixtures.

How to save money on all plumbing jobs using approved methods.

Easy to Do Professional-Like Jobs and Save Over One-Half

Get the Popular Mechanics **HOME PLUMBING GUIDE**. It shows how you can do every kind of plumbing job yourself and save from a few to hundreds of dollars. Covers plans, layouts, installation, maintenance and repair. Shows what materials to get and use, where to get them and how to do a proper job with approved methods. Few, other than the simplest tools are required and some of these can be rented. Don't pay high prices for work you can do yourself. Get the **HOME PLUMBING GUIDE** for only \$3.50. You will be amazed how jobs you thought difficult are simplified.



Clip This Ad and Mail. Money Back if Not Pleasid

Invest only \$3.50. Use the book for 7 days. Then if you are not satisfied return it for full refund of your money. Sent C.O.D. (U.S.A. only) if you prefer.

- 15 Ways to Save Money**
All about modern home plumbing
How to use plumbing tools
Getting acquainted with pipe
Planning home plumbing systems
Installing and maintaining home drainage systems
Private sewage disposal systems
Causes and cures of drainage troubles
Installing home water lines
Private water supply systems
Water Heaters
Water Conditioning
Water system troubles and cures
Installing and caring for fixtures
What to do with valves and faucets
- Over 500 How-to-do-it Pictures Guide You

POPULAR MECHANICS PRESS, Dept. HPG-10, 200 E. Ontario St., Chicago 11

YES! SEND



directly to my door every month

- I am enclosing
- \$3.50 for 1 year
 - \$8.00 for 3 years

name _____

address _____

city _____ zone _____ state _____

Hand this order to your newsdealer or send it to

POPULAR MECHANICS
200 East Ontario St. Chicago 11, Ill.

EARN \$60 A DAY!

The famous Hi-Pure Model 105, lowest-priced high-quality steam cleaner on the market, combines every engineering advance.

Your First 8 Jobs Pay For Your Cleaner

Owning your own high-profit business is easy with a Hi-Pure Steam Cleaner. Write for FREE details.

* FOB shipping point. Freight prepaid on cash orders.



MODEL 105, \$398.50*
COMPLETE

HI-PURE LABORATORIES, Evansville, Indiana

MAKE MONEY WRITING .. short paragraphs!

You don't have to be a trained author to make money writing. Hundreds now making money every day on short paragraphs. I tell you what to write, where and how to sell; and supply big list of editors who buy from beginners. Lots of small checks in a hurry bring cash that adds up quickly. No tedious study. Write to sell, right away. Send for free facts. **BENSON BARRETT, 1751 Morse Ave., Dept. 27-J, Chicago 26, Ill.**

Up to 6 MILES MORE per Gal.

Reported by Hundreds Using
MIRACLE ACTION TUR-B-LIZER

Carburetor specialists say Tur-B-lizer is best patented improvement they have seen. Tested in millions of miles of driving in cars, trucks and tractors. Easily installed. Send \$3.00 for six cylinder type, \$4.50 for eight cylinder type. Try Tur-B-lizer for 30 days. If you are not enthusiastically satisfied as claimed by hundreds of users, your money will be promptly refunded.

UNIVERSAL TUR-B-LIZER CO. 621 E. STATE ST. MILWAUKEE 2, WISC.

CUT & POLISH GEMS FOR FUN! FOR PROFIT!

PROFESSIONAL SECRETS REVEALED

Now you can quickly learn to cut and polish gem stones easily—at home. B-I-G one volume course covers every detail—where to find gems—how to turn them into precious jewels with low-cost equipment. Complete course (with FREE coupon redeemable for full purchase price) only \$2.00. Money-back guarantee!

GEMLAP, 1263 W. 76th St., Cleveland 2, Ohio



9 1/2" Height — — \$14.75

Cuckoo-Clocks, imported from the Black Forest, Germany, with woodcarvings never seen in U. S. A. before, come in 2 tone and colored. Other models from 5" to 36" from \$7.50 to \$199.50. Wholesale and Retail. Dealers and Salesmen wanted.

KRUEGER'S

23418 Harper Ave. St. Clair Shores, Michigan

FREE BOOK CATALOG

Everything—shop tools, hunting, fishing, making money at home, concrete work, welding, mail order, plastics, painting, carpentry, photography, boat building, gardening, auto repair, hobbies, home building—is listed in the new 40-page 1953 catalog of easy-to-understand Popular Mechanics books. Write for your free copy now! Dept. CT2.

Popular Mechanics Press, 200 E. Ontario, Chicago 11

THIS IS IT! AMAZING Fountain Brush Washes Your Car

in
9
min-
utes

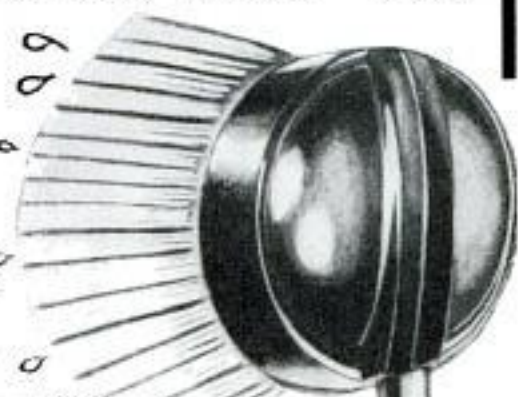

SAVE \$3.00 **1.98**
From
Factory-to-You

FREE!

OF EXTRA COST
24 CAR WASHES!

Yours FREE of extra cost, a generous supply of powerful, yet gentle AEROMAT detergent, manufactured by the makers of famous CN disinfectants. Removes road film. Leaves no streaks. Never mars finish. Package enough for 24 car washes. Saves you \$24 or more!

- Built-in-Suds Chamber!
- Soft-as-silk Bristles!
- 3-Ft. Handle Keeps You Dry!
- Rubber Bumper Protects Car!
- Rotary Hi-Pressure Action!

Thousands sold at much higher prices! Get yours now DIRECT-FROM-FACTORY and save up to \$3.00! Just attach the sensational AEROMAT WASHER to your garden hose. Place special DETERGENT in built-in Suds Chamber and wash your car sparkling clean in 9 MINUTES FLAT, 3-foot light metal handle keeps you free and clear. Powerful ROTARY HI-PRESSURE action loosens and removes all road film and dirt. The new, improved AEROMAT detergent dissolves grease like magic! Does dozens of jobs around the house—FAST! Special built-in valve to turn water on or off. Saves time, money and arm strain, too! You never get a bit messy either! Get yours NOW—direct from the factory! Send cash, check or m.o. for \$1.98. West of Mississippi, please add 22c postage (Total: \$2.20). Satisfaction guaranteed or money back.

MOTO-MATIC CO., Dept. 6-H-444
352 Fourth Ave., New York 10, N. Y.

3 FOOT HANDLE



POPULAR MECHANICS

FAMOUS LITTLE LIBRARY OF USEFUL INFORMATION

Complete Set of 126 BOOKS only \$17.95

25 BOOKS	\$3.75
12 BOOKS	\$2.00
5 BOOKS	\$1.00

SINGLE BOOK 25c

Here at amazingly low cost is the practical help and information you have always wanted. Articles in previous issues of Popular Mechanics have been classified according to subject and are now available in these handy reprint booklets.

Check titles wanted, clip ad, mail today.

HOME WORKSHOP

Power-Driven Saws—74: How to build. Drill Presses, Plans, Grinders—79. Sanders—80: Details on 8 machines. Wood & Metal-Turning Lathes—81. Filing Machine, Hack Saw, Cutoff Wheel, Shaper—82: Full details on these. Metal Lathe Tools—101: How to build. Workbenches and Tool Cabinets—47. Spray Painting—84: Proper methods. From Pattern to Casting—91: How castings are made in sand molds. How to Use a Circular Saw—135. Jigsaw Technique—136: How to use. Handsaw Know-How—137: Techniques.

HOME IMPROVEMENTS

Painting Your House Inside and Out—117. Simple Home Improvements—104: Save money. Building Extra Rooms in Your Attic—23: Add to the value of your home. Basement Playrooms—24: Build an attractive playroom in your basement. House Wiring—89: How-to-do-it. Curing Leaky Basements—45. Fitting Home Game Room—55. Built-in Fixtures—78: Several. Lower Your Fuel Cost—31: Practical kinks that will save you hundreds of dollars. Hanging Wallpaper—38: Hints and tricks. Ridding the Home of Insect Pests—107. Constructing Indoor & Outdoor Fireplaces—88: Details on stone fireplaces.

CRAFTWORK • HOBBIES

Games and Puzzles—131: Have fun at home. Model Planes You Can Build—129: Several. Fun With Your Model Railroad—127. How to Make Novelty Jewelry—126. Working with Plastics—61: Novelties, etc. 25 Shelves You Can Make—64: Wall shelves, etc. Novelties Turned on Lathes—62: Dishes, etc. Projects in Plastics—112: How to use. Inlay Pictures—Veneering—63. Whittling and Wood Carving—65: Methods. Action Toys—66: 21 easy-to-make toys. Marionettes—113: How to make and use. High Flying Kites—67: How to build. Windmills & Weather-vanes—68. Lamps in Wood, Metal, Plastic—69: Several. Bows and Crossbows—115: How to make. Playground Equipment—73: 8 projects. Metal Craft—28: Simple instructions. Weaving and Reclining—37: Full details. Gem Cutting—42: How to cut and polish.

USING TOOLS

How to Use Your Drill Press—125. Correct Measurements—106: How to obtain.

Tool and Saw Sharpening—92: Tricks and hints. Technique of Using Drills and Wood Bits—90. Successful Wood Turning—32. How to Read Blueprints—71: Tells you how. Metal Turning Lathe Kinks—95. Operating a Metal Turning Lathe—100. Heat Treating and Case Hardening—102. Working with Glass—103: Cutting, etc. Using Basic Tools—120: Tips and hints.

WELDING • SOLDERING

Rewinding & Servicing Electrical Motors—75: Repairing and rewinding motors. Electrical Appliances, How to Fix—111. Electromagnets & Solenoids—44. Transformer Construction—41: Directions. The Boy Electrician—43: Five projects. Soldering & Brazing—17: Tells how to. Arc & Spot Welders—5: How to use & build. Build Your Own Relays—123: Instructions. Home Burglar Alarms, Secret Locks and Time-Setting Systems—125. Welding with Arc and Gas—134: Tips.

AUTOMOBILE BOOKS

House Trailers—121: Build it yourself. Automobile Kinks and Shortcuts—10. Building Trailers—Small Teardrop and Utility—27: Can be built in your spare time. Motor-Driven Midget Car & Scooter—34. Curing Auto Electrical Troubles—95.

BUILD A BOAT

14 Ft. Outboard Runabout—2: How to build. Rowboats, Bicycle Boat, Small Dinghy—83. Small Sail Boats—84: For young sailors. Two Outboard Runabouts—85: 14 ft. & 12 ft. Build Your Own Canoe, Kayak, Surfboard—30: Complete building details. Fast Class-E Ice Yacht—22: Build your own.

GARDENING HELPS

Lawn and Garden Equipment—124. Handy Farm Implements—114: How to build. Tractor Attachments—116. Backyard Gardening—39: Helpful hints. Lawn & Garden Novelties—72: Easy to build. Trellises, Pergolas, Fences—76. Lawn & Garden Furniture—77. Colored Concrete Garden Furniture—6. Farm & Garden Tractors—8: How to build.

PHOTOGRAPHY

Home Movie Equipment—118: How to use. Photo Lighting—119: Helpful information. Photo Enlargers—1: Complete plans. Photo Printers & Dryer—25: Describes three. Photo Darkroom Equipment—96. Picture Projector, Trick & Table Top Photography—97: Tips on how to make. Photo Kinks—98: Money-saving ideas.

FURNITURE MAKING

Furniture Upholstery and Repair—122. Rustic Furniture—18: How to build. Children's Room Furniture—51. Book Ends—52: Good selection from 10 designs. Small Tables—54: Interesting styles. Desks—53: Many varied designs. Smoking Stands—56: Seven designs given. Plain & Novelty Wood Finishing—40. Book Cases—59: Eight designs. Magazine Racks—49: Ten attractive racks. Clock Cases—50: Several types. Serving Trays for Every Occasion—53.

MISCELLANEOUS

Cleaning Formulas—11: Make your own. Re-Silvering Mirrors—70: How to do it. How to Build a Concrete Block Machine—110: Make your own block machine. It's Easy to Tie Knots—109. Chemical Experiments—93: Several. Taxidermy—9: How to mount small animals. Log Cabins and Tourist Cottages—14. Magic for Everybody—29: Simple tricks. Trapping Small Animals—33: How to trap. Training Your Dog—35: Tricks and obedience. Small Furnaces—36: For melting copper, etc. Electroplating with Copper, Nickel, Chromium, Lead, Zinc, Cadmium—36. Plating Non-Metallic Objects—Plating with Gold, Silver, Alloys—47. Telescopes—20: Design and construction. Poultry Houses—108: How to build. Guns & Decoys—109: Clean guns, make decoys. For Better Business—130: Timely tips. For Better Business—132: Saves time. For Better Business—133: For smooth operation.

USE THIS HANDY ORDER COUPON NOW!

POPULAR MECHANICS PRESS
200 E. Ontario St., Chicago 11, Ill.
I enclose \$_____ (U.S. currency may be mailed if carefully wrapped) for "Little Library" booklets numbers:

24 Books	12 Books	5 Books	1 Book
\$3.75	\$2.00	\$1.00	25c

--	--	--	--	--	--	--	--	--	--

NAME _____

ADDRESS _____

CITY _____ ZONE _____ STATE _____

MAKE \$15,732.00 IN ONE SUMMER \$9,504.00 WITHOUT LEAVING YOUR HOME

DON'T READ THIS!

Unless you are near a healthy fire extinguisher or a plentiful supply of WATER. We cannot assume responsibility if this ad breaks out in ROARING FLAMES. So please do stop reading this until you have taken the necessary safety precautions. Yes, we have an item that's H O T —so H O T that we are not going to say other than the usual words of a good product for fear of setting this

good magazine on FIRE. This product is NEW! SENSATIONAL! COLOSSAL! AMAZING! and REVOLUTIONARY.—NO! No long story—All we have to say, and this is modestly, we have an ELECTRICALLY controlled bulb that is the BEST insect killer CONSOLIDATED RESEARCH has been able to produce—bar none. Not to be compared with any other unit ever sold.

Testimonials like these are pouring in by the hundreds.

"It works like a charm. I am amazed at its results."—Mrs. A. F. Willa, Atlantic City, N. J.

"Your magic bulb has at last solved my roach and fly problem."—Mrs. C. I. Thompson, Miami, Fla.

"Has given my family endless hours of comfort living."—Mr. P. V. Zane, Los Angeles.

You have heard of the 7 Wonders of the World. Now, consolidated research introduces the 8th Wonder, acclaimed a MUST in every home and establishment. Being hailed by salesmen as the biggest MONEY MAKER since the opening of the U.S. MINT.

ABSOLUTELY EVERYONE

Now that you have taken the safety precautions, read every word in this ad, as we have said above, this item is HOT, so hot that to be extra safe we have ordered the publishers not to use any RED ink. Now, getting serious, fellows, here's the scoop. We are going to do EVERYTHING to make you the most welcomed salesman to ever approach a customer. We will give you GLOSSIES, MATS, IMPRINTS, all the material needed for an immediate mail order set up, also documented test reports of how prominent colleges and testing labs, RATE our product, also at your disposal is a powerful pulling pitchman sound T.V. movie on Bug Weapon. The production value of this film cost us more than \$2000.00, PLUS BELIEVE IT OR NOT an advertising allowance. We will PRE-SELL this Bug Weapon for you, by launching a tremendous advertising barrage, including almost all national magazines, radio, and T.V. The entire population of the U.S. will be put in a buying mood. Especially so since hundreds of insects will help you make every sale. They will dive bomb about him, molest his comfort, interrupt his sleep, destroy his property, and spread contagious diseases about his home, and food. Business establishments suffer enormously combating the ugly insect problem. They will greet you with arms wide open. It's a tested natural with STAGGERING public acceptance and mountainous profits. Yes, you will be WELCOMED, you will be THANKED, most important you will make MONEY.

VOLUME SALES CORP., Research Dept. P-8
2000 Market Street Philadelphia 3, Pa.

New!
20th CENTURY
BUG WEAPON

**FREE
READ HOW!**

DEATH
TO DISEASE-CARRYING, DESTRUCTIVE
AND ANNOYING PESTS

**AMAZING NEW INVENTION
KILLS ALL TYPES OF INSECTS
SCIENTIFICALLY-AUTOMATICALLY**

10-YEAR GUARANTEE

Not a gadget — not a halfway measure. Not to be compared with flimsy, untried imitations. A finished quality appliance. Carries an ironclad 10-year guarantee and parts replacement policy. Bound by signature.

COST ONLY PERMITS A MONTH TO OPERATE

STOP

FLIES
ROACHES

DID YOU KNOW?

that flies and roaches are suspected carriers of 13 communicable diseases including POLIO. One fly can reproduce 8 million others. Flies seldom leave anything without first excreting on it. Don't take chances with your health. YES, you can now insect proof your home without lifting a finger. Throw out old fashioned fly swatters, and messy spray guns. A new, small, clean, decorative, little bulb enables you to destroy HUNDREDS of types of INSECTS like MAGIC. Only one 2 hour application keeps killing disease carrying, destructive and annoying insects around the clock for more than 2 weeks. More powerful than D.D.T. yet harmless to humans, pets and plants. Approved SAFE. Not a gadget, not a half way measure. Carries a 10 YEAR GUARANTEE. It must KILL not TICKLE roaches, flies, moths, ants, and hundreds of others or your money REFUNDED. For your health's sake order SEVERAL units NOW. Everyone send us a check, M.O. or cash for \$2.98—C.O.D.'s accepted. Should you, after testing your unit, decide that you would like to join us in the sales of this new public servant, we will refund your \$2.98 making your unit ABSOLUTELY FREE.

ODORLESS • SILENT
• MYSTERIOUS

FREE DEMONSTRATOR COUPON

Enclosed is \$2.98. Send me one unit for my personal use.

Enclosed is \$2.98 in cash, check or M.O. Rush me one 20th CENTURY BUG WEAPON with sales aids, and LOWER wholesale prices. However, should I become an active salesman, you of the Volume Sales Outlet are to REFUND my \$2.98 making my demonstrator FREE. Furthermore, I must agree that everything you say be true or I will return everything for a refund.

Send one MONEY MAKING sales kit C.O.D.

Lost time is lost money. Rush me dozen BUG WEAPONS, at your wholesale price. Don't forget to include my FREE demonstrator and sales aids, C.O.D.

Together with the enclosed order don't forget to show me how to make \$4.37 on each \$2.98. \$15,732.00 in one summer. \$9,504.00 without leaving my home.

NAME.....
ADDRESS.....
CITY..... STATE.....
(Members of the Mail Order Business Bureau)

**VOLUME SALES CORP., Research Dept. P-8
2000 Market Street Philadelphia 3, Pa.**

ABSOLUTELY EVERYONE MAIL THIS COUPON NOW!



**Rocket Researchers
Discover Secret of...**

1,000,000 Mile Automobile Engine

*Your Present Engine Can Last Years Longer
... Thanks to New Sintered Bronze Filter Method!*

THIS IS THE SECRET that wouldn't keep—the invention that may put men on the moon years before experts believed it could be done. This is the discovery that can make present-day automobile engines last hundreds of thousands of miles—and save millions of dollars for average car owners by reducing operating expenses. Yet, like many great discoveries, it is based on simple principles.

Friction, as every schoolboy knows, is what makes engines wear out. In early steam engines, this was such a minor problem that tallow was good enough for lubrication. Even in the first gasoline engines, almost any kind of oil could do the job.

But as engine heat increased and piston speeds approached 3000 feet per minute, lubrication engineers had to develop new oils containing "additives" you hear so much about.

Oil companies claim these additives are worth the extra 15c to 25c a quart you're paying for oil—and they're right. Purpose of these additives is to keep carbon and gum in harmless suspension in your oil—prevent deposits from forming in your engine. That's why your oil should look dark after a few miles of driving.

But here's the catch: the ordinary absorbent-type filter soaks up these valuable additives like a blotter. The more additives your oil filter soaks up, the "cleaner" your oil looks—and the more carbon, gum and varnish you may have forming in your engine.

Shocking? Yes, but that's only part of the story. Oil companies have developed still other additives—such as barium and molybdenum—which may make an engine overhaul something you don't even start thinking about

**a four page report
on the most important
lubrication discovery
in a lifetime!**

until 250,000 miles or so. But there was no point in putting these oils on the market until an oil filter could be developed that would not remove additives. True, a few of these additives are already on the market in limited quantities—but, again, they are ineffective as long as they are being soaked up in absorbent filters.

The problem: find a filter that wouldn't soak up valuable additives, but would remove the microscopic abrasives that do the real damage to precision engine parts. These "danger zone" particles range from 10 to 30 microns in size (a micron is 39 millionths of an inch)—so small that several hundred of them would simply rattle around inside the period at the end of this sentence.

Since conventional absorbent filter material couldn't be packed tight enough to stop these tiny particles without reducing oil flow, engineers decided an entirely new kind of filter material had to be developed. Obviously, it had to be metal—but there was no way of making a metal screen fine enough.

Finally, metallurgists found the answer by fusing together millions of tiny bronze balls into a porous filter. Being non-absorbent, it wouldn't remove additives, yet abrasives simply couldn't get through the spaces between the tiny bronze balls. And, since bronze just doesn't wear out, it would *never have to be replaced!*

Tests Prove Life-time Filter Adds Years to Engine Life

Samples were rushed to government proving centers for testing. Results: the Life-time bronze filter not only solved the critical problem of filtering liquid oxygen, nitrogen, etc., for guided missiles, but could save the government millions of dollars now spent on filter replacement packs for trucks, jeeps, tanks and other vehicles.

Besides government tests, millions of miles of road tests in truck, taxi and car rental fleets reveal amazing results. Cars equipped with the Life-time filter have already passed the 300,000-mile mark *without ever changing oil filters!*

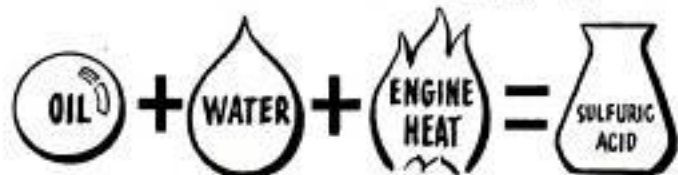

By removing water from the oil, the Life-time filter prevents formation of sulfuric acid, deadly enemy of bearings, other precision engine parts.

Micrographs Reveal How Ordinary Cloth or Paper Filters Let Abrasives Get Through



1. After 200 miles, unfiltered oil looks like this. Dark color is normal; it means detergent additives are keeping your engine clean. But abrasive particles are dangerous, should be filtered out.

2. Ordinary cloth or paper filters soak up additives, but let some abrasive particles get through when pressure forces "channels" in pack.

3. Because additives are removed, oil may look "clean" because carbon and gum are deposited in engine. Dangerous abrasives are still in oil.



250,000 MILES before a major overhaul should be normal with today's engines and oils. The Life-time bronze filter meets modern requirements.

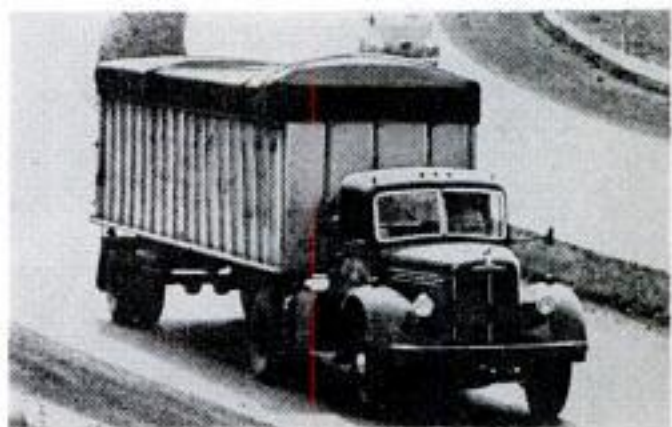

DIESEL AND GASOLINE truck fleets have proved value of Life-time bronze oil filter in hundreds of thousands of miles of road tests.

Life-time Oil Filter Never Wears Out — eliminates filter pack replacement forever!

You never change the Life-time filter — just rinse it occasionally in gasoline and it's good as new. In addition, you save the quart of oil soaked up and thrown away regularly with ordinary replacement filter packs, which can add up to a lot of oil during the life of this filter. How long is that? Well, the Life-time filter is guaranteed for 10 years.

But since bronze simply never wears out, the amount of money you save on the filter packs you don't have to buy, plus what you save in engine overhauls, is something for your life insurance man to figure out for you.

To find out how you can have a permanent bronze Life-time filter on your car, see next page.

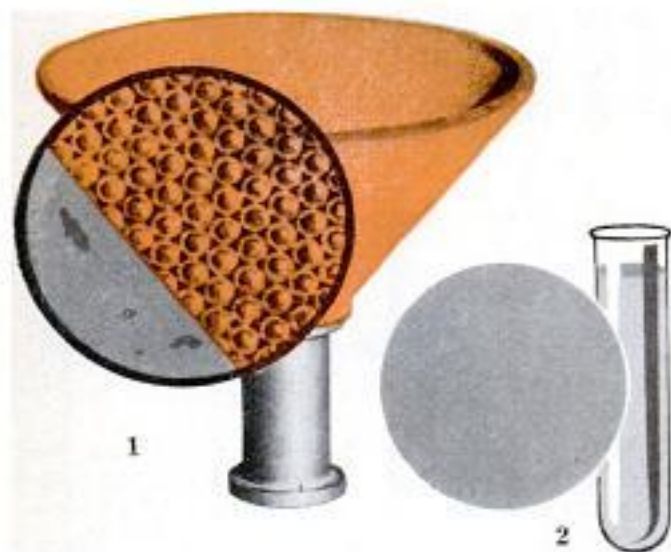

1. Since porous bronze can't "channel," abrasives can't get through—but valuable additives can, because Life-time filter is non-absorbent.

2. After 2,000 miles—or 10,000—oil is free of abrasives, but dark, proving engine is clean. Dark oil means a clean engine, just as dirty water means clean hands.

How The **LIFE-TIME** Filter Works

As dirty oil is forced through element, all harmful particles drop to bottom of filter case. Only pure, filtered oil can get back into circulation.

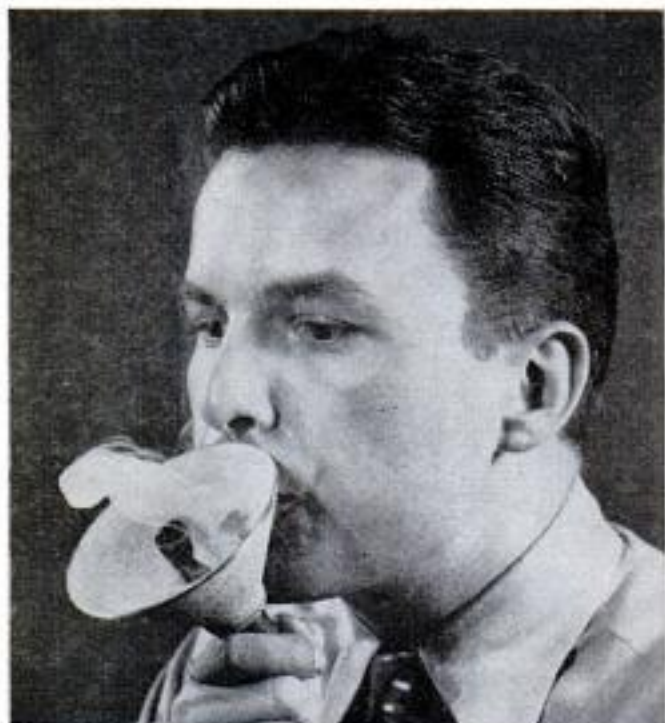

"SMOKE TEST" proves superiority of Life-time porous bronze filter. Ordinary filters cause oil pressure to drop when fibers soak up oil, expand and prevent free circulation.

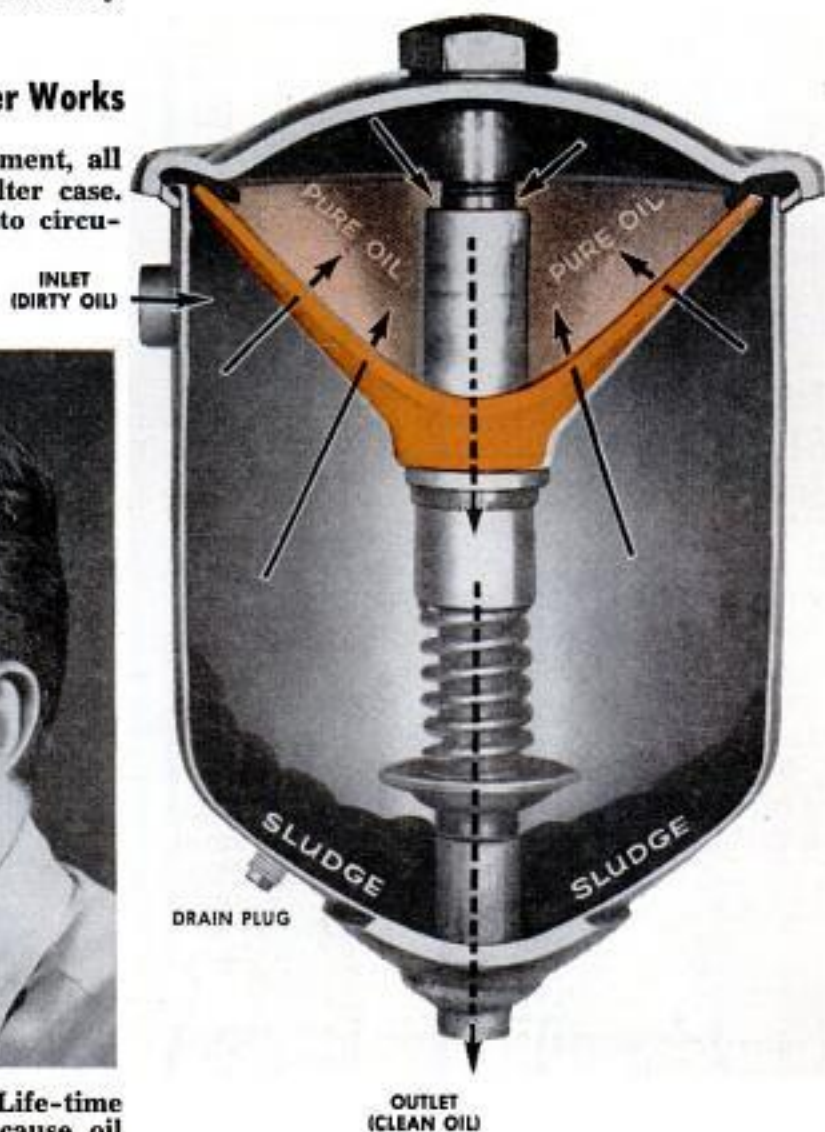

Try a Life-time Filter for 2 Weeks in Your Car or Truck

You can try a Life-time filter in your car for two weeks to see if it's really all we say it is (it is, and more). If, however, you decide you don't want to keep it because you miss the fun of buying filter packs, or for any reason, all you do is send it back for a refund, with no questions asked. Ordering is simple:

1. If your car already has an oil filter, you can convert it to a Life-time filter with a kit which replaces your throwaway pack with permanent bronze. Just send us the make and number of your present filter pack (if you know it); otherwise, send us the make, model and year of your car or truck. Enclose \$6.95 (we pay shipping) or send \$2.00 deposit (you pay balance and C.O.D. charges on arrival).

2. If your car has no filter now, or you want to replace the one you have, send us the make and model of your car and \$12.95 (we pay shipping) or \$5 deposit, balance C.O.D.

3. A few cars have full-flow filter systems; Life-time filter conversion kits for these are \$13.95.

EASY TO INSTALL

If your car already has an oil filter, you can install a Life-time permanent bronze element as easily as changing throwaway filter packs. You can put a complete Life-time filter unit on any car or truck in less time than it takes to change a tire; no special tools are needed.

Use the order form below for immediate delivery—and do it today, before you waste another cent on filter pack replacements!

Opportunities Now for Life-time Filter Dealers and Distributors

A dealer and distributor network is now being formed to handle demand generated by 4-page advertisements like this published in leading national magazines, plus sponsorship of radio and television broadcasts of the Indianapolis 500 and the Panamerican Road Race.

These valuable dealer and distributor franchises are not being sold; they are being awarded on the basis of ability to grow with us in the most ambitious expansion program in the industry.

For complete information on how you can be first with the most exciting automotive product of this decade, write or wire:

Continental Manufacturing Corporation
Dept. FPM-8, Washington Blvd. & Motor Ave., Culver City, California.



1. **CONVERSION KIT** replaces present filter element with Life-time bronze.

2. **COMPLETE UNIT** which replaces entire old filter, is easily installed.

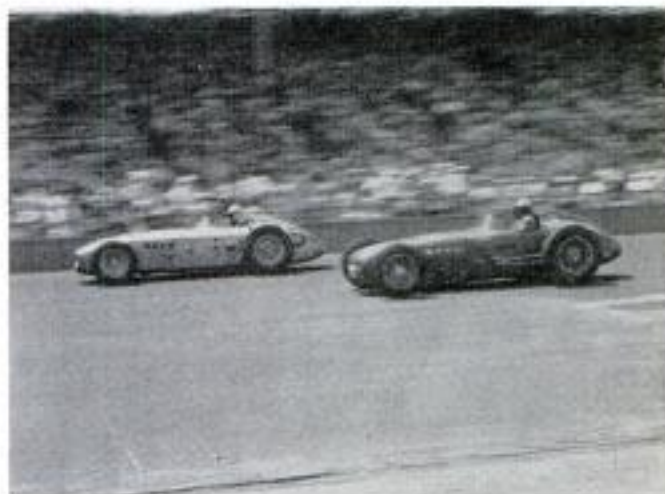

INDIANAPOLIS "500", Panamerican Road Race, other international sports events are sponsored on network radio and TV broadcasts by Continental Manufacturing for Life-time filter.

Permanent Filter Division, Dept. FPM-8
Continental Manufacturing Corp.
Washington Blvd. at Motor Ave.,
Culver City, California

Rush Life-time filter for:
Make, model, year of car _____

Present filter make and model (if known)
I enclose

- \$6.95 for conversion kit (full flow, \$13.95); factory pays shipping.
 \$2.00 deposit for conversion kit; send C.O.D.
 \$12.95 for complete unit (\$18.95 for chrome); factory pays shipping.
 \$5.00 deposit for complete unit; send C.O.D.

Name _____

Address _____

City _____ Zone _____ State _____

Things to do before you go:



BUY A NEW BATHING SUIT



MOW THE LAWN



STOP THE PAPER AND MAIL



STOP THE MILK



PACK THE BAG

and "Travelize" the **FORD**



There's a lot to be remembered before you go. But don't forget the one thing that can really add most to the pleasure you have getting there: Have your Ford thoroughly checked and "Travelized" now — before you go.

And if replacement parts are called for, remember to insist on Genuine Ford Parts. They're made right to work right to last longer in your Ford.

Every Genuine Ford Part is designed to the same specifications set by the men who originally built your Ford, and thoroughly tested before approval for manufacture. They're your best assurance that your Ford will be fun to drive!

**Wherever you go
for service insist on
Genuine Ford Parts**

POPULAR MECHANICS

WRITTEN SO YOU CAN UNDERSTAND IT
VOL. 102 NO. 2



What's on the mind of the driver pushing his racing car toward the four-mile-a-minute mark on the Bonneville Salt Flats?

“One Out of Three Smashes Up”

Writes Mal Hooper

AS I HEADED for the starting line on the Salt Flats of Utah, I remembered two cars that had gone there earlier and how they had ended up—smashed to bits on the smooth, hard salt.

I remembered the judges in the timing stand and the spectators lining the course, tense as an oncoming streamliner began to fishtail. The car rolled over and flipped end for end, hammering itself into a mass

of junk. It crashed on its back and slid past the last beam of the timing apparatus, automatically clocking its speed at more than 225 miles per hour. The car was completely ruined. Yet driver Sonny Rogers crawled out unhurt, his life saved by the roll bar and helmet.

My second memory was of Fred Carrillo. He wasn't quite so lucky when his 1300-pound streamliner began to drift away

Mechanics remove top body panel to work on engine of Hooper's car before he set 12 Class C speed marks

Hot Rod Magazine photo

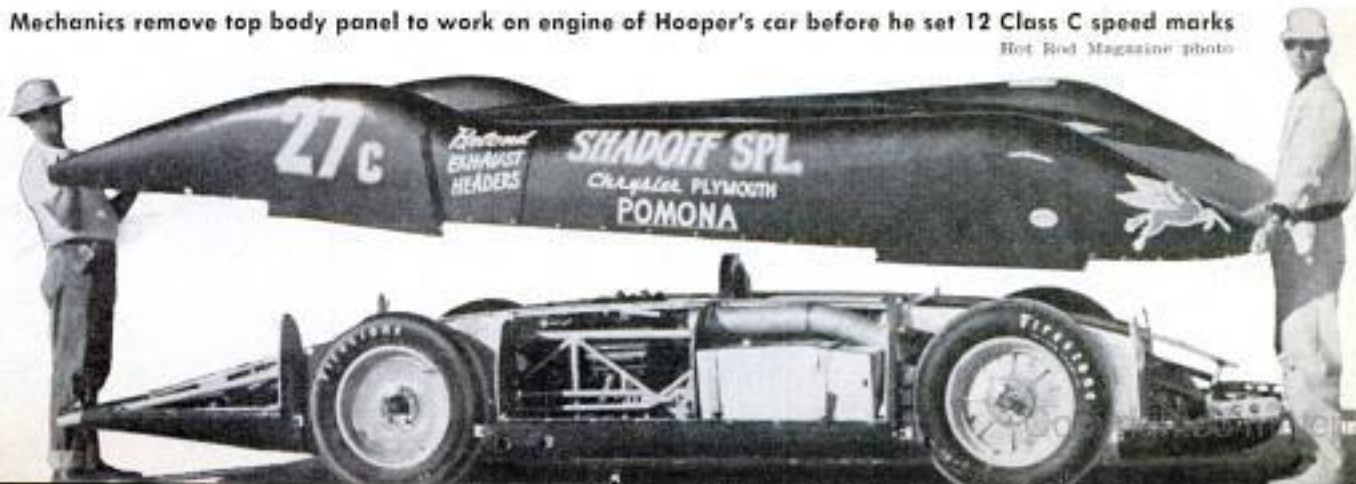

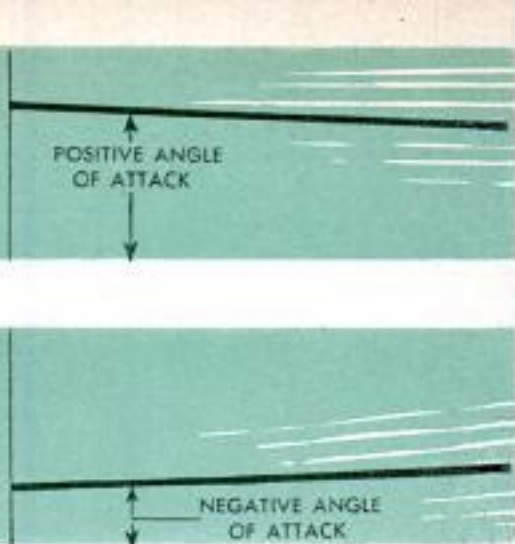
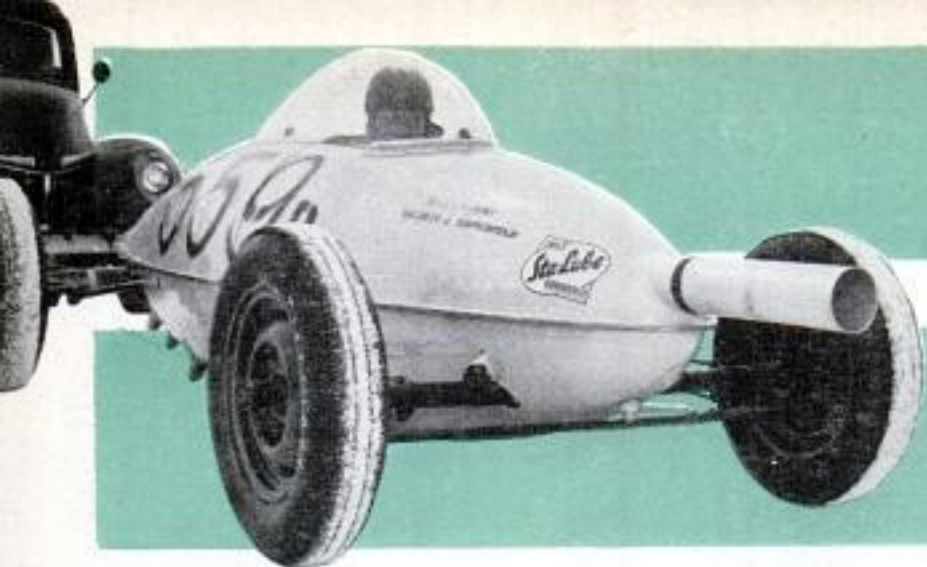

Tube extending from nose of the belly-tank lakester sucks air into its thirsty carburetor. This car covered the Bonneville course at an average 150 miles per hour

Fred Carrillo's Class B streamliner, right, flipped over at more than 200 m.p.h. He got out with only a broken left leg and injured thumb. Car was total loss



Hot Rod Magazine photo

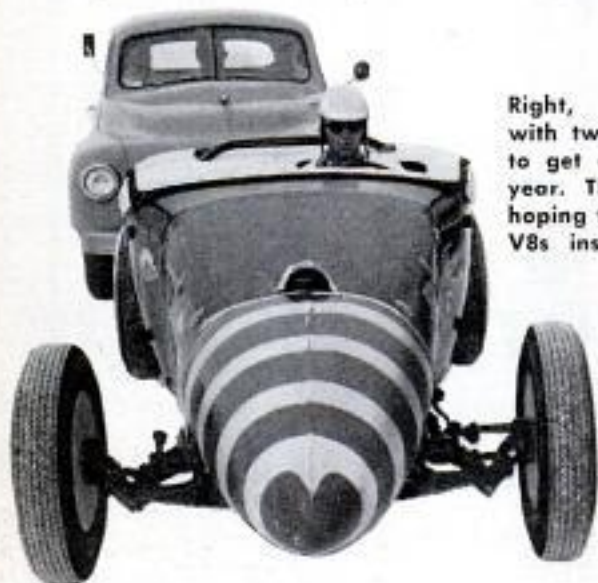

Right, LeBlanc streamliner with two V8 engines failed to get out on the salt last year. This year LeBlanc is hoping to compete with four V8s installed in the racer



Modified roadster has novel streamlined nose. It placed seventh in its class, going over the Bonneville course at an average of 141.95 m.p.h.



Official starter gives the flag to a Class B modified roadster that placed third in its class with an average of 150.25 m.p.h. Car at rear pushes roadster to get engine going



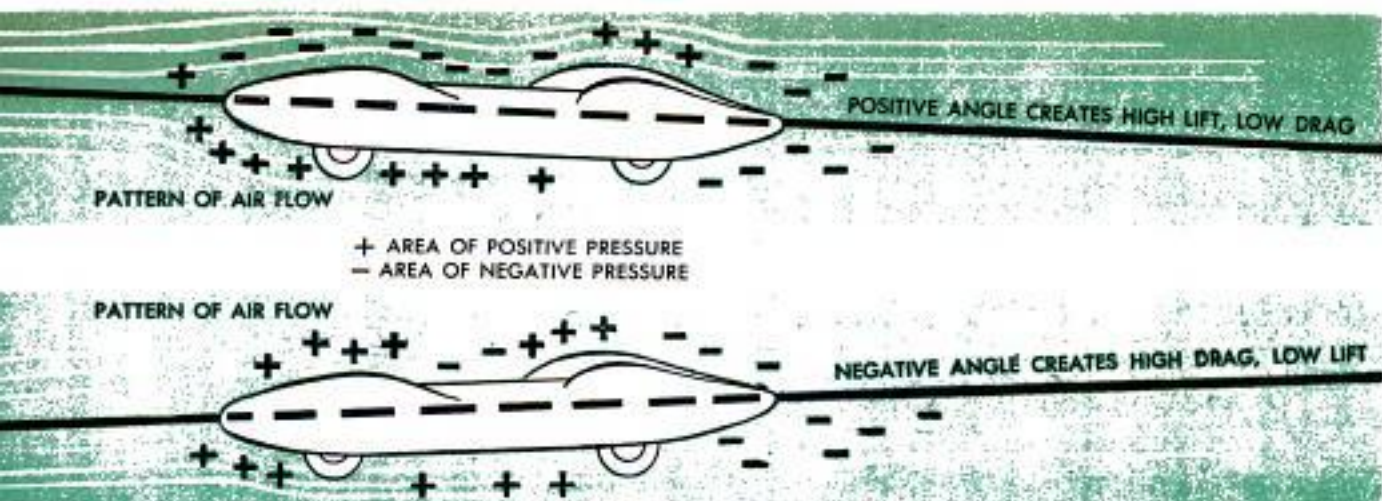

Velocity Engineering, Glendale, Calif.

Body designs determine angle of attack at high speed. Hooper's car has about two degrees of negative angle

from the black line at top speed. Carrillo corrected with his wheel and the car bounced and jumped across the salt for 2000 feet, scattering parts and pieces in all directions. It seemed impossible that Carrillo was still alive yet he emerged with no greater injury than a broken leg.

One out of every three of the high-speed streamliners that have raced against the clock at Bonneville in recent years has beaten itself to pieces on the salt.

All this was in the back of my mind as our own new streamliner approached the line to make its run for the record. Tune-up trials were over and the car had seemed perfect on its last run.

But the trials had been over a three-mile distance and now we would use the full 14-mile straightaway. Would the engine hang together for that distance and for the return run? Ray Brown had spent weeks reworking the Chrysler V8 power plant. It now produced 325 horsepower, almost

twice its original power, though it had been sleeved and destroyed to reduce its displacement to less than 305 cubic inches.

The whole team had confidence in Ray's work and so my only real worry was whether I could hold the car straight while traveling well above the take-off speed for jet aircraft. But that, too, was pretty much out of my hands. The car had been designed to be as stable as possible. It should be easy to control and there was little the driver could do if he lost control.

Dean Batchelor and John Morris of Velocity Engineering had provided about two degrees of negative angle of attack for the body. The nose tilted down just a bit. This was to prevent my becoming airborne at high speed. It would have been ideal to have designed the streamlined shape for neutral buoyancy at 250 miles per hour, obtaining enough lift from the body at that speed to almost equal the car's weight. But then a strong gust of wind could add

Outstanding for its stability, this record-breaking car made more runs than all other streamliners combined

Hot Rod Magazine photo

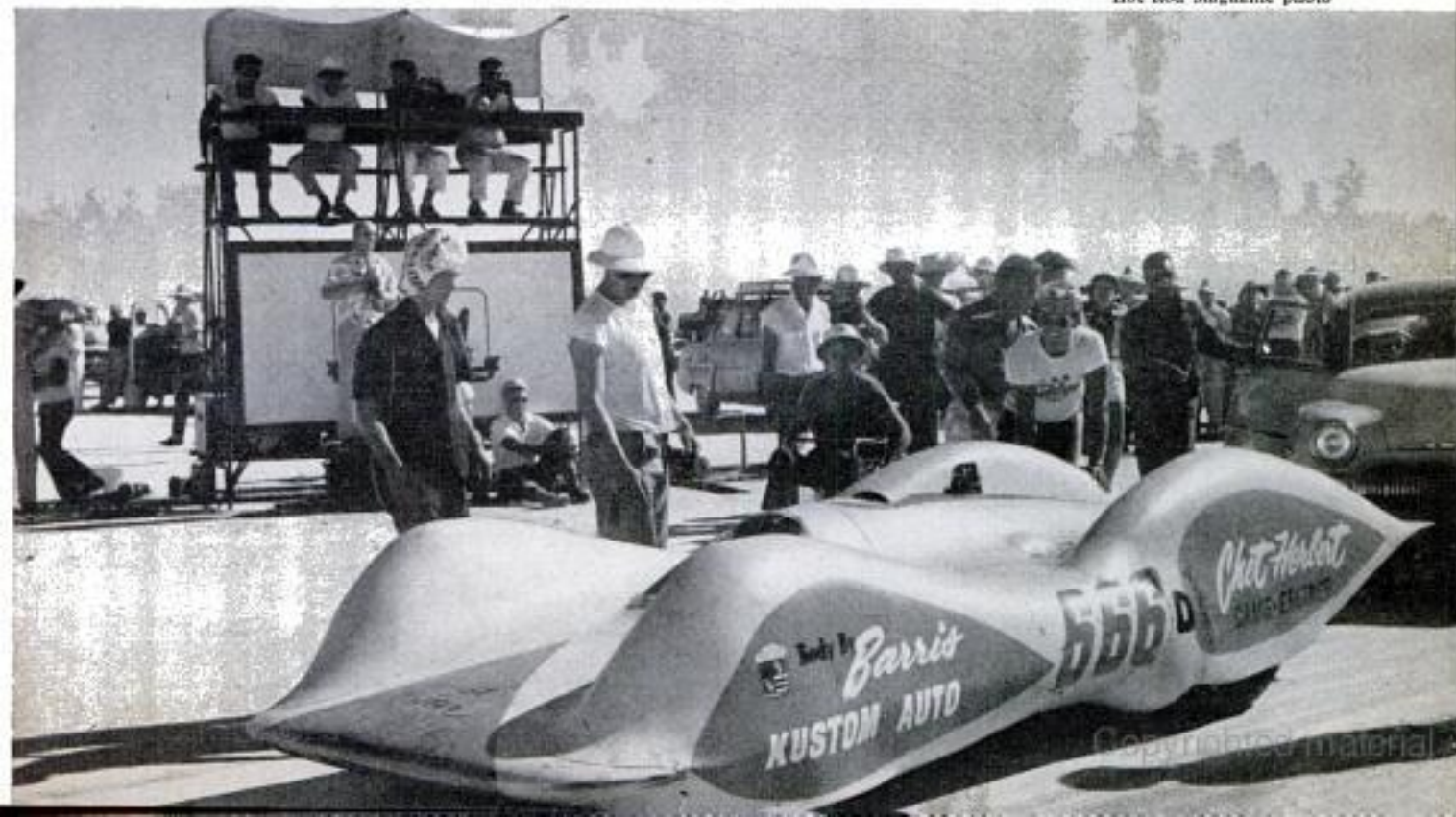

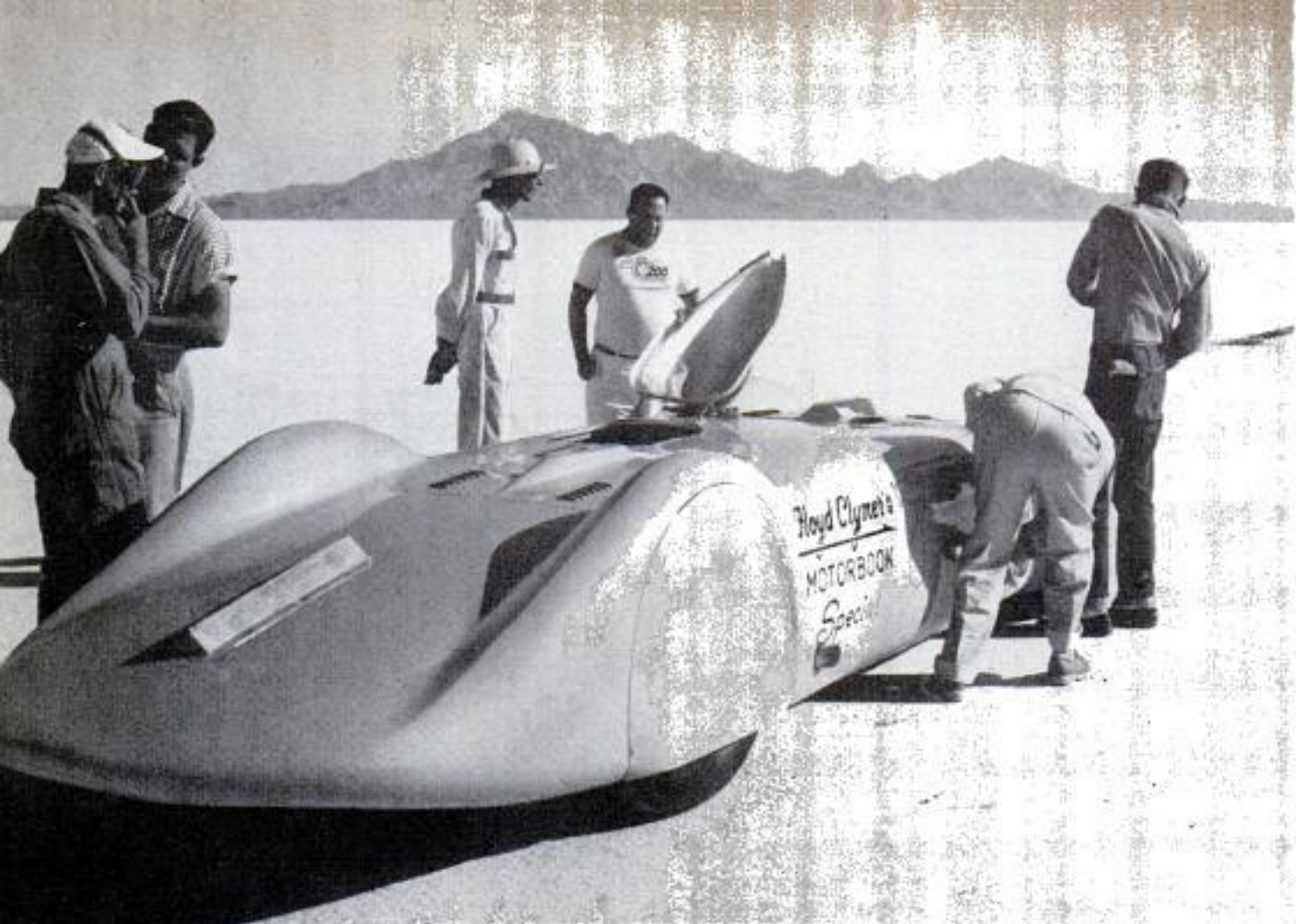

In the unlimited class, Willie Young (hatless, center) drove the Kenz twin-engine streamliner 255.41 m.p.h.

Placing canopy over driver before a run. Guide line is 14 miles long. You can't see the end from here



enough lift to raise the nose and I'd be off the ground. The negative angle of attack was a safety factor and insured stability and traction.

Another way the designers sought stability was to bring quite a bit of the car's weight to rest on the front wheels. The ideal is to place slightly more than 50 percent of the weight in front. When you throw a hammer, its heavy head tries to stay in front and the same principle can be applied to high-speed straightaway cars.

Still another way in which stability was sought was to give the car a high polar moment; that is, to arrange its weight as much as practical like a dumbbell, out at the ends. The idea is that it takes little effort to rotate a heavy ball, much more effort to rotate a dumbbell of the same weight. A car that has its heavy components placed at its ends tends to travel in a straight line. You want just the opposite effect when designing for maneuverability and cornering.

I wouldn't need to worry about losing traction. The rear end of the car was independently sprung and Carl Fleishmann had adjusted the rear torsion bars to give no more than an estimated one percent wheel slippage on the salt. The rear tires wouldn't bounce in the air and then leave long stripes of black rubber every time they came down.

The car was as safe as the engineers could make it, now we would find out if I could drive. I'd been at Bonneville before and I'd had my share of high-speed thrills. I've thrown the treads off both front tires at close to 200 miles per hour in a belly-tank speedster. I saw the rubber fly past my head and I knew I'd lost the treads and yet nothing happened to the car. There wasn't even any vibration; that didn't begin until the speed dropped under 100 miles per hour.

I settled down in the cockpit, strapped on the shoulder harness, and pulled on the helmet and goggles that would protect my eyes if the transparent canopy happened to fly off. The push car started to shove me ahead. At 50 miles per hour the engine began firing and I put my foot down on the accelerator. The car jumped ahead so fast it was doing better than 90 miles per hour within a quarter of a mile. At 5000 revolutions per minute on the tachometer I backed off the throttle, eased the two-speed transmission into high and put my foot on the floor again. The tach crept up to 6200 and we were really going.

There's no special sensation of speed once you get above 100 miles per hour. The white surface close to the car is just a blur and you don't look at it anyway. Your eyes are aimed along the black marker stripe that stretches all the way to the horizon.

But two things tell me I'm going fast. One is the sound of the front wheels and tires. They whine like a jet airplane going into a dive. There's no noise from the engine behind me, only the scream of the tires.

The other indication of speed is the "snowstorm" that starts in the cockpit at about 225 miles per hour. That's what it seems like. Actually, the particles are salt crystals whipped up from the surface and drawn in through the few openings in the body. They drift in and settle on my arms and legs.

What we were seeking were new national and international records for Class C automobiles, the class of cars powered by engines ranging from 183 to 305-cubic-inch capacity. The old international records (229.77 miles per hour for the flying mile, 211.8 miles per hour for 10 miles) had been made in Germany in 1937.

I was to make one run in each direction so the speeds of the two trips could be averaged. My rate of travel would be clocked automatically in miles per hour and kilometers per hour. We knew our car could break the record, the real trick was to get it up to top speed quickly, then decelerate as fast as possible at the end of the run.

The reason for this is that there isn't any extra room at Bonneville. The AAA laid out a 10-mile straightaway course with

Sketch of what is under the skin of the car the author drove as he set six national, six international marks

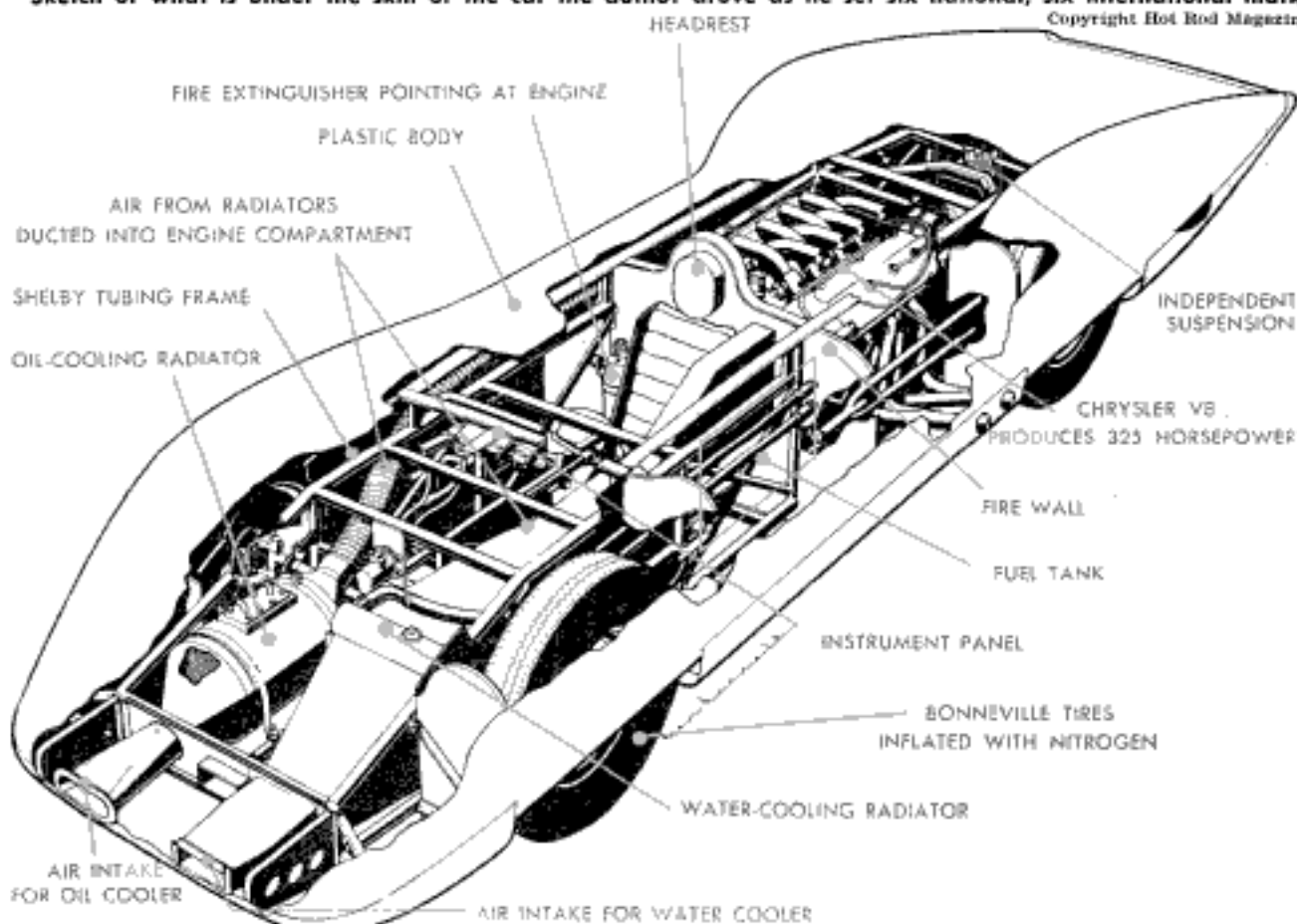

BONNEVILLE SALT FLATS
(HARD LEVEL SURFACE OF WHITE SALT CRYSTALS)

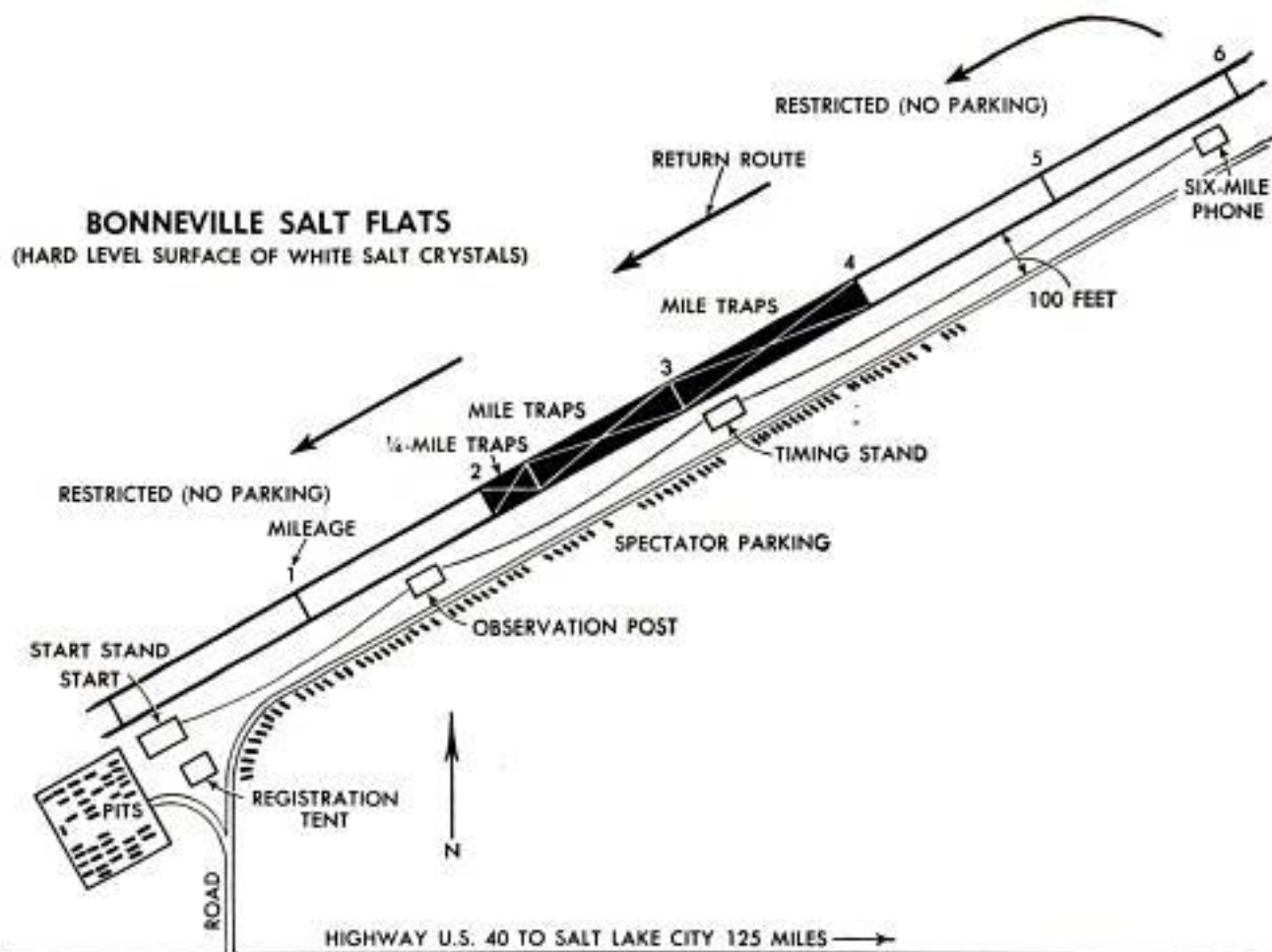

Map of the Bonneville layout. Less than half of it is shown here. It is a 14-mile straightaway altogether

Here is the author at the wheel with plastic canopy off. The instruments show water temperature, oil and fuel pressures, engine speed. Small rubber hose above the second dial carries fresh air into driver's compartment when top is sealed down



two miles of overrun at each end and that's all the room there is. A raised highway crosses one end and there's soft, wet salt at the other. Nevertheless, Bonneville is the best straightaway speed course that has been found in the world. Cobb set his 403-miles-per-hour one-way record there.

A big valley cuts through the mountains that face the course and sometimes a breeze sweeps out of the valley. Gentle as it is, this crosswind could turn you around or flip the car at high speed, so you run for records right after dawn before there's much chance of a wind.

By now I was going so fast that the mile markers were sweeping by about 15 seconds apart. But it still seemed like an eternity before I reached the eight-mile post. Running wide open for a long distance is a real strain.

At the eight-mile post I got busy and began stopping the car as fast as I could. I had two more miles to go, to be sure, and there were two additional miles of overrun.

(Continued to page 240)

Easy-to-Use Resuscitator Operates Aloft or on Ground

Developed for the Air Force, a new resuscitator can be used at high altitude or on the ground. Many resuscitators now in use will not operate at high altitude. The new instrument is simple to operate and can be used to administer oxygen, air or any mixture of gas. Because very little gas pressure is required, the resuscitator can use either a compressed gas cylinder or a blower which is operated by electricity from a wall outlet or an automobile cigarette lighter. The breathing cycle can be adjusted to the requirements of adults or infants.



Aluminum Tube Holds Fish

Anglers can carry their catch easily and display the fish attractively for photographs with a new rigid fish stringer. The stringer is an aluminum tube $13\frac{1}{4}$ inches long fitted with 16 safety-pin-type hooks mounted on swivels. Because the stringer is short it is not likely to be fouled on rocks or to interfere with the operation of a motor. Ashore, the tube becomes a convenient handle for carrying the fish.

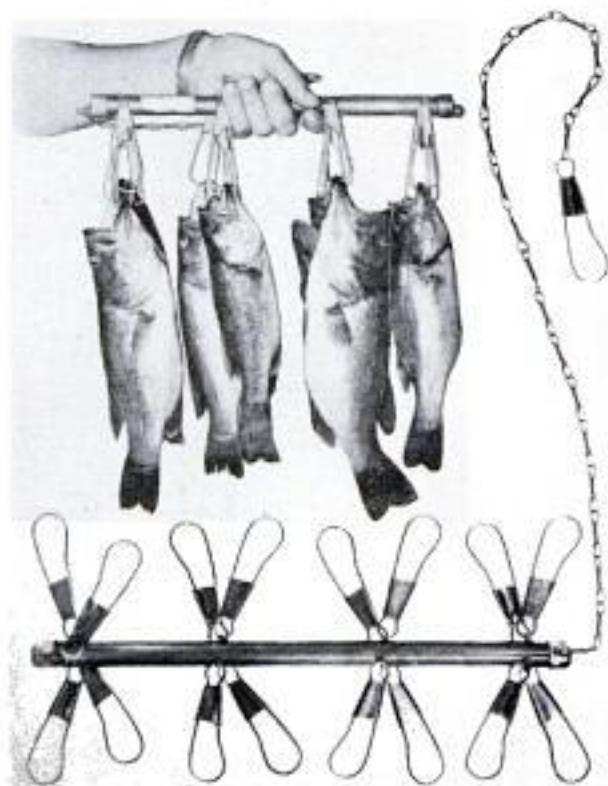

AUGUST 1954

Flashlight Changes Color

You can switch a new flashlight from white to red to green light at the flick of a finger. Motorists can use it to warn oncoming drivers when roadside repairs are being made. Boating enthusiasts, campers and hikers find it useful. Containing two standard batteries, it is $7\frac{1}{2}$ inches long and throws a 500-foot beam.

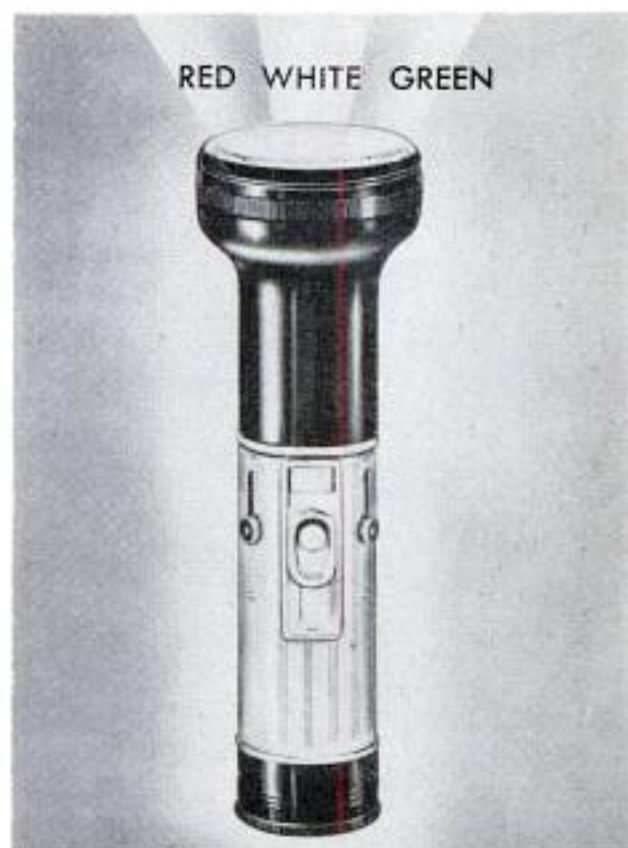

Tampa Bay Crossing Spans 14 Miles Of Tidewater

SCHEDULED TO OPEN to traffic this month, a new bridge across Tampa Bay on Florida's west coast will be the longest open-water bridge crossing in America. A combination of filled-in causeways and steel-and-concrete bridges will stretch 14 miles from shore to shore, over water open to strong tides sweeping from the Gulf of Mexico into the large bay area. Total cost of the project is \$22,250,000.

Motorists crossing the bay will make a net saving of 40 miles each way between points on the Gulf Coast Highway and the Tamiami Trail. Now they must detour through the congested Tampa area and around the bay. During the first year an estimated 660,000 motor vehicles will use the new bridges and causeways, paying a toll that is equivalent to the fee of the pres-

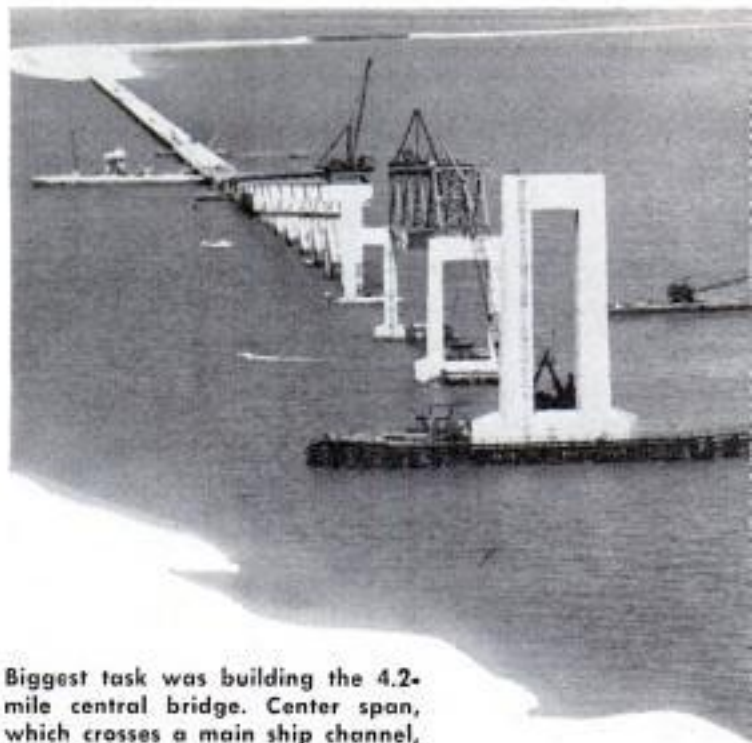

Biggest task was building the 4.2-mile central bridge. Center span, which crosses a main ship channel, is 864 feet long and 155 feet above water. Route across bay mouth joins St. Petersburg with coastal cities

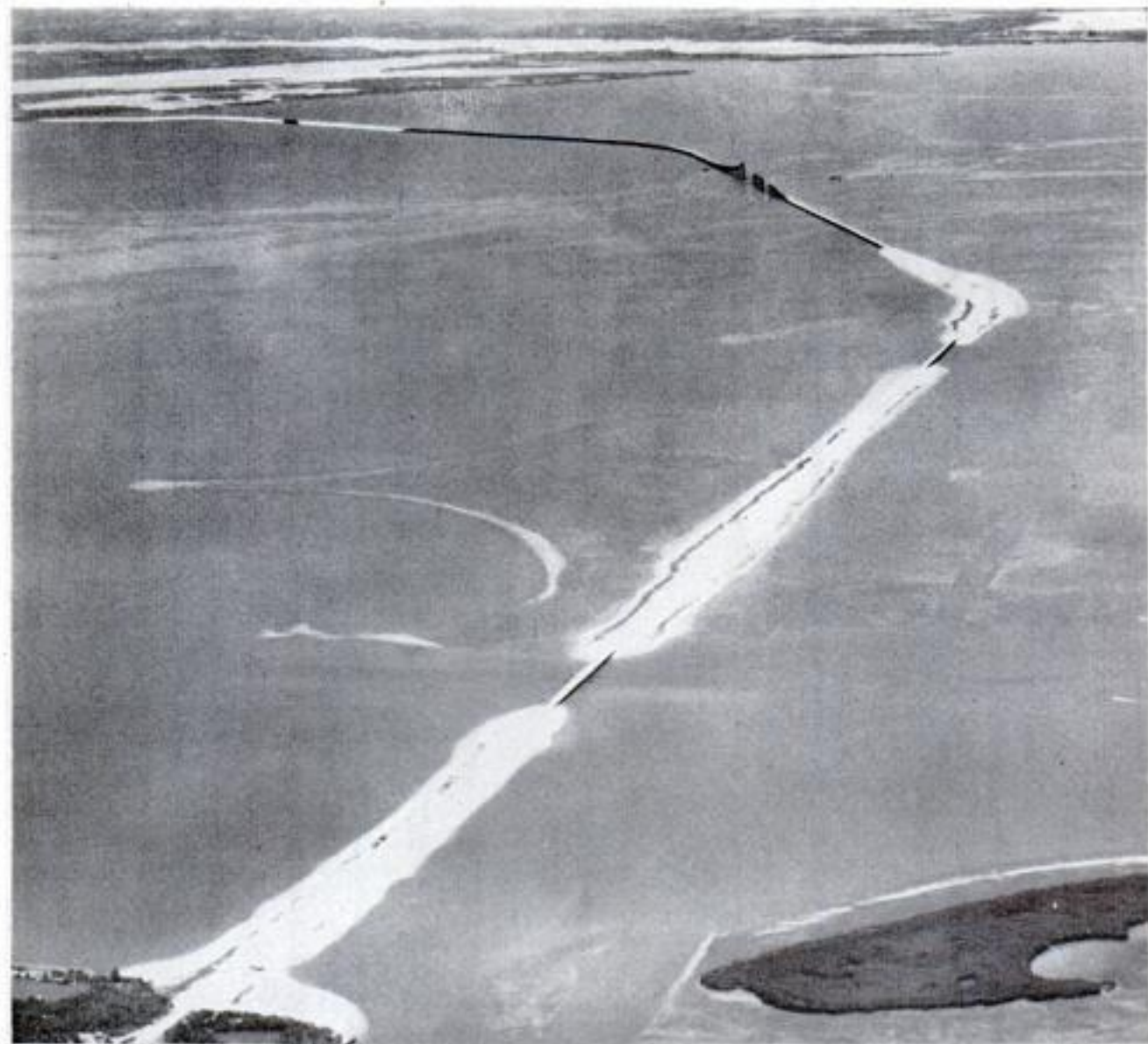

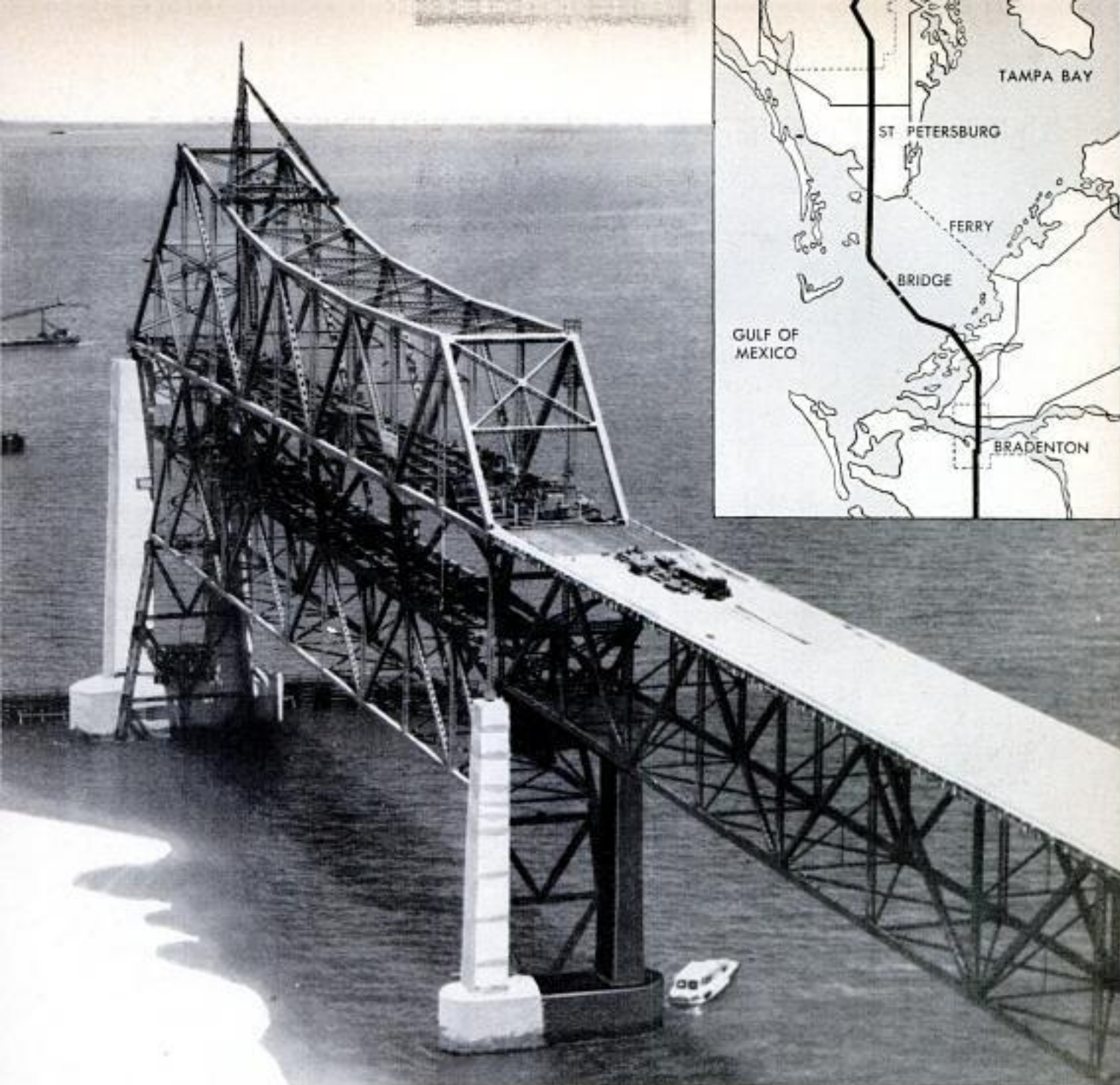

ent inadequate ferry service. Part of a system to speed traffic from the north, the project will relieve congestion and open up a large area to increased trade.

One of the objections to building the bridge was the claim that it would block the tides and cause shoaling of the ship channels which carry a large volume of foreign and domestic trade to several ports on the bay. However, because of the 135-foot distances between the concrete piers and an 864-foot opening at the ship channel, there will be 4.2 miles of virtually open water to keep the tides from millracing through any narrow openings.

Six bridges are included in the system. The longest of these is the 22,373-foot central bridge which crosses the main ship channel between St. Petersburg and Tampa. The trestle-type bridge on either side of the center span rests on hundreds of reinforced-concrete pilings. The roadway

then rises on a five-percent grade over 32 huge concrete piers resting on bedrock to the ship channel which it crosses on a fixed cantilever span 155 feet above the surface of the water. Each of the two largest piers supporting this span contains 8900 cubic yards of concrete and is set on 360 steel piles sunk 100 feet below the bay bottom.

Much of the steel work was prefabricated and floated into position. All of the concrete used was of the prestressed variety and a complete floating concrete plant was constructed for the project. Dredges pumped over 4,000,000 cubic yards of sand for the causeways.

Gales of up to 50 miles per hour hampered the building of the bridge. In one heavy wind, 17 big barges sank or drifted away. Four rigs sank and two were salvaged; one was recovered 200 miles out in the Gulf of Mexico. ★ ★ ★

Lightweight "Stretcher" Straightens Body Wrinkles



Automobile-body repair work is done quickly with a lightweight jack that mounts in an endless variety of positions and applies pressure to straighten sheet-metal kinks. The jack adapts for either pushing or pulling and is versatile enough to work around obstructions. It is especially valuable for straightening crushed headlight openings in front fenders. The pulling is done in a forward and downward direction. Other jobs for the device include straightening hoods, grilles, bumpers, body panels and door panels, as well as tie rods, sway bars and stabilizers.

Quick-Change Spinning Reel Switches Spools in a Matter of Seconds

Spools on a new lightweight spinning reel can be changed within a few seconds. Two spools are provided with the reel, one for light line and the other for heavy line. They can be switched by removing one tension nut. The reel has a swivel base. In the casting position the reel faces the target, but for reeling in it swivels back parallel to the rod so it is operated much like a bait-casting reel. The clutch on the reel is adjustable. Line twist can be eliminated in one cast by pulling the spool off its shaft, reversing its position and casting. The spool then is re-

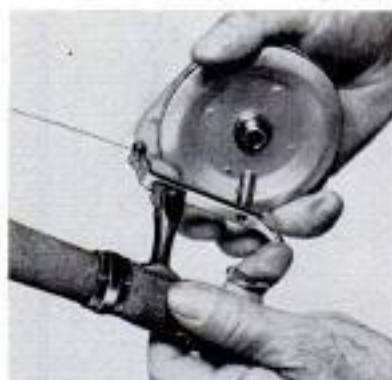

turned to its normal position for retrieving. The spools are larger in diameter than most spinning-reel spools.

Steel Cellar Door Swings Open Like Hood of Automobile

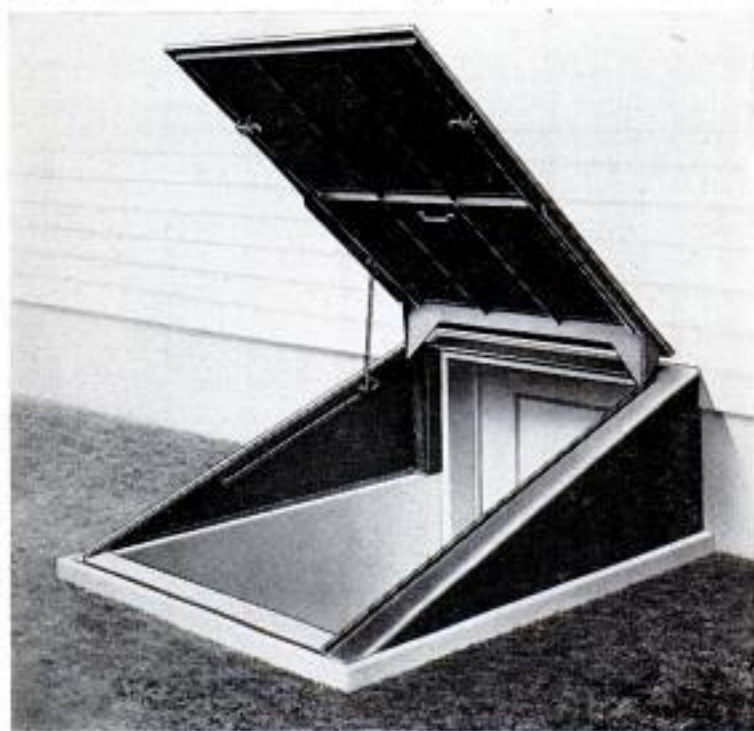

Just a slight upward push swings open the sloping door of an exterior cellar-entrance unit. A coil-spring suspension counterbalances the weight of the door for easy lifting and lowering. The sturdy, reinforced door is strong enough to walk upon, overlaps its frame to keep out wind, snow and rain, automatically locks in the full-open position and is firmly secured by slide bolts when closed. Ordinary tools are sufficient to install the preassembled all-steel unit quickly.

Information not listed on articles in the index frequently is listed in the WHERE-TO-FIND-IT LIST, which is available to readers without charge from Bureau of Information, *Popular Mechanics*, 200 East Ontario Street, Chicago 11, Illinois

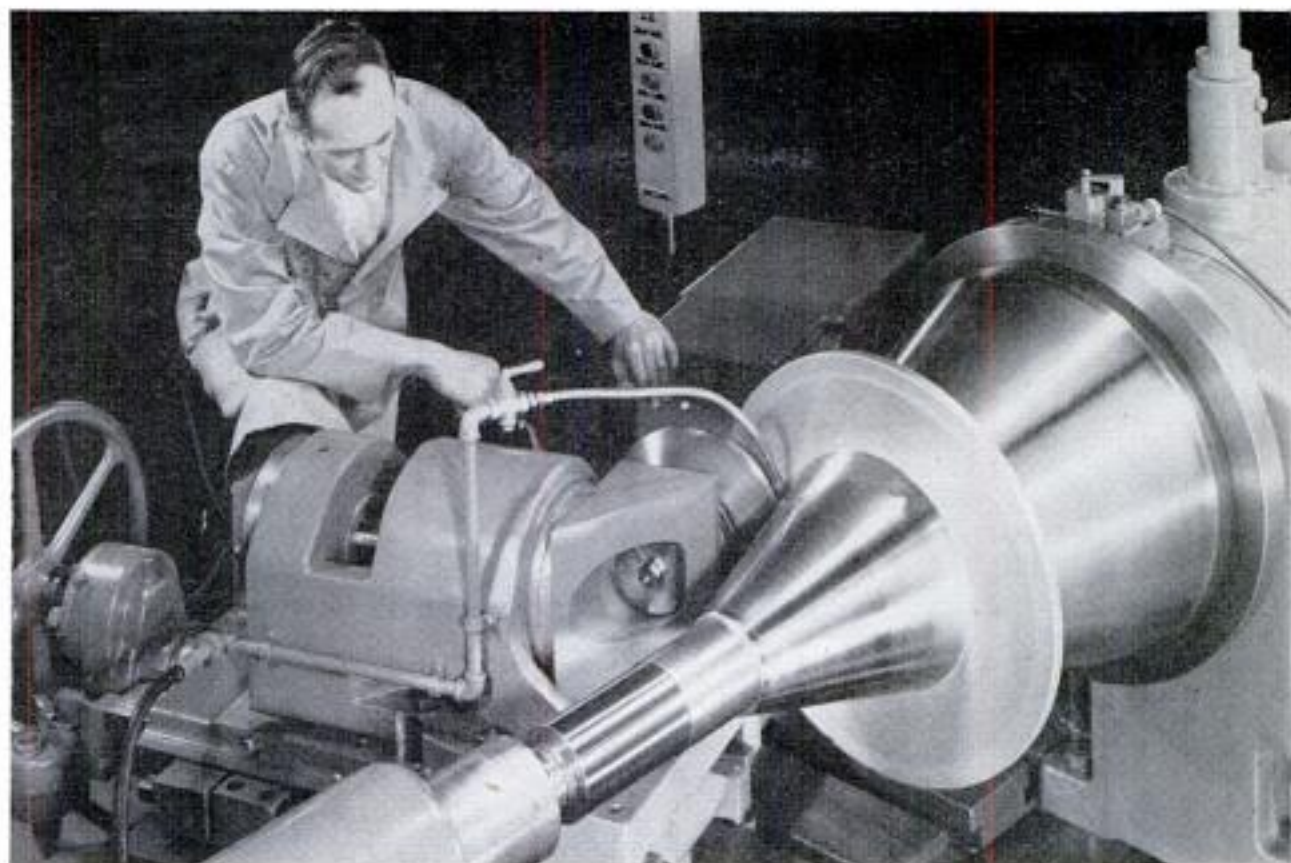

Lathe Roller Flows Metal Into Conical Shapes

IN THE FIELD of metalworking, a new and basically different process has been developed. At first glance the technique appears similar to the old process of metal spinning, in which a metal blank is formed in a circular manner around a mold. In the new process, called Floturning, great pressure is applied scientifically to cause the metal to flow in a cold state. The process starts with a simple flat blank of exactly the same diameter as the finished part but somewhat thicker than the finished wall. The blank is mounted in a lathe against a mandrel. A roller wheel then applies great pressure to the blank, actually forcing the metal to flow in a cold state up the mandrel. The machine controls the operations and in many cases the part can be produced in a single pass to finish dimensions. Conical and cylindrical shapes, or any combination of these two, are possible with the new process, which was developed by The Lodge and Shipley Company of Cincinnati, Ohio. Many hard-to-work alloys can be used.

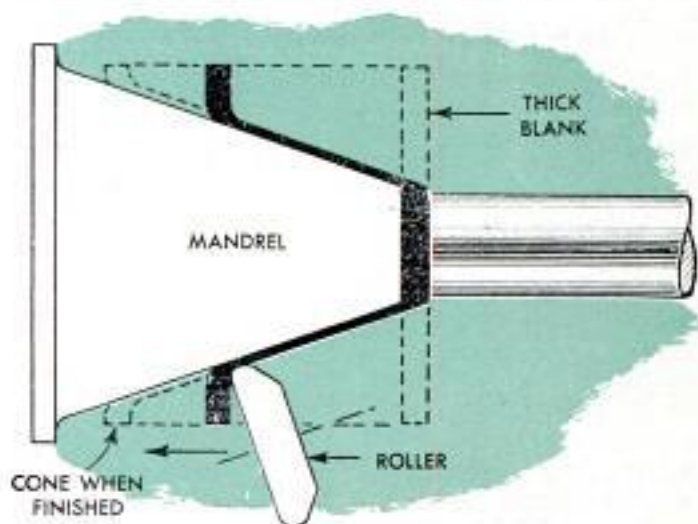

Top, roller on lathe forces metal up mandrel. Diagram shows how the process works. Below are some of the possible shapes

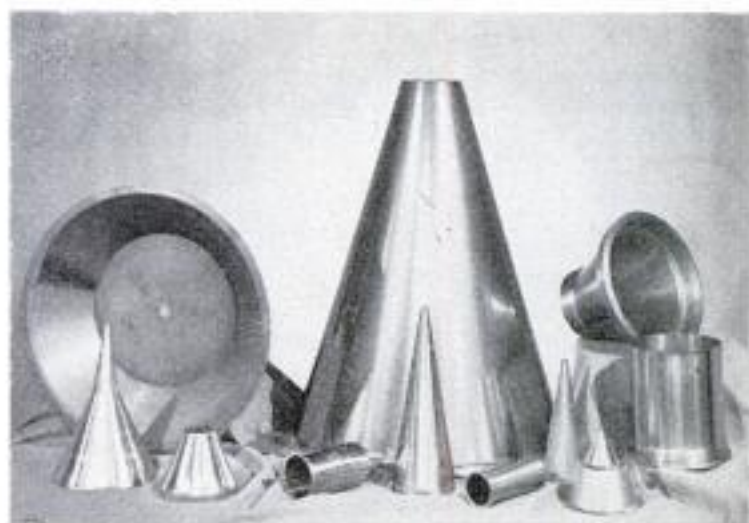

CLIMB IN BESIDE A TEST DRIVER
FOR THE THRILL OF YOUR LIFE ---

TWELVE HOURS ON THE TEST TRACK

Around and around goes the test car in dizzy circles as the driver tries to break the right front wheel

By Arthur R. Railton

IT'S MIDNIGHT. The Michigan countryside is dark except for a long, glass-walled building as brightly lighted as Times Square.

You enter the building with a test driver. Shift Three is going to work at Chrysler's new proving ground near Chelsea, Mich. Drivers from Shift Two swing dusty cars into line at gas pumps. They fill tanks, clean windshields, check oil and water, then walk into the Ready Room to make their reports.

Drivers in Shift Three take over. You open the door of a 1954 Plymouth.

You ask: Mind if I come along?

Driver: Not at all. I'll dump some sand. He drives to the Supply Room and unloads two bags from the front seat. You both get in. He drives toward the gate.

Driver: I drew a highway run tonight. Glad to get out of the snake pit. It's bad enough in daylight. At night, it's a killer!

You: What's the snake pit?

Driver: That's what we call the test track. It drives you nuts sometimes.

You: What test are you on tonight?

Driver: Transmission cycle. We've got 30 miles to go before the next cycle. Look in the book and you'll see what I mean.

You open the notebook the driver gets

Here is the wheel-break test in daylight (see above). Front hubcap fell off just as the photograph was taken



Copyright 1954 General Motors



with his assignment. It's the test car's life story—mile by mile. You look up the test description. It goes like this:

"40 to 75 WOT upshift, 10 times.

"0 to 30 WOT, stop and reverse.

"Repeat 10 times.

"50 miles at 60 plus."

You: What is WOT?

Driver: Wide-open throttle. That's the toughest thing to do to

Tires fail in about 150 laps of wheel test; wheels may last as many as 1000

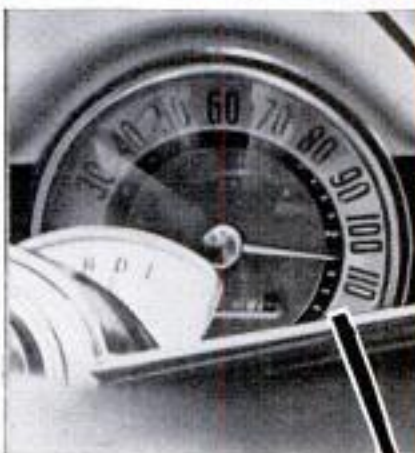

Corner of Chrysler's great run well booked. You love will handle 140 miles per hour without side thrust

Below driver takes both hands off the wheel in the middle of a curve at about 104 miles per hour! Enlarged view of the speedometer at left shows speed. You can do it at 140 in the top lane if you like to live. (Chrysler's)



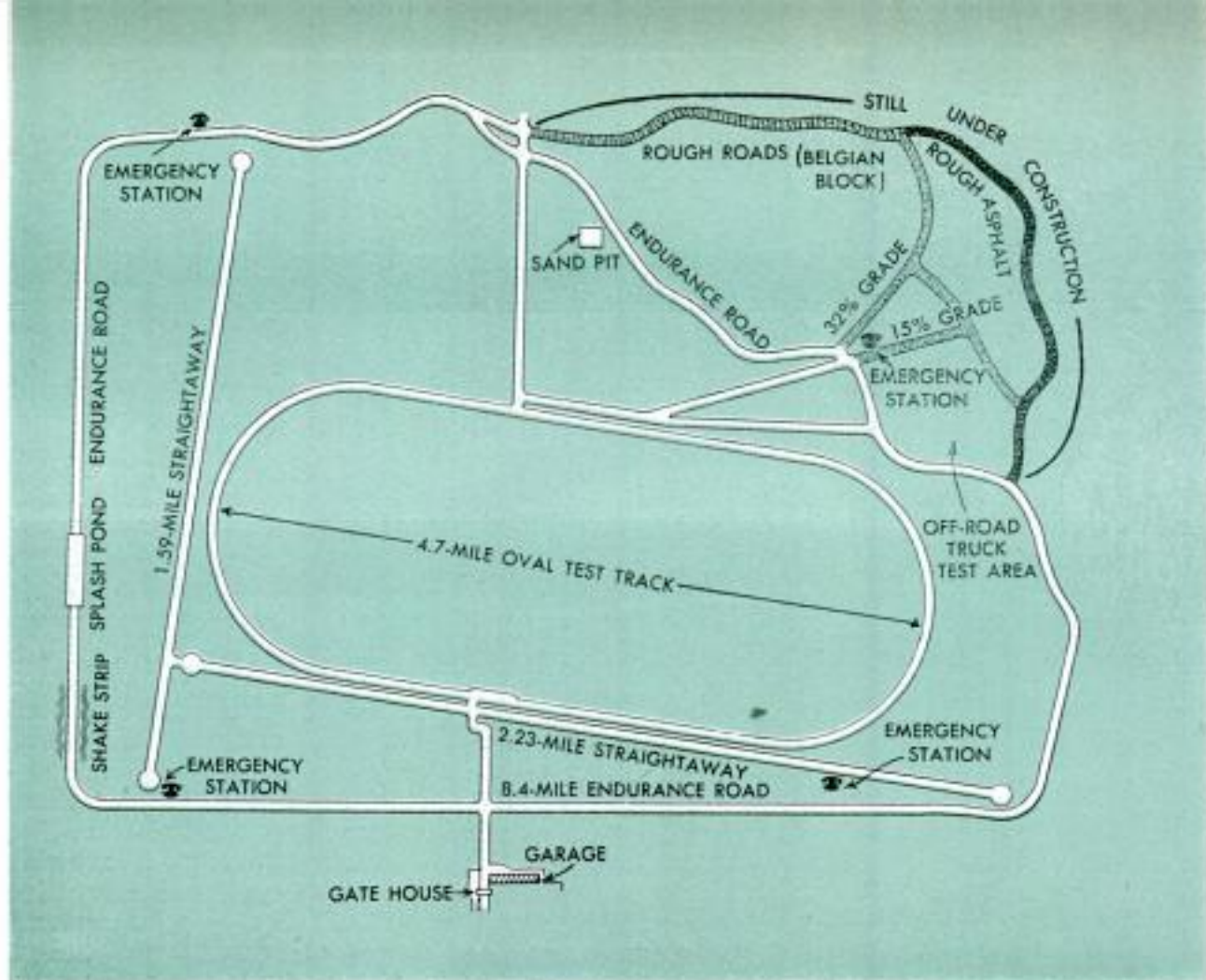

Chrysler's new proving ground covers 4000 acres. Shaded portion in upper right of map is not finished yet

Driver can't "cheat" on his test runs because tell-tale clock records what car is doing every minute



a transmission—wide-open upshift. There's a lot of torque there when the bands clamp down. This has a test transmission. Look on the back of the sun visor and see what it says.

You pull down the sun visor. On the back is a long list of parts with code numbers. Obviously there is more experimental about this Plymouth than transmission parts. One item listed is the engine.

You: What's this engine listed here?

Driver: Don't ask me. All I do is drive. And write what happens. When we work in the garage we know what's inside these cars, but when we're driving, we don't know a thing.

You sense that he's just being discreet—that he knows more than he's going to talk about. Meanwhile the Plymouth has been cruising easily at over 65.

You: How far do you go in a night?

Driver: Oh, 300 miles or so. There's too much starting and stopping in this cycle to go far. Then there's lunch and a few coffee stops. I'd say between 300 and 350 miles.

You: Can you stop when you want?

Driver: Yeah, but there's a telltale clock in back that records when you're going and when you're stopped. It shows the speed, too. We turn in the graph every morning and it doesn't look good to be stopping too often.

He swings the Plymouth onto a black-top road.



After each shift, test drivers make out their reports in the Ready Room. Chart on wall lists assignments

Driver: I always run my transmission cycles on side roads. No traffic to worry about.

He tramps on the throttle, opening it wide. The Plymouth rams ahead to about 70 before it upshifts. He lets off the throttle and the car coasts swiftly and quietly in the dark. When it's back down to 40, he steps on it again. He does this 10 times.

Driver: This engine sure wants to go!

I'd like to have it on the oval for a while. Next we do 0 to 30 at wide-open throttle.

He stops the car and again floors the accelerator. In seconds, the speedometer hits 30. He lets up and coasts down to a stop. This time, he backs up fast for about 100 feet. He does the same thing 10 times.

Driver: Funny thing, one night a driver backed into a tree doing this. The road curved and he forgot to turn. Rammed a

In the sand pit, a DeSoto does a series of figure eights to test traction, running gear and body tightness





Creeping a steep grade on the 8.4-mile endurance track, a Plymouth with an experimental engine gets airborne

tree alongside the road. Sure looked funny to see a car smashed into a tree backwards!

After the 0-to-30 cycle, the driver heads back to the highway for 50 miles at above 60.

You: What are you going to write up on this car? It seems perfect to me.

Driver: There's not much to write about, but our big job isn't finding fault. We're trying to wear these cars out. I'll mention that spark knock you heard. And there's a little front-tire vibration at high speed.

He returns to the big garage to let you out. It is still dark and you want to get on the snake pit before daybreak. You head down to the endurance track where a DeSoto is going to pick you up. A pair of headlights comes out of the night.

Driver: Come on in. Wally said you'd be down. Welcome to the snake pit. Unload a couple of sandbags, will you?

You do. The endurance track is an eight-mile route up and down hills with plenty of

curves. There is no pavement—just various gravel surfaces, from hard and smooth to soft and rough.

You: What test are you on?

Driver: An endurance run. I just barrel this car around here all night and somebody else barrels it all day. I put on about 250 miles a night. Can't average more than 45 on this road. It's too rough.

You: I just came in off the highway. Everyone thinks being inside the proving grounds is a fate worse than death. Is it?

Driver (laughing): We all gripe about it and, I guess, it's better outside on the midnight shift especially. But for high speed we all like to be inside away from the maniacs on the highway.

You: Tell me about this course.

Driver: Well, you can see it's rough. It is curving and hilly with plenty of dust in dry weather. It's not so bad right now. At times we have to wear masks, the dust is so

Driver's view of the endurance road. Test cars go around the rugged gravel circuit for thousands of miles



thick. Going around here at about 40 takes more out of a car in a day than in a month on the highway. The tires take a terrific beating. Gas economy is poor because of the poor traction on this loose gravel.

You: Ever get into a tight spot?

Driver: Not very tight. I had a blowout at 85 the other day on one of the banked curves of the oval and the car didn't even wobble. It was a front tire and the car had power steering. Then one day I had a hood fly open at 85 miles per hour. That was a thrill. The safety catch jammed. The hood bent back over the windshield like paper. Lucky I was on the track and had room to wander. It was like driving with your eyes closed at 85 miles per hour.

You: Then you don't get bored out here?

Driver: Not on this run because you have to be driving all the time. The road winds and climbs and there's no chance to get bored.

The eastern sky is beginning to brighten as you get out of the DeSoto. You want to check the oval before breakfast. You hail down a big Chrysler. It has a sign on the back that reads: Stop & Go Driving.

Driver: You won't get any thrills here. This is tame. We're doing city-traffic cycle. It's the dulllest of all, a simulated traffic condition—never over 40. I go a quarter mile at 20 miles per hour, stop, idle for 20 seconds. Then repeat it. It's just a long day's work and at the end of the day you're ready to go home.

You ask: What's the chain on the brake?

Driver: It operates a counter. It records every time I step on the brake. That's so Engineering can check up on us. There's a telltale in back, too, so you can't do a thing they don't find out about.

You: What's wrong with this car?

Driver: Not much ever shows up on this cycle—not to the driver, at least. You're not pushing it here. It's only when they tear down the transmission or brakes that they find out what's wrong. This car has an experimental set of brakes. Hear that strange noise when I put them on? That's new to me. It has high-compression heads, too. The book says to use high-octane gas only.

You: How are the new heads?

Driver: Can't tell. It's frustrating to be in a car that wants to fly and have to hold it down to 40.

You: What's the worst part of this run?

Driver: The monotony, I think.

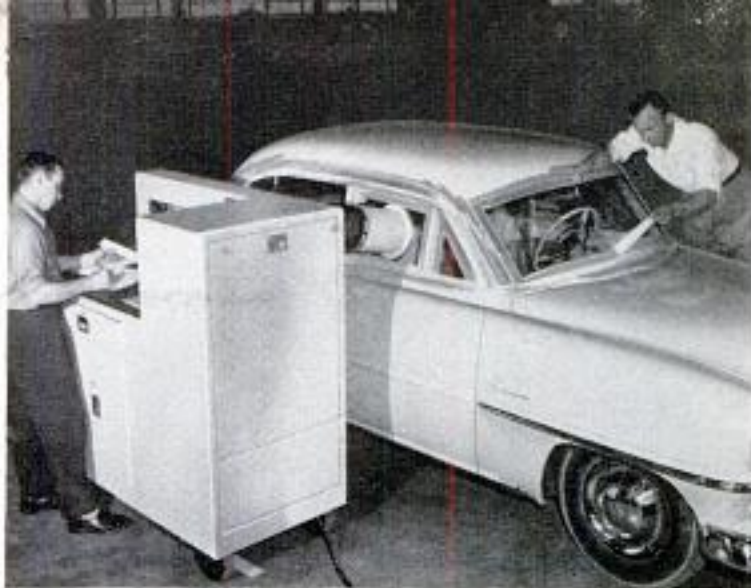

Body is sealed tight with tape and a vacuum set up inside. By removing tape, engineers can measure body leakage in any spot

Especially at this time of morning. Occasionally we used to see a deer. We had to stop high-speed night driving on the track because they hit a few deer out here.

You: Let me out next time around, I want to eat before the wheel-break test.

Driver: You'd better not. I'd take it on an empty stomach, if I were you.

You ignore his advice. After breakfast you go over to the "skid pad" where a Plymouth station wagon with its right front fender off goes round and round in a tight circle. Two drivers alternate on this run—it's too much for one driver.

Driver: You'd better get in back. I take up the whole front seat myself.

You see what he means. He sits with his back against the left door, his right leg straight across the seat and his foot pressed against the right door. His left foot operates the accelerator. You take a similar position on the back seat. The relief driver waits outside for his turn.

(Continued to page 238)

Proving-ground work is not limited to test driving. Chrysler engineers plot frontal area of a competitor, a 1954 Mercury



Detroit Listening Post



By Leo Donovan

NOW THAT Studebaker and Packard are "wed," the industry awaits what may be the next step in the move toward a Big Four: The merger of Studebaker-Packard with American Motors (Hudson-Nash).

There seems little question but that within a year Packard, Studebaker, Hudson and Nash will all be one big family. This would give the new group a complete line-up of cars from the small Rambler and even smaller Metropolitan to the big, luxurious Packard. The Studebaker truck line would fill out the enterprise.

Such a possibility permits some interesting speculation. For example, Studebaker now has an excellent, small and economical V8 engine, smaller than the Ford V8, for instance. Packard will have for 1955 a large V8 engine and, with Packard's reputation for engineering, it should be an excellent design. This would give the Big Fourth a pair of V8 engines which could power the whole line, with the possible exception of the Rambler and Champion. These two might stick with their L-head sixes for lightness and economy, although the flat head does seem to be on the way out (see page 122). Various heads, manifolds and displacements would provide ample variety of power from the same two basic engines. Both could be made in the new Packard engine plant.

And in transmissions the same story holds. Packard's Ultramatic is expected to be replaced by a new design for 1955. Studebaker already has an excellent Borg-Warner automatic transmission. These two could make the family completely independent of General Motors' Hydra-Matic (now used by Hudson and Nash).

Unitized Bodies

Hudson and Nash both use a unitized-body design. By combining talents perhaps the new group could convert Packard and Studebaker to this stronger system of construction for 1956 and subsequent models.

Where Kaiser-Willys would fit in any future merger is a question mark. The Wil-

lys Jeep is a money-maker with good consumer acceptance and military usage. It already has a substantial export trade and, if foreign markets open up, it will increase this business. But the Kaiser-Willys passenger cars apparently can't compete in costs with the Big Three or, for that matter, with the other independents.

The cold, hard facts are that no independent can compete alone. It costs many millions to retool for a new engine and about \$18,000,000 to retool for a new body shell. No single company that sells only one or two percent of the nation's cars can afford such an expense. That economic fact is resulting in the mergers of independents (currently scrambling for a total of about four percent of the market) as a way to share tooling costs.

What will happen to the Hudson Jet now that it has a more popular rival inside the family, the Nash Rambler? Hudson spent a reported \$10,000,000 on the Jet, but it didn't sell as hoped. Mechanically it is fine, all seem to agree, but it is outsold by the Farina-styled Rambler.

Don't lose sight of Chrysler's situation during all this talk about independents. The current year has not been a good one for Chrysler. General Motors and Ford have dominated production and sales.

Latest figures available at this writing show that the three Ford products (Ford, Mercury and Lincoln) increased sales over 1953 although total industry sales are down. Chevrolet, Buick and Oldsmobile are also up over 1953 while Pontiac and Cadillac are down slightly. But the big drops are in Chrysler cars (especially Dodge which is down about 50 percent) and among the independents.

1955 Announcement Dates

It looks now as though the General Motors line will come out during the period from October to November with Pontiac and Chevrolet leading the pack.

Ford cars and trucks may come out in November with Mercury and Lincoln to follow later in December.

It looks like a year-end debut for the entire Chrysler family. Apparently the last-minute styling changes have been okayed.

Studebaker is expected to announce in October or November; Packard, with new styling, engine, transmission, in January.

Hudson and Nash will show in January also. Now that Hudson is made in the Nash plant at Kenosha, Wis., it is likely that it will have the basic Nash construction. This could mean no more step-down design. The 1955 Hudson will get a new roof line, doors and grille. Nash is also expected to have sharp appearance changes this year.

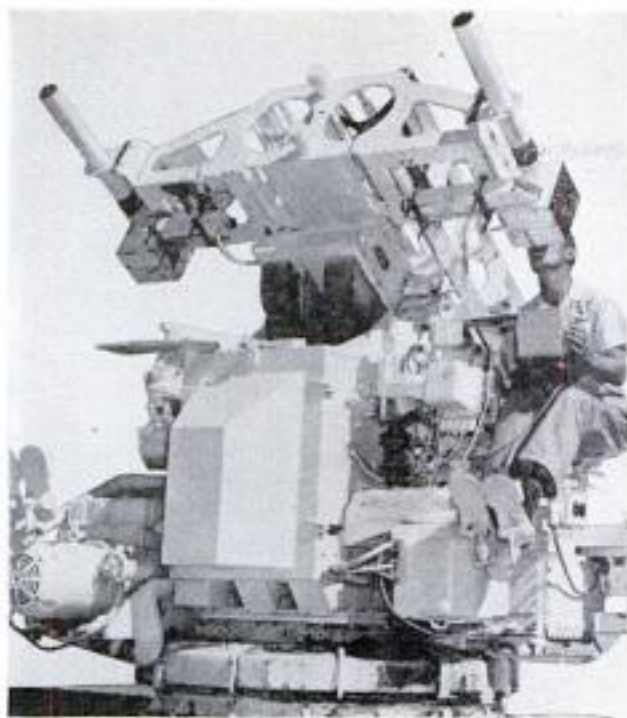

Former Antiaircraft Gun Serves as Mount for Long-Range Camera

Technicians at the Atomic Energy Commission's Sandia Laboratory in New Mexico used a former anti-aircraft gun as a camera mount in taking a picture 12 miles away. The photograph was of the Albuquerque television transmitter, located at

an altitude of 10,678 feet. The center of the former gun now has a fused-quartz mirror 12 inches in diameter with a 60-inch focal length, amplified to 360 inches by a series of lenses. A 35-mm. camera is mounted at one end of the 360-power telescope.

Infrared Lamps Heat Patrons of Sidewalk Cafe in Brussels

Infrared lamps postpone winter at a popular sidewalk cafe in Brussels. Boxlike heating units mounted on 10-foot poles on the terrace of the Hotel Metropole "toast" cafe patrons with radiant heat. The open-air terrace fronts on the Boulevard Adolph Max, offering an unobstructed view of automobiles and pedestrians.



Meter Tests Hardness By Touching Metal

Metal parts are sorted according to their hardness by an instrument that detects hardness differences instantly and at a touch. It also measures paint and metallic-plating thicknesses. The metal is not scratched or damaged in any way, the probe simply touching it. The device uses a principle similar to that of the thermocouple which measures temperature differences by voltage changes. Hardness differences cause voltage changes on a meter after amplification. The instrument was developed in General Motors Laboratories.

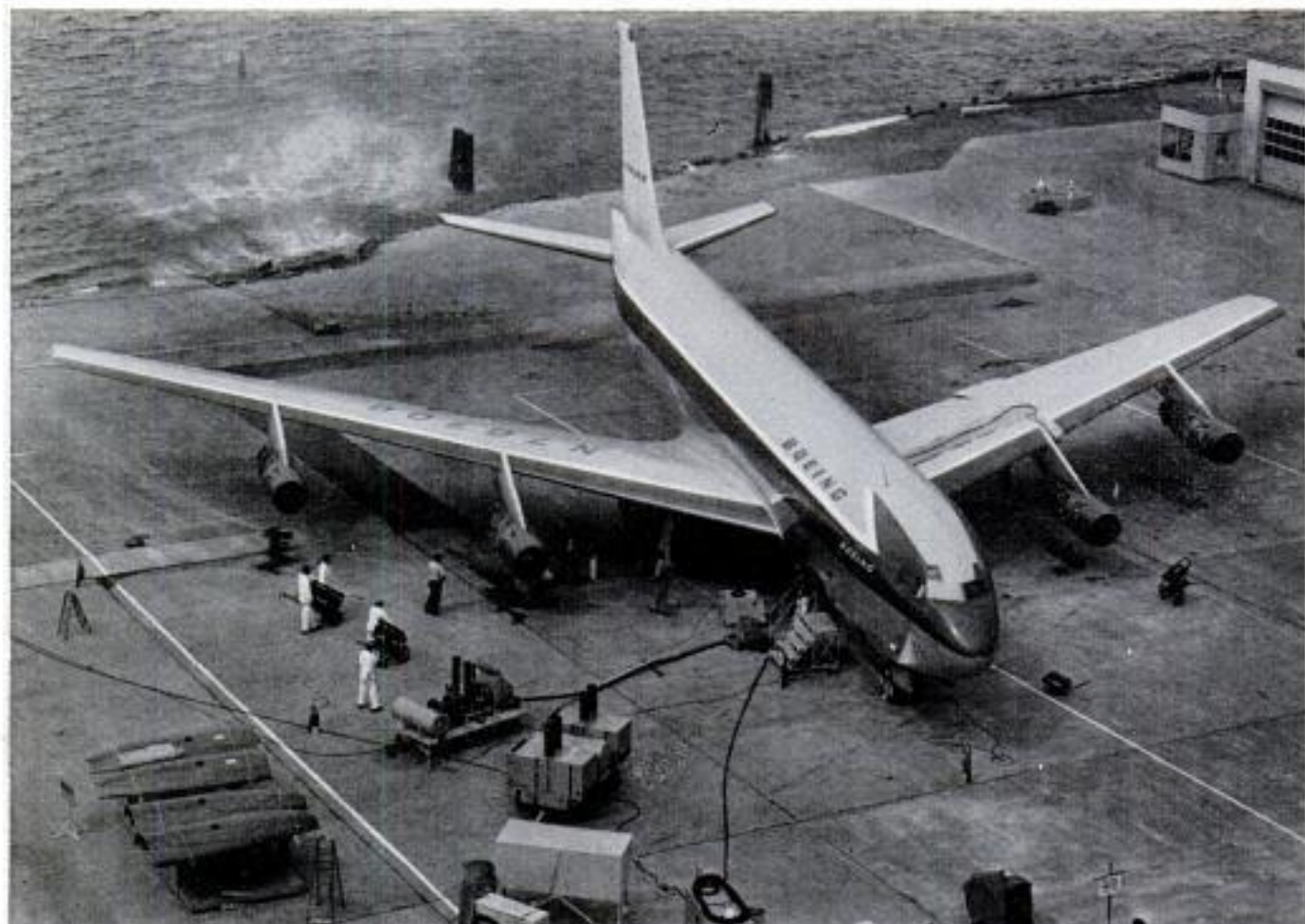

Technicians check thrust of one of the four powerful engines. Exhaust kicks up miniature storm in water

ON TRIAL . . .

America's First Jetliner

By A. M. "Tex" Johnston
Chief of Flight Test, Boeing

as told to Thomas E. Stimson, Jr.

CRASH BOATS are standing by off Mercer Island!" "All airports in vicinity of Seattle are closed to normal traffic!" "Rescue helicopter now on patrol off Seward Park!" "Fire fighters standing by!"

"Your chase plane is airborne!"

Reports like these were part of the pre-flight preparations in July when copilot "Dix" Loesch and I prepared to streak down the concrete runway at Renton Airport and lift the prototype of America's first jetliner into the air on its initial test flight.

Boeing's 707 "Jet Stratotanker-Stratoliner" is considered the safest passenger transport ever built, yet Dix and I were happy about the elaborate precautions to rescue us if anything went wrong. All our recent preflight and ground tests had been perfect. We were expecting a normal rou-

tine ride on the first flight, but there's always a chance that the unexpected can happen.

And the unexpected did happen during an early taxi test. A landing gear strut unexpectedly folded up. The plane skidded along the runway on one wing for a few feet and the whole test program was delayed during repairs.

For the first flight test, it was comforting to know that the crash boats carried diagrams of the fuselage with "Chop Here" information, and that fire fighters were standing by even though we wouldn't need their help. We had landing priority at any airport within 50 miles and, as a final precaution, we were wearing parachutes.

All of this is routine procedure at Boeing when a new design is being flown for the first time. In this case the precautions were



Author (foreground) and copilot Loesch spent hours practicing emergency procedures and use of instruments

more complete than usual, if possible, for our new plane is the pioneer American aircraft in the jet-powered passenger-transport field. Including engineering and research man-hours, this prototype was built at a cost of \$15,000,000.

The 707 has a wingspan of 130 feet and is 128 feet long. It is smaller than a B-52 bomber and is larger, heavier and faster than the British Comet. It is a brand-new design with a striking sweptback wing. We are offering it to two different markets—to the Air Force as a jet-refueling tanker or for transport, and to the airlines as America's first and the world's best jet passenger transport.

As an airliner it will cruise at 40,000 feet

at about 550 miles per hour, carrying you across the United States in about five hours. Westbound you'll almost keep pace with the sun. Eastbound you'll go from ocean to ocean in three hours if the pilot catches a lift on the high-speed jet stream high in the air.

The galley can be smaller than usual since there won't be time to serve more than one meal per flight. Depending on seating arrangements, it will carry from 80 to 130 passengers.

The Jet Stratoliner is designed to combine the best features of both jet and piston-engine aircraft, something that seemed impossible in the past. It has the high speed and altitude capabilities of a jet plane and

One of the engines is given a ground test prior to first taxi test. Each engine develops 10,000-pound thrust

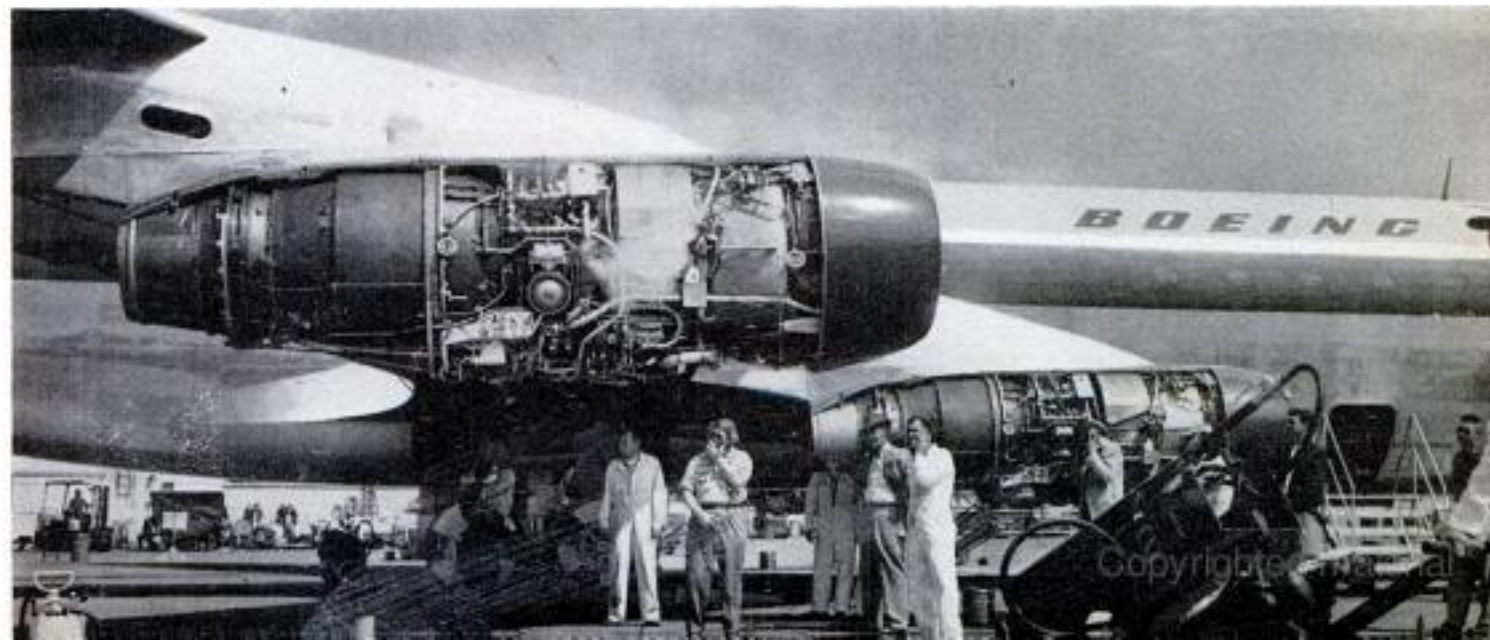



RUDDER-CONTROL TAB

ELEVATOR-CONTROL TAB

STEWARDESS' COMPARTMENT

LOADING DOOR
AFTER CARGO COMPARTMENT

AILERON

INTEGRAL FUEL TANKS

AILERON

EACH OF FOUR PODS CONTAINS
A JT-3 TURBOJET ENGINE; BECAUSE
POD IS OUTBOARD OF WING,
NO FIRE-FIGHTING EQUIPMENT
IS NEEDED

GALLEY

ENTIRE FUSELAGE INCLUDING
CARGO COMPARTMENTS PRESSURIZED
FOR TRAVEL AT 40,000 FEET

MAIN LANDING GEAR

AILERON

INTEGRAL FUEL TANKS

AILERON

80 TO 130
PASSENGERS

AIR-CONDITIONING AND
PRESSURIZING EQUIPMENT

ENGINEER'S PANEL
MAY BE SWUNG AROUND
AND VIEWED BY PILOTS

RADIO ANTENNAS
MOUNTED FLUSH
WITH SKIN

INSTRUMENTS

COPILOT

WRAP-AROUND
WINDSHIELD

PILOT

LOADING DOOR
FORWARD
CARGO
COMPARTMENT

NOSE WHEELS

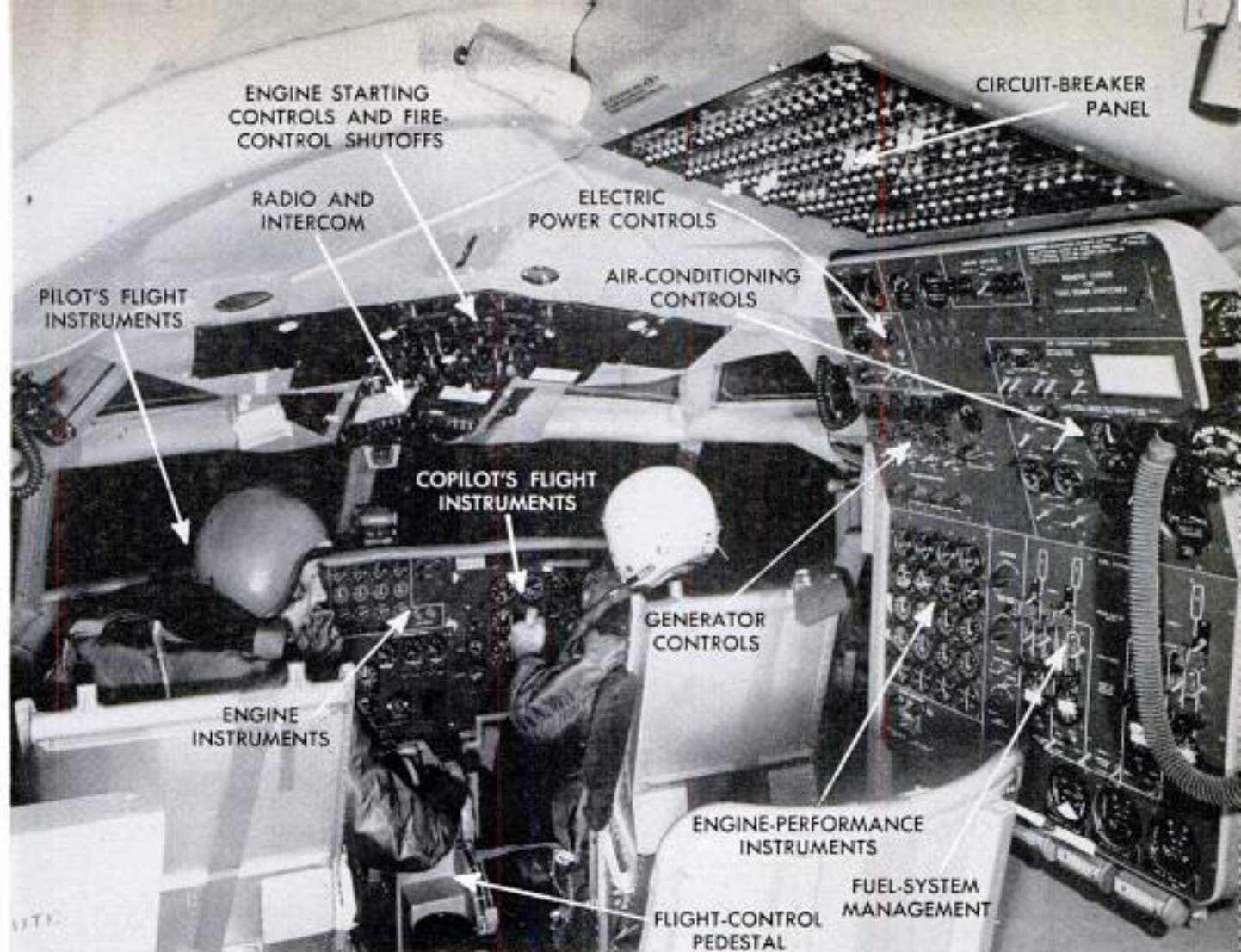

Cockpit appears to be jammed with controls, but actually has fewer instruments than a big piston-engine plane

still has the good low-speed performance of piston-engine aircraft. It can climb out of a field as fast as most transports can cruise. It can make a steep, slow approach for a landing, then brake to a minimum stop.

During the rest of this summer Dix Loesch and I will complete its Phase I testing. Among other things, this involves

proving its performance, stability and altitude capabilities. We will find out how closely it meets the specifications to which it was designed. Take-off and landing distances will be measured, as will its Mach number and indicated air-speed limitations. We'll check flutter characteristics, if any, in all speed ranges and under all conditions

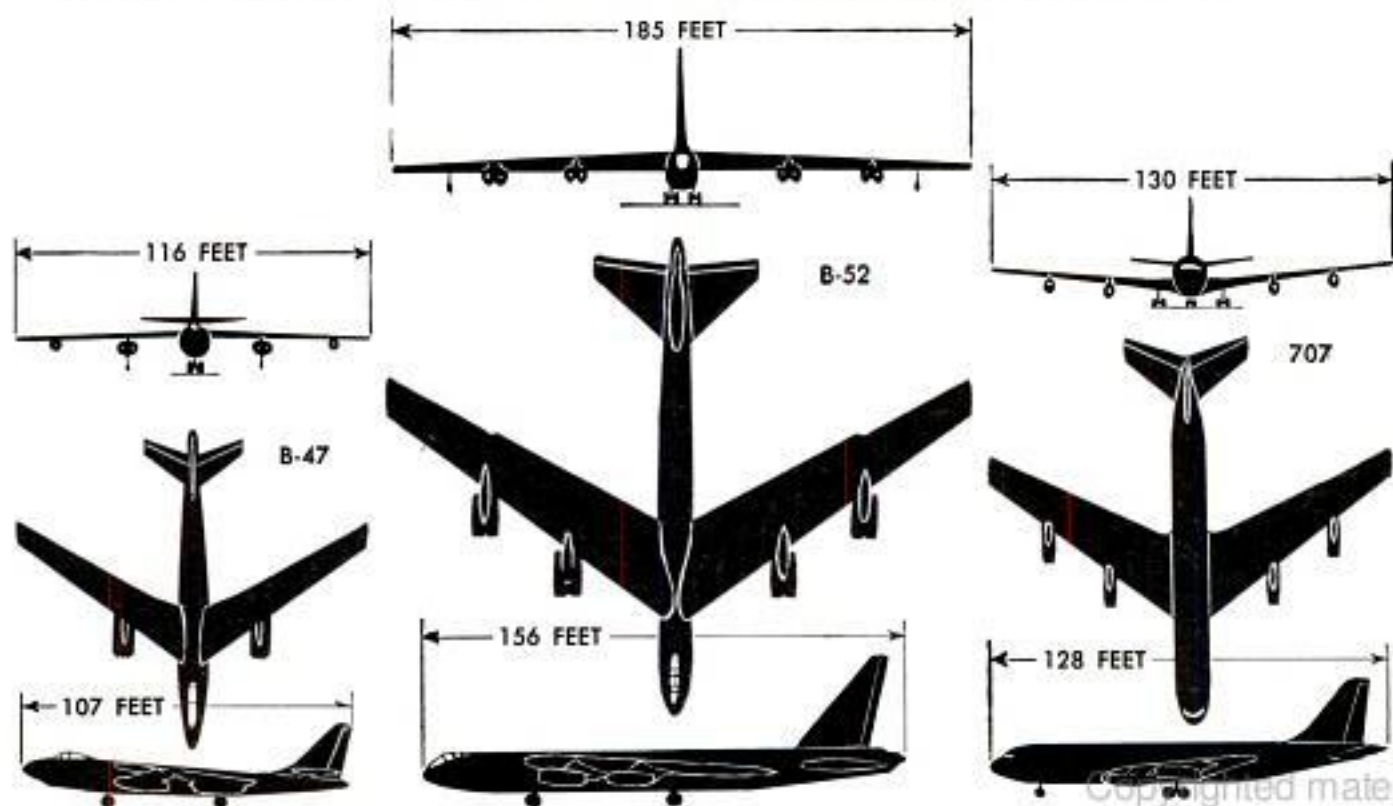



Jetliner has two main landing gears with four huge tires on each, giving pilot plenty of braking area

of loading and centers of gravity. Fuel consumption under all conditions will be measured.

Probably we'll find a few minor faults that are expected with any new design. We don't anticipate any major troubles. In fact, part of our job is to prevent any major trouble from developing. An emergency in the air usually has a small beginning that multiplies itself. Finally the plane is in real trouble. It's up to us to prevent any minor malfunction from building up into an emergency. We've worked up cockpit procedures for stopping or eliminating any adverse condition almost as soon as it starts.

Loesch and I spent more than 10 hours in the cockpit before the plane was first taxied. Part of the time we rehearsed the ordinary handling of the aircraft and the rest of the time was devoted to practicing emergency procedures. Normally, an engineer sits behind us at his panel. He's part of the flight crew, but on the first flight we left him on the ground and swung his hinged panel around so we could read its dials simply by turning our heads.

During Phase I the aircraft carries a lot of instruments that automatically measure pressures, temperatures and other conditions at numerous locations. This information is transmitted to automatic recorders and cameras mounted in the fuselage. Phase II of the test program, which we'll enter during the fall, is a development phase in which any changes that seem indicated are made and tested. We may find, for instance, that the rudder is larger than necessary. That would mean we are carrying weight that we don't need so, during Phase II, a small rudder would be tested.

One of the reasons why the 707 is regarded as the safest transport ever built is its extreme simplicity. For one thing, much of the heavy, complicated and potentially dangerous apparatus that must be lugged



Inside main cabin, an engineer starts instrument which will record plane's characteristics during flight

around with piston engines is unnecessary with jets. We don't have propellers and their complicated controls, we don't need superchargers. All in all, our cockpit has about half as many controls and indicators as has a current piston-engine passenger liner.

Nor does the 707 require an independent pressurizing apparatus or a heating plant for cabin warmth and anti-icing. The needed hot air is bled directly from the compressors of a couple of the engines. It comes off at 700 degrees, in fact, and has to be cooled by a reduction turbine before it can be used.

Another thing we don't need (and this may surprise you) is any fire-extinguishing apparatus for the engines. Each engine is carried in its own pod away from the wing. If an engine fire occurs, it takes less than a second to shut off the fuel, oil, hydraulic fluid and electricity. Then the fire blows itself out. It can't keep on burning for there's nothing left to support combustion. And the fire can't get up into the wing. This plane, incidentally, can maintain altitude, loaded, on only two of its four power plants.

Here's another thing that will surprise you. Big transports use power-boostered controls because no pilot is strong enough to manipulate the big control surfaces all by himself. But not on the 707. The plane is designed to handle with the same ease that you fly a three-place job manually. The secret is that the ailerons, rudder and elevators are equipped with small control tabs, similar to trim tabs, built into the trailing edges. The cockpit controls operate the tabs and the tabs in turn force the control surfaces in the desired direction. It's an old principle that hadn't been refined until recently, when the engineers learned how to balance the tabs and eliminate the flutter that characterized earlier designs.

If you look at the 707 wing you'll see

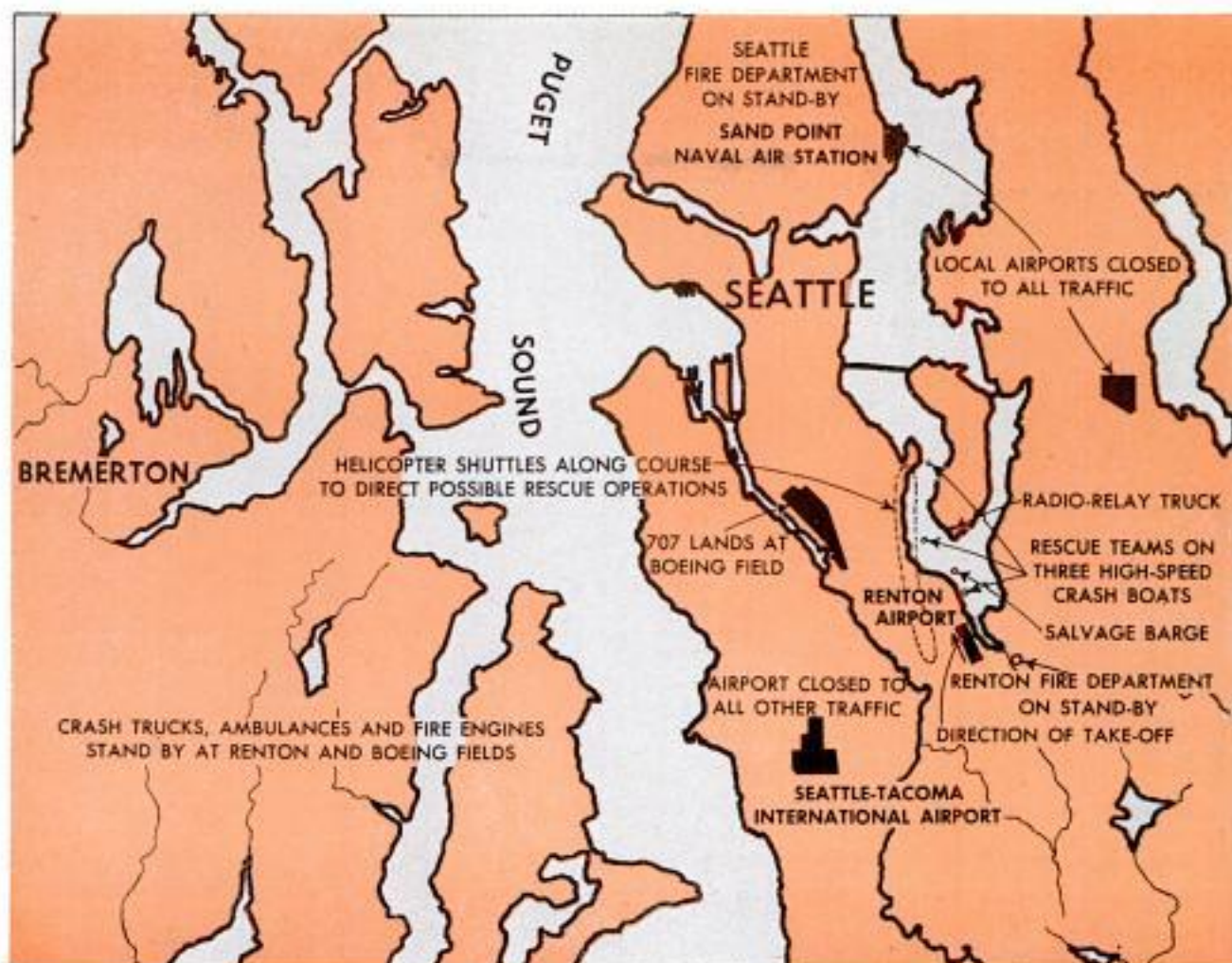

Map of the Seattle area shows some of the preparations made for the first flight test of the new jetliner

that the trailing edge has various control surfaces instead of simple ailerons and landing flaps. How these surfaces are used is still a company secret. They are part of the reason why we have take-off and approach performance that compares with piston-engine aircraft.

The 707 won't need a drag chute to serve as a brake when landing, partly because its tricycle landing gear permits normal wheel braking as compared to the bicycle landing gear on our jet bombers. Each main gear has four rubber tires and the nose gear has two, giving a lot of "footprint" area that makes for good braking and distributes our heavy load so well that we can use existing airports.

Some air disasters have occurred in the past because of improper fuel-tank venting. Explosive fumes collected inside a wing structure and then were ignited when an adjacent electric switch produced an arc. A fire or explosion was bound to happen. Authorities suspect that this has caused a number of unexplained crashes. This hazard is completely eliminated in the 707. You might say that the whole plane was built around its fuel tanks and their venting systems. Complete safety was the first

(Continued to page 248)

By pulling a single switch the copilot can cut off all fuel, oil and electricity to a burning engine



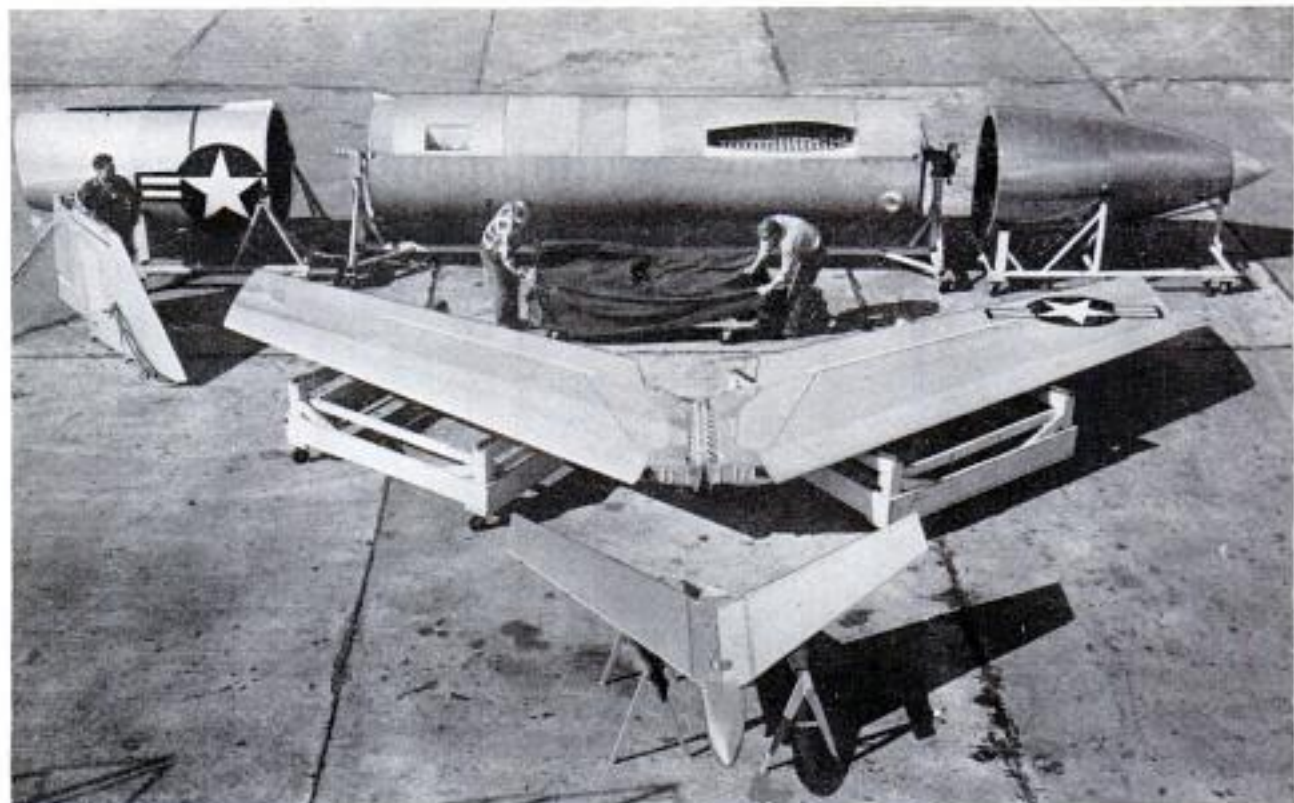

Standardized sections of the bomber are shipped in seven crates and assembled in field prior to launching. Matador roars away from its launcher with the aid of a rocket booster.



Pilotless Bomber Packed in Crates

UNDER DUTY in Germany are the first pilotless bombers to be sent overseas. The robot planes, United States Air Force B-61 Martin Matadors, are built in sections which are assembled in the field just before launching. Seven wooden crates contain the nose, wing, center section, aft tail, fin and bullet-fairing stabilizer sections and the instrumentation. No longer is it necessary for a complete unit to be assembled in a plant and shipped to its destination in a bulky package. The easily transported crates can be stacked and stored for long periods of time. All sections are interchangeable, fulfilling a long-time dream of the aircraft industry. The high-speed planes are launched from a small mobile platform. A rocket booster assists the turbojet engine at take-off.



Dome-Shaped Aluminum Auditorium Needs No Interior Supports

Twelve thousand persons can be seated in a dome-shaped metal auditorium erected at Longview, Tex., that requires no interior supports. The tentlike building, which is

85 feet high and 300 feet in diameter, was constructed at ground level by semiskilled workmen. A steel center pole was first erected, and a sliding steel collar raised gradually up the center pole until 15 successive rings of aluminum sheets had been bolted on. When the last ring was installed, the dome was lowered and firmly secured to a foundation ring of concrete. If desired, the center pole may be taken down after construction is completed. Concentric rings of acoustical material were suspended from the ceiling for sound control. Ventilation of the auditorium is through a 255-square-foot opening at the peak around the center pole. The prefabricated building could also be used as a warehouse, aircraft hangar or athletic field house.



Grubbing Tongs Attached to Tractor Chain Uproot Stubborn Brush

Brush and saplings up to five inches in diameter are uprooted with a slipproof pair of grubbing tongs. Attached to a chain drawn by a team of horses or a tractor, they tighten their hold as the pull increases. After the growth is uprooted, they are easily disengaged.

Japanese fishermen recently caught the first tagged albacore fish known to have crossed the Pacific Ocean; covering 4900 miles in 324 days, the fish averaged better than 15 miles a day.

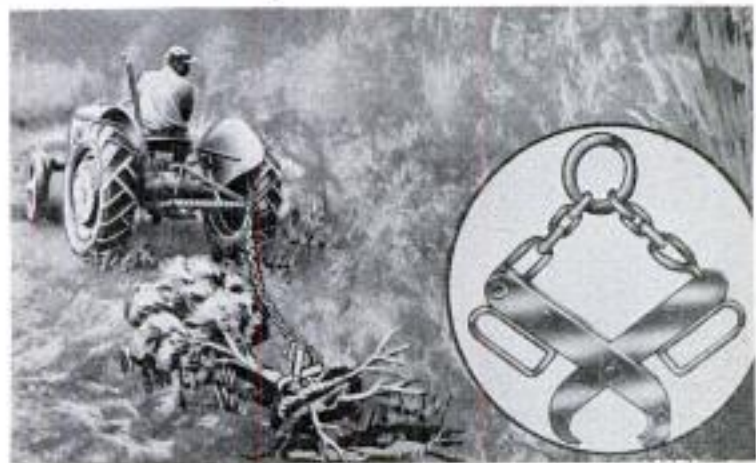



Arched Troughs Form Roof and Sides of Simple Steel Building

Arched steel troughs fastened together make up a new type of building without trusses or other supports. The building is erected on concrete slabs, and does not re-

quire heavy footings for a foundation. The length of the building is expanded simply by adding arches. It can be used as a warehouse, workshop, dwelling unit or office.

Running Model of St. Lawrence River Helps Engineers Plan Seaway

Every swirl and eddy of a 35½-mile stretch of the St. Lawrence river is duplicated in a running model built by Canadian engineers. Survey parties on the river and depth-sounding crews working in helicopters sent daily reports to Toronto during the 22 months it took to build the model. Twenty thousand metal strips embedded in the model river bed are placed to reproduce the unevenness of the actual river bed. Vertical scale is 1 to 100 while horizontal

scale is 1 to 500. Six hundred tons of compacted sand was used to fill the base of the model, which consists of two-foot squares of plywood cells. Covering the cells and sand is a two-inch skin of concrete. Built by the Ontario Hydro-Electric Power Commission at Toronto, the model is expected to save money on an American-Canadian project near Ogdensburg, N. Y. The model will help to indicate the best design for powerhouse and control dam.

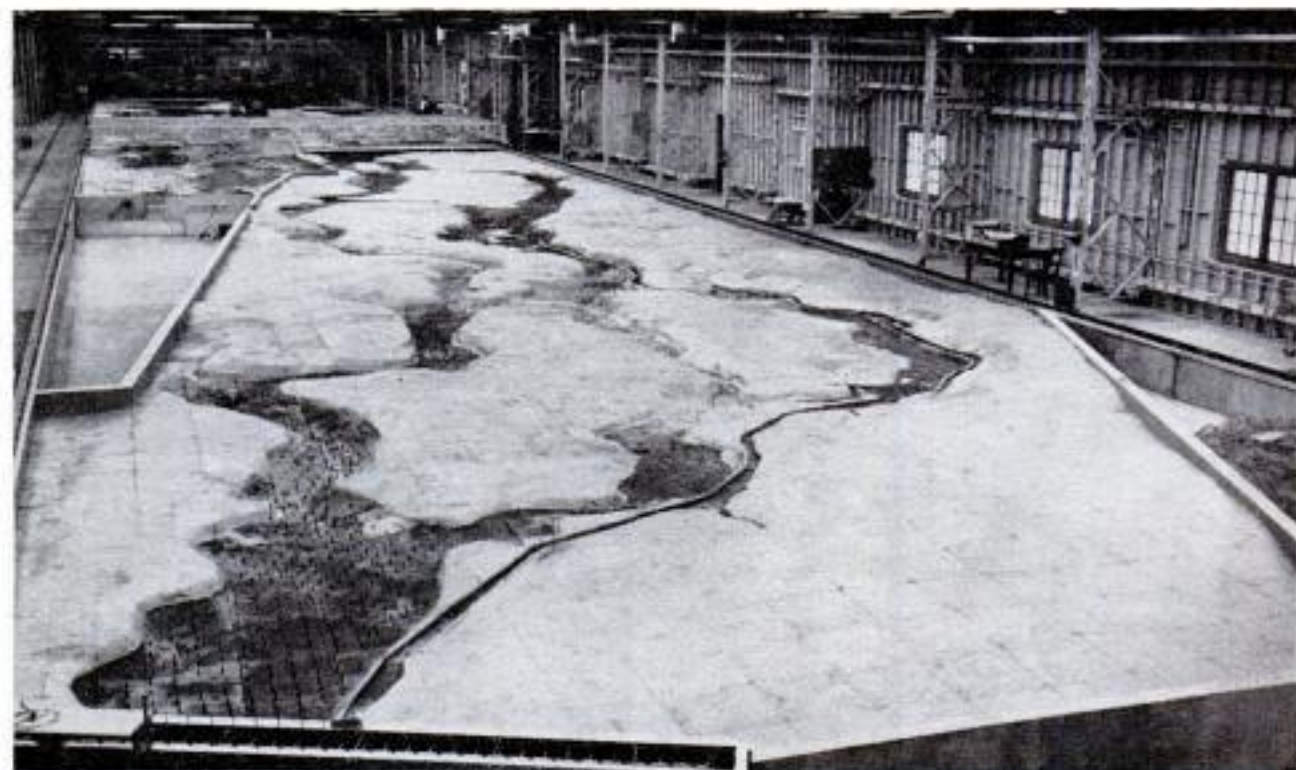

FLORIDA'S *Blow-Boat Derby*

By Max Hunn



BLOW BOATS—the work horses of the Everglades swamps—turn to sport one day of the year at a unique race in south Florida. It's a new venture for the queer craft which are blown over the soggy grasslands by airplane engines and propellers.

Blow-boat racing reached the big time in 1954 when the first state-wide air-boat derby was staged. Three elimination contests—at St. Petersburg, Miami and West Palm Beach—helped select drivers for the final race program on Biscayne Bay near Miami, Fla. An estimated 20,000 people viewed the finals from scattered points along the Rickenbacker Causeway. Prizes in the final races were \$500, \$200, \$150, \$100 and \$75—welcome bits of change for the winning drivers.

Organized air-boat racing is a very young sport, but every sign points to its rapid development in the future. Air-boat racing of

a sort dates back to 1950, the year the Air Boat Association of Florida, composed partly of sportsmen and partly of froggers, was founded. All organized racing is conducted under the sponsorship of the association.

Today's sleek aluminum racers are far different from the "meat and grocery" boats that were their ancestors. Developed in Florida about 1929, the first blow boats were used to speed in supplies and haul out the catches of professional froggers operating deep in the Everglades west of Miami. In those days the hunters speared the frogs from dugout canoes similar to those the Seminole Indians had poled through the 'Glades country for generations.

The "chow" boats plied regularly between the new Tamiami Trail (an east-west, cross-state highway) and the camps of the froggers, utilizing a newly opened canal and the natural waterways of the 'Glades.

Rescue boat retrieves a pilot who tried to take a turn too fast. Spills are frequent in blow-boat racing





Operators of an air boat make last-minute adjustments in final test run before the big competition begins

Essentially, the air boat is a 4-by-12-foot, flat-bottom, lightweight, shallow-draft, scow-type boat with an engine and propeller mounted aft. The first boats were powered by Ford engines—Model A and then V8. A few still mount auto engines, but most boats today use discarded airplane engines. Horsepower ratings vary from 40 to 265. The majority of the engines come from Cub or Lycoming planes and cost anywhere from \$75 to \$350. A few individuals have paid as much as \$750 for their motors.

Because they're airplane engines, the power plants require aviation fuel. The usual fuel is 80 octane "avgas," and regulations of the recent air-boat derby specified this octane rating. Some blow-boat operators use regular auto gasoline, but according to most experts, it doesn't work well.

Marine plywood was used in the hulls of many early boats. It was gradually displaced by aluminum, which is tough enough to stand all but the hardest knocks. The air-boat enthusiasts found that the plywood tended to become waterlogged, thus slowing the boat, and also was more susceptible to damage.

No one in Florida is making air boats commercially. They can be purchased from some of the men who build them, but there

is no manufacturing concern specializing in them. To all intents, they are homemade and strictly individual in design.

But homemade or not, they are not necessarily cheap. Depending upon the materials and the engine, the average homemade boat will cost \$1000. It can be built in two or three weeks of spare time by a person with experience, the mechanical skill and the tools. Without these, construction takes much longer.

About 1930, froggers found the air boats could be used in place of the slow-moving, hand-poled dugouts, and the boats became popular for this type of work. Today, the work-horse air boats are used for transportation in the soggy portion of the 'Glades that can be traversed by no other means. They are used for hunting, exploration, frogging or just plain adventuring. Skimming over the shallow, saw-grass-cluttered water can be thrilling and even risky, for the blow boats are as skittish as Kentucky colts.

More than one fatal accident has occurred when some driver got tangled up with a high-speed propeller. The early boats offered little or no protection from the whirling blades, but almost all of today's craft mount a protective screen and frame to pre-

A heat of blow boats roars around a turn during the final races held on Biscayne Bay near Miami, Fla.





Blow boats, which can scoot along in only a few inches of water, are made to order for the marshy Everglades

vent an accidental encounter with the prop. Nevertheless, it's good advice to look before backing.

But the propeller is not the only element of risk in air boating. The hull of an air boat is thin, and if the pilot overlooks some husky log lying submerged in the grass or plows into some other obstruction, trouble can be plentiful. The boats will bounce over many objects and, in fact, will travel over saw grass on dry land if sufficient run to gather momentum is possible. But there's always the time when it doesn't bounce.

Too, there's only one engine, and if it conks out when you're back in the 'Glades, it's a long walk back to civilization. Rescue parties are organized to retrieve some expedition which has had engine trouble deep in the endless "sea" of grass. Normal safety procedure is for air boats to travel in pairs, but frequently some venturesome individual will fail to heed the advice of the 'Glades experts, and trouble follows. Usually it means two or

(Continued to page 244)



Operator spins propeller to start engine. Protective screen guards against accidents. Most boats are powered by airplane engines which have plenty of power but are no longer airworthy. The boats are usually made by their owners, cost up to \$1000

Air boats go as fast as 65 miles per hour, are steered with an aerial rudder that deflects propeller blast



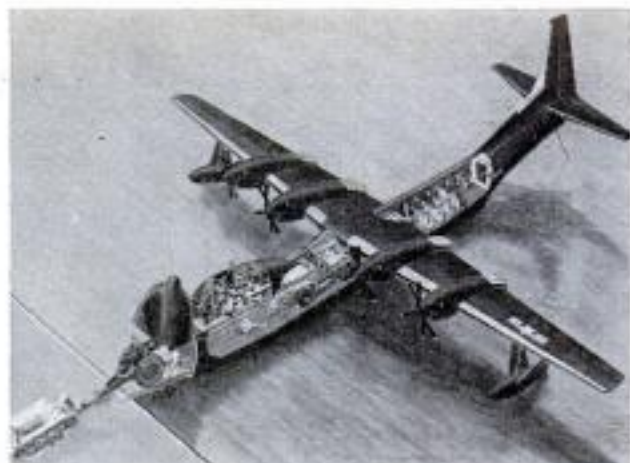

Assault Transport Plane Lands Troops on Enemy Beach

Guns, trucks, supplies or an assault company of Marines can be landed on an enemy beach by a "flying LST" that taxis up to the water's edge. The R3Y-2, a four-engine transport built by Convair, is scheduled for service with the Navy late this year. The 80-ton plane, which has a range of more than 2000 miles, lands in offshore waters and taxis to the beach. When the hull

touches sand, the bow swings upward, a ramp is dropped, and vehicles or troops debark. The R3Y-2 can carry four 155-millimeter howitzers, three 2½-ton trucks, six Jeeps, two half-tracks or several other types of military equipment. It can carry 92 litters and 12 attendants in hospital-evacuation use or can be fitted with 103 demountable seats for transporting troops.

Smallest Jet Fighter Carries Atom Bomb

Only 25 feet from wing tip to wing tip is the Navy's new Douglas Skyhawk, the smallest and lightest U. S. jet combat plane ever built. Less than half the conventional size, it is superior in performance to many current operational jet fighters. Its combat radius is greater than present propeller-driven attack craft. It can carry atom bombs or rockets, machine guns, missiles and other weapons of combat airplanes. The plane is so small that it has been designed without the folding wings that are standard on carrier-based planes.



British Braking Parachute for Airplanes Folds Itself After Use

British experts have developed a parachute that folds itself. The chute, which is being tested with a racing car, would be

used to slow landing airplanes. Upon landing, the pilot of a plane presses a button to release the chute. When the airplane slows to a given speed, he presses another button and the parachute is pulled in with a winch. A telescopic cylinder extends automatically, shrouding and stowing the parachute canopy. Normally, braking parachutes are left on the runway to be picked up later.

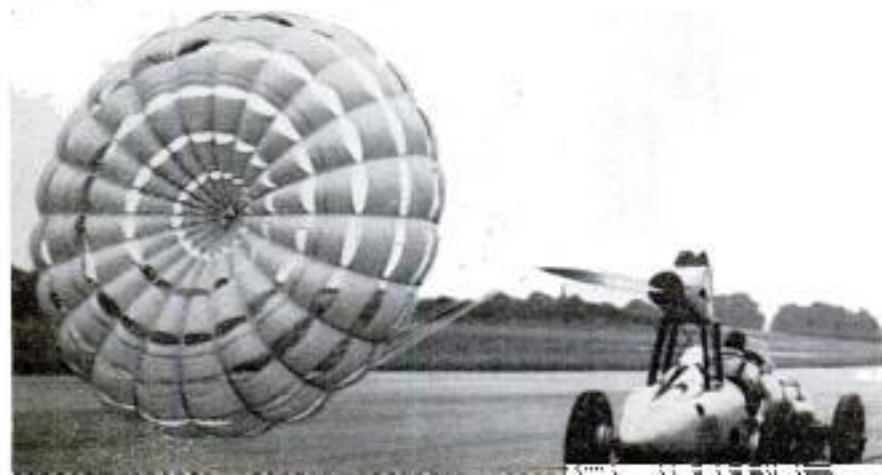



Color photographs by Don Honick

This is Monticello. Jefferson spent a lifetime building and rebuilding his home. The work of an architectural genius, it's one of the most fascinating homes ever built in America. In the end it drained away his fortune

Thomas Jefferson Lives Here

By Clifford B. Hicks

TO START UNRAVELING a fascinating story, take a look at any nickel dated after 1938. On one side you'll find a man's profile. The other side shows the outline of a building, and beneath the building appears the name Monticello.

The man and his home (for the building is one of the most fascinating homes ever built) are fittingly joined in death as in life. Thomas Jefferson must have loved Monticello with an intensity few men can experience.

The building still stands, almost 200 years after it was started, as a monument to the architectural genius of our third president. Though the story of the home is deeply rooted in the past, it doesn't end there. Each year hundreds of thousands of visitors wander through the building and across its hilltop

Milton L. Grigg, the Foundation architect, compares recast plaster frieze with a section of Jefferson's original frieze

site—more visitors than Jefferson ever saw, even in his later years when people were so curious to see him that “one woman punched her parasol through a window pane to get a better view of him,” according to his great granddaughter.

The visitors see everything exactly as Jefferson saw it, from the wallpaper in





Inside the dining-room fireplace are two dumb-waiters. One delivered wine bottles, the other took away empties

Detective work that trailed back through history uncovered and duplicated original wallpaper pattern

Hostess at Monticello demonstrates revolving door, which was turned to deliver food to the dining room



the unique octagonal bedroom to the exact type of flower he had in each flower bed. But what they can't see is equally important—the 80 steel beams carefully installed to hold up the floors, the air-conditioning ducts which Jefferson scarcely could have imagined. In fact, they can see little of the work that has gone into restoring the most unique home in American history.

Not since the early days of the Republic has there been so much activity on Monticello's little mountaintop overlooking the 192-year-old city of Charlottesville, Va. Last winter, workmen from Charlottesville who had grown up under the spell of "Mr. Jefferson's house" drove up the winding mountain road each day. Their greatest pride is the fact that you can't see what they did.

To start unraveling the story on your nickel you must go back to pre-Revolutionary days. Of all the foothills of the Blue Ridge, this was the one young Tom liked best. As a schoolboy he spent day after day clambering over the 580-foot hill (the Italian name Monticello means "little mountain") until he knew every fold of the ground, every tree on it. In 1763 he inherited the mountain from his father.

When he went away to college the mountain still called to him, and he returned at every opportunity. Some day, he vowed, he'd build a magnificent home on the very crest, where he could see the blue of the mountains to the west and the rolling green of the Piedmont to the east. To design the home, he began studying classical architecture. He taught himself well, so well that most historians agree America lost a magnificent architect when it gained one of its finest statesmen.

In 1768, eight years before the Revolution, he supervised the leveling of the mountaintop. A small brick cottage had already been built there. In 1772, when the winds of politics first started swirling about his tall figure, he married a young widow. Through a snow-storm he brought his bride to the little brick cottage, which ever since has been known as Honey-moon Cottage.

Then began a curious blend of statesmanship and architecture.



Clock which Jefferson designed is wound each Sunday morning. Cannon-ball weights in corner of room tell day of the week

Jefferson cast plaster design in the ceiling to commemorate his Presidency. Counterbalanced lamp can be raised or lowered





Hostess makes up Jefferson's own bed. Holes above ventilate his wardrobe closet. At right is his revolving table and chair

Jefferson became a member of the Continental Congress, wrote the Declaration of Independence and was elected Governor of Virginia. But always, whenever he could spare a few days, he returned to Monticello. Gradually the home took shape under his hands. No nails were available so he established a nailery on the mountain. In his own kiln he fired the bricks of red Virginia clay and waterproofed them himself with a coating of pine oil.

Only two of his six children survived infancy, and in 1782 his young wife died. Thereafter Monticello took an even larger

Heating and air-conditioning outlets, installed to preserve the home, are cleverly hidden behind cornices



place in his life. In 1784 he was sent to France, where he represented this country for four long years. But an invisible string tied him to the little Virginia mountain, and he spent much of his leisure time studying architecture and buying furnishings for his home. In all he sent 85 packing crates of furnishings back from Europe.

When he returned to America he wanted to retire to Monticello, but George Washington appointed him Secretary of State. In 1800 he was elected president and served two terms. But his home still called. Historians have calculated that he spent a solid year of his life just traveling to and from Monticello.

At last, in 1809 he was able to return. The home, in Jefferson's mind, was never finished. He was always in the process of adding to it, tearing it down, renovating or redesigning it. During his last years he became "father" of the University of Virginia and designed all of the original buildings which are still in daily use.

But the cost of Monticello and his lavish hospitality had put him deep in debt. He was a happy captive of his own home.

Jefferson once wrote in a letter to a friend "All my wishes end where I hope my days will end, at Monticello." On July 4, 1826, his days ended at Monticello, exactly 50 years after the signing of his Declaration of Independence.

In the settlement of his tangled estate, magnificent Monticello had to be sold, and thereafter the home entered dark days. A succession of owners neglected it. Rooms which had accommodated presidents and

Jefferson used this polygraph to make copies of all his work. Copies have been invaluable to historians





Sketch and floor plan of Monticello. Unique wings held quarters and work areas for the servants. Numbered areas show: 1. Honeymoon Cottage; 2. Servants' quarters; 3. Smokehouse; 4. Kitchen; 5. South passage; 6. South terrace; 7. South piazza; 8. Study; 9. Jefferson's bedroom; 10. Library; 11. Sitting room; 12. Entry hall; 13. Drawing room; 14. Dining; 15. Tearoom alcove; 16. Bedroom; 17. Octagonal bedroom; 18. North piazza; 19. North terrace; 20. North passage; 21. Icehouse; 22. Feed room; 23. Horse stables; 24. Coach and carriage house; 25. Law office

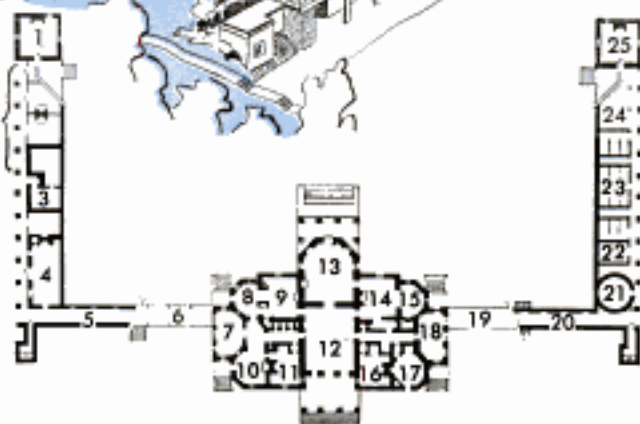

ministers were used as dumps. One lonely caretaker lived in one room after another, closing the doors behind as each room became littered with filth. Old-timers around Charlottesville even now can recall seeing cows wander in and out of the entry hall. The steps leading up to the home were so covered with refuse that a wagon could be driven right up onto the portico. Monticello was a dump, a graveyard of the past. But beneath the refuse, thanks to Jefferson's genius, Monticello lived on.

In 1923 the Thomas Jefferson Foundation was organized. School children all over the country gave their nickels (re-

member the nickel in your pocket?) and thousands of Americans contributed funds to buy the home. Monticello was bought for \$500,000, though Jefferson's daughter had trouble selling it for \$7000 in all its glory, and soon Monticello was opened to the public.

In the ensuing years some 2,750,000 Americans have visited Jefferson's beloved home. The Foundation, a nonprofit organization, charges a nominal admission fee which pays for the upkeep of the building itself, its restoration, and the recovery of the original furniture whenever a piece can be found.

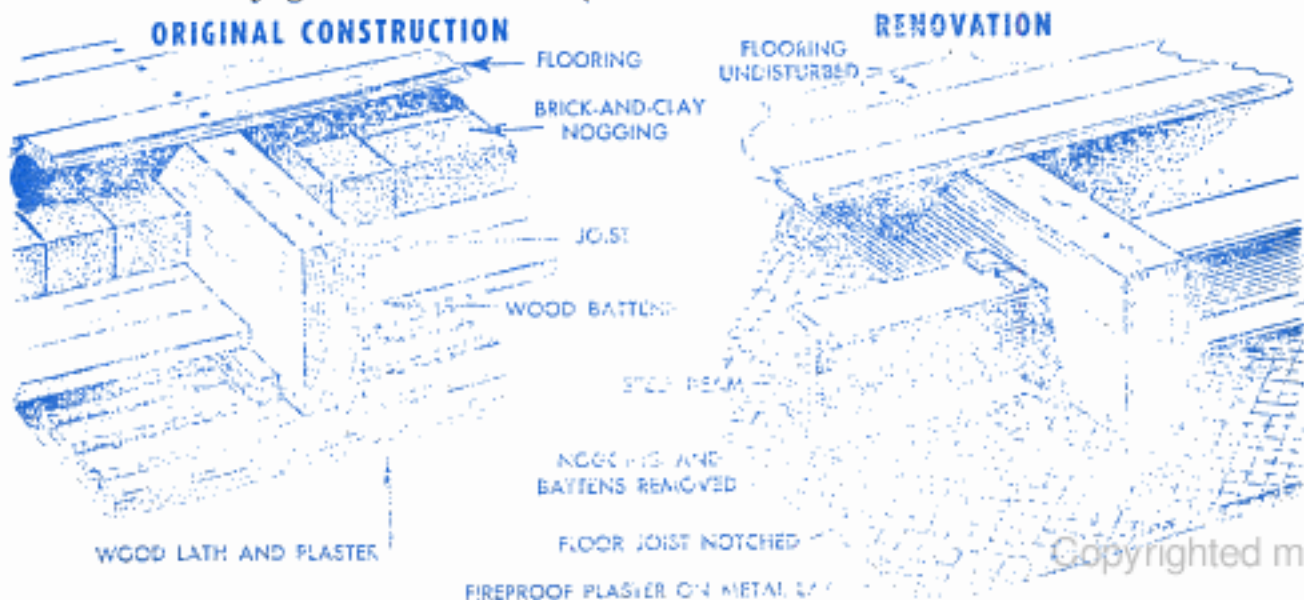



Servants' quarters and kitchen are hidden from view at Monticello, yet have their own ground-level entrances

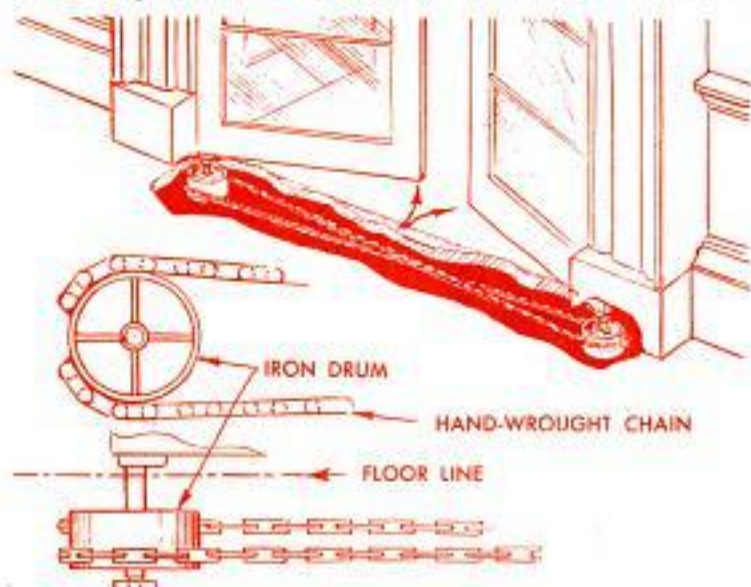

Secret of the mysterious doors that swung in unison was bared during the renovation. Crossed chain ran over two drums. When one door was opened or closed, the other swung with it. Below, only in a few spots at Monticello was major rebuilding required

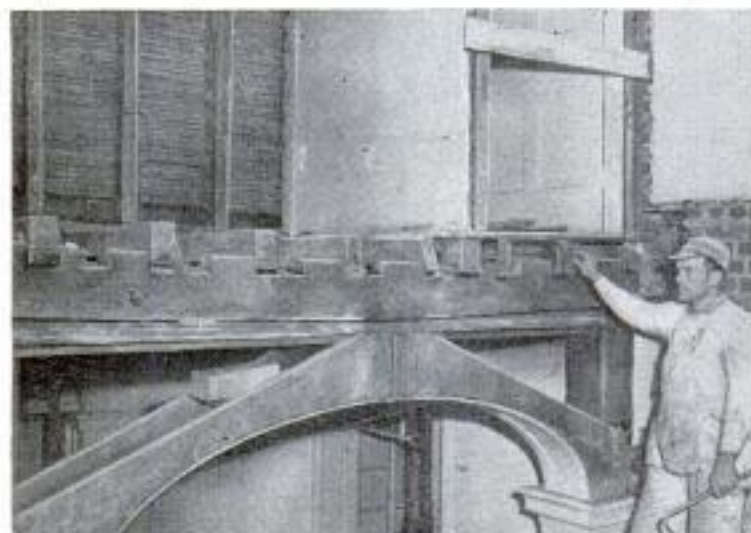

A few years ago signs of serious deterioration appeared. Floors sagged, ancient mortar crumbled away from the brickwork, the original oyster-shell plaster started to fall. The Foundation architect, Milton L. Grigg, one of America's leading authorities on colonial architecture, urged that the building be renovated. At the very moment he was meeting with the board of directors in New York a section of one of Monticello's bedroom floors collapsed into the basement in a cloud of dust and rubble.

Grigg was commissioned to go ahead with the work on the specific understanding that he would "preserve rather than restore, and restore rather than reconstruct." To Grigg, every handmade nail in Monticello is sacred. He and the contractor, R. E. Lee, Jr., of Charlottesville, were determined to hide all their work.

First step in the restoration was tuckpointing the brickwork to repair damage that had overtaken it through 180 years.

"The bricks themselves were in wonderful condition, thanks to Jefferson's 'pine oil,'" says Grigg. "In fact the bricks are superior to anything we can obtain today."

Grigg and his men chipped away some of the mortar and had it analyzed both physically and chemically. They then matched it precisely in color and texture.

After repairing the home they could proudly defy a stranger to show them where they had so much as touched the exterior. All the masonry then was given a coat of a silicone compound which forms an invisible seal, preventing water from penetrating the brick and mortar.

Actually, Jefferson's foresight as an architect was the root of the basic trouble inside Monticello. To fireproof and insulate the building Jefferson packed the area between all the floor joists with two layers of brick laid in a bed of clay. Structurally the building was strong enough to support these tons of dead weight for almost two centuries. However, later owners had permitted vines to climb in profusion over the exterior walls. The vines penetrated the mortar joints and brought moisture into this clay-and-brick nogging. Gradually the moisture built up within the floors, straining the timbers and threatening to burst the building apart.

In all, the contractor removed more than 100 tons of rubble from the floors. To prevent damage to the beautiful flooring, the work was done from below. The plaster on the basement ceiling was chipped away, the batten boards that held the nogging in place were knocked loose and the nogging itself removed. This exposed the 3½ by 10-inch yellow-pine joists. Steel beams were notched into these joists and the basement ceilings then were covered with metal lath and plastered with a fireproof volcanic-ash plaster. Not a floorboard on the first floor was touched and today the floors look exactly as they did in Jefferson's day, yet the building is considerably lighter and stronger.

Some of Monticello's secrets were uncovered during the restoration. One mystery was the action of the automatic double doors between the entry hall and the drawing room. When Jefferson opened either of the twin doors, the other door automatically opened at the same time. When either door was closed, the other swung with it. Yet no mechanism could be seen. Expert architects who inspected the home — including Grigg himself — were convinced that Jefferson hid his secret in the ceiling above the doors. However, when workmen removed the nogging from the floors beneath the doors they stumbled onto a mechanism so simple and foolproof that it works perfectly to this day. Jefferson simply made two sprockets, similar to bicycle sprockets, and connected one to the pivot point of each door. Chains, crossed in the center, are fastened to the two sprockets. When one of the doors swings open, the chains move, turning the other sprocket in the opposite direction.

(Continued to page 212)

AUGUST 1954



Lightweight Helicopter Glider Built for Less Than \$100

Not much larger than a bicycle, a helicopter glider built by Igor B. Bensen of Raleigh, N. C., can be towed into the air at 20 miles per hour and landed at seven miles per hour. Bensen, who weighs 210 pounds, has flown the machine and says it handles as easy as a bicycle. Built for engineering tests on lightweight helicopter designs, the craft is made of wood, aluminum and steel and weighs 86 pounds. It will glide or autorotate to the ground after being released by the towing vehicle. The firm does not plan to produce the craft commercially, but will make plans and kits available to those interested in building one themselves. All the materials, with the exception of one bearing, can be purchased in a lumber yard or hardware store for less than \$100.

Compact Golf-Ball Gauge Indicates Imperfections



No golfer can blame a high score on the golf ball he used if he carries a new pocket gauge. The compact instrument measures compression, elasticity, roundness, balance and size. It helps a golfer spot defective balls.

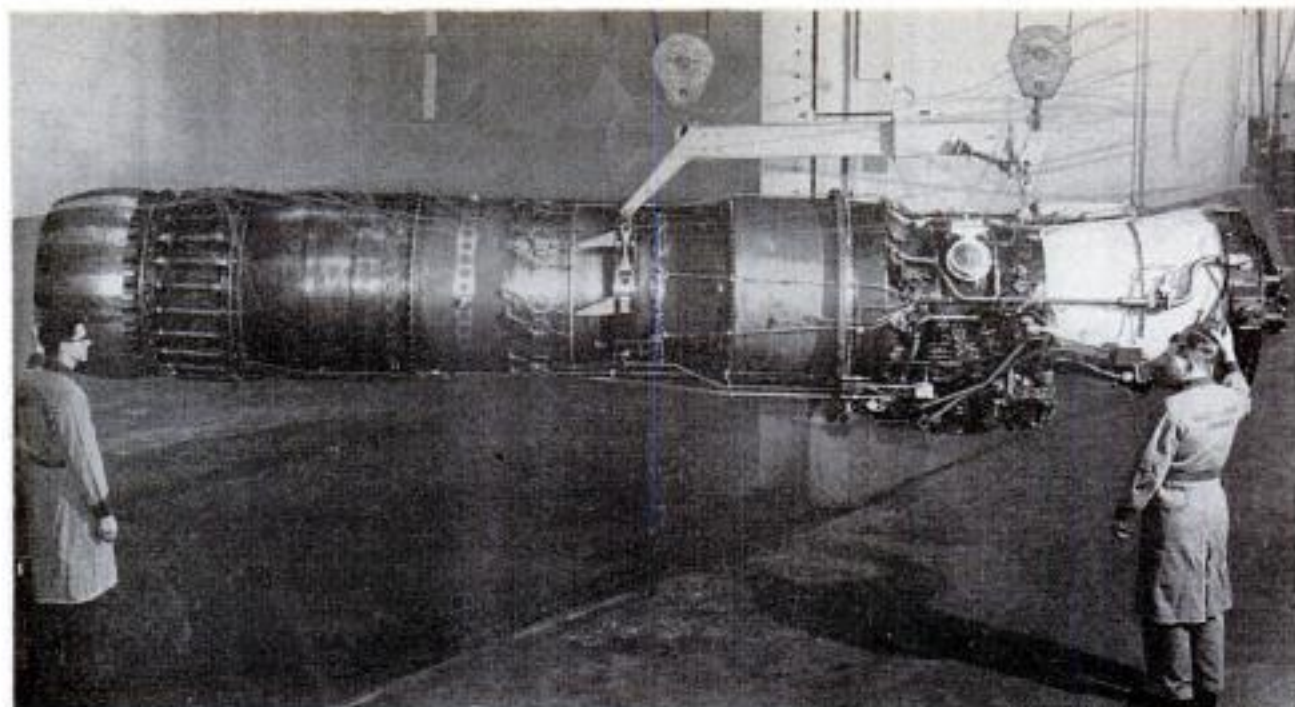

Pratt & Whitney Aircraft photo

Turbojet Engine Produces More Than 25,000 Horsepower

Producing the equivalent of over 25,000 horsepower at supersonic speeds, Pratt & Whitney's new J-57 turbojet engine with an afterburner is being put in the fastest U. S. fighters. Already installed in the F-100 Super Sabre, holder of the world speed record of 755 miles per hour, it will

also power the F-101, F-102, F4D and the B-52 bomber. The afterburner is a tube-like extension of the engine's exhaust tailpipe. When a pilot needs a large boost of power for his aircraft, he sends additional fuel in a spray into the hot exhaust gases. This increases the thrust about 50 percent.

Invisible Sentinel Times Operation of Automatic Elevator Doors

Operatorless elevator systems now are controlled by an invisible beam of light that tells the doors when to open or close. The "traffic sentinel" projects an infrared ray across the entrance of an elevator car a foot above the floor. Whenever a person moves into the car, the invisible beam

closes the door two seconds later unless it is again interrupted. As a rider exits the interval is cut to a half second. The instrument, developed by Westinghouse, may make it possible for automatic elevator systems to surpass attendant-driven systems in efficiency.

Alarm Sounds If Child or Pet Falls in Unguarded Swimming Pool

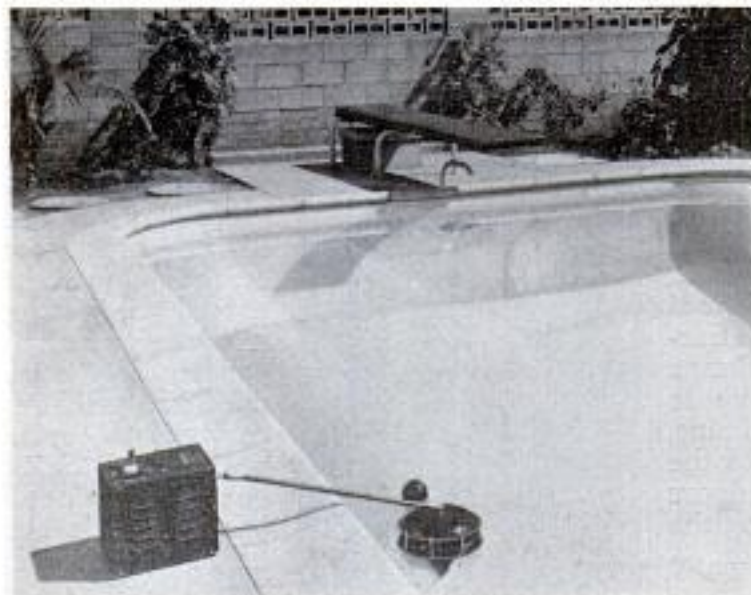

Unguarded swimming pools are automatically tended by an alarm box that signals when a child or a pet has fallen into the water. The battery-operated box is placed on the apron of the pool. Leading from the box is a metal arm that is connected to a float in the water. If a pet or youngster should fall into the untended pool, the ripple of water vibrates the sensitive float, tripping a switch to set off a loud bell. The alarm is turned off when the pool is in use.

☐ The buffalo-hide winter coats worn for many years by the Royal Canadian Mounted Police are being supplanted by nylon parkas.

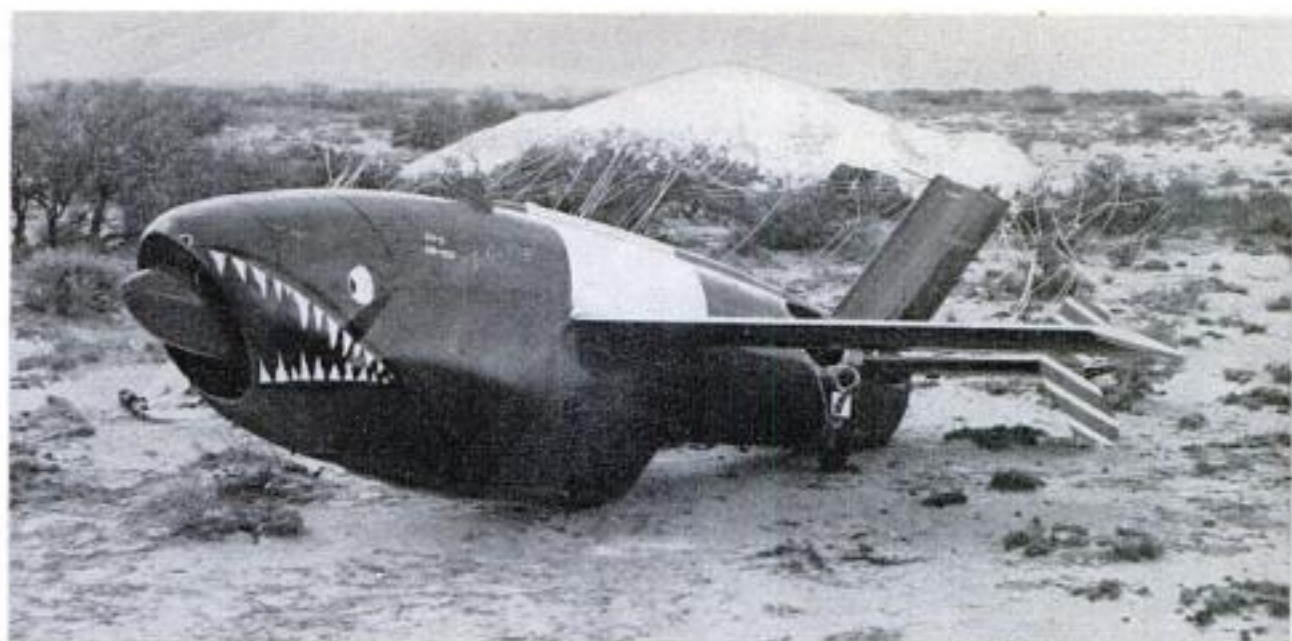

Ryan Aeronautical Company photos

Undamaged, a jet drone lies on the desert floor after a parachute drop. A trailer and crane will retrieve it

Brightly Colored "Fish" Fly High Over New Mexico's Sand Dunes

Held by a special rack, one drone is carried beneath each wing



Tiger-toothed, fire-engine-red "fish" soaring over New Mexico's sand dunes rarely get a second glance now. They are Firebee pilotless-jet target drones being flight tested by the Air Force. Imaginative paintbrushes add tiger teeth and fisheyes. The drones are launched singly from special racks mounted beneath the wings of a B-26. After an electric bomb-salvo switch starts them on their way, they are maneuvered by signals from a control box operated by an officer on the ground. The drones are parachuted to earth undamaged after each test.

Lavatory Complete With Running Water Attaches to Side of Car

One of the comforts of home—a clean face—is possible on the road when you mount a portable plumbing system on the side of your car. It's a rubber bag equipped with a faucet which attaches to the car with hooks and suction cups. Below the faucet is a small wash basin. Made in Germany, it is designed for campers and for tourists who like to "freshen up" along the way.

Wonder Oil Ignores Cold

Temperatures far lower than 100 degrees below zero fail to bother a new wonder oil developed by the Elgin National Watch Company as a watch lubricant. It should have wide usage for other precision equipment subjected to extreme cold such as gun sights, fuses, meteorological and navigational instruments, the company said.



The OWNERS



What do the owners think of the Oldsmobile? To find out, *Popular Mechanics* surveyed 1000 owners of the 1954 Olds.

Here's What They Say About Oldsmobile:

Performance

"Has a higher top speed and better acceleration than some cars with a higher advertised horsepower."

Detroit, Mich., supervisor

"In Drive range, pickup is slow at low speeds especially when making sharp turns and climbing a slight grade."

Manchester, Conn., engineer

New Body Styling

"I like the body lines and minimum external chrome. Also wide seats and broad angle of visibility."

Mercer Island, Wash., salesman

"Old conventional style gave body a more balanced look. Extra view of new windshield is of minor importance."

Kew Garden Hills, N. Y., retailer

Wrap-Around Windshield

"Visibility in cutting city corners is much better."

Detroit, Mich., structural engineer

"Visibility very poor in driving rain. Water runs down slanted windshield. Wipers are too slow to keep it clear. Sun glare very strong."

Boston, Mass., bar tender

OLDS' OWNERS LIKE PERFORMANCE AS WELL AS LOWER, WIDER BODIES

Written by Oldsmobile Owners

WHAT DO OWNERS of the 1954 Oldsmobile like best about their cars? As you may have guessed, in view of the car's reputation, the most-popular feature is performance. More owners list performance as the best-liked feature than anything else.

"I like the surging power at the slightest touch of the gas pedal."—Arlington, Mass., manager.

"Has higher top speed than cars with a higher advertised horsepower. Also better acceleration. Sensitive to gasoline though, must use highest octane for good results."—Detroit, Mich., supervisor.

"Like its ability to get out and go when necessary."—Minneapolis, Minn., lawyer.

The new body styling—the lower and wider look—was next in popularity.

"Plain, beautiful lines. Not too much chrome."—Rehoboth Beach, Del., retired professor.

"I like the over-all styling. It has a 'rich' appearance. My wife informs me that when she drives the car it gives her 'prestige.'"—Indianapolis, Ind., salesman.

"Pleasing to the eye. I like the knowledge that I am driving one of the 'better' cars."—Detroit, Mich., advertising man.

"Appears to be a much larger car than it is. I am sold on the wrap-around windshield, but should make rear window higher so I could see more in the mirror."—Covington, Ga., National Guardsman.

There are some dissenters, of course.

"I think the old conventional style gives the body a more balanced look. The extra view that the new windshield gives is of minor importance. Conventional windshield gives sufficient visibility to either side."—Kew Garden Hills, N. Y., retailer.

"I like the rise in fender line at rear door. Rear end should be lower. Unless the trunk is loaded, the rear end appears too high."—New Rochelle, N. Y., student.

Rattles Bother Owners

More owners complained of poor assembly work and resultant rattles and squeaks than of any other thing.

"Mine has squeaks and rattles that the dealer has not been able to find. Very annoying. Glass rattles in the doors. Trunk rumbles."—Russiaville, Ind., farmer.

"Body seems very solid on rough roads although they are coming out of factory loose as to doors, dash and hood. All needed tightening. Gas mileage not as good as

Clymer Road Tests the 1954 Olds

By Floyd Clymer

I DROVE a Super 88 four-door sedan 961 miles from Denver, Colo., to Dodge City, Kans., and return plus a circle trip through the Rockies out of Denver.

The Super 88, with the 185-horsepower Rocket engine of 324-cubic-inch displacement, is an excellent performer, with extremely high top speed (speedometer hit 115 miles per hour on open stretches). The

(Continued to page 220)

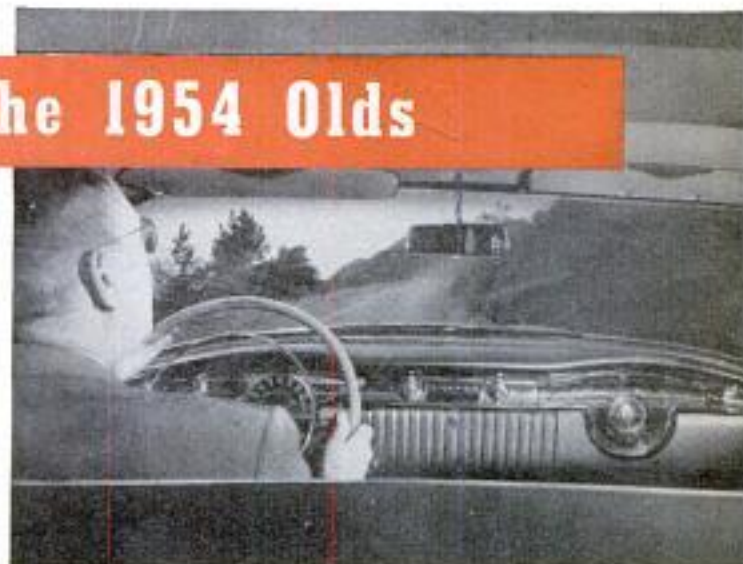

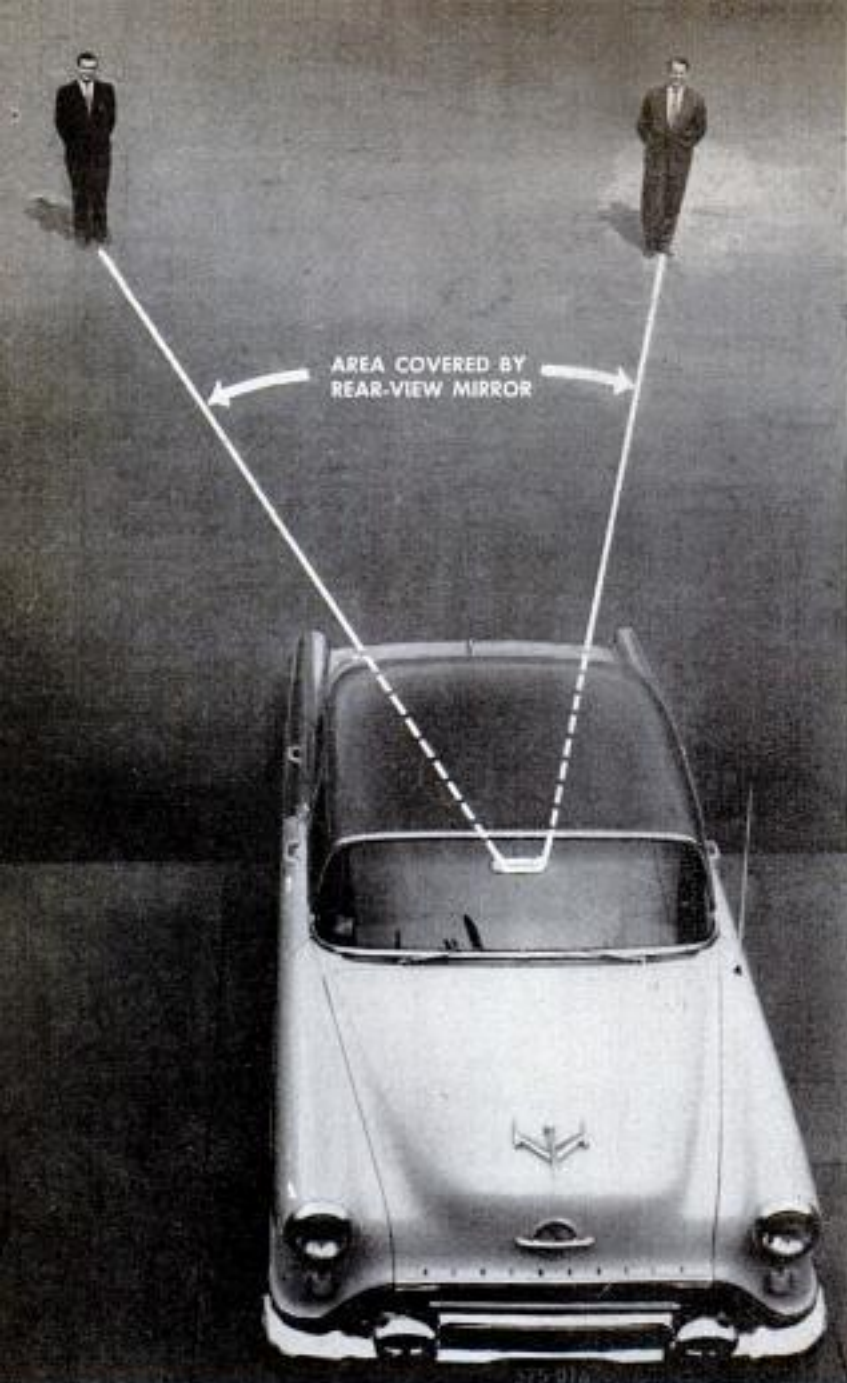

Some owners complain that vision through rear-view mirror is too narrow. The men mark the limits of driver's vision. Below, there can be no complaints about the room in the trunk of the 98! It will carry all the luggage anybody would need



could be."—Dupuyer, Mont., store owner.

"Rattles under dash."—Minneapolis, Minn., municipal worker.

Also frequently mentioned by owners is poor gasoline mileage. See Percentage Table on page 109 for average miles per gallon as reported by the owners.

"Gasoline mileage is poor in city traffic. Rattle from right front seat is very disturbing when there is no one sitting there. Back of seat shakes on every bump."—Boston, Mass., bartender.

"I would like them to install a higher rear-axle ratio to increase gas mileage." — Phoenix, Ariz., real-estate salesman.

The lower body also improves roadability, say many owners.

"The low-slung body contributes a great deal toward easy handling, takes curves with no sway whatsoever."—Detroit, Mich., transportation driver.

"Has 100 percent improved roadability and handling over 1953 Olds, which was nose-heavy and had excessive roll." — Denver, Colo., wholesaler.

"Believe that the soft suspension could be stiffened a bit for better cornering. Dislike having to back off and apply brakes for a curve." — Emmetsburg, Iowa, produce dealer.

Cracked-Windshield Rumor

As with Buick owners, the owners of the 1954 Olds seem to be afraid of cracking or popping out their wrap-around windshields when the car is jacked up. There were only three owners who reported windshields cracking, but not one of them said it occurred while the car was being jacked up. There is no evidence to support the rumor, yet it seems to persist.

Generally, the owners like the new style of windshield.

"Visibility in cutting city corners is much better."—Detroit, Mich., engineer.

"I like being able to see in any direction. Also being able to see all four fenders. Windshield should



Owners from almost every state in the nation (shown in black) took part in the PM survey



Percentages from PM Poll of Oldsmobile Owners

OVER-ALL RATING OF THE OLDS BY THE OWNERS

Excellent	74%
Good	23%
Fair	2%
Poor	1%

Have owned an Olds before?	
Yes	67%
At least 5 Olds before	11%
Would buy another Olds?	
Yes	83%
Might	16%
No	1%
Owners' rating of dealer service	
Excellent	46%
Good	32%
Fair	14%
Poor	8%
Owners' rating of engine	
Excellent	90%
Good	9%
Poor	1%
Owners' opinion of new body	
Like	92%
Dislike	4%
No comment	4%
Owners' opinion of wrap-around windshield	
Like	95%
Dislike	4%
No comment	1%

GAS AND OIL ECONOMY

Average miles per gallon		
	city	country
88 owners	14.2	17.0
Super 88 owners	14.2	17.1
98 owners	14.2	16.8
Oil consumption per 1000 miles		
	88 and Super 88	98
No quarts	97%	89%
1 quart	3%	11%
More than 1 quart	0%	0%

OPINIONS ABOUT POWER ACCESSORIES

(Percentage of owners who now have these accessories who would buy them again)

Power steering	95%
Air conditioning	86%
Power window lifts	72%
Power front seat	71%
Automatic headlight dimmer	62%

PERFORMANCE RATINGS

Acceleration from zero			
	88	Super 88	98
Excellent	67%	87%	79%
Good	29%	12%	21%
Poor	4%	1%	0%

Acceleration from 50 m.p.h.			
Excellent	70%	86%	92%
Good	26%	14%	8%
Poor	4%	0%	0%
Roadability			
Excellent	88 and Super 88	98	
Good	73%	82%	
Poor	26%	18%	
Handling			
Excellent	81%	92%	
Good	19%	8%	
Poor	0%	0%	
Structural rigidity			
Excellent	54%	50%	
Good	37%	46%	
Poor	9%	4%	

BEST-LIKED FEATURES

(In order of popularity)

- Engine performance
- Style and appearance
- Handling and maneuverability
- Visibility and wrap-around windshield
- Riding comfort
- Power accessories

MOST-FREQUENT COMPLAINTS

- Careless body work
- Poor gasoline economy
- Poor paint job
- Wind noise at high speed
- Rear-seat headroom

Owners with no complaints at all

88 and Super 88	18%
Classic 98	33%

CHANGES OWNERS WOULD LIKE

(In order of frequency of mention)

- Rear-view mirror position changed
- Better body workmanship
- Improved gasoline economy
- Dual-exhaust system
- More front-seat legroom
- Underseat heater
- More accessible oil filter

have electric wipers, though. There is really more horsepower in engine than needed."—Cheyenne, Wyo., salesman.

But while visibility may improve there apparently are some drawbacks to the windshield, according to the owners.

"New windshield comes back too far,

making it hard for large persons to get into the car."—Dayton, Ohio, salesman.

"More wiper area needed to eliminate blind spots in bad weather."—Detroit, Mich., clerk.

There were many owners who listed riding comfort as a best-liked feature, but

Oldsmobile offers the most novel two-tone combinations on the road today as these three sketches indicate

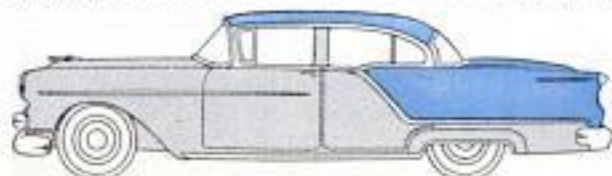

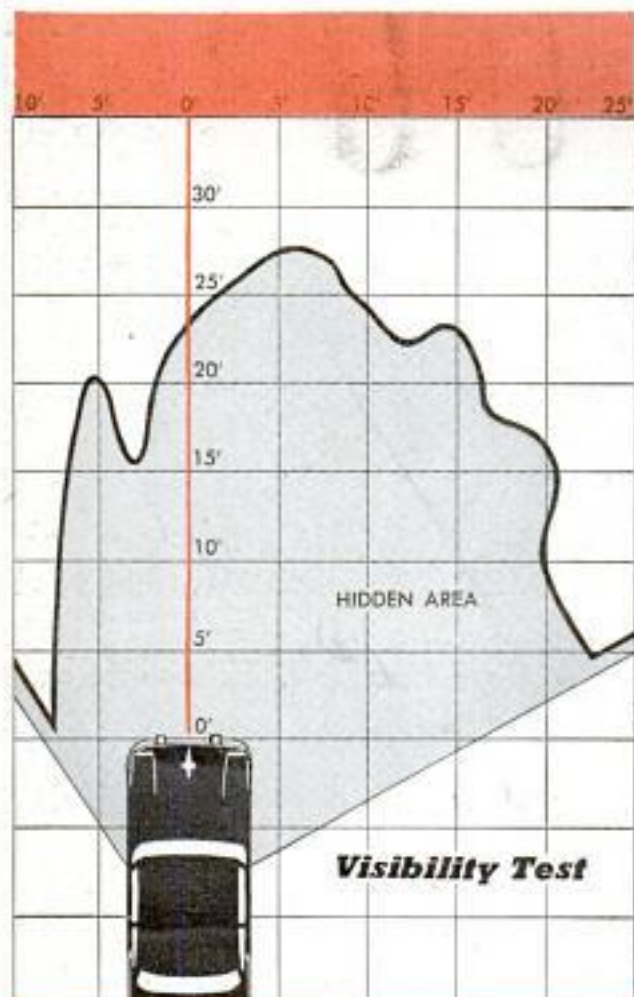

Acceleration Test

1954 OLDSMOBILE SUPER 88
with Hydro-Matic

¼ mile from zero	18.9 seconds
½ mile from zero	30.2 seconds
0 to 30 m.p.h.	3.8 sec. (Low only)
0 to 60 m.p.h.	14.1 seconds

Top speed (by speedometer) 115 m.p.h.
Actual top speed about 7% less

Economy Test

MILES PER GALLON
Constant-Speed Mileage

At constant 30 m.p.h.	22.8
At constant 50 m.p.h.	18.2
At constant 60 m.p.h.	16.4
At constant 75 m.p.h.	12.8

Cross-Country Mileage

Denver, Colo., to Dodge City, Kans.	16.6
Dodge City to Pueblo, Colo. (mostly level highways)	18.4
Pueblo to Denver (circle trip through Rockies)	16.4

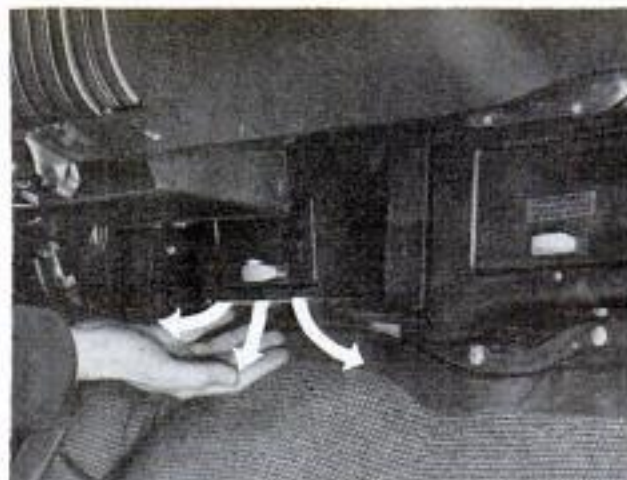

Some owners do not like the heater location on the firewall, saying heat doesn't get to rear-seat riders

as usual there were a few others who disagreed with this opinion.

"I like comfort on long trips."—Elkin, N. C., textile worker.

"Rides nice. Is easy to drive and quite economical."—Salt Lake City, Utah, traveling salesman.

"Rough riding. Also jerks every time it changes gears."—San Antonio, Tex., store owner.

By a wide margin, Oldsmobile owners say their car is wonderful. Of those reporting, 74 percent say the Olds is excellent, 23 percent say it is good, only 2 percent describe it as fair and 1 percent as poor.

Only 1 percent said they would not buy another Oldsmobile, while 83 percent said they definitely would. The other 16 percent are still uncertain.

Miscellaneous Complaints

Although most owners are enthusiastic about their Oldsmobiles, they still have complaints. And, as usual, the complaints are varied and interesting.

"Paint job is foggy in spots and in other places not much paint on it. Could stand a new paint job."—Henderson, Nev., painter (who ought to know).

There were a number of complaints about the wind noise at high speeds, due in part to the wrap-around windshield and to the cowl-level air intake.

"New windshield seems to have a lot of wind noise."—Newcastle, Wyo., foreman.

"Biggest complaint is wind noise. It would drive a sane man out of his mind in short order. When I first got the car it was so bad it was impossible to hear the radio."—Newark, N. Y., state trooper.

"Too much wind noise in air intake."—Centralia, Ill., contractor.

The following is a selection of interesting complaints mentioned by 1954 Olds owners. Most of these were mentioned by more

(Continued to page 226)



Quantity of beads on left of scales produces foam plastic on right. Twenty-pound plastic raft floats swimmer

Plastic Beads Popped Like Corn Permit Molding of Foam Plastic

Tiny plastic beads which burst and expand like popcorn when heated permit the molding of foam plastic. Formerly foam plastic could be processed only in sheets and blocks. The new material is poly-

styrene impregnated with a special foaming agent that reacts under heat. Light, buoyant and strong, the "popped plastic" can be used in life rafts, novelties and for insulation. Various densities are possible.

Unsafe Water Purified

Unsafe water is purified quickly with a plastic device that fits into a shirt pocket when not in use. Water poured into the top portion of the double bag flows through a purifying substance contained in the pinched-in waist. Bad tastes, odors and bacteria are destroyed. The 1½-quart bag can be used 100 times without reducing its effectiveness.



Weed Topper on Power Mower

On a new power mower a sickle bar moves back and forth to cut off the tops of weeds while the reel cuts the grass. The bar is in front of the reel and is low enough to cut weed tops before they go to seed, preventing the weeds from multiplying. The bar has the oscillating action of a farm mower.



Full-Length Sleeping Cot Rests on Top of Automobile Seats

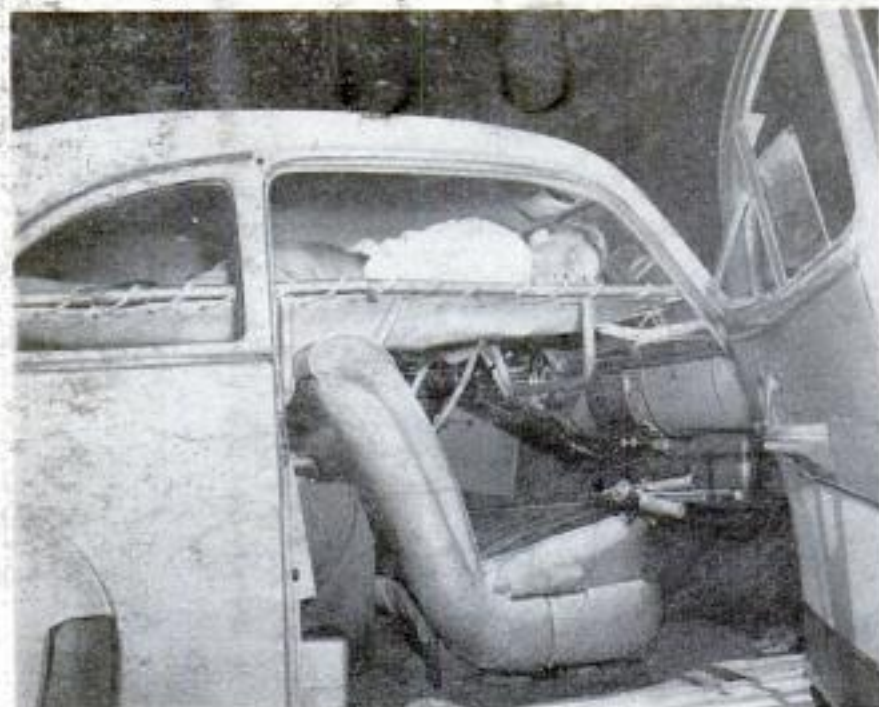

Now the traveler can install a relief bunk in his car — an aluminum cot that extends above the seats from front to rear. While one person drives the other can sleep in full-length comfort. Made of lightweight tubing, the cot is supported by legs resting above the instrument panel, on top of the two seats, and on the rear-window ledge. It is quickly removed or installed and can be folded for storage. When folded, it is easily packed into place along with any reasonable amount of luggage. The bed can be adjusted for use as a regular cot.

Single Turboprop Can Power Bomber

Test pilots flying a B-17 experimentally equipped with four piston engine-propeller combinations and a single gas-turbine-driven propeller report the bomber "picks up speed" when only the turboprop is working. It produces 5700 horsepower, about 20 percent more than the other four power plants combined.



Irrigation Dam Made From Vinyl

Vinyl plastic has found another use — in lightweight irrigation dams. The plastic sheeting is laid in the ditch and over its banks for four or more feet. A pole running through a fold in the top holds up the end across the ditch. When the ditch is flooded, the weight of water on the apron holds the dam in place. The durable sheeting is easy to fold and carry. The dams are colored so they will be easy to locate in the field.

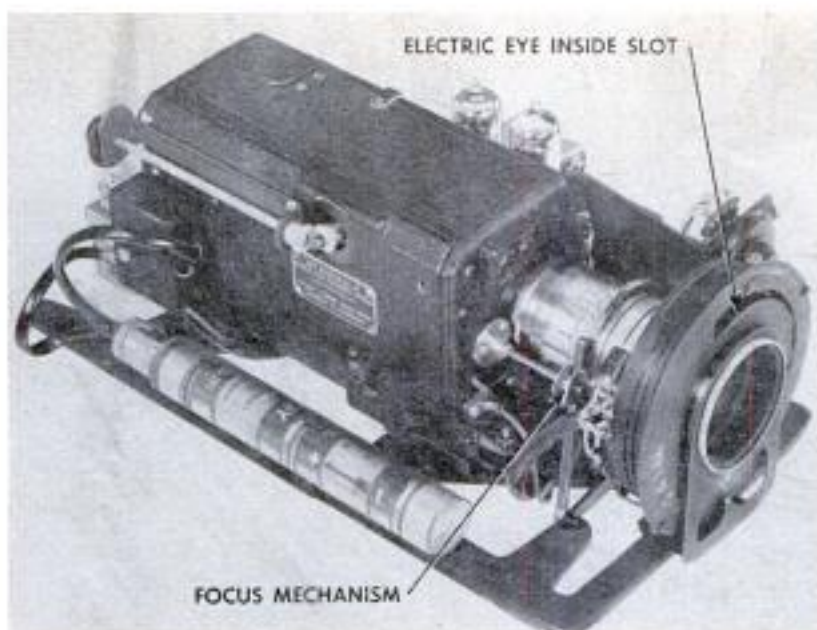

Underwater Motion-Picture Camera Takes Movies at 100 Feet

Automatically adjusting for changing light conditions, an underwater camera built by two California skin divers takes natural-light movies at depths of 100 feet and more. Basis of the unit is a war-surplus 16-millimeter wing camera. The men, Don Dotson and Bob Kimes of Culver City, Calif., installed a wide-angle lens and altered the operating speeds to those normally used in professional movie work. The waterproof case was designed and

built by them so that all operational controls are available at the diver's finger tips. Power is supplied by batteries. An electric eye measures the natural light and sets in motion a servo mechanism that changes the diaphragm opening. A shutoff stops the camera when the film magazine is exhausted, and a buzzer warns when existing light is too dim for adequate exposure at the widest aperture. Released underwater, the camera will bob to the surface.

Garden-Hose Attachment Anchored in Turf Forms Portable Shower



Outdoor showers are provided by a device that can be quickly set up on any lawn. A metal pipe with a spray head at its curved end, it has a sharp point at the other end that can be pushed into the ground to hold the assembly upright. There is a connection in the pipe at ground level for the hose.

Hypodermic Gun "Fires" Liquid Injection

see later

Scientists have developed a hypodermic instrument which hurls a tiny liquid column that can penetrate nearly four inches of tissue. The new device may be used for direct injection into internal organs and tumors. The liquid is put in a steel chamber and propelled through a .005-inch nozzle by the explosive action of a small wafer. The wafer is made from nitrosoguanidine, a heat-sensitive chemical, and is detonated by a small "soldering iron" in the device.

WHAT'S NEW FOR Your Home



1. CONTOUR-BED MECHANISM is available in sizes to fit all standard beds. Two $\frac{1}{4}$ -horsepower motors raise or lower the head or foot to the desired position. Toggle switches within reach of a bedfast person operate the mechanism. Special mattresses, either foam rubber or innerspring, are available for the bed

2. WEATHER STRIPPING for casement windows is a metal strip that just slips into place over the frame of the window without screws or nails. One form of the stripping is applied to the head and lock side, another to the hinge side and sill. There's a packaged set for standard windows or you can buy any length

3. "SNOW-ICE" sealed inside a plastic bag is frozen in your refrigerator or home freezer, then used to keep perishables fresh and cold during picnics and other outings. The material can be refrozen as many times as desired. You also can use it to keep foods cold while defrosting a refrigerator or home freezer

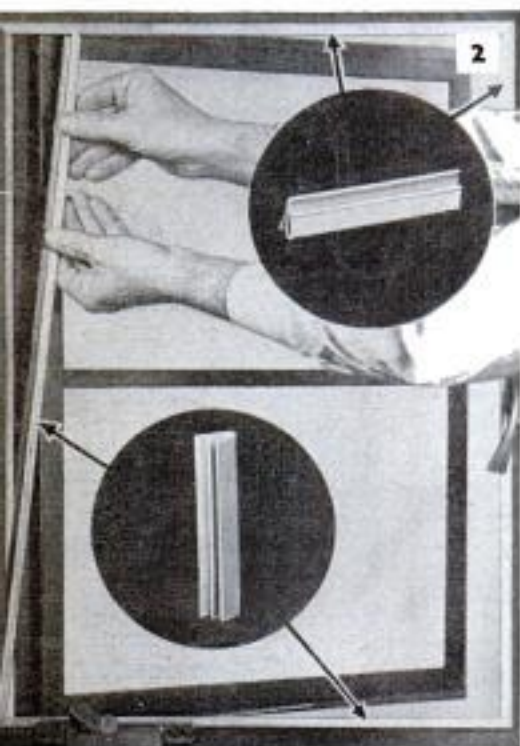



4. CRUSHED ICE slips out of a new ice-cube tray at the twist of your wrist. The flexible plastic tray is divided into slim compartments to freeze 60 ice wafers. When you twist the tray they pop out to give you crushed ice without any chopping

5. SQUEEZE CLEANER for mirrors and windows is a unit that combines a liquid cleaner, a sprayer and a squeegee. You squeeze the flexible container to spray the glass, then wipe it down with the squeegee



6. CLOTHES DRIER attaches to the door of an automatic washer. The heater-blower has a timer which is mounted on top of the machine. When the clothes have been washed and rinsed you remove a cover plate from the blower and set the timer. The clothes are tumbled while the door-mounted unit dries them



7. PORTABLE ELECTRIC OUTLET has a built-in fuse to minimize the possibility of blowing main fuses. There are four receptacles for plugs. The unit is built to withstand an electrical load up to 1000 watts without blowing fuses. In the event of an overload, the 15-amp. fuse in the unit blows first

7



8. SPRINKLER SYSTEM contains enough plastic pipe, fittings and sprinkler heads to cover an area of 1200 square feet. You assemble the system, join the parts with a special adhesive, then bury the pipe beneath the surface by opening the sod with a spade. Sprinkler heads screw on the vertical risers by hand



I'VE LOOKED INSIDE

A TORNADO

By Capt. Roy F. Hall

A MONSTER is devastating our land. It has left 4000 trails of disaster across the nation during the last 20 years. If these paths could be reduced to a single swath, it would be 500 miles wide and 10,000 miles long. In this great aisle would lie 10,000 dead, more than 100,000 injured and a billion dollars in property damage. This fiend—nature's most violent release of energy—is the roaring tornado.

In 1948 I sat on the floor of my home and

looked up into the hollow, brightly illuminated interior of one of these swirling cores. Moments before, the tornado had blown off the roof of my house, so my view was unobstructed. The core had a diameter of possibly 125 yards. I could plainly see the lower end of the core cloud several hundred feet above my head.

A moment before the tornado struck, the roaring and screeching stopped. The effect was as though plugs had





suddenly been placed in my ears. Seconds later I was knocked down by the west wall of the house but heard no noise. I crawled into the next room and sat on the floor sheltering my baby. Here I saw the south wall of the house go down, leaving us on a bare floor with nothing overhead. There was no sound. I watched my neighbor's house, 50 feet away, suddenly dissolve. There was not the faintest tinkle of sound until the tornado had passed on, when the noise came back as suddenly as it had blanked out.

For the past 20 years I have studied tornadoes. With my own eyes I have seen several of these monsters walk with devastating steps across the land—and sea.

Almost 500 persons died in the big winds during 1953, the year of the highest tornado activity on record. More than 360 tornadoes were reported. In Waco, Tex., a tornado lanced into the business district and cut a channel for 20 blocks, killing 114 people

and destroying an estimated \$50,000,000 worth of property.

Something should be done to minimize the loss of life and property, and something is being done. The U.S. Weather Bureau, in 1952, established a Radar Tornado and Storm Warning Service. This year the radar net has spread over most of the tornado-affected area of the Southwest and Middle West.

What were the meteorological conditions that gave rise to so many severe tornadoes in 1953? There is no widely accepted

About the Author . . .

Capt. Roy F. Hall retired from the Army in 1929 and immediately plunged into his hobby, the study of tornadoes. He has watched the formation of waterspouts, whirlwinds and tornadoes around the world, from Corregidor to his home in the tornado belt at McKinney, Tex. For four years he has served as an observer for the Weather Bureau

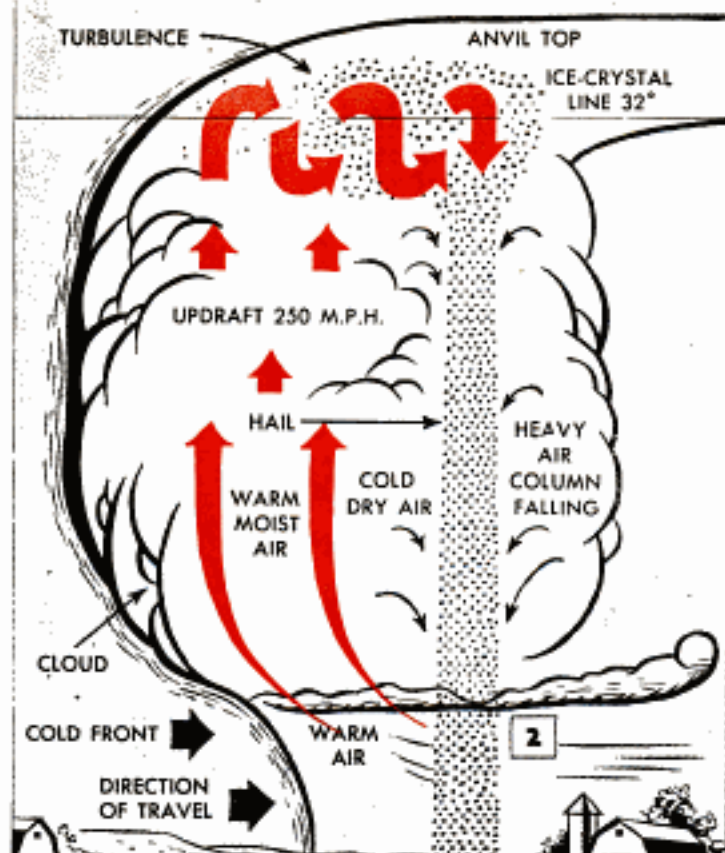
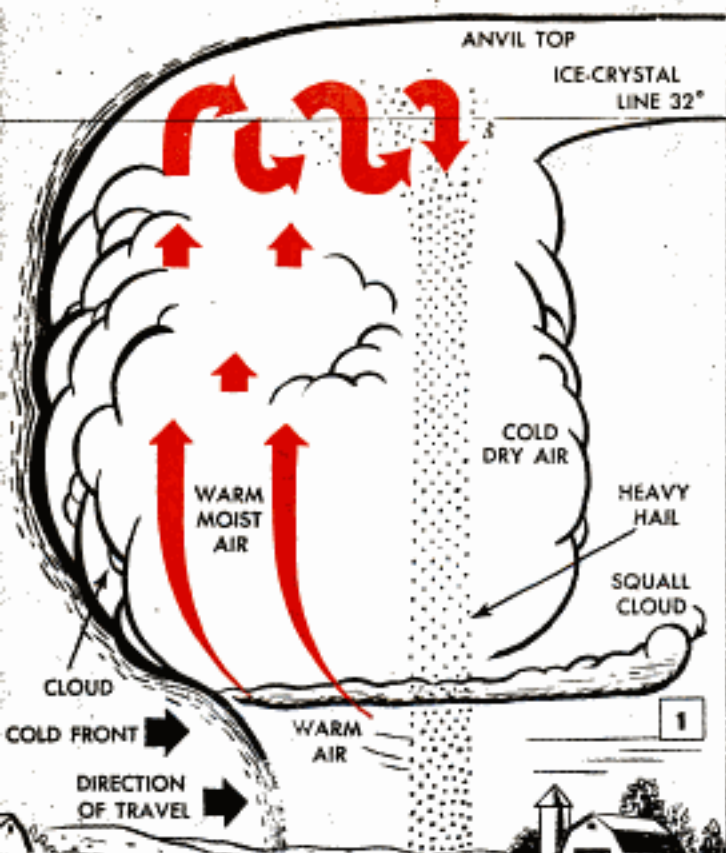

Cold front creeps forward preceded by a finger of cold air, top, trapping the warm, moist air in a pocket

Turbulence at freezing line produces heavy hail which drills hole to the ground. Cold air pours down hole

answer, as the real mechanism of the great funnel itself still is shrouded in mystery. In many years of studying, analyzing and observing tornadic funnels I have arrived at some definite conclusions regarding the mechanism of the tornado.

One discovery stands out as significant: we have held firmly to the belief that a tornado is caused by warm air surging aloft, like the lowly whirlwind. We now know that the only characteristic the two have in common is that they rotate counter-clockwise. A whirlwind is created when hot air rises from a heated surface. A tornado comes from above. It is formed in the clouds and spirals down to the earth.

A tornado is created when an overlying mass of cold, heavy air breaks through a lower layer of light, moist air. This cold, upper air, the advance guard of a ground-running cold front, seldom if ever breaks through the lighter air beneath unless it is triggered, and this triggering is the complicated part of the formation of a tornado.

If there are no prongs or tongues projecting out from the smooth elongation of the surface-running cold front, the warm ground air is shoved along at an angle ahead of it, and is gradually lifted aloft to form the familiar squall line preceding a cold front. These are the cumulus and cumulo-nimbus rain clouds. But occasionally a finger of heavy, cold air points ahead of the main cold front. Then the warm air moving along the face of the front is caught in the bay formed by the cold-front pro-

jection. It is pushed aloft by pressure from the rear and the scooping action of the cold-air mass.

Funneling upward, this warm, moisture-laden air breaks through into the overrunning dry, cold air and condenses, forming the black towering clouds immediately ahead of the cold front. The light, moist air climbs rapidly to the ice crystal, or freezing line, 15,000 to 20,000 feet, and spreads to form the anvil top of the cloud below. This anvil top, pushed by swift currents in the higher air, is shoved ahead and precedes the rain clouds. This is the high cloud that blankets the sun first on the approach of a cold front.

The moist air, rising into the dry, cold air, saturates it and is instantly condensed, forming the clouds. Some of this falls as rain and some, carried to the ice-crystal line, as sleet. If the upsurge of warm air is of high velocity, this sleet is carried back to the freezing line where it is further enlarged by having another coating of moisture frozen around it. This may occur any number of times until the sleet pellets—now hail—reach the size of baseballs.

The hail, carried farther and farther to the forefront of the anvil cloud with each ascension, finally reaches a region where it drops free of the updraft all the way to the cloud base, further cooling the already cold air above the warm-air layer. Great instability is produced in the cold upper air and in the warm air below the base of the cloud as the hail falls to the earth. From

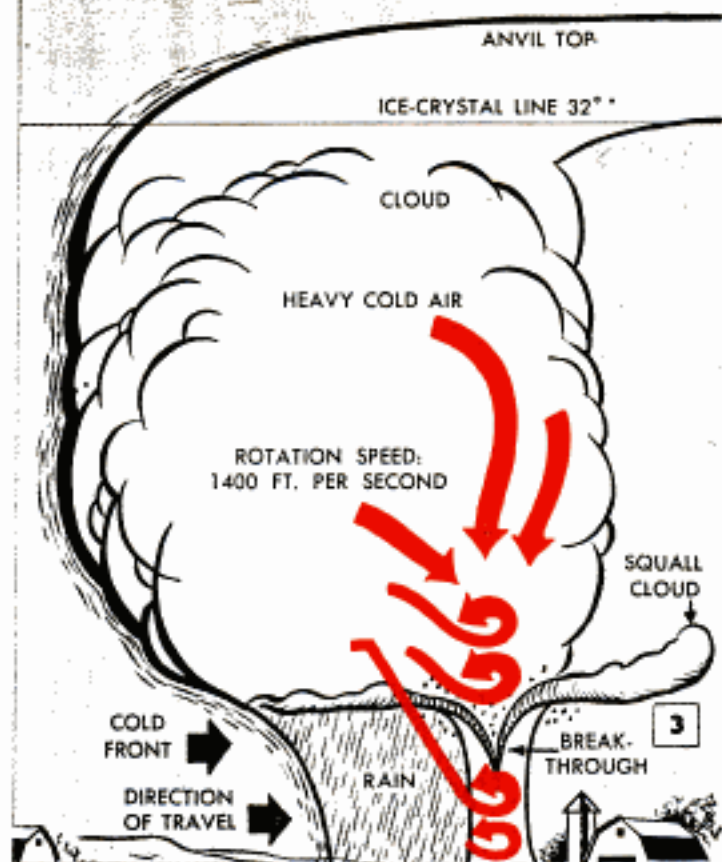

Column of cold air begins spinning, creating a vacuum which draws squall clouds down to form the core

the anvil cloud to the ground a perpendicular tube now exists, cooler and heavier than the surrounding air. Top to bottom, this weighty column starts downward throughout its length, rotating in accord with natural laws, and a tornado is born.

At this stage the tornado is invisible. The whole column whirls faster as the cold, heavy air pours down the tube to the base of the cloud. The air, gaining momentum through the break-through hole, whirls so fast that the column begins to expand from centrifugal force into a hollow tube. Clouds sucked down from above are drawn into the vacuum and the tornado funnel takes on its first visible shape.

The lower end of the column may do minor damage to the ground, but its rotational speed is not nearly as great as the cloud-filled, inverted cone just below the cloud base. Occasionally at this stage the bottom end of the clear column spins fast enough to create a minor vacuum, though this is rare. When this occurs on land a visible shaft of dust and light debris is raised upward within the column to the lower end of the cloud funnel. Normally the expansion into a partial vacuum starts above the base of the cloud and continues downward to the earth's surface.

The pressure within the funnel may reach as high as 50 percent of normal air pressure, but usually is much less. If there were no vacuum there could be no visible tornado funnel, for before the cyclone is fully developed the core of clouds from

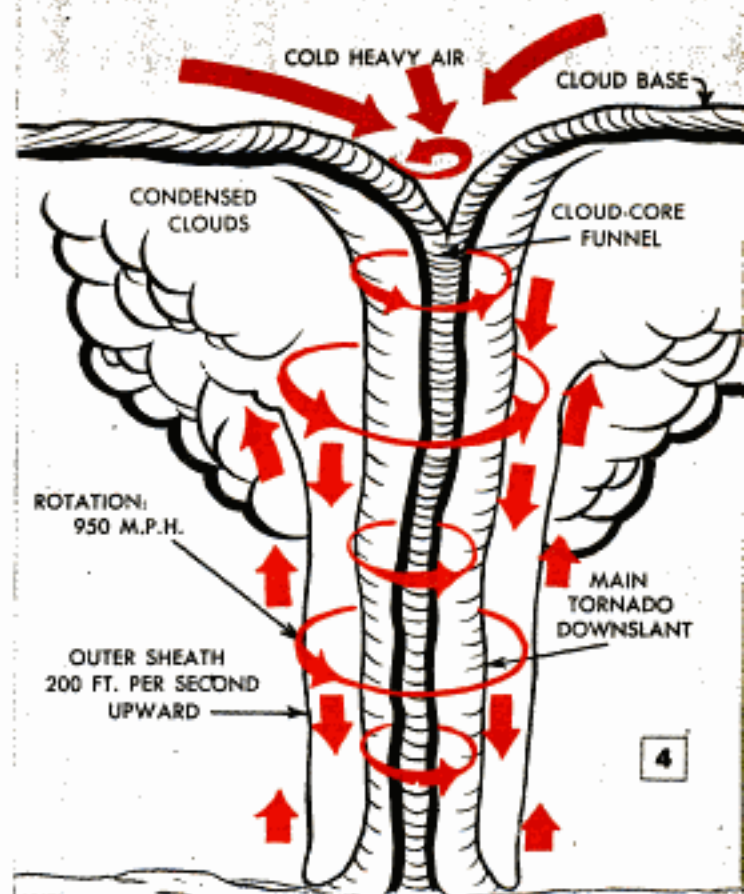

In full fury, the down-spiraling funnel folds back on itself. This outer sheath does the most damage

above composes the only portion of the column that can be seen.

The clear wind of the true tornado, however, extends much farther outward. A tornado with a base diameter of 500 yards may have a visible core diameter of only 50 feet. This core is whirling with the outer rotating winds of the tornado, but with slightly less velocity. Occasionally, the core itself rotates at around 1400 feet per second and becomes a hollow funnel within the whole tornado.

Prolonged study of tornadoes shows that the funnel is made up of three distinct parts: The interior core of clouds sucked down from above, the outer or true tornado which has a rotation speed of about 1400 feet per second and a downward spiral of 200 feet per second and the outside sheath of upward-moving wind, traveling at 200 feet per second.

The downward spiral of cold, heavy air in the tornado pushes hard on the surface of the earth and is forced outward by the terrific force of its spin away from the core. Normal air pressure then holds it against the true tornado and it climbs aloft in loose contact with the downward-moving wall of the main funnel. This is the part of the tornado that does the greatest amount of damage, and a tornado is not fully developed until this outside sheath reaches the base of the tornado cloud, usually within five minutes after the funnel core reaches the ground.

(Continued to page 218)

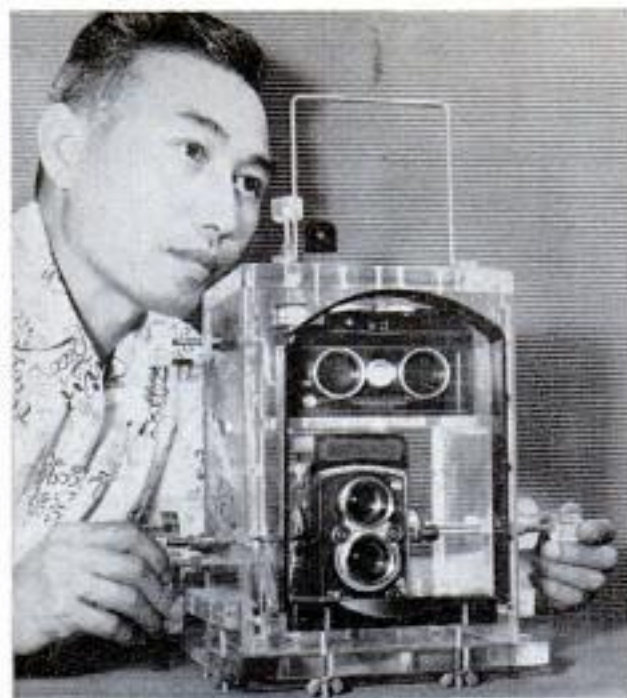

Two Cameras in Sealed Case Take Underwater Photographs

Two cameras—one conventional and one stereo—are contained in a transparent, waterproof Plexiglas case that makes underwater photography possible. The undersea explorer lines up the subject with a black sighting piece and aluminum bracket on top of the case. All settings are made with plastic knobs which project from the case. A rubber gasket on the base piece seals the case when wing nuts on the base are tightened, and air pressure inside is increased to six pounds or more with a tire pump that fastens to a valve embedded in the case. The outfit was designed and built by Frank Min of Honolulu for Dr. George W. Cottrell of Portland, Ore. It is ideally suited to the needs of a skin-diving photographer who can snap pictures of varicolored fish and lacy coral.

Salmon-Egg Dispenser Fits on Fishing Rod

Trout fishermen can keep salmon eggs in a container that clips right to the fishing rod. The container weighs only $\frac{1}{2}$ ounce so it does not materially affect the balance of the rod. An adjustable steel clip permits it to be installed on rods of any size. When an angler desires a salmon egg he pushes the dispenser toward the handle and tips the rod. This causes one salmon egg to fall into his fingers. He closes the dispenser by shoving it upward so the hole is covered by the clamp.



Unfolded Golf-Cart Handle Becomes Comfortable Seat

Golfers can rest between shots on a seat that unfolds from a caddy-cart handle. A stainless-steel and aluminum-alloy rod folds down to support the weight of the golfer; another connects to the caddy cart. The seat can also be detached and used as an easily portable chair when watching a tournament, a horse race or when hunting or fishing.

Noisy Padlock

Criminals can't pick the combination of a new stainless-steel padlock by hearing or feeling tumbler clicks. Instead of clicks, a deceptive sound issues from the lock when the combination dial is turned, frustrating the "feeler" system of lock picking.

Pressurized Gasoline Can Mounts Vanishing Hose

No funnel is needed with a five-gallon, plastic-lined gasoline can that pours through a retractable six-foot length of hose. A built-in aluminum air pump provides one or two pounds of air pressure to force out gasoline—the can does not need to be tilted. The hose, fed through a squeegee gasket, cleans and dries itself as it is pulled out or pushed back. The gasket also releases air if there is too much pressure inside. A push-button vent makes it easy to release overpressure and control the flow of gasoline by regulating the air pressure inside the can. Owners of outboard motors find the can fills their needs.

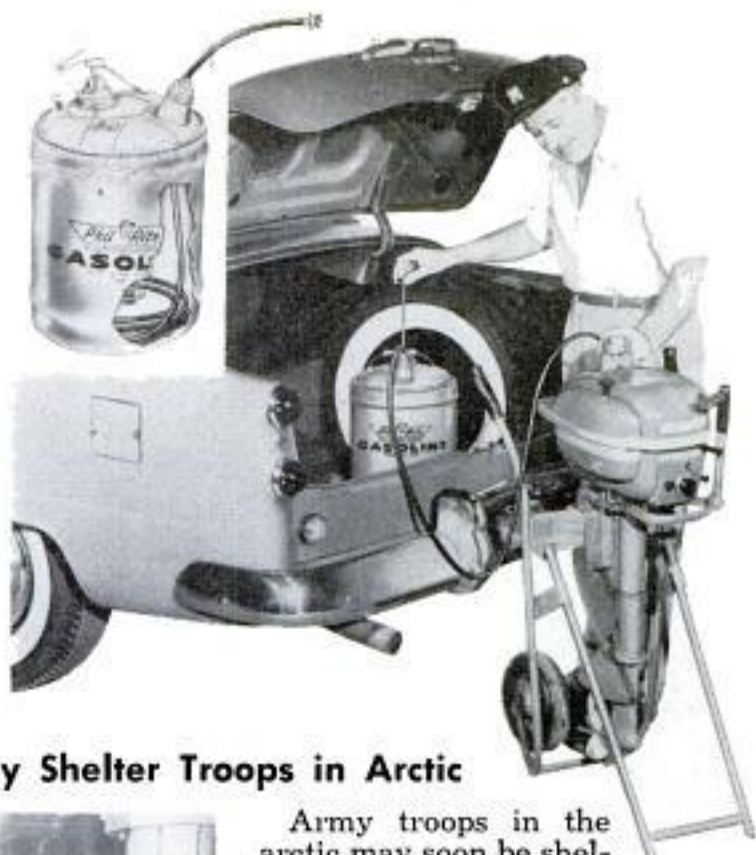

Tent Made of Fiberboard May Shelter Troops in Arctic

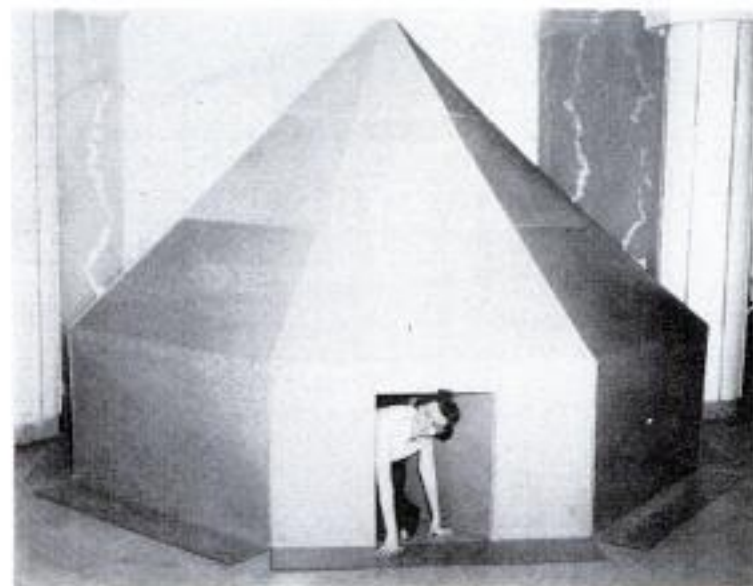

Army troops in the arctic may soon be sheltered in tents made of fiberboard—the same material from which corrugated boxes are made. The tent, 12 feet in diameter, is stapled together in sections and requires no ropes or pegs. The fiberboard is water resistant and the tent is designed as an expendable item. Accommodating 10 men, the tent is said to cost about half as much as a canvas tent and is warmer. A special "igloo" door, so small that a person must enter it on his hands and knees, is cut into one section of the tent. The fiberboard shelter is now undergoing extensive field trials.

Portable Earth Borer Works by Vibration

No soil is removed by a portable earth borer that presses a hole into the ground with a vibrating head. A five-horsepower gasoline engine mounted on wheels connects to a flexible shaft that drives the tapered vibrator head. The powerful throbbing motion produced sinks the head into the earth. A hole two inches in diameter and two to three feet deep is bored in less than a minute. A series of holes drilled around a tree or shrub permits the feeding of fertilizer directly to the roots, without waste or delay.





Engineers check valve noise in an Oldsmobile Rocket engine, an overhead-valve V8 first introduced in 1949

GOOD-BY TO THE IN-LINE FLAT HEAD

By Roger Huntington
Member, Society of Automotive Engineers

REMEMBER THE OLD DAYS—only 10 or 15 years ago—when a long straight-8 engine was the last word in road power? The longer the block and the longer the stroke, the better we liked it. That was the day of long-hooded Buicks, Packards, Studebakers, Chryslers and Hudsons. There were V-engines then, but only a dreamer would have predicted that the V would displace the in-line layout.

So what happened? Today the straight-8 is as dead as the rumble seat. The compact V8 layout has taken over. Only Packard and Pontiac are holding out in 1954 and both would have V8s today if tooling programs hadn't fouled up unexpectedly. Even the in-line 6 is losing favor: Chevrolet and Plymouth both have V8s coming up in 1955.

The same switch occurred in valve placement. Ten years ago the side-valve or flat-head arrangement was the standard. Today everybody is going to overhead valves. What caused this revolution in engines?

Block Layout

In the first place, the V8 has several important advantages over the in-line with

either 6 or 8 cylinders, regardless of valve system used. It's a temptation in a story of this kind to throw the book at you at once and imply that all factors are of equal importance. But this is an engineering matter and we won't do it that way.

There is really only one basic—and not very glamorous—reason why you probably have a V8 engine under the hood of your 1954 car. (By the way, in 1953 for the first time in history eights outsold sixes.)

Here is the reason: When a manufacturer plans a new engine he has to figure on the design being adequate for about 10 years with no major changes. Only in this way can he absorb his tooling costs without cutting into profits or raising the price of the car. (Tooling costs for a new engine these days are about \$60,000,000!) Any new design must allow for anticipated conditions in 1960 and after. The trends are so clear today that we know just about what we'll need a decade from now. Within less than 10 years we should see 100-octane pump gasoline, 12:1 compression ratios and engine speeds well over 5000 revolutions per minute. Let's see what there is about

the V8 that makes it inevitable under these conditions.

Whip and vibration in the crankshaft are the real problem. Under the pounding of very high cylinder pressure (such as you get with a 10 or 12:1 compression ratio) and especially when operating over a wide speed range, a crankshaft will act almost like taffy. Each time a cylinder fires, the crankshaft bends a little downward and each torque impulse twists it. When it springs back after each deflection, it has in it the makings of a nasty case of synchronous vibration. The results: An annoying pounding in the car, fast bearing wear and maybe a broken crank.

The only way this vibration can be prevented is with a short, stiff crankshaft and a main bearing between each throw. And that's why we have the V8. The short crank is the key.

The short stroke is a big help, too. It permits the crank journals to overlap and that means a very stiff shaft. The V8 layout just overflows with rigidity. (Ford has even come up with a new twist by extending the crankcase down below the crank center line and getting 240 degrees of web support around the main bearings.) The short stroke also permits short, stiff connecting rods. Short rods, overlapping journals on a crankshaft only about 25 inches long, and five main bearings—all add up to the answer to the problem of crankshaft whip.

And there are other advantages. The short over-all length of the engine fits in well with current styling trends toward short hoods and more seating room inside the wheelbase. The new V8 engines weigh much less per cubic inch than old in-line types, so the car weight balance can be controlled. The

INTAKE

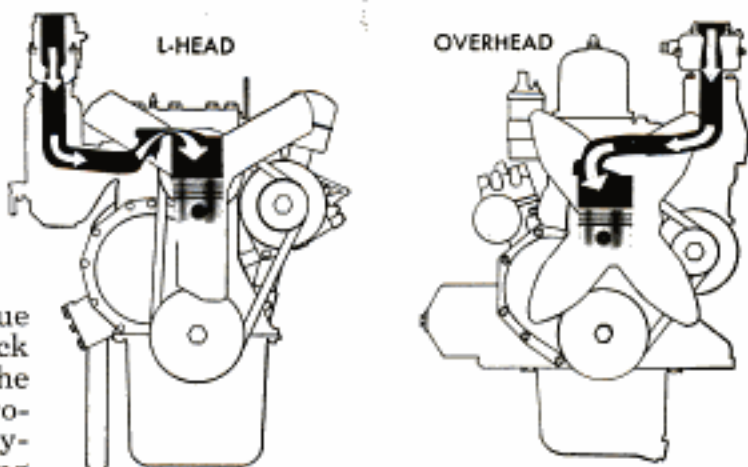

Overhead valves, right, permit unrestricted passage of fuel-air mixture into the cylinders. Flat-head design, left, has sharply restricted point where arrow narrows as mixture goes up through valves and into cylinders

CRANKSHAFT LENGTH



STRAIGHT 8



As the crankshaft gets shorter, it gets stiffer and that means better performance under high compression. The advantages of the V8 crankshaft become apparent in this comparison with a crankshaft from a straight-8 engine

Among V8 designs differences in crankshaft throw affect stiffness. Bottom crankshaft is from the long-stroke 1953 Ford V8. It has less overlap, thus less stiffness, than the crankshaft from the 1954 Ford V8 with shorter stroke

SHORT STROKE

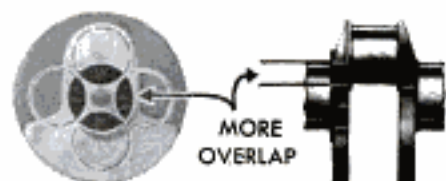

LONG STROKE

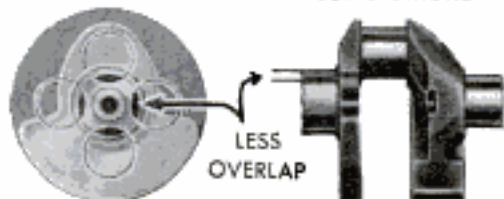

CRANKSHAFT THROW

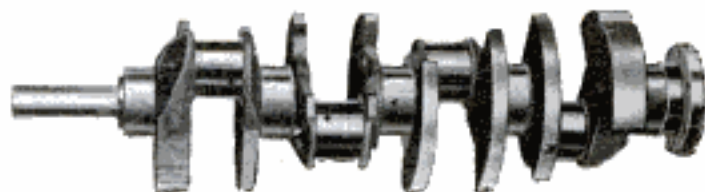

VALVE DIAMETERS

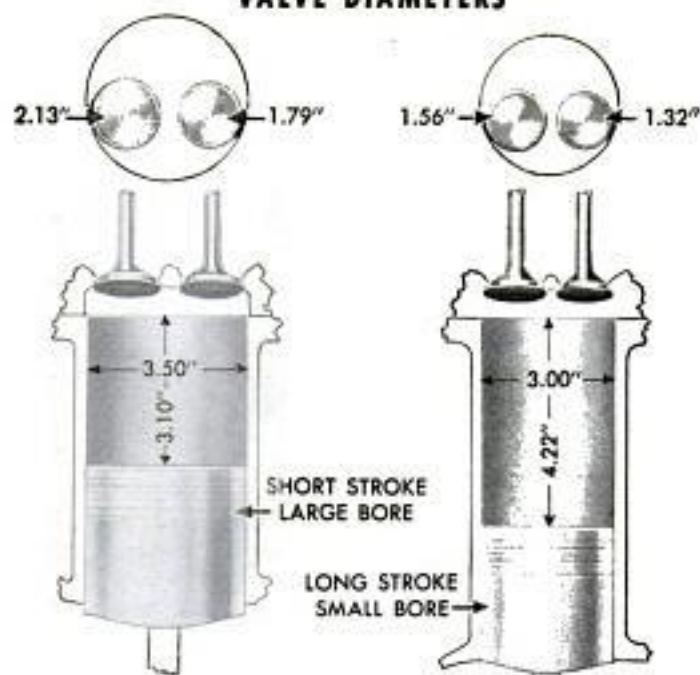

Short stroke and large bore of overhead-valve design provides room for bigger valves which make better breathing

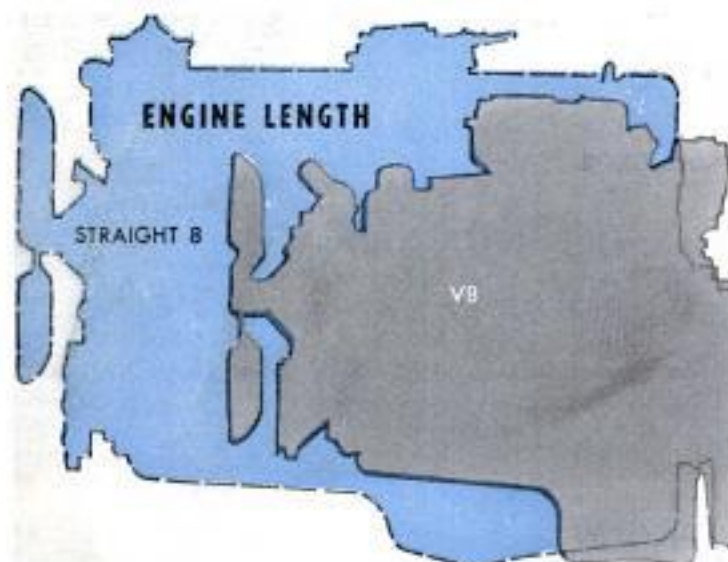

Above, V8 takes less space as diagram shows. Below, short-stroke connecting rods have much more rigidity

CONNECTING RODS



compact, square intake-manifold layout is very important: Short tubes of almost equal length distribute the fuel-air mixture more evenly to all cylinders, resulting in better performance and gas mileage. Contrast this with the long, narrow manifold on a straight 8!

But reduced friction is probably the most valuable bonus of our new V8s. At any given speed the friction loss in an engine is about proportional to piston speed. At a steady 60 miles per hour in the average car you could save up to 10 cents per hour on gasoline merely by increasing the bore and shortening the stroke an inch or so. All our new V8s feature an "oversquare" stroke-to-bore ratio—that is, the bore is larger than the stroke length. The shorter the stroke, the slower the piston speed for a given number of impulses.

Valve Layout

How about valves? How come flat heads yesterday and suddenly overheads today?

Again the answer is tied up with tomorrow's requirements. High-compression, high-output engines demand overhead valves. If you've ever tried to soup up a flat or L-head engine, you've hit this wall head-on: When you raise compression on a side-valve engine above about 8.5:1, the volume of the combustion space gets so small that there is a severe air-flow restriction across the block between the valves and cylinder. The engine can no longer breathe properly and power falls off despite the higher compression. Careful design can help—such as Hudson's relieving of the block face in 1954 models—but

you could never use 12:1 compression with normal side valves and get any performance worth talking about.

Overhead valves have no such limitation. They've been used at 20:1 compressions with good results. And they breathe a lot better anyway. The straight path from the valve port down into the cylinder cavity offers little resistance to the flow of fuel, and the breathing, both intake and exhaust, is deep and full.

A secondary consideration here is combustion control. Overhead valves allow closer control of combustion-chamber shapes. By scientifically designing this shape and by placing the spark plug in precisely the right position, engineers can often use higher compression ratios on a given fuel octane without knock.

(Continued to page 224)

Precut Packaged Fence Allows You to Build Variety of Patterns

Busy homeowners can assemble a precut packaged fence quickly and in a variety of designs. The new fencing material is of cedar cut to a triangular shape. Each package contains all parts needed for an eight-foot length of fence four feet high. Two basic fencing designs are available, a Chippendale and a picket. By simply rearranging the parts or just eliminating the small crosspieces of the Chippendale, rail and grid fences of various designs are obtained. Extra pickets and rails are available for fencing six or eight feet high. A solid panel is obtained by using reverse rails and pickets.



Each package of fencing contains all parts needed for an eight-foot length of fence four feet high. Below, fence installed

Scientist Takes Pulse Of Earth Daily

Every day geophysicist John Pettit measures the rise and fall of the earth, which "pulsates like a living heart," according to the U.C.L.A. scientist. The pulsations are caused by the gravitational pull of the sun and moon upon the elastic earth. A steady rise and fall of the earth—measuring up to two feet—follows the line of attraction of the sun and moon as the earth rotates. Pettit keeps tab by measuring changes in the force of gravity.

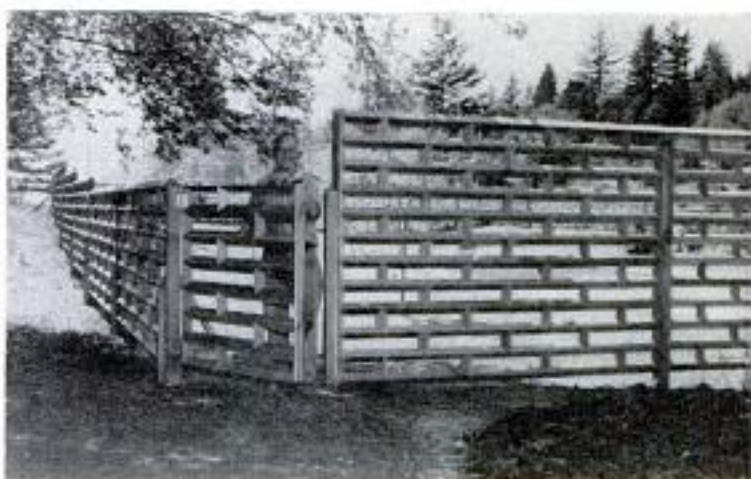

Portable Barbecue Oven With Heat Controls Holds 15 Steaks



You can barbecue a whole pig, six chickens or 15 steaks in a portable oven said to be similar in principle to the barbecue ovens of the South Seas. Insulated construction prevents heat dissipation and permits use on lawns. A 150 to 600-degree cooking thermometer is included, together with a guide dial which tells the proper cooking temperatures of different kinds of meat. A sliding stove-section door controls intensity of the fire, while a shuttered damper at the oven chimney peak provides accurate draft control. Hardwood, charcoal or briquettes serve as fuel. Ashes are easily removed from a sliding firebox and fat drips into a removable trap. Barbecue hooks and a meat retriever are standard equipment.

High-quality fertilizers are made from phosphate rock and waste carbon dioxide through a recent economical process developed by four chemical engineers of the Tennessee Valley Authority.

Road-Patching Outfit Heats Mix and Dries Hole at Same Time

Small holes in oil pavement can be repaired during wet or snowy weather with a two-wheeled patching outfit that heats the mix and dries out the hole simultaneously. The boxlike machine has a gas burner on its underside and its flame is deflected into the hole, burning it completely dry. The heat from the flame also softens the patch mix, which is stirred on a metal shelf above the burner. The gas for the burner is provided by a pressure tank.



Ultrabright Picture Tube for Radar May Be Used in Television Sets

Halftone pictures bright enough to be viewed in brilliant daylight can be retained for several minutes on a new RCA electron tube. It was designed for direct daylight viewing of radar displays in an airplane cockpit or on the bridge of a ship. Now the relatively dim images on radar screens

must be hooded to be observed and even then the viewer may have to wait several minutes before his eyes adjust to the dim light. Other uses for the tubes would be in airborne facsimile systems, oscilloscopes and telemetry. RCA believes similar tubes might be of value in television.

Floral Ferris Wheel Made From Pipe Puts Petunias on Display



Petunias ride a Ferris wheel at the T. A. Sears home near North Little Rock, Ark. Eight cradles of blazing flowers are suspended from a frame of one-inch piping that actually rotates. The stand, which is 20 feet high, was made of old pipe that was welded together and then painted white.

Recorded Bird Shrieks Free Towns of Starlings

Sound trucks broadcasting starling "distress calls" have cleared two Pennsylvania towns of bothersome birds. Pennsylvania State University scientists Hubert Frings and Joseph Jumber tape-recorded the shrieks of captured birds when they were held and shaken. Sound trucks broadcast the recorded calls under individual trees for about 30 minutes before and after sunset. After several nights of shrieking, the trees were free of starlings. Fewer than 100 birds remained in the small town of Millheim, Pa., after only three nights of treatment.

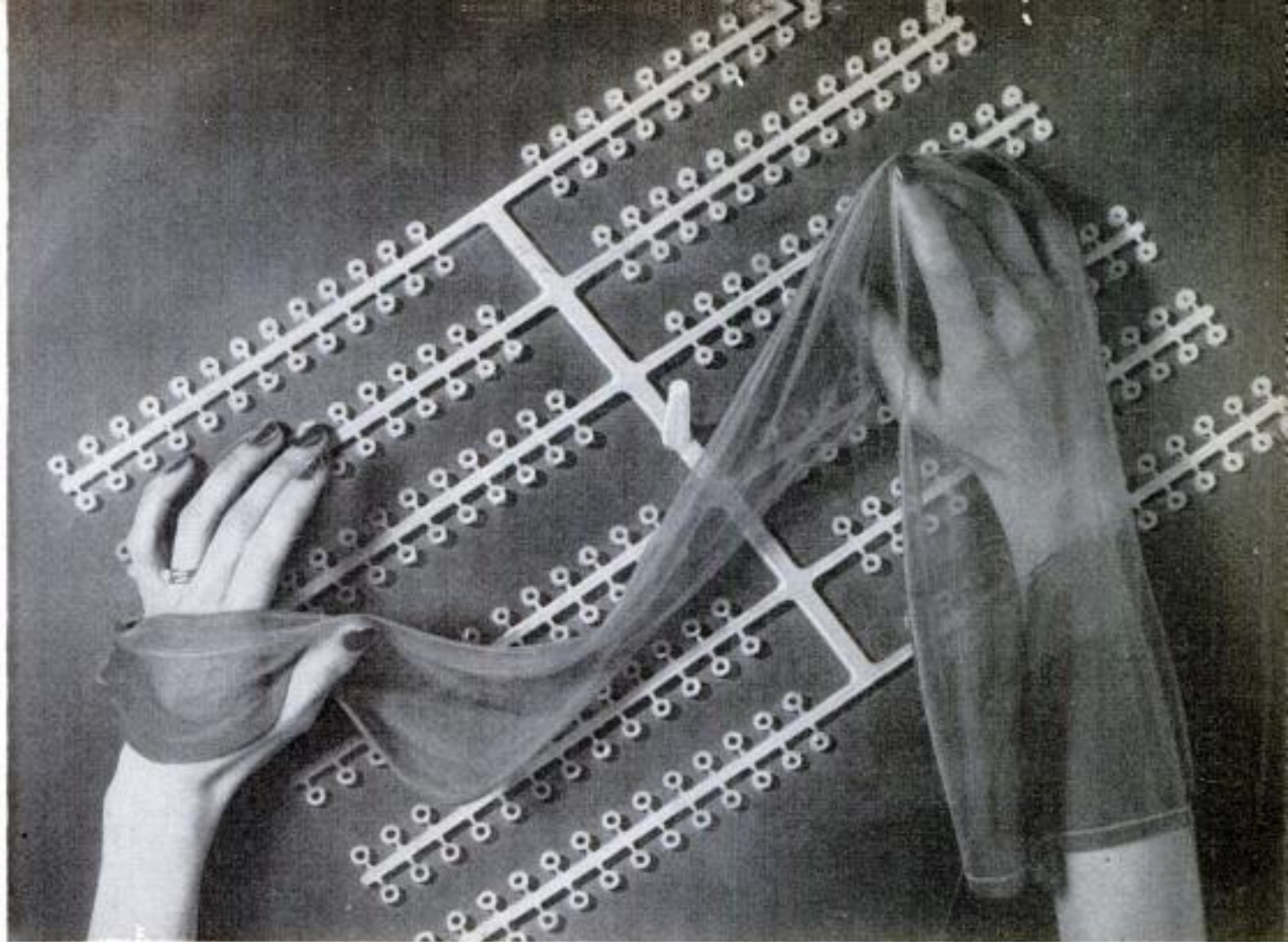

Sheer hose and plastic bearings are both nylon. Single mold, before it is broken apart, includes 312 bearings

Remember when nylon meant wartime queues lined up for scarce hosiery? Nylon means many things today—brushes and gears and egg beaters. Let's look at this amazing plastic once more as

NYLON REACHES SWEET SIXTEEN

By Robert E. Paquin

NYLON, A COMMONPLACE WORD today, is just 16 years old, yet to many it seems as if it has always been here. For only 14 years it has adorned feminine legs, but today this tough, durable chemical has invaded a variety of industries. Molded-nylon components now go into everything from egg beaters to motorcars. Nylon's amazing toughness and resistance to wear, even when lubrication is nonexistent, have made it a first-class engineering material. New uses for the versatile plastic are being found daily.

In the automotive industry nylon is used in distributor, speedometer and windshield-wiper gears, small bearings, cams and clutch and brake-pedal bushings.

The interior lamps of many cars have lenses molded of .025-inch-thick nylon. The inherent toughness of nylon enables

the thin lenses to withstand rough treatment both in assembly and service. Nylon resists the heat of the lamp and will not turn yellow with age.

One manufacturer adopted nylon for the speedometer take-off gear. The material is molded directly on the gear shaft in one operation, as compared to five separate production operations formerly required. This resulted in a 50-percent reduction in cost and improved performance.

Nylon has entered the home in the form of tough, easily sterilized combs, brush backs, tumblers, nursing-bottle funnels and kitchen utensils. Nylon rollers and slides for kitchen cabinets and stove drawers will operate for the life of the equipment with no lubrication. An added advantage is their smooth, silent operation. Nylon buttons and zippers won't break, are colorful

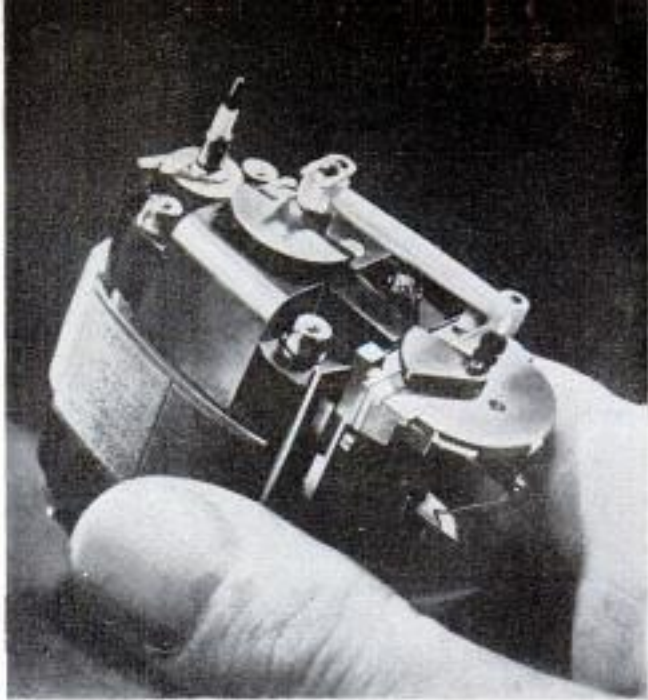
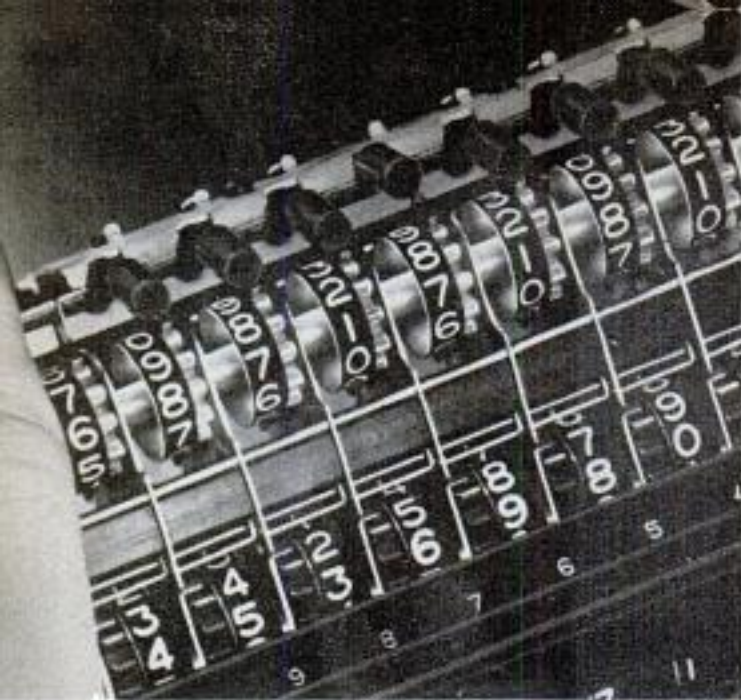

Counting dials of calculating machine, above, left, are molded of nylon. Cost of manufacture is reduced and quieter, smoother operation of dials results



All-nylon connecting rod is a key part of the high-speed electric shaver, above. It absorbs vibration, needs little lubrication and gives long service

Battery case and other parts of miner's lamp at left are molded of nylon for light weight, toughness and insulation. New uses are constantly being found

Speedometer take-off gear, lower left, made of tough nylon, is molded directly to the shaft. Four steps of production are eliminated, performance is improved

Blood-donor and receiver needles have nylon shanks molded around them. Sixteen needles are encased in one operation. Medical uses of nylon are increasing

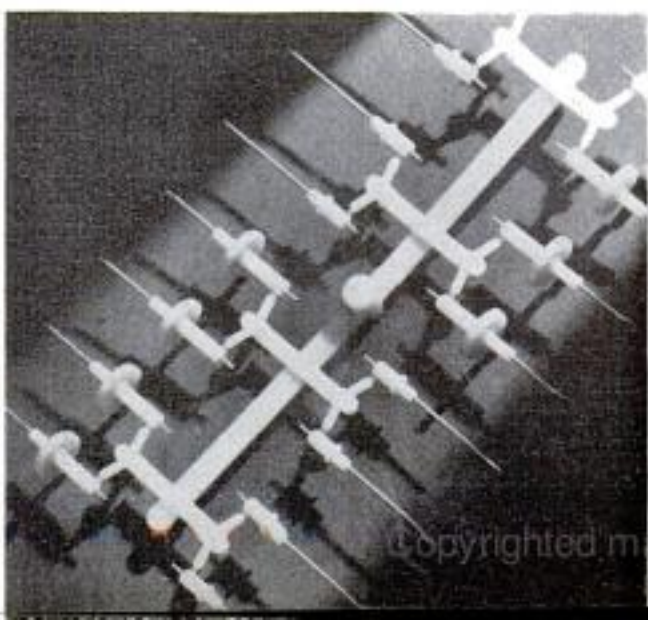
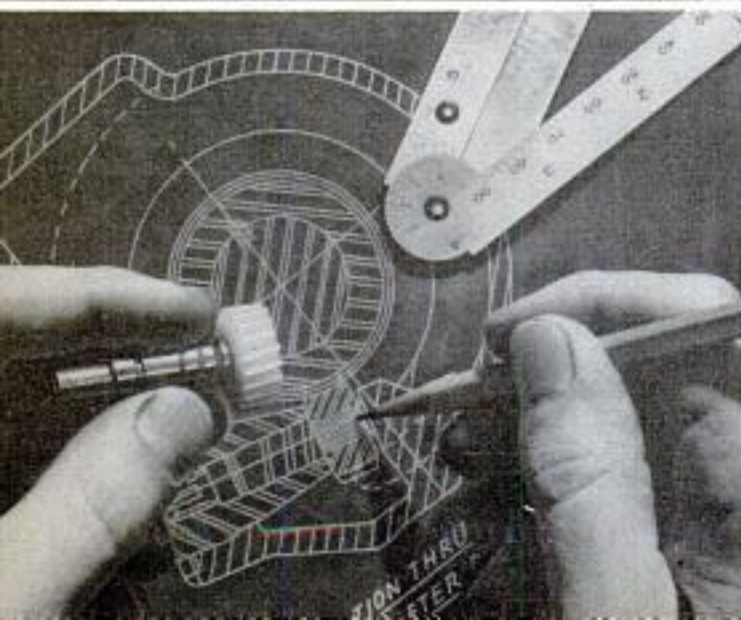

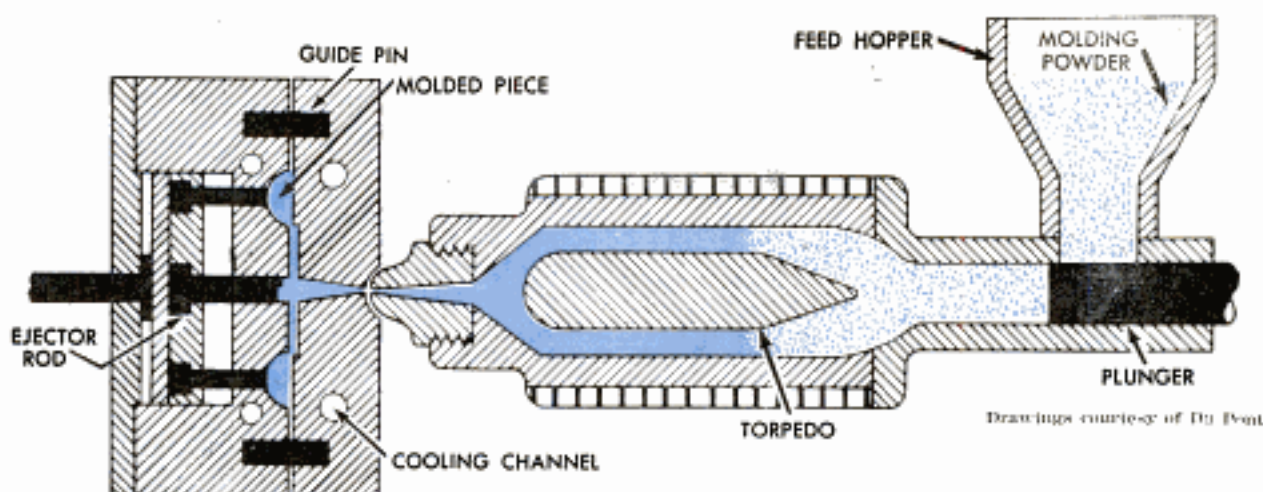

Heat and pressure in torpedo chamber of injection-molding machine cause nylon to flow into the mold cavity

and resist dry-cleaning solvents and ironing temperatures. Mixing-machine gears, washing-machine and fan parts, refrigerator-door rollers, cutlery handles, rollers and slides for windows and draperies—all these now contain nylon.

In an electric shaver, a durable nylon connecting rod transmits power from the motor shaft to the cutter blade. The connecting rod reciprocates at speeds of 15,000 to 17,000 half-cycles per minute with almost no lubrication. Nylon's ability to absorb vibration makes it ideal for many such high-speed applications.

High-quality egg beaters are provided with nylon gears which last 20 times longer than the metal gears previously used. The nylon gears operate more silently and efficiently and are not affected by salad oils and food acids. No lubrication is used.

Designed for both industrial applications and in the home workshop, a metalworker's hammer with resilient nylon faces will not mar the softest metal. In actual tests, made by pounding the nylon faces with sharp objects, it lasted 24 times longer than the next-best material tested.

Designers of business machines have turned to tough but attractive nylon for their difficult parts. One calculating machine features nylon dials, ratchets and cams. An intricate cam, now molded in a single operation, formerly required 20 production steps for its manufacture. Smoother

operation and elimination of the need for lubrication point to more and more business-equipment parts made of nylon. For example, a manufacturer of filing cabinets now equips them with noise-reducing nylon rollers.

Medical uses include hypodermic-needle parts, surgeon's scrub brushes, inspiratory valves and components for blood-transfusion apparatus. Nylon's physiological inertness and its ability to undergo repeated sterilization in a steam autoclave make it an ideal material for these and numerous other surgical and medicinal uses.

One class of aircraft uses 16 miles of nylon-covered cables and wires in each plane. The nylon covering protects the wires from gasoline and oil and resists abrasion. It also affords protection against fungi and heat. Because of nylon's toughness and wear resistance, thinner, lightweight coatings can be used.

Other aircraft uses for nylon include grommets, wire connectors, switch components, self-locking nuts, insulated tools and mechanical parts.

In hydraulic equipment, the plastic has been found to be perfect for valve seats, as its resiliency allows it to form a tight seal even where slight irregularities in the mating surfaces exist. Look for it in the form of faucet washers in the near future.

Invading the photography field, nylon is now used for gears, cams and bearings for

In wire-coating mill, nylon is extruded around a wire to form a tough, flexible, lightweight coating

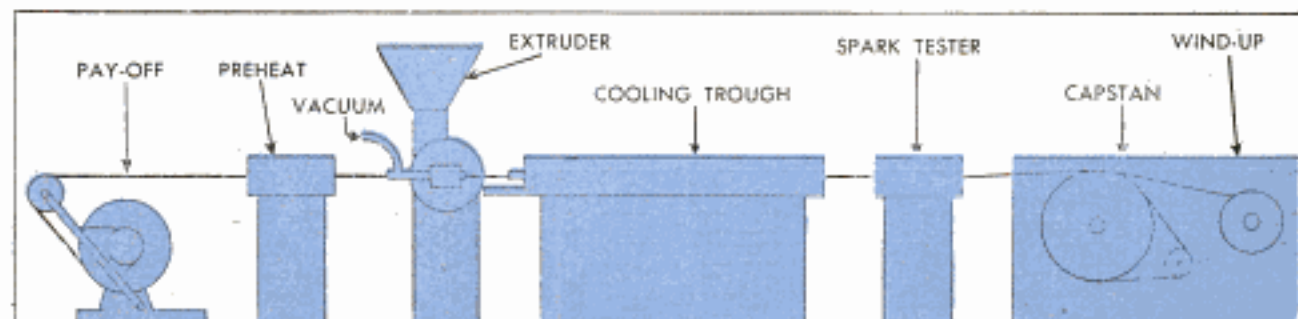

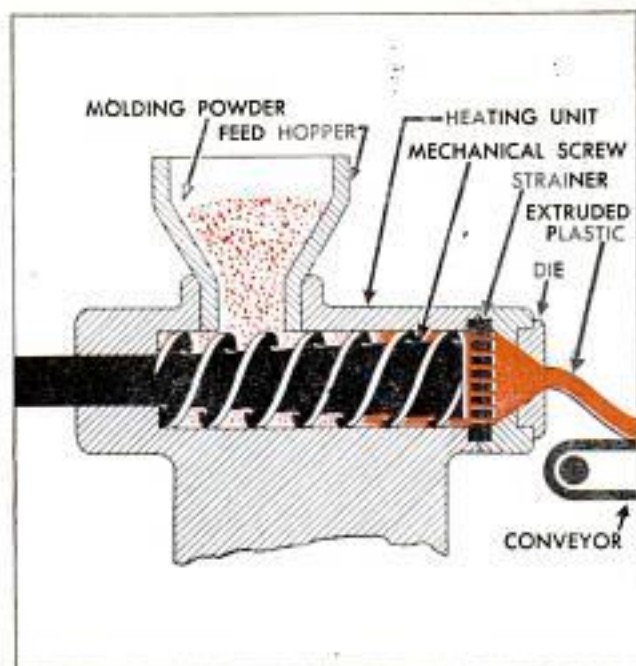

In extruding, nylon powder is plasticized by heat and pressure, squeezed through die like toothpaste



Nylon faces on metalworking hammer have impact resistance, won't chip, mushroom or harm soft metals

cameras and projectors, where its cushioning action and freedom from lubrication problems make it a welcome new material.

Nylon is not a trademark. It is the generic name for a group of compounds of polyamide resins which are related, but not identical, in chemical composition. Since it is a thermoplastic, articles molded from it can be reheated and reshaped numerous times without injury to the plastic. Thermosetting plastics, the other major type, cannot be resoftened.

Nylon was first synthesized by Du Pont chemists in the early 1930s, and research continued until its first introduction to the general public in 1938 in the form of toothbrush bristles. Its nationwide debut in women's hosiery came in 1940 and met with prompt and overwhelming success.

Nylon molding powders were introduced to the plastics industry in 1941. Constant research and development since that time has brought forth the host of present-day applications. FM-10001 nylon is the most widely used type for injection molding. The most heat-resistant member of the nylon family, it is particularly suited for gears, cams and bearings.

The most flexible nylon material is the FM-8001, which until recently could not be molded or extruded by conventional processes. These limitations have now been eliminated with the development of an improved molding powder which can be processed by any of the common techniques.

When used indoors under normal conditions, nylon undergoes no appreciable change in long service. It does not deteriorate, nor is it subject to attack by fungi, rodents or insects. Exposed to direct flame,

nylon will burn slowly, but it is self-extinguishing upon removal of the flame.

The color of articles molded from the various grades of nylon ranges from cream to light amber. Some types are translucent in thin sections. FM-6501 nylon can be made transparent by extruding the plastic directly into cold water.

A wide range of colors can be molded into some types of nylon. Solid parts can also be dyed by immersing the article in a boiling-water solution of the same dyes used for coloring nylon fabrics. Colors obtained by this method are resistant to boiling water and hot, soapy water.

Combining as it does a host of valuable properties, the future of nylon as an engineering material seems assured. There is little reason to doubt that hundreds of new uses will be discovered for this amazing plastic. ★ ★ ★

Today's Known Oil Reserves Greater Than Year Ago

Known reserves of gas and oil in the ground are greater now than a year ago, according to the American Petroleum Institute and the American Gas Association. At the end of 1953 the proved reserves of liquid hydrocarbons were 34,382,750,000 barrels compared with 32,957,205,000 barrels in 1952. A barrel is equal to 42 gallons. Reserves of natural gas were 211,447 billions of cubic feet at the end of 1953 compared with 199,716 billions of cubic feet a year earlier. Production is also up. Last year 2,614,554,000 barrels of liquid hydrocarbons and 9328 billions of cubic feet of natural gas were produced.



Sports Clothes Made of Treated Cloth Serve as Life Preservers

Wading boots and fishing vests made of a treated cloth not only are waterproof but serve as life preservers to support the wearer in the water. The cloth, imported from England, permits the passage of air but keeps out water. All the fibers running in one direction are waterproofed but

those at right angles are left untreated. When the cloth gets wet the untreated fibers swell to close the holes around them. In the boots and fishing vests, pads of Dacron covered with the waterproof cloth are sewn at various spots. The pads are buoyant enough to support the wearer.

Dispatcher 200 Miles Away Lights Burners Under Railroad Tracks

Gas burners under railroad tracks in the snowy Cascade Mountains of southern Oregon can now be ignited by flipping a switch in an office more than 200 miles away. The burners, supplied with propane

gas, are used to thaw track switches along the Southern Pacific line. Newly installed equipment enables the train dispatcher at Dunsuir, Calif., to keep switches free of ice along the distant 62-mile stretch.

Attachments Convert Lawn Mower Into Mobile Home Workshop

With a new lawn mower and its attachments you can cut grass, trim hedges, edge sidewalks and polish your car as well as sand, grind, drill and buff in your home workshop. The owner installs his own electric motor or gasoline engine on the rotary mower, which has an 18-inch blade. The key attachment is a 50-inch flexible shaft which fastens to the top of the mower's cutter-blade shaft. The hedge clipper and

other accessories are clamped in a chuck on the flexible shaft. The sidewalk edger is a whirling disk which trims grass neatly away from the edge of the walk. To use the mower as a portable workshop, the operator clamps the head of the flexible shaft in a workbench vise and installs the sanding drum, twist drills, grinding wheel or polishing pad. The mower moves around while the pad is used to polish the car.





Surplus Life Raft Doubles as Crib

After they've provided sport in the surf, war-surplus one-man life rafts can be turned upside down to make a satisfactory beach bed for babies. The raft's underside is soft and has a slight slope to the center that prevents the baby from rolling off into the sand. Because of the slight elevation, sand blown by surface winds doesn't get into the baby's eyes. The temporary crib allows parents to swim while the baby sleeps.

Discover Oldest Plants

Primitive plant fossils more than two billion years old, believed to be the oldest organisms ever found, have been uncovered on the northern shore of Lake Superior. The plants were blue-green algae and simple forms of fungi, and were taken from flint-rock deposits near Schreiber, Ont., by Prof. Elso Barghoorn of Harvard and Dr. Stanley Tyler of the University of Wisconsin. The age of the earth's crust is estimated at 3,500,000 years.

Multipurpose Plastic

Plastic with the toughness of rubber and the surface hardness of most metals promises to find wide industrial uses. The material, a styrene-type resin, is so shatterproof it can be molded into golf-club heads, so heat-resistant that it can hold boiling water, and so soluble that it can be sprayed in colors on elastic rubber surfaces but won't chip off. It was developed recently by Marbon Corporation, a subsidiary of Borg-Warner.

"Packaged Radioactivity" Treats Tissue and Makes X-Ray Photos

"Pocket size" sources of X rays for use in industry and medicine now are possible. The new method of producing X rays is the result of work at Armour Research Foundation of Illinois Institute of Technology. No bulky electronic equipment is required.

The system uses a small quantity of radioactive material surrounded by a layer of heavy metal. Beta rays, which consist of high-energy electrons from the radioactive core, drive out through the atoms of the metal. Deflection of the electrons produces

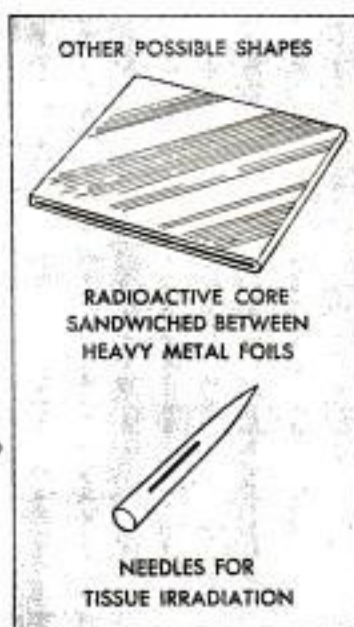
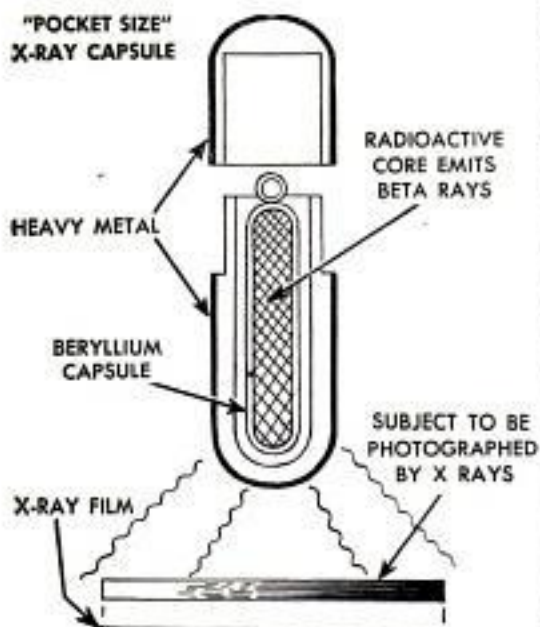

the form of energy known as X rays. The X-ray source can be made in almost any size from a tiny pellet to a large block or sheet. Thus it can be built into a needle for tissue irradiation, a capsule for general use or a flat sheet for taking X-ray photographs. Industry can use the new system for examination of vital parts. For example, the radiation source could be placed inside an airplane wing and X-ray film wrapped around the outside, and produce better pictures than obtained by present methods.



Screen Frame Fits Garden Cart to Break up Lumps in Topsoil

Lumps and clods in topsoil, peat moss and compost are broken up by a new soil sifter that fits a garden cart or wheelbarrow. The sifter is a steel screen mounted in a steel frame. Hooks at one end of the

frame anchor it to the cart or wheelbarrow. The gardener tosses topsoil into the frame, then shakes it with a handle. The handle also can be pivoted down and used as an easel for screening directly onto the ground.

Line Clip Aids Bricklayer

It's easier to lay a perfect brick wall with a metal clip that holds the line true. The clip is fastened to the line, placed atop the wall and weighted with a brickbat. The projecting slot that holds the line borders the top brick edge, maintaining absolute alignment. When supported by clips, the line won't sag or whip in the wind.

Swinging Door for Pets

Mounted in a wall or door, a swinging panel permits cats or dogs to enter or leave the house without any help. A four-way lock can be set to permit entrance only, exit only, entrance and exit, or neither entrance nor exit. The door fits openings 10 by 14 inches and will accommodate dogs up to about 24 inches high at the shoulder.

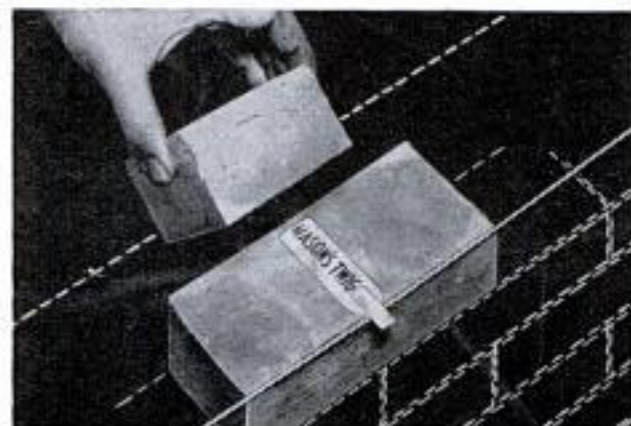

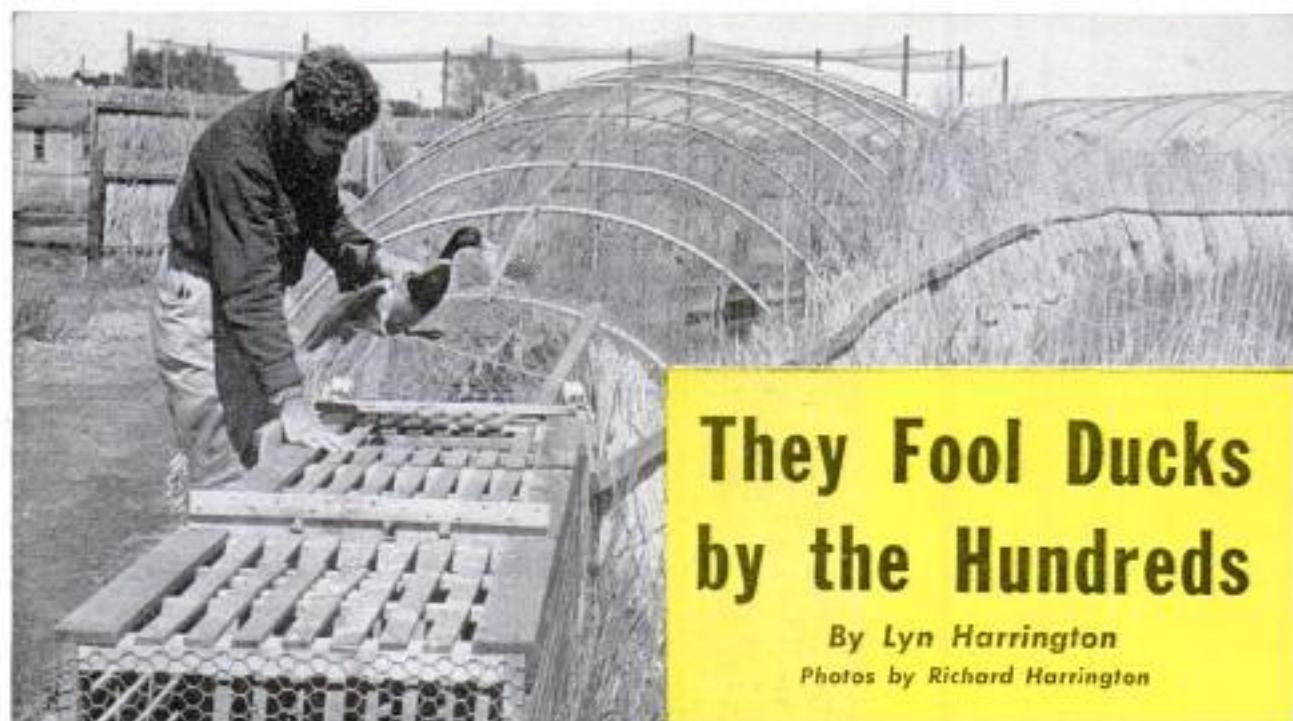

They Fool Ducks by the Hundreds

By Lyn Harrington

Photos by Richard Harrington

Mulder takes a newly caught mallard from the trap in order to band it. Crate door is closed by jerking wire

WILD DUCKS that should know better are trapped like flies in a unique installation on a midwestern Canadian lake. The huge trap is operated by the Delta Waterfowl Research Station, located on Lake Manitoba, fifty miles northwest of Winnipeg.

Delta Station technician Nan Mulder calls it a decoy pipe. It's a permanent semi-circular funnel of netting and reeds opening into a large pond and extending back

over a shallow, waterfilled trench for 50 yards to a holding pen where the birds are trapped and banded.

The station, which is operated by the Wildlife Management Institute and is dedicated to extensive scientific study of waterfowl and wildlife management, traps wild ducks, affixes small Federal-numbered aluminum bands to their legs and then releases them. Hunters who kill these banded birds return the tags to the United States

Wild ducks sun themselves about the open station pond. Later they will be lured into decoy pipe and trapped

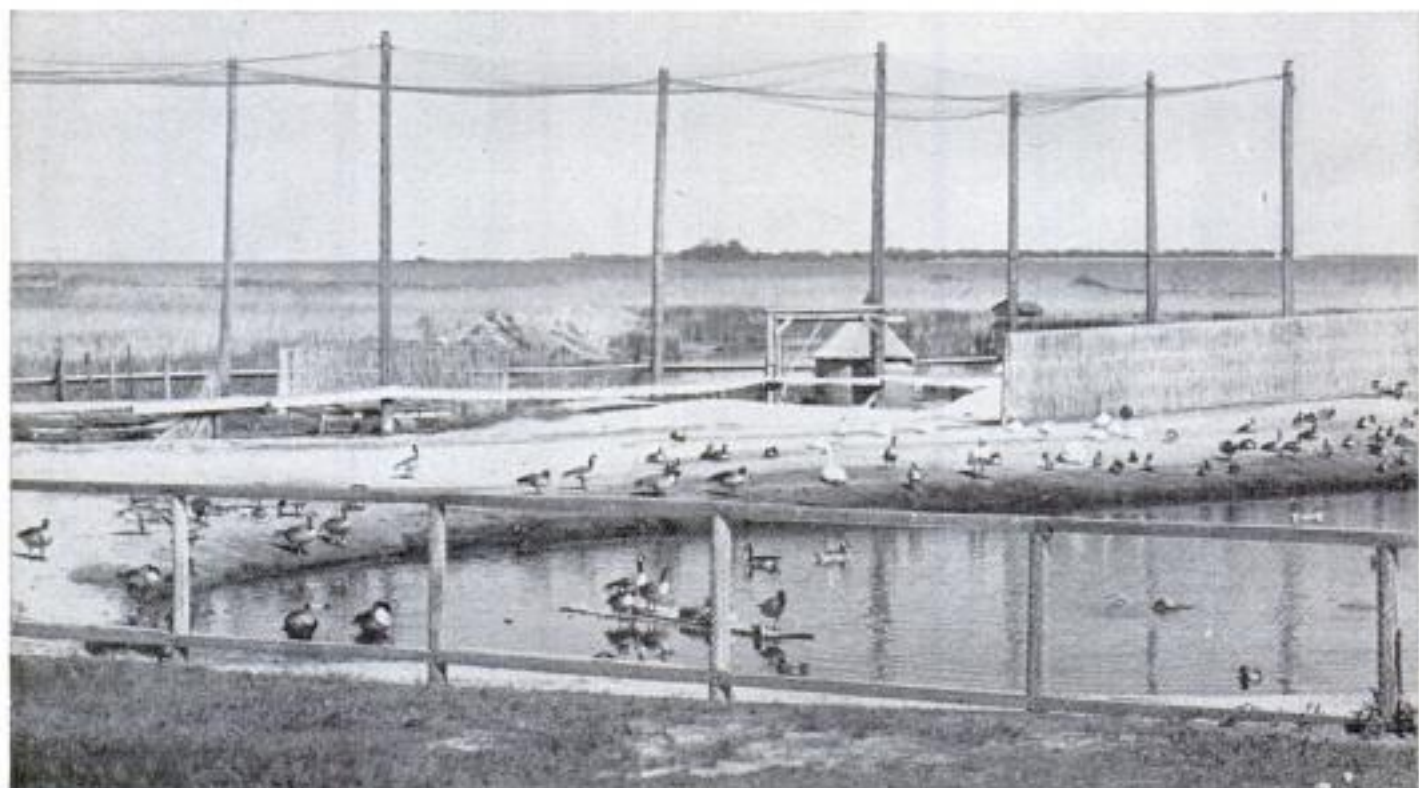

Fish and Wildlife Service in Washington, D. C., where they are carefully tabulated and the flight pattern of migratory waterfowl is determined.

Decoy pens like the one at Delta are common in Holland where ducks are trapped for market. Nan Mulder and his brother operated the 104-year-old decoy pen on their small Dutch farm until Mulder emigrated to Canada and the one spot on the continent where his specialized skills could be used.

The station already had a decoy trap of an English type, but it didn't work well. Mulder rebuilt it to the point where it now traps up to 200 birds a day.

Eventually there will be four decoy pipes in pairs facing each other, to take advantage of all winds. Last year, Ducks Unlimited, an international nonprofit organization composed of sportsmen-conservationists, supplied earth-moving equipment to excavate or dike another mile of the marsh and to dig trenches for two more decoy pipes.

The marsh must be excavated to depths of one to three feet, to accommodate both diving and wading ducks. The decoy is located so that the prevailing winds blow down its



Conservation student observes waterfowl from within a blind made of woven reeds. Station is operated by the Wildlife Management Institute, an organization devoted to scientific study of waterfowl and wildlife management. Work helps conservation in U.S. and Canada

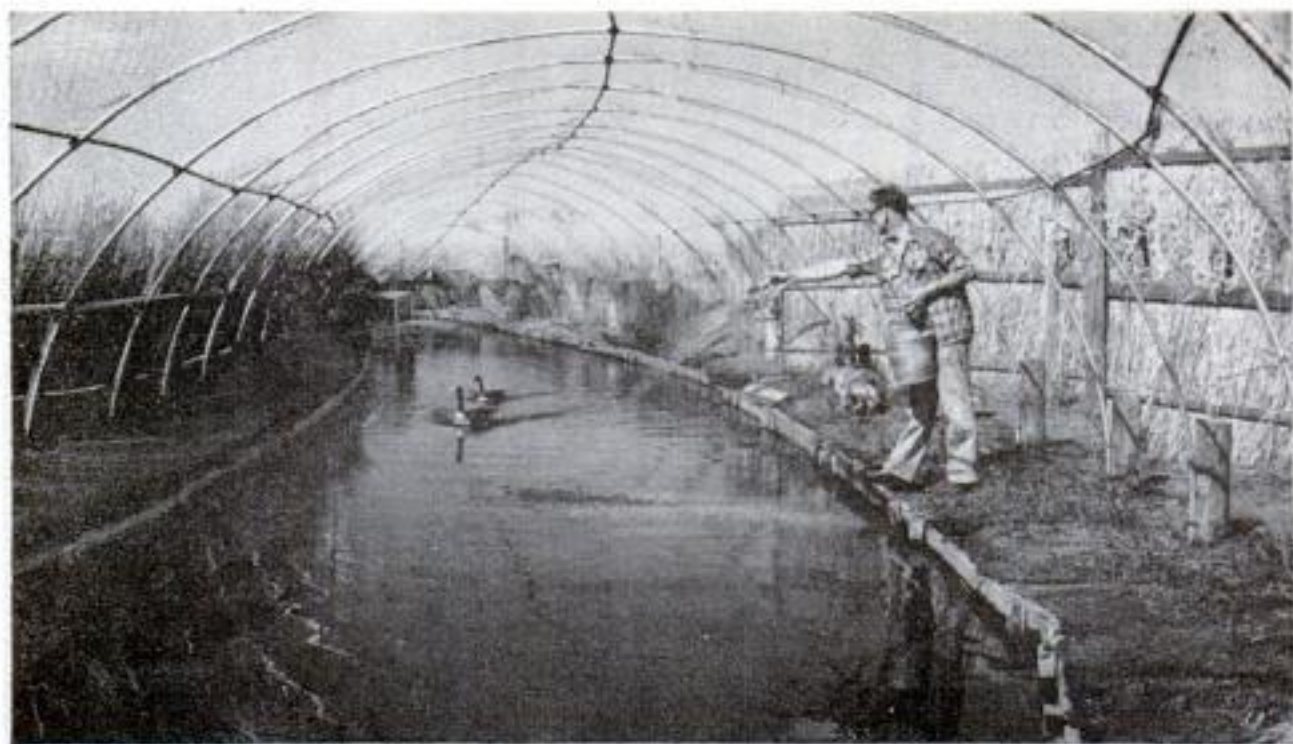

Mulder scatters feed on water to entice more birds into tunnel. They are then chased into crate at far end

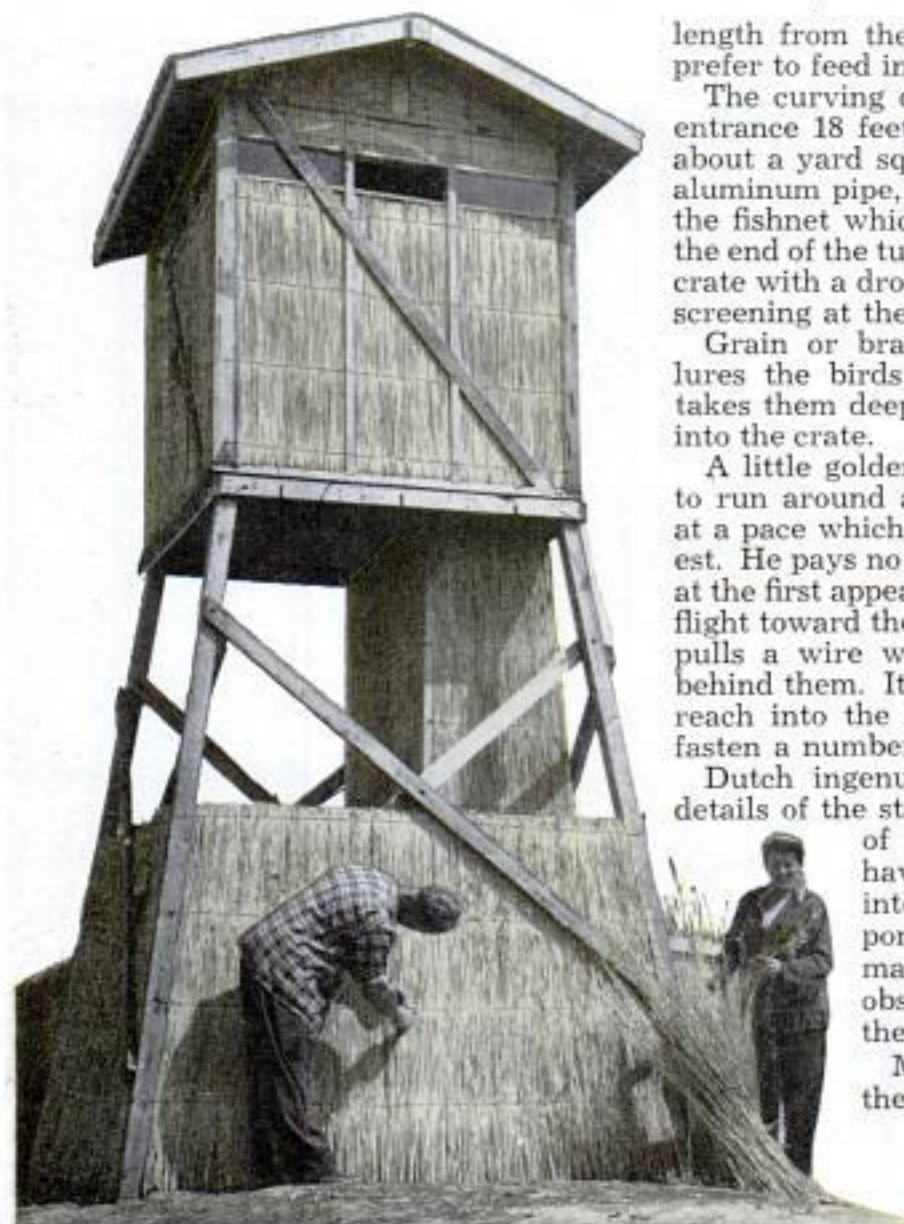

length from the narrow end, since ducks prefer to feed into the wind.

The curving decoy pipe tapers from an entrance 18 feet wide and 15 feet high to about a yard square at the trap. Bows of aluminum pipe, graduated in size, support the fishnet which encloses the tunnel. At the end of the tunnel is an eight-foot slatted crate with a drop door at one end and wire screening at the other.

Grain or bran scattered on the water lures the birds into the decoy, curiosity takes them deeper and alarm drives them into the crate.

A little golden spaniel has been trained to run around a series of slanted screens at a pace which parallels the ducks' interest. He pays no attention to the birds. But at the first appearance of Mulder, they take flight toward the end of the tunnel. Mulder pulls a wire which drops the door shut behind them. It is then a simple matter to reach into the trap, pick out a bird and fasten a numbered band about its leg.

Dutch ingenuity shows itself in many details of the station. The tall dried reeds of the marsh, for example, have been woven into screens, into fencing for the station pond, into duckblinds in the marsh and into a "gazebo," an observation post overlooking the pond.

Mulder brought with him the technique of building

"Gazebo" overlooking pond and marsh is an observation post covered with reed siding

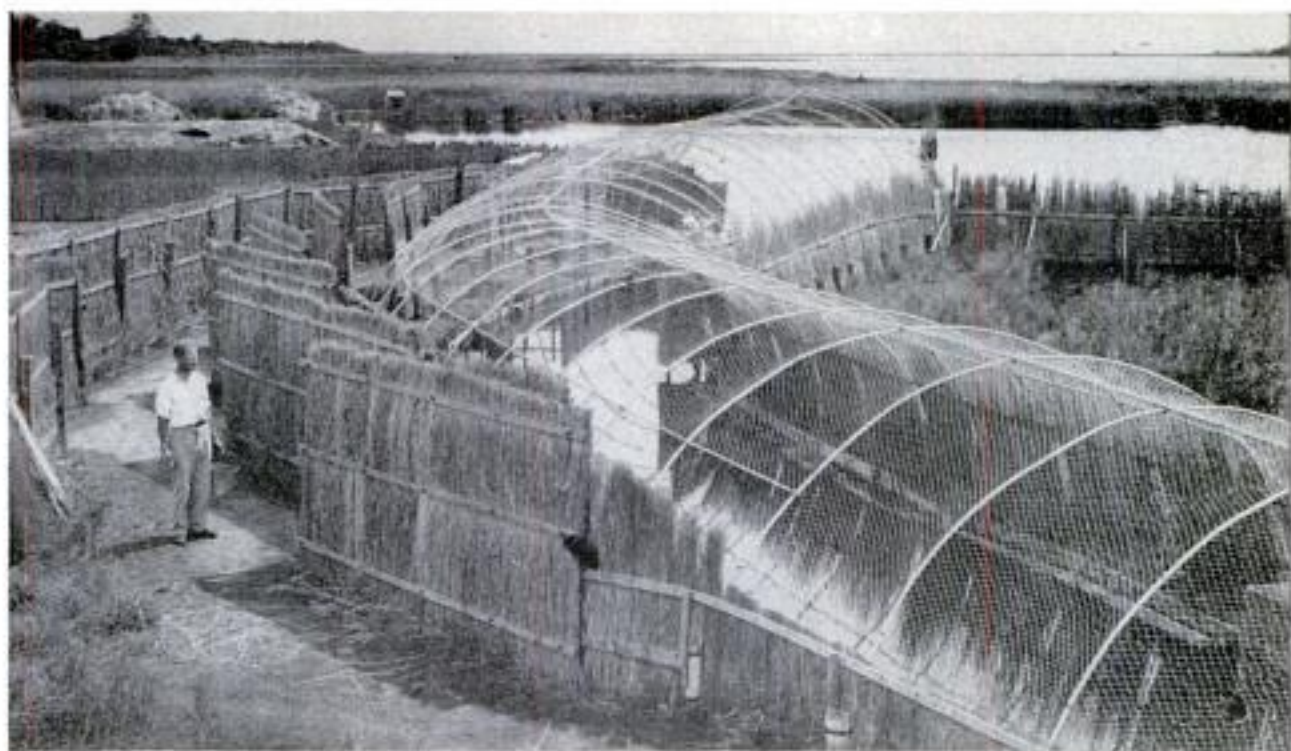

Slanting screens of reed lining sides of decoy pipe are helpful when birds are being shoed into trap

mallard nests, jug-shaped creations of dried marsh grass and galvanized stovepipe wire. In Holland, these are made of straw or willow withes and last four to seven years. Mulder keeps track of his nests and stores them during the winter. It takes Mulder 1½ to 2 hours to complete each nest. Sometimes he makes extra ones and sells them to private-estate owners.

Another way to increase the duck population is to provide more edging. Shoreline, rather than large expanses of water, is the essential ingredient in nesting success. At Delta, a long trench and more ponds were dug to create more shoreline. The ducks pre-empted the new dikes while the dragline was still at work.

The staff is now studying the effects of controlled water levels. The cheapest and simplest way of moving water is by "vyzel," a Dutch spiral pump. The pump, powered by a two-horsepower gasoline engine, has an eight-foot shaft with twin spirals 20 inches in diameter. It moves 40,000 gallons of water per hour, lifting it four feet, and it can't be clogged by duckweed or algae. The vyzel maintains the water level in several goose ponds, in the long trench and in the decoy ponds. Control gates fix the different water levels. ★ ★ ★



Mulder places mallard nest which he has built on stake in station pond. Nests are made of marsh grass and stovepipe wire

"Vyzel," a spiral pump made in Holland, raises water a height of four feet. It is used to maintain levels of goose ponds





Floating Automobile Trailer Cruises Lake Under Own Power

When it's not rolling down the highway, a trailer owned by a West Berlin woman is likely to be found cruising around a lake.

A pontoon raft turns the amphibious trailer into a houseboat. A small gasoline engine propels it when it's in the water.

Tweezers With Battery and Bulb in Handle Furnishes Own Light

Illumination right where it's needed is provided by a tweezers that has a small flashlight in its handle. The bulb is contained in the base of the blades. The instrument is designed for use on industrial assembly lines, in first-aid work and hospitals and in removing unwanted body hair. Made of surgical steel, the tweezers are precision ground after assembly to insure perfect matching. Battery and bulb are easily replaceable. The handle unscrews from the head for such changes.



Experimental Phone Booth Leaves Both Hands Free

There's no receiver to hold and no dial to turn in an experimental telephone booth that leaves both hands free. Installed at Boston's South Station, the soundproof booth has a recessed speaker, a wall-mounted microphone and a volume control that is regulated by the user. The installation can be made only where an attendant is on duty, since there is no coin box or dial in the booth.

Production of gasoline and oil directly from coal begins this summer on a commercial scale in a plant on top of a vast coal field in the Union of South Africa.



Twin-Turborotor Helicopter

Two gas turbines power the twin rotors of a helicopter modified by Kaman Aircraft in an Army-Navy project. The Boeing 502-2 turbines, which together produce 380 horsepower, are mounted side by side in the same location as was the single 240-horsepower piston engine they replaced. Their combined weight is less than that of the single engine that originally powered the HTK-1 Kaman copter. Both turbines are used for vertical take-offs.

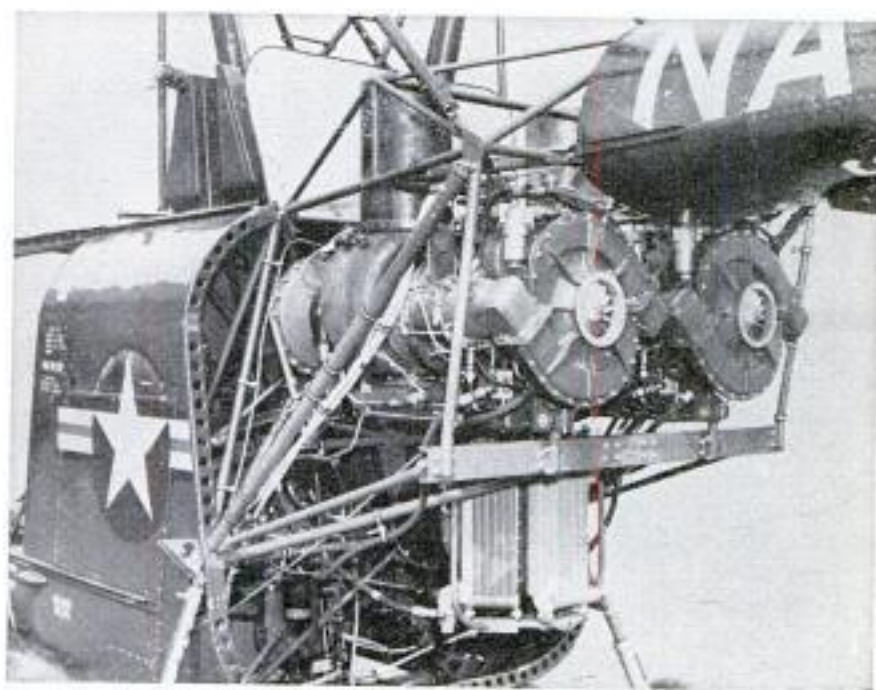

Air-Filled Hoses Are Ribs of Roomy German Sleeping Tent



Compressed air upholds a wide, low sleeping tent made in Germany. The tent is raised by pumping air into built-in hoses placed at intervals in the canvas. This eliminates the use of metal or wooden struts. When morning comes, the user can quickly deflate the tent and fold it into a 16-by-20-inch bundle.

☐ Synthetic detergents topped soap sales in 1953 with 53 percent of the total volume.

BUGS

for Sale

By
George Laycock

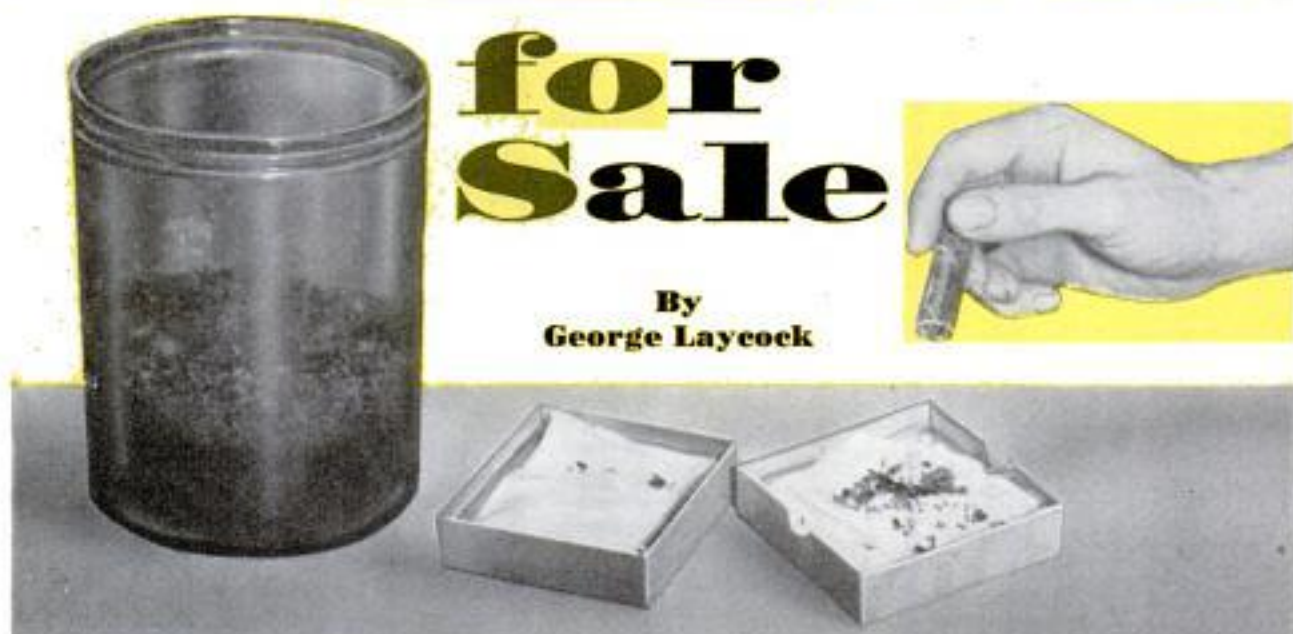
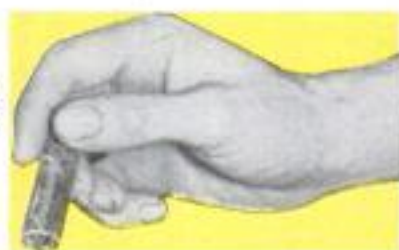

Flies in pupae form are air mailed to customers in small, cotton-lined boxes. Laboratories are eager buyers

ON THE OUTSKIRTS of Wilmington, Ohio, Dr. Frank Hazard makes a good part of his living by carefully raising some 17 species of insects—any one of which would send another person looking for the bug bomb. For the past decade Dr. Hazard has followed his unusual business, one which plays a vital role in the booming chemical-insecticide industry.

This industry, dedicated to the belief that a dead bug is a good one, is constantly coming up with new chemical concoctions for the never-ending war on insects. Then too, they have to run periodic tests to make sure their established insecticides maintain their insect killing powers. It's in testing these products that Dr. Hazard and his bug farm come into the picture. No one has found a better way to test insecticides than to see how many insects they'll kill in carefully controlled tests.

Dr. Hazard, who is also head of the Biology Department at Wilmington College, started raising insects for profit when he tested phosphorus pastes against roaches for a Midwestern company in 1942. It wasn't long until other organizations were asking him to conduct impartial tests with insecticides. Since then his business has grown steadily without benefit of advertising. Today he is kept on a monthly retainer by several large manufacturers of aerosol bombs for insects. In addition to these regular checks on established prod-

ucts he tests new insecticides and even develops new laboratory testing techniques for uncovering the killing power of various insecticides.

A few years ago his growing business forced him to build a new testing laboratory. This house of bugs is a small, one-story white structure on his farm at the edge of town. When he designed the building Dr. Hazard faced a peculiar problem: he had to test insect-killing chemicals in the same building where he was carefully raising valuable colonies of stock for future tests. He did this by erecting an eight-inch concrete-block wall across the middle of the building. There are no windows and no doors in the wall, and each room is entered through an outside door. This protects the growing insects from the death-dealing chemicals in the next room.

The rearing room measures 25 feet square. Adjoining it is a small greenhouse of 225 square feet where Dr. Hazard can rear colonies of agricultural insects on their food plants. The testing room, slightly larger than the rearing room, is equipped with its own heating and ventilating system, another protection for the growing insects.

The rearing room is populated largely by flies, roaches, and clothes moths, kept carefully isolated in jars and cages. There are also such insect pests as carpet beetles, granary weevils and the flour beetle.

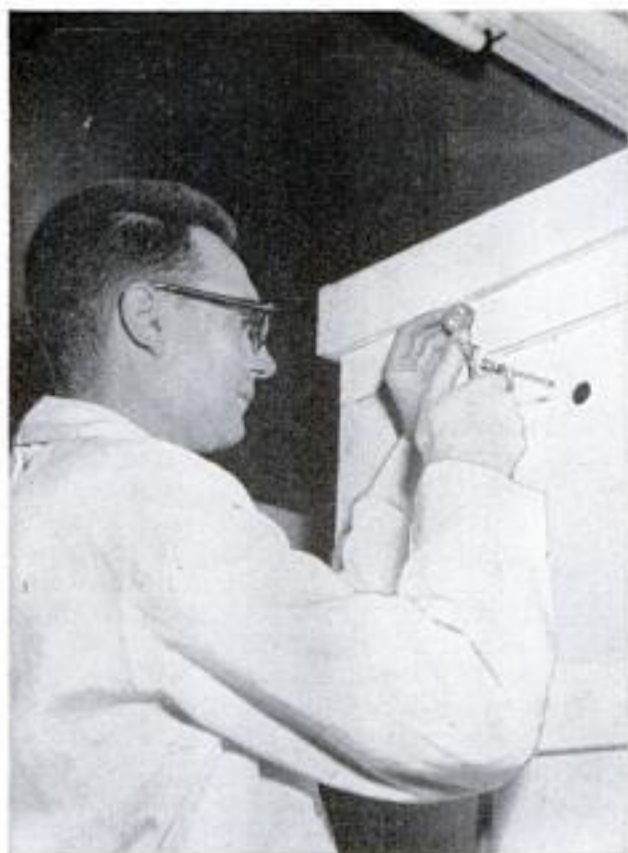

Laboratory assistant sprays a measured amount of insecticide into "death chamber" containing insects



Cage of flies is placed on turntable in test chamber. Table rotates as insecticide is sprayed into the box

The homeowner and the farmer who fight such pests likely consider it an easy task for Dr. Hazard to keep his insects healthy. But, like all livestock enterprises, raising insects presents its peculiar problems. For instance, Dr. Hazard had trouble in raising clothes moths. He tried putting them in pint jars and feeding them plain cloth but they didn't prosper. He thought about the eating habits of wild clothes moths.

Then he put loose rolls of 100 percent pure-wool cloth into the jars. And he recalled that clothes moths always eat around the soiled spots on clothing first. So he put some dried brewer's yeast on the wool, and his moths were happy from that day on.

Last summer, working with the southern army worm, the same species that was making inroads on the farmers' forage crops in the area, he hit another snag. He couldn't get the insects to lay eggs. He decided they needed higher humidity. His answer was to wrap their cage in the greenhouse with a cloth which he kept moist. The army worms lost no time in filling out the ranks.

Most of Dr. Hazard's work, however, is with the common housefly. Throughout the year he

conducts tests to see how well his clients' insecticides will kill flies. But flies in the wild vary considerably in their resistance to chemicals. To get an accurate idea of a chemical's fly-killing ability Dr. Hazard had to breed a "standard fly." He collected strains of insects from several laboratories

With aerosol bombs arrayed on his desk, Dr. Hazard records results of tests made on them for an insecticide manufacturer

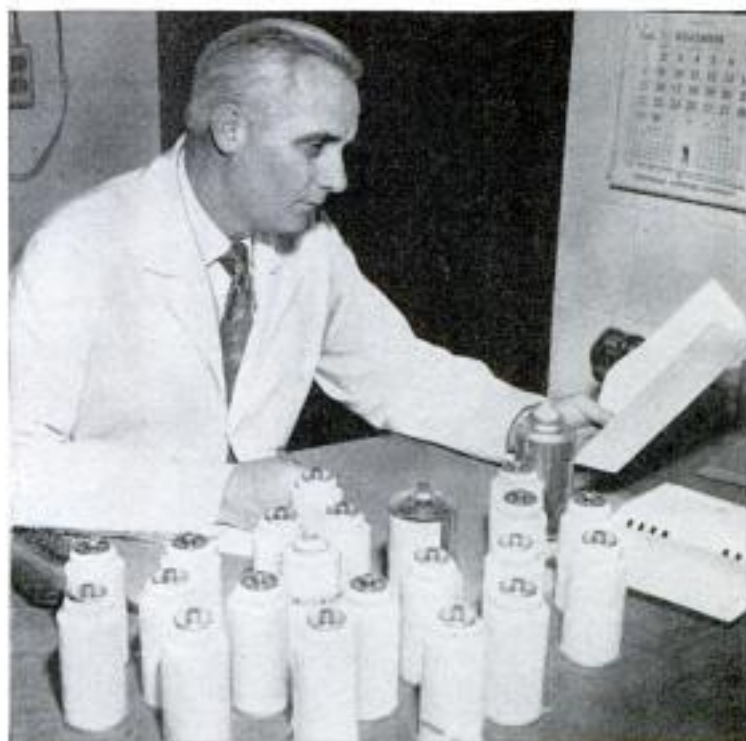



"Standard" flies are kept in foot-square cages lining the sides of the rearing room. Feeding ration consists of a mixture of milk and water. Flies will be used to test effect of insecticides



Blast of air from electric fan beneath screen separates pupae from grain mixture in which they grew. This is done before pupae are packed for shipment

Clear plastic sides of roach cage are greased with mineral oil to prevent insects from roaming. Top and bottom are wire screen

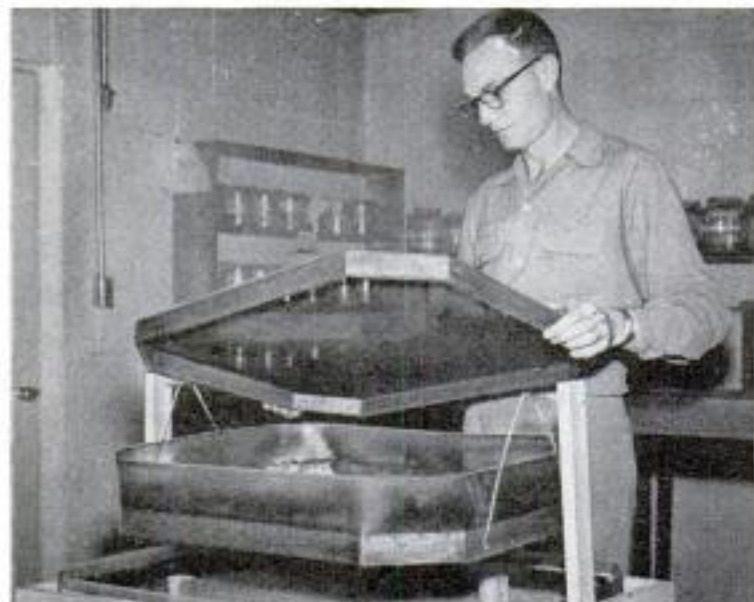

in various parts of the country and mixed them up through seven generations. The result of this breeding is a family of flies now widely known in the insecticide world as the Chemical Specialties Manufacturers Association's "standard 1951 fly."

The Wilmington House of Bugs now supplies these standard houseflies to other laboratories throughout the eastern part of the country. They are sent air mail, special delivery, in their inactive pupae stage. The usual order is for 500 to 1000 flies. They're measured out in a small vial which holds 200 pupae, packed loosely between layers of soft paper in a small box and put into the mail without delay.

The reason for the haste in shipping is due to a factor beyond any entomologist's control. Flies stay in the pupae stage only three days. If the package is delayed, the adults hatch out and die en route.

In his rearing room Dr. Hazard keeps adult flies in foot-square cages of wood and fly screen. They're fed a mixture of milk and water on cotton. They also lay their eggs on the cotton. Later the eggs are collected and used to seed mixtures of moistened alfalfa meal and bran at the rate of 2000 eggs for each one gallon jar. It's from these jars that pupae are collected for shipping to other laboratories.

But most of the flies raised here are used for tests right in the laboratory building. The most common of these tests are conducted in a pair of white gas chambers that are six-foot cubes. A small wire cage holding 100 standard flies is placed on a revolving table in the middle of one of the gas chambers. The insecticide under test is released in measured quantities into the chamber. The cage of flies is kept for 24 hours in a separate recovery room to see how many survive. From this the percentage of kill is easily computed and noted on the records.

In recent years the multimillion-dollar chemical-insecticide industry has made big strides in insect control. But for every problem solved, a new one seems to come along. "We'll always have insects," says Dr. Hazard. That's why he sees a good future for his insect farm. ★ ★ ★

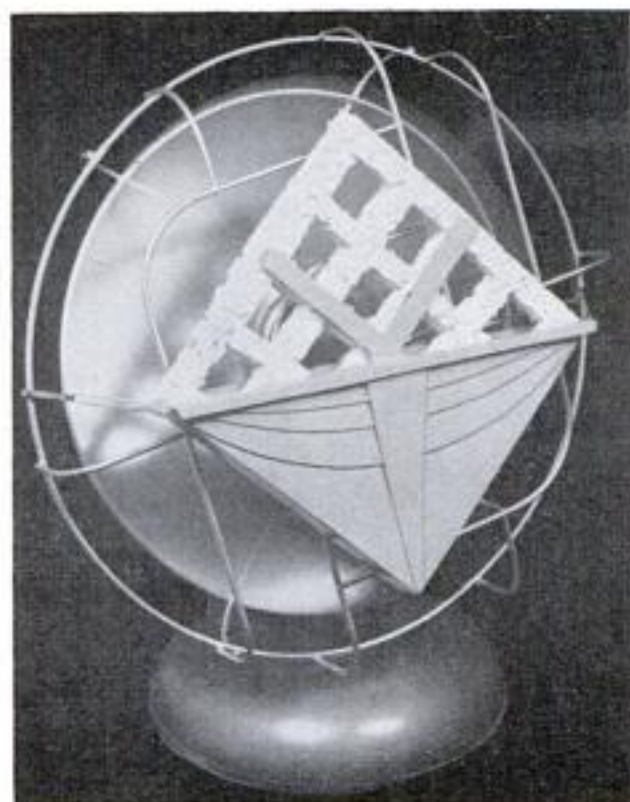

Sponge Evaporator Cools Fan's Breezes

Clipped onto an electric fan, a diamond-shaped evaporator cools the air as it comes off the blades. The evaporator consists of a plastic water tank made in the shape of a half-diamond. In this tank a diamond-shaped cellulose sponge stands upright. The sponge draws the water upward into the path of the breeze where it evaporates, cooling the air.

Leakproof Battery Stops Flashlight Corrosion

Flashlight batteries that can't corrode result from a construction that reverses the usual position of the carbon and zinc. The new battery has four zinc vanes on the inside and a carbon-lined casing, which can't corrode, on the outside. The leakproof cell will not swell, stick or jam in the flashlight. Because the zinc "fuel" is consumed more efficiently, the battery lasts longer and produces a brighter light.

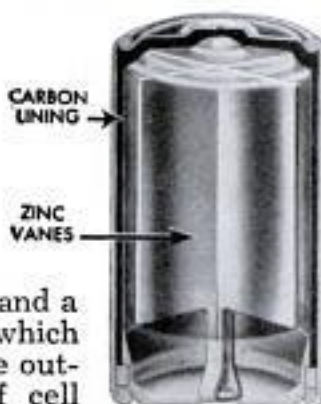

☐ Nitrogen, vital to the fertility of the soil, comes sifting down from the atmosphere onto the ground at the rate of 5.8 pounds per acre per year.



Spider Folding "Fireplace" Easy to Carry and Store

Outdoor cooking is easy with a spiderlike device that holds food above the fire. The eight metal legs of the rack fold into each other for carrying and storing. The rack is two feet wide and adjusts to fit any size pan.

Roof-Sprinkling Hose

You can cool a one-story building or the top floor of a two-story building with a perforated sprinkler hose that lies on the roof. The hose is laid along the ridge of a sloped roof or in a zigzag pattern on a flat roof. A gentle spray or a slow trickle is all that is required; the system uses a minimum of water.

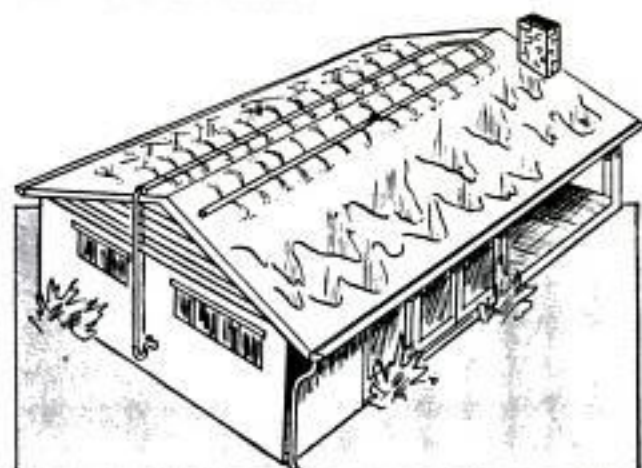



Screened Observation Platform of Trailer Folds for Transit

People who live in mobile homes (the new and approved name for trailers) can now sit on their front porches and watch the rest of the world go by. Prairie Schooner, the first company to introduce a front-door model, has brought out a front-porch design. Screened in, the porch provides a

comfortable place to relax during summer. In winter, a set of plastic storm windows converts it into a weatherproof storage room. It also makes an ideal out-of-the-house play area for children. Naturally, it folds up when the mobile home is ready to become mobile.

Flat-Bed Truck Tilts Like a Dump Truck for Loading or Unloading

With the help of a flat-bed truck that has a built-in loading winch, one man can load and unload his truck effortlessly. The machine, which is built in Germany, uses a winch to pull the load either horizontally from a railroad flatcar or up a sloping ramp from ground level. In the latter case, the truck bed tilts and a pull-out ramp extends from the back of the truck to meet the ground. A folding prop supports the rear of the truck bed. A power take-off con-



nected to the truck engine powers the winch. Wheels or rollers under the load enable it to roll more easily.

There's Everything in This Car—Even the Kitchen Sink

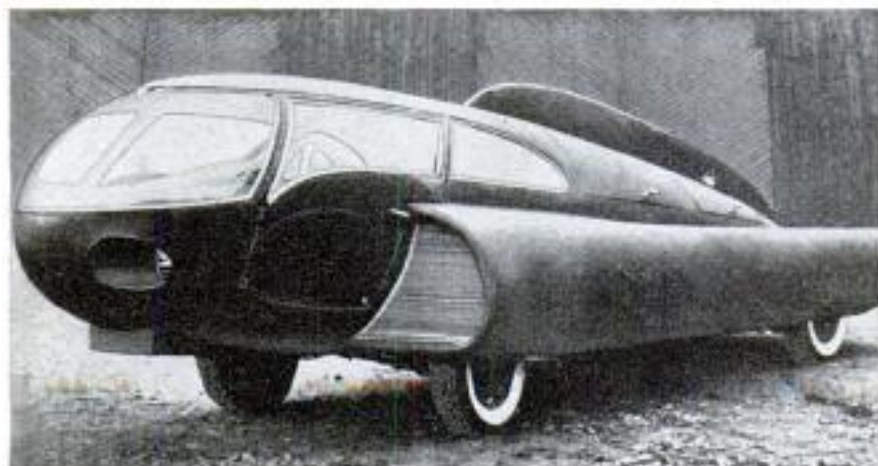

Everything is built into a car designed by a Swedish engineer—everything including the kitchen sink! The car is equipped with two beds and a kitchen. With the beds folded out of the way, it will seat seven passengers without crowding. Wheelbase is 240 inches, about six feet longer than the longest American car. Top speed is 125 miles per hour.

RADIO *Television* ELECTRONICS

SIGHT-AND-SOUND NEWS

THREE OF THE FIRST commercial color-television receivers to come off the production line at the plant of the RCA Victor Home Instrument Division are shown in photo A. These 15-in. standard models are receiving their final test. On the screen of the receiver in the foreground is a color slide, while the other two receivers show color test patterns.

High-fidelity enthusiasts can now assemble their own preamplifier from a kit which provides complete facilities for phonograph-record equalization, including the recently adopted RIAA recording characteristic now being used by Columbia, RCA Victor, Decca, Capitol and Mercury on current releases. This Heathkit unit, illustrated in photo B, includes five input channels, each with its own "level" control, and it is claimed to have sufficient gain for the finest low-output magnetic cartridges.

Lovely Hollis Burke, television starlet, demonstrates the recently introduced Hallicrafters PT-17 ultracompact 17-in. screen TV receiver in photo C. The screen occupies practically the entire front of the set, the controls being mounted on the side. Because of the compact design, the set can easily be moved from room to room.

That magnetic tape is no longer fragile, is demonstrated in photo D. Even children can play with this Lifetime magnetic tape, which is claimed to have a breaking strength of six to eight pounds.





HOW TO BUILD A LOW-COST



By Athan Cosmas W2PKD

AIRCRAFT flying at high altitudes depend almost solely upon some means of radio navigation. While certain specific frequencies and bands of frequencies are normally used for this purpose, direction-finding equipment is available for use anywhere in the range from 100 kilocycles to 200 kilocycles. This range of frequencies includes practically all services: Standard broadcast, television (TV), frequency modulation (FM), amateur and many others.

Obviously, the most effective way to remove this form of navigational aid to an attacking force would be to shut down all services. This, however, would leave Civil Defense authorities without a means of instantaneous mass communication for the broadcast of essential information and instruction to the general public.

To solve this definitely vital problem, Project Conelrad was established by Presidential executive order late in December 1951. Conelrad is a contraction of "Control of Electromagnetic Radiation." The FCC and the Air Defense Command of the U.S. Air Force, worked out a system of opera-

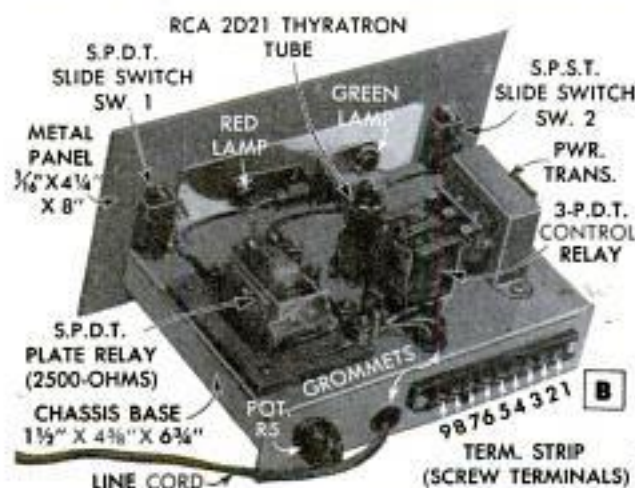

NOTE—USE OF ENERGIZE TO BREAK CONTACTS TO SHUT DOWN AN AMATEUR STATION UPON RECEIPT OF ALERT ON MONITOR RECEIVER.

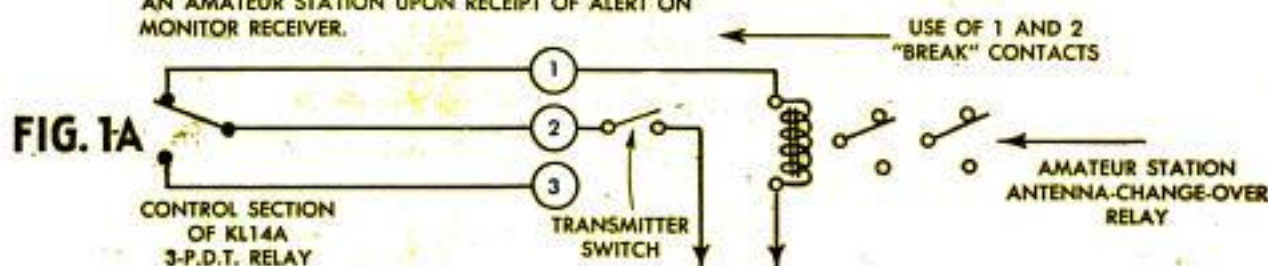

NOTE—WHEN RELAY KL14A OPERATES FOLLOWING CARRIER BREAK OF THE MONITORED STATION, THE BELL WILL RING.

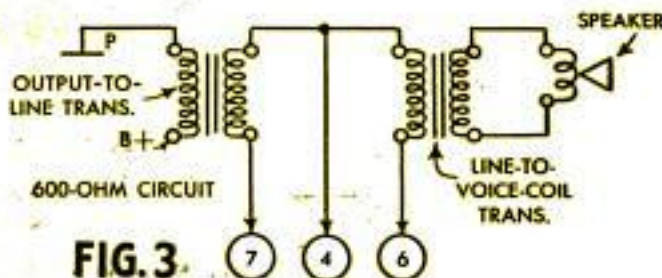
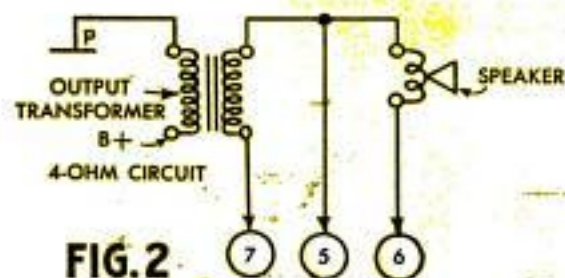
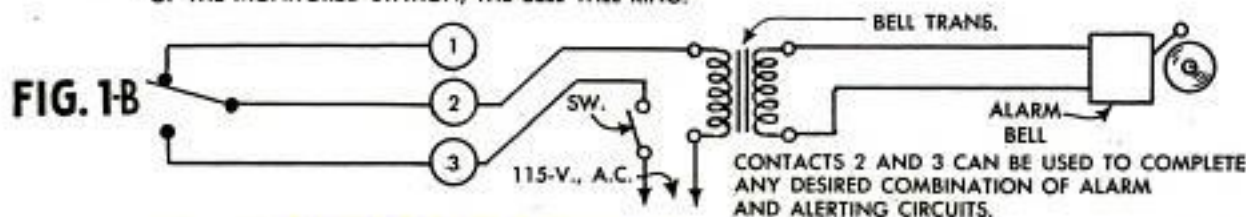

CONELRAD ALARM MONITOR

tion for standard broadcasting which minimizes the effectiveness of broadcasting signals acting as guiding beams for direction finders, but still permits broadcast of essential defense information.

At the first sign of "probable" air attack the United States may be placed under a Warning Yellow. When the attack seems imminent, the situation will be changed to Warning Red. At some time between these two warnings all radio stations will be notified of a "radio alert." Usual broadcast-station procedure will be to interrupt their carrier for five seconds, return to the air for five seconds and again interrupt for another five-second period. After the second interruption, the carrier will come on again and the stations will announce that they are leaving the air; that all listeners should immediately tune their standard-broadcast-band receivers either to 640 or 1240 kilocycles to receive broadcasts of essential information. At this point all normal services (including amateur) will cease operation. Certain broadcasting stations will shift their frequency to either 640 or 1240 kilocycles, and commence operation in controlled clusters. Since the location of the signal source is constantly changing at frequent intervals, the radiated carrier is of little, or no use for direction-finding purposes. So far as the listener is concerned, he will receive a continuous signal although its source is constantly changing.

As all transmitters except those authorized to
(Continued to page 234)

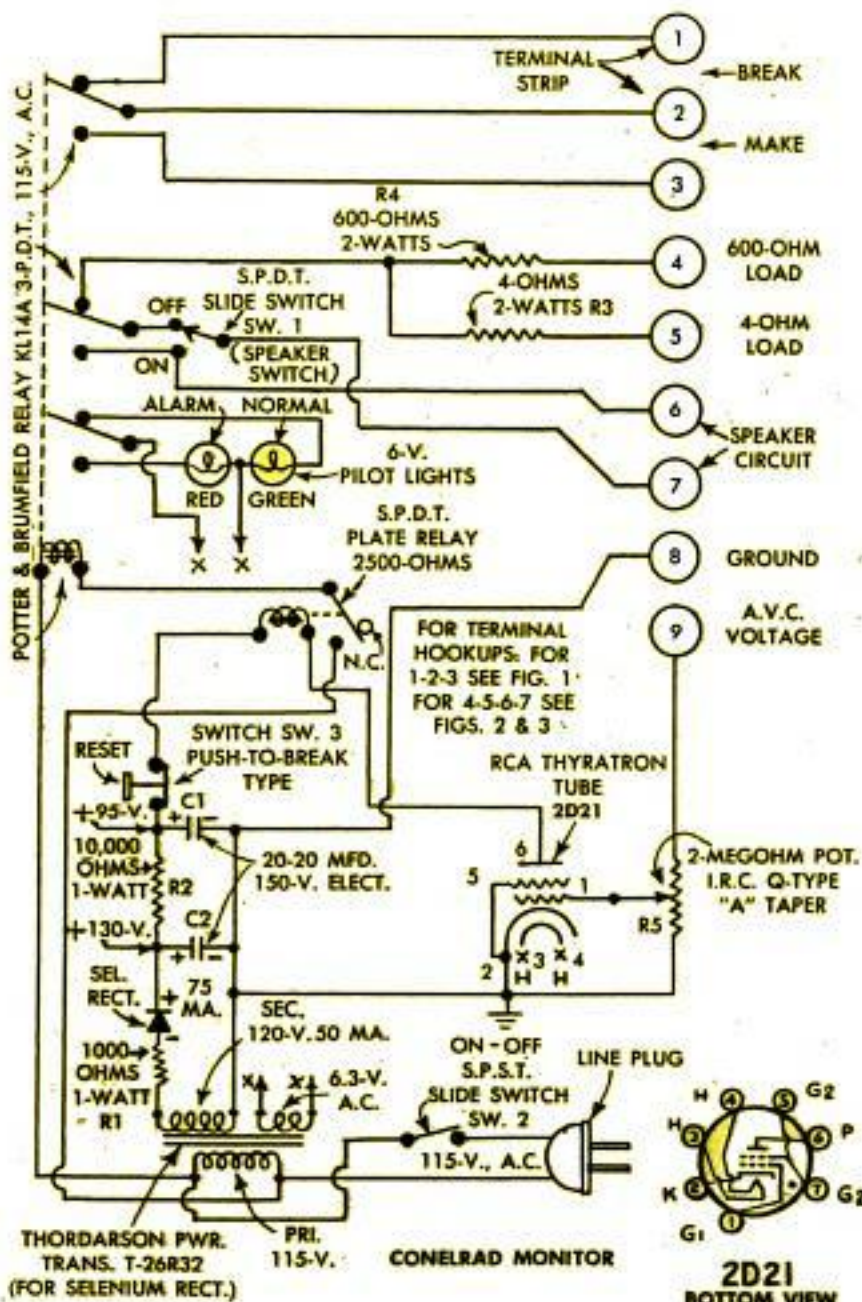

RADIO AND ELECTRONICS TODAY

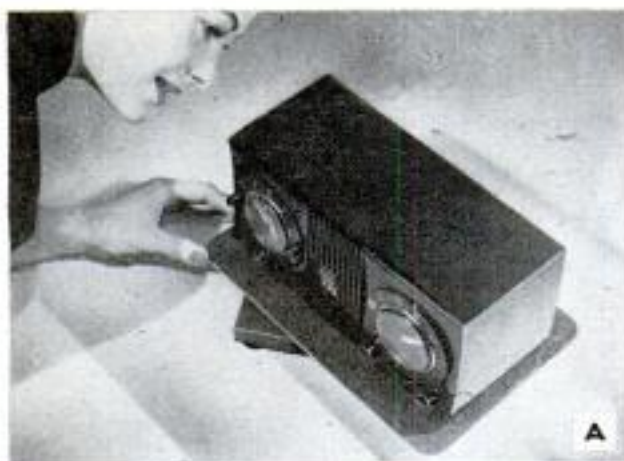

MANY OWNERS of small table-model broadcast receivers of the type that employ built-in loop antennas do not realize that they can tune in more stations and get greater clarity of signals by rotating the set. With your set mounted on the Rote-A-Tune device illustrated in photo A, you can turn it in any direction without risk of scratching the table. Thus the loop antenna will be omnidirectional in the same manner as a TV antenna becomes multidirectional when rotated.

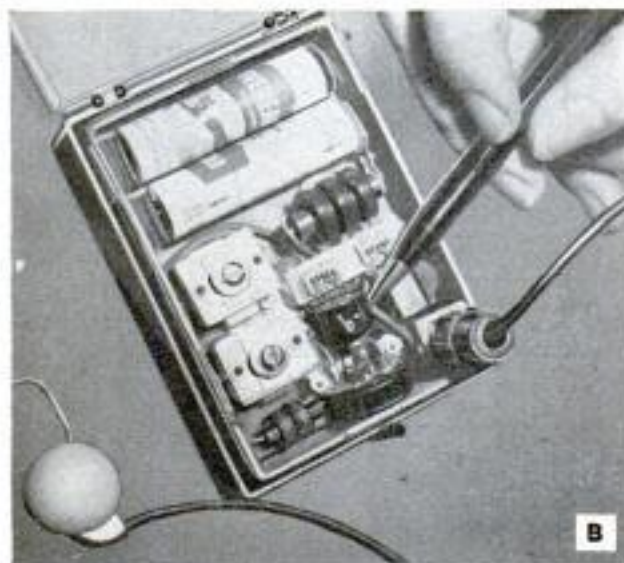

The tiny radio receiver in photo B can be worn like a hearing aid. It has been developed experimentally by two General Electric engineers, in the company's Electronics Laboratory, primarily for use in civil defense. It is tuned to the single broadcast frequency of 1240 kilocycles, which is one of the Conelrad emergency-information frequencies. The set employs two penlight batteries, and the germanium transistor and double-based diode indicated.

Amateur radio operators will be interested in the compact "phone patching" device, illustrated in photo C, for feeding telephone conversations into amateur phone transmitters. This Cesco unit is claimed to provide clear undistorted speech at 100 percent modulation and to eliminate hum.

The model-train system, illustrated in photo D, was displayed at the last Institute of Radio Engineers convention in New York City to demonstrate how germanium products can be used in power and switching circuits. Ninety-six relays and about 200 germanium diodes and power rectifiers were used. The young lady in photo E is holding a short length of special wire described by General Electric engineers as an "electrical brake" for delay lines used in color-TV sets. The electrical current takes just as long to pass through the short wire as it would through the large coil at her feet.

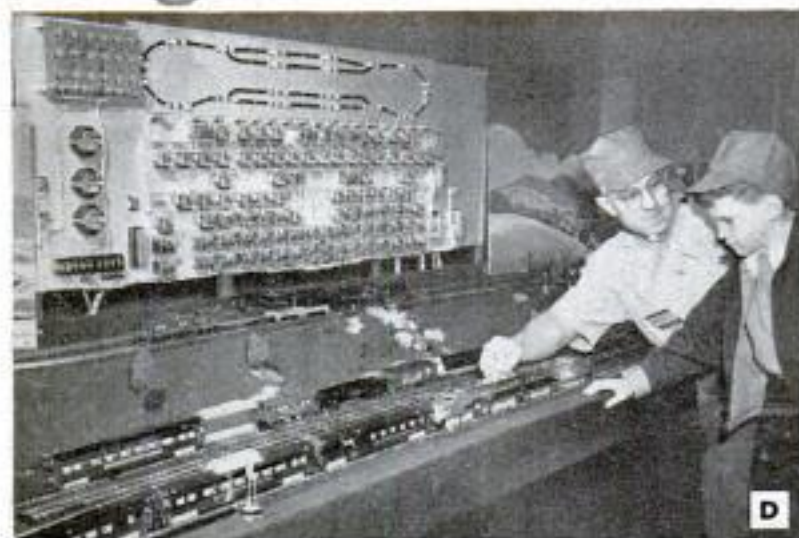

the

POPULAR
MECHANICS

X7608 SN56
CRAFTSMAN



FLUTING AND ETCHING SHEET METAL,

By Sam Brown

ONE OF THE MOST interesting ways to get started in the hobby of metalworking is by fluting and etching a disk of polished metal to form an attractive ash tray, candy dish, serving tray or wall plaque. Mirror-finished aluminum is the ideal metal for this type of work, although satisfactory results also may be had with copper, brass or pewter. Polished-metal disks are available from most handicraft dealers in various thicknesses and in a range of sizes from 4 to 22 in. in diameter. A wide variety of full-size design patterns also may be purchased.

The first step in the etching process is to clean the disk thoroughly to remove any trace of oil or dirt from the surface. This

can be done by washing with soap and water and rinsing thoroughly or by wiping the surface with alcohol. After cleaning the disk, locate a design sheet in position and fasten it to the disk with masking tape. Then slip a sheet of carbon paper under the design sheet. Use pencil-type carbon paper, as typewriter carbon paper will not transfer to the polished metal. Trace the design onto the disk as pictured in Fig. 2, using a stylus or hard pencil.

The next step, that of blocking out the design with black asphaltum varnish takes some patience but is not difficult. Although the varnish does not have to be applied smoothly, the design outline must be followed carefully and all the areas to be

Large wall plaques and trays are among the many decorative things made by etching and fluting sheet metal. Note how etched design contrasts boldly with the polished-aluminum background





Fluting tool detailed at the right is shown in use in photos above and below. Note how sheet-metal disk is held flat with wooden block while flute is bent



blocked-out must be covered completely. While applying the varnish, be sure to keep your hands away from the metal in order to avoid fingerprint smudges on the surface.

After the varnish has dried hard (from 4 to 6 hours), the disk can be fluted, Fig. 4. The fluting is done at this time so the fluted disk will form a self-contained tray for the etching solution.

An etching solution for copper or brass can be made by adding nitric acid, 1 part, to water, 3 parts, using a glass container;

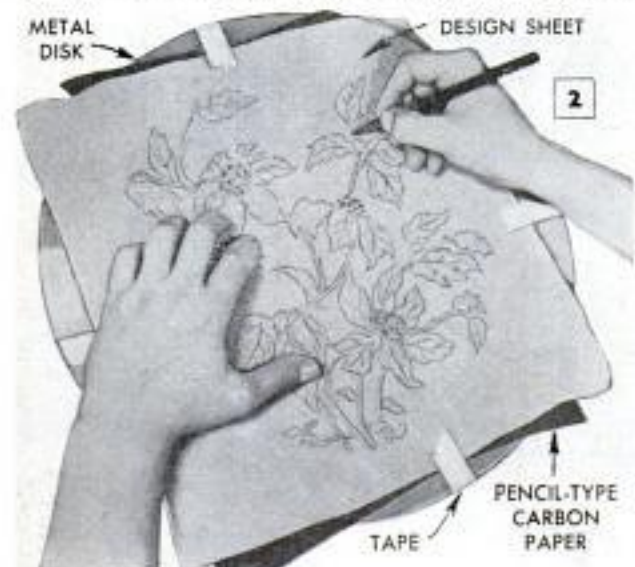

2

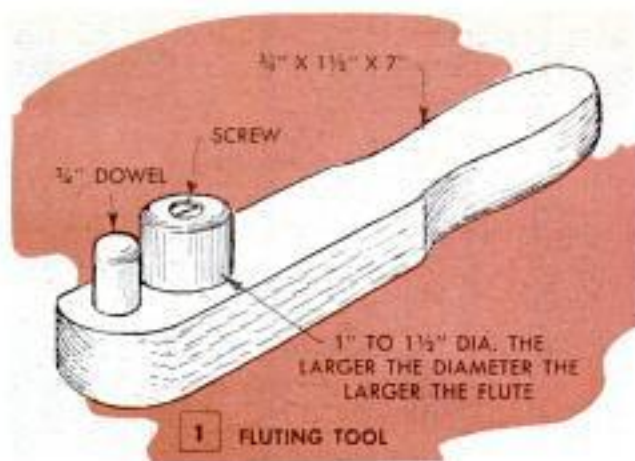

1 FLUTING TOOL

for aluminum, add muriatic acid, 1 part, to water, 2 parts, also mixing this solution in a glass container. If you prefer, nonacid chemicals which are mixed with hot water, are available for etching aluminum. *Caution:* As the acids used are extremely corrosive, handle them with care. Always add the acid to the water to prevent excessive chemical reaction as the two fluids combine, and avoid inhaling the chemical fumes.

The etching solution is poured into the fluted disk to a depth of about $\frac{1}{8}$ in. and allowed to remain on the metal for 30 to 40 min. Dispose of the acid by flushing it down the basement drain with generous quantities of water. After rinsing the etched metal thoroughly, use turpentine to wash off the black asphaltum varnish and reveal the finished design.

Fluting can be done with nothing more



3 BLOCK OUT WITH BLACK PAINT



4 FLUTE RIM OF DISK



Flutes are spaced equally by laying out paper pattern, above, and transferring to disk. Bend as below

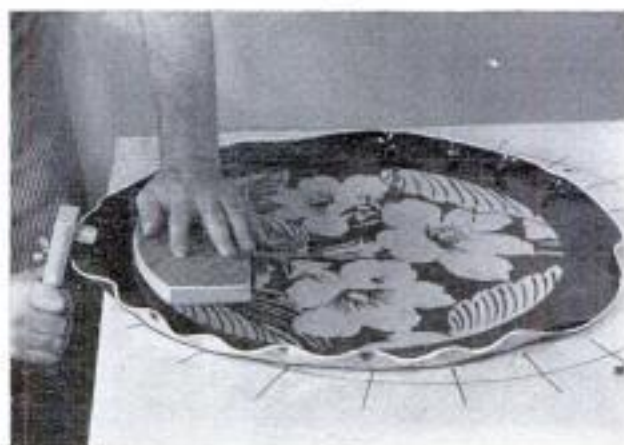

than a pair of pliers, the jaws of which have been wrapped heavily with friction tape. However, uniform results can be obtained more easily by using a simple fluting tool, Fig. 1, or the adjustable fluting tool detailed in Fig. 6. The advantage in the adjustable tool is that the spacing between the dowels can be varied to suit different thicknesses of stock. However, the tool shown in Fig. 1 can be used only on sheet metal having the same thickness as the distance between the dowels. The height of the dowels controls the depth of the flute. A flute depth of $\frac{3}{8}$ in. usually is sufficient for 4-in. trays or coasters; $\frac{1}{2}$ or $\frac{5}{8}$ in. for 6 to 9-in. disks. Flutes on large trays or wall plaques 18 to 22 in. in diameter can be made as deep as $\frac{7}{8}$ in.

The flutes are spaced and the fluting tool is used as in Fig. 5, exact spacing of the flutes being important in order to obtain uniform edges. The chart in Fig. 5 suggests flute depths in proportion to various spacings. There is no set rule insofar as flute spacing and depth is concerned. A good rule of thumb, however, is to use approximately as many flutes as the diameter of the work in inches. This spaces the flutes about 3 in. apart. To evenly distribute strain on the metal disk, first bend one flute and then the flute on the opposite side of the disk. ★ ★ ★



After disk is blocked out with varnish and fluted, etching acid is poured over design to $\frac{1}{8}$ -in. depth

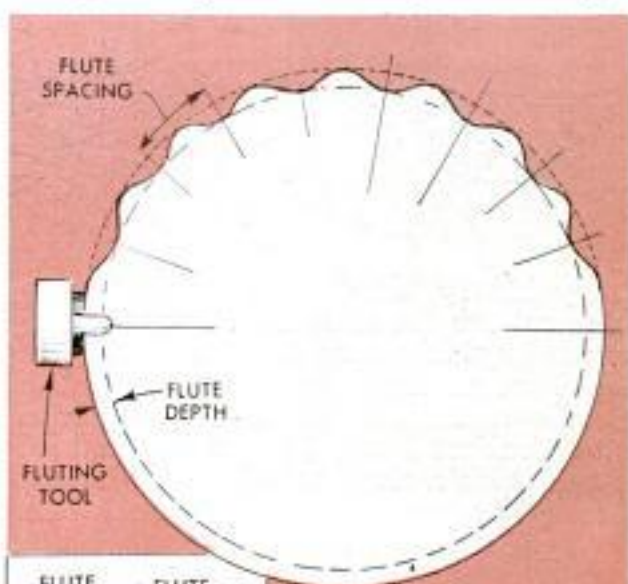

FLUTE SPACING	FLUTE DEPTH
3½"	$\frac{3}{4}$ " TO $\frac{7}{8}$ "
3"	$\frac{5}{8}$ " TO $\frac{3}{4}$ "
2½"	$\frac{1}{2}$ " TO $\frac{5}{8}$ "
2"	$\frac{3}{8}$ " TO $\frac{1}{2}$ "

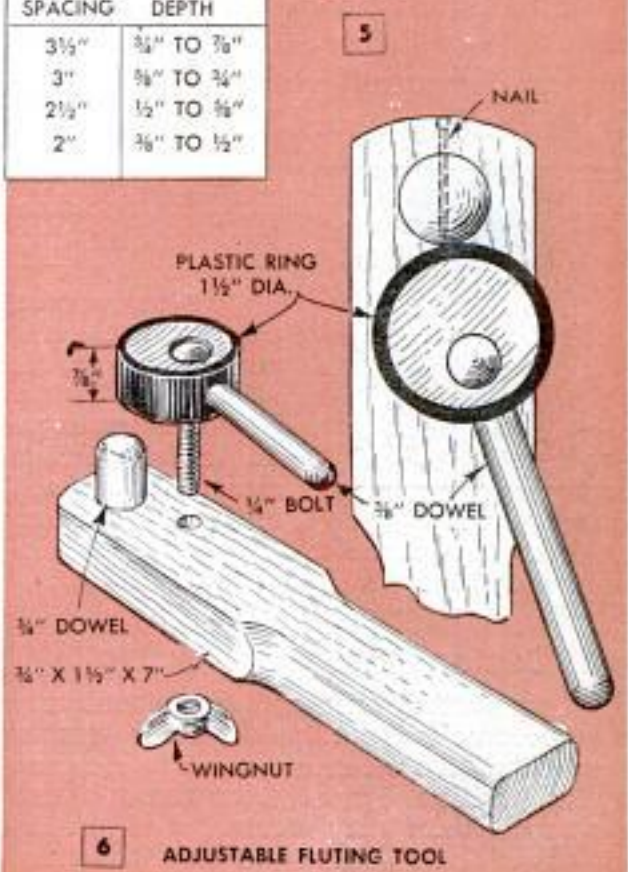

6 ADJUSTABLE FLUTING TOOL

Self-Propelled Toy "Tank" Made of Empty Spool



Try this toy "tank" as a rainy-day entertainment for the little tots. It can be assembled quickly from items at hand. The flanges of an empty spool are notched to provide traction, then the spool is fitted with a rubber band. One end of the band is held with a short matchstick, which is bradded to one end of the spool. A disk cut from a candle, and another matchstick completes the construction.

B. Jackson, Toronto, Ontario, Canada.

Stamp Removed From Envelope By Reversing Usual Method

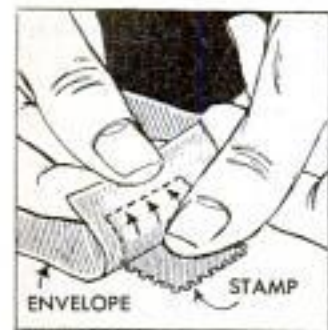

The next time you have occasion to remove a stamp from an envelope, try reversing the procedure to prevent tearing the stamp to bits. Place the envelope on a flat surface and bend it back sharply just at the edge of the stamp. Then hold the edge of the stamp down and gradually work the envelope loose.

Use Center Punch to Lock Nut

When putting on a nut that eventually may become loosened, and no lock-washer is at hand, use a center punch to lock the nut in position. First tighten the nut with a wrench, then put a center punch in the middle of the bolt end and give it a sharp rap with a hammer. This will cause the

bolt to spread slightly, so that the nut cannot come off without being forced.

Walter Shutok, Uniontown, Pa.

Dustpan Fitted With Handle Provides Child's Shovel

In winter when the small fry want to help with a snow-removal job, take advantage of their energy by furnishing them with a child-size shovel made by fitting an old dustpan with a wooden handle of the proper length. Taper

the end of a broomstick or dowel to fit inside the handle of the dustpan and secure it with a wood screw. It also may be necessary to attach light flat steel brackets from the handle to the dustpan.



Small Parts Sorted Quickly On Shower-Curtain Rings

Shower-curtain rings provide a means of keeping small parts, such as screw eyes and washers, sorted for size and kind. The rings can be hung on nails over the workbench, permitting a quick check on quantity, or they can be dropped into the toolbox where they will not be misplaced among the tools. When the job is finished, it is easy to tell which kind and size of parts need replacement.

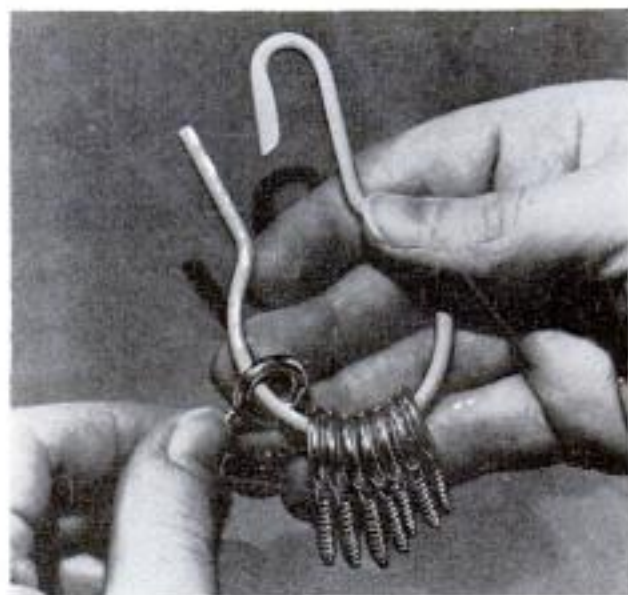

☛ If you run a sliver of metal or wood into your finger, coat the surface with fast-drying household cement and then peel it off. This usually will remove the sliver.

A Nibble Is a Catch With Tandem Fishhooks



To provide a tandem-hook arrangement, where permitted, two hooks may be coupled by passing the eye of one hook over hook of the other



When angling for small fish with worms used as bait, slip two or three worms onto hooks and leave ends loose to trail in water as attention getter



If using minnows as a lure, fit both hooks inside. The short strikers, hitting at just the tail of the minnow will catch the trailing hook, while the side strikers are caught on front hook



Slip a cricket on the leading hook and a small minnow on the trailing hook. When pulled along underwater this arrangement will make minnow appear to be chasing rapidly moving insect



When frogs are used for bait, force the first hook up through the belly so it protrudes above back and let second hook trail between legs



Another attractive lure is to fit a crawfish on the leading hook with minnow "chasing" it on the trailing hook. Variations on this particular idea are limited only by the angler's imagination

Bobby-Pin "Clamps" Suspend Brushes at Desired Depth in Solvent

The problem of keeping artists' brushes suspended in a solvent without misshaping the tips is solved by suspending them with bobby pins. A wooden strip is screwed to the edge of a shallow metal container in which the solvent is kept, and the pins are screwed to the strip by passing small wood screws through the eyes and driving them

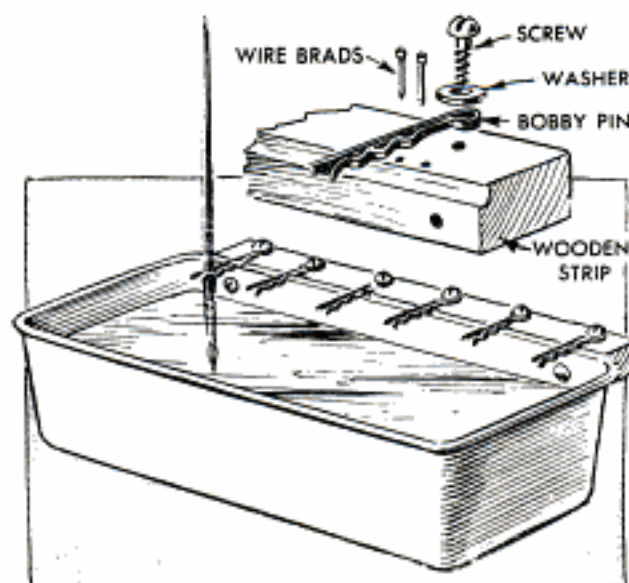

into the strip. Small wire brads on each side of the pins keep them from pivoting. The brushes can now be slipped into the bobby-pin clamps and held at any depth in the cleaning solvent. A larger version of this tray could be made for use with regular paintbrushes, using a tray of sufficient size and spring clips of the type usually employed as broom holders.

Norm Jacky, Fond du Lac, Wis.

Steel Angles on Miter Box Allow Sawing Heavy Stock

If you have ever needed a miter cut on stock that was too thick to permit the saw enough guidance in a wooden miter box, you will appreciate this idea. Screw two lengths of angle steel to the top of the box at the angle you wish to cut and the saw will have the required extra guidance.

William B. Eagan, Louisville, Ky.

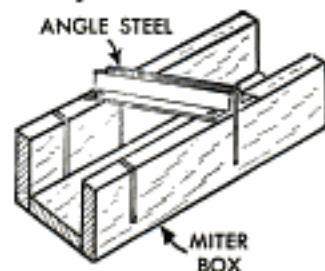

Solving Home Problems



SOAKING WALLPAPER before removing it can be done quickly and easily by applying water to the surface with an ordinary paint roller. Merely dip the roller in warm water and apply water to the wall in the same way as you would roll paint. Allow water to soak for a few minutes, then scrape off paper

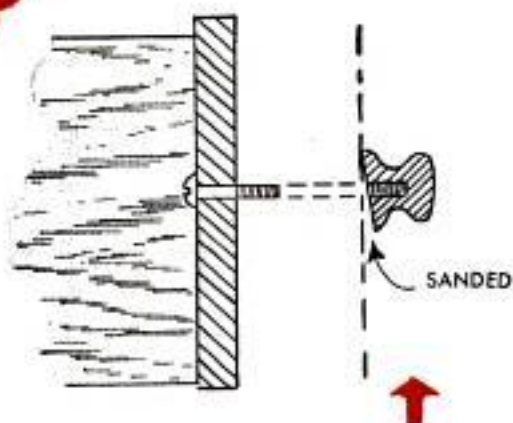

WOODEN DRAWER KNOBS that have a tendency to work loose will stay tight if the back edge of the knob is sanded to a slight bevel. In this way, the knob twists slightly on the threaded bolt when it is tightened, gripping the drawer front securely

TODDLERS CAN'T OPEN the drawers of a sewing-machine cabinet if the drawers are held closed by means of a heavy rubber band. Just drive a screw eye into the rail between the drawers, pass the rubber band through screw eye and draw ends of band over the drawer pulls. The rubber band is removed quickly

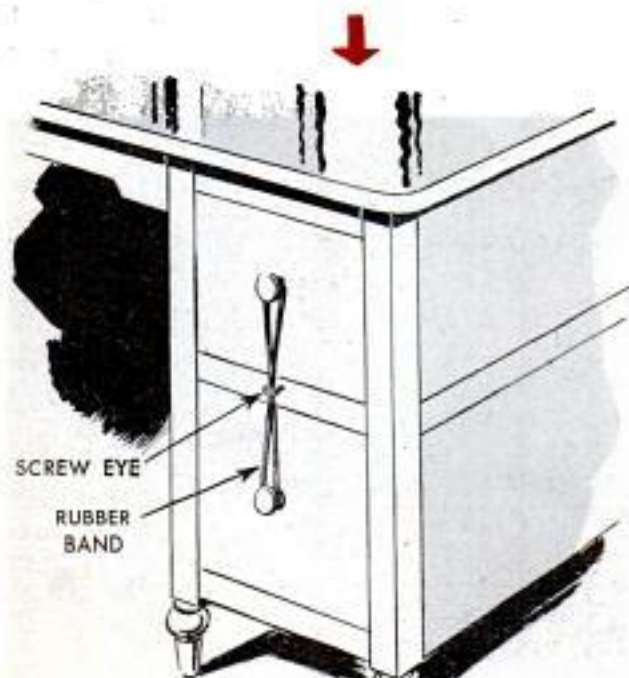

LENGTHS OF RUBBER HOSE of the type used for bathtub sprays make excellent guards for the edges of glass medicine-cabinet shelves. The hose is slit lengthwise along one side and pressed over edge of shelf. This not only keeps objects from sliding off shelves but prevents breakage against shelf edges



RUBBER SHIELD for broom handle is provided by pressing a rubber crutch tip over end of handle. The tip will prevent the handle from marring the wall when the broom is set against it and also will keep the broom from sliding to one side



SHOE-POLISHING CLOTHS made from the tops of discarded knee-length stockings are easier to use if fitted with clothespin handles. Hem both ends of the cloth and slip a clothespin inside each hem. If you prefer, place the clothespin crosswise inside the ends of the stockings and stitch on both sides of it

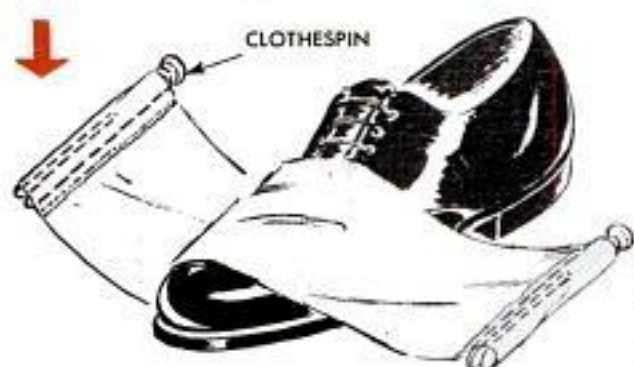

SPRING-TYPE CLOTHESPIN holds telescoping curtain rod at desired length when it is removed from hooks. Before lifting rod from hooks, clamp clothespin over larger section of rod so inside jaw of clothespin also will grip the small rod section. Remove clothespin after replacing rod on window

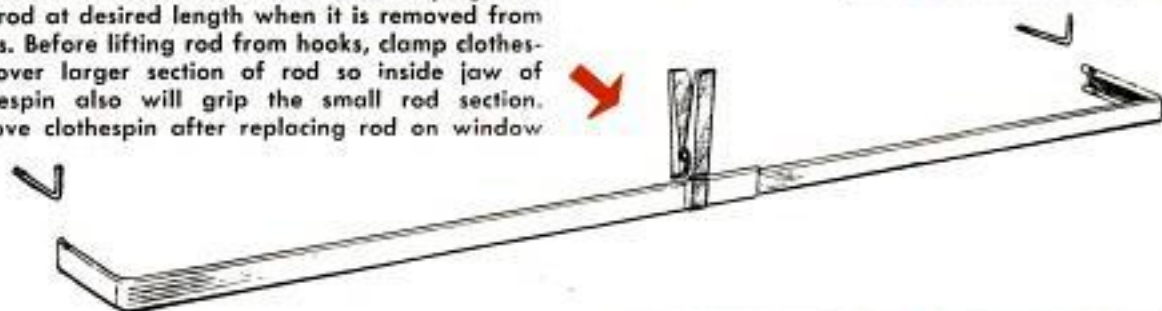

CHAIR-BACK POCKET for home hair-dressing keeps comb, shears and bobby pins within easy reach. The pocket is sewed from heavy cloth or plastic fabric and hung from chair back with loops of cord or cloth



LEATHER TABLE TOPS marred by deep cigarette burns can be repaired with melted wax. Use wax of a color that matches the leather as closely as possible and drop the melted wax into the burn hole. Then smooth wax flush with the leather surface, using warm knife blade. Although repair is not perfect, it will be almost unnoticeable if colors are matched carefully

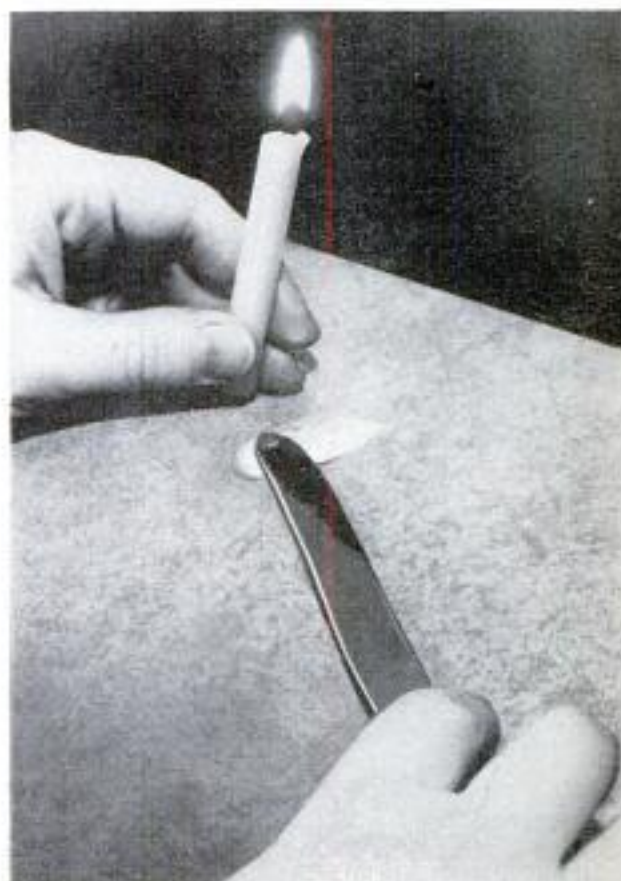

Rubber-Cup Camera "Tripod" Attaches to Car Body



For quick "tripod" shots while on an auto trip try a large suction cup of the type used on automobile-top luggage carriers. The screw in the cup will fit the camera-pan head, thus enabling you to use any smooth surface on the car as a support. If the cup does not stay in place, wet the edge with a moistened finger.

Bruce C. Vaughan, Jr., Springdale, Ark.

Sawhorse for Use on Uneven Floor Built With Just Three Legs

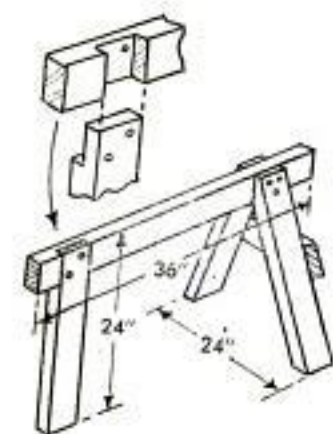

The tendency of a sawhorse to wobble on an uneven floor can be prevented by building the horse with three legs instead of the usual four. The single leg is half lapped and bolted to the cross-rail, and should be spaced no farther from the pair of legs than a distance one third more than the over-all height of the horse. The spacing of the pair of legs should be equal to, or greater than the height of the horse, to assure that it will not tip sideways.

Freezing Pipe in Emergency Shuts Off Water

One maintenance crew on a night emergency call to repair a leaking water pipe, found that there was no street shutoff valve. The problem of turning off the water was solved by breaking up a 10-lb. block of Dry Ice and packing it around the defective pipe between the break and the

street main. After an hour, the pipe was frozen solid and repairs were made, after which the pipe was allowed to thaw.

Irving H. Fox, New York City.

Properly Opened Chain Links Are Easily Retightened

When a chain is to be shortened, open one of the links by bending severed ends outward in opposite directions instead of spreading them to clear the adjoining link. This will assure that the link can be closed tightly. Use two pair of pliers with the jaws taped to prevent marring the chain.



Screen Wire Cleans Files

Unable to locate my file brush, I rolled up a piece of screen wire and rubbed one end back and forth along each file to clean it. I wrapped a piece of waste around the roll to protect my hands.

Howard E. Moody, Upper Jay, N. Y.

Razor Blade Used as Stencil

One way of adding an unusual decorative touch to a small box or other item is to use a double-edge safety-razor blade as a stencil. The shape of the opening varies with each manufacturer, allowing for a choice of designs, and the blade makes a flexible, easily cleaned stencil that will last indefinitely. Attach a strip of tape to one edge of the blade to protect your fingers, and use a stiff-bristled stencil brush with a minimum of ink or paint.

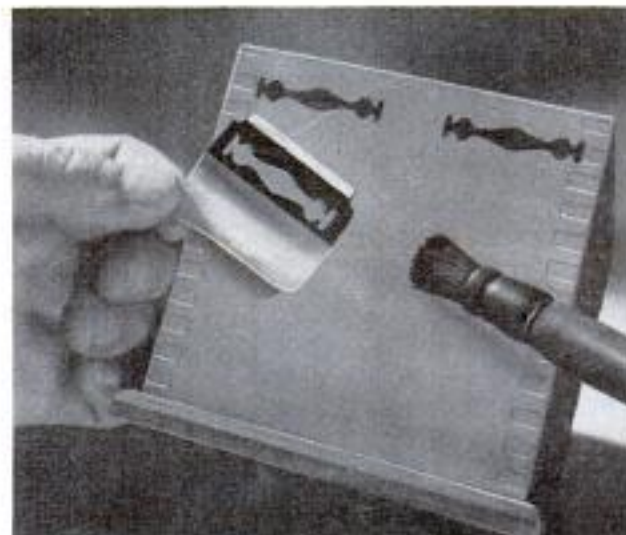

Half-Lapping Adds Rigidity to Latticework Gate

Although light and graceful in appearance, the latticework gate in the illustration is extremely rigid because of the many diagonal cross braces which are part of the design. Further strength is provided by edge-lapping the latticework at 10-in. intervals, the latticework being made from lengths of $1\frac{3}{4}$ -in. lattice stock. The arch of the gate consists of two pieces jigsawed from 2 x 8-in. stock, and joined at the center by a half-lap joint that is glued and fastened with wood screws. The pattern for the arch is laid out on 2-in. squares, as shown in the detail. The "pineapple" knobs on the gateposts are separate lathe turnings.

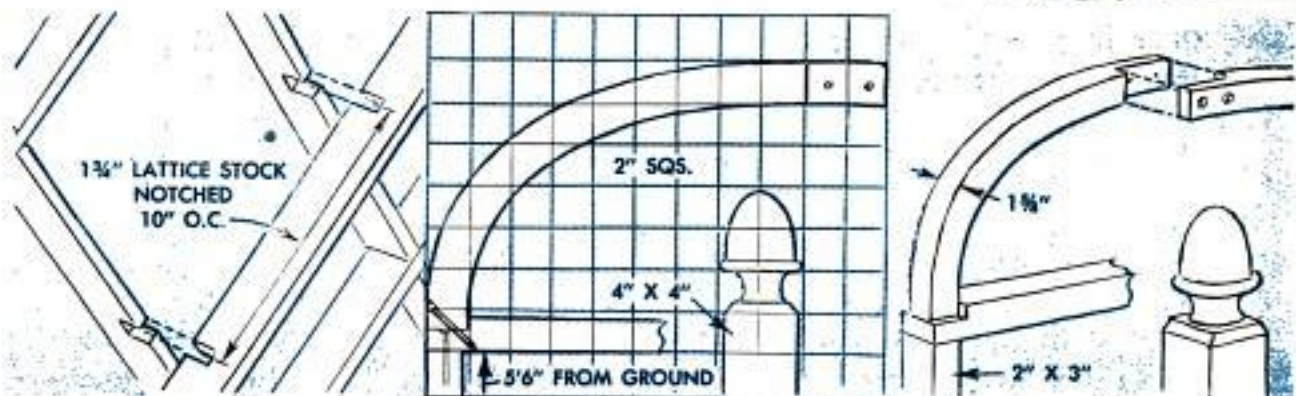

Lighter Fluid Added to Polish Improves Shoe Shine



On long motor trips, carry a jar filled with clean moist cloth squares in the car for cleaning the children's hands and faces.

By adding a few squirts of lighter fluid to a tin of shoe polish every time some of the polish is taken up by the brush, you can improve the shine on your shoes. The fluid causes the polish to spread more evenly and penetrate the leather. Only a light buffing is necessary for a good shine. After several such treatments, the shoes become waterproof and dirt resistant.

Rug Nap Raised by Steam Iron

A steam iron held over spots in your rugs and carpeting where heavy furniture has flattened the nap will restore the carpeting to its normal condition. Pass the iron back and forth over the area an inch or two from the surface.

Ted Otsu, Vancouver, B. C., Can.



Kettle Lid on Fishbowl Foins Family Cat

To keep the water free of lint and dust, as well as to discourage the fishing habits of the family cat, one housewife covers the fishbowl with an ordinary kettle lid. A lid of the proper size has air holes punched or drilled in it and is then fitted over the bowl. The lid has advantages over using a piece of screen, in that it cannot be pushed in by the cat's weight, and is easily handled by the knob at feeding or cleaning time.

Prevent Opening of Door With Outside Hinges

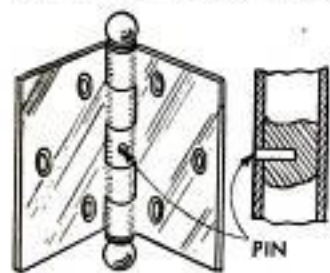

To prevent a locked door from being opened when the hinge pins are on the outside, lock the pins in place so that they cannot be removed. This is done by drilling a small hole in the pin and one leaf of each hinge and then driving a wire pin or a broken drill bit into the hole. Since this will prevent the hinge pins from being removed, the door cannot be taken off from the outside.

Holder for Ferrotypes Plates

A simple holder for ferrotypes plates may be made from a strip of hardwood, which is slightly less than the width of the plates. Slots $\frac{1}{8}$ in. wide and about $\frac{1}{4}$ in. deep are cut crossways in the strip about 1 in. apart. In use, the plates are set on edge in the slots and when the prints dry, they drop down and are held between the plates.

Putty Knife Protects Woodwork When Pulling Nails

To avoid marring the surface of painted woodwork when it is necessary to pull a nail from it, use a putty knife as a shield. Insert the blade of the knife under the hammer claw, as shown in the illustration, and roll the hammer back on it as the nail comes out. Thus protected, the surface of the paint will not be marred when the job is finished.



Decals Applied to Sheet Plastic Provide Attractive Plaques

Attractive wall plaques for any room in the house can be made easily by applying decals to small rectangles of colored plastic. The 4 x 6-in. plaques are cut from sheet plastic, $\frac{1}{16}$ in. thick, which is obtainable at most hobby stores. The edges of the two holes, which are drilled to receive a length of embroidery silk for hanging the plaques, are filed smooth to protect the silk. Thicker plastic can be used, but is more expensive and harder to work. The heavier plastic should have cut edges beveled, filed smooth, then polished.

Harry X. Lawson, Pulga, Calif.



To renew the appearance of an old screen-door spring, stretch it slightly between two nails driven into a board, and then paint it with a thin enamel of the type used for window screens. Let paint dry before removing spring from nails.

WTM 56



Protective guard of 1/4-in.-mesh hardware cloth is stapled to pulley side of wood box

New do-it-yourself kits permit homeowner to assemble his own

ATTIC FAN

By Wayne C. Leckey

AMONG THE MANY do-it-yourself products recently offered the homeowner are attic-fan kits which the buyer assembles himself and installs in a simple wooden box at a considerable saving. The kits provide all the necessary parts, namely: Fan blade, pillow-block bearings, shaft, pulleys, collars and belt, and are offered with or without a 1/4-hp. motor. The box in which the fan is mounted is assembled of 1 x 12 lumber and 1/4-in. plywood and is covered on one side with wire mesh. Some makers offer a fan that does not require a box for certain installations.

The size of your house determines the size of the fan. The fan you select should have a c.f.m. (cubic feet per minute) rating equal to or slightly greater than the gross cubic content of the house. A 36-in. fan will cool the average six-room house 15 to 25 deg. Where it is desired to cool the sleeping rooms only and not the entire house, the fan should have a capacity of 1.2 times the cubic content of the rooms to be cooled. Gross cubic content of your house is found by multiplying its width by its length by the ceiling height.

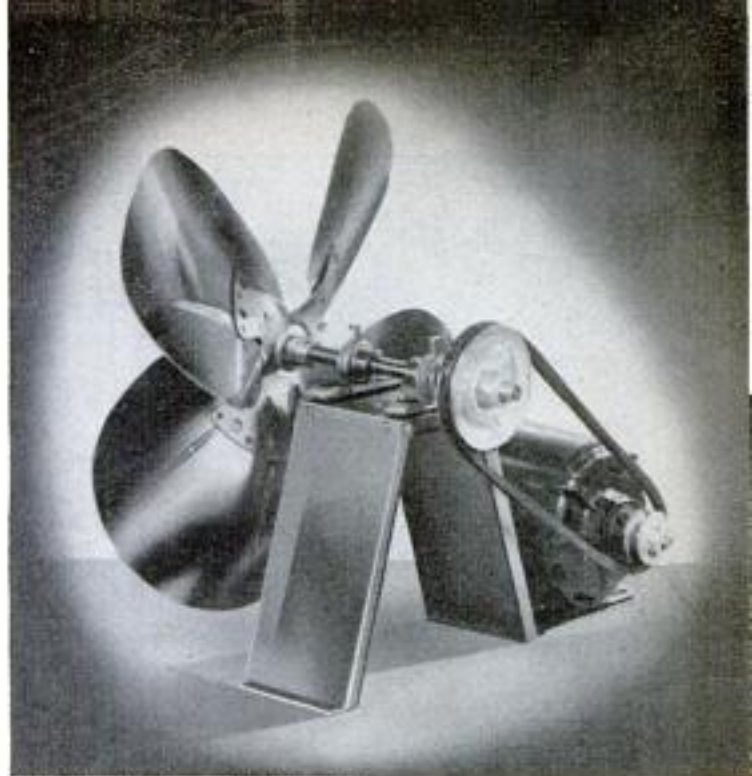

A. E. Bozz Machine and Tool Co. photo

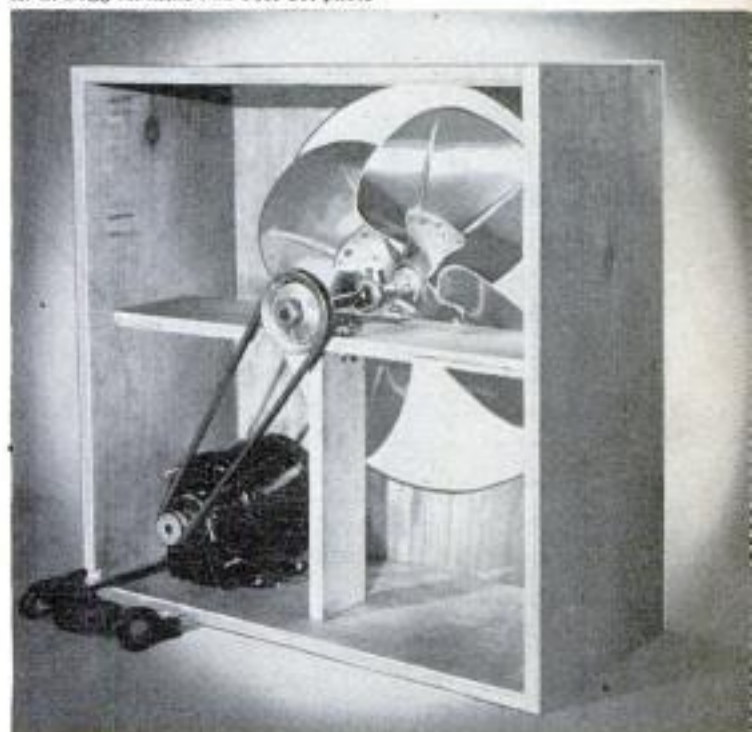

Dayton Electric Mfg. Co. photo (above)

Kloppenborg Aluminum Foundry photo (below)

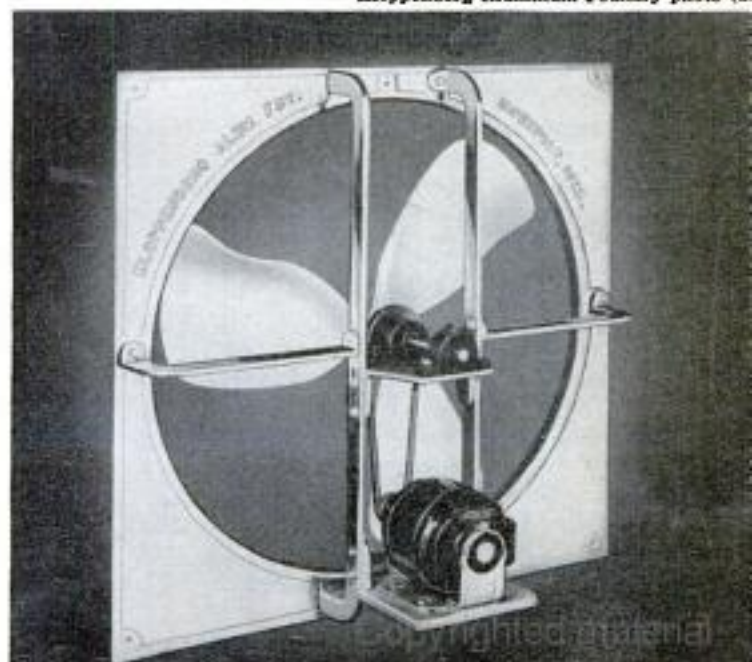



Suction box partially dismantled shows typical vertical installation of fan over ceiling grille. Pillow-block bearings do not permit horizontal mounting

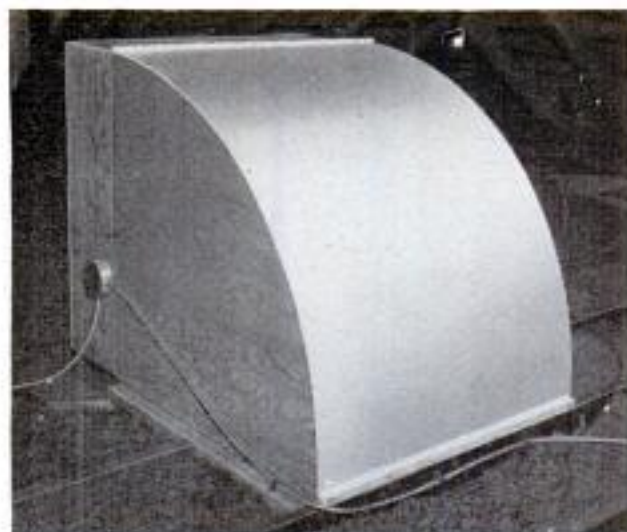

Suction box of plywood and wallboard provides duct between fan and grille. See drawing below. Fan exhausts air out attic window or louver in gable

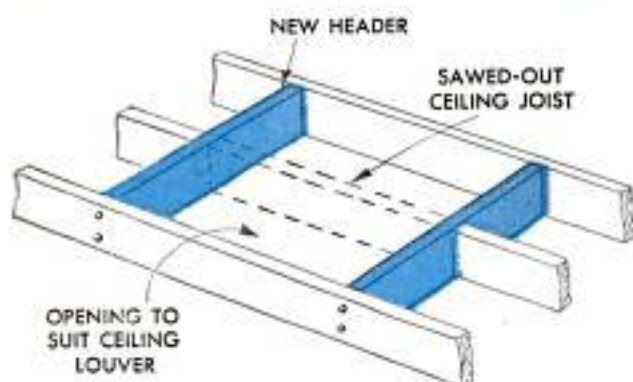

Of the two most common installations, a suction box over a ceiling grille is considered the most efficient as it allows a more even air flow throughout the house, especially when it is possible to place the grille in a hall that is fairly centrally located in the house. The suction box consists of an airtight duct or hood that connects the fan to the ceiling grille. Where the attic is prac-

Standard ceiling louver, or shutter, in hallway opens quietly when fan starts, closes automatically when fan stops. Louvers are available in various sizes



tically airtight, the fan can be set in front of a gable or dormer window fitted with a louver, or shutter. Here, the entire attic acts as a suction chamber to pull the hot air up out of the house through a stairway or ceiling grille. As the stored-up heat in the attic and living quarters is discharged out through the attic louver, cool night air is drawn into the house through open windows. In this installation, a shelf or other means is used to support the fan vertically, and a canvas duct, or sleeve, is used to connect the fan box to the outer wall. It is recommended that the distance between the fan blade and the window louver should not be less than 6 in. Such an installation, being semipermanent, allows the fan to be used elsewhere in the house as a window fan or circulating room fan. Fitted with a handle, the fan becomes a portable unit.

Fan kits are available in 20, 24, 30 and 36-in. sizes. In installing one of these fans in my home, I selected a 30-in. Dayton fan

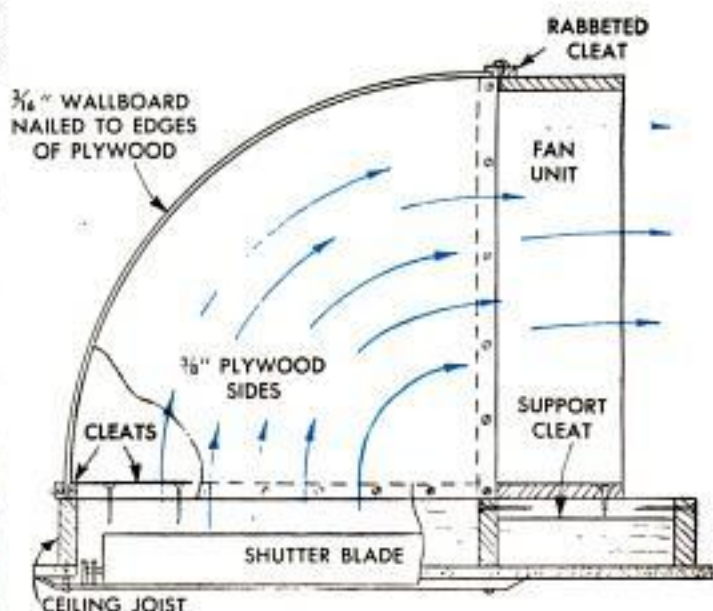

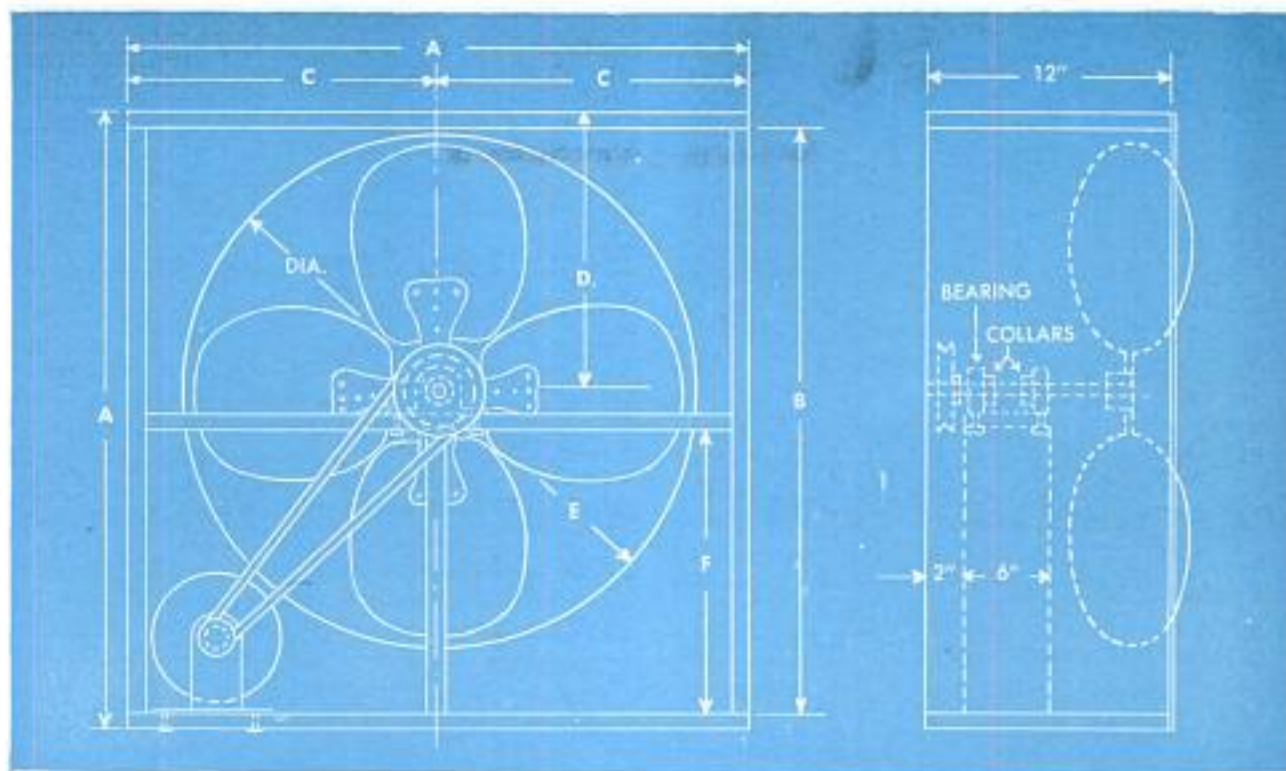

kit and installed it in a suction box over a ceiling grille which I placed in a hall between the bedrooms. My first job was to cut the opening for the grille. Here again, the size of the grille is determined by the size of the fan. Generally speaking, the grille area should be 25 percent greater than the fan area. I used a commercial shutter-type metal grille, but a wooden "egg crate"—type grille, made of half-lapped slats, will do. During winter, a piece of blanket insulation can be placed over it. In cutting the opening for the grille, I had to cut out a section of only one ceiling joist as shown in the detail on the opposite page. You may find it necessary to cut through a second joist, depending on the size of the grille. In either case, the severed joists are bridged across with headers to box-in the opening. The drawing shows how I made the suction box of plywood and wallboard. Rigid insulation board is good, too. You'll notice that I mounted the fan at the edge of the opening. Some recommend placing the fan one fan diameter from the edge of the opening. The suction box should be made as airtight as possible. I nailed cleats to the top edges of the headers and screwed the plywood sides to the cleats and to the fan box. Sheet wallboard conformed nicely to the curved sides by first slipping it under a rabbeted cleat across the top of the fan box. If the attic is insulated with loose fill, the joists should be floored in front of the fan. The drawing and chart at the top of the page give box dimensions for three different-size Dayton fans. The exhaust side of the box is faced with 1/4-in. plywood, cut out to suit the blade diameter. ★ ★ ★

BLADE DIA.	CFM CAP.	HP REQD.	DIMENSIONS (Inches)					
			A	B	C	D	E	F
20"	4840	1/4	27	25 1/2	13 1/2	11 1/2	21	12 1/2
24"	5900	1/4	30	28 1/2	15	13 3/4	25	13 3/4
30"	6700	1/4	34	32 1/2	17	16 3/4	31	14 3/4

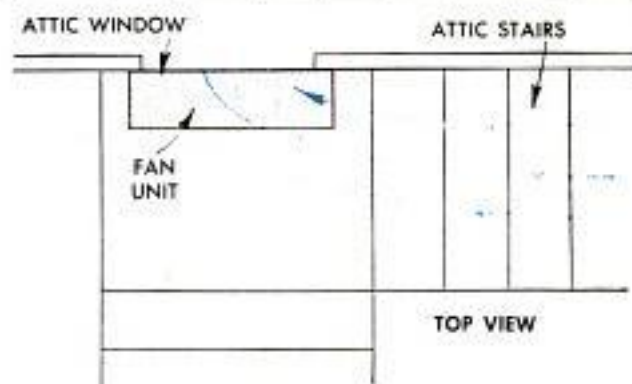

Below, where there are stairs to the attic, fan can be mounted directly in attic window and stair door left open. Such installation allows fan to be removed and used elsewhere in house as circulating fan



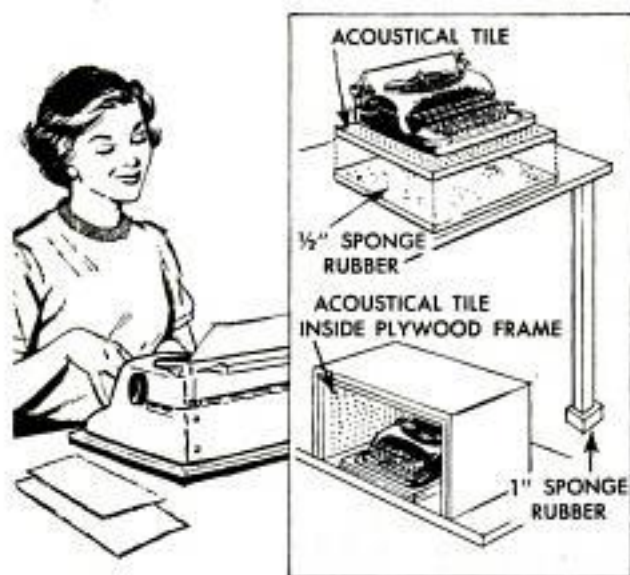

Typewriter Noise Reduced With Acoustical Tile

Other members of your family will not be annoyed by the noise of a typewriter if you take some simple steps to silence it. Since the table on which the typewriter is set acts as a sounding board, isolate the machine from it as much as possible. To do this, place a layer of sponge rubber on the table with an acoustical tile on top of it. A typewriter placed on top of these two sound deadeners is silenced considerably. The deadening effect can be increased by putting sponge rubber under the legs of the table. Further silencing can be effected by building a box, as shown, to cover three sides and the top of the machine, and lining this box with acoustical tile.

Refrigerator Frozen-Food Space Increased by Insulated Box



The freezing capacity of a home refrigerator—which has the freezer unit in the center or to one side of the top shelf—can be increased temporarily by placing an insulated cardboard box directly under the unit. Remove the top of the box, then cut the front and back so they will fit under the unit with the box resting on the top shelf. It may be necessary to remove one upper shelf in some refrigerators. Allow the two sides of the box to project up alongside the freezer unit an inch or so.

Cut each corner of the front so that it will form a pull-down "door" for the temporary unit. Line the inside of the box, including the door, with three thicknesses of corrugated cardboard for insulation.—J. F. Victor Vaughan, Montebello, Calif.

Elastic Tape Sewed to Pocket Prevents Loss of Rule

One carpenter eliminated the nuisance of having his folding rule constantly dropping from his over-all pocket by having a loop of elastic tape stitched to the front of the pocket. When putting the rule in his pocket, he slips the loop over the projecting end, as shown, which holds the rule securely, yet makes it easy to remove.

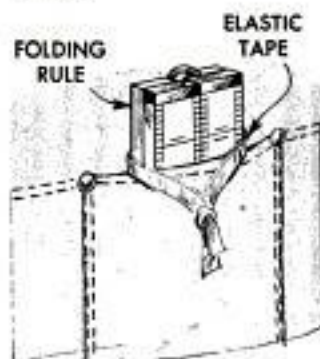

Breaking in New Penpoint

To break in a new penpoint touch it to a match or other small flame for just a moment. The flame will burn the lacquer or varnish from it, allowing the point to hold ink better and write smoothly.

A. E. Fenn, Chicago.

Drill Bit Used As Center Punch Aligns Hinge Screw Holes

If a drill bit is used as a center punch to mark the holes to be drilled for mounting a hinge, accurate alignment of the holes will be assured. Use a drill of the same diameter as the holes in the hinge, hold it upside down and tap the cutting end with a plastic or wooden mallet. The conical point at the end of the drill shank will make a mark at the true center of the hole.

Ken Murray, Colon, Mich.

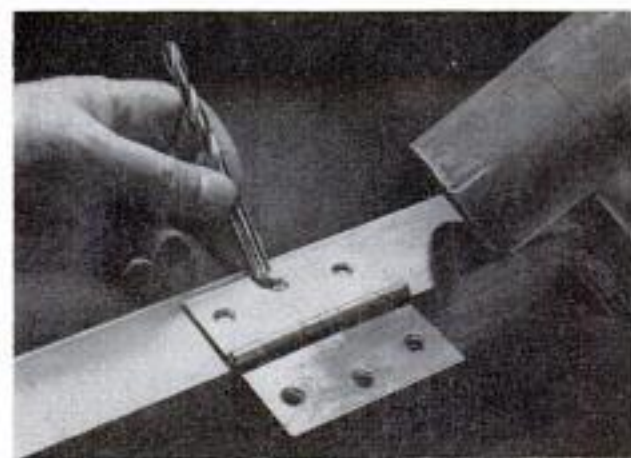

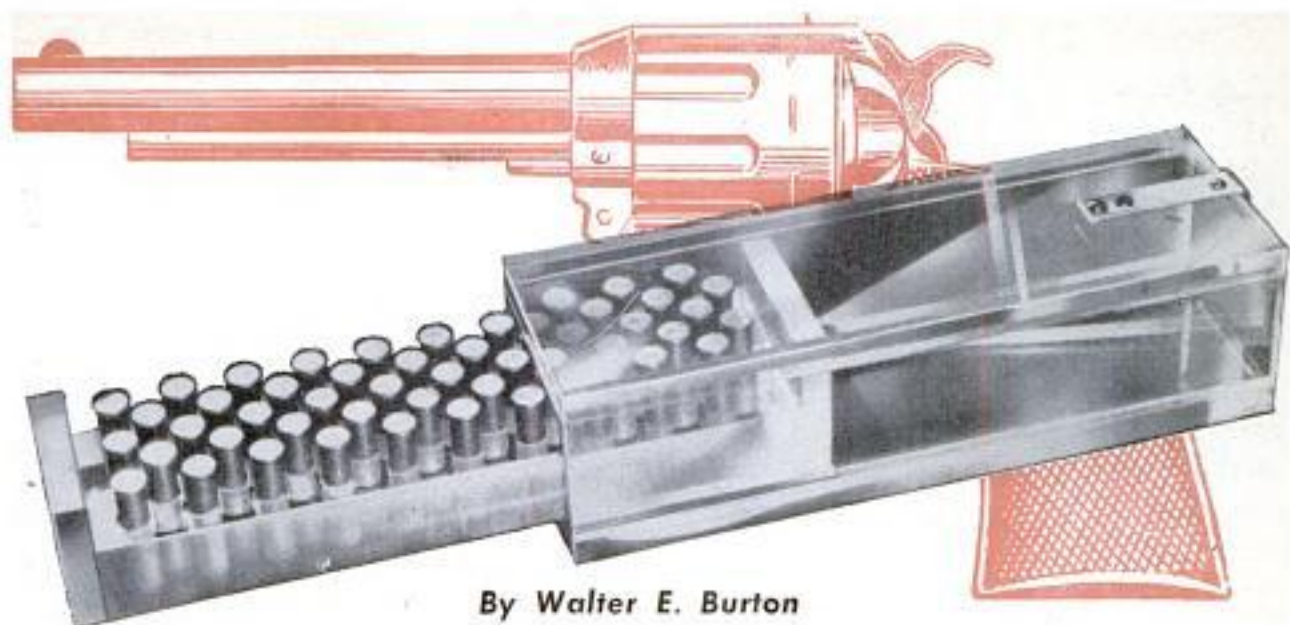

By Walter E. Burton

Clear-Plastic Cartridge Box

BOTH SAFE AND PRACTICAL, this cartridge box holds fifty .22-cal. cartridges in a sliding tray drilled to hold each cartridge separately, and the clear plastic from which it is made permits a check of the contents without sliding open the cover.

The tray is an $1\frac{1}{16} \times 1\frac{1}{2} \times 5\frac{1}{8}$ -in. block of plastic, but if plastic this thick is not available, several thinner strips can be cemented together to build up an approximate thickness. Special plastic cement is best for assembling the box, although some model-airplane and household cements can be used.

When building up the block from plastic strips, clamp them together and make sure no air bubbles are left between layers. Use a No. 1 twist drill to make holes of the proper size to receive the cartridges. Loca-

When drilling holes in plastic block, use stop on drill to assure leaving $1/16$ in. material at bottom

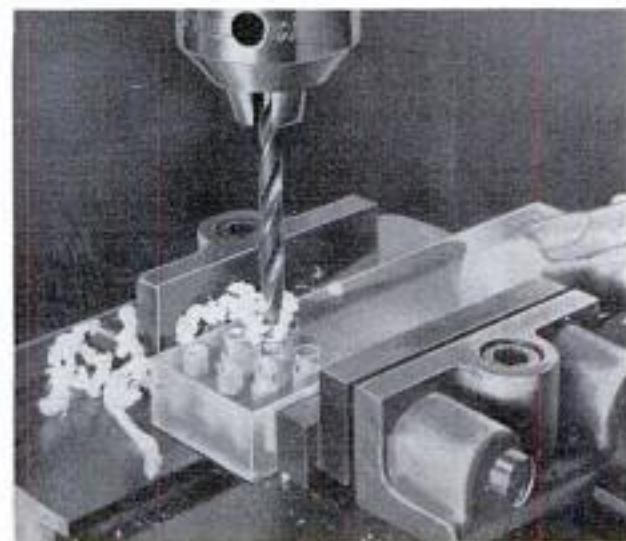

AUGUST 1954

tions for the holes should be marked on the adhesive-paper backing which is generally used to protect the plastic finish. In case there is no paper, temporarily apply a paper backing with rubber cement. It is best to use a drill press to bore the holes, but a hand drill can be used if care is taken to keep the holes straight. In either case, use a stop to assure that all holes are equal in depth and that the drill does not penetrate the block completely. Next, cement a piece of $1/4$ -in. plastic to each end of the block, allowing the edges to project about $3/32$ in. above the top.

The sliding cover is constructed from four pieces of $1/4$ -in. plastic, the two side pieces measuring $1\frac{3}{16} \times 5\frac{7}{8}$ in. The top and bottom pieces are $2 \times 5\frac{7}{8}$ in. and overlap the sides. To be sure of sliding clearance,

End pieces of $1/4$ -in. sheet plastic are cemented to drilled block. Each piece projects $3/32$ in. above top

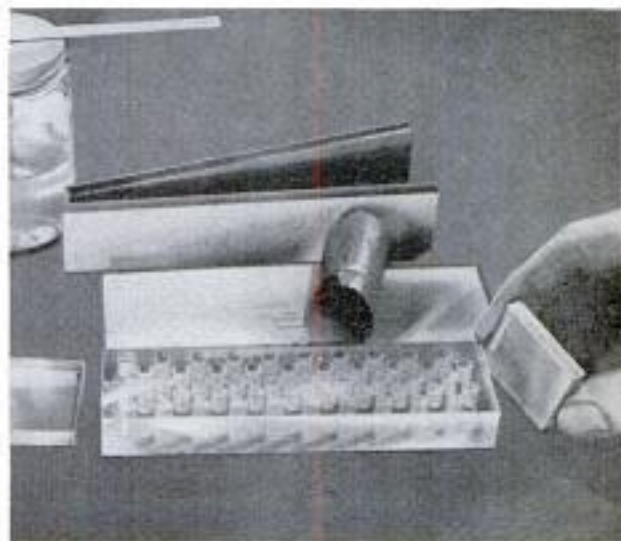



Sliding cover is assembled and clamped. Cellulose paper on block assembly assures sliding clearance

Below, file is used to smooth edges of completed box. Scratches can be removed by buffing and polishing

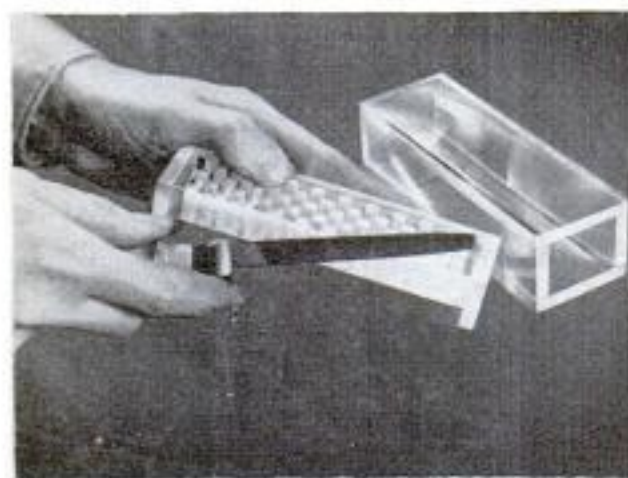

MATERIAL LIST

Clear Plastic

- 1 pc.—11/16" x 1 1/2" x 5 7/8"—Block
- 2 pcs.—1/4" x 1 1/2" x 25/32"—Ends
- 2 pcs.—1/4" x 1-3/16" x 5 7/8"—Sides
- 2 pcs.—1/4" x 2" x 5 7/8"—Top and bottom

wrap a single sheet of cellulose paper around the tray assembly and fit the cover over it. Plastic and cement will not stick to cellulose paper, and removing the paper after the box is assembled will leave ample clearance all around.

A latch, made from spring brass or other suitable metal, $\frac{3}{8}$ x $1\frac{1}{2}$ in., is used to hold the cover in place. One end of the strip is drilled to receive two small machine or self-tapping screws and the opposite end is bent at right angles $\frac{3}{8}$ in. from the end to provide a stop and finger grip. If machine screws are used, the plastic can be drilled and tapped to receive them; the self-tapping screws are driven into holes slightly smaller than their own diameter. The latch is located by centering it at one end of the lid. Next, a hole is marked on the latch so it is centered on the endpiece of the tray and a hole is drilled through latch, the lid and into the endpiece to a depth of $\frac{1}{8}$ in. A brass escutcheon pin is soldered in the hole in the latch, and cut off to just touch the bottom of the hole in the endpiece of the tray. In this way the latch pin engages the hole in the tray endpiece until released by lifting up on the latch. ★ ★ ★

Fast Method of Striking Ellipse on Layout of Doorway Arch

Masons, carpenters, plasterers and others who often find it necessary to strike an elliptical arc can make use of this simple method. A good example is the layout

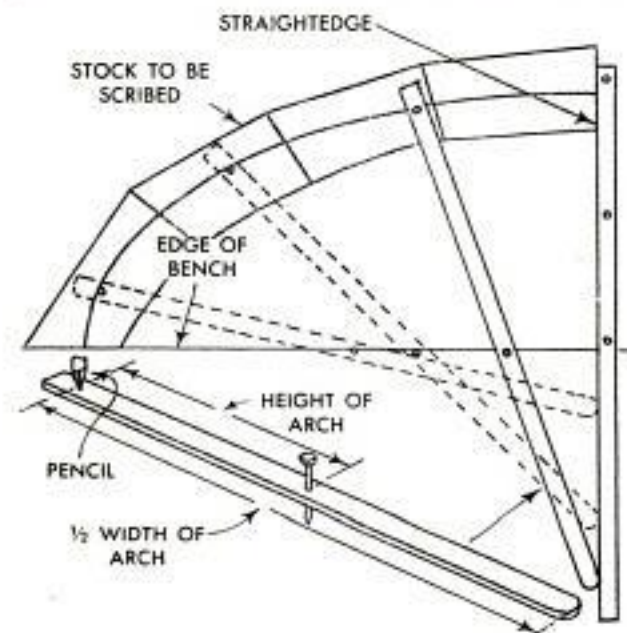

for a doorway arch. Determine the height of the arch at the center and also half the required width. Then tack a straightedge to the bench, the straightedge being placed exactly at right angles to the edge of the bench with the end projecting beyond the edge a distance slightly greater than the height of the arch. Now round one end of a strip of wood and drill a small hole near the opposite end so that you can insert the point of a pencil. Measure from the hole along the length of the strip a distance equal to the height of the arch. Drive a nail through the strip at this point. Then place this improvised scriber against the straightedge. Insert a pencil point through the hole in the scriber and hold the rounded end of the scriber against the straightedge with the nail contacting the edge of the bench. Move the scriber to the left, keeping the pencil point, the rounded end and the nail in contact until the scriber has reached a point parallel with the edge of the bench. This will scribe a true elliptical arc.

L. L. Glover, La Plata, Md.

Tissue Box Taped to Sun Visor Aids Cleaning Windshield



Taped to the sun visor, a pocket-size package of cleansing tissues will come in handy for cleaning a misty windshield or wiping a child's sticky hands. Two strips of adhesive or cellulose tape are fastened to the back of the package and allowed to extend a couple of inches beyond the ends. Two more strips are used to tape the latter strips to the visor, thus holding the package neatly in place.

Andy Vena, Philadelphia, Pa.

Paper Matchbook Cover Doubles As Emergency Shoehorn

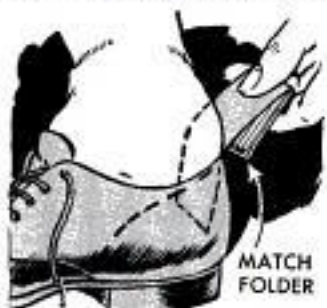

When a shoehorn is not at hand, you will find that a matchbook cover may be used instead. The outside surface of such covers usually are smooth enough to overcome friction, and the cover itself is flexible enough to conform to the shape of the heel. When inserted in a shoe as shown, the cover will allow the foot to be slipped into the shoe easily.

When a shoehorn is not at hand, you will find that a matchbook cover may be used instead. The outside surface of such covers usually are smooth enough to overcome friction, and the cover itself is flexible enough to conform to the shape of the heel. When inserted in a shoe as shown, the cover will allow the foot to be slipped into the shoe easily.

When a shoehorn is not at hand, you will find that a matchbook cover may be used instead. The outside surface of such covers usually are smooth enough to overcome friction, and the cover itself is flexible enough to conform to the shape of the heel. When inserted in a shoe as shown, the cover will allow the foot to be slipped into the shoe easily.

When a shoehorn is not at hand, you will find that a matchbook cover may be used instead. The outside surface of such covers usually are smooth enough to overcome friction, and the cover itself is flexible enough to conform to the shape of the heel. When inserted in a shoe as shown, the cover will allow the foot to be slipped into the shoe easily.



Wood Installed on Concrete Sill Without Using Screw Anchors

Mastic can be used to permit installing a wooden sill and trim on a concrete window sill without the use of screw anchors. The wooden sill is cut to a snug fit in the window frame, then removed and an even coat of mastic is spread on the concrete sill. The inside trim should be nailed to the sill piece, then the L-shape section is tapped firmly into place on the mastic on the sill to form a weathertight fit. The sill can be painted or varnished before it is installed.

Hi Sibley, Nuevo, Calif.

Space-Saving Portable Picnic Table Is Easily Disassembled

For locations where space is restricted, such as the cockpit of a small cabin cruiser, this 24 x 18-in. portable table is ideal.

Because it is easily disassembled, it also can be carried in the trunk of an automobile for use on picnics or at the beach. The top is a piece of $\frac{3}{16}$ -in. outdoor plywood, sanded smooth and varnished or painted. Wedge-shaped wooden pads at each corner of the top splay the legs to give the table stability. The legs are $\frac{5}{8}$ -in. wooden dowels 24 in. long, one end of each being fitted with a ferrule made by cutting a $\frac{3}{8}$ -in. brass-pipe nipple 4 in. long in two. The threaded ends of the fer-

rules turn into pipe flanges screwed to the wedge-shaped pads. If desired, the legs could be $\frac{3}{8}$ -in. pipe.

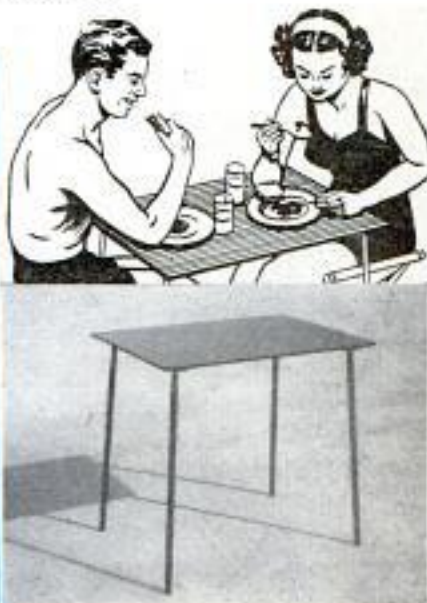
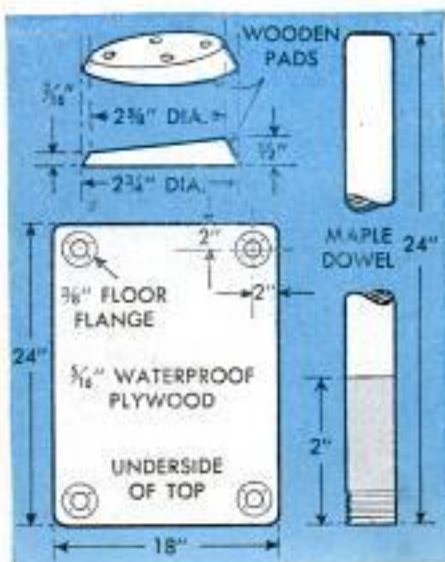

SAFE SEWAGE

How to install and maintain a septic-tank disposal system for rural and suburban homes

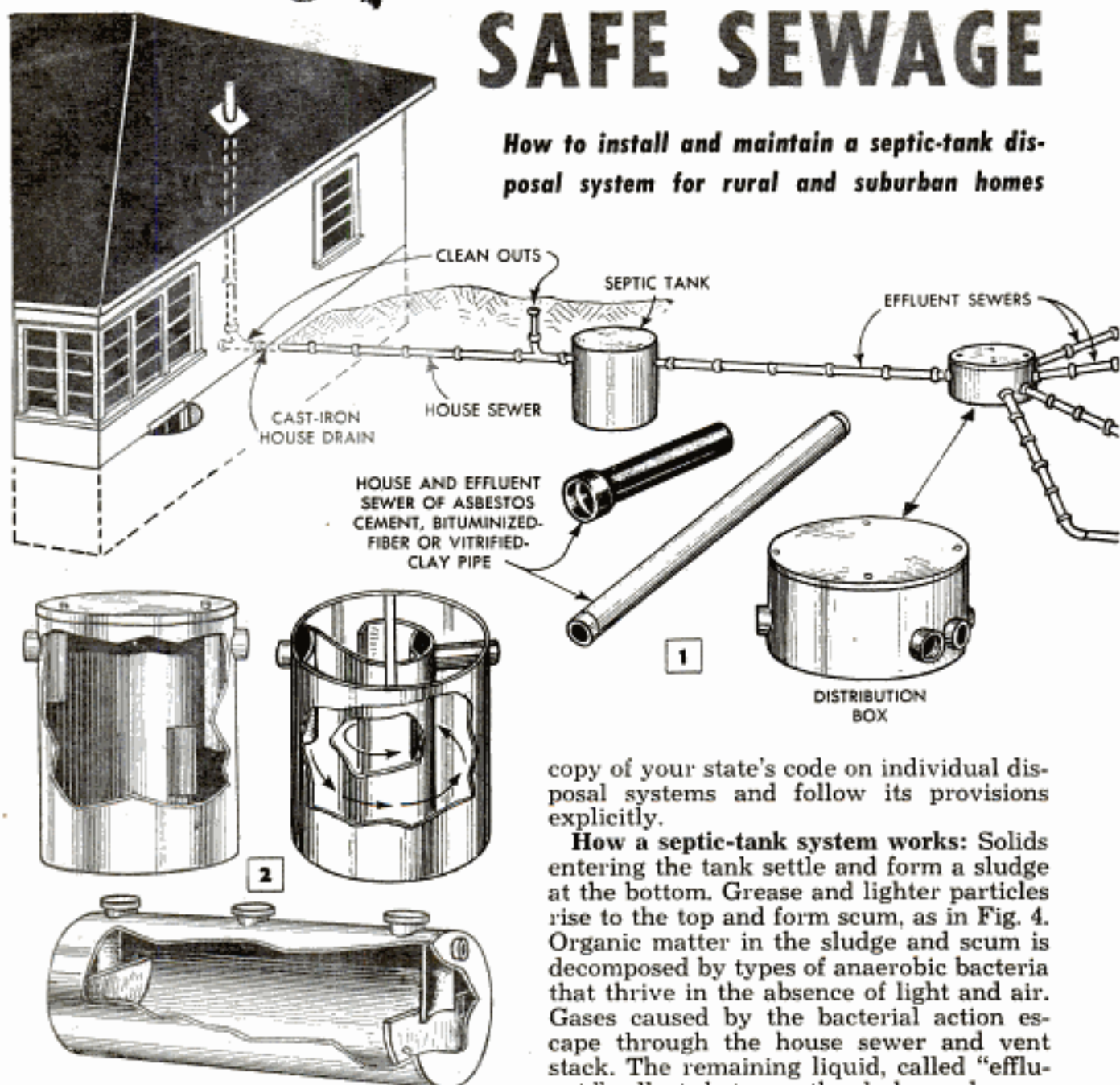

VERTICAL AND HORIZONTAL TYPES OF STEEL SEPTIC TANKS. CONSTRUCTION OF VERTICAL TYPE AT RIGHT PREVENTS DISCHARGE OF UNSETTLED SEWAGE.

IN RURAL AND SUBURBAN AREAS where there are no sewage facilities, a septic-tank system is the most practical means of sewage disposal. Any home that has running water can have such a system, and once you know how the system operates and what it requires, planning it presents few problems. Plenty of digging is required to install the system, but it is possible to rent motorized equipment to reduce the labor to a minimum.

A typical septic-tank layout is shown in Fig. 1. Ready-made steel tanks, Fig. 2, or precast concrete, Fig. 3, or tanks of vitrified-clay pipe are available. Also, you can pour concrete tanks on the site. Before planning a septic-tank installation, get a

copy of your state's code on individual disposal systems and follow its provisions explicitly.

How a septic-tank system works: Solids entering the tank settle and form a sludge at the bottom. Grease and lighter particles rise to the top and form scum, as in Fig. 4. Organic matter in the sludge and scum is decomposed by types of anaerobic bacteria that thrive in the absence of light and air. Gases caused by the bacterial action escape through the house sewer and vent stack. The remaining liquid, called "effluent," collects between the sludge and scum. When it reaches the level of the tank outlet it flows out in amounts equal to the raw incoming sewage. Sewage should be fermented in a septic tank from 24 to 72 hrs. and longer in a two-chamber tank.

The effluent runs to a disposal field, where it seeps into the soil and is made harmless by aerobic bacteria. These, unlike anaerobic bacteria, require air for life and thrive near the surface of the soil, mostly within the first 36 in. Therefore, disposal lines must not be too deep.

Selecting the site: When planning a septic-tank system, first select the site for the disposal field. Its size depends on the sewage load and the absorptive quality of the soil. After determining the size, select the site in consideration of these qualities:

1. Distance from water sources. To avoid pollution, this should be 100 ft. or more. The disposal line should be 25 ft. from any

DISPOSAL

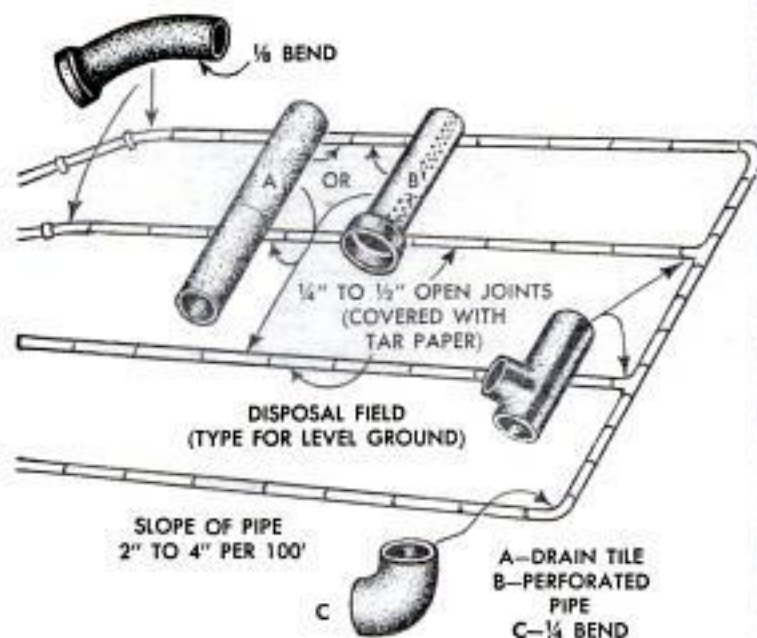

Photos on pages 107 and 108 courtesy of Portland Cement Assn.

stream and 10 ft. from a house or lot line. A distance of 50 ft. from a drilled well is safe if the well casing is watertight to a depth of 50 ft.

2. If possible, the field should be exposed to wind and sunlight.

3. The ground should be well drained, sloping away from the house and water supply.

Septic tanks: Size of the tank depends on the sewage load. Table A gives the measurements of concrete tanks of various sizes. Consult the manufacturer's data sheets for the capacity of prefabricated tanks. It is better to have a tank too large than one that just meets minimum requirements. When determining the size, consider future additions to the plumbing system. The actual working capacity of a tank is the space below the outlet. The minimum size of a one-chamber tank is 500-gal. working capacity. A two-chamber tank, Fig. 4, is more efficient and requires cleaning less often; the minimum size is 750 gal. The tank outlet usually is about 3 in. lower than the inlet. Sufficient air space should be provided above the working capacity. Any of the inlet and outlet arrangements shown in Fig. 4 will prevent turbulence in the tank when sewage flows in, and also keep the scum from flowing out. The covers should fit tightly and may be sealed with a plastic compound to keep out ground water. Large tanks should have manholes, one near each outlet. Usually a septic tank is set so that it can be covered

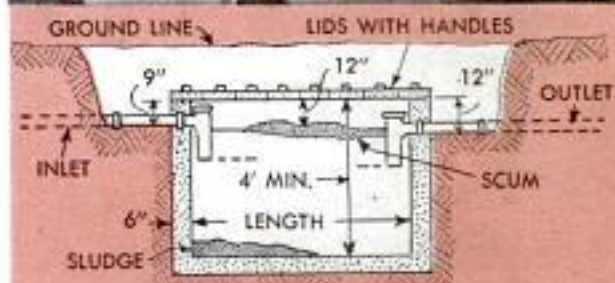

Above, the working capacity of a septic tank is the area below the outlet. Sufficient space must be allowed above the scum layer to permit proper operation. Gases which are generated escape through the inlet pipe to the house sewer and then out through the vent stack

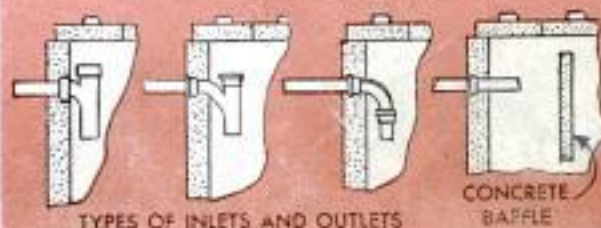
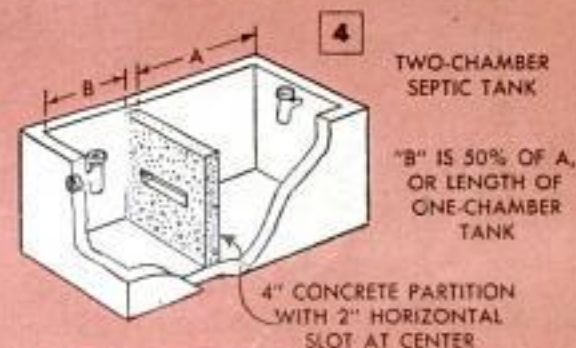

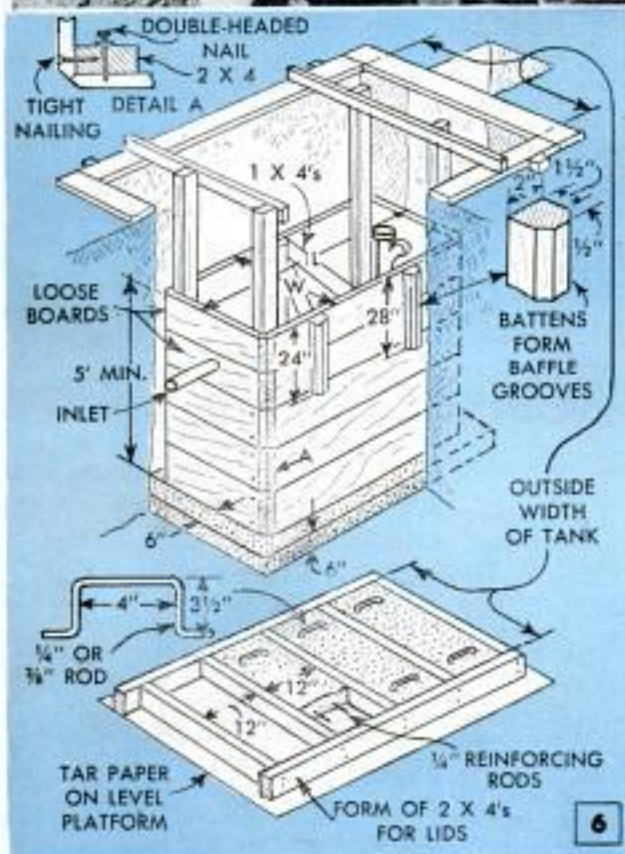

with 12 to 18 in. of earth, at which depth the inlet will be about 30 in. deep. The tank can be located any reasonable distance up to within 10 ft. of the house.

Building concrete tanks: Where the earth is firm, no outside forms are needed. Inside forms are "hung" in place as in Figs. 5 and 6. Use a 1:2¼:2 mix of portland cement, sand and gravel respectively, by volume, with just enough water added to produce a workable consistency. The tank lids are cast in a mold on a level surface. They are reinforced and provided with handles.

House drain and sewer: The house drain should extend at least 5 ft. outside the foundation wall and, as a rule, cannot be installed under a basement floor. Basement waste must be raised to the house-drain level with a sump pump. The house sewer runs from the house to the septic tank. It can be any type of good sewer pipe. The joints should be permanently tight to prevent leakage or the entrance of tree roots. If vitrified-clay pipe is used, pour the joints with special elastic joint compound. Usually, a 6-in. house drain is preferred; 4 in. is the minimum size. Cast-iron pipe is most resistant to crushing and should be used if the lines run under a driveway at a depth of less than 3 ft. The line should be straight as possible, with a slope of 1/8 in. per ft. for 5 or 6-in. pipe, and 1/4 in. per ft. for 4-in. pipe. The line from the septic tank to the disposal field should have the same slope. If the tank is over 20 ft. from the house it is advisable to have a cleanout within 5 ft. of the tank.

Size of disposal field: The area required for the field is determined by percolation tests, Fig. 7. Do not make the tests in filled or frozen ground, and if rock formations are encountered, obtain the advice of the State Board of Health. To make percolation tests, dig a number of holes with a posthole auger about 18 to 24 in. deep. Fill them with water until it seeps away at a uniform rate. Then check the time for a known

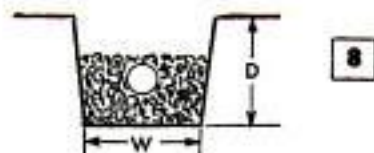

depth of water to seep away and divide this by the depth in inches to get the average seepage time per inch. Refer to Table B, which gives the absorption area (area of the trench bottom) needed for the number of persons to be served by the system. Next, refer to Table C to obtain the length and width of disposal trenches and to figure the length of pipe required. For example, if the seepage is 10 min. per in., a family

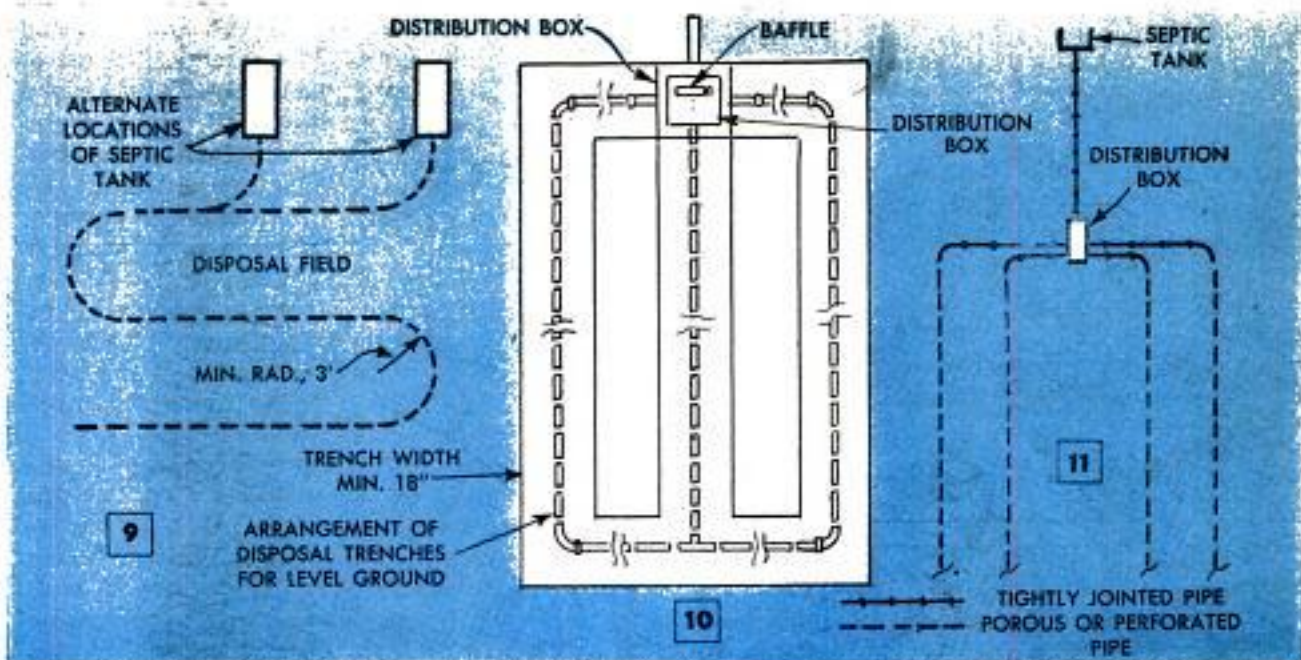

Table A

SIZES FOR SINGLE-CHAMBER CONCRETE SEPTIC TANKS

Persons served	Inside dimensions in feet			Working capacity (gals.)
	Length	Width	Depth	
4 or less	6	3	5	500
6	7	3	5	600
8	7½	3½	5	750
10	8½	3½	5	900
12	8½	4	5½	1100
14	9	4	5½	1200
16	10	4½	5½	1500

Recommended thickness of walls, 6 in.

Table B

ABSORPTION AREA AT BOTTOM OF DISPOSAL TRENCHES REQUIRED PER PERSON SERVED AS BASED ON PERCOLATION TESTS

Time of 1-in. seepage from test holes (minutes)	Absorption area per person (sq. ft.)
2 or less	26
3	30
4	36
5	40
10	52
15	63
30	90
60	120

Table C

CONVERSION OF ABSORPTION AREA TO LINEAL FEET LENGTH OF TRENCHES OF VARYING WIDTHS AND DEPTHS

Trench dimensions (in.)		Absorption area per lineal ft.
Width W in Fig. 8	Depth D in Fig. 8	
18	18 to 30	1.5
24	18 to 30	2.0
30	18 to 36	2.5
36	24 to 36	3.0

Spacing between trenches should be three times their width and not less than 6 ft.

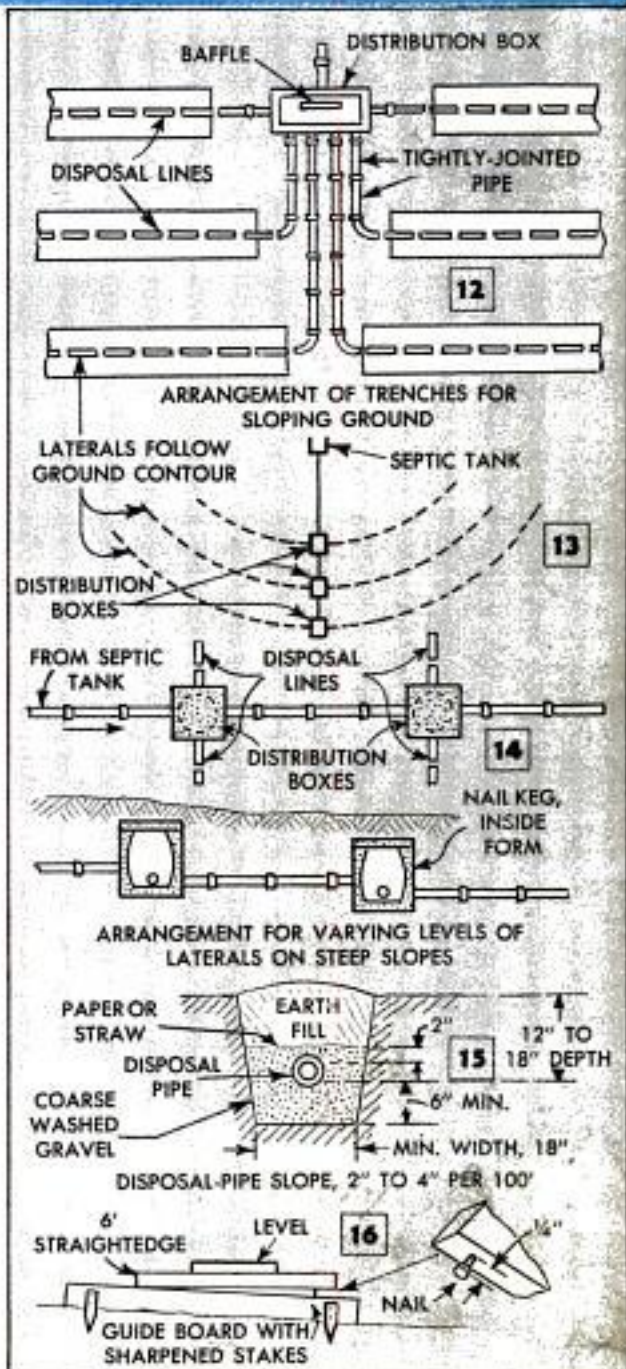



of five will require 250 sq. ft. of absorption area. Divide this by 1.5 (Table C) which gives a trench length of 173 ft. for the 18-in. width.

The disposal field should not be less than 150 sq. ft. of absorption and the lines should not be longer than 100 ft. Spacing between parallel lines should be 3 times their trench width, but not less than 6 ft. Tightly jointed pipe is used from the septic tank to the distribution box, and from the latter to the inlet end of the line.

Disposal-field design: A single line for a small system can be S-shaped as in Fig. 9. Where the ground slopes, the laterals are placed at progressively lower levels. If a line must be longer than 100 ft., use several short ones equaling the total length requirement. Two multiple-line arrangements for level ground are shown in Figs. 10 and 11. Other arrangements for sloping ground, where the laterals follow ground contour, are shown in Figs. 12 and 13. Any multiple-line system requires a distribution box. Sometimes each pair of lines is fed from a separate distribution box, as in Figs. 13 and 14.

The best depth for disposal lines is 12 to 18 in. below the ground surface, but no more than 36 in. Drainage slope of the lines

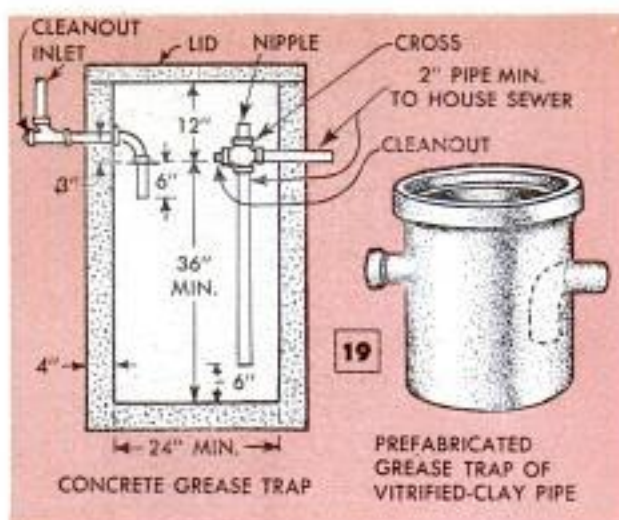

should be from 2 to 4 in. per 100 ft., but not over 6 in. per 100 ft. Trenches should not be less than 18 in. wide at the bottom. A 6-in. layer of coarse, washed gravel ($\frac{1}{2}$ to 2 $\frac{1}{2}$ -in. dia.) is required under the pipe, and a 2-in. layer over it.

Laying disposal lines: Pipe is laid to grade with a level and straightedge on guide boards, Figs. 16 and 17. The guide boards have pointed stakes nailed to them and are left permanently in place. The nail projecting from the straightedge assures getting the required slope. Drain tile is spaced from $\frac{1}{4}$ to $\frac{1}{2}$ in. at the joints, which are covered with tar paper, as in Fig. 18. Before filling the trench, the gravel layer is covered with untreated building paper, several layers of newspapers or 2 in. of straw. Where frost penetrates 5 or 6 ft., trenches are dug deeper than this, Fig. 22, and are filled with coarse gravel so that the pipe can be laid to a depth of 36 in.

Distribution boxes: Distribution boxes, Figs. 20 and 21, assure an equal distribution of the effluent to the disposal lines. A baffle is used to stop sudden surges of incoming effluent. Where a duplicate disposal field is used, Fig. 20, a stop board in the distribution box permits shutting off either field for rest or repair.

Disposal lines in tight soils: Where soils are too tight for rapid absorption (as indicated when 1-in. seepage requires 60 min. or more by percolation test) you can substitute sand-filter trenches, seepage pits or other approved means of disposal. Filter-trench construction is shown in Fig. 23. Where the surface soil is tight but is underlain with porous soil, one or more seepage pits, Fig. 24, may be used instead of disposal lines. The distance between pits should not be less than 3 times their diameter and the capacity of the pit should be no less than that of a septic tank.

Grease traps and garbage grinders: A grease trap, Fig. 19, is only needed when there is an abnormal amount of grease and

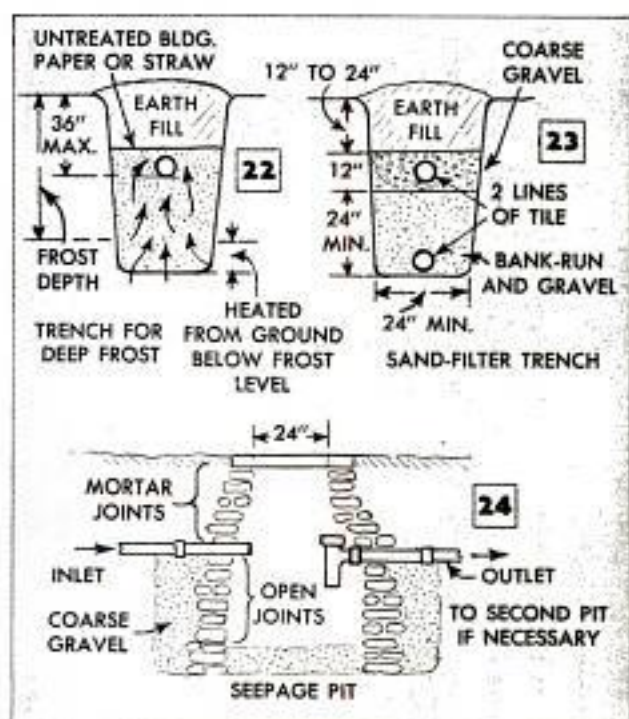
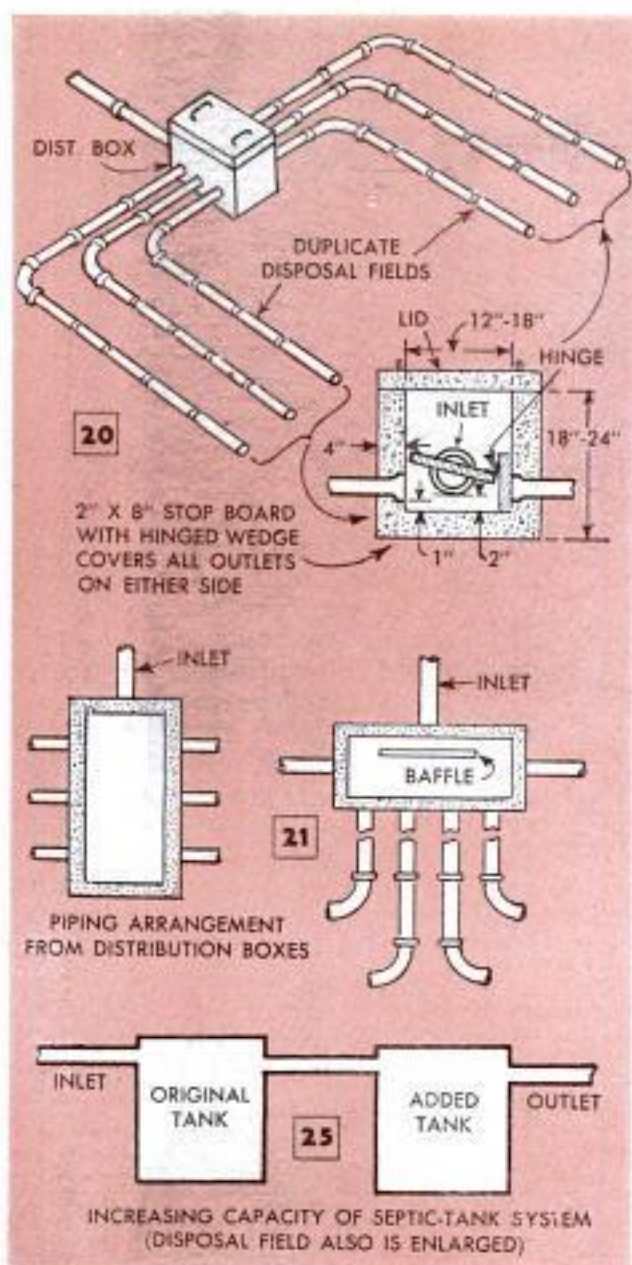

fat present in the sewage, as on a farm where considerable processing of meat and dairy products is done. However, some states require the installation of grease traps in individual disposal systems. Where one is used, an electric garbage grinder should not be installed in the kitchen waste line. Where a grease trap is not used and a garbage grinder is installed, the septic tank should be enlarged 50 percent.

Storm water and chemicals: Rainwater from roofs should not be led to a septic tank. Only normal quantities of laundry wastes should be admitted. Soap, drain solvents and other mild cleaning and disinfecting solutions will not cause trouble. However, constant disinfected wastes from sickrooms, milk rooms, strong chemicals for sterilizing equipment, pickle brine, photographic chemicals and waste from filters or water softeners should not be admitted to a septic tank.

Care and maintenance: Inspect the tank

every 12 to 18 months. Cleaning is necessary when the space for liquids between the sludge and scum is reduced to one half of the total tank depth. In small tanks, this usually takes 2 to 3 years. Larger tanks and two-chambered tanks may go 10 or 12 years before cleaning. The removed sewage has disease-producing germs and should not be used as fertilizer. It should be buried in pits and covered with an 18 to 24-in. layer of earth, at points remote from water sources. Never use any kind of open flame in a septic tank, as the gases in it often are explosive. They also may be poisonous and asphyxiating, so the tank should be ventilated thoroughly before you enter it. When it is necessary to enlarge a system, a second tank can be connected to the original one, Fig. 25, and the length of the disposal lines increased proportionately. ★ ★ ★

Corn-on-the-Cob Holders Turned from Hardwood

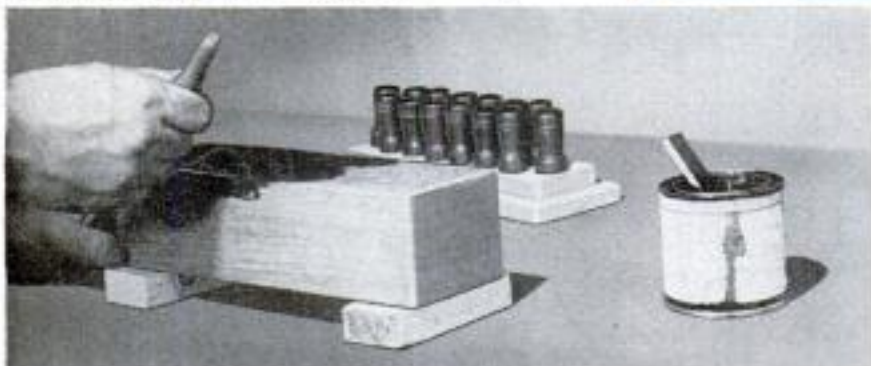
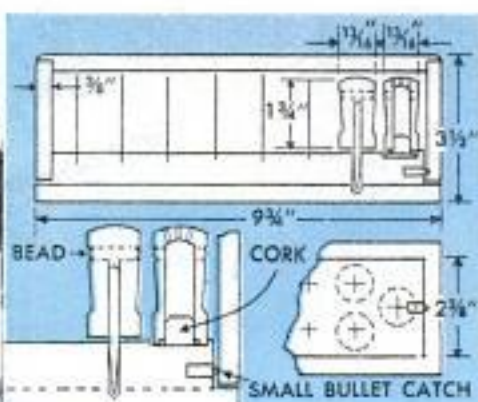

The pleasure of eating piping-hot corn on the cob is multiplied by these wooden holders that keep the fingers cool. Because of their small size they can be turned individually from hardwood scraps or in multiples from one piece. The points are made from $\frac{1}{8}$ x $\frac{1}{8}$ -in. stainless steel or aluminum stock, filed to a square point. The matching salt and pepper shakers are turned in the same way. Turn enough pairs of each to equip your family and any expected guests, and make a box just large enough to hold them. The bottom of the box acts as a tray for the holders. — Harrison Neustadt, New York City.

Shelves and Partitions Supported by Basement-Column Brackets

One home craftsman utilized normally wasted space by hanging shelves on the supporting columns in his basement workshop. Brackets to fit around $\frac{1}{8}$ x 1-in. flat steel to a U-shape. The heads were cut off $\frac{3}{16}$ -in. bolts and welded to the ends of each piece. A hardwood spacer, used with the

brackets, allows vertical mounting of wood strips or panels, while a length of angle steel, drilled to receive the welded bolts, will support a horizontal shelf. The brackets also can be used to install partitions such as when dividing the basement into rumpus rooms and laundry areas. The hardboard, plywood or plasterboard is nailed directly to horizontal wooden strips which are bolted to the posts by means of the brackets.

Arthur R. Tanner, Cold Springs, N. Y.

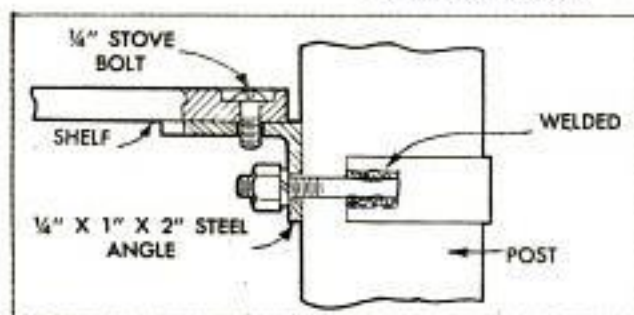
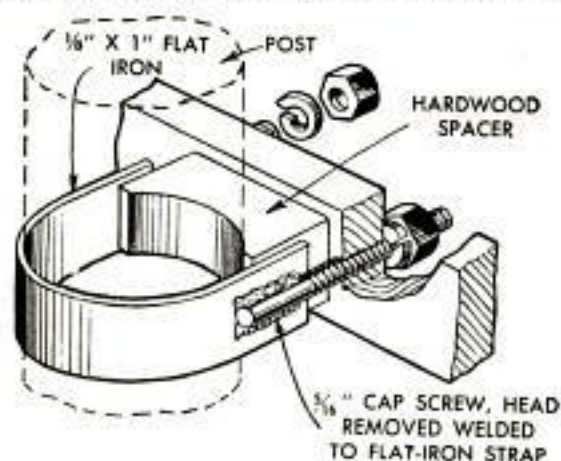

Stop Strip on Bookcase Shelf Keeps Volumes Aligned

A stop strip placed on the shelf behind books that are in constant use, will provide a means of keeping them neatly aligned with the front edge of the shelf. The strip is cut as wide as the space between the books and the back of the shelf, and just long enough to accept a set of books which are all of one size. If the bookcase has no back, it is necessary to nail or screw the stop strip to the shelf.



Folding Door Saves Needed Floor Space in Small Room

This four-panel folding door allows use of floor space ordinarily taken up by the swing of a conventional door. This feature is especially desirable in small bedrooms, both for closet as well as entrance doors to the room. The panels are $\frac{3}{4}$ -in. plywood, which can be of a wood to match the woodwork in the room. Width of the door frame divided by four determines the width of each panel. Deduct $\frac{1}{16}$ in. from the width of each panel for hinge clearance and allow $\frac{1}{8}$ -in. clearance at top and bottom. When the panels are cut, allowance must be made for the width of the saw cut. Each panel is then mortised for three $1\frac{1}{2}$ -in. butt hinges. The panel next to the frame is mortised on two sides, the inner panel on only one. A ring-type door pull is recessed near the inner edge of each inside panel. In the original installation,



the old stop-strips were removed and a $\frac{3}{4}$ -in.-sq. piece of stock was fastened across the top of the doorframe.

Thomas I. Lucci, Avon Lake, Ohio.

Small-Parts Cabinet for Shop Assembled From Precut Pieces

A space-saving cabinet for small parts, using $\frac{1}{4}$ -in. stock for the sides and backs of the drawers and $\frac{1}{8}$ -in. hardboard for the bottoms, provides a maximum of storage for any given space. All parts of the cabinet can be precut on a circular saw and

there are no horizontal partitions. The vertical $\frac{3}{4}$ -in. partitions are dadoed to provide drawer slides, and the projecting bottoms of the drawers then slide into the cuts. The cabinet assembly thus requires a minimum of fitting. The finger grips on

the drawers of the cabinet in the photo were made by drilling two holes $\frac{5}{8}$ in. deep with a $\frac{3}{4}$ -in. Forstner bit, then nailing a strip of hardboard across the top edge of the holes. Any suitable finger grip may be used. The dimensions of the cabinet given in the detail can be changed easily, to permit it to fit any available space on the shop wall. The drawers in the lower two or three rows can be made deeper to allow storage of larger items, and those in which nails, screws and other small parts are to be kept can be partitioned. — Will Thomas, Buffalo, N. Y.

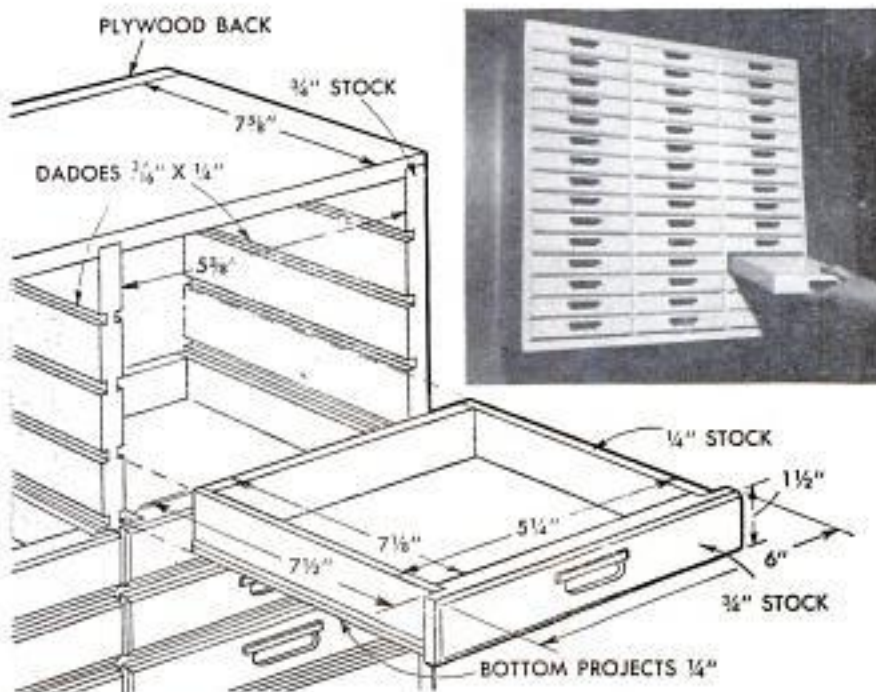

PLAN of the MONTH

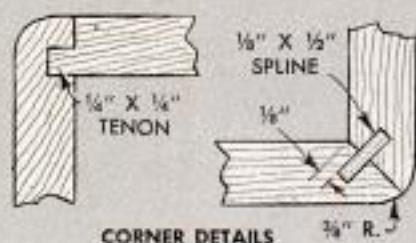
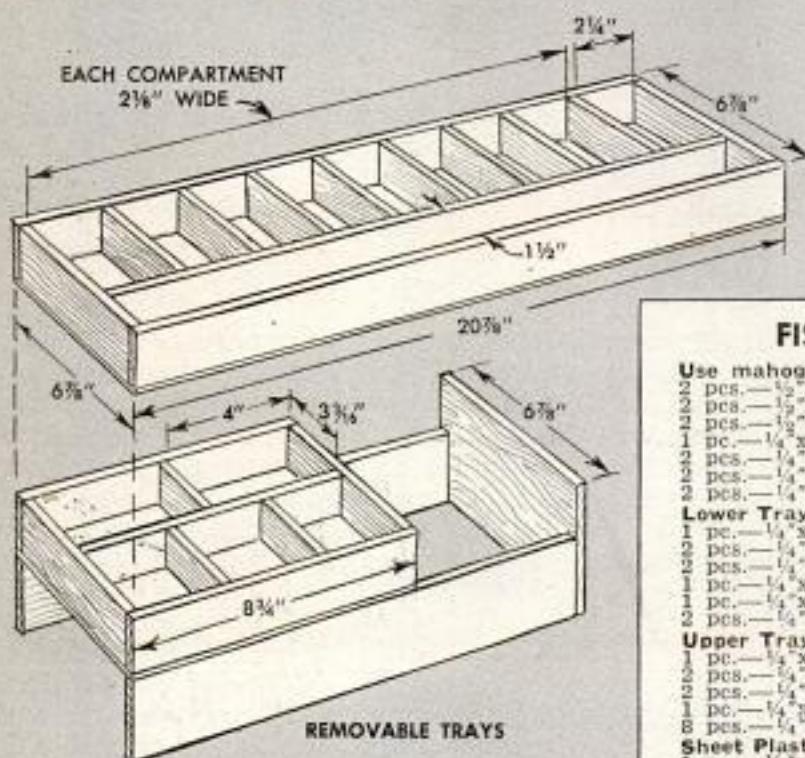
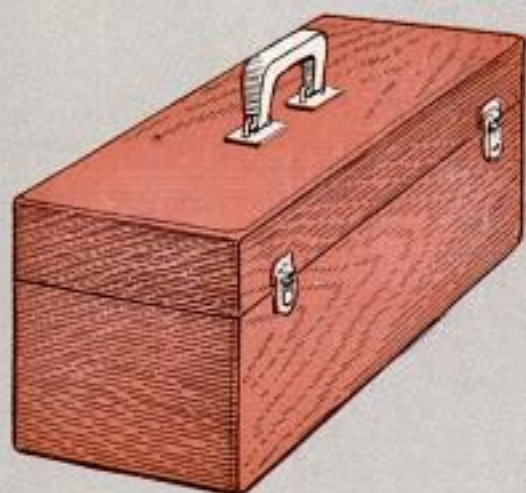
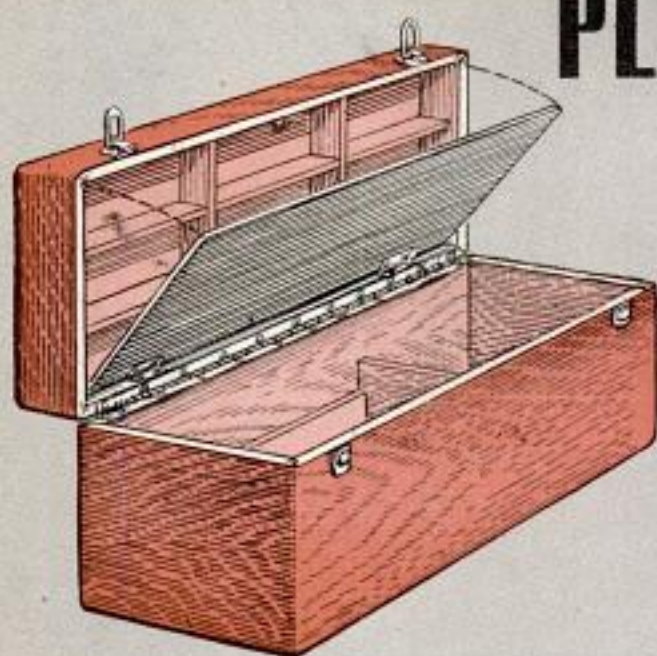

FISHING-TACKLE BOX

Use mahogany, redwood or white-pine lumber

- 2 pcs.—1/2" x 8" x 8-3/16"—Box ends
- 2 pcs.—1/2" x 8-3/16" x 21 1/2"—Box sides
- 2 pcs.—1/2" x 7 1/2" x 21 1/2"—Box top, bottom
- 1 pc.—1/4" x 1 3/4" x 6 1/8"—Bottom divider
- 2 pcs.—1/4" x 2 1/4" x 14 3/4"—Bottom tray sides
- 2 pcs.—1/4" x 1 1/4" x 21"—Top dividers
- 2 pcs.—1/4" x 1 1/4" x 7"—Top dividers

Lower Tray

- 1 pc.—1/4" x 6 3/8" x 8 3/4"—Bottom
- 2 pcs.—1/4" x 1 1/4" x 6 3/8"—Ends
- 2 pcs.—1/4" x 1 1/4" x 8 3/4"—Sides
- 1 pc.—1/4" x 1 1/4" x 8 3/4"—Divider
- 1 pc.—1/4" x 1 1/4" x 3-3/16"—Divider
- 2 pcs.—1/4" x 1 1/4" x 2-15/16"—Divider

Upper Tray

- 1 pc.—1/4" x 6 3/8" x 20 7/8"—Bottom
- 2 pcs.—1/4" x 1 1/4" x 6 3/8"—Ends
- 2 pcs.—1/4" x 1 1/4" x 20 7/8"—Sides
- 1 pc.—1/4" x 1 1/4" x 20 7/8"—Divider
- 8 pcs.—1/4" x 1 1/4" x 4 5/8"—Dividers

Sheet Plastic or Hardboard

- 1 pc.—1/8" x 6 3/8" x 20 7/8"—Inside lid

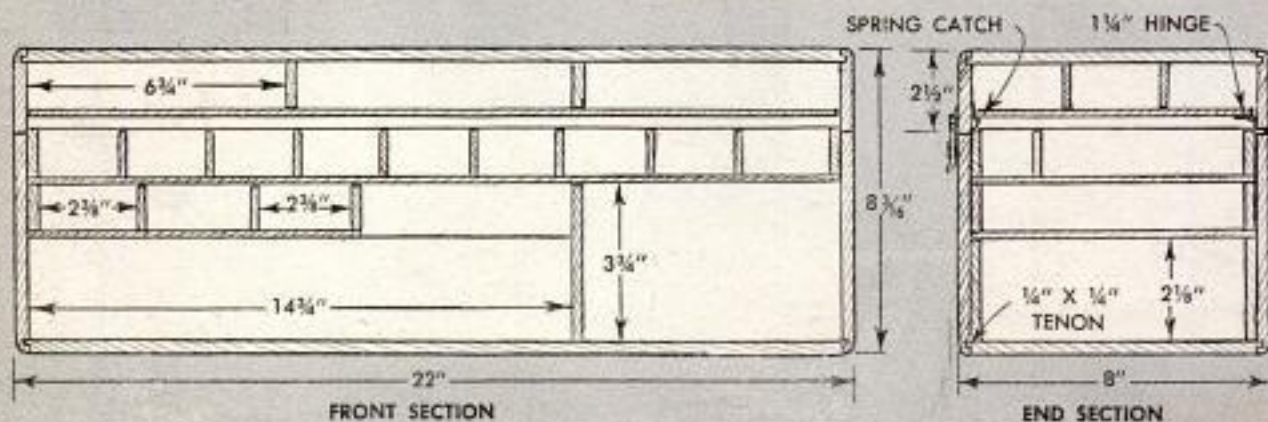

Tackle Box and Rod Cabinet

This month we feature two projects for the fisherman. On the opposite page are plans for a tackle box large enough to hold all the necessary small equipment. Note that two methods of joining the corners of the box are shown, either one of which may be used. On this page we feature plans for a wall cabinet to hold rods and reels. This makes a decorative and practical piece of furniture for the den, especially when a good hardwood is used for exposed surfaces.

MATERIAL LIST

Lumber

- 2 pcs.— $\frac{3}{4}$ " x $7\frac{1}{2}$ " x 36 "—Ends
- 2 pcs.— $\frac{3}{4}$ " x $7\frac{1}{2}$ " x $20\frac{1}{2}$ "—Shelf and bottom
- 1 pc.— $\frac{3}{4}$ " x 4 " x $20\frac{1}{2}$ "—Rod holder, bottom
- 1 pc.— $\frac{3}{4}$ " x $1\frac{3}{4}$ " x $20\frac{1}{2}$ "—Rod holder, top
- 2 pcs.— $\frac{3}{4}$ " x $4\frac{3}{8}$ " x $9\frac{3}{4}$ "—Drawer fronts
- 4 pcs.— $\frac{3}{8}$ " x $4\frac{3}{8}$ " x $7\frac{1}{4}$ "—Drawer sides
- 2 pcs.— $\frac{3}{8}$ " x $3\frac{7}{8}$ " x $9\frac{3}{8}$ "—Drawer backs

Plywood

- 2 pcs.— $\frac{1}{4}$ " x 7 " x $9\frac{1}{4}$ "—Drawer bottoms
- 1 pc.— $\frac{1}{4}$ " x $20\frac{1}{4}$ " x 34 "—Back

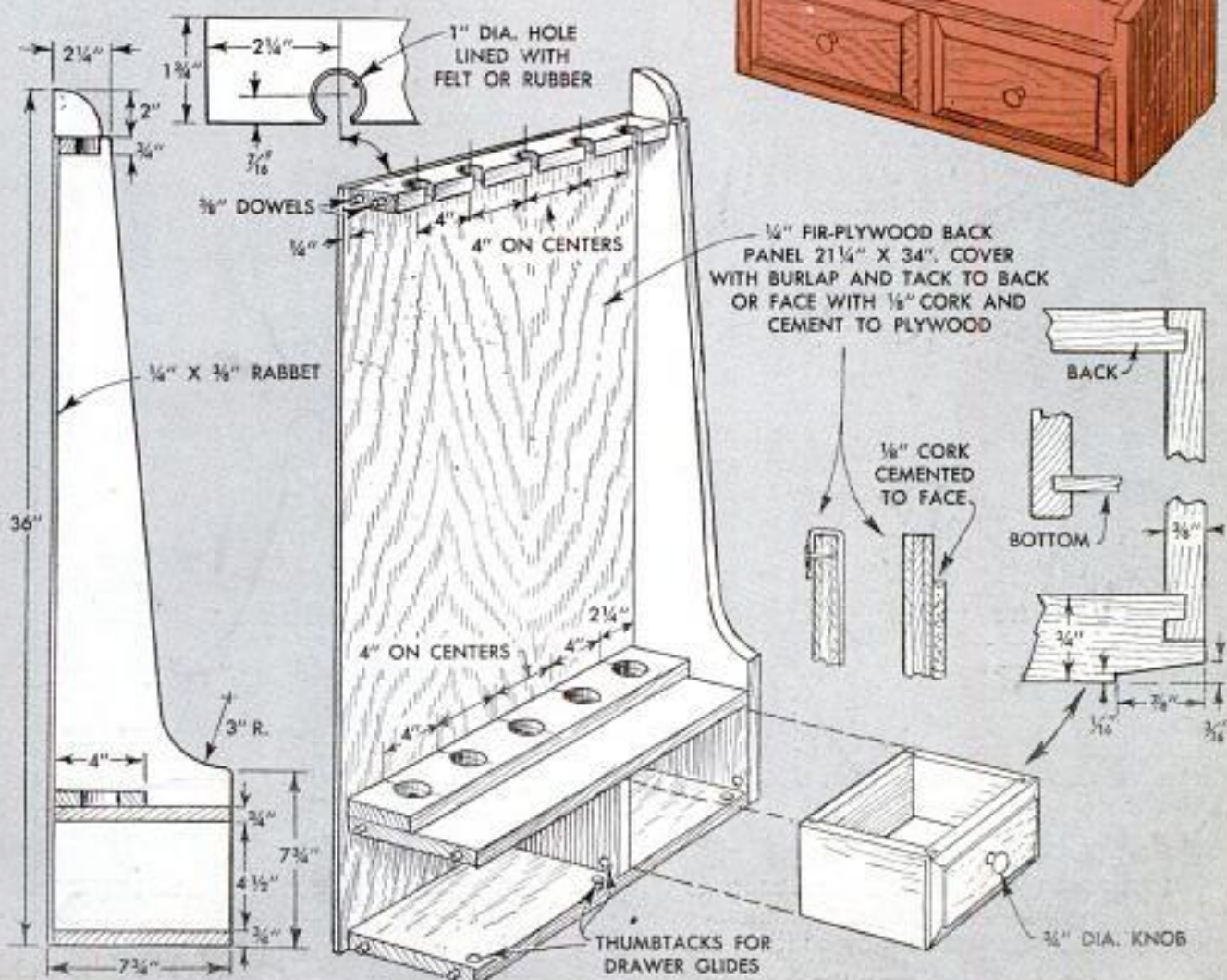
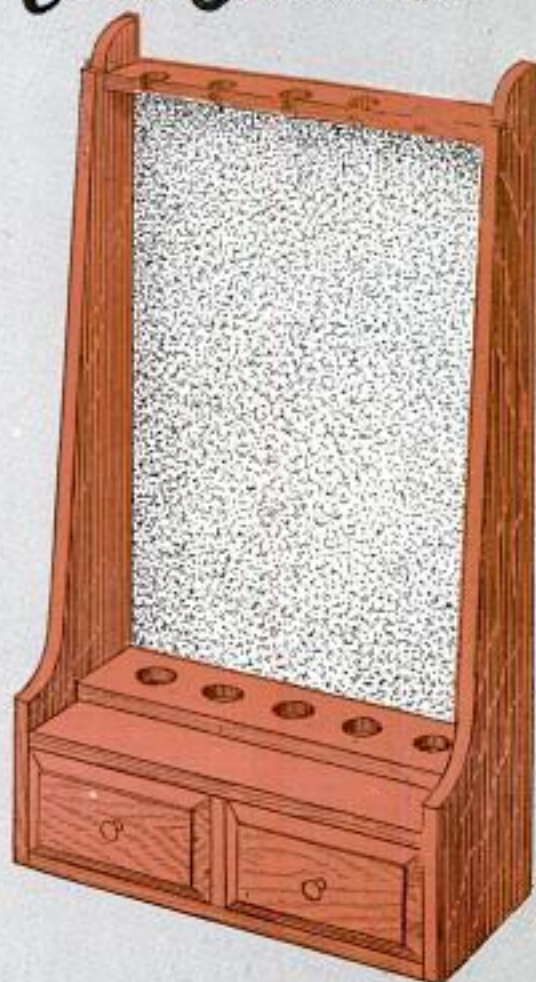



Rubber Cot Protects Finger When Filling Plaster Cracks

Although your index finger provides a handy and flexible tool for wiping patching plaster into cracks in a wall, extensive use will result in a painful abrasion. However, by wearing a rubber finger cot of the type used for handling paper, a skinned finger can be avoided. This is also handy for applying joint compound to pipe.

Screen Molding Mitered Easily While Tacked in Place

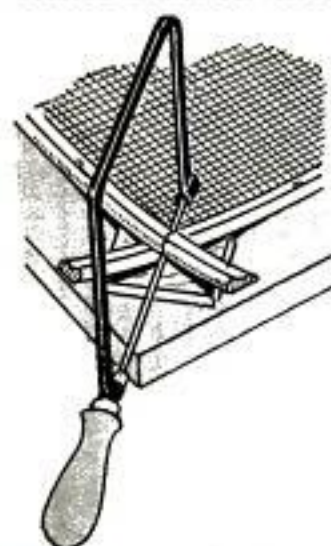

Perfect-fitting miters can be cut at the corners of window-screen molding without using a miter box. Tack the molding in place on the screen, but do not fasten the last 6 or 8 in. at each end. Slip a piece of hardboard or thin plywood under the molding where it crosses at each corner. Cut through both pieces with a hacksaw or coping saw, keeping the angle about 45 deg. The cut ends will match exactly and can be pressed tightly together and tacked into place.

"Locking" Small Screws

Small screws that have a tendency to work loose in a model engine or locomotive can be secured permanently by coating the threads with fingernail polish before tight-

ening the screws in place. A light application will do the job, yet permit their removal with a screwdriver if necessary.

Ed Packer, Chicago.

Burlap Sack Laced to Wheel Rim Keeps Newly Caught Fish Alive

One fisherman made a holder to keep his newly caught fish fresh and alive by lacing a burlap sack to the rim of an auto-steering wheel. The wheel rim fits under a steel-angle bracket screwed to the boat transom and is removed easily to permit carrying the holder ashore.



Bob Poulson, Los Angeles, Calif.

Salt Removes Soot From Carpet Without Smearing

Removing soot from a rug or carpeting with a vacuum cleaner alone will almost always result in an unsightly spot. However, if the soot spot is thickly covered with dry salt before the vacuum cleaner is used, there will be no stain or smear left.

Blanche Campbell, Las Vegas, Nev.

Tire Pressure Marked on Gauge

Rather than trying to remember the air pressure required by the tires of your car, mark them on a piece of adhesive tape and fasten it to your tire gauge. Make note of both hot and cold pressures for front and rear wheels. Maintaining the correct pressure at all times will add miles of wear to the tires and allow them to wear more evenly.—Richard Hanscom, Elmhurst, Ill.



X629

WHEN WATER'S TOO SOFT

By William Gilman

WOULD YOU STEP on the accelerator when it's brakes you need? Yet, in a way, that's what many homeowners do about "hard water" problems. The hard water they try to soften isn't hard at all. It's exactly the opposite—too soft. This may sound surprising to the country dweller or villager with his private water supply, but it's a fact that sparkling cool water fresh out of the faithful old well or spring often can be too soft.

This water, known as corrosive water, contains too much carbon dioxide and the result is messy and costly. The water eats out your pipeline and the products of that corrosion result in a long list of complaints such as clogging the plumbing with rust, leaving brown stains on washcloths and porcelain and making the water look cloudy or taste "inky." Corrosive water is far more common than you might think and, although it does not occur as often as hard water, it causes considerably more trouble when it does occur.

Once corrosive soft water is recognized for what it is, the average homeowner's water supply can be cured with a filtering treatment based on only a few dollars' worth of crushed limestone. The method is

Wooden forms are removed after 6-in. concrete walls have set. Concrete floor of tank also is 6 in. thick



Before building filtering tank, section of pipe leading from well is replaced with 1-in. copper tubing. Bypass line and valve are installed to permit using water supply while tank is being built

as foolproof as it is simple. As the water percolates through the limestone, it loses carbon dioxide and gains minerals without getting too hard. As a bonus, the limestone acts like a gravel bed in filtering out any ordinary sediment that might be in the water. In addition, the treatment tank can be built in such a way that it will increase water storage for protection against the summer dry periods that affect many wells and springs.

Water that comes from drilled wells is more likely to be too hard than too soft

To make tank watertight, corners are rounded with mortar and walls are coated with mortar to fill pores





Limestone is poured into two of the three filtering-tank compartments, in this case, forming a filtering bed 33 in. deep. Limestone compartments are 30 in. long and water-storage section is 27 in. long



Several bricks are left out of one end of each baffle (on opposite sides of tank) so water can circulate through them. Opening to water storage compartment is covered with perforated sheet of copper



Water supply must be kept clean and protected from contamination, so tank is covered with 2-piece lid of 2-in. planks. Ends and sides of planks are being faced with boards, above, which held lid in position

Photo below shows control rods for reaching valves used in this installation. End of lower rod engages standard handle on water-line gate valve. Upper rod is notched for wheel-type handle on bypass valve



Lid sections are covered with roll-type roofing to seal tank from surface drainage. A narrower strip of roofing is laid over seam formed by first two pieces. Standpipes in foreground lead to valves

Either half of finished lid can be removed, as below, to permit access to filtering tank. Two standpipes in foreground should be covered to keep out debris, inverted coffee cans serving the purpose



because it has passed through and dissolved such rock as limestone. Water that is obtained from shallow wells or springs, therefore, normally would tend to be soft—sometimes corrosively soft. As water is not always what it seems, it's best to have an analysis made for bacteria and chemical content before attempting a cure. Most state health departments will perform this analysis free.

Before the chemical analysis, however, you'll find plenty of clues which indicate that the water is corrosive. For example: The water may stain porcelain fixtures brown or red, or it might run "rusty" the first few moments after opening the tap. Then, too, it may turn cloudy after standing overnight. Even copper, brass and lead piping are not immune to this fast-rusting water.

Oddly enough, hard-water treatment can help the soft-water problem indirectly. But, at best, it only removes the products of corrosion. In severe cases, the softener itself may require protection in the form of a filtering or neutralizing tank.

The most effective solution to soft-water problems, then, is to build a filtering box, containing limestone, next to the well or spring. The box could be made of planks, but will be neater and more permanent if it is built in the form of a concrete storage tank. To keep the water in contact with the limestone as long as possible, the tank should be longer than it is wide or deep and contain a pair of baffles which divide it into three compartments. It should handle a cubic yard of crushed limestone or marble and, for the average family, have a water capacity of about 30 cu. ft. The stone particles shouldn't be too large—screenings of $\frac{1}{4}$ to $\frac{3}{4}$ -in. size are good. You also can use No. 1A road dist, the material which is applied as a top dressing on macadam pavement, or "chicken grit," having



In the photo above third compartment of filtering tank contains clear water hardened by limestone

particles which average about $\frac{1}{8}$ in. in size.

A plank lid finishes the tank. In severe winter weather, the tank should be covered with boards or straw to prevent freezing. Unlike a water softener, the filter bed doesn't need backwashing. After a couple of years you just dump in more limestone.

The photographs picture a tank 8 ft. long, 2 ft. wide and slightly over 5 ft. deep. It's installed near a typical gravity spring and its water level rises and falls with the level in the spring basin. The limestone is in the first two compartments, the last compartment containing the neutralized, clear water. Actual dimensions and elevations of the tank will depend on your particular situation. Plan the tank size according to maximum water needs. ★ ★ ★

When building filtering tank, it's sometimes well to rebuild spring, adding new concrete walls and tight cover

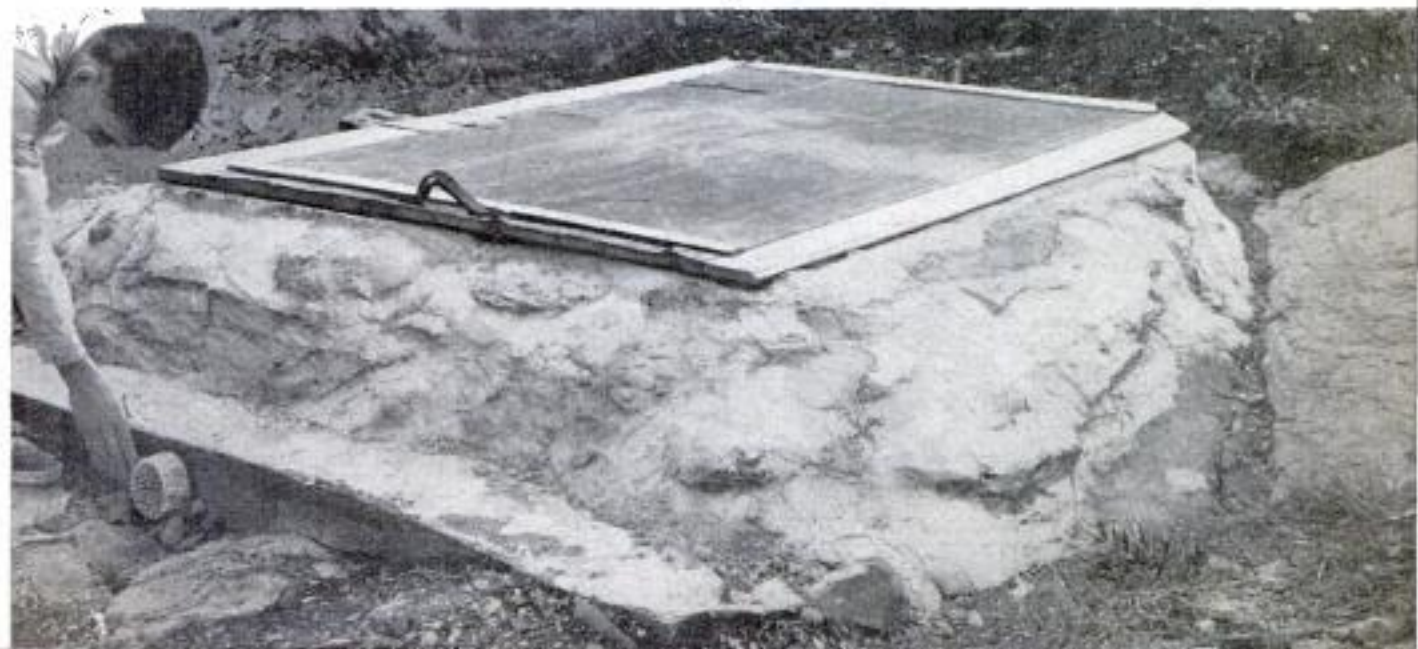

Mirror Mounted in Wooden Jig Reverses Artist's Copy



Faced with the problem of reversing the copy from which he was working, one artist developed this device to help him. It consists of a wooden base on which are mounted a mirror and a board for tacking up the copy to be reversed. The board and the mirror are mounted so that the angle between them measures 45 deg., as shown. By looking into the mirror, the artist sees a reversed reflection of the original copy on the mounting board.

Flush-Tank Handle Kept Tight With Copper-Wire Shim

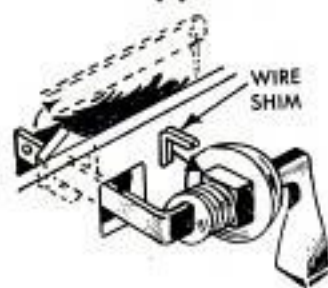

To prevent the handle on a toilet flush tank from working loose when the opening in the tank was oversize, one homeowner used a wire shim on the fitting. The shim

was formed by winding soft-brass or copper wire around the square shoulder of the fitting so that it is a snug fit in the open-

ing in the side of the tank. The shim prevents the handle fitting from twisting and thus loosening the nut. Being of brass or copper, the shim will not rust.

Hugh Lineback, Stillwater, Okla.

Bent Fishhooks Taped to Pole Make Efficient Line Guides

Fishermen who use a cane pole with a reel attached for still fishing can provide excellent guides for their line by bending fishhooks as shown in the illustration and taping them to the pole. The hook end is secured to the pole with several windings of either adhesive or friction tape and the eye of the hook, which then is in an upright position, serves as the line guide.

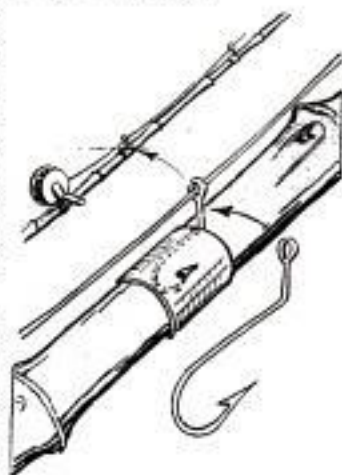

G. E. Hendrickson, Argyle, Wis.

Masking Arms of Photo Easel Squared on Ruled Card

To assure even borders on prints, the masking arms of a photographer's easel can be squared quickly by using a card ruled with crosslines at $\frac{1}{4}$ -in. intervals as shown. When the arms have been lined up with adjacent lines, masking or adhesive tape may be used to secure them in position. The back of an 11 x 14 piece of double-weight print paper is satisfactory for this purpose.

Clyde Allison, Cadillac, Mich.

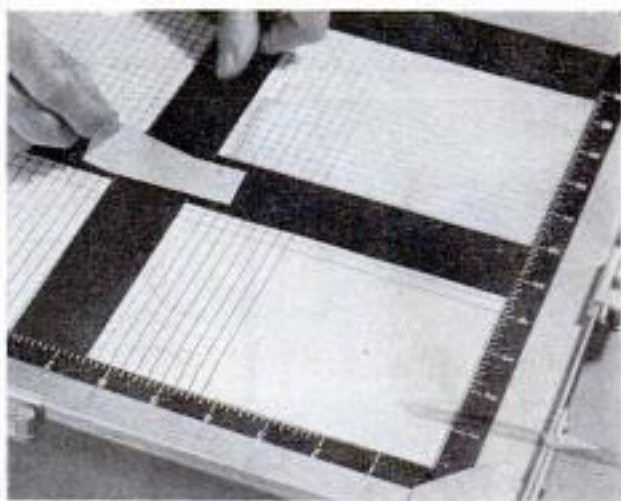

Steaming of bathroom walls when drawing water for a bath is kept to a minimum by running the cold water into the tub first.

Build Your Own Jaguar SS

Build your own model of the flashy Jaguar SS-100 from the well-detailed plans in next month's issue. The SS-100 is the British sports car that set the design and performance standards for the medium-priced sports car of today, and was the forerunner of the popular Jaguar XK-120. You will be pleased with the wealth of accurate detail that the $\frac{3}{4}$ in. to the ft. scale of the model allows

MOTORIZED WHEELBARROW

By F. Lelan Elam

To eliminate some of the back-breaking labor of hauling heavy loads of droppings from his chicken houses, one poultry farmer built a motorized wheelbarrow with a dump-type hopper. A gasoline engine is pivoted inside the frame; the pivot is parallel to the axle of the wheel. When the handle of the wheelbarrow, which is hinged just behind the cross brace, is pulled inward, it causes a rod to tip the engine forward on the pivot. A roller, powered by the engine, contacts the tire and propels the wheelbarrow. A small lever near the end of the handle is the throttle. The front end of the hopper is pivoted on the axle of the wheelbarrow, and the back end is locked to the cross brace with a latch. Releasing the latch permits the hopper to tilt forward.



The front end of the hopper is pivoted to the axle, and the back end is locked down with a latch. When the latch is released, the hopper can be tilted forward

Below are shown the details of the tipping mechanism for the hopper, control rod to tilt the engine and the position of the roller which propels the barrow

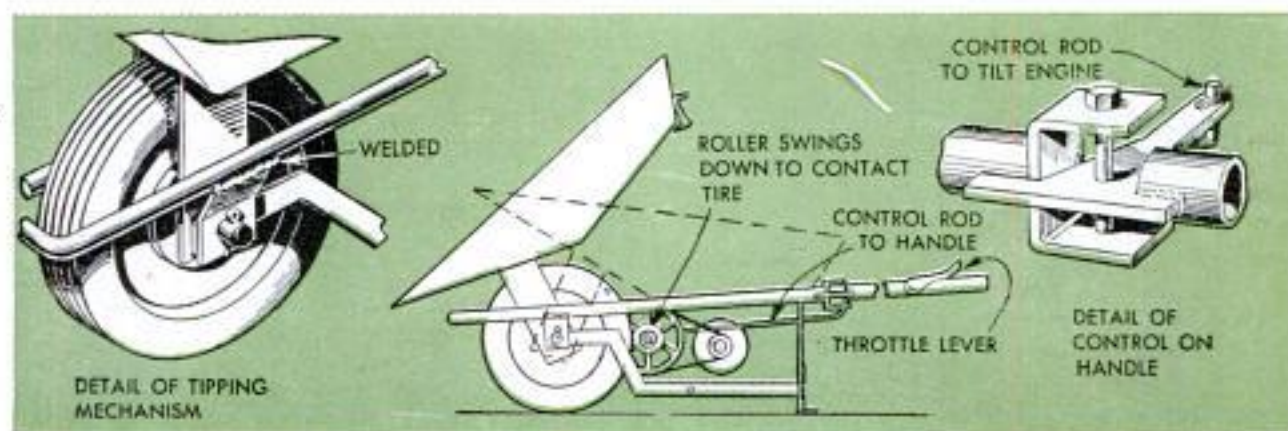

Guide Rollers at Corners of House Reduce Garden-Hose Wear

Set at the corners of a house foundation, stone terrace or brick garden border, these spool-shaped rollers protect the garden hose from undue wear as it is pulled around the sharp masonry edges. They also keep the hose from jumping low garden borders and injuring the plants. The flanged rollers can be turned from 4 x 4-in. stock as in the detail, or made from large-sized spools of the type used for tailor's thread. To set up the rollers on a lawn, drive a $\frac{3}{8}$ x 16-in. steel rod into the ground for each spool and hold the spools with cotter pins and washers. Where the rollers must be located on walks or driveways, use $\frac{3}{8}$ x 10-in. bolts, locked with mortar or lead in holes drilled in the concrete. Spikes may be used for shafts in asphalt.

Tom Riley, Portland, Ore.

Indelible-ink stains from a ball-point pen can be removed by sponging the spot with cotton soaked with rubbing alcohol.

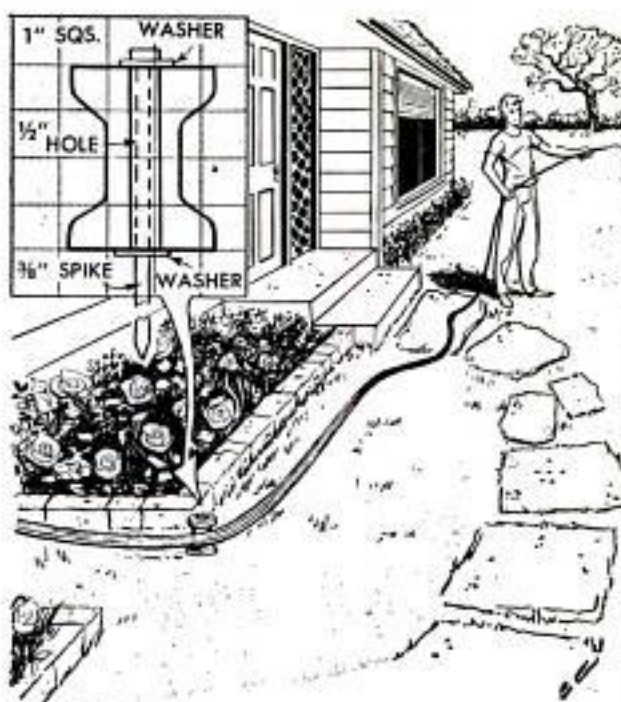



Photos from U.S. Forest Products Laboratory and National Bureau of Standards Paint Manual

Better Results in OUTDOOR PAINTING

By E. R. Haan

IS THE OUTSIDE PAINT on your home cracked, blistering or flaking off? Unless you have put off a needed repaint job too long, such a paint failure may be due to premature old age. There are many causes for paint failure other than inferior paint and it will pay you to know about them in order to avoid such failures in the future. Then your next house-painting job can have a normal life cycle. Or perhaps you will find that immediate attention now will avoid a major job of removing all the old paint later.

Modern exterior paints. A good-quality paint made by a reputable manufacturer should last four or five years on the average home. This is twice the useful life of paints made 30 years ago. Modern paints are much more opaque and thus provide more covering ability than older-type

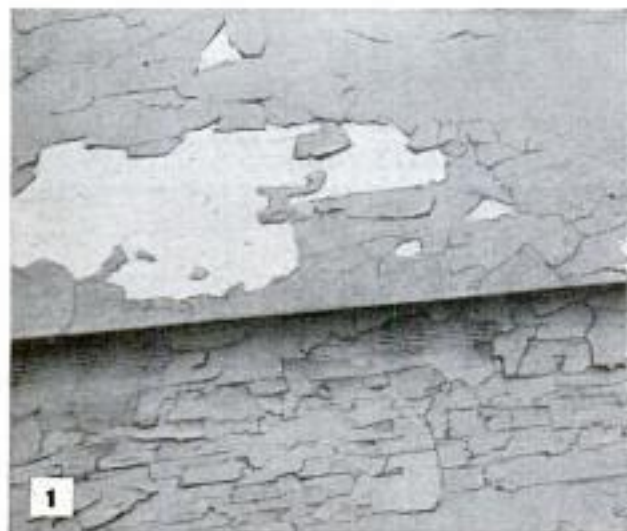

paints. White paints usually are self-cleaning, that is, the surface chalks off gradually in minute particles and washes away in the rain, carrying dust and dirt with it. Some white paints (titanium-zinc base) are fume resistant and are designed for industrial areas where fumes and gases cause early discoloration of ordinary paints.

Most white and tinted outside house paints contain quantities of white lead, zinc oxide and titanium pigments. Colored house paints have other pigments and generally outlast white and tinted types.

A good two-coat paint job of today—which is equal to three coats of the older type paints—should consist of a primer and a finish paint. It is best to use a primer and finish paint manufactured by the same company and recommended for use together. Paints and primers made by different companies may have a chemical reaction which will ruin the paint job. Also, unless it is recommended by the manufacturer, do not thin a finish paint with linseed oil to provide a primer.

When repainting is necessary. Repainting is necessary at the first sign of deterioration of the old coat. Cracks, blisters, peeling, thin spots in the paint or mildewed areas all indicate that the surface should be repainted. As soon as the paint film cracks, water can get under it and loosen paint adjacent to the cracks.

If a coat of paint was properly applied, you will notice the first signs of failure on the south side of the house because of its greater exposure to sunlight. Horizontal or sloping surfaces such as window sills, steps and porch floors will deteriorate more rapidly than on vertical surfaces such as walls. On the areas exposed to the south and those which are horizontal, apply an extra coat or two of paint. The added protection will aid in giving the over-all paint job a longer useful life.

Even the best paints are often blamed for failures which actually are caused by

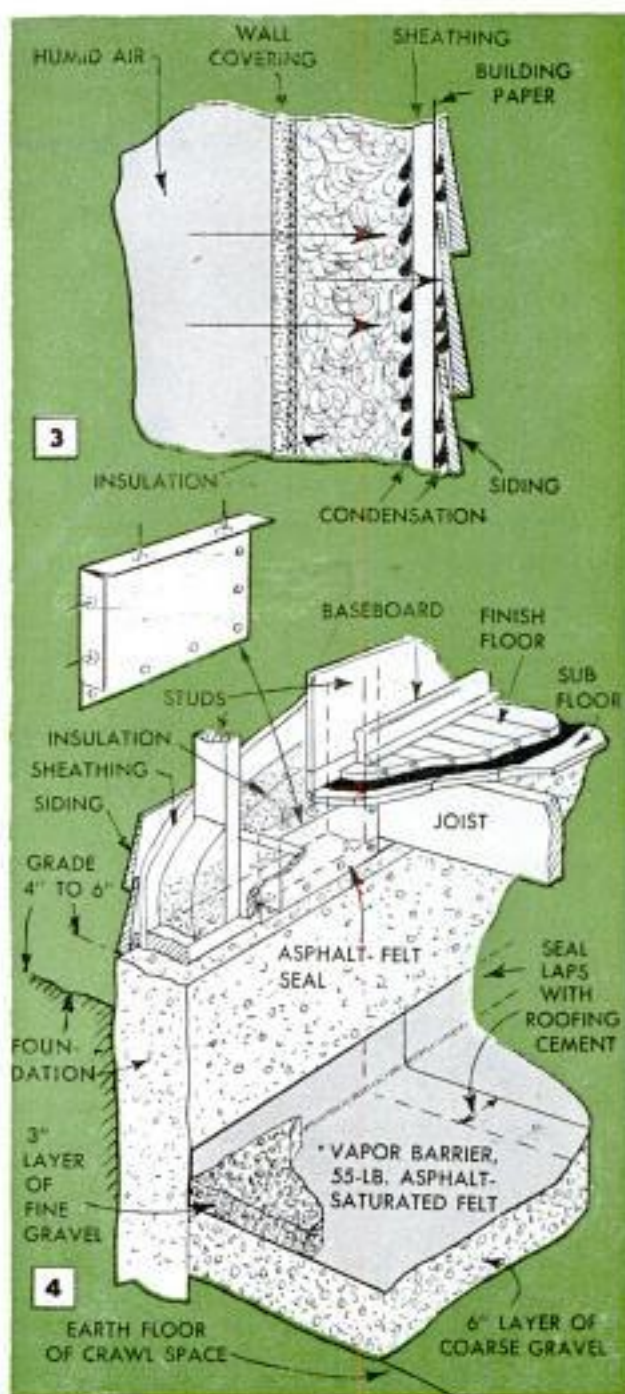

Below, unsealed spots over sappy wood and knots may olligator or peel. Seal them with aluminum paint

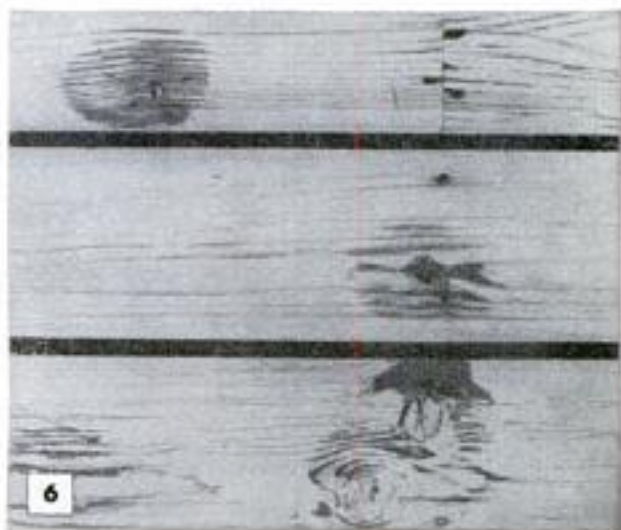
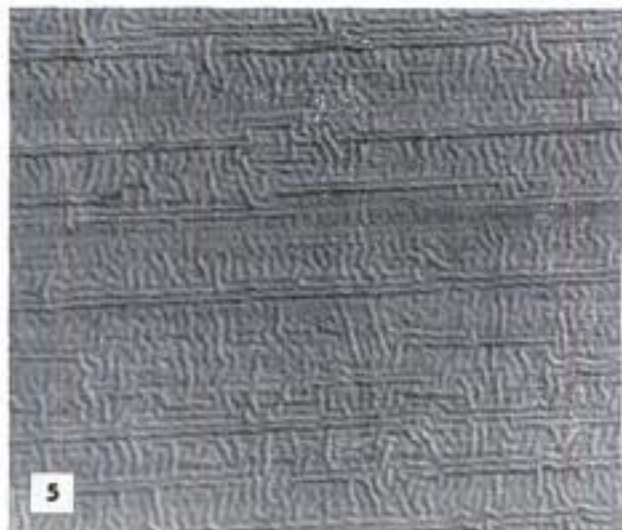

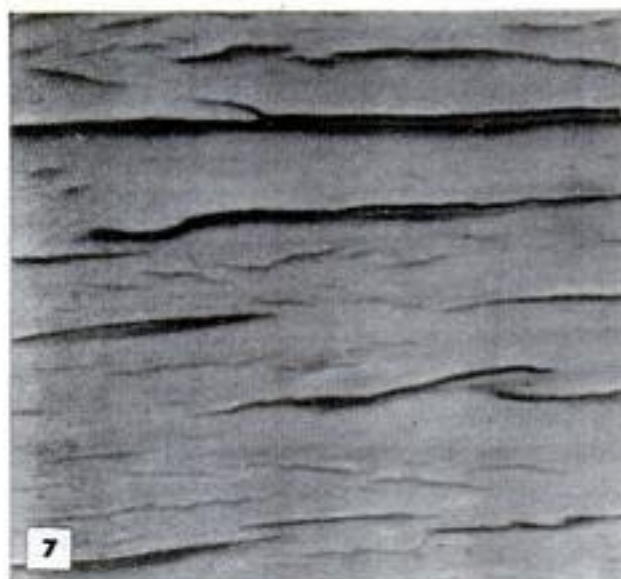

The photo above shows the effect of painting a surface too frequently. A very thick coat is produced which may crack and peel, exposing wood to moisture



Paints applied must be compatible or cracking may begin within a few months. Above photo shows result of applying finish coat over incompatible undercoat. Below, wire brushing often reveals spots where paint is intact but has lost its bond with the surface. All such paint should be removed before repainting

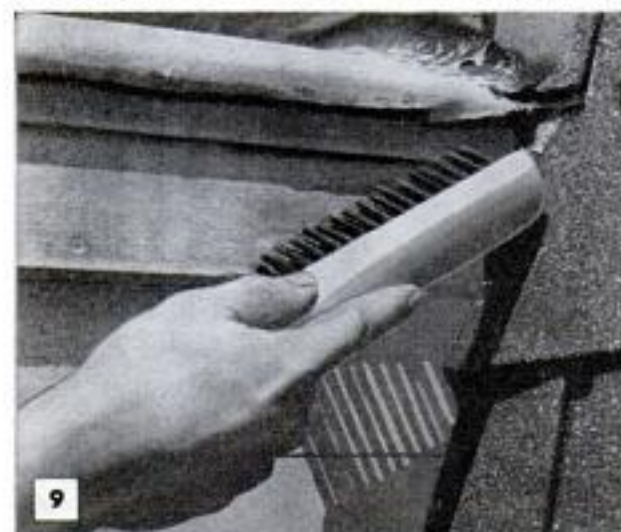

excessive moisture in the material painted, by mechanical defects of construction, by improper preparation of the surface and incorrect application of the paint.

Troubles from moisture. The most common cause of paint blistering and flaking is the presence of excessive moisture under it. This condition often is found on wood, Fig. 1, on brickwork, Fig. 2, and on concrete and stucco. Therefore, it is important first to make sure that the surface to be painted is absolutely dry and, second, that moisture cannot get into the painted material.

Excessive moisture in the air inside the house, especially in winter, is the greatest source of moisture trouble in outside paint. Water vapor readily passes through plaster and insulation not provided with a vapor barrier. Older houses which have blown-in insulation do not have a vapor barrier. The moisture from inside the house saturates the outside sheathing and siding, as indicated in Fig. 3, and the outside paint may loosen a few months after application.

The obvious cure for the problem is to reduce excessive humidity in the house. Exhaust fans in the kitchen and laundry will help. Moisture which rises from the earth in crawl spaces under the house can be controlled by covering the earth with a layer of coarse gravel over which is laid a blanket of 55-lb. asphalt-saturated felt, as in Fig. 4. Overlapping 4-in. joints are sealed with roofing cement. Openings in outside walls should also be sealed with felt. Dampness in basements and attics should be eliminated by suitable measures, such as ventilation or the installation of a dehumidifier.

The second step in controlling moisture in the house is to provide a vapor barrier on the walls themselves. This can be done by applying 2 or 3 coats of latex-base, or other moistureproof paints, on the walls and ceilings. Wallpaper can be applied over the paint, if you wish to use it in decorating. All cracks and openings at door and window frames, and even electrical outlets must be sealed to prevent the escape of moisture into the walls.

Outside the house, sources of excessive water are caused by leaking roofs, eaves troughs and downspouts. Also, wood that is in contact with the earth can draw moisture into the wall by capillary action. Any of these sources of water can be eliminated by proper maintenance and repair.

To dry wood siding that is to be painted, drive small wedges between the boards to temporarily permit air circulation. Dark mildew spots on paint indicate a high moisture content in the wood. A zinc-oxide base paint will retard mildew formation.

Failures from poor workmanship. Wrinkling of paint, especially on horizontal



10 Gutters and downspouts should be cleaned and repaired. Paint with roofing cement to preserve, patch

surfaces, Fig. 5, often results from applying it too thickly and not brushing it out uniformly. Painting at a temperature of less than 50 deg. F., will cause this trouble because at this temperature the paint will not spread properly. Wrinkling also can result from painting just before a sudden drop in temperature. Consult a weather forecast before doing any extensive painting.

Thin spots in a paint job result from attempting to stretch the coverage by adding more linseed oil than necessary, or by brushing the paint out too thinly. To make thick paint flow more satisfactorily, add turpentine, not linseed oil.

Crawling and peeling of paint often shows if it is applied to a surface that is covered with a film of oil, grease or wax. This type surface should first be cleaned with benzine before it is painted. If a paint job has a soapy finish and seems to wash away readily in the rain, it may have been applied during cold, damp weather. Also, paint which contains a water-soluble pigment, or is made water soluble by a chemical action due to weathering, will wash off easily.

Blistering of paint may result from applying it on a surface exposed to the hot sun. The heat causes rapid evaporation of the vehicle or solvent, which bubbles up through the paint and prevents proper adhesion to the surface. Paint only in the shade on hot days. A further disadvantage of painting a hot surface is that the paint dries too rapidly to permit uniform spreading. Loose, blistering paint also may result from painting over loose spots of a previous job.

Yellowing of white paint, alligating and peeling in spots over knots and sappy wood, as shown in Fig. 6, may be caused



11 Calk all cracks along door and window frames and where wood meets masonry. Get compound in deep

by not sealing these spots with aluminum paint. Aluminum paint also prevents "bleeding" through the new paint by creosote or bituminous compounds in the old coat. Paint applied at intervals of less than three years—for the sake of appearance rather than protection—will produce a thick coat that may crack, as shown in Fig. 7. Checking of paint often is caused by allowing insufficient drying time between coats. At least two days should be allowed for a coat of outside paint to dry.

Paint failure caused by lack of uniform coverage frequently can be caused by incomplete mixing of the pigment in the vehicle. A good method of mixing paint is to pour off the surface oil into a clean, empty container and to stir the remaining paint until none of it sticks to the sides or bottom of the can. Gradually pour the oil back into the paint, stirring as it is done. When completely mixed, "box" the paint by pouring it from one container to another several times.

Incompatibility of paints. When repainting, use the same kind and brand of paint as the first coat, if it has given good service. Changing brands often results in paint failure, because the new paint is definitely affected by the old paint. In some cases, cracking and alligating, as shown in Fig. 8, may start within a few months, if the old and new paints are not compatible. Although this trouble is more frequently noticed when a white paint is applied over a dark color, it happens just as often when white is applied over an incompatible white paint. To make sure of avoiding trouble, use a primer and finish coat designed for use together.

Preparation for repainting. If a new coat of paint is applied to the outside of the



A regular calking gun makes the task of preparing the exterior for repainting easier and quicker

house before the old coat has badly deteriorated, the job is fairly simple. Small areas of loosened paint should be scraped and wire-brushed and cracked boards and joints between boards should be calked with a suitable calking compound. Cement and brickwork also require calking at joints and seams. When the paint on the house is in an advanced state of decomposition, it is often necessary to remove all the old paint down to the bare finish. This can be done with chemical removers, by scraping and with a blowtorch. Electrically heated paint scrapers also are available. Mildewed areas and those streaked with dirt should be cleaned with a suitable paint-cleaning solution, rinsed with clear water, then allowed to dry completely before the new paint is applied. Areas of paint in good condition should be left, but slick or glossy spots should be rubbed with steel wool or sandpaper to provide a rough surface to which paint will firmly bond.

Nail down all loosened boards and drive in any projecting nails. Substitute slightly larger nails if the holes are enlarged. If rusty nails stain the siding, drive them below the surface with a nail set, and spot paint them. A day or so later when the paint has dried, fill in the holes with putty or calking compound.

Calking cracks. Calk all wood joints along door and window frames and wherever wood meets masonry. Be sure to get the calking compound deeply into the cracks instead of merely laying it on the surface. A regular calking gun does a quick, neat job and forces the compound into the cracks.

Where old calking compound has pulled away from the sides of a crack or joint, it may be necessary to break off and clean

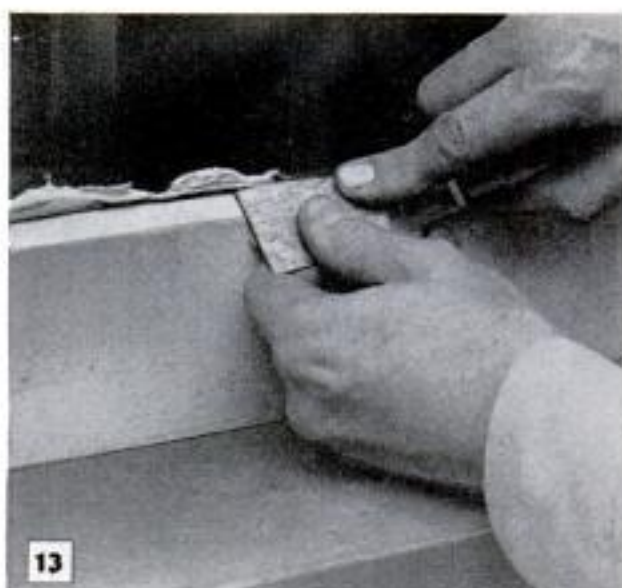

Old, cracked putty should be removed from windows and new putty applied before the repainting begins

out the old calking. Cracks at mitered corners can be covered with siding corners. These are made of metal and can be painted to match the house. Fine splits and joints in a flat surface should be filled with putty applied with a putty knife; the calking gun would apply too much. Scrape off excess putty and allow it to dry a day or two before painting.

Clean all old cracked putty from window sash. Prime the bare wood and allow it to dry before applying new putty. The sash putty also should be allowed to dry a day or two before it is painted. The sash can be painted separately from the house wall, so the putty should not delay the job.

Painting time. The best time of year for painting is during the fall months when the temperature and weather are fairly constant. Begin painting at the highest point of the house and paint down in a 3-ft. band across one side of the house. Then, moving down for another 3 ft. strip., arrange your job so you stop at a window, doorframe or dormer, so that no definite vertical break will be noticeable. Paint the corners and trim boards first, if they are the same color as the house.

Summing up. Paint the house before the old paint has deteriorated badly. A good undercoat requires little or no primer, and one coat of good paint will cover and protect the surface. When the paint is allowed to become scabby, cracked or peeling, several days may be required to remove the old paint. Two or more coats of paint will be required to cover and protect the surface thoroughly, and all joints and cracks will need an excessive amount of calking.

Prepare the surface carefully, make sure it is perfectly dry and use only a good quality paint. ★ ★ ★

Raw Potato Provides "Heat Dam" When Annealing Metal Strip



When it is necessary to anneal only the end of a length of extremely hard metal, such as a clock spring or hacksaw blade, push the metal through a raw potato. Allow only the portion to be heated to extend. The potato will absorb most

of the heat that travels beyond the heated area, thus preserving the temper in the metal that is not to be worked.

Broken Stud Quickly Removed With Discarded Tap

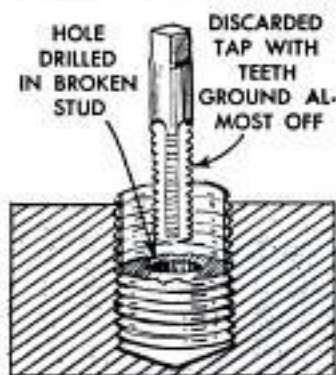

A discarded tap can be used to remove a stud or bolt that has broken off in a tapped hole. First, grind away most of the teeth on the tap. Next, drill a hole in the broken stud, of a diameter slightly smaller than the tap. Use

light hammer blows to drive the tap into the hole, then apply a tap wrench to turn both tap and stud. Penetrating oil will aid in removing the stud, and if it is especially stubborn, sharp hammer blows around the area will help break it loose.

Friction-Tape Life Prolonged By Rubber-Cement Coating



When a roll of friction tape is allowed to lie around unused, the adhesive tends to dry out and lose its stickiness. One method of preserving the life of the tape is to coat both sides of the roll with rubber cement, which

will seal the roll and keep it from drying out. A roll of tape may be kept indefinitely with such treatment because the seal remains when the tape is removed.



Sand Spike Made of Steel Rod Acts as Equipment Rack

Some bending and a little welding of $\frac{3}{8}$ -in. steel rod will provide the fisherman with a handy sand spike with which to keep his gear out of the mud and sand. The upright is a 4-ft. length of rod to which are welded cross bars, bent as shown, to act as hangers. An L-shaped footrest is welded to the upright near the bottom to facilitate driving the spike into the sand, and an eye is shaped in the top end to aid in removing it.—Ivan Grosvenor, Indian Rocks, Fla.

Syringe Keeps Lenses Mildew-Free

One cause of mildew between the elements of a camera lens is the habit of blowing across or into a lens when cleaning it. Moisture is thus carried into the lens and then sealed in when the units are reassembled. To avoid this, always clean lenses on clear, dry days, using a bulb-type syringe or other source of dry air for dusting.



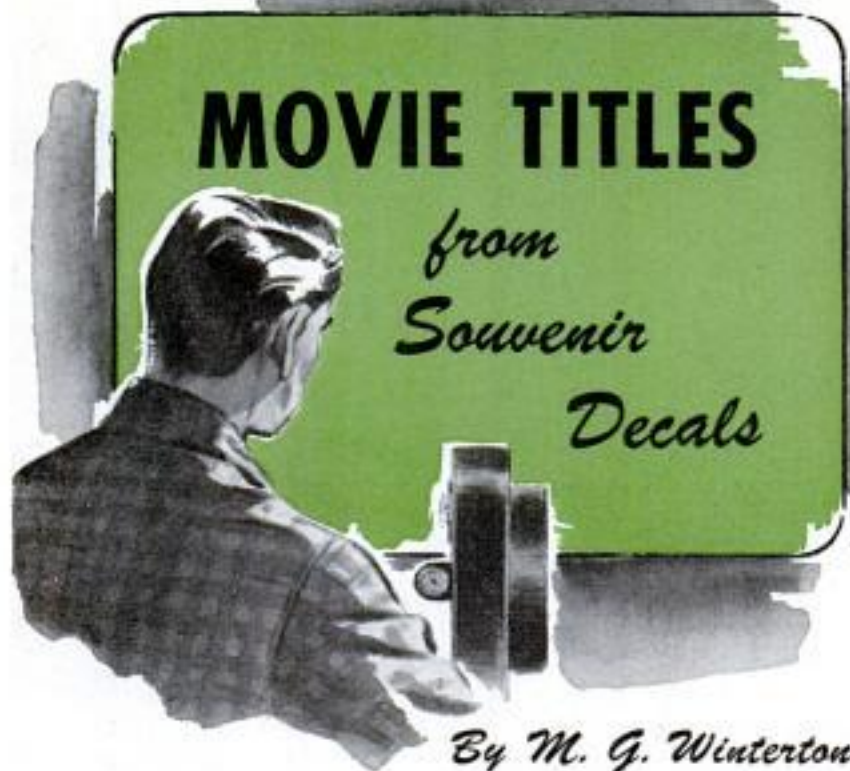

A GOOD PART of the fun of editing color vacation movies is devising and filming novel, eye-catching titles. If there is a lot of film to edit, the job of titling the sequences can be simplified by obtaining colored souvenir decals at all the interesting places you visit on the trip. The decals provide titles, notes, lettering and color ready-made.

Filming colored decals as titles gives you a choice of procedures. Several steps to produce interesting and novel effects are pictured. Others are easily devised without the necessity of making elaborate sets for filming. Perhaps the simplest set is made by trimming the decal to the borders and



Decal is trimmed to border and placed over a suitable colored background. A color print serves well

Filmed in color the decal title with its sharp detail provides a novel introduction to the sequences



Superimposed decal and background print are placed between two pieces of clear glass before filming

A variation of backgrounds can be achieved by applying decal to a background of black masking paper

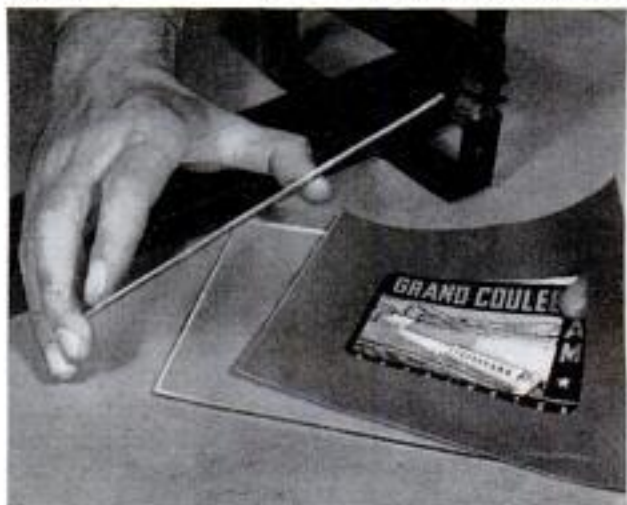

then superimposing it over a suitable color print as in the upper photos on the opposite page. The superimposed decal and print are placed between two pieces of clear glass for filming. The result is shown in the lower left-hand photo. Special care must be taken in the lighting to prevent sharp reflections from the glass. Another unusual effect is obtained by superimposing the decal on black paper and mounting between two pieces of glass for filming.

Backlighting selected decals also produces striking color effects. A typical set is shown in the upper left-hand photo below. The proper degree of backlighting must be determined by experiment. The size bulb to use and its distance from the decal depends on the detail and color in the decal itself. A light meter must be used to determine the correct exposure and, when lighted, the set should be carefully checked for light reflections before filming.

Another title-filming trick in which natural backlighting is utilized is pictured in the lower left-hand photo. A flat-sided glass fish bowl is placed before a window, prefer-

ably an upstairs window so that you can photograph against a field of blue sky. Direct sunlight should not strike the bowl. The appropriate decal is applied to the flat side of the bowl. Fill the bowl nearly full of clear water and check with a light meter for the correct exposure. Then, an instant before filming, drop two or three Seltzer tablets into the water and make the exposure at the moment of greatest effervescence. This is best done by fastening the tablets, or wafers, side by side in a short piece of rubber tubing that has been split to form a holder, as in the photo. In this way the wafers are carried quickly to the bottom of the bowl. A variation of this method is to film a live fish, either goldfish or small gamefish, in a large bowl with an appropriate decal. By exercising a little patience in waiting for the fish to strike the proper pose, a most interesting title can be produced. Still another variation, which often serves to dramatize a situation, is to photograph a suitable decal against a windowpane background while raindrops are striking the outside surface of the glass. In

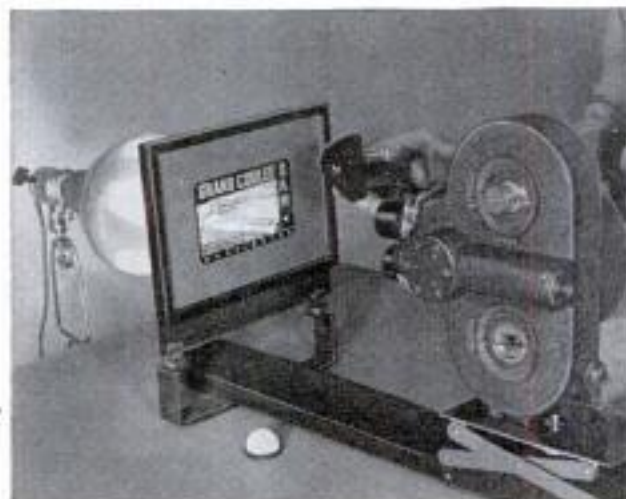

Unusual effects are obtained by backlighting colored decals. Watch light intensity and exposure timing

Filming a decal applied to a fish bowl makes appropriate title for fishing trip. Use natural backlighting

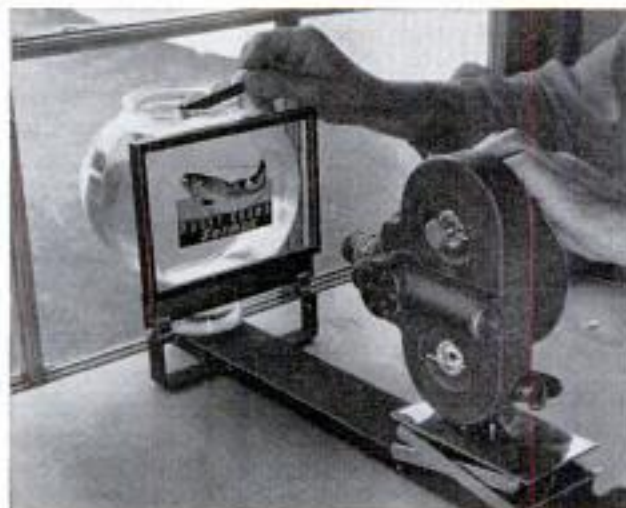

AUGUST 1954



When filmed in color a backlighted decal appears to glow like a neon light when projected on screen

Water in fish bowl can be made to effervesce by dropping in Seltzer wafers immediately before filming set



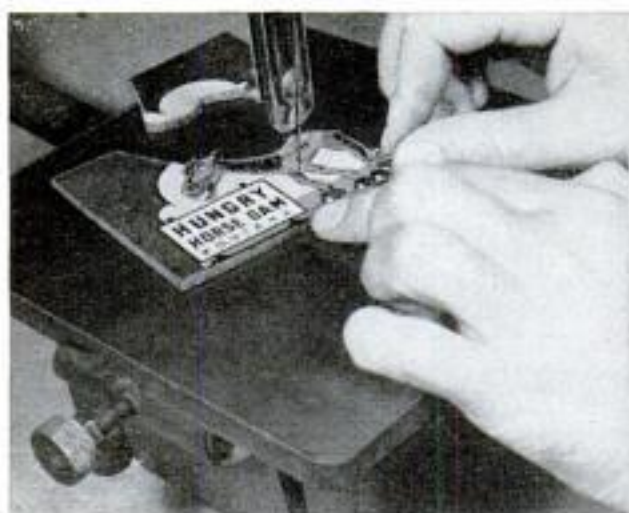

Decal often can be supplemented effectively with appropriate cutouts. After selection is made, both cutout and decal are mounted on hardboard or softwood and jigsawed to outline. Cut slowly to avoid tearing

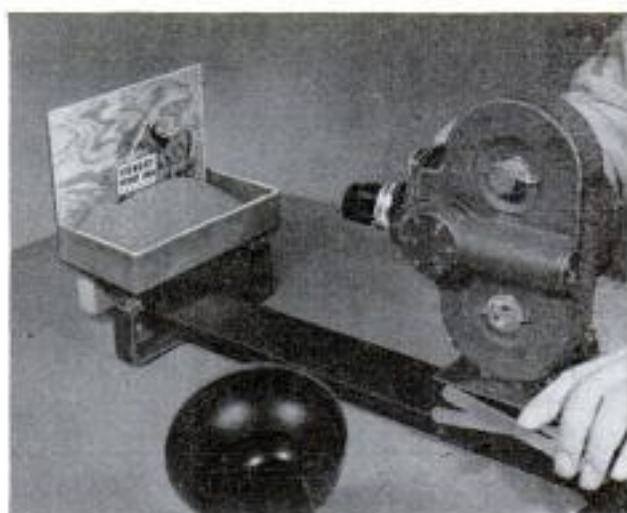

Props for the title cutout are a box filled with dry sand and a small piece of fir plywood for the background. These are set up as pictured with the cutout placed at the top of the sand which has been heaped



Here's what you get as a result of filming the set pictured in the upper right-hand photo. Note especially how the lights were arranged to cast shadows on the background. Plywood grain gives feeling of clouds

both the above variations special care must be taken in the details of the set and also in timing the exposure.

In many instances the decals can be supplemented very effectively with cutouts, comic cutouts being especially suited to this method of title making. The lower left-hand photo above shows a typical example and the two upper photos picture the method of making the set. First, a colored clipping and decal are selected and trimmed to outline. Then both are applied to $\frac{1}{8}$ -in. hardboard or softwood of equal thickness and the outline is sawed out on a jigsaw as in the upper left-hand photo. The set is built up for filming as in the right-hand photo by filling a shallow box with sand, heaping the sand as shown and placing the completed cutout at the center. Select any background that is in keeping with the color and nature of the cutout. In this case, a small piece of fir plywood served the pur-



One way of introducing motion in the title itself is to suspend decal cutout in lens field by means of two small chains. Blowing lightly on edge of cutout causes it to swing slowly while being filmed

pose adequately as the bold graining and natural color of the wood contributed to the feeling of a desert scene at sunset.

A novel treatment which causes the title to come on the screen in motion is easily carried out. The lower right-hand photo shows one variation. The decal is applied to $\frac{1}{8}$ -in. hardboard and cut to outline. Then it is supported on chains, either in the viewing frame or by some other means, so that it will swing easily in a plane at right angles to the axis of the camera lens. Just before filming, the operator blows lightly against the edge of the cutout to start it swinging. Another variation of this is to suspend the cutout by a single thread. In this case, two identical decals are used, one being applied to each side of the hardboard. Just before filming, the thread is twisted slightly and released, imparting a slow, circular motion to the cutout and presenting both decals alternately to the camera. ★ ★ ★

Pot Holder Used as "Cushion" For Baby's Safety Pins

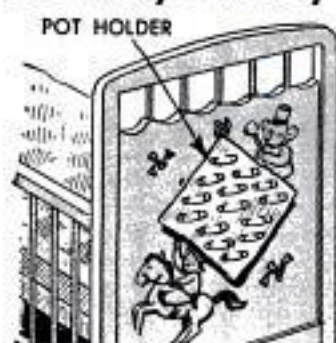

Hung on a cup hook screwed to the end of baby's crib, an ordinary pot holder will provide a handy "pincushion" for the safety pins necessary for his wardrobe. The holder has ample space for a number of pins, and can be dropped into the diaper bag when taking the baby out for a drive or visit with friends.

Victor H. Lamoy, Upper Jay, N. Y.

Jig Holds Mitered Corners When Gluing and Nailing

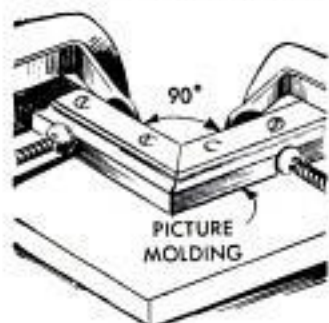

Nailing and gluing the mitered corners of picture molding to form a true right angle can be done with a homemade jig and a pair of C-clamps. The jig is two lengths of 2-in. stock which

have been carefully mitered and screwed to a base plate to form a 90-deg. angle. In use, the mitered corner of the frame is glued, clamped on the jig, then nailed and left until the glue has set.

C. H. Drew, Sparta, N. Y.



Large Plants on Movable Platforms Shifted Easily During Cleaning

Large plants will be easy to move about when cleaning a room if kept on small platforms mounted on casters. Make the platform from thick plywood, cutting the pieces slightly larger in diameter than the base of the flowerpot. If you have only thin plywood on hand, several thicknesses may be glued together to make the platform sufficiently sturdy. Next, drill the underside of the circular-shaped platform to receive three casters. However, if square or rectangular platforms are desired, four casters will be required. Finish the platforms in a color that either matches or complements the surroundings.

R. F. Donovan, Guttenberg, N. J.

Strawberry Runners Placed in Cans to Aid Transplanting

Instead of starting strawberry plants in flowerpots where frequent watering is required, I sink tin cans from which the ends have been removed, into the ground and then let runners from mature plants develop new plants inside them. A rotary opener is used to remove the ends cleanly, after which cans may be either pushed into wet ground or driven into dry ground with a wooden or rubber mallet. If driving is necessary, it's a good idea to place a small piece of board over the top of a can to prevent crushing the rim. Large "staples" formed from paper clips are used to anchor the runners in the cans. When the new

plants are well established, clip the runners, "dig" up the cans and transplant the new growth. It may be necessary to wet the soil before removal.

J. Jerome Frisch, Cincinnati, Ohio.

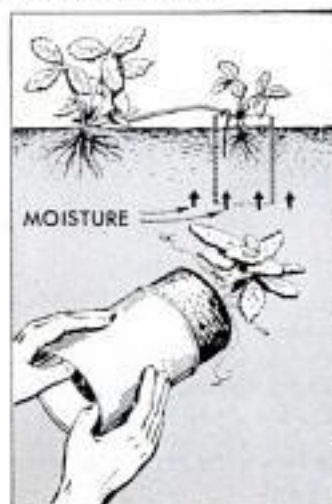



the top tread is likely to be used, then the holes can be drilled through the extension tray. If the holes are sized carefully to take the tools snugly, the ladder can be tipped to a carrying angle without having them fall out. Twin-handled tools, such as pliers, will be less likely to fall out if two small holes are drilled for them.

Tape Holds Screw on Driver In Restricted Location

A strip of friction or adhesive tape will hold a screw on the driver blade when the screw cannot be started with the fingers because of an awkward location. Cut a slot in the tape and push the screw through from the adhesive side. Then place the screwhead against the driver and pass the tape up along each side of the blade as in the photograph. After the screw is driven, pull back on the screwdriver, which will tear the tape away from the screw.

Holes in Top Tread of Ladder Prevent Dropping Tools

You can easily prevent screwdrivers and other tools from rolling off the top tread of a stepladder, where they are momentarily placed while working, by boring holes large enough to receive the blades or handles of the tools. In addition to its convenience, this method of holding tools provides a safety precaution, especially where children are likely to be near the ladder. If

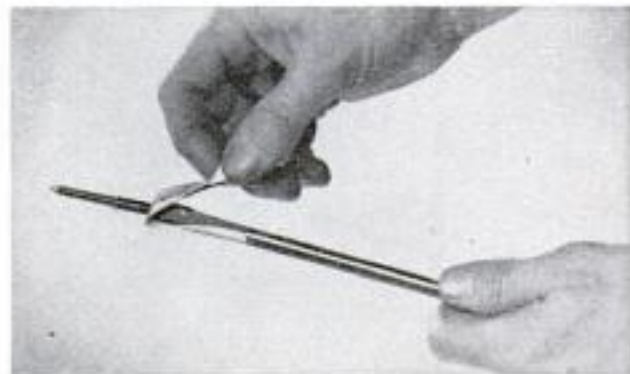

Popular Mechanics Bookshop



Plumbing Repairs

Learn how to fix faucet noises, use a water hammer, repair pipe leaks, stop condensation dripping and many, many other plumbing problems.....25c



Fences and Gates

Build your own fences, colored concrete walks, gates and arbors. A wide selection of types to choose from. Save money and materials. Easy and fun.....25c



Built-in Furniture

Hundreds of ideas for modern living. Build a foldaway crib or an on-a-door cabinet, make your own picture windows, Unit end tables etc.....25c

Can be Purchased at Your Favorite Newsstand for Only 25c Each!



SHOP NOTES

Versatile WELDING TABLE

By L. H. Houck

WELDING WITH MODERN equipment is fast, efficient and downright easy but the problem of holding parts of an assembly in place often makes welders wish for a "third hand." A sturdy all-metal table usually is the answer but its adaptability to the purpose depends largely on how it is designed and built. A suitable table must support the work firmly and the top should provide a means of attaching clamps and other holding fixtures. With these requirements in mind an experienced welder designed and built this special table for use in a job shop. As pictured in use in Fig. 1, the table is 24 in. square and 31 in. high, not including the leveling pads on the four legs, Fig. 7. It can be made any length, width or height to suit individual preferences or special requirements. Steel channels, 2 in. wide with $\frac{1}{8}$ x 1-in. webs are uniformly spaced $\frac{5}{8}$ in. apart to form the slotted top. The legs are $\frac{1}{8}$ x 2 x 2-in. steel angles with the lower ends boxed by welding on a 12-in. length of the 2-in. angle to form a square section below the stretcher frame. The boxed sections of the legs are shown in Fig. 7.

To avoid distortion in the welded assembly, it perhaps is best to fabricate the legs and stretcher frame first. The latter is made from a single length of 2-in. steel angle by cutting 90-deg. notches in one web, the center-to-center distances between the notches equal to the length of the frame plus the thickness of the material. Bend the angle at the notches to form a four-sided frame. Miter the free ends and then weld all the meeting faces. Be sure that the frame is square and flat before welding. Now, duplicate this frame, using the same procedures. The second frame forms the base, or foundation, for the channels and is welded in at the top ends of the legs. Before welding in the frames, weld the 2-in. angles to the lower ends of the legs to form the boxed sections. Then place



Above, slotted-top welding table in use. Slots permit clamping work in almost any required position. Below, circle, or ring, clamp holding work at angle. Unit is adjusted by means of leveling screws

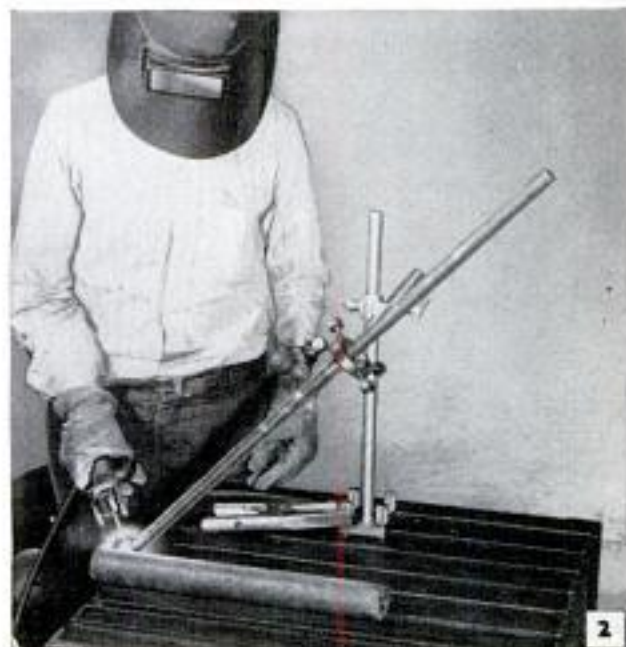



Upright leveling fixture combines with two horizontal arms to hold small work. Below, ring clamp with horizontal arm holds short round stock securely

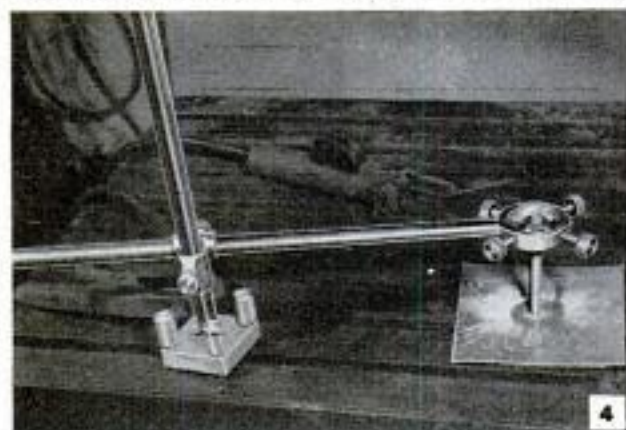

Below left, parts of table-leveling pads are assembled on table top for welding. Below right, the straddle clamp set up with two leveling fixtures for supporting one member of a two-part assembly

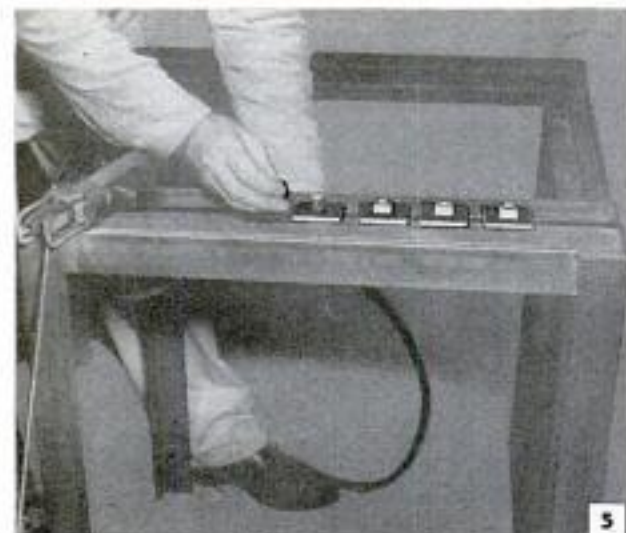

the center frame with its corners on the top ends of the boxed sections and weld in place, making sure that the assembly is square. When adequate clamping equipment is not at hand, it's a good idea to tack-weld the four legs to the center frame, then weld in the top frame and finish-weld the center frame to the legs. If the work is permitted to cool between operations there will be less chance of distortion developing as the welds are made. Note that the top frame must be welded into the assembly with the inside angle up.

The steel channels which form the slotted top are assembled in the top frame with the flat sides (webs) up and the ends flush with the top edges of the frame angles as in Fig. 10. In order to raise them uniformly to this height a 1 x 1-in. steel angle is tack-welded at each end of the top frame in the inverted position, so that it forms an inverted vee. The flanges of the channels rest on the vee to which they are welded after being spaced. As the final step in the top construction the ends of the channel webs are welded to the 2-in. steel angles that form the top frame. The welds are then filed or ground flush. This assembly forms the slotted all-metal top pictured in Figs. 1, 2, 7 and 10.

Adjustable leveling pads are attached to the four table legs. First, 2 x 2-in. squares are cut from 1/4-in. flat steel and center-drilled 1/2 in. Then assemble the four squares over one of the table slots and bolt them in place with 1/2-in. bolts as in Fig. 5. Weld the nuts to the squares and unscrew the bolts. This operation centers the nuts over the holes. Now weld the squares to the lower ends of the legs with the nuts inside the boxed sections. The pads are cut 2 1/2 in. square from 1/2 or 5/8-in. flat steel and center-drilled 1/2 in. Then cut the heads from 1/2-in. bolts and run the threads down to within about 1/2 in. of the ends. Insert the unthreaded ends of the bolts in

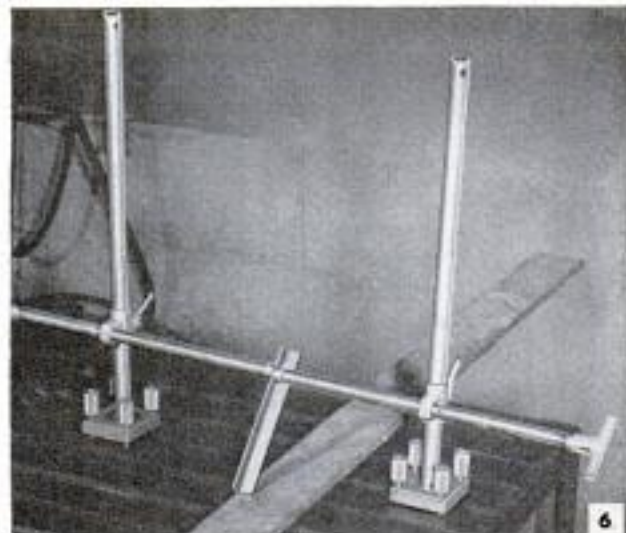

the holes in the pads and weld in place. If a lathe is at hand, chuck the pads individually and turn a recess in the bottom face of each $1\frac{1}{2}$ in. in dia. and about $\frac{1}{8}$ in. deep. Screw each pad to the legs by inserting the bolts in the holes in the squares which are already welded to the legs. Turn until the threads engage the nuts. Level the table on the floor by raising it slightly and turning the pads in or out as required. It should be remembered that the table also can be made adjustable up or down for a height variation of 6 in. or more by using longer $\frac{1}{2}$ -in. bolts threaded throughout the length and welded to the leveling pads in the manner described.

The slotted table top provides for attaching nearly all common types of clamps and also fixtures made for special work. You can make a straightedge by using a 24-in. length of 2-in. channel. Drill $\frac{1}{2}$ -in. holes near each end of the straightedge, aligning the holes with the outer table slots that the unit can be bolted in position either square or at an angle with the table top as in Fig. 1. Slotted clamps, Fig. 11, are probably the most useful of the simple clamps for holding work flat on the table in a squared position. In some cases, a machinist's vise attached to the table top as in Fig. 10 comes in handy for holding small work or a part of some holding fixture.

One of the most useful of the straddle clamps is pictured in use in Fig. 6. It consists of two adjustable leveling fixtures made as in the left-hand detail in Fig. 9. The uprights are mounted on bases, each fitted with four leveling screws. The lower end of the upright is shouldered, threaded and provided with a nut and washer by means of which the unit can be attached to the welding-table top in any position. Full-threaded clamp screws with T-handles welded to the ends are turned through sliding sleeves which may be clamped at any point on the uprights. In addition the



Welding table inverted to show the boxed sections of the four legs and the manner of assembling the leveling pads. By welding a long screw to each pad the table can be raised to any convenient height

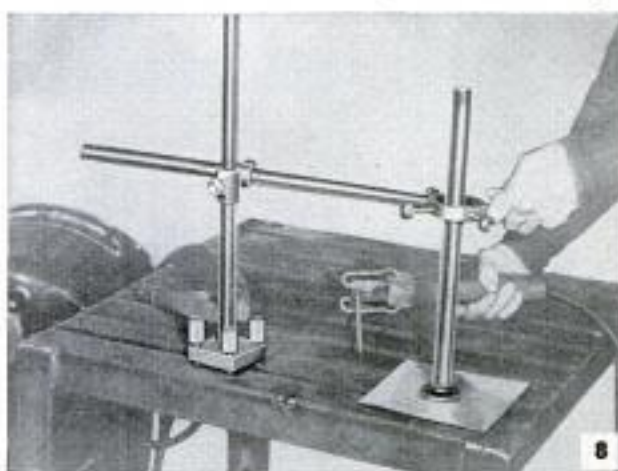

Another example of how work can be positioned vertically in a manner similar to that pictured in Fig. 4. Fixture and clamping arm with ring clamp are detailed below. Both can be made any suitable size

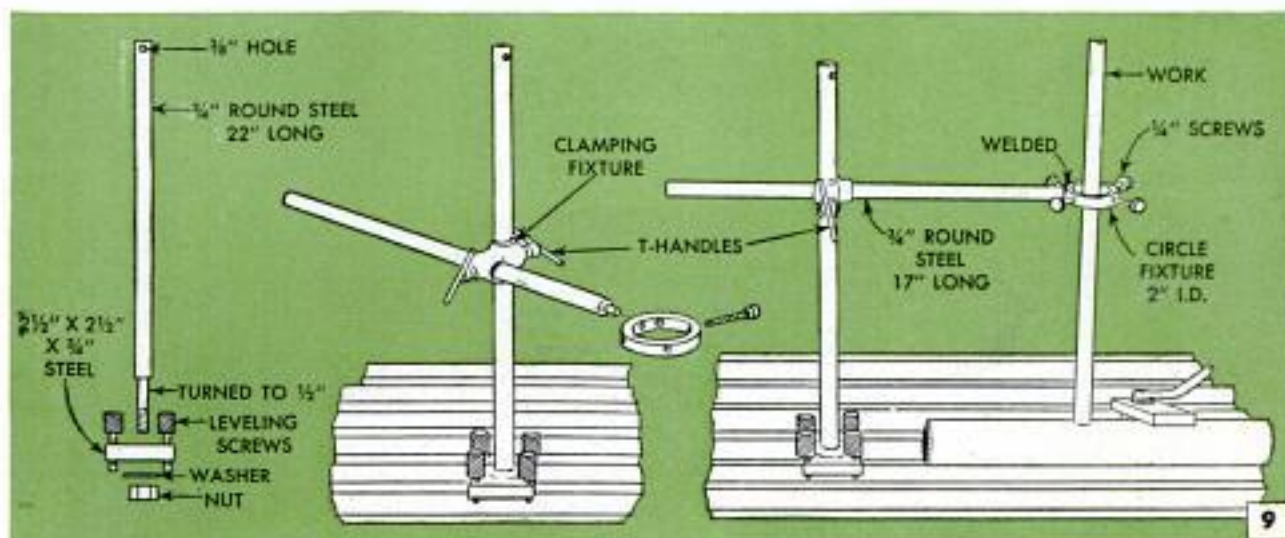

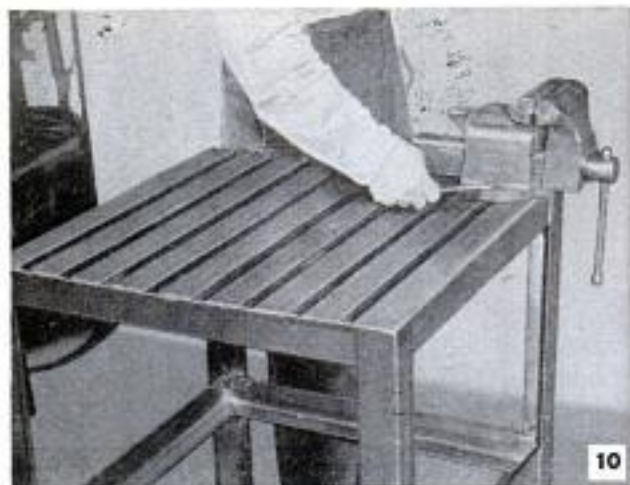

Above, even a machinist's vise comes in handy for certain types of work. Below, close-up view of the ring clamp being used in welding a small T-handle

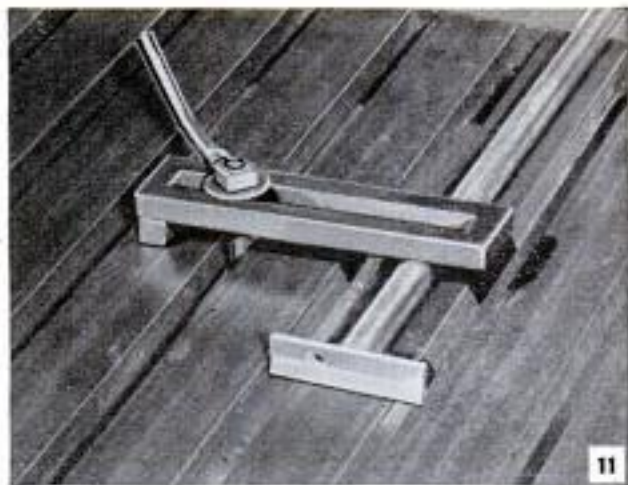

Slotted clamps should be at hand in several sizes. They can be placed at any point on the slotted table. Note how rod is welded to nut to form handle

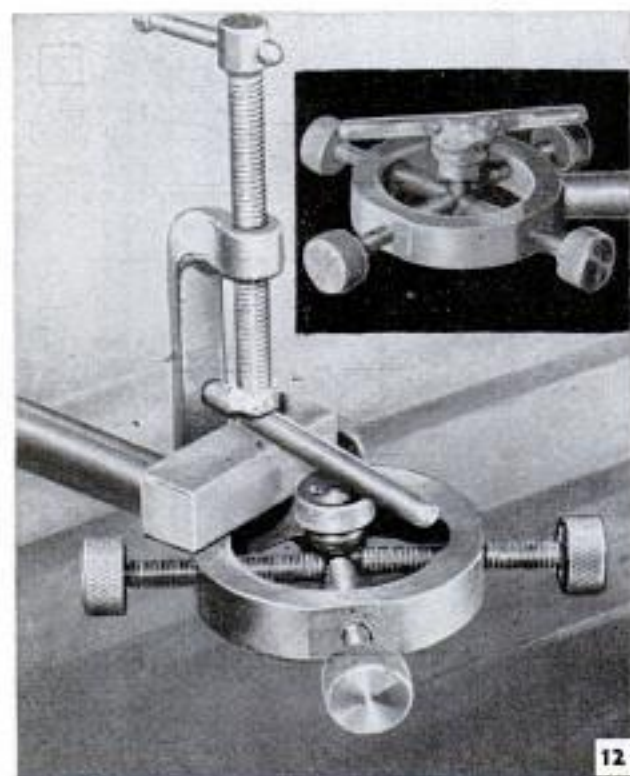

basic unit may be fitted with a single horizontal arm and a circle clamping fixture as in the center and right-hand details, Fig. 9. Figs. 2, 3, 4, 8 and 12 picture the varied uses of this auxiliary unit. The clamping fixture, Fig. 9, is made by welding two short pieces of $\frac{3}{4}$ -in. pipe at right angles and then welding on a small square of steel to form a boss which is drilled and tapped for the T-handled clamp screw. The latter is made as in Fig. 12 by welding a short length of $\frac{3}{8}$ -in. rod to the head of a bolt.

Figs. 3, 4 and 8 picture examples of the use of a single upright unit when combined with one or two horizontal arms to support the work in the desired position. The horizontal arms can be adjusted to support work at any angle, Fig. 2. Note in Fig. 9 that the inside diameter of the circle fixture, or ring clamp, is given as 2 in. This can be increased to 3 or 4 in. if desired. All clamping and holding units pictured and detailed can be made any reasonable size to suit the work to be done. ★ ★ ★

Hopper-Type Feeder for Hogs Made From Watering Tank

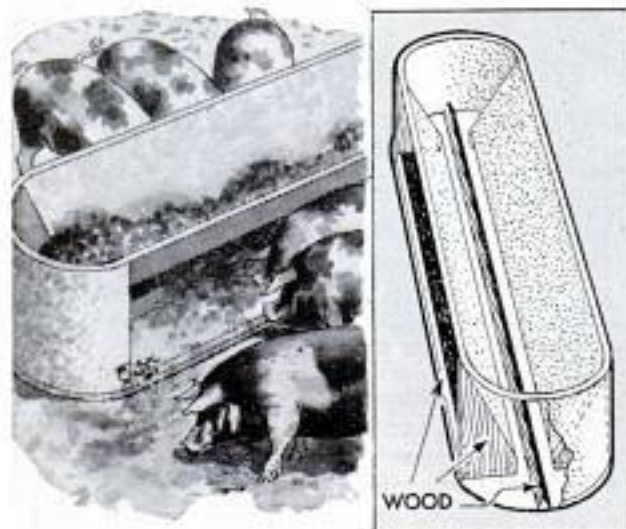

A stock-watering tank can easily be modified to provide a timesaving, hopper-type feeder for hogs. The straight sections of the sides, up to the curved ends, are cut away and bent inward toward the center to form the sloping sides of the hopper. The sides are supported at the ends by wooden brackets, cut to the desired angle, and nailed to the bottom and curved ends of the tank. Narrow feed-retaining strips are nailed to the bottom at each outer edge, and a V-shaped piece, the length of the tank, is placed in the bottom of the hopper to divert the feed to each side. If the feeder is placed in the open, it should be covered to protect the feed from rain.

Robert Bush, Tecumseh, Mich.

Compact Writing Desk Built In Unused Corner

This attractive and compact little desk will dress up an unused corner in the home, and with its pigeonholes and shallow drawer for stationery and household ledger, serves as a convenient home office. The original desk was built-in and the existing walls paneled in plywood to form the back and sides of the kneehole. However the desk can be built as an individual unit which may be placed in the corner. The desk and paneling should be finished to match the decor of the room in which it is located. Dimensions given can be changed to fit any particular space.

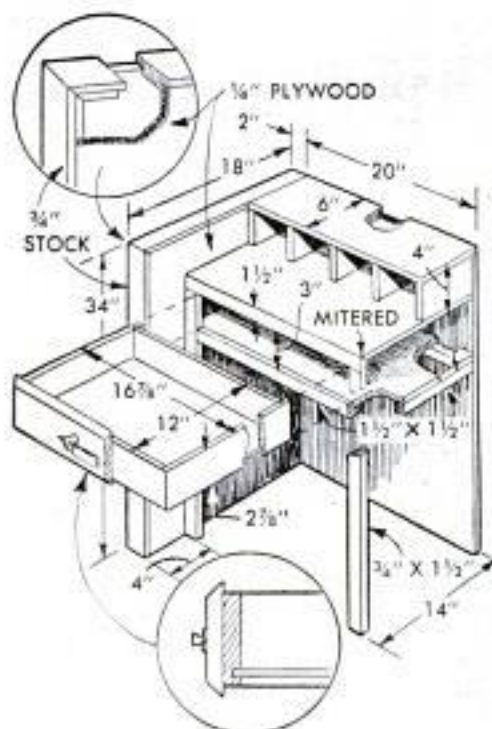

Emergency Coil Spring Wound in Vise-Held Jig

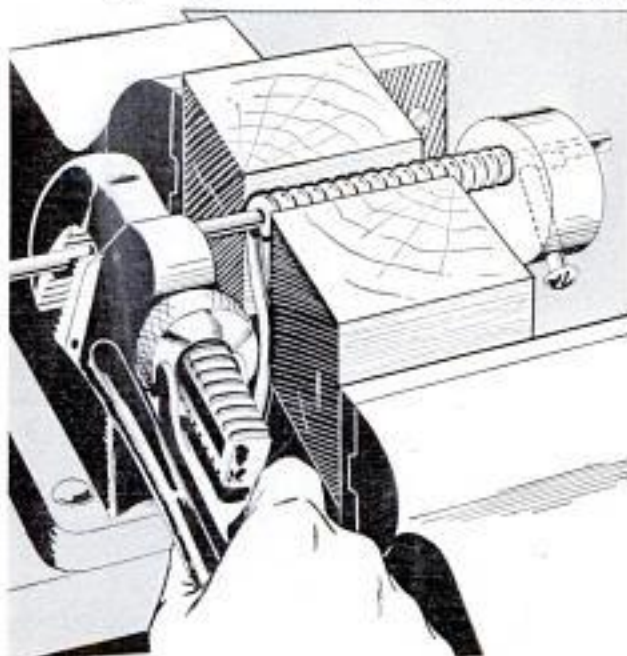

When faced with the need of making a coil spring for an emergency stand-by, one mechanic wound it on a jig consisting of a steel rod, two wooden blocks and a metal disk. A flat was filed on one end of the steel rod to allow a setscrew in the disk to anchor the end of the spring wire. The disk is drilled off-center to permit a greater depth for the setscrew hole. To make the spring, the end of the spring wire is clamped to the flat with the setscrew, and enough turns of wire are made by hand to equal the width of the hardwood blocks. Then the rod is placed between the blocks and the assembly is clamped in a vise. The vise jaws are tightened until there is a definite impression in the faces of the wooden blocks which establishes the pitch of the spring. Thus, the spring wire feeds through the "threads" in the blocks when the rod is turned with a pipe wrench.

Method for Clearing Steamed Windows of Car While Driving

An efficient way to clear up steamed windows in a car in cool or cold weather is to close all the windows and ventilating panes and then open the cowl vent so that outside air can enter the body. It is the dryness of the outside air that does the trick. Actually, little more cold air can enter the car than that which replaces warm air that has escaped through the numerous small body leaks. As a result of the positive air pressure built up by the incoming air, the car is much quieter and drafts from around

the doors are prevented. The radio, which usually is mounted beneath the vent, will help deflect the downdraft from the vent away from the feet, while turning the heater to a higher temperature will keep the inside of the car comfortable. It may be necessary at first, to use the defroster at full speed until the windows clear, after which it may be turned to low. However, best results with this arrangement can be obtained only on the open road.

Jack Probst, Royal Oak, Mich.

Handy Wall Hangers in Garage Are Discarded Auto Valves



Discarded automobile-engine valves, because their heads are large in comparison with the stems, provide excellent wall hangers for miscellaneous gear stored in a garage. Holes slightly smaller than the valve stems are drilled at an angle in the wall studding, after which the valves are driven into them from $\frac{1}{4}$ to $\frac{1}{2}$ the length of the stem.

Tape Provides Correct Angle When Grinding Small Drills



In the absence of a drill-grinding fixture, a piece of masking tape can be used to control the angle of the cutting end of small drills. Glue a piece of masking tape on the wheel guide and hold a large-size drill with its cutting edge in contact with the wheel. Cut the tape along the edge of the drill and remove the unneeded tape. Small drills now can be sharpened to the correct angle by holding them parallel to the edge of the tape as shown in the illustration.

Disk Taped to Bottom of Jug Acts as Shock Absorber

A glass jug of acid or other liquid used frequently around a shop is less likely to be broken if a disk cut from composition board is taped to the bottom. The disk will

act as a shock absorber when setting the jug on a hard surface such as a concrete floor. Cut the disk the same diameter as the jug and attach with adhesive tape.

Poultry Fountains Kept Clean

Poultry watering fountains, which quickly become scratched full of dirt and litter when placed on the ground, can be kept clean by using a chicken-wire "antiscratch" ground covering. Chicken wire is nailed to a 6 x 6-ft.

wooden frame, the assembly is laid on the ground and the watering fountain is located in the center.

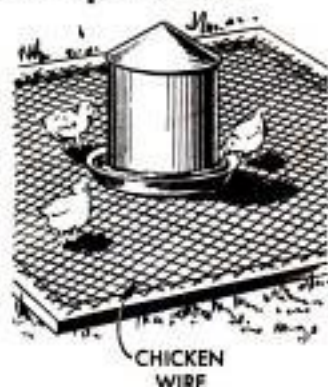

Hot-Weather Driving Kink

To prevent my car motor from overheating dangerously when driving long distances during extremely hot weather, I turn on the car hot-water heater at full heat with the fan blowing. The additional cooling area usually will keep the water from boiling.—Lt. Richard S. Downie, USNR, San Francisco, Calif.

Horse-Drawn Plow Converted For Use With Tractor

In order to convert a horse-drawn gang plow to a tractor-mounted plow, one farmer cut off the beams with a cutting torch and then welded an A-shaped frame to the beams, making the unit suitable for use with a Ford tractor hydraulic system. Two $\frac{3}{4}$ -in. bolts are utilized to provide pivot pins to which the tractor drawbars are connected. The method of mounting the pins will depend on the type of plow used.

Edward Monroe, Schuyler Lake, N. Y.

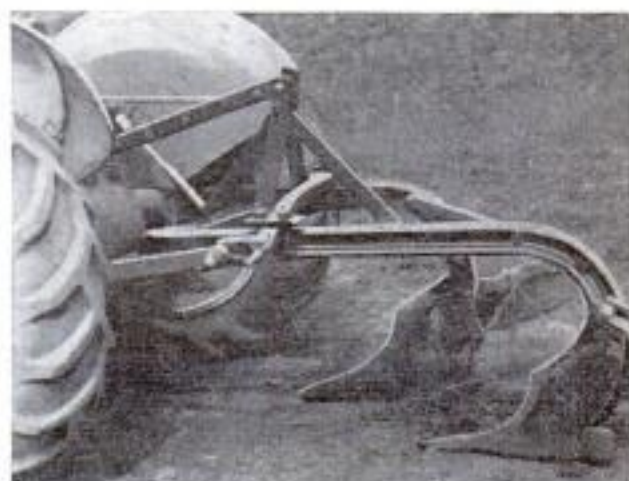

X381

LATHE BENCH BUILT IN THREE STAGES

By Stanley L. Karal

IT TAKES MANY HOURS to build a sturdy cabinet bench for a metal-working lathe, but the machine can be mounted ready for use in much less time if you build the bench in three stages as pictured at the right. After building the bench frame and mounting the lathe, the drawers and compartments can be built in whenever time permits.

A bench for a metal-working lathe must be rigid and the top must be level and sufficiently strong to support the motor drive and lathe without springing. Next in importance in the general design is the height of the bench itself, as this governs the height of the lathe spindle from the floor. Some operators of bench lathes prefer that the spindle be a little above waist height. Perhaps the best way to determine this to your own satisfaction is to place the lathe on a table and raise it, if necessary, by means of small blocks until you have the spindle at a convenient height. From this test you can decide what spindle height is most adaptable to your purpose. Note in the detail on the following page that the height of the bench is given as 31½-in. over-all. This height, plus that of the lathe itself, gave a working height from the floor that suited the owner of the lathe pictured. Check this construction detail carefully before you cut stock for the bench.

Stock 2 x 4s and 4 x 4s are used in framing the bench, the 4 x 4s being used for legs and the 2 x 4s for the top and bottom rails. The ends of the rails are mortised into the legs to their full thickness. Note that mortise dimensions are not given in the detail due to slight variations in the stock. Take measurements direct from stock at hand. Then you will be sure of a tight fit of the rails in each individual mortise. It should be noted also that other dimensions of the bench may have to be changed to accommodate the lathe at hand.

The top is made by joining two pieces of ¾-in. plywood with screws and glue. Note that the top piece is 1⅛ in. wider. When joined, the offset at the back should be ¾ in. and at the front ¼ in. The offsets form rabbets into which the back panel and the front facing board fit when these parts are applied in finishing the cabinet. Perhaps the best way of making the mortises is to saw down to depth on the gauge lines, then make a series of adjacent saw cuts inside the gauge lines and remove the waste with a chisel. Then cut the long rails to length and join to the legs with glue and ⅝-in.

1st STAGE
(FRAME)

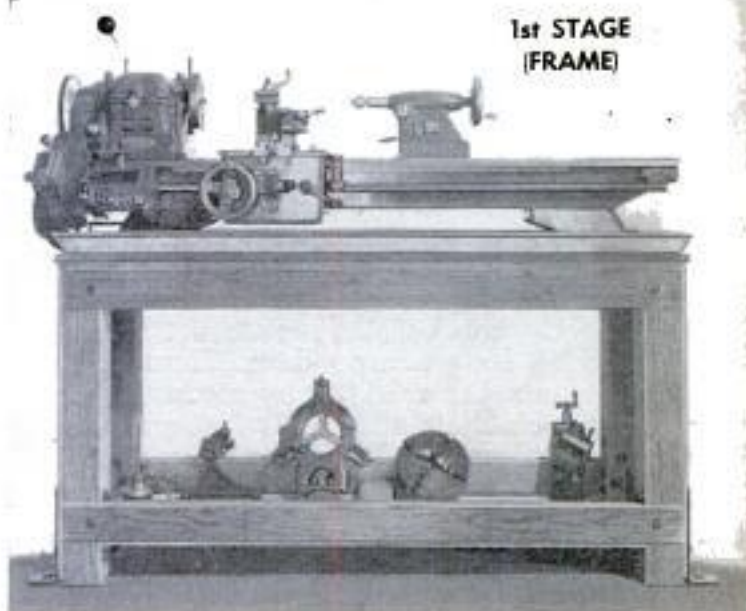

Bench with construction at first stage consists of four legs, rails, top and the plywood bottom panel

2nd STAGE
(DRAWER FRAMES
AND COMPARTMENTS)

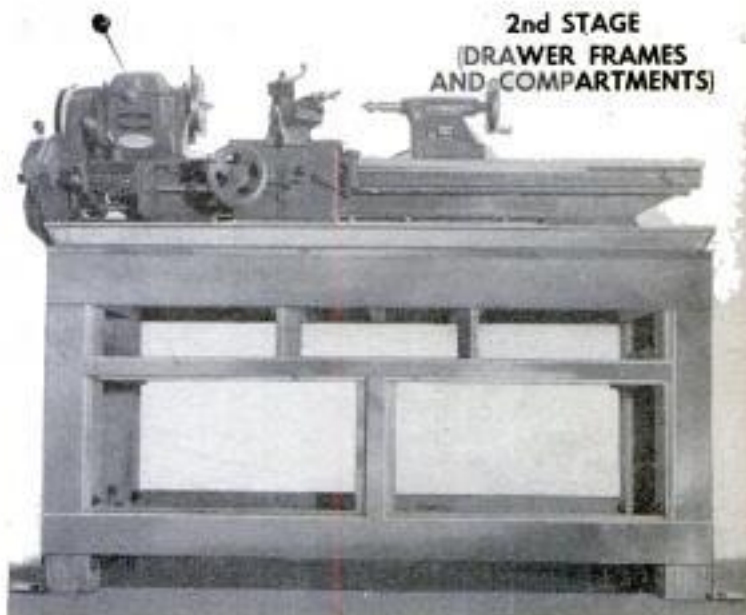

Above, second stage with cabinet framing in place. Note facing strips. Below, finished bench with three drawers and storage compartment for accessories

FINISHED BENCH

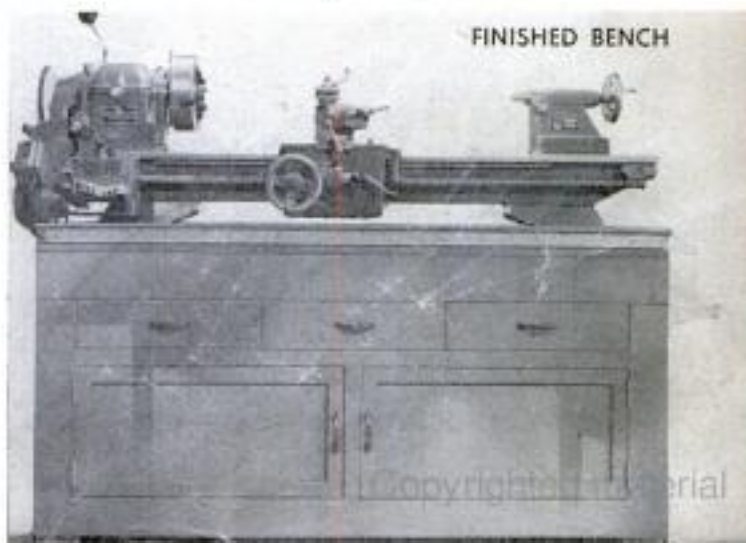

carriage bolts. Now just a reminder before joining the top rails: If you have a circular saw run $\frac{3}{4}$ -in. grooves across the inside faces of the top rails to take the drawer slides. If this is done, the $1\frac{5}{8}$ -in. notches in the drawer slides will have to be altered to fit. Cut the four short rails to length and join to the legs with glue and bolts. Before the glue sets, level the assembled frame and check for squareness at all four corners. After the glue is dry, install the center cross members between the top and bottom rails. Note that the bottom cross member is installed with the flat face up while the top member is installed edge up. The top can be attached to the frame by driving long screws down from the top face into the rails, or by means of metal angle brackets attached with screws from the underside. With the bench at this stage the lathe can be mounted. Although not essential, most operators prefer to bolt it to the top.

When building in the cabinet, first install the plywood back, bottom and end panels, fastening them in place with screws and glue. Next, install the strips at the ends of the frame to serve as drawer runners, nailing a wider piece to the back face of each

strip to form a guide. Note that these strips are cut so that the long drawer rail can be nailed to the ends. Then install the center drawer slides and nail to each the strips that form the drawer runners. Make sure that all these parts are at exactly the same height in relation to the bench frame. Install $\frac{3}{4}$ -in. facing boards on the three rails and the front faces of the legs. As detailed, the outer ends of the drawer sides, the back and the plywood bottom are housed in grooves.

If no power tools are available for cutting grooves, the parts may be butt-joined. Before making the drawers be sure to check the size of the drawer openings and allow $\frac{1}{16}$ -in. clearance. Although not detailed, the drawers can be partitioned either the short or long way if desired. Doors to the lower compartment can be of the paneled type as shown in the photo on the preceding page or made from a single plywood panel, the latter door being the simplest to make. Allow sufficient clearance so that the doors do not bind on closing. Attach metal pulls to both drawers and doors. If the bench is to be painted, you will get a better finish if you first apply a coat of sealer to all exposed parts. ★ ★ ★

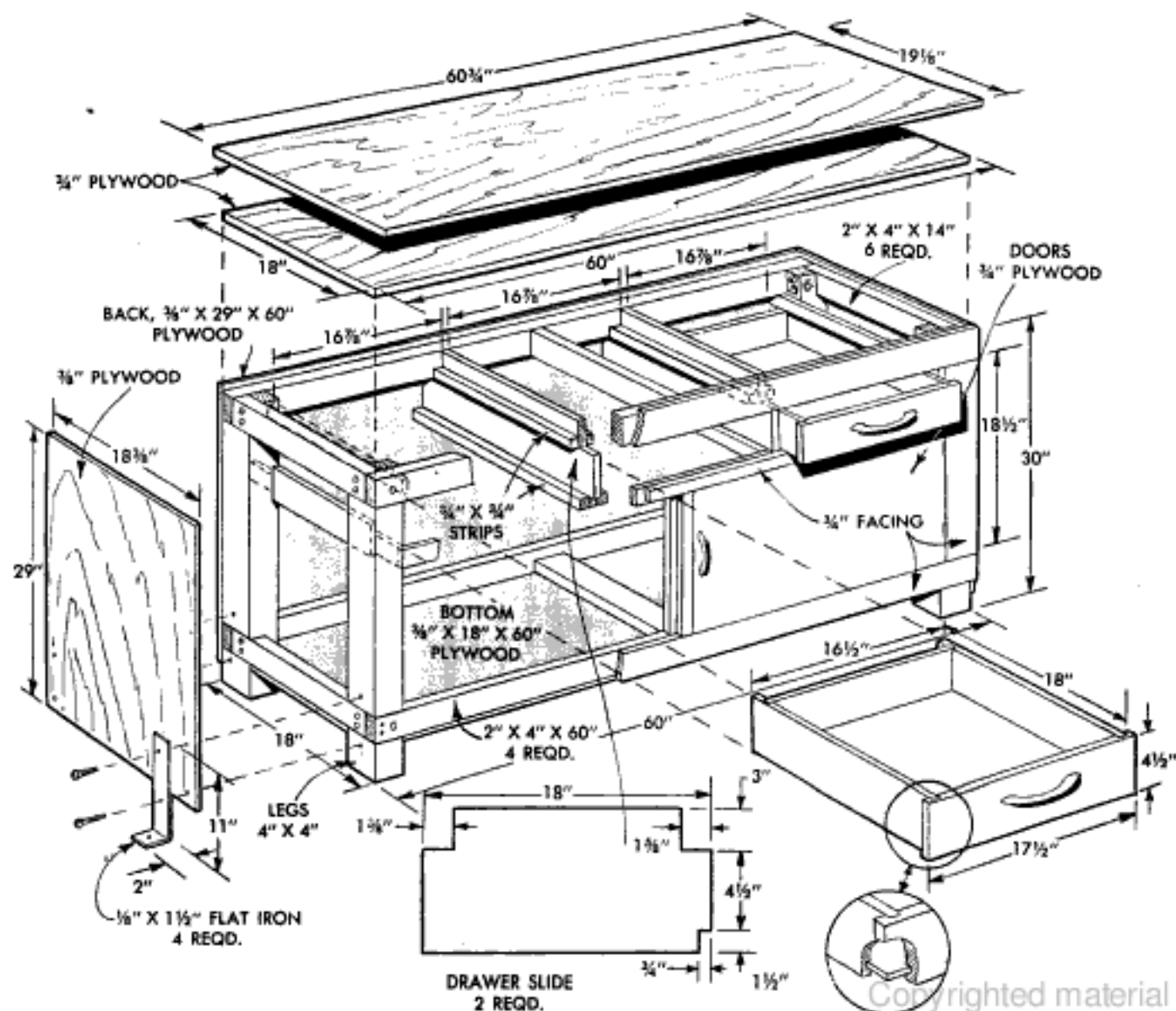

Wooden Plugs in Masonry Walls Held Tightly With Wedges

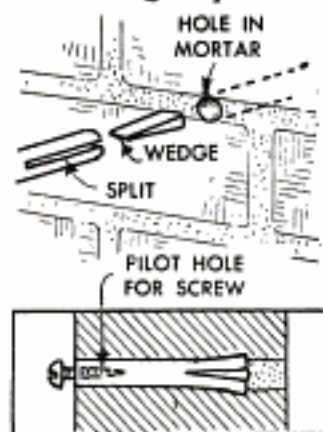

Wooden plugs used in masonry walls will not loosen readily if they are expanded with wedges driven into the inner end. Drill the holes in the masonry about 2 in. deep and just large enough to provide a snug fit for the plug. Saw a slot in one end of the plug, making it about twice as deep as the length of the wedge to prevent splitting the plug when the wedge is driven in. When installing the plugs, place the tip of the wedge in the slot and gently force in the plug. When the wedge strikes the bottom of the hole, drive the plug in with a hammer, which causes the wedge to spread the plug tightly in the hole.

Grip on Joints Push Stick Is Electric-Iron Handle

For use when running material over a jointer, this push stick employs the plastic handle from a discarded electric iron as a grip. The stick is a $\frac{3}{4}$ -in. piece of hardwood 3 in. wide and 15 to 16 in. long. A $\frac{1}{4}$ -in. recess is cut into the bottom of the front portion. Depending on the shape of the iron handle, it may be necessary to use a beveled block on top of the push stick to mount the handle. Longer flat-headed screws of the same size as used to hold the handle on the iron are used to hold it to the stick. The screw heads are countersunk to prevent damaging the jointer blades during use.

Ralph S. Wilkes, Keuka Park, N. Y.

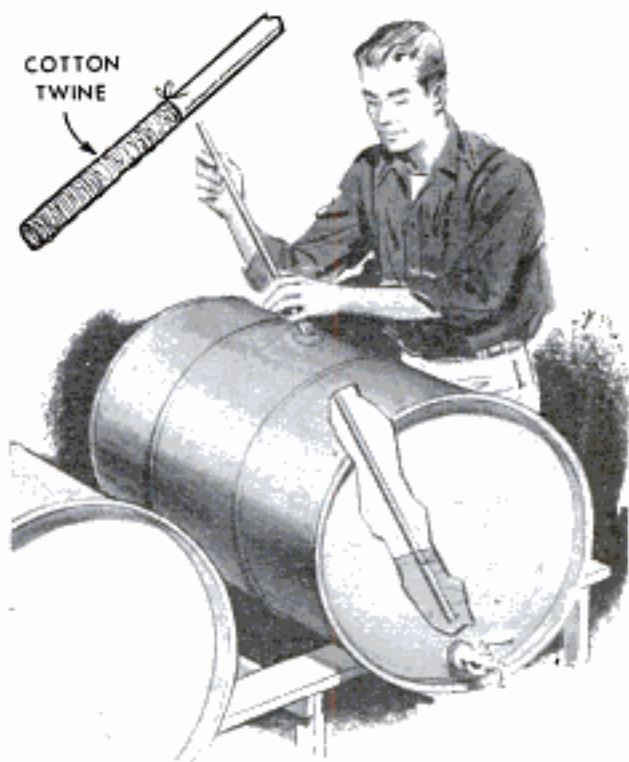
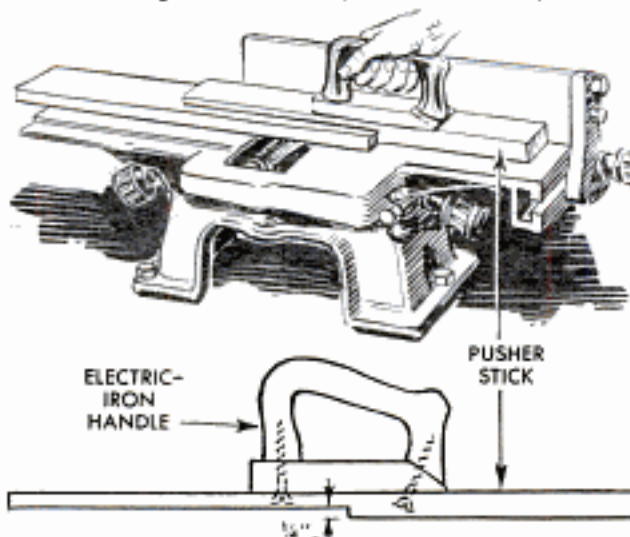

Water Content of Gasoline Barrel Easily Checked

To test gasoline stored in a barrel for the presence of water at the bottom, wrap a length of cotton string around a dowel or stick and insert in the barrel through the bung. Make sure the stick touches the bottom of the barrel at its lowest point. When the stick is withdrawn, the gasoline will evaporate quickly from it, but that portion of the stick wrapped in string, which has absorbed water, will remain wet.

Hand Truck Capacity Increased By Removable Extensions

The capacity of a hand truck, which is limited when the truck is used to carry light but bulky packages, can be greatly increased by attaching two lengths of pipe to the truck frame by means of floor flanges. The flanges are bolted to the frame as close to the lower end as possible. Lengths of pipe then can be screwed into the flanges to permit carrying large-size packages. The pipes are quickly unscrewed when the truck is to be used for other purposes.

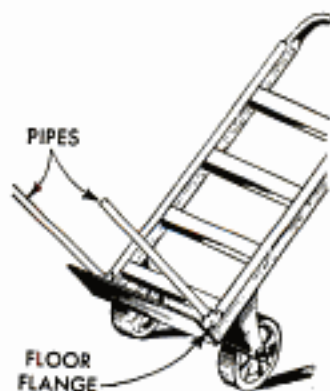

Fluorescent paper, glued to the tips of clock hands and the hour marks, will enable you to read the time in the dark.

SHOPPING FOR TOOLS



1. WIRE SPLICER automatically strips insulation and crimps wire ends in a specially designed cartridge connector which provides an insulated connection that is completely water-proof. Eliminates twisting the wire ends by hand and wrapping with insulating and friction tape. Does the complete job in seconds. Developed under the direction of the U.S. Signal Corps for maintaining communication lines near the battlefield

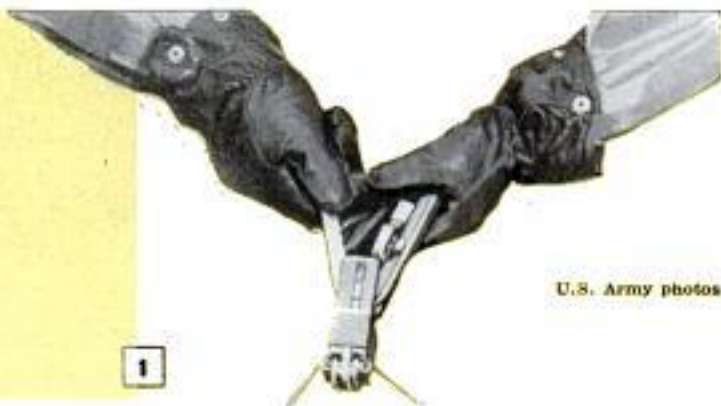

U.S. Army photos

2. BOLT-AND-NUT GAUGE provides a quick, accurate means of checking all common bolt types for length, diameter and thread size. Handy in hardware stores, factories, assembly rooms and even in the home shop. Scales are raised and are easily read against a black background. Can be carried conveniently in pocket where it is ready for quick reference

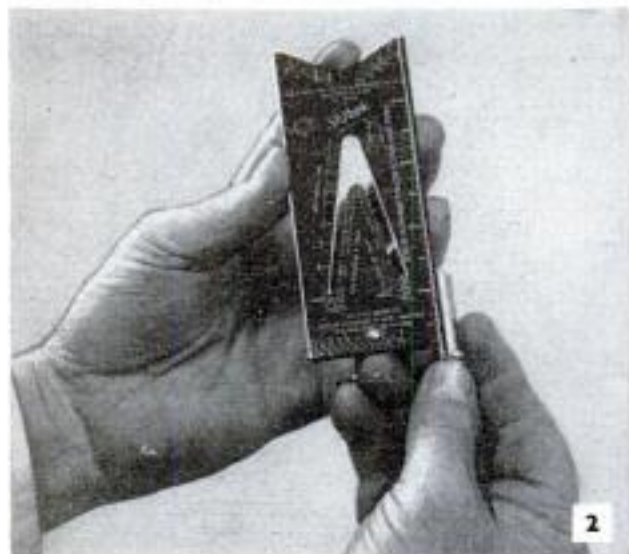

3. TAP WRENCH is designed to fit a 1/2-in. capacity geared drill chuck and in this manner utilizing the accuracy of the drill press for hand tapping. Equal in accuracy to machine tapping. Reduces tap breakage to minimum. Can also be used for hand reaming with straight reamers up to 1/2 in. in dia. For best results, use a cutting oil on both soft and hard metals

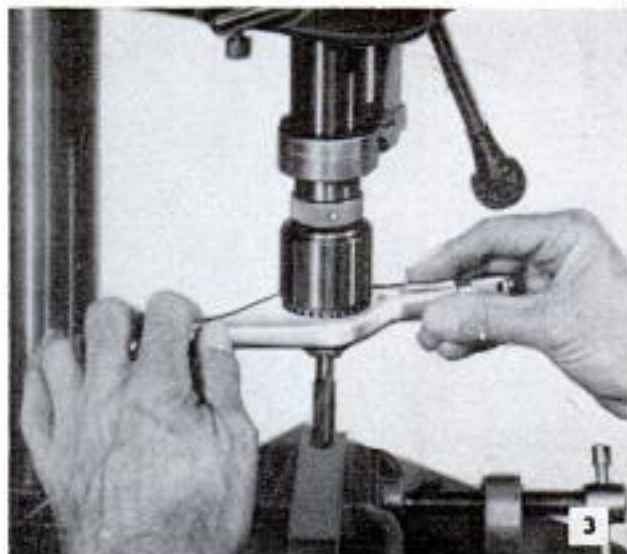

4. SPECIAL CLIPS are designed to hold cans of a uniform size, such as coffee and soup cans, on the four sides of a post or column to provide orderly, convenient storage for small items. Each can is easily removed from its individual clip without disturbing the others. Can is held securely when replaced. Clips are of metal, cadmium-plated to prevent rust. Each clip attached with screw



4

5. TOOLING CLAMP for use either with jigs and fixtures or as a holder on drill presses and milling machines is equipped with a fast-action screw that holds securely at any point along its entire length

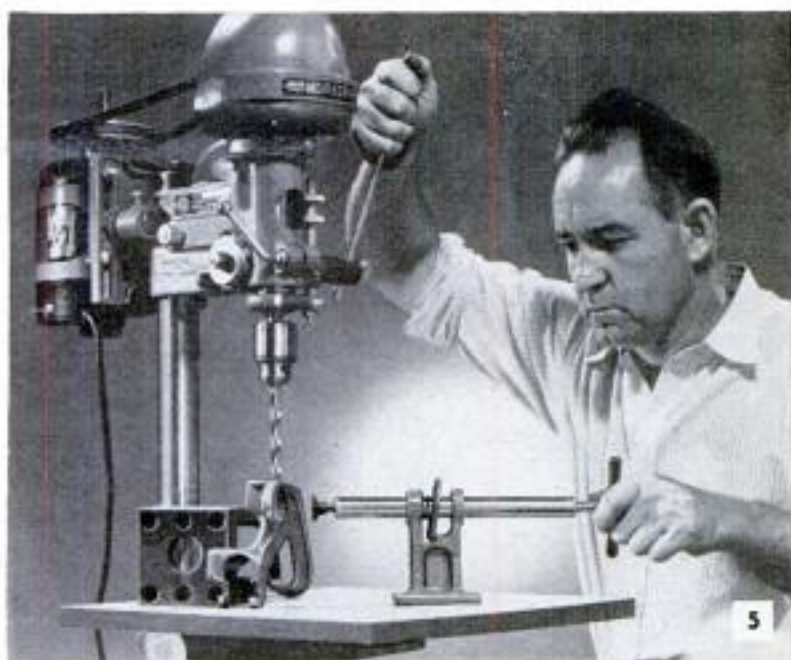

5

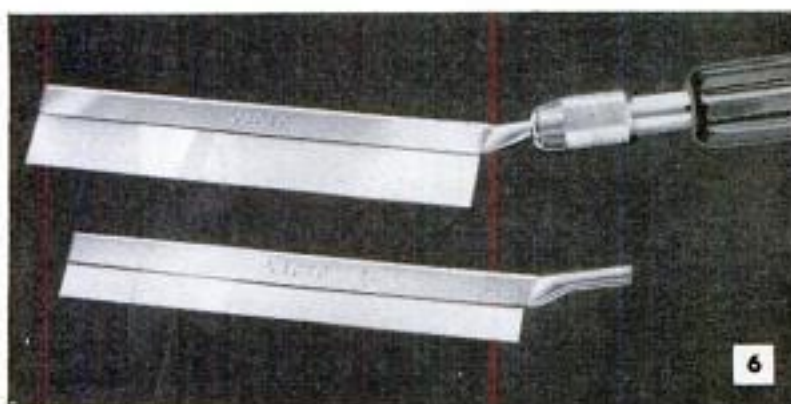

6

7. PLASTIC SCREWDRIVER HANDLE is made twist and impact-proof by press-fitting the driver shank into a hexagonal cavity by means of a plastic liner, or sleeve, which also is hex shaped



7

6. DOVETAIL SAW, or "razor" saw, comes in two blade widths of $\frac{3}{4}$ and 1 in. and is adapted to extremely fine work on wood, soft metals and plastics. Blades are replaceable and set includes a detachable handle. Blade shank is offset, a feature which permits work in corners or close to vertical member of an assembly

8. SHEET-METAL BRAKE fits onto an ordinary machinist's vise having jaws $4\frac{1}{2}$ in. or less in width. Bends 16-ga. steel up to 3 in. wide and $\frac{3}{16}$ -in. flat steel up to $\frac{3}{4}$ in. wide. Material to be bent is clamped between frame of brake and movable jaw of vise as pictured. Makes radius bends over round piece of stock



8

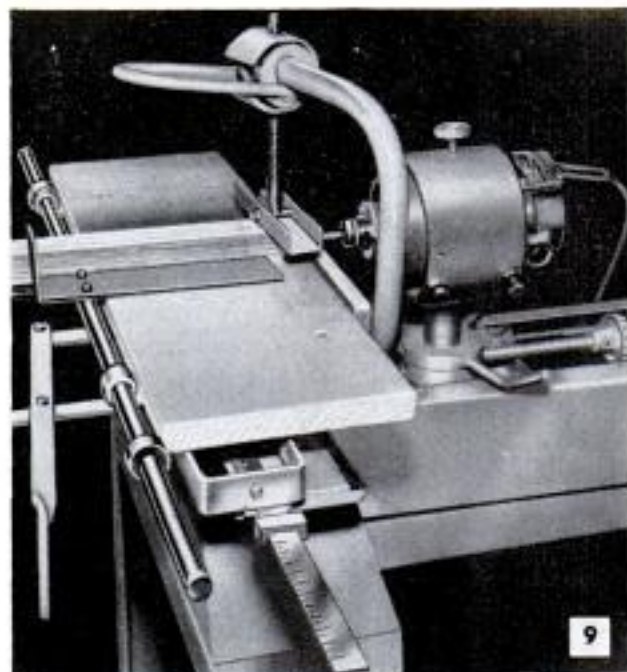

9

9. ROUTER-MORTISER for cabinet shops, pattern shops and door manufacturers handles boring and routing jobs with a high-speed efficiency equaling that of much heavier machines. Motor mounts are interchangeable for standard 1750 r.p.m. motor or high-speed router operating at 22,000 r.p.m. Maximum table travel is 12 in. Available in floor and bench types



10

10. ROTARY PLANE is powered by a 1/4-in. portable electric drill. Cuts 2 in. wide and can be tilted for cutting bevels up to 45 deg. Makes a smooth cut on hard and soft woods, plastics and aluminum. Depth of cut can be adjusted to suit different materials. Drill drives through chuck to bevel gears operating in a grease-packed housing. Weight is about 3 1/2 lb.

11. SABER-SAW ACCESSORY is now available for use on radial saw. Drive is direct from radial-saw motor. No belts or separate parts are required. Can be tilted left or right up to 45 deg. for sawing bevels on intricate scroll work. Makes inside and outside curved cuts on stock up to 2 in. thick with a maximum clearance between saber blade and radial-saw frame

12. MAGNETIC PARTS RETRIEVER is fountain-pen size and comes with an extendible tip which can be flexed to reach otherwise inaccessible places. Two models are available, one with a tip 1/4 in. in dia., the other having a tip 3/8 in. in dia. and capable of lifting much heavier objects, as in photo. Handy for lifting chips from chucks, bed ways and machine-table slots

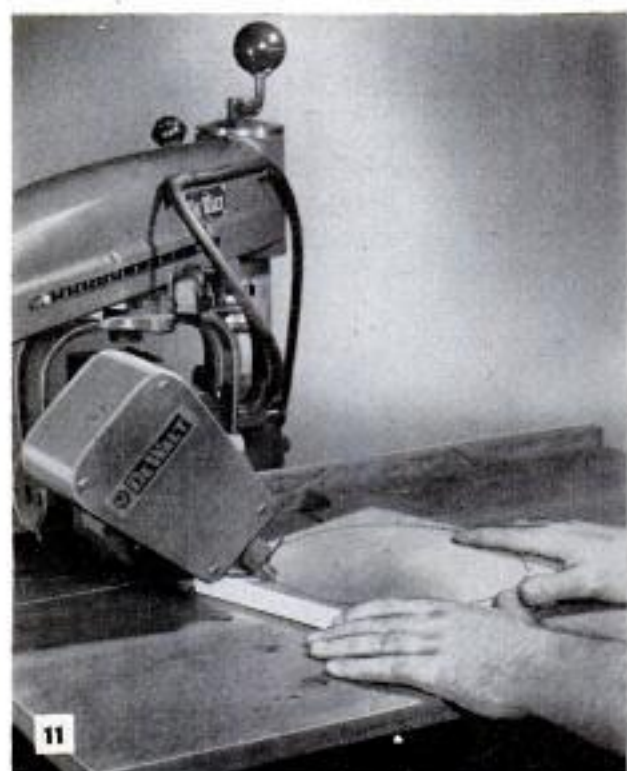

11



12

Ever been Stood up...

by a
FUEL PUMP?



It's a day you'll never forget. There you stand as the minutes tick slowly by. And somewhere, the car that *was* to have picked you up is stalled.

Any service man will tell you to check your fuel system twice a year. That goes for fuel pumps, too.

If your fuel pump is an AC—and 9 out of 10 are—it's precision-built to keep you out of trouble. But, normal wear can eventually cut down any fuel pump's efficiency. Have it checked—and if there *is* need for replacement, be sure you get an AC Fuel Pump.

**YOUR FUEL PUMP needs to be
as good as AC builds it . . .**

For example, the diaphragm is the hardest working part of the pump. That's why the AC diaphragm is made of *four* strong layers of patented-treatment, square-woven airplane cloth instead of one. AC builds it better to serve you longer.

AC SPARK PLUG DIVISION  GENERAL MOTORS CORPORATION

AUGUST 1954

Magnified section
shows 4-layer
diaphragm

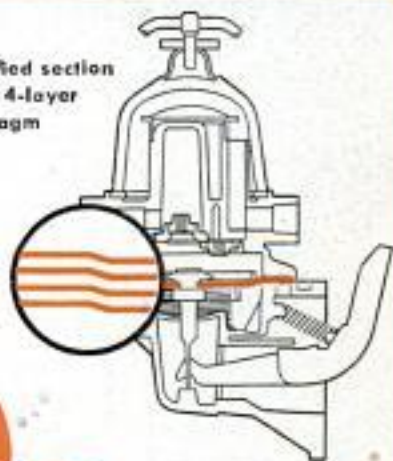

...for
**DEPENDABLE
DRIVING**

Copyrighted material 205

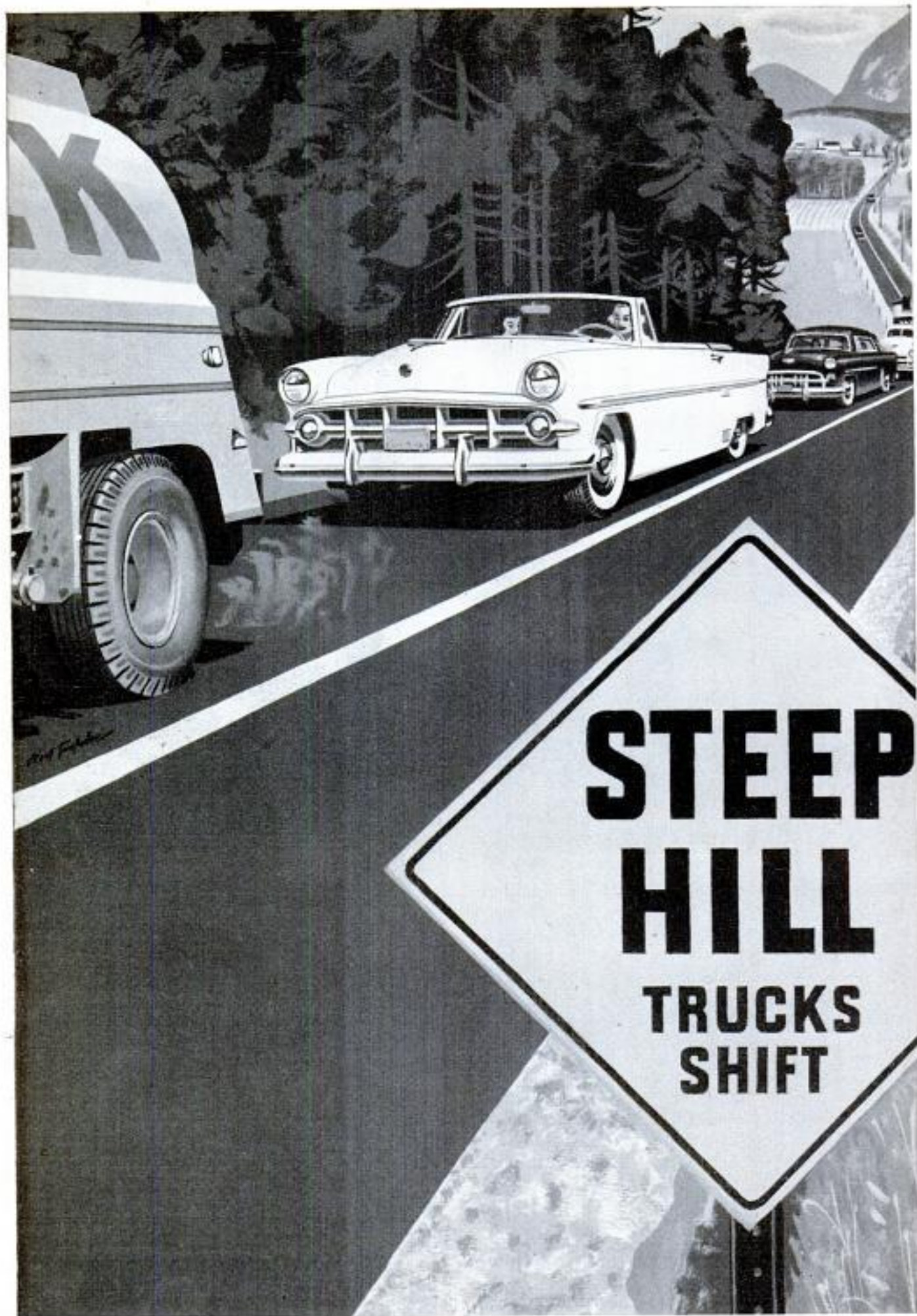

Do you avoid passing on hills and curves? It can help you

save up to 40% on your auto insurance!

Read how careful drivers get top-notch protection at rock-bottom rates with

STATE FARM MUTUAL

If you use good judgment like the motorist in this picture, you're probably a careful driver at all times.

It should be easy for you to qualify for membership with State Farm Mutual—the "careful driver insurance company." It should be easy for you to save up to 40 per cent on the cost of your auto insurance!

State Farm Mutual, you see, deliberately aims to insure *only* careful drivers. This holds accident costs to a minimum. The savings are passed back to State Farm members in the form of low rates (a practice that State Farm has followed for all its 32 years).

And State Farm's 3 million members receive many other benefits besides substantial savings. They get the extra convenience of semi-annual payments at no extra cost. If they should have an accident, they get fast, efficient claim service readily available through State

Farm's own 7,000 agents and 700 claim expeditors.

For full details—for the actual amount you can save—talk to the nearest agent listed under "State Farm Insurance" in the yellow pages of your phone book. Or write: State Farm Mutual, Dept. J-12, Bloomington, Ill.

Can You Qualify?

State Farm aims to insure careful drivers only. Drivers who can be counted on to:

- Avoid passing on hills or curves
- Be alert for emergencies
- Make full stop at stop signs
- Heed crossing signals
- Obey speed laws
- Always signal stops and turns
- Be extra careful on slick pavements
- Avoid mixing alcohol and gasoline
- Yield pedestrians the right of way

STATE FARM MUTUAL



FREE TO MEMBERS!

Ask your agent for your new State Farm insignia (like above) in bright red headlight-reflecting Scotchlite. Display it proudly on left rear car bumper to identify yourself as "careful driver, soundly insured" . . . to provide emergency reflection when parked or if taillight fails.

"the careful driver insurance company"

State Farm Insurance is written only by the
State Farm Mutual Automobile Insurance Co.
and its wholly owned affiliates:

State Farm Life Insurance Company
State Farm Fire and Casualty Company

Home office: Bloomington, Illinois. Field claim offices in 325 principal cities. 7,000 agents in 40 states, District of Columbia, and Ontario, Canada

Hear "Jack Brickhouse Sports News" Saturdays and
"Cecil Brown News Commentaries" Sundays over Mutual Stations.
Check local radio listings.

Care and Feeding of Engines



BY
S. P. CORP

DECEPTIVE GAS GAUGE

If you run out of fuel while the gas gauge says you have plenty left, there is probably electrical trouble, and here is the way to locate and correct it:

Remove the tank unit from the gasoline tank, under a plate in the luggage compartment, covering the hole while the unit is out. Connect a wire from a 6-volt battery to a Mazda "51" light bulb, then

connect the ground side of the bulb to the terminal on the tank unit. Now run a wire from the other battery post to the case of the tank unit. With the float up (full position) the light will burn brightly; light will dim as float is lowered to empty position. This indicates the tank unit is operating.

Remove wires from test equipment and re-connect the tank unit to wire from panel gauge, grounding tank unit to the car. Watch panel unit as you work float up and down. If gauge does not follow movement of float, look for a break or a short in wire from tank unit to gauge. In most units, a short will cause the panel gauge to show "full." If all wires are O.K., replace panel gauge.

If tank unit has two wires, test system by using a new tank unit to test the panel gauge by connecting it to wires 1 and 2 on the tank unit. Then ground to the car and work float as before. If panel gauge does not operate, you need a new one.

Be careful not to bend float arm of the tank unit during testing.

SEND FOR VALUABLE FREE MANUAL

"MORE POWER, Less Gas, Less Oil" is an illustrated manual on car care which can prove helpful to you in many ways. It gives you the facts on Sealed Power KromeX Ring Sets, with solid chrome face on top compression ring and on side rails of MD-50 Steel Oil Ring, for more than double normal mileage. It also shows you how the MD-50 provides complete oil control, even in badly tapered and out-of-round bores. Read it, and learn why it pays to use Sealed Power KromeX Ring Sets when your car needs new rings. For your free copy, address a postal card to Sealed Power, Dept. G-8, Muskegon, Michigan.



Sealed Power

PISTON RINGS

Clinic for Homemakers



As a service to our readers in solving the hundreds of problems pertaining to a home—inside or out—the editors of *Popular Mechanics* invite you to present your problems to The Clinic Editor for help and advice. Address your questions to The Clinic Editor, *Popular Mechanics Magazine*, 200 East Ontario Street, Chicago 11, Ill.

Chimney Problem

Q—I have an old home in the country, recently purchased, which is constructed with solid brick walls having chimneys built into the walls. In one the flue comes down only to the second floor. The other comes down to the first floor. My contractor says the chimneys will have to be rebuilt to vent a fireplace and heating plant. Is he right?

S.R., Pa.



A—It may be possible to utilize the longer flue to vent the fireplace, provided the flue is large enough, which is rather doubtful. Usually in old homes of the type you describe, the chimney flues vented wood-burning stoves or heaters of various types and sizes. Rarely are they large enough for even a medium-sized fireplace. However, in your case it may be practical to consider utilizing the longer flue for a fireplace by building up from the basement on a suitable footing and opening the wall. Build the fireplace in whatever manner is necessary to use the existing flue. In some cases such a procedure has been carried out successfully. However, this suggestion should not be taken as superseding in any way the opinion of your contractor who is already on the ground and in a much better position to judge the possibilities than we are. The other chimney undoubtedly will have to be rebuilt if it is to be used to vent a heating plant located on a first floor or in a basement.

Cracked Plaster

Q—The plaster on two ceilings in my home is quite badly cracked, the problem of repair being further complicated by the fact that the edges of the cracks are offset perhaps as much as 1/8 in. or more. My problem is should I level the plaster by sanding or some other means, then fill the cracks or should I cover the ceiling with plasterboard?—D.H., Mo.



A—We would be inclined to recommend that you cover the defective ceiling with plasterboard, although this will likely be more expensive. The

(Continued to page 210)

HOW TO GIVE YOUR HOME PROJECTS THIS PROFESSIONAL LOOK!

...make them yourself with Reynolds **Do-It-Yourself[®] Aluminum** using standard hand or power tools

You can turn out project after project easily and quickly with this astonishing new material - Reynolds *Do-It-Yourself* Aluminum. You can saw it, plane it, drill it, shape it, joint it and bend it with tools found in the average home. In fact, all leading hand and power tool manufacturers approve Reynolds *Do-It-Yourself* Aluminum.

Designed in easiest-to-use forms, Reynolds *Do-It-Yourself* Aluminum comes in sheets, tubing, rods, bars, angles, storm sash, screen sections and handy fasteners. **Caution!** Use only Reynolds *Do-It-Yourself* Aluminum. Identify before you buy - there's a special Seal on every piece to tell you it's Reynolds *Do-It-Yourself* Aluminum.



SKI-HI STILTS FOR KIDS OF ALL AGES

Two lengths of Reynolds *Do-It-Yourself* Aluminum tubing and one piece of bar stock are the necessary materials. You can turn it out in very little time by following simplified directions outlined in Easi-Bild Pattern No. 552. -25¢ with coupon



African Primitives add Decorator's Touch. Reynolds *Do-It-Yourself* embossed Aluminum simplifies making. Can be cut with scissors. Easi-Bild Pattern No. 539. -25¢ with coupon

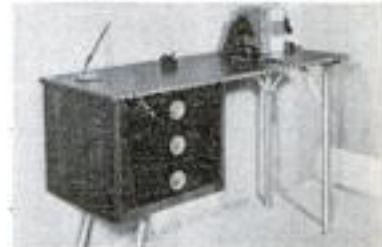

Make this Decorator's Library Desk. No special skill or experience is needed to build this smartly styled desk. Anyone can build it by following Easi-Bild Pattern No. 537. -50¢ with coupon



Porch, Game Room, Terrace Table and Modern Web Chairs. Top is made from heavy stock lumber, held together with aluminum tubing. Easi-Bild Pattern No. 554 -50¢ with coupon. Web Chairs, Easi-Bild Pattern No. 548. -50¢ with coupon



Look for this handy self-service display rack at your Hardware or Department Store or Building Supply Dealer's without delay. And give your home projects the professional look with Reynolds *Do-It-Yourself* Aluminum.

* T. M. REYNOLDS METALS COMPANY
T. M. REG. EASI-BILD PATTERN COMPANY



REYNOLDS ALUMINUM SERVICE CORPORATION

2494 South Third Street, Louisville 1, Kentucky

Please send me the following PATTERNS and free booklets (check as desired). I enclose \$..... in money order or coin. (No stamps, please.)

- | | | | |
|---|-----|--|------|
| <input type="checkbox"/> Easi-Bild Pattern #537 for Decorator's Library Desk..... | 50¢ | <input type="checkbox"/> Easi-Bild Pattern #548 for Web Chairs..... | 50¢ |
| <input type="checkbox"/> Easi-Bild Pattern #539 for African Primitives..... | 25¢ | <input type="checkbox"/> Easi-Bild Pattern #552 for Ski-Hi Stilts..... | 25¢ |
| <input type="checkbox"/> Easi-Bild Pattern #554 for Terrace Table..... | 50¢ | <input type="checkbox"/> How-To Booklet containing general instructions..... | FREE |

Name.....

Address.....

City..... Zone..... State.....

Reynolds *Do-It-Yourself* Aluminum is also available in Canada

Shavings

from the
WIZARD'S WORKSHOP
by the Weldwood Wizards with Wood

WHAT'S YOUR "SHAVING?" Want your short cut or shop trick printed? Send it to United States Plywood Corp., Box 135, N.Y. 36, N.Y. If used, we'll send you a one year subscription to this magazine. All entries become our property. None can be returned.

NOTHING CRUMBY ABOUT THIS. Take the wife's breadboard and cut a shallow rabbet all the way around. Now glue and screw a frame to the edge of the board, flush with the cutting surface. Crumbs from cutting just fall into the rabbet.

LIKE A HAPPY MARRIAGE. If you want wood joints to last, use Weldwood Plastic Resin Glue. It makes a bond stronger than the wood itself. And it gets stronger as it ages. Always in perfect condition when you want to use it, because you mix it yourself from the powder, in a few seconds. Stain-free, rot-proof, highly water resistant, inexpensive. America's largest selling wood glue.

HELP BY THE BOOKFUL. Ask The Government Printing Office, Washington 25, D.C., to send you FREE, "Hobby Publications"—a list of booklets from which you can select many useful volumes.

"LOOKS LIKE A MILLION." Here's a sure easy way to get that costly hand-rubbed "natural" finish on wood tables, book shelves, cabinets, etc. Use easy-to-apply Satinlac. Works on any wood, hard, soft, solid, or ply. Satinlac doesn't look "built-up"; doesn't darken the wood or turn yellow. Gives "pro" results and protects the wood.

NO HITS—NO ERRORS. Here's how you can banish accidental hammer dents in wood surfaces. Cut a hole through a piece of heavy cardboard. Slip it down over the nail—it will take the dent if your hammer misses.

A PRETTY PICKLE YOU'LL LIKE. Those luxurious pickled or blond wood finishes you see in the fashionable furniture stores are easily yours. Use White Firzite for blonding or pickling. For pastel tones, tint White Firzite with colors-in-oil. You'll get exciting professional results on any wood!

TRICK OF THE PAINTER'S TRADE. On soft wood or fir plywood stain jobs, you can tame that "wild" grain with a coat of Clear Firzite. Gives that smooth expensive-wood finish.

		
WELDWOOD® Plastic Resin Glue Makes a bond stronger than wood itself. Highly water resistant.	FIRZITE® White for pickled or blond effects. Clear tames wild grain on stain jobs.	SATINLAC® For exquisite natural wood finish. Enhances natural grain; preserves the surface.

At hardware, paint, lumber dealers.

United States Plywood Corporation
Dept. 135, 55 West 44 St., New York 36, N. Y.
Send me free leaflets on Weldwood Plastic Resin Glue, Firzite and Satinlac.

NAME _____

ADDRESS _____

(Continued from page 208)

question of whether or not to use plasterboard depends to a considerable extent on the general condition of the old plaster. If more than one third of the total area is loose from the lath, then we think it wise to remove the old plaster entirely and either replaster or cover the ceiling with plasterboard. In either case, it perhaps is advisable to remove the old plaster. If, on the other hand, the plaster is loose only in the immediate areas of the cracks then the plasterboard probably can be attached directly over the old plaster, or the loose plaster adjacent to the cracks can be removed and the ceiling patch-plastered to give a uniform surface over which to decorate with paint or paper. Whatever decision is made must be based on consideration of these points. In some cases it is practical to level the offsets by sanding them flush after filling the cracks with a crack filler or patching plaster. This is a dusty, disagreeable job at best and there is always the risk of removing the white coat entirely and exposing the brown coat. If the ceiling is to be papered, this will make little difference but if paint is to be used on the ceilings, then the rough brown coat will show through.



Concrete Shield

Q—I've always wondered how the concrete shields, or guards, at the top ends of drain tile leading from downspouts are installed. Mine are cracked and will require renewal within a short time. Is the concrete precast to fit the tile and, if not, how is it poured without some or all of it dropping into the tile?—G.R., Ark.

A—The simplest and perhaps the most common method is to lift out the lower section of downspout, then carefully remove the broken pieces of concrete and whatever remains of the wire retainer. Great care must be taken that the pieces do not fall into the tile. While you have the tile open flush it out with the hose. Turn the water on full force, insert the hose in the tile and push it down as far as it will go. A hard stream of water will wash away sediment, particles of slate and leaf stems that may collect in one of the turns or elbows and cause eventual clogging. Next cut a disk of fine-mesh screen (hardware cloth), about 3/8 in., to fit snugly inside the bell end of the tile. Cut a hole in the center of the screen disk to take the downspout. Place the disk in the bell end of the tile and force it down to the shoulder. Then reassemble the lower section of the downspout with the end projecting through the hole in the screen. Now mix cement and clean sand in equal proportions (or use ready-mixed cement) to a heavy consistency and trowel it into the space around the downspout, pressing it down firmly and building it up slightly higher around the spout so that it forms a watershed. Trowel the surface smooth.

Soundproofing Ceiling

Q—I would like to soundproof the ceiling over my living room so that objectionable noise does not penetrate from above or below. However, I'm told that this will require removal of the plaster and lath and replacement of the joists so that there is no wood-to-wood bearing except at the ends. This will be expensive. Is there not some cheaper and simpler way?—F.A., Ariz.

A—There are acoustical ceiling tiles available which are said to possess soundproofing qualities suitable for the purpose you have in mind. These tiles are quite inexpensive and simple to install. A common method of installation is attachment of the individual tiles to wooden furring strips nailed to the ceiling over the plaster. In nailing the strips use nails sufficiently long to pass through the plaster and lath and enter the joists a distance of an inch or more. Also, be sure that the strips are flush all the way across the ceiling. Shim up any low places. Handle the tiles carefully so that you do not break the edges or corners.

THE PEE-GEE Pocket Comparator

Sensational new precision optical measuring instrument every mechanic can afford

The "Pee Gee" Pocket Comparator is a precision optical instrument for determining extremely small dimensions. It has almost unbelievable accuracy through the use of a powerful magnifying lens (approximately 6 power) and tiny transparent patterns called "reticles" which are actually extreme reductions of large precise "Master" layouts. The "Scales" reticle, which comes in the instrument, is used to measure dimensions from .0025 to .5000 of an inch in steps of .0025, and 0 to 10 MM in steps of .2 MM.

Other reticles for measuring radii, angles, threads, thicknesses, diameters and fractional dimensions are available for the instrument. Reticles can be furnished with black or white etchings at option of purchaser. The adjustable lens barrel and reticle retainer ring are of machined aluminum with a black anodized protective finish.

This instrument is extremely valuable to printers and artists... and to those whose hobby is building scale models, collecting stamps, making costume jewelry, engraving or etching. It can also be used for a wide variety of small-dimension measuring operations in the home workshop, and is widely used in industry for precise inspection operations.

Six extra reticles for measuring:



RADI... from $\frac{1}{16}$ " to $\frac{1}{8}$ " in steps of $\frac{1}{32}$ " (Reticle #102).

ANGLES... from 0° to 90° with 5° increments (Reticle #104).

THREADS... scales for 8, 14, 16, 18, 20, 24, 28, 32 and 50 threads per inch (Reticle #105).

THICKNESS... from .002 to .016 in steps of .001 (Reticle #108).

DIAMETERS... circle scales for .005, .010, .020, .030, .040, .050, .100, and $\frac{1}{16}$ " to $\frac{1}{8}$ " in steps of $\frac{1}{32}$ " (Reticle #109).

DIMENSIONS... linear measurements from 0 to $\frac{1}{2}$ " in steps of $\frac{1}{16}$ " (Reticle #116).

In convenient permanent case. **\$4.25 postpaid.**

Inquiries from Interested Dealers Welcomed

DISTRIBUTED BY

NATIONAL TOOL CO.
11297 MADISON AVE., CLEVELAND 2, OHIO

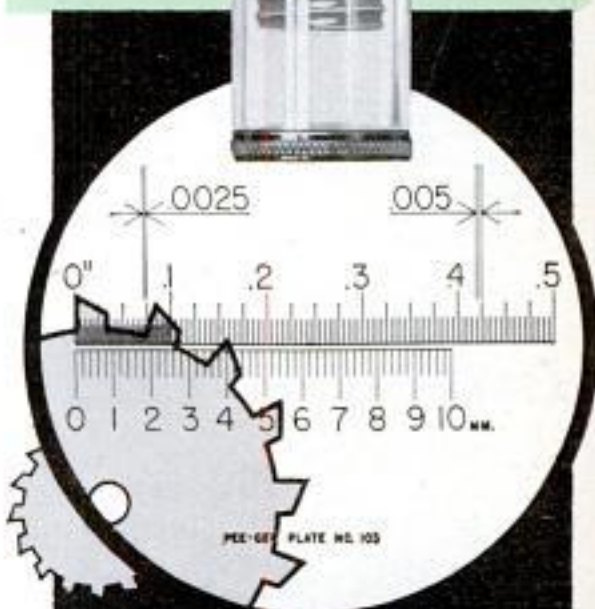

The "Pee Gee" Pocket Comparator comes with the "Scales" reticle, number 103, and instruction booklet in a dust-tight plastic container.

\$9.75 POSTPAID

SEND FOR DESCRIPTIVE FOLDER

- Send me Free Descriptive Folder.
- Send me a "Pee Gee" Pocket Comparator containing the "Scales" reticle. (Please enclose check or money order for \$9.75).
- Send me a "Pee Gee" Pocket Comparator and the convenient case containing six extra reticles. (Please enclose check or money order for \$14.00).

NAME _____

ADDRESS _____

CITY _____ ZONE _____

STATE _____

Looking for Something?



OUTBOARD
MOTORS

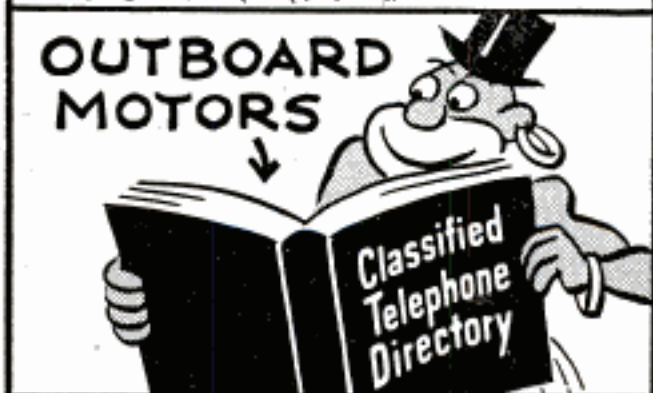

FROM AWNINGS
TO OUTBOARD MOTORS
WHATEVER YOU NEED

LOOK IN THE
'YELLOW PAGES'

OF YOUR TELEPHONE DIRECTORY

Thomas Jefferson Lives Here

(Continued from page 103)

The renovators also exploded the old story that Jefferson raised his bed to the ceiling on pulleys. The pulleys are there, it's true, but prying workmen found that the bed itself has always been bolted to the walls. Jefferson used the pulleys to operate the overhead skylight.

After a good deal of debate, the Foundation decided to install a heating-and-air-conditioning system at Monticello. Members hastily explain that the idea is *not* to turn the building into a supermodern museum, but to preserve the building itself and the centuries-old furnishings. A dehumidifying system pulls moisture from the air and the relatively constant temperature prevents damage.

When Grigg and the air-conditioning engineers set to work planning the installation they checked Jefferson's own drawings of Monticello.

"Mr. Jefferson's drawings are so specific," says Grigg, "that certain dimensions are figured down to $\frac{1}{1000}$ inch! Mr. Jefferson, in fact, helped us air condition and heat the building, for he built ventilating flues into Monticello. These built-in flues now serve as ducts for the heating and air-conditioning system."

Sensitive visitors might be appalled to see modern heat outlets in the old home, so Grigg has cleverly hidden them behind bed canopies, cornices, mirrors and pictures. You can't see them unless you're standing on a ladder or looking behind something you shouldn't be looking behind.

Grigg spared neither himself nor others in restoring the home to the glories of its Jeffersonian days. A good example is the wallpaper in the octagonal bedroom. When Grigg became the Foundation architect there was no paper on any of the walls. However, he noticed a faint pattern in the plaster in this particular room. He became convinced that there had been wallpaper on these walls early in the life of the building, and a very slight chemical reaction had etched the pattern into the plaster.

Since little wallpaper was made in this country in Revolutionary days, Grigg deduced that Jefferson had picked up the paper during his long stay in France. Off went letters with sample tracing of the pattern to museums and old wallpaper manufacturers in France, asking if by chance any old plates of that pattern had been preserved. Each letter brought a negative reply.

Then one day Grigg received a call from

(Continued to page 214)

POWER



**that turns mountains into molehills
...and miles into minutes!**

HERE'S power-riding at its thrilling best. From the moment you swing into the foam-rubber cushioned saddle . . . from the instant you twist the throttle of this breath-taking beauty, you'll know why the Harley-Davidson 74 OHV is the one motorcycle every rider wants to own. See it! Thrill to a

test ride at your dealer's today. Ask about his easy pay plans. If you now own a motorcycle, get his liberal trade-in deal. For your copy of the action-packed, picture-filled **ENTHUSIAST** Magazine and illustrated literature, send 10 cents to Harley-Davidson Motor Company, Dept. P, Milwaukee 1, Wisconsin.

HARLEY-DAVIDSON

HYDRA-GLIDE®



Now-an easy way to wash your car!

*JUST SPONGE IT ON -
RINSE IT OFF!*

FAST-ACTING, ECONOMICAL DU PONT CAR WASH

NEW DU PONT CAR WASH cleans faster and easier than you ever thought possible. Just sponge it on . . . rinse it off . . . and your car dries itself. No wiping or chamois work! Du Pont Car Wash gets off all the grease and grime . . . leaves your car spotless.



One tablespoonful washes your car. Half-pound can gives 20 washes!

DU PONT No. 7. PRODUCTS
From Chemical Research . . . For Easier Car Care



BETTER THINGS FOR BETTER LIVING . . . THROUGH CHEMISTRY

a friend in Williamsburg, Va. During the restoration of one of the homes there, a few strips of wallpaper had been found on the wall of a closet. Grigg drove over, held his traced pattern against the wallpaper and found that it matched perfectly. He's convinced that Jefferson bought the wallpaper in Europe, papered the octagonal room with it and gave the remnants of the rolls to his friends when he was next at court in Williamsburg.

Experts analyzed the paper in the closet, determined the type and the original colors. Then a well-known wallpaper manufacturer made special plates and ran off enough paper to cover the octagonal room. Today the walls look exactly as they did when Jefferson's daughter used the room.

Jefferson had embellished many of the rooms with a plaster frieze on a wide wood moulding. The figures depicted events that transpired during his eight years as President. The plaster had fallen away in some areas. Grigg carefully removed one good section of the frieze and sent it out to expert casters for duplication. Moulds were made from the Jefferson originals, and today Grigg can defy you to tell him which is the new plaster work.

During the restoration a few rotted timbers had to be replaced. Grigg figured that new beams cut on a circular saw would show curved marks that had never been seen in Jefferson's day. He insisted that the new timbers be whipsawed so the marks would be straight.

Some years ago the Garden Club of Virginia undertook to make the gardens exactly as they had been in Jefferson's day. They were aided in their work by voluminous sketches Jefferson had made of his garden plots. He brought many of the flowers and shrubs to this country from Europe. One of his pet projects was the introduction of the cork oak to this continent. He imported tiny oaks, one after another, but each died in the climate atop the mountain. Today there's a cork oak growing just a few feet from the home. Curtis Thacker, superintendent of Monticello and a real authority on its history, carefully covers the oak each winter with a burlap tent. The tree now is about 10 feet high, thanks to Thacker.

"I don't know what I'll do if the thing keeps growing until it's 40 feet tall," Thacker says. "I can't keep it covered with a tent forever. But there's some slight satisfaction in knowing that we apparently are doing something Mr. Jefferson himself couldn't do."

A high-pressure water supply and a modern fire-fighting system have been in-

(Continued to page 216)

Now! Do Your Own CEMENT Jobs with Ready-to-Use SAKRETE

Do a professional Cement Job
yourself with SAKRETE Products

SAKRETE Gravel Mix—for
major jobs.

SAKRETE Sand Mix—for
patching and pointing.

SAKRETE Mortar Mix
—for laying brick, con-
crete block or stone.

Send 10c for 44-page book
Instructions for doing
hundreds of Sakrete jobs.

Address: SAKRETE
Inc., P. O. Box 11-F
Cincinnati 17, Ohio.



JUST ADD WATER

Speedway teaches

BETTER SHOCKS

give smoother,
safer ride!



Here's what Bill Vukovich, winner of the Indian-
apolis "500" in both 1953 and 1954, says: "We
give a great deal of credit to the Monro-Matic
Shock Absorbers used on our car . . . the added
stability and control they contributed, especially
through the curves, gave us complete confidence.
These great shocks are standard equipment
with us."

SOFT, WHIPPY

SPRINGS of modern
cars must be con-
trolled by shock ab-
sorbers to prevent
dangerous bouncing
and to keep wheels
on the road for best
traction and safety.
Worn shocks should
be replaced promptly
for greater safety and
comfort.



IMPROVED

TRACTION is ob-
tained through the
action of the new
Monro-Matic Shock
Absorbers, the only
shock absorbers with
automatic adjustment.
Drivers report in
qualifying tests at
Indianapolis, "After
installing Monro-Matic
Shocks, increased
miles per hour 10%."



SEND 10 CENTS for new Shock Absorber
Manual. Tells the right shock for every car,
gives instructions for removal and installation.

MONROE AUTO EQUIPMENT COMPANY
MONROE, MICHIGAN

ESHELMAN 70 MILES PER GAL. GAS CHILD'S AUTO WITH MOTOR

Also
ADULT
1 Passenger
SPORT CAR
LOWEST
PRICE
Write for
Free Literature

Sturdy, Safe for kids. Also pulls
Mowers, Carts and Power Take-
off drives Pumps, Saws, etc.

Write for literature.

Eshelman, Dept. CM-88

119 Light St.,

Balto. 2, Md.

333 N. Michigan Ave.,

Chicago-1, Ill.

7070 N. Wood Blvd.,

Los Angeles 28, California



"HANDY TIPS FOR HANDY MEN"

BOOK OF HINTS to make home repairs and hobby
projects easier. Send 25 cents in coin to: THE
BLACK & DECKER MFG. Co., Dept. HSM, Towson
4, Maryland.

NEW WAY TO CUT PERFECT GROOVES WITH CIRCLE SAW!

Just dial any of 40 cuts. Parallel, clean, no sanding!
Leave on saw for regular cuts. For 1/2, 3/8, 3/4 and
1" arbors. At dealer's or order direct!

Send for free booklet

Only
\$4.95
per set

WARREN DADO WASHERS CO.

Dept. #28 P.O. Box 98, Detroit 2, Mich.

MAKE BIG MONEY

Sharpening Lawn Mowers...

SPARE OR FULL TIME

Mr. C. E. Hardy of Mis-
souri says, "I am doing a
fine business with the Uni-
versal Grinder. One cus-
tomer sends another. I
spent 40c for a newspaper
ad and have done nearly
\$500 worth of business." G.E. of Ark. says, "I have had my
Universal Grinder 2 months and made a net profit of \$227."



ONLY ON THE UNIVERSAL LAWN MOWER GRINDER

. . . can the inside face and edge of the stationary blade,
as well as the reel blades, be ground to proper clearance
ALL IN ONE SET-UP, without removing any blade from
either hand or power mower. Send Today for Free Details.
ROGERS MFG. CO. Dept. M-84 LINDSEY, OHIO

Take perfect pictures!

USE THE NEW



Instant reading!

No computing needed!

Correct camera settings at-a-glance for all color or black & white photography!

New color styling! In handsome "Sportsman-Gray" with bright metal trim and smart black and red accents. A full size meter, weighs only 4 oz.

Complete with neck cord in "jewel-clear" Gift Box...
Ever-ready Case... \$1.95

\$17.50

New, full size photoelectric exposure meter eliminates tricky computations and guesswork. Has changeable ASA Index Slides that correspond to all popular films—black & white, color, indoor, outdoor. By merely inserting proper slide in meter you read correct camera settings in f/stops from f/2.8 to f/22 and speeds from 1/25 to 1/200. Covers entire color film range in 1/3 f/stops and has special marks for movie settings.

Complete computer dial on back—for special films and light conditions other than normal. Calculates speeds from 1/1000 to full 16 seconds; f/stops from f/1 to f/64; ASA Indexes from .3 to 800.

AT LEADING PHOTO DEALERS EVERYWHERE

SKAN a product of **G-M LABORATORIES INC.**

4298 N. KNOX AVE., CHICAGO 41

THE "Scru-All" DRIVER GIVES YOU
**TWO IMPORTANT TOOLS
IN ONE!**



MAKES YOUR
ELECTRIC HAND DRILL
A POWERFUL
SCREWDRIVER!

Save tools! Save money! The "SCRU-ALL" Driver converts your electric hand drill in seconds. Successfully used in our factory for nearly four years. Simply chuck into your hand drill as you do a bit. A simple slip clutch assembly lets you control the speed and torque. The SCRU-ALL is a quality tool that will last for years. It adapts to hold any size bit.

"SCRU-ALL" Driver with extra Phillips bit, \$5.95 Ppd.
Please — No C.O.D.'s. **MONEY BACK GUARANTEE**

PENTAGON METAL PRODUCTS Corp.

BOX 125, SPRINGFIELD, NEW JERSEY

stalled in the mansion. The hoses and extinguishers are the only innovation which visitors can see, but here a compromise was necessary so the equipment would be instantly available.

Today, as you stroll through the mansion, you'll see the famous "gadgets" of Monticello. Some are Jefferson's inventions, others adaptations.

His old swivel chair—believed to be the first in America stands in his study. He designed a long upholstered bench that fits the contours of the chair exactly, converting it into a chaise longue. Astride the chaise longue is his worktable with a revolving top. If a book or paper lay on the other side of the table, he simply pushed the table around to bring it within reach. He was probably the first man to use storm windows. He also developed large three-sash door-windows. You simply raise the two bottom sashes to the top one, and the floor-length window becomes a door. Awning-type windows are the big news in modern homes, and you'll find several of them at Monticello, too.

In the entry hall stands the magnificent clock which Jefferson himself designed. He even imported a Swiss clockmaker to build it. The clock and its chimes are operated by 15-pound cannon-ball weights. Today, as in Jefferson's day, the weights are wound to the top of the wall each Sunday morning, and gradually descend during the week. Painted on the walls are the days of the week, and the position of the weights indicates the particular day. Here, though, Jefferson's own calculations went slightly awry, for the days from Sunday through Friday appear from the top to the bottom of the wall but there's no room for Saturday. Jefferson solved this miscalculation very simply by cutting a hole in the floor through which the weights could pass, and placing Saturday in the basement!

Hidden shutters unfold from Monticello's window casings. Outside each of the full-length windows is a wooden grille which Jefferson is said to have installed after President Madison laughed so hard he fell backward off his chair and out the window.

You'll find all these things and many more at Monticello. Thanks to the Foundation you'll see everything exactly as Jefferson saw it. And you'll feel something you can't see—the spirit of a man who worked desperately for his country while he dreamed impatiently of returning to the one spot on earth he called his own. There's some such spot that calls to each of us, and perhaps Thomas Jefferson is history's finest example of man's innate love for his home. Jefferson still lives at Monticello. ★ ★ ★



For Tasty Home Cooked Meals

drive a

REO

One reason Reo trucks are so popular mechanically is because they satisfy the "inner man". Reo drivers find that Reo dependability*, Reo power that takes steep grades in stride and Reo's easy handling in traffic get them there and back on time or ahead of schedule. Reo drivers' wives don't serve warmed up left-overs . . . Pop eats with the family when he drives a Reo!

REO

*Have you heard about Reo's Polar Plan of guaranteed maintenance?

MOTORS, INC.
LANSING 20, MICHIGAN

if you can hammer a nail...



you can build a new wall with **Knotty Pine**

PANEL SHEETROCK

T. M. Reg. U. S. Pat. Off.

THE FIREPROOF GYPSUM WALLBOARD

Simplest system ever! You just nail easy-to-handle 16" wide, ceiling-height panels right to the studs. *All at once* you have a *new decorated* wall of beautiful Knotty Pine PANEL SHEETROCK using matching colored nails. The joints are a decorative feature. Also available in plain panels you can decorate yourself, or in predecorated striated finish. Use it with modern USG Metal Trim. Ask your USG dealer, or write Dept. PM 8, Chicago 6, Ill.

UNITED STATES GYPSUM

the greatest name in building



I've Looked Inside a Tornado

(Continued from page 119)

In my trips over the country visiting areas devastated by tornadoes I have found many cases of farm wagons and even automobiles having been apparently carried up by the tornado and dropped in exactly the same spot they had been before. I knew this was impossible. With the help of other students of tornadoes and mathematicians, I have found that a tornado can exert pressure on the earth's surface of over 5000 pounds per square foot. Here we have the answer for the wagons and automobiles being pushed into the ground up to their axles, as most of them were. They had not been lifted and dropped back in the same spot; they had been shoved right down in the ground where they stood. All this was done by the wind flaring outward at the lower end of the tornado. It started back upward instantly to form the sheath, which I believe is the most destructive part of the tornado.

We're now ready to put the entire tornado into perspective. It is caused by warm, moist air rising swiftly into a cold-air medium. The tornado funnel is created when hail drills a great hole through both the upper and lower air layers. Cold, heavy air from aloft pours down this tube, rotating due to natural laws and expanding the upper column into a funnel. Clouds rush in from above to fill the vacuum thus created, which is mistakenly believed to be the tornado itself. The outer, true tornado is invisible until it folds back on itself like a glove peeled from a hand, to carry dust and debris aloft to form the fully developed, inky-black tornado funnel, the sight of which causes terror throughout the broad tornado belt.

After many years of observation and experiment, I believe this is the true explanation of the tornado. But left unexplained are these phenomena:

From what source came the bright, pale-blue light that illuminated everything as the tornado passed over my head? I saw nothing inside the funnel core emitting light. It appeared to come from everywhere, shimmering and glowing like fluorescent illumination.

And what law of air-impact pressure applies when this outer sheath of the tornado turns sharply back on itself and climbs with almost the same rotation speed as the inner-air column? I can find no acceptable law that proves two air columns can slide past each other with a closure speed of 400 miles per hour without affecting each other.

It is done within a tornado. ★ ★ ★

**RELIEVES PAIN OF
HEADACHE • NEURALGIA
NEURITIS**

FAST

The way
thousands of
physicians
and dentists
recommend



Anacin® relieves headache, neuralgia, neuritis pain fast because Anacin is like a doctor's prescription—that is, Anacin contains not just one, but a combination of medically proven, active ingredients in easy-to-take tablet form. Thousands have been introduced to Anacin through their own dentist or physicians. If you have never used Anacin, try these tablets yourself for incredibly fast, long-lasting relief from pain. Don't wait. Buy Anacin today.

Carpenters' NAILPULLER Pocket size!

Powerful, Easy to Use, Handy as a Hammer!

Satisfaction guaranteed
up to tempenny nails.

POSTPAID
U.S. ONLY

\$174

No C.O.D.
No Stamps.



Carpenters' favorite. Convenient in tight places, carries in pocket. Tool steel counteracting jaws driven into wood under nailhead. Double leverage with hammer. All steel, rustproofed.

K-D Mfg. Co., 526 N. Plum St., Lancaster, Pa.

BUILD FINE GRANDFATHER CLOCK NOW

The simple sensible Red-Kut way as thousands have — **SAVE HALF. SHOP TESTED PLANS "SPIRIT OF THE CENTURY"** Narrow waist 83" tall or stately straight side **"SPIRIT OF AMERICA."** **EASY-TO-FOLLOW** photoetched PLANS tell all—plus **BROCHURE** of heavy brass weight Westminster, tube chime, movements, gorgeous dial, 3/4" solid mahogany case kits. Send \$1.00 today — Both plans \$1.50 NOW.

KUEMPEL CHIME CLOCK CO., 27 Kuempel Bldg., Minneapolis 16, Minn.

Say You Saw It in Popular Mechanics



**BUILD
your own SMITH
AIR COMPRESSOR**

Operates spray guns, rock drills, tampers, paving breakers, sandblasting . . . Uses only 1 gallon of gas an hour! Famous the world over! Capacity 60 cu. ft.; pressure up to 100 lbs. per sq. inch. Just order the Smith Compressor Head and Accessories with complete instructions for assembling. All you need is a Ford Motor and shop facilities. Head equipped with high speed compressor valves; automatic unloading and idling.

Write for complete information!

GORDON SMITH & COMPANY, Inc.
410 College Street • Bowling Green, Ky.



**GET GOOD PERFORMANCE
THE WAY BIG FLEETS DO...**

Yellow Cab, Oakland, Cal., standardizes on Federal-Mogul oil-control engine bearings.

Yellow Cab Company rolls up more than half a million miles every month, delivering the good people of Oakland, California to their destinations.

Dependable performance is a Yellow Cab must. That's why they always replace with Federal-Mogul oil-control bearings on every engine overhaul.

Federal-Mogul oil-control bearings have led the replacement field for 30 years—because of quality. They will restore fine performance to your car, too. Ask your mechanic! **FEDERAL-MOGUL SERVICE**, Division Federal-Mogul Corporation, Detroit 13, Michigan.

for New Power . . .

FEDERAL-MOGUL

Oil-Control Bearings

BEARING
MANUFACTURERS
TO THE
AUTOMOTIVE
INDUSTRY
SINCE 1899



Every man who's building...or plans to build...needs this free book!

TRUSCON makes it EASY



TRUSCON DOUBLE-HUNG STEEL WINDOWS SERIES 138 ARE EASY FOR YOU TO INSTALL

FREE BOOK SHOWS HOW

Step-by-step guide shows you exactly how to install Truscon Double-Hung Steel Windows yourself... just as the professionals do. Hammer, screw driver and level are all the tools you need.



You buy Truscon Double-Hung Windows complete from your dealer ready for installation. All hardware is factory-attached. Stainless steel weatherstripping and spring balances are built-in. You can be sure these steel windows won't warp, swell, shrink, or rot. Won't rattle or stick. Will last a lifetime. Amazingly low cost. Types and sizes for every home style. Combination screens and storm sash, too.

Send coupon today. No obligation.



Truscon Steel Division • Republic Steel
1126 Albert St., Youngstown 1, Ohio

Please rush free book showing me how to install Truscon Double-Hung Steel Windows.

Name

Address

City Zone State

Clymer Road Tests the 1954 Olds

(Continued from page 107)

four-barrel carburetor performed perfectly with no tendency to "load up" even at altitudes ranging from 4700 feet to over 10,000 feet in the Rockies.

I found it to have improved suspension and road-holding characteristics. Even on the sharpest turns there was little evidence of roll and the body remained about as level as any modern American car I have driven.

Riding qualities are well controlled by double-action shock absorbers in front and direct-action shocks in the rear. There was some tendency for the rear end to "bottom" when hard bumps were taken at high speed.

Oldsmobile's hydraulic brakes, with total lining area of 191.7 square inches, are effective with little or no brake fading. Location of the power-brake pedal in relation to the throttle is far better than in most other cars and I found braking action better than on most other power-brake-equipped cars I have tested.

The new body developed no squeaks or rattles during my test. Acceleration is terrific and even the steepest grades in the Rockies were climbed almost as though we were on level ground.

When the Hydra-Matic shift occurs in each range it is quite noticeable and certainly is not so smooth as a torque-converter unit. There are some things I do not like about the control system. When the ignition switch is off, the shift lever may be moved to any position, yet the indicator needle (inside the speedometer dial) does not function. I also don't approve of moving the indicator dial from its former position on the steering column, where it was close to the eyes, down to the bottom of the speedometer dial. But the worst feature of this new shifting-indicator dial is that, when the lever is quickly pulled from "D" to "S" (the two normal operating positions) there is no stop and, unless the driver is careful, he is very apt to pull the lever beyond the "S" position into "Lo." For normal gear selection in traffic, however, the unit operates very well.

An extremely high rear-axle ratio of 3.23:1 makes cruising on the highway unbelievably smooth with little engine strain or vibration.

The square overhead-valve engine, with 3 $\frac{7}{8}$ -inch bore and 3 $\frac{3}{16}$ -inch stroke, is of advanced design; Oldsmobile (along with Cadillac) was the first to introduce this modern trend in engine development. While the compression ratio of 8.25:1 is unusually high and premium gasoline is

(Continued to page 222)

MOLLY

WHERE NAILS AND SCREWS WON'T HOLD ... MOLLY WILL



**PUTS
THE FIX
IN FIXTURES**

REPLACEMENT OR A REFUND OF MONEY
Guaranteed by
Good Housekeeping
IF NOT AS ADVERTISED THEREIN

Molly Screw Anchors hold any fixture securely in any hollow wall construction. Molly puts an end to loose fixtures and allows you to install new ones exactly where you want them—not where the studs are. Molly puts an end to broken wall surfaces and crumbled plaster!

Molly will not pull through. It forms its own backing and actually reinforces the area in which it is used. Once installed, anchorage is permanent. Fixtures can be removed for cleaning and be replaced in the same anchor! Mollys are inexpensive and easy to install!

**ASK YOUR HARDWARE DEALER
Write For FREE Folder!**



**EASY TO INSTALL
NO SPECIAL TOOLS NEEDED**



'WHERE SCREWS WON'T HOLD!'
USE
MOLLY
SCREW ANCHORS
MOLLY CORPORATION • DEPT. H7 • READING, PA.



MAGNETS 225 lb. PULL
GENUINE ALNICO—NEVER WEAKENS

AMAZING, PERMANENT MAGNETS—WILL NOT WEAKEN! NON-ELECTRIC
Retrieve guns, tackle, tools and other steel items from lake, river, plating tanks, drains or other hard-to-reach spots. Recover drills, tags, etc. from sweeping. Clear alley of harmful tacks, nails. Many other uses. Pays for itself quickly. **GUARANTEED.** Try any magnet one week. Money refunded if you are not well pleased.
No. M-725 (Weights 34 oz.) Has pull of 225 lbs. on steel block. \$15.00
No. M-675 (Weights 49 oz.) Has pull of 175 lbs. on steel block. \$10.50
No. M-650 (Weights 41 oz.) Has pull of 150 lbs. on steel block. \$ 8.50
No. M-500 (Weights 15 oz.) Has pull of 50 lbs. on steel block. \$ 4.00
No. M-30 Hobbyist assortment of six small magnets. \$ 1.50
Send Money Order or Check. We pay postage. No C.O.D.'s.
MIAMI MAGNET COMPANY, 3240 N. W. 27th Ave., Miami 42, Fla.



car stall?

**get
instant starts**



with a
**STEWART-WARNER
Electric
FUEL PUMP**

Yes, quick, sure, **INSTANT** starts—every time—in any weather. No more stalling! This Stewart-Warner Electric Fuel Pump delivers all the gas your engine can use the second you turn on the ignition. Operates independently of the engine. Saves your battery. Easy to install on any car or truck.

STEWART-WARNER

Instrument Division, Dept. N-84
1840 Diversey Parkway, Chicago 14, Ill.

Scrape paint quickly
ask your dealer for
Red Devil
Wood Scrapers



Red Devil Tools.

Get your **FREE** copy of "HOW TO MAINTAIN WOOD FLOORS."

MAIL COUPON TODAY

Red Devil Tools. Dept. 147
130 Coil Street, Irvington, N. J.

NAME _____
ADDRESS _____
CITY _____ ZONE _____ STATE _____

2815



So easy to install these beautiful Silentite windows

Gone are the days when windows had to be put together piece by piece! Curtis Silentite windows come to you as complete *units*—ready to go into the wall. What's more, Curtis windows have exclusive features that assure lifetime operating ease, year-round weather protection, superior beauty and lower heating costs.



Curtis Silentite casements are famous for their weather-tightness.

Curtis convertible units can function as casements, awnings or hopper-type sash.



Choose from the many beautiful styles of Curtis Silentite windows. Send for window idea booklet.

Curtis Companies Service Bureau
200 Curtis Building, Clinton, Iowa

Please send Silentite window
booklet for building and remodeling.

PM-8-54

Name.....

Address.....

City..... State.....



recommended, there was no undue pinging with regular gas. I used regular gas for about 200 miles in Colorado's high altitude, however, Oldsmobile owners will secure better results with premium gasoline.

The 12-volt electric system now used on all Oldsmobile models provides greater battery capacity, which is highly desirable with so many electrically operated units placing additional load on the battery. Power windows, power-controlled front seat, radio and heater all demand considerable voltage. Undoubtedly more cars in the future will turn to the 12-volt system.

I like the unit-type power steering used by Oldsmobile although $5\frac{1}{4}$ turns of the wheel, lock to lock, seem excessive, especially with power assistance. This unit provides a slight pressure on the wheel when driving in a straight line or in beginning a turn, so that the driver tends to have a better "feel" of the road than with some other types of power steering.

The combination of a comfortable driving position, the excellent seat cushions and rear suspension by long leaf springs makes the new Oldsmobile the most enjoyable car that I have driven over long distances.

Vision is excellent and adds greatly to driving safety. When one again drives a car with conventional-width windshield, there is a definite feeling of limited vision. I like the new wrap-around windshield. I also like the high rear-fender tips in which the taillights are housed. They serve as guides for parking or backing out of narrow driveways. Rear vision is also good.

The steering wheel is well positioned. The top of the wheel is low enough that it in no way hinders front vision. Its full-circle horn ring is smaller in diameter than most others and offers no obstruction to instrument visibility and the instrument dials, including speedometer, are very readable. The cool-air vents are direct-operating and very efficient. Heating, I think, could be improved. On a cold morning it was difficult to secure enough heat to be comfortable when driving at ordinary speeds.

One of the most appreciated features is the center-located glove compartment, which makes for quick accessibility by either driver or passenger. Directly below the glove compartment are switches to operate the courtesy light and front and rear radio speakers. The clock is on the extreme right side of the instrument panel, fine for the passenger, but a little too far away for the driver.

I am glad to see Oldsmobile continuing the needle gauges for amperes and oil

(Continued to page 224)

It's easy to make these REPAIRS

You can make loose metal, wood, or plastic parts tight; anchor bolts in concrete to stay; seal cracks in metal; tighten loose screws and fixtures in wood, metal or tile—with Smooth-On No. 1, the iron cement of many uses. Just mix, and fix. Smooth-On No. 1 hardens quickly like iron, and expands as it sets. Forced into any opening, its unique expanding action makes the repair. Keep a can on hand, it will not deteriorate. Smooth-On No. 1 is at your hardware store.



FREE Repair Handbook

40 pages, many illustrations, easy directions for ingenious time and money saving repairs you can make yourself. Write for your free copy.

SMOOTH-ON MFG. CO., Dept. 37
570 Communipaw Ave., Jersey City 4, N. J., U.S.A.

SMOOTH-ON

THE IRON CEMENT OF MANY USES

80-881

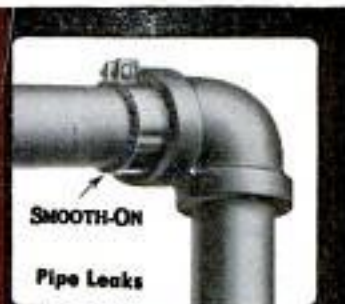

NEW, IMPROVED CALCULATOR FOR WOODWORKERS only 25c
Instantly gives information on lumber, nails, concrete mixes, painting materials, etc. Convenient, simple to read. Just set dial for nail specifications, to convert linear to board feet, find bit sizes for screws, compare characteristics of woods. 6" diameter heavily varnished cardboard. Send 25c, no stamps, please to Greenlee Tool Co., 2108 Columbia Avenue, Rockford, Illinois.

**RETAIL PRICE \$125.00
FACTORY TO YOU \$79.95**

SUPERSHOP includes precision-built 8" tilting table saw, vertical and horizontal drill press, 30" lathe, sander, grinder. 100% BALL BEARING. Write for FREE catalog, full details, trial plan. Easy Pay Plan.

POWER TOOLS, INC.
162 YATES AVENUE
BELLEVILLE, WIS.

MODERN LAWN MOWER SHARPENER

Service departments of leading Lawn Mower manufacturers use the Modern Lawn Mower Sharpener. One lever moves lawn mower into grinding position. Gasoline and oil remain in engine while sharpening, no dismantling of wheels, roller or handle. The Modern is a precision bed knife grinder—no extra grinder to buy. Imitated but never equaled—Compare before you buy. If it isn't a Modern it can't be Modern (Prices subject to change without notice)

MODERN MFG. CO.
160 N. Fair Oaks - Pasadena 1, Calif.

\$263.00
with motor
F.O.B. PASADENA

WRITE FOR FREE BROCHURE 100

Drive out **Basement dampness**

with the amazing **FRIGIDAIRE electric DEHUMIDIFIER**

18 1/4" high — 20 1/2" long — 11 3/4" wide —

Positively controls moisture in linen closets, basements, playrooms, bank vaults, workshops — or any closed area up to 10,000 cu. ft. where moisture is a problem.

Fan draws air through refrigerated coil. Moisture is condensed and collected in container. May be connected to drain. Plug into any outlet.

See your Frigidaire Dealer for further details. Or write for free folder to Frigidaire, Dept. 2275, Dayton 1, Ohio. In Canada, Toronto 13, Ontario.

Built and backed by General Motors

The easy way to paint!



Speedy Sprayer

Favorite of home owners and craftsmen for 20 years! SPEEDY SPRAYER gives your work that professional paint finish everyone admires. Sprays paint, enamel, varnish, lacquer, etc. . . . 4 to 7 times faster than hand brushing! Lightweight, portable, uses any 1/4 H.P. motor. Improved diaphragm principle assures clean, oil-free air. You'll find dozens of time and money saving uses for SPEEDY SPRAYER, including spraying insecticides 2-4-D and DDT. Complete outfit, without motor, only \$36.50.

At leading hardware, lumber, and auto supply dealers. FREE—write for handy booklet "How to Spray."

W. R. BROWN CORPORATION
2635 N. Normandy • Chicago 35, Ill.

ONLY \$36.50 LESS MOTOR

Accurate, Easy LEVELING



LEVEL EASY IS A SIMPLE WATER LEVEL COMBINED WITH A RESERVOIR FOR EASIER, MORE DEPENDABLE OPERATION

One-man operation speeds job of setting batters for foundations, and flexibility cuts costs on inside floors, ceilings and excavations. With the accuracy of a high priced instrument, LEVEL EASY is compact and durable and can be kept in a kit close to the job always handy. It can be easily adapted to level for contour plowing.

LEVEL EASY consists of 50 ft. clear tough vinyl tube in a special aluminum container. It can extend a level line almost 100 ft. in each set-up. Also complete instructions.

Check coupon now and learn more about this age-old method of leveling, or order LEVEL EASY on our unconditional money-back guarantee. Don't depend on others for grade.

HYDROLEVEL, 71 DeSoto Ave., Ocean Springs, Miss.

Please send Descriptive Folder. Mail LEVEL EASY postpaid, \$7.95 enclosed. Mail LEVEL EASY C.O.D. \$7.95 plus postal charges.

Name _____

Street _____

City _____ Zone _____ State _____

pressure. This is a far superior arrangement to the warning-light system which has recently become the designers' or engineers' dream of a quick solution to electrical and oil-pressure problems.

The massive, wrap-around bumpers are substantial and afford good protection, both front and rear. However, the two bumper guards extend too far ahead of the front bumper. I especially like the quick-acting cranks on the windows: 3 1/2 turns front and 3 1/2 turns rear are required to open and close the windows—a sensible ratio. The locations of both armrests and inside door handles are excellent and lever for front-seat adjustment is nicely located and does not require a contortionist to operate it, as is the case in some other makes.

Fuel economy of the Rocket engine is excellent for a car of its size and weight, especially when one considers that the Rocket is a powerful, high-performance engine that the average driver is more inclined to abuse.

Also offered by Olds is the Series 88, with the same wheelbase, chassis and displacement as the Super 88, but with less horsepower. The 98 Series has the same displacement and horsepower as the Super but is four inches longer (126-inch wheelbase) and shipping weight is 3865 pounds, or 112 pounds more than the Super 88. A complete line of body styles is offered, including the flashy Starfire 98 convertible. ★ ★ ★

Good-by to the In-line Flat Head

(Continued from page 124)

There's been a lot of this "mechanical octane" business in the last five years. Of course, there is hardly 100-percent agreement as to just how the chamber should be shaped. Chrysler Corporation uses an open spherical shape, while Oldsmobile, Cadillac, Studebaker and Ford products use a small wedge-shaped chamber.

However, nobody disputes the fact that overhead-valve placement is a must for tomorrow's passenger-car engine. It costs more to build and to maintain and it is a headache to design, but it does the job when you step on the accelerator.

These are the reasons why you probably bought an overhead-valve V8 this year.

It has the rigidity needed for tomorrow's outputs, the breathing and combustion control, the low friction for more miles per gallon, the compactness to hide in the confusion of today's crowded engine compartment, and it gives the smooth flow of power only a flock of cylinders can give. It had to be a V8. Too bad it couldn't have happened 20 years ago and saved us the bother of trying to build a better straight 8! ★ ★ ★

hall side

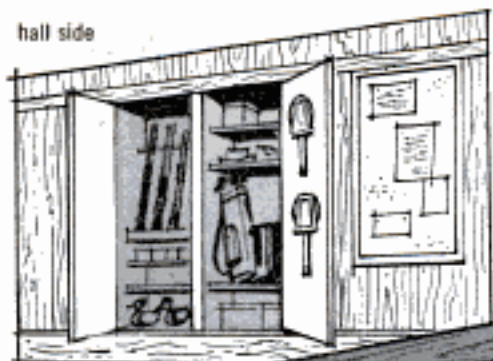

This storage wall serves two rooms!

get complete detail drawings and easy-to-follow directions in

FREE PATTERN KIT 322

—along with the picture-packed booklet, "Enchanting Homes of Western Pines." Write for it to Western Pine Association, Dept. 322-N, Yeon Bldg., Portland 4, Oregon

The clean-cutting woods of the Western Pines* prove perfect for this well-organized storage wall. Built into an existing partition—or planned for a new home—it includes a wardrobe with shoe-rack, drop-leaf desk, shelves, cupboard and sports equipment cabinet.

The smooth surface and even grain of the Western Pines take all finishes well. You'll find these carefully selected, well-seasoned woods a joy to work—and economical, too. Your local lumber dealer will give you an estimate—see him soon!



bedroom side

the Western Pines

- IDAHO WHITE PINE
- PONDEROSA PINE
- SUGAR PINE

"SHOOPER" GEIGER COUNTER



Supersensitive! Only 1 1/2 lbs! Fits pocket—uses flashlight battery. Find a fortune in uranium. Order Now! Send \$5.00, balance C.O.D. MONEY BACK GUARANTEE. FREE CATALOG—scintillator and larger uranium and metal detectors. DEALERS WANTED.

2995
COMPLETE

PRECISION RADIATION INSTRUMENTS
2235 PM S. LA BREA, LOS ANGELES 16, CALIF.

Print Your Own



Cards, Stationery, Advertising, labels, circulars, photo and movie titles, church work, tags, etc. Save money. Sold direct from factory only. Raised printing like engraving, too. **Print for Others, Good Profit.** Have a home print shop. Easy rules supplied. Pays for itself in a short time. Write for free catalog of outfits and all details.

KELSEY
EXCELLENCE
PRESSES

KELSEY PRESSES, N-37 MERIDEN, CONN.

Build this 14-foot FIBERGLAS 'PLASTIC BOAT'



only \$197.50

No experience needed; can be assembled in 12 hours with ordinary household tools. Simple 1-2-3 instructions make assembly a snap. 52" beam, 16" depth. Kit complete except paint. Cross members and seats of highest quality hardwood. Constructed of pressure molded plastic sheets. DENTPROOF . . . ROTPROOF . . . NO MAINTENANCE. Write for illustrated folder. Available assembled only \$295.00.

Plastic sheets for boat parts also available. Write . . .

UTILITY PLASTICS CO.

1544 E. 6th Dept. P.M. Tulsa, Okla.

AUGUST 1954



SPEED and ACCURACY



TORQUE WRENCH

makes no errors

No dial—no clicks. You furnish the pull... it does the job. Just set and lock. Automatically releases at desired torque and resets. 3/8" or 1/2" square drive, plain or ratchet. Every P&C Tool guaranteed—"the BEST tool money can buy". Ask your dealer for a P&C Torque Wrench today and be convinced.

P & C HAND FORGED TOOL COMPANY

Dept. H-854
Box 5926
Portland 22, Oregon

Get your P&C Tools from this convenient display.

Send 10c NOW for big P&C catalog. Complete info on over 500 tools.



Make painting easier around your home...



Pointers on painting outdoor furniture, doors, shutters, etc. If old paint is good, wash surface and sand lightly. Do hard-to-reach parts first (chair legs, door edges, etc.). Don't go back over after paint starts to set. Always...

Use brushes with bristles of Du Pont **TYNEX*** nylon

You pick up a full load of paint... flow it out in a smooth, even coat... when your brush has bristles of Du Pont "Tynex" nylon. This means faster, easier, better work on any painting job around your home.

And you'll find that "Tynex" bristles clean easily in any commercial cleaner... last up to five times longer than other types of bristles.

Send for free booklet on "How to Choose and Use a Paintbrush Bristled with Du Pont 'Tynex' Nylon." Write: E. I. du Pont de Nemours & Co. (Inc.), Polychemicals Department PM-7, Wilmington, Delaware.

**"Tynex" is Du Pont's new registered trade-mark for its genuine nylon bristles*

Look for **TYNEX** nylon bristles
when you buy brushes



The Owners Report on the 1954 Oldsmobile

(Continued from page 110)

than one owner but none by any important percentage of owners.

"Dislike the lower body as it is hard for extra large people and older people to get into the car."—Idaho Falls, Idaho, farmer.

"Poor heating system and defroster. Heater should be under the seat."—Detroit, Mich., retailer.

"Snow and ice can easily plug up the intake air vent and more than normal usage of fan is necessary."—Beacon, N. Y., laboratory worker.

1954 OLDSMOBILE SPECIFICATIONS

ENGINE

	88	Super 88	98
Type	8-cyl., V-type, OHV		
Bore and stroke	3 ⁷ / ₁₆ x3-7/16 in.		
Piston displacement	324.31 cu. in.		
Brake horsepower	170@4000	185@4000	185@4000
	r.p.m.	r.p.m.	r.p.m.
Compression ratio	8.25 to 1		
Transmissions	3-speed conventional. Hydro-Matic automatic transmission optional.		

GENERAL

Steering ratio (over-all)	27.5:1		
Turning radius	22.35 ft.	22.35 ft.	22.8 ft.
Brakes	Conventional hydraulic		
Tire size	7.60x15		
Recommended tire pressure	24 lb. front, 22 lb. rear.		
Shipping weight (4-door sedan unladen)	3692 lb.	3734 lb.	3846 lb.
Wheelbase	122 in.	122 in.	126 in.
Tread, front	59 in.	59 in.	59 in.
Tread, rear	58 in.	58 in.	58 in.
Height over-all (unladen)	62.16 in.	62.16 in.	62.16 in.
Width over-all	78.26 in.	78.26 in.	78.26 in.
Length over-all	205.26 in.	205.26 in.	214.26 in.
Road clearance	6.26 in.	6.26 in.	6.23 in.

CAPACITIES

Oil	5 qt.
Water	20.5 qt.
Gasoline	20 gal.

INTERIOR DIMENSIONS

Front-seat width	62.3 in.	62.3 in.	62.3 in.
Rear-seat width	62.4 in.	62.1 in.	62.1 in.
Headroom, front	35.6 in.	35.6 in.	35.6 in.
Headroom, rear	34.6 in.	33.8 in.	33.8 in.
Legroom, front	42.9 in.	42.9 in.	42.8 in.
Legroom, rear	43.8 in.	44.3 in.	44.0 in.

"Rear-view mirror blocks view of cars to the right at four-way stops."—Centralia, Ill., distributor.

"Bulges on front bumper protrude too far. I damaged my grille due to the fact that it hit before bumper did."—Billings, Mont., sheet-metal worker.

"Engine seems to be too sensitive. Has to be timed perfectly to get average performance. Doesn't seem to go straight down the highway. You have to drive it every second (I have power steering)."—Rapid City, S. D., contractor.

"Every time it rains, water comes in on

(Continued to page 228)

Home "Fix-it" Tips



Do a professional repair job with Plastic Wood. Apply it to cracks . . . handles like putty, hardens into wood . . . lasts as long as the wood it fixes!

YOU NEED "PLASTIC WOOD"®

EARN YOUR OWN KING MIDGET We want rider agents to demonstrate and sell the World's Lowest Priced Two Passenger Automobile. Fully assembled or bolt together parts. If there is no dealer near you send 25c for detailed literature with dealers price or \$1 (refunded first order) for this plus actual assembly book and service manual. **MIDGET MOTORS MANUFACTURING CO., Athens, Ohio.**

KING MIDGET AUTOMOBILE



STARRETT "Tools and Rules" BOOK

Describes and illustrates the precision methods skilled mechanics use. Only one dime. Write Dept. AP.

THE L. S. STARRETT CO., Athol, Mass., U. S. A.

MAGNETS

ASSORTED MAGNETS with big list of handy uses . . . 5 for \$1
 POWERFUL POCKET MAGNET ideal for testing metals . . . \$1
 RETRIEVING MAGNET pulls tools, etc., from tank or lake . . . \$3
 HOT PAD MAGNETS to insert in your own hot pads . . . 8 for \$1
 BULLETIN BOARD MAGNETS to "pin-up" memos, etc. . . 8 for \$1
 SLENDER MAGNETS remove chips from drill holes . . . 2 for \$1
 WE REFUND EVERY PENNY IF NOT 100% PLEASSED . . . POSTPAID
RONALD EYRICH, 1091 N. 48th St., MILWAUKEE 8, WIS.

Protect your home against power interruptions with an . . .

ONAN Emergency ELECTRIC PLANT

Provides dependable stand-by electricity for heating system, pumps, freezer, lights, appliances. Keeps home safe, livable. Automatic start and stop. Find out how little it costs!

Write for Folder!

D. W. ONAN & SONS, INC.
 8580 University Ave. S. E. • Minneapolis 14, Minnesota

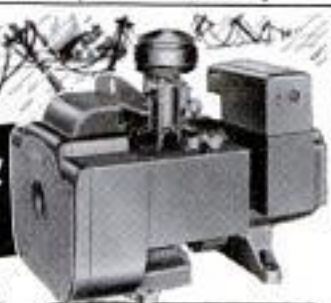

A SIZE FOR EVERY NEED

1,000 to 50,000 watts. Compact, quiet-running, easy to install. Gasoline engine powered.

NOW! An auto compass
 WITH THE SUPERIOR, SUPER-POWER
ALNICO 5 MAGNET



The NEW

Airguide AUTO COMPASS



. . . leads the field with Alnico 5, the mighty magnet that has 10 times the coercive force and 3 times the residual induction of a steel magnet . . . for outlasts and outperforms steel . . . gives faster, steadier readings.



. . . uses an 8 magnet system of aircraft type compensators which has proven most effective in offsetting surrounding metal and electrical current. Adjusts easily and quickly to finest accuracy.



. . . offers greatest visibility from all angles with the distinct VISI-DOME dial. Clean white details on jet black dome, calibrated to 5°.



. . . mounts on windshield molding with a double ball and socket bracket which permits complete flexibility of adjustment for convenient reading while driving. Easily installed. Fits all cars.



. . . harmonizes perfectly with today's modern car interiors. Choice of two beautiful colors, soft gray or tan.



AT LEADING STORES

. . . available with or without light. Lighted model has a warm green indirect glow. With light (suitable for either 6 or 12 volt systems), \$6.95. Without light, \$5.95.

. . . makes driving more care-free and more fun.

Made and Guaranteed by
AIRGUIDE INSTRUMENT CO., P-4, CHICAGO 47

EASIEST, FASTEST
paint remover
you've ever used!



New, Improved
Heavy Bodied
KLEAN-STRIP



New semi-paste won't drip off overhead or upright surfaces. Peels any finish from any surface. Non-inflammable, safe to use. Needs no after-wash.

Sold by all Klean-Strip Dealers

THE KLEAN-STRIP CO., Inc.

2340 South Lauderdale • Memphis 6, Tenn.

Now build
this attractive
**Valance-
Bookcase**
with minimum
cost and effort



This distinctive piece serves 3 desirable functions: the bookcase frames the window; the big bottom shelves hold record albums or large books; the valance decorates the window top. You build without blueprints! Our simplified Easi-Build* Pattern #271 shows how to cut each piece to exact size—how to assemble the bookcase—specifies all materials. You save up to two-thirds of the usual cost!

Homasote, Type RD, is the major material used—one of the strongest building boards you'll ever use—sold by building materials dealers throughout the U. S. and in Canada.

NEW! Three illustrated folders with 18 practical make-it-at-home projects from a room in the attic to a covered patio to a lily pond. Send today for pattern and/or folders.

*T.M. Reg. Easi-Build Pattern Company

MAKE it at home...with HOMASOTE

HOMASOTE CO., Dept. 86, Trenton 3, N. J.

I enclose: 10¢ for three folders 75¢ for Pattern #271

NAME.....

ADDRESS.....

CITY.....STATE.....

your feet through ventilating system."—Detroit, Mich., tool-and-die worker.

"Oil filter is in inconvenient place."—Morton, Ill., accountant.

"Would prefer electric windshield wipers."—Salmon, Idaho, sheep shearer.

"Rear-view mirror's size and shape 'chokes' rear view."—Cincinnati, Ohio, purchasing agent.

"Coats with cuffs on sleeves have tendency to catch on window regulator and handle of driver's door."—Brooklyn, N. Y., merchandiser.

"Clock on dash is too far to the right to be easily seen by driver."—Washington, D. C., retired owner.

"Drain channel from wrap-around windshield should be wider to prevent water from coming into car when door is opened in rain."—Downey, Calif., salesman.

"Would like to have a trip-mileage indicator on the speedometer."—Lewiston, Mont., merchant.

"Don't like automatic headlight dimmer. Doesn't work half the time. Garage says kit to repair it not available."—Plymouth, Mich., salesman.

"Top too low. Man can't sit in back seat with hat on. Legroom in back is tight."—Buckeye, Ariz., rancher.

"Wish they would reduce the horsepower."—Wichita, Kans., lithographer.

"Gas gauge still does not work. Hub caps could be improved. You have to remove the entire unit to get at lug bolts to change a tire and you almost have to bend it out of shape."—Howard, S. D., priest.

"Raw gas smell when going around turn fast."—Gaston, Ore., logger.

These are the comments of the owners of 1954 Oldsmobiles. These comments represent a total of more than a million miles of driving experience.

For Floyd Clymer's road test of the 1954 Oldsmobile, turn back to page 107. ★ ★ ★

**Electron Tube for Airplanes
Functions Over 1000 Hours**

First of its kind to be developed for mass production, a new heat-resistant electron tube will function at a bulb temperature of 572 degrees Fahrenheit for a minimum of 1000 hours. Up to now the problem of cooling or ventilating electronic equipment has been an increasingly difficult hurdle in over-all aircraft design. Developed by the Bendix Aviation Corp. primarily for military aircraft, where a single plane may have 14 electronic systems and 650 tubes, the new heat-resistant unit is also being made available for airline use. It will withstand a 200-G shock repeated 18 times per second for 200 hours.

Install this noise-muffling ceiling yourself

Why let noise take the fun out of your basement playroom? You can provide comfortable quiet—and have a handsome ceiling finish, too—simply by installing a noise-absorbing ceiling of either Armstrong's Cushiontone or Perforated Temlok Tile. It's easy, economical—do it yourself.

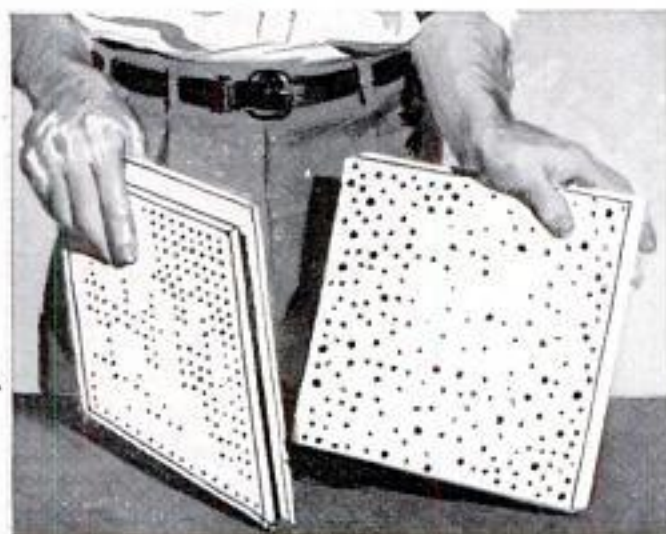

1. Both Cushiontone and Temlok Tile are perforated wood fiber materials. Cushiontone's noise-trapping holes are arranged in Armstrong's exclusive new "Full Random" pattern, while Temlok's perforations are in neat, straight rows. Both materials are factory finished, can be washed or repainted if desired.

2. Start by nailing up seasoned wood furring strips as a base for installation. 1" x 3" strips should be nailed at right angles to the joists on 12" centers. Shim the furring where needed to provide a smooth, level surface. Cushiontone can also be cemented direct to plaster or other smooth surfaces.



3. The special Lok-Bevel joint with its extra wide flange speeds nailing or stapling of Perforated Temlok Tile. The shallow-drilled nailholes in each corner of Cushiontone also help to make installation quick and easy. When nailing up Cushiontone, use nails with flatheads or collars $\frac{1}{8}$ " to $\frac{3}{32}$ " in diameter.

4. In a few hours, your noise-absorbing ceiling will be finished—a beautiful and practical ceiling for your playroom. Your whole family will be so pleased with the new-found quiet, you'll also want to sound condition your kitchen, workshop, or den with Cushiontone or Perforated Temlok Tile.

Your building materials dealer will be glad to give you full details on Full Random Cushiontone, Temlok Tile, and Armstrong's other building materials. For a free booklet on Cushiontone and Temlok acoustical ceilings, write Armstrong Cork Company, 4208 Watch Avenue, Lancaster, Pennsylvania.



ARMSTRONG'S CUSHIONTONE

Temlok® • M-67® Monowall® • Insulating Wool • Hardboards • Cushiontone®





1

Guaranteed to fire in oil. Aldor spark plugs have bi-metallic thermostat control that keeps spark plug always at peak efficiency for smoother running, easier starting. Adjusts to any heat range requirement automatically. Special non-burning electrodes. In sets (R1280-8)... **95¢** (each.)



2

Wizard fuel pumps, guaranteed for long, dependable service. Original equipment replacement. Diecast body; precision machined surfaces and parts; fully tested for correct pressure. Diaphragm of extra high quality for longer life, top performance. For all popular cars (R07201) **\$1.75**



3

Wizard De-Sludge-Er oil filter cartridge has new filter agent of 100% cellulose. Out-filters either paper or cotton. Removes sludge-forming elements from oil. Won't clog, channel or by-pass. For all cars, trucks, tractors with full-flow or by-pass systems. Chev. 1937-53 (R05814) **\$1.59**



New Power... New Beauty...

Over 45 Years... Headquarters



7

Bright, new arm rest covers snap on quickly, without removing the arm rests. Made of beautiful quilted Vinyl plastic. Choice of five popular colors—yellow, gray, blue, green or red—to harmonize with any seat cover or interior trim. Attractive pin-point Vinyl trim. Pair (2N2899-2913) **\$1.59**



8

Easy to change tires at night, spot street signs, house numbers with this all-purpose spotlight. Plugs into lighter socket, or dash socket which is included. Beautiful die-cast chrome-trimmed handle and rim with blue enamel back. On-off switch, GE bulb, 10' cord. 6-volt. (2L6116) **\$5.19**



9

Here's the quick easy way to replace brakes—Stop-Rite lined brake shoes, ready to slip right into drum. Wire-backed lining permanently bonded to shoe for positive "non-grab" braking, long quiet service. Trade-in allowance. All popular cars. Front or rear. Set of 4 as low as (3324) **\$3.75** (each.)

FREE: Mail post card today for folder explaining how to get more horsepower



4
Add new beauty to your car with these top quality Wizard Country Club Plastic Seat Covers. Beautiful Saran plastic panels with harmonizing trim, top cap, sides and back. Stay lovelier longer. Wide choice of patterns and colors sure to please. All car sizes, from (N6429-89)..... **\$26.95**



5
Get better gas mileage, smoother idling, greater power with a fully guaranteed remanufactured carburetor. All parts brand new or fully remanufactured like new. Pressure and flow-meter tested, assuring correct gas and air ratio for top performance. For all popular cars. (Exch.) (K7052)..... **\$4.75**

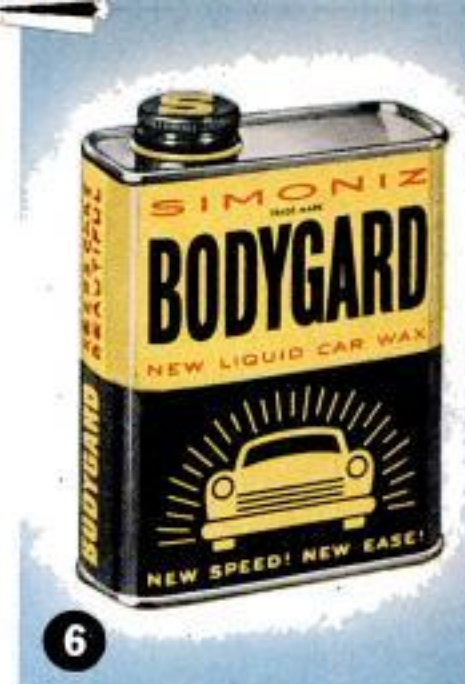

6
Gives your car showroom shine in minutes—without rubbing. Only liquid car wax with the "Simoniz Secret"! Easy to use: just spread it on, wipe it off—and a miracle takes place before your eyes! Protects better: tests prove Bodygard will outlast any other liquid wax or polish (J77112)..... **98¢**

New Safety For Your Car At **Western Auto**

For Top Quality Auto Supplies.

STORES AND ASSOCIATE STORES

NOTE: Western Auto Associate Dealers own their stores and set their own prices, terms and conditions. Prices may vary due to difference in local conditions. (PM 84)



10
Why risk worn brakes? Reline with Stop-Rite Brake Linings. Designed for individual braking requirements of all cars. Pressure molded. Wire backed for extra strength. Will not absorb grease or moisture. With rivets and instructions. Easy to install. All popular cars from (S3325) **\$1.98**



11
Don't be stranded by a worn-out fan belt. Replace now with a Western Auto extra-quality fan belt. Inner core of endless cable cords. Tough rubber cushion reduces heat, assures long life, cooler-running performance. Can't warp, slip, or stretch. Guaranteed fit. (K7105)..... **98¢**



12
More miles per gallon with Pyroil "A" for Gasoline. Makes lubrication heatproof. Reduces carbon and gum deposits. Lubricates upper part of motor, cuts repair bills. **More powerful, cleaner engine with Pyroil "B" Crankcase Oil.** Takes off harmful gum and sludge. "A" or "B" (AR1336-7)..... **Pint 98¢ (ea.)**



Buy These BOOKS at Your

HARDWARE STORE or at YOUR LOCAL NEWSSTAND

DO-IT-YOURSELF and SAVE MONEY

Popular Mechanics New Series Tells You How With Step-by-Step Directions . . . Shows You How with Photographs, Drawings and Diagrams

- 1. How to Paint Inside and Out:** Complete information on painting including how much paint to use, preparing the surface, etc.....25c
- 2. How to Lay Linoleum and Tile:** Everything you want to know about the tools to use, methods of laying plastic, asphalt and metal tile.....25c
- 3. How to Remodel Your Basement and Attic:** Fully illustrated with instructions on insulation and heating included.....25c
- 4. How to Take Care of Your Lawn:** Establish a new lawn this summer by learning how to prepare and properly condition the soil.....25c
- 5. House Wiring and Electrical Repairs:** Save many dollars rewiring your home for modern living with this book. Complete instructions.....25c
- 6. Small Boats You Can Build:** Build a dinghy, a sailing scow, a sailing knockabout and other boats with this easy to understand book.....25c
- 7. Plumbing Repairs Made Simple:** Get the facts now about your home water-system, its troubles and cures. Save labor costs.....25c
- 8. Fences, Gates, Trellises and Walks:** Beautify your yard and garden this summer with fences, gates and trellises you can build.....25c
- 9. Built-In Furniture for Your Home:** This book covers all the latest ideas in built-in furniture including how to mount photo murals.....25c
- 10. Build Your Own Barbecue:** Do-it-yourself with this step-by-step method and enjoy tasty tantalizing meals in your yard this summer.....25c
- 11. Lawn and Garden Projects:** Now you can build luxury garden equipment at little cost with this book. Only simple tools required.....25c
- 12. Three Low-Cost Homes You Can Build Yourself:** Save thousands of dollars on your future home. Three styles to choose from.....25c

Only 25c Each!



How to Check the Shock Absorbers on Your Car

SHOCK ABSORBERS ARE IMPORTANT, they slow down and even out the spring action on your car—help keep the car from "hitting bottom." Shock absorbers also help keep the car in contact with the road at all times...this means better steering control, better tire life. Because your car's shock absorbers have a big job to do, they need careful attention for they do wear out. Shock absorbers should be checked frequently, replaced as needed.



THE BUMPER-JUMPER TEST is one way to find out if your shock absorbers are working. Stand on a corner of your bumper—rock the car up and down—then jump off. If your car moves up and down more than once, you need new *Golden Glide Shock Absorbers* on that corner—repeat test on each corner, near the wheel.



WATCH YOUR TIRE TREAD. If uneven tread wear is showing, it may mean that your shock absorbers are allowing too much wheel bounce, contributing to bald spots or scuffing. If this is the case, you need new *Golden Glide Shock Absorbers*.



LOOK FOR OIL LEAKS. If you see big blotches of oil on the lower part of your shock absorbers, you can be sure that the fluid has leaked out and they are in dangerous condition and need replacement.

BE SURE TO BUY **GOLDEN GLIDE** SHOCK ABSORBERS

These are a product of America's oldest hydraulic shock absorber manufacturer. They are stronger, better protected, longer lasting. There are *Golden Glide Shock Absorbers* custom-built to do the best possible job for every make and model car. Buy them from your auto parts jobber, service station or independent repair garage. If you have difficulty locating *Golden Glide Shock Absorbers*, write us for the name of your nearest dealer. *Houdaille-Hershey Corporation, Buffalo 11, New York.*

Ride Better
Ride Safer

with

Golden Glide

CUSTOM-BUILT SHOCK ABSORBERS

If You Make Painting a Hobby-



You'll get a lot more real satisfaction and pride of ownership out of a home that is clean and neat and trim in a fresh coat of paint! Pays its own way by improving your property, too!

Because Archer Pol-mer-ik contains polymerized oil, it gives you a tougher, more durable paint film than ordinary linseed oil. When you reduce your paints with Pol-mer-ik, they brush easier, level better, and give you a smoother, dirt-resisting finish. Wonderful brush conditioner, too!

.....
 • *Handiest single product in your house or shop. Does the job of a dozen specialized products. A few of*

POL-MER-IK'S 101 HANDY USES:



REFINISHING ANTIQUES

PROTECTING LADDERS



SEALING SCREWS

PROTECTING GUN STOCKS



ARCHER
Pol-mer-ik
LINSEED OIL
PROTECTS MOST EVERYTHING

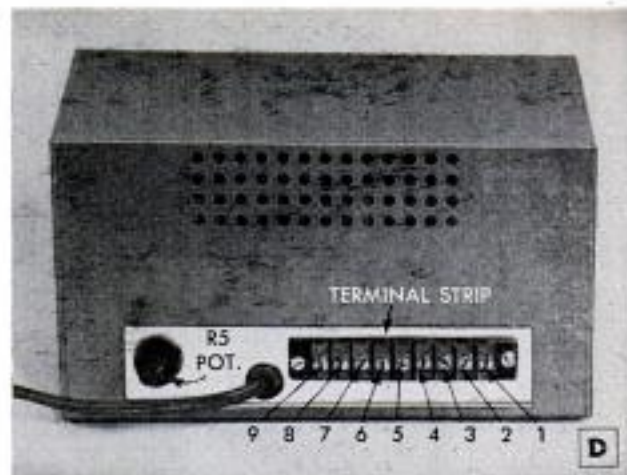

How to Build a Low-Cost Conelrad Alarm Monitor

(Continued from page 147)

continue, must leave the air as soon as the threat of air attack has been established, the burden is upon the operators to promptly receive a "radio alert" and take immediate action.

The Conelrad alarm monitor illustrated and detailed for construction, provides operators of all services with a reliable means for continuous silent or aural monitoring of a broadcast carrier and the actuating of an alarm circuit, or the immediate "cease operation" of the radio transmitter upon receipt of a "radio alert." Several choices of monitoring operations are suggested in the application diagrams, Figs. 1, 2 and 3; the unit proper appears in the complete circuit diagram of the Conelrad monitor. Photo A shows the writer and his amateur radio station in which this alarm monitor was tested. Photo B is a top view of the completed chassis base and panel. Photos C and D show front and rear views of the unit installed in a metal cabinet. An underside view of the chassis base appears in photo E. The monitor can be used in conjunction with any simple superheterodyne receiver covering the standard-broadcast band. The station operator should study photos B, C, D and E carefully before starting construction. All component parts are standard and easily available from any good radio-parts house. These parts are few in number and all are specified in the monitor-circuit diagram. The fixed resistors are all 10% carbon types. The s.p.d.t. plate relay can be either 2500 ohms or an Advance type 850, 1600 ohms. The Potter and Brumfield KL14A multiple-contact relay is a 5-amp. type, 115-v. a.c. with a 50 to 60-cycle coil. The terminal strip on the rear of the chassis base is an ICA, 9-screw terminal type, with terminals marked

(Continued to page 236)

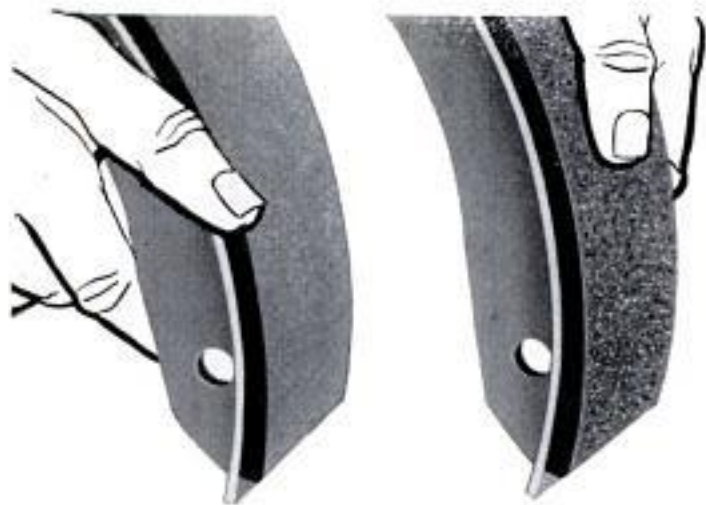

Which of these brake linings is safe?

YOU COULDN'T TELL TO SAVE YOUR LIFE UNLESS YOU KNEW THE NAME!

One of the brake linings pictured above may be a dangerous, inferior lining, which might suddenly fail—just at the moment when you need it most. The other is a *safe* lining.

Your life could depend on choosing the *safe* lining. *But neither carries a name or trademark where you can see it.* You couldn't tell which is which, could you? So you'd be just

plain lucky if you made the right choice!

But here's something to be glad of—when you buy dependable GRIZZLY Brake Linings, you don't *have* to trust your luck. We at Grizzly want your safety to be as certain as possible. That means we make the safest, most dependable brake linings on the market, but it means something else, too. . . .

when you buy

GRIZZLY

the famous name, Grizzly bear and grade are stamped on the outer side of the lining, where you can see them

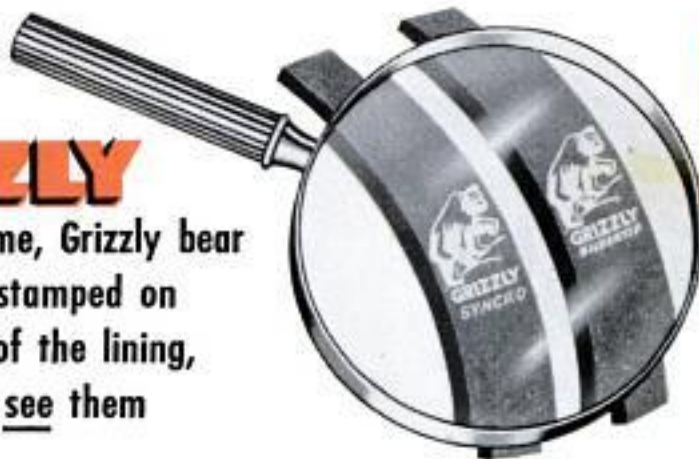

Specialized
BRAKE SERVICE

GRIZZLY BRAKE LINING



The Grizzly Authorized Brake Shoe Exchanges are provided with special branding stamps which not only show that you are getting famous, reliable GRIZZLY linings, but also show whether you are getting Grizzly *Syncro*, our excellent lining engineered for regular duty, or our special *Silvertip* lining for extra rugged high-mileage, multi-stop service.

When your brake serviceman gets his relined shoes from a GRIZZLY Authorized Brake Shoe Exchange, both you and he can take one look and know that you are getting the consistent performance and long, *safe*, service you need. The GRIZZLY reputation is known everywhere: more than forty years of making and selling *the best brake service products available.*

BUY GRIZZLY BRANDED BRAKE LINING—KNOW THE SAFETY YOU ARE GETTING



GRIZZLY
REG. U. S. PAT. OFF.
BRAKE LINING

Grizzly Manufacturing Division, Paulding, Ohio

CHANNEL LOCK pliers

The most versatile tools on your bench



insist on...

CHANNEL LOCK
TRADE MARK REG. U. S. PATENT OFFICE



here's why

Look for the Channellock line when you're shopping for hand tools. Channellock pliers offer features that you can't get with other makes. And when you buy a Channellock plier, ask to see the full line — you'll find a style and model to do any job better.



CHANNEL LOCK
TRADE MARK REG. U. S. PATENT OFFICE

THE PLIER DESIGN THAT OBSOLETE ALL OTHERS

CHAMPION DEPARTMENT TOOL CO. • MEADVILLE, PA.

from 1 to 9, as indicated in photo B.

Referring to the monitor-unit diagram, the operation is as follows: A small voltage taken from the AVC bus of the receiver places a bias on the grid of the 2D21 thyratron. A sudden loss of signal will remove this bias, allowing the 2D21 to conduct. The flow of current will cause the plate relay to function and its contacts will complete power to control the relay with the following results. (1) The green or "normal" pilot lamp will go out; the red of the "alarm" pilot lamp will come on. (2) The speaker will be connected for aural monitoring, regardless of the position of the speaker switch. (3) The contacts for the externally controlled circuit will function (see Figs. 1-A and 1-B). Contacts 2 and 3 energize the "make"; can be used to complete an alarm or alerting system. Contacts 1 and 2 can be used to instantly take a transmitter off the air, as they energize to "break." In case of an amateur station: they break the line to the antenna change-over relay, effectively putting the amateur station in the "receive" position. When the broadcasting station continues its regular programs the ham operator can quickly "reset" the push-to-break switch. The voltage applied to the grid of the 2D21 (AVC voltage) will depend upon the strength of the signal being monitored. The 2-megohm potentiometer should be set just past the cut-off point for the 2D21 thyratron. The device can be tested with a 3-volt battery, negative to terminal 9, positive to terminal 8. Suggested 4-ohm and 600-ohm speaker circuits are shown in Figs. 2 and 3.

The speaker switch permits silent or aural monitoring of the broadcast carrier. Terminals 4 and 5 allow selection of proper terminating resistor for substitute speaker load when the switch is in the "silent" position. Monitoring units of this type have been in use in broadcasting stations for over a year of 24-hour-daily operation.★★★

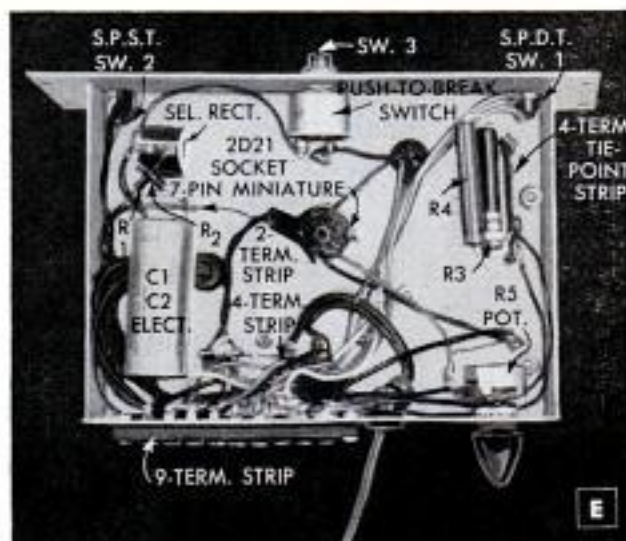

Meet the one heating expert who can save you up to 25% on fuel oil

...AND GUARANTEE IT IN WRITING!



This man offers you money-saving magic! He is your Timken Silent Automatic Direct Factory Dealer. He can cut your fuel oil bills more than any other dealer in the heating business! He sells and installs the amazing Timken Silent Automatic Wall-Flame Oil Burner—which in test after test, home after home, has cut fuel oil bills up to 25% and more!

He offers you an exclusive written guarantee of fuel savings. As an authorized factory-trained heating expert, he will scientifically test your heating plant and tell you what you can expect to save on fuel oil by replacing your gun-type burner with a new Wall-Flame burner. If you buy, he'll guarantee these oil savings in writing!

If you heat with coal, this guarantee is important to you, too. For you are assured the same fuel economy, proved over other types of oil burners in home heating tests everywhere!

Let him show you this most advanced principle of oil heating. Completely quiet, clean, and with only one moving part, this amazing burner blankets your heating plant walls with a natural, unhurried,



blue-hot flame. There is nothing to get out of order.

Phone your local dealer today for a free fuel-saving estimate! He is listed in the "yellow pages" of your phone book. Remember: *your home is like no other.* That is why it will pay you to get his expert advice. Hundreds of Timken Silent Automatic Wall-Flame Burners have already paid for themselves in fuel savings alone.



World's finest oil burner! Scientific placement of flame, complete preparation of air-fuel mixture, gives unequalled efficiency and oil savings.

FREE! SEND COUPON FOR FACTS TODAY!

A complete line of oil and gas furnaces, boilers, conversion burners and water heaters for every home heating need. No down payment. 36 months to pay!



Timken Silent Automatic Products
Timken Silent Automatic Division
Dept. PM-84, Jackson, Michigan

Show me how homeowners in my community have saved money with Timken Silent Automatic.

Name.....

Street.....

City..... State.....

Also facts on (type of equipment).....

(Students, check for special data)



FREE! New book on
MOBILE HOMES

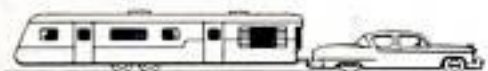

**\$2000 to \$5500
COMPLETELY FURNISHED!**



- 60 full pages of pictures, and specifications of newest trailer models!
- Biggest free book on mobile homes ever offered! 128 pages in all!

Mobile Homes Manufacturers Assn.
Dept. PM-84, 20 N. Wacker Drive,
Chicago 6, Illinois

Please send free copy of "Mobile Life".

Name _____

Street _____

City _____ Zone _____ State _____

**SEND FOR
FREE
CATALOG**



Money-Making Tools!

It's easy to own the same "pay-off" tools used and endorsed by America's top-earning mechanics! You can start building your own kit with basic Snap-on sets—add others any time. Never sold in stores—direct to users only. Send today for free catalog!

Snap-on Tools Corporation
8062-H 28th Ave., Kenosha, Wis.



Twelve Hours on the Test Track

(Continued from page 81)

Driver: When you want out, say so.

He gives it the gas and around you go, hanging on tight. The speedometer stays at 15 miles per hour. You feel like you're flying. You count the laps: 5, 10, 11, 12, 13—you wish you had taken the driver's advice and not eaten—14, 15, 16. This is not exactly pleasant. In fact, it's nauseating! You wonder if it's supposed to test wheels or men. You tap the driver on the shoulder and motion for a stop. You clamber out and spiral over to where the relief driver is waiting.

You: Tell me what's going on here? It's too much for me. I'm dizzy.

Relief driver: We're trying to break the right-front wheel. He makes 50 circles as fast as he can and then I do the same thing. How's your stomach?

You: Terrible, thank you. How long does it take to break a wheel?

Relief driver: Don't know. Some go 10 laps, some 1000. Depends on the kind of wheel. Our big headache on this test is tires. We have to change them every 150 laps or so. That's about as long as they last.

You: Don't you get dizzy?

Relief driver: At first I did, but 50 laps don't bother me now. Well, it's my turn.

The first driver gets out, walks over and lights a cigarette. There's no weave in his walk.

You: What do you think of this run?

Driver: Not much. But then each driver gets it only once or twice a month. It sure makes a long day, spinning like a phonograph record. Oh, well (looking at his watch), six more hours!

You head for the high-speed oval again. Cars speed by like racers at Indianapolis. You pick up the radiotelephone at an emergency station beside the track and ask to ride a high-speed test car. You get an okay and stop the first car that comes along with headlights on (the mark of a high-speed test car). It's a Dodge.

Driver: Get in. We have 300 more miles to run at maximum speed.

You: How fast is that?

Driver: There's a speed limit of 85 actual on the oval—about 90 on the speedometer. This Dodge will do lot more than that.

You: How fast have you driven here?

Driver: I covered 623 miles in just a few minutes over 6 hours in a Chrysler, an average of 103 miles per hour. The wind was strong that day or I would have done better. You can hold a Chrysler at 115 on the oval with no strain. Of course, we're not out here to set speed records. We only

(Continued to page 246)

Makes a Table Saw or Drill Press Out of Famous-Name Electric Drills

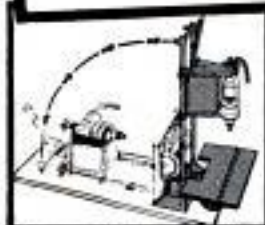

From Table Saw to Drill Press in 58 Seconds.

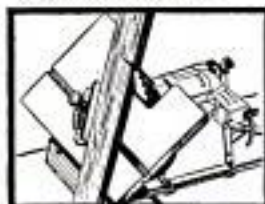

Tilt-table for angle sawing and sanding. Angles indicated.



Ideal as a grinding and buffing stand.

NOW, convert your Black & Decker, Skil, Mall or Miller-Falls 1/4" drill into a complete home workshop . . . a table saw, drill press, grinder, buffer, router. All at this amazingly low introductory price that includes basic unit, 5" saw blade, arbor, rip fence, and miter gauge.

Large cast-aluminum table top, machine finished. Heavy gauge metal parts, all ruggedly simple and of the finest quality, plus precision workmanship throughout. Hailed at the Boston and New York "Do It Yourself" Shows as one of the most promising new tools to be shown and demonstrated . . . one that adds valuable new convenience and utility to famous-name drills.

SPECIFICATIONS

Table Top	9" x 12"
Depth of Cut	1 3/4"
At 45° Angle	3/4"
Drill Stroke	4 1/2"
Capacity in Wood	1 1/2"
Capacity in Steel	1/4"
Angle Drilling	

DRILL-SHOP...

Now available for the first time

only \$29.95



Mail This Coupon Today!

McCONNELL MFG. CO., Inc.
Syracuse 6, N. Y.

Gentlemen:

Please send me full information on the Drill-Shop.

() I Have a 1/4" Drill () I Have No Drill

Name

Address

City..... Zone..... State.....

Also
Eshelman
SPORT CARS
LOWEST
PRICE
70 Miles Per Gal.
Holds 1 Adult
Free Literature

RAKES
FLOWS
CULTIVATES
HARROWS
HAULS
SPRAYS
SAWS
DOZER
MOWS
CUTS
ROLLS
TILLS
SNOW PLOW

ESHELMAN FOR Better LAWNS
And GARDENS



Women Can Operate It.
Free Catalog. Write

ESHELMAN, Dept. R-58

119 Light St.,
Balto. 2, Md.
333 N. Michigan Ave.,
Chicago - 1, Ill.
7070 Hollywood Blvd.,
Los Angeles 28, Cal.

1 to 8 H.P.
Also WALKING TRACTORS
Low as \$69

LICK SUMMER DROUGHTS!

HAVE WATER WHEN YOU NEED IT.

Drill your own wells with a sturdy CON-SOL well driller, built for years of service. Deep wells, shallow wells . . . outdoors or in cellars. Low cost makes CON-SOL easy to buy . . . light weight makes it easy to erect, operate . . . opportunities for rental, contracting, resale make it easy to get back investment. Guaranteed for 90 days against defective materials or workmanship. Drills through many feet of rock before hard insert needs renewing. Used by U.S. Depts. of Agriculture and Forestry, U.S. Navy. For 4" casings, \$385 F.O.B. factory; includes drill, boiler and 100' cable. Additional cable, up to 300', 3/4 hp electric motor or 1 1/2 hp gasoline engine, available at extra cost. Heavy duty model, for 6" casings, available with gasoline engine, at \$1295 F.O.B. factory. Prices and specifications subject to change without notice.



Write for free literature to
Dept. PM-8
CONSOLIDATED INDUSTRIES, INC.
WEST CHESHIRE, CONNECTICUT, U.S.A.

AUGUST 1954

It's easy
to "weave"
a carport



with
**MASONITE
PRESDWOOD**

It's different! Attractive! And easy to make! Use tough, grainless Masonite Tempered Presdwood®. Resists heat and cold, wind and water. Lasts indefinitely. Plan can also be used for a woven fence. See your building materials dealer. Send for "Idea Book" and carport plan No. AE-296.



NATURALLY STRONGER WITH LIGNIN

MASONITE
CORPORATION

Dept. PM-8, Box 777, Chicago 90, Ill.

Please send me plan No. AE-296 for carport and your "Idea Book." I am enclosing 10c for handling and postage.

Name.....

Address.....

Town..... Zone.....

County..... State.....

"Masonite" signifies that Masonite Corporation is the source of the product



GEE! THIS IS FUN!

Trim Grass EASILY!

20 Times Faster Than by Hand

- No Stooping
- No Tedious Clipping
- No Stiff Back

Porter-Cable
Yardmaster

Grass Trimmer

At last, faster, neater trimming in hard-to-get-at places . . . close to walls and fences . . . around trees, hedges, flower beds . . . along walks, driveways and rock gardens. Ideal for mowing steep terraces and slopes. Use it as a scythe to cut tall, coarse grasses and weeds.

Safe, Powerful, Rugged

Rustless aluminum construction. Weighs only 4 $\frac{3}{8}$ lbs. 7" hardened steel blade. Die-cast motor housing keeps out moisture, dirt and grass. Fully insulated handle encloses wiring, prevents tangling in shrubs and plants.

Jam-Proof Clutch

Blade Stops Automatically upon striking rocks, hummocks or other obstructions. Prevents motor and switch burnouts.

Clear-Vision Guard gives view of blade path when trimming close to plants.

Toggle-Switch in Handle always within convenient reach.

Strain Reliever prevents damaging strains on cord.

A Practical Reliable Tool for long, heavy-duty service.

ONLY
\$44⁵⁰

PORTER-CABLE MACHINE CO.
2448 N. Salina Street, Syracuse 8, N. Y.

Please send me complete details and name of nearest dealer for your "Yardmaster" Grass Trimmer No. 134.

Name

Street

City County State

In Canada write Strongridge, Ltd.,
124 Weston St., London, Ont.

"One Out of Three Smashes Up"

(Continued from page 70)

In four miles I had to decelerate from some 240 miles per hour to dead still.

The compression of the engine began to bring the speed down nicely as soon as I backed off the throttle but you can't afford to use this kind of brake too long. The engine would be wrecked if left in gear. Pushed by the rear wheels, the rods would stretch and the pistons would start slamming the tops of the chambers.

When the tach dropped to 3500 revolutions per minute I disconnected the power plant with the hand clutch and then the car almost seemed to pick up speed, for a streamliner has virtually no wind resistance. Nothing seemed to happen when I began pushing down on the brake pedal. The end of the measured course went by, I kept hitting the brakes and finally got the car down to a crawl. Even so, I ran into the soft salt before I could stop and eight men were needed to push the car out of the marsh and get it turned around for the return run.

The average of the two runs gave us a speed of 236.36 miles per hour for the flying mile, 215.97 miles per hour for the 10-mile distance. In all, the car broke six national and six international records. Probably we'll have to go faster still to retain these honors this coming September.

August 30 to September 6 are the dates for this year's Bonneville National Speed Trials, to be attended by hot-rod owners and automobile enthusiasts. Streamliners seeking international records will make their runs during the week following and we expect there'll be real competition in our class. Because of this, Ray Brown is adding more horsepower to our engine. So far we've used alcohol for fuel, this year we may mix 10 to 50 percent nitromethane with it. The explosive mixture will give us more speed but the big question will be whether an engine running on nitro will stay together on the 10-mile runs.

One thing we'll be needing soon is a body brake comparable to the fuselage brakes of high-speed aircraft. Speeds can go way up when we can travel wide open all the way to the finish line, then pull a lever that extends the body brake, multiplying the wind resistance of the car.

The brake surfaces will need to be located pretty far aft to insure straight-ahead travel and they would be of the split type, opening vertically. It would be suicide to attach wind brakes to the sides of the car because the slightest difference in their size or rate of opening could bring the car around in a screaming turn. ★ ★ ★

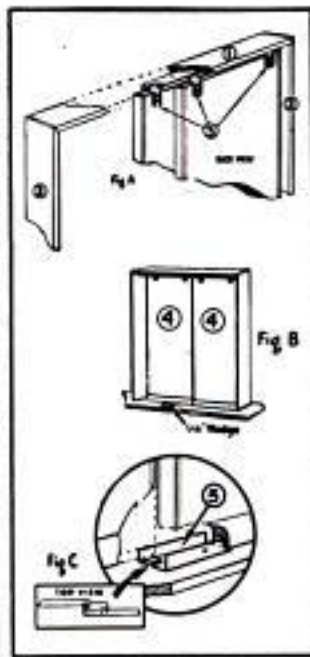

- Easy to install and maintain
- Cost less than ordinary doors
- Save up to 35% in floor space
- Slide silently without binding
- Guaranteed against warping in excess of 1/8" when properly installed and finished.

Novoply Sliding Door Units by
Weldwood



UNITED STATES PLYWOOD CORPORATION

World's Largest Plywood Organization

Weldwood Building, 55 W. 44th St., New York 36, N. Y.
U. S.-Mengel Plywoods, Inc. • Louisville, Kentucky

Relief From Driving Strain

WATCHING and worrying about directions is eliminated with a HULL AUTO COMPASS. Used more than all other makes combined, for accuracy and dependability. Insist on a Hull. Write for local dealer's name, free literature.

HULL MFG. CO. P.O. Box 246 D-8 WARREN, OHIO

Beaconlite \$6.95
Illuminated
STREAMLINE \$4.95
non-illuminated

FREE FOLDER "HOW TO SAND"
ADDRESS "Handy" SANDY
CARBORUNDUM
Niagara Falls, New York

MY NAME'S BUCK... I'M A BEAVER
MY TEETH ARE Chamfered TO CUT, TOO!

ATKINS
CHAMFER CHAIN
for all chain saws

ATKINS SAW DIVISION
BORG-WARNER CORPORATION
INDIANAPOLIS 9, INDIANA

**ADD A CLOSET
IN A HURRY**
with a NOVOPLY Sliding Door Unit

Family cramped for closet space? Make a closet and face it off with a Novoply Sliding Door Unit. It includes everything you'll need in one complete package — jambs, header with track, roller track hangers, doors with pulls and floor guides.

HERE'S ALL YOU DO:

1. Assemble header (1) and jambs (2) and place in rough opening. Shim jambs to make frame square.
2. Place adjustable overhead roller carriers (3) in grooves of overhead track in header (1).
3. Adjust doors with wedge (Fig. B) and secure with screw in carrier.
4. Install door guide clip (5) in floor (Fig. C).

You can have units ranging in height from 6' 9 1/2" to 8'; in width from 2' to 8'. Several together make a modern storage wall. Doors can be stained or left natural. Units available with or without upper storage area; in Novoply or genuine birch.

See your lumber dealer or send today for free folder.

FREE PLAN
tells how to start your own business
FILING SAWS

Here is a steady repeat CASH business you can start in your own basement or garage in your spare time. You can file hand, band and cross-cut circular saws on the Foley Saw Filer. No eye-strain—no experience needed. "The first saw I sharpened with my Foley Filer came out 100%"—writes Clarence E. Parsons.



Every saw you sharpen with the Foley Saw Filer brings you more customers. "I rented a two-car garage and have all the work I can do"—Charles H. Smith.

FREE BOOK
Shows How To Start
Send coupon today.
No salesman will call.

SEND COUPON FOR FREE BOOK

FOLEY MFG. CO., 816-4 Foley Bldg.
Minneapolis 18, Minn.

Send me free book "Money Making Facts"

Name _____

Address _____



Of all automatic drives in the low-price field:

Fordomatic is

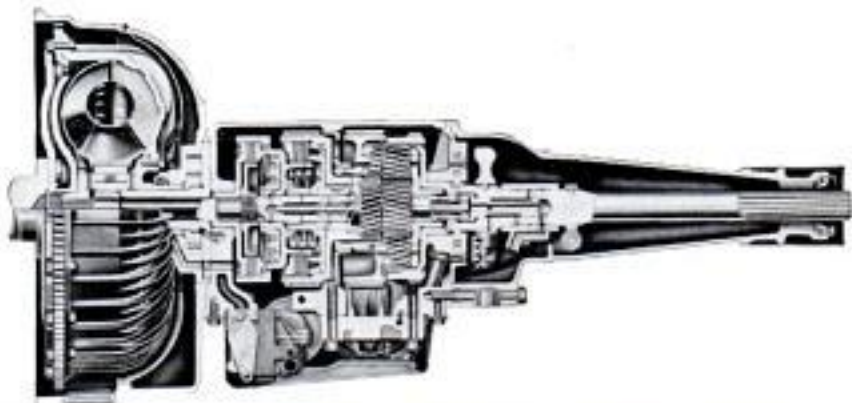

Gives you that extra "Go." Simply press down on the accelerator at any speed up to 58 mph and you get nearly 50% extra passing power with Fordomatic's automatic intermediate gear. Only Ford in its field has it.



Gives you smoother braking down hill. When selector is moved to low at speeds *above* 25 mph, Fordomatic goes into intermediate gear until speed falls *below* 25, then goes into low . . . for smoother, extra-sure braking.



Provides an extra measure of safety. Fordomatic lets you go from neutral to reverse *without* having to pass through a forward drive position. Selector must always be in neutral (N) before starter will operate.

Worth more when you buy it . . .

Worth more when you sell it!



Fordomatic Drive is available on all Ford models at extra cost.

the most versatile

Fordomatic combines a simple 3-element torque converter with a 3-speed planetary gear system to provide the widest range of fully automatic operation!

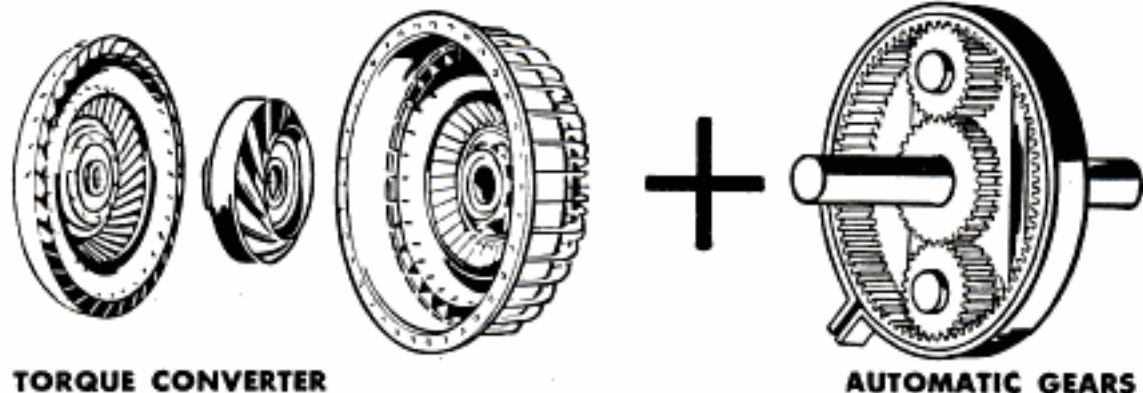

Fluid torque converter smooths the way. With Fordomatic's torque converter, power is always transmitted to the rear wheels through a "cushion of oil." There is no direct *mechanical connection* between engine and rear wheels. So you get smooth operation with a minimum of wear.

Mechanical gears widen operating range. Starts in DR range are through automatic intermediate gear which combines with converter to multiply torque as much as 3.11 times for fast, smooth starts. For unusual conditions, selector may be set at Lo to multiply torque up to 5.13 times!

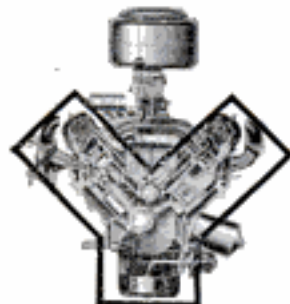

Choose the only V-8 in the low-price field! Team Fordomatic with the industry's most modern engine—the new 130-h.p. Ford Y-block V-8—and you have the smoothest, most versatile automatic "power package" in the low-price field. Deep-block, low-friction design spells smoother going, more "Go" per gallon and longer life.

Your Ford Dealer cordially invites you to Test Drive the

FORDOMATIC Ford

DO-IT-YOURSELF and
Save Over 50%
 on Extruded Aluminum
COMBINATION WINDOWS
 and **DOORS**



Compare this quality, extruded aluminum Combination Window at just \$9.95, with any \$25.00 window. You make equal savings (over 50%) on all U-Fab-It-Yourself "Home Comfortizing" Products—equal to the finest on the market—due to mass production and elimination of assembly costs, because you "do it yourself." Combination Screen - Storm Windows and Doors go up once and stay—forever.

KITS INCLUDE: All parts factory cut, drilled, mitered and hardware attached. The following Complete Line of U-Fab-It-Yourself Kits engineered for easy assembly with household tools:

- COMBINATION WINDOWS
- PICTURE WINDOWS
- COMBINATION DOORS
- BASEMENT WINDOWS
- SCREEN DOORS—SCREENS
- CASEMENT WINDOWS

Send for
FREE BOOK
 on Complete Line
 of Deluxe
 Combination
 Windows
 and Doors.

"Satisfaction Guaranteed"

U-FAB-IT-URSELF, INC.
 Worthington, Ohio

Rush me your FREE Complete Line BOOK of Deluxe Combination Windows and Doors, PM854.

Name _____

Address _____

City _____ State _____

Florida's Blow-Boat Derby

(Continued from page 95)

three days with mosquitoes and slender, if any, rations until he walks out or is rescued.

Often an air-and-ground search is organized, and when the air spotters locate the missing boat, they radio directions back to the ground party. The air boats, too, assist in the search for aircraft downed in the 'Glades. In the association is a Civil Air Patrol division of 30-odd members, who specialize in helping the rescue of airmen. Many of their boats are equipped with battery-operated headlights which permit the search to be carried on in daylight or dark.

During an extended search for Everglades victims, airplanes sighting the lost party after dark drop flares to mark the location, and the headlight-equipped air boats keep on traveling until they reach the stranded party. Without air boats there would be no efficient means of traversing the 'Glades to rescue fliers or for any other purpose.

Racing—the latest development in the use of air boats—is tricky with the shallow-draft craft. The bottom of the boat is perfectly smooth—no underwater rudder or keel to keep the boat on a straight course. Steering is accomplished by means of a stick—similar to the type used on aircraft—hitched to an aerial rudder or rudders. Some boats have only one rudder, some two—mounted directly aft of the propeller. By deflecting the propeller blast, the driver can steer his strange craft.

Coming to turns—and virtually all races are over a circular course—the air-boat driver literally skids his way around. If he hits the turn too fast, he'll slide off course and lose valuable time and distance before he gets straightened out. If he slows down too much he may be overtaken.

If he's trailing and hits the wake of the boat ahead, he's in for a rough ride and possibly a spill. Spills also can occur when the frail boats—which are actually top-heavy since the engine must be mounted high in order to provide propeller clearance, and also because the driver must ride in a high seat forward in order to see over the towering saw grass—hit a turn too fast and literally roll over. It takes a nice bit of rudder maneuvering to achieve the maximum speed on a turn and yet avoid trouble. Speeds as fast as 65 miles per hour have been achieved by air boats, and moving that fast in a craft with a high center of gravity and no keel is decidedly dangerous.

There are some 400 air boats—fresh-water craft—registered with the Air Boat Association, and experts estimate that there are 200 more salt-water craft which are unregistered. ★ ★ ★

Brand New!

WAR SURPLUS

Released Since
KOREAN TRUCE

GROBAN HYDRAULIC PUMP



NEW MANUFACTURE
Silent, High efficiency. Helical Gear Type Ball Bearing. Hydraulic Pump or Motor. Rated

1/2 Gal Per Min. at 1500 R.P.M. 1000 P.S.I. Using 6 H.P.—Reversible "Station-3/4" Pipe Thread Inlet and Outlet Ports—1/4" Drain Port—3/4" shaft with keyway and flat for either direct or pulley drive. Dimensions—5 3/4" high, 7 1/4" long, 5 1/4" wide. Shipping weight 18 lbs. Item #55 F.O.B. Chicago.....

45.50

CENTRIFUGAL PUMP

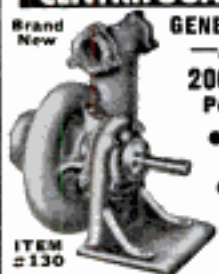

GENERAL MOTORS
—ALLISON
200 GALLONS
Per Minute

- For Draining Basements
- Fire Fighting
- Irrigation
- Fuel Transfer

ITEM #130

Swimming Pools • Home Water Systems • Dewatering

For high volume commercial, home and industrial use. Standard 2 1/2" pipe thread inlet, twin 1 1/4" pipe thread outlets. Ball bearing supported 3/4" shaft. Easy priming. Rotation, counter-clockwise facing shaft. Gov't. acq. cost \$145.00. Complete with full instructions. Ship. wt. 35 lbs. F.O.B. Chicago.....

39.50

Will deliver 200 gals. per min. against 45 ft. head using 5.2 H.P. at 3500 R.P.M.

GROBAN FOUR-WAY OPEN CENTER HYDRAULIC CONTROL VALVE



ITEM #126—Four-way open center control valve, with built-in adjustable relief valve factory set at 1000 P.S.I. Spring loaded neutral position. For use with one double acting cylinder. In neutral position cylinder is locked and pump unloaded. Can be used as single unit or mounted in series. Has 3/4" pipe thread inlet and outlet. 1/2" pipe thread cylinder ports. Finger grip handle. Ship. wt. 10 1/2 lbs.

AN OUTSTANDING BUY!
F.O.B. Chicago **21.50**

HEAVY DUTY 12 VOLT D. C. GENERATORS

ITEM #99—For trucks, autos, marine equipment, construction machinery. 12 Volts—50 amps.—6 bolt mounting flange—spline shaft—life time grease-sealed ball bearings. Mfgd. by Leeco-Neville. Acq. cost \$165.00.



NOW ONLY . . . F.O.B. Chicago..... 16.50

GROBAN HYDRAULIC SPEED REDUCER



with **FINGERTIP CONTROL**
USE FOR: • Reamer Drives • Milling Cutters • Feed Mills • Canning Machines • Conveyors • Lathes • Milling Machines • Motor Boats • Garden Tractors • Pumps.

Variable output speeds from 0 to input speed available by moving control handle. Locking handle maintains setting. Use input power of 1/4 to 1 1/2 H.P. Shafts 3/4" diam. Input rotation counter-clockwise facing shaft. Input speed 750 R.P.M. 7 1/2" x 1 1/2" x 1 1/2". Gov't acquisition cost \$428.00. Ship. wt. 31 lbs. Complete with 2 qts. of oil and full instructions. F.O.B. Chicago.....

54.50

GROBAN SUPPLY CO., Dept. PM-8
1139 S. WABASH AVE., CHICAGO 5, ILL.

DOUBLE ACTION HYDRAULIC CYLINDERS



ITEM #224—GROBAN 3 1/4" bore, 24" stroke, will lift 8250 lbs. with 1000 P.S.I. line pressure. 1/2" pipe thread ports—1 3/8" stress-proof ground, polished & plated solid steel shaft. Overall length closed 36". 1 1/2" steel wall cylinder barrel clevis mounting at base and shaft. Features: Tie Rod construction. Honed. Ship wt. 50 lbs. F.O.B. Chicago.....

39.60



ITEM #41C10 • 2" Bore • 6" Stroke • Double Acting • All Steel • 3/8" Pipe thread ports. Lift capacity 3100 lbs. with 1,000 P.S.I. line pressure. Ship. wt. 12 lbs. F.O.B. Chicago. Price ea.....

12.50

Shatterproof AIR TANK

ITEM #303—Use for air compressors, surge tanks, CO-2 tanks, liquid containers, floats, buoys. 18" long—4" diameter—1/2" pipe thread port. Ship. wt. 10 lbs. F.O.B. Chicago.....

2.50

ORDER DIRECT FROM AD SATISFACTION GUARANTEED

SEND PAYMENT OR PURCHASE ORDER TODAY

TO PLACE PHONE ORDERS CALL WEbster 9-3793

FREE FALL EDITION

1954 CATALOG, 52 PAGES, check-full of unsurpassed War Surplus Equipment Bargains for farm, home, factory, workshop. Write letter today.



Mechanics call them "America's finest."

- Sockets and attachments
- Open end and box wrenches
- Combination wrenches
- Complete tool sets

BONNEY FORGE & TOOL WORKS • ALLENTOWN, PA.

SHEET METAL BRAKES

Angles, flanges, Pittsburgh locks, 24 G, steel, heavier aluminum. Cam locking, mount on bench, truck or floor stand. Truss braced steel. Express collect. 30", 65 lbs., \$28.50. 36", 75 lbs., \$33.00. 48", 100 lbs., \$48.00. Also 8 ft. size. Floor stand, 30 lbs., \$7.00. 15" capacity 16 gauge, 40 lbs., \$21.50.



24" Squaring and slitting shear cuts sheet metal, plastic and cardboard. For bench mounting \$18.00. Floor stands \$7.00. Express Collect. Shears 24" by 16 gauge, straight or curved, any length cuts 1/4" aluminum bars. \$12.50 collect. \$14.00 postpaid.

ORDER DIRECT, OR SEND FOR CATALOGUE.

VYKE MFG. CO., P-2439 15th St., Denver 2, Colo.

BUILD YOUR OWN POWER TOOLS—TILT/ARBOR SAW



TILT/ARBOR SAW
• 27 x 28 in. table stays level. Blade tilts full 45 degrees. • 10 in. blade cuts 3 1/4 in. deep • jackscrew depth adjustment. • Floor model, 34 in. table height. • New Departure ball bearing arbor, 3/4 in. precision shaft, ready to run, 5/8 in. bore blades. • Quick positioning, self-aligning rip fence guide. • Sturdy wood, steel and aluminum construction. • No machining—build easily with hand tools only. • Capacity and performance of floor saws selling for \$150.00 and up!

BANDSAW BELT SANDER
SAVE \$50. OR MORE

GIL-BILT Metal Parts Kit, includes Plans, ball-bearing arbor, cast aluminum miter gauge and bar, rip fence guide, machined lock knobs, jackscrew mechanism with 4 1/2 in. handwheel, and all other metal parts (less blade)..... \$22.95
Same Kit with 10" combination blade..... \$25.00
Same Kit with 8" combination blade..... \$24.90
If not satisfied, return Kits in 10 days for refund of purchase price.

For shipments up to 600 miles, add 5%; over 400 add 10%. Amount in excess of actual postage will be refunded. GIL-BILT Step-by-Step pictorial plans (No blue-print reading required), full-scale patterns—actual photographs for above 10" TILT/ARBOR SAW, 8" TILT/TABLE SAW, 12" BAND SAW, 18" BAND SAW, BELT SANDER, SPINDLE SHAPER. \$1.00 each postpaid anywhere in the world or WRITE FOR FREE descriptive catalog.

GILLIOM POWER TOOLS P. O. Box 1-PH, Lambert Field, St. Louis 21, Missouri

COMPLETE PLANS only \$1.00 EACH

MONEY for MEN ALL DATA FREE

THE PLASTEX Industry needs manufacturers on small scale and for big production of Lamp and Clock Stands, Art Goods and Novelties in Plastex and Marble imitation. Experience unnecessary. Use material makes regular 10¢ store sellers. Rubber moulds furnished for speed production. Small investment brings good returns. We are now placing big Chain Store Orders with manufacturers. Ambitious men have chance for real prosperity. Our Free booklet will interest and benefit you.

PLASTEX INDUSTRIES, Dept. A
3400 Third Ave. New York 56, N. Y.

1954 CATALOG — Send 25¢
41 models for '54! See World's finest line before you buy. Rated tops in design, styling, performance by the experts. '54 Catalog plus booklet "Boat Selection, Operation, Maintenance" \$1.00.

Custom-Craft THE ORIGINAL "PACKAGED" BOAT KITS

BOAT PLANS AND FULL-SIZE PATTERNS

Over 100 Modern plans and full size patterns. Racing classes, cruisers, inboards, outboards, sail boats. By famous designers. 6' to 30'. DESIGN CATALOG only 35¢. For Design Catalog plus boat building handbook send \$1.00.

CUSTOM-CRAFT (DEPT. A) BUFFALO 7, N. Y.

BUILD or MODERNIZE

Your Garage at a Saving!



Lights in Strand door optional

Do-It-Yourself with the LIFETIME DOOR that's easiest to install!

- STRAND All-Steel Garage Doors are one-piece. The easiest of all doors to install.
- Hardware is factory-assembled, and conveniently packaged. Only your ordinary tools needed.
- Horizontal-line styling adds new beauty to your garage. Full 9-ft. width available to accommodate today's wider cars.
- You get the strength and durability of steel, galvanized for rust protection and clinging base for paint. Can't warp, sag, rot, or shrink.
- Available in 8', 9', or 16' wide Receding (track type), and 8' or 9' Canopy Type. See your lumber dealer today, and select your STRAND Lifetime, All-Steel Door.

Send 10¢ for your book of Garage Plans, or ask for free literature.



Strand Garage Door Division Dept. PM-8
 Detroit Steel Products Co.
 2253 E. Grand Blvd.
 Detroit 11, Michigan

Please send 32-page booklet of Garage Plans and Ideas. I'm enclosing 10¢ for postage and handling.

Please send free Strand literature and free Garage Plan of the Month.

Name _____
 Address _____
 City _____ Zone _____ State _____

drive as fast as Engineering tells us to.

You: What do you think about when driving at high speed?

Driver: About driving. You can't day-dream at 115 miles per hour because there are other cars out here and you sneak up on them fast. I worry some about tires although we use specially broken-in tires. We don't trust brand-new tires for that.

You: You mean it's better to use older tires for high speeds?

Driver: Tires have to be broken in if you want to be sure they'll stand up. Last night a Chrysler on highway test had a whole tread peel off a new tire at 70 miles per hour. It just peeled off sideways like the peel on a tangerine. The car held the road, though.

By now you have made several fast laps around the four-mile oval. The Dodge's speedometer reads just under 100. There is no slackening of speed on the curves. In fact, there is little sensation of speed, the steep banks offsetting the side thrust.

You: What speed will the track handle?

Driver: The top lane will take 140 without side thrust. I've never had a car up against the rail yet. It's a 35-degree slope and you've got to be going to stay up there. I think you could hit 275 here in a racer. At 140 on the top lane you can take your hands off the wheel and the car will follow the curve perfectly. Want to see?

What can you say? You're sure he knows what he's doing and you agree, weakly.

Driver: We won't be able to hold 140. We'll try it lower down at about 110.

The Dodge picks up speed. You notice that the other cars are all pulled off the track and you suspect a plot! The Dodge rams into the turn at just over 110. Half-way around, the driver raises both hands off the wheel. You hold your breath, afraid you'll throw the car off balance if you breathe! But like a train on a track, the Dodge follows the curve perfectly. The driver takes over again. On the next turn, he repeats the stunt.

Driver: See, this thing will drive itself!

You: Well, twice is enough for that. It doesn't look as though there's anything wrong here. What will you report?

Driver: Not much. Yesterday there was a high-speed miss at about 70 or so. I changed plugs but that didn't stop it. Must have been cam trouble. I notice they put a different engine in it last night. It has a converter whistle. Maybe you heard it?

You confess you hadn't, but after riding around here for 12 hours perhaps it's not strange that you didn't. On the next lap you get out and head back to the hotel and a long, deep sleep—your head still spinning slightly.

★ ★ ★



TO PAINT LIKE AN EXPERT

USE THE FINEST BRUSH

FREE BOOK — "How to Do a Good Paint Job!"
Send card (and name of your retailer, if you wish) to Baker Brush Co., Inc., 83 Grand St., New York City 13

Brushes by Baker

AMERICA'S FINEST PAINTING TOOLS

**NEW SANDER L-I-G-H-T-S
WORK AS IT SANDS!**

FREE "900"
CATALOG

Only SYNCRO "900" SANDER gives you all this: built-in work light—most powerful reciprocating sander motor (patented) and guaranteed against burn-out during ownership — removes more material with less upkeep — no twisty torque to fight—heavy duty. Write for amazing low cost, Free Syncro Catalog and new FREE "Surface Preparation" SANDING HANDBOOK!



SYNCRO CORPORATION
Dept. 1-C4, OXFORD, MICHIGAN, U.S.A.

Hurry...
Write Today!

HASTINGS

STEEL-VENT PISTON RINGS
The best money
you can spend on your car!

MOTORIZE YOUR BARBECUE!

Easily rigged up by anyone. Handles whole ham or 4 small chickens. Commercial-quality thruout—enclosed gear-head motor (110V-AC)—spring-tension bronze bearing permits spit removal—

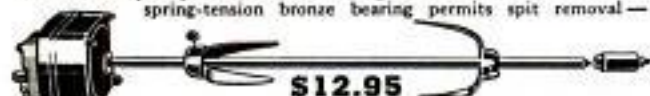

\$12.95

adjustable meat forks—heavy-duty, chrome-plated spit. Limited time, introductory offer. Postpaid. (\$12.95 Denver and West).

B & R SALES CO. — Box 952A — Muncie, Indiana

**IDEAL LAWNMOWER
SHARPENER**

BOOST YOUR INCOME

You can earn extra cash with the Model 300 Ideal Lawnmower Sharpener. Used and recommended by leading manufacturers and service shops, the Ideal has everything you need, nothing else to buy. Grinds reel and bed knife, also reconditions. Get started now in this highly profitable business. Write for catalog today.

The Fate-Root-Heath Co.
Dept. PM-8, Plymouth, Ohio



It's easy
to install...

Your own **HI-FI SYSTEM**
craftsmen

CA1 ASSEMBLY



A complete home music system

- FM-AM Tuner • Amplifier • 12" Coaxial Speaker
- 3-Speed Record Changer

Ready to install in cabinets of your choice or make your own custom installation from detailed drawings which are supplied.

See Page 148
of July Popular
Mechanics

Write for catalog 224 or send 10c for set of detailed "Build It Yourself" cabinet and speaker plans.

The Radio Craftsmen, Inc., Dept. LB
4403 N. Ravenswood Ave., Chicago 40, Illinois

**FIND OUT ABOUT AMERICA'S
NEWEST AND FINEST 8" AND 10"
TILT/ARBOR SAWS!**



ATLAS PRESS COMPANY
824 N. PITCHER ST.
KALAMAZOO,
MICHIGAN

**FREE
CATALOG**

Please send me complete information about THE GREAT NEW ATLAS SAWS with the TEN ALL-NEW FEATURES that make them the fastest, smoothest, most accurate ever offered. I want to see for myself why they are being acclaimed by commercial users and hobbyists alike.

Also send me the name of my nearest franchised ATLAS dealer.

NAME _____

ADDRESS _____

CITY _____ STATE _____

you can DO so much MORE so much BETTER with



the **ONE** shock absorber that makes **EVERY** car **RIDE BETTER** **DRIVE SAFER**

DISCOVER THE THRILL

- ... of driving at today's high speeds down a super highway smoothly, steadily—without the annoyance of wander or side-sway.
- ... of taking sharp curves easily, safely even though you come upon them unexpectedly.
- ... of gliding over rough spots or washboard sections without the bounce and wheel-fighting that often leads to loss of control.
- ... of settling down quickly after crossing railroad tracks or ruts.
- ... of being sure of better control on soft shoulders—and even in the event of a blow-out.
- ... of being able to stop suddenly without lurches.
- ... of driving mile after mile, hour after hour without strain—sure of control.

The one Shock Absorber that meets both Heavy-Duty and normal driving requirements in one unit.

Learn the facts about this new Shock Absorber principle...

Write for Free Booklet
HECKETHORN
MFG. & SUPPLY CO.
Dept. PM-2—242 W. Main
Littleton, Colorado



COLUMBUS
Luxury-ride SHOCK ABSORBER

MADE BY
HECO

LICENSED BY HECO

Available at **BETTER AUTO PARTS DEALERS EVERYWHERE**

On Trial—America's First Jetliner

(Continued from page 89)

stipulation. The main tanks are in the wings, integral with the structure. They are semipressurized with ram air to prevent the fuel from boiling during fast ascents to high altitudes. Vents are in the trailing edges, out near the wing tips. Wiring and all electrical apparatus are confined to a different zone in the wing, separated from the fuel-system areas.

Boeing has built more than 600 jet bombers, and all the experience gained in their construction is in the background of the new tanker-transport. But this is not a "warmed over" B-47 or B-52. Aside from its stock instruments and its crew seats and rudder pedals, every part of the 707 is new both in design and construction.

One trend evidenced by the 707 is its relatively stiff wing. Its tips come up only about a foot in flight, as compared to five or six times that deflection in our jet bombers. Perhaps you've noticed that the wings of a B-52 appear to droop while on the ground. They do, because of their flexibility. The wings become level when airborne. The stiffer 707 has a slight amount of positive dihedral, though this isn't apparent on the ground.

Another trend found in the 707 is that its wing skin is quite highly stressed. The skin is thick and carries much of the load, while the spars inside are very light. We are approaching the time when internal spars will serve primarily as bracers to hold the upper and lower surfaces of the wing apart.

The 707 is designed to operate from present airports and to meet all present regulations governing civil air transport. It is expected to be as easy to maintain as our present airliners and imposes much less noise and vibration on its passengers. It will carry passengers at the same cost per seat-mile as do our present-day air transports.

This is the kind of airliner you'll be riding in the future! ★ ★ ★

Paintbrushes From Chicken Feathers

Chicken feathers instead of Chinese hog bristles are used in an experimental paintbrush that doesn't require materials from behind the Iron Curtain. Keratin, a protein which forms a major part of wool, hair and fingernails is extracted from the chicken feathers and used to make the synthetic bristles. The result is a brush that closely approximates the feel and painting properties of hog bristle.

DRILL SAW REAM CUT

INTERNATIONAL
HI SPEED COPE SAW DRILL BIT



DRILL, SAW, REAM . . . metal, pipe, wood, plastic, Transite, etc. Use with any electric drill, slow drill press, lathe or milling machine. Drills own starting hole—upper part of bit is used to cut, saw or ream circles, ovals, squares or scrolls. Easy to operate. Ideal for carpenters, mechanics, electricians, plumbers, hobbyists, many others. Abrasive resistant, high speed steel. Flutes ground from solid. Will withstand severe continuous use without breaking. Resharp-ened at no charge. Takes place of up to \$50 in tools. 1/4" diameter, 2" cutting sections, total length 3 1/2". Available in three types—All Purpose, Wood, Heavy Metal. Specify type needed. Set of 3, \$11.50. Details on request. Shipped same day. Money-back guarantee. Dealer inquiries invited. **ORDER NOW! SEND CASH, CHECK OR MONEY ORDER.**

Manufactured and distributed by
INTERNATIONAL TWIST DRILL CORP.
618 Wyandotte, Rm. 639, Kansas City 5, Mo.

only
\$3.95
POST PAID

**Now you
can spray**



New 3-in-one Oil-Spra lubricates and forms a barrier against rust! No more messy rags—oily fingers! Sprays oil at touch of button!

"3-IN-ONE" OIL

COLOR PRINTS 32¢—big, brilliant Kodacolor Prints, 3 1/2 x 5 inches, from 2 x 2 slides—only 32 cents each, plus 30 cents for negative from each slide from which prints are to be made. Minimum charge, \$1. Order from your dealer.

Eastman Kodak Company, Rochester 4, N. Y.

SOUTH BEND Light Ten Lathe

Highly accurate and versatile for better than average work. 10" swing. Send for free catalog.

SOUTH BEND LATHE
South Bend 22, Ind.



DETECT RADIOACTIVITY WITH SMALLEST, LOWEST COST GEIGER COUNTER!



For your profit & security, this highly sensitive, precision geiger counter locates uranium, radium and warns of all radioactive material. U. S. Gov't. circuit. About size of king-size cigarette pack. 11 oz.

\$35.00 postpaid including single crystal earphone

Mail check or money order to **MICRO SPECIALTIES CO.,**
Dept. A, 1834 University Avenue, Berkeley, Calif.

Don't get stuck with a rust-clogged radiator!



At the first sign of **overheating** use new, improved
Du Pont COOLING SYSTEM Cleanser

If a rusty radiator causes your engine thermometer to read high on moderate summer days, don't wait for a scorcher. Put in Du Pont Cooling System Cleanser right away. It cuts grease with detergent action, cleans out scale, and *dissolves* rust so that water drains out clear. And neutralizer in each can completes the job. Du Pont Cooling System Cleanser is *thorough, safe, simple.*



Keep your radiator clean with new
DU PONT ANTI-RUST

Once your cooling system is clean, keep it that way with Du Pont Anti-Rust. This new liquid inhibitor retards rusting, inhibits acid formation and lubricates the water pump as well!

DU PONT No 7. PRODUCTS
From Chemical Research . . . For Easier Car Care



**BETTER THINGS FOR BETTER LIVING
... THROUGH CHEMISTRY**

AUGUST 1954

249
Copyrighted material

NEW! Car Compass



Patents Pending



- COMPASS • LEVEL GAUGE } All in
- ACCELERATION INDICATOR } ONE!

Distributors Wanted

Write for details on your company letterhead. Stated terms only.

Fits any car. Compass has fully adjustable permanent magnet compensators. Level gauge shows ascent or descent up to 20 degrees either side of level. Equivalent to a 36% grade. Use it as an acceleration indicator to show fast starts. Rugged construction through-out. Ideal for cars, trucks, tractors. Installs in minutes with just a screw driver. Compass easy to compensate. Write for yours!

10-Day Money-Back Guarantee.

LEVEL-X, INC.

Suite M-7, 627 Salem Ave.
Dayton 6, Ohio

Ohio Residents add 15c sales tax

ONLY
\$495

POSTPAID
IN U.S.A.

RESIN-FREE
(All Oil Base)

Liquid
Raw-Hide

2 IN 1 FINISH
for
REDWOOD

CEDAR, FIR, ETC.

Designed to restore the color and beauty of your old or faded redwood with ONE COAT. If your redwood has FADED it is usually only necessary to apply ONE COAT of 2 IN 1 FINISH to restore the redwood color and completely weatherproof the surface.

Liquid Raw-Hide 2 IN 1 FINISH has sufficient coloring matter and oil-solids to finish new wood or old raw wood with ONLY TWO COATS. \$1.75 Qt., \$5.30 Gal. Pre-paid. Guaranteed. REDWOOD FINISHING PAMPHLET WITH EVERY ORDER OR FREE ON REQUEST.

LINSEED OIL PRODUCTS CO.

1122H So. Fremont Ave., Alhambra, Calif.

"Specialists in Resin Free Finishes"



Houses must breathe or paint peels and wood rots.

All-aluminum "Midget"

Louvers allow proper circulation through walls, under eaves, roofs, floors.

You can install—drill holes, push into place. Sizes 1" through 6". At hardware, paint, lumber dealers.

Write for complete data



MIDGET LOUVER CO.

6 WALL STREET, NORWALK, CONN.

WORLD'S BEST SMALL TRENCHERS

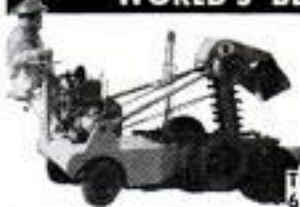

Portable DITCH-WITCH digs 2" to 6" clean, even ditches to 36" depth in all types of soil. Complete unit—self propelled—outdigs 8 men. Four rugged models.

Write for illustrated literature.
THE CHARLES MACHINE WORKS
620 B Street Perry, Oklahoma



ELECTRIC WELDER AC or DC 110 Volts

The "Little Marvel" all-metal welder. 5-year written guarantee. Welds 1/8" metal or money back. Repairs tanks, tools, fenders, machine parts, etc. Complete with everything—rods, unit, eye shield, directions.

\$8.45 plus 50c postage. Flame torch accessory for soldering, cutting, brazing \$3.95 complete with carbons, brass rods, flux. Sorry no C.O.D. Buy direct and save.

ESSAY MFG. CO., Dept. 51, Quincy 69, Mass.

\$6.45
Complete

LAWN ORNAMENT-NOVELTY PATTERNS

28 Lawn Ornament Patterns, 25c. Other Patterns: 15-20" high; Dutch Girl, Dutch Boy, Pirate, Bull Terrier, Mexican Girl, Mexican Boy, Dwarf, Penguin, Flower Girl, 15c each. 25 Novelty Patterns, 30c. All 62 Full Size Patterns, \$1.00.
Stratner Pattern Service, Dept. DR-8, Box 128, Belington, W. Va.

VARIABLE SPEED HYDRAULIC POWER TRANSMISSION



It has Infinite Speeds 0 to 550. Reverse, Automatic Overload Protection; Adjustable Torque up to 180 inch pounds. 3/8" Input and Output Shafts. It will handle 1/2 to 1 1/2 H.P. Motor. Case measures 7 1/2" long, 7" high, 6 1/2" wide. VALUE OVER \$300. Shipping Wt. 25#. On C.O.D. Orders we require a 10% only Deposit. \$54.50
Fab. Chicago

DIRZIUS MACHINE SHOP "E" 1423-25 So. 52nd Ave., Cicero 50, Ill.

SAY YOU SAW IT IN
POPULAR MECHANICS

NOW! USE YOUR WILLYS OR DODGE AS BOTH A 2 and 4 WHEEL DRIVE



Enjoy 2-wheel drive pep, speed, extra mileage, performance—keep 4-wheel drive power and traction with WARN HUBS. Change 4-wheel to 2-wheel or back in seconds with fingertip control. Front end assembly stands still in 2-wheel drive—no drag, slope shimmy, cuts front tire wear, increases gas mileage to 6 m.p.g. For Willys \$69.00, Dodge \$74.00 pr.; also Standard Hub for Willys \$20.00, Dodge \$25.00, Land Rover \$24.00 pr.; Automatic Hub for Willys \$120.00 pr., all ppd. Money back guarantee. Dealers or direct. Write for folder.

WARN MFG. CO., RIVERTON Box 6064-A3, Seattle 88, Wash.

POPULAR MECHANICS

Copyrighted material

MAKE YOUR "OWN"

All-Purpose
**OUTDOOR
TABLE**

Personalized With
Your "OWN" Initial

KOYKER TUBULAR FRAMES

make it fun to assemble this beautiful, sturdy table. Walk-in Feature, Skid Runners, Easy Storage. You supply lumber for top and benches, Koyker supplies primed tubular frames and complete hardware. Frames—\$27.50. 2 Initials—\$2.45. F.O.B. Hull, Iowa. Iowa Sales require 2% sales tax.

Dealer inquiries invited. Mail check or money order to:
KOOIKER MF'G. CO., Dept. PM-8, HULL, IOWA

BUILD YOUR OWN AIR CONDITIONERS

AND DEHUMIDIFIERS — For Home or Automobile
FROM JUNKED REFRIGERATORS — FOR \$15

Instruction books □ for Home—75c □ for Car—75c. Both for \$1.00

COMPLETE "Install-It-Yourself" KIT for Auto — ONLY \$164.70

This kit contains everything you need to install an air conditioner in your car that is equal to capacity and performance of units costing \$600 or more. Save hundreds of dollars. Send for instruction books or further information to

SEELEY PRODUCTS CO., Dept. 518, 3716 Belmont, Chicago 18, Ill.

Send for **FREE** 112 page
Illustrated Catalog of Farm, Home,
and Workshop Bargains.

Write to **WELLWORTH TRADING
COMPANY**
Dept. D8

1832 S. WABASH AVE. CHICAGO 16, ILL.

**MACHINISTS
TOOLMAKERS**



Gerstner Chests are built to satisfy the kind of men who take care of their tools. Free Catalog.

GERSTNER TOOL CHESTS

454 Columbia St., Dayton 7, Ohio

\$6.95 **DRAINS** cellars, cisterns, wash tubs;
IRRIGATES - CIRCULATES - SPRAYS



1,001 USES—HOUSE, GARDEN, FARM
Original All-Purpose Pump has 2400 GPH capacity, 360 GPH 75' high; or 1500 GPH from 25' well. Use any 1/6 to 3/4 HP motor. Stainless steel shaft, 1" inlet, 3/4" outlet. Motor coupling included.

DOES NOT CLOG OR RUST!
Postpaid if Cash with order. (West of Miss. add 50c.) **MONEY BACK GUARANTEE.** Larger Centrifugal Pumps, and Gear Pumps in all sizes.

LABAWCO PUMPS, Belle Mead 7, N. J.

PLYWOOD BOAT KITS

12 FT. \$97.00

14 FT. \$129.00

Freight included



Send for free folders on all models as low as \$39.00 freight included

TAFT MARINE WOODCRAFT

Dept. P.M., 636 39th Ave. N.E., Minneapolis 21, Minn.

Greatest Jig-Saw Value of All Time Sensational **NEW MOTO-JIG SAW**



Cuts 1 1/2" wood . . . Has
Built-in Rotary Motor!
(Not a Vibrator)



3,450
strokes per
minute

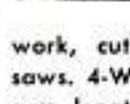

Pat.
Appl.
For

Only
\$23.50

**CREATED ESPECIALLY FOR THE
DO-IT-YOURSELF FAMILY!**

Here's the revolutionary new DREMEL Jig Saw the whole family can enjoy. Cuts 1 1/2" wood, 3/4" plywood fast as you can follow a line—also cuts metal, plastics, etc. New **ROCKER ACTION** principle maintains constant blade tension, cuts faster, lengthens blade life. Powered by a real **ROTARY** motor, it's rugged enough for production work, cuts intricate scrolls impossible for other jig saws. 4-Way Blade Holder saws in any direction, takes any length stock. Has tilting table; foolproof blade guard makes it safe for women and children. A trial will convince you that dollar-for-dollar, the new DREMEL out-performs them all!

SEE YOUR DEALER. If he cannot supply, order direct on 5-day trial, money-back guarantee. Remit in full for postpaid shipment; or send \$2, pay postman balance plus postage and COD.

DREMEL MFG. CO. Dept. 114-H, Racine, Wis.

SAVE MONEY on SURPLUS PARTS for MILITARY TYPE TRUCKS & JEEPS

4 & 6 wheel drive. FREE catalog. State make of truck or Jeep. (New Jeep Tops, steel or canvas for all models). **AMERICAN AUTO PARTS CO., Inc., 1830 Locust, Kansas City, Mo.**

Regular Price of a
Slide Rule \$4 and up



Slide Rule

92c

and this coupon
Add 8c Postage

If you can use a pencil you can use a slide rule
For bookkeepers, accountants, salesmen (figuring commissions, cost, etc.), farmers, housewives, etc. For Armed Forces highly important. Men's most useful tool. Easy to calculate instantly. Multiplying, proportions, division, roots, etc. "High Vision" Clear View Slide. Full 10" Rule. A, B, C, D, C1 and K scales. **FREE** 28-page instruction book on how to get correct answers instantly without pencil or paper.

Gene Loewy, 545 5th Ave., Dept. 43-V, N.Y. 17

Limit three rules to each coupon

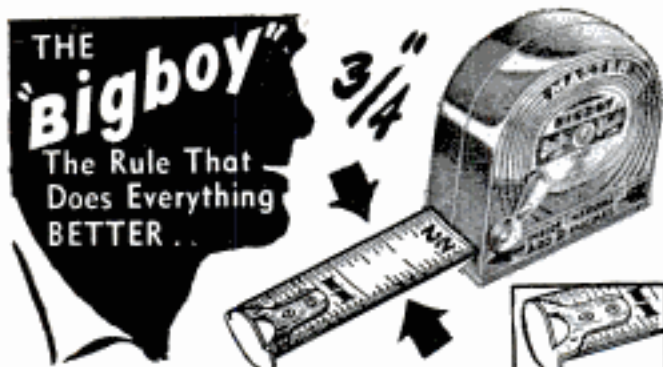

The new $\frac{3}{4}$ " Big Boy gives you the fine smooth feel that only a good steel tape can give you . . . plus the wood rule rigidity so necessary in those "over the head" measurements . . . Beautiful snow white blade is numbered, "left to right on one edge, right to left on the other, so figures are always right side up . . ." Double purpose tip allows you to use either side of the blade with equal ease . . . Push lever lock either left or right for positive holding action. See the Big Boy today, test its many exclusive features. We know you'll agree its the rule for you. Deluxe model (10 ft.) only \$3.25 ea. (Special) \$2.50 ea.



Double Tip



Blade Numbered both ways



Wood Rule Rigidity



Positive Lever Lock



Say You Saw It in Popular Mechanics

remodeling?

... use

FIR PLYWOOD

Gives you more house for your money. Best for sheathing, siding, paneling, built-ins. For "Plan with Plywood", send 10c to Douglas Fir Plywood Assoc., Tacoma 2, Wash., or see your lumber dealer today!

Buy Only DFPA-Graded Panels

WILHOLD GLUE

with Orthonal

NO WAITING—GOOEY STICKS HARDENED BRUSHES

Carry in kit or apron. Can't spill. Keeps glue fresh and clean. Wilhold—The easiest glue to use for home, hobby and shop uses. Applies white—dries colorless. Odorless. Non-inflammable. Glues wood • tile • formica • paper • china • almost everything. Grabs quick; sets fast. See Your Dealer. Send \$1.00 for Wilhold Glue-Bird. Refills—\$1.00. P. P. Money Back Guarantee.

THE BEST is EASIEST

SQUEEZE PLASTIC GLUE GUN

ACORN ADHESIVES CO., INC.

Los Angeles 31, Calif. Chicago 44, Ill.

LIMITED SUPPLY! BRAND NEW, BALL-BEARING

1½-HP, 2-HP, 3-HP ELECTRIC MOTORS

FAMOUS BRAND! SAVE WAY OVER HALF!

Powerful Capacitor motors with heavy starting torque to handle EVERY heavy-duty job. New, ball-bearing models that mount IN ANY POSITION, 3450 RPM, 115-230 volts, 60 cy., single phase. Perfect for saws, wood-working tools, blowers, grain elevators, pumps, and farm equipment. Fully Guaranteed. Save dollars. ORDER DIRECT FROM THIS AD TODAY!

1½-HP, Regularly \$110.00. Special sale.....\$47.50 fob

2-HP, Regularly \$130.00. Special sale.....\$57.50 fob

3-HP, Regularly \$160.00. Special sale.....\$75.00 fob

FREE CATALOG OF MOTORS and ELECTRICAL EQUIPMENT

ROBERTS ELECTRIC CO., Dept. P-207, 849 W. Grand, Chicago 22, Ill.

MINIATURE ENGINES

GASOLINE — STEAM

BUILD THEM YOURSELF — IN YOUR OWN SHOP WITH YOUR OWN TOOLS

Anyone with a 6" or 10" lathe and a drill press can make them.

SEND 10c FOR ILLUSTRATED CATALOG OF MINIATURE ENGINE CASTINGS AND DRAWINGS

OCTURA MODELS

P.O. BOX 536-B PARK RIDGE, ILL.

BE YOUR OWN BOSS

Make Hundreds of \$ Spare or Full Time Work

You can make simply and cheaply

NO EXPERIENCE NEEDED

Here is the ideal business with no previous experience or large investment required and no high-priced equipment to buy. A business that will return dollars for the pennies you invest.

YOU CAN CAST ANYTHING

With Flexible Mold Making and Ornamental Casting, an amazing fact-packed book, you learn how you can cast practically any article in concrete, plaster, imitation marble or any other casting material using a marvelous new process. You can make ash trays, novelties, garden and lawn ornaments and hundreds of other highly profitable items that cost you but a few cents and sell for as much as \$5.00 and more. Why you can even make true-to-life full-sized busts of your neighbors and friends.

NO EXPENSIVE MOLDS TO BUY

Why buy high-priced molds from others? Learn how you can make your own molds quickly, easily and inexpensively with materials that can be used over and over. You get copyrighted formulas, complete instructions and detailed how-to-do-it photographs as well as complete sources of supply for the few inexpensive materials you need. This is the only book printed in America today that contains instructions for making profitable papier-mache casts.

MONEY BACK GUARANTEE

Start on your road to extra income and independence today. Send only \$3.00 for your copy of Flexible Mold Making and Ornamental Casting. Complete satisfaction guaranteed or your money refunded within seven days.

POPULAR MECHANICS PRESS, Dept. 46

200 E. ONTARIO ST., CHICAGO 11, ILL.

BUSTS

GARDEN URNS

NOVELTIES

TILE

STATUARY



STOP THAT SQUEAKY FAN BELT

for only

50¢

★ A few drops of Cling-Surface stops slipping, stops squeaks, makes belts last longer. Good for all belt driven power tools and appliances, tool sold at service stations, auto parts and hardware stores. If your dealer can't supply you



Send 50¢ to: **CLING-SURFACE CO.**
1047 Niagara St. Buffalo, N. Y.
Canada: send 75¢ to **CLING-SURFACE CO.**
243 College St. Toronto 2, Ont.

Wholesale! TOOLS! GUNS! CAMERAS!

BUY TOOLS, PHOTO EQUIPMENT, SPORTING GOODS, JEWELRY AND THOUSANDS OTHER NATIONALLY ADVERTISED PRODUCTS AT BIG DISCOUNTS. SAVE ON OWN PURCHASES. BIG PROFITS SELLING TO OTHERS. POSTCARD BRINGS FREE COPY "THE WHOLESALE PLAN".

Get up to 40% off

AMERICAN BUYERS SERVICE

629 Linden Ave., Dept. 15, Buffalo 16, N.Y.

3 CU. FT. MIXER 39⁷⁵ DIRECT FROM MFR.

Fill long felt need for small mixer for concrete, feed, fertilizer, seed and many other materials. Saves 4¢ cost of ready mixed concrete. Pays for itself on first job. Combination belt pulley and crank for hand operation. Also power mixers. Write for circular.

3 Cu. Ft. Drum—Mixes 2 Cu. Ft. Concrete \$39.75
5 Cu. Ft. Drum—Mixes 3 Cu. Ft. Concrete \$49.50

108 Palisades, N. Y. Cash, Check or M. O. Money back guarantee.
UNITED STATES FORGE AND FOUNDRY CO.
CONSTRUCTION EQUIPMENT DIV. PULASKI, N.Y.



STOP RUST

Famous "Dichanite" Crystals now Available. Just sprinkle in Tool boxes, Gun Cabinets, Instrument cases. No messy oils or grease needed.

\$1 POST-PAID

FOLEY ENGINEERING,
BOX 346

Details free
Dept. P
MONTCLAIR, N. J.

"Do-It-Yourself" Begins With How

"How to Work With Tools and Wood" makes the basic do-it-yourself skill easy for handyman or homeowner. Fully illustrated, only \$2.00 post-paid. Order from Stanley Tools, 384A Elm Street, New Britain, Conn. In Canada, write to Stanley Tool Co. of Canada 384A Stanley Street, Roxton Pond, Quebec.



THE TOOL BOX OF THE WORLD
Hardware • Electric Tools • Steel Strapping • Steel

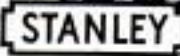

SAY YOU SAW IT IN POPULAR MECHANICS

BeMaCo Dependable AUTOMATIC SAW SET



Sets 400 teeth per minute on hand or hand saws 4 1/2 to 16 point. Hammer and anvil action sets teeth accurately and uniformly. . . . No tooth breakage. Does a perfect job. Used profitably by saw shops everywhere and saw manufacturers. Every machine guaranteed!

FAST - ACCURATE - DEPENDABLE

★ INCREASES PROFITS

BEAVER MFG. CO.

Saw Machine Div. 11-C
800 S. ISIS AVE. • INGLEWOOD, CALIF.

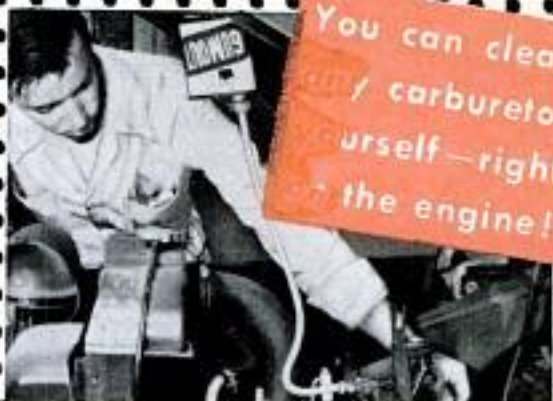

You can clean any carburetor yourself—right in the engine!

Pouring solvents or "additives" down the throat of a carburetor will not clean it.

GUMOUT forced-flow carburetor cleaning does the job right because it reaches the places that need cleaning most: the idle system, high-speed system, gas and air passages—even those all-important air bleeds. You get immediate improved engine performance... more economical performance.

GUMOUT and **KIT**, \$3.95 complete.
GUMOUT refills, \$1.50 per pint can.
Sold by leading Auto Supply Stores.

Write today for FREE illustrated 46-page Carburetor Handbook.



GUMOUT DIVISION
Pennsylvania Refining Company
2671 Lisbon Road Cleveland 4, Ohio

The New Model 70 UTILITY TESTER FOR REPAIRING ALL ELECTRICAL APPLIANCES MOTORS • AUTOMOBILES • TRUCKS

As an electrical trouble shooter the Model 70:

- Measures A.C. and D.C. Voltage, A.C. and D.C. Current, Resistances, Leakage, etc.
- Will measure current consumption while the appliance under test is in operation.
- Incorporates a sensitive direct-reading resistance range which will measure all resistances commonly used in electrical appliances, motors, etc.
- Leakage detecting circuit will indicate continuity from zero ohms to 5 megohms (5,000,000 ohms).
- Will test heaters, irons, broilers, Heating Pads, Clocks, Fans, Vacuum Cleaners, Refrigerators, Lamps, Fluorescents, Fans, Switches, Thermostats, etc.
- Will test all TV tubes for open filaments, inter-element shorts, burned out tubes, etc.



As an Automotive Tester the Model 70 will test:

- Both 6 Volt and 12 Volt Storage Batteries • Generators • Starters • Distributors • Ignition Coils • Regulators • Relays • Circuit Breakers • Cigarette Lighters • Stop Lights • Condensers • Directional Signal Systems • All Lamps and Bulbs • Fuses • Heating Systems • Hoses • Also will locate poor grounds, breaks in wiring, poor connections, etc.

Handsome round-cased molded bakelite case, 2 1/4" x 5 1/4" x 3 1/4". Complete with all test leads. Also included is a **\$2.00** book giving detailed instructions for testing all electrical appliances, automotive equipment, TV tubes, etc. Only

15⁹⁵
SHIPPED ON APPROVAL
NO MONEY WITH ORDER—NO C. O. D.

Try it for 10 days before you buy. If completely satisfied then send \$5.95 and pay balance at rate of \$4.00 per month for 3 months — No Interest or Carrying Charges. **ADD:** If not completely satisfied, return to us, no explanation necessary.

MOSS ELECTRONIC DIST. CO., Inc.
Dept. D-56, 3849 Tenth Ave., N.Y. 34, N.Y.

Please rush 1 Model 70. I agree to pay \$5.95 within 10 days after receipt and \$4.00 per month thereafter.

Name _____
Address _____
City _____ State _____



U. S. GOVERNMENT SURPLUS 3 KVA ALL PURPOSE GASOLINE POWERED GENERATOR

3 Phase — can be used single phase

only
\$295⁰⁰

LIKE NEW — \$1,000.00 value. Ideal for contractors, farmers, resorts, carnivals, oil fields, anywhere permanent or temporary power is needed. All units tested before shipment. 4 cylinder ZXB Hercules gas engine 115/120 volt 50/60 cycle, push-button electric starter and generator, full control panel.

**HEAVY DUTY OR
EMERGENCY STAND-BY POWER**

NEW ● **NEW** ● **NEW**
GOVT. COST **\$6,000.00**
OUR PRICE **\$695⁰⁰**

16.5 KW DC 160 amp at 1200 RPM, full panel board JXD 6 cylinder Hercules engine mounted on wheels. Portable. Tires \$75.00 extra. Oil fields, contractors, carnivals, circuses.

SUPERIOR TRAILER MFG. CORP.
P.O. Box 1516 • INDIANAPOLIS, INDIANA • Cable Address: INDMAC

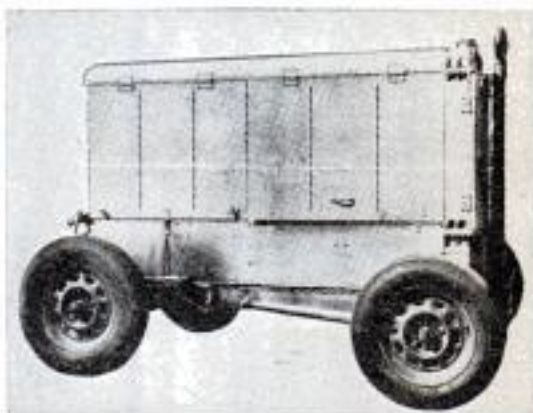

WAR SURPLUS BARGAINS

SEND FOR
1954-55
SAVE UP TO 80%
OVER 200 Big Values

FREE Catalog

SIoux FALLS SURPLUS STORE
SIoux FALLS S. DAK.

x-acto
KNIVES • TOOLS
HANDICRAFT KITS

#5 X-ACTO KNIFE \$1.20

X-ACTO, INC.
48-41 Van Dam St.
Long Island City, N. Y.

Send 20¢ for 28-page Catalog

★ **Dayton Build-It-Yourself Attic-Window Fan Kits** ★

Everything you need other than lumber, labor & Motor. Includes easy instructions. 20" Kit \$15.95, 24" Kit \$16.95, 30" Kit \$18.95. F.O.B. CHICAGO. No CODS.

N. PREHLER & CO., 1625 Milwaukee Ave., Chicago 47, Ill.

SURPLUS GIGANTIC SAVE UP TO 85%

New Hi-Speed Drills
30 ea. 1/60"-1/4" \$3.50
10 ea. 1/4"-1/2" \$3.50
(Assorted sizes)

Imported Precision Squares Accuracy Blades—
Tempered Precision Ground
2" 1.50 6" 2.30
3" 1.70 8" 2.80 Mfr. Guar.
4" 1.90 10" 3.80 Cert. Incl.
5" 2.10 12" 4.80
8 pc. Comb. Set 2" to 12" 19.95

METRO PRECISION TOOL CO.

D. C. GENERATORS For Welding
P.T. 24V. 200 amp. \$12.50. R.I. 30V. 300 amp. \$21.50. Guaranteed Perfect Including Diagram

"KANON" Precision Calipers
Import. Stain. Steel 6" Caliper w/case **9.25**

Cal. 15c or Free with Order
Check or M.O. 25% dep. on C.O.D. — F.O.B. L.A.

1507 S. La Cienega
Los Angeles 35, Cal., Dept. MB
Phone: BRadshaw 2-2828

All About TELEVISION



**How to
Replace Tubes
Install Antennas
Make Adjustments**



**Cut Down Repair Bills
... Prevent Trouble**

John Derby, well-known TV engineer, tells and shows you how to save money on the servicing and repair of your TV set. He shows you just how you can locate trouble, and in most cases make repairs yourself in the matter of minutes.

Special Picture Section SHOWS You HOW to Locate Trouble

A special chapter contains actual photos of defective TV pictures. You merely compare the picture on your screen with pictures in the book; find the trouble at once and directions which tell just how to fix it. The very first time you use *All About Television* your savings will exceed the small cost of the book. Order your copy now. Your money back in 7 days if it isn't entirely satisfactory.

POPULAR MECHANICS PRESS
200 E. Ontario St., Chicago 11, Ill.

Send at once my copy of *All About Television*. Remittance for \$1.98 enclosed. If it isn't entirely satisfactory I may return it in 7 days for a full refund.

NAME _____
ADDRESS _____
CITY _____ ZONE _____ STATE _____
 Send C.O.D. (U.S.A. only). Postage extra.

Build this Beautiful LAWN FURNITURE YOURSELF



PORCH
CHAIR



SERVING
CART



GARDEN
LOUNGE



PICNIC
TABLE



PORCH
GLIDER



ADIRONDACK
CHAIR

NO EXPERIENCE NEEDED

Smart Exclusive Styles By John Bergen
... Four Big Plans Drawn to Scale ...
Complete Material List

Now with just a few spare time hours and some inexpensive materials you can build gay comfortable lawn furniture that will make your garden more attractive ... more comfortable and more fun this summer.

No need to pay a small fortune for lawn furniture when you can build your own and save over 50% of what it would cost you already built!

Popular Mechanics four big drawn-to-scale plans show every step to follow. Complete material list tells you just what sizes of wood to buy so there will be no waste.

Make your lawn and garden the finest and most attractive on your block by building this smartly styled furniture. Enjoy real comfort during those hot summer months by making your garden your outdoor living room. Send today for your plans and material list. Complete set of four plans only \$2.00. Complete satisfaction guaranteed or your money refunded.

POPULAR MECHANICS
PRESS
200 E. Ontario St.
Chicago 11

Popular Mechanics Book for Pleasure or Profit 23 BOATS You Can Build

Build the boat you have always wanted. Build it for fun or to sell at a profit. Get Popular Mechanics 23 BOATS YOU CAN BUILD — row boats, canoes, sail boats, power boats and other craft including a 25 foot cabin cruiser. Book includes more than 500 photos, plans, diagrams and working drawings, plus step by step instruction that anyone can follow. Only simple tools needed. Material list of lumber, hardware, fittings, etc., included. Order today under money-back guarantee. Only \$2.00 postpaid.
POPULAR MECHANICS PRESS, Dept. PM3, 200 E. Ontario St., Chicago 11

Build Your Own Walks,
Driveway, Outdoor
Fireplace, Steps, Etc.

What to Make With CONCRETE



The terrific high costs of even little concrete jobs are mostly for labor. Get Popular Mechanics WHAT TO MAKE WITH CONCRETE and save all the labor costs while making your home or farm ship-shape. You can lay foundations, sidewalks and driveways; build steps, outdoor fireplaces, sandboxes, tennis courts, garden and swimming pools and other installations at very little cost. Book shows all — tells all — how to make the right mixture, plan, apply and gives 50 professional short cuts. Hundreds of pictures. Only \$2.00 postpaid. Order today. Money back if not pleased.

POPULAR MECHANICS
PRESS

Dept. PM17, 200 E. Ontario
Chicago 11, Ill.



MAKES INSULATED ELECTRICAL CONNECTIONS

Splices
Crimps
Strips
Cuts
WIRE



Only
\$3.95

AMP CHAMP HAND TOOL is an electrician's tool adapted for home workshops. Makes completely insulated splices and connections in house wiring, appliances, auto, etc. It crimps solderless terminals and connectors. It splices and strips wire. No tape or solder needed. It shears bolts leaving threads undamaged. Terminals, connectors and insulators free. \$3.95 postpaid. T. W. Berger, national dealer and consumer distributor. Aircraft-Marine Products, Inc., American Bldg., Cincinnati 2, Ohio

T. W. Berger, Inc., Distributor

1315-A, American Bldg., Cincinnati 2, Ohio

FREE!

with Kit

Terminals
Connectors
Insulators

Rush me a Champ Tool. I am enclosing \$3.95.

Name _____

Address _____

City _____

State _____

DO MORE PLANING JOBS WITH LOW COST BELSAW



Exclusive MONEY-MAKING Features: • Full 12 1/2" x 6" capacity • Power feeds at 24" a minute • Provides for Grinding Knives in the Cutterhead • Attachments for Jointing, Rabbling, Tongue, Groove, Matching. Convert low cost rough lumber into high priced cabinet finished stock ... Easy to make flooring and popular patterns. Send today for free literature and prices.

Belsaw Machinery Co., 1011 Field Bldg., Kansas City 11, Mo

LOW DOWN
PAYMENT
EASY
TERMS



FITS
SCREENS
TO 36" WIDE
PAT. PEND.

REPAIR SCREENS

Do a factory job with a
"RENCO" SCREEN STRETCHER

GUARANTEED

\$1.95 PLUS 25c POSTAGE. NO C.O.D.'s

RENCO-TOLEDO

819 REYNOLDS RD., TOLEDO 7, OHIO

LUTHY "Aero" TRIPLE ELECTRODE SPARK PLUGS

Outlast Ordinary Plugs 3 to 1

More MILES per Gal. — More R.P.M. —

Quicker Starts — TRIPLE ELECTRODES

For High Speed Performance!

Set of 6 \$5.34

Set of 12 \$7.12

LUTHY AERONAUTICAL SALES CO. Dept. 448
Jackson, Michigan
Canadian Address: Box 394, Hamilton, Ontario

Distributors
Wanted

Earn Big Money ARC WELDING!



NEW
air
cooled
gas engine
driven
arc welder



Transformer
Type Arc
Welder

Husky Boy
for indoor,
outdoor welding



Check and mail
with name and
address today!

- Husky Boy
 AC Trans. Type
 Hobart Trade
School, GI approved.
FREE booklet.

Cash in on the big demand for dependable arc welders. Set up your own shop — full or part time — with a Hobart and start earning hundreds of extra dollars.

HOBART BROTHERS COMPANY, BOX M-84, TROY, OHIO, U.S.A. Phone 21223

check
coupon
and mail

AUGUST 1954

255

NEW SURPLUS OIL CANSPOTS

For dispensing oil from one to five quart cans

SAVE 50%

Sale price—\$1.00 each or 6 for \$5.00. A \$10.00 value. Price includes all taxes and postage.

This is the well known 5 S canspot used for dispensing oil in nearly all service stations in the nation. This is genuine Army surplus. All spouts are new, and cadmium plated. Special prices on lots of 100 or more.

Special Prices on Lots of 100 or More

Pay by cash, check, or money order.

25% deposit on C.O.D.'s.

ARMY SURPLUS SALES

1820 TULARE STREET

FRESNO, CALIF.



Our 753rd Advertisement

REAL DIESEL ENGINE

\$3.95

- for planes, boats, midget cars
- 7500 RPM; 1/7 HP; ht. 3 1/2"; wt. 5 oz.
- precision machined for smooth operation

You just can't beat this price for a precision diesel engine! Streamlined, compact, easy to install. Thousands of satisfied users all over the world. Fast delivery if you ORDER TODAY! Send \$3.95 plus 25c postage.

GOTHAM HOBBY CORP. Dept. P, 107 E. 126th St. New York 35, N. Y.

Make your own Gems 29.50

The Gem Maker comes complete with all necessary equipment, including a super-charged diamond blade for sawing, and all wheels for grinding, shaping and polishing; also complete instructions. The complete equipment as shown, less motor and belt, for only \$29.50, f.o.b., Burlington, Wisconsin. Write today for information and literature.

B&I MANUFACTURING CO.
Dept. S Burlington, Wis.

FREE NEW POWER TOOL CATALOG

Gives full details on wide line of Millers Falls "Dyna-Mite" electric tools — including the most sensational new "does-everything" power tool ever developed. Also accessories, attachments, supplies. Now at printer. Reserve FREE copy. Write today: MILLERS FALLS COMPANY, Dept. PM-6, Greenfield, Mass.



IMAGINE! A COMPLETE CYLINDER and RING JOB

WITHOUT TAKING THE ENGINE APART

YALE Engine Overhaul PELLETS

- Stop Oil Burning
- Increases Gas Mileage
- Restores New-Car Power
- Save \$100 on Repairs
- Make Motors Run Quietly
- Eliminates Exhaust Smoking

\$4.95
POST PAID

Just drop Yale ENGINE-OVERHAUL Pellets into spark plug openings and . . . GO!!! While you drive, a factory smooth, metallic layer is plated over worn-cylinder walls and piston rings, restoring their precision fit and raising compression. JUST THINK! YALE ENGINE-OVERHAUL LASTS 10,000 MILES. Order Today!

SEND NO MONEY Just name and address. Pay postman \$4.95 plus postal charges or send cash and we will send postpaid. Satisfaction guaranteed.

J. BURTON ENGINEERING, 671 N. Clark, Dept. MB, Chicago 10

23 BOATS YOU CAN BUILD



You Can Build These Boats Without Experience With Few Tools, and Little Time to Spare!

And the best part is that after you have completed your boat, you will know it is seaworthy as well as eyeworthy. This book, a few tools, and some time each day in your garage or basement, is all you'll need to complete the boat of your dreams. Nothing is left to the imagination. Everything is planned for you before you turn back the cover of the book. All you do is follow simple step-by-step instructions and show how photos and drawings.

Building and Service Hints Provided

You'll learn how to build your boat right the first time. Success in building a boat depends on two things. Knowing beforehand exactly what type boat you want to build and then getting started correctly on the construction. With this book it's simple. Material lists are supplied where essential, listing lumber required, hardware, sailcloth, fittings, etc. Also included are hundreds of hints for building your boat right, the best boat for beginners, and tips on servicing boats after they are built.

Special Chapter on Boats for Sportsmen

If you are a sportsman, hunter, fisherman, trapper, or just plan to use your boat for pleasure, this chapter contains ideal craft for your use. Perhaps you have a canoe in mind, or a rowboat that can be carried on your auto. Maybe you have always wanted a duckboat but have been reluctant to purchase one because of the expense. All these boats plus a 3-sec-

tion rowboat, and 12-foot plywood outboard, are available in this one chapter alone. All are easy to construct, and beautiful to own. Step-by-step instructions, photographs and illustrations, plus important material lists carry you right through from the forming of the keel to the last coat of paint and varnish.

Half a Million Persons Build Their Own

There are more than half a million persons in the United States who regularly build boats for pleasure or for profit. They form a cross section of American life. And theirs is a double reward—the fun of building the boat, and the thrill of using it when it is finished.

Partial Listing of Boats

Think of being able to build and own the following boats: "Su-Lu" the PT-type Plywood Dinghy, 11-ft. Skiff, "Sport" a V-Bottom Inboard, "Tramp" a 15-ft. Sailing Knockabout, "Sea Craft" a 25-ft. Cabin Cruiser, "Zephyr" a 14-ft. Sailing Dinghy, "Arrowhead" a 21-ft. Sloop, a bicycle Boat, Motor-driven Paddle Board, "Skimmer" a Sturdy Plywood Kayak, "Skip" a Pram-Type Dinghy, "Tiny" a 6-ft. Training Ship, and many more, from large to small and at a fraction of the purchase cost!

7-Day Money Back Guarantee

Send for your copy of 23 BOATS YOU CAN BUILD today. Read and use it for 7 days. If it isn't entirely satisfactory return it for a full refund.

Use This Handy Order Coupon

POPULAR MECHANICS PRESS

200 E. Ontario St., Chicago 11, Illinois

Gentlemen:

Please send my copy of 23 BOATS YOU CAN BUILD. Enclosed is my remittance of \$2.00. If I am not completely satisfied with the book I will return it for a full refund after 7 days.

Name _____

Address _____

City _____ Zone _____ State _____



28-37 MILES PER GALLON?
The GANE AIR FLOW NEEDLE can give you up to 25% more gas mileage... anyone can install it. No special tools required. 2 Needles required for 8 cyl. cars. Can gain up to 2 or more miles per gallon. If fully satisfied after 10 days you pay only \$1.50 per needle. Don't pay Postman. Send no Money until satisfied on 10 Day Free Trial. Specify Year-Make Model & No. of cyl. of car.

MEHREN INDUSTRIES HOUSE OF FREE TRIAL
8666 W. Pico Blvd. Dept. PM-8 Los Angeles 35, Calif.

BUY WHOLESALE DIRECT

Save yourself up to 50% on famous nationally advertised appliances, watches, jewelry, sporting goods, guns, luggage, toys, cameras, auto supplies. Make extra money in sparetime buying for others at big savings. Start your own independent business without investment. Very profitable. Send card today for Free Copy of "Wholesale Idea."

SAVE
up to
50%

National Buyers Service, P.O. Box 426, Oakland, Calif.

SEND ONLY \$1 for next 6 issues of famous DELTA-GRAM, best home woodworking magazine you ever saw. Packed with shop-tested ideas—12 to 15 in each issue. Send \$1 (no stamps) to: Delta Power Tool Division, Rockwell Mfg. Co., 502H N. Lexington Ave., Pittsburgh 8, Pa.

Say You Saw It in Popular Mechanics



Treasure - Minerals - COINS

Easily located with new Light-weight M-Scope Detector. Superior performance, lowest price, monthly payment plan.

FREE LITERATURE
FISHER RESEARCH LAB., INC.
PALO ALTO CALIF.

Save Hundreds of Dollars Yearly With Guide to Home Repairs

Home Repairs, Modernizing Jobs Made Easy for Home Owners

Beat the high cost of home upkeep. Stop staggering labor costs. Save hundreds of dollars every year on carpentry, electrical, painting, plumbing and other jobs around the house with Popular Mechanics GUIDE TO HOME REPAIRS. Simplified how-to-do-it instructions and 646 pictures make all jobs, inside and out, easy. Covers construction, remodeling, modernizing, repairing, that you can do yourself at small cost. Repair leaky faucets for pennies; save \$10 to \$15 on new electrical outlets; save hundreds of dollars on new floors, porch repairs, tuck pointing, gutter replacements and other improvements. 192 page cloth bound book only \$2.50 postpaid. Get GUIDE TO HOME REPAIRS today under our money back guarantee.

POPULAR MECHANICS PRESS, Dept. PM1, 200 E. Ontario St., Chicago 11



CARPENTRY



ELECTRICAL WORK



INSULATION



PLUMBING

Make BIG SAVINGS With FACTORY-DIRECT PRICES!



HAND WINCHES AT FACTORY PRICES

3 to 1 ratio, 750 lb. pull, Drum has 1 1/2" spool, 6" flange. Takes 75 ft. of 3/16" cable. Stop locking pawl... \$16.95
24 to 1 ratio, Worm drive, 1000 lb. pull. Width 11" depth 7 1/2", height 7 1/2" \$26.00
10 to 1 ratio, Super-duty 4000 lb. pull. Double drum, with jaw type clutch, Wgt. 280 lbs. \$49.50

Electric Winches—Direct-to-You Prices

1/2 HP Master gearhead driven winch with drum. Will lift 500 lbs. Pull 1100 lbs. \$98.00
3/4 HP Electric Ball Bearing. Compact gear box. 12 RPM drum speed. \$165.00
3/4 HP, same as above. More lifting power, greater speed. \$185.00
Super-duty 3/4 HP Ball Bearing, with 24 to 1 worm gear reducer. Length 36", Width 20", Height 17". Pull 3500 lbs. Complete with 100 ft. of aircraft cable, up-and-down buttons... \$245.00
All electric motors Heavy-Duty. Repulsion-Induction. Instant Reverse. 110 V single phase. 3 phase available.
Complete Stock of Limit Switches, Magnetic Brakes, Magnetic Reversing Switches, Aircraft Cable

HEAVY DUTY ELECTRIC RUBBER & NEOPRENE CABLE

Submarine Cable: 2-Wire No. 10, can be used underground or overhead. 100 ft. to 1,000 ft. lengths. Regular 97c per ft.—Now 18c per ft.
15 Conductor No. 18, colored, 18 gauge, silk cover, slow burning. Regular 86c per ft.—Now 25c per ft.
20 Conductor No. 18, Neoprene Rubber covered, 300 ft. reels. In reels. per ft. regular 91c ft.—Now 30c per ft.
2-Wire No. 4, 75 ft. reels, with connectors. Regular value \$160—Now \$60.

Here are only a few big \$\$\$ savings! More in our catalog!

- | | | | |
|-----------------|-------------------|------------------|-------------------|
| Air Compressor | Electric Motors | Hand Truck | Rubber Cable |
| Air Tank | Electric Switches | Hydraulic | Rubber Wheels |
| Block & Tackle | Elevator | Cylinder | Saw Tables |
| Blowers | Drawing | Hydraulic | Shower Sprays |
| Bomb Trailer | Elevator Incline | Stacker | Starters |
| Buzz Saw | Fans, Exhaust | Beam Trolley | Tools |
| Compressor | Fans, Heat | Lawn Mower | Transformers |
| Accessories | Booster | Sulky | Winning Hoist |
| Clutches | Gas Engines | Magnetic Starter | Wilton Vise |
| Conveyors | Generators | Wall Chain Saw | Winch, Electric |
| Delta Tools | Grinders | Mail Grinder | Wrench, Hand |
| Drop Cords | 1/2 Ton Wagon | Pumps | Fire Extinguisher |
| Electric Hoists | Male Fire Pump | Reduction Gear | 4 Wheel Trailer |

Get this catalog! 88 pages, packed with useful charts, information, plans for dummy & incline elevators, more than 1100 tool and equipment items at money-saving, factory-to-you prices. Send 25c (refund with first order) or write on company letterhead for free copy.

C&H ELECTRIC MACHINE Co. Inc.

5348 W. Juneau Ave., Milwaukee 3, Wisconsin

BUILD YOUR OWN FAN



One-piece cast aluminum propellers for cooling and ventilating.

Size Inches	Polished		Unpolished		Bore Inches
	2 Blade	3 Blade	2 Blade	3 Blade	
15	\$3.00	\$4.00	\$2.50	\$3.00	1/2, 3/8, 3/4
18	3.75	5.00	3.00	4.00	1/2, 3/8, 3/4
20	4.00	5.50	3.25	4.50	1/2, 3/8, 3/4
24	4.50	6.50	4.00	5.50	1/2, 3/8, 3/4

Write for pamphlet on larger fan blades, wire guards, fan bases, shutters, pillow blocks, exhaust fan frames, etc. Dealers write for discount. Add 10% for packaging and shipping. Shipped C.O.D. or cash with order.

KLOPPENBORG ALUMINUM FDY., Dept. PM-54, Davenport, Iowa

PORTABLE JIG SAW

CUTS AS FAST AS SAWS
COSTING \$50 & UP!

Does work of Jig, Keyhole, Coping, Band Rip, Hacksaw. Has built-in air blower. Fits any 1/4" drill, cuts wood, plastics, metals.
At your dealer or try it on our 10-day trial. Send check, M.O. (Postpaid). C.O.D.'s—postage extra.

ARROW METAL PRODUCTS CO.

Dept. PM-8, 140 W. R'WAY., N.Y. 13, N.Y.

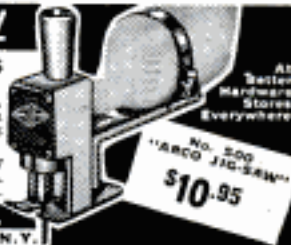

At Better Hardware Stores Everywhere

No. 200 "ARROW JIG-SAW" \$10.95

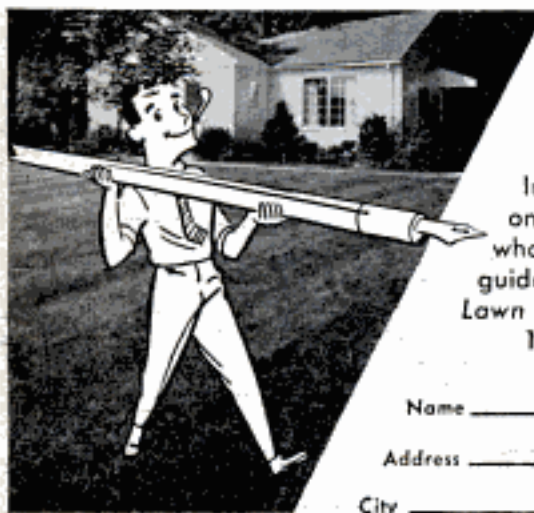

SIGN UP FOR Scott's LAWN CARE

Just fill in the coupon below to receive a free 2-year subscription. In each issue of Lawn Care you'll discover practical, seasonal tips on how to make your lawn thicker, greener, more beautiful the whole year 'round. Thousands of readers tell us, "With Lawn Care guidance you can have the finest lawn on the street." Sign up for Lawn Care today!

O M Scott & SONS CO

19 Fourth Street, Marysville, Ohio Also Palo Alto, California

Name _____

Address _____

City _____ Zone _____ State _____

WAR SURPLUS ADDITIONAL BARGAINS **SAVE UP TO 90%**

INTERIOR COMMUNICATION GONG



BAR CHIME Single stroke chime bar with sound well that gives clear resonated tone. Ideal for use indoors or out, for ranch or home, schools, plants, stores, etc. as signal system. Mfd. by Federal and Edwards & Co. Water tight construction. 115 Volt AC, 50 or 60 cycle, 1.8 Amps. Buy in single or multiple units. Wall mounting type complete with mounting bracket. Wt. 4 lbs. Approx. Govt. Cost \$37.50. NEW, closeout at \$5.95 ppd.

LOW VOLTAGE CIRCUIT TESTER

Made for U.S. Ordnance. Self-contained device makes complete & rapid check of generator battery circuit. Will check out any 6 or 12 volt system. Garages, mechanics, truck fleet owners, boat & marine mechanics. Guaranteed perfect. Shpg. Wt. 20 lbs. Approx. GOVT. COST \$175. NEW, complete with steel carrying case & instruction book. WHILE THEY LAST—\$29.75



SENSITIVE ALTIMETER in 10 Ft. Increments. NEW! Famous Pioneer! 0 to 35,000 ft. (Inches of Mercury). Tested and inspected in our own instrument lab. Guaranteed perfect. Approx. GOVT. Cost \$150. NOW ONLY \$12.95 PREPAID!



SENSATIONAL GENERATOR BUY!!

Famous Navy NEA-5 Generator. Combination AC-DC Type. AC voltage—115 V. DC voltage—24 V. 200 Amp. 2 complete generators in 1... 2 separate fields and 2 separate armatures on same shaft yet no larger than regular aircraft generator. Ideal for home, farm and shop lighting plants by hooking wires to AC side. DC side can be used for welding and operating war surplus low voltage hobby motors and equipment. Weight 54 lbs. NEW. Approx. GOVT. COST \$350. NEW \$27.50 used perfect \$18.00

MICROMETERS Chrome plated, precision engineered, carefully tool to give long life. All new 0-1" cap. \$2.25 ea. 1-2" cap. \$3.50.



Send 25¢ for big catalog. Bargains for everyone. Check. Money Order or Cash. 25% deposit on C.O.D. orders. Prices F.O.B. Culver City, Calif., unless otherwise stated.

AIRBORNE SALES CO., INC. DEPT. PM854
8501 Stellar Drive, Culver City, Calif.

Enjoy Modern Living · Make Your Home Worth More With This Popular Mechanics Book . . .



759 PICTURES

Above: How to lay a new roof over the old.

Right: New walls over the tired old walls. A few of the 83 modern kitchen ideas.



Below: Modern ceilings for old basements.

HOW TO Remodel Your Home

With Data on New Materials and Products Available to Home Owners

Here are hundreds of ways you can make a modern home out of an old house, make the house worth more and save money while doing it. If you own an old house or intend to buy one, get "How to Remodel Your Home" by E. R. Haas, formerly technical editor for Popular Mechanics. You can do the modernizing yourself or have it done for this vital book contains 547 methods and 759 illustrations covering complete modernization, adding rooms and living space, installing new kitchens and baths, adding closets, wardrobes, rumpus rooms. Complete face-lifting jobs for the outside and morale building jobs for the inside. Learn the joys and conveniences of modern living with this vital book prepared especially for the home owner. Mail coupon for your copy today.

Money Back if You Want It.

Get the book now. Check it for information that will help you improve your home for appearance, convenience and value. If not fully pleased return the book in 7 days and Popular Mechanics will refund every penny you have paid.

Big Book. Same Size as This Magazine.



What to Do! How to Do It! How to Cut Costs and Save

In this book—17 big helpful sections. They are:

From old to new—Your modern kitchen—Better bathrooms—Basement rumpus rooms—Curing wet basements—Attic space and dormers—Adding rooms to the outside—Porches and breezeways—Utilizing idle space—New look for outside walls—Modern interior walls—Heat-loss and humidity controls—Roof framing and covering—Windows that modernize—Entrances and doors—Variety in floors—Wiring, plumbing heating. In all—547 money-saving articles you can use.

CASH IN YOUR SPARE TIME

UP TO \$40 A DAY IN YOUR OWN BUSINESS. Easy to start repeat cash business at home with the New BELSAW...sharpening and setting circular saws, grinding planer and jointer knives. Low Cost, only \$15 down...Start to work the day your BELSAW arrives. No experience needed. Hundreds of jobs in your neighborhood. Send Today for Free Book, "Lifetime Security".



BELSAW MACHINERY CO.
3706-C Field Bldg., Kansas City 11, Mo.

FREE BOOK TELLS HOW

SHOPMASTER'S

NEWEST SENSATION

COMBINATION POWER TOOL



For Complete Information Write Dept. 1 ON
1214 S. 3rd St., Minneapolis, Minn.

SHOPMASTER, INC.

do it faster...better!



PLIERS, CHISELS, PUNCHES, SNIPS, ADJUSTABLE WRENCHES

Buy wherever fine tools are sold in U. S. and Canada.

KRAEUTER

Use Coupon to Get Remodeling Book

POPULAR MECHANICS PRESS, 200 E. Ontario St., Chicago 11

Send at once "How to Remodel Your Home," postpaid for \$2.95.

I understand I may return the book in 7 days for full refund.

Remittance for \$2.95 enclosed. Send book postpaid.

Send COD. I will pay postman.

Name _____

Address _____

City _____ State _____

FREE

Sixty-page illustrated Catalog on **FANS, Fan Kits, Fan Parts, and Blades**

PENNSYLVANIA WHOLESALE DISTRIBUTORS
108 NORTH 6th ST., PHILADELPHIA 6, PA.



MACHINE SHOP EQUIPMENT

The **NEW** edition of the famous Center Tool Co. Catalog is now ready! Every workshop owner should have a copy. 240 pages full of illustrations, descriptions, and prices of the latest tools made by best known manufacturers in U.S. You pay the cost of printing — \$1.00. We refund your \$1.00 with first order of \$25.00 or more. Prompt delivery on most tools. Send check or money order today!

CENTER TOOL CO.

108 Lafayette St., Dept. C, New York 13

GIGANTIC SURPLUS SALE!

- Paint Spray Outfits
- Gasoline Chain Saw
- Water Pumps
- Binoculars
- Tarpaulins
- Electronic
- Air Compressors
- Hydraulic Units
- Electric Tools
- Air Tanks
- Power Plants
- Display Lights
- Surveying Inst.
- Weed Spray Outfits

FREE CATALOG Burden Pays All Freight 1000s items. Send Card Today!

FREE CATALOG

BURDEN SALES COMPANY

803 "O" ST. LINCOLN, NEBRASKA

CRESCENT TOOLS

Give Wings to Work

ASK YOUR
HARDWARE
DEALER

Enjoy the Fascinating Story of the Horseless Carriage in

It's thrilling, fascinating, informative. From the very first gasoline-propelled buggy to the cars of today and the atomic auto of the future. The first cars—the men who made them—the scrambled start and development of the fabulous auto industry—the story of auto racing. 166 thrilling action pictures—old-time cars—racing cars—early auto advertising — automotive oddities. Listing of 2000 U. S. autos included. Ideal gift book. Cloth bound, only \$3.00 by mail. Money back if not pleased. Paper covered edition \$1.00 at newsstands.



POPULAR MECHANICS PRESS, Dept. PM15, 200 E. Ontario St., Chicago 11

Send for **FREE** Literature

on the New 1955

MIDWEST TELEVISION and RADIO Line

Featuring 21" and 27" TV Receivers



NEW LOW FACTORY PRICES

30 DAYS TRIAL EASY TERMS

TABLE MODELS • CONSOLES • CHASSIS

For its 35th Anniversary Year Midwest offers sensational values in big-picture VHF or All-Channel TV receivers in your choice of mahogany, walnut, or blond finishes with new performance features and long-distance reception. Also new 1955 Midwest 5-band Series 16 radios and radio-phonographs. Buy your new Television or Radio receiver direct from the Midwest Factory on 30 Days Trial... Easy Terms... and at **LOW FACTORY PRICES!**

SEND THIS COUPON ON 2c POST CARD FOR NEW 1955 FREE MIDWEST LITERATURE

MIDWEST RADIO & TELEVISION CORP.

Dept. 251, 909 Broadway, Cincinnati 2, Ohio

NAME _____

ADDRESS _____

CITY _____ ZONE _____ STATE _____



TESTS LIVE OR DEAD CIRCUITS UP TO 600 VOLTS!

NEW Desco CIRCUITRACER—thousands in use—by Auto-Lite, Bendix, General Electric, electricians, servicemen. For all electrical, Hi-Fi, radio-TV, automotive, aircraft, marine. Locates grounds, opens shorts. Tests tube filaments; plates, screens; vibrators, output voltages. Ind. AC or DC. Ind. through 20 megohms res. Tests your wiring before you apply power. Kit includes Incand. signal light, neon lamp, batteries, 12-pg book "Tracer Tips." Rugged lifetime constr. Ironclad money-back guarantee.

COMPLETE KIT \$4.95

POSTPAID
Does job of instruments from \$15 to \$50



Circuitracer

DESCO MFG. CO., 601 E. WALNUT, PASADENA 1, CALIF.

ORDER BY MAIL — FOR C.O.D. ENCLOSE DEPOSIT OF \$1.00

Dealers inquire



Say You Saw It in Popular Mechanics

See it!

Living plant and animal life in and around your home. Free Micro-Manual tells you how to use, where to look.

OVER 3,000 in use in schools, universities, by hobbyists. 15X eyepiece included in purchase price. 4X, 8X, 10X, 12X eyepieces available. See catalog. Excellent optics throughout. Plano, concave mirror. 6-aperture diaphragm, condenser. Triple revolving turret. All metal, heavy and substantial.

Mechanical stage is \$14.95 extra. Shipped in fitted hardwood cabinet, insured. Made by quality Japanese optical mfrs. to our rigid designs and specs.

10-DAY MONEY-BACK GUARANTEE. One third deposit on C.O.D. Calif. resid. add 3% state tax. Schools and Dealers inquire.

FREE Micro-manual & 44 pg. Catalog shipped with order or mailed free on request. Microscopes from \$9.95 up — telescopes, binoculars, slide-making supplies.



150-300-600 POWER

MODEL 615

\$29.95 POSTPAID

the AKRON

109 AKRON BLDG.

4379 SUNSET BLVD., LOS ANGELES 27, CALIFORNIA

FREE

AUTOMATIC AIR COMPRESSOR

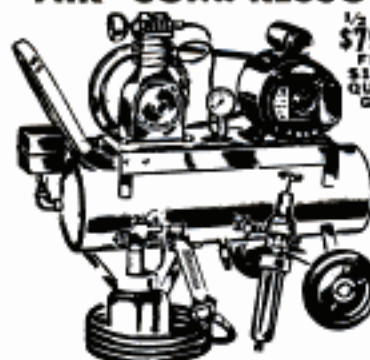

1/2 HP heavy duty R.I. or Cap. motor, 115-V, 60 Cy. AC... \$23.50
 X2 Quincy 3 CFM, 100-150 lb. compressor... \$20.50
 Automatic adjustable pressure switch... \$6.50
 Tank 8x26, rubber tired wheels and handle... \$17.00
 Adjustable pressure regulator and gauge... \$6.00
 Moisture filter—\$3.25
 V-belt drive... \$2.75
 Hose and tire chuck \$2.50
 Safety valve... \$1.50
 Check valve & copper tubing... \$3.75
 Small parts shipped parcel post prepaid at above prices.

Complete 1/2 HP unit assembled, ready to use—Plus Special FREE \$12.00 value Quart External Atomizing Spray Gun with every unit... \$54.5. \$89.00 FOB Chicago
 Save \$10.00 — 1/2 HP outfit knocked down, you assemble, free spray gun, \$12.00 value. —SK-5... \$79.00 FOB Chicago.
 —SK-100 — 1 HP Motor 15x30 Tank Twin Cylinder 9 CFM Compressor, All Access, You assemble, Free Gun... \$169.50 FOB
 Write for CIRCULAR: Listing Motors; ALL SIZES; Fans and Air Compressors—ALL SIZES.

C. MARSHALL SALES

3546 W. Fullerton Ave. Dept. P-8 Chicago 47

DRIVE 500,000 MILES

Without Need Of A Major Overhaul ENGINEERS HAVE PROVEN THIS POSSIBLE. They have shown that the combustion process produces more than a gallon of water in vapor or steam for every gallon of fuel burned. Some of these vapors enter crank case causing rust, varnish, acids and sludge.

INSTALL POWER VENTILATION—GET UP TO 2 or 3 MORE MILES PER GALLON—CUT ENGINE WEAR UP TO 40%—

Increase the overall operating efficiency of your car with amazing Moto-Vent. Positive Power Ventilation removes water vapors, sulphur and other corrosive materials that enter crank case. Not a "gimmick" or "gadget" but a precision engineered instrument designed to give better engine performance, up to 2 or 3 more miles per gallon and cut engine wear up to 40%. Oil and water vapors are fed back into the combustion chambers where they give you water injection and overhead lubrication. No extra oils or additives needed.

EASY TO INSTALL—DO IT YOURSELF. Fits all cars, trucks, tractors—old or new. Install Moto-Vent between oil breather and intake manifold in less than half hour. Will soon pay for itself.

FREE 30 DAY TRIAL OFFER. Moto-Vent complete with all fittings and easy to follow installation chart only \$4.95 postpaid, or, C.O.D. plus charges. Try for 30 days. If you are not completely satisfied, return for full refund. Send order or write for further FREE particulars, today!

PRECISION PRODUCTS CO., Dept. 20, Harvard, Ill.

PUMP WATER FAST!



DRAIN WASH TUBS, CELLARS, CISTERNS IRRIGATE—FILL TANKS—DRAW WELL WATER

Pumps 2800 GPH. 420 GPH at 75' High or 1600 GPH from 25' well. Sturdy, Rustproof Alloy Metal. Six Blade Impeller. Uses any 1/8 to 1/2 H.P. Motor. Will not leak or clog. Fits any garden hose. Immediate Money Back Guarantee. Send Check, M.O., or C.O.D. \$8.95 U.S.

MOORE MANUFACTURING CO.
 SWEDSBORO 1 NEW JERSEY

SAY YOU SAW IT IN POPULAR MECHANICS

HARDWARE MIXTURE Newly manufactured to ARMY-NAVY specifications. Not Surplus. Every item Cadmium plated to prevent rusting. Well mixed assortment of popular and useful sizes of bolts, nuts, washers, machine screws, cotter pins, clamps, locknuts, clevis bolts, rivets, lockwashers, sheet metal screws, etc. Hundreds of items to the pound. All shiny new and unused. 5 lbs. \$3.95; 10 lbs. \$7.75. Shipped prepaid. Add 10% west of Mississippi.

PYRALIN CLEAR PLASTIC SHEETS Can be used any place glass is used. Easily cut straight or curved with tin snips, and formed to any shape by light heating. Hundreds of uses around the workshop making windows, stormwindows, picture frames, furniture, jewelry, decorations, gifts, novelties, toys, etc. Sheet 20" x 50" x .080 thick. \$8.75, Express Collect.

AIRCRAFT ALUMINUM TUBING Soft enough to be bent, strong enough for table legs, conduit, bracing, toys, and dozens of other uses. Each piece complete with fittings. The tubing you receive may have a machine bend, (not kinks) which can be easily straightened. Available only in random lengths and diameters, approximately 3/16" to 3/4" I.D. and 2-4' long. Assorted: 50 ft. \$3.75; 100 ft. \$7.00; 250 ft. \$15.00, Express Collect.

No COD—Money back guarantee—FREE list of other items
WESTAIR, INC., 33 Virginia Road, White Plains, N.Y.

AIR CONDITION FOR ONLY \$26



Evaporative air conditioner easily assembled in minutes with screw driver, pliers. Heavy duty, rust resistant. Adjustable louvers direct air. Powerful 1/2 hp, 115-v AC shaded pole motor. Balanced fan. Rocky Mountain copper filter. Clog-free drip trough. Adjustable side panels for snug, easy window-fit. Brass metering valve, toggle switch, pipe connection, 2 1/2" tubing. Send \$5.00 m.o. or check; balance C.O.D. plus shipping. Pay full amount; save shipping cost. Supply limited—ACT NOW!

WEATHER MERCHANTS
 2913-A Gaston Avenue
 Dallas 4, Texas

MOTOR GUARANTEED FOR ONE YEAR

WOODCRAFTSMEN'S 144 page ENCYCLOPEDIA 15¢



Bargain book of every conceivable wood-working item and tools. Full of How-To-Do-It information, illustrations, projects and ideas. Domestic and imported woods, inlays, panels, etc. Send for your copy today. Biggest 15¢ worth ever offered.
CRAFTSMAN WOOD SERVICE CO.
 Dept. 448, 2729 S. Mary Street, Chicago 8, Illinois

Earn Big Money! DRY CLEAN RUGS



New Easy Way! Dry clean rugs on location in homes, stores—fast and easy—machine does hard work for you! Amazing ALM-13 machine with Float-Action Brush whirrs cleaning material into rug fibers—gets out grime, dirt like magic! Use rug at once. Also, use same machine with no-tool attachments to clean, wax, polish any floor—make extra profits! Write for details.

AMERICAN Floor Surfacing Machine Co.
 535 So. St. Clair St., Toledo 3, Ohio

MACHINE TOOL RECONDITIONING & THE ART OF HAND SCRAPING

— ILLUSTRATED —
 SEND TODAY FOR FOLDER DESCRIBING BOOK
MACHINE TOOL PUBLICATIONS, 382 Holly Ave., St. Paul 2, Minn.

THE FINEST IN SPRINKLERS

Cover any area 8 to 60 sq. ft. Only adjustable oscillator made to operate on 5 to 100 lbs. pressure. Self-lubricating, highest quality rust proof parts. Order now. Introductory offer...



\$19.95 ppd.

M. F. ENGINEERING, 13828 S. Western, Blue Island, Ill.

MORE For Your Money in a SHAW DU-ALL



Improved design, better value in 1 1/2, 2 1/2, 3.5 H.P. walking tractors. New, low cost, streamlined 2 1/2, 3, 5, 8 H.P. riding tractor, inexpensive, new 1 1/2 H. P. tiller that pulverizes up to 12 inch swath 6 inches deep, and less. Automotive gears on heavier models. Prices will please you. FREE CATALOG. Write today.

SHAW MFG. CO. 6682 N. 4th St., Columbus, Ohio

WELD BRAZE SOLDER CUT 4WAY ONLY \$14.75 f.o.b. factory



Acclaimed by thousands of Homeowners, Mechanics and Hobbyists as the welder of 1001 uses. Easily operated from properly wired 110 volt. AC or DC line. The ideal gift with a life-long use... Order today on 10 day money back guarantee.

FOUR-WAY WELDER CO., Dept. F2-H 1810 S. Federal St. • Chicago 16, Ill.

Complete with Twin Carbon Arc Torch and accessories... to handle all metal-craft work.

2500 lb. HOIST

A SURPLUS
\$100 VALUE
ONLY
2950
WITHOUT MOUNT

We've sold hundreds of these to garages, machine shops, truckers, boat yards and boat owners, etc. Has a 2500 lb. capacity through a 28 to 1 gear ratio. Has bronze worm gear drive, 18 feet of high tensile, steel cable, 3/16" in diam. Originally used as Bomb Hoist.

MOUNTING FRAME
Specially designed and engineered for the above hoist. Allows an easy universal mount. Frame ONLY **300**



NAVY SURPLUS PORTABLE WINCH HOIST
LIFTS 1500 POUNDS
Made for U.S. Navy Bar. of Ordnance, as a Bomb Hoist. Has a 21 to 1 gear ratio, 40" tubular one extension with a 3" pulley on the end. Drum has 12 ft. of 3/16", high tensile strength, steel cable. Handle has a ratchet brake. Ideal for "swing about", truck or platform loading. Overall length is 48". **2750**



RIGHT ANGLE DRIVE
Has direct 1 to 1 ratio through 90° bevel gears. Drive & take-off shafts are 3/8" diameter. Gears are self-lubricating, hi-speed steel. Ideal for use on power tools, flex drives, etc. Size: 2 1/2" x 2 1/2" x 1 1/2". **225**



180° OFFSET DRIVE
For use where tremendous power at low take-off RPM is desired. Drives through a chain of 6 gears, rotating a self-lubricating, hi-speed roller bearings. Has an 85 to 1 gear ratio. Take-off shafts are 1 1/2" and 3/8" diameter. USED **675**
NEW **1295**

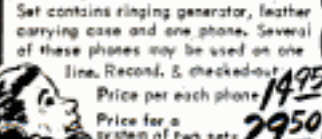

ARMY FIELD PHONES
A private phone or intercom system. Easy to operate. Ideal for use on farms, target range, mountains or forest or any place portable two-way communication is desired. Gives clear reception up to 15 miles. Uses two standard batteries. Set contains ringing generator, leather carrying case and one phone. Several of these phones may be used on one line. Recond. & checked-out. Price per each phone **1495**
Price for a system of two sets **2950**

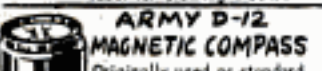

MACHETTE
Has 18", Vanadium steel blade. Hardwood handle. Belt sheath, 23" overall. **198**
A campers friend.

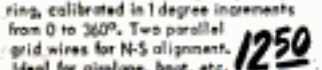

MARINE BOLD KNIFE
Top quality steel, 15" long. With belt sheath. **198**
Ideal for clearing brush.

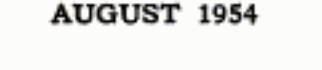

ARMY D-12 MAGNETIC COMPASS
Originally used as standard navigational equipment on all Army Aircraft. A real War Surplus BARGAIN. Has a rotating verge range ring, calibrated in 1 degree increments from 0 to 360°. Two parallel grid wires for N-S alignment. Ideal for airplane, boat, etc. **1250**

SAVE UP TO 85% ON GOVERNMENT SURPLUS

CENTRIFUGAL PUMP & MOTOR
DELIVERS UP TO 700 G.P.H.
Excellent for draining cellars, rock garden waterfalls, fish ponds, swamps, water circulators, evaporative coolers, etc. Powered by the famous G.E. 110 volt, 60 cycle motor. Has 1 inch standard pipe inlet - 3/4" to 1 inch hose outlet.
A Government Surplus Bargain - made to sell for many times our price. Completely reconditioned **\$20 VALUE ONLY 769** and ready to run.

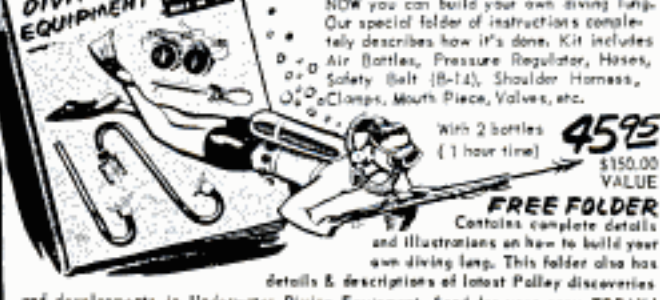
NOW! BUILD-IT-YOURSELF DIVING LUNG

NOW you can build your own diving lung. Our special folder of instructions completely describes how it's done. Kit includes Air Bottles, Pressure Regulator, Hoses, Safety Belt (8-14), Shoulder Harness, Clamps, Mouth Piece, Valves, etc.
With 2 bottles **4595**
(1 hour time) **\$150.00 VALUE**
FREE FOLDER
Contains complete details and illustrations on how to build your own diving lung. This folder also has details & descriptions of latest Palley discoveries and developments in Underwater Diving Equipment. Send for your copy TODAY!



GENUINE AN-6004-1 Type DILUTOR DEMAND PRESSURE REGULATOR
Recommended type. Gives proper regulation of air on demand. **1095**



LEAD WEIGHTS - SLETTED **85¢**
QUICK-RELEASE SAFETY BELT - For use with above slatted weights. **100**

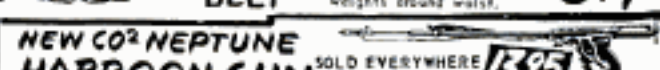

G.I. SURPLUS CARTRIDGE BELT
Individual pockets allow for exact distribution of ballast weights around waist. **89¢**

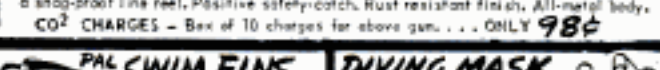

NEW CO2 NEPTUNE HARPOON GUN SOLD EVERYWHERE **1395**
AT \$29.95
Has JET POWER - Simplest, most efficient underwater gun we know of. Designed for one arm use. Weighs only 27 ounces. Has 13 ft. of 150 lb. test NYLON line on a snap-proof line reel. Positive safety-catch. Rust resistant finish. All-metal body. CO2 CHARGES - Box of 10 charges for above gun. **ONLY 98¢**



PAL SWIM FINNS
New, best grade. Of top quality flexible rubber with treaded bottom and adjustable heel strap. Will floor and are fully waxed for speed and protection. Vented for air and drainage. Sizes: Small, Med., large. **299**
95 VALUE



DIVING MASK
WITH 2 BUILT-IN SNORKLE TUBES
The famous Medusa mask. Fully covers both mouth & nose. Top quality. Has two built-in snorkle breathing tubes. **1095**

WORLD'S MOST AMAZING BARGAIN CATALOG

SAVE UP TO 85% ON WAR SURPLUS
1954 EDITION - 320 PAGES FULLY ILLUSTRATED
Packed with SENSATIONAL VALUES in WAR SURPLUS, FACTORY CLOSE-OUTS and GENERAL MERCHANDISE!
Thousands of items in Hand & Power Tools, Gadgets & Hobbyist items of all types, Outdoor and Sporting Equipment, Photo Supplies & Cameras, Hardware, Foam Rubber, Industrial Tools, Precision Instruments, Microscopes, Aircraft Parts, including the LARGEST stock of Hydraulic Cylinders, Valves, Pumps, Motors, Fittings, Tubing, etc. We have on hand over 20,000 cylinders in over 61 sizes and types. Send for your copy TODAY!
SEND 50¢ To cover HANDLING and MAILING COSTS... CREDITED to your first order.

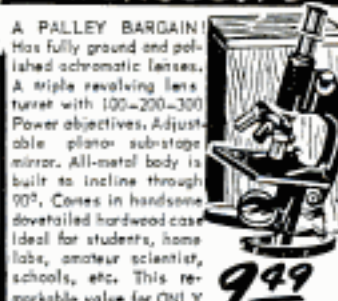

PALLEY SUPPLY CO 2263 E. VERNON AVE. DEPT. PM-B LOS ANGELES 58, CALIF.

100-200-300 POWER MICROSCOPE

A **PALLEY BARGAIN** Has fully ground and polished achromatic lenses. A triple revolving lens turret with 100-200-300 Power objectives. Adjustable plano-substage mirror. All-metal body is built to incline through 90°. Comes in handsome dovetailed hardwood case ideal for students, home labs, amateur scientist, schools, etc. This remarkable value for ONLY **999**



ARMY RIFLESCOPE AND SPECIAL MOUNT

A top quality Rifle Scope, built to rigid Gov't specifications - plus our own specially designed Mount. The Rifle Scope contains the finest, precision achromatic optics. Five double element lenses - fully corrected for spherical aberration and color. Has full 3 power magnification. Dat reticle. The newly developed Palley Scope Mount may be used with any type rifle. Has adjustments for windage and elevation. Will allow you to remove scope from mount for carrying or storage, and in addition you can remove the scope without disturbing your pre-set windage & elevation settings. Made of hardened alloy steel. Price for Scope alone ONLY **995**
MOUNT ALONE (without scope) **1500**
Scope and Mount, BOTH **2495**

SAVE 800 ON THIS NEW .22 CAL AIR RIFLE

Take advantage of our Bankrupt Stock BUY! SAVE! Made in Belgium for HyScore. Requires no pumping, just cock & fire. Has ALL STEEL fully rifled barrel, 17 1/2" long. A beautiful natural finish, hardwood stock. Takes .22 caliber pellets or darts. An ideal training rifle for youngsters and excellent for indoor target practice. Overall lgh. 40 1/2". Weight 5 pounds. Quantity limited. **1095**



AIR CORPS RUBBER BOAT
Ideal for rivers, lakes, oceans, etc. Made to top Gov't specifications. Reconditioned & ready

1 MAN **2295** 5 MAN **5995**
7 MAN **6995**
HAND AIR PUMP **3.95**

SAVE UP TO 85% ON WAR SURPLUS

1954 EDITION - 320 PAGES FULLY ILLUSTRATED
Packed with SENSATIONAL VALUES in WAR SURPLUS, FACTORY CLOSE-OUTS and GENERAL MERCHANDISE!
Thousands of items in Hand & Power Tools, Gadgets & Hobbyist items of all types, Outdoor and Sporting Equipment, Photo Supplies & Cameras, Hardware, Foam Rubber, Industrial Tools, Precision Instruments, Microscopes, Aircraft Parts, including the LARGEST stock of Hydraulic Cylinders, Valves, Pumps, Motors, Fittings, Tubing, etc. We have on hand over 20,000 cylinders in over 61 sizes and types. Send for your copy TODAY!
SEND 50¢ To cover HANDLING and MAILING COSTS... CREDITED to your first order.

Order From This Ad. Pay by M.O. or check. P.O.'s accepted from S&B firms. To deposit with C.O.D.'s. All Prices FOB Los Angeles.

COMPLETELY AUTOMATIC DIVING LUNGS



ONLY
59.50

Built to strict military & I.C.C. specifications send check or Money Order, today. Avoid seasonal rush! If C.O.D., \$15 with order. \$6 deposit holds unit. Illustrated literature on request.

DIVE-CRAFT, INC. Box 37, Wilmerding 8, Pa.

FIRST TIME
AT THIS LOW PRICE

RE-BREATHER TYPE

America's greatest value in a dependable quality shallow water (to 35 ft.) Oxygen Re-breathing set—needs no underwater adjustments. Brand new U. S. Navy surplus, made by Mine Safety Appliances Co. All accessories and instructions included. 2500# pressure gauge, nylon adjustable harness, quick release buckle, wrench. Rust-proof. Baralyme Chemical type; amazingly economical automatic demand mechanism. 2 hours underwater time!

DIVE-CRAFT, INC. Box 37, Wilmerding 8, Pa.



**OVER 700%
PROFIT!**
WITH THE
**PDQ CHAMPION
PHOTOMASTER**

Makes finished pictures in 2 minutes. Takes and finishes 30 to 40 everlasting, black and white or sepia photos an hour. No dark room. Guaranteed not to fade. Photos taken on "SUPER-SPEED" direct positive paper. Picture size 2 1/2 x 3 1/2 in. Complete, easy-to-operate portable photo studio. Size 4 1/2 x 5 x 10. Wt. 6 lbs. **700% PROFIT.** Write quick, get details about the great PDQ CHAMPION PHOTOMASTER.

P D Q CAMERA CO.
1161 N. CLEVELAND AVE. Dept. PM-854 CHICAGO 10, ILL.

Say You Saw It in Popular Mechanics

START YOUR OWN BUSINESS (FULL OR SPARE TIME)

with **ROTO-HOE**

In many communities we need active mechanically-inclined men as dealers to sell and service ROTO-HOE and attachments. It's pleasant, outdoor work and you will find it's easy too. These popularly priced power garden tools have won the hearts of tens of thousands of American home owners and gardeners—in fact, ROTO-HOE is now the largest selling tool of its kind in the world!

If you are not afraid to get out, make calls, and demonstrate ROTO-HOE, and do the small amount of servicing required, you should be able to develop your own highly profitable spare time (or full time) business—on a minimum investment. We furnish you names of prospects in your neighborhood also circulars, catalogs, and other sales material . . .

Write today for full information—it may be the opportunity you wanted for years!
ROTO-HOE & Sprayer Company, Box 19, Newbury, Ohio

JOINT AND SHARPEN ALL SAWS

SAVE TIME AND \$\$\$

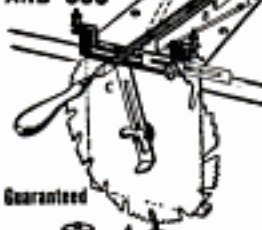

Sensational new Super Filer No. 11 joints and sharpens both hand and circular saws 6" to 10" with all teeth the correct height, depth, pitch and bevel. Easy to use—when file hits hardened steel roller, teeth are finished. Saw runs true and smooth with no side pull. Complete with special 8" file \$9.95 ppd. **FREE FOLDER.**

"TRU-CIRCLE" saw set. Automatically sets teeth at 10° or more \$2.95.

FILE SAWS THE RIGHT WAY

SO EASY with this new filing jig and jointer anyone can now sharpen any hand saw like new! When file hits hardened steel rollers teeth are finished and EXACTLY THE SAME HEIGHT. All teeth cut and saw runs true and smooth. Jig and instructions \$2.95 postpaid. Free Folder. **A. D. McBURNEY, 5908 Hollywood Blvd., Hollywood 28, Calif., Dept. A-44**

SHOP BY MAIL AT SCHUPACK

100 PIECES FOR ELECTRIC GRINDER \$1.00
2 CIRCULAR SAWS \$1.25
12MM SANDER SET \$1.25
12 MILLY CUTTERS \$5.00
SAFETY GOGGLES \$1.00

1001 TOOL BARGAINS

Send for this Amazing Schupack Bargain Catalog Today. Each and every item is fully illustrated—you can see what you get! It's crammed full of Brand New necessities for tool shops, factories, garages, home workshops and hobbyists all over the U.S.A. Save up to 100% on abrasives of all types, grinding wheels, mounted stones, sanding discs, circular saws, rotary cutters, miniature cutters, power drills, chisels, scrapers, and hundreds of other items. Write today—enclose 10c for postage and handling.

SCHUPACK SUPPLY CO.
7331 Cottage Grove Ave.
Dept. M-57, Chicago 19, Ill.

WHAT'S NEW ABOUT NEW SHOP SMITH

Everything! It's even more accurate, more versatile, easier to operate! See it at your dealer's now. For big, new, free booklet with 20 pages of pictures, data, drop a card to: **SHOPSMITH, Dept. 266-B, 12819 Coit Rd., Cleveland 8, Ohio**

BUILD YOUR OWN ARC-WELDER

We show you how to build NEW powerful welder. No rewinding. Uses most any surplus aircraft generator. Easy to build, 75-300 amps. Complete **PLANS 25c.** Send today and we'll include **FREE** our Big War Surplus & Electrical Catalog.

LEJAY MFG. CO., 1247 LEJAY BLDG., MINNEAPOLIS 8, MINN.

PUNCH PRESS

1 Ton Power Bench Type Make Your Shop Complete Powerful — Dependable — Economical
Easily make your own dies for light stampings, forming, riveting etc. Ideal for production or experimental work. Replaces more expensive presses. Uses 1/4 to 1/2 H.P. motor. Weight 165 lbs. Fully guaranteed. Only \$97.50 less motor. Write for free circular.
ALVA F. ALLEN
Dept. PM, Clinton, Missouri

Erect it yourself and SAVE!

- Easily assembled
- Steel or Aluminum
- Garages & Bldgs. for all purposes
- Shipped Anywhere **\$279 UP**

Write for Folder
JOHN COOPER CO., 306 2nd St., HACKENSACK, N. J.

TERRIFIC VALUES

GIANT 2000-2500

WATT PLANT
110-120 v. 60 cye. AC. absolutely the best made in the world—dynamically balanced armature; heavy windings develop up to 2000 watt overload for motor starting. Skid mounted—portable. Powered by an easy starting Briggs or 6 HP Wisconsin engine—complete with all accessories; engine easily disconnected for other uses. Big outlet box, voltmeter, no wiring necessary. Ample current for all purposes. Factory warranty. (Item 31) Wt. 210 lb. Reg. price \$585. Special at..... **\$299.50**
Same plant with electric self starter (Item 31a)..... **\$359.50**
Generator only and control box..... **\$169.50**
DUAL VOLTAGE 110-220 available on any of above models for \$28.00 additional.



(Item 31)

JET STEAM MASTER



Now, a new super efficient portable steam generator that provides live steam at 100 lbs. pressure in 60 seconds from a cold start! The first quality steam blower ever offered at this low price. Instantly cleans sticky grease, dirt, rust, oil, paint, etc., off motors—farm implements and road machinery. Pays for itself in a few weeks. Sterilizes as it cleans—milk machines, tanks, milk lines, hog houses, chicken houses and breeding pens. Ideal for sterilizing soil in greenhouses and hot beds—blowing out frozen earth, water pipes, materials, etc. Melts ice, snow in a flash. Fully automatic—oil fired with built-in water circulating pump. Draws water from faucet or from barrel or bucket. Simple and safe, anyone can use it—built-in safety valve. Complete with new triple efficiency jet steam gun—automatically mixes in soap or detergent if desired. Has 10" semi-automatic wheels. Wt. 250 lbs. (Item 463) Spec. factory price..... **\$298.00**

EXTENSION CORD

Use indoor or out. Resists oil, grease or water. Extends electricity up to 400 ft. without voltage drop. Complete with heavy rubber insulating and 14-2 conductor, stranded wire encased in a treated braided jacket. So tough that you can drive over it. Use indoors or out. Resists oil, grease or water. Extends electricity up to 400 ft. without voltage drop. Complete with heavy rubber insulating and 14-2 conductor, stranded wire encased in a treated braided jacket. So tough that you can drive over it. Use indoors or out. Resists oil, grease or water. Extends electricity up to 400 ft. without voltage drop. Complete with heavy rubber insulating and 14-2 conductor, stranded wire encased in a treated braided jacket. So tough that you can drive over it.

Item 161	40 ft.	2 1/2 lbs.	\$1.99
Combination	2-40 ft. and 1-20 ft. (total 100 ft.)		\$4.95
NEOPRENE CABLE #14-2 (Item 185) Heavy duty, very flexible, 20 year quality. Wt. 9 lbs. 100 ft. Complete with rubber plug and outlet. A terrific buy at only..... \$8.95			
NO. 12-2 POWER CABLE. Very flexible rubber covered, special outside shield for grounding power tools, etc. 50 ft. (Item 199) wt. 8 lbs. \$6.95. 100 ft. (Item 200)..... \$12.95			

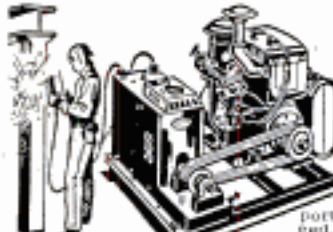

POWER MASTER DC ARC WELDERS
Now! a portable, rugged, industrial type welder with terrific performance, yet at a price hundreds of dollars less than you'd expect. Senior model made for years of trouble-free, continuous service. High capacity DC welding unit enables you to tackle any job with confidence—easily welds anything up to 2" plate using from 1/16" to 1/4" rods. Built-in stabilizer and cooling system makes an easy to strike and hold. Dual control rheostat provides low heat soldering, brazing and welding from 30 to 300 amps. Complete with instructions, guarantee and triple V-belt or flat pulley. You can pay more, but you can't buy a better welder.

COMPLETE POWER MASTER (Illustrated above) powered by a 1 1/2 hp., air cooled Wisconsin engine. Wt. 480 lbs. (Item 280). Compares with welder costing \$1200. Factory price..... **\$449.50**
WELDER ONLY—DUAL CONTROL MODEL. Same as above, but drive with your tractor, jeep or gas engine of 14 HP or more. (Item 38a.) Wt. 110 lbs. **\$119.50**
WELDER ONLY—STANDARD MODEL. Same as above but with single rheostat for heavy metal welding only. (Item 38.) Wt. 110 lbs. \$400 value. Special..... **\$99.75**
WELDING KIT Two 10 ft. leads, welding helmet, electrode holder, ground clamp. Sold only with welder at..... **\$10.50**

at MASTER MECHANIC'S

Direct from Factory Prices

PORTABLE LIGHT PLANTS

Ideal for your camp, cottage, trailer or boat!

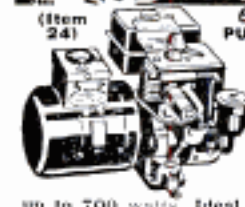

600-700 WATT PUSH BUTTON START
115 v. 60 cye. AC. Powered by a rugged 2 HP easy starting Briggs engine. No wiring necessary; just plug in and operate. Plenty of current for any oil burner, freezer, brooder, emergency lights, etc., which require up to 700 watts. Ideal for Civil Defense and Fire Dept. Complete with Voltmeter and built-in winding to charge 6 v. auto batteries. (Item 24.) Wt. 75 lbs. Easily fits in car trunk. Be prepared if storm knocks out..... **\$143.50**
1000-1200 Watt Plant (Item 45) same as Item 24 but larger generator and engine with 50% greater output..... **\$199.50**
1500-1700 Watt Plant (Item 20) similar to Item 24, but has three times more capacity. Wt. 175 lbs. Factory price..... **\$279.50**
LITTLE GIANT—350 WATT (Item 27) 115 v. DC 1 1/2 hp. Briggs engine. Perfect for lights, radios, small power tools. Wt. 65 lbs. Factory price..... **\$99.75**



(Item 21)

MASTER-LITE 2500 Watt Plant
110/120 v. 60 cye. AC. A powerful plant, ruggedly constructed and yet designed for easy portability. Can be started by rope or built-in 12 v. electric push button starter. Built-in winding to charge battery. Powered by a big 5.10 HP Briggs engine, complete with all accessories. Includes control box, voltmeter, and handy plug-in power receptacle. An ideal plant for permanent or stand-by service. Wt. 225 lb. Reg. price \$645.00..... **\$329.50** (Item 21) Factory Price
3000-3500 WATT PLANT (Item 198) 110-220 v. 60 cye. AC Belt Drive. Wls. engine Push Button Start. Wt. 370 lbs. **\$399.50**
GENERATOR ONLY for belt drive. **\$239.50**
We make fully automatic controls to operate any of the above light plants. Write for details. We make all sizes up to **25,000 Watts.**

9 TON HYDRAULIC PRESS

A tremendously powerful hydraulic press, capable of exerting 18,000 lbs. pressure. Pays for itself many times over—straightening bent connecting rods, king pins, crank shafts, axles, link pins and bars—or pushing out frozen bearings and bushings. Developed pressure under precise control and visible at all times on accurate gauge. Complete with both large and small axels and jigs to straighten any size of curve or bend. (Item 464) Wt. 110 lb. Actual list price \$365. Our special close-out price..... **\$69.50**

Variable Speed Selector
Heavy duty, made by B. F. GOODRICH for industrial use. Provides instant speed changes for any drive. For machine tools, dryers, printing, conveyors, production lines, hoists—any operation requiring variable speed. Employs reliable "trouble free" planetary system. No hydraulic power losses. Infinite range, smooth operation, easy installation. 3 sizes: 1 1/2-1 hp. 36 lbs.; 1-2 hp. wt. 55 lbs.; 2-3 hp. wt. 105 lbs. Reg. list \$228, \$252 and \$352. Our prices..... **\$79.50, \$89.50 and \$114.50**

AIR COMPRESSOR ACCESSORIES
Pressure Gauge, range 0-160 lbs. 1/4" pipe thread connection, 2" face..... **\$1.50**
Check Valve, solid bronze, 300 lbs. pressure, works in all positions. 1/4" or 3/8" pipe threads, (specify)..... **\$3.35**
Pressure Regulator, solid brass, std. 1/4" pipe thread, reduces any pressure to a range of 0-50..... **\$3.75**
Pop (safety) Valve, adjustable from 0-200 lbs. 1/4" pipe thread..... **\$1.40**
SPECIAL..... All four above..... **\$8.95**
Pressure Switch for pumps and compressors, 0-85 lbs. \$5.95; 0-150 lbs. with unloader 3 HP. 240.95; 0-200 lbs. 15 HP. **\$12.95**

44 PC. SOCKET SET
Highest quality guaranteed non-breakable sockets made by Husky. Beautifully matched chrome thin wall alloy absolutely the best. Complete range of 21 sockets from 1/4" thru 7/16" (1/4" drive) & 7/16" thru 1-1/16" (3/8" drive). Two extensions, reversible 1 1/2" ratchet, 3 drift punches, sliding "T" head, all angle coupling, 1/2" speeder, 1/4" breaker, 5 pc. high chrome alloy combination wrench set and 8 pc. offset wrench set in big doghouse tool box with ample room for other tools. Reg. \$49.50. Wt. 16 lb..... **\$21.95**

SAVE UP TO 85%

DIESEL LIGHT PLANT

(Item 1660) Diesel Master—1 1/2 kw. 115-230 v. AC single or 3 phase, 1800 rpm direct connected. Electric self-starting. Engineered for permanent power where continuous low-cost, heavy duty service is important. Wt. 1350 lb. Reg. list \$3650.00. Factory price..... **\$1895.00**



(Item 1660)

18-11 kw. GAS DRIVEN PLANT. 115-230 v. 60 cye. AC. single or 3 phase, powered by 4 cylinder Wisconsin air cooled engine. Belt driven. Simple, reliable, 5 V-belt drive mounted on rubber skid. (Item 213) (with crank start) **\$1075.00**
Same plant with self-starter..... **\$1145.00**

CONDITIONAIRE ATTIC FANS

Now, at new low cost, you can relax... live and sleep in cool comfort. Master Mechanic's attic fans exhaust stale, hot humid air, pull in fresh cool air. High contour blade design and venturi shaped frame move large volume of air—cool the entire house in a few minutes at quiet low speed. Dynamically balanced blade, rubber mounted shaft and motor, assure smooth quiet operation. Pre-drilled frame is easily mounted in a few minutes, just cut opening and built in place. Complete with heavy duty 1/4 or 1/2 hp. electric motor. Conditionaire fans are built in our factory—you buy them at low factory prices.



Blade Opening	Rooms	Wt.	Item	Price
24"	24 x 24	5 75 lb.	555	\$66.50
30"	34 x 34	7 90 lb.	555a	\$74.50
36"	40 x 40	9 105 lb.	555b	\$82.50
42"	46 x 46	11 150 lb.	555c	\$92.50

Add \$6.00 to above prices for horizontal mounting.

HEATING & VENTILATING FAN

(Item 10) Easily installed in furnace pipes. Forces even heat in all rooms. Over range moves kitchen smoke and odors. Powerful continuous duty motor, 110-120v. AC. Mount in wall or ceiling to ventilate any area. Quiet, super-efficient fan moves huge volume of air, 3400 to 600 CFM.

8" Fan, wt. 5 lb.	\$6.85
9" Fan, wt. 6 lb.	\$7.85
10" Fan, wt. 7 lb.	\$8.85
12" Fan, wt. 8 lb.	\$9.85



HEAVY DUTY FAN. Semi-enclosed motor, suitable for spray booths, restaurant exhausts, poultry houses, etc. 10" Fan, wt. 8 lbs. (Item 10E)..... **\$11.95**
12" Fan, wt. 10 lbs. (Item 10D)..... **\$12.95**

CONDITIONAIRE VENTILATING FANS

Save our money installing your own exhaust fan. Efficient propeller type blade moves huge volume of air quietly and effortlessly. Heavy welded frame—pre-drilled for easy installation. Just cut opening and bolt in place. Continuous duty motors. Ideal for attics, restaurants, garages, barns, chicken houses, etc. Control manually or with thermostat.

Blade Opening	CFM	Wt.	Item	Price	
16"	1814"	2925	17 lb.	365a	\$27.95
18"	1984"	3400	27 lb.	365b	\$31.95
20"	2154"	4100	30 lb.	365c	\$39.95



THERMOSTATS; BARN type (range 40°-60°), Wt. 2 lbs. **\$6.95.** **ATTIC type** (50°-90°), Wt. 2 lbs. **\$11.95**

52 pc. SOCKET SET

Highest quality guaranteed non-breakable sockets made by Husky. Beautifully matched chrome thin wall alloy absolutely the best. Complete range of 21 sockets from 1/4" thru 7/16" (1/4" drive) & 7/16" thru 1-1/16" (3/8" drive). Two extensions, reversible 1 1/2" ratchet, 3 drift punches, sliding "T" head, all angle coupling, 1/2" speeder, 1/4" breaker, 5 pc. high chrome alloy combination wrench set and 8 pc. offset wrench set in big doghouse tool box with ample room for other tools. Reg. \$49.50. Wt. 16 lb..... **\$21.95**

44 PC. SOCKET SET
Highest quality guaranteed non-breakable sockets as above. Complete range of 21 sockets from 1/4" thru 7/16" (1/4" drive) & 7/16" thru 1-1/16" (3/8" drive). Two extensions, reversible 1 1/2" ratchet, 3 drift punches, sliding "T" head, all angle coupling, 1/2" speeder, 1/4" breaker, 5 pc. high chrome alloy combination wrench set and 8 pc. offset wrench set in big doghouse tool box with ample room for other tools. Reg. \$49.50. Wt. 16 lb..... **\$21.95**

Send check or M.O. Prices f.o.b. factory. 10 Day Money back guarantee. SEND 16c for... **BIG 1954 Catalog**

MASTER MECHANIC MFG. CO., DEPT. 300

Burlington, Wis.

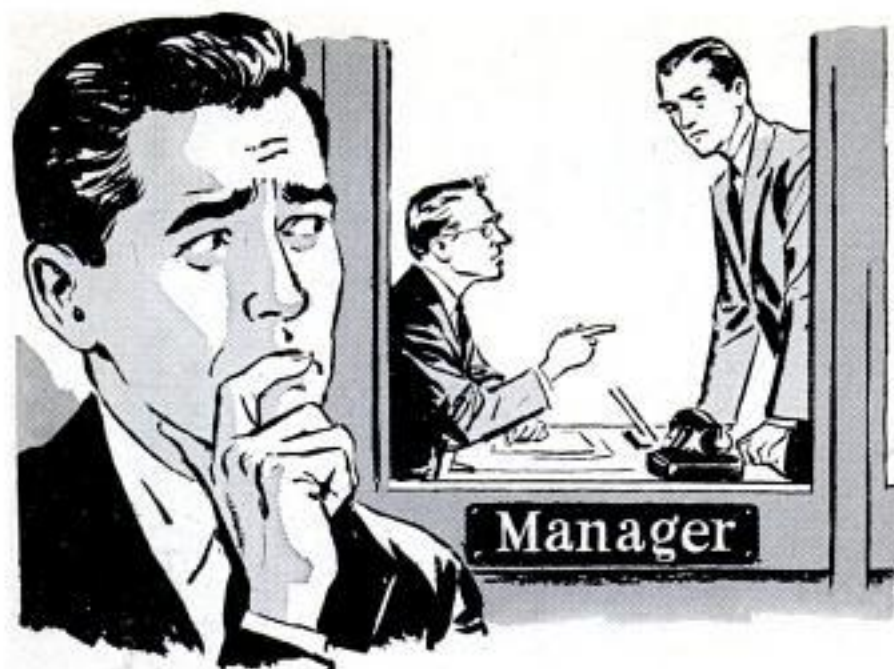

What's your boss saying about you?

The door is usually open. Today it's closed. They're talking about you . . . about your future. You don't have to hear to know what they're saying. Because there's nobody who knows more about you and your present job than you.

O.K. . . . So you have "experience." Five years on the same job.

Have you *mastered* the job . . . learned everything there is to know about it?

If your answer is "yes," success is right around the corner. But if the answer is "no," then your experience doesn't amount to much. And chances are these things are true about you: you just "coast" along with things . . . you do nothing and go

home all tired out. BEWARE! Those are danger signals. Unless you take a fresh look at things, you'll be doing the same job at the same salary for the next five years. And the next five.

What you can do about your future

If you want to succeed . . . make more money, earn the respect of your family and community . . . you have to take the bull by the horns. Success doesn't just come along. You have to meet it halfway. So act NOW and make your experience mean something. Add I.C.S. training to your record and start going places. Do it at home, in your spare time, for a few cents a day.

Does it work? These facts answer that. A recent survey shows that in a single 120-day period, 1973 I. C. S. students were promoted to better jobs. If you had acted a year ago, one of them could have been you. So mail the coupon below today.

Pick your favorite subject

277 I. C. S. courses to choose from. 203 expert I. C. S. instructors to give you personal help. No time or expense going to and from classes. No interference with business and social life.

Your first step

Sit down *right now* and fill out the coupon below. Check your favorite subject. I. C. S. will send you FREE and without obligation of any sort, two books. One, "How to Succeed," tells you how to start climbing to the top. Second book outlines the opportunities in the field of your choice. Don't waste any more time. DO something about your future!



For Real Job Security—Get an I. C. S. Diploma!

I. C. S., Scranton 9, Penna.

INTERNATIONAL CORRESPONDENCE SCHOOLS

ICS

BOX 5629-L, SCRANTON 9, PENNA.

(Partial list of 277 courses)

Without cost or obligation, send me "HOW TO SUCCEED" and the opportunity booklet about the field BEFORE which I have marked X:

ARCHITECTURE and BUILDING CONSTRUCTION

- Air Conditioning—Refrig.
- Architecture
- Building Contractor
- Building Maintenance
- Carpenter and Mill Work
- Estimating
- Heating
- Painting Contractor
- Plumbing
- Reading Arch. Blueprints
- Steamfitting

ART

- Cartooning
- Commercial Art
- Fashion Illustrating
- Magazine Illustrating
- Show Card and Sign Lettering
- Sketching and Painting

AUTOMOTIVE

- Auto Body Rebuilding
- Auto Elec. Technician
- Auto-Engine Tune Up
- Automobile Mechanic

AVIATION

- Aeronautical Engineering Jr.
- Aircraft & Engine Mechanic

BUSINESS

- Advertising
- Bookkeeping and Accounting
- Business Administration
- Business Correspondence
- Certified Public Accounting
- Creative Salesmanship
- Federal Tax
- Letter-writing Improvement
- Managing Small Business
- Office Management
- Retail Business Management
- Sales Management
- Stenographic-Secretarial
- Traffic Management

CHEMISTRY

- Analytical Chemistry
- Chemical Engineering
- Chem. Lab. Technician
- General Chemistry
- Natural Gas Prod. & Trans.
- Petroleum Engineering
- Plastics
- Pulp and Paper Making

CIVIL, STRUCTURAL ENGINEERING

- Civil Engineering
- Construction Engineering
- Highway Engineering
- Reading Struct. Blueprints
- Sanitary Engineering
- Structural Engineering
- Surveying and Mapping

DRAFTING

- Aircraft Drafting
- Architectural Drafting
- Electrical Drafting
- Mechanical Drafting
- Mine Surveying and Mapping
- Ship Drafting
- Structural Drafting

ELECTRICAL

- Electrical Engineering
- Electrical Maintenance
- Electrician Contracting
- Linemen

HIGH SCHOOL

- Commercial
- Good English
- High School Subjects
- Mathematics

LEADERSHIP

- Foremanship
- Industrial Supervision
- Leadership and Organization
- Personnel-Labor Relations

MECHANICAL AND SHOP

- Gas—Electric Welding
- Heat Treatment Metallurgy
- Industrial Engineering
- Industrial Instrumentation
- Industrial Supervision
- Machine Design-Drafting
- Machine Shop Inspection
- Machine Shop Practice
- Mechanical Engineering
- Quality Control
- Reading Shop Blueprints
- Refrigeration
- Sheet Metal Worker
- Tool Design Toolmaking

RADIO, TELEVISION

- Electronics
- Practical Radio—TV Eng'ng
- Radio and TV Servicing
- Radio Operating
- Television—Technician

RAILROAD

- Air Brakes Car Inspector
- Diesel Locomotive
- Locomotive Engineer
- Section Foreman

STEAM AND DIESEL POWER

- Combustion Engineering
- Diesel—Elec. Diesel Eng's
- Electric Light and Power
- Stationary Fireman
- Stationary Steam Engineering

TEXTILE

- Carding and Spinning
- Cotton, Rayon, Woolen Mfg.
- Finishing and Dyeing
- Loom Fixing
- Textile Designing
- Textile Eng'g Throwing
- Warping and Weaving

MISCELLANEOUS

- Domestic Refrigeration
- Marine Engineering
- Ocean Navigation
- Shipfitting
- Short Story Writing
- Telephony

Name _____ Age _____ Home Address _____

City _____ Zone _____ State _____ Working Hours _____ A.M. to P.M. _____

Occupation _____

Canadian residents send coupon to International Correspondence Schools, Canadian, Ltd., Montreal, Canada. . . . Special tuition rates to members of the U. S. Armed Forces.



Take a vacation in your car...



Travel by air...



...or go fishing.

3 Easy Ways to Ruin Your Battery This Summer

...and two ways to make it last longer

by Frank E. Williams, Inventor of the Life-Time Battery

YOU MIGHT AS WELL BE WARNED right now that I believe my company makes the best battery in the world—the *Life-Time* battery—that we guarantee it for six years, and that my purpose in writing this is to convince you that you ought to buy one.

Obviously, our chances of selling you a battery with a six-year guarantee are better if your present battery conks out for keeps after you've had it only a few months... which often happens.

I don't mind telling you why ordinary batteries fail and how to make yours last longer, because this is the quickest way to explain how we solved some technical problems in developing the *Life-Time* battery.

Why Your Battery Fails

Although you often don't realize your battery is done for until the first cold morning,

what ruins ordinary batteries is actually not cold, but heat.

One way to overheat your battery is to take a long summer trip with your generator set a little too high. Another way: leave your car at home in the garage while you're away on vacation. As the water evaporates, your battery plates dry out and harden permanently in summer heat. The same thing can happen if you go fishing for a couple of weeks and leave the car with your wife without telling her to have the water level checked regularly.

The cruel fact is that an ordinary battery is a fairly delicate thing.

Why Can't Better Batteries Be Built?

Twelve years ago, I asked myself that question. First, I reviewed every plate material that had been tried since Volta's original battery in 1801, including Ritter's gold-

ammonia battery and Gautherot's platinum plate experiments over 150 years ago. Working with metallurgists, it was fairly easy to find an alloy—now called the "neutronic plate"—which we developed for higher power.

But the big problem—heat—still had to be solved. Ordinary material used for the insulators that keep battery plates apart breaks down under heat and acid—allowing the plates to buckle and short. We either had to find a new insulating material, or find a way to keep batteries cooler.

As it happened, we did both. We found a porous synthetic insulator that was completely unaffected by acid, yet let the acid circulate freely, acting as a built-in cooling system.

Torture-Testing the Life-Time Battery

Tested by one of the largest U. S. laboratories, the *Life-Time* battery cranked an engine for over 17 minutes and 57 seconds in 160-degree heat without damage! Later, in the cold test, it ran for 17 minutes and 54 seconds!

Other tests proved an amazing thing: the best time to get a *Life-Time* battery is in Summer. Much like breaking in a new car, the *Life-Time* battery will get better with use, gaining power for Winter.

How Long Will the Life-Time Battery Last?

We guarantee the *Life-Time* battery for six years—a figure called "conservative" by the multi-million-dollar company which backs our bonded guarantee. Actually, it may last considerably longer: recently, for example, we have started adding Tellurium (atomic number 52, with 3 isotopes) to our grid metal for still longer life.

How Much? And Where?

The *Life-Time* battery sells for one price for all cars: \$29.95 for six-volt sizes, \$34.95 for 12-volt; both guaranteed for six years (saving you about \$100 over normal battery replacements and a lot of trouble during the next six years).

Ten thousand dealers have the *Life-Time* battery. If you don't know the address of your nearest *Life-Time* dealer, you can order by mail from the coupon below and we'll have your nearest dealer install a *Life-Time* battery for you.

Shock-proof Catalytic Case

Greater reserve fluid capacity

Synthetic insulators keep battery cooler



Super-power Neutronic plates

Dealers and Distributors Needed to Fill Orders

If you have a retail business and would like to fill orders from ads like this reaching 50,000,000 motorists, plus radio and TV sponsorship of the Indianapolis "500" and the Pan-American Road Race, fill out the coupon below.

If you can warehouse and deliver *Life-Time* batteries to our dealers in your area, write us about distributor territories open:

Continental Manufacturing Corporation
Dept. PM-8
Washington Blvd. at Motor Avenue
Culver City, Calif.

Dealer Information Request

Continental Manufacturing Corporation
Dept. PM-8
Washington Blvd. at Motor Avenue
Culver City, Calif.
Gentlemen:

I have a retail business and am interested in filling orders here for *Life-Time* batteries. Please rush me complete information about a dealership.

Name _____
Address _____
City _____ Zone _____ State _____

Continental Manufacturing Corporation
Dept. PM-8
Washington Blvd. at Motor Avenue
Culver City, Calif.

Gentlemen:
Please have my nearest dealer or warehouse install a *Life-Time* battery in my

Make, model, year of car or truck _____
I enclose \$29.95 for 6-volt \$34.95 for 12-volt; there will be no charge for shipping or handling.
I enclose \$5.00 deposit, will pay the balance on arrival.

Name _____
Address _____
City _____ Zone _____ State _____

Diagram at right shows how thinner insulators (gray) allow use of thicker, more powerful plates (black) in *Life-Time* than in ordinary battery at left. © 1954

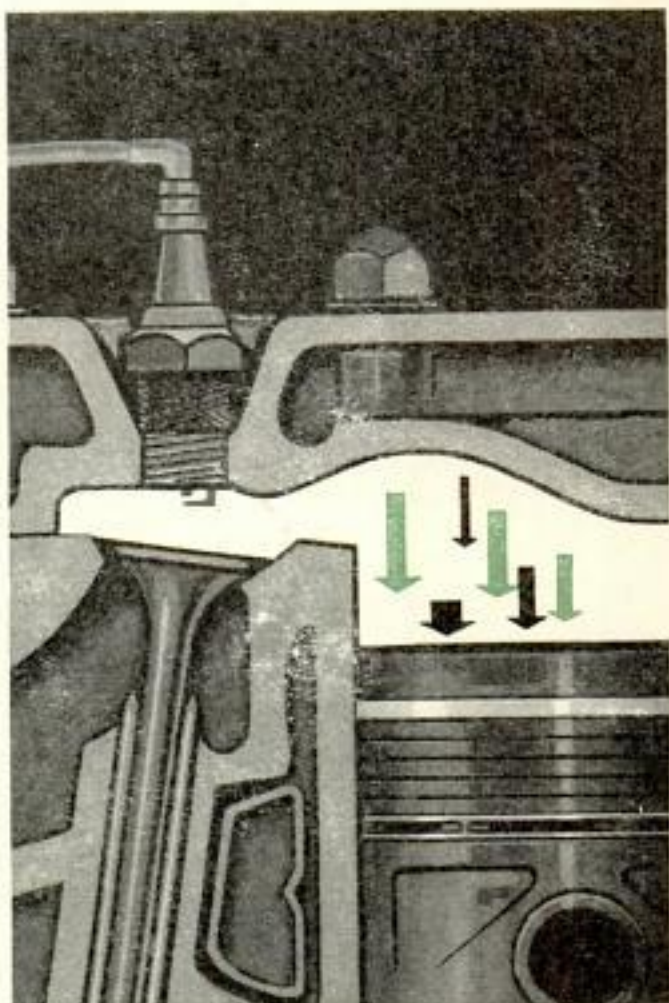
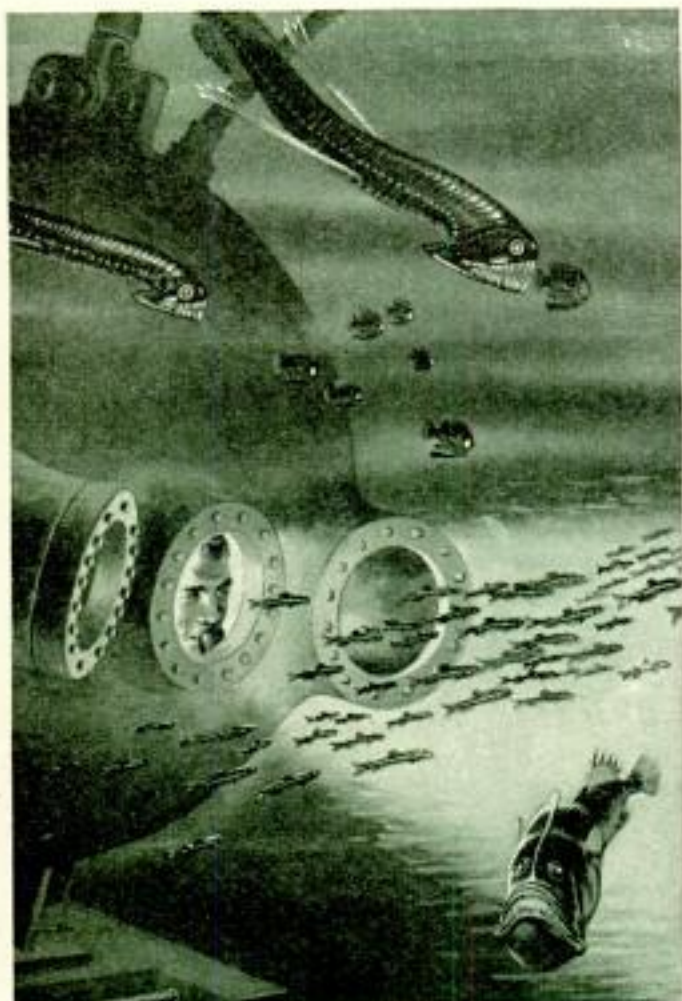

WHERE IS PRESSURE GREATER...

*100 fathoms under the sea
...or inside your car's engine?*

When combustion occurs, pressure within the cylinders of your car's engine goes as high as 600 lbs. per square inch...actually twice as high as the pressure at 100 fathoms below the sea!

Old style top piston rings, operating where pressure is greatest, heat is highest, and lubrication is poorest, wear *twice* as fast as modern chrome rings. But in Perfect Circle's 2-in-1 Chrome Piston Ring Set, BOTH the top ring AND the oil ring rails are chrome plated...assuring thousands of extra miles! Perfect Circle Corporation, Hagerstown, Ind.; The Perfect Circle Co., Ltd., Toronto, Ont.

PROTECTION WHERE
PRESSURE IS GREATEST



SOLID CHROME PLATING on both top and bottom rings gives complete wear protection throughout entire area of ring travel. Rings are lapped-in at factory, making tedious break-in unnecessary.

Perfect Circle

2 in 1 Chrome Piston Rings
THE STANDARD OF COMPARISON

Copyrighted material