

JULY 1954

35 CENTS

# POPULAR MECHANICS

## MAGAZINE

WRITTEN SO YOU CAN UNDERSTAND IT

U.S. TRADE MARK FOR ALL RIGHTS RESERVED



*The Cover:*

**Robot TV Sights Forest Fires**  
—Page 97

**THE '54 FORD**  
AND WHAT WE THINK OF IT

—By Floyd Clymer and the Ford Owners Themselves

*For the Craftsman*  
**Build Your Own Portable Barbecue**



# It's America's *VERSATILE* Outboard!



If you're thinking of "a little more power" for your boat, better think of the Sea-Horse 10. You can fish with it—just as you do with a little motor. You can carry it. You can handle it easily. *Yet it will power a real load smartly and swiftly!*

With 10 full horses you get that extra margin of power required to lift a runabout into a plane, without falter — *and with company along.* You've got power to tow water skiers. Even among cruiser owners, there are those who prefer the "10" to any other size.

It's amazing versatility is making the Sea-Horse 10 America's most popular outboard. There's nothing sweeter on water!

**FREE!** New 1954 Sea-Horse Catalog, packed with data on new outboard developments. Write for it . . . See your Johnson Dealer. Look for his name under "Outboard Motors" in your classified phone book.

**JOHNSON MOTORS, 400 Pershing Road, Waukegan, Illinois**  
*In Canada: Mfd. by Johnson Motors, Peterborough*

## THE NEW 1954 SEA-HORSES

**ELECTRIC STARTING SEA-HORSE**  
**25 — 25 hp.** . . . . . \$498.00\*  
**SEA-HORSE 25—25 hp. Ready-Pull starting.** . . . . . \$410.00\*  
**SEA-HORSE 10—10 hp. The fast "all-around" motor.** . . . . . \$297.50\*

**SEA-HORSE 3½—"Suspension Drive" sensation. It's QUIET** \$210.00\*  
**SEA-HORSE 3—32-lb. twin!** . . . \$145.00  
**SHIP-MASTER REMOTE CONTROL—Shift-and-throttle. Fits "5½," "10", both "25's."** From . . \$29.50

 All prices f.o.b. factory, subject to change. OBC certified brake hp at 4000 rpm. \*Includes Mile-Master Fuel System.



SEA-HORSE 10

## HIGHLIGHTS:

Equipped with full size fuel system (6-gallon Mile-Master) for long range operation. Fitted for remote control of throttle, shift and steering. Full Gear Shift, Twist-Grip Speed Control. Air Intake Silencers. Up-and-Off Motor Hood. Hi-torque performance — brilliant getaway.

**Johnson** **SEA-HORSES**  
**FOR DEPENDABILITY**



# PACKED WITH POWER TO SPARE!



Double Eagle—T. M. The Goodyear Tire & Rubber Company, Akron, Ohio

## The New Double Eagle 125 Battery

One look at the impressive facts below quickly shows why Goodyear's new Double Eagle 125 is the first truly *modern* battery for modern cars!

- 1 67% more starting stamina than other batteries of its size and type (Group I).
- 2 39% greater power reserve—for operating accessories.
- 3 Grids 33% more resistant to battery-killing overcharges.
- 4 Rubber and glass insulation around *each* of the 19 power-producing plates — for longer, more efficient life.
- 5 Jet-styled Polystyrene case—lighter, and twice as strong as the finest rubber case.

**It's Dry-Proof, Too!** 3½ times more fluid above plates means filling only 3 times a year in normal use.

**Attention Vacationists:** If your present battery is 1½ years old or more, it could die on your trip—out where you might have to buy an "off brand." Why not play it safe? See your Goodyear Dealer this week end about installing the dependable and power-packed Double Eagle 125. Goodyear, Battery Dept., Akron 16, Ohio.

# GOODYEAR

BATTERIES FOR AUTO, TRUCK AND TRACTOR



We think you'll like THE GOODYEAR TELEVISION PLAYHOUSE—every other Sunday—NBC TV Network

JULY 1954

This One



Z5WT-SS0-Q47W

1

Copyrighted material



*The Bell Solar Battery. A square yard of the small silicon wafers turns sunshine into 50 watts of electricity. The battery's 6% efficiency approaches that of gasoline and steam engines and will be increased. Theoretically the battery will never wear out. It is still in the early experimental stage.*

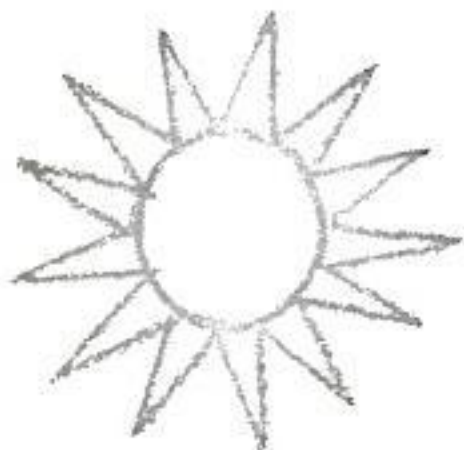
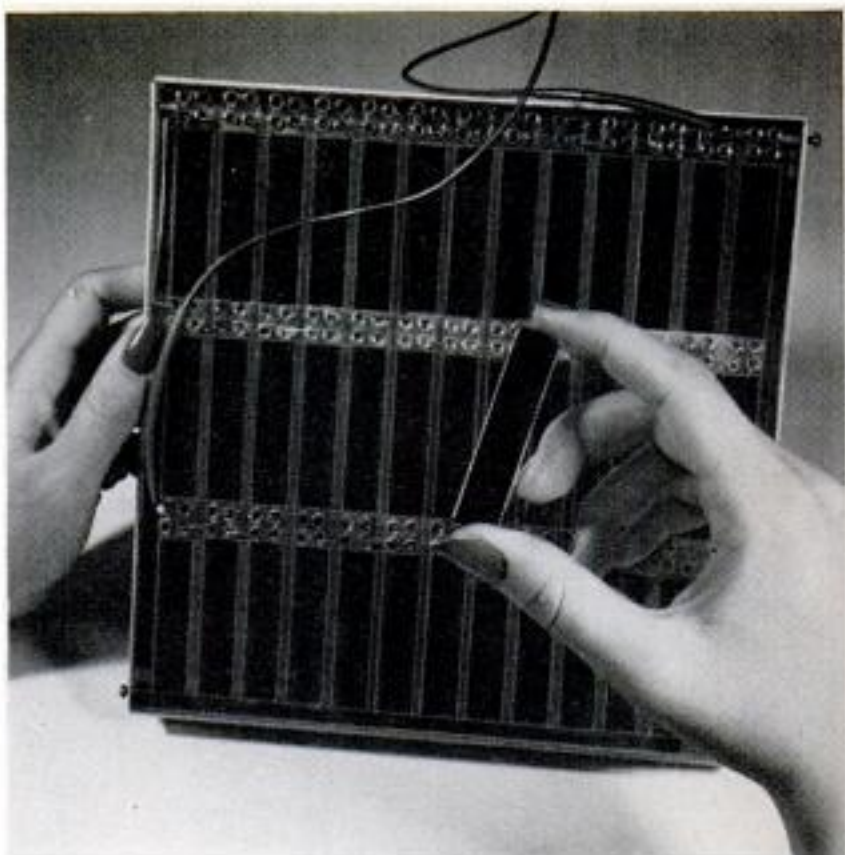

## Bell Solar Battery

Bell Laboratories scientists have created the Bell Solar Battery. It marks a big step forward in converting the sun's energy directly and efficiently into usable amounts of electricity. It is made of highly purified silicon, which comes from sand, one of the commonest materials on earth.

The battery grew out of the same long-range research at Bell Laboratories that created the transistor—a pea-sized amplifier originally made of the semiconductor germanium. Research into semiconductors pointed to silicon as a solar energy converter. Transistor-inspired techniques developed a silicon wafer with unique properties.

The silicon wafers can turn sunlight into electricity to operate low-power mobile telephones, and charge storage batteries in remote places for rural telephone service. These are but two of the many applications foreseen for telephony.

Thus, again fundamental research at Bell Telephone Laboratories paves the way for still better low-cost telephone service.



*Inventors of the Bell Solar Battery, left to right, G. L. Pearson, D. M. Chapin and C. S. Fuller—checking silicon wafers on which a layer of boron less than 1/10,000 of an inch thick has been deposited. The boron forms a "p-n junction" in the silicon. Action of light on junction excites current flow.*



### BELL TELEPHONE LABORATORIES

IMPROVING TELEPHONE SERVICE FOR AMERICA PROVIDES CAREERS  
FOR CREATIVE MEN IN SCIENTIFIC AND TECHNICAL FIELDS



# Popular Mechanics Magazine

Registered in U. S. Patent Office and Canada

H. H. WINDSOR, Founder

H. H. WINDSOR, JR., Editor and Publisher



## this month's cover

NO HUMAN EYE yet has seen that crackling fire, but the fire fighters know exactly where it is. Inside the plastic dome is a TV camera which revolves constantly to watch the forest. Fifty miles away a man scans several screens and suddenly spots the smoke. He checks the azimuth markings on the screen, then finds the same smoke on another screen. By plotting the two bearings he learns the exact location of the fire. The Louisiana Forestry Commission now is using TV cameras to spot fires. This is just one of many exciting developments in forest-fire fighting. A feature on page 97 shows how these ideas make "Every Man a Forest-Fire Fighter"

Information not listed on articles in the index, starting on page 12, frequently is listed in the WHERE-TO-FIND-IT LIST, which is available to readers without charge. A copy may be obtained by writing to the Bureau of Information, Popular Mechanics, 200 E. Ontario, Chicago 11, Ill.

Published monthly by Popular Mechanics Company, 200 E. Ontario St., Chicago 11, Ill. H. H. Windsor, Jr., president; Wm. Harrison Petridge, exec. vice-pres.; D. F. Windsor, vice-president and secretary-treasurer; H. H. Windsor III, vice-president; Clover L. Perkins, advertising manager; Alan M. Devos, circulation manager. Single copy in the United States and Canada, 45 cents; subscription rates in the United States and possessions, Canada, Philippines and countries of the Pan-American Postal Union: 1 year \$3.50; 2 years \$6.00; 3 years \$8.00. To all other countries add \$1.00 a year over United States prices for overseas postage. If you plan to move, notify us at least 30 days in advance so you will not miss an issue. Give both your old and new addresses. Entered as Second Class Matter, September 15, 1903, at the Post Office at Chicago, Illinois, under Act of March 3, 1879. Entered as Second Class Matter at Post Office Dept., Canada. Registered as Second Class Matter at the Post Office at Mexico, D. F., Mexico, June 20, 1950. Copyright 1954 by Popular Mechanics Company. Copyright under International Copyright Union. Copyright in France. All rights reserved under Pan-American Copyright Union. Printed in the United States of America.

Volume 102 JULY 1954 Number 1

Address all communications to: 200 E. Ontario St., Chicago 11, Ill.

Managing Editor.....Roderick M. Grant  
Assistant Managing Editor.....Wayne Whittaker  
Shop Notes and Crafts Editor.....James R. Ward  
Radio-Television, Electronics Editor.....Frank L. Brittin  
Associate Editor.....Clifford B. Hicks  
Associate Editor, Automotive.....Arthur R. Railton  
Associate Editor, Shop Notes and Crafts.....Wayne C. Leckey  
Assistant Editor, Shop Notes.....W. Clyde Lamme  
Assistant Editor, Crafts.....Frank N. Stephany  
Assistant Editor, Makeup.....John C. Dalen  
Automotive Correspondent.....Leo Donovan  
Art Director.....Frank Beatty  
Assistant Editors: Leonard F. Hilts, Jay W. Hedden, Elliott H. McCleary  
Eastern Editor.....Richard F. Dempewolff  
Empire State Bldg., Room 2906, New York City 1  
Western Editor.....Thomas E. Stimson, Jr.  
Suite 1010, 3460 Wilshire Blvd., Los Angeles 5, Calif.  
London Manager.....Douglas W. Wedderspoon  
Eagle House, Jermyn St., London S. W. 1, England  
Director, Bureau of Information.....Allan Carpenter  
200 E. Ontario St., Chicago 11

## In This Issue . . .

Mr. Hamlin Will Fix Anything - - - -	65
Behind the Split Screens of TV - - - -	73
The Car That Comes in a Crate - - - -	80
Midget Subs Play Target for Killers - - - -	84
Slow Down and Live Longer - - - -	91
Every Man a Forest-Fire Fighter - - - -	97
The Owners Write About Their New Fords - - - -	106
What's New for Your Home - - - -	114
Our Hottest Ship's on Shore - - - -	116
It's Raining Baby Trout - - - -	120
Monsters in Your Tool Chest - - - -	126
He'll Dress It in Copper - - - -	134
Radio, TV and Electronics - - - -	145

## For the Craftsman . . .

Hand-Carved Mirror Frames and Shelves - - - -	149
Knockdown Pier for the Summer Cottage - - - -	154
Practice for Better Fishing - - - -	158
Solving Home Problems - - - -	162
Shuffleboard for Your Basement - - - -	166
Garden Dining Made Easy - - - -	170
Make Your Own Water Skis - - - -	177
Save \$100 on Your Next Vacation - - - -	184
A Darkroom in a Cabinet - - - -	188
Milling Arm for Drill Press - - - -	191
Select the Right Nail - - - -	194
Shopping for Tools - - - -	202

Other items, and manufacturers of available products described, are listed on pages 12, 14 and 16

JULY 1954

3

Copyrighted material



# Texaco

## Tips on car care



### How to get more miles from your tires

If your tires aren't inflated to the proper pressure, you won't get maximum mileage from them. To enjoy longer trouble-free life from your tires, see your Texaco Dealer for regular tire check-ups. He'll inspect the sidewalls for bruises and cuts. He'll check to make sure each tire is inflated to the correct pressure. If your tires show signs of uneven wear, your Texaco Dealer will detect it, make recommendations accordingly.

### How to get that "cushiony" ride

Once Marfak lubricant goes on the job, it stays put — for one thousand miles or more. It's tough, extra stretchy (notice the sealing film of Marfak on the tie rod end). Marfak clings to chassis points of friction and wear . . . resists jar-out and squeeze-out far longer. For you, this all adds up to a smoother cushiony ride. And remember: your Texaco Dealer applies Marfak by chart — never by chance. Get Marfak lubrication today. See your Texaco Dealer . . . the best friend your car has ever had.

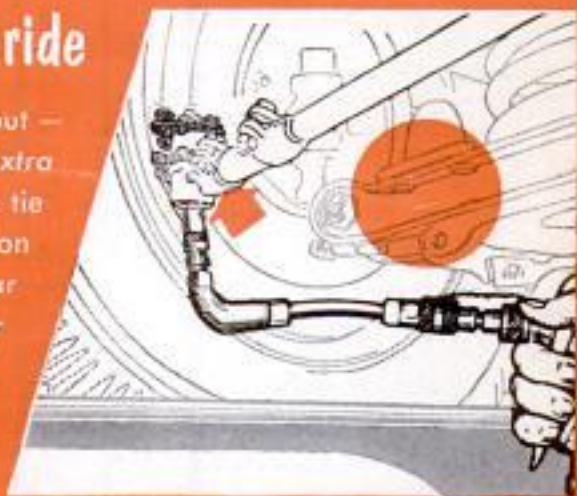

THAT "CUSHIONY" FEELING LASTS LONGER WITH

THE TEXAS COMPANY  
**TEXACO DEALERS**  
IN ALL 48 STATES



Texaco Products are also distributed in Canada and in Latin America





Alas, this is Alec,  
 whose car polish 'twould seem  
 Can produce nothing more  
 than a very thin gleam.  
 So when sandflies and beetles  
 fly onto the premise  
 He appears to be playing  
 motorized tennis.



Not so, with McPhiter!  
 He always selects  
 The easy-on wax  
 that's rock-hard—that protects!  
 For Bodygard's finish  
 no bug juices can pass  
 And his paint job's as safe  
 as if kept under glass!  
 (He feels extra breezy, 'cause the job is so easy.)

**MORAL: Use New Liquid Bodygard—  
 the first, easy wipe-on wax that  
 protects your car with this  
 rock-hard finish. Protects 9 times  
 longer than skimpy-shine polishes.**

YOU CAN'T SHINE DIRT,  
 SO CLEAN YOUR CAR FIRST.

Every car must be cleaned before it's waxed.  
 Simoniz Liquid Kleener cleans better, faster.

Copyright 1954 by Simoniz Company

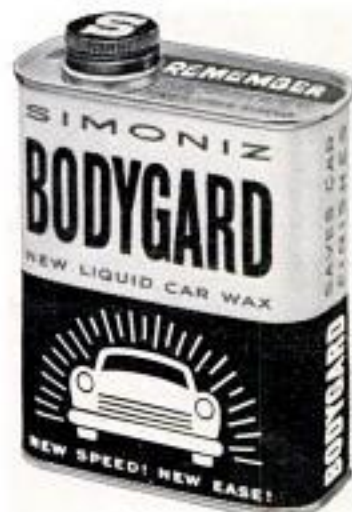

True Simoniz Quality in  
 a Liquid Car Wax. **Only 98¢**



# Hey SKINNY!

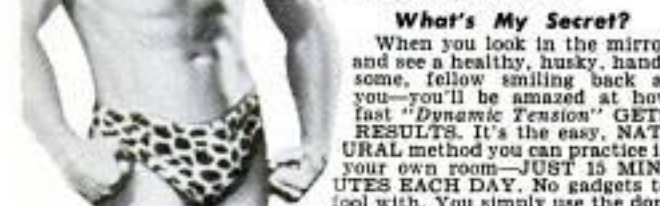

**I Can Make YOU a New Man, Too In Only 15 Minutes a Day!**

PEOPLE once laughed at my skinny 97-lb. body. I was ashamed to strip for sports. Girls made fun of me behind my back. THEN I discovered "Dynamic Tension." It made me such a complete specimen of manhood that I hold the title, "The World's Most Perfectly Developed Man."

**What's My Secret?**

When you look in the mirror and see a healthy, husky, handsome, fellow smiling back at you—you'll be amazed at how fast "Dynamic Tension" GETS RESULTS. It's the easy, NATURAL method you can practice in your own room—JUST 15 MINUTES EACH DAY. No gadgets to fool with. You simply use the dormant muscle-power in your own body—watch it grow into solid LIVE MUSCLE. See your shoulders broaden... your scrawny chest swell with inches of new muscle... those spindly legs and arms bulge with new power... and your whole body starts to feel "alive," full of zip and go!

**FREE MY 32-PAGE ILLUSTRATED BOOK IS YOURS—NOT FOR \$1 OR 10c—BUT FREE**

Send now for my book, *Everlasting Health and Strength*. 32 pages of photos, valuable advice. Shows what "Dynamic Tension" can do for YOU. Answers vital questions for fellows who want a better build. It's yours—ABSOLUTELY FREE! Rush coupon to me personally: CHARLES ATLAS, Dept. 8G, 115 East 23rd St., New York 10, N. Y.



**CHARLES ATLAS, Dept. 8-G  
115 East 23 St., New York 10, N. Y.**

Send me—absolutely FREE—a copy of your famous book, *Everlasting Health and Strength*—32 pages, crammed with photographs, answers to vital questions and valuable advice. This book is mine to keep, and sending for it does not obligate me in any way.

Name \_\_\_\_\_ Age \_\_\_\_\_  
Please print or write plainly  
Address \_\_\_\_\_  
City \_\_\_\_\_

in this corner.....  
**THE EDITORS**



**To the Editor:**

I was aware that Popular Mechanics published several foreign editions. However, you might like to know that your English edition is read by a man in Iran who does not read English! The following account was received from our United States Operations Mission in Iran. It shows how a small businessman in an underdeveloped area made a success of a manufacturing business while contributing to our anti-malaria program in the country.

William J. Caldwell,  
Director, Office of Public Reports,  
Foreign Operations Administration,  
Washington, D. C.



Hossein Moayeri, at 35, is a successful Tehran manufacturer whose craftsmanship, business ability and energy resulted



in his success and a great service to his country. If it had not been for Moayeri, the effort of the Iran-American Public Health Cooperative to eliminate malaria would have been greatly retarded and many more people would now have malaria.

Two years ago the malaria program in Iran faced a shortage of both DDT and spraying equipment. Technical cooperation was able to divert DDT stocks to Iran but was faced with delays of up to nine months in getting spray equipment. Then Health Division technicians discovered a few of the sprayers they already possessed had been made in Tehran by Mr. Moayeri's small factory. They informed him they needed several hundred spray guns by a certain date; he said he could make the

(Continued to page 8)



# 5 reasons why ACCOUNTANCY



**offers you MORE MONEY . . . and SUCCESS!**

**REASON #1.** If you were an expert accountant right now, chances are you would find yourself among the highest-paid of all professional men and women. Even back in "depression years," surveys showed that accountants earned more on the average than men in other major professions.

**REASON #2.** The demand for accountants is great—everywhere. All businesses must have trained accountants to cope with ever-growing requirements. It's a profession offering wide opportunity—always—to the man who knows.

**REASON #3.** You can fit into any business, anywhere in the country—because accounting principles are universal. Think what this means in terms of security and independence!

**REASON #4.** Accountancy is open to all. Any man or woman of good intelligence, who enjoys figure work and is willing to follow LaSalle's systematic "problem method" plan, can rapidly qualify for a highly profitable, enjoyable lifetime career . . . and he doesn't have to finish his training before beginning to "cash in."

**REASON #5.** Without losing a day from your present work, you can prepare in spare hours at home, at low cost, under LaSalle's step-by-step "Problem Method" of "learning by doing." This famous plan accounts for LaSalle's remarkable record of having trained nearly 10 per cent of all Certified Public Accountants in the U. S. . . . and of having put many thousands of others into high-paying careers.

Send today for Free Sample Lesson and "Accountancy, the Profession That Pays." Learn about the five great fields of opportunity . . . and LaSalle's time-tested plan for helping men and women to rapid advancement, higher income, greater prestige and professional standing. The coupon below will bring this information to you—without cost or obligation.

**MAIL THE COUPON—NOW**

**GET FREE SAMPLE LESSON**



**LaSalle Extension University**  
— A Correspondence Institution —  
Dept. 764H, 417 S. Dearborn St., Chicago 5, Ill.

Please send me, free of all cost or obligation, a sample lesson in Accounting . . . also, your 48-page illustrated book, "Accountancy, the Profession That Pays."

Name . . . . . Age . . . . .  
Address . . . . .  
City, Zone, State . . . . .

**LASALLE**  
417 S. Dearborn St.,  
CHICAGO 5, ILL.

JULY 1954



# WHAT ALL AUTO MECHANICS WANT TO KNOW

1664 PAGES



This Big Practical Book gives full information with working diagrams covering the principles, construction, ignition, service and repair of modern cars, trucks and buses.

### Diesel Engines, Hydrumatic & Fluid Drives Fully Explained.

A complete Guide of 1664 pages, with over 1500 illustrations showing inside views of working parts, with instructions for service jobs.

### IT PAYS TO KNOW

How to fit pistons—How to locate engine knocks, How to fit connecting rod bearings—How to service main bearings—How to recondition valves—How to time valves—How to adjust fan belts—How to adjust carburetors and chokes, How to rebuild a clutch—How to service automatic transmissions—How to service brakes—How to adjust steering gear—How to cope with ignition troubles—How to service distributors—How to time ignition—How to "tune up" an engine.



**\$4 COMPLETE • PAY \$1 A MO.**  
TO GET THIS ASSISTANCE FOR YOURSELF SIMPLY FILL IN AND MAIL COUPON TODAY.

Step up your own skill with the facts and figures of your trade, Audels Mechanics Guides contain Practical Inside Trade Information in a Handy Form. Fully illustrated and Easy to Understand. Highly Endorsed. Check the book you want for 7 DAYS FREE EXAMINATION. Send No Money, Nothing to pay postman.

## MAIL ORDER



**Check NOW!**

You Can Look Over Any Guide In Your Own Home — Start the Easy Payments If Satisfied

**MAIL THIS TODAY**



Name \_\_\_\_\_  
Address \_\_\_\_\_  
Occupation \_\_\_\_\_  
Employed by \_\_\_\_\_

AUDELS, Publishers, 49 W. 23 St., NEW YORK 10, N. Y.

Please send me postpaid for FREE EXAMINATION books marked (X) below. If I decide to keep them I agree to mail \$1 in 7 Days on each book or set ordered and further mail \$1 monthly on each book or set until I have paid price, otherwise I will return them.

- |   |      |
|---|------|
| <input type="checkbox"/> AUTOMOBILE MECHANICS GUIDE, . . . . .                  | \$ 4 |
| <input type="checkbox"/> TRUCK & TRACTOR GUIDE, 1299 Pages . . . . .            | 4    |
| <input type="checkbox"/> DIESEL ENGINE MANUAL, 575 Pages . . . . .              | 2    |
| <input type="checkbox"/> MACHINISTS HANDY BOOK, 1650 Pages . . . . .            | 4    |
| <input type="checkbox"/> WELDERS GUIDE, 400 Pages . . . . .                     | 1    |
| <input type="checkbox"/> BLUE PRINT READING, 416 Pages . . . . .                | 2    |
| <input type="checkbox"/> MATHEMATICS & CALCULATIONS, 700 Pages. . . . .         | 2    |
| <input type="checkbox"/> SHEET METAL PATTERN LAYOUTS, 1100 Pages . . . . .      | 4    |
| <input type="checkbox"/> SHEET METAL WORKERS HANDY BOOK, 388 Pgs. . . . .       | 1    |
| <input type="checkbox"/> MECHANICAL DRAWING GUIDE, 160 Pages . . . . .          | 1    |
| <input type="checkbox"/> MECHANICAL DRAWING & DESIGN, 480 Pages . . . . .       | 2    |
| <input type="checkbox"/> AIRCRAFT WORKER, 240 Pages . . . . .                   | 1    |
| <input type="checkbox"/> TELEVISION SERVICE MANUAL, 384 Pages . . . . .         | 2    |
| <input type="checkbox"/> RADIOMANS GUIDE, 914 Pages . . . . .                   | 4    |
| <input type="checkbox"/> ELECTRONIC DEVICES, 216 Pages . . . . .                | 2    |
| <input type="checkbox"/> ELECTRIC MOTOR GUIDE, 100 Pages . . . . .              | 4    |
| <input type="checkbox"/> ELECTRIC WIRING DIAGRAMS, 272 Pages . . . . .          | 1    |
| <input type="checkbox"/> ELECTRICIANS EXAMINATIONS, 250 Pages. . . . .          | 1    |
| <input type="checkbox"/> ELECTRIC POWER CALCULATIONS, 425 Pages. . . . .        | 2    |
| <input type="checkbox"/> HANDY BOOK OF ELECTRICITY, 1440 Pages. . . . .         | 4    |
| <input type="checkbox"/> ELECTRIC DICTIONARY, 9000 Terms . . . . .              | 2    |
| <input type="checkbox"/> ELECTRIC LIBRARY, 7000 Pages (12 Book Set) . . . . .   | 18   |
| <input type="checkbox"/> MARINE ENGINEERS HANDY BOOK, 1258 Pgs. . . . .         | 4    |
| <input type="checkbox"/> SHIPFITTERS HANDY BOOK, 250 Pages . . . . .            | 1    |
| <input type="checkbox"/> REFRIGERATION & Air Conditioning, 1280 Pgs. . . . .    | 4    |
| <input type="checkbox"/> MILLWRIGHTS & MECHANICS GUIDE, 1200 Pgs. . . . .       | 4    |
| <input type="checkbox"/> POWER PLANT ENGINEERS GUIDE, 1500 Pages . . . . .      | 4    |
| <input type="checkbox"/> ENGINEERS & FIREMANS EXAMS, 525 Pages . . . . .        | 1    |
| <input type="checkbox"/> PUMPS, Hydraulics & Air Compressors, 1658 Pgs. . . . . | 4    |
| <input type="checkbox"/> ENGINEERS LIBRARY (3 Book Set) . . . . .               | 9    |
| <input type="checkbox"/> MECHANICAL DICTIONARY, 950 Pages . . . . .             | 4    |
| <input type="checkbox"/> GARDENERS & GROWERS GUIDES (4 Book Set) . . . . .      | 6    |
| <input type="checkbox"/> CARPENTERS & BUILDERS GUIDES (4 Book Set) . . . . .    | 6    |
| <input type="checkbox"/> PLUMBERS & Steamfitters Guides (4 Book Set) . . . . .  | 6    |
| <input type="checkbox"/> MASONS AND BUILDERS GUIDES (4 Book Set) . . . . .      | 6    |
| <input type="checkbox"/> PAINTERS & DECORATORS MANUAL, 450 Pgs. . . . .         | 2    |
| <input type="checkbox"/> HOUSE HEATING GUIDE, 1000 Pages . . . . .              | 4    |
| <input type="checkbox"/> OIL BURNER GUIDE, 384 Pages . . . . .                  | 1    |

(Continued from page 6)

equipment in time if he had two more special machines, and the material, for which he lacked funds.

Technical cooperation officials informed him if he would take the contract he would be given advances. He accepted and started immediately to design and make the two machine tools. He completed the contract satisfactorily. Since then he has had other technical cooperation contracts, has reduced the price of the original spray gun from 1200 rials to 650 rials so that it can be sold to many more villagers and farmers, [was able to] raise wages of his employees from 40 to 100 percent and has developed more efficient spray equipment.

Mr. Moayeri has been mechanically inclined all his life. After attending a trade school he entered the Iranian Army, was assigned to the Air Force as a mechanic. He served two years in the army and then returned to civilian life as a mechanic.

Through all the years he has been a close student of the American magazine known as *Popular Mechanics*, although he does not speak or read English. He states that he usually could get the mechanical ideas presented from just the pictures and drawings in the magazine.

Three and a half years ago he decided to become a manufacturer and opened a small factory which has since more than doubled. He now operates his own small foundry and has 12 lathe and machine operators. Several of the machines were designed and made by him including a large machine to "true" brass rods used for the manufacture of spray nozzles.

### To the Editor:

I have read with interest your article "Does Earth Have Tiny Moons?" in the April 1954 issue, page 155.

Sponsored only by our wives and using homemade 6-inch telescopes and the public library, Richard Holpuch and myself not only believe but are certain we have discovered "moons" circling the earth. Our tentative results are in the hands of Harvard astronomers right now for analysis.

With regard to your article, there is no lower limit to the possible size of any "moonlets" circling our earth, they could easily be gravel-sized for example. The ones we have found to be visible in a 6-inch telescope are of necessity larger or we would be unable to see them, but many smaller ones may exist.

There is, incidentally, an upper limit to their possible distance from the earth (except beyond the moon) and it is some 45,000 miles less than the upper figure you

(Continued to page 10)



# ARE YOU TOO OLD TO LEARN?

*not at all, scientists say*

New tests show that: your ability to think increases with age; your powers of deduction are greater; your judgment is better.

In the I. C. S. files are thousands of cases of men and women of every age. Their successes, their promotions, their raises prove that men and women past school age can learn!

**I.C.S. GIVES YOU EXPERT GUIDANCE FREE!** Do you have the feeling you're "stuck" in your job? Your trained I.C.S. counselor will appraise your abilities, help you plan for the future.

**IT'S NEVER TOO LATE TO GET STARTED!** You study with I.C.S. at home, in your spare time. There's no interference with business or social activity. Famous I.C.S. texts make learning easy. Don't delay. Pick your field from the coupon below. And mail it today!



## 3 FREE BOOKS

36-page, pocket-size guide to advancement. a gold mine of tips on "How to Succeed." Big catalog outlining opportunities in your field of interest. Also free sample I. C. S. lesson.

**For Real Job Security — Get I. C. S. Training!**

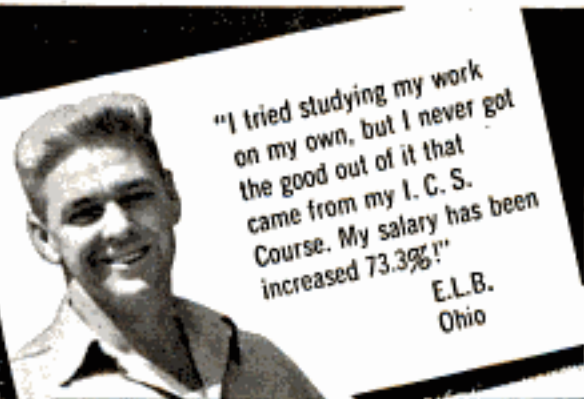

"I tried studying my work on my own, but I never got the good out of it that came from my I. C. S. Course. My salary has been increased 73.3%!"  
E.L.B.  
Ohio

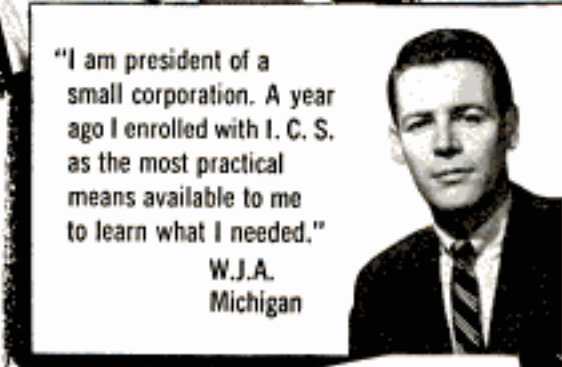

"I am president of a small corporation. A year ago I enrolled with I. C. S. as the most practical means available to me to learn what I needed."  
W.J.A.  
Michigan



"It's been so long since I went to school, I've forgotten much. But now that I'm taking an I. C. S. Course, I have confidence in my ability again."  
H.A.R.  
New Jersey

Actual statements. Posed by models.

**I. C. S., Scranton 9, Penna.**

## INTERNATIONAL CORRESPONDENCE SCHOOLS



**BOX 5624-L, SCRANTON 9, PENNA.**

(Partial list of 277 courses)

Without cost or obligation, send me "HOW to SUCCEED" and the opportunity booklet about the field BEFORE which I have marked X (plus sample lesson):

- |   |  |   |  |  |
|---|--|---|--|--|
| <p><b>ARCHITECTURE and BUILDING CONSTRUCTION</b></p> <ul style="list-style-type: none"> <li><input type="checkbox"/> Air Conditioning—Refrig.</li> <li><input type="checkbox"/> Architecture</li> <li><input type="checkbox"/> Building Contractor</li> <li><input type="checkbox"/> Building Maintenance</li> <li><input type="checkbox"/> Carpenter and Mill Work</li> <li><input type="checkbox"/> Estimating</li> <li><input type="checkbox"/> Heating</li> <li><input type="checkbox"/> Painting Contractor</li> <li><input type="checkbox"/> Plumbing</li> <li><input type="checkbox"/> Reading Arch. Blueprints</li> <li><input type="checkbox"/> Steamfitting</li> </ul> <p><b>ART</b></p> <ul style="list-style-type: none"> <li><input type="checkbox"/> Cartooning</li> <li><input type="checkbox"/> Commercial Art</li> <li><input type="checkbox"/> Fashion Illustrating</li> <li><input type="checkbox"/> Magazine Illustrating</li> <li><input type="checkbox"/> Show Card and Sign Lettering</li> <li><input type="checkbox"/> Sketching and Painting</li> </ul> <p><b>AUTOMOTIVE</b></p> <ul style="list-style-type: none"> <li><input type="checkbox"/> Auto Body Rebuilding</li> <li><input type="checkbox"/> Auto Elec. Technician</li> <li><input type="checkbox"/> Auto-Engine Tune Up</li> <li><input type="checkbox"/> Automobile Mechanic</li> </ul> | <p><b>AVIATION</b></p> <ul style="list-style-type: none"> <li><input type="checkbox"/> Aeronautical Engineering Jr.</li> <li><input type="checkbox"/> Aircraft &amp; Engine Mechanic</li> </ul> <p><b>BUSINESS</b></p> <ul style="list-style-type: none"> <li><input type="checkbox"/> Advertising</li> <li><input type="checkbox"/> Bookkeeping and Accounting</li> <li><input type="checkbox"/> Business Administration</li> <li><input type="checkbox"/> Business Correspondence</li> <li><input type="checkbox"/> Certified Public Accounting</li> <li><input type="checkbox"/> Creative Salesmanship</li> <li><input type="checkbox"/> Federal Tax</li> <li><input type="checkbox"/> Letter-writing Improvement</li> <li><input type="checkbox"/> Managing Small Business</li> <li><input type="checkbox"/> Office Management</li> <li><input type="checkbox"/> Retail Business Management</li> <li><input type="checkbox"/> Sales Management</li> <li><input type="checkbox"/> Stenographic-Secretarial</li> <li><input type="checkbox"/> Traffic Management</li> </ul> <p><b>CHEMISTRY</b></p> <ul style="list-style-type: none"> <li><input type="checkbox"/> Analytical Chemistry</li> <li><input type="checkbox"/> Chemical Engineering</li> <li><input type="checkbox"/> Chem. Lab. Technician</li> <li><input type="checkbox"/> General Chemistry</li> <li><input type="checkbox"/> Natural Gas Prod. &amp; Trans.</li> <li><input type="checkbox"/> Petroleum Engineering</li> <li><input type="checkbox"/> Plastics</li> <li><input type="checkbox"/> Pulp and Paper Making</li> </ul> | <p><b>CIVIL, STRUCTURAL ENGINEERING</b></p> <ul style="list-style-type: none"> <li><input type="checkbox"/> Civil Engineering</li> <li><input type="checkbox"/> Construction Engineering</li> <li><input type="checkbox"/> Highway Engineering</li> <li><input type="checkbox"/> Reading Struct. Blueprints</li> <li><input type="checkbox"/> Sanitary Engineering</li> <li><input type="checkbox"/> Structural Engineering</li> <li><input type="checkbox"/> Surveying and Mapping</li> </ul> <p><b>DRAFTING</b></p> <ul style="list-style-type: none"> <li><input type="checkbox"/> Aircraft Drafting</li> <li><input type="checkbox"/> Architectural Drafting</li> <li><input type="checkbox"/> Electrical Drafting</li> <li><input type="checkbox"/> Mechanical Drafting</li> <li><input type="checkbox"/> Mine Surveying and Mapping</li> <li><input type="checkbox"/> Ship Drafting</li> <li><input type="checkbox"/> Structural Drafting</li> </ul> <p><b>ELECTRICAL</b></p> <ul style="list-style-type: none"> <li><input type="checkbox"/> Electrical Engineering</li> <li><input type="checkbox"/> Electrical Maintenance</li> <li><input type="checkbox"/> Electrician <input type="checkbox"/> Contracting</li> <li><input type="checkbox"/> Linemen</li> </ul> <p><b>HIGH SCHOOL</b></p> <ul style="list-style-type: none"> <li><input type="checkbox"/> Commercial</li> <li><input type="checkbox"/> Good English</li> <li><input type="checkbox"/> High School Subjects</li> <li><input type="checkbox"/> Mathematics</li> </ul> | <p><b>LEADERSHIP</b></p> <ul style="list-style-type: none"> <li><input type="checkbox"/> Foremanship</li> <li><input type="checkbox"/> Industrial Supervision</li> <li><input type="checkbox"/> Leadership and Organization</li> <li><input type="checkbox"/> Personnel-Labor Relations</li> </ul> <p><b>MECHANICAL AND SHOP</b></p> <ul style="list-style-type: none"> <li><input type="checkbox"/> Gas—Electric Welding</li> <li><input type="checkbox"/> Heat Treatment <input type="checkbox"/> Metallurgy</li> <li><input type="checkbox"/> Industrial Engineering</li> <li><input type="checkbox"/> Industrial Instrumentation</li> <li><input type="checkbox"/> Industrial Supervision</li> <li><input type="checkbox"/> Machine Design-Drafting</li> <li><input type="checkbox"/> Machine Shop Inspection</li> <li><input type="checkbox"/> Machine Shop Practice</li> <li><input type="checkbox"/> Mechanical Engineering</li> <li><input type="checkbox"/> Quality Control</li> <li><input type="checkbox"/> Reading Shop Blueprints</li> <li><input type="checkbox"/> Refrigeration</li> <li><input type="checkbox"/> Sheet Metal Worker</li> <li><input type="checkbox"/> Tool Design <input type="checkbox"/> Toolmaking</li> </ul> <p><b>RADIO, TELEVISION</b></p> <ul style="list-style-type: none"> <li><input type="checkbox"/> Electronics</li> <li><input type="checkbox"/> Practical Radio—TV Eng'ng</li> <li><input type="checkbox"/> Radio and TV Servicing</li> <li><input type="checkbox"/> Radio Operating</li> <li><input type="checkbox"/> Television—Technician</li> </ul> | <p><b>RAILROAD</b></p> <ul style="list-style-type: none"> <li><input type="checkbox"/> Air Brakes <input type="checkbox"/> Car Inspector</li> <li><input type="checkbox"/> Diesel Locomotive</li> <li><input type="checkbox"/> Locomotive Engineer</li> <li><input type="checkbox"/> Section Foreman</li> </ul> <p><b>STEAM AND DIESEL POWER</b></p> <ul style="list-style-type: none"> <li><input type="checkbox"/> Combustion Engineering</li> <li><input type="checkbox"/> Diesel—Elec. <input type="checkbox"/> Diesel Eng's</li> <li><input type="checkbox"/> Electric Light and Power</li> <li><input type="checkbox"/> Stationary Fireman</li> <li><input type="checkbox"/> Stationary Steam Engineering</li> </ul> <p><b>TEXTILE</b></p> <ul style="list-style-type: none"> <li><input type="checkbox"/> Carding and Spinning</li> <li><input type="checkbox"/> Colton, Rayon, Woolen Mfg.</li> <li><input type="checkbox"/> Finishing and Dyeing</li> <li><input type="checkbox"/> Loom Fixing</li> <li><input type="checkbox"/> Textile Designing</li> <li><input type="checkbox"/> Textile Eng'g <input type="checkbox"/> Throwing</li> <li><input type="checkbox"/> Warping and Weaving</li> </ul> <p><b>MISCELLANEOUS</b></p> <ul style="list-style-type: none"> <li><input type="checkbox"/> Domestic Refrigeration</li> <li><input type="checkbox"/> Marine Engineering</li> <li><input type="checkbox"/> Ocean Navigation</li> <li><input type="checkbox"/> Shipfitting</li> <li><input type="checkbox"/> Short Story Writing</li> <li><input type="checkbox"/> Telephony</li> </ul> |
|---|--|---|--|--|

Name \_\_\_\_\_ Age \_\_\_\_\_ Home Address \_\_\_\_\_

City \_\_\_\_\_ Zone \_\_\_\_\_ State \_\_\_\_\_ Working Hours \_\_\_\_\_ A.M. to P.M. \_\_\_\_\_

Occupation \_\_\_\_\_ Canadian residents send coupon to International Correspondence Schools, Canadian, Ltd., Montreal, Canada. . . . Special tuition rates to members of the U. S. Armed Forces.



# HOW TO FIX ANY PART OF ANY CAR

**QUICKLY--EASILY--RIGHT!**

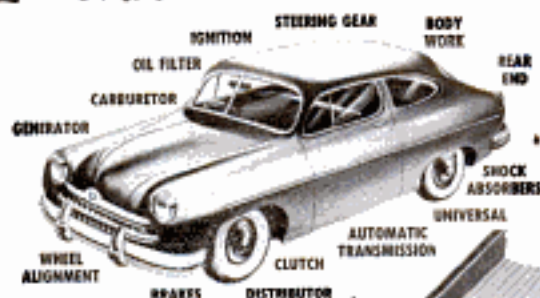

**FREE 7-DAY TRIAL**

Whether you're a beginner or an expert mechanic — now you can "breeze through" any "fix-it" job from simple carburetor adjustment to complete overhaul. Just look up job in index of MOTOR'S Brand-New 1954 Auto Repair Manual. Follow simple step-by-step directions, clear pictures, Presto—the job is done!

No guesswork! MOTOR'S MANUAL takes you from "scratch" — shows WHERE to start, WHAT tools to use. Covers EVERY job on EVERY car built from 1949 thru 1954!

**Everything You Need to Know "Boiled Down" from 140 Official Shop Manuals**

NEW, REVISED, ENLARGED, 1954 Edition contains the "meat" from over 140 OFFICIAL shop manuals — simplified for YOU. 22,598 essential repair specifications on over 685 classic models. ONE THOUSAND big pages. More than 2,950 "this-is-how" pictures. 227,000 service and repair facts. Leads beginners every step of the way. Time-saving factory repair procedures for experts. Instructions and pictures so clear you CAN'T go wrong. Used by U. S. Army and Navy.

**Try Book FREE 7 Days**

SEND NO MONEY! Pay postman nothing. Make Manual show you what it's got. Unless you agree this is the greatest time and work saver you've ever seen—return book in 7 days and pay nothing. Mail coupon today to: MOTOR—Book Dept., Desk 1G, 250 W. 55th St., New York 19, N. Y.

**MOTOR'S AUTO REPAIR MANUAL**

Covers 685 Models All These Makes

- |           |            |
|-----------|------------|
| Buick     | Lincoln    |
| Cadillac  | Mercury    |
| Chevrolet | Nash       |
| Chrysler  | Nash       |
| Crosley   | Rambler    |
| De Soto   | Oldsmobile |
| Dodge     | Packard    |
| Ford      | Plymouth   |
| Frazer    | Pontiac    |
| Henry J   | Studebaker |
| Hudson    | Willys     |
| Kaiser    |            |

**Same FREE Offer On MOTOR'S Truck and Tractor Manual**

Covers EVERY job on EVERY popular make gasoline truck, tractor made from 1939 thru 1953. FREE 7-Day Trial. Check proper box in coupon.



(Continued from page 8)

mentioned. At this point and beyond the moon's gravity would capture them.

I must also disagree with your lower limit of distance as our own family of moonlets lies much nearer than this boundary. Even as close as 300 miles from the earth there is not enough atmosphere to slow objects down appreciably.

John P. Bagby,  
Skokie, Ill.

**To the Editor:**

The article "Fourth of July the Year Around" in the April 1954 issue, was well written and excellently illustrated. However, there are several errors of fact which need correcting.

The micrograin propellant, mentioned in the article as "a type developed for use in military rockets," was actually discovered by two members of the Reaction Research Society, George James and John Cipperly, in 1943 and has never been used by the military in any way. Its low cost and ease of handling have made it an excellent solid propellant for the civilian rocket societies to whom the RRS has made the formula available without restriction or charge.

The Reaction Research Society, whose flight rocket graces the first page of the article, has erected a 40-foot launching tower and a two-ton test stand—largest facilities ever built by a nonprofessional group—at the Mojave Test Area. Its address is: Box 1101, Glendale 5, Calif. The Pacific Rocket Society address is: Box 698, Hancock Station, Los Angeles 44, Calif.

With thanks and appreciation of your interest in us and also in our friendly rivals, Arthur Louis Joquel II,  
Reaction Research Society,  
Glendale, Calif.

**To the Editor:**

On reading the article by Rafe Gibbs, "The Battle of the Sagebrush Busters" (PM, Jan. 1954), I have noticed an error in the term used for the Australian farmer. The correct colloquialism is "Cockies," not "Cookies." The term does not apply to farmers as a whole but mainly to those with small holdings on the coastal belt, the principal one being dairying. Out west of the divide, where station properties of 10,000 acres or more are common, they are known as "Graziers," wool and wheat being their main interest. . . . Floyd Clymer's survey is interesting as it keeps us in touch with the latest auto trends, majority of which we don't see out here due to the dollar shortage.

Bruce W. Chambers,  
Sydney, N.S.W., Australia

**MAIL COUPON NOW FOR 7-DAY FREE TRIAL**

**MOTOR BOOK DEPT.**  
Desk 1G, 250 W. 55th St., New York 19, N. Y.

Rush to me at once (check box opposite book you want):

MOTOR'S New AUTO REPAIR MANUAL. If O.K., I will remit \$1 in 7 days, \$2 monthly for 2 months and a final payment of 50c (plus 35c delivery charges) one month after that. Otherwise I will return the book postpaid in 7 days. (Foreign price, remit \$5 cash with order.)

MOTOR'S New TRUCK & TRACTOR REPAIR MANUAL. If O.K., I will remit \$2 in 7 days, and \$2 monthly for 3 months, plus 35c delivery charges with final payment. Otherwise I will return book postpaid in 7 days. (Foreign price, remit \$20 cash with order.)

Print Name..... Age.....

Address .....

City..... State.....

Check box and save 35c delivery charge by enclosing WITH coupon entire payment of \$8.95 for Auto Repair Manual (or \$8 for Truck & Tractor Repair Manual.) Same return-refund privilege.





# I WILL TRAIN YOU AT HOME FOR GOOD PAY JOBS IN RADIO-TELEVISION

J. E. SMITH has trained more men for Radio-Television than any other man. OUR 40th YEAR.

**America's Fast Growing Industry Offers You Good Pay—Bright Future—Security**

## I TRAINED THESE MEN

 "Started to repair sets six months after enrolling. Earned \$12 to \$15 a week in spare time."—Adam Kramlik, Jr., Sunneytown, Pennsylvania.

 "Up to our necks in Radio-Television work. Four other NRI men work here. Am happy with my work."—Glen Peterson, Bradford, Ont., Canada.

 "Am doing Radio and Television Servicing full time. Now have my own shop. I owe my success to N.R.I."—Curtis Stath, Ft. Madison, Iowa.

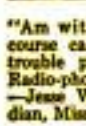
 "Am with WCOC. NRI course can't be beat. No trouble passing 1st class Radio-phone license exam."—Jesse W. Packer, Meridian, Mississippi.

 "By graduation, had paid for course, car, testing equipment. Can service toughest jobs."—E. J. Streitenberger, New Boston, Ohio.

**AVAILABLE TO VETERANS UNDER G. I. BILLS**

Training plus opportunity is the PERFECT COMBINATION for job security, good pay, advancement. In good times, the trained man makes the BETTER PAY, GETS PROMOTED. When jobs are scarce, the trained man enjoys GREATER SECURITY. NRI training can help assure you more of the better things of life.

**Start Soon to Make \$10, \$15 a Week Extra Fixing Sets**

Keep your job while training. I start sending you special booklets the day you enroll, that show you how to fix sets. Multitester built with parts I send helps you make \$10, \$15 a week extra fixing sets while training. Many start their own Radio-Television business with spare time earnings.

**My Training Is Up-To-Date**  
You benefit by my 40 years' experience training men at home. Well illustrated lessons give you basic principles you need. Skillfully developed kits of parts I send (see below) "bring to life" things you learn from lessons.

## You Learn by Practicing with Parts I Send

Nothing takes the place of PRACTICAL EXPERIENCE. That's why NRI training is based on LEARNING BY DOING. You use parts I furnish to build many circuits common to Radio and Television. As part of my Communications Course, you build many circuits, including low power transmitter shown at left. You put it "on the air," perform procedures required of broadcast operators. With my Servicing Course you build modern Radio, etc.; use Multitester you build to make money fixing sets in spare time while training. You can stay at home, keep your job, learn Radio-TV in spare time at low cost. Mail coupon for book showing other equipment you build and keep.

**The Tested Way To Better Pay!**



**Television Making Good Jobs, Prosperity—** Even without Television, Radio is bigger than ever. 115 million home and auto Radios are big market for servicing. 3000 broadcasting stations use operators, technicians. Government, Aviation, Police, Ship, Micro-wave Relay, Two-way Radio Communications for buses, taxis, trucks, R. R. are growing fields. Television is moving ahead fast.



About 200 Television stations are now on the air. Hundreds of others being built. Good TV jobs opening up for Technicians, Operators, etc.



25 million homes now have Television sets. Thousands more are being sold every week. Get a job or have your own business selling, installing, servicing.

## Radio-TV Needs Men of Action—Mail Coupon

Without obligating you in any way, I'll send an actual lesson to prove that my training is practical, thorough; 64-page book to show good job opportunities for you in Radio-TV. Terms for NRI training are as low as \$5 a month. Many graduates make more in two weeks than total cost of training. Mail coupon now. J. E. SMITH, President, National Radio Institute, Dept. 4GA, Washington 9, D. C. OUR 40TH YEAR.

**Good for Both—FREE**

MR. J. E. SMITH, President, Dept. 4GA  
National Radio Institute, Washington 9, D. C.  
Mail me Sample Lesson and 64-page Book, FREE.  
(No salesman will call. Please write plainly.)

Name.....Age.....  
Address.....  
City.....Zone.....State.....  
VETS write in date of discharge.....

**The ABC's of SERVICING**  
**How to Be a Success in RADIO-TELEVISION**





## Try the Novel Rubber Band Test

Place a rubber band around the handles of a No. 234 "Multi-Plier," and grip a hard-to-hold object, like a piece of pipe. Suspend the plier by one handle only, and note how the jaws hold the weight securely without further pressure. Now try the same test with an ordinary two-piece plier — see what happens.

# Sensational "Multi-Plier"

**Increases Your Gripping Power 10 Times!**

## Unique 3-Piece, Compound Leverage Design Is Greatest Plier Development in 19 Years

Everyone should own PROTO'S new "Multi-Plier" — a multi-purpose, multi-pressure plier that is really a "chest of tools in one." By using a patented 3-piece design to compound the leverage, pressure applied to the handles is increased *ten times* at the-jaws. That means you can hold square, round and even tapered objects securely with just a slight grip. The plier gets into hard-to-reach places, works safely at any angle, and holds small or large objects, having four different jaw opening positions. First try this revolutionary plier — No. 234 — at your PROTO dealer's, and then buy one! Send 10¢ for 68-page catalog of entire PROTO line to

**PLUMB TOOL COMPANY**

2255Q Santa Fe Ave., Los Angeles 54, California



## BENDIX BRAKE PLIER

Actually three tools in one, the new No. 216 plier handles three big jobs on Bendix brakes. Special jaws remove the hold-down cup. One handle releases anchor pin springs. The other handle replaces these springs. Get this plier now and save precious time on Bendix brake work.

**Also NEW!**

5486



Eastern Factory—Jamestown, N.Y.  
Canadian Factory—London, Ont.

## WHERE-TO-BUY-IT INDEX

Source of supply appears after items commercially available

### AUTOMOTIVE

Italy predicts its gas-turbine auto will hit 155 miles per hour...	71
Is the tractor on the truck or the truck on the tractor?.....	104
Highway "Pullman" sleeps eight.....	113
Auxiliary motor runs trolley bus.....	132
Windshield washer with pedal.....	224
California customs.....	130

### AVIATION

Aircraft cannon fires at record rate of 1700 rounds per minute (Ford Motor Co., Detroit, Mich.).....	71
Supersonic delta-wing interceptor (Convair, San Diego 12, Calif.).....	79
Model of USS Forrestal gives preview of biggest aircraft carrier	79
Test pads glued to aircraft easily removed with Dry Ice.....	119
Tailless German glider.....	132
Pilot talks to tower via "phone-VHF linkage".....	138
Jet pilot files on his stomach in British experiments.....	139
Gold-plated windshields.....	143

### FARM

Rake "pampers" hay to prevent loss of protein-filled leaves (New Holland Machine Co., New Holland, Pa.).....	90
Reversible plow alters automatically (Be-Ge Mfg. Co., Gilroy, Calif.).....	112
Seed harvester slashes, "swallows" and windrows sugar-beet crop.....	119

### FISHING

Winder loads spinning reels (Continental Arms Corp., 697 Fifth Ave., New York 22).....	119
Chemical found in human hand chases fish from danger areas.	124
Does buzzing attract fish? British anglers think so.....	133
Grapple and spot marker retrieve lost fishing gear (House of Ideas, 1309 State St., Racine, Wis.).....	133

### HOUSE AND HOME

57-pound plastic bathing pool holds 1600 gallons of water (Doughboy Industries Inc., New Richmond, Wis.).....	96
Bathtub door prevents slipping.....	112
What's New for Your Home	
Dust catcher (Production Engineers Co., 306 Stuart St., Boston 16, Mass.).....	114
Garbage eliminator (Bardmatic Corp., Muskegon, Mich.).....	114
Lock catch for hooks (Wham-O Mfg., 604 S. Marengo, Alhambra, Calif.).....	114
Motif design roller for painting walls (Motifs, Inc., 165 Beechnut St., Fond du Lac, Wis.).....	114
Brush-on liquid masking tape (Reardon Co., 7501 Page, St. Louis, Mo.).....	115
Gas-oven lighter (Webster Publishing Co., Box 6104, Atlanta, Ga.).....	115
Rubber-covered brackets hold bed sheets (Better Sleep Co., 44 Pittsford Way, New Providence, N. J.).....	115
Utensil rack and shelf (Carl-Son & Co., 1630 N. Damen, Chicago 47, Ill.).....	115
Venetian-blind cleaner (Albert Peterson Mail Order House, 8640 N. Leonard St., Portland 3, Ore.).....	115
Matching storm window contains swing-out center section (Brown-Graves Co., Akron 1, Ohio).....	123
Telescoping awning opens electrically (Childers Mfg. Co., 625 Yale, Houston, Tex.).....	124
Porcelain patching kit (Renew Porcelain Patch Kit Co., 28 E. Wellesley Drive, Pleasant Ridge, Mich.).....	133
Motor-driven master switch controls many circuits at once (General Electric, 1285 Boston Ave., Bridgeport 2, Conn.)	137
Moth paste kills and cleans.....	143
Crab-grass knife (M. H. Varn, 817 14th St., N.W., Washington, D. C.).....	228

### LAWN AND GARDEN

Insecticide fogger for power mowers uses original containers (Harold W. Glessman, Inc., 930 S. 48 St., Omaha, Neb.).....	72
Attachment for portable electric drill starts gasoline engine (Flint Engineering Co., P.O. Box 605, Flint, Mich.).....	78
You assemble this miniature garden tractor from a kit of parts (Belsaw Ride-Trac Div., Field Bldg., Kansas City 11, Mo.).....	78
Rotary garden sprayer throws an eight-foot stream of dust (Jackson & Perkins Co., Newark, N. Y.).....	90

### MISCELLANEOUS

Robot pitcher throws small rubber balls for indoor batting drill (Dedoes Industries, 2070 W. Eleven Mile Rd., Berkley, Mich.).....	71
Parachute golf ball slows practice shots (Treasure Mart, 1407 Maple Ave., Hillside, N. J.).....	72
Sliding tie rings anchored in floor track secure heavy equipment (Brown-Line Corp., 341 N. Foothill Rd., Beverly Hills, Calif.).....	78
Fresh-air gymnasium for Texas school open on two main sides	83
Steel-drum swimming raft quickly assembled (Ballard Systems, Box 60, Buchanan, Mich.).....	96
Portable German television tower mounts on transmitter trailer.....	104
Endless belt takes dictation in magnetic recorder (Pierce Dictating Co., 5900 N. Northwest Hwy., Chicago 31).....	111
Portable compressor for skin divers (Cornelius Co., 550 39th Ave., N.E., Minneapolis 21, Minn.).....	111
Stroller is light enough to be carried on arm like umbrella.....	112
Plastic liner for leaky gas pipes ends need for replacement.....	123

(Continued to page 14)



# INVENTORS

Learn how to protect your invention. The U. S. Patent Laws provide that any new and useful art, machine, article of manufacture, or composition of matter, or any new and useful improvement thereof, may be patented if the act of invention is involved. Therefore, every inventor with a valuable invention should take advantage of the Patent Laws and proceed for patent protection in order to safeguard his rights.

A patent gives the inventor the exclusive right to prevent others from making, using, or selling the invention claimed in the patent for a period of seventeen years.

The Patent Laws were enacted for the benefit of the inventor to give him protection for the features of his invention which are patentable. These features must be properly and concisely set forth and claimed in a formal application for patent, in order to comply with the requirements of the Patent Laws. For that reason, unless the inventor is familiar with patent matters, he should engage a competent registered patent attorney or agent to represent him. We are registered to practice before the U. S. Patent Office and are prepared to serve you in the handling of your patent matters.

A specially prepared booklet entitled "Patent Guide for the Inventor", containing detailed information with respect to patent protection and procedure, together with a "Record of Invention" form will be promptly forwarded to you without obligation upon request.

---

**CLARENCE A. O'BRIEN & HARVEY JACOBSON**

*Registered Patent Attorneys*

41-G DISTRICT NATIONAL BUILDING

WASHINGTON 5, D. C.



(Continued from page 12)

Treated paper needs no carbons (National Cash Register Co., Dayton, Ohio).....124  
 "Automat" sells toys to youngsters.....124  
 Log brands foil rustlers.....129  
 Electric calendar shows the day, date and month.....133  
 Vending-machine diner lets passengers serve themselves.....139  
 Paving machine with 60-foot reach asphalts steep levee slope.....142  
 Lightweight aluminum rack holds pack in comfortable position.....143  
 Relay guards lines.....144  
 Supergear French bike gives cyclist choice of several speeds.....144  
 Sound-absorbing veneer ceiling panel.....220  
 Two-piece car (Bliven Oak, Walled Lake, Mich.).....228

**PHOTOGRAPHY**

Electronically controlled cameras on plane shoot travel film.....111  
 "Million dollar" camera aid for jets built from surplus parts.....137  
 Kodak introduces low-priced camera, viewer for stereo fans (Eastman Kodak Co., Rochester 4, N. Y.).....143

**SCIENCE**

Electronic brain will compute tolls on Pennsylvania Turnpike (IBM, 590 Madison Ave., New York 22).....72  
 Motorized wheel chairs step over curbs and climb stairs.....83  
 Improved transistors resist heat and air (Sylvania Electric Prods., Inc., Woburn, Mass.).....90  
 Scientists finally find long-sought "ghost" particle inside atom.....90  
 Electronic guides for blind detect with reflected light.....104  
 "Tea kettle" atomic reactor "percolates" to produce power.....105  
 Dye traces eddies formed by boat.....124  
 Gadgets ease chores of physically handicapped.....125  
 Tricky zirconium hailed vital metal of atom age.....128  
 Steel tube shrunk by vacuum to fit inside smaller tube.....132  
 Master system performs many tests at one time.....144  
 99.9999999 percent purity gained in metal process.....137  
 Radar beams may be lethal.....137

**TOOLS**

Water gun forces spinning nylon brush through cylinder (Elliott Co., Inc., Jeanette, Pa.).....105  
 Thumbtack tool drives, extracts and stores supply of tacks (Ossow Products Co., Inc., 95-10 228 St., Queens Village, N. Y.).....139

**Radio-Television and Electronics**

Small-town veterinarians make radio pay (Motorola, Inc., 4545 W. Augusta Blvd., Chicago 51).....145  
 All-channel VHF-TV antenna (Technical Appliance Corp., Sherburne, N. Y.).....146  
 Rhombic-conical UHF-VHF antenna for CBS Mobile-TV installation. (JFD Mfg. Co., Inc., 6101 16th Ave., Brooklyn, N. Y.).....146  
 Adjustable VHF-UHF stacked-V TV antenna (American Phenolic Corp., 1830 S. 34th Ave., Chicago 50).....146

Bo-ty UHF-TV antenna (1830 S. 30th Ave., Chicago).....146  
 VHF-UHF indoor TV antenna (JFD Mfg. Co., Inc., 6101 16th Ave., Brooklyn, N. Y.).....147  
 Stacked conical TV-antenna array (JFD Mfg. Co., Inc., 6101 16th Ave., Brooklyn, N. Y.).....147  
 Adjustable V-beam TV antenna (JFD Mfg. Co., Inc., 6101 16th Ave., Brooklyn, N. Y.).....147  
 Television-antenna kits (Admiral Corp., 3800 Cortland St., Chicago 47).....147  
 TV-antenna rotator (Leader Electronics Inc., 2925 E. 55th St., Cleveland 27, Ohio).....147  
 Double co-lateral all-channel TV antenna (Finney Co., 4612 St. Clair, Cleveland, Ohio).....147  
 Matched home-music assembly (Radio Craftsman, Inc., 4401 N. Ravenswood Ave., Chicago 40).....148

**Craftsman and Shop Notes Index**

**AUTOMOTIVE**

Built-in air cooler for your car.....153  
 Hand signals made more visible with reflective tape on glove.....161  
 Automatic hill-holder.....181

**HOUSE AND HOME**

Full-size mower cut in half provides lawn trimmer.....156  
 Large window fan controlled by refrigerator-defroster unit.....156  
 Dehumidifier makes basement more livable.....157  
 Barrier in private driveway keeps trespassers out.....161  
 Solving Home Problems—  
 At canning time.....162  
 Locating screweyes for a screen-door hook.....162  
 Paint from a small can.....162  
 Flashlight lens protected with rubber ball.....162  
 Telescoping curtain rods kept at proper length.....162  
 Old fruit-jar rings placed over plants.....163  
 Children's boots and galoshes kept together.....163  
 Painting a basement floor.....163  
 Replacement for plastic-hose connector.....163  
 Vent your clothes drier.....165  
 Furniture polish is applied easily with window-spray attachment.....168  
 Replace sink-drain cleanout plug with open-end brass gate valve.....169  
 Vines tied to wall or trellis with pipe cleaners.....186  
 Paint mark on adjustment wheel permits easy thermostat check.....190  
 Ridding yard of ants.....190

**MISCELLANEOUS**

Authentic look given model-boat sails with aid of electric fan.....152  
 Corkscrew rod anchors boat in river bank.....156  
 Linked fishing snags and swivels make strong watch chain.....156

(Continued to page 16)

**NEW GREASELESS WAY TO KEEP YOUR HAIR NEAT ALL DAY**



**New Vitalis with V-7 makes even dry, unruly hair easy to manage**

V-7, the *greaseless* grooming discovery now in Vitalis, outdates messy oils. Keeps your hair neat, yet you never have an over-slick, plastered-down look.

Vitalis gives extraordinary protection against "summer dryness"—dull, brittle hair, parched scalp. It maintains your hair's natural moisture balance better than any other leading tonic.

**VITALIS®**  
HAIR TONIC  
WITH V-7



PRODUCT OF BRISTOL-MYERS

Excursioneering this summer? Use Vitalis . . . and stay as unruffled as this!



How's your

# BATTING AVERAGE

with the boss?



Are you still making a hit? Are you up for the job ahead? Here's a sure way to score in any league!

If your boss is like most, he's casting his critical eye on everybody these days. He wants to know how you stack up. Are you making good—or marking time? When the changes come, will you go up—or out?

This is no time for casual resolve. What you plan to do six months from now may be too late. You've got to prove your worth—NOW!

## 2 FREE BOOKS

Free, illustrated catalog outlining opportunities in the field that interests you. Also 36-page, pocket-size guide to advancement, "How to Succeed," a gold mine of helpful tips. Just mail the coupon!

### FOR REAL JOB SECURITY—GET I. C. S. TRAINING

The quickest, surest way to impress your boss is to show him that you're better equipped than the next guy. And here's where I. C. S. can go to bat for you!

I. C. S. training is approved training! Leading companies know it—and use it! At your request, your boss will get regular reports of your progress with I. C. S. More important, he'll notice the immediate improvement in your work.

### LEARN IN YOUR SPARE TIME—SET YOUR OWN PACE

I. C. S. instruction is *personalized* instruction. No interference with other activities. No slow classmates to hold up your progress. You forge ahead as rapidly as your time and ability permit!

I. C. S. Courses are practical, up-to-the-minute. What you learn one night, you apply the next day. You get bedrock facts and theories *plus* everyday know-how. Graduates get the famous I. C. S. diploma—recognized everywhere. "I got a break over more experienced fellows because of my I. C. S. training," says M. A. D., Suncock, N. H.

### QUICK WAY TO TEST YOUR EXECUTIVE ABILITY

Successful men know how to make decisions. Don't put it off! Mail the coupon today!

For Real Job Security—Get I. C. S. Training!

I. C. S., Scranton 9, Penna.

## INTERNATIONAL CORRESPONDENCE SCHOOLS

ICS

BOX 5625-L, SCRANTON 9, PENNA.

(Partial list of 277 courses)

Without cost or obligation, send me "HOW TO SUCCEED" and the opportunity booklet about the field BEFORE which I have marked X:

- |  |  |   |   |   |
|--|--|---|---|---|
| <p><b>ARCHITECTURE and BUILDING CONSTRUCTION</b></p> <ul style="list-style-type: none"> <li><input type="checkbox"/> Air Conditioning—Refrig.</li> <li><input type="checkbox"/> Architecture</li> <li><input type="checkbox"/> Building Contractor</li> <li><input type="checkbox"/> Building Maintenance</li> <li><input type="checkbox"/> Carpenter and Mill Work</li> <li><input type="checkbox"/> Estimating</li> <li><input type="checkbox"/> Heating</li> <li><input type="checkbox"/> Painting Contractor</li> <li><input type="checkbox"/> Plumbing</li> <li><input type="checkbox"/> Reading Arch. Blueprints</li> <li><input type="checkbox"/> Steamfitting</li> </ul> <p><b>ART</b></p> <ul style="list-style-type: none"> <li><input type="checkbox"/> Cartooning</li> <li><input type="checkbox"/> Commercial Art</li> <li><input type="checkbox"/> Fashion Illustrating</li> <li><input type="checkbox"/> Magazine Illustrating</li> <li><input type="checkbox"/> Show Card and Sign Lettering</li> <li><input type="checkbox"/> Sketching and Paining</li> </ul> <p><b>AUTOMOTIVE</b></p> <ul style="list-style-type: none"> <li><input type="checkbox"/> Auto Body Rebuilding</li> <li><input type="checkbox"/> Auto Elec. Technician</li> <li><input type="checkbox"/> Auto-Engine Tune Up</li> <li><input type="checkbox"/> Automobile Mechanic</li> </ul> | <p><b>AVIATION</b></p> <ul style="list-style-type: none"> <li><input type="checkbox"/> Aeronautical Engineering Jr.</li> <li><input type="checkbox"/> Aircraft &amp; Engine Mechanic</li> </ul> <p><b>BUSINESS</b></p> <ul style="list-style-type: none"> <li><input type="checkbox"/> Advertising</li> <li><input type="checkbox"/> Bookkeeping and Accounting</li> <li><input type="checkbox"/> Business Administration</li> <li><input type="checkbox"/> Business Correspondence</li> <li><input type="checkbox"/> Certified Public Accounting</li> <li><input type="checkbox"/> Creative Salesmanship</li> <li><input type="checkbox"/> Federal Tax</li> <li><input type="checkbox"/> Letter-writing Improvement</li> <li><input type="checkbox"/> Managing Small Business</li> <li><input type="checkbox"/> Office Management</li> <li><input type="checkbox"/> Retail Business Management</li> <li><input type="checkbox"/> Sales Management</li> <li><input type="checkbox"/> Stenographic-Secretarial</li> <li><input type="checkbox"/> Traffic Management</li> </ul> <p><b>CHEMISTRY</b></p> <ul style="list-style-type: none"> <li><input type="checkbox"/> Analytical Chemistry</li> <li><input type="checkbox"/> Chemical Engineering</li> <li><input type="checkbox"/> Chem. Lab. Technician</li> <li><input type="checkbox"/> General Chemistry</li> <li><input type="checkbox"/> Natural Gas Prod. &amp; Trans.</li> <li><input type="checkbox"/> Petroleum Engineering</li> <li><input type="checkbox"/> Plastics</li> <li><input type="checkbox"/> Pulp and Paper Making</li> </ul> | <p><b>CIVIL, STRUCTURAL ENGINEERING</b></p> <ul style="list-style-type: none"> <li><input type="checkbox"/> Civil Engineering</li> <li><input type="checkbox"/> Construction Engineering</li> <li><input type="checkbox"/> Highway Engineering</li> <li><input type="checkbox"/> Reading Struct. Blueprints</li> <li><input type="checkbox"/> Sanitary Engineering</li> <li><input type="checkbox"/> Structural Engineering</li> <li><input type="checkbox"/> Surveying and Mapping</li> </ul> <p><b>DRAFTING</b></p> <ul style="list-style-type: none"> <li><input type="checkbox"/> Aircraft Drafting</li> <li><input type="checkbox"/> Architectural Drafting</li> <li><input type="checkbox"/> Electrical Drafting</li> <li><input type="checkbox"/> Mechanical Drafting</li> <li><input type="checkbox"/> Mine Surveying and Mapping</li> <li><input type="checkbox"/> Ship Drafting</li> <li><input type="checkbox"/> Structural Drafting</li> </ul> <p><b>ELECTRICAL</b></p> <ul style="list-style-type: none"> <li><input type="checkbox"/> Electrical Engineering</li> <li><input type="checkbox"/> Electrical Maintenance</li> <li><input type="checkbox"/> Electrician <input type="checkbox"/> Contracting</li> <li><input type="checkbox"/> Lineman</li> </ul> <p><b>HIGH SCHOOL</b></p> <ul style="list-style-type: none"> <li><input type="checkbox"/> Commercial</li> <li><input type="checkbox"/> Good English</li> <li><input type="checkbox"/> High School Subjects</li> <li><input type="checkbox"/> Mathematics</li> </ul> | <p><b>LEADERSHIP</b></p> <ul style="list-style-type: none"> <li><input type="checkbox"/> Foremanship</li> <li><input type="checkbox"/> Industrial Supervision</li> <li><input type="checkbox"/> Leadership and Organization</li> <li><input type="checkbox"/> Personnel-Labor Relations</li> </ul> <p><b>MECHANICAL AND SHOP</b></p> <ul style="list-style-type: none"> <li><input type="checkbox"/> Gas—Electric Welding</li> <li><input type="checkbox"/> Heat Treatment <input type="checkbox"/> Metallurgy</li> <li><input type="checkbox"/> Industrial Engineering</li> <li><input type="checkbox"/> Industrial Instrumentation</li> <li><input type="checkbox"/> Industrial Supervision</li> <li><input type="checkbox"/> Machine Design-Drafting</li> <li><input type="checkbox"/> Machine Shop Inspection</li> <li><input type="checkbox"/> Machine Shop Practice</li> <li><input type="checkbox"/> Mechanical Engineering</li> <li><input type="checkbox"/> Quality Control</li> <li><input type="checkbox"/> Reading Shop Blueprints</li> <li><input type="checkbox"/> Refrigeration</li> <li><input type="checkbox"/> Sheet Metal Worker</li> <li><input type="checkbox"/> Tool Design <input type="checkbox"/> Toolmaking</li> </ul> <p><b>RADIO, TELEVISION</b></p> <ul style="list-style-type: none"> <li><input type="checkbox"/> Electronics</li> <li><input type="checkbox"/> Practical Radio—TV Eng'ing</li> <li><input type="checkbox"/> Radio and TV Servicing</li> <li><input type="checkbox"/> Radio Operating</li> <li><input type="checkbox"/> Television—Technician</li> </ul> | <p><b>RAILROAD</b></p> <ul style="list-style-type: none"> <li><input type="checkbox"/> Air Brakes <input type="checkbox"/> Car Inspector</li> <li><input type="checkbox"/> Diesel Locomotive</li> <li><input type="checkbox"/> Locomotive Engineer</li> <li><input type="checkbox"/> Section Foreman</li> </ul> <p><b>STEAM AND DIESEL POWER</b></p> <ul style="list-style-type: none"> <li><input type="checkbox"/> Combustion Engineering</li> <li><input type="checkbox"/> Diesel—Elec. <input type="checkbox"/> Diesel Eng's</li> <li><input type="checkbox"/> Electric Light and Power</li> <li><input type="checkbox"/> Stationary Fireman</li> <li><input type="checkbox"/> Stationary Steam Engineering</li> </ul> <p><b>TEXTILE</b></p> <ul style="list-style-type: none"> <li><input type="checkbox"/> Carding and Spinning</li> <li><input type="checkbox"/> Cotton, Rayon, Woolen Mfg.</li> <li><input type="checkbox"/> Finishing and Dyeing</li> <li><input type="checkbox"/> Loom Fixing</li> <li><input type="checkbox"/> Textile Designing</li> <li><input type="checkbox"/> Textile Eng'g <input type="checkbox"/> Throwing</li> <li><input type="checkbox"/> Waring and Weaving</li> </ul> <p><b>MISCELLANEOUS</b></p> <ul style="list-style-type: none"> <li><input type="checkbox"/> Domestic Refrigeration</li> <li><input type="checkbox"/> Marine Engineering</li> <li><input type="checkbox"/> Ocean Navigation</li> <li><input type="checkbox"/> Shipfitting</li> <li><input type="checkbox"/> Short Story Writing</li> <li><input type="checkbox"/> Telephony</li> </ul> |
|--|--|---|---|---|

Name \_\_\_\_\_ Age \_\_\_\_\_ Home Address \_\_\_\_\_

City \_\_\_\_\_ Zone \_\_\_\_\_ State \_\_\_\_\_ Working Hours \_\_\_\_\_ A.M. to P.M. \_\_\_\_\_

Occupation \_\_\_\_\_ Canadian residents send coupon to International Correspondence Schools, Canadian, Ltd., Montreal, Canada. . . . Special tuition rates to members of the U. S. Armed Forces.





# "HOW I MADE MY HOBBY PAY OFF!"

*I've always been interested in cars, then one day I met Joe...*

HI, JOE! SINCE WHEN ARE YOU IN THE AUTO REPAIR BUSINESS?

EVER SINCE I STARTED LEARNING AUTO MECHANICS AT HOME. I EARN WHILE I LEARN, THE NATIONAL SCHOOLS WAY!

SOUNDS GREAT! I HEAR THAT TOP MECHANICS MAKE REAL MONEY THESE DAYS!

YOU SAID IT! I MAY EVEN OPEN MY OWN REPAIR SHOP WHEN I GRADUATE.

NATIONAL SCHOOLS SENT ME THIS SWELL AUTOMOTIVE TOOL KIT—IT'S PART OF MY COURSE!

WHAT A DEAL. I'M FINDING OUT ABOUT THIS AUTO MECHANICS COURSE TODAY!

## SHOP-TESTED HOME TRAINING AUTO MECHANICS & DIESEL NATIONAL SCHOOLS

Technical Trade Training Since 1905  
LOS ANGELES 37, CALIFORNIA

In Canada: 811 West Hastings Street, Vancouver, B.C.

APPROVED FOR G.I. TRAINING. Both Home Study and Resident courses offered. Job placement assistance, too! Find out today!

### MAIL NOW TO OFFICE NEAREST YOU!

(mail in envelope or paste on postal card)

NATIONAL SCHOOLS, Dept. DB-74

4000 S. FIGUEROA STREET  
LOS ANGELES 37, CALIF.

OR

323 WEST POLK STREET  
CHICAGO 7, ILL.

Please rush FREE BOOK "Your Future in Auto Mechanics & Diesel," and FREE LESSON. I understand there is no obligation, no salesman will call.

NAME \_\_\_\_\_ BIRTHDAY \_\_\_\_\_ 19\_\_

ADDRESS \_\_\_\_\_

CITY \_\_\_\_\_ ZONE \_\_\_\_\_ STATE \_\_\_\_\_

Check if interested ONLY in Resident Training at Los Angeles.  
VETERANS: Give date of discharge \_\_\_\_\_

(Continued from page 14)

Trailer coupler serves as anvil.....	164
Iron separates postage stamps.....	164
Rocks to anchor picnic cloth placed in corner pockets.....	164
Sandpaper inside paper cup provides pointer for pencil.....	168
Fisherman's personal "smokehouse" utilizes wooden icebox.....	169
Bright lights and pane of glass permit tracing picture.....	176
Homemade ferrotype plate.....	176
Rubber band through cover holds pencil on notebook.....	180
Pencil clip smooths errors on mimeograph stencil.....	180
Coin provides equal spacing of lines when using triangle.....	181
Ladder rest on lamp standard provides safety factor.....	182
Charcoal fired over gas flame to assure quick blaze.....	182
Clothespin ho'ds table cloth.....	182
Disposable icebox for picnics.....	183
Bulb carried in flashlight provides emergency spare.....	186
Folding flowerpot stand cut from plywood.....	186
Rubber tabs hold paper on board without puncture marks.....	189
Improvised builder's level used in running grades.....	183
Milk cartons bleach celery.....	199
Oil drum mounted on barrel cart serves as poultry waterer.....	200

### PAINTS AND PAINTING

Prevent paint skinning.....	156
Paper plate taped to paint can provides nontipping base.....	157
Test paint colors with blotter.....	164
Wire coat hanger bent into hook used as paintbrush rest.....	182
Numerals on metal rule or square can be renewed with paint.....	201

### PHOTOGRAPHY

Darkroom should be painted in proper color.....	152
Renewing photoflood reflectors.....	164
Flashlight batteries dated.....	176
Airtight seals for solution bottles provided by plastic liners.....	180
Negative viewer always at hand when installed in desk drawer.....	180
Notch cut in cardboard mounts aligns slides for viewing.....	183
Dry glossy prints.....	187
Black paper helps in computing exact diameter when enlarging.....	189
Small sheets of clear plastic made from old negatives.....	189

### TOOLS

Rubber tubing on wrench handle prevents bruised fingers.....	164
Depth stop on lathe-chuck jaws speeds setup of thin stock.....	193
Properly shaped cold chisel required for efficient cutting.....	200
Drip-type oiler adapted to lubricated drill-press work.....	201
"Pivot gauge" sets alignment between lathe centers.....	201
Shopping for Tools—	
Flat-lapping machine (Spitfire Tools Co., 2931 N. Pulaski Rd., Chicago).....	202
Machinists hand plane (Fenn-Wey Co., 11705 Detroit Ave., Cleveland 7, Ohio).....	202
New side-cutting pliers (Utica Drop Forge & Tool Corp., 2500 Whitesboro St., Utica 4, N. Y.).....	202
Pressure-grip wrench (Paver, Inc., 700 S. Second, W. Salt Lake City, Utah).....	202
Wood-lathe attachment for radial saw (American Machine & Foundry Co., 511 Fifth Ave., New York 17).....	202
Double torch (Cedarberg Mfg. Co., Inc., 527 S. Fourth St., Minneapolis 15, Minn.).....	203
Grinding attachment.....	203
Hand hone (Chicago Wheel & Mfg. Co., 1101 W. Monroe St., Chicago).....	203
Leveling attachment (M&J Specialty Co., Red Hook, Dutchess Co., New York).....	203
Work guide (Walker-Turner Div., Kearney & Trecker Corp., Plainfield, N. J.).....	203
Improved dovetail jig (Porter-Cable Mach. Co., 28 Exchange St., Syracuse 3, N. J.).....	204
Radiant keyhole sleeve (Bernard Heinz, Scranton Life Bldg., Scranton, Pa.).....	204
Right-hand rule (Carlson & Sullivan, Inc., 1617 California Ave., Monrovia 7, Calif.).....	204
Sand polisher (Cycle Mfg. Co., Inc., 2140 S. Delaware St., Denver, Colo.).....	204
Special household glue (Semrow Plastics Co., 6126 Northwest Hwy., Chicago 31).....	204

### WORKSHOP HINTS

Can opener cuts small hole in light sheet metal.....	152
Clips provide thread strength on light-gauge sheet steel.....	152
Working handle for wire solder prevents burned fingers.....	152
Dowels in multiple bench stop hold irregular shapes.....	168
Eraser-stick brushes utilized on home-workshop jobs.....	168
Removing rust from files.....	168
Simple coffee table is a on>-evening project.....	169
Improvised self-opening pliers.....	176
Length of rope provides clamp for holding irregular shapes.....	176
Small leaks repaired in oil or water tanks.....	180
Bench stop held with C-clamp.....	182
Holder for small drill bits made from tobacco can.....	182
Envelope holds sheets of paper for accurate trimming.....	186
Wax coating on steel rule retards rust and wear.....	186
Reflector for drop light cut from tin can.....	190
Pigeon-hole cabinet keeps bolts sized for instant selection.....	193
Soldering aid formed from sharpened length of coat-hanger wire.....	199
Vacuum-cleaner attachment screened when used in home workshop.....	200

**IMPORTANT NOTICE**—It is the intention of this magazine to provide its readers with information regarding the latest developments in the mechanical arts. We take no responsibility as to whether the disclosures contained in our articles are covered by patents and advise readers to investigate this subject before making, using, or selling any of the products, machines, or processes described in order to avoid possible liability for patent infringements.



# INVENTORS

If you believe that you have an invention, you should find out how to protect it. The first step is to have a search made of the prior pertinent U. S. patents. If a report on this search indicates that the invention appears patentable you can apply for a patent, and the specifications and claims should be prepared.

The firm of McMorrow, Berman & Davidson, with offices in Washington, D. C., is qualified to take the necessary steps for you. We can make a preliminary search on your invention, advise you whether we think it can be patented, and prepare your application for patent.

Unless you are fully familiar with the U. S. Patent Laws, we recommend that you engage the services of a Registered Patent Attorney to protect your interests. The patent laws are *your* laws. A patent gives you the right to prevent others from making, using or selling the invention claimed in your patent for a period of 17 years.

Use these patent laws for your protection. Investigate whether your invention can be patented. If you have what you believe to be an invention, we suggest that you have this firm make a search for you.

*Send for a copy of our Patent Booklet entitled "How To Protect Your Invention," containing information about patent protection and patent procedure. Along with this we will also send you an "Invention Record" form, for your use in writing down and sketching details of your invention. We will mail them promptly. No obligation. They are yours for the asking.*

## McMORROW, BERMAN & DAVIDSON

*Registered Patent Attorneys*

**PATENTS • COPYRIGHTS • PATENTS**

1354 VICTOR BUILDING, WASHINGTON 1, D.C.



## WHAT SECRET POWER DID THIS MAN POSSESS?



BENJAMIN FRANKLIN  
(A Rosicrucian)

WHY was this man great? How does anyone—man or woman—achieve greatness? Is it not by mastery of the powers within ourselves? Know the mysterious world within you! Attune yourself to the wisdom of the ages! Grasp the inner power of your mind! Learn the secrets of a full and peaceful life!

Benjamin Franklin—like many other learned and great men and women—was a Rosicrucian. The Rosicrucians (NOT a religious organization) first came to America in 1694. Today, headquarters of the Rosicrucians send over seven million pieces of mail annually to all parts of the world. Write for YOUR FREE COPY of "The Mastery of Life"—TODAY. No obligation. No salesmen. A non-profit organization. Address: Scribe H.B.L.

THIS BOOK FREE!



## The ROSICRUCIANS

SAN JOSE • (AMORC) • CALIFORNIA

SEND THIS COUPON

Scribe H.B.L.  
The ROSICRUCIANS (AMORC)  
San Jose, California  
Please send me the free book, *The Mastery of Life*, which explains how I may learn to use my faculties and powers of mind.

Name \_\_\_\_\_  
Address \_\_\_\_\_  
City \_\_\_\_\_

## COULD YOU USE AN *Extra* \$5000 A YEAR?



Many successful salesmen pick up an extra \$5,000 or more every year by selling SENTRY personal safes in addition to their regular line. SENTRY can increase your income 2 ways: 1. Double the chance of making a sale to new prospects. (90% of householders, farmers, and business men are virgin prospects.) 2. Bring money from call-backs to satisfied users of your present line. Your cost is so low that, even with a king size mark-up, you undersell all competition. A few exclusive territories still left, but don't delay. Write Dept. PM-7 giving address including county.



**BRUSH-PUNNETT CO.**  
545 WEST AVE., ROCHESTER 11, N. Y.

## Worry of FALSE TEETH Slipping or Irritating?

Don't be embarrassed by loose false teeth slipping, dropping or wobbling when you eat, talk or laugh. Just sprinkle a little FASTEETH on your plates. This pleasant powder gives a remarkable sense of added comfort and security by holding plates more firmly. No gummy, goeey, pasty taste or feeling. It's alkaline (non-acid). Get FASTEETH at any drug counter.

**BUY IT WHOLESALE!** FREE THE WHOLESOME PLAN!  
GET UP TO 40% OFF  
Start a Buying Service At Home, 24 Hours. Get Big Name Merchandise For Self and Clients Up to 40% Less Than Reg. Price. Sales Easy As You Can Give Sizeable Discounts. Still Make Fat Commissions. Post Card Brings Free Copy.

**AMERICAN BUYERS SERVICE**  
631-R Linden Ave., Buffalo 16, N. Y.

**Learn ACCOUNTING**  
Business Administration  
Bookkeeping, secretarial and allied subjects at home in your spare time or attend nationally approved resident school. Write for FREE Success Book giving complete details on courses, plans, rates and employment opportunities. G.I. approved.

**Hills BUSINESS UNIVERSITY AND EXTENSION SCHOOL**  
619 W. MAIN ST. OKLAHOMA CITY 2, OKLAHOMA

## Ball-Bearing SPEED WHEELS



JUVENILE WHEELS (No bearing, solid tires)	
5" . . . . .	45¢
6" . . . . .	65¢
7" . . . . .	75¢
(Semi-pneumatic tires, ball bearing)	
8x1.25 . . . . .	\$1.85
8x1.75 . . . . .	1.95
8x2 . . . . .	2.20
10x1.25 . . . . .	\$2.20
10x1.75 . . . . .	2.30
10x2 . . . . .	2.65
12x1.75 . . . . .	3.45
INDUSTRIAL WHEELS	
(Log Base, Semi-Pneumatic tire)	
6x2 SW . . . . .	\$3.45
6x2.00 . . . . .	4.00
8x2.00 . . . . .	5.20
8x2.50 . . . . .	5.40
16x4.00 . . . . .	15.15
(Smooth Base, Pneumatic tire and tube)	
8x3 2 ply . . . . .	\$10.00
10x3.50 2 ply . . . . .	10.55
12x4 2 ply . . . . .	14.41
4.00x8 2 ply . . . . .	13.10
14x4.50 2 ply . . . . .	15.96

CASTERS—Now Available No c.o.d. orders. Prices F.O.B. our plant.  
**JIM BROWN TOY COMPANY**  
1055 HOME AVENUE PM-754 AKRON 10, OHIO



# THESE MEN ARE GETTING PRACTICAL TRAINING IN **ELECTRICITY**

—ELECTRONICS

*On Real:*



**A.C. and D.C. MOTORS  
GENERATORS  
SWITCHBOARDS  
CONTROLLERS  
WIRING JOBS  
APPLIANCES  
ELECTRONIC UNITS**

*(Shown at left—Instructor explaining operation and testing of a large Motor Generator in our A.C. Department.)*

# AND **TELEVISION-RADIO**

*On Real:*

**TELEVISION SETS  
RADIO RECEIVERS  
F.M.  
(Frequency Modulation)  
ELECTRONICS  
RECORD CHANGERS  
AUTO RADIOS  
PUBLIC ADDRESS Systems**

*(Right—Instructor helping students check the wiring and trace circuits of television receivers.)*



## Train in the great **SHOPS** of **COYNE**

**Largest, Oldest, Best Equipped School Of Its Kind In The U. S.**

Whether 17 or up to 45 years of age, prepare for your future now. Don't be satisfied with a "No Future" job. Train the Coyne way for a better job in a field that offers a world of opportunities in the years ahead.

**FINANCE PLAN** Enroll now, pay most of tuition later. Part-time employment service while training, if needed.

**WE TRAIN YOU IN CHICAGO.** At Coyne you learn on real, full-size equipment. Trained instructors show you how, then you do practical jobs yourself. No previous experience or advanced education needed.

**CLIP COUPON NOW** for big new illustrated Coyne book "Guide to Careers in ELECTRICITY and TELEVISION-RADIO". No obligation; no salesman will call. Get vital facts now!



*Mail Coupon for  
Big Free Book*

**APPROVED  
FOR  
VETERANS**

**B. W. COOKE, President  
COYNE ELECTRICAL SCHOOL  
500 S. Paulina St., Chicago 12, Ill. Dept. B4-72H**

Send **BIG FREE** book and details of your training offer. This does not obligate me and no salesman will call. I am interested in:

**ELECTRICITY**       **TELEVISION-RADIO**

NAME .....

ADDRESS .....

CITY.....STATE.....

**B. W. COOKE, Pres. COYNE FOUNDED 1896  
ELECTRICAL SCHOOL**

**A TECHNICAL TRADE INSTITUTE CHARTERED NOT FOR PROFIT  
500 S. PAULINA St., CHICAGO, Dept. B4-72H  
ELECTRICITY ★ RADIO ★ TELEVISION ★ REFRIGERATION ★ ELECTRONICS**



# CAR BURNING OIL?

## Engineer's Discovery Stops It Quick Without A Cent for Mechanical Repairs

If your car is using too much oil—if it is sluggish, hard to start, slow on pickup, lacks pep and power—you are paying good money for oil that's burning up in your engine instead of providing lubrication. Why? Because your engine is leaking. Friction has worn a gap between pistons and cylinder wall. Oil is pumping up into the combustion chamber, fouling your motor with carbon. Gas is exploding down through this gap, going to waste.

### SAVE \$50 to \$150 REPAIR BILL

Before you spend \$50 to \$150 for an engine overhaul, read how you can fix that leaky engine yourself in just a few minutes, without buying a single new part, without even taking your engine down! It's almost as easy as squeezing toothpaste out of a tube, thanks to the discovery of a new miracle substance called Power-Seal! This revolutionary new compound combines the lubricating qualities of Moly, the "greasy" wonder metal, with the leak-sealing properties of Vermiculite, the mineral product whose particles expand under heat, (up to 30 times original size).

Just squeeze Power-Seal into your motor's cylinders through the spark plug openings. It will PLATE every surface of pistons, piston rings, cylinder walls with a smooth, metallic film that won't come off . . . fill all the cracks, scratches and scorings caused by engine wear. It closes the gap between worn piston rings and cylinders . . . stops oil pumping, gas blow-by and restores compression. And this genuine plating is self-lubricating for Moly reduces friction as nothing else can. It is the lubricant so indestructible as to be used in U. S. atomic energy plants and jet engines! It never drains down, never leaves engine dry — you get more power, speed, mileage!

### MAKES WORN OUT TAXI ENGINE RUN LIKE NEW! "BEST INVESTMENT EVER," Says Owner



Test Engineer's notarized figures show increase in compression on 1950 DeSoto taxi that had run 98,086 miles. Just one Power-Seal injection increased pop and power, reduced gas consumption, cut oil burning by nearly 50%!

	Cyl. 1	Cyl. 2	Cyl. 3	Cyl. 4	Cyl. 5	Cyl. 6
BEFORE	90 lbs	90 lbs	103 lbs	90 lbs	80 lbs	100 lbs
AFTER	115 lbs	115 lbs	117 lbs	115 lbs	115 lbs	115 lbs

### TRY IT FREE — SEND NO MONEY!

You don't risk a penny to prove that Power-Seal will make your car run like new! Just mail coupon. On arrival, pay postman \$4.95 for Regular Size (for 4 or 6-cyl. cars) or \$7.95 for Jumbo Size (8-cyl. cars and trucks) plus Gov't Postage and C.O.D. charges. Put it in your engine for 30 days' free trial. If you are not getting better performance out of your car than you thought possible, have not stopped oil burning, have not increased gas mileage — return the empty tube and get your money back in full. Power-Seal is absolutely harmless; lasts 10,000 miles; cannot hurt the finest car in any way. It can only preserve and protect your motor. Mail coupon NOW.

#### RUDSON AUTOMOTIVE INDUSTRIES

Dept. 261, 666 Fifth Ave., New York 19, N. Y.

**RUDSON AUTOMOTIVE INDUSTRIES, Dept. 261**  
666 Fifth Ave., New York 19, N. Y.

Please send me . . . . . tubes of the amazing new POWER SEAL.

Regular Size, for 4- and 6-cyl. cars, \$4.95  
 Jumbo Size, for 8-cyl. cars and trucks, \$7.95

On arrival, I will pay the postman the price indicated above plus Gov't. Postage and C.O.D. charges. I must see an immediate improvement in the pep and power of my car, less oil consumption, greater gas mileage, reduced engine noise, easier starting, faster pickup, within 30 days, or you will refund my full purchase price.

Name . . . . .  
Address . . . . .  
City . . . . . Zone . . . . . State . . . . .

Save More! Send cash, check, or money order with coupon and we will pay all postage charges. Same money-back guarantee.

IN CANADA: 1184 Castlefield Ave., Toronto 10, Ont.—ADD 55 CENTS

LOW OVERHEAD-LARGE VOLUME SALES & SMALL PROFITS  
BRING YOU THESE "LOWEST PRICES."  
WHAT GOOD IS A TIRE WITHOUT A TUBE?  
TUBE FREE WITH EVERY TIRE AT NO EXTRA COST

**WHY PAY MORE!**

20 YEARS AT THIS ADDRESS  
AN ESTABLISHED POLICY OF CAREFUL SELECTION ASSURES YOU, MANY HAPPY MILES. BE WISE—TRY ONE—YOU'LL BUY MORE! WE WELCOME COMPETITION. NO ONE CAN TOUCH OUR QUALITY & PRICE!

**YOU GET WHAT WE ADVERTISE**

GOOD USED TIRES — NOT RECAPS — NOT RETREADS  
TAKE THE 10% DISCOUNT WE OFFER & PUT MONEY IN YOUR POCKET!  
EVERYBODY MAY TAKE **10% off** ON EVERY TIRE

20 MONTHS WRITTEN GUARANTEE

600-16 \$3.52	820-15 \$4.92	600-20 \$7.52	32x6(8) \$8.72
650-16 4.22	700-15 3.92	650-20 7.62	32x6(10) 10.72
700-16 4.42	670-15 4.02	700-20 8.82	900-20 13.22
650-15 3.82	710-15 4.32	750-20 8.52	1000-20 14.02
760-15 4.42	550-17 3.72	825-20 14.12	1100-20 16.82

**FREE** If you buy 3 Passenger tires, we GIVE the 4th tire FREE with 32 mos. guarantee **FREE**

Specialists in Truck Tires—Selected for Toughest Jobs—Tops in Value  
32 MOS. WRITTEN GUARANTEE, 34 MOS. WRITTEN GUARANTEE.

600-16 \$5.02	475-19 \$5.12	700-15(6) \$8.42	700-20 \$10.62
600-16(6) 6.32	640-15 4.72	750-16(8) 8.42	750-20(10) 13.02
650-16 6.52	670-15 5.12	700-17 8.72	750-20(8) 12.72
650-16(6) 7.02	710-15 5.22	750-17 10.52	825-20 17.82
700-16 6.12	760-15 6.72	750-18 10.42	900-20 17.62
750-16(6) 8.32	800-15 8.02	825-15 10.92	1000-20 16.52
850-16 3.92	820-15 6.12	600-20 8.72	1100-20 17.02
550-17 4.22	670-16 5.02	650-20 9.52	100-22 17.82
650-15 5.02	760-16 7.02	32x6(8) 10.52	1000-22 17.92
700-15 5.12	700-16(6) 7.12	32x6(10) 12.92	1100-24 22.92

ALL WHITE WALLS \$1.00 extra (Military tread)—750x20—\$14.02

Thousands of tires shipped all over the U.S.A. All tires shipped F.O.B. Phila. Send Check or M.O. with this ad. Dept. 2, No. C.O.D.

**STANDARD 834 N. Broad St., Philadelphia 30, Pa.**

**NEW! CHEAP! OIL BURNER**  
AMAZING HEAT INVENTION

FITS IN ANY COAL STOVE, RANGE, BOILER OR FURNACE. No more shoveling Coal or Ashes. This Universal Unit makes one of the quickest, hottest, cheapest fires known. Sold on a 60 day Money-Back Guarantee. Send No Money. You will receive Agents Prices and full details by sending your name to

**NORTHWEST MFG. CO., 10-J Main, Mitchell, South Dakota**

**TASOPE PHOTO-ENGRAVING PLANTS**

Establish your own profitable PHOTO-ENGRAVING business. Make cuts for newspapers, printers, and advertisers. Make etched name plates, plaques etc. Instructions furnished, no experience necessary. Sold direct from factory since 1931. First five hundred cuts sold locally or by mail will pay for plant and pay you well for your time. Write for FREE catalog.

**TASOPE, DEPT. PM7, AURORA, MO.**

**RUPTURE**

RELIEF...OR YOUR MONEY BACK  
Original, patented Web, copied but never matched. Users say it's best ever. Relief or no cost to you. Write:

**WEB TRUSS CO., Dept. M-7, Hagerstown, Md.**

**EARN \$10 PER HOUR GROWING MIDGET TREES!**

AT HOME! - SPARE TIME! - NO EXPERIENCE NEEDED!

It's New! Amazing! FULL GROWN living dwarf trees — only 12 INCHES HIGH! Elm, orange, oak, cypress—any kind! All BLOOM and even BEAR FRUIT. Perfect, healthy specimens, but miniature! Make costly home decorations and beautiful expensive centerpieces (sold for over \$1,500 each). It's easy! Fun! A new fascinating artistic HOBBY — a new fabulous \$\$\$\$\$\$ BUSINESS! Real seed and sensational new growing secret plan details. BOTH FREE!

**FREE! GENUINE SEED AND PLAN**

HOW TO LEARN GROWING SECRETS  
FREE SEEDS

**NATIONAL NURSERY GARDENS, Dept. M-7**  
8463 SO. VAN NESS, INGLEWOOD 4, CALIFORNIA



Now IN YOUR OWN HOME Learn

# TELEVISION RADIO ELECTRONICS

*the Amazingly Effective*

## D.T.I. WAY

—with the aid of BOTH  
HOME EQUIPMENT  
and HOME MOVIES

What will mailing the coupon below do for YOU? Just this! You'll find out about one of today's most remarkable... practical ways to prepare to get into America's amazing billion dollar opportunity field of TELEVISION-RADIO-ELECTRONICS. You'll see how to get into fascinating work that pays well... that offers one of America's most promising futures... that enables you to start your own business almost "on a shoe string," if you prefer this to a job opportunity.

And above all, you'll get some GOOD NEWS especially welcomed by men anxious to earn REAL MONEY in this thrilling field. For you'll see that NOW you can get the kind of practical, laboratory-type training so desirable for making real progress in Television-Radio-Electronics AND WITHOUT LEAVING HOME.

You'll see that DeVry Technical Institute sends everything needed to set up your own HOME LABORATORY.

You get and keep the same type of basic electronic equipment used in our modern Chicago Training Laboratories. You get home training that includes the knowledge and experience gained from training thousands of students first hand in Chicago.

And to top it all, you use DTI's amazingly effective and exclusive home training aid—INSTRUCTIVE MOVIES. But why not get the complete story? Mail coupon today for information-packed literature.

### MODERN LABORATORIES

If you prefer, get all your preparation in our new Chicago Training Laboratories—one of the finest of its kind. Ample instructors, modern equipment. Write for details!

### MILITARY SERVICE!

If you're subject to military service, the information we have for you should prove very helpful. Mail coupon today.

Get this  
information-  
packed  
publication

## FREE!

*Mail Coupon Today*

DEVRY TECHNICAL INSTITUTE, Dept. PM-7-K  
4141 BELMONT AVE., CHICAGO 41, ILL.

I would like your valuable information-packed publication showing how I can get started toward a good job or my own business in Television-Radio-Electronics.

Name..... Age.....  
Street..... Apt.....  
City..... Zone..... State.....

NO PREVIOUS EXPERIENCE NEEDED  
NOW... get  
**EVERYTHING  
YOU NEED**  
for real Laboratory-  
type training  
**AT HOME**

Above:  
Work over  
**300**  
fascinating  
experiments  
with this  
equipment

1. Build over 300 fascinating experiments from 16 BIG SHIPMENTS of Electronic-Radio parts which you KEEP.

2. Build valuable commercial-type test equipment—as shown to the left—which you KEEP. This includes a quality 5 INCH oscilloscope and jewel bearing Multi-Meter—both highly useful for Television work.

3. Build and keep a big 21 INCH Set. (D.T.I. offers another home training in Television-Radio-Electronics, but without the TV set.)

4. Use a 16 mm. movie projector and new series of highly instructive movies—a wonderful aid to help you grasp important fundamentals faster... easier... better.

5. Enjoy well-illustrated, easy-to-read lessons with handy FOLD-OUT diagrams.

6. Get an honest-to-goodness EMPLOYMENT SERVICE to help you get a good job after graduating—or assistance in starting your OWN SALES AND SERVICE BUSINESS. Mail coupon today for the complete details.

D.T.I.'s Training is available in Canada



# 21 INCH

Build and keep this BIG DTI Engineered TV set—easily converted to U.H.F. (DTI offers another home training, but without the TV set.)



"ONE OF AMERICA'S FOREMOST TELEVISION TRAINING CENTERS"

## DEVRY TECHNICAL INSTITUTE

AFFILIATED WITH  
DEFOREST'S TRAINING, INC.  
CHICAGO 41, ILLINOIS

**89 WAYS TO EARN MONEY IN TELEVISION RADIO ELECTRONICS**



# DRAFTSMEN



**CASH BIG  
PAY CHECKS!**

Train Now for  
more success,  
greater security

**LEARN AT HOME IN SPARE TIME  
(or at college in Chicago)**

Check the want ads in any newspaper—SEE the big-pay opportunities open to you as a draftsman. What's more, you can learn this well-paid, prestige profession at home—quickly, easily! No special talent needed. Get complete, step-by-step Chicago Tech lessons in the mail, spend a few pleasant hours studying each week. In a short time you'll be a well-trained draftsman, ready to take your pick of many good jobs. Act now!



**Free Information—Mail Coupon Today!**

Get FREE TRIAL LESSON plus information about C.T.C. practical training. Learn what successful Chicago Tech graduates say about high pay and opportunities in drafting. No charge, or obligation.

## CHICAGO TECHNICAL COLLEGE

H-252 Tech Bldg., 2000 So. Michigan Ave.  
Chicago 16, Illinois

Mail me FREE lesson with facts about big opportunities in DRAFTING.

Name \_\_\_\_\_ Age \_\_\_\_\_

Address \_\_\_\_\_

City \_\_\_\_\_ Zone \_\_\_\_\_ State \_\_\_\_\_



C7

**Colorcreting Can Be  
Your Big Opportunity**

Local  
Colorcretors  
are Needed Everywhere

Colorcreting is a small investment enterprise, rich in sales potentials, high in income possibilities. Work is easy and fascinating. No experience required; we supply complete instructions.

Colorcreting is a building-beautifying process, with Colorcrete being pneumatically applied to new or old masonry surfaces such as concrete or stucco. Lasts indefinitely—25 years or more. Easily cleaned. Gleaming white, or a choice of 30 colors.

Colorcrete equipment is compact and portable. Easy to operate and practically wear-proof. Easy-payment terms when desired. Write at once for Opportunity Book.

**COLORCRETE**

Colorcrete Industries, Inc.  
570 Ottawa Ave., Holland, Michigan

## 56 Pages of Outdoor Fireplace Designs and Ideas



A COMPLETE GUIDE you or your builder can easily follow to get a perfect "fun center" for your family and guests. Includes "outdoor" recipes and menus, clever cook-nook accessories. Illustrates all-metal fireplace units that simplify correct construction with any masonry. Send only 25c for your copy. The Majestic Co., Inc., 436 Erie St., Huntington, Indiana.

Only 25c Postpaid

New Beauty for Your Lawn



## GIANT BALLOONS

Surplus U. S. Gov't. (new-coverage) NEOPRENE weather, target balloons. For FUN or PROFIT. Great sport in the backyard or for parties, picnics, dances, fairs. MONEY-MAKERS. Use these balloons to attract crowds to civic events, conventions, exhibitions, trade shows, TERIFIC for high school and college PROMS. All sizes are approx. inflated size. Postage prepaid on prepaid orders.  
3 ft. dia. 49c — 6 ft. dia. 99c  
13 ft. dia. \$1.59 — 20 ft. dia. \$1.95  
• Calif. residents please add sales tax.

WAR ASSETS DIV. VOLUME SALES CO.

Dept. W-754 3930 Sunset Blvd. Los Angeles 29, Calif.

## REAL ESTATE BE A BROKER

PAYS BIG! SEND FOR FREE, BIG, ILLUSTRATED CATALOG NOW! Graduates report making substantial incomes. Start and run your own business quickly. Men, women of all ages, learn easily. Course covers Sales, Property Management, Appraising, Loans, Mortgages, and related subjects. STUDY AT HOME or in classrooms in leading cities. Diploma awarded. Write TODAY for free book! No obligation. Approved for World War II and Korean Veterans  
**WEAVER SCHOOL OF REAL ESTATE** (Est. 1939)  
Suite 300 Law Bldg. Dept. PM Kansas City, Mo.

FREE  
BOOK  
TELLS  
HOW

## Build your own JET ENGINE!



Order these plans today

1. JET PROPELLED BICYCLE. Assemble your own. Photo and instructions. \$1.00.
2. HOW TO MAKE EXPERIMENTAL JET ENGINES. Seven sheets drawings with information and instructions. \$2.50.
3. BOTH OF ABOVE in one order \$3.75. SEND NO MONEY. Order both at once \$3.75 C.O.D. in USA plus c.o.d. postage. Send check or money order and we pay postage. Get other information too. Rush Order.

J. HOUSTON MAUPIN, Dept. 55, Tipp City, Ohio

## STUDY INDUSTRIAL DESIGN

You can train at Art Center School in California with practicing-professionals for upper-level jobs in INDUSTRIAL DESIGN. Recent graduates have been added to the staff at General Motors, Chrysler, Raymond Loewy, Henry Dreyfuss, etc. Majors in transportation, general product design, structures, community development, furniture design, packaging, display. 4-year degree courses. Learn to combine imaginative design with technical proficiency, coordinate utility and beauty, stimulating environment. Field trips. Advantages of mild Southern California climate and nearby holiday spots. Coed. Placement service. Write for catalog.

ART CENTER SCHOOL, Edward M. Adams, Director  
5353 WEST THIRD STREET, LOS ANGELES 5, CALIFORNIA

## AVIATION Pays You More With a Schooling at PARKS

### NOW! A&E MECHANIC LICENSE COURSE

45-week course, all phases aircraft & engines.

Enrollment Dates: Sept. 1-2, 1954

**FLIGHT COURSES**—Private, Commercial, Instrument, Instructor, Multi-Engine.

**DEGREE COURSES**—B.S. degree in 3 yrs. from Saint Louis University — Aero. Engineering, Maint. Engineering, Aero. Administration.

All Parks Schooling Approved for Veterans  
Write Today.

**PARKS COLLEGE** ARNOLD HALL  
EAST ST. LOUIS, ILL.

POPULAR MECHANICS



# AMAZING BARGAINS!

Direct - from - Importer - to - You!

**GERMAN POWERHOUSE BINOCULARS**  
**9 X AREA MAGNIFICATION!**  
**20 Mile Range! - Save \$7.00!**

**4.98**  
 WITH CASE

A lifetime bargain for **POPULAR MECHANICS** readers! . . . **THORESEN** - - world's greatest importer of German binoculars - - now brings you the renowned **POWERHOUSE** Binoculars at an unbelievably low price! Actually give **9 X AREA MAGNIFICATION!** Latest streamlined design, as illustrated in greatly reduced size. A **HINGE** model - - you can adjust to the **EXACT** space between your eyes. Aluminum Center-post focusing gives you clear, sharp viewing. . . **SEE UP TO 20 MILES AWAY!** Sturdy but lightweight (11 1/2 oz.) A real triumph of the German optical industry!

**PRECISION GROUND LENSES**

The **POWERHOUSE** LENSES are the crowning feature of this great binocular - - each and every lens is ground & polished to a high tolerance, then carefully checked for accuracy! **NOT** moulded plastic type stamped out by the million! You get **CRYSTAL-CLEAR** viewing! No excessive distortion or "ghosts" found in cheap glasses. Were you to spend \$25, we wouldn't give you better lenses! Send coupon **TODAY** and get your **POWERHOUSE** Binoculars at this low introductory price of **4.98** tax paid, including handsome case. Sorry, but limited import supply forces us to restrict orders to **ONE** binocular per reader.

No. 6. **POWERHOUSE** Binoculars & Case. 4.98 tax paid

Enjoy **BASEBALL, Racing, Movies, TV, Nature, Plays** the **SPEKTOSCOPIES** Way!



**NOW!**  
**1.98**  
 FTI

**GET CLOSE-UP VIEWS ALL DAY WITHOUT FATIGUE!**

**SAVE \$8.00**

IMPORTED FROM  
**GERMANY**

Western Germany's famed binocular-spectacles are worn just like ordinary eyeglasses - - they give **MAGNIFIED VIEWING** - - hour after hour - - without fatigue! Greater range than many expensive opera & field glasses and far greater field of view than some selling for many times more! **INDIVIDUAL** eye focusing - - clear, sharp viewing whether at a ball game, a movie or sitting beside your TV set! Sparkling Ebony design - - weigh only 1 oz! Germany's need for dollars makes the special low price possible - - **\$1.98** tax & postpaid, a saving of \$8.00 or more. Use handy coupon, order **TODAY!**  
 No. 90. **SPEKTOSCOPIES**. \$1.98 tax paid

## Solingen Steel HUNTING KNIFE

**3.95** INCLUDING LEATHER SCABBARD

The famed **BLACK FOREST HUNTING KNIFE** made in Solingen, Western Germany of superfine Nicht Rostend (non-rusting) steel is **NOW** available through **THORESEN'S!** Rugged beauty of this superb knife has already won recognition for design in industrial circles on the Continent - - and its utility and value as an aid in hunting & fishing has made it a prime favorite with sportsmen all over Europe. Blade is actually sharp enough to shave with; will stand up against most rugged treatment; genuine leather scabbard is metal-tipped. Length, 10 in. Tough, sturdy Solingen Steel assures you years of dependable service.

**MAKE THIS TEST!**

Place a thick metal disc or foreign coin on the ground. Plunge the point of the Black Forest knife downward. The knife will completely pierce the thick metal - - with **NO** damage to the blade! The sleek, graceful lines of this German import also provide an ideal rec room or den decoration; a dandy gift for men! Send coupon **NOW** with **3.95** for knife & scabbard, tax & postpaid.  
 No. 80 Black Forest Knife & Scabbard . . . . . 3.95 tax paid

**Use this coupon to order any item on this page**

**SAVE MONEY WITH THIS COUPON!**

**THORESEN'S, Dept. 6-G**  
**352 Fourth Ave., New York 10, N. Y.**

**RUSH** the items checked on 5 Day Free Trial-Money Back Guarantee. ( ) Payment enclosed. Send tax & postpaid. ( ) Send C.O.D. plus postal charges.

- No. 6 -Powerhouse Binoculars (4.98)
- No. 90-Spektoscopes (1.98)
- No. 80-Black Forest Knife (3.95)

NAME \_\_\_\_\_

ADDRESS \_\_\_\_\_

CITY \_\_\_\_\_ ZONE \_\_\_\_\_ STATE \_\_\_\_\_

**CANADIANS:** Save Tariff. Send orders direct to **THORESEN CO.** Dept. 6-G, 45 St. James St. W, Montreal 1, P. Q.



# FOR YOUR VOCATIONAL TRAINING

COME TO  
**THE COLLEGE OF TECHNOLOGY  
UNIVERSITY OF HOUSTON**

(LOCATED IN FABULOUS HOUSTON, TEXAS)

**FOR SUCCESS . . .** Select one of these fascinating vocational fields:

- Automotive Mechanics    Automotive Body and Paint  
 Automotive Upholstery and Trim    Furniture Upholstery  
 Machine Shop    Radio Servicing    Television Servicing  
 Welding    Woodworking

**TRAIN NOW** for the job you want . . . a job with a good income and security. Train at the University's College of Technology . . . rated one of the best in the country.

- Beautiful 250 acre campus • Air conditioned classrooms and residence halls • Graduate placement
- University television and radio station • Modern, extensive equipment • Part-time job while in school
- Co-educational • G.I. approved—V.A. on campus
- Open to high high school graduates or equivalent
- Aptitude testing and vocational guidance • Sept., Feb., June semesters

SEND FOR FREE illustrated brochure now.  
Mark X before your choice of subject.

**UNIVERSITY OF HOUSTON—COLLEGE OF TECHNOLOGY**  
DEPT. 174 — HOUSTON 4, TEXAS

## EVEN IF YOU DON'T KNOW A NOTE OF MUSIC NOW...

**YOU CAN LEARN YOUR FAVORITE  
INSTRUMENT THIS EASY A-B-C WAY**

No special "talent," no previous training needed. This U.S. School home-study method is so successful because you learn to play by playing real tunes by note, right from the start. And just think, you can learn your favorite instrument for only a few cents a day!

If interested, mail coupon for FREE 36-page Book showing how easy it is to learn any instrument, right at home, in spare time, without a private teacher. No obligation; no salesman will call on you. **U. S. SCHOOL OF MUSIC, Dept. 307, Port Washington, New York. (56th Year)**



**U. S. SCHOOL OF MUSIC,**  
Dept. 307, Port Washington, N. Y.

Please send me your 36-page illustrated Free Book. I would like to play (Name Instrument).

Instrument \_\_\_\_\_ Have you Instrument? \_\_\_\_\_

Name \_\_\_\_\_  
(Please Print)

Address \_\_\_\_\_

## AQUA-LUNGS

### FROGMEN SUITS SPEAR GUNS

**SELF-CONTAINED DIVING**—A comprehensive diving digest reviewing various types of equipment and a thorough study of underwater pressure and its effects. Includes a decompression table showing how much time can be safely spent at various depths. Send now 60c in coin to receive this 50c booklet.

**DIVING GEAR**—A 16 page beautifully illustrated catalogue showing the latest available foreign and domestic diving equipment: frogman suits, masks, spear guns, snorkel tubes, swim fins and "Aqua-Lungs." Send only 15c in coin.

SEND FOR THESE VALUABLE BOOKLETS TODAY  
**U. S. DIVERS CORP., 1045 Buxton Ave., W. Los Angeles 24, Cal.**

# LAW...

**STUDY AT HOME** Legally trained men win higher positions and bigger success in business and public life. Greater opportunities now than ever before.

**More Ability: More Prestige: More Money** We guide you step by step. You can train at home during spare time. Degree of LL.B. We furnish all text material, including 14-volume Law Library. Low cost, easy terms. Get our valuable 68-page "Law Training for Leadership and Evidence" books FREE. Send NOW.

**LASALLE EXTENSION UNIVERSITY, 417 South Dearborn Street**  
A Correspondence Institution Dept. 764L Chicago 5, Ill.

## LEARN LOCKSMITHING

Learn this fascinating, profitable trade from experts in your spare time at home! Age or physical handicap no disadvantage. Year around, steady income. Full or part time. Practical, illustrated lessons. You can make money even while learning! All materials and special tools supplied without extra charge.

**INSTITUTE OF LOCKSMITHING, Dept. P-56**  
15 PARK AVENUE RUTHERFORD, N. J.  
Lic. by N.J. State Board of Education  
Approved for Veterans

send for FREE BOOKLET

## FALSE TEETH WEARERS

35 days supply new, improved RIGIDENT Comfort-Cushion DENTURE RETAINER only 35c at drug counters. Sent postpaid when ordered direct. Keep dentures tighter, more comfortable, odorless, with user-proved RIGIDENT • RIGIDENT PRODUCTS CO.  
Suite 623-PM, 610 So. Broadway, Los Angeles 14, Calif.

## BUILD LUGGAGE AT HOME WE SELL YOUR PRODUCTS!

**ONLY NEW HOME MONEY-MAKING PLAN IN YEARS!**

Make Luggage and cases for traveling, photographers, musicians, salesmen, electronics, tools, portables, 1001 other items. Also repair Luggage. No special equipment needed. BIG Profits. We supply complete instructions—everything. Write for free details and Business Plan. **ABARSI CASECRAFT, Dept. G-7, 805 W. Sunset Blvd., Los Angeles 12, Calif.**

Say You Saw It in  
**POPULAR MECHANICS**

## "YOU ARE UNDER ARREST!"

Help Bring Crooks to Justice Through Scientific  
**CRIME DETECTION!**

We have taught thousands this exciting, profitable, pleasant profession. Let us teach you, in your own home. Learn Finger Printing, Firearms Identification, Police Photography, Criminal Investigation Methods thoroughly, quickly, at small cost. Over 800 of all U. S. Bureaus of Identification employ I. A. S. students or graduates. We can prepare you for this fascinating work, during spare time. Write today, stating age.

**INST. OF APPLIED SCIENCE, 1928 Sunnyside Ave., Dept. 135B, Chicago 48, Ill.**

## Learn BAKING At Home

Baking is one of America's high industries in wages. Nearly depression-proof. Thorough basic home course lays sound foundation. If you have aptitude, write for FREE BOOKLET. "Opportunities in Commercial Baking."

**NATIONAL BAKING SCHOOL**  
835 Diversey Parkway Dept. 135B Chicago 14, Ill.



# 330 DIFFERENT STAMPS

for only **25¢**

(Catalog value, \$6.85)



**SOUTH POLE SET**

plus **12 GIANT TRIANGLES**

(Alone worth 50¢)

Valuable imported collection includes new **CROATIA** giant triangle set—6 postage, 6 airmails—picturing exotic flowers and birds in full color! You also get **SOUTH POLE**—unique set of 4 to carry mail from Antarctic Base; **PORTUGUESE COLONIES**—1951 Sacred Art Collection from scarce colonies like Cape Verde, Angola, etc.; **RUSSIA**—World War I enormous charities portray St. George slaying the Dragon; plus hundreds more! Grand total of 330 stamps—reg. \$6.85 value—all yours for just 25¢ to introduce our Bargain Approvals. Included **FREE**—Midget Encyclopedia of Stamps!

Send 25¢ Today. **ASK FOR LOT FO-17**

**ZENITH CO., 81 Willoughby St., Brooklyn 1, N.Y.**

# Learn to MOUNT BIRDS



## Tan SKINS, make up FURS

Be a Taxidermist. Double your hunting fun. We teach you at Home. Mount Birds, Animals, Fish, Heads, common specimens. Fun and profits. Decorate home and **MAKE MONEY**. Mount game, tan for others. See profits in spare time. **WRITE TODAY.** 100 game pictures in **FREE BOOK**. Hunters, get your copy. It's **FREE**. Now Free. Send post card. State your AGE. **NORTHWESTERN SCHOOL OF TAXIDERMISTRY** Dept. 2507 Omaha, Nebraska

# MAKE TREMENDOUS PROFITS

Have fun! Earn Big Money! Cast plastic figurines, book ends, plaques, novelties at home in your spare time with X.L. rubber molds! **NO EXPERIENCE NEEDED!** Models and rubber for 3 molds, only \$1.00 incl. Start your business now! Send 25¢ for 40 page catalog. **3403 SO. MADISON, DEPT. PM2** MUNCIE, INDIANA

**LOOK! A MILLION THRILLS!**

High Power **BINOCULARS**

**30 DAY FREE TRIAL**

Finest Precision Optics  
Money Back Guarantee  
Easy Pay Plan

Free! Catalog & Book  
"How to Select Binoculars"

Dept. M87 43 E. Green  
Pasadena, Calif.

33 Models  
**\$9.95 UP**

**BUSHNELL Binoculars**

# Build Your Own Mower with POWER MOWER KITS

**FREE PLANS LOW FACTORY PRICES DIRECT TO YOU**

With Triangle's precision made ready to use Kits. Parts and Engines, you can easily build as fine performing power mower as you could buy ready made, at a Big Saving. Our Free Plans guide you. Choose from: 6 build-it-yourself Kits, 4 models of complete mowers with or without engines; and 4 models ready to assemble at a Big Saving. 18 or 20 inch sizes in 3 and 4 wheel models—belt or direct drive. Our guarantee protects you and our **LOW FACTORY PRICES DIRECT TO YOU** save you up to 40%. Write **TODAY** for your set of Free Plans and complete descriptive literature.

**▲ TRIANGLE MANUFACTURING CO., Box M-32, Fort Scott, Kansas**



Come on, Buddy, Quit being a **BAG OF BONES** Weaking LIKE I WAS

**He Pall!** **WIN \$100.00 as I just did**

**IN 10 MINUTES OF FUN A DAY**

You can do ALL I did!  
**I gained 25 Terrific LBS. of HANDSOME POWER-PACKED MUSCLES all Over!**

I improved My **HE-MAN LOOKS 1000%**  
I won NEW STRENGTH  
I won NEW POPULARITY

**JIM NORMAN AFTER He Mailed Coupon**

Everybody admires Jim's build NOW He's a WINNER in ALL SPORTS

I Mailed the Coupon and got these **5 PICTURE PACKED He-Man Courses Which YOU Can NOW get FREE**

Before \$1 price goes back Millions Sold for \$1.00

**YOU CAN WIN a BIG 15" SILVER CUP as I just did! with YOUR NAME engraved on it!**

**1 HOW TO BUILD A MIGHTY CHEST**

"I gained 25 lbs. of muscles."

Come on **PAL**, Now YOU give me **10 PLEASANT MINUTES A DAY** In Your Own Home Like Jim Did and I'll give you **A NEW HE-MAN BODY** for your OLD SKELETON FRAME

**2 HOW TO BUILD A MIGHTY ARM**

"I added 7 inches to my CHEST 3 inches to each ARM."

**NO!** I don't care how skinny or flabby you are I'll make you **OVER** by the SAME method I turned myself from a wreck to the strongest of the strong.

**3 HOW TO BUILD A MIGHTY BACK**

Develop YOUR **520 MUSCLES** Gain **POUNDS, INCHES FAST!**

**YES!** You'll see **INCHES** of **MIGHTY MUSCLE** added to your **ARMS** and **CHEST**. Your **BACK** and **SHOULDERS** broadened. From head to heels you'll be a **WINNER** in **EVERYTHING** you tackle.

**4 HOW TO BUILD A MIGHTY GRIP**

**5 HOW TO BUILD A MIGHTY LEGS**

**LAST CHANCE - ALL FREE COUPON!**

**1. Photo Book of STRONG MEN**  
**2. MUSCLE METER 3. FIVE COURSES**

Dept. PM-47  
Tell Me How To WIN \$100, etc.

**JOWETT INSTITUTE OF PHYSICAL TRAINING**  
220 FIFTH AVENUE, NEW YORK 1, N. Y.

Dear George, Please mail to me **FREE** Jowell's Photo Book of Strong Men and a Muscle Meter, plus all 5 **HE-MAN** Building Courses: 1. How to Build a Mighty Chest, 2. How to Build a Mighty Arm, 3. How to Build a Mighty Back, 4. How to Build a Mighty Grip, 5. How to Build Mighty Legs—Now all in One Volume "How to become a Mighty HE-MAN." ENCLOSED FIND 10¢ FOR POSTAGE AND HANDLING (no C.O.D.'s).

NAME \_\_\_\_\_ AGE \_\_\_\_\_  
ADDRESS \_\_\_\_\_  
CITY \_\_\_\_\_ ZONE \_\_\_\_\_ STATE \_\_\_\_\_



Build your own Breeze . . .

SAVE UP TO 75%



ANYONE CAN ASSEMBLE WINDOW OR ATTIC FANS WITH

"BUILD YOUR BREEZE" **FAN KITS**

Everything you need to assemble a quiet, efficient window or attic fan is included . . . No special tools or skill necessary . . . You SAVE up to 75%! Here's what you get: Fan Spider, Masonite Blades, Rubber-mounted Bearings, Shaft, Belt, Pulleys, Bolts and a famous EASI-BILD Pattern showing you how to assemble your own low cost cooling system in a matter of a few hours! All you furnish is Lumber and 1/4 HP Motor! There's a size for every need:

- 30" Cools average home, \$15.95 P.P.
- 36" Size for large homes, \$19.50 P.P.
- 24" Size for small homes, \$14.95 P.P.
- 20" Apt. or office size, \$13.95 P.P.

Send check or money order for immediate shipment postpaid on a money-back guarantee! Circular Free!

FAN KIT COMPANY, Box 5842-M, Memphis 4, Tenn.

**FREE** **1954** **CATALOG**  
WORLD RADIO LABORATORIES

"The World's Largest Distributor of Amateur Radio Transmitting Equipment."

Jam packed with bargains—everything in Radio, TV, and Hi-Fi—for Handyman, Ham, Experimenter or Serviceman!

- Pay Only 10% Down
- Easy Terms
- Liberal Trade-Ins
- Save Over 50% on Used Equipment
- Over 600 guaranteed reconditioned items.



**WORLD RADIO LABORATORIES**  
3415 W. Broadway — Council Bluffs, Iowa  
Leo I. Meyerson **PERSONALIZED SERVICE**

**MAIL HANDY COUPON**

WORLD RADIO LABORATORIES, INC. Dept. PM-7  
3415 W. Broadway — Council Bluffs, Iowa 3"x4" U.S.  
 Free 1954 Catalog  Used Eq't List  Radio Map 25c

NAME \_\_\_\_\_  
ADDRESS \_\_\_\_\_  
CITY \_\_\_\_\_ STATE \_\_\_\_\_

more jobs than graduates

**ENGINEERS**  
If you are an interesting person, you will pay you to write Box D, including a complete history of the college and education.

Demand for our engineering graduates exceeds supply. Effective placement! Study in this world-famed college . . . established 1884. New term starts quarterly. Approved for Korean Vets.

**Bach. Sc. degree in 27 months**

Bachelor of Science in Mechanical, Civil, Electrical, Chemical, Aeronautical, Radio (Television), Administrative Engineering; Business Administration and Accounting. Also 36-weeks certificate courses in Surveying, Drafting, Secretarial Science. Intensive program: technical fundamentals accented. Small classes: personalized instruction. For earnest, mature students whose time and budget require accelerated courses and modest costs. Preparatory courses.

Beautiful campus in friendly college town. Well-equipped, new and modernized buildings and labs. Enter Sept., Jan., March, June. Write Jean McCarthy, Director Admissions, for Catalog and View Book.



**TRI-STATE COLLEGE**  
474 College Avenue Angola, Indiana

A "GOOD HAND" HELPS YOU SUCCEED!  
**LEARN TO WRITE WELL**

Handwriting quickly improves with our easy-to-understand picture lessons! Put your spare time to good use; send today for  FREE BOOKLET, "How to Become a Good Penman," or check volumes wanted below at \$1 each:  Business Writing  Artistic Writing  Card Writing  Bird & Design Flourishing  Engraving Alphabets. COMPLETE SET \$4.50. Ask for price list of penman's supplies.

beautifully written, plus special pen-point for shaded writing. **OUR 33rd YEAR**  
**Only 10c**

**TAMBLYN SCHOOL of PENMANSHIP**  
S.A. Ziller, Pres., 442 Ridge Bldg., Kansas City, Mo., USA

**SHINE WITHOUT 'POLISH'**  
New Invention! • Sells Like Wild

Replaces messy pastes, liquids. Simply glide over shoes—and presto! —you have a lustrous, long-lasting shine. No mess, no fuss. Shoes gleam like mirror. For Men's, Women's, Children's Shoes. Take orders! Earn money!

**SAMPLES FOR TRIAL**  
Sample offer sent to all who send name at once. Postcard will do. SEND NO MONEY—just your name. KRISTEE CO., Dept. 676, AKRON 8, OHIO

**STUDY AT HOME LAW FREE BOOK!**  
**PREPARE FOR THE BAR**

Write today for your copy of our FREE book, "THE LAW-TRAINED MAN," which describes the famous Blackstone home-study course in bar and business law. All needed instruction material furnished including big 16-volume law library. Bachelor of Laws (LL.B.) degree awarded. Moderate tuition; easy monthly terms. Write today.

**Blackstone School of Law** 225 N. Michigan Ave.  
Founded 1890 Dept. 50-B, Chicago 1, Illinois

**MAKE EXTRA MONEY PLASTICS LEARN AT HOME**

There are RICH OPPORTUNITIES for MEN and WOMEN with "know-how" in Plastics. Interstate's new Plastics course tells and shows how to make hundreds of fast selling items out of Plastics. Gives complete training in fabrication, casting, lamination, molding, internal carving, etc. in simple, easy, step-by-step language and pictures. Plastics and Fabricating Kits for 23 valuable Plastic items come with training at no extra cost. **START A PLASTICS BUSINESS OF YOUR OWN.** No other industry holds such promise for the future. You can make big money manufacturing novelties, toys, signs, etc., in your own home in spare or full time. Don't wait! Learn NOW how Interstate's Plastics Training qualifies you for success in the Plastics field.

**PLASTICS AND SUPPLIES FURNISHED FOR 23 VALUABLE PROJECTS**

**INTERSTATE TRAINING SERVICE**  
Dept. C-3-G Portland 13, Oregon



# MAKE \$15,732.00 IN ONE SUMMER \$9,504.00 WITHOUT LEAVING YOUR HOME

# DON'T READ THIS!

Unless you are near a healthy fire extinguisher or a plentiful supply of WATER. We cannot assume responsibility if this ad breaks out in ROARING FLAMES. So please do stop reading this until you have taken the necessary safety precautions. Yes, we have an item that's H O T —so H O T that we are not going to say other than the usual words of a good product for fear of setting this

good magazine on FIRE. This product is NEW! SENSATIONAL! COLOSSAL! AMAZING! and REVOLUTIONARY.—NO! No long story—All we have to say, and this is modestly, we have an ELECTRICALLY controlled bulb that is the BEST insect killer CONSOLIDATED RESEARCH has been able to produce—bar none. Not to be compared with any other unit ever sold.

Testimonials like these are pouring in by the hundreds.

"It works like a charm. I am amazed at its results."—Mrs. A. F. Wills, Atlantic City, N. J.

"Your magic bulb has at last solved my roach and fly problem."—Mrs. C. I. Thompson, Miami, Fla.

"Has given my family endless hours of comfort living."—Mr. P. V. Zane, Los Angeles.

You have heard of the 7 Wonders of the World. Now, consolidated research introduces the 8th Wonder, acclaimed a MUST in every home and establishment. Being hailed by salesmen as the biggest MONEY MAKER since the opening of the U.S. MINT.

**ABSOLUTELY EVERYONE**

Now that you have taken the safety precautions, read every word in this ad, as we have said above, this item is **HOT**, so hot that to be extra safe we have ordered the publishers not to use any **RED** ink. Now, getting serious, fellows, here's the scoop. We are going to do **EVERYTHING** to make you the most welcomed salesman to ever approach a customer. We will give you **GLOSSIES, MATS, IMPRINTS**, all the material needed for an immediate mail order set up, also documented test reports of how prominent colleges and testing labs, **RATE** our product, also at your disposal is a powerful pulling pitchman sound T.V. movie on Bug Weapon. The production value of this film cost us more than \$2000.00, **PLUS BELIEVE IT OR NOT** an advertising allowance. We will **PRE-SELL** this Bug Weapon for you, by launching a tremendous advertising barrage, including almost all national magazines, radio, and T.V. The entire population of the U.S. will be put in a buying mood. Especially so since hundreds of insects will help you make every sale. They will dive bomb about him, molest his comfort, interrupt his sleep, destroy his property, and spread contagious diseases about his home, and food. Business establishments suffer enormously combating the ugly insect problem. They will greet you with arms wide open. It's a tested natural with **STAGGERING** public acceptance and mountainous profits. Yes, you will be **WELCOMED**, you will be **THANKED**, most important you will make **MONEY**.

VOLUME SALES CORP., Research Dept. P-7  
2000 Market Street Philadelphia 3, Pa.

MOSQUITOES SILVER FISH  
MOTHS TERMITES  
**New!** 20th CENTURY BUG WEAPON **FREE READ HOW!**  
**DEATH**  
TO DISEASE-CARRYING, DESTRUCTIVE AND ANNOYING PESTS  
LICE GNATS  
FLIES SPIDERS  
ROACHES ANTS  
**AMAZING NEW INVENTION**  
**KILLS ALL TYPES OF INSECTS**  
**SCIENTIFICALLY-AUTOMATICALLY**

## 10-YEAR GUARANTEE

Not a gadget — not a halfway measure. Not to be compared with flimsy, untried imitations. A finished quality appliance. Carries an ironclad 10-year guarantee and parts replacement policy. Bound by signature.

COST ONLY PENNIES A MONTH TO OPERATE

**STOP**

FLIES  
ROACHES  
**DID YOU KNOW?**

that flies and roaches are suspected carriers of 13 communicable diseases including **POLIO**. One fly can reproduce 8 million others. Flies seldom leave anything without first excreting on it. Don't take chances with your health. **YES**, you can now insect proof your home without lifting a finger. Throw out old fashioned fly swatters, and messy spray guns. A new, small, clean, decorative, little bulb enables you to destroy **HUNDREDS** of types of **INSECTS** like **MAGIC**. Only one 2 hour application keeps killing disease carrying, destructive and annoying insects around the clock for more than 2 weeks. More powerful than D.D.T. yet harmless to humans, pets and plants. Approved **SAFE**. Not a gadget, not a half way measure. Carries a **10 YEAR GUARANTEE**. It must **KILL** not **TICKLE** roaches, flies, moths, ants, and hundreds of others of your money **REFUNDED**. For your health's sake order **SEVERAL** units **NOW**. Everyone send us a check, M.O. or cash for \$2.98—C.O.D.'s accepted. Should you, after testing your unit, decide that you would like to join us in the sales of this new public servant, we will refund you \$2.98 making your unit **ABSOLUTELY FREE**.

**ODORLESS • SILENT**  
**• MYSTERIOUS**

## FREE DEMONSTRATOR COUPON

- Enclosed is \$2.98. Send me one unit for my personal use.
- Enclosed is \$2.98 in cash, check or M.O. Rush me one 20th CENTURY BUG WEAPON with sales aids, and LOWER wholesale prices. However, should I become an active salesman, you of the Volume Sales Outlet are to **REFUND** my \$2.98 making my demonstrator **FREE**. Furthermore, I must agree that everything you say be true or I will return everything for a refund.
- Send one **MONEY MAKING** sales kit C.O.D.
- Last time is lost money. Rush me ..... dozen **BUG WEAPONS**, at your wholesale price. Don't forget to include my **FREE** demonstrator and sales aids, C.O.D.
- Together with the enclosed order don't forget to show me how to make \$4.37 on each \$2.98, \$15,732.00 in one summer, \$9,504.00 without leaving my home.

NAME.....  
ADDRESS.....  
CITY..... STATE.....  
(Members of the Mail Order Business Bureau)

**VOLUME SALES CORP., Research Dept. P-7**  
**2000 Market Street Philadelphia 3, Pa.**

**ABSOLUTELY EVERYONE MAIL THIS COUPON NOW!**



own your own business! earn up to  
**\$75 A DAY CLEAR PROFIT**  
 in your back yard or basement!

**MAKE CONCRETE BLOCKS With Amazing New  
 LOW PRICED GENERAL BLOCK MACHINE**

**NOW! Big Building Boom**

**Profits Within Your Reach**

You don't need much cash to cash in on the building boom! New high speed, low cost General Block Machine produces up to 1,000 concrete blocks a day for homes, factories, buildings, garages. Your profit mark-up is 100% to 150%! Fool-proof, easily operated, sturdy steel machine can make any size from 4" to 12". These superior 3-core blocks meet all building code requirements for foundation, chimney, corner, sash and many other types of blocks. Works indoors or out. Sand, cement and water available anywhere! Simple operating instructions and mixing formulae for cement and cinder blocks supplied FREE. Get full details, no obligation!

**EXTRA!**

Amazing illustrated book gives floor plans for 6 sensational concrete block bungalows. Tells how to lay blocks, lay out building lines, mix concrete, build steps, porch and concrete floors all at great savings. Written by experts. Can save many times the cost of the machine! Get it now! No strings attached.



R.L.T. of New York City Reports:  
 "My General Block Machine PAID FOR ITSELF IN FIRST 2 WEEKS!"  
 Thousands now in use the world over!  
 Write for FREE details TODAY

HOW TO BUILD YOUR OWN CONCRETE BLOCK HOME  
 Only 1 Prepared

Book sent free if you buy machine. \$1 refunded if you buy later.

**GENERAL ENGINES COMPANY**

Dept. M-74, 307 HUNTER STREET, GLOUCESTER, N. J.

**Get into Good Paying  
 AUTO BODY and FENDER WORK**



**BIG DEMAND** in Auto Body and Fender work. Start training now in your spare time at home for good pay work. Practical shop experience included. U. E. I. Training covers metalwork, welding, painting, etc. Placement service—or we will show you how to start your own shop. Behind U. E. I. TRAINING is a large national organization founded 1927. Write today for **FREE FACTS**—No obligation.

Write for Free Facts

**AUTO-CRAFTS DIVISION**  
 2523 SHEFFIELD AVE., UTILITIES ENGINEERING INSTITUTE  
 DEPT. XC-30, CHICAGO 14, ILLINOIS



**HANDS TIED?**  
 —because you lack a  
**HIGH SCHOOL DIPLOMA**

• You can qualify for an American School Diploma in spare time at home! If you have left school, write or mail coupon for FREE booklet that tells how. No obligation of any kind.

**OUR 57TH YEAR**

**AMERICAN SCHOOL, Dept. VB45**  
 Drexel at 58th, Chicago 37, Illinois

Please send FREE High School booklet.

Name.....

Address.....

City & State.....

Canadian Residents: Complete Canadian Course Available. Write American School, 1616 St. Lawrence St. West, Montreal.

**START YOUR OWN  
 ELECTRICAL APPLIANCE  
 REPAIR BUSINESS**



Repair electrical appliances of friends and neighbors. Service electrical equipment in factories, stores, etc. Work full or part time! New Shop Method home-training system. Rush name today for **FREE BOOK** and special form for getting Electronic Kit. Valuable Heating Element Kits, Advisory Service and Illustrated Instructions on new easy-payment plan. Pay later from **EARNINGS WHILE LEARNING**. Rush name today.  
**CHRISTY TRADES SCHOOL**  
 4804 N. Kedzie, Dept. D-3203, Chicago 25

**EARN WHILE YOU LEARN**  
**UPHOLSTERY**  
**BE YOUR OWN BOSS**



"Learn-by-Doing" at home—earn **EXTRA CASH** in spare time. Get a better job—be your own boss. UTS easy, practical course teaches you professional furniture upholstery, reupholstery, slipcovers, drapery making. **FREE**—tools, frames, materials to make 3 beautiful pieces upholstered furniture worth over \$239. Free illustrated Book. Write Upholstery Trades School, Dept. CL-309, 721 Broadway, New York 3, N. Y.



**MECHANICAL DENTISTRY**

A profession offering unlimited opportunities. Most modern and complete course embracing every branch from Plate to Porcelain Work, which prepares you to work for Dentists or start your own business. Individual instruction—practical training in day or night school. No books—no classes. Catalog upon request.  
**McCARRIE SCHOOL OF MECHANICAL DENTISTRY**  
 207 N. Broad Street Dept. 31 Philadelphia 7, Penna.

**Secrets of VENTRILOQUISM**  
**Now Revealed!**



Easy to learn in 60 to 90 days with our Home Study Course. **RESULTS GUARANTEED.** Make Money! Be Popular! Have Fun! Big Opportunity! Radio, Television, Stage Appearances! For **FREE** information regarding price and terms, **WRITE**. You must state your age. Dummy Catalog 25c.  
**FRED MAHER SCHOOL OF VENTRILOQUISM**  
 Box 36, Studio G Kensington Station Detroit 24, Michigan

Say You Saw It in Popular Mechanics

**GROW ORCHIDS AT HOME**  
**BIG PROFITS SPARE OR FULL TIME**

World's most thrilling hobby—profitable home business. Single Orchid plant may multiply into many—such as valuable as the first. Successful home grower shows you how! Raise gorgeous Cattleyas, Cymbidiums, Epidendrums, on living-room table. Big-profit orders come from friends, neighbors, florists, etc.—also Mail Orders. Illustrated secrets of the experts in simple "show-how" language **AND** blooming-size Orchid plants sent at **NO RISK**. Everything you need to start—for pleasure or profit. **FREE**—full details—**SEND NO MONEY**. Write today. **TROPICAL FLOWERLAND, Dept. 317, 4822 Wilshire, Los Angeles 5, Calif.**

**TELEPHONES**



**Desk Stand Style**  
 Slightly used but in excellent condition  
 Many Valuable Uses  
 Inter-House Phones House to Barn, etc.  
 Loud Speakers Microphones  
 Educational Purposes, Toys, etc.

Come complete, ready to use with wiring diagrams included. **\$2.75** Postpaid in U.S.A.  
 Two complete for only **\$5.00**  
**TELEPHONE LAMP KIT**—with illustrated instructions for making Desk Telephone Lamp including all parts (chips, nipples, push switch, cord, plug, etc.)  
 . . . \$6.50 Ppd. (Shade is not included).

**MICROPHONE, Dept. X-1602, 1760 W. Lunt Ave., Chicago 26, Ill.**

**Learn PHOTOGRAPHY at Home**

Splendid opportunities. Prepare in spare time. Practical! basic training. Long-established school. Send for free book. "Opportunities in Photography." No obligation.  
**AMERICAN SCHOOL OF PHOTOGRAPHY, 835 Diversey Pkwy., Dept. 1358, Chicago 14, Ill.**

POPULAR MECHANICS



# BRAND NEW! Firestone TIRES

BRAND NEW—FIRST QUALITY  
FIRESTONE PASSENGER TIRES

**SAVE UP TO 50%**

SEND FOR FREE CATALOG

BRAND NEW—FIRST LINE—HEAVY DUTY  
FIRST QUALITY—SENSATIONAL VALUES

TRUCK TIRES		PASSENGER TIRES	
Size	Full Price	Size	Full Price
700x15 6 ply	25.79	750x20 10 ply	50.42
600x16 6 ply	17.98	825x20 10 ply	58.50
650x16 6 ply	21.58	825x20 12 ply	59.73
700x17 6 ply	30.75	900x20 10 ply	70.55
600x20 6 ply	24.31	900x20 12 ply	83.84
650x20 8 ply	31.47	1000x20 12 ply	89.27
700x20 8 ply	35.45	1100x20 12 ply	104.78
700x20 10 ply	42.48	1000x22 12 ply	94.08
750x20 8 ply	45.15	1100x22 12 ply	110.75
		1100x24 12 ply	115.10

(Order by Mail—Send check or M.O.) • (all prices f.o.b. plant)  
Farmers—Full line of tractor tires—Write for Prices

**S & S TIRE CO.** 1400 HADDON AVE.  
CAMDEN 3, N. J.

## STAMP COLLECTORS 25¢

327 GENUINE STAMPS ONLY



**#1.** Valuable foreign stamps showing Famous Americans, New Uruguay Roosevelt, Washington, Lincoln & MacArthur on Indonesian and Moluccas issues. Even from "Behind the Iron Curtain" stamps show Americans. ALSO fantastic Monte Carlo triangle shows giant ship "United States"!!

**#2.** EXOTIC collection Yemen U.P.U., Pope Plus triangle, African natives, Israel, San Marino, Allied Military set and many other fine stamps.

**YOU GET** "Americana" collection alone worth more than price of entire lot! Exotic and special imported collection. 327 different stamps in all! Just 25¢ to introduce our approval service to you.

**FREE** (with order): Magnify glass, hinges and perforation gauge!

**NATIONAL STAMP SALES, 832 8th Av., Dept. 300, New York 19, N.Y.**

## ★ WORK FOR UNCLE SAM ★

**U. S. GOV'T. JOBS! AS HIGH AS \$4205.00 YEAR TO START.** Men, women, 18-55. Common education often sufficient. Write immediately for **FREE 36-PAGE BOOK** with list of positions, salaries, sample tests and full particulars telling how to qualify for them. (Not Gov't. Controlled)

**Franklin Institute, Dept. P-83, Rochester 4, N. Y.**

### BEING PUSHED AROUND??



Why take any more nonsense from bullies, wise guys and other pests? The next time they try to get smart—give them the surprise of their lives! It's easy when you know **POLICE JIU JITSU!** This complete, fully illustrated course comes to you in our volume. The same as taught to police, marines, "G" men, soldiers, sailors and members of the U. S. Coast Guard. By all means, just clip to this ad and we will send **POLICE JIU JITSU** to you postpaid by return mail. Satisfaction guaranteed or your money back.

**BOOKS PUBLISHING CO., AMITYVILLE, N. Y.**

Say You Saw It in Popular Mechanics

### PUMP WATER FAST!



**DRAIN WASH TUBS, CELLARS, CISTERNS.** Famous #7 pumps 2800 GPH. 420 GPH at 75' high or 1600 GPH from 25' well. Sturdy, rustproof Alloy Metal. Six Blade impeller. Uses any 1/4 to 1/2 H.P. Motor. Will not leak or clog. Fits any garden hose. Immediate money back guarantee. Send Check, Money Order, or C.O.D. **\$8.95**

**IRRIGATE, FILL TANKS, DRAW WELL WATER.** Heavy duty #8 Pumps 7000 GPH. 1000 GPH 75' high — 3000 GPH from 25' well. Rustproof Alloy Metal. 8 blade impeller. 1" inlet — 1" outlet. Standard Pipe Threaded. Money back guarantee. Send check, **\$11.95** Money Order, or C.O.D.

Free Catalogue — Gear Pumps — Deep and Shallow Well Pumps.

**MOORE MANUFACTURING CO.**  
SWEDSBORO 6 NEW JERSEY

# BECOME A Mechanical Engineer

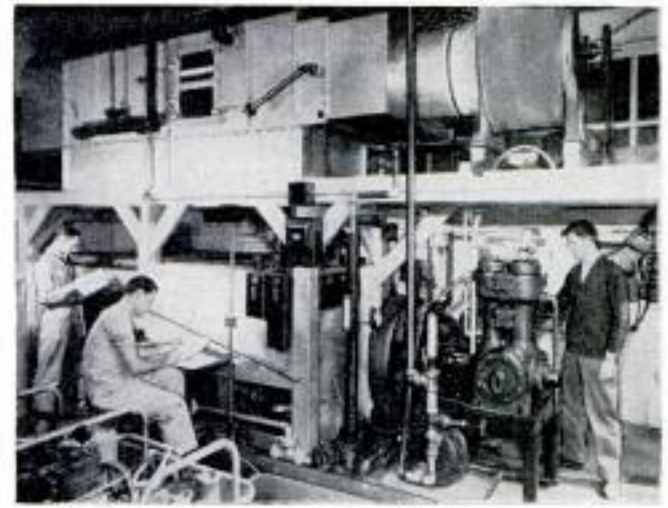

**B. S. Degree in 36 months**

Mechanical Engineers hold respected, well-paying, and highly interesting jobs in many fields of industry. You can prepare now... for a secure future and a well-paid career as an engineer or engineering technician at the Milwaukee School of Engineering... in one of America's leading industrial centers.

Choose from these courses at the Milwaukee School of Engineering

<b>ENGINEERING 36 months, Bachelor of Science Degree</b> <ul style="list-style-type: none"> <li>Mechanical Engineering with a major in Design, Metal Fabrication or Plant Engineering.</li> <li>Electrical Engineering with a major in Electronics or Power.</li> </ul>	<b>TECHNICIAN 12 to 18 months</b> <ul style="list-style-type: none"> <li>Radio and Television</li> <li>Electronics</li> <li>Electrical Power</li> <li>Mechanical Technician</li> <li>Air Conditioning</li> <li>Welding</li> </ul>
<b>SERVICE 6 to 12 months</b> <ul style="list-style-type: none"> <li>Electricity</li> <li>Refrigeration</li> </ul>	<ul style="list-style-type: none"> <li>Heating</li> <li>Welding</li> </ul>

General preparatory course — 3 months.

TERMS OPEN SEPTEMBER, JANUARY, APRIL, JULY

Faculty of specialists. Over 50,000 former students. Annual enrollment from 48 states and 23 overseas countries. *Non-profit. 51st year.* Military, Practical or Academic training evaluated for advanced credit. Approved for Veterans Training. Write for details today.

## MILWAUKEE SCHOOL OF ENGINEERING

MILWAUKEE SCHOOL OF ENGINEERING  
Dept. PM-754, 1025 N. Milwaukee  
Milwaukee 1, Wisconsin

Send for free illustrated career booklets  Mechanical  
 Electrical Technology  Radio-TV Technology

I am interested in \_\_\_\_\_  
(name of course)

Name \_\_\_\_\_ Age \_\_\_\_\_

Address \_\_\_\_\_

City \_\_\_\_\_ Zone \_\_\_\_\_ State \_\_\_\_\_

If veteran, indicate date of discharge \_\_\_\_\_







# OWN your OWN

## Radiator Repair Business

**\$995.00 Starts You . . . Equips You**

Many cities offer exclusive opportunity for business minded men in fast growing auto radiator repair service. New modern equipment brings in good profits and makes work easy and interesting. For \$995.00 (financing available) you can own a rewarding business. You will be trained by the world's largest radiator equipment manufacturer FREE in their own plant. Write today for FREE information. Radiator repair training alone also available. Full course only \$100.00. Write to:

Inland Mfg. Co. Dept. PM-7 1108 Jackson St.  
Omaha 8, Nebraska



**SAVE UP TO 50%**  
ON FAMOUS ITALIAN  
**ACCORIONS**

Buy direct from America's leading distributor. Offers Students, Teachers and Professionals SPECIAL DISCOUNTS. Send now for FREE Literature and lowest wholesale prices. Easy Terms. Trade-ins accepted. Write today. ACCORDION MANUFACTURERS & WHOLESALE OUTLET DEPT. R-74 2003 W. CHICAGO AVE., CHICAGO 22, ILL.

**5 DAY FREE TRIAL**

### EARN WHILE YOU LEARN AT HOME

## How to Make Money in PHOTOGRAPHY

If you are OVER 17—good pay, fascinating work await you in photography! Start making money quickly in sparetime—step into your own studio or exciting job. LEARN-BY-DOING method trains you at home! Write TODAY for FREE catalog. Also Resident Training. 44th Year! GI Approved. NEW YORK INSTITUTE OF PHOTOGRAPHY Dept. 49, 10 W. 33 St., New York 1, N.Y.

Send for FREE BOOK

### BUILD YOUR OWN SMALL HOME—\$750



Save rent, mortgage payments; own your own home. Takes 14 days to build. FREE EXPANSION PLANS. Four complete rooms & bath. Stereo block construction. Plans, drawings, instructions \$1.00. Free. Money-back guarantee. Modern Building Designers, 49 W. 44th St., Dept. A, N.Y.C. 36.

### IMPROVE YOUR PENMANSHIP

*Write Like This*

YOUR penmanship can be improved in 3 hours or corrected to your satisfaction in 10 hours' practice with my DEFINITE HAND CONTROLS. New way!

WRITE OZMENT BOX 668 34-N, ST. LOUIS, MISSOURI

Complete OUTLINE FREE!

### BECOME AN EXPERT IN

# TRAFFIC

Traffic men earn \$4,000 to \$10,000 and up. Thousands of firms need experts on rates, tariffs, regulations. We train you thoroughly in spare time at home for executive traffic jobs. Personal training under traffic authorities. Placement counsel and help. Write for free 48-page book "Traffic Management—the Fast Growing Profession."

LASALLE Extension University, 417 So. Dearborn St. A Correspondence Institution Dept. 764T Chicago 5, Ill.

### 250 POWER . . . .



only \$3.49 postpaid

Complete Telescope Lens Kit only \$3.49 postpaid. Conquer Space. Explore the Universe. Planets, Moon Craters, New Stars, etc. Complete Lens Kit consists of 80 inch focal length ground and polished objective lens, eyepiece lenses for 50 POWER, 100 POWER, 150 POWER, 200 POWER, 250 POWER, and all necessary lens fittings. Easy to make from simple step by step instructions. (Trinoid and mount not included.) Money back guarantee.

BUSSE SALES CO., Hartford, Conn., Dept. PM 23



**Sells First Article to Look Magazine Although Only Halfway Through Course**

"My first attempt at writing for a national magazine was an article in answer to one that appeared in Look Magazine. My response was chosen as the best. The editor expressed interest in the fact I was studying your course. The check I received more than pays for the course."—Glenn Dunlap, Painesville, Ohio

## To People who want to write but can't get started

DO YOU have that constant urge to write but fear that a beginner hasn't a chance? Here is what the former editor of Liberty said:—"There is more room for newcomers in writing than ever before. Some of the greatest writing men and women have passed from the scene. Who will take their places? Fame, riches and the happiness of achievement await the new men and women of power."

### A Chance to Test Yourself—FREE

The Newspaper Institute of America offers a FREE Writing Aptitude Test. Its object is to discover more men and women who can add to their income by fiction and article writing. The Writing Aptitude Test is a simple but expert analysis of your latent ability, your powers of imagination, logic, etc. Those who pass this test are qualified to take the famous N. I. A. course based on the practical New York Copy Desk Method which teaches you to write by writing! You work at home, in leisure time, constantly guided by experienced writers. Soon you acquire the coveted "professional" touch. Then you are ready to market your stories, articles and news items.

### Mail the Coupon Now

Taking the FREE Writing Aptitude Test requires but a few minutes and costs nothing. So mail the coupon now. Take the first step towards the most enjoyable and profitable occupation—writing for publication! Newspaper Institute of America, One Park Avenue, New York 16, N. Y. (Founded 1925) (Licensed by State of New York)

**FREE**

Newspaper Institute of America  
One Park Avenue, New York 16, N. Y.

Send me, without cost or obligation, your Writing Aptitude Test and further information about writing for profit as promised in Popular Mechanics, July.

Miss \_\_\_\_\_  
Mrs. \_\_\_\_\_  
Mr. \_\_\_\_\_  
Address \_\_\_\_\_

City \_\_\_\_\_ Zone \_\_\_\_\_ State \_\_\_\_\_  
(All correspondence confidential. No salesman will call on you.) 77-L-784

Check here if Veteran.

Copyright 1953 Newspaper Institute of America



● **NEW PROFIT MAKING MACHINE FOR YOUR PRESENT OR NEW BUSINESS AND FOR ALL WHO SELL MILK SHAKES**

# MILLSHAKE

**Makes 25¢ Shake for less than 7¢!**  
**Combines freezing, flavors and blending in one efficient unit!**  
**Saves labor—Convenient—Fast!**  
**Completely automatic, serves shakes in seconds!**  
**A sensational customer attraction!**



Millshake is new and different—a complete milk shake production machine including insulated refrigerated mix supply and flavor compartment. Operation is fully automatic so even young inexperienced help can serve fresh-made, wholesome shakes and malts like an expert. Making a shake is as quick and easy as 1, 2, 3. Merely open draw-off gate for basic vanilla shake, add flavor and use built-in shielded blender. Complete shake is ready in less than 10 seconds. Gone forever is back-breaking, money-wasting, time-consuming scooping of hard ice cream, handling of milk and flavors. One low-cost mix replaces ice cream and milk handling and storage. Everything is right at hand—a finished shake without moving!

Besides saving time, labor and material costs, the Millshake has proven itself to be a sensational traffic builder wherever installed! Its modern, gleaming white finish with blue hood and tray are without comparison for beauty and quality. Get the facts on Millshake—world's newest and finest money-making shake machine. Write for Brochure 954 now! Mills Distributors cover the nation—Coast to Coast.

**MILLS INDUSTRIES, INC.**  
 4114 FULLERTON AVENUE • CHICAGO 39, ILLINOIS

**OWN a Business**

If employed, start part time. Alert dealers can gross \$5 hourly profit on own service plus \$3 on EACH serviceman. Clean, revive, moth-proof rugs & upholstery on location. No shop needed. Services nationally advertised. Repeat customers. Easy to learn. We locally train and assist you. Quickly established. Easy terms. Send today for FREE booklet. No obligation.

**DURACLEAN CO., 4167 Duraclean Bldg., Deerfield, Ill.**

## Paint STRIPES with New "PAINT PEN"!

**Makes Straight, Curved or Parallel Lines!**

Just fill glass vial with any color paint. Use like a fountain pen to stripe furniture, bikes, autos, model planes, toys, linoleum, wall board. Beautiful, clean, crisp results every time, like professional painters. No experience needed to draw straight, curved, circular or evenly spaced parallel lines. Can't clog or smear. May also be used with glue, tempera, textile paint, or ceramic underglazes. Paints on wood, glass, plastics, metal, fabrics and paper. Lasts a lifetime. Only \$1 postpaid, complete with tip for 1/16 inch stripe. C.O.D.'s plus postage. Used by industry. Order your Paint Stripping Tool TODAY!

**New! "DOUBLE-STRIPER" MODEL Only \$2.95**

Newest paint stripping invention. Makes DOUBLE stripes—one wide and one narrow or two wide or two narrow at the same time. Or adapt quickly for wide or narrow single stripe. Makes 5 combinations. FREE—Send postcard for complete information... or order now... \$2.95.



**\$1.00**

**DEALERS**

Master Paint Stripping Tool packed in Display Cartons of 1 dozen. Fast, profitable seller. Write for discounts.

**Attention All Home Craftsmen!**

New Paint Stripping Tool gives "professional" results every time, yet simple and easy to use as a fountain pen. Adjustable guide keeps lines straight as an arrow. Just as easy to make curves or free-hand designs. Adds new beauty, finished look to everything you paint. Send \$1 now.

**WENDELL MFG. CO., Dept. 3-1  
 4234 Lincoln Ave., Chicago 18, Illinois**

**6 Other Complete Tools**

Complete tools for 1/64, 1/32, 3/64, 5/64, 3/32 or 1/8 inch stripes, \$1.50 each. Extra tips 75¢ ea. COMPLETE KIT with ALL TIPS, \$5.00. (Also 1/4" tip, only \$1.00). All tips interchangeable.

**INSURED TIRE SERVICE POPULAR BRANDS**

**FREE** INSURANCE POLICY given with each used tire sold. We guarantee the amount of service you pay for.

Tube Given Free with Each Used Passenger Tire Upon Request

**SPECIAL! Deduct 10% on orders for Two or More used tires**

**YOU CAN'T LOSE!!**

Super Quality	Rugged Performance	15 Months Insured Service
600x16 \$3.65	670x15 \$3.95	700x16 \$4.45
650x15 3.85	670x16 4.05	710x15 4.35
650x16 4.25	700x15 3.95	760x15 4.45
650x17 4.65		550x17 4.65

Supreme Quality	Nothing Finer	30 Months Insured Service
600x16 \$5.25	475x19 \$5.45	700x20 \$10.45
600x16 (6) 6.75	640x15 4.95	750x20 (8) 15.50
650x16 5.75	670x15 5.35	750x20 (10) 17.50
650x16 (6) 7.25	710x15 5.45	825x20 21.50
700x16 6.35	760x15 5.95	900x20 19.95
750x16 (6) 8.45	800x15 6.35	30x5 11.25
550x18 4.95	820x15 6.35	600x20 10.95
550x17 4.75	550x15 5.35	600x20 11.75
650x15 5.25	670x15 5.35	1100x22 21.95
700x15 5.35	700x16 (6) 10.25	1100x22 22.75
	32x6 (10) 12.75	1100x24 25.95

Whitewalls \$1.00 extra.

**MIDLAND TIRE SALES** Speedy shipments on Mail Orders. F.O.B. Chicago. Insurance policy sent with each order. Deduct 10% on orders for 2 or more used tires. Send CHECK or MONEY ORDER.—No COD's.  
 3701 S. Normal, Dept. PM-24, Chicago 9, Ill.

**"How to Make Money with Simple Cartoons"**

A book everyone who likes to draw should have. It is free; no obligation. Simply address **FREE BOOK**

**CARTOONISTS' EXCHANGE**  
 Dept. 97 Pleasant Hill, Ohio

**DEVELOP A HE-MAN VOICE!**

Write for FREE book "How to Strengthen Your Voice for Greater Success" by Eugene Fruchtinger. No obligation. Book will be mailed at once in plain wrapper, postpaid. Just send your name and address. State age.

**PREFECT VOICE INSTITUTE, 210 S. Clinton St., Studio GW-2, Chicago 6, Ill.**

**WHOLESALE Electric Guitars - Parts - Build Your Own**

Accordions, amplifiers, double-necks, triple-necks, pickup mikes, mandolins, non-electric instruments, etc. 1954 Models wholesale. Free Catalog. Free home study course with instruments. Parts and plans available to build your own 4 or 8 string or multi-neck electric guitar. Martin and Fender available at list price.

**CARVIN CO., Box 28 P.M.7, Baldwin Park, Calif.**

**make your own Gems 29.50 F.O.B.**

The Gem Maker comes complete with all necessary equipment, including a super-charged diamond blade for sawing, and all wheels for grinding, shaping and polishing; also complete instructions. The complete equipment as shown, less motor and belt, for only \$29.50, f.o.b., Burlington, Wisconsin. Write today for information and literature.

**B&I MANUFACTURING CO.**  
 Dept. 5 Burlington, Wis.

**Say You Saw It in POPULAR MECHANICS**

**Catalog of 3000 Novelties 10c**

Send 10c for amazing catalog of novelties, live animals, scientific supplies, hobbies, funmakers, planes & boats, lemons, magic tricks, joke articles, unusual seeds, gadget time-savers, cameras, optical goods, projectors, movies, lucky jewelry, religious novelties, disguises, musical instruments, stamps, coins, puzzles, fortune tellers, radios, auto & bike accessories, telescopes, magnifiers, compasses, banks, smokers' gadgets, artists' supplies, printing sets, engines, motors, shockers, knives, billfolds, guns, rifles, sports, books, games, plants, etc. Send 10c (3 for 25c—get for friends!).

**JOHNSON SMITH & CO., Dept. 826, Detroit 7, Michigan**

**YOU CAN BUILD A VIOLIN FOR PLEASURE OR PROFIT**

Now you can build a rich toned mellow violin modeled after a famous "Strad." YOU CAN MAKE A STRADIVARIUS VIOLIN contains 8 full scale plans plus complete instructions. You work directly from the plans with no confusing scale of dimensions to translate. Detailed instructions for each step including varnishing and stringing—even shows how to build your own tools. Cloth bound. Order today from

**POPULAR MECHANICS PRESS . . . \$3.50**  
 200 EAST ONTARIO STREET, CHICAGO 11, ILLINOIS



**THIS WIRE HAS NOT BEEN OVERSEAS**  
This high quality two conductor communication wire offered in No. 18 and No. 22 gauge is ideal for intercoms, lead-ins, telephones, in-door and out-door speaker extensions, doorbells, signal and burglar alarm systems, shofirring, etc., etc. **SAMPLES ON REQUEST.**

**U.S. GOV'T CLOSEOUT**



*Wire*

**U. S. Signal Corps Communication Wire**  
TWISTED TWO CONDUCTOR No. 18 STRANDED \$5.00  
\$7.50 per 1000 ft. TWISTED TWO CONDUCTOR No. 22 STRANDED

**Won't Last Very Long at These Prices**  
**Stock Up Now — Subject to Prior Sale — Order Today**  
**W-110-B — TWO CONDUCTOR #18 STRANDED** (four steel and three copper strands) rubber covered plus weatherproof cotton braid and twisted, 5,280 feet per steel reel. Only \$3.50 per thousand feet on 5,280 foot reels or \$18.25 per reel.  
**W-130—TWO CONDUCTOR #22 STRANDED** and twisted (one copper and six steel strands) in your choice of rubber or plastic insulation, 10,000 feet per steel reel. Only \$3.50 per thousand feet on 10,000 foot steel reel or \$35.00 per reel.  
(Note: Steel strands are incorporated for extra tensile strength and are tinned and treated for efficient conductivity.)  
Wt. per 100 ft. #18 wire, 23 lbs. Wt. per 1000 ft. #22 wire, 11 lbs.  
All these way below market prices, our stock will not last long. Take advantage of this exceptional closeout and **STOCK UP NOW!**  
Prices F.O.B. Chicago. Include approx. postage on orders paid for in advance. C.O.D. orders enclose 25% balance sent C.O.D.

**U. A. S. Corp.** Dept. PM-7, 5637 W. 63rd Pl. Chicago 38, Illinois

**DIVING EQUIPMENT HEADQUARTERS**  
Aqua-Lungs — Recirculating Sets, Sports Diving Masks and Fins, Italian and French Importations, Deep-sea Navy surplus (new) rigs complete for contractors and salvage work, Mask Type Commercial Sets.  
World's Largest Stock — Write for Catalog — 20c

**M & E MARINE SUPPLY CO., P.O. Box 601-Y, Camden 1, N. J.**

**RUPTURED?**

Something different. Light. Cool. No leg straps. No elastic. No pressure on hips or spine. Inexpensive. Worn by Mechanics, Farmers, Doctors, etc. everywhere. Guaranteed. Write  
**HAND-LOCK PRODUCTS** EST. 1893 DEPT. PM, PRESTON, ONT., CAN.

**HELPFUL BOOKS**

Send post card asking for **FREE** catalog  
Popular Mechanics Press, 200 E. Ontario, Dept. 601, Chicago 11

**BENJAMIN SUPER CO<sub>2</sub> GAS CARBINE—\$16.50**

**NEWEST TARGET RIFLE — 22**  
**IDEAL FOR SMALL GAME**  
**ECONOMICAL SAFE-NON-TOXIC ACCURATE-CONVENIENT PRACTICAL** Easy to operate—No spring recoil — No pumping. Uses low cost Soda Cartridges Cal. .22 Benjamin H-C Pellets and Darts.  
Benjamin CO<sub>2</sub> Gas Pistols Also Available  
WRITE FOR FREE ILLUSTRATED FOLDER OF ALL MODELS BENJAMIN AIR RIFLES AND BENJAMIN AIR PISTOLS BENJAMIN AIR RIFLE CO.  
896 MARION ST., ST. LOUIS 4, MO. U.S.A.

**"HOW TO EARN MONEY IN YOUR SPARE TIME"**

**SENT FREE! RUSH POST-CARD NOW!**  
In your own home... **PRINT WITHOUT A PRINTING PRESS.** Miracle New Printing Method. Print full color **SIGNS, POSTERS, BANNERS, FABRICS**—anything. Print hundreds at a time (\$100.00 jobs cost you less than \$10). **NO ART** ability necessary. It's easy! We supply everything! **REPRESENTATIVES WANTED.** Unlimited profit opportunities. Help fill **HUGE DEMAND.** Write!  
**SCREEN-PRINT, DEPT. 27, 1010 S. LOS ANGELES ST., LOS ANGELES 15, CALIF.**

**Get into RADIO-TELEVISION ELECTRONICS by Shop-Method Home Training**

You receive this Multitester

Superheterodyne Receiver

**GOOD JOBS AWAIT THE TRAINED RADIO-TV TECHNICIAN!**  
Business of Your Own • Broadcasting • Radio Manufacturing, Sales, Service • Telecasting • Television Manufacturing, Sales, Service • Laboratories: Installation, Maintenance of Electronic Equipment • Electrolysis, Call Systems • Theatre Sound Systems, Police Radio • Garages: Auto Radio Sales, Service • Sound Systems, Telephone Companies, Engineering Firms, etc.  
**WE BRING NATIONAL SCHOOLS TO YOU!** There is a place for you in the great Radio-Television-Electronics industry when you are trained as National Schools will train you at home! **OUR METHOD IS PROVED BY THE SUCCESS OF OUR GRADUATES SINCE 1905.**

**YOU RECEIVE PARTS** for Signal Generator, T.R.F. Receiver, Audio Oscillator and Superheterodyne Receiver, plus professional Multitester shown above. **No extra charges. EARN WHILE YOU LEARN—we show you how!**

**APPROVED FOR G. I. TRAINING**

**FREE "RADIO-TV BOOK & SAMPLE LESSON!"**

**MASTER ALL PHASES!** Get Master Shop-Method Home Training from an Established Resident Technical Trade School with its own Training Shops, Laboratories, Studios—almost 50 Years of Successful Experience in Training Ambitious Men.

**NATIONAL SCHOOLS**

Technical Trade Training Since 1905  
**LOS ANGELES 37, CALIFORNIA**  
In Canada: 811 West Hastings Street, Vancouver, B. C.  
**BOTH HOME STUDY AND RESIDENT COURSES OFFERED**

**MAIL NOW TO OFFICE NEAREST YOU!**

(mail in envelope or paste on postal card)

**NATIONAL SCHOOLS, Dept. RB-74**

4000 S. FIGUEROA STREET LOS ANGELES 37, CALIF. OR 323 W. POLK STREET CHICAGO 7, ILL.

Please rush **FREE BOOK & FREE LESSON.** I understand there is no obligation, no salesman will call.

NAME \_\_\_\_\_ BIRTHDAY \_\_\_\_\_ 19\_\_\_\_

ADDRESS \_\_\_\_\_

CITY \_\_\_\_\_ ZONE \_\_\_\_\_ STATE \_\_\_\_\_

Check if interested **ONLY** in Resident training at Los Angeles. **VETERANS:** Give date of discharge \_\_\_\_\_



THE NEW MODEL TV-11

# TUBE TESTER



### SPECIFICATIONS

- Uses the new self-cleaning Lever Action Switches for individual element testing.
- Because all elements are numbered according to pin-number in the RMA base numbering system, the user can instantly identify which element is under test. Tubes having tapped filaments and tubes with filaments terminating in more than one pin are truly tested with the Model TV-11 as any of the pins may be placed in the neutral position when necessary.

- The Model TV-11 does not use any combination type sockets. Instead individual sockets are used for each type of tube. Thus it is impossible to damage a tube by inserting it in the wrong socket.
- Free-moving built-in roll chart provides complete data for all tubes.
- Phono Jack on front panel for plugging in either phones or external amplifier will detect microphonic tubes or noise due to faulty elements and loose external connections.

Operates on 105-130 Volt 60 Cycles A.C. Hand-rubbed oak cabinet complete with portable cover. **\$47<sup>50</sup>**

**SHIPPED ON APPROVAL  
NO MONEY WITH ORDER - NO C. O. D.**

Try it for 10 days before you buy. If completely satisfied send \$11.50 and pay balance at rate of \$6.00 per month for 6 months—No Interest or Carrying Charges Added. If not completely satisfied, return to us, no explanation necessary.

MOSS ELECTRONIC DISTRIBUTING CO., INC.  
Dept. D-44, 3849 Tenth Ave., New York 34, N. Y.  
Please rush 1 Model TV-11. I agree to pay \$11.50 within 10 days after receipt and \$6.00 per month thereafter.

Name \_\_\_\_\_  
Address \_\_\_\_\_  
City \_\_\_\_\_ Zone \_\_\_\_\_ State \_\_\_\_\_

**Learn TELEVISION-ELECTRONICS RADIO**  
2 Big Books **FREE**  
Train at Home—Get Big Kits of Radio Parts!  
Prepare now in spare time. Practical instruction. Write for details and 2 Radio Books—ALL FREE! Rush name today!  
SPRAYBERRY ACADEMY OF RADIO  
Dept. 10-L 111 No. Canal Chicago 6, Illinois

## I'll Send You This Handsome SAMPLE CASE - FREE



and Show You How to Make Up to \$30.00 in a Day

Mail coupon for this Free Tailoring Sample Case packed with 150 beautiful, big-value suit and overcoat fabrics. Take orders from friends, fellow-workers, others, for fine quality, made-to-measure clothes. Pocket big cash profits in advance. Because wearing our suits and overcoats brings more orders, we make it easy for you to get your own clothes without to cost. No experience is needed. **SATISFACTION GUARANTEED. SEND NO MONEY.** Just fill out and mail coupon—today!

**W. Z. GIBSON, INC., 500 South Throop Street DEPT. N-516 CHICAGO 7, ILLINOIS**

**W. Z. GIBSON, INC., Dept. N-516  
500 S. Throop St., Chicago 7, Ill.**

Dear Sir: I WANT A MADE-TO-MEASURE SUIT TO WEAR AND SHOW, without paying 3c for it. Rush details and Sample Kit of actual fabrics, ABSOLUTELY FREE.

NAME \_\_\_\_\_ AGE \_\_\_\_\_  
ADDRESS \_\_\_\_\_  
CITY \_\_\_\_\_ STATE \_\_\_\_\_

## GLASS SPINNING ROD and SPIN REEL



A complete Spin Fishing Outfit, only \$9.95! Positively no backlash with UNITED'S quality spin outfit. Offer includes a sturdy, featherweight aluminum reel, synchro-meshed for smoothest performance. 3:22 gear ratio! Full ball pickup. Unbreakable spool (250 yd. capacity). AND a 6 1/2 ft., 2 piece spinning rod, of precision laser-ground laminated glass fibre. Case included. Exclusive construction features assure championship performance. A bargain buy!

**\$9.95**

USE 10 DAYS

If not satisfied return for refund. Cash orders prepaid. C.O.D.'s require \$2.00 deposit.

UNITED PRODUCTS CO., 9043 S. Western, Dept. RS-108, Chicago 20, Ill.

## Sample IMPORTS

FROM FOREIGN LANDS—Exciting, useful sample, products from France, Germany, India, etc., sent to you. Established Import-Export firm offers men or women FREE plan for big profit, world-wide, mail-order business at home; or travel abroad. No capital or previous experience needed. Overseas bargains bring high U. S. prices. Write today for FREE plan!

Mellinger, Dept. A257, 1717 Westwood, Los Angeles 24, Cal.

## EXPLORE UNDERSEAS

with ESSED DUAL DIVING LUNGS

Now all swimmers can enjoy the thrills and sport of underwater exploration with the inexpensive ESSED DUAL DIVING LUNG. Special design features allow low selling price, yet permit the inclusion of all features of the higher priced equipment. Design permits lower operational cost than with any other type diving unit. Rush postcard for FREE CIRCULAR.

EXPLORATION SURVEYS & EQUIPMENT DEVELOPMENT  
Dept. M 561 Garden Ave. Woodbridge, N. J.

Say You Saw It in Popular Mechanics

## Build this Beautiful LAWN FURNITURE YOURSELF



PORCH CHAIR



SERVING CART



GARDEN LOUNGE



PICNIC TABLE



PORCH GLIDER



ADIRONDACK CHAIR

### NO EXPERIENCE NEEDED

Smart Exclusive Styles By John Bergen . . . Four Big Plans Drawn to Scale . . . Complete Material List

Now with just a few spare time hours and some inexpensive materials you can build gay comfortable lawn furniture that will make your garden more attractive . . . more comfortable and more fun this summer.

No need to pay a small fortune for lawn furniture when you can build your own and save over 50% of what it would cost you already built!

Popular Mechanics four big drawn-to-scale plans show every step to follow. Complete material list tells you just what sizes of wood to buy so there will be no waste.

Make your lawn and garden the finest and most attractive on your block by building this smartly styled furniture. Enjoy real comfort during those hot summer months by making your garden your outdoor living room. Send today for your plans and material list. Complete set of four plans only \$2.00. Complete satisfaction guaranteed or your money refunded.

POPULAR MECHANICS PRESS  
200 E. Ontario St. Chicago 11



**WAR SURPLUS BARGAINS!**

**WAR SURPLUS BARGAINS**

**\$500,000.00 INVENTORY for QUICK LIQUIDATION**

Surplus items—hundreds of them for home, shop, factory, farm and outdoor use. New items, used items, reconditioned items—all at tremendous savings—all priced for quick sale.

**Page After Page of Values**

This big catalog shows page after page of amazing money saving values. Write for your copy today. Send 10c to cover postage, mailing, etc. Write today! **SEND TODAY FOR YOUR COPY**

**10c**

**FIELD TELEGRAPH TRANSMITTER & RECEIVER SET**

Complete; includes transmitter with pair of head phones, sending telegraph key, buzzer, double throw switch. Original cost of this instrument to English government well over \$100.00. Ship. wt. 20 lbs. each. Allow sufficient postage or will be shipped express charges collect. Two 4½ volt C batteries needed in each set. Batteries 45c each extra. Wire needed to connect for operation. No 438. Complete set of two... **\$15.00**  
One set ..... **\$7.95**

**STARK'S** 509 So. State St. Dept. PM-547 CHICAGO 5, ILL.

**150 British Empire STAMPS**

Get these valuable stamps from the far corners of the British Empire—guaranteed to be worth at least \$3.00 in Standard Stamp Catalog. Act now and we will include a FREE copy of the "Stamp Collector's Manual," and other offers. Send 25c TODAY to help pay for postage and handling charges.

**KENMORE, Milford YH-396, N. H.**



**CURE SELF-CONSCIOUSNESS!**

How to develop a strong, positive personality—get rid of timidity, bashfulness, shyness and fear. Successful self-instruction lessons based on new principles of practical psychology. Healthy self-confidence can be yours! Complete course of 22 home-study lessons. **NOT** a book. Full price only \$6.95 postpaid, or COD plus postage. Mailed sealed in plain wrapper. Satisfaction guaranteed or refund. Order "Curing Self-Consciousness Course" today. Nelson-Hall Co., 210 S. Clinton St., Dept. 26W-2, Chicago 6, Ill.

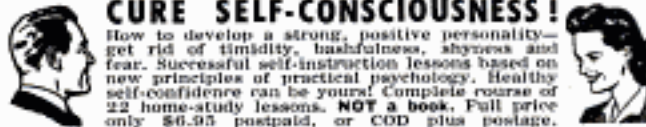

**SEA LEGS** PRICES from **\$39.00**

**QUALITY BOAT KITS** F. O. B. DEFIANCE, OHIO  
WRITE FOR FREE LITERATURE  
**PERNEY WOODCRAFT INDUSTRIES**  
1301-09 Ottawa Ave., Dept. 7-M Defiance, Ohio

**How to Build Your Own GARAGE**

Save as Much as 50% of Usual Construction Costs

Get Popular Mechanics' brand new book **How to Build Your Own Garage** by Wayne Leckey, Assistant Shop Notes Editor, and find out how you can build your own garage at savings of 50% of usual cost. Leckey tells in famous step-by-step instructions and shows in big, clear photos, drawings and diagrams how to perform every building operation from laying the concrete to installing the final trim. There are 25 designs. Brick, frame, and concrete block fully covered. Send \$3.50 for your copy. 7-day money back guarantee.

POPULAR MECHANICS PRESS, 200 E. Ontario, Chicago 11, Ill.



**FREE**

**A NEW HOME INDUSTRY**

**OPPORTUNITIES UNLIMITED!**

Let us show you how extremely easy and PROFITABLE it is to make beautiful and useful things out of **LIQUID PLASTICS, LIQUID MARBLE, LIQUID IVORY, LIQUID GLASS, CERAMICS, ETC.**... as easy as pouring water out of a glass! Make novelties, jewelry, gifts, artware, toys, tools, dials, gadgets, ornaments—a million useful things! We supply everything—**MATERIALS** and **INSTRUCTIONS!** Send only 25c for big 44 page catalog of casting materials, molds and accessories and we will include free of extra cost a remarkable book, **"THE WONDERS OF LIQUID PLASTICS"**... that will open your eyes to wonders you never dreamed of! Send 25c today—this may be the lucky coin that will start the most fascinating and profitable phase of your life!

**PLASTICAST COMPANY, (Dept. C)**  
P.O. Box 6737 Chicago 80, Ill. (Write to either address) P.O. Box 987 Palo Alto, Calif.

**PLASTIC LAMINATING**

This remarkable Plastic Laminating Machine will earn \$18.00 an hour right in your kitchen! Big profits laminating Business, Social Security, Identification, Credit CARDS of all kinds, photos, posters, clippings, etc. Price complete (illustrated) \$25.00 plus postage. Others higher. Literature free.

**PLASTICAST CO.**  
(Address in ad above)



**Say You Saw It in POPULAR MECHANICS**

**PREPARE FOR BETTER JOB, BIGGER PAY IN SPARE TIME AT HOME**

Today, choose the job you want—and prepare for it in time you might otherwise waste. Or if you are already in the work you like best, start training now for quicker promotion and increased pay. During more than 50 years **AMERICAN SCHOOL** has helped ambitious people to reach higher goals. Check subject that interests you and mail coupon for full information.

**AMERICAN SCHOOL, Dept. GB45, Drexel at 58th, Chicago 37, Ill.**

Without obligation, please send **FREE** and postpaid, full particulars about the subject checked below.

Accounting	Drafting—Building Trades	Plastics Engineering
Air Conditioning	Drafting—Machine Trades	Plumbing—Practical
Architecture & Building	Electrical Engineering	Private Secretary
Automotive Technician	Electricity—Practical	Refrigeration
Better Foremanship	Electronics—Industrial	Retail Merchandising
Bookkeeping	High School Courses	Salesmanship—Outside
Business Management	Machine Shop Operations	Sheet Metal Work
Contracting	Mathematics & Slide Rule	Tool Making
Diesel Technician	Mechanical Engineering	

NAME..... Occupation.....  
Home Address..... Age.....  
CITY..... STATE.....  
Canadian Residents: Write American School, 1610 Sherbrooke St. West, Montreal

**MAIL COUPON NOW**



# Inventors

The following are the usual preliminary steps to take toward patent protection.

Make a disclosure of your invention; sign, date and have this document witnessed by two or more people who understand your invention; authorize your registered patent attorney or agent to conduct a preliminary search among previously granted U. S. patents for similar types of invention; secure a report on the probable patentability of your invention and a recommendation of the further course to take.

We shall be glad to send you without obligation our instructive booklet, "Patent Protection for Inventors" and our "Evidence of Invention" disclosure form.

**VICTOR J. EVANS & Co.** *Merlin M. Evans*  
REGISTERED PATENT ATTORNEY  
930-H MERLIN BUILDING, WASHINGTON 6, D. C.

**30 POWER! 8½ OUNCES** WHISPER WEIGHT

Nearest Pocket Telescope engineered for UNITED to give you sharper, clearer, crisper images and smooth, easy-sliding focusing action. Use indoors, outdoors, vacationing, trips, closeup and long distance viewing. **\$9.95** **TAX FREE**

NOT A CHEAPLY MADE TOY TELESCOPE. It's a precision all metal, chrome finished achromatic masterpiece. Interiors of VITAL front Achromatics are COATED assuring needle sharp viewing! Price includes handsome carrying case. Made in Japan. UNCONDITIONALLY GUARANTEED. Try for 30 days. If not satisfied return for immediate refund. Cash orders postpaid. C.O.D.'s require \$2.00 deposit. UNITED BINOCULAR CO., 9043 S. Western Ave., Dept. C-7608, Chicago 20, Illinois. DEALERS WANTED.

**\$2.95 OR 2 FOR \$5.00!**  
Complete tested and guaranteed with inter-noon instructions, 50 ft. of wire and roll of tape (offer good for this month only). Write for free list of telephones. All shipments FOB Simpson, Pa.  
**TELEPHONE ENGINEERING CO.**  
Dept. 784 Simpson, Pa.

**SAVE HUNDREDS OF DOLLARS**

Priced far below steam cleaners of similar characteristics, the new Hi-Pure Hi-Power Model 105 combines every advantageous new concept in engineering. Gives high-pressure steam in 70 seconds. Completely automatic. Portable, economical, safe. UNCONDITIONALLY GUARANTEED! New "Jet" Steam Gun mixes soap and steam automatically.



**FREE service for life of cleaner!**

BE IN BUSINESS FOR YOURSELF with a Hi-Pure Hi-Power Model 105. Many owners find that it pays for itself completely in a few weeks. Enjoy the advantages of your own profitable business.

Write for **FREE DETAILS.**  
**HI-PURE LABORATORIES, Evansville, Ind** and

Model 105, complete **\$398.50\***

\*FOB shipping point. Freight prepaid on cash orders

# INVENTORS

IF YOU WISH TO PROTECT YOUR INVENTION, You should take steps to protect it by a U. S. Patent. Write me for "INVENTION RECORD" form

**CARL MILLER**  
REGISTERED PATENT ATTORNEY  
WOOLWORTH BLDG., 35th FLOOR, 74A  
NEW YORK CITY

**PATENTS**  
**C. A. SNOW & CO.**  
REGISTERED PATENT ATTORNEYS  
WRITE FOR INFORMATION TO  
428 SNOW BUILDING, WASHINGTON 1, D. C.

# INVENTORS

Send for **PATENT INFORMATION** Book and **INVENTOR'S RECORD** without obligation  
**GUSTAVE MILLER**  
74-PM WARNER BUILDING  
WASHINGTON 4, D. C.

**REGISTERED PATENT ATTORNEY**  
ASSOCIATE EXAMINER  
U. S. PAT. OFF. 1922-1929  
Patent Attorney & Advisor  
U. S. NAVY DEPT. 1930-1947  
**PATENT LAWYER**

# INVENTIONS WANTED

If you want to market, or sell, your invention for cash or royalties, Write for our Free Booklet. Send no drawings. We also welcome hearing from firms, or private capital, wishing to review inventions in any field. We will be glad to send notice of our clients' inventions.

**GLOBAL MARKETING SERVICE**  
1404 Mitchell Street Dept. PD Oakland 1, Calif.

# YOUR OWN TV BUSINESS

Learn TV-Radio Servicing, Radar, Sonar, Electronics in your spare time by interesting Christy Shop-Method Home Training. The only complete course. 19 Training Instruments included. Pay for training while learning by servicing TV and Radio sets for neighbors and friends. Thousands have FREE BOOK and FREE SAMPLE LESSONS. Write **CHRISTY TRADES SCHOOL**, Dept. T-303, 4804 N. Kedzie Ave., Chicago 25.

# INVENTORS

Whether an invention is patentable can be substantially determined by a search of the U. S. Patent records. Without obligation, write for information explaining the steps you should take to secure a patent.

**JOHN N. RANDOLPH**  
Registered Patent Attorney  
201 Columbian Building, Washington 1, D. C.

# INVENTORS

I shall be pleased to furnish you, upon request, with full information relative to patent procedure—without any obligation on your part.

**PATRICK D. BEAVERS**  
Registered Patent Attorney  
934 Columbian Building Washington 1, D. C.



# Shrinks Hemorrhoids Without Surgery

Science Finds Healing Substance That Relieves Pain—Shrinks Hemorrhoids

Science has found a healing substance that shrinks hemorrhoids, stops pain promptly, ends bleeding — without surgery. Doctors report actual shrinking of hemorrhoids. Sufferers say, "Hemorrhoids have ceased to be a problem." The secret is Bio-Dyne® — already widely used for healing injured tissue. This substance is now available in a hemorrhoid ointment called Preparation H\*. Ask your druggist for Preparation H. Money back guarantee. \*Trade Mark

# SHORTHAND in 6 WEEKS

Famous SPEEDWRITING shorthand. 120 words per minute. No symbols; no machines; uses ABC's. Easiest to learn; write and transcribe. Low cost. 250,000 taught by mail. For business and Civil Service. Typing available. 31st year. Write for FREE booklet to:

# Speedwriting

Dept. 1507-4, 55 W. 42 St., New York 36 (R)

DAN LURIE  
"America's Most  
Muscular Man"  
—on television's  
"Big Top."



FAMOUS DAN LURIE

# BARBELLS

with 4 courses—low factory prices  
50 lb. set...\$ 8.48 | 150 lb. set...\$20.48  
100 lb. set... 13.98 | 200 lb. set... 25.98

Write for Free Catalog Order by Mail: 50% with order, bal. C.O.D. Extra wts. 13c per lb., P.O.B. plant

DAN LURIE BARBELL CO.

52-M-7 Bristol St., Dept. 459-G, Brooklyn, N. Y.

# WHEELS WHEELS WHEELS

7" Disc Wheel 3/4" Tire 3/4" sleeve	45c ea.
8" Disc Wheel 1 1/4" Tire 1/2" sleeve	70c ea.
7" Disc Wheel 1 1/4" Tire 1/2" ball bearing	\$1.00 ea.
8" Disc Wheel 1 1/2" Tire 1/2" ball bearing	\$1.35 ea.
8" Disc Wheel 1.50 semi-pneum. Tire 1/2" B.B.	\$1.50 ea.
8" Disc Wheel 2" semi-pneum. T. 1/2" B.B.	\$1.50 ea.
10" Disc Wheel 1.75 semi-pneum. T. 1/2" B.B.	\$1.50 ea.
10" Disc Wheel 2.75 semi-pneum. Tire 5/8" B.B.	\$3.50 ea.
12" Disc Wheel 1.75 semi-pneum. T. 1/2" B.B.	\$1.85 ea.

Above wheel prices include hub cap, Plus Postage, C.O.D.'s accepted.  
AXLES—Sizes 3/16 in., 1/4 in., 5/16 in.—Cut to sizes—End holes drilled.

UNITED WHEEL STAMPING CO.  
12131 S. PEORIA STREET PM-7 CHICAGO 43, ILLINOIS

Do a Real Professional-Like Job  
Yourself and SAVE

# HOW to PAINT

With Brush and Spray

Covers All Painting Methods and Materials

You can do professional-like painting and finishing jobs yourself and save about two-thirds of the cost. Sam Brown, noted craft authority, makes it so easy for you in his book, HOW TO PAINT WITH BRUSH AND SPRAY. Order your copy now and enjoy this tremendous saving. It covers exterior painting, wall and interior decorating, furniture finishing, concrete painting — every type of painting with brush, spray gun, roller and other methods. Tells what finish is best; what materials to use, etc. No previous experience necessary. Fully illustrated. Order by mail. Only \$2.50. Money back if not pleased.

POPULAR MECHANICS PRESS, Dept. PM18  
200 E. ONTARIO ST., CHICAGO 11, ILL.



# BIG VALUES IN ALLIED'S LATEST TV-RADIO SUPPLEMENT



# FREE send for it

Everything for Experimenters, Builders, Amateurs, Servicemen, Hi-Fi Fans



Send for our latest bargain-packed Supplement listing big values and new releases in TV accessories, custom chassis, High Fidelity systems and components, P.A. systems, recorders, FM and AM radios, Amateur supplies, test instruments, builders' kits, electronic parts, tubes, tools and books. Make your selections from the world's largest stocks of electronic supplies at lowest, money-saving prices!

# ALLIED RADIO

100 N. Western Ave., Dept. J-G-4  
Chicago 80, Illinois

Send for Supplement **FREE**

# ALLIED RADIO

# GREER SHOP TRAINING

2230 So. Michigan Blvd.  
Chicago 16, Illinois

# Leader in Practical Training for 50 Years

Gain success by learning a trade offering security and high pay—go into business for yourself.

# Get the "Know-how" at Greer

You learn in our new, large, modern shops by working with latest tools and equipment of the trade — tear down, inspect, repair and rebuild... under supervision of experts. Greer founded 1902. Over 51,000 successful grads. Part time, full time, day and evening. E-Z terms. Mail coupon today.

CLIP COUPON . . . MAIL TODAY  
Greer Shop Training—2230 South Michigan  
Chicago 16, Illinois Desk 213

Please send information about trade checked:

- |   |   |
|---|---|
| <input type="checkbox"/> In our Chicago Shops:            | <input type="checkbox"/> Auto Mechanics   |
| <input type="checkbox"/> Body, Fender Repair              | <input type="checkbox"/> Diesel Mechanics |
| <input type="checkbox"/> Welding—Arc, gas                 | <input type="checkbox"/> Tool & Die       |
| <input type="checkbox"/> Refrigeration & Air-conditioning | <input type="checkbox"/> Machinist        |
| <input type="checkbox"/> Piano tuning                     |   |

APPROVED FOR CIVILIANS (check which) and G.I.'s  
ATTENTION: HIGH SCHOOL GRADUATES.  
Write for information on 2 year DIESEL-AUTOMOTIVE ENGINEERING COURSES.

Name \_\_\_\_\_  
Address \_\_\_\_\_  
City \_\_\_\_\_  
State \_\_\_\_\_





# Make your own Belt Drive Attic or Window Fan!

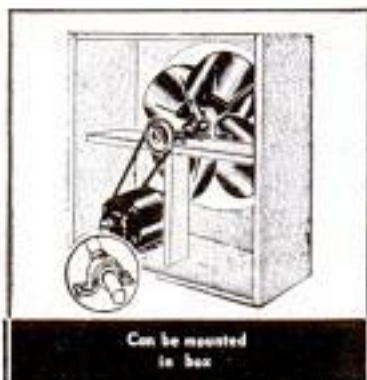

Agents Wanted

Can be mounted in box

### LESS MOTOR

Model No.	Blade Size	Cu. Ft. per Min.	Rooms Av.	Motor Req.	Retail Value	Your Cost
K20	20"	3000	4	1/4	\$23.95	\$14.95
K24L	24"	4000	5	1/4	27.45	17.95
K24	24"	5000	6	1/4	30.95	19.95
K30	30"	7000	7	1/4	34.95	22.95
K36	36"	10,000	8	1/2	44.95	29.95
K42	42"	12,500	9	1/2 or 3/4	51.95	34.95
K48	48"	16,300	12	1/2 - 3/4	59.95	39.95

For Ball Bearing Oilless Rubber Teflon Bearing Add \$10.00 to C.O.D. amount.

Send check in full with order.

Send 10c for wholesale fan and parts catalog with over 100 models to choose from, including name brands

### EMECO ELECTRIC (Fan Division)

800 W. Randolph St. Dept. 347 Chicago 6, Ill.

# Save on all PLUMBING JOBS

When You Build - When Making Improvements - Repairs - Maintenance



How to plan plumbing installations, select materials and fixtures.

## Get POPULAR MECHANICS Home Plumbing Guide



How to save money on all plumbing jobs using approved methods.

Easy to Do Professional-Like Jobs and Save Over One-Half

Get the Popular Mechanics HOME PLUMBING GUIDE. It shows how you can do every kind of plumbing job yourself and save from a few to hundreds of dollars. Covers plans, layouts, installation, maintenance and repair. Shows what materials to get and use, where to get them and how to do a proper job with approved methods. Few, other than the simplest tools are required and some of these can be rented. Don't pay high prices for work you can do yourself. Get the HOME PLUMBING GUIDE for only \$3.50. You will be amazed how jobs you thought difficult are simplified.

Clip This Ad and Mail. Money Back if Not Pleased

Invest only \$3.50. Use the book for 7 days. Then if you are not satisfied return it for full refund of your money. Sent C.O.D. (U.S.A. only) if you prefer.

### 15 Ways to Save Money

All about modern home plumbing  
How to use plumbing tools  
Getting acquainted with pipe  
Planning home plumbing systems  
Installing and maintaining home drainage systems  
Private sewage disposal systems  
Causes and cures of drainage troubles  
Installing home water lines  
Private water supply systems  
Water Heaters  
Water Conditioning  
Water system troubles and cures  
Installing and caring for fixtures  
What to do with valves and faucets

Over 500 How-to-do-it Pictures Guide You



POPULAR MECHANICS PRESS, Dept. HPG-10, 200 E. Ontario St., Chicago 11

now! Beauty for the housetops



WARD  
DYNON-VANE  
CONICAL

Styled for beauty... engineered for top performance. Insist on Ward Tele-vane TV antennas for new or replacement installations. Ask your TV service man about Tele-vanes today!

THE WARD  
PRODUCTS CORP.

Division of  
The Gabriel Co.  
1148 Euclid Ave.  
Cleveland, Ohio

The Ward Products Corp., Div. The GABRIEL Co.  
Dept. PM-754, 1148 Euclid Ave., Cleveland 15, Ohio  
Send me free folder describing the complete line of Ward Tele-vane TV Antennas.

Name \_\_\_\_\_  
Address \_\_\_\_\_  
City \_\_\_\_\_ State \_\_\_\_\_

## SEND ME



every month so I am sure to see each new issue. Here's

- \$3.50 for 1 year  
 \$8.00 for 3 years

name \_\_\_\_\_

address \_\_\_\_\_

city \_\_\_\_\_

zone \_\_\_\_\_

state \_\_\_\_\_

Hand this order to your newsdealer or send it to

POPULAR MECHANICS  
200 East Ontario St. Chicago 11, Ill.



## 60 POWER TELESCOPE \$3.98

**VARIABLE EYEPIECE 20x-40x-50x—BRASS BOUND**  
**NEW!** Three telescopes in one. 3 different magnifications. 20 power for ultra-bright images with 40 and 60 power for extra long range. Guaranteed to bring distant objects, people, sports events, ships, moon, stars, etc. 60 times as close. Made in U.S.A.



Most powerful for anywhere near the money. 3 sections. Closes to 1 ft. long. Contains 4 ground and polished lenses. Also used as a powerful compound microscope. Directions included. Mass production enables us to offer this instrument at amazing price of \$3.98 complete. Money back guarantee. We pay postage. Get yours now. As A Microscope

**CRITERION CO.**  
 DEPT. PMB 24  
 331 CHURCH ST.  
 HARTFORD 3, CONN.

## RUPTURED

### BE FREE FROM TRUSS SLAVERY

NOW there is a new modern Non-Surgical treatment that permanently corrects rupture. These Non-Surgical treatments are so certain, that a Lifetime Certificate of Assurance is given. Write today for our New FREE Book that gives facts that may save you painful and expensive surgery, and tells how non-surgically you may again work, live, play and love and enjoy life in the manner you desire. There is no obligation. Excelsior Hernia Clinic Dept. 8305 Excelsior Springs, Mo.

## BUILD your own TV set

YES. Build your own top-quality TV Set. We supply complete equipment, tools, instruction as part of America's finest Home-Study TV Course. Be a highly-paid TV Technician. Install, Repair, Service all makes of sets. No experience needed. Many excellent jobs now open. Or start your own business. Send today for big FREE Book, "You and Television."

**COMMERCIAL TRADES INSTITUTE**  
 Dept. T2-7 1400 Greenleaf Ave. Chicago 26, Ill.

## LEARN WATCH REPAIRING

**AT HOME** Modern, original instruction. Prepare for a position or start in business after completing our course. Write Today!  
**WISCONSIN SCHOOL OF WATCH REPAIRING**  
 759 N. Milwaukee St. Dept. M Milwaukee 2, Wis.

## STUDY AT HOME

### WITH AN EDUCATIONAL INSTITUTION

Courses in **ARTS AND SCIENCES:** Philosophy; Education; Letters; Public Health; Medical Jurisprudence; Psychology; Sociology; Physics; Chemistry; Geology; Pol. Science; Theology; Law; Business and Commerce; Accounting; Mathematics; Statistics; Agriculture. **ENGINEERING:** Electrical, Civil, Mechanical, Drafting, Architectural, Steam, Diesel, Aeronautical, Radio, Structural, Mining, Industrial, Petroleum, Refrigeration, Chemical. Send for free catalog. McKinley-Roosevelt Incorporated, 4610-K32, Sheridan Rd., Chicago 40, Illinois

## PREPARE FOR THE BEST JOBS IN INDUSTRY

**TRAIN at HOME**  
 IN YOUR SPARE TIME  
 or at  
**ALLIED INSTITUTE**  
 in Chicago

- MECH. ENGINEER
- DRAFTSMAN
- TOOL DESIGNER
- TOOL ENGINEER
- TOOL & DIE MAKER
- MASTER MACHINIST

### NO RECESSION FOR ALLIED TRAINED MEN

**MORE JOBS THAN GRADUATES** Shortages of Draftsmen, Designers, Tool Engineers, Machinists, Tool & Die Makers are so widespread that you can pick a highly paid key job and look forward to Achievement and Security.

You can begin your training in Short Courses and continue progressively to a Bachelor Degree in 26 months.

Allied is approved by Industry, Dept. of Education, Office of Public Instruction, State of Illinois, U.S. Veterans Admin., U. S. Dept. of Justice. Accredited; C. S. A.

SEND FOR **FREE BOOKS**

**ALLIED SCHOOL OF MECHANICAL TRADES**  
 1338-42 South Michigan Ave. Dept. PM-7 Chicago 5, Illinois

SEND ME WITHOUT OBLIGATION INFO. ON YOUR COURSES:

HOME STUDY  RESIDENT  VETERAN  NON VETERAN

NAME \_\_\_\_\_

ADDRESS \_\_\_\_\_ AGE \_\_\_\_\_

CITY \_\_\_\_\_ STATE \_\_\_\_\_

## PUT SOME FUN IN YOUR LIFE!

### WITH S-T-R-E-T-C-H-I-N-G RUBBER DOLLARS

Need a Party Fun Maker? Entertaining at Home? Going on a Trip? Planning a Vacation? Going to a Convention? Or, Looking For a Business Good Will Gift? We guarantee that a supply of S-T-R-E-T-C-H-I-N-G RUBBER DOLLARS will create a lot of Good, Old Fashioned Fun and plenty of Good Will, besides. Hand out with hotel, taxi and restaurant tips and get many dollars worth of cheerful service. Bundle of 15, only \$1.00 Ppd., 50 for \$2.50.

**FREE** with each order.—Rubber Fish Measuring Rule. Brand new exciting fun novelty for the "THAT-LONG" Fisherman Story.  
**MEINHARDT'S, 4224 Lincoln, Chicago 18, Ill.**

## Get into.. PLASTIC LAMINATING AT HOME!



Get **ORDERS** and **CASH** from your mailman—do work in **SPARE TIME** at home—or expand into **FULL TIME** business. Send coupon for Free facts about the newest and most fascinating of all home operated businesses. For the first time a simplified machine brings the fabulous profits of **Plastic Sealing and Plastic Laminating** within the reach of the small operator. Anyone can learn to operate the machine with a few minutes practice—then with our **Magic Mail Plan** can get mail orders pouring in daily with cash in every envelope. **No canvassing—no selling.** We even

**Make \$20 to \$30 a Day by.. MAGIC MAIL PLAN!**

supply the circulars you mail to bring back cash and orders. Don't waste a minute. Rush your name. We'll send you **FREE** and postpaid, pictures, prices, details, and all the facts you need to start. Mail coupon or send name on postcard. No charge. Warner Electric Co., 1512 Jarvis Av., Dept. L-10-I, Chicago 26, Ill.

### Make Thousands of Beautiful Art Creations

- COSTUME JEWELRY • CIGARETTE BOXES TRAYS • CANDLESTICKS • COASTERS LAMP BASES • BOOK ENDS...ALL IN SPARKLING COLORED PLASTIC**



**THIS MAN**... is taking out of the machine a Plastic Sealing Job—ordered by mail—only 11c in material cost brings back \$2.55 in cash by mail. Capacity of machine: **\$25.00 profit per hour of operation.**

**WARNER ELECTRIC CO., 1512 Jarvis Av. Dept. L-10-I, Chicago 26, Ill.**  
 At no cost to me, please rush complete details postage prepaid. I am under no obligation.

Name \_\_\_\_\_

Address \_\_\_\_\_

City \_\_\_\_\_ Zone \_\_\_\_\_ State \_\_\_\_\_



# STOP BURNING OIL!



**LOSING POWER  
WASTING \$\$\$**

When your car "eats-up" oil, loses that get-up-and-go power, has poor gas mileage, it's a sure sign that you have worn rings, pistons, and cylinder walls in your engine. This is robbing you of driving pleasure and valuable \$\$\$ to the tune of \$250 every 10,000 miles in oil, gas, and repair bills.

## WHAT CAN YOU DO ABOUT IT?

You can either have an expensive overhaul job done or offset this wear with a

## RING-RE-NU MOTOR RECONDITIONER KIT

It's the inexpensive, proven answer to a worn engine. This terrific 1-2 combination restores power and zip to your car without expensive repair work, reduces oil burning, slashes gas consumption, brings back that "new car" performance to your car.

### HERE'S HOW THIS DOUBLE VALUE KIT PERFORMS!

- 1. PVR COMPOUND**—is a hard hitting engine reconditioner that removes sludge, tars, sticky greases from a tired, worn engine. Pour in carburetor, idle engine. Leaves rings, valves, pistons whistle clean, ready for . . .
- 2. RING-RE-NU**—this amazing compound when squeezed by tube on pistons forms a tough, pliable, self-expanding seal on rings and pistons to compensate for wear.

**RESULT!**—You get power-packed, economical driving pleasure. Good for 10,000 plus miles. Adds years to the life of your car. Guaranteed not to harm the finest engine. Takes only 30 minutes to install.

**PROVEN SUCCESSFUL!** Over 100,000 customers acclaim results! —

You risk no money!—Ring-Re-Nu must reduce oil burning—improve compression in your car. Try it for 400 miles — if results aren't favorable—return empty tube and can — full purchase price refunded!

1 tube kit \$4.95 ppd. treats all cars except large 8 cyl. autos which require 2 tube kit at \$8.95 ppd. sold with money back guarantee. C.O.D.'s accepted. \$1 deposit required, bal. and postage on arrival.)  
**FREE** with your order from this ad — one "Micro-Moly" crankcase treatment worth \$1.50!

RUSH ORDER TO:

## RICHIE DISTRIBUTING, INC.

11916 MADISON AVE. • DEPT. M7 • CLEVELAND 7, OHIO



Only \$4.95

POSTPAID

## HELPFUL BOOKS

Send post card asking for FREE catalog

Popular Mechanics Press, 200 E. Ontario, Dept. 601, Chicago 11

## ENGINEERING DEGREE IN 27 MONTHS

### Big Demand for Graduates

**Aeronautical, Chemical, Civil, Electrical, Mechanical and Radio Engineering (inc. TV and Electronics)**

Hundreds of young men are earning B. S. ENGINEERING DEGREES annually in this recognized institution — year around operation. New terms start quarterly. Many students earn a major part of their college expenses in this large industrial center.

Low tuition. Competent instruction. Thorough, intense, practical program. Modern, well-equipped laboratories including new physics laboratory and modern wind tunnel. Individualized instruction emphasized.

Government approved for G.I.'s. Engineering preparatory courses. Students from 48 states and 21 foreign countries. Enter September, December, March, June. Send coupon for free catalog and full information. Enroll now.

SEND COUPON TODAY

## INDIANA TECHNICAL COLLEGE

574 E. Washington Boulevard  
Fort Wayne 2, Indiana

Please send me free information on B.S. Engineering Degree in 27 months as checked.

- Aeronautical,  Chemical,  Civil,  Electrical,  
 Mechanical,  Radio-Television

Name \_\_\_\_\_

Address \_\_\_\_\_

IT'S DANGEROUS (VERY DANGEROUS) TO PAY LESS For "Family-Safe" Fine Used Tires Year after year, Popular Mechanics brings us to you



**FREE** THIS PICTURED TIRE ASK TRAY WITH YOUR NAME WITH TWO OR MORE TIRES  
CAR TIRES \$3 (20 Mo.) TRUCK \$9 (Guar. Tires)



**GOODYEAR** These Are Not Recaps Firestone, U. S. And Others

Free Tube with Tire

Our Prices with new tire guar. are up to **65% DISCOUNT** Cheaper than new Tire Prices  
America's Most respected Golden Rule Guarantee **FREE REPLACEMENT** IF TIRE IS DEFECTIVE

You Receive **32 MONTHS GUARANTEE BOND**

600-16	\$4.67	640-15	\$4.37	FINE RUGGED TRUCK TIRES	
600-16(G)	5.77	670-15	4.87	750-16(G)	\$9.77
650-16	5.07	710-15	4.87	700-20	\$9.77
650-16(G)	6.57	760-15	5.27	700-17	8.87
700-16	5.57	800-15	5.77	750-17	10.47
700-16(G)	6.07	820-15	5.77	700-15(G)	7.67
750-16(G)	7.77	850-15	4.67	700-15	9.47
850-17	4.17	700-15	4.77	800-20	7.67
475-15	4.27	825-15	4.17	650-20	8.97

WHITEWALLS \$1 EXTRA; & DELUXE WHITEWALLS \$2 EXTRA

I have personally pinpoint inspected every tire, as if our very future depended on it. Not 1 tire, I wouldn't use myself.



### MILITARY GRIP (Not Retreads)

**750-20** Super 20 Mos. \$10.27  
Rugged 34 Mos. \$12.57  
**900-16** Super 20 Mos. \$10.27  
Rugged 34 Mos. \$13.97

"I ask one chance to treat you right." Mort Blatt Mgr. Faithfully serving motorists, hospitals, schools & churches since 1917.

**BLATT** PHILA., PA., 11th & SPRING GARDEN ST. Send ck. or M.O.

Order from our MIAMI, FLA., 2827 N.W. 7th AVE. and this store nearest you ad.

—Thousands of shipments rushed all over the world.

## PLYWOOD BOAT KITS

12 FT. \$97.00

14 FT. \$129.00

Freight Included



Send for free folders on all models as low as \$39.00 freight included

**TAFT MARINE WOODCRAFT**

Dept. P.M., 636 39th Ave. N.E., Minneapolis 21, Minn.

BUILD YOUR OWN

## AIR CONDITIONERS

AND DEHUMIDIFIERS — For Home or Automobile FROM JUNKED REFRIGERATORS — FOR \$15

Instruction books show you how □ for Home—\$0c □ for Car—\$0c

COMPLETE "Install-It-Yourself" KIT for Auto — ONLY \$164.70

This kit contains everything you need to install an air conditioner in your car that is equal to capacity and performance of units costing \$600 or more. Save hundreds of dollars. Send for instruction books or further information to

**SEELEY PRODUCTS CO.,** Dept. 51, 3716 Belmont, Chicago 18, Ill.

Say You Saw It in Popular Mechanics

## SKYMASTER RADIO PALM SIZE

1000 MILE RECEPTION! Not A TOY! NOT A GADGET! ELECTRON TUBE PERSONAL RADIO COVERS BROADCAST BAND 540 to 1600 KC WITH PERFECT TONE. Thousands in use. Hearing aid battery powered. For home, office, camp, hospital, etc. GUARANTEED precision-built parts. Kit includes photodiagram for easy assembling. Batteries PLUS EXTRA "A" BATTERY \$1.50. Radio-type 1500 ohm ALNICO MAGNET EARPHONE \$1.45, or 1900-ohm HEARING AID EARSET (\$10 value) only \$4.95. C.O.D. orders accepted with \$1 deposit.



**\$6.75**

POSTPAID Factory assembled (set only) \$8.95

**PRECISION ELECTRONICS, Dept. 7, Placerville, Calif.**



**WORLD'S  
BEST  
WANT AD  
MEDIUM**

# CLASSIFIED Advertisements



Advertisements in this section \$1.00 per word, each insertion, minimum 10 words, payable in advance.

To be inserted under proper classification, copy must be in our office the

20th of the second month preceding date of issue

F. W. Johnson, Manager, Classified Advertising

Popular Mechanics Magazine, 200 East Ontario Street, Chicago 11, Illinois

## YOU'LL PROFIT

By reading and answering the classified ads in this section. Hundreds of opportunities for you to make and save money

### AUTOMOBILES, MIDGET CARS

**FIBERGLAS** Automobile bodies. Build your own. Everything needed. Lowest prices. Information, materials catalog 10c. Gem-O-Lite, Box 6867A, North Hollywood, California.

**FIVE** More miles per gallon with your '41 to '48 Chevy. No parts to buy. Do it yourself easily. Send 25c for complete instructions. D. E. Smith, 4010 Harney, Omaha 3, Nebr.

**NON-Profit** organization offers automobile literature—Old, new and foreign; dealer books, service manuals, glossy photographs; free motor magazines. Write today; get on free mailing list. Auto Maniacs, Inc., Stockbridge, Mich.

**200 MILES** Gallon, average car. Make your own carburetor. Complete patent details plus comments. 29 page booklet \$2. Behling, Box 935, Dept. 1A, Inglewood, Calif.

**"THE Truth About Water Injection."** \$1. Stan Stanton, Liberty, New York.

**HI-Mileage** speed equipment from the world's largest supplier. Dual manifolds, finned heads, electric doors, lowering sets, fuel savers, thousands of items for all cars. Huge catalog, 25c. (Illustrated literature free). Wholesale to garages. Newhouse Automotive Industries, Los Angeles 22.

**WRITE** For free sample copy. Pranson's Motor News, Eugene, Oregon.

### AUTO SUPPLIES AND EQUIPMENT

**GENUINE** Oldsmobile parts and accessories. Hard to get body, chassis parts from 1932 through 1954. Wholesale prices Hoffman Motors, East Hartford, Conn.

**SENSATIONAL** Free trial offers! Surplus stock of famous Gale Hall automotive instruments, brand new, original cartons! Try at our risk for seven days—then send payment or return merchandise! Professional compression testers, originally \$10.75, now \$2.98! Combination vacuum gauge fuel pump tester, originally \$8.10, now only \$3.00! Original Gale Hall motor condition/gasoline economy gauges for permanent dashboard mounting, originally \$7.50, now \$2.98! (Deluxe all-chrome custom foreign model, originally \$14.95, now only \$4.98!) (Add 40c to each price for postage.) Order now! New England Surplus Sales, Dept. PM-7, Newburyport, Mass.

**SPARK** Plugs, air-cooled, sizes and heat ranges, for all engines, 50c each. Cash with order. Prepaid. Hager, Denton, Md.

**AMAZING** "Tops" radiator cleaner cleans and copper plates. \$1.98 post paid. Wasco, Post Office Box 1231, Sandusky, Ohio.

**SPEED** Equipment—Any car. Write Power, 327 W. 117th, Hawthorne, Calif.

**FOR** A better motor for \$3.00. Use Lachapelle's 100,000 miles treatment. Free data. Ferns Products, 8120-B Walnut Dr., Los Angeles 1, Calif.

**LACHAPELLE'S** Treatment. (Patented.) For only \$3.00, will make any gasoline motor better. Free data. Master, Box 3, Station C, Hamilton, Ontario, Canada.

**FELT** Back floor mats (seconds) to fit cars before 1941 only \$2.19 post paid. Sandy Sales, 927 W. Washington St., Sandusky, Ohio.

**INCREASING** Ignition voltage improves running. Literature. Centson's, 3333 Neehah, Chicago 24.

**CUSTOM** Accessories headquarters. New summer catalog, just out, most complete ever. Jam-packed with items not in stores. New low prices. 25c. Eastern Auto, 3319-PMC South Grand, Los Angeles 7, Calif.

**AUTO** Radios wholesale. Send year and make car. Free literature. Prices. Cherry Radio, 1438 Belfield, Philadelphia 40, Penna.

**CADILLAC**, Buick, Olds, Pontiac owners! Listen to your engine accelerate. If it misses, you are wasting gasoline! Restore your distributor with genuine Spark-O-Liner and new breaker plate. Get it from your auto electric supply company, \$1.50 each. Free literature. Hove, 5606 Clinton Avenue, Minneapolis 19, Minnesota.

**SAVE** Gas, oil, repairs, improve compression, power of old motors with Lachapelle's Motor Treatment (patented). Only \$3.00 delivered. Money back guarantee. You can't lose. Free circular. Joe Dillon, Authorized Warehouse and Agents Distributor, Box 323-W, Bridgeport, Ohio. Exclusive distributorships, agencies open.

**THIEF** Chaser. Free trial! Protect your car, tires and accessories from theft. Free literature. Novak Company, 3131 West 13th, Gary 71, Indiana.

**JACK** Repair kits. Repair your own. Make money repairing for others. Send \$1.00 for "Jack Service Manual" and kit price list. Refundable. Jack Parts Co., 2000 So. Claiborne, New Orleans, La.

**BUY** Wholesale nationally advertised auto supply, thousands other products at big discount. Free "Wholesale Plan." American Buyers', 629-D Linden, Buffalo 16, New York.

**THOUSANDS** Of readers have asked for it! Here is Build Your Own Garage, \$3.50, by Wayne C. Leckey. Choose from 25 different designs and build attractive and sturdy garage. Step-by-step instructions, photographs and drawings help. Order from Popular Mechanics Press, 200 E. Ontario, Chicago 11, Ill.

**END** Oil changing! Refine your oil as you drive! Refinol antiquates all other oil filters. Free booklet on saving your car or tractor motor. International Refinol Company, 8848 W. 47th, Brookfield, Ill. "Chicago's technical suburb."

**"OVER** 200 Miles per gallon gas your car," claims inventor. Free information. Gane Economy Club, 8664 West Pico, Department PM7, Los Angeles 35, California.

**AUTO** Door arm rest covers. All colors. Same as original. Easily cemented on. State make, model, year, and color. \$1.59 a pair pp. No. c.o.d.'s. Arm Rest, 204 Brown St., Waltham, Mass.

**SAVE** Money on maintenance, gas and oil. Get more power, performance for your car, truck, bus. Write Box #926, Richfield, Minnesota.

**SAVE** Your life with amazing new "Torsion-Flex" Sway-Bilizers! Stops sway, skid, slide. Postal brings free illustrated literature, gift offer. Sway-Bilizer, 5434-A Higgins, Chicago 30.

**AUTOMOBILE** Accessories, for free trial! Write Neher Industries, LaVerne, Calif.

**ELECTROPLATE** Auto parts, novelties, mirrors. Easy, inexpensive home processes. Free booklet. Tyco Metals, Box 13231-BG, Houston 19, Texas.

**BRUSH** Plating outfits connect to a battery. No tanks or shop required. Free particulars. Gunmetal Co., Ave. J., Decatur, Ill.

**CAR** Burning oil? Losing compression? Try Clifford's Compression Seal. \$2 post-paid. Clifford's Engineering, 1329 Seventh, Aurora, Illinois.

**FORD-T** parts—Engine and chassis. Parts for other old models. Special parts made to order. B. S. Wisneski, Milwaukee 7, Wisconsin.

### AUTO TRAILERS

**HOUSE** Trailers, Chris-Craft, 14 ft. Atho De Witt, Agent, Almont, Michigan.

**HOUSE** Trailer axle assemblies. Save money. Write Goldsworthy Trailers, 8108 S.E. Taylor Court, Portland 16, Oregon.

**ASSEMBLE** Yourself. Trailer kits. Pick-up coach kit. Blueprints. Literature 10c. Comstock Trailers, 585-K, Parsons, Kans.

**EXCEPTIONAL** Expanding eight foot trailer. Accommodates family of five. Build yourself. Literature 10c. Fra-Mar Company, Jones Avenue, Wilmington, Mass.

**TRAILER** Building. Illustrated, 20c. Craftsman Books, Box 1153, Milwaukee 1, Wis.

### MOTORCYCLES, BICYCLES, MOTORSCOOTERS AND SUPPLIES

**SMITH** Motorwheel \$15. Maytag twin engine \$5, garden tractor \$10, Check motorcycle \$35. Servicycle \$35. (Mailorder only.) Send 25c for Directory Number 60. Just out, listing these and hundreds of other bargains in new and used midget cars, motorscooters, engines, parts, plans for homebuilders, etc.. (35c by first class mail.) Midget Motors Directory, Athens, Ohio.

**AMAZING** "Mobylette" with automatic clutch, lightweight motorbike, \$179.50 retail including federal tax. New in U.S.A. Exclusive territories—Salesmen, agents, dealers, distributors. Write P.O. Box 128, Hammel Station, Rockaway Beach, N. Y.

**WHIZZER** Motorscooter \$20.00; two-speed Cushman motorscooter \$20.00; Indian Scout motorcycle \$49.00; midget car \$15.00; homemade motorscooter \$6.00. Send 25c (35c first class mail) for catalog #25 jammed with sensational bargains in wheels, motors, motorscooters, midget cars, motorbikes, construction plans, etc. Gail, 1213 Jefferson, Toledo, Ohio.

**NSU** And BMW motorcycles, 1½ to 35 hp., singles and twins, chaindrive and shaftdrive. Some dealerships open. Butler & Smith, P.O. Box 45, New York 24, N. Y.

**"BUZZZZ"**—The motorcycle magazine. International coverage. Thoroughly illustrated. Yearly \$2.00. Sample 25c. 5424-A Sawyer, Chicago 25.

**RECONDITIONED** Motorcycles and motors, Chromium accessories. Complete stock Indian parts. Expert rebuilding. Fast service. Indian Motorcycle Sales, Kansas City 27 Mo.

**PARTS**, Pistons, new, used. Harley, Indian, Henderson, list 10c. Ballak, 811 N. 9th, St. Louis 1, Missouri.



**REBUILT** Gasoline engines \$17.00 to \$37.00. Cauffiel Motor Industries, Temperance, Michigan.

**HARLEY-Davidsons** — America's best used buys! We pay shipping on motorcycles. Genuine new, used, parts, accessories for current and obsolete models. Send 25c for bulletin, catalog. Knuth's (Harley-Davidson factory dealer), 1753 Muskego, Milwaukee, Wis.

#### AVIATION

**LIGHTPLANE** Circular, illustrated, 20c. Craftsman Books, Box 1153, Milwaukee 1, Wisconsin.

**BUILD** And fly Lincoln sport biplane. Plans \$3.00. A. G. Hagen, 8954 Gravelly Lk. Dr., Tacoma, Washington.

**FLY** Captive soaring 46" glider. Excite your community! \$1.00 pp. Box 505, Fairhope, Alabama.

**PROPELLERS**, Plans, supplies for air boats, snow sleds. Literature. Gano Propeller, Box 3284A, Ft. Worth, Texas.

**FREE**: Monthly aircraft, electronic, gadget list. Dick Rose, Everett, Wash.

**PROPELLERS**, Plans, kits for snow sleds, air boats. Immediate delivery. Catalog 25c. Banks-Maxwell, Box 3301E, Ft. Worth, Texas.

#### BATTERIES, GENERATORS

**EDISON** Nickel odorless storage batteries. 12 to 600 ampere hour. Any voltage. Long guarantee. Literature. Hawley Smith Co., Croton Falls 1, N. Y.

#### ELECTRICAL SUPPLIES

**REWINDERS**, Supplies, motors, instructions, plans. Modern, Box 4704, Kansas City 8, Mo.

**LAMP** Supplies — Wholesale. Any amounts. All parts for repairing and building lamps. Catalogue 15c. Brown Lamp Co., Box 501-Wellston Sta., St. Louis 12, Mo.

**LAMPS**—25c Brings bargain catalog showing all parts for repairing, building. Contains instructions for electrifying vases, oil lamps, etc. Gyro Lamps, 5462P Clark, Chicago 40.

#### WELDING, SOLDERING, PLATING

**"BUILD-UR-OWN"** a.c. welder and a.c. power plant with a good used engine and low cost Hobart generator. Welds anywhere and supplies 5KW stand-by power for any emergency. Write Hobartweld, Box M-743, Troy, Ohio.

**ACETYLENE** Welding outfits, new \$49.00; used \$29.00. Arcwelders \$49.50. Eagle Welding, Dept. PM, 5085 Broadway, Chicago 40, Ill.

**ELECTRO** Plating equipment—New and used. Complete assemblies. All sizes for all types of plating. Baby shoe metallizing sets. Mounts, supplies, instructions. Free catalog. Hollywood Bronze Supply, 1624-C E. First Street, Los Angeles 33, Calif.

#### MACHINERY, TOOLS, SUPPLIES

**MACHINISTS** — Starrett 454A height gauge, with case, \$49.50 cash with order postpaid, or c.o.d. Lippincott Supply Co., 105 Lincoln Highway, Vallejo, California.

**PNEUMATIC** CP251 alligator jaw rivet squeezers \$37.50. 3 pneumatic bench type staking presses \$85.00 each. Other reconditioned air tools, #1, #2, #3 grommet die sets \$1.50 each size. Twin pump units \$12.50. Bergner, 3029 No. Broadway, St. Louis 7, Mo.

**BIG** Factory catalog! Buy direct—Save middleman's profits; hundreds of labor saving tools and equipment; tremendous savings. Send 10c. Master Mechanic Mfg., Dept. CL-26, Burlington, Wis.

**MOTORS**, Machine tools, surplus. List 25c, refunded. Felco, Box 1300, San Francisco, Calif.

**OVER** 8000 Readers enjoying our monthly tabloid. Filled with used mining machinery bargains. Send \$1.00 for year's subscription! Mining News, Middlesboro, Ky.

**GEAR** Motors—New unopened 110/220 v, 1/3 hp., 57 r.p.m. output 222 inch lbs. Open garage doors, fences etc. \$55.00 f.o.b. Doyle, 51 Scio Street, Rochester, New York.

**NEW** Mail electric drills, 1/2", \$15; 1/4", \$34.95. Jacobs chucks. Wilt Surplus, 7829 S. Racine, Chicago 20, Ill.

**FLEXIBLE** Metal hose with fittings for water, steam, liquids. Etc electrical connections save money. Bergner, 3029 No. Broadway, St. Louis 7, Mo.

**ALLEN** One ton power bench type punch press. \$97.50. Circular. Allen, Dept. PMB, Clinton, Missouri.

**SHEBEL** Saw filer. Files all saws. Circular. A. P. Shebel, 730 S. 2nd St., Milwaukee 4, Wis.

**NEW** All steel drill press vise, 3 1/2" hardened jaws, \$9.95. Money back guarantee. Free circular. B. M. Sypher Co., 208 Cherry St., Toledo, Ohio.

#### ENGINES, MOTORS, DYNAMOS

**MARINE** Industrial engines, equipment, parts. Helwege Co., 741 S. Ocean, Freeport, N. Y.

**ALTERNATING** Current generators 750 watt \$38.50; 5000 \$185.00. Motors 1 horse \$37.50; 2, \$67.50; 3, \$87.50. Butler, 1885 Milwaukee, Chicago 47.

**WINDING** Data. 225 motors, single and three phase, \$1.00. Data Company, Box 7631, Kansas City 28, Mo.

**INVALUABLE** Motor winders handbook, simplifies complicated reconnecting. \$4.98. Jednak, Clinton, Penna.

**REBUILT** Gasoline engines \$17.00 to \$37.00. Cauffiel Motor Industries, Temperance, Michigan.

#### BOATS, OUTBOARD MOTORS

**BOAT** Kits. Build your own boat. Easy to follow instructions. Literature free. Paramount Boat Company, 2202 N. Prairie, Joliet, Illinois.

**SAVE** Dollars when you buy used in-board or outboard motors. All kinds boat propellers and supplies. 25c brings complete data. Masters, 210 W. Chicago Ave., Chicago 10, Ill.

**HOW** To build boats book \$1.00. Free literature on sailing catamaran. Widd Hauber, 2451 18th Ave. No., St. Petersburg, Florida.

**SIMPLIFIED** Plans for amateurs. Outboards — inboards — 12'-22'. New 18' 6" "hot rod" inboard. Glen Designs, Box 568, Compton, California.

**BUILD** Beautiful fiberglass-plastic boats without using molds. New patented method. Write Speedcraft, 2450 Emerson, off Square Lake Road, Pontiac, Michigan.

**BUY** Wholesale nationally advertised outboards, thousands other products at big discount. Free "Wholesale Plan." American Buyers', 628-D Linden, Buffalo 26, N. Y.

**FIBERGLAS** Permanent boat coating. Everything needed. Lowest prices. Complete catalog 10c. Gem-O-Lite, Box 6867B, North Hollywood, California.

**NONCORROSIVE** Screws, studs, nuts, washers and specialties reasonably priced. R. Freas, 1012 Maple Street, Conshohocken, Penna.

**SAVE** Money have fun—Build your own boat. Popular Mechanics "23 Boats You Can Build" tells and shows you how. 192 pages, 500 illustrations, detailed diagrams and material lists. Everything from 10 ft. dinghy to 25 ft. cabin cruiser. Only \$2. Order today from Popular Mechanics Press, 200 E. Ontario, Chicago 11, Illinois.

**FULL** Size, cut-to-shape boat patterns, blueprints, 7 1/2-38 feet. New 1954 illustrated "Build a Boat" catalog of 50 naval architect-designed cruisers, runabouts, sloops, skiffs, outboard boats, sailing, racing, houseboats, 50c. Marine hardware catalog, \$1.50. Bigger, better 1954 "How to Build Boats" book, \$2.50. PolyWog Houseboat Plans, \$12. Cleveland Boat Blueprint Co., Dept. A-66, 9400 Steinway, Cleveland 4, Ohio.

**FIBERGLAS** Your boat for permanent waterproofing. Easily applied. Complete instructions. Guaranteed materials. Wholesale prices. Complete kits \$12.00 up. Free lists. Afj Plastics, Dept. PM, P.O. Box 1233, Ft. Worth, Texas.

**LEAKPROOF** Your boat with new, revolutionary polyester-fiberglass containing X 303. Easier application, smoother finish. Literature, sample 10c. M-H Plastics, 341 Albany, Ferndale, Mich.

**MARINE** Conversions for Ford and Jeep engines. Catalog 10c. Lehman Manufacturing Company, 872D Broad Street, Newark 2, New Jersey.

**NEW**, Used, rebuilt marine motors. Marine conversions, fittings. Free catalog. Stokes Marine Supply, Dept. 24, Coldwater, Michigan.

**BUILD** Marine engines with Federal conversion kits. Federal Marine Motors, 9011 Cottage Grove Ave., Chicago 19, Illinois.

**FREE** Catalog! Boat kits, trailers, fiberglass, marine hardware. Luger Industries, Dept. KD, 3207 Fremont South, Minneapolis, Minnesota.

**JOHNSON** Outboard specialists. Used parts for all models at substantial savings. Prompt quotations. Specify model serial. Crandall-Hicks, 910 Commonwealth, Boston, Mass.

**AIR** Boat plans, kits, supplies, catalog 25c. Banks-Maxwell, Box 3301F, Ft. Worth, Texas.

#### ATHLETIC EQUIPMENT, BODY BUILDING COURSES

**12** MUSCLE Courses \$2.00. Results guaranteed. Sid's System, PM, Southgate, California.

**FRENCH** Briefs, Zebra or leopard. \$3.00. Maribill, Box 32, Garland 6, Texas.

**GREAT** Strength easily obtained. See page 42, Popular Mechanics, May issue 1954.

#### SPORTING GOODS, GUNS, FISHING TACKLE, ARCHERY, TRAPPING

**CATALOG** On government surplus from country's largest surplus organization specializing in outdoor, sporting goods, clothing, camping equipment. Hundreds of items including tents, rubber boats, tarpaulins, swim fins. Only 10c! Rockaway Sales Co., Dept. PM, Route 46, Rockaway, New Jersey.

**CAMPING** Equipment, tents (direct from manufacturer), sleeping bags, air-mattresses. Low prices. Send 10c for 72 page illustrated tent-camping equipment-tent maintenance catalogue. Mor-San Sales, 10-21R 50th Avenue, Long Island City 1, New York.

**DIVING**, Spearfishing catalog 25c. Underwater World, Box 475B, Huntington, New York.

**JAP** And Mauser military guns make fine hunting rifles. Do it yourself in your spare time. Save money. Complete easy to follow instructions only 10c. Fajen's, Warsaw, Missouri.

**SAVE** 50% On finest bows, arrows, complete bowhunting outfits, etc. Free catalog and "How to Hunt with Bow & Arrow" booklet. Send 25c for handling. Malibu Archery, 3156-G Eighth Street, Los Angeles 5, Calif.

**DIVING** Lung compressor. Make your own. Write Pierre, 628 Greenwood Ave., Trenton, N. J.

**FREE** Fishing catalog—132 pages. Over 3000 hard to find fishing specialties. Netcraft Company, Dept. PM7, Toledo 13, Ohio.

**CATCH** Plenty fish! New scientific formula. Terrific results! 50c. Satisfaction guaranteed. Revealer, 1749 Grand Concourse, New York 53.

**HELPFUL** Hints for fishermen, hunters, campers, sports, archers and boatmen. "Outdoor Sports Manual" published by Popular Mechanics Press, \$2.00. Send for your copy today! Popular Mechanics Press, 200 E. Ontario St., Chicago 11.

**BUY** Wholesale. Name brands, sporting goods, 10,000 other items. Free "Wholesale Buying." National Buyers Service, 1213ED, Capitol, Houston, Texas.

**RIFLES** Built to order. Your action or mine. Prices. Illustrations. Kenneth Clark, Madera, Calif.

**BUY** Wholesale nationally advertised sporting goods, thousands other products at big discount. Free "Wholesale Plan." American Buyers', 627-D Linden, Buffalo 16, N. Y.

**BOWS**—Semifinished, lemonwood \$3.25; bamboo-backed osage \$12.00; laminated bamboo \$22.50; postpaid. Catalog, Jim Deeds Archery, 5151 Branciforte Drive, Santa Cruz, California.

**MOLDS** For fisherman's sinkers, sigs, squids, casting and spinning lures. Free catalog. Sweet's Molds, Tonawanda 1, New York.

**HOLLOWGLASS** Fishing rods. Save over half. Buy complete kits. Casting, spinning, fly and boat, \$4.95 to \$7.95. Assemble yourself. Full instructions. Makit Rod Company, Dept. PM, 429 Fulton, Ft. Worth, Texas.

**JAP** Rifle altering to 30-06. \$6.00. Catalog 5c. T. P. Shop, West Branch 11, Mich.

**5000** BARGAINS. Firearms, binoculars, war relics. Catalog 50c. Smith Firearms, Runnemed, N. J.



180 PROFUSELY Illustrated pages antique pistols, swords, daggers, armor, etc. 50c. Robert Abels, M860 Lexington Ave., New York 21.

**CAST Iron molds**—For casting fishermen's sinkers. Free illustrated booklet. Reading Instrument Co., Box 78, Reading, Penna.

**FREE Copy!** "The Archers" Magazine." Request: 1200 Walnut St., Philadelphia 7, Penna.

**FISHERMEN**—Catch more fish with Minno-Priskee. \$1.25. Literature. Bava, 2655B East Canfield, Detroit 7, Michigan.

**SWIMMERS**, Spearfishermen—Finest imported equipment. Illustrated catalog 25c. Aquafun, Davenport 7, Iowa.

**DIVING Equipment** for spear fishermen, skin divers and professional divers. Send 25c for catalog. Desco, 234 N. Broadway, Milwaukee 2, Wis.

### **BINOCULARS, TELESCOPES, MICROSCOPES, MAGNIFIERS**

**DYNASCOPE**—New sensational reflector telescope 65X-130X-167X, 4 power finder, fully achromatic, 5 foot tripod, complete ready for use. Send for details. Criterion Mfg., Hartford, Conn., Dept. DP-2.

**WAR Surplus bargains!** Millions of lenses, instruments, telescopes, binoculars, components! World's greatest optical market place! Send only \$1.00 for beginner's 10-lens kit and big instruction booklet, Stock CH. Write for catalog "CH" free! Edmund Scientific Corp., Barrington, N. J.

**GIANT 100X**, guaranteed, clear vision, brass and steel tubing, completely assembled telescope on heavy tripod \$7.95 f.o.b. factory. Also 400X telescope makers lens kit \$3.95 postpaid. Free literature. Carl Jamer, Manorville 1, N. Y.

**GIANT 100X** ready to use telescope. Steel and brass tube construction. Extra heavy tripod. Two eyepieces. Helioscope instructions. \$7.50. Other telescopes at \$12.00 and \$16.00. Free information. 400X telescope makers kit contains brass focusing tube, 5 lenses, erector, instructions—\$3.75. Suffolk Science, Riverhead 3, N. Y.

**REFLECTOR Telescope kits** from \$6.25. All parts designed and built at our Hoboken factory. Mirror cells, diagonals, focusing mounts, tripods, tubing, oculars. Fully guaranteed. Free illustrated catalog. Easy time payments and lay-away plan available. Send orders and inquiries to Esco Products, Dept. PM-2, 1428 Willow Avenue, Hoboken, N. J.

**SAVE 25%!** Get interesting facts. Free 52 page binocular, telescope catalog. \$3.95 to \$250.00! United, 9043 S. Western, A-7008, Chicago 20. Dealers wanted.

**LOWEST Prices**, all sizes binoculars, telescopes, microscopes, 8X30 \$32.00. Free catalogue. Joe's Binocular Sales, 4827 Second Blvd., Detroit 1, Michigan.

**TELESCOPES**, Microscopes, binoculars for quarter century. Big bargain scientific catalog 10c. Harry Ross, 70 West Broadway, New York 7, N. Y.

**IMPORTER'S** Amazing prices, binoculars, microscopes. Free trial. Folder, "Binocular Selecting," price lists free. Dealers write. Prentiss Importers, Mercury Bldg., West Los Angeles 25, Calif.

**SPECIALIST**, Used, new microscopes. Prepared slides. Supplies. Telescopes. Free illustrated catalog. Nassau Optical, 9 W. Greenwich, Roosevelt, New York.

**REFLECTING Telescopes**, 60X, completely assembled \$29.75. Guaranteed observatory clearness. Free information. Skyscope, 475 Fifth Avenue, New York 17.

**MAKE 6"** Telescope refl. ctor. Glass, abrasives, instructions—\$10.50. F. Cameron, Box 65, Inwood 96, N. Y.

### **PETS—DOGS, BIRDS, RABBITS, HAMSTERS, ETC.**

**ST. Bernard's**, Boxers, Hof Kennels, 5136 Cascade Rd. S.E., Grand Rapids 6, Mich.

**"MONKEYS**, Their Training, Care and Feeding," new booklet describing 30 most popular varieties. 25c postpaid includes importers price list, Tropical Hobbyland, 1531 N.W. 27th Ave., Miami, Fla.

**MAKE \$10,000.00** Raising chinchillas, pigeons, rabbits or cavies for us. Free information. Keeney Brothers Farms, New Freedom 2, Penna.

**CHINCHILLAS** Book, breeding and care \$2.00. Ludwig Ranch, Mohnton 10, Penna.

**BABY Raccoons**, skunks—Immediate shipment. Catalog, 25c. Shady Fur Farm, Springfield, Minn.

**GUINEA Pigs**, Amazing profits. Booklet free. Taylors, B426A, Hapeville, Georgia.

**CHINCHILLAS**, Guaranteed breeders. Guaranteed against loss. Bright's Chinchilla's, 2312 N. 38 Street, Kansas City, Kansas.

**HAMSTERS**—Golden; young, \$4.00 pair, fully developed, \$5.00 pair. Adirondack Hamstery, Prospect 22, New York.

**RABBITS**, Amazing cash income. Booklet free. Tayco Rabbitry, Hapeville, Ga.

**CHINCHILLAS**—Registered. Guaranteed reproduction. Unbelievable price. Free literature. Far-West Chinchilla, 1445A Jones, San Francisco 9, California.

**RAISE Pedigreed Angora wool rabbits** with earthworms. Woodside, Piqua, Ohio.

**SELF-Cleaning**, sanitary, precision built rabbit hutch. Blueprints \$1.00. Williams, 5340 Canal Blvd., Indianapolis, Indiana.

**DEODORIZED Skunks** \$20.00. Monkeys, snakes, etc. Catalogue, literature, 50c. Trails Zoo-5, St. Stephen, S. C.

**MINK**—Easily raised anywhere. Top quality breeders. Free information. Huebl Minkery, LeSueur, Minn.

**ROVER Repeller**, Protection for female dogs while in season, guaranteed, \$1.00. Plymouth Products, Box 67, Boston 34, Mass.

**RAISE Money-making Angora**, New Zealand rabbits. Particulars free. White's Rabbitry, Jackson, Mich.

**START Right** by knowing facts about rabbit raising. Illustrated booklet describing all breeds, housing, feeding, breeding, marketing. 48 pages 10 cents. American Rabbit Breeders Association, 36 ARBA Building, Pittsburgh, Penna.

**STANDARD Rabbit Journal**, Milton 3, Penna. Year \$1.00. Sample dime. Beginners manual 25c.

**GROW Mushrooms**, Cellar, shed, and outdoors. Spare, full time, year round. We pay \$3.50 lb. We paid Babbitt \$4,165.00 in few weeks. Free book. Washington Mushroom Ind., Dept. 171, 2954 Admiral Way, Seattle, Washington.

**MAKE Big money!** Raise Chinchilla rabbits. Cash markets supplied. Write today! Rockhill Ranch, Sellersville 15, Penna.

**MINK Raising information** free. Complete. Lake Superior Mink Farm, Superior, E.E.I., Wisconsin.

**CHINCHILLAS** (No rabbit.) Easily raised anywhere. Profitable. Big future. Terms. Hibner Chinchillas, Ithaca, Mich.

### **FARMS, FARM LANDS, REAL ESTATE**

**STROUT Realty catalog** mailed free! Farms, homes, businesses, 34 states, coast-to-coast, 3240 bargains described. World's largest; 54 years service. Strout Realty, 7-M So. Dearborn St., Chicago 3, Ill.

**\$5.00 MONTHLY** Buys 40 acres productive land; near town. Price \$240.00. Free list. Box 425-P, Carthage, Mo.

**FARM** And business catalog free! Big edition. Hundreds of bargains from \$1000 up. Maine to Florida. West's, M-7, Pittsburgh 17, Penna.

**JOIN The money makers** in Houston—America's fastest growing city. Business booming. Many industries needing more employees. For fine profits get your choice homesite in popular new addition, only \$345, low terms. Information free. Preston Wood, Box 413, Houston, Texas.

**FARM-Ranch opportunities**, Favorable conditions. Washington, Minnesota, Montana, Idaho, Oregon, North Dakota. Literature, farm descriptions. Specify which state. J. W. Haw, 119 Northern Pacific Ry., St. Paul 1, Minn.

**HOMESITES \$400**—Convenient payments. California's finest garden section. On Morro Bay's scenic shores. Wonderful fishing, boating, bathing. Fertile soil, softest water, temperate climate, congenial community. Free literature. Richard Otto, Department M, San Luis Obispo, Calif.

**GIANT Listings** free. Timber, grazing, retirement, etc. Address—Armstrong, Shook, Missouri.

**FREE California ranch land catalog**, \$10 to \$25 acre. Easy terms. Write Pacific Lands, 1621BW, Cahuenga, Hollywood 28, Calif.

### **PLANTS, SEEDS, NURSERY AND GARDEN SUPPLIES**

**NEW Sprinkler sprays 4 ways!** Square, 1/2-circle, 1/4-circle, oblong. Saves water! Literature free. King Sprinkler, 105 Laurel Ave., Menlo Park, Calif.

### **PROFITABLE OCCUPATIONS**

**MAN Or woman** with spare time to try our food and household products, at home, and supply neighbors. Make good money. Big box of full-size products sent on free trial. Blair, Dept. 31MP-2, Lynchburg, Va.

**WELDING Pays big money**. Learn easily at best equipped school in country. Non-profit school with low cost training. G.I. approved. Write Hobart Trade School, Box M-742, Troy, Ohio.

**MAN Wanted**—Are you dissatisfied with your work? Would you like a business of your own? If so, write Rawleigh's, Dept. G-GG-PPM, Freeport, Ill.

**HOME Mailorder beginners**. Sources, methods, information. Free literature. Carnahan Bros., 5582-G Nelson, Cypress, Calif.

**MUSHROOMS** Grown boxes, barrels. Manureless process 50c. Spawn \$1.00. Gordon's, 553 William, Winnipeg, Manitoba.

**MAGAZINE Subscriptions**, highest commissions, bonus. Qualified Publications, 451-LB Kingston, Brooklyn, N. Y.

**FOREIGN-U.S. job list**. So. America, Alaska, Spain, Europe. Fare paid. 1000's jobs open U.S. to \$18,000. Trades, office. Unskilled, skilled. Send stamped self-addressed envelope. Job Opportunities, Waseca, IE, Minn.

**SELL Popular Mechanics** and all other magazine subscriptions. Free catalog, supplies. Subscription Service Company, Dept. B, P.O. Box 2070, Birmingham, Alabama.

**CONSTRUCTION Job list**. Published monthly, \$1.00. Dempster's Construction Scout News, Dept. 268-PM-1, Bridgeport, Ill.

**FREE!** "301 Profitable Small Businesses!" Amazing shoeing plans! Work home! Start sparetime! Deumant Surveys, Kenmore 23-PM, N. Y.

**"LATEST Copyrighted Reports!"** Who to contact for highest paying jobs in over 38 countries, including U.S., Spain, South America, Alaska, Europe, Africa, Canada, etc. Listings of employers with contracts who hire skilled, unskilled, professional, supervisory, clerical, trades, laborers, many others. Pay up to \$1550 monthly. Also best oil, aviation, mining opportunities. Only \$2. Airmail \$2.25. (C.O.D.'s accepted). Includes one year registration and advisory service. Application forms. We can help you find employment. Only service with unconditional guarantee of satisfaction or money back. Immediate service. International Reporter, Box 1047-PE, St. Louis 1, Missouri.

**OVERSEAS Jobs**. Big pay, transportation, expenses. Clerical, professional, mechanical workers. Most all trades. Latest listings aviation industry, construction, manufacturing, oil companies, government agencies, many other opportunities. Up to date information on securing employment, contracts, income tax, application forms. \$1.00. Overseas Jobs, Dept. G-4, Box 67, Vincennes, Ind.

**\$10,800 PROFITS!** Your own mailorder business! No risk! Success plan free! Treasury, 709 Webster, New Rochelle L-25, N. Y.

**MEN Wanted** now for foreign construction employment on American bases in Europe, South America, Far North and other countries. Truck drivers, \$3.55 hour. Clerks, \$3.00 hour. Carpenters, \$3.70 hour. Laborers, \$3.00 hour. Many other trades wanted with wage rate accordingly. Up to 70 hour week with time and one half for all over 40 hours. Transportation paid. 8 to 24 month contract. Also jobs with ship, oil, mining, aviation firms and construction jobs in U.S.A. with wage rate in 71 of the larger cities. Full information of all firms hiring, jobs open, wage rate, sample contract, medical examination, application form, etc., air mailed to you for only \$2.00. Foreign Construction Bulletin, P.O. Box 393, Dept. 30, Dallas, Texas.

**WANT A diesel job?** New opportunities to increase income? Higher pay. More money. We can help you qualify. Tools. Shop method home training. Write today! Diesel, Tractor, Heavy Equipment Division, Interstate Training Service, Dept. B3G, Portland 13, Oregon.

**FOREIGN Jobs**, Contracts underway and soon starting in Africa, South America, Canada, England, Europe, South Pacific, Middle East, Mexico and Alaska. Send \$1.00 for foreign job news, information, application forms, etc. DCS Foreign Job News, Dept. 248-PM-2, Bridgeport, Ill.



BUY Wholesale 450,000 products. Literature free. Carter, Box 6011-P, Chicago 30.

BUY Wholesale thousands nationally advertised products at big discount. Free "Wholesale Plan." American Buyers', 628-P Linden, Buffalo, N. Y.

ST. Lawrence Seaway starting. Opportunities for high paying jobs. Information \$1.00. Ellis Enterprises, Box 298, Station-H, Montreal 25, Canada.

EVERYBODY Likes candy. Learn to make professionally. Our 44th year. Ragsdale Candies, D6, East Orange, New Jersey.

\$1300.00 MONTHLY For truck drivers, \$1400.00 monthly for carpenters, electricians, plumbers, mechanics, \$1200.00 for clerks and laborers. Replacement hiring now being done. Full information and complete foreign listings, with current information on Spain, Korea, Australia, Alaska and Canada. \$1.00. 10,000 men and women needed for new state side project! Complete information and other domestic listings. \$1.00. Dept. 3-G. Opportunities Unlimited, 1110 Commerce Bldg., St. Paul, Minn.

MAKE Beautiful colored mantels, building and flagstone from concrete. Instructions \$2.00. Stonetex, 333 Manhasset Rd., Pittsburgh 27, Penna.

SIGN Painting pays amazing profits. You do professional work using "All-In-One" master letter patterns. Windows, buildings, trucks, banners, cards, cutout letters. Complete set 1 1/4" to 12" with instructions \$1.00 prepaid. Eyerly Co., B-583, Newton, Iowa.

FREE Folio describing "\$45,000; Unlimited Vacations Plan." No canvassing, mail-order, merchandise, equipment. Unknown. Works itself—home! Keep job. Haylings, Carlsbad, Calif.

I Average \$125 weekly selling books by mail! So can you! Start sparetime! Work home! Cooper, 245 Taunton, Buffalo, N. Y.

START "Silver plating service." Franchise. Exclusive. NuSilver, 508-PM7-PO, Aurora, Illinois.

RAISE Pheasants on \$100 week plan. Little capital and space can make you independent. Free details. Great Central System, Columbus 1, Kansas.

FOREIGN, Latin American, domestic employment. 1954 "Foreign Service Directory" originator of job news by copyright, gives up-to-minute facts on military and civilian construction; Canadian, Alaska construction; major oil companies; aviation; manufacturers; steamship lines; mining; importers-exporters; how-when-where to apply with application form. Free—Hot list firms hiring. \$1.00 postpaid. Global Reports, Box 883-P, Hollywood 28, Calif.

ALASKA! Last American frontier. \$1.00 brings 1954 business directory and government map. Military and civilian construction; homestead and highway facts; mining, aviation, fur farming, grazing, timber, travel directions. List of firms hiring. How to apply. Alaska Opportunist, Box 92-P, Hollywood 28, Calif.

GROW Mushrooms. Cellar, shed, and outdoors. Spare, full time, year round. We pay \$3.50 lb. We paid Babbitt \$4,185 in few weeks. Free book. Washington Mushroom Ind., Dept. 99, 2954 Admiral Way, Seattle, Wash.

BE The Popular Mechanics representative in your neighborhood and earn big profits in your spare time. Write Popular Mechanics Magazine, Room 408M, 200 E. Ontario St., Chicago, Ill.

FREE Book "505 Odd, Successful Businesses." Work home. Expect something odd! Pacific, Oceanside, Calif.

ALASKAN Jobs! Over 150 new construction projects with names, addresses, companies hiring. Thousands needed. Highest wages. Military, private construction, mining, fishing, lumbering, aviation, railroads, homesteading. Skilled, unskilled workers. Salary information. Alaskan map included. Sample application \$1.00 complete. Alaskan Opportunities (PM), Box 362, Kenmore, Washington.

MAKE Flexible molds. Cast figurines, plaques. Free sample. Tooker, 630-M Chestnut, Hamilton, Ohio.

CALIFORNIA Opportunities. Men, women job information. Enjoy life, work and live better. Write, Information Service, Box 927, Santa Monica, Calif.

## BOOKS, PERIODICALS, PICTURES, POSTCARDS

SPIRALETTE Album—10 colorful Yosemite views 25c. Dwight's Views of Delight, Boulder Creek, Calif.

BOOKHUNTERS! All subjects. Send wants! College Book Service, 52 W. Kingsbridge Rd., New York 68, N. Y.

ILLUSTRATED Comics, 24 all different \$1. Terrific illustrated stunts and tricks 50c. Aladdin Book Co., 210-PM Fifth Avenue, New York 10.

BOOK Catalogue, 1000 bargains, send 10c. Books Publishers, Amityville, N. Y.

PICTURE Post cards from your photograph. 1000, \$11.00. Raum's, 4154 Fifth Street, Philadelphia 40.

NATIONAL Geographic Magazines, 1888-1952. Periodical Service, Box 465-PM, Wilmington, Delaware.

SPARETIME Profits taking subscriptions, all magazines. Wholesale catalog free. Cassell Agency, Westfield 2, New Jersey.

BOOKS Found! Any author, old or new. Rush titles wanted; no obligation. International Bookfinders, Box 3003-PM, Beverly Hills, California.

BOOKHUNTERS! All subjects. Send wants! Jaher Book Service, 620-P East 178 Street, New York 57.

BOOKFINDERS! All subjects. Send wants! Plymouth, Box 365-B, Far Rockaway, N. Y.

## GAMES, TOYS, NOVELTIES

WILD Animal and bird films in beautiful color or b. and w. 2" x 2" slides and 8mm or 16mm movies. Write for free literature. Wild Life Films, 1511 AG Strohm Ave., North Hollywood, Calif.

BUY Wholesale nationally advertised cameras, photo supplies, thousands other products at big discount. Free "Wholesale Plan." American Buyers, 629-PP Linden, Buffalo 16, N. Y.

HUNDREDS Of helpful, practical articles in Popular Mechanics "Photo Handbook." A guide to better pictures, more profit, section on gadgets and equipment. Save dollars, get expert aid. \$2.00, 158 pages Popular Mechanics Press, 200 East Ontario, Chicago 11, Illinois.

BUY Wholesale. Name brands, cameras, photo supplies, 10,000 other items. Free "Wholesale Buying." National Buyers Service, 1213ED Capitol, Houston, Texas.

## MAGIC TRICKS, PUZZLES, JOKER NOVELTIES

FREE Bag full of amazing tricks. Send dime for handling. Starling Co., 2206M Starling Ave., New York City 62.

FREE Magic and novelty catalog, includes 14 wonderful magic tricks fully illustrated and described. Read all about our free gift offer. Chicago Magic Center, PM-7, 19 W. Randolph St., Chicago 1, Ill.

VENTRILOQUISM Easy to learn in 60 to 90 days! Home study course! Results guaranteed. For free information write stating your age. Dummy catalog 25c. Fred Maher School of Ventriloquism, Box 36, Studio PM-7, Kensington Station, Detroit 24, Michigan.

BE A magician. Large professional magic catalog of latest tricks. 35c. Ireland, C-109 North Dearborn, Chicago 2.

FREE Catalog. Best magic. Practical jokes. Top Hat Magic, Evanston, Illinois.

FREE Lists, magic tricks, novelties. Mearns Magic Shop, Hopewell 3, Va.

NEW Illustrated catalogue of new club, parlor, pocket and stage tricks 25c. Mimeographed catalogue 10c. New joke lists 5c. Eagle Magic, Minneapolis 2, Minn.

WE Supply every noted magician. Large professional catalog \$1.25. Holden's, 120 Boylston Street, Boston, Mass.

500 TRICKS, Douglas famous 120-page catalog, only 10c. Fastest service to magicians for 30 years. Send 10c today. Douglas Magicland, Dept. 1, Dallas, Texas.

2500 TRICK Catalogue (512-pages), pocket, parlor, stage. World's finest magic. Catalogue \$2.00 (dollar trick included free). Kanter's, M-1311 Walnut, Philadelphia 7.

PROFESSIONAL Catalog, 175 pages, 25c. Williams, 909 Plymouth, Ellwood City, Penna.

SENSATIONAL Magician's wand 25c. (Vanishes handkerchief!) Catalog included. Box 1352-PM, Philadelphia 3.

## COINS, TOKENS, CURRENCY

\$15.00 FOR 89c! Album, details \$1 (refundable). Decto, Box 153M7, Dabel Station, Dayton, Ohio.

OLD Money wanted. Will pay fifty dollars for nickel of 1913 with liberty head (no buffalo). We pay cash premiums for all rare coins. Send 4c for large coin folder. May mean much profit to you. Numismatic Co., Dept. 20, Fort Worth, Texas.

JAPANESE Invasion notes 1c to \$1000.00 set \$1.00. 100pp. illustrated coin catalogue, 25c. Shultz, Salt Lake City 10, Utah.

FREE! Foreign coin, numismatic and coin collectors illustrated catalog to approval service applicants. Send 3c postage. Tatham Coinco, Springfield 30, Mass.

INDIAN Cent with bargain lists 10c. Hutchinson, 3463 "I" Street, Philadelphia 34, Penna.

CONFEDERATE And Southern bank notes, 3 different, \$2.00. 50 mixed Indian pennies, \$2.00. Ben's Coin Shop, 31 N. Clark, Chicago 2.

World's Greatest magazine for coin collector's and wooden nickel 10c. Lawrence Brothers, Anamosa, Iowa.

GET Profit and pleasure in collecting old coins. Send 10c for 36-page illustrated coin catalog. You'll be delighted with it. Send for it now. B. Max Mehl, 370 Mehl Building, Fort Worth, Texas. Largest rare coin establishment in U. S. Established 54 years.

COIN Collector's Magazine. Over 1000 pages per year. Sample copy 30c; \$3.00 per year. Hewitt, 7320-J Milwaukee, Chicago 31.

U. S. Large cent, 2c, 3c all for \$1. Bargain list included. Delmaco, Box 1123, Wilmington, Del.

UNITED States Rare Coin Value Guide, 48 pages 50c. Fortunes in rare coins. Ideal, 4644-P Geary, San Francisco 18, California.

## STAMP COLLECTING

THREE Beautiful sets, plus Ceylon Royal visit and new U. S. 8c, only 25c to approval applicants. Wilvan Stamps, Box 472, Slatersville, R. I.

U. S. Special deliveries E 1/19 complete, used \$9.00; Mint \$55.00 to adult collectors supplying want list, references. Oil Huppert, Box 12 B, Brooklyn 29, N. Y.

FREE! Prized set of 4 United Nations stamps, sample stamp newspaper. Send 10c to cover handling costs. Approvals, Littleton Stamp Co., Littleton C1, New Hampshire.

FIRST U. N. set. Among world's prettiest. Only 10c. Approvals, Welles, Box 1248-R, New York City 8.

MINT Five pound British Colony stamp, guaranteed genuine, face value \$25. Just 25c to introduce our famous approvals. Viking, 11-2 Northern Blvd., Great Neck, N. Y.

FREE!—Big United States catalog. Valuable guide and check list. Hundreds of illustrations. Approvals, Harrisco, 468-P Transit Bldg., Boston 17, Mass.

POLAR Bear triangle, giant George Washington, six colored Ecuador, Arctic triangle, first American commemorative, Corsica, Devils Island, others. Everything free with approvals. Capital Stamps, Little Rock 2, Ark.

FABULOUS Collection—Roosevelt and dictator stamps. Mammoth fascinating collection of Roosevelt and dictators including Stalin, Tito, Franco, Lenin, Hitler and great many others plus free booklet and bargain lists. All for 10c with approvals. Jamestown Stamp, Jamestown, Dept. 413, N. Y.

ECONOMICAL 1/2c-1c-2c-Approvals, 22,000 varieties available. Dresel, Box 270-n, New York 25, N. Y.

LOOKING For better U. S. approvals? Write. New-Way Stamp, Lawrence, Mass.

FAROUK, 27 Different Egypt, 10c with approvals. Excello Stamp Company, Box 489, Red Bank, N. J.

125 DIFFERENT 10c With approvals. Pyron, Box 740, Bellport, New York.

PHILIPPINES, 20 Different 10c. Approvals. Moffat's, 921 College, Rock Hill 10, South Carolina.

20c MINT Philippine special delivery—10c. Smithco, Northeast 6618, Kansas City 23, Mo.

50 DIFFERENT Bulgaria 10c! Approvals. Ensign Stamp Company, Dept. M, Berdan Avenue, Paterson 2, New Jersey.



**FREE 200** Different with approvals. Al Gray, Box 18, Hawthorne, Calif.

**NICE** Used U.S. on approval. Sam Shock, 51 Victoria, Asheville, N. C.

**VALUE** Packed U.S. commemorative mixture. 500 large @ \$3.00. Satisfaction guaranteed. Leslie J. Wiggins, Box 72-A, Guild, N. H.

**FREE!** Big United States catalog. Just published by world's largest stamp firm. Hundreds of illustrations. Lists United States postage stamps complete; big values in United States and foreign packets; amazing clearance sale bargains; beginner's kits; special offers; valuable information. Approvals included. Harrisco, 226-F Transit Building, Boston 17, Mass.

**MOZAMBIQUE** Company set free. Approvals. Weitz, Box 82F, Orange, N. J.

**TELEVISION** Stamp and 50 different 5c with approvals. DeRespinis, G.P.O. Box 771 A, New York City.

**SEND \$1.00** Bill for 125 different African stamps. Bornman, 278, Kitwe Rhodesia, Africa.

**DEALERS**—Wholesale list. Postage 3c. Frank, 5031 Queensberry, Baltimore 15, Maryland.

**FINE** Approvals. Fast, personal service. What countries do you prefer? I'll send their stamps. Skinner, 438 Locust, Long Beach 12, California.

**ROOSEVELT** Greece, Pope triangle, Greenland, Israel, 51 others, 5c. Approvals. Longhorn, Box 3068-M, Lubbock, Texas.

**BARAINS** Galore! Ask for "Stamps of Quality" price list today. Elholms, 821 Hayes, Racine, Wisconsin.

**FREE!** Pretty Mozambique butterfly, Monaco ship triangle, Hungary sports diamond, Macao flower stamps to new approval applicants. Moulblow, Box 278P, East Northport, New York.

**EXCITING** Treasure hunt! Cloth bag containing over 1,000 unsorted stamps, on paper, weighed out as imported. Over 30 countries. Postpaid, guaranteed, only \$1. Harrisco, 495 Transit Bldg., Boston 17, Mass.

**TOPS!** Free book "How to Collect Stamps." Send for your copy today! Approvals. Littleton Stamp Co., Littleton El. N. H.

**125 DIFFERENT** United States—\$1.00. Approvals. Utechts, 1143D North Keeler, Chicago 31.

**SPAIN** 100 Different, 10c to approval applicants. Morrel, 263 Fenimore St., Brooklyn 25, N. Y.

**PAYING** High prices for approvals? If your collection numbers under 15,000 try our 1c and 2c approvals. In books of 1,000. Special offer to customers. U. S. also available. Clark Stamp Co., Dept. A-42, Muskegon Heights, Mich.

**PICTORIAL** Packet—triangle, bicolors, etc. Exceptional value, only 10c! Approvals. Cole, 43-A Rinevalt, Buffalo 21, N. Y.

**SPECIAL!** 1000 Different \$1.00. Approvals. Baird-Stamps, Box 8713, Portland 7, Oregon.

**EXOTIC** Oriental collection. 105 all different stamps from Borneo, Hong Kong, Malaya, Sarawak, Korea, Japan and many other strange countries of the Far East plus free booklet and bargain lists. All for only 10c to new approval customers. Jamestown Stamp Co., Jamestown, Dept. 313, N. Y.

**PICTORIAL.** Angola, Mozambique, Hungary, a fine assortment of stamps, 3 different sets depicting wildlife in natural colors, plus 100 attractive stamps. 10c to approval applicants. Modern Stamp Co., Dept. A-6, Ferrysburg, Mich.

**1500 MIXED** Foreign stamps \$1.00. No approvals. Aaron, 4802 E. 14th, Oakland 1, Calif.

**COLONIAL** Collection free—Magnificarous collection, British, French, American and other colonies. Flowers, animals, commemoratives, triangles, pictorials, high values all free plus Philatelic Magazine. Send 5c for postage. Empire Stamp Company, Dept. PM, Toronto, Canada.

**CIPEX** Souvenir sheet plus 25 different U.S., 10c. Approvals accompany. Village Stamps, 90-39 214 St., Queens Village 28, N. Y.

**101 DIFFERENT** Worldwide: Triangles, commemoratives, pictorials, 10c. Approvals. Free \$5.00 U.S. stamp. V-Ann, G.P.O. 871M, Brooklyn 1, New York.

**GERMANY.** Nazi army ships, airplanes, rockets, Hitlers (18) given approval buyers. William Deems, Ravenswood, W. Va.

**500 DIFFERENT** Attractive stamps, a special assortment worth many dollars, from Macao, Ruanda-Urundi, Congo, Monaco, Vatican, Angola, Mozambique, etc. Entire collection only 50c to approval applicants—U. S. or foreign. Roseland Stamp Co., Dept. A-32, Spring Lake, Mich.

**PLEASURE** is yours for pennies when you select from our big books of 1000 stamps. Clean and neatly arranged stamps for your selection. Scott's catalog number and price under each stamp, but large discounts allowed. Write today and watch your collection grow. Wolverine Stamp Service, Dept. A-22, Fruitport, Mich.

**FREE** Complete set of famous Americans, flags, parks and presidentials to approval buyers. Send 5c for 15 of the above stamps plus full particulars. Triboro Stamp Company, 145 Nassau Street, Dept. 107, New York 38, N. Y.

**FREE!** \$10,000 Airmail! Canadians! Colonials! Commemoratives! Approvals. Keating, 2520 Boulevard, Jersey City, N. J.

**START** Your own stamp business. Send 10c for wholesale catalog. Shepard, Box 1147, Chicago.

**BEAUTIFUL** Pictorials. Penny approvals. Collection 10c. Bristol Stamps, Collinsville, Conn.

**FREE!** Worldwide collection with colorful approvals. Monjar, Fairmont, Cincinnati 14, Ohio.

**FREE!** 25 Different Switzerland, with swell approvals. Kardell, Box 2058-E, Santa Fe, New Mexico.

**100 DIFFERENT** Netherlands—5c. Approvals. Held, 372 Dodge, Buffalo 8, N. Y.

**BEAUTIFUL** "Lady Godiva" stamp 25c. Approvals. Royal Stamp Company, Tamaqua, Penna.

**90,000 STAMPS:** Grabbag 40c. Big lot, better stamps, \$1. Extra special, \$2. Giant assortment, \$5. Persil, 436 New York Ave., Brooklyn 25, N. Y.

**100 DIFFERENT** 10c with approvals. Jacobsen, 4395-C Broadway, New York 40, N. Y.

**FREE!** New! Different! Stamp catalog and check list! Send today! Ewing, 2133 Lunt, Chicago 45.

**GIANT** Collection! Over 200 different stamps including: Timor, Rhodesia, Mauritius, etc. Rushed, only 10c to approval applicants. Evden, Box 128, Valley Stream 35, N. Y.

**15 DIFFERENT** United States stamps over 50 years old. Entire collection only 10c. Approvals accompany. Tristamps, Democrat 4, N. J.

**I** Buy stamps. Charles Mekeel, 2101 East Market, York, Penna.

**REQUEST** Approvals receive Lundy Island sheet free. Elmont Stampco, New York 1, N. Y.

**1c AND 2c** Mounted approvals. Tobysco, Box 255, Gloversville, N. Y.

**50 FOREIGN.** All different, only 10c with approvals. Just Stamps, P.O. Box 727, New Britain, Connecticut.

**FREE!** Latest exclusive bargain catalog, attractively illustrated! Over 1,000 mixtures, packets, accessories listed! Worldwide coverage! Sample packet included with approvals. Tower, 1630-A Melrose, Chicago 13.

**FREE** — 105 Different British Colonies, Aden to Zanzibar! High catalog; pictorials. Approvals. Send 10c for mailing. Kenmore, Milford 8T, N. H.

**50 DIFF.** U. S. commemoratives 25c. Mammoth packet list free. Econopackets, Box 168, Riverside 9, Calif.

**650 DIFFERENT** Foreign stamps \$1.00. Personal Stamp, 612 Washington Ave., Northampton, Penna.

**NUDES** Set: Colorful approvals 10c. Atlas, 2830-M, Eisenhower, Racine, Wis.

**LORE** Galore! Fascinating, informative approvals. Stamplore, Box 1062, Sherman Oaks, California.

**329 DIFFERENT** Worldwide stamps 25c including Hitler heads, British colonies, French colonies, rarities, unusuals. Everything complete 25c to adults requesting approvals. Canada Stamp Co., 1907 Main St., Dept. 118, Niagara Falls, N. Y.

**FREE** U. S. illustrated bargain catalogue. Rothberg's, 44 Bromfield, Boston 8, Mass.

**UNITED STATES**—58 different including 8 airmails, 15 commemoratives, 10c. Approvals. Sunset, Box 47, South Gate, Calif.

**UNITED STATES.** 75 different, 10c. Approvals. Farmer, 4913 Rosewood, Los Angeles 4, Calif.

**SAVE** Money! Buy stamp packets. Worldwide selection. Bargain pricelists free. Webb, 2200 Quintara, San Francisco 16, Calif.

**FREE—50** Different, with approvals. Fahsing, Dept. PM, Atascadero, California.

**65 ALL** Different U. S. stamps. Includes 50 year olds, commemoratives, airmails and \$5.00 stamp. Only 10c. Approvals. Willett Co., Box 511-L, Port Chester, New York.

**225 STAMPS** For only 10c! This mammoth value includes airmails, pictorials; stamps from strange countries cataloguing up to 25c each! Also approvals. Mystic Stamp Company, Camden 80, New York.

**PREMIUMS** Free to purchasers of my better foreign approvals. Faith, 1339 1/2 Westminster, Alhambra, Calif.

**FREE—Valuable** illustrated catalog. Over 1100 special offers, attractive bargains! Approvals. Kenmore, Milford 8-C, N. H.

**HERE** We are, 1050 diff. fine stamps. Only 25c with our fine beginner and advanced approvals. Central Stamp Service, 1220 N. Irwin Ave., Green Bay, Wis.

**ANIMALS.** Birds, triangles, flowers, butterflies, fish, ships, locomotives, kings, dictators, multicolored, historical, geographical, musical, batties, giants, midgets and over 100 others—only 25c with approvals. Adults please. Canada Stamp Co., 1907 Main St., Dept. 318, Niagara Falls, N. Y.

**HANDSOME** New Zealand 1943 Elizabeth and Margaret Rose triangles only 10c to approval applicants. George Richie, 1539 Sixth, Alameda, Calif.

**WOW!** 153 All different Germany, 10c. Zeppelins, semi-postals, airmails, high values, big bargain lists and approvals included. Jamestown Stamp, Jamestown 512, New York.

**STAMPS** Wanted. Min. and used, collections, accumulations. Good grades only. Buy outright if bargain. What have you? Write, give details. Vanroy Shirk, Lebanon, Penna.

**TRIANGLES.** Birds, butterflies, flowers —Big packet 10c with approvals. Southwest Stamps, Box 117, Long Beach 1, Calif.

**300 DIFFERENT.** Triangle, airmail, pictorials, etc. 25c. 500 mixed U. S. 25c. Carlton's, Tulunga, Calif.

**200 DIFFERENT.** Including Roosevelt triangle, 10c to approval applicants. M. Avalon Stamp Company, Springfield, Mass.

**FREE** 119 Foreign stamps including Africa, Australia, Pakistan, China, India, Russia and Scandinavia. Send 10c for postage and handling. With approvals. Niagara Stamp Co., Niagara-on-the-Lake 81, Canada.

**50 DIFFERENT** Worldwide 3c! Approvals. Vinny Jo, Box 3062, Seattle 14, Wash.

**AMAZING** Offer! 200 United States stamps—including commemoratives, airmails, high denominations to \$1.00. Only 10c to approval applicants! Illustrated bargain lists free. Mystic Stamp Co., Dept. 80, Camden, New York.

**50 DIFFERENT** Argentine 10c. Approvals. Reuter, 611 W. 40th Pl., Los Angeles 37.

**100 DIFFERENT** Spain 25c. Penny approvals included. Reed, Box 990, Chicago 90, Ill.

**OLD** Scarce U.S. seconds on approvals. Slight imperfections, lowest prices. Hernefield, Clintonhill Sta., Newark 8, N. J.

**327 DIFFERENT** Stamps 25c! Including early Canada, Newfoundland, British Colonies, Vatican, Red Russia, Hitler heads, Indian states, animals, airmails, French Colonies, rarities, unusuals. Every stamp different. Rare bargain with approvals. Money back guarantee. Niagara Stamp Co., Niagara-on-the-Lake 61, Canada.

**WORLD'S** Largest stamp (7 1/2 x 14 inches). A real curiosity! Retail for 50c, only 3c to approval applicants. Tatham Stamp Co., Springfield 20, Mass.

**SPEND** Pennies! Not dollars! Thousands of fascinating stamps to choose from our 1c and 2c approvals. No premiums. Just honest value. Pat F. Knowles, Box 2247, Van Nuys, Calif.

**COLOSSAL** Stamp zoo free! Jungle beasts, wildlife, domestic animals—Fifteen different, including rhinoceros, elephant, snake, tiger, zebu, kangaroo, koalabear, emu, kookaburra, bull, horse. Extraordinary accompanying approvals. Send 10c for postage and handling. Niagara Stamp Co., Niagara-on-the-Lake 51, Canada.



400 DIFFERENT Fine stamps, thirty countries, \$1.00. Chess, Sutton-Coldfield, England.

25 MULTICOLORED Triangles, only 25c with beginner or advanced approvals. Low prices. Essex, 5946 Arlington, Los Angeles 43, Calif.

BARGAINS Galore. Low priced approvals. Schur, Box 117, Williamsville 21, N. Y.

TRADE your extra stamps. Join our stamp club. \$1.00 for two years. Free information. Valley Stamps, Box 87, New Cuyama, Calif.

FREE Sample—interesting, informative, illustrated! National Stamp News, Anderson, South Carolina.

OLD U.S. approvals. Low prices. MacG., 2905 Observatory, Cincinnati 8, Ohio.

50 DIFFERENT United States 5c with bargain approvals. Lists, Bookman, Manatee 1, Florida.

SENSATIONAL, United States, United Nations, Confederate States, catalogue free. Stone's, 45 Bromfield, Boston 8, Mass.

96 PAGE Illustrated U. S. price list. Send 10c, cost of mailing. DeLisle, 154 S. Second St., San Jose, Calif.

DIRECTORY Of 113 hobbies magazines (15 Stamp) 25c. Maurice, 8817 Quincy, Detroit 4.

### ANTIQUES, RELICS, INDIAN GOODS, CURIOS

6 GEM Arrowheads \$2.00. 4 fine arrowheads \$1.00. Notched tomahawk \$1.00. List free. Lear's, Glenwood, Arkansas.

ANTIQUE Firearms, swords, illustrated booklet 25c. Westbrook, 738 Royal Street, New Orleans, La.

4 PERFECT Arrowheads \$1.00. Flint knife 35c. Perfect pipe \$3.50. Flesher 35c. Tomahawk \$1.00. Flint fish hook \$1.00. List 10c. H. Daniel, Lamar, Ark.

INDIAN Beadwork, leathers, beads, feathers, moccasins, wigs, supplies; buying direct from Indians; prices reasonable. Free list. Pawnee Bill's Indian Trading Post, Box 35-P, Pawnee, Oklahoma.

4 SELECTED Arrowheads \$1.00. List 5c. H. Talburt, Calico Rock, Ark.

### PRECIOUS STONES, MINERALS

JOIN The thousands whose hobby is gem cutting, jewelry making, mineral collecting. Send only \$3.00 today—for 12 monthly issues of national how-to-do-it magazine. Sample copy 25c. Gems & Minerals, Dept. A-7, Palmdale, California.

COLLECTORS! \$2.00 Brings twelve beautiful genuine specimens from gemland Brazil. \$3.00 brings perfectly cut ten carat Braziltopaze. Airmail bills or check. No postal money orders. Jean Bach, 413 Praia Icaral, Niteroi, Brazil.

TUMBLING Gemstones, five highly polished brilliant tumbled gems. \$2.00 tax incl. p.p. Gem's, Box 15, Bowling Green Station, New York 4, N. Y.

METAL Detectors. Free details. Reed Engineering, 620 S. Inglewood, Inglewood, Calif.

3 IMPORTED Genuine precious stones—Cut, polished \$2.50. Barry, 447 Book Building, Detroit 26, Michigan.

GENUINE Diamond, rough, one carat \$20.00. Sample diamond \$2.00. House of Diamonds, Box 1119B1, Grand Central Station, New York 17.

GEMCUTTING. Silvercraft authority. Illustrated magazine tells how. Cut rocks, make jewelry. 150 ads illustrating equipment, offering gems for collectors, cutters. Postal brings literature. Lapidary Journal, Drawer B, Palm Desert, Calif.

GEMSTONES. Mineral specimens. Every variety. Lowest prices. Free booklet. Plummer's, 4720 Point Loma Ave., San Diego 7, Calif.

ROCKS, Ores, minerals precisely analyzed \$5. Absolute spectrographic detection of 45 elements including uranium. Free information. Keldon Research, Box 2559F, Los Angeles 54, Calif.

SAPPHIRE, Topaz, tourmaline, garnet, peridot, 5 uncut gem specimens, \$1.00. O'Brien's, 1116M Wilcox, Hollywood 38, Calif.

LAPIDARY—Four square inches native Texas stones slabbed 3/16" thick. \$1.00 to Rocks, Box 8817, Houston 5, Texas.

### HOBBIES AND COLLECTIONS

FREE—Packet 25 stamps, pictorials, etc. Free attractive approvals. Hemmer, 133 Virginia Avenue, Dayton 10, Ohio.

WORLD'S Smallest Bible 50c, three, \$1.00. Empires, Box 301, Amesbury 2, Mass.

FREE Giant Popular Mechanics 40 page book catalog! Over 400 books to choose from. Send name and address to Popular Mechanics Press, 200 E. Ontario, Chicago 11, Ill.

NAZI, Soviet, medals, campaign ribbons. Big packet. Lists. \$1.00. Medcrafts, 1921 34th St. S.W., Calgary 2, Canada.

INVENTING Can be an interesting and profitable hobby. Write for complete particulars. Institute of American Inventors, Dept. 40-E 631-E St. N.W. Washington 4, D. C.

### CAMERAS, PHOTO SUPPLIES

WHOLESALE Photographic supplies. Cameras, films, projectors, enlargers. Write for free catalog. Capitol Photo Supplies, 2428 Guadalupe, Austin, Texas.

VACATION Special stereo camera, viewer, slidemounts. Complete outfit \$20.00. Keys Stereo, 3823 E. 7th, Long Beach 4, Calif.

BASS Says: Quality cameras since 1910. When in Chicago visit the camera cross roads of the world, or write us for your favorite equipment, new or used. Satisfaction guaranteed. Bass Camera Co., Dept. AG, 179 W. Madison St., Chicago 2, Ill.

PHOTOGRAPHY For pleasure or profit. Learn at home. Practical basic training. Long established school. Free booklet. American School of Photography, 835 Diversey Parkway, Dept. 3432, Chicago 14, Illinois.

FREE Photographic bargain book packed with hundreds of fine values in still and movie cameras, lenses and latest accessories, both in new and used. Write now for your free copy to Central Camera Co., Dept. 9E, 230 S. Wabash Ave., Chicago 4, Ill. (Photographic headquarters since 1899.)

ENORMOUS Camera profits. Five complete plans and over 100 best selling markets. send \$1.00. Kappeler, 458 Queen St., Woodbury, N. J.

DISCOUNTS To 40%—Cameras, projectors, tape recorders, lenses. Write for individual quotations, no catalogs. Classified Camera D, 253 E. 94 St., Brooklyn, N. Y.

### PHOTO FINISHING

PHOTO Print bargain only \$1.00—Oversize prints of 8 or 12-exposure film plus new roll freshly-dated Kodak film. 24-hour service; skilled finishers. Free catalog of photo novelties and portfolio of Christmas photo greetings. Whitehall Studios, Dept. 15, Elmira, N. Y.

JUMBO Prints, 8-exposure roll 30c; 12 exposure, 45c; 16 exposure 55c. Reprints, oversize 4c. Guaranteed quality. Mail Order Photo Service, Box 297, Watertown, Wisconsin.

ROLLS, Reprints, jumbos in albums, 8-30c; 12-40c; 16-50c. Bob's Photo, Box 23, Fairmont, W. Va.

SENSATIONAL! 8 Jumbos, 25c; 12, 35c. 35mm.-36 exposure, \$1.00. Guaranteed quality. With this ad only. Flash-Photo, Box 36B, Brooklyn 4, N. Y.

MODERN Beauty enlargement from your roll or negatives 4c each. Trial offer. Modern Film Service, Box 3938PM, Shaker Square Station, Cleveland 20, Ohio.

SPECIAL Offer—8 jumbos 25c; 12, 35c. with this ad. Western Photo, PM74, Box 298, San Francisco 1, Calif.

BEAUTIFUL Jumbo prints, 8 exposure roll 40c. 12-55c, 16-70c, 20-95c, 36-\$1.60. Reprints 5c. Pacific Photo Service, Box 666, San Francisco 1, Calif.

YOUR B&W roll and \$1 brings 12 jumbo album prints and fresh roll Verichrome film plus gift enlargement coupon. B&B Photos, Box 379B, Hillside, Illinois.

TWO-Bits (25c) 8-exposure roll developed, jumbo prints. Electronically processed, satisfaction guaranteed. 12 exposure 35c; 16 exposure 50c. 35mm finegrain 20 exposure 90c. 36 exp. \$1.25. Dated borders. Reprints, jumbo, 4c (minimum 5). Cash only. No stamps. Fast service. Alamo Photo Co., Dept. A, San Antonio 6, Texas.

FILMS—Finest quality. Fastest service. 8 exposure 50c; 12 exposures 75c; 16 exposures \$1.00. Enlarge to super size in album. Camera, Box 280-x, West Chester, Penna.

KING-Size prints from your roll film, less than 5c each, developing included. Finest quality, fast service from photo capital of the world. Over 200,000 satisfied customers. 8 exposure roll 35c; 12, 60c; 16, 75c; 20, 90c; 36 \$1.50. Money-back guarantee. Send for free mailing bag, price list, special summer offer. Rochester Laboratory, Rochester 1, New York.

35MM Specialists. Fine grain developing. 20 exposures 95c, 36 exposures \$1.40. Free mailers and prices on others. Tops Photo Service, Lyons, New York.

JUMBO Album prints, 8 exp. 35c; 12, 50c; reprints 6c. No c.o.d. Free mailers. Southwestern Photo, Tyler, Texas.

THE Photo Mill. Immediate service. Eight exposure roll developed and one print each good negative 30c; two, 40c; one jumbo each 35c; two 65c. Write for complete prices and mailers. The Photo Mill, Dept. K, 1311 Hennepin, Minneapolis, Minn.

TWO Beautiful prints from each picture on roll. 8 exposure 35c, 12 exposure 45c. Thirty-three years of satisfied customers. Quick service. Lens Photos, Dept. J-4, Janesville, Wis.

FAST. Same day service! 8 oversized prints only 35c; 12-50c, 16-65c. Satisfaction guaranteed. This ad worth 10c toward first roll. Trial offer only! PicSure, Box 899-B, Philadelphia 3, Penna.

BEAUTIFUL Enlargement from each picture on roll. 8 exposure 35c; 12 exposure 45c. Cut Rate Photos, Dept. B-4, Janesville, Wis.

GUARANTEED Quality. Fast service. Eight jumbos in beautiful super pak plastic ring binder albums only 35c. Send for free mailers and particulars of our complete photo finishing service. Grand Fotos, G.P.O. Box 1410, New York 1, N. Y.

TWO Prints each good negative, 8 exposures, 35c; 12 exposures, 50c; reprints, 4c. Maxfair Photo Service, Box 617-K, Toledo 1, Ohio.

TOP Quality. Fast service. 8 jumbos 35c in beautiful super pak album. 16 contacts 40c. Reprints—Jumbos 4c; contacts 3c. Satisfaction guaranteed. Write for free mailers and circulars. Fast-X-Photo, Box A, Jersey City, N. J.

6 OR 8 Picture roll 35c. 12 or 16 picture roll 55c. Each roll developed and printed in handy album pack. Send coin with roll. No c.o.d.'s. Mailing containers sent free. Deluxe Film Service, Box 1268-A, Shreveport, Louisiana.

ENLARGEMENTS! Eight 5 x 7s or five 8 x 10s, \$1.00. Wilart Enlargers, Box 967, Little Rock, Ark.

12 JUMBOS From any size roll developed 35c with this ad only. S. Skrudland, Lake Geneva, Wis.

8 JUMBO Prints in album 30c; 12 exp. 45c; 20 exp. 85c; 36 exp. \$1.25. Free mailer. Mel's Photo, Box 106F, Brooklyn 20, N. Y.

### MOTION PICTURES AND SOUND EQUIPMENT

RECORDERS. Equipment. Reasonable. Fine recordings. Boynton Studio, 10 Pennsylvania, Tuckahoe, N. Y.

16MM. Sound projectors, used. Film 400' sound \$1.95. Free lists. National Cinema, 71 Dey Street, New York City.

FREE: Blackhawk's summer sale catalog new and used 16mm., 8mm. films, used 16mm. sound projectors, new 2" x 2" color slides. Blackhawk Films, 1245 Eastin, Davenport, Iowa.

8 & 16MM. Professional national parks movies in Kodachrome, list 10c. Ideal, 4644 W. Geary, San Francisco 18, California.

WILD Animal and bird films in beautiful color and b. and w. 2" x 2" slides and 8mm or 16mm movies. Write for free literature. Wild Life Films, 5151 AG Strohm Ave., North Hollywood, Calif.

8-16MM. Silent-sound film rental library. Free catalogue (sample film 10c). Garden, 317 West 50th, New York 19.

5,000 8-16MM. Silent-sound films. International. 2120 Strauss, Brooklyn 12.

CLEARANCE Sale of 16mm. sound films. Want a real buy in 16mm. sound films? Take advantage of the I.C.S. 1954 clearance sale of 16mm. sound features, comedies, cartoons, educational films, religious subjects—new, used. Send for our giant list "A" today stating machine you own (make and model). Institutional Cinema Service, Inc., 1560-PM Broadway, New York 36, N. Y.



EARN Up to \$15.00 daily with your movie projector! Details free! Metcalf, 10896 Glenroy, Chicago 43.

MOVIE Camera film: 8mm. roll \$1.50, 16mm. 100' \$3.00. Free processing. Better Films, 742 New Lots, Brooklyn, N. Y.

TAPE Recorders, tapes, accessories. Unusual values. Dressner, 624-M East 20th Street, New York City 9.

GUARANTEED Fresh 8mm. roll, magazine; 16mm. roll, magazine movie films. Color, b&w. Free catalog. ESO-R, 47th Holly, Kansas City 2, Missouri.

16MM Sound projectors, film, rental, sale. Free catalogs. National Cinema, 71 Dey Street, New York City.

## MUSIC AND MUSICAL INSTRUMENTS

SONGWRITERS! Outstanding offer. Ray Hibbler, C-5, 8898 Oleander, Chicago 31, Ill.

1954 ACCORDIONS—Wholesale. Free catalog. American Accordion Center, PM-7, 5329 Belmont, Chicago.

NEW Songwriters can now sell their songs! My new, easy method reveals professional secrets of profitable songwriting. Free details. Meadowlark Music School, 300 Sumner Road, Colorado Springs, Colo.

POEMS Wanted for musical setting. Send poems. Free examination. Five Star Music Masters, 830 Beacon Bldg., Boston, Mass.

AMATEUR Songwriters! Top-notch Broadway staff offers expert professional opinion-suggestions for improving your song or lyric. Enclose \$1.00 with each manuscript or recording. Amateur Songwriters Workshop, P.O. Box 359A, Times Square Station, New York 36, New York.

MUSIC Arranged, songs printed. Frank Wildt, Music Publisher, Lancaster, Penna.

WANTED! Poems for musical settings. Write Songwriting Service, 2959 Division, Chicago 22.

SONGS Arranged—Prepared for publication. Melodies composed. Royal Crown Music Co., 1658 Broadway, New York 19.

WANTED! Poems for musical settings. Write Songwriters' Service, Clifton, N. J.

YOUR Voice made loud, clear and powerful with my diaphragm exerciser. Inexpensive. Write, Inventor Oz, 34V, Box 665, St. Louis, Mo.

ACCORDIONS, Wholesale to everyone. Save up to 60%. All national known brands. Free catalogue. Del Principe, 29 South Cicero, Chicago 44.

SONGPOEMS Wanted. Mail to: Tin Pan Alley, Inc., 1650 Broadway, New York 19, N. Y.

POEMS Wanted for musical setting. Send poems. Free examination. Crown Music Company, 1476 Broadway, New York City 36.

FREE Record of your song. Your words, my melody. Free information. Johnny Mack's Melody Mart, 1094 West 39th Street, Dept. A, Los Angeles 37.

SONGWRITERS! Protect your ideas! Hold all songs, poems! Write for safe correct procedure first! Song Service, Dept. P, 333 W. 56th St., New York 19, N. Y.

POPULAR Songs. How to write and sell them. Write for free booklet Successful Songwriting, Gateway Songs, Box 2470, Hollywood 28, Calif.

SONGWRITERS! Send poems, songs. Music Service, 243 West 72nd St., PM, New York 23.

WRITE Songs. Big money and reputation. Write for information. J. Gordon Pub. Co., 4700 South California Avenue, Chicago.

POEMS Wanted for musical setting. Send poem for immediate consideration and free rhyming dictionary. Richard Brothers, 24 Woods Building, Chicago 1.

## RADIO AND TELEVISION

NEW TV catalog free. Loaded with bargains for TV servicemen, technicians, installers. Finest new TV antennas, motorless directronics, multi-channel yags, UHF antennas, converters, motors, boosters, parts, instruments, hundreds of quality accessories at money-saving prices. Get your catalog now! National Electronics, 3007 Delco Bldg., Cleveland 3, Ohio.

REPAIR Your own TV. Detailed instructions prepared exclusively for your model—Plus introductory bonus. Send make, model, \$1.00. Personal TV, Box 66, Little Neck, N. Y.

EXPERIMENTERS. Build a sensitive, selective crystal receiver. Send 50 cents for copyright plans to Colter, Box 60, Boston, Mass.

REAR Speaker for auto radios. Easy to install: no special tools needed. Selector switch operates front, rear, or both speakers. \$9.95 postpaid. Guaranteed. CFJ Sales, 644 Nelson Pl., Dept. 1, Newport, Ky.

RADIO TUBES, all types, guaranteed. Ideal Service, 4644 Geary, San Francisco 18, California.

BUILD 15 Radios at home—Only \$19.95 complete. Learn radio construction, theory, trouble-shooting, code, F.C.C. regulations. Complete radio course includes all parts, components, instruction books, etc. Free radio tester and soldering iron. You keep everything. No experience required. Money-back guarantee. Order direct or send for descriptive literature. Valuable radio and TV guide upon request, free of charge, no obligation. Progressive Edu-Kits Inc., 497 Union Ave., Dept. PM19, Brooklyn 11, N. Y.

SAVE—Fix any TV set. Illustrated, diagrammed, easily understood copyright book. Diagnosing, correcting TV troubles. Explains functions, phases. 2nd edition ready. Send \$1. Telefax Co., 18332 Woodward, Detroit 3, Mich.

INCREDIBLE! One tube radio receives television, FM, CAP and amateur broadcasts. Very easy and inexpensive to build. Diagram with special tube only \$2.00. Springfield Enterprises, Box 54-B7, Springfield Gardens 13, New York.

TELEVISION Antennas. Build for profit. Dimensions, drawings. Channels 2-13. \$1.00. Electronics, 29-C Clymer, Burlington, Vermont.

REPAIR Your own TV! Instructions compiled exclusively for your model. New, expanded book makes repairs simple as replacing light bulbs. Send set name, model number, \$1.95. Satisfaction guaranteed or money back. LS Engineering, Box 4113R, No. Hollywood, Calif.

FREE. Get on our radio and electronics mailing list. A.R.I., Box 1438, Denver, Colorado.

CRYSTAL Radio experimenters. Write Leslie Hulet, R4, Lakewood, New Jersey.

MAKE Simple, tubeless, batteryless, distance-getting radio. Genuine Melomite crystal, detector, illustrated instructions. 50c postpaid. Allen, 427-PM3, Clinton, Missouri.

PHONOGRAPHS Attached to any radio by anyone. Instructions \$1.00. Box 601, Phenix City, Ala.

## BUSINESS OPPORTUNITIES

METALIZE Baby shoes, jewelry, gifts. Bronze, gold, silver. Free bulletin. Kiktavi, 7217-PY South Broadway, Los Angeles 3.

\$1000 MONTHLY Possible from your own easily learned office business. Write Cole Associates, Syracuse 2, N. Y.

COST OF things going up faster than your income? You can make more full or part time as a Rawleigh dealer. Write for full particulars. Rawleigh's, Dept. G-RR-FPM, Freeport, Ill.

FORTUNES Made raising crickets and fishworms. Raising and marketing instructions. \$1.00. Breeder redworms, \$4.50 per 1000 postpaid. Carter Farms, Plains, Georgia.

NATURAL Molding rubber, extra thick. Free sample. Flock, W. Wooley, 115-A Donald, Peoria, Ill.

WHAT'S Your field of interest? Whatever it is, specialized magazines will help you get ahead. Examine current copies of those covering your field through our easy-to-get-acquainted service. Choose from 437 covering all fields—business, trades, agricultural, professions, insurance, real estate, music, educational, hobbies, sports, etc. Current list free. Commercial Engraving Publishing Company, 34C North Ritter, Indianapolis 19, Indiana.

RED Hot home business. Big profit. Details and material 25c. Diaz, Box 11338, Tampa, Florida.

BIG Money selling and installing this new, low-priced burglar alarm. Real protection for homes, shops, stores, etc. Write for details. Protect-O-Larm, 6012 Irving Park Road, Chicago 34.

OWN A garden golf business. Experience unnecessary. Brockway, Seaside, Oregon.

FREE Literature. Fishworms 200—\$1.00. Breeders' Manual, \$1.00. Postpaid. Dixdok, Kent, Ohio.

IMPORT! Coffee, cigarettes, novelties, consumer goods. Opportunities bulletin 25c. Warner, Box 6, Fort Scott, Kansas.

SELL Popular Mechanics and all other magazine subscriptions. Free catalog, supplies. Subscription Service Company, Dept. A, P.O. Box 2070, Birmingham, Alabama.

PROFITABLE Home business, 50 ideas free. Oren Robertson, Bonita, Louisiana.

WANTED! Home producers, by manufacturers in our clearing house service. Become subcontractor, casting plastic products for these companies. Thousands of easy-to-make items required for consumer-industrial use. Cash in at home, without previous experience. Plastic Service Associates, Dept. 7-PM, East Boston 28, Mass.

MAKE Rubber stamps, repair dolls; learn silk screen printing. Catalogue (60 ideas) free. Universal, Box 1076-A, Peoria, Ill.

MAKE Money by mail order. Free catalogue shows how. Details free. Opportunities Unlimited, Dept. 6, Box 1576, Boston, Mass.

OPPORTUNITY Seekers write James Leigh, 537 Chester Street, Oakland 20, California.

\$1000 MONTH Raising earthworms. Instructions 25c. Wiggler Farms, Burt 3, Michigan.

OPERATE "Escalator" mailorder system, selling our products or any products. Write: Selbyco, Decatur 25V, Illinois.

PROFITS At home molding jungle masks, wall plaques, etc. Instructions and sample to copy, \$1.00. Cera-Masques, Box 481, Fontana, California.

LIQUID Rubber, make flexible molds. Free sample. Chaney, 1130 E. 16th St., Jacksonville 6, Fla.

FREE Booklet, "Mail Order Confidential." Elson, Box 1631-F, Fargo, N. Dak.

LIST Your name in "Big Mail." Get many offers. 25c coin. Refundable. Walter Rix, Box 6521-A, Cleveland 1, Ohio.

GET \$10 Orders by mail! 100% profit! Everything furnished. Terrill, Bogard 10, Mo.

MAKE Perfumes, other products. Sell mailorder. Formula catalogue free. International, 6347 Parnell, PM-7, Chicago 21, Illinois.

LEARN Sewing machine repair, electrify, trade, sell. How to make big money at home sparetime. New zigzag machines, parts, etc., wholesale. Free details. Taylor Service, Hamilton PM-7, Ohio.

EARN Extra money, spare time, from typewriter or sewing machine. Free details. McKinley Home Enterprises, 817-A Park S.W., Canton, Ohio.

MONEY, Typing, sewing! Details free. Edwards, 3915-PM, 12th, Des Moines 13, Iowa.

BECOME A game warden, or join forestry, park, lookout, wildlife conservation services. Enjoy outdoor work, good pay, real security. Complete information free! Write Home-Study Institute, 3156JY West Eighth, Los Angeles 5, California.

EXPORT Business easy made! Substantial income from home. No merchandise buying. Full setup service, includes everything. Hermes Exports, 152 West 42, New York 18.

TIN-Cans. Turn them into cash. Nine methods. Instructions 50c. Charles Company, 12-DCA, Norwood, Ohio.

OPERATE Sewing machine repair business from home. Our guaranteed plan assures success. Easily learned. Amazing profits. Write immediately. Purdy's, 1416½ North Rusk, Weatherford, Texas.

FREE Wholesale catalog! Make up to 500% profit! Novelties, gifts, premiums, costume jewelry, wrist watches, housewares, name brand merchandise. No junk, sell to stores or individuals. Write for catalog No. 5. Heath Distributing Company, 506 Broadway, Macon, Georgia.

IMPORT-Export: Opportunity, profitable, world-wide, mail-order business from home, without capital; or travel abroad. Established world trader ships instructions for no-risk examination. Experience unnecessary. Free details. Mellinger A707, Los Angeles 24.

MAILORDER—Operate profitable home business using free advertising method. Revealing information free. Seidel, 7070-HP Hollywood, Los Angeles 28.



**START** Your own business at home. Sell subscriptions for popular magazines. Liberal commissions. Send for supplies, etc. DeSales Magazine Service, 60 East 42nd St., New York 17, N. Y.

**BUY** Wholesale. Thousands items. Free lists. Triple J Industries, 132 Berkshire, Bridgeport 8, Conn.

**EARN \$2.00 Hour!** I do—making sandals. Young's, 1308-PM, South First, Arcadia, California.

**WANTED**—New items for mailorder. 50% drop-shipment. \$1.00 to \$10.00 sellers. F. Childress, R-1, Taylors, South Carolina.

**FREE!** "301 Profitable Small Businesses!" Amazing shoestring plans! Work home! Start sparetime! Deumant Surveys, Kenmore 23-PM, N. Y.

**NEWEST** Spare, full-time home business. \$5 to \$10 hour possible. Paint with suede—The finish with touch and eye-appeal. Beautifully auto dashboards, signs, radios, toys, figurines, lamps—1001 others. Complete, step-by-step instructions sent for no-risk examination. Free details. Coast, 1004-MW So. Los Angeles St., Los Angeles 15.

**START** Your own business on credit. Your own boss. 1638 of our dealers sold \$5,000 to \$27,500 in 1953. We supply stocks, equipment on credit. 200 home necessities. Sales experience unnecessary. Pleasant profitable business backed by world-wide industry. Write Rawleigh's, Dept. G-U-PPM, Freeport, Ill.

**ADVERTISING** Book matches—Cash in on big demand; sell union label matches. Cuts for all businesses and political parties. Free powerhouse selling kit, low prices, protection guaranteed on repeat orders. Cash commissions. Superior Match Co., Dept. MX-734, 7530 Greenwood, Chicago.

**GROW** Orchids at home—Profitable, fascinating. Year 'round. Maine to California. No greenhouse. Gorgeous cattleyas, cymbidiums, etc. Successful home grower shows you how. Full details free. Flowerland, 4622-PC Wilshire, Los Angeles 5.

**MAKE** And sell rhinestone jewelry. Rhinestones 25c gross. Free catalog. Ebert, Box P183, East Orange, New Jersey.

**STEADY** income at home; mailorder or local. C. C. Graham, 1236 Granger Ave., Lakewood 7, Ohio.

**FREE!** Complete mailorder business. No investment! Everything furnished! Terrific profits! Write today. Veejay Vitamins, 18707 Cimsta, Los Angeles 18, California.

**FREE** Wholesale price list—Refrigerators, television, silverplate, watches, gifts. Belmont, 202 Hindsdale St., Brooklyn 7, N. Y.

**BUY** Wholesale. 4,000 name brand items. Start your own business. Wide open field. Profits unlimited. Catalog 25c. Wholesalers Mart, P.O. Box 8125EI, Houston, Texas.

**BOOKKEEPERS!** Keep books, small firms. Spare time. Heffernan, 37-06 Jerusalem Avenue, Wantagh, New York.

**\$15 AN Hour.** Become tax expert. New tax law enormously increases demand for tax consultants. Dignified year-round business. Work home or office; full, spare time. We train you, experience unnecessary. Free details. Union Institute, Lakewood 2-L, N. J.

**HOME** Business—Mailing literature to new mothers. Details free. K & M Products, 3634-A Homewood, Toledo 12, Ohio.

**COFFEE** Going higher, sell substitute. Formula \$1.00. Krystr, Felton, Calif.

**BIALEKS** Famous liniment really repeats. \$1.00, refundable. Frank Bialek, Junction City, Wis.

**START** A buying service, buy wholesale thousands nationally advertised products. Make big profits selling at sizable discounts. Postcard brings details. American Buyers, 627-P Linden, Buffalo, N. Y.

**EARN \$100 Month.** easy, breeding hybrid earthworms. Big demand. No expenses. Free information. Earthworm Gardens, 19 Peacock Bldg., El Monte, Calif.

**WHOLESALE** Catalog free. Name brand watches, appliances, cameras, sporting goods. 1000 tested sellers. General Wholesalers, P.O. Box 3058EP, San Francisco, Calif.

**FRANCHISE** Opportunities nationwide. Secure details immediately. National Franchise Reports, 920 N. Michigan Ave., Chicago 11, Ill.

**WHOLESALE** Prices. Quality printing. Free catalog, samples. Dealers wanted. Sutton Printing, Box 853-M, Waycross, Georgia.

**RAISE** Earthworms! Easy! Profitable! Dime brings information plus unusual true story, "An Earthworm Turned His Life." Earthmaster System, 8E, El Monte, Calif.

**FREE** Folio describing "\$45,000 Unlimited Vacations Plan." No canvassing, mail-order, merchandise, equipment. Unknown. Works itself—home! Keep job. Haylings, Carlsbad, Calif.

**IMPORT**—No risk plan offers big profits. Sparetime. Showing Mexican hand tooled leather hand bags, hand painted skirts. Frontier Imports, Box 3032, Sta. A, El Paso, Texas.

**MAIL** Order business. Send for imported catalog from manufacturers rep. 298 pages, over 3000 items for only \$5.00. Bakalich, 1149 East Pico Blvd., Los Angeles 21, Calif.

**START** A profitable cash business in your home. Tested plans and copyrighted instructions. Circular free. G. Bowman, 7119-C Clyde Avenue, Chicago 49, Illinois.

**SELL** Name brands—No inventory. Manhattan, 225 W. 57 St., New York City.

**ALUMINUM** Awnings—Sell yourself, sell neighbors. Baked enamel colors. Factory prices. Write Groff, Box 10254, Tampa, Fla.

**I Average** \$125 weekly selling books by mail! So can you! Start sparetime! Work home! Cooper, 245 Taunton, Buffalo, N. Y.

**MEN** Wanted—Build luggage and cases at home. We sell your products, supply complete instructions, materials, everything. No special equipment needed. Free details. Cascraft, 805-G7 Sunset, Los Angeles 12, Calif.

**PRINT** without a printing press! Amazing new method! Print colorful signs, banners, cards, posters, glassware; anything at home. Big profits. Moneymaking opportunity! We supply everything. Beautiful sample, home-business plan free! Write Screen-Print Company, Los Angeles 15, California.

**\$900 A Year** sparetime sharpening saws at home. No selling. Hardware stores get saws on commission basis. Free booklet tells how. Victor Foley Company, Columbia Heights, Minnesota.

**MAKE** Money at home as renewal headquarters for all magazines. Liberal commissions. No experience. No capital needed. Supplies furnished. Write for free catalog. McGregor Magazine Agency, Dept. 500B, Mount Morris, Ill.

**OVER 700%** Profit making finished photos in 2 minutes on the spot in daylight without darkroom. No experience needed. Simple directions teach you quickly. Write P D Q Camera Co., 1161 N. Cleveland Ave., Dept. PM, Chicago 10, Illinois.

**ELECTROPLATE** Auto parts, novelties, mirrors, baby shoes. Easy, inexpensive home processes. Free booklet. Tyco Metals, Box 12321-MM, Houston 19, Texas.

**BOOKKEEPERS.** Keep books, small firms spare time. Manual latest technique by C.P.A., \$3.00. Modern Business, Box 406, Youngstown 1, Ohio.

**MAKE** Money at home doing easy pleasant work. Everything furnished. Good earnings. Write, Murray's, Box 4006, Mott Park Station, Flint 4, Michigan.

**MAKE** Money at home—Mail cards, circulars feature real merchandise. Everything furnished. Big earnings. Phillip's, Box 3-P, Boston 22, Mass.

**UNUSUAL** Mail order ideas, sources. Details free. Fax, Box 241, Brownwood, Texas.

**RECAST** Old batteries into new. Latest achievements. Battery Laboratories, Minneapolis.

**LEARN** Metalizing baby shoes, gifts, etc. Bronze, gold, silver. Folio free. Kiktavi, 7217-PM South Broadway, Los Angeles 3.

**WHOLESALE** Of sensational nationally advertised appliances, silverware, watches, cameras, etc. Start your own business. Full details. Send 50c for catalogue. International Sales Co., 175 Fifth Ave., New York 10, N. Y.

**START** Venetian blind laundry. Profitable lifetime business. New machine. Free booklet. F. C. Co., 442 N. Seneca, Wichita 12, Kansas.

**UNUSUAL** Homework opportunity, spinning Angora sparetime for us. Men, women. Angora House, PM, Springfield, Illinois.

**HOW** And where to obtain capital. Particulars free. Star Service, Wapakoneta, Ohio.

**MAKE** Money at home. Write, Falcon House, Winnebago 2, Ill.

**TO \$40.00 Weekly.** Sparetime, home operated mailorder business. Successful beginner's plan. Everything supplied. Lynn, 10420-M National, Los Angeles 34, Calif.

**COPUBLISH** Mail Sale Advertiser, leading mail order paper. Details, latest copy, dime. Vanroy Shirk, Lebanon, Penna.

**EARN** Money at home! Homemaker Magazine tells how. Sample, 25c. Sizemore, Box 7, 4917 Kostner, Chicago 30.

**DOLLARS** In personalized baby record books. Sell by mail. Eleven thousand new prospects daily. Use same literature we do. No-Co-Ro, Oakland 6, California.

**SCHEMER** Magazine, Canfield 1, Ohio, monthly mailorder ideas, plans. Year \$1.00. Sample 20c.

**PLASTERCRAFT** Molds, liquid rubber, plasters, floccs, candle supplies. Catalog and manual free. Blue Rapids Supply, Blue Rapids, Kansas.

**BUY** It wholesale! Manufacturers, distributors offer 850,000 items. Literature free. Olsen, 1231-A East Third St., Duluth 5, Minn.

**GROW** Mushrooms. Cellar, shed, and outdoors. Spare, full time, year round. We pay \$3.30 lb. We paid Babbitt \$4,165.00 in few weeks. Free book. Washington Mushroom Ind., Dept. 172, 2954 Admiral Way, Seattle, Washington.

**POPCORN** And potato chip equipment. Leco, Box 933-A, Springfield, Ohio.

**\$46 FROM** Square foot plywood; jigsaw necessary. Write: Woodarts, Bridgewater, Mass.

**BUY** Wholesale thousands items. Lists free. Cottage Industries, Omaha 12, Nebr.

**\$25 WEEKLY** Working two hours daily at home. Lycke, Box 2471-A, Cleveland 12, Ohio.

**BREED** Rare tropical fish at home. Earn big money! Learn secrets! Help fill huge demand. Amazing opportunity! Free plan. Tropicals, 1008-F Los Angeles St., Los Angeles 15.

**INCOME** From local information. No selling. Write Neherco, La Verne, Calif.

**RESILVERING** Mirrors, formula 50c; two-way lookout mirrors. (No one sees you), 50c; coppered mirrors, 50c. All \$1.00. Nelko-Mir, Box 3462-J, Chicago 54.

**LIVING** Miniature ("Ming") trees only 10 to 20 inches tall. Grow at home. Big profits! Spare time opportunity. Fascinating! Amazing! Write for free seed and plan. National Nursery, Dept. FC, Inglewood 4, California.

**MAKE** Money spare or full time, casting metal toys and novelties. Big wholesale and chain store demand for autos, soldiers, ashtrays, banks, etc., keeps manufacturers busy. Production moulds furnished for up to 100 and more castings per hour. No experience or special place necessary. Write for information and illustrations of patterns needed. Metal Cast Products Co., Dept. A, 1696 Boston Road, New York 60, N. Y.

**OPERATE** Profitable mail order business. Write Walter Service, 4159-A East 112th, Cleveland 5, Ohio.

**GOOD** Paying business silvering mirrors, plating autoparts, reflectors, bicycles, bathroom fixtures, etc., by late method. No tanks or shop required. Outfit furnished. Free booklet. Gunmetal Co., Ave. H, Decatur, Illinois.

**MINK** Raising information free. Complete. Lake Superior Mink Farm, Superior, EEL, Wisconsin.

**COLORGLAZED** Concrete pottery made without molds. Patented method. Cemetery products, novelties, tiles. Basement leak-sealing. Money-making projects. Booklet, details free. Men only. National Potteries Company, Grand Rapids, Minnesota.

**FREE** Book "505 Odd, Successful Businesses." Work home. Expect something odd! Pacific, Oceanside, Calif.

**PIX** Typewriters. Free booklet describes our modern, inexpensive home-study course. Factory methods taught. Write Typewriter, Building 1, Tarentum, Penna.

**MONEY** In new greaseless doughnuts. Start in kitchen. No smoke. Sell stores. Free recipes. M. Ray Company, 2605 South 15th Ave., Minneapolis 7, Minn.

**BRONZED** Baby shoe supplies, instructions, mountings. Metal bookends, \$1.50 pair. Free catalog. National Bronze Supply, Box 56, Los Angeles 32, Calif.

**FORM** A buyers or consumers group. My plan successful. Excellent moneymaking opportunity. Free details. Putnams, Box 74A, Columbus Grove, Ohio.



**MAKE Flexible molds.** Cast figurines, plaques. Free sample. Tooker, 630-R Chestnut, Hamilton, Ohio.

**START Profitable spare time business.** Co-publish "Mail Order World" leading trade magazine. Opportunities and invaluable information for beginners. Sample copy 25c. Beecher Publications, Box 2161-B, Cincinnati 1, Ohio.

**START Your own mail order business.** "Mail Order Business Manual" reveals proven methods. No crackpot schemes. Bud E. Hine, Box 93, Battle Creek, Mich.

**MONTHLY Repeat business** which you can operate in your own community. For free details write Grasak, 321-28th Street, McKeesport, Penna.

**COLOR Concrete with chemicals.** Marble-glass cement benches, pottery. Start, home, shop. Many designs: birdbaths to waterfalls. Your chance for fame, fortune. 10c brings sample, pictures. Write: Hollywood Cementcraft, 8527-R Wonderland, Hollywood 46, California.

**MAKE \$50.00 Per day** selling room air conditioners. Buy wholesale. Box 793, La Crosse, Wisconsin.

**MAILORDER Home business!** Details stamp. Shirley, 20-Raspeburg, Baltimore 6, Maryland.

**MILLION Articles wholesale.** Supply source directory 10c. Idealer, Park Ridge, Illinois.

**SELL Books, merchandise by mail.** Good profits. We furnish circulars, names—Ship your orders. National, Box 88, Dorchester, 22G, Mass.

**MONEY Getters club!** Receive 1,000 or more different money-making propositions. Year's membership now only 25c. Satisfaction guaranteed or money back. Storm-Associates, Cedarville, New Jersey.

**\$26,500 SALES In two weeks!** Amazing radio-mail order method. Free details. Broadcast Service, 1412-T Great Northern Building, Chicago 4, Illinois.

#### **MONEYMAKING OPPORTUNITIES**

**TESTED Plans for home operated business.** Free details. Gilchrist Sales Company, 13 Brown Avenue, Cortland, New York.

**START Home mailorder.** Details. Gimbart, 1454 W. Washington, Petersburg, Virginia.

**MONEY Making plans and manuals.** Literature free. Kaiser, 136B Gamewell, Hackensack, N. J.

**400 RADIO Stations active.** Free radio advertising. Pay commission only on orders received. Free information. Mishek, IC, Waseca, Minn.

**ATTENTION: Typewriter owners.** Make handsome profits. Write today. Groves Company, 682, Hastings 8, Nebraska.

**24 MONEY Makers 10c.** Midwest Sales Co., Nevada 106, Mo.

**PRESERVE Living flowers to last indefinitely.** Interesting! Profitable! Maxson, Falls Church 18, Virginia.

**NEW Baby Items.** Agents, salesmen, distributors. Natural for mail order. Write: Liebig Industries, Beaver Dam 5, Wis.

**MEN, Women: Add \$50 weekly** to present income. No selling or collecting. Chamber of Commerce approved. Write today for information. Independent Driver Training, 1301c Shaftesbury Road, Dayton 6, Ohio.

**100% PROFIT! Mexican featherbird pictures.** Hot sellers! Edmunds, 3009-P Weaver Ave., Baltimore 14, Md.

**NEED Extra money? New plan.** No investment. Sparetime. Sample, details free. Transamerican, Box 815-A, Atlanta 1, Ga.

**FREE! "301 Profitable Small Businesses!"** Amazing shoestring plans! Work home! Start sparetime. Deumant Surveys, Kenmore 23-PM, N. Y.

**CRAZY Waiting mice.** Raise these funny pets. You can't buy them anywhere. Try to. Special offer. Details free. S. E. Keegan, 7835 Mill Road, Philadelphia 17, Penna.

**\$200 MONTHLY Possible raising earthworms!** Backyard, garage, basement. Complete, illustrated booklet explains raising, feeding, packing, marketing. 25c postpaid! Ozark Worm Farm-J, Willow Springs, Missouri.

**ENJOY A profitable hobby** at home raise New Zealand White-Rabbits sell top notch breeders at \$10 each. My folio 50c explains everything. Buckeye Hobbies, 1711 East 82nd Street, Cleveland 3, Ohio.

**INCREASE Your income,** turn your spare time into cash—Making quick-selling, highly profitable lamps and fiber glass shades. Every home a prospect for one or more. Hundreds already doing it, so can you. No experience needed. No special tools required. Gearon's big, new 72 page 1954 Illustrated Catalog No. 8 will show you how, quickly. One special 8-page section shows 6 beautiful lamps in kit form, ready for you to assemble. Another 12-page section shows you how to make stunning, ultra-modern fiber glass shades. Page after page filled with wide variety of other attractive shades, shade frames, figurines, and lamp bases. Also oil lamp converters, boring compound, and all kinds of cords, sockets, pipes, harps, finials, bases, and hundreds of other parts. Everything you need. And you can buy everything wholesale, sell at retail, make big profits, fast. Send only 25c right now for Gearon's big 1954 catalog and wholesale price list. Like hundreds of others, you'll be glad you did. Gearon Co., Dept. 363-B7, 27 S. Desplaines, Chicago 6, Ill.

**EARN Money evenings,** copying and duplicating comic cartoons for advertisers. Adservice, Argyle 1, Wisconsin.

**MAKE Money at home** as renewal headquarters for all magazines. Liberal commissions. No experience, no capital needed. Supplies furnished. Write for free catalog. McGovgor Magazine Agency, Dept. 500C, Mount Morris, Ill.

**BUY Wholesale.** Name brand products. 4000 items. Sell homes, organizations. Big profits. Act now. Catalog 25c. Wholesalers Mart, P.O. Box: 6125EH, Houston, Texas.

**MAKE Extra money.** Start profitable mail order business. Free information. Bruce, Box 2551, Salt Lake City, Utah.

**NEW 7"-11" Ultra-blue signs.** 7c, retail 50c. Sample free! Lowy, 812 Broadway, Dept. 301, New York 3.

**MAKE Money at home** doing easy pleasant work. Everything furnished. Good earnings. Write: West Distributors, 7 South Harlem St., Worcester, Mass.

**TRIPLE Your profits.** Let me write your sales letters and catalog. Advice free. Winslow, Suite 635-A, 4980 Marine Drive, Chicago 40.

**FREE Folio** describing "845,000; Unlimited Vacations Plan." No canvassing, mail-order, merchandise, equipment. Unknown. Works itself—home! Keep job. Haylings, Carlsbad, Calif.

**START A buying service,** buy wholesale thousands nationally advertised products. Make big profits selling at sizable discounts. Postcard brings details. American Buyers, 630-P, Linden, Buffalo, N. Y.

**SELL Merchandise by mail** from your home. Everything supplied. Big profits. Light-Way Service, 3121 N. Hamlin, Chicago 18, Ill.

**NEW: Make-sell plastic plants.** Look, feel real. Kit \$2.00. Mario Studios, 1157 Belmont, Chicago 13.

**GET Free copy of "Opportunity,"** the magazine that shows you the way to unlimited profit possibilities. Gilbert, Room 1708, 28 East Jackson, Chicago 4.

**DOLLARS In your mail box daily.** No stock investment. Particulars free. Gem, 44-B Atlantic, Pleasantville, New Jersey.

**MAIL Letters** featuring real merchandise. Get \$10 orders in every mail. 100% profit. Everything furnished. Products, Box 23, Boston 17, Mass.

**EARN Extra income at home.** Honest, dignified, steady self-employment. Local or mailorder. Graham Company, 1236 Granger Ave., Lakewood 7, Ohio.

**PRINTING And office supplies** wholesale. 20,000 items. Literature free. Royal, Box 368-A, Cleveland 27, Ohio.

**CHINCHILLAS: Profitable.** Raise in spare room, cellar. Terms. Ross Chinchilla Ranch, 749 Rincon, El Sobrante 11, California.

**GROW Mushrooms.** Cellar, shed, and outdoors. Spare, full time, year round. We pay \$3.50 lb. We paid Babbitt \$4,165.00 in few weeks. Free book. Washington Mushroom Ind., Dept. 173, 2954 Admiral Way, Seattle, Washington.

**SPARETIME Profits** taking subscriptions, all magazines. Wholesale catalog free. Cassell Agency, Westfield 2, New Jersey.

**SELL Titania gems; \$9.75 carat** wholesale. More brilliant than diamonds. Free catalogue. Diamonte, 1404-M Mitchell, Oakland 1, California.

**50,000 ARTICLES Wholesale.** Source directory, dime. Nelko, Box 3462-DR, Chicago 54.

**READ Progressive Mailtrade,** the magazine that tells how to make money by mail. Dime brings sample and special offer. Progressive Mailtrade, Box 351, Sheboygan, Wisconsin.

**FREE Book "505 Odd, Successful Business-nesses."** Work home. Expect something odd! Pacific, Oceanside, Calif.

**PUBLISH Your own magazine.** Handsome 52 page format, well edited, illustrated. Cost low as \$1.00 month. Brings you prestige, profits. 25c brings sample, details. National, Ord, Nebr.

**GENERAL Contest Bulletin.** Issued monthly. Sample, 10c. 1609½ East 5th, Duluth, Minn.

**MAKE To \$4.50 hour** doing common pen lettering. National Artists, 801½-A North Marsalis, Dallas 3, Texas.

**SELL By mail! Earn extra money!** Informative booklet 25c. Beecher Publications, Box 2161-B, Cincinnati 1, Ohio.

**FREE! Many money making offers.** Boyer, 65 Uptown, Hoboken, N. J.

**300% PROFIT Making** and selling seamless wallets. Only scissors needed. Send \$1.00 for pattern. Barcklow, King St., Woodbury, N. J.

**FREE Literature** describing moneymaking mailorder plans. Lewis Barlett, Richland, Georgia.

**WINNING Prize contests** is fabulous, confidential, home opportunity! Send stamp! National Contest Bulletin, Box 2685-P, Miami 16, Florida.

**TYPEWRITER Owners.** Make handsome profits. Get details today. Groves Company, 682, Hastings 8, Nebraska.

#### **FORMULAS, PLANS, ETC.**

**LIFETIME Business!** Manufacture extremely profitable products! Lists free! Thermolab, Peoria 4, Ill.

**MILLER'S Modern manufacturing formulas** make fast-selling products that get the business and pay! Fifty years supplying the best. Late literature free! Liscombe Miller, Chemist, Tampa, Florida.

**FORMULAS: All kinds.** Latest, best. Literature free. Kemixal, Park Ridge, Ill.

**REAL Manufacturing formulas.** Lists free. Cummings, Chemist, Gordon Ave., Syracuse 4, N. Y.

**FREE Formula catalog.** Anything analyzed \$35. Western Chemical, Salem, Ore.

**ANY Formula—\$3.00.** Satisfaction guaranteed. Free lists. Miller, 24 Whitwell Place, Brooklyn 15, N. Y.

#### **PLASTICS**

**SPECIAL Plastic** for laminating photos, etc. Details free. Solomonson, 46 Cornhill, Boston 8, Mass.

**PLASTICS Home-craft course** for men and women. Tells and shows how to make hundreds of fast selling plastics products. All plastics and materials for 23 projects included in course. No special tools needed. Course pays for itself. Write for free booklet. Interstate Training Service, Dept. D-3-O, Portland 13, Oregon.

**PLEXIGLAS Closeout** — Masked, square foot— $\frac{1}{8}$ —\$1.20,  $\frac{1}{4}$ —\$1.90,  $\frac{1}{2}$  tubing 15c ft. List 25c. Plastics, Box 602A2, Janesville, Wis.

**EARN Big profits** with Perma-Pruf lifetime protection for social security cards, drivers licenses, snapshots, etc. Everybody a prospect. \$1.00 brings sales kit. Davis Plastic Company, Dept. A., Madisonville, Kentucky.

**FIBERGLAS.** Polyester, Plexiglas, Acetate, Vinylite: Casting, coating plastics: Fast service, best prices. Catalog—10c. Gem-O-Lite, Box 6867P, North Hollywood, California.

**PLASTIC, Sheets, rods, tubes, etc.** Free list. Plastic Supply Co., 2901 N. Grand Blvd., St. Louis 7, Mo.

**PLEXIGLAS Sheets—Cut to size.** Clear. All thicknesses. Standard outdoor translucent colors. McClarin Plastics, P.O. Box 168H, Hanover, Penna.

**PLEXIGLAS, Lucite.** Any size sheets. Square foot (12 x 12) cost,  $\frac{1}{16}$ ", \$1.18;  $\frac{1}{8}$ ", \$1.55;  $\frac{3}{16}$ ", \$1.90;  $\frac{1}{4}$ ", \$2.25. Add 15% for postage. Minimum order \$3.00. Almac Plastics, 600 Broadway, New York City.



## CHEMISTRY

"SPECTACULAR Chemical Experiments" manual, second improved printing, not mimeographed. Interesting and thorough. Contains complete formulas, set-ups, instructions, special data on thermites, fulminates, acetylides, nitrogen iodides, explosive powders, etc. Only \$1.00 postpaid. Chem-Tech Laboratories, 368CX Riley, Buffalo 8, New York.

**CHEMICAL Problems**—Prompt, expert advice. Satisfaction guaranteed. Send \$3.00 per problem. S. Steiner (Consultant) Rm. 940, 127 N. Dearborn, Chicago, Ill.

SEE Cosmic rays, radio activity. New laboratory certified cloud chambers, \$8.50. Write for free specifications. Atomic Laboratory, Box 343, Berkeley, Calif.

**AMAZING** New book of science. Experiments, formulas and catalogue of laboratory supplies. Only 25c. National Scientific Co., Dept. PM7, 2204 W. North Ave., Chicago 47, Ill.

**NEW** Idea chemical and apparatus outfits for home experimenting. Photo-scales, microscopes, chemicals, biological and laboratory supplies in small quantities. Catalog 25c. Established 1931. John H. Winn, 124A West 23rd Street, New York, N. Y.

**CHEMICALS** And apparatus for industrial, analytical, and private laboratories. Catalog 25c. Dept. M-50, Biological Supply Co., 1176 Mt. Hope Ave., Rochester 20, N. Y.

**ILLUSTRATED** Catalog: Chemistry, mineralogy, biology 20c. Tracey Laboratories, Evanston, Illinois.

## AGENTS WANTED

**AT Last!** Something new and sensational in Christmas cards. Make extra money fast! Show satins, velours, metallics. Gets easy orders. Pays up to 100% cash profit. 30 free samples. With name, 50 for \$1.50. Big line. Amazing new glitter-brite ornaments, napkins, gifts, stationery. Several \$1.00 boxes on approval. Pure Greetings, 2801 Locust, Dept. 440-J, St. Louis, Mo.

**NEW** Plastic mending tape. Just press on! Repairs clothing instantly. Lightning seller. Samples sent on trial. Kristee, 57, Akron, Ohio.

**60% PROFIT** On cosmetics—Why make less? Famous nationally advertised Studio Girl Hollywood Cosmetics pays 60%! Make \$25 day! Hire others. Write or wire for free samples, details. Studio Girl, Glendale, Calif. Dept. PM-74.

**CHRISTMAS** Cards pay 75c profit on \$1.25 assortment. Exclusive 40 for \$1 name imprints; gift wraps by-the-yard; 200 new fast-sellers. Cash bonus. 5 assortments on approval. Cardinal, 1400 State, Dept. 79-K, Cincinnati 14.

**1000% PROFIT!** Machineless plastic laminating. No experience needed! Agents kit 50c. Berea Photo's, Berea, Ohio.

**SELL** "The Automatic Bible." Allman, 90 Coral Street, Paterson 2, N. J.

**OPERATE** "Escalator" mailorder system, selling our products or any products. Fastest, most revolutionary mailorder system known. Write: Selbyco, Decatur 26Y, Illinois.

**MAN** TO earn \$150 up per week. Long needed invention. Advertised worldwide. Prospects everywhere. Full or part time. Exclusive. No investment. Free use of samples. Write Red Comet, Inc., Dept. 391-L, Littleton, Colorado.

**MAKE** Money fast—For yourself, church, organization. Selling friends, neighbors big value \$1.00 and \$1.25 Christmas and all occasion greeting cards. Leading 21 card boxes, religious and novelty assortments. Gift wrappings, stationery, children's items, gifts, gadgets. Deluxe imprinted Christmas cards. Over 200 items—profits to 100%. Experience unnecessary. Free gift for promptness. Bonus. Free selling plant! Samples on approval. Hedenkamp, 361 Broadway, Dept. PM-32, New York.

**SAVE!** Make big money in sparetime. Buy nationally advertised merchandise wholesale. Catalog 25c. refundable. A Sales, 18-PM City Terrace, Newburgh, N. Y.

**RUN** A spare-time greeting card and gift shop at home. Show friends samples of our new 1954 Christmas and all-occasion greeting cards. Take their orders and earn up to 100% profit. No experience necessary. Costs nothing to try. Write today for samples on approval. Regal Greetings, Dept. 40, Ferndale, Michigan.

**SELL** New 3-dimensional "action" Christmas, birthday, get well cards. Make \$30, \$75, \$100 extra money. Profits to 120%, plus extra cash bonus. Write for feature assortments on approval, free samples personal Christmas cards, stationery, free color catalog, selling guide. New England Art Publishers, North Abington 733-B, Mass.

**MAKE** \$50.00 In spare time with amazing new Presto fire extinguisher. No experience needed. Write for free sales kit. Merlite Industries, Dept. 57C, 114 East 32 St., New York 16, N. Y.

**BIGGER** Profits selling greeting cards. Get list of sensational factory surplus bargains. \$1.25 boxes for 50c, \$1 boxes for 35c—While they last! Big line new 1954 Christmas cards, stationery, gifts, assortments on approval, personalized samples free! Midwest Cards, 1113 Washington, Dept. G-135, St. Louis, Mo.

**EXTRA** Money every week. I'll send you full-size Blair household products on free trial. Show them to friends and neighbors. You can make big extra profits. Write Blair, Dept. 31MP-1, Lynchburg, Va.

**APPLIANCES**, Cameras, watches! Large coded wholesale catalogue! Cam Company, 6066PM-20th Ave., Brooklyn 4, N. Y.

**NEW** Bathroom deodorizer. Hangs on wall. Banishes odors bathroom, kitchen. Lightning seller. Samples sent on trial. Kristee, 58, Akron, Ohio.

**MAKE** Money introducing world's cutest children's dresses. Big selection, adorable styles. Low prices. Complete display free. Rush name. Harford, Dept. M-1341, Cincinnati 25, Ohio.

**DESK** Signs, nameplates. Free samples. Biggest profits. Whitney Signs, West Springfield, Mass.

**MEN-Women**: 100% profit, taking orders for Sweet Georgia Brown beauty products. Colored people buy on sight. Sample offer. Valmor, 2451-BHS Michigan, Chicago 16.

**EASY** Extra income—Sell sensational new silicone scorch resistant ironing board cover. Good Housekeeping approved. Terrific \$1.98 seller! Send for free complete selling kit. Sample cover \$1.10. Menell Products, Dept. P-P.O. Box 431, Midtown Station, New York 18, N. Y.

**BEAUTIFUL** Feather pictures. 200% profit! Free sample. Apartado 9036, Mexico 1, D.F.

**BLOUSES**, Lingerie, hosiery, brand new line. Sensational new money making plan. Write American Mills, Dept. 423, Indianapolis.

**MONEY** For Xmas! Make \$50 and more during spare time. Friends, neighbors—everyone buys from Elmira's exquisite new sparkling line. Imprinted Christmas cards for as little as 3c. Personalized stationery, napkins, large gift wrappings with free accessories, ribbon ties—All fine quality money saving values. No experience needed. Send name and address for free portfolios, catalog, assortments on approval. Bonus plan. Elmira's "portable gift shop" makes money first day. Write today. Elmira Greeting Card Co., Dept. C-198, Elmira, N. Y.

**AGENTS-Salesmen**: Sell beautiful hand-colored plastic enlargements and sensational new personalized photo compacts, rings, bracelets, lockets, etc. Experience unnecessary. 40% advance commissions. We deliver, collect. Wonderful sideline—Better full time. Free sample outfit. Novel Portrait Co., 3243 North Ave., Chicago, Ill.

**HOTTEST** Wholesale sellers anywhere in appliances, cameras, watches, giftwares, sporting goods. Catalog free. General Wholesalers, P.O. Box 3638EF, San Francisco, Calif.

**FREE** Illustrations. Sterling silver neck chains and miraculous medals. \$2.75 to \$10.35 dozen. Sixteen different returnable samples \$7.50. Three samples \$1.00. Unique Chain, 473-M Hendrix, Brooklyn 7, New York.

**NEW** Electric light bulb kills flies, moths, cockroaches. Every home needs one or more. Your profit \$1 on each. Write Alexander Sales Co., 520 Fifth Ave., New York 36, N. Y.

**BUY** Wholesale thousands nationally advertised products at big discount. Free "Wholesale Plan." American Buyers, 629-P Linden, Buffalo, N. Y.

**AGENTS**—New revolutionary mass market safety auto accessory. Big profits. No competition. Low priced. Territories open. Parnat Machine Works, 1819 Vyse Avenue, New York 60, N. Y.

**BALL** Pens \$10.00 gross, retractable pens \$2.50 dozen, needlebooks with threader \$8.25 gross. Lutzker, 871PM East 170th, New York City 59.

**YOUR** Own business—Used suits \$1.50, overcoats 65c, mackinaws 35c, shoes 12 1/2c, ladies coats 30c, dresses 15c. Enormous profits. Catalog free. Moro, 1218 South Jefferson, Chicago 7.

**HAVE** A complete store in your pocket. Buy wholesale and make big profits. Send for free general merchandise catalog now. Jay Norris, Dept. P, 445 Broome St., New York City.

**PRINTING**, Advertising salesmen—Excellent moneymaking sideline selling decalcomania name plates, small quantities. Automobile initials, sign letters. Free samples. Ralco, XL, Boston 19, Mass.

**CALIFORNIA** Sweet smelling beads. Sensational sellers. Free particulars. Mission, 2328PM West Pico, Los Angeles 6, Calif.

**WINDOW** Sign letters. Samples free. West Coast Sign Letter Service, P.O. Box 697, Escalon, Calif.

**GOLD** Or silver letters, numbers. Windows, doors, trucks. 1" to 6". 500% profits. Free samples. Atlas-T, 544 West 76th, Chicago 20.

**BARGAINS**, Job lots, close-outs! Save up to 50% on clothing, hosiery, notions, drugs, toiletries, gifts, jewelry, television, etc. 2000 items. 25c brings wholesale bargain catalog with special get acquainted offer which includes free \$1.00 merchandise certificate. Reliable Jobbers, 311-B North Desplaines, Chicago.

**\$1.00 PROFIT** Selling \$2.95 photo enlargement deal. Allen Studio, Riegler Bldg., Little Rock, Ark.

**MAKE** Extra money. Sell front door name plates to friends, neighbors. Retail \$1.98; you make \$1.00! Free selling kit. Modern Engraving Co., P.O. Box 194, Boston 14, Mass.

**AGENTS**—300% Profit selling genuine gold window letters; stores and offices. Free samples. Metallic Sign Letter Co., 431-D North Clark, Chicago.

**WHOLESALE** Catalog! Rock bottom prices! Nationally advertised appliances, watches, typewriters, cameras, tools, toys, housewares, phonographs. Consolidated Distributors, Box 1537A, Paterson, New Jersey.

**AMAZING** Bath sponge. Washes back easily. Suds as it washes. Uses soap scraps. Big profit. Whirlwind seller. Write for free sample offer. Magica Products, Wollaston 70, Mass.

**IT'S** So terrific you'll actually sell thousands! Brand new \$2.95 pocket check protector. Sales pouring in. A tremendous deal for you. Get your town today. Federal Products, Evanston 15, Illinois.

**EASY** Handwork makes fast-selling useful articles. Sample free. Sunmade Company, Brockton 64, Massachusetts.

**BUY** Wholesale—Nationally advertised merchandise radios, appliances, cookwear, watches, jewelry, typewriters, silverware, fans, etc. Send 25c for illustrated catalogue. Box 1621, Detroit 31, Mich.

## SALESMEN—DISTRIBUTORS

**\$10,000 PROFIT** Selling printing, matches, specialties! Arrow dealer tells how he did it in giant free sales outfit. You can do it too—without experience. Write Arrow Press, 615-H Fourth Ave. So., Minneapolis, Minn.

**MAKE** \$523.20 A month—Even if you take only four orders a day, for amazing new Presto-Matic defroster. Fits any refrigerator. Sells itself in seconds. Write for free sales kit. Merlite Industries, Dept. PD-77C, 114 East 32 St., New York 16.

**LEARN** Where millions in profits from Bible sales have gone! Receive free proven sales course and whole story of how you can get these profits! Also free catalogue of six of the world's finest Morocco grain genuine leather covered Bibles and related items! Joseph W. Cain, Wholesaler, Box 3065P, San Antonio 1, Texas.

**EVERY** Home, hotel, hospital wants new, sensational bathtub safety device. Prevents slipping. Make \$250 weekly easily. Rush name. Savalife, Kessler Corporation, 385AU, Fremont, Ohio.

**SELL** "Dandy" profitable fast moving automotive accessory. Dandy, Box 5, Columbus, Ind.

**\$300 WEEKLY**. Every car owner buys. Repeats. Wonder Glaze 7, Bay Port, Mich.



**AD Matches!** Sell amazing designs—20, 30, 40 and 240-light book matches. Bigger spot cash commissions; every business a prospect. Low prices for high quality. Repeats. Start without experience; men, women; full, part time. Buy nothing! Sales kit furnished. Match Corp., Dept. PM-55, Chicago 22, Illinois.

**ANYONE** Can sell famous Hoover uniforms for beauty shops, waitresses, nurses, doctors, others. All popular miracle fabrics—Nylon, dacron, orlon. Exclusive styles, top quality. Big cash income now, real future. Equipment free. Hoover, Dept. D-100, New York 11, N. Y.

**SUMMER Clearance.** Lawnmowers (40% off). Sell dealers. Terms. Rotacut-51. Excelsior Springs, Mo.

**GET Professional results every time** by learning how from easy-to-understand Popular Mechanics Press title "How to Paint With Brush and Spray," \$2.50. Write Popular Mechanics, 200 E. Ontario St., Chicago 11, Ill.

**CALENDARS.** Advertising novelties, matches. All styles, including religious, varnished, 12 sheet, girls. Hundreds of advertising novelties, book matches, etc. Fleming Calendar Co., Sales Division, 6539 Cottage Grove, Chicago 37, Ill.

**SALESMEN—Quick money.** \$100.00 week easy. Take orders electroplated and bronze colored baby shoes. Beautiful mounts. Details. Baby Shoe Novelties Sales, 5628 Angeles Vista, Los Angeles 43, Calif.

**ADVERTISING Book matches—Cash in on big demand!** Sell union label matches. Cuts for all businesses and political parties. Free powerhouse selling kit, low prices, protection guaranteed on repeat orders. Cash commissions. Superior Match Co., Dept. M-754, 7530 Greenwood, Chicago.

**AMAZING Profits for you selling** Sunshine quality Christmas cards. No investment or experience necessary. Nationally famous 21 cards for \$1.00. Sells on sight! Imprints, Carrier-lives, religious, gift wraps, many others. Samples on approval, write: Sunshine Art Studios, Inc., Dept. PM-7, Springfield 1, Mass. Pasadena 3, Calif. (Note: East of Rockies address Springfield office.)

**MEN! Money! Miracle Spray-A-Tint** tints windshields, gives marvelous glare-protection, plus new 1954 look! Sprays on in jiffy. Reduces glare from sun, snow, headlights, etc. Lasts for years. Auto-truck owners buy on sight! Profits 100% up! Spray-A-Tint, Dept. PM-6, Consumers Bldg., Chicago 4, Illinois.

**BOOK Distributors wanted!** Reply. Tradebooks, P.O. Box 1029, New Haven, Conn.

**FORTUNE Profits packaging magic** "Whiter" white-side tire cleaner concentrate. Details free. Aino, 3157-A Scranton, Cleveland 9, Ohio.

**BIG Money-making opportunity.** Exclusive line work uniforms. Jackets, pants, shirts, coveralls. Advertising embroidered. Every business prospect. Outfit free. Master Div., 257 Water, Ligonier, Ind.

**BIG Money now—With sensational new product** that will puncture proof auto and truck tires in minutes! Amazing demonstration. Every motorist needs, wants, buys! Write for money-making details. Everlast, Dept. B-10, Consumers Bldg., Chicago 4, Ill.

**BUY Wholesale thousands nationally advertised products** at big discount. Free "Wholesale Plan." American Buyers, 630-D Linden, Buffalo, N. Y.

**FACTORY Introduction.** Original! Saleable sample, \$1.00. Box 5, Tower City, Penna.

**IS \$210 A week worth a postcard to you?** Then rush card with name and address for special free trial plan that sells amazing new automatic refrigerator defroster like hot cakes! Write to Mr. Lewis, D-Frost-O-Matic Corp., Dept. P-102, 173 W. Madison, Chicago 2, Illinois.

**NEW Jobs open in selling.** Send name, address for five free issues of Opportunity Magazine's money-making guide, listing hundreds of companies who'll pay you well, full or part-time. No experience needed. Opportunity, 28 E. Jackson, Dept. 17, Chicago 14, Ill.

**GOOD Man can make \$3,000 next 90 days.** Every house in town wants amazing Nilite glowing curbside numbers. Automatic free trial plan pays profits day after day. Write for free details. Nilite, 173 W. Madison, Dept. 301, Chicago 2, Ill.

**SAVE \$150.00.** Buy nationally known air conditioners at wholesale, Box 793, La Crosse, Wisconsin.

**SENSATIONAL Insect-O-Lite destroys** insects by vaporizing chemical with heat of electric bulb. Retail for \$8.95. 100% profit for agents. Insect-O-Lite Co., Cincinnati 6, Ohio.

## EDUCATIONAL AND INSTRUCTION

**ENGINEERING,** College-level, home study, catalog free. Midwest Engineering School, 10923 Hillcrest, Hickman Mills, Missouri.

**MAKE Good money** in camera repairing and servicing. Learn how. Ed. Valera, 4202 N. Wolcott, Chicago 13, Ill.

**STUDY Real estate.** Write DeVoto, 1949 Junipero Serra, San Francisco 25, Calif.

**WELDING Training** pays at Hohart Welding School, Box M-741, Troy, Ohio. VA contract. Best equipment. Catalog free.

**COMPLETE Your high school at home** in spare time with 57-year-old school. Texts furnished. No classes. Diploma. Information booklet free. American School, Dept. KB45, Drexel at 58th, Chicago 37, Illinois.

**HIGH School—No classes.** Study at home. Spare time. Diploma awarded. Write for free catalog HF-45, Wayne School, 2527 N. Sheffield, Chicago 14, Ill.

**LEARN Priceless secrets** of Technical Metaphysics. Easy to learn. Only school of its kind. Write: Premier College of Technical Metaphysics, 2532 McKenzie St., Vancouver, B.C., Canada.

**WANT A diesel job?** New opportunities to increase income. Higher pay. More money. We can help you qualify. Tools. Shop method home training. Write today! Diesel, Tractor, Heavy Equipment Division, Interstate Training Service, Dept. B3-G, Portland 13, Oregon.

**MEDICAL Laboratory technique.** Learn at home. Catalog free. Century College, 9 East Ohio, Chicago 11, Illinois.

**IT'S Fun learning a language** by Linguaphone. At home, easily master French, Spanish, German, Russian—29 languages by Linguaphone World's Standard Conversational Method. It's like living in another land, you listen, you hear men and women speak, you understand, you speak. Save time, money. Gain job, school, travel, cultural opportunities. Write for free book. Linguaphone Institute, 8307 RCA Building, New York 20.

**CORRESPONDENCE Courses,** educational books bought, sold, rented. Catalog free. Willard Bayles, 211 Essex, Hackensack, New Jersey.

**FLY As a steward-purser.** Work but 85 hours a month, starting salary \$235 up. G. I. approved. Free catalogue. Air-Purser School, Room U, 1030 Nicollet, Minneapolis, Minnesota.

**INCREDIBLE! Become mental superman overnight!** Free booklet! Bijou, Box 1727-MM, Hollywood 28, California.

**10 SUCCESSFUL Ways** to win any argument. Complete, 25c. Debate, Box 641, Albuquerque, New Mexico.

**USED Correspondence courses** and educational books bought, sold, rented. Catalog free. Educational Exchange, Summerville, Ga.

**GIANT Gov't surplus "selling" course!** 562 pages selling secrets! Big workbook included! \$1.00. Porter Surplus, 272-PM Central, Rockland, Mass.

**PHYSICAL Therapy and massage.** We train you at home. Earn big profits from your own private practice or work with hospitals and doctors. Free catalog. National Institute, Desk 4, 4868½ Sheridan Road, Chicago 40, Illinois.

**HIGH School diploma at home.** Licensed teachers—Approved materials. Southern States Academy, Box 144-MX, Station E, Atlanta, Georgia.

**STUDY By correspondence** for Doctor's degree in Psychology, Metaphysics and Divinity. College of Divine Metaphysics, Dept. P-M, 2811 North Illinois St., Indianapolis 8, Indiana.

**BECOME A doctor** of psychology or metaphysics. Learn secret of contentment, happiness. Win degree of Ps.D. or MsD. Solve mental worries. Free book. College of Universal Truth, 5038-C Broadway, Chicago.

**BE A real estate broker.** Study at home. Write for free book today. G.I. approved. Weaver School of Real Estate, 304 Law Bldg., Kansas City, Missouri.

**SECRET Investigation.** Experience unnecessary. Investigators particulars free. George Wagner, M125 West 86th, New York 24.

**GROW Mushrooms.** Cellar, shed, and outdoors. Spare, full time, year round. We pay \$3.50 lb. We paid Babbitt \$4,165.00 in few weeks. Free book. Washington Mushroom Ind., Dept. 174, 2954 Admiral Way, Seattle, Washington.

**EARN While you learn.** Auto and diesel mechanics master this top paying trade. Many graduates earn \$100 a week and up. Approved for Korean veterans. For free information write Dept. No. 256, Nashville Auto-Diesel College, Nashville 3, Tenn.

**BOOKKEEPERS!** Increase your earnings! Operate your own simplified "Dollar-A-Week" bookkeeping and tax service. Full or spare time. Details free. No obligation. Ellis, Box 200, Cedar Grove, North Carolina.

**MEDICAL Laboratory technicians** in great demand. We train you in your own home. Catalogue free. Imperial Technical Institute, Box 973-J, Austin, Texas.

**INVESTIGATOR Training.** Phillips Secret Service System, 1917-B North Kenneth, Chicago 39.

**USED Correspondence courses** and books sold and rented. Money back guarantee. Catalog free. (Courses bought.) Lee Mountain, Pisgah, Alabama.

**AUCTIONEERING—Be an auctioneer.** Earn big money. Term soon. Write for catalog. Kansas City Auction School, Suite 307 Shankman Building, 3119 Troost, Kansas City, Missouri.

**UNIVERSITY Degrees** by residence and correspondence. Golden State University, Hollywood, Calif.

**PIANO Tuning** pays. Learn this profitable profession at home easily with patented Tunometer and mechanical aids. No knowledge music necessary. Diploma granted. Veteran approved. Write for booklet. Niles Bryant School, 3731 Stockton Blvd., Dept. P, Sacramento 20, Calif.

**"INDUSTRIAL Drafting Opportunities."** Free booklet. Write—Industrial Training, 1704-A Frederick, Fort Worth 7, Texas.

**GOVERNMENT Position!** Home training for examination, \$9.95. Refunded if don't pass. Write, Oment Instructions, 34-CS, St. Louis, Mo.

**EARN Big pay.** Become criminal investigator. Wonderful field to work in. Train at home. Very easily mastered. Details free. C I & I Academy, 257 South Spring Street, Los Angeles 12, California.

## PLAYS, STORIES, MANUSCRIPTS

**NO Luck finding a book publisher?** Write for free Booklet PM. Vantage Press, 120 W. 31, New York.

**BEGINNING Writers:** Get \$1 to \$20 checks daily writing simple children's stories, articles, poetry in your sparetime. Experience unnecessary. Our instructions reveal how. Details free. W. Herman, 5927 Euclid, Cleveland 3, Ohio.

**BOOK Manuscripts invited—Cooperative publishers** since 1925. Meador Press, 324 Newbury St., Boston 15, Mass.

## BUSINESS SERVICE

**SWAP List.** Thousand offers. Dollars saved. Rush quarter. Traders' Club, Alger, Mich.

## SPECIAL SERVICES

**AIRMAILED Remails Arabia or Lebanon.** \$1.00 each. Staast, Box 2635, Dhahran, Saudi Arabia.

**LETTERS Retailed** from New York City 25c each. Other major cities in U.S. 30c. Havana, Bermuda, Trinidad. Request rates. Make our address yours. \$5.00 month. Prompt reliable service. Ardell, 251 W. 15 St., New York 11, N. Y.

**HELP Wanted ads** from Cincinnati air mailed \$1.00. L&M, 3136 Portsmouth, Cincinnati, Ohio.

**STARTING A business?** Need help? Avoid costly pitfalls. Write Marchner Business Service, 2053 East Main St., Rochester 9, N. Y.

**KEEP Out of dog house.** We remember birthdays, anniversaries and shop (even Xmas) to fit budget. \$2 to \$2000. Send stamped addressed envelope and 20c. Box 227, Rettil, Washington.

**NEW York remails.** 25c. Puley, 515 W. 174th St., New York 32, N. Y.



## CARTOONING, COMMERCIAL ART, SHOWCARD & SIGN PAINTING, TATTOOING

"HOW To Earn \$100-\$200 Monthly With Simple Cartoons." Folio \$2.00. Jerry Borosky, 42 Clement, San Francisco, Calif.

CHALK Talks. Laugh producing program, \$1.00. Catalog 10c. Balda The Cartoonist, Oshkosh, Wisconsin.

## ADVERTISING AGENCIES, LETTER WRITERS, FOR ADVERTISERS

FRESH Mailing lists, guaranteed. Opportunity seekers, mail buyers, births, brides. Other classifications from our own files. Transamerican, Box 815, Atlanta 1, Georgia.

NAMES New N.C. mothers. Births May-June 1954. 200-\$1.00. Treb, 2339 Winthrop, Charlotte 3, N. C.

20,000 NAMES And addresses of nationally selected curious potential customers. Order at \$1.00 per 100 names. Kane & Kane, 296 Harrison Street, Niles, Ohio.

MAILING Lists, most any classification. 1000 names \$5.00. 1000 your circulars mailed with ours \$4.00. 5000 your circulars printed and mailed \$12.95. Write Dixie Mailers, King, North Carolina.

ADS Placed in out of town newspapers and magazines. Low rates. Catalogue free. Ideas that pay. Baker Advertising Agency, Successors Ankrum Agency, 189 W. Madison, Chicago 3.

BEFORE Advertising get instructive Ad-Guide and Ratebook, 10c. Ideas developed. Advertisements prepared free. Chicago Advertising Agency (Established 1900), Chicago 4.

## RUBBER STAMPS AND OFFICE SUPPLIES

SAVE Money. Say it with rubber stamps. Ours excel with lowest prices. 35c up. Try us. 100% guarantee. Catalog 10c refunded. Esco, 174 Print, 8 Holt, Dayton 7, Ohio.

FULL Size 3 line. \$1.00. Adstamp. 65 Cline, Dayton 9, Ohio.

RUBBER Stamps by professional craftsmen. 3 lines \$1.00. Price list, South Coast Press, P.O. Box 2074, San Bernardino, Calif.

3 LINES \$1.00 Additional lines 25c. Free pad or airmail stamp. Expert craftsmen. Printex, Roanoke, Virginia.

3 LINES, \$1.00. Fast service! Catalogue. Johnson Press, Box 6-A, New York City 26.

## TYPEWRITERS, DUPLICATORS, OFFICE DEVICES

RECONDITIONED Typewriters, duplicating, printing devices, \$25.00 up. Supplies. Appliances. DixieGraph, King, N. C.

## PRINTING, MULTIGRAPHING, MIMEOGRAPHING, GUMMED LABELS

1000 RAISED Printing business cards, \$4.00. Samples free. Simon, 1556 Hoe Avenue, New York 60.

OFFSET Printing \$6.50 - 1000, 8 1/2 x 11, 16 lb. National Letter, 1463 Broadway, New York 36.

ENVELOPES - 6 1/2. Printed. 500, \$2.25; 1000, \$3.75; 2000, \$6.50; l.o.b. Hargraves, Box 517, Corning, N. Y.

100 8 1/2 x 11 HAMMERMILL Letterheads and 100 envelopes \$1.95 postpaid. H. Hudson, Centredale, R.I.

BUSINESS Cards. Finest vellum. 1000, \$3.50; 500, \$2.00. Free type-chart. Quality Products, Box 145, Madison, Ohio

RAISED Lettering business cards \$3.95 thousand. John Wood, Box 723, Tyler, Texas.

OFFSET And letterpress printing. Submit specifications for estimate. Raum's, 4154 Fifth Street, Philadelphia 40.

QUALITY Printing, reasonable prices, estimates free. Barber, 596 Girard, Marion, Ohio.

100 LETTERHEADS Or envelopes \$1.00. Two colors \$1.50. Broadbrook, Botsford, Conn.

STATIONERY, Cards, labels, miscellaneous. Samples free. R. Bailey, Monterey, Tenn.

EXPERT Printing business and personal. price lists, samples, free. Steinbergen, 1274-V, New York City 59.

BETTER Printing - Lowest prices, all kinds. Samples, estimates. Reporter, Chelsea, Oklahoma.

100 ENVELOPES. Printed 2-colors \$1.25. Box 523, Rochester 2, N. Y.

MIMEOGRAPHING - Letters, price lists, formulas, instructions. Lowest prices. Lem's Letter Shop, 9710 Stanton, Detroit 8.

500 3 1/2 x 2 1/4 FOUR Line gummed stickers 50c. Red border \$1.00. Moritz Printery, Saginaw, Mich.

ATTRACTIVE Labels, stickers. Inexpensive. Samples, Fame, 291 Ellis, San Francisco 2, Calif.

JOB Printing, letterheads, envelopes, circulars. Printing, 21 Barclay, Portsmouth, Virginia.

FREE Samples, airmailed. Distinctive letterpress, color litho, raised printing. Prompt service. D & M Sales Company, 1438 Gravenstein North, Sebastopol, Calif.

## PRINTING OUTFITS AND SUPPLIES

MAKE Your own self-molding rubber stamps and printing cuts. Pexirubber, Argyle 1, Wisconsin.

ENRICH Your spare time, use genuine printing outfits. "How to Print" booklet; price 25c - easy rules; print in one day. We supply presses, etc., factory to you. Start your own business. Do church, club, commercial work, etc. Craftsmen M'chy., 551 Atlantic Avenue, Boston 10, Mass.

PRESSES, Type, cabinets, supplies. List for stamp, Lincoln Press Company, 220-G Hartwell, Fall River, Mass.

DO Your own printing. Save money. Simple rules. We supply everything. Print for others; good profit. Raised printing like engraving too. Have home shop. Details free. Kelsey Presses, V-11, Meriden, Connecticut.

PRINTING Presses, type, supplies. Lists Jc. Turnbaugh Service, Loysville, Penna.

PRESSES, Supplies, rubber stamp machines. Catalog 10c. Box 211-P, Springfield, Missouri.

FREE Booklet, "Make Your Own Cuts." Amazing new process. Walp, Box 4308-M, Mobile, Ala.

## PATENT ATTORNEYS

INVENTORS - If you believe you have an invention, you should find out how to protect it. The firm of McMorrow, Berman & Davidson with offices in Washington, D. C., is qualified to take the necessary steps for you. Send for copy of our patent booklet "How to Protect Your Invention." We will also send you an "Invention Record" form. No obligation. They are yours for the asking. McMorrow, Berman & Davidson, Registered Patent Attorneys, 134-F Victor Building, Washington 1, D. C.

INVENTORS - If you have a valuable invention, you are advised to authorize a preliminary search through appropriate classes of United States patents. This firm is registered to practice before the patent office and is available to make such search and report to you concerning the probable patentability of your invention. Instructive booklet with "Evidence of Invention" form sent upon request. Victor J. Evans & Co., 931-H Merlin Building, Washington 6, D. C.

INVENTORS: Learn how to protect your invention. Special booklet "Patent Guide for the Inventor" containing detailed information concerning patent protection and procedure together with "Record of Invention" form will be promptly forwarded to you upon request - without obligation. We are registered to practice before the U. S. Patent Office and prepared to serve you in the handling of your patent matters. Clarence A. O'Brien & Harvey Jacobson, Registered Patent Attorneys, 41B-G District National Building, Washington, D. C.

CANADA - Ramsay Company Registered, 273 Bank Street, Ottawa, Canada.

"INVENTOR'S Guide" and "Record of Invention" free on request. Frank P. Ledermann, Registered Patent Attorney, 154 Nassau Street, New York City.

PATENTS. "Proof of Invention" free. E. E. Vrooman, Registered Patent Attorney, 507 McKim Building, Washington 5, D. C.

PATENTS - Irving L. McCathran, 315 McLachlan Bldg., Washington 1, D. C. Registered Patent Attorney.

INVENTORS: When you are satisfied that you have invented something of value write me, without obligation, for information as to what steps you should take to secure a patent. Write Patrick D. Beavers, Registered Patent Atty., 925 Columbian Bldg., Washington 1, D. C.

C. A. Snow & Co. - M427, Snow Building, Washington 1, D. C. Registered Patent Attorneys. Write for information.

INVENTORS - For "Invention Record" form, contact Carl Miller, Registered Patent Attorney, Woolworth Building, New York.

INVENTORS: Without obligation, write for information explaining the steps you should take to secure a patent. John Randolph, Registered Patent Attorney, 203 Columbian Bldg., Washington 1, D. C.

## FOR INVENTORS

INVENTORS - This firm is registered to practice before the United States Patent Office and is available to assist you in the preparation and prosecution of your patent application. "Patent Protection for Inventors" booklet containing detailed information and steps to take toward patent protection will be sent upon request. No obligation. Victor J. Evans & Co., 932-H Merlin Building, Washington 6, D. C.

INVENTORS - If you believe you have an invention, you should find out how to protect it. The firm of McMorrow, Berman & Davidson with offices in Washington, D. C., is qualified to take the necessary steps for you. Send for copy of our patent booklet "How to Protect Your Invention." We will also send you an "Invention Record" form. No obligation. They are yours for the asking. McMorrow, Berman & Davidson, Registered Patent Attorneys, 134-E Victor Building, Washington 1, D. C.

INVENTORS: Learn how to protect your invention. Special booklet "Patent Guide for the Inventor" containing detailed information concerning patent protection and procedure together with "Record of Invention" form will be promptly forwarded to you upon request - without obligation. We are registered to practice before the U. S. Patent Office and prepared to serve you in the handling of your patent matters. Clarence A. O'Brien & Harvey Jacobson, Registered Patent Attorneys, 41-A-G District National Building, Washington, D. C.

INVENTION Analysis and appraisal. Particulars. N. W. Halsey, Box 65, Jackson Heights, N. Y.

MONEY From your valuable ideas! The International Inventors Club helps you patent and sell your inventions. Membership only \$15 year. Free information. 6514 Metropolitan Station, Los Angeles 55, California.

MONEY From your ideas. Information free. Grayland, 5312 PM6 Grace, Chicago 41.

UNLIMITED Money to promote your invention! New manual tells exactly where - how! Can be worth thousands! Costs only \$2.00. Send today! Bruce Associates, 6773P Santa Monica Blvd., Hollywood 38, California.

ANY Promising invention designed, developed or marketed. Industrial Engineering Research Institute, 132 Nassau, New York 38.

INVENTORS - Send for free patent information book and inventor's record. Registered Patent Attorney, Associate Examiner, Patent Office 1922-29; Patent Attorney & Advisor, Navy Department 1930-47. Gustave Miller, 54A Warner Building, Washington 4, D. C.

PATENT Searches, \$5.00, including patent copies. Same reliable search as conducted for patent attorneys. Free protection forms. Patent Service Institute, 945-A Pennsylvania Avenue, Washington 4, D. C.

INVENTORS - For "Invention Record" form, contact Carl Miller, Registered Patent Attorney, Woolworth Building, New York.

SEARCHES - Put your patent searches in the hands of a registered patent attorney or agent, as he qualifies to give a worthwhile patentability report. Record of invention form upon request and information on patent protection. Patrick D. Beavers, Registered Patent Attorney, 936 Columbian Bldg., Washington 1, D. C.



**INVENTORS:** Information on patent procedure furnished on request, without obligation. John Randolph, Registered Patent Attorney, 202 Columbian Building, Washington 1, D. C.

I Sell patents. Established 1900. Charles A. Scott, 733PM Garson Avenue, Rochester 9, N. Y.

**INVENTORS:** If you have an invention for sale, patented or unpatented, write Institute of American Inventors, Dept. 40A, 631-E St. N.W., Washington 4, D. C.

"INVENTOR'S Guide" and "Record of Invention" free on request. Frank P. Ledermann, 154 Nassau Street, New York 38, N. Y.

**INVENTORS**—Better help, cheapest. Proof. Write, Demitz, Box 5641, Norfolk 3, Virginia.

**PATENT** Searches \$5. 48-hour airmail service. Record of invention forms free. Write Patent Engineering Service, 711 14th Street, N.W., Washington 5, D.C.

**PATENT** Searches \$5. 48-hour service. Free record of invention. Write Raymond L. Smith, Patent Searcher, 622 Sheraton Building, Washington 5, D. C.

**PATENT** Searches, including copies of nearest patents, \$5. Reports airmailed within 48 hours. More than 75 registered patent attorneys use my service. For free invention protection forms, write Miss Ann Hastings, P.O. Box 176, Washington 4, D.C.

**PATENT** Services, \$5, including patent copies, 48-hour air mail service. Invention protection forms free. Patent drawings prepared. Edward Abber, Warner Bldg., Washington 4, D. C.

**CASH** For your idea. 280 manufacturers need inventions, patented or unpatented. List free. Invention Bureau, 208M Clinton, Oak Park, Ill.

#### INVENTIONS WANTED

**ESTABLISHED** Manufacturer wants patented or unpatented items to manufacture. Preferably metal products. Cash or royalty basis. Lorwood Industries, 2287 Riverside Drive, Los Angeles 39, California.

**GUARANTEED** Promotion services. Patented, unpatented inventions. Free particulars. Superior Inventions, 240 South Beverly, Beverly Hills, Calif.

**INVENTORS:** If your invention is adaptable to our business we will contract on cash or royalty. If not, we will try to place. Free booklet. Kessler Sales Corporation, 37A, Fremont, Ohio.

**INVENTORS:** We sell your manufactured inventions, merchandise nationally. Thousands of buyers. No cost plan. Details free. A. Smith-Parrish Co., 809 G Street, Rupert, Idaho.

**OPPORTUNITY** For limited number who have inventive ability. Inventors Research, 1154 N. Western, Hollywood, Calif.

**INVENTORS** don't sell your invention, patented or unpatented, until you receive our offer. Write Cowgill, Box 298, Marson, Ohio.

**INVENTIONS** Promoted. Patented or unpatented. Established 1911. Write Adam Fisher Company, 5418 Idaho, St. Louis, Mo.

**INVENTIONS** Wanted. Patented, pending only. Inventors Patent Exchange, Hartford 1, Conn.

**INVENTORS:** Hundreds of manufacturers have requested our assistance in locating marketable new products. Complete information free. Institute of American Inventors, Dept. 40-D, 631-E St. N.W., Washington 4, D. C.

**INVENTIONS** Wanted. Patented; unpatented. Tremendous manufacturers lists. Global Marketing Service, 1404 Mitchell, Oakland 1, California.

**INVENTIONS** Wanted. Patented or patented pending. 23 years experience promoting inventions. National Service Bureau, 3120 Meramec, St. Louis 18, Mo.

#### PATENTS FOR SALE

**LOCKED** Out? Safe key locker is answer to lost key problems for homes, autos, etc. Patent 2,672,043 available on very reasonable royalty basis. L. Fleischman, 2190 Geary St., San Francisco 15, Calif.

**INVENTORS:** Test the commercial value of your patented or unpatented inventions, quickly and inexpensively. Write for free information. Institute of American Inventors, Dept. 40-B, 631-E St. N.W., Washington 4, D. C.

**HINGE.** That makes pickup into hay truck, stock truck, or covered truck. Hinger, 1830 Armstrong, Colorado Springs, Colorado.

**SALD:** Basic patented Seim Pullers. Hundreds infringed. Big money involved. Buyer collects. Inventor Berglann, P.O. Box 61, Astoria, Oregon.

#### MANUFACTURING

**WANTED:** Aeronautical, mechanical and electronic accessories to manufacture and sell. Cash or royalty. Robbins Aviation, 1735 W. Florence Ave., Los Angeles 47, California.

**WE** Design, develop, build, inventions, machinery, appliances. Henry, 2815 Blvd., Jersey City 6, N. J.

**MODELS** — small lot manufacturing. Metals, plastics, etc. Milburn, Burlington, Kentucky.

#### MODELS, MODEL SUPPLIES

**FAMOUS** German Fleischmann steam engines \$5.95 to \$85.00 and mechanical snips 79c to \$45.00 postpaid. Catalog 35c. Merio, 50-18 94 St., Elmhurst 73, N. Y.

**1954 CAR** Models. 1/25 scale, all metal, chrome trim. Send for catalog. Cars & Hobbies, Dept. PM-20, 2333 Haddon, Chicago.

**SHIP** And yacht model fittings; blueprints. Send 25c for illustrated catalog listing hundreds of items. A. J. Fisher, 1002-1 Etowah Ave., Royal Oak, Mich.

**SHIP** And other scale models. Most complete line in New England. Kits, fittings, plans, books, tools, engines, motors. Illustrated catalog 25c. James Bliss & Co., Inc., Dept. SM, 342 Atlantic Ave., Boston 10, Mass.

**WALSA** Wood, Grade AAA. Free sample, price list. Sig Mfg. Co., Montezuma, Iowa.

**NEW** Completely revised giant 88-page 1954 "O" gauge catalog for model railroads. Scale and tinplate. Fully illustrated. Hundreds of car kits all types, steam locomotives, diesels, specialty items and parts galore. Catalog cost of 75c refunded with first \$5.00 order. All-Nation Hobby Shop, 182 N. La Salle St., Dept. A, Chicago 1, Ill.

#### HOME CRAFTSMEN

**LEATHERCRAFT** For pleasure or profit. Make easy-to-assemble purses, belts, gloves, woolskin toys, 100 other items for gifts or to sell. Send 10c today for big catalog. Largest leathercraft stock in U.S. J. C. Larson Co., 820 S. Tripp, Dept. 4250, Chicago 24.

**ELECTRIC** Kiln for making expensive porcelain enameled jewelry and complete kit, including beautiful enamels (powdered glass, not paint), jewelry parts, and everything necessary to make handsome earrings, pins, etc. Creative, profitable hobby in recognized art medium! First time offered—\$6.95, plus 35c postage. Louisiana residents add 2%. Lea's, Dept. A, Box 582 SLI, Lafayette, La.

**101 FULL** Size patterns. Smart, new gifts, novelties, lawn figures, shelves, action windmills, alphabets. Plus "Make Money Jig Sawing." Only \$1.00. Mastercraft 75M, 7041 Olcott, Chicago 31, Illinois.

**HARDWARE** Supplies, tools, prefab furniture. Complete catalog 25c. Handcraft, 2235W McKinley Blvd., Milwaukee 8, Wis.

**VENEERS** .010" Thick. Glueable without press. Mahogany, birch, others. Free samples. Write Miles Goff, North Girard, Penna.

**16 NEW** Lawn chairs, 22 picnic tables, benches, trellises, etc. All 38 plans with necessary full size patterns, \$1.00. Mastercraft 75M, 7041 Olcott, Chicago 31, Ill.

**HAVE** Fun, make money. 110 jigsaw patterns. Trace, cut, paint. Unusual animals, shelves, etc. \$1. Trans Plans, 35-22C 191 St., Flushing, N. Y.

**89 FULL** Size jig saw patterns of beautiful shelves, ornaments, toys, novelties. Plus "How, Where to Sell." Only \$1.00. Mastercraft 74M, 7041 Olcott, Chicago 31, Illinois.

**LEATHERCRAFT.** Tremendous stock of leather, tools, supplies, and kits. In leather business over forty years. Send 10c for big catalog. Sax Bros., 1111 No. 3rd, Dept. PM7, Milwaukee 3, Wisconsin.

**LAMP** Size cypress knee, nipple installed \$2.00. Cy Products, Dept. 2-K, Lafayette, La.

**RATIOMOTORS**—New unopened 110/220 v. 15 hp., 57 r.p.m., output 222 inch lbs. Open garage doors, fences, etc. \$55.00 f.o.b. Doyle, 51 Scio St., Rochester, N. Y.

**FORMICA,** Plastic veneer, Reynolds' aluminum, other products. Free literature. Home Craft Supplies, 1124 Rebecca Ave., Pittsburgh 21, Penna.

**HAND** Or power saw owners! Flower boxes, bright wooden flowers ideal for spring or fall. Seattle dog, cigarette box, bellboy ashtray stand 33" high, shelves, novelties. Full size patterns, \$1.25. Home Craftsman, Box 423, Fort Dodge, Iowa.

**LEATHERCRAFT,** Metal tooling, textile painting, beadcraft, shellcraft, many other crafts. Fun, easy, profitable! Free, big, illustrated catalog. Write today. Kit Kraft, Dept. 257, Hollywood 46, Calif.

**PLASTICS** Home-craft course for men and women. Tells and shows how to make hundreds of fast selling plastics products. All plastics and materials for 23 projects included in course. No special tools needed. Course pays for itself. Write for free booklet. Interstate Training Service, Dept. D-3-G, Portland 13, Oregon.

**FREE "Do-It-Yourself"** leathercraft catalog. Tandy Leather Company, Box 791-D5, Fort Worth, Texas.

**TOUGHEST,** Glossiest home bake-on enamels you ever saw. Also, a new economical paint saver. Write Chemicals International, Marshall, Illinois.

**BUY** Wholesale nationally advertised power, hand tools, thousands of other products at big discounts. Free "Wholesale Plan." American Buyers', 628-PP Linden, Buffalo 16, N. Y.

**COMPLETE** Detailed information on the requirements, design installation, operation, maintenance and repair of home plumbing systems, including the proper use of tools and materials, is given the layman in Home Plumbing Guide, \$3.50. It's the first book for the layman in it's field and one that answers a long-felt need. Easy to understand! Hundreds of illustrations, diagrams and drawings. Order today Popular Mechanics Press, 200 E. Ontario, Chicago 11, Illinois.

**"DO-IT-YOURSELF"** LeatherKraft catalog free! Drop 2c postcard Box 397-O, Tandy Leather, Tulsa, Oklahoma.

**MONEY** At home! Create beautiful costume jewelry. Send 25c for sample pin, quality rhinestones, complete catalogue. Beck Jewelry Co., 245 Straight Street, Paterson, N. J.

**129 NEW** Full size jigsaw patterns. Unusual novelties, gifts, lawn figures up to 22 inches high, action (merry-go-round) windmill, toys, useful gadgets. Artist drawn. \$1. Craftplans, 1321-A South Michigan, Chicago 5.

**LEATHER,** Tools, lacings, supplies. Free catalog. National Handicraft, 199 William St., New York 7.

**STYLECRAFT** Sure fire hits. "Pre-traced" leather kits. Handbags, billfolds, filigree belts, over fifty other projects. Patterns on leather. Why trace? Just carve, assemble and lace. Large assortment "precarved" kits also available. Send 25c for catalog, free folder. Refunded first order. Apache Leather Company, 2804 E. Washington St., Phoenix, Arizona.

**35 LAWN** And garden ornament patterns. Full size, ready cut, colors indicated. Only \$1.00. Lincoln Craft Studio, Columbia, Conn.

**KNOCKDOWN** Cedar chests. Lumber and veneers. Free price list. Giles & Kendall Company, Huntsville, Ala.

**FREE** Information. Money-making full size patterns. Professional designs. Furniture, gift shop items. Write Jigsaws, 117 Worth, New York 13.

**"TOPS"** In everything for leathercraft. Lowest prices. Genuine "Craftool" stamps. Catalog 10c. Crown Leather Company, 22 Spruce Street, New York 38.

**KNOCKDOWN** Cedar chests and lumber. Free price list. Bedford Lumber Company, Shelbyville, Tennessee.

**MAKE** Beautiful lamps, smoking stands, and etc. from our Cholla cactus wood. One piece to make table lamp \$1.00 postpaid. Free price list. ChollaCraft, 7133 Hi Way 80 East, El Paso, Texas.

**COMPLETE** Plans for 6 foot sawbuck table and bench; with full size patterns, assembly drawings, and building procedure. 50c postpaid. Mavon Design Studio, P.O. Box 62-M, Stamford, Conn.



## MAKE IT YOURSELF

**WINDOW Fan kits**—All parts necessary to make 30 inch fan except motor and box. \$16.50 postpaid. Free circular. McDonald's, Bay St. Louis, Mississippi.

**GEIGER Counter** and metal detector kits. Inexpensive, educational. Free literature. Electronic Applications, Box 4973, Washington 8, D. C.

**BEAUTIFUL Birdhouse** in kit form, plans included. Send \$1.50. Schomaker, 511 Helois Ave., New Orleans, La.

**50 TOY Plans** 50c. Easily built using household items. M. Mascorro, 1039 Waverly, San Antonio 1, Texas.

**INFLATE Balloons** with lighter-than-air gas. Enjoy fascinating new hobby and unusual sport. Build your own apparatus. Send messages hundreds of miles. Use for target practice. Simple, low cost, easy-to-build. Diagrams, formula, complete instructions. Send \$1. Central Machine Works, Dept. PM, Sioux City, Iowa.

**AWNINGS**—All-aluminum. Make your own! Assemble America's most beautiful aluminum door canopies and window awnings. The sides are pre-assembled. Save 50%. Factory to you. Free measuring chart and literature. Herbert's Aluminum Awnings, Dept. 1, 3974 St. Charles Rd., St. Louis 14, Mo.

**ADVICE** On building construction problems. \$1.00 per question. Roth Tech, Box 2283, Youngstown 4, Ohio.

**MAKE Spool doll**, weather prophet, candle, wall hanger, baby shoes. Instructions \$1.00. Norris' 1025 Security Bldg., Long Beach 2, California.

**FANS**—Window and attic, from kits, Torrington steel blades, full size patterns. Catalog free. Gilliom Power Tools, Dept. 40, Lambert Field, St. Louis 21, Mo.

**"BABY Sitter."** Hear baby from any room or neighbor's home. Simple instructions, 50c. Koch, 75 Farmington, Rochester 9, N. Y.

**NEW Campfire**, world's greatest discovery for campers, picnickers, sportsmen. Cook meals even in subzero temperatures, cost nothing. Complete instructions \$1. Turk, 815½ Delmar, St. Louis, Mo.

**BUILD** Inexpensive concrete blockmaker. Motor-hand. Also mixer. Make blocks for 5 room house for \$93. Write, C. Lee, Mountain View, Oklahoma.

**300 PROJECTS** You can make—In Popular Mechanics' 32-page blueprint catalog. Send 3c stamp for copy. Popular Mechanics, 200 E. Ontario St., Chicago 11, Ill.

**CALIFORNIA Redwood burl**—2x6x8, 90c; 2x8x8, \$1.45; 2x10x10, \$2.25; 3x10x10, \$3.20. Postpaid. Hardwood price list. Fernwood Products, 5151 Branciforte Drive, Santa Cruz, California.

**GENUINE Savings.** Chain saw, also outboard motor, build-it-yourself kit arrives with step-by-step directions. You assemble and save. Preston, Box 5142, Grosse Pointe, Mich.

**GRANDFATHER Clock** easily built. Big savings. See ad on page 245.

**POWER Mower kits**, tree plans, instructions, parts list. Temco Mowers, Springfield 1, Missouri.

**"SITTING Ducks,"** an exciting water sport. For everyone in your beach party. You make it yourself from easily obtainable parts, in a few minutes. Instructions and rules \$1.00. Idio Products, Box 2737, Cleveland 11, Ohio.

**BUILD** Permanent awnings, patios, jalousie porch, bathtub and shower enclosures. Aluminum prefabricated frames. Assemble yourself and save. Close-out prices. Russ Smith, 1555 Ridgewood, Cleveland 7, Ohio.

**AWNINGS**—Aluminum. Free-do-it-yourself plan. For own home or start business. Write Garden State, Route 17, Lodi, N. J.

## WATCHES, OLD GOLD, JEWELRY

**WATCHMAKERS' Tools**, materials, supplies, watches. Catalog. Gales, Box 1000, Chicago 90, Ill.

**JEWELRY Making.** Profit! Fun! See "Electric Kiln" listing under "Home Craftsman."

**QUALITY Jewelry** at bargain prices! Large line of watches, rings, necklaces, etc., at unheard of low prices. Write immediately for our big illustrated catalog. Send 50c in coin to Ohio Valley Specialties Co., Box 158, Owensboro, Ky.

**WATCHES** Overhauled \$4.50. One year's guarantee. Berkowitz, 1150 Castlehill, New York 61.

**WATCH** And clock repairing books for hobbyists. Free information. North American, Dept. 14-G, 2320 N. Milwaukee, Chicago 47, Illinois.

**MAKE Rhinestone jewelry**—No tools needed. Huge profits. Catalog, instructions, sample pin, stones, and color chart of actual rhinestones 50c. Refundable. Bergen Arts, 128M Main, Hackensack, N. J.

**HIGHEST Prices** for gold, silver, platinum, diamonds, watches, gold teeth. Satisfaction assured. Goods returned if offer unsatisfactory. United Smelting Works (Old Reliable), 6-B East Monroe, Chicago 3.

**RHINESTONES, Jewelry settings**, cameos, sequins, beads, hobby kits. Send 10c for illustrated catalog. J & M Novelties, Dept. CH-3, Griffith, Indiana.

**HIGHEST Cash** paid for old gold, broken jewelry, gold teeth, watches, diamonds, silverware, spectacles, platinum. Free information. Satisfaction guaranteed. Rose Refiners, Heyworth Bldg., Chicago 2, Ill.

**FREE Sample pair** of earrings shows you how easy it is to make beautiful costume jewelry. Over 5000 styles listed in new catalog. 23c. Barry's, 178 Ardsley Court, Newark, N. J.

**JEWELRY Making** can be a profitable hobby—Send 20c for our latest illustrated catalog. Mildy-Fair Co., G.P.O. Box 1328, New York City.

**WATCHMAKERS'—Jewelers'** complete informative catalogue 20c. Bengale Company, Culver City, California.

## TOBACCO, SMOKERS' SUPPLIES

**FOR Sale**, satisfaction. Piltomat aluminum tip cigarette holders \$1.00. Anchor, 9350 Terry, Detroit 27.

## RAZORS, BLADES, SHARPENING

**ENJOY** Perfect shaves daily. Each blade gives 100 smoother-than-new shaves using Renuit—Proven aid to full shaving comfort. Conditions blade-edge each time in 10 seconds, saves on blades. No risk, try Renuit one year, full refund if not satisfied. \$1.98 prepaid. P. M. Renuit, 2609 N. 61st Street, Milwaukee 10, Wis.

## FOR THE HOME

**FIRE**, Effective new extinguisher. Home, car, business. Millions sold. Details free. Day, Mount Morris 2, New York.

**MURALS**, Natural colors, 40"x60", \$14.75. Catalog 10c. Shriber's, 1920 Beaver, Pittsburgh 33, Penna.

**SEPTIC Tanks**, outdoor toilets reconditioned, deodorized without digging, pumping. Easy, guaranteed do-it-yourself method free. Write Granite State Industries, Box 507B, Manchester, N. H.

**FOAM Rubber furniture cushions.** Factory seconds, 50% discount. Free catalog. Perma-Foam, 140-C Main Street, East Orange, New Jersey.

## OF INTEREST TO WOMEN

**EMBROIDER** Stamped lines. Buy direct from manufacturer and save. Send for free catalog. Merrilee, Dept. 594, 22 West 21st Street, New York 10, N. Y.

**BAROAINS** Direct from Ireland to you. Pure Irish linen double damask tablecloths, 54"x54", \$5. Handpainted pure linen guest towels, \$3 pair. Lovely hand-embroidered pure linen handkerchief, \$1 each. Postpaid. Quick service. Send cash, check, money order. Irish Parcels, 59 Merrion Square, Dublin, Ireland.

**"PRO-Tec-Ur-Dor."** Every automobile needs. Write. Lindner, 153-P West 33, New York 1.

**NEW Towels**—Large size, assorted colors. Money back guarantee. 12 for \$1. Order now! Murray Hill House, 304-PM East 32nd Street, New York.

**GARMENT Bags**—Giant size (58"x48"). Heavyweight plastic, 100% moth and vermin proof. New! Not seconds. Money back guarantee. 3 for \$1.00. Order now! Handicraft Mills, 304-PM East 32nd Street, New York.

**GROW Mushrooms.** Cellar, shed, and outdoors. Spare, full time, year round. We pay \$3.50 lb. We paid Babbitt \$1.165.00 in few weeks. Free book. Washington Mushroom Ind., Dept. 176, 2954 Admiral Way, Seattle, Washington.

**NYLONS 14c.** Anklets 6c, socks 9c, print 17c, panties 12c, dresses 50c, slips 47c, undershirts 17c, robes \$1.65, spreads \$2.65, jewelry \$1.25, watches \$3.50, electric razors \$2.00, aspirin \$1.00—1,000, brushes 9c, razor blades 1½c, pens 8c, combs 1½c. Complete stock list, picture catalogue, 25c. Send immediately. Sibert's, Chattanooga 4, Tennessee.

**MAKE Big money** at home! Invisible reweaving pays \$10.00 profit an hour spare time. Make tears, cuts, holes disappear from fabrics. Constant demand from laundries, cleaners, homes assures steady earnings. Details free. Fabricer, Dept. C, 8342 S. Prairie, Chicago 19, Ill.

**PROFITABLE Home business.** Make fast-seller chenille monkey trees, dolls, flowers. Terrific holiday demand. Information free. Velva, Bohemia 16, N. Y.

## FOR SALE—MISCELLANEOUS

**HEARING Aid** batteries, wholesale. Free list. Habs, Box 51, York, Penna.

## WANTED—MISCELLANEOUS

**SCRAP Mercury (quicksilver)** containers supplied—Tantalum, bismuth, tungsten. Metallurgical Products Company, Established 1909, 35th and Moore Sts., Philadelphia 45, Penna.

**QUICKSILVER.** Platinum, silver, diamonds, indium. Write. Wholesale Terminal, Norwood, Massachusetts.

## PERSONAL

**LETTERS** Remailed Milwaukee, 25c. George, Box 1763, Milwaukee 1, Wis.

**MIAMI Or Hollywood, Florida.** Letters remailed. 25c. Classified \$1.00. Hopes, Box 129, Hollywood, Florida.

**BOSTON, Mass.,** letters remailed 25c. Prompt service, Richmond, 45A Bowdoin St., Boston.

**HONOLULU,** Hawaii remailings, 25c. Confidential services. Leong, 1119 Pawaia Lane, Honolulu.

**NEW York City** letters remailed 25c each. Frank Kelly, 1521 Nelson Ave., Bronx 52, New York.

**SIXTEEN** Deckled half-fold photos \$1.00. Send photo or negative. Conaways, Box 7261, San Antonio 10, Texas.

**CALIFORNIA** Mail address! Receiving-forwarding. Monthly rates. Letters remailed 25c. Shanks, Box 3110, San Francisco 19.

**ATLANTA** Address, business or personal. Monthly rates. Details free. Remails 25c. Confidential. Everett's, Box 815, Atlanta 1, Georgia.

**AFRICA**—Letters reairmailed \$1 each. Ordermail, Box 10300, Johannesburg, S. Africa.

**LETTERS** Remailed, Albany, N. Y., 25c. Local information \$1.00. Hale, Box 1, Glenmont, N. Y.

**NEW York City**—Letters remailed 25c each. Ten postcards \$1.00. Ferguson, P.O. Box 716, Grand Central Station, New York 17, N. Y.

**ESOTERIC Curiosa**, rare adult books, manuscripts, pamphlets, readers, booklets; English, French, German. Indicate title, author or subjects desired. Send stamped envelope for reply. Francene, Box PM-2, 949 Broadway, New York 10, N. Y.

**WHOLESALE** Nationally advertised merchandise, 20-50% discounts. Sell retail, make big profits. Big catalog 50c. Willshire, Box 815, Atlanta 1, Georgia.

**ENID** Remailing, 25c a letter, 7 for \$1. Vaughn Knott, 421 So. Harrison, Enid, Okla.

**LETTERS** Remailed from Cincinnati, Ohio, 25c each, 5 for \$1.00. L&M, 3136 Portsmouth, Cincinnati, Ohio.

**"HOW Can I find out?"** You can! Information confidentially developed. Any matter, person, problem. Worldwide. Officially licensed. Established 1922. William Herman, 170 Broadway, New York City.

**SAN Antonio** remails 25c. Alamo Service, 1622 Alhambra, San Antonio, Texas.

**REMAIL.** Alaska \$1.00. Samuel Fairchild, 246 Fourth Avenue, Anchorage, Alaska.

**PHOTOSTAMPS** Give originality to your letters, postcards and greeting cards. They are real glossy photographs of yourself in stamp form. Produced from any size negative or positive. Only \$2.00 for 200; or doublesize, 100. Samples, details, 10c. Pabians, Box 1547, Washington 13, D. C.



PARIS Remails, 3 letters \$1.00. Sloan, 14 Rue D'Abbeville, Paris X, France.

LOS Angeles remails 25c. Forwarding confidential. Mercier, 835 South Oxford, Los Angeles 5, Calif.

CHICAGO Remails 25c. Forwarding confidential. Winslow, Suite 635, 4980 Marine Drive, Chicago 40.

MEXICO Remail 25c—6 for \$1.00. Frontier, Box 3032 Sta. A. El Paso, Texas.

ALL States and foreign remailing. Business and personal address, details 10c. Chicago postmark 25c. Macks Mailorder, 5656 No. Hermitage, Chicago 26-Y, Ill.

LETTERS Remaild 25c. Personal forwarding address. Monthly rates. Hicks Service, Box 1547, Washington 13, D. C.

MEXICAN Law office. Bank references. P.O. Box 41, Juarez, Chih., Mexico.

REMAILS Cripple Creek, Colo. World's greatest gold camp. 25c. Palace Hotel, Cripple Creek, Colo.

LETTERS Remaild 25c. Receiving-forwarding address. Hackney, 1201 Columbia, Houston 8, Texas.

MEN! Women! Want beautiful well groomed hair? Get large Lanolin Protegin Cream \$1.00. Jordan, 743 Dorrance, Philadelphia 46, Penna.

JAPAN Air remails \$1. 6 for \$5. Paul Schumann, CPO Box 130, Yokohama.

SEATTLE Confidential remail letters, 25c. C. H. Bell, Box 91, Enumelaw, Wash.

JAPAN—Letters remailed, 25c, airmail \$1.00. Rogers, 1933 S.E. 32nd Place, Portland, Oregon.

#### MISCELLANEOUS

RETAPE Your Venetian blinds yourself. Plastic or cotton. Information free. Hochhalter Blind Co., Bloomington, Illinois.

URANIUM, Gold, silver, treasure. New power-packed, highly sensitive metal detectors and Geiger counters. Kit and factory assembled models from \$34.50. Lightest weight, guaranteed. Free literature. Electronic Applications, Box 4975, Washington 8, D. C.

GET The opportunity packet for the latest and best money-making offers in mail-order. Everything for 25c. Redmon, Capitol Heights 1, Maryland.

AMAZING Spanish amole root—Senorita's secret sun-cured shampoo for cleaning scalp, invigorating hair growth, giving romantic luster, removing dandruff. Generous supply \$3.75. Spanish Spur Trading Post, Mesilla, New Mexico.

IMPORTED Handwoven Mexican sarapes. Sample 10c. Box 7187D, San Diego 7, Calif.

RESEARCH. Accurate information any subject \$2. Box 7187C, San Diego 7, Calif.

GERMAN Address lists! Anything manufactured 25c. refundable. Burke Associates, Manchester 1, Mass.

CATALOG Of the most efficient sewer, cesspool and drain cleaning equipment. A model and product to handle any drain or cesspool problem. Electric Sewer Cleaning Co., Boston 34, Mass.

OPERATE Collection agency. "Gold Mine" opportunity. Lifetime business. Be respected. Franklin Credit, Roanoke 7, Virginia.

FREE Razor or woman's gift. 100 double edge blades \$1.00. Bolash, Box 12, New York 13, New York.

BOOKS! Any subject! Motors, machinery, radium, ore deposits, hydraulics, electricity, decorating, minerals, oil, \$2.95 each. Burke Associates, Manchester 1, Mass.

MAKE More money. "Financial Secrets" shows how. "Master Plan for Success" included. Both guaranteed. Send \$1 today. Best Books, 6711-Y Sunset, Hollywood 28, California.

SAVE 20% To 50%. Jewelry, radio, television, furniture, pianos, appliance, sporting goods. Free information. Merchandise Buying Service, 8231 Buffalo Ave., Chicago 17, Illinois.

CLOGGED Drains opened by new powerful chemical called Sursolvent. Removes grease, soap, tree roots, etc., without expensive digging and electric rodding machines. Simple to use. Mix with water and pour down sink. Postal brings free details. Electric Sewer Cleaning Co., Allston 34, Mass.

WANTED. Manufacturer needs home-workers for light pleasing work. Free instructions. Prompt wages. Particulars 25c. Valentine, Mullino, Oregon.

UNPAINTED Wall plaques, figurines. Free catalogue. Ball's Plastercraft, Toler, Ky.

INCREDIBLE! Become mental superman overnight! Free booklet! Bijou, Box 1727-MM, Hollywood 28, California.

GOLD, Silver, metal detectors. Geiger counters for uranium. Mineralsights. Sensational new fully guaranteed models. None finer. Information free. Detectron Corp., 5420 Vineland Ave., North Hollywood, California.

BUY Wholesale thousands nationally advertised products at big discount. Free "Wholesale Plan." American Buyers, 631-D Linden, Buffalo, N. Y.

"X-RAY Mind." Stupendous mental power. (Details 10c). Krishnar Institute, 1912 Lincoln-Park-West, Dept. MP, Chicago 14.

NATIONALLY Advertised electric shaver, large discount; write for information. Apex, 67-30 213 St., Bayside, N. Y.

BUILD Electric concrete mixer with simple hand tools, from material available around average workshop. Actually better than expensive manufactured mixer. Equally suitable for mixing poultry feed; dry chemicals. Makes perfect tumbler for industrial purposes. Complete prints, instructions, \$1.00. Bldmore Manufacturing Company, Box 281, Lynwood, Calif.

HOME Study for game warden, fish, park, forestry, wildlife and patrol service. Details free. Write Delmar Institute, A5, Whittier, Calif.

RECEIVE Magazines, samples, catalogues. Mails from everywhere. Offers, hundreds. Get listed 25c. Rorick, Box 86, Cincinnati 26, Ohio.

OUTDOOR Toilets, cesspools, septic tanks cleaned, deodorized with amazing, safe, harmless powder. Easy, economical to use. Saves digging, pumping. 150,000 customers guarantee satisfaction. Details free. Burson Laboratories, Dept. O-36, Chicago 22, Illinois.

TREASURE Finders for gold, silver and minerals. Money back guarantee, best available. Also Geiger counters for uranium prospectors, free information. Write Goldak Company, 1541 West Glenoaks, Glendale 1, Calif.

GROW Mushrooms. Cellar, shed, and outdoors. Spare, full time, year round. We pay \$3.50 lb. We paid Babbitt \$4,165.00 in few weeks. Free book. Washington Mushroom Ind., Dept. 175, 2954 Admiral Way, Seattle, Washington.

PANNING Gold—Free lesson; catalogue of mining, mineral books, supplies. Old Prospector, Box 729D1, Lodi, Calif.

SELECTIVE Metal and mineral detector. Revolutionary design. Distinguishes metals from black magnetic sands. Readily detects metals under salt water. Also Geiger counters. Free literature. Gardiner Electronics Company, 2018 N. Dayton, Phoenix, Arizona.

ATTENTION, Homeowners, nationally advertised hardware, tools, housewares, garden supplies, terrific savings. GB Enterprises, Box 75, Dept. A18, Merrick, Long Island, New York.

TREASURE—M-Scope Geiger counters, mineral locators. Why buy something inferior when you can buy the best at a lower price? Backed by years of experience. Fully guaranteed by factory. Detects minerals, metals, gold, silver, coins. Payment plan available. Proven superior performance. Free 16 page illustrated booklet. Fisher Research Lab., Inc., Palo Alto, California.

CIGARETTES—Roll 200 mild, tasty, guaranteed to please for 75c. Details free. Pete Moberly, Box 857, Owensboro, Ky.

WHOLESALE—500,000 Articles. Directory 10c. E. Ross, 516 Fifth Ave., New York 36.

## LEARN MEAT CUTTING AT NATIONAL

Pay After Graduation



The steady dependable trade of Meat Cutting taught easily in 8 short weeks. YOU LEARN BY DOING under actual meat market conditions in big modern school at Toledo.

For beginners or men with experience. Get a profitable store of your own. Remember, PEOPLE MUST EAT! Big pay jobs. Free employment help. Thousands of successful graduates.

Buying, cutting, percentage, pricing, advertising, selling, etc. A complete retail meat education. National School established over 30 years. Get National training NOW. Pay your tuition in easy weekly payments

after you graduate. Send coupon for FREE 52 page school catalog — TODAY. G.I. approved.

National School of Meat Cutting, Inc., Dept. 50-G, Toledo 4, Ohio

Send me your FREE school catalog on National Training at Toledo in Meat Cutting, Meat Merchandising and Self Service Meats. No obligation. No salesman will call.

Name \_\_\_\_\_ Age \_\_\_\_\_

Address \_\_\_\_\_

City \_\_\_\_\_ State \_\_\_\_\_

Approved for training Korean Veterans



**LOOK BETTER!  
FEEL BETTER!**

USE A  
**Vibrosage**  
ELECTRIC MASSAGER

- Professional-Type
- 4 Scientifically Designed Applicators
- Sanitary

A few minutes daily use of VIBROSAGE gives that stimulating, healthful aid to circulation . . . relief from aches and pains. Four applicators assure maximum effectiveness for scalp, face and body. Operates on 110 volt, 60 cycle A.C. Five day trial—money-back guarantee! If your dealer cannot supply you, send \$8.50 check or money order, for pre-paid shipment. Or, send \$2; pay postman balance plus postage and C.O.D. charges.

BEAUTY APPLIANCE CORP., Dept. V524-G, RACINE, WIS.



**Tiny Telescope**  
*Give "CLOSE-UPS"*  
FROM MILES AWAY

ONLY  
**\$3.95**  
TAX FREE

NO RISK TRIAL OFFER. If not 100% satisfied after 10 Day Trial return for full refund. Cash orders \$3.95 postpaid. (C.O.D. \$4.51) UNITED BINOCULAR CO., 9043 S. Western, Dept. PT-7708, Chicago 20.

A Powerful telescope yet the size of your thumb! Conceals completely inside palm of hand! A revolutionary German made optical achievement. Precision easy-slide operation. Scientifically ground lens provide Brilliant Illumination, sharp detailed images, Lustrous ALL CHROME with black trim. An all purpose performer . . . instant focusing from 2 feet to infinity! NOT A TOY! Case 50c extra.

**Up to 6 MILES MORE per Gal.**

Reported by Hundreds Using  
**MIRACLE ACTION TUR-B-LIZER**

Carburetor specialists say Tur-B-lizer is best patented improvement they have seen. Tested in millions of miles of driving in cars, trucks and tractors. Easily installed. Send \$3.00 for six cylinder type, \$4.50 for eight cylinder type. Try Tur-B-lizer for 30 days. If you are not enthusiastically satisfied as claimed by hundreds of users, your money will be promptly refunded.

UNIVERSAL TUR-B-LIZER CO. 621 E. STATE ST. MILWAUKEE 2, WIS.

**DO YOU LIKE TO DRAW?**

SEE HOW EASY IT IS  
Step by Step!



Enjoy drawing, painting, advertising art and cartooning at home in your spare time. Earn while learning. Step-by-step method helps beginners quickly. Low tuition. 40th year. Send coupon for free booklet. No salesmen.

Send free "Art for Pleasure & Profit."

Washington School of Art  
Studio 127 N  
Washington 5, D.C.

Name \_\_\_\_\_  
Address \_\_\_\_\_ Age \_\_\_\_\_  
City, Zone, State \_\_\_\_\_

**EAT ANYTHING  
WITH FALSE TEETH**

If you have trouble with plates that slip, rock and cause sore gums—try Brimms Plasti-Liner. One application makes plates fit snugly without powder or paste, because Brimms Plasti-Liner hardens permanently to your plate. It relines and refits loose plates in a way no powder or paste can do. Even on old rubber plates you get good results six months to a year or longer. **YOU CAN EAT ANYTHING!** Simply lay soft strip of Plasti-Liner on troublesome upper or lower. Bite and it molds perfectly. *Easy to use, tasteless, odorless, harmless* to you and your plates. Removable as directed. Plate cleaner included. Money back if not completely satisfied. If not available at your drug store, send \$1.25 for reliner for 1 plate.



PLASTI-LINER INC., Buffalo 11, New York — Dept. 54-A5

**BRIMMS PLASTI-LINER**  
THE PERMANENT DENTURE RELINER

**WATCHMAKING**

Learn at home • FREE sample lesson • Approved for Vets.  
**CHICAGO SCHOOL OF WATCHMAKING**  
2330 N. MILWAUKEE AVE., DEPT. 174, CHICAGO 47, ILL.

**ENGINEERING DEGREE IN 27 MONTHS**

**INDIANA TECHNICAL COLLEGE**

B. S. DEGREE, Aeronautical, Chemical, Civil, Electrical, Mechanical and Radio Engineering (inc. TV and Electronics), Drafting, 3-yr. G.I. Gov't. approved. Low rate. Earn board. Large industrial center. Students from 48 states, 21 countries. Demand for graduates. Enter September, December, March, June. Write for catalog, 1674 E. Washington Boulevard, Fort Wayne 2, Indiana.

**PLEASE  
SEND ME**



for the time checked.  
I am enclosing . . .

- 1 year \$3.50
- 2 years \$6.00

name \_\_\_\_\_  
address \_\_\_\_\_  
city \_\_\_\_\_ zone \_\_\_\_\_ state \_\_\_\_\_

Hand this order to your newsdealer or send it to

**POPULAR MECHANICS**  
200 East Ontario St. Chicago 11, Ill.



## NEW SURPLUS CAN SPOUTS

For dispensing oil from one to  
five quart cans

No. 5 S

**SAVE 50%** \$10.00  
VALUE

Sale price—6 for \$5.00 or \$1.00 each.  
Price includes all taxes and postage

This is the well known 5 S spout used  
for dispensing oil in nearly all service  
stations in the nation. This is genuine  
Army surplus. All spouts are new, and  
cadmium plated.



SPECIAL  
PRICES ON  
LOTS OF  
500 OR MORE

Pay by cash, check, or money order.  
25% deposit on C.O.D.'s.

### ARMY SURPLUS SALES

1820 TULARE STREET

FRESNO, CALIF.

## PAGEMASTER HOMES . . . designs of tomorrow you can afford today!



Now . . . own a home that's  
the envy of your neighbors  
while saving up to 35% on  
today's building costs! A  
PAGEMASTER Home is quickly  
and easily built by you  
. . . complete panelized sections  
are delivered ready for  
immediate erection.



24'x38' with 4'x14' T

For you who prefer a ranch home design, the No. 533  
Humboldt is the perfect answer. With three roomy bedrooms  
and a step-saver kitchen, this PAGEMASTER home will  
ideally fit your family's every need. For full-color pictures  
and complete description of the Humboldt and many other  
popular styles, send 25c today for the Pagemaster Book  
of Homes. You'll find the styles supremely modern and  
the quality — highest!

**Pagemaster**  
HOMES

**PAGEMASTER HOMES**  
300 Pierce St.  
Shakopee, Minnesota

"PANELIZED FOR EASY ERECTION"

## MONEY MEN ALL FREE

THE PLASTEX Industry needs manufacturers on small  
scale and for big production of Lamp and Clock  
Stands, Art Goods and Novelties in Plastex and Marble  
imitation. Experience unnecessary. 1cc material makes  
regular 1 lb. sturdy solid. Rubber moulds furnished for  
speed production. Small investment brings good re-  
turns. We are now placing big Chain Store Orders with  
manufacturers. Ambitious men have chance for real  
prosperity. Our Free booklet will interest and benefit you.

**PLASTEX INDUSTRIES, Dept. A**  
3400 Third Ave. New York 56, N. Y.

## DRAFTING — DESIGN — MATHEMATICS — SURVEYING

Aircraft, Mechanical, Electrical, Architectural, Structural, Building  
Construction Estimating, Blueprint Reading, Mathematics—  
Refresher & Higher, Physics, Classes Days, Even, Start Any Monday.  
**MONDELL INSTITUTE, 230 WEST 41st ST., NEW YORK 36, N. Y.**  
44 years Preparing Thousands for Technical & Engineering Positions  
APPROVED FOR KOREAN VETS AND NON-IMMIGRANT STUDENTS

**NOW - IT'S EASY!** Solder like an Expert!  
IT'S NEW  
**USE "MIRACLE SOLDER PAINT"**

JUST PAINT ON AND HEAT  
Solder All Common Metals  
**FASTER • STRONGER • MORE ECONOMICAL**  
ONE LB. = 4 LBS. ORDINARY "WIRE" SOLDER  
FREE "Soldering Technique Guide" Agents Wanted  
**BOW SOLDER PRODUCTS**  
251M FREEMAN ST. • BROOKLYN 22, N.Y.

ONE LB.  
**\$2.95**  
POSTPAID  
GUARANTEED

## U.S.A.F. SPIT and GAFF EMERGENCY KIT

**PLUS  
FREE CATALOG**

Ideal for sportsmen . . . rust-  
proof steel Used for roasting over  
fire spearing or gaffing  
as a weapon, etc. Compact .  
carry in pocket or tackle box.  
Limited supply.

Postage Prepaid **\$1.50 value**  
**49c**

**FISLER'S** ORDER TODAY

1329 Main, Dept. PM7 Kansas City, Missouri

## HOW TO GET ABSOLUTELY PURE PAINT

All Paint is composed of 3 things. 1—PIGMENT. 2—BINDER. 3—THINNER. BUT each of these  
must be PURE to give you an absolutely PURE  
Paint. 1. The only Pigment in POLAR WHITE is  
TITANIUM. It contains no filler. Titanium has  
terrific HIDING POWER. 2. The Binder in POLAR  
WHITE is pure polymerized OIL chemically modi-  
fied to give DURABILITY and FAST DRYING.  
3. The Thinners in POLAR WHITE are pure and  
evaporate like Turpentine. Now YOU can buy  
absolutely PURE SMOG-PROOF, MILDEW RE-  
SISTENT WHITE PAINT that can be color tinted.  
Order LIQUID RAW-HIDE POLAR WHITE. Only  
\$2.40 Qt., \$7.50 Gal. Prepaid. Guaranteed.  
Literature is for free.

**LINSEED OIL PRODUCTS COMPANY**  
1122G So. Fremont Avenue, Alhambra, Calif.

"so pure — it's got to be good"



**SAVE UP TO 85% ON GOVT SURPLUS**

**CENTRIFUGAL PUMP & MOTOR  
DELIVERS UP TO 700 G.P.H.**



Completely reconditioned and ready to run. Excellent for draining cellars, rock garden waterfalls, fish ponds, sumps, water circulators, evaporative coolers, etc. Powered by the famous G.E. 110 volt, 60 cycle motor. Has 1 inch standard pipe inlet port and 3/4" to 1" hose outlet port. Made to sell at many times our low price. A Gov't Surplus Bargain. . . . . **769**



**NEW NAVY WADING SUITS**

BACK IN STOCK AGAIN! Will make Surf and DEEP Stream Fishing a pleasure. Also ideal for use whenever it is necessary to protect the body or clothes from mud, moisture, silt, etc. Made to Gov't specifications. Originally used as an "Overboard Suit" in landing operations. Made of heavy duty rubberized canvas. Has valvanized seams. Built-in rubber gloves and boots. **1095**

ORDER FROM THIS AD - Pay by Money Order or Check. P.O.'s accepted from D&B firms. 1/2 deposit with C.O.D.'s. Prices FOB Los Angeles.

**WORLD'S MOST AMAZING BARGAIN CATALOG**

**320 PAGES FULLY ILLUSTRATED**

Packed with SENSATIONAL VALUES in WAR SURPLUS, FACTORY CLOSE-OUTS and GENERAL MERCHANDISE!

Thousands of items for the HOBBYIST, GADGETEER, etc. Includes Hand & Power Tools, Microscopes, Binoculars, Precision Instruments, Outdoor & Sport Equipment, Photo Supplies & Cameras, Hardware, Foam Rubber, Industrial Tools, Aircraft Supplies such as - over 20,000 Hydraulic Cylinders in 61 sizes & types, also Hydraulic motors, pumps, fittings, tubing, valves, etc. Also hundreds of War Surplus Gadgets and parts.



SEND 50¢ To cover the cost of HANDLING & MAILING - REFUNDED with your first order!

**PALLEY SUPPLY CO.**

3263 E. VERNON AVE., DEPT. PM-7  
LOS ANGELES 58, CALIF.

WHAT A WONDERFUL *New Idea*

**GEORGE**

SELF-PROPELLED  
DUMP  
BARROW



ADD-TACHMENTS FOR USE WITH SAME POWER UNIT  
• ROTARY MOWER  
• SNOW FLOW  
• GARDEN TOOLS

ONLY \$154.00 F.O.B.

WRITE FOR ILLUSTRATED BROCHURE

Dept. B GEORGE GARDEN TOOLS • SULLIVAN, ILL.

**BUILD 15 RADIOS AT HOME WITH THE PROGRESSIVE RADIO "EDU-KIT"**

ONLY **\$19.95** COMPLETE

All Parts, Instructions, Soldering Iron, Tester Included. Money Back Guaranteed.  
PROGRESSIVE "EDU-KITS" INC.  
Dept. PM-519, 497 Union Ave., Brooklyn 11, N.Y.

PROGRESSIVE "EDU-KITS" INC.

Dept. PM-519, 497 Union Ave., Brooklyn 11, N.Y.

RUSH ME THE FOLLOWING:

- Free Descriptive Literature—No Obligation.
- Free Valuable Radio and TV Guides—No Obligation.

Name \_\_\_\_\_

Address \_\_\_\_\_

City \_\_\_\_\_ State \_\_\_\_\_

**A MICHIGAN PROPELLER MATCHED TO YOUR OUTBOARD MOTOR, BOAT AND LOAD**



WILL PROVIDE BETTER PERFORMANCE

FOR RACING OR PLEASURE

Write for FREE 1954 catalog. Contains much helpful boating data and carefully engineered propeller recommendations.

MICHIGAN WHEEL CO., Dept. P-87  
GRAND RAPIDS 3, MICHIGAN

**9 1/2" Height — — \$14.75**



Cuckoo-Clocks, imported from the Black Forest, Germany, with woodcarvings never seen in U. S. A. before, come in 2 tone and colored. Other models from 5" to 36" from \$7.50 to \$199.50. Wholesale and Retail. Dealers and Salesmen wanted.

**KRUEGER'S**

23418 Harper Ave. St. Clair Shores, Michigan



**28-37 MILES PER GALLON?**

The GANE AIR FLOW NEEDLE can give you up to 25% more gas mileage . . . anyone can install it. No special tools required. 2 Needles required for 8 cyl. cars. Can gain up to 2 or more miles per gallon. If fully satisfied after 10 days you pay only \$1.50 per needle. Don't pay Postage. Send no Money until satisfied on 10 Day Free Trial. Specify Year-Make Model & No. of cyl. of car.

**MEHREN INDUSTRIES HOUSE OF FREE TRIAL**  
8666 W. Pico Blvd. Dept. PM-7 Los Angeles 35, Calif.

**Treasure - Minerals - COINS**

Easily located with new Light-weight M-Scope Detector. Superior performance, lowest price, monthly payment plan.

FREE LITERATURE

**FISHER RESEARCH LAB., INC.**  
PALO ALTO CALIF.



**RADIO** Engineering. All phases radio & electronics theory & practice; television; FM; broadcasting; servicing; aviation, marine & police radio. Prepare for high pay; 18-month course. Graduates in demand by major companies. Enter Jan., March, June, Sept. Regular campus life. Write for catalog.  
**VALPARAISO TECHNICAL INSTITUTE, Dept. D, Valparaiso, Ind.**

**BUILD YOUR OWN FAN**



One-piece cast aluminum propellers for cooling and ventilating.

Size Inches	Polished 2 Blade	Polished 3 Blade	Unpolished 2 Blade	Unpolished 3 Blade	More Fans
15	\$3.00	\$4.00	\$2.50	\$3.00	1 1/2, 3 1/2, 5 1/2
18	3.75	5.00	3.00	4.00	1 1/2, 3 1/2, 5 1/2
20	4.00	5.75	3.25	4.50	1 1/2, 3 1/2, 5 1/2
24	4.50	6.50	4.00	5.50	1 1/2, 3 1/2, 5 1/2

Write for pamphlet on larger fan blades, wire guards, fan bases, shutters, pillow blocks, exhaust fan frames, etc. Dealers write for discount. Add 10% for packaging and shipping. Shipper C.O.D. or cash with order.

**KLOPPENBORG ALUMINUM FDY., Dept. PM-54, Davenport, Iowa**

Say You Saw It in Popular Mechanics

**DINSMORE AUTO COMPASSES**



Especially traveling with America's finest auto compass. Accurate - dependable - trouble-free. Quickly and conveniently mounted on any car.

Always insist on a DINSMORE - It's the only compass approved by auto manufacturers. Send for free folder "Points, Knives, Compasses" and name of nearest dealer.

Guide-way 34.00 Non-Illuminated

DINSMORE INSTRUMENT COMPANY  
1802-33 Kefauver St., Flint, Michigan



Travelite Only \$549 Illuminated



## Build this 14-foot FIBERGLAS PLASTIC BOAT



only \$197.50

No experience needed; can be assembled in 12 hours with ordinary household tools. Simple 1-2-3 instructions make assembly a snap. 52" beam, 16" depth. Kit complete except paint. Cross members and seats of highest quality hardwood. Constructed of pressure molded plastic sheets. DENTPROOF... ROTPROOF... NO MAINTENANCE. Write for illustrated folder. Available assembled only \$295.00.

Plastic sheets for boat parts also available. Write...

### UTILITY PLASTICS CO.

1544 E. 6th Dept. P.M. Tulsa, Okla.



## MINIATURE MODELS GASOLINE - STEAM

BUILD THEM YOURSELF - IN YOUR OWN SHOP WITH YOUR OWN TOOLS

Anyone with a 6" or 10" lathe and a drill press can make them.

SEND 10c FOR ILLUSTRATED CATALOG OF MINIATURE ENGINE CASTINGS AND DRAWINGS

**OCURA MODELS**  
P.O. BOX 536-A PARK RIDGE, ILL.

## VARIABLE SPEED HYDRAULIC POWER TRANSMISSION



It has infinite speeds 0 to 550. Reverse. Automatic Overload Protection! Adjustable Torque up to 180 inch pounds. 5/8" Input and Output Shafts. It will handle 1/2 to 1 1/2 H.P. Motor. Case measures 7 1/2" long, 7" high, 6 1/2" wide. VALUE OVER \$300. Shipping Wt. 25#. On C.O.D. Orders we require a 10% only \$54.50  
Depos. Fab. Chicago

DIRZIUS MACHINE SHOP "D" 1423-25 So. 52nd Ave., Cicero 50, Ill.

## 3 CU. FT. MIXER 39.75 DIRECT FROM MFR.

Fills long felt need for small mixer for concrete, feed, fertilizer, seed and many other materials. Saves cost of ready mixed concrete. Pays for itself on first job. Combination belt pulley and crank for hand operation. Also power mixers. Write for circular.

3 Cu. Ft. Drum—Mixes 2 Cu. Ft. Concrete ..... \$39.75  
5 Cu. Ft. Drum—Mixes 3 Cu. Ft. Concrete ..... 59.50

FOB Pulaski, N. Y. Cash, Check or M. O. Money back guarantee

UNITED STATES FORGE AND FOUNDRY CO.  
CONSTRUCTION EQUIPMENT DIV. PULASKI, NEW YORK



## MAKE BIG MONEY!

Be a floor surfacing contractor and sand both new and old floors. Sanders are easy to operate and better still, you're your own boss. Write for latest "sell-off" booklet entitled "Opportunities in Floor Surfacing", enclosing 25 cents in coin or stamps to cover handling.

### AMERICAN

FLOOR SURFACING MACHINE CO.  
525 So. St. Clair Street - Toledo 3, Ohio

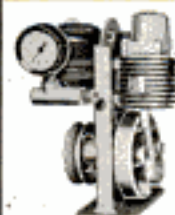

## Paramount AIR COMPRESSOR

COMPARE Price - Features - Savings!

Reg. \$24.95. Ball bearing, piston-type compressor of revolutionary new design. Can't be matched as an all-purpose, low cost unit. New principle operates it on conventional 1/4 HP - BUT delivers MORE air than ordinary 1/4 HP unit. For professional paint spraying, tire inflating, insecticiding and hundreds other uses in shop, farm, home! Delivers 2 1/2 cu. ft. air per minute. Includes Tank - Order now and SAVE! Satisfaction guaranteed or money back. We pay postage.

\$12.95

FREE Catalog of FANS and ELECTRICAL VALUES

ROBERTS ELECTRIC CO., 849 W. Grand, Dept. 197, Chicago 22, Ill.

## Simplest, Lowest-Cost

## RADIANT HEAT REFLECTOR!



Shut out Summer Heat, Save Winter Fuel—with

## REYNOLDS ALUMINUM REFLECTIVE INSULATION

This low cost, readily installed aluminum foil bonded to tough kraft paper in walls or attic provides real insulation. Keeps winter heat in, summer heat out! Costs only about \$40 over ceilings of average 6-room house! Clean, odorless, pliable. Perfect vapor barrier, fire-retardant. Readily tacked or stapled over ceilings, under rafters, between wall studs, under ground floors. Rolls 250 sq. ft., 25", 33", 36" wide. Makes great reflectors for radiators, photolights, etc. Mail coupon for free samples.

### ALUMINUM GUTTERS



Easy to install, slip joints - no soldering. Non-staining. Rustproof. Aluminum Nails. Rustproof, never stain, stay tight.

## REYNOLDS Do-It-Yourself\* ALUMINUM



New kind of aluminum - easy to saw, drill, join, shape with ordinary woodworking tools. At hardware and lumber supply dealers.

\*Reg. U. S. Pat. Off.

See your Building Supplies or Hardware Dealer

## REYNOLDS Lifetime ALUMINUM BUILDING PRODUCTS

SEE "MISTER PEEPERS," starring Wally Cox, Sundays, NBC-TV.

MAIL THIS COUPON NOW!

Reynolds Metals Company  
Building Products Division  
2035 So. Ninth St., Louisville 1, Ky.

Send full information and FREE SAMPLES of Reflective Insulation. Also full details about

Gutters & Downspouts  Nails  Flashing

Name \_\_\_\_\_

Address \_\_\_\_\_

City \_\_\_\_\_ State \_\_\_\_\_





# MAXIMUM PROTECTION ...mile after mile

WOLF'S HEAD Motor Oil—100% Pure Pennsylvania—is specially refined from nature's finest crude, provides rich, tough, long-lasting protection against engine heat and friction. Scientifically Fortified, it cleans as it lubricates... protects against sludge, rust, deposits. Be particular—insist on WOLF'S HEAD!

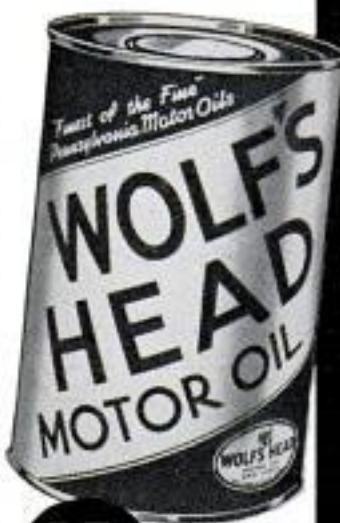

**45¢**  
A QUART

Write for free  
Weather Guide Folder

WOLF'S HEAD OIL REFINING CO., INC.  
OIL CITY, PA.  
GLENDALE 27, NEW YORK

## this **ONE** GOVERNOR

fits ALL popular  
farm & industrial  
gasoline engines



## **PIERCE** LONG RANGE Universal Governor

Instant variable speed selection and accurate engine control at any speed setting within 1600 to 2500 RPM. Higher and lower ranges obtainable by simple change of pulley. Also "constant speed" operation.

Accurate, dependable speed control for engines operating corn shellers, drag lines, hoists, arc welders, trucks and tractors with power take-offs, etc.

Write for Complete Information.

DEALERSHIPS  
AVAILABLE

"World's Most  
Experienced Governor  
Manufacturer"

**THE PIERCE**  
GOVERNOR CO., Inc.  
1652 Ohio Avenue, Box 1000  
Anderson, Indiana, U. S. A.

ONLY  
**\$39.50**

Pulley extra  
Send Check or  
Money Order.  
State Make,  
Model of engine.

## MACHINED PARTS READY TO ASSEMBLE DO IT YOURSELF MODEL 120 FAN KIT DO IT YOURSELF

- FOR HOME - FARM - SHOP!
- 20" ALUMINUM BLADE WITH STEEL HUB
- 4840 CUBIC FT. OF AIR PER MINUTE
- RUBBER MOUNTED BEARINGS
- COMPLETE V BELT DRIVE
- STEEL FAN SHAFT & COLLARS
- ALL HARDWARE TO ASSEMBLE
- ALL YOU NEED IS ANY 1/4 TO 1/2 HP



FAN KIT  
ONLY  
**\$15.95**

- 28x24x1 1/2 WINDOW KIT BOX
- JUST SAW & NAIL - FITS MOST WINDOWS (INSTRUCTIONS & KEY INCLUDED)

**\$5.95**

Send Check or M.O.  
R.O. B. Plant - 14 lbs  
25% Deposit on C.O.D.

DEALER  
INQUIRY  
INVITED

A. E. BOGG MACHINE & TOOL COMPANY  
311 JEFFERSON ST. JEFFERSON CITY, MO.

Dept.  
**754**

## 4 out of every 10 batteries NEED RECHARGING!

WT-60 Charge Tester reveals individual cell condition for fast, accurate battery maintenance. Locates faulty cables, ground straps. Price \$19.00. Write to:

**WILLARD STORAGE BATTERY CO.**  
248 EAST 131st STREET, CLEVELAND 1, OHIO



## TRANSFORMER WELDER \$19.95 FOB QUINCY

Complete with everything. Ready to plug in. 110 volts AC. 15-30 Amps. 3 heats. Welds metal from 1/16" to 1/4" using 1/16" to 3/32" standard rods. Guaranteed unconditionally. 10-day trial. No C.O.D. Does everything welders costing up to \$75.00 do. Buy direct and save.

ESSAY MFG. CO., INC., Dept. 51, Quincy 69, Mass.



## MAKE YOUR OWN FOUNTAINS, LAKES, RIVERS, WINDOW DISPLAYS

Get real live action with miniature water pump. Only 4 3/4" high — 3 1/4" wide. Threaded for pipe or uses 3/8" rubber tubing. Sturdy rustproof alloy metal — mounted on rubber. 110 A.C. — 60 cycle. 1/250 H.P. Pumps 50 gal. per hr. Complete — ready to work. Immediate money back guaranter. Send check or M.O. Or send C.O.D., you pay postage. Dealers wanted.

**MOORE MANUFACTURING CO.**  
SWEDSBORO 15 NEW JERSEY

**\$9.95**  
IN  
U.S.

## PORTABLE JIG SAW

CUTS AS FAST AS SAWS  
COSTING \$50 & UP!

Does work of Jig, Keyhole, Coping, Hand, Hip, Hacksaw. Has built-in air blower, fits any 1/4" drill, cuts wood, plastics, metals.

At your dealer or try it on our 10-day trial. Send check, M.O. (Postpaid), C.O.D. — postage extra.

**ARROW METAL PRODUCTS CO.**

Dept. PM-7, 140 W. B'WAY., N.Y. 13, N.Y.



At  
Better  
Hardware  
Stores  
Everywhere

No. 500  
"ARCO JIG-SAW"  
**\$10.95**

**WARNING!** VETERANS DISCHARGED BEFORE AUG. 20, 1952, must be IN TRAINING by Aug. 20, 1954, or lose G.I. rights to free education under NEW G.I. bill. Train at home to become a TV Technician! Time is short. Send for FREE LITERATURE. (Non-vets too!) **RADIO-TELEVISION TRAINING ASSOCIATION**, Dept. M-7B, 52 E. 19th St., N. Y. 3, N. Y.

## FREE CATALOG

Over 300 books on Fishing, Hunting, Home Repairs and Improvements, Bricklaying, Welding, Home Workshop, Power Tools, Hobbies, Crafts, Home Building, Trades, Making Money at Home, Furniture Making, Woodworking, Carving, Photography, Art, Drawing, Mechanisms, Engineering, Refrigeration, Plumbing, Radio-TV, Electricity, Automobiles, Farming, Livestock, Gardening, Decorating, Painting, many, many more. Send for yours today.

POPULAR MECHANICS PRESS, 200 E. Ontario St., Chicago 11

POPULAR MECHANICS



# MAKE BIG MONEY

Sharpening Lawn Mowers...

SPARE OR FULL TIME

Mr. C. E. Hardy of Missouri says, "I am doing a fine business with the Universal Grinder. One Customer sends another. I spent 40c for a newspaper ad and have done nearly \$500 worth of business." G.E. of Ark. says, "I have had my Universal Grinder 2 months and made a net profit of \$227."



## ONLY ON THE UNIVERSAL LAWN MOWER GRINDER

... can the inside face and edge of the stationary blade, as well as the reel blades, be ground to proper clearance ALL IN ONE SET-UP, without removing any blade from either hand or power mower. Send Today for Free Details. ROGERS MFG. CO. Dept. M-74 LINDSEY, OHIO

Our 743rd Advertisement

### REAL DIESEL ENGINE

\$3.95

- for planes, boats, midget cars
- 7500 RPM; 1 1/7 HP; ht. 3 1/2"; wt. 5 oz.
- precision machined for smooth operation

You just can't beat this price for a precision diesel engine! Streamlined, compact, easy to install. Thousands of satisfied users all over the world. Fast delivery if you ORDER TODAY! Price \$3.95 plus 25c postage.

GOTHAM HOBBY CORP. Dept. P, 107 E. 126th St. New York 35, N. Y.



### TREASURE -- \$10,000

New locator detects metals, valuable minerals and buried treasure. Money-back guarantee of superiority.



Also geiger counters. Govt. reward of \$10,000 for uranium discovery. Write for FREE information.



### THE GOLDAK COMPANY

1542 W. GLENDALE BLVD., GLENDALE 1, CALIF.

### SET-UP - KNOCKDOWN SAWHORSE with Jiffy BRACKETS



No nails or bolts... use 2x4's for legs. 2x4 or wider for crossbar. Rugged, sturdy, easy to move, saves storage space. Sold by hardware and building material dealers, or order direct.

GRAND HAVEN STAMPED PRODUCTS CO., Grand Haven, Mich.

Send for **FREE** 112 page Illustrated Catalog of Farm, Home, and Workshop Bargains.

Write to Dept. D7 **WELLWORTH TRADING COMPANY**

1832 S. WABASH AVE.

CHICAGO 16, ILL.

### CUT BUILDING COSTS 2/3! Make Your Own Concrete BLOCKS and BRICKS To Use or Sell

New superior moulds make absolutely square, true, easy-to-lay blocks which will pass any building code. Production is fast... easy. One durable \$30 machine will make four 5"x8"x12" blocks per minute—1,000 a day. Pays for itself in one day! Sell blocks for big profit... or save 2/3 building cost for yourself. POST CARD BRINGS FREE FOLDER.

ECONOMY MFG. CO.

DEPT. P STONE MOUNTAIN, GA



**BILL VUKOVICH SAYS, "I BELIEVE TRACTION MASTER TO BE THE FINEST SAFETY DEVICE EVER OFFERED THE MOTORING PUBLIC."**



'53 winner of 500 mile Indianapolis Speedway, Bill Vukovich, shown holding Traction Master.

"I installed a pair of Traction Masters on my new 1954 Ford Victoria. To say that I am pleased is a definite understatement. The Victoria now has more stability in turns, on rough roads, on wet or slippery pavements, and on the straight-away that is beyond comprehension. When the brakes are applied either for a normal stop, or for a quick or sudden stop, the rear wheels do not bounce or skid. The car comes to a complete stop in considerably less distance with absolute safety. I believe Traction Master to be the finest Safety device ever offered to the Motoring Public."

Sincerely yours,  
Bill Vukovich

- Eliminates Drive Line Snap
- Gives More Stability on Turns
- Stops Your Car up to 40% Faster
- Gives 50% More Traction on Wet Roads and Snow
- Prevents Sudden Forward Weight Transfer in Quick Stops
- Increases Brake Lining Life Up To 50%
- Stabilizes Your Car if a Blowout Occurs
- Increases Tire Mileage up to 73 1/2%
- Stabilizes Your Car on Rough Roads

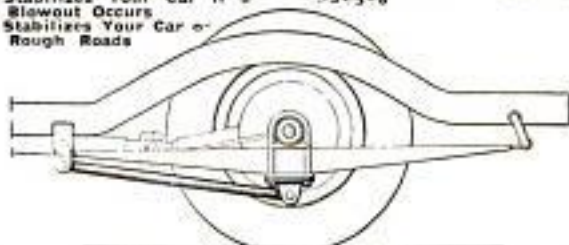

Money Back Guarantee. Order Direct. State make of car and year. Money will be refunded if you don't positively get a Safer ride, and improved performance. **\$34.95**

CAN BE SELF-INSTALLED WITHOUT SPECIAL TOOLS  
WRITE FOR FREE BROCHURE

**AUTO-MASTER CORPORATION**

165 Eleventh Street (Dept. PM), San Francisco, California

### CUT COSTS with ALLEN Punch Press

**1-Ton Power Bench Type**  
Powerful, Dependable, Economical

For light work—stamping, forming, riveting, etc.—Metal, fiber or other material.

Overall height 17 1/2" ... Base size 8 1/2"x8 1/2" ... Die bed 5 1/2" x 8 1/2" ... Ram face 1 1/2" x 3 1/2" Ram stroke 3/4" ... Positive 3/4" ram adjustment ... Sturdy, single pin, non-repeat hand lever clutch. V-belt drive. Weight 105 lbs. Requires only 1/2 to 1/2 H.P. Motor.

The machine of a thousand uses! Adequate for many types of work now done on larger presses at less greater expense.

**30-Day Money-Back Guarantee**

Order TODAY. Price \$97.50 F.O.B., Clinton, Mo. (Includes Motor bracket, V-belt, motor pulley, less motor).



\$97.50

FREE CIRCULAR

**ALVA F. ALLEN,**

Dept. PM,

CLINTON, MO.



handiest tube  
you'll ever find  
... for many  
home repairs!



**Dicks - Pontius  
WHITE WONDER**

**sealing compound**

A gleaming white sealing compound—perfect for replacing loose or broken tiles, filling cracks in woodwork and around sinks, basins and tubs—patching plastic, ceramics, furniture, picture frames. Many other uses! Moisture-proof, heat-resistant!

Just squeeze tube. Applicator tip is built in for quick easy use! Get D-P WHITE WONDER Sealing Compound now—at leading hardware, paint and building supplies stores. Always ask for D-P compounds—they're easier to use!

The Dicks-Pontius Company • Dayton, Ohio  
Alexandria, Va. • Decatur, Ga. • Dallas, Texas

**UNPRECEDENTED VALUE!**

WAR  
SURPLUS

**TILT-TOP TANDEM  
TRAILERS** Original Gov't  
cost—\$2,890.00

EXCELLENT  
CONDITION

**\$29500**

F.O.B. ATLANTA  
When did your  
dollar Buy more—

Made by  
FREHAUF  
Trailer Co.



Photo shows  
trailer in  
tilted  
position.

**MANY USES FOR TRANSPORTING HEAVY,  
HARD-TO-LOAD ITEMS** such as caterpillars, road  
and ditching machinery, tool's, lathes, concrete blocks.  
Makes perfect cattle trailer, horse van, or heavy boat  
trailer. All steel construction makes it easily modified  
to fit your needs.

**SPECIFICATIONS!**

- Overall length—176"
- Overall width—89½"
- 13" loading height
- 6 volt electric brakes
- 6 hole Budd wheels—750x20 Tires
- Length of bed—114"
- Approx. 5000 lb. weight
- 4 to 5 ton capacity
- 2 ft. Heavy gauge tailgate, serves as loading ramp.

ONE HUNDRED DOLLAR DEPOSIT REQUIRED ON  
EACH ORDER. BALANCE COD OR OPEN TERMS

**CALL, WIRE OR WRITE FULTON AUTO EXCHANGE**  
2235 Stewart Avenue Telephone Fairfax 8606  
Dept. P.M., Atlanta, Ga.

"Specializing in Sales of Government Surplus."

**SAVE 1/2 on WATER SKIS**

**\$15<sup>30</sup>**



Simply assemble and finish our new water ski kit and you have a pair of skis worth twice the price of the kit. Skis are 7 ply moulded plywood, 67½" long, 7" wide, 9/16" thick. Sturdy rubber foot pieces. All parts plus instructions included—\$15.30. Order from your Michigan dealer or MICHIGAN WHEEL CO., Dept. P-97, Grand Rapids, Mich, C.O.D. orders accepted.

**SAVE! 20" REVERSIBLE WINDOW FAN**



Three speeds, in or out, electrically reversible. Adjustable to fit different window sizes.

**ONLY \$49.95**

Send for complete list of fan parts. (LIST \$99.50)

PENNA. WHOLESALE DISTRIBUTORS  
108 N. 6th St. Phila. 6. Pa.



**NEW TRIG-AID CALCULATOR  
SIMPLIFIES TRIGONOMETRY**

- (1) By omitting (32) trig book formulas.
- (2) By omitting square root formulas.
- (3) By Defining the three sides of R.T.
- (4) By using diagrams in two colors thus separating known & unknown dimensions in right triangle solutions. Made of durable white plastic, pocket size, price \$1.00 plus 3c stamp. No C.O.D. Send to TRIG-AID SALES, 4133 Warwick, Long Beach 8, Cal.



**NEW BIKE MUFFLER**

This easy to attach muffler will give your bike the sound like a real motor—sent postpaid for \$2.75 check or money order. C.O.D. plus postage.

"BIKE SALES," Box 417, Bradner, Ohio



**FINE BOWS and ARROWS**  
SELECTED RAW MATERIALS

**Catalog 5c** Send for it  
**HAND BOOK**—Illustrated  
Instructions on Making and  
Shooting Archery Tackle—75c  
L. E. STEMMLER CO.  
Manorville (Box 3) L. I. N. Y.

**LIFE BATTERY OFFERS REMARKABLE  
MONEY-BACK BUSINESS OPPORTUNITY!**

If you qualify as distributor in exclusive area, you can earn \$800 per month and more. This is a multi-million dollar business. permanent and sound. Some investment for merchandise required, but your success is assured in 60 days or investment returned. Address:

**LIFE BATTERY CORP.**

12909 Venice Boulevard

Venice 5, California

**MAKE UP TO \$5 AN HOUR WITH**

**EASISHARP**



**MONEY  
MAKING  
SALES PLAN FREE**

Big profits in your spare time sharpening scissors. We show you how to start making money immediately. This is your chance now to have your own business with Easisharp. Sharpens a pair of scissors in less than two minutes! A child can operate it. Weighs only 10 lbs. Every home, barber, tailor, dressmaker

—everybody uses scissors and all need sharpening two to four times a year. Don't let some one else get ahead of you. Write immediately to

**SERR-EDGE MACHINE CO., 9731 Loran Ave., Cleveland, Ohio**



**OVER 700% PROFIT!**  
WITH THE  
**PDQ CHAMPION PHOTOMASTER**



Makes finished pictures in 2 minutes.  
Takes and finishes 30 to 40 ever-lasting, black and white or sepia photos an hour. No dark room. Guaranteed not to fade. Photos taken on "SUPER-SPEED" direct positive paper. Picture size 2 1/2 x 3 1/2 in. Complete, easy-to-operate portable photo studio. Size 4 1/2 x 5 x 10. Wt. 6 lbs. **700% PROFIT.** Write quick, get details about the great PDQ CHAMPION PHOTOMASTER.

**P D Q CAMERA CO.**  
1161 N. CLEVELAND AVE. Dept. PM-754 CHICAGO 10, ILL.

**LUTHY "Aero" TRIPLE ELECTRODE SPARK PLUGS**  
Outlast Ordinary Plugs 3 to 1

More MILES per Gal.—More R.P.M.—Quicker Starts — TRIPLE ELECTRODES For High Speed Performance! Better heat resistance and superior insulation from famous "LUMOX" Insulators first developed for aircraft. Now available for cars and trucks, all makes and models. Pre-gapped to eliminate guesswork gapping! Order now!

Set of 6 \$5.34 Set of 8 \$7.12

Packed in Engineered Sets! Pat. For Applied

**Distributors Wanted**

**LUTHY AERONAUTICAL SALES CO.** Dept. 447 Jackson, Michigan  
Canadian Address: Box 394, Hamilton, Ontario

**ASSEMBLE YOUR OWN DIVING LUNG**  
Save 50% or More!

**FREE Catalog!** Underwater swimming equipment. Write today!

We furnish the parts and instructions. Complete outfits \$39.95 and \$49.95. Write for descriptive literature.

**ED. AGUADO TRDG. CO.**  
Dept. K, Box 4525 Plaza Sta. St. Louis, Mo.



**ELECTRIC WELDER, WORTH \$250.00**  
200 to 250 Amps. 24 Heats. Weld Anything. Build it yourself. We furnish prints with full instructions. Send \$5.00 with order. We pay postage. **L. HOWARD ELECTRIC SERVICE, 629 E. Eldridge, Flint, Michigan.**

**CRAFT HEADQUARTERS**

**Leathercraft** send for complete catalog today **FREE**

Metal Tooling, Textile Painting, Shellcraft, Beadcraft, many more

- COMPLETE SUPPLIES
- QUICK SERVICE
- BEST VALUES

**KIT KRAFT**—Dept. 26, 7373 Melrose Ave., Hollywood 46, Calif.

**NOW! USE YOUR WILLYS OR DODGE AS BOTH A 2 and 4 WHEEL DRIVE**



Enjoy 2-wheel drive pep, speed, extra mileage, performance—keep 4-wheel drive power and traction with **WARN HUBS**. Change 4-wheel to 2-wheel or back in seconds with fingertip control. Front end assembly stands still in 2-wheel drive—cuts drag, stops shimmy, cuts front tire wear, increases gas mileage to 6 m.p.g. For Willys \$60.00, Dodge \$74.00 pr.; also Standard Hub for Willys \$20.00, Dodge \$23.00, Land Rover \$24.00 pr.; Automatic Hub for Willys \$120.00 pr., all ppd. Money back guarantee. Dealers or direct. Write for folder.

**WARN MFG. CO., RIVERTON Box 6064-A3, Seattle 88, Wash.**



At the first sign of **overheating** use new, improved **Du Pont COOLING SYSTEM Cleanser**

If a rusty radiator causes your engine thermometer to read high on moderate summer days, don't wait for a scorcher. Put in Du Pont Cooling System Cleanser right away. It cuts grease with detergent action, cleans out scale, and dissolves rust so that water drains out clear. And neutralizer in each can completes the job. Du Pont Cooling System Cleanser is *thorough, safe, simple.*



Keep your radiator clean with new **DU PONT ANTI-RUST**



Once your cooling system is clean, keep it that way with Du Pont Anti-Rust. This new liquid inhibitor retards rusting, inhibits acid formation and lubricates the water pump as well!

**DU PONT No. 7. PRODUCTS**  
From Chemical Research . . . For Easier Car Care



**BETTER THINGS FOR BETTER LIVING ... THROUGH CHEMISTRY**





*You'll See America Better If You*  
**SEE YOUR CHAMPION SPARK PLUG DEALER FIRST**

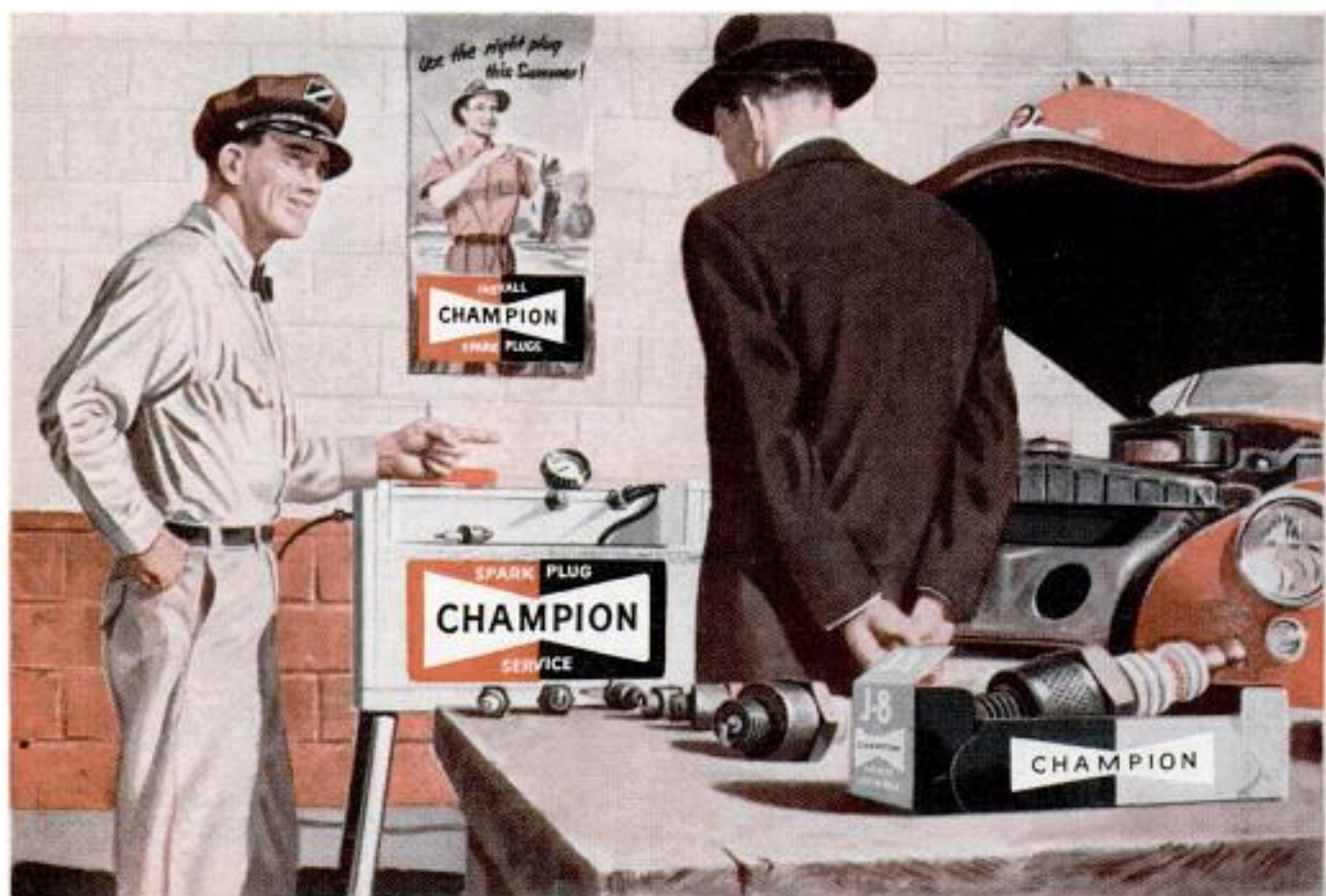

Don't let a lazy, inefficient engine take the fun out of your vacation. You've planned and waited all year for this trip . . . start right with a visit to your Champion dealer for a pre-vacation plug check.

Stand by and judge for yourself as your Champion dealer rates the efficiency of your spark plugs on his modern service equipment.

He'll clean and reinstall them properly or, if you wish, install a set of new Champions.

Full-firing Champion Spark Plugs

maintain efficiency under the hardest driving and provide an extra reserve of power in the tight spots. They'll pay for themselves before you're home again—in performance, economy and peace of mind.

CHAMPION SPARK PLUG COMPANY, TOLEDO 1, OHIO



**'INSIST ON CHAMPIONS WITH THE EXCLUSIVE FIVE-RIB INSULATOR!'**



# POPULAR MECHANICS

JULY  
1954

WRITTEN SO YOU CAN UNDERSTAND IT  
VOL. 102 NO. 1

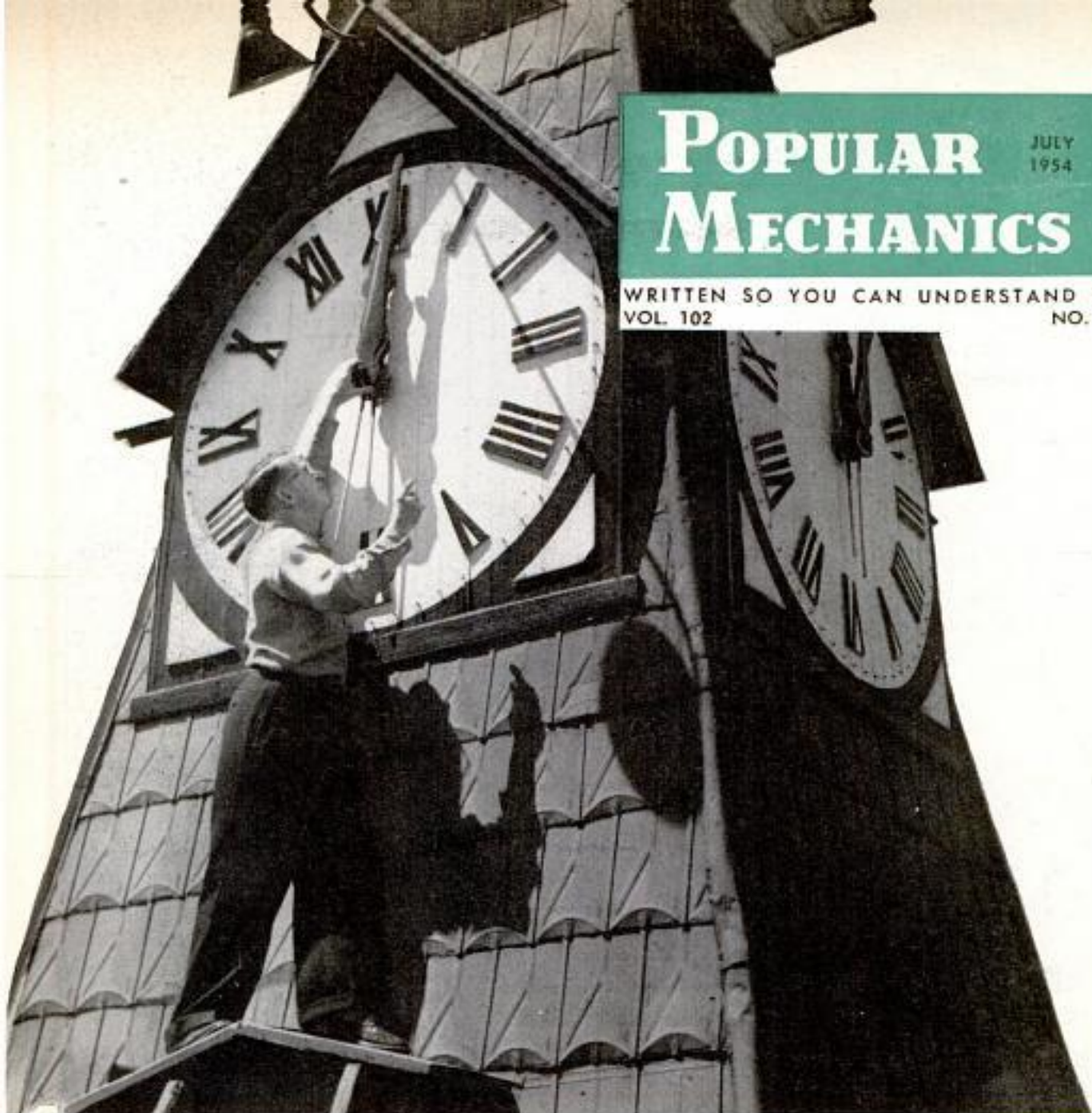

Working five stories above ground level, the community handyman carefully adjusts Statesville's town clock

## *Mr. Hamlin* **WILL FIX ANYTHING**

**By Max Tharpe**

**C**RACKING SAFES, building cameras and guns, repairing airplanes, tricycles, town clocks or egg beaters are all in day's work for LeRoy Hamlin. He calls himself a "mechanical detective." Actually, he is the "Mr. Fixit" of Statesville, N. C. Anything that goes out of whack in Statesville is likely to become Hamlin's personal responsibility and it's a rare occasion when he is stumped.

"My job is to outsmart the Gremlins that disrupt

To a child the biggest problem in the world can be a broken tricycle. Hamlin is never too busy to fix one







Five dump trucks stood idle until Hamlin climbed out on the end of this crane to unsnarl jammed cables

Girl in a fix calls "Mr. Fixit." When she couldn't get a ring off, he cut it with inverted saw blade

Hamlin is an old hand at swapping. Here he trades one of his pistols for unborn calf from this cow







Hamlin may be called halfway across the state to open a safe which has been jammed or blasted by thieves

the machinery in our community," he points out. "Every wire, every spring has a duty to perform. When something fails, my work begins."

Rarely does Hamlin see blueprints of any of the complicated machinery he is called upon to repair. Most of his trouble shooting is accomplished by trial and error—but with uncanny success. Recently he was called out to open a safe that had been badly damaged by professional crooks who bungled a safe-blasting job. By using his methodical approach, Hamlin had the safe open in a few minutes—with a bent coat hanger! Only \$1.75 had been locked inside.

Naturally he's not telling how safes can be opened with coat hangers. "Opening any safe is purely a mechanical operation," is his only comment. He should know. Working entirely by instinct, he recently built a complete new combination lock and dial for another blasted safe.

In a medium-size town like Statesville, with 20,000 population, there are few replacement parts for many kinds of factory

or home equipment. Hamlin solves the broken-parts problem by making them himself. "This is a piston for a French motorcycle that I am working on now," he'll tell you, pointing to a casting in his basement. "How else could that boy get his motorcycle running again?"

An elaborate metal lathe is Hamlin's greatest help. He has built in modifications and attached devices to cut gears, rifle gun barrels and do almost any job a machine shop might do. One of his pet projects is turning out .22-caliber target pistols of his own design. He believes in dropping the barrel as low as possible and in making the bore slightly smaller than usual in diameter, to add greater power and accuracy through the greater pressure built up in the chamber. Hamlin takes pride in demonstrating the pistols to visitors. He can hit carpet tacks at a distance of 12 to 14 feet.

Although he has built many of his own rifles, Hamlin's gunsmith work is mostly in replacement parts for the broken rifles of



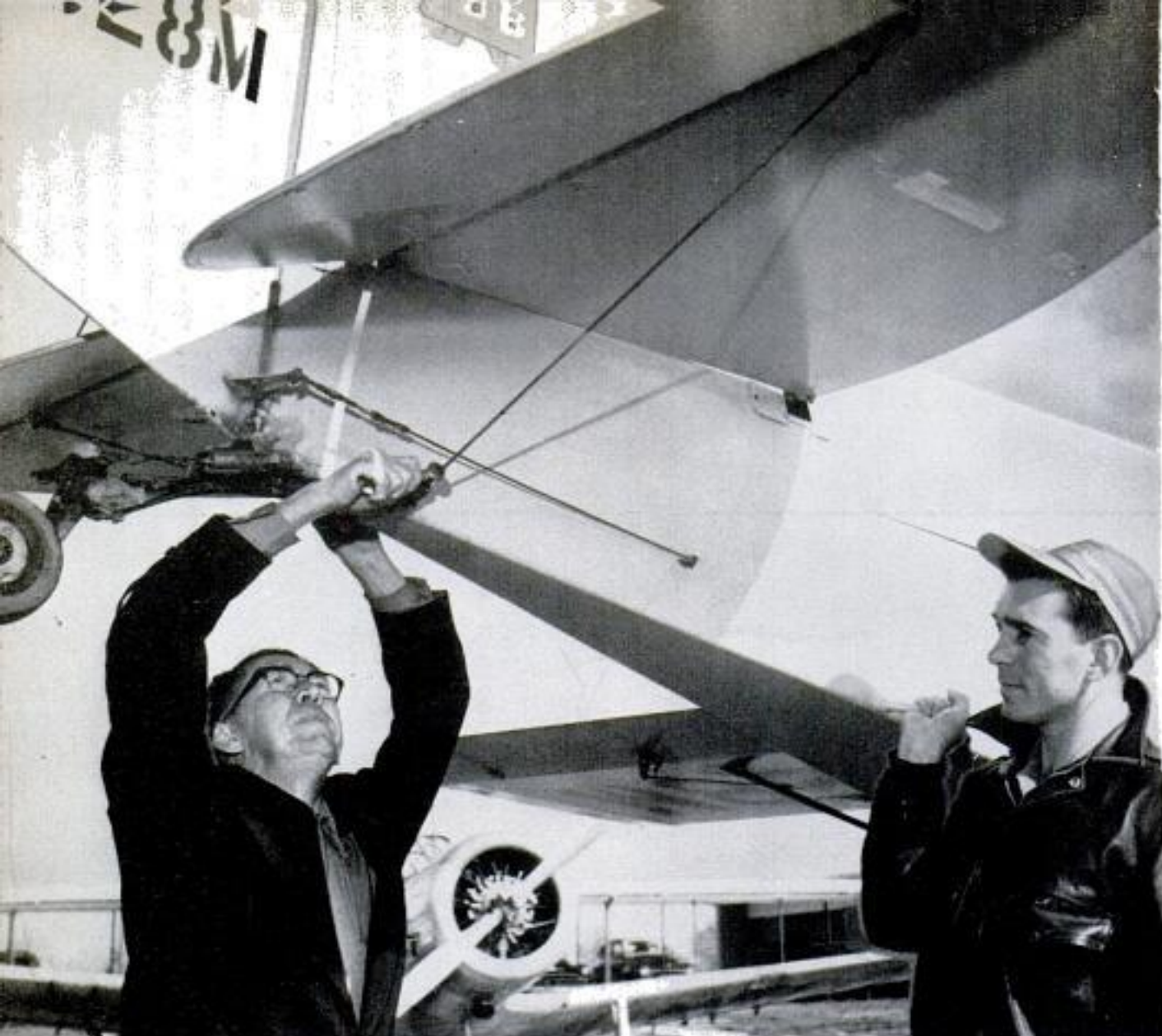

An old-time barnstorming pilot, Hamlin has no trouble fixing tail assembly of plane damaged in rough landing

neighbors. His biggest ordnance secret lies in the perfect setting of sights—a trick that has earned him a wide reputation among local hunters.

Guns seldom call for emergency repairs—but other things do. When Statesville's only bakery broke down, with its mixers full of rising dough, Hamlin had to drop everything and work through the night. He turned out the needed parts in a few hours. While making the repairs he discovered that, by making a few adjustments, he could double the speed of the bread-wrapping machinery. By the next morning the bakery was operating more efficiently than before it broke down.

Improving the things he repairs is standard Hamlin policy. When Statesville's fire-alarm system for calling out volunteers failed, Hamlin not only got it working again but speeded up its operation. Before it broke, volunteer firemen had to wait patiently to count the slow bellows of a horn that sounded like a tired cow. When Hamlin was finished, the horn sounded off the

numbers in a new code like wild geese calling.

Hamlin's early life set the stage for his handyman role. As a boy he lived near a machine shop in Mansfield, Ohio. By the time he was 16 he had built a model steam engine. His first job was running a lathe to make parts for threshing machines. By 18 he learned to fly and was an accomplished airplane mechanic. Barnstorming pilots who used his father's cow pasture at Mansfield, Ohio, trained him in exchange for his assistance in maintaining their cumbersome old biplanes.

His experience as a telegraph operator for the railroad gave Hamlin important training in electrical principles. When the first radio-broadcast stations went on the air, he began to build the bulky, earphone-equipped squealing radio receivers of that day. He became one of the earliest licensed amateur-radio operators.

A man like Hamlin was bound to invent something sooner or later. When his wife complained of an overheating iron, he set



out to solve that problem. He found that by installing a bimetallic automatic-cutoff switch in the wiring circuit, the circuit would break when excessive heat caused the contact points to expand and separate. Unfortunately, he lost legal interest in his patent rights when his backer and manufacturer died without leaving papers protecting Hamlin's interest.

A semiautomatic picture booth for making "pictures while you wait" was developed and introduced by Hamlin at the Chicago World's Fair.

During the depression years he moved his picture machines all over the country, traveling by trailer with his wife and growing family.

It was while pulling his trailer through Statesville back in 1940 that his overloaded car broke down. Before Hamlin could get the needed parts, which were two weeks in arriving, the town began to learn that he was a jack-of-all-trades. People drifted in to give him their mechanical mysteries. He liked the town and built his home there.

Hamlin still loves his work. "It's



Gremlins get into gadgets and it's part of Hamlin's job to take them out. Housewives are continually popping in with everything from egg beaters to eyeglasses and small appliances

While telephone-line crew waits, he drops other work to rush repairs on automatic cable-hanging machine

Mixing machine full of rising dough broke down in town's one bakery. He worked all night to repair it

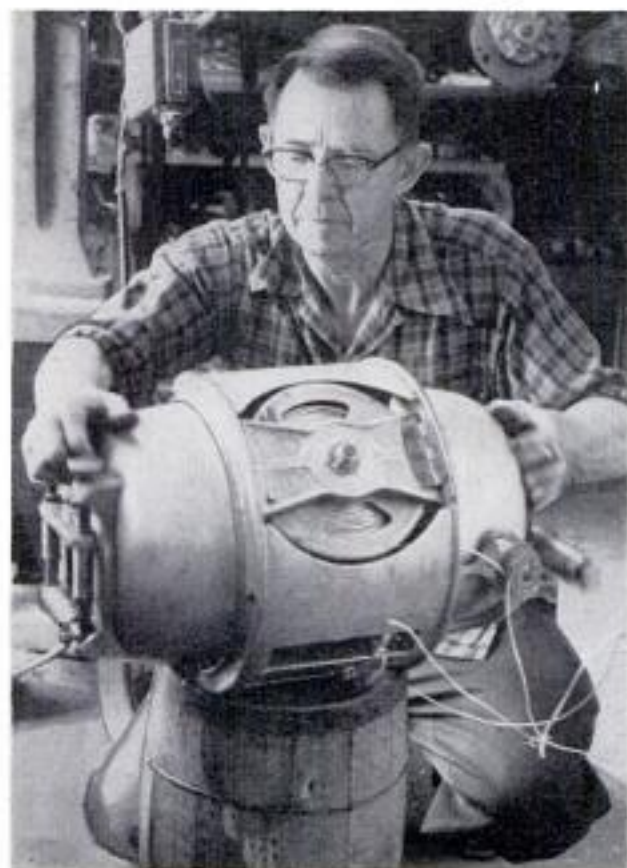





Sportsman brings his rifle to Hamlin for emergency repairs. Hamlin's specialty is pistols, which he designs and makes himself



Photography? That's another of Hamlin's specialties. He makes the replacement parts himself. Below, a sideline business is taking "while-you-wait" photos with booth cameras of his own design



an endless adventure," he explains, "and the payoff is in the satisfaction of doing things that seem impossible."

Not all the work is as pressing as unjamming stuck elevators, or getting cranes to operate again. Hamlin is always glad to take time to help anyone with minor catastrophes. Children bring him their toys; housewives bring lamps and toasters. He's never too busy to help out anyone in trouble, from the smallest tot with a broken tricycle to a businessman with a problem that might affect hundreds of people.

"When someone brings me a mechanical 'mystery,'" says Hamlin, "my first step is to find the clues and study them. I figure out what is not performing, determine what must be done to restore the machinery—and then do it."

He's the best camera repairman for hundreds of miles around, and can repair electric eyes, electronic flash guns, solenoid flash trippers, shutters and other equipment. His ability along this line is a result of his years of traveling with cameras and building cameras for his own use. Hamlin will frequently make necessary camera replacement parts himself.

The real pay-off on Hamlin's concern over Statesville's problems came when he was near death following a series of chest and back operations in 1951. For weeks neighbors took care of seven of his nine children. Friends all over town helped with food and meals while Mrs. Hamlin was at his bedside. Local groups helped with the huge hospital bills.

Back in his shop, the town is running smoother again, and his reputation is spreading further. He has been making regular trips to the big Lockheed plant at Marietta, Ga., where he has been helping rig assembly lines for the B-47E Stratojet bomber and the brand-new C-130 jet transport. Today, hardly a person within miles of Statesville can say that he hasn't benefited, at least indirectly, by LeRoy Hamlin's presence. ★ ★ ★



## Aircraft Cannon Fires at Record Rate of 1700 Rounds per Minute

Now in production for the Air Force is a new cannon for fighter planes which can fire shells at the record rate of 1700 rounds per minute. The gun is based on a German prototype. This weapon was modified and new models designed over a period of eight years. The final weapon, recently put into production, has a multichambered drum. A slide mechanism brings the chambers successively into alignment with the barrel. It fires 20-mm. shells or 60-cal. bullets.



## Robot Pitcher Throws Small Rubber Balls for Indoor Batting Drill

Pitching small rubber balls at various speeds, a portable electric machine permits batting practice to be held indoors without

a net. Being small, the balls sharpen the batter's eye. They are soft enough so they are not dangerous. The machine throws

600 balls per hour. A regulation bat is used. The balls are about as big as ping-pong balls. Any space 20 feet long with enough width to swing a bat in is large enough. Five speed adjustments are possible, from a very fast ball to a slow floater. The machine comes in three sizes. The largest is for professional teams or schools. Smaller models are designed for amateur groups and individuals desiring bat practice.



## Italy Predicts Its Gas-Turbine Auto Will Hit 155 Miles Per Hour

With an estimated top speed of 155 miles per hour, an experimental gas-turbine automobile has been tested by the Fiat Company of Italy. Under development for five years, the car has no transmission, the only foot controls being accelerator and brake. The two-stage turbine produces 200 horsepower at 22,000 revolutions per minute. Top speed to date is said to be 125 miles per hour. No suitable heat exchanger (like the regenerator in the Chrysler turbine) has been developed

by Fiat as yet and fuel consumption is twice that of a piston engine. The engine is mounted in the rear.







## Insecticide Fogger for Power Mowers Uses Original Container

Lawns and shrub areas are covered with insecticide by a power-mower attachment that uses the original insecticide can as a container for the fluid. The user simply punches a hole in the bottom of the can and secures it with a spring to a platform

on the mower. The dispenser uses the engine exhaust to produce an insecticide fog in front of the mower, blanketing the average lawn in 30 minutes with a pint of fluid. Use of the original can ends breakage and corrosion problems.

## Electronic Brain Will Compute Tolls on Pennsylvania Turnpike

Toll operations on the Pennsylvania Turnpike will be speeded by a combination electric-eye-and-scale "checker" at each interchange. A system of electric eyes counts the number of axles on each car or truck entering the turnpike and a scale weighs the vehicle as it is driven up to the toll booth. The whole process is automatic

and is done while the vehicle is in motion. Even when following bumper to bumper, vehicles of all sizes are processed without delay. The data is then printed on a toll card which is handed to the driver as he goes through the gate. The new system, which also will help the Turnpike's book-keeping system, will be in use by 1955.

## Parachute Golf Ball Slows Practice Shots

Golfers can practice their drives in the back yard, using a golf ball that is attached to a bright-red cloth parachute. A 20-inch string connects the parachute to the regulation, long-service ball and keeps the chute out of the way while the golfer is teeing off. The parachute slows the driven ball to a safe speed and stops it quickly, preventing injury to passers-by or damage to neighbors' windows.

More iron ore was produced in the United States during 1953 than ever before—a total of 133,500,000 tons, 3,000,000 tons more than was produced in the previous record year of 1951.

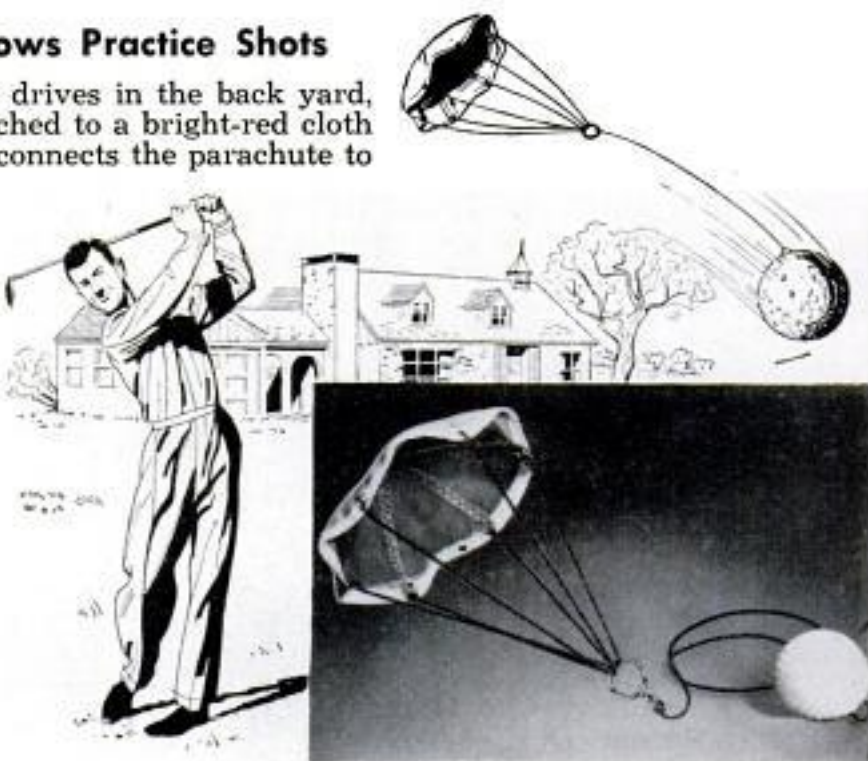





Donald O'Connor in Hollywood talks to Fredric March in New York as each watches the other on split screen

## Behind the Split Screens of TV

By Jan and Bob Jensen

Engineers in telephone video-control center backstage at Pantages Theater in Hollywood make final adjustments before the telecast

**I**F MR. KIPLING had been sitting in the gilt-edged Hollywood audience that March evening in 1954 when the Academy of Motion Picture Arts and Sciences presented the Oscars in their 26th annual awards ceremony, he would have had to eat his words that "East is East and West is West and never the twain shall meet." They not only met, they talked to each other. On the large television-projection screen at the back of the golden bronze-draped stage, Donald O'Connor, master of ceremonies on the West Coast, was brought face to face with Fredric March on the East Coast, and the many thousands of miles lying between their

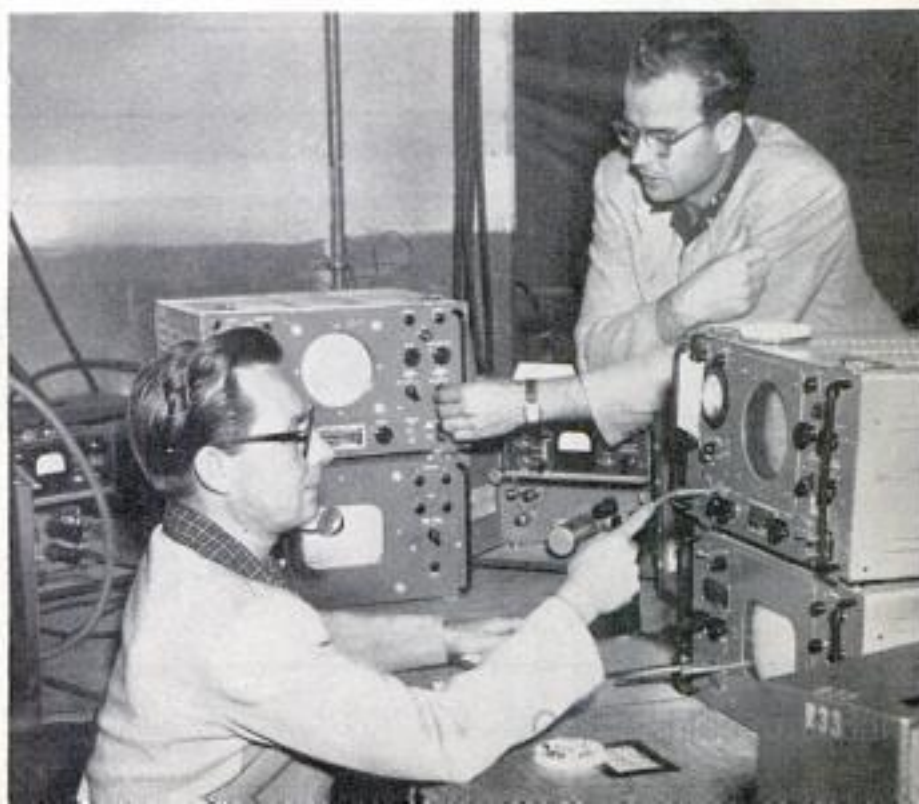



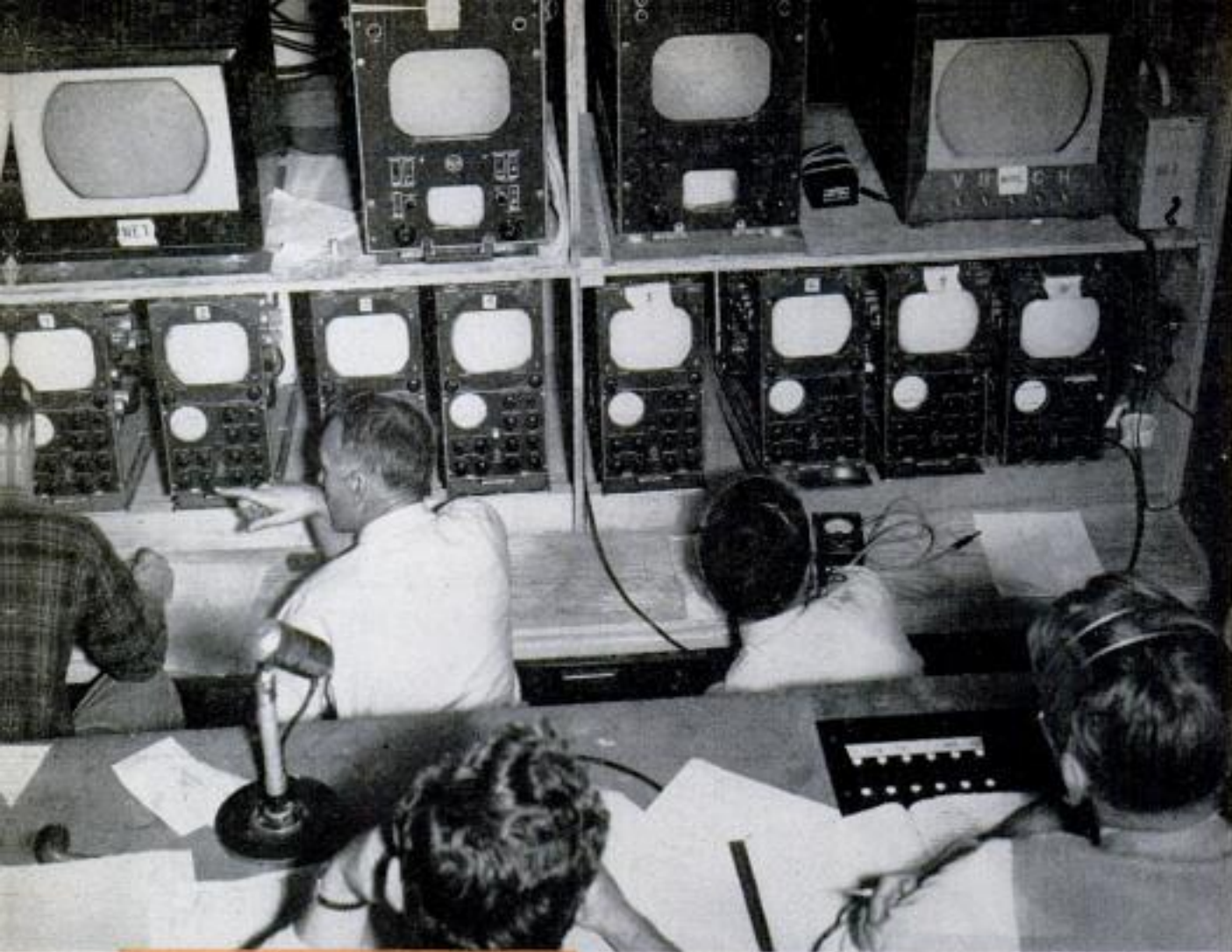

Technical and program directors face a bank of preview and program monitors and camera-control units. A total of 24 monitors was installed backstage, in the prestrooms and booths

Telephone engineer adjusts microwave reflector atop Pantages Theater in Hollywood, where the main program originated. Master-control studios were two blocks away from the theater

respective noses had been eradicated by the magic of the communications era in which they live, so that the two were presented in one picture not only to the select audience of 2800 in the Pantages Theater in Hollywood, but to millions of TV viewers throughout the nation.

No Oscar was awarded to those skilled engineers "behind the scenes," the men with the ear-phones clamped to their heads. But behind the glittering production "out front" was an unprecedented engineering extravaganza. Hollywood, Burbank, New York and Philadelphia were

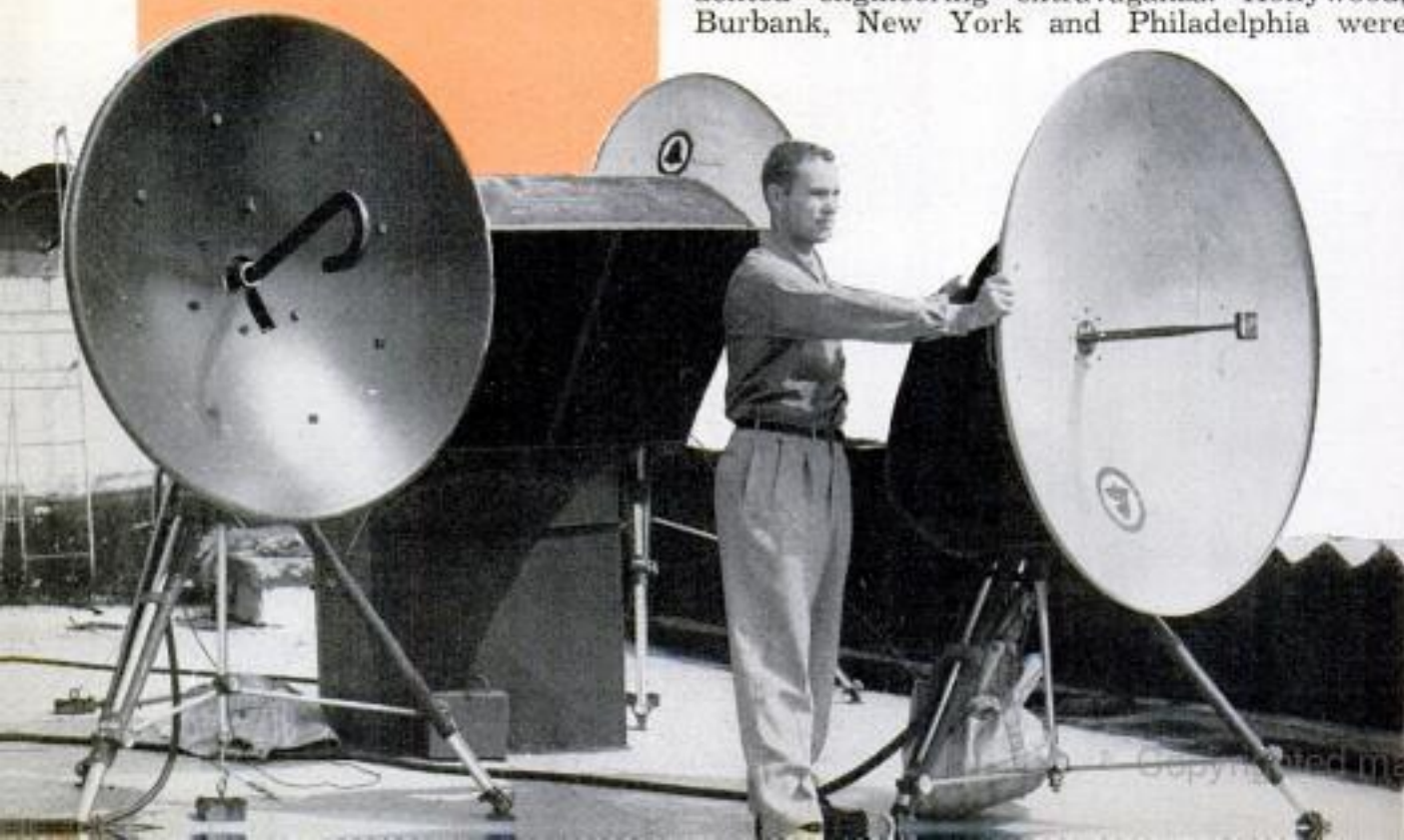





**Tuxedo-clad camera man atop huge crane photographs celebrities as they arrive for the Oscar presentation**

linked as though under one roof for the two-hour program.

When the last golden statuette had been presented and the white ties and ermine departed from the klieg-light gleam, a tired sleepy-eyed crew of engineers, in rumpled, rented tuxedos, was left to pack up the equipment and sigh, "Well, we did it. There were no boo-boos."

It was a satisfactory feeling, after the agitated past 24 hours at the Pantages Theater, a few steps from the corner of Hollywood and Vine. No tuxedos then, but old work clothes, flannel shirts and jeans, in a bustling beehive of preparation. The only calm note was the huge replica of an Oscar standing quietly off stage center.

Workmen with coils of cables hustled back and forth. The orchestra was rehearsing repeatedly one musical phrase, "When you wish upon a star" culminating in a brilliant fanfare, over and over again, dominating the other sounds in the huge theater—the soft mutter of voices, a hammer at work, and the steady hum of the air conditioning outside the improvised television-control room backstage.

Specially built soundproof

rooms were temporary headquarters for TV and radio, with an announcer's booth, swathed in monk's-cloth draperies, tucked away in a corner with only a television monitor from which to describe the evening's events. The door to the NBC-TV booth was propped open for ventilation and, inside, busy engineers checked equipment and studied the wavering green

**Engineer Bob Finch listens critically to orchestra balance at equipment which fed musical portion of program to TV and radio**







Engineers keep watchful eyes on entire television production at NBC's Hollywood master-control room



Two cameras mounted on 12-foot tower in center of theater are used in shots of entire stage. Three cameras on stage were used for close-ups. Below, at Burbank studios, actor Paul Douglas awaits cue to start commercial to be inserted in Academy Awards program. Other commercials came from film studio



'scopes on the banks of field-camera control units. Paper coffee cups were strewn about their control desks. Most of these tired-looking men had averaged two hours' sleep, for only the day before had they been able to land full force in the theater. Camera and power cables had been installed a week before, but work had been limited to a few hours.

At least 30 NBC engineers were in the theater itself, with another group at the Burbank studios where commercials originated and, of course, the master-control technicians in Hollywood. In addition, there were at least a dozen audio and video telephone men working with them.

Most interesting of all in the intricate setup was a portable wipe unit, designed and built by a field engineer in four weeks' time. Inserted in the control panels, it was responsible for the difficult split-screen effect, with Hollywood on one half and New York or Philadelphia on the other, both appearing in one picture. To get the special effect, the output of the New York video circuit was fed into a high-quality 17-inch picture monitor in a booth backstage at the Pantages, the picture retelevised and fed into the mixing system and portable wipe unit, producing the split-screen result.





Television-audio engineer Bill Cole checks incoming program from New York during dress rehearsal of show

Excitement was as contagious as measles that busy morning in the dim half-light of the Pantages backstage. Somewhere a saw was whining. Telephones were ringing. The audio engineer twisted a few knobs and listened intently in his earphones. "There's still buzz on those mike lines," he said. "It's got to be ground loops. Let's put in a booster amplifier and feed high level instead of low."

They were using 16 mikes altogether, and 24 monitors had been installed in the pressrooms, announcer's booths and backstage which would be fed video and audio. The big-screen projector was installed by RCA, with special equipment to drive it in order to project a reverse picture from behind the screen, instead of from its normal position out in front. To produce such a picture, it is necessary to reverse the horizontal scanning of the projection tube. Since light energy was transmitted through the screen, it was impossible from the rear to tell if the projector was in focus, or had the proper amount of brightness and contrast. So there was a monitor in the audience manned by an engineer with a private line who literally "talked him in," telling him which knobs to turn and adjust.

Eight cameras were ready, two outside the theater and six inside. One was in the theater lobby and the other mounted on a crane across Hollywood Boulevard to televise the celebrities as they arrived. Inside, two cameras were on the tower in the center of the house. One camera on this platform had two turrets, making a total of eight lenses available instead of the usual four. They were using four Electro-

Zooms—the lens which can change from a wide shot to a close-up with a flick of a switch—and one English-designed Zoomar. Three cameras were on stage—two on pedestals and one mounted on a crane dolly.

Simultaneously, a radio broadcast of the event was being carried, using much of the same equipment and program material. In the improvised radio booth, constructed off stage left, one engineer monitored the orchestra. A feed from his equipment went to the radio engineer in the same booth, while another leg of this same feed went to the television-audio engineer who mixed it with the TV portion of the program. Similarly, a feed from the TV-audio system, with dialogue from the Pantages stage and the audio portions from New York and Philadelphia, was made back to the radio-broadcasting equipment. Another set of amplifiers, bridged from the TV equipment, fed the PA system inside and outside.

Installing the equipment was something else again. A doorway adjacent to the stage had to be removed just to bring in a camera crane and its equipment.

At least a dozen holes were drilled in the stage floor in order to get cables through to the basement before the realization came that it was a double-concrete structure. The camera cables ended up being run through the plenum chambers of the heating system. To get to the camera on the crane across Hollywood Boulevard, they had to go through the gridiron (the framework above the theater stage supporting the pulleys that raise and lower scenery), through the ventilator, across

(Continued to page 232)



## You Assemble This Miniature Garden Tractor From Kit of Parts



With a new kit of parts you can assemble a miniature garden tractor for lawn mowing and rolling, grading, cultivating and removing snow. The kit includes all the parts except the engine. Any  $1\frac{1}{2}$  to 3-horsepower gasoline engine can be used. The little tractor stands only 31 inches high and is  $49\frac{1}{2}$  inches long, but there's a seat big enough for one adult or two children. The speed is variable from two to eight miles per hour depending upon the diameter of the engine pulley.

## Sliding Tie Rings Anchored in Floor Track Secure Heavy Equipment

Outboard motors or other heavy items won't roll around the rear of a station wagon when tied down to floor tracks similar to those used on cargo aircraft. Rings that fit into the track hold the tie-down ropes securely without slipping. Each ring can be locked in position at any point along its track. The rear seat of the station wagon can be fitted to roll in the tracks. The seat can thus be secured at any desired position or reversed if necessary. Other uses of the track are for automobile-top carry-alls and for tying down heavy equipment that is shipped in over-the-road trucks.



## Attachment for Portable Electric Drill Starts Gasoline Engine



You can start a gasoline engine without jerking a rope when you use a new attachment for an electric drill. The starter is designed primarily for persons with a heart condition or back trouble. One part of the attachment fits on the drill and the other part on the engine. You engage the two parts and turn on the drill to start the engine. The attachment replaces the rope starter on power mowers, garden tractors, water pumps, generators and other machines driven by gasoline engines.

☐ Originally developed as a nonskid coating for Navy ship decks, a plastic paint is available for coating stairs and floors with abrasive aluminum-oxide granules in a plastic base to increase friction.





Consolidated Vultee Aircraft Corp. photos

## Supersonic Delta-Wing Interceptor Is Tested by Air Force

Supersonic speed is expected from the Air Force's new delta-wing interceptor, the F-102. Neither performance figures nor dimensions of the Convair-built craft have been announced, but it has been

under tests at Edwards Air Force Base since December. It is slated to be equipped with a Wright J-67 turbojet engine, one of the most powerful types now in operation, and is designed for all types of weather.

## Model of USS *Forrestal* Gives Preview of Biggest Aircraft Carrier

Modelmakers have unveiled a miniature replica of the USS *Forrestal*, the Navy's latest and biggest aircraft carrier. It is scheduled for launching late in the fall. The fixed-island structure, the canted flight deck and the four deck elevators, three on the starboard side and one on the

portside, are shown in the model. Four catapults appear as white lines. Lining the sides of the flight deck are hinged radio antennas which swing down out of the way when the *Forrestal* is launching or retrieving planes. The canted flight deck was decided upon after the keel was laid.

Official U.S. Navy photo





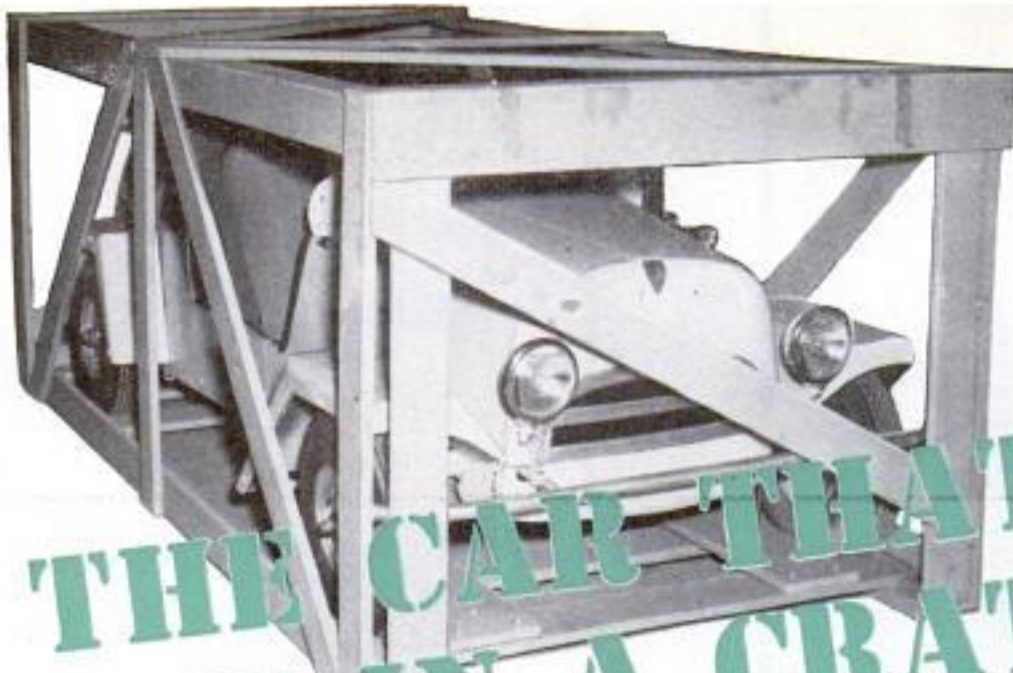

# THE CAR THAT COMES IN A CRATE

By Steve Libby

**N**EEED A NEW CAR? And a garage? You can get them both for about \$600 if you buy a King Midget, the car that comes in a crate. The crate, with siding nailed on and a peaked roof added, makes a fine garage, as some owners have discovered.

Most King Midgets, though, aren't pushed into a crate garage every night. More likely, they share a full-size garage with a full-size automobile, taking up not much more room than a power mower and a wheelbarrow.

What is the King Midget? Many persons

have never seen one although it has been in production since 1946. Today there are several thousand Midgets in use all over the world.

The small car is the result of an idea of two Athens, Ohio, men—Dale Orcutt and Claude Dry. After the war, they started experimenting with a lightweight car based on airplane-type construction. They hand-built nine test models and then moved into an old motor-scooter factory to make the new car in earnest. For a while the manufacture of two-wheel motor scooters paid

King Midget chassis, showing perforated side members and location of the air-cooled, one-cylinder engine

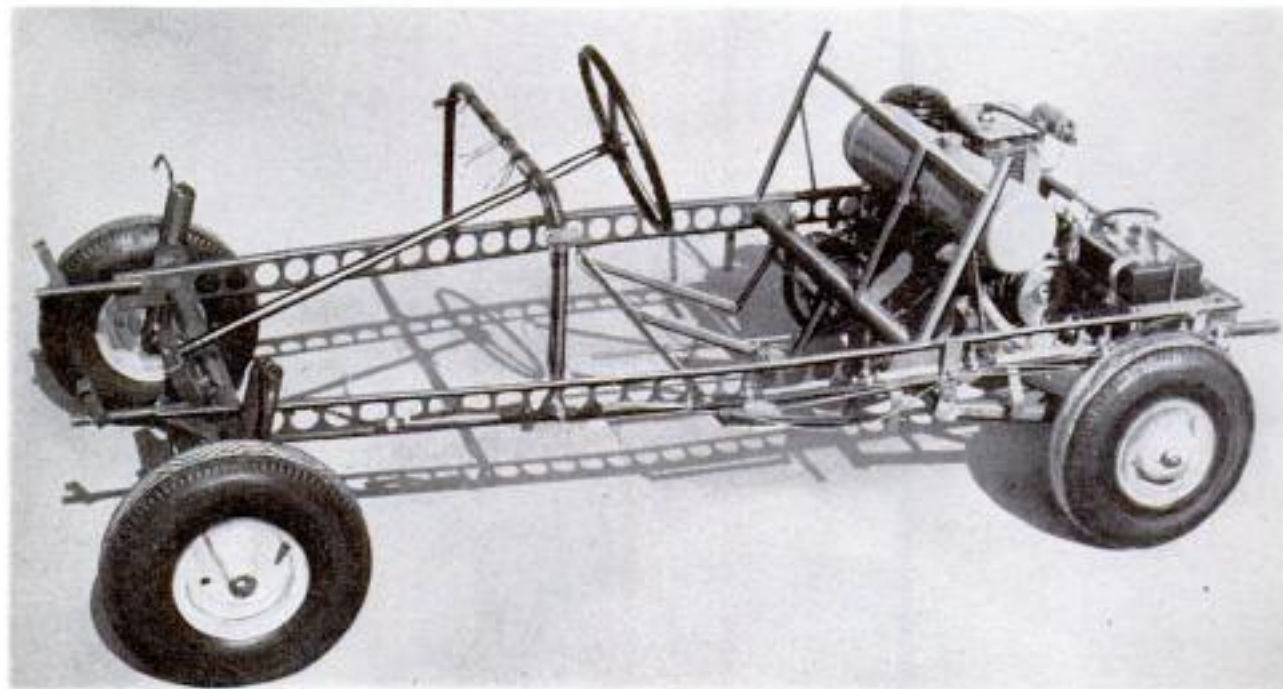





Despite its size, the King Midget isn't afraid of hard work. Here it tows a small speedboat and trailer

the bills, but soon the King Midget became the breadwinner.

With a 72-inch wheelbase, the King Midget is about two inches wider and six inches shorter than the Crosley (no longer in production). It is of all-steel construction, with frame members being formed of aircraft tubing and perforated channeling for strength and light weight.

Top speed is about 50 miles per hour. Driving the car is simplicity itself. There is no foot clutch. To go forward, you merely put the shift lever in Drive and step on the throttle. The only foot controls are a brake pedal and an accelerator. De luxe models have an automatic transmission with two speeds forward. Standard models

have only one gear ratio for forward speed. It has a reverse gear, of course.

What does it cost? The basic price is about \$560, complete and ready to drive. You can pay as much as \$700 for one, if you want such extra-cost items as the automatic transmission, electric starter or a nonstandard color that adds \$10 to the bill (standard color is described as a "rich cream" by the manufacturers).

The King Midget is chain driven and uses 5½-inch tires, little more than 18 inches high. One finger can turn the steering wheel even with the car standing still. The car turns around inside an 11-foot circle. Brakes are internal expanding and on the rear wheels only. Because most of the

At famed Cypress Gardens, the tiny cars drive down to the water's edge. If one gets stuck, it is picked up!





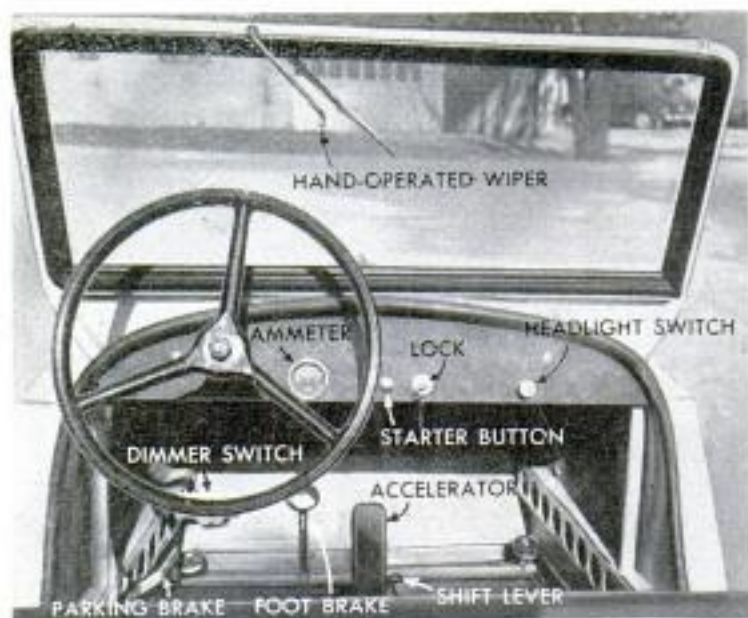

Don't look for luxury or fancy styling inside the car (or outside either). Labels show the various controls used by the driver. The only foot pedals are accelerator and brake pedals, plus the dimmer switch. Horn button, not visible, is on dash



No sissy, the tiny car shown above made the trip from Michigan to Mexico and back with two persons and luggage aboard. Below, you can buy a Midget as a kit and assemble it yourself, but it saves only about \$20. Almost all of them are sold assembled



weight is there (it being a rear-engine car), braking efficiency is equal to that of a four-wheel-brake car.

Its one-cylinder, air-cooled Wisconsin engine weighs about 75 pounds dry; the whole car weighs 550 pounds. Without the extra-cost electric starter, you turn over the engine with a rope pull, similar to that on an outboard motor. Being air cooled, the engine has no radiator and no cooling problem, even in hottest weather (King Midgets are in use in almost every country in the world, including hot climates as in Saudi Arabia).

The car passes safety requirements of all states, having safety-glass windshield, sealed-beam headlights, stoplight, electric horn, windshield wipers (hand operated) and a high brake efficiency.

With its rear engine, the King Midget has traction under almost all conditions. If it should get stuck, you can pick up the front end yourself or with the help of another person pick up the rear end or with three others you can pick up the whole thing and carry it to firmer ground!

Yet it is no toy, having plenty of durability and "muscle" built into it. One owner drove from Michigan to Mexico and back with a passenger, baggage and camping equipment aboard. Total weight of the load was much more than the weight of the unladen car. It would be the equivalent of taking a long trip in a normal-size car loaded with more than two tons of passengers and luggage!

King Midgets go from 50 to 65 miles on a gallon of gasoline. Three pints of oil fill the engine.

The top is semiconvertible—it does not fold, but can be removed. It has no trunk, the engine filling the rear compartment. There is room for two suitcases behind the driver's seat. The space under the hood is filled by legs.

Because of its original design, the King Midget has many unusual ideas. For example, the stoplight switch is simply a pressure switch on the face of the brake pedal. When you step on the brake, you close the switch, turning on the stoplight. Altogether, there are over 60 patents granted or pending on various features of the car that comes in a crate. ★★ ★





Electric chair is designed specifically for going up and down stairs. Attendant is needed to steady it



Curb-stepping wheel chair easily climbs over small obstructions when center tail wheel is retracted

## Motorized Wheel Chairs Step Over Curbs and Climb Stairs

Two inventors—Ove Hauschild of Copenhagen, Denmark, and R. E. Church of Elkin, N. C.—have similar ideas about giving the wheel-chair patient more mobility. The Danish invention is an electric stair-climbing chair. Three small wheels connected by a vee belt rotate around each end of the axle. The chair will go up or down the steepest stairs, although an attendant is needed to steady the device. The

American vehicle is powered by a two-horsepower gasoline engine and enables the operator to ride over curbs, climb steep grades and negotiate two or three steps at a time—all without outside aid. On each side, a large wheel at the front is connected to a small rear wheel by a vee belt. In normal-travel position the vehicle rides on the two main wheels and a center tail wheel which turns for steering.

## Fresh-Air Gymnasium for Texas School Open on Two Main Sides

Children at a new Corpus Christi, Tex., school will get plenty of fresh air and sunshine when they're exercising in a unique open gymnasium. The gymnasium court is completely open on two sides, because out-

door play is possible 96 percent of the school year. A curved roof which rests on a supporting wall and one end of the gymnasium locker building protects the court from rain and direct sunshine.

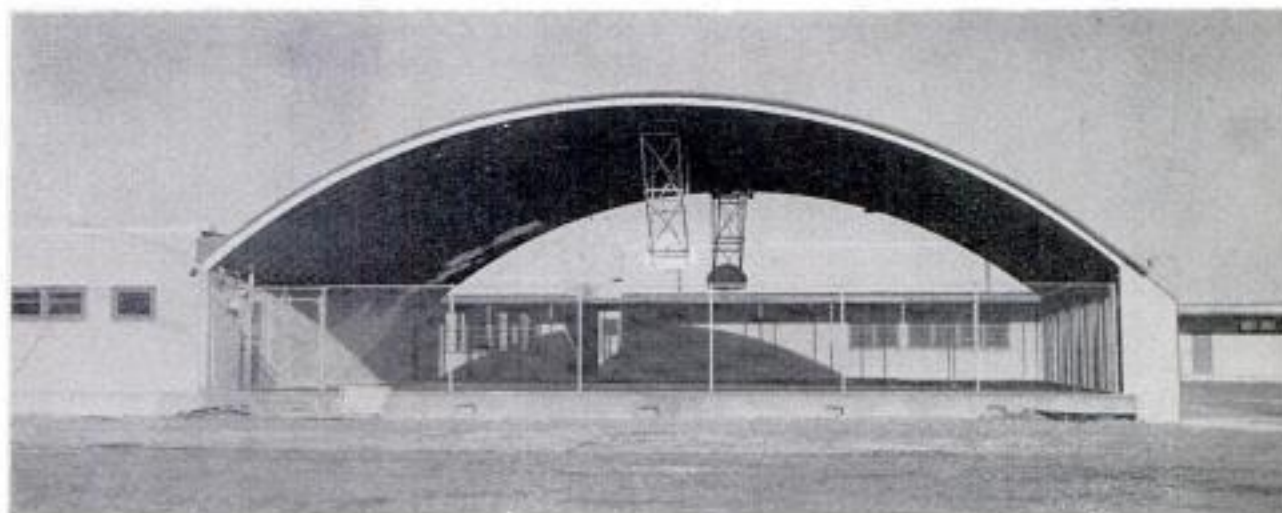



# MIDGET SUBS PLAY TARGET FOR KILLERS

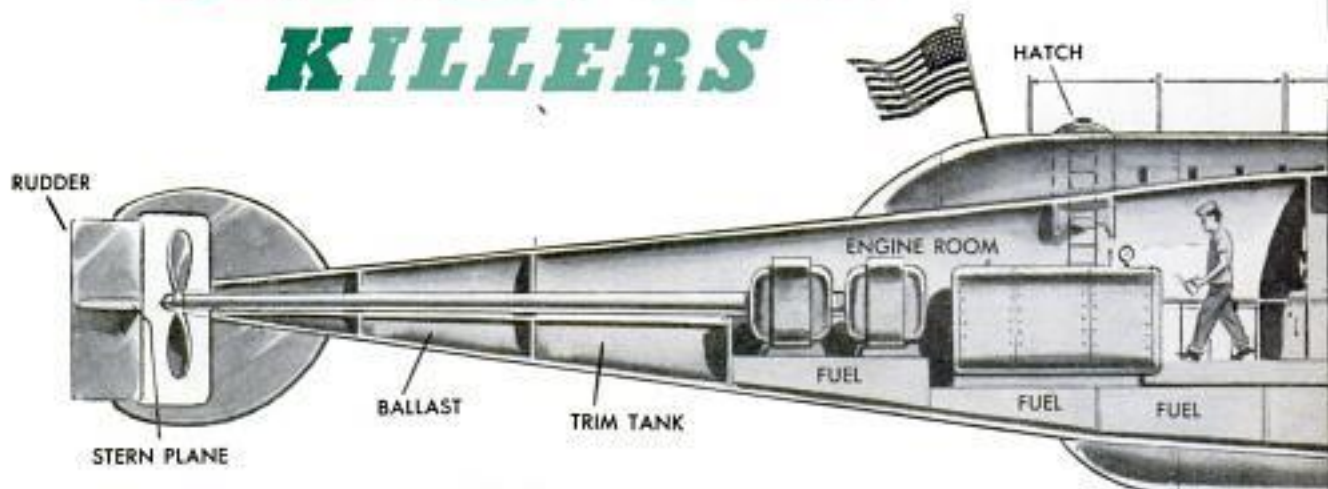

By Richard F. Dempewolff

**F**ANCY BALL SUGAR, this is Hambrook George. . . We will use grenades on the next three runs. . . Stand by to mark center."

The cryptic message on the underwater phone meant we were about to be "depth charged" with grenades. Fancy Ball Sugar was our code name in a cat-and-mouse game between destroyer and submarine. Hambrook George was the leader of a three-destroyer-escort task force whose mission for the day was to "scratch one submarine"—us.

Fluorescent light glinted off myriad dials in the cramped control room of the brand-new midget submarine T-2, as she fishtailed evasively through the midnight-blue Gulf water. We crept along at three knots. Our depth needle wavered at 110 feet under the

hand of the helmsman, sitting at a radically new joy-stick control by which he "flew" the sub like an airplane. Lt. Edward Holt, captain of the unique craft, sat hunched before the window of the sonar screen, watching a cathode ray shoot green graphs of light across the range grid. Through his earphones, and over the loudspeaker connected with the sonar, the grating sound of a destroyer escort's whirring propeller overhead grew louder and louder, scraping the silence. The "pip" on the screen showed he had our range, was bearing down fast.

"Mark center!" A voice from the ship upstairs boomed over the underwater phone speaker. An instant later, an ear-splitting crack ricocheted through the jam-packed spaces of the baby sub with the noise impact of a 60-mm. cannon.

Three-hundred-foot fleet sub in background dwarfs T-2, which is 131 feet from bow to tip of its submerged tail





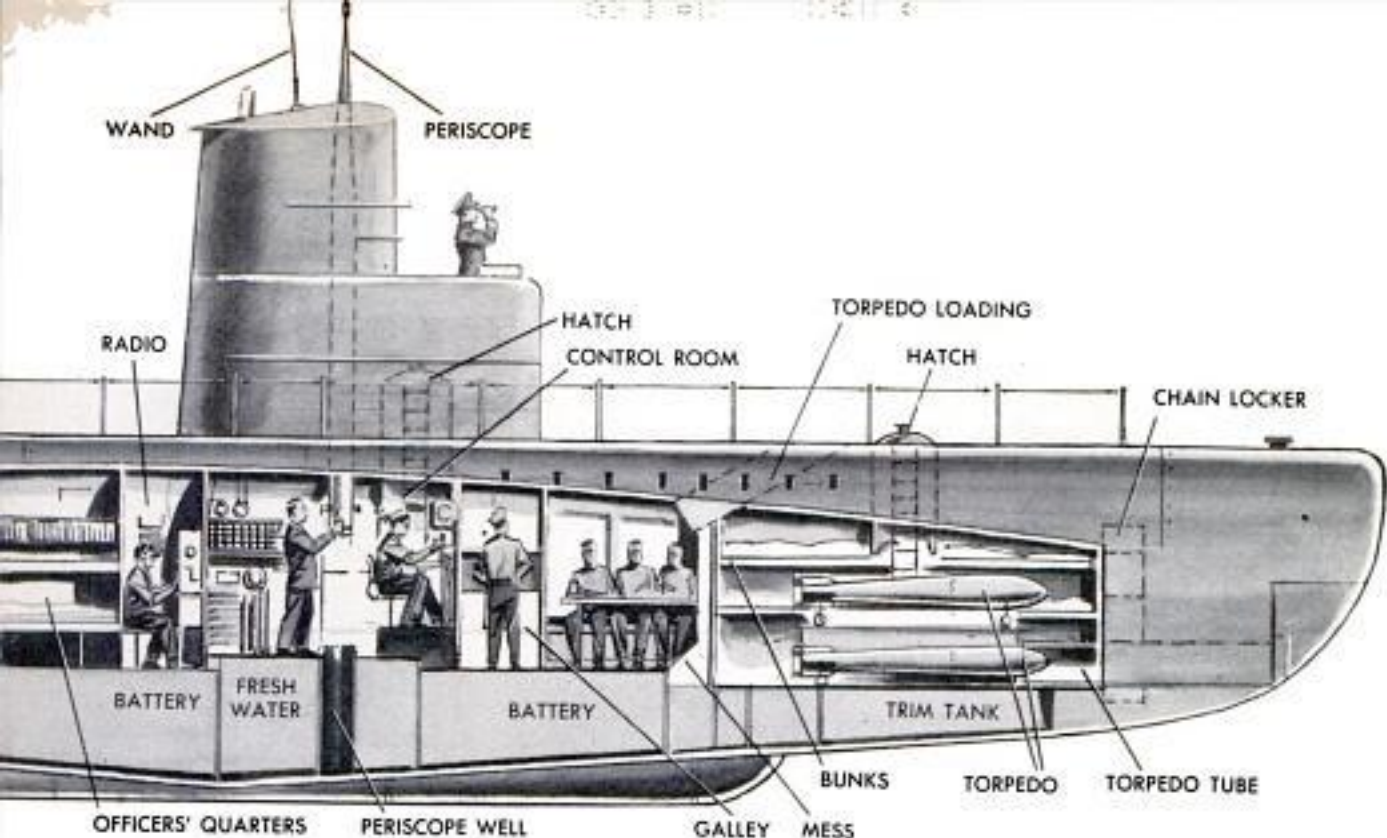

"Vent one thousand," somebody muttered. "We're dead."

"Vent one thousand," is seagoing vernacular for "sub sunk," and if that grenade had been a depth charge, we would have been dead. Lt. Holt was already making his report to the DE (destroyer escort): "... one zero yards dead ahead my bow ... good shot."

Although the grenades were "local color" especially for my benefit, there was nothing simulated about the rest of this business. Every man involved was deadly serious. The work is part of a vast Navy program designed to train surface crews in the vital business of locating, running down and destroying enemy submarines, using a frightening array of complex electronic

**A push forward on the joy stick points the sub down, a pull brings her up. Wheel at top steers the rudder**

gear that does everything but talk. Submariners learn evasive tactics and, in some mock battles, strike back at the surface forces with dummy torpedoes.

The T-boats, T-1 and T-2 (T stands for "target trainer"), are the newest tools in the program and, it's hoped, will prove how easy or tough it is for a sub to elude the "hound dog" tactics of surface anti-sub forces. Fresh off the General Dynamics Corporation's ways in New London, Conn. last year, they have been winning their spurs the hard way at the Navy's Key West Base ever since.

T-boats are smaller than any U.S. sub that has slid down the ways since the "B-class" boats of 1907. Two jumps would carry you across the T-2's 13-foot beam. Walk

**Bow planes regulate pitch of sub's dive and retract into hull when not in use. Joy stick controls them**







Operations over, the midget sub sails home. Captain Holt and his exec ride the conning tower as sailors rig lines for docking. Below, Holt checks location of DE on sonar screen as it passes over and drops "charge," tells skipper if he was close enough for hit



down the lean deck and you soon run out of ship. She's only 131 feet (a fleet sub is about 300 feet) from rakish bow to the weir guards surrounding her single screw—and nearly a third of her over-all length is just a tunnel for the shaft. It never clears the surface. But the housing for her rudder humps out of the water some thirty feet aft, so that when she's underway she looks like a mother whale followed by a pup. Her pint-size conning tower is wide enough so you have to be a tightrope walker to squeeze past it.

It takes 14 men and two officers—or a fifth the number for a big sub—to run a T-boat, and it's a good thing it doesn't take more. The spaces below deck are crammed with a plumber's nightmare of gleaming steel gear, meters, dials, levers and switches. Two main bulkheads divide the hull into three compartments. Up in the bow, men sack in with the torpedoes. Bunks fit between and atop the "fish" with, as one man puts it, "snoring clearance of about three inches." There's even a bunk on the single torpedo tube, which is the T-2's only weapon. Two steps take you through the hatch to the crew's mess—a short narrow shelf from which four thin men can eat, once they've learned to do it with elbows pinned to their hips. Behind them, E. T. "Frenchie" LeFevre, the ship's cook and most popular crew member, serves up rare fare of frog legs, lobster tails, shrimp and other nonregulation morale-boosting dishes, in a galley that measures a full two by three feet. Frenchie's built-in coffee urn is overhead. But his freeze locker, which takes up most of the area in this space, will stock enough provisions to keep his eager customers supplied with full meals for 20 days at sea, and on lean rations for another 10.

Midship compartment on the T-2 houses the control room, radio shack and just about the smallest officers' quarters in the Navy. Here, Capt. Holt and his executive officer, Lt. (jg) McQuilling—both six-footers—jackknife themselves into five-foot bunks, which they have to make up themselves each morning since there's no place on board to stow such luxuries as a steward.

The midget's twin diesels that spin the generators to charge the batteries which, in turn, drive the big electric motor that turns the screw, are squeezed in the long tubular compartment at the after end of the boat. A compact arrangement of batteries fill the round belly of the sub. The four main-ballast tanks, for diving her, circle up inside her pressure hull. Every inch is utilized.

"For training in peacetime, and possible coastal and harbor work in war, she's a





Destroyer escort 218 is leader of the surface task force of three DEs out to "kill" the midget submarine

nifty little boat," says Captain Holt. "Mass produced, she'd cost a fraction of a large sub, and is remarkably economical to run. The fuel tanks hold 5500 gallons, against the 105,000 gallons in a fleet-type sub, and she'll go 2000 miles on them. While her top speed of 10 knots will never break records, she can spin around on a dime. She rides a sea better than a big sub, because the small bow rides with it. She's lively in the water. Because of her size, she's mighty hard to find. She's so splinter thin that if we run her bow-on or stern-on toward any destroyer bent on her destruction, she won't give any more sonar return than a fish on their ranging scopes."

You're not on board the T-2 long before you realize that her 14-man crew is unusual. There's an air of efficient informality that Capt. Holt compares with a baseball team. "Every man," he explains, "knows how to play every other man's position." You may find Frenchie, still wearing his "cook's hat," taking his trick as "pilot" on the joy stick after the frog legs are cleaned up. Chief of the boat, John Ott, is officially first-class radioman in charge of communications. But he may be found on deck heaving lines when T-2 gets underway, down below on the hydraulic manifold during diving or surfacing operations, or relaying orders from the exec in the control room.

With such a small crew, there can't be any pure specialists. If one man is laid up another must fill in. Everyone on a T-boat is a T-boat enthusiast. He has to be. "She's a working son-of-a-gun," one of the men explains. "Four hours sleep in every 24 is a good average, and there's not much room for time off." Actually every T-boat man is a double volunteer—first he had to volunteer for sub duty; then he had to

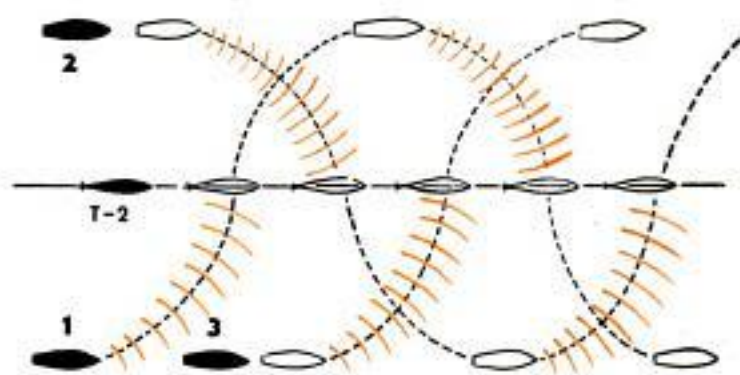

Sketch shows how surface ships make runs on midget sub T-2. Below, rocket-propelled "hedgehog" depth charges are launched singly, in series or all at once





**NEGATIVE GRADIENT IN OCEAN TEMPERATURE IS A CONDITION WHERE AT A CERTAIN DEPTH, TEMPERATURE SUDDENLY DROPS. IT BENDS SONAR BEAM DOWN, SO SUB CAN HIDE IN THE COOL LAYER.**

**POSITIVE GRADIENT SURFACE WATER OF COOL TEMPERATURE OVERLAYS A WARM LAYER, AND SONAR BEAMS BEND UPWARD, INCREASING RANGE. SUB SKIPPERS DON'T LIKE IT, SINCE THEY CAN'T COME IN CLOSE WITH SAFETY, OR EVADE DETECTION**

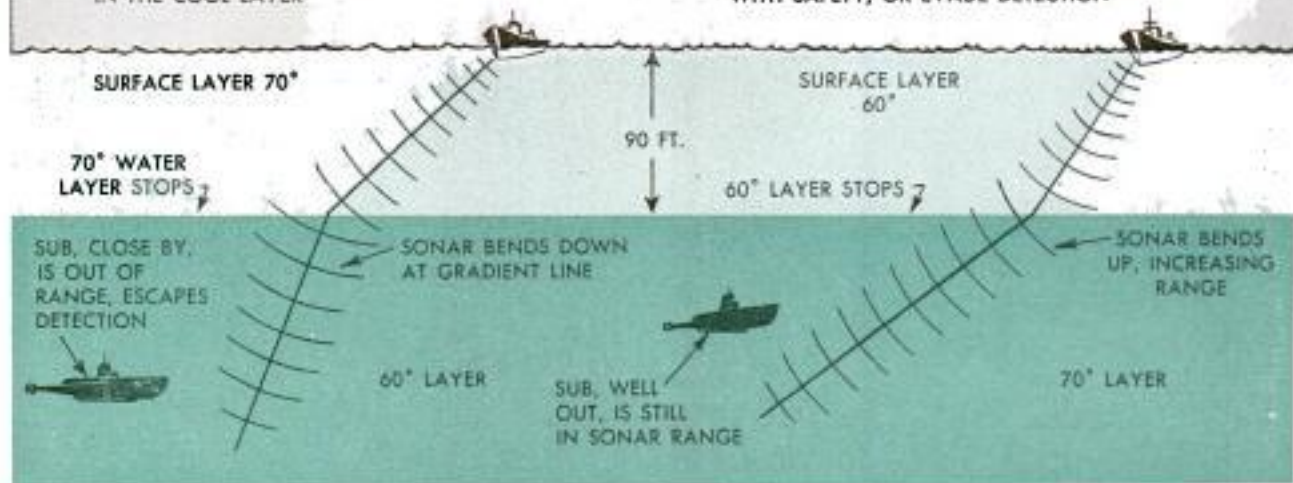

Range of sonar detection equipment often depends upon presence of warm or cool layers that bend beams

volunteer again for service on T-boats.

Despite her cramped spaces, there are no short cuts in the business end of the T-2. All her working equipment from periscope and snorkel to air conditioning is standard. Her sonar, radar and radio gear are the same as on any big sub. In time of war, Holt thinks she could do a fine patrol or harbor defense job—at a fraction of the cost of a fleet-type boat.

To watch her in operation on a problem exercise is an experience in peak coordination. T-2's day starts at dawn. Lines are heaved, and off she goes out the Key West channel to take up duty as underwater clay pigeon for the three "enemy" DEs that will spend the day making runs on her. From now on, T-2 is "Fancy Ball Sugar" on the communication frequencies. The lead surface ship, DE 218, is Hambrook George, and the midget will take orders from its skipper, Lt. Cmdr. Jackson Morton. Plowing the blue water behind 218 come "Daphne Tare" and "Forfeit Fox," two more destroyer escorts. The fun starts when the ships reach their assigned area.

In the 10-by-10 confines of T-2's control room, every man is at station when orders blare over the radio from Hambrook George to commence the exercise.

"Straight board—pressure in the boat," snaps the exec. T-2's siren blares. A horn like the Klaxon on a 1910 car blasts through the spaces.

The chief of the watch, manning the hydraulic manifold, moves like greased lightning. He flips a lever that claps the main induction hatch shut with a crack like a .45 fired into an empty steel drum. One hand turns a valve to secure the snorkel; the other throws switches that secure remaining hatches. On the lighted panel in

front of him, red "Os" indicating open holes blink out and are replaced by a "straight board" of red dashes. The boat is secure.

"Submerge to 30 feet," comes the order from McQuilling.

Bang! bang! bang! bang! The sharp crack of solenoids ramming home echo down the compartments as the craft is vented and sea water gushes into the ballast tanks. Silence shrouds the boat as diesels cut out and battery power surges to the soundless motors. At 30 feet (periscope depth), the order comes to "zero bubble," or level her off for a final check. Vents slam shut. The midget steadies in the water as Captain Holt ups periscope for a last look around.

Diving-officer McQuilling scans the instruments. At a signal from the skipper he gives the final diving order: "Hundred and ten feet, five degrees—down bubble."

In his seat behind the tricky joy stick, the "pilot" flips the switch that rigs bow diving planes. T-2's deck tilts forward and down she goes to working depth. No other sub has bow planes like the T-boats. When secured, they fit in slots, completely hidden from view under the deck. When "rigged," they hinge forward out of the slots at a down angle for instant dive. By pushing his stick forward, the helmsman can increase the angle on the planes. By pulling back, he reverses them and the sub "flies" up through the water. Turning the wheel atop the joy stick steers the rudder. On most submarines, three men at three different controls handle the chores that a T-boat helmsman can do alone.

A hundred and ten feet was our working depth the day T-2 performed for *Popular Mechanics*. Down below our course was set, the boat was trimmed, and off we went on a five-hour hounds-and-hares chase.



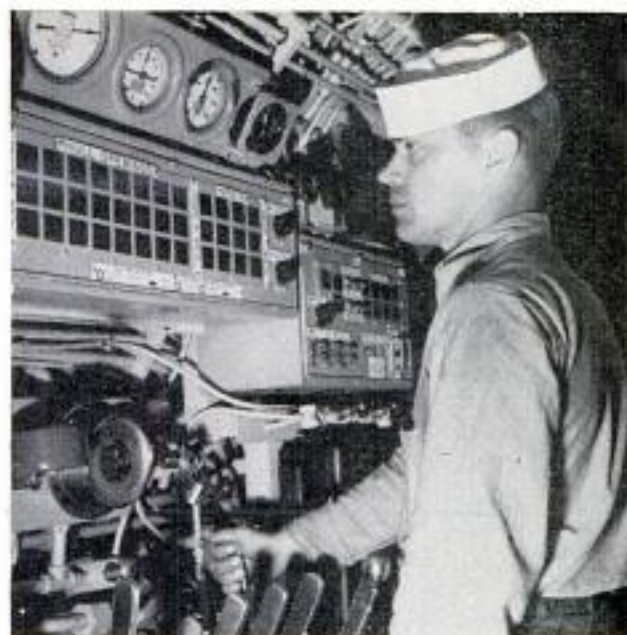

Signal flare projectile goes into ejector. Chief Ott, right, regulates ballast and closes hatches with hydraulics

On the surface, three DEs line up for the "kill"—two on one side, one on the other, crossing our track in turn, dropping imaginary charges and calling for accuracy reports.

At the sonar scope, Captain Holt watches their approach, listens for their "mark center" call at the point they choose to drop their imaginary depth charges and reports hits and misses over the underwater phone. The gobbledy-gook chatter, mixed with the sound of whirring propellers overhead, sounds like talk between space ships: "Fancy Ball Sugar, this is Forfeit Fox" . . . (pause) . . . "MARK CENTER!"

Noting the location of the pip made by the DE on the sonar range screen at the instant of "mark center," Holt reports his "death" or escape: "Forfeit Fox, this is Fancy Ball Sugar . . . Your closest approach—one, zero, zero. At mark center, fo-wer, zero, zero yards." Up on Forfeit Fox's bridge, sonar students huddle to find why their aim was off, as the ship goes to the end of the line for another try.

In this hunt-and-kill business, subs may try evasive tactics, as we did that day—fishtailing down the course. They may also carry sonar students, and fire back at their attackers with dummy torpedoes. Although the T-boats are equipped to do this, and will, they haven't tried yet. But most of the men on board have played in such games on fleet-type subs. Sometimes, the competition gets keen enough so that both sides will fudge on enemy "hits," reporting a near miss instead. Arguments ring over the underwater phone.

But during more elaborate exercises, in which weapons are used, it's not easy to cheat. At "mark center," the surface ship fires a pattern of rocket-type charges,

called hedgehogs. The bristling launcher is designed to send them arching out over the water, spread thin like buckshot from a shotgun and bracket the sub. Each is smeared with dye to stain the water where it enters. At "mark center," the sub must release a bubble from her oxygen banks, or a flare from her ejector tube.

"Subs can't fudge on that system," says Lt. Cmdr. Morton of DE 218. "We can see where the bombs went in and where the flare or bubble comes up. Sometimes a bubble will boil right up through a patch of dye. When it does, we call it 'Roger, slug, zero' which means—scratch one sub. Fifty yards away would be 'Roger, slug, five,' and so on."

There have been some amusing episodes with the flares. A flare is a five-pound, shell-shaped device about 18 inches long. It is fired from the sub's ejector tube, bounds to the surface, explodes like a July 4th aerial bomb and sends a colored flare sailing skyward. On the way down, a tiny parachute opens and drops the flare slowly into the sea. Like any sub, T-2 carries three kinds: yellow means "preparing to surface"; green means "torpedo fired"; red means "sub in distress." Green is used in the exercises.

"We landed one right on the deck of an attacking destroyer," Holt recalls. "And one day, we even managed to send one sailing up to hit a blimp that was flying in low, trying to make a sneak attack on us."

Excitement runs at a high pitch during the double-edged battles between destroyer and sub. One fleet-sub skipper was so intent on "getting" his attacker one day, that he broached (surfaced) right under the ship, rolled over and lost a good-size chunk

(Continued to page 240)



## Rake "Pampers" Hay to Prevent Loss of Protein-Filled Leaves

Hay gathered by a new side rake is "babied" so it loses fewer of its leaves. The leaves are important to livestock diet because in legume hay about 75 percent of the protein is in the leaves. The new rake has five bars on the raking reel and moves the hay almost at right angles to the direction of travel. This reduces the forward motion of the hay, causing less damage. The angle of the tines can be adjusted to make a tight windrow for silage or a fluffy one for baling.



## Scientists Finally Find Long-Sought "Ghost" Particle Inside Atom

At last scientists have trapped an atomic "ghost" particle that has eluded them for years. The particle is the neutrino. The chase began 20 years ago when scientists were forced to acknowledge the existence of the particle if their atomic theories were correct. Neutrinos are so small that they

have practically no mass or electric charge. No direct evidence of the neutrino was found until the Los Alamos Scientific Laboratory devised a scintillation counter that was thousands of times more sensitive than any other device to reactions caused by neutrinos.

## Rotary Garden Sprayer Throws an Eight-Foot Stream of Dust

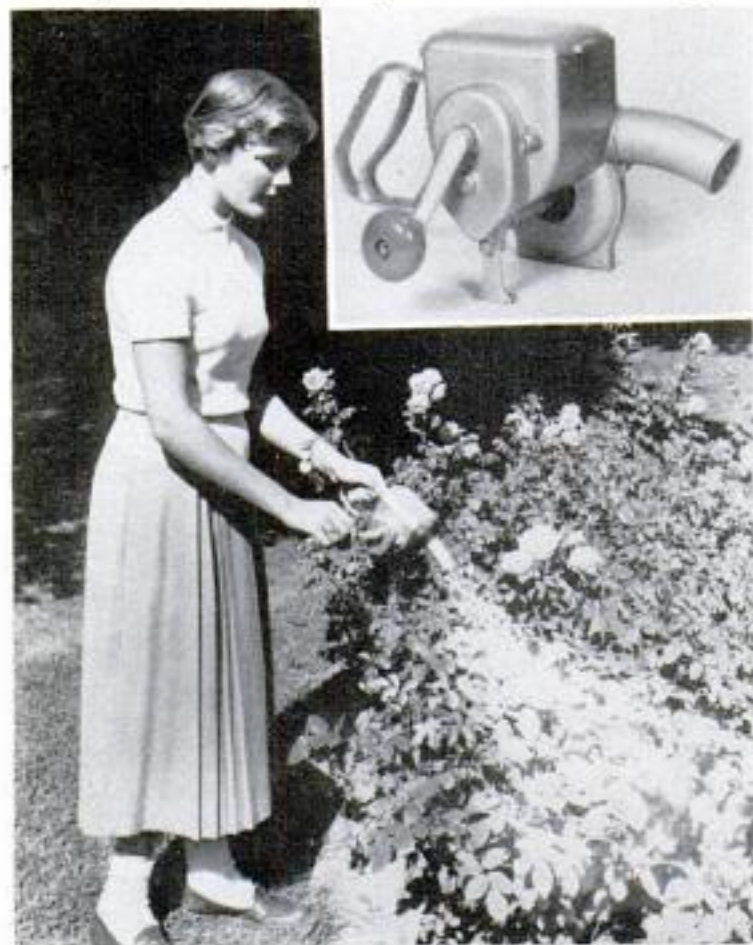

With a miniature rotary duster, gardeners can hurl a stream of dust eight feet long to reach bushes ordinarily inaccessible to them. The little duster weighs only 24 ounces yet it will hold enough dust to cover 200 rose bushes. Turning the handle generates an air stream which carries the dust.

## Improved Transistors Resist Heat and Air

Transistors made from a "stabilized germanium" resist their two worst enemies—heat and air. As a result, the electronic devices can be used for military equipment like radar and for commercial electronic computers. An alloy of 98 percent germanium and 2 percent silicon, treated in molten potassium cyanide, has been found by Sylvania engineers to be "quite successful" in resisting heat. Some alloys of germanium and silicon will operate at 350 degrees Fahrenheit, they say. Germanium crystals usually don't amplify above 212 degrees Fahrenheit.





Most fatal accidents involve clear weather, a straight road, a car in good condition PLUS too much speed

The State of Washington is getting tough with killers on the highway. Its advice to drivers is simple:

## **SLOW DOWN AND LIVE LONGER**

*By Rafe Gibbs*

**WHAT ARE POLICE** in your community doing to protect you from death on the highway? Are they tough enough—to keep you alive?

Last fall, Gov. Arthur B. Langlie of Washington got tough. "Kill a man with a gun and we call it murder," he told the public. "Run him down with a two-ton steel machine and we call it an accident. . . . I am determined to use every means at my command to repel this killer."

In his intense campaign aimed at cutting the traffic fatality toll in half, he ordered into action radar and radio equipment, electric timing devices, disguised patrol cars with a minimum of police identification and plain-clothes officers.

Arrests for traffic violations in the state

shot up 70 percent. The lives saved? The goal was almost achieved. In 1952, the traffic fatalities for the last two months totaled 134; in 1953, 78.

Throughout the State of Washington today are men, women and children who got an extension on their lives simply because their police got tough.

It was a rain-soaked night on Highway 99—"Fatality Alley"—between Seattle and Tacoma. A state-police car roared down the wet pavement. The speedometer needle nudged up to 90, then moved to 93.

Finally the police car had closed in enough on its quarry for the sergeant at the wheel to turn on the siren. The screaming sound brought a 1946-model light sedan to a slithering stop.



On facing page, a Washington policeman follows a suspected traffic violator, the "trafficamera" (upper left) recording the whole scene as he drives past

Frame from a film taken by the trafficamera shows car passing a truck and going 52 miles per hour. The camera automatically records the time and date also



The sergeant turned on the spotlight and, as he moved toward the sedan, its hatless driver got out, staggered and demanded:

"What's the beef?"

"Speeding—and I guess driving while under the influence, too. How many drinks have you had tonight?"

"A few—six or seven. How should I know? I'm not drunk. Just a little dizzy. And I wasn't speeding."

"Before I took after you, you clocked with radar at 85 in a 50-mile zone, and..."

"Radar... say, that ain't legal."

When Governor Langlie's traffic war got underway there was much argument as to whether the use of radar was legal.

The radar unit used in checking traffic consists of a transmitter in a small black box—about the size of an automobile battery case. The box, set in the rear end of a parked patrol car, sends out a beam through an opaque plastic window. This beam, held on a passing car, bounces back, and a calibrating dial, connected to the transmitter, registers the vehicle's speed.

The radar units, which cost about \$1000 each, are now being utilized in varying degrees by more than half the states. Some states, such as Oklahoma which has big "Radar Enforced Speed Limit" signs posted beside "Welcome to Oklahoma" signs on all highways leading into the state, make no bones about the use of radar. Other states, because of legal complications or criticism, have radar on an "experimental" basis.

Washington, with an antispeed-trap law, had not used radar until Governor Langlie declared war on speeders. As various prosecutors in Washington pressed for a decision on the legality of radar sleuthing,

the governor asked his attorney general for a ruling. It was his opinion that radar was not a speed-trap device and, because there was no chance of human error, its evidence could be used in court.

Added State Patrol Sgt. E. J. Loerch, one of the officers in charge of radar work: "The device is accurate within two miles in computing speeds."

Washington's first radar patrol was established on the opening day of the traffic war at a school crossing on the Seattle-Tacoma highway. A patrolman sat in the back seat of a parked police car, watching a gauge. As a car passed, he said:

"Thirty-one miles per hour. Eleven over the limit."

Another officer in the front seat flipped a microphone switch and broadcast a description of the speeding car. Several hundred yards ahead, as the speeding car passed, a patrol car swung into the highway behind it and turned on the red light. The arrest was made... as simple as that.

Particularly effective among the modern weapons ordered into use by Governor Langlie in Washington's traffic war were the airborne ones—not in trapping speeders, but in deterring them. At first, a big helicopter was used to hover over the main highways spoked to the hub of busy Seattle. But this proved expensive to operate for long periods and the State Patrol later turned primarily to light aircraft of the Washington Air National Guard.

The aircraft were equipped with two-way radio in contact with patrol cars.

"We spotted few speeders from the air," said Captain Clinton Johnson of the Guard. "The plane overhead just naturally kept





the drivers below within speed limits. But what we did see were cars following others too closely, motorists squirreling or hogging a lane or maybe slowing up a lot of traffic and getting other drivers impatient. We radioed the patrol cars and they took over from there."

Probably the most frequent violation noted — and a dangerous one, particularly on slippery highways—was that of following too closely.

Then there were the patrol cars without the familiar white sides. Langlie's terse announcement that these were to be used stirred up some protest—until it was explained that there would be no question in the mind of a motorist as to who was stop-

ping him even before he was flagged down.

Bearing down on traffic violators were blue, green or brown sedans — even two-toned jobs. And sometimes the police in them were in plain clothes. But the cars carried sirens concealed under hoods, had red blinker lights and license plates with the unmistakable police "SX."

A patrolman picked up a driver weaving erratically through traffic at high speeds. The driver, who admitted drinking "10 or 15 glasses of beer," had a drunkometer reading of .207, with .150 generally considered evidence of intoxication. His explanation to the judge, who fined him \$100 and revoked his driver's license for a year:

"I thought the officer's car behind me

Today's speeds don't permit fast stops. Chart shows distance required to stop from even moderate speeds

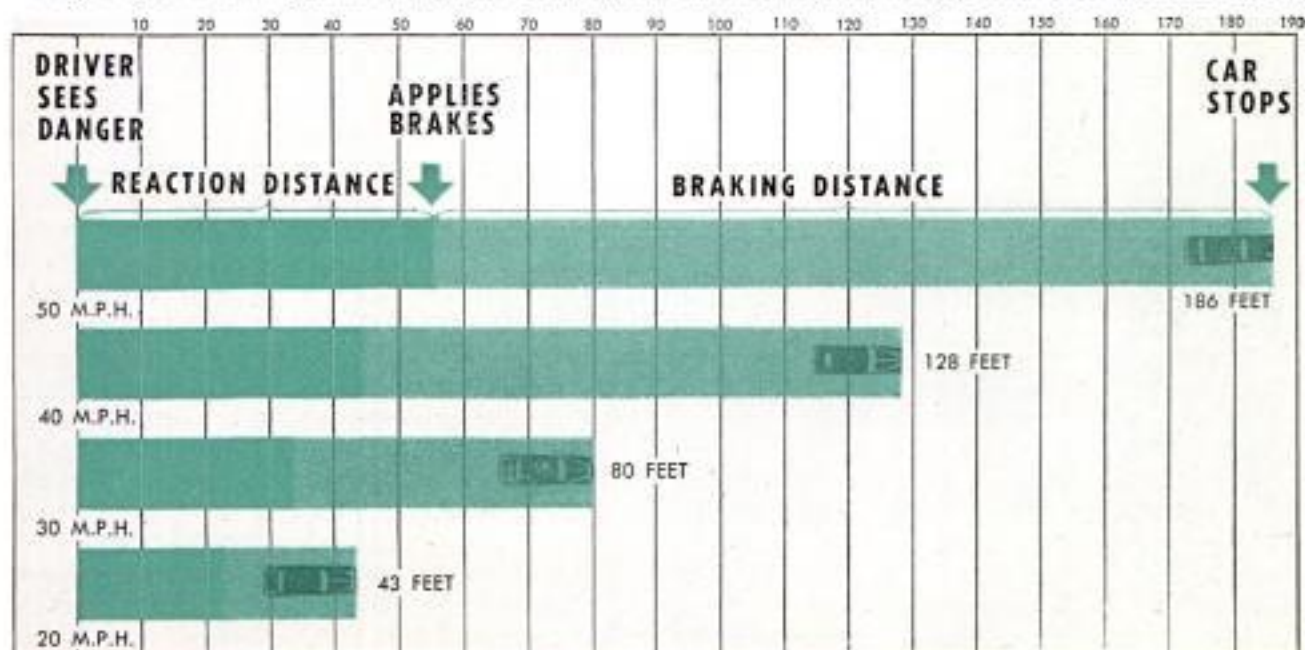





Washington uses aircraft to police roads in heavy-traffic periods. Violations are radioed to patrol cars

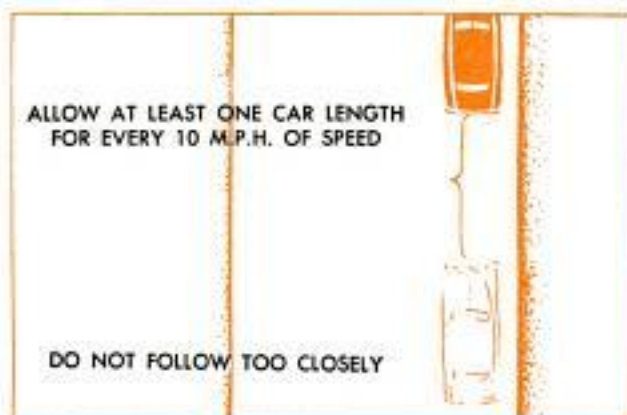

Speedometer of the radar unit gives the speed of approaching cars. A second car picks up violators



was some of my friends from the tavern I had just left. I was only showing off for their benefit."

And what was the public reaction in Washington to the traffic war? When police action gets so tough it can reach out and grab even you, you are not inclined to like it—unless you can see direct benefits for you. And it is difficult to prove that it is *your* life that is being saved by tough police action.

But an odd thing happened. Fast-driving motorists forced to take it easier on the highway, liked the slower pace. With the more orderly flow of traffic, there was less starting and stopping, less driver strain.

One Olympia-to-Seattle commuter found that he had to get up 15 minutes earlier to make the trip.

"But now I am enjoying the ride," he said. "Before I was a bundle of nerves."

As the campaign went into 1954, it did so with the use of a newly developed state "traffcamera" patrol car. With a 35-millimeter camera mounted on the car's windshield, the patrolman takes still shots or movies of violators in cars ahead. Automatically recorded on the film are the time and speed of travel. Pictures taken are used as evidence in court or for educational and training purposes.

In the United States today, someone is injured every 24 seconds in a motor-vehicle accident, someone is killed every 14 minutes. If the police in your community are not tough enough—and your support is needed to make them tough—you may have only 14 minutes to live. ★ ★ ★



**T**RADITIONAL summer doldrums that settle over the auto industry in July usually mark the end of the spring-summer sales season.

Dealers have found that each year most new models and a vast percentage of used cars are sold before the American public takes its summer vacation.

While things may be quieting down in the hinterlands, Detroit is buzzing as the industry works feverishly on patterns, tools, dies, jigs and fixtures for next year's cars. The manufacturing end of the business is in a literal sweat to meet ever-closer deadlines. Competition has not ended for the year, it is intensified by the pressure to get the 1955 models ready.

The sales race between Chevrolet and Ford will be interrupted only long enough for a "pit stop" to make new-model changes. This race dominated the industry during the first half of the year.

Chevrolet and Ford will come whizzing out of the pits in completely new cars. Plymouth, which fell behind this year, hopes to regain third place by entering the race with its redesigned 1955 models earlier than its rivals—although word persists at Chrysler Corporation that the new models won't be out until late December or early January.

#### Spies Are Working Overtime

Busier than ever is each company's "fifth column" that spies on the new models and reports the details to competition. These well-organized informers (without which no company would think of operating) are now known as "G-2" instead of by the more offensive term, "spies." Considering the vast number of blueprints that passes through so many hands in the mass-production schedule, it is amazing how little information gets out to the public.

But what has become common, well-founded gossip, is that Chevrolet and Pontiac will introduce completely new models with new engines (V8s, of course), new body shells, new ornamentation, panoramic windshields and mechanical improvements. They will have even more extensive changes than were made on the 1954 Cadillac, Buick and Oldsmobile lines.

All Chrysler's passenger-car models—Chrysler, DeSoto, Dodge and Plymouth—will be redesigned and restyled with panoramic windshields. The windshield wrap-around reportedly will be most pronounced on the Chrysler and more modified on the DeSoto, Dodge and Plymouth, sources say. While the tooling costs are secret, early estimates exceed \$130,000,000 for the four Chrysler lines.

Plymouth's new V8 engine (said to develop 135 horsepower and to be a small



**Dodge V8 without the hemispheric combustion chamber) and the body changes will get a big play in the ads.**

Ford, too, will have a completely new model in 1955 with an improved V8 engine. Some engineers believe that the Mercury V8 (modified, of course) will be the power plant in the 1955 Ford and a more powerful V8 will be put in the Mercury.

#### Packard's V8 Engine

Behind the main tent, Packard has been making tremendous strides in its two-year rejuvenation program. Its 1955 models will also have the panoramic windshield and extensive appearance changes. And its new V8 engine is rumored to fulfill Packard's reputation as an outstanding engine maker. Another rumor is that it will be made available to other independents in a consolidation-to-cut-costs program outside the Big Three. Financial interests are trying to bring about a merger of Packard and Studebaker, one source reports.

Production of Ford's Thunderbird sports convertible is expected to precede announcement of the 1955 standard models. Mercury, which did well with sales during the first half of 1954, is expected to mass-produce the XM-800—its dream car.

**The popularity of the Chevrolet Nomad, the low-silhouette Corvette station wagon which won so much attention at Motorama showings, has encouraged stylists and engineers alike to take serious notice of its design possibilities. Some even say that this type of body may succeed the hardtop convertible in popularity.**

Sliding doors, instead of the conventional hinged type, are due for increased use in sports-type cars. Like several other ideas introduced by Kaiser (such as tail-lights in rear-fender fins), sliding doors were first shown in the Kaiser Darrin.

By the way, Chrysler now lists Sonotone's nickel-cadmium battery as optional equipment (\$100). See *PM* March 1954 for details about this battery that lasts from 10 to 15 years. ★ ★ ★



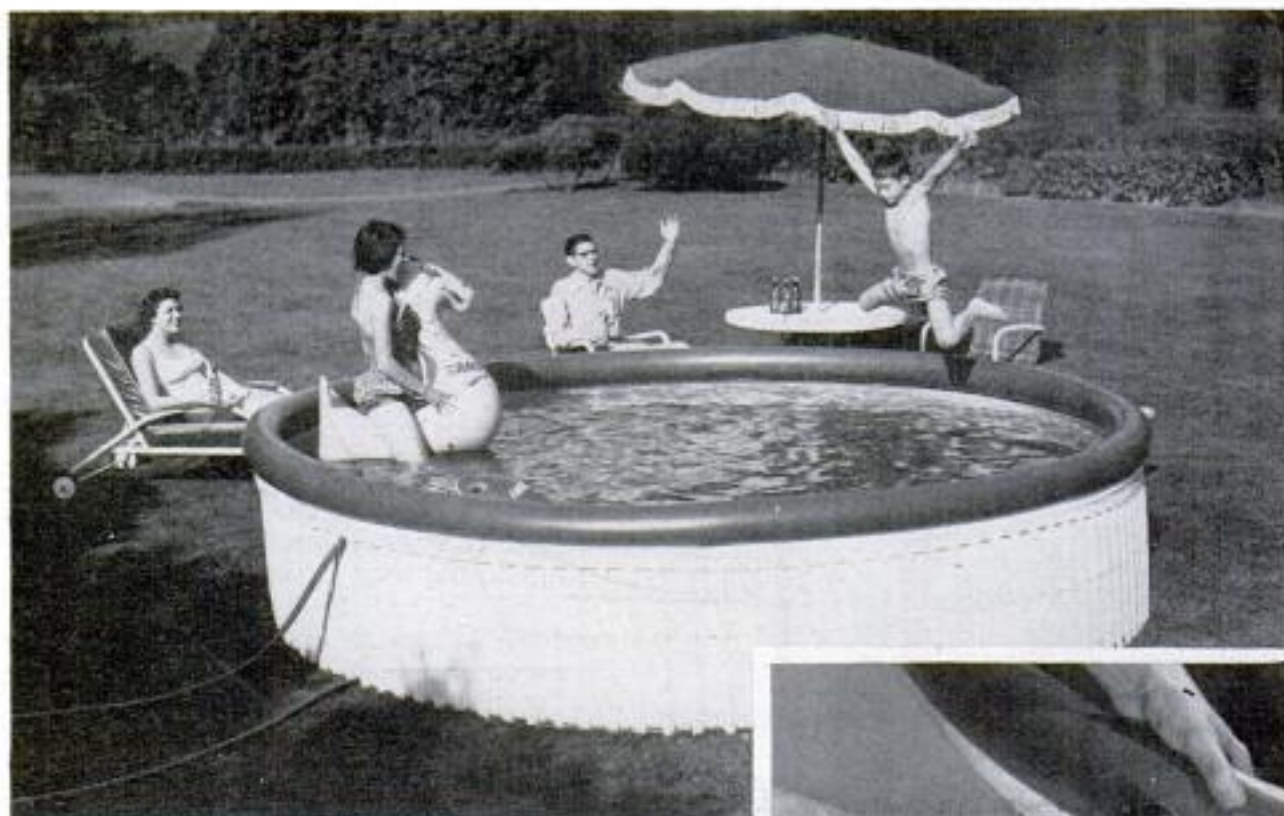

Two-foot depth allows shallow diving by small children. Air from vacuum cleaner, above, inflates liner. Installing the pool, left, requires no tools and little time. Protective bumper overhangs circular side wall of wooden stakes that upholds pool

## 57-Pound Plastic Bathing Pool Holds 1600 Gallons of Water

You don't have to dig a pit for a backyard bathing pool that's two feet deep, 12 feet in diameter and holds 1600 gallons of water. It sits right on top of the lawn. The sides of the circular pool are upheld by a

wooden fence. The plastic pool with its vinyl lining and protective bumper is inflated with a vacuum cleaner after it is placed over the side walls. Weight of the deflated pool is only 57 pounds.

## Steel-Drum Swimming Raft Quickly Assembled



Welded-steel understructure gives raft rigidity and long life. The raft fills need of camps, resorts, vacationers

One man can quickly set up a steel-drum raft that is shipped disassembled. The raft deck is of thick, warp-resistant construction with white canvas molded to it. Safety features include rounded edges, splinter-free surfaces and a welded-steel grab rail. One or more ladders are firmly attached to the corners, which has a welded-steel understructure. The raft is made in four-by-eight-foot sections, each containing four drums for proper buoyancy.





Industrial Forestry Association photo

Here the old enemy is encircled and a lumber-company forester stands watch as it slowly burns itself out

*Television spots the blaze in the pine woods, walkie-talkies direct the attack. The new strategy in tinder-dry timberland makes*

## EVERY MAN A FOREST-FIRE FIGHTER

By Tom Riley

QUIETLY, A TREMENDOUS revolution is going on in our forest lands. Throughout the fire season each recent year, from April into November, there has been a rush of activity in the woods as never before. A constantly increasing army of workers armed with better methods and better equipment (including television) is engaged in a knockdown fight against that ancient enemy—fire.

Despite the fact that more people are visiting the forest lands every year, there has been a steady decrease in forest-fire damage. One of the reasons for this is that

an informed public is more careful of its campfires and cigarettes than in the past. Other important factors are the many improvements in fire-fighting methods.

The newest and most exciting development in spotting forest fires—the use of remotely controlled television cameras in lookout towers—is now being tried out by the Louisiana Forestry Commission. They call it “detecto-vision.” An industrial-type television camera in a Plexiglas dome is mounted on top of a tower. The camera rotates continuously, scanning the treetops exactly as a towerman does but in a more



deliberate manner. It also sees more because it is equipped with a telephoto lens and can pick up a cow munching grass four miles away. Fires have been spotted as far as 20 miles from the camera.

Azimuth markings are located on the dome so the TV camera picks up the degree readings at the same time as it scans the landscape. A special bifocal lens makes it possible to read the close-up numbers on the dome. Microwaves transmit the images to a television set 50 miles away. Remotely controlled cameras installed in several towers with one central-control station manned by a single operator could "cover" a large area, technicians believe. A television receiving set for each of the cameras would be located in the central station. By reading the azimuth bearing on a fire off two sets, the operator could immediately ascertain its exact position.

While the nation's forest-fire fighters are watching the Louisiana experiments with intense interest, legions of tin-hatted "youngsters" continue to patrol vast timber areas. Grizzled old stump ranchers out West are astounded at the number of patrols, especially in regions where formerly more than one man in ten miles was considered a crowd. But the old-timers admit the youngsters are winning the fight.

The chances are that any new lookout tower you see straddling a mountaintop this summer will be manned by a state ranger or company tree-farm employee. In many cases the tower will be festooned with VHF antennas because the logger and his associates today have the largest industrial radio network of the nation. Also, that tanklike contraption feeding a flickering torch in a mountain meadow is not a misplaced welding torch, but a silver-iodide rain maker in an experiment of wrenching rain from summer clouds for a dry forest "farm." The civilian fire fighters are trying

Gasoline "speeder" is used to transport men to work on logging railroad and also serves to patrol the tracks every day during the fire season



This typical tree-farm lookout station in Washington is manned continuously during the fire months

everything. That bright red pickup truck you meet when trout fishing is not a fuel truck for a near-by logging show; it's one of the logging outfit's fire-patrol vehicles, constantly roaming the forest-protection roads. The plain fact is that the federal forest ranger no longer stands alone in the protection of our forests. He is, and gladly, becoming but one cog in a much larger machine. Our Forest Service has been doing a good job of protecting the national forests for five decades, but that land is all it does protect. Approximately 75 percent of the forest land of this nation is owned by farmers, ranchers and forest-products industries. Other great acreages are owned by states, counties and city water bureaus. In all that timber, usually handier to populated areas than the national forests, is where most forest fires occur.

Formerly, there seemed no way to guard against fire, because the cost of protecting private timber year after year was too





Bulldozer goes in to strengthen fire line along road at scene of cedar ground fire on tree farm in Idaho

high. Today, one simple idea has changed the picture completely—tree farms. Since 1941, lumbermen, other forest owners and farmers have been investing heavily in tree farms, with the idea of having a perpetual timber crop by raising new trees as the old are being cut and by replanting denuded stumplands of the past. "As a result," as one lumberman puts it, "we've just had to provide better fire protection—everywhere." The stakes have become bigger. West Coast lumbermen alone are shooting at a sustained-yield program on their growing tree farms that make the 1849 gold rush just peanuts.

Nice thing about it is that the loggers, tree farmers and local government are teaming closely together to perpetuate their vast and intermingled timber holdings—and thus are perpetuating truly huge vacation areas for America. You'll find lumber companies today that are building attractive roadside campgrounds for tourists in beautiful forested areas of their tree farms, for the same reason Forest Service campgrounds were made, to give choice camps at locations where the fire danger can be kept to a minimum. Some tree farmers are even hauling hunters into their timberlands, using their trucks because the roads are impassable to ordinary cars. They charge nothing, ask only in return that the

Tree-farm workers take a breather beside portable fire pump which sucks water from pond in Northwest

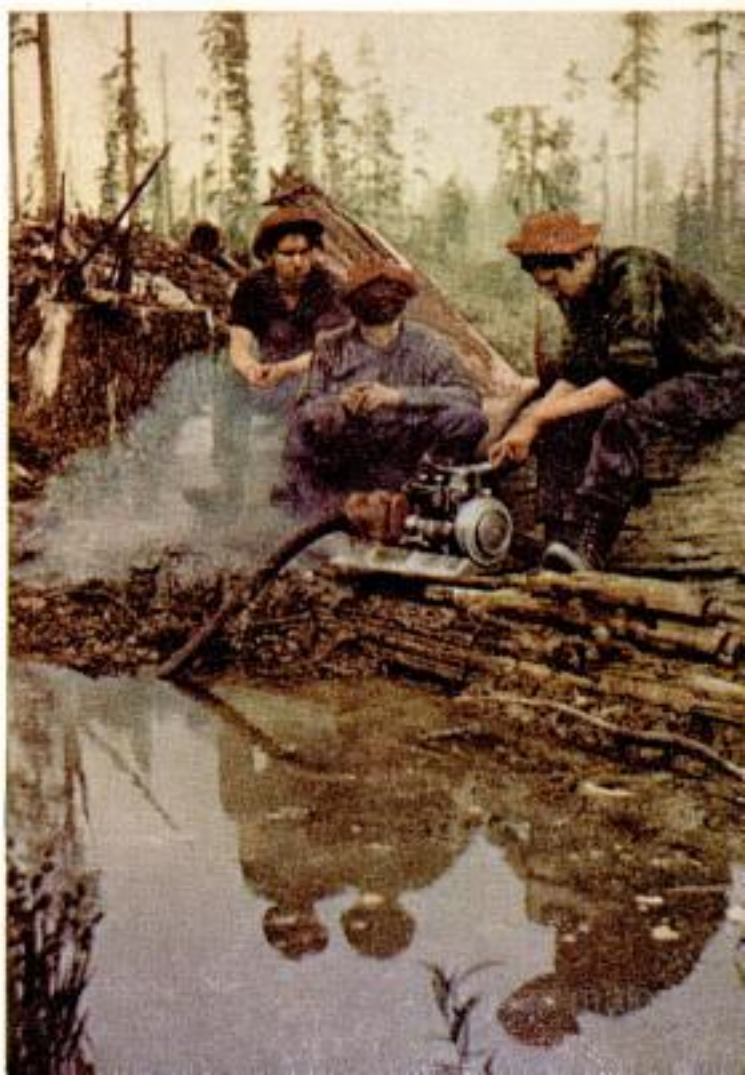





Weyerhaeuser Company photo

Diesel engines are used on logging railroads because the fire danger is less than with a steam locomotive

Roadside sign along highway on Oregon coast gives fire-danger conditions to motorists near big forest



hunters be careful with their campfires and matches. The cooperation has paid off.

One of the biggest things in this all-out, everybody's fight against forest fire is the use of VHF radio. In Oregon, for instance, say a logging crew is working a side far back in the Cascade Mountains. Deep in a timbered canyon, this crew could be completely isolated from the rest of the world. However, the foreman of practically every woods crew has a portable walkie-talkie with him today. If vehicles can get to the spot, he will have a larger VHF receiver-transmitter in his pickup truck. If the crew in the canyon spots a fire they cannot handle alone, they radio immediately for help from other loggers and the state forestry department. If the lookout in any tower in the region spots smoke, he will call in to a district dispatcher of a state-wide fire-radio network who, in turn, will immediately have an experienced logging crew out to control the fire. The logging crews are subject to fire-call at any time.

Today's loggers have also become weathermen. Any fair-sized logging operation now maintains a portable weather station. Each day a member of the crew daintily twirls the tiny fan of a psychrometer—to check the all-important relative humidity. The minute the humidity drops to the fire-danger point (30 percent in the Pacific Northwest), the logging operation shuts down completely until the humidity rises.



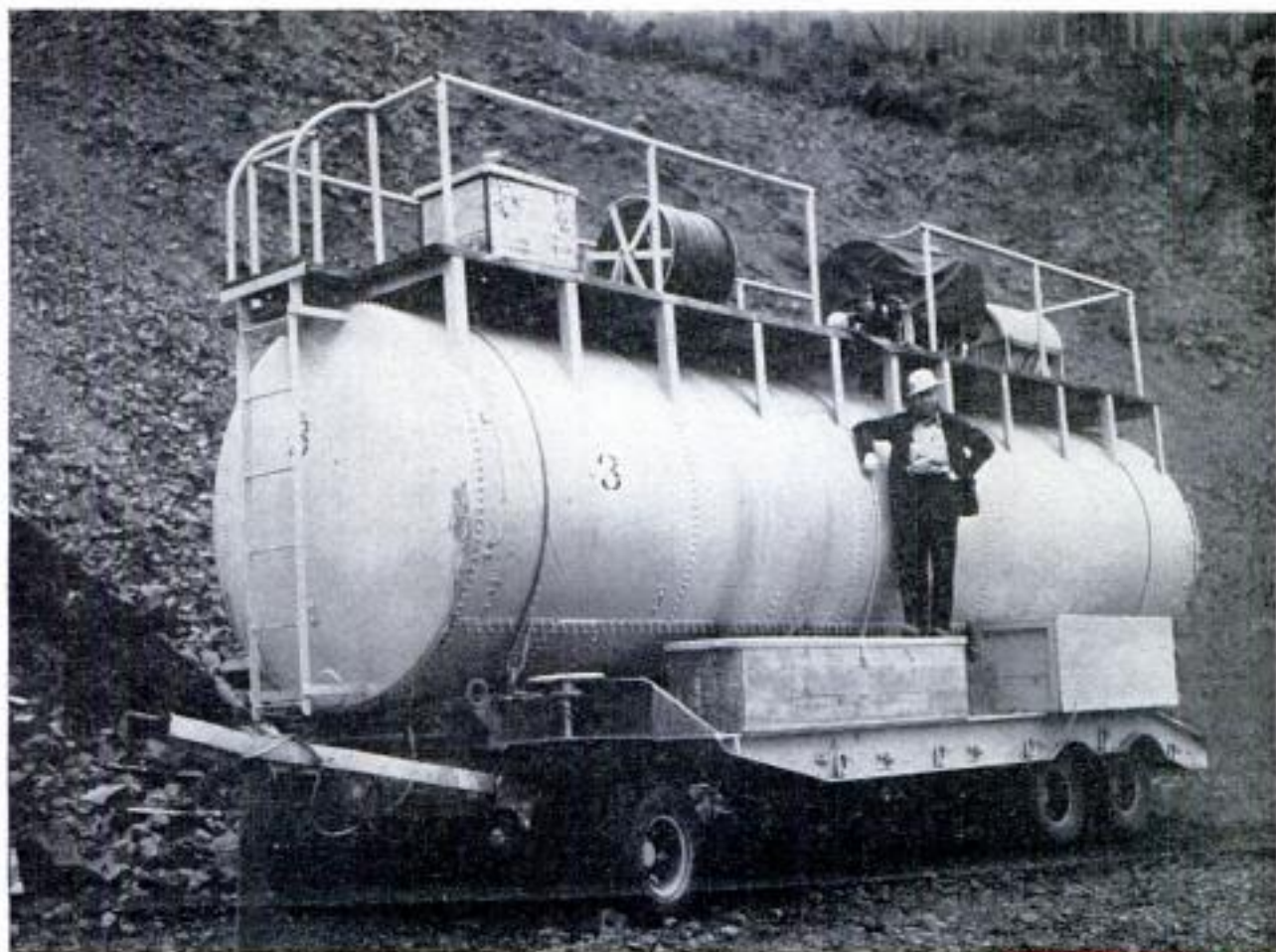

Weyerhaeuser Company photo

Tree farms keep huge water tankers handy in areas where water holes are scarce. This one holds 8000 gallons

Fire-weather forecasts of the U. S. Weather Bureau are sent out on the forest-radio system, so that loggers and tree farmers will also know what to expect tomorrow.

Other methods of communications are constantly being tried by the timbermen. It is hard for an outsider to realize how little a person can see when in the deep woods engulfed in cubic miles of smoke. Light airplanes are used to patrol areas not covered by lookout towers. When a forest fire is raging, these planes not only radio information to the walkie-talkies scattered along the fire line but some, equipped with powerful loudspeakers under the wings, swoop down to blare instructions and information to every man below. Another aerial method successfully used in Idaho is a flying darkroom. A plane equipped with a portable darkroom takes aerial photos of the fire, develops them while circling above and drops prints to the men below so they will know what is going on—both before them and over the next mountain.

How do they fight a forest fire? Most of the battles are simple in plan, rough in effort. For a smouldering, lightning-hit snag, a man or two hikes in to fall it and then douse it with water from a back-pack pump. On a larger fire, the men go in to make a fire line at or ahead of the fire. First, they cut down all trees and brush

Standard fire pump mounted on pack board is used as portable unit and is attached to a power-saw motor







Louisiana Forestry Commission photo

Microwave transmitter attached to lookout tower beams picture taken by TV camera in plastic dome to central control station

Closeup of plastic dome on lookout tower shows remotely controlled TV camera and the azimuth markings

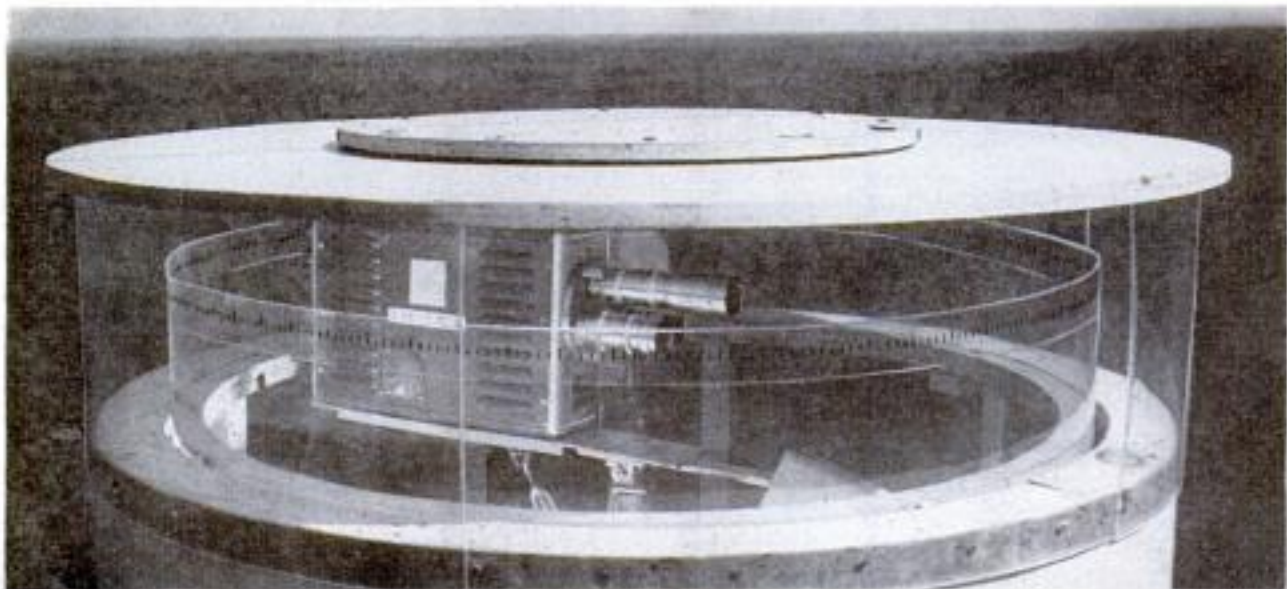

with power saws or hand tools to make a trail several feet wide. Next, with shovels or bulldozer they cut a trench in the trail to expose raw soil. A backfire is then started to burn back slowly from the trench toward the real fire. When the flames meet, both fires die for lack of fuel. When possible, a road is used as the fire line; there pumper trucks can douse the timber alongside to stop the flames. Sometimes, when bone-dry timber and a strong wind combine, the fire becomes an explosive monster, a crown fire that roars violently through the treetops, actually leaping in one gulp across a canyon or ridge. A wide roadway or even a river may not stop it.

"Stop 'em when small," is the password among the civilian fire-fighters. A smouldering snag is a cinch to stop, but if a wind blossoms it into a 1000-acre fire, that's a different matter. A promising development for hitting fires quickly is the chain-saw pump, recently developed by a West Coast timber company. This is a standard 1½-inch fire pump mounted on a pack board. It has a special coupling that allows it to be attached to a power-saw gasoline motor. Practically all logging outfits use power saws today, and thus they can have a fire pump always on hand. Someone grabs the pack-board pump; another man some lengths of fire hose. The power-saw operator detaches the motor from his saw, brings it up to the fire to connect to the pump



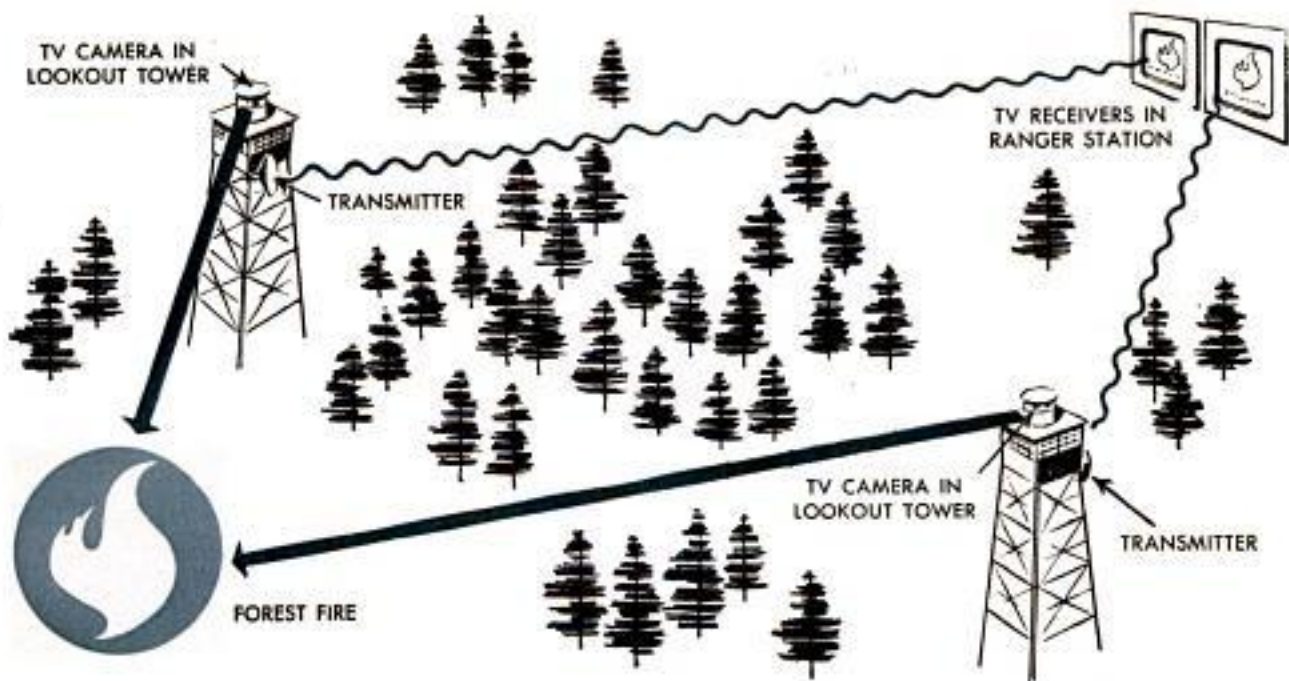

Fire can be "spotted" in ranger station by studying the images with azimuth markings on two TV receivers

and the outfit is ready to use. An important point is that the power-saw operator knows every eccentricity of that motor and can get it going under the worst of conditions.

These civilian fire fighters have championed the use of vehicles in fire-protection work. Most lumber companies today have mobile fire patrols, men who do nothing in fire season but prevent and control forest fires in their timberlands. The state governments and forest protective associations (groups of neighboring tree farmers) have similar mobile patrols, as well as lookout towers on the mountaintops. The fact that untouched timberland is decreasing has greatly helped the use of vehicles for fire patrol—each new logging road makes it that much easier to spot and get to a fire. On the tree farms, thousands of miles of fire roads have been built so that fires can be reached quickly.

The roads strictly for fire protection are rough-torn tunnels through the timberland, accessible only in dry weather, the only time needed. Favorite vehicles of the mobile patrolmen are the Jeep and Dodge Power Wagon—four-wheel drives and pickup beds to carry men and equipment where needed. From the roads they travel, the patrolmen also favor oversize mud-and-ice tires. Many of the pickups have two-way radio; others rely on a network of telephones in the woods. Most of these patrol trucks carry water tanks and a small high-pressure pump

with hose. The pump works two ways—when near a water source it pumps directly into the fire by means of a suction line. In dry areas, the pump fills the tanks at a water hole and then empties the tanks at the fire. Fog nozzles are used to economize the water from the tanks. On railroad logging operations, the patrolmen use gas-powered speeders to patrol the tracks in a similar manner. You seldom see a steam locomotive on a logging railroad today—diesels are much less of a fire hazard.

(Continued to page 212)

Until television takes over the job, alert watchmen in lookout towers will continue the job of manning the fire finders





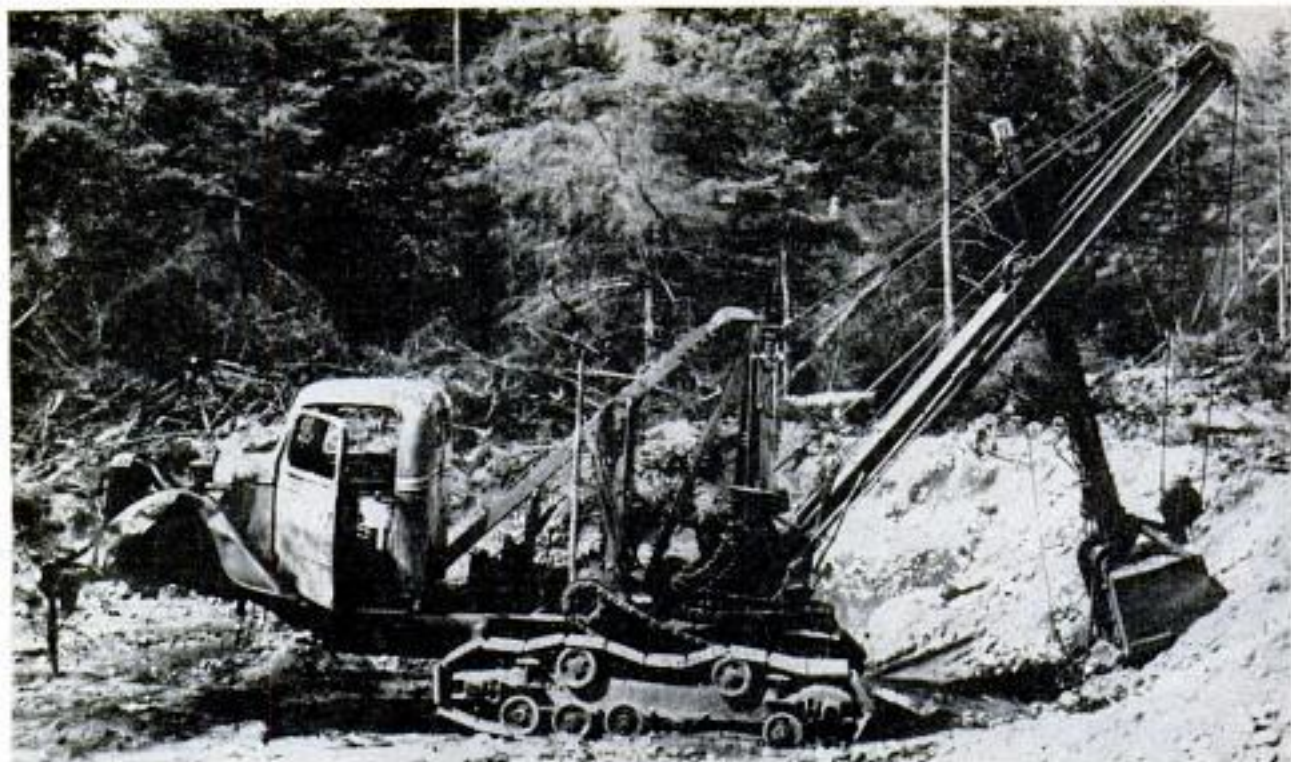

### Is the Tractor on the Truck or the Truck on the Tractor?

Better look twice at this odd power shovel. Is the tractor on the truck, or the truck on the tractor? Actually the original motor of the power-shovel tractor was replaced with a Ford V-8 truck motor with the cab and part of the body frame still in-

fact. Despite its weird appearance the arrangement proved quite satisfactory, for the shovel now works faster and with more power than it did before. The shovel is used by a New York paper company to dig gravel for maintaining their logging roads.

### Portable German Television Tower Mounts on Transmitter Trailer



Televised German sports events are relayed to the main station by a mobile unit which swings into action in a few minutes. The transmitter is housed in a trailer which mounts an antenna mast that is quickly erected by cables and winch. A technician located in a cage at the top of the tower aims the antenna "mirror" to keep line-of-sight contact with the central station.

### Electronic Guides for Blind Detect With Reflected Light

Electronic guides for the blind are being developed which warn the users of obstacles and potential hazards, such as curbs. A Signal Corps instrument which is carried like a lunch pail sends out a beam of light which is reflected by obstacles. The reflected light is picked up by a built-in receiving optical system and a vibrator in the handle translates the reflections into warnings and reassurances for the user. A similar device developed at M.I.T. warns by means of stimulator points on the handle. High-frequency vibrations in future electronic guides may warn of obstacles, and low-frequency vibrations of curb step-downs.



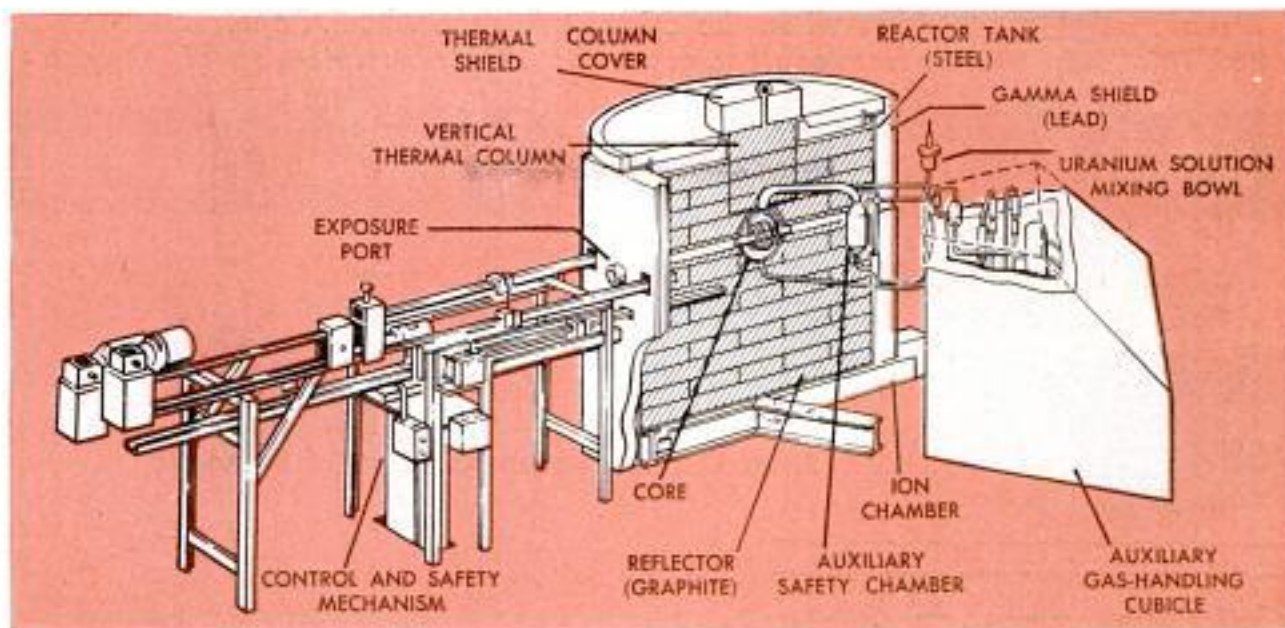

Core of the "tea kettle" is filled with uranium solution. Safety rods run through it to control the fission

## "Tea Kettle" Atomic Reactor "Percolates" to Produce Power

Described as a "percolating tea kettle," a new atomic reactor built for the Atomic Energy Commission develops 100 watts of power. The reactor is the largest one ever built which operates on a closed-cycle system. A fissionable uranium compound is contained in a water solution which is sealed inside the reactor, retaining all the radioactive by-products instead of exhausting them into the open air. About four gallons of the solution are in a steel sphere. Safety rods run into the sphere to control the fission. A new development is an auxiliary safety chamber. If fission gets beyond a certain rate, gas "percolates" through the solution to carry the material into the safety chamber and away from the sphere.

Scientist checks the core component before it is installed in its housing to complete the little reactor



## Water Gun Forces Spinning Nylon Brush Through Cylinder

Tubes in condensers and heat exchangers are quickly cleaned by water pressure, using a gun which forces water and spinning nylon brushes through the openings. The operator inserts the brush in the tube and presses the tapered nozzle of his water gun into the tube end. The spiral design of the

brush gives it a spinning, scouring motion as the water rushes through. Sludge and other soft deposits, together with the spinning nylon brush, shoot out the other end of the tube, where the brushes are recovered for repeated use. Air pressure can also be used to drive the brushes.





The real test of a car starts when the owner takes the wheel. *Popular Mechanics* asked 1000 Ford owners from coast to coast about their cars. Here's what they say

## The OWNERS REPORT: The OWNERS REPORT:



### **Best-Liked Features of 1954 Ford V8**

41% ENGINE AND PERFORMANCE

30% HANDLING EASE

22% STYLING

### **Owners Report on New V8 Engine**

64% HAS GIVEN NO TROUBLE

31% HAS GIVEN SOME TROUBLE

5% HAS GIVEN CONSIDERABLE TROUBLE

### **Owners Report on Acceleration**

61% EXCELLENT

34% GOOD

5% POOR



The OWNERS REPORT



The OWNERS



## FORD'S SWITCH TO OVERHEAD VALVES BOOSTS PERFORMANCE, SAY V8 OWNERS

Written by Ford Owners

**F**ORD AND V8 go together—like bacon and eggs. This year for the first time in 22 years, Ford brought out an all-new V8, complete with overhead-valves, square design, deep block and many other improvements. What do Ford owners have to say about it?

The new engine is far and away the best-liked feature of the 1954 Ford, according to our survey of 1000 Ford owners. Forty-one percent said the engine and its performance were the things they liked most in their new Fords.

"Being a race fan and a fanatic for per-

### FLOYD CLYMER'S ROAD TEST OF THE 1954 FORD V8

**I** DROVE THE TEST CAR, a Ford Victoria Crestline, from Los Angeles to Boise, Idaho, via San Francisco, Reno and Elko, Nev.—a distance of 1352 miles.

Under the hood was the new valve-in-head V8 with 130 horsepower. The "square" engine (3.62-inch bore and 3.60-inch stroke) gets the extra horsepower not by added displacement but by the use of overhead valves and high-turbulence combustion chambers. The block extends below the center of the crankshaft, offering more rigidity.

The new engine has more wallop at all speeds than the previous V8. It cruises nicely at 80 to 85 miles per hour with a top speedometer reading of 100. It is

(Continued to page 222)

formance, I probably demand more from my car than the average owner. The 1954 Ford is the best over-all car I have ever owned."—Centerburg, Ohio, plasterer.

"I like its ability to start quickly in all kinds of weather and its quick getaway."—Cheyenne, Wyo., railroad mail clerk.

"What I like best is the go-power in any gear. It is amazing how fast it will get up and go."—Fairmont, W. Va., miner.

"Have just returned from a 4800-mile trip into Mexico. Have nothing but praise for the new engine."—Eugene, Ore., owner.

However, there are some owners with reservations about the new engine.

"Valve-in-head engine too noisy. Tappets still loud after 1000-mile adjustment."—Glascow, Mont., physician.

"It doesn't seem to have the acceleration that my '51 had."—Sturgis, S. D., conservation worker.

"Like the getaway from a stop, but lost a lobe on camshaft at 3600 miles."—Reno, Nev., clerk.

"New engine is more powerful. It had a bad valve, but it was replaced at no cost

Floyd Clymer tested the Ford V8 for 1352 miles, many of them on winding mountain roads, and calls it "tops in the low-price field for handling"







Owners in almost every state (those shown in red on map) took part in the PM survey of the 1954 Ford

## Percentages from PM Poll of 1954 Ford V8 Owners

### OVER-ALL RATING OF THE FORD V8 BY THE OWNERS

Excellent .....	56%
Good .....	37%
Fair .....	7%
Poor .....	0%

Previous Ford owners .....	83%
Owners of 5 or more Fords previously .....	25%

#### Owners' rating of dealer service

Excellent .....	41%
Good .....	31%
Fair .....	16%
Poor .....	12%

#### Would buy another Ford?

Yes .....	77%
Might .....	20%
No .....	3%

#### Owners' opinion of ball-joint front suspension

Like .....	96%
Dislike .....	2%
No comment .....	2%

#### Owners' opinion of dash indicator lights

Like .....	66%
Dislike .....	31%
No comment .....	3%

#### Average miles per gallon

City driving .....	15.4
Country driving .....	18.5

#### Owners' comparisons of economy of new engine

Better than previous Ford V8 .....	46%
Same as previous Ford V8 .....	40%
Worse than previous Ford V8 .....	14%

#### Oil consumption per 1000 miles

No quarts .....	86%
One quart .....	8%
More than one quart .....	6%

#### Experience with new V8 engine

Have had no trouble .....	64%
Have had some trouble .....	31%
Have had considerable trouble .....	5%

#### Most frequent engine trouble:

Valves .....	8%
Oil or water leaks .....	6%
Frequent stalling .....	5%

#### Handling characteristics

Excellent .....	74%
Good .....	24%
Poor .....	2%

#### Roadability

Excellent .....	63%
Good .....	36%
Poor .....	1%

#### Structural rigidity

Excellent .....	47%
Good .....	46%
Poor .....	7%

#### Acceleration from 0 m.p.h.

Excellent .....	61%
Good .....	34%
Poor .....	5%

#### Acceleration from 50 m.p.h.

Excellent .....	56%
Good .....	40%
Poor .....	4%

### BEST-LIKED FEATURES

Engine and performance .....	41%
Handling ease .....	30%
Styling and appearance .....	22%
Comfort and riding quality .....	19%
Roadability and front suspension .....	19%

### MOST FREQUENT COMPLAINTS

Rattles and shakes .....	13%
Poor body assembly .....	9%
Noisy engine .....	8%
Low gasoline mileage .....	7%
Oil-filter location .....	6%

Owners with no complaints at all.....30%

to me."—Huron, Ohio, production manager.

"Can't feel the difference in pickup with increased power of valve-in-head engine."

—Rahway, N. J., salesman.

#### Handling Praised by Owners

Second to performance in the list of best-liked features is handling ease.

"I am particularly pleased with the way my Ford handles on New Hampshire roads, considerably more curvy than in other sections of the country."—Concord, N. H., state employee.

"I like the way it holds the road and its ease of handling. Also the smooth-riding feature on rough country roads."—New Ulm, Minn., salesman.

"Excellent handling takes all the work out of driving."—Dallas, Tex., metalworker.

"We use our Ford hard both in fields and on roads, which are just dirt and gravel. There is no pavement less than 15 miles from us. Have no complaints as to handling."—Perth, N. Dak., farmer.

Next on the list of best-liked features is styling, with 22 percent mentioning it.



"It's a sporty looking car. Not too big and it fits in any garage."—Moonachie, N. J., refrigeration serviceman.

"Ford has gone completely above competition in attractiveness of body styles and colors. However, it has a long way to go in so far as rattles are concerned."—Chattanooga, Tenn., attorney.

"Distinctive styling. Upholstery gives it a tailored look."—New Market, Iowa, farmer.

### Body Rattles Are Big Complaint

Most frequently mentioned complaint of the Ford owners is that the body rattles or that it makes too many noises.

"Body is shaky with too many rattles and squeaks. Very poor body rigidity. When you close the doors the posts are so weak they move."—Waterbury, Conn., master toolsetter.

"Some door play and body rattles in several places around dash and windows."—Sioux City, Iowa, meat processor.

Somewhat related to body rattles is the second most frequent complaint—poor assembly.

"It seems as though the car was just thrown together. I found places where bolts fell out altogether."—Larsen, Wash., sergeant.

"Doors and trim are not finished. Doors do not close right. Rain comes in over the top. Trim is loose."—Bronx, N. Y., lawyer.

"Had trouble with engine heating before I got it home the first time. Had bad thermostat. Engine leaked oil and water. One shock was out of its socket and bent over."—Lewiston, Idaho, power-shovel operator.

"Hood out of line, causing paint to chip."—Washington, D. C., airline superintendent.

"Dash had to be removed before door would shut properly."—Baring, Mo., farmer.

"Rear cross brace on frame was not riveted properly. Had been welded but not properly. I had to have it welded again."—Hampton, Va., office chief.

### Owners Praise Riding Comfort

Nineteen percent of the owners listed riding comfort as a best-liked feature. Frequently the phrase "rides and feels like a big car" was written by the owner.



Owners praise the new Ford engine with its overhead valves and high-turbulence combustion chambers. But there were some complaints about the location of the oil filter (in the circle above) and the distributor

To service the oil filter, you have to put the car up on a lift. Even then it is not easy to get at. Owners say the new location makes it almost impossible for them to change filter cartridge themselves





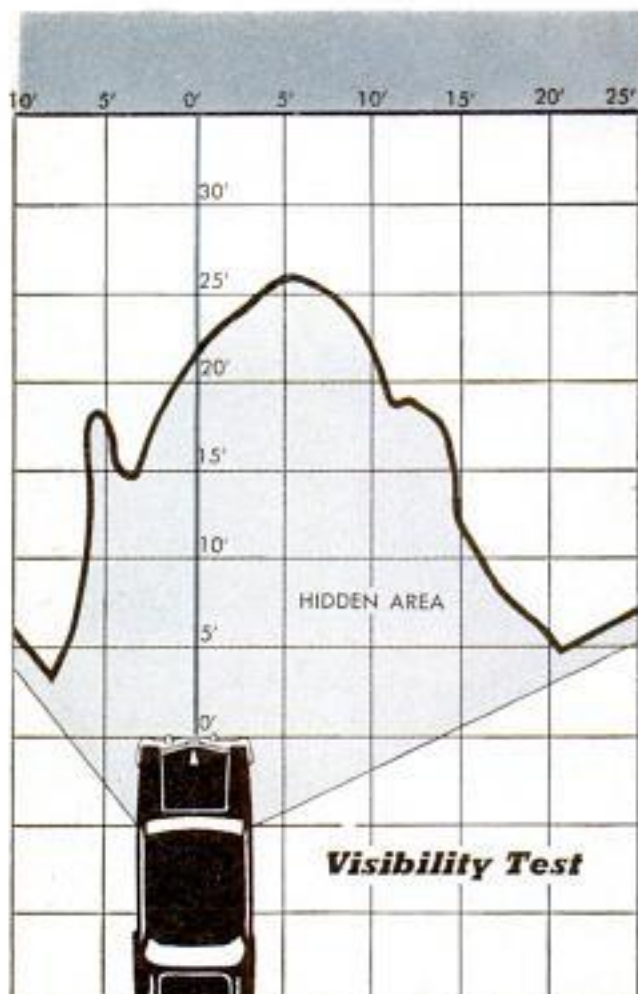

Windshield reflections are a nuisance in this transparent-top model that has a light-colored dashboard

"Drives, rides and handles like one of the heavier and more expensive models." —Washington, D. C., bookbinder.

"Has the bigger-car feel."—Fargo, N. D., store manager.

There were some complaints, however, that the front seat was poorly shaped. Here is one of them:

"Front seat backrest is very fatiguing. Would like better design."—Hackensack, N. J., engineer.

Also high on the owners' list of desirable features was Ford's roadability and its ball-joint front suspension.

"About half of my driving is on country gravel roads and this car holds road best of any. Have kept track of all gas going

(Continued to page 214)

### Acceleration Test

1954 FORD VICTORIA V8  
with Fordomatic

¼ mile from zero	Drive range only	21.9 sec.
	Low and Drive	21.3 sec.
½ mile from zero	Drive range only	33.1 sec.
	Low only	5.2 sec.
0 to 30 m.p.h.	Drive range only	17.4 sec.
	Low and Drive	16.9 sec.

Top speed by speedometer.....99 m.p.h.  
Actual top speed about 6% less

### Economy Test

MILES PER GALLON  
Constant-Speed Mileage

Constant 30 m.p.h.	25.4
Constant 50 m.p.h.	23.5
Constant 60 m.p.h.	20.2
Constant 75 m.p.h.	15.3

Cross-Country Mileage

* Los Angeles to San Francisco, Calif.	19.4
** San Francisco to Reno, Nev.	18.3
** Reno to Boise, Idaho	20.8

\*Used premium gasoline      \*\*Used regular gasoline

Arrows show flow of air inside engine. Clean air carries corrosive fumes out to the atmosphere

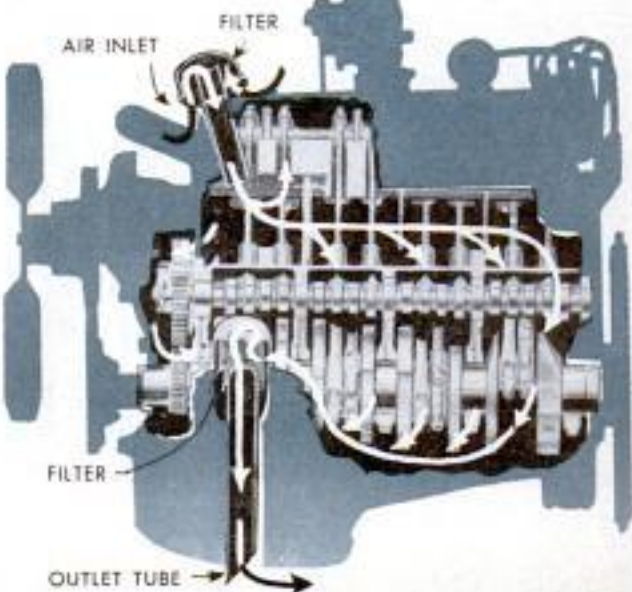





United Air Lines photos

Sighter (left) is used by color-camera operator inside the aircraft. Right, inserting camera in box in tail

## Electronically Controlled Cameras on Plane Shoot Travel Film

Encased in aluminum boxes attached above and below an airliner, electronically operated 16-mm. color cameras shot the aerial footage for a California travel film. One box was mounted on the leading edge of the vertical stabilizer and the other was

suspended at the rear of the fuselage of a United Airlines transport plane. Inside the aircraft, both cameras were controlled by an operator using a sighter that duplicated the area they could photograph. Touching a button activated the shutters.

## Portable Compressor For Skin Divers

Tanks of compressed breathable air, such as used by underwater swimmers and fishermen, are recharged quickly by a portable compressor that weighs only 50 pounds. It is powered by a  $\frac{1}{2}$ -horsepower electric motor and compresses 70 cubic feet of air in 100 minutes. A separator prevents the entrance of oil or moisture into stored air.



## Endless Belt Takes Dictation In Magnetic Recorder

Dictation is recorded on an endless magnetic belt in a new office machine. Although magnetic recording is not new, this is said to be the first office machine using a magnetic belt instead of reels of wire or tape. The belt can be used thousands of times, folded flat for mailing, or filed for future reference. Up to 15 minutes of dictation can be recorded on each belt. To correct an error, the dictator simply backs up the belt and redictates over his mistake.

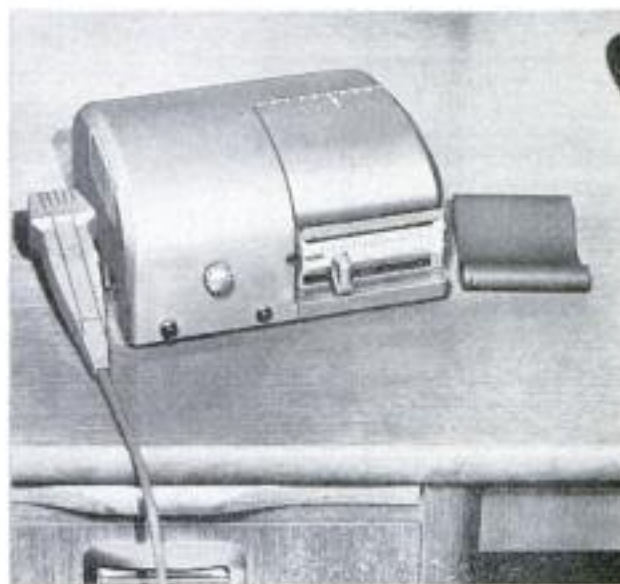



## Stroller Is Light Enough to be Carried on Arm Like Umbrella



Compact enough to be carried over the arm like a folded umbrella, a lightweight stroller is proving to be a big hit with British mothers. Called the "Slickster," the stroller was developed by an English schoolteacher after his wife complained about the awkward bulk of most models. Now she can carry it with her on the bus. The stroller weighs only four pounds yet it is strong enough to support an adult. It can be used as a high chair simply by locking it with a snap-on brake.

## Bathtub Door Prevents Slipping

Slipping while climbing in or out of the bathtub will be a thing of the past if Swedish inventor Per Bergman has his way. Bergman has come up with a tub with a door. Turn two handles, pull toward you and a section of the tub swings out. The door is compressed against a gasket around the frame to provide a watertight seal. The tub with a door is designed primarily for old or disabled persons.



## Reversible Plow Alters Automatically

Contour plowing is speeded with a two-way plow that automatically reverses itself when it is raised at the end of each furrow. Engineered to fit all three-point hitches, the plow mounts two 26-inch disks scoured by one-piece, full-width scrapers. All the operator has to do is to pull the quadrant lever to lift the plow; the rest is automatic. Clean plowing and ruggedness are some other features of the unit.



# Highway "Pullman" Sleeps Eight



Scrivener prepares breakfast in the land yacht's compact kitchen. Beside him are combination sink, electric range and refrigerator. Electric roaster is separate unit

YOU CAN cook a meal or take a shower in a Greyhound bus that's been remodeled by a San Antonio, Tex., lumberman. Ernest Scrivener, who likes to take his friends along on trips, converted the bus into a rolling abode that sleeps eight and includes a living room and complete kitchen. Guests can telephone, lounge on comfortable couches, or bathe in a sit-down shower while they're moving through the countryside. The bulky vehicle gets only five miles to the gallon of gasoline, but this includes the fuel needed to supply the electric-power unit. Fresh water is stored in a 200-gallon tank and waste water empties into a large container beneath the bus. Hot and cold running water for the kitchen and bathroom is supplied under high pressure. Besides plenty of hot water heated by an electric unit, the bus has summer air conditioning and heat in the winter.

Pullman-type bunks include reading lamps and shelves for personal articles. Luggage is stored beneath bus



Mobile telephone keeps guests in touch with home or office, can be operated while the bus is in transit

Scrivener takes the wheel. Bus gets five miles to the gallon, including fuel for electric-power unit





# WHAT'S NEW FOR Your Home



**LOCK CATCH** for hooks, above, prevents small children from unlatching screen doors and windows. It can be snapped quickly into position with one hand

**GARBAGE ELIMINATOR** disposes of refuse by chemical action, which liquefies deposits. After the chemical is applied to the first deposit, the action continues automatically



**DUST CATCHER**, operating as attachment to a vacuum cleaner, pulls in dust when mop is shaken over conical-shaped receptacle. This makes it possible to shake the mop without scattering dust



**MOTIF DESIGN ROLLER** for painting walls applies any one of a choice of 32 patterns or a combination of both patterns and colors can be used. Any type of paint can be used in rollers





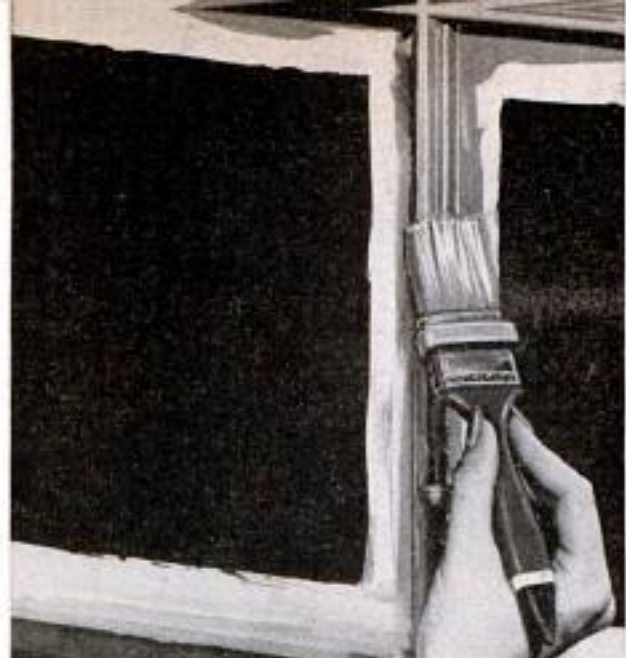

**BRUSH-ON LIQUID MASKING TAPE** dries to consistency of plastic film and can be peeled off after paint is applied. Any of the liquid that spreads over onto wood areas actually bonds to it and becomes a base for paint



**VENETIAN-BLIND CLEANER** has a pair of revolving brushes that whisk the dust into an attached vacuum cleaner. Driven by air, the self-cleaning brushes are shaped to fit the contours of the curved slats



**GAS-OVEN LIGHTER** that is ignited by flame from a top burner has a long-lasting element that is extinguished by retraction

**RUBBER-COVERED BRACKETS** that hold bed sheets and blankets several inches above the sleeper's feet can be folded down onto the mattress when not being used

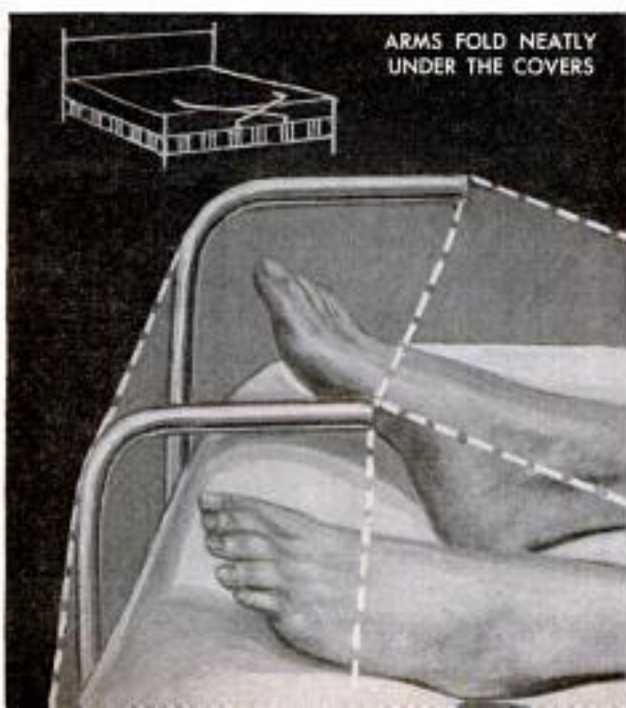

ARMS FOLD NEATLY UNDER THE COVERS

**UTENSIL RACK** and shelf is held firmly in place by a clip arrangement that slips between a kitchen cabinet or counter and the wall. It is adjustable



Copyrighted material



# Our HOTTEST Ship's on Shore



Decontamination team in protective garb goes through drill. Man at left checks companion for radioactivity

**P**REPARE for atomic attack!" The startling order echoes through the ship. Suddenly, the air is alive with noise. Then, through the racket comes the penetrating sound of general-quarters alarm as men race for battle stations.

String of "hot" luminous buttons is hidden in pipe just before mock attack. Monitors must locate it

It's all over in a moment, except for one thing. From decks, bulkheads and crannies of the ship's superstructure, atomic radiation is pouring. Monitoring teams dressed in goggle-eyed masks, coveralls, and carrying nuclear counters prowl through the

Trainee with radiation counter spots location of buttons. Via intercom he will notify damage control

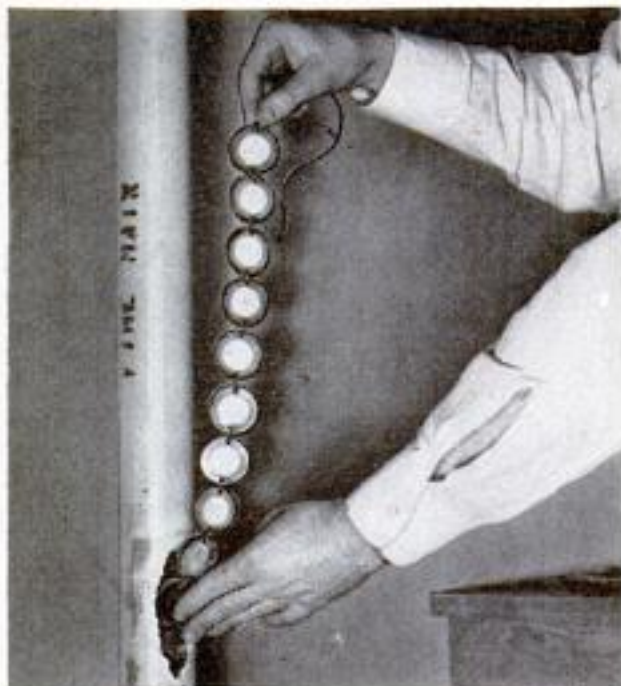



affected areas. They take readings and report dangerous radioactive spots to a damage-control center below, where decontamination squads are dispatched to remove the source of the dangerous rays.

Week after week, this same action-filled scene is re-enacted at the Fleet Training Center in Norfolk, Va. Here, within the walls of the Center's Atomic Defense School, sits the victim of hundreds of "atom bomb" attacks—a full-scale mock ship simulating the superstructure of a destroyer escort. Built of plywood, the structure towers three stories to a vaulted ceiling with built-in horizons. The make-believe training ship is complete with hatches, ladders, intercom system, portholes, bridge, decks and other standard features, adding realism to the mock attacks.

Under the command of Lt. E. J. Leahy, director of the school, the much-bombed "ship" is made to come alive with real radioactivity in order to train special crews in the atomic-defense school's specialty—shipboard monitoring and decontamination.

It all began soon after a towering mass of radioactive water erupted from Bikini Lagoon following the explosion of an underwater atom bomb. Of the unmanned naval ships stationed around the rim of

the blast, some collapsed and others sank. The battered wrecks still afloat were "sizzling hot with radioactivity," newspapers said.

But the Navy wasn't sinking anything salvable. Decontamination crews, clad in protective clothing, removed most radioactive particles by physical methods—by scrubbing, washing down and wet sand-blasting. Chemical solvents ate away stubborn radioactive surfaces so they could be washed overboard. Even left alone, dangerous rays slowly died away. The aircraft carrier *Independence*, close to "ground zero" at Bikini, lost its dangerous radioactivity in a year and now serves as a floating experimental laboratory.

Today, the navy is preparing its crews to cope with atomic attacks by a standard procedure. The intensive five-day course at Norfolk includes a series of lectures in general-quarters assignments, damage control, monitoring and decontamination of the men. Then comes the "battle problem."

On the day Lieutenant Leahy sounds general quarters, every man knows where he's supposed to go. Some men scurry to the bridge, others to various compartments. The personnel decontamination station is manned and ready to cleanse anyone

**Trial run starts after officer raises radioactive materials from lead shields. Decontamination teams go to work**

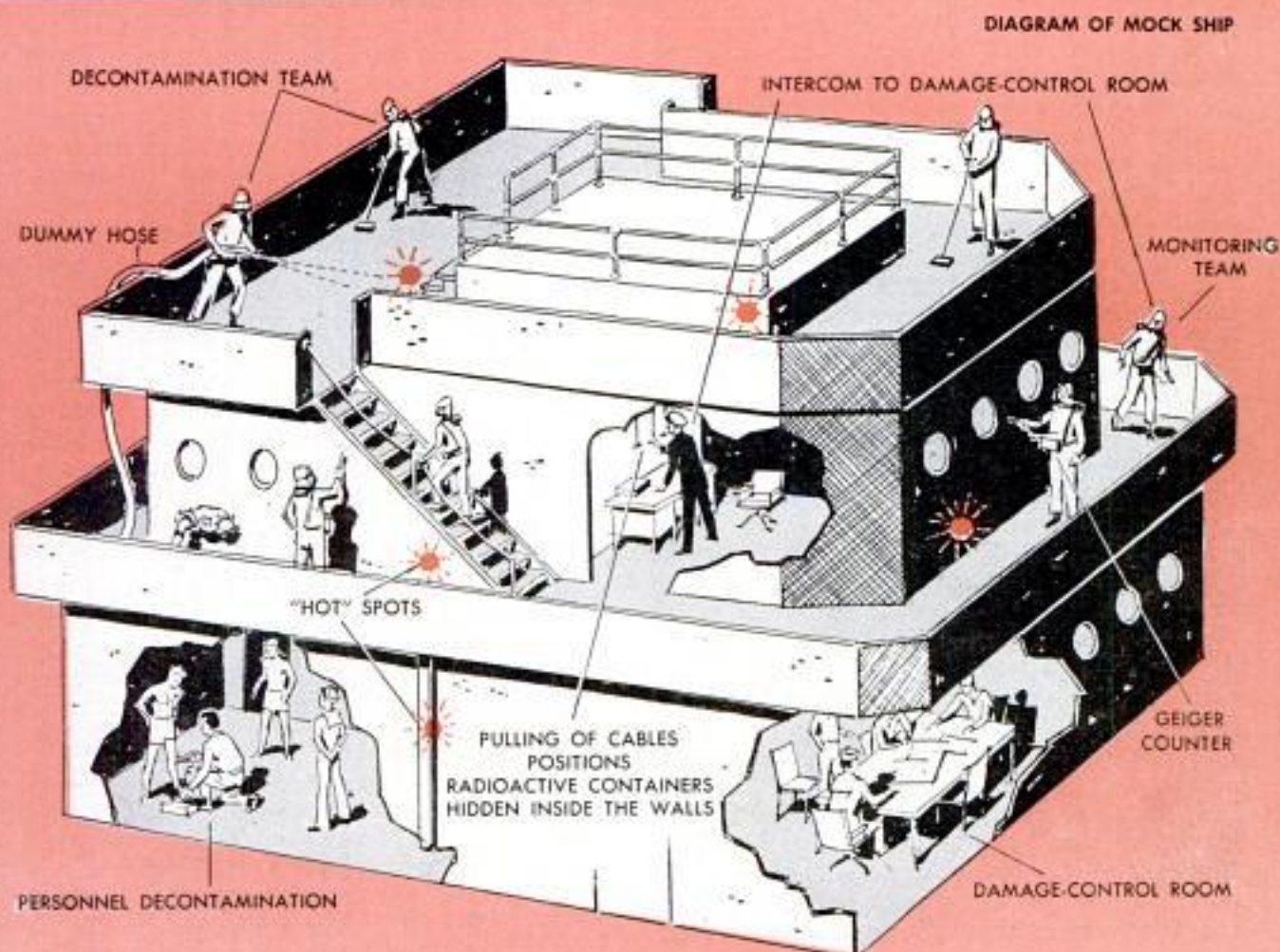





Radioactive sample encased in lead shield fastens at top to cable. Radioactivity is released when . . .



Instructor pulls cable, exposing sample any amount. As the decontamination proceeds, he lowers samples

who gets a simulated overdose of rays. Men are posted at telephones and speaking tubes. Details are dispatched to close hatches and to man the dummy fire hoses, which they use to "spray down" all weather surfaces on the ship. "It's easier to wash radiation from a wet surface than a dry one," Lieutenant Leahy explains.

All hands duck inside the ship as the "atomic explosion" thunders down on them in a shattering tape-recorded maelstrom of sound. Within minutes, the trainee monitoring teams in their strange costumes are out on deck with radiation detectors, "sniffing" around for "hot" areas. Needles waver and instruments crackle here and there around the ship, excited by genuine rays.

Before the problem starts, the instructors conceal heavy lead containers of radium and cobalt 60 in special hiding places. Cables, hooked to the radioactive specimens, lead up to the bridge where a Navy chief petty officer can lift them free of the containers, permitting their radiations to be picked up.

Radium-coated buttons may be dropped in a hole in a pipe. Even a small bit of radium can make a pretty hot area around itself.

When crew finds a hot spot, its location is instantly reported to Damage Control Central over the intercom system. Down below, officers grouped around a table in the damage-control room map the hot spots as they are reported. Decontamination squads in protective clothing are dispatched

immediately to these areas with proper scrubbing equipment. Sawdust, simulating radioactive material is swept up and the radiation source is lowered back into its container so that when the monitors recheck the spot they can legitimately report no radiation.

When all the teams have completed their rounds and the last "hot spot" is cleaned up, all hands report to personnel decontamination, where Geiger counters explore them personally for any radioactive material they may have picked up. To add realism, some of the school's garments are equipped with hidden luminous buttons. Hence, the monitors find that a few men are "hot" and have to be decontaminated. Corpsmen check them for "open wounds," and hurry them off to a soapy shower and rubdown. Then they're monitored again. If they still tweak the needle, back they go for another shower until they are completely decontaminated.

When the last man clears the monitors, the plywood ship can chalk up another atomic attack survived in its program of training our fleet in the business of preserving men and ships in case of atomic war. ★ ★ ★

If you do not find the information you need in the WHERE-TO-BUY-IT INDEX, starting on page 12, sources of further information are available without charge from Bureau of Information, *Popular Mechanics Magazine*, 200 E. Ontario St., Chicago 11



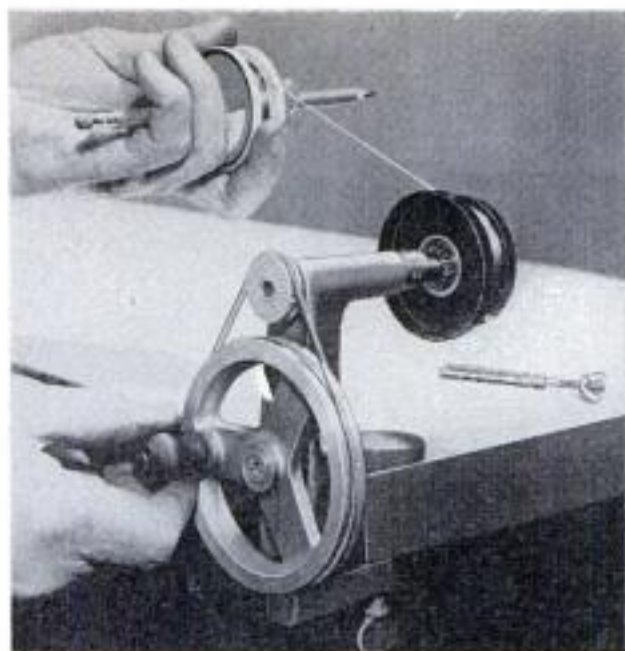

### Winder Loads Spinning Reels

Fishing lines can be transferred to spools used on spinning reels without a twist with a hand winder. It accommodates several sizes of spools. The line is cross-wound by moving the factory spool back and forth. The winding device also can be employed to put backing under a spinning line and to reverse a line onto a standard spinning-reel spool.



Consolidated Vultee Aircraft Corp. photo

### Test Pads Glued to Aircraft Easily Removed With Dry Ice

Using Dry Ice saves tension pads worth \$60,000 yearly at an aircraft plant. Glued to aircraft surfaces for test purposes, the four-inch-square rubber pads were formerly removed by using a hack saw or an electric iron. Both methods destroyed the pads, which cost \$12 each. Applying Dry Ice makes it possible to pry the pads off easily and preserves them for future use.

### Seed Harvester Slashes, "Swallows" and Windrows Sugar-Beet Crop

Eight rows of sugar beets are slashed and windrowed at one time by a big harvesting machine that appears to swallow the crop. The machine, designed and built by Lemuel E. Shaw of Hemet, Calif., harvests sugar beets planted for seed only. The stalks form a matted growth up to six feet high, and

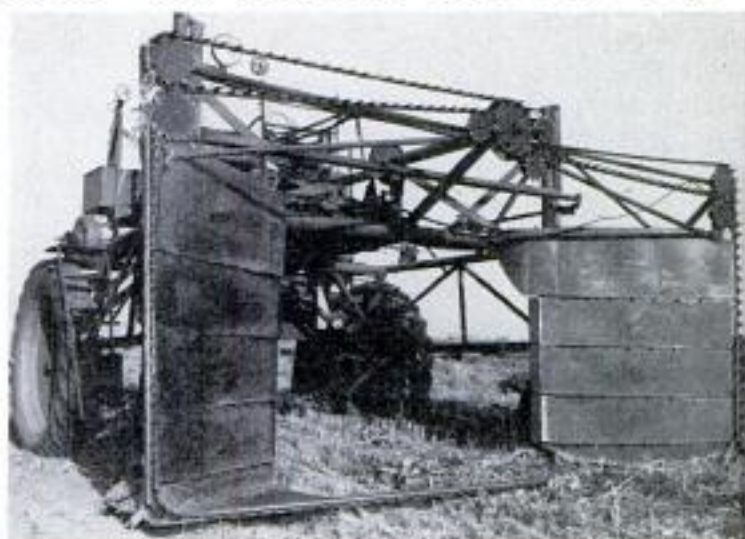

the cutter slashes through them at speeds up to 15 miles per hour. On the front of the machine are two contrarotating chains with steel cutting blades welded to the links. Deflectors behind the chains guide the cut stalks through the open throat of the machine and place the seed-bearing tassels in the center of the windrow in preparation for harvesting the seed.





A moment after the drop the water turns to mist and thousands of fingerling trout plunge toward the lake

## ***It's Raining BABY TROUT***

By Claude M. Kreider

**L**AST SUMMER almost 3,000,000 baby trout "rained down" over 662 blue lakes in California's lofty Sierras.

This was not a miracle of nature brought about by the storm clouds hovering over the high peaks. It was a manmade phenomenon, the result of a long experiment in modern trout culture and the planting of fish by airplane.

For many years Sierra lakes, barren of fish life, and other lakes heavily fished, were stocked with trout by the use of pack mules, each carrying two 10-gallon cans of baby fish. Many were lost in transport, others injured. The packers had to stop often along the rough trails to replenish the water in the cans and thus provide the necessary oxygen to keep the fish alive.

Often there was no trail, even for the sure-footed mules, and the men had to complete the journey carrying the cans upon their backs. Several days were often required for one journey. And the cost was prohibitive, averaging almost \$20 per thousand trout.

Aerial planting today does the job for \$1.25 per thousand fish, and far more can be stocked during the short Sierra summer than could be planted with pack trains.

Experimental airplane stocking was first undertaken by the California Department of Fish and Game in 1946, using a small, 165-horsepower monoplane. This was not quite suitable for the job of flying over 14,000-foot peaks, where strong down drafts and sudden air currents whipped through the granite canyons and basins.

Would trout live when dropped at the high speed necessary for safe flight? Fish were dropped in five-gallon ice-cream containers, the bottoms sealed with wax, and in tin cans with no lids. Fish were dumped directly from the plane.

The "free falling" method was found best, in which the fish were "rained down" with the water which carried them. Today trout up to four inches in length can be dropped with 100 percent survival. Those weighing six to eight to the pound show a survival of 85 percent. But larger fish up



to 15 inches in length are killed by the impact.

The plane in use today is a Beechcraft, powered with two 450-horsepower engines. And chief pilot of the department, Al Reese, whose job is probably one of the most ticklish in peacetime aviation, can whip it down with rare precision over a remote lake for a fish drop.

Always a problem in fish transportation is sufficient aeration of the water in the fish cans. In land travel by truck, a small compressor furnishes air, and the same method has been adapted to use in the plane.

The fingerling trout are carried in 10-gallon aluminum cans with wide mouths. From eight to fifteen are carried for a fish drop, although more are possible, and 10,000 fingerlings have been dropped at one time.

A compressor driven by a 24-volt electric motor supplies air to the cans through a battery of rubber hoses. Another hose aerates the water in the planting hopper.

The 50-gallon hopper is made of aluminum and has crimped and welded seams. A rectangular opening cut in the floor of the

Copilot of the plane pours water and baby trout into the planting hopper just before arrival at the lake



At the hatchery a fish culturist removes infertile eggs. Those that remain may inspire some "big fish" stories in the future

fuselage, accommodates its bottom flap. This is hinged on the forward side, and is quickly opened by a hand lever operated by the copilot or fish culturist when a drop is to be made.

A smaller opening through the floor just back of the hopper provides space for a range finder, which is used by the operator to gain an accurate "sight" on the lake to be planted.

On target! He sights down through an aiming hole, pulls lever at right instant to "bomb" lake with fish







Formerly the mountain lakes could only be stocked with fish brought in by pack train over remote trails

A preliminary flight is usually made at high altitude, the plane often rising to 20,000 feet while the problem is studied. Area maps are of little use in this work, but aerial photographs are useful in pin-pointing many small unnamed lakes not shown on any map.

Most of the trout to be planted are pro-

**Baby trout are extremely sensitive. Ice is added to cans to keep temperature just right and air hoses aerate the water**



duced at the Mt. Whitney State Hatchery at the base of the Sierras. These are trucked to the airstrip in ordinary 10-gallon fish cans and there transferred to the aluminum cans aboard the plane.

The cans must be strategically placed in the fuselage for balance and best handling of the plane. So closely does the mighty Sierra wall arise to the west that the pilot must fly back and forth to gain sufficient elevation to clear the peaks, many of them 14,000 feet high.

Small lakes are passed over in a few seconds. The correct descent for safety and accurate fish dropping must be gauged as the plane clears jagged peaks and basin walls and slants steeply down to that tiny, blue "dot" below.

The operator at the hopper has already poured fish and water from one or more cans into the hopper. As the plane slants down he takes a last, quick sight through the small opening and pulls the release lever. Fish and water are actually sucked from the hopper. The water is at once converted to mist by the propeller wash and resembles a puff of white smoke. But the little trout drop unharmed into their new environment. Only a few fish hit the water head first.

The accuracy of this target work is astounding. Al Reese and his assistant can score a bull's-eye on a tiny lake with a surface area of only two or three acres. Many of

(Continued to page 226)





### Matching Storm Window Contains Swing-Out Center Section

You're hardly aware of the presence of a new storm window that matches the inner sash and contains a center section that swings out when the inner window is opened. A coupler joins the inner and outer casement-type sections. The storm sash

comes complete with glass, weather stripping and necessary hardware. It is part of a prefabricated window installation or can be added to existing windows of the same type. Installation is simple, needing only five storm-sash fasteners.

### Plastic Liner for Leaky Gas Pipes Ends Need for Replacement

Leaky gas lines in Denver are repaired with a plastic "inner tube" that makes them good as new. A pneumatic reamer powered by a portable air compressor works its way through the pipe, producing a smooth, even bore. Lengths up to 80 feet are cleaned with

the tool. Then the plastic pipe is pushed through and the new connection made. The old pipe does not have to be dug up, and the new lining is said to be more permanent than metal—it cannot corrode, and is not damaged by soil chemicals.







## Telescoping Awning Opens Electrically

With the push of a button you can open or close a new telescoping awning made of aluminum. A  $\frac{1}{20}$ -horsepower electric motor mounted below the awning does the work. It is designed for stores and residences, and can also be operated manually.

## Treated Paper Needs No Carbons

You don't need carbons to make copies of a letter you write on a chemically treated paper. The pressure of a pencil or typewriter character causes a chemical on the back of one sheet to unite with a chemical on the top of the next sheet. The result is a blue copy of the original impression. Four handwritten copies and up to seven typewritten copies can be produced with the method.

## Chemical Found in Human Hand Chases Fish From Danger Areas

Small doses of a mysterious substance found in the human hand, deer's foot and seal skin may prevent salmon from straying on their way to and from inland spawning areas. Introduced into the water around

high dams, polluted waters and diversion channels, the chemical repels the fish. The substance is being analyzed by Canadian scientists in an attempt to discover its physical and chemical properties.

## "Automat" Sells Toys To Youngsters

When youngsters in Stockholm go shopping they can buy their toys in a new "automat for playthings." The display machine is divided into bins with a window in each bin. The child inspects the toys through the windows and deposits his money to receive the toy he selects.

## Dye Traces Eddies Formed by Boat

How eddies are formed when a boat or submarine moves through the water is revealed by a method developed in Yugoslavia. An object coated with silica gel is placed in a water stream containing a tiny amount of dye that coats on different parts of the object shows how the water passed over it and where eddies were formed. The method is also helpful in the study of rivers and fluid flow in water pipes.







Clamp acts as the "hand" holding a potato peeler

## Gadgets Ease Chores Of Physically Handicapped

Most of the back-bending, lifting and pulling is eliminated from housework in a kitchen designed especially for physically handicapped housewives. It is being used in the occupational therapy department of a London hospital. The kitchen is U-shaped and has a sink in the middle. An "overhead railway" with a sling to support weak arms and shoulders runs across the room. There is a safety belt attached to the sink for women who cannot stand without help. A universal clamp, attached to the work bench, solves the problem of peeling potatoes or grating cheese with the use of only one arm. Many ideas used in the model kitchen can be easily adapted for home use.

Suction pad holds saucepan steady while one-handed person stirs. A small, hand-turned tap releases pot

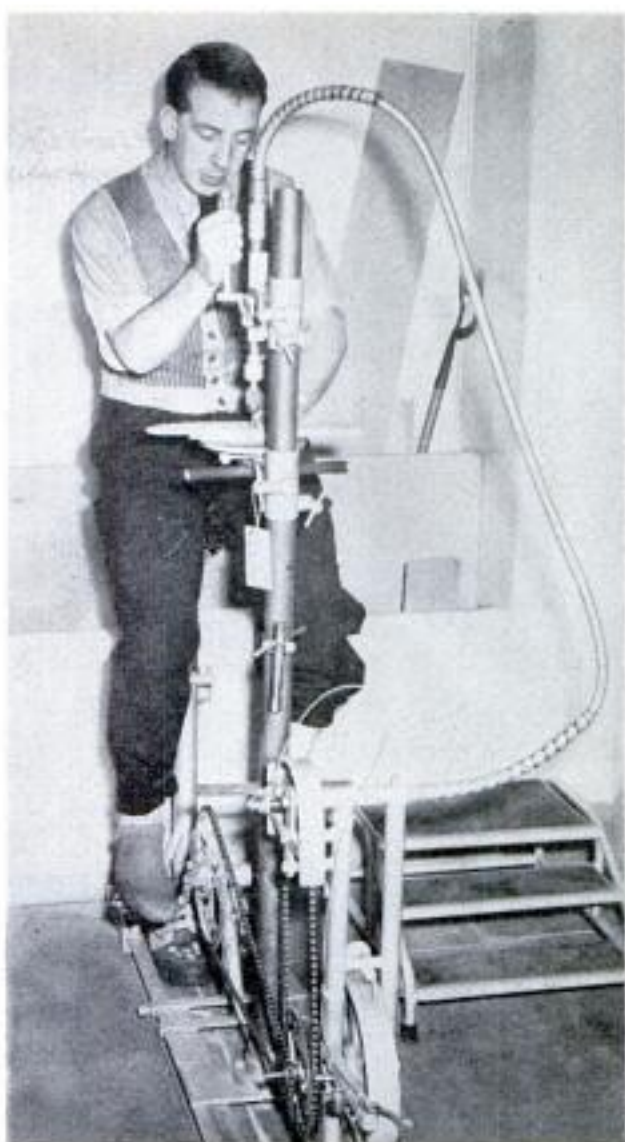

Using a pedal-driven drill operated through a flexible shaft, a patient gets work done and exercises weakened leg muscles. Below, slings brace weak arms and a press clamp grips bread while it is being cut







But you should have seen the one that got away!



"Gad, Orville, it flies!"

# MONSTERS

"You know how I love olives!"

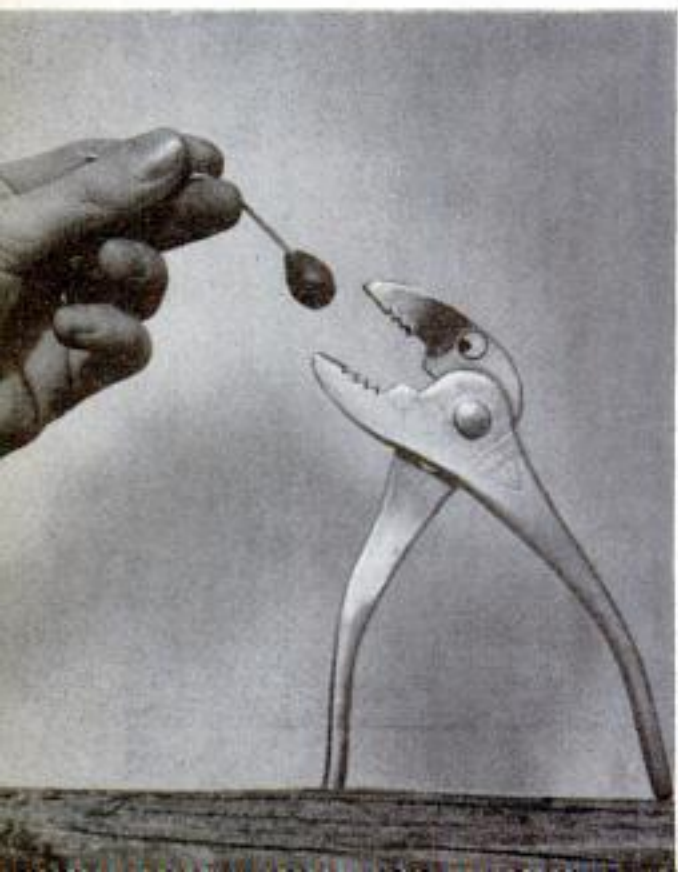

Moose heading east? Dragon heading west?





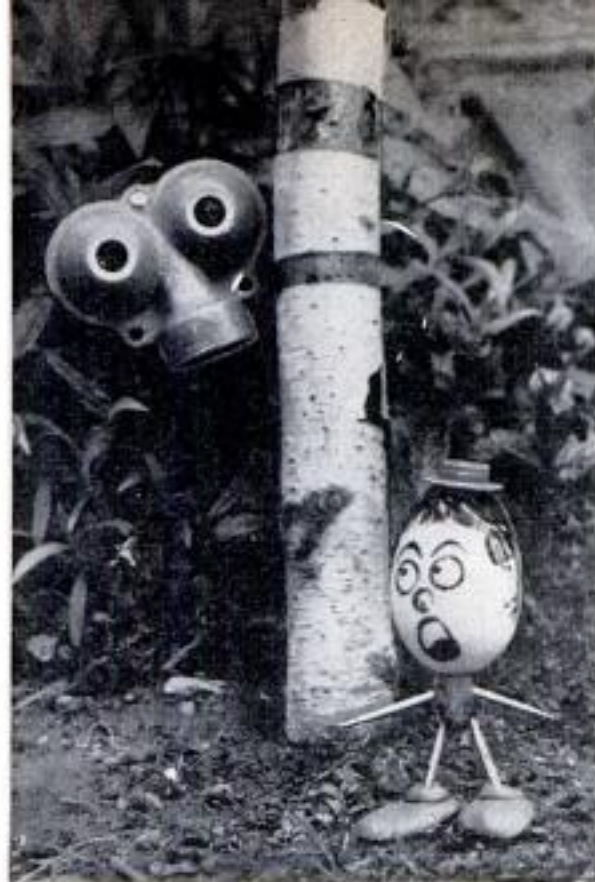

"Now do as you're told! Climb back in that saucer and take off again!"



You never know what you'll find when you lift up a rock and look underneath

## IN YOUR TOOL CHEST

By Barnett Fowler

**D**ON'T ASK ME WHY, but I took these pictures. And now, to cap it all, I'm submitting them, in case your readers might be interested. Tools can't talk back, and maybe it's just as well. However, mute as they are, tools make fine animal crackers if they're touched up with a spot of paint and posed just right. Pliers and clothesline tighteners, hinges and lawn sprinklers can become pleasant little "monsters" that will pose willingly for your camera. We even converted an old furnace damper control into a moose or a strange little creature with an up-turned nose, depending upon how you look at him. Almost any tool or piece of junk can be made into an odd being of one kind or another. Best of all, it's fun for kids as well as adults. Why not open your tool chest and try it yourself? ★ ★ ★

Son of the author tries making a creature of his own. All that's required is imagination plus a spot or two of paint







Glistening bars of zirconium, 99.9 percent pure, are raised from tank which has been flooded with water as a precaution against fire. Metal is deposited on wires by electrochemical action. Below, ingots of zirconium being tested for hardness before production use at Westinghouse Atomic Power Division



## Tricky Zirconium Hailed Vital Metal of Atom Age

INDUSTRY'S NEWEST discovery is a curious, silvery metal known to man for over 150 years. In powdered form it can easily explode. It burns fiercely. Water thrown on it merely spreads the blaze. If handled properly, it is strong, stable and corrosion-resistant. Otherwise, it's unworkable and corrodible.

But because it doesn't absorb neutrons (the atomic bullets that split uranium bombs and keep the atomic engine "running") atomic scientists place zirconium second only in importance to uranium.

Discovered in 1789, zirconium didn't come into its own until 1948. Then it was selected for use in the first atomic submarine after tests with iron, steel and other metals failed.

Zirconium's nonmilitary uses are as varied and paradoxical as the metal itself. Compounds of the metal are used in making poison-ivy ointments, water-repellents, and for improving the quality of furs. Zircon gems, a diamond-like crystal form, are sold widely in jewelry stores.

Extensive ore deposits have been found in Australia, Brazil, and on Florida and Oregon beaches. But extraction is a costly process.

Production begins with zirconium sponge—porous chunks resembling coke. The ore is dumped into a tank with a compound of zirconium and iodine. Hairpin-shaped wires of zirconium are suspended from the top of the tank. When electricity is passed through the wires a chemical reaction occurs. Pure zirconium is separated from the compound and deposited on the wires. The iodine freed attracts more zirconium from the sponge ore and the cycle continues. Eventually, the laden wires are removed and melted into ingots which are then forged and rolled into shapes usable by the atomic-power plant.

The metal's noncorrosion properties promise it a bright future in the chemical and petroleum industry. Surgeons may use it to make repairs in the human skeleton. After a long adolescence, the strange metal has come of age.





Log is branded with a blow from heavy hammer that is faced with company symbol

## LOG BRANDS FOIL RUSTLERS

COWBOYS DON'T HAVE a monopoly on branding. For over a hundred years timbermen have branded logs with such symbols as pigs, cows, birds, keys, barrels, pistols, arrows and even animal tracks.

Loggers apply their marks with a heavy branding hammer which drives an impression deep into the end of a log. Even if the branded portion of the log is sawed off, chemical treatment will reproduce a legible impression of the mark to thwart timber rustlers.

An owner's brand is usually applied several times around the perimeter of the log so that scalers can read the brand no matter in what position the log is floating. "Bark hacks" cut into a log with an ax were once used for identification purposes. They were replaced by branding, however, because sorters and tallymen wasted too much time turning logs to locate the marks.

Weyerhaeuser Timber brand contains company initials. Other brands are at right

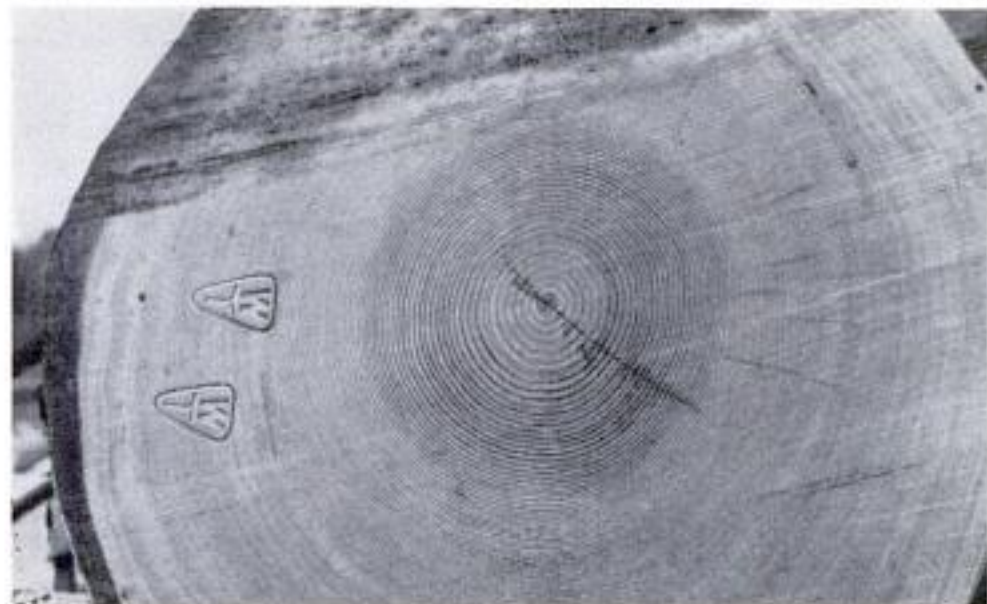

JULY 1954

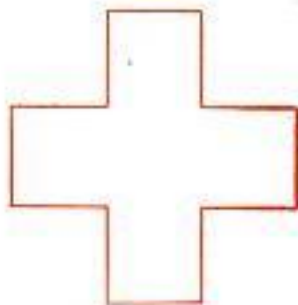
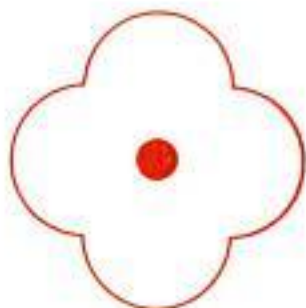



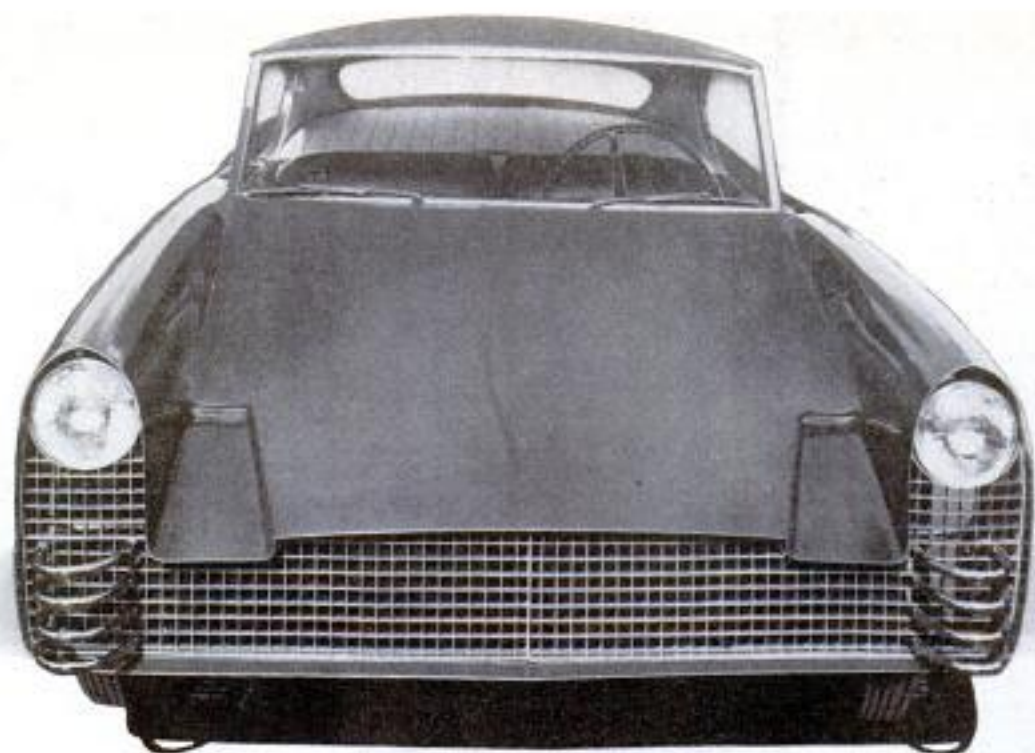

Built by Jay Everett of Los Angeles, a trim sports coupe features an aluminum body and a Cadillac engine

## California Customs

**M**ANY A MAN has built his own house. Why, asks the custom-car fraternity, shouldn't he build his own car? And many of them do build their own with an imagination and vigor that, sometimes at least, puts Detroit's "dream cars" to shame.

Not all custom cars look good to everyone—they are not intended to. They are a revolt against mass-produced conformity. Sometimes the desire to be different runs away with the design, sometimes not.

The usual procedure is to start with a conventional frame (although a sports-car frame such as a Kurtis may be used), then combine custom-made parts with elements

of production cars to get a desired design.

For example, the "Baby LeSabre" shown on the opposite page was originally a Crosley station wagon. Its nose and hood are cut down from a 1948 Ford; part of the front fenders are 1941 Oldsmobile; the windshield is a portion of a 1952 Buick's; the front bumper combines parts of a 1948 Kaiser and a Mercury; tail-fin lights are 1948 Cadillac; instrument panel is from a 1951 Pontiac and the rest of the body is hand molded of 20-gauge metal.

California has many talented custom-car builders. Shown here are three examples of their craftsmanship. ★ ★ ★

Everett coupe has tubular steel frame, uses the tubing to carry water from engine to rear-mounted radiator

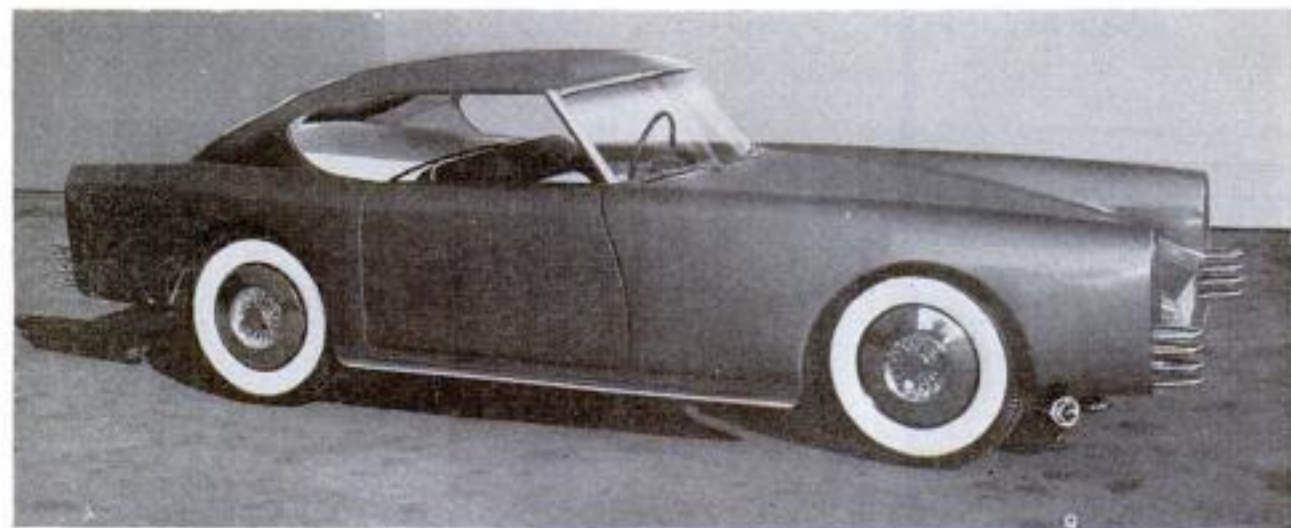



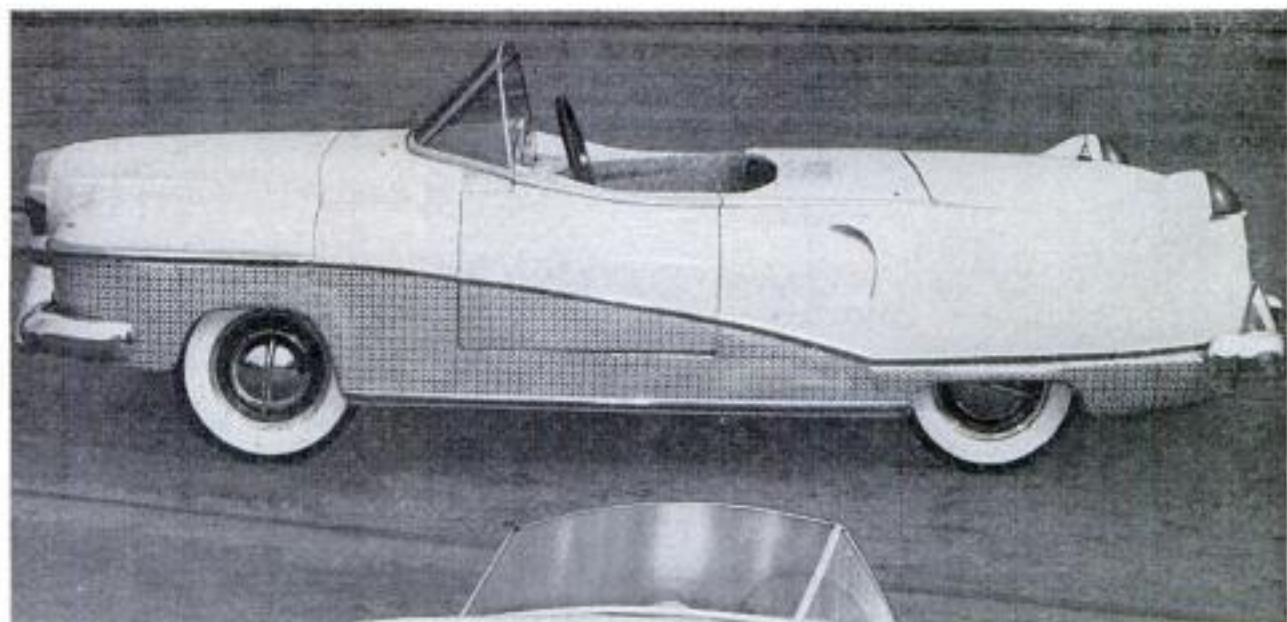

Another Los Angeles custom-car hobbyist, Frank Mann, salvaged a wrecked Crosley as the basis for what he calls "Baby LeSabre." Decorative basketwork is metal screening and is removable to simplify body polishing

Frequently, the cars retain original lines, but with the customized exaggerations. This, of course, is an Oldsmobile, lengthened and lowered. One-piece top is removable. Souped-up engine has two four-throat carburetors

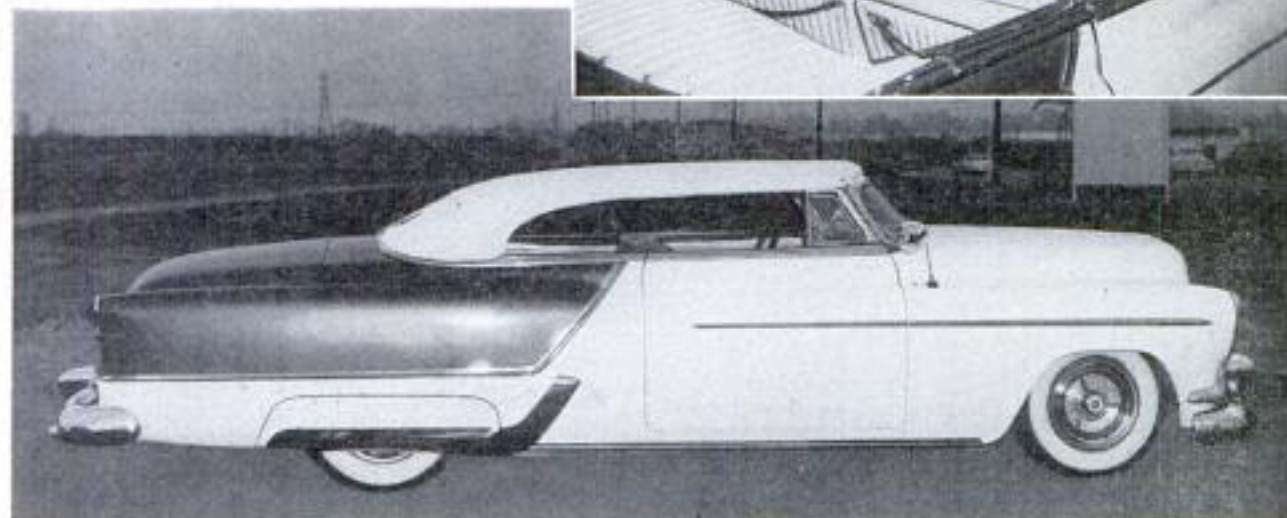



## Steel Tube Shrunk by Vacuum to Fit Inside Smaller Tube



Faced with the problem of slipping a 10-foot stainless-steel tube, 12 inches in diameter, over one 12½ inches in diameter, Solar Aircraft Company solved it by using a vacuum technique. The corrugated inner tube and its shroud are used in making augmentors which give forward thrust from exhaust gases. A pump attached to one end of the inner tube shrinks it to about 11⅝ inches. After the outer tube is slipped over it, atmospheric air increases the inner tube to fit the outer shroud.

## Auxiliary Motor Runs Trolley Bus

Even when it's off its trolley a new German electric bus keeps on running. A small Volkswagen engine beneath the floor is coupled to an electric generator that supplies power to cross railroad tracks, go around traffic jams and travel to and from car barns without using a trolley line. The auxiliary motor can propel a fully loaded bus.

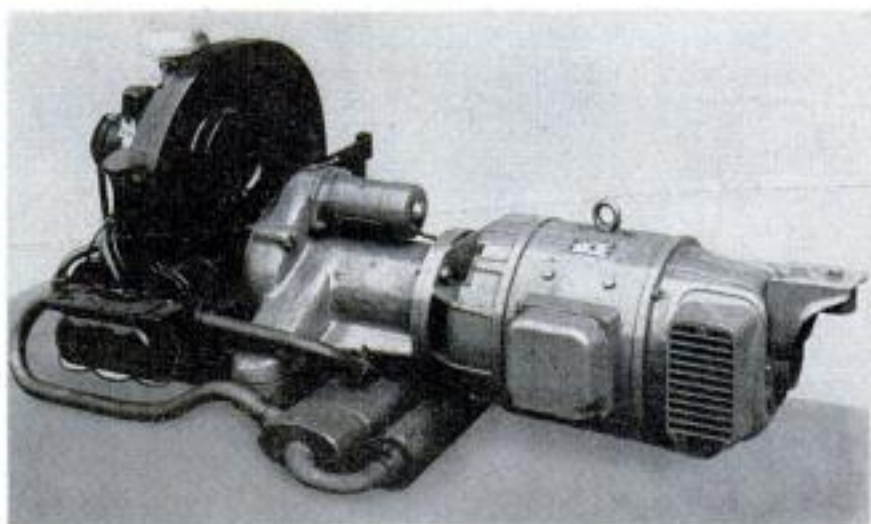

## Tailless German Glider

Seating two, a glider recently demonstrated at Augsburg, Germany, is almost all wing and has no tail. It is said to be the only tailless model flying in Europe today. Gliding, a popular sport in prewar Germany, is once again being revived.

☞ Rutgers University physicist Ira M. Freeman proposes that radioactive wastes be disposed of by shooting them into space or to other planets by rocket instead of burying them in the earth or sea, as is now done.





## Grapple and Spot Marker Help Retrieve Lost Fishing Gear

Dismayed fishermen who drop their rods, reels or even motors overboard have a chance of retrieving them if they carry a spot marker and miniature grapple. As soon as equipment is lost the marker is dropped overboard. A sinker carries one end of a line to the bottom and the other

is fastened to a float. The angler then opens up a miniature grapple, drops it overboard on another line and pulls it back and forth across the bottom. With a reasonable amount of luck he'll snag the lost gear and can pull it up. The spot marker and grapple are stored in a canvas bag.

## Does Buzzing Bottle Attract Fish? British Anglers Think So

Several British authorities on fishing are enthusiastic about a new "buzzing bottle" which is said to attract fish. J. Grygar, a displaced person now living in Wales, invented the bottle after recalling how his grandfather attracted fish to a boat with a jar of live bees. Grygar built a battery-operated buzzer into a small jar. The an-

gler anchors the boat and sets the jar afloat. The buzzing sound, transmitted through the water, is said to fool fish into believing that insects are on the surface. It's up to the fisherman, of course, to make the catch once the fish are in the vicinity. Does it work? A good many British anglers seem to think so.

## Electric Calendar Shows the Day, Date and Month

Three hands revolve on the face of an electric calendar to tell you the day of the week, the date of the month and the month of the year. The clock corrects itself for the 28, 30 and 31-day months and needs adjustment only once in four years—on February 29. Power failures up to eight hours will not affect its accuracy.

## Porcelain Patching Kit

Nicks and scratches in porcelain-finished refrigerators, ranges and bathtubs are hidden with a porcelain patching kit for home use. A tube of filler, a bottle of glaze and simple instructions are included in the packet.





Geranium leaves really started  
Jake Dyson in business with a profit.  
Whether it's geraniums or baby shoes  
or fresh-caught fish,

## HE'LL DRESS IT IN COPPER



Dyson's daughter proudly wears earrings and pin which her father made from plant leaves

By  
*John F. Blaney*

Artist in copper buffs a pair  
of plated 19th century shoes  
which will be made into lamps

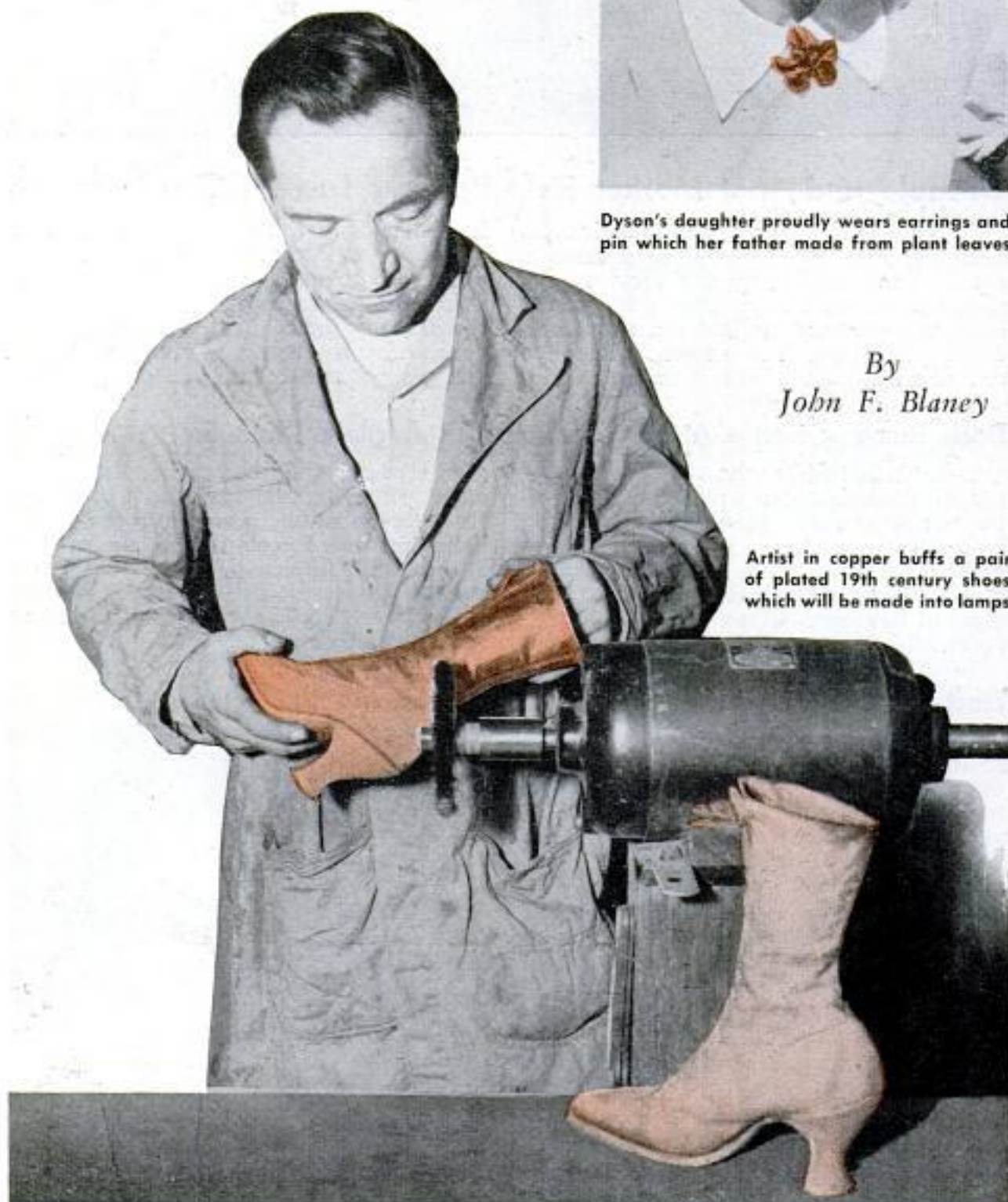





He also is an artist in hammered copper. The metal in his hand will be transformed into a gleaming ash tray

**PICKING MONEY** off trees is the business of Jake Dyson, Sacramento, Calif.

A copperplater, Dyson selects leaves from trees and bushes and converts them into gleaming earrings, candleholders and other objects of art. Every tiny vein of each leaf is preserved in a bright coating of copper.

For 30 years Dyson has been copperplating objects, mostly in someone else's shop. Not long ago, striking out on his own, he started copperplating novelty items in his

basement. Before long the demand for his work was so great that he had to expand.

Dyson rented larger quarters and started building his own facilities from anything he could find. He located a small electrolysis tank but couldn't find anything suitable for the larger fixing tank he required. Finally he hit upon the idea of using a surplus B-29 wing tank. Its large capacity and rubber-type fabric made it ideal.

Now Dyson will tackle almost anything

Plated leaf shows every tiny vein that appears in natural leaf. Right, Dyson plated the glove of a former boxer

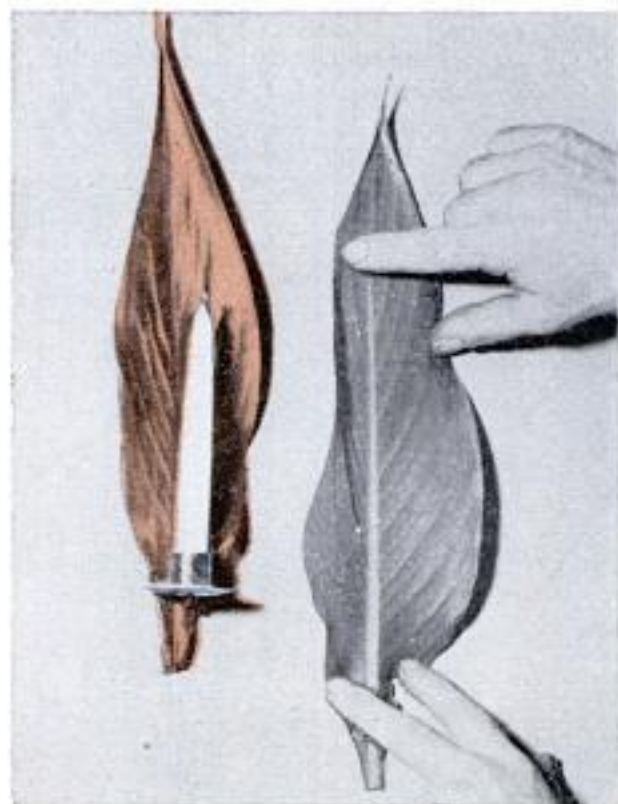



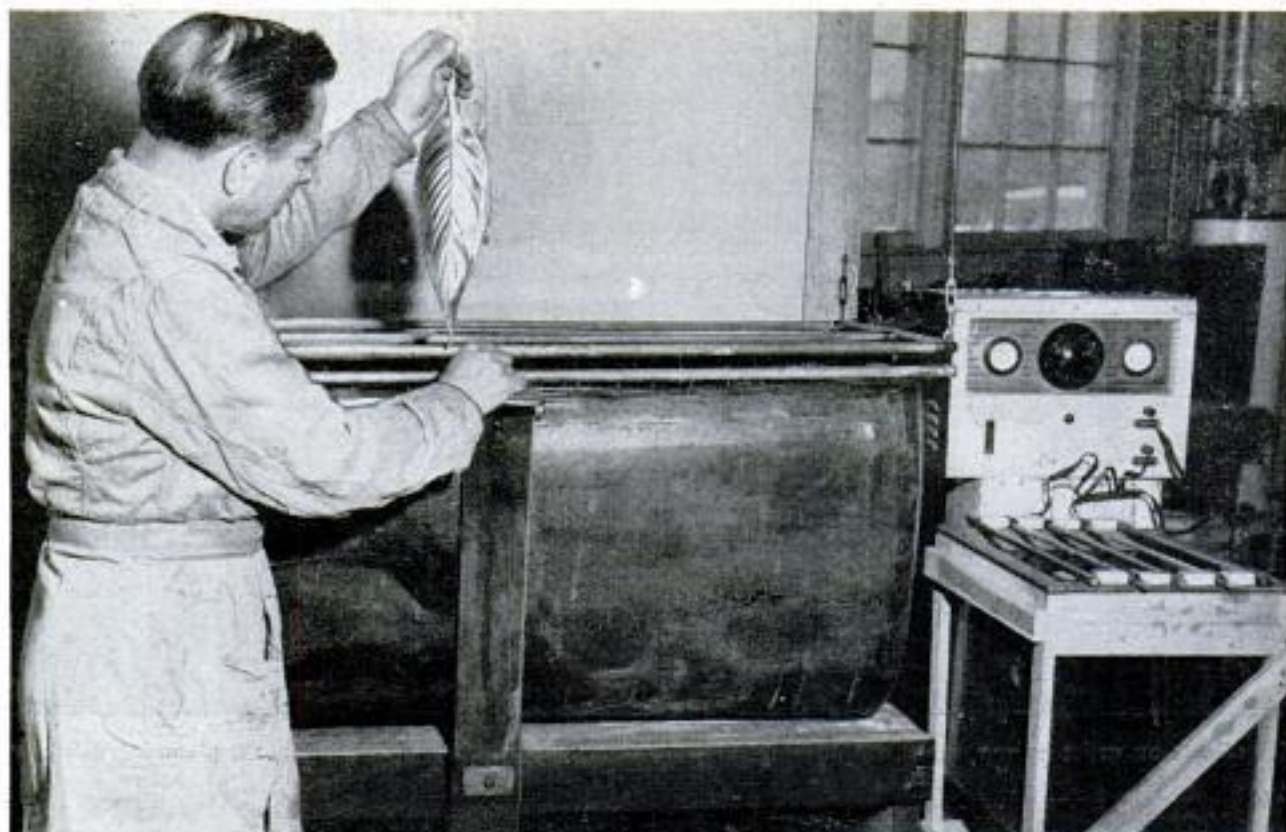

Surplus aircraft wing tank became a large fixing tank in Dyson's shop. Here he checks a copperplated leaf

In his homemade spray booth he sprays a decorative horse's head with copper. Below right, he mounts baby shoes in unique style

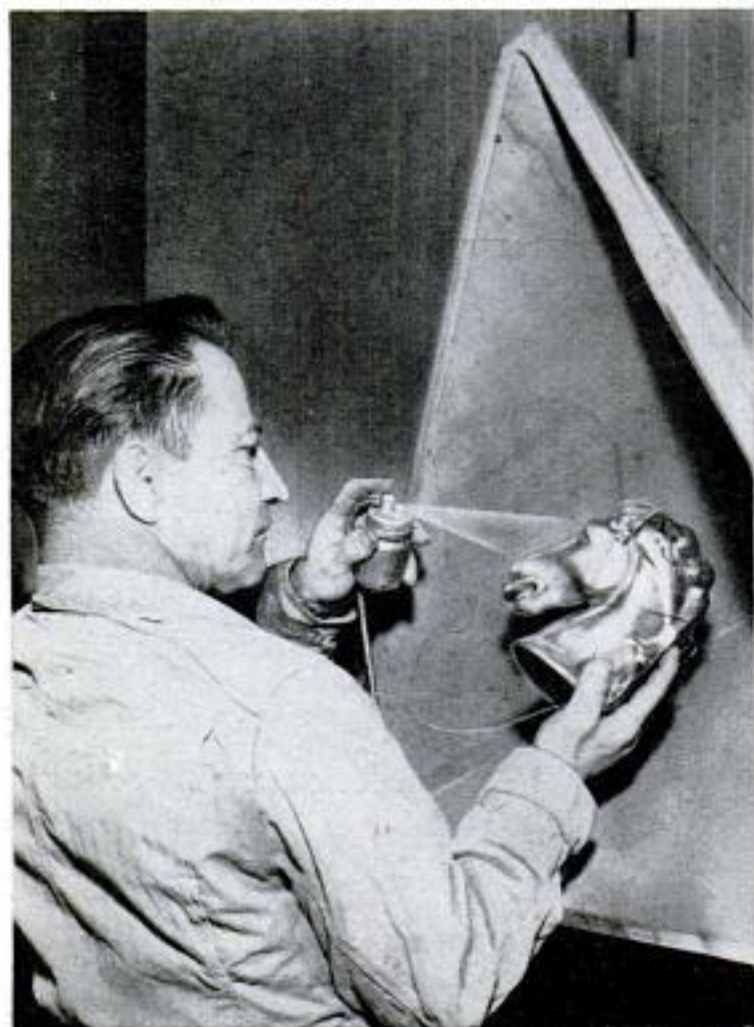

in the way of a copperplating job. Gleaming leaves are his specialty. Under his expert hands, tiny geranium leaves become earrings and larger leaves become glistening candleholders.

On special order he also plates such items as boxing gloves, baby shoes and model airplanes. Once he even took on the job of plating a rattlesnake. For a proud fisherman he recently copperplated a prize catch.

Copperplating is just one of Jake Dyson's many talents.

He also makes beautiful hammered-copper items. His specialties in this line are barbecue covers, large plates and unique copper planters. ★ ★ ★



POPULAR MECHANICS



## 99.99999999 Percent Purity Gained in Metal Process

Metal and other substances can be refined to 99.99999999 percent of purity with a method developed by Bell Telephone Laboratories. The impure fraction is the equivalent of a pinch of salt in 35 freight cars of sugar. A thin strip of germanium to be used in transistors is placed beside a track along which travels a circular electrical heater. As the heater moves down the strip, it produces a molten zone that pushes the impurities to one end of the strip. The impure section is then cut off and discarded. Bell believes the result is the "purest material in existence."

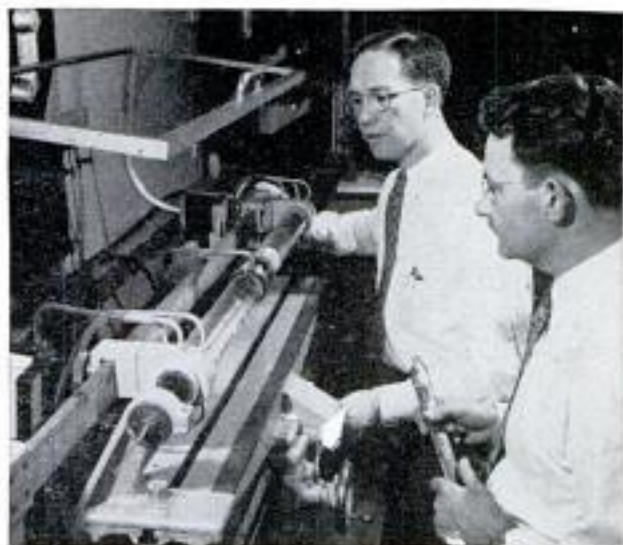

## "Million Dollar" Camera Aid for Jets Built From Surplus Parts



Starting with an idea and \$100 worth of surplus parts, Lt. Harlan Williams and Chief J. L. Rains produced what the Navy terms a "million dollar" invention. It is an image-motion compensator that permits sharp, clear pictures to be taken from fast, low-flying jet aircraft. During the split second that the shutter clicks, the device moves the camera slightly to compensate for the airplane's speed of 600 or more miles per hour. The effect is that of shooting from a stable platform. It took Williams, a pilot, and Rains, a metalsmith, both stationed on the aircraft carrier USS *Philippine Sea*, just one week of spare-time work to fashion it from spare parts.

## Motor-Driven Master Switch Controls Many Circuits at Once

You can control 25 electrical circuits at once and turn on a preselected pattern of lights in a house equipped with a new motor-driven master switch. Low-voltage remote-control switches located about the house allow you to control the entire lighting system from any of various points. In factories, offices and institutions, the switch can be used to control banks of lights. The 25 circuits on one motor-driven switch can be connected to 25 other motor-driven switches to achieve a one-location control of 625 lighting circuits.

## Radar Beams May Be Lethal

Harmful consequences might result from inadvertent exposure to the beams of high-powered airborne radar the Navy will shortly be operating, according to Comdr. Sidney I. Brody. Commander Brody, Navy medical officer, said that in tests cataracts had been produced in the eyes of animals. He urged the use of neon bulbs to warn of the existence of a dangerous field.

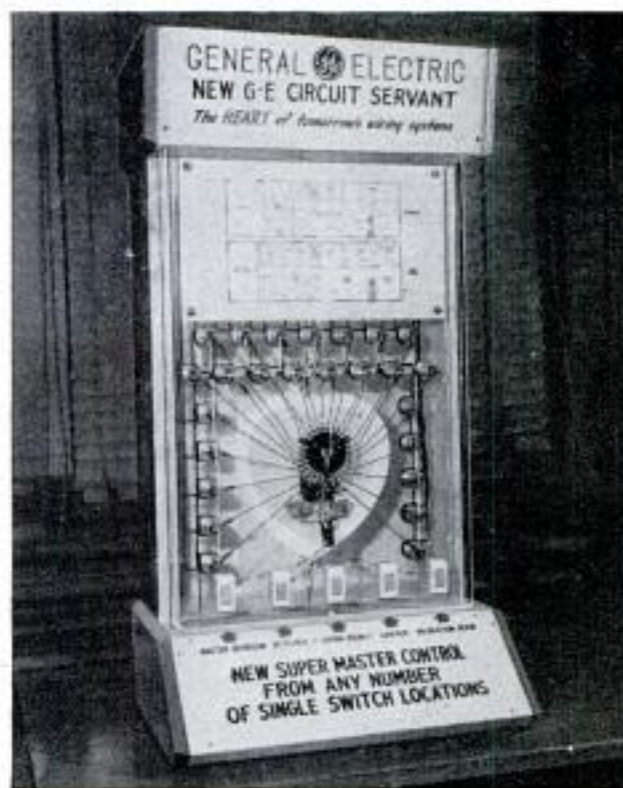





In flight, a Northwest pilot checks with Minneapolis over VHF-telephone system. Below, the shaded areas indicate ranges of VHF stations en route

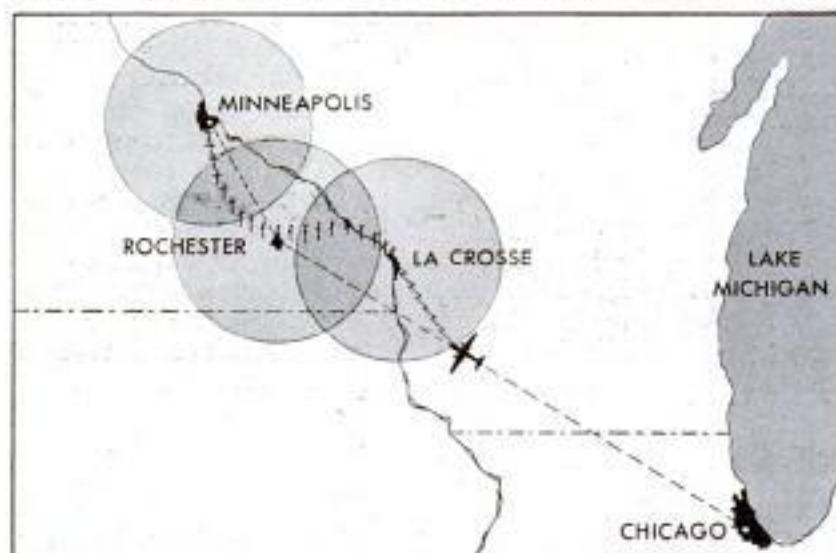

Incoming reports are copied on a teletypewriter for relay to other points. Right, center dial controls primary power to "slave" stations



## Pilot Talks to Tower Via Phone-VHF Linkage

THROUGH A combination of long-distance telephone and VHF-radio facilities, pilots of Northwest Orient Airlines now come into voice contact with the Minneapolis tower from approximately 200 miles out. Although VHF is limited to line-of-sight, the system developed by Collins Radio extends it to allow coverage over any distance without the cost of additional operators. Unattended VHF stations at two cities en route, controlled by Minneapolis and connected to it by long-distance telephone, are the links through which communications flow between planes and the home base. On the remainder of the route the pilot has voice contact at all times with Chicago or Madison, Wis. All air-to-ground talk is also copied on teletypewriters and relayed to operational centers en route. When the Minneapolis operator presses a foot switch, transmitters there and at the "slave" stations go on. When he releases the switch, all the transmitters are off and the receivers go on. The remote control is achieved by use of a tone which is transmitted to the stations via telephone lines.

Collins Radio Company photo



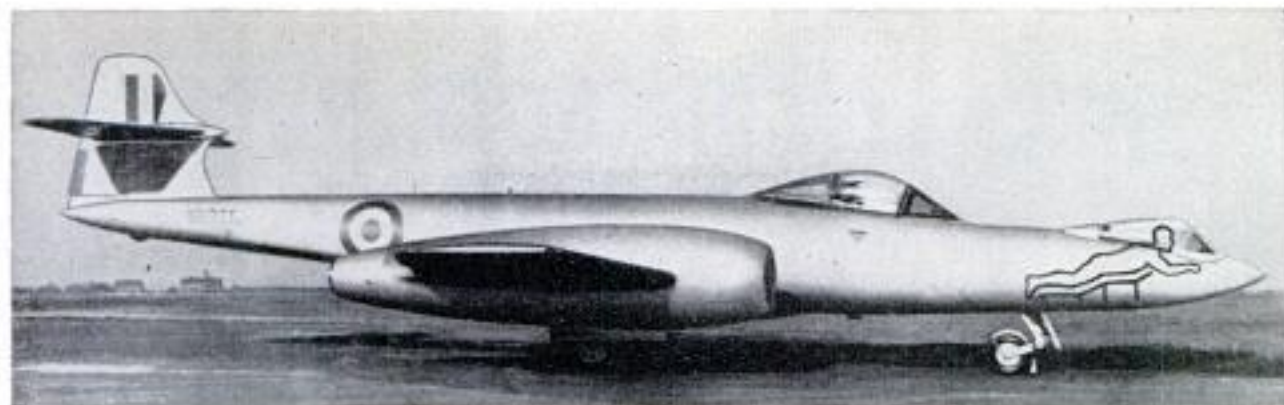

British Information Services photo

## Jet Pilot Flies on His Stomach in British Experiments

Test flights are being made in England of a prone position for pilots, designed to lessen fatigue and permit fliers to withstand more Gs (force of gravitational pull). It will also permit design of slimmer fuse-

lages. The experimental plane, a Meteor jet, has the prone-position installation in the nose with special controls for the pilot. Another pilot occupies a conventional cockpit during the test.

## Thumbtack Tool Drives, Extracts and Stores Supply of Tacks

Thumbtacks are stored in a tiny device that also provides a means of driving and extracting them. One end of the tool is magnetized to hold the tack in various driving positions. At the other end is a small claw that slides under the head of an embedded tack and pops it into the container. A sliding cover permits access to the tack supply. Draftsmen and artists find the tool handy.

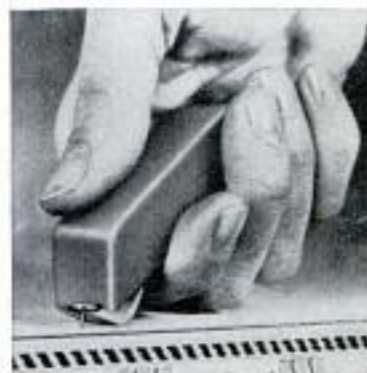

## Vending-Machine Diner Lets Passengers Serve Themselves

Vending machines replace waiters in the new buffet cars on some Pennsylvania Railroad trains. Six automatic machines offer the passengers several kinds of sandwiches, soft drinks, coffee, ice cream and

other desserts—all at reasonable prices. There are seats for 12 patrons and a stand-up counter. An attendant at the counter mixes beverages and supplies change for the vending machines.





# PRECAST CONCRETE HOUSE



Contemporary in design with picture window and roof overhang, this house can be completed in two weeks

**S**OMETHING NEW in the way of concrete homes is happening almost overnight in the vicinity of Napa, Calif. Twenty-ton cranes swing precast wall and roof sections into place in a few hours. An entire house can be ready for occupancy in two weeks. Buyers are given a choice of the shell house for \$6270 (walls and roof), just the walls for \$4420, or the finished home for \$12,900. The house has three bedrooms and contains 1242 square feet of living

space plus a 480-square-foot garage. There are 84 square feet of closet space, a sliding glass window wall in the dining room, a picture window, fireplace, tile bath and central heating. The walls are one-piece units of steel-reinforced prestressed lightweight concrete six inches thick. Window and door frames, conduit and piping, electrical outlets and switch boxes are cast right into the walls. These walls can be made in lengths up to 40 feet. They are

A 20-ton crane lifts wall section into place. Three workmen plus crane operator can erect shell in half a day

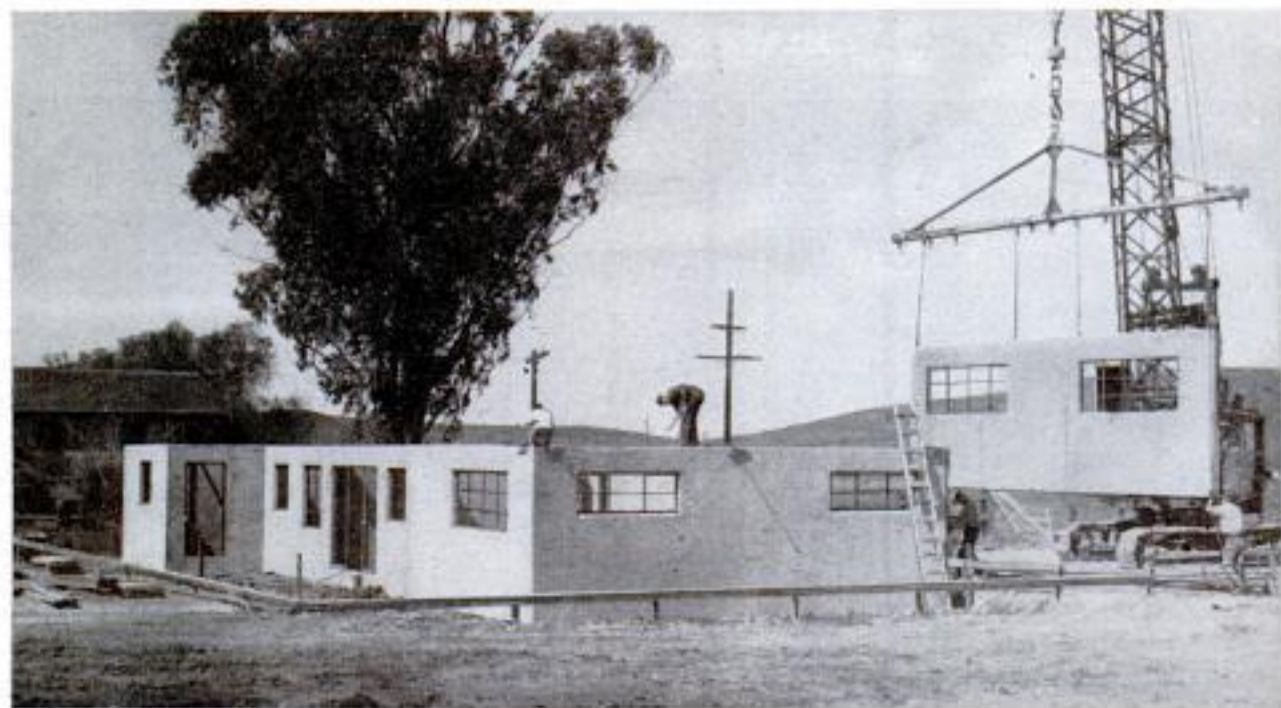





Workmen prepare to guide one-piece wall section into place. The wall is six inches thick and made of steel-reinforced lightweight concrete. The door and window frames are cast right into the solid wall

welded to steel base plates in the concrete pier-type foundations. The only joints in the upright walls are in the corners which are welded together at three places with steel plates. Interior corner joints are covered with wood moldings and, on the outside, the corner joinings are caulked and then hidden by downspouts. Slabs for the roof come in precast six-inch-thick units which are welded to the walls and to each other. The four-inch slab floor is attached to precast reinforced steel hooks in the wall to pull the entire house together. Interior walls have a smooth finish which can be painted or papered. Two finishes are available for the exterior walls, either a broom texture or a steel-trowel finish. Four basic floor plans are available, all with three bedrooms. The house was developed as a sideline product by the Basalt Rock Company of Napa, which ordinarily deals in road-construction materials, lightweight-concrete building units and steel pipe. The company has spent several years of research and experimental work on the project. ★ ★ ★



Above, workman is welding a corner joint in the upright walls. The walls are also welded to steel base plates set in the concrete pier-type foundations. Below, as roof panel is lowered by crane, two men ease it into proper position. These roof slabs are six inches thick and are welded to the walls and to each other to form a sturdy home







Dump truck unloads hot asphalt into side hopper of paving machine. Up to 800 tons of asphalt are laid per day

### Paving Machine With 60-Foot Reach Asphalts Steep Levee Slope

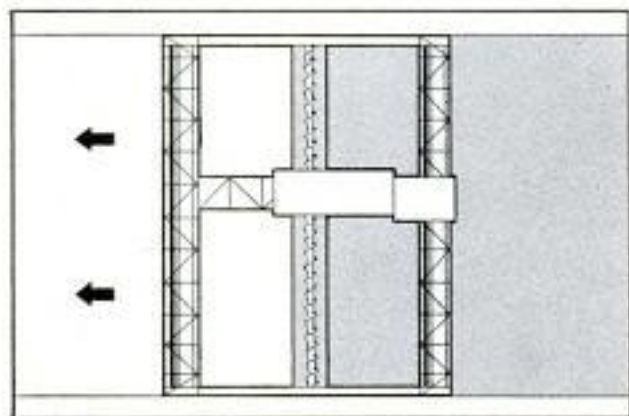

Auger midway between rollers distributes asphalt

Men with hooks lift wire mesh so that it is embedded in center of asphalt



PAVING A STEEP levee slope is a fast process with a 20-ton "land plane" which has a center section suspended from a frame supported by front and rear rollers. Hot asphalt is dumped into a hopper at the top of the levee and is augered into a 60-foot center distributor box. Within this box another screw distributes material evenly down the slope. Hydraulic jacks raise and lower the distributor box as needed to lay a thickness of  $3\frac{1}{2}$  inches, which is compacted to three inches by the heavy rear rollers. The entire machine is self-propelled by electric motors attached

to two winches at the forward end, with cables from the winches running to a deadman anchor several hundred feet ahead. Electric power for all motors is furnished by a generator sled-mounted behind a tractor, which also serves as an anchor to keep the machine from sliding down the slope. The machine was designed by contractor Bert Altfillisch for a flood-control job in Long Beach, Calif. It was expected to pay for itself on this first job by reducing labor expense. The machine handles up to 800 tons of hot asphalt per day. Altfillisch contracted for paving 1,664,000 square feet of flood-control channel.



## Kodak Introduces Low-Priced Camera, Viewer for Stereo Fans

Breaking into the rapidly growing three-dimension-camera field, Eastman Kodak announces a 35-millimeter stereo camera that sells for less than \$100, one of the lowest priced on the market. The camera has matched color-corrected lenses which are coated for increased light transmission and decreased internal reflections. The shutter has four speeds ranging from  $\frac{1}{25}$  to  $\frac{1}{200}$  second. It also has built-in flash synchronization. Double exposures are impossible as the shutter is cocked as the film is advanced. A simplified exposure calculator helps the photographer select the proper lens opening for the light available. Other features include a spirit level built into the camera body, an exposure



counter, a film-type indicator and an automatic film threader. Kodak has also announced a stereo viewer that comes as either a battery model or a 110-volt model.

### Gold-Plated Windshields

Gold-plated windshields on which ice can't form have been developed for British aircraft. A thin gold film only .0000002 inch thick that is applied beneath the outer layer of the laminated glass conducts electricity to heat the windshield. When military needs are fulfilled, the manufacturer expects to produce similar windshields for automobiles.

### Moth Paste Kills and Cleans

Suits, hats and blankets are cleaned and mothproofed with a paste that is diluted in hot water and sponged on the fabric. This is one of two new products of an English chemical firm. The other item is a shampoo for carpets that also acts as a moth-and-germ deterrent. One tube of the shampoo paste, diluted in hot water, cleans 30 square yards of carpet.

### Lightweight Aluminum Rack Holds Pack in Comfortable Position



Hiking in hot weather is much more comfortable when your pack is mounted on a sturdy aluminum-alloy rack that is curved to fit your back. The pack rests on heavy cord that is stretched across the rack, leaving an open-air space between pack and back. The  $1\frac{3}{4}$ -pound rack can be adjusted to fit children or adults. Horseback riders, cyclists and skiers find that the rack balances the pack load for maximum comfort. Hunters use it to carry game bags and gear.



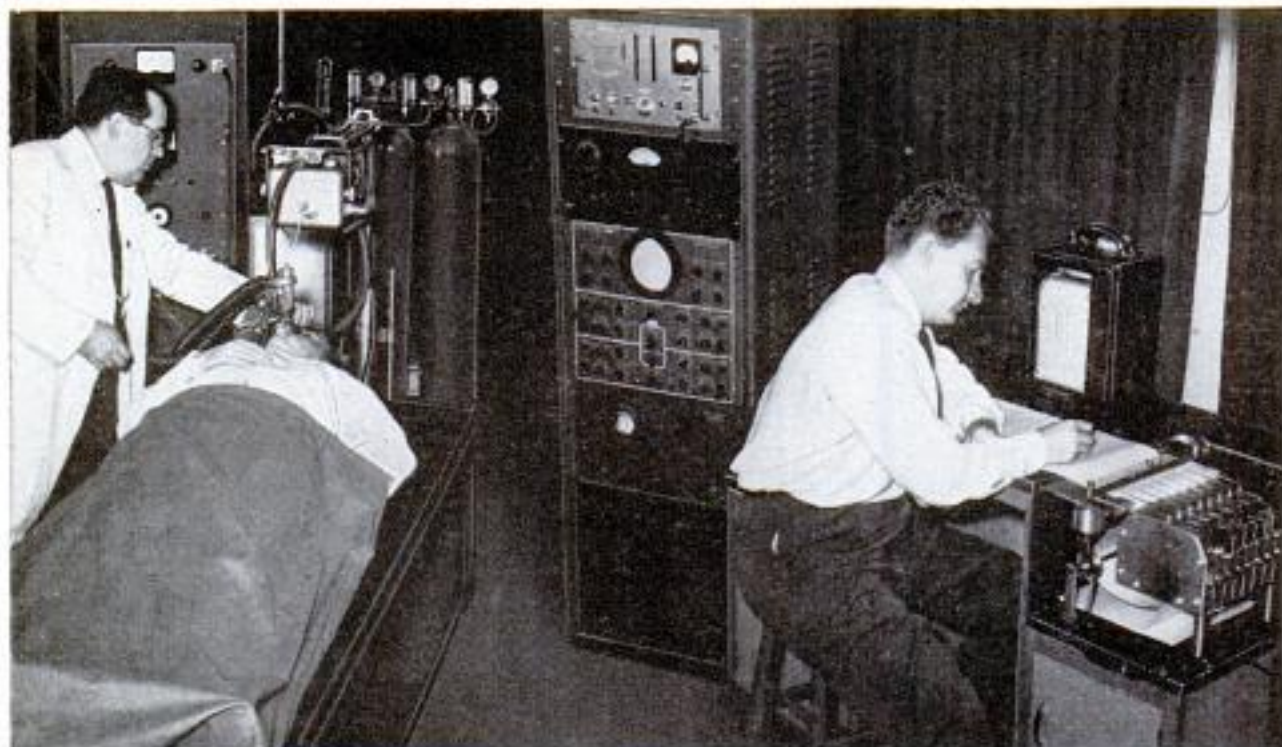

## Master System Performs Many Medical Tests at One Time

Many kinds of body functions are tested and recorded at one time by a system developed at Baylor University College of Medicine and Southwestern Poliomyelitis Respiratory Center in Houston, Tex. The apparatus takes down the patient's electrocardiogram, pulse, blood pressure, blood oxygen saturation, speed of breathing, air volume and measures the oxygen, nitrogen and carbon dioxide of the breath. Attach-

ments on the arms, wrists and in the mouth receive the data and feed them into four separate electronic banks. These, in turn, are wired into a central charting mechanism, also electronic, which directs writing pens as they record all the results on one moving piece of graph paper. The conventional method is to record bodily functions separately and then patch them together by guesswork. Cost of the system: \$55,000.

## Supergeared French Bike Gives Cyclist Choice of Several Speeds

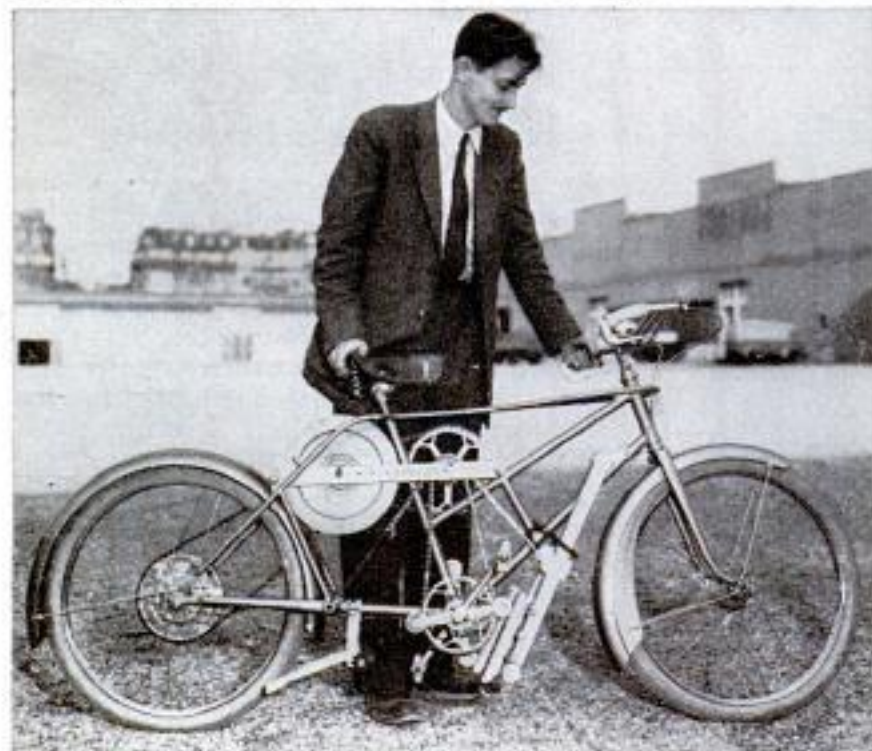

There's a weird assortment of sprockets and chains incorporated into a supergeared bicycle invented in France. The chains appear to run at random all over the framework of the bicycle, but the arrangement gives the rider a choice of several gears. The bicycle has two-wheel brakes.

## Relay Guards Lines

Within  $\frac{1}{60}$  second after trouble develops, an electronic "watchman" trips a giant circuit breaker to kill a power line. The electronic relay, which has a vacuum tube as its basic working part, acts as a protective fuse.



# Radio Television Electronics

## SMALL-TOWN VETERINARIANS MAKE RADIO PAY

THREE PROGRESSIVE Midwestern veterinarians are using a two-way radio system in order to earn more money for fewer hours of work. The trio—Dr. Donald W. Rawson, Dr. William K. Specht and Dr. G. C. Poppenhouse—have built their small-town veterinary practice into a flourishing business with this system that keeps them in constant touch with their office, homes and customers, in a 20-mile radius around Milledgeville, Ill.

Their new office and clinic are shown in photos C and D. The 60-ft. telephone pole in the rear of the building supports the antenna for a Motorola 60-watt FM base station which serves as the heart of the system. Each doctor has a 30-watt 2-way unit in his car. Photo A shows Mrs. Rawson at a remote-control console in the Rawson kitchen, a few blocks from the base station in the clinic. At the flick of a switch she can talk to her husband by radio in his car or by intercom if he is at the clinic. Thus she becomes chief dispatcher when the doctor is out on calls after office hours. In photo B, he answers an emergency call.





# HOW TO SELECT YOUR

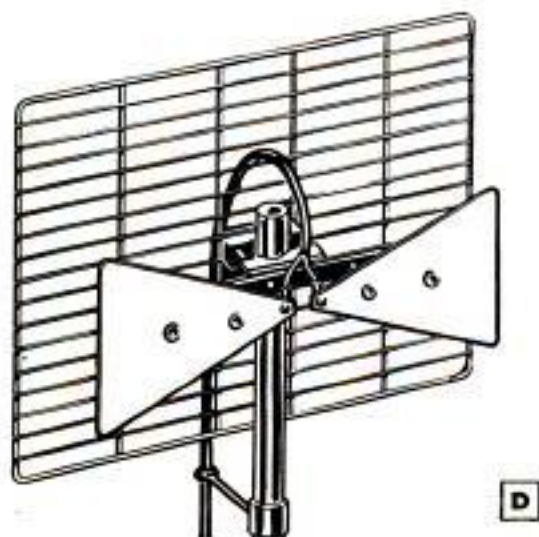
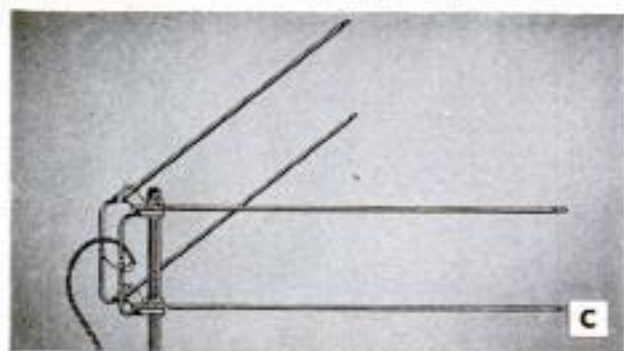

**YOUR LOCATION** is the deciding factor in choosing the correct type of TV antenna from a wide variety of designs. The new UHF channels 14 to 83 require additional antennas. The long-awaited color-TV programs will require no antenna change, and that is welcome news to many prospective color-television-set owners.

For maximum results, your television-antenna array must be highly selective on the TV channels employed by the stations in your area. If it is not efficient on each channel, it will include scattered and delayed reflected signals and the result is troublesome ghosts. To receive the AM (video) picture and FM (audio) signals head-on at greatest efficiency, it must be cut to favor those particular channels, and correctly oriented in the direction of such stations. If this is not done, the best TV-set tuner made will be handicapped even on strong local stations.

This becomes more important in fringe areas remote from TV-broadcasting stations. Multiple-bay TV-antenna arrays, and specially designed "Yagi"-type multiple parasitic-element arrays are employed to advantage in such areas.

There are about 45 or 50 different VHF and UHF TV-antenna designs available. Each manufacturer uses standard electrical formulas, and supplements these with months and sometimes years of field test-

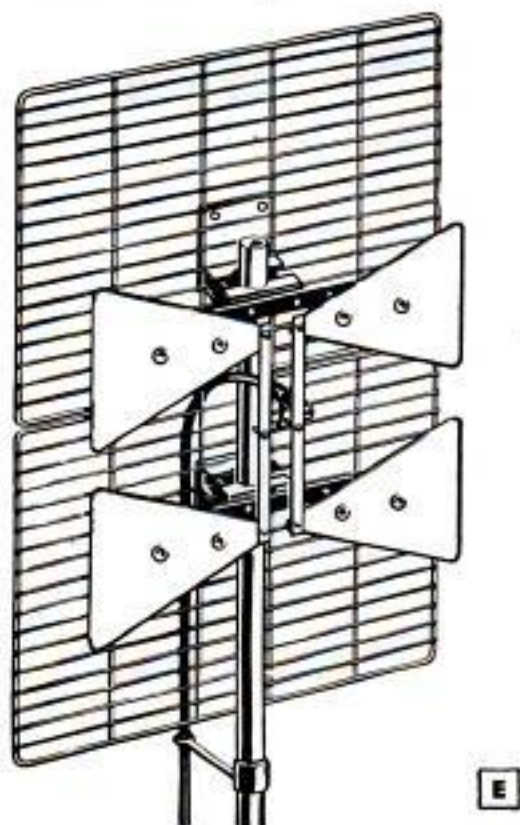



# TELEVISION ANTENNA

ing in order to solve specific location receiving problems. Ordinary homemade "plumbing" construction jobs with the difficult to obtain hard-aluminum tubing are not recommended except for the dyed-in-the-wool experimenter.

One of the simplest, and usually sure-fire methods for the new TV-set owner to select an efficient type for his particular location is to visit the neighbors and check up on their results. In some areas you will find a number of different types in use but they will usually follow a general pattern as the TV servicemen have learned by experience just what type gives maximum results in that particular neighborhood. The necessary height is determined by the distance from the transmitting stations, and the topography of the surrounding country. Even though you may be located comparatively near the desired stations, intervening hills and buildings may make it necessary to do some experimenting if you have no near-by neighbors to check with.

The fringe-area TV antenna must be carefully selected to include the desired channels, and if the broadcasting stations are not all located in the same general direction a remotely controlled rotating device, such as the one illustrated in photo J, may be employed to "aim" the antenna array to the desired station. In ultra-fringe

(Continued to page 234)

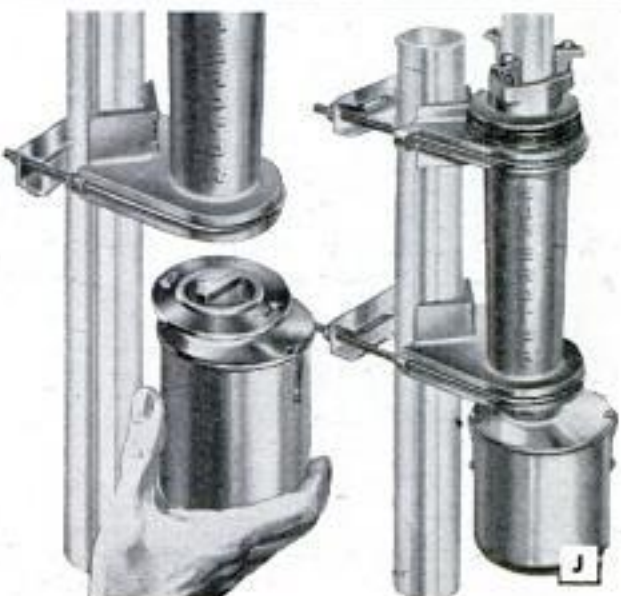
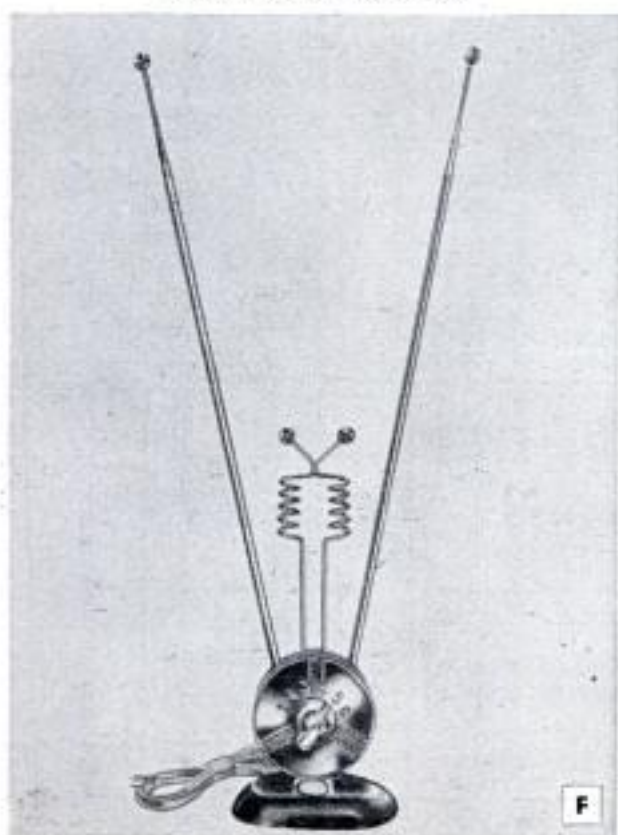
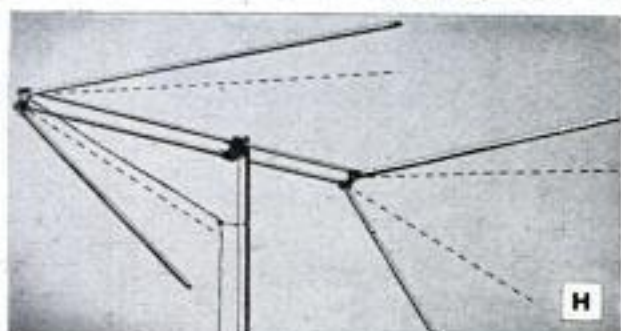
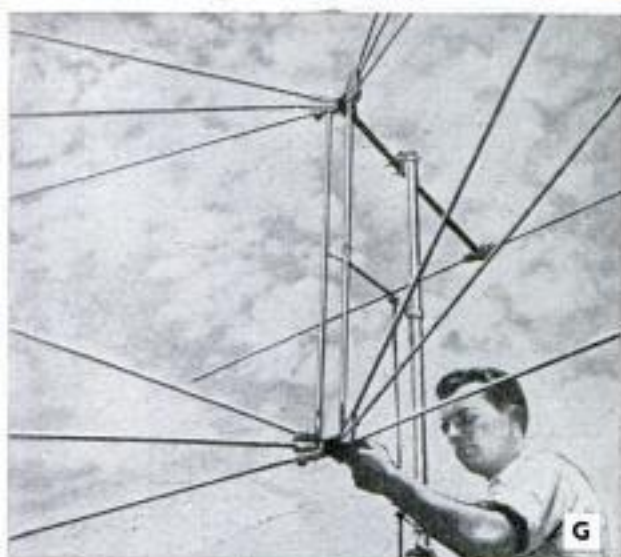



# MATCHED HOME-MUSIC ASSEMBLY

NOW YOU CAN purchase a complete home-music system in a packaged assembly, known as the Craftsmen CA1, and install it in any custom-type equipment cabinet of your choice. All the units, photos A to E, are provided in a single carton, complete with a changer mounting board, all necessary connecting cables, photo E, and mounting hardware.

The 12-in. speaker system, photo A, is a high-fidelity specially designed type which includes a wide-angle dispersion, horn-loaded tweeter which is coaxially mounted in a 12-in. woofer for single point sound distribution.

Photo F shows a suggested folded-horn enclosure for the speaker; this is detailed in Fig. 1. The C-400 high-fidelity 10-watt amplifier, photo B, employs two 6V6 output tubes in push-pull. The Craftsmen type C10 FM-AM tuner, illustrated in photo C, is a popular model used in many home-music systems.

A three-speed automatic record changer is included. This unit, shown in photo D, is complete with a GE "Triple play" phono pickup cartridge. The assembly gives the high-fidelity amateur a carefully matched home-music system.

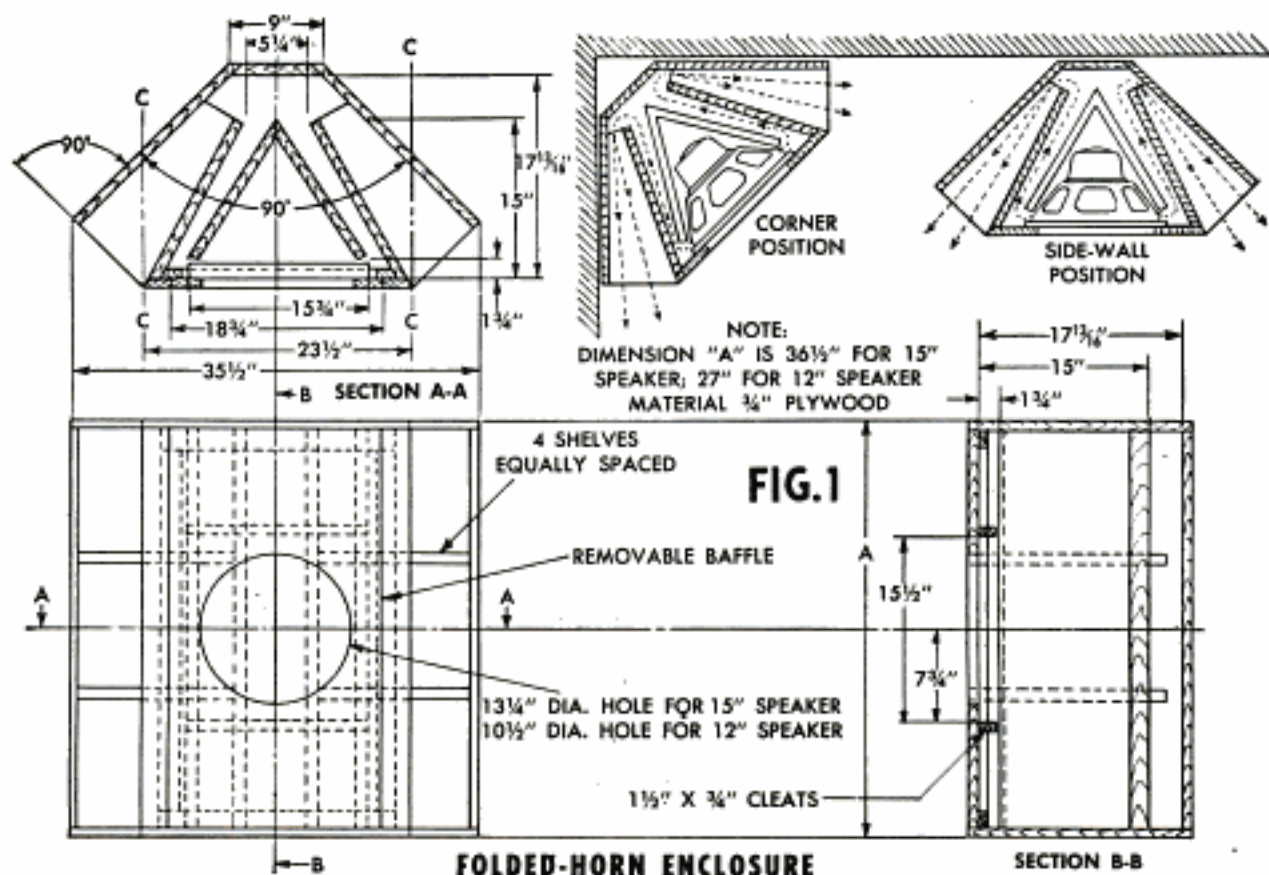
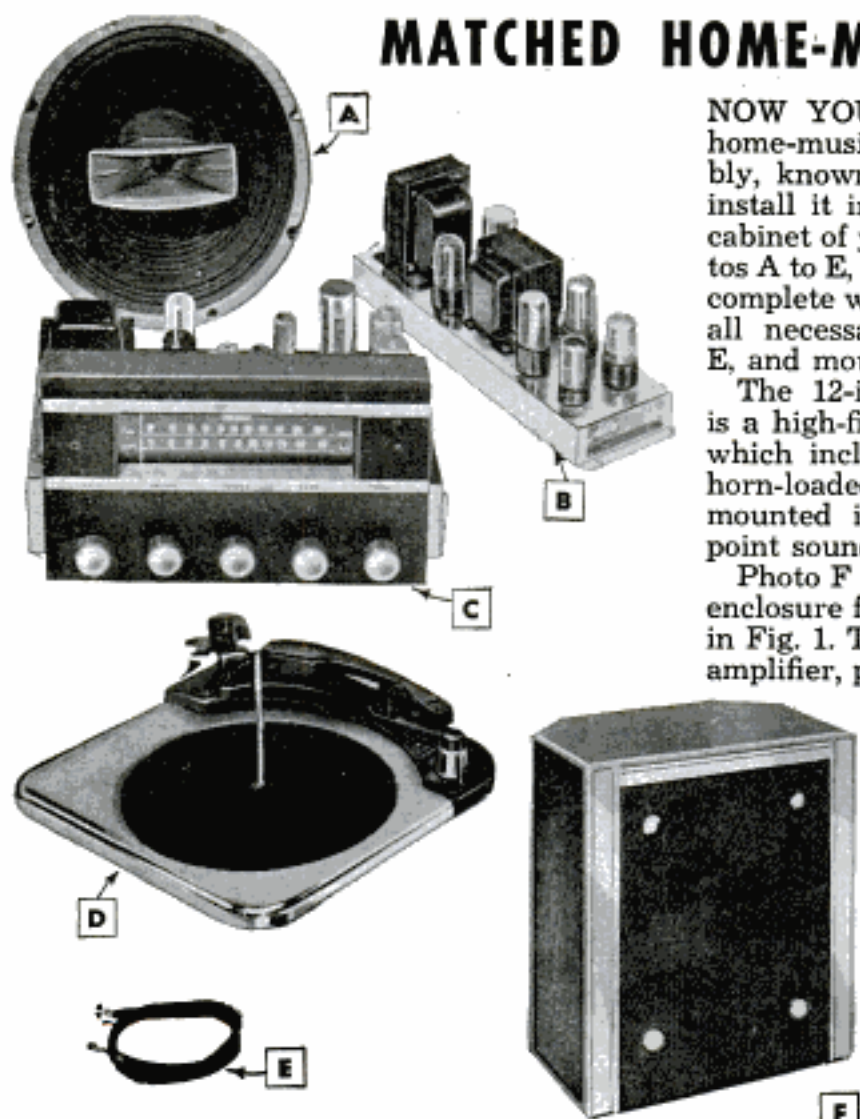



the

POPULAR  
MECHANICS

## CRAFTSMAN



By John Bergen



## Hand-Carved MIRROR FRAMES and SHELVES

**G**RACEFULLY CARVED in bas-relief from soft pine and finished in bone white antiqued with gold, these classic-looking mirror frames and shelves will add an interesting and distinctive touch to the walls of your living room or hall. The carving is not as difficult as it may look. The work is simplified to a great extent by rough-sawing the scroll and leaf outlines beforehand. Thus, the carving is limited to the actual surface shaping of the leaf design.

The steps in making the pierced circular

frame pictured above are the same for making the shelves. In each case, the frame is rough-sawed from a built-up blank of 2 x 6 clear white pine. However, your first job is to make a full-size pattern of the design. Actually, only half of the complete pattern need be drawn as it can be duplicated by merely flipping it over and tracing through from the reverse side to form the complete pattern. To enlarge the magazine pattern given on the following page, rule off on paper the same number of squares







as indicated, drawing 1-in. squares. Number the squares across the top of your paper and down along one side and number the squares on the magazine page in the same numerical order. These numbers will help in spotting the design in each corresponding square. Enlarging a pattern by the square method if you haven't done it before, involves little more than duplicating in each square of your ruled paper the portion of the design that falls in the same square of the magazine drawing. If you are careful in following the same curvature of line in each corresponding square, you'll have a perfect full-size pattern.

Over-all size of the glued-up blank is given on the facing page. Divide the blank in half with a center line and then transfer the full-size pattern to the work, tracing first one half and flipping the pattern over to complete the other half. Small tabs of cellulose tape are handy to keep the pattern in position while tracing. In rough-sawing the frame to line, it will require a jigsaw to make the inside cuts. Use a fairly coarse blade and give it time to cut.

Next, the frame is rabbeted to take the mirror and backing. The rabbet is indicated by a dotted line and its size is given in section A-A. It should be cut on a shaper, or with a router fitted with a rabbeting bit. This can be done before sawing the pattern, if desired. Now, attach the cutout to a piece of plywood with small screws driven through from the back of the plywood into the thicker parts of the cutout. Most of the carving is done with a carver's gouge of wide, flat sweep. Note the relief in sections A-A, B-B, also sections at the top and bottom of the frame. The trick in carving designs of the type detailed is to remove waste in a series of very light scoop cuts, working always with the grain. At the rounded ends of the concave forms the cuts should be very short to avoid lifting a long splinter. The carver's gouge must be ground, honed and leather-stropped to a razor edge. Vertical cuts at the ends of the concave sweeps are made with a carver's corner chisel, which is similar to a lathe skew chisel. Run straight down with the corner chisel so that the chips from the concave cut will break off square without following the grain of the wood past the point desired.

Ordinarily, carvings are never sanded unless the work is to be enameled or finished with gold leaf. Otherwise stain, apply wax and polish lightly with a soft-bristle brush. If desired, a small quantity of rottenstone can be added to the wax before applying. This gives the wood a grayish tone which is quite attractive. When fitting the mirror be sure to cut the backing piece slightly undersize. ★ ★ ★

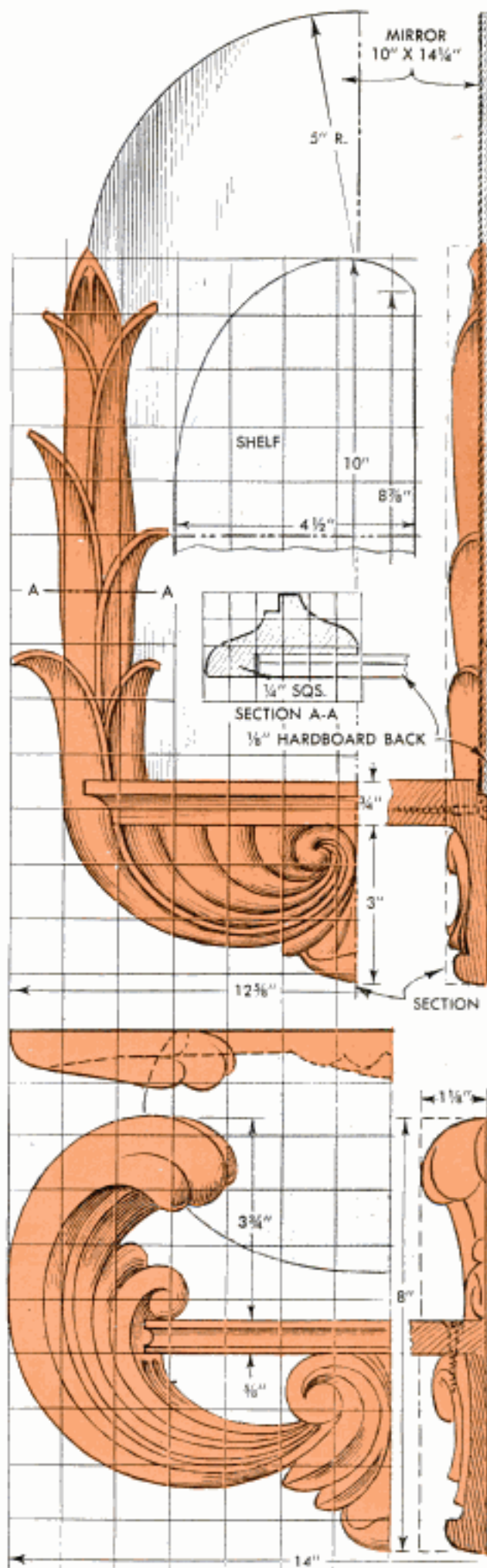



## Authentic Look Given Model-Boat Sails With Aid of Electric Fan



The realistic shape of wind-filled sails on a ship model is easily produced by spraying on sail-stiffening solution while the sails are bellied in the breeze of an electric fan. The stiffening solution consists of either starch or glue mixed with water, or shellac thinned with alcohol. Cover the hull and fittings of the model while spraying to prevent them from staining.

## Working Handle for Wire Solder Prevents Burned Fingers

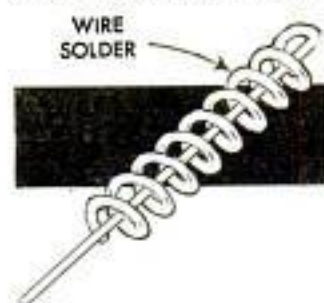

A handle wound from the wire itself will prevent wire solder from becoming too hot to hold while soldering. Wrap a suitable length, 2 or 3 ft., around a pencil, then pull off the coils. Pass

one end of the wire through the center of the turns. The solder now can be held around the loops and worked close to the torch or iron without danger of burned fingers. Additional solder is supplied by pulling the end through the coils.

Henry Josephs, Sarasota, Fla.

## Darkroom Should be Painted In Proper Colors

Photographic darkrooms should be painted a color that is not harmful to the developing procedure. If the darkroom is used only for printing, it should be painted a red, orange or yellow. These colors

absorb the violet, blue and green rays of light, which are the rays that fog your paper. A darkroom used specifically for negative processing of panchromatic films can be painted a green tone. Green absorbs the red and blue light rays that affect panchromatic film, causing fog.

Robert C. Florian, Cicero, Ill.

## Can Opener Cuts Small Hole In Light Sheet Metal

A round or irregular hole frequently can be cut in light sheet metal with a knife-type can opener more easily than with regular metal shears. Shears require that the metal on one side of the cut be lifted, a difficult thing to do when cutting a small hole. To use the can opener, punch a hole,



insert the opener and cut back to the hole.

W. F. Schaphorst, Newark, N. J.

## Clips Provide Thread Strength On Light-Gauge Sheet Steel

When sheet-metal screws must be used to assemble aluminum or light-gauge sheet steel, steel clips should be used to provide adequate thread strength. The clips are rectangles of heavy-gauge sheet steel, folded in half and slipped over the edge of the aluminum. The holes for the screws then are drilled through the clips and the aluminum. The clips also may be used on a sheet-metal assembly where the original holes have become oversized.

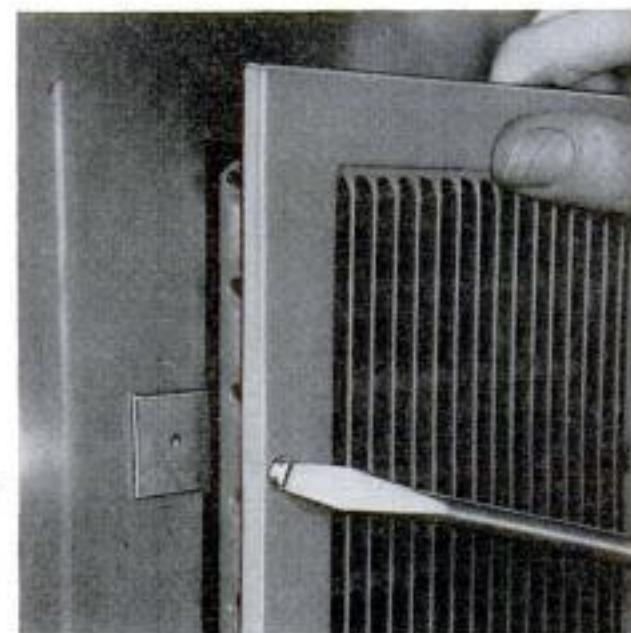



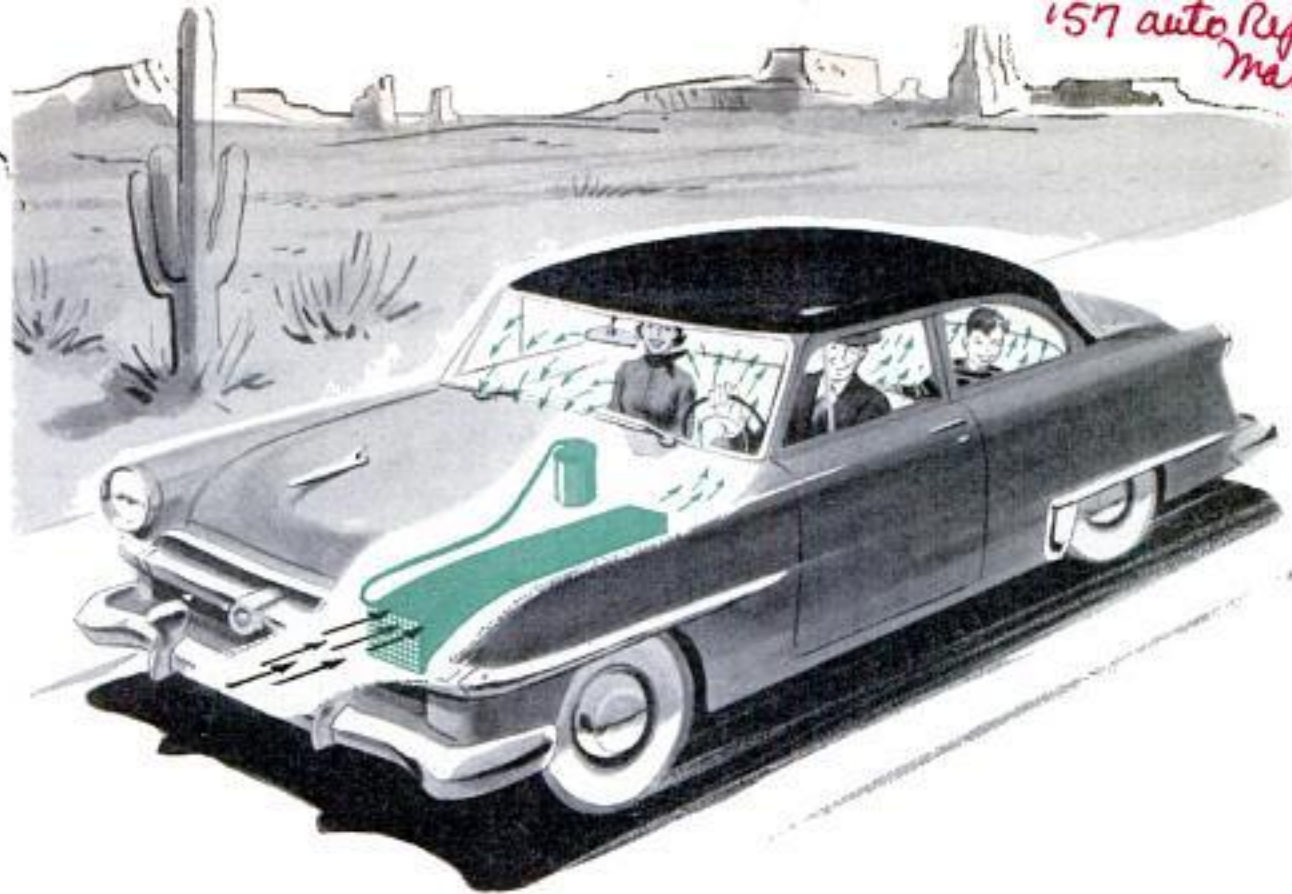

## Built-In Air Cooler for Your Car

IF YOUR CAR is vented by sheet-metal tubes leading from the grille and also has a windshield washer, an evaporative-type cooler can be installed in one of the tubes as pictured. Evaporative coolers are ineffective on humid days, but are quite effective on hot days when the humidity is low. As shown in the detail, the windshield washer is used to supply water through a length of hose to the  $\frac{3}{4}$ -in.-dia. canvas soaker which rests on top of the cooling element. This is a 1-in. mat of excelsior, sandwiched between two pieces of  $\frac{1}{4}$ -in.-

mesh screen, which is cut to fit the vent opening and wired in place.

The installed unit should be tested with the car standing still. With the motor running, press the washer button on the dashboard. If water floods the cooler, cut the hose at some point and install a 3-in. length of copper tubing. Squeeze one end of the tubing partly shut and repeat the test. Adjust the size of the opening in the tubing until water just drips from the soaker into the cooler. Remember to check the water in the tank frequently when using the cooler.

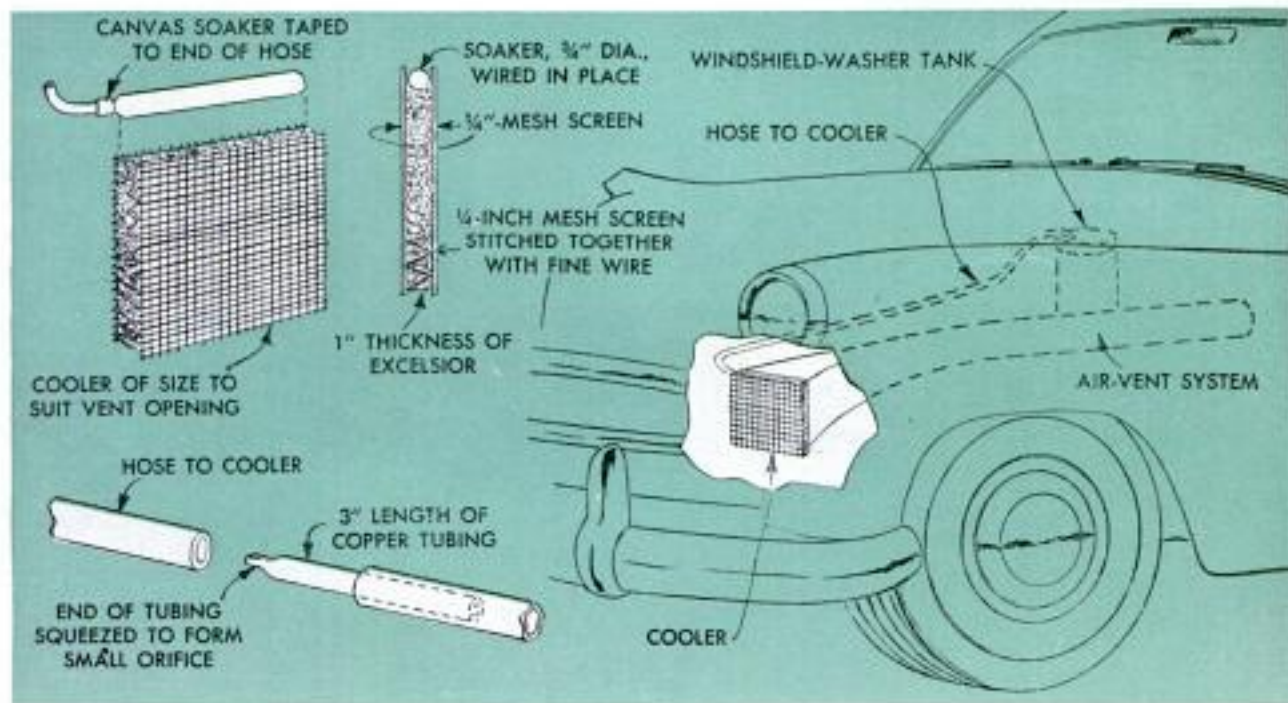



# Knockdown Pier for Summer Cottage

By William Spencer Bowen



Note how the pier deck planks rest on stringers—three to each section. The ends of the stringers are supported by the post-assembly cross members, and the two outer stringers are lashed tightly against the posts.

These young men set up a 3-section pier in just 50 min., including the time required to remove the pier members from storage in a boathouse. Either rocks, as shown, or short posts support beach end of pier.

**B**UILT IN 14-FT. SECTIONS, this lake-beach pier can be set up or dismantled in less than an hour. For years of extra usefulness, it can be stored under cover during the winter months. The sections are supported by pairs of 4 x 4-in. posts, as shown in the detail, each pair of posts being bolted permanently to two 2 x 12-in. cross members. The lower ends of the posts are tapered roughly to a ½-in. point. Thus, if the beach is rocky, the pointed ends of the posts will better penetrate between the rocks. Or, if the beach has a mud or sand bottom, each post can be set in a ½-in. hole drilled in the center of an 18-in. foundation pad cut from 2 x 12-in. lumber.

The ends of the deck planks are supported by 14-ft. stringers tied to the posts, and the center is supported by a third stringer held in place only by the weight of the planks. Note in the lower right-hand detail that cleats are nailed to the undersides of the deck planks to engage the tops of the side stringers. When determining the lengths of the posts, be sure that there will be enough clearance below the planking for normal wave action. Otherwise the planks may be lifted out of position. To keep the planks from warping, coat both sides with spar varnish. The pieces of the pier sections can be floated out when setting up the pier and floated back to shore when it is dismantled, eliminating the chore of carrying the lumber. ★ ★ ★





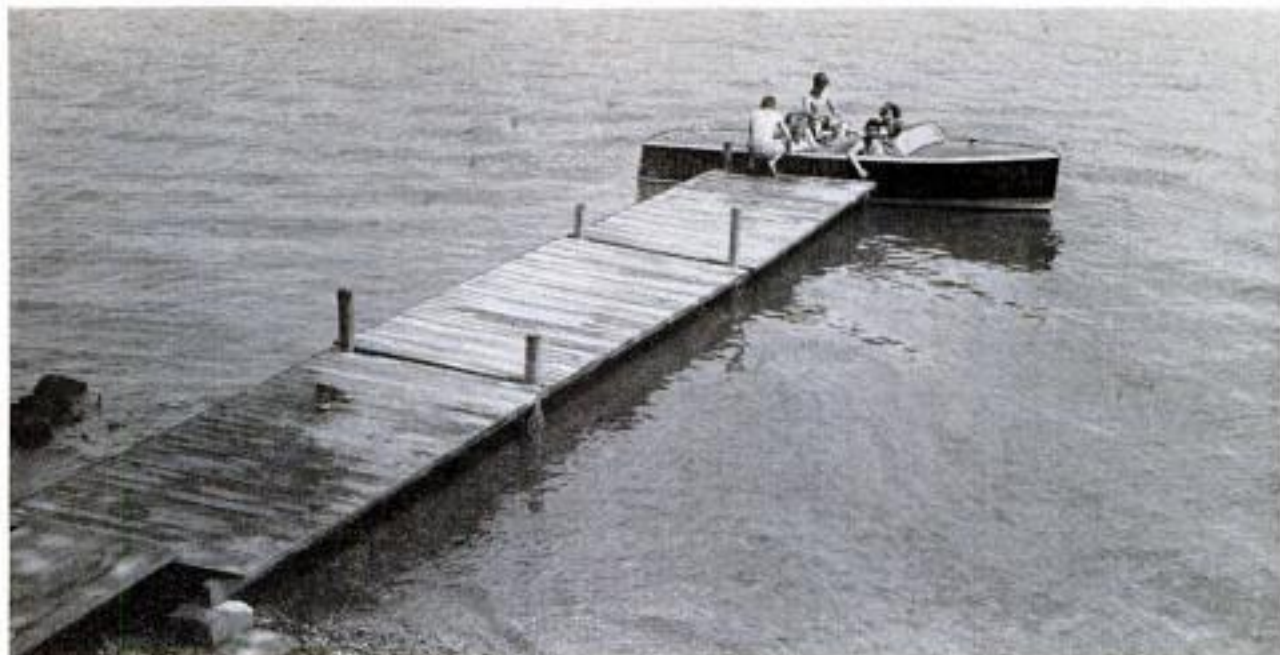

An hour before this boat pulled up to the knockdown pier, all the pieces of the pier were still in storage

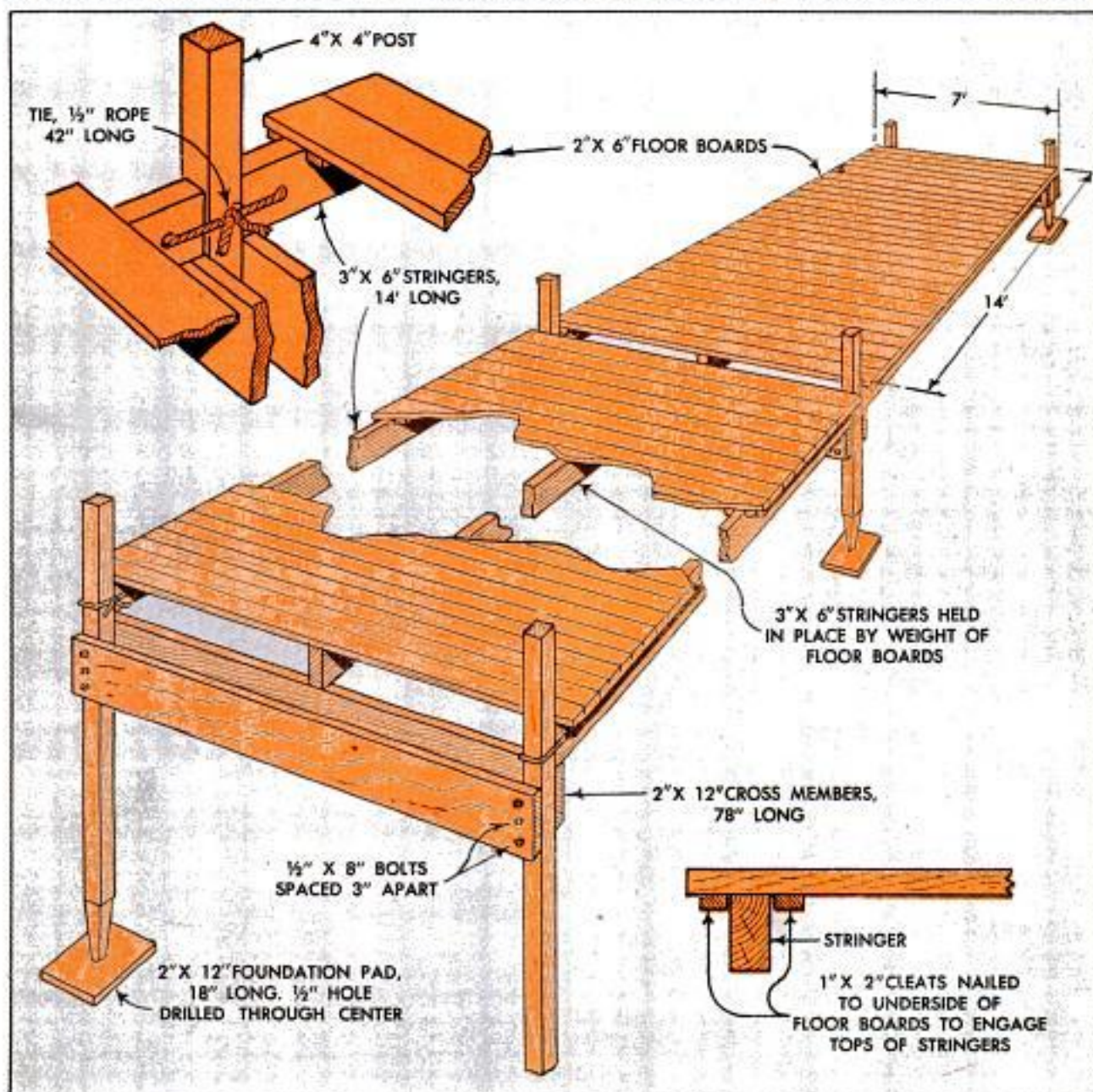



## Large Window Fan Controlled By Refrigerator-Defroster Unit



Running the window fan after midnight one home craftsman found, was not necessary to keep the house cool, so he utilized the plug-in automatic-defrosting device from the refrigerator to control the running time. The defrosting unit regulates the fan to shut off after midnight for one, two or three hours. At the predetermined time the fan starts again and runs for two or three hours before time for the family to arise in the morning.

Mrs. Lewis C. Rudd, Kansas City, Mo.

## Corkscrew Rod Anchors Boat In River Bank



When a river fisherman wants to tie up at shore, a dock, tree or post is not always available to which he can anchor his boat. One fisherman solved this problem by bending an iron rod as shown in the detail. Then, using

the "handle" on the end of the rod, he forces the corkscrew end of the rod into the soft earth of the bank, after which he secures the tie rope to the eye in the end of the rod.

## Prevent Paint Skinning

The amateur painter who works only in evenings and over week ends usually finds the paint "skinned over" when he returns to it the next day. To prevent this, simply float a thin film of turpentine on the surface of the paint and then crimp a piece of

household aluminum foil around the top of the can. This airtight seal will prevent skinning over and the turpentine can be stirred in when the paint is to be used.

Dik Warren Twedt, Wilmette, Ill.

## Full-Size Mower Cut in Half Provides Lawn Trimmer

A regular lawn mower cut in half does an excellent job of trimming and mowing along fences, around flower beds and other places where a full-size mower would be awkward to use. After cutting the mower in half,



half, a welded bracket of flat and angle steel is made to support the reel, cutter bar, roller and cross bar. The flat-steel fork of the handle is reshaped so the handle is moved to one side and closer to the wheel.

## Linked Fishing Snaps and Swivels Make Strong Watch Chain

A watch or key chain much stronger than the ordinary variety may be made by linking together a sufficient number of swivels and snaps of the type ordinarily used for fishing tackle. For the fisherman such chains, in addition to being attractive and inexpensive, have another advantage. When the last snap is gone from his tackle box and the nearest tackle store is some distance away, he can borrow one from the chain.—John Krill, North Lima, Ohio.





## Dehumidifier Makes Basement More Livable

If high humidity is a problem in your basement and the cost makes an electric dehumidifier out of the question, a calcium-chloride dehumidifier is a relatively inexpensive solution to the problem. While not as clean or effective as the electric type, the calcium-chloride type will remove considerable moisture from the air, depending on its size. Capacity of the one shown is 1 to 2 gals. per day.

In use, the fan circulates air through the calcium chloride, which is contained in a screen cone, and out the top of the dehumidifier. As the air passes through the chloride, moisture is absorbed by the chemical, which slowly dissolves and changes to a liquid as it reaches the saturation point. This liquid drops from the lower end of the cone into a container or, still better, a rubber tube which carries it to a drain. Since the liquid is slightly corrosive, do not get it on your clothing.

Your local tinsmith can make the galvanized sheet-metal container to the dimensions given. The cone-shaped container is suspended inside the metal container from the top. The fan, which is available from most refrigerator-supply dealers, is about  $\frac{1}{50}$  h.p., and is bolted to the container, using a rubber gasket to help absorb vibration.



If a single gasket does not quiet the fan, it may be necessary to enlarge the bolt holes in the container and use gaskets under the nuts also. If the holes are enlarged, be sure the fan is mounted so that the bolts do not touch the sides of the holes, which would transmit the vibration to the container.

Grover Brinkman, Okawville, Ill.

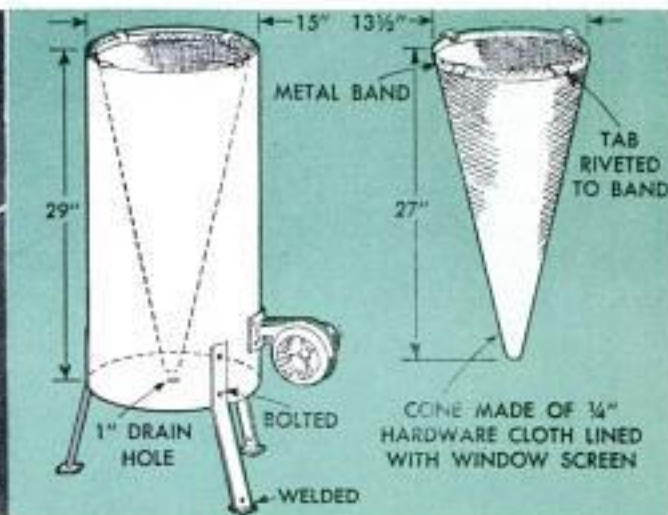

## Paper Plate Taped to Paint Can Provides Nontipping Base

Taping a paper plate to the bottom of a paint can will add three advantages to the usual one of preventing paint from dripping on the floor. First, the plate is always in place under the can. Second, both plate and paint may be moved with one hand while a paintbrush is held in the other. Third, the paint is less likely to be accidentally upset, because the plate will act as a wide base for the can. Masking tape is the easiest and most practical type of material to use for this purpose.

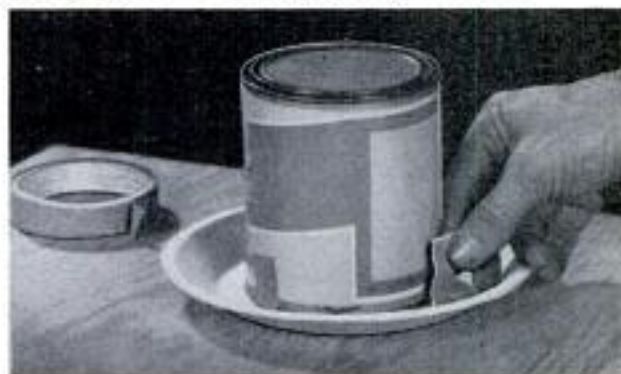





Finish of forward cast in fly casting. Loop of line has just been released to shoot fly farther out. Shooting the line takes a lot of diligent practice



## PRACTICE for BETTER FISHING

By Claude M. Kreider  
and Ray Chapin

**I**T TAKES SKILL to drop a fly naturally onto trout or bass waters, or pop a heavy lure out among the lily pads where a notional old lunker may be lurking. You acquire the necessary skill by diligent practice with balanced tackle. In general, if you're a beginner, practice for distance first, then refine the technique until you can drop a fly into a 30-in. circle at 50 ft., or spin a lure into the same space from 75 ft. With a plug rod, a good caster will score two out of three bull's-eyes from 80 ft. or more.

Balanced tackle means a matched rod, reel and line for a given purpose. Lures also can be included for purposes of comparison as tackle and lures will be selected for the fish you expect to take. However, there is some flexibility in selection. For example, bass tackle often is suitable for taking trout and pan fish and a trout rod



can be used for other species of fish under most conditions.

Practice can be carried out almost anywhere there is sufficient space, on the lawn or over a farm pond or park lake. You may find it advantageous to join a club where organized casting-practice events are held regularly in the off-seasons. At these events you can get helpful guidance from experienced fishermen in the mechanics of casting artificial lures with light tackle. If you prefer to acquire the basic fundamentals and a bit of polish before venturing into an event, then work out on the lawn at the start. Use an old bicycle-wheel rim as a target. Whether you work with a fly rod or a bait rod, the basic procedure is much the same. On the bait rod the reel is mounted above the hand grip, while on the fly rod it is below the hand grip, as in the photo at the right. In bait casting, the reel plays an important part as correct thumbing is necessary in obtaining distance and accuracy. Use a multiplying, level-wind reel on a bait rod.

The cast is made with a wrist snap with the elbow held close to the side. Note the position of the rod and line in the four views at the right. These picture the vertical bait cast with a lure weighing from  $\frac{1}{2}$  to  $\frac{3}{4}$  oz. and a bait rod  $5\frac{1}{2}$  to 6 ft. in length, using a line of from 8 to 12-lb. test. Rod movement is from 10 to 1 o'clock, the movement, or swing, beginning at 10 and ending at approximately 10 on the clock dial, which is used for purposes of illustration. The rod comes up slowly from 10 to 1 o'clock as in the first and second views. Power for the forward movement, or cast, is imparted by wrist action and is applied just as the weight of the plug flexes the rod after the line straightens on the back half of the cast. On the forward cast, thumbing the reel keeps slack out of the line, controls distance and to some extent accuracy. A smooth rhythm in all the movements does the trick. Sudden jerks or a hard forward whip may loop the line and also throw the aim of the cast far off the target. Work with the target fairly close at first, then gradually increase the distance until you are throwing a plug 75 ft. or more. After you become fairly proficient, try working over still water, using the wheel rim or an old auto tire as a target. You will find that working over water is somewhat more difficult due to the changed light conditions, also the problem of estimating distance over water. Stick to the overhead cast. The side cast is permissible when bait casting from a boat, or when it's necessary to get distance against the wind. However, most bait casters will recommend that you practice the overhead cast consistently for hair-line accuracy. Overhead casting results in

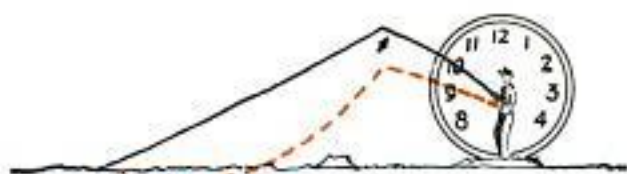

First step in fly or bait casting, using the overhead cast. Rod at 10 o'clock lifts line from water

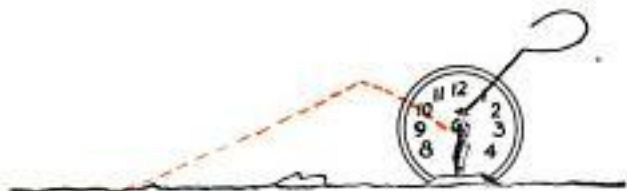

Back cast completed with rod at 1 o'clock. Line is straightening. Rod is held ready for forward snap



Forward cast completed and line straightening out over water. Note position of rod on the clock dial



Lure has dropped into water and line is going slack. At this point retrieve is started. Below, two types of fly reels. Note that reels are below rod grip







Above, lake fishing with fly requires a slow retrieve. Some fishermen retrieve the line in the left hand as shown. Below, the technique of spin-casting can be learned in a few minutes at a park pool or at home



less trouble with looping and backlashing of the line under difficult stream and lake conditions, or when handling deep-running plugs and certain types of wobblers and spoons.

In plug casting, the weight of the lure at the rod tip flexes the rod and builds up its drive, or propelling, power.

In fly casting, weight is built up in the line rather than in the lure. In fly tackle, balance means the relation of line weight to the length and power of the rod. A 9-ft. fly rod, weighing from 5 to 6 oz. is an all-around choice but, of course, individual preferences and special requirements will vary the choice. A good fly rod requires a line to fit. A fairly stiff rod will handle a level line of size B or C, the latter being the smaller; about .050 diameter. For best results a stiff fly rod should be teamed with a double-taper line, usually designated HCH, in which the heavy section serves to flex the rod properly on the back cast, while the lighter end, .025 diameter, insures extreme accuracy and delicacy in dropping the fly.

A third type of fly line, having what is known among fly fishermen as a "torpedo head," is popular for handling large flies, poppers and small lures for bass and pan fish; also when wet-fly fishing for trout. This line is essential for long-distance casting. On a 9-ft. rod of stiff action the torpedo line should be of GAF or GBF size. The

Reel in the left hand is level-wind type used by bait casters where free-running and fast-retrieve features are essential. Reel held in the right hand is a single-action fly reel. It weighs only 4 oz.

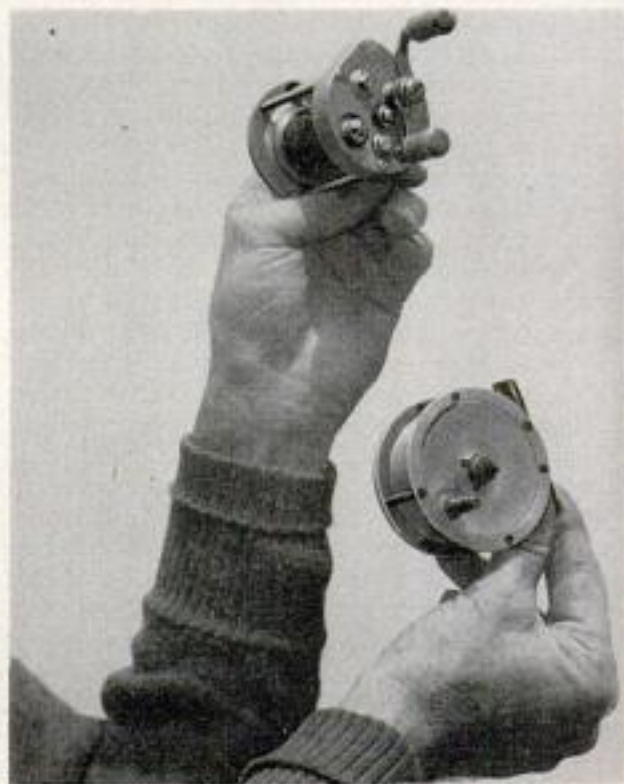



middle letter, A or B, indicates that approximately 20 ft. of A or B-size line is well toward the forward end so that its weight will flex the rod. The F portion is the running line, while the point, tapering down to the leader, is G-size. Fly lines are of braided oiled silk or nylon, thoroughly waterproofed and polished for smooth running. Be sure that the line size fits your rod. A light fly rod may require a level D line, a double-taper HDH, or even a line as light as the E-size for best results.

The fly reel is single action, made as light as practicable, as a heavy reel gives a pendulum effect and slows rod action. The reel is a relatively unimportant item of fly tackle, serving only as a line holder in average work. Some fly fishermen prefer an automatic reel which winds automatically at the touch of a finger. Its principal advantage lies in its ability to take up slack quickly when playing a fish.

In practice fly casting, start with about 30 ft. of line beyond the rod tip. Generally it's best to work over water right from the start. With the line out, raise it from the water with a fairly sharp snap of the wrist, bringing the rod back overhead to the 1-o'clock position. Hold until the line straightens and the rod flexes slightly. Start the forward cast instantly with a quick snap of the wrist. Follow through, stopping with the rod at approximately 10 o'clock. Just as in bait casting, the important thing in this maneuver is to wait until the rod flexes before starting the forward cast. If you start the forward swing too quickly you may snap the fly off the leader. Some beginners get the feel of the rod more quickly by making only the backward cast repetitively until they can time the forward cast perfectly. When whipping a fly over difficult streams expert fly fishermen often strip off 6 to 10 ft. of line from the reel, holding this in loose coils in the left hand. Just as the line straightens on the forward cast, this slack is fed into the line, thus shooting the fly 6 or 8 ft. farther. It's a neat trick and requires a lot of practice, but it's a big help in getting the fly into a trout pool underneath, low, overhanging tree branches.

Spinning tackle probably comes the nearest to being the ideal all-around gear for fresh-water fishing. Spin-fishing requires use of a light, whippy rod of 7 to 8 ft. length and a spinning reel of the fixed-spool type. Light braided nylon or silk lines or a smooth-running monofilament line generally are preferred for spin casting. The line whips from the fixed reel spool in spirals, making a backlash impossible. A pickup finger is then engaged and the line is wound back on the reel during the retrieve. ★ ★ ★

## Hand Signals Made More Visible With Reflective Tape on Glove



A strip of reflective cellulose tape, fastened to the back and palm of the left-hand glove, will aid in making a motorist's hand signals more visible. Even with electric-turn indicators, it is advisable to use hand signals as an added safety measure.

H. L. Armitage, Calgary, Can.

## Barrier in Private Driveway Keeps Trespassers Out

To prevent the nuisance of having a number of strange cars pulling into his driveway to turn around, one homeowner set up a barrier across the entrance. The barrier was made by cutting a number of 2-ft. lengths of old garden hose and setting them upright in a trench dug across the drive and filled with concrete. To a motorist driving by, these pieces of hose resemble sections of pipe and discourage him from entering the drive, while the homeowner may drive over them without damaging his car. For easy removal the hose also could be fitted in lengths of pipe anchored in concrete. — Bruce C. Vaughan, Jr., Springdale, Ark.



Blackboard chalk can be used to repair holes in plaster walls. Sharpened point of the chalk is pressed into the hole, and chalk is cut off flush with the wall. Patch is sanded and given a coat of shellac to seal surface before it is painted or papered.



# Solving Home Problems



**AT CANNING TIME** or whenever you must use a paring knife steadily, a pad on the back of the knife will prevent a blister or sore finger. The pad is thick-wall rubber tubing, slit and slipped over the blade

**PAINT FROM A SMALL CAN** is easier to use if the can is put into a discarded coffee cup. The handle of the cup makes it easy to hold and any drippings which run down the side of the can will be caught

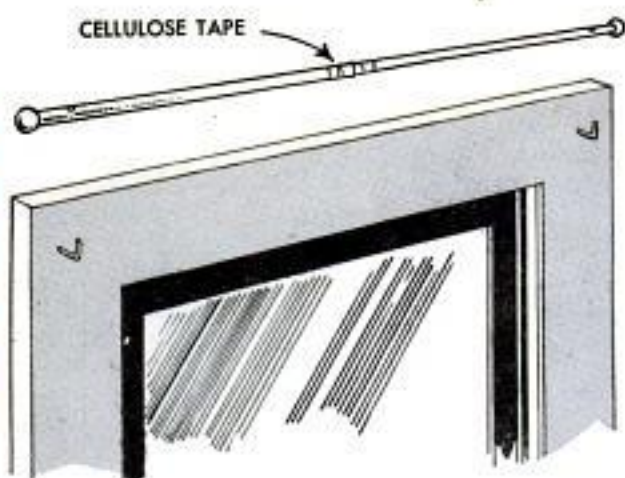

**TO KEEP TELESCOPING CURTAIN RODS** at their proper length when they are taken down for cleaning, wrap the joints of the rods with cellulose tape. Then, when they are replaced, the rods will slip easily in position

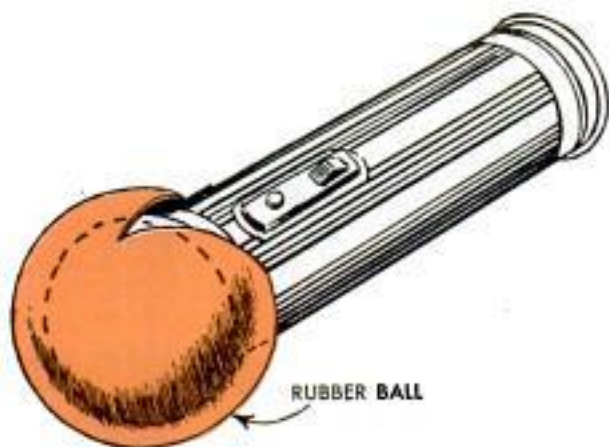

**THE LENS OF A FLASHLIGHT** carried in a fishing-tackle box can be protected from scratching or breaking by means of a cover slipped over it. The cover is made by cutting a wedge from a child's hollow rubber ball, as shown, so that the opening is just wide enough to fit snugly over the end of the flashlight

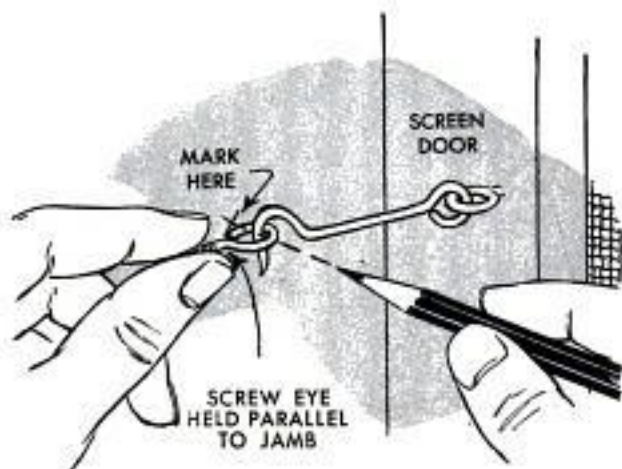

**LOCATING A SCREW EYE** for a screen-door hook is easy if you follow the marking method shown. After the hook is in place, slip the eye over it. Swing the hook against the jamb and hold the threaded portion of the eye parallel to the jamb. Then simply mark the jamb at the point where screw eye touches it





**OLD FRUIT-JAR RINGS** placed over plants when they first appear above ground will serve as markers to indicate those needing special attention

**PAINTING A BASEMENT FLOOR** is much less work if paint is applied with a paint roller fastened to a mop handle. With this method, the job can be done from standing position in half the usual time



**CHILDREN'S BOOTS AND GALOSHES** can be kept together and readily identified at home and at school if clipped together with a spring-type clothespin on which the name or initials have been painted in a bright color. Clips also can be used with mittens



**WHEN YOU CAN'T OBTAIN** a replacement for a damaged plastic-hose connector, the clamp-on type made for rubber hose can be used. Buy one that fits snugly into the plastic hose and discard the clamp. Warm the plastic until it softens slightly, then insert the new connector and bind it in place with a strong fishing-line, using the fishing-rod whip shown above

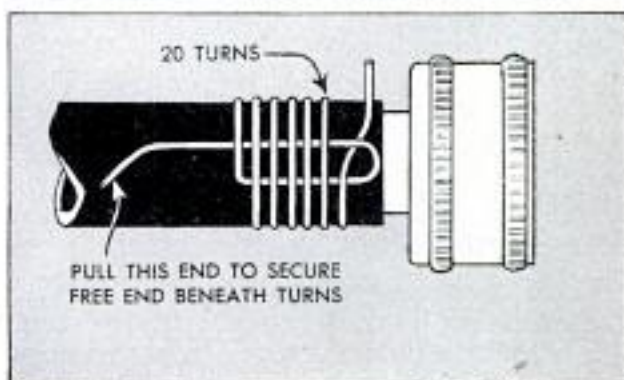



## Rocks to Anchor Picnic Cloth Placed in Corner Pockets



You won't have to worry about the wind disturbing a picnic cloth if you sew a pocket in each corner of the cloth to hold a fair-size rock. Then, when ready to spread out the picnic cloth, all you have to do is slip a rock in each of the pockets. This idea also might be used in cloths used on outdoor tables. If you use a cloth somewhat larger than the table top, the stones in the pockets will hang down over the edges of the table, holding the cloth firmly in place.

Blanche Campbell, Las Vegas, Nev.

## Trailer Coupler Serves as Anvil

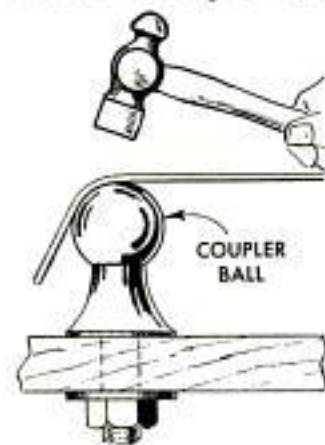

When it is necessary to bend sheet metal or wire to a small radius, a trailer-hitch coupler will serve as a convenient anvil. The threaded bolt of the ball is inserted through a hole in the workbench and secured with a washer and nut. If portability is desired, so that

the anvil can be used on the job, it is mounted on a short length of heavy board and carried in the tool box. In use it is placed on two supports or sawhorses.

William B. Eagan, Louisville, Ky.

## Test Paint Colors With Blotter

Paint generally dries to a somewhat lighter color than it appears in the can. When mixing colors, especially water-mix paints, test the color by painting a small

patch on a blotter. The blotter will absorb the liquid from the paint and the sample will dry in a matter of minutes, allowing you to see the exact hue the mixture will be when dry.—Tom Griberg, Moline, Ill.

## Renewing Photoflood Reflectors

When a photoflood reflector becomes dull and smudged, rub the inside surface with steel wool to restore its original bright finish. Use a medium-grade steel wool and polish evenly over the entire surface.



## Iron Separates Postage Stamps

Unused postage stamps that have stuck together should not be soaked apart, as this spoils the mucilage. Instead, lay a thin paper over them and run a moderately hot iron over the paper. They will come apart easily and the mucilage can still be used.

Mrs. Les B. Schultz, Cicero, Ill.

## Rubber Tubing on Wrench Handle Prevents Bruised Fingers

Protection for the fingers when unlocking an adjustable, clamp-type wrench, may be provided by a short length of rubber tubing. This is fitted to the inside surface of the locking handle. If the tubing will not stay in place, it can be slipped over the handle to provide the same protection against skinned and bruised fingers.



☞ To make it easier to saw designs out of plywood and prevent it from chipping at the edges, coat the work with white shellac.



# Vent Your Clothes Drier

BESIDES POSSIBLY DAMAGING woodwork and walls, the moisture-laden air from a clothes drier will cause uncomfortably high humidity in hot weather and in cold weather will "steam" the windows. Venting the exhausted air to the outside of the house will overcome this problem. As most modern driers have provisions for outside venting, it is necessary only to connect regular furnace ducting of a suitable size and shape to the drier outlet and run it to the outside.

Some driers exhaust through a lint box at the front of the drier at floor level. A conversion kit to change the outlet to the rear is available at your appliance dealer. The kit contains a new lint box that seals the front opening, and a rear duct fitting that replaces a cover plate on the back of the drier. The fitting will receive standard  $3\frac{1}{4}$  x 10-in. rectangular ducting. Driers which already exhaust at the rear need only be fitted with ducting.

Methods for venting driers installed on the first floor or basement are detailed at the right. The first-floor vent goes directly through the wall, while the basement installation requires that the ducting pass through the sill joist or a window. A piece of hardboard or sheet metal replaces the glass in the window and provides an opening of the proper-size. A rustproof louver should be fitted on the weather end of the vent. If possible, the duct should not be longer than 10 ft., as a longer run of ducting will require the installation of a booster fan to assure proper exhausting of the humid air. If the vented moisture stains the siding above the louver, it may be necessary to extend the duct, or fit it with a cowl. Also, a side shield may be necessary if a prevailing wind causes similar trouble.

Tom Riley, Portland, Ore.

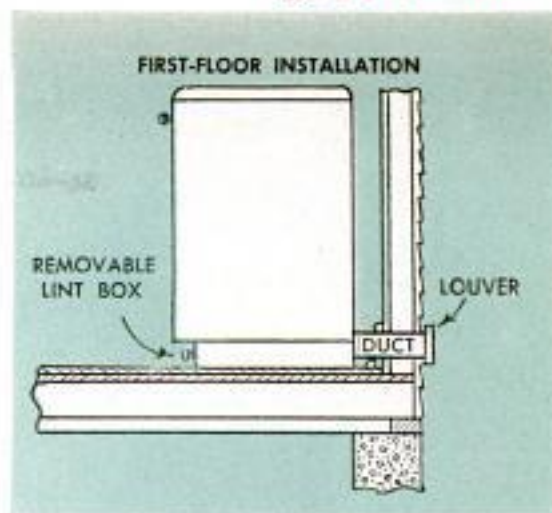

Details show three methods of venting clothes driers, one for first-floor installation, two for basement. Regular metal furnace ducting and elbows are used to exhaust the moisture to outside





X615

D-1-Y#2

WTM 56



# SHUFFLEBOARD FOR YOUR BASEMENT

By Clifford B. Hicks

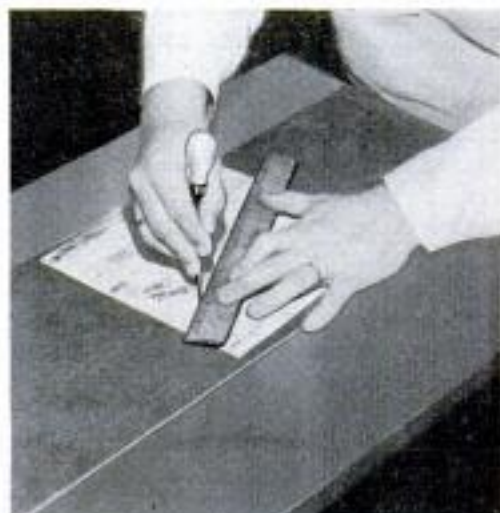

Asphalt tile can be cut by scoring on both sides with an awl, then snapping sharply

**S**HUFFLEBOARD, the game that long has challenged the ocean traveler and summer-resort visitor, now is becoming a great favorite in the home. Thanks to modern tile inserts and scaled-down playing equipment, shuffleboard has moved into home basements and recreation rooms.

The object of the game is to slide disks from one end of the court to the scoring area at the other end. Half the fun of the game is banging your opponent's disk off a scoring area. Until recently the game made few appearances in home recreation rooms because the regulation court is 52 ft. long—too long for most basements. Now along comes the smaller tile court and the new shuffleboard equipment, only  $\frac{2}{3}$  regulation size. The disks, for example, are only 4 in. in dia. instead of 6 in. This makes it possible to scale down the entire court without scaling down any of the fun. The recommended length of the scaled-down court is 29 ft. 3 in., (center diagram, opposite page), but it can be made as short as 25 ft. 6 in. by decreasing the area between the "dead lines." The regulation court is shown in the top diagram. Tile inserts for this full-size court are available on order through your local floor-tile dealer.

The shuffleboard set consists of four aluminum cues and eight disks. Your flooring dealer can tell you where to buy the set or he can order one for you.

The inlays for the scoring areas are available in kit form. Each kit contains two scoring areas, or one complete court. The only cutting required is the trimming of the field tile immediately adjoining the scoring diagram. In the case of asphalt tile, this is done easily by scoring the tile with an awl on both sides and then snapping it on the scored line. Vinyl tile is simply cut with a sharp knife. For ease of installation, the scoring inserts are made to fit exactly into an area covered by six 9-in. tiles in one direction and five 9-in. tiles in the other.

Starting in the center of the area chosen for the court, lay the tile to the points of the scoring areas. Because these points lie exactly at the midpoint of a 9-in. tile, snap a chalk line from these points to the end of the court to represent the lines down the middle of the scoring inserts. Lay both inserts next, and then fill in the rest of the tile around the court.

For further information on how to lay a tile floor, see page 175 of the November 1951 issue of *Popular Mechanics*. ★ ★ ★



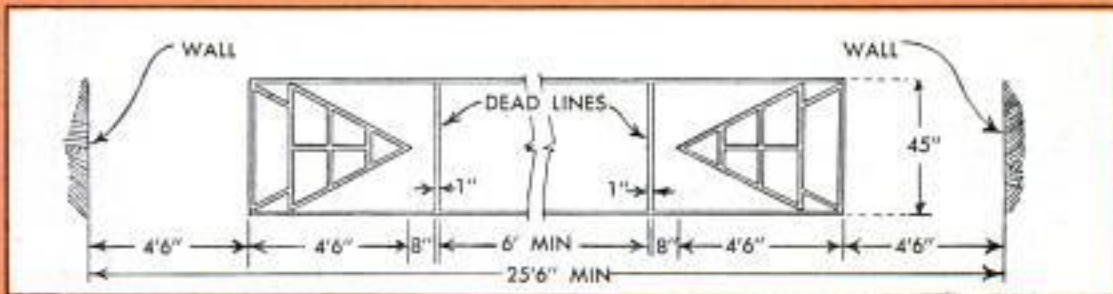
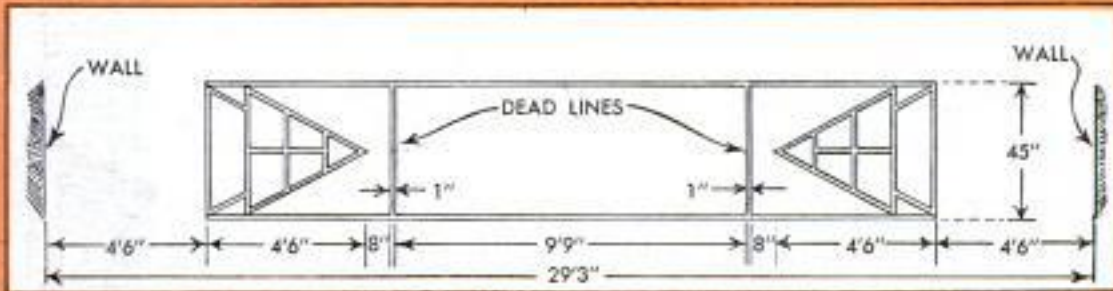
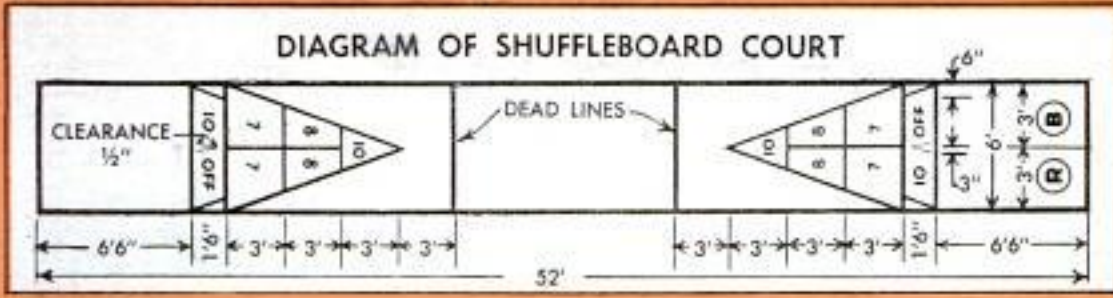

The top diagram above shows the dimensions for a regulation shuffleboard court. The middle diagram gives the measurements of the scaled-down court, on which equipment that is  $\frac{2}{3}$  of regulation size is used. Bottom diagram shows the minimum dimensions that can be used when laying out a shuffleboard court

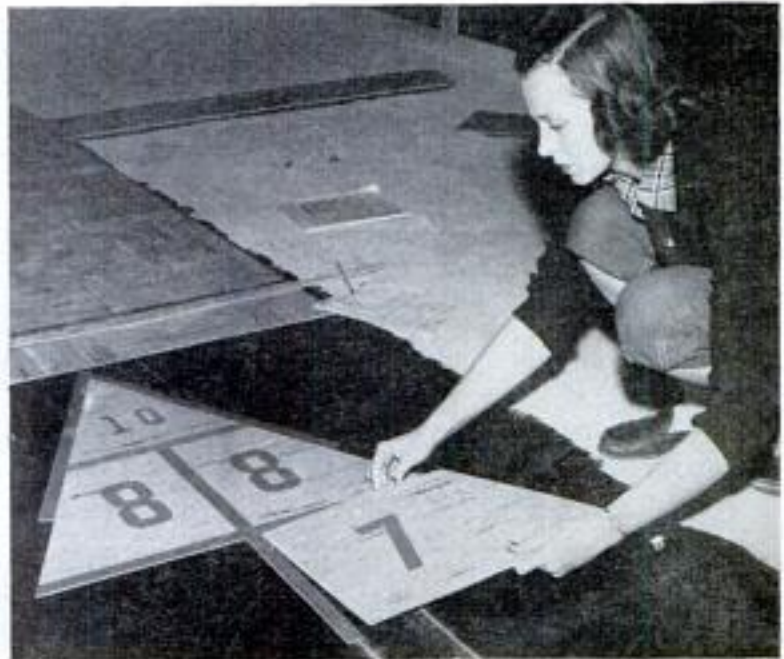
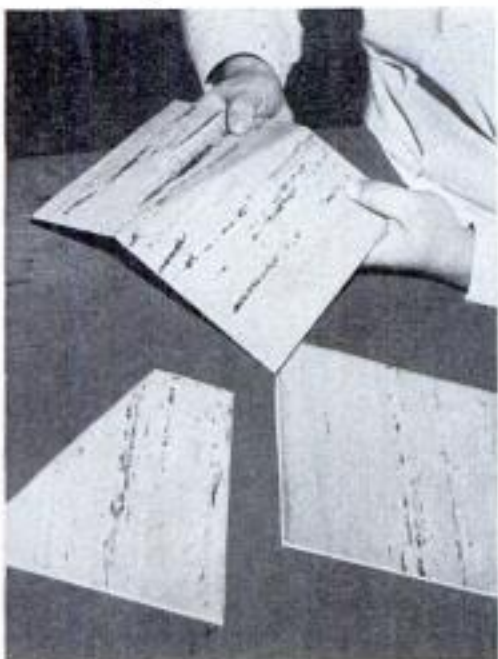



## Dowels in Multiple Bench Stop Hold Irregular Shapes



Adjustable to fit a variety of shapes, the multiple bench stop shown in the illustration consists of a piece of plywood drilled to receive  $\frac{1}{2}$ -in. wooden dowels. These are cut into 3-in. lengths and the holes are drilled to provide a snug fit. The plywood may be clamped to the workbench or held with dowels fitted in holes drilled in the bench top.—Walter L. White, Chicago.

## Sandpaper Inside Paper Cup Provides Pointer for Pencil



Draftsmen and artists who use a sandpaper block to keep pencil points sharp will find that an ordinary paper cup can be used to eliminate the mess caused by using this method. Staple a strip of fine sandpaper inside the upper edge of the cup. When the pencil is sharpened the wood and graphite dust will fall inside. The cup can be discarded when the sandpaper wears out.

## Removing Rust From Files

A little muriatic acid, applied full strength with a small brush, will be found effective for cleaning a badly rusted file. After a few minutes, rinse away the acid with running water. If some traces of rust still re-

main, a second application will be necessary. When no more rust remains, use a soda-and-water solution to neutralize whatever acid is left on the file, rinse thoroughly and dry. Then apply a coating of thin oil. Clinton R. Hull, Costa Mesa, Calif.

## Eraser-Stick Brushes Utilized On Home-Workshop Jobs

When eraser sticks, which are used in most offices, are discarded, the brush on the end usually is still in good condition and can be used in countless ways around the home workshop. It is ideal for applying shellac to gaskets and compound to pipe joints. The brush also can be used to scrub gasoline into hard-to-reach places for a thorough cleaning job when overhauling motors and other machinery.

Jos. J. Frisch, Cincinnati, Ohio.



## Furniture Polish Is Easily Applied With Window-Spray Attachment

Polish may be applied to furniture in a thin, uniform coat with a spray attachment, such as used for window-cleaning preparations. Since the bottle is always capped when the attachment is in place, there is no chance of spilling the polish. If the attachment does not fit the bottle in which the polish is contained, the liquid may be transferred to a container that will accept the sprayer.





# Simple Coffee Table Is a One-Evening Project

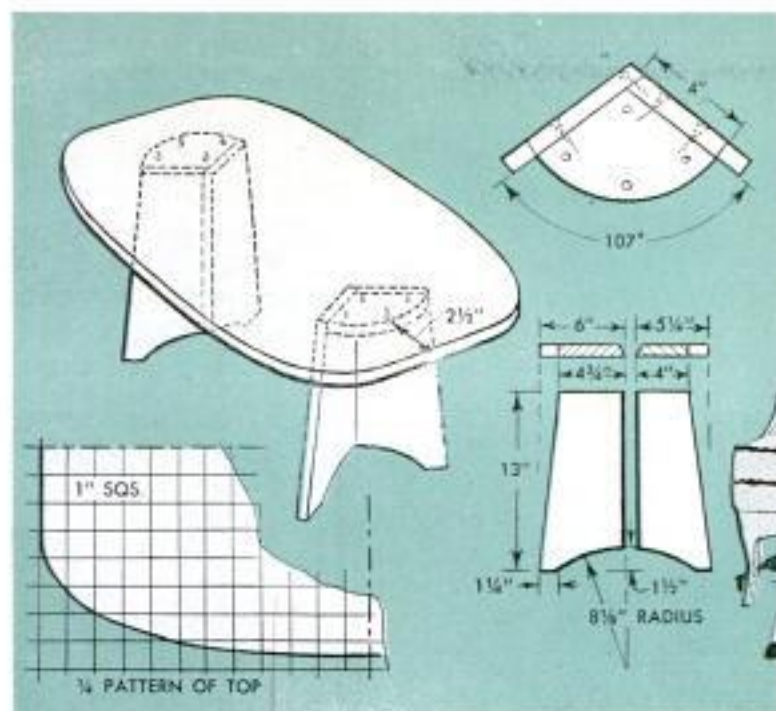

The original of this coffee table was made of hardwood salvaged from an old bed and a radio cabinet. However, it can be made from  $\frac{3}{8}$ -in. plywood or, for an exceptionally fine job, solid-stock walnut or mahogany can be used. The construction is simple and the detail above gives all information. If you want a stain and scratchproof finish, apply a decorative laminate to the top of table.—Elmer W. Ferris, Winnetka, Ill.

## Fisherman's Personal "Smokehouse" Utilizes Wooden Icebox

Utilizing an old-fashioned wooden icebox, this "smokehouse" permits a fisherman who does not have access to a smokehouse to cure his own catch. The smoke is generated by setting a cast-iron frying pan, filled with maple chips, on an electric hot plate which is placed in the bottom of the icebox. The fish are placed on metal trays on the shelves in the upper section of the box. With both doors closed, a length of 1-in. pipe, set in a hole cut in the top of the box, allows the excess smoke to seep out. Individual tastes will vary, but in the original smokehouse, two hours was sufficient for a good smoking.

Thomas P. Ramirez, Fond du Lac, Wis.

## Replace Sink-Drain Cleanout Plug With Open-End Brass Gate Valve

Because the cleanout plug for the kitchen sink is opened only when the sink is stopped up, it often rusts and becomes very difficult to open. This can be avoided if the cleanout plug is removed and replaced with an ordinary open-end brass gate valve. With this in place, all you have to do to clean out the drain is to open the gate valve and insert the wire or snake.

Art Frank Williams, Wood-Ridge, N. J.

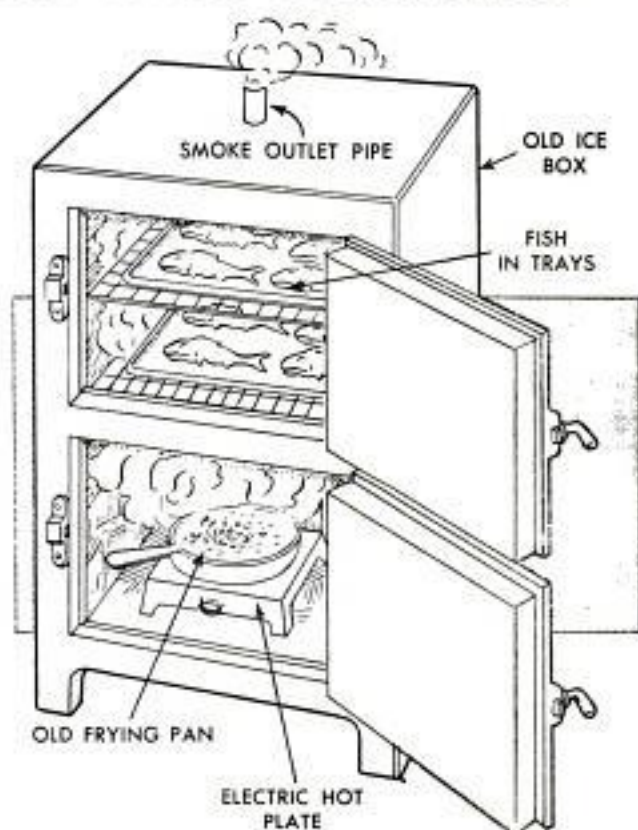

☐ An old jar rubber, glued to the bottom of a dog's food dish, will help prevent it from sliding about while the dog is eating.



# GARDEN DINING

## Made Easy

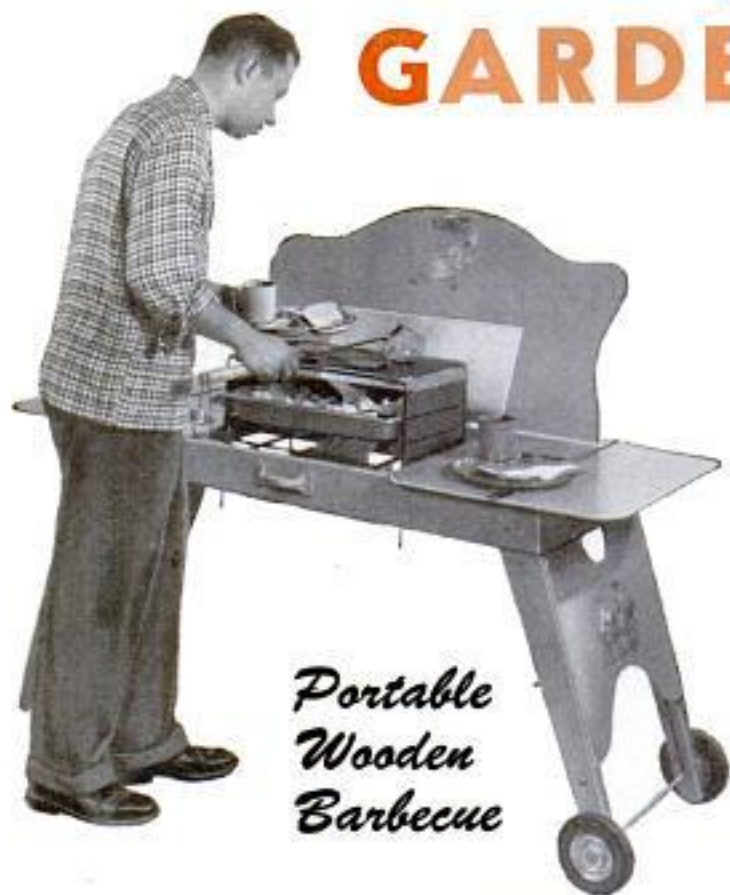

*Portable  
Wooden  
Barbecue*

**T**HE PORTABLE BARBECUE pictured in use above is made of common lumber and hardboard. It handles most any popular charcoal grill or a small gasoline stove, and it folds conveniently for carrying as in the photo at the right. Note in the construction details of this barbecue how the upper portions of the legs are rounded so that the notches formed on the edges of the legs serve as stops when they engage the edges of the end aprons. A locking



*Lawn  
Chair*

Seems like summer's twice the fun when you can serve your guests on the terrace or in the back yard. Here is a choice of two portable barbecues to make outdoor cooking a pleasure, plus a comfortable lawn chair with drop-leaf arms

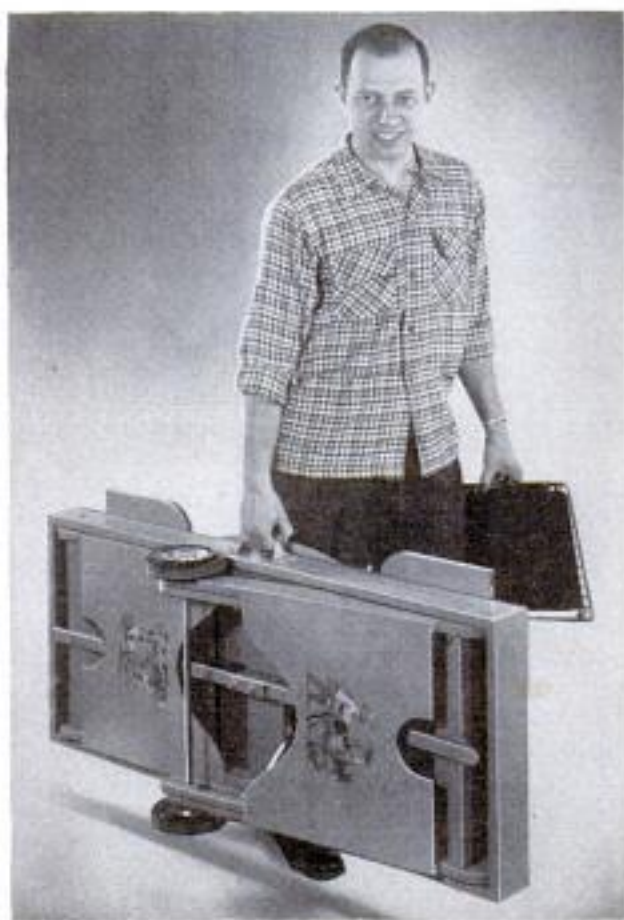

Portable wooden barbecue is fitted with convenient carrying handle and folded legs are held in place with friction catch. Leaves and windbreak fold flat

stretcher holds the legs in the open position and a cabinet-type friction catch holds the legs in the folded position. A catch on one leg is all that is necessary and its location should be determined with the legs folded. Note that the legs are fitted with extensions to permit leveling the barbecue as well as raising it to the desired height. On the leg unit which is fitted with the wheels, the extensions are slotted to slip over the axle and down beyond the wheels.

The aluminum barbecue also is a folding unit, but differs from the wooden unit in



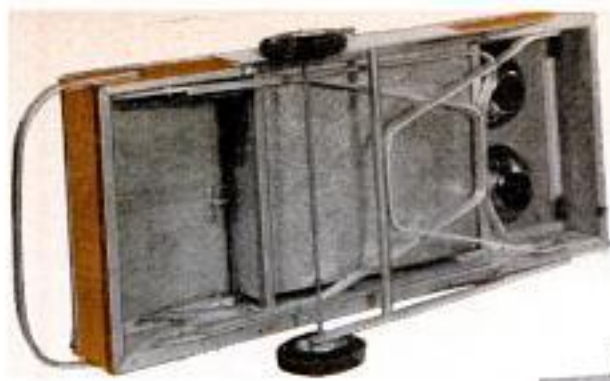

## Portable Aluminum Barbecue

Photo of barbecue, above, shows how the legs appear in the folded position. When the barbecue is set up, ordinary desk-front supports lock legs in place



Construction of aluminum barbecue is started by making a wooden apron of 1 x 6-in. stock, mitering the corners of the apron. Then 3/8-in.-plywood top pieces are fitted to apron, leaving space between them for the grill. Bottom of apron is trimmed with aluminum angle and front and back top edges are fitted with channels to take the sliding leaves. Note that each channel is made of two lengths of angle which are riveted together after the first length has been screwed to edge of apron. The legs of barbecue are made of 1/4 x 1-in. flat aluminum as shown, utilizing U-shaped braces for extra rigidity

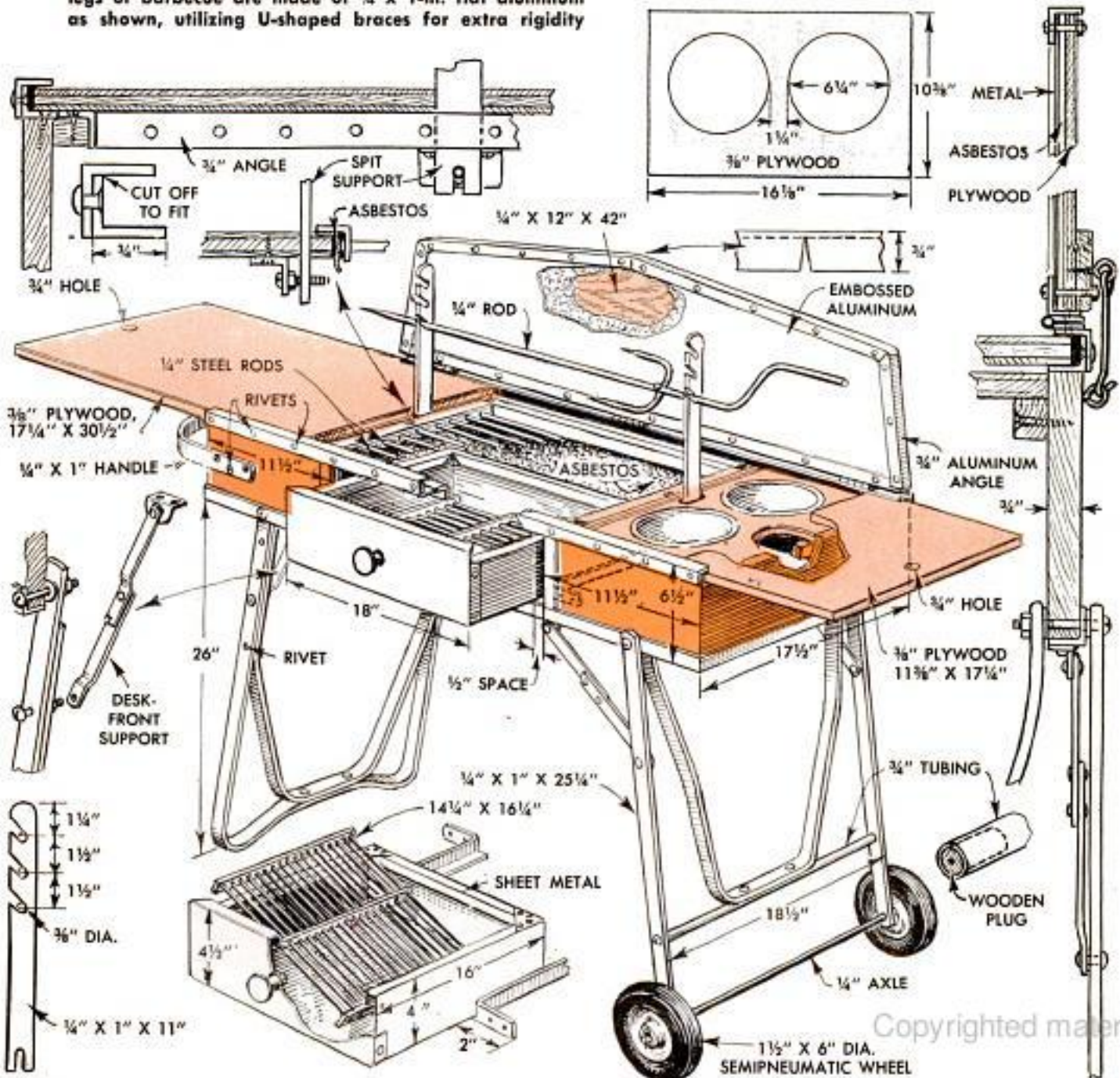





Photos above show the steps in folding the portable wooden barbecue. First, windbreak is folded down and leaves are folded over windbreak, elbow cabinet catches holding them in place. Then the legs are folded, as above, with barbecue resting on its side

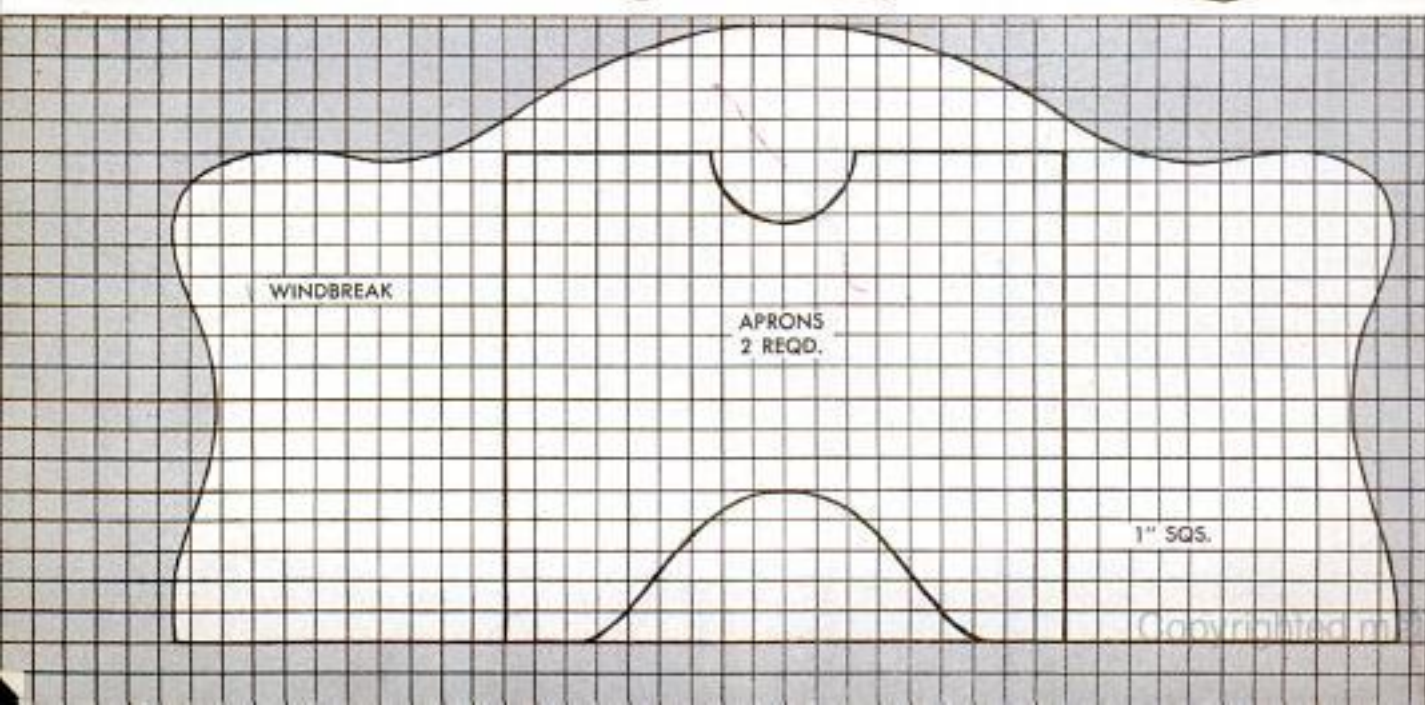
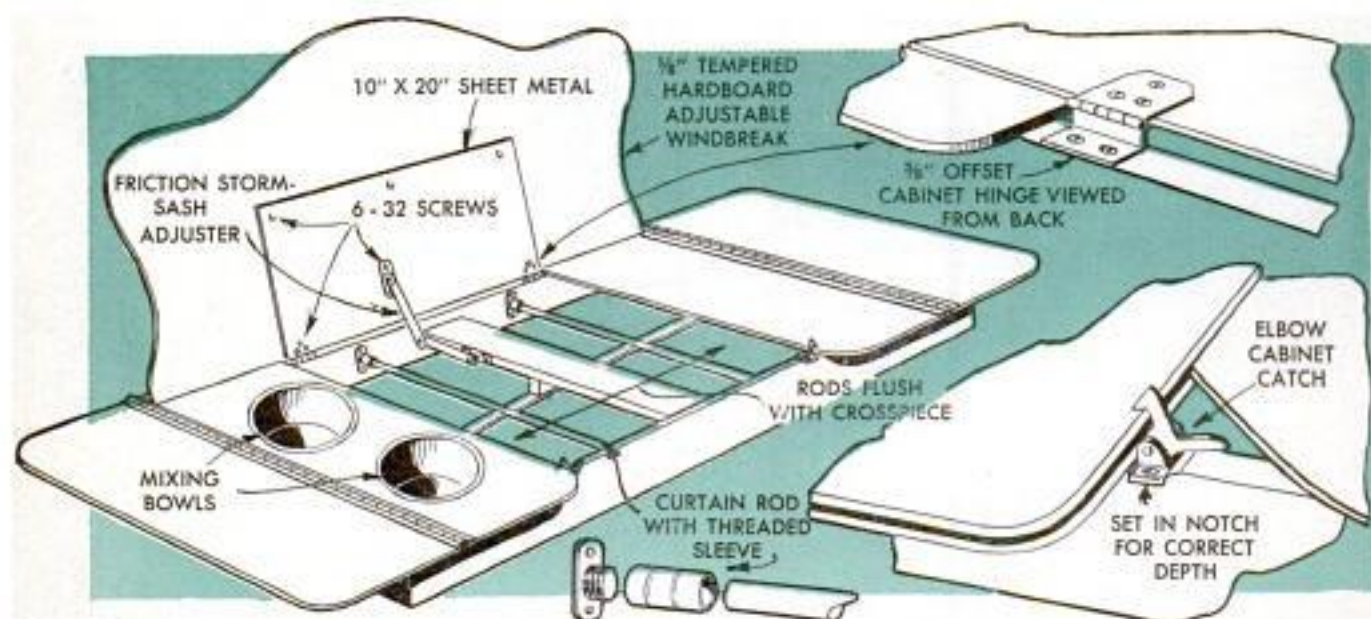









Front and rear views of lawn chair, above and below, show convenient drop-leaf arms in raised position. Crossrail between arms supports back slats

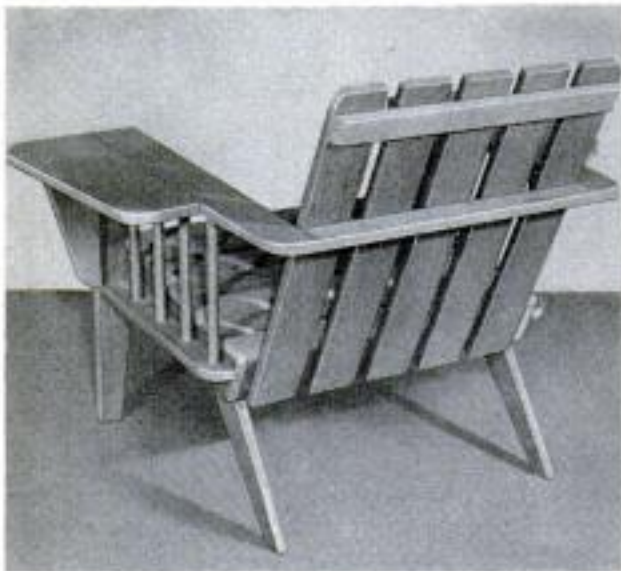

that it has a self-contained charcoal burner. The latter is a sheet-steel drawer which contains a bottom grid of steel rod and flat stock as detailed. The grill also is of steel rod. The rest of the metal parts—legs, top framing, windbreak framing, channel for the sliding leaves, and the spit—are made of Do-It-Yourself Aluminum. Either 8 or 10-in. desk-front supports are used to hold the folding legs in the open position. The wooden table apron is of 1 x 6-in. stock, while the table top pieces and sliding leaves are of  $\frac{3}{8}$ -in. plywood. The apron in back of the fire drawer as well as the edges of the drawer cutout and the edges of the top pieces on which the grill rests are lined with asbestos to prevent charring from the heat of the charcoal fire. Asbestos sheet is also sandwiched between the plywood backing and the aluminum front of the windbreak.

The comfortable lawn chair detailed on these two pages features drop-leaf arms that provide "table" space for refreshments, food or ash trays. The chair is built of  $\frac{3}{4}$ -in. stock (1-in. lumber) as in the details. Note that the side seat rails are mounted at an angle of 8 deg. to the front rail. The back rail is installed at an angle of 15 deg. to the side rails to give the proper tilt to the chair back. The chair arms are fitted with rungs of  $\frac{3}{4}$ -in. dowel. The lower ends of the dowels are glued in holes drilled in the bottom arm rails, while the upper ends are glued in blind holes in the top arm rails. Each drop leaf is hinged to the top arm rail and is held in the raised position by a drop-leaf support. The latter is hinged to swing under the top arm so the drop leaf can fold flat. ★ ★ ★

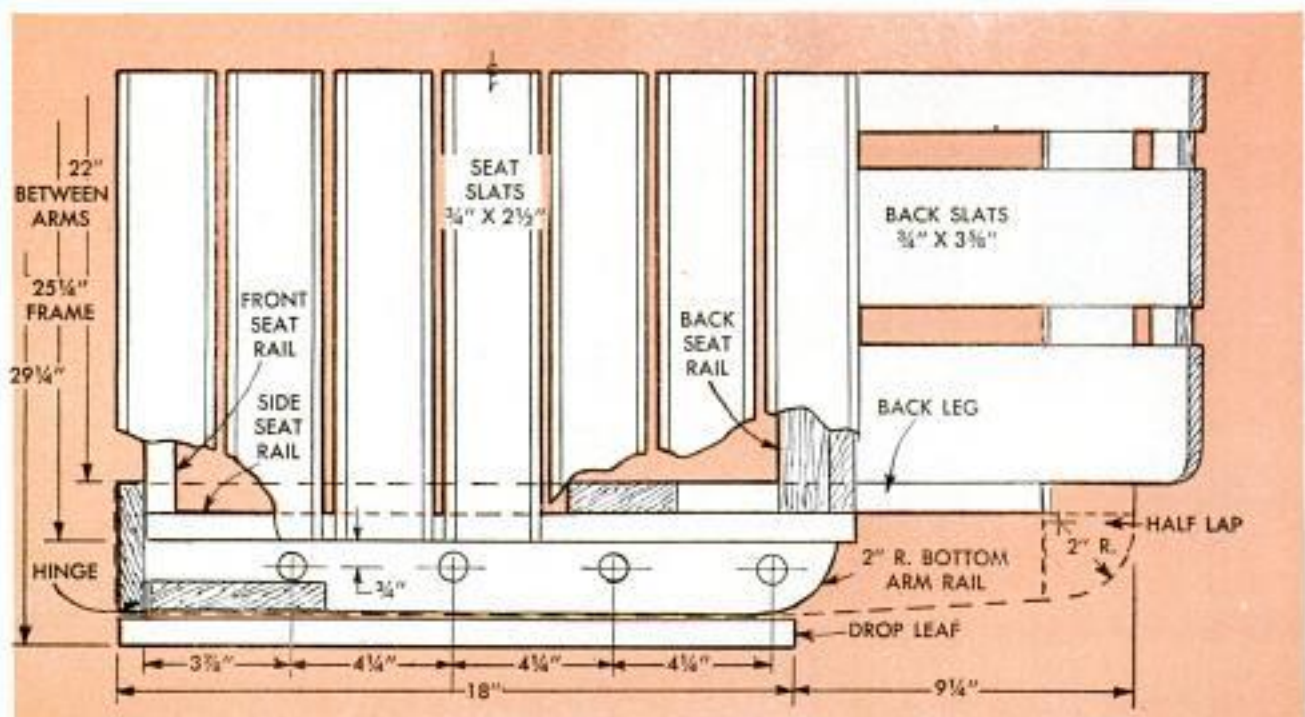



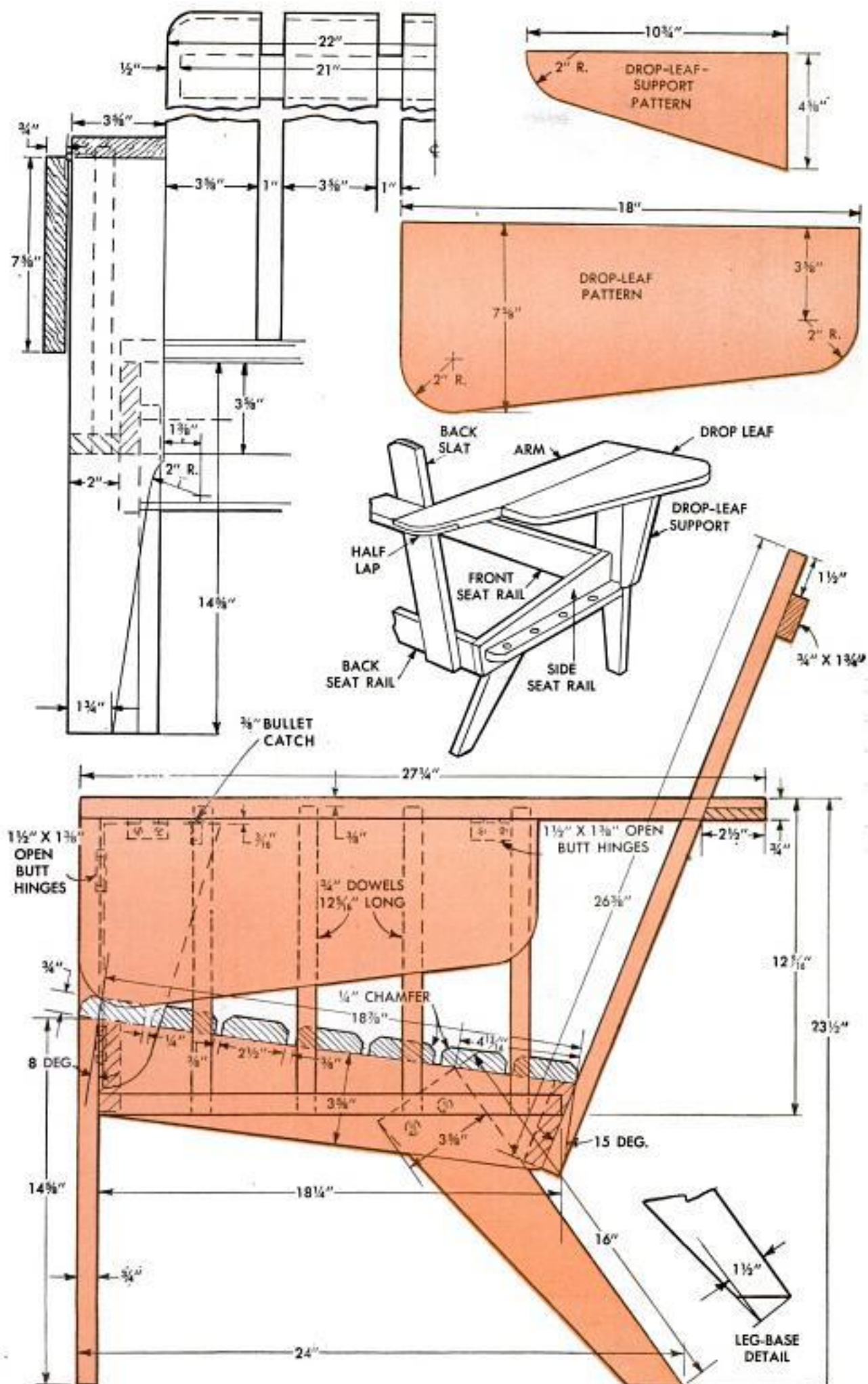



## Length of Rope Provides Clamp For Holding Irregular Shapes

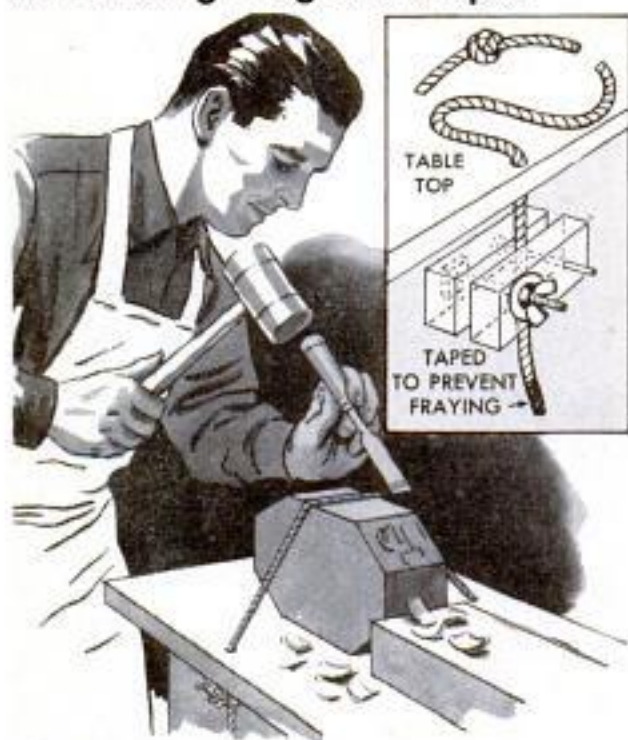

If you have experienced difficulty holding an irregularly shaped piece of work in a wood vise, this simple rope clamp will be a welcome tool. In use, a  $\frac{1}{4}$ -in. rope is passed through two holes drilled in the bench top near the front and rear edges. The rear end is knotted and the end at the front is run through a clamp on the bench apron. The clamp consists of one block nailed to the apron and another block, which slides on a nail guide and is held with a bolt and wing nut.

Walter L. White, Chicago.

## Flashlight Batteries Dated



When replacing batteries in a flashlight or photo flashgun, write the date of insertion on a piece of adhesive tape and stick it to the sides of the batteries. This date will serve as a reminder that

the batteries must be replaced at regular intervals and warn you when the batteries are becoming overage.

Eugene Lee Burner, Morgantown, W. Va.

## Homemade Ferrotyping Plate

A smoothly lacquered sheet of tempered hardboard makes an excellent substitute for a metal ferrotyping plate, and one that does not require waxing to prevent stick-

ing. In use, the board is sponged off in the normal way, then the prints are applied and squeegeed to the plate with a roller and left to dry.

Andrew Brennan, Philadelphia, Pa.

## Improvised Self-Opening Pliers

When an assembly job requires the use of self-opening pliers, the home craftsman may convert a pair of utility pliers for this purpose by using a large safety pin or length of clock spring. Cut off the head and sharp point of the pin, spread it to the required span and tape it to the inside surfaces of the plier handles. If a piece of clock spring is used, bend it U-shaped and tape it in the same manner.



## Bright Light and Pane of Glass Permit Tracing Picture

Set vertically in two notched blocks, a pane of glass will permit anyone to trace accurately a photograph or drawing. The picture to be copied is thumbtacked to a horizontal surface and the glass is set alongside. A strong light then is placed so that the picture is reflected vividly on the glass. Next, a sheet of paper is tacked to the surface on the opposite side of the glass. It now is possible to look through the glass and trace the reflection on the paper. The reflection and copy will, of course, be reversed.



☐ The bottom half of a milk carton makes a good "pot" for starting house or garden plants. When ready to transplant, merely cut away the paper box. Soil stays intact around the tender roots.



WTM 56

Make Your Own *Book for Boys*

# Water Skis

By Don Skillman

**T**HE CONSTANTLY increasing number of motorboat owners have brought about an equal rise of interest in water sports, among which water skiing is one of the most thrilling. Any craftsman can make his own water skis at less cost than buying them, and will have the added pleasure of building his own equipment.

Spruce is the first choice of wood for the skis, followed by ash, Port Orford cedar and yellow cedar. Whatever wood is used, be sure it is vertical-grained so it will take a smooth bend. If you do not have a jointer, have the lumberyard surface and joint the lumber to a finished dimension of  $\frac{5}{8}$  x 6 in. and square off both ends. The length of the skis is determined by the weight of the skier and the horsepower of the motorboat used. The table at the end of this article (page 179) provides that information. While at the lumberyard get four lengths of  $\frac{5}{8}$  x  $\frac{5}{8}$  x 18-in. white oak to be used as the rudders. If oak is not obtainable, the same kind of wood as used for the skis may be used for the rudders. An alternate material for the rudders, depending on personal preference, is 1 x 1-in. aluminum T-bar. The rudders also can be purchased ready-made in some sports stores.

Bending the ski blanks is the first and most difficult step in making the skis, and requires building a bending jig. The jig is built from two 1 x 6s about 6 ft. long. One



As you rush along in the wake of a couple of husky outboards, water skis give wings to your flying feet

end of each board is cut to form the desired radius—20 in. for 5 ft. or less, and 22 in. for 6-ft. skis—and the two 1 x 6s are then joined by cross cleats 14 in. long. The curved section of the jig is either planked solidly with narrow strips, as shown in the detail, or covered with a piece of hardboard to provide a smooth surface.

After the jig is built, the ski blanks must be steamed so they can be bent. The easiest way for the home craftsman to do this is to set up a 55-gal. oil drum on bricks in the back yard, fill it with water to a depth of 18 in. and build a wood fire under it. The ski blanks are placed in the boiling water and steamed for at least an hour. If the

The "islands" under the foot bindings of these finished skis are shapes cut from thin stock stained dark

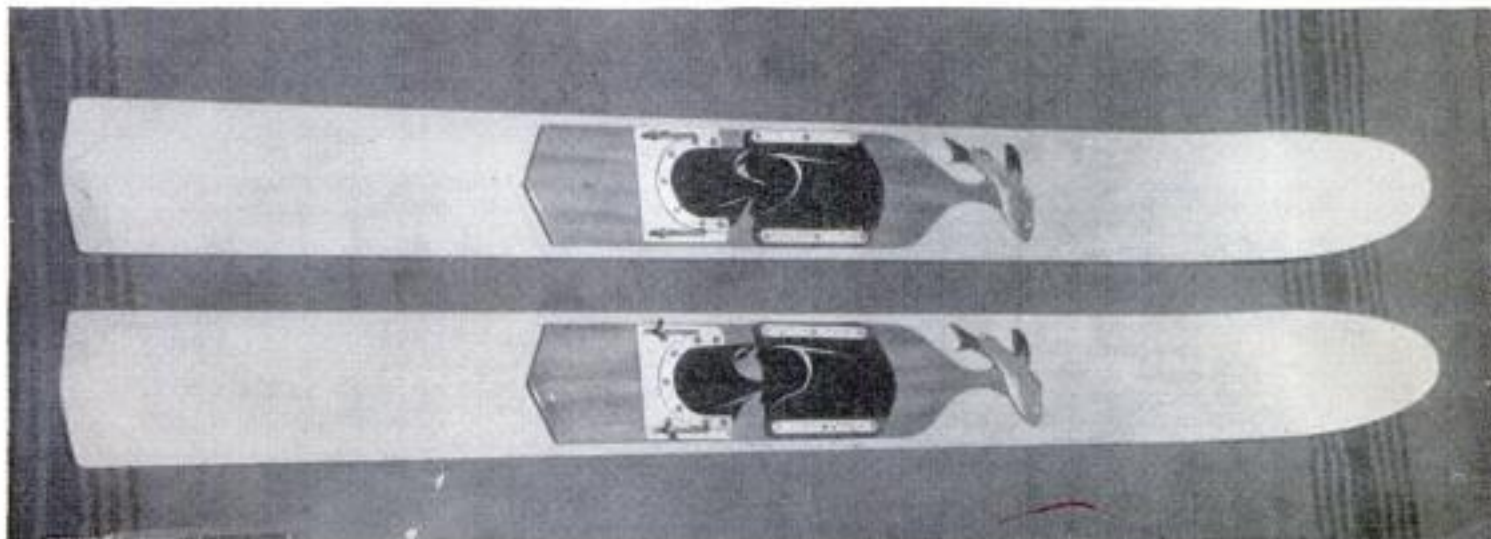



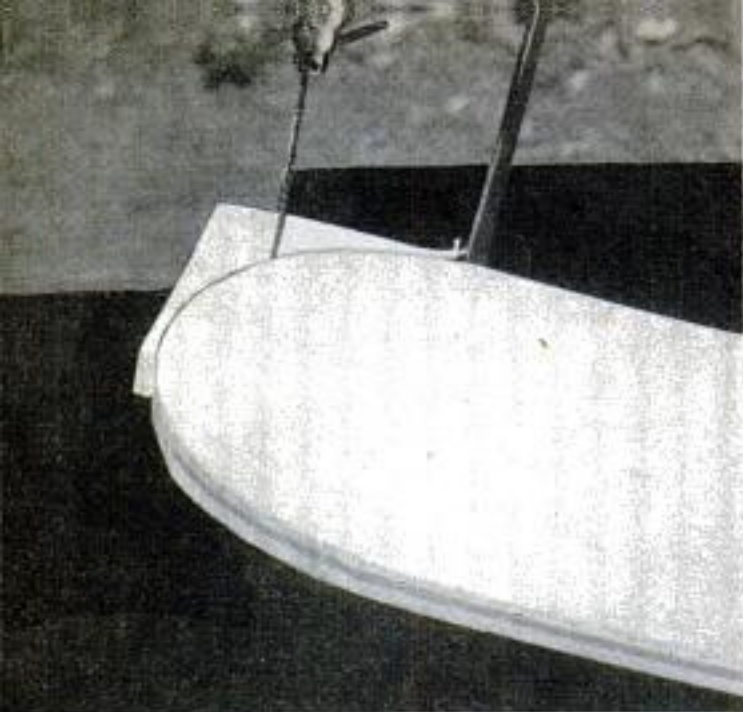

The rounded front of the skis is cut with a coping saw after 6-in. radius has been marked from pattern



After cutting the rounded front end of the skis, carefully sandpaper away all roughness and sharp edges

wood is not sufficiently pliable at the end of that time, add more water and boil the blanks longer. When the blanks have been thoroughly steamed, remove them from the water and, holding them side by side, quickly clamp the steamed end over the curved end of the bending jig. Press the opposite ends of the blanks down and hold them with clamps or sandbags. Make sure the straight portion of the skis are parallel to the jig. Use shims and weights or clamps

to correct any undesired bends. After the blanks are clamped into place, allow plenty of time to dry and set. One week is the minimum, two weeks are better.

When the blanks are thoroughly dry and set, the next step is to round the front end of each ski. Make a paper pattern, using a 6-in. radius, and then trace the curve on the skis. Cut the curve with a coping, jig or bandsaw. Now, sand all surfaces and apply three coats of spar varnish, allowing

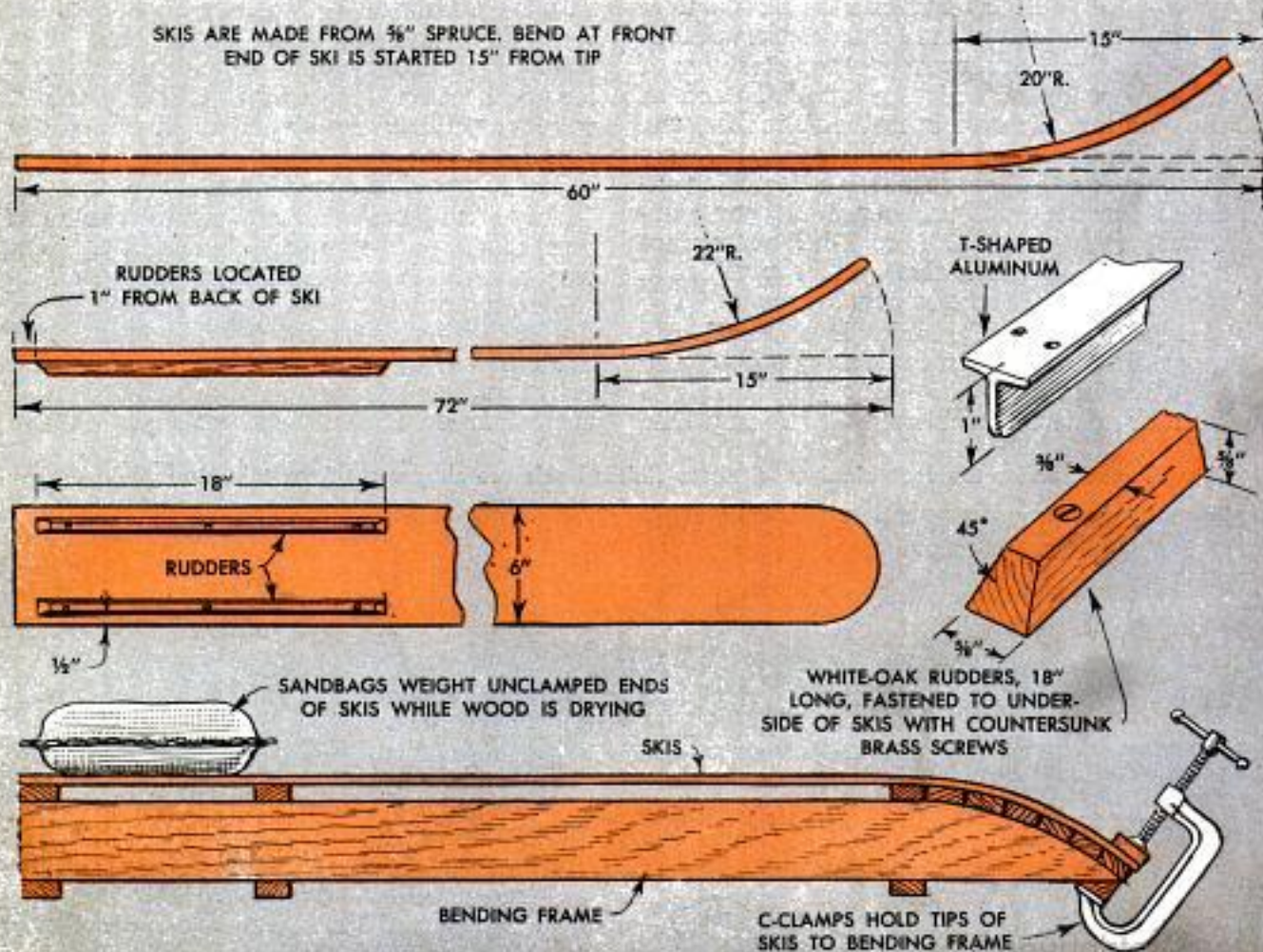



plenty of time for drying between each coat.

The next step is to install the rudders. If wooden rudders are used, they should be shaped to the dimensions given in the detail, sanded and varnished. Use three 1-in. No. 6 brass screws to attach each rudder. Holes must be drilled and countersunk in the aluminum rudders to permit installation. The rudders are located 1 in. from the rear end of the skis and  $\frac{1}{2}$  in. from the edges of each ski.

Bindings for the feet are next. They also can be purchased ready-made from a sporting-goods store, but the craftsman can make them from sheet brass or aluminum which is easily cut and worked with wood-working tools. The rubber used is salvaged from truck inner tubes; the rubber is extremely tough and is  $\frac{1}{8}$  in. thick. The half-patterns for the rubber sections of the heel and toe bindings are drawn on  $\frac{1}{2}$ -in. squares, the paper folded and the completed pattern traced directly on the rubber. The slotted heel plate is drilled and tapped for 10-32 brass machine screws, which are used to hold down the U-shape piece which, in turn, holds the rubber of the heel binding. Wing nuts are used on the  $\frac{1}{4}$ -in. screws which hold the heel plate to permit adjusting the bindings. The strips for holding the toe bindings are drilled and countersunk to receive brass wood screws.

When installing the bindings, balance

**TABLE TO DETERMINE LENGTH OF SKIS**

Weight of Skier	100-120	140	160	180	200	200 up
10 hp.	4½ ft.	5 ft.	5½ ft.	6 ft.	6 ft.	6 ft.
15 hp.	4½ ft.	4½ ft.	4½ ft.	5 ft.	5½ ft.	5½ ft.
15-30 hp.	4½ ft.	4½ ft.	4½ ft.	4½ ft.	5 ft.	5 ft.
inboards	4½ ft.	4½ ft.	4½ ft.	4½ ft.	4½ ft.	4½ ft.

the skis on a thin edge to find the exact center of balance. Locate the bindings so the ball of the foot touches directly on this spot.

The "islands" under the foot bindings are simply ornamental wooden shapes cut from thin stock and stained or varnished a contrasting shade. Figures or designs may be carved or jigsawed and fastened to the islands, as shown in the picture of the completed skis, to give individuality to your skis. If you do use islands on your skis, find the center of balance after they are in place; it is important that the ball of the foot rests on this balance point so that the skis will ride properly in the water.

After the last coat of varnish is completely dry, all you need to try out the product of your labor is a body of fairly calm water and a friend with a motorboat. Use a good, strong tow rope; one can be purchased at a sporting-goods store. If you haven't been on water skis before, take it easy at the start. At 30 m.p.h., the surface of the water is a lot harder than it is when you are swimming. ★ ★ ★

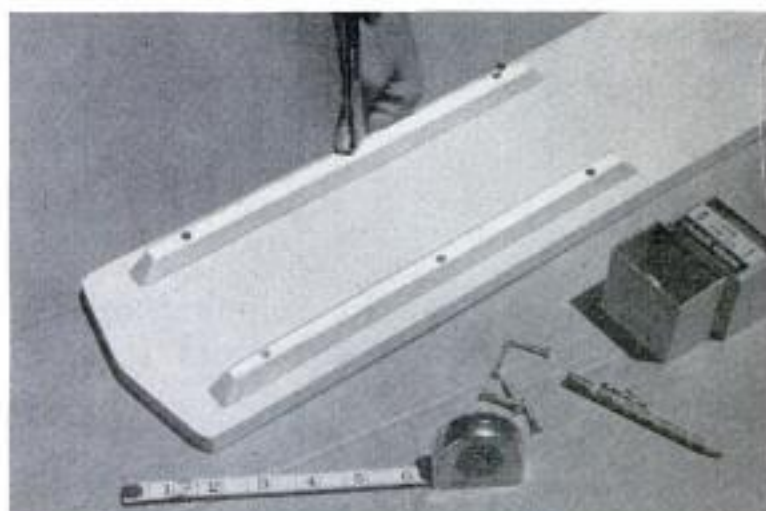
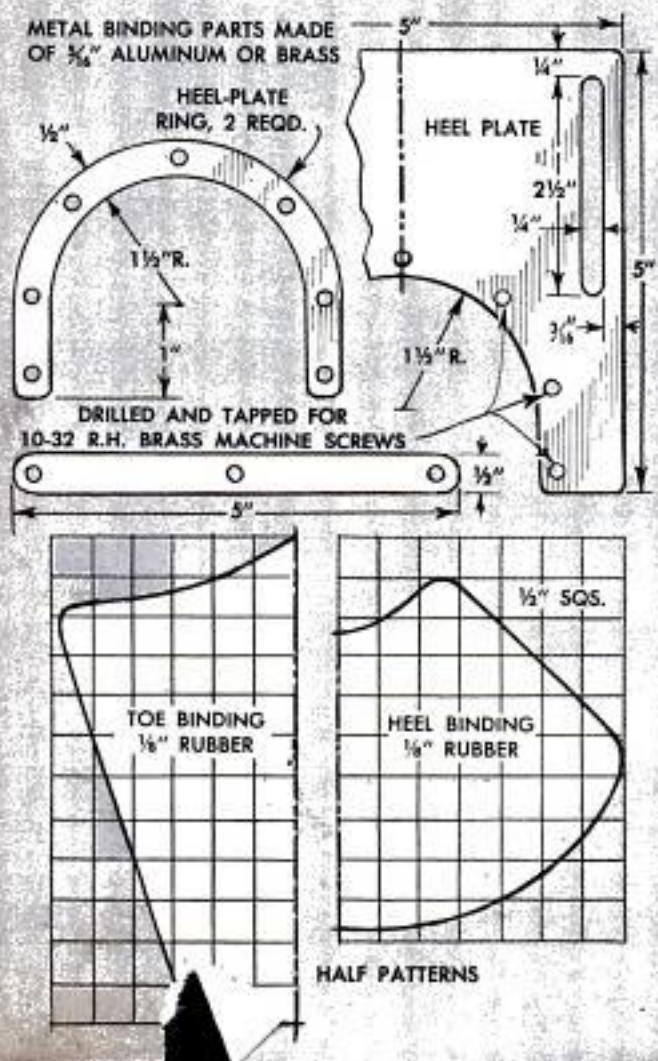

Each rudder is fastened 1 in. from back of ski and  $\frac{1}{2}$  in. from edge. Three 1-in. No. 6 screws are used

The toe section of the completed foot bindings is fastened with wood screws, the heel with wing nuts

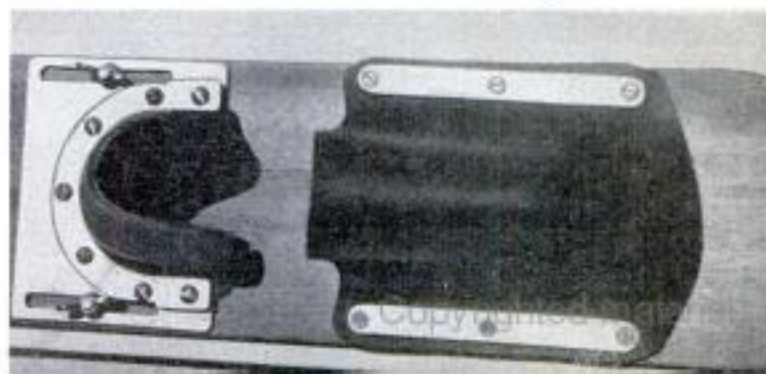





### Negative Viewer Always at Hand When Installed in Desk Drawer

A desk drawer is an ideal spot for a viewer used in cropping photo negatives, or for tracing drawings. The viewer can be made by installing two lamp bulbs inside the drawer and topping them with a piece of translucent glass set flush with the drawer top. Cleats will support the glass and a porcelain receptacle and a Y-plug will take care of the bulbs, which should be centered under the glass. The glass should be slightly shorter than the length of the drawer to provide an opening for ventilation and for storage of the lamp cord. Two or three strips of tape will keep the glass in position.

### Airtight Seals for Solution Bottles Provided by Plastic Liners

Airproof seals for caps on bottles and jars containing photographic solutions can be made from vinyl-type upholstery material. Remove the original liners and replace them with disks cut from the plastic.



### Pencil Clip Smooths Errors On Mimeograph Stencil

When correcting a mimeograph stencil, the errors must be smoothed over before the correction fluid is applied to prevent the fluid from flowing through. As the special burnisher for the purpose is not always at hand, the ball tip of a pencil clip may be used instead. For convenience, reverse the clip on the pencil, as shown in the drawing.



### Small Leaks Repaired In Oil or Water Tanks

An emergency repair for small leaks in oil or water tanks can be improvised from a self-tapping screw, a nut and a rubber washer. Use a screw of a size that will fit the hole, slip a nut over the screw, then force a rubber washer over the end of the screw. The screw, pulling into the hole, will force the nut against the rubber washer, expanding it to seal the leak. If an oil tank is being repaired, apply a small amount of varnish or shellac to the rubber washer.

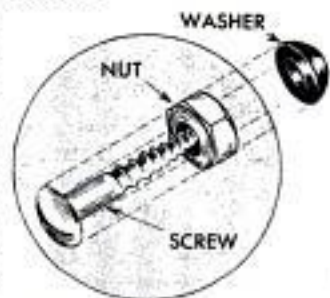

Mitchell Jaskiewicz, Chicago.

### Rubber Band Through Cover Holds Pencil on Notebook

To keep a pencil at hand inside the cover of a notebook, insert a rubber band through two holes punched in the cover. Then knot the band near each end to provide loops for the pencil and also to keep the band in place. A small ruler, dividers and other equipment can be carried in the same way. A flat rubber band is preferable to a round one for this particular purpose.



G. E. Hendrickson, Argyle, Wis.





## Automatic Hill-Holder

Six speeds forward, no-clutch shifting and an automatic hill-holder are all available if your car is equipped with a Borg-Warner overdrive unit. As shown in the middle circuit of the wiring diagram at the right, the overdrive governor is bypassed and a toggle switch, which is installed on the dash, is wired between the solenoid and the ground. When the switch is in the "on" position, you have overdrive range in all gears, engine-compression braking and the hill-holder. Downshift from overdrive range to conventional is done by simply pressing the accelerator all the way down. **Warning:** Most transmissions will not go into reverse when the switch is in the on or overdrive-range position. Flip the switch to "off" before shifting to reverse. When the switch is in the off position, the transmission will be in the conventional range, have "free wheeling" and no-clutch shifting. If it is desired to have the transmission operate in the regular manner, a three-pole switch can be wired into the circuit as shown in the lower circuit in the wiring diagram.

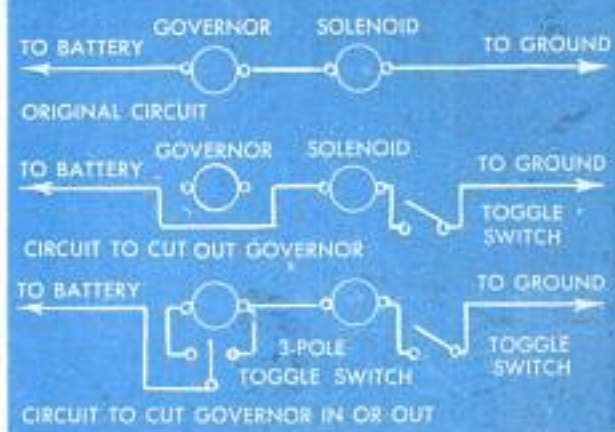
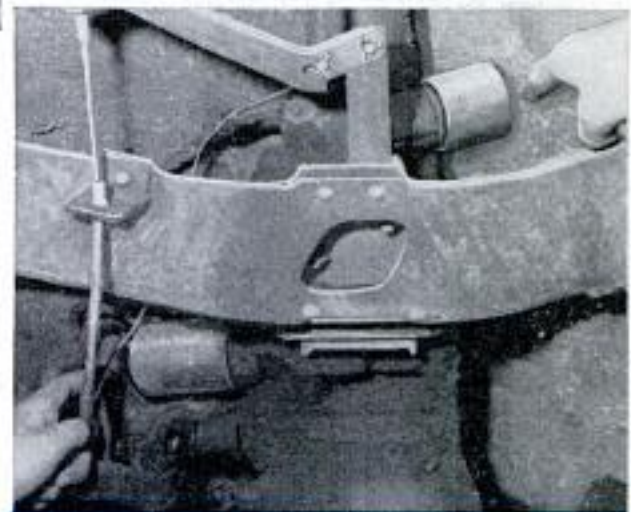

## Coin Provides Equal Spacing of Lines When Using Triangle

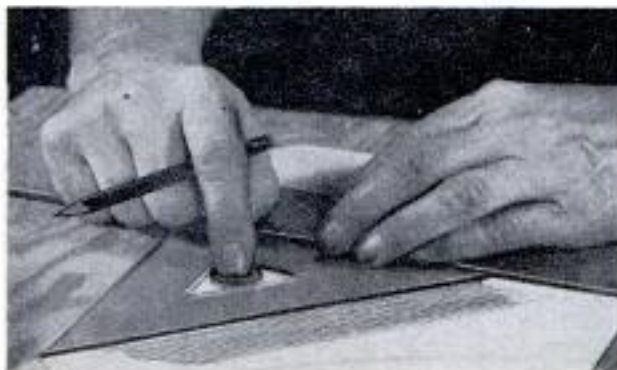

When it is necessary to rule a series of equally spaced lines with a triangle, a coin smaller than the opening in the triangle can be used to accurately space the lines. Draw the first line, holding the coin inside the triangle against the side being used. Then move the coin to the opposite side of the opening, holding the triangle firmly in place. Next, hold the coin and move the triangle. The distance between the coin and the triangle will, of course, determine the distances between the ruled lines.





### Ladder Rest on Lamp Standard Provides Safety Factor

Welded to an outdoor-lamp standard just beneath the light, a 2-ft. length of pipe will provide a ladder rest which is a definite safety factor when changing the bulb or cleaning the reflector. When the ladder is placed against the rest it will not have the tendency to twist or slip sideways, as when rested directly against the standard.

Bob Poulson, Los Angeles, Calif.

### Bench Stop Held With C-Clamp

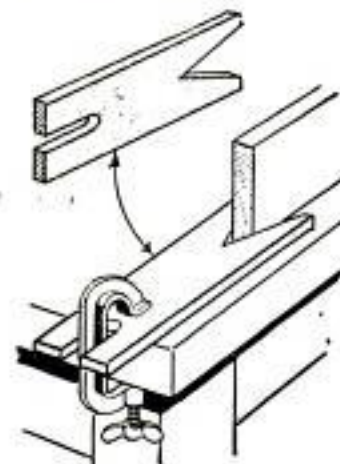

A bench stop cut from  $\frac{1}{4}$ -in. plywood, and clamped in place, will eliminate the need for nailing cleats or blocks to the top of your workbench. One end is slotted to straddle a C-clamp, and the other end is V-notched to take the work, as shown in the detail.

### Wire Coat Hanger Bent Into Hook Used as Paintbrush Rest

Shaped from a wire coat hanger, this simple hook provides a means of holding a brush on the edge of a paint can. Easily slipped in or out of the hook, the brush will not be submerged in paint nor fall on the floor. The hook of the coat hanger is bent at right angles to its original position and shaped to fit over the brush handle. The cross bar of the hanger is cut in the middle and the hanger then is wrapped around the paint can. The cut ends are twisted together and the excess wire snapped off.—Ken Murray, Colon, Mich.

### Charcoal Fired Over Gas Flame To Assure Quick Blaze

Charcoal, which is sometimes difficult to ignite, may be pre-fired to assure a quick blaze in your barbecue pit or brazier. Place the charcoal in an old heavy-duty bucket which has holes punched in the bottom. Set the bucket on a gas burner over a high flame for 5 or 10 minutes, then remove to the fire. To prevent particles of charcoal from sifting into the gas burner, shake the bucket thoroughly before placing on the stove.—W. S. Head, El Cajon, Calif.



### Holder for Small Drill Bits Made From Tobacco Can

A practical holder for small drill bits may be made by punching a number of holes through one side of a tobacco can. The can is fastened over the workbench in a horizontal position.



### Clothespin Holds Table Cloth

To prevent wind from disturbing the cloth on any outdoor barbecue or picnic table, screw a spring-type clothespin under each corner of the table. After the cloth is spread on the table, the corners are clamped into the clothespins, eliminating tacks or weights to hold the cloth in place.

Norm Jacky, Fond du Lac, Wis.





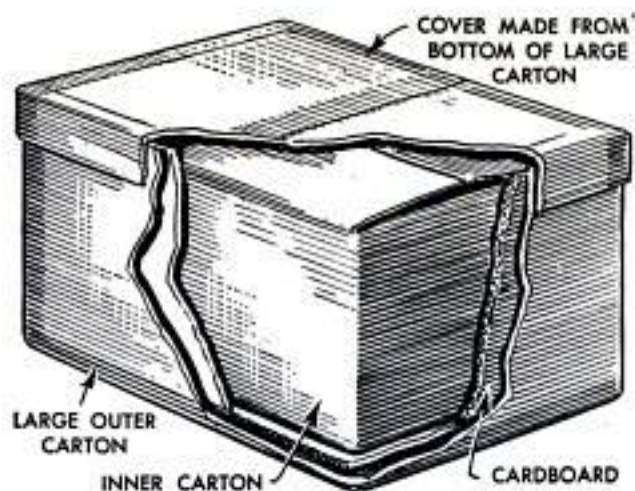

## DISPOSABLE ICEBOX FOR PICNICS

For an impromptu outing or other occasion requiring an emergency icebox, try the one pictured. It costs nothing to make and can be discarded after serving its purpose. The icebox consists of one cardboard carton set inside of another, with space between them for more cardboard or crumpled newspaper as insulation. A cover for the box is made by cutting the bottom from a slightly larger carton and fitting it over the assembly. To chill the contents of the box, make a dripless "cake of ice" by filling a quart can with water, coffee or some other beverage, allowing room for expansion, and freezing it in the ice-cube compartment of the refrigerator. When the liquid is frozen solid, the can is capped and put inside the box to keep the contents cool. It will provide refrigeration for five or six hours if the box is sealed with gummed tape after packing. Ice cubes and frozen foods may be kept frozen longer if they are wrapped in several layers of newspapers before being put in the icebox.

John Jobson, Hollywood, Calif.



Above, can in which a beverage has been frozen is packed along with perishables to provide refrigeration for five or six hours if the box is sealed with tape



Cardboard from cut-up box is inserted between inner and outer cartons, above, to act as insulation

## Notch Cut in Cardboard Mounts Aligns Slides for Viewing

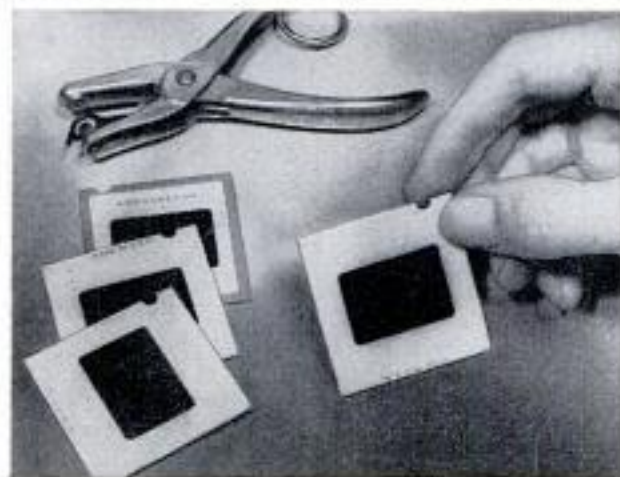

To avoid projecting or viewing a color transparency upside down or reversed, hold the picture in its proper position and notch the upper right hand corner of the cardboard mount with a paper punch. The notch will permit proper positioning of transparencies for insertion in the viewer, even in a darkened room, by feeling the notch with the fingers. This idea also could be used to aid in storing the transparencies in the proper position.

☞ Before putting lawn furniture outside in the spring, give it a coating of household wax to protect it from the weather and make cleaning easier.



# SAVE \$100 on your NEXT VACATION

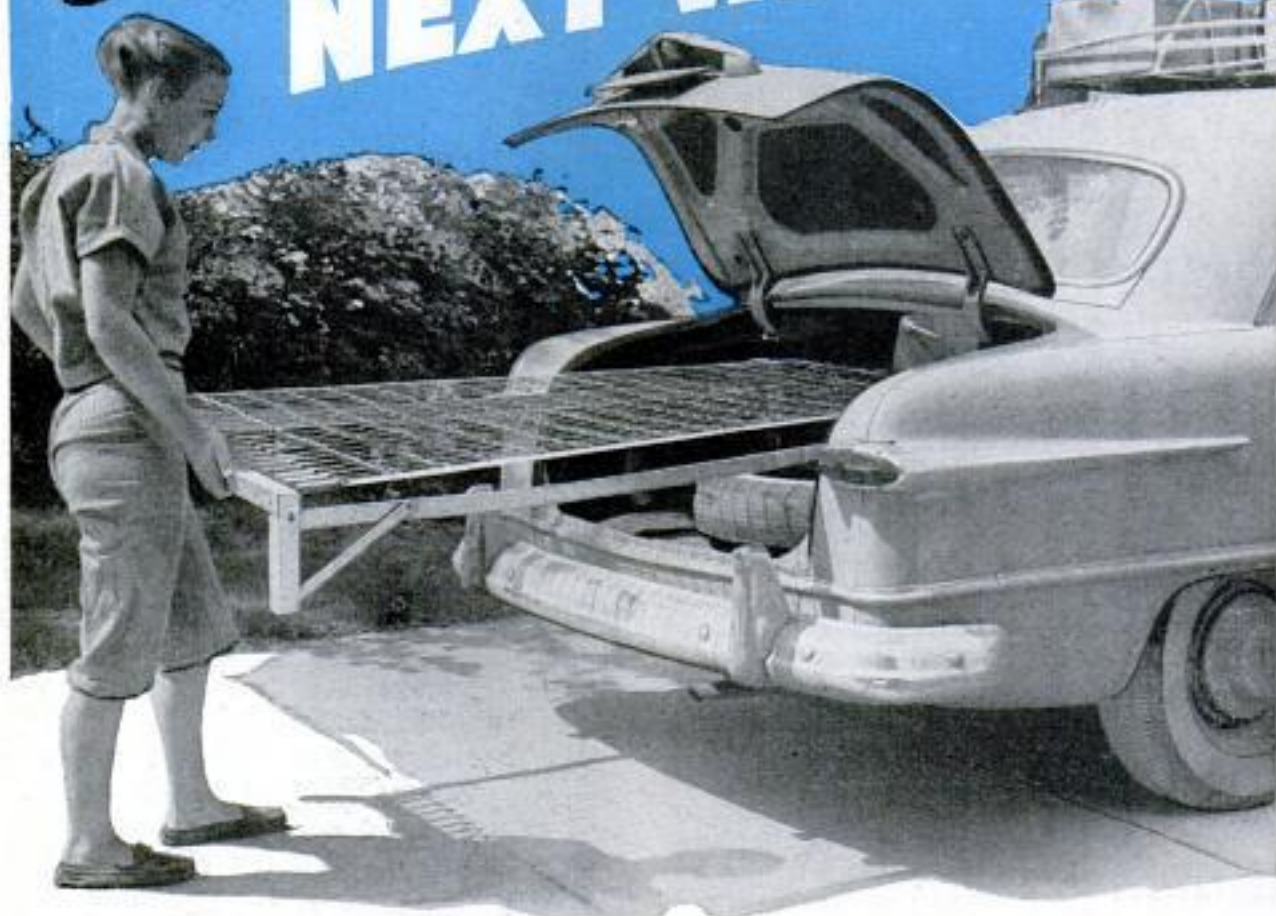

By Ron and Marion Anderson

**S**TOP FOR THE NIGHT when and where you wish, and at the same time stretch your vacation budget, by building a bed right into your car. We did it, and now find that vacation costs average \$100 less because the cost of sleeping accommodations is cut down. We never have to wire ahead for reservations and there is no more stopping in the middle of the afternoon in order to secure accommodations for the night. Figures issued by some of the state tourist bureaus show that more and more people are making their homes for the night wherever they park their cars.

Installing a bed in most cars is easy. It took us less than an hour to make the installation in our 1951 Ford. First remove the back seat and then take out the fiberboard partition behind it. Next, take out the two steel diagonal braces by cutting them free with a hacksaw. These may be replaced later by bolting them back into place, using small steel angles and reinforcing plates that can be purchased at any

After the back seat is taken out and the diagonal braces are removed, bed is installed through trunk

Adequate space for storing spare tire and luggage is available under the bed and at the foot in trunk





hardware store. However, we never did put them back, and after two years the car body shows no signs of weakness.

The next step is to buy a steel-frame twin bed with flat springs. Sand and paint the frame, and then slide it into the car through the trunk. Since the standard twin bed is 39 in. wide, it should fit through the trunk opening easily. However, to be certain, take the measurements from your car before selecting the bed, or you may have to cut it down. This isn't difficult, but it is extra work that might be avoided. Either an innerspring or stuffed mattress can be used. We chose the stuffed type because it was thinner and took up less room, yet provided plenty of comfort.

With the mattress on the bedframe there is still room to dress at the side of the bed, and space under the bed and at the foot for luggage and the spare tire. Screens may be installed in the back windows by removing the metal window frames or trim, taping plastic screen wire in place, and then replacing the frames. For privacy, shades can be made for the windows by cutting cardboard to the size of each window. This is taped over the window at night and stored at the head of the bed during the day.

Although much of the convenience of traveling with a car bed comes from being able to stop when and where you wish, you may prefer to park overnight at one of the hundreds of trailer camps dotting the country. Standard rate for parking your car and using toilet and shower facilities is \$1 for the night. Camp sites are available in national and state parks. And often large restaurant and gas-station stops have places for you to park. In addition, with your car as a sturdy, weatherproof "tent," you can have all the pleasures of camping out.

Screens for rear windows are provided by taping plastic screening in place after removing window frames



JULY 1954



Above, bed is shown in place and made up ready for use. There is space for dressing beside the bed



Strip of hardboard 4 in. wide is taped across front of shelf under rear window to keep articles in place

As window frame is replaced, screen is stretched and made smooth. Window still can be opened and closed



185





### Folding Flowerpot Stand Cut From Plywood

A flowerpot stand that can be slipped together in a few moments and disassembled for storage just as quickly can be made from light plywood or hardboard. The two body pieces are slotted centrally to fit into each other at right angles. The upper edges of these pieces are recessed to take the circular top which is notched to take the tabs of the body pieces. Glue applied to all joints will make a permanent job, if desired. The same design in heavier wood can be used as a child's stool, or in cardboard, as a display stand, to be used when window dressing.

### Wax Coating on Steel Rule Retards Rust and Wear

By applying a coating of paste wax to both sides of a steel retractable rule you not only can "lubricate" its movement but also retard the formation of rust. Apply only a small amount of wax and then wipe it off lightly with a clean, dry cloth. This leaves an almost invisible coating remaining which is sufficient for the purpose.

Glen F. Stillwell, Manhattan Beach, Calif.

### About Water That's Too Soft

Surprising as it seems, a great many of common plumbing troubles often are caused by water that is too soft—corrosive water that even attacks copper and brass. Biggest problem is that most people think hard water to be the culprit and correct accordingly. But, find out for yourself in next month's story

### Vines Tied to Wall or Trellis With Pipe Cleaners

Vines that are slow to "take hold" on a wall or trellis, can be tied in place by pipe cleaners, which are ideal for this use because they are not likely to damage the vine. To attach the pipe cleaners to a brick wall, tie them to projecting nails driven into the mortar joints. On a trellis, they are simply tied to the lattice work.

Hi Sibley, Nuevo, Calif.



### Envelope Holds Sheets of Paper For Accurate Trimming

When trimming a number of sheets of paper on a cutting board, you can hold them together evenly by slipping the flap of an envelope over one edge of the sheets.

Tap the envelope on a flat surface once or twice to square up the sheets against it, then hold the paper firmly on the board for cutting.



### Bulb Carried in Flashlight Provides Emergency Spare

You won't have to grope in the dark when a flashlight bulb burns out, if a spare bulb is carried in the end cap of the case. A piece of friction or adhesive tape will hold the bulb in place and allow it to be removed easily.



Unaffected by photo chemicals when hardened, tire filler can be used to mend cracks in plastic developing tanks and trays.



# DRYING GLOSSY PRINTS

By Wallace Hanson

TRYING TO GET a mirror finish on your snapshots or enlargements can be a frustrating chore, especially if you are just beginning to process your own pictures at home. First attempts generally result either in the prints sticking to the plate like glue or drying unevenly, spotty and wrinkled. Obtaining a perfect gloss on your prints is more tricky than difficult, and most home photo finishers will do well to remember that a chrome or enameled ferrotype plate is a piece of photo equipment that should be "pampered" once it is conditioned to turn out prints of professional quality. Follow the tips used by the experts.

Below, hold each print separately under running water to rid it of grit, sediment and other foreign matter that may have collected on it. Specks may remain to mar glossy finish when prints are merely transferred from washing pan directly to ferrotype plate



Chrome-on-brass ferrotype plate is preferred to steel as it will not rust. Wash away grit under cold water

Below, place print face down on ferrotype plate and run a stream of cold water between print and plate. This forms cushion of water between the two, eliminating air pockets and providing a perfect bond between print emulsion and the ferrotype plate

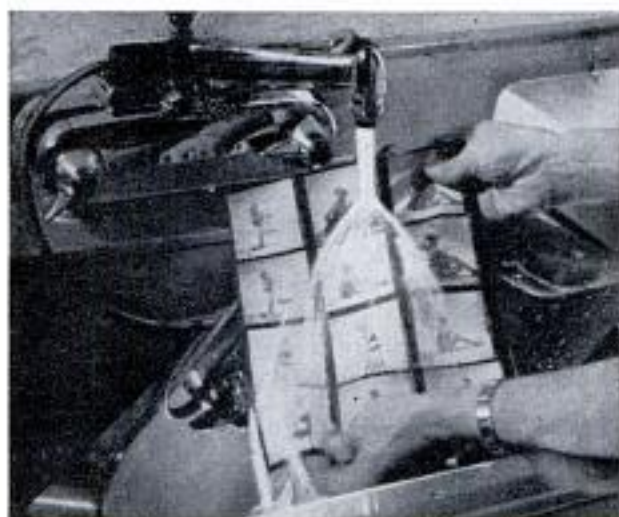

Below, turn a print tray upside down and place ferrotype plate on it. Wipe print against the plate with a wide-blade squeegee. Pan allows excess water to drain off without chance of water running back under print along with dust to mar the glossy finish



Below, when using a chrome plate and electric drier, leave prints covered until canvas feels dry. Removing cover too soon will oyster-shell the gloss. Don't use black enamel plates in drier. Instead, place the plate under blotter and dry at room temperature

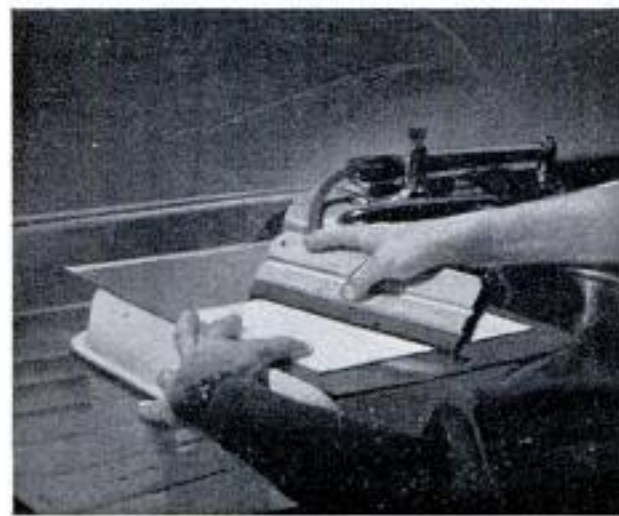



# A DARKROOM IN A CABINET

By M. E. Withey

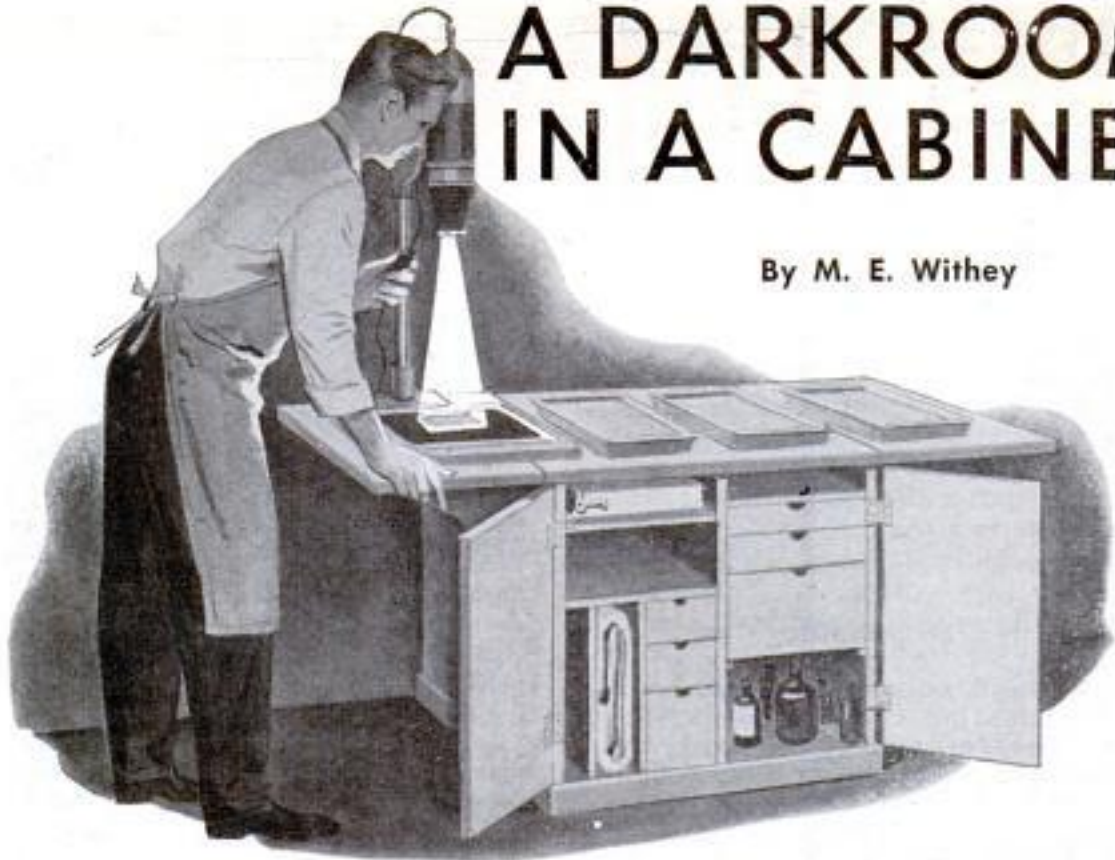

**T**HE LIMITED DARKROOM space available to many amateur photographers is utilized to full advantage by this compact storage cabinet and work counter. The cabinet, when closed, occupies only 20 x 32 1/4 in. of floor space, yet when the two 14-in. extension leaves are open, a work surface 60 1/4 in. long is provided. The larger pieces of equipment fit neatly inside the cabinet; the enlarger and paper trimmer

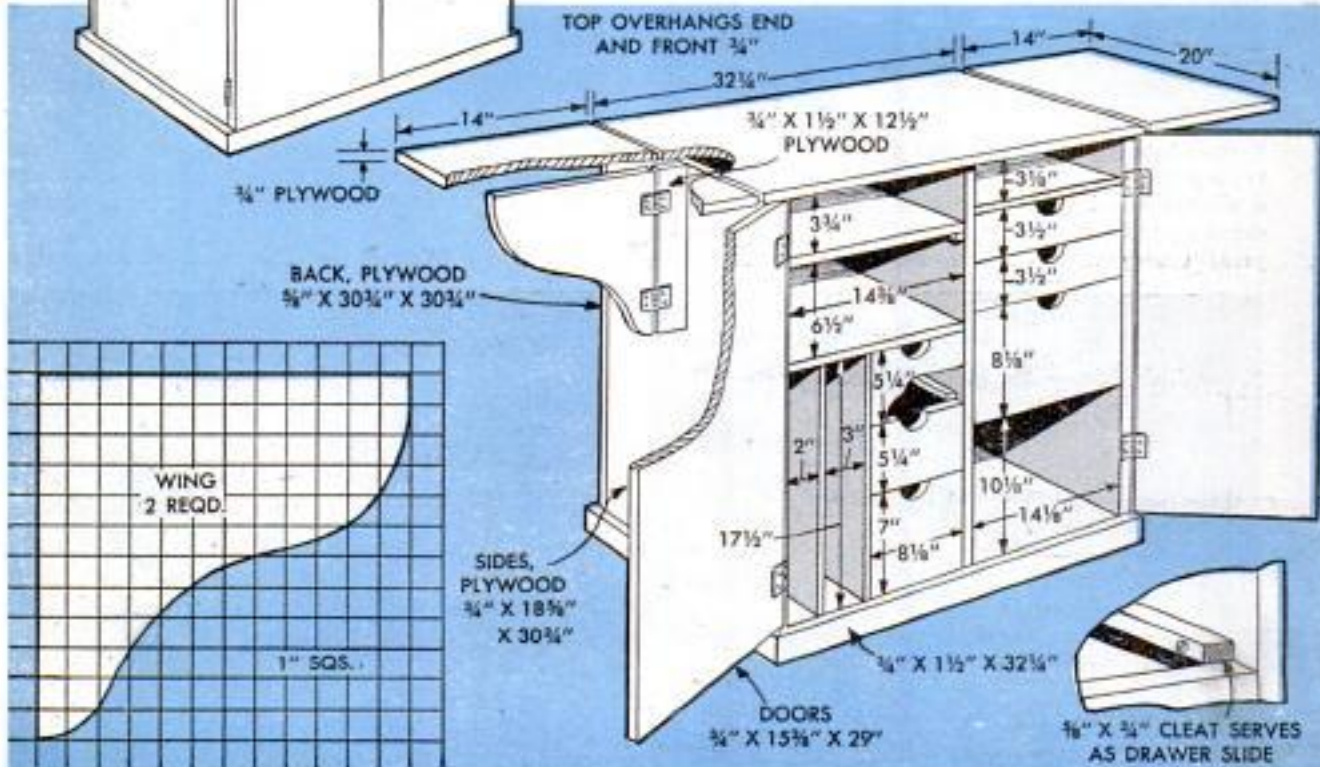
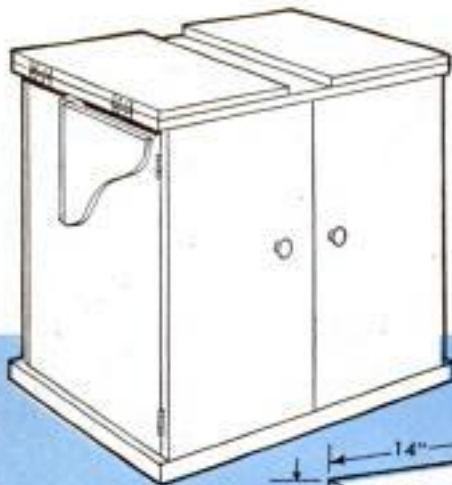



fit on two horizontal shelves, the enlarger base and easel and the print drier, in two vertical bins. Except for the drawer slides and the floor rail, the cabinet is cut from easily worked plywood. Although the detail shows the floor rail to run on three sides of the cabinet, it actually is necessary only at the front, where it is flush with the closed doors. The detail below shows a third way of adding the rails across front and back. The sides of the cabinet extend to the floor, while the top of the bottom shelf is 1½ in. above the floor. Hardboard can be substituted for the plywood used for the back.

All joints should be glued and fastened with wood screws to insure a rigid structure. Piano-type hinges may be used to hinge the extension leaves, although plain butt hinges will do. In attaching the hinges, drive the screws into the edges of the ¾-in.-plywood top.

As shown in the detail of the drawer, the front panel of each drawer extends ⅝ in. below the bottom of the drawer to allow for the slides. The dimensions given for the cabinet will fit the storage requirements for the average pieces of equipment, but it is wise to check the size of your own equipment to be sure it will fit in the cabinet.

Linoleum or plastic laminate should be used on the top surfaces to protect the wood from photographic chemicals. The cabinet itself may be stained or painted to match or contrast with any room decor. The inside, as well as the outside should be varnished or painted. ★ ★ ★

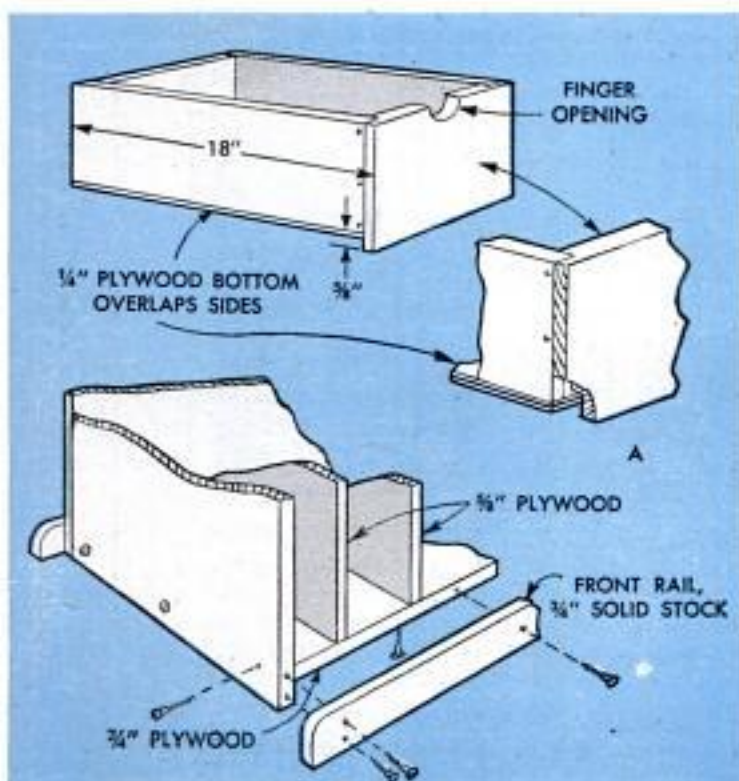

JULY 1954

## Black Paper Helps in Computing Exact Diameter When Enlarging

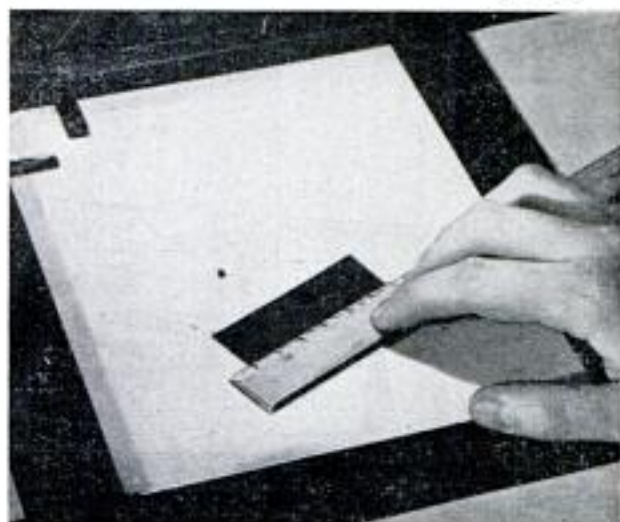

If your enlarger post is not calibrated to permit enlarging to an exact diameter quickly, substitute a strip of black paper 1 in. long for the negative. Focus sharply, and then measure the projected image with a ruler. An image 3 in. long indicates a 3-dia. enlargement, a 3½-in. image a 3½-dia. enlargement, and so on. Computation of odd sizes is thus simplified.

R. F. Donovan, Guttenberg, N. J.

## Rubber Tabs Hold Paper on Board Without Puncture Marks

Sheets of paper or card stock can be held on a drawing board securely, without being defaced with the usual thumbtack punctures, by using rubber tabs as illustrated. The tabs are held on the board by thumbtacks. To use such tabs, push the thumbtack through the tab and then start the tack into the drawing board. Slip the edge of the paper or card under the rubber and force the tacks down.

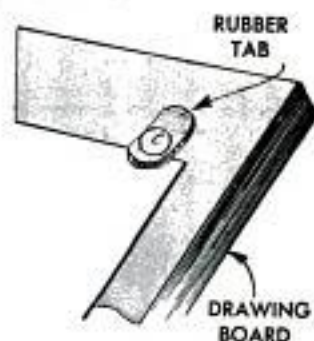

## Small Sheets of Clear Plastic Made From Old Negatives

Old cut-film negatives will provide the modelmaker and hobbyist with excellent sheets of clear plastic. The emulsion is softened by immersing the film for 5 min. in a solution of glacial acetic acid, 100 drops, and water, 1 pint. The emulsion then is wiped off with a cloth.—Henry A. Miller, Orpington, Kent, England.



## Reflector for Drop Light Cut From Tin Can

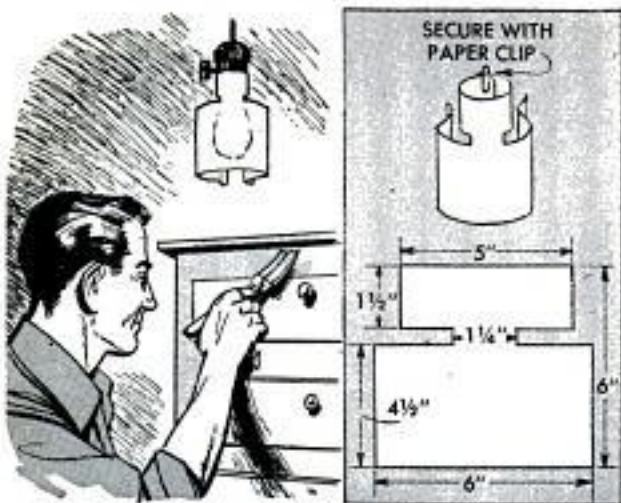

The glare of an exposed light bulb on an extension cord or drop cord can be shielded by means of a reflector cut from light sheet metal or asbestos paper. A medium-size tin can will furnish enough sheet metal for the reflector. It can be cut to the dimensions given in the detail and bent to a "spring" fit and clamped around the socket. If asbestos paper is used, a paper clip will hold it in place.

## Ridding Yard of Ants

Wishing to destroy ants in several large ant hills in his yard, one homeowner inverted a flowerpot over each hill and poured a small amount of carbon tetrachloride through the hole in the bottom.

The resulting fumes exclude all the oxygen inside the pot almost immediately, thus killing the ants covering the hill as well as many caught near the surface.

John A. Comstock, Wellsboro, Pa.

## Paint Mark on Adjustment Wheel Permits Easy Thermostat Check

A small dot of paint or nail polish on the adjustment wheel of a room thermostat will provide a means of quickly checking to see if the furnace has been set for the correct temperature. Paint the dot at the temperature setting which is normally used. If the thermostat is to be checked at night, luminous paint might be used.



## Popular Mechanics Bookshop



### Home Repairs

HERE IS a book filled with hundreds of photographs that show you just how to save money doing your own home repairs. In cloth bound \$2.50

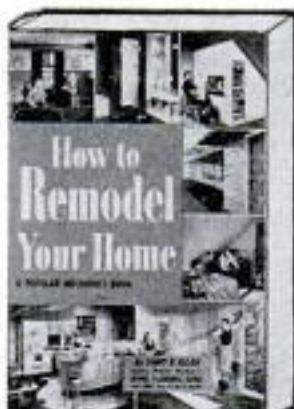

### Remodel Your Home

NOW IS the time to give your home the "face lifting" it needs. And it's so simple with this up-to-the-date book. Can be purchased at the newsstands for only 75c

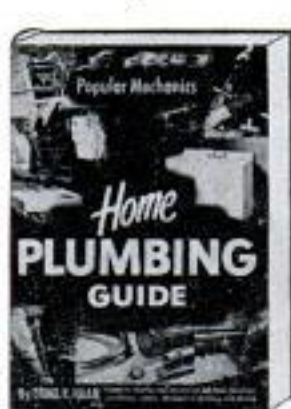

### Home Plumbing Guide

NOW complete data on home plumbing with a book that is easy to understand. Hundreds of illustrations, diagrams and drawings. In cloth only \$3.50

All books available from Popular Mechanics Book Dept., 208 E. Ontario St., Chicago 11, Ill.





# SHOP NOTES

## MILLING ARM FOR DRILL PRESS

By Walter E. Burton

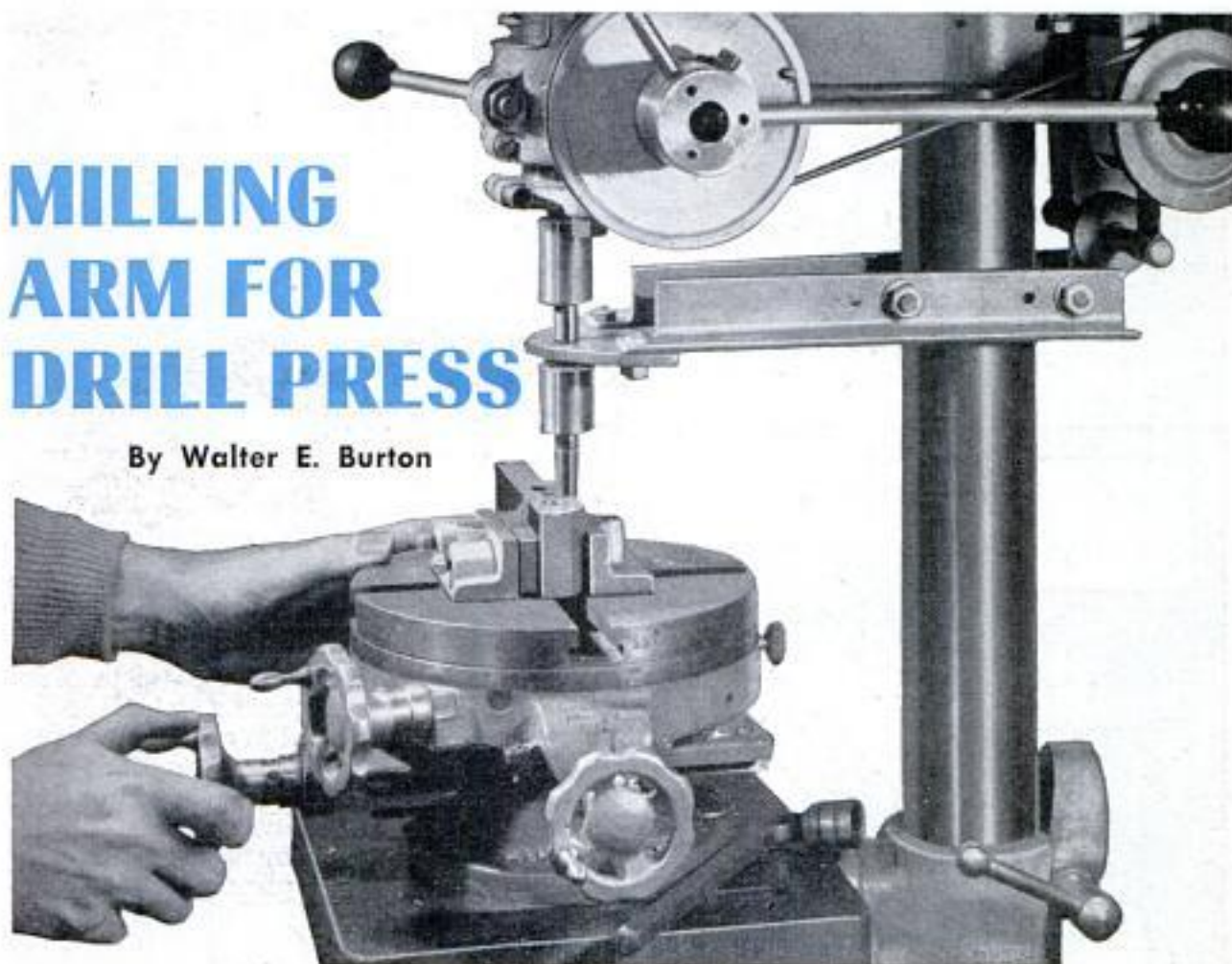

**B**Y ADDING a milling arm which provides a bearing for carrying heavy lateral thrust, your drill press can be made to serve as an accurate vertical milling machine for light work. The arm, pictured in position in the photo above, is clamped to the drill-press column and supports the auxiliary sleeve chuck in the manner shown. The auxiliary chuck can be driven by a conventional drill chuck or by means of the interchangeable spindle furnished as an accessory with some types of drill presses. The accessory spindle is shown in use in the photo above and also in the upper right-hand photo on the following page.

For an occasional job the arm can be made from light steel angle as pictured, but for more accurate repetitive work the supporting arms should be made from  $\frac{3}{4}$  x  $1\frac{1}{4}$ -in. steel with the split sleeve bearing held in a  $\frac{1}{2}$ -in. steel plate as in the center detail on the following page. Slotting both the holder and the bearing provides an

adjustment for eliminating any side play in the bearing. Shallow concaves must be milled or filed in both arms so that they can be clamped rigidly to the drill-press column. This operation must be done with care so that when in position the arm is precisely at right angles to the axis of the drill-press spindle. Before the final filing of the concaves, make the extension sleeve as in the upper detail on the following page. Note that the detail shows three flats milled (or filed) on the shank of the sleeve. These are 120 deg. apart so that the chuck jaws will close on a flat surface to give adequate driving power without any slippage. Machine the extension to the dimensions given from one piece of tool steel and drill and tap for set screws as indicated. When used with an accessory drill-press spindle, as pictured, only one flat is necessary and it should be slightly longer than indicated in the detail. Machine the lower end of the shank to a close fit in the bearing, bringing it down to the final



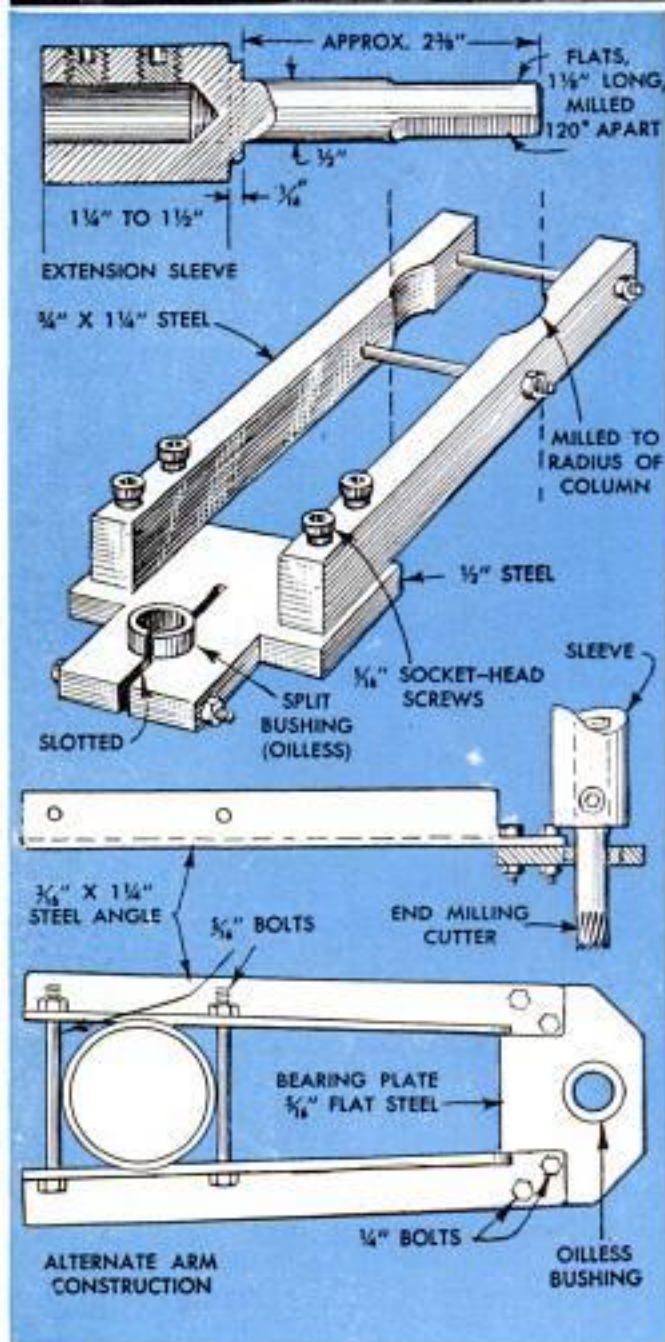
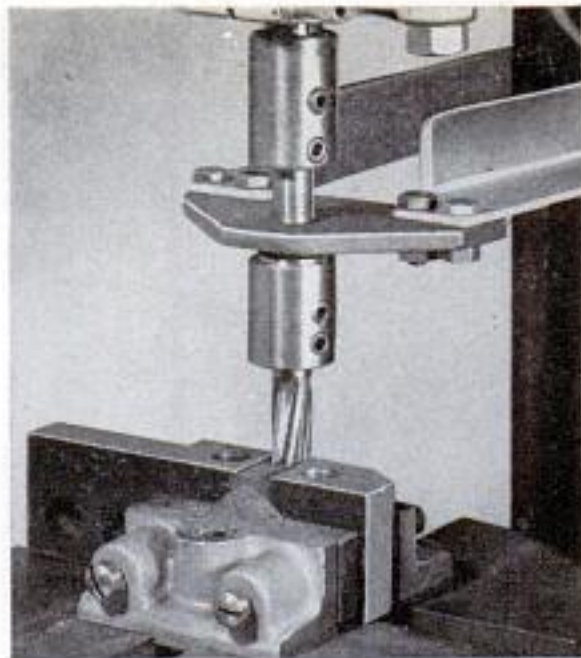
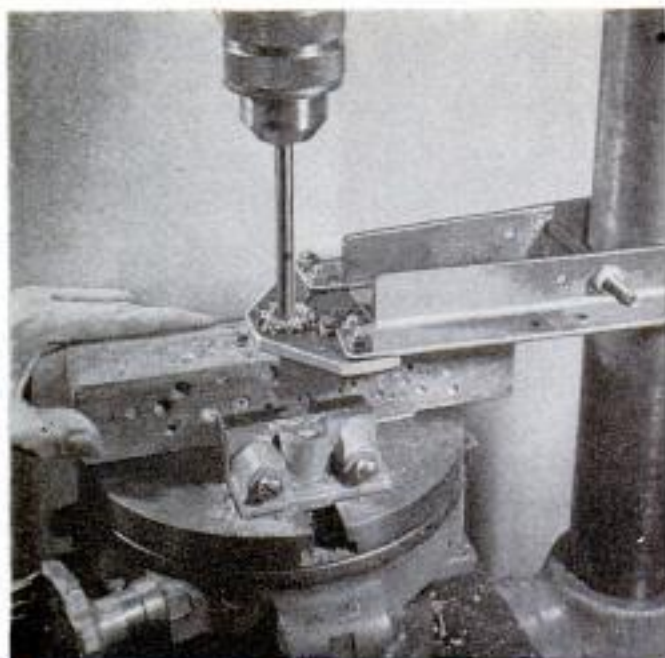

Above, left, drilling the hole in the bearing plate for the bushing. Hole later is reamed to take bushing. Right, unit in operation taking cut across thickness of work. Note spiral cutter

dimension with a fine file if no lathe grinder is available.

Then make a trial assembly of the completed arm with all parts in place, including the extension sleeve. Rotate the spindle by hand to check for runout in the spindle and extension. Slight misalignment in either the vertical or horizontal plane will cause binding. Correct any such tendency by filing the concaves until the rotating parts turn freely. Be sure to tighten the spindle lock each time the parts are tested. If you are building the heavier-type unit, center detail at the left, adjust the split bushing by tightening the clamping bolt to take out any side play that may cause chattering when milling the harder metals.

For average work in both hard and soft metals, the four-lipped end mill with a straight shank generally gives best results. These come with straight and spiral flutes and in certain soft metals the spiral-fluted cutter usually gives the smoothest cut. However, either type can be used with good results. In the right-hand photo, above, a spiral end mill is pictured taking a typical milling cut across the narrow width of the stock. The universal table, pictured in the left-hand photo above and also on the preceding page, feeds in two directions, right and left and in and out, by handwheel feed. The platen also rotates by hand feed. The work is held in a special clamp as shown. Other types of clamping fixtures can be attached to the table when necessary. ★ ★ ★



## Depth Stop on Lathe-Chuck Jaws Speeds Setup of Thin Stock



When a quantity of thin disks are to be faced-off in the lathe, setup time can be kept to a minimum by fitting each jaw of the lathe chuck with an adjustable depth stop. Drill and tap the first step of each jaw to receive a  $\frac{3}{16}$ -in. cap screw. A locknut is screwed onto each screw to hold the adjustments at any predetermined point. The adjustments are made with a depth gauge and measured from the face of the jaw. It may be necessary to temper the jaw to permit drilling and tapping. — E. J. Gilkerson, Columbus, Ohio.

## Pigeon-Hole Cabinet Keeps Bolts Sized for Instant Selection

Copying an idea from a hardware store, one farm owner built a pigeon-hole cabinet for bolts and similar parts in his farm shop. With everything neatly sorted and sized, finding a particular bolt or part takes only a moment. The size of each section in the cabinet would vary for individual needs, but the cabinet pictured is made of 1-in. stock and each section is a 5-in. cubical. The vertical and horizontal strips were half lapped at each intersection to make the cabinet of interlocking construction. A  $\frac{1}{2}$  x 1-in. strip is nailed across each horizontal row to aid in holding the parts that are stored in each bin.

A. M. Wettach, Mt. Pleasant, Iowa.



## Improvised Builder's Level Used in Running Grades

A simple and inexpensive construction level for setting house foundations, concrete forms and for laying out farm terraces and ditches can be assembled quickly

from a hand sighting level, a broom clamp and a camera tripod fitted with a tilt head. The level must be of the optical type having adjustable magnification. Enlarge the

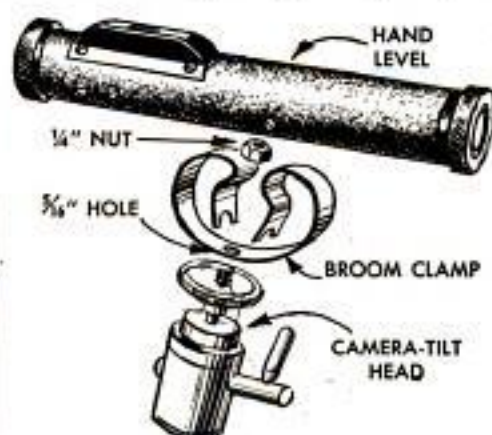

screw hole in the broom clamp and fit the clamp over the threaded stud at the top of the tilt head. Fasten it in place with a hex nut as shown. When assembled in this way the clamp holds the level sufficiently rigid for all practical purposes and the tilt head provides a fine adjustment when needed. Hand-sighting levels of the type required can be bought from mail-order houses.

Tom Riley, Portland, Ore.



# SELECT THE

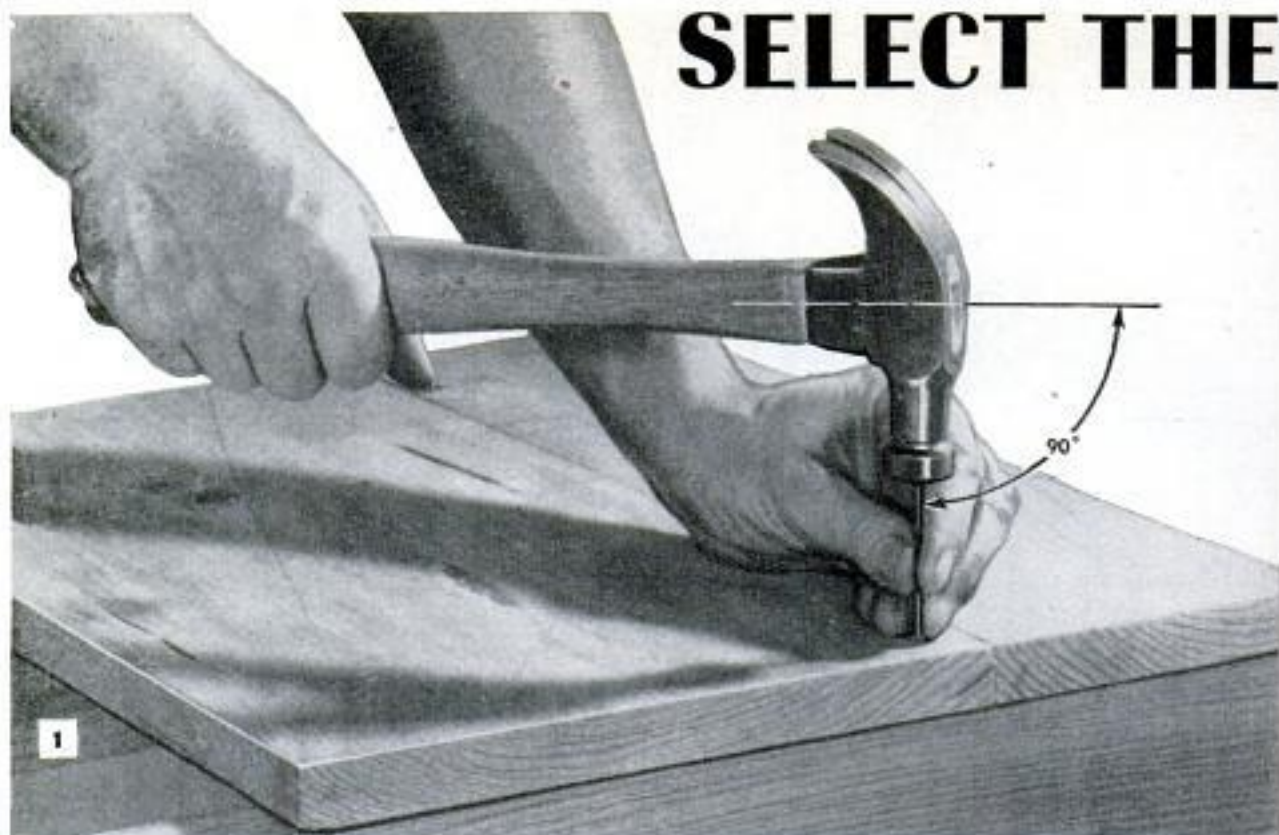

**T**HERE ARE NOW over a hundred types of nails available and from these you can select a nail for any specific job where nails can be used as fasteners. They are obtainable not only as types but also in many sizes in nearly all types. In addition to variations in shape and size, nails are supplied in varying degrees of hardness for special purposes. When exceptional holding power is necessary, as on parts which will be subjected to unusual strain or vibration, it is advisable to use adhesive-coated, etched or barbed nails. Where rust is likely to cause discoloration of the work

or affect the holding power of the nail, it's a common practice to use Parkerized, cadmium-plated or heavily galvanized nails in a size and type suited to the requirements. In some cases stainless steel, copper, bronze or aluminum nails will best serve the purpose. An example is the use of aluminum nails for attaching wooden siding. Aluminum nails do not corrode and the heads of the nails can be painted over without any special treatment to prevent rust and the resulting discoloration of the paint.

**Hammers:** Nearly all types of common nails can be driven with a single hammer

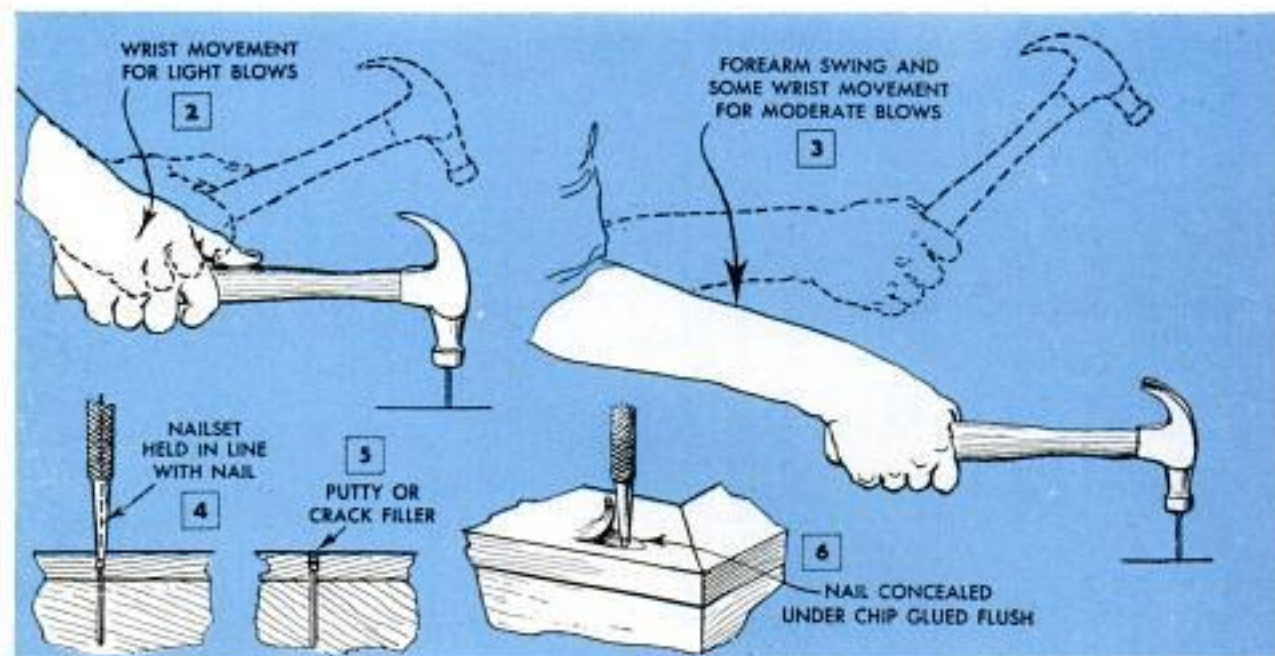



SN 56

# RIGHT NAIL

By E. R. Haan



Nailing techniques and kinds of nails are varied to suit the job to be done

having the weight and balance that suits the user's individual preferences. Hammer-head weights in the standard types range from 7 to 28 oz. with the 13 and 16-oz. heads an all-around choice of carpenters and others who use hammers for nail-driving exclusively. For delicate work, such as nailing flooring and trim in building construction, carpenters generally prefer a hammer with a lighter head as it is more easily controlled. A high-grade nail hammer, or claw hammer as it is commonly called, will have a highly finished head with claws of a uniform length, the poll will have a 2-deg. toe-in and the handle will be correctly shaped to provide the user with a comfortable hand-hold in the proper position in relation to the length of the handle. These points of construction give a hammer what experienced users call hang and balance, quality features that determine its accuracy and ease of handling. For ordinary work the face of the poll is crowned slightly and the edge beveled all around. For some specialized jobs the poll is checkered. Fine, sharp checkering on the face of the poll prevents it from slipping off the head of the nail when working under difficult conditions. Figs. 1, 2, 3 and 16 show how to hold a hammer when delivering both light and heavy blows. An important point in correct handling is brought out in Fig. 1. Note that the axis of the hammer is approximately at right angles to that of the nail as the blow is completed. If the handle is a few degrees down or up, the head of the hammer may "glance" off the nail and injure the fingers or bend the nail. If the hammer has the correct balance and weight for the job, it will fall naturally

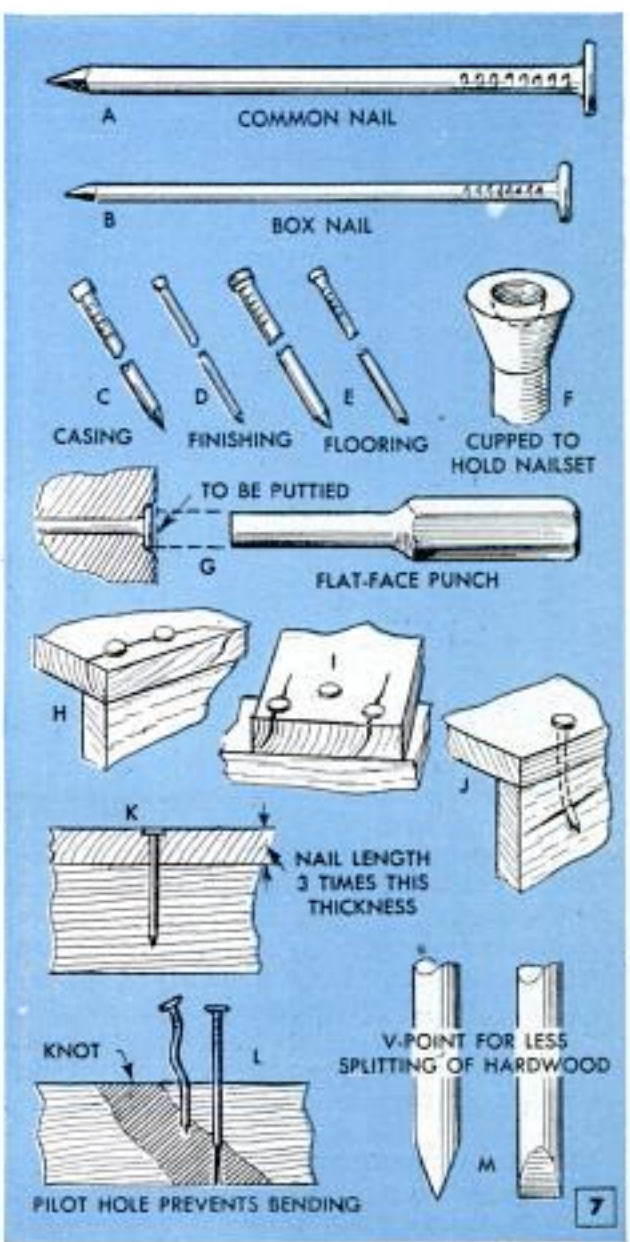



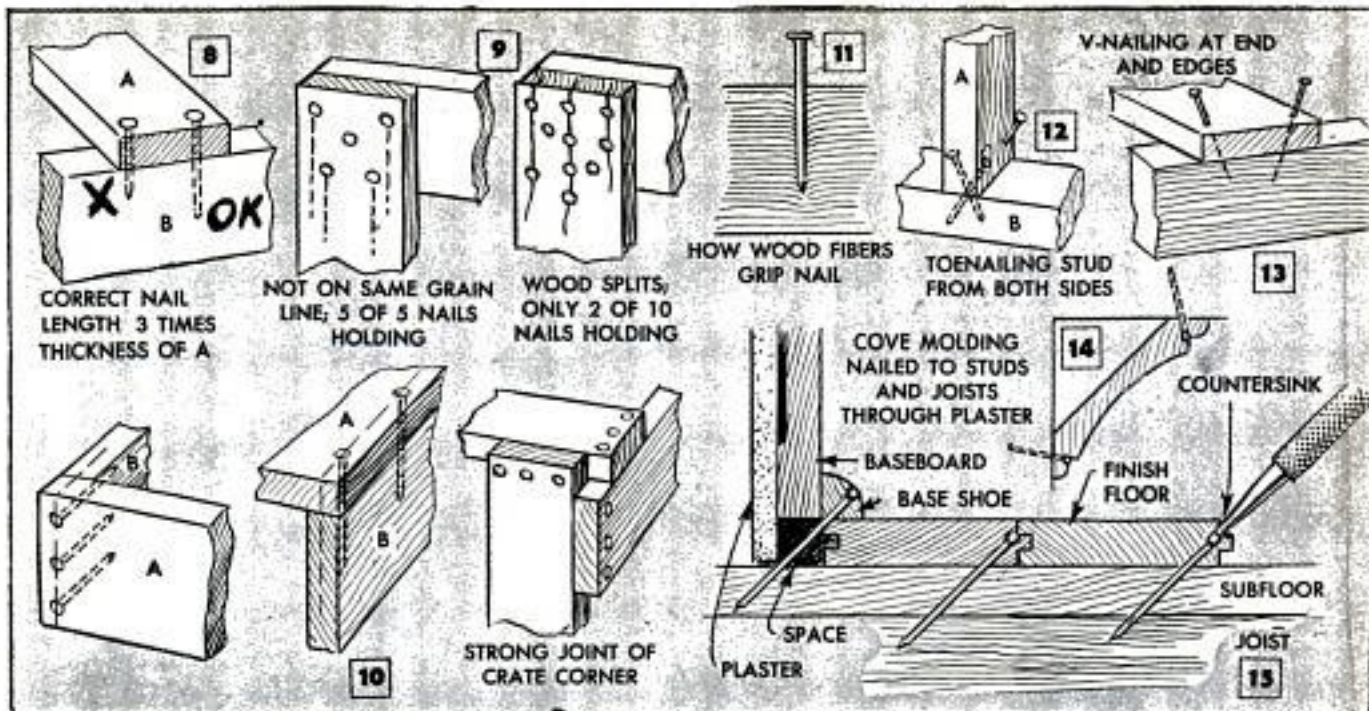

into this position at the end of the stroke. When light blows and positive control are necessary, it's a common practice to grip the hammer handle as in Fig. 2, with the thumb extended along the handle, as indicated. On the other hand, when it takes the maximum arm swing to deliver a series of heavy blows, the arm action will be smoother if the handle is gripped as in Fig. 3.

**General-purpose nails:** The measure of the length of common nails is indicated by an old symbol, the letter "d," meaning

penny. The d-sizes range from 2d to 60d. The 2d to 16d nails increase by  $\frac{1}{4}$  in. as in the table on page 198. Those above 16d increase by  $\frac{1}{2}$  in. The common wire nails, detail A, Fig. 7, are used mostly for joining house framing. Such nails should not be used on siding or in joining any other part of the structure where they will be exposed directly to the weather. Use aluminum or copper nails in exposed places. Note the similarity between the common nail and the box nail, detail B, Fig. 7. The finishing nails, details C, D and E, Fig. 7, include three types which vary in gauge and also have slight variations in the shape of the heads. The heads of these nails are cupped slightly, detail F, to hold a nail-set when setting the heads below the surface, as in Figs. 4 and 5. Ordinarily, the holes made by setting are filled with putty or a crack filler, but on fine cabinet work the heads often are blind-set as in Fig. 6. Flooring nails have blunt points for easier driving with less tendency to split the hardwood. Casing nails, detail C, have tapered heads and are used for interior trim and cabinet construction. On exceptionally fine work in hardwoods, finishing nails often are used instead of casing nails. They are smaller in diameter and have smaller heads which can be sunk below the surface with a nail-set with less tendency to split the stock.

**Nailing procedures:** Nails driven too close to the edges or ends of stock are likely to split the wood, details H and I, Fig. 7. When edge-nailing as in detail J, adverse grain may force the point of the nail sideways so that it breaks out on the face of the stock. When starting nails under these conditions be sure that the nail is centered. In certain hardwoods, such as



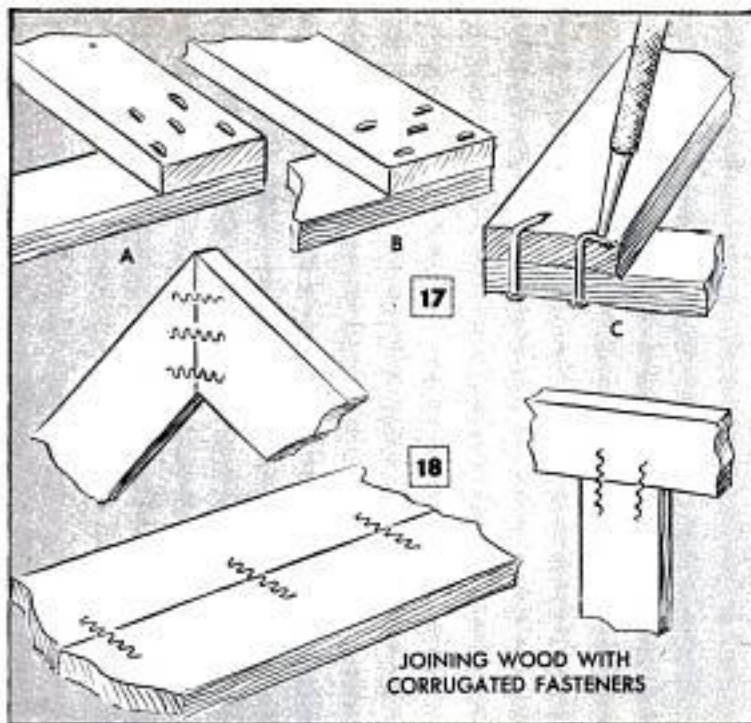

JOINING WOOD WITH CORRUGATED FASTENERS

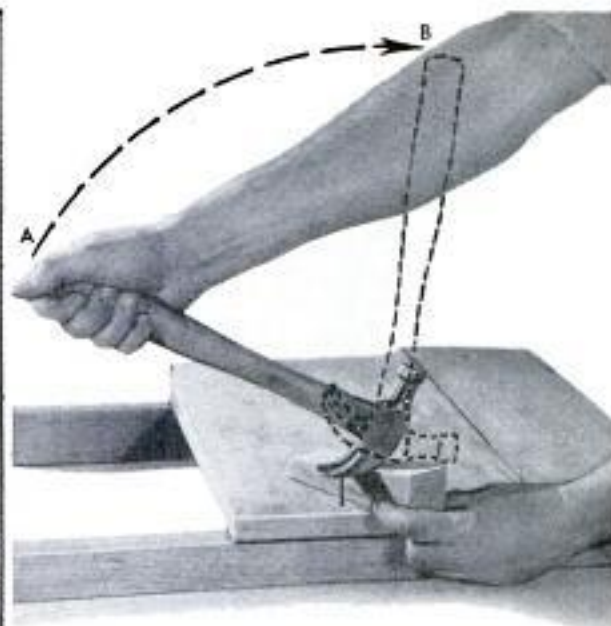

19

oak, it is advisable to drill a pilot hole slightly smaller than the diameter of the nail, or use a nail with a V-point, detail M. Often it is necessary to drive a nail through a knot as in detail L, Fig. 7. A pilot hole will prevent splitting of the stock. For maximum holding power on wood-to-wood joints, it's a common rule that the nail length should be three times the thickness of the piece being attached, detail K, Fig. 7, and A and B, Fig. 8. Whenever it is necessary to set flat nailheads use a flat-face punch as in detail G, Fig. 7. When joining two pieces of wood of equal width at right angles, as in the right and left-hand views in Fig. 9, take careful note of the direction of the grain. Then drive the nails so that no two of them are on the same grain line. Note the center line on the parts A and B in Fig. 10, the left-hand view, compared with those on the parts A and B in the center view. In both types of joints it is essential that the nails be centered through both pieces of stock. In hardwood this should be done by means of pilot holes drilled through the pieces A, the holes entering the pieces B about  $\frac{1}{4}$  to  $\frac{1}{2}$  in. to guide the points of the nails.

The holding power of a nail is due to the wedging action of the wood fibers, Fig. 11. This varies very little in average work even though the nails are driven into the wood at an angle as in toe-nailing a stud, A, to the plate or sill, B, Fig. 12, or in V-nailing as in Fig. 13. Another example of V-nailing, or angle nailing, is that of joining flooring to the subfloor as in Fig. 15, also the base shoe in the same detail. In attaching cove molding, Fig. 14, it sometimes is necessary to drive nails at an angle. Nails can be clinched across the grain or with the grain as in details A and B, Fig. 17. Usually they are more easily clinched with the grain, as in detail A, but they do not hold as well and there is always the possibility of splitting the wood. When nails must be clinched flush with the surface, turn the points with a hammer, then clinch flat with a nailset as in detail C, Fig. 17.

**Special-purpose nails:** Corrugated fasteners, a form of special nail, are widely used in assembling frames, boxes and crates and in joining narrow widths of stock to make a wide piece. Fig. 18 shows three typical examples of the

#### STEEL-WIRE GAUGE

	.2830	1	●
$\frac{3}{32}$	.28125	2	●
	.2625		
$\frac{1}{4}$	.250	3	●
	.2437		
$\frac{5}{32}$	.2253	4	●
	.21875		
$\frac{3}{8}$	.2070	5	●
	.1920		
$\frac{5}{16}$	.1875	6	●
	.1770		
$\frac{3}{8}$	.1620	8	●
	.15625		
$\frac{5}{16}$	.1483	9	●
	.1350		
$\frac{1}{2}$	.1250	10	●
	.1205		
$\frac{5}{8}$	.1055	12	●
	.09375		
$\frac{3}{4}$	.0915	13	●
	.0800		
$\frac{7}{8}$	.0720	15	●
	.0625		
$1$	.0540	17	●
	.0475		
$1\frac{1}{8}$	.0410	19	●
	.0348		
$1\frac{1}{4}$		20	●

FRACTIONS (in.)      DECIMAL SIZES (in.)

AMERICAN STEEL & WIRE CO.  
STEEL-WIRE-GAUGE NO.





20

Courtesy Nichols Wire & Aluminum Co.

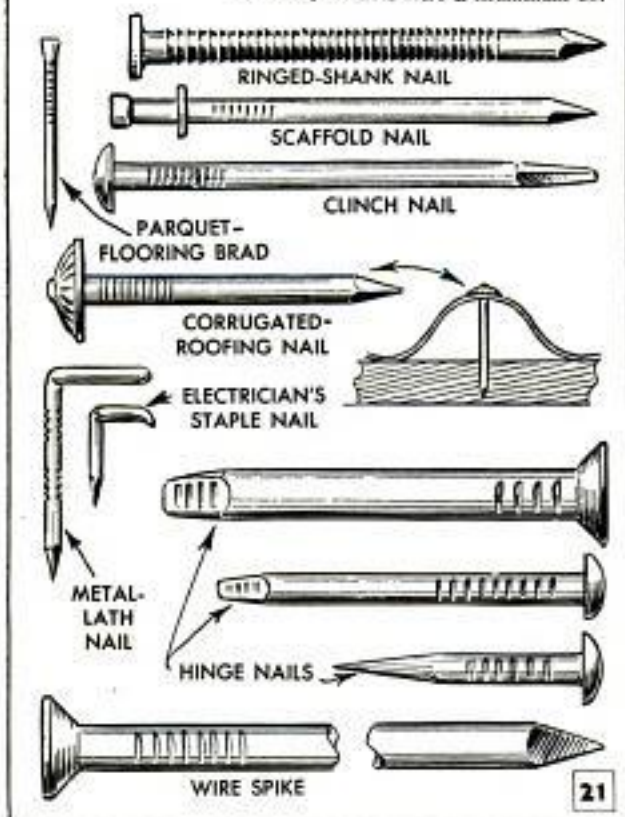

21

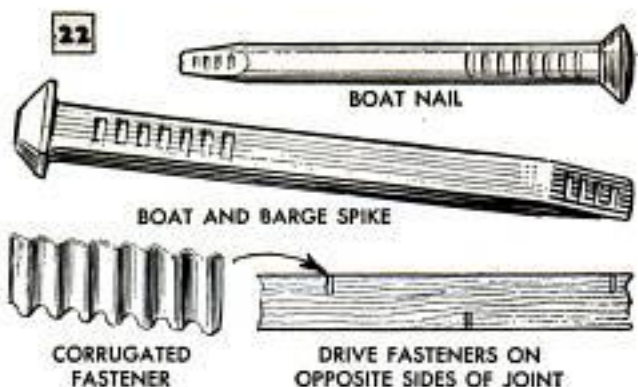

CORRUGATED FASTENER DRIVE FASTENERS ON OPPOSITE SIDES OF JOINT

use of corrugated fasteners. A somewhat stronger joint will result if the parts are drawn together with clamps before nailing with the fasteners. Corrugated fasteners come in various widths and lengths which adapt them to a wide range of use on stock of different thicknesses. When joining narrow widths of stock edge to edge it usually is best to drive the fasteners in from both sides, spacing them uniformly along the full length of the joint, as in the lower detail in Fig. 22.

Other special nails are shown in Fig. 20, 21 and 22. Aluminum nails, Fig. 20, are widely used for attaching siding as they do not corrode. The ringed-shank nail, Fig. 21, has been designed for use where unusual holding power is required. The rings on the shanks are beveled at a 45-deg. angle, on the sides facing the point, so that they spread the wood fibers without severing them. The other sides of the rings are at a 90-deg. angle to engage the fibers which tend to resume their original position. This makes it necessary to break most of the fibers in order to remove the nail. Scaffold nails have two heads, Fig. 21, and are driven in up to the lower head. In this position the upper head projects, making the nail easy to remove with a claw hammer. Such nails are used for temporary construction, scaffolding and any other type of assembly which must be built so that it can be dismantled without damage. Clinch nails, Fig. 21, have duck-bill points especially designed for easy clinching. Parquet-

TYPE & PURPOSE	PENNY SIZE (d)	NAIL SIZES															
		2	3	4	5	6	7	8	9	10	12	16	20	30	40	50	60
	LENGTH (in.)	1	1 1/4	1 1/2	1 3/4	2	2 1/4	2 1/2	2 3/4	3	3 1/4	3 1/2	4	4 1/2	5	5 1/2	6
COMMON NAILS: For most rough work like framing	GAUGE	15	14	12 1/2	12 1/2	11 1/2	11 1/2	10 1/4	10 1/4	9	9	8	6	5	4	3	2
	HEAD DIA. (in.)	11/64	13/64	1/4	1/4	17/64	17/64	9/32	9/32	5/16	5/16	11/32	13/32	7/16	15/32	1/2	17/32
	NO. PER LB.	847	543	294	254	167	150	101	92	66	61	47	29	22	17	13	10
BOX NAILS: Smooth or barbed; for boxes, crates, etc.	GAUGE		14 1/2	14	14	12 1/2	12 1/2	11 1/2		10 1/2		10	9				
	HEAD DIA. (in.)		7/32	7/32	7/32	17/64	17/64	19/64		5/16		11/32	3/8				
	NO. PER LB.		588	453	389	225	200	136		90		69	50				
CASING NAILS: For cabinet work, interior trim, etc.	GAUGE			14		12 1/2		11 1/2		10 1/2		10					
	HEAD DIA. (ga.)			11		9 1/2		8 1/2		7 1/2		7					
	NO. PER LB.			489		244		147		96		73					
FINISHING NAILS: For finer work than casing nails	GAUGE		15 1/2	15		13		12 1/2		11 1/2							
	HEAD DIA. (ga.)		12 1/2	12		10		9 1/2		8 1/2							
	NO. PER LB.		880	630		288		196		124							



**A** 

**B** 

**FLOORING BRADS**  
 (A) 10 ga., 8d, plain or barbed. Head dia. 7 ga. 105 per lb.  
 (B) 11½ ga., 8d, plain or barbed. Head dia. 8 ga. 142 per lb. Easier driving in hardwood without splitting



**WOOD-SIDING NAILS**  
 Range from 5 to 10d and from 14 to 19½ ga.



**ASPHALT-ROOFING NAILS**  
 Galv., smooth or barbed. Lengths, ½, 1, 1½, 1¾, 2 and 2½ in. Gauges, 13, 11 and 10. Head dia. from 9/32 to ½ in. Some checkered



**STANDARD SHINGLE NAILS**  
 From 1¼ to 1¾ in. in length. 14 to 12 ga. 271 to 434 per lb., depending on size. Use 1¼-in. for wood shingles laid over old shingles or roofing. Have regular or blunt diamond point



**INSULATION SHEATHING**  
 Galv. and barbed. Lengths, 1¾ and 2 in. 11 ga. 7/16-in. head. 155 and 136 per lb. Use 1¾-in. length for gypsum sheathing



**INSULATION LATH**  
 Blued, 1½ and 1¾-in. lengths, 13 ga., ¾-in. heads. 499, 294 per lb. For gypsum lath use 1¾-in. length



**BARBED ASBESTOS-SHINGLE NAILS**  
 Lengths 1¼, 1½, 1¾ and 2 in. 247, 210, 183 and 162 per lb. 13½ ga., 13/32-in. heads without fins



**HARDBOARD AND BUILDING-BOARD NAILS**  
 7 lengths from 1 to 1½ in. by ¼-in. steps. 17 ga., 3/32-in. head. Needle point. Bright galv. or cadmium plated. 885 to 1555 per lb., depending on size



**GYPSUM WALLBOARD**  
 Cement coated. Lengths, 1¾, 1¾ and 1¾ in. 14, 13½ and 13 ga. 7/32, 15/64 and ¼-in. heads. 493, 366 and 278 per lb



**RED-CEDAR SHINGLES**  
 3 or 4d for new roofs. 614 or 473 per lb. 5 or 6d for shingles over old roofs. 404 or 276 per lb. Head dia. 7/32 in. 3 or 5d for 16 or 18-in. shingles. 4 or 6d for 24-in. shingles. Gauges 14½, 14, 14 or 13 for 3, 4, 5 and 6d sizes



**SMALL WIRE BRADS:**

Length (in.)	Gauges	Length (in.)	Gauges
3/16	20-24	¾	13-22
¼	19-24	¾	13-21
½	18-24	¾	13-20
¾	14-23	1 & 1½	12-20

Larger sizes also available, including brad-head nails from 2 to 60d with same shank size as common nails



**UPHOLSTERER'S TACKS**

No.	Length (in.)	No.	Length (in.)
2	¼	10	¾
2½	5/16	12	11/16
3	¾	14	¾
4	7/16	16	13/16
6	11/16	18	¾
8	9/16	22	1

(Carpet tacks usually come Nos. 3, 4, 6, 8 and 10)

flooring brads come both plain and coated, the latter having somewhat greater holding power. Leakproof nails are used for attaching corrugated roofing. Only one of several types is shown in Fig. 21. Electrician's staple nails and metal lath nails are similar but are used for different purposes. The electrician's nail is used to hold runs of insulated wire in temporary installations. As its name implies, the metal-lath nail is used exclusively for attaching metal lath in building construction, as the nail is especially made for this one purpose. The chisel-pointed hinge nails, Fig. 21, are available in sizes ranging from 4d to 20d. The heads come countersunk and also oval shaped, as indicated in the details. Boat nails, Fig. 22, come both round and square, the square nails being available in lengths up to 15 in. Both come heavy galvanized and also in solid copper, which is

expensive but noncorrosive, a definite advantage in boat construction.

**Pulling nails:** Hammers come with curved claws and straight, or ripping, claws. The ripping hammer has straight claws and is designed for removing siding and sheathing. The straight claws can be driven behind the boards to start the nails. However, the ripping hammer is not so suitable for pulling nails as is the hammer with curved claws. When necessary to remove a number of nails, make a wedge-shaped fulcrum block to use under the hammer head, as in Fig. 19. By using the block, the nail will be lifted straight upward without bending. The handle stroke can be made from A to B without undue strain on either the handle or the head of the hammer. Move the block farther under the hammer head after each stroke to gain advantage of greater height. ★ ★ ★

## Soldering Aid Formed From Sharpened Length of Coat-Hanger Wire

The sharpened end of a length of coat-hanger wire, heated in the torch flame, will pick up a ball of solder and permit it to be placed accurately on a joint to be soldered. The wire is shaped as shown in the photograph, the end opposite the point being bent to form a foot. A loop is formed in the middle of the wire to provide a thumb rest.—Hugh Botts, New York City.

## Milk Cartons Bleach Celery

To bleach celery plants in my garden, I remove the tops and bottoms from cardboard milk cartons and slip them over the plants. This method also keeps the stalks clean.—Milton Giese, Lomira, Wis.

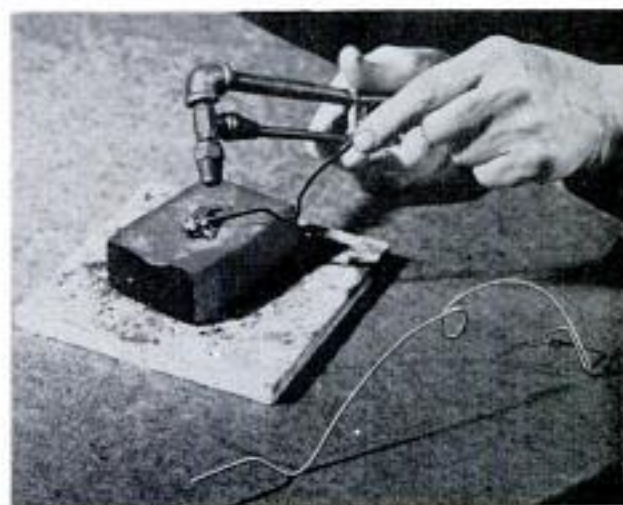



## Oil Drum Mounted on Barrel Cart Serves as Poultry Waterer

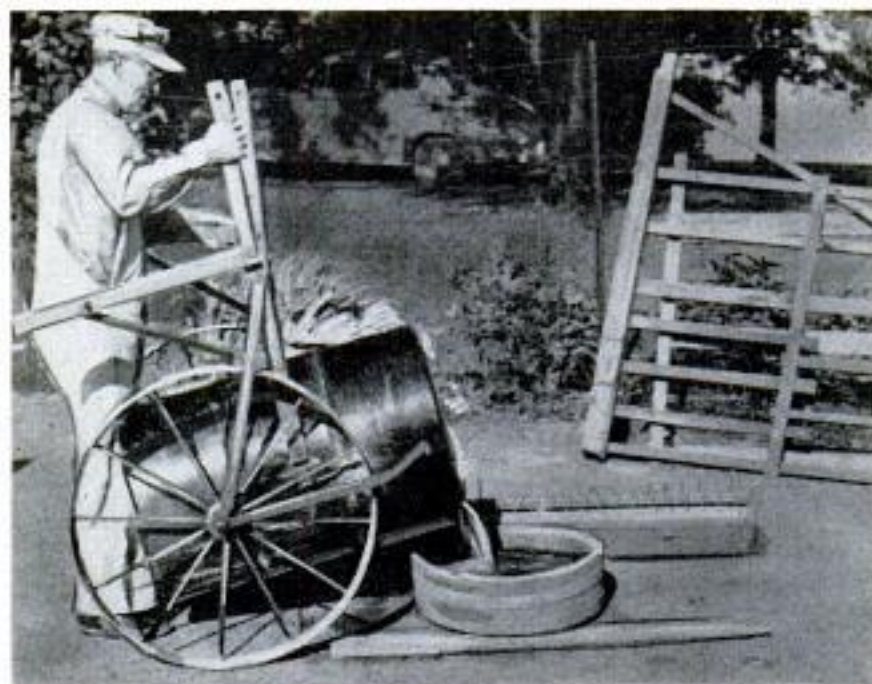

Mounted on an improvised barrel cart so it can be pushed into the poultry yard, this 50-gal. oil drum makes the job of watering a large flock of poultry much easier. Cultivator wheels, 36 in. in dia., turn on stub axles which are bolted or welded to the sides of the drum. Flat-steel braces are bolted to the outer ends of the axles and to the drum and handles as pictured. It empties with little difficulty when the handles are raised. A counterbalance in the bottom will prevent it from tipping too quickly. — A. E. Holden, Angola, Ind.

## Vacuum-Cleaner Attachment Screened When Used in Home Workshop

Using a vacuum cleaner to clean the shop is a quick and convenient method, but it usually is tough on the cleaner. A piece of  $\frac{1}{4}$ -in. wire mesh fitted over the openings of the attachments will prevent large shavings, sticks and other debris from clogging the hose. Screws, nails and other small but heavy objects also will be stopped. The wire mesh is cut larger than the opening, then bent and sprung to fit so that it can be removed easily.

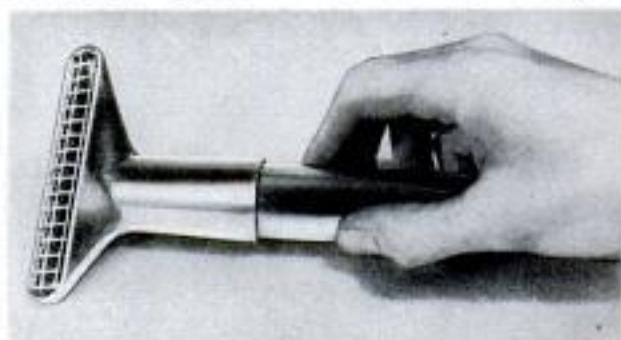

## Properly Shaped Cold Chisel Required for Efficient Cutting

To do the most efficient job of cutting, a cold chisel should be drawn out to a long taper and both sides of the cutting edge should be of the same width. An off-center edge is used only when cutting off bolt or

rivet heads. To aid in dissipating heat and shock, the cutting edge should be slightly rounded when doing heavy work. Also, it is advisable to use a mechanical aid to hold the chisel on some jobs. One method, using a pair of pliers held with a strong rubber band, is shown in the photo. Holding the chisel with the palm of the hand upwards will prevent smashed knuckles. The soft part of the hand will absorb much more punishment without physical damage. The striking surface of all cold chisels should be free of ragged and projecting bits of steel that might fly off when struck with a hammer and injure the worker. — Glen F. Stillwell, Manhattan Beach, Calif.

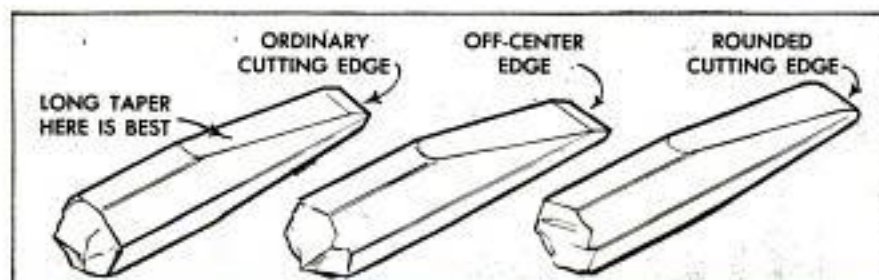



## "Pivot Gauge" Sets Lateral Alignment Between Lathe Centers

Accurate lateral alignment between lathe centers is assured by the use of a "pivot gauge" made from two 6-in. lengths of  $\frac{5}{8}$ -in.-sq. cold-rolled steel. The dimensions of the gauge are shown in the detail. The steel blocks must be clamped together and accurately drilled and reamed for the  $\frac{1}{4}$ -in. pivot pin. The holes at the lower end of the gauge are drilled with a 60-deg. center drill to receive the lathe centers. After the gauge is drilled and assembled, and before the alignment marks are scribed, use a test bar to set up the lathe centers. When the indicator gauge shows zero for the full length of the test bar, remove the bar, install the pivot gauge and scribe a mark across the top of both blocks. The gauge then can be used to set the lateral alignment

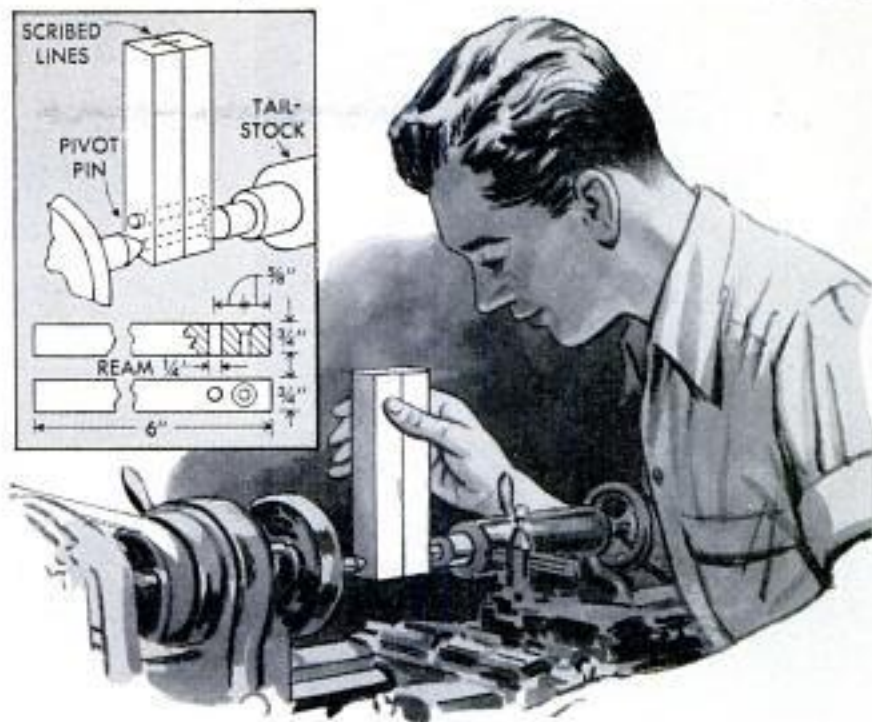
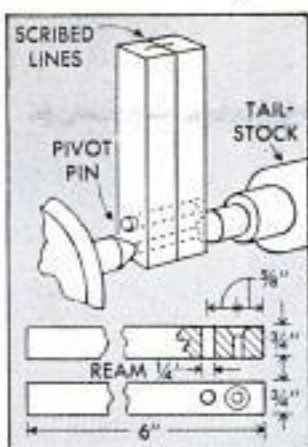

between lathe centers by moving the tailstock until the scribed lines meet exactly when the gauge blocks are held upright. C. W. Woodson, Chicago.

## Numerals on Metal Rule or Square Can Be Renewed With Paint

If the numerals and markings on a square or metal rule have become difficult to read, clean the tool with steel wool and apply a coat of bronze or black paint. Then wipe off the excess paint. This will leave paint

only in the depressed numerals and lines. Use bronze or light-colored paint on tools painted black, while black paint will be most visible on polished metals.

Clinton R. Hull, Costa Mesa, Calif.

## Drip-Type Oiler Adapted to Lubricated Drill-Press Work

A drip-type oiler can be adapted to provide a steady flow of lubricant to light work on a drill press or lathe. The oiler is screwed into a pipe flange, which provides a means of clamping it to a bracket bolted to the machine. A short pipe nipple is screwed or brazed to the lower end of the flange and fitted to receive a length of copper tubing. The tubing then is shaped to feed oil to the drill or work. A pipe cleaner in the end of the tubing prevents an excessive flow of oil, and can be held directly against the turning work in a lathe or drill bit in a drill press. — Hi Sibley, Nuevo, Calif.

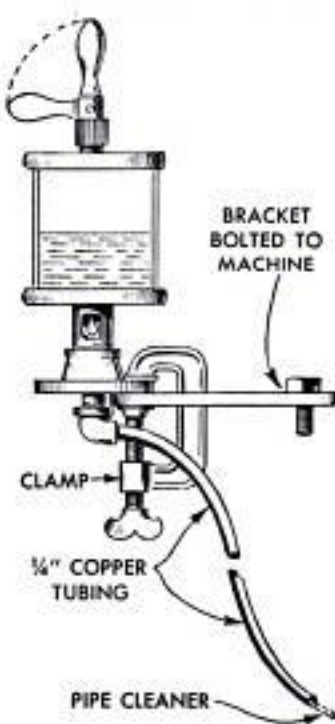



# SHOPPING FOR TOOLS



**1. FLAT-LAPPING MACHINE** is designed for precision finishing of parts having flat surfaces. The lapping plate is 24 in. in dia. and is spirally grooved to carry the abrasive. Nearly all flat-lapping operations on small parts can be carried out with the work hand-held as pictured without the use of special holders or collets. Machine requires space only 25 x 25 in.



**2. MODELMAKER'S HAND PLANE** utilizes an ordinary double-edged safety razor blade. Lifts paper-thin shavings when used on either hard or softwood. Just the thing for shaping model parts of balsa or other extremely soft woods which require very sharp cutting tools for accurate work. Plane also is useful for fitting cabinet doors, drawers and moldings



**3. PRESSURE-GRIP WRENCH**, or ply wrench, has a pivoted jaw that automatically adjusts from  $\frac{1}{8}$  to  $1\frac{1}{2}$  in. Suitable for use on pipe, tubing, solid rounds, hex shapes and conventional nuts. User simply drops the wrench over the part to be held or turned and the jaws adjust as pressure is applied to the wrench handle. Special design of the jaw teeth minimizes slippage

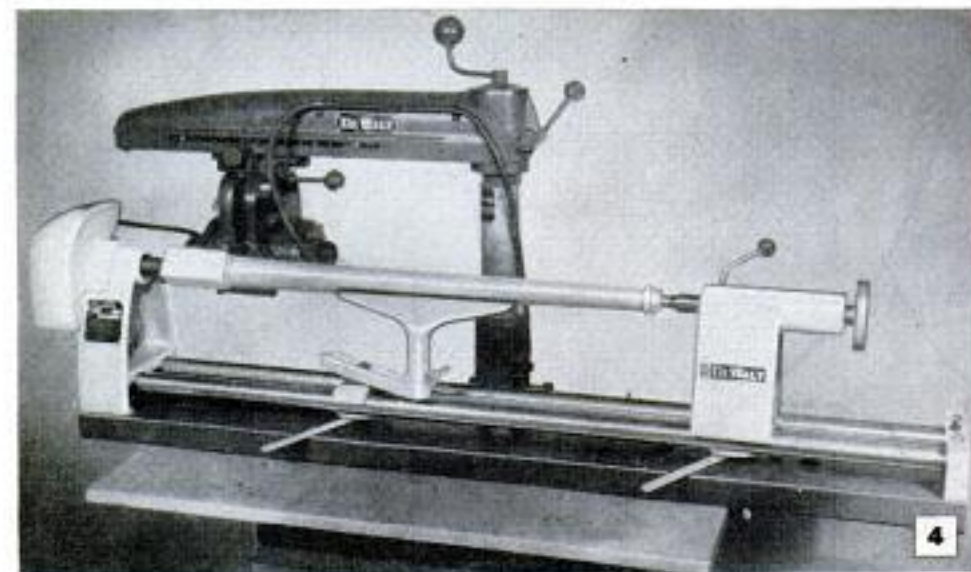

**4. WOOD-LATHE ATTACHMENT** for radial saw has a 12-in. swing and takes stock up to 37 in. in length between centers. Unit mounts on the radial-saw table and is driven by saw motor as pictured. Can also be set up and driven as an independent machine by any separate motor when desired. Comes complete with accessories for faceplate turning and metal spinning



**5. NEW SIDE-CUTTING PLIERS** come fitted with a special throat piece which grips cut end of wire and prevents it from dropping onto "live" electrical assemblies and causing a short circuit. Also prevents short pieces of wire from flying sidewise and causing possible eye injury to others working near by. Holder is available on both diagonal and straight pliers



**6. GRINDING ATTACHMENT** traverses automatically right and left and also feeds automatically into wheel at an adjustable rate. This permits grinding bevels on edge tools at any desired angle without danger of overheating and drawing temper. Tool carriage is designed to prevent any tendency to chattering as tool traverses face of wheel. Traverse is full 3 in.

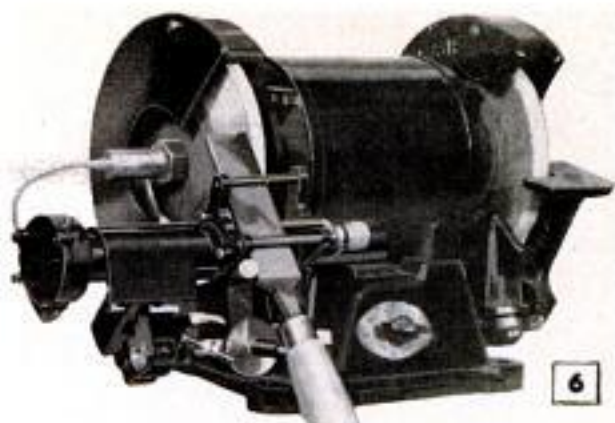

**7. WORK GUIDE** clamps to the column of a small drill press and is used to hold or position work without the use of C-clamps or other types of hold-downs. Consists of the clamping device and a machined right-angle piece which is adjustable in or out and also laterally across the machine table. Available with an extension piece as pictured in the right-hand view

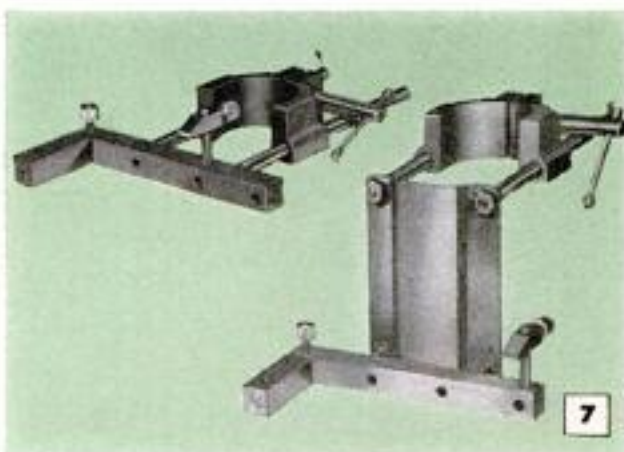

**8. HAND HONE** for touching up cutting edges of carbide tools extends between-grinds tool life as much as 30 percent. Single-point carbide tools are honed without removing from the machine. With care, tools can be hand-honed several times before relief angles are changed sufficiently to make regrinding necessary. Available in several sizes and also in different grades



**9. LEVELING ATTACHMENT** for portable electric drills enables the operator to drill accurate holes at any angle. Consists of a circular bubble level mounted on a bracket having graduations from 0 to 90 deg. Bracket is attached to body of portable drill and locked at the angle desired. Operator starts drill and holds it so that bubble remains in center of viewer

**10. DOUBLE TORCH** has been especially designed for sweating joints in copper tubing, copper piping and copper soil stacks. Torch consists of two "jaws" which encircle the joint when closed by hand pressure. Each jaw is fitted with three flame jets. When both are closed by hand pressure the six jets heat the joint uniformly. Two sizes take tubing from 3/8 to 4 in.







11

**11. SANDER-POLISHER** duplicates natural hand motion in either sanding or polishing operations. Leaves no swirl marks on the work due to counterbalancing action of two floating heads when polishing or sanding. This eliminates "throwing," a common problem when finishing surfaces with high-speed rotary polishers having only a single disk. Eliminates handwork

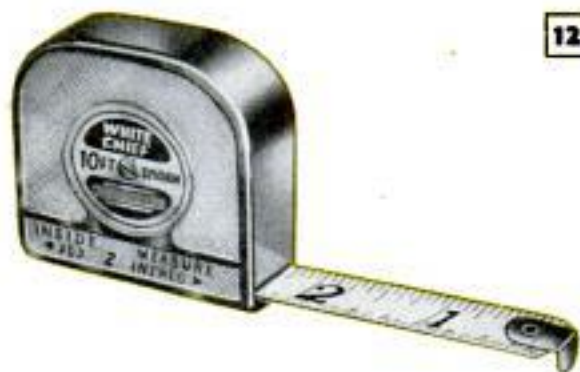

12

**12. RIGHT-HAND RULE** is designed for convenience when measuring from right to left and laying off dimensions with pencil or scribe held in right hand. In this position the figures and graduations are right side up on the white blade. Chrome-plated case is precisely 2 in. wide. This distance is added to all in-between measurements. Steel blade is full 10 ft. long



13

**13. RADIANT KEYHOLE SLEEVE** glows in the dark, making it easy to insert key in the lock in total darkness. Can be attached to practically all types of cylinder locks, including auto-door locks, residential and office locks of the common types. One-piece insert in the right-hand view is shown in place on the lock cylinder in the left-hand view with key in position

**14. SPECIAL HOUSEHOLD GLUE** in a plastic applicator is now available. Adhesive joins porcelain, wood, fabric, plastic or thin metals. To use, the extended tip of the plastic capsule is snipped off and the container becomes an applicator. Any glue remaining in the applicator quickly sets and seals the small opening in the tip. Glue remains fresh indefinitely

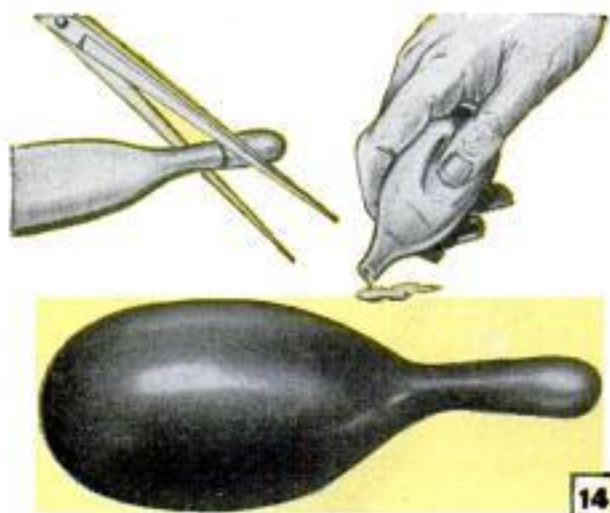

14

**15. IMPROVED DOVETAIL JIG** for use with electric router produces perfectly matched dovetail joints in drawers and cabinet parts. Cuts the pins and sockets on both parts simultaneously. Takes stock up to 12 in. wide and 5/16 to 1 in. thick. Router is guided by a finger template which is available in two sizes for making dovetails 1/4 or 1/2 in. wide



15



# Make the picture perfect with a "Travelized" Ford!



There's nothing like a sweet-running Ford to make those carefree summer trips *perfect*.

The best way to make certain your Ford's in "trip-top" shape is to have it checked and "Travelized" *now*—before you go away. If replacement parts are needed, insist on the parts that are made *right* for your Ford—Genuine Ford Parts. They're made to the same specifications set by the men who originally built your Ford. And they're made to work right to last longer in your Ford!

**Wherever you go for service  
insist on  
Genuine Ford Parts**



SURE SIGNS OF SAVINGS







Normal photograph

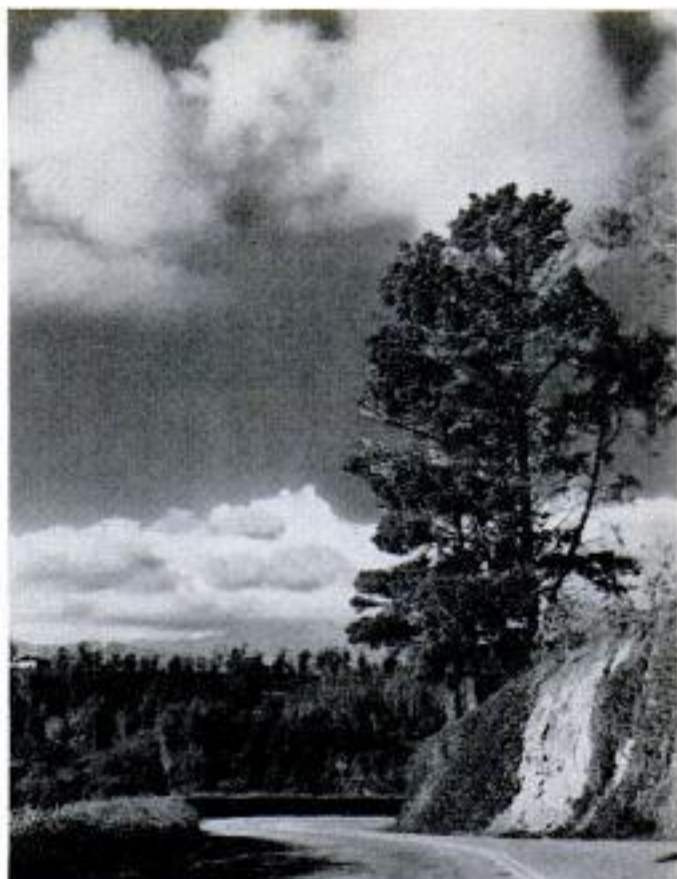

Taken with red (A) filter

## How Kodak Wratten Filters give your snapshots true-to-life sparkle

**Designed to assure "high-fidelity" results,  
they are the world's standard for photographers,  
engineers, and scientists**

**T**HE HIGH FIDELITY you read about in musical reproduction is arrived at by electronic filters. In somewhat the same way, photographic filters assure true-to-life realism and sparkle in your snapshots.

They act upon the colors of a scene in such a way that, in a black-and-white snapshot, these colors assume the relative brightnesses seen by the human eye. In this way, white clouds are made to stand out in fleecy grandeur. Green foliage becomes sharply real and well defined. Close-ups of

human subjects are thrillingly lifelike.

This "high fidelity" given to your snapshots by Kodak Wratten Filters is one of the most enjoyable discoveries you can make in photography.

For nearly half a century Kodak Wratten Filters have been the world's standard of accuracy and precision not only in photography but in many other areas of science and engineering. Such universal acceptance is due to the way these filters are made. (See picture story on next page.)



# How Kodak Wratten Filters are made



**Highest quality dyes.** Kodak uses hundreds of different filter dyes, specially selected for purity and brightness, and carefully blended for precise color quality required for each filter.



**Meticulously filtered.** After the dyes are blended according to strict formula, they are filtered and refiltered to obtain the optical quality specified by the Kodak Research Laboratories.



**Dyes are color-matched.** Each dye solution must match a color standard. A special instrument—a spectrophotometer of unusual design—controls the color of the filters.



**Gelatin is "clarified."** In this machine specially selected, color-free gelatin is given high clarity by centrifuging it under vacuum to remove possible foreign particles.



**Dyes mixed with gelatin.** The carefully standardized dye solutions are accurately metered into the liquid gelatin. The resulting crystal-clear mixture is again filtered.



**Coating on glass.** The dyed gelatin solution is uniformly coated on ground and polished glass sheets and then dried. Here coated sheets are being removed from the dryer.



**Conditioned for two weeks.** The dried gelatin coating is removed from the glass and conditioned for two weeks in special racks. It is then inspected for color and physical quality.



**Glass cut, polished like fine lens.** For protection and ease in handling, Wratten Filters are mounted between ground and polished glass. Unmounted filters for laboratory use are lacquered.



**Cemented for permanence.** A continuous layer of cement permanently bonds filter, glass and metal protecting ring into a single unit—like your camera lens.

Prices of Kodak Wratten Filters start as low as 50 cents unmounted, \$1.75 mounted. Consult your dealer for details. Ask for informative filter booklet.

**Eastman Kodak Company**  
Rochester 4, N. Y.

**Kodak**  
TRADE-MARK



# Care and Feeding of Engines



BY  
S. P. CORP

## WINDSHIELD WATER LEAKS

If heavy rain leaks in around your windshield, it means that the edges of the windshield need to be resealed in the following manner:

### WINDSHIELD SEALING

Remove center division bar by taking screws out from inside. If leaks occur at center of instrument panel, center bar may not have been tightened correctly. Loosen, but do not remove, garnish molding around inside of windshield. Remove windshield wiper arms and stainless steel molding from the outside of the windshield, using care in working it away from glass.

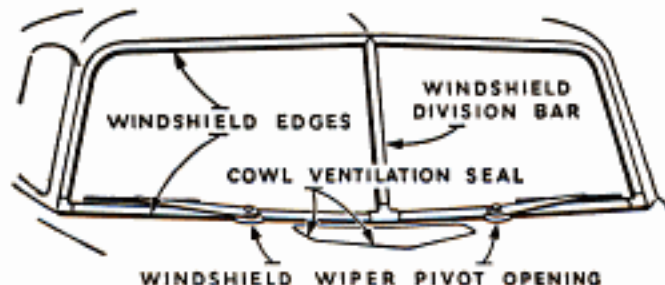

Now seal weatherstrip against the body opening by lifting the rubber and applying a good grade of windshield sealer. Use a nozzle-type applicator so as to force the sealing compound up and around the body edge where the rubber fits up over the edge. It is not required to seal between glass and rubber unless glass has been replaced. In such a case, remove inside garnish molding and apply sealer between glass and weatherstrip. Seal the windshield all along the bottom and for a short distance up the sides. Wipe off excess sealer and replace moldings, drawing them up so the rubber is slightly compressed. Use a cleaning fluid to remove excess sealing compound.

### FREE HELP ON CAR CARE

When it's time to re-ring your engine, be sure to use a Sealed Power KromeX Ring Set, with solid chrome faces on top compression ring and rails of steel oil ring. These rings are factory seated for fast break-in and immediate oil control, and their chrome faces fight heat, friction, abrasion and corrosion—the enemies of ring life. For your free copy of the illustrated manual, "MORE POWER, Less Gas, Less Oil," simply address a postal card to Dept. G-7, Sealed Power, Muskegon, Michigan.



# Sealed Power

## PISTON RINGS

# Clinic for Homemakers



As a service to our readers in solving the hundreds of problems pertaining to a home—inside or out—the editors of *Popular Mechanics* invite you to present your problems to The Clinic Editor for help and advice. Address your questions to The Clinic Editor, *Popular Mechanics Magazine*, 200 East Ontario Street, Chicago 11, Ill.

### Flat Roof or Gable?



Q—*I'm ready to build a new home but can't decide on whether to select a style having a flat roof or a conventional low-pitch gable roof. I like the flat-roof homes but am told these are not practical, that is, from the standpoint of durability. What are some of the advantages of both types? Will flat-roofed homes become "dated"?* — B.W., Pa.

A—We'd suggest that you consider the compromise between the two, the so-called shed roof. Many homes both large and small are now being built with variations of this type of roof. We see no reason why this type of home could not be made as attractive and practical as those of more conventional styling. All existing homes are dated whenever there are marked changes in architectural design. This should not be a reason for sacrificing the type you like for something less desirable. Properly designed and built there is no reason why a flat-roofed home should not give good service. In some localities a flat roof will accumulate heavy loads of snow and ice under certain weather conditions during the winter months. This can cause damage to a flat roof improperly constructed, of course. On an average, the flat-roofed home is somewhat cheaper to build because of less labor involved. However, at least a part of this saving will be offset by increased cost of the necessary materials. In more conventional homes of the ranch type with low-pitched roofs the roofing materials are subjected to somewhat less "wear."

### Paint Defects

Q—*What causes checking, blistering and wrinkling of paint when applied to wooden siding?* — A.J., Minn.

A—Checking generally means short, narrow breaks in the paint film. As a rule both checks and cracks (longer and larger cracks) are the result of shrinking and hardening of the paint film so that it no longer has sufficient elasticity to resist atmospheric changes. Moisture penetrating the walls from the room side is a common cause of blistering paint. Moisture in the form of vapor will penetrate all common building materials except barriers, and eventually will collect under the paint film. Moisture in the form of excess humidity may have as its source steam from the preparation of food in the kitchen, laundering and shower bathing. In new homes slow drying of plaster is a cause of paint blistering on exterior walls. A common cause of wrinkling is the application of a

(Continued to page 210)



No wonder it's called  
"Miracle Vinyl-Flooring"!



# MATICO ARISTOFLEX

RESISTS GREASE, ACID, ALKALI AND GRIME!

You'll call it "miracle flooring," too, when you see for yourself how rugged, durable MATICO Aristoflex shrugs off household acid, alkali and grease... stays new and sparkling looking with easy damp moppings. Biggest miracle of all is the price! Produced especially to meet the needs of homeowners everywhere, MATICO

Aristoflex is low in cost... gives you more for your money. And you can install economical Aristoflex in every room in your home... from basement to attic. See Aristoflex in 12 rich, clear colors at your MATICO dealer soon. You'll find him listed in your classified telephone directory.



## MASTIC TILE CORPORATION OF AMERICA

Joliet, Ill. • Long Beach, Calif. • Newburgh, N. Y.

Manufacturers of:

Aristoflex • Confetti • Parquetry • Asphalt Tile • Cork Tile • Plastic Wall Tile

### INSTALL IT YOURSELF AND SAVE!

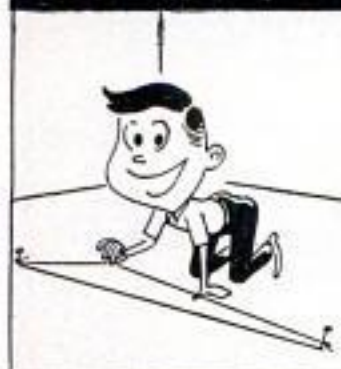

It's easy! Just mark a straight line through the center of your room in both directions, using a chalk and line. Be careful not to cover up your guide lines.



With a notched trowel, spread adhesive over one-half of your room at a time. Leave only a thin coat of adhesive on the floor.



After adhesive becomes tacky, snap the tiles into place. Do not slide tiles or adhesive will push up between the tiles.



Here's the best part! Show your wife your handiwork. (Don't tell her what a cinch it is with MATICO's easy-to-follow instructions).



## DO-IT-YOURSELF PROJECT WITH TRIPLE PAY-OFF

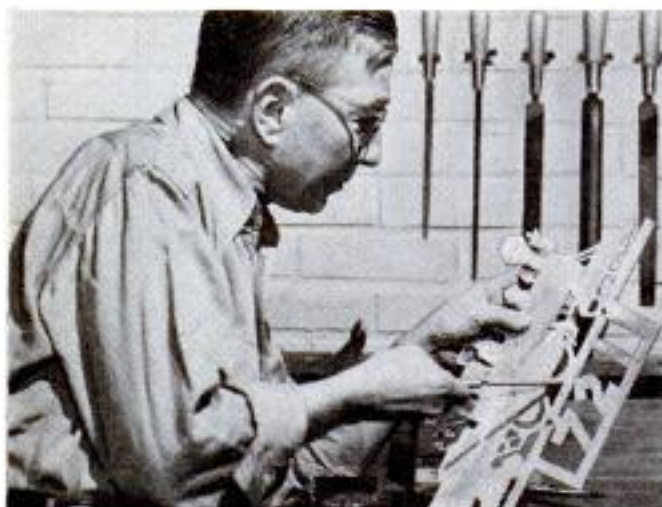

In making his own house sign (for example), this man is (1) saving money, (2) adding to the value of his home, and (3) having a lot of fun doing it.

What's more, his pride of achievement is heightened by his possession and use of good files. They're NICHOLSON. This and BLACK DIAMOND are the most famous two brands in the world.

He knows their teeth are sharp, evenly high, of uniform hardness, and have extra-long life. They're the choice of both the professional and the exacting amateur craftsman. They've the quality good hardware and tool-supply dealers like to recommend.

**FREE—"File Philosophy,"** Nicholson's famous 48-page illustrated book on kinds, use and care of files. Shows and describes many types of files for use on all sorts of projects comprising hard or soft metals, wood, plastics, etc. Send for it.

### NICHOLSON FILE COMPANY

22 Acorn Street, Providence 1, R. I.

(In Canada: Nicholson File Company of Canada Ltd., Port Hope, Ontario)

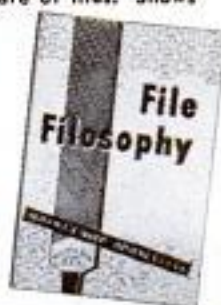

# NICHOLSON FILES FOR EVERY PURPOSE

(Continued from page 208)

heavy finish coat over undercoats which are not thoroughly dry. It should be understood that only the more common causes of paint defects are given above. There are, of course, other causes. In some cases application of a heavy primer to dry, soft woods causes absorption of the oils in the paint before these have a chance to set properly. This can cause peeling.

### Moisture Condensation

**Q**—Can you explain how and why moisture condenses in the walls of buildings and also how it came to be a serious problem in ordinary house construction?—C.E., Ind.

**A**—Space does not permit an extended discussion of this problem, but perhaps a basic cause of wall condensation can be outlined briefly. Because of what is known as vapor pressure, air containing moisture escapes through the walls and ceilings of the house when the outside temperature is lower than that inside the building. At the same time, heat loss through an uninsulated wall tends to prevent a lowering of the temperature within the wall to the condensation point. For this reason, such walls remain comparatively dry. Some years ago, when house walls were insulated with sawdust and other fine materials, the insulating properties of these materials greatly retarded, but did not entirely prevent, the passage of heated, moisture-laden air through the walls and ceilings. This slowing up of the process of air and heat transfer usually resulted in a gradual lowering of the temperature within the walls to a point where the water vapor in the air condensed, generally on the inner surface of the sheathing boards. At this point, the beads of moisture formed frost if the temperature was sufficiently low, or penetrated the sheathing and siding to the paint film if the temperature at the inner surface of the boards was above the point where frost would be formed or condensation take place. This penetration of moisture through the boards from the back is a cause of peeling paint, rotted framing and a general condition of dampness throughout the whole structure. Manufacturers of insulating materials in various forms have developed vapor barriers which are installed along with the insulation in the form of moisture-resistant covers, or "envelopes," for the insulating material itself, and also in separate sheet forms which are tacked over the studding under the plaster. These barriers are fully effective only if they are installed in accordance with the manufacturer's instructions.

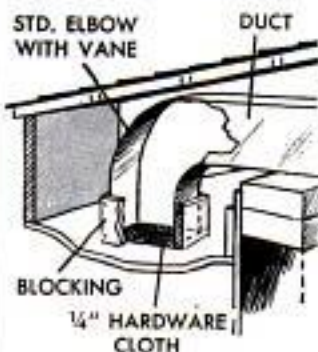

### Kitchen Fan Vent

**Q**—I want to install a kitchen ventilating fan in my new home which has wide overhanging cornices. I have planned to carry the exhaust duct from the fan into the attic space, but how to vent the fan from there is my problem. Should the fan be vented through the wall or is there some way to vent it through the attic?—A. T., Tenn.

**A**—It should be comparatively simple to run the vent into the attic and across the floor to the plate and out through a down-turned elbow as detailed in the accompanying sketch. Usually there is sufficient room between the top of the plate and the underside of the roof boards for a small duct placed either edgewise or flat. You may have to have a special elbow made by a local tinsmith to fit the space available. Cut an opening the exact size of the elbow opening in the bottom of the cornice, or soffit, add blocking to hold the end of the elbow in place. Then cover the opening with fine-mesh screen to keep out birds and insects. In some locations and under certain weather conditions this type of installation may permit cold air to filter back through the vent into the kitchen. Because of this possibility it's a good idea to install a turn damper or shut-off vane in the duct in such a way that it can be operated from some convenient location by means of pull chains or a lever.



# MAKE YOUR OWN PORCH and PLAY-YARD EQUIPMENT

for Outdoor Living this Summer!

*It's Easy and Simple to do with Amazing*

## REYNOLDS *DO-IT-YOURSELF*\* ALUMINUM



**SAND BOX** with Reflective Sun Shade provides happy hours for youngsters, protects them from hot sun. Shade adjusts to any height, lowers to serve as cover. Rust-proof, so easy to clean. Plan #112, 25c with coupon.



**FOLDING TABLE.** Ideal for cards, informal eating, serving, base for portable grills . . . indoors or outdoors. It's all aluminum . . . stays bright and new-looking, won't ever rust. Reynolds Plan #110, 25c with coupon.



**HANDSOME PICNIC HAMPER** is a picnic to make with Reynolds *Do-It-Yourself* Aluminum. Sturdy, lightweight, plenty of room for food and picnic equipment. Reynolds Plan #111, 25c with coupon.

It's no trick at all to make things with amazing Reynolds *Do-It-Yourself* Aluminum. All you do is follow any of our simple plans (see coupon below) . . . and make things that would do credit to a professional craftsman.

**Easier to Work than Wood . . .** this fabulous material is specially engineered for use with *standard* woodworking hand or power tools. You can saw it, drill it, plane it, joint it, just like you do wood. And think of the other advantages: Reynolds *Do-It-Yourself* Aluminum is bright and beautiful, it's strong and sturdy, and it will never rust . . . perfect for outdoor use as well as indoors. Mail the coupon for the simple Reynolds Plans today.

**CAUTION:** Use only Reynolds *Do-It-Yourself* Aluminum . . . ordinary aluminum may harm tools. Look for special Seal (shown on coupon) attached to each piece.



**SMART PORTABLE SERVING CART . . .** a marvelous convenience indoors and outdoors. Light, functional and rustproof, it's a simple job with this fabulous Aluminum. Reynolds Plan #114, 25c with coupon.

\*T. M. Reynolds Metals Company

SEND FOR THESE EASY PLANS TODAY!



**REYNOLDS SALES COMPANY**  
2494 South Third Street, Louisville, Kentucky

Please send me Reynolds *Do-It-Yourself* Aluminum Plans as checked below. I enclose 25c in cash or money order for each Plan ordered.

- Reynolds Plan #112 for SAND BOX . . . 25c  
 Reynolds Plan #110 for FOLDING TABLE . . . 25c  
 Reynolds Plan #111 for PICNIC HAMPER . . . 25c  
 Reynolds Plan #114 for SERVING CART . . . 25c  
 How-to Booklet containing general instructions and suggested projects . . . . . **FREE**

Name .....

Address .....

City..... Zone..... State.....

Reynolds *Do-It-Yourself* Aluminum is available in Canada





**Your Lumber and  
Building Material  
Dealer**



**One best  
one stop  
source.....**

## **FOR ALL HOME-OWNER AND HOBBY-CRAFT NEEDS**

Buy your "do-it-yourself" requirements where the professional builder buys—at your neighborhood Lumber & Building Material dealer's.

You'll find him a one-stop source for the best in power and hand tools... cabinets, plywood, paints, hardware, wallboard and floor coverings... all kinds of lumber and building materials—all of professional quality...and in price ranges to fit your budget.

There are more than 20,000 Lumber & Building Material dealers from Coast to Coast—in big city and small town, stocked and equipped to serve and advise you as capably as they serve the nation's professional builders.

Buy your "do-it-yourself" hand hobby-craft requirements from your neighborhood Lumber & Building Material dealer—and save.



*This advertisement is sponsored by the publishers of BUILDING SUPPLY NEWS and PRACTICAL BUILDER as a service to the public.*

## **Every Man a Forest-Fire Fighter**

*(Continued from page 103)*

Heavier equipment is kept in strategically placed fire headquarters of the forest protective associations and state forestry departments. The proven mainstays are large pumper trucks and bulldozers for building fire lines. Some of the privately owned pumpers are the envy of a city fire department and fairly similar. One of the most popular is a model built in California on a Ford F-8 truck chassis. It carries 1000 gallons of water and a high-pressure fog-spray pumping system that will handle two high-pressure hoses or three low-pressure forestry lines. These pumpers will draw from their own tanks or from a water hole, as do the lighter patrol trucks. Also used on some tree farms are huge tank trailers, carrying up to 8000 gallons and pump equipment. They are drawn by bulldozers.

Other fire protection goes on the year 'round. Water holes and storage ponds in mountain streams are developed alongside the fire roads for the pumpers. Slash is an all-season fight—getting rid of the tinder-like treetops and other debris of logging.

Civic groups have been doing their part in this enlarged battle against fire. The Keep America Green program, sponsored by the forest industries, has done a grand job. You will probably see Keep Washington Green or Keep Virginia Green signs along the highways, as the program is organized by states. Youth groups, too, have been active. In Oregon, 25,000 boys and girls are organized in the Green Guard; they learn how to report fires, how to prevent them and what to do at a fire. Indiana has its young Forest Fire Fighters, Minnesota its Forest Rangers Clubs and many other states have similar youth organizations that do effective fire-prevention work.

Because all these civilians are working hard, the forest fires of our nation have been reduced to the point today where they destroy only one-third as much standing timber as do insects. But it is still a real fight because fire still destroys the greatest number of trees. It burns tomorrow's crop—the young trees, the seedlings and the cones on the ground. The expanded army still needs your help this coming season. Careless smokers, people who toss away lighted cigarettes, are starting about a fourth of the forest fires today. Fire bugs, those few who deliberately start forest fires, cause as many more. Thoughtless campers who fail to make sure their campfires are out and summer lightning storms are other principal causes. You can't help the lightning but don't be one of the other three. ★ ★ ★



# For greater driving safety, one control now operates MoPar windshield washers and wipers



**MOPAR ISN'T JUST THE NAME OF A WINDSHIELD WASHER.** It identifies thousands of parts and accessories especially designed for your Plymouth, Dodge, De Soto, or Chrysler car or Dodge truck. Drive in where you see the MoPar sign for the finest in parts and accessories.

**PARTS DIVISION • CHRYSLER CORPORATION  
DETROIT 31, MICHIGAN**

JULY 1954



**YOU CAN KEEP YOUR HANDS ON THE WHEEL . . .** forget about fumbling for a wiper knob when you want a clean windshield. Just touch your toe on the foot button of the new MoPar "Jiffy Jet" windshield washer. Twin nozzles start to spray . . . wipers start to clean . . . *simultaneously, automatically.* Wipers will keep cleaning after spray stops until you release foot button.



**STRONG SPRAY EVEN ON HILLS** or when passing. That's because "Jiffy Jet" does not depend on engine vacuum like most windshield washers . . . won't dribble or stop when you accelerate. Spray pressure at the nozzles is *3 times* stronger than with most washers, too . . . blows out dirt that might clog nozzle openings otherwise.



**GET THE NEW "JIFFY JET"** from your nearest Plymouth, Dodge, De Soto, Chrysler dealer or wherever you see the MoPar sign. And look for the MoPar label whenever you want the *official* Chrysler Corporation parts and accessories. They are all factory engineered and inspected to *fit right, work right, last longer.*

213

Copyrighted material



Your engine's life depends on a film of oil thinner than a cigarette paper!

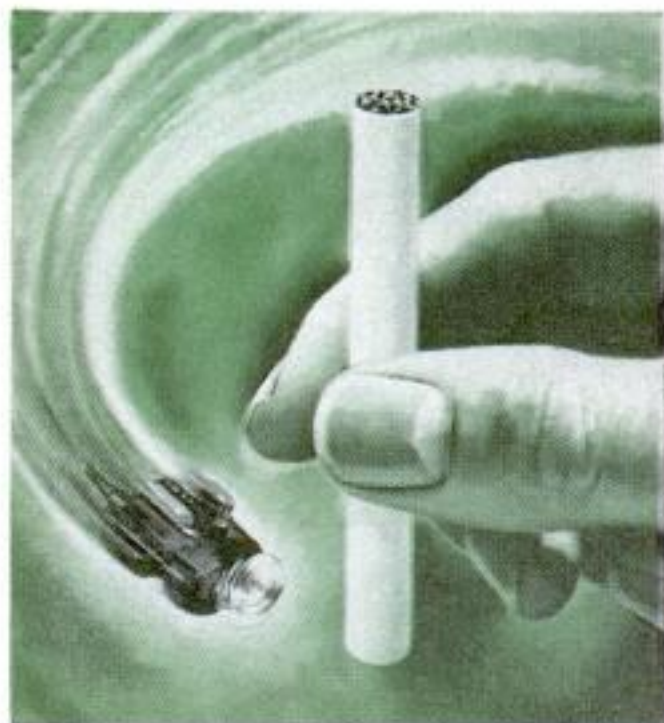

Press a cigarette paper between your fingers. It's thicker than the film of oil that guards your car, as it flows between high-speed moving parts.

Use high-quality Quaker State for the super film that gives longer-lasting lubrication.

**IT'S A SUPER FILM!** Good name for the fine film of oil that protects your car's engine from wear—the film you get from Quaker State Motor Oil. Heat-resistant, pure, free-flowing, this superb motor oil is refined from 100% Pure Pennsylvania Grade Crude Oil—nature's best. It is designed and tested for today's high-compression engines, the result of 50 years of continuous improvement. So rich, so stable, every quart lasts longer—goes farther.

ASK FOR...



Quaker State Motor Oil is made to suit the requirements of all makes of cars and for every type of service. Ask your dealer.

QUAKER STATE OIL REFINING CORPORATION, OIL CITY, PA.  
Member Pennsylvania Grade Crude Oil Association

## Owners Report on the 1954 Ford

(Continued from page 110)

into it and average is about 14 miles per gallon."—Muscatine, Iowa, county worker.

"Most outstanding feature is the ball-joint suspension, particularly on rough roads I travel."—Miles City, Mont., game warden.

"My only complaint is a slight bumping noise in the front-end suspension."—Cross, S. C., housewife.

"Car pulled to the right bad, but they realigned the front end. Now OK. Had one bad tire which was out of round and a wheel had a high place which was ground down. These caused car to bump."—Chattanooga, Tenn., steamfitter.

"Don't like ball-joint suspension. Not built strong enough. I hit a six-inch hole and the repairs cost me \$74."—Hot Springs, S. D., cook.

"Ball-joint suspension and new engine make it a fine road car. You've got power plus control."—Thompson, N. D., rancher.

### Some Owners Complain of Engine Noise

High on the complaint list was engine noise due principally to the overhead valves.

"Tappets noisy even after 1000-mile adjustment. Not adequate insulation between engine compartment and driver. Rear end hums between 55 and 65."—Dearborn, Mich., automotive designer.

(Continued to page 216)

One owner says Ford's chrome strip (right) should be lower to protect paint in situations like this

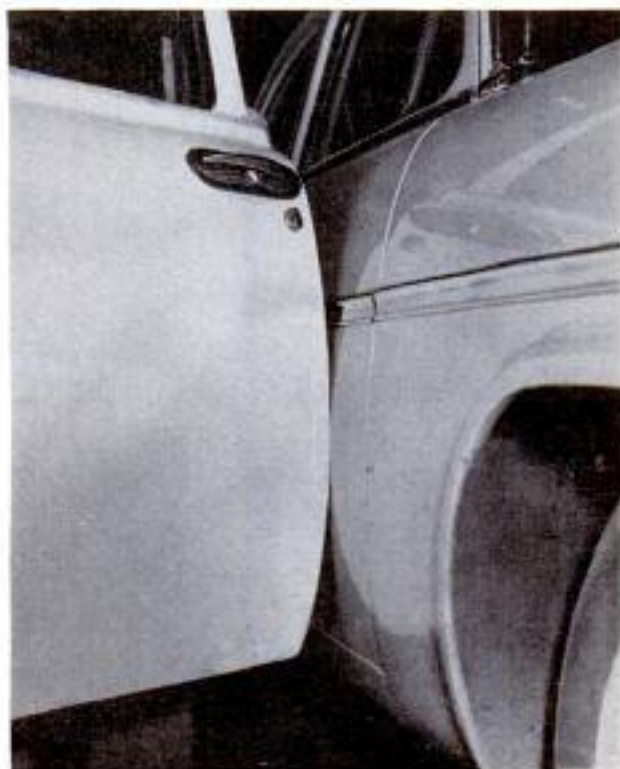





Hack Saws                      Back Saws  
 Mitre Saws                  Coping Saws  
 Compass Saws              Keyhole Saws  
 Pruning Saws                Nests of Saws  
 Mechanic-Kut Circular Saws

# No More Wrist Strain!

- All Atkins handsaws (and only Atkins) have the famous *Perfection Handle*—a basic design change to permit faster, easier cutting with no wrist strain!

Atkins *Perfection Handle* applies cutting pressure on a straight line from the elbow, through the wrist, to the middle of the cutting edge. There's no wrist action... less fatigue... the cut runs perfectly true!

WHEN YOU BUY A SAW, BUY A GOOD ONE—ATKINS!

# ATKINS

ATKINS SAW DIVISION

Borg-Warner Corporation • Indianapolis 9, Indiana



The Modern PLASTIC for lasting Home Repairs

PERMANENTLY mends cracks or holes in wood, tile, stone or plaster. Sticks and stays put—Does not chip, shrink or fall out. Easy to use. Economical. Mold it, chisel it, polish or paint it. If unobtainable from your lumber, paint or hardware dealer, the big 4-lb. can will be sent you post-paid (in U.S.) for only \$1.25. Full money-back guarantee, order now.

DONALD DURHAM CO.

Box 804-T Des Moines, Iowa

SAY YOU SAW IT IN POPULAR MECHANICS



QUALITY UNSURPASSED—  
 PERFORMANCE UNEQUALLED

Yet Cost No More Than  
 Ordinary Screwdrivers!

## HOLD-E-ZEE

The Original AUTOMATIC GRIP  
 SCREWDRIVERS

*Much Wanted  
 Special Features*

UPSON BROS., INC., ROCHESTER 14, N.Y.

EXCLUSIVE  
**LOK-BLOK**<sup>®</sup>

Makes Blade  
 Twist & Impact  
 Proof

AT ALL  
 LEADING  
 DEALERS

# DAMP BASEMENT?



Just plug in  
 the amazing

## FRIGIDAIRE ELECTRIC DEHUMIDIFIER

Only 18¼" high—20½" long—11¼" wide

Positively controls moisture in linen closets, basements, storerooms, workshops, or any closed area up to 10,000 cu. ft. where moisture is a problem. Fan draws air through refrigerated coil. Moisture is condensed and collected in container. May be connected to drain. Dry, filtered air flows into room.

See your Frigidaire Dealer for further details. Or write for free folder to Frigidaire, Dept. 2247, Dayton 1, Ohio. In Canada, Toronto 13, Ontario.



Built and backed by General Motors





# Now-an easy way to wash your car!

*JUST SPONGE IT ON -  
RINSE IT OFF!*

## FAST-ACTING, ECONOMICAL DU PONT CAR WASH

NEW DU PONT CAR WASH cleans faster and easier than you ever thought possible. Just sponge it on . . . rinse it off . . . and your car *dries itself*. No wiping or chamois work! Du Pont Car Wash gets off all the grease and grime . . . leaves your car spotless.



One tablespoonful washes your car. Half-pound can gives 20 washes!

**DU PONT No 7. PRODUCTS**  
From Chemical Research . . . For Easier Car Care



BETTER THINGS FOR BETTER LIVING . . . THROUGH CHEMISTRY

"Valves too noisy. Require adjustment too often."—Minquadale, Del., mechanic.

Other complaints include poor gasoline mileage, inconvenient location of oil filter and distributor.

"Mileage on new engine is very poor. May increase but doubt it. Rear windows of Ranch Wagon all leak."—Cromwell, Conn., manager.

"Don't like gas mileage. Ash tray in wrong place. Oil filter in inconvenient location."—Santa Rita, N. M., dispatcher.

### 1954 FORD SPECIFICATIONS

Mainline, Customline and Crestline models

#### ENGINE

Type	Six-cyl., OHV	Eight-cyl., V-type, OHV
Bore and stroke	3.82x3.80 in.	3.50x3.10 in.
Piston displacement	223 cu. in.	239 cu. in.
Brake horsepower	115 at 3900 r.p.m.	130 at 4200 r.p.m.
Compression ratio	7.2 to 1	7.2 to 1
Transmissions	3-speed conventional.	Overdrive or torque converter with planetary gears optional.

#### GENERAL

Steering ratio (over-all)	25.3:1
Steering wheel, lock-to-lock	4.5 turns
Turning radius	20.58 ft.
Brakes	conventional hydraulic
Tire size	6.70x15
Recommended tire pressure	26 lbs. front, 23 lbs. rear
Shipping weight (4-dr. sedan, unladen)	3174 lb.
Wheelbase	115.3 in.
Tread, front	58 in.
Tread, rear	56 in.
Height over-all (unladen)	64.1 in.
Width over-all	74.3 in.
Length over-all	198.3 in.
Road clearance	6.6 in.

#### CAPACITIES

Oil	4 qt.	5 qt.
Water	15 qt.	20 qt.
Gasoline	17 gal.	17 gal.

#### INTERIOR DIMENSIONS

Front-seat hip room	58.9 in.
Rear-seat hip room	58.9 in.
Headroom, front	35.4 in.
Headroom, rear	34.2 in.
Legroom, front	42.8 in.
Legroom, rear	41.5 in.

"Traveled 450 miles in mountains with 150 miles of it on dirt and mud roads with lot of stop-and-go driving. Gasoline mileage was 15.8 for the week. I am well satisfied."—Wellsburg, W. Va., fieldman.

"Oil filter hard to change. Cost extra to have it changed."—Kramer, N. D., soldier.

"Do not like distributor at rear of engine."—Jal, N. M., utility worker.

"Engine unhandy to work on."—Dwyer, Wyo., rancher.

#### Miscellaneous Complaints

"Speedometer makes too much noise."—Sioux City, Iowa, photographer.

(Continued to page 218)



# HOW YOUR SHOCK ABSORBERS WORK



Without shock absorbers, your car would be as bouncy as an old spring wagon. It would be unsafe too. The modern shock absorber works on a hydraulic principle—slows down and evens out the spring action—helps keep your car from "hitting bottom." In doing this job, your shock absorbers give you a more comfortable, safer ride. They control the spring action, reduce the sway on curves where an extra inch or two of

sway may cause you to completely lose control of your car. Shock absorbers have another important job—they help keep the tires in contact with the road at all times. This provides better steering control, safety against skids and gives you better tire life. Car designers give shock absorbers a big job to do and so they need careful attention; for *they do wear out*. Shock absorbers should be checked frequently, replaced as needed.

## HOW TO INSTALL SHOCK ABSORBERS

Study carefully the way your old shock absorbers were installed. Remove them carefully, loosening the top nut first. Install the new shock absorbers in the same position as the old. Be careful not to install shock absorbers upside down—the part number should be at the top. New rubber bushings should be installed whenever new shocks are put on. When tightening the nut on the top and on the bottom, be careful not to distort the shape of the rubber bushings.

## When you need shock absorbers be sure to buy genuine **GOLDEN GLIDE SHOCK ABSORBERS**

These are a product of America's oldest hydraulic shock absorber manufacturer. They are stronger, better protected, long lasting. There are *Golden Glide* Shock Absorbers custom-built to do the best possible job for every make and model car. Buy them from your jobber, service station or independent repair garage. *Houdaille-Hershey Corporation, Buffalo 11, New York.*



This is a view of a typical rear end shock absorber installation. At the top of advertisement on the right, you will see a typical front end shock absorber installation.

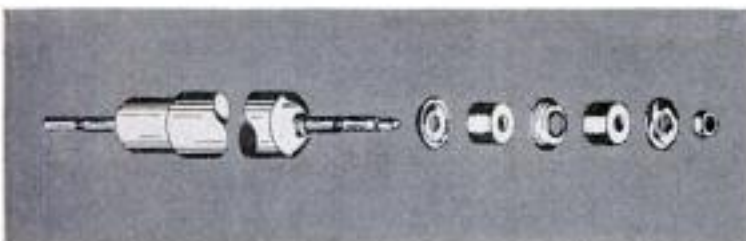

Here is the way to assemble the parts on the end of a bayonet type shock absorber. Draw up the nuts snugly, but do not distort the rubber bushing.

For a Safer,  
Better Ride it's **Golden Glide**

Copyrighted material



**NOW!** *An auto compass*  
 WITH THE SUPERIOR, SUPER-POWER  
**ALNICO 5 MAGNET**



The  
 NEW

*Airguide*  
**AUTO COMPASS**

... leads the field with Alnico 5, the mighty magnet that has 10 times the coercive force and 3 times the residual induction of a steel magnet... for outlasts and outperforms steel... gives faster, steadier readings.

... uses an 8 magnet system of aircraft type compensators which has proven most effective in offsetting surrounding metal and electrical current. Adjusts easily and quickly to finest accuracy.

... offers greatest visibility from all angles with the distinct VISI-DOME dial. Clean white details on jet black dome, calibrated to 5°.

... mounts on windshield molding with a double ball and socket bracket which permits complete flexibility of adjustment for convenient reading while driving. Easily installed. Fits all cars.

... harmonizes perfectly with today's modern car interiors. Choice of two beautiful colors, soft gray or tan.

... available with or without light. Lighted model has a warm green indirect glow. With light (suitable for either 6 or 12 volt systems), \$6.95. Without light, \$5.95.

... makes driving more care-free and more fun.

**AT LEADING STORES**

Made and Guaranteed by  
**AIRGUIDE INSTRUMENT CO., P-4, CHICAGO 47**

"Only improvement I could suggest is to do away with trunk 'lip' over which everything must be lifted in or out."—St. Louis, Mo., executive.

"Too many turns required to raise or lower windows."—Mattoon, Ill., student.

"Should change position of chrome strip along side. Paint takes a beating when someone parks beside me and opens the door so hard it bounces off paint instead of the chrome strip."—Chattanooga, Tenn., announcer.

"Inaccessible grille. When I wash the car I leave too many 'holidays.' Only a child's hand could pass between bumper guards and through intake cowls."—Detroit, Mich., teacher.

"No light on Fordomatic quadrant for night driving."—Summit Station, Ohio, highway worker.

"Would like to be able to open trunk without having to unlock it. I live in the country and trunk doesn't have to be locked all the time and I use it often."—Corder, Mo., farmer.

"Ash tray hard to get at under radio."—Rozet, Wyo., rancher.

"Passing gear cuts out too soon."—Travis, Calif., Air Force enlisted man.

**Additional Comments**

There is a controversy about the use of lights on the dash to warn of low oil pressure and battery discharge instead of the needle-type meter. Most of the owners (66 percent) prefer the lights.

"If trouble develops, you are warned at once."—Snohomish, Wash., body man.

"Light saved motor when mechanics failed to tighten valve covers and oil leaked."—Cooperstown, N. D., bank teller.

"Light indicators far superior to gauges for women and inexperienced drivers, but I prefer meter to read amperes. Flashing light sufficient for oil."—Tacoma, Wash., engineer.

When asked about the new engine, 64 percent of the owners stated they have had no trouble with it. There were 31 percent who had some trouble and 5 percent who had considerable trouble. Here are some examples of the troubles reported by owners in the survey:

"Valves froze at 500 miles."—Lyndhurst, N. J., banker.

"Valves stuck first hour I had it. Tappets loosen up too fast."—Willard, Ohio, electrician.

"Dealer running oil survey to determine exact amount of oil used. Promised to correct excessive oil consumption."—Birmingham, Ala., coal miner.

"Ten-cent oil plug became loose and to  
 (Continued to page 220)



RELIEVES  
HEADACHE  
NEURALGIA  
NEURITIS PAIN

**FAST**



**Here's Why...**

Anacin® is like a doctor's prescription. That is, Anacin contains not one but a combination of medically proved active ingredients. Anacin is specially compounded to give FAST, LONG LASTING relief. Don't wait. Buy Anacin today.

**WHAT'S NEW  
ABOUT NEW**



Everything! It's even more accurate, more versatile, easier to operate! See it at your dealer's now. For big, new, free booklet with 20 pages of pictures, data, drop a card to: SHOPSMITH, Dept. 265-B, 12819 Coit Rd., Cleveland 8, Ohio

**NEW, IMPROVED CALCULATOR  
FOR WOODWORKERS only 25c**

Instantly gives information on lumber, nails, concrete mixes, painting materials, etc. Convenient, simple to read. Just set dial for nail specifications, to convert linear to board feet, find bit sizes for screws, compare characteristics of woods. 6" diameter heavily varnished cardboard. Send 25c, no stamps, please to Greenlee Tool Co., 2107 Columbia Avenue, Rockford, Illinois.

See You Saw It in Popular Mechanics

Protect your home against  
power interruptions  
with an...

**ONAN Emergency  
ELECTRIC PLANT**

Provides dependable stand-by electricity for heating system, pumps, freezer, lights, appliances. Keeps home safe, livable. Automatic start and stop. Find out how little it costs!

Write for Folder!



**A SIZE FOR EVERY NEED**  
1,000 to 50,000 watts.  
Compact, quiet-running,  
easy to install. Gasoline  
engine powered.

**D. W. ONAN & SONS, INC.**  
8579 University Ave. S. E. • Minneapolis 14, Minnesota

JULY 1954

**A SURE CURE  
FOR SICK  
HORSEPOWER!**



*Triple-Action*  
**PERMATEX  
"TOON-OYL"**



The carbon gums and tars that form in your engine would make you sick too! —These deposits make your engine sluggish—your horsepower balky. Knocks and slow starts are another sign that your engine is gumming up—losing power—wasting gas. Bring your engine back to peak performance with "triple-action" Permatex "Toon-Oyl".

- 1 Toon-Oyl dissolves carbon gums, frees sticky hydraulic valves.
- 2 Toon-Oyl reduces friction by coating cleaned parts with a tough lubricating film.
- 3 Toon-Oyl neutralizes acid action—a principal cause of engine wear.

Get full power from your car. Add a quart of triple-action Permatex "Toon-Oyl" to your engine oil. You'll feel the difference in the first few miles you drive.

Send for free illustrated catalog!  
**PERMATEX COMPANY, INC.**

Brooklyn 35, N. Y.

Over 50 Chemical Products  
For Better Automotive Maintenance

Look for the distinctive Permatex label at your service station or garage. It has been your guarantee of quality for over 45 years.



## Do-it-Yourself with the new Weldwood® PRESTO-SET\* GLUE

Perfected at last! A ready-to-use glue worthy of the Weldwood name. Works like a wizard on just about everything made of wood, cloth, leather, fibre, paper, etc.

Use Presto-Set to make drapery cornices; to repair luggage, sports goods, furniture, toys, record albums; to mount maps, snapshots, collections, awards, etc.

For fast-setting glue jobs in home, hobby, shop, PRESTO-SET does it all, and better.

At lumber, paint or hardware stores, in 25¢ and 45¢ tubes, pint and quart bottles. If not yet stocked send 25¢ for a full size tube. Larger sizes for industrial users.



**FREE!** Leaflet of many uses. Write Dept. PPM-73, Box 205, New York 46  
**UNITED STATES PLYWOOD CORPORATION**



## HOW TO GET A NEW GARAGE DOOR AT LESS THAN HALF PRICE!

Yes, you can have a swing-up garage door like the one shown here—complete with Stanley Swing-Up Hardware for less than half what you'd normally pay!

How? Build it yourself from Easi-Bild's\* Pattern No. 86. It's easy! No special tools—no special skill! Just follow the clear, "can't-go-wrong" directions of the pattern. Tells you everything—including what materials to buy,

where and when to use them. Stanley Garage Door Set is simplicity itself to install. You'll be amazed how quickly you can do the job—and mighty proud of your results.

Ask your dealer for Simplified Directions for Installing Stanley Garage Hardware and Easi-Bild Pattern. Or use coupon below. \*Trade Mark Reg. U.S. Pat. Off. — Easi-Bild Pattern Co.

EASI-BILD PATTERN CO., Dept. S-4, Pleasantville, N.Y.  
Enclosed is 50¢ in coin, money order, check for  
Garage Door Pattern No. 86

Please send Simplified Directions for installing  
( ) Single ( ) Double Garage Door Hardware.

NAME \_\_\_\_\_

ADDRESS \_\_\_\_\_

CITY \_\_\_\_\_ ZONE \_\_\_\_\_ STATE \_\_\_\_\_

replace it whole engine had to be taken out."—Napoleon, N. D., writer.

"Points burned out in first 3000 miles."—San Antonio, Tex., Air Force pilot.

"Stalls when braked faster than normally, especially going down hill."—Orange, N. J., accountant.

### Owners Praise Durability

Many owners stated that their Fords stand up well under very rough treatment.

"The car is ready to take any kind of treatment and still stand up under it. I am very hard on a car."—Louisville, Ohio, electrician.

"Stands up under hard driving."—Onawa, Iowa, veterinary.

"I like its ability to take punishment. We live on a sheep ranch and use car to go over the prairie. It takes rough bumps and hard usage very well."—Newell, S. D., rancher.

When asked to give the Ford an over-all rating, 56 percent of the owners described it as excellent, 37 percent as good, only 7 percent said it was fair, and only one owner rated the car poor, less than one half of one percent—a remarkable record of owner satisfaction.

A comparatively high percentage of owners listed no complaints at all—30 percent to be exact. This, too, is owner satisfaction that Ford can be proud of. Many cars much higher priced than the Ford can't match these figures. See the Percentage Table on page 108 for more details on how owners rate their Fords. ★ ★ ★

[Floyd Clymer's road-test report begins on page 107.]

## Sound-Absorbing Veneer Ceiling Panel

Paper, resin and a veneer made from wood usually left in the woods as waste, have been combined to make a ceiling panel that absorbs sound like perforated acoustic tile. The panels are made of paper treated with synthetic resins to waterproof and strengthen it, resulting in a one-inch-thick honeycomb. To this are glued thin facing panels of Douglas fir white-pocket veneer. White-pocket veneer comes from the heart of over-mature Douglas fir in which the wood is dotted with minute holes or pitted with a decorative white substance. The holes and white pockets in the wood kill ceiling echoes by permitting sound to pass through the face panel into the honeycomb core, which absorbs and deadens it. In addition, the holes and pockets lend a decorative appearance to the panel, similar to that of pecky cypress.



Your **ELECTRIC DRILL** Trims  
**HEDGES — SHRUBS — GRASS**  
with **ROTO-TRIM**  
DRILL ATTACHMENT

FITS ANY  
1/4" DRILL

Today's Greatest  
Hedge Trimmer VALUE \$12.95  
Yours, Postpaid, for only **\$12.95** (Less Drill)

Keep your whole yard neatly tailored . . . trim hedges, shrubs, and hard-to-reach grass easily and smoothly with this new, inexpensive drill attachment. ROTO-TRIM quickly converts any 1/4" drill into an easy handling, keen-cutting Hedge Trimmer.

Quality Built throughout. Rigid steel and aluminum construction with smooth-running hardened steel gears and cam in one-piece case. Cutting blades are 10" long, of high-carbon steel, heat-treated, precision ground and designed for maximum safety and efficiency.

Easy to Use! Quickly attached to drill—flats simplify chucking. Light weight and precision balance make ROTO-TRIM much easier to handle than more expensive trimmers. Handle turns blade to any angle.

Order TODAY! Don't miss this chance to get your ROTO-TRIM Hedge Trimmer Attachment while still available at today's low price of \$12.95.

**UNCONDITIONAL 10-DAY MONEY BACK GUARANTEE!**  
Send check, cash or M. O. and we'll ship postpaid — direct from factory to you.

Dept. 752 **ROTEX COMPANY** 837 WEST DAVIS DALLAS 8, TEXAS

**NEW WAY TO CUT PERFECT GROOVES WITH CIRCLE SAW!**

Just dial any of 40 cuts. Parallel, clean, no sanding! Leave on saw for regular cuts. For 1/2, 3/8, 3/4 and 1" arbors. At dealer's or order direct!

Only **\$4.95** per set

Send for free booklet

**WARREN DADO WASHERS CO.**  
Dept. # 27 P.O. Box 98, Detroit 2, Mich.

**REVIVE YOUR OLD PAINT BRUSHES**

Restore neglected brushes. Use BRISSEL-TONE to clean them easily. Simply soak brushes in BRISSEL-TONE and wash old dried paint away with WATER. Re-use BRISSEL-TONE many times. Speedy, thorough, economical. Send \$1.00 plus 25c postage for can of BRISSEL-TONE today.

**MONTGOMERY CHEMICAL COMPANY**  
P.O. Box 187-A, Jenkintown, Pennsylvania

**THE BEST IN PLIERS? CHAN NEL LOCK**

TRADE MARK REG. U.S. PATENT OFFICE

**CHAMPION D'ARMENT TOOL CO., MEADVILLE, PA.**

Say You Saw It in Popular Mechanics

**MODERN LAWN MOWER SHARPENER**

Service departments of leading Lawn Mower manufacturers use the Modern Lawn Mower Sharpener. One lever moves lawn mower into grinding position. Gasoline and oil remain in engine while sharpening, no dismantling of wheels, roller or handle. The Modern is a precision bed knife grinder—no extra grinder to buy. Imitated but never equaled—Compare before you buy. If it isn't a Modern it can't be Modern (Prices subject to change without notice)

**MODERN MFG. CO.**  
160 N. Fair Oaks - Pasadena 3, Calif.

WRITE FOR FREE BOOKLET 100 **\$263.00** with motor P.O.R. PASADENA

**DEGREASER!**  
engine shampoo

QT. SIZE CONCENTRATE  
MAKES 2 GALLONS

THE ORIGINAL SELF-EMULSIFYING DEGREASER

**Gunk**

ONE QUART

NO WORK!

Takes cling out of oil and grease . . . emulsifies it . . . so that all dirt may be hosed off as easily as you rinse hands under water faucet.

Launders engines faster, more completely, and safer than steam cleaning (warm the engine). Self scouring action brings out factory new appearance . . . provides accurate visual inspection . . . Gunked engines run cooler.

Get Genuine Gunk in quart and larger sizes at better wholesale auto suppliers throughout the country . . . Flatly refuse imitations.

Extra strength, ready-to-use Gunk in pint containers is available from any of the Harley-Davidson Motorcycle Dealers everywhere.

**The CURRAN CORPORATION, Lawrence, Mass.**

Have more garage storage space with **MASONITE** Peg-Board\* **PANELS**

Your garage can be neat and tidy. Use these easy-to-put-up 4-ft. x 8-ft. panels with handy hangers.

\*Reg. T.M. U.S. Pat. Off. B. B. Butler Mfg. Co., Inc.

**NATURALLY STRONGER WITH LIGNIN**

**PRESWOOD WOOD MADE BETTER**

**MASONITE CORPORATION**  
Dept. PM-7, Box 777, Chicago 90, Ill.

Please send Idea Book and Plan AE-274 for Garage Interior. I enclose 10c to cover postage and handling.

Name . . . . .  
Address . . . . .  
Town . . . . . Zone . . . . .  
County . . . . . State . . . . .

"Masonite" signifies that Masonite Corporation is the source of the product



# PROVEN SAVINGS FOR CAR OWNERS!



Motor Vehicle Research, Inc.  
**PROVED**

Automotive  
**LIQUI-MOLY**<sup>®</sup>  
ANTI-FRICTION ENGINE PLATING



Saves **56%**  
ON OIL

Saves **17%**  
ON GAS

**SAVES ENGINE WEAR**

- Protects against engine seizures
- Reduces engine temperatures
- Prevents dry starts

*Easy to use...*  
**ADD ONE CAN TO MOTOR OIL TODAY!**

**LIQUI-MOLY** coats all engine friction-surfaces with a protective anti-friction metal plating of slippery Molybdenum Disulfide. Your engine gains new smooth gliding power—not possible with oil alone. Proved in millions of cars, trucks, buses and tractors.

At gas stations, auto supply stores, etc.

**MAIL ORDERS ACCEPTED**

if your dealer does not yet have **LIQUI-MOLY**.

## COMPLETELY GUARANTEED

**MOLY MOTOR PRODUCTS CORP.**  
Dept. M-3, 1155 Broadway, New York 1, N.Y.

Please send me:

\_\_\_\_\_ cans **\$1.50** size **LIQUI-MOLY** ..... \$ \_\_\_\_\_

\_\_\_\_\_ cans **\$3.75** size **LIQUI-MOLY** ..... \$ \_\_\_\_\_

\_\_\_\_\_ tubes **\$1.25** size **GEARLUBE BOOSTER**  
for transmissions and differentials ... \$ \_\_\_\_\_

Add 15c for postage and handling ..... \$ **.15**

**FREE WITH EVERY ORDER: 16 Page Booklet**  
on "How to Get Out of Trouble on The Road" ..... \$ \_\_\_\_\_

Total

Name \_\_\_\_\_

Address \_\_\_\_\_

City \_\_\_\_\_ Zone \_\_\_\_\_ State \_\_\_\_\_

(No C.O.D. Send cash, check or money order)

## Floyd Clymer's Road Test of the 1954 Ford V8

(Continued from page 107)

more economical and has less vibration than the old flat-head engine.

The ball-joint front end is outstanding. Not only does the car steer more easily but cornering at all speeds and maneuverability have been improved by this feature. I'd rate Ford tops in the low-price field for handling.

The test car was equipped with power steering. The driver retains normal feel of the road that is not evident in some other types of power steering. Over-all ratio with or without power is 25.3 to 1, with 4½ turns of the wheel from lock to lock.

Ford power brakes are the best I've found on any car tested. There seemed to be less fade and under all conditions the pedal retained the same movement—even at high speeds, in the mountains, the desert heat and through a hard rain for 200 miles.

Gasoline economy was good (see Economy Test page 110). The engine uses regular gas. (In the 1954 Mobilgas Economy Run a Ford V8 averaged 23.38 miles per gallon to place third. A Studebaker Champion won with 29.58 miles per gallon.)

Fordomatic Drive has the advantage of positive automatic gears plus the smoothness of a torque converter. The automatic intermediate gear provides fast getaway. The drive is constant through the converter and there is no clutch for rigid connection between engine and rear wheels. The converter is air cooled. Although upshifts can be felt, they are smooth. Starting in Drive with moderate throttle, there is a slight hum while accelerating. All gear changing takes place smoothly and almost effortlessly between 17 and 65 miles per hour, depending on throttle opening. With wide-open throttle it upshifts at about 60.

Over Donner Summit, we reached an altitude of 7135 feet. The car performed exceptionally well. We were in a severe storm during which rain, sleet and snow fell for a couple of hours and the Ford handled very well on the slippery highway.

The body is solid and tight. No water leaks developed. Doors open and close easily. A couple of squeaks and rattles developed and for some unknown reason disappeared.

Driving position is comfortable. Vision through the curved windshield is good. Rear vision is excellent. The top half of the steering wheel is sometimes in the line of forward vision. I'm a tall person and shorter persons must find the steering wheel

(Continued to page 224)



## A BIG-VALUE HOME!

You get most for your money in a roomy, convenient, furnished and equipped Schult. Insulated for all-season family comfort. Quality, value famed for 20 years! Find out...

**SCHULT** SEND FOR **FREE FOLDER**



**SCHULT CORP. DEPT. 3207, ELKHART, IND.**

## AIR CONDITION ONE TO THREE ROOMS FOR ONLY \$26

Evaporative air conditioner easily assembled in minutes with screw driver, pliers. Heavy duty, rust resistant. Adjustable louvers direct air. Powerful 1/2-hp. 115-v AC shaded pole motor. Balanced fan. Rocky Mountain aspen filters. Clog-free drip trough. Adjustable side panels for snug, easy window-fit. Brass metering valve, toggle switch, pipe connection, 25' tubing. Send \$5.00 m.o. or check; balance C.O.D. plus shipping. Pay full amount, save shipping costs. Supply limited - ACT NOW!



**WEATHER MERCHANTS**  
2913-A Gaston Avenue  
Dallas 4, Texas

**MOTOR GUARANTEED FOR ONE YEAR**

## WORLD'S BEST SMALL TRENCHERS

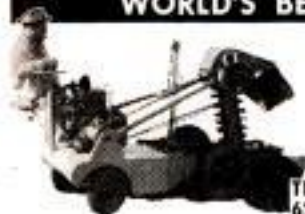

Portable DITCH-WITCH digs 2" to 6" clean, even ditches to 36" depth in all types of soil. Complete unit—self propelled—outdigs 8 men. Four rugged models.

Write for illustrated literature.  
**CHARLES MACHINE WORKS**  
620 B Street Perry, Oklahoma

## FREE BOAT KIT CATALOG

12 ft. Runabout Pictured.

- Assemble your own boat
- No experience necessary
- Save 1/2 to 2/3 "factory built" prices
- Prices include freight and paint

8' to 14' Models from \$39.25



Marine Hardware, Fiberglass & Trailers

**LUGER INDUSTRIES** Kit Division 3207 FREMONT AVE. SO. MINNEAPOLIS 8, MINN.



# Dayton FLOATS

For CASTING & STILL FISHING

Used by **MILLIONS** of FISHERMEN!

AT LEADING DEALERS EVERYWHERE!

## THE BEST GLUE YOU CAN BUY



Why risk glue failure due to changing moisture and heat conditions . . . in any of your projects? Made from resorcin resin, **ELMER'S WATERPROOF GLUE** is the *only* wood glue packaged for home use that meets U. S. Military Specification MIL-A-397 for waterproof glue. Use it for building or repairing boats, indoor or outdoor furniture, toys and sports equipment. At better marine supply, lumber and hardware dealers. Write for folder: The Borden Company, Chemical Division, Dept. PM-74, 350 Madison Avenue, New York 17, N. Y.



© T. R. C.

# ELMER'S WATERPROOF GLUE

With our simple pattern you build this **LEAN-TO STORAGE SHED** AT MINIMUM COST



Now have that storage shed you need so badly — for tools, bicycles, hose, bulky objects. With simplified Easi-Bild® Pattern #89, you do a professional job—without blueprints. The pattern takes the mystery out of building . . . specifies all materials required . . . shows how to cut each piece to exact size . . . how to assemble the finished shed. You save up to two-thirds of the usual cost!

The major material used is Homasote — the oldest and strongest insulating-building board on the market — sold by building materials dealers throughout the United States and in Canada.

NEW! Three illustrated folders suggesting 18 practical make-it-at-home projects from a new room in the attic to chests and bookcases. Mail today for pattern and/or folders.

\*T.M. Reg. Easi-Bild Pattern Company

**MAKE it at home . . . with HOMASOTE**

HOMASOTE CO., Dept. 84, Trenton 3, N. J.

I enclose:  10¢ for 3 folders  50¢ for Pattern #89

NAME.....

ADDRESS.....

CITY.....STATE.....

My lumber dealer is.....



for  
**Extra Speed, Power**  
*Use*  
**Duals or Headers**

with  
**Factory Duplicate**

or **DYNATONE®**

**Deep, Mellow Tone Mufflers**



Less back pressure! That's the secret of extra power, speed and gas mileage gained from duals or headers. Available with either factory duplicate type mufflers (made to car specifications or better) or with Dynatone deep, mellow tone mufflers (engineered not packed).

Easy to install—all parts and illustrated instructions are included. Made to permit use of heat riser butterfly. Exhaust pipes have adjustable or rigid flanges and are beaded and sized for trouble-free installation. Tail pipe ends bent to angle of original equipment for balanced appearance. Available for most V-8 engines.

See your dealer or write for details.



**The Dynatone Muffler—with the Deep Mellow Tone—is also Available for Single Installation**

**GOERLICH'S**

619 Smith St., Dept. 27-G, Toledo 1, Ohio

located too high. Either a smaller wheel or a lower steering column would eliminate this annoyance.

Instrument panel is well protected from sun glare. The switch-key-starter is operated by the left hand, awkward for most right-handed drivers. Ford sticks with the hand-operated choke and I'm just old-fashioned enough to like it.

The heater is efficient, but the control levers could be simplified. It was necessary to use the blower to get enough heat during the cold stretches. Windows require four turns to open or close—this is excessive.

The speedometer is directly in front of the driver and easy to read. Ford now has a transparent plastic insert in the speedometer housing and daylight comes in through it to light the back of the numerals. Elimination of the upper half of the horn ring has aided driver's vision. Warning lights are used for generator and oil signals. I prefer regular needle gauges.

It is obvious that Ford is becoming more popular with owners and the new overhead-valve engine must have something to do with it. For the first time in many years, Ford was in top place in sales during the first three months of 1954. ★ ★ ★

**Windshield Washer With Pedal**

Both the windshield wiper and the washing jets begin operating when you step on the button of a new attachment for Chrysler Corporation cars. You don't have to fumble with two controls. Fluid is contained in an unbreakable, vinyl container. Washer and wiper are started and stopped by the foot control. To turn on wiper alone, you use the regular dash control.





# THE MOST EFFICIENT WRENCH ON THE MARKET



for **AUTOMOTIVE · TELEVISION  
RADIO · INSTRUMENTS  
and ASSEMBLY WORKERS**

- .. it **HOLDS** (NUT OR BOLT)
- .. it **STARTS** and **TIGHTENS**
- .. it **RELEASES!**

# "G" GRIP SPINTITE WRENCHES

PATENTS PENDING

... it's all a ONE HAND OPERATION

FINEST QUALITY STEEL SHANK AND SLEEVE  
BRIGHT PLATED FINISH  
STRONG PLASTIC HANDLE  
SPECIAL SIZES AND MATERIALS TO ORDER

- GRIPS nuts or bolts of any material
- HOLDS firmly in any position
- TIGHTENS nut or bolt securely
- RELEASES at the pull of the fingers

Write for catalogue

MAKERS OF THE ORIGINAL  
**SPINTITE** WRENCHES  
OVER 150 STYLES AND SIZES

**STEVENS WALDEN Inc.**

480 SHREWSBURY STREET — WORCESTER, MASSACHUSETTS

WORLD-FAMOUS  
HAND TOOLS  
FOR OVER  
50 YEARS

## MOTORISTS—Had your Oil Filter checked recently?

If not, chances are it's choked up—can't keep up its engine-saving, money-saving work. Better put in a new Purolator Refill. (Costs as little as \$1.60.)

**PUROLATOR**  
World's Finest OIL FILTER



## FREE CRAFT CATALOG



120 PAGES... Craft Supplies, Tools, Designs, Instruction Books from America's Largest, Most Complete Handcraft Stock.

Send for your free copy NOW!

**GRIFFIN CRAFT SUPPLIES**

5626-A Telegraph Ave • Oakland 9, Calif.

**EARN YOUR OWN KING MIDGET** We want rider agents to demonstrate and sell the World's Lowest Priced Two Passenger Automobile. Fully assembled or bolt together parts. If there is no dealer near you send 25c for detailed literature with dealers price or \$1 (refunded first order) for this plus actual assembly book and service manual.  
**MIDGET MOTORS MANUFACTURING CO., Athens, Ohio.**

**KING  
MIDGET  
AUTOMOBILE**



## NEW ROTARY STORAGE STAND

Boon to the home workshop because:



ONLY \$15.50

Complete

3-Tray Unit No. 8116-C

1. Stores 2 to 4 times as many different items (nails, screws, washers, etc.) as with drawers or boxes.
2. Prevents rust, dust, damage and corrosion.
3. Items instantly visible through the combination of glass jars and rotary action.
4. Eliminates mixing of small parts.
5. Accessibility through easily removed jars.
6. Includes ten 4-ounce, eight 8-ounce and six 16-ounce glass storage containers.
7. Assembles to a sturdy, compact height of 13 3/4 inches.
8. Ideal for handy, time-saving use in workshop, den, lab, toolroom, office or kitchen.
9. Priced right—at only \$15.50.

**Immediate  
Delivery!  
ORDER  
TODAY  
From This Ad!**

**The Union Metal Manufacturing Co.,  
Canton 5, Ohio**

10-day money-back guarantee if not satisfied!

Please send me, shipment prepaid, the 3-tray Vu-O-Matic Rotary Stand No. 8116-C. Enclosed is my check (or money order) for \$15.50... or

Send C.O.D., freight charges collect.

Name \_\_\_\_\_

Address \_\_\_\_\_

City \_\_\_\_\_ Zone \_\_\_\_\_ State \_\_\_\_\_



# EASY

DOES IT WITH

## USG DURON\*

the hardboard of 1001 uses



You can build it yourself easier, faster—and the job comes out *right* with DURON because *this* hardboard is made for easy sawing, bending, nailing, laminating, drilling. Smooth on both sides, responds well to edge treatment—the finished job actually *looks professional*. You needn't paint the rich brown surface of DURON—but if you want to, it takes paint beautifully! Try this practical hardboard in your home workshop!

### FREE PLAN BOOK

12 pages of easy-to-follow plans for making useful things. Ask your dealer or write Dept. PM-7, 300 W. Adams, Chicago 6.



\*T. M. Reg. U.S. Pat. Off.

### UNITED STATES GYPSUM

The Greatest Name in Building

### It's Raining Baby Trout

(Continued from page 122)

these little, blue tarns are surrounded by peaks, and only precise handling of the plane will clear them safely.

For some time Al Reese worried over the many tons of water which had to be carried to keep the little fish alive. In the 1952 planting he carried a total load of 25,000 gallons of water over the mountains. Could the work be accomplished with less?

The answer came with experiments in drugging small trout. Ordinarily the fish are active and alert and use a great deal of oxygen. Experiments showed that sodium Amytal, a barbiturate, would quiet the fish when a half-grain of the drug was added to a gallon of water.

Thus only one-third to one-half as much water had to be carried, for the fish enter a state approaching suspended animation. Only 200 trout were formerly carried to a gallon of water. The drug now permits 500 or more to the gallon. Tests proved that the fish were not harmed by the drug and became normally active after the drop.

A major operation in 1953 was the stocking of 46 high-altitude lakes with the exotic golden trout, native only to the Sierras and found originally in only one small stream near Mt. Whitney.

Landing at the Tunnel airstrip in the mountains, one of the highest landing fields in the nation, trout which had been taken with hook and line were flown down to the hatchery to be used for brood stock. And other goldens, already raised there to fingerling size, were flown back over the peaks to stock the lakes with 200,000 of these rare and beautiful fish.

The airplane promises a big future for these beautiful and gamy specimens. They will not retain their bright coloring in low-altitude waters and are best adapted to lakes lying from 10,500 to 13,000 feet. Pack-train transportation to these remote waters is only possible for a scant two months in summer when trails are clear of snow. The plane can drop them early in the season and after autumn snows close the trails.

The time saved in aerial planting is enormous. A 40-minute round trip from the hatchery can plant remote lakes, far back in granite-ribbed basins which would take a pack train loaded with fish cans at least two days to reach. Cost of operating the plane is figured at about \$32 an hour.

The longest haul from take-off point to planting location was 140 miles for the round trip. The highest lake planted was in the Mt. Whitney area, at 13,600 feet, less than 1000 feet below the top of the highest mountain in the United States. ★ ★ ★





Ride a hobby...

Only 15¢

FOR FUN AND PROFIT

Save money, have fun building furniture for your home, handy household articles, toys for children — quickly — simply — economically — with a set of Rogers easy-to-follow Project Plans. Included, too, are instructions on how to set up a simple workshop. With these plans you'll get a full bottle of Rogers Glue — a clear, pure, strong glue that's easy to work with and keeps joints really solid. There's a ton of strength in every drop. Entire package only 15c — a modest investment for a useful and satisfying hobby. Send 15c to Rogers Isinglass & Glue Co. Gloucester Mass. Buy Rogers Glue at Your Local Hardware Store.



"A Ton of Strength in Every Drop"



PRECISION PLIERS

For accurate, exacting work use the fine, small pliers jewelers and watchmakers use — Kraeuter's Precision Pliers. Matched in size and handle shape, drop forged from selected tool steel, machined and heat treated to exacting specifications. For hobby crafters, model builders, TV and radio technicians.

Buy wherever fine tools are sold in U. S. and Canada.



KRAEUTER

SAY YOU SAW IT IN POPULAR MECHANICS

SHOPMASTER'S

NEWEST SENSATION

COMBINATION POWER TOOL



For Complete Information Write Dept. 10M 1204 S. 3rd St., Minneapolis, Minn.

SHOPMASTER, INC.



MIRROLURES



The lure with the BUILT-IN FLASH!

- Send for FREE Fisherman's Log with color "How to Use" insert. Record trips—know lures to use.



The L&S BAIT CO. Inc., Bradley 42, Illinois

FREE BOOK

TELLS HOW TO MAKE DAMP BASEMENTS DRY!

New OASIS Air Drier gets rid of the MOISTURE MONSTER

If you have a moisture or dampness problem in your basement, workshop, or in any other damp area, the amazing new Oasis Air Drier will put an end to it! The Oasis Air Drier takes moisture-laden air from the room, removes the water, and blows the dry air out into the room. Removes up to 3 gallons of water every 24 hours! Stops rust... mildew... warped floors and woodwork... sweating pipes... mold... musty odors!



STOPS MOISTURE DAMAGE TO:

- Workshops
- Dark rooms
- Model railroads
- Machinery, tools



GET YOUR FREE BOOK!

Tells moisture danger signs! How to make basements dry... how to prevent dampness damage. Mail coupon.



OASIS Air Drier

ELECTRICAL DEHUMIDIFIER

EBCO MANUFACTURING CO.

393 W. Town St., Columbus 8, Ohio

Send FREE book—"How to Stop Moisture Damage."

NAME \_\_\_\_\_

ADDRESS \_\_\_\_\_

CITY \_\_\_\_\_ STATE \_\_\_\_\_





## Custom-Craft THE ORIGINAL "PACKAGED" BOAT KITS

SEND 25c for BIG 1954 CUSTOM-CRAFT CATALOG  
See the world's finest, most complete line before you decide. Rated tops in design, styling and performance by the experts! Save over 50%! 41 New models! Easy to assemble! Mahogany parts, brass screws. \$49.50 up! Catalog plus booklet "Boat Selection, Operation & Maintenance" \$1.00 (Refunded on purchase). DEALERS INQUIRE!

## Modern BOAT PLANS



With FULL-SIZE PAPER PATTERNS  
EASIER TO BUILD, SAVES TIME, MONEY

Over 150 modern plans and patterns with material lists and building procedure. Racing classes, cruisers, inboards, outboards, sailboats, 8 to 36 ft. All materials, fittings, etc. available at "Package" prices. Big savings! Design Catalog tells all!

SEND 35¢ for 1954 DESIGN CATALOG

Design Catalog PLUS boat building handbook, \$1.00

## ARMOR-GLASS CUSTOM-CRAFT'S NEW SUPER-XXX FIBERGLAS

Permanently leakproof your boat! End annual painting and calking forever. Easy to apply to any boat. Indestructible! Hundreds of other uses.

SEND 10c for detailed folder and "How-to-Measure Form." Send \$1.00 for folder and measuring form PLUS two valuable booklets: "How-to-Use Armor-Glass" and "How-to-Build your own Fiberglass Boat or Auto Body." Dozens of other ideas!

### PATCH and REPAIR KIT: 55

Includes generous supply of Fiberglass cloth, Super-XXX Resin PLUS plans for making Fiberglass tool or tackle box. Dozens of uses: Repairing, patching, etc. DEALER INQUIRIES INVITED.

CUSTOM-CRAFT • DEPT. 7 • BUFFALO 7, N. Y.



plus  
**REAL SECURITY**  
with  
**CORBIN PADLOCKS**



If you need several padlocks for garages, sheds, boats, etc. . . . ask your dealer for Corbin Padlocks keyed alike. Then you'll never have to fumble for the right key. On the other hand, you can have the keys all different, no matter how many padlocks you require. Or, Corbin Padlocks can be master-keyed. Whatever you decide — GET CORBIN SECURITY! That's what you need in a padlock! Available in every price range at better stores.

IF IT'S WORTH LOCKING, IT'S WORTH A CORBIN PADLOCK!

**CORBIN CABINET LOCK** Division  
The American Hardware Corporation  
New Britain, Connecticut



## Two-Piece Oar

You can break a new oar into two sections for easy carrying in car trunk or boat bottom. A quick twist of the wrist meshes a spring lock which joins the ash handle and the hollow aluminum blade. Three thicknesses of aluminum on its edges make the blade dentproof and its hollow, watertight construction causes the oar to float if it is dropped overboard. The adjustable oar lock is clamped to the handle. No holes are bored through the wood.

## Crab-Grass Knife

With a new sawtooth knife you can sever tufts of crab grass from their roots. The bare spots then are reseeded and a healthy stand of grass prevents sunlight from reaching the top of the crab-grass root. The blade of the knife is slipped under the tuft of crab grass but not into the soil. A sawing motion cuts off the tuft. The blade has a double edge so it will cut from either direction.





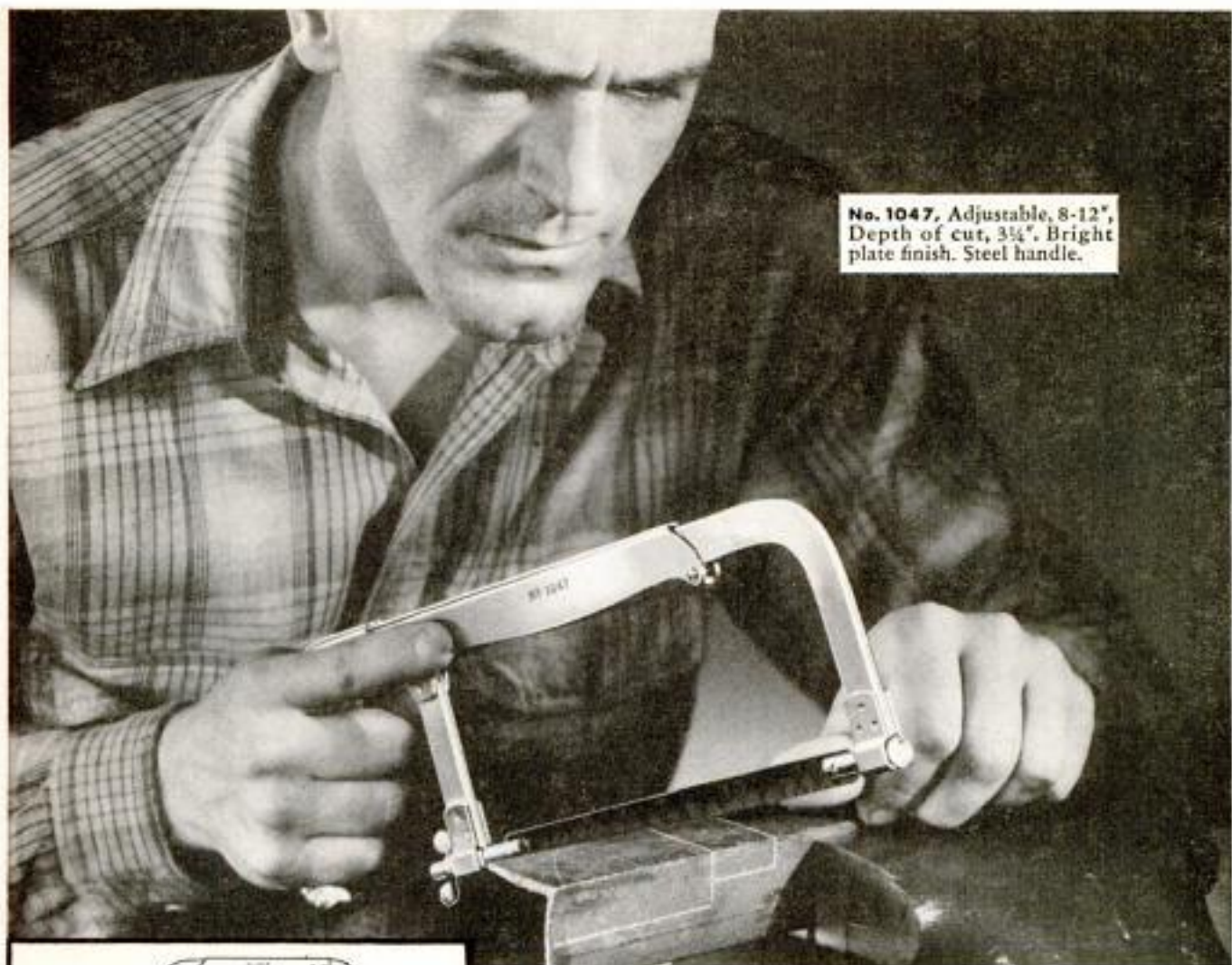

No. 1047, Adjustable, 8-12",  
Depth of cut, 3 1/4". Bright  
plate finish. Steel handle.

**No. 1042**  
Adjustable, 8-12". Depth of cut, 2 1/2". Bright plate finish. Wood handle.

**No. 1046**  
Adjustable, 8-12". Depth of cut, 2 1/2". Bright plate finish. Steel handle.

**No. 1049**  
Adjustable, 8-12". Depth of cut, 3 1/4". Bright plate finish. Neoprene handle.

**No. 1044N**  
Solid frame, 12". Depth of cut, 3 1/4". Bright plate finish. Neoprene handle. Also No. 1044 with steel handle.

## CRESCENT HACKSAWS

● Strong, rigid, well-balanced Crescent Hacksaws are designed for the exacting mechanic. Choose from five popular patterns having wood, steel or Neoprene handles. The Neoprene handles are far superior to plastic. They are impervious to oil and acid, unaffected by extremes of heat or cold, have high dielectric value and are practically unbreakable. Sold by Industrial Distributors and Hardware Dealers everywhere.

**CRESCENT TOOLS**

*Give Wings to Work*

*Sign of the Artisan  
Symbol of Excellence*



Crescent is our trade-mark, registered in the United States and abroad, for wrenches and other tools. Sold by leading distributors and retailers everywhere and made only by **CRESCENT TOOL COMPANY, JAMESTOWN, NEW YORK**





1  
Add new beauty to your car with these top quality Wizard Country Club Plastic Seat Covers. Beautiful Saran plastic panels with harmonizing trim, top cap, sides and back. Stay lovelier longer. Wide choice of patterns and colors sure to please. All car sizes. Plastics from .....\$26.95

2  
**Wizard Quality Chamois** adds new sparkling luster to auto, furniture, windows, silverware, glassware. Highly absorbent. Strong and durable, yet soft and pliable. Will not scratch finest surface when used wet or dry. Can be washed over and over again. 21" x 27" (378230) Ea \$2.75

3  
**Wizard De-Sludge-Er** oil filter cartridge has new filter agent of 100% cellulose. Out-filters either paper or cotton. Removes sludge-forming elements from oil. Won't clog channel or by-pass. For all cars, trucks, tractors with full-flow or by-pass systems. Chev. 1937-53 (R55814) .....\$1.59



## New Power...New Beauty.™

Over 40 Years...Headquarters

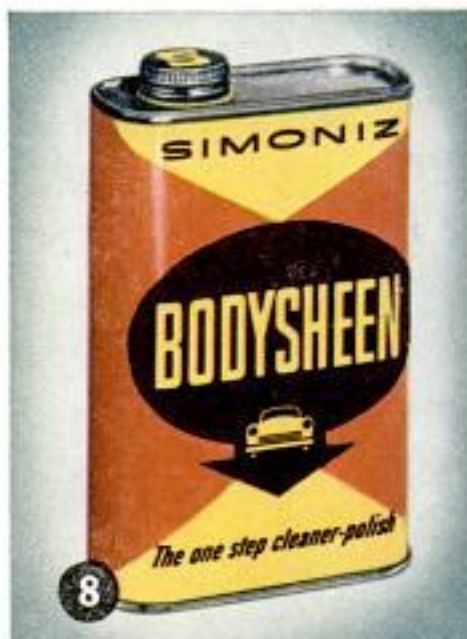

7  
\***Gleaming chrome exhaust deflectors** and extensions give long-lasting beauty to your car. Keeps exhaust off bumper. Easy to attach and styled to fit your car. Western's Exhaust Deflector. Simple, flared design. (CR2806) 49c Exhaust Extension. (8" x 2 1/2") Straight-tube type. (CR2807) \$1.09

8  
**The one-step cleaner-polish!** New Simoniz Bodysheen cleans and polishes, in one easy simple step. Wipe Bodysheen on, then wipe it off and see your car gleam. Brings out natural brilliance, enriches colors. Gives your car a tough, long-lasting, weather-resistant finish. (377112) ..... 98c

9  
**Here's the quick easy way** to replace brakes—Stop-Rite lined brake shoes, ready to slip right into drum. Wire-backed lining permanently bonded to shoe for positive "non-grab" braking, long quiet service. Trade-in allowance. All popular cars. Front or rear, as low as .....\$3.75 (each.)

FREE: Mail post card today for folder explaining how to get more horsepower

Copyrighted material





4

Add new beauty and style to your car's interior, and protect your floor mat from excessive wear with these handy rubber utility mats. Also has many uses around the house. Easy to clean. Yellow, green, red, blue and black.  
 17" X 17" (2N1385-9) ..... Ea. 89c  
 17" X 20" (2N1110-14) ..... Ea. \$1.19



5

**Drednaut Hydraulic Jack** takes work and danger out of tire changing. Easy wrist-action lifts any car. Twist—it's down, safely and smoothly. Precision built to meet most severe passenger service requirements. Raises from 7" high to 14 1/4". Pumping handle included. (A6188) ..... \$9.95



6

**Complete Wizard Tune-Up Kit** saves gas, gives your car easier starting, smoother running, better performance all season. Easy to install yourself. Contains all ignition parts needed for complete tune-up: heavy duty points, condenser, rotor. Complete, easy instructions. Chev. 1933-52 (18-4815-6) ..... \$1.05

# New Safety For Your Car At **Western Auto**

STORES AND ASSOCIATE STORES

For Top Quality Auto Supplies.

NOTE: Western Auto Associate Dealers own their stores and set their own prices, terms and conditions. Prices may vary due to difference in local conditions. (PM 74)



10

**Why risk worn brakes?** Reline with Stop-Rite Brake Linings. Designed for individual braking requirements of all cars. Pressure molded. Wire backed for extra strength. Will not absorb grease or moisture. With rivets and instructions. Easy to install. All popular cars from..... \$3.45



11

**Wizard "Twin-Fire"** patented spark plug gives top performance twice as long as single electrode plugs. Each electrode fires one at a time while the other "rests", stays accurately gapped up to twice as long. All chrome shell prevents rust. Guaranteed 18,000 miles. Each, in sets..... 75c



12

**Spotlight where you need it!** Just plug this portable spotlight into lighter socket: use for street signs, tire changing, house numbers. Wire stores on reel-type handle when not in use. On-off switch. GE bulb, 10' cord. Plastic construction, with metallic finish. Plastic storage bag. (24417) \$3.75



POPULAR MECHANICS

# HOT ROD Handbook

and Directory of America's  
Finest Speed Shops

75c

IN UNITED STATES  
AND CANADA

*How to...*

HOP UP AN ENGINE  
GET 25% MORE HP.  
DESIGN A CHASSIS  
FORM A HOT-ROD CLUB  
QUALIFY FOR RACING  
Plus complete listings  
OF MANUFACTURERS...  
SPEED SHOPS...HOT-ROD  
AND SPORTS-CAR  
ASSOCIATIONS

By **GEORGE HILL**

Charter Member, 200 MPH Club



**Buy This New 144 Page Book  
at Your Favorite Newsstand Today!.**

**Only 75c**





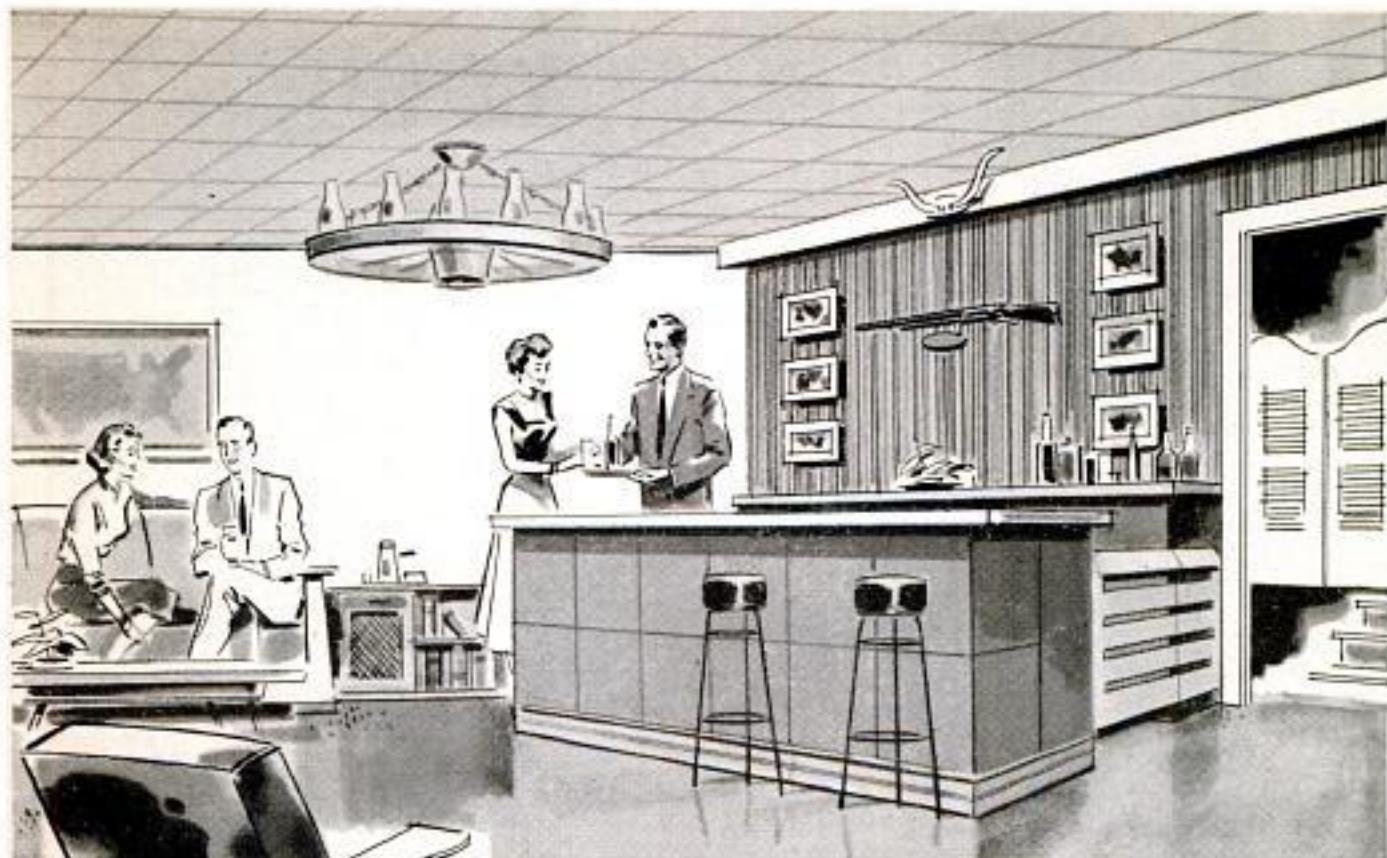

Three types of Upson Panels are used to finish this striking recreation room. See below for details.

# Ideas for weekend remodeling

with **UPSON DO-IT-YOURSELF PANELS**



Upson makes a complete line of Panels for remodeling your home. In the recreation room pictured above for instance . . . the ceiling is covered with Upson Ceiling Tiles, washable, durable, attractive. The wall behind the bar is stunning Upson Striated Panel, easy to apply, easy to paint. The far wall is Upson Strong-Bilt Panel, a

permanent, crackproof wall that adds lasting beauty. Even the bar is paneled with Upson.

See your lumber dealer and look over every Upson Panel type. Insist on the name "Upson" for top quality material.

For full details, *mail coupon today!*



↑ Idea. Cover inside of closet doors with Upson Peg-it Panel. Makes handy storage space.

→ Upson All Weather Sheathing, heavy duty, waterproofed, perfect for siding a garage.

## upson / DO-IT-YOURSELF / panels

PROVEN QUALITY YOU CAN TRUST

THE UPSON COMPANY,  
477 UPSON POINT, LOCKPORT, NEW YORK



Please send FREE details on \_\_\_\_\_ (name of product)

Please send FREE folder on all Upson Panels.

Name \_\_\_\_\_

Street \_\_\_\_\_

City \_\_\_\_\_

State \_\_\_\_\_



# WELD IT YOURSELF! IN A JIFFY!

**Weld, Cut, Braze, Solder  
IRON, STEEL, BRONZE, BRASS,  
ALUMINUM & OTHER METALS**

Tool and Equipment breakdowns are always annoying and costly. Don't let them bother you. Get a Dynamic Arc Welder. You can do expert work on your very first job. Welders operate from any properly wired 110 V. AC line. Also make your own wrought iron furniture, railings, fences & knick-knacks. Repair fenders, & bodys, etc. with the handiest "tool" in your workshop. A Dynamic Welder will pay for its low cost of \$38.50 F.O.B. in both time and money.

**DYNAMIC INDUSTRIAL type  
transformer Arc Welder**  
75 amp. output for industrial  
or Workshop use.

**DYNAMIC  
WELDER CO.**

Dept. D2-G, 1808 S. Federal  
Chicago 16, Ill.

## EASY PAY PLAN

Low down pay-  
ment. Pay as you  
weld. Sold on  
money-back guar-  
antee. Send for  
details. Complete  
outfit only

**\$38.50**

F.o.b. factory



**Free Details and "How to Weld"**

**AT ALL HARDWARE STORES**

**FULLER'S "SCREW  
HOLDER"**

SCREW DRIVERS



**NOW!** do the job at HALF THE COST!

- Spring Clip holds and sets screws tightly!
- Reaches those "out of the way" spots!
- In 3 1/2", 4 1/2", 6" and 8" lengths —
- also 4" Phillips type!
- Hi Carbon Blades! • Unbreakable Amber Handles!

**ONLY 30c**

(3 1/2" x 1/8" blade)

**FULLER TOOL CO., Inc. 3522 Webster Ave., N. Y. 67**  
Export Sales Dept., John H. Graham Co., 105 Duane St. • New York, U. S. A.

## HELPFUL BOOKS

Send post card asking for **FREE catalog**

Popular Mechanics Press, 200 E. Ontario, Dept. 601, Chicago 11

### A PERFECT PICTURE OF YOUR BEST BET — BULLDOG COUPLERS!

Model No. 1-C for light-duty trailers,  
capacity 2500 lbs. 1 1/4" ball with nut  
included . . . \$6.36 Fed. Tax incl.



Manufacturers of **TORQ-LESS AXLES,  
BULLDOG COUPLERS** and **BULLDOG  
FARM JACKS**. Write for Brochure 13G  
on complete line.

**HAMMER BLOW TOOL COMPANY**

"As old as the Industry"  
**WAUSAU, WISCONSIN**

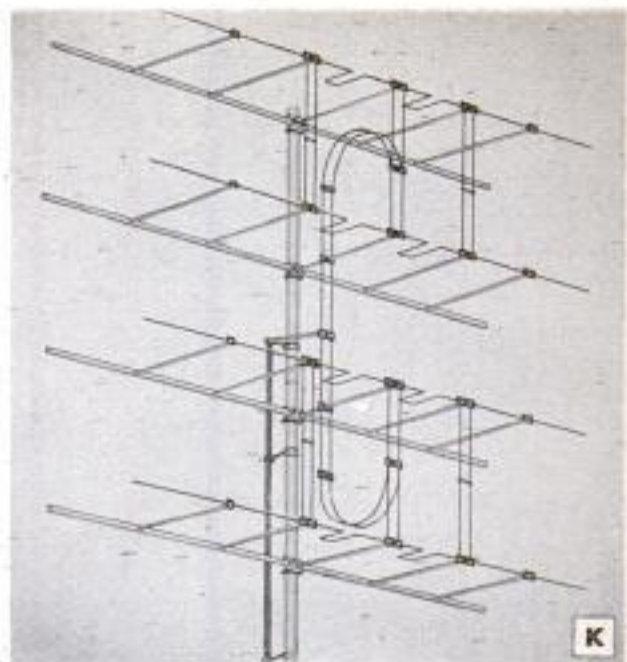

## How to Select Your Television Antenna

(Continued from page 147)

areas a TV-antenna booster will some-  
times be required. If you are close to pow-  
erful TV stations you can often get satis-  
factory results from an indoor-type antenna  
of the "rabbit ear" type, or with one built  
into the set by the manufacturer.

In its simplest form the ideal long-dis-  
tance TV antenna is a type that has been  
employed by amateur radio operators for  
many years, for both receiving and trans-  
mitting. It consists of a receiving-rod ele-  
ment (dipole) shaped like a hairpin, meas-  
uring exactly half the wavelength of a  
single channel, a twin-line lead-in goes  
from its center terminals to the antenna  
posts on the TV set. A rod behind this di-  
pole acts as a reflector to bounce the signals  
back to it and into the line that goes to the  
set. A third element in front of the dipole is  
called a director. The director acts like the  
front lens of a telescope to select and ampli-  
fy the signal, which in this case is concen-  
trated on the receiving dipole.

The length of the elements and the  
spacing between them is determined by  
the use of the electrical formulae. Several  
director elements in front of the dipole  
act like multiple lenses to amplify the sig-  
nal before it reaches the dipole. Variations  
of this design give excellent results on the  
TV channels. Although ordinarily limited  
to a single-band array, new developments  
in design provide true Yagi high-grain per-  
formance on all of the VHF-television  
channels 2 through 13 using a single array.

A stacked array of this type is illustrated

(Continued to page 236)



JOBS ARE EASIER WITH THE  
**Westinghouse**  
*HANDY-CRAFT*  
**Motor**

for HOMES  
FARMS  
SHOPS

IN THE HOME

ON THE FARM

## Free Westinghouse motor guide saves you money 4 ways!

Are odd jobs around the home and farm stealing a big hunk of your time, pleasure and budget? Your free copy of the Westinghouse motor guide will show you how a versatile Westinghouse Handy-Craft® motor can make those "fix-it" jobs and chores easier, more fun—while it saves you money. Check with your Westinghouse Handy-Craft motor dealer (local hardware, automotive or electrical appliance store) or use coupon below.

J-21856

- Helps you choose the *right* motor for any application.
- Guides you in the selection of proper accessories and pulleys.
- Shows you how to make your motor portable to handle a 1001 jobs.
- Tells you how you can make your motor last longer—with minimum care.

Look for this decal. It will identify your local Westinghouse Handy-Craft motor dealer.



YOU CAN BE **SURE**... IF IT'S  
**Westinghouse**



### SEND THIS COUPON TODAY!

WESTINGHOUSE ELECTRIC CORPORATION  
Handy-Craft Motors, P. O. Box 5151, Cleveland 1, Ohio

Please send me a copy of your FREE Handy-Craft motor guide.

I would like complete drawings and instructions for constructing the Handy-Crafter coffee table.

Name \_\_\_\_\_

Address \_\_\_\_\_

City \_\_\_\_\_ Zone \_\_\_\_\_ State \_\_\_\_\_



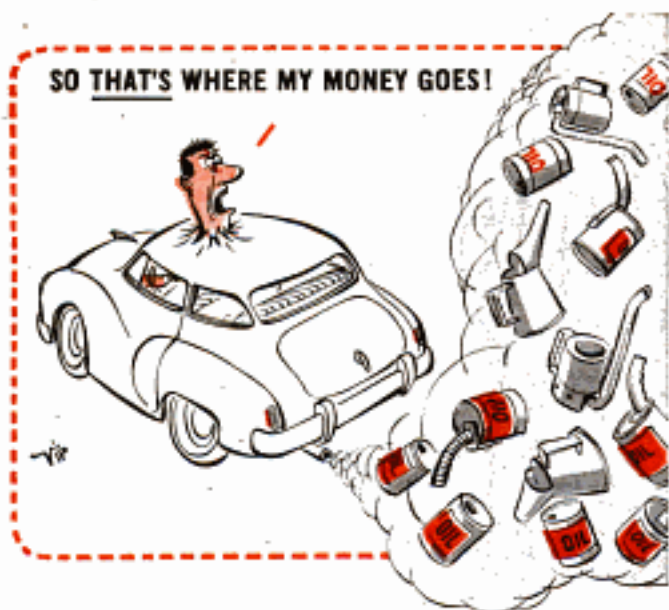

## This oil-pumper needs Tough-but-oh-so-gentle piston rings\*

Oil-pumping is just the start of expense and trouble—the first danger signal from worn-out piston rings. The longer you let those old rings stay in, the more oil you'll use, the more power you'll lose, and the bigger your repair bill will be!

As your engine gets older, it runs hotter because of accumulations in the cooling system. The cylinders wear tapered and out-of-round—need more oil on the walls.

It requires a special type of piston rings—*replacement rings*—to deliver this extra oil, under full control, without waste.

Hastings pioneered in the development of steel oil-control rings and revolutionized the entire piston ring industry. Hastings makes replacement rings exclusively, devotes all its research, on the highways and in the laboratory, to the particular replacement problems of each make and type of engine.

That's why Hastings Rings *stop* oil-pumping, *check* cylinder wear, *restore* engine performance—in re-ringing, re-bore and re-sleeve installations.

So go to your motor specialist at the first sign of oil-pumping or performance drop-off. If rings are the trouble, ask him to install a Hastings Steel-Vent replacement set. Truly the best money you can spend on your car!

HASTINGS MANUFACTURING COMPANY • HASTINGS, MICHIGAN  
HASTINGS, LTD., TORONTO

Piston Rings, Casite, Caslube, Drout, Oil Filters, Spark Plugs

## HASTINGS STEEL-VENT PISTON RINGS

*Regular or Chrome*



**TOUGH** on Oil-Pumping  
**GENTLE** on Cylinder walls

in photo A. Designed for fringe and ultra-fringe installations, it consists of two complete arrays stacked for maximum gain. Where extreme-distance reception is not required, a dipole and reflector alone or, with a single director added, will give satisfactory results. The manufacturer cuts the elements to include the average of all the frequencies in one band. For example, you can have a hi-low Inline array with short elements to receive channels 7 to 13, and another longer element array below it on the mast to receive channels 2 to 6, and FM sound which lies between channels 6 and 7. Another variation is the UHF-VHF rhombic-conical shown in photo B. The rhombic, or diamond-shaped section is for UHF and the conical section for VHF reception. This combination covers all channels 2 through 83 and is useful for trailer-TV installations for extensive travelers.

The UHF channels 14 to 83 are the shorter waves and the signals are not receivable as far as the VHF signals. These waves are so short that the elements and spacing become miniature in comparison to VHF arrays. You should consult your newspaper and local authorities as to the type of TV reception now available or planned, in your locality, before buying or changing, your TV antenna. Photo C shows an adjustable VHF-UHF stacked-V antenna. The angle of the vee peaks a certain frequency range. This double-V array requires no reflector and, like the Yagi, it is very directive. Photos D and E, show the Bo-ty UHF antenna which is a variation of the simple dipole, with triangular sheets of metal instead of rods. The stacked type for fringe areas is illustrated in photo E. These specialized UHF antennas are equipped with reflectors for increased gain and the rejection of unwanted reflections from back and sides. The stacked type is for increased gain in weak-signal areas.

For those who must use a combination VHF-UHF indoor antenna, the one shown in photo F has been tested with highly satisfactory results claimed. One type of VHF stacked fringe-area antenna favored in many localities is the conical array, illustrated in photo G, which has dipoles arranged like the ribs of an umbrella. It is claimed to have high gain and low-loss features, and comes in one preassembled unit. In photo H we have an adjustable V-beam. One position provides high gain on all VHF channels, another position on all UHF and VHF channels. One TV-set manufacturer makes available 9 TV outdoor-antenna kits, one of which is shown in photo I. A double co-lateral all-channel array for ultra-fringe areas is illustrated in photo K.

\*\*\*



## "TINY ATOM" ELECTRIC MOTORS POWERFUL-COMPACT-PRACTICAL

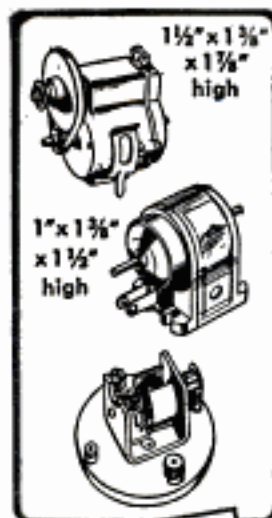

1 1/2" x 1 3/4"  
x 1 1/2"  
high

1" x 1 1/4"  
x 1 1/2"  
high

Wilson's dry-cell operated motors are "tops"—in design, sturdy construction, electrical characteristics and power. Thousands in use by model builders, experimenters, model railroaders and in industry. Three tested styles—every one FULLY GUARANTEED.

**Model 5002**—Metal cased, reversible, Alnico-field motor with built-in speed reducer. Pulleys for 4000 and 1000 RPM. Mounting bracket and belt supplied. For 3-4 1/2-6 volts. Price \$3.00.

**Model 3100**—"Tiny Atom" motor—speeds up to 6000 RPM. Double extended shaft. Permanent Alnico-V magnet field, wound rotor. Heavy duty transparent plastic case. For 1 1/2-3 volts, price \$2.00. For higher voltages, price \$2.50.

**Motor Kit No. 96**—Sturdy, steel frame, 3-6 volt motor. Permanent Alnico V magnet, ball-bearings. Reversible and fast-cooling. In clear plastic box with 2 pinions, gear, worm and pulley. Price \$4.00.



Result with order and we pay postage in U.S.A. No C.O.D. Add 3% Sales Tax for delivery in Ohio. Write Dept. PM.

For quick delivery  
see your local dealer  
— or order direct

**WILSON'S OF CLEVELAND**

425 Lakeside Ave., N.W. • Cleveland 13, Ohio

## NEW!

### OIL MIST SPRAY!

3-IN-ONE's Oil-Spra protects tools with fine mist of oil! Press button for penetrating oil spray! It's so easy to use!



## "3-IN-ONE" OIL

ALSO  
CHILD'S  
2 PASS.  
MOTOR  
CAR

Write For  
Free  
Literature

**ESHELMAN** HOLDS 1 ADULT

AUTO  
WITH  
MOTOR

LOWEST PRICE  
70 Miles Per Gal. Gas.  
25 Miles  
Per Hour.

**Eshelman**  
DEPT. CM-87  
119 Light St.,  
Baltimore 2, Md.  
333 N. Michigan Ave.,  
Chicago-1, Ill.  
7070 Hollywood Blvd., L. A. 28, Cal.



Write for  
Free Literature

## Take The "PAIN" Out of PAINTING!



Basements . . . Fences . . . Furniture . . .

## USE A BECKER CO. SPRAY GUN

Take It Anywhere! No Compressor . . .  
No Electric Cords Needed. Sprays:  
Paints, Oil, Varnishes, Insecticides, etc.

Men! Women! Here's the easy way to lick those tough, tedious, tiresome paint jobs. Becker Spray Gun is fun to use. Requires no electricity or compressors—pressurized by low-cost CO-2 cartridges each sprays up to 21 sq. containerful. Used 5 years successfully in industry.

SEE YOUR DEALER! If he cannot supply, order direct for postpd. shpt. Extra cartridges 10 for \$1.

**SULLIVAN-BECKER CO.**  
Dept. 114-G Kenosha, Wis.



ONLY  
**\$19.95**  
with box of  
10 cartridges

## MOST FOR YOUR MONEY!



## 6" PRECISION LATHE

In the low-cost precision lathe field Atlas is first choice for the home shop . . . for development or commercial work! Outstanding features include: Timken tapered roller bearings—quick-change countershaft—V-Belt drive—reversible automatic longitudinal power feed—precision ground bed ways—8 to 96 threading range—16 speeds, 54 to 3225 R.P.M. You can DO so much MORE so much BETTER with an Atlas! See it at your nearest Dealer's, or—

WRITE FOR FREE CATALOG TODAY



*Atlas Press Company*

Quality Machine Tools Since 1911

ATLAS WOODWORKING POWER TOOLS  
ATLAS METALWORKING MACHINE TOOLS  
CLAUSING HEAVY DUTY MACHINE TOOLS  
724 N. PITCHER ST., KALAMAZOO, MICHIGAN

## Make \$20 to \$30 a Week EXTRA MONEY!

With the high prices of food, clothing and everything else, just think what you could do with extra money every week! Turn your spare time into CASH—sharpening saws with a Foley Automatic Saw Filer pays up to \$3 or \$4 an hour. Start in your basement or garage—no experience necessary. "The first saw I sharpened with my Foley Filer came out 100%"—writes Clarence E. Parsons. No canvassing—"I advertised in our local paper and got in 93 saws!"—says M. L. Thompson. With a Foley you can file all hand saws, also band and cross-cut circular saws.

### FREE BOOK Shows How to Start

It explains how you can get business from home owners, farmers, carpenters, schools, factories, etc. "I get work from 20 to 30 miles away!"—says Charles H. Smith. Free Book, "Money Making Facts," tells how to start. Send coupon today—no salesman will call.

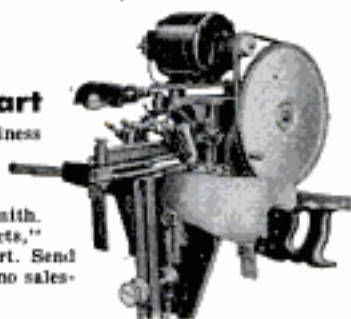

### Send Coupon for FREE BOOK

**FOLEY MFG. CO.** 716-4 FOLEY BLDG.  
MINNEAPOLIS 18, MINN.

Send me free book  
"MONEY MAKING FACTS"

Name \_\_\_\_\_  
Address \_\_\_\_\_



Whole town's talking  
about her hedges!



Porter-Cable  
Yardmaster Tools

New

## HEDGSHEAR

Whose neatly trimmed hedges stir all the favorable comment in your neighborhood? Chances are they belong to the homeowner using a Yardmaster Hedgshear!

And small wonder! This perfectly-balanced hedge trimmer weighs only 5 lbs.—can be whisked over the thickest shrubbery with the greatest of ease. You make graceful curves or ruler-straight tops and sides in seconds... actually trim 100 ft. of hedge in 30 minutes or less! Saves time! Saves work!



Has such quality features as heavy-duty motor, worm-gear drive, hardened steel cutter bar, long-wear bronze bearings, trigger switch with lock button—yet priced to give unequalled value—

Only \$42.95  
(plus tax)

See it at  
your local  
Porter-Cable dealers,  
or mail coupon  
for full details

PORTER-CABLE Machine Co.  
2447 N. Salina St., Syracuse 8, N. Y.

In Canada, send to: Strongridge, Ltd., London, Ont.

Name .....

Address .....

City.....County.....State .....

## Behind the Split Screens of TV

(Continued from page 77)

the building roof, which is in three levels, to the marquee and then across the street.

"But the trolley-car maintenance crew," said an engineer, "took the camera cables over their high-voltage lines across the boulevard for us."

Close to the television booth backstage was an improvised telephone control center roped off in a corner. Here all of the incoming and outgoing video feeds were regulated and monitored.

"Really, there were no problems to speak of," a telephone supervisor said, "for NBC gave us the order in plenty of time, with at least four full days to install equipment."

While NBC had one microwave, the telephone company had eight. They actually used six, with two in reverse. Six circuits and two spares all were going to their Gower Street control center in Hollywood. In addition, there were eight audio lines for radio and TV, one circuit each for production and engineering, and a private phone to connect Donald O'Connor to the studio in Philadelphia, not to mention many business telephones.

Equally as interesting as the split-screen effect was the method of delaying the arrival time of the video signals from the Hollywood film studio and the Burbank commercial studio in order to tie them all together at the Pantages, thus allowing fades from one to the other.

Precaution is an engineer's middle name. He is always ready with an answer if a crisis rears its head. Therefore, that afternoon the crew used the emergency gasoline-engine power supply for the rehearsal, just to be sure it would carry the load if needed. As stand-bys, there were a special 1000-ampere d.c. generator for lighting and the telephone company's separate gasoline generator.

Throughout the day, as problems cropped up, they were speedily solved. There was no complete rehearsal, only segments. A microwave cable had moisture in it, but it was replaced. There was a round-robin feedback but it was remedied by reducing the speaker level in Philadelphia.

It was certainly no accident that the final star-studded production glided by as smoothly as an Olympic skier. So closely knit was the show, few people realized the dancers in the commercials were in the Burbank studios, yet using the orchestra music from the Pantages Theater, several miles away, that Philadelphia and New York were not sitting in the front-row seats and that the insert from Mexico was a film from another studio.

★ ★ ★



BRAND NEW!  
**RUGGED!! 25 TON MASSIVE!!**  
**HYDRAULIC CYLINDER**  
 • ALL STEEL CONSTRUCTION  
 • 8" BORE—15" STROKE  
 • DOUBLE ACTION



ITEM #1815

50,000 LBS. PRESSURE WITH 1000 P.S.I. PUMP OUTPUT.

- UP TO 70,000 LBS.—CAPACITY ON INTERMITTENT SERVICE.
- SOLID STEEL 2 1/2" PISTON ROD
- 1" PORTS
- OVERALL DIAMETER—10 1/4"
- DISTANCE BETWEEN CENTERS—28 1/4" CLOSED—43 1/4" OPEN.

**IDEAL FOR:**

- HYDRAULIC PRESSES • DUMP TRUCK HOISTS • TD-18, TD-24 INTERNATIONAL HARVESTER DOZERS AND GRADERS • LEVELING RAMPS • INDUSTRIAL MACHINERY • ROAD MACHINERY • FARM MACHINERY • HYDRAULIC TAIL GATES

Replacement cost—\$300.00. Shipping Wt.—185 lbs. **SPECIAL PRICE F.O.B. Chicago..... 95.00**

**BRONZE & MONEL BALL BEARING GEAR PUMPS**



ITEM #204 For—

- Insecticide Pumping and Spraying—of D.D.T., 2-4-D, Chlorodane, etc.
- Self-Priming—use as Shallow Well Pump
- For Sprinklers • Home Water Systems • For Sump Pump

For P.T.O., Direct or Pulley Drive • Rated—6 G.P.M. at 600 R.P.M.—18 G.P.M. at 1800 R.P.M., 36 G.P.M. at 3600 R.P.M. • Pressures to 250 P.S.I. • Use 3/4" to 5 H.P. • 1" Pipe Thread Inlet, 1" hose thread outlet. • Shipping Wt.—15 lbs. F.O.B. Chicago... **24.50**

**FREE SUMMER-FALL EDITION**

1954 CATALOG, 52 PAGES, chock-full of unsurpassed War Surplus Equipment Bargains for farm, home, factory, workshop. Write letter today.

BRAND NEW!  
**WAR SURPLUS**

Released Since  
**KOREAN TRUCE**

**GROBAN FOUR-WAY OPEN CENTER HYDRAULIC CONTROL VALVE**



ITEM #126—Four-way open center control valve, with built-in adjustable relief valve factory set at 1000 P.S.I. Spring loaded neutral position. For use with one double acting cylinder. In neutral position cylinder is locked and pump unloaded. Can be used as single unit or mounted in series. Has 3/4" pipe thread inlet and outlet. 1/2" pipe thread cylinder ports. Finger grip handle. Ship. wt. 10 1/2 lbs.

**AN OUTSTANDING BUY! F.O.B. Chicago 21.50**

**BERRY — HEAVY DUTY HYDRAULIC PUMP or MOTOR**

ITEM #166—use on road machinery, vibrators, paper mills, wire reels, hydraulic presses, speed control units. Ball bearing construction, balanced cam design assures high efficiency performance. When used as a pump delivers 11 G.P.M., 1000 P.S.I., 8 H.P. At 1800 R.P.M. as a HYDRAULIC MOTOR: Rated up to 12 H.P. up to 2400 R.P.M. Standard 3/4" pipe thread ports. 3/4" shaft with keyway. Dimensions: 14 1/2" x 8 1/2" x 7". Weight 63 lbs. Regularly \$212.00. **OUR SPECIAL PRICE 59.50 F.O.B. Chicago 2 for 110.00.....**

**DOUBLE ACTION HYDRAULIC CYLINDER**

ITEM #31C—3 1/2" bore, 11" stroke. Alloy steel cylinder wall, Micro-Honed and all steel 1 1/2" diameter piston rod. 19 1/2" overall length closed. Clevis mounting at base and shaft. Will lift 9625 lbs. with 1000 PSI Pump Pressure. Uses 3/4" tubing fittings. (Fittings to pipe thread: two 3/4" MPT @ 35c.) A \$102.00 value. Shipping weight 11 lbs. F.O.B. Chicago... **25.00**

**ORDER DIRECT FROM AD • SATISFACTION GUARANTEED**  
 Send Payment Or Purchase Order Today

**GROBAN SUPPLY CO. Dept. PM-7**  
 1139 S. WABASH AVE., CHICAGO 5, ILL.

BRAND NEW! JUST RELEASED!  
**BLACKHAWK HAND-HYDRAULIC PUMP**

ITEM #82. Perfect for Hydraulic Presses, Snow Plows, Farm Wagons, Jacks and Farm Plows. A few easy strokes of the 20" handle and you can lift 5000 lbs., using a 2 1/2" bore — Hydraulic Cylinder. Blackhawk Model P-151—complete with built-in oil tank and release valve.



Rated 1200-8400 lbs. per square inch. Dim.: 9"x7"x6". Ship. wt. 35 lbs. Worth much more. F.O.B. Chicago..... **22.50**

**A. C. ELECTRIC GENERATOR**

ITEM #G-75—Electric generator, 7500 Watts, 120/240 Volt, 60 Cycle, 1800 R.P.M. single phase current, for standard 3 wire circuits, double ball-bearing construction, standard 1 1/4" shaft with keyway, and included at no extra price, 5-groove six inch pulley for belt drive. Direct connected self-excited. Foot Mounted, Gov't. Acquisition Cost: \$545.00. Dim.: 34" x 11 1/2". Ship. wt. 320 lbs. F.O.B. Chicago. **Price Slashed To... 295.00**

**D. C. GENERATORS**

**IDEAL FOR WELDING GENERATOR**  
 Type R-1, ITEM #91 rated 300 Amps.—50 Volts. Mfd. by Jack & Heinz, Government Acquisition Division. Cost \$380.00. Ship. wt. 55 lbs. Dimensions: 10"x10"x7". Complete with instructions to connect as Welder. F.O.B. Chicago..... **35.00**

**TO PLACE PHONE ORDERS CALL Webster 9-3793**

**SUPERIOR QUALITY**



Built with painstaking care from carefully selected materials. Free Catalog.  
**GERSTNER TOOL CHESTS**  
 454 Columbia St., Dayton 7, Ohio

**"SHOOPER" GEIGER COUNTER**



Supersensitive! Only 1 1/2 lbs. Fits pocket—uses flashlight battery. Find a fortune in uranium. Order Now! Send \$5.00, balance C.O.D. **MONEY BACK GUARANTEE. FREE CATALOG**—scintillator and larger uranium and metal detectors. **DEALERS WANTED.**

**2995 COMPLETE PRECISION RADIATION INSTRUMENTS**  
 2235 PM S. LA BREA, LOS ANGELES 16, CALIF.

**BREAKS THE GRIP OF RUST**



**KROIL**, the amazing chemical lubricant, creeps into millionth inch spaces and loosens frozen metal parts when all others fail. Used by 12,000 leading industrial shops. Try KROIL on money back basis—gallon \$3.85 FOB factory—or send \$1.50 for two 8 oz. spout cans—Postpaid.

**KANO LABS.** 1032 THOMPSON LANE NASHVILLE 11, TENNESSEE

**\$40 A DAY BUSINESS**

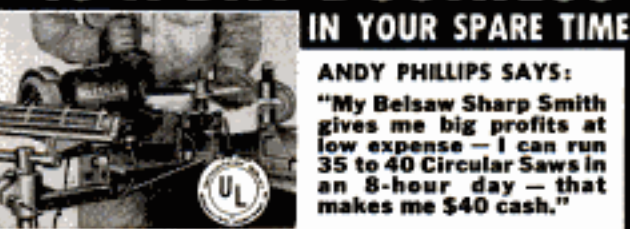

**IN YOUR SPARE TIME**

**ANDY PHILLIPS SAYS:**  
 "My Belsaw Sharp Smith gives me big profits at low expense — I can run 35 to 40 Circular Saws in an 8-hour day — that makes me \$40 cash."

"I also get BIG EXTRA PROFITS... up to \$4 an hour... by grinding planer and jointer knives — there's always a demand for this kind of work."

You can start this REPEAT CASH business in your own home or garage while you are working at your regular job. Easy to operate, no experience needed. "My BELSAW paid for itself the first month." — H. J. Opie

For as little as \$15 down payment, you can get your BELSAW SHARP SMITH rushed to you.

**FREE book tells how** — YOU can start making money the very day your BELSAW SHARP SMITH arrives. Hundreds of jobs in your own neighborhood. Send for Free book "Life-Time Security."  
**BELSAW MACHINERY CO**  
 3706-B Field Building Kansas City 11, Mo.



Regular Price of a Slide Rule \$4 and up



**Slide Rule 92c** and this coupon Add 8c Postage

If you can use a pencil you can use a slide rule. For bookkeepers, accountants, salesmen (figuring commissions, cost, etc.), farmers, housewives, etc. For Armed Forces highly important. Men's most useful tool. Easy to calculate instantly. Multiplying, proportions, division, roots, etc. "High Vision" Clear View Slide. Full 10" rule. A, B, C, D, C1 and K scales. **FREE** 28-page instruction book on how to get correct answers instantly without pencil or paper.

**Gene Loewy, 545 5th Ave., Dept. 43-T, N.Y. 17**  
 Limit three rules to each coupon



MORE FOR YOUR MONEY IN 1954

# SHAW "DU-ALL"

## Garden and Small Farm Tractors

### Sturdy Work Saving Walking Tractor

New  
Low  
Prices  
Walking  
Tractors  
\$99.50  
up

Utility  
Tractors  
\$298.50 up.

H. P. models. None better for all 'round work.



Best buy in 1½, 2½, 3, 5 H. P. Handle 6, 8, 10 inch plows. All tools and attachments. Variable speeds, adjustable wheel widths, individual gang tool controls. Three speeds and reverse automotive gears on 3 and 5

### New, Low Cost, Streamlined Riding Tractor

3, 5, 6 H. P. Pull 8, 10, 12 inch plows, 28 inch tread, 56 inch wheel base, 3 speeds and reverse automotive gears. Individual brakes aid in short turning. ¼ to 7 M. P. H. Nothing else like it in a powerful, practical tractor at bed rock cost.



### Inexpensive Tiller..Lawn Mower

Nine inch rotor pulverizes up to 12 inch swath 6 inches deep, or less. Extremely low cost. Rotor quickly replaced with single wheel for lawn mowing, hauling, etc.



See the  
Shaw Dealer

**FREE  
CATALOG**  
Low Prices  
Return Mail.  
Write Today.

**SHAW MANUFACTURING CO.**  
4507 Front St., Galesburg, Kansas  
666-G N. 4th St., Columbus, Ohio

## MAKES INSULATED ELECTRICAL CONNECTIONS

Splices  
Crimps  
Strips  
Cuts  
WIRE



**AMP CHAMP HAND TOOL** is an electrician's tool adapted for home workshops. Makes completely insulated splices and connections in house wiring, appliances, auto, etc. It crimps solderless terminals and connectors. It splices and strips wire. No tape or solder needed. It shears bolts leaving threads undamaged. Terminals, connectors and insulators free. \$3.95 postpaid. T. W. Berger, national dealer and consumer distributor. Aircraft-Marine Products, Inc., American Bldg., Cincinnati 2, Ohio

**FREE!**  
with Kit  
Terminals  
Connectors  
Insulators

T. W. Berger, Inc., Distributor  
1315-JY, American Bldg., Cincinnati 2, Ohio

Rush me a Champ Tool. I am enclosing \$3.95.

Name \_\_\_\_\_  
Address \_\_\_\_\_  
City \_\_\_\_\_ State \_\_\_\_\_

## Midget Subs Play Target for Killers

(Continued from page 89)

of conning tower. Fortunately the damage was all in the outer skin.

The real fun for submariners comes when they fire dummy torpedoes at their attackers. "They're supposed to fire below the ship," Lt. Holt explains, "but once in a while, a 'fish' will act up. Once or twice I've seen them hit a ship—and believe me, even a dummy packs a wallop. Those boys know they've been hit. The fish leaves a dent that doesn't get pounded out in an auto-body shop, and I saw one that punched a hole in a target ship."

Despite his enthusiasm for the war games, Commander Morton has a fine regard for the safety of the men under water. There's nothing a sub skipper hates more than another sub working in the same area with him. Since he can't see out, he must depend on instruments that can't see in all directions at once. The grim spectacle of two subs ramming each other 100 feet deep in the ocean is not pretty. "We saw a group working in toward us the other day," says Morton. "Suddenly the surface ship contacted us and reported she'd lost her sub. So, out we went over the underwater phone—contacted the missing sub, then rang our sub in on the same frequency and held a three-way conversation. In a few minutes we had headed both subs in opposite directions and surfaced them—much to the relief of everyone. That underwater phone is one of the best things we've got on this DE besides the Mark V."

A day's exercise at Key West is never finished until the last DE has made its last run on the midget sub—and, like batters at batting practice, any DE skipper wants his last crack at the ball. It's usually late afternoon when Captain Holt takes off his headset and passes the word: "Stand by to surface. Yellow flare away."

"Yellow flare away, sir," shouts Frenchie or Smitty, or John Ott, or Jim Dudgeon—or whoever happens to ram the aluminum cylinder out the ejector tube in the tight space behind the crew's quarters.

"Blow the main ballast," orders the skipper. "Blow number one." There's a rush of water, a hiss of air and up goes T-2.

"Open the main induction!" Warm fresh air swirls into the midget. Ears pop as the pressure goes out with a hollow roar. Holt and McQuilling climb through the dripping hatch to the conning tower, and T-2 plows back to Key West, draining white foam from her plunging sides. She's earned her keep another day. ★ ★ ★



## Make BIG SAVINGS With FACTORY-DIRECT PRICES!



**HAND WINCHES AT FACTORY PRICES**  
 3 to 1 ratio-700 lb. pull. Drum has 1 3/4" spool, 6" flange. Takes 75 ft. of 3/16" cable. Stop locking pawl. . . . \$16.85  
 24 to 1 ratio. Worm drive, 1000 lb. pull. Width 11", depth 7 1/2", height 7 1/4" \$28.00  
 10 to 1 ratio. Super-duty 4000 lb. pull. Double drum, with jaw type clutch. Wgt. 280 lbs. . . . \$49.50

**Electric Winches—Direct-to-You Prices**  
 1/2 HP master gearhead driven winch with anti-rattle. Will lift 500 lbs. Pull 1100 lbs. . . . \$98.00

1/2 hp electric Bau steering. Compact gear box. 12 RPM drum speed. . . . \$165.00  
 3/4 HP, same as above. More lifting power, greater speed. \$185.00  
 Super-duty 3/4 HP Ball Bearing, with 24 to 1 worm gear reducer. Length 36". Width 26". Height 17". Pull 3500 lbs. Complete with 100 ft. of aircraft cable, up-and-down buttons. . . . \$245.00  
 (All electric motors Heavy-Duty, Repulsion-Induction. Instant Reverse. 110 V single phase, 3 phase available.)  
 Complete Stock of Limit Switches, Magnetic Brakes, Magnetic Reversing Switches, Aircraft Cable  
**CABLE** 1/4" pre-formed aircraft cable. . . . 17c ft.  
 3/16" pre-formed aircraft cable. . . . 12c ft.

### HOT ROD SUPERCHARGER

Extra soup and go at a price you can't afford to miss! Mfr'd by Borg-Warner. Specifications: 7 1/2" deep, 7" high. Wgt. 17 lbs. Compact and sturdy, 4 base mounting holes, 3/4" outlet, 3/8" shaft with female Lovejoy coupling. Priced today at \$85. SPECIAL NEW only. \$31.00. **SEND \$18.95**



Here are only a few big \$ \$ savings! More in our catalog!

Air Compressor	Electric Motors	Hand Truck	Rubber Cable
Air Tank	Electric Switches	Hydraulic Cylinder	Rubber Wheels
Block & Tackle	Elevator	Hydraulic Stacker	Saw Tables
Blowers	Drawing	Hydraulic 1 Beam Trolley	Shower Sprays
Bomb Trailer	Elevator Incline	Lawn Mower	Starters
Buzz Saw	Fans, Exhaust	Sulky	Tools
Compressor	Fans, Heat	Magnetic Starter	Transformers
Accessories	Booster	Mail Chain Saw	Whiting Hoist
Clutches	Gas Engines	Mail Grinder	Winch, Electric
Conveyors	Generators	Pumps	Winch, Hand
Delta Tools	Grinders	Reduction Gear	Fire Extinguisher
Drop Cords	1/2 Ton Wagon		4 Wheel Trailer
Electric Hoists	Male Fire Pump		

Get this catalog! 88 pages, packed with useful charts, information, plans for dummy & incline elevators, more than 1100 tool and equipment items at money-saving, factory-to-you prices. Send 25c (refund with first order) or write on company letterhead for free copy.

**C&H ELECTRIC MACHINE Co. Inc.**

434 N.W. Juneau Ave., Milwaukee 3, Wisconsin

WHEN IT COMES TO WOOD FILLERS THERE'S NO SUBSTITUTE FOR PLASTIC WOOD!



Plastic Wood is stronger—resists weather. Sands down to a smooth, hard finish. Professional craftsmen have preferred Plastic Wood for more than 50 years because it takes paint, varnish and other finishes best. Will not chip, crack or peel . . . won't pull away! In cans and tubes.

In Natural and 8 wood colors!

## "PLASTIC WOOD"

FAMOUS DREMEL ELECTRIC COPING SAW . . . LONG TIME FAVORITE WITH CRAFTSMEN!

**AMAZING FOOT-A-MINUTE (7,200 Strokes Per Min.) CUTTING SPEED!**

**ONLY \$6.85** with 3 saw blades

Make your own jig saw. Complete plans and six project patterns, included FREE.

**FREE PROJECT PLANS**

Here is a high speed, electric power tool with hundreds of household and workshop uses! It's so easy to handle women and children love it, yet so rugged it is used by craftsmen, tile layers and carpenters. Has amazing capacity—easily cuts asphalt and rubber tile, masonite and formica, wood up to 3/4" thick! Perfect for coping and jig saw work, making knick-knacks, toys, other hobby projects. Has high speed reciprocating motor, only two moving parts, never needs oiling. Proved on the job and in thousands of homes.

Cuts scrolls like magic!

**SEE YOUR DEALER.** If he cannot supply, order direct on 5-day trial, money-back guarantee. Remit in full for postpaid shipment; or send \$2, pay postman balance plus postage and COD.

**DREMEL MFG. CO.** Dept. 114-G, Racine, Wis.

**GIVE TRAFFIC JAMS THE SLIP WITH A HULL AUTO COMPASS**

Leave main highways at will, without losing bearings on strange side roads. A HULL gets you there the quickest, surest way. Write for local dealer's name, free literature.

**HULL MFG. CO.** P.O. Box 246-D-7 Warren, Ohio

**BeaconLite** \$6.95  
**STREAMLINE** \$4.95  
(Standard not slip)

**FREE FOLDER "HOW TO SAND"**  
 ADDRESS "Handy" SANDY  
**CARBORUNDUM**  
 Niagara Falls, New York

Say You Saw It in Popular Mechanics

**IDEAL LAWNMOWER SHARPENER**

**BOOST YOUR INCOME**

You can earn extra cash with the Model 300 Ideal Lawnmower Sharpener. Used and recommended by leading manufacturers and service shops, the Ideal has everything you need, nothing else to buy. Grinds reel and bed knife, also reconditions. Get started now in this highly profitable business. Write for catalog today.

**The Fate-Root-Heath Co.**  
 Dept. PM-7, Plymouth, Ohio



**WAR SURPLUS** AND OTHER **BARAINS** **SAVE UP TO 90%**



**NEW P1 GENERATORS**

Electric Auto-Lite, 200 Amps, 24 Volt, 2500 RPM, Dandy arc welder, Wt. 53 lbs. Approx. Govt. Cost \$450. NEW, \$17.50 incl. easy to follow diagram.

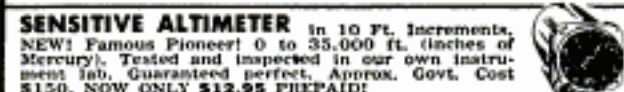

**SENSITIVE ALTIMETER** in 10 Ft. Increments. NEW! Famous Pioneer! 0 to 35,000 ft. (Inches of Mercury). Tested and inspected in our own instrument lab. Guaranteed perfect. Approx. Govt. Cost \$150. NOW ONLY \$12.95 PREPAID!

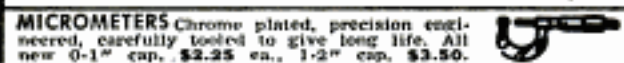

**MICROMETERS** Chrome plated, precision engineered, carefully toolled to give long life. All new 0-1" cap. \$2.25 ea., 1-2" cap. \$3.50.

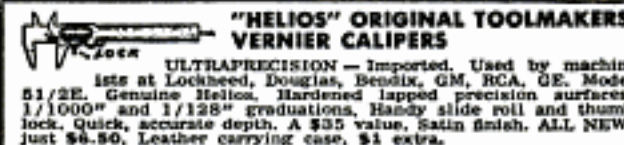

**"HELIOS" ORIGINAL TOOLMAKERS VERNIER CALIPERS**  
ULTRAPRECISION — Imported. Used by machinists at Lockheed, Douglas, Bendix, GM, RCA, GE, Model 51/2E. Genuine Helios. Hardened lapped precision surfaces. 1/1000" and 1/128" graduations. Handy slide roll and thumb lock. Quick, accurate depth. A \$35 value, Satin finish. ALL NEW, just \$6.50. Leather carrying case, \$1 extra.

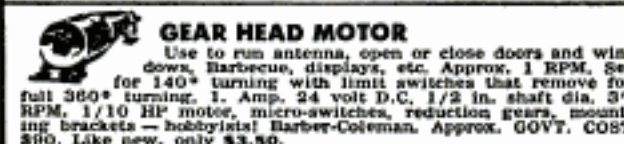

**GEAR HEAD MOTOR**  
Use to run antenna, open or close doors and windows, Barbecue, displays, etc. Approx. 1 RPM. Set for 140° turning with limit switches that remove for full 360° turning. 1. Amp. 24 volt D.C. 1/2 in. shaft dia. 3" RPM. 1/10 HP motor, micro-switches, reduction gears, mounting brackets — hobbyist! Barber-Coleman. Approx. GOVT. COST \$80. Like new, only \$3.50.

Send 25¢ for big catalog. Bargains for everyone. Check, Money Order or Cash. 25% deposit on C.O.D. orders. Prices F.O.B. Culver City, Calif., unless otherwise stated.

**AIRBORNE SALES CO., INC. DEPT. PM754**  
8501 Stellar Drive, Culver City, Calif.

**Opportunity for Men with Automotive Background and Executive Ability**

Manufacturer and marketer of nationally-advertised line of automotive products now expanding operation here and abroad. Distributors needed to warehouse and administrate to growing dealer network. If you have organizational ability and are financially responsible, write for details.

Your inquiry held in confidence; Write: Box P.M.-7, 10418 Venice Blvd., Los Angeles 34, Calif.

Shoots glaziers' points into hardest wood  
ask your dealer for  
**Red Devil**  
diamond point driver

**Red Devil Tools.**  
Get your FREE copy of "HOW TO FIX BROKEN WINDOWS."  
MAIL COUPON TODAY  
**Red Devil Tools.** Dept. 146  
130 Coit Street, Irvington, N. J.

NAME \_\_\_\_\_  
ADDRESS \_\_\_\_\_  
CITY \_\_\_\_\_ ZONE \_\_\_\_\_ STATE \_\_\_\_\_



See it!  
microscopic life  
around you...  
Free 44 page catalog



**FREE-MICRO MANUAL**  
elementary slide making at home, where to find subjects.

**BOTH FREE** — Send post card or letter — dealers inquire.



**AKRON**

105 AKRON BLDG., 4373 SUNSET BLVD., LOS ANGELES 27, CALIF.



**MAGNETS** 225 lb. PULL  
GENUINE ALNICO — NEVER WEAKENS

**AMAZING, PERMANENT MAGNETS—WILL NOT WEAKEN! NON-ELECTRIC**  
Retrieve guns, tackle, tools and other steel items from lake, river, plating tanks, drains or other hard-to-reach spots. Recover drills, taps, etc. from sweeping. Clear alley of harmful tacks, nails. Many other uses. Pays for itself quickly. **GUARANTEED.** Try any magnet one week. Money refunded if you are not well pleased.  
No. M-725 (Weights 54 oz.) Has pull of 225 lbs. on steel block. \$15.00  
No. M-675 (Weights 49 oz.) Has pull of 175 lbs. on steel block. \$10.50  
No. M-650 (Weights 41 oz.) Has pull of 150 lbs. on steel block. \$ 8.50  
No. M-500 (Weights 15 oz.) Has pull of 50 lbs. on steel block. \$ 4.00  
No. M-30 (Hobbyist assortment of six small magnets) \$ 1.50  
Send Money Order or Check. We pay postage. No C.O.D.'s.  
**MIAMI MAGNET COMPANY, 3240 N. W. 27th Ave., Miami 42, Fla.**

**RETAIL PRICE \$125.00**  
**FACTORY TO YOU \$79.95**

**SUPERSHOP** includes precision-built 8" tilting table saw, vertical and horizontal drill press, 30" lathe, sander, grinder. **100% BALL BEARING.** Write for **FREE** catalog, full details, trial plan. Easy Pay Plan.  
**POWER TOOLS, INC.** 161 YATES AVENUE, BELLEVILLE, WIS.



**SILVER SOLDER TORCH & KIT \$7.95**  
JOINS ALL METALS PERMANENTLY  
Do your own repairing. KIT includes one tube silver solder paste and 10 5-in. lengths silver solder alloy. **Hottest ALCOHOL TORCH** known. 2700° F. flame. Operates in any position, indoors or out. Pint of special fuel included. Complete outfit ready for use \$7.95 postpaid. TORCH alone with pint of special fuel \$6.85. KIT alone \$1.65. Instructions included.  
**AMERICAN PRODUCTS CORP., 422 S. Dearborn, Dept. 3-G, Chicago**

**SEND ONLY \$1** for next 6 issues of famous **DELTA-GRAM**, best home woodworking magazine you ever saw. Packed with shop-tested ideas—12 to 15 in each issue. Send \$1 (no stamps) to: Delta Power Tool Division, Rockwell Mfg. Co., 502G N. Lexington Ave., Pittsburgh 8, Pa.

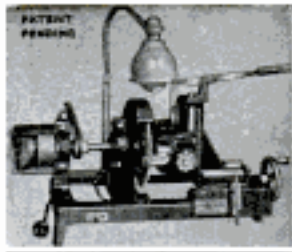

**Start a NEW BUSINESS!**  
or Add to your present Repair Business  
**SHARPEN DULL PIPE WRENCHES**  
PIPE TAPS & DIES  
"GUM" CIRCULAR SAWS  
Also MOTOR DRIVEN ROTARY HONE  
Write for Information  
**J. C. MOORE INDUSTRIES**  
BOX M 276 FREDONIA, PA.



**SUPER DRILL GRINDER**  
Sharpens round shank drills from 3/32" to 1/2" in diameter, up to 6" long. Grinds old drills like new in 4 different point angles, using hand or power grinding wheels. Money-back guarantee... only \$2.95  
At Dealers or Postpaid  
**A. D. McBURNEY** Dept. A-43  
5908 Hollywood Blvd. Hollywood 28, Calif.



# GIGANTIC MAIL SALE

WAR SURPLUS  
EXCESS INVENTORY  
BANKRUPT STOCK

## AIR COMPRESSOR ITEMS

- Finest piston 100-lb compressor, 3 c.f.m. Build your own air system. Special . . . . . \$19.95
- Also tanks, regulators, etc., at big savings. Send for data.

## DELUXE POWER PLANT

- Marvelous 3000-4000-w. 115-v. 60-c plant. Army's finest, 4-cyl. water cooled engine, fully standard. Govt. cost over \$600. Sp. . . . . \$349.50
  - 115/230-v. Trans. \$19 extra.
- Many other plants and generators on sale.

## BROAD SWATH WEED SPRAYER

- Scouting make gear, multi-jet unit. Sprays 41'. Complete with finest bronze gear pump, hose, barrel mtg., valves, etc. \$150 value. Special . . . . . \$77.95
- Many other buys in weed spray units.

All Items in this ad sent  
PREPAID

## VACATION TRIP SPECIALS



### AIR TANK

• Large 10"x18" 400-lb. test tank with gauge, hose, tire chuck, nozzle. Fill tires, wading pool, air mattress, spray lawn. SALE . . . . . \$15.95 Ppd.

## CAR BATTERY SEARCHLIGHT

• Hi-intensity 8-v mile beam. With case, colored filters. Ideal for camp. 848 tires at night. Cost over \$30 . . . . . \$4.39 Ppd.

## FARM-CONTRACTOR LEVEL

• Complete with rod, tripod. Precision \$70 unit. . . . . \$37.95 Ppd.

## SPECIAL OF THE MONTH

### New Tool Chest

#### 28"x38"x20"

• Finest wood cabinet design. Four lift-out drawers, excellent hardware, etc. Heavy, durable. Ideal for home shops, contractors, tool rooms, etc. Govt. cost \$59.60. SALE . . . . . \$21.95 Ppd.

## SUPER CLOSEOUT BARGAINS

- Army Hip Boots (10, 11 or 12) . . . \$ 7.89
- Giant Flood Light (see May ad) . . . \$49.50
- Army Parts Cleaner . . . . . \$29.50
- Generator (200 amp DC) 115-v AC . . \$29.45
- Centrifugal Pump (100 gpm) . . . . \$29.50

ORDER FROM AD or write for big  
**FREE CATALOG** 1000s of items! Motors, sporting goods, hand and electric tools, watches, tarps, winches. Write today!

**BURDEN SALES COMPANY**  
802 "D" Street LINCOLN, NEBRASKA

## PUMP WATER FAST!

DRAIN WASH TUBS, CELLARS, CISTERNS  
IRRIGATE—FILL TANKS—DRAW WELL WATER

Pumps 2800 GPH, 420 GPH at 75' High or 1600 GPH from 25' well. Sturdy, Rustproof Alloy Metal. Six Blade Impeller. Uses any 1/8 to 1/2 H.P. Motor. Will not leak or clog. Fits any garden hose. Immediate Money Back Guarantee. Send Check, M.O., or C.O.D. **\$8.95** U.S.

**MOORE MANUFACTURING CO.**  
SWEDSBORO 1 NEW JERSEY

## PADHACKSAW—The New Modern Hacksaw!

Does the work of 5 ordinary jigsaws or hacksaws. 11 inches long. Made in England of fine tempered metal. Removable blade. Spring action makes sawing semi-automatic. **\$2.98** postpaid. Saws to any depth and shape. Not Limited by old Hacksaw frame.

MODERN PRODUCTS, 231 West Adams St., Jacksonville 5, Fla.

**GIANT BITE Swivel Action** **\$6.95**  
Light-Weight ALUMINUM ANCHOR  
Wgt. 4 1/2 lbs. Holds equivalent of 12-lb. iron. SNAGPROOF. NON-CORROSIVE.  
**P. J. QUATTRO** c/o WEST LEYDEN STAGE HOME, NEW YORK

**STARRETT "Tools and Rules" BOOK**  
Describes and illustrates the precision methods skilled mechanics use. Only one dime. Write Dept. AP.  
**THE L. S. STARRETT CO.,** Athol, Mass., U. S. A.

**LAWN ORNAMENT-NOVELTY PATTERNS**  
28 Lawn Ornament Patterns, 25c. Other Patterns: 15-20" high: Dutch Girl, Dutch Boy, Pirate, Bull Terrier, Mexican Girl, Mexican Boy, Dwarf, Penguin, Flower Girl. 15c each. 25 Novelty Patterns, 30c. All 62 Full Size Patterns, \$1.00.  
Strother Pattern Service, Dept. DR-8, Box 128, Beltington, W. Va.

**Wholesale! TOOLS! GUNS! CAMERAS!**  
BUY TOOLS, PHOTO EQUIPMENT, SPORTING GOODS, JEWELRY AND THOUSANDS OTHER NATIONALLY ADVERTISED PRODUCTS AT BIG DISCOUNTS. SAVE ON OWN PURCHASES. BIG PROFITS SELLING TO OTHERS. POSTCARD BRINGS FREE COPY "THE WHOLESALE PLAN".  
**AMERICAN BUYERS SERVICE**  
629 Linden Ave., Dept. 15, Buffalo 16, N.Y.

**New Arc Welder**  
Costs Little,  
**PAYS BIG!**

**200 amp. Air Cooled Engine Driven**  
The Hobart "Husky Boy" gives fast, strong welds at lower cost. It's light, rugged and compact . . . welds anywhere. Designed to handle both general shop and outside repair work, it's a real profit maker anywhere! Cash in on "big pay" emergency repair work.  
**HOBART Bros. Co.,** Box M-74, Troy, Ohio

SEND FOR  
**FREE CATALOG**



## Money-Making Tools!

It's easy to own the same "pay-off" tools used and endorsed by America's top-earning mechanics! You can start building your own kit with basic Snap-on sets—add others any time. Never sold in stores—direct to users only. Send today for free catalog!  
**Snap-on Tools Corporation**  
8062-G 28th Ave., Kenosha, Wis.



Also Eshelman **SPORT CARS** **LOWEST PRICE** **70 Miles Per Gal.** **Holds 1 Adult** **Free Literature**

**ESHELMAN BOAT TRAILER**  
Lowest Price  
Easy Load • Easy Haul • Easy Launch  
**ONLY \$79**

Write for Catalog  
Top quality welded steel construction. Shipped complete with Hi-Speed wheels, tire, tabs, hitch, etc. Write  
**ESHELMAN CO., Dept. BT-107**  
119 Light St., Baltimore 2, Md.;  
333 N. Michigan Ave., Chicago 1, Ill.;  
7070 Hollywood Blvd., Los Angeles 28, Cal.

## GET THIS STRAIGHT you can't beat an EMPIRE LEVEL

For improved accuracy, better visibility, less breakage, use the new Empire 9" aluminum Torpedo pocket level with machined bottom groove and protected, easy-reading vials. See your dealer today for all-purpose Empire Levels.

**EMPIRE LEVEL MFG. CO.** 10930 W. Potter Rd., Dept. PM Milwaukee 13, Wisconsin

Say You Saw It in Popular Mechanics

Check coupon, mail with name and address for complete data.

**A. C. Welder**  
Transformer Type AC Welder for shop use on single phase power.

"Husky Boy"  
 Transformer Type AC Welder  
 Reg. El. Drive  
 Hobart GI approved School  
 FREE Welder's Pocket Guide  
Box M-74, Troy, O.

Phone 21223



# DRILL SAW REAM CUT

## INTERNATIONAL

### HI-SPEED COPE SAW DRILL BIT



DRILL, SAW, REAM . . . metal, pipe, wood, plastic, Transite, etc. Use with any electric drill, slow drill press, lathe or milling machine. Drills own starting hole—upper part of bit is used to cut, saw or ream circles, ovals, squares or scrolls. Easy to operate. Ideal for carpenters, mechanics, electricians, plumbers, hobbyists, many others. Abrasive resistant, high speed steel. Flutes ground from solid. Will withstand severe continuous use without breaking. Resharpens at no charge. Takes place of up to \$50 in tools. 3/4" diameter, 2" cutting sections, total length 3 1/2". Available in three types—All Purpose, Wood, Heavy Metal. Specify type needed. Set of 3, \$11.50. Details on request. Shipped same day. Money-back guarantee. Dealer inquiries invited. ORDER NOW! SEND CASH, CHECK OR MONEY ORDER.

Manufactured and distributed by  
**INTERNATIONAL TWIST DRILL CORP.**  
618 Wyandotte, Rm. 638, Kansas City 5, Mo.

only  
**\$3.95**  
POST PAID

## REMOVE Paint EASILY



## WONDER-PASTE

makes a simple job out of removing tough paint, varnish, enamel, etc. . . Softens up finish so it comes off easily—not coat by coat, but all in one scraping. Stays put on upright surfaces. Stays moist so you can work on large areas. Excellent indoors or out. At paint and hardware stores.

Write for Wonder-Paste leaflet—and advice on your removing problem.

Wilson-Imperial Company, 119 Chestnut St., Newark 5, N.J.



## Say You Saw It in Popular Mechanics

### AUTOMATIC AIR COMPRESSOR

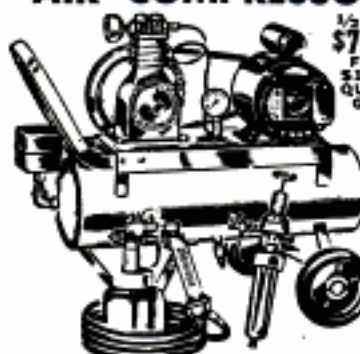

1/2 HP heavy duty R.I. or Cap. motor, 115-V, 60 Cy. AC . . . \$23.50  
K2 Quincy 3 CFM, 100-150 lb. compressor . . . \$20.50  
Automatic adjustable pressure switch . . . \$4.50  
Tank 8x26, rubber tired wheels and handle . . . \$17.00  
Adjustable pressure regulator and gauge . . . \$6.00  
Moisture filter—\$3.25 V-belt drive . . . \$2.75  
Hose and tire chuck \$2.50  
Safety valve . . . \$1.50  
Check valve & copper tubing . . . \$3.75  
Small parts shipped parcel post prepaid at above prices.  
Complete 1/2 HP unit assembled, ready to use—Plus Special FREE \$12.00 value Quart External Atomizing Spray Gun with every unit . . . \$A-S. \$89.00 FOB Chicago  
Save \$10.00—1/2 HP outfit knocked down, you assemble, free spray gun, \$12.00 value. \$K-5 . . . \$79.00 FOB Chicago.  
\$K-75—3/4 HP Motor 12x24 Stainless Steel Tank, wheels, all accessories, large 4 CFM compressor, free gun . . . \$123.50 FOB  
\$K-100—1 HP Motor 15x30 Tank Twin Cylinder 9 CFM Compressor, All Access. You assemble, Free Gun . . . \$169.50 FOB  
\$K-150—1 1/2 HP 110-220 V. A.C. unit. Same as above, Larger Motor, Larger Capacity. All accessories . . . K.D. \$199.50  
Write for CIRCULAR: Listing Motors; ALL SIZES; Fans and Air Compressors—ALL SIZES.

**C. MARSHALL SALES**

3546 W. Fullerton Ave. Dept. P-7 Chicago 47

## FREE! SOUTH BEND CATALOGS

- . . . 9" to 16" SWING LATHES
- . . . 14" DRILL PRESSES
- . . . 7" BENCH SHAPER
- . . . ATTACHMENTS

Write today—check catalog wanted

**SOUTH BEND LATHE WORKS**  
425 E. Madison St., South Bend 22, Ind.



## NEW SANDER L-I-G-H-T-S WORK AS IT SANDS!

FREE '900' CATALOG

Only SYNCRO '900' SANDER gives you all this! built-in work light—most powerful reciprocating sander motor (patented) and guaranteed against burn-out during ownership—removes more material with less upkeep—no twisty torque to fight—heavy duty. Write for amazing low cost, Free Syncro Catalog, Free "Sand To Get Results—Not To Make Sawdust."

**SYNCR CORP.**  
Dept. 1-84, OXFORD, MICHIGAN, U.S.A.



Hurry . . . Write Today!

## DO MORE PLANING JOBS WITH LOW COST BELSAW



Exclusive MONEY-MAKING Features: • Full 12 1/2" x 6" capacity • Power feeds at 24" a minute • Provides for Grinding Knives in the Cutterhead • Attachments for Jointing, Rabbeting, Tongue, Groove, Matching. Convert low cost rough lumber into high priced cabinet finished stock . . . Easy to make flooring and popular patterns. Send today for free literature and prices.

Belsaw Machinery Co., 1011 Field Bldg., Kansas City 11, Mo.

## "HANDY TIPS FOR HANDY MEN"

BOOK OF HINTS to make home repairs and hobby projects easier. Send 25 cents in coin to: THE BLACK & DECKER MFG. Co., Dept. H7M, Towson 4, Maryland.

## \$6.95 DRAINS cellars, cisterns, wash tubs; IRRIGATES - CIRCULATES - SPRAYS



1,001 USES—HOUSE, GARDEN, FARM Original All-Purpose Pump has 2400 GPH capacity, 360 GPH 75' high; or 1500 GPH from 25' well. Use any 1/8 to 3/4 HP motor. Stainless steel shaft, 1" inlet, 3/4" outlet. Motor coupling included.

DOES NOT CLOG OR RUST! Postpaid if cash with order. (West of Miss. add 50c.) MONEY BACK GUARANTEE. Lancer Centrifugal Pumps, and Gear Pumps in all sizes. LABAWCO PUMPS, Belle Mead 7, N. J.

## SAVE MONEY ON SURPLUS PARTS for MILITARY TYPE TRUCKS & JEEPS

4 & 6 wheel drive. FREE catalog. State make of truck or Jeep. (New Jeep Tops, steel or canvas for all models). AMERICAN AUTO PARTS CO., Inc., 1830 Locust, Kansas City, Mo.



## WOODCRAFTSMEN'S 144 page ENCYCLOPEDIA 15¢

Bargain book of every conceivable wood-working item and tools. Full of How-To-Do-It information, illustrations, projects and ideas. Domestic and imported woods, inlays, panels, etc. Send for your copy today. Biggest 15¢ worth ever offered.

**CRAFTSMAN WOOD SERVICE CO.**

Dept. A-7, 2729 S. Mary Street, Chicago 8, Illinois



**x-acto**  
KNIVES • TOOLS  
HANDICRAFT KITS



#62  
**VIZI-DOME KNIFE SET**  
\$2.50  
X-ACTO, INC.  
48-41 Van Dam St.  
Long Island City, N. Y.

Send 20¢ for 28-page Catalog



**BUILD YOUR OWN ARC WELDER OR LIGHT PLANT**

**D-C GENERATOR**

Save \$750 to \$500

**\$15.50** used, good cond. Instruct. incl. for Comb. welder & light plant. 200 amps. 28 Volts. Or Bend **\$21.50** New. Price F.O.B. K.C. MO.

**CONVERTS TO ARC WELDER 200-250 AMP. OR LIGHT PLANT CAP. LOAD 5000 WATTS**

Stock #711 D.C. Generator R-1 Jack & Me. nts. Rated 300 Amp. 30 Volts. Gov't cost \$300.00. Instructions for converting to welder or light-plant incl. **\$25.50**

**RHEOSTAT #R-27** Heavy duty for regulating the voltage on the converted P.T. Re-l. Welder, & A.C.-D.C. type **\$6.95** post paid

**D. C. GENERATOR.** Brand new. Navy Type for Farm-Home-Ranch. Delivers 430 Volts D.C. at 3450 R.P.M. Ball bearing supported. Fan cooled armature. Self lubricating bearing. #211220-A. Wt. **\$7.50** 2 lbs. Net only.

**WEAVER HYDRAULIC HAND PUMP** New With Built in Check & Relief Valve. For oil or Hydraulic Fluid. Rated 2000 P.S.I. **\$9.95** data incl. \$75.00 Value.

**HYDRAULIC SOLENOID CONTROL VALVE BENDIX #81560** For remote control & for hydraulic cylinders. For 24V. D.C. & applicable for 110V. A.C. 800 to 1500 P.S.I. \$35.00 value. Instructions included. **\$3.95 ea. \$7.50** post paid

**VALUABLE GEARS BARGAIN SPEED REDUCER #11** or 10-1 ratio 90 degree angle 1/2" splined shaft 3 min. holes **\$6.45** post paid

**BOMB INTERVOLOMETER.** New. Can be set to release current at fixed time or split second timing. Size 5"x 9"x3 1/2". For 24V. D.C. & applicable for 110V. A.C. **\$4.95** \$50.00 value.

**DILUTER DEMAND OXYGEN REGULATOR** 200 P.S.I. for "Diving lung." **\$5.95** post paid

**CUNO OIL FILTER** Aircraft type. Filters oil without cartridge replacements. Just turn handle and cartridge is clean. Standard 3/4" inlet and outlet ports. STOP CHANGING OIL. Instructions **\$4.95** post paid

Send CHECK OR M. ORDER. PRICES F.O.B. KCMO EXCEPT when marked POSTPAID U.S.A.

**MAKES IDEAL WINCH HOIST**

**AIRCRAFT STARTING MOTOR**

Operates on 12 or 24 Volts. Gives high torque, slow speed and tremendous power. Applicable for pulling or moving heavy loads. Makes ideal winch or heavy duty hoist. For belt or direct drive. Mfg. by Jack & Helms, O. Cost over \$300.00. Ship. wt. 55 lbs. **\$9.95** F.O.B. Stock #410

**ELECTRIC ACTUATOR** Incl. 1/2 H.P. motor for lifting, lowering remote control, etc. Motor drives actuator in a 6 1/2" travel through a reduction gear box. For 24V. D.C. & applicable for 110 V. A.C. Rated load 2800 lbs. **\$9.95** AALM. Instruction incl.

**SELF PRIMING ELECTRIC BLACK & DECKER MOTOR & PUMP UNIT.** For oil burners, Aquarium fluid metering, coolant pressure lubricating, etc. Motor rated 1/30HP 1200 R.P.M. For 24 to 32V. D.C. & applicable for 110V. A.C. 7/8"x3 1/4"x2 1/4" **\$9.95** Data incl. \$50.00 value.

**PESCO LARGE VOLUME UTILITY PUMP** For Water, Oil, Insecticides, etc. Incl. built in relief. 400 G.P.H. 1/2" drive spline shaft. 3/4" size. Data incl. **\$7.95** Stock #6001

**THOMPSON MOTOR DRIVEN PUMP.** Incl. built in motor for 24V. D.C. & applicable for 110V. A.C. Ideal for pumping, fuel, oil, hot water heating circulator, etc. Capacity 300 G.P.H. Instructions incl. **\$8.95** #1200

**WINCH HOIST.** Portable giraffe neck. 1500 lbs. max. Has 21 to 1 gear ratio, 40" tube extension with 3" pulley, 12 Ft. of 3/16" cable & handle with ratchet brake. **\$24.50**

**BEAM ROTATOR MOTOR.** Reversible geared motor for TV aerials, Ham. FM, etc. Light weight. Approx. 7 R.P.M. For 24V. D.C. & applicable for 110V. A.C. **\$12.95** Instruction incl.

**VICKERS CONSTANT DISPLACEMENT HYDRAULIC PUMP** New. #PF713-20. 373 G.P.H. at 3750 R.P.M. 1000 P.S.I. 410 cu. in. rev. **\$14.50** post paid

**VICKERS PUMP** #PF28-2711-257E. 400 G.P.H. 3750 R.P.M. 1500 P.S.I. 507 cu. in. rev. New. **\$17.50** post paid

**VICKERS PRESSURE & RELIEF VALVE, ADJUSTABLE 1/2" A.C. tube ports.** New. #501 **\$5.50** post paid

**STRATOPOWER CONSTANT DISPLACEMENT PUMP** For hydraulic cylinders, tractors, bulldozers, etc. 400 G.P.H. at 3750 R.P.M. 1250-1400 P.S.I. Has built in relief. **\$37. \$150.00 value. \$17.50** Instructions

**PESCO OIL HYDRAULIC PUMP.** Gear type by pressure. 227 cu. in. rev. 198 G.P.H. 1500 P.S.I. Male 3/4" shaft 1 1/16" dia. **\$9.95** 3/4" ports. #700

**AIR OR OIL HYDRAULIC CYLINDERS** Stock #211 Double action 1 1/2" Bore, 6" Stroke, 3/4" Dia. shaft. Clevis mounting base and shaft end. Capacity 1160 lbs. with 1000 P.S.I. **\$8.95** post paid

Stock #512 Double action 2 1/4" bore, 4" stroke, 3/4" dia. shaft incl. Built in relief. Size 14" retracted. **\$50.00 value. \$8.50** post paid

Stock #212 Double action 4" Bore, 10 3/4" Stroke, 1-3/16" dia. shaft. Rated 12,500 lbs. with 1000 P.S.I. Clevis mounting. O. Gov't cost over \$300.00. **\$27.50**

**FOUR WAY HYDRAULIC VALVE** Poppet Type Spring loaded pressure balanced Open Center in Neutral position. 1500 P.S.I. 3/4" tube ports. #327. **\$7.95** post paid

**No. 21 FOUR WAY HYDRAULIC VALVE** Off at neutral with built in relief for limit of cylinder strokes. With 3 positions, raise, stop lower and hold, 3/4" ports. #617 **\$9.95** post paid

**PESCO EQUALIZER VALVE No. 397-D.** New For 2 cylinders or 2 systems, will prevent uneven movement due to unbalanced **\$9.95** post load. Data incl. \$75.00 value

**FOUR WAY SOLENOID VALVE** Operates on 24V. D.C. & applicable for 115V. A.C. For operating hydraulic cylinder, remote control, etc. 3/4" ports. **\$9.95** New. \$50.00 value, #1213

**MULTIPLE FOUR WAY SOLENOID VALVE UNIT** Consisting of 3 four way valves in one unit. It will operate 5 double action valves separately or in any combination of 5. For 24V. D.C. & applicable for 110V. A.C. Instructions incl. **\$17.50** O. cost over \$200.00 #44R122

**Hydraulic Accumulators - Bendix Ball Type** Dia. 5 1/2". Built to stand 2000 P.S.I. Stock #A-65. Wt. 4 lbs. only. **\$5.50**

**BENDIX ACCUMULATOR, Ball Type.** Dia. 10 1/2". Built to stand 2000 P.S.I. **\$12.95** Wt. 15 lbs. Stock #A-85. Only

**GENERAL SALVAGE CO., 2922 E. 27 St., Dept. 774, Kansas City, Mo.**

**MAGNETS**

ASSORTED MAGNETS with big list of handy uses. **5 for \$1**

POWERFUL POCKET MAGNET ideal for testing metals. **\$1**

RETRIEVING MAGNET pulls tools, etc., from tank or lake. **\$3**

HOT PAD MAGNETS to insert in your own hot pads. **8 for \$1**

BULLETIN BOARD MAGNETS to "pin-up" memos, etc. **8 for \$1**

SLENDER MAGNETS remove chips from drill holes. **2 for \$1**

WE REFUND EVERY PENNY IF NOT 100% PLEASED **POSTPAID**

**RONALD EYRICH, 1091 N. 48th St., MILWAUKEE 8, WIS.**

**SAY YOU SAW IT IN POPULAR MECHANICS**

**Print Your Own**

Cards, stationery, circulars, tags, labels, photo and movie titles, advertising, etc. Save money. **Print for Others, Good Profit!** easy rules sent. Raised Printing like Engraving, too. Send direct from factory only. Write for free catalog of outfits and all details. **KELSEY PRESSES, N-37, Meriden, Conn.**

**WELD BRAZE SOLDER CUT**

**4WAY ONLY \$14.75** e.o.b. factory

**WELDER**

Complete with Twin Carbo Arc Torch and accessories... to handle all metal-craft work.

Reclaimed by thousands of Homeowners, Mechanics and Hobbyists as the welder of 1001 uses. Easily operated from properly wired 110 volt AC or DC line. The ideal gift with a life-long use... Order today on 10 day money back guarantee.

**FOUR-WAY WELDER CO., Dept. F2-G 1810 S. Federal St. • Chicago 16, Ill.**

**BUILD FINE GRANDFATHER CLOCK NOW**

The simple sensible Red-I-Kut way as thousands have - SAVE HALF. SHOP TESTED PLANS "SPIRIT OF THE CENTURY" Narrow waist 8 1/2" tall or stately straight side "SPIRIT OF AMERICA" EASY-TO-FOLLOW planbook PLANS tell all-plus BROCHURE of heavy brass weight Westminster, tube chime, movements, prisms, dials. 3 1/2" solid mahogany case kits. Send \$1.00 today - Both plans \$1.50 NOW.

**KUEMPEL CHIME CLOCK CO., #7 Kuempel Bldg., Minneapolis 16, Minn.**

**HANDY GASKET AND WASHER MATERIAL KIT**

**9 PIECES OF VARIOUS GASKET MATERIALS FOR EVERY PURPOSE**

All 6 Inches Square As Listed Below

**BROWN FIBRE 1/4" - 1/2" - 3/8" - 1/2" THICK - RED RUBBER 1/4" THICK COMPRESSED ASBESTOS 1/4" THICK - ASBESTOS PAPER 1/4" THICK CORK 1/4" THICK - CORK AND NEOPRENE 1/4" THICK**

Have you ever needed a piece of gasket or washer material around the house, workshop, garage, farm... to fix a faucet, lawn mower, tractor, car or 1,000 other things that need a gasket or washer. Keep this handy inexpensive kit around at all times. Larger size sheets can be furnished. Write for prices on your special requirements.

**\$1.00 POSTPAID NO C.O.D.'s PLEASE**

**LEROY COMPANY Department G 2135 Margaret St. Philadelphia 24, Pa.**



# BUILD YOUR OWN POWER TOOLS— WITH GIL-BILT

## Exclusive GIL-BILT Build-It-Yourself Features

- No machining—build easily with hand tools only
- No blueprint reading—step-by-step pictorial plans, full scale patterns, actual photographs
- Sturdy wood, aluminum and steel construction
- Capacity and performance of commercial saws selling for \$60 and up
- Proved performance. Nationally advertised and sold for 7 years. Satisfied customers around the world

### GIL-BILT 10-in. TILT/ARBOR SAW



- 27x28 in. table, 13 1/2 in. capacity in front of blade
- 10 in. blade cuts 3 1/4 in. deep, tilts full 45 degrees
- Floor model 34" high, table always stays level
- New Departure ball bearing arbor, 3/4" precision shaft turned down for 5/8" bore blades, alum. housing, shipped ready to run
- Jackscrew and 4 1/2 in. dia. handwheel lowers and raises blade
- Cast aluminum miter gauge and self-aligning rip fence guide

GIL-BILT Metal Parts Kit includes Plans, ball bearing arbor, miter gauge and bar, rip fence guide, dado insert, lock knobs, jackscrew mechanism and handwheel, and all other metal parts (less blade)..... \$22.95  
 Same Kit with 10" Combination Blade \$25.90  
 Same Kit with 8" Combination Blade \$24.90

### GIL-BILT 12-INCH BAND SAW



- Cuts to center of 24 inch circle
- Handles stock up to 6 inches thick
- 18x18 inch table tilts 45 degrees
- Lower wheel and drive pulley runs on sealed New Departure Ball Bearings: Upper wheel runs on two 3/8" bore Oilite Bronze bearings
- Upper wheel tension and tilt mechanism of cast aluminum, completely assembled
- Upper and lower blade guides. Each has ball thrust bearing, self-lub bronze jaws
- Rigid cast aluminum wheels fully machined ready-to-install. Heavy rubber tires
- Uses standard 78 inch blades up to 3/4 in. wide
- Fully enclosed mechanism for utmost safety

GIL-BILT Metal Parts Kit includes Plans, rubber tires, aluminum wheels, 3/4 in. blade, ball bearing spindle, tilt mechanism, blade guides, table tilt segments, and all other metal parts..... \$23.95  
 Return Kits in 10 days for refund if not satisfied.  
 For shipments up to 600 miles, add 5%; over 600 add 10%

Amount in excess of actual postage will be refunded.

Order Kit now, or order Plans at \$1.00 each and Kit later less cost of plans. Write for FREE Catalog. P. O. Box 1-PC, Lambert Field St. Louis 21, Missouri

### GILLIOM POWER TOOLS

HOBBYISTS,  
SHOP OWNERS

## "NEW" DRAWER KITS



24 GAGE METAL 20 Drawers \$6.95 Ppd.

Now you can build your own unit and save many dollars over cost of drawer units of comparable size, we furnish unpainted, heavy gage metal drawers, 8" deep x 1 1/2" high x 4 1/2" wide, drawer pulls have card guides, sets shipped with instructions for building outer case of plywood, plywood not included, factory to you, makes this price possible. Set of 20 drawers \$6.95 postpaid. Denver & West add \$1.00 extra for postage. Send Check or Money Order No C.O.D's.

KRUEGER MACHINE & TOOL WORKS  
Dept. A, Box 92, Morocco, Indiana

ENCLOSED is ( ) check ( ) money order amt. \$ \_\_\_\_\_  
 please send me ( ) sets

NAME \_\_\_\_\_

ADDRESS \_\_\_\_\_

CITY \_\_\_\_\_ ZONE \_\_\_\_\_ STATE \_\_\_\_\_

## PARTS KITS

PLANS ONLY  
\$1.00 EACH  
POSTPAID

## JOINT AND SHARPEN ALL SAWS

SAVE TIME AND \$\$\$



Sensational new Super Filer No. 11 joints and sharpens both hand and circular saws 6" to 10" with all teeth the correct height, depth, pitch and bevel. Easy to use—when file hits hardened steel roller, teeth are finished. Saw runs true and smooth with no side pull. Complete with special 8" file \$9.95 ppd. FREE FOLDER.

"TRU-CIRCLE" saw set. Automatically sets teeth at 10° or more \$2.95.

FILE SAWS THE RIGHT WAY



SO EASY with this new filing jig also jointer anyone can now sharpen any handsaw like new! When file hits hardened steel rollers teeth are finished and EXACTLY THE SAME HEIGHT. All teeth cut and saw runs true and smooth. Jig and instructions \$2.95 postpaid. Free Folder. A. D. MCBURNEY, 5908 Hollywood Blvd., Hollywood 28, Calif., Dept. A-43

## SHOP BY MAIL AT SCHUPACK

100 PIECES FOR ELECTRIC GRINDER 4 Repair Kits	\$1.00
3 CIRCULAR SAWS	\$3.00
2 DRUM SANDER SETS	\$2.00
12 REPAIR CUTTERS	\$5.00
SAFETY GOGGLES	\$1.00

## 1001 TOOL BARGAINS

Send for this Amazing Schupack Bargain Catalog Today. Each and every item is fully illustrated—you can see what you get! It's crammed full of Brand New necessities for tool shops, factories, garages, home workshops and hobbyists all over the U.S.A. Save up to 100% on abrasives of all types, grinding wheels, mounted stones, sanding discs, circular saws, rotary cutters, miniature cutters, power drills, chisels, scrapers, and hundreds of other items. Write today—enclose 10c for postage and handling.

SCHUPACK SUPPLY CO.  
7331 Cottage Grove Ave.  
Dept. M-56, Chicago 19, Ill.

## BUILD YOUR OWN ARC-WELDER

We show you how to build NEW powerful welder. No rewinding. Uses most any surplus aircraft generator, Easy to build. 75-300 amps. Complete PLANS 25c. Send today and we'll include FREE our Big War Surplus & Electrical Catalog.



LEJAY MFG. CO., 1247 LEJAY BLDG., MINNEAPOLIS 8, MINN.

## DO IT YOURSELF WITH SMITH'S



FOLD-UP SAW PONIES. Size 26" high, 30" long. Hang up when not in use. Metal tube, rubber tipped legs; can't scratch floors; non skid; black wood top; very sturdy; light weight. For carpenters, painters, contractors. For cleaning walls, picnic bench, work table, etc. Painted yellow and black. Ideal present for home use. Money back guarantee. \$12.95 per pair. P.P. paid. Name "Saw Ponies" registered. Patent pending.

Smith's Mfg. Co. SUTTON'S BAY, MICHIGAN

## HANDY-ANDY SHOVEL



PRICE \$1.39  
EACH PREPAID.  
Send check or money order.

A practical and durable shovel for camping, as an auto shovel, for Boy Scouts, a play shovel and many other uses. Hi-carbon steel blade—6 3/4" wide by 8" long. Hardwood handle—overall length 25".

M. M. RITTENHOUSE, Dept. PM 1, Akron, Indiana

Say You Saw It in Popular Mechanics

## SHEET METAL BRAKES

Angles, flanges, Pittsburgh locks. 24 G. steel, heavier aluminum. Cam locking, mount on bench, truck or floor stand. Truss braced steel. Express collect. 30" 85 lbs., \$28.50, 36" 75 lbs., \$33.00, 48" 100 lbs., \$48.00. Also 8 ft. size. Floor stand, 22 lbs., \$7.00. 15" capacity 10 gauge, 40 lbs., \$21.50.

IRON BENDER 14"x3" \$9.50. TURNING BENDER 3/4"x1", \$6.00. SHEARS 7x18 ea. steel, \$14.00; 24" turning and slitting shear, 24 ga. 16 ga. aluminum, \$38.00. New 12" Vise Brake, \$14.50, P. Paid.

(Immediate delivery. Order direct, cash or C.O.D., or send for folder)  
 VYKE MFG. CO., P-2439 15th St., Denver 11, Colo.



# BUY direct from MASTER MECHANIC FACTORY - SAVE up to 85%

## GIANT 2000-2500 WATT PLANT

110-120 v. 60 cyc. AC. absolutely the best made—exclusive dynamical ball bearing construction; heavy windings develop up to 5000 watt overload for motor starting. Skid mounted—portable. Powered by an easy starting Briggs or 4 HP Wisconsin engine—complete with all accessories: engine easily disconnected for other uses. Rig outlet box, voltmeter, no wiring necessary. Ample current for all purposes. Factory warranty. (Item 31) Wt. 210 lb. Reg. price \$595. Special at... **\$299.50**



(Item 31)

Same plant with electric self starter (Item 31a) **\$359.50**  
Generator only and control box... **\$169.50**  
**DUAL VOLTAGE** 110-220 available on any of above models for \$28.00 additional.

## JET STEAM MASTER



now, a new super efficient portable steam generator that provides live steam at 100 lbs. pressure in 40 seconds from a cold start! The first quality steam blaster ever offered at this low price. Instantly cleans sticky grease, dirt, rust, old paint, etc., off motors—farm implements and road machinery. Pays for itself in a few weeks. Sterilizes as it cleans—milking machines, tanks, milk lines, hot houses, chicken houses and breeding pens. Ideal for sterilizing soil in greenhouses and hot beds—thawing out frozen earth, water pipes, materials, etc. Melts ice, snow in a flash. Fully automatic—oil fired with built-in water circulating pump. Draws water from faucet or from barrel or bucket. Simple and safe, anyone can use it—built-in safety valve. Complete with new triple efficiency jet steam gun—automatically mixes in soap or detergent if desired. Has 10" semi-pneumatic wheels. Wt. 250 lbs. (Item 433) Sinc. factory price... **\$298.00**

## EXTENSION CORD

...a new heavy duty, made of Buna rubber insulated #14-2 conductor, stranded wire enclosed in a treated braided jacket. So tough that you can drive over it. Use indoors or out. Resists oil, grease or water. Extends electricity up to 400 ft. without voltage drop. Complete with heavy rubber plug and outlet. (Item 16) 40 ft. 2 1/2 lbs. **\$1.99**  
Combination 2-40 ft. and 1-20 ft. (total 100 ft.)... (Item 16c) **\$4.95**  
**NEOPRENE CABLE** #14-2 (Item 185) Heavy duty, very flexible, 20 year quality. Wt. 9 lbs. 100 ft. Complete with rubber plug and outlet. A terrific buy at only... **\$8.95**  
**NO. 12-2 POWER CABLE.** Very flexible rubber covered, special outside shield for grounding power tools, etc. 50 ft. (Item 109) Wt. 3 lbs. **\$4.95**. 100 ft. (Item 200)... **\$12.95**

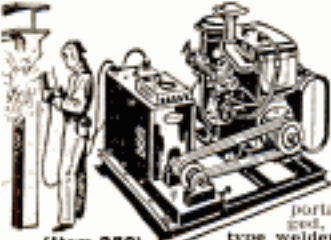

## POWER MASTER DC ARC WELDERS

Now! a portable, rugged, industrial type welder with terrific performance, yet at a price hundreds of dollars less than you'd expect. Senior model made for years of trouble-free, continuous service. High capacity DC welding unit enables you to tackle any job with confidence—easily welds anything up to 2" plate using from 1/16" to 1/4" rods. Built-in stabilizer and cooling system makes are easy to strike and hold. Dual control rheostat provides low heat soldering, brazing and welding from 30 to 300 amps. Complete with instructions, guarantee and triple V-belt or flat pulley. You can pay more, but you can't buy a better welder.  
**COMPLETE POWER MASTER** (Illustrated above) powered by a 14 hp., air cooled Wisconsin engine. Wt. 480 lbs. (Item 280) Complete with welder coating **\$449.50**  
**WELDER ONLY—DUAL CONTROL MODEL.** Same as above, but drive with your tractor, jeep or gas engine of 14 HP or more. (Item 38a.) Wt. 110 lbs. **\$119.50** 8-1/2 hp. value...  
**WELDER ONLY—STANDARD MODEL.** Same as above but with single rheostat for heavy metal welding only. (Item 38.) **\$99.75** Wt. 110 lbs. \$400 value. Special...  
**WELDING KIT** 20 ft. leads, welding helmet, electrode holder, ground clamp. Sold only with welder at... **\$10.50**

## PORTO-POWER 1500-1700 WATT PLANT



115/120 v. 60 cyc. AC. Push button start. Powered by a 4 HP Briggs engine. This plant combines the compactness and easy portability of the smaller plants, but has a high output to handle heavier starting loads. Built-in winding for charging 12 v. batteries. An ideal standby power plant for operating lights, sump pumps, oil burners and communication systems. Perfect for contractors and line crews. (Item 20.) Wt. 146 lbs. Factory Special Price... **\$279.50**

For charging 12 v. batteries. An ideal standby power plant for operating lights, sump pumps, oil burners and communication systems. Perfect for contractors and line crews. (Item 20.) Wt. 146 lbs. Factory Special Price... **\$279.50**

## MASTER-LITE 2500 Watt Plant

110/120 v. 60 cyc. AC. A powerful plant, ruggedly constructed and yet designed for easy portability. Can be started by rope or built-in 12 v. electric push button starter. Built-in winding to charge battery. Powered by a big 5.10 HP Briggs engine, complete with all accessories. Includes control box, voltmeter, and handy plug-in power receptacle. An ideal plant for permanent or stand-by service. Wt. 225 lb. Reg. price \$645.00 **\$329.50** (Item 21) Factory Price...  
**3000-3500 WATT PLANT** (Item 198) 110-220 v. 60 cyc. AC Belt Drive, Wis. engine Push Button Start. Wt. 370 lbs. **\$399.50**  
Heavy Duty... **\$239.50**  
**GENERATOR ONLY** for belt drive... **\$239.50**



(Item 21)

## PORTABLE LIGHT PLANTS

Ideal for your camp, cottage, trailer or boat!

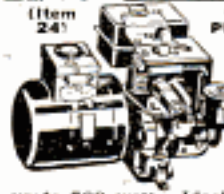

**600-700 WATT PUSH BUTTON START**  
115 v. 60 cyc. AC. Powered by a rugged 2 HP easy starting Briggs engine. No wiring necessary; just plug in and operate. Plenty of current for any oil burner, freezer, brooder, emergency lights, etc., which require up to 700 watts. Ideal for Civil Defense and Fire Dept. Complete with voltmeter and built-in winding to charge 6 v. auto batteries. (Item 24.) Wt. 75 lbs. Easily fits in car trunk. Be prepared if storm knocks out... **\$143.50**  
**1000-1200 Watt Plant** (Item 45) same as Item 24 but larger generator and engine **\$199.50** with 50% greater output.  
**LITTLE GIANT—350 WATT** (Item 273) 115 v. 60 cyc. Briggs engine. Perfect for lights, radios, small power tools. Wt. 65 lbs. Factory price... **\$99.75**  
We make fully automatic controls to operate any of the above light plants. Write for details. We make all sizes up to 25,000 Watts.

## HEATING & VENTILATING FAN

(Item 10) easily installed on furnace pipes. Forces even heat to all rooms. Over range removes kitchen smoke and odors. Powerful, continuous duty motor. 110-120 v. AC. Mount in wall or ceiling to ventilate any area. Quiet, super-efficient fan moves huge volume of air. (400 to 600 CFM).  
8" Fan, wt. 5 lb. **\$6.85**  
9" Fan, wt. 6 lb. **\$7.85**  
10" Fan, wt. 7 lb. **\$8.85**  
12" Fan, wt. 8 lb. **\$9.85**  
**HEAVY DUTY FAN.** Semi-enclosed motor, suitable for spray booths, restaurant exhausts, poultry houses, etc. 10" Fan, wt. 8 lbs. (Item 10E)... **\$11.95**  
12" Fan, wt. 10 lbs. (Item 10D)... **\$12.95**



## CONDITIONAIRE VENTILATING FANS

Save big money installing your own exhaust fan. Efficient propeller type blade moves huge volume of air quietly and effortlessly. Heavy welded frame—pre-drilled for easy installation. Just cut opening and bolt in place. Continuous duty motors. Ideal for attics, restaurants, garages, barns, chicken houses, etc. Control manually or with thermostat.  
**Blade Opening CFM** Wt. Item  
16" 1814" 2925 19 lb. 365a **\$27.95**  
18" 1914" 3600 27 lb. 365b **\$31.95**  
20" 2114" 4100 30 lb. 365c **\$39.95**  
**SHUTTERS**—open automatically. 16" wt. 10 lb. **\$9.00**; 18" Wt. 12 lb., **\$10.25**; 20" Wt. 14 lb. **\$11.25**.  
**THERMOSTATS:** BARN type (range 40°-60°), Wt. 2 lbs. **\$6.95**. ATTIC type (50°-90°), Wt. 2 lbs. **\$11.95**



## HI-LINE 6000 WATT PLANT

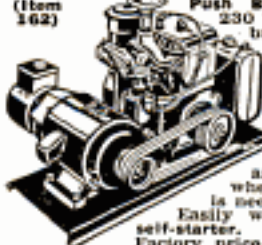

Push Button Start 115-230 v. 60 cyc. A.C. A brute of a power plant with a rugged 14 hp. Wisconsin engine. Plenty of electricity for ranges, water heaters, freezers, pumps, machinery, etc. Affords both 110 and 220 volts. Ideal where heavy current is needed. Wt. 500 lbs. Easily worth \$995. With self-starter... **\$645.00**

Same plant, but with crank start, **\$885.50**  
Generator and control box only, belt driven. Use your own engine or tractor. Wt. **\$345.00**  
240 lbs. (Item 163) Factory price

## 9 TON HYDRAULIC PRESS

A tremendously powerful hydraulic press, capable of exerting 18,000 lbs. pressure. Pays for itself many times over—straightening bent connecting rods, king pins, crankshafts, axles, link pins and bars—or pushing out frozen bearings and bushings. Developed pressure under precise control and visible at all times on accurate gauge. Complete with both large and small anvils and jigs to straighten any kind of curve or bend. (Item 464) Wt. 110 lbs. Actual list price \$365. Our special close-out price... **\$69.50**



## 52 pc. SOCKET SET

Highest quality, guaranteed non-breakable sockets made by Husky. Beautifully matched chrome this wall alloy absolutely the best. Contains a complete set of 28 sockets in 1/2", 3/4", 1", 1 1/4", 1 1/2", 1 3/4", 2", 2 1/4", 2 1/2", 3", 3 1/4", 3 1/2", 4", 4 1/4", 4 1/2", 5", 5 1/4", 5 1/2", 6", 6 1/4", 6 1/2", 7", 7 1/4", 7 1/2", 8", 8 1/4", 8 1/2", 9", 9 1/4", 9 1/2", 10", 10 1/4", 10 1/2", 11", 11 1/4", 11 1/2", 12", 12 1/4", 12 1/2", 14", 14 1/4", 14 1/2", 16", 16 1/4", 16 1/2", 18", 18 1/4", 18 1/2", 20", 20 1/4", 20 1/2", 22", 22 1/4", 22 1/2", 24", 24 1/4", 24 1/2", 26", 26 1/4", 26 1/2", 28", 28 1/4", 28 1/2", 30", 30 1/4", 30 1/2", 32", 32 1/4", 32 1/2", 34", 34 1/4", 34 1/2", 36", 36 1/4", 36 1/2", 38", 38 1/4", 38 1/2", 40", 40 1/4", 40 1/2", 42", 42 1/4", 42 1/2", 44", 44 1/4", 44 1/2", 46", 46 1/4", 46 1/2", 48", 48 1/4", 48 1/2", 50", 50 1/4", 50 1/2", 52", 52 1/4", 52 1/2".  
List price \$62.00. Factory special... **\$27.95**

Highest quality, guaranteed non-breakable sockets made by Husky. Beautifully matched chrome this wall alloy absolutely the best. Contains a complete set of 28 sockets in 1/2", 3/4", 1", 1 1/4", 1 1/2", 1 3/4", 2", 2 1/4", 2 1/2", 3", 3 1/4", 3 1/2", 4", 4 1/4", 4 1/2", 5", 5 1/4", 5 1/2", 6", 6 1/4", 6 1/2", 7", 7 1/4", 7 1/2", 8", 8 1/4", 8 1/2", 9", 9 1/4", 9 1/2", 10", 10 1/4", 10 1/2", 11", 11 1/4", 11 1/2", 12", 12 1/4", 12 1/2", 14", 14 1/4", 14 1/2", 16", 16 1/4", 16 1/2", 18", 18 1/4", 18 1/2", 20", 20 1/4", 20 1/2", 22", 22 1/4", 22 1/2", 24", 24 1/4", 24 1/2", 26", 26 1/4", 26 1/2", 28", 28 1/4", 28 1/2", 30", 30 1/4", 30 1/2", 32", 32 1/4", 32 1/2", 34", 34 1/4", 34 1/2", 36", 36 1/4", 36 1/2", 38", 38 1/4", 38 1/2", 40", 40 1/4", 40 1/2", 42", 42 1/4", 42 1/2", 44", 44 1/4", 44 1/2", 46", 46 1/4", 46 1/2", 48", 48 1/4", 48 1/2", 50", 50 1/4", 50 1/2", 52", 52 1/4", 52 1/2".  
List price \$62.00. Factory special... **\$27.95**

## 44 Pc. SOCKET SET

(Item 506) Same unconditionally guaranteed, non-breakable sockets as above. Complete range of 21 sockets from 1/2" thru 7/16" (1/2" drive) & 7/16" thru 1 1/16" (3/4" drive). Two extensions, reversible 1 1/2" ratchet, 3 drift punches, sliding "T" head, all angle coupler, 1/2" speeder, 1/2" breaker, 5 pc. high chrome alloy combination wrench set and 8 pc. offset wrench set in big doghouse tool box with ample room for other tools. Reg. \$49.50. Wt. 16 lbs. **\$21.95**

(Item 506) Same unconditionally guaranteed, non-breakable sockets as above. Complete range of 21 sockets from 1/2" thru 7/16" (1/2" drive) & 7/16" thru 1 1/16" (3/4" drive). Two extensions, reversible 1 1/2" ratchet, 3 drift punches, sliding "T" head, all angle coupler, 1/2" speeder, 1/2" breaker, 5 pc. high chrome alloy combination wrench set and 8 pc. offset wrench set in big doghouse tool box with ample room for other tools. Reg. \$49.50. Wt. 16 lbs. **\$21.95**

## MASTER AIR COMPRESSOR

**COMPARE!** This is the only compressor built with a NO RUST stainless steel tank. Safe up to 500 lbs. (Item 209) High pressure type for large volume of air for heavy duty service. For paint spraying, inflating truck & auto tires, greasing & the hundreds of other jobs done by compressed air. Piston type, 2" bore compressor with built-in air filter. Master built with high strength alloys and precision bearings. Tank, 12"x24", 2100 cu. in. cap. Equipped with automatic switch that starts and stops motor to maintain desired pressure (up to 150 lbs.) and check valve, safety valve, gauge, shut-off valve, 20 ft. air hose and tire chuck. Beautifully balanced on ball bearing wheels and rubber tires. Don't take chances with used or surplus equipment. Our compressors are factory new and are guaranteed SAFE. Low factory prices. With 1/2 HP., 110 v. AC motor. Reg. \$175. (Item 209b)... **\$109.50**



Tank Tested up to 500 lbs. per sq. in.

## AIR COMPRESSOR ACCESSORIES

Pressure Gauge, range 0-160 lbs. 1/2" pipe thread connection, 2" face... **\$1.50**  
Check Valve, solid bronze, 200 lbs. pressure, works in all positions. 1/2" or 3/4" pipe threads, (specify)... **\$3.35**  
Pressure Regulator, solid brass, std. 1/2" pipe thread, reduces any pressure to a range of 0-50... **\$3.75**  
Pop (safety) Valve, adjustable from 0-200 lbs. 1/4" pipe thread... **\$1.40**  
**SPECIAL**... All four above... **\$8.95**  
Pressure Switch for pumps and compressors, 0-85 lbs., **\$5.95**; 0-150 lbs. with unloader 15 HP., **\$10.95**; 0-200 lbs. 15 HP., **\$12.95**



Send check or M.O. Prices f.o.b. Factory. 10 day Money back guarantee. SEND 10c for... **MASTER MECHANIC MFG. CO., DEPT. 26M** Burlington, Wis. **Catalog**



# QUESTIONS

and

# ANSWERS

## about Kaiser's supercharged "power-on-demand"

**Q: What is "power-on-demand"?**

**A:** "Power-on-demand" is the new kind of power produced by Kaiser's newly designed Super-power Engine, with supercharger. It combines breathtaking acceleration and performance with small-car economy.

**Q: Where else are superchargers being used today?**

**A:** Almost every airliner you ride in uses superchargers to gain speed and altitude. They are also used in some racing cars and expensive custom jobs.

**Q: How is Kaiser's supercharger different?**

**A:** Kaiser's is a variable-drive supercharger, controlled by a solenoid switch on the accelerator. It operates whenever the engine is running, with slight output at normal speeds and maximum acceleration instantly when you step down on the gas. It's virtually silent in operation.

**Q: How does it work?**

**A:** It forces the fuel-air mixture into the combustion chamber under high pressure, for faster, more effective combustion, thus preventing starvation in any cylinder, *even when driving at highest altitudes.*

**Q: Is it available on any other car?**

**A:** No. It was developed by Kaiser and

McCulloch engineers as an integral part of the new engine for the '54 Kaiser Manhattan—the only production car factory equipped with a "blower."

**Q: How many horsepower does Kaiser's supercharged engine develop?**

**A:** Up to 140 h.p. at 3900 r.p.m., and up to 215 pounds of torque at 2400 r.p.m.

**Q: Is it expensive to operate?**

**A:** No. The small engine displacement saves money in normal driving—you pay for extra power only when you use it.

**Q: How does it work with Hydra-Matic?**

**A:** "Power-on-demand" *plus* Dual-Range Hydra-Matic\* is the next step ahead in effortless driving. (Overdrive\* also available.) Your Kaiser dealer will gladly arrange a test drive.

*\*Optional at low extra cost.*

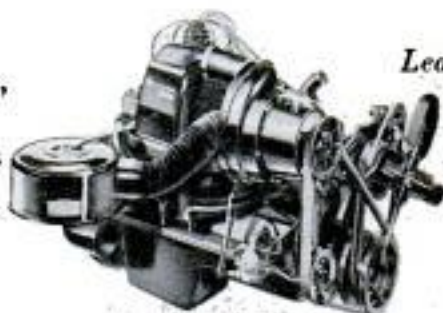

Learn more about  
"power-on-demand"  
at your Kaiser dealer's.



Drive with "power-on-demand" in the new

# '54 Kaiser

©1954 KAISER-WILLYS SALES DIVISION, WILLYS MOTORS INC., TOLEDO, OHIO



take your pick of summer fun

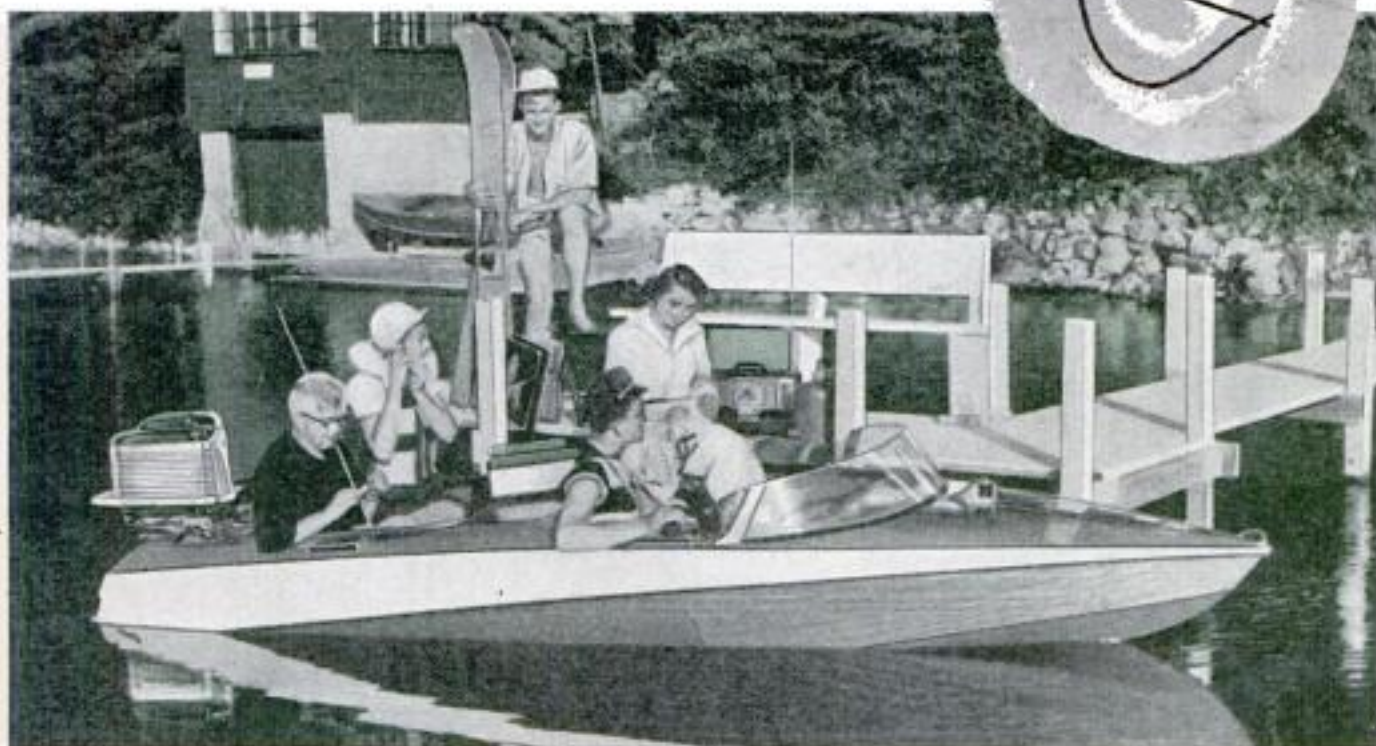

enjoy it more with a  
KIEKHAEFER  
**MERCURY**



What's your pleasure? Fishing . . . water skiing . . . an outboard cruise on your favorite waterway . . . a day's outing for the whole family? You'll find more enjoyment in all of these — with a Mercury! Your Mercury dealer is listed in the yellow pages of your phone book.



Today's  
Most  
Powerful  
Outboard!

**40** h.p.  
**MARK 50**

FORWARD, NEUTRAL, REVERSE

- 4 Cylinders in Line • Famous Thunderbolt engine for super-smooth power flow . . . overlapping torque
- "Hi-Thrust" Lower Unit
- Remote Fuel Tank
- Optional: Exclusive 12-volt electrical system — starter and generator to power lights, accessories



16 h.p. alternate  
twin  
**MARK 20**

- Famous Hurricane powerhead • Reverse Gear and Neutral
- Compact design—big engine performance
- Remote Fuel Tank

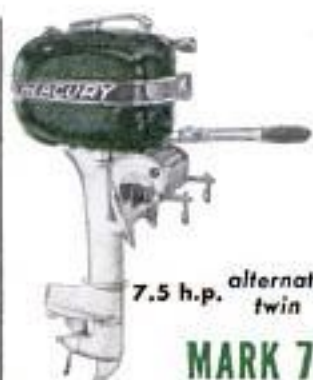

7.5 h.p. alternate  
twin  
**MARK 7**

- Reliable Rocket engine • Duo-Flex Propeller Clutch—no shear pin
- Waterproof Magneto and Spark Plugs



5 h.p. alternate  
twin  
**MARK 5**

- Weighs only 40 pounds! • Push-Button Clutch • Dual-Purpose Drive—truly weedless

Write for **FREE** illustrated catalog.  
Features of Mercury motors are protected  
by issued or pending patents.

© 1954 Kiekhaefer Corporation, Fond du Lac, Wis.

Program Chairmen: Ask your  
dealer about Mercury's excit-  
ing sound, color, water sports  
films. No obligation.



John Wayne...a Camel fan goin' on 24 years!

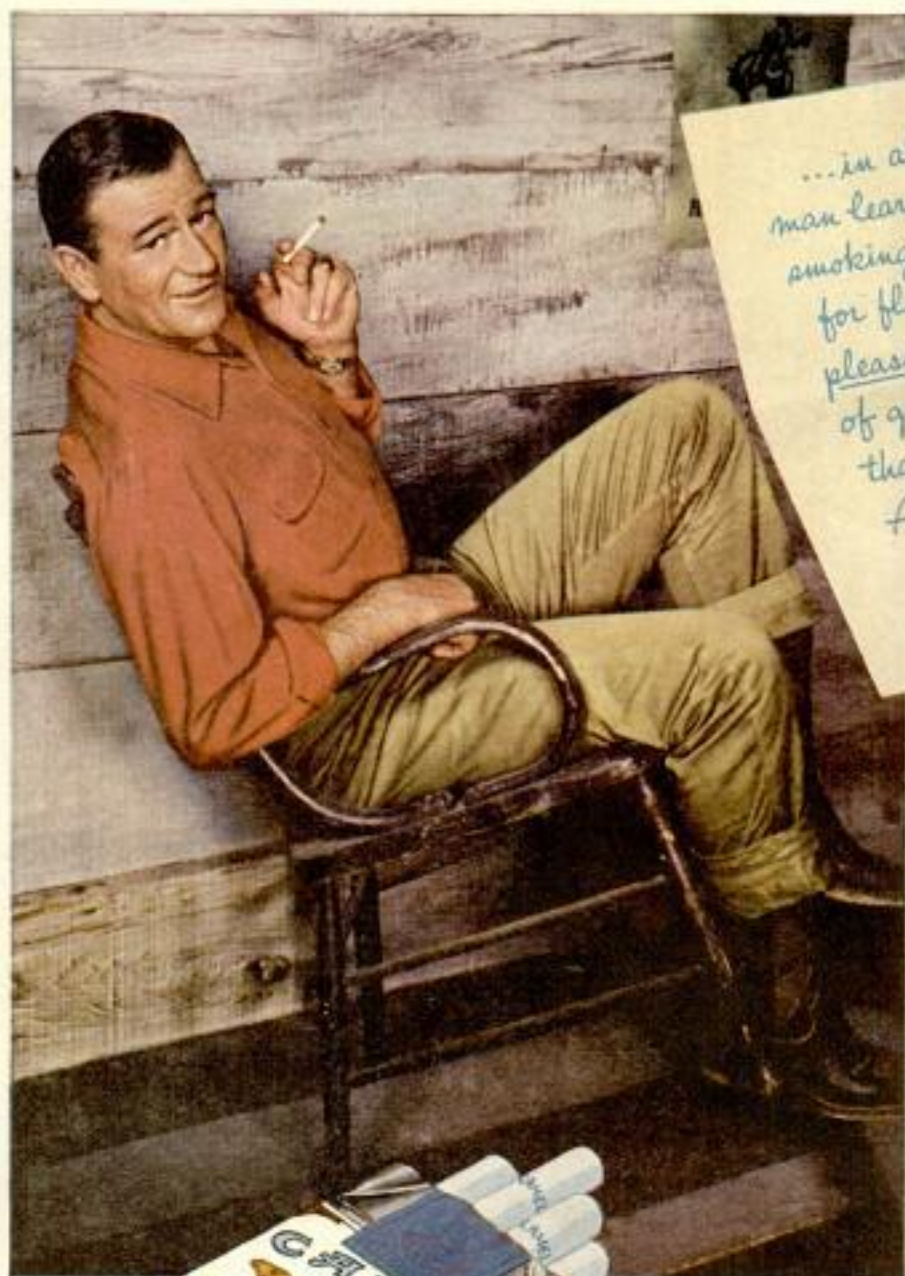

...in all that time, a man learns how to enjoy smoking—for mildness, for flavor, for pure pleasure. It's kind of gratifying to see that my cigarette is America's choice, too.

John Wayne

TALK TO Camel smokers like John Wayne, popular Hollywood star, and you'll quickly see why Camels keep increasing their lead over the next brand! Clearly, nothing matches Camels' blend of costly tobaccos for genuine mildness and specially-rich flavor! If you smoke for the pure pleasure of smoking, try Camels for 30 days. See what you've been missing!

*Make your own 30-day Camel Mildness Test... see why more people find more pure pleasure in Camels, year after year!*



**Camels First in Sales!\***

Lead second brand by record

**50<sup>8</sup>/<sub>10</sub>%**

\*Printers' Ink, 1964



For **MILDNESS**  
...for **FLAVOR**

Camels agree with more people than any other cigarette!

Copyrighted material