

POPULAR MECHANICS

LINE

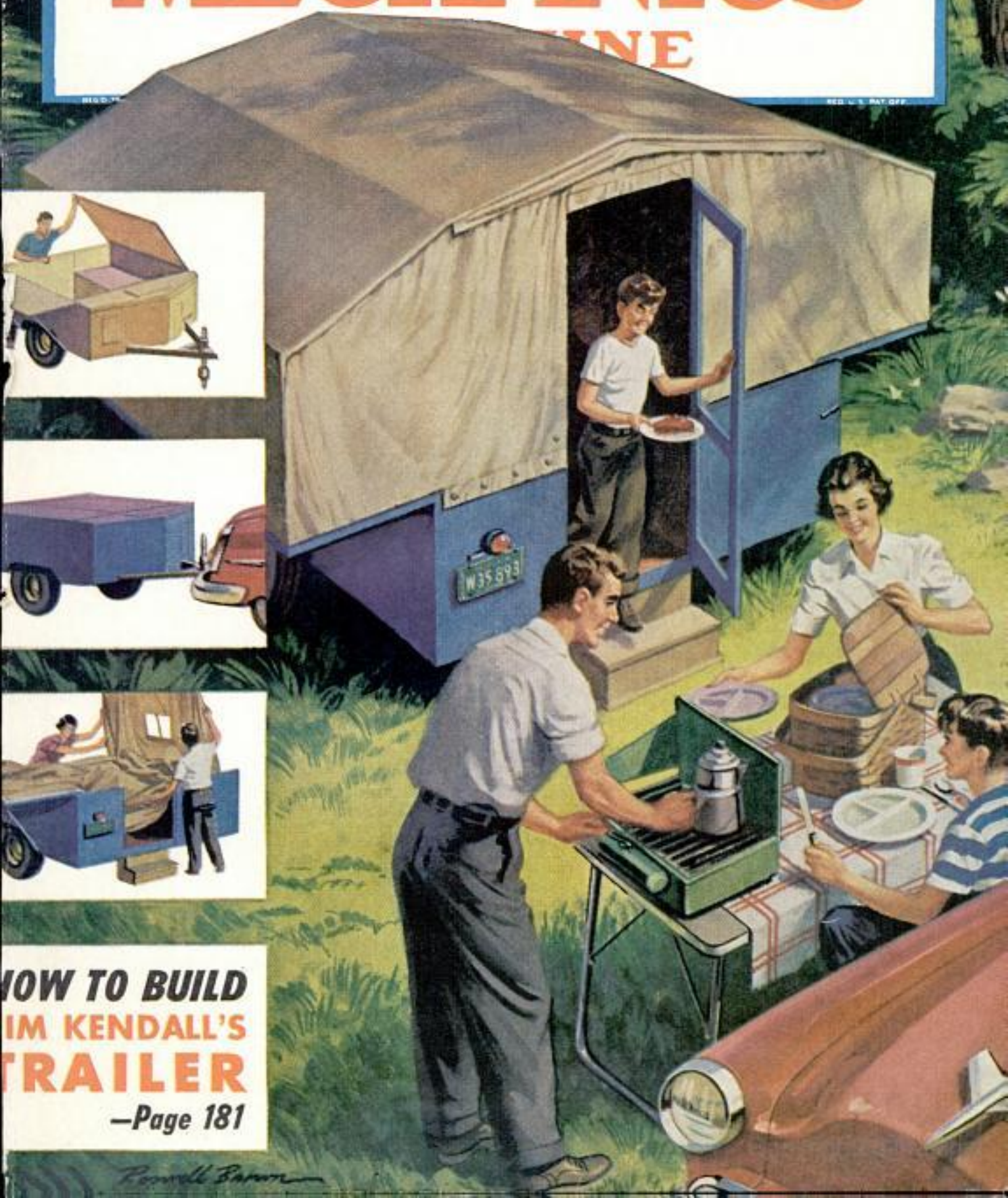

**HOW TO BUILD
MIM KENDALL'S
TRAILER**
—Page 181

Ronald Barron

Get Aboard AMERICA'S FASTEST GROWING SPORT!



Mr. and Mrs. America and their children are discovering that their dream boat is at last a reality... thanks to the outboard cruiser! Here is a cruiser to suit average circumstances. Not only is it easy on the budget. It is easy to care for, easy to store, to transport, to service, to operate. No special abilities are required, no unusual facilities. And you can use such a boat on most any waters!

JOHNSON'S contribution to outboard cruising has been exceedingly important. **DEPENDABLE** power, in a portable unit, separate, long range fuel system, remote control of throttle, shift and steering, and now—*electric starting*—all these provide the very basis of the outboard cruising idea. Wherever you look you'll find Johnson Sea-Horses predominantly favored for this great new sport. Ask your Johnson Dealer. Look for his name under "Outboard Motors" in your classified telephone directory.

FREE! The 1954 Sea-Horse Catalog—packed with data on new outboard developments. Write for your copy. Sent free.

JOHNSON MOTORS, 400 Pershing Road, Waukegan, Illinois
In Canada: Mfd. by Johnson Motors, Peterborough

5 GREAT SEA-HORSES FOR 1954

- ELECTRIC STARTING SEA-HORSE 25**—25 hp. The "automatic" outboard \$498.00*
- SEA-HORSE 25**—25 hp. With Ready-Pull starting \$410.00*
- SEA-HORSE 10**—10 hp. The all-around motor—with terrific getaway. \$297.50*
- SEA-HORSE 5½**—5½ hp. New! "Suspension Drive." It's quiet! \$210.00*
- SEA-HORSE 3**—3 hp. A 32-lb. twin! With amazing Angle-matic Drive. \$145.00
- SHIP-MASTER REMOTE CONTROL**—For "5½," "10," both "25's." From \$29.50

*OBC certified brake hp at 4000 rpm.
Prices f.o.b. factory, subject to change.
Includes Mile-Master Fuel System.



**NEW ELECTRIC STARTING
SEA-HORSE 25**

Johnson
SEA-HORSES
FOR **DEPENDABILITY**

Get 67% More

STARTING PEP and GO



— with this new
power-packed
Double Eagle 125 Battery!



Here's the answer to your car's power plant needs — a new super battery — the Dry Proof Double Eagle 125. Built to deliver 67% more starting stamina than standard batteries of its type and size (Group I), Goodyear's new Double Eagle also has the deep power-reserve needed to operate radio, heater and all a modern car's many accessories.

What's more, because there's 3½ times more solution above the plates, this Double Eagle 125 Battery is Dry Proof, too—needs filling only three times a year in normal use. And superior rubber and glass plate insulation makes it highly resistant to battery-killing acid, heat and pressure.

When it's time to replace your present battery, see your Goodyear Dealer about the plastic-cased, yellow and blue Double Eagle 125—the super battery with power to spare. Goodyear, Battery Dept., Akron 16, Ohio.

GOODYEAR

DRY-PROOF DOUBLE EAGLE BATTERY

Double Eagle—T. M. The Goodyear Tire & Rubber Company, Akron, Ohio

This One



SNLR-KH6-5JQG

MAY 1954

1

ny gied material



TELEPHONE SCIENCE GUIDES A **PUNCH**

NO ENEMY CAN DODGE

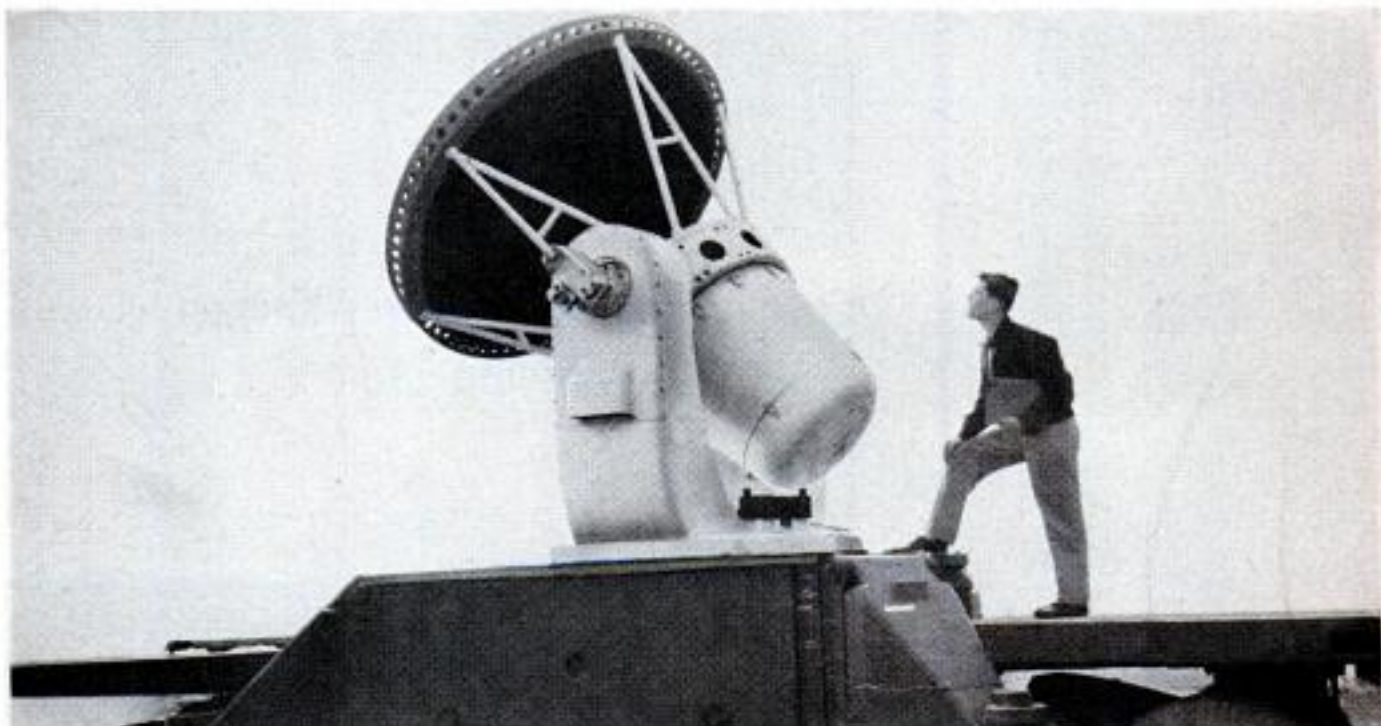

(Upper left) — Nike's missile climbs to destroy an enemy, under guidance of complex electronic controls. A radar is shown at right. Nike (pronounced Ny'kee) is named after the Greek goddess of Victory.

Is it possible to guide an anti-aircraft missile so that it will track down and destroy a rapidly maneuvering target? No one knew the answer for sure when the U. S. Army put this question to Bell Telephone Laboratories in 1945.

The special skills and techniques developed to create the nation's communications network uniquely fitted Bell scientists to answer this question. They recommended a new system, Nike, and then worked to bring it into being with

engineers from Army Ordnance, Western Electric Company and Douglas Aircraft Company.

The first Nike installation has been made, and more will follow. Thus, America's defenses grow stronger through a new extension of frontiers in the communications art. It is a proud achievement of the knowledge and skills first developed at Bell Telephone Laboratories to make the nation's telephone service ever better.

BELL TELEPHONE LABORATORIES
*Improving telephone service for America provides careers for
creative men in scientific and technical fields*



Popular Mechanics Magazine

Registered in U. S. Patent Office and Canada

H. H. WINDSOR, Founder

H. H. WINDSOR, JR., Editor and Publisher



this month's cover

Roughing it deep in the North woods is like camping in the backyard for the Jim Kendall family. Now they enjoy the independence of both motel and restaurant in a compact, collapsible camping trailer that sleeps four. Craftsman Jim, who teaches machine shop at Oak Park High, Oak Park, Ill., tells how you, too, can rough it in style with a copy of his "motel on wheels"

next month . . .

It's one of the forgotten stories of human ingenuity—the logging of the biggest trees on earth, 50 years ago. With little more than a hand ax, how could you fell and move a tree 30 feet in diameter and 300 feet high? You'll learn how it was done in the story "When the Giants Fell"

Information not listed on articles in the index, starting on page 12, frequently is listed in the WHERE-TO-FIND-IT LIST, which is available to readers without charge. A copy may be obtained by writing to the Bureau of Information, Popular Mechanics, 200 E. Ontario, Chicago 11, Ill.

Published monthly by Popular Mechanics Company, 200 E. Ontario St., Chicago 11, Ill. H. H. Windsor, Jr., president; Wm. Harrison Feltz, exec. vice-pres.; D. F. Windsor, vice-president and secretary-treasurer; H. H. Windsor III, vice-president; Clover L. Perkins, advertising manager; Alan M. Deyoe, circulation manager. Single copy in the United States and Canada, 35 cents; subscription rates in the United States and possessions, Canada, Philippines and countries of the Pan-American Postal Union, 1 year \$3.50; 2 years, \$6.00; 3 years \$8.00. To all other countries add \$1.00 a year over United States prices for overseas postage. If you plan to move, notify us at least 30 days in advance so you will not miss an issue. Give both your old and new addresses. Entered as Second Class Matter, September 15, 1903, at the Post Office at Chicago, Illinois, under Act of March 3, 1879. Entered as Second Class Matter at Post Office Dept., Canada. Registered as Second Class Matter at the Post Office at Mexico, D. F., Mexico, June 20, 1950. Copyright 1954 by Popular Mechanics Company. Copyright under International Copyright Union. Copyright in France. All rights reserved under Pan-American Copyright Union. Printed in the United States of America.

Volume 101 MAY 1954 Number 5

Address all communications to: 200 E. Ontario St., Chicago 11, Ill.

Managing Editor.....Roderick M. Grant
 Assistant Managing Editor.....Wayne Whittaker
 Shop Notes and Crafts Editor.....James R. Ward
 Radio-Television, Electronics Editor.....Frank L. Brittin
 Associate Editor, Aviation.....Aubrey O. Cookman, Jr.
 Associate Editor.....Clifford B. Hicks
 Associate Editor, Automotive.....Arthur R. Railton
 Associate Editor, Shop Notes and Crafts.....Wayne C. Leckey
 Assistant Editor, Shop Notes.....W. Clyde Lammy
 Assistant Editor, Crafts.....Frank N. Stephany
 Assistant Editor, Makeup.....John C. Dalen
 Automotive Correspondent.....Leo Donovan
 Art Director.....Frank Beatty
 Assistant Editors: Leonard F. Hiltz, Jay W. Hedden, Elliott H. McCleary
 Eastern Editor.....Richard F. Dempewolf
 Empire State Bldg., Room 2906, New York City 1
 Western Editor.....Thomas E. Stimson, Jr.
 Suite 1010, 3460 Wilshire Blvd., Los Angeles 5, Calif.
 London Manager.....Douglas W. Wedderspoon
 Eagle House, Jermyn St., London S. W. 1, England
 Director, Bureau of Information.....Allan Carpenter
 200 E. Ontario St., Chicago 11

In This Issue . . .

HOW TO GUARD YOUR HOME AGAINST FIRE	81
<i>Prevent tragedy in your home inexpensively</i>	
EGG FOR AN ATOMIC ENGINE	89
<i>Building a power plant for the submarine Sea Wolf</i>	
THE OWNERS REPORT: MERCURY FOR 1954	102
<i>Clymer records pros and cons of Merc owners</i>	
MEXICO BUILDS A GLAMOUR CAMPUS	113
<i>In color—Modern architecture south of the border</i>	
GUARDING THE GRAVEYARD OF SHIPS	128
<i>Coastguardsmen earn their pay here</i>	
RESTORING ANTIQUE CARS IS MY HOBBY	138
<i>Frank Stokes tells about a new, fast-growing hobby</i>	
IT'S MOVING DAY FOR WILDLIFE	154
<i>Transplanting wildlife will mean better hunting for you</i>	

For the Craftsman . . .

CARE AND USE OF PAINTBRUSHES	168
<i>Your task will be easier if you take care of 'em</i>	
FAMILY CAMPING TRAILER—PART I	181
<i>Jim Kendall tells how it's built</i>	
CRUSETTE—12-FOOT UTILITY OUTBOARD	190
<i>Tom Riley and John Bergen come up with a good one</i>	
FROM TANK TO CARBURETOR	197
<i>How the fuel system of your car works</i>	
HOW TO CUT COPED JOINTS	205
<i>Sam Brown takes the mystery out of a puzzler</i>	
THE HOW OF STRAIGHT SHAPING	212
<i>Make your own special moldings</i>	

Special Features

Vertical Take-Off	96
New Tools for Your Lawn	100
Bathyscaphe	110
Magic Boxes	118
Firing Aluminum with Color	124
Lumber Cafeteria	134
Auto Penthouse	145
Boy's Room Goes Western	165
Make It a Magic Party	174
Let's Go Fishin'	177

Regular Features

Detroit Listening Post	98
What's New for Your Home	146
Solving Home Problems	178
Plan of the Month	186
Shopping for Tools	218
Radio, TV, Electronics	
Color TV Today	161
First Aid for Radios	162
Tiny Transistor Receiver	163

Other items, and manufacturers of available products described, are listed on pages 12, 14 and 16

Quick facts about

Ford's new Ball-Joint Front Suspension

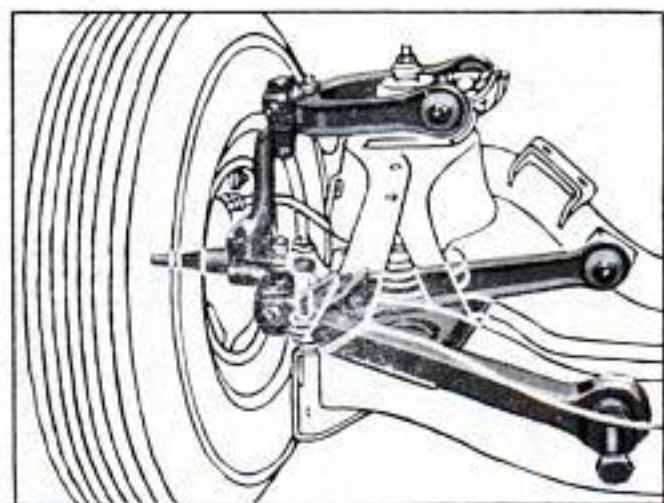

SIMPLER DESIGN

The kingpin on which each front wheel turns right or left in conventional systems has been replaced. Gone, too, are the "hinges" on which the wheel moves up and down. Two simple ball joints now take care of *both* motions.



LONGER LIFE

Ford ball joints (two for each front wheel) are completely sealed against dirt and water by a unique rubber-and-metal shield at each joint. This keeps wear at a minimum . . . aids in retaining that new-car "feel" longer.



It's the greatest riding and steering advance since independent front wheel suspension. It makes all handling easier . . . absorbs road shocks far more effectively . . . keeps wheels in line longer.
And only Ford in the low-price field has it!



EASIER HANDLING

In steering, each wheel turns on ball joints instead of on a conventional kingpin. Ford ball joints are self-aligning, can't stick or bind. They're spring-loaded, too, to compensate for wear and keep steering consistently easy.



QUICKER SERVICING

Ford's new ball-joint system eliminates 12 of 16 points of wear found in conventional suspensions. Thus, there are only four lubrication points. Rubber bushings at inner ends of control arms insulate chassis from road noises.

IT'S JUST ONE OF FORD'S MANY "WORTH MORE" ADVANCES

Ford's new Ball-Joint Front Suspension, teamed with Ford's all-new chassis, new springs and shock absorbers and hulltight Crestmark Body, brings you the most comfortable ride ever in a low-priced car. And Ford's new 115-h.p. I-block Six and 130-h.p. Y-block V-8 are the most modern engines in the industry!

Your neighborhood Ford Dealer
cordially invites you to Test Drive a

'54 FORD

HOW TO FIX ANY PART OF ANY CAR

QUICKLY--EASILY--RIGHT!



FREE 7-DAY TRIAL

Whether you're a beginner or an expert mechanic—now you can "breeze through" any "fix-it" job from simple carburetor adjustment to complete overhaul. Just look up job in index of MOTOR'S Brand-New 1954 Auto Repair Manual. Follow simple step-by-step directions, clear pictures. Presto—the job is done!

No guesswork! MOTOR'S MANUAL takes you from "scratch"—shows WHERE to start, WHAT tools to use. Covers EVERY job on EVERY car built from 1940 thru 1954!

Everything You Need to Know "Boiled Down" from 140 Official Shop Manuals

NEW, REVISED, ENLARGED, 1954 Edition contains the "meat" from over 140 OFFICIAL shop manuals—simplified for YOU. 22,598 essential repair specifications on over 685 chassis models. ONE THOUSAND big pages. More than 2,950 "this-is-how" pictures. 227,000 service and repair facts. Leads beginners every step of the way. Time-saving factory repair procedures for experts. Instructions and pictures so clear you CAN'T go wrong. Used by U. S. Army and Navy.

Try Book FREE 7 Days

SEND NO MONEY! Pay postman nothing. Make Manual show you what it's got. Unless you agree this is the greatest time and work saver you've ever seen—return book in 7 days and pay nothing. Mail coupon today to: MOTOR—Book Dept., Desk 1E, 250 W. 55th St., New York 19, N. Y.

MOTOR'S AUTO REPAIR MANUAL

Covers 685 Models All These Makes

- | | |
|-----------|------------|
| Buick | Lincoln |
| Cadillac | Mercury |
| Chevrolet | Nash |
| Chrysler | Nash |
| Crosley | Rambler |
| De Soto | Oldsmobile |
| Dodge | Packard |
| Ford | Plymouth |
| Frazer | Pontiac |
| Henry J | Studebaker |
| Hudson | Willys |
| Kaiser | |

Same FREE Offer On MOTOR'S Truck and Tractor Manual

Covers EVERY job on EVERY popular make gasoline truck tractor made from 1939 thru 1953. FREE 7-Day Trial. Check proper box in coupon.



MAIL COUPON NOW FOR 7-DAY FREE TRIAL

MOTOR BOOK DEPT.
Desk 1E, 250 W. 55th St., New York 19, N. Y.

Rush to me at once (check box opposite book you want):

- MOTOR'S New AUTO REPAIR MANUAL. If O.K., I will remit \$2 in 7 days, \$2 monthly for 2 months and a final payment of 35c (plus 35c delivery charges) one month after that. Otherwise I will return the book postpaid in 7 days. (Foreign price, remit \$8 each with order.)
- MOTOR'S New TRUCK & TRACTOR REPAIR MANUAL. If O.K., I will remit \$2 in 7 days, and \$2 monthly for 3 months, plus 35c delivery charges with final payment. Otherwise I will return book postpaid in 7 days. (Foreign price, remit \$10 each with order.)

Print Name..... Age.....

Address

City..... State.....

Check box and save 35c delivery charge by enclosing WITH coupon entire payment of \$5.95 for Auto Repair Manual (or \$8 for Truck & Tractor Repair Manual.) Same return-refund privilege.

in this corner.....

THE EDITORS



"Cat" Inspires "Kitten"

Walter G. Lamb, an engineering student at U.C.L.A., has designed and built a miniature catamaran powered by an outboard motor. Lamb's craft was prompted by Gar Wood's big catamaran *Venturi* (PM, Oct. 1949). The designer of the miniature "cat"



Gar Wood's 188-foot *Venturi* inspired Lamb to build a 20-foot catamaran powered by an outboard motor

says he'll match her against any conventional hull of similar size, weight and power. The top speed for his craft is 25 miles per hour when powered by the 16-horsepower motor. There's a roomy cabin and a large open cockpit astern for fishing. Now Lamb is designing racing runabout versions of the catamaran.

Army Maps Fish

Servicemen serving in the American Occupation Zone of Austria are participating in a unique fish-reporting program. The goal is to restock the lakes, rivers and brooks in the Zone while enjoying good fishing. Every serviceman who wants to fish pays a small fee to the provost marshal for a license. The money thus collected is turned over to the Austrian government for the restocking program. The real novelty of the plan is the compulsory fishing

(Continued to page 8)

This **FREE SAMPLE LESSON** will prove you can become an expert **BOOKKEEPER... ACCOUNTANT** OR **C.P.A.**

FREE SAMPLE LESSON

We offer you this free sample lesson so that you can prove to yourself that you CAN master Accountancy—quickly, thoroughly—in spare time at home.

You will see exactly how LaSalle's famous "Problem Method" works... how you are led step-by-step through actual accounting work—learning by doing and not by study of theory alone. First you tackle easy problems, then more difficult ones—until soon you master them all. And at every step you have the close personal guidance of LaSalle's large staff of C.P.A. instructors.

**Nearly 10%
of all C.P.A.'s
in the U.S. have
been trained by the
LaSalle Problem
Method**

GOOD-PAY JOBS IN 5 BIG FIELDS

If you were an expert accountant right now, chances are you would find yourself among the highest-paid of all professional men and women. Surveys show that accountants earn more than those in other major professions.

There are five big fields of opportunity open to Accountancy-trained men and women... opportunities that are wide open and highly inviting, offering maximum income and job security in good times or bad. And under LaSalle's "Problem Method" you can start earning while still learning—either in spare-time or full-time employment... or in business for yourself with no capital required.

Get the latest information by sending for our 48-page book, "Accountancy, the Profession That Pays"... plus free sample lesson. The coupon at right will bring both to you without cost or obligation. LaSalle Extension, 417 S. Dearborn St., Chicago 5, Ill.

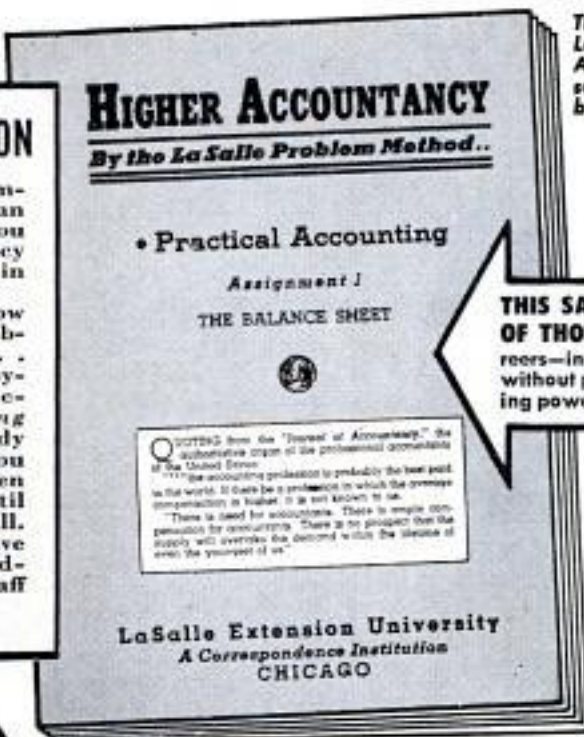

This well-paid LaSalle-trained Accountant's success could be yours.



THIS SAME LESSON HAS STARTED HUNDREDS OF THOUSANDS toward well-paid accounting careers—in business, government, and as C.P.A.'s. Even without previous knowledge, progress is rapid—earning power climbs fast. This sample lesson shows why.

IF you have been envying the high incomes and good jobs enjoyed by thousands of men and women Accountants today... incomes ranging from \$4,000 to \$10,000 and more per year... why not launch such a career for yourself?

Do you doubt that you can?

Then let us send you—without cost or obligation—the same Lesson Number One with which LaSalle has started several hundred thousand

men and women toward successful accounting careers. We want you to see for yourself how this remarkable method, originated by LaSalle, makes Accountancy simple, interesting, practical, and certain... how it leads you step-by-step to a complete mastery of Accounting—and on up to the coveted degree of Certified Public Accountant if you so aspire.

It doesn't matter whether you've had previous bookkeeping experience, or whether you don't know a debit from a credit. Whether you wish to qualify as an expert bookkeeper, advanced accountant, cost accountant, auditor, government accountant, income tax specialist, or public accountant... you'll find in LaSalle's Problem Method the exact plan to prepare you rapidly and inexpensively—in spare hours at home—without losing a day from your present job.

So right now, today... if you are an adult, employed, and earnestly ambitious for rapid advancement in this highest-paying of all professions... send your name and address on the coupon below. We'll send the free sample lesson—plus our 48-page book outlining today's career opportunities and how you can qualify for them. A coupon like this has started many thousands toward greater success. It can do the same for you. Mail it today!

Clip Coupon... Mail TODAY!

LaSalle Extension University... A Correspondence Institution
Dept. 564H, 417 S. Dearborn Street, Chicago 5, Illinois

YES, I want to see how LaSalle's "Problem Method" works... how I can qualify for high-pay Accountancy positions. Send Free Sample Lesson—also your 48-page book, "Accountancy, the Profession That Pays" ...all without cost or obligation.

Name..... Age.....
Street Address.....
City, Zone & State.....
Present Position.....



**"Cake" *not* wood
mellows
your smoke**

**and the
exclusive
honey lining
cakes Yello-Bole
imported briar far faster
than any pipe at any price!**



From the first puff, Yello-Bole's real honey builds up a healthy, protective cake. It mellows the smoke, absorbs tars and resins. The filter refines the rest. Yello-Bole smokes so clear, clean, cool and sweet you don't have to inhale to enjoy it. Treat yourself to a healthier-smoking, honey-lined Yello-Bole—in handsome new shapes and finishes!

PROOF?

Yello-Bole is the world's largest selling pipe

YELLO-BOLE

\$1.00
TO
\$2.50



(Continued from page 6)

map. Each serviceman who has any luck must report his catch on a standard form, listing the species, length or weight and geographical area where the catch was made. On the back of the form is a map of the Zone with each fishing area numbered,



so he can locate his catch geographically. By tabulating the information on the forms and plotting it on the map, military authorities can indicate to Austrian officials the areas that might become "fished out." This greatly simplifies the restocking program. The result: Better catches for servicemen while they're in Austria, and lakes and rivers teeming with fish when they leave.

To the Editor:

Scientists claim that at 300 miles from the earth's surface the temperature is 4000 degrees, increasing outward as a result of cosmic-ray activity. If this is so, there is no metal that could withstand disintegration in outer space. This seems borne out by the disintegration observed in the long trails of matter following comets. Meteors are reduced to relative pebbles when they reach the earth occasionally as meteor remnants. This condition never seems to be mentioned in the stories and speculations about interplanetary and space travel. Of course, if it is so, it would nip all such space fancies in the bud. Does this disintegration by cosmic rays constitute an insurmountable obstacle?

Alliston Cragg
Charleston, W. Va.

Individual molecules of air at 4000 degrees would strike the hypothetical space ship, but there would be so few of them that one authority says the heat in thousands of cubic miles of this thin air would not raise the temperature of a space ship by a thousandth of a degree.

(Continued to page 10)

For real job security...

FILL THE GAPS IN YOUR TRAINING

THE pressure is mounting. Competition for jobs is growing fast. Business and industry are tightening up. Every man or woman holding a good job is now, in effect, "on probation."

Are there "weak spots" in your training? Now's the time to get after them! Six months from now may be too late.

How can you fill the gaps — quickly? International Correspondence Schools can help you! There's no faster, surer way to get exactly the training you need!

You have 277 famous, spare-time I. C. S. Courses to choose from: trade, industrial engineering, office, executive, high school. Or you can arrange for "refresher" courses, advanced training or special instruction combining two or more specific business or technical subjects.

I. C. S. has the most complete line-up of job-related instruction you can find anywhere. Courses are tailored to fit your needs. This means you waste no time on subjects you can't use. You lose no time traveling back and forth to classes. You set your own schedule—no interference with business or social activities.



Find out for yourself how quickly, how thoroughly I. C. S. can fill the gaps in your training! No obligation. Just mark and mail the coupon!

2 FREE BOOKS

32-page, pocket-size gold mine of facts, "How to Succeed," plus catalog outlining opportunities in field that interests you!

For Real Job Security — Get I. C. S. Training!

I. C. S., Scranton 9, Penna.

INTERNATIONAL CORRESPONDENCE SCHOOLS



BOX 5619-L, SCRANTON 9, PENNA.

(Partial list of 277 courses)

Without cost or obligation, send me "HOW TO SUCCEED" and the opportunity booklet about the field BEFORE which I have marked X:

ARCHITECTURE and BUILDING CONSTRUCTION

- Air Conditioning—Refrig.
- Architecture
- Building Contractor
- Building Maintenance
- Carpenter and Mill Work
- Estimating
- Heating
- Painting Contractor
- Plumbing
- Reading Arch. Blueprints
- Steamfitting

ART

- Cartooning
- Commercial Art
- Fashion Illustrating
- Magazine Illustrating
- Show Card and Sign Lettering
- Sketching and Painting

AUTOMOTIVE

- Auto Body Rebuilding
- Auto Elec. Technician
- Auto-Engine Tune Up
- Automobile Mechanic

AVIATION

- Aeronautical Engineering Jr.
- Aircraft & Engine Mechanic

BUSINESS

- Advertising
- Bookkeeping and Accounting
- Business Administration
- Business Correspondence
- Certified Public Accounting
- Creative Salesmanship
- Federal Tax
- Letter-writing Improvement
- Managing Small Business
- Office Management
- Retail Business Management
- Sales Management
- Stenographic-Secretarial
- Traffic Management

CHEMISTRY

- Analytical Chemistry
- Chemical Engineering
- Chem. Lab. Technician
- General Chemistry
- Natural Gas Prod. & Trans.
- Petroleum Engineering
- Plastics
- Pulp and Paper Making

CIVIL, STRUCTURAL ENGINEERING

- Civil Engineering
- Construction Engineering
- Highway Engineering
- Reading Struct. Blueprints
- Sanitary Engineering
- Structural Engineering
- Surveying and Mapping

DRAFTING

- Aircraft Drafting
- Architectural Drafting
- Electrical Drafting
- Mechanical Drafting
- Mine Surveying and Mapping
- Ship Drafting
- Structural Drafting

ELECTRICAL

- Electrical Engineering
- Electrical Maintenance
- Electrician Contracting
- Lineman

HIGH SCHOOL

- Commercial
- Good English
- High School Subjects
- Mathematics

LEADERSHIP

- Foremanship
- Industrial Supervision
- Leadership and Organization
- Personnel-Labor Relations

MECHANICAL AND SHOP

- Gas-Electric Welding
- Heat Treatment Metallurgy
- Industrial Engineering
- Industrial Instrumentation
- Industrial Supervision
- Machine Design-Drafting
- Machine Shop Inspection
- Machine Shop Practice
- Mechanical Engineering
- Quality Control
- Reading Shop Blueprints
- Refrigeration
- Sheet Metal Worker
- Tool Design Toolmaking

RADIO, TELEVISION

- Electronics
- Practical Radio—TV Eng'ing
- Radio and TV Servicing
- Radio Operating
- Television—Technician

RAILROAD

- Air Brakes Car Inspector
- Diesel Locomotive
- Locomotive Engineer
- Section Foreman

STEAM AND DIESEL POWER

- Combustion Engineering
- Diesel—Elec. Diesel Eng's
- Electric Light and Power
- Stationary Fireman
- Stationary Steam Engineering

TEXTILE

- Carding and Spinning
- Cotton, Rayon, Woolen Mfg.
- Finishing and Dyeing
- Loom Fixing
- Textile Designing
- Textile Eng'g Throwing
- Warping and Weaving

MISCELLANEOUS

- Domestic Refrigeration
- Marine Engineering
- Ocean Navigation
- Shipfitting
- Short Story Writing
- Telephony

Name _____ Age _____ Home Address _____

City _____ Zone _____ State _____ Working Hours _____ A.M. to P.M. _____

Occupation _____

Canadian residents send coupon to International Correspondence Schools, Canadian, Ltd., Montreal, Canada. . . . Special tuition rates to members of the U. S. Armed Forces.

YOU CAN START A
\$40 A Day
Business
 IN YOUR SPARE TIME!



Andy Phillips says:

"My BELSAW SHARP SMITH gives me big profits at low expense — I can run 35 to 40 circular saws in an 8-hour day—that makes me \$40 cash — I also get BIG EXTRA PROFITS... grinding planer and joiner knives — always a big demand for this kind of work."

YOUR OWN CASH BUSINESS

You can start this REPEAT CASH business in your own home or garage while you are working at your regular job. Easy to operate, no experience needed. "My BELSAW paid for itself the first month."—*H. J. Opie*

For as little as \$15 down payment, you can get your BELSAW Sharp Smith rushed to you.

NO EXPERIENCE NEEDED...

YOU can start making money the very day your BELSAW Sharp Smith arrives. Earn \$4 to \$5 an hour in your SPARE TIME sharpening circular saws and machine knives for your neighbors, builders, lumber yards, and factories. A pleasant spare-time hobby that gives you extra cash income and can be built into a full-time \$40-a-day business.

FREE BOOK TELLS HOW ▶

You can start this REPEAT CASH business right at home in your spare time.

Send Coupon or Postcard Today
 No Salesman Will Call

BELSAW MACHINERY CO
 37-M Field Bldg., Kansas City 11, Mo.

Send FREE book, "Lifetime Security"

Name _____

Address _____

City _____ State _____



(Continued from page 8)

To the Editor:

The picture of the "Electrical Music Mentor" in the October, 1953, issue reminded me of the trouble encountered in learning to play a piano. To make this possible I designed a device which projects a moving score of music on a screen. The score



appears in one of two forms, classical or simplified. Familiarity is acquired by running the machine at slow speed. It shows the player what to do and when. The picture shows the writer playing the piano with the aid of the device. Only one of them has ever been built.

F. Thannhauser
 Royal Oak, Mich.

To the Editor:

A long time ago a certain saying rang through the households of this country: "What this country needs is a good five-cent cigar." Every time a woman gets into my small car she says, "Now this is what I need."

From hearing this so often it seems that this is the time for manufacturers to listen to the pleas of women as they proclaim: "What this country needs is a good small car."

This statement means a small car with excellent brakes and enough power to go down Main Street to the market, to clubs, to the library and to the children's schools.

(Continued to page 20)

You Practice **SERVICING** with Kits I Send You



Nothing takes the place of PRACTICAL EXPERIENCE. That's why NRI training is based on LEARNING BY DOING. You use parts I send to build many circuits common to Radio and Television. With my Servicing Course you build the modern Radio shown at left. You build a Multimeter and use it to help make \$10, \$15 a week fixing sets in spare time while training. All equipment is yours to keep. Coupon below will bring book of important facts. It shows other equipment you build.

You Practice **BROADCASTING** with Kits I Send You



As part of my Communications Course I send you parts to build low-power Broadcasting Transmitter at left. Use it to get practical experience. You put this station "on the air" . . . perform procedures demanded of broadcasting station operators. An FCC Commercial Operator's License can be your ticket to a bright future. My Communications Course trains you to get your license. Mail coupon. Book shows other equipment you build for practical experience.

I Will Train You at Home in Spare Time to be a **RADIO-TELEVISION** Technician



TELEVISION

Making Jobs, Prosperity

25 million homes have Television sets now. Thousands more sold every week. Trained men needed to make, install, service TV sets. About 200 television stations on the air. Hundreds more being built. Good job opportunities here for qualified technicians, operators, etc.



America's Fast Growing Industry Offers You Good Pay, Success

Training PLUS opportunity is the PERFECT COMBINATION for job security, advancement. When times are good, the trained man makes the BETTER PAY, gets PROMOTED. When jobs are scarce, the trained man enjoys GREATER SECURITY. NRI training can help assure you and your family more of the better things of life. Radio is bigger than ever with over 3,000 broadcasting stations and more than 115 MILLION sets in use, and Television is moving ahead fast.

N.R.I. Training Leads to Good Jobs Like These

I TRAINED THESE MEN

-  "Am transmitter-studio operator at KPAT. Most important day of my life was when I enrolled with NRI."—Elmer Frewaldt, Madison, S. Dakota.
-  "Made my first \$100 from spare time work before I finished my course. Now I average better than \$10 a week, spare time."—Frank Borer, Lorain, Ohio.
-  "I've come a long way in Radio and Television since graduating. Have my own business on Main Street."—Joe Travers, Asbury Park, New Jersey.
-  "I didn't know a thing about Radio. Now have a good job as Studio Engineer at KMMJ."—Bill Delzell, Central City, Nebraska.

BROADCASTING: Chief Technician, Chief Operator, Power Monitor, Recording Operator, Remote Control Operator. **SERVICING:** Home and Auto Radios, Television Receivers, FM Radios, P.A. Systems. **IN RADIO PLANTS:** Design Assistant, Technician, Tester, Serviceman, Service Manager. **SHIP AND HARBOR RADIO:** Chief Operator, Radio-Telephone Operator. **GOVERNMENT RADIO:** Operator in Army, Navy, Marine Corps, Forestry Service Dispatcher, Airways Radio Operator. **AVIATION RADIO:** Transmitter Technician, Receiver Technician, Airport Transmitter Operator. **TELEVISION:** Pick-up Operator, Television Technician, Remote Control Operator.

Start Soon to Make \$10, \$15 a Week Extra Fixing Sets

My training is practical, complete; is backed by 40 years of success training men at home. My well-illustrated lessons give you basic principles you need and my skillfully developed kits of parts "bring to life" things you learn from the lessons. I start sending you special booklets that show you how to fix sets the day you enroll. Multimeter you build with my parts helps you discover and correct set troubles, helps you make money fixing neighbors' sets in spare time while training. Many make \$10, \$15 a week extra this way.

Mail Coupon — Find Out What Radio-Television Offer You

Act now to get more of the good things of life. I send actual lesson to prove NRI home training is practical, thorough. My 64-page book "How to be a Success in Radio-Television" shows what my graduates are doing and earning. It gives important facts about your opportunities in Radio-Television. Take NRI training for as little as \$5 a month. Many graduates make more than the total cost of my training in two weeks. Mail coupon now to: J. E. SMITH, President, Dept. 4EA, National Radio Institute, Washington 9, D. C. Our 40th year.

AVAILABLE to all qualified **VETERANS** UNDER G. I. BILLS

Good for Both — FREE

MR. J. E. SMITH, President, Dept. 4EA
National Radio Institute, Washington 9, D. C.
Mail me Sample Lesson and 64-page Book, FREE.
(No salesman will call. Please write plainly.)

Name Age

Address

City Zone State

VETS write in date of discharge



Mail Today-Tested Way to Better Pay

Major Car Manufacturers Approve Amazing PROTO Torquer!

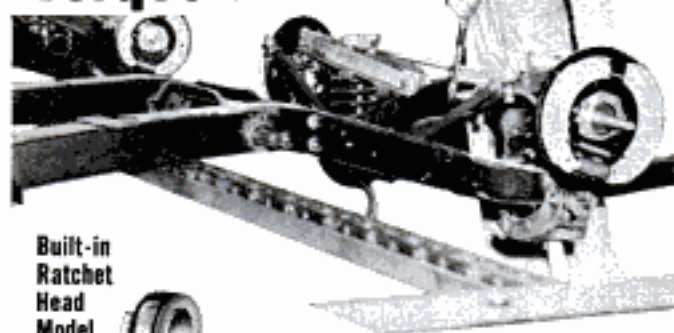

Head Only of Plain Head Model



In your service work, follow the lead of several car manufacturers who made comparative tests and found that the sensational PROTO Torquer is faster, sturdier, and more accurate than indicating types. You'll like its automatic torque-limiting release, trouble-free construction, micrometer-type adjustment, and lack of pointers and dials. Various sizes are available in foot-pound or inch-pound models, with plain or reversible ratchet head. Start saving precious time now by buying the models you need from your PROTO dealer. Send 10¢ for 68-page catalog to

PLOMB TOOL COMPANY
2255K Santa Fe Ave.,
Los Angeles 54, Calif.

NEW! Torquer Adapters

These four new torque wrench adapters simplify torquing on overhead valve engines. Their unique shapes clear obstructions, but do not affect the Torquer's accuracy.

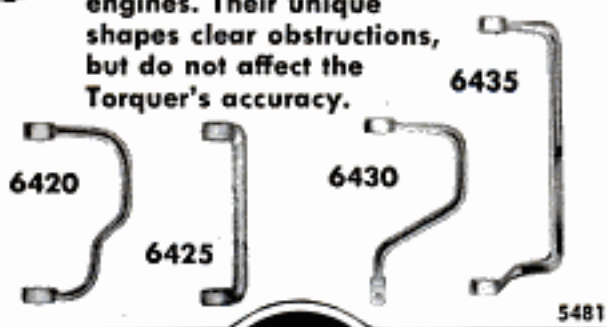

Eastern Factory—Jamestown, N.Y.
Canadian Factory—London, Ont.

WHERE-TO-BUY-IT INDEX

Source of supply appears after items commercially available

AUTOMOTIVE

- Plymouth sport coupe has matched luggage..... 88
- Detroit Listening Post..... 98
- Chrysler's Plymouth-installed gas turbine.....107
- Rear-engine auto carrier mounts bunk under cab.....123
- Air Force sergeant builds convertible for son at cost of \$125..133

AUTOMOTIVE ACCESSORIES

- Nash low-cost air conditioner cools or heats by turning knob. 86
- You can be your own highway patrolman with buzzing "speedometer" (Code Industries, Inc., 625 S. Goodman St., Rochester 20, N. Y.)..... 99
- Streamlined aluminum upper berth clamps to automobile roof.108
- Crankcase-oil reservoir fills engine automatically.....108
- You can assemble your own four-bunk vacation trailer with kit (Chris-Craft Corp., Algonac, Mich.).....122
- Inside windshield wiper anchored to suction cup (Strong's, 4217 E. 14th St., Oakland, Calif.).....144
- Auto penthouse will sleep four (Maurice W. Reed, Silver Lake, Ind.).....145
- Hinged wings on automobile mirror increase rear vision (Lifetime Auto Accessories Corp., 1816 Boston Rd., New York 60).....151
- Hand-held pneumatic tool forces tire bead from rim (Renew Bicycle Shop, 145 President St., Passaic, N. J.).....244

AVIATION

- Electronic system used by Air Force lands 120 planes per hour.112
- Midget pusher sports plane can fly 200 miles per hour.....118
- Radio waves hold robot helicopter in fixed hovering position.122
- "Tennis net" crash barrier halts jet planes at end of runway.127
- German pilot builds "windmill" for ground-sky travel.....153

BOATS AND BOATING

- Variable-pitch propeller for outboard motor (Mid-States Mfg. Corp., Inc., Pittsburg, Kans.)..... 99
- Aircraft engine and propeller blow aluminum craft along water.....121
- Transparent plastic boat passes tests in France.....121
- Working model of Columbia River steamer complete to last detail.....133
- Rolling mast platform permits easy loading of long cargo.....160
- Nylon boat cover (Plano Plastic Products, 6900 Colgate Ave., Cleveland 2, Ohio).....266

CONSTRUCTION

- Mexican suspension bridge built in shape of basket handle...123
- House suspended in space rests on tapered beams.....148
- Earth tamper mounted on trench filler packs automatically...158
- Self-contained electric heating shaft installed between studding (Electrend Products Corp., St. Joseph, Mich.).....160

FARM AND GARDEN

- Two-piece kit seals breaks in plastic garden hose (Res-Q Products Co., Box 211, Van Nuys, Calif.)..... 99
- New tools for your garden—
- Staggered wheels on rotary mower (RPM Mfg. Co., Lamar, Mo.).....100
- Lawn trimmer (Seymour Smith & Son, Inc., Oakville, Conn.).....100
- Leaf burner (Gardening Products Inc., 519 Forest St., Arlington, N. J.).....100
- Robot mower (Western Tool & Stamping Co., 2725 2nd, Des Moines, Iowa).....100
- Exhaust silencer (Maxim Silencer Co., 85 Homestead Ave., Hartford, Conn.).....100
- Soil aerator (Engman Mfg. Co., 1317 Locust, Des Moines, Ia.).....100
- Rotary mower (Sensation Mower, Inc., Ralston, Neb.).....100
- Adjustable sprinkler (Scoville Mfg. Co., Waterburg 20, Conn.).....100
- "Whip end" garden hose (Pioneer Rubber Mills, 345 Sacramento St., San Francisco 11).....100
- Root soaker (Jons Mfg. Co., St. Matthews, S. C.).....100
- Root-crop spray prevents sprouting.....109
- Burlap grain bin (Bemis Bros. Bag Co., 408 Pine St., St. Louis 2, Mo.).....158

INDUSTRY

- Roller-welder unit does work of seven spot-welding machines (Solar Aircraft Co., 2200 Pacific Hwy., San Diego 12, Calif.).....148
- Hydraulic rake mounted on tractor clears sugar cane from field.....158
- Clay-extrusion machine.....236

RECREATION AND HOBBIES

- Tiny railroad with only 156 feet of track spans oceans.....120
- Plastic pinochle tally keeps changing record of game progress (W. B. Cline, Rt. 3, Box 1020, Bremerton, Wash.).....127
- Aluminum golf cart has numbered slots for 14 clubs (Metal Craft, Inc., 102 E. Court St., Cincinnati 2, Ohio).....159

SCIENCE

- Pin-size neon glow lamp aids timing of film..... 86
- Ten-foot X-ray picture reveals minute flaws in steel castings.112
- Electrons photograph stars to produce sharper and faster pictures.....121
- H-bomb element may help war on cancer.....126
- Silicon transistor.....137

(Continued to page 14)

INVENTORS

Learn how to protect your invention. The U. S. Patent Laws provide that any new and useful art, machine, article of manufacture, or composition of matter, or any new and useful improvement thereof, may be patented if the act of invention is involved. Therefore, every inventor with a valuable invention should take advantage of the Patent Laws and proceed for patent protection in order to safeguard his rights.

A patent gives the inventor the exclusive right to prevent others from making, using, or selling the invention claimed in the patent for a period of seventeen years.

The Patent Laws were enacted for the benefit of the inventor to give him protection for the features of his invention which are patentable. These features must be properly and concisely set forth and claimed in a formal application for patent, in order to comply with the requirements of the Patent Laws. For that reason, unless the inventor is familiar with patent matters, he should engage a competent registered patent attorney or agent to represent him. We are registered to practice before the U. S. Patent Office and are prepared to serve you in the handling of your patent matters.

A specially prepared booklet entitled "Patent Guide for the Inventor", containing detailed information with respect to patent protection and procedure, together with a "Record of Invention" form will be promptly forwarded to you without obligation upon request.

CLARENCE A. O'BRIEN & HARVEY JACOBSON

Registered Patent Attorneys

41-E DISTRICT NATIONAL BUILDING

WASHINGTON 5, D. C.

(Continued from page 12)

Atomic by-product gauges irrigation.....	143
Algae "seasoning".....	152
Pressured fluid forms tight seal around supersonic wind valve.....	152
Titanium plentiful in Hawaii.....	159
Locust carousel checks duration and speed of insect's flight.....	159
Chemists synthesize sugar.....	160
"Atomic" microscope.....	200

HOUSE AND HOME

What's new for your home—	
Reservoir for steam iron (Sunbeam Corp., 5600 Roosevelt Rd., Chicago 50).....	146
Pickup cord (Westland Plastics Inc., 3317 E. Pico Blvd., Los Angeles 23, Calif.).....	146
Hat holder (Keepshape Hat Rest Co., 141 W. Jackson Blvd., Chicago 4).....	146
Feed-down racks (Amana Refrigeration, Inc., Amana, Iowa).....	146
Electric frying pan (Sunbeam Corp., 5600 Roosevelt Rd., Chicago 50).....	146
Adjustable glide (N. C. Kirst & Co., 104 S. Main St., Fond du Lac, Wis.).....	147
Wall refrigerator (General Electric, 310 W. Liberty, Louisville 2, Ky.).....	147
Knife sharpener (Selective Products Co., 2803 Los Flores Blvd., Lynwood, Calif.).....	147
Plunger for drains (Vac-Co Pump Co., Inc., 2323 E. 45th St., Indianapolis 5, Ind.).....	147
Candle carburetor (A-Try Mfg. Co., 5503 W. Edmunds St., Chicago 30).....	147

MISCELLANEOUS

Plastic shield for police offers protection from bullets (T. J. Goechner, 900 N. Locust, Compton, Calif.).....	86
Adapter converts black-and-white TV set to color for \$100.....	88
Dome car has upper lounge.....	95
Computers use costly metal.....	99
Models replace surveyors in planning New Jersey's highways.....	109
Heart-lung machine does both jobs during 26-minute surgery.....	109
Portable chest unfolds to provide table for drawing or drafting (P. Leslie Ferris, 6214 Morningside Dr., Kansas City, Mo.).....	120
Train for Turkey has compact diesel engine built into truck.....	126
Quickly erected portable grandstand will seat nine spectators.....	137
TV links bank and branch to speed operations.....	137
Two-part baby carriage divides to carry groceries or parcels.....	143
Airborne baby's berth suspended from wall.....	144
Bedside air conditioner purifies, cools and dries air.....	144
Balloon-type seat cushion folds to fit shirt pocket (Products Unlimited, Inc., Box 322, Fairfield, Conn.).....	152
Los Angeles bus loaders use "Pogo stick" fare boxes.....	152
Lamp mounted on typewriter floods paper with light (Hudson & Co., 116 New Montgomery St., San Francisco 5).....	153

Adaptable canvas is tent or tarp (Barker Mfg. Co., Honeyoye Falls, N. Y.).....	158
Transparency viewer carried in vest pocket (Eastman Kodak Co., Rochester 4, N. Y.).....	240
Telephone translators.....	266
"Brief case" camp kit totes shovel, ax and water.....	270

Craftsman and Shop Notes Index

AUTOMOTIVE

Black tape on automobile antenna stops reflected spotlight glare.....	167
Battery cable quickly attached by using grip-type pliers.....	210
Burned distributor-cap contact causes misfiring of engine.....	220

FARM

Hand grip for dairy brush.....	167
Tags attached to young trees with split section of hose.....	176
Junked walking-plow beam supports rural mailbox.....	200
High-pressure insecticide sprayer utilizes gear-type pump.....	208
Trailer-mounted corn sheller driven by tractor take-off.....	217
Hayrake teeth divide trough.....	220
Fence opening for farm dogs provided by suspended tire.....	220

FISHING AND BOATING

Let's go fishin'.....	177
Antiproof docking facilities improvised for cabin cruiser.....	188
Inner tube with a sail tows heavy fishing line offshore.....	189

HOBBIES, NOVELTIES AND TOYS

Bas-relief carving of Lincoln bust.....	173
Make it a magic party.....	174
Small doll's bed is assembled quickly from two cigar boxes.....	200

HOUSE AND HOME

Porcelain insulator converted into clothesline clamp.....	167
Emergency plug for small leak cut from sheet rubber.....	172
Cord shortened without cutting by taping inside lamp base.....	172
Laying roll roofing effectively.....	172
Replace Venetian-blind cord by using old one as guide.....	176
Steel angle on stairwell railing prevents dangerous "perching".....	176
Curtain rod easier to push through curtain.....	178

(Continued to page 16)

IMPORTANT NOTICE—It is the intention of this magazine to provide its readers with information regarding the latest developments in the mechanical arts. We take no responsibility as to whether the disclosures contained in our articles are covered by patents and advise readers to investigate this subject before making, using, or selling any of the products, machines, or processes described in order to avoid possible liability for patent infringements.

New Greaseless Way To Keep Your Hair Neat All Day

Vitalis Hair Tonic with V-7 makes even dry, unruly hair easy to manage.

Keeps hair neat with V-7, new greaseless grooming discovery that outdates messy oils. Never a gummy film or "oil-slick" look!

Prevents Dryness. What's more, new Vitalis maintains your hair's natural moisture balance better than any other leading tonic. Try new Vitalis with V-7—you'll like it.

VITALIS® with V-7

PRODUCT OF BRISTOL-MYERS



Can you profit by their mistakes?

"Not getting enough education"

You needn't make that mistake. You can get that better job, those big promotions, the regular raises that so many I. C. S. students report. And you can do it without

"going to school," without interfering with your present job or your social life.

YOU can study with I. C. S. at home, in your spare time!



"Wrong choice of career"



When you study with I. C. S. you have 303 courses to choose from. And part of our job here at I. C. S. is not only giving you instruction

but making sure you pick the course that's right for you!

YOU get expert guidance FREE from I. C. S.!

"Failed to seize opportunities"

Your opportunity is right here on this page. Don't pass it by. Don't put it off. Write now and let us send you "How to Succeed" and

full information on any of the fields listed below.

YOU get 2 FREE books if you mail the coupon today!



For Real Job Security — Get I. C. S. Training!

I. C. S., Scranton 9, Penna.

INTERNATIONAL CORRESPONDENCE SCHOOLS

ICS

BOX 5620-L, SCRANTON 9, PENNA.

(Partial list of 277 courses)

Without cost or obligation, send me "HOW TO SUCCEED" and the opportunity booklet about the field BEFORE which I have marked X:

- ARCHITECTURE and BUILDING CONSTRUCTION**
- Air Conditioning—Refrig.
 - Architecture
 - Building Contractor
 - Building Maintenance
 - Carpenter and Mill Work
 - Estimating
 - Heating
 - Painting Contractor
 - Plumbing
 - Reading Arch. Blueprints
 - Steamfitting
- ART**
- Carboning
 - Commercial Art
 - Fashion Illustrating
 - Magazine Illustrating
 - Show Card and Sign Lettering
 - Sketching and Painting
- AUTOMOTIVE**
- Auto Body Rebuilding
 - Auto Elec. Technician
 - Auto-Engine Tune Up
 - Automobile Mechanic

- AVIATION**
- Aeronautical Engineering Jr.
 - Aircraft & Engine Mechanic
- BUSINESS**
- Advertising
 - Bookkeeping and Accounting
 - Business Administration
 - Business Correspondence
 - Certified Public Accounting
 - Creative Salesmanship
 - Federal Tax
 - Letter-writing Improvement
 - Managing Small Business
 - Office Management
 - Retail Business Management
 - Sales Management
 - Stenographic-Secretarial
 - Traffic Management
- CHEMISTRY**
- Analytical Chemistry
 - Chemical Engineering
 - Chem. Lab. Technician
 - General Chemistry
 - Natural Gas Prod. & Trans.
 - Petroleum Engineering
 - Plastics
 - Pulp and Paper Making

- CIVIL, STRUCTURAL ENGINEERING**
- Civil Engineering
 - Construction Engineering
 - Highway Engineering
 - Reading Struct. Blueprints
 - Sanitary Engineering
 - Structural Engineering
 - Surveying and Mapping
- DRAFTING**
- Aircraft Drafting
 - Architectural Drafting
 - Electrical Drafting
 - Mechanical Drafting
 - Mine Surveying and Mapping
 - Ship Drafting
 - Structural Drafting
- ELECTRICAL**
- Electrical Engineering
 - Electrical Maintenance
 - Electrician Contracting
 - Lineman
- HIGH SCHOOL**
- Commercial
 - Good English
 - High School Subjects
 - Mathematics

- LEADERSHIP**
- Foremanship
 - Industrial Supervision
 - Leadership and Organization
 - Personnel-Labor Relations
- MECHANICAL AND SHOP**
- Gas—Electric Welding
 - Heat Treatment Metallurgy
 - Industrial Engineering
 - Industrial Instrumentation
 - Industrial Supervision
 - Machine Design-Drafting
 - Machine Shop Inspection
 - Machine Shop Practice
 - Mechanical Engineering
 - Quality Control
 - Reading Shop Blueprints
 - Refrigeration
 - Sheet Metal Worker
 - Tool Design Toolmaking
- RADIO, TELEVISION**
- Electronics
 - Practical Radio—TV Eng'ng
 - Radio and TV Servicing
 - Radio Operating
 - Television—Technician

- RAILROAD**
- Air Brakes Car Inspector
 - Diesel Locomotive
 - Locomotive Engineer
 - Section Foreman
 - Stationary Steam Engineering
- DIESEL POWER**
- Combustion Engineering
 - Diesel—Elec. Diesel Eng's
 - Electric Light and Power
 - Stationary Steam Engineering
- TEXTILE**
- Carding and Spinning
 - Cotton, Rayon, Woolen Mfg.
 - Finishing and Dyeing
 - Loom Fixing
 - Textile Designing
 - Textile Eng'g Throwing
 - Warping and Weaving
- MISCELLANEOUS**
- Domestic Refrigeration
 - Marine Engineering
 - Ocean Navigation
 - Shipfitting
 - Short Story Writing
 - Telegraphy

Name _____ Age _____ Home Address _____

City _____ Zone _____ State _____ Working Hours _____ A.M. to P.M. _____

Occupation _____

Canadian residents send coupon to International Correspondence Schools, Canadian, Ltd., Montreal, Canada, . . . Special tuition rates to members of the U. S. Armed Forces.



"HOW I MADE MY HOBBY PAY OFF!"

I've always been interested in cars, then one day I met Joe..."

HI, JOE! SINCE WHEN ARE YOU IN THE AUTO REPAIR BUSINESS?

EVER SINCE I STARTED LEARNING AUTO MECHANICS AT HOME. I EARN WHILE I LEARN, THE NATIONAL SCHOOLS WAY!

SOUNDS GREAT! I HEAR THAT TOP MECHANICS MAKE REAL MONEY THESE DAYS!

YOU SAID IT! I MAY EVEN OPEN MY OWN REPAIR SHOP WHEN I GRADUATE.

NATIONAL SCHOOLS SENT ME THIS SWELL AUTOMOTIVE TOOL KIT—IT'S PART OF MY COURSE!

WHAT A DEAL. I'M FINDING OUT ABOUT THIS AUTO MECHANICS COURSE TODAY!

SHOP-TESTED HOME TRAINING AUTO MECHANICS & DIESEL NATIONAL SCHOOLS

Technical Trade Training Since 1905
LOS ANGELES 37, CALIFORNIA

In Canada: 811 West Hastings Street, Vancouver, B.C.

APPROVED FOR G. I. TRAINING. Both Home Study and Resident courses offered. Job placement assistance, too! Find out today!

MAIL NOW TO OFFICE NEAREST YOU!

(mail in envelope or paste on postal card)

NATIONAL SCHOOLS, Dept. DB-54

4000 S. FIGUEROA STREET
LOS ANGELES 37, CALIF.

OR

323 WEST POLK STREET
CHICAGO 7, ILL.

Please rush FREE BOOK "Your Future in Auto Mechanics & Diesel," and FREE LESSON. I understand there is no obligation, no salesman will call.

NAME _____ BIRTHDAY _____ 19__

ADDRESS _____

CITY _____ ZONE _____ STATE _____

Check if interested ONLY in Resident Training at Los Angeles.

VETERANS: Give date of discharge _____

(Continued from page 14)

Linoleum-binding tape	178
Milk carton filled with sand for doorstep	178
Individual saltcellars for picnicking	178
Sealing envelopes with ice cubes and cloth	178
Children can't lock themselves in bathroom	178
Handy basement rack	179
Rubber pad for food-chopper clamp	179
Storing canned goods	179
Cup-and-saucer rack fashioned from brass or copper wire	180
Inexpensive and decorative patio gate insures privacy	189
Metal shelf brackets modified for use as temporary supports	196
Water tank decorate driveway	196
Pencil ferrule pits cherries	200
Stair tread protects window sill against flowerpot stains	200
Sill-cock provides handy drinking fountain for children	204

LAWN AND GARDEN

Protect knees when gardening with pads cut from inner tube	167
Make handy offset weeding tool from ordinary table knife	176
Tipping bird bath attracts songbirds and keeps cats away	180
Garden watered from leaky hose	188
Light attached to lawn mower powered by small generator	196
Discarded hacksaw blade made into effective garden weeder	200
Plant cuttings rooted easily in plastic wrapper	204

MISCELLANEOUS

Refinish metal name plates with lacquer and sandpaper	166
Dip-painting irregular objects	167
Mirror used for emergency notes when paper is not available	176
Wooden strip used as handle for small magnifying glass	200
Flexible water-pipe joints from auto-radiator hose	210

OFFICE, SHOP AND STORE

Yellow laundry soap on fingers aids rapid handling of papers	196
Roughened surface of triangle takes pencil marks easily	210
Ash tray beside drawing board keeps work space clear	210

PHOTOGRAPHY

Ornamental plastic switch plate masks photographic prints	172
Ventilator for photo darkroom made from stovepipe elbows	173
Emergency darkroom safelight	188
Mixing-spoon handle graduated to measure photo solutions	188
Plastic food boxes protect film when stored in refrigerator	188
Speed Graphic operating steps noted on parallax finder	189
Keep prints from slipping	196
Photo lamp from odd parts	201
Camera support is improvised with two chairs and books	202
Hose used as funnel holder	202
Negatives stored in file box	202
Hot water softens sponge for wiping photoprints	202
Print drier	203
Curved tin deflector on tray permits uniform print-washing	204

TOOLS

Solder refaces punch anvil	180
Notched jaws improve vise	209
Wheel puller	211
Shopping for tools—	
Hole saw (Erwood, Inc., 1770 W. Berteau Ave., Chicago 13)	218
Mortising table (J. D. Wallace & Co., 134 S. California, Chicago 13)	218
Rolling tool rack	218
Variable-speed drive (Logan Engineering Co., 4901 W. Lawrence Ave., Chicago 38)	218
Vibrationless filing machine	218
Angle gauge (Christensen & Kroil, P. O. Box 284, McMinnville, Ore.)	219
Double-cut linoleum knife ("G" 22 Mfg. Co. Ltd., 1201 Congress Ave., Houston, Tex.)	219
Impact press (Heidrich-Nourse Co., 631 E. Third St., Los Angeles 13, Cal.)	219

WORKSHOP HINTS

Chrome kitchen chair converted to temporary youth seat	172
Release clutch of bar clamp by using C-clamp	204
How to cut coped joints	205
Internal screw threads measured with aid of lead pencil	208
Movable light over workbench slides along overhead wire	208
Spring unwound on steel rod	208
Left-hand thread on round stock cut with right-hand tap	210
Angle-steel spring compressor for valve-in-head engines	217
Rack formed with sawhorses aids in cutting fence wire	217
Hypodermic syringe lubricates small electric motors	220
Screwdriver holds small bolts to loosen rusted nut	220

Radio-Television, Electronics

Television today (Color TV sets in production: Admiral Corp., 3800 W. Cortland, Chicago; Midget private-wire TV system: RCA Victor, Radio Corporation of America, Camden, N. J.; Tubes for color TV receivers: General Electric Corp., Syracuse, N. Y.)	161
First-aid hints for table-model radios	162
High-frequency transistors in experimental receiver (RCA Research Laboratories, Princeton, N. J.)	164

☛ The capture of a six-foot shark more than 2300 miles from the ocean, in the Peruvian headwaters of the Amazon River, has been reported recently by Stanford University ichthyologist George S. Myers.

INVENTORS

If you believe that you have an invention, you should find out how to protect it. The first step is to have a search made of the prior pertinent U. S. patents. If a report on this search indicates that the invention appears patentable you can apply for a patent, and the specifications and claims should be prepared.

The firm of McMorrow, Berman & Davidson, with offices in Washington, D. C., is qualified to take the necessary steps for you. We can make a preliminary search on your invention, advise you whether we think it can be patented, and prepare your application for patent.

Unless you are fully familiar with the U. S. Patent Laws, we recommend that you engage the services of a Registered Patent Attorney to protect your interests. The patent laws are *your* laws. A patent gives you the right to prevent others from making, using or selling the invention claimed in your patent for a period of 17 years.

Use these patent laws for your protection. Investigate whether your invention can be patented. If you have what you believe to be an invention, we suggest that you have this firm make a search for you.

Send for a copy of our Patent Booklet entitled "How To Protect Your Invention," containing information about patent protection and patent procedure. Along with this we will also send you an "Invention Record" form, for your use in writing down and sketching details of your invention. We will mail them promptly. No obligation. They are yours for the asking.

McMORROW, BERMAN & DAVIDSON

Registered Patent Attorneys

PATENTS • COPYRIGHTS • PATENTS

1352 VICTOR BUILDING, WASHINGTON 1, D. C.



Save \$8.00
NOW!

\$1.98
EACH

NOW!
GET CLOSE-UP
VIEWS ALL DAY
WITHOUT
FATIGUE!

Here for the first time—Germany's famous **SPEKTOSCOPIES** — a revolutionary concept in optics. Wear them like ordinary eye glasses — hour after hour — without fatigue. Feather weight — only 1 oz. You'll hardly **FEEL** them! Yet here is a new, truly powerful optical design that gives you greater range than many expensive opera or field glasses and a far greater field of view than some selling for many times more! Has **INDIVIDUAL** eye focusing for clear, sharp viewing, whether you're looking at a play in the first row or a seashore scene miles away! **SPEKTOSCOPIES** are ideal for indoors, outdoors or distant scenes or close-by viewing. Special low price — **\$1.98** a saving of 8.00 or more!

Enjoy at our risk for 5 days. You must be delighted! Otherwise your 1.98 will be refunded with no questions asked! Limited supply forces us to place a limit of 2 per customer. Send check or m.o. for prompt, free delivery. COD's sent plus COD fees. Use convenient coupon below!

5 DAY FREE TRIAL!

International Binocular Co. Dept. 6-E-90
352 Fourth Avenue, New York 10, N. Y.

International Binocular Co., Dept. 6-E-90
352 Fourth Avenue, New York 10, N. Y.

RUSH _____ **SPEKTOSCOPIES** at 1.98 each (LIMIT-2) on 5 day home trial. You are to refund my 1.98 if I am not fully delighted.

Payment enclosed. Send post free. Send COD plus post.

Name _____

Address _____

Town _____ State _____

CANADIANS: Mail orders direct to our Canadian plant: Thoresen Co., Dept. 6-E-90, 45 St. James St., West, Montreal 1, Que.

This is the first time that this type of optical instrument has ever sold for less than \$10.00. The favorable rate of exchange and Germany's need for dollars makes it possible. We have been chosen as the exclusive distributor for **SPEKTOSCOPIES** to the American public. Get yours now at our low, low introductory price of **1.98** tax & post paid!



Train for Better
Jobs in

ELECTRICITY OR TELEVISION-RADIO

in Great
Shops of COYNE

GREAT OPPORTUNITY FIELDS

Conditions are changing. Many "one operation" jobs that have paid well will not last. *Don't be satisfied with a "no future" job.* Whether 17 or up to 45 years of age, train the Coyne way for a better job and a real future in **ELECTRICITY** or **TELEVISION-RADIO**, fields that offer a world of opportunities.

YOU can TRAIN in great CHICAGO SHOPS

Train on real, full-size equipment at COYNE where thousands of successful men have trained for over 55 years—largest, oldest, best equipped school of its kind—established in 1899. No advanced education or previous experience needed. TRAINING APPROVED FOR VETERANS.

B. W. COOKE, President

COYNE
ELECTRICAL SCHOOL

FOUNDED 1899

A TECHNICAL TRADE INSTITUTE CHARTERED NOT FOR PROFIT
500 S. PAULINA STREET, CHICAGO, Dept. 54-72H

ELECTRICITY ★ RADIO ★ TELEVISION ★ REFRIGERATION ★ ELECTRONICS

START NOW—PAY LATER—Finance Plan and Easy Monthly Payment Plan. Also part-time employment help for students.

Get FREE Book

Send coupon for 48 page illustrated book "Guide to Careers in Electricity and Television-Radio." No cost; no obligation; no salesman will call. Get vital facts now!



B. W. COOKE, President
COYNE ELECTRICAL SCHOOL
500 S. Paulina St., Chicago 12, Ill., Dept. 54-72H

Send BIG FREE book and details of your training offer. This does not obligate me and no salesman will call. I am interested in:

Electricity Television-Radio

Name _____

Address _____

City _____ State _____

COYNE offers
LOW COST

TELEVISION RADIO-ELECTRONICS

Training in
Spare Time AT HOME



The future is YOURS in TV-RADIO!

A fabulous field—good pay—fascinating work—a prosperous future! Good jobs galore, or independence in your own business!

Coyne brings you the first *truly lower cost*, MODERN—QUALITY Television Home Training; training designed to meet Coyne standards. Not an old Radio Course with Television "tacked on". Here is MODERN TELEVISION TRAINING including working knowledge of Radio. Includes UHF and Color TV. No Radio background or previous experience needed. Personal guidance by Coyne Staff. **Practical Job Guides** to show you how to do actual servicing jobs—*make money early in course.*

Don't pay for a lot of costly extras—*pay only for what you learn!* The extras "thrown in" may look impressive, by and large they add little to what you actually **LEARN**—but how they do add to the price! With Coyne Television Home Training you pay only for your training, *no costly extras.*

B. W. COOKE, President

COYNE
ELECTRICAL SCHOOL

FOUNDED 1899

A TECHNICAL TRADE INSTITUTE CHARTERED
NOT FOR PROFIT

500 S. Paulina Street, Chicago 12, Dept. 54-HT2

ELECTRICITY ★ RADIO ★ TELEVISION ★ REFRIGERATION ★ ELECTRONICS

SEND COUPON FOR FREE PICTURE FOLDER

and full details, including easy Payment Plan. No obligation, no salesman will call.



COYNE ELECTRICAL SCHOOL
Television Home Training Div.
500 S. Paulina St., Chicago 12, Ill., Dept. 54-HT2

Send Free Picture Folder and details on Television Home Training. This does not obligate me and no salesman will call.

Name _____

Address _____

City _____ State _____

These great minds were Rosicrucians . . .



Francis Bacon Benjamin Franklin Isaac Newton

WHAT SECRET POWER DID THEY POSSESS?

Why were these men great?

How does anyone—man or woman—achieve greatness? Is it not by mastery of the powers within ourselves?

Know the mysterious world within you! Attune yourself to the wisdom of the ages! Grasp the inner power of your mind! Learn the secrets of a full and peaceful life!

Benjamin Franklin, statesman and inventor . . . Isaac Newton, discoverer of the Law of Gravitation . . . Francis Bacon, philosopher and scientist . . . like many other learned and great men and women . . . were Rosicrucians. The Rosicrucians (NOT a religious organization) have been in existence for centuries. Today, headquarters of the Rosicrucians send over seven million pieces of mail annually to all parts of the world. Address: Scribe D.T.T.

THIS BOOK FREE



The ROSICRUCIANS

San Jose (AMORC) California, U.S.A.

SEND THIS COUPON

Scribe D.T.T.
The ROSICRUCIANS
(AMORC)

San Jose, California, U.S.A.

Please send me the free book, *The Mastery of Life*, which explains how I may learn to use my faculties and powers of mind.

Name _____

Address _____

City _____

State _____

(Continued from page 10)

The small car also requires seat covers that can be washed with soap and water, stainless-steel trim or no trim and enough room for the children and market bags. This small car should be short and narrow. On the errands of a woman there are many parking problems.

A woman does not ordinarily buy a car in the way her husband buys one. He likes to buy the most powerful, shiniest, fanciest and longest. When a lady buys a car she looks at the dashboard and the upholstery. She then asks the salesman about the motor and brakes. He explains everything. Most of this she does not understand but she tries to look wise. She wants to know how many miles to the gallon. The salesman tells her the length of the car and he closes the front door so she can hear how solidly it is built. She asks again about the length. His statement will haunt her every time she parks this beautiful car. She asks him if he has anything shorter as she just wanted something in which to go to the store.

Eventually she wonders what she is doing in this powerful machine. She wonders why she averages only 15 miles a gallon. She wishes she had a small car but her husband said the big car was safe.

Every driver of a small car will vouch for its safety. When a woman drives a small car over 50 miles per hour she feels as if she is in a jet plane and slows down. She finds that when a driver wishes to pass her he will blow the horn. She can be as far over to the right as she can get—but he will still blow the horn. He is afraid he might hit the little thing and he *does* want her to see a *big* car go by. If the small car wiggles itself ahead in traffic—and it usually can—the driver to be afraid of is the one you just passed. He is going to show *you* when the light turns green. He almost hits another car to prove that his car has IT, and he smiles at you in his rear-view mirror.

The small car is a necessity to suburban living. Give women a car they can skip around in. Give it an all-steel body, a short wheel base and, if trim is necessary, stainless steel. Give it a washable interior, a four-cylinder motor, a small gas tank, excellent brakes and paint it a color which can be seen—no middle-value colors.

A few months ago you featured an article on the future of small cars in this country. The opinions of the three or four men discussing the situation resulted in the statement that there was not too much possibility of marketing such a car.

Nobody even asked the women!

Marie M. Larsen
Baltimore, Md.

All Electronic Parts
YOURS TO KEEP!

Now!
Work over
300
practical projects
WITH THESE
PARTS!!!



MULTIMETER



5 INCH
"SCOPE"

....TO
HELP YOU LEARN

TELEVISION

RADIO-ELECTRONICS Now ... at home in spare time you can get BOTH the very training and subsequent Employment Service you need to help you start earning real money in America's thrilling, multi-billion dollar opportunity field of Television-Radio-Electronics. Now that Television is coming to almost every community, here is a chance of a lifetime to prepare to cash in on one of Television's great expansions.

D.T.I.'s amazingly practical home method enables you to set up your own HOME LABORATORY. You get many Electronic parts which you mount on individual bases with spring clip connectors. Tops for experimenting! Add or remove parts in a jiffy. No wasted hours of soldering and unsoldering for each project. You spend minimum time to get maximum knowledge of important circuits that really work. In fact, you get exactly the same type of basic training equipment used in our Chicago training laboratory—one of the nation's finest.

Build and KEEP This VALUABLE TEST EQUIPMENT

Your home laboratory projects also include building and keeping a versatile 5 inch Oscilloscope and precision Jewel Bearing Multi-Meter. These quality commercial test instruments help you EARN WHILE YOU LEARN and will prove mighty valuable, should you later decide to start your own full time TV-Radio service business. You also build and keep a quality 21 inch TV SET.

D.T.I. Provides EVERYTHING YOU NEED to master TELEVISION

In addition to your home laboratory and easy-to-read lessons, you even use HOME MOVIES—a wonderfully effective and exclusive D.T.I. training advantage. You watch hidden actions ... see electrons on the march. Important fundamentals ... become "movie clear," helping you learn faster ... easier ... better.

Full time Residential training in D.T.I.'s great Chicago laboratories also available. MAIL COUPON TODAY for all facts. (If subject to Military Service, you'll especially welcome the information we have for you.)

**89 WAYS
TO
EARN
MONEY**



HOME MOVIES

MAIL COUPON TODAY!

DeVRY TECHNICAL INSTITUTE DEPT. PM-5-K
4141 BELMONT AVE., CHICAGO 41, ILL.

I would like your valuable information-packed publication showing how I can get started toward a good job or my own business in Television-Radio-Electronics.

Name _____ Age _____

Street _____ Apt. _____

City _____ Zone _____ State _____



"ONE OF AMERICA'S FOREMOST
TELEVISION TRAINING CENTERS"

DeVRY TECHNICAL INSTITUTE

AFFILIATED WITH

DeFOREST'S TRAINING, INC.

CHICAGO 41, ILLINOIS

DRAFTSMEN

**EARN
BIG MONEY!**



Want more money? Steady employment? Clean, interesting work? Look into Drafting. You'll quickly see why there's real opportunity, more money in this prosperous professional-type work. Want ads show trained draftsmen are in great demand. Find out how you can qualify in a few months for a good job in Drafting.

**LEARN IN SPARE TIME—AT HOME
(or at the College in Chicago)**

A few hours of pleasant home study every week—that's all. All the tools you need to train at home; valuable drawing outfit included. For 50 years this nationally famous school has prepared men quickly for good positions in industry.

FREE INFORMATION—SEND COUPON

Find out how C.T.C. practical training has boosted the pay for hundreds, what it can do for you. Learn what Chicago Tech graduates say about their work, earnings, success. Don't wait! Investigate now. Send for this **FREE TRIAL LESSON**. No charge for this lesson, now or later. Fill out and mail coupon or send post card today.



**CHICAGO
TECHNICAL COLLEGE**

E-252 Tech Bldg., 2000 So. Michigan Ave.
Chicago 16, Illinois

Mail me **FREE** Lesson with information about big opportunities in **DRAFTING**.

NAME.....AGE.....

ADDRESS.....

CITY.....ZONE.....STATE.....

100 YEAR OLD U.S. STAMPS



We will send "On Approval" all United States stamps, even those over 100 years old. We will also send "On Approval" all foreign stamps in singles and sets, including such famous issues as Coronations, Roosevelts, etc. Ours is the only stamp house able to render such service. Just send 10c for our introductory bargain of 50 different U.S. stamps and fascinating stamp literature.

GLOBUS STAMP CO.

268 — 4th Ave. New York 10, N.Y. Dept. 213

A "GOOD HAND" HELPS YOU SUCCEED!

LEARN TO WRITE WELL

Your Name
beautifully written, plus special pen-point for shaded writing.
Only 10¢

Handwriting quickly improves with our easy-to-understand picture lessons! Put your spare time to good use! Send today for **FREE BOOKLET**: "How to Become a Good Penman," or check volumes wanted below at \$1 each: Business Writing Artistic Writing Card Writing Bird & Design Flourishing Engraving Alphabets. **COMPLETE SET \$4.50.** Ask for price list of penman's supplies.

TAMBLYN SCHOOL of PENMANSHIP
S.A. Ziller, Pres., 442 Ridge Bldg., Kansas City, Mo., USA

'How to MAKE MONEY with Simple CARTOONS'



A book everyone who likes to draw should have. It is free; no obligation. Simply address **FREE BOOK**

CARTOONISTS' EXCHANGE
Dept. 95D Pleasant Hill, Ohio

WATCHMAKING

Learn at home • **FREE** sample lesson • Approved for Vets.
CHICAGO SCHOOL OF WATCHMAKING
2330 N. MILWAUKEE AVE., DEPT. 154, CHICAGO 47, ILL.

\$750 BUILDS 4 ROOMS & BATH!

WHY PAY RENT? For Seven Hundred Fifty Dollars and 30 days of your spare time, you can build yourself this Beautiful Home. Living Room 11x15, Front bedroom 9x11, Back bedroom 10x12, Kitchen 9x11, Bath 5x5, Hall 3x4. Wind out steel casement windows, Concrete block, stuccoed. Step-by-step illustrated instructions, blueprint and material list \$1.00 ppd. No COD. Moneyback guarantee. Economy Home, Dept. C Box 645 Columbus 16, Ohio



Get into Good Paying AUTO BODY and FENDER WORK

BIG DEMAND in Auto Body and Fender work. Start training now in your spare time at home for good pay work. Practical shop experience included. U. E. I. Training covers metal work, welding, painting, etc. Placement service—or we will show you how to start your own shop. Behind U. E. I. TRAINING is a large national organization founded 1927. Write today for **FREE FACTS**—No obligation.

UTILITIES ENGINEERING INSTITUTE
2523 SHEFFIELD AVE., DEPT. XC-29, CHICAGO 14, ILLINOIS

Write for
Free Facts

How to banish the fear of Unemployment



I know the thoughts that go through the heads of men who work for others. I was in that spot myself. What if a depression comes? What if we have a strike? What if the boss turns against me? What would happen if I got sick — or hurt? These are the thoughts I had — the thoughts that must come to any serious minded man who has the responsibility of a family. My problem was solved the day I started in business for myself. Might that be your solution, too?

By Raymond E. Brandell

Years ago when new acquaintances asked me what I did, I used to reply with a laugh, "I'm a wage slave." Inside me I was pleased with my lot because it gave me a feeling of security to know that that same pay check was coming in every Friday, rain or shine.

"Rain or shine" was what I thought until the blow struck. I wasn't among the first to be laid off because I had been on the job three years. Some of the "juniors" went first. But eventually my day came, too. For many weeks I looked for other work. Finally, one grim night, I sat down in my bedroom alone and faced the facts. I was a dependent. I was dependent on the vicissitudes of business. I was dependent on the whims of a boss. I was no more important than a tool that could be picked up or laid down. And, when the foreman laid me down, it was no more important to industry or to the world than if a man had laid down a screw driver. The joke about being a "wage slave" had turned on me.

That black night was the turning point. I decided then that my only salvation was to start a business of my own. Even if I had to half starve, at least I would accomplish two things: I'd free myself from the ups and downs of other peoples' businesses. And I'd be a slave no longer. I would taste the sweet nectar of independence. What I made would be my own. The hours I worked would be my decision. Suddenly, for the first time, I knew the fierce joy that comes to every small business man when he looks around his shop and says, "This is mine."

The decision was one thing. The accomplishment was another. And many and many's the time I thought, "If I had only started a little business on the side before all this happened—how much further along I would have been when the shop closed down."

The going was rough. The opportunities then were not what they are today. Today there are a dozen

small business opportunities to fit the skills and leanings of almost anyone. There are many little businesses that can be started at home, in spare time, without risking the job or sacrificing the pay check. One of the liveliest of these is a particular branch of the Plastics business. And one of the most interesting, too.

When you think of Plastics, you probably think of the enormous plants that have sprung up around the magic of today's synthetics. Plant equipment alone calls for investments of millions of dollars. Obviously not a business for a beginner. But this one special branch of the business is one that will never be invaded by the big moguls of the trade. They can't touch it. And, fortunately, it's a branch of Plastics that can be fabricated on a small, inexpensive machine that can be set up in any corner of a room where you have an electrical outlet and a cold water faucet. Kitchen, garage, basement, even a spare room if there's a sink and an outlet.

I have been a success in my business. What is even more important, I have been a happy person, because it worked out so that the business that made me independent was the business of helping others become independent, too.

I have a set of simple instructions. Not a correspondence course, but an instruction book that shows you in easy step-by-step pictures and

directions how to do six things: 1) How to start on a shoestring. 2) How to operate the equipment. 3) What to make. 4) How to get others to sell the things you make so there is never any canvassing needed on your part. 5) How to get firmly established in spare time. 6) How to expand into a full time operation any time you feel you want to, or are ready.

The space here does not permit giving you the whole story. Let me send it to you in printed form without any charge and without obligation. Just your name in full is all I need. And since I haven't any salesmen, you won't be pestered with any calls or high pressure selling. I have a printed circular that I'll send you, and in the letter that goes with it, I'll give you the facts you need to decide in the quiet of your own home whether this is the time to make your decision.

I could have saved myself three years of hard struggle if I had prepared in advance. Doesn't it make sense — in the face of present rumors — to give this matter some serious thought, right now? Send me your name — no money. I think you'll be glad you read this page when you see the way in which I can open doors for you into the wonderful world of personal independence. Mail the coupon, today, or a post card with your name and address. I'll do the rest.

RAYMOND E. BRANDELL

1512 Jarvis Avenue, Dept. L-10-E, Chicago 26, Ill.

Raymond E. Brandell, 1512 Jarvis Ave., Dept. L-10-E, Chicago 26, Ill.

Dear Mr. Brandell: Please send information showing how I can start a profitable manufacturing business in my home in spare time. All the information you send will be mailed to me free of charge and no salesman is to call on me. I am not under any obligation to go ahead with the business and there is no charge for this information now or any other time.

Name _____

Address _____

City _____ Zone _____ State _____

WHAT ALL AUTO MECHANICS WANT TO KNOW

1664 PAGES



This Big Practical Book gives full information with working diagrams covering the principles, construction, ignition, service and repair of modern cars, trucks and buses.

Diesel Engines, Hydrumatic & Fluid Drives Fully Explained.

A complete Guide of 1664 pages, with over 1500 illustrations showing inside views of working parts, with instructions for service jobs.

IT PAYS TO KNOW

How to fit pistons—How to locate engine knocks, How to fit connecting rod bearings—How to service main bearings—How to recondition valves—How to time valves—How to adjust fan belts—How to adjust carburetors and chokes, How to rebuild a clutch—How to service automatic transmissions—How to service brakes—How to adjust steering gear—How to cope with ignition troubles—How to service distributors—How to time ignition—How to "tune up" an engine.



\$4 COMPLETE - PAY \$1 A MO. TO GET THIS ASSISTANCE FOR YOURSELF SIMPLY FILL IN AND MAIL COUPON TODAY.

Step up your own skill with the facts and figures of your trade. Audels Mechanics Guides contain Practical Inside Trade Information in a Handy Form. Fully illustrated and Easy to Understand. Highly Endorsed. Check the book you want for 7 DAYS FREE EXAMINATION. Send No Money. Nothing to pay postman.

MAIL ORDER



Check NOW!

You Can Look Over Any Guide In Your Own Home — Start the Easy Payments If Satisfied

MAIL THIS TODAY



AUDEL, Publishers, 49 W. 23 St., NEW YORK 10, N. Y.

Please send me postpaid for FREE EXAMINATION books marked (x) below, if I decide to keep them I agree to mail \$1 in 7 Days on each book or set ordered and further mail \$1 monthly on each book or set until I have paid price, otherwise I will return them.

- AUTOMOBILE MECHANICS GUIDE, \$4
- TRUCK & TRACTOR GUIDE, 1299 Pages 4
- DIESEL ENGINE MANUAL, 575 Pages 2
- MACHINISTS HANDY BOOK, 1650 Pages 4
- WELDERS GUIDE, 400 Pages 1
- BLUE PRINT READING, 416 Pages 2
- MATHEMATICS & CALCULATIONS, 700 Pages 2
- SHEET METAL PATTERN LAYOUTS, 1100 Pages 4
- SHEET METAL WORKERS HANDY BOOK, 388 Pgs. 1
- MECHANICAL DRAWING GUIDE, 160 Pages 1
- MECHANICAL DRAWING & DESIGN, 480 Pages 2
- AIRCRAFT WORKER, 240 Pages 1
- TELEVISION SERVICE MANUAL, 384 Pages 2
- RADIOMANS GUIDE, 914 Pages 4
- ELECTRONIC DEVICES, 216 Pages 2
- ELECTRIC MOTOR GUIDE, 1000 Pages 4
- ELECTRIC WIRING DIAGRAMS, 272 Pages 1
- ELECTRICIANS EXAMINATIONS, 250 Pages 1
- ELECTRIC POWER CALCULATIONS, 425 Pages 2
- HANDY BOOK OF ELECTRICITY, 1440 Pages 4
- ELECTRIC DICTIONARY, 9000 Terms 2
- ELECTRIC LIBRARY, 7000 Pages (12 Book Set) 18
- MARINE ENGINEERS HANDY BOOK, 1258 Pgs. 4
- SHIPFITTERS HANDY BOOK, 250 Pages 1
- REFRIGERATION & Air Conditioning, 1280 Pgs. 4
- MILLWRIGHTS & MECHANICS GUIDE, 1200 Pgs. 4
- POWER PLANT ENGINEERS GUIDE, 1500 Pages 4
- ENGINEERS & FIREMANS EXAMS, 525 Pages 1
- PUMPS, Hydraulics & Air Compressors, 1658 Pgs. 4
- ENGINEERS LIBRARY (3 Book Set) 9
- MECHANICAL DICTIONARY, 950 Pages 4
- GARDENERS & GROWERS GUIDES (4 Book Set) 6
- CARPENTERS & BUILDERS GUIDES (4 Book Set) 6
- PLUMBERS & Steamfitters Guides (4 Book Set) 6
- MASONS AND BUILDERS GUIDES (4 Book Set) 6
- PAINTERS & DECORATORS MANUAL, 450 Pgs. 2
- HOUSE HEATING GUIDE, 1000 Pages 4
- OIL BURNER GUIDE, 384 Pages 1

Name _____
 Address _____
 Occupation _____
 Employed by _____ P-5

LOW OVERHEAD-LARGE VOLUME SALES & SMALL PROFITS BRING YOU THESE "LOWEST PRICES."
 WHAT GOOD IS A TIRE WITHOUT A TUBE?
TUBE FREE WITH EVERY TIRE AT NO EXTRA COST



WHY PAY MORE!

YOU GET WHAT WE ADVERTISE

GOOD USED TIRES — NOT RECAPS — NOT RETREADS
WINTER SPECIALS—SEND THIS AD EVERYBODY 10% off ON EVERY TIRE

600-16	\$3.42	820-15	\$4.82	600-20	\$6.52	32x8(8)	\$8.02
650-16	4.12	700-15	3.82	650-20	7.02	32x8(10)	9.02
700-16	4.32	670-15	3.82	700-20	7.92	900-20	10.22
650-15	3.72	710-15	4.12	750-20	8.02	1000-20	13.12
760-15	4.32	550-17	4.32	825-20	13.02	1100-20	13.02

Specialists in Truck Tires—Selected for Toughest Jobs—Tops in Value
EXTRA SPECIAL—30 MONTH WRITTEN GUARANTEE—FREE TUBE

600-16	\$5.12	475-19	\$4.72	700-15(4)	\$8.52	700-20	\$10.82
600-16(6)	6.32	640-15	4.82	750-16(8)	10.82	750-20(10)	16.32
650-16	5.62	670-15	5.32	700-17	9.82	750-20(8)	11.02
650-16(6)	7.22	710-15	5.42	750-17	11.62	825-20	18.02
700-16	6.12	760-15	5.82	750-15	10.52	900-20	17.02
750-16(6)	8.62	800-15	6.32	825-15	12.62	1000-20	17.52
825-16	4.62	820-15	6.32	600-20	8.52	1100-20	17.02
550-17	4.62	670-16	6.22	650-20	9.92	1100-22	18.32
610-15	5.12	760-16	7.12	32x6(8)	11.02	1000-22	18.22
700-15	5.22	700-16(6)	7.32	32x6(10)	13.12	1100-24	19.82

ALL WHITE WALLS \$1.00 extra (Military treads)—750x20—\$14.02

Thousands of tires shipped all over U.S.A. All tires shipped F.O.B. Phila. Send Check or M.O. with this ad. Dept. 2.
STANDARD 834 N. Broad St., Philadelphia 30, Pa.

I'll Send You This Handsome SAMPLE CASE - FREE



and Show You How to Make Up to \$15.00 in a Day

WRITE for this FREE Tailoring Sample Case packed with 100 beautiful, big-value suit and overcoat fabrics. Take orders from friends, fellow-workers, others, for fine quality, made-to-measure clothes. Pocket big cash profits in advance. Because wearing our suits and overcoats brings more orders, we make it easy for you to get your own clothes without the cost. No experience is needed. **SATISFACTION GUARANTEED. SEND NO MONEY.** Rush your name, address, and age—today!

W. Z. GIBSON, INC., 500 South Throop Street DEPT. K-516 CHICAGO 7, ILLINOIS

Do FALSE TEETH Rock, Slide or Slip?

FASTEETH, an improved powder to be sprinkled on upper or lower plates, holds false teeth more firmly in place. Do not slide, slip or rock. No gummy, gooey, pasty taste or feeling. **FASTEETH is alkaline (non-acid).** Does not sour. Checks "plate odor" (denture breath). Get **FASTEETH** at any drug counter.

STUDY AT HOME

WITH AN EDUCATIONAL INSTITUTION
 Courses in **ARTS AND SCIENCES**: Philosophy; Education; Letters; Public Health; Medical Jurisprudence; Psychology; Sociology; Physics; Chemistry; Geology; Pol. Science; Theology; Law; Business and Commerce; Accounting; Mathematics; Statistics; Agriculture. **ENGINEERING**: Electrical, Civil, Mechanical, Drafting, Architectural, Steam, Diesel, Aeronautical, Radio, Structural, Mining, Industrial, Petroleum, Refrigeration, Chemical. Send for free catalog.
McKinley-Roosevelt Incorporated, 4610-K32, Sheridan Rd., Chicago 40, Illinois

VALUES FROM \$10 TO \$10,000

OUT OF PAWN

GENUINE DIAMONDS

SEND FOR **FREE CATALOG**

SAVE UP TO 50% AND MORE

DIAMONDS FROM ESTATES, BANKS, CONDEMNED PLACES OFFERED AT SUBSTANTIAL SAVINGS

All diamonds reset in brand new modern mountings. Sold with a written iron-clad money back guarantee. Over 100,000 satisfied customers have bought diamonds from Berman's.
Our selection—your own bank or any pawnshop agency.

Berman's Diamond Loan Bank
 Dept. P —BERMAN BLDG., BALTIMORE 1, MD.

THOUSANDS FIND NEW INTEREST, NEW HAPPINESS IN LIFE!



**See For Yourself How A Few Hours
At Arthur Murray's Opens The Door
To Good Times And Popularity**

Join the happy group who have found that dancing can lead the way to confidence and fun. Come to Arthur Murray's. Hundreds of thousands of shy people have become gay extroverts almost overnight through learning to dance the Arthur Murray Way. You see Arthur Murray has so perfected his teaching methods that anyone, even a beginner, can go dancing after just a few lessons. Then, too, Arthur Murray combines lessons with parties so that you get real ballroom experience while you learn. So don't miss out on good times any longer. Visit your Arthur Murray studio now. See coupon below for free offer.

FUN FOR ALL AT OUR STUDENT-TEACHER PARTIES! Everybody is invited to these gay, get-together parties and what a time you have! Making new friends, learning new dances, practicing up on new steps.

*Exclusive Arthur Murray "Magic Step"
Makes Learning to Dance Faster...More Fun!*

HOW OTHERS HAVE FOUND POISE, NEW CONFIDENCE AT ARTHUR MURRAY'S



"I thought learning to dance would be hard and take forever. Was I surprised when I found I could actually dance after my very first lesson and that the lessons were fun, too. And what a wonderful time I've had ever since," says Arthur Murray student, Martha Stone.



MEET JOYCE LYONS, a typical Arthur Murray teacher, pleasing personality, anxious to help others.



© Arthur Murray, Inc.

Free DANCE BOOK AND 2 STUDIO LESSONS

Send this coupon to your nearest
ARTHUR MURRAY STUDIO
(Consult your telephone directory)

Gentlemen:

Send me the new "Murray-Go-Round", 64 pages of dancing hints, news and studio information. I'm sending this coupon in right away so that I will get a certificate for 2 FREE half-hour dance lessons.

NAME _____ PHONE NO. _____

ADDRESS _____

CITY _____ STATE _____



"I never danced and was too shy to learn. Just a few lessons at Arthur Murray's changed all that," says Paul Chauvin, Arthur Murray graduate. "Now I have more confidence and really enjoy myself at parties."

PM-6-64



YOU
can
acquire

LAW NIGHTS AT HOME! L. L. B. DEGREE

LaSalle's famous Law Library—used as reference in many Law libraries and Law offices—has enabled thousands to master Law surprisingly fast, in spare hours at home, for business and professional advancement.

These 14 remarkable volumes, compiled by leading professors and lawyers, cover the whole basic field of Law in condensed, orderly, simplified manner.

You advance rapidly with this great library, plus special lectures furnished. We guide you step-by-step with personalized Problem Method of instruction . . . you learn by doing—handling legal problems—not by memorizing rules.

Send for two FREE 48-page booklets, "Law Training for Leadership," and "Evidence," answering questions about Law and its value to you, and telling how LaSalle Law graduates are winning rapid advancement in business and public life. Mail coupon below. No obligation.

LA SALLE EXTENSION UNIVERSITY A Correspondence Institution

417 S. Dearborn St. Dept. 564L Chicago 5, Ill.

Send me your two FREE booklets described above, without obligation.

Name.....Age.....

Street.....

City, Zone & State.....

ENGINEERING DEGREE IN 27 MONTHS

Big Demand for Graduates

Aeronautical, Chemical, Civil, Electrical, Mechanical and Radio Engineering (inc. TV and Electronics)

Hundreds of young men are earning B. S. ENGINEERING DEGREES annually in this recognized institution — year around operation. New terms start quarterly. Many students earn a major part of their college expenses in this large industrial center.

Low tuition. Competent instruction. Thorough, intense, practical program. Modern, well-equipped laboratories including new physics laboratory and modern wind tunnel. Individualized instruction emphasized.

Government approved for G.I.'s. Engineering preparatory courses. Students from 48 states and 21 foreign countries. Enter June, September, December, March. Send coupon for free catalog and full information. Enroll now.

SEND COUPON TODAY

INDIANA TECHNICAL COLLEGE

554 E. Washington Boulevard
Fort Wayne 2, Indiana

Please send me free information on B.S. Engineering Degree in 27 months as checked.

Aeronautical, Chemical, Civil, Electrical,
 Mechanical, Radio-Television

Name.....

Address.....

OWN Your Own Business



PATENTED
PORTABLE
EQUIPMENT

\$5 per hour

Clean and Methproof rugs and upholstery "in the home", office, institution. If now employed, you can operate in spare time and build a permanent full-time business.

Alert dealers can gross \$5 hourly profit on service they render plus \$3 on EACH serviceman. We locally train and assist you. Easy to learn . . . quickly established.

DURACLEAN cleans by absorption! No scrubbing, soaking or shrinkage. Dirt and grease vanish . . . matted pile rises . . . colors revive. Furnishings used again same day.

DURAPROOF resists moths and carpet beetles. Your service backed by an International Money Back 4 Year Warranty.

We furnish enough material to return your total investment. Send TODAY for FREE booklet explaining details and EASY TERMS.

DURACLEAN CO., 4-165 DURACLEAN BLDG.
DEERFIELD, ILL.



Send
for
FREE
BOOKLET

LEARN LOCKSMITHING

Learn this fascinating, profitable trade from experts in your spare time at home! Age or physical handicap no disadvantage. Year around, steady income. Full or part time. Practical, illustrated lessons. You can make money even while learning! All materials and special tools supplied without extra charge.

INSTITUTE OF LOCKSMITHING, Dept. P-54
15 PARK AVENUE RUTHERFORD, N. J.
Lic. by N.J. State Board of Education
Approved for Veterans

IMPROVE YOUR PENMANSHIP

Write Like This

YOUR penmanship can be improved in 3 hours or corrected to your satisfaction in 10 hours' practice with my DEFINITE HAND CONTROLS. New way!

WRITE OZMENT BOX 665
34-N, ST. LOUIS, MISSOURI

Complete
OUTLINE
FREE!

Catalog of 3000 Novelties 10c

Send 10c for amazing catalog of novelties, live animals, scientific supplies, hobbies, funmakers, planes & boats, looms, magic tricks, joke articles, unusual seeds, gadget time-savers, cameras, optical goods, projectors, movies, lucky jewelry, religious novelties, disguises, musical instruments, stamps, coins, puzzles, fortune tellers, radios, auto & bike accessories, telescopes, magnifiers, compasses, banks, smokers' gadgets, artists' supplies, printing sets, engines, motors, shockers, knives, billfolds, guns, rifles, sports, books, games, plants, etc. Send name, address & 10c to:

JOHNSON SMITH & CO., Dept. 789, Detroit 7, Michigan

RUPTURED?

Something different. Light. Cool. No leg straps. No elastic. No pressure on hips or spine. Inexpensive. Worn by Mechanics, Farmers, Doctors, etc., everywhere. Guaranteed. Write

HAND-LOCK PRODUCTS EST. 1893
DEPT. PM, PRESTON, ONT., CAN.



CARTOONING!

For fun and profit! Made easy with amazing new method. Now anyone, young or old, can learn to draw professional looking cartoons with few hours practice! No talent or skill necessary. Over 475 illustrations. Complete outfit and instructions. Only \$2.00

CARTOON-CRAFT Dept. 1M

5864 Hollywood Blvd., Hollywood 28, Calif.

POWER MOWERS & KITS

FREE
PLANS

Build your own quality mower with our LOW COST KITS. Parts, Engines. Free Plans guide you. 3 and 4 Wheel Kits, complete. Parts precision finished, ready to use. Write TODAY for Free Plans, Low Prices, Parts List and Guarantee.

3 & 4 Wheel Model 4 Wheel Direct Drive

America's Finest Power Mowers completely assembled in 3 and 4 wheel models. Belt or direct drive. 18" and 20" sizes. Nationally known make engine. Latest improved features, sturdy construction and money back guarantee fully described in color folder. Write today.

▲ TRIANGLE MANUFACTURING CO., Box M-30, Fort Scott, Kansas



3-WHEEL KIT NO. T-800

Premium Performance! Increased Mileage!

TCP NOW IN CANS!!!

ADD IT TO YOUR GAS YOURSELF AND START SAVING MONEY TODAY!

TCP (Tri-cresyl Phosphate) is the sensational new gasoline additive. Field tests prove that TCP gives more power and increased mileage in your car. But until now, you could buy TCP only blended with high-priced premium gas. Now you can get TCP in cans in concentrated form... add it yourself to your favorite brand of regular gas... get premium performance—more mileage, greater power, longer engine life—with lower-cost regular gas and save money on every tankful.

How does TCP give these marvelous results?

These cars were designed to run on regular gas: Chevrolet, Chrysler, De Soto, Dodge, Ford, Hudson, Mercury, Nash, Plymouth, Pontiac, Willys, Kaiser, Buick (Special). Most car owners know a new car soon loses its "pep"—has less power, gives poorer mileage. Expensive high octane "premium" gas is necessary to obtain the same performance which regular gas gave when the car was new. This phenomenon, called "increase in octane requirement", was a mystery to automotive engineers for many years.

U.S. AIR CORPS RESEARCH

During World War II, research by the Air Corps and private industry established that increase in octane requirement results from lead deposits in the cylinder. These deposits cause "pre-ignition"—premature explosion of the gasoline-air mixture before it is ignited by the spark plug. When pre-ignition occurs, the piston is still moving in a direction opposite to that in which the exploding gases have to push it. Thus there is a great loss of power and efficiency—and a great waste of gasoline—not only because the exploding gases have to work against the motion of the piston, but also because the gas-air mixture is not fully compressed when explosion occurs.

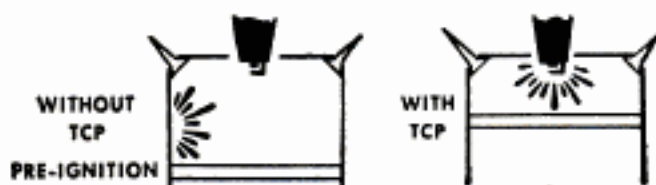

In correct ignition, compression raises the temperature of the gas mixture to a very high point, but never above the temperature at which it explodes. Lead oxides and halides reduce the temperature at which the air-gas mixture explodes, thus causing premature ignition and consequent

loss of power and gasoline waste. Automotive engineers have now found that cars operated in normal type driving increase from 5 to 15 numbers in octane requirement in a few thousand miles because of the formation of combustion chamber deposits.

TCP eliminates pre-ignition

TCP converts the lead oxides and halides into lead phosphate, an infusible high melting point compound which does not stick to the surfaces of the cylinder. Instead, the microscopic particles are swept out of the cylinder with the exhaust gases.

Field tests with TCP confirmed laboratory findings. In cars operated on ordinary commercial gasoline, pre-ignition became evident shortly before 100 hours and progressed to a severe state at 150 hours. Within a short time after introduction of TCP at the 150 hour mark, pre-ignition ceased completely.

Other advantages of TCP

TCP not only prevents pre-ignition, but is an excellent solvent for gums and resins, which cause sticky valves. Because of its solvent properties, fuel injection systems are kept cleaner and lacquering of engine parts is decreased. For the same reason, use of TCP also reduces deposit of carbon up to 50%. TCP has also proved effective as an upper cylinder lubricant.

Another important result of the removal of harmful lead deposits is a great decrease in spark plug fouling which causes spark plugs to misfire with consequent poor engine performance.

While the use of many fuel additives must be carefully controlled since an excess will produce extremely corrosive products, this is not true of TCP. In fact, an excess of TCP provides better anti-rust protection and upper cylinder lubricating as well as increased cleaning action.

GET IT TODAY!

TCP concentrate in cans is now on sale at most automotive supply dealers. If your dealer does not have it yet, send in the coupon below, and begin to get premium performance at regular gas prices!



QUART CAN—Sufficient for 12 tankfuls of regular gasoline . . . a 3 months supply . . . only \$2.00.



AMERICAN TCP CORPORATION
342 Madison Ave., New York 17, N. Y. PM 5
Please send me quart cans of TCP concentrate at \$2.00 per quart can. Enclosed is check or money order for \$.....
NAME.....
ADDRESS.....
CITY.....STATE.....

New Money-Maker!

Light-Reflecting CURB-SIDE HOUSE NUMBER

Fastest seller in years! A smart-looking house number by day... and at night thousands of tiny lenses on each number sparkle and reflect light from auto headlights, streetlights, etc., making numbers easy to read on darkest night.

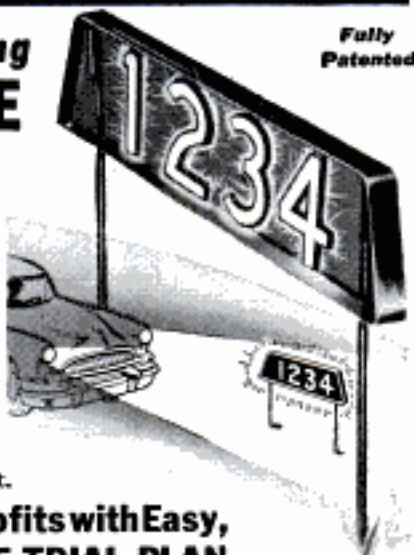

Fully Patented

Sensational Profits with Easy, Sure-Fire FREE TRIAL PLAN

Thousands of home-owners say "Yes, we'll keep it" when you set up this handsome NiLite Light-Reflecting Curbside House Number. Every area in America is awaiting "gold mine" of profits for men who get started NOW. Amazingly low priced—yet \$40.00 in a day and more is easy with unique, effective FREE TRIAL Plan which sells 8 out of 10 homes. We show you how to make money selling on your own, getting others to sell for you, and cleaning up with Fund Raising Plan used by churches, clubs, scouts, and other organizations. Rush your name and your address for full details, sent FREE. Write TODAY.

DISTRIBUTORS
A real bonanza! Rich, unworked territories open for topmen. Write!

NILITE SIGN CO., 173 W. Madison Street, Dept. H80, Chicago 2, Ill.

Shows You The Easy Way To Do 1600 Jobs

HOW TO DO your own home maintenance—expertly. How to improve your home, do building and decorating—at less cost in time and money.

CLEAR, SIMPLE instructions and step-by-step pictures make even difficult jobs easy. Owners report: "the best book in the field."

We guarantee! that the 510-page *Better Homes & Gardens Handyman's Book* will save you more than its cost within the first 6 months. Get it wherever books are sold, or use handy coupon to order by mail.



\$3.95

BETTER HOMES & GARDENS

406 Meredith Bldg., Des Moines 3, Iowa
Please send me the **HANDYMAN'S BOOK**. I enclose check OR money order for \$3.95. (Canada, \$4.50.) If not entirely satisfied, I may return book in 10 days and my money will be refunded.

Name _____
Address _____
City _____ State _____

Shrinks Hemorrhoids Without Surgery

Science Finds Healing Substance That Relieves Pain—Shrinks Hemorrhoids

Science has found a healing substance that shrinks hemorrhoids, stops pain promptly, ends bleeding—without surgery. Doctors report actual shrinking of hemorrhoids. Sufferers say, "Hemorrhoids have ceased to be a problem." The secret is **Bio-Dyne®**—already widely used for healing injured tissue. This substance is now available in a hemorrhoid ointment called **Preparation H***. Ask your druggist for Preparation H. Money back guarantee. *Trade Mark

Learn to MOUNT BIRDS

Tan SKINS, make up FURS

Be a Taxidermist. Double your hunting fun. We teach you at Home, Mount Birds, Animals, Fish, Heads, common specimens. Fun and profits. Decorate home and **DO MAKE MONEY**. Mount game, tax for others. Big profits in spare time. **WRITE TODAY.**

100 game pictures in **FREE BOOK** hunters, get your copy. It's Now Free. Send post card. State your AGE, NORTHWESTERN SCHOOL OF TAXIDERMISTRY, Dept. 2505, Omaha, Nebraska

Learn ACCOUNTING Business Administration

Bookkeeping, secretarial and allied subjects at home in your spare time or attend nationally approved resident school. Write for **FREE Success Book** giving complete details on courses, plans, rates and employment opportunities. G.I. approved.

Hills BUSINESS UNIVERSITY AND EXTENSION SCHOOL
619 W. MAIN ST. OKLAHOMA CITY 2, OKLAHOMA

BUILD LUGGAGE AT HOME WE SELL YOUR PRODUCTS!

ONLY NEW HOME MONEY-MAKING PLAN IN YEARS!

Make Luggage and cases for traveling, photographers, musicians, salesmen, electronics, tools, portables, 1001 other items. Also repair Luggage. No special equipment needed. **BIG PROFITS.** We supply complete instructions—everything. Write for free details and Business Plan. **ABARSI CASECRAFT, Dept. H9, 805 W. Sunset Blvd., Los Angeles 12, Calif.**

Ball-Bearing SPEED WHEELS

JUVENILE WHEELS (No bearing, solid tires)	
5"45c
6"65c
7"	
8x1.25	\$1.85
8x1.75	1.95
8x2	2.20
10x1.25	\$2.20
10x1.75	2.30
10x2	2.65
12x1.75	3.45
INDUSTRIAL WHEELS	
(Lug Base, Semi-Pneumatic tire)	
6x2 SW	\$3.45
6x2.00	4.00
8x2.00	5.20
8x2.50	5.40
10x2.00	6.90
10x4.00	15.15
12x3.00	9.20
(Smooth Base, Pneumatic tire and tube)	
8x3 2 ply	\$10.00
10x3.50 2 ply	10.55
12x4 2 ply	14.41
4.00x8 2 ply	13.10
14x4.50 2 ply	15.96

CASTERS—Now Available. No c.o.d. orders. Prices F.O.B. our plant. Write for circulars on all wheels.

JIM BROWN TOY COMPANY
1095 HOME AVENUE PM-454 AKRON 10, OHIO

Spare-Time Income from Gardencrete



Bird Baths
Jars and Vases
Flower Boxes
Flagstones
Lawn Seats
etc. etc.



Wherever there's pride of home, there's a place for Gardencrete. That's why the sales field is so broad, and so rich in profit potentials.

Gardencrete is basically made of cement and sand, then Colorglazed in a choice of 30 attractive colors that stay new. Easily washed or scrubbed. Add beauty to every lawn and garden.

On a small investment for molds and Colorglazer you can develop a line of products that sell for two or three times your cost of materials and labor. Easily made in shed or garage. We supply full instructions.

Write for book "Make Money." Describes equipment and gives figures on costs and selling prices on dozens of different items.

**Colorcrete
Industries, Inc.**
710 Ottawa Avenue,
Holland, Mich.

The Bird Bath shown
above, sells for \$6.50.
Cost of materials and
labor, \$2.35. Your
mark-up, \$4.15.



CASTING SECRETS REVEALED

Big money! Cast 1000's of plaques, figurines, etc. with X.L. rubber molds. No exper., little capital req. X.L. rubber pls. \$2.50, qts. 84 (postage extra). Models, rubber for 3 molds, \$1.50 ppd. U. S. only. Send 25c (refundable) for 40 pp fact catalog.

**HUGE PROFITS!
MORE MONEY!**

PLASTIC ARTS STUDIO, Dept. 2,
3403 S. Madison St., Muncie, Ind.



Learn LANDSCAPE GARDENING

A thorough, interesting home study course for those who wish to become LANDSCAPE ARCHITECTS, GARDENERS, DESIGNERS, etc., for profit or pleasure. Write today for FREE INFORMATION to:
NATIONAL LANDSCAPE INSTITUTE
Dept. P-5, 310 So. Robertson Blvd., Los Angeles 48, Calif.

SHORTHAND IN

Famous SPEEDWRITING shorthand. 120 words per minute. No symbols; no machines; uses ABC's. Easiest to learn, write and transcribe. Low cost. 250,000 taught by mail. For business and Civil Service. Typing available. 31st Year. Schools in over 400 cities. Write for FREE booklet to:

Speedwriting
Dept. 1505-4
55 W. 42 St., N.Y. 36, N.Y.

**6
WEEKS**

ITALIAN ACCORDIONS AT LOWEST WHOLESALE PRICES

**"PAY AS
YOU PLAY"**
Small Down Payment
As Little As
\$10 per
month

**DIRECT from
Importer to You!**

SATISFACTION GUARANTEED, or your money back! NOW you can save up to 30% by direct purchase from America's leading distributor of famous genuine ITALIAN ACCORDIONS. TRADE-INS ACCEPTED

Send for FREE Illustrated Catalog!

ACCORDION MANUFACTURERS & WHOLESALE OUTLET
2003 West Chicago Ave. Dept. R54, Chicago 22, Ill.

**5-DAY
FREE
TRIAL**

Get into RADIO-TELEVISION ELECTRONICS by Shop-Method Home Training



↑ You also
receive this
Multitester

Superheterodyne
Receiver

GOOD JOBS AWAIT THE TRAINED RADIO-TV TECHNICIAN!
Business of Your Own • Broadcasting • Radio Manufacturing, Sales, Service • Telecasting • Television Manufacturing, Sales, Service • Laboratories: Installation, Maintenance of Electronic Equipment • Electrolysis, Call Systems • Theatre Sound Systems, Police Radio • Garages: Auto Radio Sales, Service • Sound Systems, Telephone Companies, Engineering Firms, etc.
WE BRING NATIONAL SCHOOLS TO YOU! There is a place for you in the great Radio-Television-Electronics industry when you are trained as National Schools will train you at home! OUR METHOD IS PROVED BY THE SUCCESS OF OUR GRADUATES SINCE 1905.
YOU RECEIVE AND KEEP Signal Generator, T.R.F. Receiver, Audio Oscillator and Superheterodyne Receiver, plus professional Multitester shown above. *No extra charges.*
EARN WHILE YOU LEARN—we show you how!

APPROVED FOR G. I. TRAINING



**FREE
RADIO-TV
BOOK &
SAMPLE
LESSON!**

MASTER ALL PHASES! Get Master Shop-Method Home Training from an Established Resident Technical Trade School with its own Training Shops, Laboratories, Studios—almost 50 Years of Successful Experience in Training Ambitious Men.

NATIONAL SCHOOLS

Technical Trade Training Since 1905

LOS ANGELES 37, CALIFORNIA

In Canada: 811 West Hastings Street, Vancouver, B. C.

BOTH HOME STUDY AND RESIDENT COURSES OFFERED

MAIL NOW TO OFFICE NEAREST YOU!

(mail in envelope or paste on postal card)

NATIONAL SCHOOLS, Dept. RB-54

4000 S. FIGUEROA STREET
LOS ANGELES 37, CALIF.

OR 323 W. POLK STREET
CHICAGO 7, ILL.

Please rush **FREE BOOK & FREE LESSON**. I understand there is no obligation, no salesman will call.

NAME _____ BIRTHDAY _____ 19 _____

ADDRESS _____

CITY _____ ZONE _____ STATE _____

Check if interested **ONLY** in Resident training of Los Angeles.
VETERANS: Give date of discharge _____

EXPANDING AMERICA Needs DRAFTSMEN Now!



**LEARN AT HOME AND GET
ON THE SURE ROAD TO
BIG MONEY**

Today more than ever Draftsmen are needed. America must produce better war and peace time equipment if America's well-being and prosperity is to continue. Draftsmen command big part or full time wages... own tremendous money earning businesses.

**VALUABLE EQUIPMENT
SENT TO YOU**

Everything you need to train at home supplied. Professional set of drafting instruments, all drafting equipment needed and portable drafting table all furnished on **PAY AS YOU LEARN PLAN**. RUSH name today for **FREE Book**.

CHRISTY TRADES SCHOOL, 4804 N. Kedzie, Dept. DB-2703, Chicago

**own your own business! earn up to
\$75 A DAY CLEAR PROFIT
in your back yard or basement!**

**MAKE CONCRETE BLOCKS With Amazing New
LOW PRICED GENERAL BLOCK MACHINE**

**NOW! Big Building Boom
Profits Within Your Reach**
You don't need much cash to cash in on the building boom! New high speed, low cost General Block Machine produces up to 1,000 concrete blocks a day for homes, factories, buildings, garages. Your profit mark-up is 100% to 150%! Fool-proof, easily operated, sturdy steel machine can make any size from 4" to 12". These superior 3-core blocks meet all building code requirements for foundation, chimney, corner, sash and many other types of blocks. Works indoors or out. Sand, cement and water available anywhere! Simple operating instructions and mixing formulae for cement and cinder blocks supplied **FREE**. Get full details, no obligation!

EXTRA!
Amazing illustrated book gives floor plans for 6 sensational concrete block bungalows. Tells how to lay blocks, lay out building lines, mix concrete, build steps, porch and concrete floors all at great savings. Written by experts. Can save many times the cost of the machine! Get it now! No strings attached.



**R.I.T. of
New York
City Reports:
"My General
Block Machine
PAID FOR ITSELF IN FIRST
2 WEEKS!"**
Thousands now in use
the world over!
Write for **FREE** details
TODAY

**HOW TO
BUILD
YOUR OWN
CONCRETE
BLOCK
HOME**
Only 1/2 paid

Book sent free if you buy machine. \$1 refunded if you buy later.

GENERAL ENGINES COMPANY

Dept. M-54, 307 HUNTER STREET, GLOUCESTER, N. J.

MAKE EXTRA
MONEY

PLASTICS

LEARN
AT HOME

LEARN HOW
TO MAKE
fast-selling
PLASTIC
NOVELTIES
FURNITURE
JEWELRY



SIGNS
TOYS
LAMPS

There are **RICH OPPORTUNITIES** for **MEN** and **WOMEN** with "know-how" in **Plastics**. Interstate's new **Plastics** course tells and shows how to make hundreds of fast selling items out of **Plastics**. Gives complete training in fabrication, casting, lamination, molding, internal carving, etc. in simple, easy, step-by-step language and pictures. **Plastics** and **Fabricating Kits** for 23 valuable **Plastic** items come with training at no extra cost. **START A PLASTICS BUSINESS OF YOUR OWN**. No other industry holds such promise for the future. You can make big money manufacturing novelties, toys, signs, etc., in your own home in spare or full time. Don't wait! **Learn NOW** how Interstate's **Plastics** Training qualifies you for success in the **Plastics** field.

PLASTICS AND SUPPLIES FURNISHED
FOR 23 VALUABLE PROJECTS

INTERSTATE TRAINING SERVICE
Dept. C-3-E Portland 13, Oregon

High Power BINOCULARS

FREE 14-PAGE BOOK & CHART



\$9.95
UP

Know the facts! Learn meaning of
Power, Field, Coating. Latest data.
33 Models sold on

**30 DAY
FREE TRIAL**



BUSHNELL'S, M85 Bushnell Bldg., Pasadena, Calif.

STUDY INDUSTRIAL DESIGN

You can train at **Art Center School** in California with practicing-professionals for upper-level jobs in **INDUSTRIAL DESIGN**. Recent graduates have been added to the staff at **General Motors**, **Chrysler**, **Raymond Loewy**, **Henry Dreyfuss**, etc. Majors in transportation, general product design, structures, community development, furniture design, packaging, display, 4-year degree courses. Learn to combine imaginative design with technical proficiency, coordinate utility and beauty. Stimulating environment. Field trips. Advantages of mild Southern California climate and nearby holiday spots. Coed. Placement service. Write for catalog.

ART CENTER SCHOOL, Edward M. Adams, Director
5353 WEST THIRD STREET, LOS ANGELES 5, CALIFORNIA

TASOPE PHOTO-ENGRAVING PLANTS



Establish your own profitable **PHOTO-ENGRAVING** business. Make cuts for newspapers, printers, and advertisers. Make etched name plates, plaques etc. Instructions furnished, no experience necessary. Sold direct from factory since 1931. First five hundred cuts sold locally or by mail will pay for plant and pay you well for your time. Write for **FREE** catalog.

Material Cost
Of This Cut 34¢
Selling Price
\$1.00 And Up

TASOPE, DEPT. PM5, AURORA, MO.

AUTO SEAT COVERS

DIRECT FROM MANUFACTURER
SAVE DOLLARS

CUSTOM MADE FOR YOUR CAR
Guaranteed Perfect Fit



Front and Rear
\$16.85 Postpaid
Rear Center Drop
Arm Models
\$20.00 extra

Save Plastic at the price you would normally pay for ordinary fiber covers.

BEAUTIFUL PLAIDS Blue - Green - Maroon.

Simulated Leather Caps.

IMPORTANT: Specify Car Make, Model Name or No., Year, 2 door, 4 door, Coupe, etc. Also color you want. Order yours now when you can get them at this amazing low cost. Send check or M.O. and save C.O.D. charges.

ARTRICH 54-01 QUEENS BOULEVARD • WOODSIDE 77, NEW YORK

RUPTURE



RELIEF...OR YOUR MONEY BACK
Original, patented **Web**,
copied but never matched.
Users say it's best ever. Relief
or no cost to you. Write:

WEB TRUSS CO., Dept. M-5, Hagerstown, Md.

Learn BAKING At Home

Baking is one of America's high industries in wages. Nearly depression-proof. Thorough basic home course lays sound foundation. If you have aptitude, write for **FREE BOOKLET**, "Opportunities in Commercial Baking."

NATIONAL BAKING SCHOOL
835 Diversey Pkwy. Dept. 1355 Chicago 14



POPULAR MECHANICS

BUILD your own TV set

YES, actually build a valuable TV Set right at home. At the same time learn all about installing, repairing, servicing—and get ready for a Big-Pay Job in America's fastest-growing, most exciting industry. The CTI TV Train-at-Home Plan is preparing hundreds for bigger pay TODAY—and a brighter Future TOMORROW. No experience needed. We supply easy-to-understand instructions—made clear with hundreds of charts, diagrams, photos—plus TWENTY KITS of Parts, Professional Equipment and Tools. Get a TV Set to ENJOY. Get set to ENJOY a TV Future. Make money in spare time while taking Course. THOUSANDS SUCCEEDING! So can You. Send today for big FREE Book, "You Can Succeed in Television."

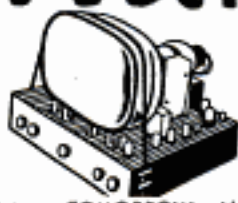

COMMERCIAL TRADES INSTITUTE

Dept. T2-5, 1400 Greenleaf Ave., Chicago 26, Ill.

MAKE \$5 PER HOUR WITHOUT A PRINTING PRESS

PRINTING REVOLUTIONARY NEW SCREEN METHOD

PRINT colorful signs, posters, banners, fabrics, wall paper, show cards—ANYTHING! Print on any surface. NO printing press or special equipment is needed with this amazing "approved" new printing secret. 300% profit on nearly every job. Easy to learn—NO EXPERIENCE or art ability necessary. Exceptional opportunity. Complete illustrated detailed plan and colorful sample FREE—Write.

SCREEN-PRINT COMPANY, Dept. 2-5
1010 So. Los Angeles St., Los Angeles 15, Calif.

FREE complete "BIG MONEY" Plan and SAMPLE!



REAL ESTATE BE A BROKER

PAYS BIG! SEND FOR FREE, BIG, ILLUSTRATED CATALOG NOW! Graduates report making substantial incomes. Start and run your own business quickly. Men, women of all ages, learn easily. Course covers Sales, Property Management, Appraising, Loans, Mortgages, and related subjects. STUDY AT HOME or in classrooms in leading cities. Diploma awarded. Write TODAY for free book! No obligation. Approved for World War II and Korean Veterans.

WEAVER SCHOOL OF REAL ESTATE (Est. 1936)
Suite 300 Law Bldg. Dept. PM Kansas City, Mo.

FREE BOOK TELLS HOW

STUDY AT HOME **LAW** FREE BOOK! PREPARE FOR THE BAR

Write today for your copy of our FREE book, "THE LAW-TRAINED MAN," which describes the famous Blackstone home-study course in bar and business law. All needed instruction material furnished including big 16-volume law library. Bachelor of Laws (LL.B.) degree awarded. Moderate tuition; easy monthly terms. Write today.

Blackstone School of Law 225 N. Michigan Ave.
Founded 1890 Dept. 55. Chicago 1, Illinois



MADE \$106 his FIRST WEEK

Thanks to NYI TRAINING IN PHOTOGRAPHY

NYI Graduate N. C. Buchner, Tulsa, Okla., says: "I took in \$106 the first week in my own studio. My NYI training has certainly paid off fast." Practical, personal guidance by experts and famous low-cost, LEARN-BY-DOING method train you quickly, easily at home as you learn to make money 90 ways with a camera — for a high-pay job, prosperous career, or extra income. FREE catalog gives exciting details. Our 44th year. Also Resident Courses. G.I. approved.

N. Y. INSTITUTE OF PHOTOGRAPHY
Dept. 49, 10 W. 33 St., New York 1, N. Y.

FIX CARS!

All Makes—All Models

Cylinders Timing Clutch Tune-ups Overhauls Carburetor Ignition Brakes Rear end Generator Cooling All standard and Automatic transmissions, etc. Universal



Here's the Help You Need!

Fix cars easier than you may have thought possible! Train to be a well-paid expert in a field that is clamoring for good men!

Just look up in the giant 752-page Chilton "ALL CARS" Manual the make, model and part of the car you want to repair. It shows what to do . . . exactly how to do it. Covers step-by-step details on specific jobs . . . not a lot of meaningless theory. Widely used in garages, schools and for Army-Navy training. Ideal for teaching beginners. A gold mine of time-saving data for experienced mechanics. Helps you work faster—and better!

MAKES TOUGH JOBS EASY . . . MAKES EASY JOBS A CINCH!

GIANT NEW EDITION

Tips for training beginners! . . . helps experienced mechanics do jobs in minutes instead of hours!

Published by Chilton . . . world's largest automotive publishers.

Only \$5.95

Contains easy-to-understand service details on every model made from 1940 through 1953: BUICK, CADILLAC, CHEVROLET, CHRYSLER, DE SOTO, DODGE, FORD, FRAZER, HENRY J., HUDSON, KAISER, LINCOLN, MERCURY, NASH, OLDSMOBILE, PACKARD, PLYMOUTH, PONTIAC, STUDEBAKER, WILLYS—over 1100 models. 350 Quick Check Data Tables and more than 1800 illustrations explain service operations almost at a glance. Order Chilton "ALL CARS" Manual in coupon. Practice 10 days free!

FIX CHEVROLETS!

This 132-page Manual makes it twice as easy to be an expert on Chevrolet repairs! Covers EVERY Chevrolet car made from 1940 through 1953. Complete—accurate—authentic. Dozens of clear illustrations plus 55 page section "General Service and Trouble Shooting." Order Chevrolet Manual in coupon. Money-back guarantee!

Only \$2.75

FIX FORDS!

Handle practically any Ford repair job easier than you may have dreamed! Manual gives step-by-step service instructions on EVERY model between 1940 and 1953 plus section on "General Service and Trouble Shooting." Over 440 illus.; 36 Quick Check Data Tables, etc. Specify Chilton Ford Manual in coupon. Money-back guarantee!

Only \$2.75

FIX PLYMOUTHS! DODGES and DESOTOS!

Here is your master guide to fast, easy service on EVERY Plymouth, Dodge and DeSoto between 1940 and 1953. 132 pages; over 245 illus.; 53 Quick Check Data Tables plus 55-page section on "General Service and Trouble Shooting." Order Chilton Plymouth Manual in coupon. Money-back guarantee!

Only \$2.75

PRACTICE 10 DAYS FREE!

The Chilton Co., Dept. PM-54
56th & Chestnut Sts., Philadelphia 39, Pa.

Send the big CHILTON "ALL CARS" MANUAL (price \$5.95) for 10-day FREE EXAMINATION. If O.K., I will promptly remit \$1.95 (plus 35¢ postage); then send \$2 monthly for 2 months. Otherwise, I will return manual postpaid in 10 days and owe you nothing.

Check here to order individual car make manuals: Chilton "CHEVROLET" Manual, Price \$2.75 Chilton "FORD" Manual, Price \$2.75 Chilton "PLYMOUTH-DODGE-DESOTO" Manual, Price \$2.75

NOTE: Individual car make manuals sold for cash with order (we pay postage.) Or, we ship C.O.D. and you pay postman manual price plus post office charges. Specify which method desired. Any manual returnable in 10 days if not satisfactory and we guarantee to refund your \$2.75.

OUTSIDE U.S.A.—Cash only. Prices: "ALL CARS" Manual, \$6.95; individual manuals \$3.00 each. Same 10-day return privilege with money refunded.

Name _____
Address _____
City, Zone, State _____

GROW Living MIDGET TREES!

EARN \$1000 PER HOUR!

- AT HOME
- IN SPARE TIME
- NO EXPERIENCE NEEDED



It's new! Amazing! At last, the secret of growing miniature (MIMI) trees can be yours. FULL GROWN, dwarf trees—only a few inches high. Beautiful miniature fir, orange, oak, Chinese elm, peach, pine, cypress—any kind! ALL BLOOM and even BEAR FRUIT. All perfect healthy specimens—but miniature in size! Make costly home decorations and expensive centerpieces. (SOLD FOR OVER \$1,500 EACH) Big demand. Costs only pennies—takes only minutes per week. IT'S EASY! Fun! A new fascinating hobby—a new fabulous \$\$\$\$ business. Send for free secret plan details and real seed.

HELP US FILL HUGE DEMAND!

These trees are being demanded by STORES CLUBS • HOTELS • FLORISTS • HOUSEWIVES • INTERIOR DECORATORS • COLLECTORS • HOBBYISTS — A Big Money Opportunity FOR YOU.

FREE! GENUINE SEED AND PLAN!

NATIONAL NURSERY GARDENS, Dept. M-5
8463 South Van Ness
Inglewood 4, Calif.
Rush me FREE plan and seed IMMEDIATELY!

Name _____
Address _____ Zone _____
City _____ State _____



INSURED TIRE SERVICE POPULAR BRANDS



SPECIAL! 10% off on orders for two or more used tires

FREE INSURANCE POLICY given with each used tire sold. We guarantee the amount of service you pay for.

Tube Given Free with Each Used Passenger Tire Upon Request

YOU CAN'T LOSE!!

Super Quality — Rugged Performance — 15 Months Insured Service	
600x16 \$3.65	670x15 \$3.95
650x15 3.89	670x16 4.05
650x16 4.25	700x15 3.95
	760x16 4.45
	820x15 4.95
	820x16 4.45

Supreme Quality — Nothing Finer — 30 Months Insured Service	
600x16 \$5.25	675x19 \$5.45
600x16 (G) 6.75	640x15 4.95
650x16 5.75	670x15 5.35
650x16 (G) 7.25	710x15 5.45
700x16 6.35	760x15 5.95
750x16 (G) 8.45	800x15 6.35
550x18 4.95	820x15 6.35
550x17 4.75	850x15 6.35
650x15 5.25	670x16 5.15
700x15 5.35	700x16 (G) 10.25
	12x6 (10) 12.75
	1100x24 25.95

Whitewalls \$1.00 extra.

MIDLAND TIRE SALES
Speedy shipments on Mail Orders. F.O.B. Chicago. Insurance policy sent with each order. Deduct 10% on orders for 2 or more used tires. Send CHECK or MONEY ORDER.—No COD's.
3701 S. Normal, Dept. PM-22, Chicago 9, Ill.

Secrets of VENTRILOQUISM Now Revealed!



Easy to learn in 60 to 90 days with our Home Study Course. RESULTS GUARANTEED. Make Money! Be Popular! Have Fun! Big Opportunity! Radio, Television, Stage Appearances! For FREE information regarding price and terms, WRITE. You must state your age. Dummy Catalog 25c.
FRED MANER SCHOOL OF VENTRILOQUISM
Box 36, Studio E, Kensington Station
Detroit 24, Michigan

LEARN MEAT CUTTING



Train quickly in 8 short weeks at Toledo for a bright future with security in the vital meat business. Big pay, full-time jobs—HAVE A PROFITABLE MARKET OF YOUR OWN! Pay after graduation. Diploma given. Job help. Thousands of successful graduates. Our 31st year! Send NOW for FREE catalog. No obligation. GI approved.
NATIONAL SCHOOL OF MEAT CUTTING, Dept. 50-E, Toledo 4, Ohio

GREER SHOP TRAINING

Leader in Practical Training for 50 Years

Gain success by learning a trade offering security and high pay—go into business for yourself.

Get the "Know-how" at Greer

You learn in our new, large, modern shops by working with latest tools and equipment of the trade — tear down, inspect, repair and rebuild . . . under supervision of experts. Greer founded 1902. Over 51,000 successful grads. Part time, full time, day and evening. E-Z terms. Mail coupon today.

CLIP COUPON . . . MAIL TODAY
Greer Shop Training—2230 South Michigan
Chicago 16, Illinois Desk 213

Please send information about trade checked:
In our Chicago Shops: Auto Mechanics
 Body, Fender Repair Diesel Mechanics
 Welding—Arc, gas Tool & Die
 Refrigeration & Air-conditioning
 Machinist Piano tuning
APPROVED FOR CIVILIANS and G.I.'s (check which)

ATTENTION: HIGH SCHOOL GRADUATES.
Write for information on 2 year DIESEL-AUTOMOTIVE ENGINEERING COURSES.

Name _____
Address _____
City _____
State _____ Age _____



Learn CARTOONING

at home in spare time . . . the quick easy London Picture Chart way. Teaches how to originate—today's big need. Scores of successes. Send 10c for Picture Chart (to test ability) and full details. Please state age.
London School of Cartooning, 5405 CTS Bldg., Cleveland 14, O.

STOP RADIO & TV NOISES INSTANTLY



NEW PATENTED ELECTRONIC INVENTION "CLEAR TONE" filter eliminates noisy interference caused by all motor appliances, autos, oil burners, etc. Simply plug radio or TV cord into filter and filter into wall socket. Enjoy "CLEAR TONE" reception. Try 5 days—MONEY BACK GUARANTEE.
Send 10c for postage & handling

Household Prod., Dept. PM-5, Scarsdale, N.Y.

MAKE CRIME YOUR BUSINESS

ON THE SIDE OF THE LAW!

Help fight crime! . . . Earn steady good pay as a Finger Print Expert or Investigator. I.A.S. trains you—by easy, low-cost home study lessons. Learn the exciting work in spare time. Write for full details now!

OVER 800 POLICE BUREAUS...

Employ I.A.S.-trained men . . . proof of what I.A.S. can do. Write today (state age) for details. No obligation. No salesmen will call.

INSTITUTE OF APPLIED SCIENCE

(A Correspondence School Since 1916)

1920 Sunnyside Ave., Dept. 1355 Chicago 40, Illinois

MEN WANTED!



Make \$15-\$20 in Few Hours Spare Time—up to \$210⁰⁰ a Week FULL TIME — with Amazing D-FROST-O-MATIC!

Millions of housewives want this sensational new Automatic Refrigerator Defroster! No more messy hand defrosting! Just plug in D-FROST-O-MATIC and refrigerator is defrosted automatically every night! Sales easy, sure when you leave D-FROST-O-MATIC on FREE TRIAL—housewives won't let you take it out! Saves money, food, time, work! **Big profits for you**—up to \$210.00 a week full time—\$15 to \$20 in just a few spare hours! Start spare time and build big, prosperous business . . . quickly, easily!

Rush Name Today for Profit Details and FREE TRIAL PLAN!

SELLY of California
started in his spare time and now sells 15000 D-Frost-O-Matics a month!

More than 29,000,000 prospects waiting! Rush your name and address today. We'll airmail exciting facts, proof and sure-profit Free Trial plan. No obligation. Write today. **D-FROST-O-MATIC, Dept. P-6**
173 W. Madison Street, Chicago 2, Ill.

CRAFT HEADQUARTERS

Leathercraft send for complete catalog today **FREE**

Metal Tooling, Textile Painting, Shellcraft, Beadcraft, many more

- COMPLETE SUPPLIES
- QUICK SERVICE
- BEST VALUES

KIT KRAFT—Dept. 26, 7373 Melrose Ave., Hollywood 46, Calif.

250 POWER

Complete Telescope Lens Kit only **\$3.49** postpaid

Conquer Space, Explore the Universe, Planets, Moon Craters, New Stars, etc. Complete Lens Kit consists of 80 inch focal length ground and polished objective lens, eyepiece lenses for 50 POWER, 100 POWER, 150 POWER, 200 POWER, 250 POWER, and all necessary lens fittings. Easy to make from simple step by step instructions. (Tripod and mount not included.) Money back guarantee.

BUSSE SALES CO., Hartford, Conn., Dept. PM 21

MAKE MONEY raising Calves, Chinchillas, Minks, Rabbits, Pigeons and Guinea pigs for our big market. Send 25c for full information that explains everything about the big proposition we have to offer you.

KEENEY BROTHERS FARMS, New Freedom, Pa., R.D. 2, Box 104

\$1300 BUILDS INCOME DUPLEX

FINANCIAL SECURITY! You can build your own duplex from our easy to follow plans. Concrete block, steel windows, all climate designed. Each side contains 11' x 18' Living room and Kitchenette, 10' x 11' Bedroom, 6' x 9' Bath, 3 closets and pantry. Genuine full size blueprint, step-by-step instructions, and material cost list—\$1.00 ppd. Money back guarantee.

BAILEY BUILDERS, 915 Pyramid Bldg., Little Rock, Ark.

56 Pages of Outdoor Fireplace Designs and Ideas

A COMPLETE GUIDE you or your builder can easily follow to get a perfect "fun center" for your family and guests. Includes "outdoor" recipes and menus, clever cook-nook accessories. Illustrates all-metal fireplace units that simplify correct construction with any masonry. Send only 25c for your copy. **The Majestic Co., Inc., 436 Erie St., Huntington, Indiana.**

Only 25c Postpaid

New Beauty for Your Lawn

How To Enjoy an OUTDOOR COOK NOOK

FREE GET THE WORLD'S LEADING TV & RADIO CATALOG

ALLIED'S 1954 ELECTRONICS BUYING GUIDE

268 VALUE-PACKED PAGES

SAVE ON EVERYTHING IN TV AND RADIO

Allied Radio
100 N. Western Ave., Chicago 80, Ill.
catalog No. 133 1954

Everything for Experimenters, Builders, Amateurs, Servicemen, Engineers and Soundmen . . .

Get ALLIED's big 268-page Catalog featuring the world's largest selections of latest top-quality electronic equipment at lowest, money-saving prices. See the newest in custom TV chassis, TV accessories, FM and AM radios, High-Fidelity sound, Amateur equipment, P.A. systems, recorders, test instruments, builders' kits, industrial electronic supplies—plus thousands of parts, tubes, tools and books. Get more for your money—send today for your **FREE 1954 ALLIED Catalog!**

NEW HOME OF ALLIED RADIO
ultra-modern facilities TO SERVE YOU BEST

ALLIED RADIO SEND FOR FREE CATALOG

ALLIED RADIO CORP., Dept. 5-EE-4
100 N. Western Ave., Chicago 80, Illinois

Rush FREE 1954 ALLIED 268-Page Catalog

Name _____

Address _____

City _____ Zone _____ State _____

Here's the Kind of MEN I Build!



CHARLES ATLAS

**Will You Let Me
PROVE I Can Make
YOU a New Man?**

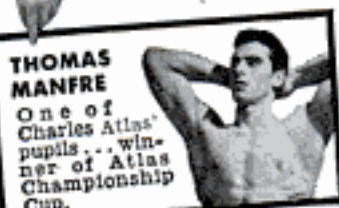

THOMAS MANFRE
One of
Charles Atlas' pupils... winner
of Atlas
Championship
Cup.

I don't care how old or young you are, or how ashamed of your present physical condition you may be. Just give me 10 minutes a day, and I'll start giving you RESULTS that you can SEE, FEEL, and MEASURE with a tape! I can broaden your shoulders, strengthen your back, develop your whole muscular system INSIDE and OUTSIDE! I can add inches to your chest... give you a vise-like grip... make your legs powerful... help cram your body as full of strength, red-blooded vitality your friends will be amazed!

WRITE FOR FREE BOOK. 32 pages about how "Dynamic Tension" changed me from 97-lb, weakling into "World's Most Perfectly Developed Man"—and what I'll prove it can do for YOU. Charles Atlas, Dept. SE, 115 E. 23 St., New York 10, N. Y.

**CHARLES ATLAS, Dept. SE,
115 East 23rd St., New York 10, N. Y.**
Send me—absolutely FREE—a copy of your famous book, "Evertasting Health and Strength"—32 pages, crammed with photos and valuable advice. No obligation.

Name _____ Age _____
Address (Please print or write plainly) _____
City _____ State _____



WOODCRAFTSMEN'S

144 page
ENCYCLOPEDIA 15¢

Bargain book of every conceivable wood-working item and tools. Full of How-To-Do-It information, illustrations, projects and ideas. Domestic and imported woods, inlays, panels, etc. Send for your copy today. Biggest 15¢ worth ever offered.

CRAFTSMAN WOOD SERVICE CO.
Dept. A5F, 2729 S. Mary Street, Chicago 8, Illinois

Paint STRIPES with New "PAINT PEN"!

**Makes Straight, Curved
or Parallel Lines!**

Just fill glass vial with any color paint. Use like a fountain pen to stripe furniture, bikes, autos, model planes, toys, linoleum, wall board. Beautiful, clean, crisp results every time, like professional painters. No experience needed to draw straight, curved, circular or evenly spaced parallel lines. Can't clog or smear. May also be used with glue, tempera, textile paint, or ceramic underglazes. Paints on wood, glass, plastics, metal, fabrics and paper. Lasts a lifetime. Only \$1 postpaid, complete with tip for 1/16 inch stripe. C.O.D.'s plus postage. Used by industry. Order your Paint Stripping Tool TODAY!



**\$1.00
DEALERS**

Master Paint Stripping Tool packed in Display Cartons of 1 dozen. Fast, profitable seller. Write for discounts.

Attention All Home Craftsmen!
New Paint Stripping Tool gives "professional" results every time, yet simple and easy to use as a fountain pen. Adjustable guide keeps lines straight as an arrow. Just as easy to make curves or free-hand designs. Adds new beauty, finished look to everything you paint. Send \$1 now.
**WENDELL MFG. CO., Dept. 3-E
4234 Lincoln Ave., Chicago 18, Illinois**

6 Other Complete Tools
Complete tools for 1/64, 1/32, 3/64, 5/64, 3/32 or 1/8 inch stripes, \$1.50 each. Extra tips 75¢ ea. COMPLETE KIT with ALL 7 TIPS, \$5.00. (Also 1/4" tip, only \$1.00). All tips interchangeable.

New! "DOUBLE-STRIPER" MODEL Only \$2.95

Newest paint striping invention. Makes DOUBLE stripes—one wide and one narrow or two wide or two narrow at the same time. Or adapt quickly for wide or narrow single stripe. Makes 5 combinations. FREE—Send postcard for complete information... or order now... \$2.95.

COMBINATION STETHOSCOPE

SURPLUS—NEVER USED

High Chrome Finish



\$2.95 Postpaid
REGULARLY \$12.00

A professional instrument for detecting delicate mechanism defects.

No C.O.D.'s. Send Check or Money Order to Dept. PM 5

JOB LOT TRADING 53 Vesey St. NYC

BREED • TROPICAL FISH •

EARN \$\$\$\$\$\$ at HOME DURING SPARE TIME. Wonderful new Home-Business opportunity! HELP US FILL HUGE DEMAND from 20 million hobbyists. Some Rare beautiful multi-colored species sold for \$75 PR. AND MORE. It's easy! It's fun! WE SUPPLY EVERYTHING YOU NEED. Write for FREE plan, reprint, folder and all the details. Please state your age. TROPICAL FISH BREEDERS OF AMERICA, Dept. D5, Los Angeles 15, Calif.



Plates Required 1509

Genuine Dupont Plastic NEW FALSE PLATE

From Your Old, Loose Plate NO IMPRESSION NEEDED New, revolutionary Duplication System actually transforms your old, loose, cracked, chipped plate into a new, natural-pink Dupont Plastic Plate with same teeth of new, natural matched teeth. ONE DAY SERVICE!

Only **\$18.95**

SEND NO MONEY—just your name and address for FREE details. Save at our low price! Highest prices paid for Dental Gold. ALL-STATE DENTAL LABORATORIES, 22 W. Madison, Dept. 437, Chicago 2.

30-DAY MONEY-BACK TRIAL

PLEASE SEND ME



for the
time checked.
I am enclosing . . .

- 1 year \$3.50
 2 years \$6.00

name _____
address _____
city _____ zone _____ state _____ C-54

Hand this order to your newsdealer or send it to

POPULAR MECHANICS
200 East Ontario St. Chicago 11, Ill.

POPULAR MECHANICS

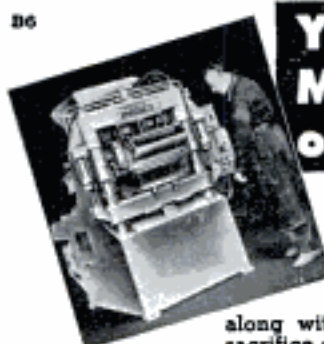

You Can Be a Manufacturer of BRIKCRETE

"The World's Most Modern Masonry" is produced in a chain of independently owned local plants. That's why such low prices go along with such high quality without sacrifice of manufacturing profits. Local materials and local labor cut freight and distribution.

Brikrete brings a super-masonry down to price levels of frame. Gives owners incentive to buy.

Brikrete has design, size, and color in keeping with the modes of today. Self-contained insulation values—12" long—8" or 4" thick—range of 14 colors. Suited to every kind of construction—residential, commercial, industrial.

Many territories are open for additional local plants. Franchise protection. Equipment available on easy terms, or basic machine can be leased to responsible operators. Write today for interesting Brikrete Book No. 2.

Brikrete Associates, Inc.
4679 Division Avenue, S.
Grand Rapids 8, Mich.



*The World's
Most Modern Masonry*

BLOOD PRESSURE GAUGE \$5.98

for home use.....



Apparatus comes complete with instruction manual telling what blood pressure reading actually is, what it means to you and what you can do for it. Anyone can operate the dependable Mercury type gauge without assistance. You will be able to check your condition daily and in the privacy of your own home! You can count on years of dependable service from your apparatus and remember, two pressure readings alone are worth the cost of the entire outfit. Everything you will need is sent prepaid for just \$5.98 or C.O.D. plus charges. Free circular sent on request.

JOY SPECIALTY COMPANY
2320-A West Hubbard St. Chicago 12, Ill.

BECOME AN EXPERT IN TRAFFIC

Traffic men earn \$4,000 to \$10,000 and up. Thousands of firms need experts on rates, tariffs, regulations. We train you thoroughly in spare time at home for executive traffic jobs. Personal training under traffic authorities. Placement counsel and help. Write for free 48-page book "Traffic Management—the Fast Growing Profession."

LASALLE Extension University, 417 So. Dearborn St.
A Correspondence Institution Dept. 564T Chicago 5, Ill.

FREE CATALOG

OF AUTHENTIC
WESTERN CLOTHING

Send for free, new, colorful catalog showing authentic western wear for spring and summer at low, direct-to-you prices. The West's most complete catalog, the bible of western stockmen for over 30 years. Send for your free beautiful catalog, today!

MILLER STOCKMAN SUPPLY CO.
1296 Sixteenth St. Denver, Colo.



PUMP WATER FAST!

DRAIN WASH TUBS, CELLARS, CISTERNS. Famous #7 pumps 2800 GPH. 420 GPH at 75' high or 1600 GPH from 25' well. Sturdy, rustproof Alloy Metal. Six Blade impeller. Uses any 1/2 to 1/2 H.P. Motor. Will not leak or clog. Fits any garden hose. Immediate money back guarantee. Send Check, Money Order, or C.O.D. **\$8.95** H.S.

IRRIGATE, FILL TANKS, DRAW WELL WATER. Heavy duty #8 Pumps 7000 GPH. 1000 GPH 75' high — 3000 GPH from 25' well. Rustproof Alloy Metal. 8 blade impeller. 1" inlet — 1" outlet. Standard Pipe Threaded. Money back guarantee. Send check, **\$11.95** H.S. Money Order, or C.O.D.

Free Catalogue — Gear Pumps — Deep and Shallow Well Pumps.
MOORE MANUFACTURING CO.
SWEDSBORO 6 NEW JERSEY

FOR YOUR

TECHNICAL EDUCATION

COME TO THE

UNIVERSITY OF HOUSTON

(LOCATED IN FABULOUS HOUSTON, TEXAS)

FOR SUCCESS . . . Select one of these fascinating technical fields:

- Air conditioning and refrigeration technology
 Diesel technology Electrical technology
 Drafting technology Electronic technology

TRAIN NOW for the job you want . . . a job with a good income and security. Train at the University's College of Technology . . . rated one of the best in the country:

- Beautiful 250 acre campus
- Air conditioned classrooms and Residence Halls
- Graduate placement
- Short or longer programs
- University television and radio station
- Opportunity to extend your education and earn a college degree
- Accredited curricula
- Modern, extensive equipment
- Part-time job while in school
- Co-educational
- G.I. approved — V.A. on campus
- Open to high school graduates or equivalent
- Aptitude testing and vocational guidance
- June, Sept., Feb., semesters



EZEKIEL W. CULLEN BUILDING

UNIVERSITY OF HOUSTON—COLLEGE OF TECHNOLOGY

DEPT. 154 — HOUSTON 4, TEXAS

SEND FOR FREE illustrated brochure Now.

Mark X before your choice of subject.

Name.....Age.....

Address.....

City.....State.....

Inventors

The following are the usual preliminary steps to take toward patent protection.

Make a disclosure of your invention; sign, date and have this document witnessed by two or more people who understand your invention; authorize your registered patent attorney or agent to conduct a preliminary search among previously granted U. S. patents for similar types of invention; secure a report on the probable patentability of your invention and a recommendation of the further course to take.

We shall be glad to send you without obligation our instructive booklet, "Patent Protection for Inventors" and our "Evidence of Invention" disclosure form.

VICTOR J. EVANS & Co. *Merlin M. Evans*
REGISTERED PATENT ATTORNEY
930-E MERLIN BUILDING, WASHINGTON 6, D. C.

UP TO 6 MILES MORE PER GALLON
Reported by Hundreds Using
MIRACLE ACTION TUR-B-LIZER
Carburetor specialists say Tur-B-lizer is best patented improvement they have seen. Tested in millions of miles of driving in cars, trucks and tractors. Easily installed. Send \$3.00 for six cylinder type, \$4.50 for eight cylinder type. Try Tur-B-lizer for 30 days, if you are not enthusiastically satisfied as claimed by hundreds of users, your money will be promptly refunded.
Mechanics-Salesmen Make big money selling and installing. Write for full facts.
UNIVERSAL TUR-B-LIZER CO.
621 E. STATE ST. MILWAUKEE 2, WISC.



Easy as A-B-C



Be Your Own MUSIC Teacher

LEARN AT HOME THIS QUICK MONEY-SAVING WAY

Simple as A-B-C. Your lessons consist of real selections, instead of tiresome exercises. You read real notes—no "numbers" or trick music. Some of our 900,000 students are band LEADERS. Everything is in print and pictures. First you are told what to do. Then a picture shows you how. Then you play it yourself and hear how it sounds. Soon you are playing your favorite music. Mail coupon for Free Book and Lesson Sample. Mention your favorite instrument. U.S. School of Music, Studio 308, Port Washington, N.Y.

FREE BOOKLET

U.S. SCHOOL OF MUSIC, Studio 308, Port Washington, N.Y.
Please send me Free Booklet and Lesson Sample. I would like to play (Name Instrument).

Instrument? _____ Have you _____
Instrument? _____

Name _____ (Please Print)

Address _____

INVENTORS

IF YOU WISH TO PROTECT YOUR INVENTION, You should take steps to protect it by a U. S. Patent. Write me for "INVENTION RECORD" form

CARL MILLER
REGISTERED PATENT ATTORNEY
WOOLWORTH BLDG., 35th FLOOR, 54A
NEW YORK CITY



PATENTS

C. A. SNOW & CO.

REGISTERED PATENT ATTORNEYS
WRITE FOR INFORMATION TO
428 SNOW BUILDING, WASHINGTON 1, D. C.



INVENTORS

Send for **REGISTERED PATENT**
PATENT INFORMATION **ATTORNEY**
Book and **ASSOCIATE EXAMINER**
INVENTOR'S RECORD U.S. PAT. OFF. 1922-1929
without obligation
GUSTAVE MILLER Patent Attorney & Advisor
54-PM WARNER BUILDING U. S. NAVY DEPT. 1930-1947
WASHINGTON 4, D.C. **PATENT LAWYER**

INVENTORS

Whether an invention is patentable can be substantially determined by a search of the U. S. Patent records. Without obligation, write for information explaining the steps you should take to secure a patent.

JOHN N. RANDOLPH
Registered Patent Attorney
201 Columbian Building, Washington 1, D. C.

INVENTORS

I shall be pleased to furnish you, upon request, with full information relative to patent procedure—without any obligation on your part.

PATRICK D. BEAVERS
Registered Patent Attorney
934 Columbian Building Washington 1, D. C.

Say You Saw It in Popular Mechanics

COMPLETE NEW

FALSE IN
PLATE 24
HOURS



FROM YOUR OLD \$15.95
NOW LOW AS . . .

New process transforms old, broken or loose plates into new lightweight plastic plates. NO IMPRESSION NEEDED. Let us help you enjoy life again. You will marvel at this revolutionary new method. Using your own old plates, we will remake them completely in only 24 hours. Missing teeth are carefully matched and replaced. Work is done on an absolute MONEY BACK GUARANTEE. Quit Suffering!

SEND NO MONEY —Just rush your name and address for full FREE DETAILS. If your teeth are loose, we'll tell you how to tighten them before duplication. Act now.
Tru-Grip Dental Labs., 7th Fl., 127 N. Dearborn, Dept. 98, Chicago 2, Ill.

Price! Profit! Prospects!



SENTRY SAFES
give you all 3

PRICE: 35% to 50% lower than comparable small safes.
PROFIT: Because your cost is low, you can take a big mark-up and still undersell all competition. Just one SENTRY sale a day can bring you \$8,000 a year!
PROSPECTS: 95% of the personal safe market (professional men, executives, farmers, householders) untouched because only SENTRY offers such quality fire and theft protection for so little. Choice, exclusive territory. Drop shipments if desired. Send for full details. Write to Dept. PM-5, giving address, including county.



BRUSH-PUNNETT CO.
345 WEST AVE., ROCHESTER 11, N. Y.

AMAZING NEW POCKET SIZE RADIO
Really Works—Small as a Pack of Cigarettes!



FITS IN ANY POCKET OR PURSE—GETS LOCAL RADIO STATIONS WITH CLEAR BELL-LIKE TONE—NO STATIC OR INTERFERENCE! NEEDS NO TUBES, BATTERIES OR COMPLICATED HOOKUPS! NO AC PLUG INS! Nothing to wear out. Thousands of users—many report years of service. Uses new crystal diode and Hi-Q coil. SELF-CONTAINED SPEAKER PHONE. Just the tiny radio to take with you ANYWHERE YOU GO—ON TRIPS, VISITING, ETC.—for real fun and enjoyment—ANYTIME. **SEND ONLY \$1.00** (bill, ck., m.o.) and pay postman \$3.99 C.O.D. postage of send \$4.99 for c.p. delivery. COMPLETE READY TO LISTEN. MIDWAY CO., Dept. PPM-5, Kearney, Nebr.

Sample IMPORTS



FROM FOREIGN LANDS—Exciting, useful sample, products from France, Germany, India, etc., sent to you. Established Import-Export firm offers men or women FREE plan for big profit, world-wide, mail-order business at home; or travel abroad. No capital or previous experience needed. Overseas bargains bring high U. S. prices. Write today for FREE plan! Mellinger, Dept. 255, 1717 Westwood, Los Angeles 24, Cal.

WHOLESALE Electric Guitars - Parts - Build Your Own
Accordions, amplifiers, double-necks, triple-necks, pickup mikes, mandolins, non-electric instruments, etc. 1254 Models wholesale. Free Catalog. Free home study course with instruments. Parts and plans available to build your own 6 or 8 string or multi-neck electric guitar. Martin and Fender available at list price. **CARVIN CO., Box 28 P.M. 5, Baldwin Park, Calif.**



LAW
Men and women **STUDY AT HOME** for Business Success and **LARGER PERSONAL EARNINGS**, 44 years expert instruction—over 114,000 students enrolled. LL.B. Degree awarded. All text material furnished. Easy payment plan. Send for **FREE BOOK**—"Law and Executive Guidance"—NOW!
AMERICAN EXTENSION SCHOOL OF LAW
Dept. PM-74, 664 N. Michigan Ave., Chicago 11, Illinois

See You Saw It in Popular Mechanics

60 POWER TELESCOPE \$3.98
VARIABLE EYEPIECE 20x-40x-60x — BRASS BOUND NEW! Three telescopes in one. 3 different magnifications. 20 power for ultra-bright images with 40 and 60 power for extra long range. Guaranteed to bring distant objects, people, sports events, ships, moon, stars, etc. 60 times as close.



Most powerful for anywhere near the market. 5 sections. Closes to 1 ft. long. Contains 4 ground and polished lenses. Also used as a powerful compound microscope. Directions included. Mass production enables us to offer this instrument at amazing price of \$3.98 complete. Money back guarantee. We pay postage. Get yours now. **Criterion Co., 331 Church St., Hartford, Conn., Dept. PMB 23**

Become an Electrical Engineer
with Bachelor of Science Degree
in 36 months



Major in Power or Electronics at Milwaukee School of Engineering
Over 50% of the nation's industrial leaders began their careers with engineering training. Today the need for Electrical Engineers and Technicians is growing rapidly... the opportunities great! Prepare now for your future at Milwaukee School of Engineering.

Plan Your Career — Eight Courses Give You Wide Range of Study

ENGINEERING COURSES

Electrical Engineering—Bachelor of Science Degree
Save a valuable year through optional year 'round study.

Electronics major	36 months
Power major	36 months

TECHNICIAN COURSES

Electro Technician	12 months
Electronic Technician	12 months
Radio Technician	12 months
Radio and Television Technician	18 months

SERVICE COURSES

Electrical Service	6 months
Radio and Television Service	12 months

Terms open July, September, January, April
Approved for veterans. Prior Military, Practical or Academic training evaluated for advanced credit. Faculty of specialists. 50,000 former students. Annual enrollment from 48 states and 23 overseas countries. 51st year. Non-profit. Residence courses only. Send handy coupon today.

MECHANICAL TECHNOLOGY COURSES — Also available, Service and Technician courses 6 to 18 months — Heating, Refrigeration, Welding, Air Conditioning and Mechanical — B.S. Degree in Mechanical Engineering with a major in Design, Metal Fabrication, or Plant Engineering. Also, general 3-month preparatory course.

MS-7



MILWAUKEE SCHOOL OF ENGINEERING

MILWAUKEE SCHOOL OF ENGINEERING
Dept. PM-554, 1025 N. Milwaukee St., Milwaukee, Wis.
Send free illustrated career booklets Electrical Technology Mechanical Technology Radio-Television.
I am interested in..... (name of course)
Name.....
Address.....
City..... Zone..... State.....
If veteran, indicate date of discharge.....

FREE 1954 CATALOG

WORLD RADIO LABORATORIES

"The World's Largest Distributor of Amateur Radio Transmitting Equipment."

Jam packed with bargains — everything in Radio, TV, and Hi-Fi — for Handyman, Ham, Experimenter or Serviceman!

- Pay Only 10% Down
- Easy Terms
- Liberal Trade-Ins
- Save Over 50% on Used Equipment
- Over 600 guaranteed reconditioned items.



WORLD RADIO LABORATORIES
3415 W. Broadway — Council Bluffs, Iowa

Leo I. Meyerson

PERSONALIZED SERVICE

MAIL HANDY COUPON

WORLD RADIO LABORATORIES, INC. Dept. PM-5
3415 W. Broadway — Council Bluffs, Iowa 3 1/4' U.S.
 Free 1954 Catalog Used Eq't List Radio Map 25c

NAME _____
ADDRESS _____
CITY _____ STATE _____



Glide

LIKE AN INDIAN GUIDE

Down the twisting streams, across the ruffled lakes, your Old Town Canoe is your dependable friend for fishing and hunting. Sturdy and strong for long trips, yet light and easy to carry. Perfectly balanced. An Old Town is designed like a birchbark, but built for many years of adventure and sport. Easy to own.

FREE CATALOG shows all kinds of canoes and outboards, sailboats, dinghies, rowboats.

OLD TOWN CANOES

Old Town Canoe Co., 145 Middle St., Old Town, Maine
PLEASE SEND ME FREE CATALOG

Name _____
Address _____
City _____ State _____

LIGHT WHERE YOU NEED IT! HEADLIGHT

REG. \$5.95 VALUE!

\$2.44

POSTPAID

Perfect for mechanics, sportsmen, hunting and fishing.
PLUS Fislser's Complete Catalog FREE!

Sturdy steel, finished in zinc-chrome plate. Handy switch. Durable fibre head piece with adjustable back strap, lined with sponge rubber pads. Takes 2 flashlight batteries and bulb. Bulb included. For 2 batteries add 25c.

ORDER TODAY

Fislser's

1329 Main, Dept. PMS, Kansas City, Mo.

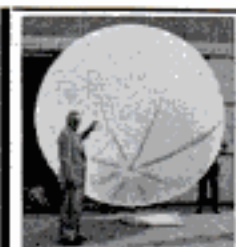

GIANT BALLOONS

Surplus U. S. Gov't. (new-overflow) NEOPRENE weather, target balloons. For FUN or PROFIT. Great sport in the backyard; or for parties, picnics, dances, fairs; MONEY-MAKERS. Use these balloons to attract crowds to civic events, conventions, exhibitions, trade shows. TERRIFIC for high school and college PROMS. All sizes are approx. inflated size. Postage prepaid on prepaid orders. 18", 3 for 55c—3 ft. dia. 49c—6 ft. dia. 99c 13 ft. dia. \$1.59 — 20 ft. dia. \$1.95

* Calif. residents please add sales tax.

WAR ASSETS DIV. VOLUME SALES CO.

Dept. M-5-54A 3930 Sunset Blvd. Los Angeles 29, Calif.



Decorate your lawn with

FLORIDA FLAMINGOS

Made of aluminum castings, about 30" high and enameled flamingo red. \$7.90 pair postpaid. Money back guarantee. Agents wtd. Send remittance to:

CERTIFIED PRODUCTS CO.
Dept. 140 Louisville, Ky.

We also make aluminum castings from your patterns or samples.

TOOTHACHE? DENT'S

Ask your Druggist for

TOOTH GUM
TOOTH DROPS
POULTICE



Make Your Own TV REPAIRS!

This Book Can Save You \$50 - \$100 Per Year

Fix 85% of TV troubles, easy as replacing light bulb! Save \$\$\$! New TV REPAIR GUIDE reveals many "trade secrets" on trouble-shooting, tube replacing, antenna adjustment, everything. Makes repairs fast, easy, safe! Includes detailed layout of your TV. Gives Tube prices—prevents overcharging. Save set make, model.

MONEY BACK IF NOT WORTH TEN TIMES THE PRICE!

L. S. ENGINEERING, Dept. S-5, Box 4113, North Hollywood, California



FREE CATALOG

Over 300 books on Fishing, Hunting, Home Repairs and Improvements, Bricklaying, Welding, Home Workshop, Power Tools, Hobbies, Crafts, Home Building, Trades, Making Money at Home, Furniture Making, Woodworking, Carving, Photography, Art, Drawing, Mechanics, Engineering, Refrigeration, Plumbing, Radio-TV, Electricity, Automobiles, Farming, Livestock, Gardening, Decorating, Painting, many, many more. Send for yours today.

POPULAR MECHANICS PRESS, 200 E. Ontario St., Chicago 11

BRAND NEW! Firestone TIRES

SAVE UP TO 50%

SEND FOR FREE CATALOG

BRAND NEW—FIRST QUALITY PASSENGER TIRES

All Tires Carry	BLACK WALL TIRES 4 PLY FULL PRICE
Famous Firestone	640 x 15 11.92
Unconditional Guarantee	650 x 15 14.29
	670 x 15 12.50
	710 x 15 13.88
	760 x 15 15.12
	600 x 16 11.12
	650 x 16 14.73

BRAND NEW—FIRST LINE—HEAVY DUTY FIRST QUALITY—SENSATIONAL VALUES

TRUCK TIRES	Full Price
700x15 8 ply	25.79
600x16 6 ply	17.78
650x16 6 ply	21.58
700x17 6 ply	30.75
600x20 6 ply	24.31
650x20 8 ply	31.47
700x20 8 ply	35.45
700x20 10 ply	42.48
750x20 8 ply	45.15

Special Brand New Whitewall Tires (Factory Blemish)

Whitewall Tires	Full Price
First Line 4 ply Pass.	15.24
670 x 15	15.24
710 x 15	16.83
760 x 15	18.41
800 x 15	20.23
820 x 15	21.04

SUPER SPECIAL!
1st. Qual. Armstrong
670 x 15 11.91

(Order by Mail—Send check or M.O.) • (all prices f.o.b. plant)
Farmers—Full line of tractor tires—Write for Prices

S&S TIRE CO. 1400 HADDON AVE. CAMDEN 3, N. J.

Distributors, Jobbers and Salesmen!

Get the facts—just the facts on big money maker for service stations, garages, etc. Everybody will buy—build large repeat business. Exclusive territories available. Act fast. Write for free sample and details.

JOHN J. GRIFFIN CO., INC.
NATIONAL SALES OFFICE, DEPT. PM
4343 FRANKFORD AVE. PHILA. 24, PA.

Finish HIGH SCHOOL AT HOME

Complete 4 Yrs. in 12 Months

Learn More! Earn More! Enter professional or technical schools. Advance Socially. Live a Happier, Fuller Life. Individual Courses or complete schedule. WRITE FOR SCHOOL BULLETIN.

ACADEMY FOR ADULTS
30 W. Washington, Dept. PM-504, Chicago, Ill.

LEARN WATCH REPAIRING

AT HOME Modern, original instruction. Prepare for a position or start in business after completing our course. Write Today!

WISCONSIN SCHOOL OF WATCH REPAIRING
759 N. Milwaukee St. Dept. M Milwaukee 2, Wis.

"REFLECTO-GLO" LETTERS

FOR CARS—TRUCKS—BIKES—TRAILERS.

New! Promotes Safety. Large RED LETTERS on SILVER Scotchlite reflects Two-Tone light—fifty times greater than white paint with amazing brilliance. Individual, easily applied adhesive backing, durable and weather resistant. Sent postpaid.

ANY 8 letters A-Z. 1 3/4 x 2 in. \$2 Add'l letters 20c ea. RED reflective safety STRIPPING 48" x 1" \$1 Ppd.

ROYAL TRADING CO. P. O. Box 1512 Chgo. 90, Ill.

The WONDERS of LIQUID PLASTICS

**MANUFACTURE WITHOUT TOOLS OR MACHINERY!
EASILY MAKE \$5.00 AN HOUR!**

No previous experience or special ability required! NO TOOLS OR MACHINERY required . . . the entire process is about as easy as pouring water out of a glass! The WONDERS OF LIQUID PLASTICS make all this possible! Many of the products made with our liquid plastics are so beautiful and attractive that we have created an unusual demand for this type of merchandise! That's why we will pay you \$5.00 an hour (materials extra) to make the items shown here and in our catalog for you!

UNLIMITED POSSIBILITIES

Work with LIQUID IVORY, LIQUID GLASS, LIQUID MARBLE, LIQUID EBONY, LIQUID PORCELAIN, LIQUID WOOD, LIQUID GEMSTONE and many other LIQUID PLASTICS and in a matter of minutes turn them into an endless and valuable procession of beautiful imbedded jewelry, novelties, ornaments, statuettes, bookends, lamps, pensets, lighters, ashtrays, keychains, figurines, curios, SOUVENIRS, art and gift products, fishing lures, BOATS, GADGETS galore, exquisite GEMS! Make gears, tools, dice, forms, handles, dials, knobs, MACHINE PARTS, models of inventions, pistol grips . . . the list is endless! The only LIMITATION is your IMAGINATION! Liquid Plastics are the blessing of every creative and ambitious person . . . with these materials ANYONE can create and manufacture by the THOUSANDS and at a tiny fraction of what it would cost by any other method! Just send 25c and we will send you our book, "HOW TO MANUFACTURE WITHOUT TOOLS OR MACHINERY," included with our big 64 page catalog describing all the materials mentioned above; also details of our \$5.00-an-hour offer! Do it today . . . we want you to share in these wonderful opportunities as soon as possible!

PLASTICAST CO., (Dept. C)
P.O. Box 5737 (Write to P.O. Box 987
Chicago 80, Ill. either address) Palo Alto, Calif.



PLASTIC LAMINATING

This remarkable Plastic Laminating Machine will earn \$18.00 an hour right in your kitchen! Big profits laminating Business, Social Security, Identification, Credit CARDS of all kinds, photos, passes, clippings, etc. Price complete (illustrated) \$35.00 plus postage. Others higher. Literature free.

PLASTICAST CO.
(Address in ad above)

Prints Postal Cards!

FREE Use on 30 Day Trial! Send name today for facts and FREE Illustrated Book of unique advertising plans and, money-making ideas for your business. Learn how others are boosting sales with post card ads . . . easy with Cardmaster.

Cardmaster Co., 1920 Sunnyside, Dept. 1315, Chicago 40, Ill.

EXPERIENCED or NOT...

MODERN AUTOMOTIVE DIAGNOSIS TECHNIQUE
is your Stepping Stone to **SUCCESS**

Learn to earn **HIGH PAY** in 12 weeks!

Prepare for a big income—unlimited opportunity in the vast, ever-growing field of modern automotive service—IN 12 WEEKS! SUN, the world's largest manufacturer of scientific automotive test equipment, offers now their MODERN AUTOMOTIVE SERVICE course—the only one of its kind.

YOU TRAIN in Detroit—The Motor City—at the completely-equipped SUN resident school. Your attention is focused on scientific testing—the only way to avoid guesswork servicing cars.

YOU LEARN basic operating principles and maintenance techniques by working on all types of the latest engines, transmissions, brakes, etc.

YOU USE the latest scientific test instruments to observe performance and pin-point trouble.

INVESTIGATE TODAY—take the first step NOW to MORE MONEY, a secure future—and your choice of location when you graduate. Recommended by motor manufacturers. Approved for veterans. Classes scheduled in Detroit Technical Training Center.



Sun Electric Corporation, Dept PM-154
6321 Avondale Ave., Chicago 31, Illinois
Please send free details on MODERN AUTOMOTIVE SERVICE course.

NAME _____
ADDRESS _____
CITY _____ ZONE _____ STATE _____

SEND FOR FREE BROCHURE • ALL DETAILS NO OBLIGATION

NEW MIRACLE TUBELESS HEARING AID REVEALED

- Costly B-Battery Eliminated
- All Battery Costs Slashed 80%
- Powered by Three Transistors
- Vacuum Tubes Banished Forever

FREE BOOK! Write today for authoritative illustrated book describing this new Atomic Age miracle invention, the Transistor, and what it means to the hard of hearing. No obligation whatsoever! A postcard will do.

Beltone HEARING AID CO.
2900 West 36th Street, Dept. 3245
Chicago 32, Illinois

SAVE \$65 on this LUXURIOUS \$100 CONTOUR CHAIR

Scientific correct design for the restful, healthful, relaxing which is so beneficial to heart, nerves, muscles. Adjusts for perfect sitting or reclining... most popular chair in the home. Firestone foam rubber and washable, pliable genuine Duran upholstery. Would cost \$100 or more in any store. Shipped all ready to put together in less than one evening by anyone who can use a screwdriver. No cutting, no drilling, no skill needed. A woman can do it. Order now! Everything needed for only \$34.95, f.o.b. Balto. State color wanted: Forest Green, Strato-Grey, Lipstick Red, Walnut Brown. Enclose \$5 deposit, balance C.O.D. Money Back guarantee. Return in 10 days if not satisfied. Order today.

\$34.95

For Everything Needed Complete to Put It Together in One Evening



GENUINE
FOAM
RUBBER

RESTECRAFT, Dept. 71,
Mathison Bldg., Baltimore 2, Md.
Make Money Selling and Assembling Contour Chairs For Friends.

TRAINED MEN NEEDED

BIG PAY—GOOD FUTURE

- | | |
|-------------------------------------|--------------------------------------|
| <input type="checkbox"/> TELEVISION | <input type="checkbox"/> ELECTRONICS |
| <input type="checkbox"/> DIESEL | <input type="checkbox"/> AUTO |

WHY WORK FOR LOW PAY or risk being out of a job??? Usually the properly trained man has a steady job... through good times or bad. Even back during DEPRESSION there was a big demand for Bailey Trained men.

In only 5½ to 6 months we can train YOU to enter one of the big pay fields!

No previous experience or special education necessary. With our method of training you do not spend years pouring over books, figures, charts and graphs. You learn by rebuilding, repairing, testing and operating the most modern equipment, under the guidance of experienced, courteous and friendly instructors. This method of training gives you the experience and confidence required to step right into the big pay jobs without spending years as a mechanic's helper.

It's EASIER and COSTS LESS than you may think to get this residence shop training... we help you find part-time jobs while in school—full-time jobs after graduation. Check subject above in which you are interested and mail for complete information.

BAILEY Technical SCHOOLS

Veteran Approved

1634 S. Grand St. Louis 4, Mo.

NAME.....AGE.....
STREET.....
TOWN.....ZONE.....STATE.....

Would You Like to Make \$1,000 A MONTH?

That's what Stanley Hyman made selling the amazing new PRESTO Fire Extinguisher!



Science's New Midget Miracle—“PRESTO”

A MAZING new kind of fire extinguisher does job of bulky extinguishers that cost 4 times as much. Ends fires fast as 2 seconds. Fits in palm of hand. Never corrodes. Guaranteed for 20 years! Sells for only \$3.98! Show it to owners of homes, cars, boats, farms, etc., and to stores for resale—make good income. Write for FREE Sales Kit. No obligation.



Stanley Hyman

MERLITE INDUSTRIES, Dept. 55, 114 East 32nd St., New York 16, N. Y. In Canada: Mopa Co., Ltd., 371 Doved St., Montreal 1, P. Q. (If you want a regular Presto to use as a demonstrator, send \$2.50. Money back if you wish.)

LEARN REAL ESTATE BUSINESS

Be A Broker Study At Home
BROKERS EARNINGS OFTEN EXCEED \$10,000 PER YEAR

For a HIGH INCOME, Lifetime career become a Real Estate Broker. No other profession offers even and women from 18 to 65 such rich rewards in so short a time. Seavy Home Study Course is written so simply anyone with grammar school education can easily master real estate operation. Covers all subjects thoroughly. Special emphasis on HOW TO CLOSE SALES. Diploma awarded. The low cost will surprise you. Start now, be running your own profitable business quickly. Send for free illustrated folder TODAY. No obligation.

SEAVY REALTY INSTITUTE

1750 Colorado Blvd. • Los Angeles 41, California • Dept. PM



FINE BOWS and ARROWS
SELECTED RAW MATERIALS

Catalog 5c Send for it
HAND BOOK—Illustrated
Instructions on Making and
Shooting Archery Tackle—75c

L. E. STEMMLER CO.
Manorville (Box 3) L. I. N. Y.



MECHANICAL DENTISTRY

A profession offering unlimited opportunities. Most modern and complete course embracing every branch from Plate to Porcelain Work, which prepares you to work for Dentists or start your own business. Individual instruction—practical training in day or night school. No books—no classes. Catalog upon request.
McCARRIE SCHOOL OF MECHANICAL DENTISTRY
207 N. Broad Street Dept. 29 Philadelphia 7, Penna.



Earn BIG STEADY MONEY SELL WORK UNIFORMS!

It's easy with TOPPS great "Panoramic" line that spreads out over 8 feet wide! Swatches are king size! Style figures are big, full color—they almost pop off the page! Prospects are everywhere—garages, service stations, factories, etc. Profits are big—one man made \$896 on a single sale! Selection of sizes, fabrics (including DuPont's miracle ORLON), colors, embroidery is unlimited. Start spare time... you'll make it a career! Get the "Panoramic" line FREE. Write TODAY.
TOPPS Dept. 615 - Rochester, Indiana



\$2.95 EACH OR 2 FOR \$5.00!

Genuine Telephone Company Upright Telephone complete with cords, in tested and guaranteed condition with 50 ft. of wire, roll of tape, inter-communication instructions. Tape and wire offer for this month only. Complete line of telephones, dial, magneto, inter-communication, etc. Write for free list. All shipments F.O.B.

TELEPHONE ENGINEERING CO.

Dept. 584 Simpson, Pa.

YOU'LL CATCH BIGGER FISH

and have more fun catching them after you read Popular Mechanics HOW TO TEMPT A FISH. Here is the experience of veteran guides and fishermen brought to you for hours of enjoyable reading. Many pages of brilliant full color ketchchrome plates. Covers every phase and style of fishing—even tells where to find the big ones and what baits to use. Hundreds of kinks and tips to make every trip more enjoyable. Endorsed by leading sportsmen throughout the country. 128 pages. \$2.00 illus.

POPULAR MECHANICS PRESS \$2.00
200 E. Ontario Street, Chicago 11



POPULAR MECHANICS

Copyrighted material

NO BETTER RELIEF AT ANY PRICE
for ACID INDIGESTION

TUMS

SAFE, FAST, SURE, PLEASANT

STILL ONLY 10¢ A ROLL

HULA POPPER • GETS BIG BASS

Surface popping lure. Ideal combination of noise, action, casting and hooking qualities. Pops, plunks, jerks, twitches — obeys your slightest wrist command. Rubber Hula Skirt imitates live bug. At your dealer 5/8 oz. or 1/4 oz., \$1.25. Fly rod size, 75c.



FRED ARBOGAST CO. INC., 2255 W. North St., Akron 3, Ohio

FREE WRITE TODAY FOR YOUR BIG FREE ARBOGAST COLOR CATALOG—FULL OF PICTURES OF CATCHES

HE-MAN VOICE!

STRENGTHEN your voice this tested scientific way. Yes—you may now be able to improve the POWER of your speaking and singing voice . . . in the privacy of your own room! Self-training lessons, mostly silent. No music required.

FREE BOOK Write TODAY for Eugene Feuchtinger's great booklet "How to Develop a Successful Voice." It's absolutely FREE! You must state your age. Booklet mailed postpaid in plain wrapper. No salesman will call. Send your name and age RIGHT NOW! Perfect Voice Institute, 210 S. Clinton St., Studio EW-2, Chicago 6, Ill.



BUY IT GET UP TO 40% OFF **WHOLESALE!** **FREE** THE WHOLE SALES PLAN

Start a Buying Service At Home. SPARETIME. GET BIG NAME MERCHANDISE FOR SELF AND CLIENTS UP TO 40% LESS THAN REG. PRICE. SALES EASY, AS YOU CAN GIVE VISIBLE DISCOUNTS. STILL MAKE FAT COMMISSIONS. Post Card Brings Free Copy

AMERICAN BUYERS SERVICE

631-R Linden Ave., Buffalo 16, N. Y.

RADIO Engineering. All phases radio & electronics theory & practice; television; FM; broadcasting; servicing; aviation, marine & police radio. Prepare for high pay; 18-month course. Graduates in demand by major companies. Enter Jan., March, June, Sept. Regular campus life. Write for catalog. VALPARAISO TECHNICAL INSTITUTE, Dept. D, Valparaiso, Ind.

OWN YOUR OWN BUSINESS!

Repair electrical appliances of friends and neighbors.
Service electrical equipment in factories, stores, etc.

New Shop Method home training system. Rush name today for FREE BOOK and special form for getting Electronic kit, illustrated instructions on new easy payment plan. Pay us later with your EARNINGS WHILE LEARNING.

CHRISTY TRADES SCHOOL 4804 N. Kedzie Ave., Dept. D-3003, Chicago 25

AVIATION

Pays You More With a Schooling at PARKS

NOW! A&E MECHANIC LICENSE COURSE

45-week course, all phases aircraft & engines. Enrollment Dates: Sept. 1-2, 1954

FLIGHT COURSES—Private, Commercial, Instrument, Instructor, Multi-Engine.

DEGREE COURSES—B.S. degree in 3 yrs. from Saint Louis University — Aero. Engineering, Maint. Engineering, Aero. Administration.

All Parks Schooling Approved for Veterans Write Today.

PARKS COLLEGE ARNOLD HALL EAST ST. LOUIS, ILL.

STOP BURNING OIL!

LOSING POWER
WASTING \$\$\$



When your car "eats-up" oil, loses that get-up-and-go power, has poor gas mileage, it's a sure sign that you have worn rings, pistons, and cylinder walls in your engine. This is robbing you of driving pleasure and valuable \$\$\$ to the tune of \$250 every 10,000 miles in oil, gas, and repair bills.

WHAT CAN YOU DO ABOUT IT?

You can either have an expensive overhaul job done or offset this wear with a

RING-RE-NU MOTOR RECONDITIONER KIT

It's the inexpensive, proven answer to a worn engine. This terrific 1-2 combination restores power and zip to your car without expensive repair work, reduces oil burning, slashes gas consumption, brings back that "new car" performance to your car.

HERE'S HOW THIS DOUBLE VALUE KIT PERFORMS!

- 1. PVR COMPOUND**—is a hard hitting engine reconditioner that removes sludge, tars, sticky greases from a tired, worn engine. Pour in carburetor, idle engine. Leaves rings, valves, pistons whistle clean, ready for . . .
- 2. RING-RE-NU**—this amazing compound when squeezed by tube on pistons forms a tough, pliable, self-expanding seal on rings and pistons to compensate for wear.

RESULT!—You get power-packed, economical driving pleasure. Good for 10,000 plus miles. Adds years to the life of your car. Guaranteed not to harm the finest engine. Takes only 30 minutes to install.

PROVEN SUCCESSFUL! Over 100,000 customers

acclaim results! —

You risk no money!—Ring-Re-Nu must reduce oil burning—improve compression in your car. Try it for 400 miles — if results aren't favorable—return empty tube and can — full purchase price refunded!

1 tube kit \$4.95 ppd. treats all cars except large 8 cyl. autos which require 2 tube kit at \$8.95 ppd. sold with money back guarantee. (C.O.D.'s accepted. \$1 deposit required. bal. and postage on arrival.)

FREE with your order from this ad — one "Micro-Moly" crankcase treatment worth \$1.50!

RUSH ORDER TO:

RICHIE DISTRIBUTING, INC.

11916 MADISON AVE. • DEPT. MS • CLEVELAND 7, OHIO



Only \$4.95 POSTPAID

SAY YOU SAW IT IN POPULAR MECHANICS

FREE! GET ALL THESE 5 PICTURE-PACKED COURSES

If you mail coupon NOW! Millions have been sold at \$1.

In 10 Minutes of FUN a day I changed myself from this Bloodless, Pitiful SKINNY SHRIMP to this **NEW MUSCULAR RED-BLOODED HEAD-TO-TOE HE-MAN!**

Ken GRIMM AFTER MAILING COUPON

I just GAINED 35 NEW LBS. OF SHAPELY POWER-PACKED MUSCLES!

You can do the same as I and THOUSANDS have. You can add 10 inches to your CHEST 6 inches to each ARM and the rest in proportion as I did. NOT friend you don't have to be SKINNY, WEAK or FLABBY any more just mail NOW the FREE coupon below as I did.

Besides getting ALL 5 Courses FREE you'll ALSO get FREE a big BOOK of PHOTOS of STRONG MEN and BOYS who were WEAKINGS like you BEFORE mailing coupon.

HOW YOU CAN WIN A BIG 15" TALL SILVER CUP as I just did and how to WIN \$100

LAST CHANCE COUPON — 5 COURSES FREE!

JEWETT INSTITUTE, Dept. PM-45
208 Fifth Avenue, New York 1, N. Y.
Dear George: Please mail to the above FREE Jewett's Photo Book of Strong Men, a Muscle Metal, plus all 5 Muscle Building Courses, "How to Become a Mighty He-Man," ENCLOSED FIND 50¢ for postage and handling (no C.O.D.'s).

NAME _____ AGE _____
ADDRESS _____
CITY _____ STATE _____

Start Spare Time Business MAKE UP TO \$10 an HOUR

Do-it-yourself
on own house
THEN EASILY SELL
Neighbors & Friends

You Pay Only
\$6.65*

(buy glass & screen
cloth locally)

You Sell For
\$22.00

You Make
Better Than
100%
PROFIT

*28 1/2"x58" redwood win-
dow. Other sizes and alu-
minum slightly higher.

A Few Dealer
Territories
Still Available

Assemble and Install Buckeye Combination STORM WINDOWS

- Factory-To-You In Knock Down Form
- Easy Assembly
- Redwood or Aluminum
- Glass and Screen Interchangeable
- Each Size Packaged Separately



No get-rich-quick scheme. Sound legitimate business opportunity. No special tools to buy. No big inventory to buy. Order as needed. Thousands sold in past 20 years. Our reputation your guarantee of quality.

Can be FHA Financed
Added to any home for an little as \$5.00 per month. No down payment. See your bank.

WRITE FOR DETAILS TODAY

BUCKEYE SCREEN & WEATHERSTRIP CO.
1380 S. 22nd Street, Columbus, Ohio

BENJAMIN SUPER CO₂ GAS CARBINE-\$16.50

NEWEST TARGET
RIFLE-22
IDEAL
FOR
SMALL
GAME



ECONOMICAL
SAFE-NON-TOXIC
ACCURATE-CONVENIENT
PRACTICAL. Easy to operate—No spring
recoil—No pumping. Uses low cost Soda Cartridges
Cal. .22 Benjamin H-C Pellets and Darts.

Benjamin CO₂
Gas Pistols
Also Available

WRITE FOR FREE ILLUSTRATED FOLDER OF ALL MODELS
BENJAMIN AIR RIFLES AND BENJAMIN AIR PISTOLS
BENJAMIN AIR RIFLE CO.
896 MARION ST., ST. LOUIS 4, MO. U.S.A.

LOOK BETTER! FEEL BETTER!

USE A Vibrosage

ELECTRIC MASSAGER

- Professional-Type
- 4 Scientifically Designed Applicators
- Sanitary

A few minutes daily use of VIBROSAGE gives that stimulating, healthful aid to circulation... relief from aches and pains. Four applicators assure maximum effectiveness for scalp, face and body. Operates on 110 volt, 60 cycle A.C. Five day trial—money-back guarantee! If your dealer cannot supply you, send \$8.50 check or money order, for pre-paid shipment. Or, send \$2; pay postman balance plus postage and C.O.D. charges.

BEAUTY APPLIANCE CORP., Dept. V524-E, RACINE, WIS.



REPLATE ELECTROPLATE

with METAL
NO TANKS USED

Any object in home, shop, garage or start your own well paying electroplating business. NEW SIMPLIFIED METHOD

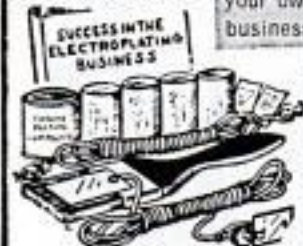

SUCCESS IN THE ELECTROPLATING BUSINESS

NOW, using this NEW plating kit it's easy for anyone to electroplate any object for themselves or for others. RESTORE old articles to look like new again by plating it with a REAL METALLIC coating using our kit. Even non-metals such as leather, rubber, cloth, etc. can be given a metal coat. The complete outfit and all the instructions on plating metal and non-metal objects with nickel, copper, chrome, gold, etc. plus full data on starting an electroplating business and obtaining all the business you desire and make BIG MONEY full or spare time. ONLY \$5.95. SEND NO MONEY now if you wish. We will send you everything C.O.D. plus postage. OR SEND \$5.95 NOW and receive it postpaid. If after trying it, you are not completely satisfied we will immediately refund your money.

W. Z. NATIONAL SALES CO.
113-2 W. 42nd St., N.Y. 36, N.Y.

JUST A FEW OF THE MANY OBJECTS YOU CAN NOW REPLATE

TOOLS, SILVERWARE, JEWELRY, AUTO PARTS, HOUSEHOLD ARTICLES, BABY SHOES, SPORTS EQUIPMENT, INSTRUMENTS, & 1001 ARTICLES.

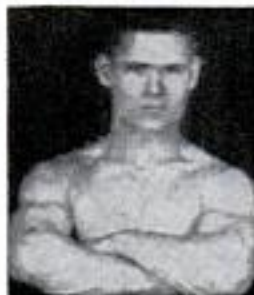

GREAT STRENGTH! EASILY OBTAINED!

Send \$1 for Complete Arm, Chest and Back Muscle Building Course and apparatus. Noticeable Results Guaranteed in 7 days or \$1 Refunded.

J. A. DRYER
Box 5527-P, Chicago 80, Ill.

FREE! "THE TRUTH ABOUT LEARNING TO DRAW"

Revealing New Release may save you money and disappointment. Don't enroll for any "Art Course" before reading facts. Sent free by ART ASSOCIATES, 918-F St. Paul Street, Baltimore, Maryland.

LOCKSMITHING & Key Making



PRACTICAL UP-TO-DATE COURSE—ONLY \$4.95

Easy-to-learn modern information for self-instruction. How to work on locks, de-code, make master-keys, repair, install, service, etc. For every handyman, home owner, carpenter, mechanic, service station operator, fix-it shop, hardware dealer, gunsmith. 53 plain illustrated lessons. FULL PRICE ONLY \$4.95. SEND NO MONEY. Just pay postman plus C.O.D. postage. Or send \$4.95 with order, we'll ship postpaid. Satisfaction guaranteed or refund. NELSON-HALL CO., 210 S. Clinton Ct., Dept. EW-2, Chicago 5, Ill.

MEN AND WOMEN TRAINED AT HOME FOR PROSPEROUS BUSINESS IN UPHOLSTERING

Tools, Supplies, everything necessary to get started sent. Illustrated training shows how — progress rapidly. No previous experience necessary. Make over old furniture, sell for many times cost to you. Establish full or part time money making business. Free booklet explains plan. Send name, address to

COMMERCIAL TRADES INSTITUTE
1400 GREENLEAF, DEPT. U2-5, CHICAGO 26, ILL.

Say You Saw It in Popular Mechanics

TELEPHONES



Desk Stand Style
Slightly used but in excellent condition
Many Valuable Uses
Inter-House Phones
Loud Speakers
Educational Purposes, Toys, etc.
House to Barn, etc.
Microphones

Come complete, ready to use with wiring diagrams included. Two complete for only \$5.00
\$2.75 Postpaid in U.S.A.
TELEPHONE LAMP KIT — with illustrated instructions for making Desk Telephone Lamp including all parts (barn, nipples, push switch, cord, plug, etc.) ... \$6.50 Ppd. (Shade is not included).

MICROPHONE, Dept. X-1402, 1760 W. Lunt Ave., Chicago 26, Ill.

POPULAR MECHANICS

Copyrighted material

**SAVE 75%
ON**



WORK CLOTHES!

**SURPLUS STOCK FROM
MIDWEST SUPPLY FIRM!**
Terrific values you've got to see to believe!

SHIRTS 79c
Made to sell for 2.99! Now Only 4 for \$2.99

What a buy! 4 for the price of one! These shirts, though used, are washed, sterilized and ready for long, tough wear. In blue or tan. Send name, address, neck size.

PANTS to match
Sold for 3.95 now only **99c**
Unbelievable Bargains! Send waist measure and inside leg length. 4 for \$3.75

COVERALLS ... wear 'em used and save plenty! Originally 5.95. Now only **\$1.95**
Send chest measurement. 3 for \$5.75

SATISFACTION GUARANTEED! Your money back if you can beat these bargains anywhere! You can't lose so order **TODAY** for immediate delivery! Pay postman or send money with your order and save postage. \$1.00 deposit on C.O.D. orders.

GALCO SALES CO. Dept. 135
7120 Harvard Ave. • Cleveland 5, Ohio

FREE! 105 British Empire STAMPS

Amazing offer! Worth over \$2 in Standard Catalog, sent FREE to make new friends. From Aden to Zanzibar—far corners of the world—including sensational new Queen Elizabeth, unusual stamps from Pitcairn, Cayman, Falkland Is. Free booklet "How to Recognize Rare Stamps"; interesting approval offers included. Send 10c for postage and handling. **KENMORE STAMP CO., Milford TN-380, N. H.**



WHEELS WHEELS WHEELS

- 7" Disc Wheel 3/4" Tire 3/4" sleeve 45c ea.
 - 8" Disc Wheel 1 1/8" Tire 1 1/8" sleeve 70c ea.
 - 7" Disc Wheel 1" Tire 3/4" ball bearing 80c ea.
 - 8" Disc Wheel 1 1/4" Tire 1 1/2" ball bearing \$1.00 ea.
 - 6" Disc Wheel 1.50 semi-pneum. Tire 1 1/2" B.S. \$1.35 ea.
 - 8" Disc Wheel 2" semi-pneum. T. 1 1/2" B.S. \$1.50 ea.
 - 10" Disc Wheel 1.75 semi-pneum. T. 1 1/2" B.S. \$1.50 ea.
 - 10" Disc Wheel 2.75 semi-pneum. Tire 1 1/2" B.S. \$3.50 ea.
 - 12" Disc Wheel 1.75 semi-pneum. T. 1 1/2" B.S. \$1.85 ea.
- Above wheel prices include hub cap. Plus Postage, C.O.D.'s accepted. AXLES—Sizes 5/16 in., 3/8 in., 1/2 in.—Cut to size—End holes drilled.

UNITED WHEEL STAMPING CO.
12131 S. PEORIA STREET PM-5 CHICAGO 43, ILLINOIS



GROW ORCHIDS AT HOME **BIG PROFITS SPARE OR FULL TIME**

World's most thrilling hobby—profitable home business. Single Orchid plant may multiply into many—each as valuable as the first. Successful home growers show you how! Raise gorgeous Cattleyas, Cymbidiums, Epidendrums, on living-room table. Big-profit orders come from friends, neighbors, florists, etc.—also Mail Orders. Illustrated secrets of the experts in simple "show-how" language AND blooming-size Orchid plants sent at **NO RISK**. Everything you need to start—for pleasure or profit. **FREE**—full details—**SEND NO MONEY**. Write today. **TROPICAL FLOWERLAND, Dept. 313, 4622 Wilshire, Los Angeles 5, Calif.**

PLYWOOD BOAT KITS



12 FT. \$97.00
14 FT. \$129.00
Freight included

Send for free folders on all models as low as \$39.00 freight included
TAFT MARINE WOODCRAFT
Dept. P.M., 636 39th Ave. N.E., Minneapolis 21, Minn.

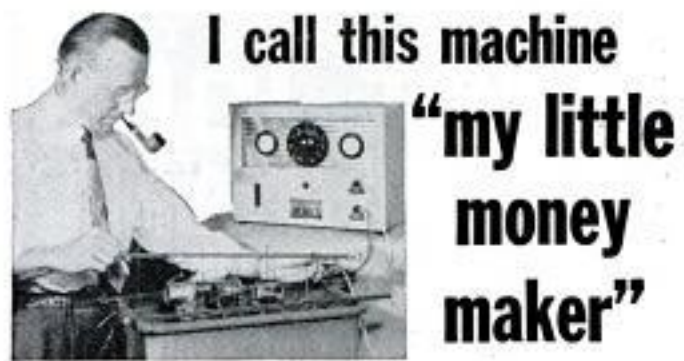

I call this machine "my little money maker"

You can put it anywhere—kitchen, attic, basement. It makes money for you while you're at work, asleep or at the movies. It turns out a product that sells for \$6.00. Materials cost you only 54c. So you make more than \$5.00 on each one. No house to house selling. I show you how to get orders by mail or through neighborhood stores. Millions of mothers everywhere want their baby's first shoes "Bronzed." The demand is increasing all the time. And it's so easy to metalize baby shoes at home, in spare time, while you keep your present job. It's the kind of work the whole family will have fun doing. The information I send you tells how you can get one of these "little money makers" too. There is no cost or obligation. So send a note or a postcard to me, John J. Mason, 1512 Jarvis Avenue, Chicago 26, Illinois and I'll send all this money making information by return mail, free and postage paid. Write to me right away so I can show you how to get started making as high as \$10 an hour in your spare time.

PREPARE FOR BETTER JOB, BIGGER PAY IN SPARE TIME AT HOME

Today, choose the job you want—and prepare for it in time you might otherwise waste. Or if you are already in the work you like best, start training now for quicker promotion and increased pay. During more than 50 years AMERICAN SCHOOL has helped ambitious people to reach higher goals. Check subject that interests you and mail coupon for full information.

AMERICAN SCHOOL, Dept. G545, Drexel at 58th, Chicago 37, Ill.

Without obligation, please send FREE and postpaid, full particulars about the subject checked below.

- Draughting—Building Trades
- Drafting—Machine Trades
- Electrical Engineering
- Electronics—Practical
- Electronics—Industrial
- High School Courses
- Machine Shop Operations
- Mathematics & Slide Rule
- Mechanical Engineering

- Plastics Engineering
- Plumbing—Practical
- Private Secretary
- Refrigeration
- Retail Merchandising
- Salesmanship—Outside
- Sheet Metal Work
- Tool Making

NAME..... OCCUPATION.....
HOME ADDRESS..... CITY..... STATE.....
CITY..... STATE.....

MAIL COUPON NOW

PREPARE FOR THE BEST JOBS

IN INDUSTRY

TRAIN at HOME
IN YOUR SPARE TIME
or at
ALLIED INSTITUTE
in Chicago

- MECH. ENGINEER
- DRAFTSMAN
- TOOL DESIGNER
- TOOL ENGINEER
- TOOL & DIE MAKER
- MASTER MACHINIST

NO RECESSION FOR ALLIED TRAINED MEN

MORE JOBS THAN GRADUATES Shortages of Draftsmen, Designers, Tool Engineers, Machinists, Tool & Die Makers are so widespread that you can pick a highly paid key job and look forward to Achievement and Security.

You can begin your training in Short Courses and continue progressively to a Bachelor Degree in 26 months.

Allied is approved by Industry, Dept. of Education, Office of Public Instruction, State of Illinois, U. S. Veterans Admin., U. S. Dept. of Justice. Accredited: C. S. A.

SEND FOR
FREE
BOOKS

ALLIED SCHOOL of MECHANICAL TRADES
1338-42 South Michigan Ave. DEPT. 5, Chicago 5, Illinois

SEND ME WITHOUT OBLIGATION INFO. ON YOUR COURSES:

HOME STUDY RESIDENT VETERAN NON VETERAN

NAME _____

ADDRESS _____ AGE _____

CITY _____ STATE _____



Bar Bells

Buy Direct From Factory **\$8.95**
Write for free booklet and price list. up

INDEPENDENT IRON WORKS
2416 East 23rd Street, Dept. B
Los Angeles 58, Calif.

Learn TELEVISION-ELECTRONICS

2 Big Books **FREE** Train at Home—Get Big Kits of Radio Parts! Prepare now in spare time. Practical instruction. Write for details and 2 Radio Books—ALL FREE! Rush name today!
SPRAYBERRY ACADEMY OF RADIO
Dept. 10-J 111 No. Canal Chicago 6, Illinois

RADIO

GO PLACES
LEARN ANOTHER LANGUAGE

EASILY — QUICKLY
by **LINGUAPHONE** **IN 20 MINUTES A DAY**

World's-Standard CONVERSATIONAL METHOD

FRENCH SPANISH GERMAN ITALIAN RUSSIAN JAPANESE PORTUGUESE—any of 29 Languages
Are interesting job, travel, armed services', cultural opportunities passing you by because you speak only one tongue? Learn another language **AT HOME** the same, natural, easy way you learned English long before you went to school. **YOU LISTEN**—you hear native men and women speak—you understand—**YOU SPEAK**. Worldwide educational endorsement; over a million home-study students of all ages. **FREE BOOK**. "Passport to a New World of Opportunity," gives fascinating facts. **WRITE TODAY!**

LINGUAPHONE INSTITUTE, 143-05 RCA Building, N.Y. 20, N.Y.

Send me your **FREE** book. I want to learn _____ language.

Name _____

Address _____

City, Zone & State _____

HOW TO MAKE Your Old Boat NEW

How to build your own FIBERGLASS BOAT

These Two Manuals Tell You How To:
• Protect your old boat permanently with liquid Castoglas • Form resilient plastic skin tougher than steel, lighter than aluminum • Make hulls leak-proof, weather-proof • Lay fiber mat and glass cloth for new boats • Build your own non-rusting, non-corroding tanks, compartments • Repair pipes, etc. • Skid-proof decks • Illustrated step-by-step instructions show how



BOTH FOR 25¢

YOU CAN DO-IT-YOURSELF easily and save one-half to two-thirds of cost. Send 25c for these two practical books. Satisfaction guaranteed. Limited edition, so order today.

DEALER: WRITE FOR PROPOSITION

MARINE DIV. **THE CASTOLITE COMPANY**
DEPT. ME-1 Mfg. Chemists—WOODSTOCK, ILL.

FURNITURE for YOUR BEDROOM



SAVE MONEY, be the envy of your neighbors by making this beautiful bedroom suite yourself! Only a power saw and jointer are needed to turn out this smart suite, featuring bed with storage space, three-piece vanity with cosmetic compartment and makeup mirror, Mr. and Mrs. dresser, and twin night stands with drawers. Letters demanding detailed plans poured in after this furniture was pictured in Popular Mechanics Magazine. Now the 4 plans are ready—easy-to-follow scale drawings—and they're yours for only \$2.00! Send for a complete set today.

POPULAR MECHANICS PRESS
200 EAST ONTARIO STREET, CHICAGO 11, ILL.

SEND ME



every month so I am sure to see each new issue. Here's

- \$3.50 for 1 year
 \$8.00 for 3 years

name _____

address _____

city _____ zone _____ state _____

Hand this order to your newsdealer or send it to

POPULAR MECHANICS
200 East Ontario St. Chicago 11, Ill.

The Most Fascinating Book About the Automobile Ever Printed!

Popular
Mechanics

AUTO ALBUM

The Motor Car in Picture
and Story from
1769 to 1952



You'll Find...
The Answers... the Fascinating Stories...
in the AUTO ALBUM

Who built the first horseless carriage?

Who obtained the first U.S. patent on an automobile?

Where did the name "automobile" come from?

Are you familiar with the workings of the Stanley Steamer... the "electrics"... the famous Ford Model T?

Do you know when the first Indianapolis race was won... by whom... at what speed?

Do you know the story of Henry Ford, Barney Oldfield, Ransom Olds, Walter Chrysler, W. C. Durant and other automotive giants?

166 Illustrations Including
94 Old-Time Cars — 22 Auto
Ads of By-Gone Days!

Here is a book you can't help enjoying and wanting, whether or not you have, or ever will own an automobile. It is the fascinating, thrilling and informative story of the horseless carriage from the first gasoline-propelled buggy to a forecast of the atomic car of the future.

Popular Mechanics AUTO ALBUM by Throm and Crenshaw presents America's first cars and the pioneering men who made them; the scrambled start and the development of the fabulous auto industry; the story of automobile racing; the growth of the Nation's highways. It is a book that just had to be published.

To Read... to Enjoy...
to Remember!

More than one-half of the book is pictures, most of them action pictures, from photos of old-time cars in operation. Other pictures show race cars from 1911 to 1951; early auto advertising, picturing 32 cars priced from \$375 to \$6000; tri-cycle autos, wind wagons, auto cycles and other automotive oddities. A roll call of horseless carriages is included — the names of more than 2000 cars made in the United States.

Gift Book of the Year

Get the fascinating AUTO ALBUM for yourself today. Send it as a gift to friends and business associates. Order on coupon below. Money refunded if you are not entirely pleased.



Cloth
Binding

Use Coupon to Get AUTO ALBUM

POPULAR MECHANICS PRESS, 200 E. Ontario, Chicago 11

Send at once postpaid — copies of Popular Mechanics AUTO ALBUM at \$3.00 each. Remittance enclosed. Send COD. I will pay postman plus charges. I understand books are returnable in 7 days for full refund if I am not pleased.

Name _____

Address _____

City _____ Zone _____ State _____

STOP MISPLACED-itis!



60 SEPARATE COMPARTMENTS
20 TRANSPARENT DRAWERS

- A See what's in each drawer
B Drawers can't fall out or spill contents
C Label slot on face of each drawer
D 7 different ways to make drawer compartments

Stop frantic searching for small items... here's perfect storage for every small article up to 6" long for sewing, office or hobby bench... threads, pins, nuts, bolts, stamps, jewelry, cosmetics, fishing lures, etc. Crystal-clear transparent plastic drawers for quick picking—can not spill—yet instantly removable. Welded, silver-grey, all steel cabinet with rubber feet.

No. 36—36 compart., 12 draw., 6½ x 12½ x 6", \$6.95

No. 60—60 compart., 20 draw., 10½ x 12½ x 6", \$9.95

No. 96—96 compart., 32 draw., 15½ x 12½ x 6", \$14.95

No. 144—144 compart., 48 draw., 22½ x 12½ x 6", \$21.95

BUY DIRECT BY MAIL. Send check or money order today! Sent postpaid. Money back if not delighted.

AMERICAN HOMECRAFT CO., Dept. 145
3710 MILWAUKEE AVENUE, CHICAGO 41, ILLINOIS

BUILD IT FIX IT with AMBROID

● Ready-to-use
● Fast drying
● High tensile strength
● Transparent
● Waterproof

IT STAYS STUCK

Dries entirely by evaporation of the solvent. Quick setting—no distortion. Ideal for assembling, repairing, home crafts, electrical work, factory, workshop or household use. Send postcard for free literature.

EE Try Ambroid in your business, too. For over 40 years recognized as the leading industrial adhesive of its type.

Art galleries, museums, and leading industrial concerns, rely on AMBROID

TRY A TUBE TODAY—At most hardware stores and hobby shops. If your dealer cannot supply you, send 30c for big 2 oz. tube, postpaid. Money back guarantee.

AMBROID 303 FRANKLIN ST.
BOSTON 10, MASS.

POPULAR MECHANICS

FAMOUS LITTLE LIBRARY OF USEFUL INFORMATION

Complete Set
of 126 BOOKS
only \$17.95

25 BOOKS	\$3.75
12 BOOKS	\$2.00
5 BOOKS	\$1.00

SINGLE BOOK 25¢

Here at amazingly low cost is the practical help and information you have always wanted. Articles in previous issues of Popular Mechanics have been classified according to subject and are now available in these handy reprint booklets.

Check titles wanted, clip ad, mail today.

HOME WORKSHOP

Power-Driven Saws—74: How to build.
Drill Presses, Plans, Grinders—79.
Sanders—80: Details on 8 machines.
Wood & Metal-Turning Lathes—81.
Filing Machine, Hack Saw, Cutoff Wheel, Shaper—82: Full details on these.
Metal Lathe Tools—101: How to build.
Workbenches and Tool Cabinets—47.
Spray Painting—84: Proper methods.
From Pattern to Casting—91: How castings are made in sand molds.
How to Use a Circular Saw—135.
Jigsaw Technique—136: How to use.
Bandsaw Know-How—137: Techniques.

HOME IMPROVEMENTS

Painting Your House Inside and Out—117.
Simple Home Improvements—104: Save money.
Building Extra Rooms in Your Attic—23: Add to the value of your home.
Basement Playrooms—24: Build an attractive playroom in your basement.
House Wiring—89: How-to-do-it.
Curing Leaky Basements—45.
Fitting Home Game Room—55.
Built-in Fixtures—78: Several.
Lower Your Fuel Cost—31: Practical kinks that will save you hundreds of dollars.
Hanging Wallpaper—38: Hints and tricks.
Ridding the Home of Insect Pests—107.
Constructing Indoor & Outdoor Fireplaces—88: Details on stone fireplaces.

CRAFTWORK • HOBBIES

Games and Puzzles—131: Have fun at home.
Model Planes You Can Build—129: Several.
Fun With Your Model Railroad—127.
How to Make Novelty Jewelry—126.
Working with Plastics—61: Novelties, etc.
25 Shelves You Can Make—64: Wall shelves, etc.
Novelties Turned on Lathe—62: Dishes, etc.
Projects in Plastics—112: How to use.
Inlay Pictures—Veneering—63.
Whittling and Wood Carving—65: Methods.
Action Toys—66: 21 easy-to-make toys.
Marionettes—113: How to make and use.
High Flying Kites—67: How to build.
Windmills & Weather-vanes—68.
Lamps in Wood, Metal, Plastic—69: Several.
Bows and Crossbows—115: How to make.
Playground Equipment—73: 8 projects.
Metal Craft—28: Simple instructions.
Weaving and Re-caning—37: Full details.
Gem Cutting—42: How to cut and polish.

USING TOOLS

How to Use Your Drill Press—125.
Correct Measurements—106: How to obtain.

Tool and Saw Sharpening—92: Tricks and hints.
Technique of Using Drills and Wood Bits—90.
Successful Wood Turning—32.
How to Read Blueprints—71: Tells you how.
Metal Turning Lathe Kinks—99.
Operating a Metal Turning Lathe—100.
Heat Treating and Case Hardening—102.
Working with Glass—103: Cutting, etc.
Using Basic Tools—120: Tips and hints.

WELDING • SOLDERING

Rewinding & Servicing Electrical Motors—75: Repairing and rewinding motors.
Electrical Appliances, How to Fix—111.
Electromagnets & Solenoids—44.
Transformer Construction—41: Directions.
The Boy Electrician—43: Five projects.
Soldering & Brazing—17: Tells how to.
Arc & Spot Welders—5: How to use & build.
Build Your Own Relays—123: Instructions.
Home Burglar Alarms, Secret Locks and Time-Setting Systems—128.
Welding with Arc and Gas—134: Tips.

AUTOMOBILE BOOKS

House Trailers—121: Build it yourself.
Automobile Kinks and Shortcuts—10.
Building Trailers—Small Teardrop and Utility—27: Can be built in your spare time.
Motor-Driven Midget Car & Scooter—34.
Curing Auto Electrical Troubles—95.

BUILD A BOAT

14 Ft. Outboard Runabout—2: How to build.
Rowboats, Bicycle Boat, Small Dinghy—83.
Small Sail Boats—84: For young sailors.
Two Outboard Runabouts—85: 14 ft. & 12 ft.
Build Your Own Canoe, Kayak, Surfboard—30: Complete building details.
Fast Class-E Ice Yacht—22: Build your own.

GARDENING HELPS

Lawn and Garden Equipment—124.
Handy Farm Implements—114: How to build.
Tractor Attachments—116.
Backyard Gardening—39: Helpful hints.
Lawn & Garden Novelties—72: Easy to build.
Trellises, Pergolas, Fences—76.
Lawn & Garden Furniture—77.
Colored Concrete Garden Furniture—6.
Farm & Garden Tractors—8: How to build.

PHOTOGRAPHY

Home Movie Equipment—118: How to use.
Photo Lighting—119: Helpful information.
Photo Enlargers—1: Complete plans.
Photo Printers & Dryer—25: Describes three.
Photo Darkroom Equipment—96.
Picture Projector, Trick & Table Top Photography—97: Tips on how to make.
Photo Kinks—98: Money-saving ideas.

FURNITURE MAKING

Furniture Upholstery and Repair—122.
Rustic Furniture—18: How to build.
Children's Bobm Furniture—51.
Book Ends—52: Good selection from 10 designs.
Small Tables—54: Interesting styles.
Desks—53: Many varied designs.
Smoking Stands—56: Seven designs given.
Plain & Novelty Wood Finishing—40.
Book Cases—59: Eight designs.
Magazine Racks—49: Ten attractive racks.
Clock Cases—50: Several types.
Serving Trays for Every Occasion—53.

MISCELLANEOUS

Cleaning Formulas—11: Make your own.
Re-Silvering Mirrors—70: How to do it.
How to Build a Concrete Block Machine—110: Make your own block machine.
It's Easy to Tie Knots—105.
Chemical Experiments—93: Several.
Taxidermy—9: How to mount small animals.
Log Cabins and Tourist Cottages—14.
Magic for Everybody—29: Simple tricks.
Trapping Small Animals—33: How to trap.
Training Your Dog—35: Tricks and obedience.
Small Furnaces—36: For melting copper, etc.
Electroplating with Copper, Nickel, Chromium, Lead, Zinc, Cadmium—86.
Plating Non-Metallic Objects—Plating with Gold, Silver, Alloys—87.
Telescopes—20: Design and construction.
Poultry Houses—108: How to build.
Guns & Decoys—109: Clean guns, make decoys.
For Better Business—130: Timely tips.
For Better Business—132: Saves time.
For Better Business—133: For smooth operation.

USE THIS HANDY ORDER COUPON NOW!

POPULAR MECHANICS PRESS
200 E. Ontario St., Chicago 11, Ill.
I enclose \$_____ (U.S. currency may be mailed if carefully wrapped) for "Little Library" booklets numbers:

24 Books	12 Books	5 Books	1 Book
\$3.75	\$2.00	\$1.00	25¢

NAME _____

ADDRESS _____

CITY _____ ZONE _____ STATE _____



BEFORE AFTER



ATTENTION: MEN & WOMEN

Do you want a perfect body? Are you interested in glowing, abundant health? If so, do as Miss Paula Trimmer, Mr. John Oschner and thousands of others have done. Send today for the most revolutionary, easy-to-do course in Physical Conditioning ever offered to the public. No fancy equipment to buy. Do these simple exercises in the privacy of your own home. Complete home training course for both sexes and all ages in three profusely illustrated volumes and including special diets, all for only \$5.00 postpaid. Results guaranteed or money refunded. Send check, money-order or \$5.00 currency today to —

JACK LA LANNE

Dept. A, 422-13th St., Oakland 12, Calif.



HAVE A BIGGER — MORE EFFICIENT HOME WORKSHOP

Popular Mechanics **PLANNING YOUR HOME WORKSHOP** shows you how to make use of every inch of space in your workshop; detailed floor plans, wiring layouts and power tool hookups plus actual photographs of famous home workshops you can use as models. Save money by building your own shop furniture. Special Where-to-Buy-It Guide, 450 Illustrations, Cloth Bound, Working Diagrams. Order your **\$2.50** copy today from
POPULAR MECHANICS PRESS
200 E. Ontario Street Chicago 11

FALSE TEETH WEARERS

35 days supply new, improved **RIGIDENT Comfort-Cushion DENTURE RETAINER** only 35¢ at drug counters. Sent postpaid when ordered direct. Keep dentures tighter, more comfortable, odorless, with user-proved **RIGIDENT • RIGIDENT PRODUCTS CO.**
Suite 623-PM, 610 So. Broadway, Los Angeles 14, Calif.

HELPFUL BOOKS

Send post card asking for **FREE** catalog
Popular Mechanics Press, 200 E. Ontario, Dept. 601, Chicago 11

OWN A... FORD?

FIX IT YOURSELF!

Popular Mechanics Magazine has just published a new **Owners Manual** covering all 1941 to 1952 models of Ford cars . . . So accurate mechanics use it . . . so simple a woman can understand it.

Save money on your Ford car repairs. Prevent trouble. Enjoy care-free driving. Increase trade-in value. Avoid major repairs by fixing minor troubles before they get serious. Get sparkling performance at all times. Has 272 pages, more than 350 photos, diagrams, tables, charts, breakdown drawings, plus clear, non-technical directions that make all repairs simple as A B C. Written by Ed Paeker with the assistance of the Ford Motor Company. Shows you how to diagnose all Ford troubles by feel, sound, sight, smell and performance. Simple trouble shooting. Permanent repairs. Emergency repairs. Plus, "How to get value from garages."

MONEY BACK IF IT DOESN'T SAVE MORE THAN IT COSTS!

One minor repair will save the cost ten times over. Read it. Then you decide. If you don't see that you'll save more than the cost, send it back for refund. **SEND NO MONEY.** Send postcard. Ask for the **Ford Manual**. Postman will deliver C. O. D. for \$3.50 plus postage. Or, save postage by sending \$3.50 with order. Send today. Save its cost on your next repair.

POPULAR MECHANICS PRESS

200 E. Ontario, Dept. 90, Chicago 11, Illinois



Koenig ALL-STEEL CABS FOR JEEPS

SAFETY FOR PASSENGERS AND CARGO THAT ONLY STEEL CAN GIVE



Full cabs cover entire body. Half cabs cover front passenger compartment.

Available in full cabs and half cabs for all Willys Jeeps.

- ★ **PROTECTION** — Complete protection from all weather. Valuable cargo protected by locks.
- ★ **SAFETY** — All-steel, welded construction. No rivets. Safety glass used throughout.
- ★ **COMFORT** — Full air-spaced head lining and door lining. No vibration.
- ★ **CONVENIENCE** — Roll down windows, full opening.

KING WINCHES for all Willys Jeeps, 4 W.D. trucks and 4 W.D. station wagons. **ALSO ALL OTHER MAKE TRUCKS.**

KING WINCHES get you through mud, sand, snow, slush, gulleys and icy slopes when wheel traction fails. For hoisting and moving machinery, logs and heavy objects where strong, smooth pull on a cable will make work easier, safer and more economical.



KOENIG CABS and **KING WINCHES** available through **KAISER-WILLYS DISTRIBUTORS** and **DEALERS.**

KING Galvanized Hand Winch. Tested over 1000 lbs. Capacity 100' 1/4" cable. Can't rust. All steel construction, with bronze bearings throughout. Mounts horizontally or vertically. Right hand or left. Adjustable handle lever. Positive ratchet either direction.

Koenig Free

Write for descriptive literature

Dept. M, 2214 Washington Ave. Houston 10, Texas

"I DOUBLED MY INCOME IN LESS THAN A YEAR as a CUSTOM UPHOLSTERER"

Alvin Lederkramer, formerly low-paid Auto Mechanic, earned extra money while learning! Now has **BIG PAY JOB!**

NOW — You Can Become An Expert UPHOLSTERER AT HOME

Right at home in your spare time, **YOU** can become a skilled, expert upholsterer. Not only can you **EARN WHILE YOU LEARN**, but your course includes **FREE—ALL** tools, complete frames, fabrics and materials you use to make beautiful upholstered furniture and slip covers worth over \$200.—yours to keep or sell.

Step into a well-paid job—**BE YOUR OWN BOSS**, or make big spare-time money. Our practical, **UTS N.Y. State Approved** training qualifies you quickly. You will actually be upholstering furniture almost **AT ONCE!** Course includes professional custom upholstery, reupholstery, furniture finishing, repairs, slip covers, window cornice, cushion and drapery making; a lesson "Starting Your Own Upholstery Business" and Wholesale Supply Service privileges.



Our **FREE** book, "Your New Way to a Successful Career" tells how you prepare at home for this big pay, big opportunity trade. **WRITE TODAY.** Training in N.Y. School also available. **Upholstery Trades School, Dept. CE-301, 721 Broadway, New York 3.**

SEND FOR BIG FREE BOOK

UPHOLSTERY TRADES SCHOOL, Dept. CE-301
721 Broadway, New York 3, N. Y.

Send me free book on:

Home Study N. Y. School Training

Name _____

Address _____

City _____ Zone _____ State _____

Check here if Korean veteran

BUILD YOUR OWN MOTOR SCOOTER!



PRICE COMPLETE **\$39.95** F.O.B. ST. LOUIS, MO.

The Hurricane Scooter Kit comes to you complete as illustrated, ready for the motor. This scooter will perform beautifully with a motor from 1 h.p. to 1½ h.p. with speeds up to 25 miles per hour. Will carry a 200-lb. load. Not a toy, but a sturdy, medium-sized all-steel scooter. Kit includes everything except motor.

Send post card for descriptive folder.

ST. LOUIS PRODUCTS CO., BOX 24 PE, NORMANDY 21, MO.

High School at Home

Many Finish in 2 Years

No classes. No time wasted going to and from school. Progress as fast as your time and abilities permit. Standard H. S. texts supplied. Thousands enroll each year in this 57-year-old school. Send for FREE descriptive booklet.

AMERICAN SCHOOL, Dept. H545
Drexel at 58th St., Chicago 37, Ill.

Without obligation, please send FREE descriptive booklet.

Name _____

Address _____

DAN LURIE
"America's Most
Muscular Man"
—on television's
"Big Top."



FAMOUS DAN LURIE

BARBELLS

with 4 courses—low factory prices

50 lb. set... \$ 8.48 | 150 lb. set... \$20.48

100 lb. set... 13.98 | 200 lb. set... 25.98

Write for Free Catalog Order by Mail: 50% with order, bal. C.O.D.
Extra wts. 13c per lb., F.O.B. plant

DAN LURIE BARBELL CO.

1701-M-5 Pitkin Ave., Dept. 459-E, Brooklyn, N. Y.

Say You Saw It in Popular Mechanics



START AS HIGH AS \$3,795.00 A YEAR

MEN—WOMEN
Thousands ap-
pointments being
made. 36-page
Book FREE.
Vets Get
Preference
Mail Coupon
Today. SURE.

Prepare NOW for next exams

FRANKLIN INSTITUTE (Not Gov't Controlled)

Dept. M-53, Rochester 4, N. Y.

Star: Rush without charge (1) 36-page book with

list of U.S. Government Jobs; (2) Tell me how to

qualify for one.

Name _____

Address _____

Age _____

NEW! ALL ABOUT TELEVISION



Service Your TV Set Yourself and Save Hundreds of Dollars . . . Save on the Purchase of a New Set!

Here's the brand new book that tells and shows you how 9 times out of 10 you can service your TV set yourself and save the \$5 to \$25 fee charged by professional repairmen for service calls.

Make Most Repairs Yourself

Here are famous step-by-step instructions by John Derby, famous television engineer, which make it possible for you to locate trouble quickly and repair it in the matter of minutes. Hundreds of "show-how" photos, drawings and diagrams actually show you just how to go about making most TV repairs.

Actual Photos Show You How

A special illustrated section contains actual photographs of imperfect TV pictures. By comparing the picture on your set with those in the book you immediately identify the trouble and then by following Derby's instructions you make the adjustment or repair which will give you perfect reception once again.

Find out how to install your own antenna at a savings of as much as \$20 . . . how to replace burned-out picture tubes . . . how to get the best reception in outlying areas . . . how to save money when buying a new set . . . what to look for when you purchase a TV set.

Go "Behind the Scenes"

Go with Derby into TV studios and see stars in action . . . see how television shows are produced and what goes on "behind the scenes."

No other TV book on the market is so comprehensive and so chock-full of valuable information.

Money Back Guarantee

Send just \$1.98 for your copy of "All About Television." Read it for seven full days and unless you agree that it can save you hundreds of dollars and enable you to service your TV set yourself just slip it back in its wrapper and return it to us for a full refund.

Order on this Handy Coupon

POPULAR MECHANICS PRESS

200 E. Ontario Street, Chicago 11, Ill.

Remittance for \$1.98 enclosed. Rush postpaid my copy of "All About Television." Unless it is entirely satisfactory I may return it within seven days for a full refund.

NAME _____

ADDRESS _____

CITY _____

ZONE STATE _____

Send C.O.D. (Postage extra)

THIS WIRE HAS NOT BEEN OVERSEAS
 This high quality two conductor communication wire offered in No. 18 and No. 22 gauge is ideal for inter-rooms, lead-ins, telephones, indoor and outdoor speaker extensions, doorbells, signal and burglar alarm systems, shot firing, etc., etc. **SAMPLES ON REQUEST.**

U.S. GOV'T CLOSEOUT
Wire
U. S. Signal Corps Communication Wire
 TWISTED TWO CONDUCTOR No. 18 STRANDED per 1000 ft. \$5.00
 TWISTED TWO CONDUCTOR No. 22 STRANDED per 1000 ft. \$7.50

NEW WAR SURPLUS
 Made to rigid Signal Corps specifications

Won't Last Very Long at These Prices
Stock Up Now — Subject to Prior Sale — Order Today
W-110-B — TWO CONDUCTOR #18 STRANDED (four steel and three copper strands) rubber covered plus weatherproof cotton braid and twisted, 5,280 feet per steel reel. Only \$3.50 per thousand feet on 5,280 foot reels or \$18.25 per reel.
W-130—TWO CONDUCTOR #22 STRANDED and twisted (one copper and six steel strands) in your choice of rubber or plastic insulation, 10,000 feet per steel reel. Only \$3.50 per thousand feet on 10,000 foot steel reel or \$35.00 per reel.
 (Note: Steel strands are incorporated for extra tensile strength and are lined and treated for efficient conductivity.)
 Wt. per 100 ft. #18 wire, 28 lbs. Wt. per 100 ft. #22 wire, 11 lbs. All these way below market prices, our stock will not last long. Take advantage of this exceptional closeout and **STOCK UP NOW!**
 Prices F.O.B. Chicago. Include approx. postage on orders paid for in advance. C.O.D. orders enclose 25% balance sent C.O.D.

U. A. S. Corp. Dept. PM5, 5637 W. 63rd Pl. Chicago 38, Illinois

Operation "EASY STREET"
 Take the Red Comet road to Big Profits

Earn up to \$10,000 or more per year!
Nothing to invest! Full or part time!
 Make year-round profits selling famous Red Comet automatic fire extinguishers. Easy to sell! Every home, farm, business a prospect. Advertised Post, Collier's, Country Gentleman. Priced to sell quickly—a sales "natural"!

FREE SALES KIT
 Demonstrator units, sales literature, etc., furnished you FREE. Handsome leather-type kit. Tried and proved over 21 years, it will make you an independent business man. Someone in your community will be appointed soon. Write for details today!

RED COMET, Inc.
 Dept. 336-L, R.C. Bldg., Littleton, Colo.

U.S. Pat. D 153853 D 153854

FREE BOOK CATALOG

Everything—shop tools, hunting, fishing, making money at home, concrete work, welding, mail order, plastics, painting, carpentry, photography, boat building, gardening, auto repair, hobbies, home building—is listed in the new 40-page 1953 catalog of easy-to-understand Popular Mechanics books. Write for your free copy now! Dept. CT2,
 Popular Mechanics Press, 200 E. Ontario, Chicago 11

Smarter Low-Cost Boating

NOW ONLY 95.— UP

Your steadier, sturdier, streamlined Travel Craft Supreme

FOLBOT
 for **EASIER FISHING**
Better Hunting

ACTION CATALOG FREE

1 to 4 seaters, paddling, yacht-smart sailing, quieter motoring 1 to 10 HP

Tiny Telescope
gives "CLOSE-UPS"
FROM MILES AWAY

A Powerful telescope yet the size of your thumb! Conceals completely inside palm of hand! A revolutionary German made optical achievement. Precision easy-slide operation. Scientifically ground lens provide Brilliant Illumination, sharp detailed images. Lustrous ALL CHROME with black trim. An all purpose performer... instant focusing from 2 feet to infinity! **NOT A TOY!** Case 50¢ extra.

ONLY \$3.95 TAX FREE

No Risk TRIAL OFFER. If not 100% satisfied after 10 Day Trial return for full refund. Cash orders \$3.95 postpaid. (C.O.D.'s \$4.51)
UNITED BINOCULAR CO., 9043 S. Western, Dept. PT-301, Chicago 20.
DEALERS WANTED

.22 RIFLE CARBINE STYLE
\$14.95

German Precision, simplified, 4 lb. FEATHERWEIGHT rifle. 34" long. Flanged. 1 screw takedown. Automatic ejector with self adjusting sporting rear sight, blade front sight, HIGHLY POLISHED BOLT ACTION. Blued. Amazingly accurate. Replacement parts easily secured. SHOTS AMERICAN LONGS, SHORTS, LONG RIFLE (regular & hi-powered). 10 DAY NO RISK TRIAL. If dissatisfied return for refund. Transportation collect. C.O.D.'s require \$2 deposit. Mail Orders Only. State Age.

UNITED ARMS, 9043 S. Western, NHOB-685, Chicago 20.

SPINNING REEL \$4.99

Guaranteed top performance at bottom price. Featherweight aluminum. Positively no Backlash. Hard brass synchro-meshed gears. Full ball pickup, fingertip drag control. Unbreakable spool (250 yd. capacity).

USE 10 DAYS AT OUR RISK
 If not satisfied return for refund. Add \$1.00 postage, handling. Immediate delivery. **UNITED PRODUCTS CO., 9043 S. Western Ave., Dept. 5PR-102, Chicago 20.**

30 POWER! WHISPER WEIGHT
8 1/2 OUNCES

Nearest Pocket Telescope engineered for UNITED to give you sharper, clearer, crisper images and smooth, easy-sliding focusing action. Use indoor, outdoor, vacationing, trips, closeup and long distance viewing. 3" closed, 14 1/2" extended.

\$9.95 TAX FREE

NOT A CHEAPLY MADE TOY TELESCOPE. But a precision, all metal, chrome trimmed achromatic masterpiece. Interiors of VITAL front Achromatics are COATED assuring needle sharp viewing! Pyrex includes handsome carrying case. Made in Japan. **UNCONDITIONALLY GUARANTEED.** Try for 30 days. If not satisfied return for immediate cash refund. Cash orders postpaid. C.O.D.'s require \$2.00 deposit. **UNITED BINOCULAR CO., 9043 S. Western Ave., Dept. ARF-7308, Chicago 20, Illinois. DEALERS WANTED.**

HELPFUL BOOKS

Send post card asking for FREE catalog

Popular Mechanics Press, 200 E. Ontario, Dept. 601, Chicago 11

FOLBOT CORP. -PM-
 Stark Industrial Park, Charleston, S.C.

Name: _____
 Address: _____
 City: _____ State: _____

WHY PAY MORE? Family-safe Partially-used **TIRES (NOT RECAPS)**
MONTH AFTER MONTH. FOR YEARS, YOU SEE OUR AD.



FREE TIRE ASH TRAY
WITH YOUR NAME
WITH TWO OR MORE TIRES
CAR \$3 (20 Mo.) TRUCK \$11
TIRES \$3 (20 Mo.) TRUCK \$11
TAKE 10% DISCOUNT



GOODYEAR, FIRESTONE, GOODRICH, U.S. & OTHERS. FREE TUBE WITH EVERY TIRE

America's Most Respected Golden-Rule Guarantee

FREE REPLACEMENT IF DEFECTIVE.	
32 Mos. or 50,000 Miles	34 Mos. or 55,000 Miles
600-16 \$5.14	640-15 \$4.84
600-16(6) 8.64	670-15 5.24
650-16 5.64	710-15 5.34
650-16(6) 7.14	760-15 5.84
700-16 6.24	800-15 6.24
700-16(6) 7.24	820-15 6.24
750-16(6) 8.34	850-15 5.14
850-17 4.44	700-17 2.24
875-19 5.34	800-20 4.00
WHITEWALLS \$1 EXTRA	700-20 10.74
	32x6(R) 10.74
	11.04 750-20 13.24
	Tough, Rugged truck Tires
	6-8-10-12-14-Ply Tires
	11.04 750-20 13.24
	9.34 825-20 17.74
	8.94 900-20 17.84
	11.84 1000-20 16.84
	8.24 1100-20 17.84
	9.74 1200-20 18.84
	10.74 1000-22 18.04
	11.04 1100-22 18.04

MILITARY GRIP (Not Retreads) **MUD-GRIP RETREADS**
750-20 Super 20 Mos. \$12.22 Rugged 34 Mos. \$14.44
900-16 Super 20 Mos. \$12.22 Rugged 34 Mos. \$14.44
Any Car \$7 32 Mo. Guar.

"I have personally pinpoint inspected every tire, as if our very future depended on it. There's not a tire here I wouldn't use myself. I ask one chance to treat you right." Mort Blatt, Mgr., Faithfully serving motorists, hospitals, schools & churches since 1917.
BLATT PHILA., PA., 11th & SPRING GARDEN ST. Send ck. or M.O. and this ad.
MIAMI, FLA., 2827 N.W. 7th AVE.
—Thousands of shipments Rushed all over the world.

MILLIONS NEED NEW INVENTION:

Amazing new tool cleans, fluffs, vitalizes paint roller jacket in seconds. A streamline method to eject the wool jacket from the roller without handling. No expensive roller cleaning fluid to buy. Same paint roller may be used for years. Gives your electric drill another profitable use. Money back guarantee. Send just 59c to:
SPIN-IT, INC., Dept. 101
838 N. 13th St., Milwaukee, Wis.
DEALER INQUIRIES INVITED

earn \$15 as TAX EXPERT

We train you! Men, Women urgently needed for this booming year 'round business. Earn big fees as Tax Consultant. Make day's pay in hours. Work at home or office. Full, spare time. No experience necessary. FREE details. Write today.
UNION INSTITUTE, Lakewood 9-A, N. J.

BEING PUSHED AROUND??

Why take any more nonsense from bullies, wise guys and other pests? The next time they try to art smart—give them the surprise of their lives! It's easy when you know **POLICE JIU JITSU!** This complete, fully illustrated course comes to you in one volume. The same as taught to police, marines, "G" men, soldiers, sailors and members of the U. S. Coast Guard. By all means, send \$1 to this ad and we will send **POLICE JIU JITSU** to you postpaid by return mail. Satisfaction guaranteed or your money back.
BOOKS PUBLISHING CO., AMITYVILLE, N. Y.

Say You Saw It in POPULAR MECHANICS

ELECTRIFY your SEWING MACHINE

NEW LOW PRICE! \$9.95 1 YEAR GUARANTEE

Buy direct from manufacturer and save! Kit comes fully wired, installed in a jiffy. Fits all machines! You get **ALL-NEW PARTS**
• Motor & Bracket
• AC-DC 115v 60c
• Multi-speed foot control
• Cord set & block
• Easy instructions
• Steel pulley & belt

FREE . . . reg. \$2.95 chrome SEW-LITE given with every kit.
10 DAY FREE TRIAL—ORDER NOW!
Send no money, pay COD or send money order and we'll pay postage. Please state whether wheel on your machine turns toward you or away from you. Shipping wt. 6 lbs.
SENIOR SEWING MACHINE CO.
Box 147 Dept. PM55 Brooklyn 6, N. Y.

BE YOUR OWN BOSS
Make Hundreds of \$ Spare or Full Time Work

You can make simply and cheaply

NO EXPERIENCE NEEDED
Here is the ideal business with no previous experience or large investment required and no high-priced equipment to buy. A business that will return dollars for the pennies you invest.

YOU CAN CAST ANYTHING
With *Flexible Mold Making and Ornamental Casting*, an amazing fact-packed book, you learn how you can cast practically any article in concrete, plaster, imitation marble or any other casting material using a marvelous new process. You can make ash trays, novelties, garden and lawn ornaments and hundreds of other highly profitable items that cost you but a few cents and sell for as much as \$5.00 and more. Why you can even make true-to-life full-sized busts of your neighbors and friends.

NO EXPENSIVE MOLDS TO BUY
Why buy high-priced molds from others? Learn how you can make your own molds quickly, easily and inexpensively with materials that can be used over and over. You get copyrighted formulas, complete instructions and detailed how-to-do-it photographs as well as complete sources of supply for the few inexpensive materials you need. This is the only book printed in America today that contains instructions for making profitable papier-mache casts.

MONEY BACK GUARANTEE
Start on your road to extra income and independence today. Send only \$3.00 for your copy of *Flexible Mold Making and Ornamental Casting*. Complete satisfaction guaranteed or your money refunded within seven days.

POPULAR MECHANICS PRESS, Dept. 46
200 E. ONTARIO ST., CHICAGO 11, ILL.



Save on all PLUMBING JOBS

When You Build - When Making Improvements - Repairs - Maintenance

Get **POPULAR MECHANICS Home Plumbing Guide**



How to plan plumbing installations, select materials and fixtures.

15 Ways to Save Money
All about modern home plumbing
How to use plumbing tools
Getting acquainted with pipe
Planning home plumbing systems
Installing and maintaining home drainage systems
Private sewage disposal systems
Causes and cures of drainage troubles
Installing home water lines
Private water supply systems
Water Heaters
Water Conditioning
Water system troubles and cures
Installing and caring for fixtures
What to do with valves and faucets

How to save money on all plumbing jobs using approved methods.

Easy to Do Professional-Like Jobs and Save Over One-Half

Get the Popular Mechanics **HOME PLUMBING GUIDE**. It shows how you can do every kind of plumbing job yourself and save from a few to hundreds of dollars. Covers plans, layouts, installation, maintenance and repair. Shows what materials to get and use, where to get them and how to do a proper job with approved methods. Few, other than the simplest tools are required and

some of these can be rented. Don't pay high prices for work you can do yourself. Get the **HOME PLUMBING GUIDE** for only \$3.50. You will be amazed how jobs you thought difficult are simplified.

Clip This Ad and Mail. Money Back if Not Pleased

Invest only \$3.50. Use the book for 7 days. Then if you are not satisfied return it for full refund of your money. Sent C.O.D. (U.S.A. only) if you prefer.



Over 500 How-to-do-it Pictures Guide You
POPULAR MECHANICS PRESS, Dept. HPG-10, 200 E. Ontario St., Chicago 11

Now You Can Upholster Any Piece of Furniture!

Upholster—Restyle Any Piece of Furniture Yourself

John Bergen, custom furniture designer, tells and shows you how to transform old out-of-date furniture into brand new smart-looking comfortable furniture in his new book **ALL ABOUT UPHOLSTERING**.

No Experience Needed

Bergen tells you every step to follow in amazingly clear easy-to-understand step-by-step instructions and then shows you how in hundreds of big, clear drawings and photos. You read and see how to strip the old frame, install new webbing and springs, apply burlap, install stuffing and padding, fit the muslin cover and the final fabric and install trim.

Use New Materials—Methods

Now you can have furniture upholstered with foam rubber, sagless springs and other new materials that add so much to comfort and durability and are so costly when included in new furniture.

Save 50% of Usual Cost

Don't pay a small fortune for new furniture when you can make your old furniture better than new! Why pay high prices to have someone else upholster and restyle your old furniture when you can do it yourself for cost of materials alone? It's easy and it's fun.

Special Chapter on Slipcovers

Learn how to make custom-made slipcovers with professional look and fit. Find out how you can realize tremendous savings by investing a few spare-time hours and the cost of a few yards of fabrics.

7-Day Money Back Guarantee

Send for your copy of **ALL ABOUT UPHOLSTERING** today. Read and use it for 7 days. If it isn't entirely satisfactory return it for a full refund.

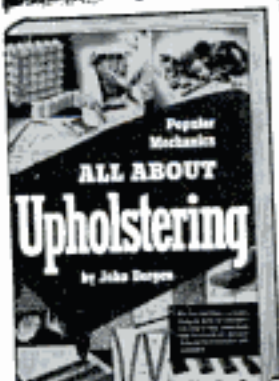

more jobs than graduates

Demand for our engineering graduates exceeds supply. Effective placement! Study in this world-famed college... established 1884. New term starts quarterly. Approved for Korean Vets.

ENGINEERS
 If you are an interesting person, pay you to write Box D 3 including a complete history of engineering and education.

Bach. Sc. degree in 27 months

Bachelor of Science in Mechanical, Civil, Electrical, Chemical, Aeronautical, Radio (Television), Administrative Engineering; Business Administration and Accounting. Also 36-week certificate courses in Surveying, Drafting, Secretarial Science. Intensive program: technical fundamentals accented.

Small classes: personalized instruction. For earnest, mature students whose time and budget require accelerated courses and modest costs. Preparatory courses.

Beautiful campus in friendly college town. Well-equipped, new and modernized buildings and labs. Enter June, Sept., Jan., March. Write Jean McCarthy, Director Admissions, for Catalog and View Book.



TRI-STATE COLLEGE

454 College Avenue

Angola, Indiana

STAMP COLLECTORS!

317 STAMPS - 25c plus FREE Stamp Encyclopedia



Special imported collection includes **STALIN DEATH STAMP**; New Zealand **QUEEN VICTORIA** 98-year-old proof (sold \$5 at auction); plus hundreds more from all over the world! 317 different stamps—reg. \$3.50 value—all yours for 25c with Bargain Approvals. Fascinating book included, free.

SEND 25c TODAY ASK FOR LOT FO-15 ZENITH CO., 81 Willoughby St., Brooklyn 1, N.Y.



MAKE BIG MONEY

RAISE PARAKEETS
 Tremendous Cash Market. No experience needed. FREE Illustrated Booklet, WRITE TODAY
PARAKEET BREEDERS ASSN. OF AMERICA
 Dept. 14, 4333 Lovers Lane, Dallas 25, Texas

WARNING! VETERANS DISCHARGED BEFORE AUG. 20, 1952, must be IN TRAINING by Aug. 20, 1954, or lose G.I. rights to free education under NEW G.I. bill. Train at home to become a TV Technician! Time is short. Send for FREE LITERATURE. **RADIO-TELEVISION TRAINING ASSOCIATION**, Dept. M-5B, 52 E. 19th St., New York 3, N. Y.

PORTABLE GARAGE

\$6.75 (Former Price \$10.00)

USE IT ANYWHERE

- Folds compactly • Keeps rain, snow, dust, salt air, sun away
- Protects your car's finish • Durably constructed of vinyl plastic
- Springlike elasticized bottom, holds securely • Fits all makes
- Direct from MFG. • Enclose payment of \$6.75 plus \$3.35 postage or sent C.O.D. 10-Day Money Back Guarantee.

EXTRA HEAVY GARAGE \$8.95 (Formerly \$12.00)

MARDO SALES CORP.

480 LEXINGTON AVE., DEPT. G-012, NEW YORK 17, N. Y.



Plastic Vinyl

USE THIS HANDY ORDER COUPON

POPULAR MECHANICS PRESS, Dept. AAU
 200 E. Ontario St., Chicago 11, Illinois

Gentlemen:

Please send my copy of **ALL ABOUT UPHOLSTERING**. Enclosed is my remittance of \$3.50. If I am not completely satisfied with the book I will return it for a full refund after 7 days.

Name _____

Address _____

City _____ Zone _____ State _____

DO YOU LIKE TO DRAW?

SEE HOW EASY IT IS Step by Step!



Enjoy drawing, painting, advertising art or cartooning at home in your spare time. Earn while learning. Step-by-step method helps beginners quickly. Low tuition. 40th year. Send coupon for free booklet. No salesmen.

Send free "Art for Pleasure & Profit."

Washington School of Art
 Studio 125 N
 Washington 5, D.C.

Name _____

Address _____ Age _____

City, Zone, State _____



THAT'S YOU UP THERE

where
the living's good!

That's YOU, elevated to the world's best living by the proven brands of products that never let you down—and for a very down-to-earth reason: each manufacturer has to live up to the highest standard set by his competitors. His product *has* to be good to survive—it's as simple as that. So if he changes it at all, you can be sure he's aiming at something better.

That's why you can shop so confidently, so profitably, so easily, by buying products with responsible names. Living on top of the world?—you bet! But you're on ground as safe and sound as your own back yard.

*Easy to keep up on what's good:
just read the ads in this magazine.*

**BRAND NAMES
FOUNDATION**
INCORPORATED

A NON-PROFIT EDUCATIONAL FOUNDATION
37 WEST 57 STREET, NEW YORK 19, N. Y.

**WANT CONFIDENCE? PATRONIZE THE DEALER
WHO PROVIDES YOUR FAVORITE BRANDS**

Reading time: 3 minutes to learn how to

- cut engine wear up to 38%
- prevent loss of power, compression
- save 15%-25% on oil . . . without ever changing your oil filter

This Gadget is Worth \$320,000,000

...and I Discovered it by Accident!

by Albert Wells

IT ALL STARTED the day I got the bill: \$214.36 for an engine overhaul—and I had only 28,000 miles on the car!

I told my troubles to a neighbor—a lubrication engineer—told him how I'd always changed oil every 1500 miles, changed filters every 5,000 miles. His answer floored me.

"You've been wasting your money," he said. "We've spent millions developing oil additives that keep carbon, gum and abrasives from damaging your engine. Your oil costs about 15¢ more a quart because of those additives. Yet oil filters on the market today are made of rag or paper—they soak up additives like a blotter. The more often you change oil filters the more money you waste!"

"But don't I need a filter to take the impurities out of the oil?" I asked.

He took a deep breath. "This will really shock you. Engine damage is done by abrasives 10 to 40 microns in size (a micron is .000039"). Your oil filter can't take them out because rags or paper can't be packed tight enough without stopping oil flow when the fibers soak up oil and expand."

"Isn't there any kind of filter that does the job it's supposed to do?"

"No, except for the porous bronze filters they're making for supersonic aircraft. And you can't buy a filter like that for your car."

I asked myself: "Why not?" Next day, I tracked down the outfit that was making the filters for aircraft, and got the answer. These porous bronze filters were made by fusing together millions of tiny bronze balls. Non-absorbent, they didn't remove additives, yet they removed abrasives in the 10-to-40 micron danger zone. Could they be made for automobiles? Again, the answer floored me.

LIFETIME FILTER TESTED IN CARS, TRUCKS, BOATS

Test models had already been used in cars and trucks

OPPORTUNITY FOR DEALERS AND DISTRIBUTORS

A dealer and distributor network is now being formed to handle demand generated by advertising and editorial features in national magazines. If you can qualify, you can be first with the most exciting automotive product of this decade, to win new customers and build a substantial business. These valued franchises are not being sold; they are awarded on the basis of ability to grow with us. For complete details, write or wire: Continental Manufacturing Corporation, Dept. FPM-5 Washington Blvd. & Motor Avenue, Culver City, Calif.

©1954



for millions of miles, proving the porous bronze filter: 1. Never needs replacing. 2. Saves the quart of oil thrown away with ordinary filter packs. 3. Increases engine life.

Trouble was, almost the entire production was being absorbed by military and industrial users.

That day I went to work on the biggest job of my life: setting up production of the Lifetime porous bronze permanent filters for cars and trucks (an estimated \$320,000,000 replacement industry)

HOW TO GET A LIFETIME FILTER FOR YOUR CAR

Try the Lifetime filter on your car for 2 weeks: if it isn't all I say, you get your money back; if you keep it, you're through buying filter packs—the Lifetime filter is guaranteed for 10 years, actually will last many times that long.

For complete unit, including case and fittings (install on any car in 10 minutes), send make, year and model of your car and \$12.95 (we pay shipping).

For conversion kit, which replaces your present filter pack with Lifetime bronze, send make and number of filter and \$6.95 (we pay shipping).

Or send only \$2 deposit, pay C.O.D. charges on arrival. But do it today—don't waste another cent on filter pack replacements!



Complete Lifetime Filter; fits any car.



Lifetime Conversion Kit; replaces ordinary packs with permanent bronze element.

Permanent Filter Division, Dept. FPM-5
CONTINENTAL MANUFACTURING CORP.
Washington Blvd. at Motor Ave., Culver City, Calif.

Ship complete unit conversion kit

Make, model, year of car: _____

Present filter make (if known) _____

I enclose \$12.95 for complete unit (\$18.95—chrome)

\$6.95 for conversion kit

\$2.00 deposit; send C.O.D.

Name _____

Address _____

City _____ Zone _____ State _____



DON'T BE BLINDFOLDED
by Battery Ballyhoo!



LIFE Batteries are **Guaranteed for the Life of Your Car**

Here's why you will agree LIFE is your best battery buy. There are no tricks or gimmicks, such as pro-rated replacement costs or time limits hidden in the unusual LIFE guarantee. *LIFE BATTERIES are guaranteed for the life of your car.* A LIFE Battery ends replacement costs for as long as you keep your car.

If ever found defective, your LIFE Battery will be replaced *free of any cost.*

LIFE BATTERIES have been tested under the most rigorous conditions by a leading independent research laboratory before this revolutionary guarantee was offered to you. Before you buy any battery, check with your LIFE representative, or write direct for complete information.

IMPORTANT DISTRIBUTOR FRANCHISES

Valuable LIFE Distributor Franchises are available in some key territories. Write, wire or phone Franchise Division.

LIFE BATTERY CORPORATION

12909 Venice Boulevard, Venice 44, Calif.



NO OTHER BATTERY CAN MAKE ALL THESE STATEMENTS

- Guaranteed for the life of your car
- Unfailing performance under extreme conditions
- First battery to be awarded "Car Life" Seal of Merit
- World's finest battery
- No pro-rated replacement charges
- Phenomenal recuperative power under heavy load
- No time limit to guarantee
- Ends battery replacement costs



**WORLD'S
BEST
WANT AD
MEDIUM**

CLASSIFIED Advertisements



Advertisements in this section \$1.00 per word, each insertion, minimum 10 words, payable in advance.

To be inserted under proper classification, copy must be in our office the 20th of the second month preceding date of issue

F. W. Johnson, Manager, Classified Advertising
Popular Mechanics Magazine, 200 East Ontario Street, Chicago 11, Illinois

YOU'LL PROFIT

By reading and answering the classified ads in this section. Hundreds of opportunities for you to make and save money

AUTOMOBILES, MIDGET CARS

FIBERGLAS Automobile bodies. Build your own. Maurice Lannon's Fiberglass "How" book—\$2.50. Information, materials catalog 10c. Oem-O'-Lite, Box 6867A, North Hollywood, California.

ANTIQUE Automobile color slides, 2x2. Illustrated catalog free. Universal Slide Company, Box 779A, Beverly Hills, Calif.

SPEED Shangri-La! Racing, rodding, restyling requirements. Al Price, 64 Afton, PM-5, Rochester 12, N. Y.

HI-Mileage-speed equipment from the world's largest supplier. Dual manifolds, finned heads, electric doors, lowering sets, fuel saver, thousands of items for all cars. Huge catalog 25c (illustrated literature free). Wholesale to garages. Newhouse Automotive Industries, Los Angeles 22.

NON-PROFIT Organization offers automobile literature—Old, new and foreign; dealer books, service manuals, glossy photographs; free motor magazines. Write today; get on free mailing list. Auto Maniacs, Stockbridge, Mich.

HOW To Restore Antique and Classic Cars: Big new 176 page book includes four color section showing great classics. Hundreds of photographs. Only \$3. Write Popular Mechanics Press, 200 E. Ontario, Chicago 11, Illinois.

AUTO SUPPLIES AND EQUIPMENT

AUTO Body repairing made easy. Guaranteed to save you money! Complete kit \$3 postpaid. Plastic Metals, 1393 East 33rd, Cleveland, Ohio.

GENUINE Motor treatment, Lachapelle's (patented). Only \$3.00 delivered. Restores compression, power. Saves gas, oil, repairs. Money back guarantee. You can't lose. Free circular. Write Joe Dillon, Authorized Warehouse and Agents Distributor, Box 323-U, Bridgeport, Ohio. Exclusive distributorships, agencies open.

SENSATIONAL Free trial offers! Surplus stock of famous Gale Hall automotive instruments, brand new, original carions! Try at our risk for seven days—then send payment or return merchandise! Professional compression testers, originally \$10.75, now \$2.98! Engine analysis vacuum gauges, originally \$12.50, now \$4.55! Fuel pump testers, originally \$8.10, now \$3.09! Original Gale Hall motor condition/gasoline economy gauges for permanent dashboard mounting, originally \$7.50, now \$2.98! (Add 40c to each price for postage). Order now! New England Surplus Sales, Dept. PM-5, Newburyport, Mass.

THIEF Chaser. Guaranteed to stop auto thieves forever. 25 cents per year. Free literature. Novak Company, 3131 West 13th, Gary 51, Indiana.

TINT Your own windshield soft blue-green at tiny cost. Amazing new product Spray-A-Tint applied in minutes. Spray type container. Guaranteed. \$2.50 postpaid. P & D Shopping Service, P. O. Box 6971, Washington, D. C.

GENUINE Chevrolet parts, wholesale prices, send model and year. Example, ring set, chrome-plated oil rings, regular \$13.35 only \$9.95, postpaid U.S.A., money orders only. Wholesale, Box 75, Tishomingo, Oklahoma.

CHEVROLET Remanufactured Rochester carburetors \$4.95 outright. Carbo, 10452 Magnolia, No. Hollywood, Calif.

AUTO Door arm rest covers. All colors. Same as original. Easily cemented on. State make, model, year, and color. \$1.59 a pair pp. No. c.o.d.'s. Arm Rest, 204 Brown St., Waltham, Mass.

ECONOMY. Guaranteed or money back "Supervising Auto Maintenance" book for the non-mechanic. Save on repairs, gas, etc. \$2.00 postpaid. Auto, 665 Glenridge, Miami 49, Fla.

RESTORE That fresh delightful "new car smell" to your automobile. Bottle, 50c postpaid. Seeley, 3716E Belmont, Chicago 18, Ill.

BUY Wholesale nationally advertised auto supplies, thousands other products at big discount. Free "Wholesale Plan." American Buyers', 629-D Linden, Buffalo 16, New York.

RADIATOR Plugged with lime? Try Winn-Sol, \$1.50 postpaid in United States. Agents wanted. Winn-Sol, Oshkosh, Wis.

AIR Conditioner, save \$500! Equip your car for \$164.70 with complete kit. Free literature. Seeley, 3716E Belmont, Chicago 18, Ill.

WHOLESALE Automobile supplies. Catalog 25c. Refundable. Charles Wholesale, Batesville, Arkansas.

SAVE Money on maintenance, gas and oil. Get more power, performance for your car, truck, bus. Write Box #926, Richfield, Minnesota.

STOP Hub-cap thefts with Kap-Lox (patented). \$1.98 set of four postpaid. K&W Sales Company, 4609 Sixth South, Seattle 8, Wash.

WHITWORTH Size sockets, 1/2" square drive. Set of 7, 3/16w. to 9/16w., \$5.45. Metric tools, safety belts, Pierlot, 1010 South Fir, Inglewood 1, Calif.

SPEED Equipment. Any car. Write Power, 327 W. 117th, Hawthorne, Calif.

CRUMBLESS Super coil—Literature. Also automotive tool catalog. White's, Catawissa, Penna.

BRIGHTER Auto lights. Safer, better driving lights. New kit adapts present equipment. Guaranteed. \$2.50. Free literature. Pyramid Engineering, 500 Clayton, Tupelo 1, Mississippi.

SAVE Your life with amazing new "Torsion-Flex" Sway-Bilizers! Stops sway, skid, slide. Postal brings free illustrated literature, gift offer. Sway-Bilizer, 5434-A Higgins, Chicago 30.

AUTOMOBILE Accessories, for free trial! Write Neher Industries, LaVerne, Calif.

AUTO Radios wholesale. Send year and make car. Free literature. Prices, Cherry Radio, 1438 Belfield, Philadelphia 40, Penna.

LACHAPELLE'S Treatment. Makes any gasoline motor better, even a brand new one. Ferns Products, 8120-B Walnut Dr., Los Angeles 1, Calif. Free data.

RESTORE Power! Compression! Save oil! Revolutionary! Piston seal. \$2.00. Box 12302, Los Angeles 64, California.

TRUCK Parts—New and reconditioned military and civilian. Most complete stock in world. Mutual Truck Parts Co., 2000 Wabash, Chicago 16.

IGNITION Improved will increase ignition voltage up to 500 volts, easier starting, higher r.p.m. Jumper cable and instructions \$1.00. Moore Devices, Batavia, Ohio.

AUTO Radios at wholesale. List free. Regent, 801 Erie, Philadelphia 40.

NEW And used parts at savings. Complete guaranteed parts service for all models cars and trucks, late or old. Largest in the west. Army parts specialists. No catalog—Write for quotations. Fast mail order service. Pioneer Auto and Truck Parts Co., 734 W. 13th Avenue, Denver, Colorado.

FORD-T Parts—Engine and chassis. Parts for other old models too. Special parts made to order. We buy surplus items. B. S. Wisneski, Milwaukee 7, Wisconsin.

CUSTOM Accessories headquarters. Electric push button doors-trunks, bull noses, custom grilles, speed dress-up equipment. 40 page catalog hundred photos—25c. Eastern Auto, 3319A South Grand, Los Angeles 7, Calif.

ELECTROPLATE Auto parts, novelties, mirrors. Easy, inexpensive home processes. Free booklet. Tycos Metals, Box 13231-BG, Houston 19, Texas.

CHEVROLET Owners: Stop tappet noise with Kaye Tappet Silencers. Quality product. Easy to install. Complete set \$5.95. Kaye Products, 2067 B S. Layton Blvd., Milwaukee, Wis.

BRUSH Plating outfits connect to a battery. No tanks or shop required. Free particulars. Gunmetal Co., Ave. J., Decatur, Ill.

CAR Burning oil? Losing compression? Try Clifford's Compression Seal. \$2 postpaid. Clifford's Engineering, 1329 Seventh, Aurora, Illinois.

AUTO TRAILERS

EXCEPTIONAL Expanding eight foot trailer. Accommodates family of five. Build yourself. Literature 10c. Fra-Mar Company, Jones Avenue, Wilmington, Mass.

BUILD Your own trailer! Plans for all kinds. Illustrated catalog 10c. Jim Dandy, 125-M, Wausau, Wisconsin.

MOTORCYCLES, BICYCLES, MOTORSCOOTERS AND SUPPLIES

WHIZZER Motorscooter \$20.00; two-speed Cushman motorscooter \$20.00; Indian Scout motorcycle \$40.00; midget car \$15.00; homemade motorscooter \$6.00. Send 25c (35c first class mail) for catalog #25 jammed with sensational bargains in wheels, motors, motorscooters, midget cars, motorbikes, construction plans, etc. Gail, 1313 Jefferson, Toledo, Ohio.

MIDGET Auto \$45. Villiers motorcycle \$35, Cushman less motor \$25. Whizzer motorbike \$35, Whizzer motor \$5. (Mail-order only). Send 25c for Directory Number 99, listing these and hundreds of other bargains in new and used midget cars, motorscooters, engines, parts, plans for homebuilders, etc. (35c by first class mail.) Midget Motors Directory, Athens, Ohio.

MOTO-Scout replacement parts, assembly kits. American Moto-Scout Co., Chicago 25, Ill.

"BUZZZZ"—The motorcycle magazine. International coverage. Thoroughly illustrated. Yearly \$2.00. Sample 20c. 5424-A Sawyer, Chicago 25.

RECONDITIONED Motorcycles and motors. Chromium accessories. Complete stock Indian parts. Expert rebuilding. Fast service. Indian Motorcycle Sales, Kansas City 27, Mo.

AVIATION

PROPELLERS, Plans, kits for snow sleighs, air boats. Immediate delivery. Catalog 25c. Banks-Maxwell, Box 3301E, Ft. Worth, Texas.

FLY Captive soaring 46" glider. Excite your community! \$1.00 pp. Box 506, Fairhope, Alabama.

PROPELLERS, Plans, supplies for air boats, snow planes. Catalog 10c. Universal Propellers, Box 3123A, Ft. Worth.

FREE: Monthly aircraft, electronic, gadget list. Dick Rose, Everett, Wash.

WHO To contact for employment in aviation. Airlines, factories, corporations, cropdusters, etc. Pilots, mechanics, all others. Experienced and unskilled. Foreign and American. Guaranteed reports only \$1.00. Research Services, Box 2904-PM, St. Louis 17, Missouri.

PROPELLERS, Plans, supplies for air boats, snow sleighs. Literature. Gano Propeller, Box 3284A, Ft. Worth, Texas.

BATTERIES, GENERATORS

EDISON Nickel odorless storage batteries. 12 to 600 ampere hour. Any voltage. Long guarantee. Literature. Hawley Smith Co., Croton Falls 1, N. Y.

ELECTRICAL SUPPLIES

MOTOR Rewinding supplies, instructions, plans. Modern, Box 4704, Kansas City, Mo.

TELEPHONE Wire, communication, blasting, signal use. Two-conductor, insulated copper-steel army field wire. Mile reel \$16.00, half-mile \$9.00. Surplus telephones. Write for folder. Loris Sales, P.O. Box 1896-B, Sacramento, California.

LAMP Parts, electrical supplies. Complete stock. Free catalogue. Kassel's, Box 2227, Fort Worth, Texas.

ELECTRICIAN'S Tool for making solderless connections that enables anyone to do professional-like jobs. Crimps terminals and connectors. Splices, cuts and strips wire. Shears bolts without damaging threads. Complete kit; tool, terminals, connectors and insulators, formerly \$5.00, now \$3.95 postpaid. Aircraft Marine Products Inc., 1330-C, American Building, Cincinnati 2, Ohio.

ELECTRIC Pencil: Engraves all metals \$1.50. Beyer Mfg., 10511-H Springfield, Chicago 43.

LAMPS—25c Brings bargain catalog showing all parts for repairing, building. Contains instructions for electrifying vases, oil lamps, etc. Gyro Lamps, 5402P Clark, Chicago 40.

WELDING, SOLDERING, PLATING

THE Magna-Weld lens for welders who need bifocal glasses. The Magna-Weld lens is an optically ground magnifying cover glass, 2" x 4 1/2", fits all standard helmets. Price \$5.00. See your dealer, or write Industrial Optical Co., 10 E. Church St., Jacksonville, Florida.

WELDERS—Electric, various models, \$28.50 to \$235.00, direct from manufacturer. Free literature. Champion Welder Mfg., 193MP Centre St., New York 13, N. Y.

"BUILD-UR-OWN" a.c. welder and a.c. power plant with a good used engine and low cost Hobart generator. Welds anywhere and supplies 5KW stand-by power for any emergency. Write Hobartweld, Box M-543, Troy, Ohio.

WELDERS—Build wrought iron railings. Knockdown save 50%. Free circular. Clinton Knox, P.O. Box 162, West Bridge-water, Penna.

ELECTRO Plating equipment—New and used. Complete assemblies. All sizes for all types of plating. Baby shoe metallizing sets. Mounts, supplies, instructions. Free catalog. Hollywood Bronze Supply, 1624-C E. First Street, Los Angeles 33, Calif.

WELDERS 110V, \$29.50, 220V, \$49; combination \$54. Morris, 1070 Inner Drive, Schenectady 3, N. Y.

ACETYLENE Welding outfits. New \$49.00, used \$29.00; arcwelders \$49.50. Dept. PM, Eagle Welding, 5085 Broadway, Chicago 40, Illinois.

MACHINERY, TOOLS, SUPPLIES

CARBIDE Tipped shaper cutters for wood, aluminum, plastics. Choice of 30 shapes. Low cost. Free literature. Write. Machinery Dealers, 606 W. Lake Street, Chicago, Illinois.

BIG Factory catalog! Buy direct—Save middleman's profits; hundreds of labor saving tools and equipment; tremendous savings. Send 10c. Master Mechanic Mfg., Dept. CL-4, Burlington, Wis.

MOTORS, Machine tools. List 25c. Felco, Box 1300, San Francisco, Calif.

NEW Mall electric drills, 1/4", \$15; 1/2", \$34.95. Jacobs chucks. Wilt Surplus, 7629 S. Racine, Chicago 20, Ill.

ALLEN One ton power bench type punch press. \$97.50. Circular. Allen, Dept. PMB, Clinton, Missouri.

SHEBEL Saw filer. Files all saws. Circular. A. P. Shebel, 730 S. 2nd St., Milwaukee 4, Wis.

ENGINES, MOTORS, DYNAMOS

ALTERNATING Current generators. 750 watt, \$38.50. 5000, \$185. Motors, 1 horse, \$37.50. 2, \$67.50. 3, \$87.50. Butler, 1885 Milwaukee, Chicago 47.

INVALUABLE Motor winders handbook. Simplifies complicated reconnecting. \$4.98. Jednak, Clinton, Penna.

REBUILT Gasoline engines, \$17.00 to \$37.00. Cauffiel Motor Industries, Temperance, Michigan.

WINDING Data. 225 motors, single and three phase, \$1.00. Data Company, Box 7631, Kansas City 28, Mo.

BOATS, OUTBOARD MOTORS

RUBBER Boat bible with prices, 10c. Ort, Thomasville 563, Penna.

FULL Size, cut-to-shape boat patterns, blueprints, 7 1/2-33 feet. New 1954 illustrated "Build a Boat" catalog of 50 naval architect-designed cruisers, runabouts, sloops, skiffs, outboard boats, sailing, racing, houseboats, 50c. Marine hardware catalog, \$1.50. Bigger, better 1954 "How to Build Boats" book, \$2.50. PolyWog Houseboat Plans, \$12. Cleveland Boat Blueprint Co., Dept. A-66, 9400 Steinway, Cleveland 4, Ohio.

"HOW To Make Your Old Boat New With Liquid Glass" and "How To Build Your Own Fiberglass Boat." These 2 illustrated manuals show step-by-step method. Both for 25c from Marine Div., Dept. ME-101, Castolite, Woodstock, Illinois.

BOAT Kits. Build your own boat. Easy to follow instructions. Literature free. Paramount Boat Company, 2202 N. Prairie, Joliet, Illinois.

GET Our big 234 page boat hardware and equipment catalog. Send \$1.00 for cost of handling, refunded with first order. Garland Frasher Marine Sales, 2626 Fifth Ave., Huntington, W. Va.

BOAT Trailers—Complete; tires, tubes, wheels, bearings, coil springs, automatic swaybar, hitch. Factory prices. Literature 10c. LeHoskey's, Winsted Road, Torrington, Connecticut.

AIRPLANE Floats (pontoons) for boats. Catalogue 10c. Ort, Thomasville 569, Penna.

AIR Boat plans, kits, supplies, catalog 25c. Banks-Maxwell, Box 3301P, Ft. Worth, Texas.

CONVERT Fords and Jeeps to 100% marine engines with Osco's world famous Convo-Kits. Deluxe catalogue 50c (coin). Oscomotors, 3627B Lawrence, Philadelphia 40, Penna.

FIBERGLAS Permanent boat coating. Maurice Lannon's Fiberglass "How" book—\$2.50. Complete catalog 10c. Gem-O-Lite, Box 6867B, North Hollywood, California.

BOAT Kits, plans and patterns for America's fastest and finest outboard racers, runabouts, fishing boats, hunting skiffs and canoes. Illustrated literature 25c. Schneider Boats, Dept. PM, 1913 Vilet, Milwaukee 5, Wis.

KIT, Hardware catalog 15c. Boatbuilders Marine, 55-M Sorrento, Allston, Mass.

OUTBOARD Cruiser 15', 17', 20'. Simplified plans for amateurs. Glen Designs, Box 568, Compton, California.

FIBERGLAS Your boat for permanent waterproofing. Easily applied. Complete instructions. Guaranteed materials. Wholesale prices. Complete kits \$12.60 up. Free lists. Ajax Plastics, Dept. PM, P.O. Box 1323, Ft. Worth, Texas.

BUY Wholesale nationally advertised outboards, thousands other products at big discount. Free "Wholesale Plan." American Buyers', 628-D Linden, Buffalo 26, N. Y.

SAIL Your canoe! Rig easily built home. Detailed plans, instructions—\$1.98; plus illustrated sailing instructions, free. Koch Engineering, Box 69, New York 28, N. Y.

PROTECT Plywood forever with perfected Fiberglass you can't strip off with hammer and chisel. Ev-R-Shield, Dept. C-1, Joppa, Md.

MARINE Conversions—Willis to Cadillac. Catalogue and conversion hints free. Barr Marine Products, 2796 Castor Avenue, Philadelphia 34, Penna.

SAVE 2/3 Cost. Assemble your own boat. We furnish parts. No experience necessary. Rowboats, cruisers. Illustrated catalog 25c. Midwest Boat Company, Menomonee Falls, Wisconsin.

LEAKPROOF Your boat with new, revolutionary polyester-fiberglass containing X 303. Easier application, smoother finish. Literature, sample 10c. M-H Plastics, 341 Albany, Ferndale, Mich.

BUILD A 21 foot plywood outboard cruiser, also other plans including a sailing catamaran. Literature free. Widd Hauber, 2451 18th Ave., No., St. Petersburg, Florida.

BUILD Beautiful fiberglass-plastic boats without using molds. New patented method. Write Speedcraft, 2450 Emerson, off Square Lake Road, Pontiac, Michigan.

FOAM Rubber boat mattresses made to order. Free catalog. Perma-Foam, 140-C Main Street, East Orange, New Jersey.

"P38" Belly tanks, \$9.95. Free picture. Anzio Boat, 89, Merced, California.

MARINE Conversions for Ford and Jeep engines. Catalog 10c. Lehman Manufacturing Company, 972D Broad Street, Newark 2, New Jersey.

NEW, Used, rebuilt marine motors. Marine conversions, fittings. Free catalog. Stokes Marine Supply, Dept. 24, Coldwater, Michigan.

BUILD Marine engines with Federal conversion kits. Federal Marine Motors, 9011 Cottage Grove Ave., Chicago 19, Illinois.

ATHLETIC EQUIPMENT, BODY BUILDING COURSES

GREAT Strength easily obtained. Send \$1 for complete arm, chest and back muscle-building course and apparatus. Noticeable results guaranteed in 7 days or \$1 refunded. Joseph Dryer, Box 5527, Chicago 80.

WANT Muscles? Get the facts about the Besco system of barbell training. Harry Paschall, Box 88, Pompano Beach, Fla.

SPORTING GOODS, GUNS, FISHING TACKLE, ARCHERY, TRAPPING

MINNOW Saver that works! Invented by a commercial producer of minnows. Money saving device for minnow fishermen. Fits any bucket you already have, more than doubles its capacity. Discharges large amounts of air into the water, same principle fish hatcheries use in transporting fish. About the size of electric razor, driven from cigar lighter, tall light wire, or 6 volt battery. Long life, money back guarantee. Light weight model \$2.98, heavy duty model in rubber case \$4.98. The Minnow Saver, Lockwood, Missouri.

MOLDS For fisherman's sinkers, jigs, squids, casting and spinning lures. Free catalog. Sweet's Molds, Tonawanda 1, New York.

SAVE 50% On finest bows, arrows, complete bowhunting outfits, etc. Free catalog and "How to Hunt with Bow & Arrow" booklet. Send 25c for handling. Malibu Archery, 3156R-B Eighth Street, Los Angeles 5, Calif.

FREE Fishing catalog—132 pages. Over 3000 hard to find fishing specialties. Netcraft Company, Dept. PM3, Toledo 13, Ohio.

FREE Copy! "The Archers' Magazine." Request: 1200 Walnut St., Philadelphia 7, Penna.

5000 COLTS, Flintlocks, Kentuckies, Wheellocks, antique-modern gun bargains. Catalog only 50c. Agramonte's, Yonkers 20, N. Y.

IMPORTED, Stilettoes, daggers, throwing, pocket, hunting knives, etc. Free catalog. J. D. Clinton, 94 Church, Mt. Clemens 2, Michigan.

TENTS (Direct from manufacturer), camping equipment, sleeping bags, air mattresses. Low prices. Send 10c for 72 page illustrated tent-camping equipment-tent maintenance catalogue. Mor-San Sales, 10-21R 50th Avenue, Long Island City 1, New York.

BARBELLS, Exercise equipment. Courses. Free booklet. Good Barbell Co., Reading, Penna.

HOLLOWGLASS Fishing rods. Save over half. Buy complete kits. Casting, spinning, fly and boat. \$4.95 to \$7.95. Assemble yourself. Full instructions. Makit Rod Company, Dept. PM, 429 Fulton, Ft. Worth, Texas.

FISH Hook remover. Unhooks in 3 seconds and you don't have to touch the fish. Old commercial secret now manufactured for you, the sport fisherman. Guaranteed. Send \$1.00. Youngbrand Mfg. Co., 51 N.W.S. River Drive, Miami, Fla.

BASS-O-Lure attracts fish to your bait on a money back guarantee! Send only \$1.00 to Bass-O-Lure, Box 345, Van Nuys, California.

TENTS, Complete line, all purpose. Send for reasonable price list. Delano Studios, Suite PM, 31 E. 18th Ave., Denver 2, Colo.

180 PROFUSELY Illustrated pages antique pistols, swords, daggers, armor, etc. 50c. Robert Abels, M860 Lexington Ave., New York 21.

BUY Wholesale nationally advertised sporting goods, thousands other products at big discount. Free "Wholesale Plan." American Buyers', 627-D Linden, Buffalo 16, N. Y.

JAP Rifle altering to 30-06, \$6.00. Catalog 5c. T. P. Shop, West Branch 11, Mich.

5000 BARGAINS, Firearms, binoculars, war relics. Catalog 50c. Smith Firearms, Runnemed, N. J.

SHOTGUNS, Rifles, Revolvers, 500 modern, obsolete. Also cartridges. Each list 10c coin. Ed Howe, 52 Main, Coopers Mills, Maine.

CAST Iron molds—For casting fishermen's sinkers. Free illustrated booklet. Reading Instrument Co., Box 78, Reading, Penna.

BINOCULARS, TELESCOPES, MICROSCOPES, MAGNIFIERS

BINOCULAR Specialists, all makes repaired. Zeiss, Hensoldt dealer. Tele-Optics, 5514 Lawrence, Chicago 30.

GIANT 100X day and night telescope. Completely assembled with extra eyepiece. Heavy hardwood tripod. Steel and brass tube construction \$7.50. Other telescopes at \$12 and \$16. 400X telescope makers kit contains brass focusing tube, erector, 5 lenses, instructions, \$3.75. Suffolk Science, Riverhead 3, N. Y.

SPECIALISTS, Used, new microscopes. Prepared slides. Supplies. Telescopes. Free illustrated catalog. Nassau Optical, 9 W. Greenwich, Roosevelt, N. Y.

BINOCULARS, Telescopes, microscopes, terrific values \$3.98 up. Request free money saving catalog. Criterion, Hartford, Conn. Dept. P22.

WAR Surplus bargains! Millions of lenses, instruments, telescopes, binoculars, components! World's greatest optical market place! Send only \$1.00 for beginner's 10-lens kit and big instruction booklet. Stock CH. Write for catalog CH free! Edmund Scientific Corp., Barrington, New Jersey.

REFLECTOR Telescope kits from \$6.25. All parts designed and built at our Hoboken factory. Mirror cells, diagonals, focusing mounts, tripods, tubing, oculars. Fully guaranteed. Free illustrated catalog. Send orders and inquiries to Esco Products, Dept. PM-1, 1428 Willow Avenue, Hoboken, N. J.

IMPORTERS' Amazing prices, binoculars, microscopes, gunsopes. Free trial. Folder, "Binocular Selecting," pricelists free. Dealers wanted. Prentiss Importers, Mercury B'de, West Los Angeles 25, Calif.

SAVE 25%! Get interesting facts. Free 52 page binocular telescope catalog. \$3.95 to \$250.00! United, 9043 S. Western, A-7008, Chicago 20. Dealers wanted.

8x FINDER Scope, \$1.00. "Beginners Astronomy," 25c, catalog, kits, supplies. Telescope Supply, Box 685, Dallas, Texas.

GIANT 100X steady to use day and night telescope. Steel and brass tubing construction. Heavy hardwood tripod, Helioscope instructions. \$7.95 job factory. 400X telescope makers lens kit has brass focusing tube, 5 lenses, erector, instructions, \$3.95. J. A. Spald, Carl Jamer, Manorville 1, N. Y.

MAKE 6" Telescope reflector. Glass, abrasives, instructions—\$10.50. F. Cameron, Box 65, Inwood 96, N. Y.

LOWEST Prices, all sizes binoculars, telescopes, microscopes, 8X30 \$32.00. Free catalogue. Joe's Binocular Sales, 4827 Second Blvd., Detroit 1, Michigan.

PETS—DOGS, BIRDS, RABBITS, HAMSTERS, ETC.

FISHWORM Raising pays worthwhile profits! Illustrated booklet explains raising, feeding, packing, marketing. 25c. Oark Worm Farm-J, Willow Springs, Mo.

ATTRACT The birds with a hollowed log house. Free literature. Hawkins, Palestine, Texas.

GUINEA Pigs. Profitable business. Booklet free. Taylors, 426A, Hapeville, Georgia.

ANGORAS, Chinchillas, White Giants. World's most profitable rabbits! Catalog free. Grinstead's, Edwardsville, Illinois.

CHINCHILLAS—Registered. Guaranteed reproduction. Unbelievable price. Free literature. Far-West Chinchilla, 1446A Jones, San Francisco 9, California.

"RAISING Chinchillas For Profit," 141 page book. Authentic. Illustrated, \$3.50. Elsworth, Box 6P, San Mateo, Calif.

RABBITS—Amazing home enterprise. Booklet free. Tayco Rabbitry, Hapeville, Georgia.

WE Raise chinchillas in our basement. Very profitable sideline. Write for brochure. Merrill Hendrickson, Franklin, Ind.

CHINCHILLAS Rented, offspring bought. R. Rau, Route 2, Jeannette 3, Penna.

ROVER Repeller. Protection for female dogs while in season, guaranteed, \$1.00. Plymouth Products, Box 67, Boston 34, Mass.

HAMSTERS. Full grown stock at \$3 pair. Free information. Oehman, Hebron, Ind.

SELF-Cleaning, sanitary, precision built rabbit hutch. Blueprints \$1, Williams, 5340 Canal Blvd., Indianapolis, Indiana.

NATURALIST'S Catalog 10c. Chameleon 75c. Alligator \$4.15. Hamsters \$2.75 pair. Quivira Specials, Topeka 51, Kansas.

ST Bernard puppies! Reg'd! Spring delivery. Details, prices, charming pictures free upon request. Manitou Kennels, Watrous, Sask, Canada.

HAMSTERS—Fine small pets. Send 10c for folder or \$1.00 for complete hamster manual. Anderson's Hamstery, 35 Oneida, Pontiac, Michigan.

HAMSTERS—Golden; young, \$4 pair, fully developed, \$5 pair. Request prices on rare albinos. Adirondack Hamstery, Prospect 10, New York.

RAISE Moneymaking Angora, New Zealand rabbits. Particulars free. White's Rabbitry, Jackson, Mich.

START Right by knowing facts about rabbit raising. Illustrated booklet describing all breeds, housing, feeding, breeding, marketing. 48 pages 10 cents. American Rabbit Breeders Association, 36 ARBA Building, Pittsburgh, Penna.

PREPAB Dog houses. Free catalog. Webb Company, 184-CPM, Drexel, Mo.

STANDARD Rabbit Journal, Milton 3, Penna. Year \$1.00. Sample dime. Beginner's manual 25c.

RAISE Rabbits. Make money. Send 25 cents for market information, housing plans, prices for starting stock. A. Johnson, Box 694, Kansas City, Mo.

GROW Mushrooms. Cellar, shed, and outdoors. Spare, full time, year round. We pay \$3.50 lb. We paid Babbitts \$4.165.00 in few weeks. Free book. Washington Mushroom Ind., Dept. 171, 2954 Admiral Way Seattle, Washington.

MAKE Big money! Raise Chinchilla rabbits. Cash markets supplied. Write today! Rockhill Ranch, Sellersville 15, Penna.

MINK Raising information free. Complete. Lake Superior Mink Farm, Superior, Wis. Wisconsin.

CHINCHILLAS (No rabbit.) Easily raised anywhere. Profitable. Big future. Terms. Hibner Chinchillas, Ithaca, Mich.

FARMS, FARM LANDS, REAL ESTATE

SOUTHERN California—Solve your vacation, health, retirement and investment problems forever in favored location. In nine years this area has grown from 64 persons to a population of nearly 23,000. Payroll from one permanent installation alone is approximately \$2,000,000.00 per month. Present growth and future opportunities are tremendous. City residential lots near center of town with streets, water and electricity; in and paid for. Full price \$400. \$10 down and \$10 a month and no interest. Offer definitely limited. Write at once. Free details mailed. "California in 54," 836 Crenshaw Boulevard, Dept. B, Los Angeles 5, California.

FARMS, Homes, businesses, 34 states, coast-to-coast, 3240 bargains described. World's largest; 54 years service. Strout Realty, 7-M So. Dearborn St., Chicago 3, Ill.

FARM And business catalog free! Big edition. Hundreds of bargains from \$1000 up. Maine to Florida. West's, M-5, Pittsburgh 17, Penna.

FARMS, Houses, businesses wanted. Free information. Toole's, Box 84, Evansville, Indiana.

POOR Man's chance, \$5.00 monthly buys 40 acres productive land; near town; price \$200; free list. Box 425-P, Carthage, Missouri.

HOUSTON Is the fastest growing city in America. Come here now and profit from its fortune-making future. Beautiful homesites in desirable suburb for only \$345—Easy terms. Booklet free. "Preston" Wood, Box 413, Houston, Texas.

SOUTH Carolina homesites \$235. \$8.75 monthly, development adjoining Lake Greenwood, send 10c additional information. Bob Hollingsworth, Box 824, Greenwood, South Carolina.

SILVER Creek acres, 600 lots, \$10. Hunting, Fishing, Peachy roads. Dime brings folder. Alger, Michigan.

ISLAND Adventurers—Own an island retreat for as little as \$10 an acre. Thousands now available. Easily accessible. Within 100 mi. of your home. Unexcelled hunting, etc. Many with wild remote appeal for the hardy adventurer. Listings, full information \$1. Islands, Box 13, Easton, Md.

FREE California ranch land catalog. \$10 to \$25 acre. Easy terms. Write Pacific Lands, 1621BW, Cahuenga, Hollywood 28, Calif.

FLORIDA—Beautiful retirement homesites near gulf coast. Excellent hunting, fishing in 9 fresh and salt water rivers. 11 bays and gulf. \$250 at \$10 monthly. Free literature. V. M. Mathews, Box 1406, Asheville, N. C.

CANADIAN Tax sale lands for three dollars an acre and up. Small monthly payments. Farms, timber, hunting and fishing camps, minerals. Limited number of properties. Write at once for free catalogue. Tax Sale Service, Room 105, 120 Bloor St. W., Toronto 5, Canada.

GET Ozark property sales lists free. Address Armstrong, Shook, Missouri.

FARM-Ranch opportunities. Favorable conditions. Washington, Minnesota, Montana, Idaho, Oregon, North Dakota. Literature, farm descriptions. Specify which state. J. W. Haw, 119 Northern Pacific Ry., St. Paul 1, Minn.

FLORIDA's Choicest lakefront lots. Eastis-DeLand highway. \$10 monthly without interest. Free literature. Koepke, Eastis Florida.

FLORIDA Choice lakefront lots available. Best fishing, hunting. Terms. Grace Parker, Paisley, Florida.

HOMESITES \$400—Convenient payments. California's finest garden section. On Morro Bay's scenic shores. Wonderful fishing, boating, bathing. Fertile soil, softest water, temperate climate, congenial community. Free literature. Richard Otto, Department M, San Luis Obispo, Calif.

PLANTS, SEEDS, NURSERY AND GARDEN SUPPLIES

GROW Christmas trees. Ornamental landscape evergreens. Profitable. Quality planting stock at wholesale on quantity. Free list. Planting guide. Suncrest Evergreen Nurseries, Dept. PM, Johnstown, Penna.

POULTRY, FARM SUPPLIES

RAISE Turkeys the new way. Write for free information explaining how to make up to \$3000 in your own backyard. Address—National Turkey Institute, Dept. 3, Columbus, Kansas.

PROFITABLE OCCUPATIONS

MUSHROOMS Grown boxes, barrels. Manureless process 50c. Spawn \$1.00. Gordons, 353 William, Winnipeg, Manitoba.

OWN A profitable business. Established firms offer exclusive, protected franchise! No stock! No selling! Amazing profits possible! Mercury Products, 400 Woodstock, Tonawanda, N. Y.

LEARN Squaredance calling. Easy, fun. Guarantee \$100-\$300 month spare time. Renwood Industries, Box 225, Fullerton, Calif.

FOREIGN Jobs. Contracts underway and soon starting in Africa, South America, Canada, England, Europe, South Pacific, Middle East, Mexico and Alaska. Send \$1.00 for foreign job news, information, application forms, etc. DCS Foreign Job News, Dept. 268-UQ, Bridgeport, Ill.

BEGINNERS Home mailorder instruction handbook. 25c. Carnahan Bros., 5582-A Nelson, Cypress, Calif.

WANT A diesel job? New opportunities to increase income. Higher pay. More money. We can help you qualify. Tools. Shop method home training. Write today! Diesel, Tractor, Heavy Equipment Division, Interstate Training Service, Dept. B3E, Portland 13, Oregon.

SELL Popular Mechanics and all other magazine subscriptions. Free catalog, supplies. Subscription Service Company, Dept. B, P.O. Box 2070, Birmingham, Alabama.

FOREIGN And domestic jobs. High pay to \$14,000. Fare paid. Alaska, South America, U.S., etc. Stamped self-addressed envelope brings reply. Foreign Opportunities, Waseca 1C, Minnesota.

OVERSEAS Jobs. Big pay, transportation, expenses. Clerical, professional, mechanical workers. Most all trades. Latest listings aviation industry, construction, manufacturing, oil companies, government agencies, many other opportunities. Up to date information on securing employment, contracts, income tax, application forms. \$1.00. Overseas Jobs, Box 67-G-2, Vincennes, Ind.

\$10,800 PROFITS! Your own mailorder business! No risk! Success plan free! Treasury, 709 Webster, New Rochelle L-23, N. Y.

FOREIGN Jobs—Names and addresses of companies to contact. \$1.00. Fitzgerald, Dept. A-2, 3038 West Wellington, Chicago 18, Ill.

FOREIGN Employment. Top paying jobs overseas. Earn more than \$1,500 monthly. Men and women wanted immediately for all types of jobs in Europe, Africa, Latin America, South America, Canada, Mexico, South Pacific, Asia. Truck drivers, clerks, laborers, electricians, carpenters, construction workers, etc. For full information by return mail, including wages, conditions, firms hiring, hours, application blanks, etc., send \$1.00 to Foreign Employment Information Bureau, Claiborne Towers, P.O. Box 1408, New Orleans 12, Louisiana.

ALASKAN Jobs! Over 150 new construction projects with names, addresses companies hiring. Thousands needed. Highest wages. Military, private construction, mining, fishing, lumbering, aviation, railroads, homesteading. Skilled, unskilled workers. Salary information. Alaskan map included. Sample application \$1.00 complete. Alaskan Opportunities (PM), Box 362, Kenmore, Washington.

CONSTRUCTION Job list. Published monthly. \$1.00. Dempster's Construction Scout News, Dept. 268-UP, Bridgeport, Ill.

FREE! "301 Profitable Small Businesses!" Amazing shoestring plans! Work home! Start sparetime! Deumant Surveys, Kenmore 23-PM, N. Y.

RETIREMENT Homes, easy payments, nothing down. Details, Perry, Briarhill, Penna.

ALASKA. Get facts, not fiction. Current, on the spot reports on employment, climate, housing, homesteading, etc. Nothing to subscribe to. Airmailed \$2 cash, or m.o. Alaska Research, Box 823, Anchorage, Alaska.

I Average \$125 weekly selling books by mail! So can you! Start sparetime! Work home! Cooper, 245 Taunton, Buffalo, N. Y.

WELDING Pays big money. Learn easily at best equipped school in country. Non-profit school with low cost training, G.I. approved. Write Hobart Trade School, Box M-642, Troy, Ohio.

PROFITS To \$5 hour! Engraving plastic titleplates, novelties. New engraving, carving machine, "Dupliscaler." Details, sample 25c. Desco Distributors, 5282-F Van Nuys, Van Nuys, Calif.

MEN Wanted. Build luggage and cases at home. We sell your products. Complete instructions. No special equipment needed. Free details. Cascraft, 805-D6 Sunset Blvd., Los Angeles.

GO West! California, Oregon, Washington, foreign. Jobs, business opportunities. Housing, cost of living, recreation, schools. Up to minute information. Send \$2 to Professional & Business Xchange, 3972 Main, Riverside, California.

INTERNATIONAL Employment reports! Who to contact—how to apply for high paying jobs in 38 countries, including U.S., Spain, Alaska, South and Central America, Europe, etc. Listings of employers with contracts (names, addresses, projects; complete information) who hire skilled, unskilled, professional, supervisory, clerical, laborers, trades, many others. Also best oil, aviation, manufacturing opportunities. Only \$2 (airmail \$2.25). Includes one year registration and advisory service. We can help you find employment. Only service with unconditional guarantee of satisfaction or money back. International Reporter, Box 1047-PC, St. Louis 1, Missouri.

MEN Wanted for jobs on foreign, Latin America and Far North projects. Truck drivers, \$3.55 hour. Electricians, \$4.00 hour. Carpenters, \$3.70 hour. Laborers, \$3.00 hour. Clerks, \$3.00 hour. Most all trades wanted. Up to 70-hour week with time and one half for all over 40 hours. Transportation paid. 3 to 24 month contract. Full information of all firms hiring, living conditions, family accommodations, wages, hours, age, contract requirements, application form, etc., \$1.00. Air mail \$1.24. Foreign Construction Bulletin, Dept. 20, P.O. Box 393, Dallas, Texas.

THOUSANDS Of opportunities will be available on the St. Lawrence seaway project. Get information now. \$2.00. Ellis Enterprises, Box 298, Station H, Montreal, Canada.

MAGAZINE Subscriptions—Highest commissions, bonus. Qualified Publications, 451-Y Kingston, Brooklyn 25, N. Y.

WHOLESALE Food jobbing. Low-cost, outdoor business you can afford. Uncrowded. Pays its own way. Small middlemen earn \$85/170 weekly servicing retailers. Thousands needed. Easy to learn, build from home. Free: "Fortunes in Jobbing." Business Extension Service, Egg Harbor City, N. J.

START Profitable business service. Become tax consultant. Large fees year 'round. Experience unnecessary. Write, Union Institute, Lakewood 2-H, N. J.

CATERING Course. First 3 lessons \$10. Parks Catering, 1618 Rhode Island Ave. N.W., Washington, D. C.

FOREIGN Jobs, information airmailed \$1.00. Information Service, B-902, South San Francisco, California.

INDUSTRIAL Bridgeport, Connecticut, classifieds airmailed, \$1. Dunning's PM-1, 1980 Huntington Tpke., Trumbull, Conn.

AUCTIONEERING. Home study course. Diploma granted. Auction School, Ft. Smith, Ark.

SET Rhinestone jewelry. Easy money-maker. Catalog, instructions 25c. Bergen Arts, 128M Main, Hackensack, N. J.

\$1300.00 MONTHLY For truck drivers, \$1400.00 monthly for carpenters, electricians, plumbers, mechanics, \$1200.00 for clerks and laborers. Replacement hiring now being done. Full information and complete foreign listings, with current information on Spain, Korea, Australia, Alaska and Canada, \$1.00. 25,000 men and women needed for new stateside project! Complete information and other domestic listings, \$1.00. Dept. 3-E, Opportunities Unlimited, 1110 Commerce Bldg., St. Paul, Minn.

BUY Wholesale thousands nationally advertised products at big discount. Free "Wholesale Plan." American Buyers', 628-P Linden, Buffalo, N. Y.

YOUR Opportunity—Mail order. Very instructive "how" book, 25c. Midland Specialties, Box 653, Topeka, Kansas.

START A museum with \$22.50. Details free. Pacific Research, Box 907, Phoenix, Arizona.

HOME Typing—Profitable! Send 50c for copyrighted information. Gaunt, 827-A Irving Park, Chicago 13.

SELF-Service garage. How to start this profitable business in a small way. Free literature. Box 772-M, Benicia, Calif.

MEN Wanted now in South America, Alaska, Africa, Australia. \$400 to \$1200 monthly. Travel paid. Complete information and application forms \$1.00 postpaid. Airmail \$1.25. Kemah Company, 3618-A Washington, Houston 7, Texas.

FOREIGN Employment construction work. If interested in foreign projects with high pay write Foreign Service Bureau, Dept. P.M., Metuchen, New Jersey.

RAISE Pheasants on 100 week plan. Little capital and space can make you independent. Free details. Great Central System, Columbus 1, Kansas.

FOREIGN, Latin American, domestic employment. 1954 "Foreign Service Directory" originator of job news by copyright, gives up-to-minute facts on military and civilian construction; Canadian, Alaska construction; major oil companies; aviation; manufacturers; steamship lines; mining; importers-exporters; how-when-where to apply with application form. Free—Hot list firms hiring. \$1.00 postpaid. Global Reports, Box 883-P, Hollywood 28, Calif.

ALASKA! Last American frontier. \$1.00 brings 1954 business directory and government map. Military and civilian construction; homestead and highway facts; mining, aviation, fur farming, grazing, timber, travel directions. List of firms hiring. How to apply. Alaska Opportunist, Box 92-P, Hollywood 28, Calif.

GROW Mushrooms. Cellar, shed, and outdoors. Spare, full time, year round. We pay \$3.50 lb. We paid Babbitt \$4,165 in few weeks. Free book. Washington Mushroom Ind., Dept. 99, 2954 Admiral Way, Seattle, Wash.

BE The Popular Mechanics representative in your neighborhood and earn big profits in your spare time. Write Popular Mechanics Magazine, Room 408M, 200 E. Ontario St., Chicago, Ill.

FREE Book "505 Odd, Successful Businesses." Work home. Expect something odd! Pacific, Oceanside, Calif.

BOOKS, PERIODICALS, PICTURES, POSTCARDS

PICTURE Post cards from your photograph. 1000, \$11.00. Raum's, 4154 Fifth Street, Philadelphia 40.

FRIENDLY Bookfinders, all subjects. Send us your wants. Free catalog on costume books, "Gay 90s" wasp-waists, high heels, etc. Naboma Company, Box 20725, Pico Heights Station, Los Angeles 6, Calif.

PERFORM Thrilling strong man stunts. Fully illustrated new book 50c. Aladdin Book Co., 210-PM Fifth Avenue, New York 10.

1954 BOOKS All national clubs. 50% discount. Swap deal on mysteries. Duggan, 192 North Clark, Chicago.

ILLUSTRATED Comic books. Grownups love 'em. Vest pocket size, 24 for \$1. All different! Vim Rogers, Dept. PM, Box 14738, Cimarron Station, Los Angeles 18, California.

SUBSCRIPTIONS Taken over 3,000 magazines. Write for prices. Addison, 1840-B Addison, Chicago 13, Illinois.

TELEVISION And technical books. Free list. Tradebooks, P.O. Box 1039P, New Haven, Conn.

HOW To live without money. Free literature. H. M. Bishop, 405 Second St., Neenah, Wisconsin.

BOOKS Located. No charge for searching. Delta Book Service, 2856a Woodlawn Terrace, Memphis, Tenn.

MIDGET Bible, size of stamp. Beautiful cover, 200 pages, pictures. Money-back guarantee. \$1. James, Box 1261, Lubbock 1, Texas.

WORLD'S Smallest Bible 50c. Three, \$1. Empires, Box 301, Amesbury, Mass.

FREE Samples. Many 10c items. Walter Mondscheln, Box 222, Chicago 90.

BOOKHUNTERS! Scarce, unusual, miscellaneous books supplied. Atlantic Book Service, Cedar Street, Charlestown 29, Massachusetts.

NATIONAL Geographic Magazines, 1888-1952. Periodical Service, Box 465-PM, Wilmington, Delaware.

SPARETIME Profits taking subscriptions, all magazines. Wholesale catalog free. Cassell Agency, Westfield 2, New Jersey.

BOOKS Found! Any author, old or new. Rush titles wanted; no obligation. International Bookfinders, Box 3603-PM, Beverly Hills, California.

BOOKHUNTERS! All subjects. Send wants! Jaheer Book Service, 620-P East 17th Street, New York 57.

GAMES, TOYS, NOVELTIES

BINGO Games and latest equipment, wholesale. Warwick Press, Warwick, R. I.

FULL Gross toy balloons only \$1.48 post-paid—About 1c each. Factory imperfects for color, etc., but all inflate. Assorted shapes, sizes. Quantities limited. No c.o.d.'s. Williams Sales, 4858 West Strong, Chicago 30.

MAGIC TRICKS, PUZZLES, JOKER NOVELTIES

FREE Magic and novelty catalog, includes 14 wonderful magic tricks fully illustrated and described. Send only 10c to cover cost of mailing. Read all about our free gift offer. Chicago Magic Center, 19 W. Randolph St., PM-5, Chicago 1, Ill.

VENTRILLOQUISM Easy to learn in 60 to 90 days! Home study course! Results guaranteed. For free information write stating your age. Dummy catalog 25c. Fred Maher School of Ventriloquism, Box 36, Studio PM-5, Kensington Station, Detroit 24, Michigan.

NEW Illustrated catalogue of new club, parlor, pocket and stage tricks 25c. Mimeographed catalogue 10c. New joke lists 5c. Eagle Magic, Minneapolis 2, Minn.

VENTRILLOQUISM Selftaught. Quick, easy instructions, 25c. Dummies. Ventriloquist, Calallen, Texas.

BE A magician. Large professional magic catalog of latest tricks. 35c. Ireland, C-109 North Dearborn, Chicago 2.

FREE Catalog. Best magic. Practical jokes. Top Hat Magic, Evanston, Illinois.

WOODEN Nickels, catalog, trick, 25c. Fun'n Magic, 423-P North St. Marys, San Antonio 5, Texas.

REAR View mirror attachment for glasses. Free details and gift. Starling Co., 2206M Starling Ave., New York City 62.

WE Supply every noted magician. Large professional catalog \$1.25. Holden's, 120 Boylston Street, Boston, Mass.

500 TRICKS, Douglas famous 120-page catalog, only 10c. Fastest service to magicians for 30 years. Send 10c today. Douglas Magicland, Dept. 1, Dallas, Texas.

2500 TRICK Catalogue (512-pages), pocket, parlor, stage. World's finest magic. Catalogue \$2.00 (dollar trick included free). Kanter's, M-1311 Walnut, Philadelphia 7.

PROFESSIONAL Catalog, 175 pages, 25c. Williams, 900 Plymouth, Ellwood City, Penna.

STAMP COLLECTING

ZOO Parade 10 different bi-colored stamps depicting queer Clvet from Liberia, Bay-thighed Diana, monkey, Sudan camel, hedge-hog, rabbit, squirrel, fox, finch, Golya, Gullipan including big triangles, regular \$1.00 value only 10c to approval applicants. Roseland Stamp Co., Dept. A-34, Spring Lake, Mich.

FREE — 105 Different British Colonies, Aged to Zanzibar! High catalog; pictorials. Approvals. Send 10c for mailing. Kenmore, Milford 8T, N. H.

FREE Sample stamp newspaper, valuable information on collecting, special lists. Approvals. Littleton Stamp Co., Littleton A1, New Hampshire.

FIRST U. N. set. Among world's prettiest. Only 10c. Approvals. Welles, Box 1248-R, New York City 8.

1,000 STAMPS For you to look at. Big attractive approval books of beautiful stamps. Pick and choose to suit yourself, at 1c to 5c each! Let us show you the economical way to a large, worthwhile collection. Wolverine Stamp Service, Dept. A-24, Fruitport, Mich.

NOT 5, Not 10, but 15 giant stamps 10c with approvals. Premiums each purchase. Heritage Hobbies, 52½ Balmforth, Danbury, Conn.

50 DIFF. U. S. commemoratives 25c. Mammoth packet list free. Econopackets, Box 168, Riverside 9, Calif.

COLONIAL Collection free—Magnificaroculous collection, British, French, American and other colonies. Flowers, animals, commemoratives, triangles, pictorials, high values all free plus Philatopic Magazine. Send 5c for postage. Empire Stamp Company, Dept. PM, Toronto, Canada.

SETS On approval, 25c for Belgium B332-41 catalogue \$1.24. Kozorog, 1095 East 64th, Cleveland, Ohio.

DEALERS—Wholesale list. Postage 3c. Frank, 5031 Queensberry, Baltimore 15, Maryland.

EXCHANGE Your duplicate stamps. Send 100 different and dime. Receive all different foreign. Koosel, 196 Second, Port Arthur, Ontario, Canada.

FINE Approvals. Fast, personal service. What countries do you prefer? I'll send their stamps. Skinner, 438 Locust, Long Beach 13, California.

50 DIFFERENT Bulgaria 10c! Approvals. Ensign Stamp Co., Dept. M, Berdan Ave., Paterson 2, N. J.

SENSATIONAL U. S., Confederate states catalogue free. Stone's, 45 Bromfield, Boston 8, Mass.

BARGAINS Galore. Low priced approvals. Chur, Box 117, Williamsville 21, N. Y.

DIRECTORY Of 113 hobbies, magazines (15 Stampic) 25c. Maurice, 8837 Quincy, Detroit 4.

U. S. 125 Different commemoratives, etc. 25c. C. P. Steger, Steger, Ill.

650 DIFFERENT Foreign stamps \$1.00. Personal Stamp, 612 Washington Ave., Northampton, Penna.

FREE! 3 Mozambique butterfly stamps to new approval applicants. Moulblow, Box 278K, East Northport, New York.

1000 DIFFERENT With approvals \$1.00. Jacobsen, 4395-A Broadway, New York 33, N. Y.

ISRAEL UPU 35c. High quality foreign approvals. Nacks, Box 3, Brooklyn 12, N. Y.

LOOKING For bargains? Try our 1c and 2c approvals mounted in books of 1,000. We believe in both quantity and quality. First try will satisfy. Clark Stamp Co., Dept. A-44, Muskegon Heights, Mich.

90,000 STAMPS Sale! Grabbag 30c. Big lot \$1. Extra special \$2. Persil, 436 N. Y. Ave., Brooklyn 25, N. Y.

FREE Valuable mystery gift. Approvals. Raymax, 37-Z Maiden Lane, New York City 38.

TETE-Beche bi-colored triangles. A beautiful set of stamps showing trains, planes, boats. This set, worth 50c. This plus 100 other stamps will be sent for only 25c with approvals. Modern Stamp Co., Dept. A-8, Ferrysburg, Mich.

ISRAEL, 25 Different for only 25c. Bargainful approvals. Dresel, Box 270-L, New York 25, N. Y.

WEIRD Volcao triangle, giant George Washington, others, six colored Ecuador, first U. S. commemorative. Devils Island, others. Free with approvals. Capital Stamps, Little Rock 4, Arkansas.

FREE Complete set of famous Americans, flags, parks and presidentials to approval buyers. Send 5c for 15 of the above stamps plus full particulars. Triboro Stamp Company, 145 Nassau Street, Dept. 105, New York 38, N. Y.

100 BRITISH Empire 10c. Approvals. Sadler, 9013 Central, Kansas City 14, Mo.

ITALY Workers set free with custom made approvals by country. Hall of Stamps, 4327-A Marr, Centerline, Mich.

NIGERIA Used coronation set free with depression priced approvals. Gobie Approvals, 931-A Emwell, Ferndale 20, Mich.

NUDES Set: Colorful approvals 10c. Atlas, 2830-M, Eisenhower, Racine, Wis.

MONACO Nudes complete 10c. Approvals. Royal Stamp Company, Tamaqua, Penna.

FREE! Mint British Colonies from Tonga, Seychelles, Brunel, Transjordan, Sarawak, Solomon Islands, Caymans, Gilbert Ellice. Free with approvals. Viking, 11-Z Northern Blvd., Great Neck, N. Y.

COLLECTIONS By countries and world wide at a saving of up to \$2 for your dollar. Ask for free list. Approvals include. Frasek Co., White Plains, N. Y.

WORLDWIDE Bargain approvals. Free gift. Mange, Box 8, Hanover, Penna.

25 COLOMBIA, Mystery gift. 10c. Smitheo, Northeast 6618, Kansas City 23, Mo.

ILLUSTRATED U. S., European catalog, 4c. Ace, 1431 Grace, Cleveland 7, Ohio.

LORE Galore! Fascinating, informative approvals. Stamplore, Box 1062, Sherman Oaks, California.

100 DIFFERENT U. S. commemoratives \$1.25. Gold, 62-95P Saunders, Rego Park 74, N. Y.

UNITED States commemoratives, 30 different, 25c. Approvals. Altopa, 2624-D North Albany, Chicago 47.

REQUEST Approvals receive Lundy Island sheet free. Elmont Stamps, New York 1, N. Y.

SWITZERLAND Prize package, 50 different—Trains, bridges, castles, commemoratives, bi-colors, pictorials. Unusual cancellations! Only 10c with approvals. Molzan, 720 Pomona, El Cerrito 8, California.

329 DIFFERENT Worldwide stamps 25c including Hitler heads, British colonies, French colonies, rarities, unusuals. Everything complete 25c to adults requesting approvals. Canada Stamp Co., 1907 Main St., Dept. 118, Niagara Falls, N. Y.

U. S. Illustrated price list free. Lush, 6422 Ellisworth, Detroit 38, Mich.

SPEND Pennies! Not dollars! Thousands of fascinating stamps to choose from our 1c and 2c approvals. No premiums! Just honest value! Pat F. Knowles, Box 2247, Van Nuys, California.

START Your own stamp business. Send for free book. Donald Shepard, Box 1147, Chicago.

FREE U. S. illustrated bargain catalogue. Rothberg's, 44 Bromfield, Boston 8, Mass.

FREE! Big United States catalog. Valuable guide and check list. Hundreds of illustrations. Approvals. Harrisco., 464 Transit Bldg., Boston 17, Mass.

\$2.35 FOR 10c. Triangles, Sports, topical included in coll. of 110 diff. stamps, only 10c with approvals. Schenck, 1650 Ocean Parkway, Brooklyn 23, N. Y.

SIX Beautiful complete mint sets free with our really excellent approvals. San Francisco Stamp Co., Box 1606, San Francisco, Calif.

UNITED States—58 different including 8 airmails, 15 commemoratives, 10c. Approvals. Sunset, Box 47, South Gate, Calif.

UNITED States. 75 different, 10c. Approvals. Farmer, 4913 Rosewood, Los Angeles 4, Calif.

MINT U. S. flag set, complete, \$1.00. Free list. Brooks, 2352M East 23rd Street, Brooklyn 29, New York.

ILLUSTRATED "International Stamp News" magazine, 12 issues \$1.00, lists bimonthly worldwide new issues, order blank enclosed. Commo Stamps, Box 56, Brooklyn 29, N. Y.

FREE—Large lists philatelic, numismatic. Special 25c. 88 flags, 84 coats-arms, stamps valued \$1. Approvals. Saturn, 758 Main, Buffalo, N. Y.

APPROVALS For the advanced collector. 10 mint blocks 10c. A.H., 1207 Northland Ave., Buffalo 15, N. Y.

WORLD'S Oldest stamp! 1840 Great Britain 1p. \$9.00 catalogue. Special, \$1.00. Approvals. Brooks, 2352X East 23rd Street, Brooklyn 29, New York.

FREE!—New stamp book! Tells "how to collect stamps," why you will enjoy and profit by this fascinating hobby. Includes complete illustrated listing of United States postage stamps; big values in United States and foreign packets; low-cost beginner's outfits; clearance sale bargains; special offers; albums, supplies, etc. A gold mine of valuable information! Money-saving prices! 64 pages profusely illustrated, just published by world's largest stamp company. Approvals included. Write today! Harris & Co., 459 Transit Bldg., Boston 17, Mass.

12 DIFFERENT Triangles 5c with penny-approvals. Penny-proval Company, 29-4 New York Building, Saint Paul, Minn.

WONDERFUL! Numerous flowers, birds, fishes, butterflies, zoo stamps, triangles, etc. Everything 10c with approvals. H. Howard, 5400 7th St. N.W., Washington 11, D. C.

SAVE Money! Buy stamp packets. Worldwide selection. Bargain pricelists free. Webb, 2200 Quintara, San Francisco 18, Calif.

SEND 100 Different and 25c coin for 100 different. Barnes, Box 226-P, Portsmouth, Va.

FREE—50 Different, with approvals. Palsing, Dept. PM, Atascadero, California.

EXCHANGE Your duplicate stamps. Send 100-200 different foreign and 15c. Receive all different. Patterson, 5624 Broadway, Lancaster 10, New York.

WORLDWIDE Variety packets 100, 10c; 500, 75c; 1000, \$1.75; 5000, \$13.75. Philatelic House, Rockville Centre, N. Y.

FREE Stamp Finder. Tells at a glance country to which any stamp belongs. 32 pages profusely illustrated. Garcelon, 35, Calais, Maine.

FREE. 4 Germany pictorial sets. Approvals. Pleasure Stamps, 1865P-52nd, Brooklyn 4, New York.

65 ALL Different U. S. stamps. Includes 50 year olds, commemoratives, airmails and \$5.00 stamp. Only 10c. Approvals. Willett Co., Box 511-L, Port Chester, New York.

CIPEX Souvenir sheet plus 25 different U. S. 10c. Approvals accompany. Village Stamps, 90-39P 214 St., Queens Village 28, N. Y.

PREMIUMS Free to purchasers of my better foreign approvals. Faith, 1339 1/2 Westminster, Alhambra, Calif.

FREE—Valuable illustrated catalog. Over 1100 special offers, attractive bargains! Approvals. Kenmore, Milford 8-C, N. H.

TWO \$5.00 U. S. stamps plus 20 different with U. S. approvals. Send 10c to Irwin Stamp Co., Box 11-05, Brooklyn 30, N. Y.

GIANT Collection! Over 200 different stamps including: Timor, Rhodesia, Mauritius, etc. Rushed, only 10c to approval applicants. Evden, Box 128, Valley Stream 22, N. Y.

44 PICTORIALS. Extraordinary value, only 25c! Approvals. Cole, 43-A Rinewalt, Buffalo 21, N. Y.

HERE We are, 1050 diff. fine stamps. Only 25c with our fine beginner and advanced approvals. Central Stamp Service, 1220 N. Irwin Ave., Green Bay, Wis.

ANIMALS, Birds, triangles, flowers, butterflies, fish, ships, locomotives, kings, dictators, multicolored, historical, geographical, musical, battles, giants, midjets and over 100 others—only 25c with approvals. Adults please. Canada Stamp Co., 1907 Main St., Dept. 318, Niagara Falls, N. Y.

HANDSOME New Zealand 1943 Elizabeth and Margaret Rose triangles only 10c to approval applicants. George Richie, 1539 Sixth, Alameda, Calif.

NO Rareties, no junk, just good solid approvals for serious collectors. Dominion Stamp Company, Arlington, Va.

WOW! 153 All different Germany, 10c. Zeppelins, semi-postals, airmails, high values, big bargain lists and approvals included. Jamestown Stamp, Jamestown 512, New York.

UNITED Nations cover free to applicants of U. S. or British Colonial approvals. A. Taylor, Skyland, N. C.

FREE! \$10,000 Airmail! Canadians! Colonials! Commemoratives! Approvals. Keating, 2520 Boulevard, Jersey City, N. J.

BARGAINS Galore. Low priced approvals. Schur, Box 245, Buffalo 12, N. Y.

STAMPS Wanted. Mint and used, collections, accumulations. Good grades only. Buy outright if bargain. What have you? Write, give details. Vanroy Shirk, Lebanon, Penna.

TRIANGLES. Birds, butterflies, flowers—Big packet 10c with approvals. South-west Stamps, Box 117, Long Beach 1, Calif.

300 DIFFERENT. Triangle, airmail, pictorials, etc. 25c. 500 mixed U. S. 25c. Carlton's, Tujunga, Calif.

FIUME 27-32 Mint, 5c. Illustrated price lists. Approvals. Norbert W. Payne, Box 227-P, Orchard Park, New York.

200 DIFFERENT. Including Roosevelt triangle. 10c to approval applicants. M. Avalon Stamp Company, Springfield, Mass.

FREE Sample—Interesting, informative, illustrated! National Stamp News, Anderson, South Carolina.

FREE 119 Foreign stamps including Africa, Australia, Pakistan, China, India, Russia and Scandinavia. Send 10c for postage and handling. With approvals. Niagara Stamp Co., Niagara-on-the-Lake 81, Canada.

50 DIFFERENT Worldwide 3c! Approvals. Vinny Jo, Box 3062, Seattle 14, Wash.

AMAZING Offer! 200 United States stamps—including commemoratives, airmails, high denominations to \$1.00. Only 10c to approval applicants! Illustrated bargain lists free. Mystic Stamp Co., Dept. 80, Camden, New York.

WONDERFUL Offer — 7 complete mint sets only 10c with approvals. Reich (M26), 1033 Lawrence, Chicago 40.

ALBUM! Capacity over 1,000 stamps! Only 10c! Stampmart, Hartford 1, Conn.

CANADA—100 Different, 25c with approvals. Crown Stamps, Box 331, Toronto, Canada.

225 STAMPS For only 10c! This mammoth value includes airmails, pictorials; stamps from strange countries cataloguing up to 25c each! Also approvals. Mystic Stamp Company, Camden 80, New York.

50 DIFFERENT Argentine 10c. Approvals. Reuter, 611 W. 40th Pl., Los Angeles 37.

UNITED States approvals. Select copies. Used, mint. Kingsbury, So. Woodbury 2, Vermont.

100 DIFFERENT Spain 25c. Penny approvals included. Reed, Box 980, Chicago 90, Ill.

OLD Scarce U. S. seconds on approvals. Slight imperfections, lowest prices. Herfield, Clintonhill Sta., Newark 8, N. J.

327 DIFFERENT Stamps 25c! Including early Canada, Newfoundland, British Colonies, Vatican, Red Russia, Hitler heads, Indian states, animals, airmails, French Colonies, rarities, unusuals. Every stamp different. Rare bargain with approvals. Money back guarantee. Niagara Stamp Co., Niagara-on-the-Lake 61, Canada.

WORLD'S Largest stamp (7 1/2 x 14 inches). A real curiosity! Retail for 50c, only 3c to approval applicants. Tatham Stamp Co., Springfield 30, Mass.

UNITED States—40 different 10c; 40 different commemoratives 25c. No approvals. Seidenberg, Appleton 944, Wis.

TRADE Your extra stamps. Join our stamp club. \$1.00 for two years. Free information. Valley Stamps, Box 87, New Cuyama, Calif.

COLOSSAL Stamp zoo 10c. Jungle beasts, wildlife, domestic animals—Fifteen different, including rhinoceros, elephant, snake, tiger, zebu, kangaroo, koalabear, emu, kookabura, bull, horse. Extraordinary accompanying approvals. Niagara Stamp Company, Niagara-on-the-Lake 51, Can.

COINS, TOKENS, CURRENCY

BRILLIANT Uncirculated 1/2—Booker T. Washington sets: 1946, \$4.95; 1947, \$6.75; 1948, \$8.95; 1949, \$9.45; 1950, \$9.45; 1951, \$9.95. Carver sets: 1951, \$8.45; 1952, \$8.45; 1953, \$8.45; 1954, \$10.00. All ten sets \$79.75. Giant bargain coin catalogue 35c. Bebee's, 4514 North 30th, Omaha 11, Nebraska.

OLD Money wanted. Do you know that coin collectors pay up to \$100 for certain U. S. cents? And high premiums for all rare coins? We buy all kinds. Send 4c for large coin folder. May mean much profit to you. Numismatic Co., Dept. 20, Fort Worth, Texas.

\$15.00 FOR 89c! Album, details \$1. (Refundable.) Decto, Box 153M5, Dabel Station, Dayton, Ohio.

WANTED—Indian, Lincoln cents. Liberty nickels; U. S. coins. Free list. Provenzano, 2419 N. Nordica, Chicago 33.

FOREIGN Coin collections 50c, \$1, \$3 each. Descriptive lists free. Webb, 2300 Quintara, San Francisco 16, Calif.

1916-DIME. Good. \$6.00. Russell, 3123A Chippewa St., St. Louis 18, Mo.

LARGE Cent, 2c piece, 3c piece, all for \$1. Monthly bargain list included. Del-maco, Box 1123, Wilmington, Del.

BARGAIN List, 2 large United States cents, \$1.00. Economy Sales Co., Mansfield, Mass.

100 DIFFERENT Foreign bills—\$1. Free list. Dwight Musser, Dunbar, West Va.

JAPANESE Invasion notes 1c to \$1000.00 set \$1.00. 100pp. Illustrated coin catalogue, 25c. Shultz, Salt Lake City 10, Utah.

FREE! Foreign coin, banknote and coin collectors illustrated catalog to approval service applicants. Send 3c postage. Tatham Coinco, Springfield 30, Mass.

INDIAN Cent with bargain lists 10c. Hutchinson, 3463 "I" Street, Philadelphia 34, Penna.

CONFEDERATE And Southern bank notes, 3 different, \$2.00. 50 mixed Indian pennies, \$2.00. Ben's Coin Shop, 31 N. Clark, Chicago 2.

WANTED—1894-S dime pay \$500.00. Certain 1913 nickel \$1,000.00. 1901-S quarter \$20.00 to \$150.00. Hundreds of others. Know their true value. Complete illustrated catalogue 25c. Worthycoin Corporation, (D-325), Boston 8, Mass.

GET Profit and pleasure in collecting old coins. Send 10c for 56-page illustrated coin catalog. You'll be delighted with it. Send for it now. B. Max Mehl, 370 Mehl Building, Fort Worth, Texas. Largest rare coin establishment in U. S. Established 54 years.

COIN Collector's Magazine. Over 1000 pages per year. Sample copy 30c; \$3.00 per year. Hewitt, 7320-J Milwaukee, Chicago 31.

WORLD'S Greatest magazine for coin collector's and wooden nickel 10c. Lawrence Brothers, Anamosa, Iowa.

ANTIQUES, RELICS, INDIAN GOODS, CURIOS

6 GEM Arrowheads \$2.00. 4 fine arrowheads \$1.00. Notched flint tomahawk \$1.00. List free. Lear's, Glenwood, Ark.

CATALOG 25c. Four arrowheads \$1.00. Flint hoe \$1.00. Locations given. Tilton Relics, Topeka 51, Kansas.

12 SELECTED Indian arrowheads \$5.00 postpaid. Also coins, guns. Potawatomi Museum, Angola 3, Indiana.

4 PERFECT Arrowheads \$1.00. Flint knife 35c. Perfect pipe \$3.50. Flesher 35c. Tomahawk \$1.00. Flint fish hook \$1.00. List 10c. H. Daniel, Lamar, Ark.

4 SELECTED Arrowheads \$1.00. List 5c. H. Talbert, Calico Rock, Ark.

PRECIOUS STONES, MINERALS

COLLECTORS! \$2.00 Brings twelve beautiful genuine specimens from gemland Brazil. \$3.00 brings perfectly cut ten carat Braziltopaz. Airmail bills or check. Jean Bach, 413 Praia Icaral, Niteroi, Brazil.

12 ATTRACTIVE Genuine mineral specimens \$1.00. Capital Gems, Box 141, Orange, N. J.

ATOMIC-Uranium ore—Making millionaires everywhere. Generous sample sent postpaid \$1 so you can identify it and check your seiger counters. Box 970H, Colorado Springs, Colorado.

FIND Uranium with our prospector's maps of Western states showing radioactive anomalies detected from air by A.E.C. \$5 per state, postpaid. Bell Maps, 314 California Bldg., Denver 2, Colorado.

ACTIVATE Fluorescent minerals. Powerful 250 watt ultra violet lamp. Fits ordinary socket. \$3.00. Polton, 7259 Claremont, Chicago 36.

DIAMONDS Rough. Guaranteed genuine. Origin Africa, Brazil. Send \$2.00. House of Diamonds, Box 1118B, Grand Central Station, New York 17.

GEMCUTTING. Silvercraft authority. Illustrated magazine tells how. Cut rocks, make jewelry. 150 ads illustrating equipment, offering gems for collectors, cutters. Postal brings literature. Lapidary Journal, Drawer B, Palm Desert, Calif.

VALUABLE Kit for geologist or mineralogist; beautifully packaged; contains many gem specimens and minerals (including uranium). Complete with professional type 5000 hour ultra violet lamp and fluorescent specimens. Map of "lost mines," magnifying glass, compass, instructions and club membership with each kit. Kit: special \$6.95. (Membership entitles you to special rates in outstanding course on mineralogy and gemology.) Write Mineral-Course, 1501 Crossroads of the World, Hollywood 28, California.

ROCKCRAFT. Interesting, profitable. Send \$1.00 for practical instructions. New and used equipment list free. Dewing, 1923 Empire, Burbank, Calif.

URANIUM. Big samples. Radioactivity guaranteed. One dollar. No stamps. WRS, Alameda, New Mexico.

GEMSTONES. Mineral specimens. Every variety. Lowest prices. Free booklet. Plummer's, 4720 Point Loma Ave., San Diego 7, Calif.

ROCKS, Ores, minerals precisely analyzed \$5. Absolute spectrographic detection of 45 elements including uranium. Free information. Keldon Research, Box 2555P, Los Angeles 54, Calif.

INDUSTRIAL Mineral prospecting pays big when you hit! Free instructions. Stratex Instruments, 1861E Hillhurst, Los Angeles 27.

FUN With rocks! Rockhound's own monthly magazine featuring mapped trips, gem cutting, silverwork, minerals, 9,000 already enjoy it, so will you. Only \$3.00 year. Gems and Minerals, Box 716P, Palm-dale, Calif.

SAPPHIRE, Topaz, tourmaline, garnet, peridot. 5 uncut gem specimens, \$1.00. O'Brien's, 1116M Wilcox, Hollywood 36, Calif.

HOBBIES AND COLLECTIONS

AFRICAN Wood carvings, unusual. collector's items, in rare native hardwoods. Statuettes 5" high \$2.00. Illustrated circular free. Eastwest, 491 Lawrence Rd., West Hempstead, N. Y.

JUST Out! 1954 directory hobby home-craft sources. 1550 addresses, 359 categories, 212 chances to regain purchase price. A must for all hobbyists. Order now, only \$1.00. Hobby Homecraft Directory, Sidney 3, Ohio.

FREE Giant Popular Mechanics 40 page book catalog! Over 400 books on workshop planning, home building, household repairs, projects, motoring, sports, photography, money making opportunities, machinery, inventions, crafts, hundreds more. Many not available in stores. Send postcard today to Popular Mechanics Press, 200 E. Ontario, Chicago 11, Ill.

UNUSED Matchbook covers, 100 different \$1.00. 36 page catalog 25c. Match-cover album \$3.00. Charles Edelman, 1311C East 84, Cleveland 3, Ohio.

NAZI, Soviet, medals, campaign ribbons. Big packet. Lists, \$1.00. Medcrafts, 1923 34th St. S.W., Calgary 2, Canada.

INVENTING Can be an interesting and profitable hobby. Write for complete particulars. Institute of American Inventors, Dept. 40-E 631-E St. N.W. Washington 4, D. C.

SAVE Money, have fun—Build your own boat. Popular Mechanics "23 Boats You Can Build" tells and shows you how. 192 pages, 500 illus., detailed diagrams and material lists. Everything from 10 ft. dinghy to 25 ft. cabin cruiser. Only \$2.00. Order today from Popular Mechanics Press, Dept. 107, 200 E. Ontario, Chicago 11, Ill.

CAMERAS, PHOTO SUPPLIES

FREE Photographic bargain book packed with hundreds of fine values in still and movie cameras, lenses and latest accessories, both in new and used. Write now for your free copy to Central Camera Co., Dept. 9E, 230 S. Wabash Ave., Chicago 4, Ill. (Photographic headquarters since 1899.)

AT Last! 3-D projection from your 2x2 slides or 8mm. and 16mm. movies with the new Panoscope screen. No glasses. No attachments. No gimmicks. 10 day money back trial guarantee. Price \$24.50 postpaid. Dealers Mart, 54 Beverly Rd., Dept. PM5, New Rochelle, N. Y.

HUNDREDS Of helpful, practical articles in Popular Mechanics "Photo Handbook." Guide to better pictures, more profit, section on gadgets and equipment. Save dollars—get expert aid. \$2.00, 153 pages. Popular Mechanics Press, 200 E. Ontario, Chicago 11, Illinois.

BUY Wholesale nationally advertised cameras, photo supplies, thousands other products at big discount. Free "Wholesale Plan." American Buyers', 629-PP Linden, Buffalo 16, N. Y.

WILD Animal and bird films in beautiful color or b. and w. 2" x 2" slides and 8mm or 16mm movies. Write for free literature. Wild Life Films, 5151 AE Strohm Ave., North Hollywood, Calif.

DISCOUNTS To 40%—Cameras, projectors, tape recorders, lenses. Write for individual quotations, no catalogs. Classified Camera, D253 E. 94 St., Brooklyn, N. Y.

BASS Says: Quality cameras since 1910. When in Chicago visit the camera cross roads of the world, or write us for your favorite equipment, new or used. Satisfaction guaranteed. Bass Camera Co., Dept. AG, 179 W. Madison St., Chicago 2, Ill.

PHOTOGRAPHY For pleasure or profit. Learn at home. Practical basic training. Long established school. Free booklet. American School of Photography, 835 Diversey Parkway, Dept. 3432, Chicago 14, Illinois.

WHOLESALE Photographic supplies. Cameras, films, projectors, enlargers. Write for free catalog. Capitol Photo Supplies, 2428 Guadalupe, Austin, Texas.

CAMERA Profits. Copyrighted. Guaranteed. \$1.00. Gumbert, 1454 West Washington, Petersburg, Virginia.

PHOTO FINISHING

FREE Flash Exposure Guide for color, b&w. Rush postcard with this ad, name and address. Garden City Photo, Box 237-E, Garden City, N. Y.

SPECIAL Offer, 8 jumbos 25c, 12-45c with this adv. Western, PM54, Box 298, San Francisco 1, Calif.

TRIAL. Rolls developed, printed jumbo size in attractive album folders, 25c and this ad. Reprints 4c. Church's, Enterprise, Ore.

8 JUMBO Prints in album 30c; 16 exp. 55c; 35 mm. 20 exp. 85c; 12 exp. roll 45c; 36 exp. \$1.25. Mel's Photo Service, Box 106F, Brooklyn 20, N. Y.

INTRODUCTORY Offer—8 exp. roll for 25c with this ad. Famous for highest quality developing during 15 years of expert service. Vermont Prints, Box 151N, Rutland, Vermont.

35MM Specialists. Fine grain developing. 20 exposures 95c, 36 exposures \$1.40. Free mailers and prices on others. Tops Photo Service, Lyons, New York.

ROLL Film or reprints. Jumbo 8, 30c; 12, 40c; 16, 50c. Bobs Photo Service, Box 23, Fairmont, W. Va.

THE Photo Mill. Immediate service. Eight exposure roll developed and one print each good negative 30c; two, 40c; one jumbo each 35c; two 65c. Write for complete prices and mailers. The Photo Mill, Dept. K, 1511 Hennepin, Minneapolis, Minn.

TWO Beautiful prints from each picture on roll. 8 exposure 35c, 12 exposure 45c. Thirty-three years of satisfied customers. Quick service. Lens Photos, Dept. J-4, Janesville, Wis.

FAST. Same day service! 8 oversized prints only 35c; 12-50c, 16-65c. Satisfaction guaranteed. This ad worth 10c toward first roll. Trial offer only! PicSure, Box 899-B, Philadelphia 5, Penna.

BEAUTIFUL Enlargement from each picture on roll. 8 exposure 35c; 12 exposure 45c. Cut Rate Photos, Dept. B-4, Janesville, Wis.

BEAUTIFUL Jumbo prints, 8 exposure roll 40c, 12-55c, 16-70c, 20-95c, 36-\$1.60. Reprints 5c. Pacific Photo Service, Box 666, San Francisco 1, Calif.

12 JUMBOS From any size roll developed 25c with this ad only. S. Skrudland, Lake Geneva, Wis.

GUARANTEED Quality. Fast service. Eight jumbos in beautiful super pak plastic ring binder albums only 35c. Send for free mailers and particulars of our complete photo finishing service. Grand Fotos, G.P.O. Box 1410, New York 1, N. Y.

TWO Prints each good negative, 8 exposures, 35c; 12 exposures, 50c; reprints, 4c. Mayfair Photo Service, Box 617-K, Toledo 1, Ohio.

TOP Quality. Fast service. 8 jumbos 35c in beautiful super pak album. 16 contacts 40c. Reprints—Jumbos 4c; contacts 3c. Satisfaction guaranteed. Write for free mailers and circulars. Fast-X-Photo, Box A, Jersey City, N. J.

CUSTOM Jumbo album prints! 8 exposure 35c; 12, 50c. Special! 35mm 36 exp. \$1.00. Free mailer. Flash Foto, Box 36M, Brooklyn 4, N. Y.

6 OR 8 Picture roll 35c. 12 or 16 picture roll 55c. Each roll developed and printed in handy album pack. Send coin with roll. No c.o.d.'s. Mailing containers sent free. Deluxe Film Service, Box 1268-A, Shreveport, Louisiana.

ENLARGEMENTS, 8x10 Oil colored \$2.00. Miniatures. Free price lists. George Brewer, 5864-D Hollywood Blvd., Hollywood 28, California.

ENLARGEMENTS! Eight 5 x 7's or five 8 x 10's. \$1.00. Wilart Enlargers, Box 967, Little Rock, Ark.

MOTION PICTURES AND SOUND EQUIPMENT

16MM. Movie subjects. Dime brings 32-page catalog listing hundreds of titles, new and used, at bargain prices. Blackhawk Films, 1243 Eastin, Davenport, Iowa.

8-16MM. Silent-sound film rental library. Free catalogue (sample film 10c). Garden, 317 West 50th, New York 19.

5,000 8-16MM. Silent-sound films. International, 2129 Strauss, Brooklyn 12.

CLEARANCE Sale of 16mm. sound films. Want a real buy in 16mm. sound films? Take advantage of the I.C.S. 1954 clearance sale of 16mm. sound features, comedies, cartoons, educational films, religious subjects—new, used. Send for our giant list "A" today stating machine you own (make and model). Institutional Cinema Service, Inc., 1360-PM Broadway, New York 36, N. Y.

RENT 16MM. sound feature pictures—\$3.95, three days, including all postage. 1954 home rental list free. Eastin Pictures, Davenport, Iowa.

8 & 16MM. Professional national parks movies in Kodachrome, list 10c. Ideal, 4644 W. Geary, San Francisco 18, California.

EARN Up to \$15.00 daily with your movie projector! Details free! Metcalf, 10806 Glenroy, Chicago 43.

8MM. Movie subjects. New 150' films, \$2.98. 50' 8mm. prevue film, 32-page catalog. 59c. Catalog only, 10c. Blackhawk Films, 1242 Eastin, Davenport, Iowa.

MOVIE Camera film: 8mm. roll \$1.50, 16mm. 100' \$3.00. Free processing. Better Films, 742 New Lots, Brooklyn, N. Y.

TAPE Recorders, tapes, accessories. Unusual values. Dressner, 624-M East 20th Street, New York City 9.

GUARANTEED Fresh 8mm. roll, magazine; 16mm. roll, magazine movie films. Color, b&w. Free catalog. ESO-R, 47th Holly, Kansas City 2, Missouri.

16MM. Sound projectors—Excellent used units, all makes, many models, \$119.95 up; some \$99.95. Dime brings illustrated catalog. Blackhawk Films, 1241 Eastin, Davenport, Iowa.

MUSIC AND MUSICAL INSTRUMENTS

1954 ACCORDIONS—Wholesale. Free catalog. American Accordion Center, PM-6, 5329 Belmont, Chicago.

MUSIC Arranged. Songs printed. Frank Wildt, Music Publisher, Lancaster, Penna.

WANTED! Poems for musical settings. Write Songwriters' Service, Clifton, N. J.

YOUR Voice made loud, clear and powerful with my diaphragm exerciser. Inexpensive. Write, Inventor Oz, 34V, Box 665, St. Louis, Mo.

ACCORDIONS, Wholesale to everyone. Save up to 60%. All national known brands. Free catalogue. Del Principe, 29 South Cicero, Chicago 44.

SONGWRITERS! Outstanding offer. Ray Hibbler, C-5, 6808 N. Oleander, Chicago 31.

SONGPOEMS Wanted. Mail to: Tin Pan Alley, Inc., 1630 Broadway, New York 19, N. Y.

POEMS Wanted for musical setting. Send poems. Free examination. Five Star Music Masters, 630 Beacon Bldg., Boston, Mass.

RECORDS, 18 Hits for \$1.97. Choose popular, blues, rhythm, or hillbilly by popular singers. Rose Records, 31 Westfield Ave., Elizabeth, N. J.

SONGS Arranged—Prepared for publication. Melodies composed. Royal Crown Music Co., 1658 Broadway, New York 19.

SWISS Music movements assorted tunes \$1.70. Helax, 218 West 72nd Street, New York City.

POEMS Wanted for musical setting. Send poems. Free examination. Crown Music Company, 1476 Broadway, New York City 35.

FREE Record of your song. Your words, my melody. Free information. Johnny Mack's Melody Mart, 1094 West 39th Street, Dept. A, Los Angeles 37.

SONGWRITERS! Protect your ideas! Hold all songs, poems! Write for safe correct procedure first! Song Service, Dept. P, 333 W. 56th St., New York 19, N. Y.

POPULAR Songs. How to write and sell them. Write for free booklet Successful Songwriting, Gateway Songs, Box 2470, Hollywood 28, Calif.

SONGWRITERS! Send poems, songs. Music Service, 243 West 72nd St., PM, New York 23.

WRITE Songs. Big money and reputation. Write for information. J. Gordon Pub. Co., 4700 South California Avenue, Chicago.

POEMS Wanted for musical setting. Send poem for immediate consideration and free rhyming dictionary. Richard Brothers, 24 Woods Building, Chicago 1.

RADIO AND TELEVISION

NEW TV catalog free. Loaded with bargains for TV servicemen, technicians, installers. Finest new TV antennas, motorless directronics, multi-channel yagis, UHF antennas, converters, motors, boosters, parts, instruments, hundreds of quality accessories at money-saving prices. Get your catalog now! National Electronics, 3065 Delco Bldg., Cleveland 3, Ohio.

REPAIR Your own TV—It's fun, safe, easy! Detailed instructions compiled exclusively for your model. Send set name, model number, \$1.00. L. S. Engineering, Box 4113-M, North Hollywood, Calif.

BIG Business, build your own photo relay business. Step by step instructions \$1.50. Outlet for checking the transformer plus instructions \$3.75. Tele Diagnosis Co., 155 W. 72, New York, N. Y.

DIAGRAMS For repairing radios \$1.00. Television \$2.00. Give make and model. Diagram Service, 672-PM, Hartford, Conn.

SAVE Money—Repair your own T.V. For \$19.95 we will send you a complete set of tubes, RCA, GE, etc. No picture tube. Send name and model number of your set with \$5.00 to: Cadillac Trading, 231-07 Linden Blvd., Dept. B, Jamaica 11, N. Y.

TELEVISION Interference eliminated with effective high-pass filter. Guaranteed \$1.00 postpaid. BMB Co., Box 25, Bethpage, New York.

DIAGRAMS: Complete manufacturers photo diagrams for television and radio repair. Radio \$1.00. Television \$2.00. Give make and model number. Diagram Service, 2016 So. 33 St., Milwaukee 15, Wis.

BUILD 15 Radios—Only \$19.95 complete. Learn radio construction, theory, troubleshooting, code, F.C.C. regulations. Complete radio course includes all parts, components, instruction books, etc. Free radio tester and soldering iron. No experience required. Money-back guarantee. Order direct or send for descriptive literature. Valuable radio and TV guide upon request, free of charge, no obligation. Progressive Edu-Kits Inc., 497 Union Ave., Dept. PM17, Brooklyn 11, N. Y.

TELEVISION Picture tubes. Top quality. Unconditionally warranted one year. \$1.20 per inch. Any size 10" to 21". Safe shipment guaranteed. Commercial Tube, 840 Cherry St., Detroit 1, Mich.

BUILDER'S Handbook. Plans, instructions, 25c. Alena, Box 24, Astoria 6, N. Y.

BUILD Your own electronic organ, or miniature electronic brain. Jim Kirk, 1552 Church Street, San Francisco 14, Calif.

BUILD Your own top quality TV set. We supply complete equipment, tools, instructions as part of America's finest home-study TV course. Be a high-paid TV technician. Install, repair, service all makes of sets. Many excellent jobs now open. Or start your own business. Get full facts free. Write: Commercial Trades Institute, Dept. CT2-5, 1400 Greenleaf Ave., Chicago 26, Ill.

REPAIR Radios. Simple instructions \$1. Slate's Radio Service, Corsicana, Texas.

COLOR Television! Enjoy 3 color television screen now. Easily attached. No tools needed. Beautiful color tones. Cuts down glare and snow. Send \$1.00 for size 10", 12" or 14"; \$1.25, 17"; \$1.50, 20"; \$2.21"; \$2.50, 24"; \$3.27". Prompt shipment. Satisfaction guaranteed. Dealers opportunity. Zingo Products, Johnstown 7, New York.

BUILD Crystal radios. Sensational Melomite crystal and detector with instructions and plans, 50c postpaid. Satisfaction guaranteed. Allen, 427-PM5, Clinton, Missouri.

CLEARCO Crystal radio kit \$1.50; preassembled \$1.75. Free catalogue. Clearco Crystal Co., Box 1857, Milwaukee, Wis.

F.C.C. Commercial operator license quickly. Grantham, 6054 Hollywood Blvd., Hollywood 28, California.

FREE. Get on our radio and electronics mailing list. A.R.I., Box 1438, Denver, Colorado.

CRYSTAL Radio experimenters. Write Leslie Hulet, R4, Lakewood, New Jersey.

FREE Giant Popular Mechanics 40 page book catalog! Over 400 books on workshop planning, home building, household repairs, projects, motoring, sports, photography, money-making opportunities, machinery, inventions, crafts, hundreds more. Many not available in stores. Send postcard today to Popular Mechanics Press, 200 E. Ontario, Chicago 11, Ill.

BUSINESS OPPORTUNITIES

DO It with "Floating Henryburgers." Over million sold in 1953. Rare opportunity. State type of place now operating or present occupation. FH Systems, P.O. Box 936, Wichita, Kans.

START Your own business on credit. Your own boss. 1658 of our dealers sold \$5,000 to \$27,500 in 1953. We supply stocks, equipment on credit. 200 home necessities. Sales experience unnecessary. Pleasant profitable business backed by world-wide industry. Write Rawleigh's, Dept. E-U-PPM, Freeport, Ill.

BEGINNERS. 10,000 Word book "Build Your Own Mail Order Business." Honest. Profitable. Facts. Ideas. All meat, no advertising. 25c refundable. Bertelsman Services, 85 Nineteenth, Newport, Ky.

SUCCESS In mailorder if you follow our suggestions. Informative treatise 25c. Griffie Enterprises, Box 91, Station D, Toledo 8, Ohio.

MAKE Rubber stamps. Big profits. Instructions 25c. Scoone's, Box 664P, Miami 38, Florida.

MAILORDER Home business using free advertising method. Information free. H. F. Seidel, 7070 Hollywood Blvd., Hollywood 28, California.

IMPORT-Export: Opportunity, profitable, world-wide, mail-order business from home, without capital; or travel abroad. Established world trader ships instructions for no-risk examination. Experience unnecessary. Free details. Mellinger 705, Los Angeles 24.

SEWING Machine—Repair, sales, servicemen needed. Previous experience unnecessary. Operate home setup. Spare, full time. New zigzag machines, motors, parts, etc., supplied. Write today. Taylor Service Co., Hamilton PM-5, Ohio.

MONEY, Typing, sewing! Details free. Edwards, 3915-PM, 12th, Des Moines 13, Iowa.

EARN \$2 Hour! I do—making sandals. Young's, 1308-PM, South First, Arcadia, California.

MONEY Getter's magazine! Read it! Learn how you can make money at home by mail! Crammed with money-making ideas, discounts, benefits, special services included free! Sample, 25c; 6 months, \$1; year, \$2. Magazine, G.P.O. Box 972, New York 1.

\$1.00 GUARANTEES You a life time business or your money back upon returned catalog before ten days. This is an appliance business. All popular brands including popular brand jewelry. You buy direct from the wholesale house. This is no gyp outfit. You can start selling to your friends, then go into your own mail order house business. You cannot be undersold. You buy direct from the wholesale house. We are not at liberty to give you the wholesaler's name until you get the catalog. F. Reiser, 19-21 White St., Paterson, N. J.

OPERATE Escalator mailorder system, selling our products or any products. Fastest, most revolutionary mailorder system known. Write: Selbyco, Decatur 156, Ill.

START A lettershop on a shoestring! Sales \$56,000. Started \$36.00. Information? Merritt, Box 13, Basking Ridge, N. J.

START Proven home business with little or no capital, without risking those hard earned dollars. So simple you begin making big full or sparetime profits at once. No stock, no advertising. Complete plan only \$1. D. J. Manning, 120 West 56th St., Bayonne, N. J.

\$1,000 MONTH Raising earthworms. Instructions 25c. Wiggler Farms, Burt 3, Michigan.

MAKE Big money! Operating home mail-order business. Sparetime, small capital. Jackson, Newfoundland 8, Kentucky.

NEWSPAPERS. Turn them into cash. Eighteen methods. Instructions 50c. Charles Company, 12-DBY, Norwood, Ohio.

"MAIL Order World" and "Opportunities Preferred" combined. Become a co-publisher. Low cost. Earn profits on advertising and subscriptions. Sample copy 25c including detailed instructions. Beecher Publications, Box 2161-B, Cincinnati 1, Ohio.

RAISE Orchids—At home. Big profits. Fascinating. Year 'round any climate. No greenhouse. Instructions, including blooming-size orchid plant, sent for no-risk examination. Free details. Flowerland, 4622-DY, Wilshire, Los Angeles 5.

NEWEST Spare, full-time home business. \$5 to \$10 hour possible. Paint with suede—The finish with touch and eye-appeal. Beautify auto dashboards, signs, radios, toys, figurines, lamps—1001 others. Complete, step-by-step instructions sent for no-risk examination. Free details. Coast, 1004-MT So. Los Angeles St., Los Angeles 15.

FREE! "301 Profitable Small Businesses!" Amazing shoestring plans! Work home! Start sparetime! Deumant Surveys, Kenmore 23-PM, N. Y.

OWN A garden golf business. Experience unnecessary. Brockway, Seaside, Oregon.

PRINT Without a printing press! Amazing new method! Print colorful signs, banners, cards, posters, glasswear; anything at home. Big profits. Money-making opportunity! We supply everything. Beautiful sample, home-business plan free! Write Screen-Print Company, Los Angeles 15, California.

SAWDUST. Turn it into cash. Twenty methods. Instructions 50c. Charles Company, 12-DBW, Norwood, Ohio.

\$900 A Year sparetime sharpening saws at home. No selling. Hardware stores get saws on commission basis. Free booklet tells how. Victor Foley Company, Columbia Heights, Minnesota.

START Your own business at home. Sell subscriptions for popular magazines. Liberal commissions. Send for supplies, etc. DeSales Magazine Service, 60 East 42nd St., New York 17, N. Y.

MAKE Money at home as renewal headquarters for all magazines. Liberal commissions. No experience. No capital needed. Supplies furnished. Write for free catalog. McGregor Magazine Agency, Dept. 500B, Mount Morris, Ill.

OVER 700% Profit making finished photos in 2 minutes on the spot in daylight without darkroom. No experience needed. Simple directions teach you quickly. Write P D Q Camera Co., 1161 N. Cleveland Ave., Dept. PM, Chicago 10, Illinois.

TIN-Cans. Turn them into cash. Nine methods. Instructions 50c. Charles Company, 12-DBX, Norwood, Ohio.

IMPORT! Export! Profitable details free. Warner's, Box 6, Ft. Scott, Kansas.

BE Independent! 20,000 words \$2.00. Satisfaction guaranteed. Taylors, Box 206-T, Three Lakes, Wisconsin.

EARN \$5 Hourly contracting floor sanding; evenings, weekends, fulltime. Machinery sold. Nothing down, balance monthly. Rader, Box 8436, Kansas City 14, Missouri.

MAKE Money! 50 ideas free. Boyer, 65 Uptown, Hoboken, N. J.

LEARN Auctioneering. Sample lesson free. Homestudy or residential. Nelson Auction School, Renville, Minnesota.

SELL Popular Mechanics and all other magazine subscriptions. Free catalog, supplies. Subscription Service Company, Dept. A, P.O. Box 2070, Birmingham, Alabama.

\$26,500 SALES in two weeks! Amazing radio-mail order method. Free details. Broadcast Service, 1413-P Great Northern Building, Chicago 4, Illinois.

NO Investment. 1000% profit. Complete laminating outfit, 25 salesplans, mailorder, \$1.00. Permaco, Box 6346PM, Philadelphia 39.

MONTHLY Repeat business which you can operate in your own community. For free details write Grosak, 321—28th Street, McKeesport, Penna.

WANTED! Home producers, by manufacturers in our clearing house service. Become subcontractor, casting plastic products for these companies. Thousands of easy-to-make items required for consumer-industrial use. Cash in at home, without previous experience. Plastic Service Associates, Dept. 5-PM, East Boston 28, Mass.

ELECTROPLATE Auto parts, novelties, mirrors, baby shoes. Easy, inexpensive home processes. Free booklet. Tyco Metals, Box 12321-MM, Houston 19, Texas.

PROFITABLE. Fascinating mailorder opportunities in your own home. Free brochure. Lorimer's, Box 2429, Greensboro, N. C.

EXCLUSIVE Franchised distributor. Amazing crushed cedar! Applied like paint. Cedarizes closets, chests, drawers. Hardware, paint, builders' dealers, contractors large buyers. Low cost, big profit potential! Attractive bags. Write for sample, details. Plant, 90-A Summit Ave., Brookline, Mass.

MINIATURE Trees—Why pay \$2.00—\$10 for growing secrets? Free details. Tiny Trees, 5038 N. Winthrop, Chicago 40.

MAILORDER—Can be operated from any home on very little capital. For free information write R. A. C., Box 103, Elkhart, Ind.

MAKE Perfumes, other products. Sell mailorder. Formula catalogue free. International, 6347 Farnell PM-5, Chicago 21, Illinois.

WHAT'S Your field of interest? Whatever it is, specialized magazines will help you get ahead. Examine current copies of those covering your field through our easy-to-get-acquainted service. Choose from 4,387 covering all fields—business, trades, agricultural, professions, insurance, real estate, music, educational, hobbies, sports, etc. Current list free. Commercial Engraving Publishing Company, 34C North Ritter, Indianapolis 19, Indiana.

ADVERTISING Book matches—Cash in on big demand; sell union label matches. Cuts for all businesses and political parties. Free powerhouse selling kit, low prices, protection guaranteed on repeat orders. Cash commissions. Superior Match Co., Dept. MX-554, 7530 Greenwood, Chicago.

MONEY Getters club! Receive 1,000 or more different money-making propositions. Year's membership now only 25c. Satisfaction guaranteed or money back. Storm-Associates, Cedarville, New Jersey.

FLORIDA Opportunities! Hundreds of jobs, businesses, farms, groves, homes. Free details! Florida Opportunity Bulletin, Box 456-N14, Coconut Grove, Miami 33, Florida.

BUILD Luggage and cases at home. We sell your products. No special equipment needed. Free details. Cascraft, 805-P5 Sunset Blvd., Los Angeles.

MAILORDER. Operate profitable home business. Free details. Guymon Direct Sales, Dept. 25, Box 535, Guymon, Okla.

BOOKKEEPERS. Keep books, small firms spare time. Manual latest technique by C.P.A., \$3.00. Modern Business, Box 406, Youngstown 1, Ohio.

FREE Literature describing many money-making plans. H. A. Steinmetz, 132 Berkshire Ave., Bridgeport 8, Connecticut.

REINK Typewriter ribbons. Special black ink with applicator, 50c coin. Feature Service, Drawer 791, Chicago 90.

HAVE Home mail business—Get red hot plans, ideas that assure big earnings. Write: Norman, 896 W. Aldine, Chicago 13A, Ill.

BUILD 3 Bedroom home—\$590.00. Itemized details free. Buildit, Box 322, Arkansas City 1, Kans.

MAKE Money at home doing easy pleasant work. Everything furnished. Good earnings. Write: Murray's, Box 4006, Mott Park Station, Flint 4, Michigan.

SELL To women by mail from your home—Repeat order merchandise. Everything furnished. Big profits. Mohawk, 37A, Second, Amsterdam, N. Y.

EARN Extra cash operating sparetime circular mailing service. Money-making information furnished. Jennings, 1540 First, Sarasota, Florida.

DEPRESSION-Proof business—Make tough, durable plastic of waste, easily. Makes attractive, resilient floors, walls, built-ins. Stucco. Build for half. Bays Laboratory, Oklahoma City 9.

GET Newest, best merchandise, book mail selling offers. National, Box 88A, Dorchester 22, Mass.

BUY Wholesale. Hundreds nationally advertised products. Watches, housewares, jewelry, appliances, etc. Save. Make money. Free details. National Buying Service, Radio City Station, Dept. M, Box 324, New York City 19, N. Y.

PRINT For profit at home. Amazing new method prints colorful posters, banners, greeting cards, glasswear—anything. Hundreds at time. No press needed. No art. Fantastic profits! Need representative your area immediately! Free home-business plan. Screen-Print, Los Angeles 15, California.

MAKE Money at home—Mail cards, circulars feature real merchandise. Everything furnished. Big earnings. Philip's, Box 3-P, Boston 22, Mass.

MAKE Money by mail order. Free catalogue shows how. Details free. Opportunities Unlimited, Dept. 6, Box 1576, Boston, Mass.

MAKE Perfumes, other products, home. Carelabs, 1914 Chouteau-PM5, St. Louis 3, Missouri.

SELL By mail to auto owners—Everything furnished. Eastern, Box 142P, Dorchester 22, Mass.

FREE Wholesale catalog! Make up to 500% profit! Novelties, gifts, premiums, costume jewelry, wrist watches, housewares, name brand merchandise. No junk, sell to stores or individuals. Write for catalog No. 5. Heath Distributing Company, 306 Broadway, Macon, Georgia.

QUATEMALAN Typical handmade products: Excellent gift shop items. (Leather bags, belts, skirts, Indian dolls, baskets, etc.) Mail orders filled. Dealers inquiries invited. Write airmail for free catalog. Mapilon, Box 268, Guatemala, C. A.

MAKE Perfumed stationery. Profitable local-mailorder business. Sample free. Renzi Press, 24-R North 7th, Newark 7, New Jersey.

BREED Parakeets at home. Sensational big profit opportunity! Free confidential details. Parakeets, Box 2127, Inglewood, Calif.

EARTHWORM Breeding! Extra money! Big money! First get unusual true story, "An Earthworm Turned His Life." Send dime. Earthmaster System, 8D, El Monte, Calif.

EXPORT American products to Middle East markets by mail. New ways to import Eastern goods. Write to: A. Majid Shamkani, Margil, Basrah, Iraq.

COMPLETE Rubber mat factory. Power machines. Make mats for homes, factories, stores, etc., from cheap junk tires. In double garage space two people can make \$200 profit per six hour day! We show you how. Total investment only \$2,650 complete. Easy terms. Simmons & Sons, 1619 Prospect, Indianapolis 3, Indiana.

ESTABLISH Profitable automatic shoe shine route. Proven. Write Jiffy Shine, 1630 S. 2nd St., Philadelphia, Penna.

UNUSUAL Mail order ideas, sources. Details free. Fax, Box 241, Brownwood, Texas.

SENSATIONAL Reworking offer. \$44.75 value for only \$8.65. Professional equipment and course. Rush postal for thrilling free details. Invisible Reworking Institute, Dept. 456B, La Mesa, California.

START A buying service, buy wholesale thousands nationally advertised products. Make big profits selling at sizable discounts. Postcard brings details. American Buyers, 627-P Linden, Buffalo, N. Y.

AMERICA Is still the land of golden opportunities. Fortunes are still begging to be made. Learn how to establish and operate the business of your own choice. Complete business kits only \$5.00. Details free. Golden Opportunity Business Kits, 2096 Stanley Ter., Union, N. J.

ALASKA Business opportunities. \$1 brings catalog of listings. Write Samuel Fairchild, 246 4th Avenue, Anchorage, Alaska.

DON'T Be Mr. Average Man. Operate your own business. Very desirable, non-perishable, no chemicals or liquids, highly profitable. Write for details. Protecto Products Company, Box #543, Oak Park, Illinois.

START Your own mail business at home in your sparetime with small investment. Proven merchandising methods. No crackpot schemes. Write, Craig, Southern Pines 1, North Carolina.

MAKE Candy at home. We teach by mail to make delicious candy, operate candy shop. Send card for details. Richards Candies, 420 Main St., Stroudsburg, Penna.

BIG Money! Start your own plastic business at home. Spare or full time. (Also valuable liquid marble information.) Free catalog. Write: Bing Products, PM-553, Watertown 72, Mass.

UNCLE Sam tells how to finance and operate many businesses. Copyrighted folio revealing many bargain manuals, \$1. Loan booklet included. A-B Enterprises, 9814 McMillan Avenue, Silver Spring, Maryland.

LIQUID Rubber, make flexible molds. Free sample. Chaney, 1130 E. 16th St., Jacksonville 6, Fla.

AMAZING Opportunity! Start profitable collection agency! Become co-partner. Valuable franchise available. Write: Edmondson, Box 4865-P, Atlanta 2, Ga.

MEXICO! Imports! Curious wholesale! Giftshop, collector's items! Sample and price list, 50c! Filmer, 910 Marion, Pharr 10, Texas.

FORTUNES Made raising crickets and fishworms. Sell by mail. Raising and marketing instructions, \$1.00. Breeder redworms, \$5.00 per 1000 postpaid. Carter Farms, Plains, Georgia.

RECAST Old batteries into new. Latest achievements. Battery Laboratories, Minneapolis.

LEARN Metalizing baby shoes, gifts, etc. Bronze, gold, silver. Folio free. Kiktavi, 7217-PM South Broadway, Los Angeles 3.

WHOLESALE Of sensational nationally advertised appliances, silverware, watches, cameras, etc. Start your own business. Full details. Send 50c for catalogue. International Sales Co., 175 Fifth Ave., New York 10, N. Y.

TERRIFIC Home business opportunity. Mail literature featuring real merchandise to new mothers. Everything furnished. Schlott, 219C 5th Ave., Brooklawn, N. J.

START Venetian blind laundry. Profitable lifetime business. New machine. Free booklet. F. C. Co., 442 N. Seneca, Wichita 12, Kansas.

LATEX For molds. Free instructions casting statuary, novelties. Major Chemical, 21 Allerton St., Boston 19, Mass.

CO-Publish wonderful mailorder magazine. Work home. Sample, instructive manual 25c. Dispensa, 2020 Harbor, Ash-tabula, Ohio.

RAISE Rose bushes. Full instructions \$1 cash, check, m.o. Marvin Todd (Nurseryman), Route 7, Box 572, Tyler, Texas.

UNUSUAL Homework opportunity, spinning Angora spartime for us. Men, women. Angora House, PM, Springfield, Illinois.

HOME Business mailing literature to new mothers. Details free. K & M Products, 3634-A Homewood, Toledo 12, Ohio.

12 PRACTICAL Mail order plans 50c. Box 631, Canton, Ohio.

CO-PUBLISH Reliable mailorder magazine. Sample 25c. Details free. Rockaway-Hall Company, Box 95B, Rockaway, Ore.

MILLION Articles wholesale. Supply source directory 25c. Idealer, Park Ridge, Illinois.

HOW And where to obtain capital. Particulars free. Star Service, Wapakoneta, Ohio.

MAKE Money at home. Write, Falcon House, Winnebago 2, Ill.

TO \$40.00 Weekly. Sparetime, home operated mailorder business. Successful beginner's plan. Everything supplied. Lynn, 10420-M National, Los Angeles 34, Calif.

SPARE Time business. No investment. Details free. Howell, 1320 St. Andrew, New Orleans 13, La.

COPUBLISH Mail Sale Advertiser, leading mail order paper. Details, latest copy, dime. Vanroy Shirk, Lebanon, Penna.

EARN Money at home! Homemaker Magazine tells how. Sample, 25c. Sizemore, Box 7, 4917 Kostner, Chicago 30.

DOLLARS In personalized baby record books. Sell by mail. Eleven thousand new prospects daily. Use same literature we do. No-Co-Ro, Oakland 6, California.

MAKE Rubber stamps, repair dolls; learn silk screen printing; invisible reweaving. Catalogue (60 ideas) free. Universal, Box 1076-A, Peoria, Ill.

SCHEMER Magazine, Canfield 1, Ohio, monthly mailorder ideas, plans. Year \$1.00. Sample 20c.

NATURAL Molding rubber, extra thick. Free sample. Flock, tinsel, candle wax. W. Wooley, 115-A Donald, Peoria, Ill.

PLASTERCRAFT Molds, liquid rubber, plasters, flocks, candle supplies. Catalog and manual free. Blue Rapids Supply, Blue Rapids, Kansas.

EARN Money! Amazing plans! Easily mastered. Details. Brunst, 216-B West Jackson, Chicago 6, Illinois.

GROW Mushrooms. Cellar, shed, and outdoors. Spare, full time, year round. We pay \$3.50 lb. We paid Babbitt \$4,165.00 in few weeks. Free book. Washington Mushroom Ind., Dept. 172, 2954 Admiral Way, Seattle, Washington.

COLOR Concrete with chemicals. Marble-glaze cement benches, pottery, garden ornaments. Home — shop. 10c brings sample, pictures. Hollywood Cementcraft, 8527-R Wonderland, Hollywood 46, Calif.

POPCORN And potato chip equipment. Leco, Box 933-A, Springfield, Ohio.

BUY It wholesale! Manufacturers, distributors offer \$30,000 items. Literature free. Olsen, 1231-A East Third St., Duluth 5, Minn.

BOOKKEEPERS. Increase earnings operating sensational bookkeeping service. Kern, 4942 Vineland, North Hollywood, Calif.

\$46 FROM Square foot plywood; jigsaw necessary. Write: Woodarts, Bridgewater, Mass.

BUY Wholesale thousands items. Lists free. Cottage Industries, Omaha 12, Nebr.

\$23 WEEKLY Working two hours daily at home. Lycke, Box 2471-A, Cleveland 12, Ohio.

START Your own profitable home mail-order business! We supply everything! Write today! Studio Products, Box 564-A, Glendale 5, Calif.

BREED Rare tropical fish at home. Earn big money! Learn secrets! Help fill huge demand. Amazing opportunity! Free plan. Tropicals, 1008-F Los Angeles St., Los Angeles 15.

INCOME From local information. No selling. Write Neberco, La Verne, Calif.

RESILVERING Mirrors, formula 50c; two-way lookout mirrors, (No one sees you), 50c; coppered mirrors, 50c. All \$1.00. Nelko-Mir, Box 3462-J, Chicago 54.

START Home manufacturing business. Make cleaners, soaps, polishes, cosmetics. Free literature. Kemix, Park Ridge, Ill.

LIVING Miniature ("Ming") trees only 10 to 20 inches tall. Grow at home. Big profits! Spare time opportunity. Fascinating! Amazing! Write for free seed and plan. National Nursery, Dept. FC, Inglewood 4, California.

MAKE Money spare or full time, casting metal toys and novelties. Big wholesale and chain store demand for autos, soldiers, ashtrays, banks, etc., keeps manufacturers busy. Production moulds furnished for up to 100 and more castings per hour. No experience or special place necessary. Write for information and illustrations of patterns needed. Metal Cast Products Co., Dept. A, 1696 Boston Road, New York 60, N. Y.

NEW Exceptionally profitable plans, ideas for home operated mail business. Rush name. Miller, 1772-P Carlyon Road, East Cleveland 12, Ohio.

GOOD Paying business silvering mirrors, plating autoparts, reflectors, bicycles, bathroom fixtures, etc., by late method. No tanks or shop required. Outfit furnished. Free booklet. Gunmetal Co., Ave. H, Decatur, Illinois.

OPERATE Profitable mail order business. Write Walter Service, 4159-A East 112th, Cleveland 5, Ohio.

MINK Raising information free. Complete. Lake Superior Mink Farm, Superior, EEL, Wisconsin.

COLORGLAZED Concrete pottery made without molds. Patented method. Cemetery products, novelties, tiles. Basement leak-sealing. Money-making projects. Booklet, details free. Men only. National Potteries Company, Grand Rapids, Minnesota.

FREE Book "505 Odd, Successful Businesses." Work home. Expect something odd! Pacific, Oceanside, Calif.

FIX Typewriters. Free booklet describes our modern, inexpensive home-study course. Factory methods taught. Write Typewriter, Building 1, Tarentum, Penna.

MONEY In new greaseless doughnuts. Start in kitchen. No smoke. Sell stores. Free recipes. M. Ray Company, 3605 South 15th Ave., Minneapolis 7, Minn.

VENDING Machines — No selling. Operate a route of coin machines and earn amazing profits. 32-page catalog free. Parkway Machine Corporation, Dept. 72, 715 Ensor St., Baltimore 2, Md.

BRONZED Baby shoe supplies, instructions, mountings. Metal bookends, \$1.50 pair. Free catalog. National Bronze Supply, Box 56, Los Angeles 32, Calif.

MONEYMAKING OPPORTUNITIES

OPERATE Profitable home mailorder letter shop. Write. Continental Publishers, 1332 So. 61st, Milwaukee 14, Wis.

MEXICAN Featherbird pictures. Big profits! Hot sellers! Edmunds, 3009 Weaver Ave., Baltimore 14, Md.

WINDSHIELD Wiper rebuilding brings big profits. Free particulars. Hardy's Service, 878 East Waterloo, Akron 6, Ohio.

PRINT Without a printing press! Amazing new method! Print colorful signs, banners, cards, posters, glassware — anything at home. Big profits. Money-making opportunity! We supply everything. Beautiful sample. Home-business plan free! Write Screen-Print Company, Los Angeles 15, California.

FRENCH-Type perfume really sells! \$1.00 brings \$4.50 flacon, details (refundable). Elliott-Stuart, 4616-A Hollywood Blvd., Hollywood 27, Calif.

FREE! "301 Profitable Small Businesses!" Amazing shoestring plans! Work home! Start sparetime. Deumant Surveys, Kenmore 23-PM, N. Y.

EARN Money evenings, copying and duplicating comic cartoons for advertisers. Adservice, Argyle 1, Wisconsin.

MAKE Money at home as renewal headquarters for all magazines. Liberal commissions. No experience, no capital needed. Supplies furnished. Write for free catalog. McGregor Magazine Agency, Dept. 500C, Mount Morris, Ill.

FREAKWOOD Lamp kits, ming tree kits, planter kits, abstract art kits. Ming Company, Box 373, Reno, Nevada.

DO It with "Floating Henryburgers." See ad under "Business Opportunities."

\$10,800 PROFITS! Your own mailorder business! No risk! Success plan free! Treasury, 709 Webster, New Rochelle, PM-23, N. Y.

PRESERVE Living flowers to last indefinitely. Interesting, profitable! Maxson, Falls Church 18, Virginia.

PROFITABLE Enterprises. Work home. Free literature. Thomas Walker, 3042 Madeline Street, Oakland 2, California.

LET'S Strike it rich. Write Alliance Sales, 568-O, Alliance, Nebraska.

THREE Terrific items. Big profits. Penants for auto dealers, gas stations, etc. New pocket-cushion for sport fans. Color television screens. Erteo Sales, P.O. Box 2205, Port Wayne, Ind.

CONVINCE Yourself: Hundreds of Ways to Make Money. Milmac, 724 E. 260, Euclid 23, Ohio.

CHINCHILLAS Rented, we pay up to \$300 each for offspring. Write: R. Rau, Route 2, Jeannette 4, Penna.

BUY Wholesale — Thousands nationally advertised items. Save — Make money! Free details. Durex Company, Box 672-P, Chicago 90.

GET Free copy of "Opportunity," the magazine that shows you the way to unlimited profit possibilities. Gilbert, Room 1700, 28 East Jackson, Chicago 4.

TYPEWRITER Owners. Make handsome profits. Get details today. Groves Company, 682, Hastings 8, Nebraska.

MAKE Money. Surefire mailorder. Write Dexter, Box 208, Culver City, California.

DOLLARS In your mail box daily. No stock investment. Particulars free. Gem, 44-B Atlantic, Pleasantville, New Jersey.

CIGARETTES — Roll 200 mild, tasty, guaranteed to please for 75c. Details free. Pete Moberly, Box 881, Owensboro, Ky.

ADDED Income selling by mail. Roblin Sales, 1001 Curtiss, Downers Grove, Ill.

MAIL Letters featuring real merchandise. Get \$10 orders in every mail. 100% profit. Everything furnished. Products, Box 23, Boston 17, Mass.

ALUMINUM Awnings, baked enamel colors. Wholesale factory prices. Install yourself. Write Groff Awnings, Box 10254, Tampa, Florida.

MECHANICS, Filling station operators. How to make up to \$800 more profit per month. Rush \$2 for complete details. Northern Mechanics, Box 13, Faribault, Minnesota.

"TYPEWRITER Profits." Copyrighted. Guaranteed. \$1.00. Gimbirt, 1454 West Washington, Petersburg, Virginia.

START A profitable subscription business in spare time! We need men and women (young or old) as representatives for all leading national magazines. Liberal commissions paid for new and renewal subscriptions. Start earning money in this pleasant work at once! Clip this ad and send with your name and address to: Agency Bureau, Dept. PM, Hearst Magazines, 250 West 55th St., New York 19, N. Y.

MONEY Raising hybrid earthworms. Prolific breeders. No overhead. 100% profit. Free instructions. Write today. Earthworm Gardens, 14 Peacock Bldg., El Monte, Calif.

MONEY Found. Be our agent in your community. Top quality watches, diamonds, jewelry, etc., at wholesale prices. Amazing profits. Lifetime income. Experience unnecessary. Send for free catalog. Zerah Bros., 602 Mission St., Dept. M31, San Francisco 5, Calif.

TYPISTS! Make money at home! Write R&M Service, 2 Madison, Greencastle, Ind.

INCREASE Your income, turn your spare time into cash — Making quick-selling, highly profitable lamps and fiber glass shades. Every home a prospect for one or more. Hundreds already doing it, so can you. No experience needed. No special tools required. Gearon's big, new 72 page 1954 illustrated Catalog No. 8 will show you how, quickly. One special 8-page section shows 6 beautiful lamps in kit form, ready for you to assemble. Another 12-page section shows you how to make stunning, ultra-modern fiber glass shades. Page after page filled with wide variety of other attractive shades, shade frames, figurines, and lamp bases. Also oil lamp converters, boring compound, and all kinds of cords, sockets, pipes, harps, finials, bases, and hundreds of other parts. Everything you need. And you can buy everything wholesale, sell at retail, make big profits, fast. Send only 25c right now for Gearon's big 1954 catalog and wholesale price list. Like hundreds of others, you'll be glad you did. Gearon Co., Dept. 503-B5, 27 S. Desplaines, Chicago 6, Ill.

EARN Extra income at home. Honest, dignified, steady self-employment. Local or mailorder. Graham Company, 1236 Granger Ave., Lakewood 7, Ohio.

BIG Profits selling used cars. Free details. James E. Smith, 601 N. Willow, Chattanooga 4, Tenn.

MEN, Women: Add \$50 weekly to present income. No selling or collecting. Chamber of Commerce approved. Write today for information. Independent Driver Training, 1801a Shaftesbury Road, Dayton 6, Ohio.

OUR Service solves "What to sell by mail" problem. Information 25c. Market Specialist, Box 76, Washington 4, D. C.

START A buying service, buy wholesale thousands nationally advertised products. Make big profits selling at sizable discounts. Postcard brings details. American Buyers, 630-P Linden, Buffalo, N. Y.

IN Your spare time earn 100% profit on plastic lamination. Every adult a double prospect. 25c brings samples and details. Presto Sales, Box 171, Breton Woods, N. J.

PROFITS Guaranteed for sparetime. No investment. Not mail order. Canvassing unnecessary. Nothing to make or learn. New plan. Free details. Transamerican, Dept. 70, Box 815, Atlanta 1, Georgia.

HOUSEWIFE'S Delight. Apron with two matching potholders. Terrific sales appeal. Details-sample 70c. Step Saver Mfg. Co., 1671 Milwaukee Ave., Chicago 47, Ill.

CASH Profits for you operating a candy kitchen in your own home with exceptional profits. Details free. Heasty, 917 Galardon Dr. N.W., Albuquerque, New Mexico.

PRINTING And office supplies wholesale. 20,000 items. Literature free. Royal, Box 363-A, Cleveland 27, Ohio.

CHINCHILLAS: Profitable. Raise in spare room, cellar. Terms. Ross Chinchilla Ranch, 749 Rincon, El Sobrante 11, California.

MONEY At home! Opportunities, offers. Free details. Rockaway-Hall Company, Box 95A, Rockaway, Oregon.

BUY Wholesale! Nationally advertised products. Tremendous discounts. Particulars free. Econ-O-Mart, Box 535-B, Morristown, New Jersey.

FLEXIBLE Rubber moulds for plaster and Marbleite figurines. Sample and large illustrated catalog 25c, refunded on first order. K-C Novelities, Dept. 4, Easthampton, Mass.

GROW Mushrooms. Cellar, shed, and outdoors. Spare, full time, year round. We pay \$3.50 lb. We paid Babbitt \$4,165.00 in few weeks. Free book. Washington Mushroom Ind., Dept. 173, 2954 Admiral Way, Seattle, Washington.

SPARETIME Profits taking subscriptions, all magazines. Wholesale catalog free. Cassell Agency, Westfield 2, New Jersey.

EARN \$50.00 Daily making mats, shoes and mud guards from old tires. S and S Patents Inc., 1307 North Clark St., Chicago 10, Ill.

SELL Titania gems; \$9.75 carat wholesale. More brilliant than diamonds. Free catalogue. Diamondite, 1404-M Mitchell, Oakland 1, California.

50,000 ARTICLES Wholesale. Source directory, dime. Nelko, Box 3462-DR, Chicago 54.

READ Progressive Mailtrade, the magazine that tells how to make money by mail. Dime brings sample and special offer. Progressive Mailtrade, Box 357, Sheboygan, Wisconsin.

FREE Book "505 Odd, Successful Businesses." Work home. Expect something odd! Pacific, Oceanside, Calif.

PUBLISH Your own magazine. Handsome 52 page format, well edited, illustrated. Cost low as \$1.00 month. Brings you prestige, profits. 25c brings sample, details. National, Ord, Nebr.

GENERAL Contest Bulletin. Issued monthly. Sample, 10c. 1609 1/2 East 5th, Duluth, Minn.

MAKE To \$4.50 hour doing common pen lettering. National Artists, 801 1/2-A North Marsalis, Dallas 3, Texas.

MANUFACTURER—Wants reliable men-women for profitable mail-order work. Home, Sparetime. Liebig, Beaver Dam 4, Wisconsin.

FOREIGN Employment construction work. If interested in foreign projects with high pay write Foreign Service Bureau, Dept. PM, Metuchen, New Jersey.

FORMULAS. PLANS. ETC.

MANUFACTURE Extremely profitable chemical products. Literature 10c. Thermolab, Peoria 4, Ill.

PRODUCT Analysis, manufacturing formulas, processes developed. Moderate fees. Plastics, Box 1574, Boston 4, Mass.

FREE Formula instruction sheet, list. Sacco, Box 711, Binghamton, New York.

FORMULAS, \$1 Each; home profits plans. Write: G. Calderon, 80 East 115th Street, New York 29, N. Y.

FORMULA Fortunes, 10,000 trade secrets. Authentic 900 page volume, \$3.95 postpaid. Brockway, 1145 High, Topeka 1, Kansas.

LABORATORY Tested formulas. Catalog free. Pont Chemical Company, Terre Haute 2, Indiana.

FREE Chemicals offer. Profitable specialty manufacturing formulas. Crotona, 1725 Fulton Avenue, New York 57.

ANY Formula \$3.00. Catalog-mfg. treatise 10c. J. Belfort, 192 N. Clark, Chicago 1.

ANY Formula \$5.00. Satisfaction guaranteed. Jack, Consulting Chemist, 5138 Gairnor, Philadelphia 31.

CHEMICAL, Metallurgical, manufacturing formulas, processes developed. Moderate prices. Louis Johnson, 6238 S. Parkway, Chicago 37.

MILLER'S Modern manufacturing formulas make fast-selling products that get the business and pay! Fifty years supplying the best. Late literature free! Liscombe Miller, Chemist, Tampa, Florida.

FORMULAS; All kinds. Latest, best. Literature free. Kemixal, Park Ridge, Ill.

GENUINE Manufacturing formulas. Latest. Literature free. Nelko, 3462-P Merchandise Mart, Chicago 54.

REAL Manufacturing formulas. Lists free. Cummings, Chemist, Gordon Ave., Syracuse 4, N. Y.

FREE Formula catalog. Anything analyzed \$35. Western Chemical, Salem, Ore.

PLASTICS

FIBERGLAS, Polyester, plexiglas, acetate, vinylite. Casting, coating plastics. Maurice Lannon's Fiberglass "How" book now ready—\$2.50. Fast service, best prices. Catalog 10c. Gem-O-Lite, Box 6867P, North Hollywood, California.

PLASTIC Items developed, manufactured. Free consultations. Karmel Plastics, 141 Grand Ave., Brooklyn.

PLASTICS Home-craft course for men and women. Tells and shows how to make hundreds of fast selling plastics products. All plastics and materials for 23 projects included in course. No special tools needed. Course pays for itself. Write for free booklet. Interstate Training Service, Dept. D-3-E Portland 13, Oregon.

PLASTIC, Sheets, rods, tubes, etc. Free list. Plastic Supply Co., 2901 N. Grand Blvd., St. Louis 7, Mo.

NEW Liquid casting plastic. Clear, colors. Preserve flowers, insects, photos permanently. Saw, drill, carve. Send 25c for Castolite Casting Manual and proved success plan showing how to make money at home. Castolite, Dept. E-101, Woodstock, Illinois.

PLEXIGLAS Sheets—Cut to size. Clear. All thicknesses. Standard outdoor translucent colors. McClarin Plastics, P.O. Box 168H, Hanover, Penna.

LEARN Plastics at home. Complete kit—\$5.98 postpaid. Dime brings sample plastic, three experiments, full details. Plastic Projects, Box 5151, Detroit 35, Mich.

PLEXIGLAS, Lucite. Any size sheets. Square foot (12 x 12) cost, 1/16" \$1.18; 1/8" \$1.55; 3/16" \$1.90; 1/4" \$2.25. Add 15% for postage. Minimum order \$3.00. Almac Plastics, 600 Broadway, New York City.

CHEMISTRY

SPECTACULAR Chemical experiments manual, second improved printing, not mimeographed, interesting and thorough. Contains complete formulas, set-ups, instructions, special data, on thermites, fulminates, acetylides, nitrogen iodides, explosive powders, etc. Only \$1 postpaid. Chemi-Tech Laboratories, 568CV Riley, Buffalo 8, New York.

CHEMICALS, Supplies, catalog 20c. Laboratory Sales, Box 161A, Brighton, Mass.

AMAZING New book of science. Experiments, formulas and catalogue of laboratory supplies. Only 25c. National Scientific Co., Dept. PMS, 2204 W. North Ave., Chicago 47, Ill.

FUTURE Chemists of America. All ages. Systematic instruction. First lesson 25c. Parkway Laboratory, 1004n Second Ave., Pittsburgh 19, Penna.

ARE You having difficulty locating chemicals? We specialize in rare chemical sources, organic and inorganic. Send us your requirements. Fabian Chemical Co., Box 63, Ottawa, Canada.

ILLUSTRATED Catalog: Chemistry, mineralogy, biology 20c. Tracey Laboratories, Evanston, Illinois.

NEW Idea chemical and apparatus outfits for home experimenting. Photo-scales, microscopes, chemicals, biological and laboratory supplies in small quantities. Catalog 25c. Established 1931. John H. Winn, 124A West 23rd Street, New York, N. Y.

CHEMICALS And apparatus for industrial, analytical, and private laboratories. Catalog 25c. Dept. M-50, Biological Supply Co., 1176 Mt. Hope Ave., Rochester 20, N. Y.

AGENTS WANTED

AGENTS—Salesmen: Sell beautiful hand-colored plastic enlargements and sensational new personalized photo compacts, rings, bracelets, lockets, etc. Experience unnecessary. 40% advance commissions. We deliver, collect. Wonderful sideline—Better full time. Free sample outfit. Novel Portrait Co., 3343 North Ave., Chicago, Ill.

MAKE Money introducing world's cutest children's dresses. Big selection, adorable styles. Low prices. Complete display free. Rush name. Harford, Dept. L-6341, Cincinnati 25, Ohio.

NEED Extra cash? Get it selling Blair's unusual line of household and food products. Every housewife a prospect. Products sent on free trial. Write Blair, Dept. 31ME, Lynchburg, Va.

AD Matches! Sell amazing designs—20, 30, 40 and 240-light book matches. Bigger spot cash commissions; every business a prospect. Low prices for high quality. Repeats. Start without experience; men, women; full, part time. Buy nothing! Sales kit furnished. Match Corp., Dept. PM-53, Chicago 22, Illinois.

MEN—Women: 100% profit, taking orders for Sweet Georgia Brown beauty products. Colored people buy on sight. Sample offer. Valmor, 2451-BH3 Michigan, Chicago 16.

BALL Pens \$10.00 gross, retractable pens \$2.50 dozen, needlebooks with threader, sunglasses, comb sets. Lutsker, 871MM East 170th, New York City 59.

SPARE Time money plus new car as encouragement bonus. Amazing 60 gauge nylons 3 pairs guaranteed 3 months. Write Wilknit, 1745 Washington, Greenfield, Ohio.

KITCHEN Gadgets wholesale. Famous fast sellers. Milford Products Company, 3325-X North Pulaski Road, Chicago 41, Illinois.

FREE Hosiery! Sensational new way earn to \$3 hour in spare time! Introduce amazing hosiery by giving away free pairs to every man and woman (regardless whether or not final purchase is made) just to prove how good they are! Wonderful luxurious nylon stockings, guaranteed against runs and snags, nationally known, sold coast to coast. New miracle one size two-way stretch men's nylon hose, contains no elastic, yet fits every size foot from 9 to 14! Never sags or droops, clings to foot like second skin. Outlasts several pairs ordinary hose and guaranteed one full year! Money or experience unnecessary. Buy nothing. Deliver nothing. Advance cash plus huge cash bonus to 40%. Your own hose as extra bonus. Special manager plan so you can appoint agents. Nothing like this ever offered before. Samples of stockings and miracle socks with complete money-making outfits free and prepaid. Nothing to pay now or later. Absolutely no obligation. Simply mail postcard with your name and address. Kendex, Babylon 43, N. Y.

EASY Handwork makes fast-selling useful articles. Sample free. Sunmade Company, Brockton 64, Massachusetts.

BUY Wholesale. 25,000 items. Catalogue 25c. Matthews, 1472-B3 Broadway, New York City 36.

PRINTING, Salesbooks, envelopes. Free illustrated catalog. Erasco, Dept. PM, Bronx 72, N. Y.

SELL Perfume wholesale. Billows, 110-05 37 Ave., Corona, 68, N. Y.

BEAUTIFUL Feather pictures. 200% profit! Free sample. Apartado 8036, Mexico 1, D. F.

NEW Plastic mending tape. Just press on! Repairs clothing instantly. Lightning seller. Samples sent on trial. Kristee 56, Akron, Ohio.

BIG Profits selling ties (\$2.60 values), \$6.50 dozen. Free catalog. Empire Cravats, 611A Broadway, New York 12.

SELL Wholesale nationally advertised merchandise. Your own business easily developed. Catalog, details—50c (refundable). Bergen Novelty Sales Co., Dean St., Englewood, New Jersey.

BEST Source for nylons and men's socks. Rich Supply Co., 215 W. 98th St., New York 25.

JAPANESE Artificial-pearl Necklace! Earring! Samples \$1.00. Details: Tsuboi, Kamakura 27, Japan.

BIG Profits. Razor blades, other items. Free sample, lists. Hansen Sales, 4908-P Ohio, Chicago 44.

YOUR Own business—Used suits \$1.50, overcoats 65c, mackinaws 35c, shoes 12 1/2c, ladies coats 30c, dresses 15c. Enormous profits. Catalog free. Moro, 1218 South Jefferson, Chicago 7.

WHOLESALE Catalog! 25-65% discounts! Nationally advertised appliances, watches, typewriters, cameras, tools, toys, housewares, phonographs. Consolidated Distributors, Box 1537A, Paterson, New Jersey.

EASY Extra income—Sell sensational new silicone scorch resistant ironing board cover. Good Housekeeping approved. Terrific \$1.98 seller! Send for free complete selling kit. Sample cover \$1.10. Menell Products, Dept. P, P.O. Box 431, Midtown Station, New York 18, N. Y.

FINE, Hand tooled leather handbags from Mexico. Need only be shown. Prices competitive. Pan-American, Box 481, Chula Vista, California.

BUY Wholesale thousands nationally advertised products at big discount. Free "Wholesale Plan." American Buyers, 629-P Linden, Buffalo, N. Y.

APPLIANCES, cameras, radios, toys, typewriters, watches. Large coded wholesale catalogue! Cam Company, 6806PM—20th Ave., Brooklyn 4, N. Y.

HAVE A complete store in your pocket. Buy wholesale and make big profits. Send for free general merchandise catalog now. Jay Norris, Dept. P, 445 Broome St., New York City.

PRINTING, Advertising salesmen—Excellent moneymaking sideline selling decalcomania name plates, small quantities. Automobile initials, sign letters. Free samples. Balco, XL, Boston 19, Mass.

CALIFORNIA Sweet smelling beads. Sensational sellers. Free particulars. Mission, 2328PM West Pico, Los Angeles 6, Calif.

WINDOW Sign letters. Samples free. West Coast Sign Letter Service, P.O. Box 697, Escalon, Calif.

MEXICAN Feather pictures. \$1.25 stamps brings \$2.50 worth samples. Artex Art. Apartado 762, Mexico City.

GOLD Or silver letters, numbers. Windows, doors, trucks, 1" to 6". 500% profits. Free samples. Atlas-T, 544 West 79th, Chicago 20.

BARGAINS. Job lots, close-outs! Save up to 50% on clothing, hosiery, notions, drugs, toiletries, gifts, jewelry, television, etc. 2000 items. 25c brings wholesale bargain catalog with special get acquainted offer which includes free \$1.00 merchandise certificate. Reliable Jobbers, 311-B North Desplaines, Chicago.

SAVE 50-75% On household appliances. Free particulars. Wholesale catalog. Nueblings-P. Sacklerville, N. J.

MAKE Extra money. Sell front door name plates to friends, neighbors. Retail \$1.98; you make \$1.00! Free selling kit. Modern Engraving Co., P.O. Box 194, Boston 14, Mass.

AGENTS: Stamping names on key protectors. Sample 25c. Stamping outfits, checks, social security and name plates. Hart Mfg. Co., 303 Degraw St., Brooklyn, N. Y.

AGENTS - 300% Profit selling genuine gold window letters; stores and offices. Free samples. Metallic Sign Letter Co., 431-D North Clark, Chicago.

\$1.00 PROFIT Selling \$2.95 photo enlargement deal. Allen Studio, Riegler Bldg., Little Rock, Ark.

SALESMEN—DISTRIBUTORS

\$10,000 PROFIT Selling printing, matches, specialties! Arrow dealer tells how he did it in giant free sales outfit. You can do it too—Without experience. Write Arrow Press, 515-F Fourth Ave. So., Minneapolis, Minn.

HOTTEST Line ball pens, retractable pens. Banker's approved. Metal cap and clip. Press button write, press clip close. Sensational \$2.40 dozen; \$23.95 gross; refills \$1.00 dozen; \$10.00 gross. Rush money for sample dozens. Greenhut Trading, 277 Broadway, Dept. 416, New York 7, N. Y.

MAIL-Me-Thursday collection letters. Terrific profits. Repeats. 530MP, Ellis, San Francisco 9.

IS \$210 A week worth a postcard to you? Then rush card with name and address for special free trial plan that sells amazing new automatic refrigerator defroster like hot cakes! Write to Mr. Lewis, D-Frost-O-Matic Corp., Dept. P-102, 173 W. Madison, Chicago 2, Illinois.

CHECK This ad, interesting work. Sell stores, fast repeating products. Big profits. Quirk's, 1, North Madison, Ohio.

ADVERTISING Specialty salesmen wanted! Free samples! Parkhurst Specialties, Lansing 10, Michigan.

CALENDARS, Advertising novelties, matches. All styles, including religious, varnished, 12 sheet, girls. Hundreds of advertising novelties, book matches, etc. Fleming Calendar Co., Sales Division, 6539 Cottage Grove, Chicago 37, Ill.

SALESMEN: Home sales. Repeat food supplement item. Wonderful seller for wagonmen. Vitamin-cosmetic salesmen. Smylax, 4546 N. Hazel, Chicago, Ill.

AMAZING New tropical auto paste wax. Apply entire car. Easily wiped off. Glass-like finish. Unlike others. Whirlwind seller. Big profit. Free sample offer. Tropi-Cana Polish Co., Box 455, Biscayne Annex, Miami 52, Fla.

ADVERTISING Book matches—Cash in on big demand; sell union label matches. Cuts for all businesses and political parties. Free powerhouse selling kit, low prices, protection guaranteed on repeat orders. Cash commissions. Superior Match Co., Dept. M-554, 7530 Greenwood, Chicago.

RED Hot! Sell dealers lawnmowers 40% deal. Leads furnished. Rotacut-51, Excelsior Springs, Mo.

\$50.00 DAILY Selling gasoline station pennants. Central Flag, Rossmoyne 1, Ohio.

BUY Wholesale thousands nationally advertised products at big discount. Free "Wholesale Plan" American Buyers, 630-D Linden, Buffalo, N. Y.

MEMO Blotters—Billfold secretaries. Dynamic advertising mediums. Big commissions. Excellent repeats. Peters Associates, Vandalia, Ohio.

BIG Money. Every car owner buys, repeats. Wonder Glaze, Bay Port 7, Mich.

LEARN Where millions in profits from Bible sales have gone! Receive free proven sales course and whole story of how you can get these profits! Also free catalogue of six of the world's finest Morocco grain genuine leather covered Bibles and related items! Joseph W. Cain, Wholesaler, Box 5065P, San Antonio 1, Texas.

NEW Jobs open in selling. Send name, address for five free issues of Opportunity Magazine's money-making guide, listing hundreds of companies who'll pay you well, full or part-time. No experience needed. Opportunity, 28 E. Jackson, Dept. 17, Chicago 14, Ill.

EDUCATIONAL AND INSTRUCTION

IT'S Fun learning a language by Linguaphone. At home, quickly, easily learn to speak French, Spanish, German, Russian, Japanese—29 languages by Linguaphone World's Standard Conversational Method. It's like living in another country. Save time, work, money. Send for free book, Linguaphone Institute, 8305 RCA Building, New York 20.

HOW To write short stories, mysteries, articles. Learn at home for career or extra part-time income. Graham Doar sold one story to Post, CBS radio and NBC-TV. Professional writers show you how. Send today for free lesson. Palmer Institute of Authorship, Desk TM-54, 1680 N. Sycamore, Hollywood 28, Calif.

ENGINEERING, College-level, home study, catalog free. Midwest Engineering School, 10923 Hillcrest, Hickman Mills, Mo.

LEARN Real estate business. Highly profitable. Easily learned, complete home-study course. Cost surprisingly low. Diploma awarded. Write for free literature. Seavy Realty Institute, 1750-M Colorado, Los Angeles 41, California.

BEGINNER'S Home-study mailorder course. \$2.00. Spencer Williams, Mount Airy, Maryland.

WANT To climatize your home, or get into growing air conditioning business? Facts. Gardner, Box 4287-B, Philadelphia 44, Penna.

LEARN Handwriting character analysis. Booklet \$1.00. Lucas, 2419 Sunset Boulevard, Los Angeles, California.

FLY As a steward-purser. Work but 85 hours a month, starting salary \$235 up. G. I. approved, free catalogue. Air-Purser School, Room P, 1030 Nicollet, Minneapolis, Minnesota.

HIGH School diploma at home. Licensed teachers—Approved materials. Southern States Academy, Box 144-MX, Station E, Atlanta, Georgia.

CORRECT Your thinking and change your life! Write Christian Way of Life School, Box 7D, Main Office, Louisville 1, Kentucky, U.S.

LEARN Priceless secrets of Technical Metaphysics. Easy to learn. Only school of its kind. Write: Premier College of Technical Metaphysics, 2532 McKenzie St., Vancouver, B. C., Canada.

COMPLETE Your high school at home in spare time with 57-year-old school. Texts furnished. No classes. Diploma. Information booklet free. American School, Dept. X545, Drexel at 58th, Chicago 37, Illinois.

WANT A diesel job? New opportunities to increase income. Higher pay. More money. We can help you qualify. Tools. Shop method home training. Write today! Diesel, Tractor, Heavy Equipment Division, Interstate Training Service, Dept. B3-E, Portland 13, Oregon.

PROFITABLE Diamond facts. Send only \$2.00. Includes wholesale catalogue. Jonure Enterprises, Donora 26, Pennsylvania.

STUDY By correspondence for Doctor's degree in Psychology, Metaphysics and Divinity. College of Divine Metaphysics, Dept. P-M, 2811 North Illinois St., Indianapolis 8, Indiana.

SMASH Worries, fears and problems with our lifechanging "Thought and Behavior Control" method. Many helped. Write today for free eye-opening lecture. Applied Christian Psychology, Inc., Box 1924-E, Louisville 1, Ky.

CORRESPONDENCE Courses rented, sold, bought. Lists free. Magnolia Press, Box 1272-P, Burbank, Calif.

OPERATE A collection agency business. Very profitable. Easily learned. Write Cole & Associates, Syracuse 2, N. Y.

HIGH School—No classes. Study at home. Spare time. Diploma awarded. Write for free catalog HF-43, Wayne School, 2327 N. Sheffield, Chicago 14, Ill.

WELDING Training pays at Hobart Welding School. Box M-541, Troy, Ohio. VA contract. Best equipment. Catalog free.

WORK For U. S. govt! Men-women, 18-55. Start high as \$316.00 month. Qualify now! 23,000 jobs open. Experience often unnecessary. Get free 36-page book showing jobs, salaries, requirements, sample tests. Write: Franklin Institute, Dept. N-24, Rochester, N. Y.

SIGN Painting—Learn easy. Complete \$2. Particulars free. John Blackwell, Inverness, Florida.

OWN Collection agency office. Pays big! Free details. Franklin Credit, Roanoke 7, Va.

PROFESSIONAL Inventing pays big royalties! Introductory lesson 50c. N. W. Halsey, Box 65, Jackson Heights, N. Y.

USED Correspondence courses and educational books bought, sold, rented. Catalog free. Educational Exchange, Summerville, Ga.

BECOME A doctor of psychology or metaphysics. Learn secret of contentment, happiness. Win degree of Ph.D. or M.S. Solve mental worries. Free book. College of Universal Truth, 5038-C Broadway, Chicago.

ANY Question under the sun answered. Only one book. Money back guarantee. Research Bureau, Box 43, Grand Rapids 9, Michigan.

INVESTIGATOR Training. Experience unnecessary. Many opportunities. Send for free particulars. Also credentials. Exchange Secret Service System, 4360 Broadway, Chicago 13, Ill.

INCREDIBLE! Become mental superman overnight! Free booklet! Bijou, Box 1727-MH, Hollywood 28, California.

ABC Shorthand \$2.00, returnable. Zimman, 215-P West 91, New York 24, N. Y.

PIANO Tuning pays. Learn this profitable profession at home. Our Tunometer and mechanical aids make learning easy. No knowledge music necessary. Diploma granted. Largest and oldest school—56th year. G.I. approved. Write for booklet. Niles Bryant School, 78 Bryant Bldg., Washington 16, D. C.

BE A real estate broker. Study at home. Write for free book today. G.I. approved. Weaver School of Real Estate, 304 Law Bldg., Kansas City, Missouri.

FINGERPRINTING Course \$12.00, details. Alabama School of Fingerprinting, 414 South 10th Street, Bessemer, Alabama.

GROW Mushrooms. Cellar, shed, and outdoors. Spare, full time, year round. We pay \$3.50 lb. We paid Babbitt \$4,165.00 in few weeks. Free book. Washington Mushroom Ind., Dept. 174, 2954 Admiral Way, Seattle, Washington.

SECRET Investigation. Experience unnecessary. Investigators particulars free. George Wagner, M125 West 86th, New York 24.

MIDLAND Linotype School. Charles City, Iowa. Civilian and Veteran Courses. Free placement. Established 1909.

EARN While you learn. Auto and diesel mechanics master this top paying trade. Many graduates earn \$100 a week and up. Approved for Korean veterans. For free information write Dept. No. 256, Nashville Auto-Diesel College, Nashville 3, Tenn.

BOOKKEEPERS! Increase your earnings! Operate your own simplified "Dollar-A-Week" bookkeeping and tax service. Full or spare time. Details free. No obligation. Ellis, Box 200, Cedar Grove, North Carolina.

MEDICAL Laboratory technicians in great demand. We train you in your own home. Catalogue free. Imperial Technical Institute, Box 973-J, Austin, Texas.

INVESTIGATOR Training. Phillip Secret Service System, 1917-B North Kenneth, Chicago 39.

USED Correspondence courses and books sold and rented. Money back guarantee. Catalog free. (Courses bought.) Lee Mountain, Pisgah, Alabama.

PLAYS, STORIES, MANUSCRIPTS

BOOK Manuscripts invited—Cooperative publishers since 1925. Meador Press, 334 Newbury St., Boston 15, Mass.

BEGINNING Writers: Get \$1 to \$20 checks daily writing simple children's stories, articles, poetry in your sparetime. Experience unnecessary. Our instructions reveal how. Details free. W. Herman, 5927 Euclid, Cleveland 3, Ohio.

NO Luck finding a book publisher? Write for free Booklet P.M. Vantage Press, 120 W. 31, New York.

BUSINESS SERVICE

ZINC Photoengravings—6 inches \$1.80. Free price list. Miller-Holles, Box 894, Alliance, Ohio.

SPECIAL SERVICES

CHICAGO Help wanted columns air-mailed \$1.00. #21, 839 Wilson, Chicago.

INFORMATION On anything. Ferguson Research Specialists, 116-14 141 St., South Ozone Park 36, N. Y.

CONFIDENTIAL All points. "Allstates" remailing, 25c. Profitable "Allstates" directory listing, 25c. Premiums included. Confide, 570 So. 6th, San Jose 12, Calif.

BEAUTIFUL Gulf Coast. Biloxi. Letters remailed 25c. J. A. F., 123 Morrison Ave., Biloxi, Miss.

CARTOONING, COMMERCIAL ART, SHOWCARD & SIGN PAINTING, TATTOOING

"HOW To Make Money With Simple Cartoons"—A book everyone who likes to draw should have. It is free; no obligation. Simply address Cartoonists' Exchange, Dept. 95C, Pleasant Hill, Ohio.

DRAW Lightning quick cartoons! Entertain, be popular. Be a television artist. Chalk talk and cartooning made easy, \$1. Graphic Arts, 2826-F Texas, Vernon, Tex.

LEARN Sign lettering few minutes. Easy method. Copyrighted code. Profitable complete instructions \$1.00. Lesson free. Hub Art Center, 84 West Newton Street, Boston, Mass.

EARN Extra money in cartooning. Free trial lesson tests your ability. Write Kaydee, 1412 Great Northern Bldg., Chicago 4.

FREE—Cartooning lesson proves you can draw! Jakiela, 2644-N Western, Chicago 47.

CASH For simple cartoons. J. Borosky, 42 Clement, San Francisco, Calif.

CHALK Talks. Laugh producing program, \$1.00. Catalog 10c. Balda The Cartoonist, Oshkosh, Wisconsin.

ADVERTISING AGENCIES, LETTER WRITERS, FOR ADVERTISERS

FREE Copy, layout service. Mailorder ad, 1,600,000 nationwide circulation, \$28.70 inch. 24-word classified, 20 big Sunday newspapers, \$30. Advertising ratebook free. Chicago Advertising Agency (Established 1900), Chicago 4.

MISPLACED Or misaimed advertising could be costing you money. A goal-minded program engineered by Welsh-Barber Company will produce more sales for your advertising dollar. Free booklet gets you started. Welsh-Barber Company, 1512 Hermosa Place, South Bend, Indiana.

MAILING Lists, most any classification. 1000 names \$5.00. 1000 your circulars mailed with ours \$4.00. 5000 your circulars printed and mailed \$12.95. Write Dixie Mailers, King, North Carolina.

ADVERTISE: 24 Words, 100 Canadian newspapers \$5.50. Lists free. Advertising Bureau, 10511-C Springfield, Chicago 43.

ADS Placed in out of town newspapers and magazines. Low rates. Catalogue free. Ideas that pay. Baker Advertising Agency, Successors Ankrum Agency, 189 W. Madison, Chicago 2.

ADVERTISERS! Reach nearly 18,000,000 readers. 25 Sunday national key newspapers. 18 words, \$59.00. "Terrific pullers." 20 popular newspapers, \$11.50. Free booklet. Special—One inch display 2-821,198 circulation, \$51.10. Newmark's Advertising Agency (Established 1893), 217-7th Ave., New York 11.

RUBBER STAMPS AND OFFICE SUPPLIES

THREE Line rubber stamp, self inking pad, plastic case \$1.00. Anderson, Box 855, Mountain Home, Tennessee.

GET Our catalog first. Stamps 35c up. Stock cuts \$1.00 up. Letterheads, envelopes 100—\$1.00 up. Labels 500—50c up. Catalog 10c, refunded. Esco 154 Print, 8 Holt, Dayton 7, Ohio.

SAVE On printing. Use made-to-order rubber stamps. Free price list. Miller-Holles, Box 894, Alliance, Ohio.

FREE Pad with 3-line stamp. \$1.00 cash with order. Bailey's, Lewiston, Idaho.

RUBBER Stamps by professional craftsmen. 3 lines \$1.00. Price list. South Coast Press, 2128 Mt. View, San Bernardino, California.

3 LINES, \$1.00. Fast service! Catalogue. Johnson Press, Box 6-A, New York City 26.

TYPEWRITERS, DUPLICATORS, OFFICE DEVICES

RECONDITIONED Typewriters, duplicating, printing devices, \$25.00 up. Supplies, Appliances, DixieGraph, King, N. C.

PRINTING, MULTIGRAPHING, MIMEOGRAPHING, GUMMED LABELS

ATTRACTIVE Labels, stickers. Inexpensive. Samples. Fame, 291 Ellis, San Francisco 2, Calif.

RAISE-Print business cards, 1000 \$3.85. Blue Print, 689 Lee, Atlanta, Ga.

PRINT Without a printing press! Amazing new method! Print colorful signs, banners, cards, posters, glasswear—anything at home. Big profits. Money-making opportunity! We supply everything. Beautiful sample. Home-business plan free! Write Screen-Print Company, Los Angeles 15, California.

BUSINESS Cards. Finest available. Colors. All-Trades, Box 278, Hempstead, N. Y.

DISTINCTIVE Printing. Samples, prices. Klifford, 545 North Oakland, Pasadena 4, California.

MIMEOGRAPHING—Anything and everything. 250 copies, 8½x11, \$2.25. Samples. Pennway, Adams Ave., Scranton, Penna.

BUSINESS Cards. Printing. Reasonable. Free samples. Lites, 5352-PM Princeton, Chicago 9.

BUSINESS Cards boost prestige. Free samples. Bowden Printing, 7160B Allentown S.E., Washington 22, D. C.

OFFSET Printing, \$6.50—1000, 8½x11 16 lb. National Letter, 1463 Broadway, New York 36.

100 LETTERHEADS Or envelopes \$1.00. Two colors \$1.50. Broadbrook, Botsford, Conn.

ATTRACTIVE. Modern two color shipping labels. 200 \$1.00, samples. Lawndale, West Franklin, N. H.

BUSINESS Cards, raised printing 1M \$3.65 postpaid; offset letters, forms. Tuttle Publ., Rutland, Vt.

100 8½x11 LETTERHEADS, \$1.00—Envelopes 6.00. Beautifully printed. Maywood Industries, Box 6, Riveredge, New Jersey.

TWO Color 8½x11 letterheads, 500, \$3.50. Samples. D'Yarmett Printing, Newark, Ohio.

BUSINESS Cards 1000—\$2.50. Samples. Fullers, 41 Brewster, Providence, R. I.

JOB Printing. Letterheads, envelopes, circulars. Printing, 21, Barclay, Portsmouth, Virginia.

PRINTING—Office supply catalogs 25c. Refundable. Wallace, 1072 Tower Grove, Saint Louis 10, Missouri.

100 ENVELOPES. Printed 2-colors \$1.25. Box 523, Rochester 2, N. Y.

MIMEOGRAPHING—Letters, pricelists, formulas, instructions. Lowest prices. Lem's Letter Shop, 5710 Stanton, Detroit 8.

500 ¾x2¼ FOUR Line gummed stickers 50c. Red border \$1.00. Moritz Printery, Saginaw, Mich.

BUSINESS. Personal stationery. Catalogs free. Howprint, 723-M Eunice, Webster Groves 19, Missouri.

PRINTING OUTFITS AND SUPPLIES

MAKE Your own self-molding rubber printing cuts. Plexirubber, Argyle 1, Wis.

ENRICH Your spare time, bank account, using small-cost genuine printing outfits. Free booklet shows how, dozens examples; easy rules; print in 1 day. We supply presses, etc., factory to you. Start your own business. Do church, club, commercial work, etc. Craftsmen M'ch'y., 551 Atlantic Avenue, Boston 10, Mass.

FREE Booklet, "Make Your Own Cuts." Amazing new process. Walp, Box 4308, Mobile, Ala.

PRESSES, Type, cabinets, supplies. List for stamp. Lincoln Press Company, 220-D Hartwell, Fall River, Mass.

PRESSES, Supplies, paper. Catalog 10c. Custom, Box 211-P, Springfield, Missouri.

DO Your own printing. Save money. Simple rules. We supply everything. Print for others; good profit. Raised printing like engraving too. Have home shop. Details free. Kelsey Presses, V-11, Meriden, Connecticut.

PRINTING Presses, type, supplies. Lists 3c. Turnbaugh Service, Loysville, Penna.

PATENT ATTORNEYS

INVENTORS: Learn how to protect your invention. Special booklet "Patent Guide for the Inventor" containing detailed information concerning patent protection and procedure together with "Record of Invention" form will be promptly forwarded to you upon request—without obligation. We are registered to practice before the U. S. Patent Office and prepared to serve you in the handling of your patent matters. Clarence A. O'Brien & Harvey Jacobson, Registered Patent Attorneys, 418-D District National Building, Washington, D. C.

INVENTORS—If you believe that you have an invention, you should find out how to protect it. The firm of McMorro, Berman & Davidson is qualified to take the necessary steps for you. Send for copy of our patent booklet "How to Protect Your Invention" and "Invention Record" form. No obligation. McMorro, Berman & Davidson, Registered Patent Attorneys, 134-B Victor Building, Washington 1, D. C.

INVENTORS—If you consider your invention to be something of importance, take steps to protect it with a United States Patent which gives you the right to exclude others from making, using and selling your invention as claimed. "Patent Protection for Inventors" outlines steps to take to secure patent protection. Mailed promptly without obligation. Victor J. Evans & Co., Merlin M. Evans, Registered Patent Attorney, 931-E Merlin Building, Washington 6, D. C.

CANADA—Ramsay Company Registered, 273 Bank Street, Ottawa, Canada.

"INVENTOR'S Guide" and "Record of Invention" free on request. Frank P. Ledermann, Registered Patent Attorney, 154 Nassau Street, New York City.

ALL Latin America, patents, trademarks, pharmaceutical licenses. Box 830, Lapaz, Bolivia.

PATENTS—Irving L. McCathran, 315 McLachlen Bldg., Washington 1, D. C. Registered Patent Attorney.

REGISTERED Patent attorney offers services. Sanders, 6430 Evans, Chicago 37, Ill.

INVENTORS: When you are satisfied that you have invented something of value write me, without obligation, for information as to what steps you should take to secure a patent. Write Patrick D. Beavers, Registered Patent Atty., 935 Columbian Bldg., Washington 1, D. C.

PATENTS. "Proof of Invention" free. E. E. Vrooman, Registered Patent Attorney, 507 McKim Building, Washington 5, D. C.

INVENTORS: Without obligation, write for information explaining the steps you should take to secure a patent. John N. Randolph, Registered Patent Attorney, 203 Columbian Bldg., Washington 1, D. C.

C. A. Snow & Co.—M427, Snow Building, Washington 1, D. C. Registered Patent Attorneys. Write for information.

INVENTORS—For "Invention Record" form, contact Carl Miller, Registered Patent Attorney, Woolworth Building, New York.

FOR INVENTORS

INVENTORS: Learn how to protect your invention. Special booklet "Patent Guide for the Inventor" containing detailed information concerning patent protection and procedure together with "Record of Invention" form will be promptly forwarded to you upon request—without obligation. We are registered to practice before the U. S. Patent Office and prepared to serve you in the handling of your patent matters. Clarence A. O'Brien & Harvey Jacobson, Registered Patent Attorneys, 41A-D District National Building, Washington, D. C.

INVENTION Development, pilot models made; mechanical, electrical. Complete shop facilities. Free information. United Tool & Engineering Co., 1720 Harris, Independence, Mo.

OBTAIN Patents yourself. Infallible instructions \$1.00. Refunded if unsatisfied. Superior, 240 South Beverly, Beverly Hills, Calif.

INVENTORS—Send for free patent information book and inventor's record. Registered Patent Attorney, Associate Examiner, Patent Office 1922-29; Patent Attorney & Advisor, Navy Department 1930-47. Gustave Miller, 54A Warner Building, Washington 4, D. C.

INVENTORS—If you believe that you have an invention, you should find out how to protect it. The firm of McMorrow, Berman & Davidson is qualified to take the necessary steps for you. Send for copy of our patent booklet "How to Protect Your Invention" and "Invention Record" form. No obligation. McMorrow, Berman & Davidson, Registered Patent Attorneys, 134-A Victor Building, Washington 1, D. C.

INVENTORS—This firm is registered to practice before the United States Patent Office and is available to assist you in the preparation and prosecution of your patent application. "Patent Protection for Inventors" booklet containing detailed information and steps to take toward patent protection will be sent upon request. No obligation. Victor J. Evans & Co., 932-E Merline Building, Washington 6, D. C.

PATENT Searches \$5.00. 48-hour airmail service. Record of Invention forms free. Write Patent Engineering Service, 711 14th Street N.W., Washington 5, D. C.

PATENT Searches, including copies of nearest patents, \$5.00. Reports airmailed within 48 hours. More than 75 registered patent attorneys use my service. For free invention protection forms, write Miss Ann Hastings, P. O. Box 176, Washington 4, D. C.

PATENT Searches \$5.00. 48-hour service. Free Record of Invention. Write Raymond L. Smith, Patent Searcher, 623 Sheraton Building, Washington 5, D. C.

MAKE Your invention pay. Mine paid over \$750,000.00. My book tells what I learned hard way, inventors should know, avoid, save thousands, help you make fortune. Only \$1.00. Free particulars, and "Invention Record" blank. Inventors Service, P. O. Box 5, Station B, Omaha, Nebraska.

PATENT Searches, \$5.00, including patent copies. Same reliable search as conducted for patent attorneys. Free protection forms. Patent Service Institute, 945-A Pennsylvania Avenue, Washington 4, D. C.

CASH For your idea. 200 manufacturers need inventions, patented or unpatented. List free. Invention Bureau, 208M Clinton, Oak Park, Ill.

INVENTORS — For "Invention Record" form, contact Carl Miller, Registered Patent Attorney, Woolworth Building, New York.

SEARCHES—Put your patent searches in the hands of a registered patent attorney or agent, as he qualifies to give a worthwhile patentability report. Record of invention form upon request and information on patent protection. Patrick D. Beavers, Registered Patent Attorney, 936 Columbian Bldg., Washington 1, D. C.

INVENTORS: Information on patent procedure furnished on request, without obligation. John Randolph, Registered Patent Attorney, 202 Columbian Building, Washington 1, D. C.

I Sell patents. Established 1900. Charles A. Scott, 773PM Garson Avenue, Rochester 9, N. Y.

INVENTORS: If you have an invention for sale, patented or unpatented, write Institute of American Inventors, Dept. 40A, 631-E St. N.W., Washington 4, D. C.

"INVENTOR'S Guide" and "Record of Invention" free on request. Frank P. Ledermann, 154 Nassau Street, New York 38, N. Y.

INVENTIONS WANTED

INVENTORS: If your invention is adaptable to our business we will contract on cash or royalty. If not, we will try to place. Free booklet. Kessler Sales Corporation, 55A, Fremont, Ohio.

INVENTIONS Promoted, Patented, unpatented. Free particulars, Superior, 240 South Beverly, Beverly Hills, Calif.

CASH Buyers for ideas and inventions. Write National Inventors Institute, 4097 East 131st St., Cleveland 5, Ohio.

INVENTORS don't sell your invention, patented or unpatented, until you receive our offer. Write Cowgill, Box 298, Marion, Ohio.

MAKE Money from your ideas, gadgets, patents. Get "Inventors Guide." Helpful book tells you how. Send \$1.00, includes list of needed inventions. We have buyers. Inventors Creative Service, 354 South Spring, Los Angeles 13, Calif.

INVENTIONS Promoted, Patented or unpatented. Established 1911. Write Adam Fisher Company, 5418 Idaho, St. Louis, Mo.

INVENTIONS Wanted, Patented, pending only. Inventors Patent Exchange, Hartford 1, Conn.

INVENTORS: Hundreds of manufacturers have requested our assistance in locating marketable new products. Complete information free. Institute of American Inventors, Dept. 40-D, 631-E St. N.W., Washington 4, D. C.

INVENTIONS Wanted, Patented; unpatented. Tremendous manufacturers lists. Global Marketing Service, 1404 Mitchell, Oakland 1, California.

INVENTIONS Wanted, Patented or patent pending. 23 years experience promoting inventions. National Service Bureau, 3120 Meramec, St. Louis 18, Mo.

PATENTS FOR SALE

SALE: Basic patented sein pullers. Hundreds infringed. Big money involved. Inventor Bergmann, P.O. Box 61, Astoria, Oregon.

PATENT No. 2,433,743 electric safety centering device for arbor or sleeve work. LaVerne Dickens, 236 N. Genesee St., Montour Falls, N. Y.

INVENTORS: Test the commercial value of your patented or unpatented inventions, quickly and inexpensively. Write for free information. Institute of American Inventors, Dept. 40-B, 631-E St. N.W., Washington 4, D. C.

MANUFACTURING

MODELS — Small lot manufacturing. Metals, plastics, etc. Milburn, Burlington, Kentucky.

MODELS, MODEL SUPPLIES

NEW Completely revised giant 88-page 1954 "O" gauge catalog for model railroads. Scale and tinplate. Fully illustrated. Hundreds of car kits all types, steam locomotives, diesels, specialty items and parts galore. Catalog cost of 75c refunded with first \$5.00 order. All-Nation Hobby Shop, 182 N. La Salle St., Dept. A, Chicago 1, Ill.

LIVE Steam engine, 10 1/2" high, ready-to-run, \$5.95 postpaid. Catalog 35c. Merlo, 50-18 94th Street, Elmhurst 73, N. Y.

1954 CAR Models, 1/25 scale, all metal, chrome trim. Send for catalog. Cars & Hobbies, Dept. PM-18, 2333 Haddon, Chicago.

GET Your copy of Modeler's Design Data \$1.00. Box 3128, Fort Worth, Texas.

HOBBIES, Gas airplanes, HO railroad, ships, interesting crafts, catalog 10c. Marvin's Hobby, 7137 West 80th, Overland Park, Kansas.

SHIP And yacht model fittings; blueprints. Send 25c for illustrated catalog listing hundreds of items. A. J. Fisher, 1002-1 Etowah Ave., Royal Oak, Mich.

BUILD Historic ships, vehicles. 50c to \$9.00 kits. Illustrated catalog 10c. Ideal Models, 21 West 18th Street, New York 11.

STEAM Locomotives, 1 1/2", 1", 3/4", 1/2", 1/4" scales. Castings, rail, steam fittings! Thorough drawings with instructions. Catalog 50c. Little Engines, Wilmington, California.

SHIP And other scale models. Most complete line in New England. Kits, fittings, plans, books, tools, engines, motors. Illustrated catalog 25c. James Bliss & Co., Inc., Dept. SM, 342 Atlantic Ave., Boston 10, Mass.

BALSA Wood, Grade AAA. Free sample, price list. Sig Mfg. Co., Montezuma, Iowa.

HOME CRAFTSMEN

VENEERS, Single ply: Walnut, mahogany, birch, oak, cherry. 8c square foot, minimum 25 feet. Prepaid. No c.o.d.'s. Minnesota Woodworkers Supply, Box 233, Hopkins, Minnesota.

METAL—Rounds, flats, sheets. Small order inquiries invited. Will's Crafts Service, PM Box 3922, Detroit 27, Mich.

129 NEW Full size jigsaw patterns. Unusual novelties, gifts, lawn figures up to 22 inches high, action (merry-go-round) windmill, toys, useful gadgets. Artist drawn \$1. Craftplans, 1321-A South Michigan, Chicago 5.

20 COMPLETE Plans. Detailed instructions. Tables, chests, desks, others. \$1.00. Easycraft, Box 162, Cincinnati 1, Ohio.

LEATHERCRAFT Supplies. Pre-cut kits, tools, etc., large stock. Catalog 10c, refunded first order. Whitman Saddle Mfg. Co., 1723 Powers St., C5, Cincinnati 23, Ohio.

JIGSAW Patterns! Large variety especially for boys, \$1.00. Pauls, 2333A North 35th, Milwaukee 8, Wis.

GLUE, Packaged at bulk prices; animal, casein, resin, liquid. Save up to 60%. Inquire. Minnesota Woodworkers Supply, Box 233, Hopkins, Minnesota.

LAMP Size cypress knee, nipple installed \$2.00. Cy Products, Dept. 2H, Lafayette, La.

16 NEW Lawn chairs, 22 picnic tables, benches, trellises, etc. All 38 plans with necessary full size patterns, \$1.00. Mastercraft 53M, 7041 Olcott, Chicago 31, Ill.

TOUGH Finishes with home bake-on-yourself enamels. Write Chemicals International, Marshall, Illinois.

KILN Dried hardwoods. Send 15c (refunded first order) for hand-book-price list. Corbett Cabinet Co., St. Marys 1, Penna.

101 FULL Size patterns. Smart, new, gifts, novelties, lawn figures, shelves, action windmills, alphabets. Plus "Make Money Jig Sawing." Only \$1.00. Mastercraft 55M, 7041 Olcott, Chicago 31, Illinois.

VENEERS .010 Inch thick. Gluable without press. 18x24 inch and smaller sheets. Mahogany, birch, maple, cedar. Write for samples, prices. Goff, Smith Street, North Girard, Penna.

GRANDFATHER Clocks, weight driven movements. Willis Bros., 237 South Ellwood Ave., Baltimore 24, Maryland.

CARVING Leather's fun. Makes money, too! We'll send catalog, then it's up to you. Write Tandy Leather, Box 398-A, Tulsa.

COMPLETE Detailed information on the requirements, design, installation, operation, maintenance and repair of home plumbing systems, including the proper use of tools and materials, is given the layman in Home Plumbing Guide, \$3.50. It's the first book for the layman in its field and one that answers a long felt need. Easy to understand! Hundreds of illustrations, diagrams and drawings! Order today. Popular Mechanics Press, 200 E. Ontario, Chicago 11, Ill.

89 FULL Size jig saw patterns of beautiful shelves, ornaments, toys, novelties. Plus "How, Where to Sell." Only \$1.00. Mastercraft 54M, 7041 Olcott, Chicago 31, Illinois.

PLASTICS Home-craft course for men and women. Tells and shows how to make hundreds of fast selling plastics products. All plastics and materials for 23 projects included in course. No special tools needed. Course pays for itself. Write for free booklet. Interstate Training Service, Dept. D-3-E, Portland 13, Oregon.

LEATHERCRAFT. Tremendous stock of leather, tools, supplies, and kits. In leather business over forty years. Send 10c for big catalog. Sax Bros., 1111 No. 3rd, Dept. PM5, Milwaukee 3, Wisconsin.

LEATHERCRAFT. Metal tooling, textile painting, bendcraft, shellcraft, many other crafts. Fun, easy, profitable! Free, big, illustrated catalog. Write today. Kit Kraft, Dept. 255, Hollywood 46, Calif.

90 ALL New, full size lawn ornament and novelty patterns, up to 20" high. Only \$1.00. Mastercraft 52M, 7941 Olcott, Chicago 31, Illinois.

LEATHER. Tools, lacings, supplies. Free catalog. National Handicraft, 199 William St., New York 7.

FURNITURE Handles. Solid brass. Free literature. Colony House, Box 1892, Huntington, West Virginia.

OVER 100 Patterns for lawn figures, toys, novelties, etc. Only \$1.00. Free pen. Patterns, 1433 South, Toledo, Ohio.

SENSATIONAL New do-it-shop, 7 power tools in 1. Free details. Addison, 1840A Addison, Chicago 13, Illinois.

STYLECRAFT Sure fire hits. "Pre-traced" leather kits. Handbags, billfolds, filigree belts, over fifty other projects. Patterns on leather. Why trace? Just carve, assemble and lace. Large assortment "precarved" kits also available. Send 25c for catalog, free folder. Refunded first order. Apache Leather Company, 2804 E. Washington St., Phoenix, Arizona.

BUY Wholesale nationally advertised power, hand tools, thousands of other products at big discounts. Free "Wholesale Plan." American Buyers', 628-PP Linden, Buffalo 18, N. Y.

LEATHERCRAFT. Everything needed by beginners, advanced hobbyists and professional leatherworkers. Largest stock of supplies in U.S. Moderate-priced tooling leathers, top quality calfskins, tools, supplies, kits. Send 10c for big catalog. J. C. Larson Co., 820 S. Tripp, Dept. 4050, Chicago 24.

METALCRAFT: Complete stock of tools and all the craft metals. Free catalog. Patterson Brothers, 15 Park Row, New York 38, N. Y.

HOBBYISTS, Machinists, steel, aluminum, brass, rod, sheet, catalogue. Arcy Co., Lynbrook 2, N. Y.

THOUSANDS of readers have asked for it! Here is Build Your Own Garage, \$3.50, by Wayne C. Leckey. The amateur, without any previous building experience, can choose from 25 different designs and build an attractive, sturdy garage. Step-by-step instructions, photographs, drawings and diagrams. 128 pages of complete and detailed instructions. Order now from Popular Mechanics Press, 200 E. Ontario, Chicago 11, Ill.

ASSEMBLE Jewelry, gifts. Free catalog, details. Novelcrafts Co., 25C Adrian Ave., New York 63, N. Y.

35 **LAWN** and garden ornament patterns. Full size, ready cut, colors indicated. Only \$1.00. Lincoln Craft Studio, Columbia, Conn.

KNOCKDOWN Cedar chests. Lumber and veneers. Free price list. Giles & Kendall Company, Huntsville, Ala.

FREE Information. Money-making full size patterns. Professional designs. Furniture, gift shop items. Write Jigsaws, 117 Worth, New York 13.

"TOPS" In everything for leathercraft. Lowest prices. Genuine "Craftool" stamps. Catalog 10c. Crown Leather Company, 22 Spruce Street, New York 38.

KNOCKDOWN Cedar chests and lumber. Free price list. Bedford Lumber Company, Shelbyville, Tennessee.

MAKE IT YOURSELF

MELT Iron for castings. Literature. Ursutz Burner Co., Box 2293, Globe, Ariz.

BUILD Inexpensive concrete blockmaker. Motor—hand. Also mixer. Both for less than \$10. Then make blocks for 5 room house for \$95. Write. C. Lee, Mountain View, Oklahoma.

LUMBER Core plywood, 3/4"; walnut, mahogany, birch, oak, cherry. Cut exact size, guaranteed first quality. 68c square foot. No c.o.d.'s. Minnesota Woodworkers Supply, Box 233, Hopkins, Minnesota.

CAST Metal, yourself. Free literature. Castings, Box 124, Lynwood, Calif.

HOBBY-Horse. Assemble yourself. Only screwdriver and paint needed. It's safe, sturdy, stands 2'x3', 3/4" stock. Complete kit, f.o.b. \$9.75. Ralph Eckensberger, Bath, Pennsylvania.

FANS—Window and attic. From kits. Torrington steel blades, full size patterns. Catalog free. Gilliom Power Tools, Dept. 30, Lambert Field, St. Louis 21, Mo.

ELECTROPLATE. Baby shoes, hardware. Inexpensive process. Write Easy-Plater, Box 2939M, Red Lion, Penna.

CONSTRUCT—Electronic organ less than \$95. Details free. Lacoa, 1744 North Thompson, Bayshore, New York.

MOTO—Scooter replacement parts, assembly kits. American Moto-Scooter Co., Chicago 25, Ill.

PLYWOOD Desk-table tops, any size; guaranteed first quality. Walnut, mahogany, birch, oak, cherry. 3/4"—68c square foot, 1 1/2"—98c. No c.o.d.'s. Minnesota Woodworkers Supply, Box 233, Hopkins, Minnesota.

CONSTRUCT 3 Bedroom ranch house. Large rooms—Fireplace for \$1475. Plans \$1.00. Peter Alan, Box 8, Canarsie, N. Y.

HI-POWER Slingshot hunting rifle. Easily made. Free plans. Umako, Box 4133-B, Long Beach, Calif.

GRANDFATHER Clock easily built. Big savings. See ad on page 271.

AIR Conditioner, save \$400.00! Build your own for home or automobile from junked refrigerator. Instruction book—50c. (Specify whether for home or automobile). Seeley, 3716E Belmont, Chicago 18, Ill.

BUILD Electric cement mixer for \$25.00. Better than commercial models. Complete blueprints, one dollar. Bildmore Manufacturing Co., Box 281, Lynwood, Calif.

POWER Mower kits, tree plans, instructions, parts list. Temco Mowers, Springfield 1, Missouri.

MAKE Your own electric fuse plugs. Model \$1.00. W. Stonebraker, 6006 Harney, St. Louis 20, Mo.

AWNINGS—All-aluminum. Make your own! Assemble America's most beautiful aluminum door canopies and window awnings. The sides are pre-assembled. Save 50%. Factory to you. Free measuring chart and literature. Herbert's Aluminum Awnings, Dept. 1, 6974 St. Charles Rd., St. Louis 14, Mo.

MAKE Your own stone-veneer. Economical, easily made, quickly applied. Looks like genuine stone. Formulas, illustrations, patterns \$1.00. Alburg, Box 17, Carrollton, Mich.

BUILD A treasure and metal detector. Lightweight, sensitive, inexpensive. Complete kits, free literature. Dept. 1, Electronic Applications, Box 4975, Washington 8, D. C.

COMPLETE Information, design, installation, repair of home plumbing. Easy to understand hundreds of illustrations. Order Home Plumbing Guide today, only \$3.50. 7 day money back guarantee. Popular Mechanics Press, 200 E. Ontario, Chicago 11, Illinois.

WATCHES, OLD GOLD, JEWELRY

WATCH And clock repairing books for hobbyists. Free information. North American, Dept. 14-E, 2320 N. Milwaukee, Chicago 47, Illinois.

WATCHMAKERS' Tools, materials, supplies, watches. Catalog. Gales, Box 1000, Chicago 90, Ill.

WATCHMAKING For pay or pastime. Free sample lesson. Chicago School, Dept. PM5, 2330 Milwaukee Ave., Chicago 47, Ill.

RHINESTONES. Jewelry settings, cameos, sequins, beads. Send 10c for illustrated catalog. J & M Novelties, Dept. CE-3, Griffith, Ind.

HIGHEST Prices paid for old gold, silver, platinum, diamonds, watches, gold teeth, spectacles. Cash immediately. Goods returned if offer unsatisfactory. United Smelting Works, (The Old Reliable), 6-B East Monroe, Chicago 3.

WATCHMAKING—Learn. Material, instructions for start and wholesale precision tool supply catalog, all \$1.50. Refund not satisfactory. Stewart's, 727 Market, St. Louis 1, Mo.

HIGHEST Cash paid for old gold, broken jewelry, gold teeth, watches, diamonds, silverware, spectacles, platinum. Free information. Satisfaction guaranteed. Rose Refiners, Heyworth Bldg., Chicago 2, Ill.

FREE Sample pair of earrings shows you how easy it is to make beautiful costume jewelry. Over 5000 styles listed in new catalog, 25c. Barry's, 178 Ardsley Court, Newark, N. J.

JEWELRY Setting pearls—Gross assortment, quarter. Cosmopolitan, Box 176-B, New York 8.

JEWELRY Making can be a profitable hobby—Send 20c for our latest illustrated catalog. Milady-Fair Co., G.P.O. Box 1328, New York City.

TOBACCO, SMOKERS' SUPPLIES

50 **MATCH**-Books. Metallic. Delicately perfumed. Gold stamped with your name or monogram in useful plastic drum. \$2.25 postpaid, U.S.A. only. Holley's Gold Stamping Specialties, Suite 612-A, 216 W. Jackson Blvd., Chicago 6.

CIGARETTE Connectors, patent pending. 15c+15c handling. Anchor, 14450 Dexter, Detroit.

PIPE Smokers! Cigar smokers! Free illustrated catalog offers fabulous savings on choice imported and domestic pipes, cigars, tobaccos, supplies. Write Wally Frank, Dept. 1, 150 Nassau St., New York 38, N.Y.

RAZORS, BLADES, SHARPENING

INTRODUCTORY Offer—Double edge blades 100, \$1.00; 500, \$4.00. Satisfaction guaranteed. Howard, 3909—13th Ave., Brooklyn 18, N. Y.

FOR THE HOME

FOAM Rubber furniture cushions. Factory seconds. 50% discount. Free catalog. Perma-Foam, 140-C Main Street, East Orange, New Jersey.

OF INTEREST TO WOMEN

DO It with "Floating Henryburgers." See ad under "Business Opportunities."

COLGATE'S Lustre-Creme shampoo. 4 lbs. \$4.25. Geller, 2089 Matthews Ave., New York City.

REMNANTS, Large quilt material, quality washable cottons, details free. Edwards, 430-B Hodges Ave., San Jose 23, California.

SEWING Machine profits. Copyrighted. Guaranteed. \$1.00. Gimbirt, 1454 W. Washington, Petersburg, Virginia.

MEXICAN Cook book—Thirty-five selected recipes of tasty Mexican dishes, one dollar. Mrs. Carmen Davila M., 300 Exchange Building, Nashville, Tenn.

SENSATIONAL Reweaving offer, \$44.75 value for only \$8.65. Professional equipment and course. Rush postal for thrilling free details. Invisible Reweaving Institute, Dept. 456A, La Mesa, California.

\$30.00 **WEEKLY** Making roses at home. Easy. Write, Studio Company, Greenville 9, Penna.

NYLONS 14c, Anklets 6c, socks 9c, print 17c, panties 12c, dresses 50c, slips 47c, undershirts 17c, robes \$1.65, spreads \$2.65, jewelry \$1.25, watches \$3.50, electric razors \$2.00, aspirin \$1.00—1,000, brushes 9c, razor blades 1 1/2c, pens 8c, combs 1 1/2c. Complete stock list, picture catalogue, 25c. Send immediately. Sibert's, Chattanooga 4, Tennessee.

GROW Mushrooms. Cellar, shed, and outdoors. Spare, full time, year round. We pay \$3.50 lb. We paid Babbitt \$4,165.00 in few weeks. Free book. Washington Mushroom Ind., Dept. 176, 2954 Admiral Way, Seattle, Washington.

MAKE Big money at home! Invisible reweaving pays \$10.00 profit an hour spare time. Make tears, cuts, holes disappear from fabrics. Constant demand from laundries, cleaners, homes assures steady earnings. Details free. Fabricon, Dept. C, 8342 S. Prairie, Chicago 19, Ill.

PROFITABLE Home business. Make fast-seller chenille monkey trees, dolls, flowers. Terrific holiday demand. Information free. Velva, Bohemia 16, N. Y.

FOR SALE—MISCELLANEOUS

HEARING Aid batteries, wholesale. Free list. Habs, Box 51, York, Penna.

SAVE. Join mail order group. Free details. Color-Glo Products, Monument Beach, Mass.

100 **MONEY** Making plans \$1.00. Empire Distributors, Box 301, Amesbury, Mass.

HAND Carved Western leather belts \$8.95. Lillard's Leathercraft, Priona, Tex.

FIRE Truck, 1936, but supreme condition. Henry J. Haldeman, Girard, Kansas.

TIN Cans—New surplus. Friction top, 2¢, 3¢; 5¢, 4¢; 10¢, 6¢. A. W. Glawe Co., Milwaukee 13, Wis.

SURPRISE List unusual special services, novelties, gifts, souvenirs, 10¢. Remails 15¢. National Capital Services, Box 76, Washington 4, D. C.

WANTED—MISCELLANEOUS

OLD Trick penny banks. Big prices. Gordon Grimes, 2000 Marber, Long Beach 15, California.

CASH For old 35mm movies, silent, sound. Studios, Box 382, Lima, Ohio.

SCRAP Mercury (quicksilver) containers supplied—Tantalum, bismuth, tungsten. Metallurgical Products Company. Established 1909, 35th and Moore Sts., Philadelphia 45, Penna.

QUICKSILVER, Platinum, silver, diamonds, indium. Write. Wholesale Terminal, Norwood, Massachusetts.

PERSONAL

BORROWING By mail. Loans \$50 to \$600 to employed men and women. Easy, quick. Completely confidential. No endorsers. Repay in convenient monthly payments. Details free in plain envelope. Give occupation. State Finance Co., 323 Securities Bldg., Dept. R-14, Omaha 2, Nebraska.

MIAMI Beach, Fla. letters remail 25¢. Pronto, P.O. Box 118.

YOU May be a missing heir! Find out by reading "The Missing Heir's Key-Family History." Price \$1.00. Family Service, Box 1745, Baton Rouge, Louisiana.

CASH Prize prosperity contest. Everyone eligible. Useful gift. Details, stamp please. Nestle, Sanford, Michigan.

LETTERS Remailed from Albany, N. Y., 25¢. Hale, Box 1, Glenmont, N. Y.

ATLANTIC City remaining 12 scenic postals \$1.00. Letters 25¢. Pickens, 414 Wistar Place, Atlantic City, N. J.

LETTERS Re-mailed. 25¢ each; 6 for \$1. Xebec, 814-M&M Bldg., Houston 2, Texas.

LETTERS Remailed 25¢. Personal forwarding address. Monthly rates. Hicks Service, Box 1547, Washington 13, D. C.

SANTA Barbara remail 25¢. Monthly rates. Classified \$1.00. Roads-End, Box 278, Santa Barbara, California.

IN The South it's Houston, remails 25¢. Want ads airmailed \$1. Other services. I. Lewis, Box 16061, Houston 22, Texas.

LETTERS Remailed: Venezuela, Jamaica, Trinidad, Curacao, Dominican Republic: Fifty cents coin. Caribbean Postmarks, Box 2493, New Orleans, La.

DENVER. Remails 25¢. Receiving, forwarding available. Job ads airmailed \$1.00. Personal service. Comanche-B, Box 7817, Lakewood, Colorado.

BE The Popular Mechanics representative in your neighborhood and earn big profits in your spare time. Write Popular Mechanics Magazine, Room 408M, 200 E. Ontario St., Chicago, Ill.

LETTERS Remailed, historic Philadelphia, 25¢. Bond, 441 W. Norris St., Philadelphia, Penna.

ESOTERIC Curiosa, rare adult books, manuscripts, pamphlets, readers, booklets; English, French, German. Indicate title, author or subjects desired. Send stamped envelope for reply. Francene, Box PM-1, 949 Broadway, New York 10, N. Y.

BE Rich. Make more money. Financial secrets revealed. Satisfaction guaranteed. Send \$1. Allen, 6711-G Sunset, Hollywood 28, Calif.

ESTABLISH Chicago address. Mail forwarded daily. Free details. Remails 25¢. Continental, 20 West Jackson, Chicago 4.

MEXICAN Law office. Bank references, P.O. Box 41, Juarez, Chih., Mexico.

CLEVELAND Remail—4 for \$1.00. Scenic post cards 10 cts., each. Adv. section Clev. paper \$1.00. Central Products, 1932 Lorain Ave., Cleveland 2, Ohio.

REMAIL Alaska \$1.00. Samuel Fairchild, 246 4th Ave., Anchorage, Alaska.

LETTERS Remailed 25¢ coin, 5 Virginia Beach postcards \$1.00 remailed. Barnes, Box 226-R, Portsmouth, Va.

JAPAN—Letters reairmailed \$1. Discounts to agents. Dalevi, 569, 3-chome, Shimo-Meguro, Meguro-ku, Tokyo.

LETTERS Remailed 20¢. Literature, samples, 10¢. Perril, 436 New York Ave., Brooklyn 25, N. Y.

MEXICAN Law. General Practice Attorney, 1203 Arizona St., El Paso, Texas.

"HOW Can I find out?" You can! Information confidentially developed. Any matter, person, problem. Worldwide. Officially licensed. Established 1922, William Herman, 170 Broadway, New York City.

LETTERS Remailed 25¢. Personal receiving-forwarding address available. Write for rates. McLaughlin, 800 Stewart, Columbus 6, Ohio.

NEW York City—Letters remailed 25¢ each. Bonomo, 54 Jefferson St., Brooklyn 6, New York.

MISCELLANEOUS

\$1,000 BUILDS 5 Room, 3 bedroom home. 33' x 27'. Plans \$1.00. Free information. John Feller, Lawrenceburg, Indiana.

PROPERTY Bargains from tax delinquent real estate. Send \$1.00 for "Tax Bargain Guide." Information includes most states. J. J. Marshall, 151 Arvin, San Antonio 9, Texas.

GABARDINE Pants, \$6.95. Extra pair, \$2.95. All sizes. Blue, tan, brown, gray. Yale Clothing, Meriden, Conn.

BIG Mails; magazines; catalogs; offers; opportunities; propositions; listing. 25¢. Xebec, 814-M&M Bldg., Houston 2, Texas.

ATTENTION, Homeowners, nationally advertised hardware, tools, housewares, garden supplies, terrific savings. GB Enterprises, Box 75, Dept. A18, Merrick, Long Island, New York.

KOREAN Human interest photographs. 8 for \$1.00. Guaranteed. John McCown, Catlettsburg, Kentucky.

UNPAINTED Figurines, wall plaques. Free catalogue. Ball's Plastercraft, Toler, Ky.

YOU Can build your own home for \$4500 to \$7046. Books that take you through every step. Popular Mechanics famous Concrete Block House, \$2.00; Your Home and How to Build It Yourself, \$3.00; Ranch-Type House You Can Build, \$3.50. Full-sized plans available. Popular Mechanics Press, 200 E. Ontario, Chicago 11, Ill.

CLOGGED Drains opened by new powerful chemical called Sursolvent. Removes grease, soap, tree roots, etc., without expensive digging and electric rodding machines. Simple to use. Mix with water and pour down sink. Postal brings free details. Electric Sewer Cleaning Co., Allston 34, Mass.

BOYS American deluxe 22 pc. carpenter tool set. Metal case. 6 lbs. \$6.00. Groff Specialties, Zanesville, Ohio.

FREE 1954 Catalog on government surplus bargains from country's largest surplus organization specializing in outdoor, sporting goods, clothing, camping equipment. Tents, rubber boats, tarpaulins, swim fins, hundreds of other items. Rockaway Sales Co., Dept. PM, Route 46, Rockaway, New Jersey.

SWAPPERS—Join club. Swap anything. Quarter brings big swap list, details. Michigan Traders' Club, Alger, Michigan.

GROW Chinese bean sprouts for home use or resale. Complete instructions, recipes and package Mung beans \$1.00 postpaid. Oriental Food Products, 3327 Klein St., St. Louis 7, Mo.

BUY Name brands wholesale. Send 25¢ for catalog. Box 1621, Detroit 31, Mich.

COMBINATION Ball point pen and cigarette lighter. \$1.50. Guaranteed. H. M. Bishop, 405 Second St., Neenah, Wisconsin.

MEN Perflex (patented) lawn mower sharpener \$1.00. Jarcho, 5959 E. Alameda, Los Angeles 1, California.

"MASTER Plan for Success." Brings money, jobs, etc. Financial secrets included. Satisfaction guaranteed. Send \$1. Allen, 6711-R, Sunset, Hollywood 28, Calif.

IMPORTED Handwoven Mexican sarapes. Double bed size \$17. Box 7187A, San Diego 7, Calif.

BUY Wholesale thousands nationally advertised products at big discount. Free "Wholesale Plan." American Buyers, 631-D Linden, Buffalo, N. Y.

"X-RAY Mind." Stupendous mental power. (Details 10¢). Krishnar Institute, 1912 Lincoln-Park-West, Dept. MP, Chicago 14.

INCREDIBLE! Become mental superman overnight! Free booklet! Bijou, Box 1727-MH, Hollywood 28, California.

300 PROJECTS You can make—In Popular Mechanics 32-page Blueprint catalog. Send 3¢ stamp for copy. Popular Mechanics Press, Dept. 106, 200 East Ontario St., Chicago 11, Ill.

GOLD, Silver, metal detectors, Geiger counters for uranium. Mineralights. Sensational new fully guaranteed models. None finer. Information free. Detectron Corp., 5420 Vineland Ave., North Hollywood, California.

HOME Study for game warden, fish, park, forestry, wildlife and patrol service. Details free. Write Delmar Institute, A5, Whittier, Calif.

MARBELCRETE—Stops all dusting and wearing away of cement floors. Permanent treatment. Information free. Becker Paint & Varnish Co., Bay City, Michigan.

LOCATE Hidden treasure, distinguish minerals from metals with the Model 100 Detector. Weighs 5 pounds, extremely sensitive. Factory assembled \$79.90 or kit form \$39.90. Free literature. Dept. P, Electronic Applications, Box 4975, Washington 8, D. C.

FREE List for post card. Soaps, blades, lotions, and other masculine necessities at large savings. Sullivan, Box 5635, Chicago 80, Ill.

PANNING Gold—Free lesson; catalogue of mining, mineral books, supplies. Old Prospector, Box 729D1, Lodi, Calif.

YOU Can build your own home for \$4500 to \$7046. Books that take you through every step. Popular Mechanics famous Concrete Block House, \$2.00; Your Home and How to Build It Yourself, \$3.00; Ranch-Type House You Can Build, \$3.50. Full-sized plans also available. Popular Mechanics Press, 200 E. Ontario, Chicago 11, Ill.

RECEIVE Magazines, samples, catalogues. Mails from everywhere. Offers, hundreds. Get listed 25¢. Rorick, Box 86, Cincinnati 26, Ohio.

GROW Mushrooms. Cellar, shed, and outdoors. Spare, full time, year round. We pay \$3.50 lb. We paid Babbitt \$4,165.00 in few weeks. Free book. Washington Mushroom Ind., Dept. 173, 2954 Admiral Way, Seattle, Washington.

OUTDOOR Toilets, cesspools, septic tanks cleaned, deodorized with amazing, safe, harmless powder. Easy, economical to use. Saves digging, pumping. 150,000 customers guarantee satisfaction. Details free. Burson Laboratories, Dept. O-36, Chicago 22, Illinois.

300 BIG Mails guaranteed. Samples, plans, offers, propositions, 12 months listing, \$1.00 refundable. Wright Publications, 2270 Hubbard, Memphis 8, Tenn.

SELECTIVE Metal and mineral detector. Revolutionary design. Distinguishes metals from black magnetic sands. Readily detects metals under salt water. Also Geiger counters. Free literature. Gardiner Electronics Company, 2018 N. Dayton, Phoenix, Arizona.

TREASURE Finders for gold, silver and minerals. Money back guarantee, best available. Also Geiger counters for uranium prospectors, free information. Write Goldak Company, 1541 West Glenoaks, Glendale 1, Calif.

TREASURE—M-Scope Geiger counters, mineral locators. Why buy something inferior when you can buy the best at a lower price? Backed by years of experience. Fully guaranteed by factory. Detects minerals, metals, gold, silver, coins. Payment plan available. Proven superior performance. Free 16 page illustrated booklet. Fisher Research Lab., Inc., Palo Alto, California.

TREASURE Of invaluable information for anyone planning a vacation trip is John P. Arnold's Motor Tourists Guide. Complete with 12 pages of maps, the Guide tells how to pick the right place to go, the most effective way to travel, how to budget the trip, choose the right clothes to take along, motor courts and how to choose the one to stay in, what to do in case of accident, and what equipment to take along. The book, \$1.00, shows highways, scenic roads, recreational and sport areas. Popular Mechanics Press, Dept. M.T., 200 E. Ontario, Chicago 11, Ill. Send in your order today!

Perfect
TV Pictures—
ON ALL CHANNELS

150

Miles or more
from TV Stations
UHF and VHF

FINCO® 400-A
Double CO-Lateral
TV ANTENNA

WRITE TODAY FOR
Interesting Free
LITERATURE.

- Perfect Pictures— ALL CHANNELS — UHF and VHF
- Perfect Pictures— TESTED AND PROVED RIGHT HERE
IN TOWN — IT'S THE BEST!
- Perfect Pictures— ONE TRANSMISSION LINE,
NO SWITCHING!
- Perfect Pictures— ALL YEAR 'ROUND — WEATHERPROOF,
ALUMINUM CONSTRUCTION!



Patent Nos.
2,566,287,
2,630,531,
2,655,599

Look for the
FINCO RED SEAL
Your Protection
Against
Inferior
Imitations

THE FINNEY COMPANY

Dept. PM-5 • 4612 St. Clair Ave. • Cleveland 3, Ohio

Say You Saw It in Popular Mechanics

SPORT AND PROFESSIONAL
DIVING
EQUIPMENT

"IF IT'S FOR DIVING
DESCO MAKES IT!"

WORLD'S LARGEST MANUFACTURER
OF DIVING EQUIPMENT. LITERATURE ON REQUEST.

DIVING EQUIPMENT & SUPPLY CO. Dept. P, 234 N. Broadway
Milwaukee 2, Wis.

Build your own JET ENGINE!

Order these plans today

1. JET PROPELLED BICYCLE. Assemble your own. Photo and instructions, \$1.00.
2. HOW TO MAKE EXPERIMENTAL JET ENGINES. Seven sheets drawings with information and instructions \$2.95.
3. BOTH OF ABOVE in one order \$3.75. SEND NO MONEY. Order both at once \$8.75 C.O.D. in USA plus c.o.d. postage. Send check or money order and we pay postage. Get other information too. Rush Order.

SEND NO MONEY

J. HOUSTON MAUPIN, Dept. 55, Tipp City, Ohio

Aluminum Screen Patches
with the tiny patented hooks

4 for 25c

HUSH-A-DOOR stops door slam
on screen door or storm door. 60c

AT LOCAL STORES OR POSTPAID FROM

SCREEN PATCH CO., 1620 CALLOWHILL ST., PHILA. 30, PA.

WIN A NEW CAR . . .

One of 251 BIG PRIZES in Crosman's BIG Contest. TV sets, outboards, radios, cameras. Easy to Win! Senior and Junior Divisions. Ask any sporting goods dealer for FREE entry blank and contest rules.

FREE

CROSMAN ARMS CO., FAIRPORT, N. Y., Dept. 45
MAY 1954

U-MAK-IT BOAT KITS

30 OUTBOARD & INBOARD MODELS
to choose from:
ROWBOATS • PRAMS • RUNABOUTS • CRUISERS

Now you can build your own boat with simple hand tools and no previous building experience. It's easy—you save half the cost. Each part of the famous U-Mak-It boat kit is precision machined—frames, stem, transom, keel, and planking, etc., are ready for assembly. Kits are complete in every detail. Only the finest materials are used. For high performance, safety and durability investigate U-Mak-It boat kits, today!

SEND FOR BIG ILLUS. CATALOG

Shows complete U-Mak-It line: construction details, incl. everything to build your own. Engines, conversions, hardware, paint and color chart.
SEND 35c COIN TODAY!

U-MAK-IT products

703-P Whittier St. • Bronx 59, N.Y. City

SURE THEY'RE GOOD!

...you set
the standards
yourself



Products with brand names that you call for again and again are literally just what you order, because you yourself are constantly dictating their quality standards.

Your approval is the measuring stick that manufacturers go by. *You* decree how a seam will be sewn, an edge ground, a design balanced. *You* say if a flavor will be sharpened, a fragrance tempered, an angle softened, a color heightened. Products stand or fall on your acceptance . . . so their makers keep quality up, UP to the point that keeps you buying.

Man, you're the boss. And lady, you couldn't be closer to quality control if you sat in the manufacturers' collective lap.

Guide to good buying: the ads in this magazine.

BRAND NAMES FOUNDATION INCORPORATED

A NON-PROFIT EDUCATIONAL FOUNDATION
37 WEST 57 STREET, NEW YORK 19, N. Y.

**WANT QUALITY? PATRONIZE THE DEALER
WHO PROVIDES YOUR FAVORITE BRANDS**

STOP WASTING GAS

SAVE AS MUCH AS 25%
ON GASOLINE BILLS ALONE
WITH THE **ATOM BUSTER**

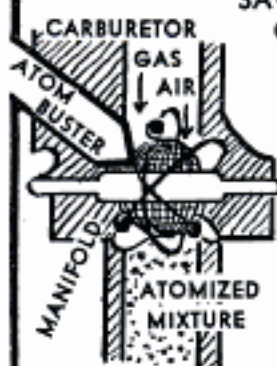

Why pay for gas your car never uses? During every mile you drive, your car blows high-cost, raw, unburnt gasoline out the exhaust. Gas you bought, but never used. That's why the **ATOM BUSTER**, the precision-built, patented atomizer, can pay for itself in one month of normal driving. Simply installed between carburetor and manifold the wire mesh and steel balls churn the mixture of gas and air

into a highly volatile mass of gaseous vapor that's ready to explode with full power. There's no waste! You get greater engine efficiency, more money-saving mileage for your car. You start Big-Savings the minute you install the fully tested and guaranteed **ATOM BUSTER**. If not available at your auto supply store, send check or money order for only \$4.98 direct to manufacturer giving make and model car. **ATOM BUSTER** will be sent Post Paid by return mail.

**ABSOLUTE
SATISFACTION
GUARANTEED**

Desoto Eng. & Mfg. Co.
Dept. PM-4 CLARKSDALE, MISS.



ELECTROPLATING

BY SIMPLE TANKLESS PROCESS!

A FASCINATING HOBBY OR
BUSINESS OF YOUR OWN!

Course of instruction with each kit. PLUS many MONEY MAKING formulas. Electroplate novelties, silverware, jewelry, auto parts, plumbing fixtures, bicycle parts, radio trim, hardware, etc.

Only \$4.95
for
Silver, Copper,
Nickel or
Cadmium

\$5.95 for
24 x 24 tank

BIG MONEY full or spare time. Gas Stations, garages, homes, used car dealers, institutions. Demands everywhere. ONLY \$4.95. SEND NO MONEY. Kit, instructions and formulas sent C.O.D. plus postage. Or send \$4.95 and receive outfit postpaid. Money refunded within 7 days if not satisfied.

CAPITOL PLATING CO. • 4213M Queensbury Rd. • Hyattsville, Md.

DRAFTING — DESIGN — MATHEMATICS — SURVEYING

Aircraft, Mechanical, Electrical, Architectural, Structural, Building Construction Estimating, Blueprint Reading, Mathematics—Refresher & Higher, Physics, Classes Days, Even, Start Any Monday. **MONDELL INSTITUTE, 230 WEST 41st ST., NEW YORK 36, N. Y.** 4-2 • Preparing Thousands for Technical & Engineering Positions **APPROVED FOR KOREAN VETS AND NON-IMMIGRANT STUDENTS**

"Building Beautifiers" Can Earn High Incomes

Colorcrete, a cementitious plastic, gives lifetime beauty and protection to drab, dirty masonry — concrete, stucco, etc. — on all kinds of buildings. Tough, tenacious, enduring. Easily cleaned. Helps to daylight dark interiors. Choice of gleaming white or 30 colors. Applied under pneumatic pressure to form an inseparable bond.



More Colorcretors are needed to supply the ever-increasing demand. Low investment appeals to men of limited capital. Work is easy, fascinating, highly profitable. Broad opportunity to develop a lifetime business. No special ability or experience needed because we supply full instructions and sales co-operation. Colorcrete machine is simple to operate, easy to move around. Write today for Opportunity Book.

Colorcrete Industries, Inc. **COLORCRETE** CO
570 Ottawa Av., Holland, Mich.

another

RUDGE

"BRITAIN'S BEST BICYCLE" SINCE 1869

special



\$69.75

Prices FOB Boston
Dymohub lighting additional.

the
SPORTS LIGHT COASTER



with the
TRI-COASTER HUB

It's almost like a car! It's the newest, safest, most exciting Rudge of them all—the Sports Light Coaster with the Tri-Coaster Hub.

This handsome bicycle combines in one amazing Tri-Coaster Hub, safe foot brake, three-speed gear, plus the Rudge hand brake.

Available in Rudge's traditional black. Also for women in Mediterranean blue, for men in Burgundy red.

Write for more information to:

Raleigh Industries of America,
Dept. M • 687 Boylston St. • Boston 16, Mass.

Completed Popular Mechanics Ranch Type House and exact scale pictorial room and suggested furnishing layout. To right of dotted line is BASIC HOUSE. Expansion to the left. Designed for easy building in two convenient steps.



Basic house includes living room, dining area, two bedrooms, kitchen, bath, utility room and car port. Can be built for about \$5000.

More than 100,000 families have built their own homes in the past few years, doing all of the work, or most of it themselves. Right now, one of every five homes being built is at least partially owner-built. This proves that you too, if you can use hammer and saw, can build your own home and save more than one-half of the cost.



Build the Basic House First



Add When You Need More Room

When expanding you add garage and breezeway, and car port becomes third bedroom. About \$2500.

Get this Newest Popular Mechanics "Build-It-Yourself" Book and Building Plans and Save Many Thousands of Dollars

Book gives complete step by step instruction in simple language. Hundreds of pictures, actual photos and diagrams, showing every phase of construction, guide you from start to finish. Ten working size blueprints give floor plans, elevations, notes on construction, framing, lumber list, specifications, plumbing and wiring diagrams.

part of it. And at the same time, save in labor costs, more than he spends for material.

Order Book and Plans Now

Use the handy coupon below to order your copy of the RANCH-TYPE HOUSE BOOK AND PLANS. Read the book; study the plans and then you will be prepared to go right ahead when you are ready to build. Even if you have the house mainly built by others, you can still enjoy a tremendous savings by using the instructions and blueprints from Popular Mechanics.

Read How and See How — Simplified Instruction

You read "how-to-do-it" in the book. You see how it looks in actual pictures. You follow the plans for dimensions and details. You make use of labor-saving kinks and special methods developed especially for the project.

No Previous Building Experience Required

Any ordinary handy man, using only simple tools, can build this house with little or no assistance and enjoy every



Use This Handy Order Coupon

POPULAR MECHANICS PRESS
200 E. Ontario St., Chicago 11, Ill.

Send at once my copy of the Ranch-Type House Book and Plans as checked below:

- | | |
|--|--|
| <input type="checkbox"/> Remittance enclosed | <input type="checkbox"/> Send C.O.D. (postage extra) |
| <input type="checkbox"/> Ranch Type House Book | \$ 3.50 |
| <input type="checkbox"/> Set of 10 Blueprints | 13.50 |
| <input type="checkbox"/> Book and Blueprints | 15.00 |
| <input type="checkbox"/> Duplicate Set of Blueprints | 5.00 |

Name _____

Address _____

City _____ Zone _____ State _____

Beat the High Cost of Home Owning It's Easier Than You Think

Here is a dream home that can become a reality without too much worry about money. Build this beautiful Ranch Type Home yourself. Simply follow the Popular Mechanics RANCH TYPE HOUSE BOOK AND PLANS. You can save \$7,000 to \$10,000 and have one of the most desired homes of these times. You can build it all now—or part of it—and add garage, breezeway and another bedroom later on without affecting the basic house.

Modern Design • Fully Finished • All-Season
Build this Home Anywhere and Save

Designed for Popular Mechanics by John F. Whelan, famous West Coast architect and designer of homes and entire villages. It's a year 'round house, 81 feet long and 29 feet wide. Fully insulated. Finished outside and inside with durable plywood and requires no plastering. Brick "island wall" and big fireplace in living room. Heating, unique ventilating system and latest development in electric wiring included. A dream home that can easily come true and a home that can grow with the family.

Reduced size illustrations from book. Building roof truss on floor for easy construction. Mrs. Tom Riley, Portland, Oregon, shingles the roof on her Popular Mechanics Ranch Type House





take your vacation
WITH YOU
wherever you go

KLEPPER

**UNSINKABLE AERIUS
FOLDING BOAT**

EASY TO SET UP: A child can do it!

STURDY: Tough, resilient hull of multi-ply rubber tire construction on rugged frames of seasoned mountain ash and plywood. Superior in quality, workmanship to any similar product. No tools needed, no bolts. New snap-lock fittings.

UNSINKABLE: Air tubes around the gunwales keep it always above water.

See the **KLEPPER FOLDING BOATS** at
1472 Broadway New York 18, N. Y.

- Holds 4 adults, plus gear
- Tacks like a dream under sail
- Skims over water with light outboard
- Paddles better than light canoe
- Chosen by Byrd, Amundsen for expeditions
- A Klepper crossed the Atlantic sailed by Captain Romer

Write for
FREE
Catalogue



Stows away in 2 easy-to-carry packages, fits into car trunk, goes wherever you go. Sets-up into trim 17 footer in minutes. Ideal for boating, fishing, hunting or white water thrills.

ready to launch
from **\$159**



KLEPPER CO. Dept. PM-5, 1472 Broadway
New York 18, N. Y.

Please send me free illustrated color catalogue

Name _____
Address _____
City _____ Zone _____ State _____

FREE 10 U.S. STAMPS

COLORFUL set of 10 famous historic U. S. stamps—all different—sent FREE to secure names for our mailing list. Each stamp worth real money. We'll also send other interesting offers for your inspection, plus FREE copy of our helpful "How to Collect Stamps." Supply limited. Rush name, address and 10c to help cover actual postage and handling to:

**LITTLETON STAMP CO., Dept. PM-5,
Littleton, N. H.**

ENGINEERING DEGREE IN 27 MONTHS

INDIANA TECHNICAL COLLEGE

B. S. DEGREE, Aeronautical, Chemical, Civil, Electrical, Mechanical and Radio Engineering (inc. TV and Electronics). Drafting, 1-yr. G.I. Gov't. approved. Low rate. Earn board. Large industrial center. Students from 48 states, 21 countries. Demand for graduates. Enter June, September, December, March. Write for catalog, 1634 E. Washington Boulevard, Fort Wayne 2, Indiana.

NOW! EQUIP Your Car WITH HYDRAULIC Power Brakes!

FITS ALL CARS! INSTALL THEM YOURSELF IN 30 MINUTES!

SPECIAL INTRODUCTORY OFFER \$19.95 FOR LIMITED TIME ONLY

(Trucks: Light \$24.95, 1/2 & 2 ton \$38.75)

Bring your OLD CAR up-to-date or save up to 1/3 the cost of Power Brakes on your NEW CAR. Power Brakes double braking power with half the effort, give the driver better control, safer stops, reduce driver fatigue. PAY FOR THEMSELVES by increasing brake life and Tire Mileage. Ordinary cost is up to \$80, but now this Time-Tested Power Brake Kit is available at a Startling Low Introductory Price. EASY TO INSTALL—NO EXPERIENCE or special tools necessary (or your garage will install for a few dollars.) GUARANTEED 5 YEARS. Amazing 30 day "try-before-you-buy" money back offer. Send cash, check or money order or write for additional information. DEALERSHIPS AVAILABLE. CONTINENTAL ENGINEERING PROD. CO., Dept. B-5 10418 Pecker Blvd., Culver City, California

Say You Saw It in
POPULAR MECHANICS

WAR SURPLUS BARGAINS

WAR SURPLUS BARGAINS

\$500,000.00 INVENTORY for QUICK LIQUIDATION

Surplus items—hundreds of them for home, shop, factory, farm and outdoor use. New items, used items, reconditioned items—all at tremendous savings—all priced for quick sale.

Page After Page of Values

This big catalog shows page after page of amazing money saving values. Write for your copy today. Send 10c to cover postage, mailing, etc. Write today! **SEND TODAY FOR YOUR COPY**

10c

FIELD TELEGRAPH TRANSMITTER & RECEIVER SET

Complete: includes transmitter with pair of head phones, sending telegraph key, buzzer, double throw switch. Original cost of this instrument to English government well over \$100.00. Ship. wt. 20 lbs. each. Allow sufficient postage or will be shipped express charges collect. Two 4 1/2 volt C batteries needed in each set. Batteries 45c each extra. Wire needed to connect for operation. No 438. Complete set of two... **\$15.00**

One set **\$7.95**

STARK'S 509 So. State St.
Dept. PM-545
CHICAGO 5, ILL.



Now—caulk cracks
and crevices around
your home this
modern easy way!

DICKS-PONTIUS
WHITE Caulking
Compound in
a giant tube!

- Dozens of home maintenance uses.
- No gun—no mess! Just squeeze the tube!
- Collapsible tube comes ready-loaded with 1/10 gal. of highest quality, white D-P Caulking Compound.
- Tube has built-in applicator tip—and cap screws over it for storage.

GET IT NOW! On sale at leading hardware, paint and building supplies stores. D-P products are easier to use! Always ask for them by name.

The Dicks-Pontius Company • Dayton, Ohio
Alexandria, Va. • Decatur, Ga. • Dallas, Texas

FREE 100 WAYS TO MAKE EXTRA MONEY

Rush postcard for FREE Opportunity Magazine: 1,000 ways to make extra money without leaving home or your job. Many make \$100 to \$500 monthly and more without experience. Nothing to buy. No obligation. No matter where you live, no matter what your age or occupation, send postcard now for FREE copy.

OPPORTUNITY 28 E. JACKSON, DEPT. PM-1 CHICAGO 4, ILL.



GET THESE NEW
**WIND
SILENCERS**
FOR YOUR CAR!



Stop wind roar from window vents. Fit on and add to appearance of any car. Stainless steel. Easily attached with pat. clip. No screws. Designed by U. of M. aerodynamic engineers. Tested, Highway Dept., approved for clear vision. Send only \$2.98 pair plus 12¢ mailing. If not satisfied, return undamaged in 10 days for full refund.

UNCONDITIONAL
MONEY-BACK
GUARANTEE
ONLY
\$2.98
PAIR

WIND SILENCERS
2288 Univ. Ave., St. Paul 14, Minn.



DRIVE 500,000 MILES

Without Need Of A Major Overhaul ENGINEERS HAVE PROVEN THIS POSSIBLE. They have shown that the combustion process produces more than a gallon of water in vapor or steam for every gallon of fuel burned. Some of these vapors enter crank case causing rust, varnish, acids and sludge.

INSTALL POWER VENTILATION—

GET UP TO 2 or 3 MORE MILES PER GALLON—
CUT ENGINE WEAR UP TO 40%—

Increase the overall operating efficiency of your car with amazing Moto-Vent. Positive Power Ventilation removes water vapors, sulphur and other corrosive materials that enter crank case. Not a "gimmick" or "gadget" but a precision engineered instrument designed to give better engine performance, up to 2 or 3 more miles per gallon and cut engine wear up to 40%. Oil and water vapors are fed back into the combustion chambers where they give you water injection and overhead lubrication. No extra oils or additives needed.

EASY TO INSTALL—DO IT YOURSELF. Fits all cars, trucks, tractors—old or new. Install Moto-Vent between oil breather and intake manifold in less than half hour. Will soon pay for itself.

FREE 30 DAY TRIAL OFFER. Moto-Vent complete with all fittings and easy to follow installation chart only \$4.98 postpaid, or, C.O.D. plus charges. Try for 30 days. If you are not completely satisfied, return for full refund. Send order or write for further FREE particulars, today!

PRECISION PRODUCTS CO., Dept. 15, Harvard, Ill.



TAP JAW

ADAPTS DIE STOCK TO TAP WRENCH. Needed in Machine Shops, Garages, Home Workshops. Wherever Tap Wrenches Are Used. Makes it possible for you to use your Die Stock as a

Tap Wrench. Tap Jaws come in 3 sizes. Each Tap Jaw has 4 sizes of openings! Every size tool from the largest to the smallest can be securely held.
1 1/2" Diam.—5/16" to 3/8" machine taps \$1.80
and 1/8" to 3/8" pipe taps
2" Diam.—3/8" to 1/2" machine taps \$3.15
and 1/4" to 1/2" pipe taps
2 1/2" Diam.—3/4" to 1 1/4" machine taps \$4.15
and 3/4" to 3/4" pipe taps

Order Today! Satisfaction, or Your Money Refunded.
MURRAY BROTHERS MFG. CO., 1625 N. Elston Ave., Chicago, Ill.

HELPFUL BOOKS

Send post card asking for FREE catalog
Popular Mechanics Press, 200 E. Ontario, Dept. 601, Chicago 11

YES! SEND



directly
to my door
every month

I am enclosing

- \$3.50 for 1 year
 \$8.00 for 3 years

name _____

address _____

city _____

zone _____

state _____

A-54

Hand this order to your newsdealer or send it to

POPULAR MECHANICS
200 East Ontario St. Chicago 11, Ill.

YOU PLAN IT

YOU BUILD IT

YOU SAVE

UP TO 35%

●How can they do it? That's what your friends will ask—that's what will *surprise* you about Pagemaster's "know-how", after you build this gracious ranch-style home at a savings on today's building costs of up to 35%. Add a garage now or later and the gracious lines of the No. 542 James will be even more enhanced.

Imagine receiving a complete house in one "package", all ready for you to erect. What's more, your new home will be planned just the way you want it. Don't delay! Get the complete Pagemaster story, and see how easy it is to own the house of your dreams—at a price you will be glad to pay. Highest quality materials throughout, Pagemaster homes meet and exceed FHA and VA financing requirements.

Write TODAY! Many excitingly new models to choose from. Send 25c in coin for full-color catalog. Let Pagemaster help you from there!

Pagemaster
HOMES

300 PIERCE ST., SHAKOPEE, MINNESOTA

"PANELIZED FOR EASY ERECTION"



No. 542 JAMES—
3 Bedrooms, Study,
Dining Room,

1241 Sq. Ft., Only \$5,057.

PAGEMASTER HOMES, Shakopee, Minnesota

Gentlemen: Send your full-color catalog of beautiful Pagemaster Homes. 25c in coin is enclosed.

NAME _____

ADDRESS _____

CITY _____ STATE _____

FROM Mowing TO Tilling...

IN LESS THAN 1 MINUTE WITH Triple-M QUICK-HITCH LOCK

For all-around, year-around ease, utility and economy, see Triple-M garden and yard equipment. In less than a minute, you can attach tiller, mower or snow thrower to your Multi-Purpose Power Unit, and you're ready for any kind of work. You just release the QUICK-HITCH LOCK to remove one unit; then roll in another; couple it; tighten lock by hand and you're ready to go. No shoving, no heavy lifting, no tools needed.

The powerful Triple-M Unit does the hard work. One-Spot Control from behind the handles gives complete command of all operations—mowing lawns or high grass or trimming close to borders . . . mulching leaves . . . tilling or cultivating . . . clearing snow.

Triple-M equipment costs less and takes less storage space than separate single-purpose tools. You can buy what you need now, add others later. See your Triple-M dealer and have him show you the year-around, all-around values of Triple-M, or write us for illustrated folder.



Triple-M PRODUCTS
DIVISION

The Motch & Merryweather Machinery Co.
55409 BRIGHAM ROAD, GATES MILLS, OHIO

STOP RUST

FROM MOVING IN
WHEN ANTI-FREEZE
IS DRAINED OUT!



WITH
PERMATEX
WATER PUMP LUBRICANT
and RADIATOR ANTI-RUST

All types of permanent Anti-Freeze contain a rust inhibitor. When you drain your anti-freeze for warm weather driving and refill with clear water . . . look out—that's when the rust moves in . . . Prevent this rust from forming . . . protect your engine and water pump . . . add a can of Permatex Water Pump Lubricant and Radiator Anti-Rust. It keeps water crystal clear and lubricates the pump . . . stops squeaks and squeals, prevents wear.

Send for free illustrated catalog

**LOOK FOR THE DISTINCTIVE
PERMATEX LABEL**

at your service station or garage.
It's been your guarantee of quality
for over 45 years.



OVER FIFTY CHEMICAL PRODUCTS FOR BETTER
AUTOMOTIVE MAINTENANCE

PERMATEX COMPANY, INC., Brooklyn 35, New York

ADDS

ACTION TO ANY LURE!

TEN SHAPES
FOUR COLORS

JOHNSON'S PORK RIND

Gives any lure that extra flash and flutter that attracts big fish. A really improved rind—supple, yet tough. Colors are fast. No salt brine to corrode tackle.

FREE New Booklet
"FISHING SECRETS"
LOUIS JOHNSON CO.



1547-P Deerfield Rd., Highland Park, Illinois

SAVE 1/2 on WATER SKIS

\$15³⁰



Simply assemble and finish our new water ski kit and you have a pair of skis worth twice the price of the kit. Skis are 7 ply moulded plywood, 67½" long, 7" wide, 9/16" thick. Sturdy rubber foot pieces. All parts plus instructions included—\$15.30. Order from your Michigan dealer or MICHIGAN WHEEL CO., Dept. P-95, Grand Rapids, Mich. C.O.D. orders accepted.

new!

No. 4 HAWAIIAN WIGGLER



WRITE FOR
BIG FREE
CATALOG

Weighted, flexible, weedless spinner fly—casts like a bullet, sinks quickly, runs deep. More flash for trolling. Won't twist line or hang up. 1/4 oz. or 3/8 oz. — \$1.15 each.

FRED ARBOGAST CO., INC., 2205 W. North St., Akron 3, Ohio

Say You Saw It in Popular Mechanics

4 WHITE WALLS \$9.95

100% NATURAL RUBBER

EASY TO PUT ON!

Turn your present black tires into custom white side walls, with these thick, natural rubber WHITE WALLS. Absolute perfection and satisfaction assured. Everything furnished for all four tires. Mail check or money order NOW. Introductory price for complete kit: only \$9.95 postpaid. Sold coast to coast.



Department: M

P.O. Box 11758
Wagner Station
Los Angeles 47, California

CUSTOM SIDEWALLS

POPULAR MECHANICS

YOU CAN HAVE THIS

RIDING TRACTOR

FOR ONLY...

\$99.50

RIDE-TRAC Makes Fun Out of Your Lawn and Garden Work!



For the FIRST TIME you can have a COMPLETE KIT and ASSEMBLE YOUR OWN RIDE-TRAC in a FEW HOURS... SAVE OVER \$150.00!

A POWERFUL RIDING TRACTOR AT LOW COST!

Make all your lawn and garden chores easier with the new, sturdy RIDE-TRAC. Equipped with a draw bar hitch, your RIDE-TRAC will pull standard attachments for lawn and garden. It can be as powerful as you need. Safe for the whole family to use—so simple you need never worry about breakdowns or repairs.

Now kids really enjoy doing more work around the home. Regardless of age, you can count on a lot of help after you get your RIDE-TRAC. Your children will jump at the chance to do those yard and garden chores. Your RIDE-TRAC is completely safe for the youngsters and very easy to operate. They will learn driving safety in your own back yard.



RIDE-TRAC DOES MANY JOBS

RIDE-TRAC is a complete riding tractor and will give you the same performance as others costing \$250.00 to \$500.00. It will give you good service for years. You'll be amazed at the jobs you can do with your RIDE-TRAC... Now you can mow, seed and fertilize, pull loads, grade, cultivate, remove snow... RIDE in comfort while your RIDE-TRAC does all of your lawn and garden work.

ONE SATURDAY AFTERNOON CAN SAVE YOU \$150.00

The RIDE-TRAC Kit is so easy to assemble—you can do it in one afternoon—let the whole family help, it's lots of fun. No machining—No welding—No holes to drill—Assemble the RIDE-TRAC with your own hand tools. Simple step-by-step picture plans. All materials are furnished and guaranteed. You don't need to be a mechanic or have any mechanical experience to assemble your RIDE-TRAC. Order RIDE-TRAC Now; Save Over \$150.00...

USE ANY 1½ TO 3 H. P. GASOLINE ENGINE

We furnish the engine mounts so that you will have no trouble putting the engine on. You can use any low-cost 1½ to 3-H. P. engine.

THE COMPLETE RIDE-TRAC KIT COSTS YOU ONLY \$99.50

Your RIDE-TRAC Kit gives you a rugged, all-steel chassis, complete fully guarded belt drive with differential action for short turns, heavy duty rubber tired wheels, all-steel dash and double seat, bevel-gear steering assembly, slotted engine mounts for fast, easy fitting of 1½ to 3 H. P. engine, throttle control, rear draw bar hitch and front end mounting holes for standard lawn and garden tools, all nuts and bolts furnished. RIDE-TRAC is complete in every detail. You do no machining—no welding—no holes to drill—all materials are furnished. You buy nothing else but the engine. With the RIDE-TRAC Kit you get simple picture plans that anyone can follow. All parts are guaranteed.

USE COUPON BELOW TO ORDER YOUR RIDE-TRAC KIT

You can order your complete RIDE-TRAC Kit now or, if you prefer, send \$1.00 for the Plans only and order your complete RIDE-TRAC Kit after you see how easy it is to build. Use the coupon below to order your complete RIDE-TRAC Kit on 30-Day Money-Back Guarantee. Send \$25.00 with order and your RIDE-TRAC will be sent to you C. O. D. for \$74.50 plus freight charges. The entire RIDE-TRAC Kit weighs only 125 pounds. You will receive your RIDE-TRAC about 10 days after you order.

USE YOUR RIDE-TRAC THE YEAR 'ROUND

Spring, Summer, Winter or Fall your RIDE-TRAC is the handiest machine around the home. You won't let a week-end go by without using the RIDE-TRAC, ideal for every use including snow plowing in the Winter. Dollar for dollar you can't beat the low-cost RIDE-TRAC for usefulness and pleasure.

MONEY-BACK GUARANTEE

If you are not entirely satisfied with the RIDE-TRAC return it within 30 days and you will get your purchase price back. The RIDE-TRAC Kit is guaranteed against mechanical defects for one year.

BELSAW MACHINERY CO
Manufacturers of Farm Equipment For Over 30 Years

ORDER YOUR RIDE-TRAC TODAY

BELSAW RIDE-TRAC DIVISION 9001 Field Bldg., Kansas City 11, Mo.

Please send me the RIDE-TRAC Kit on 30-day guarantee.

Enclosed find \$25.00 (check or money order). I will pay balance C. O. D.—plus freight.

Enclosed find \$99.50 (check or money order). Send the RIDE-TRAC Kit by PREPAID FREIGHT.

Please send me the Plans Only for the RIDE-TRAC Kit. Enclosed find \$1.00 to be credited against my later order for the RIDE-TRAC Kit.

NAME _____

ADDRESS _____

CITY _____

STATE _____

Which is hotter?



Inside an engine?



Inside molten lava?

Answer: When combustion occurs, the temperatures within the cylinders of an automobile engine frequently go as high as 4800° F. . . . *more than three times as hot as flowing volcanic lava!*

The advantages of chrome plated top piston rings in this area of intense heat, highest pressure and poorest lubrication have been recognized by automotive manufacturers everywhere . . . *and 34 out of 36 engine manufacturers installing chrome rings use Perfect Circles!*

For replacement, Perfect Circle 2-in-1 Chrome Sets offer solid chrome plating on BOTH top and bottom rings . . . for thousands and thousands of extra miles of sustained power and oil economy. Perfect Circle Corporation, Hagerstown, Indiana; The Perfect Circle Co., Ltd., Toronto.

Perfect Circle

2-in-1 Chrome Piston Rings

The Standard of Comparison

Solid chrome plating on top and bottom rings gives wear protection throughout entire area of ring travel. Rings are lapped-in at factory, eliminating tedious break-in.





**HOW TO
GUARD YOUR
HOME AGAINST**

fire

National Board of Fire Underwriters photo

Here's advice
from the experts on
fire extinguishers
and detectors

FIRE-PREVENTION experts are appalled by one startling fact: there is less protection against fire in the average home than in any other building in which people spend a portion of their days.

Every year, fire safeguards reach new heights in factories, schools, churches, business institutions and hotels, but the home—the place closest to the heart of mankind—remains neglected in millions of cases. The experts believe the reason for this is the old and faulty psychology of: "It can't happen to me."

The tragedy is that it does happen. There

is an average of 1100 home fires every day in the United States, according to the National Fire Protection Association. The toll in lives per day is 30 persons (a high percentage are children) and the property loss runs into millions.

The causes of home fires are so varied that they emphasize the uncomfortable fact that a home without fire protection is a dangerous place. The careless use of matches and smoking materials is responsible for 30 percent of home fires from known causes over a 10-year period. Other causes on the list are: Accumulations of rubbish



in basements and attics, faulty wiring, defective chimneys and furnaces or other heating equipment, careless use of combustibles such as flammable cleaning fluid and roofs which are not fireproof. Ninety percent of home fires are due to carelessness or negligence and could easily have been prevented or checked in an early stage before much damage was done.

"Homeowners are wrong if they think they have to spend a lot of money to get a minimum of fire protection for their homes," says John J. Ahern, director of the department of fire protection and safety engineering at Illinois Institute of Technology. "In fact, a great deal of protection can be had without spending a cent or by the use of materials and equipment found in every home."

Here are some safeguards suggested by Ahern: The knowledge by every member of the family (old enough to use the telephone) of how to call the fire department; family fire drills with and without the use of ordinary exits from the home—this is important in an emergency; strategic placement of fire buckets that can be filled with water to be tossed on a fire; availability of the garden hose for putting out fires the year 'round; the storage of a plentiful supply of ordinary baking soda in the kitchen for putting out grease fires.

Ahern stresses the importance of keeping the garden hose handy and ready for use. If attached to the outside of the house in summer, some arrangement should be made so it could be pulled quickly through a window. In winter, the hose should not be put away in some remote corner, but attached



Class A Fires

Paper, wood and similar combustibles. Extinguishers: Bucket spray pump, hand-operated pump tank, soda-acid, foam.

Class B Fires

Flammable liquids or greases requiring smothering effect. Extinguishers: Foam, vaporizing-liquid, carbon-dioxide, dry-chemical.

Class C Fires

Live electrical equipment. Extinguishers: Vaporizing-liquid, carbon-dioxide, dry-chemical.

to a basement connection awaiting an emergency.

The second step in fire protection requires a small outlay of money—especially small in proportion to the protection it will afford. This is the purchase of a bucket spray pump or a portable extinguisher. The spray pump, familiar to most gardeners and owned by many, is a handy and inexpensive gadget (from \$8 to \$12) for putting out a small blaze. All you have to do is fill a bucket with water, stick the pump in the bucket and start to pump. The bucket can be refilled by a helper without diminishing the 20 to 30-foot spray of water.

There are scores of portable fire extinguishers on the market, certainly more than enough to confuse the average homeowner. His problem, however, is simplified by studying the kinds of fires he may encounter in the home and the half-dozen basic types of extinguishers and what they can do. Good portable extinguishers range in price from \$20 to \$40.

A preliminary "must" in the purchase of any extinguisher is that it bear the label of approval by Underwriters' Laboratories or Factory Mutual Laboratories. These labels are a guarantee to the buyer that the product has been carefully tested and approved for a specific use. The National Fire Protection Association and other such organizations highly recommend that homeowners purchase only approved equipment. They report that numerous extinguishers on the market are no more effective than a can of warm beer would be if it were shaken up and punctured.

In the language of the fire experts there are three classifications of fires: A, B and C. Class A fires are confined to ordinary combustible materials such as paper, wood or cloth where the quenching and cooling effects of quantities of water, or solutions containing large amounts of water, are of major importance. Class B fires are defined as fires in flammable liquids or greases where a blanketing or smothering effect is essential. Class C fires occur in live electrical equipment where a nonconducting extinguishing agent must be used. The use of water on a Class C fire

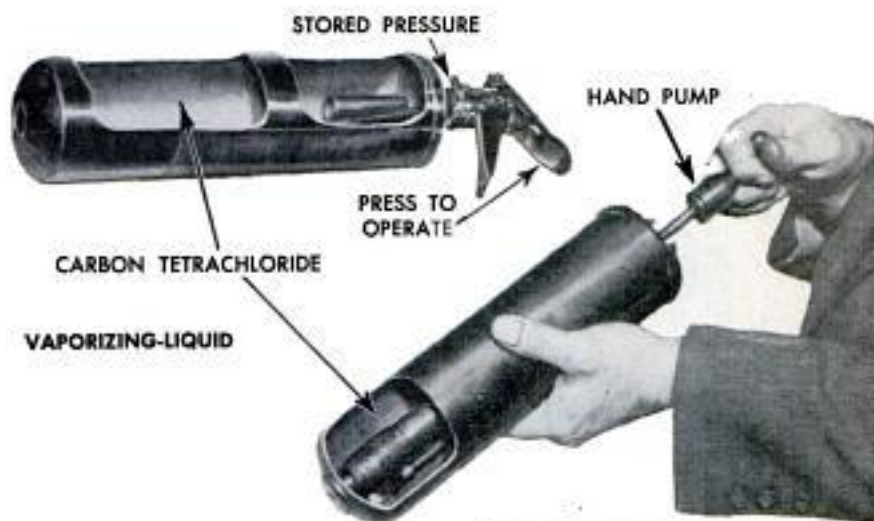



Underwriters' Laboratories photos
Underwriters' experts test dry-chemical extinguisher in lab



Engineers use a one-quart vaporizing-liquid extinguisher to put out blaze in cotton waste soaked with gasoline. Below, testing a carbon-dioxide extinguisher on a fire made by igniting two gallons of gasoline in a four-foot iron container



Here are two means of fire protection at low cost—bucket spray pump, garden hose

is dangerous and not advisable.

Most home fires are in Class A or B, but most extinguishers which are effective on Class B are also useful for Class C. The basic types of extinguishers are the hand-operated pump tank, soda-acid, foam, vaporizing-liquid, carbon-dioxide and dry-chemical.

For ordinary home use the most highly recommended and inexpensive type is the 2½-gallon hand-operated pump tank. A five-gallon size is also available, but the smaller tank is more desirable because it is easier to carry around and can be refilled by a helper while in use. The tank is filled with plain water or a nonfreezing solution. It produces a stream that will travel 30 to 40 feet. The experts like this tank for its simplicity of operation and ease of maintenance. A variation of this model is the stored-pressure tank with an attached carbon-dioxide cylinder which saves pumping. The gas is released into the cylinder by pressure on the handle. For adequate protection, a two-story home should have two extinguishers of this type with one kept on the second floor.

Another favorite for Class A fires is the 2½-gallon soda-acid extinguisher. It contains water in which bicarbonate of soda has been dissolved. A bottle in the top of the tank holds sulphuric acid. When the extinguisher is turned upside down the chemicals mix to form a gas which forces the water out.

The foam extinguisher closely resembles the soda-acid type. It contains a metal cylinder filled with aluminum sulphate. When

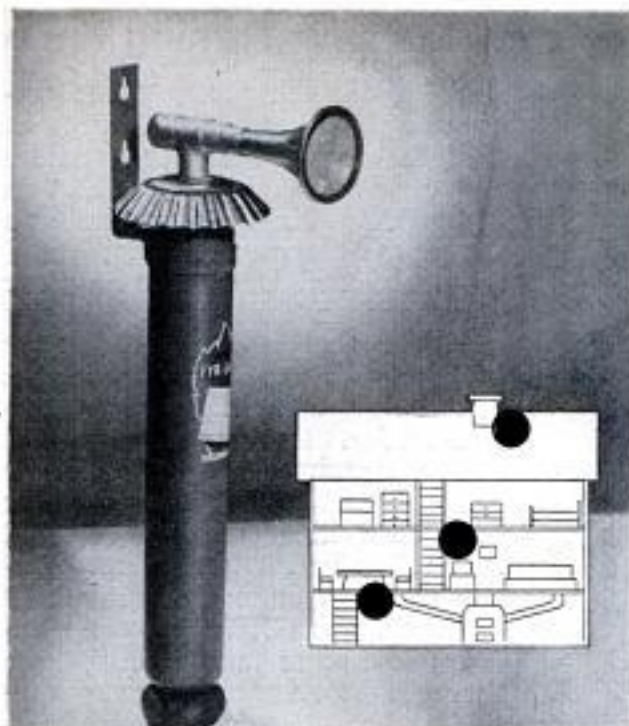

Fyr-Larm Company photo

Whistle-type detector goes off with blast when the temperature climbs. Sketch shows the best locations

the extinguisher is tipped over, the aluminum sulphate mixes with the soda water and a foam-making ingredient. A 2½-gallon tank expels about 20 gallons of foam. The foam smothers Class B fires, but due to the water content is also used for Class A.

The vaporizing-liquid extinguisher is available in both hand-pump and stored-pressure models. Recommended for both Class B and C fires, it contains carbon tetrachloride under pressure. The most common size contains a quart of liquid and the stream will travel 20 feet or more for about 30 seconds. The gas formed by the vaporization of the liquid is toxic and this extinguisher shouldn't be used in confined areas.

Also recommended for both Class B and C fires, is the carbon-dioxide extinguisher. It has a hornlike nozzle through which carbon-dioxide gas escapes when a valve is opened. The extinguisher has a maximum range of about eight feet, but it should be held as close to the fire as possible.

The dry-chemical extinguisher is available in several styles, all depending on a small cartridge of carbon dioxide for pressure. The dry chemical used is ordinary bicarbonate of soda which is expelled in a cloud that travels 20 to 25 feet. It is effective for Class B and C fires.

Safeguards that reach into the realm of superior home protection are the fire detectors. Many families are suffocated by smoke before they ever have a chance to use an extinguisher. One simple and inexpensive detector (\$12.50) is a whistle that gives forth a shrieking blast when the temperature rises to 136 degrees F. The cylin-

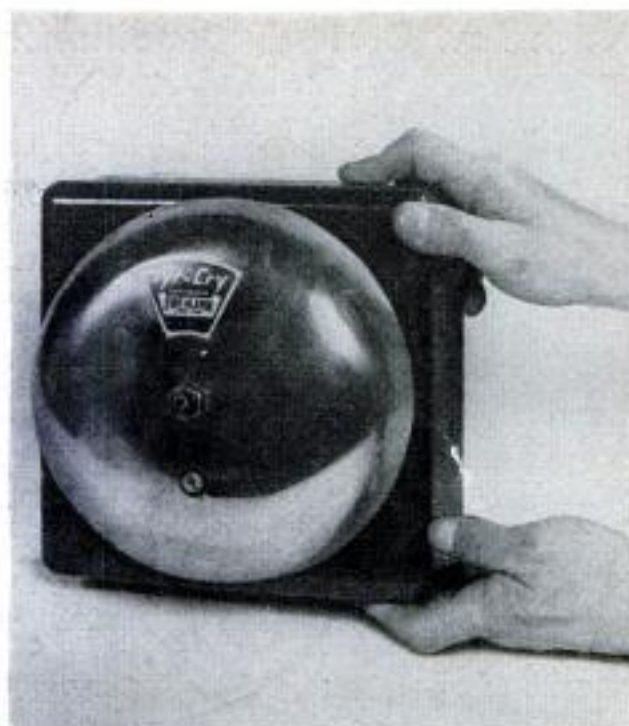

Fyr-Fyter Company photo

This gong produces loud noise for five minutes if set off by temperature rise. It's wound like a clock

der attached to the whistle is filled with a harmless gas held back by a link of fusible metal. The manufacturer recommends the placement of these whistles in areas where heat would gather in case of fire such as the top of the basement stairs, the ceiling of the stairwell in a two-story house and in the attic at the peak of the roof.

Another fusible-link type of detector sets off a bell alarm when the temperature climbs to 133 degrees F. This simple and effective alarm is wound like a clock.

Most other types of detectors are connected with the electrical system. One consists of small thermostats (\$1.25 each) placed against the ceiling of every room and installed with a closed-circuit system on a series loop using a relay with a dry battery for current supply or a trickle-charger wet battery. On an open-circuit system a direct connection can be made to the electric source of supply or a dry or wet-cell battery.

Another simple detector is formed by two thinly insulated wires. When the insulation melts, the wires complete a circuit to set off an alarm. Then there are rate-of-change detectors which set off an alarm when there is a rapid rise in temperature.

Other elaborate and expensive electronic smoke detectors can "smell" flammable gases in the air or "see" smoke in the space between a lamp and a photocell.

All the experts agree that adequate safeguards are available to suit every home and pocketbook. The hardest part is to convince the average homeowner that "it can happen to me." ★ ★ ★

Nash Low Cost Air Conditioner Cools or Heats by Turning Knob

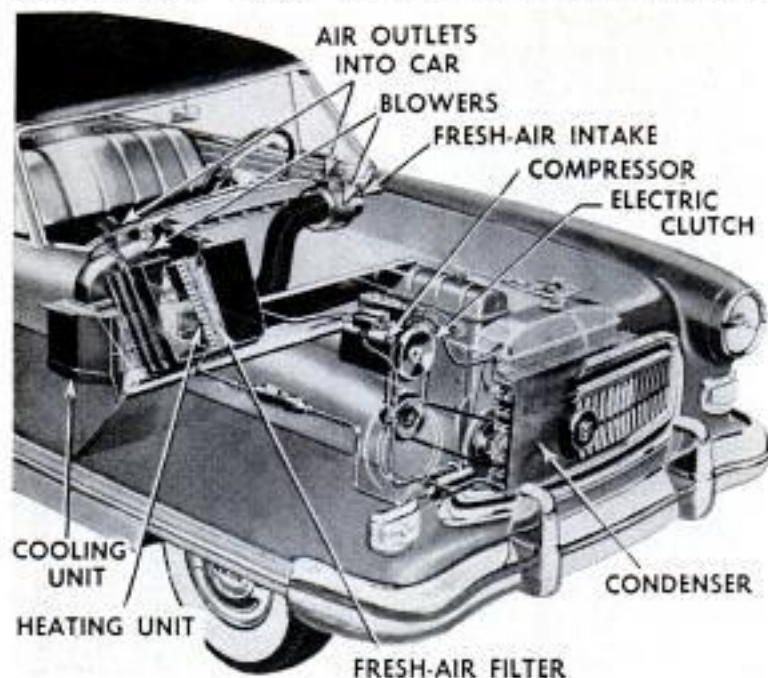

Nash, the company that pioneered the heater that brings in air from outside the car, now offers the industry's first combination heater and air conditioner. The entire system mounts forward of the dashboard. There are no parts in the trunk. Pricewise, it is the lowest in the industry, selling for \$395 factory installed or almost \$300 below competitive combinations. One knob controls both heating and cooling. Fresh air enters the cowl intake, passes through a filter to remove dust and pollen and is intermixed with air from within the car (ratio: 30 percent fresh air, 70 percent interior air). The air then passes through a cooler (or heater in winter) and out two dash outlets.

Pin-Size Neon Glow Lamp Aids Timing of Film

No bigger in diameter than a pinhead, a tiny neon lamp developed by Westinghouse will be used to time pictures taken during guided-missile tests. It also can be used for similar camera work in laboratories where space is cramped. The neon bulb is $\frac{1}{50}$ of an inch in diameter and an inch long, and generates a $\frac{1}{40}$ -watt glow between two electrodes spaced $\frac{1}{25}$ of an inch apart. Fifty of the tiny lamps are to be situated along a strip of 35-mm. motion-picture film to provide the timing data needed. According to Westinghouse, the lamp is the smallest in the world. It has only $\frac{1}{3}$ the diameter of the grain-of-wheat lamp, previous holder of the world's smallest-lamp title since 1932. It can be powered by hearing-aid batteries.

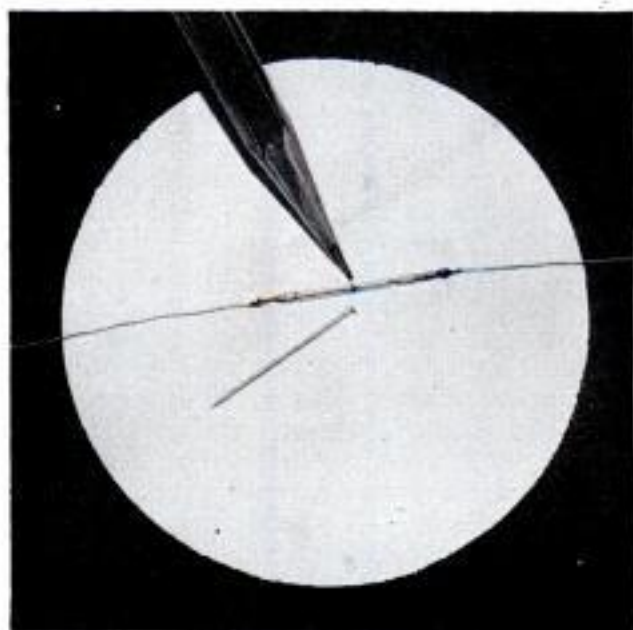

Plastic Shield for Police Offers Protection From Bullets

Light enough to be held in one hand (11 pounds), a plastic shield for police and other law-enforcement officers stops bullets fired from as close as 20 feet. Made of laminated glass fiber, the shield effectively stops slugs fired from a 12-gauge shotgun, a .38-caliber pistol and a World War I Mauser. The shield is fitted with a small, bulletproof glass window that allows observation while giving protection. As a bullet plows through the various plies of the plastic shield, its velocity is spent by the absorption of energy.

☐ Visitors to national parks in 1953 totaled 46,224,794—a new high.



In display built to demonstrate robot navigator, white dot on map simulates aircraft it would be mounted in and its present position is indicated on bottom-left box. Only four boxes mounted on console are in the airplane

Robot Navigator Guides Jet Pilots

SITTING IN A WELTER of wavering needles and spinning dials as he hurtles through space, the harried jet-fighter pilot has no time to sit around casually plotting positions with pad and paper. Newest aid for the supersonic "flyboys" is an electronic wizard that continually plots the plane's position—on the wing and without any ground contact whatever. Two sets of rotating numbers that look just like the mileage and trip totalers on the speedometer of your car tell the pilot his exact latitude and longitude at any given instant. Developed by the Ford Instrument Company for the Air Force, the new "ground-position indicator" is a compact, 45-pound set of four little black boxes: Indicator (which the pilot reads); computer control (where information is fed in); computer (that does the calculating) and an amplifier (to supply power). Before taking off, the pilot dials his wind speed and direction, and magnetic variation, on the knobs of the computer control. On the indicator he sets in his take-off longitude and latitude. The robot does the rest. From the plane's compass and air-speed indicator, changes in the speed and direction are fed into the computer.

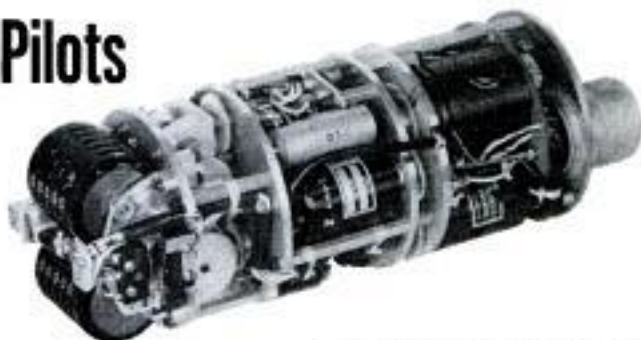

Ford Instrument Company photos
Counters at left end of indicator unit, above, tell pilot the aircraft's present latitude and longitude

Information needed by robot navigator, such as wind force and direction, is dialed on the computer box

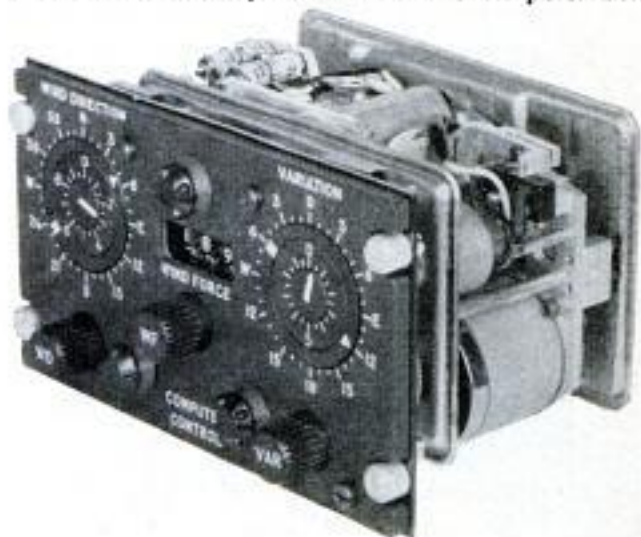

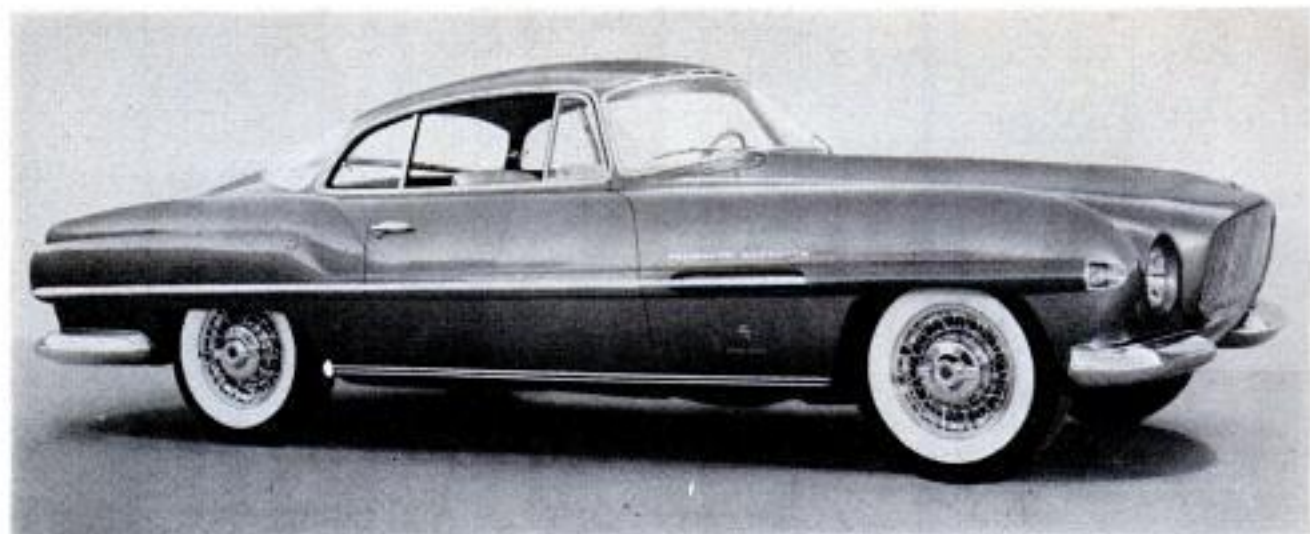

Only 54 inches high, the Explorer has almost as much headroom as a production Plymouth. It is 185 inches long. Right, matched luggage fits neatly behind seat

Plymouth Sport Coupe Has Matched Luggage

Chrysler stylists have given the experimental Plymouth sport coupe a forward-slanting grille and recessed headlights. One of the newest so-called dream cars which Detroit turns out with regularity these days, the Explorer was built on a standard Plymouth chassis. The power plant is the 110-horsepower Plymouth engine. Ghia of Turin, Italy, made the body and it is recognizably Italian in character. No production plans are contemplated, Chrysler says. The interior is especially luxurious. Two individual seats, upholstered in white leather, are separated by a leather-covered compartment for maps and

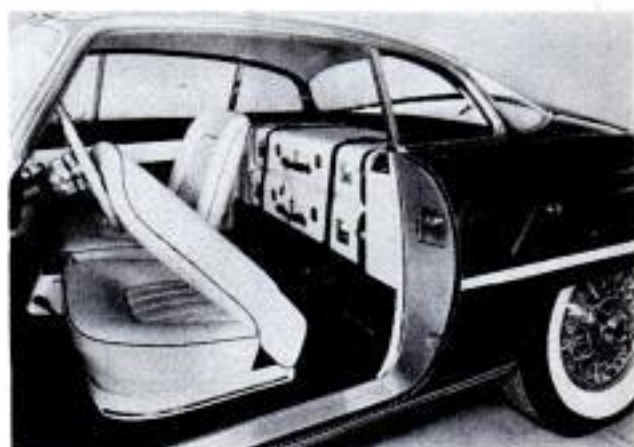

other items. The ash tray is there also. Behind the seats are two pieces of matched luggage with tie-down straps. Unusual also are the combination taillight-tail pipe assemblies. The twin exhaust pipes end within a chrome housing that also encircles the taillights.

Adapter Converts Black-and-White TV Set to Color for \$100



Converting your black-and-white TV set to color may cost less than \$100 with a system developed by electronics engineer Robert P. Benjamin. The adapter converts the color signal to a system which can be used with a three-color wheel. The wheel rotates before the black-and-white tube and is synchronized with the color signals so that the appropriate filters pass before the screen as the successive color information is transmitted. The only modification of the black-and-white set is the addition of four simple connections to the base of certain tubes in the receiver. The converted receiver works well under the present compatible-color television system, in which color signals are broadcast with black-and-white signals, but are not picked up by standard receivers. Benjamin used a five-year-old set in a recent demonstration to bring in a full-color network program. The device is not yet in production.



EGG for an ATOM ENGINE

By Richard F. Dempewolff

Artist's conception depicts "launching" scene as hull section containing *Sea Wolf's* prototype engine is rolled into giant steel egg for atomic baptism

WHEN THE BLUNT-NOSED *Nautilus*, world's first atomic-powered submarine, skidded into the Thames River at New London, Conn., last January, an even more curious hull was being readied for an even more curious ride this spring. No cheering, fanfare or champagne was to mark the strange new "skidding," however. There would not be a splash, either, because the nearest open water is 20 miles away.

The "hull" section, a long cylinder banded by steel ribs encircling its 20-foot girth, looks more like a half-finished section for a vehicular tunnel than part of a ship. Actually, it is the pressure-hull section enclosing a prototype of the engine and reactor compartments of the *Sea Wolf*—atomic submarine number two. Until recently, it was resting on a slab out of doors on the rolling fields near West Milton, N. Y.

Cutaway drawing of sphere, hull and fuel-service section shows water-filled tank (1) to shield the reactor, and cell (2) that holds liquid metal used as heat-exchange fluid. Also shown are the control panels (3), reactor section of hull (4), with the atomic pile (5). Molten sodium passes through the pile and heats water to steam in the boiler (6). The steam drives turbines (7) enclosed in the end section of pressure hull (8). Lead container for uranium rods (9) rides dolly to service cell. Near by is the fuel storage pit (10) and above is the traveling crane (11) for refueling and servicing. On the opposite page the fuel storage tunnel is shown below the fuel-element service cell which

has massive concrete walls. Until needed the uranium rods are stowed in a heavy lead container (12) and pulled out of the tunnel through a hatchway by a mechanical hand (13) which passes them to cleaning station (14) where tons of water wash the rods. At scanning station (15) electric eyes examine them for flaws. Next stop is the inspection and measuring area (16). Robot hands (17) pull them apart and the rods pass to the sample cutting station (18) which chops off a chunk. At the adjoining station (19) "burned up" portion of rod is canned for shipment to a reprocessing center. Also shown are decontamination area (20), concrete walls (21) six feet thick, and shielded monitor station (22)

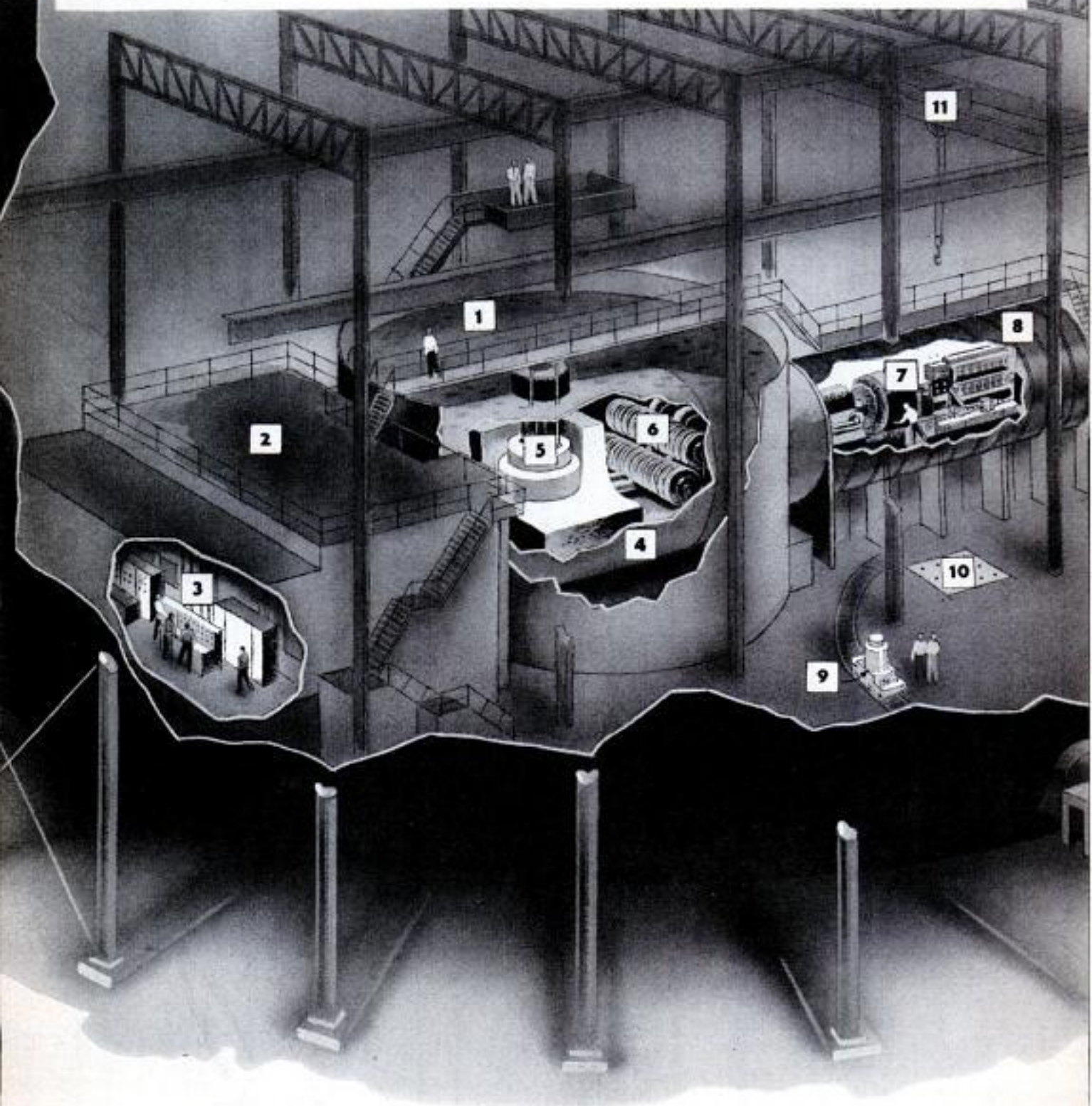

But, a few months ago, against a backdrop of empty land and sky, the odd hull rumbled slowly on steel rollers. It slid about 200 feet, through a hole in the curving wall of the world's biggest manmade ball—a \$2,000,000, 225-foot shell of steel that had been built close by to receive it. Welders swarmed in to seal up the hole, and a mantle of secrecy dropped over the great egg.

Inside the giant sphere, where during construction hollow echoes bounced 'round and 'round off the curving wall until they merged with an incessant background roar, General Electric Company scientists from KAPL (Knolls Atomic Power Laboratory) will install a new kind of atomic engine in the ribbed-hull section. A vast tank for water will be built around the reactor portion. "This," explains one scientist, "is not a big bathtub to simulate 'ocean conditions,' as many folks like to imagine. It's additional shielding to absorb any stray radiation from the reactor."

Uranium rods are serviced for shipping in fuel-element service cell. Number references are on opposite page

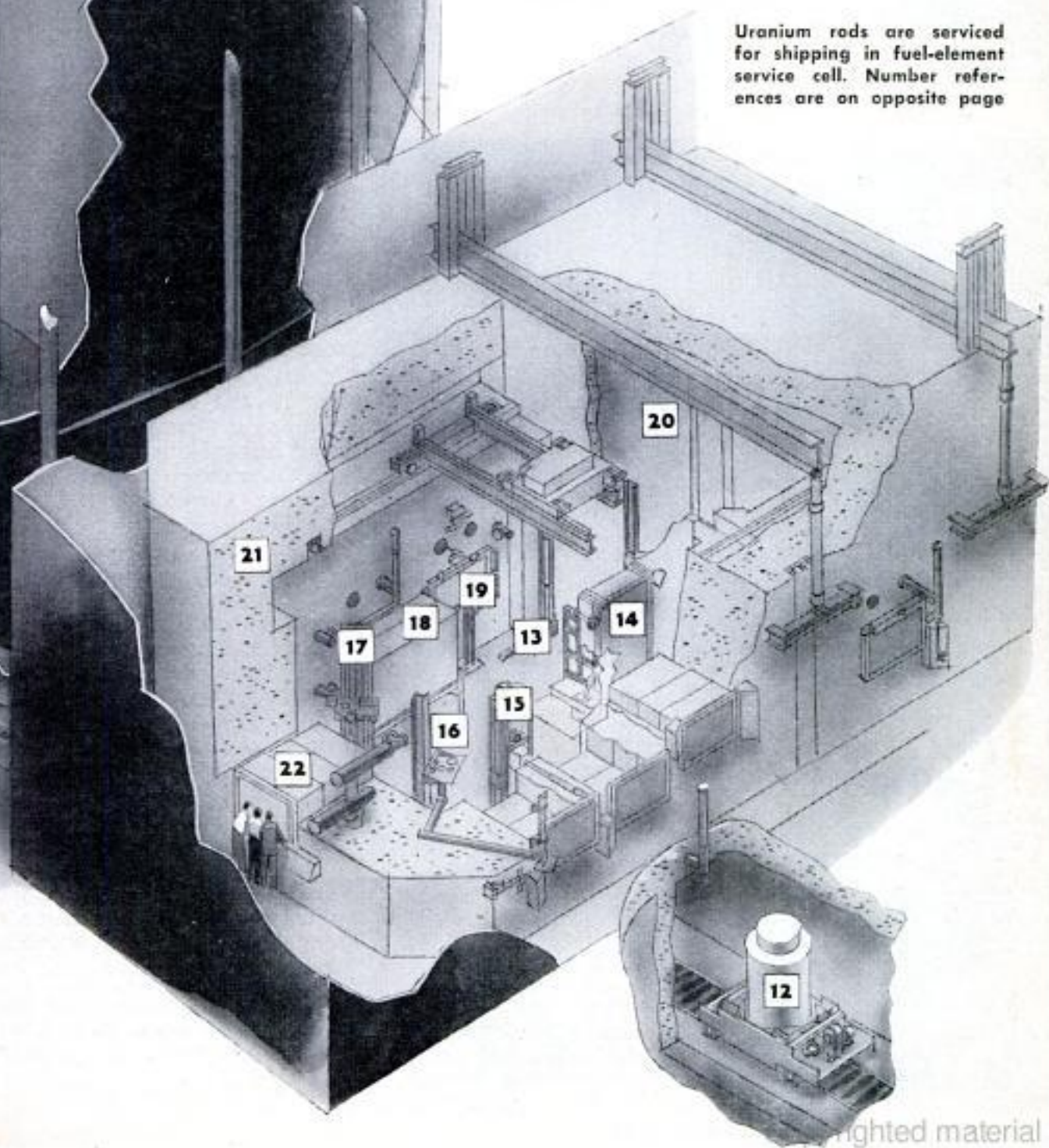

lighted material



Five miles of welds on exterior of steel sphere were brushed with a soap solution to test for air leaks

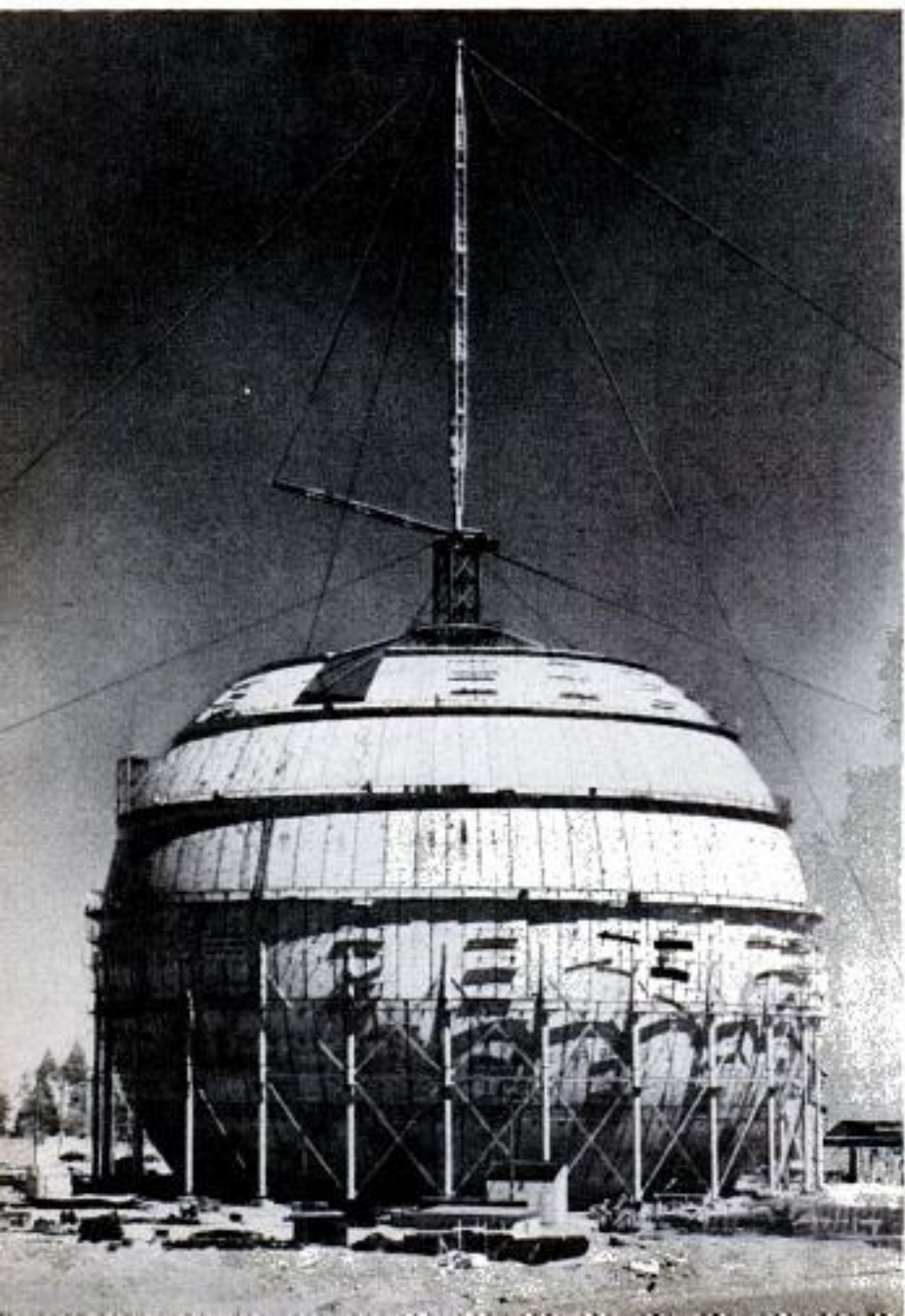

One day this year, the atomic furnace will "go critical," or begin its self-sustained chain reaction. Cranes, dollies and elaborate controls inside the huge globe will enable men to service their "hot" power plant remotely, and to eliminate the "bugs" in it. Sometime in 1955 or 1956, if all goes well, a similar atomic engine will be installed in the completed 300-foot hull of the *Sea Wolf*, now on the ways of the General Dynamics Corporation in New London.

Like the *Nautilus*, the *Sea Wolf* will be a revolution in underwater craft. Both of the submarines will reportedly burn about a pound of uranium fuel (a chunk the size of a golf ball) each month. Since atomic engines need no air to keep them going, as diesels do, these subs will be able to cruise below the surface without snorkels for weeks or months—limited only by the ability of their crews to "take it." "Around the world submerged" is the hopeful phrase you hear. The *Nautilus*' engine reputedly will drive her over 30 knots. Although both

Last sections of 225-foot steel sphere are fitted into place. It's as high as a 20-story building, cost \$2,000,000

have the same horsepower, rumor puts the *Sea Wolf* as high as 60 knots (destroyers make only 35 knots under ideal conditions).

Interior design of the atom-age underwater ships will raise the eyebrows of old submariners, accustomed to deflating their chests and sucking in their stomachs when passing each other in companionways, to whamming shins and foreheads against the rims of hatches made for midgets and to sleeping in cranies between and around live torpedoes.

Though a third of each sub's football-field length is occupied by atomic engine and propulsion gear, they'll have more and better use of precious space than any undersea craft known. They'll be the first subs with a full-fledged staircase for two-way traffic. They'll abound with unique design tricks. Crews will sleep in tiered, built-in bunks with foam cushions that convert to lounges when not in use. Each man will boast his own fold-away, Pullman-type lavatory with fluorescent lighting, built into his locker side. After chow, mess tables will fold away overhead. Behind a sliding panel in one bulkhead will be hidden movie projectors, TV, radio, record player and other equipment to make a recreation room. Bright-red leather seat cushions, yellow walls, soothing tans, greens, browns and soft lighting will replace the hospital-white enamel and glaring bulbs of the standard underwater fleet.

One of the trickiest features in the atom subs—besides their engines—is the fact that the helmsman will "fly" his ship like an airplane. In the control room of ordinary

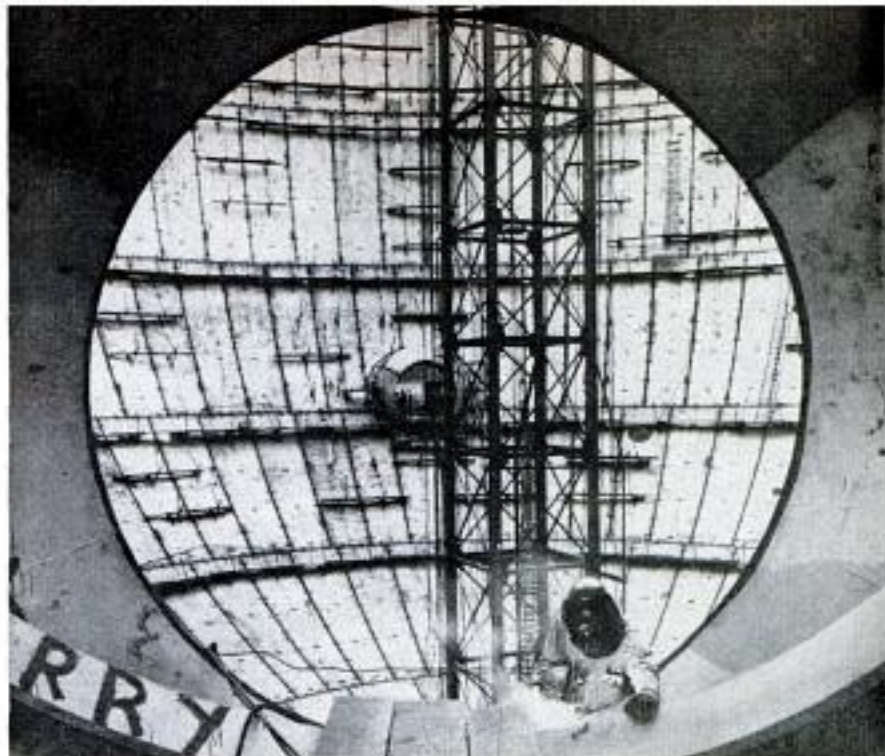

A welder works on circular opening in which one of the entrance locks to sphere was placed. Another opening for emergencies is in the background

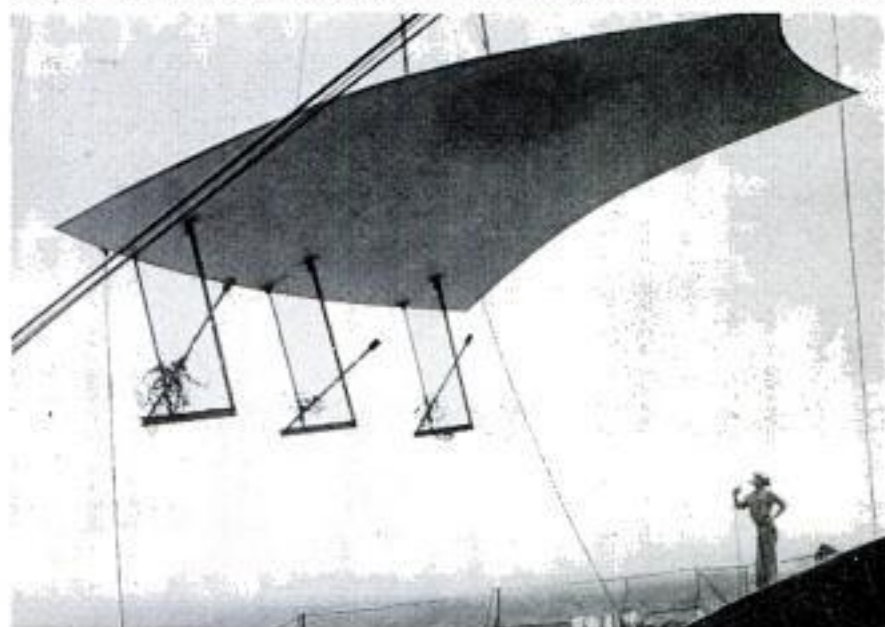

An inch-thick 20-ton steel plate is hoisted into place to form sturdy shell for giant egg. Dangling projections beneath are built-in supports for catwalks that were later removed. Below, future atomic sailors study system that carries hot liquefied metal from atomic reactor to boilers

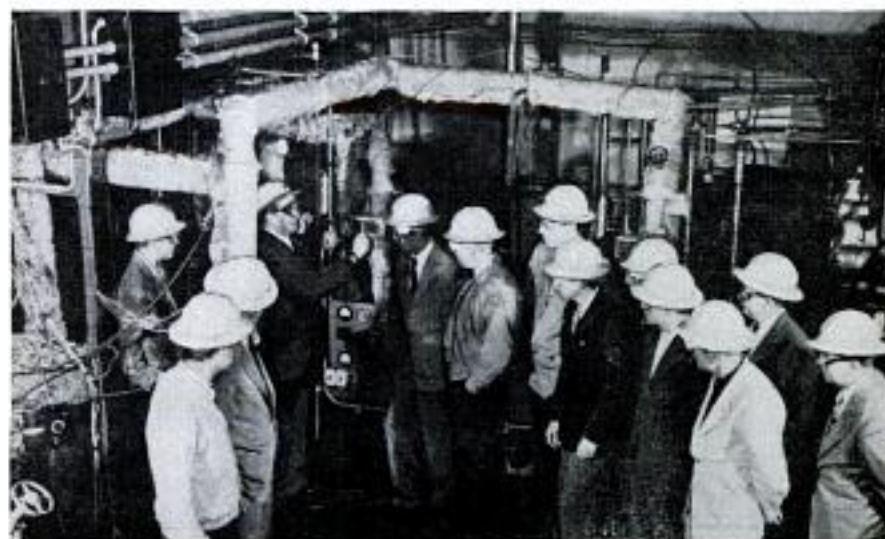

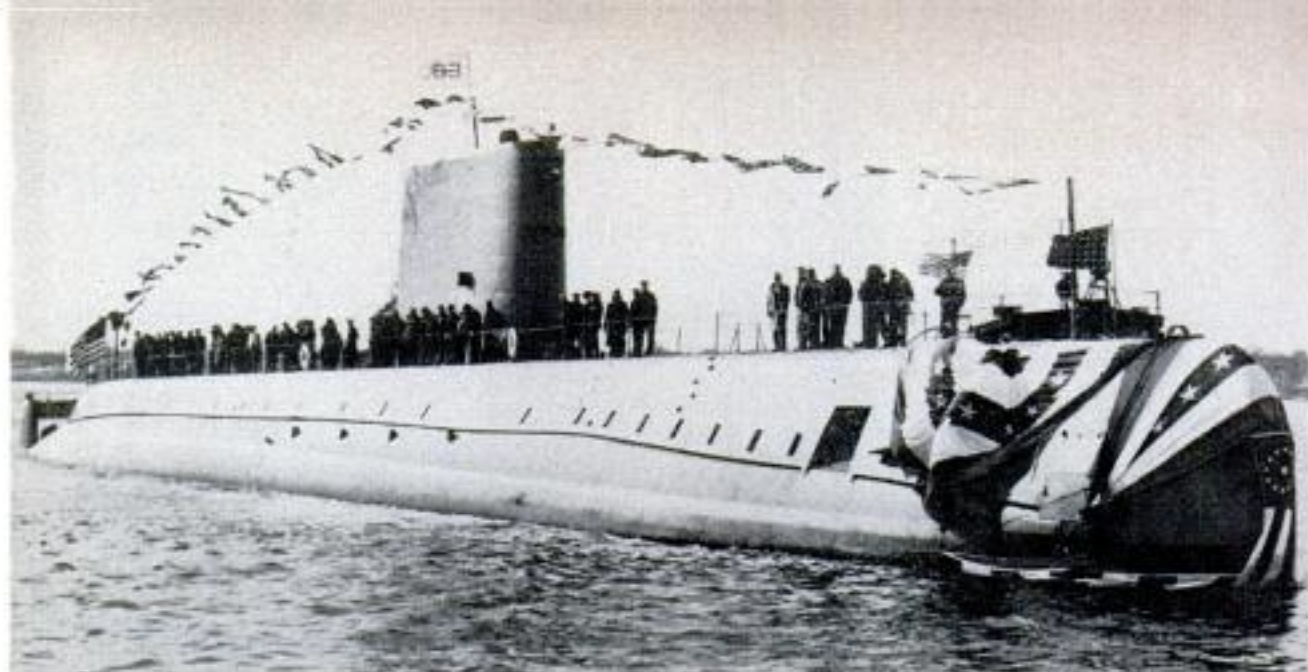

World's first atomic-powered submarine, the USS *Nautilus*, launched early this year, may make 30 knots

subs during diving or surfacing operations, you'll find one man handling the bow diving planes, another at the stern plane controls and a third at the helm. Now these three positions have been linked to "single stick" control like an aircraft. The positions can, however, be handled individually in emergency, and ballasting is still a separate operation.

So much for similarities between the two new subs. What's different about the engine that will drive the *Sea Wolf*? And what's the idea of the gigantic egg from which it will be hatched?

"The *Nautilus*," explains Dr. Kenneth H. Kingdon, technical director of KAPL, "has what we call a 'thermal reactor.' The speeding atomic particles that create heat by collision with other atoms are slowed down by water. It might be called a 'slow' reactor, in contrast to the atom bomb, which is the 'fastest' reactor of all. The atomic pile that powers the engine for the *Sea Wolf*, on the other hand, will produce fissions by means of particles that have been only partly slowed down. It's called an intermediate reactor."

That, incidentally, is where the *Sea Wolf's* atomic power plant gets its project name, "SIR"—for Submarine Intermediate Reactor.

There's another difference, too. The *Nautilus'* power plant uses water to carry heat from atom pile to machinery. In SIR, the atomic pile will produce heat, but molten sodium metal will be used to carry heat to the boilers, where it will pass through a shielded exchanger to nonradioactive steam that can spin the turbines that turn the sub's propellers.

Instead of using regular pumps to push the radioactive fluid metal through the closed system, SIR's builders can use electromagnetic pumps with no moving parts that might break down. The metallic liquid

can be pulled through the system by magnetic pulses from outside the pipes.

If air or water gets to sodium, it will erupt in violent flame. Hence, SIR's plumbing will have a superleak-detection system as a safety backstop. And for a superbackstop while the tricky engine is being constructed; General Electric built the giant sphere to house it.

"We believe nothing can possibly get out of hand," one of the GE project men points out, "—certainly nothing serious. But we're fooling with materials that are radioactive and flammable. So, to play extra safe, we decided to put our engine in a powerhouse that could be sealed up tight—like a big pressure vessel—to prevent *anything* from escaping."

That's just what the 3850-ton sphere does. Billowing out of the earth like a satellite come to rest, the vast steel ball enclosed 5,800,000 cubic feet of space. But you could pump an extra 8,000,000 cubic feet of air inside, and nothing would happen. The 682 plates of one-inch steel are built to withstand an inside pressure of 20 pounds per square inch (about what you put in your car tires).

You get some idea of the colossal proportions of the structure when Gordon Harman, one of the field engineers engaged in putting it together, leads you in through one of the two tiny entries. Both are small steel tunnels piercing smaller spheres that are inserted in the shell of the big sphere—like globular gun blisters in the side of a bomber. "Two spheres intersecting make the strongest kind of opening," Harman explains.

Ship-type hatches slam shut behind you with a resounding clang that booms back a dozen times from the interior of the giant orb. High overhead, the black steel dome is lost in blue haze. Harman reels off

(Continued to page 262)



Rear portion of dome is a club lounge for 18 people. Also on top level are 57 angled seats. Stainless steel covers exterior

Dome Car Has Upper Lounge

FULL-LENGTH DOMES top a set of new coaches designed for Santa Fe's Chicago-Los Angeles and Chicago-Oklahoma City runs. Each of the streamlined lounge cars will seat 103 passengers—57 in angled seats on the upper deck, 18 in an upper lounge and 28 in a club lounge on the lower level.

Features of the car include fluorescent lighting, a public-address system for music and announcements, finger-tip-controlled doors and a solar control that automatically regulates dome temperature in relation to the amount of sunlight. Decoration is in bright colors.

Lower level contains a lounge in Indian motif seating 28 passengers. Decorated Lucite panels divide area



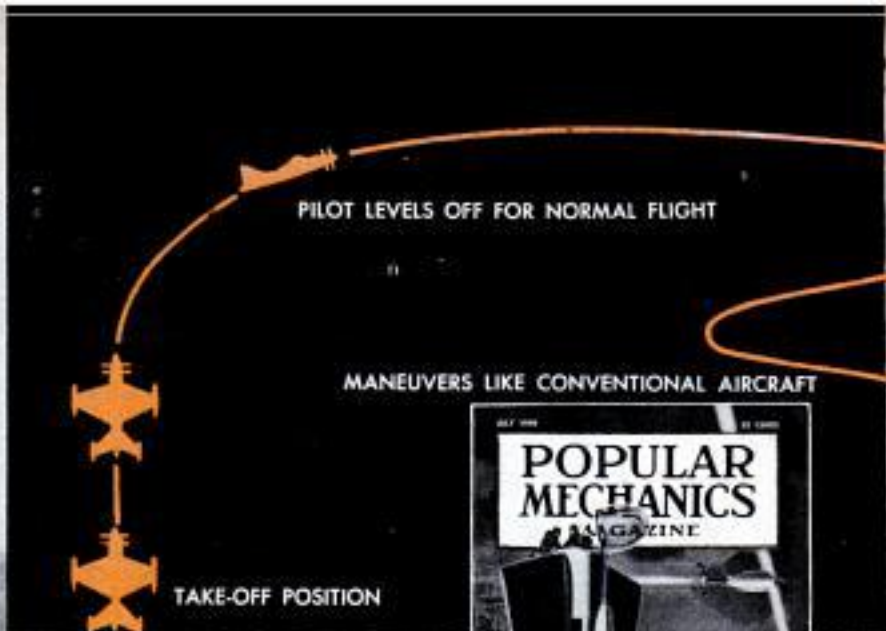

Landing and taking off, the Lockheed XFV-1 stands upright, using four fins as "feet." Right, *Popular Mechanics'* July 1949 cover forecast vertical take-off craft, with an article by helicopter manufacturer Stanley Hiller, Jr., explaining how they would operate. Hiller proposed rocket-powered ascents



Heads-Up Fighters

TWO EXPERIMENTAL fighters, built to fly straight up from standing starts on their tails and then level off for conventional high-speed flight, are now being tested by the Navy. The Convair XFY-1 and Lockheed's XFV-1 both land by backing straight down onto a plot of ground the size of a tennis court, or even onto the deck of a ship. The former has a delta-wing shape and the latter a modified straight wing. Each has been under construction for nearly three years and they are equipped with specially designed contra-rotating propellers, powered by twin-tur-

bine Allison engines. A tilting seat permits the pilot to be semiupright while the aircraft is vertical and in his normal position during level flight. Because both planes land in an upright position, extra strength and weight were built into their tails. This also prevents them from being blown over when parked in a high wind. They rest on steel landing legs projecting down from shock absorbers. Convair's plane, nicknamed the "Pogo Stick," has undergone tethering tests inside a 200-foot-high hangar, climbing and descending on a steel cable stretched from floor to roof. ★ ★ ★

Initial thrust power of delta wing Convair XFY-1, below, almost equals that of four Sabre Jets at take-off

Consolidated Vultee Aircraft Corp. photo



PILOT PULLS PLANE INTO A VERTICAL STALL TO LAND ON TAIL, CONTROLLING RATE OF DESCENT BY MEANS OF POWER APPLIED TO PROPELLER

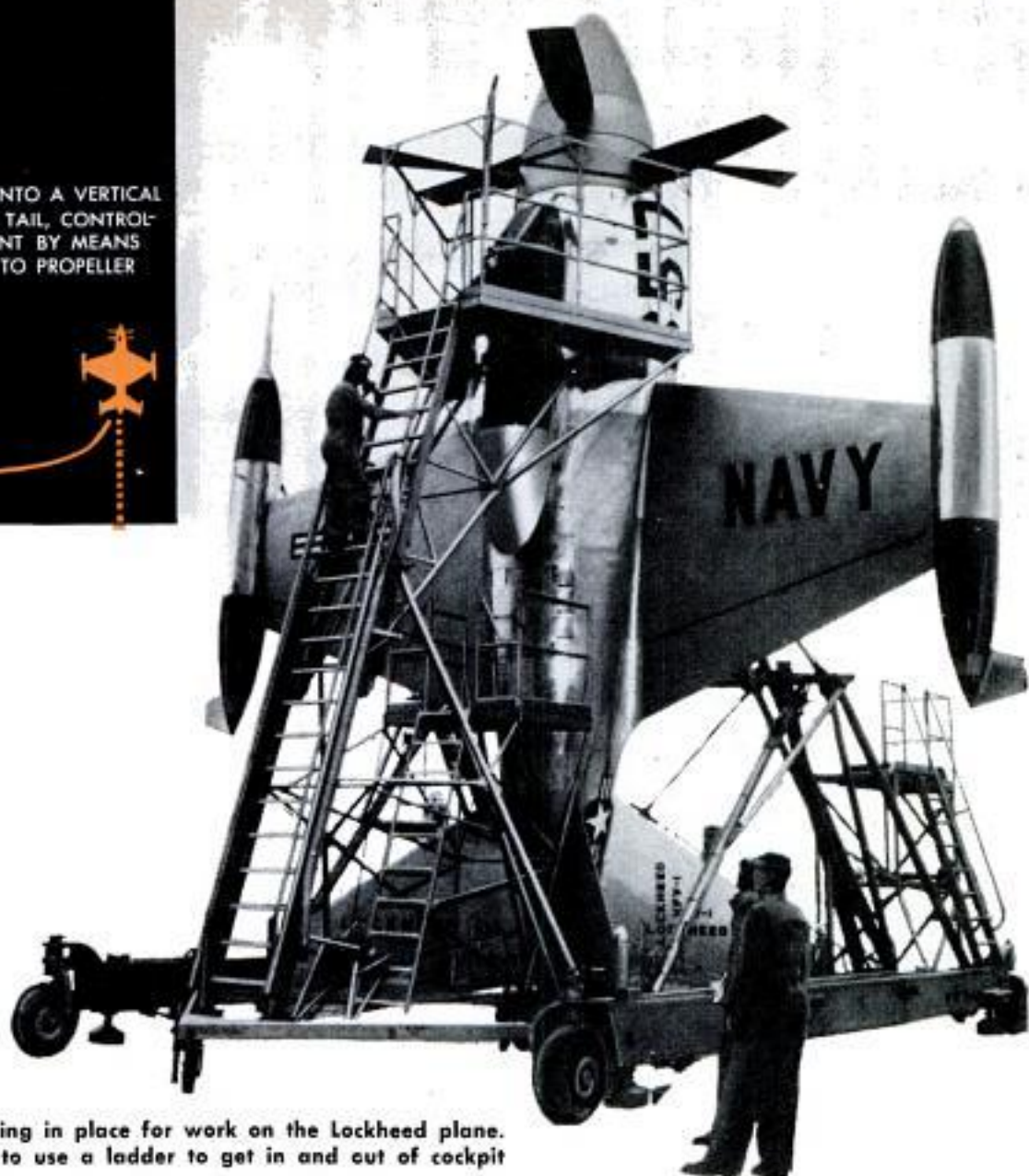

Special scaffolding in place for work on the Lockheed plane. Pilot will have to use a ladder to get in and out of cockpit

High, old-style landing gear will be used on the XFV-1 during its first test flights and then discarded

Lockheed Aircraft Corp. photo



Detroit Listening Post



By Leo Donovan

THAT FORD FX Atmos, the "dream car" with no engineering but lots of styling including pistol grips instead of a steering wheel, may not be such a flight of fancy after all. Edward R. Dye of the Cornell Aeronautical Laboratory believes that the steering wheel and its post may be replaced by aircraft-type levers.

Dye believes that cars eventually will be designed so the occupants will walk away from crashes occurring at 50 or 60 miles per hour. This will require car-body material that will absorb much more crash impact than today's steel does.

A psychological obstacle to sales has been public reaction to the dream cars and the promised beauty of next year's models, say some dealers. At the auto shows, the customers look at the dream cars and decide that the 1954 production models look mighty dull. So they decide to wait for next year.

"Putting the advertising so far ahead of the current models has sort of backfired," says one sales executive.

Chrysler has been so plagued with rumors that it will come out very early with 1955 models that it is issuing firm denials. It definitely will not happen, says Tex Colbert, Chrysler president.

Foreign-Car Sales Down

In 1953 imports of European-made cars declined one percent from 1952 after a series of annual increases. The decline began last June and continued gradually through December. Total European-car imports for 1953 were 29,178. The MG was the most popular, the Hillman Minx second, the Jaguar third, the English Ford fourth and the Austin fifth. The Volkswagen doubled its sales over 1952, but still didn't make the top five.

Detroit gossip about further mergers often includes some truck manufacturer. Actually, Nash has been doing development engineering on trucks for quite a while. Packard has in the works a V8 engine which could be the power plant for

several cars should there be a further merger with American Motors (Hudson and Nash). One reason for the consolidation of independents is the economies that result from interchangeable components.

Chrysler surprised everybody (including itself) with the sudden success of its Plymouth-installed gas turbine (see page 107). Even the most optimistic engineers at Chrysler expected there would be delays due to minor operational problems once the turbine was installed in a car. But the whole power unit worked like a charm.

The company claims to have solved both the exhaust-heat and fuel-economy problems, but at this writing won't give definite figures about economy. Previous turbines have been extremely wasteful of fuel at low speeds and while idling.

The wonderful characteristic of the turbine is its high torque and power over a large speed range as compared with an internal-combustion engine. It may be that future cars will operate with only one gear ratio, the transmission being used merely for reverse operation. Other advantages include light weight, fewer parts (about a tenth of those in a conventional engine), no cooling system needed, electric ignition needed only for starting and a wide choice of usable fuels.

Be Careful of That Plastic Top

Ford advises new owners of the Skyliner with the transparent plastic top not to dust it with a dry cloth because the rubbing action sets up an electrostatic charge which attracts more dust. Also the top scratches easily if wiped while dry. Grease spots may be removed by rubbing lightly with a kerosene-dampened cloth, then washing with soap and water. Don't use acetone, carbon tetrachloride, alcohol, benzine or gasoline as they may soften the plastic.

Brake manufacturers contend that price-cutting tactics in the brake-replacement business have resulted in inferior materials showing up on the market. This includes both linings and hydraulic fluids. Apparently, you get what you pay for.

Of course, some original-equipment brakes offer more, or at least different, safety features than others, but the cold fact is that in the Daytona stockcar race almost all the cars suffered brake troubles at some time during the contest.

Another big problem is lubrication of the new high-compression engines. Valve springs are stiffer and cams lift higher in the new engines creating more friction, which means more wear unless the oils stand up under the terrific pressures. Factory engineers say no single oil has been produced to accomplish the results they seek.



Variable-Pitch Propeller for Outboard Motor

You change the pitch of a new outboard-motor propeller with a simple control lever. The variable-pitch propeller gives the boat a wide range of power and speed variations, both in forward and reverse. For example, you can set the motor to run at its most efficient speed, and use the pro-

PELLER to cut down the boat speed for trolling. The control lever, mounted on the motor cowling, enables the operator to change the blade pitch without lifting the propeller out of the water. Various models of the propeller are available to fit standard motors from 3½ to 10 horsepower.

You Can Be Your Own Highway Patrolman With Buzzing "Speedometer"

You will have no excuse for breaking the law when you equip your car with an audio "speedometer." The device attaches to the present speedometer cable and notifies you by intermittent buzzing when you exceed a preset speed limit. Of course, this limit is under your control. You set it into the machine at any time. To set in a speed, you merely drive your car at the desired speed and then turn a dashboard knob

until you hear an intermittent buzzing. After that, whenever your car exceeds the speed, the buzzer warns you—the greater the excess, the louder the buzzing. It is designed to help you stay within the speed law in busy traffic areas where you can't take your eyes off the road to look at the speedometer. Also available is a dash-mounted light that flashes when you exceed the self-imposed speed limit.

Two-Piece Kit Seals Breaks in Plastic Garden Hose

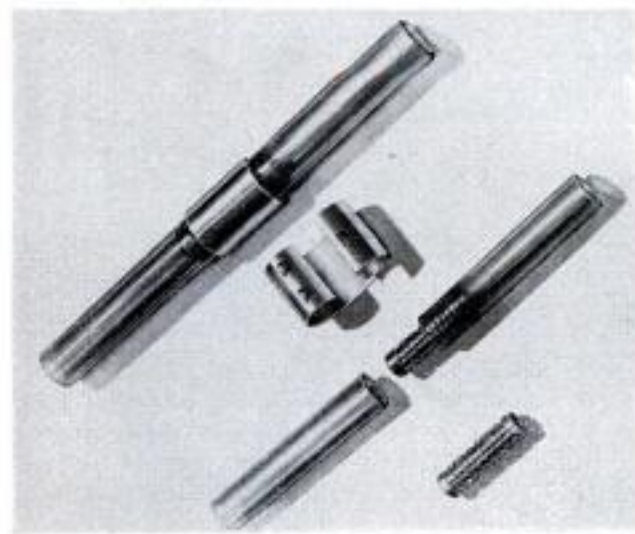

Plastic garden hose is quickly repaired with a simple two-piece kit. The hose is cut in two at the leak, dipped in hot water and reconnected with a brass nipple that fits inside the hose. A rustproof steel clamp fits over the joint and snaps into place to form a permanent seal.

Computers Use Costly Metal

Metal that costs \$2,000,000 a ton now goes into the small memory cores of high-speed electronic computers. But the individual sheets of metal have only ¼ the thickness of a human hair. The metal is 79 percent nickel and four percent molybdenum, combined with steel.



1. STAGGERED front wheels of rotary power mower allow contour cutting on hilliest lawn. Handle brackets permit the handle to be removed easily for storage

2. LAWN TRIMMER powered by electricity is operated from a standing position and is easy to maneuver. Slip clutch prevents damage to rotary cutting blade

3. ROBOT MOWER is operated from a simple remote-control panel attached to a 40-foot cord. Motor is electric. Carrying arm keeps cord out of way when mower turns

4. LEAF BURNER on wheels lets you burn leaves anywhere in the yard, ends piling and carrying. Shielding prevents heat damage to rubber tires or to the lawn



NEW TOOLS

5. EXHAUST SILENCER for four-cycle gasoline motors quiets power mowers, garden tractors, pumps, compressors and generators. It will not plug up with carbon, cause overheating or result in loss of power

6. SOIL AERATOR replaces roller on power lawn mower, punctures turf with star-shaped spikes. The spikes leave small holes in the lawn which prepare the soil for seeding, aerate turf and hold moisture

7. ROTARY MOWER that picks up its clippings blows grass and leaves into a lightweight catcher mounted on the chassis. Air blast compacts the load of cut grass, doubling the normal capacity of catcher

8. ADJUSTABLE SPRINKLER can be set to cover any area between 10 and 50 feet in diameter. The double-headed sprinkler rotates on 22 ball bearings, assuring smooth sprinkling even at low pressures

9. "WHIP END" garden hose connecting faucet with main hose saves wear and tear on the longer length, is inexpensive to replace. The short length, if left on the faucet, aids connection of the main hose

10. ROOT SOAKER can water five widely separated shrubs or plants at once with multiple tubes. Soaker attaches to faucet or garden hose and consists of three nine-foot lengths and two twelve-foot lengths



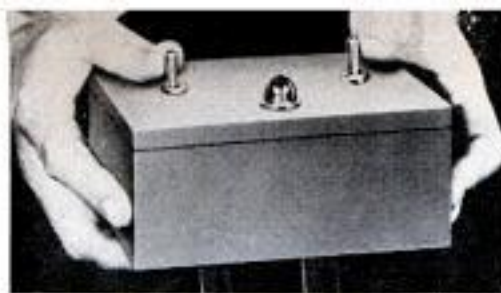

3



4

FOR YOUR LAWN



6



7



9

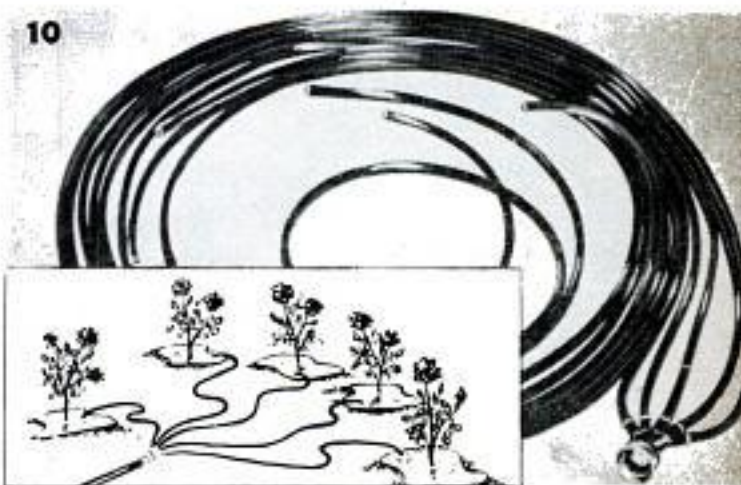

10

The OWNERS REPORT:

The true test of a car begins when the owner takes the wheel. *Popular Mechanics* asked Mercury owners from coast to coast about their cars. Here is what they say



New Overhead-Valve Engine

"Very good. Idles rough at times, but may need a carburetor adjustment."

Overland Park, Kans., salesman

"I like the extra horsepower, but don't like the overhead valves. Noisy."

Sanford, N.C., businessman

"Good. I like solid valve lifters, but they are a bit noisy. Engine slow to start when hot."

New Orleans, La., contractor



Ball-Joint Front Suspension

"I like the cornering qualities."

Klamath Falls, Ore., truck driver

"I like it. No tire noise on curves."

Boulder, Colo., salesman

"Seems to handle better on rough roads."

Keupston, N.D., farmer

Transparent Plastic Roof



"Needs a curtain at times."

Oxford, Kans., farmer

"Excellent. A convertible without the wind."

New York City Aviator

"A very weird sensation to be driving through a snowstorm. Makes the car seem colder."

*Minneapolis, Minn.
used-car dealer*



MERCURY'S NEW V8 ENGINE RATES HIGH WITH THE OWNERS

By Floyd Clymer

BIGGEST NEWS at Mercury for 1954 is its overhead-valve V8 engine, an all-new design that develops 161 horsepower. What do the owners think of it? Let's look at the results of our survey of 1000 Mercury owners.

More than half (56 percent) of the owners responding are enthusiastic about the power plant—have nothing but praise for it. About a third (30 percent) like the engine but with minor reservations. Only a small fraction (3 percent) state that the engine is disappointing. The other 11 percent are reserving judgment until later, they say.

"My '54 Mercury really has get-up-and-go over last year's model."—Greentown, Ind., bookkeeper.

"Wonderful pickup. Easy on gas. Doesn't take a back seat to competition."—Buxton, N. D., contractor.

"Reserve power of engine at high speeds is really tremendous."—Jacksonville, Fla., sales engineer.

"The way it performs from 50 to 80 miles per hour is what I like best. It will get you around a car and back on your side of the road with the best of them."—Siltcoos, Ore., sawyer.

"I think it is going to hold up fine as I have already driven it hard for 8000 miles."—Richland, Ind., plant superintendent.

"I drove my 1954 Mercury at 105 miles per hour with five adults in it. It felt as

safe at 105 as at 55."—Salem, Ore., lineman.

"Power is perfect for weight of car."—Oakridge, Ore., engineer.

What are the factors that make the engine just a little less than perfect, according to 30 percent of the owners? Valve noise and poor gasoline economy lead the list.

"A very powerful engine, but makes too much noise."—Brooklyn, N. Y., plasterer.

"Should get better gas mileage. Hydraulic valve lifters should be used to silence tappets."—New Orleans, La., fireman.

"Gas economy sacrificed for performance to too great a degree."—Newark, N. J., attorney.

Owners Report No Bugs in Engine

One of the frequently heard warnings to new-car buyers is to beware of a new engine in its first year because of possible bugs in production. Prospective buyers don't have to worry about this in the 1954 Mercury, according to the owners. There doesn't seem to be any chronic fault in the engine. Ninety percent of the owners have had no trouble at all. There were 10 percent who reported that engine work had been done, but in most cases it involved minor jobs like tightening down valve covers to stop oil leaks. Another fault among the 10 percent of engines that had to be worked on was automatic-choke trouble.

"Automatic choke sticks a lot and you

Off-road tests by Clymer demonstrate the Mercury's hill-climbing ability. Note the new rear-fender shape



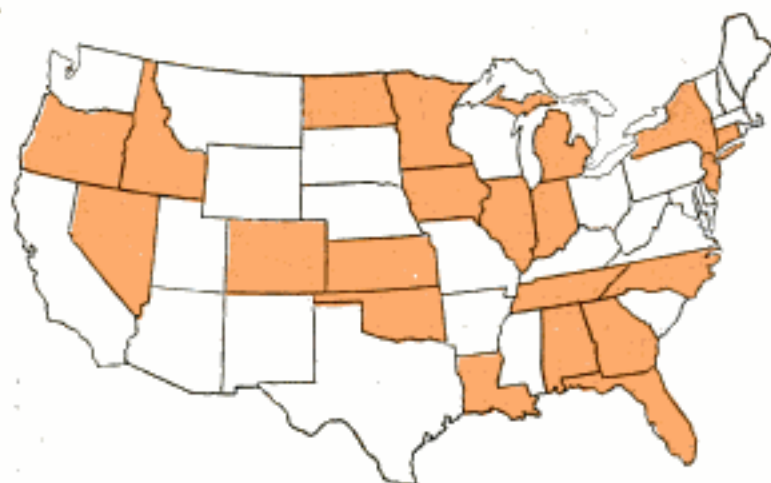

Owners in 21 states from Atlantic to Pacific report on the new Mercury's performance

Percentages from PM Poll of 1954 Mercury Owners

OVER-ALL RATING OF THE MERCURY BY THE OWNERS

excellent	56%
good	36%
average	6%
poor	2%

Previous Mercury owners	68%
Owners of 5 or more Mercurys previously	7%

Owners rating of dealer service

excellent	39%
good	20%
average	22%
poor	19%

Would buy another Mercury?

yes	70%
might	26%
no	4%

Ratings on particular features

	Like	Acceptable	Dislike
Exterior styling	92%	7%	1%
Visibility, forward	90%	10%	0%
Interior styling	86%	14%	0%
Visibility, rear	86%	12%	2%
Riding comfort	78%	19%	3%

Owners opinion of ball-joint front suspension

Like	79%
Dislike	3%
No difference	2%
No comment	16%

Average miles per gallon

	Merc-O-Matic	Overdrive	Conventional
city	13.4	14.7	15.1
country	16.6	18.2	18.1

Oil consumption per 1000 miles

No quarts	71%
1 quart	5%
More than 1 quart	5%
Did not answer	19%

Average mileage for change of oil

	1640
--	------

Handling

excellent	83%
good	16%
unsatisfactory	1%

Roadability

excellent	72%
good	26%
unsatisfactory	2%

Structural rigidity

excellent	54%
good	41%
unsatisfactory	5%

Acceleration from 0 m.p.h.

excellent	66%
good	30%
unsatisfactory	4%

Acceleration from 50 m.p.h.

excellent	71%
good	27%
unsatisfactory	2%

New overhead-valve engine

good to excellent	56%
good with reservations	30%
poor to fair	3%
no comment	11%

BEST-LIKED FEATURES

Engine performance	47%
Styling and appearance	37%
Ease of handling	36%
Riding comfort	18%
Roadability	13%
Economy of operation	6%

MOST FREQUENT COMPLAINTS

Body fitting and assembly	33%
Low gas mileage	14%
Engine—noise and carburetor trouble	7%
Poor dealer service	3%
Lack of interior room and comfort	3%

Owners with no complaints at all

	11%
--	-----

REASON THEY BOUGHT MERCURY

Previous satisfactory Mercury ownership	25%
Styling and appearance	23%
Engine performance	21%
Trade-in and resale value	9%
Reputation and recommendation from other owners	3%
Ball-joint front suspension	3%

can't start the engine for a while."—Newark, N. J., chauffeur.

"Oil leak in valve cover. Gas leaks from carburetor on hard right turns."—Stillwater, Minn., physician.

There was no evidence of unusual oil consumption—a fault that sometimes shows up in our surveys of new engines. Only 5 percent of the owners state that they add more than one quart in each 1000 miles; 71 percent add no oil between changes; 5 percent add one quart. The other 19 percent did not answer the question.

Engine Faults Mentioned

But, overwhelming as the praise is, there were some owners who reported troubles.

"Have had both heads blow gaskets and the transmission go out because of lack of dealer service."—Hermiston, Ore., truck driver.

"Just had a new block assembly installed (at 1200 miles) due to cracked piston which ruined the block. Both cylinder-head gaskets were leaking."—Gibsonville, N. C., service-station operator.

"Had a porous block. This defective en-



Clymer says of the new Mercury suspension: "Corners can be taken at high speeds with little body roll"

gine replaced immediately with a new one. Car is now in good shape."—New York technician.

"Until I had different jets put in the carburetor, my best mileage was 13.1. Now it is 15.3. Spark plugs gave out at 3000 miles. Must use premium gasoline to keep engine from knocking."—Ellerbe, N. C., parts manager.

Among the tiny minority of owners registering dissatisfaction with the new engine, some claimed performance was little, if any, improved.

"Does not seem to have more than average power. Not as much as advertising claims lead one to believe."—Essex Falls, N. J., engineer.

"Takeoff and acceleration only slightly increased, though it does seem to climb hills with more ease."—Cleveland, Tenn., technician.

"Can't see where increasing horsepower

to 161 has increased pep and speed at all over the old engine."—Atlanta, Ga., aircraft inspector.

Average Gasoline Mileage

There is no question but that many owners are disappointed in the gasoline economy of the new engine. It was second only to poor body assembly in the list of most-frequent complaints, with 14 percent saying gasoline mileage is too low. Average mileage of owners reporting was 13.4 miles per gallon in the city and 16.6 miles per gallon in the country (both figures for cars equipped with automatic transmissions). The owners of overdrive and conventional transmissions reported slightly higher averages. ([See Percentage Table, page 104](#), for details.)

"I like everything about it except the gas mileage. I think I have a bum carburetor."—Clarksville, Tenn., club manager.

Plastic roof lets sun glare through (wavy line) and reflects instrument lights at night (dotted line)

Clymer admires the new overhead-valve engine. Arrow points to power-brake unit available on Mercury

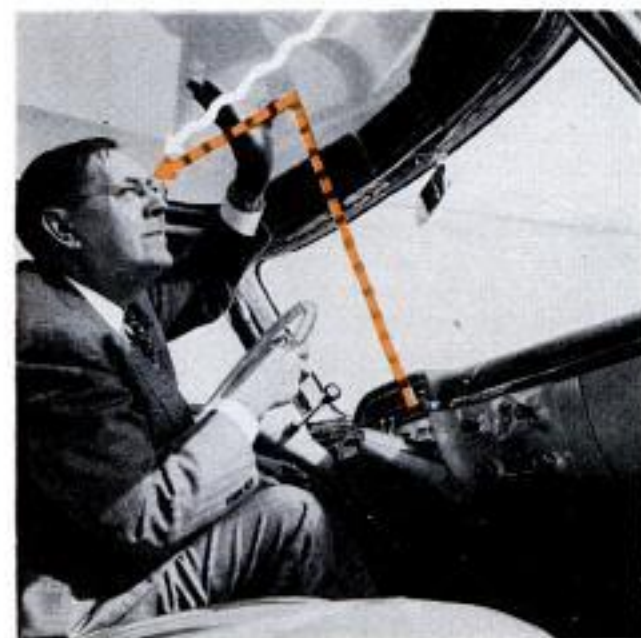

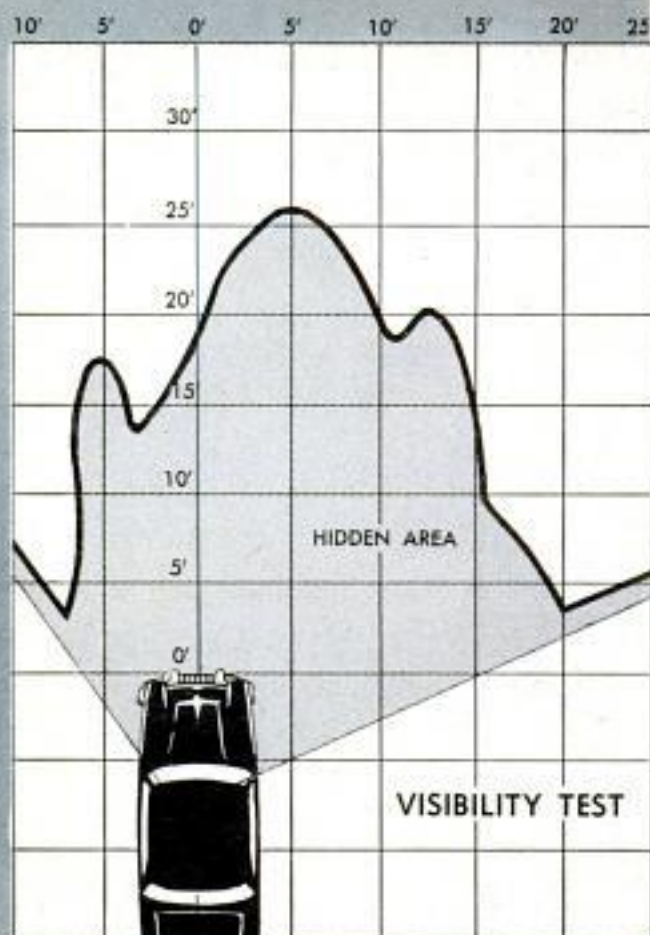

ACCELERATION TEST

1954 MERCURY SUN VALLEY
with Merc-O-Matic Drive

¼ mile from zero	21.3 sec.	Drive range only
	20.1 sec.	Low range only
½ mile from zero	32.8 sec.	Drive only
	32.3 sec.	Low and Drive
0 to 30 m.p.h.	3.9 sec.	Low only
0 to 60 m.p.h.	16.3 sec.	Drive only
	15.9 sec.	Low and Drive

Top speed by speedometer.....102 m.p.h.
Actual top speed about 8% less

ECONOMY TEST

MILES PER GALLON
Constant-Speed Mileage

At constant 30 m.p.h.	24.3
At constant 50 m.p.h.	18.2
At constant 60 m.p.h.	17.1
At constant 75 m.p.h.	12.9
Cross-Country Mileage	
Detroit, Mich. to Springfield, Ill. (cold weather, some snow and ice)	16.8
Springfield, Ill. to Kansas City, Mo. (traffic, level highway)	17.2
Denver, Colo. to Las Angeles (mountains and desert)	19.3

✱

Who are the owners in the Owners Report? They are 1000 persons chosen at random from owners of the 1954 Mercury all over the country. The names are taken from state registration lists by an independent agency. PM exerts no control over the selection

"Surprised at low mileage obtained in city driving. Actually 4 miles per gallon less than a 1950 Mercury owned by my parents."—Chicago truck driver.

"Got very good gas mileage on my '50 and '53, but am very much dissatisfied with mileage on the '54. Had it back for service several times. They either cannot do anything about it or don't know how."—Tampa, Fla., contractor.

Transparent-Plastic Top

Mercury was the first production model to offer a transparent-plastic roof insert. It accounts for only a small percentage of the total ownership, but it is different and, therefore, of interest. Of the owners reporting, only 10 percent have the plastic-top model, the Sun Valley.

Generally, the reaction was enthusiastic. Most owners were happy that they bought the Sun Valley.

"You have the advantage of a hardtop, the next thing to a convertible."—Johnson City, Tenn., owner.

"Excellent. A convertible without the wind."—New York Naval aviator.

"Sure beats convertibles in this climate."—Cary, Ill., railroad agent.

"Fine now, but in July and August?"—Flushing, N. Y., distributor.

"A lot of glare at high noon."—Newington, Conn., pharmacist.

"It's just a novelty. I would not buy this model again."—Prospect Heights, Ill., salesman.

"A very weird sensation to be driving through a snowstorm. Makes the car seem colder."—Minneapolis, Minn., used-car dealer.

Ball-Joint Suspension

General approval of the new ball-joint front suspension system was registered by the owners, with 79 percent stating that they like it, only 3 percent disliking it, 2 percent stating they could see no difference, and 16 percent making no comment.

"Greatest improvement in years. Steers and handles on curves at 60 as if only doing 35. Absorbs great deal of road shock."—Irvington, N. J., law student.

"Like it due to no tire noise on curves."—Boulder, Colo., salesman.

The 3 percent who dissented complained that the suspension is noisy at times.

"Knocks over rough roads."—Detroit, Mich., repairman.

"Okay except when turning into a drive where there may be a small break in pavement at the curb. There is an extreme jerk on the steering wheel."—Clearwater, Fla., manufacturer.

"I haven't noticed any difference from

(Continued to page 250)



Fitting neatly under the hood of a Plymouth, the turbine is simple, has a fifth as many parts as a piston engine



President L. L. Colbert of Chrysler demonstrates how cool the exhaust is

Gas-Turbine Plymouth

By Arthur R. Railton
Automotive Editor

CHRYSLER ENGINEERS have done the "impossible." They built a gas-turbine engine that fits in a Plymouth without changing anything but a few brackets and, even more amazing, they have eliminated the bugaboo of high fuel consumption and high exhaust temperatures.

Secret of the new turbine is a regenerator or heat exchanger that uses hot exhaust gases to preheat the compressed air before it enters the combustion chamber, cooling the gases and, at the same time, increasing fuel economy. The trick was to make a regenerator that would be efficient and yet occupy little space.

The engine will burn a wide variety of fuels. In tests, unleaded gasoline was used and economy equaled that of a piston engine. Being pistonless, it has no knock problem, making unnecessary high-octane fuels.

Power output is 120 horsepower, but its torque equals that of a 160-horsepower piston engine. Having some characteristics of a torque converter, the engine could be used without a transmission. It is 200 pounds lighter and has one fifth as many parts as a piston engine.

Noise seems to be no problem. There is a noticeable hiss or whine, most of which comes from the front end, not from the exhaust. It is the sound of huge volumes of air being compressed by the whirling blades.

Production will depend upon the availability of strategic materials needed to withstand the high temperatures of the engine. Other big problems include costs of machining and fabricating these metals.

Engine is lowered into car. Heat exchanger is visible atop engine

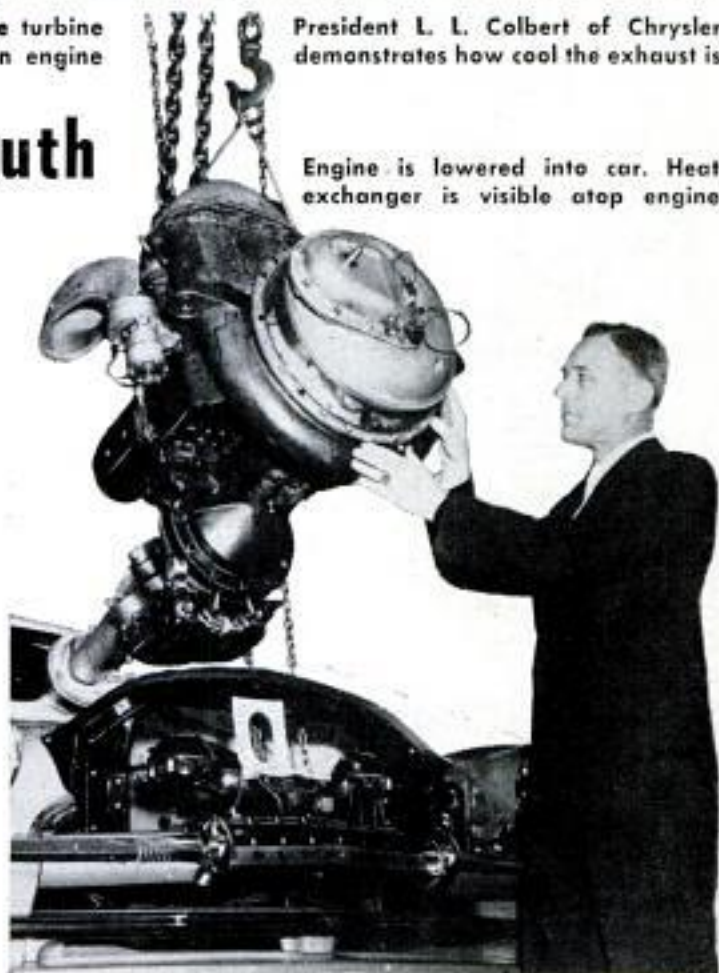
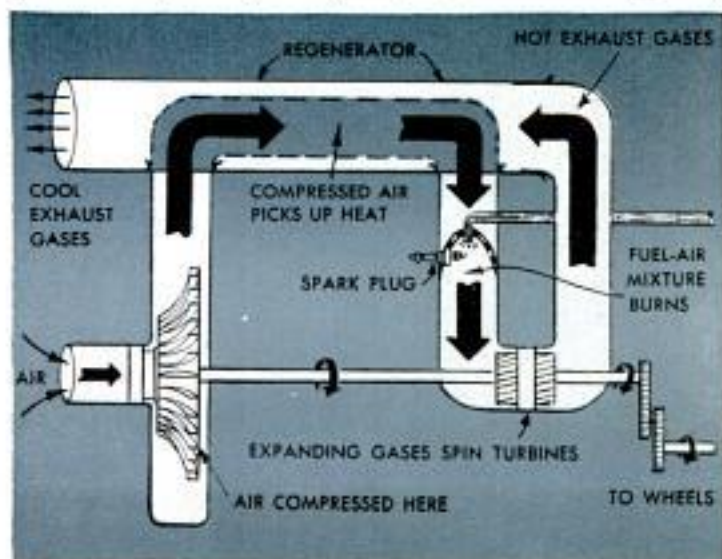

Diagram of turbine, which idles at 20,000 r.p.m., has a top speed of 50,000 r.p.m. Spark plug is for starting only





Streamlined Aluminum Upper Berth Clamps to Automobile Roof

Sportsmen, salesmen and vacationists can now add a comfortable upper bunk to their automobiles. A streamlined aluminum unit that fits firmly on any hardtop car roof serves as a weather shelter, a bed and an extra storage compartment. The

metal top springs up to expose a canvas shelter with watertight Zippers on both sides, a screened window and a 48-inch-wide mattress. A light but sturdy snap-on ladder gives easy access to the bed. The unit is both dustproof and waterproof.

Crankcase-Oil Reservoir Fills Engine Automatically

You throw away the dipstick when you install a crankcase-oil reservoir system in your automobile. The system consists of a large jar that mounts on the firewall behind the engine. Two lengths of tubing run down into the crankcase through the dip-

stick hole. A third tubing hooks into the intake manifold for a vacuum supply. Whenever the crankcase level drops below the proper mark, oil from the jar is introduced to bring it back to the correct level. To check the oil level, you simply look at

the jar. If there is oil in it, you have the proper amount of oil in the engine. When the oil level drops in the jar, you add a quart in the normal way and the excess oil is drawn up into the reservoir for storage until needed. Because the motion of the car keeps the oil level going up and down continuously, there is a constant interchange of oil between the crankcase and the reservoir, so you can also tell the condition of the oil in the system by inspecting the jar.

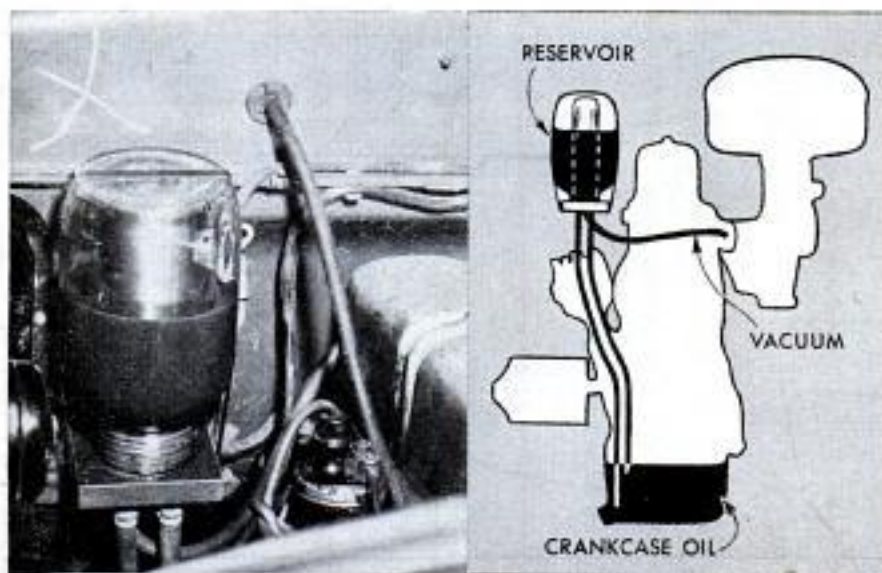

Models Replace Surveyors in Planning New Jersey's Highways



Using a method developed during World War II, the New Jersey Highway Authority has replaced the slow and expensive surveying method of highway planning with models based on aerial photographs. A 2000-foot-wide strip along the proposed route is photographed from an airplane using stereoscopic cameras. Contour maps are made from the three-dimensional photographs. Contours are traced on wallboard, cut out like a jigsaw puzzle and assembled as a scale model of the terrain. With the model, engineers determine the best route for the new highway, computing average elevation of the roadbed, plotting bridge sites and planning drainage systems.

Heart-Lung Machine Does Both Jobs During 26-Minute Surgery

For what is believed to have been the first time, a machine took over the functions of both the heart and lungs of a patient during surgery. The apparatus pumped an 18-year-old girl's blood and oxygenated it while one of the inner walls of her heart was sewed up. The operation took 26 minutes. Dr. John H. Gibbon, Jr., of Jefferson Medical College, Philadelphia, the inventor of the machine, performed the surgery.



Root-Crop Spray Prevents Sprouting

Potatoes and onions won't sprout in the storage bin if they are sprayed before harvesting with a new chemical. Absorbed by the leaves, the growth inhibitor works down into the bulbs, stopping further cell division. The spray, maleic hydrazide, is the same solution used to retard the growth of grass along lawn edges. Properly stored potatoes are kept from sprouting for up to 12 months, Spanish onions up to eight months.



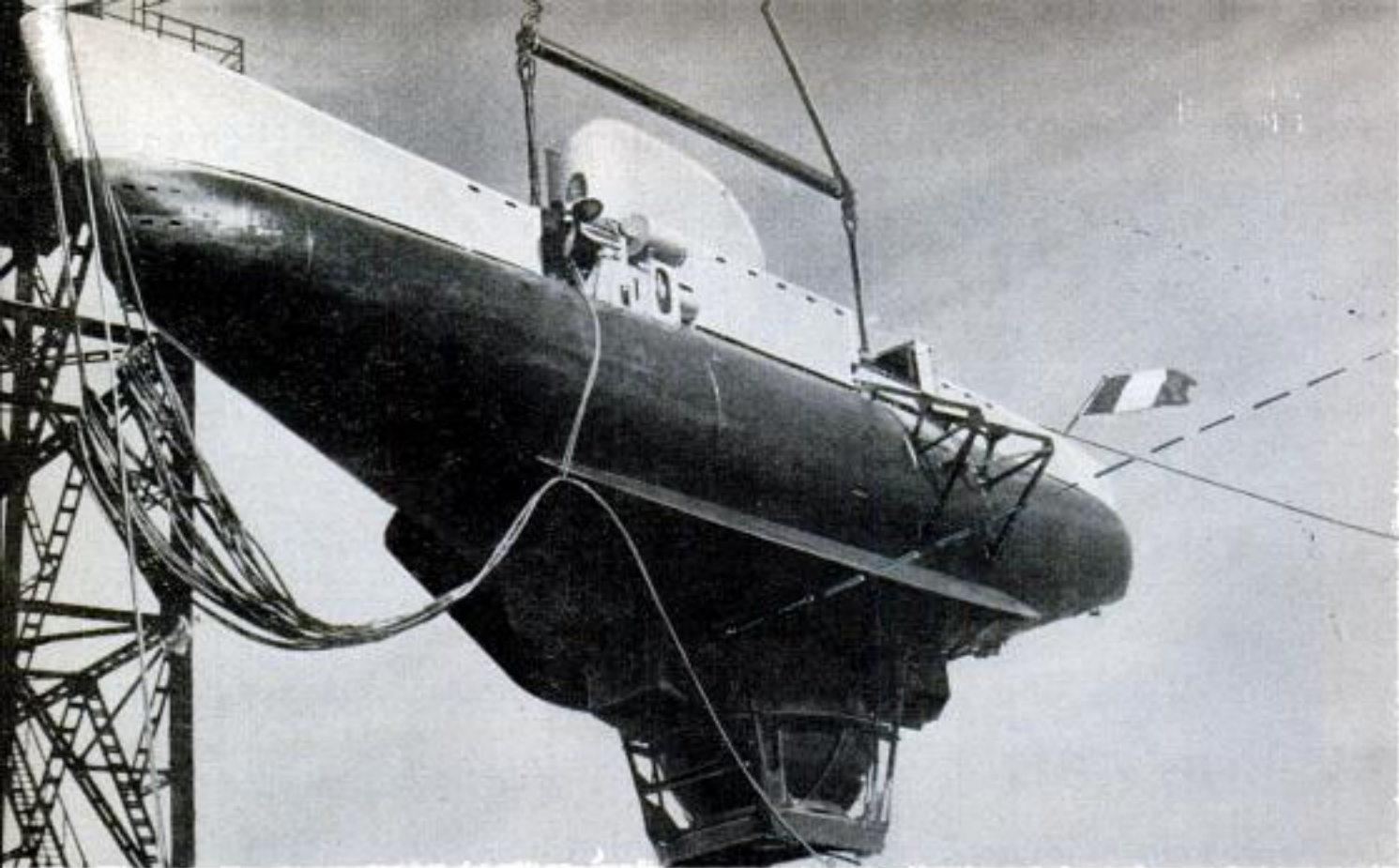

Bathyscaphe is lowered into ocean for test dive. Sphere on platform at bottom is the only watertight section

13,000 Feet Under the Sea In the French Bathyscaphe

SCIENCE REACHED new heights—or, more properly, depths—of exploration a few weeks ago when two French naval officers, manning one of the weirdest vessels ever constructed, plunged to a record depth of 13,284 feet under the sea. Called a bathyscaphe, it resembles a crude sub.

At midmorning the two men, Lt. Comdr. Georges Houot and Lt. Pierre Willm, dropped down through the conning tower and disappeared into a metal sphere fastened beneath the superstructure. Closing the hatch after them, they started the slow, vertical descent into the depths of the Atlantic off Dakar. No cable connected the vessel with the surface. About three hours later a guide rope beneath the bathyscaphe bumped the ocean floor, and the two men had set a new depth record for underwater exploration. Approximately two hours later they bobbed to the surface, determined to make other dives as soon as possible. The bathyscaphe is designed primarily for deep-sea research, and not just as a means of setting a new depth record.

Actually the vessel is a free balloon in reverse. The only watertight portion is the steel sphere, designed to withstand a pressure of 5676 pounds per square inch. Most of the superstructure consists of tanks filled

with gasoline. An opening connects these tanks with the sea water, so the inside and outside pressures are virtually the same. Since the gasoline is lighter than water, it remains in the top of the tanks and provides buoyancy for the vessel.

When the men are ready for a dive they enter the sphere through a vertical lock. The lock then is filled with water, causing the bathyscaphe to sink. The farther it sinks the faster it descends because the gasoline is compressed by the sea water.

Aboard the vessel are four containers filled with iron shot. This ballast gives the men a means of controlling the rate of descent and also of returning to the surface. They throw magnetic switches which cause the iron pellets to pour slowly out of the containers, slowing the descent. When the divers are ready to leave the ocean bottom they dump more ballast until the bathyscaphe becomes lighter than the sea water (because of the gasoline) and begins to ascend. In this way the state of near equilibrium between the weight of the vessel and the buoyancy of the gasoline can be controlled.

The greatest known ocean depth is 35,435 feet, and the men believe that depth can be reached in a bathyscaphe.

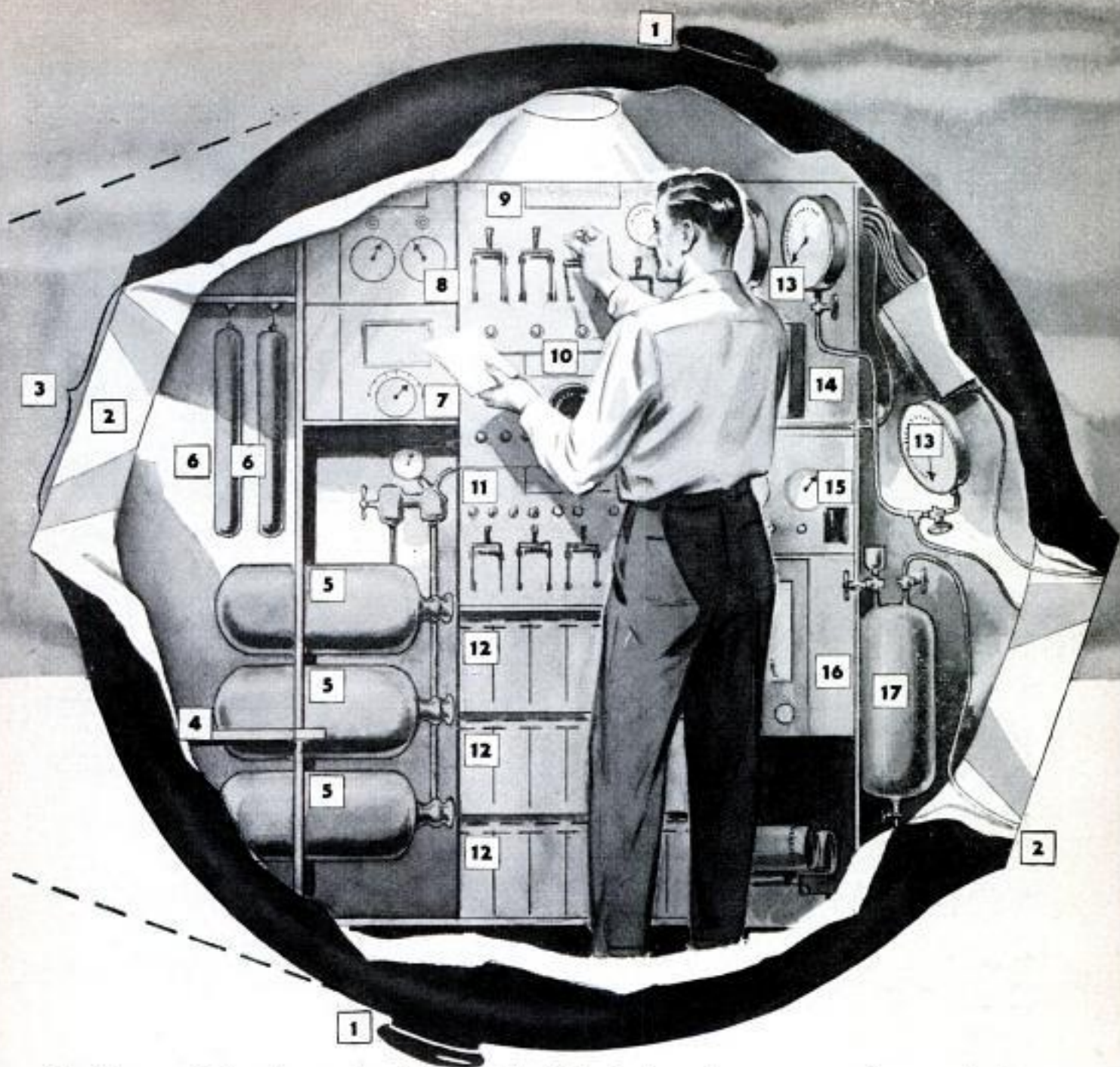

↑ 1. Clamps seal joints between hemispheres; 2. Portholes; 3. door; 4. entrance step; 5. oxygen bottles; 6. sodium carbonate, which absorbs carbon dioxide; 7. temperature gauges; 8. vertical compass; 9. electric switches; 10. shot gauges; 11. Ballast control; 13. pressure gauges; 14. automatic ballast release; 15. water-gasoline level gauge; 16. sounding instrument; 17. mechanism for sampling sea water

↓ 1. Nonwaterproof superstructure; 2. conning tower; 3. access hatch; 4. iron-shot containers; 5. gasoline tanks; 6. area filled with sea water; 7. guide rope; 8. exterior lights; 9. security ballast

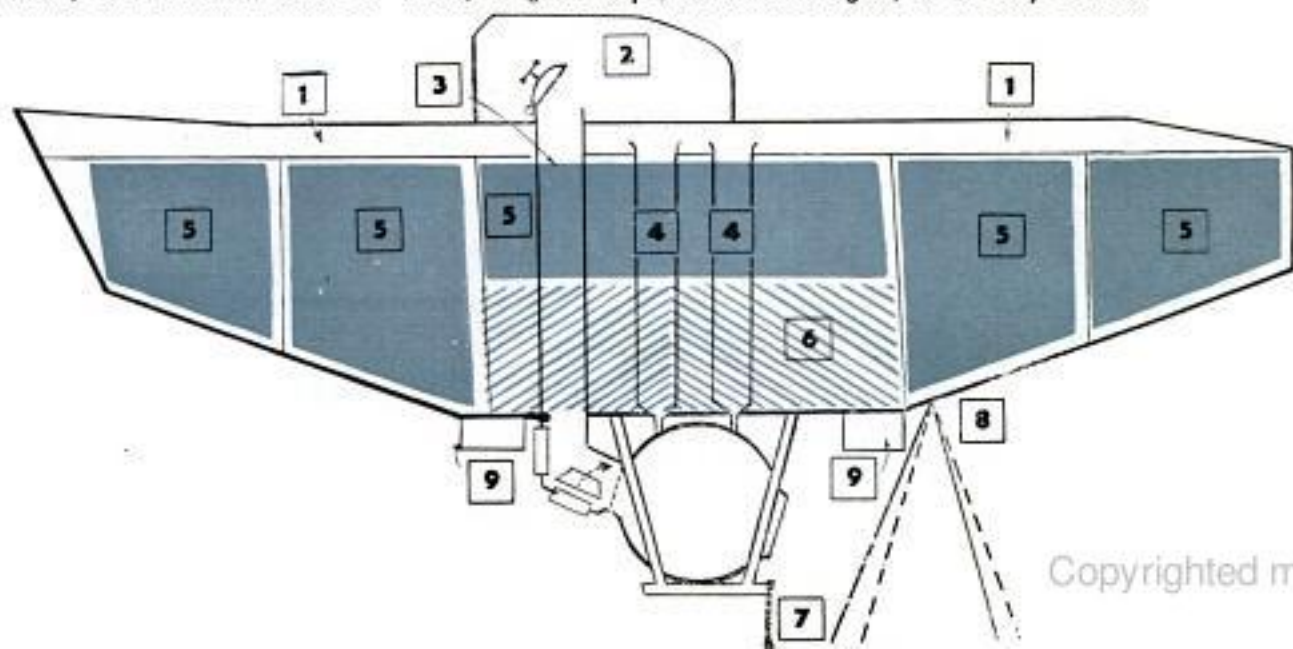

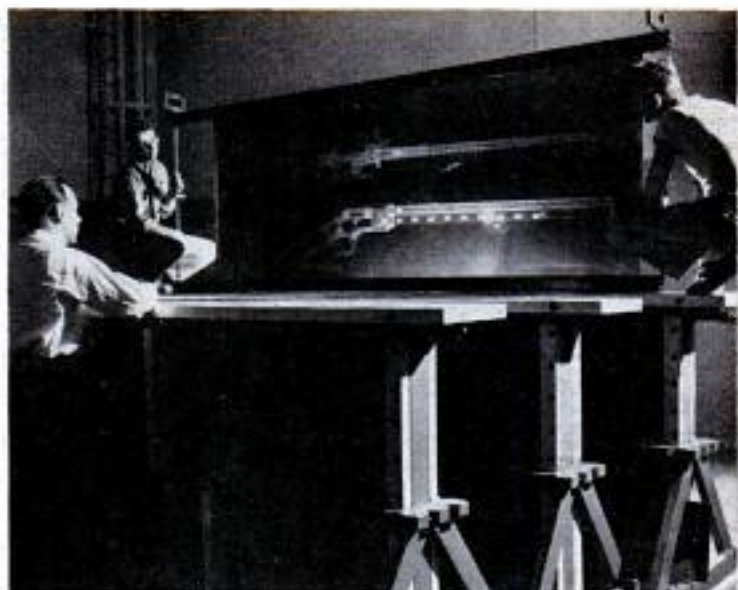
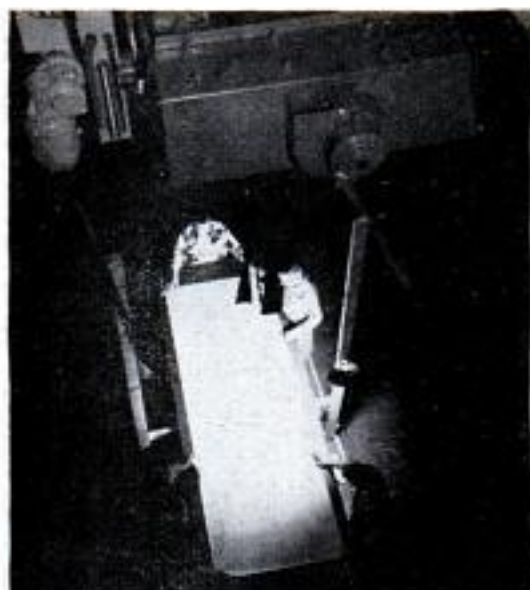

Rifles are suspended between betatron, top left, and film platform, below. Right, finished X-ray picture

Ten-Foot X-Ray Picture Reveals Minute Flaws in Steel Castings

Just to show how big an X-ray picture they could take, technicians at an Allis-Chalmers laboratory in Milwaukee used a single film 10 feet long and 40 inches wide. Subjects of the picture were two big-game rifles which were suspended eight feet above the film and four feet below the X-ray source to magnify the image three times. A 22,000,000-volt betatron swept an X-ray beam back and forth along the length

of the rifles to produce sharply defined images of both guns. The film lay on a fiber-board platform and was covered with a sheet of 16-gauge steel which absorbed secondary radiation and served as an intensifying screen. After the exposure, the film was developed and fixed in three 90-gallon rectangular tanks. The experiment demonstrated the ability of the method to reveal minute flaws in steel castings.

Electronic System Used By Air Force Lands 120 Planes Per Hour

Called "Volscan," a new automatic control system developed by the Air Force can handle 120 incoming aircraft per hour, compared with a top of about 40 which can be brought in by manual systems. It was designed to avoid the "stacking up" of jet

aircraft at busy bases since their rate of fuel consumption increases rapidly as soon as they lose altitude. At Fort Dawes, Winthrop, Mass., the control room is in an underground concrete bunker, hundreds of yards from the radar truck and antenna.

"Volscan" radar truck and antenna are hundreds of yards from control room, right, in underground bunker

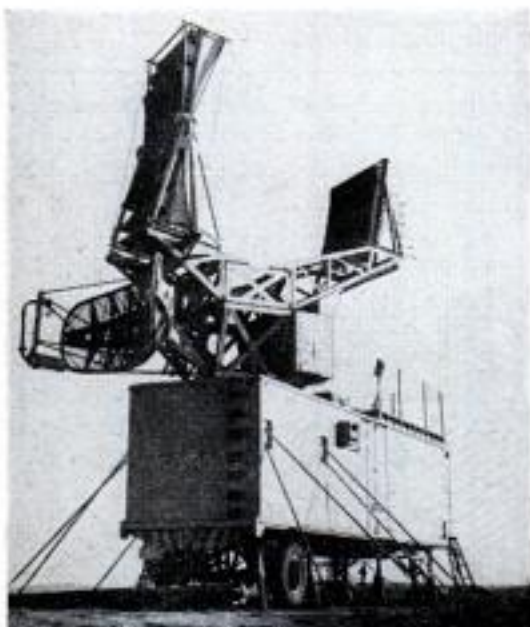



MEXICO BUILDS A *Reprinted from Highlights* GLAMOUR CAMPUS

By Thomas E. Stimson, Jr.

ONE OF THE strangest buildings ever constructed, it stands on stilts, its thin concrete roof pulled taut around the entire structure like the canvas of some ultramodern covered wagon. Beneath the roof, ionization chambers and automatic neutron counters keep a 24-hour watch on the cosmic rays that strike through the thin concrete with virtually no interference.

The building is the Pavilion of

Above, library is covered with colorful mosaics. Below, classrooms and laboratories have glass walls

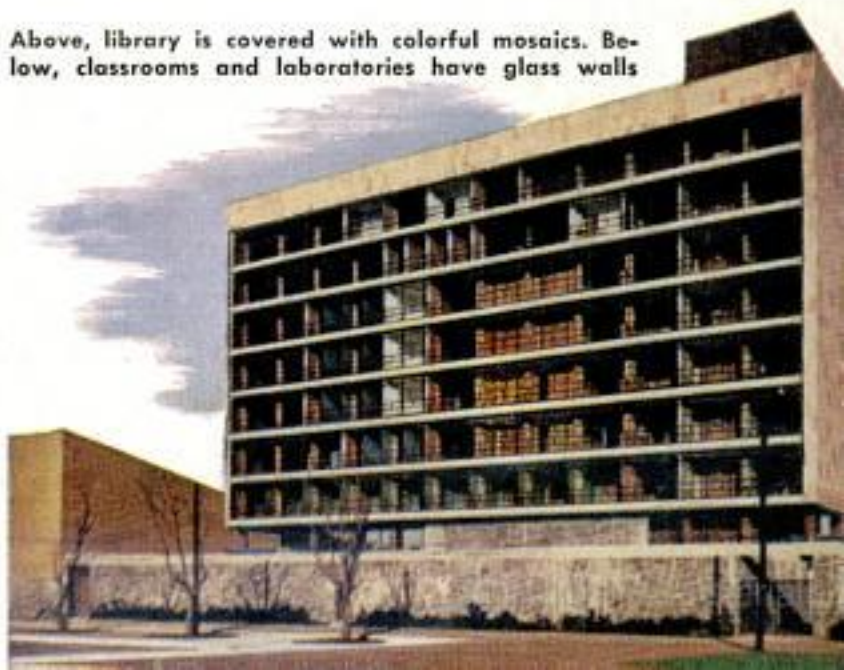



Artists worked from scaffolding on medical building. Aztec mosaic of glass tiles depicts Life and Death

Cosmic Rays at the University of Mexico. In a way, it symbolizes the rest of the campus, for here, blazing with color, are some of the most unique school buildings ever to welcome a student.

"Magnifico! Fantastico!"

This year tourists and educators from many parts of the world are echoing those words as they visit the new campus.

Recently housed in an assortment of ramshackle structures, North America's oldest university has just moved into the brand-new group of buildings conceived by Mexico's greatest architects and engineers and dedicated to the proposition that school buildings can be beautiful as well as useful.

The results are so spectacular that most

visitors feel a real envy for the 25,000 students who will be studying literature or engineering, architecture, medicine or other courses on the new campus.

The university traces its history back to 1551 when the "University of New Spain" was granted a charter by the King of Spain. Shortly afterward the name was changed to the "Royal and Pontifical University of Mexico" and was supported by endowments from Mexico's gold mines. The school was abolished during various revolutions, and in recent years has operated on funds from the sale of land grants. The present campus consists of more than 1500 acres of ancient lava flows, called the Pedregal, at the southern edge of Mexico City.

The new campus represents the largest

single construction project in Mexico since ancient times and was built at record speed. It was started in 1950 during the regime of President Miguel Aleman, and a huge statue of him stands at one end of the main esplanade. Most of the buildings are of the modern "international" style. The stadium and some of the sports facilities are deliberately styled to resemble Mexico's volcanoes and her ancient Indian pyramids.

About \$25,000,000 has been spent to date and a similar sum is being used for furnishings and equipment. The whole project is so vast that it is known officially as "Ciudad Universitaria" or "University City." Eventually a civic center complete with stores, markets and theaters will be erected for the convenience of students and professors.

The magnificent new stadium is suitable for football and for all track and field events. Authorities hope Mexico will be chosen as host for one of the future World Olympic Games. Some coaches don't believe their sea-level athletes could put on a good show in the 7500-foot elevation of Mexico City, but Mexicans explain that almost anyone becomes acclimatized after about 10 days in the thin air. Most Olympic teams spend that much time in practice at the scene of the games. Next year the Pan American Games, comparable to a regional Olympics, will be held at the university.

In designing the stadium the engineers noted that everyone likes to sit near the 50-yard line, so they created a structure that is low at each end and has a high sweep along each side. This puts more than the customary



Huge Olympic Stadium was designed to resemble the crater of a volcano. High sides are opposite the mid-field marker, giving more of the spectators seats on the 50-yard line. Seating capacity of the stadium is 103,000



Seating areas are reached through 48 tunnels. Running track of the stadium is surfaced in black volcanic crushed rock. Below, three swimming pools are interconnected so casual swimmers can wander from one to another. Underwater windows help the coaches train their student swimmers





Entire end of one science building is a painted mural which depicts the combining of knowledge from various civilizations. Bas-relief by famed artist Diego Rivera decorates side of stadium. It is made of thousands of pebbles stained with acids

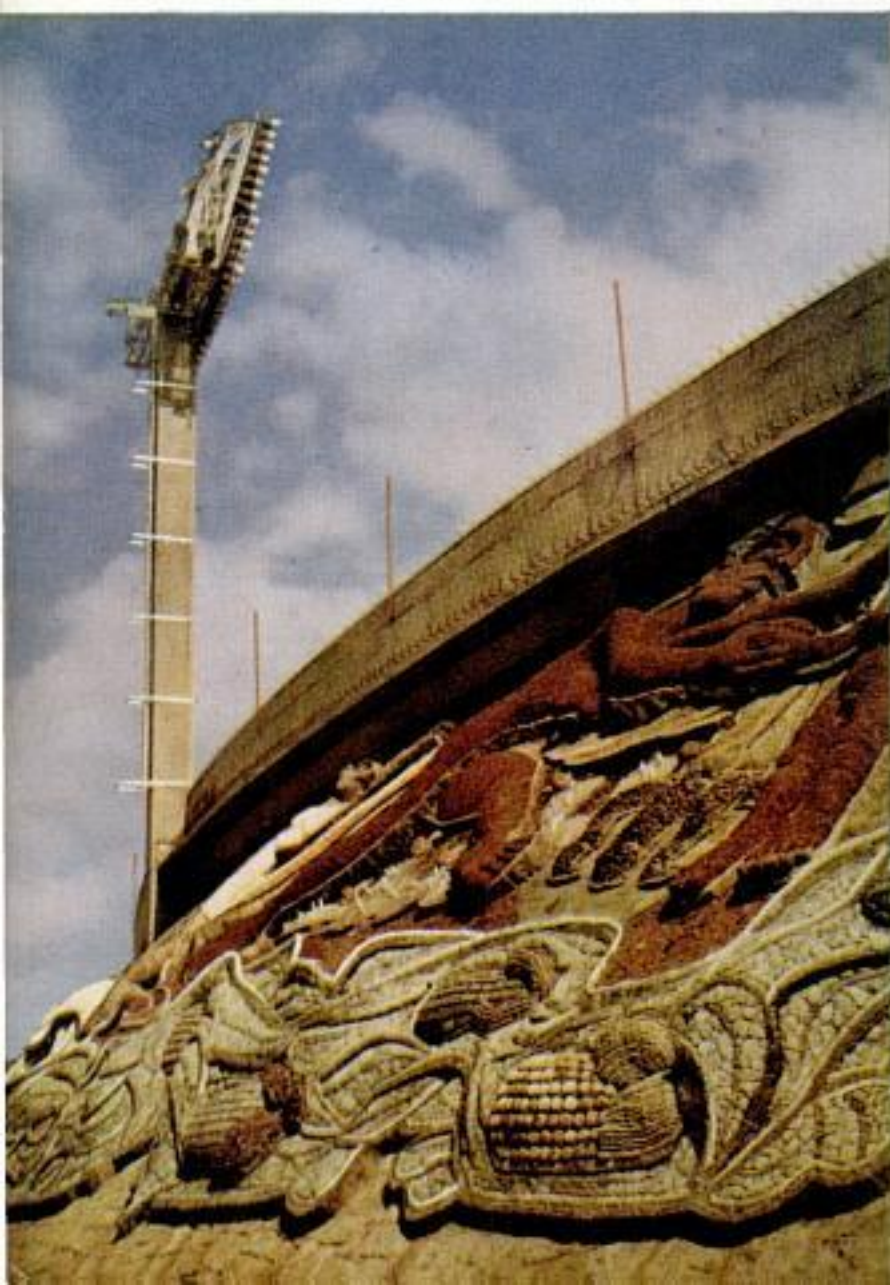

number of spectators in the most desirable zone. Seating is in two tiers, with a capacity of 103,000.

The stadium was shaped by scooping out soil and lava rock from the middle and using this material to build embankments along the sides. Not only did this method cut ordinary construction costs by more than half, but it provided a desired craterlike resemblance to Mexico's volcanoes. Very little steel or concrete was required except for facing the compacted dirt fills and for the cantilevered balcony and the 48 access ramps and tunnels.

The stadium has a complete floodlighting system, a public-address system that reaches all areas, a 200-foot-long press box and outlets for television cameras at strategic points in addition to telephone, telegraph and teletypewriter facilities.

On another part of the campus are an eight-lane Olympic championship swimming pool, a huge practice pool and a championship diving pool. All three pools are connected by water channels spanned by low bridges. Casual swimmers can wander from pool to pool.

The water is heated, chemically purified and automatically circulated. The championship diving and swimming pools have underwater lighting and underwater

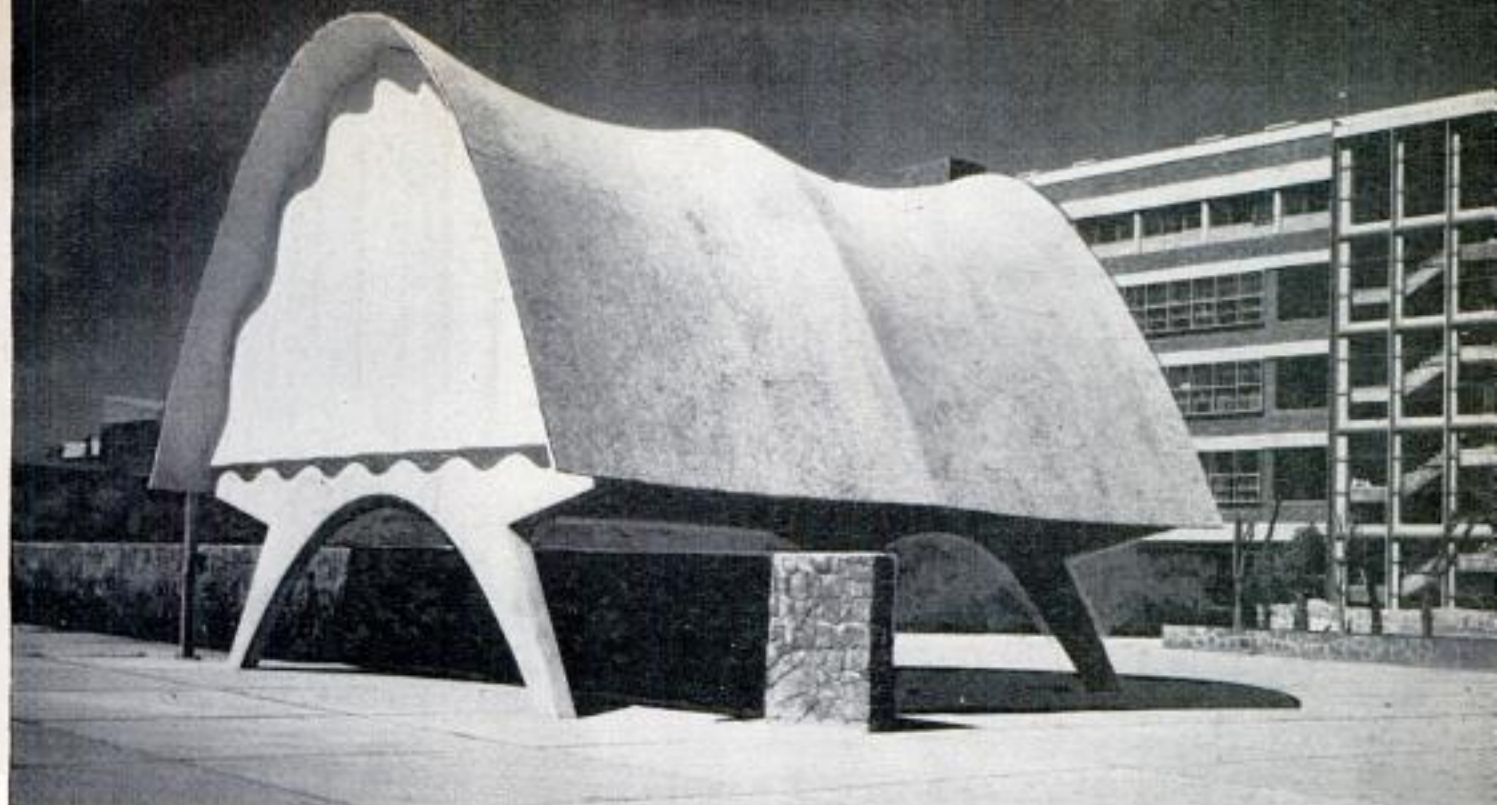

Mounted on stilts, the Pavilion of Cosmic Rays houses automatic neutron counters and ionization chambers

windows from which the coaches can watch the form displayed by their students. Spectators were seated on a few rows of stone steps when the pools were first used. After the first big water meet was held it was found necessary to add a spectator stand.

Other sports facilities on the campus include a baseball stadium with seats for 3000 spectators, a practice stadium for field and track with bleachers seating 4000 people, three practice fields for soccer or
(Continued to page 242)

Sprawling campus was designed by 150 architects, built by 10,000 workers and provides facilities for 28,000 students

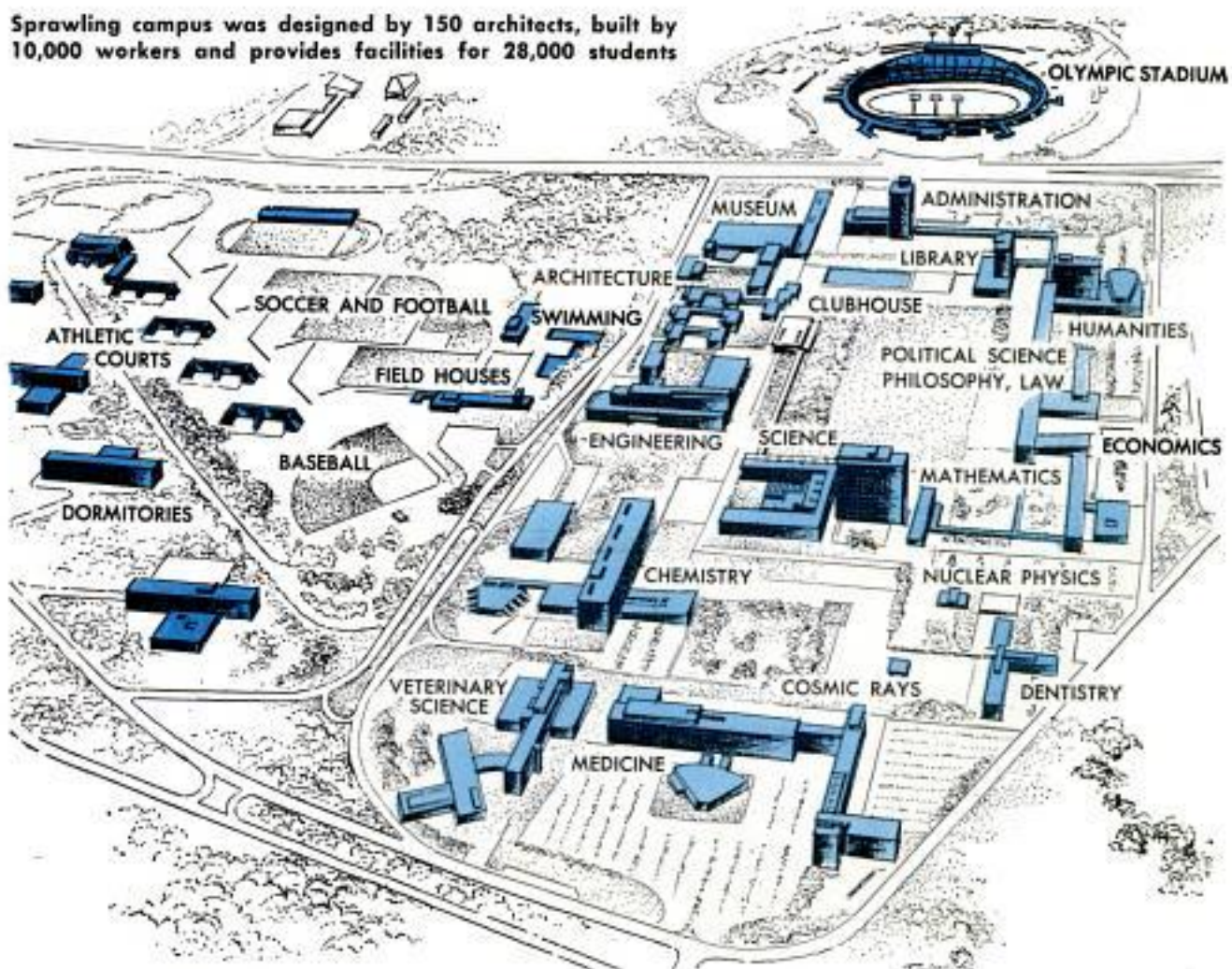



Casement-window unit by Chrysler Airtemp takes the place of one of the windows, doesn't project outside. Servel's casement unit masquerades as a wall cabinet, is set in three cooling positions by pulling drawer

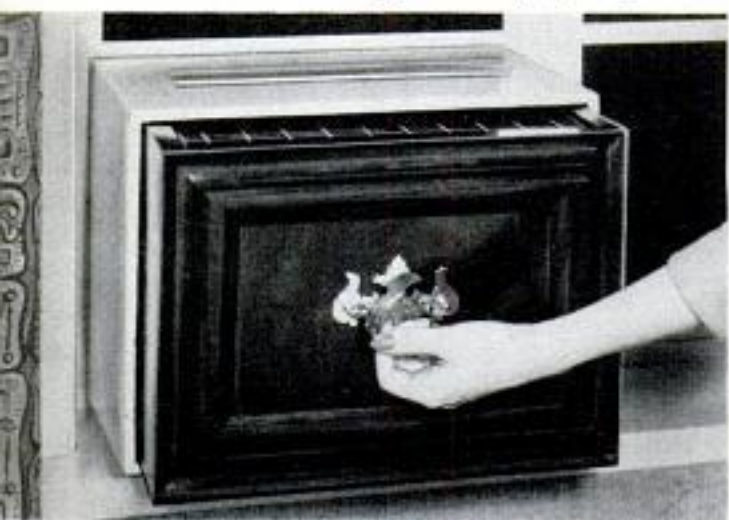

Wood-cabinet "consolette" by Philco fits casement windows and city codes which bar projecting units

Magic Boxes Fight Heat

SLEEPLESS NIGHTS and sweltering days don't have to be a part of the "good old summertime," as more Americans are finding out every year. Air-conditioner sales are skyrocketing. Many people, because of cost or a radiator-heating system that can't be converted to central air conditioning, are installing room air conditioners. The 1954 units not only chill a room, but dry and filter the air, and can be set to bring in fresh air or exhaust stale air. Some are regulated by thermostat and some can be run at reduced speeds for quiet night operation. Optional features include heating coils and heat pumps for spring and fall and a device that switches the unit on at a preset time. Costs range upward from the \$200 price of the smallest unit.★★★

Clip-off filter of mineral wool is fed from a roll. When used section becomes dirty, it is pulled down and cut off. This is a Magic Chef feature. Some filters are reusable

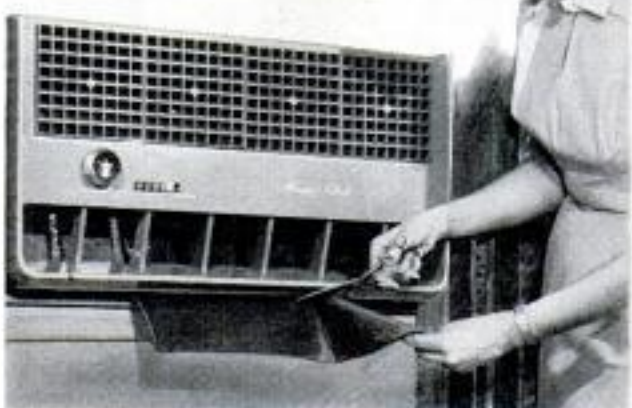



Carrier's portable, designed originally for hospitals, is also handy for anyone who wants his bedroom cooled at night and his living room air conditioned during the daytime

Diagram shows how a unit soaks up heat on one side, blows it out the other. Heat pump—now on many models—just reverses flow with valves. Compressing refrigerant releases heat

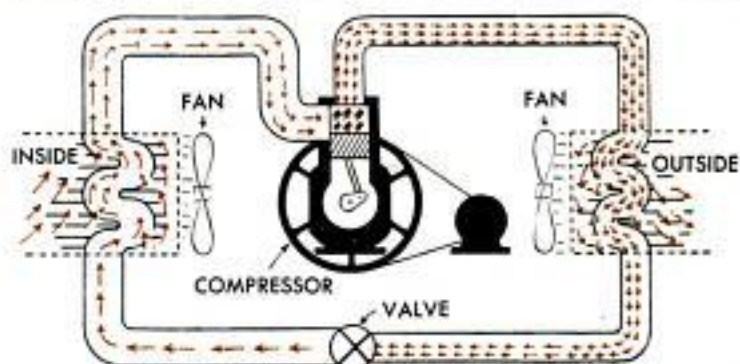

Fabric-covered International Harvester blends with decorating scheme, can be covered with any drapery material. General Electric, below, offers increased cooling and dehumidification, quiet, gentle air flow



Flush-mounted Mitchell projects only two inches into room. Special insulation muffles sound. Coils supply heat for fall and spring. Fedders has lift-out glass-fiber filter, grille that is turned to direct air flow

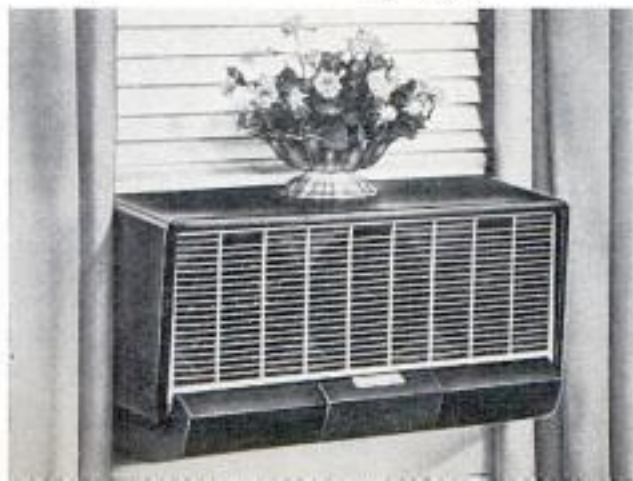



Midget Pusher Sports Plane Can Fly 200 Miles Per Hour

Less than six feet high and only 18 feet long, a midget pusher-type aircraft has made its initial trial flights at Los Angeles. The builders, Hugh Crawford and Roger Keeney, estimate the 85-horsepower Con-

tinental engine will provide a top speed of 200 miles per hour and a cruising speed of approximately 165 miles per hour. The tiny sports craft, identified as the Serra S-1, has a wing span of 20 feet.

Portable Chest Unfolds to Provide Table for Drawing or Drafting

All the supplies for drawing or drafting can be packed away in a portable chest that opens to provide a convenient working surface. The chest has adjustable drawers for holding bottles of ink and paints, brushes and paper. It may be placed on a table or self-supported on three legs which unfold.

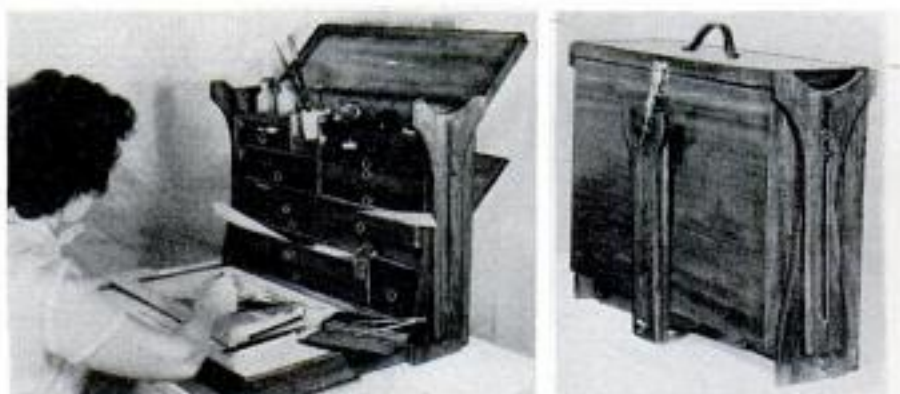

Tiny Railroad With Only 156 Feet of Track Spans Oceans



U. S. Navy photo

Though its route length is only 156 feet, one of the world's most unusual railroads has been operating between Korea and America for more than a year. It is an HO-gauge type, owned and operated by crew members of the aircraft carrier *USS Lake Champlain*. The model railroaders operate their colorful handmade engines and cars in a space about 70 square feet. An elaborate electric block system, employing 21 electrically operated switches, is used throughout the trackage. The control panel, mounted on red Plexiglas, is entirely homemade. The layout includes a passenger terminal, a freight yard and a village.



Aircraft Engine and Propeller Blow Aluminum Craft Along Water

Literally blown along the water by an aircraft engine and propeller, a homemade aluminum boat skims the surface at speeds up to 40 miles per hour. Albert A. Johann and his son Jack, both of Milwaukee, Wis.,

built the boat in their spare time. More than 5000 rivets went into the construction. Power for the craft is supplied by a four-cylinder airplane engine which turns a five-foot propeller.

Electrons Photograph Stars to Produce Sharper and Faster Pictures

Clearer and faster pictures of the stars are made by a new method that combines electronics with photography. In the usual method, light from a star is focused through a telescope on a photographic plate. In the new method, developed in France, the light strikes a light-sensitive plate which gives off electrons. On the average, the plate emits one electron for every four photons,

or units, of light. The electrons are focused on a target photographic plate by a potential difference of 30,000 volts to produce the picture. When light falls directly on a photographic plate, only about one out of every 200 light units causes a reaction, so the new method has a 50-to-1 advantage over the conventional method. Its advantages resemble those of the electron microscope.

Transparent Plastic Boat Passes Tests in France

Completely transparent, a plastic boat built by Jacques Jaham of Paris has been successfully tested in France. It is 13 feet long and weighs 390 pounds. It seats four comfortably, and is powered by outboard motor

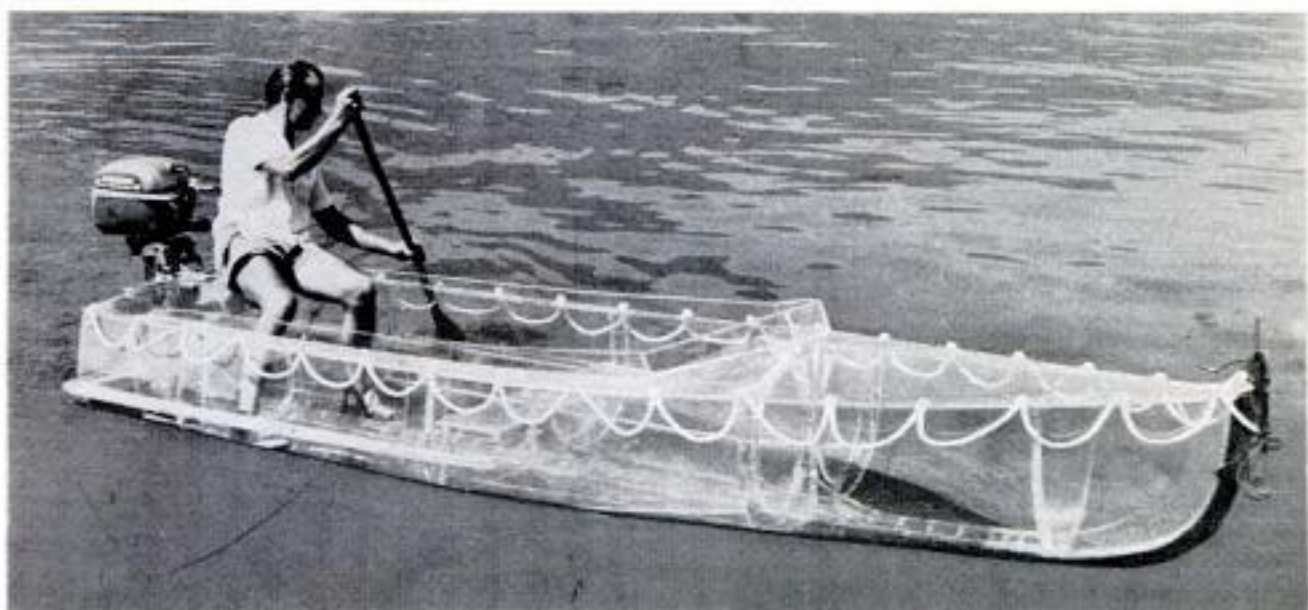

Radio Waves Hold Robot Helicopter in Fixed Hovering Position



Remotely controlled by radio signals and an automatic pilot, a helicopter has been held in a hovering position over a selected point to an accuracy of better than five feet. The aircraft was controlled with equal precision at both low and higher altitudes, and was landed several times within two feet of the central point. Four ground-relay stations using Raydist, a continuous-wave radio-location system, were used for the demonstration with a twin-rotor helicopter. A transmitter was installed in the helicopter. Signals from two Raydist stations were compared in one instrument to indicate longitudinal movements of the helicopter, while signals from two others were compared in a second instrument. Any deviations from the preset control pattern caused the autopilot to reposition the craft.

You Can Assemble Your Own Four-Bunk Vacation Trailer With Kit

Following the trend started by the motorboat industry, vacation trailers are now being sold in kit form. You buy the trailer as a collection of precut parts, some of which are partially assembled, and put it together yourself. Birch paneling for the interior is supplied as well as aluminum exterior sheets, door and windows. Everything needed to assemble the trailer is included except tires and tubes. Once assembled, the trailer has ample headroom as well as space for a dinette, kitchen area, a closet and bunks to sleep four persons. Interiors are furnished by the owners.

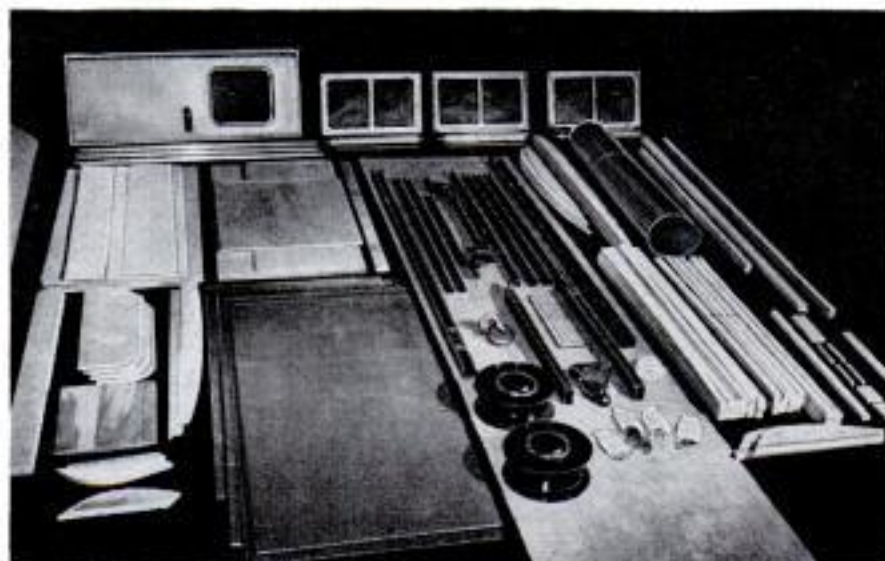

Information not listed on articles in the index, starting on page 12, frequently is listed in the WHERE-TO-FIND-IT LIST, which is available to readers without charge. A copy may be obtained by sending a postcard to the Bureau of Information, Popular Mechanics Magazine, 200 East Ontario Street, Chicago 11



Auto transport with engine between front and middle wheels carries seven cars instead of six. Relief driver, left, sleeps in recessed bunk between seats



Rear-Engine Auto Carrier Mounts Bunk Under Cab

Instead of an engine, a sleeping bunk for relief drivers is mounted beneath the cab of a snub-nose auto carrier. The 200-horsepower horizontal-type diesel engine is located low in the frame midway between the front and center wheels. The unusual design allows an additional car to be carried above the cab. The motor has two radiators located just behind the front wheels; the vent at the front of the truck is a fresh-air intake for the bunk. Clearance height of the loaded unit is 12½ feet. Cost of the custom-built carrier: \$21,000.

Mexican Suspension Bridge Built in Shape of Basket Handle

Slender arch ribs shaped like the handle of a basket support with cables a 250-foot bridge spanning the Rio Blanco River near Vera Cruz, Mexico. The all-welded bridge was built by Mexicans from an American

design. Strength and safety factors are as high as conventional constructions. The bridge flooring is a diagonal gridwork. As striking as its design is the bridge's color scheme—bright orange and cherry red.



FIRING ALUMINUM with COLOR

By William Dinwoodie



Winter exhibits brightly colored bowls, plates, tumblers, plaques, trays and panel of fired aluminum. Designs are cut through the enamel or consist of gold-leaf decoration

A NEW LOOK for offices and homes of the future is promised by a process of fusing brightly colored porcelain enamel to aluminum.

Edward Winter, a pioneer craftsman in the field of enameled metal, is conducting a test of the new process in Cleveland.

In three months he designed and completed a full line of dinnerware attractive enough to hang on the wall and so durable that it can be dropped on concrete without

denting or scratching. Another Winter product is an enameled aluminum panel that may some day be used to surface the interior walls of offices and homes. Finished plain or with a design, in one or several colors, the panel could also be used in lawn furniture, stoves or table tops.

Winter starts with sheet aluminum, cutting it to shape and molding it to form on lathes. The metal is dipped in dilute sulphuric acid and rinsed in a hot alkali bath.

Pieces are baked in a huge box-type furnace, receiving four six-minute firings at 1000 degrees Fahrenheit





Complete buffet table service is of aluminum fired with porcelain enamel. Colors range from chartreuse to gold

Spraying with colored enamel base follows. A dentist's sharp-edged prober is used to scratch out the design in the enamel. Then, after a 30-minute drying period at 350 degrees Fahrenheit, the article is fired at

1000 degrees for about six minutes in a large furnace, and this step repeated three or four times. Exposed parts of the design are polished, and the edge polished and stoned. ★ ★ ★

Prior to decoration bare aluminum bowls are stacked in dipping rack and pickled in dilute sulphuric acid

With a dental tool Winter cuts design in opaque enamel surface of mixing bowl to expose aluminum beneath



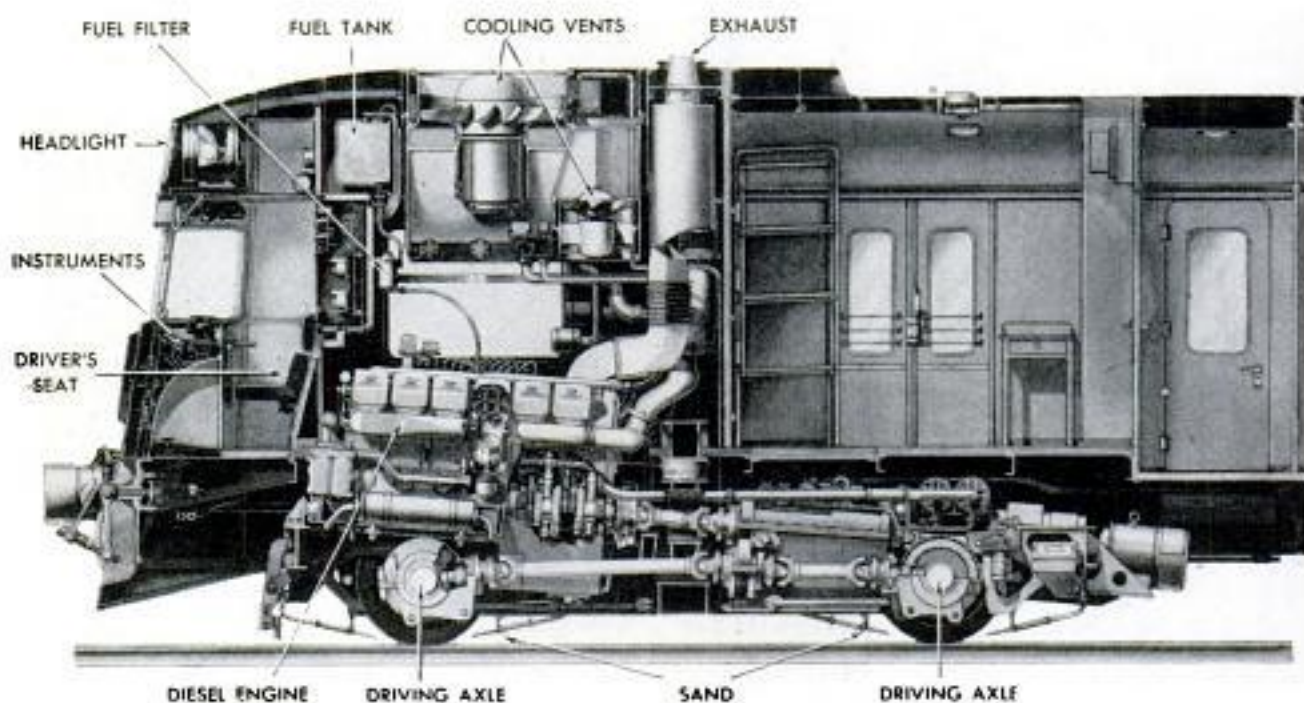
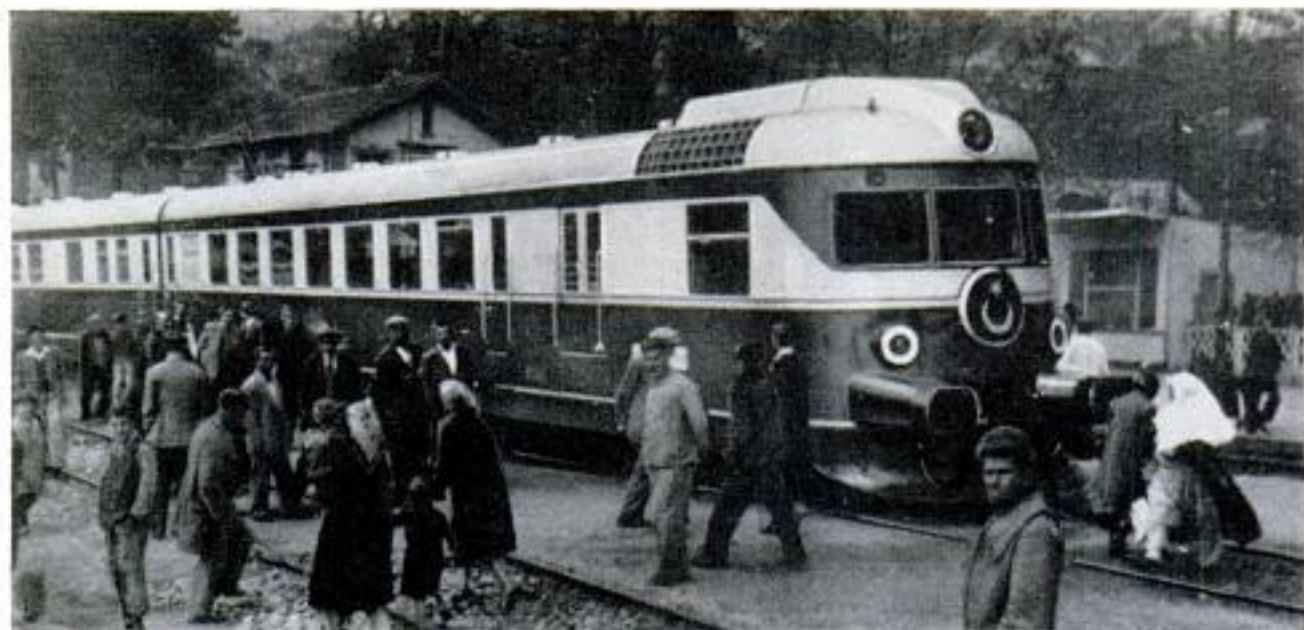

Train for Turkey Has Compact Diesel Engine Built Into Truck

Virtually the entire diesel engine of a new European train is built into the truck. The train, built in Germany for the Turkish Railways, has three articulated coaches. The compact 12-cylinder diesel engine is installed between and above the two axles of the front truck. Both axles are drive

axles. Above the engine is the cooling system and the fuel supply. The three coaches are made of lightweight alloys to reduce weight and thereby boost the horsepower per ton. There are two engines in the complete train, each developing 550 horsepower at 1500 revolutions per minute.

H-Bomb Element May Help War on Cancer

Cancerous tissue cells may soon become the most important targets of hydrogen-3, or tritium, which has gained such ill fame as the main constituent of hydrogen bombs. According to Dr. Dietrich E. Beischer of the U.S. Naval School of Aviation Medicine, its radioactivity may be used to remove cancerous cells without damaging normal cells. Tritium, now available in

quantity, has an extremely short range of radiation, making it particularly suited to the selective destruction of cancer cells. Certain chemical compounds are taken up by cancer cells more readily than by healthy cells. If these compounds are "tagged" with tritium, the short-range rays will reach only the cells which take up the compound, leaving other cells undamaged.



"Tennis Net" Crash Barrier Halts Jet Planes at End of Runway

Similar to an aircraft carrier's arresting gear, a new "tennis net" barrier keeps airplanes from rolling off the end of the runway after landing. It was developed by the Air Force for use on tiny airstrips in Korea, primarily to halt crippled jets after emer-

gency landings. When the nose of a plane touches the nylon net it triggers an arresting cable that engages the main landing gear. The cable drags heavy chains along the sides of the runway to slow the plane's roll.

Plastic Pinochle Tally Keeps Changing Record of Game Progress

Score, trump, bid and meld information are recorded on a flat plastic pinochle tally that fits in the hand. As the game progresses, numbered wheels inside the double card are rotated to expose the proper number combinations. An automatic locking mechanism prevents rotation of the disk when the device is placed on the table.

Information not listed on articles in the index, starting on page 12, frequently is listed in the WHERE-TO-FIND-IT LIST, which is available to readers without charge. A copy of this list may be obtained simply by sending a postcard to the Bureau of Information, Popular Mechanics Magazine, 200 East Ontario Street, Chicago 11, Illinois

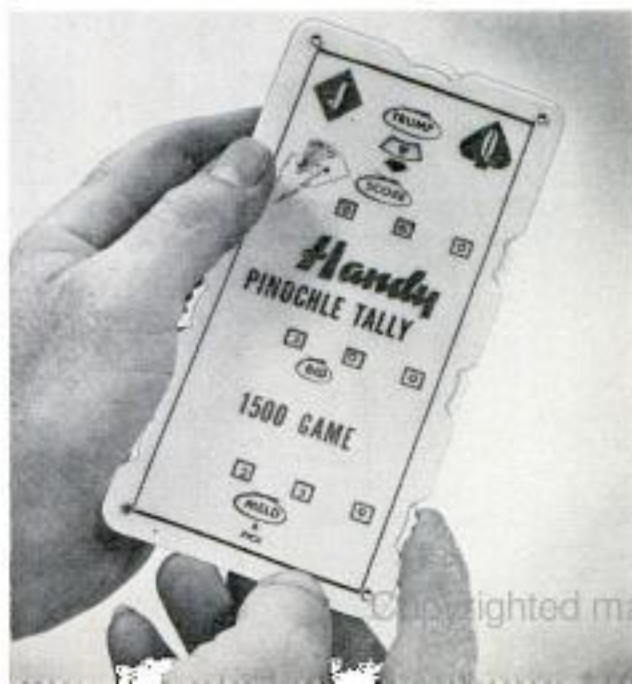

GUARDING THE



IT'S MIGHTY ROUGH tonight." The young seaman of the U. S. Coast Guard's *Triumph* looked worried. But John Cathers, stocky chief boatswain's mate and skipper of the motor lifeboat, grinned reassurance.

"Plenty rough—and that's good. None of these fishing boats will try crossing the bar till flood tide . . . I hope."

The bar was one that seafaring men from 'round the world have talked about—respectfully if sometimes profanely—since 1792. That was the year Captain Gray, a Yankee fur trader, sailed his ship *Columbia*—after many frustrating attempts—across the bar. It lies at the mouth of the Columbia River, which gathers strength for 1210 miles through seven western states, and smites the sea between Washington and Oregon shores. At crest periods, a million cubic feet of water per second rushes against the sea. And the mightier

sea pushes back with its tremendous force.

This then—with the linked coastal areas—has been called the "graveyard of ships." More than 150 ships lie buried there. But ship deaths have been few in recent years, due in good measure to the rugged men of the U. S. Coast Guard and their rugged craft such as the *Triumph*—*Semper Paratus*, "always ready."

"Look, skipper . . . that crabber . . . she's heading in. Somebody aboard must have a heavy date in Astoria."

Cathers didn't bother with reply, but ordered full speed ahead. Soon both *Triumph* and crabber were being smashed by waves that shattered timber and men. Roaring



GRAVEYARD OF SHIPS

down upon the crabber came a 15-footer. When the crabber nosed clear, its engine was dead.

"We'll have to get a line aboard her," said Cathers.

And get a line aboard they did. The crabber, with soaked crew of two, was towed back out to sea.

"You fellows all right?" megaphoned Cathers.

"Yeah. We got plenty of time to get the engine started—now."

"Just routine" is the way this incident was described to us as we sat in the snug warmth of the Coast Guard station at Point Adams near the mouth of the Columbia. But it's just such routine as this—along with expert shepherding by members of the Columbia River Bar Pilots Association, millions of dollars spent in jetty construction and channel maintenance, and modern technical equipment—that has cheated the graveyard of many a corpse.

Most persons think of the bar as merely a thin strip to be crossed to safety. But, at its mouth, the Columbia is more than five miles wide, and the bar area, where fresh and salt water come to grips, extends out about six miles. Millions of tons of shifting sand have been deposited at the mouth of the river and it has been a continuing engineering problem to keep clear a main

channel—about 40 feet deep and some 2000 feet wide.

If there were headstones for the buried ships they would carry many distinguished names — *Tonquin*, *Isabella*, *Desdemona*, *Great Republic*, *Peter Iredale*, *Peacock*. . . The *Peacock*—now, there was a sturdy craft. She was a United States Navy ship, an 18-gun sloop of war, which started across the bar July 18, 1841. Missing the main channel, she plowed into sand, and was fast at the mercy of pounding waves. Desperately, the crew pitched all cargo overboard. Cannons and shot went, too.

Then the anchor chain broke, and the *Peacock* twisted broadside to the waves. The pounding grew more intense, pumps clogged, crew members struggled on the gun deck in water to their waists. The ship's launch—last hope of escape—was washed away. Then riding high, came a huge Indian war canoe. In two trips, the natives aboard paddled all seamen to safety, but the *Peacock* was gone.

Then there was the *Mindora*, 400-ton coastal freighter, noted for her long wait—28 days—to cross the bar in the winter of 1853. Food and water ran low, mutiny

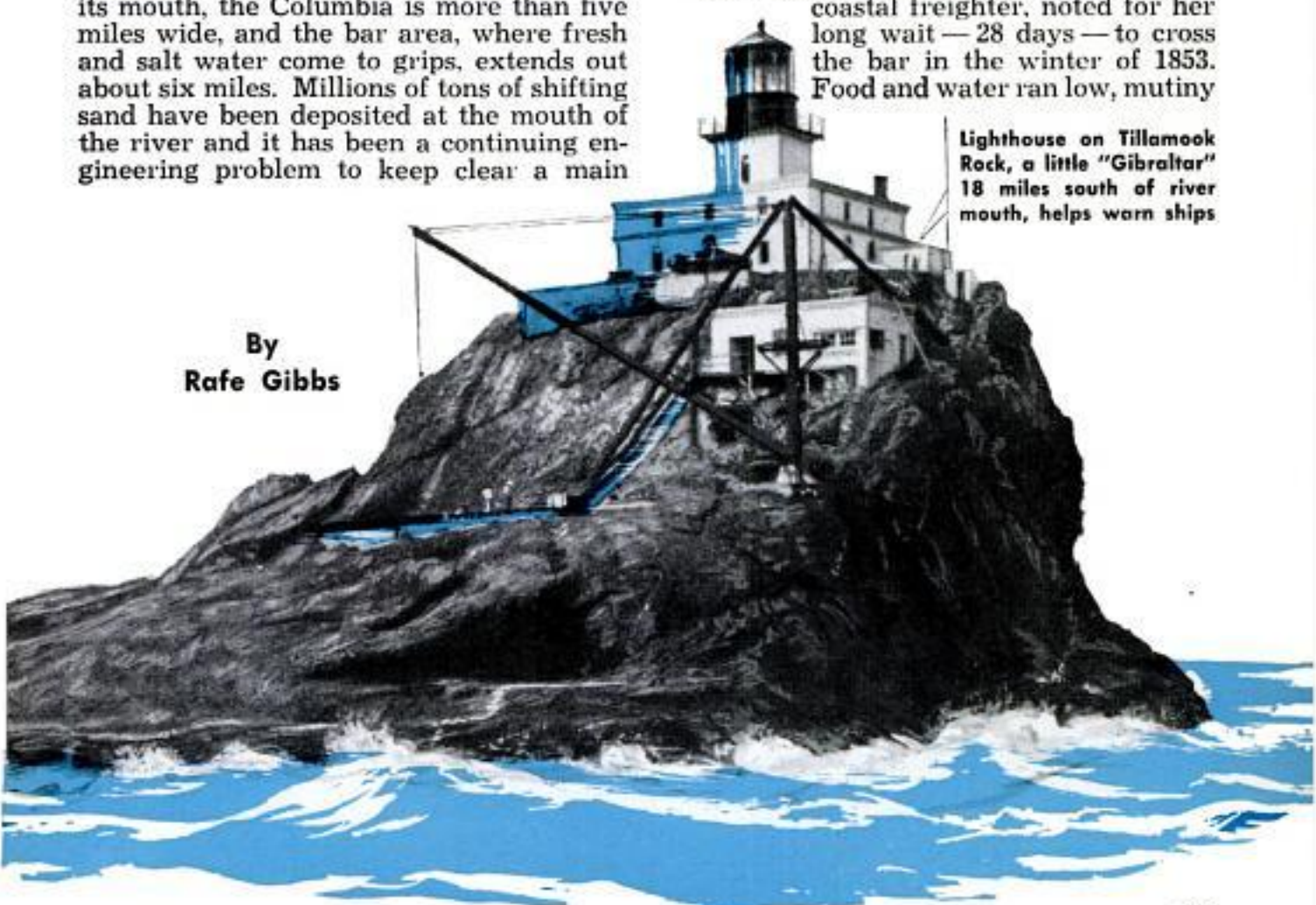

Lighthouse on Tillamook Rock, a little "Gibraltar" 18 miles south of river mouth, helps warn ships

By
Rafe Gibbs



Coast Guard's nonsinkable motor lifeboat *Triumph* stands always ready for action at mouth of Columbia

Below, fresh batteries are lowered into a bell buoy. An electrically operated buoy weighs about 35,000 pounds



threats high. On Jan. 12, a temporary calm prevailed, and the *Mindora* tried the crossing that was her last. Crew members escaped in a lifeboat.

Tragedy marked the crossing of the trader *Industry* in 1865. When she cracked up in a storm, some crew members and eight passengers set off in two rafts. Six of the passengers, including a 12-year-old girl and four crew members, were swept overboard. A fifth crew member died of exposure.

On Jan. 19, 1947, the steamship *Drexel Victory* struck an obstacle that cracked her hull and eventually sent her down. It is believed the obstacle may have been the iron skeleton of an early wreck.

The Coast Guard's *Triumph* helped rescue the crew during the night of the *Drexel Victory*'s demise. But it is the prevented wrecks in which the Coast Guard takes particular pride. "Cheating the graveyard," they call it.

We asked Chief Boatswain's Mate Cathers to tell us of a day with the *Triumph*. But he insisted first on talking about the *Triumph* herself—for good reason. There is only one more like her in the entire Coast Guard, and this sister craft also plies Northwest waters, working out of Grays Harbor, Washington.

Nonsinkable, noncapsizable, the *Triumph* is a 52-foot motor lifeboat, double-planked with mahogany and teakwood for sturdiness. Her frames are of bent oak. Her electronic equipment, including



Coast Guard crew from Port Adams struggles to pull a pleasure craft from rocks and cheat the graveyard

depth and direction finders, is the last marine word. She is powered by an eight-cylinder, 170-horsepower diesel engine. In her are seven watertight compartments—any two of which will float her. On the keel is fastened a seven-ton piece of bronze as a counterbalance.

"She's rolled over 100 degrees in the curl of a breaker—without capsizing," said Cathers.

A day with the *Triumph*?

"Well, I'll try to make short a day that turned out to be a long one," nodded Cathers, downing coffee that would—and did—scald your correspondent. "Early one morn-

ing we went out to Tillamook Rock to service the lighthouse there. There were southeast storm warnings, but not too serious—then. Heading back we got a distress signal from the fishing craft *San Antone*.

"A 70-foot dragger, the *San Antone* was disabled 10 miles northwest of the Columbia Bar. We took her in tow, and started across the bar on the first of the ebb tide. Then the winds came—60 to 70 miles per hour. Gusts up to 80. For three hours all we did was hold our own. We rode out swells ranging up to 40 feet in height. It was 3:30 a.m. when we towed the *San Antone* into safe harbor. We didn't have a

Broken and twisted lumber schooner lies aground in the turbulent waters near mouth of Columbia River

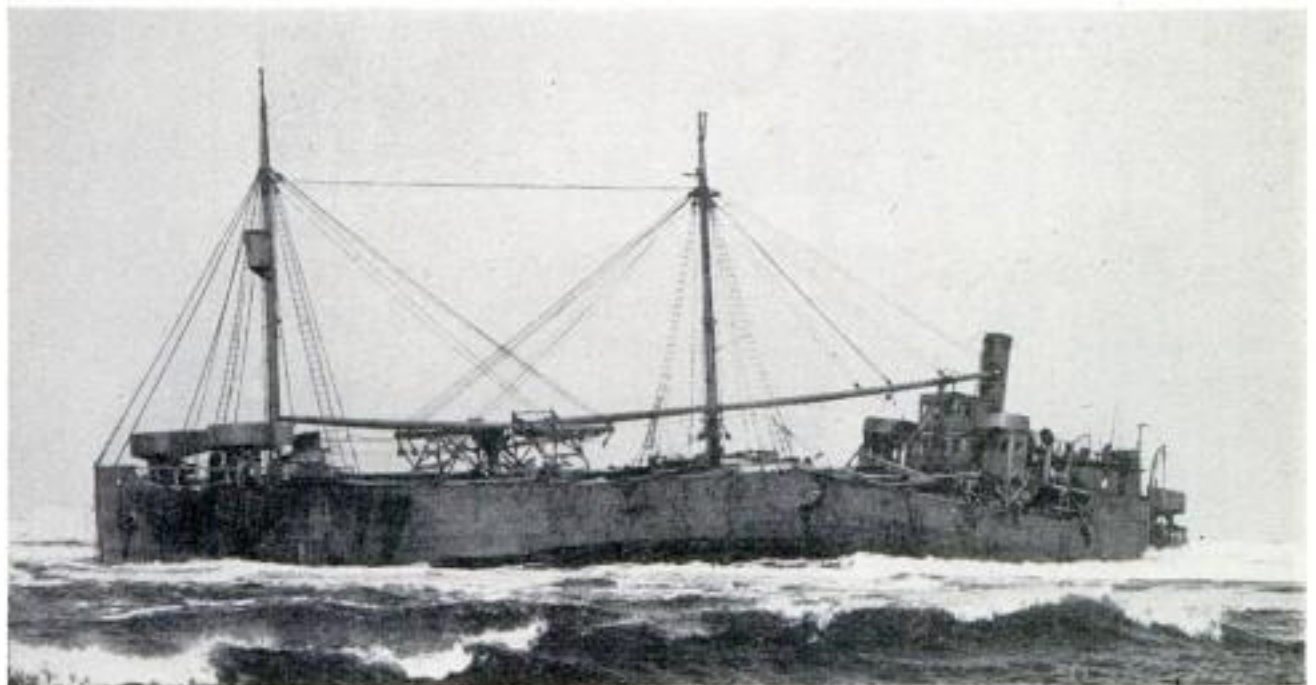



Nine-ton concrete block used in anchoring huge buoys is loaded aboard one of the busy Coast Guard ships

dry stitch on us for more than 13 hours. Say, the coffee tasted good—when we finally got a cup.”

Commercial-fishing boats—and there are hundreds which work out of Astoria—give the Coast Guard the most business. Bigger craft can stand rougher water, and they are usually under the guidance of Columbia pilots who know the bar like an old friend

Radar reflectors placed on buoys can be “picked up” by ship’s radar at twice the distance of ordinary buoy

U. S. Coast Guard photo



or treacherous enemy, as the case may be.

Probably the most red-faced fisherman was the one who got lost in the fog recently while coming into the river on a strong ebb tide, and happily sighted a big vessel ahead of him. For hours, the fisherman kept his boat just behind the other ship. Came the sun, and the fisherman saw what he had been “following”—the Coast Guard’s light-ship *Columbia*, which stays anchored the year-round out in the mouth of the river. The current had been just strong enough for the fisherman to think he was moving.

Then in the summer comes Astoria’s famed Salmon Derby. Several thousand boats a day clog the mouth of the Columbia as fishermen seek the biggest of king salmon.

“A man could almost cross the Columbia by leaping from boat to boat,” said Chief Boatswain R. C. Van Hiene, commander

(Continued to page 230)

Ship’s “skeletons” are washed ashore from the graveyard of ships. This one was once the *Peter Iredale*



Air Force Sergeant Builds Convertible for Son at Cost of \$125

Powered by a motor-scooter engine of four horsepower, a miniature convertible was built by M/Sgt. Charles E. Robinson of Nashville, Tenn., for his eight-year-old son. Total cost of parts was \$125. The frame of the car is made of two-inch pipe, the body of galvanized sheet metal and the radiator grille of heavy wire mesh. It has a 53-inch wheelbase. Top speed is 20 miles per hour, but a governor holds it down to 10 miles per hour when the boy is driving. The gasoline tank holds one gallon, making a full tank cheap even at today's prices!

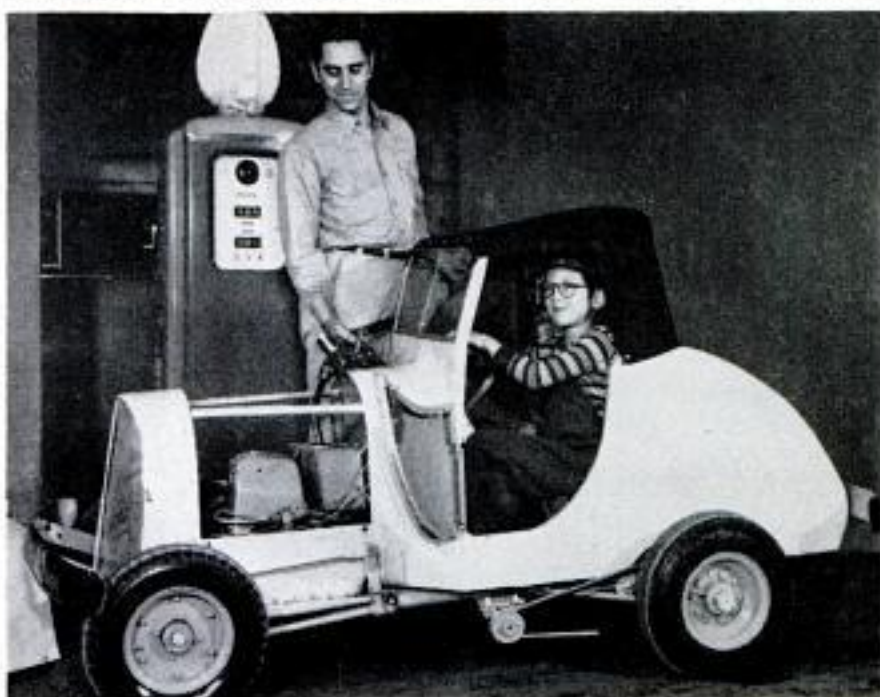

Working Model of Columbia River Steamer Complete to Last Detail

When George Young of Seattle saw a picture of the *Harvest Queen* in Tom Riley's article, "The Sternwheeler Still Rules the River" (*PM*, June 1948), he started work on a six-foot replica of the famous Columbia River steamer. After 13 months he produced an exact model scaled at 1:32 with tiny gangplanks, fittings, berths, boiler and

engine. In the ship's lounge are armchairs, tables and lamps—even a grand piano. Lights go on in the cabins and artificial smoke pours from the stack. An electric motor drives the paddle wheel which can push the craft along at 18 miles per hour. The boat is "moored" before a replica of the old-time Astoria, Ore., wharf.

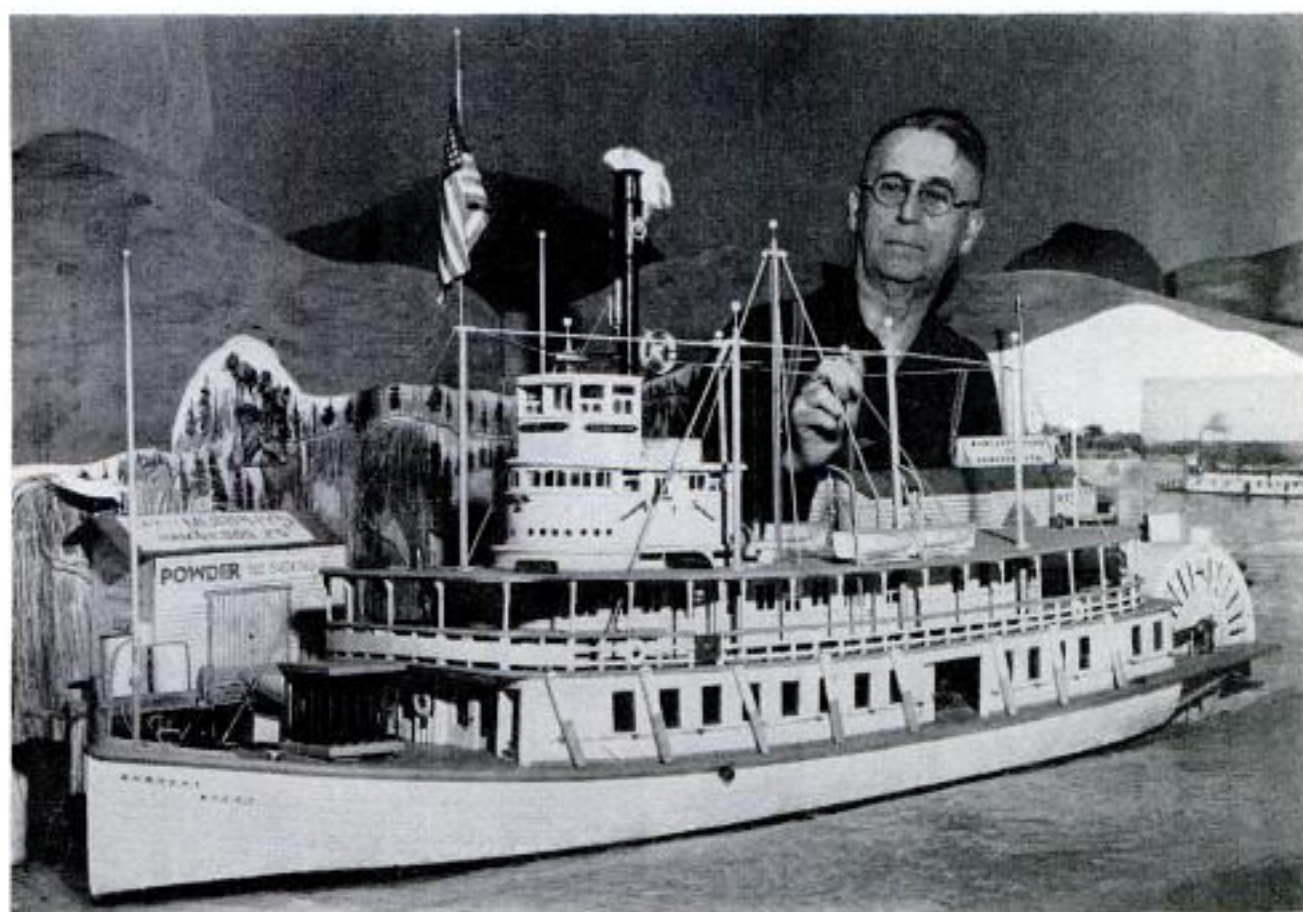

Lumber CAFETERIA

A SELF-SERVICE lumberyard in Van Nuys, Calif., makes it easy for home-workshop enthusiasts to pick out just the materials and tools they need for any job. It's one example of a new kind of business that is springing up around the country.

All types of lumber are stored in open racks, with each kind and grade of wood clearly marked on a placard, together with the price per foot or per piece. On a busy Saturday afternoon (the yard does 60 percent of its business on week ends) you'll find stars of radio, television and the movies mingling with other customers who may have driven 50 miles to make purchases.

The idea got its start three years ago when Ed Goldsmith was placed in charge



Large overhead signs identify the different types of lumber. Gil Mershon, TV singing star and home craftsman, selects some framing material for a cornice

Standard sizes of plywood and other hardboards are racked in the yard, each rack carrying a placard that tells the price. Mershon inspects sheet of plywood

Huge advertisement for the self-service lumberyard dwarfs man who has just purchased a screen door and is carrying it to car in parking lot that adjoins the yard



of retail sales. One of the first things he did was to dress up the small area in the yard office where building sundries were on display. Since then the whole building has twice been doubled in size to accommodate sales that have increased up to 100 per-

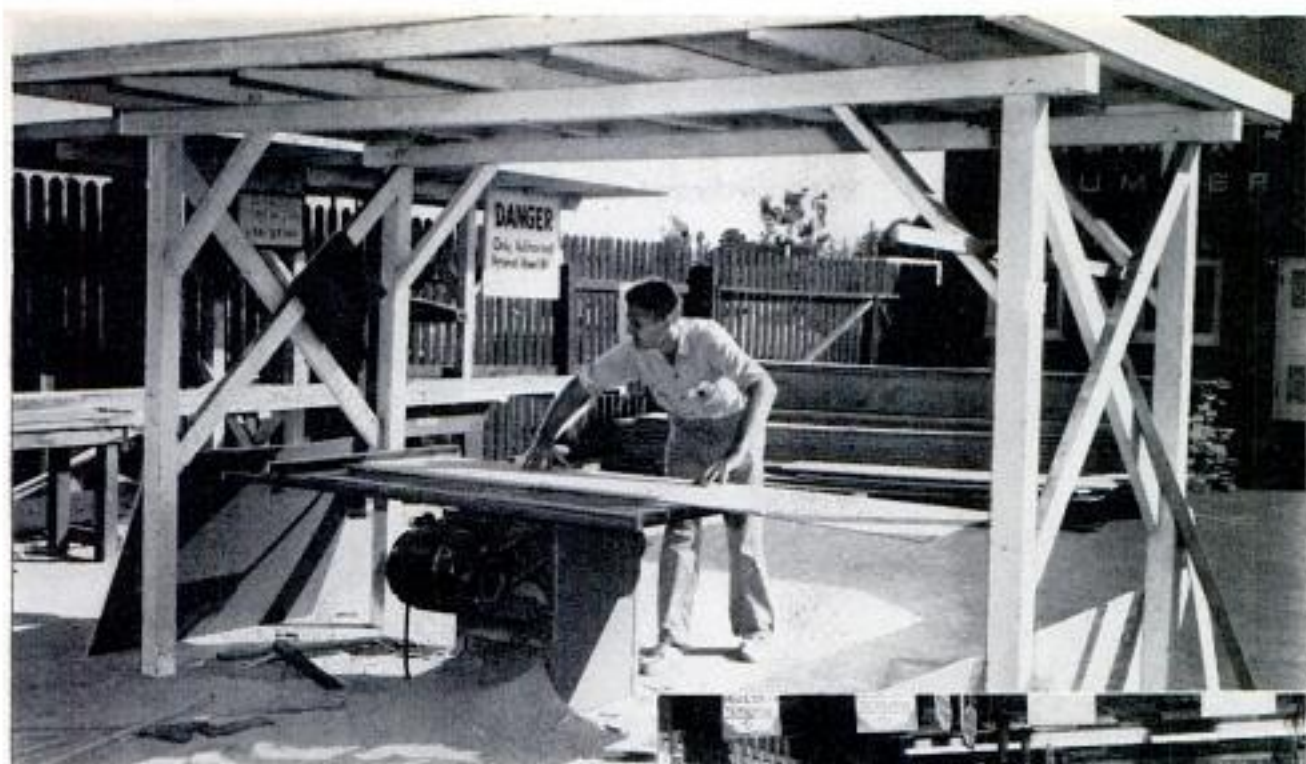

Yard employee cuts lumber to exact specifications of customer. Another employee will itemize materials that you need to install a shelf or build a house

Retail store includes thousands of items displayed in self-service racks and bins. Decorators' corner includes paint, supplies, even adhesive wallpaper

Customers can find the details of almost anything they want to build from *Popular Mechanics* do-it-yourself books and other publications in library



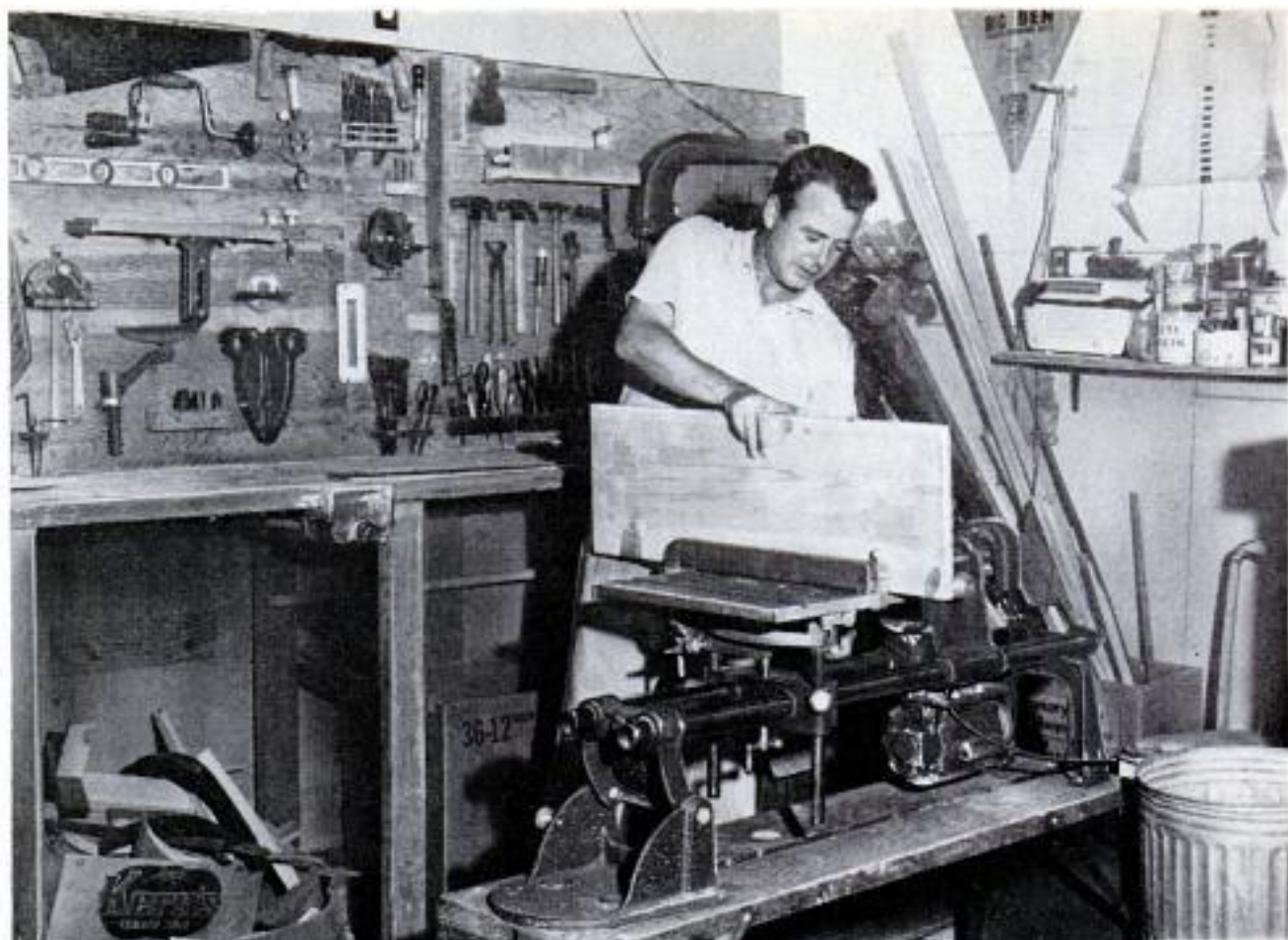

Back home, Gil Mershon prepares to shape some wood he bought at the self-service lumberyard

Spare-time craftsmen like Mershon are clients of the lumber cafeteria



cent every few months. The whole yard has been revamped to cater to its home-workshop trade. Now Goldsmith finds that space is running short once more.

If you visit Neiman-Reed you'll find an attractive retail store with thousands of items displayed on self-service racks and bins. Complete lines of electrical and plumbing supplies are on view, as are

paints, garden equipment, power and hand tools.

Out in back, near the racks on which lumber is stacked, is a "bargain pile" of scrap wood that once had to be burned. In it you may find just the small piece you want, priced at a few cents. Out in back, too, is a big table saw on which a yard man will trim your purchases to the exact size you need.

Ed Goldsmith attributes the fantastic growth of the self-service lumberyard to three kinds of service in particular. One of these is the library corner where

Popular Mechanics do-it-yourself books and similar publications are loaned and sold. Here a customer can find necessary construction details.

If he needs still more advice he can get all he wants, free, from a builder who is on duty every week end. The third service concerns hours. The yard is open on Saturdays until 5, on Sundays until 2.

It is estimated that home-workshop enthusiasts spend half a billion dollars a year on their hobby, and Ed Goldsmith is ready to believe it. ★ ★ ★



Depositor signs withdrawal slip on telautograph. Signature is duplicated by similar unit at main bank



In main bank, 40 blocks away, depositor's card is placed under the lens of closed-circuit TV camera

TV Links Bank and Branch To Speed Operations

Closed-circuit television, a telautograph, and an intercom system link a branch office with the New York Savings Bank. Bank officials say that the hookup cuts personnel requirements, 25 percent of the operating costs and half the floor space that would ordinarily be needed by the new branch bank. The telautograph allows you to write your name at the branch office and have it duplicated by a writing machine at the main bank. Signatures and balances recorded at the main bank are photographed with a television camera and the picture sent by coaxial cable to a receiver at the branch bank for checking.

Picture of depositor's card appears on television screen at branch office. Teller compares signatures



Quickly Erected Portable Grandstand Will Seat Nine Spectators

For field trials and events held where there are no stadiums, a portable grandstand devised by an English family may be the answer. Nine persons can be seated on its three levels. The device can be carried in a station wagon and erected in a few minutes.

Silicon Transistor

Silicon instead of germanium is used to make a transistor that should solve a pressing heat problem in airborne electronic equipment. Germanium transistors can't resist the heat of conventional vacuum tubes in such compact installations. Silicon is also far cheaper than germanium, which costs \$500 a pound. Not yet in production, the indium-coated silicon transistor, developed by Philco, must wait until improvements can be made in silicon refinement.



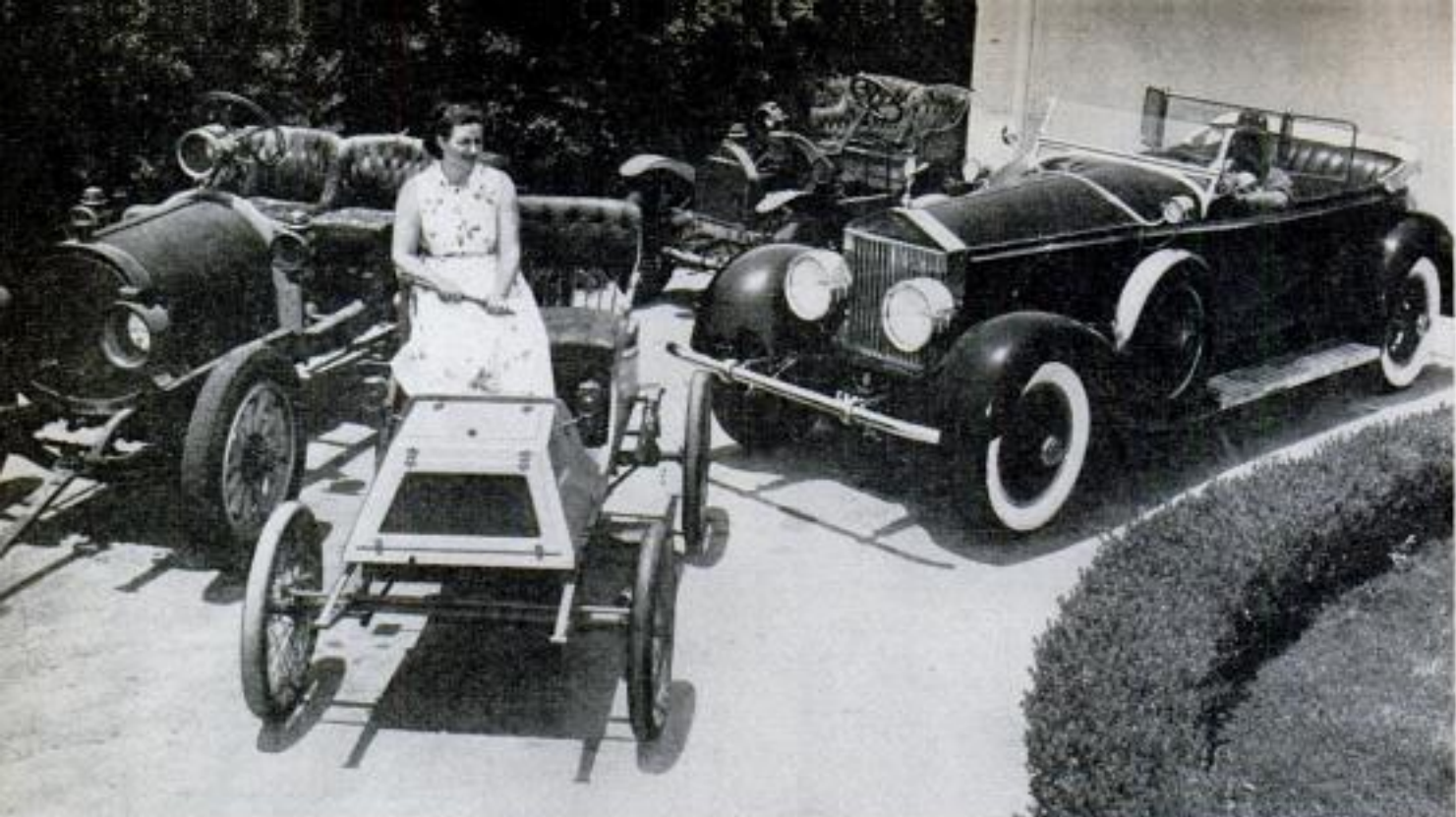

The author's wife holds the tiller of a 1900 Tuckermobile. Other cars: Pope Hartford, Brush, Rolls Royce

RESTORING ANTIQUE CARS IS MY HOBBY



Presently the author, Frank Stokes, is working on a 1913 Pope Hartford. It has a 35-horsepower engine

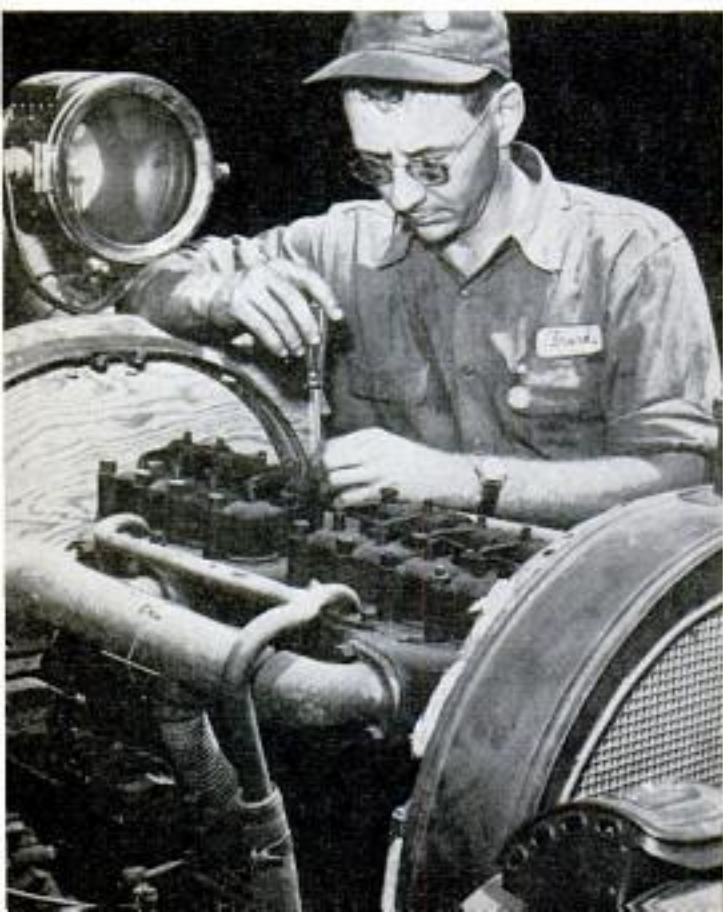

By Frank Stokes

As told to Andrew Hamilton

AS THE OWNER of a small orange grove in Covina, Calif., just about 25 miles east of Los Angeles, I do a lot of swapping with other citrus growers. One day in 1944, while trading some farm equipment, I acquired four 30 x 3½ tires. I couldn't use them, so I advertised them for sale.

Next day when a man bought them without haggling over price, I was curious.

"What are you going to use those skinny little tires on?"

"Got a 1910 Brush," he replied. "These will fit perfectly."

I didn't realize it, but the antique-car bug bit me right then. A couple of weeks later, I found a 1906 two-cylinder Buick for sale in a Claremont garage for \$150. It was in pretty bad shape, but I hauled it home on a trailer. During the next few months I found a good radiator, had some fenders made and replaced the tires. I was hooked—good.

Since the end of World War II, the hobby of owning and restoring antique cars has snowballed. ("Antiques" are usually considered of pre-1915 vintage.) Today there

are about 3000 old-car fans in the United States and 300 in southern California where I live—perhaps the most active center in the country.

It used to be that antique-car collectors were mostly well-to-do personalities but today you'll find them on all social and economic levels.

Most antique-car fans belong to one or more of the three largest clubs—the Horseless Carriage Club, the Antique Automobile Club of America and the Veteran Motor Car Club.

These clubs are valuable because they publish magazines with information about old cars and parts suppliers and sponsor meetings at which you can get acquainted with other hobbyists and hear talks by old-time auto builders. In addition, they sponsor trips in antique cars.

The Horseless Carriage Club each summer runs at least one long week-end trip—to San Francisco, to San Diego or to Riverside and Long Beach. Our club also meets once a year for an annual field meet—where cups are awarded for the best restored cars and races are held.

But the biggest thrill I get out of the hobby is fixing the cars up—nursing an

old piece of junk back to the proud status it once enjoyed. In the past 10 years, I've had about 25 old cars—including some dimly remembered names like Pope Hartford, Flanders, Metz, Overland, Burtnett-Brunell and Saxon, and more famous ones like Model-T Ford, Stutz and Pierce Arrow.

One of my most interesting cars was a 1911 Cadillac that I picked up for \$400 along with a 1917 Franklin. I traded the Franklin to another collector but the Cadillac I kept. Then, the Cadillac wasn't the prestige car that it is today, being outranked by Locomobiles, Pierce-Arrows and others. But with a coat of Brewster Green paint, the upholstery refurbished, brass lamps polished, a new set of tires and a new top on it, the Cadillac was a Queen of the Highways.

Another interesting antique of mine, believe it or not, is a Tucker. This one was built about 1900 by J. O. Tucker of Santa Clara, Calif., and it bears no relation whatever to the ill-fated Tucker car of the post-war years.

J. O. Tucker built exactly six Tuckermobiles and the curator of the Los Angeles County Museum has helped me to establish the fact that mine is No. 2. It looks like a

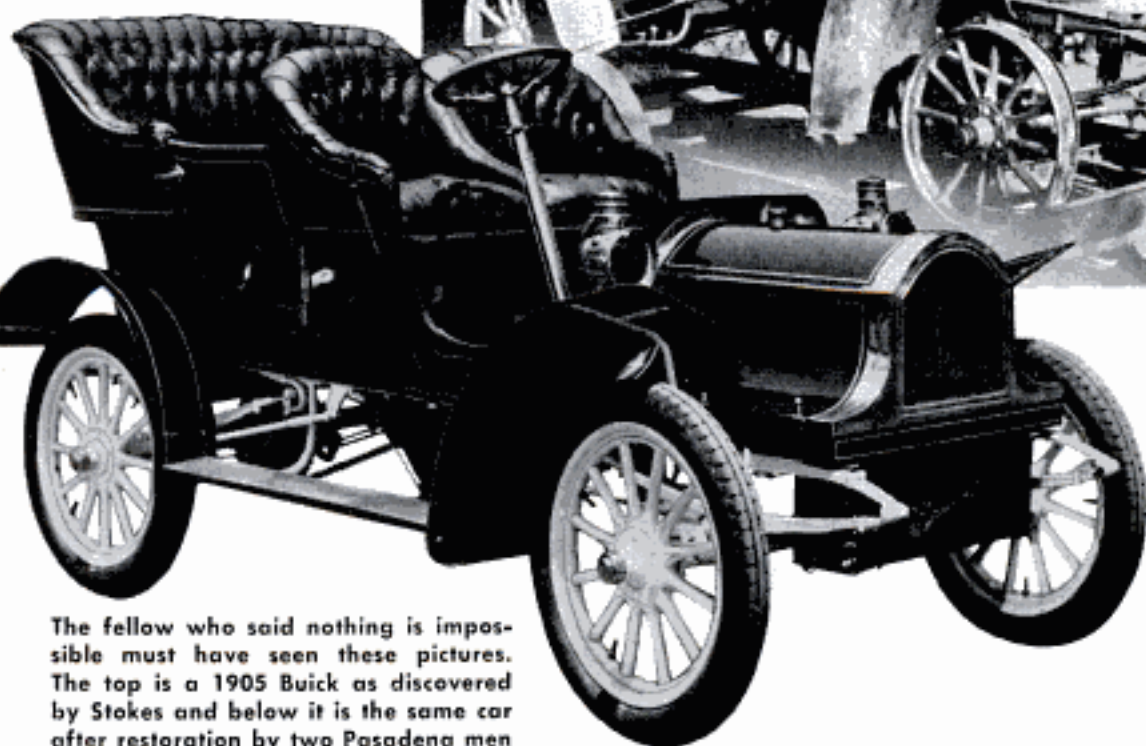
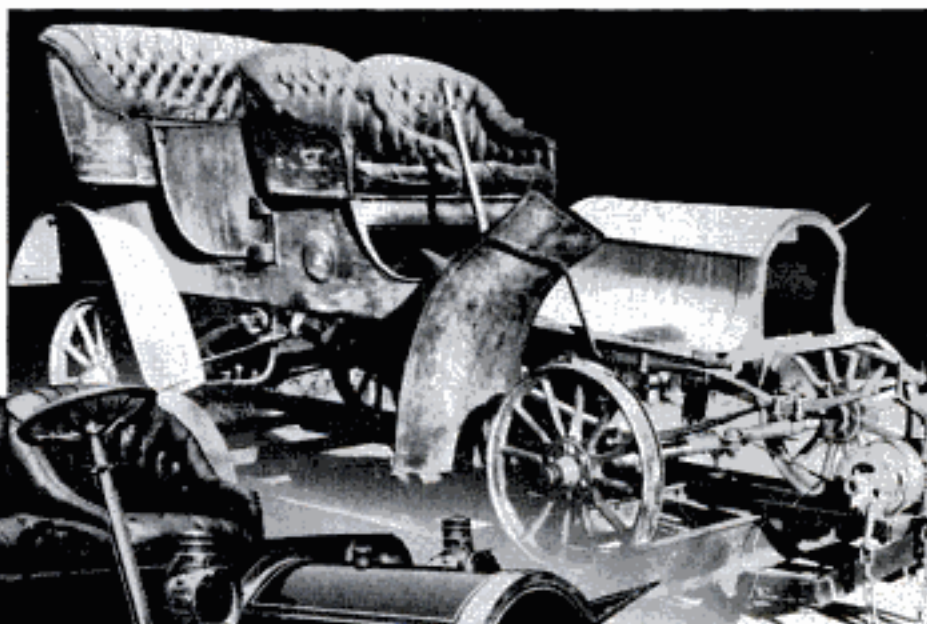

The fellow who said nothing is impossible must have seen these pictures. The top is a 1905 Buick as discovered by Stokes and below it is the same car after restoration by two Pasadena men

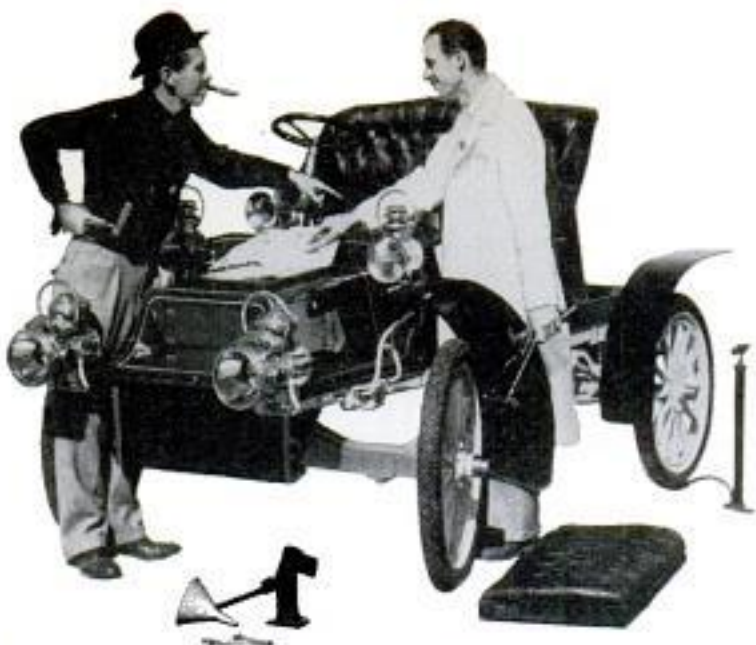

Two hobbyists discuss the restoration of a 1904 Cadillac

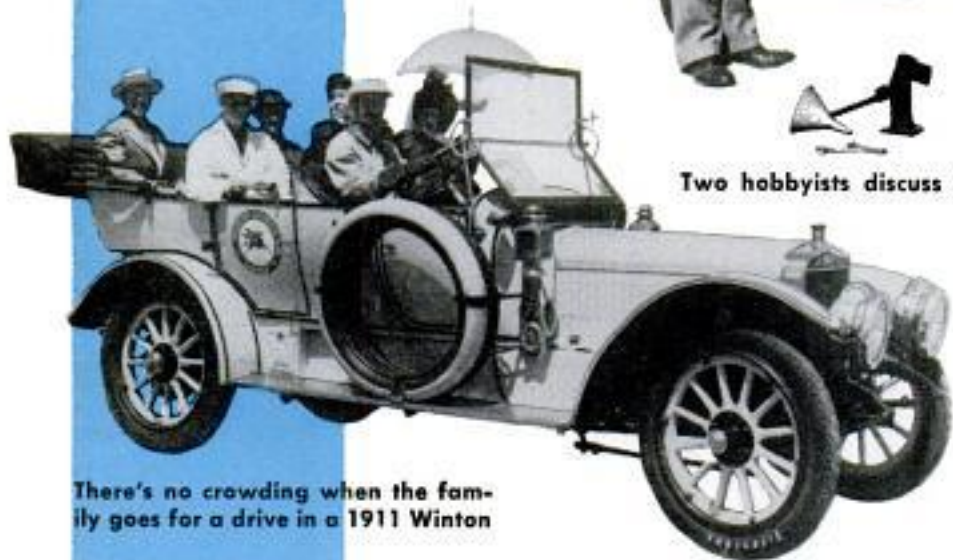

There's no crowding when the family goes for a drive in a 1911 Winton



The author and his wife, wearing the styles of the year, pose in front of their 1911 Cadillac



Model T Fords, like the 1914 model, are popular with collectors because so many are still around

real "horseless carriage"—with a 5-horsepower, two-cylinder opposed engine under the seat, a tiller instead of a steering wheel and a crank on the side. It passed through several hands before I bought it from a dealer in Long Beach for \$350.

A recent trend in old cars is the sudden popularity of what are called "classic cars"—roadsters or touring cars built in the period approximately 1925-1942. They include such proud old names as Rolls Royce, Pierce-Arrow, Lincoln, Cadillac, Duesenberg, Stutz. The Classic Car Club of America was organized recently and already has nearly 1000 members.

About three years ago, I picked up one of these "classics"—a 1929 Rolls Royce Ascot Sport Model Phaeton, which originally sold for \$25,000. The previous owner had spent \$1500 trying to get it back into good running shape, but he hadn't relined the brakes properly, had left some parts out of the carburetor so that it coughed and sputtered and couldn't make more than 45 miles per hour. He had put the steering assembly together wrong so that it turned only to the left.

After I'd taken this Rolls off his hands, I tore it apart and reassembled it. I had been afraid that the aluminum head was pitted (it will do that unless you use distilled water), but it wasn't. The motor was in excellent shape. But I did have to write to the Rolls Royce headquarters in England for new parts and exploded views of the carburetor. The one-shot lubrication system was fouled up. But all that was wrong with the steering assembly was that the Pittman arm was hooked up wrong. It now runs perfectly.

When you fix up an antique or classic car, you can figure on putting out up to \$1000 or more—depending, of course, on what shape it's in and how much of the work you do yourself. But most antique-car hobbyists look upon this not as an expense but as an investment. You can realize much if not all of your money out of the deal any time you want to sell or trade—and antique-car fans do a lot of both.

An antique-car fan usually specializes in one or two

kinds of car restoration. My particular bent is mechanical and I like to repair motors. Some like to do the leather-upholstery work, some like to cast hard-to-find parts, some like to paint. Very few are skilled in all phases of restoration. So when one of my cars needs painting or upholstery, I send it to a member of the Horseless Carriage Club who specializes in that sort of thing. A hobbyist himself, he'll take infinitely more pains with the job than a regular commercial outfit with no knowledge of or love for ancient cars.

Here's a rough idea of some of the prices you'll have to pay for having old cars restored: Motor overhaul, at least \$200; new upholstery in the diamond-shaped, tufted-leather patterns of bygone days, \$200-\$250 for a roadster; new top, \$100; tires, \$200-\$250; new radiator, \$100; body work and fenders, \$50-\$100; painting and striping, \$150 or more; miscellaneous items like brass acetylene lights, rubber-bulb horn, etc., \$50-\$75.

An antique or classic car will be in better shape after a complete overhaul than the day it first rolled out of the factory. Why? Because the parts will be made out of better metal, the motor will be dynamically balanced, it will be using better grade oil, the paint, upholstery and tires will be of better quality. Because today's gasolines just don't digest well with the old-type carburetor and manifold, many antique-car hobbyists put modern carburetors and heated manifolds on the old cars. This is considered "ethical" if you bolt them on so that the original parts can be easily put back whenever desired.

How good a rebuilt antique can be is

One of the early nickel jitneys was a 1914 Ford. It is still taking trips with the auto hobbyists





Amidst smoke and clatter, Mr. and Mrs. Stokes race a 1905 Buick and 1910 Maxwell in the 1900 Tuckermobile

illustrated by what happened at Corona, Calif., not long ago. This little community, surrounded by a three-mile circular track (now a paved street), was once the site of some famous road races in which Barney Oldfield, Ralph DePalma and other racing greats competed.

In a recent reenactment of these races, some ancient cars were being paced around the track by a 1953-vintage police car. One of the drivers, at the wheel of 1908 custom-built race car, just couldn't resist the urge. He stepped on the gas and roared ahead of the police car. It never did catch him.

Because of the recent popularity of restoring old cars, the antique buggies are getting scarcer. But you can still find rare specimens of the 2700 models that have been manufactured by American auto makers since the turn of the century, some of them in surprising places—on old estates or on farms where storage space exists. And there's nothing that excites an antique-auto fan like the rumor of a stored car.

Why do people become antique-car hobbyists? The reasons are many and varied: Some people get a creative kick out of breathing life into a chugging, clanking monster; some like the fascinating history that is wrapped up in these old buggies; some enjoy the attention it brings them

when, clad in goggles and linen duster, they proudly drive a 50-year old car down a modern highway.

You'll find that the general public is keenly interested. On the highway, you're a marked object. Cars give you plenty of room even though some of them shout good naturedly, "Get a horse!" You can't leave an antique car parked for one minute. People will steal your horns or headlights, kids will get their sticky fingers all over the brass and nickel work and there's one species of human being that loves to give your hood a resounding whack with his fist and announce, "They don't make cars like this any more!"

Every antique-car hobbyist has a gleam in his eye—like the mountain climber contemplating an unscaled peak, the fisherman who knows about a pool where the "big ones" lie, or a garden enthusiast who has just planted a new species of dahlia. The lure of any hobby lies in work yet undone.

In my barn I've got the remains of an old Pope Hartford with a custom speedster body. It cost \$3000 new in 1913 and is just like the Pope my Dad had for his first car. I hope to pass it on some day to my son (now three years old). He'll have a car that will scorch down the highway at 80 miles per hour and make other drivers sit up and take notice!

★ ★ ★



Carriage body lifts out and is carried by strap handles. Bottom can be folded or loaded with heavy packages

Two-Part Baby Carriage Divides to Carry Groceries or Parcels

Versatile is the word for a German baby carriage that separates into two parts for special uses. The carriage body can be lift-

ed out of the frame and used as a market basket. The carrying frame can be folded or used to carry bags and cases.

Atomic By-Product Gauges Irrigation

Radioactive rubidium—an atomic by-product—tests the efficiency of irrigation on Hawaiian sugar plantations. Rubidium is introduced into the irrigation lines and is carried by the water to all parts of the irrigated area. A radiation counter is used to determine the amount of rubidium absorbed by the soil at any one point in the field. The method, by determining how much irrigation water is absorbed by the soil, also measures the distribution of fertilizers introduced into the irrigation system.



Bedside Air Conditioner Purifies, Cools and Dries Air



Wheeled to the side of a patient's bed, an air conditioner for hospital use feeds air directly into a transparent-plastic canopy about the patient. In addition to supplying extra oxygen to seriously ill persons, the machine relieves the distress of various kinds of respiratory cases. Temperature, humidity, purity and oxygen content are controlled. Fully automatic controls maintain a steady supply of clean air or oxygen, which is water-screened as it passes through a sealed cleaning chamber. A sturdy refrigeration unit keeps the air at a constant temperature, and a specially designed evaporator unit removes excess moisture from the air. Transparency of canopy prevents a shut-in feeling.

Inside Windshield Wiper Anchored to Suction Cup

If you've ever wished for a windshield wiper that cleans the inside of your windshield of mist or steam, a California manufacturer has the answer. It's a hand-operated wiper with the arm attached to a suction cup. Only seconds are required to take the wiper from the glove compartment and attach it to the windshield. The metal parts of the wiper are chrome-plated; its total length is 12 inches. The wiper squeegee can be detached and used to clear back and side windows inside and out.

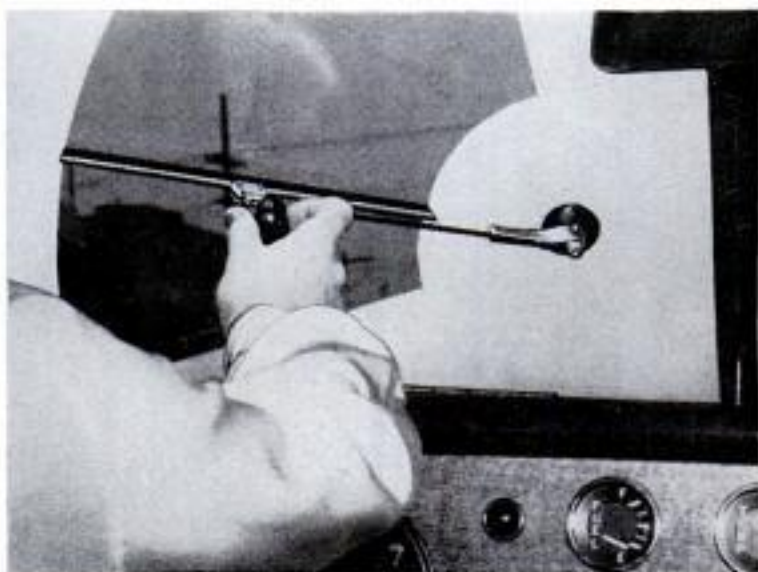

Airborne Baby's Berth Suspended From Wall

Comfortably situated in a wall berth next to his mother, the infant tourist aboard a trans-Pacific airliner finds that traveling isn't much different from nursery life. Two sturdy hangers on one side and an overhead arm supporting the opposite side hold the airborne cradle firmly against the wall. Result is a more pleasant trip for both mother and child. Installation or removal of the cradle is easy.

☐ Antibiotics added to the fillings of tooth cavities help prevent further decay, according to a report given before the American Dental Association.

Auto Penthouse Will Sleep Four

YOU DON'T have to be rich to live (temporarily, at least) in a penthouse that perches atop an automobile. Designed to sleep four in comfort, the canvas-sided cabin folds into a unit low enough so you can drive into your garage without having to take it off the car. Opened up in five minutes or less, it has four bunks, storage space for bedding and clothing and four screened windows for light and ventilation.

No great strength or skill is required to fold and unfold the cabin and, according to the maker of the cabin, a woman can operate it as easily as a man.

The two ends of the cabin are of lightweight water-resistant plywood. The bunks are of canvas. The two sides are also canvas. When opened up, the unit has considerable rigidity. There is a ring on each corner of the top to which guy ropes can be secured in case of a severe windstorm.

The forward end of the cabin is supported on the roof by nine suction cups. The rear end is held up by tubular brackets that clamp to the bumper. They do not interfere with access to the trunk.

A canopy is available to be attached to the rear of the cabin at ground level to provide a cooking and eating enclosure.



You can drive into your garage with the cabin in place on roof. When you store it, it hangs from the garage rafters above car.



To set up cabin, you remove the ladder from its special storage compartment, climb up and raise roof by unfolding plywood ends.



Ladder has a safety handrail. Door of cabin opens onto a small stoop. Canopy at rear provides an enclosed area for cook. Food is stored in trunk of car.

WHAT'S NEW FOR Your Home



- 1. RESERVOIR** for steam iron that weighs only 2 $\frac{3}{4}$ pounds attaches to edge of ironing board, holds 40 ounces of water and feeds it to iron for two hours of steady ironing. Constant supply assures full steam at all times. Removing tube converts iron to dry operation



- 2. PICKUP CORD** permits children to retrieve cups and toys they have tossed away. Two-foot cord anchored to suction cup checks toy's fall just short of floor

- 3. HAT HOLDER** protects shape of hat when it's not being worn, prevents the rim from becoming dented or curled. Pocket in center of the plastic rack holds gloves

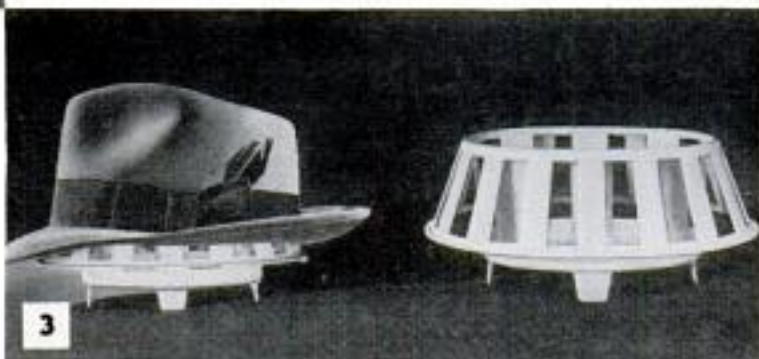

- 4. FEED-DOWN RACKS** in door of vertical home freezer store various-width food packages like bars in a candy machine. As bottom box is removed, next drops into place. Door holds 96 packages of food, 20 cans of juice concentrates

- 5. ELECTRIC FRYING PAN** cooks foods at exactly the right heat with aid of thermostat. Proper dial settings for various foods are listed on handle. Pan can be set on the table





6

6. ADJUSTABLE GLIDE levels tilted furniture, allowing jammed drawers and doors to open easily. Upper shaft is driven into leg and the proper height obtained by twirling an adjusting nut.

7. WALL REFRIGERATOR stores food at handy height, has magnetically sealed doors, partial thin-wall insulation. Refrigeration mechanism is in the top. Model is experimental, not in production.

8. KNIFE SHARPENER also buffs tarnished silver. Pressure on lid of motor spins shaft on which are mounted sharpening and buffing wheels. Plastic guard covers one wheel when other is used.

9. PLUNGER clears drains entirely by suction instead of forcing stoppage further down in pipe. Rubber cup rests on plate with hole in center. Valve drops over hole when cup is depressed.

10. CANDLE CARBURETOR assures a steady, smokeless flame. Coil around wick causes air turbulence for maximum efficiency. Glass guard stops drafts and dripping, smotherers flame in candle stub.

10



7



8

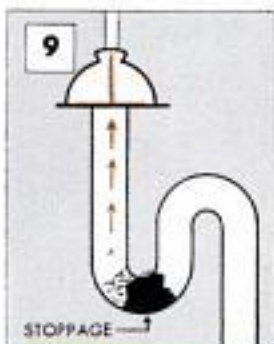

9

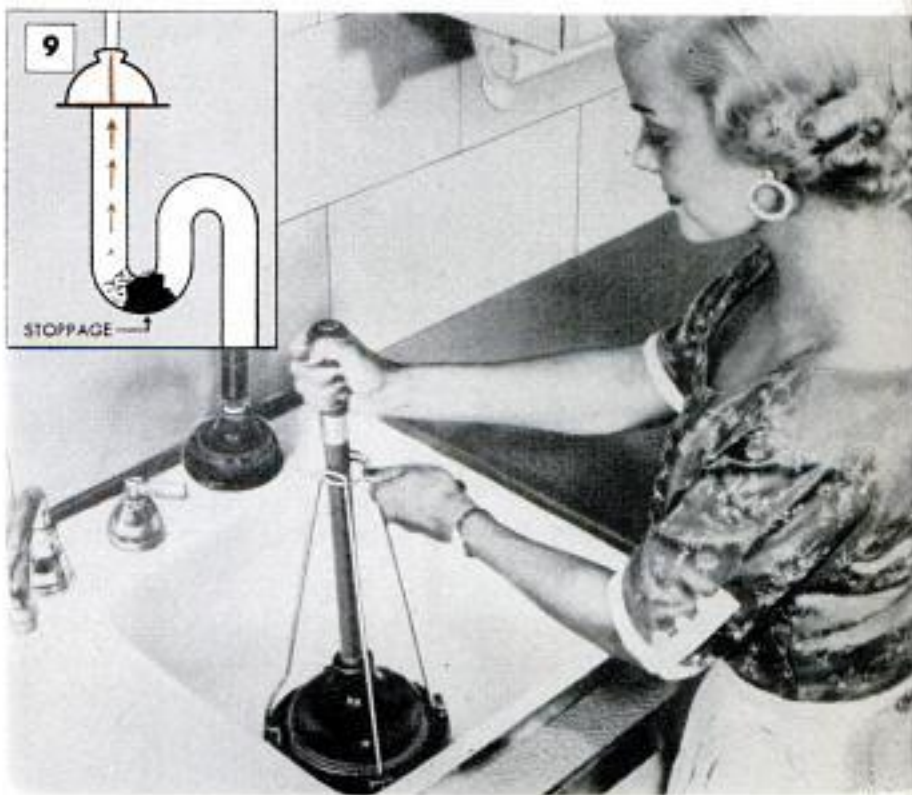



Architect's attractive home on hillside lot seems to float on air but actually rests on sturdy steel beams

Three 32-foot-long tapered I-beams support the house. They are partly buried and anchored in concrete caissons. Trench under beams is for long retaining wall

Photo by Julius Shulman

House Suspended in Space Rests on Tapered Beams

William Alexander, California architect, solved the problem of his sharply sloping hillside lot by building a studio-home with no vertical supports. The house is suspended in space and supported by three steel I-beams that taper from three feet to six inches. Tail ends of the beams are bolted and welded to steel plates set in 22-foot-deep rock-cut caissons filled with concrete. Almost a third of the beams are buried underground. A 60-foot retaining wall of reinforced concrete braces the hill from which the beams protrude. Floor supports made of 2 by 16-inch wood joists span the girders and extend eight feet on each side. Interior finish includes cork floors and plywood walls and ceilings.



Roller-Welder Unit Does Work of Seven Spot-Welding Machines

While the work remains stationary, a specially designed roller-welder zips around the work to make circular welds at greatly lessened cost and time. Built at a cost of \$14,000, the device replaces seven spot welders costing \$49,000 and cuts the cycle time from 4 hours to 45 minutes in welding seams on an exhaust cone for a jet engine. It requires only one operator against the seven needed for the spot welders. The upper electrode, carrying 14,000 amperes, revolves around the work; the lower electrode is mainly an air-operated clamp.

Four tons of earth must be moved for every carat of diamond mined.

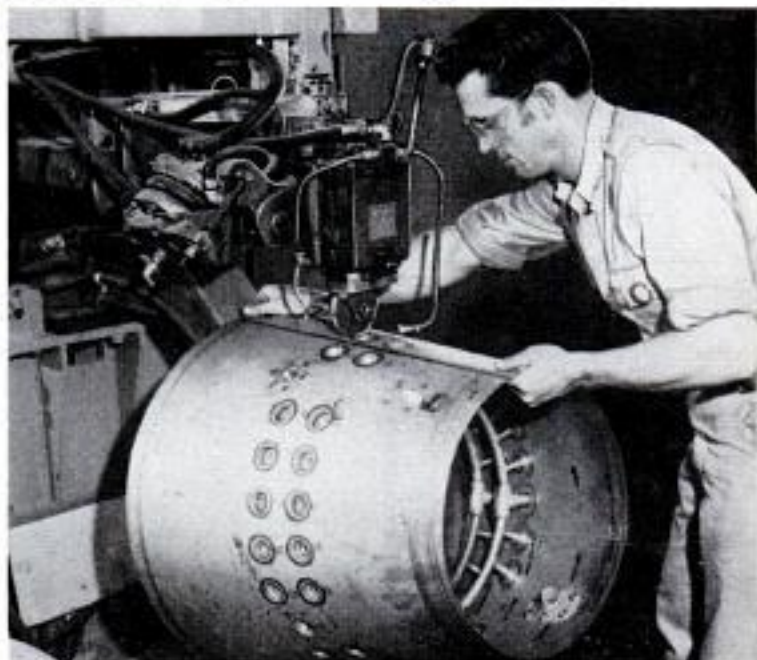



By A. B. Kennerly

IF YOU LIKE to work in the woods and have the patience to wait for cash-producing trees to mature, then the business of growing and managing a forest is the business for you.

An excellent market is waiting for you. The pulpwood industry alone needs more than 14,000,000 cords of pulpwood every year to keep paper plants supplied in the South. Everything points to an increase in the need for pulpwood in the future according to Southern Pulpwood Conservation Association. In fact the pulp and paper industry now ranks among the leading businesses in the South.

Forest managers can make a good living from the sale of products from the forest, especially with the start of a good timber stand. Many operators have set aside a tract of timber from which they expect to derive college funds for their children.

You can make a start by acquiring and developing a timber tract. Earnings will start the first year if you can afford to buy a tract with merchantable trees. Your alternative is to buy abandoned farm land to start a new forest.

The minimum acreage you will need depends on whether or not you will work in

the forest yourself, and what profits you expect from it. A safe minimum from which to figure is about 160 acres per man. Since one man can hardly work in the forest alone, but needs a helper for sawing and other kinds of work, the smallest tract should be 320 acres.

The other factor in determining the size of your operations is the amount of return you expect. You can safely figure a net return of three to four dollars per acre per year. Two sections (two square miles) are not unusual in forest holdings and could return as much as \$5000 a year.

Patience required is borne out by figures which reveal the rate of growth of saw logs. From time of planting to age of 25 years, pine trees will grow to a diameter of 10 inches and will contain about 32 board feet of lumber. But during the next six years these same trees will grow to 12 inches in diameter, and will contain 60 board feet of lumber, or just about double the yield. Obviously, it would not be good business to cut the tree at 10 inches, then wait another 25 years to accomplish what could be done in another six years by waiting.

The surprising thing in timber management, however, is that by waiting still



Small trees culled from timber tract in thinning can be cut into posts, and there's a never-ending demand for them in farm areas



Small operators usually air-dry their lumber before marketing it. This lumber will be planed to finish it, then sold either direct to a customer or shipped to a lumberyard. Below, the use of forest lands for grazing can be another source of profit



another six years, the number of board feet will again be doubled. Trees that had 32 board feet of lumber at 25 years will now have four times that amount or 125 board feet at 37 years, according to the Texas Forest Service.

Since the average operator cannot or is unwilling to wait so long for returns, the obvious thing to do in good timber management is to sell some and save some.

This calls for partial cutting in the timber tract every few years. "Partial cutting of timber is like making withdrawals from a savings account," suggests the Southern Pulpwood Association. "A portion may be withdrawn whenever needed, and the remainder continues to bear interest in the form of growth."

It doesn't pay to harvest trees for only one product. The tallest and straightest trees usually bring the most money when sold for poles. It would be foolish, therefore, to sell them for pulpwood. The next in quality sell for saw logs and veneer blocks, and the remainder for ties, pulpwood and fence posts.

The value of the pulpwood market is mainly for cash income from what otherwise would be a waste product. During the development of a forest it is necessary two or three times to thin the stand in order for trees to have room for growth. It does not pay an individual to grow timber altogether for pulpwood. The price it brings does not offset the cost of bringing it up to a pulpwood stand. But with the main income being derived from poles and saw logs, the sale of thinnings and saw-log tops for pulpwood brings income from parts of the forest that could not be sold before pulpwood markets were developed.

The more processing the timber owner can do to his harvest, the greater will be his profit. Many owners of timber land rig up small sawmills to cut the logs into boards. The boards then are air-dried and either processed still further by planing, or they are shipped to big mill operators and lumberyards.

Small trees cut from the timber tract in thinning can be sold as fence posts. Such posts usually are shipped to a commercial treat-



Timber can be cut and then sold as is, but the timber owner who also has a small sawmill can boost his profits. He then can offer semi-finished or fully processed lumber to customers or yards

ing plant where they are processed to minimize moisture absorption and lengthen their life. Every farmer in the area is a potential customer.

Logs which are too rough to be worked into finished lumber can profitably be cut into railroad ties. And another good source of income to the owner of a timber tract is the using or leasing of forest land for grazing. Timber tracts will not support the

beef production of good pasture land, but the grass is there and might as well be turned into a profit. Timber owners who don't want to go into beef production may lease their land to neighboring farmers.

For the investor who wants the highest return on his money in the shortest possible time, the best opportunity offered in forestry is the purchase of 25-year-old stands of timber. These would average about 10 inches in diameter. Such timber with 100 trees to the acre would have a timber value of \$96 an acre figuring stumpage at \$30 a thousand. In 12 years the trees will have grown to the extent that they would be worth \$375 an acre, giving a return of about 32 percent each year.

While money may not grow on trees, a good forest manager can get a lot of money out of trees. ★ ★ ★

Hinged Wings on Automobile Mirror Increase Rear Vision

Two hinged wings that attach to the existing rear-view mirror provide the driver with a wide-angle view to the rear and eliminate dangerous blind spots in that direction. The hinged principle enables the driver to adjust the two smaller mirrors for maximum view, not only to the rear but also on each side. No tools are required to install the device. It is also said to be a boon for the driver who is trying to watch the actions of children in the back seat.

☐ Africa's first television station, opened in December, is located at Casablanca, Morocco.



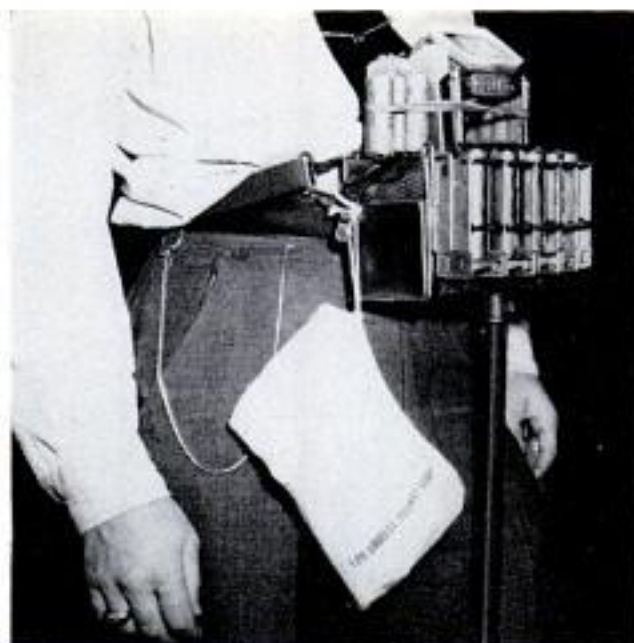

Los Angeles Bus Loaders Use "Pogo-Stick Fare Boxes"

Popularly called "Pogo-stick fare boxes," a new type of collection box is being used by traffic loaders for Los Angeles buses. Traffic loaders are at busy stops to collect fares from riders before the buses arrive. Strapped to the waist and supported by a steel post, the unit consists of a fare receiver box that empties into a sealed safe, and a money changer. It has separate compartments for transfers and zone tickets.



Balloon-Type Seat Cushion Folds to Fit Shirt Pocket

You can tuck a new inflatable seat cushion into your shirt pocket for carrying. No larger than a pack of cigarettes when deflated, it is blown up like a toy balloon to form a comfortable, attractive, full-sized pillow. Sport fans, tourists, automobile drivers and servicemen find it suits their many needs. The pillow is made of tough, durable plastic for long wear and is available in solid colors or plaids.

Pressured Fluid Forms Tight Seal Around Supersonic Wind Valve

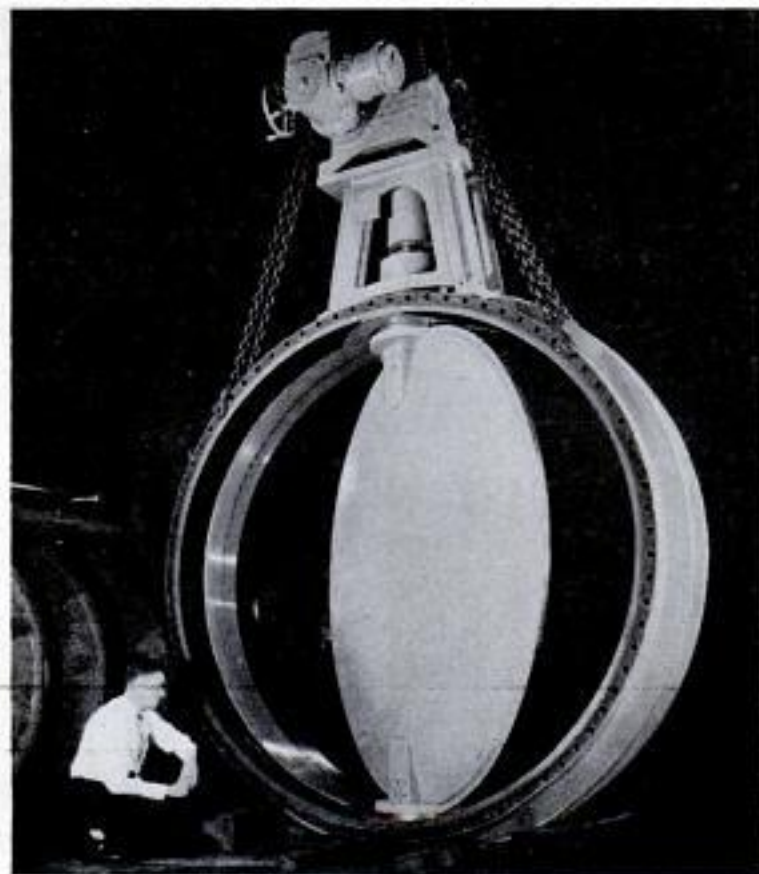

Tremendous air pressures and extreme temperatures ranging from minus 65 degrees to 750 degrees Fahrenheit make the job of sealing valves in supersonic wind tunnels doubly difficult. A new 108-inch butterfly valve solves the problem with a continuous stressed-steel band welded to the inside of the valve body. When the valve is closed, the flexible steel band is inflated by a pressured fluid until it contacts the disk edge and prevents air leakage.

Algae "Seasoning"

Food is improved in taste when enriched with high-protein algae, according to a recent report. Chlorella, the one-celled plant that promises to be a low-cost food source, was added to soups, breads, jelly rolls, noodles and ice cream. Tasters found that all the foods were improved in taste and that the enriched breads and ice cream were particularly good.



German Pilot Builds "Windmill" for Ground-Sky Travel

Flight at up to 110 miles per hour and ground travel at 45 is expected of an "air scooter" patented by a former German fighter pilot. Resembling a helicopter, it will have five seven-foot rotors revolving over the cabin at 200 revolutions per min-

ute. Inventor Walter Wiesske, who has been testing a model with eight rotors, believes full-scale production models will sell for approximately \$1000. American, Canadian and Australian firms have indicated interest in the versatile vehicle.

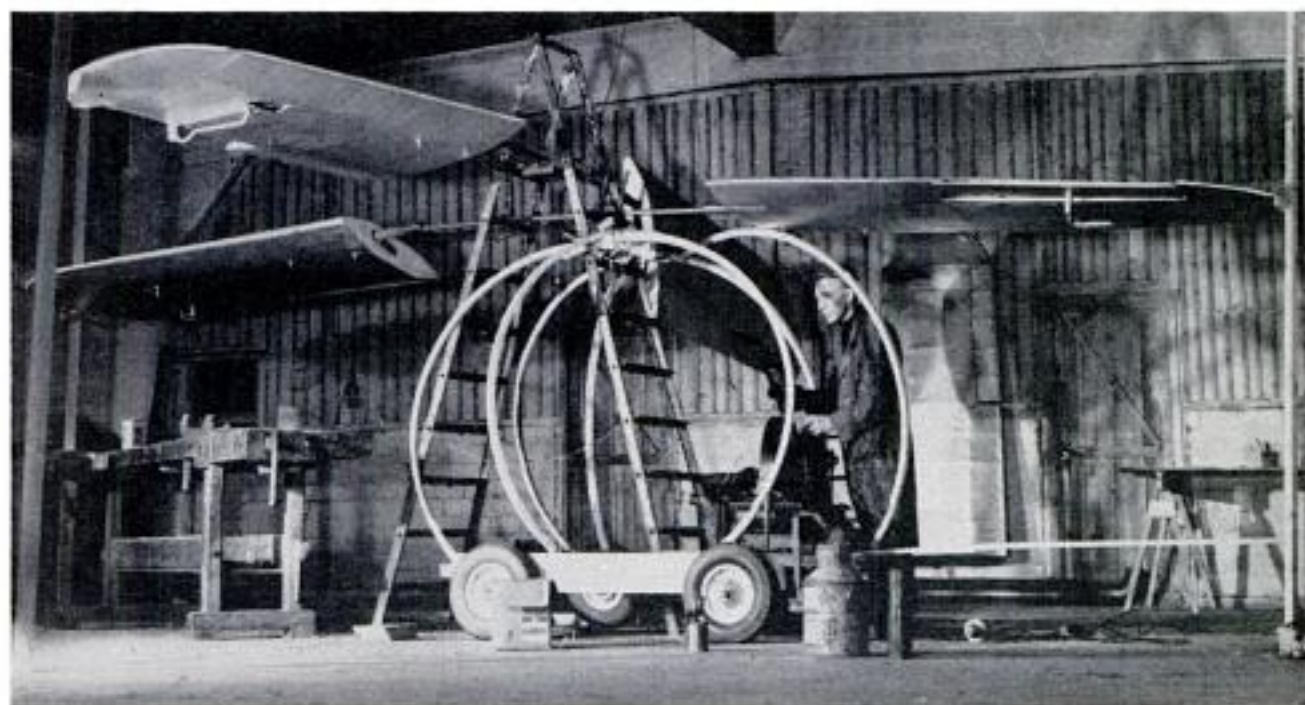

Lamp Mounted on Typewriter Floods Paper With Light

Eye strain is reduced for typists by a new light that attaches directly to the typewriter. Made of $\frac{5}{8}$ -inch aluminum tubing, the tubing folds back with the paper holder.

☐ Fatalities per 100 million passenger miles on U.S. scheduled airlines have dropped from 15 for the five years 1932-36 to 1.7 for the five years 1947-51.



IT'S MOVING DAY FOR WILDLIFE

A MOUNTAINEER with fire in his eyes recently bearded some Kentucky wildlife specialists in their offices in Frankfort. "First you fellows passed a law to make the kids go to school," he said. "Then you turned deer loose to eat the gardens so the kids wouldn't have anything to eat. Then you turned bear loose, and panther and other varmints to eat the kids on the way to school. This," he thundered, "has gone fur enough!"

The game managers couldn't deny that they released deer and even bear in the mountains, for this transplanting of wildlife has become one of the favorite and one of the best ways of improving hunting. There is widespread belief among professional game managers that, contrary to the old mountaineer's opinion, this big manmade game migration still hasn't gone "fur" enough.

Above right, little deer tied in burlap bag is "weighed in" before trip to new home. Below, crates are hauled in to move trapped bison
Fish and Wildlife Service photo

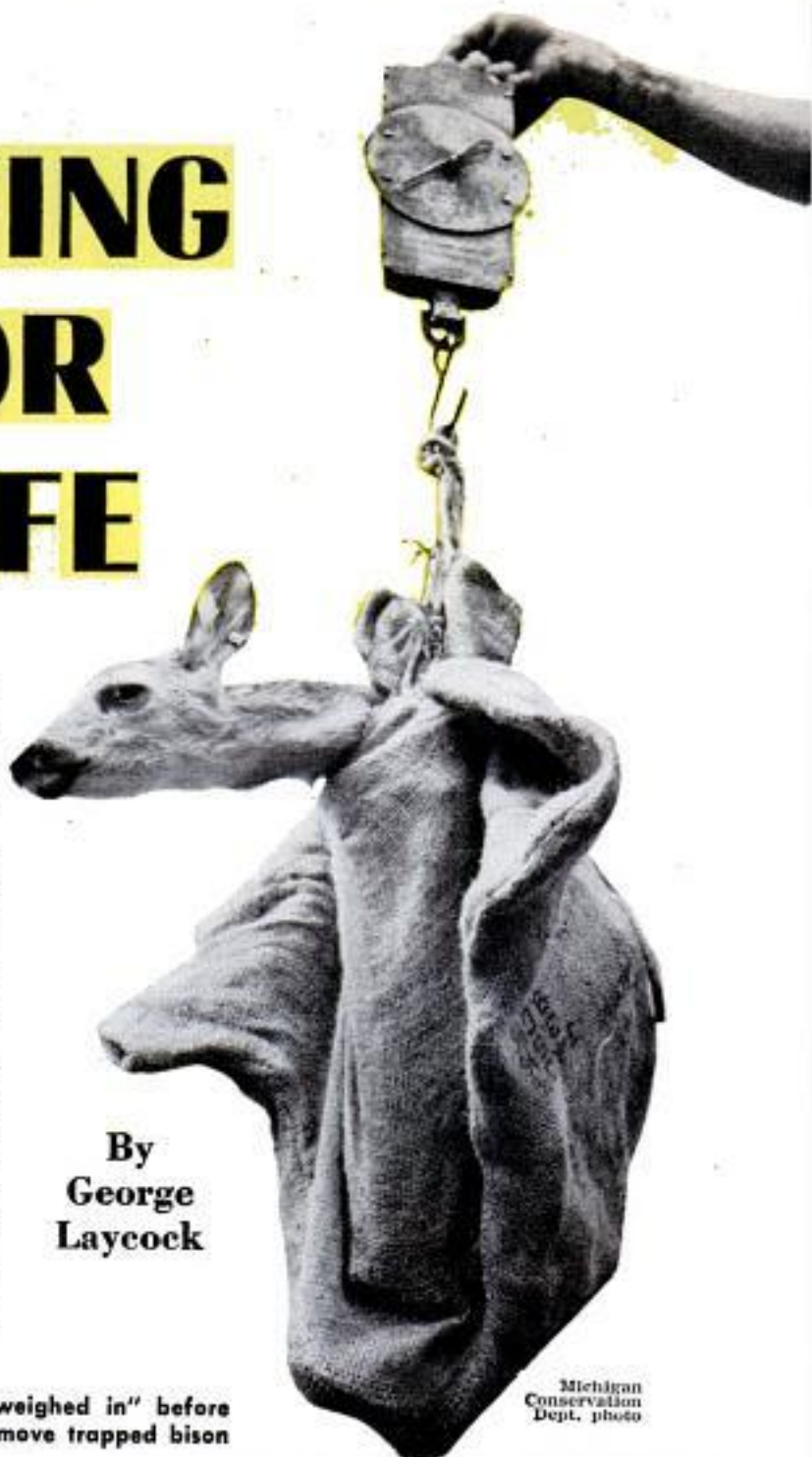

By
George
Laycock

Michigan
Conservation
Dept. photo

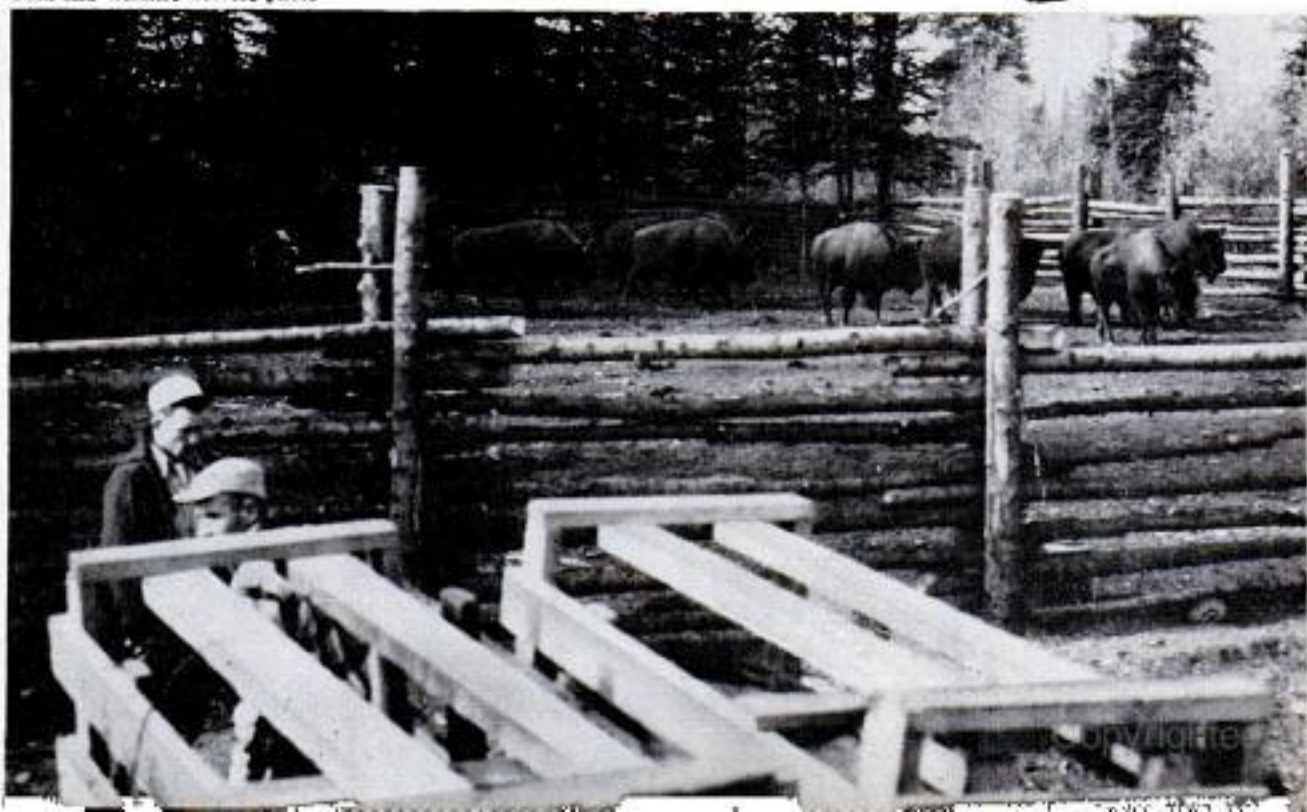



Fish and Wildlife Service photo

Wary handlers slipped rubber hose over horns of mountain goat which was trapped at Kodiak Island, Alaska

Game technicians in every part of the country are gathering up everything from bobwhites to bighorns. Then they're hauling them across the state, and sometimes halfway across the country and dumping them where there is food and cover but a scarcity of game. Because they've learned to fit the animal to the environment they can thin out game surpluses and build up thin populations all in one operation. They've developed this live-trapping and

transplanting into an art, for experience has shown that this method can mean quick build-ups in game population and better hunting for the license buyer.

Man now knows a great deal about a game animal's needs. As one wildlife expert explained it, "We've changed the complexion of the land. We're going against nature. The game and the people are both living under artificial conditions, and the laws of the wilderness no longer apply."

"Eager beavers," destined to restock an Oregon area where there is a scarcity of game, are loaded aboard truck

U.S. Forest Service photo





Fish and Wildlife Service photo

Chukar partridge are trapped in grain-baited pens, then transferred to crates. Every trapped bird is banded before release

Drumming grouse investigates another bird. Actually it is a mirror hung inside the trap. Grouse triggers door behind him

Colorado Game & Fish Dept. photo



Captive should read "Photo by Fred Harvey, Kentucky Division of Game & Fish"

"Live-trapped animals that grew up in the wild survive better than game raised in captivity, and they are far less expensive," says Don Strode, in charge of Kentucky's Pittman-Robertson projects.

Practically every type of game in the country has been trapped and moved. Bobwhite, raccoon, grouse, rabbit and deer have been transplanted by the hundreds. During the winter of 1947-48 Wyoming game specialists trapped and moved eight moose. By 1939 Colorado had trapped and moved 152 mountain sheep, plus another 16 which she traded to Montana for eight mountain goats.

Texans have used airplanes to help round up more than 2600 antelope and chase them into long funnel-shaped traps. This technique has made a big change in the national antelope population in the past quarter century, for 25 years ago there were plenty of people willing to predict that the antelope was doomed to extinction. Today the antelope is secure and it's largely because wildlife experts have learned how to fit the animal to his environment.

In the early days of antelope trapping they were herded into traps made of wire fencing. But when they dashed against the fences and broke their necks in large numbers, the game technicians searched for a better way to trap them. This led to a funnel trap in which the smaller areas at the rear of the trap are made of six-foot fences of three-inch cord mesh. The antelope still dashes crazily against the traps but now he bounces back like a trapeze performer who missed his partner. At the back of the traps the antelope herders drive their catch into narrow crowding pens darkened by canvas curtains. From there they go into net loading chutes one or two at a time, where they're caught by hand, crated and hauled off to new range.

And what Texas and some other states have done for antelope, Arizona has tried with bison. Two thriving herds in that state started with 42 of the lumbering animals trapped and moved a few years back.

Nine states have trapped and moved wild turkeys; Texas alone has transplanted some 3000 of the

big birds. Seventeen states moved 8470 beaver, some of which were even parachuted into isolated waters from bush-hopping planes.

In the winter of 1940-41 South Dakota trapped and released in better range some 8500 ringnecks. The Wildlife Management Institute said of the project, "Each of these wild-wise ringnecks is worth a half dozen of the pen-reared innocents. In these moves, however, the first step is to size up the landscape and only release game where it has a chance of success."

Kentucky learned this lesson well when she imported game-farm pheasants and turned them loose in her rather meager river bottoms. These birds soon left their Old Kentucky Home to the bobwhites and the grouse. The pheasant has steadfastly refused to live in the hill lands, although pressure from sportsman's groups sometimes forces the technicians into making another try at an experiment that has consistently failed. One of the Kentucky immigrants left the river bottom where he was released and headed straight for the Ohio River and the corn fields of the Midwest. He flew more than 40 miles and in a careless moment crashed through a school-house window in Louisville.

Kentucky has done other jobs of wildlife moving to the satisfaction of everyone. "Since 1945," Don Strode says, "we have released 570 deer, 92 turkeys, 70 beaver and 10 black bears."

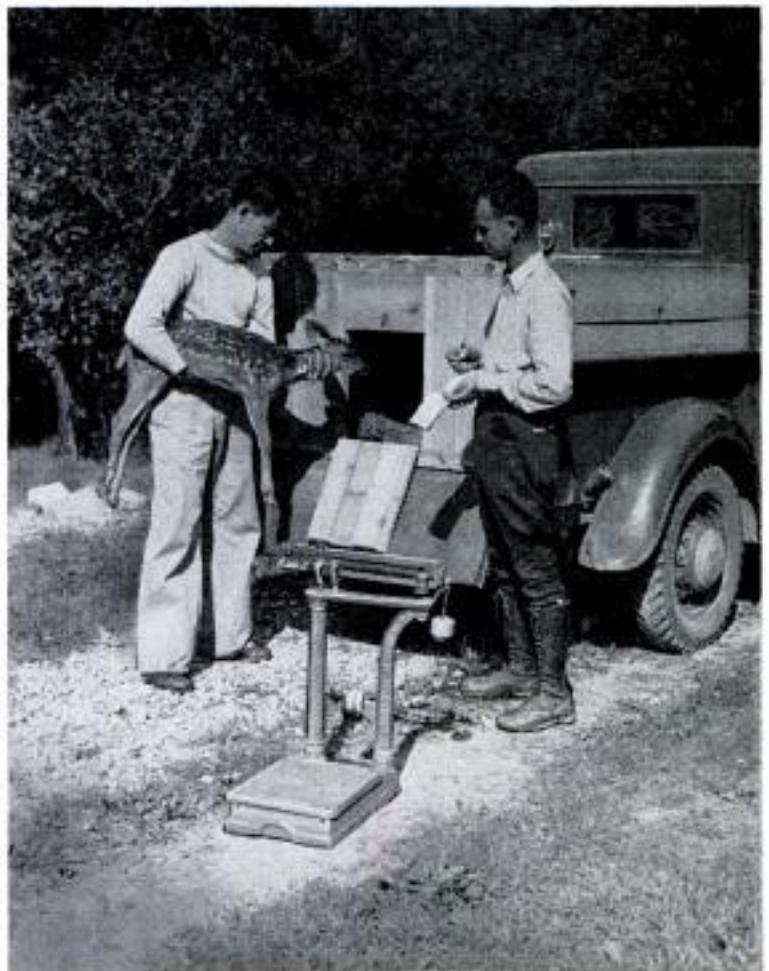

U.S. Forest Service photo
Six-months-old fawn raised at Pisgah Game Refuge in North Carolina will be shipped hundreds of miles to another state

Bear are generally taken in boxlike traps. The big difference between a bear and deer trap is the strength of the box, for a self-respecting bear could tear his way out of a wooden deer trap. The sides and ends of bear traps are generally reinforced with

(Continued to page 238)

Antelope rounded up in Montana are driven into pens made of nets. They will be transplanted to another area

Fish and Wildlife Service photo



Earth Tamper Mounted on Trench Filler Packs Automatically

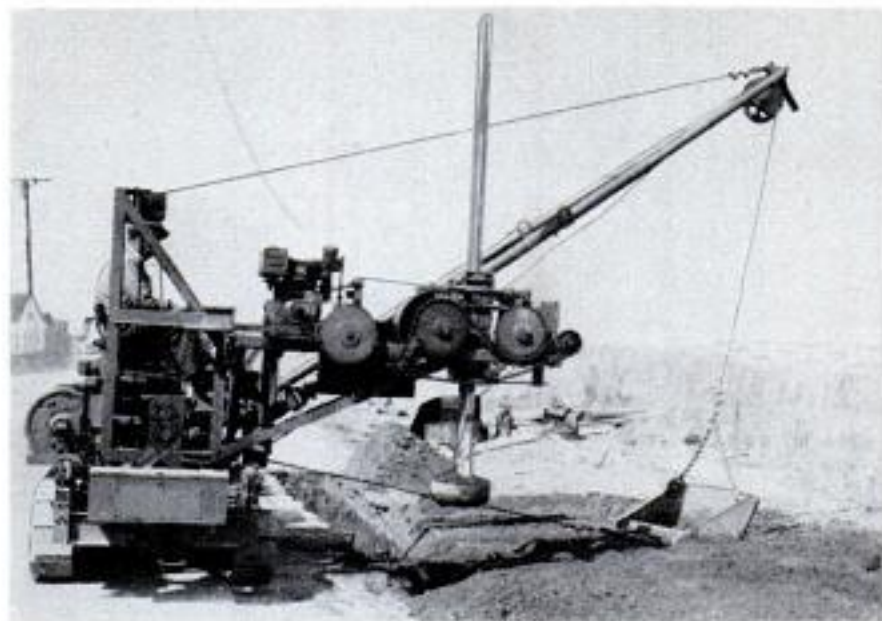

No operator is needed to control an earth tamper which is mounted on a trench filler and packs the earth down as fast as the back filler dumps it. From the machine projects a boom supporting a bucket, or "hoe," which scoops the earth into the trench. Mounted on a frame behind is the automatic tamper, powered by its own gasoline engine, which packs the loose dirt into the ditch as the machine rolls along. The rig was developed by a Cleveland firm for laying pipe.

Burlap Grain Bin For Outdoor Storage

King-size gunny sacks holding 600 bushels each are serving as economical outdoor-storage bins for surplus grain. The mammoth sacks are made of waterproofed burlap and lined with paper. Each bin is about 18 feet across at the base and 14 inches in diameter at the top. A 30-inch neck that facilitates loading can be folded down against the side for sealing. Grain stored in the burlap bin brings up to 30 cents more a bushel than grain stored on the ground—and storage in the bin costs only about 10 cents a bushel.



Hydraulic Rake Mounted on Tractor Clears Sugar Cane From Field

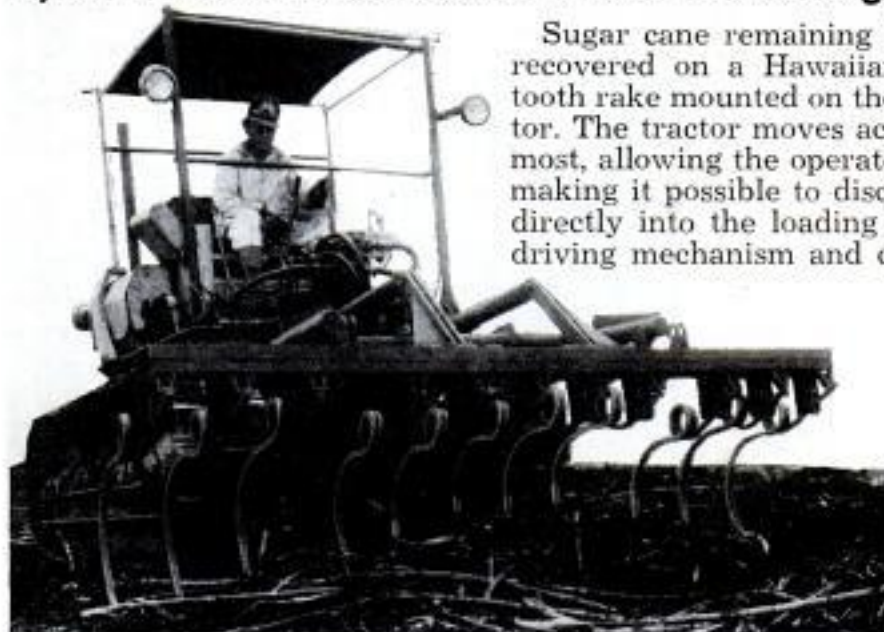

Sugar cane remaining in the fields after harvest is recovered on a Hawaiian plantation with a spring-tooth rake mounted on the rear of a crawler-type tractor. The tractor moves across the field back end foremost, allowing the operator an unobstructed view and making it possible to discharge the accumulated cane directly into the loading windrow. The driver's seat, driving mechanism and controls are repositioned for backward driving. Hydraulically operated, the oversize rake is raised to discharge its load and elevates itself automatically when an obstruction is encountered.

Three tons of industrial diamonds worth \$50,000,000 were imported by the United States in 1953.

Locust Carousel Checks Duration and Speed of Insects' Flight

Flying locusts hitched to an improvised merry-go-round tell scientists at the Anti-Locust Research Center in London's Natural History Museum the insects' speed and duration of flight. Suspended from a circular wire frame that turns on a central pivot, the insects instinctively beat their wings and start the frame going. As they fly about the circle, they are carefully watched by scientists engaged in a detailed study of the insect.

Titanium Plentiful in Hawaii

Much sought after as a jet-engine material, titanium may be more plentiful in Hawaii than in Brazil, where the United States now gets most of its supply. More than 80 percent of the soil in some areas consists of the ironlike material, according to Dr. G. Donald Sherman of the University of Hawaii's soil department. Closeness of the ore to the surface and its density will make it an easy material to mine.

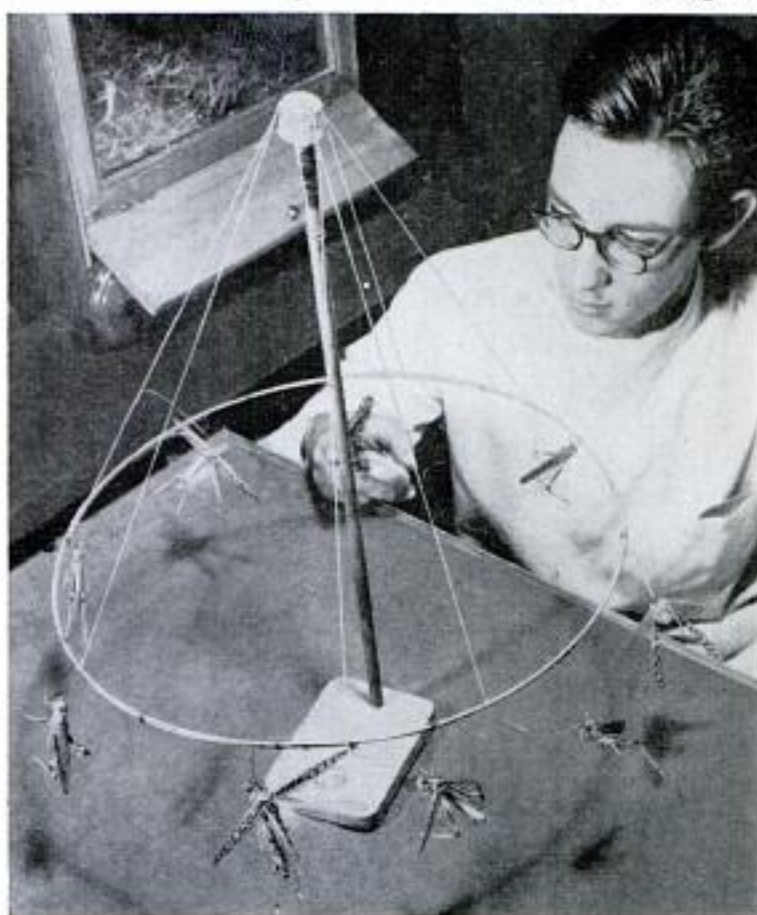

Aluminum Golf Cart Has Numbered Slots for 14 Clubs

Fourteen golf clubs have individually numbered slots in a cart that eliminates the need for a golf bag. Balls, shoes, tees and other items are carried in a Zippered bag attached to the handle. The clubs rest head down, putting the weight over the wheels

where it is easier to move. The clubs cannot rattle or become marred. A metal plate on the cart's aluminum frame serves as a seat between shots. Weighing 12 pounds, the complete unit can be folded for storage in an automobile or locker.



Self-Contained Electric Heating Shaft Installed Between Studding



Economical and efficient electric heating is the purpose of a built-in wall unit that extends from floor to ceiling. Air enters the top and is discharged from the bottom of the self-contained heating shaft, which mounts its own fan, thermostat and heating coils. Even distribution of heat is the reason given for the economy of the unit; each shaft takes about the same amount of electricity required by a flatiron—a total of about 7400 watts is needed for heating a small five-room basement home in northern climate. One or more units is installed between the studding of each room, but as there is no connection of ducts and no central furnace, installation cost is low and space is saved. The units may also supplement present heating systems when extra rooms are built into a house or when garages are to be heated. The heating element may be turned off in the summer when only ventilation is required.

Rolling Mast Platform Permits Easy Loading of Long Cargo

Extremely long loads may be lowered directly into the hold of the Dutch freighter *Muphrid N* by simply rolling the mast forward, out of the way. Raised up on four wheels which travel in grooves along the side of the hold, the mast platform is pulled aft or forward with the aid of one of the diesel-driven winches mounted on either side. Rolled completely forward, the platform clears 72 feet of the 90-foot hold.

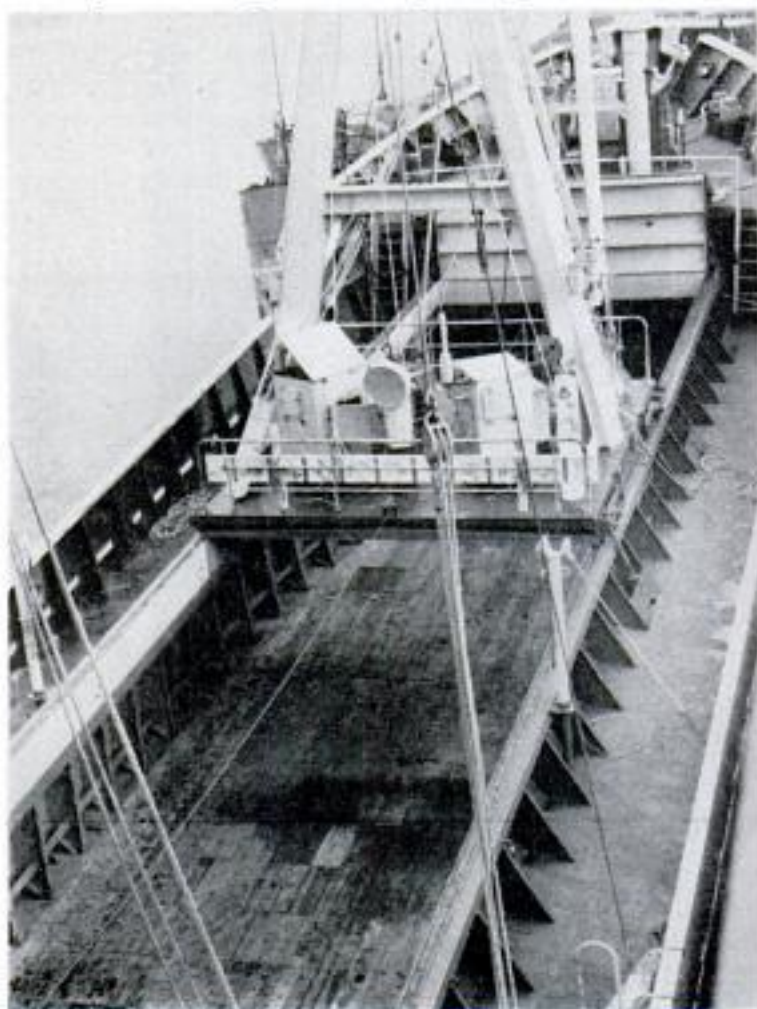

Chemists Synthesize Sugar

Two Canadian researchers have solved a classical chemical problem—the synthesis of sugar. Since all the energy of the sun which is used by nature starts out as sugar, formed in plants by photosynthesis, the feat is a chemical milestone. Knowledge gained during the project promises to aid in the synthesis of many substances. Malt sugar and trehalose as well as sucrose—common table sugar—were synthesized for the first time. Glucose, the central compound in nature, forms a portion of the sucrose molecule.

160 Dr. Raymond Lemieux
Dept. of Chemistry
Univ. of Ottawa
Ottawa, Ont.-Canada

Radio Television Electronics

TELEVISION TODAY

PRIVATE-WIRE television systems are now being demonstrated in salesrooms of electronic-parts distributors throughout the country. These midget "TV Eye" cameras, shown in photo A, are in production at the RCA Victor Division in Camden, N. J. The operator is shown inserting the Vidicon pickup tube which is the heart of the simplified 4-pound TV camera. Any home-type TV receiver can be used without modification as a monitor, the system connecting through the set's antenna terminals by means of a cable. Applications include remote observation in hospitals and factories; promotion of products and services in stores and hotels; also detailed demonstrations in classrooms.

Manufacturers of color-television receivers are giving special attention to provisions for easy access to chassis for picture tube and other service adjustments. The top of the Admiral color-TV set lifts off as illustrated in photo B. The main controls from left to right are as follows: Tiny knob at extreme left adjusts color intensity; the large knob controls volume and contrast. The dial knob at the right tunes the various channels, the same as on standard black-and-white television sets. Photo D shows a subassembly area in the Admiral plant where inspectors are checking power-supply units and video components.

One of General Electric's newly developed receiving tubes for color-TV sets is displayed by the young lady in photo C. This tiny tube will regulate the average brightness of the three primary colors on the picture screen. The large color wheel is televised in test transmissions. ★ ★ ★

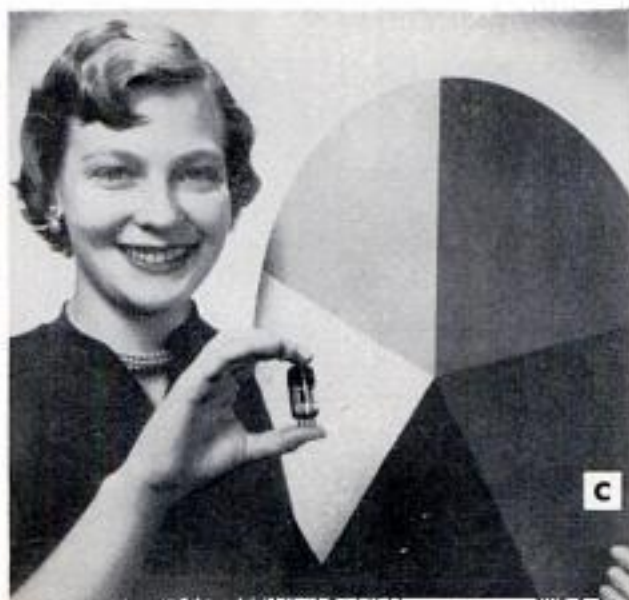

First-Aid Hints for



OWNERS of table-model radio receivers often have several around the house that are in need of slight repairs. Many times you can save dollars—and have fun—by making such minor repairs yourself. If you are an average radio-set owner you probably do not know much about the various components and circuits, so this does not mean that you should tamper with a valuable console radio. Even an inexpensive table model is a complicated device for the beginner and it is subject to damage.

However, if you are careful and can restrain the urge to experiment, the accompanying photos will show you several simple dollar-saving repairs that anyone can easily make at home. First, never attempt to repair a set with the power connected. As with a lamp, or any other electrical device, even though it is turned off, the switch terminals carry 110 or 115 volts, ready to "bite" unwary fingers. So the first thing to do is to pull the power-cord plug out of the wall receptacle. With the radio turned "on," high voltages are present in the set, so do not take a chance even though you are only replacing tubes or a pilot light. Never plug in a radio set to test a repair without first sliding the chassis back into the cabinet; this is a simple precaution against shock. Also, never attach an external ground wire to an a.c.-d.c. set. Most table-model radios are of this type. The use of any kind of external antenna wire is okay, but do not connect the wire to anything that makes metallic contact with the earth. This means radiators, water pipes, gas pipes or similar earth-connected metallic bodies.

To function properly, radio tubes should make good contact in their sockets. The tube prongs sometimes corrode slightly and make poor contact. They may be dusted off and cleaned with carbon tetrachloride as illustrated in photo A. Remove the

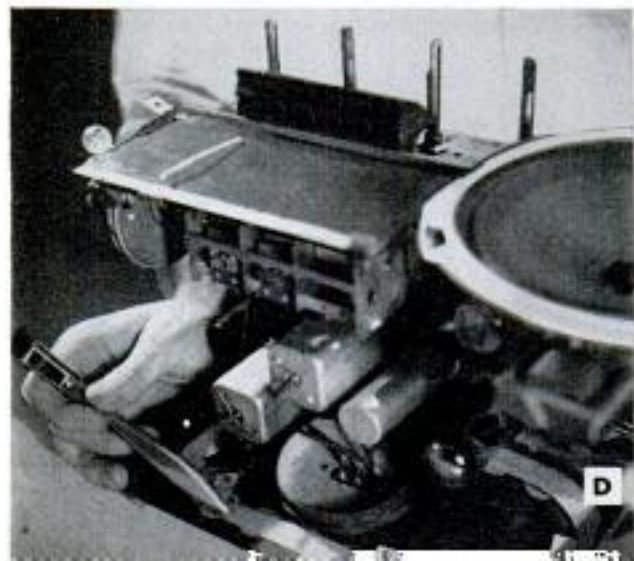
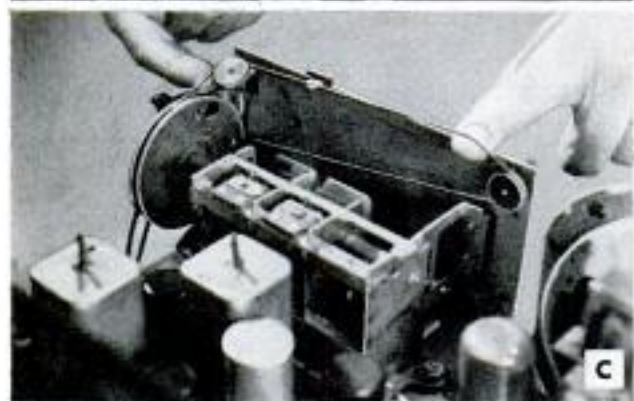

Table-Model Radios

tubes one by one to be sure you get them back in their proper sockets. If each socket is not identified with its tube number, and there is no tube-position chart on the inside or underside of the cabinet, mark the tube positions on the chassis with ink or scratch the numbers on with an ice pick or similar sharp tool. This is important if you take all the tubes out to have them tested. Any tube that is not making good contact in the socket will cause set noises, and may even make it inoperative. A good stiff brush and a little carbon tetrachloride, applied as shown in photo A, is recommended when servicing old sets.

Bent tuning-condenser plates are a frequent cause of trouble. These may be straightened with a knife blade as illustrated in photo B. Unless the plates are actually touching, do not try to straighten them as some manufacturers bend the plates deliberately. A loose dial cord is shown in photo C. Tighten the cord and retie the knot if possible. Unless the cord is too loose, a simple method is to use some of the "no slip" preparations which increase the friction of dial cords and pulleys. These are to be found in all radio-parts house catalogs.

If volume is lacking in a set of the type using a built-in loop antenna, add a 15 or 25-ft. length of small insulated wire. If the set has no external antenna post marked A or ANT., wind two turns of similar wire around the edge of the antenna loop, see photo D, to provide greater pickup. Connect one end to the outer end of the main loop winding, or anchor it at some convenient point for inductive pickup. Then run the wire around the room or connect it to an outside antenna.

Contacts on a short-wave band-changing switch should be kept clean with a brush and a little carbon tetrachloride, as shown

(Continued to page 228)

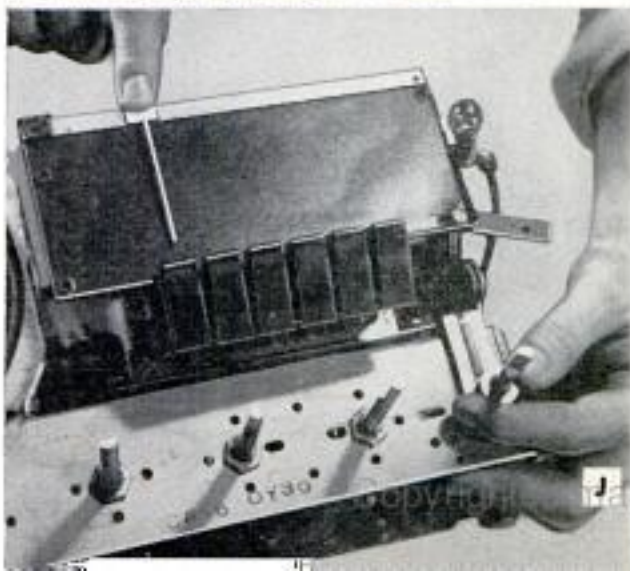
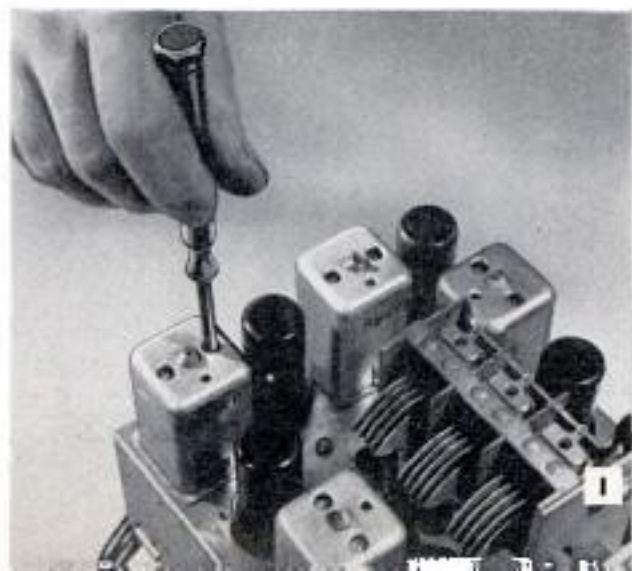
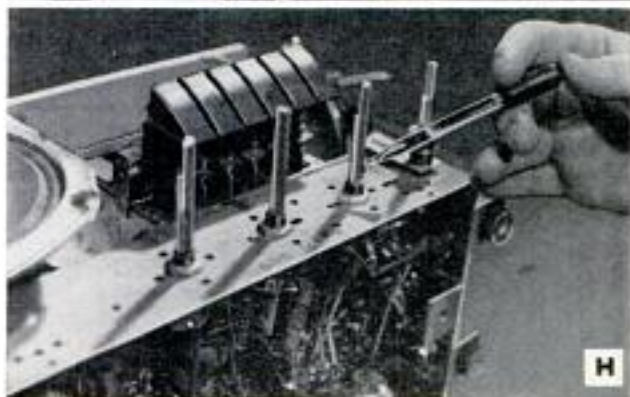
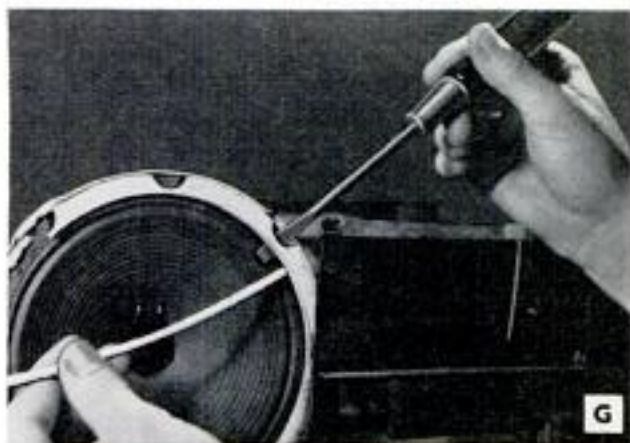

High-Frequency Transistors In Experimental Receiver

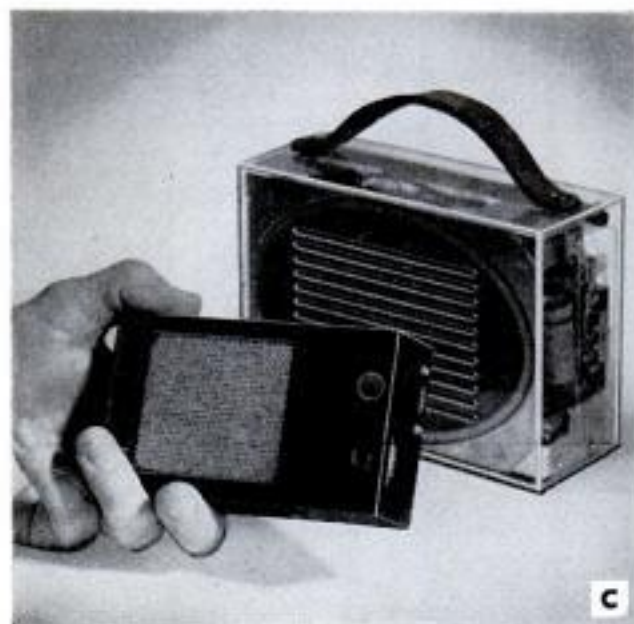
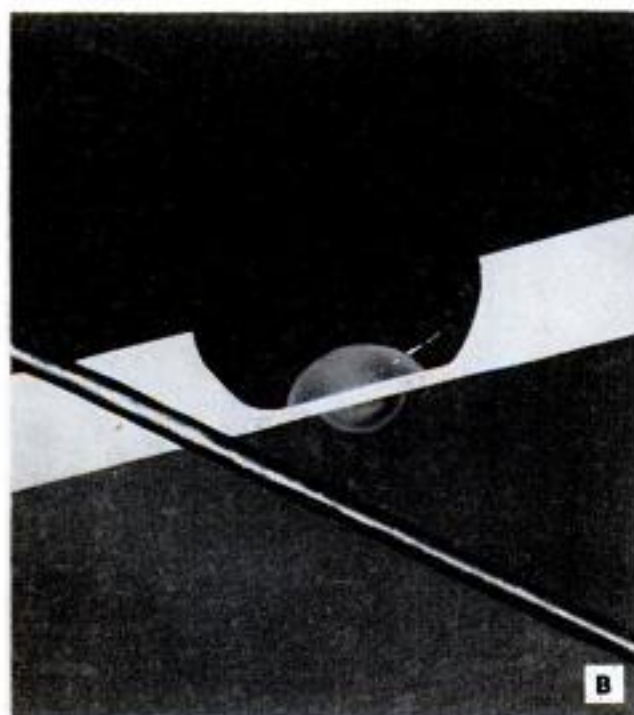
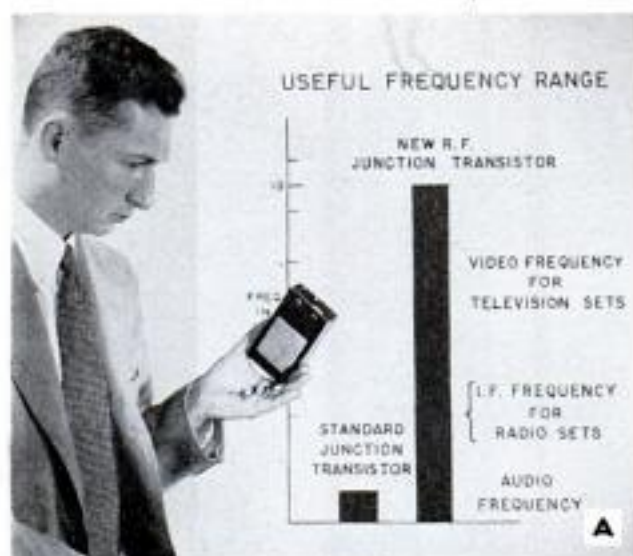

LABORATORY technicians have fun in demonstrating some of the new transistor-operated radio devices that are being developed in the David Sarnoff Research center at Princeton, N. J. One demonstration that recently attracted attention in Times Square, New York City, was made by an engineer walking along the street with a radio blaring away full blast from an inside pocket. The experimental 6-volt receiver weighed one pound.

This vest-pocket model shown in photos A and C employs eight new high-frequency-type junction transistors which would probably cost about \$80.00. Other parts, which include a 2-by-3-in. speaker, are all standard. The receiver measures $5\frac{1}{2}$ in. long, $2\frac{3}{4}$ in. wide and it is only $1\frac{3}{8}$ in. deep. It will probably not be in production for nearly two years and by that time these expensive transistors will no doubt be reduced in cost by mass production.

The chart in photo A indicates the greatly increased scope of future applications for these new h.f. transistors which amplify at frequencies up to 10 megacycles. The working area is thinner than the human hair; a comparison cross-section, illustrated in photo B, shows a "well" drilled in the center of a germanium crystal wafer leaving an extremely thin layer of crystal $\frac{1}{500}$ th of an inch thick. This is done with a drill vibrating at supersonic frequencies. Wire connections are embedded in each of the two gray "dots." The dots form junctions for transistor action. A larger experimental receiver using the new transistors also appears in photo C. In photo D, Dr. C. W. Mueller of the research staff is shown checking one of these new h.f. transistors that operate on tiny batteries. ★ ★ ★

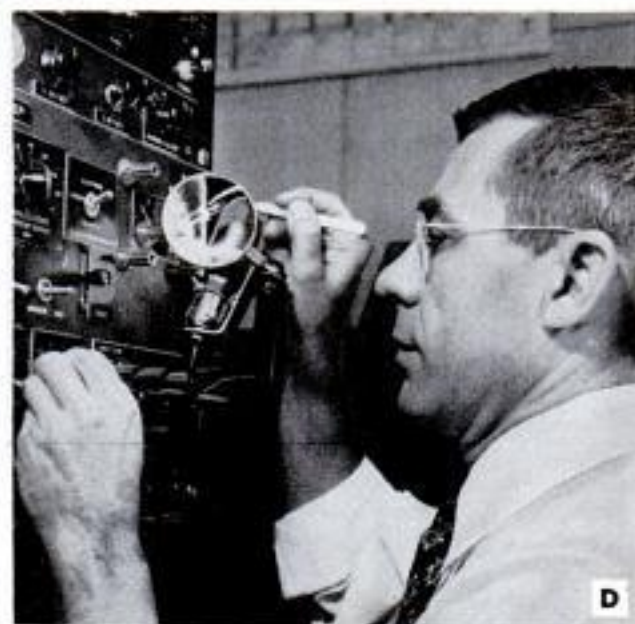

the POPULAR MECHANICS CRAFTSMAN



By Hi Sibley

Young TV cowpokes have a bunkhouse all their own when



A BOY'S ROOM GOES WESTERN

IF YOU HAVE some gun-totin' cowboys in the family, you can make their make-believe world a near reality by converting their room into a TV ranch house, complete with built-in bunks. Such a transformation need not be costly. False beams of second-grade knotty pine added to the ceiling and stained to give a rustic effect, a photomural of a western scene applied to a wall, hooked throw rugs and an old-fashioned, lantern-type fixture all add to the over-all atmosphere of the old West. Imitation knotty-pine paneling of gypsum can be used to treat the walls, and a few pieces of pine or maple furniture will provide the final touch.

Photomurals can be obtained in black and white or tinted. You can even have them made from your prize negatives. Unmounted prints are attached to plastered walls with ordinary wallpaper paste. Usually, the print is moistened on both sides with a sponge and then paste is applied to the back. The print is hung like wallpaper, wrinkles being smoothed out quickly with

a soft brush. Excess paste is wiped from the face of the print with a dampened sponge. When the print is made up of several sections, the sections are usually marked from left to right and matching edges are lapped $\frac{1}{4}$ in.

Knotty-pine gypsum paneling, which is 16 in. wide and 8 ft. long, is exceedingly easy to apply. Applied vertically, the individual panels are cemented in place and held at top and bottom with a single nail, which is later concealed by a baseboard at the floor line and a molding at the ceiling. The panels come prefinished.

The built-in bunk beds pictured in the photo at the top of the page are not difficult to make. Featuring a dual headboard, the two bunks are an integral unit which can be permanently fastened to the floor or left free to pull out. For added convenience in making the beds, the headboard can be an individual unit permanently fastened in place, with each bunk being a separate unit. This is hinged to the dividing headboard at the front to permit each bunk to be swung

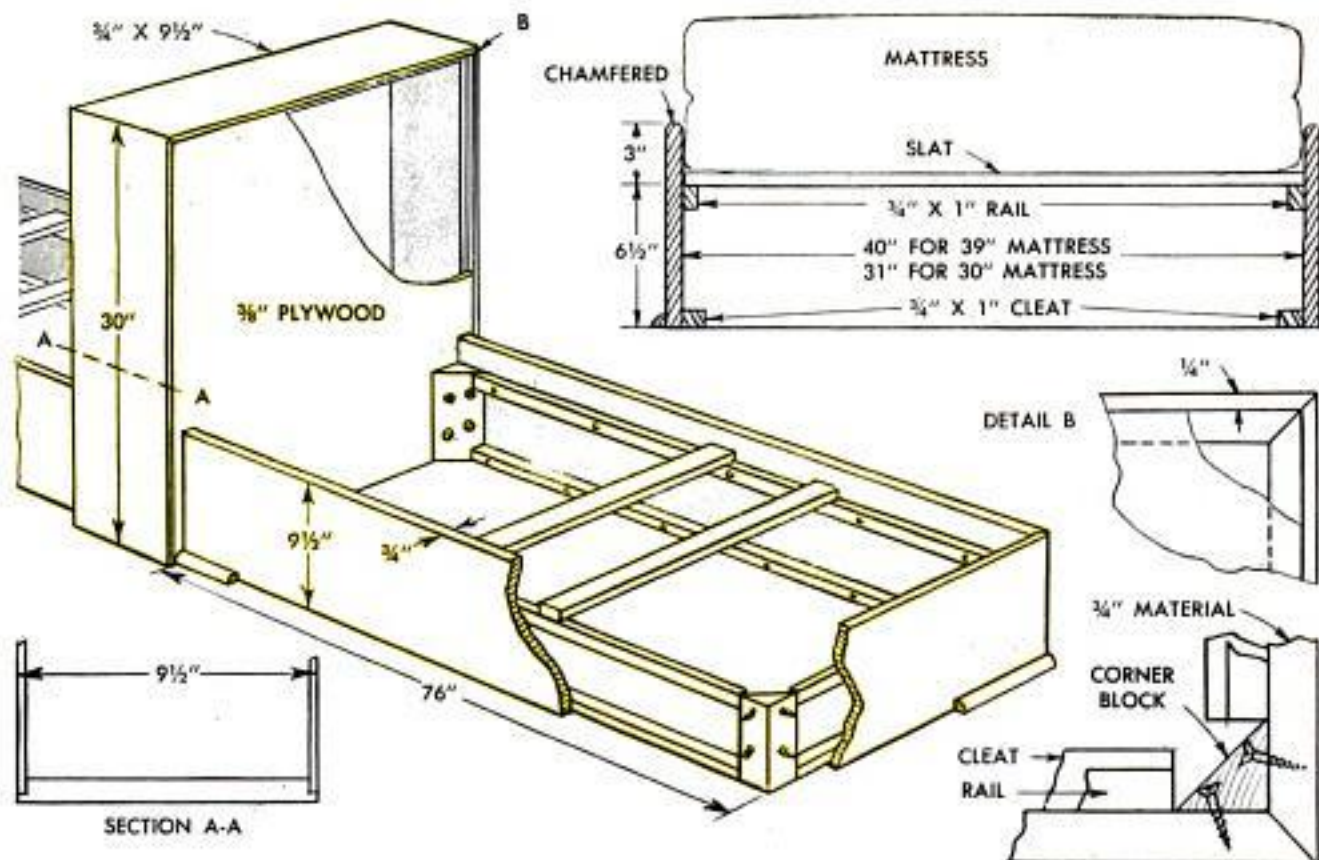

out on casters. The bunks are built for either a standard 30 or 39-in. mattress. The headboard consists of 1 x 10 lumber, rabbeted along the edges to receive $\frac{3}{8}$ -in. plywood panels flush. Where you do not have a means of cutting a rabbet, the latter can be formed by adding cleats to the three inside faces. The same-size stock (1 x 10) is used for the side and end boards of the bunks. Note that triangular corner blocks are used to strengthen the mitered corners and to attach the side members to the head-

board. Rigidity is added to the side members by two longitudinal cleats, the upper ones serving also to support three or four 1 x 3 bed slats. You'll note that the corner blocks are kept even with the upper cleats. The lower cleats provide a means of fastening the bunks to the floor with a couple of screws. Finally, sections of quarter-round are added to the lower edges of the side and end members. The completed job should, of course, be stained dark to blend into the room's Western atmosphere. ★ ★ ★

Refinish Metal Name Plates With Lacquer and Sandpaper

Metal name plates having raised lettering, such as the data plate on a motor or the shutter-speed chart on a reflex camera, can be refinished easily. First, the surface is cleaned with lacquer thinner or other solvent, then an even, not-too-heavy coat of dark-colored lacquer is brushed over the entire surface. After the lacquer has dried, use small block of wood wrapped with fine sandpaper or abrasive cloth and polish the raised portions of the plate. This will make the lettering stand out brightly against the dark background. Finally, spray a protective coat of clear lacquer over the plate, or wax and polish it.

Walter E. Burton, Akron, Ohio.

☐ An easy way to remove corrosion from inside the ferrule of a fishing rod is to wrap a small wad of medium-fine steel wool around a dowel chucked in an electric drill and carefully run it into the opening.

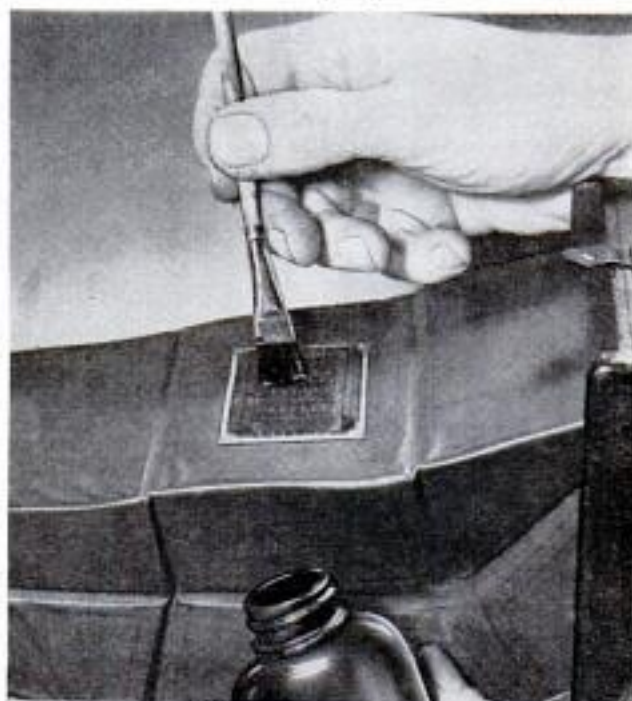

Protect Knees When Gardening With Pads Cut From Inner Tube

To protect your knees when working on wet or rough ground in the garden, you can cut neat, lightweight protectors from a length of inner tube. Cut the back of the section so that two straps are formed, as shown in the detail. These should be spaced so one strap grips the leg above the knee and the other below it.

W. P. Barenz, Milwaukee, Wis.

Dip-Painting Irregular Objects

Time and money may be saved by dip-painting irregular-shaped objects with enamel or oil-base paints floated on water. Dip-painting saves time and trouble, as compared to brush or spray, because it thoroughly coats all hard-to-reach surfaces. By floating the paint on water in a fairly deep container, the necessity for a large quantity of paint is eliminated. The objects to be painted are dipped beneath the surface through the film of paint, then slowly lifted. The excess paint is allowed to drain.

Henry G. Borchardt, Chicago.

Hand Grip for Dairy Brush

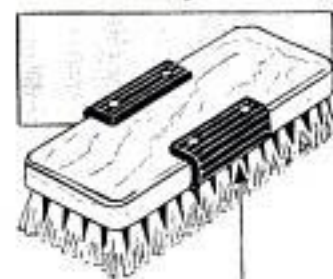

RUBBER HOSE

Split sections of corrugated garden hose nailed to the opposite edges of a scrub or dairy brush will provide grips to ease hand strain. The grips will be appreciated especially when the brush is used

for long periods and the hands are wet and slippery, requiring a tight grip.

G. E. Hendrickson, Argyle, Wis.



MAY 1954



Porcelain Insulator Converted Into Clothesline Clamp

A simple clamp that will eliminate tying knots when tightening a clothesline is made by using a porcelain insulator of the type shown. A $\frac{3}{16}$ -in. round-headed bolt with wing nut and washer converts the insulator to a clamp. If the head of the bolt turns when tightening the wing nut, place a sharp-tooth lock washer between the bolt head and the top of the insulator.

Arthur Trauffer, Council Bluffs, Iowa.

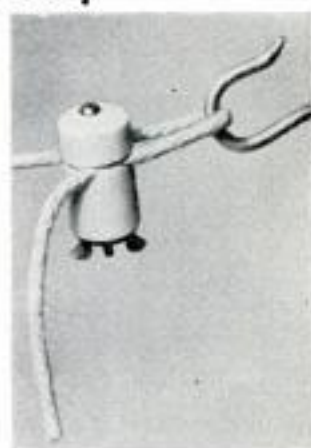

Black Tape on Automobile Antenna Stops Reflected Spotlight Glare

A chromium automobile antenna won't reflect the glare of your spotlight if you put a narrow strip of black masking tape along the side of the antenna facing the driver's seat. The momentary blindness resulting from such glare, if you are driving with the spotlight on, can be a serious hazard. Masking tape used in this manner has the advantage of being easy to put on and take off.—Ken Murray, Colon, Mich.

□ Besides providing a handy "pincushion" for preventing tacks, brads and small nails from being lost on the job, a cake of household soap also lubricates the points, making them easier to drive.

167

Copyrighted material

PAINTBRUSHES

Will do a better job and last longer if you know how to select, use and care for them

By Bernard Gladstone



After brush has been spun dry, bristles are combed out as above, to remove kinks. Below, wrap the brush in heavy paper and lay it flat for long storage

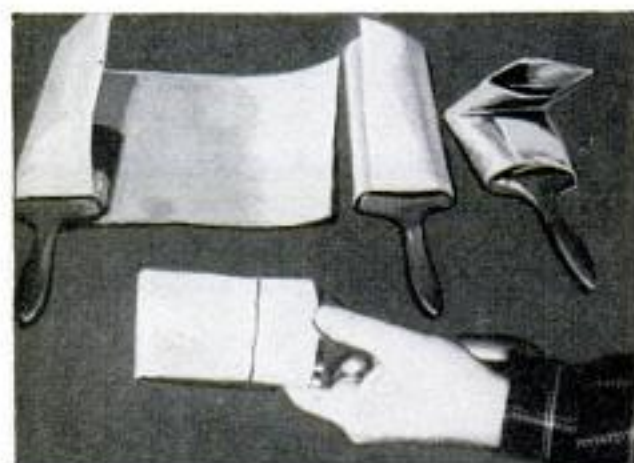

Enlarged view of bristles, below, shows "flags" on good brushes. Flags are visible when brush is held up against light. Brush without flags leaves marks



IN PAINTING, as in other types of work, the quality of the finished job depends to a large extent on whether or not you use the proper tools. Economy when purchasing a paintbrush is no substitute for quality, as an inferior brush cannot possibly turn out a good job. And a top-quality brush, when properly handled, will produce a smooth, streakless finish and will outwear several of the cheaper variety.

The best paintbrushes are made of 100 percent pure Chinese hog bristles which have been carefully selected and blended. There are also nylon brushes of excellent quality on the market, which wear well on rough surfaces such as raw lumber. However, they should never be used with shellac, as the alcohol in the shellac will soften the bristles. The bristles can be restored by immersing for 30 min. in boiling water and then drying thoroughly.

To compare brush values, run a pencil through the bristles at the heel of the brush next to the ferrule. Carefully separate the bristles to expose the setting, which is a block set into the ferrule to separate the bristles and to provide a well for the paint. In a good brush this is no wider than absolutely necessary, and is often split into 2 or 3 dividers. This will provide the user with a fully stocked brush and cause the bristles to lie together at the tip to form a good cutting edge. If the block is too thick, the edge of the brush will split lengthwise.

Grasp the brush as for painting and press down with moderate pressure on a flat surface. A good brush will form a sharp chisel edge. Now hold the brush up to the light and examine the bristle tips. Little split ends or "flags" can be seen on a good brush. Without these "flags," a brush will leave streaks in the finished job. A fine brush has flagged bristles in staggered lengths, so that a new set of bristle ends is presented as the longer ones are worn down.

You want not only a good quality brush but also the right brush for the job. The most common types are shown in the accompanying illustration to help in determining your needs.

Having purchased a new brush, it's important to break it in properly. Unwrap



the brush and, holding firmly in one hand, slap the bristles vigorously across the other hand. Then hold it up to the light and remove any loose bristles you see. Spin the handle rapidly between the palms and again remove any loose bristles. Then comb the bristles straight to remove any curl. Now wrap the bristles in heavy paper and suspend the brush in linseed oil for at least 24 hrs. The oil should overflow the top of the wrapper and saturate the bristles. Nylon brushes do not need to be soaked, but this is very important with hog bristles, as they are porous. Soaking in linseed oil seals up the bristles, helping to keep them flexible, and makes the brush easier to clean. Remove most of the oil by dragging the flat side of the brush against a wire fastened across the top of the can. Take out the remaining oil by twirling the handle between the palms, with the brush held well down into an empty can. Then wash in two rinses of clear turpentine and spin dry again. Finally, comb out any kinks.

To use a paintbrush properly, dip about $\frac{1}{3}$ to $\frac{1}{2}$ the length of the bristles into the paint. Dip it slowly to allow time to soak up the maximum amount of paint. When removing the excess paint, draw the brush flat across a wire fastened across the top of the can. Never draw it edgewise, as this



Above, two methods of suspending brushes in solvent. Brushes should not be allowed to rest on bottom of can, as resulting curled bristles cannot be straightened



After soaking new brush in linseed oil for 24 hrs., it is spun dry by rolling rapidly between palms. Brush is held well down in empty pail for spinning



- 1—Flat wall, long haired, 3-5 in.
- 2—Flat wall, short haired, 3-5 in.
- 3—Oval varnish, 2-3 in.
- 4—Flat varnish, 2-3 in.
- 5—Flat sash, 1-2½ in.
- 6—Angular sash, 1-2½ in.



Above, a wire stretched across the paint bucket offers a double advantage. Excess paint is removed by drawing brush across it, and when brush is not in use wire acts as a rest

Proper procedure of dipping brush is shown at the left. One-third to $\frac{1}{2}$ of bristle length is dipped slowly, so that brush can absorb maximum amount of paint. Paint with end of bristles



Never paint with the edge of a brush, as this will cause "fingering." For sash and other narrow places, use a sash brush, which is made to be used edgewise



The photo above shows a badly "fingered" brush which has been used edgewise so often that its normal brushing characteristics have been ruined

When washing out a brush after painting, work it vigorously against the sides and bottom of the solvent container. Change the solvent several times

Use the thumb and forefinger to help remove all of paint. Squeeze from the ferrule down toward the tip of the bristles, dipping in the solvent each time



will cause it to "finger" or separate into clumps. Professional painters often prefer to tap the tip of the flat side of the brush lightly against the inside of the can, which leaves the brush more fully loaded.

Brushing varnish, enamel and lacquer calls for a fully loaded brush and a minimum of brush strokes. Brush out the paint in smooth, parallel strokes, and then cross it once to smooth out any brush marks. On vertical work, finish up with long light strokes running the length of the work. Keep checking back for 15 or 20 min. to catch any runs. Hold the brush at a 45-deg. angle and brush with $\frac{1}{2}$ to $\frac{1}{2}$ of the bristle length. Don't press down hard, as you will then be painting with the sides of the bristles instead of the ends, causing a streaky job. Never use a brush edgewise, because it will "finger," ruining its good brushing characteristics. If you have narrow surfaces to cut in, use a sash brush, which is made to be used edgewise. If occasionally you have to use the edge of the brush always finish up with a few flat strokes to remove the fingering.

When painting up into a corner, never poke the brush into it. Start the brush a little way from the joint, apply moderate pressure to fan out the bristle, and gradually work the cutting edge into the corner.

If brush cleaning is done immediately after use, it is a comparatively simple task. First wipe off as much of the excess paint as possible and then wash thoroughly in the appropriate solvent by working the brush vigorously against the container sides and bottom. Squeeze the bristle out with the thumb and forefinger, working from the ferrule to the tip. Repeat the process several times, using fresh solvent each time. Then spin the brush dry, between the palms and comb out. If the brush is to be used again in a day or so, wrap in heavy paper, saturate in linseed oil and lay it flat. If the brush is being stored for a longer time, after using the solvent wash thoroughly in warm water and neutral soap. Clean carefully around the ferrule and heel of the brush. Separate the bristles to expose the block and scrape the plug clean of any paint. A wedge of hardened paint will cause the brush to bulge at the ferrule and flare at the tip, making it difficult to spread paint evenly. When the brush is clean, rinse in running water, spin dry and comb out. Then allow it to dry thoroughly. Never dip a paintbrush that is damp into oil or paint, as this will cause the bristles to lose their spring. After the brush is dry, wrap in heavy paper, soak in linseed oil and lay flat in a cool, dry place. If the brush is stored for a lengthy period, unwrap it occasionally and resaturate with linseed oil. ★ ★ ★



A wire brush can be used to scrape dried paint from the handle, around the ferrule and from the heel. In stubborn cases, wire brush is used on bristles



Before storing a paintbrush for a long period, separate bristles as shown above and clean paint from the well with a screwdriver or narrow putty knife

Sometimes a badly-caked brush can be salvaged but it will never be as good as a brush which has been well cared for, and reclaiming it is a lot of work



Chrome Kitchen Chair Converted to Temporary Youth Seat



By modifying one of the chrome-tubing chairs from the kitchen set, one father improvised a practical "youth chair" for his young daughter. The chair seat was removed from the tubing frame and two lengths of 2 x 4 were cut to the width of the seat. Holes were drilled and countersunk in the 2 x 4s which were then fastened to the chair bottom with long flatheaded wood screws. Next, the 2 x 4s were fastened to the tubing frame by using the wood screws that originally held the seat to the frame. The youth chair matches the kitchen furniture, and can be quickly changed to its original size when the child outgrows it.

Mrs. C. A. Anderson, Port Huron, Mich.

Cord Shortened Without Cutting By Taping Inside Lamp Base

Pulling the extra cord inside the lamp base and taping it in flat loops will solve the problem of shortening an excessively long lamp cord. Besides permitting a neat appearance, the hidden loops can be quickly unwound, should the lamp be moved to a location that requires a longer cord to reach a receptacle. Twine also could be used to hold the loops.

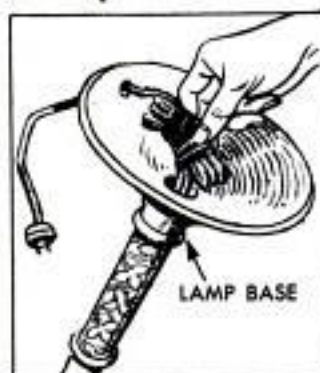

Hugh Lineback, Stillwater, Oklahoma.

Emergency Plug for Small Leak Cut From Sheet Rubber



A pinhole leak in a pan or pail can be plugged in an emergency by using a wedge-shaped sliver of rubber cut from sheet rubber or an inner-tube. Force the point of the

wedge into the hole and pull it through from the other side. When you release tension on the wedge, the rubber will expand and fill the hole.

W. F. Schaphorst, Newark, N. J.

Ornamental Plastic Switch Plate Masks Photographic Prints

To give an unusual border to small photographic prints, mask them with an ornamental plastic switch plate of the type available in most hardware and dime stores. Lay the switch plate over a 5 x 7-in. sheet of enlarging paper and print the picture in the 2½ x 4-in. opening. Thus, when the printing is completed, the picture will be framed by a white ornamental border in the shape of the switch plate, and the edges of the enlarging paper will be black. Similar frames can be cut from ¼-in. plywood if special patterns are wanted.

H. Leeper, Canton, Ohio.

☐ The most weathertight method of applying roll roofing is to lay it horizontally, lapping each course at least 2 in. Building paper used as an underlayer for shingles should be put on the roof at a 45-deg. angle.

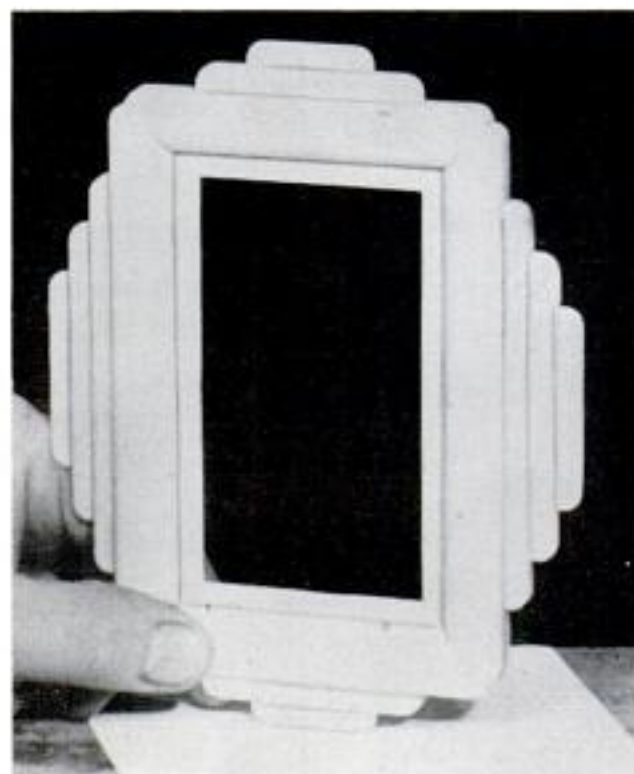

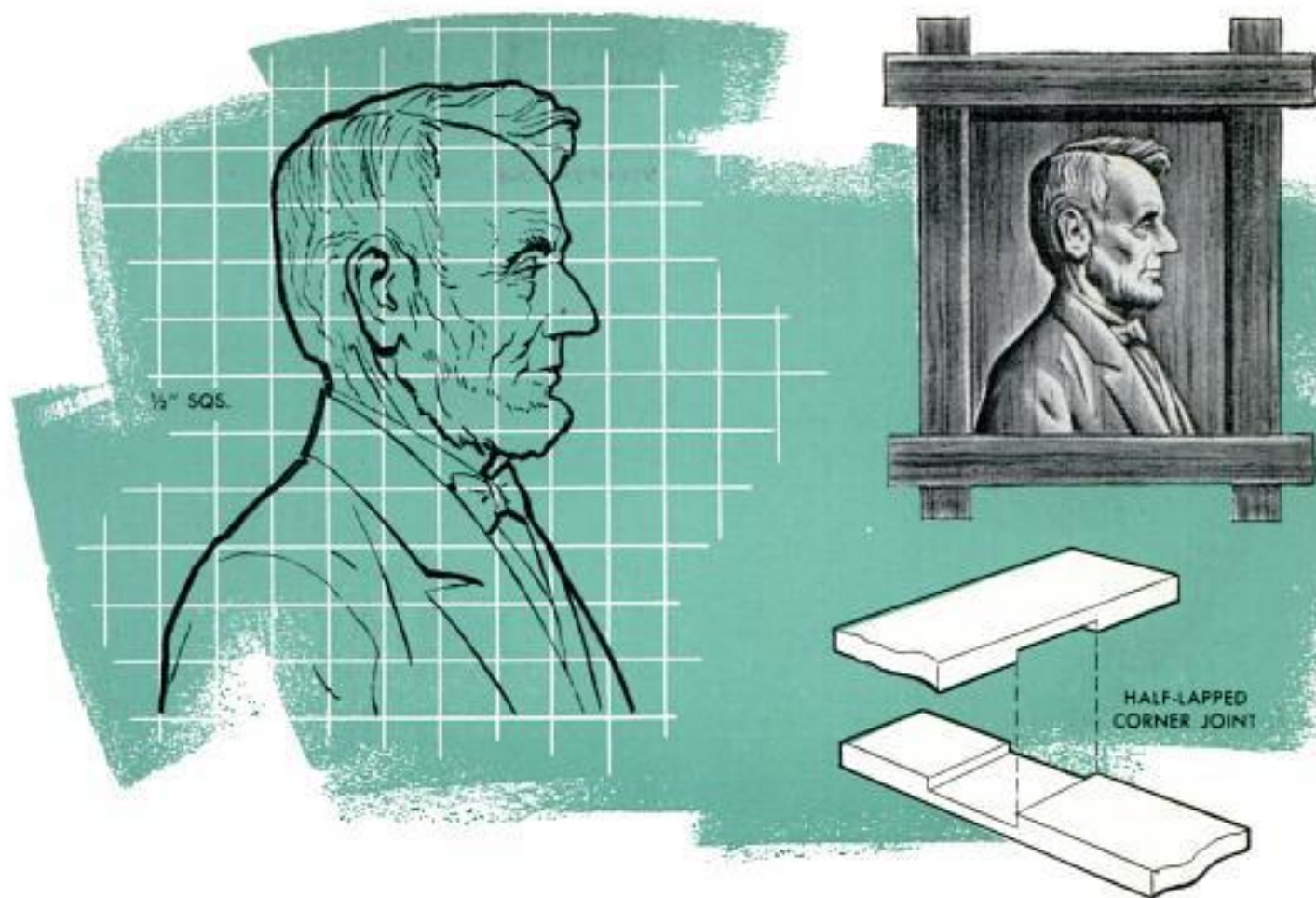

BAS-RELIEF CARVING OF LINCOLN BUST

A hand-carved bas-relief of Lincoln, complete with matching rustic frame, makes a unique wall decoration and will add to your reputation as a skilled craftsman. Actually, however, more patience than skill is required to carve it. The carving can be made smaller or larger, but the original was carved on a piece of $\frac{3}{4}$ x 14 x 16-in. mahogany. Any close-grained hardwood, suitable for carving, may be used. The figure can be transferred to the wood by drawing $\frac{1}{2}$ -in. squares on the work and then copying the drawing from this page. Or, a suitable picture of Lincoln may be traced onto the wood with carbon paper. Although the carving can be done with an ordinary pocketknife, three wood-carving chisels — a

By **I. M. Fenn**

straight, a V-shape and a gouge—will make the work easier. Clamp firmly to workbench and use both hands on the chisel, guiding with one hand and pushing with the other. The direction of cut should be away from you. Start from the outside of the figure and work in. When removing larger pieces of waste wood, cut across the grain, not with it. To get a better idea of the proportions and curves of the face, have someone pose for you. The finished carving is framed with matching wood, the corners being half-lapped as shown above. Both the frame and the carving are rabbeted on all four sides so the backs of the frame and carving will be flush. The completed job is rubbed with boiled linseed oil, then polished with wax.

Ventilator for Photo Darkroom Made From Stovepipe Elbows

Assembled in a plywood panel cut to fit a window in a photo darkroom, two stovepipe elbows will provide a novel lightproof ventilator that is inexpensive and easy to install. Fastened together at one end, the elbows are turned in opposite directions to prevent as much light as possible from passing through them. If some light is reflected through the opening, the addition of semicircular baffles of light plywood or

hardboard wedged into the ends of the pipe will prevent this. They should be placed opposite each other about 2 in. apart. The panel may be mounted in the window permanently or secured in such a way that it may be removed whenever desired.

Hugh Lineback, Stillwater, Oklahoma.

☛ Grease stains on a rug can be removed with carbon tetrachloride and a clean cloth.

MAKE IT A MAGIC PARTY

ENTERTAINING MAGIC can be made the theme of your next party if the stunts shown on these pages are used as games. Explain to the guests that each stunt is based on simple physical principles and let them try to figure out how they work. For example, a coin dipped in water and placed over the mouth of an empty bottle will lift when the hands are used to warm the air inside the bottle. The expanding air forces its way out. A full glass of water will hold quite a few small nails or pins before running over, surface tension permitting the water to rise above the rim of the glass. A burning match dropped into an empty tumbler consumes the oxygen, thereby reducing the volume of air and creating a partial vacuum if the hand is placed tightly over the glass before the match burns out. This allows the tumbler to be lifted with the palm of the hand. Sugar normally does not burn when a match is applied to it, but it will burn if white cigarette ash is dusted on the cube beforehand. Break a yardstick in half with a single sheet of newspaper as pictured on the opposite page. The yardstick is slipped under the paper, atmospheric pressure on the paper holding down one end of the stick while the other is struck. For the final stunt, a match is frozen to an ice cube to permit lifting it out of water. ★ ★ ★

The young lady below lifts a heavy water tumbler by placing her palm flat across the top. Flame of a match dropped into the tumbler consumes oxygen, thus reducing gas volume. A partial vacuum results



"Squeeze" the bottle to lift the coin on top. Moistened coin lifts when warmth of hands expands air in bottle and excess pressure is forced out past coin



Due to surface tension, water in full tumbler can be displaced to rise above rim without overflowing





Cube of sugar burns readily when heated with a match flame. But your guests won't be able to do it



Add pinch of white cigarette ash to sugar cube before heating. Invisible ashes will assure a flame



Break a yardstick in two with a sheet of newspaper. Place the paper flush with the edge of a table, slip yardstick halfway under paper and strike it a quick blow. Air pressure on the paper holds yardstick



Using just a paper match, lift the ice cube from the water. This one is a real fooler. Drop a pinch of table salt on the ice and hold the match against it. Ice melts and refreezes to "cement" match to cube



Make Handy Offset Weeding Tool From Ordinary Table Knife



An ordinary table knife makes an excellent weeding tool, especially around low-growing shrubbery. An offset is bent in the steel blade by clamping it in the vise. The offset allows the gardener to get beneath the weed roots to lift the whole plant out. Friction tape is wound around the handle to provide a better grip.

Hi Sibley, Nuevo, Calif.

Steel Angle on Stairwell Railing Prevents Dangerous "Perching"

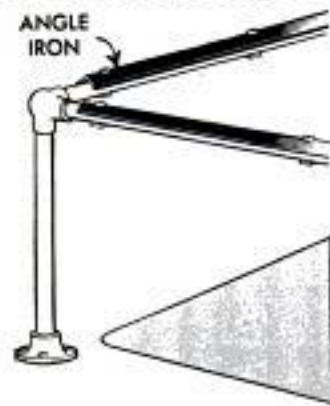

A steel angle bolted to the pipe railing around a stairwell will discourage the dangerous practice of sitting on the rail. The angle is bolted with the heel up to assure an extremely uncomfortable seat for anyone trying to sit on it.

Replace Venetian-Blind Cord By Using Old One As Guide

The worn cord in a Venetian blind can be replaced in a few minutes' time if it is done before the old cord breaks. Butt the end of the new cord against the old one and fasten it with staples or by sewing. Then wrap the joint with cellulose tape to make

a smooth connection that will not snag in the slats or over the pulleys. When the cord is pulled through to the side of the blind, be sure to allow enough cord to make the loop as long as the blind is high.

Ed Packer, Chicago.

Tags Attached to Young Trees With Split Section of Hose

Damage to newly planted trees from the wire with which the name tag is attached may be avoided if the tag is first wired to a split section of rubber hose. It is sometimes desirable to leave the tags on young trees, but the wire eventually will cut into the tender bark as growth takes place. However, the section of hose slipped over the trunk or branch of the tree will expand with the growth and cause no damage.

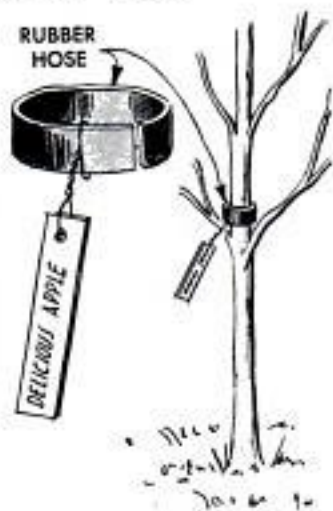

Mirror Used for Emergency Notes When Paper Is Not Available

A vanity mirror of the type carried by many women in their handbags, makes an excellent emergency "memo pad" when pencil and paper are not available. A lipstick or eyebrow-pencil message can be readily erased from the glass with cleansing tissue.—Wm. I. Todd, Burbank, Calif.



Before refinishing any wooden surface, the old finish should be completely removed down to the raw wood.

Let's Go FISHIN'

By Russ Jenkins

Good fishing doesn't depend on expensive equipment. Sometimes a little homemade lure will get the bigger ones when fancier varieties won't. This lure consists of a number of brightly colored sequins threaded on the shank of the hook, with a bit of bright-red rubber as a tail or wiggler to attract attention. Most notion stores have sequins

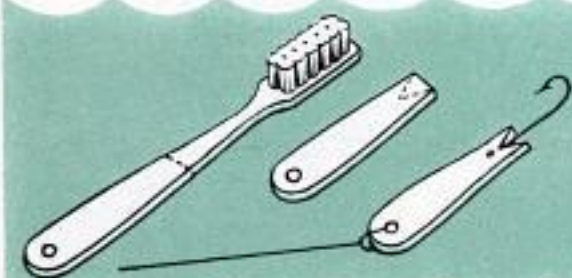

Red worms often are more gray than red by the time they are put on a hook as bait, which may make them less effective, since the color is a part of their attraction. To get that bright color back again, paint the worm with Mercurochrome, using a small water-color brush. With these bright worms on your hook, watch the number of strikes increase

The colorful plastic handle of an old toothbrush can be transformed with very little effort into a fine wobbling minnow to fool even the warriest of pan fish. Cut off the end of the handle as shown and notch it. Then embed the hook in the notch and hold it in place with a pin through the handle. The leader is attached to the handle eye

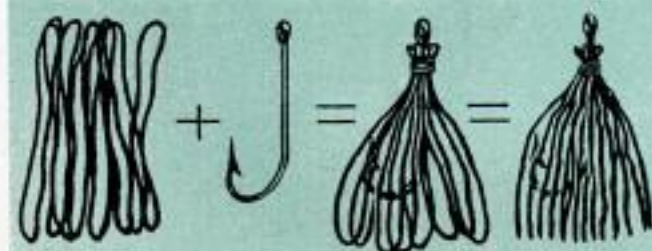

Most fish get hooked because of curiosity. They will investigate almost anything that catches their eye and, for that reason, flashing baits are good fish-getters. Here is one you can add to your collection with only a few moments of labor. Bend a paper clip as shown, to form a loop and two small hooks. Put it through the eye of the fishhook and wire it in place. Then slip polished bits of metal over each hook of the clip and bend arms to hold

Here's another kind of wiggler that you can use to disguise your hook. A number of small rubber bands are fastened to the shank of a hook with fine wire, and then the lower ends are trimmed off. If they are available, use red or other colored bands. This is simple to make, yet seems to get the attention of even wary big-mouth bass



Solving Home Problems

CURTAIN ROD is easier to push through hem of curtain if a safety pin is inserted in end of the rod to serve as a guide. Simply open safety pin and wedge its arms between sides of the rod

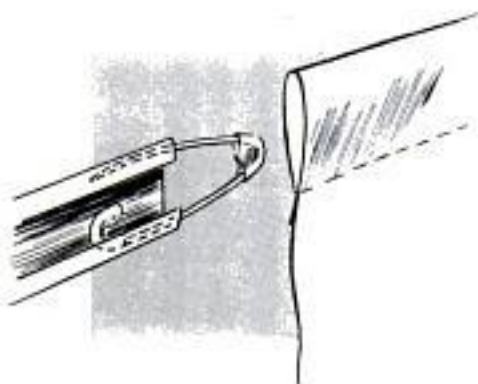

LINOLEUM-BINDING TAPE purchased in roll form can be straightened before use by means of a thread spool and screwdriver. Slip spool over screwdriver blade, as at right, and pass tape under the spool against the direction of curl

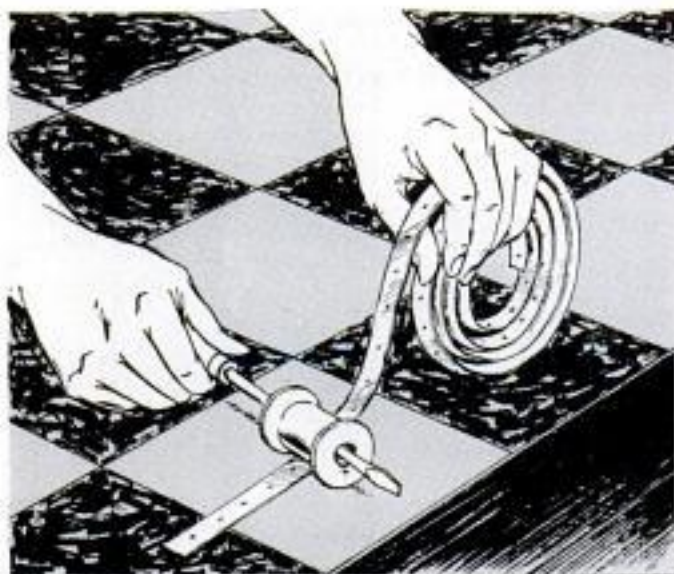

MILK CARTON filled with sand provides door-stop for holding screen door open when carrying packages or furniture through doorway. Use a quart-sized carton and tape closed after filling

INDIVIDUAL SALTCELLARS for picnicking are had by using either metal or paper milk-bottle caps. Just wash and dry bottle caps, and then store so you'll have a number of them for picnics

SEALING ENVELOPES for a large number of greeting cards or letters, below, is speeded and made more pleasant by moistening flaps with ice cube wrapped in clean cloth. The ice normally will melt fast enough to keep the cloth damp while using

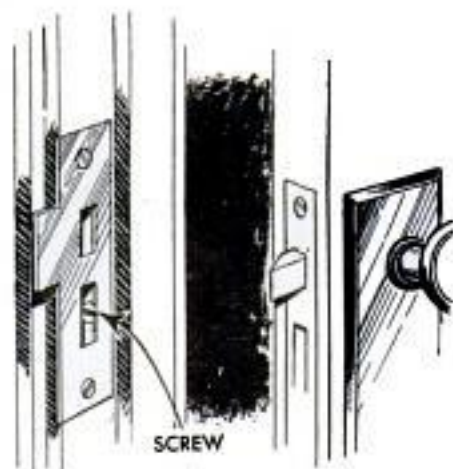
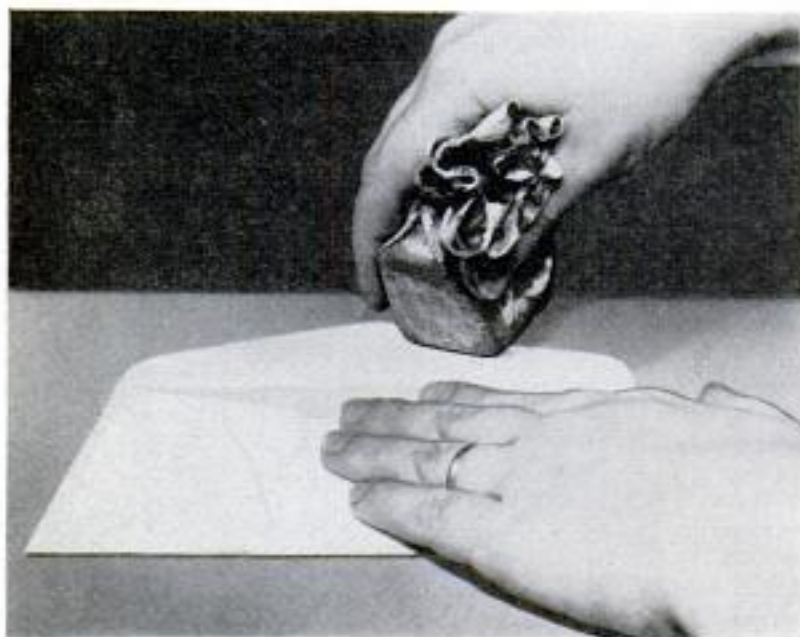

CHILDREN CAN'T LOCK themselves in the bathroom if screw is used to keep lock bolt from engaging strike plate. Drive screw through slot in plate and into doorframe so head of the screw is flush with the surface of the plate

HANDY BASEMENT RACK for work gloves and notes or receipts can be improvised from several ordinary mouse-traps. Wooden bases of the traps are cut to length and screwed to scrap lumber. Rack is mounted in convenient spot

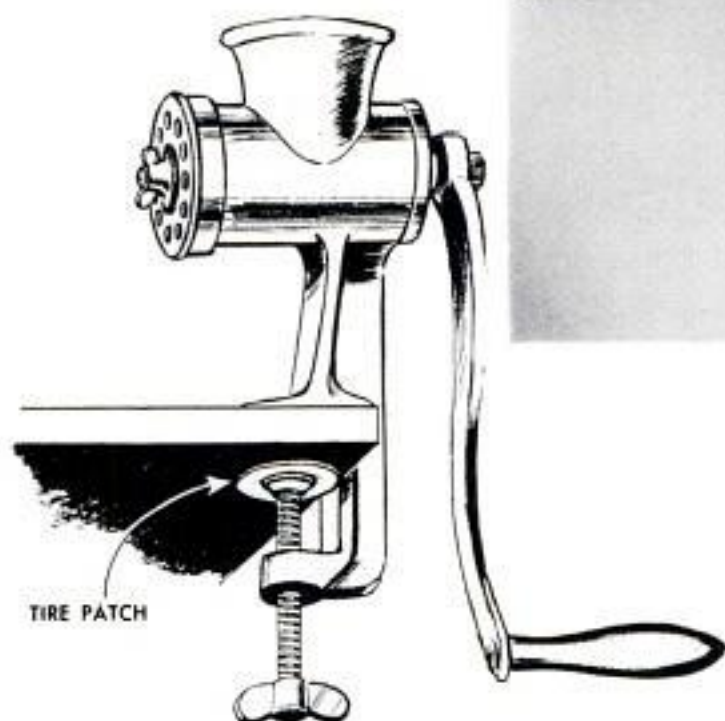
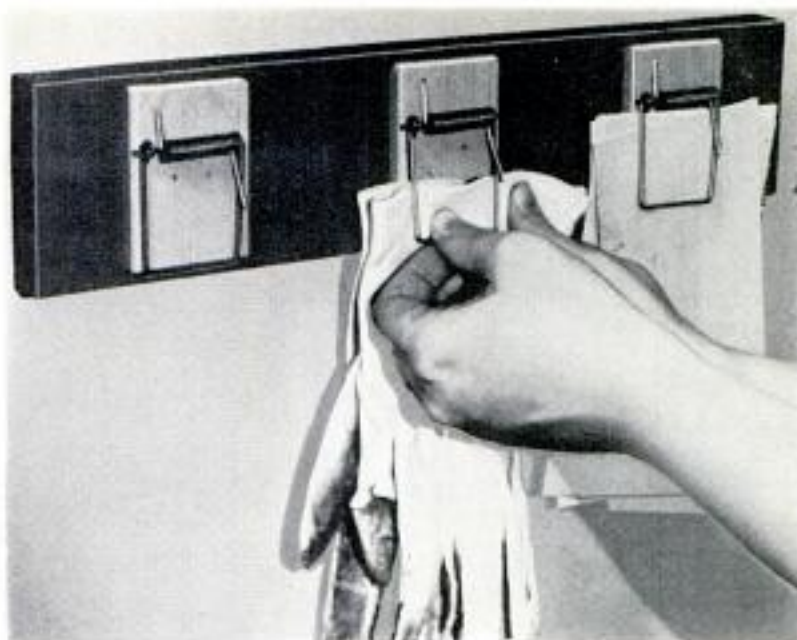

RUBBER PAD for food-chopper clamp assures nonslip grip on table top. The pad is made by cutting a disk from a piece of old inner tube and cementing the disk to the underside of table-top overhang, positioning disk so clamp will tighten over it

STORING CANNED GOODS in unusually small amount of space is possible by installing these sliding shelves in kitchen base cabinet. Shelf sides are of 1 x 2 and bottoms of hardboard or plywood. Cleats fastened to sides of cabinet serve as guides, and the shelves are spaced varying distances to suit can sizes



Cup-and-Saucer Rack Fashioned From Brass or Copper Wire

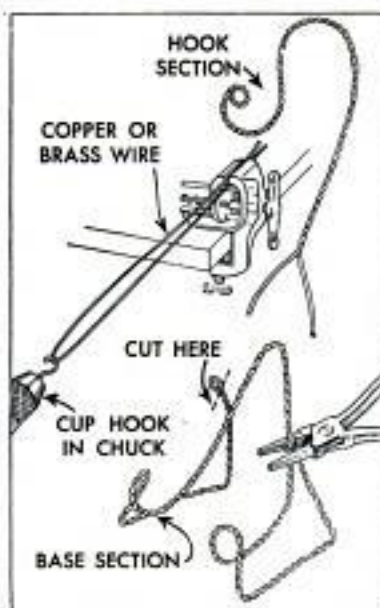

Fashioned of bright brass or copper, this twisted-wire rack will display a prized cup-and-saucer set to excellent advantage. Two lengths of 16-ga. wire, one 68 in. long and the other 24 in., are looped double and twisted in a vise, as shown. Allow the ends of the short length, which forms the hook, to extend about $2\frac{1}{2}$ in. These ends are used to tie the hook to the base section. The required dimensions may, of course, vary.—Roberta L. Fairall, La Crescenta, Calif.

Tipping Bird Bath Attracts Songbirds and Keeps Cats Away

If you want to put a birdbath in your yard to attract song birds, and at the same time save the birds from being molested by prowling cats, this tipping birdbath will serve both purposes. A 5-ft. length of soil pipe is set in the ground so that 3 ft. of it projects above the surface. The bowl of the bath, which is a cover from a garbage can, is held on the base by a sash weight tied to the handle and suspended inside the soil pipe. When a cat attempts to get at birds in the bath, the cover tips and spills water on him. The sudden loss of support, plus the water bath, will discourage even the most persistent cat. The cover will right itself as soon as the weight is removed, because of the sash weight. The soil pipe and garbage-can cover could be painted a bright color, or stones and colored bits of pottery might be cemented around the soil pipe as decoration.—Jerry Dunham, Chicago.

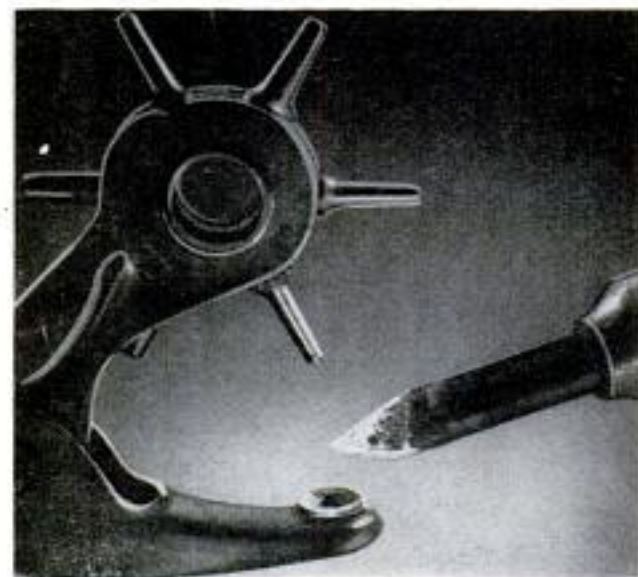
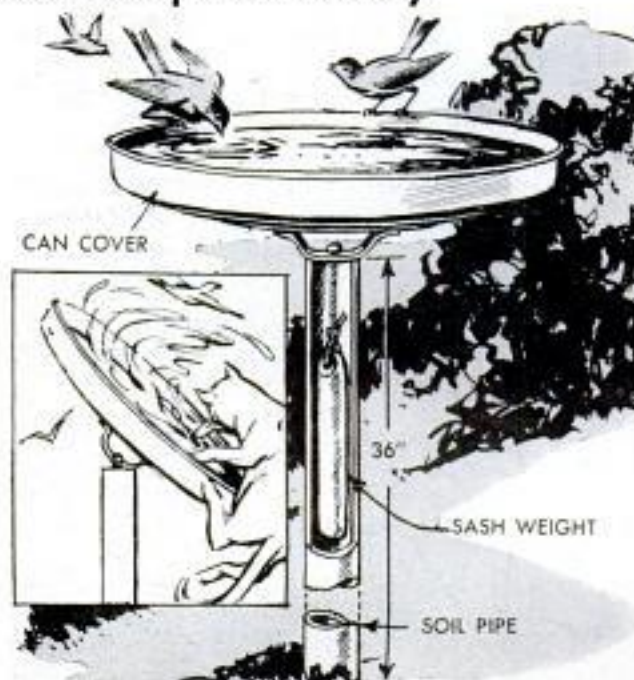

Solder Refaces Punch Anvil

The useful life of a leather punch can be effectively increased by refacing the worn surface of the anvil with solder. The solder should be applied heavily, keeping the soldering iron on the anvil until the solder flows into a smooth surface. After this refacing, future repairs are easily made by reheating the solder until it melts into a smooth surface.

☐ Mixed nails, screws and other small parts may be sorted easily if they are dumped on a sponge-rubber pad, such as a chair cushion or kneeling pad. The resilient surface permits the parts to be picked up easily, and prevents rolling or skidding.

X726

WTM 56
+
SERVICE FILE
BOOKLET #200



Craftsman Jim Kendall, high-school shop instructor at Oak Park, Ill., tells how he built his . . .

FAMILY CAMPING TRAILER

LIKE SO MANY outdoor-loving Americans, my family thoroughly enjoys spending its vacations and long week ends camping out—roughing it, so to speak—while exploring the many lakes and back trails of this great U.S.A. After having roughed it several summers in true Boy Scout style, we decided to design and build a camping trailer that would incorporate “all the comforts of home” in a compact, two-wheel job capable of being trailed safely at highway speeds.

Having two boys, Bruce and Craig, I knew that the trailer would have to sleep at least four. It would have to be small enough to park in my two-car garage, and it would need a roomy ice chest to handle an ample food supply. It also would have to afford adequate protection in bad weather and, preferably, be collapsible, which meant finding a way of erecting and dis-

Part I

mantling it without a lot of work. In short, a fold-away “tent” on wheels was what we needed.

The trailer you see pictured below fulfills all these requirements. And, after having put it through a tour of the West last summer (a grueling test of some 5000 miles), we found the trailer towed beautifully, provided all the comforts we had hoped for and caused a mild sensation wherever we set up camp or pulled stakes. When open, each overhanging wing of the trailer to which the tent is permanently attached, accommodates a full-size air mattress to provide comfortable sleeping for four. The deep insulated ice chest at the front of the trailer is easy to reach both when the trailer is open or closed. The boys found this feature especially convenient for getting Cokes and other treats while on the road. Likewise, two lock-fitted

Independent of motel and restaurant, the Kendall family are enjoying camp life at its best with their trailer





Pipe extensions are screwed on lid supports to increase their length

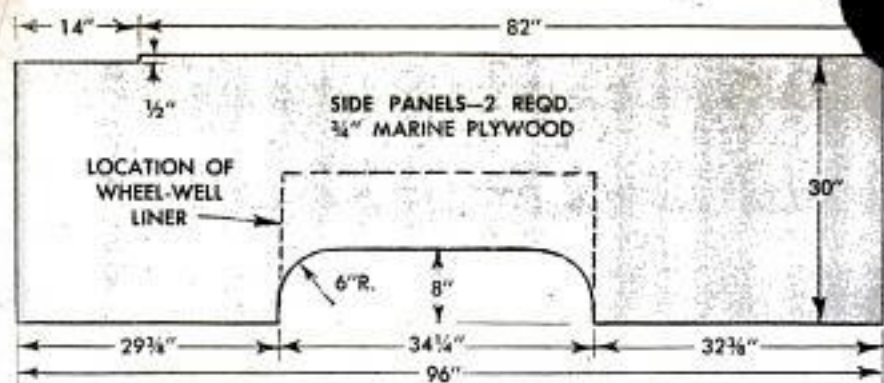

1

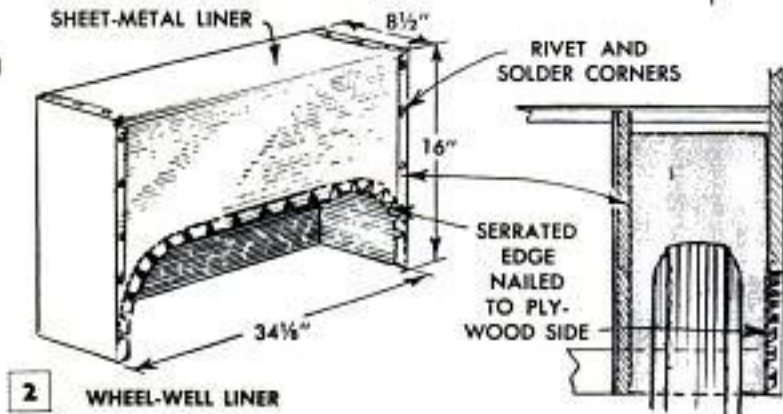
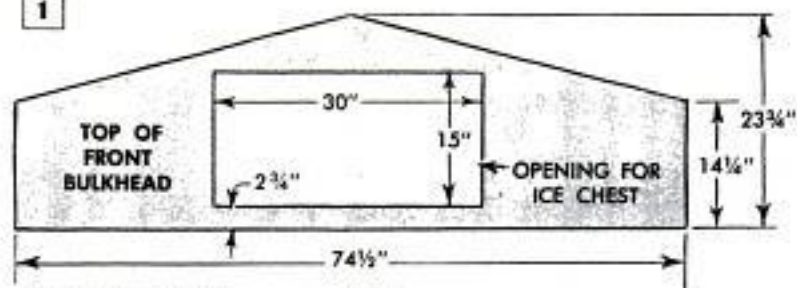

2 WHEEL-WELL LINER

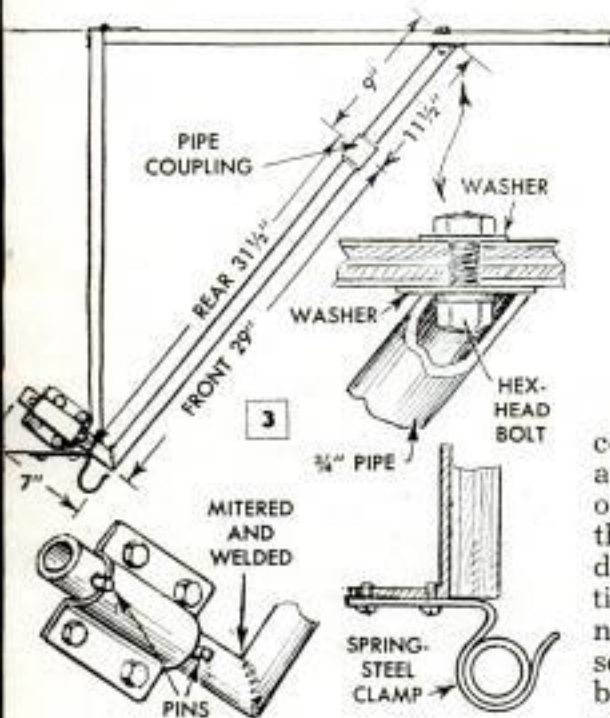

3

Below, bolt-head studs project from lids to engage ends of pipe supports



compartments in the nose of the trailer permit quick access to items that might be needed en route without opening the trailer itself. Two persons can easily erect the canvas top in a few minutes, and a full-length screen door keeps flies and mosquitoes outside. The center portion of the trailer interior affords space to store an aluminum table-and-chair set, as well as a camp stove. The screen door stows away in a trap door in the floor, and built-in compartments with sliding doors provide plenty of room for cooking utensils, bedding and clothing.

Down to the last nut and bolt, the trailer cost me \$457.31 to build. However, we later found we could have saved as much as \$30 on the cost of the canvas top (\$133) by having the awning makers sew it together during their slack season. If materials can be salvaged and a second-hand running gear purchased, the cost can be reduced considerably.

I made the bed of the trailer body from lengths of 3-in. channel iron and 1-in. angle iron, and welded the 18 separate pieces into a rigid framework. The channel stock is used for the main members of the bed and the tongue, these parts being shaded in the plan drawing, Fig. 5. Note that the forward ends of the two center members of the bed are cut at a 13-deg. angle to match the slant of the two front members of the bed. I laid out the members squarely on my garage floor to assure a flat assembly when welding the joints. The various members are placed in position, with the flat side of the channel facing outward. The two center channels are spaced 36 in. apart and butt-welded to the front and rear members. Two short lengths of channel, 16 3/4 in. long, are butt-welded to the center members on each side of the bed to form the wheel wells.

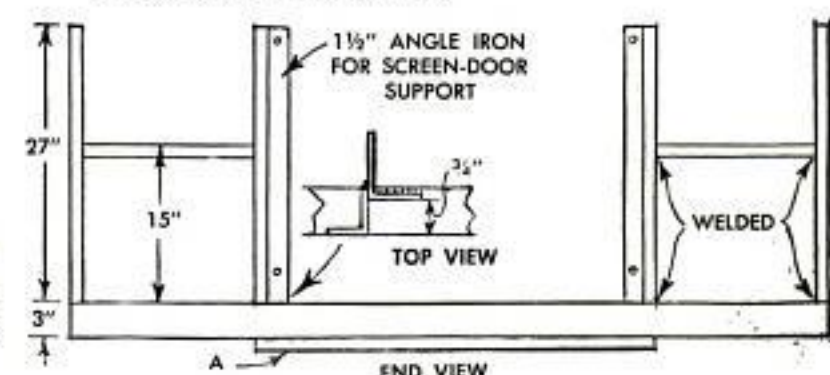
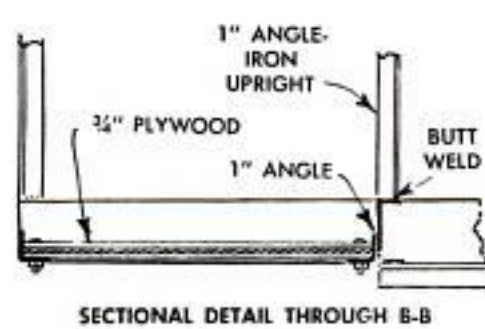
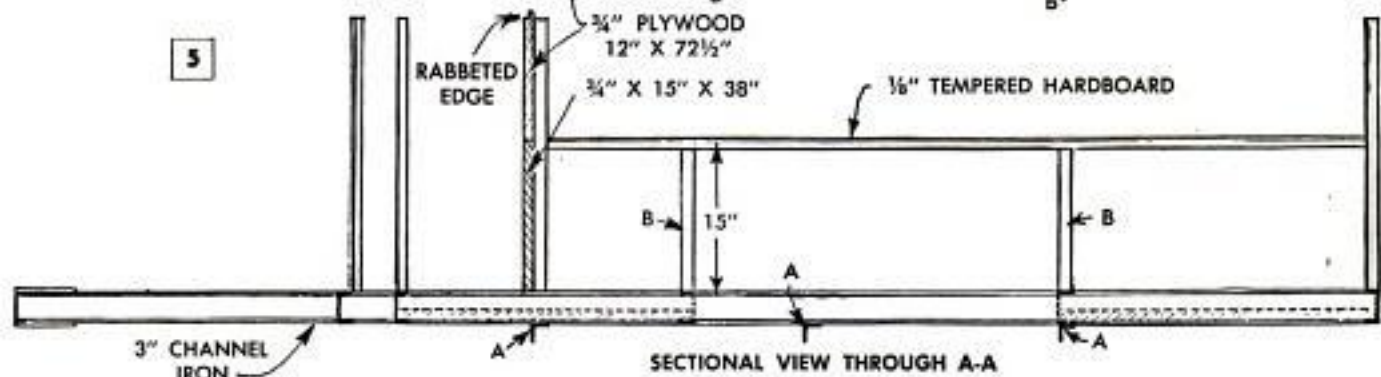
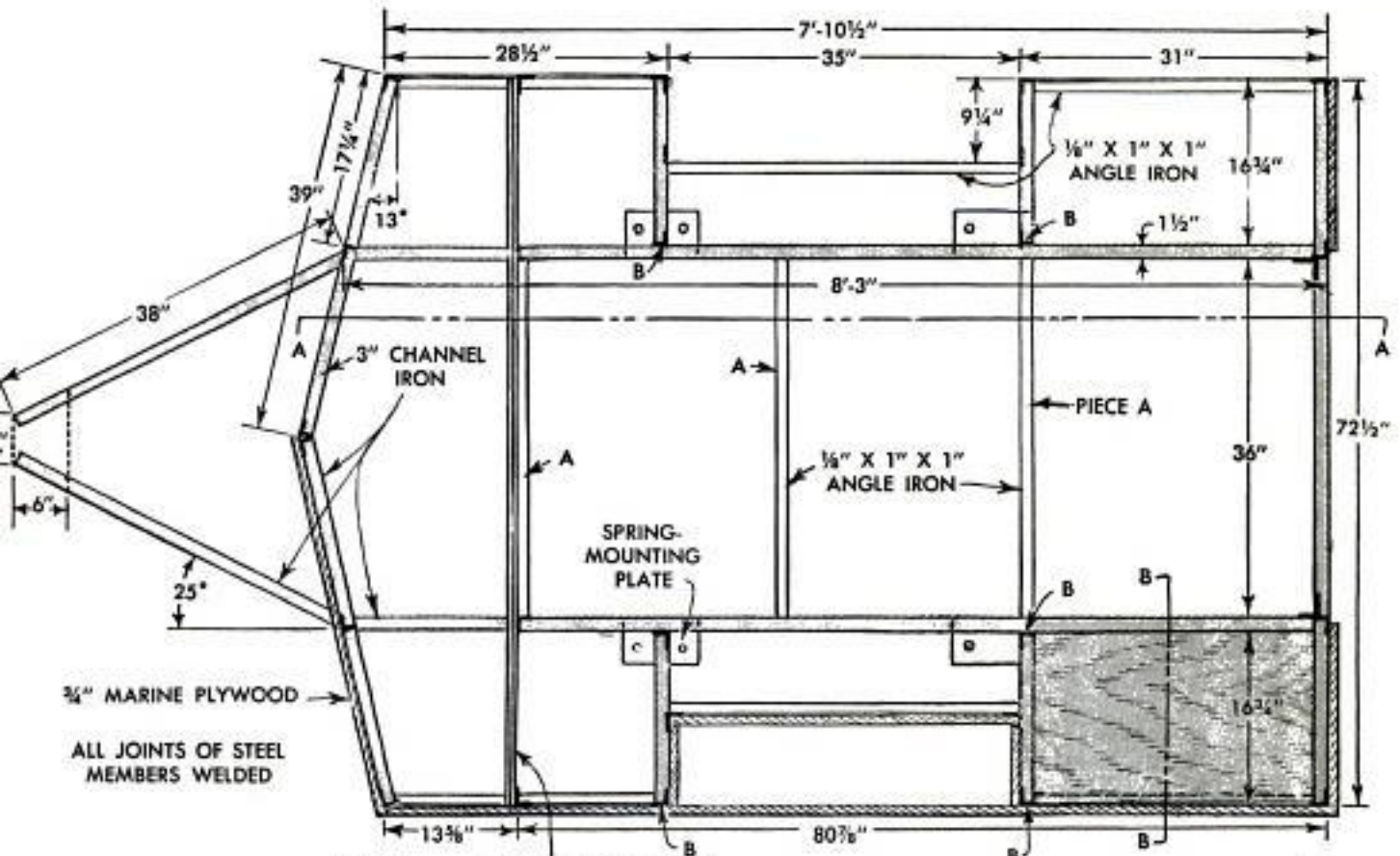
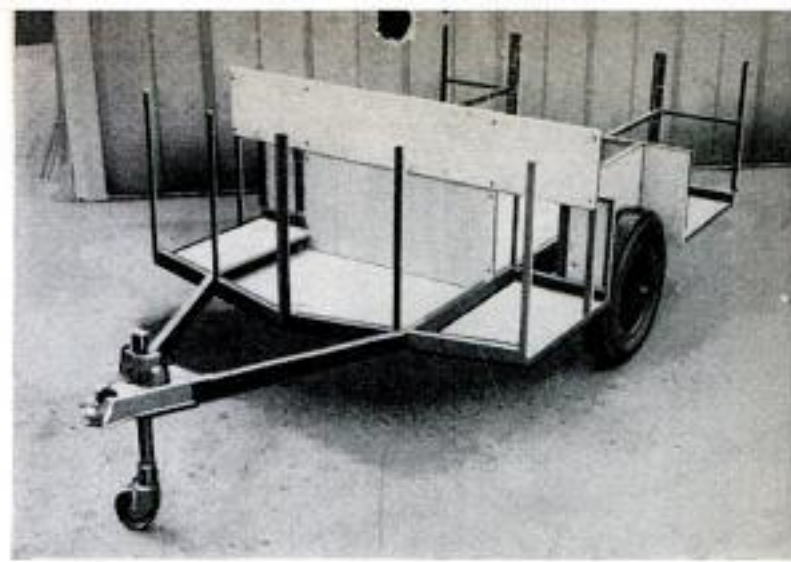
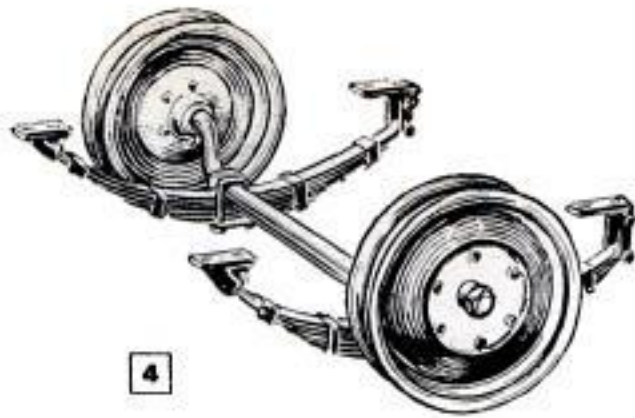

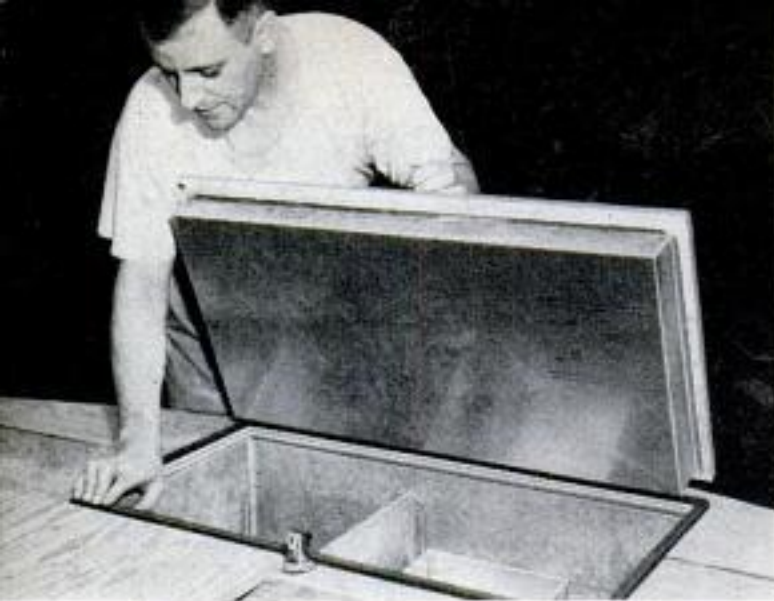

Weather stripping provides a seal for ice-box cover

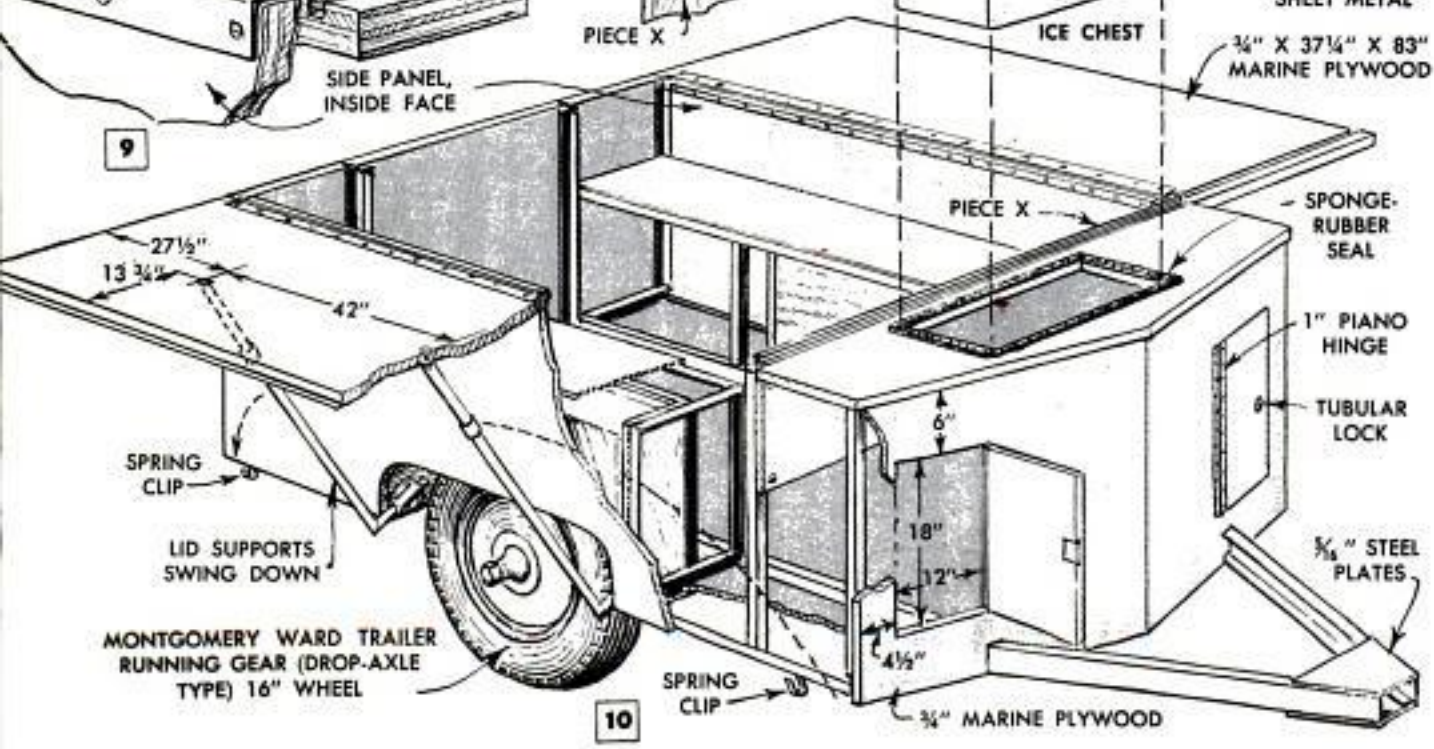
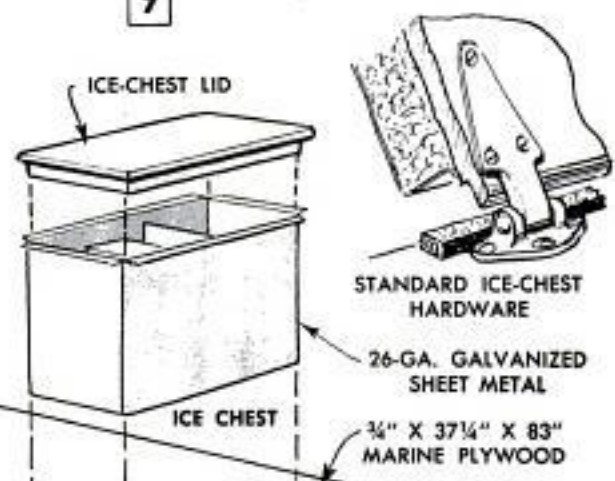
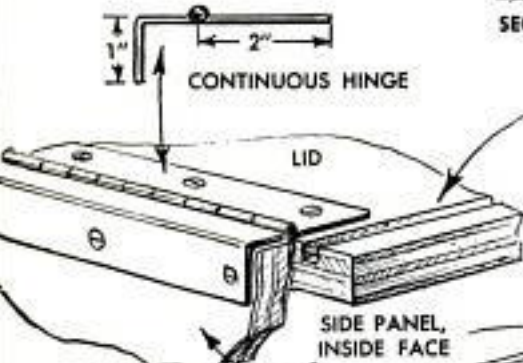
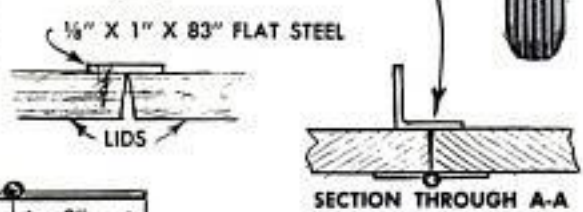
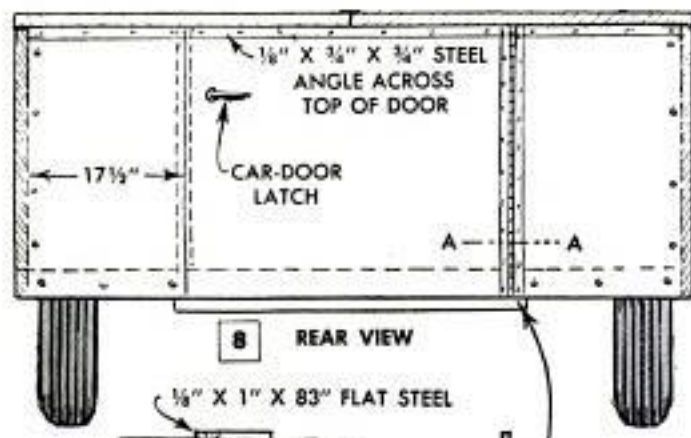
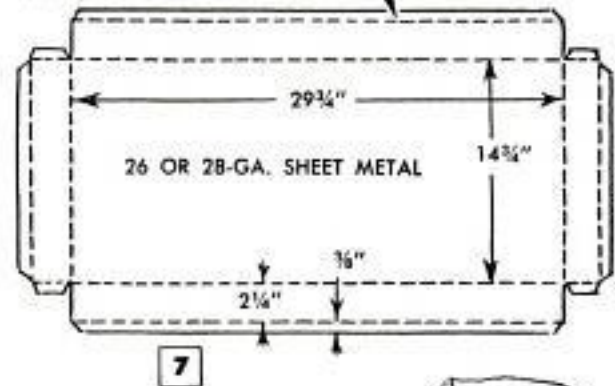
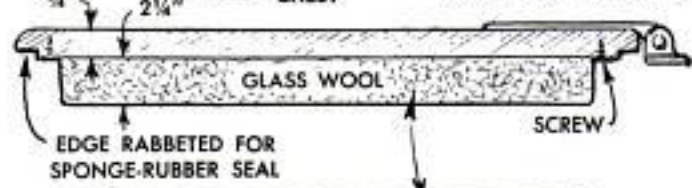
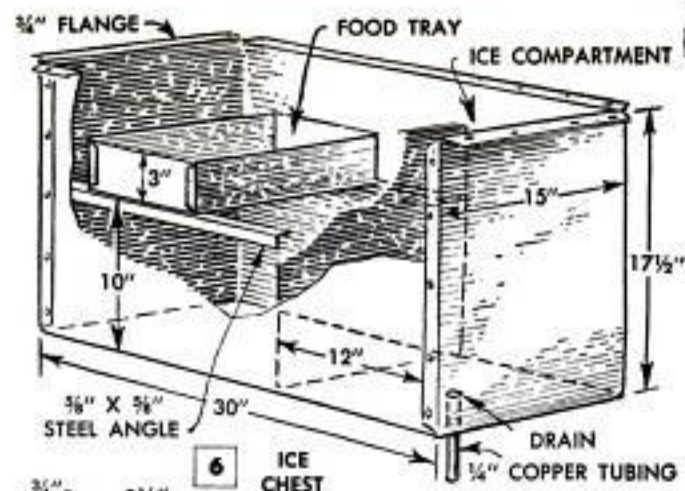

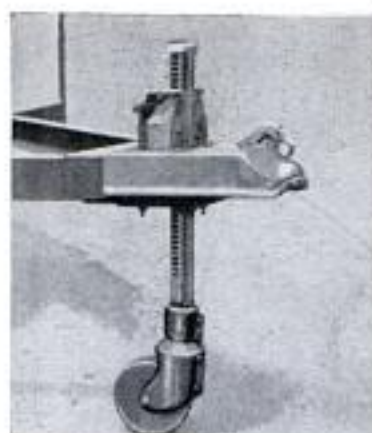

I used an Atwood commercial trailer hitch that bolts to the channel-iron tongue. Hitch permits easy rolling

Three pieces of angle iron, marked A on the drawing, are cut 39 in. long and welded to the underside of the two center channels. These pieces provide support for a $\frac{3}{8}$ -in. plywood floor. Lengths of angle iron also are welded along the center channels and along the outer edges of the bed at the sides as indicated in section B-B, Fig. 5.

You can use any suitable two-wheel running gear, Fig. 4. I purchased a 58-in., drop-axle type having 16-in. wheels from Montgomery Ward for about \$60. Spring-mounting plates, $\frac{3}{8}$ x 6 x 8 in., are welded to the bed on the underside at the points shown and drilled for the shackle bolts.

The locations of the angle-iron posts to which the sides of the body are bolted, are spotted on the plan drawing. These are cut from 1-in. angle iron. A total of 24 are needed, ten of these being 27 in. long, two 29 in. long and twelve 14 in. long, the latter ones being located at the wheel wells, B in Fig. 5. All posts are merely butt-welded on end at their respective locations. If you study the plan carefully, you can see the way each post faces. Holes for bolting the plywood sides to the posts should be spotted and drilled before the posts are welded in place. Drill six holes for $\frac{3}{16}$ x $1\frac{1}{4}$ -in. carriage bolts in each 27-in. post, spacing them about 5 in. apart. The two 29-in. posts are butt-welded to the edge of the 1-in. angles along the sides $13\frac{5}{8}$ in. back from the front corner posts. These particular posts support the plywood bulkhead, marked X in Fig. 10. Note that this piece is rabbeted along the top edge to engage a groove on the underside of each trailer lid to give a watertight joint. Looking at the end view, Fig. 5, you'll notice that the 1-in. posts at the rear-door opening have a second post of $1\frac{1}{2}$ -in. angle iron welded to them. These are set in $\frac{3}{4}$ in. and provide a bolting surface for attaching the frame of

the screen door to be described later. Finally, lengths of 1-in. angle iron are welded across the tops of the 14-in. posts and between the posts at the rear of the bed. Study section A-A, Fig. 5, and the end view. These members form a shelf on each side which is covered with hardboard.

The outside is covered with $\frac{3}{4}$ -in. marine plywood. Figs. 1, 8 and 10 give the sizes for the various panels. Exact lengths should be taken directly from the trailer bed, adding $\frac{3}{4}$ in. to the length of the side panels to lap the plywood applied to the back. Before the side panels are permanently bolted in place, the wheel wells first are lined with plywood and then fitted with a sheet-metal liner. This is soldered and riveted as in Fig. 2, the cut-out edge being serrated to form tabs for nailing the liner to the edge of the plywood side panel.

Figs. 6 and 7 detail the ice chest and its cover. You'll notice that the plywood part of the cover is rabbeted around the edges to bear against a length of sponge-rubber weather stripping applied around the opening in the bulkhead cover board. Standard ice-chest hardware is used to hinge the cover and provide a positive seal. The ice chest itself hangs in the opening by flanges, and glass-wool insulation is packed solidly around it. The lids, or doors, which overhang the sides when the trailer is open, are hinged with lengths of 4-in. continuous hinge which I bent in a sheet-metal brake, as indicated in Fig. 9. I could buy this hinge only in 6-ft. lengths so I made up the difference by adding a section to it. Fig. 3 shows how the pipe supports for the lids are installed. These pivot in brackets located in the wheel wells and swing up from spring clamps to engage bolt-head studs projecting from the top surface of the lids. Pipe extensions are stowed separately.★★★

(To be continued)

PLAN of the MONTH..

REMOVABLE MAPLE TOP
 $\frac{3}{4}$ " X $14\frac{1}{2}$ " X $22\frac{1}{2}$ "

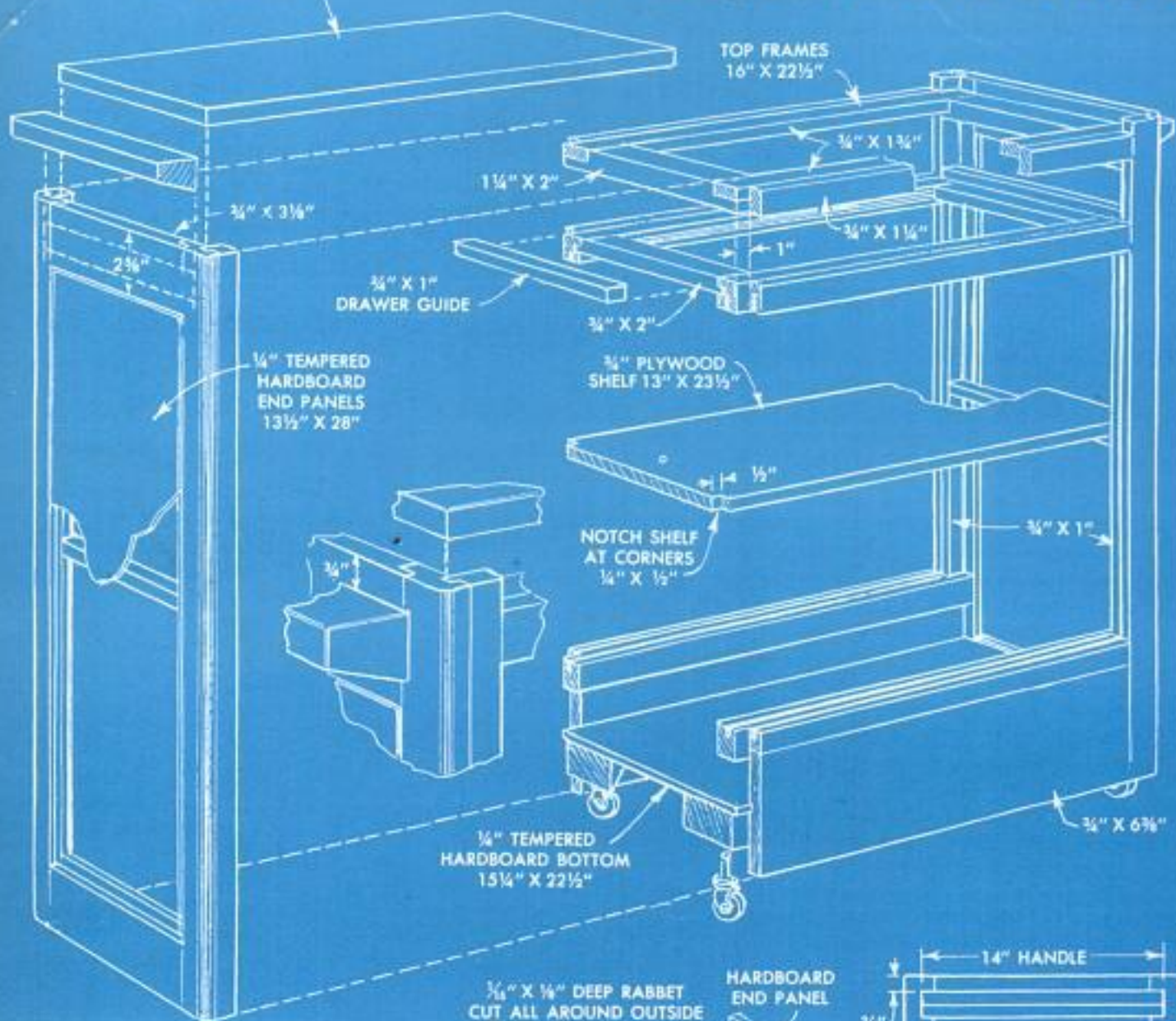

$\frac{3}{8}$ " X $\frac{1}{4}$ " DEEP RABBET CUT ALL AROUND OUTSIDE EDGES OF END PANELS

HARDBOARD END PANEL

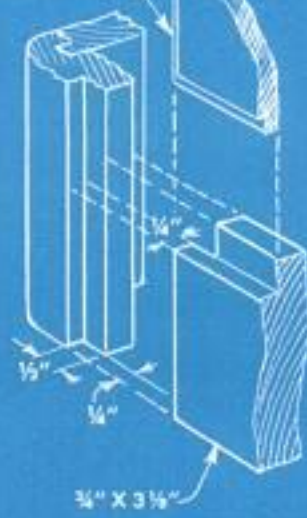
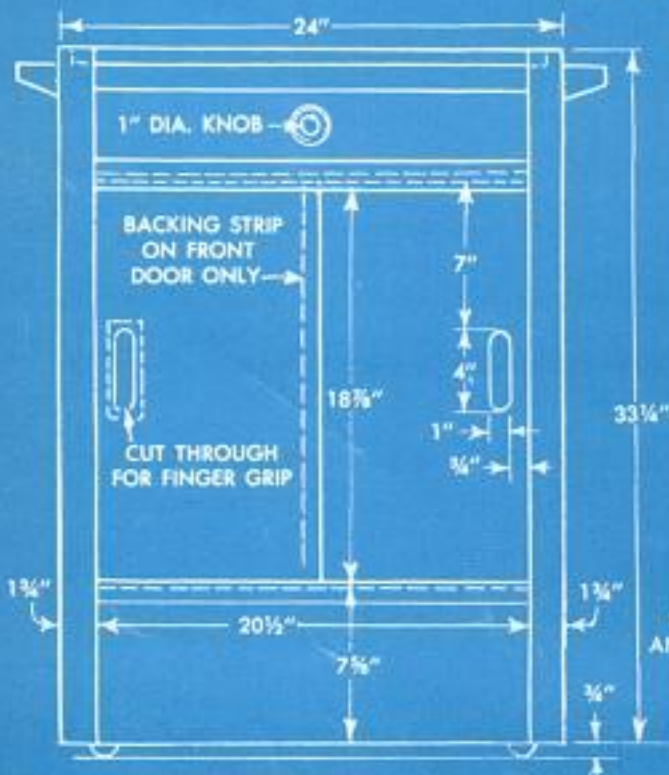

NOTE: SLIDING DOORS ON FRONT AND BACK, DRAWER CAN BE OPENED FROM FRONT OR BACK

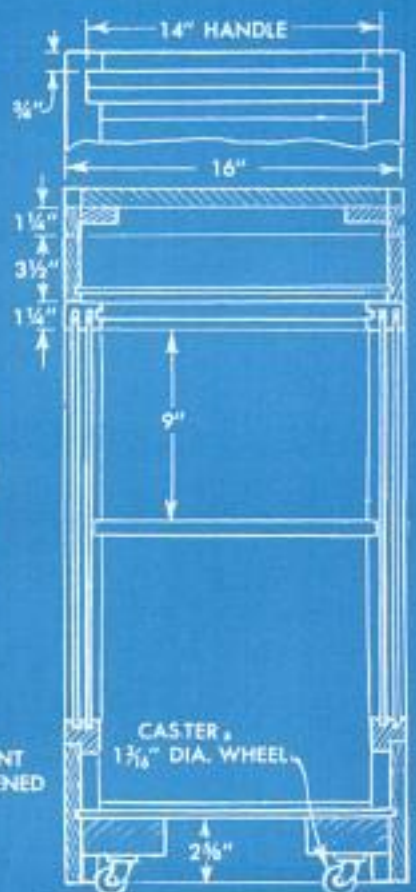

Antproof Docking Facilities Improvised for Cabin Cruiser

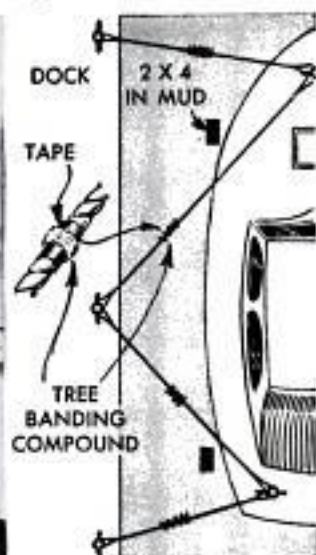

Ants won't be able to board a cabin cruiser if the boat is kept away from the dock by 2 x 4s driven into the mud about 18 in. from the dock. The lines, water hose and electric cable that must run from the boat to the dock are wrapped for several inches, between the dock and the boat, with friction tape, and a tree-banding compound is smeared on the tape. The tree-banding compound will stop all crawling insects from coming up the lines and each application will last for two or three months even under a hot sun.

Mixing-Spoon Handle Graduated To Measure Photo Solutions



To permit accurate measurement of photo-solution ingredients being mixed in an ungraduated crock, one photographer graduated the handle of his mixing spoon. For mixing 1 gal. of solution, he poured 3 qts. of water into the crock. Holding the handle of the spoon down in the

crock until it touched the surface of the water, he painted a thin stripe at the point where the handle contacted the lip of the crock. Then he poured another quart of water into the crock and repeated the marking process. With the handle thus marked he can accurately mix the solution.

Arthur Trauffer, Council Bluffs, Iowa.

Plastic Food Boxes Protect Film When Stored in Refrigerator

If you store photo film in the family refrigerator to protect the emulsion against deterioration, store the film in regular plastic food containers. The containers will prevent possible food spillage from damaging the film and are available from most stores that handle household accessories.

George B. Harran, Westfield, Mass.

☐ Dip the end of a tube of shaving cream into water, after removing the cap, and you will find that the cream has less tendency to adhere to the end of the tube.

Emergency Darkroom Safelight

A simple, inexpensive darkroom safelight that can be put up quickly for emergencies can be made by covering a 10-watt bulb with an ordinary kraft-paper bag. The bag should be fairly heavy and fit over the bulb without



too much play. This type of safelight is good only for use with photographic printing papers and should not be used when loading film. The paper bag also presents a fire hazard.—Robert C. Florian, Chicago.

Garden Watered From Leaky Hose

A leaky garden hose that seems worthless can be used to irrigate gardens and flower beds. With a leather punch, make holes all along that section of the hose which will lie in the garden when it is stretched out. Then turn on the water at low pressure.



Inexpensive and Decorative Patio Gate Insures Privacy

To assure privacy in his patio, and yet have an inexpensive door of neat appearance that would permit quick identifying of callers, one homeowner designed and built the one shown. It is made of shiplap or tongue-and-groove boards assembled on 2 x 4 braces. The irregularly jigsawed bars of the window grill are installed between cleats and decorative molding as in the sectional detail. The gate may be painted a bright color, or perhaps treated with a dark stain to simulate an antique door.

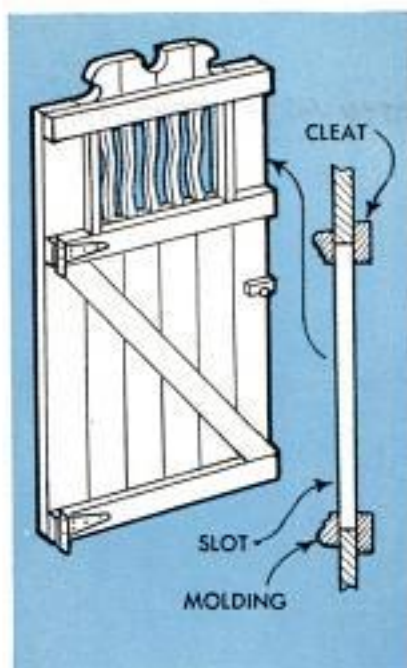

Speed Graphic Operating Steps Noted on Parallax Finder



The letters OPACSF, printed on a piece of masking tape and stuck on a parallax finder, serve as a reminder of the steps to be taken in operating a Speed Graphic camera. It is necessary then only to memorize that the letters stand for the following: O, open focal plane; P, parallax set; A, aperture set; C, cock shutter; S, slide withdrawn; F, focus. This method of learning routine operations in their proper order can be applied to many other jobs in photography.—A. M. Wettach, Mt. Pleasant, Iowa.

Inner Tube With a Sail Tows Heavy Fishing Line Offshore

When no boat is available, an inflated inner tube rigged with a sail will carry a heavy fishing line out into a lake or river beyond where it could be cast by hand. Fastened to each side of the sail, a yoke, to which the fishing line is tied, keeps the

sail facing the wind. The line is supported by floats spaced about 10 ft. apart, between which leaders and hooks are tied. The depth of water and type of fishing will determine the length of the leaders. With an offshore wind blowing the inner tube away from the beach, the fishing line is played out the desired distance. This method also could be used to keep a youngster busy fishing from the shore, thus eliminating the hazards of the child using a boat alone. In some states "trotline" fishing, as this method is called, requires a special license or is prohibited by law, therefore carefully check your own state's game laws before using.—H. M. Springstun, Corpus Christi, Texas.

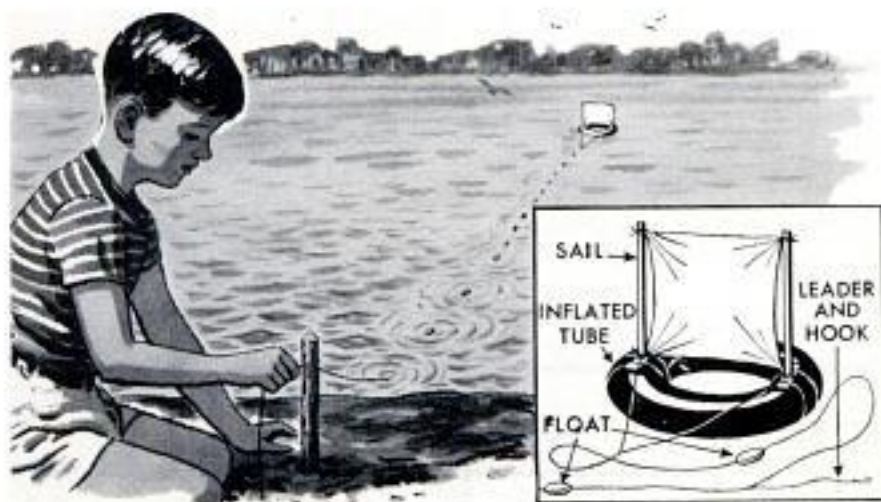

PLAN #101
\$2.00
(full size)

SEE CLASSIFIED LETTER
FILE

CRUSETTE WTM '56

12-FOOT UTILITY OUTBOARD

By Tom Riley

Designed by
John Bergen

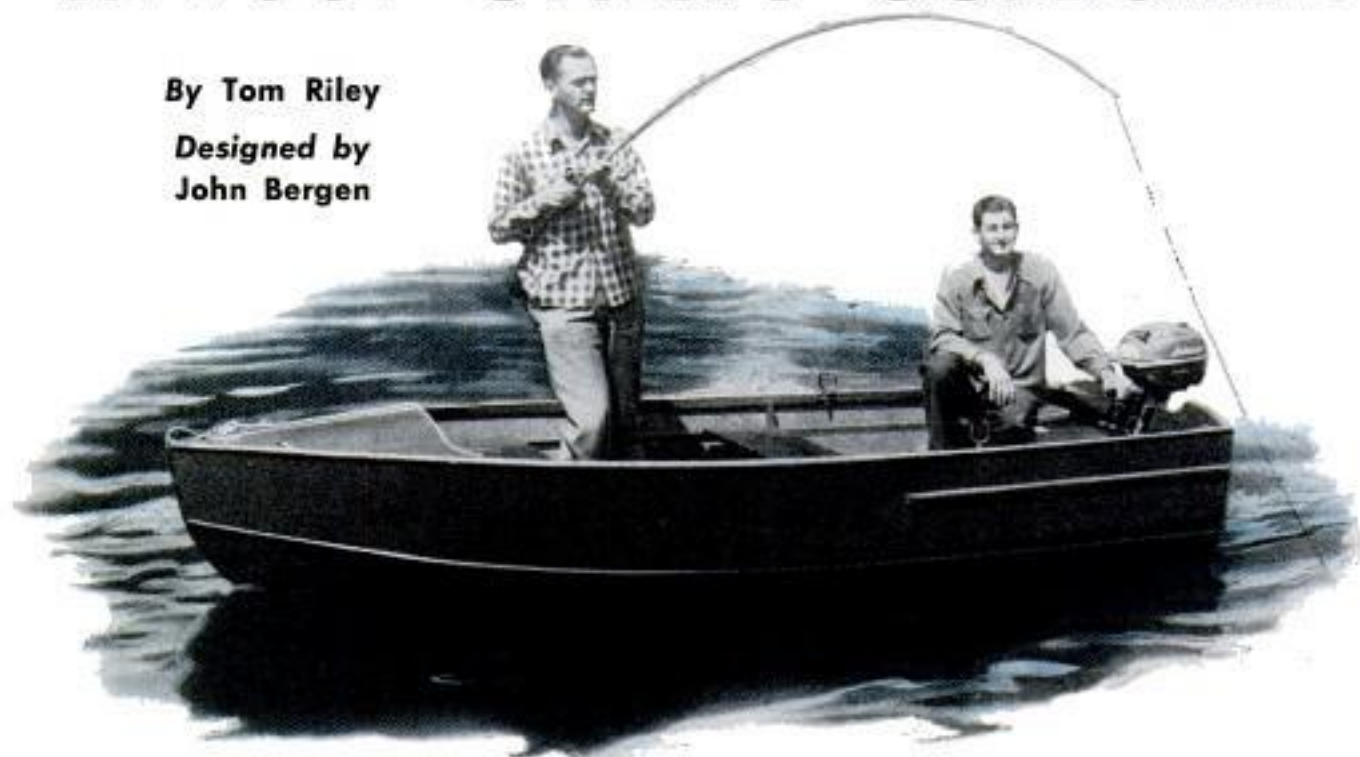

CRUSETTE is an ideal 12-ft. utility outboard for those who want a seaworthy craft for fishing and family outings, plus a hull that is capable of an occasional burst of speed. With clean bow, V-bottom hull and high sheer, Crusette can be trusted in rough weather, and her 4½-ft. beam and sharp chines give unusual stability. She is powered satisfactorily with a small motor, although a more powerful motor (10 to 15

hp.) will give her real speed when wanted.

The plywood hull is built easily on a 2 x 10 strongback, locating the frames as in Figs. 2 and 8. The side and bottom panels may be cut from two 4 x 14-ft. sheets of ¼-in. waterproof fir plywood. On the original craft, ⅜-in. marine plywood with the outside surface of vertical-grain fir was used. Oak or mahogany should be used for the outer stem, outside keel, spray rails and

Crusette is built upside down on a strongback which is later removed. Legs hold boat at working height

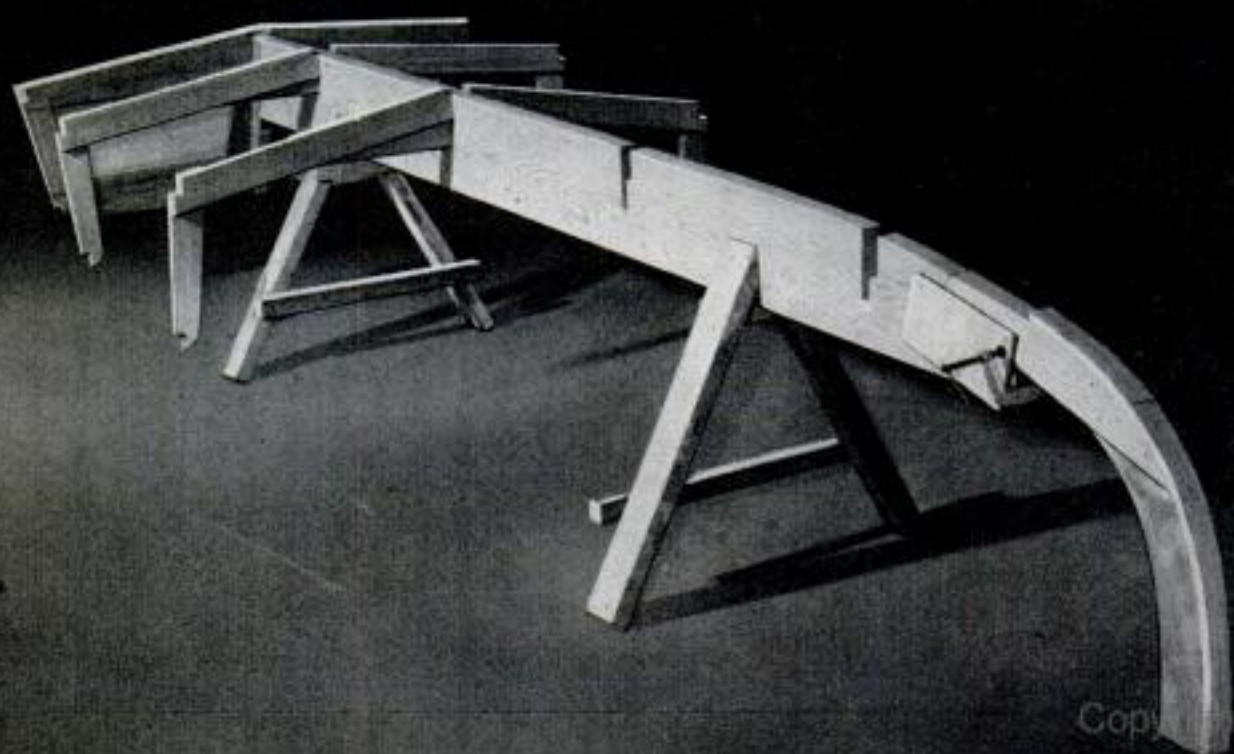

Plans #101 further info. in Classified Letter
 (overwritten) on Dimensions were made on full-size pattern (1/10) which are how exact

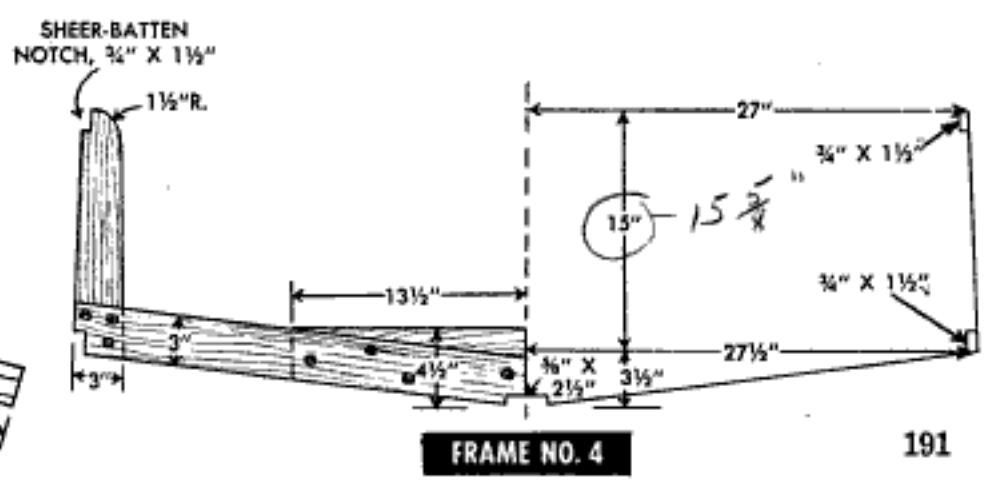
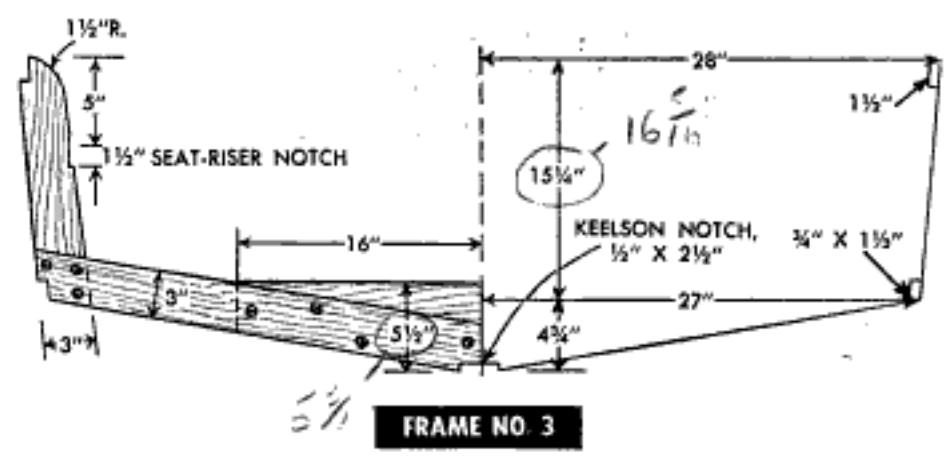
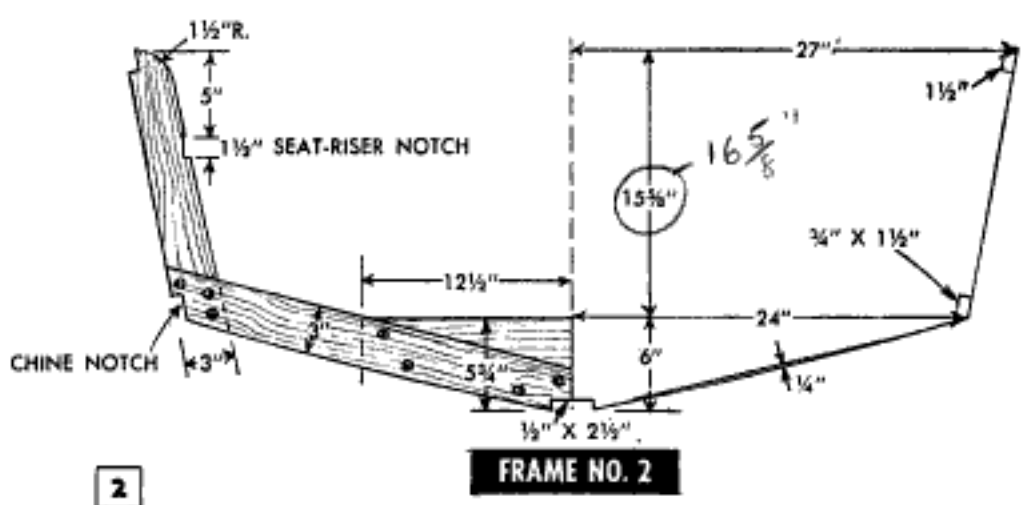
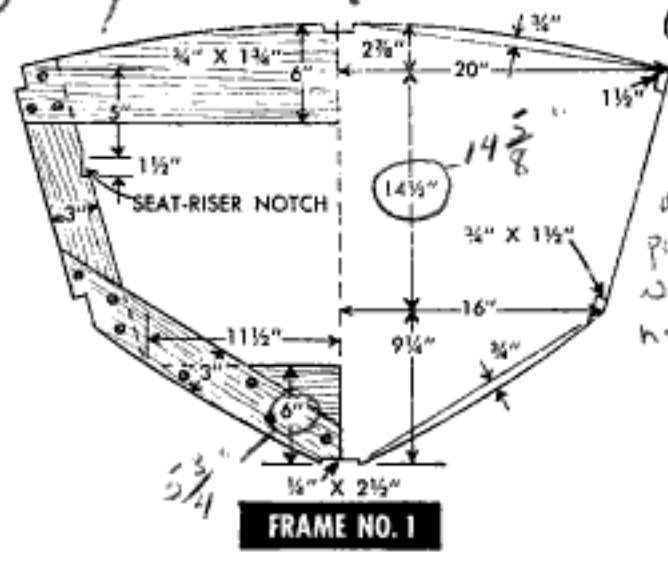
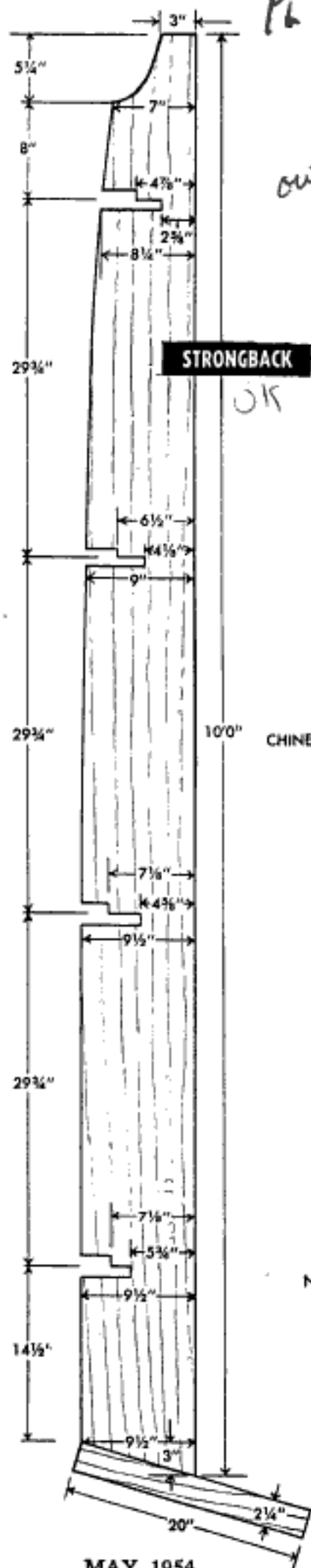

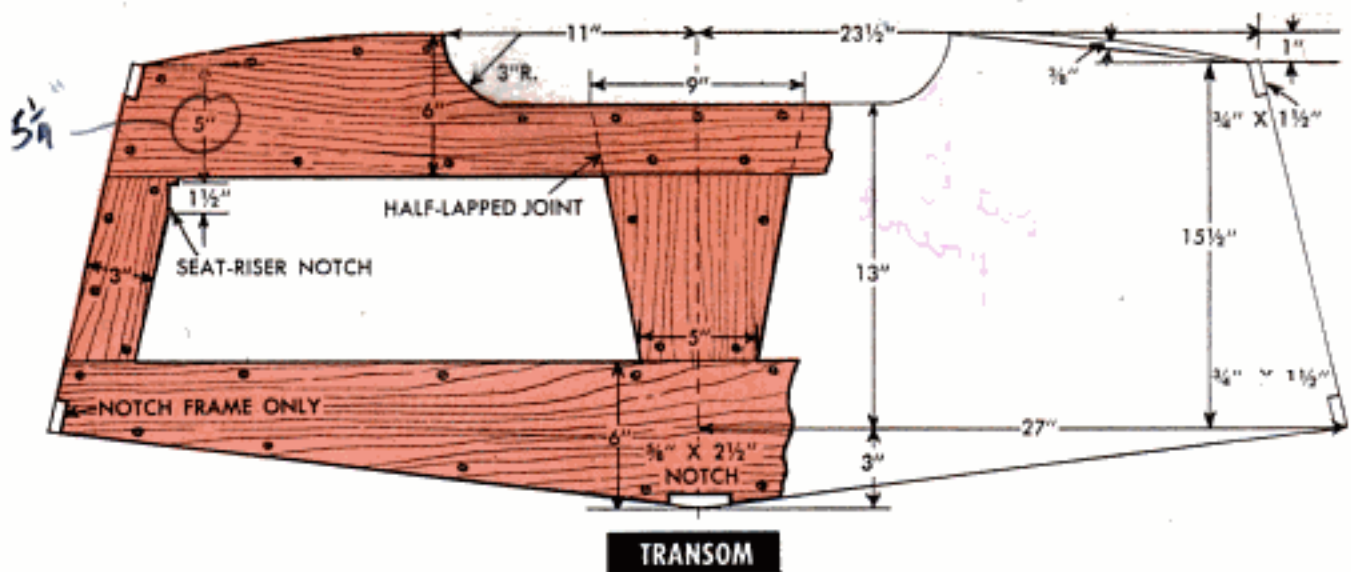

TRANSOM

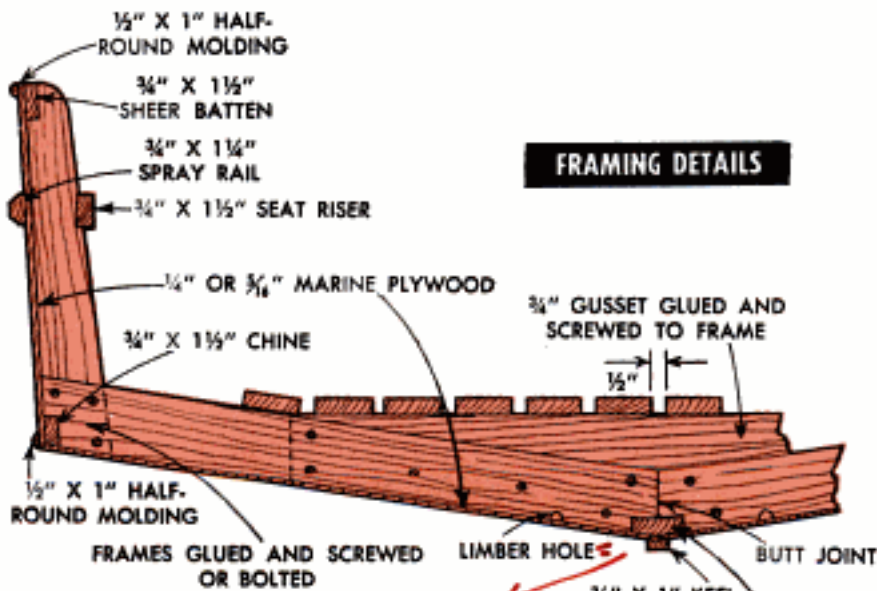

FRAMING DETAILS

3

"Conduits or gutters on either side of keelson to permit water to drain to pump well."

STEM DETAIL

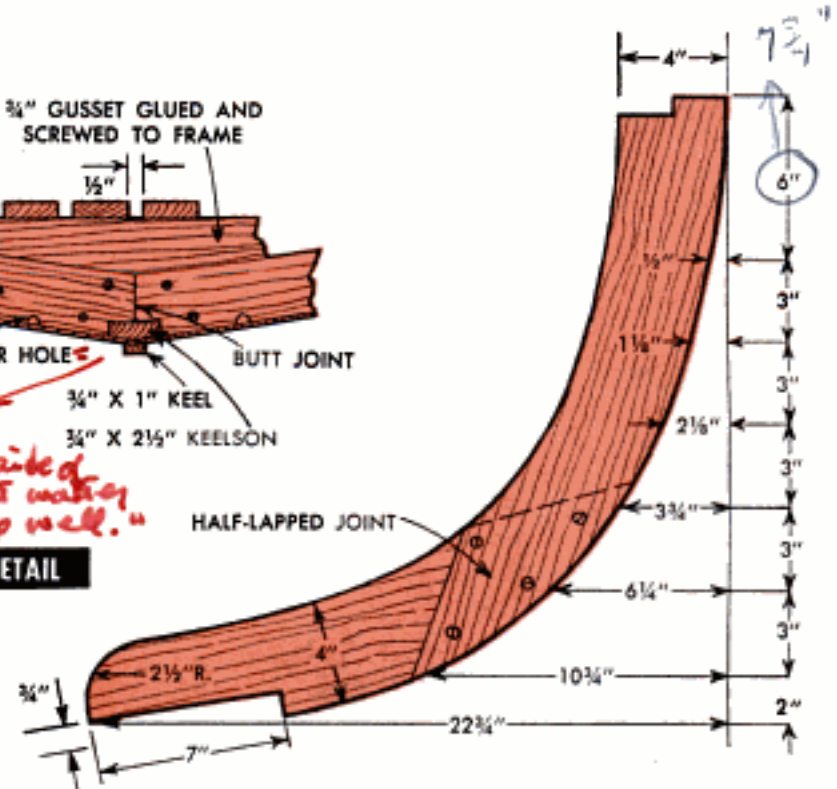

PROFILE

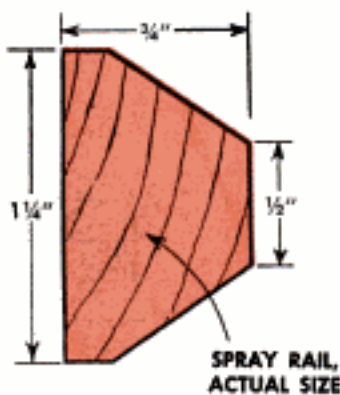

SPRAY RAIL, ACTUAL SIZE



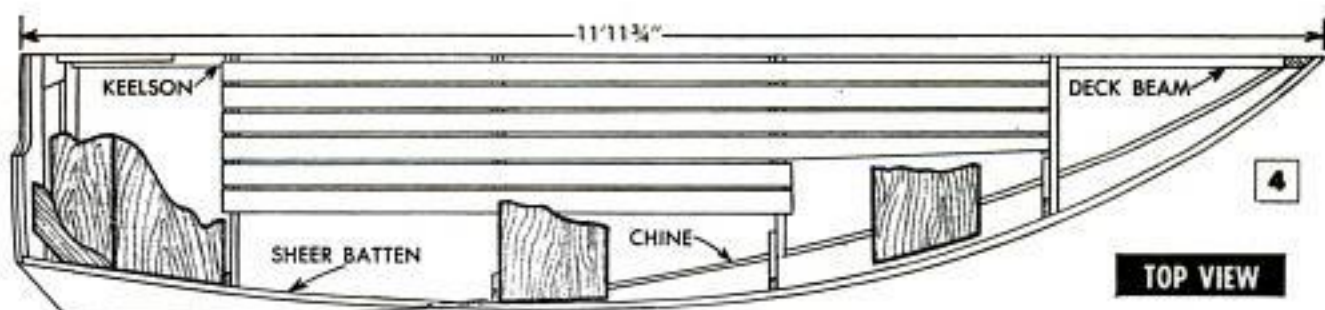

half-round moldings, while frames, seats and floorboards can be of any clear boat-building lumber. If softwood is used for these parts, the boat can be "dressed up" with a mahogany-plywood foredeck, sheer battens and upper moldings.

To build the boat, first cut the strongback from a length of 2 x 10, as detailed in Fig. 2. Screw the transom brace to the stern end of the strongback and notch the bow end roughly to receive the finished stem. Set up the strongback on a fairly level surface, Fig. 1, attaching the legs with screws.

Next lay out the frames and stem full-size on wrapping paper, laying out all the frames, one over the other, on the same sheet of paper. This is done by using a different-colored pencil for each frame. In this way, errors can be detected quickly. Cut the frame members to size and assemble with waterproof glue and screws. Rough out all the notches for the chines and sheer battens. Assemble the transom frame **similarly**, Fig. 3, and then glue and screw the frame to the 3/4-in.-plywood transom. Do not notch the plywood transom; the chines, sheer battens and keelson butt against it.

Set the completed frames in the notches of the strongback and attach the transom, clamping it to the transom brace. Then make the stem, Fig. 3, and clamp it to the strongback, using a C-clamp and two plywood gussets, as in Fig. 1. The gussets are nailed only to the strongback so it can be

Stem is held to strongback with two plywood gussets and a C-clamp. Gussets nailed only to strongback

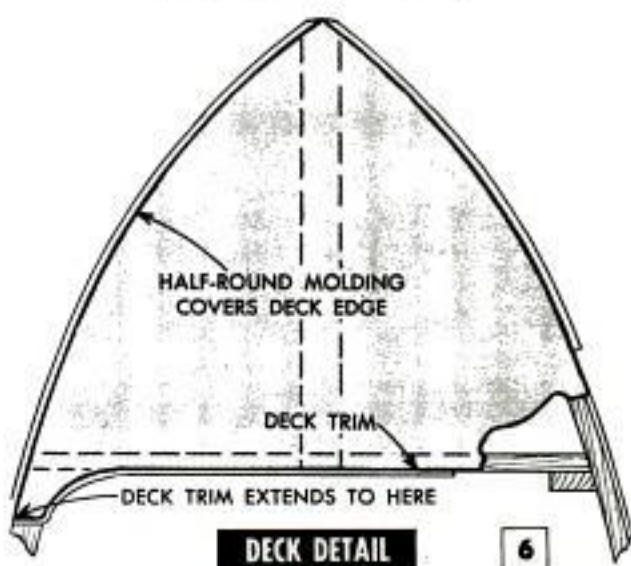
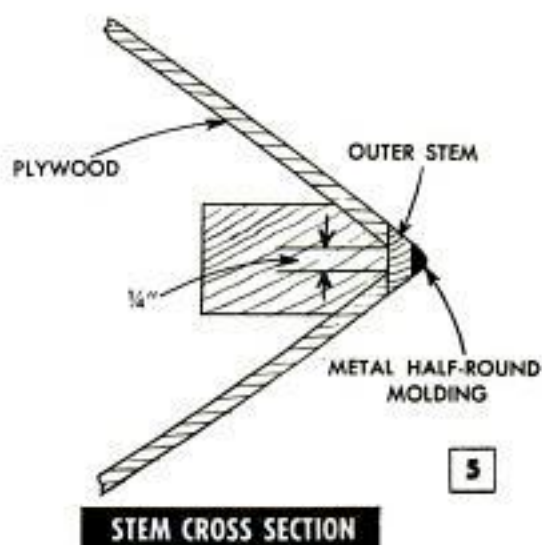
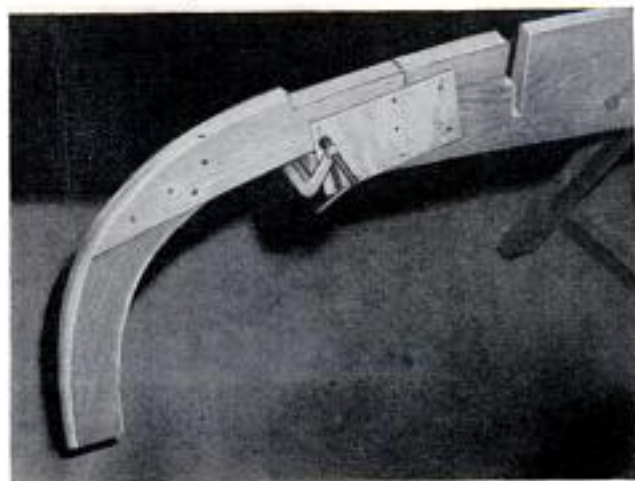

Outer stem is faired into outer keelson. Metal half-round screws onto stem and keelson, extending 5 ft.

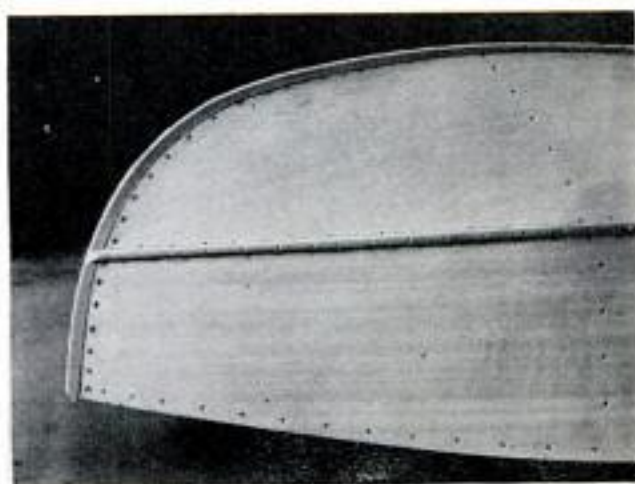

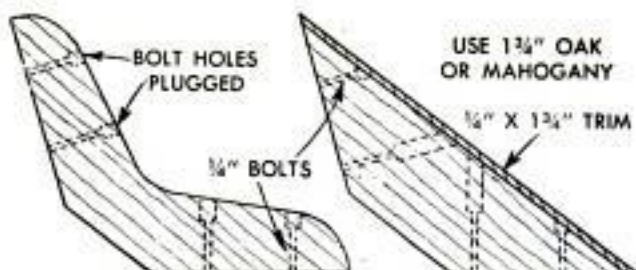

ALTERNATE METHODS OF CUTTING KNEES

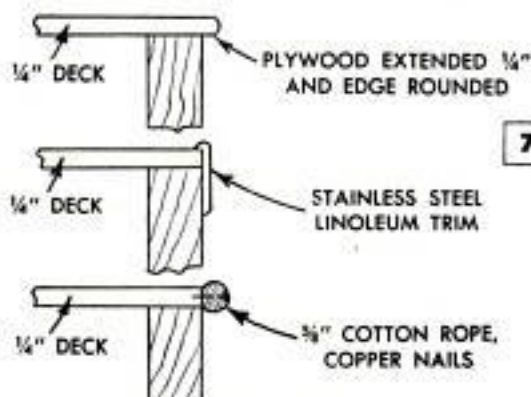

DECK-TRIM METHODS

Alternate methods of cutting transom knees and finishing edge of plywood decking. Waterproof deck seam

removed easily from the completed hull.

To prevent frames No. 2, 3 and 4 from warping as the battens and plywood are applied, clamp or screw boards across the gunwale ends of the frames. Also, install both of the chines, side planks, etc., at the same time to equalize strain. Attach the keelson to the transom first; then work forward, screwing it to each frame with two 1½-in. screws. Next, add the chines and sheer battens and fair down all the surfaces with a plane so the planking will rest properly at all points. Cut the plywood side pieces first and install them together, beginning at the transom. Drive a ¾-in.

flat-headed screw every 2 in. along the chines and transom, 1½ in. along stem and every 3 in. along the sheer battens and frames. Attach the plywood bottom panels, spacing the screws 2 in. apart, except on the frames where the spacing should be 3 in. Screw the outer keel in place and then the outer stem which is faired into the keel (Fig. 3, profile view, and Fig. 5). Attach the half-round molding at the chines, turn the boat over and remove the strongback. With the hull rightside up, install the seat risers, the deck and the transom knees, Figs. 4 and 7. Mahogany plywood makes the most attractive decking, Fig. 6. ★ ★ ★

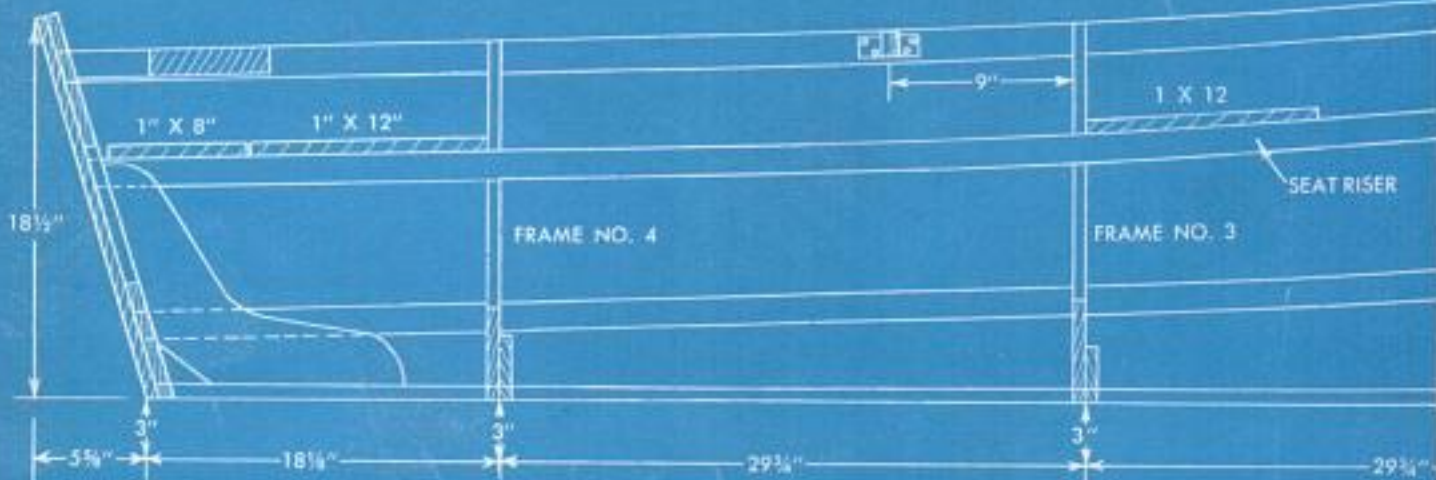

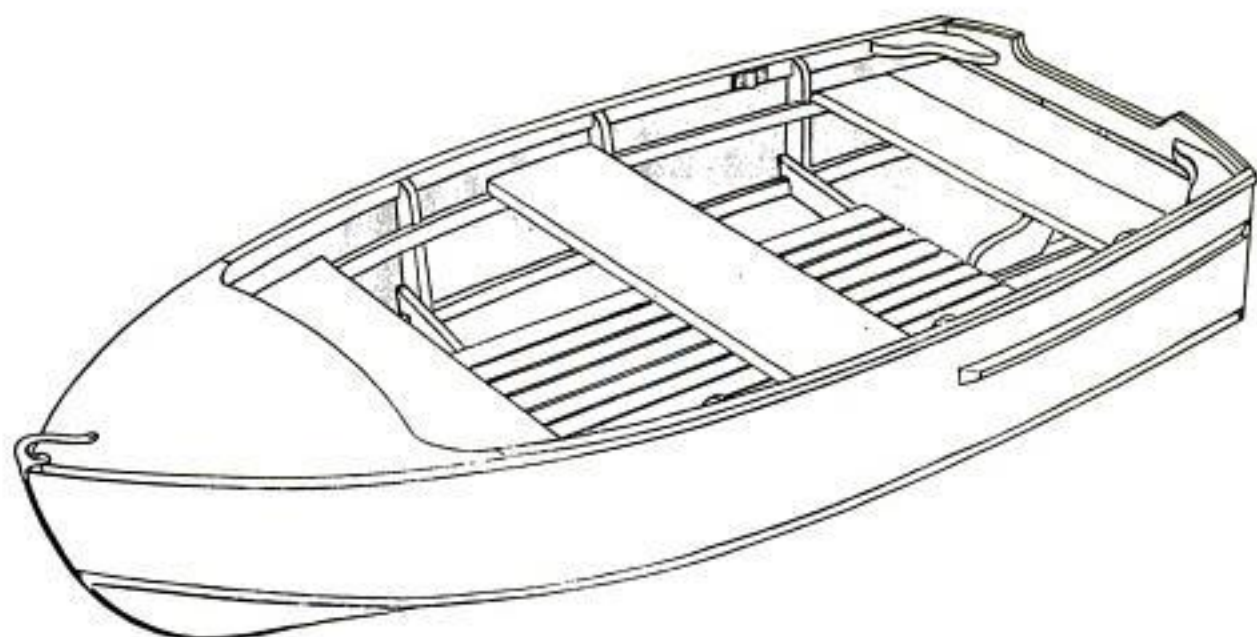

MATERIAL LIST

Marine plywood:

- 2 pcs.— $\frac{1}{4}$ " or $\frac{5}{16}$ " \times 48" \times 14"—Bottom and sides
- 1 pc.— $\frac{3}{4}$ " \times 21" \times 5"—Transom
- 1 pc.— $\frac{1}{4}$ " \times 36" \times 43"—Deck (or use waste)

Mahogany or oak:

- 1 pc.— $\frac{3}{4}$ " \times 1" \times 12"—Keel
- 2 pcs.— $\frac{3}{4}$ " \times 1 $\frac{1}{4}$ " \times 54"—Spray rails
- 1 pc.— $\frac{3}{4}$ " \times 1" \times 48"—Outer stem
- 1 pc.—1 $\frac{3}{4}$ " \times 5" \times 30"—Knees
- 4 pcs.— $\frac{1}{2}$ " \times 1" \times 14"—Half-round moldings

Mahogany, oak, spruce, pine, cypress or fir:

- 2 pcs.— $\frac{3}{4}$ " \times 1 $\frac{1}{2}$ " \times 14"—Sheer battens
- 2 pcs.— $\frac{3}{4}$ " \times 1 $\frac{1}{2}$ " \times 14"—Chines
- 2 pcs.— $\frac{3}{4}$ " \times 1 $\frac{1}{2}$ " \times 10"—Seat risers
- 1 pc.— $\frac{3}{4}$ " \times 1 $\frac{3}{4}$ " \times 36"—Deck batten
- 1 pc.— $\frac{3}{4}$ " \times 2 $\frac{1}{2}$ " \times 12"—Keelson
- 3 pcs.— $\frac{3}{4}$ " \times 3" \times 12"—Frames
- 2 pcs.— $\frac{3}{4}$ " \times 6" \times 12"—Frames
- 1 pc.— $\frac{3}{4}$ " \times 9" \times 10"—Motor board
- 1 pc.— $\frac{3}{4}$ " \times 12" \times 12"—Seats
- 1 pc.— $\frac{3}{4}$ " \times 8" \times 48"—Rear seat
- 1 pc.—1 $\frac{3}{4}$ " \times 6 $\frac{1}{4}$ " \times 24"—Stem

- 1 pc.—1 $\frac{3}{4}$ " \times 5" \times 24"—Stem
- 8 pcs.— $\frac{5}{8}$ " \times 2 $\frac{1}{2}$ " \times 8"—Floorboards
- 4 pcs.— $\frac{5}{8}$ " \times 2 $\frac{1}{2}$ " \times 6"—Floorboards

Common lumber:

- 1 pc.—1 $\frac{3}{4}$ " \times 9 $\frac{1}{2}$ " \times 10"—Building form
- 1 pc.—1 $\frac{3}{4}$ " \times 2 $\frac{1}{4}$ " \times 21"—Transom form

Miscellaneous

- 1 lb. Waterproof resin or marine glue
- 1 pt. Emulsified rubber joint sealer or "C" quality marine glue
- 1 pr. 6 $\frac{1}{2}$ " oars
- Primer coat and paint or varnish

Brass or galvanized hardware:

- 5 gross 1" No. 8 flat-headed screws
- 1 gross 1 $\frac{1}{4}$ " No. 8 flat-headed screws
- 1 gross 1 $\frac{1}{2}$ " No. 8 flat-headed screws
- $\frac{1}{2}$ gross $\frac{3}{4}$ " No. 6 oval-headed screws
- 1 lb. 1 $\frac{1}{4}$ " Shingle nails
- 5 ft. $\frac{1}{2}$ " Metal halfround (stem)
- 1 Bow lifting handle
- 1 pr. Oarlocks

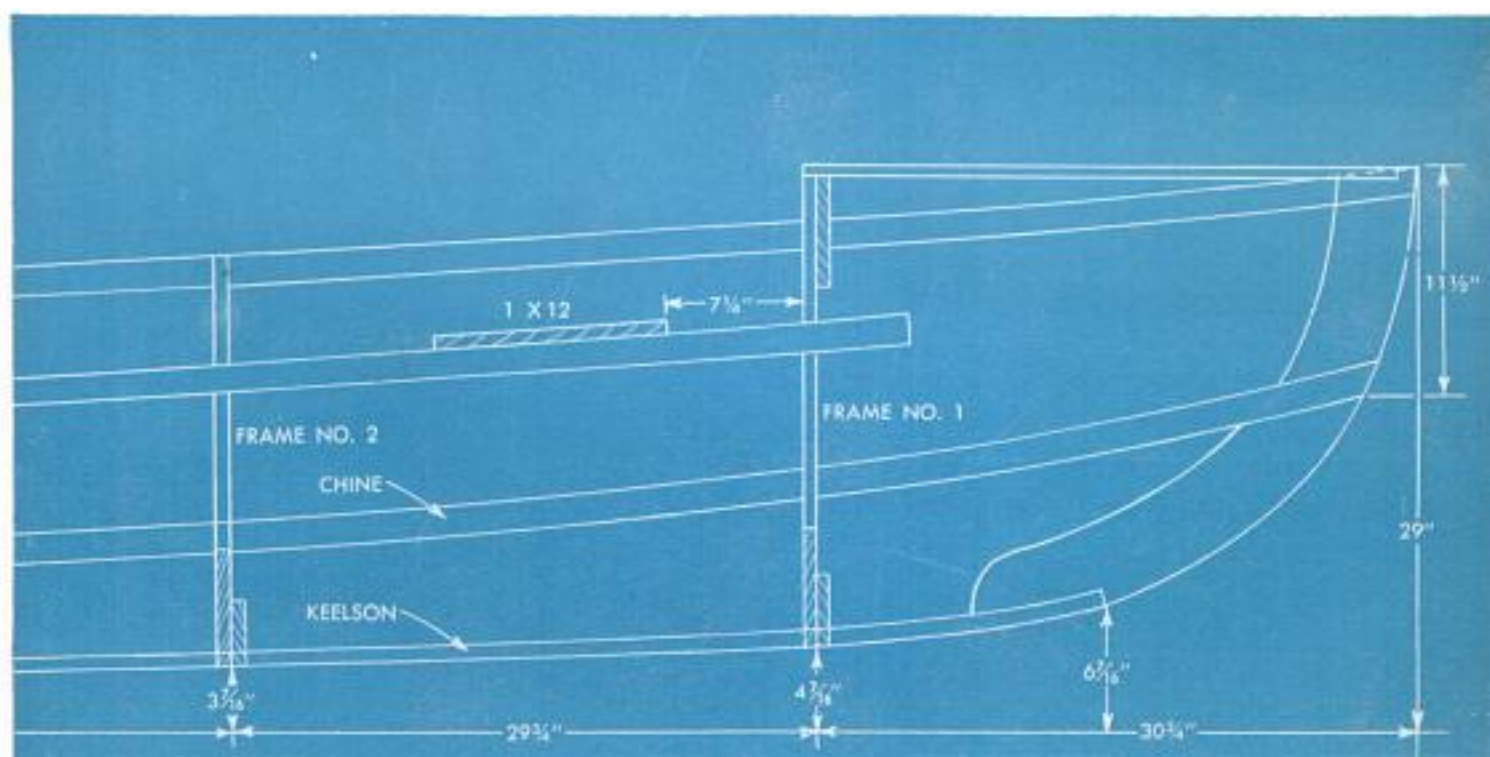



Light Attached to Lawn Mower Powered by Small Generator

When rainy weather and overtime hours kept one man from getting his lawn cut in full daylight he added a generator-powered bicycle light to his power lawn mower. He clamped the headlight to the handle so the beam of light would shine over the motor and onto the lawn ahead of the mower. The bicycle generator used is the type having a friction drive wheel that runs against the bicycle tire. The generator was mounted so the drive wheel would bear against the drive belt of the mower.

Metal Shelf Brackets Modified For Use as Temporary Supports

Temporary shelf supports that are easily removed can be made by filing the screw holes in standard metal shelf brackets to a keyhole shape. The brackets then can be hung on screws that project slightly from a wall.



When the temporary shelf is no longer needed, the brackets are removed by lifting them slightly so the screwheads will pass through the larger part of the keyhole.

Water Tanks Decorate Driveway

Old hot-water tanks can be used as sturdy, decorative corners for a driveway entrance. They are set in the ground in the same manner as a post, and then painted. To lengthen the life of the tank, fill it with a watery cement after setting it in the ground.—Walter Shutok, Uniontown, Pa.

Yellow Laundry Soap on Fingers Aids Rapid Handling of Papers



A bar of yellow laundry soap is an excellent substitute for glycerine often used by printers and others whose work requires the rapid handling of sheets of paper. Occasionally rubbing the fingers over the soap will coat them with a rosin-like

substance which the soap contains. Single sheets of paper may then be quickly picked up from a stack.

The Luxury of a Porch...

To be outdoors in a refreshingly cool breeze yet shaded from the hot sun and insects, lounging in downright comfort, is a luxury any homeowner can enjoy by adding a porch or breezeway to his home. Read the detailed story in next month's issue that tells how to do it yourself

Keep Prints From Slipping

The annoyance of having prints slip when cut on a trimmer can be eliminated by applying rubber cement along the edge of the board as shown. The cement should be allowed to dry before beginning the cutting operation. One application lasts for months.—Clyde Allison, Cadillac, Mich.

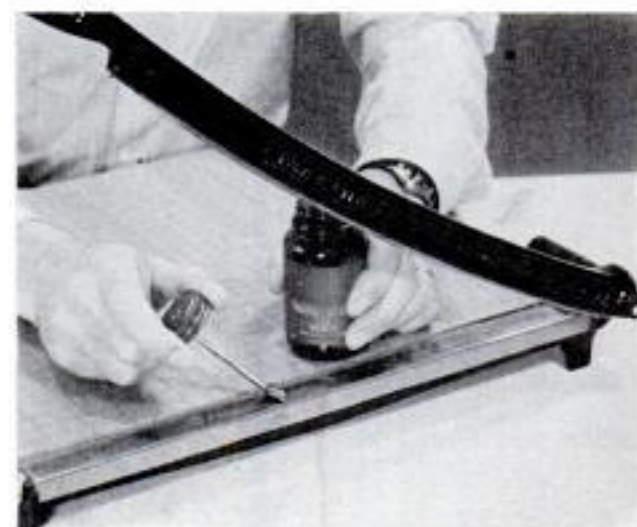

Economy and efficiency in the operation of your car depend largely on your fuel system. You should know how it works

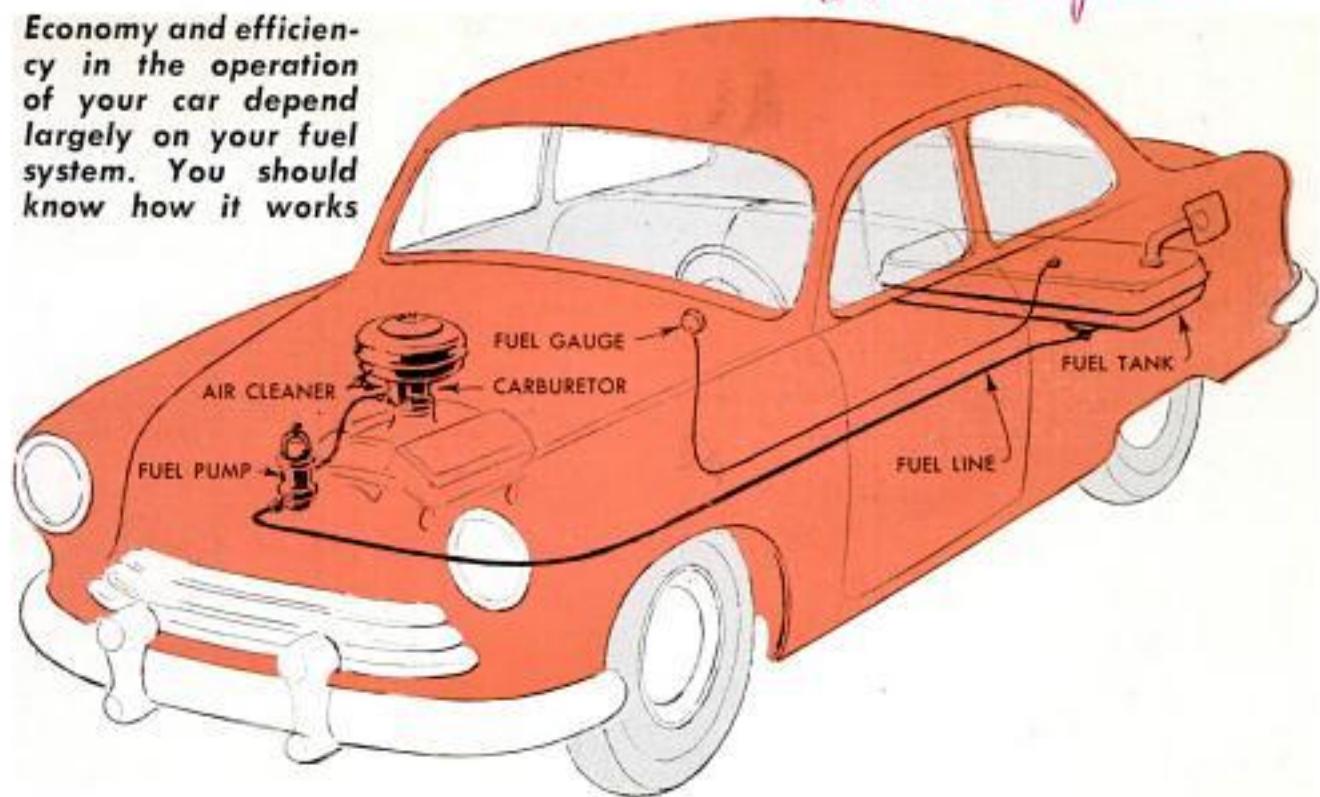

FROM TANK TO CARBURETOR

BEFORE GASOLINE, the lifeblood of your automobile engine, is utilized as heat energy, the fuel system must provide several definite and necessary services. A typical passenger-car fuel system, shown in the phantom drawing above, consists of a tank, pump, carburetor, fuel line, air cleaner and a manifold-heat control valve. The fuel line runs from an outlet at the bottom of the tank to the pump. The outlet generally is fitted with a strainer and sediment trap to keep the fuel as clean as possible. The pump in the majority of modern passenger cars is of the diaphragm type and is actuated by a rocker arm which is moved by an eccentric on the engine camshaft. The pump usually is located as near to the carburetor as possible, but away from the manifold heat. In some cases it is necessary to install a metal shield between the pump and manifold to prevent vapor locks from manifold heat.

Electric fuel pumps, although sometimes more expensive than the diaphragm type, have advantages over the latter. An electric pump can be installed near the tank itself or in any comparatively cool spot, thus minimizing vapor locks. Also, the electric pump starts supplying gasoline as soon as the ignition is turned on. The starter is not required to turn over the engine several times before gasoline is pumped to the carburetor. However, a diaphragm-type fuel pump, if properly serviced, will give years of good service.

Quite often the fuel pump contains a secondary unit, which is the vacuum-booster pump, operated by the same rocker arm that actuates the fuel pump. Three views of a combination fuel-pump vacuum booster are illustrated. The booster serves to increase the vacuum needed to operate the windshield-wiper motors when the engine manifold vacuum is low, as when the engine is being accelerated rapidly. All fuel pumps, with or without a vacuum booster, have a filter and sediment bowl at the bottom, which collects dirt and other foreign matter. The sediment bowl is easily removed by loosening the bolt that passes through its center. When the bowl is removed for cleaning, the gaskets should be replaced if they are not in good condition.

Operation of a typical fuel-pump vacuum booster combination can be followed by reference to the lettered sketch. Rotation of the camshaft eccentric actuates rocker arm A, pivoted at B, which pulls link C and diaphragm D upward against spring pressure E. This creates a vacuum in pump chamber F. This suction stroke of the pump causes fuel from the tank to enter sediment bowl H through inlet G. The fuel passes through strainer I and enters pump chamber F. On the return stroke, spring pressure E pushes the diaphragm D downward, forcing fuel from chamber F through outlet valve J and out through discharge K to the carburetor. When the carburetor bowl is full, the carburetor-float valve is closed,

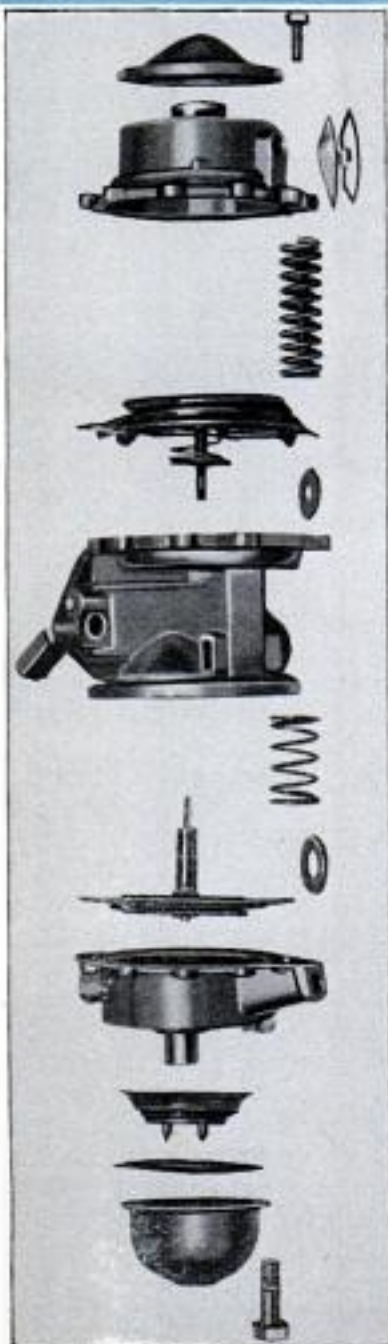
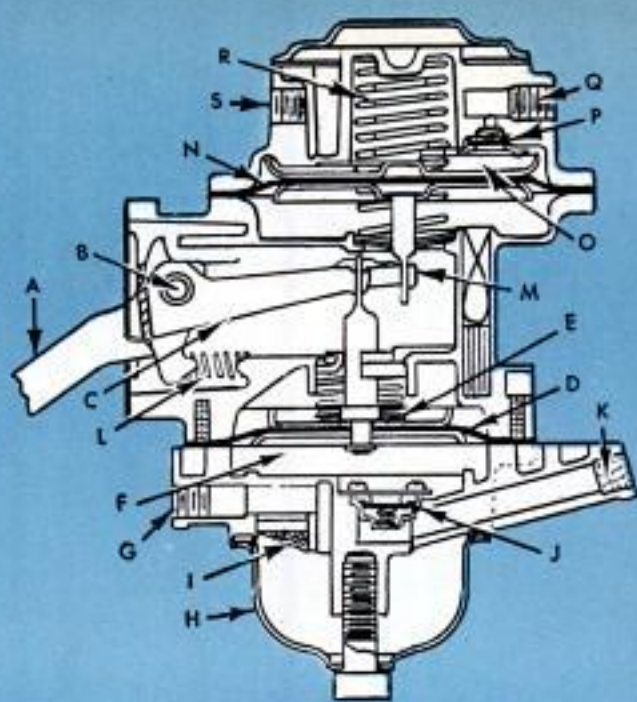
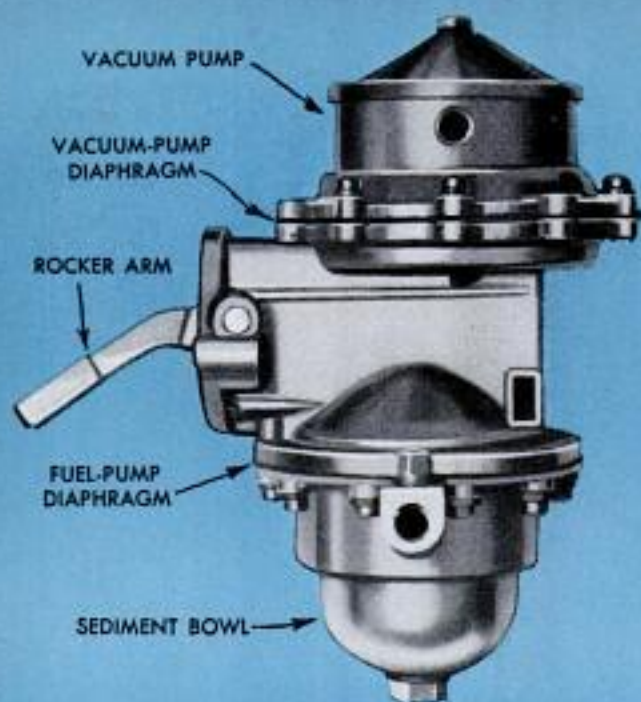

Below left, is exploded diagram of combination fuel pump-vacuum booster. Above left, assembled unit is shown with parts named. Drawing, above right, is cross section with all parts lettered for reference

thus setting up a back pressure in pump chamber F. This pressure holds diaphragm D upward against spring pressure E. Thus, the fuel pump is inoperative until the carburetor-float valve opens and the back pressure is released. Spring L simply serves to keep the rocker arm in constant contact with the camshaft. Hard starting or a "flattening out" of engine speed in highway driving indicates that the fuel pump should be tested.

Operation of the vacuum booster, which is actuated by the same arm as the fuel pump, is as follows: Rotation of rocker arm A, pivoted at B, pushes link M and diaphragm N upward. This expels the air in the chamber O through the exhaust valve P and out Q to the intake manifold. On the return stroke, spring R pushes diaphragm N downward, creating a suction in chamber O, thus drawing air through inlet S from the windshield-wiper motor. When the windshield wipers are not being used, manifold vacuum holds diaphragm N upward against spring pressure R so that the diaphragm does not make a complete stroke for every stroke of rocker arm A. When manifold vacuum is greater than the vacuum created by the pump, air will flow from the windshield wiper through both valves of the vacuum pump and the operation of the wiper motor then is the same as if the pump were not connected. Sluggish windshield wipers or a sudden excessive oil consumption calls for a check of the vacuum booster.

The carburetor receives the fuel from the pump, mixes it with the proper amount of air and distributes the vaporized mixture in the correct proportions to the engine. The carburetor and choke were discussed in the July, 1953 *Popular Mechanics* and require no further description in this article.

An air cleaner is clamped to the top of the carburetor. A typical cleaner is pictured. Air entering the carburetor first passes through oil-soaked wire mesh to remove dust and impurities. The oiled mesh also quiets the rushing sound made by the air as it enters the carburetor. In extremely dusty areas, a heavy-duty type air cleaner which contains an oil bath is used. Air entering the cleaner is first directed

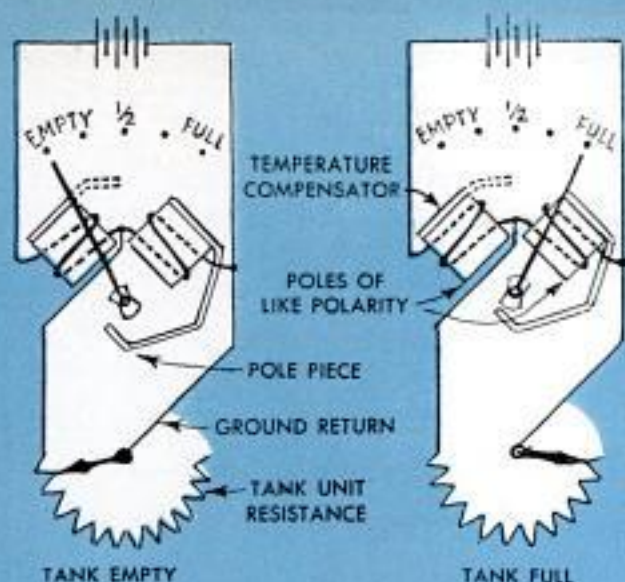

THE A.C. FUEL GAUGE



Photo, above right, shows disassembled air cleaner. Maintenance consists of cleaning the filter element with gasoline, then re-oiling. Below right, representative manifold-heat regulator valve is shown

against a pool of oil which removes the heavier particles of dust. The velocity of the air also causes a small amount of oil to be carried up into the mesh strainer, thus keeping it lubricated.

A representative type of manifold heat-control valve is shown in the sketch. The heat-control valve permits hot exhaust gases to heat the incoming cold fuel-air charge during starting and warm-up periods. The action of the valve is automatically controlled by a thermostatic spring, assisted by a counterweight. When the engine is cold, all exhaust gases are directed against the intake manifold at a point just below the carburetor. Sometimes this area is part of the intake-manifold casting, and the intake and exhaust manifolds are bolted together with a gasket used to prevent exhaust gases escaping. In other types, such as the one shown, the manifolds are open to each other, but a heat-riser tube extends down into the exhaust manifold from the intake, thus preventing the exhaust and intake gases from mixing. The heat-riser tube is simply a one-piece cylinder with the bottom end sealed. The cold-air-and-gas mixture drops into this tube, is heated and then drawn into the engine cylinders. When the engine reaches operating temperature the thermostatic spring and counterweight close the valve so that heat no longer contacts the heat-riser area. Do not use oil on the shaft of the manifold heat-control valve. It will cook to a gum and jam the shaft. Occasionally apply a small amount of baking soda mixed with

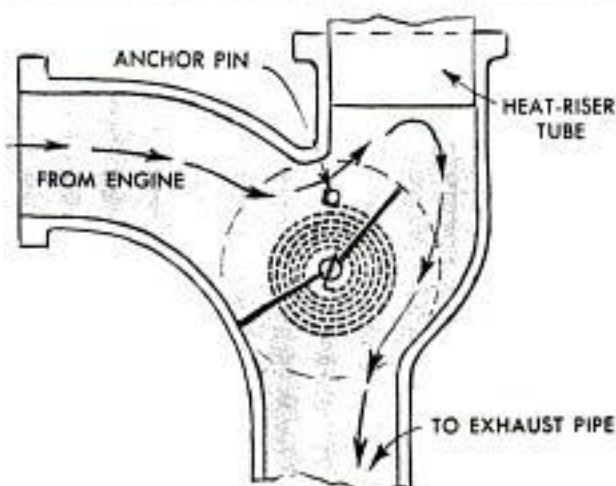

kerosene to the shaft of the valve. Shown above, left, is a sketch of one type of electric fuel gauge. The motion of the tank float causes the movable contact to slide over a rheostat. The tank unit is grounded out of the gauge circuit when the tank is empty and the float is at its lowest position. Current then passes through only the coil on the empty side of the dash unit because the coil on the full side is of a higher resistance. The pointer is attracted towards the energized coil which causes the dial to register an empty tank. When the tank is filled and the float rises, the rheostat is placed back in the circuit by the movement of the tank-unit contact. The rheostat places resistance in the circuit which causes current to flow through the coil on the full side of the dash gauge. The indicator on the dash gauge then moves toward the full side in direct ratio with the amount of current running through the coil. Compensators are wired into the circuit to allow for changes in air temperature and fluctuations in voltages.

★ ★ ★

Small Doll's Bed Is Assembled Quickly From Two Cigar Boxes



Small but attractive, this doll bed is made from two matching cigar boxes and their tops. First the tops are removed and then the sides are cut with a coping saw as shown in the drawing, any desired design being used. The head and foot of the bed are made from the tops of the boxes. Finally the bed is assembled with glue or brads and given a suitable coat of enamel or lacquer.

Stair Tread Protects Window Sill Against Flowerpot Stains

Cut to fit a window sill on which potted plants are placed, a rubber or plastic stair tread will protect the paint or varnish from stains and discoloration. It also will prevent warping of the wood, caused by water which is spilled from the watering can, or which seeps through the drain holes in the bottoms of the flowerpots.



H. Radzinsky, New York City.

Junked Walking-Plow Beam Supports Rural Mailbox

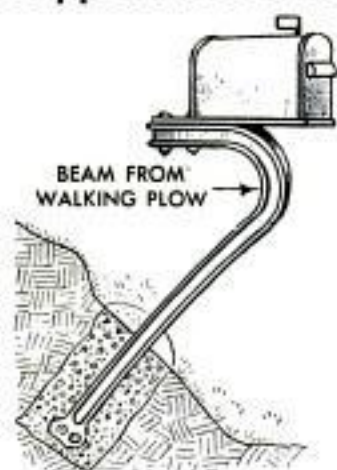

An excellent rural mailbox support that is especially suitable for erection on a sloping roadside bank can be made from the steel beam of a junked walking plow. A steel flat is bolted to the top of the beam to support the mail box, and the beam is set in concrete.

Pencil Ferrule Pits Cherries

The chore of pitting fresh cherries for pies and other desserts is less arduous when a simple cherry pitter made from a common lead pencil is used. The eraser is carefully removed from the brass ferrule of the pencil, and the ferrule cavity is cleaned and sterilized either by boiling or by holding for a few moments over an open flame. Pushing the ferrule through each cherry quickly removes the pit.

Harry Lawson, Pulga, Calif.

Wooden Strip Used as Handle For Small Magnifying Glass

A small magnifying glass that is difficult to hold between the fingers will be much easier to handle if attached to a wooden strip such as a tongue depressor. A thin strip of adhesive or masking tape is used to bind the lens to the strip. To make it even more convenient to use, determine the height above the printed page at which the glass is in focus. Then measure this distance on the strip and tape the glass to it at that point.



Discarded Hacksaw Blade Made Into Effective Garden Weeder

This handy weeder and cultivator for use in the flower garden can be made from a 10-in. hacksaw blade by bending the blade and attaching it to a handle as shown in the photograph. The handle is made of 1x3x5-in. hardwood. To fasten the blade to the handle, two screws are put in each side.



PHOTO LAMP from ODD PARTS



Photo at left shows completed lamp. Those above picture how drapery rod serves as adjustable column. In center photo lower end of rod is being attached to wooden base

By H. Leeper

UTILIZING common household items which normally are discarded after serving their purpose, you can assemble a practical photo lamp in a single evening. The body, or housing, of the lamp is made from a potato-chip can. This is supported on a telescoping drapery rod, the lower end of which is attached to a heavy wooden block. A metal base also can be used; the round cast-iron base from an old hot-water tank is just the thing. Several holes are drilled through both sections of the drapery rod so that a pin can be inserted to hold the lamp at the desired height. A hole cut in the bottom of the potato-chip can (housing) takes the two-piece porcelain lamp socket as in the two photos at the right. After the socket is in place it is protected by a small can cut in half, leaving two short ears, or tabs. These are bent outward for attachment to the bottom of the housing with sheet-metal screws. A number of small holes are drilled in a pattern through the top of the housing to permit heat to escape. A No. 1 photoflood bulb gives the proper amount of light. By cutting a 3-in. hole through the lid of the can and using this as a "lens," as in the lower right-hand photo, a fairly sharp spot will be obtained.

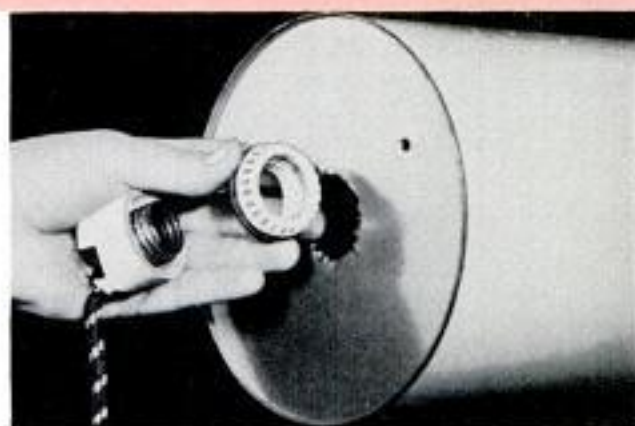

Above, two-piece porcelain socket of type used in signs is inserted in hole cut in bottom of can. Below, socket is protected by cover cut from small can. Metal tabs on can are drilled for metal screws



Lower left, No. 1 photoflood bulb gives ample light without excessive heat. Lower right, a hole about 3 in. in dia. in can lid gives fairly sharp spot. Can lid is removed when lamp is used for floodlighting

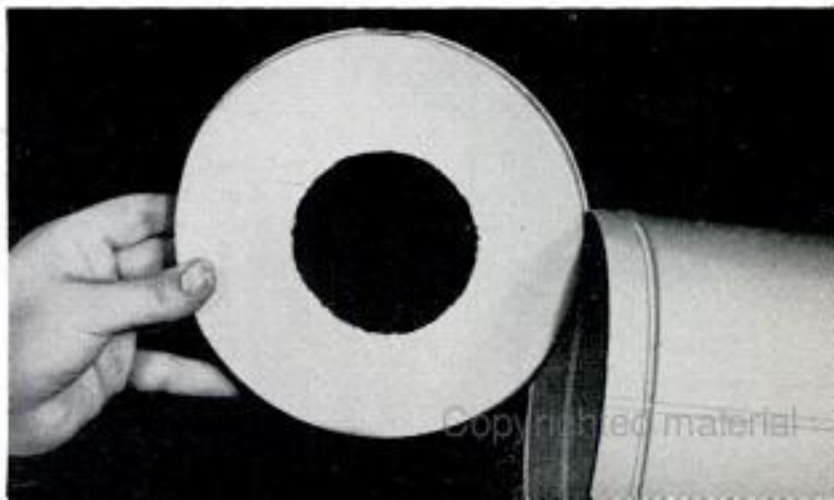
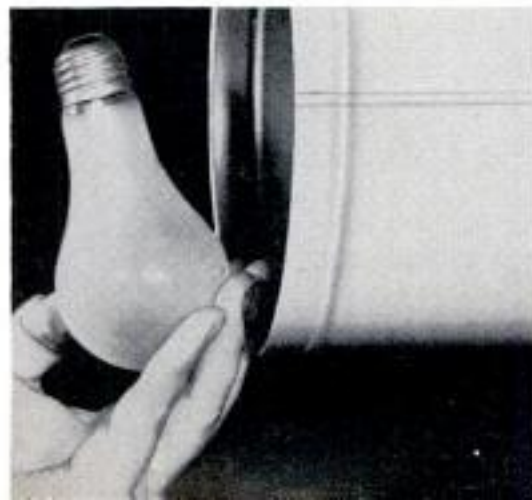

Camera Support Is Improvised With Two Chairs and Book



In the event a tripod is not available when taking pictures requiring steady support for a camera, a couple of straight-backed chairs and a book or length of board can be combined to do the job. Place the chairs at an angle and set the book across them as shown to form a platform.

Negatives Stored in File Box

Negatives can be stored in standard card file boxes to preserve them and to keep them readily accessible. Index cards made for the file box are used as dividers, and the negatives are indexed according to subjects or to the date a picture is taken, whichever is most convenient. To make finding of the exact negative easier, the subject and date of each can be marked in the margin in white ink. Then the negative

is stored with that margin up so that it can be read at a glance and without removing it.—Blanche Campbell, Las Vegas, Nev.

Hose Used as Funnel Holder

Photographers and others who use glass funnels in their work will find that there is less danger of breakage if a short piece of radiator hose is used to support the funnel in a jug or bottle. The hose should be notched at both ends to permit air to escape from the container when liquid is poured through the funnel. The hose should be just long enough to support the funnel slightly above the neck of the bottle, as shown in the sketch.

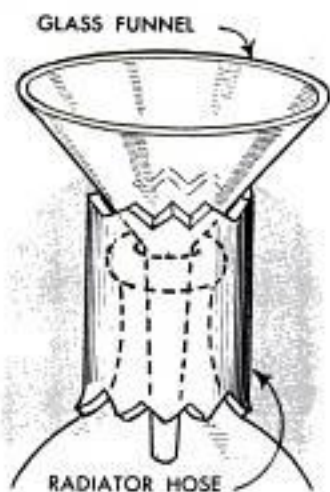

Hot Water Softens Sponge For Wiping Photoprints

When used on films or for wiping down prints, the new viscose-type sponge may prove a little too coarse. One way to make the sponge soft is by immersing it in hot water—which won't damage the sponge in any way—and the hotter the water is the softer the sponge will become.

Popular Mechanics Bookshop



Land a Summer Job

HERE'S THE BOOK for students 14 to 21 years old. It describes how to land a summer job with good income and fine possibilities for the future. 75 cents



Golf Directory

POND'S GUIDE to 1870 North American Golf Courses contains complete descriptions and the author's ratings of all the finest courses. The price is \$1.00



Lower Golf Scores

HERE ARE hundreds of tips on every phase of golfing, including stance and grip, putting, chip shots, cut shots, run-up shots and others. Price is 75 cents

All books available from Popular Mechanics Book Department, 208 E. Ontario St., Chicago 11

PRINT DRIER

By Harry J. Lance

WITH LIMITED SPACE available, drying a large batch of photo prints can become a real problem, especially if time also is limited. To overcome the difficulty, one photographer designed and built this unusual print drier. It consists of 8 muslin or mosquito-netting "shelves" 36 in. wide and wound on adjustable rollers so that tension can be maintained. The supporting frame is made collapsible by means of bolts and wing nuts, permitting it to be disassembled and stored when not in use. As detailed, the unit provides space for nearly 200 prints in the 8 x 10-in. size. It can be made larger or smaller to suit individual requirements. Details below show the construction. Four uprights are joined to four stretchers as in the left-hand detail, and the joints are blocked in two directions to provide the necessary rigidity. Drill bolt holes in the two pieces, then bolt together and screw the blocks in place. A few spots of glue under each block will help to strengthen the joint. Now clamp the uprights together and locate holes for the dowels 8 in. apart, measuring from one end. Note that the right-hand detail below specifies $\frac{3}{4}$ -in. dowels. For greater rigidity drill the uprights for 1-in. dowels. Reassemble the frame, cut the dowels to length and fit them in the holes. Then drill small holes from the edge of each upright, each hole located so that it passes through the center



Drier can be set up indoors or out and can be made larger or smaller to suit requirements. Fabric "shelves" are 36 in. wide

of the dowel. These holes should be slightly larger in diameter than an 8d nail. The latter serves as a key to prevent the dowels from turning. Cut the muslin or netting in 9-ft. lengths, making sure that the ends are square. Tack the ends to the dowels, spacing the tacks about 1 in. apart. Then remove the nail keys at the ends of the dowels and wind the fabric equally on each dowel. Number one end of each dowel so that they may be replaced in the proper order when the unit is reassembled after being stored.

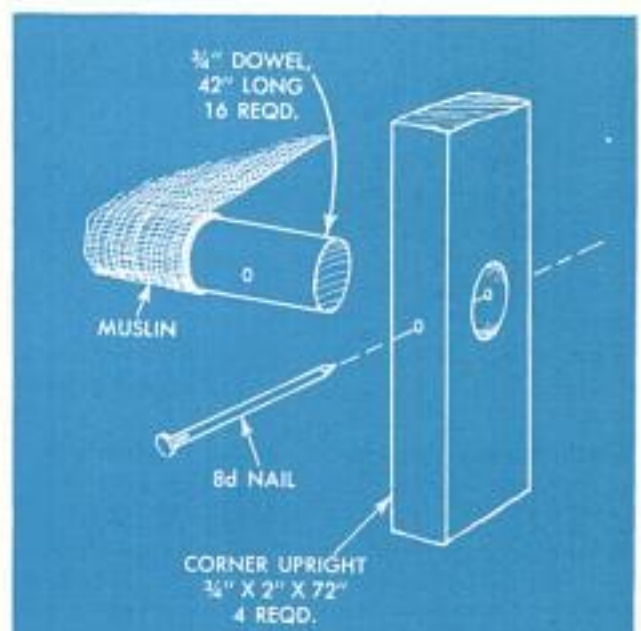
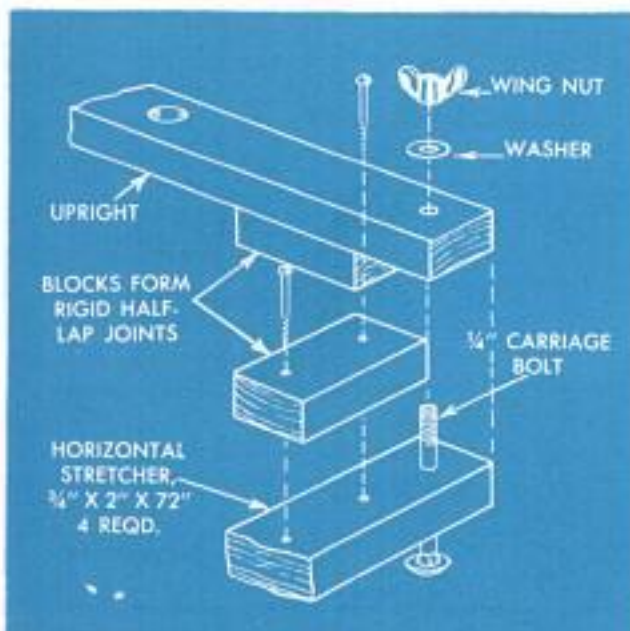

Sill-Cock Unit Provides Handy Drinking Fountain for Children



When the hot-weather thirst of two small children kept their parents busy providing drinks, their father made this outside drinking fountain which attaches to the sill cock. The parts are obtainable at most hardware stores and can be assembled in a matter of minutes to produce the fountain. The L-shape swivel connector is the type used to prevent kinking the hose at the faucet. It is screwed onto the faucet, then the automatic nozzle is screwed onto it. The filter is the slip-on type, usually used on kitchen faucets to aerate the water. The automatic nozzle has a spring-loaded handle and can be adjusted as to amount of flow. A pan may be placed beneath the fountain if no drain is present. This also assures the family dog of a supply of water.

Darrel Ward, Topeka, Kans.

Plant Cuttings Rooted Easily In Plastic Wrapper

Plant cuttings can be rooted easily by starting them in wrappers cut from thin sheet plastic. First cover the end of the stem with damp sphagnum moss and then wrap with the sheet plastic, binding it around the stem with string or a rubber band. If sealed tightly, the wrapper will retard evaporation of moisture from the moss sufficiently to allow roots to develop in a few weeks.—John Krill, North Lima, Ohio.

Curved Tin Deflector on Tray Permits Uniform Print-Washing

When washing prints, some amateur photographers simply arrange a developing tray beneath a water tap so the water strikes one of the slanted sides and is deflected along the bottom of the tray. With some trays, this creates enough turbulence to keep the prints off the bottom and in continual motion. However, a more dependable method which can be used with practically any kind of glass or enameled tray, pan or small tank is to bend a piece of tin so it hooks over the edge of the tray, with the remainder bent in a curved shape



inside the tray as shown. Due to the broad curvature of the sheet metal, the stream of water is deflected uniformly along the bottom of the tray, thus creating sufficient turbulence to keep even large prints in continual motion.

□ If the doorway of your garage is a little narrow, it's a good idea to nail lengths of garden hose to corners of the doorframe to prevent marring the finish of a car.

Release Clutch of Bar Clamp By Using C-Clamp



The use of a C-clamp to loosen the jammed clutch leaves of the adjustable pad of a bar clamp will prevent cracking or breaking the casting of the pad. Forcing the leaves with hammer blows is definitely not recommended because of the danger of breaking the casting. A C-clamp, used as shown, will provide a strong, even pull.

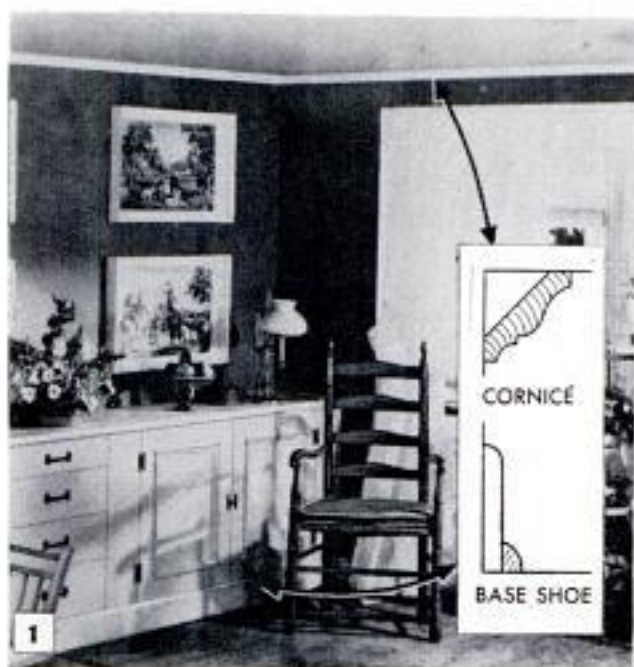

How to Cut COPED JOINTS

By Sam Brown

A **COPED JOINT** is made by cutting the reverse shape of the molding on one end of a piece of molded stock and then joining this to another piece at right angles, as in the corner of a room. The resulting joint has the same appearance as a mitered joint on identical pieces of molding but, in addition, has the advantage of not showing a crack between the joining members should the wood shrink after installation. Two common applications of the coped joint are the cornice mold and base shoe shown in the photo and detail, Fig. 1.

Basic procedure: Figs. 2 to 6 inclusive show the procedure in making a coped joint. First it is necessary to fix in mind the differentiation between the base and back of the molding. In the shoe mold shown in the detail, the narrow, flat side is the base and the wider, flat side the back. When the miter is cut, Fig. 4, the base is always down as indicated. In the crown molding, Fig. 7, the base is the flat side that fits against the ceiling. After cutting the miter on the shoe mold, the cope cut is made by following the miter line with a coping saw, the molding

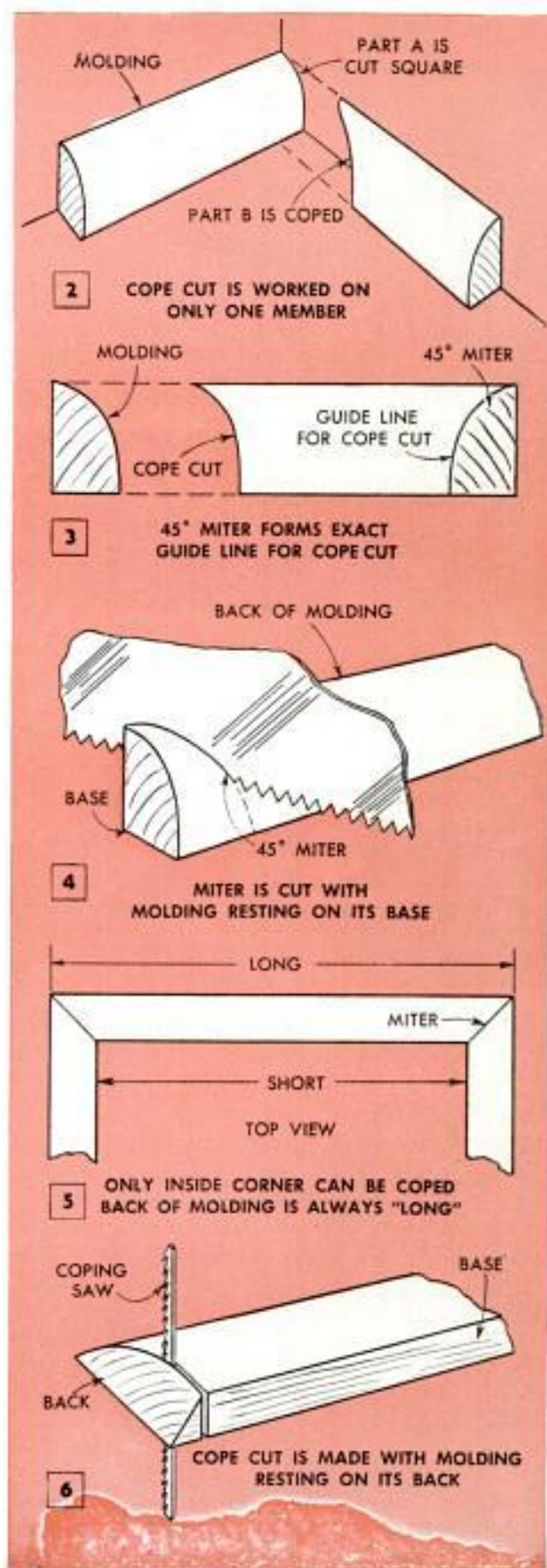

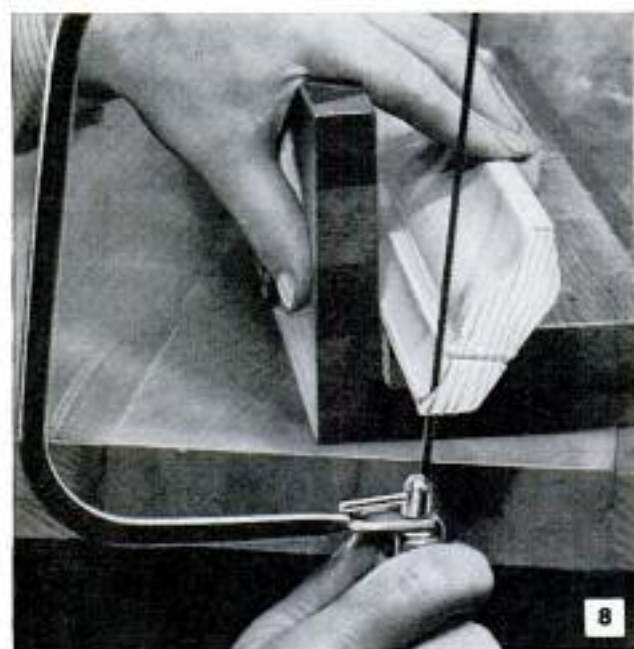
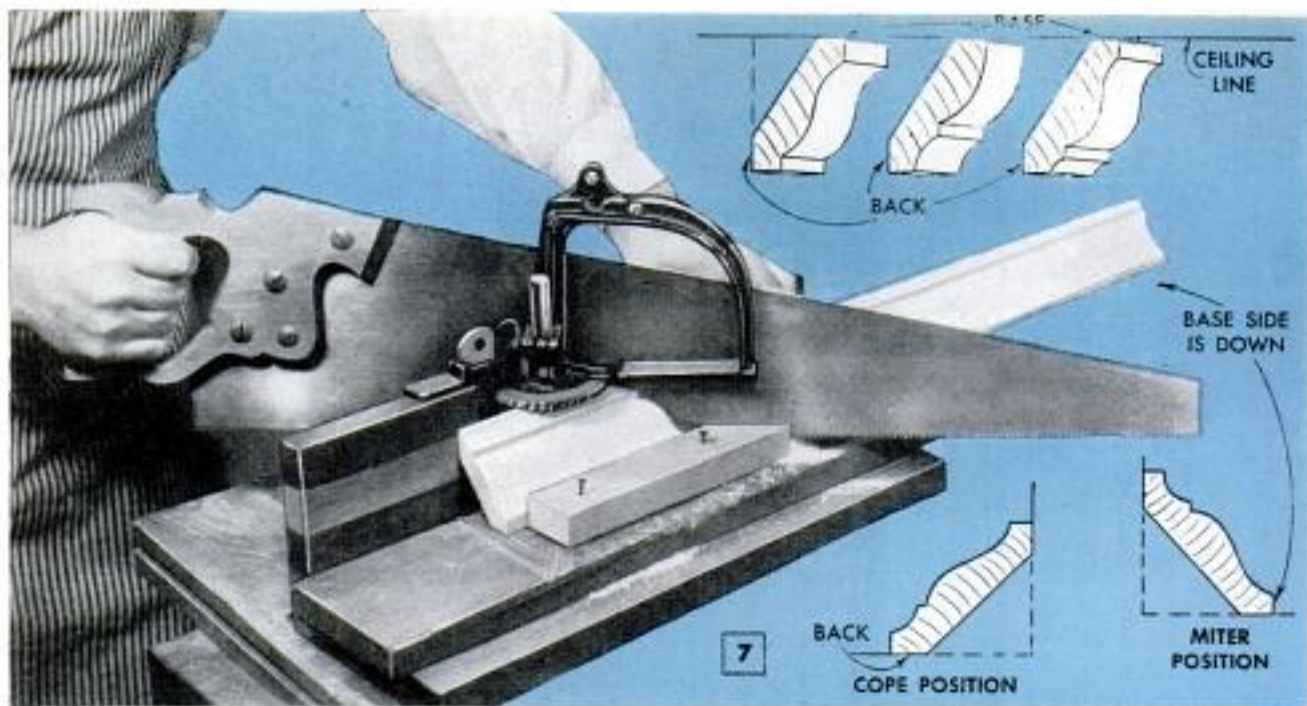

Above, making the cope cut after mitering the end of the molding. Miter cut is guide for the cope cut. Below, checking the accuracy of the joint after coping. When coping the stock is slightly undercut

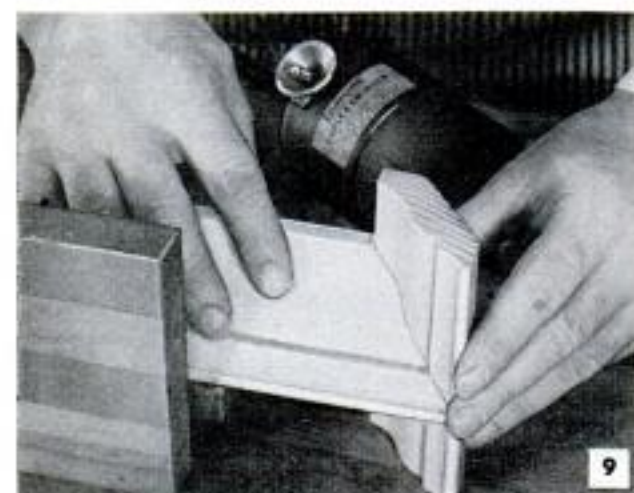

resting on the back as in Fig. 6. Care must be taken to follow the line of the miter precisely as otherwise the joint will not fit snugly when the parts are placed at right angles. The edge will be somewhat easier to follow if blackened by rubbing with a carpenter's pencil. Use a fine-toothed blade in the coping saw as it is easier to control.

Coping crown molding: Typical crown moldings are shown in Fig. 7. Many shapes and sizes are available. One of the most common applications of the crown mold is that of room trim, Fig. 1. Generally such cornices consist of one molding, but in some cases the cornice may be built up of several moldings of varying sizes. If the job is new to you and if you are working with moldings of fairly large size, then it's well to keep in mind that as a rule the predominating curve of the cornice molding generally gives the best appearance when placed at the top. The three sections in the upper detail, Fig. 7, are examples of this basic rule. However, the rule applies more specifically to one-piece molded cornices. Also, identifying two of the three flat surfaces as base and back is simply a convenient way of keeping the parts in order on a given job. The terms do not in any way designate the type of moldings used. It's a good idea to mark the moldings before you begin fitting as this will help to eliminate the possibility of error. After marking all pieces, follow the basic procedure in cutting—hold the base side down for the miter cut and place the molding with the back down for the cope cut. Note the cope and miter positions in Fig. 7, also Fig. 8. Cutting is done generally in a miter box as pictured, the molding being supported by a stop nailed or clamped to the bottom of the

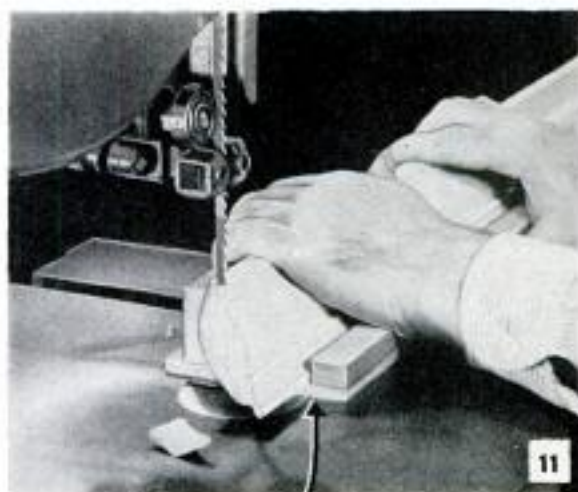

Moldings can be mitered and coped on power tools, using the circular saw for the miter cut and the bandsaw and simple jig for the cope cut

box. If a power saw is used a stop is clamped to the crosscut guide as in Fig. 10. Coping cuts also can be made on a bandsaw by making a simple jig as shown in Fig. 11. When fitting, it is best to make the first cope cut on a short piece of waste molding so that the fit can be carefully checked as in Fig. 9. The accuracy in following the guide line formed by the miter cut determines the fit when the parts are placed together in their proper relation. Because of this, carpenters and interior trimmers usually undercut very slightly when coping, although some workmen prefer to do this as a separate operation, using a rotary file, or burr, driven by a flexible shaft or hand grinder as in Fig. 14. On some types of moldings the rotary file is suitable for undercutting.

Order of fitting: Although experienced carpenters and trimmers often fit moldings on the two long sides of a room and then cope both ends of the two shorter pieces to fit, less experienced workers usually will find it easier to fit the pieces successively around the room. Figs. 12 and 13 show how to proceed in this manner by coping one end of each piece and fitting mitered joints at outside corners. Fig. 13, details A to D inclusive, shows how to cope the molding in a square or rectangular room. Fig. 12, details A to F inclusive, shows how molding is fitted when an offset in the wall is involved. One thing to keep in mind while carrying out the installation in any room is that the molding has a "long" and "short" side after mitering, Fig. 5. When fitting the lengths of molding that have square-cut ends, avoid forcing into the corners as the pressure may break the plaster. If a piece must be coped and at the same time cut to length, the initial miter cut is made to the same length as would be required were the joint a simple miter. It's a good idea to make careful measurements of the walls before cutting stock. ★ ★ ★

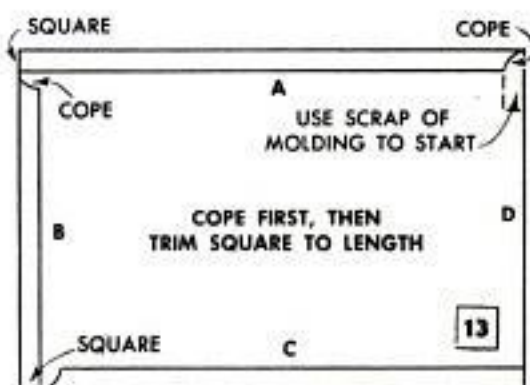
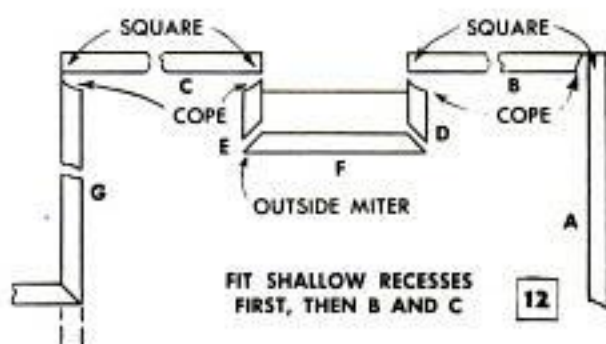

Some workmen prefer to undercut the cope with a rotary file, or burr, driven by means of a hand grinder





Movable Light Over Workbench Slides Along Overhead Wire

To provide a good light for the entire length of your workbench, attach a bench light to a spool that slides on an overhead wire as shown in the illustration. The wire is extended the length of the bench at a convenient height. The slider can be made from either a large thread spool or from a porcelain insulator. The electric cord just in back of the socket is wrapped once around the spool and taped in place. To keep it from getting in the way, the cord is supported along the wire by several small hooks or loops.

Richard Somerville, Corona, Calif.

Internal Screw Threads Measured With Aid of Lead Pencil

To measure internal screw threads that are in an awkward location or are difficult to see, use a short length of dowel or a round lead pencil to take an impression of the threads. Press the pencil firmly against the threads to make a sharp indentation in the wood, then use a center gauge to determine the number of threads per inch from the impressions. As a rule, the hardwood dowel will give a cleaner, sharper impression than the softwood of the pencil.

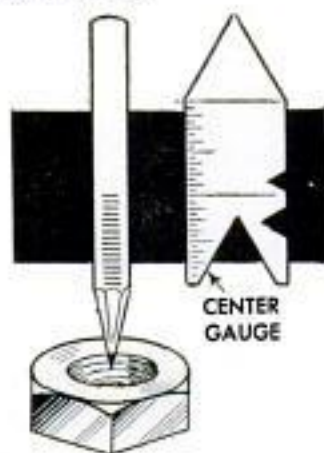

E. J. Gilkerson, Columbus, Ohio.

Spring Unwound on Steel Rod

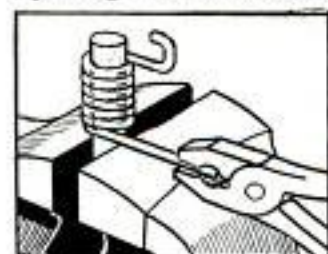

If a light coil spring must be unwound so that a new hook can be formed on the end, first slip the spring over a steel rod. Clamp the rod in a vise and grip the

end of the spring with a pliers. A steady pull will unwind the coils without kinking the wire. Unwind only enough to provide sufficient wire for the hook.

High-Pressure Insecticide Sprayer Utilizes Gear-Type Pump

Because his low-pressure, tank-type insecticide sprayer was slow and inefficient, one farmer built his own high-pressure unit utilizing a gear-type pump purchased as war surplus. A relief valve, set to open at 85 lb. pressure is installed in the line to the spray head. When the line pressure goes over 85 lb., the relief valve allows insecticide under pressure to pass through the return line to the supply pail, where it keeps the insecticide solution mixed thoroughly. A 1/4-hp. electric motor is used to drive the pump. The original spring valve on the spray-head pipe was replaced by a high-pressure air valve. The higher pressure required a small orifice in the spray head, so the original hole was brazed shut and a No. 60 drill was used to make the new orifice. Air-hose couplings are used on the hose lines.—F. Clements, Seattle, Wash.

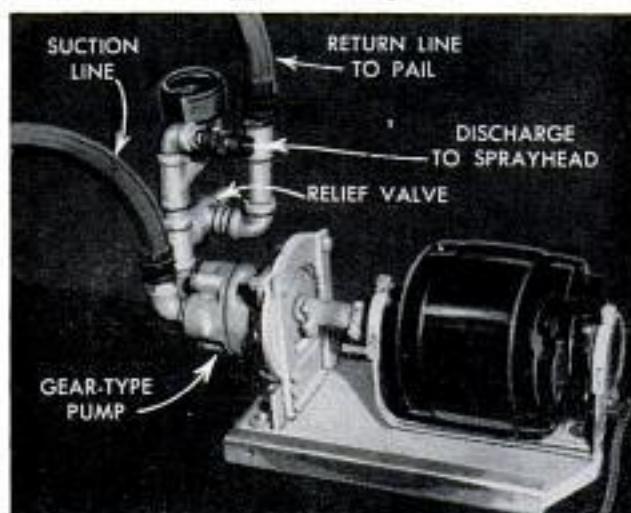

☐ Clothes can be hung on nails which have been driven through corks without danger of tearing.

NOTCHED JAWS IMPROVE VISE

By Walter E. Burton

REGISTERING SLOTS cut into the jaws of a small vise from the top greatly widen the range of its usefulness, especially in the home shop. Small vises of the clamp-on type having solid jaws are the most suitable for altering. Vises having hardened jaw inserts can be altered by substituting inserts of mild steel. The two photos below and the upper detail at the right show how the jaws are slotted. The width and depth of the slot are not given as they are determined from the size of the vise at hand. Note in the upper detail that the slot is cut to a depth that brings the rounded bottom of the slot just below the lower inside corner of the jaw. When the slot is cut to this depth, the vise can be used for clamping operations such as that pictured in the lower right-hand photo. By fitting a flanged pad, the vise will serve as an arbor press for a considerable range of work. In order to drill and slot the jaws it usually is best to dismantle the vise so that the jaws can be drilled separately. Drill $\frac{3}{8}$ or $\frac{1}{2}$ -in. holes through the jaws to form round-bottom slots. Then cut out the waste by sawing down from the top of the jaw with a hacksaw. Two cuts will be necessary to form the sides of each slot. Then smooth the sides with a file. Reassemble the vise and check the register of the slots. For such an operation as that in the lower left-hand detail it is important that the corners of the slots register. If this is off when the jaws are tightened, it can be corrected by filing.

Slotted vise jaws aid in making certain complicated bends in sheet metal. Bending a tab as in the photo below is an example. Note depth of slots in jaws

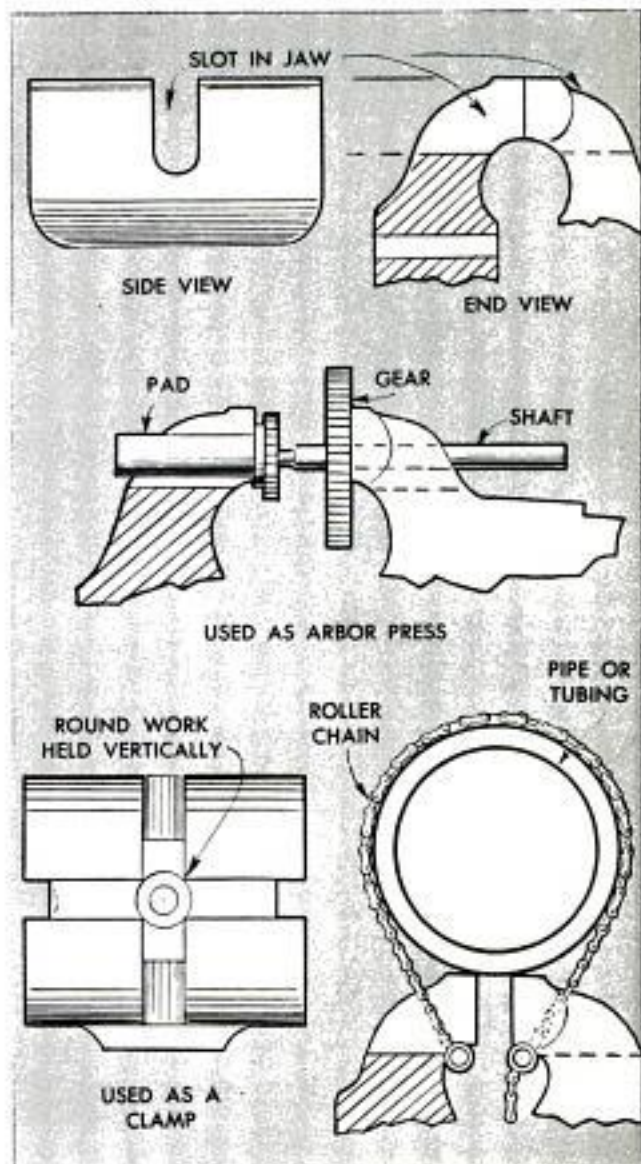
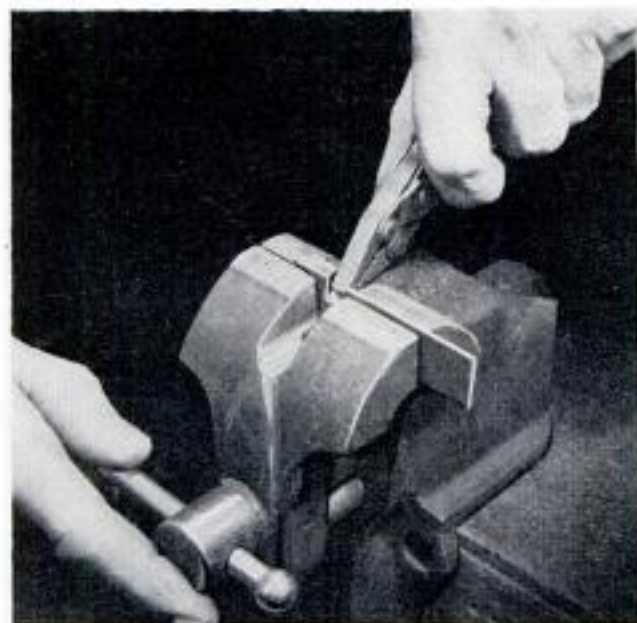

By using length of chain as in photo below and detail above, pipe or tubing can be held securely. Pins passing through chain links engage vise jaws

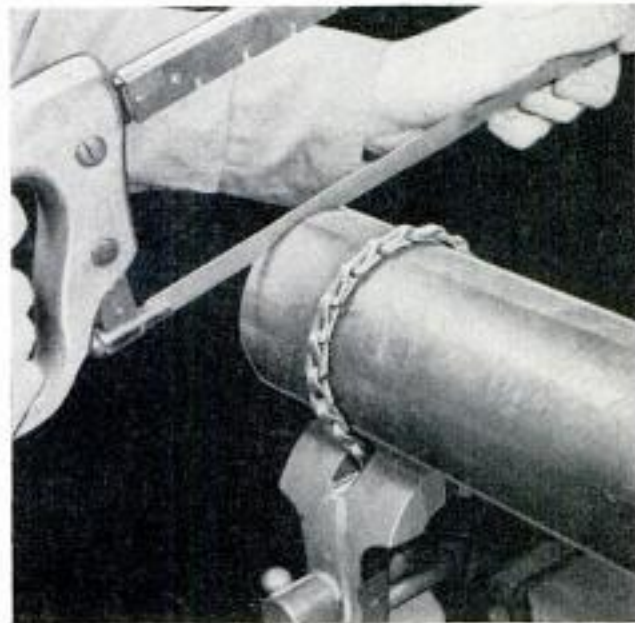

Ashtray Beside Drawing Board Keeps Work Space Clear

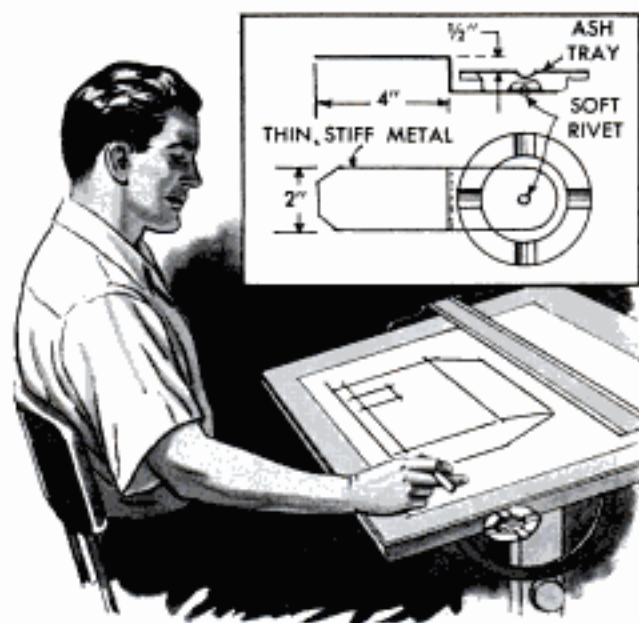

A draftsman who smokes finds it is difficult to place an ashtray where it will be convenient to use, yet out of the way when using the drafting tools. A small ashtray riveted to an offset strip of light sheet metal solves this problem. The sheet metal is thin enough to slip under the linoleum top without interfering, and the offset allows using the T-square without danger of knocking the cigarette off.

L. E. Reichenbaugh, Tulsa, Okla.

Left-Hand Thread on Round Stock Cut With Right-Hand Tap

When left-hand dies are not available, a left-hand thread can be cut on round stock for emergency use, by turning the stock against a right-hand tap. Select a tap of the same diameter as the rod to be threaded, then drill two

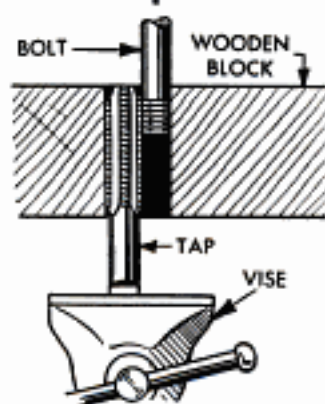

overlapping holes through a block of hardwood to take the tap and the rod. The holes should overlap a distance approximately equal to the depth of the threads. Insert the tap in one of the holes in the wooden block and lock the squared end securely in a vise. Break, or chamfer, the sharp corner at the end of the rod with a file so that the tap will start easily. Then insert the chamfered end of the rod in the hole adjacent to the tap and turn slowly to the left.

L. M. Lefler, Abilene, Texas.

Flexible Water-Pipe Joints From Auto-Radiator Hose

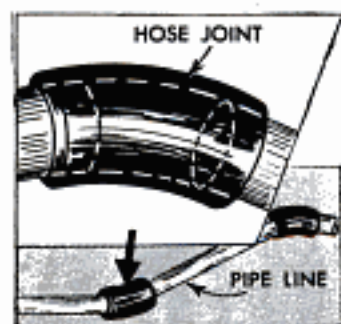

Leaks from broken joints, often experienced when a temporary water line is laid above ground, can be avoided by using lengths of automobile radiator hose as flexible joints. A garage or

service station often has a scrap pile of discarded hoses, available without charge. If the hose is slightly too large for the pipe, regular radiator-hose clamps can be used.

Roughened Surface of Triangle Takes Pencil Marks Easily



Accurate reference or comparative-measurement marks may be penciled on the edges of a draftsman's plastic triangle if the surface is slightly roughened with fine emery cloth or sandpa-

per. The triangle will remain transparent enough for all practical purposes and the pencil marks are easily erased.

☐ To loosen rusted screws, hold a nail set with the point near one end of the slot so that striking it with a hammer will break the rust seal and start the screw in a counter-clockwise direction.

Battery Cable Quickly Attached By Using Grip-Type Pliers

Tow-truck operators have found that on emergency calls when they must attach cables to the battery of the stalled car, the cables are much easier to attach and detach if they are soldered to grip-type pliers. The pliers quickly clamp to the battery post, making a good connection.



WHEEL PULLER

By C. W. Woodson

IT TAKES ONLY a minute to change pulleys on motors or other shop equipment when you have this wheel puller handy. It does the trick without any damage to the pulley or shaft. As dimensioned in the details at the right, the unit is suitable for small pulleys or gears, 3 in. or less in diameter. By simply making the bar longer the tool can be made of sufficient size to handle pulleys up to 6 in. in diameter without increasing the sectional size of any of the parts. Slots in the crossbar are formed by drilling adjacent holes and then filing out the waste. The slots permit a range of adjustment on the hook bolts for pulleys of varying diameter. Hook bolts are made by filing or grinding away the square head of a machine bolt, leaving a lug as shown in the lower right-hand detail. The pressure screw is shouldered to $\frac{1}{2}$ in. for a $\frac{1}{2}$ -13 thread. This is standard practice but is not essential. Where a lathe is not available you can simply thread a length of $\frac{1}{2}$ -in. rod, grind one end to a sharp point, at an angle of about 60 deg., and then drill a hole transversely near the other end for the sliding handle. Ordinarily, sliding handles are made of drill rod with machined end caps drilled and reamed to a drive fit over the ends of the rod. The caps can be eliminated and punch marks made near each end of the rod to prevent it from sliding out of the hole in the pressure screw. When removing a pulley, especially one of larger diameter, be sure that the lugs engage the rim of the pulley correctly so that pressure is exerted in line with the shaft.

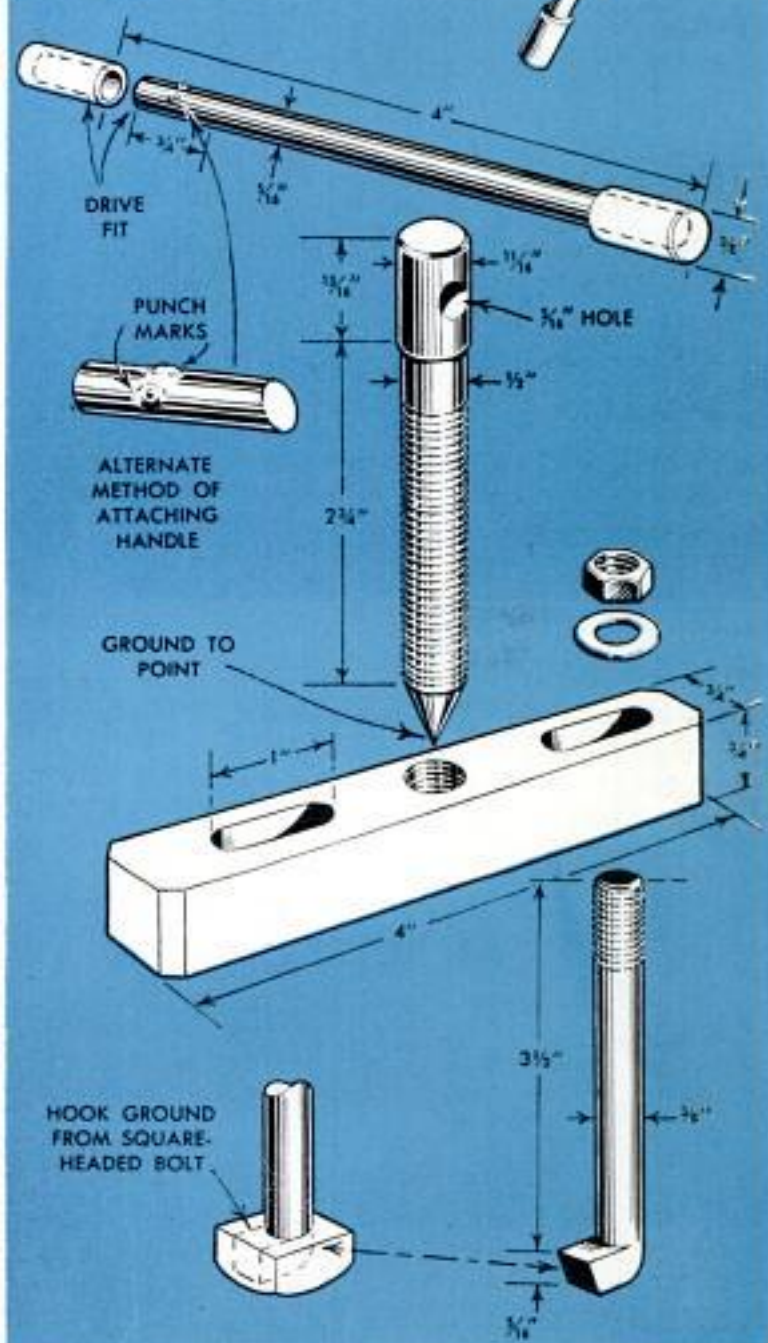

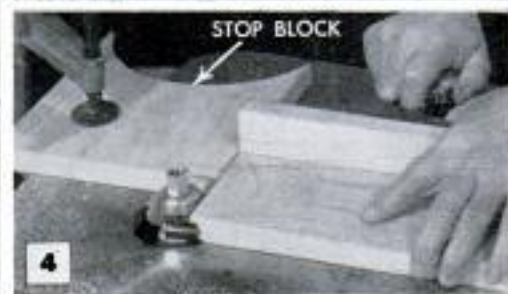
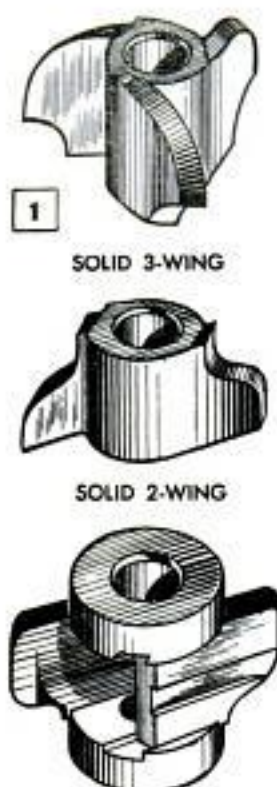

The how of STRAIGHT SHAPING

STRAIGHT MOLDINGS in a variety to suit almost any requirement can be run on a small spindle shaper. Practically any molding shape required in ordinary cabinet joinery can be made if a suitable set of cutters is at hand. Cutterheads and knives are available which incorporate several shapes on a single cutting edge. This enables the operator to combine the cuts on one strip of stock to produce the molding shape desired. Combination cuts made with the knives running on the upper and lower edges, or corners, of the stock are detailed in Fig. 11. Some moldings made in this manner will require the use of two or more knife shapes. The same knife shape also can be used to produce different sizes and types of moldings. Note, for example, the use of the knife A in Fig. 11. Then compare with the use of the same knife in Fig. 47. The letter designations in Figs. 11, 14, 17 and 18 are intended merely as a convenience in comparing the various setups in which the same knife, or knives, are used. The letters are not in alphabetical order. Nearly all machines are supplied with a guard. In the accompanying photos, guards have been removed for clarity.

The standard shaper fence, Fig. 2, is used to guide the stock in common straight-shaper cuts running with the length of the material. Where a cut must be run across end grain on narrow pieces the stock is guided by a miter gauge as in Fig. 3. On certain cuts it is necessary to use a stop block as in Fig. 4.

Cutter equipment: For use on small machines the most popular are the two and three-wing cutters, Fig. 1. These are solid cutters having integral knives. The industrial type of shaper head consists of two collars and two separate knives as in the lower two details in Fig. 1. The edges of the knives fit in grooves milled in the collars. On some heads of this type the grooves are milled with the bottoms at only a slight angle as shown. On others the grooves

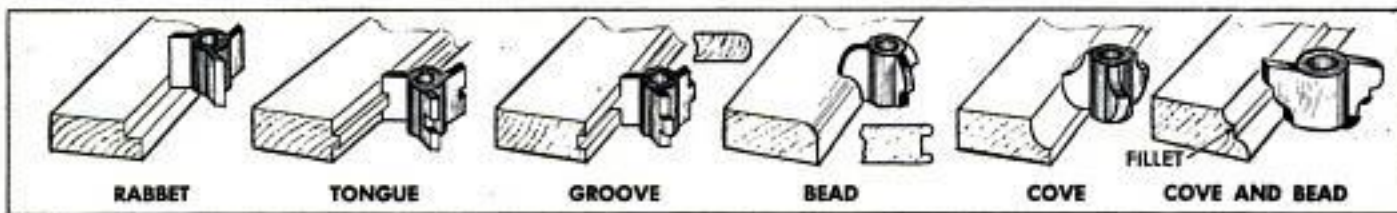
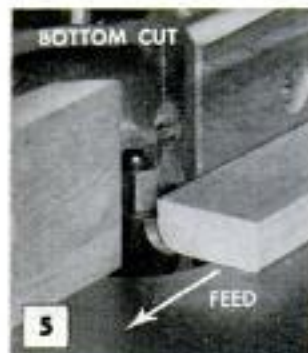

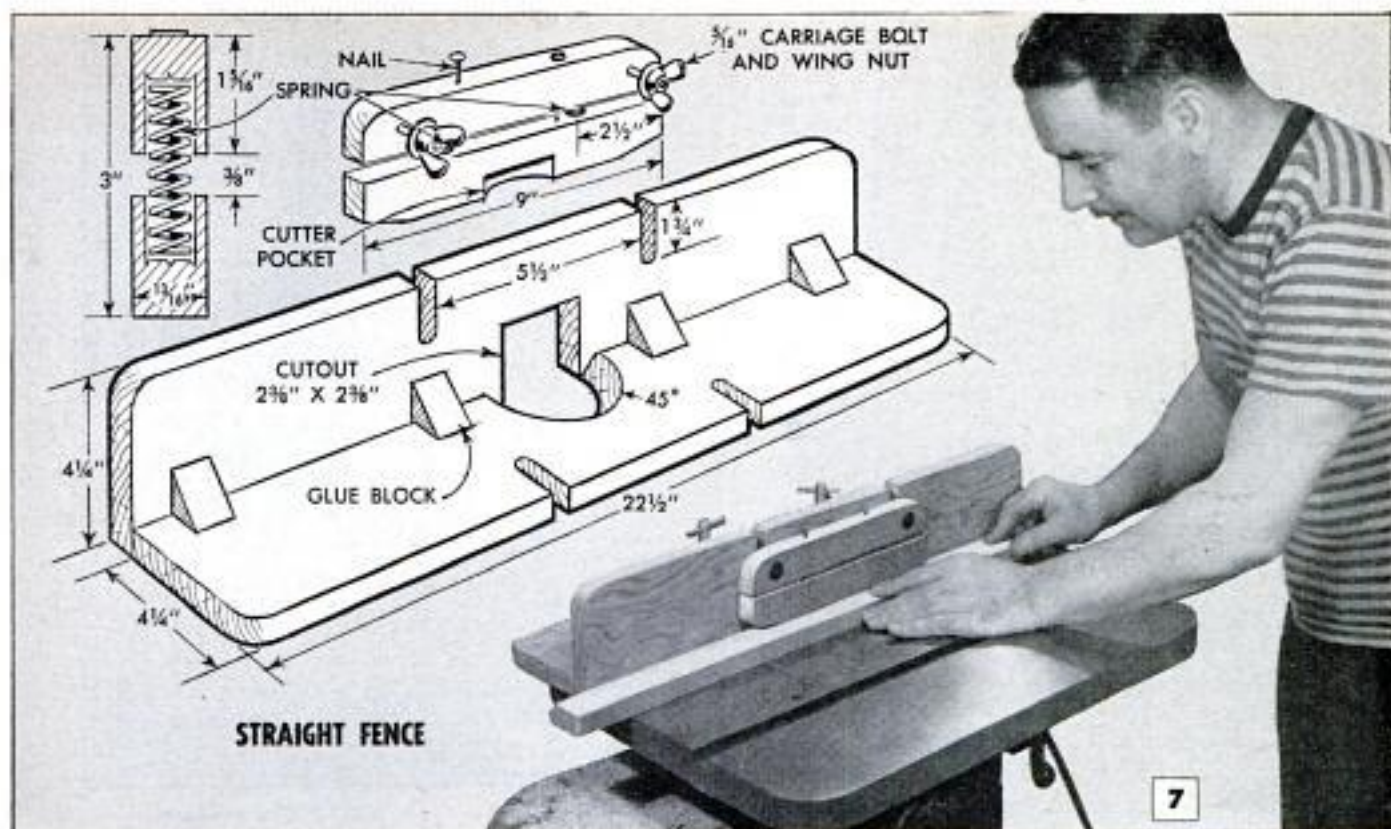

are V-shaped with one side vertical, the other milled at an angle. Cutters are milled with corresponding bevels. Some collars of this type are fitted with a pin as in the lower detail, Fig. 1. The pin engages a hole drilled in one edge of the cutter as indicated. This feature is valuable in that it returns the cutter to the same position each time it is removed for sharpening.

Work feed: Normally the work is fed from the right with the cutter rotating counterclockwise. Adverse grain in the wood may make it necessary to reverse the shaper spindle or the cutter and feed from the opposite direction, Fig. 21. However, spindles on late-model machines are driven at high speeds and this makes it possible to feed against the grain with comparatively little danger of tearing or splintering the wood. Wherever practical, the cut should be made with the cutter running on the underside of the stock, Fig. 5. Top cutting, Fig. 6, is always avoided by careful operators whenever possible as there is danger of damaging the molding should the

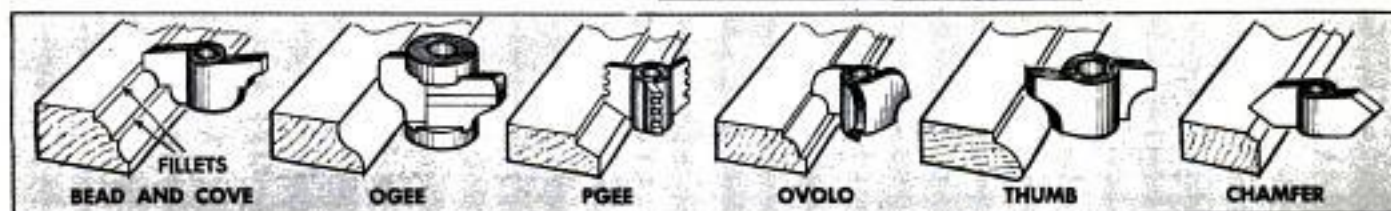
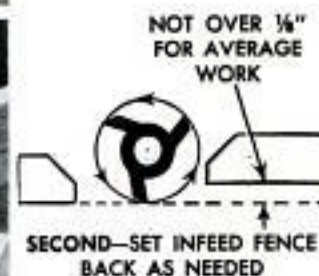
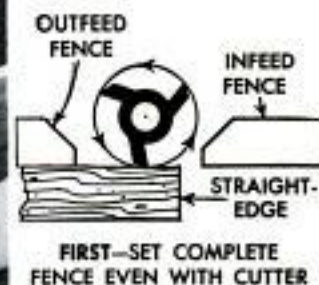

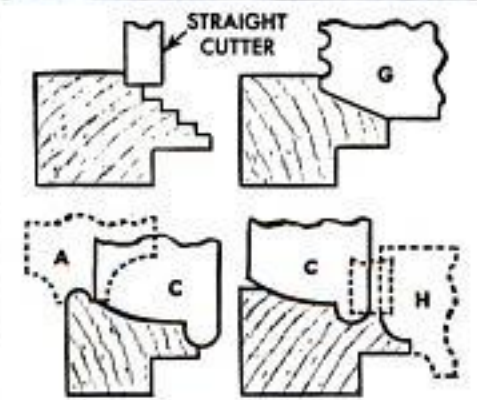
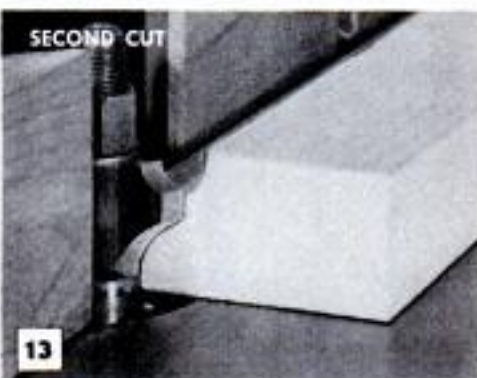
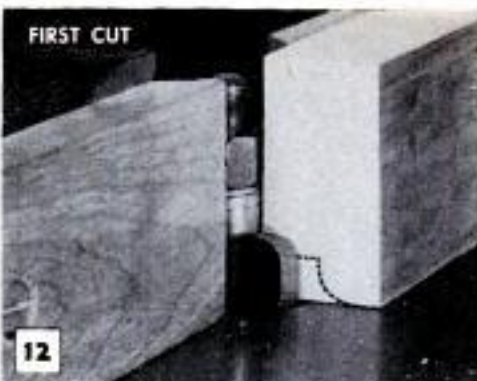
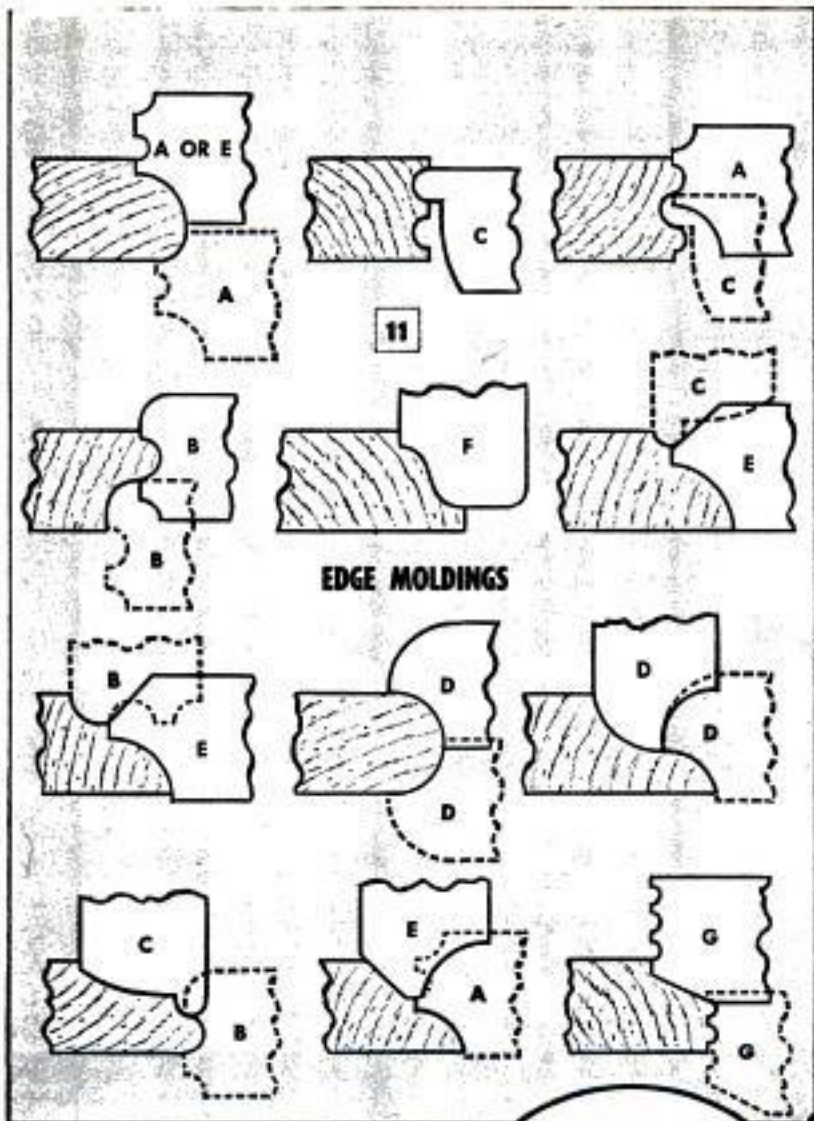

14 PICTURE FRAMES

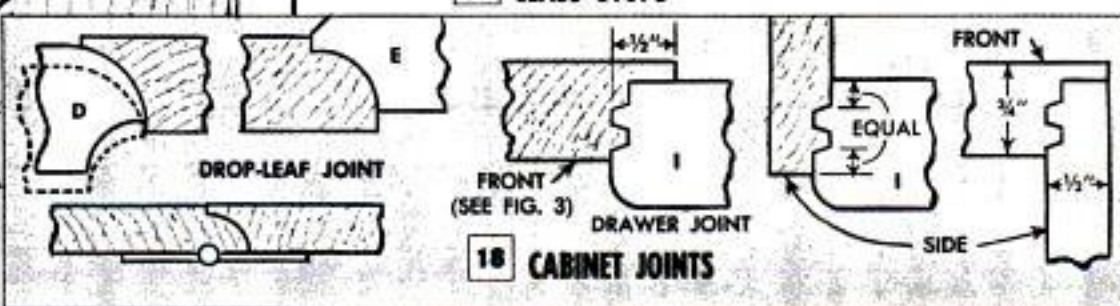
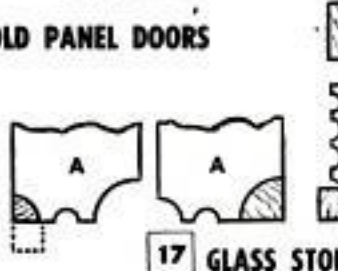
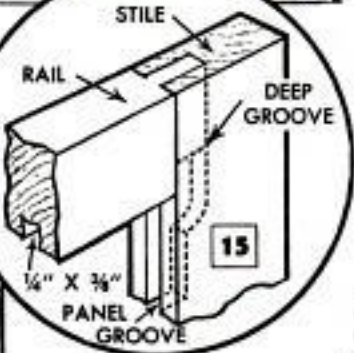
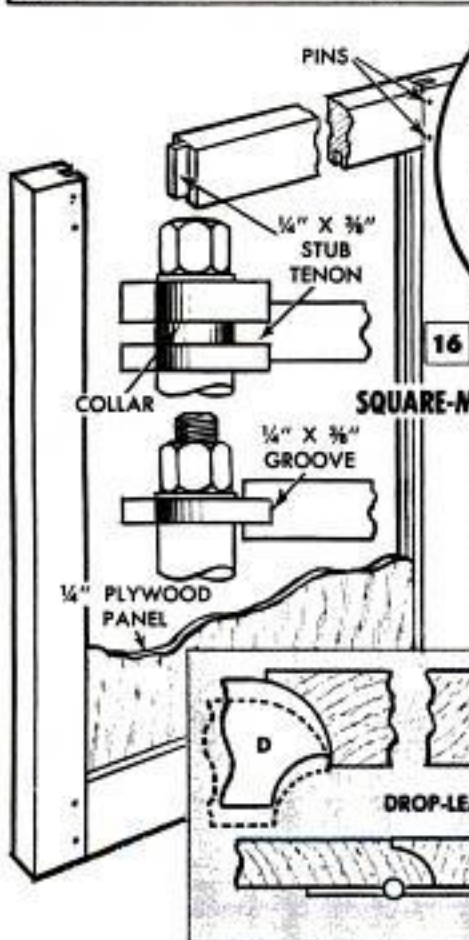

stock tilt slightly on machine table.

Auxiliary fence: Many shaper operators make an auxiliary straight fence with a pressure shoe, or hold-down, for use when shaping straight work. Such a fence can be used on all molding cuts which do not remove all the stock from the edge, Figs. 11, 14, 15 and 18. When all the stock will be removed in either the first or second cuts, Figs. 12 and 13, it is necessary to use the adjustable fence with which the machine comes equipped. This fence is set for the cut as in Figs. 8, 9 and 10. Note that it is set to support both the cut and uncut wood.

Bevels and chamfers: Such cuts are run with the auxiliary table, or guide, shown in Fig. 19. A straight cutter is commonly used. The table is supported against the outfeed fence and the adjustment of the fence itself determines the depth of cut. This should not exceed $\frac{1}{8}$ in. for each pass.

Crosscuts: These are run with the stock supported against the miter gauge, Fig. 3, or a backing block, Fig. 20. When the crosscut also is a face cut, the use of an auxiliary guide, or fence rider, is necessary, Figs. 22 and 23. The job can be done as in Fig. 24 but the method shown is not always satisfactory except on stock wider than 6 in. This is due to the poor support across the fence opening. Another method is to support the stock vertically against an auxiliary fence patterned after that detailed in Fig. 7. This type of fence spans the shaper cutter and permits face-molding narrow stock. Use a wooden spring, or hold-in, as in Fig. 24.

Door-lip molding: This type of molding is run with the setup

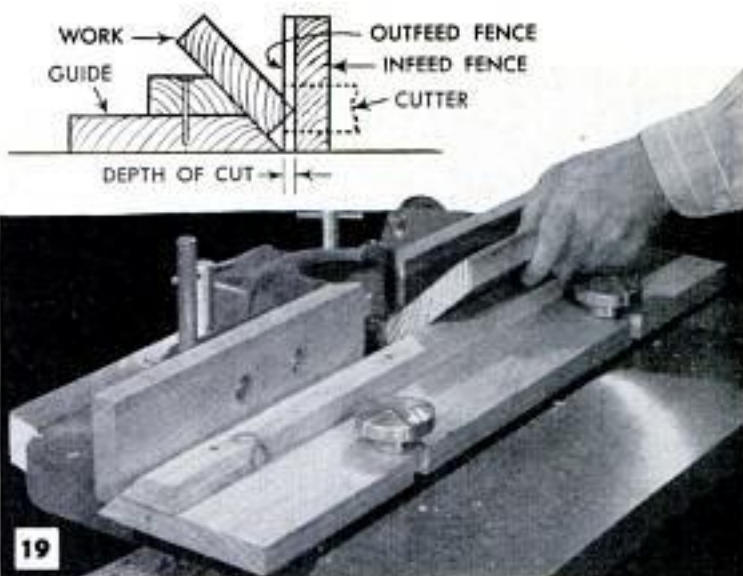

Beveling and chamfering cuts are run on shaper with a special angle guide. Adjustable shaper fence determines depth of cut

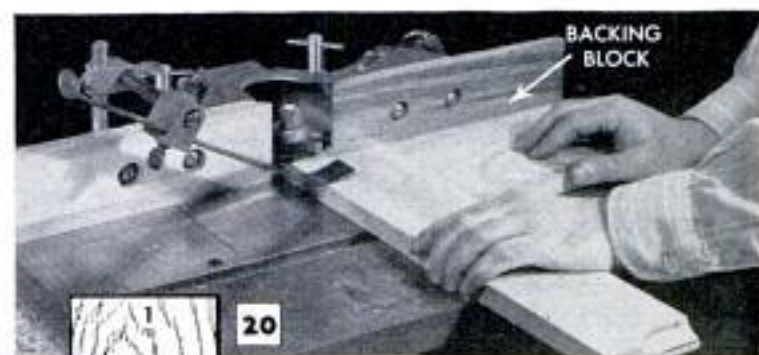

Molding cuts across end grain should be worked with a backing block to prevent splintering. Note use of a spring hold-down



When the molding cut must run across the grain and on the face of the stock, use the setup pictured above. The setup shown at the left is permissible only on stock wider than 6 in.

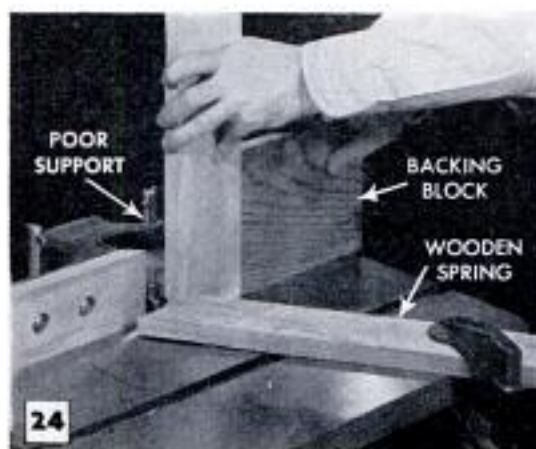

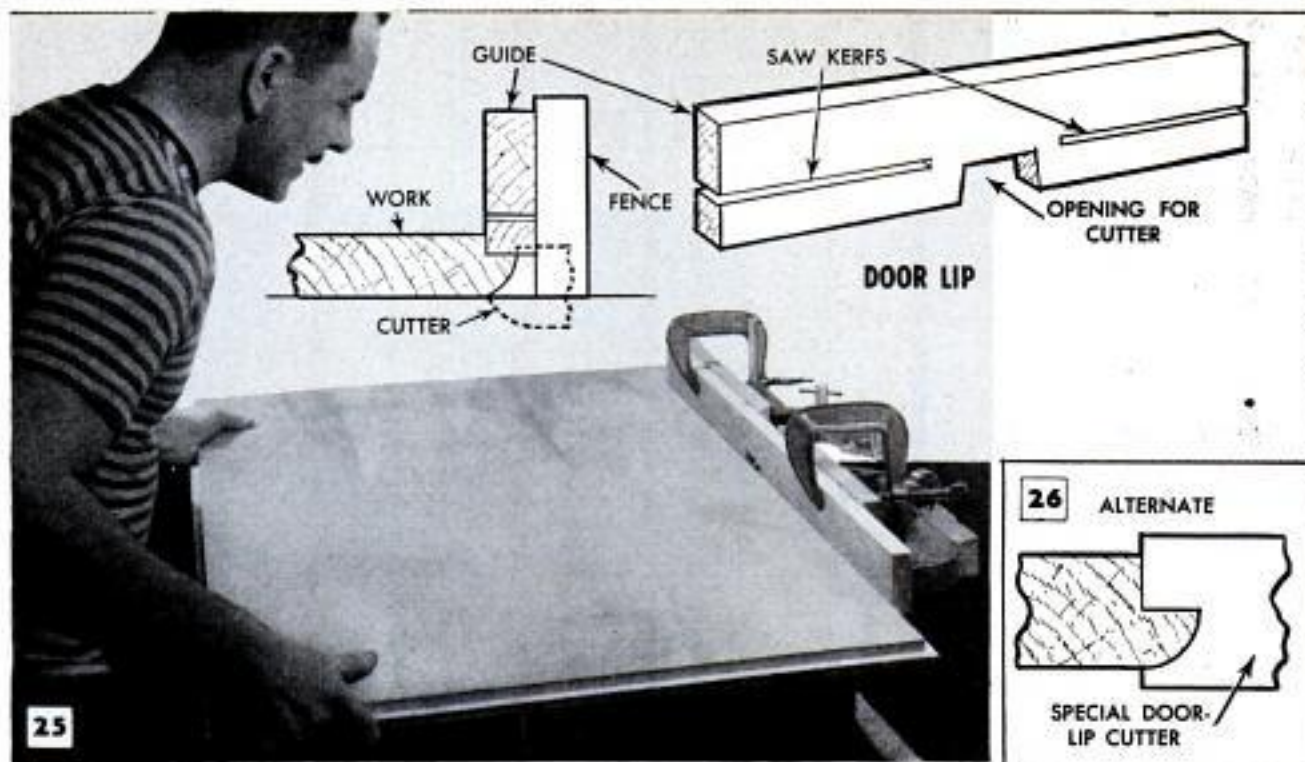

Running a door-lip molding in two operations is best practice on small machines. Sectional detail shows setup

shown in Figs. 25 and 26, the latter showing a special door-lip cutter which runs the shape in one pass. In the first method, which is the most reliable on small machines, the rabbet is run first with a straight cutter, Fig. 25. Then a guide is clamped to the shaper fence and adjusted to a height that will permit the lip of the stock to slide under it as in the sectional detail. The lip is rounded with a second pass of the stock, using cutter A or D, Fig. 11. This type of setup also works well when running the stiles and rails for square-mold panel doors, Fig. 16. The combined guide and hold-down

strip clamped to the fence prevents the stock from lifting through warp or manipulation which, of course, will result in a wavy cut.

Strip moldings: Short runs of narrow strip moldings are usually carried out by shaping the edges of wide boards and then ripping off the strips to the required width or thickness, as the case may be. On longer runs the use of precut strips is faster. Using a hold-in and hold-down as in Fig. 27 the job is simple and safe. Stock to be precut should be carefully selected for straightness of grain and freedom from knots. ★ ★ ★

Where a number of strip moldings are to be made, the job is worked with the setup detailed and pictured below

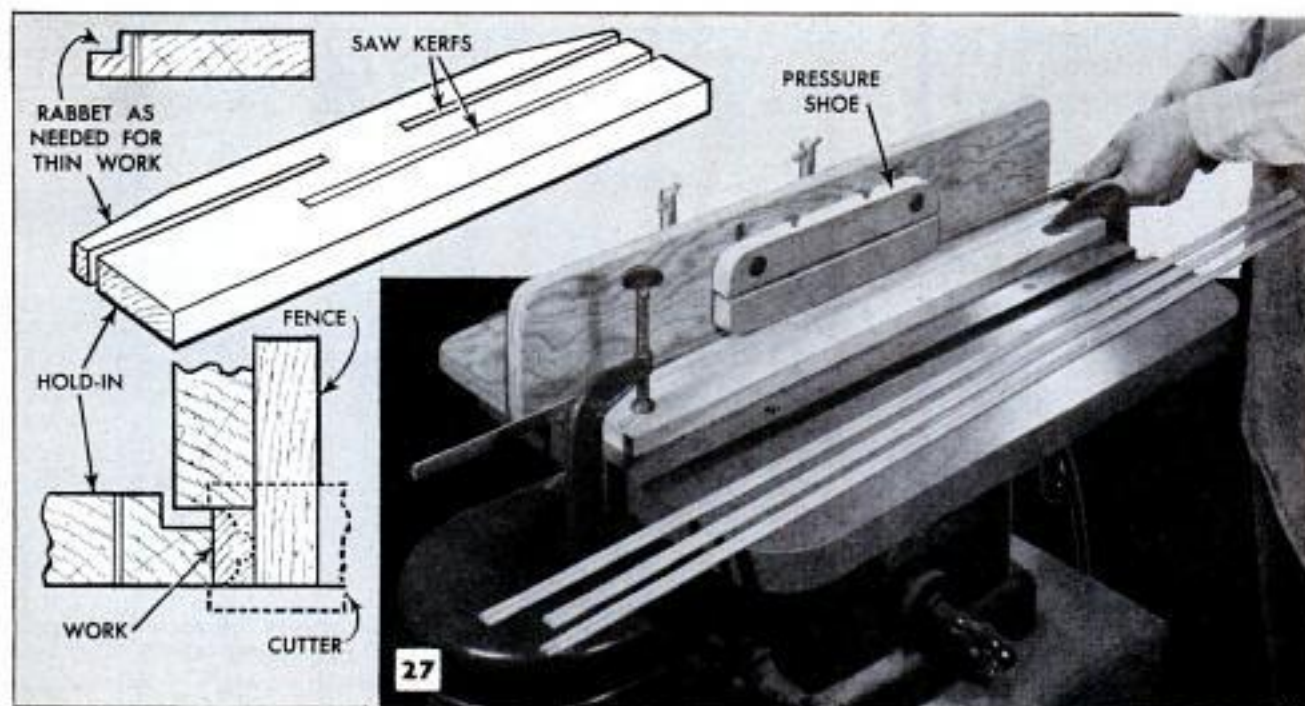

Angle-Steel Spring Compressor for Valve-in-Head Engines

Because his valve-spring compressor did not furnish enough leverage to compress the springs on a valve-in-head engine easily, one home mechanic made his own with $\frac{3}{4}$ x $\frac{3}{4}$ -in. angle steel. A wooden block $1\frac{3}{4}$ x 3 in. was cut from 1-in. stock and bolted to the narrow end of the compressor, with the 3-in. measurement in line with the angles. A $2\frac{1}{2}$ -in. length of the angle then was bolted to the wide end of the compressor frame, which was thus a closed triangle. In use, the narrow end of the angle frame is slipped under a length of 1 x 3-in. oak which is bolted to the head on the side opposite the valves. With the angle frame adjusted to clear the keepers, a light pres-

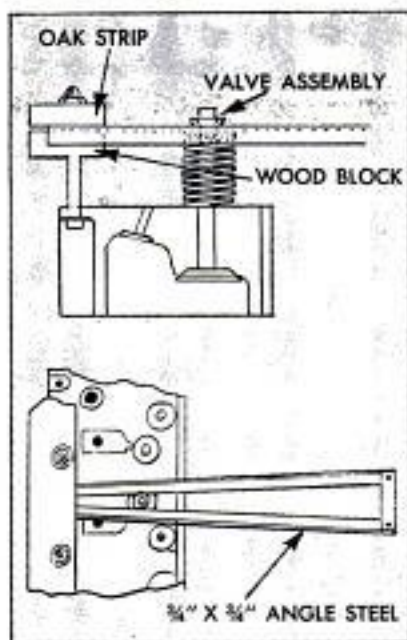

sure will compress the spring. Support the head at each end when replacing the valves, so they can be held in place.

Perry W. Trout, Kansas City, Mo.

Rack Formed With Sawhorses Aids in Cutting Fence Wire

To overcome the tendency of poultry wire to curl back toward the roll as it is being unrolled for cutting to the lengths required, one farmer assembled a rack from lengths of pipe laid across two sawhorses as shown. With the roll mounted to turn on a pipe rested across bracing members of the sawhorses, the end of the wire is drawn up over a second pipe laid across top members and then pulled back sharply to bend it in the opposite direction. This usually is sufficient to cause the wire to lie flat for cutting. The second pipe is held in place by means of a stop formed by a 2 x 4 clamped to the sawhorses, which also prevents the horses from moving apart.

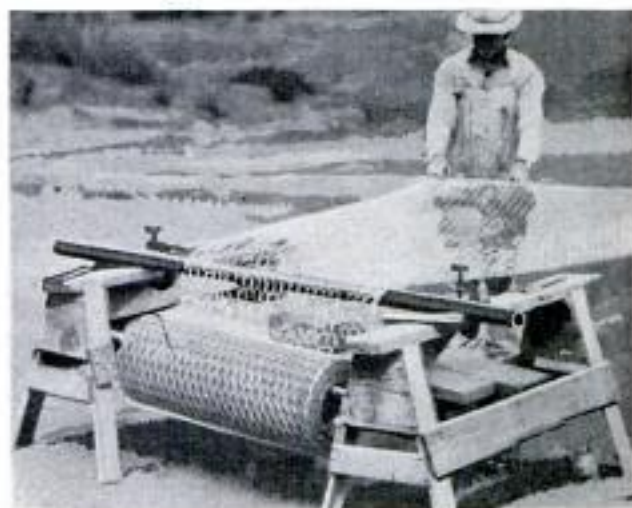

Trailer-Mounted Cornsheller Driven by Tractor Take-Off



A light, cylinder-type cornsheller is easily adapted to power take-off drive by mounting it on a low-wheeled trailer and fitting it with a jackshaft mounted on the sheller frame as pictured. The power take-off shaft is connected to the jackshaft by means of a splined sleeve and universals. The jackshaft runs in self-oiling bearings and is flat-belted to the cylinder shaft of the sheller, the size of the flat-faced driving pulley being determined by the regular speed of the tractor take-off. An idler pulley running on a spring-tensioned shaft automatically maintains belt tension.

A. M. Wettach, Mt. Pleasant, Iowa.

SHOPPING FOR TOOLS

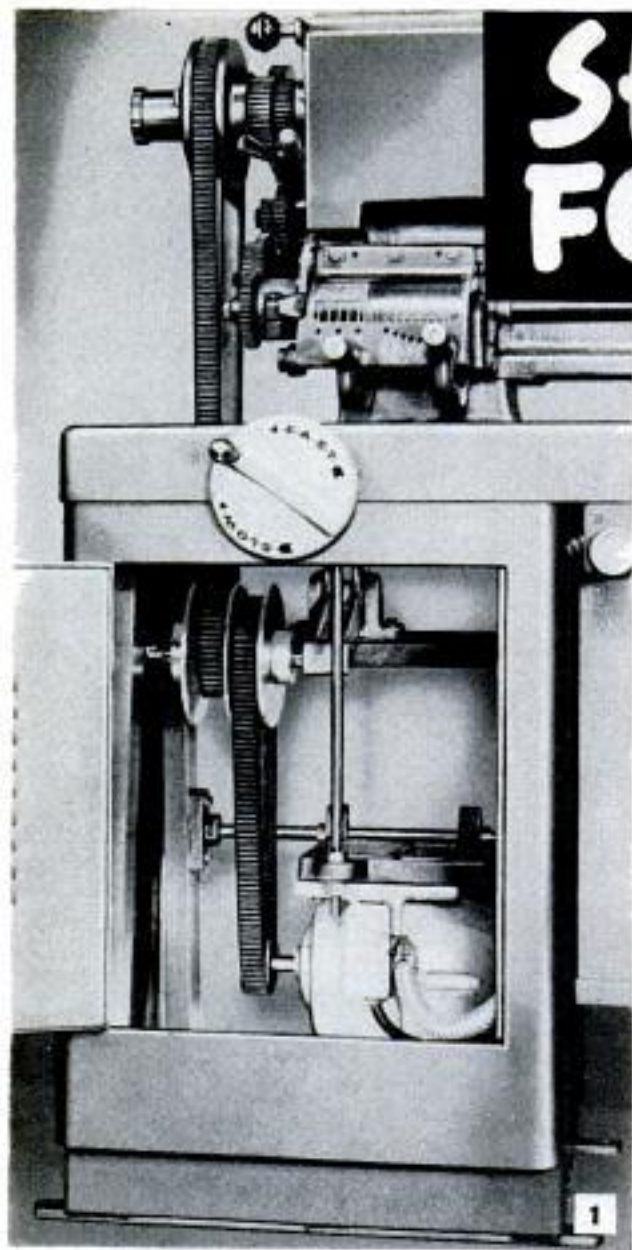

1. VARIABLE-SPEED DRIVE for a popular 12-in. lathe gives infinite speed variation between 38 and 1575 r.p.m. without stopping the lathe. Speed is changed throughout entire range by turning handwheel. With back gears engaged speed range is 38 to 295 r.p.m.

2. ROLLING TOOL RACK provides storage space for 100 tools used by auto mechanics, maintenance men and machine rebuilders. Sloping racks have 360 holes for attachment of spring clips with self-tapping screws. Kit, or rack, is 12 x 12 x 22 in., weighs 9 lb.



3

3. HOLE SAW is adjustable to any diameter from 1 1/4 to 2 1/2 in. Calibrated dial indicates settings of the three cutting blades. Cuts circular disks, washers, gaskets and plugs with clean, sharp edges, in metal, wood and plastics. Can also be used as wood planer

4. MORTISING TABLE for hollow-chisel mortising, routing and planing operations on drill press or mortising machine. Fits table of any small drill press and provides horizontal table travel of 12 in. Work is clamped securely in position against a steel fence

5. VIBRATIONLESS FILING MACHINE for hand finishing operations, die filing, profiling and all delicate operations where close work is necessary with a hand-held tool. Gives both reciprocating and rotary motion to special files, burrs and various grinding cones



2

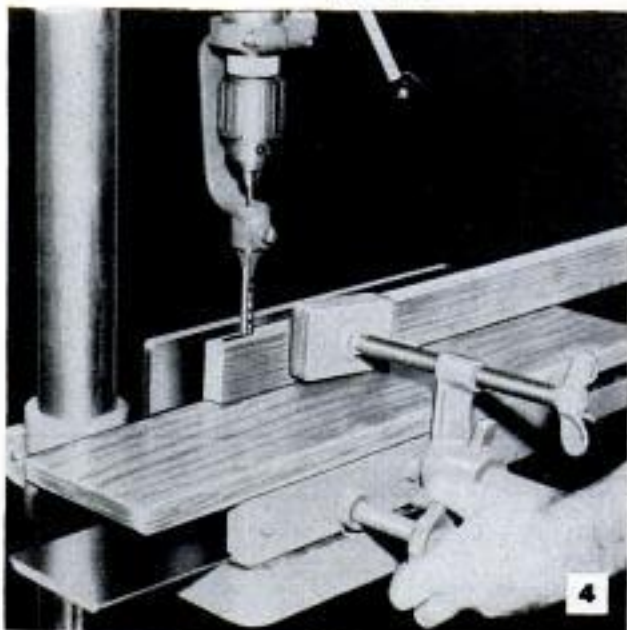

4

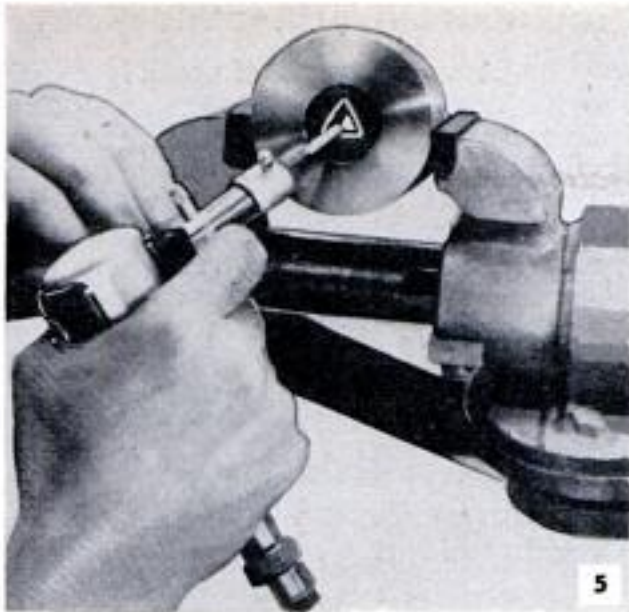

6. ANGLE GAUGE has movable circular dial, one side showing all angles in degrees while the reverse side of dial translates degrees to inches-per-foot drop, carpenter-square measurements and percentages of grade. Saves time when figuring roof framing, leveling floors and foundations. Degree meter also is used to survey rough ground, grade ditches and roads

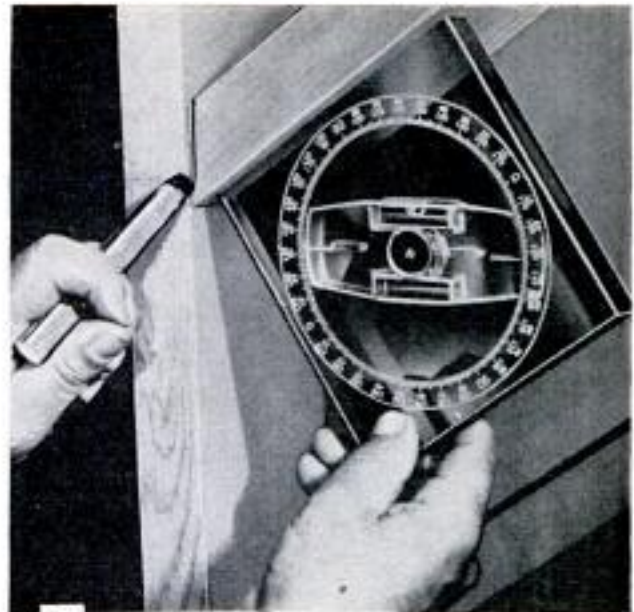

7. DOUBLE-CUT LINOLEUM KNIFE utilizes two cutting wheels with overlapping edges instead of the conventional blade. Overlap of the cutting edges keeps them sharp, due to the honing action as they rotate. Oil-impregnated felt disks, or wipers, keep the cutting edges clean. Knife frame is made with an offset which aids in guiding the knife along guide line

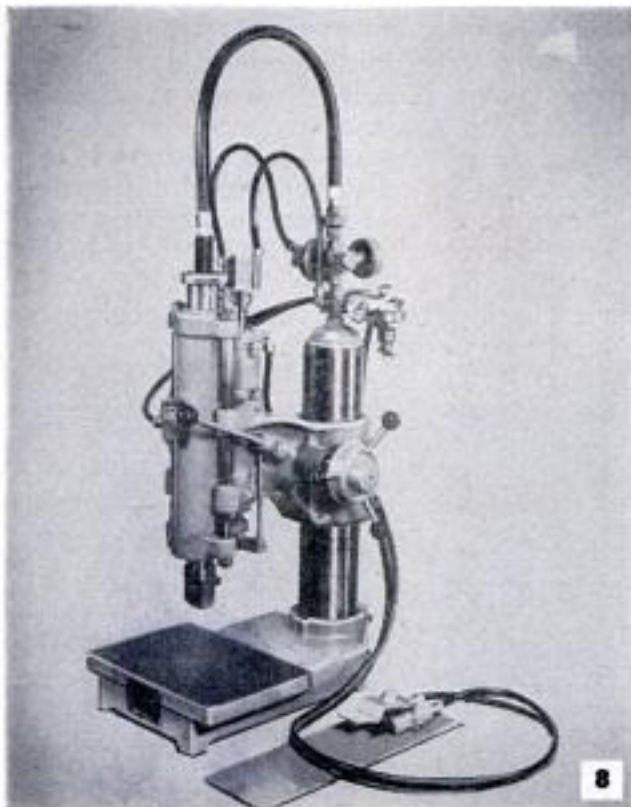

8. IMPACT PRESS gives positive uniformity of impact force and speeds up to 10,000 complete cycles per hour. Press is air-operated; handles uniform work with a clearance of as little as .005; delivers an impact which can be varied from 30 to 30,000 lb.



Fence Opening for Farm Dogs Provided by Suspended Tire



Burned Distributor-Cap Contact Causes Misfiring of Engine

Here's one to think of when your auto or tractor misses regularly on acceleration and all the ordinary checks fail to locate the trouble. Uniform clearance between the rotor arm and the contacts in the distributor is important. Remove the cap and examine it carefully for arc streaks which look like shallow scratches. These generally lead away from a badly burned contact, which may be the cause of excessive clearance. More rarely, the offending contact has been damaged by other causes or is slightly misplaced in the cap. Check for excessive clearance by placing a small piece of wax on each contact in the cap, then turn the engine over with the cap in place. The rotor arm will cut through the wax and thus indicate the variation in clearance. A damaged cap should be replaced, but engine performance can be restored by placing a drop of solder on the contact having the widest clearance and filing to the correct spacing.

Hayrake Teeth Divide Trough



Permanent dividers on a hog trough make it difficult to clean. To avoid this, one farmer made dividers by setting hayrake teeth in the concrete feeding floor, spacing them the proper distance apart. For unobstructed cleaning it is only necessary to slide the trough out through the row of dividers.—G. E. Hendrickson, Argyle, Wis.

To eliminate the risk of possible injuries to his dogs whenever they jump over a barbed-wire fence, one farmer rigged up an old tire as shown at a point where they most frequently attempted to traverse the barrier. The tire was slotted so that two adjacent strands of wire could be spread apart and caught over and under it, suspending the tire in the air while at the same time providing a cushioned opening through which the dogs could jump.

Screwdriver Holds Small Bolt To Loosen Rusted Nut

When the head of a small bolt is inaccessible to a wrench, a slot sawed in the threaded end will permit it to be held with a screwdriver while the nut is removed. Make the cut deep enough so that the screwdriver won't slip as pressure is applied to the nut. If the nut is rusted to the threads tightly, a little kerosene or penetrating oil, preferably the latter, will aid in loosening it.

Richard Hanscom, Elmhurst, Ill.



Hypodermic Syringe Lubricates Small Electric Motors

An inexpensive hypodermic syringe and needle will provide a means of accurately measuring the application of small quantities of lubricating oil. Ideal for use when repairing or servicing small electric motors, such as those used in working models and electric shavers, the hypodermic will apply as little as one drop at a time. The needle may be embedded in a cork to protect it when not in use.





Weep for poor Willie,
 who thinks he's done fine
 If he gets nothing more
 from car polish - but shine...

So when it starts raining,
 this well-meaning fella
 Has to let his wife drive
 while he holds an umbrella.



But look at Joe Robust!
 His sagacious selection
 Is an easy-on wax
 that gives rock-hard protection!

For Bodygard wax
 holds off nature's barrage
 And his paint job's as safe
 as if in a garage!

(He feels extra breezy, 'cause the job is so easy.)

**MORAL: Use New Liquid Bodygard -
 the first, easy wipe-on wax that
 protects your car with this
 rock-hard finish. Protects 9 times
 longer than skimpy-shine polishes.**

YOU CAN'T SHINE DIRT,
 SO CLEAN YOUR CAR FIRST.

Every car must be cleaned before it's waxed.
 Simoniz Liquid Kleener cleans better, faster.

Copyright 1954 by Simoniz Company

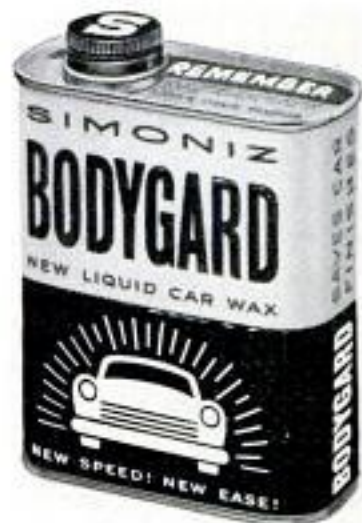

True Simoniz Quality in
 a Liquid Car Wax. **Only 98¢**

Here's the inside story on Kodak carrying cases

by **A. E. Lechleitner**
Supervising Design Engineer
Eastman Kodak Company



**We buy the best top-grain leather
obtainable—and even then only 70%
passes our inspectors**

When people visit our factory, they are surprised to see how particular we are about the quality of our carrying cases.

Here you see the inside story on a camera case (this one is for the Kodak Signet 35

Camera). And opposite are highlights in the production of a "hard" case for a Kodak movie projector. There's a fine Kodak case for nearly every Kodak camera and projector. At Kodak dealers.

Stylists design new models

When Kodak engineers create a new camera, the next step is for stylists to take over and fashion a carrying case. A new case must not only protect; it must also add to operating ease and complement the camera's beauty.



40 operations for average case

It's hard to believe, but a leather case like the one for the Kodak Signet Camera goes through 40 precise manufacturing steps. The final product is unsurpassed for quality and what we call "hidden values."



Only top-grain leather

We buy only the best top-grain cowhide. And even then, 30% is rejected in

final tests as not being quite good enough to meet our high standards.

Vegetable-tanned for moisture-proofing

The primary function of a leather case is protection. Each piece of top-grain leather that eventually goes into a Kodak case has been vegetable-tanned. This process interlocks the leather fibers to provide maximum durability. This is the acme of leather processing. We never sand or fill-in cracks either. In the long run these flaws would show up and weaken the whole case.

Many rigorous laboratory tests

Kodak has one of the most extensive research labs for testing leather. There are literally dozens of tests that all leather samples must pass before being accepted for use. On the right you see the bursting-test machine that subjects the leather to a pressure of several hundred pounds per square inch. We know that leather passing this test will withstand hard knocks and will take plenty of abuse for years.



We also test for ability to withstand flexing in cold weather. The picture at left shows finished leather cases in a refrigerator room where the temperature is 0° F. If the leather shows no cracks after exposure to this test, it passes.

And so it goes. It's a matter of test after test. Sample leather is tested for finish, fading, and aging. At right you see leather cases being tested in an aging oven. Inside this oven, sample cases are left for long periods of time. Terrific heat simulates years and years of deterioration. This severe test subjects a case to the most rigorous conditions it might meet during a lifetime.



Machines cut leather to perfect pattern

The approved leather is now ready to be cut into bottom, top and side pieces. Precision tools (right) insure a perfect fit for each model.



Skilled workers sew with long-staple cotton thread

Durable thread is used for joining the pieces of leather to form the case. Corners are lock-stitched.

Metal reinforcements are rustproof



In cases for some camera models we insert metal reinforcing for extra support. This metal is rust-proofed to insure long-lasting protection. And the leather lining is finished smooth for better wear and appearance. Also makes it scuffproof.



You get top value for your money

As you can see by now, there's no compromise on quality of materials or smartness of design when Kodak makes a carrying case for your camera. Even in our simulated-leather cases for inexpensive models, the materials and workmanship are of the best. These cases also are tested for aging, peeling, fading, cracking.

With all this "to-do" about building a carrying case, you might expect the price to be exorbitantly high. Not at all! Over the years we have been able to introduce new economies all along the line. The end result is absolutely top value in camera cases.

A Kodak "hard" case for projectors will support a 180-pound man

You'll never do it, most likely, but you *could* safely stand on top of our projector cases—those for both movie and slide projectors. They're that strong and rugged. And a good thing too, because optical systems and lamps are fragile at best. They deserve the utmost protection—a Kodak carrying case.



Carefully select materials

Shockproof plywood—and a product called heavy chipboard—are our best materials today for these cases.

Lock corners for long life

The simplest way to make

a box is to take pieces of wood, slap them together, and glue or nail. But that's not the way we do it (see picture above).

Fine-quality hardware

We find customers with cases that are 20 years old and older getting the same good service out of them as when they were first made.

Sanforized® linings won't shrink

Our research lab learned that ordinary cotton lining shrank too much. Now all Kodak hard-case linings are shrinkproof (shrinkage will not exceed 1%).

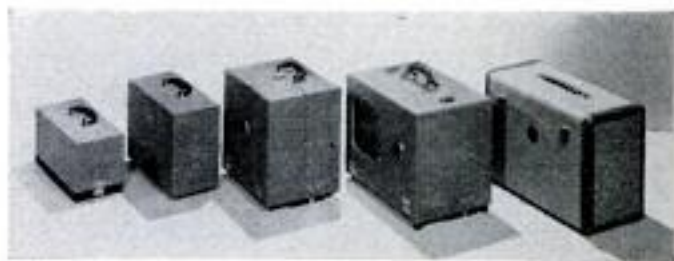

Wide assortment of Kodak hard cases

We make all our own cases for our slide and movie projectors. The next time you're in the market for a projector, check the quality of the cases you see. And when you look at the Kodak cases, remember the inside story of "hidden values."

Eastman Kodak Company
Rochester 4, N.Y.

Kodak
TRADE-MARK

REJOICE !!

With
Millions
of



HAPPY USERS!

Enjoy The Latex Paint with Everything BUILT IN!



SATIN LUMINALL

With Satin Luminall the job is done when common paints have just begun. Thanks to exclusive concentrated formula, one coat primes, seals, undercoats and finishes! No thinners, wall-dopes or solvents to buy! Scrubbable!

FREE! 50 REAL PAINT CHIPS IN
"MATCH-A-CHIP"
BROCHURE . . . COLORS EVERYONE LOVES

LUMINALL PAINTS
Dept. 30, 3617 South May Street
Chicago 9, Illinois

Please send FREE "Match-a-Chip" Color Chart and complete information on Satin Luminall, the latex paint with everything built in.

Name _____
Address _____
City _____ Zone _____ State _____

Luminall Paints

Chicago 9, Newark 5, Los Angeles 1
Luminall Paint Dealers Throughout the
U.S.A. — See Yellow pages Phone Book
MILLIONS OF HAPPY USERS KNOW THE LUMINALL
LABEL IS THE FINEST GUARANTEE IN PAINTS

Clinic for Homemakers



As a service to our readers in solving the hundreds of problems pertaining to a home—inside or out—the editors of Popular Mechanics invite you to present your problems to The Clinic Editor for help and advice. Address your questions to The Clinic Editor, Popular Mechanics Magazine, 200 East Ontario Street, Chicago 11, Ill.

Finishing Problem

Q—I have an old oak dining set, both chairs and table having rope-turned legs. The filler appears to be almost black. However, all the pieces are in very good condition. I'd like to remove all the old finish back to the bare wood and finish in the newer limed oak. Can you advise and give the correct procedure?—R. Y., Vt.



A—Lack of space will prevent us from giving you complete instructions. Remove the surface coatings of the old finish with varnish remover. The remover will take off the surface finish quickly but will not lift the filler. This must be scraped off with a cabinet scraper on all flat surfaces. On the curved surfaces use a coarse sandpaper to get back to the bare wood. Finish up with fine sandpaper. Then apply a white filler (some finishers apply a thin wash of white shellac as the first coat) and, before the filler sets, wipe off to expose the grain of the wood. Use a coarse cloth, such as cheesecloth or burlap, and rub across the grain until all excess filler has been removed. Follow with the finishing coats. This method removes all the filler from the surface of the wood, leaving it only in the pores of the grain pattern. Much of the wood is exposed in its natural color. Some finishers prefer a lighter color and use white lead as a filler. Paste white lead is reduced to the consistency of heavy cream and brushed on the wood. After partially setting it is rubbed off lightly to expose only a small proportion of the wood in the natural color. We suggest that you try test panels.

Removing Oil Stain

Q—My garage has stucco walls. Some time ago I had the misfortune to spill a quantity of crankcase oil on the stucco making a stain spot which is about 2 ft. wide and approximately the same height. At the time I wiped off the excess oil but the discoloration so far has defied all efforts at removal. Have you any suggestions?—C. M., Okla.



A—Usually such stains yield to a vigorous scrubbing with a brush and a strong solution of trisodium phosphate. Several separate applications may be necessary, especially if the stain is old and the

(Continued to page 226)

Texaco Tips

on car care

How to help keep your brake system in safe condition

Your car's hydraulic brake system is your No. 1 safety guard while driving. To keep it in good operating condition, see your nearby Texaco Dealer for inspections. He will check brake lines, making certain there are no leaks. He will check the fluid level in the master cylinder. If necessary, he will add fluid. Your Texaco Dealer's know-how helps make your driving safer — and more enjoyable.



A



B



How to wear-proof your engine

Nature's best motor oil couldn't keep up with today's high-compression engines. So Texaco engineers developed a motor oil that actually wear-proofs your engine for the life of your car — *Advanced Custom-Made Havoline*. With its *Balanced-Additive* formula, Havoline keeps your engine clean, free from harmful sludge, rust and acids. Notice the difference between these two piston pins after a tough 21 hours of stop-and-go tests. Pin "A" shows rust deposits even with a good heavy duty motor oil. But pin "B" remained clean and rust-free — proof that today's best motor oil is made . . . not born. Drive in for *Advanced Custom-Made Havoline* today! See your Texaco Dealer . . . the best friend your car has ever had.

THE TEXAS COMPANY
TEXACO DEALERS
in all 48 states

Texaco Products are also distributed in Canada and in Latin America



Care and Feeding of Engines

BY
S. P. CORP



ENGINE TUNE-UP

A thorough engine tune-up, to bring all working parts up to standard performance, should follow this order:

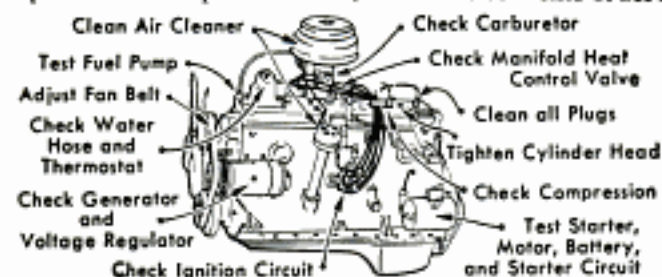

Tighten cylinder head bolts to engine specifications. **Remove spark plugs** and test cylinder compression. Reading on first stroke should be 75% of total reading. If not, poor valve operation is indicated. Compression should be equal on each cylinder.

Clean, inspect, adjust spark plugs. Replace any burned or corroded. Check battery cables. Clean, fill, and test battery. Test starting motor circuit for speed of engine turnover and correct current draw.

If battery won't stay charged or drinks too much, check charging circuit, adjust fan belt, check generator output and calibrate voltage regulator.

Check ignition system for high resistance through poor connections or burned contacts. Test coil and condenser to see if they are up to specifications.

Test fuel pump. It should deliver 5 to 6 ounces in 15 strokes, or 1 pint in 45 seconds at idle speed.

Clean gasoline filters. Free up and lubricate manifold heat control valve. Clean and refill air cleaner with engine oil.

Check carburetor with vacuum gauge, a tachometer for engine speed, and a combustion meter for correct fuel-and-air mixture. Adjust idle speed to specifications. *This is a must for cars with automatic transmissions.*

Inspect water hose connections and water pump. See that thermostat is assuring correct engine temperature.

Make final road test. Engine should operate smoothly from idle speed to top speed, and accelerate without hesitation, to assure your summer driving pleasure.

FREE MANUAL ON CAR CARE

When you re-ring use Sealed Power KromeX Ring Sets, factory-seated for fast break-in and immediate oil control. Top compression ring and side rails of steel oil ring are chrome-faced to fight heat, friction, abrasion, and corrosion. Write for your copy of the illustrated manual, "MORE POWER, Less Gas, Less Oil." It contains many valuable hints on car care. Just address a card to Sealed Power, Dept. G-5, Muskegon, Mich.



Sealed Power

PISTON RINGS

(Continued from page 224)

oil has penetrated to a considerable depth. However, in some cases this treatment is not fully satisfactory. A second method is to spray the affected area with a lacquer reducer (thinner). This procedure usually is effective in washing away the oil stain, but has two serious objections, the cost of the reducer and the fact that it is highly flammable. For these reasons we would hesitate to recommend its use, unless special precautions are taken to lessen the fire hazard. Nonflammable carbon tetrachloride also may be used but again the cost of the solvent may be prohibitive. A third method, safer and fully as reliable, is the use of fuller's earth saturated with kerosene. This mixture is plastered over the stained area and allowed to stand until it "dries" to the point where it can be brushed off. More than one application will be necessary.

Staking Tomatoes

Q—Several friends have suggested that I stake tomato vines to obtain larger and more perfect fruit. However, others say that this causes what they call sunburn. I'm also told that staking materially reduces the yield from each plant. What are the advantages and disadvantages, if any? What type and variety of plants are best for staking?—M. R., Ind.



A—As you have suggested, there is considerable difference of opinion among home gardeners on whether or not to stake, or otherwise support, tomato vines. A practical reason for staking the plants is the lack of space in the average home garden. This alone usually is sufficient reason for recommending the practice. There are different methods of staking. Some gardeners prefer to train individual plants to a single tall stake; others set four plants equally spaced two ways so that the plants are about 2½ to 3 ft. apart. A stake is driven close to each plant and the upper ends of the stakes are bent inward and tied or wired together, forming a teepee-like structure or framework. This arrangement has much to recommend it as each vine can be individually trained (tied) to its own stake. Any common variety of plants can be staked.

Removing Concrete Spatters From Flagstones

Q—Recently I had some remodeling done on my home and in the course of the work, concrete was spattered on the smooth flagstones of a walk that passes near one wall. So far these spatters have defied all my efforts at removal. Is there any other way?—S. B., Mo.

A—Dilute muriatic-acid solution usually does the trick but we would hesitate to recommend its use due to the danger of etching the smooth surface of the stones. A safer way, although it involves more time and labor, is to wet the flagstones thoroughly and then rub the concrete spatters with the coarse side of an oilstone (emery stone). Use plenty of water to prevent the emery stone from glazing. When nearly all the spot has been removed, turn the stone over and rub with the fine side. The coarse side of the emery cuts fairly fast and care should be used to prevent "grooving" of the surface of the flagstone.

Cleaning White Tile

Q—I have a ceramic-tile floor in the bathroom which is discolored after many years of use. Scrubbing in the usual way does not remove the discoloration. Is there any way to clean it thoroughly?—W. T., Pa.

A—One way to clean white tile is to make a thin paste, about the consistency of thick cream, of white portland cement and water. Spread the mixture with a brush or cloth and then rub with a coarse cloth or a piece of burlap. When the paste film thickens during the rubbing, add a little water. Then wipe dry with a clean cloth, preferably burlap. This treatment not only cleans the tile but brightens the joints between the tiles.

Motorola CAR RADIO

Lowest Price Ever

only \$39⁹⁵



**PUSHBUTTON
MODEL 554**

Here's a luxury car radio at a budget price! Five-station, push-to-lock pushbutton tuner. New larger speaker for new depth in tone. Low battery drain. \$54.95.

Powerful! Rich Superior Tone

Razor-Sharp Selectivity

Powerful! Rich Superior Tone!

Razor-Sharp Selectivity!

Drive to your authorized Motorola dealer and get this spectacular radio buy! The powerful, top-performing Model 404 radio at the low, low price of \$39.95! Rugged! Shock-resistant! Has five tubes plus rectifier and superheterodyne receiver. Automatic volume control reduces fading. Heavy-duty vibrator power supply for low battery drain. Hear it today—installed while you wait!

MODEL 404



Better See the Motorola TV Hour on ABC-TV Tuesday nights in most cities

Better See **Motorola** Golden Voice Radio

First-Aid Hints for Table-Model Radios

(Continued from page 163)

in photo E, to insure good reception. Crackling noises heard while tuning are often caused by dust between the variable-condenser plates. A simple way to solve the problem is to blow it out, using a short length of rubber tubing as shown in photo F; a pipe cleaner also may be used for this purpose. Loose speaker cones cause rattles which can often be eliminated with a little household cement under the rim as indicated in photo G. Tears in the paper cone can be patched with cellulose tape. A few drops of carbon tetrachloride applied with a medicine dropper, as illustrated in photo H, will sometimes quiet a noisy volume control. Photo I indicates something that a novice should never attempt. The adjustment of small screws in the tops of i.f. transformers. They must be set in proper relation with each other and such adjustments should be made by a radio serviceman as they require special equipment. To repair a broken dial cord, use strong fish-line. Before removing the broken cord see if you can trace out the winding method used. Make a sketch of the pulleys and the cord-winding details. Now remove the old cord. In most cases there will be three turns around the tuning-dial control shaft. Use the same tension spring and the station-indicator pointer that were attached to the old cord. Now tune in a station of known frequency, preferably at the high end of the broadcast band. Hold the dial-tuning shaft firmly with one hand as illustrated in photo J, and then fasten the station-indicator pointer on the dial cord so that it points to the proper frequency for that station.

When replacing the chassis in the cabinet, see that all control shafts are lined up with their respective front panel holes. If the dial opening is provided with a clear plastic window, clean this first. After the chassis is in position, replace the chassis-mounting screws on the underside of the cabinet. If these screws are provided with soft-rubber mounting bushings do not fasten the screws down tight.

If your set is an a.c.-d.c. type and it does not operate when you plug it into the wall receptacle, merely reverse the line plug in the wall socket. Some table-model sets tune to both the broadcast and short-wave bands. Servicemen are often called because the set will not tune in the broadcast band only to find that some member of the family has tuned the band-selector switch to short-wave bands. ★ ★ ★



This 100% Pennsylvania motor oil with *the Tough-Film* stands up under intense heat, resists formation of oil-wasting engine deposits. Your engine stays clean, smooth-running, *uses less oil*. And because Pennzoil lasts so long, it guards against costly wear caused by acids and friction. Switch to Pennzoil now!

As big a difference as ever!

Most motor oils now contain detergents. A detergent's job is not to lubricate, but to improve conditions under which oil lubricates. Pennzoil, too, contains detergents, but its basic lubricating quality, resulting from superbly refined Pennsylvania crude, still provides an extra margin of safety.

Sound
your Z
at this sign...



© 1954, The Pennzoil Co.
Member Penn Grade Crude Oil Assn., Permit No. 2
BETTER DEALERS IN EVERY STATE FEATURE
PENNZOIL MOTOR OILS & LUBRICANTS

You can do the whole job with a **MONTA MOWER**



The MontaMower smoothly cuts a full 16" swath of grass, cleanly cutting all the dandelions and tall lawn weeds which the reel-type mower leaves standing . . . no more going back over the lawn with a whipper!

The MontaMower "Trims-As-It-Cuts" right up close to fences, trees, buildings, walks, shrubs, flower gardens and cement walls. Practically eliminates all hand trimming!

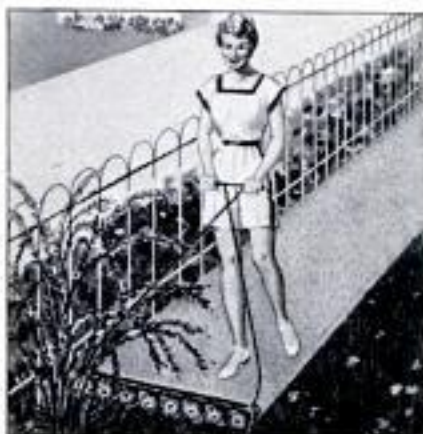

The MontaMower is so light (9½ lbs.), so sturdy and responsive that even women and teenagers can mow steep terrace banks up, down, or across, with scarcely any effort!

ONLY MONTAMOWER TRIMS AS IT MOWS -- IN ONE EASY OPERATION

The versatile MontaMower is actually "Two-Tools-In-One" . . . an efficient lawn mower and a very fast lawn trimmer. Due to its unique, patented design, it is the only machine that does the whole job of lawn cutting and trimming in one easy operation. Its live, precision mechanism first gathers, then smoothly cuts a clean 16" swath through grass, dandelions and tall lawn weeds as evenly as a pair of keen-edged shears. It cuts right up to trees, walls, fences and borders . . . "Trimming-As-It-Cuts" . . . leaving practically no back-breaking, time-consuming work to be done by hand. Enthusiastic owners throughout the world tell us the MontaMower

is the most practical hand lawn mower ever designed! Even power mower users say it's a "Must" for close-quarter mowing and all the trimming.—SOLD WITH OUR WRITTEN GUARANTEE!

HERE'S HOW IT WORKS

Eight pairs of newly designed, Self-Cleaning and Self-Sharpening, precision made and fitted, tool steel cutting discs revolving toward each other gather the grass and cut it cleanly with a new shearing action at the intersections of the discs.

TRY THE VERSATILE MONTAMOWER ON YOUR OWN LAWN . . . ON APPROVAL

An actual trial on the lawn where it is to be used is the most convincing proof of the exclusive advantages of a MontaMower and its superiority to conventional mowers. We have, therefore, developed a most attractive "TRY IT ON YOUR OWN LAWN ON APPROVAL OFFER" for those who are definitely in the market for lawn mowing equipment of one type or another. Don't miss this opportunity to see for yourself how invaluable the MONTAMOWER would be to you! Act NOW! Fill out the coupon below . . . Mail it today!



MontaMower Distributing Co., Sales and General Offices
PM-45 KEELER BLDG., GRAND RAPIDS 2, MICHIGAN
Gentlemen: Kindly send me (FREE OF CHARGE) completely illustrated, descriptive literature, price, guarantee information, and full details of your attractive "TRY IT ON YOUR OWN LAWN ON APPROVAL OFFER."

NAME _____
ADDRESS _____
CITY _____ ZONE _____ STATE _____

SOLD DIRECT ONLY — NO AGENTS — NO DEALERS
HOWEVER, YOU CAN PAY FOR YOUR MONTAMOWER THRU OUR OWNER'S COOPERATION PLAN!

Gardeners you know:



Merton Wump

Merton is a booster. Gives his plants a big boost of some special concoction every week or so. Has the tallest grass and widest flowers for a short time. Then, no matter how many boosters he applies, everything fades out on Merton. Trouble is he never gets to the root of the matter. Isn't aware that only a complete plant food gives the over-all nourishment a plant requires.

Many gardeners, like Merton, don't realize that what goes on *underground* is every bit as important as what meets the eye.

In fact, the development of deep, foraging roots is the real key to gardening success. Thus, the popularity of Vigoro*.

For Vigoro feeds the entire plant—roots, stems, leaves, blades and all! That's why Vigoro-fed lawns and gardens come up sound and healthy and stay that way far longer. Vigoro actually helps increase the humus of your soil in lawns because it encourages new roots to replace old.

There are now *two* kinds of Vigoro. Regular and new water soluble Instant Vigoro. Both will make plants grow and thrive even in the poorest soils.

*Vigoro is the trade-mark for Swift & Company's complete, balanced plant food.



Regular
VIGORO
•
Instant
VIGORO

Guarding the Graveyard of Ships

(Continued from page 132)

of the Points Adams Lifeboat Station. "The fishermen are safe enough as long as they stay in the river, but we have to keep herding back 200 to 300 strays a day. The fishermen show up in every type of craft you can imagine."

Two small boys probably came up with the most novel—and dangerous—craft. Lashing together two telephone poles and attaching an outboard motor to them, the boys were fishing their way well out to sea when the Coast Guard caught up with them.

During the derby, a transient fishing village springs up on the Washington bank of the Columbia. It is called appropriately Derbyville.

One day two fishermen, long on fishing enthusiasm but short on navigation knowledge, set out from Derbyville. They figured they would have no trouble if they hugged the Washington shore. Six hours later, however, they hailed a commercial troller. Much to their surprise, they were 20 miles up the coast from the Columbia. The troller signaled the Coast Guard, advising that it had customers.

Various navigational aids are used in cheating the graveyard of ships. To get first-hand information on them, we called on Lieut. C. D. Eubanks, commander of the Coast Guard Base at Tongue Point on the Columbia, which has the major job of keeping the navigational aids in top shape. He took us to the shop where buoys were being sandblasted.

"Used to have to scrape off old paint, rust and barnacles with a wire brush before repainting them," he said. "Now the buoys are made slick and clean in a hurry with sandblasting, and their life in the water has been extended considerably."

You don't get an idea of the size of a buoy until you see one up for repairs. In the water, not much of a buoy protrudes. Some we saw on the Tongue Point dock seemed as big as a house—well, at least cabin-sized. Buoys vary from 7 to 38 feet in height, weigh from 1095 to 20,616 pounds. An electrically operated bell buoy, when loaded with huge batteries weighs 35,000 pounds. The largest buoys carry 72 batteries. Bell buoys in the Columbia are electrically operated because the swell of the water is not enough—except at the bar when the water is acting up—to ring the bell.

Eubanks pointed to old No. 8 up for repairs. It rides the thrashing waters of the bar and, to keep it in position, it must be anchored with two huge concrete blocks,

(Continued to page 232)

NOW IS THE TIME TO INSTALL FULL-FIRING CHAMPION SPARK PLUGS TO TUNE-UP WINTER-WEARY ENGINES!

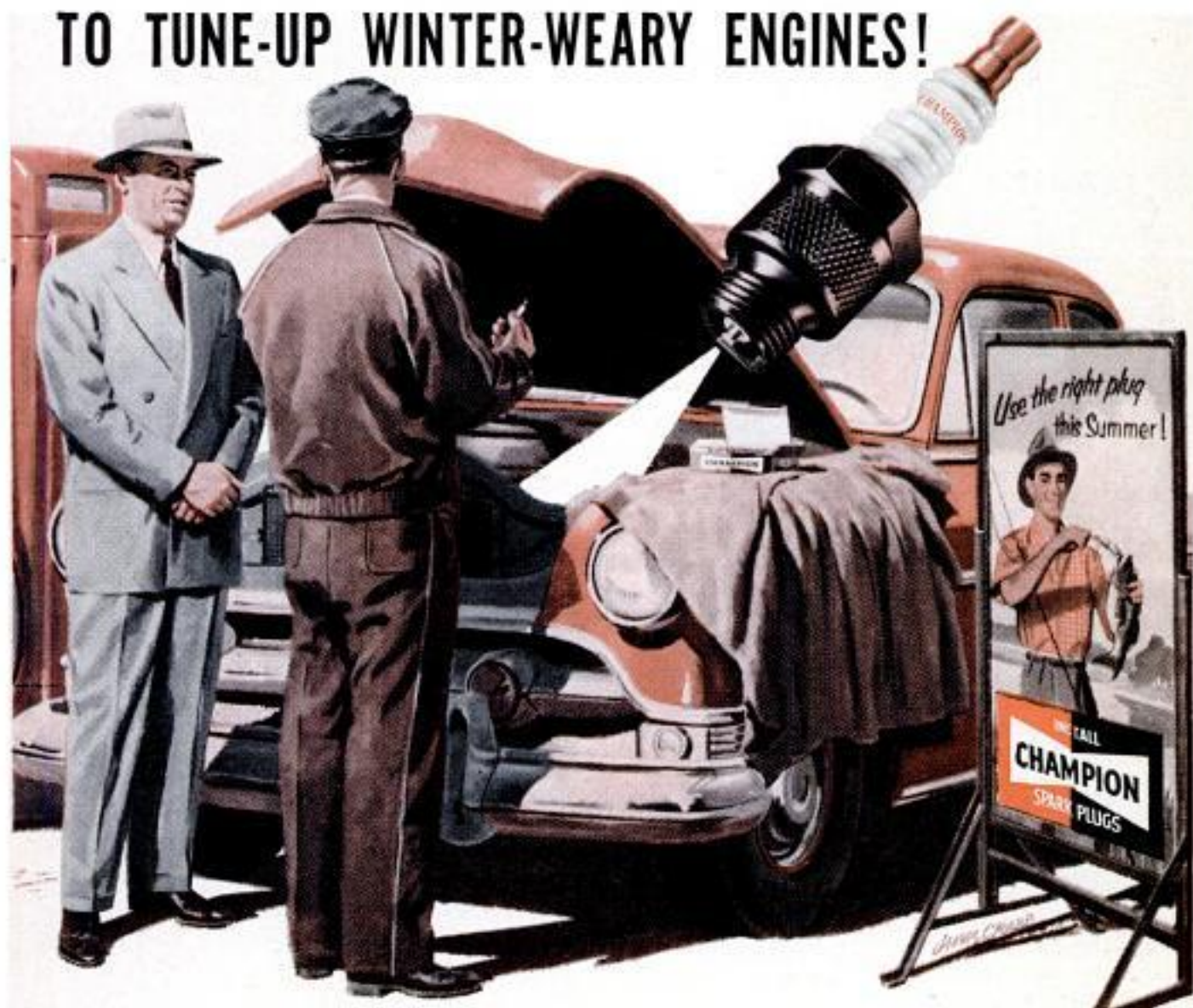

Install new Champions now to offset the damaging effects of limited use or winter storage and help your engine do a first-class job for you this summer.

Quickest, surest way to wake up your engine for increased summer activities is to install a set of new Champion Spark Plugs.

Champion's full-firing spark—delivered through the finest insulator known to ceramic science to special alloy electrodes—turns every drop of gasoline into power. No unburned fuel remains to build up harmful deposits and thin your crankcase oil. That means you can drive longer, and harder this summer and still enjoy better performance and economy.

Now is a mighty good time to see your nearby Champion dealer and start getting all the power you're paying for!

CHAMPION SPARK PLUG COMPANY, TOLEDO 1, OHIO

I installed

B.F. Goodrich
Koroseal
FLOOR TILE



because...

IT OFFERS ALL THESE IMPORTANT FEATURES

B. F. Goodrich Koroseal is the ONE floor tile that combines these 4 desirable features:

NEVER NEEDS WAXING! Minimum care — stays bright with an occasional washing and light buffing.

DEFIES DESTRUCTION! Super-resistant to oils, fats, greases . . . even cleaning fluids and alkalis.

ANTI-SLIP SURFACE! Safe to walk on, always!

MAXIMUM WEAR! The same material from top to bottom — no coating, no lamination.

You increase the value of your home when you install beautiful B. F. Goodrich Koroseal Floor Tile . . . and you can do the job yourself! The 80 gage thickness, made especially for homes, is easy to install when you use the B. F. Goodrich Installation Kit. Ask your dealer for guidance.



Send for **FREE** full color folder.

B. F. Goodrich Co., Dept. PM5
Flooring Div., Watertown 72, Mass.

Name _____

Address _____

City _____ State _____

each weighing nine tons, 36,000 pounds in all.

Not only are there different types of buoys, including those with whistles, but the buoys have different colors. The color of a buoy indicates the side of the channel to take. Lighted buoys have different characteristics, varying from 15 to 75 flashes per minute. Then there are short and long flashes. The idea in entering the Columbia is to know what particular buoy is where. That's where the professional river pilots come in.

On July 27, 1953, occurred an historic event. A tender, working out of the Tongue Point Base, placed in the mouth of the Columbia the first buoy with a radar reflector. Others were to follow. A radar-equipped ship approaching such a buoy receives a big "pip" on its radar screen.

In the early part of World War II, radar reflectors were placed on permanent structures to warn ships. These were known to the layman as "echo boards."

Aiding navigation at the Columbia's entrance was radio. Then came loran—long-range navigation aid. Ships equipped with special loran receivers can pick up electromagnetic waves far out to sea.

But, with all the scientific developments in recent years, men of the sea coming to the Columbia still count heavily on the lighthouses that have served them for many decades in good weather and foul.

Patriarch of the lighthouses serving the area is that on Cape Disappointment, whose craggy slopes jut out from the Washington shore. Completed in 1856, the tower light—more than 200 feet above the sea—casts a beam of 58,000 candlepower for many miles. Then, in 1881, came the light at Tillamook Rock—75,000 candlepower, and in 1898 the one at North Head—260,000 candlepower.

Tillamook Rock stands at a strategic point 18 miles south of the mouth of the Columbia. A little "Gibraltar," the rock rises 86 feet above sea level.

"It's 131 feet from the sea to the lantern," said A. E. Anderson, civilian supervisor of aids and navigation at Tongue Point Base, who did duty on the rock as a young man. "The book says 130 feet, but I measured the distance, and know better. Sometimes measuring was the most exciting thing a man had to do in his spare time."

In fierce storms, waves break over the light. Wire mesh shields it on the seaward side to keep rocks from breaking it.

In 1948, when Coast Guard funds ran low, the Tillamook light almost went out. But commercial fishermen howled like a nor'easter. The light is still burning.

Three days after the Japanese plummeted bombs on Pearl Harbor Dec. 7, 1941,

(Continued to page 236)

INTRODUCING...

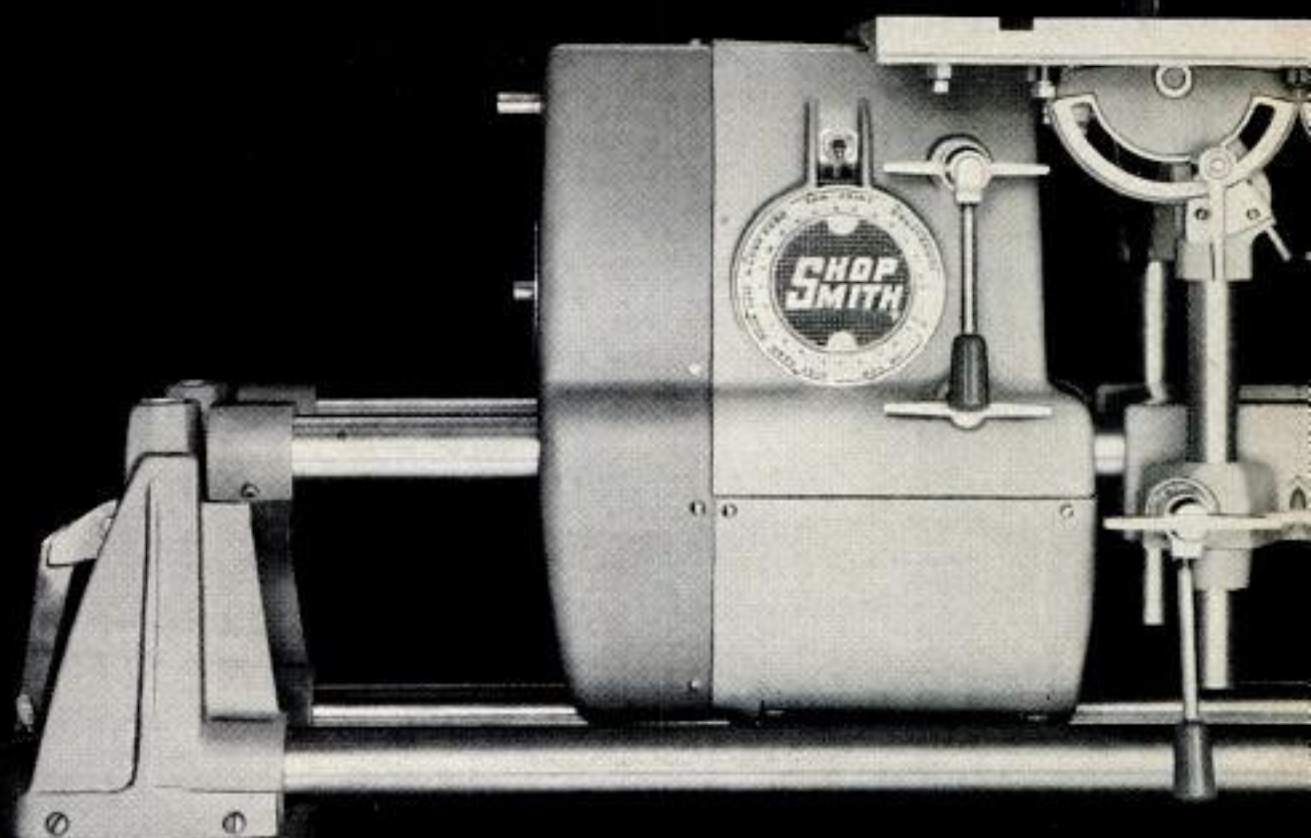

An entirely new concept in power tools . . . a change so significant that it outdates all former standards for judging tool performance. Imagine the very finest power shop you could buy, engineered into a single unit and delivered complete, ready to plug in . . . with a built-in $\frac{3}{4}$ -hp. motor . . . a revolutionary method for changing speeds without changing belts . . . plus many, many more exciting features.

Copyrighted material

NEW SHOPSMITH

advanced engineering makes it the only power tool to put precision woodworking within the reach of everyone!

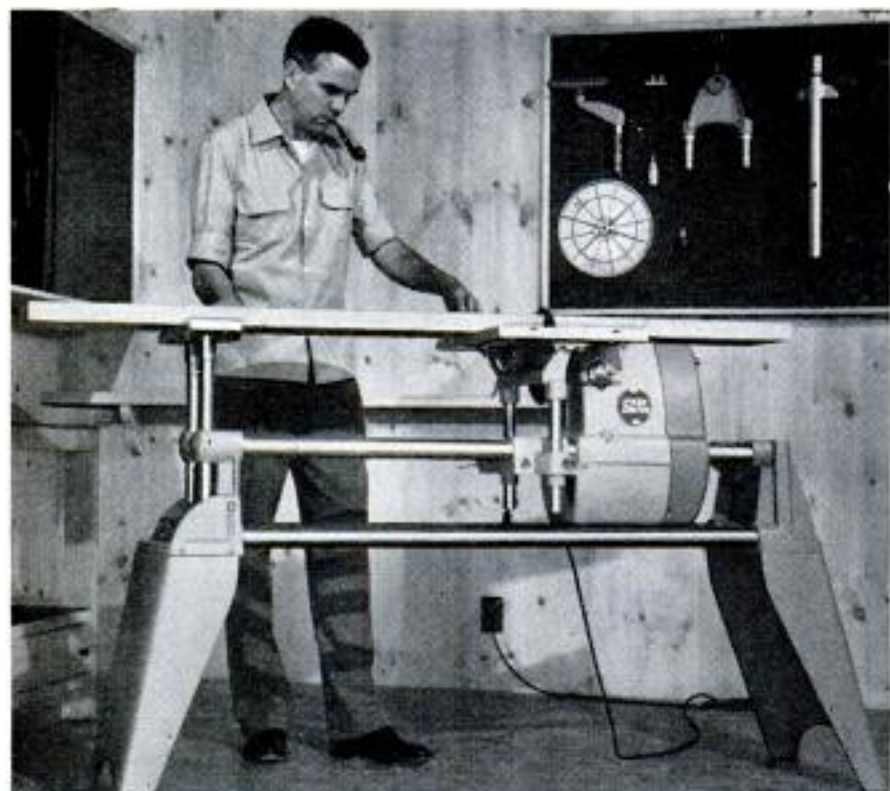

SHOPSMITH Mark 5 IS COMPLETE! It's delivered to you ready to plug in. And like your automobile, it comes factory assembled, factory adjusted, factory tested. No bench, motor and switch to buy. No belts, pulleys and wires to attach. No rust worries — rods and tubes are hard-chrome plated! Everything is an integral part of the compact unit *plus* all you need to make it a 9" circular saw, 12" disc sander, 34" wood lathe, 16½" drill press, horizontal drill. The price complete..... **\$269⁵⁰**

For six years, SHOPSMITH* has been the unchallenged leader in power tools. Over 150,000 owners enthusiastically acclaim the SHOPSMITH principle as the only truly practical basis for multi-tool operation.

And now comes the second great revolution in power tools — an entirely new SHOPSMITH! Here are standards of design you'll recognize as so advanced, you know it will take years to match them — standards of versatility, precision, convenience and safety so new and different, you'll appreciate why SHOPSMITH Mark 5 is the *one* tool for modern living — why it *alone* is the tool for *you* and *all* the things you want to do.

*Reg. Trade Mark

SHOPSMITH Mark 5 is built for hairline accuracy!



MITER GAUGE. It's accurate to the exact degree of angle. Locks in table slots as handy sanding and drilling jig.



RIP FENCE. Squares and locks front then back with single handle. Easily set off-square for special operations.

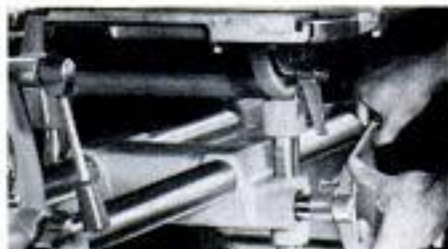

TABLE HEIGHT. Quickly, accurately set by lever-operated double rack and pinion. Faster than other methods.

MARK 5

SHOPSMITH Mark 5 HAS GREATER CAPACITY than any power tool at any price! Its $\frac{3}{4}$ -hp. motor has ample power for the toughest operations. 9" circular saw cuts 4' x 8' panels in half either way. Lathe has 16 $\frac{1}{2}$ " swing... 12" sanding disc has big 14" x 18 $\frac{3}{4}$ " table... drill press drills to center of 16 $\frac{1}{2}$ " circle... horizontal drill capacity is unlimited!



SHOPSMITH Mark 5 HAS SPEED-DIAL. By itself, Speed-Dial is the most significant power tool advance in years. It automatically selects the correct speed for the job at hand — does it with a twist of the dial. No more guesswork. No more belt changing. No makeshift operations with one-speed or wrong-speed spindles. Simply turn the dial to the place marked saw, jointer, sanding, jig saw, dadoing, etc. — or make infinitely variable settings from 700 to 5200 rpm.

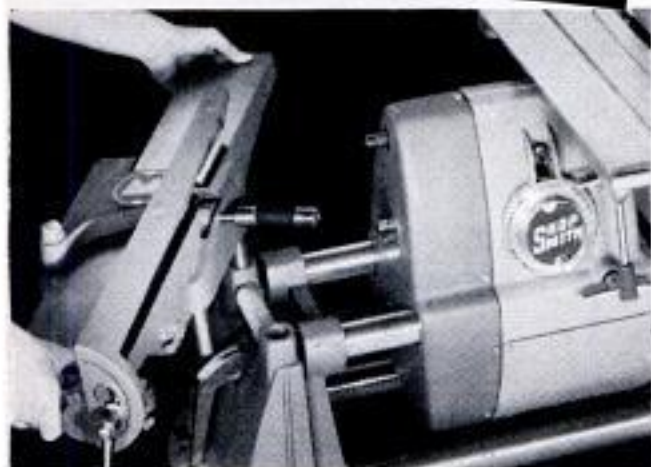

SHOPSMITH Mark 5 HAS POWER MOUNT. Add a jointer, jigsaw, bandsaw, etc. — with one twist of a handle, one turn of a set screw. Set up useful tool combinations in seconds — saw-jointer, jigsaw-sander, band-saw-sander, lathe-grinder, many others! Power mount tools take no extra floor space — can be operated at optimum speeds.

SHOPSMITH Mark 5 IS THE SAFEST TOOL EVER DESIGNED! Belts, pulleys, shafts and motor — they're all completely enclosed! Even the switch is guarded — it can't be bumped ON accidentally, yet it's easily snapped OFF. All control handles are clearly labeled — on both sides!

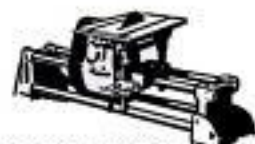

9" CIRCULAR SAW



12" DISC SANDER



16 $\frac{1}{2}$ " x 34" LATHE
16 $\frac{1}{2}$ " DRILL PRESS



HORIZONTAL DRILL

Premier showing of **SHOPSMITH Mark 5** at leading hardware and department stores, and Montgomery Ward retail stores. **NOW!**



QUILL DEPTH STOP. Simple dial setting: 0- $\frac{1}{4}$ ". More accurate drilling, saw settings, duplicate sanding.

MAGNA ENGINEERING CORPORATION

Dept. 261-B, at factory nearest you:
12819 Coit Rd., Cleveland 8, Ohio, OR
Menlo Park, California.

I want to know more about the new SHOPSMITH. Please rush me your free, new 20-page catalog with illustrations, data, complete specifications.

Name _____

Address _____

City _____

State _____



all lights at the mouth of the Columbia were ordered off—and their value was proved in a costly way. The steamship *Mauna Ala*, loaded with a \$750,000 cargo of 60,000 Christmas trees, turkeys and other holiday goods, was en route to Honolulu. Ordered back to the nearest port, she tried to enter the mouth of the Columbia in the blackout, and went down to a watery tomb in the graveyard.

In cheating the graveyard today, millions of dollars have been spent, particularly for jetty improvements. But the investment is considered a good one, because some 2000 ships annually carry heavy cargoes up river, mostly to Portland, Ore.

"When I first came to the mouth of the Columbia in 1917 as a ship's radio operator we had nothing to guide us except visual aids," said Edwin Lamb, base storekeeper at Tongue Point. "We had no depth finders on the ships, no radar, no loran. Now crossing the bar is not so tricky—that is, in the summer. But come winter with its bad storms—well, a skipper still better watch his Ps and Qs or his ship will be pushing up barnacles in the graveyard." ★ ★ ★

Clay-Extrusion Machine

Simulated chrome strips, instrument panel trim, door and window moldings are

extruded like spaghetti from a machine used by clay modelers at Ford design laboratories. Clay used in building experimental designs is forced through a tube capped by an aluminum disc. A slot punched in the disc determines the shape of the continuous clay ribbon which emerges.



BUILD BETTER FOR LESS!

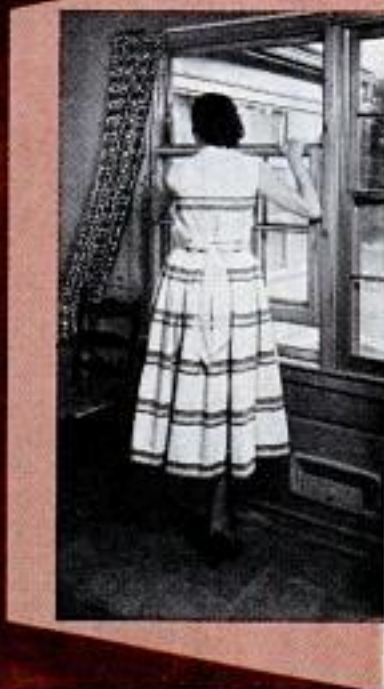

Builders and buyers know that R·O·W windows offer the best in construction, materials, and beauty—plus the lift-out feature. Yet, R·O·W windows usually cost *LESS* than other quality wood windows *WITHOUT* the removable feature.



Look for the cups!

See your local lumber dealer or write R. O. W. SALES CO. 1330-80 ACADEMY AVENUE • FERNDAL 20, MICHIGAN

R·O·W is the registered trade-mark of the R.O.W. Sales Co.

THEY CAN'T **RUST** if you keep them in DRY VAPOR **PACKVELOPES**[®] with VPI*



without
protection

with oil
protection

with VPI
protection

HERE'S positive RUST PROTECTION for circular saws • chisels • drills • auger bits
pruning shears • steel rules and tapes
planes • compasses • dividers • calipers
hunting knives • marine and fishing gear
hooks and flies • spark plugs • auto parts
and accessories • micrometers • files • taps
dies • golf clubs • any steel tools

YOU NEED NO OIL, NO GREASE, NO FUSS OR MUSS • Just pack them and forget them.

Send for Berlin & Jones' big no-rust miracle package containing a dozen assorted VPI* envelopes, large size to protect circular saws, others for tools and small parts—plus a big 12 x 36 sheet of VPI* coated Kraft paper, enough to protect an average power tool or to line a large tool chest and drawers. You get the same rust protection used by the U. S. Government and leading industries in this no-rust miracle package for only \$2. Included free is a handy booklet of practical proven VPI* uses. Money back if not satisfied.

*Vapor Phase Inhibitor

INDUSTRIAL USERS

Cut costs way down on handling and packing of ferrous materials. Get same rust protection as used by U. S. Government. Write for Technical bulletin on VPI to: Engineering Department, Berlin & Jones, 601 W. 26th St., N. Y. 1, Dept. P.

HARDWARE JOBBERS

Every hardware store can sell VPI packages on sight to their trade with our self-service, self-selling kit. Makes money for you and the retailer without effort. Write for complete details to Berlin & Jones, 601 W. 26th St., New York 1, N. Y., Dept. P, Wholesale Division.

No oil, no grease, no goo, no dirty degreasing job, no clean-up necessary—thanks to this miracle paper which turns destructive moisture into protective VPI vapor... giving you years of positive protection from rust.

HUNTERS • PROTECT YOUR GUN FROM RUST

Just slip it into a specially made **PACKVELOPE GUNBOOT** with VPI. Will keep it rustproof for years. No oil, no grease, no cleaning. Only \$2. Satisfaction guaranteed or money refunded.

- SHELL OIL invented VPI
- MONSANTO makes VPI
- BERLIN & JONES brings you VPI

Established 1843



USE THIS MONEY BACK GUARANTEE COUPON

BERLIN & JONES CO., INC., Dept. P M

601 West 26th Street, New York 1, N. Y.

Send me _____ (through my dealer) no-rust miracle package(s) of VPI envelopes and paper at \$2 per pkg.

Send me _____ VPI Gunboots @ \$2 each.

Name _____

Address _____

City _____ Zone _____ State _____

My dealer's name is _____

Address _____

Enclosed check money order



Painting's a

SNAP

with

DURAVAL

A TEXOLITE[®] PAINT PRODUCT

- 23 ready-to-use colors; over 100 decorator blends; many more you can create yourself from just two colors.
- It's rubberized—it's scrubberized.
- Dust-free in just 20 minutes. Leaves no "painty" odor; minimizes brush marks.
- Thrifty—one gallon covers up to 450 sq. feet. Brushes or rollers come clean in ordinary water.

For further information see your TEXOLITE paint dealer, or write Dept. PM 5, 300 West Adams Street, Chicago 6, Illinois.

*T. M. Reg. U.S. Pat. Off.



UNITED STATES GYPSUM

the greatest name in building

It's Moving Day for Wildlife

(Continued from page 157)

metal and are sometimes made with iron bars like a miniature jail cell. These are covered with brush and baited with such delicacies as honey or cooked bacon. The bears trip them when they go in for a snack. Such traps are sometimes used in the national parks to remove bears that threaten tourists. The bears are taken, traps and all, back to the interior of the park areas and released and since the average black bear has little wanderlust, they settle down as though nothing had ever happened to them.

One reason the game specialists prefer live-trapped animals to game-farm stock is the fact that those reared in the open survive better when released. They usually expect a high rate of survival of live-trapped and transplanted game if it is put in habitat similar to the type it came from. The losses then are mostly limited to trapping mortality, for usually a few are lost in trapping and transit. One fall, Kentucky lost a couple of deer to poachers who killed them right in the traps. Another deer was killed by the trapdoor and a couple of antlered bucks did each other in when they were housed together in a holding pen. The trappers now eliminate this type of death battle by sawing the antlers off before moving bucks from traps to the holding pen.

It's a guiding rule in moving live game from one place to another that you take only surplus animals and always leave plenty of "seed" stock to furnish good hunting and adequate breeding for the future. The game managers keep a sharp eye on these things. If a wildlife census shows an overabundance of rabbits, deer, pheasants or coons they begin to worry. They know that overcrowding can lead to plenty of trouble usually in the form of starvation or an outbreak of disease. Even if there is no disease outbreak few hunters want to walk all over the country tracking down a lot of game so thin you can "slit open the hide and shake out the bones."

For every surplus of game they can find the game managers usually know of several localities suffering shortages. If a state has depleted areas and no surpluses within its boundaries it will often buy stock from outside the state and release it where it will do the most good.

Fred Hardy, Kentucky's "grouse man," traps about 30 grouse a year in the course of his research work. He uses a small wire-box trap with a mirror fastened in one end. He sets the box on a drumming log. The strutting cock bird takes his position on the

(Continued to page 240)

Truck Sad?

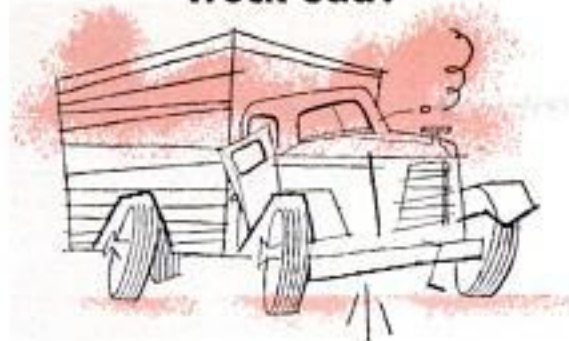

Business Bad?



Competitor Glad?



Owner Mad?



**It's Time
You Had a
Look at the
New
'54 REO**



REO MOTORS, INC.
LANSING 20, MICHIGAN

Manufacturers of Commercial and Military Trucks • Buses • Power Lawn Mowers • Children's Wheel Goods & Play-ground Equipment • Inboard Engine Kits for Small Boats • Replacement Engines for Trucks • Industrial Engines

Don't let that old truck drive you into a rage or into the "red"...drive away in a brand new '54 REO. Thanks to Reo's *Gold Comet* power and more pay-load-design, you'll enjoy the lowest cost miles in trucking. And all the while, you'll be luxuriating in that comfortable new cab with increased head and leg room—full 30" doors—new steering wheel angle with unobstructed driver viewing—dependable wide angle electric windshield wipers...foam rubber seat available on all models. Get the facts, better yet, get the feel by taking the wheel of that outstanding '54 Reo.





Quit driving an oil-burner— get new piston rings!

Oil pumping is just the start of expense and trouble—the first danger signal from worn-out piston rings. The longer you let those old rings stay in, the more oil you'll use, the more power you'll lose, and the bigger your repair bill will be!

As your engine gets older, it runs hotter because of accumulations in the cooling system. The cylinders wear tapered and out-of-round—need more oil on the walls.

It requires a special type of piston rings—replacement rings—to deliver this extra oil, under full control, without waste.

Hastings makes replacement rings exclusively, devotes all its research on the highways and in the laboratory, to the particular replacement problems of each make and type of engine.

That's why Hastings Rings *stop* oil-pumping, *check* cylinder wear, *restore* engine performance—in re-ring, re-bore and re-sleeve installations.

So go to your motor specialist at the first sign of oil-pumping or performance drop-off. If rings are the trouble, ask him to install a Hastings Steel-Vent replacement set. Truly the best money you can spend on your car! Hastings Manufacturing Company, Hastings, Michigan; Hastings Ltd., Toronto; Piston Rings, Spark Plugs, Oil Filters, Casite, Drout.

HASTINGS STEEL-VENT PISTON RINGS



Regular or Chrome

Tough on Oil-Pumping
Gentle on Cylinder walls

drumming log and starts beating the air with his wings and setting up his peculiar low-pitched music. Then he finds he's not alone and he enters the cage to do battle with his image.

"Live-trapped birds are worth a good price," says Don Strode. "Take turkeys, for instance. We figure every bird trapped and released is equal to \$1000 worth of game-farm turkeys. Turn a game-farm turkey out near a barnyard and first thing you know he's eating with the chickens. You've lost a turkey." A grouse may cost \$25; a turkey, \$50 to \$100.

This transplanting of wildlife is one of the most effective wildlife-management techniques the specialists have yet found for improving hunting. That's why the big wild-game move goes on year after year in practically every state of the nation. ★ ★ ★

Transparency Viewer Carried in Vest Pocket

Color photographers no longer have to carry bulky equipment around to show off their slides. Now available is a tiny pocket-size viewer that can be carried in the pocket of a vest, shirt or jacket. It accommodates two-by-two-inch cardboard mounts and glass slides. The polished optical lens gives a four-times magnification and the grained plastic screen provides over-all illumination. Folded, the viewer is less than three inches long and approximately two inches wide. It uses transmitted light for illuminating the transparencies.

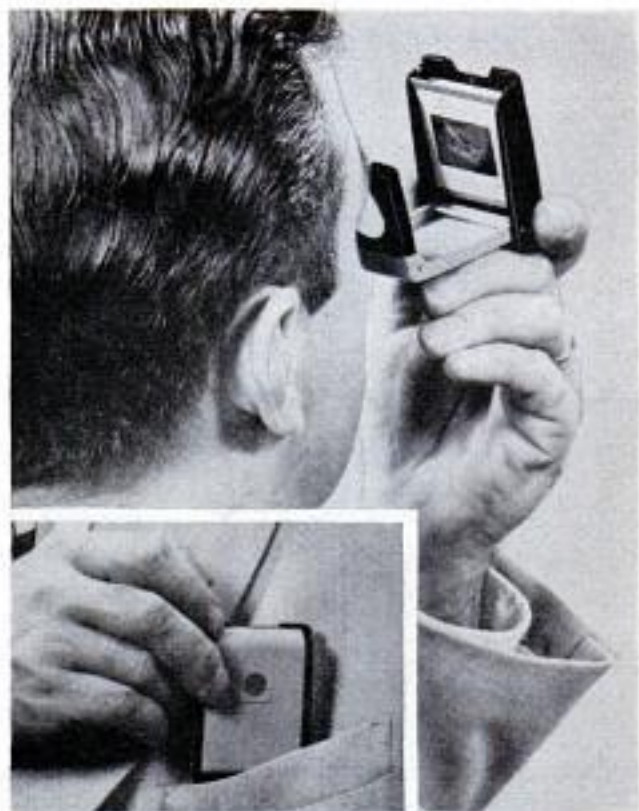

Now in the famous MOUNTIE too!
**REVOLUTIONARY NEW MARLIN
 MICRO-GROOVE
 RIFLING***



**20% to 25% more accurate than small-game
 or plinking rifles with conventional barrels!**

WORLD'S ONLY .22 with split-second lever action—that's the match-
 less Marlin 39-A. Now both the regular 39-A and the 39-A Mountie
 come with Marlin's fabulously accurate new Micro-Groove Rifling.



CHECK! Two typical 10-shot patterns
 fired at 100 yards by a noted gun edi-
 tor and marksman. Note (at left)
 tight group from a Marlin .22 with
 revolutionary new Micro-Groove
 Rifling—exclusively Marlin's. Note
 wider dispersion of group at right,
 fired from new .22 of famous make
 with regular rifling. *Two years of in-
 tensive firing shows Micro-Groove
 increases accuracy 20% to 25%!*



THE REASON: Note that Micro-
 Groove Rifling (left) has SIXTEEN
 . . . SHALLOW . . . grooves as com-
 pared to regular rifling (right) with
 SIX . . . DEEP . . . grooves. Easy to
 see why Micro-Groove means faster,
 more even dissipation of heat
 through the barrel . . . far less gas
 leakage, too—a major cause of bul-
 let "flipping" at the mouth of the
 barrel. Far less barrel erosion, too.

• See Marlin Micro-Groove at your dealer now. Available in all Marlin bolt
 actions and semi-automatics, too. Same models also may be had with Marlin's
 long-famed Ballard type rifling. Sold in U. S. A. and Canada.

**Trademark and Patent Pending*

39-A MOUNTIE.
\$60.85. Straight—
 not pistol-grip (for
 swift removal from
 scabbard) and 20"
 barrel. Weight only
 6 lbs. (approx.).

Regular 39-A with
 pistol-grip and 24"
 barrel also avail-
 able. \$60.85. Other
 Marlin .22's from
 \$24.95. Prices
 slightly higher west
 of the Rockies.

**THE NAME
 FOR GAME**

Marlin

**FINE GUNS
 SINCE 1870**

VALUABLE COUPON—MAIL TODAY!

The Marlin Firearms Co., Dept. 5-PM, New Haven, Conn.
 Send me catalogue with information and photo-illustra-
 tions of Marlin Guns, plus new cartoon booklet, "More
 Fun with Your .22 Rifle." Also send me a pack of (please
 check preference) single or double-edge Marlin
 Razor Blades. I enclose 10¢ for handling.

Name _____

Street _____

City _____ Zone _____

County _____ State _____



edge
your lawn
permanently

with **NO-SEE**
GRASS BARRIER



STOPS GRASS
HERE!

Underground "fence" keeps grass in its place. Stops bluegrass (including new Merion), quack grass, Bermuda, St. Augustine, Bent and others from spreading into cultivated areas. Install NO-SEE around trees, shrubs, foundation plantings, flower beds; along fences, hedges and driveways. Mow right over it, trimming edge neatly. Gives your lawn that well-cared-for look with half the labor.

NO-SEE is made of corrugated, galvanized steel. Sections two feet long by 4 inches deep key together with special clips. Easy to install; just drive down to soil level. Bends around corners; follows contour of soil.

Eliminates grass trimming and edging



BEFORE—Mower leaves grass and weeds around trees. Hand trimming is necessary.

AFTER—Trim as you mow! With one wheel in cultivated area, you trim edges neatly.

If your local hardware, nursery, garden or department store cannot supply you, order direct from one of the following:

- Breck's Boston, Massachusetts
- Farmer Seed & Nursery Faribault, Minnesota
- Drumcliff Co., Dept. S.E. Towson 4, Maryland
- Montgomery Ward & Co. (All mail order houses)
- Security Feed & Seed Co. Greenville, S. Carolina
- Western Seed Co. 1425 15th St., Denver 2, Colo.
- Templin-Bradley Co. 5700 Detroit, Cleveland, Ohio
- Hallowell Seed Co. 519 Market St., San Francisco 5, Calif.
- Vannegut Hardware 402 W. Maryland, Indianapolis 9, Ind.
- F. W. Belgiano 411 New York Ave. N.E., Washington 2, D.C.
- Vaughan's Seed Co. 47 Barclay, N.Y., N.Y.; 10 W. Randolph, Chicago, Ill.

Manufactured by:

KEELOR STEEL, INC., 963 9th St. S. E., Minneapolis 14, Minn.

Mexico Builds a Glamour Campus

(Continued from page 117)

American football, and an indoor court for the fast Latin-American game of jai alai.

Also on the campus are two softball diamonds, a dozen tennis courts, a dozen outdoor basketball courts that also are suitable for volleyball, eight courts for the game called handball fronton, and eight larger courts for a Latin-American game similar to squash. The exterior walls of these courts are sloped like Mexico's ancient pyramids and are faced with rough volcanic stone taken from the site. An enormous gymnasium in which indoor basketball may be played will be built later this year.

Academic buildings on the campus are arranged in groups. Some are large enough to contain all the facilities for such subjects as dentistry or chemistry. This arrangement allows a student of dentistry, for example, to go from class to class without rushing from one part of the huge campus to another. Some of the classroom buildings are glass-walled skyscrapers, others are long and low, and still others rest on platforms that are supported above the ground on concrete pillars.

Near the Pavilion of Cosmic Rays is the Institute of Nuclear Physics with an adjoining "Garden of Radiation" surrounded by stone walls to absorb the rays from atom-smashing machines.

One outstanding building is the central library. From a distance it looks like a huge, oblong, intricately decorated cake. The structure is 116 feet tall, 190 feet long and 45 feet wide, and each of its exterior walls is ornamented with mosaic murals depicting stages in Mexico's history. Each mosaic consists of millions of bits of rock ranging from black obsidian to brown and pink marbles painstakingly cemented in place.

The two lower floors of the library contain reading rooms with windows of thin, translucent sheets of white marble. The 10 upper floors of the structure have no windows and contain storage stacks with a capacity of 120,000 volumes in addition to microfilm files.

Mexico is a center of mural art, and murals of various kinds are used for ornamenting large areas on many of the buildings. Some murals are painted in vivid plastic paints and others are composed of small glass tiles that were fired especially for the university. Still others, as in the case of Diego Rivera's ornamentation on the stadium walls, are made up of stones

(Continued to page 244)

An easier, better way to fine natural wood finishes

The full story of REZ — a remarkable group of products which actually become part of the wood! While they help you achieve beautiful natural-grained finishes, they also give you real protection against moisture—prevent swelling, warping, weather-staining.

No matter what you're working on—from new exterior siding to cabinets or furniture—you can get handsome finishes with all the warmth and rich beauty of natural wood *far easier*—with Rez.

Developed in the same Monsanto laboratories which serve the great West Coast lumber industry, Rez is made from a synthetic resin which has unusual properties beneficial to wood.

Penetrates the pores of wood

Instead of merely putting a layer of glossy material over the surface—instead of just penetrating lightly—the first coat of Rez sinks deep into the pores and bonds with the wood. Then a quick and easy finish coat of Satinwood (or High Gloss) Rez completes the job.

Result: Not just shiny surface beauty—but all the depth and gleam of hand-rubbed wood. Beauty that *lasts*, too, because it's moisture-sealed.

When you use wood — use Rez

Use **CLEAR REZ** first in finishing any type of wood interior walls; on the inside and outside of drawers and cabinets to prevent swelling,



warping, drawer sticking. Use it, too, as the best undercoat for paint.

Use **WHITE REZ**: for an easy 2-step way to achieve blonde finishes so hard to create any other way.

Use **REZ COLOR TONES**: for distinctive color finishes that do not conceal the grain—indoors and out. In redwood, mahogany, sage, driftwood and cedar; can be intermixed to create special effects.

Use **REDWOOD REZ**: for true redwood color that doesn't darken with years. The pigment in Redwood Rez creates a barrier against the sun's rays, prevents weather-staining.

LAUX [®]
Rez BECOMES PART
OF THE WOOD

Gives you deep-sealed protection—deeper, warmer natural-grained beauty, too.
Ask your dealer about REZ today

VALUABLE BOOK — "How to Create the Finest Wood Finishes." Complete step-by-step instructions; many illustrations. Mail this coupon with 25¢ to:

MONSANTO CHEMICAL COMPANY
Merchandising Division
1700 South Second St., St. Louis 4, Mo.

Name.....

Address.....

City..... Zone..... State.....

"Actionrod"

**BAIT-CASTING RODS
PREFERRED BY EXPERTS**

\$45⁰⁰

Actionrod No. 3962-D
Deluxe Model



Actionrod No. 3962-S
Standard Model \$35.00

For the master fisherman—a tubular glass custom-made Bait-Casting Actionrod. Long-lasting Carboly guides and tip. Deluxe model has interchangeable medium and light action tips. Deluxe tube and bag included.

\$9⁴⁵



Actionrod
No. 1300

A top value at a moderate price with many deluxe features. Tubular glass tip, stainless steel guides and tip top, chuck handle with screw type reel lock, specie cork grip and polished aluminum fore-grip. Bag included.

ORCHARD INDUSTRIES, INC. • HASTINGS, MICH.

Actionrod

AMERICA'S FAVORITE GLASS ROD

cut to shape and stained to the desired colors by means of acids.

It was a happy coincidence when Mexico decided to erect its new center of knowledge on the Pedregal. More than 80 centuries ago a strong civilization flourished there. Then a succession of lava flows from a near-by volcano buried all evidence of human existence except one pyramidlike temple that still projects up through the volcanic rock. Known as Cuicuilco, this temple is judged to be the oldest thing built by man that exists on the American continent. On the site of this ancient civilization now stands the newest campus in the world. ★ ★ ★

Hand-Held Pneumatic Tool Forces Tire Bead From Rim

Flat tires are forced off their rims with a small tool that is attached to a service-station air hose. A hooked plunger on the bottom of the tool is inserted between tire and rim. Air from the hose pushes the plunger down, forcing the bead off the rim. Stepping on the tire and pulling up on the wheel completes the job.



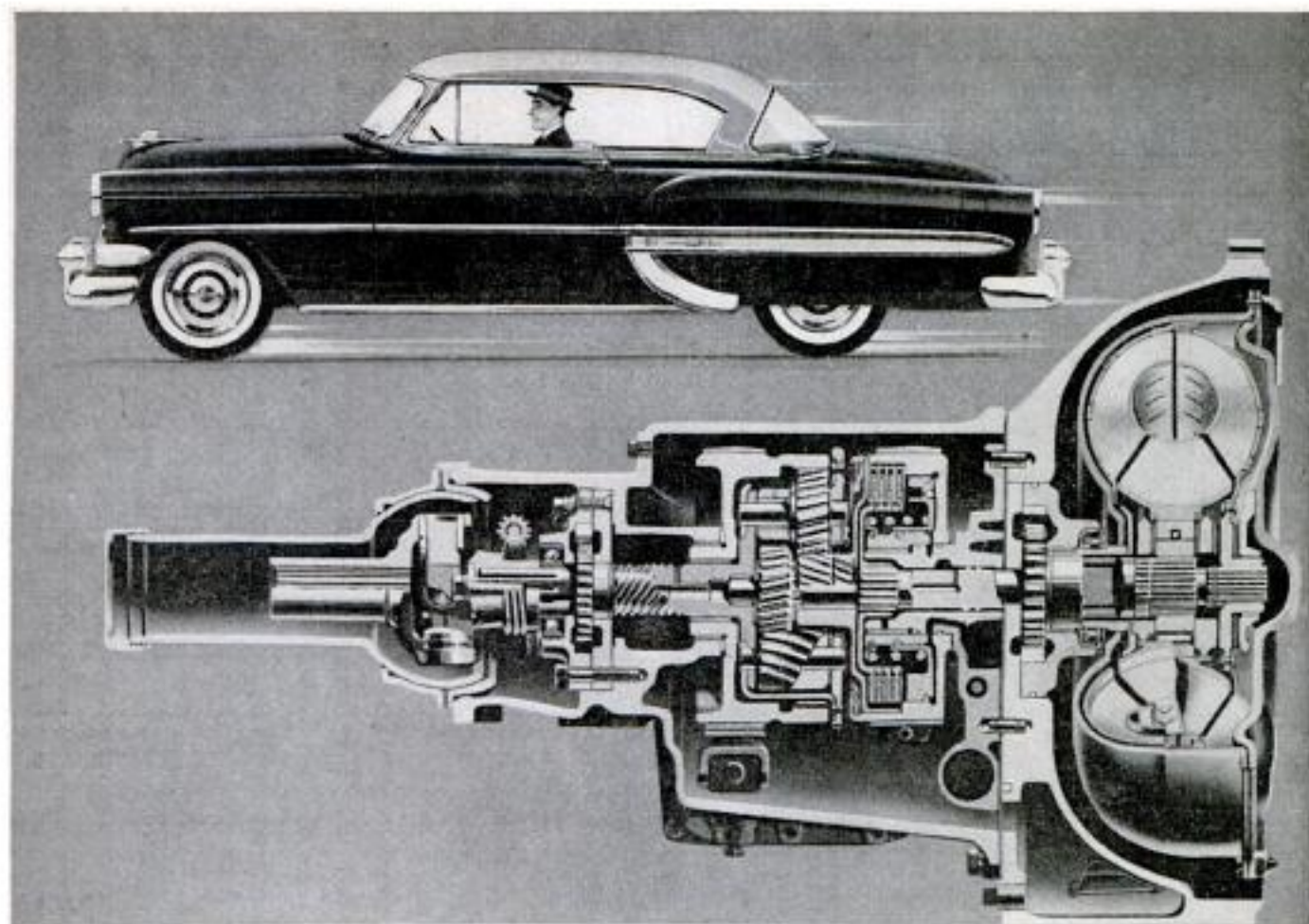

Advanced Chevrolet Engineering brings
LIVELIER, THRIFTIER PERFORMANCE
with a "stepped-up" Automatic Power Team

Thrilling new performance is yours, when you command Chevrolet's stepped-up Automatic Power Team. There has never been a Chevrolet that responded so eagerly to your touch on the accelerator. At the green of "go," its automatic getaway moves you ahead smoothly and positively. The automatic passing range gives you new safety in city traffic. You ease up hills almost as if they weren't there. Yet you obtain this spirited performance with money-saving gas mileage. In one extra-cost option, "Blue-Flame 125" valve-in-head engine, Powerglide automatic transmission and Econ-o-Miser rear axle are teamed to provide the finest, most responsive no-shift driving you have ever experienced in a car of such low cost.

The deep breathing valve-in-head engine—the most powerful Chevrolet passenger car engine ever built—develops 125 horsepower. And its 7.5 to 1 compression ratio, the highest in any leading low-price car, squeezes more work out of gasoline. In the transmission, the highly efficient, three-element hydraulic torque converter makes torque multiplication and cruising oil-smooth. Automatic Low provides swifter, safer getaway and pickup at a touch. Shifts to Low and Reverse are made through planetary gears. The Automatic Power Team is available in every Chevrolet model. See your Chevrolet dealer and try it. Discover how lively yet thrifty a car can be. . . . Chevrolet Division of General Motors, Detroit 2, Michigan.

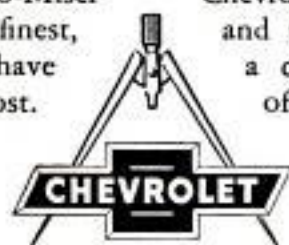

EVER FINER ENGINEERING

EVER FINER CHEVROLETS



1

Add new beauty to your car with these top quality Wizard Country Club Plastic Seat Covers. Beautiful Saran plastic panels with harmonizing trim, top cap, sides and back. Stay lovelier longer. Wide choice of patterns and colors sure to please. All car sizes. Plastics from\$26.95



2

Wizard Quality Chamois adds new sparkling luster to auto, furniture, windows, silverware, glassware. Highly absorbent. Strong and durable, yet soft and pliable. Will not scratch finest surface when used wet or dry. Can be washed over and over again. 21" x 27" (3P48230) Ea. \$2.65



3

Wizard De-Sludge-Er oil filter cartridge has new filter agent of 100% cellulose. Out-filters either paper or cotton. Removes sludge-forming elements from oil. Won't clog channel or by-pass. For all cars, trucks, tractors with full-flow or by-pass systems. Chev. 1937-53 (RR5814)\$1.59



New Power...New Beauty...

Over 40 Years...Headquarters



7

Gleaming chrome exhaust deflectors and extensions give long-lasting beauty to your car. Keeps exhaust off bumper. Easy to attach and styled to fit your car. Western's Exhaust Deflector. Simple, flared design. (CR2806) 49c Exhaust Extension. (8" x 2 1/2") Straight-tube type. (CR2807) \$1.09

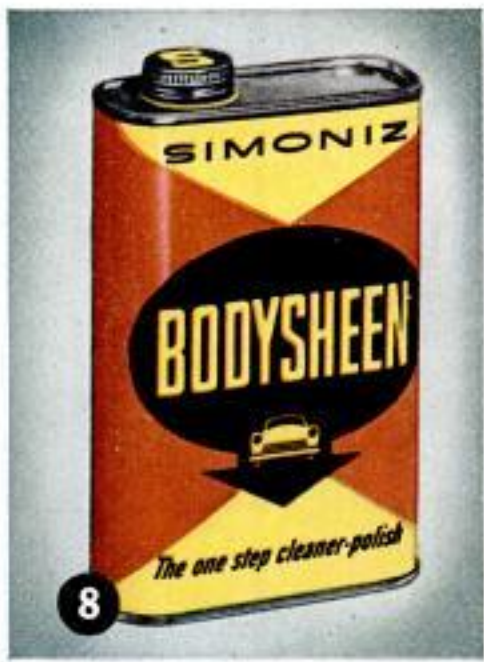

8

The one-step cleaner-polish! New Simoniz Bodysheen cleans and polishes, in one easy simple step. Wipe Bodysheen on, then wipe it off and see your car gleam. Brings out natural brilliance, enriches colors. Gives your car a tough, long-lasting, weather-resistant finish. (3P7112) 98c



9

Here's the quick easy way to replace brakes—Stop-Rite lined brake shoes, ready to slip right into drum. Wire-backed lining permanently bonded to shoe for positive "non-grab" braking, long quiet service. Trade-in allowance. All popular cars. Front or rear, as low as \$3.75 (each.)

FREE: Mail post card today for folder explaining how to get more horsepower



4

Drednaut Hydraulic Jack takes work and danger out of tire changing. Easy wrist-action lifts any car. Twist—it's down, safely and smoothly. Precision built to meet most severe passenger service requirements. Raises from 7" high to 14 $\frac{1}{4}$ ". Pumping handle included. (A6188) **\$9.95**



5

"Reddi-Rak" Car Top Carrier—new advanced design, complete, assembled, ready to install. Adjustable—mounts on any car top in a minute. Big 3 $\frac{1}{4}$ " suction cups can't slip. Heavy web straps anchor to rain guard—hold big load safely. Heavy gauge steel. Pr. (C5232) **\$7.95**



6

Why risk worn brakes? Reline with Stop-Rite Brake Linings. Designed for individual braking requirements of all cars. Pressure molded. Wire backed for extra strength. Will not absorb grease or moisture. With rivets and instructions. Easy to install. All popular cars from..... **\$3.45**

New Safety For Your Car At Western Auto

STORES AND ASSOCIATE STORES

For Top Quality Auto Supplies.

NOTE: Western Auto Associate Dealers own their stores and set their own prices, terms and conditions. Prices may vary due to difference in local conditions. (PM54)



10

Deluxe magnetic dash tray keeps sunglasses, pencils, pad, maps, etc. conveniently within reach. Large enough to hold sandwich and drink, compact—fits any dash. Removable chrome-finish ash tray. Hidden compartment. Colorful plastic. Velvet-soft inside finish (C81378) ... **\$1.59**



11

Wizard "Twin-Fire"® patented spark plug gives top performance twice as long as single electrode plugs. Each electrode fires one at a time while the other "rests", stays accurately gapped up to twice as long. All chrome shell prevents rust. Guaranteed 18,000 miles. Each, in sets..... **75c**



12

Why risk an overhaul? Replace your worn-out engine with a Wizard-ized Engine—get up to 3 times the miles! All moving parts brand new or fully remanufactured like new. New-car engine guarantee. Installation arranged. For Ford, Chev., Plym., and others. As low as (each) **\$149.50**

from your car. Write Western Auto, Dept. 200E, 2107 Grand, Kansas City, Mo.



BUY THESE NEW **POPULAR MECHANICS** DO-IT-YOURSELF BOOKS AT YOUR NEWSSTAND

Only 25c Each!

HOW TO PAINT INSIDE AND OUT: Complete instructions for all interior and exterior painting using all types of finishes. Covers every phase of painting technique, handling brushes, preparation of paint, painting metal, spraying, masking, importance of primers. Enables the amateur to do a professional-looking job the very first time. Also covers all necessary materials. **25c**

HOW TO LAY LINOLEUM AND TILE: Tells and shows you how to lay all types of tile including rubber, asphalt, etc., as well as linoleum and similar floor coverings. Complete instructions for the use of plastic wall tile. Step-by-step directions plus many show-how photographs, drawings and diagrams make it easy. **25c**

HOW TO REMODEL YOUR BASEMENT AND ATTIC: Transform wasted space into additional bedrooms or game rooms. Book covers dormer construction, unusual wall coverings, insulation, weatherproofing, installation of doors and windows, use of glass block, installation of plasterboard, and other approved building methods and materials. **25c**

HOW TO TAKE CARE OF YOUR LAWN: Be sure to buy this book if you want to have a better lawn this summer. Complete instructions for the establishment of a new lawn or the maintenance of an older lawn including fertilizing, raking, rolling, watering, mowing, weed removal, destruction of trees and stumps, various types of grass, etc. **25c**

HOUSE WIRING AND ELECTRICAL REPAIRS: Everything you have ever wanted to know about making household electrical repairs. Tells how to locate shorts, install fluorescent fixtures, rewire for modern living, repair electric irons and other everyday household appliances plus many valuable hints and kinks for every homeowner. **25c**

SMALL BOATS YOU CAN BUILD: Build your own boat and save! Complete step-by-step instructions plus diagrams and photographs for building the boat of your choice. Choose from a 10-foot plywood dinghy, a 16-foot plywood sailing scow, 15-foot sailing knockabout, 8-foot duckboat or a "marine mustang." Also contains many helpful hints for every boating enthusiast. **25c**

These books are now available at your favorite newsstand and will soon be on sale at your local IRHA Hardware store

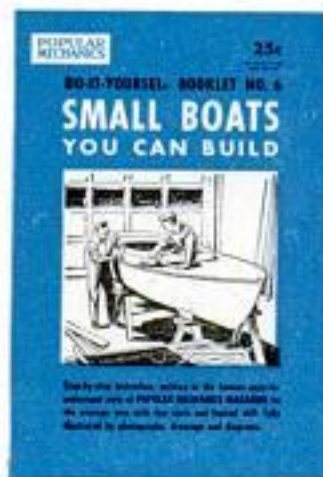
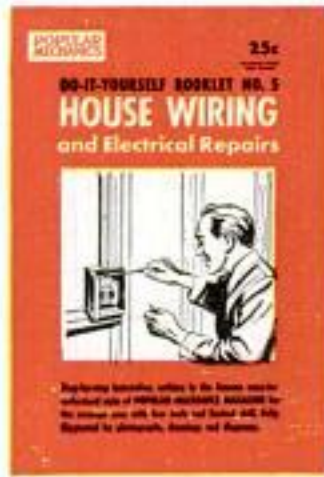
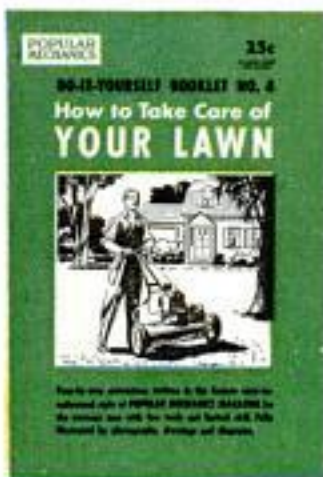
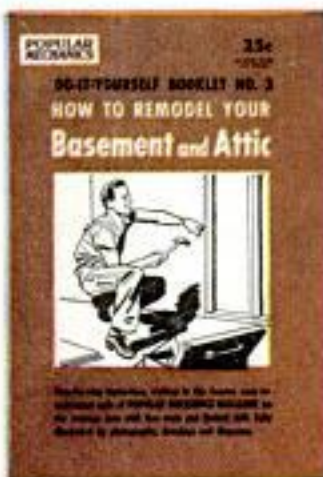
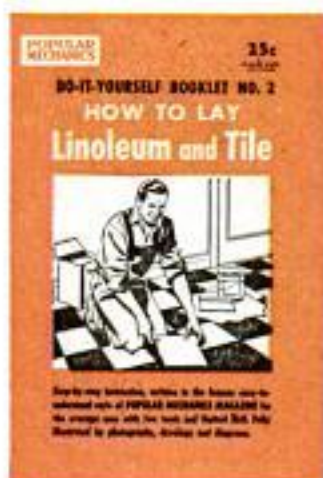



Brig. General David Sarnoff, Chairman of the Board, Radio Corporation of America

Sees No. 1 wish come true!

Television Tape Recording by RCA Opens New Era of Electronic Photography

In 1956, RCA's General Sarnoff will celebrate his 50th year in the field of radio. Looking ahead to that anniversary, in 1951 he asked his family of scientists and researchers for three gifts to mark the occasion: (1) A television tape recorder, (2) An electronic air conditioner, (3) A true amplifier of light.

Gift No. 1—the video tape recorder—has already been successfully demonstrated, two years ahead of time! Both color and black-and-white TV pictures were instantly recorded on magnetic tape without any photographic development or processing.

You can imagine the future importance of this development to television broadcasting, to motion pictures, education, industry and national defense. And you can see its entertainment value to you, in your own home. There the tape equipment could be used for home movies, and—by connecting it to your television set—you could record your favorite TV programs.

Expressing his gratitude for this "gift," General Sarnoff called it the first major step in an era of "electronic photography." He said it was only a matter of time, perhaps two years, before the finishing touches would bring this recording system to commercial reality.

Such achievements as this, stemming from pioneering in research and engineering, make "RCA" an emblem of quality, dependability and progress.

RADIO CORPORATION OF AMERICA

World leader in radio—first in television



Get Out of the "Snapshot Class"!



Graflex Prize-Winning Photo by Doris Pinney

GRADUATE TO A...

Graphic



There's no trick to making fine portraits...action shots...and extra money, too, in your spare time when you shoot with a Pacemaker Graphic. These great cameras are as easy to use as less versatile cameras, yet can give you the large, clear pictures editors want. Have your Graflex dealer show you

why the rugged Graphics are the favorites of 93.9% of America's press photographers. See both the Pacemaker Graphics—Speed and Crown—each in three sizes. And be sure to see the amazing Century Graphic, now only \$122.50 with coated f/4.5 lens.

YOU CAN OWN A GRAPHIC PRESS OUTFIT FOR AS LITTLE AS \$29 DOWN!

Here's everything you need to start earning money with your photo skill! Complete outfit includes Pacemaker Graphic with lens and shutter of your choice—plus a sheet film holder; coupled rangefinder (installed); and a Grafite Flash with connecting cord. Ask your dealer about time payments.

GRAFLEX®

Prize-Winning Camera



For FREE Illustrated booklet on how to choose a modern camera, write Graflex, Inc., Dept. PM-21, Rochester 8, New York

The Owners Report on the Mercury

(Continued from page 106)

the old suspension."—Hialeah, Fla., pilot.

When asked to rate handling and roadability, both of which are influenced by the front suspension, the owners were virtually unanimous in praise of the Mercury. Slightly less than 1 percent rated handling unsatisfactory, while 2 percent said roadability was unsatisfactory. In fact, many owners (36 percent) gave ease of handling as the feature they liked most about their cars. And 13 percent gave roadability as the best-liked feature.

Most-Frequent Complaints

By far the most-frequent complaint was that assembly and workmanship were poor. There were 33 percent of the owners who mentioned this weakness and some were very outspoken about it.

"Delivered practically 'knocked down' and had to make repeated trips to dealer to get things to work. Door troubles. Leaks badly around windshield. Merc-O-Matic growls when standing still."—Nashville, Tenn., executive.

"Too many adjustments to be made after delivery, unable to tell who owns the car, you or the garage. Have added four spark plugs, new battery, reworked fuel pump, greased speedometer cable, new radio and have had in garage constantly for oil leaks."—Chattanooga, Tenn., executive.

"Very poor body. Probably due to assembly. Too many squeaks, groans and rattles. Looked like a butcher put it together."—Paterson, N. J., engineer.

"The car would be perfect if the doors wouldn't shake. Whole car rattles. I would love to talk to a broad-minded factory man who didn't think I was another crab."—Clearwater, Fla., motel operator.

Low gasoline mileage, engine noise and carburetor trouble and poor dealer service were the next most frequent complaints.

When asked about the quality of their dealer service, the owners were not very flattering. Only 39 percent said it was excellent; 20 percent said good; 22 percent said average; and 19 percent rated it poor.

A rather frequent specific complaint involved the front seat (not the four-way power seat but the manually adjusted type).

"Front seat slides forward momentarily when you make a quick stop."—Hickory, N. C., millwright.

"Front seat seems loose on track."—Nashville, Tenn., lawyer.

Comparatively few owners had absolutely no complaints at all to make about

(Continued to page 252)

Animals Protect Themselves

Swans protect their young by beating off their enemies with powerful wings—and by striking them with horny beaks at the end of long, muscular necks. Small enemies find swans very formidable opponents.



CAR ENGINES NEED THE EXTRA PROTECTION OF AC ALUVAC

Small but vicious enemies attack your car engine, too—a dozen kinds of dirt and metal bits carried in your engine oil could do great harm unless taken out of circulation. AC Aluvac traps them all—the dirt and sludge that clog rings and valves—the abrasives that wear down and damage finely engineered precision moving parts.

Therefore, millions of motorists now use Aluvac Replacement Elements regularly—and more new cars are protected by AC Aluvac Elements than by any other brand of oil filter element.

Aluvac's large filtering area and small filtering pores make it the finest engine protection available to motorists.



Standard Factory Equipment on

Cadillac



Standard or Optional Factory Equipment on
CHEVROLET, BUICK, OLDSMOBILE and GMC

AC SPARK PLUG DIVISION  GENERAL MOTORS CORPORATION

INSTALL IT

Yourself

and

SAVE!

YOU CAN GET

25 to 40%

**BETTER
RECEPTION**
on your present TV
Set... any make...
and you're ready
for **COLOR!**

ANTENNA KITS
FROM
Admiral
WORLD'S LARGEST TELEVISION
MANUFACTURER

Priced from

\$13⁹⁵

LIST

at your **Admiral**
dealer

UHF Kits
VHF Kits
All-Channel Kits

Kits contain everything needed...antenna, mast, mast mount, guy wires, insulators, lead-in...down to the last screw-eye. Step-by-step instructions are easy to follow. No experience or special tools needed. High-gain antennas get excellent reception. Finest quality, tested and guaranteed by Admiral. Buy from your Admiral dealer.



their new cars. Only 11 percent wrote "none" in the section labeled "Here are my specific complaints."

Best-Liked Features

Performance of the new overhead-valve engine was the best-liked feature among owners with almost half (47 percent) listing it.

Styling and appearance (both inside and out) were also among the best-liked features with 37 percent listing them.

1954 MERCURY SPECIFICATIONS

ENGINE

Type	8-cyl., V-type, OHV
Bore and stroke	3.62x3.10 in.
Piston displacement	256 cu. in.
Brake horsepower	161 @ 4400 r.p.m.
Torque	238 @ 2500 r.p.m.
Compression ratio	7.5 to 1
Transmissions	3-speed conventional, Overdrive or Merc-O-Matic torque converter with planetary gears optional.

GENERAL

Steering ratio (over-all)	25.4:1
Steering wheel, lock-to-lock	5 1/4 turns
Turning radius	20.43 ft.
Brakes	Conventional hydraulic
Tire size	7.10x15
Recommended tire pressure	26 lb. front, 22 lb. rear
Shipping weight (4-door sedan, unladen)	3650 lb.
Wheelbase	118 in.
Tread, front	58 in.
Tread, rear	56 in.
Height, over-all	64.1 in.
Width, over-all	74.4 in.
Length, over-all	203.7 in.
Road clearance	6.3 in.

CAPACITIES

Oil	5 qt.
Water	19 qt.
Gasoline	19 gal.

INTERIOR DIMENSIONS

Front-seat width	58.9 in.
Rear-seat width	58.9 in.
Front headroom	35.4 in.
Rear headroom	34.2 in.
Legroom, front	42.8 in.
Legroom, rear	41.5 in.

"Its smooth lines and fine exterior trim and color schemes are tops."—Livonia, Mich., salesman.

"My bittersweet-and-black Monterey hardtop is the best and most beautiful car I have owned of seven new ones since World War II—all of them in the same or higher price levels."—Grosse Pointe, Mich., housewife.

Equally popular with the Mercury's good looks are its fine handling characteristics.

"Steering is very good and car is excellent in holding the road around curves."—Cicero, Ill., tool and die maker.

"Excellent handling and roadability. Rides firm and not too soft."—Boonville, N. Y., power-station operator.

"It holds course on any kind of road at all speeds."—Klamath Falls, Ore., tractor operator.

However, there were a few dissents.

"Still too much roll to body, coupled with

(Continued to page 256)

Look what you can do with this New Black & Decker Saw!



\$64.50
B&D Utility 6"
Heavy-Duty Adjustable Saw
COMPLETE WITH BLADE

Try it yourself and get a chance to win \$1,000.00

Get a demonstration of this wonderful new saw at your Utility dealer. Then fill out a free entry blank, describing the features you like best—and you may win \$1000 in Black & Decker's big Saw Contest!



Bob Davis says:

Send 25c for my "Handy Tips" booklet, full of home repair ideas plus information on patterns for projects like sample below. * (No stamps, please).

*T. M. Reg. East-Bild Pattern Company

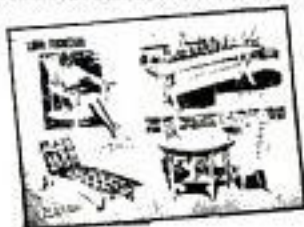

For address of your nearest dealer see "TOOLS - ELECTRIC" in the Yellow Pages of your telephone book.

Need more living space? Do-it-yourself materials let you convert your attic or basement at far less cost than you ever dreamed! And the new Black & Decker Utility 6" Adjustable Saw takes the back-breaking work out of the job!

This new saw makes angle cuts, bevel cuts—every cut you need to add a beautiful room to your home, or make book-cases, cabinets, etc. You can get information on plans and patterns by mailing the coupon below, and your dealer will advise you on materials. When you visit him, ask to try the new Adjustable 6" Saw—as well as the larger 7-, 8- and 9-inch Heavy-Duty Utility Saws!



Fully adjustable for every depth and angle cut from 2" at 90° to 1 1/4" at 45°.



Powerful B&D-built motors take the tough spots without overheating or slowing.



New lever arm permits safe retraction of lower guard to make pocket cuts.



B&D saw-grip handle is always at natural sawing angle. Rugged, king-size shoe gives better balance.

Black & Decker

UTILITY® PORTABLE ELECTRIC TOOLS

Bob Davis, Home Service Dept. H5M, The Black & Decker Mfg. Co., Towson 4, Md.
Please send me "Handy Tips for Handy Men." I am enclosing 25c.

Name _____

Address _____

City _____ Zone _____ State _____



◀ **Traffic laws say: "Full Stop at Stop Signs."**

If you always stop, it can help you...

save up to 40% on your auto insurance!

Read why careful drivers get top-notch protection at rock-bottom rates with

STATE FARM MUTUAL

If you drive carefully, like the man in the picture (and his small friend on the sidewalk) . . . you're already well on your way toward reducing the cost of your auto insurance.

Now, all that's left to do is contact your State Farm agent. He will tell you how we seek to insure *careful drivers only* . . . how we save money on their accident-free driving . . . how we pass this saving back to our members in the form of *rock-bottom rates*.

If you qualify, he will quote you rates that are *as much as 40 percent lower* than the cost of equivalent protection from other good companies.

More than 3 million car owners (more by far than any other company insures) already save on our "careful driver" insurance. They buy it on a convenient semi-annual payment plan. If they *do* have an accident, they get prompt,

courteous "round the clock" service from State Farm's 7000 agents and 700 claim expeditors.

Want more information? Call the agent listed under "State Farm Insurance" in your classified directory, or write: State Farm Mutual, Dept. J-9, Bloomington, Illinois.

Can you qualify?

State Farm aims to insure careful drivers only. Drivers who can be counted on to:

- Make full stop at stop signs
- Heed crossing signals
- Obey speed laws
- Be extra careful on slick pavements
- Keep car in good shape
- Avoid passing on hills or curves
- Avoid mixing alcohol and gasoline
- Yield pedestrians the right of way

STATE FARM MUTUAL



FREE TO MEMBERS!

Ask your agent for your new State Farm insignia (like above) in bright red headlight-reflecting Scotchlite. Display it proudly on left rear car bumper to identify yourself as "careful driver, soundly insured" . . . to provide emergency reflection when parked or if taillight fails.

"the careful driver insurance company"

*State Farm Insurance is written only by the
State Farm Mutual Automobile Insurance Co.
and its wholly owned affiliates:*

**State Farm Life Insurance Company
State Farm Fire and Casualty Company**

*Home office: Bloomington, Illinois. Field claim offices
in 300 principal cities. 7,000 agents in 40 states, District
of Columbia, and Canada*

Hear "Jack Brickhouse Sports News" Saturdays and "Cecil Brown
News Commentaries" Sundays over Mutual Stations.
Check local radio listings.

COOL YOUR ENTIRE HOUSE

For as little as
\$139.95

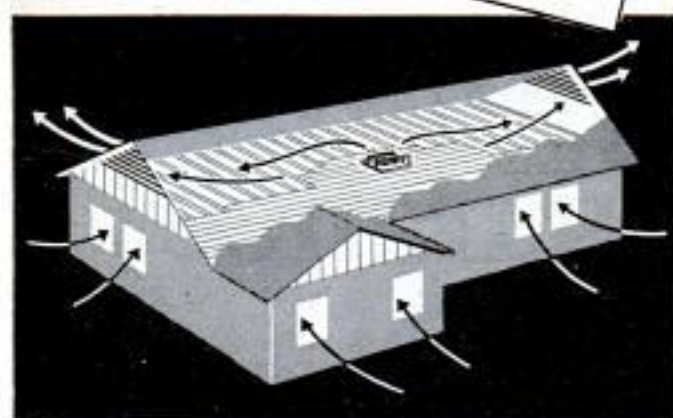

Hunter Attic Fan pulls in cool air through open windows, exhausting hot stuffy air through attic louvers. On hottest summer nights it circulates cooling breezes through every room. Cost of operation is only a few cents a night. Hunter's 67-year experience assures carefree performance. Sizes are available for small or large homes, with prices starting at \$139.95 including automatic ceiling shutter.



You can easily install a Hunter Attic Fan in your home. No special wiring is required. Compact unit requires only 18" to 26" attic clearance. Look in your classified directory and phone the Hunter dealer to enjoy cool comfort in your home at lowest cost. Mail coupon for copy of free booklet.

MAIL FOR FREE BOOKLET

Hunter Fan and Ventilating Company
Box 2858-BK, Memphis 2, Tennessee
Send a copy of "Change Your Home
from Hot to Cool" to:

Name _____
Address _____
City & State _____

HUNTER ATTIC FANS

the many turns due to high steering ratio. You can still get into trouble at speeds motor will deliver, although new suspension is vast improvement over earlier models."—Jackson, Tenn., plant manager.

Miscellaneous Comments

There are always many interesting, although sometimes not significant, comments from owners. Some of them are quoted below.

"Dislike dealers putting name plates on rear of car."—St. Augustine, Fla., bar owner.

"Heater controls very poorly constructed. Reflection from instrument panel on windshield. Nearly impossible to reach ashtray from the driver's seat."—Hammondspport, N. Y., insurance man.

"Sloshing noise in gas tank when it is full."—Jacksonville, Fla., welder.

"On crooked roads gasoline is slopping someplace and inside of car smells. Dealer cannot seem to correct it."—Yachats, Ore., manufacturer.

"Angle of accelerator pedal makes right leg uncomfortable on long drives. Low gas mileage."—Atlanta, Ga., minister.

"So far the '54 has been okay except for a fuel pump. Service on new cars no good until the guarantee has expired."—Foley, Fla., welder.

"Changing over to automatic transmission as all overdrives in this area have a definite roar at about 70 that nothing could solve."—Clarenda, Iowa, professional man.

"When you open the doors in the rain, the seats get wet because of the narrow top."—Oak Ridge, Tenn., inspector.

"Sports coupe is too low for tall people. Must remove hats in car."—Cazenovia, N. Y., machinist.

"Not enough room inside car."—Bismarck, N. D., salesman.

"Should have a decent-size glove compartment. Why is ignition on left side for right-handed persons?"—Old Forge, N. Y., insurance man.

We asked the owners if they would buy another Mercury. Only 4 percent said they would not; 70 percent said they definitely would; and 26 percent said they might.

When asked to give the Mercury an overall rating, 56 percent of the owners called it excellent, 36 percent good, 6 percent average and only 2 percent described it as poor. For additional details and percentages see the Percentage Table on page 104.

And now for my own test: I drove a 1954 Sun Valley (plastic top) Monterey coupe from the factory at Wayne, Mich., to Los Angeles via Kansas City and Denver—a distance of 2685 miles.

(Continued to page 258)



Crescent Standard Pattern Snip, No. S412, 12". Also in seven other sizes 7" to 14".



COMBINATION PATTERN
U412, 12" only.



HEAVY DUTY SNIPS
U416, 16" only.



CIRCULAR CUTTING SNIPS
T412, 12". Also in 7" size.

CRESCENT SNIPS

All Crescent Snips are forged of selected steel and blades ground on special grinding machines. They are hardened by Crescent's own selective induction process to insure long, satisfactory service. These easy-cutting, well-balanced snips are made in four patterns; standard, circular cutting, combination and heavy duty. *Sold by Industrial Distributors and Hardware Dealers everywhere.*



*Sign of the Artisan
Symbol of Excellence* [®]



Crescent is our trade-mark, registered in the United States and abroad, for wrenches and other tools. Sold by leading distributors and retailers everywhere and made only by **CRESCENT TOOL COMPANY, JAMESTOWN, NEW YORK**

Wherever stops were made, the plastic top attracted attention. A filling-station attendant remarked, "Whew, more glass to clean." One important driving advantage I found was that it permits you to see overhead-hanging traffic lights easily. Everyone seems to think the plastic top will mean more heat inside the car in summer. My test was made in winter, so I cannot comment on it. There is considerable glare when driving against the sun—a sliding shade would eliminate this objection. The plastic is tinted and Mercury claims that even in hottest weather, it gets only two degrees warmer inside than in a conventional model.

It is fascinating to drive and, during storms, it is strange to see it being splashed by rain or snow. I noticed at night I could see the reflection of the instrument panel in the top, a distraction that you must get used to.

Mercury changed from the old L-head V-8 to the new overhead-valve design. The new engine has slightly better acceleration, power, top speed and gasoline mileage than the 1952 Mercury I previously tested. I found regular gasoline satisfactory, although I would use premium gas if I were a Mercury owner.

The compression ratio has been increased to 7.5:1, and horsepower from 125 of last

year to 161. Torque rating is 238 pound feet between 2200 and 2300 revolutions per minute.

In the first 500 miles I drove many miles in a heavy snowstorm. Later, on long open stretches of the West, I drove at extremely high speeds. Top speed by speedometer was 102. Like most speedometers, it was fast by about 8 percent.

(Incidentally, at Daytona Beach Speed Week, a stock Mercury averaged 96.665 miles per hour on the flying mile to win the 250-299 cubic-inch-displacement class.)

Roadability and maneuverability are extremely good. The car corners far better than the average 1954 automobile. The ball-joint front suspension is definitely an advanced design of which I approve. It makes for ease of operation, both in turning and up-and-down movement of the wheels. Mercury steers easier than any other car of its weight. Power steering is optional, but I see little need for it on a car that steers so easily. Corners can be taken at high speeds with little body roll because of the excellent suspension. It is very hard to make the car hit bottom on hard bumps at any speed.

I found little brake fading, regardless of speed or constant use on winding mountain highways in the Rockies.

(Continued to page 260)

Only \$6 for the LIFE of your Car  Truck  or Tractor 

Get a MOTALOY Ring & Valve Job While You Drive - for only \$6!

DO IT YOURSELF . . . This proven way . . .

- ★ INCREASES GAS MILEAGE
- ★ RAISES ENGINE COMPRESSION
- ★ STOPS COSTLY OIL BURNING

No work to do. No equipment to buy. Just drop Motaloy tabs in your fuel tank. That's all! Scientifically compounded tablets made of nine metals start immediate action to improve engine performance . . . saves you real money.

1954 MODEL CARS

Stop trouble in new cars before it starts and increase engine life. Motaloy helps retain factory compression and performance thousands of miles longer. Proven in over 263,400 cars — ask your mechanic!

MOTALOY IS GUARANTEED —
IF WORKS, OR YOUR MONEY BACK!

ORDER TODAY! MAIL COUPON RIGHT NOW!

ROBERT E. OLSON CO., INC.
Rm. 124, South Texas Bldg.,
San Antonio, Texas

I enclose \$6. Please rush me passenger-car size Motaloy prepaid. (No C.O.D.'s please). Please send me free literature ().

Name _____
Address _____
(Please Print)
City _____ State _____

HERE'S HOW AMAZING MOTALOY WORKS



As you drive, Motaloy tabs create a metallic "dust". This passes to combustion chambers where heat creates a carbon-removing action. Then Motaloy actually replates pistons, rings, cylinders and valves. This is an anti-friction plating that gives a smoother, more powerful, quieter engine.

READ THESE LETTER EXCERPTS FROM OUR FILES

- INDEPENDENT LABORATORY, TEXAS: "Performance tests show by use of Motaloy, oil consumption was reduced; compression definitely increased." D.W.C.
- OFFICIAL STATE AGENCY, FLORIDA: "Remarkable improvement in compression, smoothness and quietness since using Motaloy." D.H.R.
- MECHANIC, STATE HIGHWAY DEP'T.: "By placing Motaloy in gas tank, noticed improvement in compression and gas mileage; decrease in oil consumption." J.B.S.

Available in 3 sizes.
\$6 size for vehicles
making more than 8
miles per gallon.



MOTALOY

REG. U.S. PAT. OFF.

ROBERT E. OLSON CO., Inc.
Rm. 124 So. Texas Bldg., San Antonio, Texas

DISTRIBUTOR TERRITORIES AVAILABLE

Learn how homeowners everywhere save money by installing their own

MATICO TILE FLOORING



MATICO's New Improved Install-It-Yourself System Makes It Easy!

Yes, you can enjoy colorful, durable MATICO Asphalt Tile Flooring in your home at amazing low cost by installing MATICO yourself. You can't buy a more economical type of luxury flooring than MATICO. It lasts for years... is easy to keep sparkling clean and comes in 32 striking decorator colors that can't wear off because colors and marbleization go clear through the tile.

It's a cinch to install, too, with MATICO's tested install-it-yourself instruction booklet... tile calculator... and special tool kit. Why, you can finish a room in just a few hours.

Why put up with a dingy, worn-out floor when it costs so little to install a MATICO tile floor yourself.

See your classified telephone directory for the name of your MATICO dealer.



1—Mark straight lines through the center of the room in both directions, using a chalk and line.

2—With a notched trowel, spread adhesive evenly over floor and allow to "set."



3—Press tiles into position. You can walk on MATICO as soon as floor is in place.



MASTIC TILE CORPORATION OF AMERICA

Joliet, Ill. • Long Beach, Calif. • Newburgh, N. Y.

Manufacturers of:

Aristoflex • Confetti • Parquetry • Asphalt Tile • Cork Tile • Plastic Wall Tile

MASTIC TILE CORPORATION OF AMERICA
Dept. M2-5, P. O. Box 986, Newburgh, N. Y.

Please send me MATICO's money-saving install-it-yourself instruction kit and complete color chart.

Name

Address

City..... Zone..... State.....

4C137



Service station proprietor, William Vasey, Greenwich, Conn., says: "If your filter's clogged like this, better put in a Purolator Micronic Refill right away!"

**"Right here, in the book that came with your car*, it says—
Change your Oil Filter every 5,000 miles"**

***17 out of 18 leading car makers recommend oil filter changes at least every 5,000 miles, on the average, depending on car and driving conditions.**

Grit and sludge in the oil can ruin any engine . . . run up expensive repair bills. A regularly changed Purolator[®] Oil Filter traps them and keeps them from damaging delicate engine parts.

If you've driven 5,000 miles since changing your oil filter, it's probably clogged. Install a new Purolator Micronic[®] Refill—fast! Costs as little as \$1.60. Takes a few minutes. *More car makers specify Purolator than any other oil filter.*

©Purolator Products, Inc., Rahway, N. J.; Toronto, Canada.

PurOlator

World's finest **OIL FILTER**

"Remember—there's a Purolator engineered for every make of car," says Mr. Vasey. "We recommend them for all the cars we service."

MONEY-SAVING RULE: Check your Oil Filter every time you change your oil



Merc-O-Matic drive operates smoothly and without jerk. At speeds below 58 miles per hour, intermediate ratio (passing gear) is brought into use by depressing accelerator pedal to the floorboard. The drive is constant through the torque converter, there being no lock up or positive drive such as there would be with a clutch. There is a parking lock with a lever indicator and this is good.

The interior finish is above average. Driving position is good, with plenty of arm and legroom even for a tall person. Mercury has thrown away the useless upper portion of the horn ring. No car of any make has better instrument vision than Mercury. The starter is operated by a twist of the key. I am right handed and dislike the awkward key location at the left of the steering column. Right-handed persons far outnumber "southpaws" and Mercury should relocate the key switch for right-hand convenience.

Front vision is good (see Visibility Chart page 106), although the hood is rather long and high. A shorter, or more sloping, hood would give closer ground vision in front of the car. Rear vision is adequate.

The body is tight and I found no rattles, squeaks or leaks during the test. Doors fit tight, but require too much pressure or slamming for closing.

The wide hood ornament is attractive and gives the impression that air is admitted through it. Unfortunately, I think, Mercury does not take advantage of this ornament. It should be slotted to let fresh air flow in over the top of the engine. This would increase performance and afford better hot-weather cooling.

I tested the Mercury Sun Valley under more varied weather conditions than usual, from bitter cold to desert heat (but not hot enough to test summer use of the plastic top). On gray, cold days, it felt colder inside the Sun Valley than in conventional cars, but it was only an illusion. ★ ★ ★

"Atomic" Microscope

With a new microscope which uses atomic particles as "eyes," scientists can "see" how a living or metal structure fits together. The microscope, developed at the University of Michigan, will help researchers discover where the atoms of one component of an alloy are located in the metal. The specimen to be examined contains some radioactive atoms which emit beta rays. The microscope discovers the area of greatest activity. The researcher then converts to an ordinary microscope-lens system for a visual examination of that section.

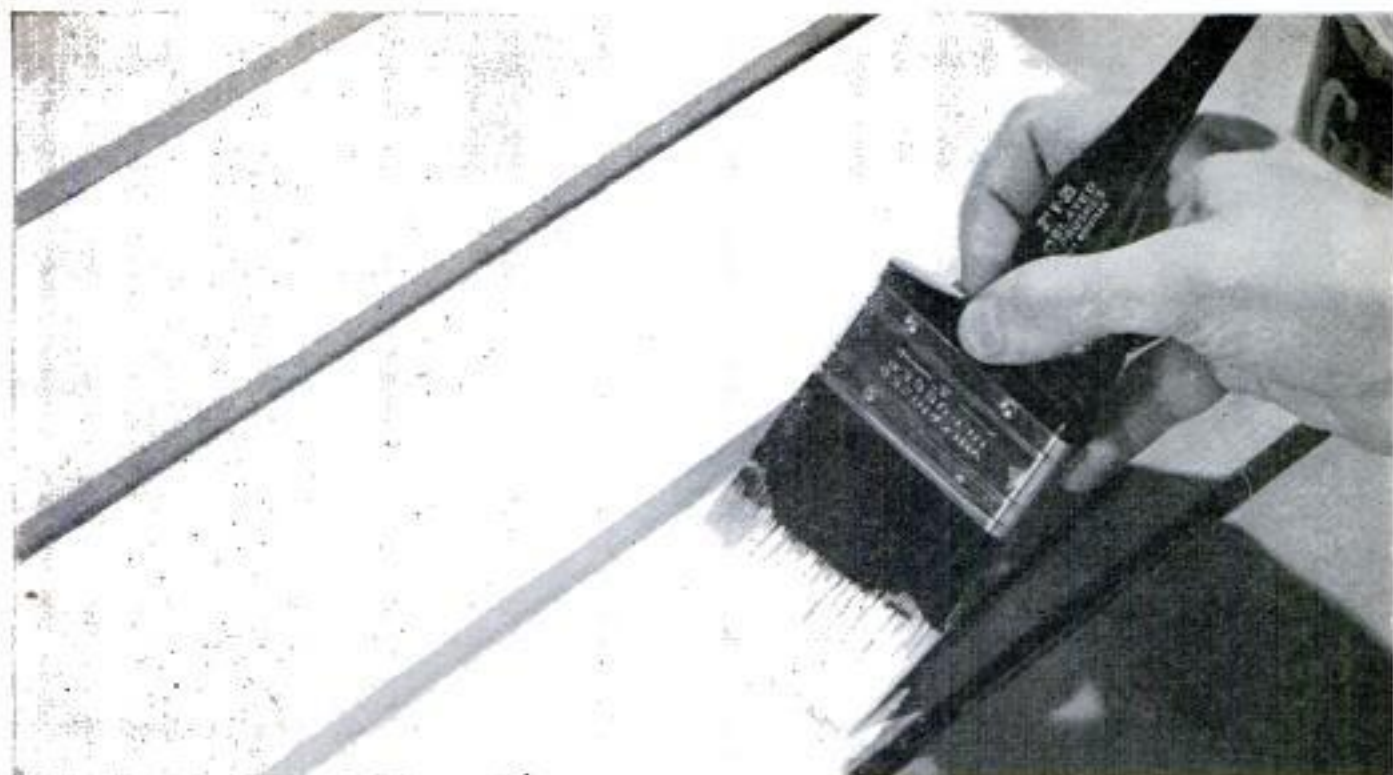

Proved by rigid tests!

NEW ONE-COAT HOUSE PAINT

saves you 1/2 the time, nearly 1/2 the cost!

Unretouched photo, above, shows how Glidden Endurance Imperial gives gleaming 2-coat whiteness in one stroke over siding with 15 years' accumulation of dirt and grime. Once around the house is all it takes with Glidden Endurance Imperial.



"TORTURE CHAMBER!" One-Coat Imperial outlasts other paints, regardless of coats, when exposed to continuous artificial sun and rain in the Weatherometer.

"BODY" MEASURING MACHINE! Imperial's formula leads the field with 90% pigment and vehicle solids. These ingredients — not thinners — give you protection.



Write now for a **FREE** copy of "How to Paint," the perfect guide for do-it-yourself painters.

THE GLIDDEN COMPANY
Department PM-5, Cleveland 2, Ohio
In Canada: The Glidden Co., Ltd., Toronto



Glidden

ENDURANCE IMPERIAL

© Copyright 1954, The Glidden Co., Cleveland 2, Ohio

Greatest
wood-boring tools
ever developed

Stay sharp
10 times longer
than ordinary
power bits

Even cut
thru screws
and wire nails



Set No.
8006

NEW

DYNO-MITE

**HIGH-SPEED
POWER BITS**

Here's the last word in wood-boring efficiency! "Dyno-Mite" Bits give you all the advantages of the modern flat-blade design that is rapidly replacing conventional auger bits for power drilling. And, in addition, "Dyno-Mite" Bits have high-speed steel blades — stay sharp ten times longer — even cut thru screws and wire nails without damaging their cutting edges!

Yet "Dyno-Mite" Bits cost no more than ordinary tool-steel bits!

Available in 6 diameters, $\frac{3}{8}$ " to 1", singly or in sets. All with $\frac{1}{4}$ " shanks. If your dealer cannot supply you, send check or money order for \$6.45 for No. 8006 Set of 6 sizes, postpaid.



Here's Proof of Amazing Cutting Power. One "Dyno-Mite" Bit, preparing demonstration blocks like the one at left, was still going strong after cutting thru 15 ft. of hard maple, 188 screws, 376 wire nails!

FREE at your hardware store, new Millers Falls Power Tool Catalog — or send 10c to cover mailing and handling.

MILLERS FALLS COMPANY
Dept. PM-2
Greenfield, Mass.



The Mark of Superiority

Egg for an Atom Engine

(Continued from page 94)

facts and figures that make your head spin: "It sits in a bowl-shaped concrete foundation like an egg in a cup," he says. "Thirty-eight feet of the underside is below ground level. The rest soars 5 stories higher than Niagara. It measures 706 feet around the equator," he adds, as though discussing another world. "It's so big that the barometer records .25 inches less mercury at the 'north pole' than at the 'south pole.' There's so much surface that queer things could happen if we didn't allow for them. Ordinary New York weather—a warm sun on one side and a polar wind on the other; a sudden low-pressure storm in midsummer—might create pressure differentials capable of pushing a mammoth dimple in the steel hide. Actually, size for size, the sphere is much thinner in proportion than the shell around an egg. We fixed all that by putting strain gauges on all the columns. They tell us when stresses are too great at any point. We equalize them by jacking procedures."

Erection of a building as unorthodox as the giant sphere called for plenty of American ingenuity. First, 26 tubular steel columns, each 76 feet high and two feet across, were set on the foundation rim. Then 78 big steel plates were welded to the column tops in a vast circle, forming the sphere's midriff. "Until the last gap was closed," Harman reveals, "everyone had his fingers crossed. You don't think of one-inch plate steel as something you bend or twist into odd shapes with ease. But those big plates flapped and twisted in the wind like limp sails. Once the circle was completed, of course, they formed a rigid belt."

So accurate was the engineering that only $\frac{3}{8}$ inch separated the last two plates raised into position. With the equator anchored, the bottom of the sphere was hung from it, and the dome raised on it, tier by tier. Each tier was held in place until welded by long steel arms reaching out from the derrick mast like spokes of an umbrella.

Then, one of the strangest operations of all took place. Section by section, welds over the entire ball were smeared with a soapy solution. Air was pumped into the tightly sealed sphere until 20 pounds' pressure was reached. Workmen peered over every inch of weld—looking for telltale soap bubbles that would indicate a leak. Not one was found in all the five miles of welded seams.

Once that was done, some 30,000 tons of fill cascaded into the sphere's bottom, bringing a flat, interior floor right up to

(Continued to page 264)

PENTA THE CLEAN WOOD PRESERVATIVE

DOW



You apply clean PENTA to wood in minutes,
get extra years of use and satisfaction

The Dow Chemical Company
Dept. PE 766N
Midland, Michigan



- Please send FREE BOOKLET—"Handyman's Guide to Home Wood Preservation."
 Send the name of my nearest PENTA dealer.

Name _____

Address _____

City _____ Zone _____

State _____

When you spend a few minutes in treating your gate and lawn furniture with a clean PENTA* solution, your final satisfaction with the job is multiplied many times over. Almost *any* wood article you can build *lasts years longer* with a PENTA treatment, because this modern preservative works in the *grain* to give effective protection against termites and decay. Simply flood clean PENTA on with a broad brush, or dip individual pieces before assembling. PENTA itself leaves a natural appearance, but does not interfere with finishing—leaves wood pleasant to handle and work.

Dow's free booklet, "Handyman's Guide to Home Wood Preservation", gives valuable information on how to use PENTA for protection of storm windows and screens, porches, fence posts and other decay-danger areas. Send for your copy today. Your local lumber dealer or hardware store stocks brand-name preservatives containing *PENTACHLOROPHENOL in both regular and water-repellent types. Look for the name PENTA on the label. THE DOW CHEMICAL COMPANY, Midland, Michigan.

you can depend on DOW CHEMICALS

DOW

So easy to Remove Paint



You'll be amazed at how thoroughly Wonder-Paste softens up paint, enamel, varnish, etc. Makes the old finish come off easily—not coat by coat, but all in one scraping. Use indoors or outside—on floors, trim, furniture, etc. Does not run on vertical surfaces. At paint and hardware stores.

Write for Wonder-Paste leaflet—and advice on your removing problem.

Wilson-Imperial Co., 119 Chestnut St., Newark 5, N.J.

WONDER-PASTE

Over 4 million cans sold—it must be good!

Science Speeds Shaving With "Canned Lather"!

That's right! They've invented a gadget that makes shaving faster, easier, more pleasurable! Now you can get rich, creamy lather right out of a can . . . ready to use!

No brush to slow you down . . . no greasy cream to clog your razor. Just push valve . . . out comes lather! That's AERO SHAVE . . . the wonderful new "canned lather" that contains 3 beard-softeners to wilt toughest whiskers in a jiffy . . . plus soothing lanolin to protect your skin against shaving irritation.

Get AERO SHAVE Lather Bomb today . . . in the handy metal container with the turret top that won't leak when you travel.

Big Bargain! Aero Shave is the lowest priced "push-button" lather bomb on the market today!

USE "PUSH-BUTTON" LATHER

AERO SHAVE



Also economical King Size—12 oz. only 98¢

ground level. This is the floor on which the strange, new engine will be built and tested—inside the biggest air-conditioned globe in existence. Most of its secrets will be sealed up tight. There's only one airtight globular entrance through which human traffic will pour. The other is reserved for the dolly on which rods of U-235 will ride in a gigantic lead container. Even atomic submarines must be refueled occasionally, and this is where the job will be done—in a unique concrete building called the fuel element service cell, right alongside the sphere.

In KAPL's laboratories, on an intricate cutaway model, you can see the process for handling the "hot" rods carried out in miniature. The machine that pulls the partially burned uranium rods from the reactor core in the sub is a sort of immense cap that is picked up by a 40-ton overhead traveling crane in the sphere and set down snugly over the reactor section of the hull. Under this heavily shielded "hood," the rods are pulled by robot mechanisms inside. No one will tell you how this is done or exactly what the rods are like. But when they're hauled out, they are dropped immediately into a ring of small tubular holes in a solid lead container five feet across and eight feet high. This case rides a tiny railroad, on the back of the dolly.

The tracks weave out through the sphere wall and into the fuel element service cell. Here, behind six-foot concrete walls, the uranium rods are handled by an army of robots, controlled by men looking at them through six-foot-thick windows filled with dense liquid to shield them against the deluge of atomic particles. An overhead crane outside the cell reaches down, lifts the multiton container off the dolly and drops it through a hole in the floor to a deep tunnel, onto another dolly where the hot material can be stored. One by one, the fuel rods are brought up by a robot arm. Once in the cell, a big manipulator that can grasp and lift one ton in its crushing steel grip, or pick an egg off the floor without cracking the shell, passes the fuel rod through a complex series of automatic machines. A long rod is seized in steel fingers and placed into a rack, where torrents of water wash it down. The arm grabs it and inserts it into a "scanning station," where radiation-sensitive eyes examine it minutely and record what they see. A third robot inspects and photographs it. Out comes the big arm again, to move the cylinder along to the disassembly station. Actually, only part of the rod is a fuel section. The disassembler removes this and pulls the rest of the rod apart. Most of it can be re-used.

(Continued to page 268)

Double Savings!

✓ Save on Price ✓ Save on Installation

Duo-Matic

"Do-It-Yourself"
TRIPLE-TRACK
All-Aluminum
Storm-Screen
Windows

\$29.95 Value **\$15.95**

Easily Installed By Anyone!

Lowest price ever for any comparable window!
Rugged, all-aluminum construction . . . triple-track design means glass and screen inserts are always in place, ready for immediate use.

At leading lumber and hardware dealers everywhere — or write

the weather-proof co. Dept. PM
1407 E. 40th St., • Cleveland 3, Ohio



Guaranteed by
Good Housekeeping

For opening sizes up to and including 39" x 55" double-hung windows. Other sizes slightly higher.

NEW!

OIL MIST SPRAY!

3-IN-ONE's Oil-Spra protects tools with fine mist of oil! Press button for penetrating oil spray! It's so easy to use!



"3-IN-ONE" OIL

SAY YOU SAW IT IN
POPULAR MECHANICS

The NEWEST and FINEST: Buck's 400 Series

CHROME EDGE CHISELS

You get: ★ The Finest Cutting Edges
★ Tough Tenite II Handles with Inserted Steel Caps
★ Rust Proof Tools



Plastic pocket Kit - 4 Sizes \$9.40

Most complete line of Chisels, Gouges and Carving Tools
CATALOG AVAILABLE!

BUCK BROS. INC.
RIVERLIN WORKS MILBURY, MASS.

1" - \$2.60

3/4" - \$2.40

1/2" - \$2.30

3/8" - \$2.10

ANNOUNCING

AMERICA'S GREATEST "DO-IT-YOURSELF" SANDER!

New!

New!



LIGHTS
YOUR
WORK
AS YOU
SAND . . .

ONLY
\$39.95

The ONLY Portable
with ALL These Features!

(1) Motor guaranteed against burn-out during ownership or replaced free. (2) Removes more material with less upkeep than any other sander at any price. (3) Over 1000 hours of continuous sanding without breakdown in laboratory endurance trial. (4) Work-Light standard equipment — a Syncro "first" for portable sanders of its type. (5) Vibration-absorbing handle floats in rubber (Pat. Pend.). (6) Easy to use, hand operated, positive paper holding clamps. (7) One hand operation—no jumpy, twisty torque to fight. (8) Most powerful reciprocating sander motor (Patented). (9) No oiling—power unit floats in rubber—no cams, bushings, belts or gears to wear out.

'900' OFFERS
MORE
THAN ANY
OTHER SANDER
REGARDLESS
OF
PRICE!

Standard Models: 210-125 Volt AC. Other volt-ages, cycles available.



No. 504
\$19.95



No. 504-D
Deluxe Sander
In Metal Case: \$22.95

PRESENT, PROSPECTIVE SANDER OWNERS! This new husky '900' SYNCRO is the best portable for home use—costs less than many others! Try this superior, powerful tool on "do-it-yourself" jobs—save many times its cost! Because '900' is so new—and your dealer may be sold out—do this: Send \$39.95 and your dealer's name with coupon—we will ship '900' to you—and see your dealer profits from your purchase. Then—use your '900'—see how it sands better, quicker, easier, smoother one-handed than "bucking" torque-knobbed "Two-handed" portables do! If not 100% satisfied—return '900' prepaid, undamaged, within 10 days of receipt—we'll refund \$39.95 promptly! Or write for FREE facts today. (Dealers—See Your Jobber!)

WITH BUILT-IN LIGHT

NEW
'900'

SYNCRO SANDER

INDUSTRIALLY RATED

Send Coupon for TRIAL ORDER or FREE CIRCULAR:

SYNCRO CORP., Dept. 1-54, OXFORD, MICHIGAN

TRIAL ORDER: I enclose: \$39.95 for No. 900 — \$22.95 for No. 504-D — \$19.95 for No. 504. Send sander prepaid, with accessories, on 10 Days Money Back Trial Offer.

C.O.D. ORDER: I enclose \$5.00 down. Send model No. with accessories. I will pay balance plus postage, C.O.D. fee on arrival. Same 10 Days Money Back Trial.

FREE CIRCULAR: Send new free Syncro Sander Circular. Dealer's Name, Address

WRITE YOUR OWN NAME, ADDRESS BELOW!

FISH AND CAMP SPECIAL!



101 P.C. SPINNING OUTFIT!

AIREX "MASTEREEL" & H-1 REGISTERED SPINNING ROD & COMPLETE SPIN KIT

CERTIFIED
\$58.25
VALUE

\$29.95

ONLY AT
KLEIN'S
\$2.00 Deposit
on COD's

For fishermen who want the biggest selling spinning outfit in the World—fine thoroughly dependable quality—yet Bargain Priced! Complete 101 p.c. outfit includes: (1) Brand new, first quality, latest model Airex "Mastereel" (\$22.75 separately), extra reel spool, Airex reel bag, brake dressing (2) Herrocks-Ibbotson's finest \$27.50 value individually Registered "Admiral De-Luxe" Spinning Rod. Your choice of 6 1/2 ft. Solid Power Glass, 6 1/2 or 7 ft. Tubular Power Glass. Canvas and solid fiber Rod Cases included. (3) Complete Accessory Kit includes 100 yds. finest DuPont Nylon Spinning Line, transparent plastic tackle box containing 6 famous lures, and snaps, swivels, line clips, anti-twist keels, plastic and cork floats, reel grease, fish stringer, disgorger, assorted hooks, sinkers, leaders. (4) Spinning Instruction Booklet. You get everything you need to go fishing! Certified \$58.25 Value, all for only \$29.95.

Buy 2 Complete 101 p.c. outfits and save still more... 2 FOR \$57.85

SEND \$1.39 ADDITIONAL ON EACH OUTFIT IF YOU WANT THE MASTEREEL "ARISTOCRAT" WITH FULL SAIL LINE PICKUP.

BRAND NEW, FIRST QUALITY! \$24.50 VALUE! GENUINE DUPONT NYLON AIR MATTRESS

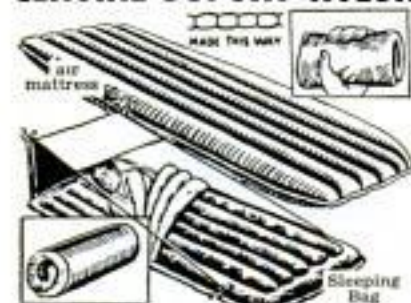

\$9.95
EACH

3 for \$26.85
6 for \$47.70
12 for \$89.95

Save \$14.55 on each of these Supreme Quality Genuine DuPont 100% Nylon Air Mattresses! Don't compare these magnificent, long wearing Nylon Air Mattresses with the cheap and fragile plastic imitations you see everywhere! Every air mattress made to U. S. Army Quartermaster Specifications. The tough, durable Nylon fabric is rubber impregnated to lock in the air and take lots of abuse. Weighs only 2 1/2 lbs. Folds to small compact size. New type air valve permits easy filling without pump. Ends are slightly contoured to fit all sleeping bags. Big 25" x 73" inflated size. New, fresh stock. Here's real sleeping comfort for camping and outdoor use. Ideal for campers, outfitters, and surf-riders.

AIR MATTRESS AND ARKTIK SLEEPING BAG

America's finest sleeping bag value! Famous Arktik quality throughout! Air Corps Balloon Cloth top covering. Water repellent ground cloth. Warm red flannel lining. Full 100" heavy duty zipper. Filled with 4 lbs. of new Kapok. 34" x 63". Folds to compact bedroll. Has mattress pocket. Certified \$44.50 COMBINATION VALUE.

Sleeping Bag Only (no air mattress)
\$29.00 Value \$14.95

BOTH FOR
\$22.95

3 outfits
for \$59.85

AIR MATTRESS, SLEEPING BAG, AND TENT

Two Man Tent. (85" x 60") Roomy enough for 3 people. 5 oz. Oxford Cloth. Fire and Mildew Resistant. Meets Government Specifications. Sewed-in floor and mosquito bar. Weatherproof but weighs only 9 lbs. Stakes, Poles, Ropes included. You get Air Mattress, Sleeping Bag, and Tent, a Certified \$66.50 Value.

Tent Only (no mattress or bag)
\$22.00 Value \$13.95

ALL FOR
ONLY
\$34.95

3 complete outfits
\$99.85

SEND PAYMENT IN FULL OR AS LITTLE AS \$2.00 DEPOSIT ON COD'S

KLEIN'S GUARANTEE SINCE 1885

Klein's gives you 30 Days Free Trial on all Mail Order Purchases with an unconditional Money Back Guarantee of Satisfaction. All articles are Brand New, First Quality, 1884 Models. Low Prices are due to our big volume and direct-to-you sales.

KLEIN'S

Klein's Sporting Goods, Inc.
Dept. P.M.5 ORDER BY MAIL
227 W. Washington St.,
Chicago 6, Illinois



Nylon Boat Cover

Boatowners can protect their craft and motors from rain with a new boat cover made of treated nylon. The cover fits snugly down over the gunwales and the motor. Arched steel ribs prevent water from standing in pockets on the cover. The chemically treated nylon repels water and won't mildew. The cover simply is unrolled over the boat. In the event of a sudden rain it can be installed while the boat is out in the lake, protecting the occupants and their equipment. The cover is available in sizes to fit craft up to 22 feet long.

Telephone Transistors

Several telephone conversations can be carried on one rural party line with a system using transistors. Eavesdropping is impossible. The tiny battery-powered transistors, mounted on the telephone poles, place different calls on different frequencies. The conversations are sorted properly at the line's terminal. Bell Telephone, which plans an experimental installation at Americus, Ga., says the transistors should prove to be economical on telephone lines as short as five miles.

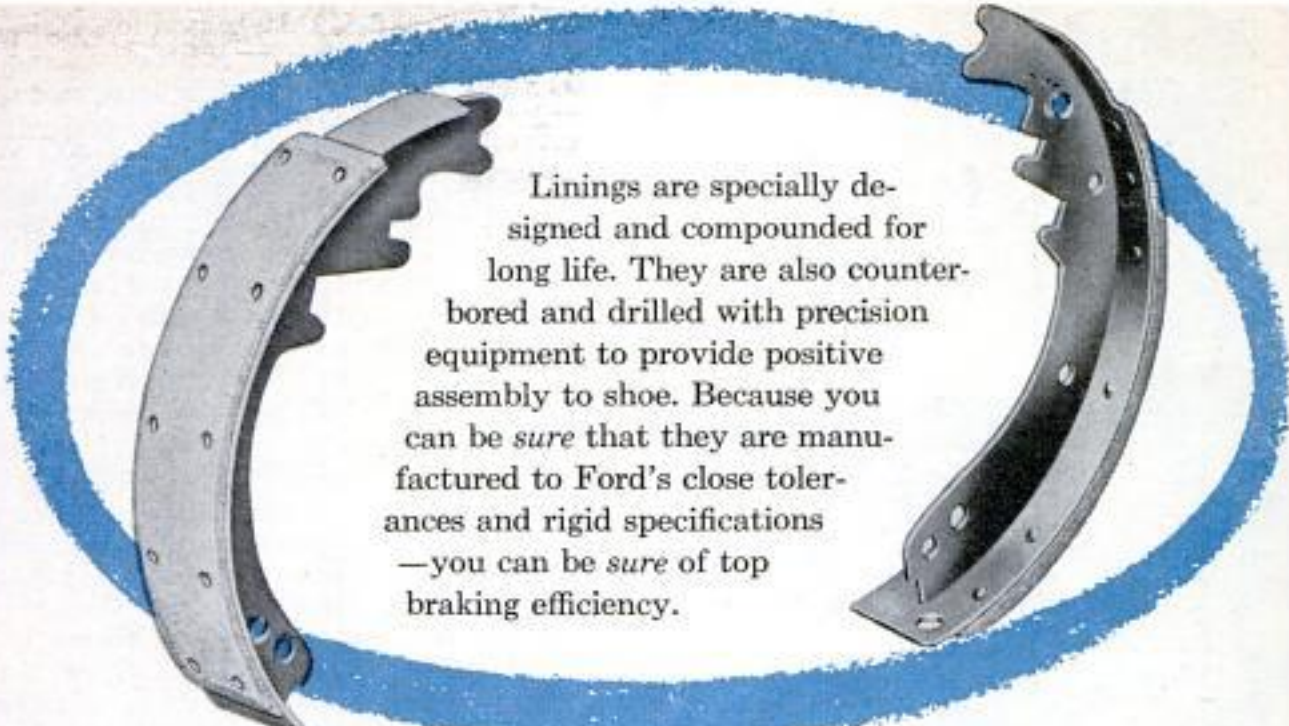

Linings are specially designed and compounded for long life. They are also counter-bored and drilled with precision equipment to provide positive assembly to shoe. Because you can be *sure* that they are manufactured to Ford's close tolerances and rigid specifications—you can be *sure* of top braking efficiency.



**Get the Brake Lining
that's made right
for your FORD**

**Every single Genuine Ford Part—like the brake lining shown above—is made *right!*
... to the same specifications set by the men who originally built your Ford!**

With fair-weather traffic "just around the corner," it's great to *know* your Ford will stop safely, smoothly, and surely. That's why *now* is the time to have worn brake linings replaced—and with Genuine Ford Brake Linings! They're made of materials specified by the men who built your Ford ... given 3,250 Track Tests before approval for manufacture. And they're made right to work right to last longer in your Ford.

"TRADE" WHERE YOU SEE THIS SIGN





**for fast,
clean work**

Greenlee Chisels

Let high-quality GREENLEE chisels help you speed jobs and put an extra-fine finish on your work. Each is carefully balanced, easy to hold. Blade is of selected tool steel that long retains its fine-cutting edge. Attractive green plastic handle provides comfortable, sure grip. Choice of Socket Butt, Socket Firmer, and Tang Butt types to suit your preference and requirements. GREENLEE chisels can be purchased singly or in handy sets packed in handsome wood cases, plastic rolls, or metal-edge boxes. See your hardware or building supply dealer.



SPECIAL OFFER... GREENLEE Woodworking Calculator only 25c. Converts linear to board feet, gives nail specifications, tool sharpening tips. Compares woods, gives bit sizes for screws, concrete mixes, painting information, etc. Convenient... simple to read. 6" diameter circular shape... heavily varnished cardboard. Send 25c (no stamps please).

GREENLEE TOOL CO.
2105 Columbia Ave., Rockford, Illinois

The fuel section is then passed to the shearing station, where a punch and die separate the last bits of extraneous material from the portion that will be processed. What's left is grabbed by the robot arm again and passed to a mechanical gadget that puts each fuel section into a container and seals it. These are dropped into a bigger lead container, dollyed out of the service cell, and put on board a railroad car for shipment to some atomic center where the potent material will be renewed and made into fresh rods that can make the cosmic fire to drive the *Sea Wolf*—or any sub like her—for another 30,000 miles or so.

Needless to say, no ordinary crews can be expected to walk aboard a submarine like the *Sea Wolf* and run it. "Everyone, from cook to captain," explains Commander Neymark, project engineer formerly in charge of the crew at KAPL, "must learn how to work in the brand-new environment of radiation. It's safe enough if you know about it. The cooks must learn problems associated with long submergence. Certain cooking fats, combining chemically with other gases that have accumulated in the tight spaces after weeks of cruising below the surface, might poison the air faster than it could be replaced by new equipment said to separate oxygen from the sea water and bring it into the sub. All hands must be thoroughly informed on such things as radiation tolerances, and what to do if the pipes containing the incendiary, radioactive molten metal should spring a leak. Sodium will burst into flame on contact with air—or water. Every man jack must know exactly how to fight sodium fire."

A core of 40 men and four officers has been boning up on all the facts about the *Sea Wolf*. By the time she's launched, they'll have had three years of training. They will train the other 40 who come aboard to man the big sub—and they should be able to do a superb job. The handpicked enlisted men were high-school graduates who have already logged a B average in a college cram course on atomic physics, which they recently completed at near-by Union College. After touring KAPL and GE to study every phase of their reactor in production, they plowed through a half year of college math, thermodynamics, electrical engineering, reactor engineering, metallurgy and electronics. They helped fabricate reactor parts, and worked with the designers and engineers actually assembling the experimental engine at KAPL. They studied the reactors at Hanford and Arco, spent weeks aboard destroyers studying design and operation of

(Continued to page 270)

BRAND NEW WAR SURPLUS - BUY NOW SHOP by MAIL and SAVE

25 TON CAPACITY HYDRAULIC CYLINDER

- ALL STEEL CONSTRUCTION
- 8" BORE—15" STROKE
- DOUBLE ACTION



ITEM #1815

- 20,000 LBS. PRESSURE WITH 1000 P.S.I. PUMP OUTPUT.
- UP TO 70,000 LBS.—CAPACITY ON INTERMITTENT SERVICE.
- SOLID STEEL 2 1/2" PISTON ROD
- 1" PORTS
- OVERALL DIAMETER—10 1/2"
- DISTANCE BETWEEN CENTERS—28 1/4" CLOSED—43 1/4" OPEN.

IDEAL FOR:
 • HYDRAULIC PRESSES • DUMP TRUCK HOISTS • TD-18, TD-24 INTERNATIONAL HARVESTER DOZERS AND GRADERS • LEVELING RAMPS • INDUSTRIAL MACHINERY • ROAD MACHINERY • FARM MACHINERY • HYDRAULIC TAIL GATES

Replacement cost—\$300.00.
 Shipping Wt.—185 lbs.

SPECIAL PRICE 95.00

- 7 1/4" BORE—15 1/4" STROKE
 - 41,300 LBS. PRESSURE WITH 1000 P.S.I. PUMP OUTPUT.
- OTHER FEATURES SAME AS ABOVE
 Replacement cost \$260.00.
 Shipping Wt.—155 lbs.

SPECIAL PRICE 80.00

CENTRIFUGAL PUMP

Brand New GENERAL MOTORS —ALLISON
200 GALLONS Per Minute

- For Draining Basements
- Fire Fighting
- Irrigation
- Fuel Transfer
- Swimming Pools • Home Water Systems • Dewatering

For high volume commercial, home and industrial use. Standard 2 1/2" pipe thread inlet, twin 1 1/4" pipe thread outlets. Ball bearing supported 3/4" shaft. Easy priming. Rotation, counter-clockwise facing shaft. Gov't. acq. cost \$145.00. Complete with full instructions.
 Ship. wt. 35 lbs.

39.50

Will deliver 200 gals. per min. against 65 ft. head using 5.2 H.P. at 3500 R.P.M.

CONTINENTAL "RED SEAL" ENGINE

ITEM #97—Model No. AA-7, economical operating 1 1/2 H.P. engine for use with lawn mowers, garden tractors, pumps, generators, compressors, etc. Runs 5 hours on 1 gallon of gas! Single cylinder, 4 cycle, with 8:1 gear reducer at 3600 R.P.M. engine speed; shaft turns at 600 R.P.M. Complete with muffler, starter rope, oil bath air cleaner, killer button, and governor. Dimensions: 17" x 13 1/4" x 15".

Ship. Wt. 60 lbs.

47.50

FREE SUMMER EDITION

1954 CATALOG, 52 PAGES, chock-full of unsurpassed War Surplus Equipment Bargains for farm, home, factory, workshop. Write letter today.

GOV'T. SURPLUS! JUST RELEASED!

2-TON, 6-WHEEL HYDRAULIC LIFT TRAILERS

USE FOR: Conveyor ramp • Boat trailer • Lumber • Pipe • Pole trailer • Machinery trailer • Hydraulic dump for grain wagon • Coal truck • Lift truck • Variable height hydraulic work table • Removable rack permits use of hydraulic lift for other installations. Outstanding features of these trailers are—4000 lbs. pay load, 2 individual hydraulic lifts complete with hand pumps and valves. 18"x5.5 pneumatic tires included. Manual screw-down brakes. Ball-bearing axles. V-shape load rack—8' long. Towing tongue. 54" lift. Wheelbase 98". Ground clearance 4 1/2". Tread width—52". Overall width—58". Overall length including drawbar—167". Gov't. cost \$685.00. Ship. wt. 1400 lbs. F.O.B. Chicago.



ITEM #356
169.50

HYDRAULIC SPEED REDUCER with FINGERTIP CONTROL

USE FOR: • Reamer Drives • Midget Cars • Feed Mills • Canning Machines • Conveyors • Lathes • Milling Machines • Motor Boats • Cream Separators • Garden Tractors • Pumps

Variable output speeds from 0 to input speed available by moving control handle. Locking handle maintains setting. Use input power of 1/4 to 1 1/2 H.P. This Westinghouse-Oil Gear Unit consists of a variable displacement hydraulic pump feeding a fixed displacement hydraulic motor. Adjustable relief valves set at factory for 100 inch pounds of torque may be reset up to 180 inch pounds. Independent reverse control allows full output power and speed selection in either direction of rotation. Shafts measure 3/8" diam., include keyway. Input rotation is counter-clockwise facing shaft. Recommended input speed not to exceed 750 R.P.M. Overall dimensions, 7 1/2" x 7 1/2" x 1 1/2". Gov't. acquisition cost \$428.00. Ship. wt. 31 lbs. Complete with 2 qts. of oil and full instructions. F.O.B. Chicago.

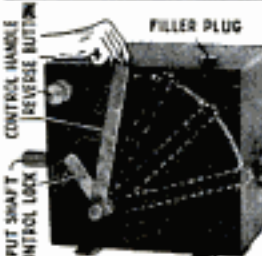

ITEM #115
54.50

DOUBLE ACTING HYDRAULIC CYLINDER

Item #1036—Double acting hydraulic cylinder, 3" bore, 36" stroke, 1 1/2" pipe thread ports. 1 1/2" solid steel shaft. Overall length closed 49", clevis mounting at base and shaft. FEATURES: • Cup & Chevron Packing • All Welded Construction • Precision Ground and Honed Construction • Will lift 7000 lbs. Gov't. acquisition cost \$428.00. Ship. wt. 57 1/2 lbs. F.O.B. Chicago.



50.00

NOW... SAVE \$161.00 on this \$250.00 VALUE 350 WATT A. C. PORTABLE ELECTRIC LIGHT PLANT

Compact Electric Plant suited for small homes, cabins, campers, hunting and fishing camps, trailers and small electrical home appliances. Operating costs! About 50¢ per hour. Runs exceedingly quiet. Sturdily constructed for dependable service. Net weight only 88 lbs. can be carried from place to place, or transported in trunk of car. 350 Watt — 110 Volt — 60 Cycle — A.C. Model—38.5, 38-3, made by Midget Mfg. Co. 1 Cylinder, 4 Cycle Engine complete with muffler, starting rope and oil bath air cleaner, direct coupled to a 350 Watt Generator with voltage control rheostat and twin outlets. Engine speed 1800 R.P.M. Shipping weight 116 lbs. Commercial List Price \$250.00

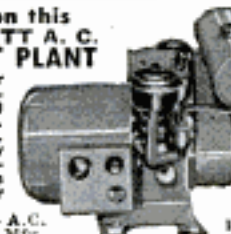

89.00

A. C. ELECTRIC GENERATORS

Power these electric generators with your own gasoline engine, power take-off, or electric motor, and save the difference.

ITEM #G-3—3000 Watts, 120 Volt, 60 Cycle, 1000 H.P.M. single and three phase, for two or three wire circuits. Excellent source of electricity for portable or stand-by use for homes, farms, hatcheries, radio stations, factories. Built by Hobart Mfg. Co. to exacting specifications of the U. S. Army. Ball-bearing, generator, fan cooled. Equipped with standard 1 1/2" shaft with keyway for direct or pulley drive. Built-in Self-Exciter Foot Mounted. Gov't. Acquisition Cost: \$325.00, Dim.: 21"x13" Dia. Ship. wt. 280 lbs. New Low Price... **155.00** F.O.B. Chicago

ITEM #G-75—Electric generator, 7500 Watts, 120 Volt, 60 Cycle, 1800 R.P.M. single and three phase current, for 2 or 3 wire circuits, double ball-bearing construction, standard 1 1/2" shaft with keyway, and included at no extra price, 5-groove six inch pulley for belt drive. Direct connected Self-Exciter Foot Mounted. Gov't. Acquisition Cost: \$345.00, Dim.: 34"x11 1/2". Ship. wt. 420 lbs. Price Slashed To... **269.00** F.O.B. Chicago



ITEM #G-75

FOUR-WAY, OPEN CENTER CONTROL VALVE

Four-way open center control valve, with built-in adjustable relief valve factory set at 1000 P.S.I. Spring loaded neutral position. For use with one double acting cylinder. In neutral position cylinder is locked and pump unloaded. Can be used as single unit or mounted in series. Has 3/4" pipe thread inlet and outlet. 1/2" pipe thread cylinder ports. Newly manufactured to our specification. Ship. wt. 8 1/4 lbs. An outstanding buy!..... **21.50** F.O.B. Chicago



ITEM #128

SELF-PRIMING HAND FLUID PUMP WITH STRAINER

ITEM #129—Type D-2—May be used as a boat balling pump, sump pump, barrel pump, fuel transfer pump, for water, oil, gasoline, insecticides, etc. Bronze and aluminum construction, 1/2 in. pipe thread ports. Fine general utility hand pump. Capacity—200 Gal. per hour. Ship. wt. 6 lbs. F.O.B. Chicago..... **11.95**



BRAND NEW! JUST RELEASED! BLACKHAWK HAND-HYDRAULIC PUMP

ITEM #82. Perfect for Hydraulic Presses, Snow Blowers, Farm Wagons, Jacks, and Farm Pumps. A few easy strokes of the 20" handle and you can lift 5000 lbs., using item 355—Hydraulic Cylinder. Blackhawk Model P-151—complete with built-in oil tank and release valve. Rated 1200-8400 lbs. per square inch. Dim.: 10"x7"x6". Ship. wt. 35 lbs. Worth much more. F.O.B. Chicago..... **22.50**



HEAVY DUTY RHEOSTAT

ITEM #372—Use for controlling field current of A.C. and D.C. generators; for battery charger control; for lighting dimmers; speed controllers, model railroad voltage controller. Manufactured by Ward-Leonard, 12.5 ohms, 10 to .3 amps, 350 watts capacity. Designed for dashboard or panel mounting. With pointer knob... **9.95** Post-paid



300 AMP. D. C. GENERATORS

IDEAL FOR WELDING GENERATOR Type R-1, ITEM #91 rated 300 Amps. — 30 Volts. Mfd. by Jack & Heints. Gov't. Acq. Cost \$380.00. Ship. wt. 55 lbs. Dimensions 10"x10"x7". F.O.B. Chicago..... **35.00**

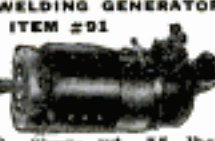

ORDER DIRECT FROM AD SATISFACTION GUARANTEED SEND PAYMENT OR PURCHASE ORDER TODAY

TO PLACE PHONE ORDERS CALL WEbster 9-3793

GROBAN SUPPLY CO. Dept. PM-5
 1139 S. WABASH AVE., CHICAGO 5, ILL.

steam machinery. Meanwhile, other Navy men spent a month sealed up in the submarine *Haddock*, tied up alongside a dock in New London—in an endurance “submergence” test designed to simulate problems that will be faced by crews who may cruise around the world without ever seeing the sky.

Not all the problems are technical. It isn't natural for man to seal himself in a container with 80 fellow men for weeks at a stretch. “The effects of long submersion on a man's ability in his job is something we don't know much about,” explains one human engineer involved with the problem. Under normal circumstances, the way a fellow next to you sucks at a tooth, taps his fingers or butters his bread may not even be noticed. But after 50-odd days of having to watch or listen to your bunkmates' nervous habits, such small things have a way of grating on temperaments and becoming almost intolerable.

None of these things has been overlooked in training and screening the crews for the two new subs. By the time the *Sea Wolf's* crew completes training at West Milton and takes off for New London to help put their ship together before taking it over, they'll be one of the most highly trained groups of men ever to move in on a piece of Navy equipment—the likes of which no

Navy man has ever had to run. These new subs are among the most formidable weapons in world history. ★ ★ ★



“Brief Case” Camp Kit Totes Shovel, Ax and Water

One wooden handle serves for both the ax and the shovel of a 7¼-pound camper's kit that can be carried like a brief case. The waterproof carrying case doubles as a two-gallon water bag. The metal-capped end of the handle is secured to the ax head or shovel by a bolted metal clip. The kit fulfills the legal requirement for tools required of campers in national parks and forest areas.

Buy **EVANS** for
EXTRAS
in 6, 8, 10 and New 12 Foot
“WHITE-TAPES”



FREE WITH EVERY TAPE
— this sparkling crystal
Tenite utility case.

This is the BUY for your money — the original, reasonably priced “White-Tape” by EVANS. Your measuring tape dollar goes further! Chrome plated, sturdy case. Snow-white Bonderized steel blades with jet markings, easy to read, last longer. Velvet push-pull action. Instant change replacement blades available. 12-foot size, made *only* by EVANS, has convenient new blade markings in feet and inches as well as regulation inches.

Evans & CO. 410 Trumbull St., Elizabeth, N. J.

EVANS
L-O-N-G “WHITE-TAPES”
25-50-75-100 Ft. Lengths. Sensibly priced from \$3.49. In transparent utility box. Leather grained vinyl cover. Hook ring attachment no extra charge.
Sold Only Through Retailers

EVANS, THE LARGEST PRODUCERS OF STEEL TAPES WORLD-OVER

**RELIEVES
HEADACHE
NEURALGIA
NEURITIS PAIN**

FAST



Here's Why...

Anacin® is like a doctor's prescription. That is, Anacin contains not one but a combination of medically proved active ingredients. Anacin is specially compounded to give FAST, LONG LASTING relief. Don't wait. Buy Anacin today.

SEA LEGS PRICES from **\$39.00**

QUALITY BOAT KITS F. O. B. DEFIANCE, OHIO
WRITE FOR FREE LITERATURE
PENNEY WOODCRAFT INDUSTRIES
1301-09 Ottawa Ave., Dept. 5-M Defiance, Ohio

BUILD FINE GRANDFATHER CLOCK NOW

The simple sensitive Red-I-Kut way as thousands have — SAVE HALF. SHOP TESTED PLANS "SPIRIT OF THE CENTURY" Narrow waist 83" tall of stately straight side "SPIRIT OF AMERICA." EASY-TO-FOLLOW photograph PLANS tell all—plus BROCHURE of heavy brass weight Westminster, tube chime, movements, porcelain dials, 3/4" solid mahogany case kits. Send \$1.00 today — Both plans \$1.50 NOW.

<p>Also Eshelman SPORT CARS WORLD'S LOWEST PRICE 70 Miles Per Gal. Holds 1 Adult Free Literature</p>	<p>RAKES CULTIVATES HARROWS HAULS SPRAYS SAWS DOZER MOWS CUTS ROLLS TRACTORS TILLS SNOW PLOW</p>	<p>ESHELMAN FOR Better LAWNS And GARDENS</p> <p>Women Can Operate It. Free Catalog. Write</p> <p>ESHELMAN, Dept. R-55 119 Light St., Baltimore, Md. 333 N. Michigan Ave., Chicago - 1, Ill. 7070 Hollywood Blvd., Los Angeles 28, Cal.</p>
	<p>1 to 8 H.P. Also WALKING TRACTORS Low 33 \$69</p>	

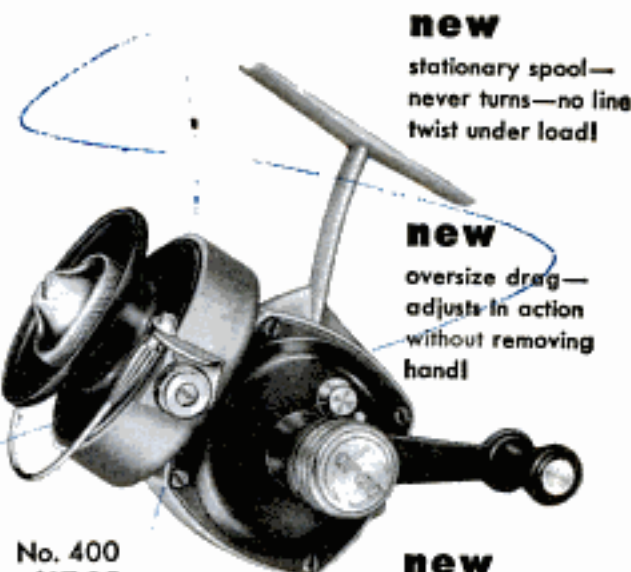

No. 400
\$17.95

new
stationary spool—
never turns—no line
twist under load!

new
oversize drag—
adjusts in action
without removing
hand!

new
geared-action drag
—extra smoothness,
power and long
life!

new

Bronson Spinit

Try the new Bronson "Spinit"—the only American made spinning reel that doesn't twist the line when the drag slips—the spool never turns in either direction.

And new Spinit geared-action drag works on the crankshaft, not the spool—you always get accurate, steady tension. New oversize button can be adjusted with a fingertip while you play the fish.

See the Bronson Spinit at your sporting goods counter—only \$17.95. Other Bronson and Bronson-made J. A. Coxé reels are priced from \$2.95 to \$33.00.

BRONSON REEL CO., BRONSON, MICHIGAN
(Div. of Higbie Mfg. Co.)



**The Modern PLASTIC
for lasting Home Repairs**

PERMANENTLY mends cracks or holes in wood, tile, stone or plaster. Sticks and stays put—Does not chip, shrink or fall out. Easy to use. Economical. Mold it, chisel it, polish or paint it. If unobtainable from your lumber, paint or hardware dealer, the big 4-lb. can will be sent you post-paid (in U.S.) for only \$1.25. Full money-back guarantee, order now.

DONALD DURHAM CO.
Box 804-T Des Moines, Iowa

Bronson Royal-Matic
No. 390 • \$10.95

Outworks, outlooks them all—blue-green anodized aluminum, bronze bearings, silent wind, free-stripping with governor-controlled retrieve.



**Trims Grass
Edges Lawns
Trims Hedges**

Trim Master

Patented

The most versatile electrical trimmers in the low price field. Does all three lawn care jobs with professional precision — an hour's trimming in 5 minutes. So light, so easy to operate, *anyone* can use it! See them at your hardware or garden supply dealer.

Trim Master Jr.
for heavy duty
lawn care \$44.95

Trim Master Bantam
priced for every
home owner \$27.95



Write for complete literature

E. F. BRITTEN CO., INC.

27 South Avenue W., Cranford, New Jersey

BE YOUR OWN BOSS!

Make Up to \$50 Daily As a
Floor Surfacing Contractor

BE INDEPENDENT! You can be free of bosses and layoffs and earn as high as \$50 a day sanding floors with Clarke equipment. A small investment will start you off in the growing building field. Get ready now for good pay and a big future. Start the way hundreds of successful contractors have by mailing this coupon today.



CLARKE SANDING MACHINE CO.

455 Clay Avenue Muskegon, Mich.

I'm interested! Send me complete free details on how to be a floor surfacing contractor.

NAME _____

STREET _____

CITY _____

STATE _____

**CATCH 'EM
KING-SIZE
WITH
THE Flatfish**



If you want to get away from the minnow plague and hook into lunkers for a change, tie on a Flatfish and go after the king-size fellows that the Flatfish has such an overpowering attraction for. World's largest selling plug. Over 12,500,000 sold. Get it at your tackle dealer's or write for 48-page book with fishing secrets of famous anglers.

HELIN TACKLE CO.

Free CATALOG

3669 Meldrum Detroit 7, Mich.

CUT BUILDING COSTS 1/3! Make Your Own Concrete BLOCKS and BRICKS To Use or Sell



New superior moulds make absolutely square, true, easy-to-lay blocks which will pass any building code. Production is fast... easy. One durable \$30 machine will make four 8"x8"x12" blocks per minute—1,000 a day. Pays for itself in one day! Sell blocks for big profit... or save 1/3 building cost for yourself. POST CARD BRINGS FREE FOLDER.

ECONOMY MFG. CO.

DEPT. P STONE MOUNTAIN, GA.

SHEET METAL BRAKES

Angles, flanges, Pittsburgh locks.

24 G. steel, heavier aluminum. Cam locking, mount on bench, truck or floor stand. Truss braced steel. Express collect. 30", 60" lbs., \$28.50. 36", 75 lbs., \$33.00. 48", 100 lbs., \$48.00. Also 8 ft. size. Floor stand. 22 lbs., \$7.00. 15" capacity 16 gauge, 40 lbs., \$21.50.

IRON BENDER 1/4"x3" \$9.50. TUBING BENDER 3/4"x1", \$6.00. SHEARS 7x16 ga. steel, \$14.00; 24" squaring and sitting shear, 24 ga. 16 ga. aluminum, \$38.00. Mand Bending Brake, 14", \$6.50 P. Paid.

Immediate delivery. Order direct, cash or C.O.D., or send for folder!

VYKE BRAKE CO., P-2439 15th St., Denver 11, Colo.

SEND FOR OUR NEW CATALOG

SAVE ON SURPLUS TOOLS & EQUIPMENT!

Choose from many hundreds of new and used Gov't. and industrial surplus tools, equipment and supplies at a fraction of their normal cost! Write today—send 10c with your request for Catalog B to



**T&T TOOL CO. 7667 GRAND RIVER
DETROIT 4, MICH.**

EARN YOUR OWN KING MIDGET We want rider agents to demonstrate and sell the World's Lowest Priced Two Passenger Automobile. Fully assembled or bolt together parts. If there is no dealer near you send 25c for detailed literature with wholesale dealers price or \$1 (refunded first order) for this plus actual assembly book and service manual. **MIDGET MOTORS MANUFACTURING CO., Athens, Ohio**

KING MIDGET AUTOMOBILE



POPULAR MECHANICS

Copyrighted material

ARE YOU MISSING THE BIGGEST THRILLS IN RADIO?

Get a hallicrafters Short-Wave and Hear it All!

You don't know how exciting radio can be until you've listened to today's short-wave. You hear stations from all over the world—broadcasting both in their own languages and English—mostly English. You hear ships at sea, planes in the air, police and military broadcasts that trigger tomorrow's headlines. You hear London, Paris, Rome, Rio—Moscow propaganda and our answers to it on the Voice of America. And plenty more!

Hallicrafters is by long odds the leader in the short-wave field. An unmatched record of dependability with amateurs, plus 20 years' experience in producing vital military radio communications equipment, stand back of every receiver sold under the Hallicrafters name. See your dealer today. Hear a Hallicrafters—and you'll choose a Hallicrafters!

4401 West Fifth Avenue, Chicago 24, Illinois • Hallicrafters Ltd., 51 Camden Street, Toronto, Canada



FAMOUS HALLICRAFTERS 5-38C—Most popular communications-type receiver in the world! Has electrical band-spread tuning to separate crowded stations. High gain circuit pulls in stations from all over the world. You hear five wave-bands. Regular broadcast plus 540 kc to 32 mc. Operates on regular 110 V AC/DC. **Only \$49.95**

hallicrafters

The Name Is Famous

Radio • Television • High Fidelity

MODERN LAWN MOWER SHARPENER

Service departments of leading Lawn Mower manufacturers use the Modern Lawn Mower Sharpener. One lever moves lawn mower into grinding position. Gasoline and oil remain in engine while sharpening, no dismantling of wheels, roller or handle. The Modern is a precision bed knife grinder—no extra grinder to buy. Imitated but never equaled—Compare before you buy. If it isn't a Modern it can't be Modern (Prices subject to change without notice)

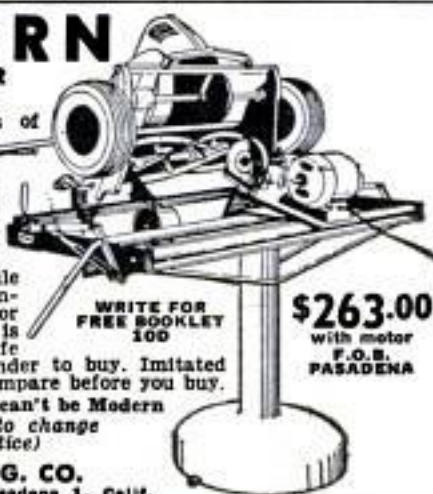

WRITE FOR FREE BOOKLET 100 **\$263.00** with motor F.O.B. PASADENA

MODERN MFG. CO.
160 N. Fair Oaks • Pasadena 1, Calif.

LOOK-

A great value! Sturdy metal case. Rich two-tone green finish. Gold-color bright plated lens ring. Famous G. E. Sealed Beam unit. See your dealer... Get one!

DELTA ELECTRIC CO.
Marion, Indiana

Delta-RAY SEALED BEAM Electric Lantern

A SEALED BEAM ELECTRIC LANTERN for only **\$5.50** less 6V battery



MAY 1954



Build your own room divider!

Save money! Build this room divider-desk with strong, grainless Masonite Presdwood® and plan #AE-295. Works like wood. 33 types and thicknesses at your building materials dealer's.

Send for "Idea Book." Lists free plans.

NATURALLY STRONGER WITH LIGNIN

PRESWOOD WOOD MADE BETTER

MASONITE CORPORATION
Dept. PM-5, Box 777, Chicago 90, Ill.

Here's a dime to cover expenses of sending "Idea Book" and plan #AE-295.

Name.....

Address.....

Town.....Zone.....

County.....State.....

"Masonite" signifies that Masonite Corporation is the source of the product

273



More Power for TOUGH JOBS!

Gravely Rotary Mower attachment makes the toughest mowing jobs *easy*. Lawn or weeds, cut 30-inch swath fast and clean with suction-tip, file-sharpened knives.

Gravely does jobs other tractors won't . . . because the 5-HP Gravely has the *extra* power that makes tough jobs easy.

Let us show you the advantages of the Gravely's *extra* power . . . all-gear drive . . . power reverse . . . your choice of 21 tools to do every mowing, gardening or upkeep job . . . *faster, better, easier!*



Write for FREE Booklet
"Power vs Drudgery"

GRAVELY TRACTORS, INC.
BOX 563 DUNBAR, W. VA.

U-BUILD IT • FIREPLACE AQUARIUM

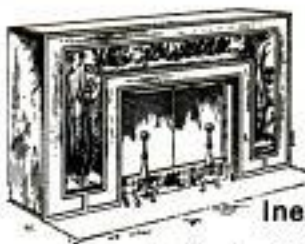

MONEY MAKING HOBBY

Can be built around any standard hearth. Beautifies. Colorful. Recirculating water. Tropical fish. Growing plants. Also lights up.

Inexpensive and easy to build.

Entirely New and Unusual

SPECIAL COPYRIGHT PLANS \$2 PPD. NO COD.

A. J. BERNA COMPANY

20160 SHERWOOD

DETROIT 34, MICH.



WOODCRAFTSMEN'S
144 page
ENCYCLOPEDIA 15¢

Bargain book of every conceivable wood-working item and tools. Full of How-To-Do-It information, illustrations, projects and ideas. Domestic and imported woods, inlays, panels, etc. Send for your copy today. Biggest 15c worth ever offered.
CRAFTSMAN WOOD SERVICE CO.
Dept. A5B, 2729 S. Mary Street, Chicago 8, Illinois

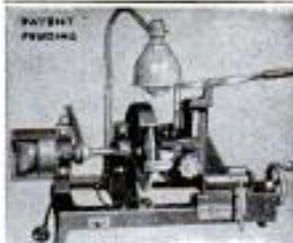

Start a NEW BUSINESS!

or Add to your present
Repair Business
SHARPEN DULL PIPE WRENCHES
PIPE TAPS & DIES
"GUM" CIRCULAR SAWS
Also MOTOR DRIVEN ROTARY HONE
Write for Information

J. C. MOORE INDUSTRIES
BOX M 276 FREDONIA, PA.



Print Your Own

Cards, stationery, circulars, tags, labels, photo and movie titles, advertising, etc. Save money. **Print for Others, Good Profit!** Easy rules sent. Raised Printing like Engraving, too. Sold direct from factory only. Write for free catalog of outfits and all details. **KELSEY PRESSES, M-37, Meriden, Conn.**



G E A R S

In Stock - Immediate Delivery
Gears, speed reducers, sprockets, "trust bearings, flexible couplings, pulleys, etc. A complete line is carried in our Chicago stock. Can also quote on special gears of all kind. Send in your blueprints and inquiries.

Send for Complete Catalog No. 10
CHICAGO GEAR WORKS
440-50 N. Oakley Blvd., CHICAGO 12, ILL.

Take The "PAIN" Out of PAINTING!



Basements . . . Fences . . . Furniture . . .

USE A BECKER CO₂ SPRAY GUN

Take It Anywhere! No Compressor . . . No Electric Cords Needed. Sprays: Paints, Oil, Varnishes, Insecticides, etc.

Men! Women! Here's the easy way to lick those tough, tedious, tiresome paint jobs. Becker Spray Gun is fun to use, requires no electricity or compressors—pre-pressurized by low-cost CO₂ cartridges each sprays up to 21 sq. containerful. Used 5 years successfully in industry.

SEE YOUR DEALER! If he cannot supply, order direct for postpaid. Extra cartridges 10 for \$1.

SULLIVAN-BECKER CO.
Dept. 114-E Kenosha, Wis.



ONLY
\$19.95
with box of
10 cartridges

How to cut glass



Simple instructions make glass cutting safe and easy. Free book tells how, shows in pictures. Limited printing. Free copy is yours if you write now. Send handy coupon today!

FREE

MAIL THIS HANDY COUPON RIGHT AWAY

Red Devil Tools, Irvington 11, N. J.
Please send free copy of Booklet HT-206
"How to Cut Glass."

NAME _____
ADDRESS _____
CITY _____ STATE _____

Winco® electric power

WHEREVER you need it!

Hunting and fishing lodges, camps, cottages—wherever lights and power are needed away from electric lines. Winco Portable Power Generators have belted construction for peak efficiency. Sold with standard 4-cycle engines.



WHENEVER you need it!

You can keep power tools, lights, all essential electric equipment going during power failures with a Winco power Generator. Models available from 700 to 12,000 watts. Write today for complete descriptive literature or contact your nearest dealer.



Winco® WINCHARGER CORPORATION SIOUX CITY 2, IOWA

Subsidiary of ZENITH Radio Corp.



GET THIS STRAIGHT you can't beat an EMPIRE LEVEL



For improved accuracy, better visibility, less breakage, use the new Empire 9" aluminum Torpedo pocket level with machined bottom groove and protected, easy-reading vials. See your dealer today for all-purpose Empire Levels.

EMPIRE

LEVEL MFG. CO.

10930 W. Potter Rd., Dept. PM
Milwaukee 13, Wisconsin



PUMP WATER FAST!

DRAIN WASH TUBS, CELLARS, CISTERNS
IRRIGATE—FILL TANKS—DRAW WELL WATER

Pumps 2800 GPH. 420 GPH at 75' High or 1600 GPH from 25' well. Sturdy, Rustproof Alloy Metal. Six Blade Impeller. Uses any 1/8 to 1/2 H.P. Motor. Will not leak or clog. Fits any garden hose. Immediate Money Back Guarantee. Send Check, M.O., or C.O.D. **895** U.S.

MOORE MANUFACTURING CO.
SWEDSBORO 1 NEW JERSEY

REPLACE LOOSE FAUCET HANDLES

... QUICKLY! EASILY! AT LOW COST!

WITH
NUWAY
TAMP-ON
REPLACEMENT
FAUCET HANDLES!

Are guaranteed
to delight you
or your money
back



• Sensational new replacement ends loose faucet trouble! Replace loose metal or china handles! Anyone can install in a matter of minutes with light hammer and screwdriver! Beautiful Chrome finish, modern design, rugged construction, top quality! Will never slip or wear loose! Special insert within handle having four sharp hardened edges cuts life-time locking grooves ending trouble permanently! Order at once... you'll be delighted! Write!

Type "A" per pair postpaid \$2.00 Type "B" per pair postpaid \$1.00

NUWAY Company • 257 Richton, Detroit 3, Mich.

Save money DO IT YOURSELF with SPEEDY RIVETS



BIND REPORTS



REPAIR LUGGAGE



FIX FOOTWEAR



MEND CLOTHES

Do jobs you never thought you could do yourself... fasten leather, cloth, paper, plastic sheeting... ideal for craftwork, too... quick, secure, permanent. Simply punch a hole in each part to be fastened, push rivet together through holes, place on firm surface and swat with a hammer. Gilt, nickel, black, brown finishes. Large (6 to a card) or small (10 to a card) sizes.



AT HARDWARE COUNTERS
EVERYWHERE 15¢ per card

THE DOT LINE

3229 South Ashland Ave., Chicago 8, Illinois

THE NEW MODEL TV-11

TUBE TESTER



SPECIFICATIONS

- Uses the new self-cleaning Lever Action Switches for individual element testing.
- Because all elements are numbered according to pin-number in the RMA base numbering system, the user can instantly identify which element is under test. Tubes having tapped filaments and tubes with filaments terminating in more than one pin are truly tested with the Model TV-11 as any of the pins may be placed in the neutral position when necessary.

- The Model TV-11 does not use any combination type sockets. Instead individual sockets are used for each type of tube. Thus it is impossible to damage a tube by inserting it in the wrong socket.
- Free-moving built-in roll chart provides complete data for all tubes.
- Phone Jack on front panel for plugging in either phones or external amplifier will detect microphonic tubes or noise due to faulty elements and loose external connections.

Operates on 105-130 Volt 60 Cycles A.C. Hand-rubbed oak cabinet complete with portable cover. **\$47.50**

**SHIPPED ON APPROVAL
NO MONEY WITH ORDER - NO C. O. D.**

Try it for 10 days before you buy. If completely satisfied send \$11.50 and pay balance at rate of \$6.00 per month for 6 months—No Interest or Carrying Charges Added. If not completely satisfied, return to us, no explanation necessary.

MOSS ELECTRONIC DISTRIBUTING CO.
Dept. D-24, 3849 Tenth Ave., New York 34, N. Y.
Please rush 1 Model TV-11. I agree to pay \$11.50 within 10 days after receipt and \$6.00 per month thereafter.

Name _____
Address _____
City _____ Zone _____ State _____

Say You Saw It in Popular Mechanics

Your ELECTRIC DRILL Trims HEDGES — SHRUBS — GRASS with **ROTO-TRIM** DRILL ATTACHMENT

FITS ANY 1/4" DRILL
Today's Greatest Hedge Trimmer VALUE \$12.95 (Less Drill)
Yours, Postpaid, for only **\$12.95**

Keep your whole yard neatly tailored . . . trim hedges, shrubs, and hard-to-reach grass easily and smoothly with this new, inexpensive drill attachment. ROTO-TRIM quickly converts any 1/4" drill into an easy handling, keen-cutting Hedge Trimmer.

Quality Built throughout. Rigid steel and aluminum construction with smooth-running hardened steel gears and cam in one-piece case. Cutting blades are 10" long, of high-carbon steel, heat-treated, precision ground and designed for maximum safety and efficiency.

Easy to Use! Quickly attached to drill—flats simplify chucking. Light weight and precision balance make ROTO-TRIM much easier to handle than more expensive trimmers. Handle turns blade to any angle.

Order TODAY! Don't miss this chance to get your ROTO-TRIM Hedge Trimmer Attachment while still available at today's low price of \$12.95.

UNCONDITIONAL 10-DAY MONEY BACK GUARANTEE! Send check, cash or M. O. and we'll ship postpaid — direct from factory to you.

Dept. 752 **ROTEX COMPANY** 837 WEST DAVIS DALLAS 8, TEXAS

A third hand for painters!

**WHIZZER
Can and Brush
Holder**



NO MORE PAINT DRIP!

Smooth, durable plastic pistol grip, spring steel band holds all quart cans firmly. Brush clip eliminates drips, messy brush handles, smeared hands. Carry paint and brush easily, safely, comfortably, even while climbing ladders. Guaranteed.

If dealer can't supply you, order direct. **\$7.00** Postpaid

WHIZZER PRODUCTS CO., 338 S. SANFORD, PONTIAC, MICH.

MAGNETS 225 lb. PULL
GENUINE ALNICO - NEVER WEAKENS

AMAZING, PERMANENT MAGNETS—WILL NOT WEAKEN! NON-ELECTRIC Retrieve guns, tackle, tools and other steel items from lake, river, plating tanks, drains or other hard-to-reach spots. Recover drills, taps, etc. from sweeping, clear alley of harmful tacks, nails. Many other uses. Pays for itself quickly. GUARANTEED. Try any magnet one week. Money refunded if you are not well pleased.

No. M-725 (Weights 54 oz.) Has pull of 225 lbs. on steel block. \$15.00
No. M-675 (Weights 49 oz.) Has pull of 175 lbs. on steel block. \$10.50
No. M-650 (Weights 41 oz.) Has pull of 150 lbs. on steel block. \$ 8.50
No. M-550 (Weights 15 oz.) Has pull of 50 lbs. on steel block. \$ 4.00
No. M-30 Hobbyist assortment of six small magnets. \$ 1.50

Send Money Order or Check. We pay postage. No C.O.D.'s.
MIAMI MAGNET COMPANY, 3240 N. W. 27th Ave., Miami 42, Fla.

NEW WAY TO CUT PERFECT GROOVES WITH CIRCLE SAW!

Just dial any of 40 cuts. Parallel, clean, no sanding! Leave on saw for regular cuts. For 1/2, 3/8, 3/4 and 1" arbors. At dealer's or order direct! Send for free booklet

Only \$4.95 per set

WARREN DADO WASHERS CO.

Dept. # 25 P.O. Box 98, Detroit 2, Mich.

SUMP PUMPS 2,400 GALLON CAPACITY

1 1/4" outlet — No screen to clog — fool proof
The time tested Lokomona sump pump is absolutely automatic — has a special fool-proof trap at the intake—oilless bearing at the bottom. Made of aluminum casting. It's 4 1/2" high and carries a 1/2 H.P. 100 V. A.C. heavy duty motor. The pump is designed for continuous service. Enclosed switch. All parts always available. Order yours today. C.O.D. If cash with order, we pay freight.

\$46.50 COMPLETE
\$28.00 LESS MOTOR
\$24.50 PUMP ONLY

MONEY BACK GUARANTEE
LOKOMONA PUMP CO., P.O. BOX 86, ROYAL OAK 1, MICH.

CLEANS BATTERY PLATES WHILE IN USE

You can add new pep and months of service to your old battery! Batteries "slow down" due to sulphation... DUBLE-power removes sulphation, makes your battery efficient again.



DUBLE Power puts new life in old batteries!
Treatment ONLY \$1.50 at your service station or garage

CONTINENTAL LABORATORY, INC., 4727 N. E. PRISCOTT, PORTLAND 13, OREGON

FRAMED IN FAME—
Safety-Engineered
**UTILITY
AXLES**



MODEL 1-UCO, shown, features 1½" square axle of solid steel; 2500 lb. capacity. Comes completely equipped, except for tires. List price \$65.29, Fed. Ex. Tax included, F.O.B. Wausau. Other models to 5000 lb. capacity. We manufacture a complete line of trailer axles, couplers and jacks. Write for Brochure 13-E

HAMMER BLOW TOOL CO.

"As old as the Industry!"
WAUSAU, WISCONSIN

MAK-A-LITE

**PERMANENT STEEL ASSEMBLY
TO MAKE POWERFUL,
PORTABLE LIGHT**

Hooks up 6-volt battery and 95,000 c.p. light. Inexpensive way to make a light that is more powerful than other lights costing \$20. 1 minute to assemble. Won't rust or corrode. Guaranteed. To order MAK-A-LITE send us \$1.00. Battery and bulb available at auto supply stores.



BARNES-DIVINE MFG. CO., INC.
425 S.W. 24 Oklahoma City, Okla.

NO C.O.D.'s

make your own Gems 29.50
F.O.B.

The Gem Maker comes complete with all necessary equipment, including a super-charged diamond blade for sawing, and all wheels for grinding, shaping and polishing; also complete instructions. The complete equipment as shown, less motor and belt, for only \$29.50, f.o.b., Burlington, Wisconsin. Write today for information and literature.

B&I MANUFACTURING CO.
Dept. S Burlington, Wis.



STOP DRIP

caused from sweating or condensation on cold water pipes. Turn idle basement space into play, work or store rooms. Just wrap cork-filled NoDrip Tape around pipes and joints and the job's done—permanently.

**NO Drip
TAPE**

Roll covers about 10 feet of ½" pipe, \$1.69. Higher west of Rockies and Canada. Get at Hardware, Paint, Dept. Stores, or sent postpaid. Write for free circular. J. W. Mortell Co., 522 Burch St., Kankakee, Ill.



Planning to build, remodel or repair?
**This Spring let
SKIL tools
do your work!**



...while they pay
for themselves
with the dollars
you'll save!

Want to *improve* the value of your home by many, many dollars at the cost of a very few? SKIL Home Shop Tools are the way to do it!

A SKIL Saw is the world's finest portable saw for remodeling your home, cutting plywood panels, sheeting, siding. You can even cut stone, metals or compositions with special blades. With a SKIL Saw Table and Sander-Shaper Kit, you have an *unbeatable* table saw combination to do precision sawing plus the shaping and sanding necessary in building cabinets, furniture—all projects of this kind with professional results!

SKIL Home Shop and Builders Saws are available in six models. 6", 7¼", 8¼" blade sizes. From \$43.95.*

*Prices subject to change without notice.



**SKIL ¼" Drill Meets
Every Handy Man
and Hobby Need.**



**SKIL 2¼" Belt Sander
for Professional
Finishes.**

To save you time and work, there are more than **22 SKIL Home Shop Tools**. Visit your hardware dealer, appliance or department store.

Made only by SKIL Corporation
formerly SKILSAW, Inc.
5033 Elston Ave., Chicago 30, Illinois
3601 Dundas St. West, Toronto 9, Ont.
Factory Branches in All Leading Cities

SKIL
HOME SHOP TOOLS

PIONEER WORK SAVERS
 NOW BETTER THAN EVER—GREAT NEW 1954
SHAW
 "DU-ALL"
Garden and Small Farm Tractors

Plow.. Cultivate.. Mow.. Rake.. Bulldoze..
 Saw Wood.. Make Many Other Hard Jobs Easy



Sturdy 1½ to 5 H.P. Walking Tractor

Low New Prices
 Walking Tractors \$99.50 up.
 Riding Tractors \$298.50 up.

Best for all around garden and lawn work. Variable speeds, adjustable wheel widths, individual gang tool controls. 3 speed and reverse automotive

gears on 3 and 5 H.P. models. Superb traction, deep plowing, easy handling. All wanted tools and attachments.

Rugged, Low Cost 2½, 5, 8 H.P. Streamliner

Powerful, practical, streamlined, comfortable. Pulls 8, 10, 12 inch plows, cultivators between 38" rows, bulldozes, mows lawns, operates belt attachments. 3 speeds and reverse automotive transmission. Friction brakes, ¾ to 7 M.P.H. Nothing else like it in a tractor that will get the work done.



Inexpensive New Tiller... Lawn Mower

Nine inch rotor pulverizes 12 inch swath 6 inches deep. 1½ H.P. Extremely low cost. Rotor quickly replaced with single wheel for lawn mowing, hauling, etc.



Also larger 8, 12 H.P. riding tractors with 3 speeds and reverse automotive gears.

See the SHAW Dealer Write direct for FREE CATALOG complete Shaw line.

SHAW MANUFACTURING CO.
 4505 Front St., Galesburg, Kansas
 668-G N. 4th St., Columbus, Ohio



FOR SMOOTHER PAINTING



USE THE FINEST BRUSH

FREE BOOK—"How to Do a Good Paint Job." Send card (and name of your retailer, if you wish) to Baker Brush Co., Inc., 83 Grand St., New York City 13

Brushes by Baker

AMERICA'S FINEST PAINTING TOOLS

REDI-RODS
STEEL BARS
 FOR CONSTRUCTION AND REPAIR JOBS

HUNDREDS OF USES
IN HOME and SHOP

Here's just the material for your special projects and odd jobs—steel bars in handy, standard lengths. Inexpensive, and readily available, too.

Made by Makers of popular REDI-BOLT Threaded Steel Rods



SIZES

ROUNDS (36" Lengths)
 1/4", 5/16", 3/8", 7/16", 1/2", 5/8", & 3/4" diam.

FLATS (36" Lengths)
 3/4", 1", & 1-1/4" wide x 1/8" thick.

ANGLES (36", 48", & 60" Lengths). All 1/8" x 1-1/4" x 1-1/4".

Ask Your Hardware Dealer, or write
REDI-BOLT, INC., 5330 Indianapolis Blvd., East Chicago, Ind.

TREASURE -- \$10,000

New locator detects metals, valuable minerals and buried treasure. Money-back guarantee of superiority.

Also geiger counters. Govt. reward of \$10,000 for uranium discovery. Write for FREE information.



THE GOLDAK COMPANY
 1542 W. GLENDALE BLVD., GLENDALE 1, CALIF.

BUILD YOUR OWN FAN



One-piece cast aluminum propellers for cooling and ventilating.

Size	Polished	Unpolished	Base
Inches	2 Blade	2 Blade	2 Blade
15	\$3.00	\$4.00	\$2.50
18	3.75	5.00	3.00
20	4.00	5.50	3.25
24	4.50	6.50	4.00

Write for pamphlet on larger fan blades, wire guards, fan bases, shutters, pillow blocks, exhaust fan frames, etc. Dealers write for discount. Add 10% for packaging and shipping. Shipped C.O.D. or cash with order.

KLOPPENBORG ALUMINUM FDY., Dept. PM-54, Davenport, Iowa



TRANSFORMER WELDER \$19.95 FOR QUINCY

Complete with everything. Ready to plug in. 110 volts AC. 15-30 Amps. 3 heats. Welds metal from 1/16" to 1/4" using 1/16" to 3/32" standard rods. Guaranteed unconditionally. 10-day trial. No C.O.D. Does everything welders costing up to \$75.00 do. Buy direct and save.

ESSAY MFG. CO., INC., Dept. 51, Quincy 69, Mass.

L&S MIRROLURES



The lure with the **BUILT-IN FLASH!**

- Send for FREE Fisherman's Log with color "How to Use" insert. Record trips—know lures to use.



The L&S BAIT CO. Inc., Bradley 22, Illinois

POPULAR MECHANICS

Copyrighted material

NO NAILS
NO BOLTS
NO SCREWS

YIPEE-E-E
A SAWHORSE
IN A JIFFY



WITH **Jiffy** SAWHORSE BRACKETS

ALL WELDED construction. Use any 2x4's for legs and cross bar.

SET UP OR knocked down instantly. Easy to move from job to job, and easy to store.

FOR SALE BY most hardware and lumber stores. If your dealer cannot supply you, write us direct.



At Work



At Home



GRAND HAVEN STAMPED PRODUCTS CO.
GRAND HAVEN, MICH.

ALSO CHILD'S 2 PASS. MOTOR CAR For Kids 5 to 15

ESHELMAN HOLDS 1 ADULT

AUTO WITH MOTOR

WORLD'S LOWEST PRICE
70 Miles Per Gal. Gas.
25 Miles Per Hour.

Eshelman

DEPT. CM-85
119 Light St.,
Balto 2, Md.
333 N. Michigan Ave.,
Chicago 1, Ill.
7070 Hollywood Blvd., L. A. 28, Cal.



Write for Free Literature



LAWN ORNAMENT-NOVELTY PATTERNS

28 Lawn Ornament Patterns, 25c. Other Patterns; 15-20" high; Dutch Girl, Dutch Boy, Pirate, Bull Terrier, Mexican Girl, Mexican Boy, Dwarf, Penguin, Flower Girl, 15c each. 25 Novelty Patterns, 30c. All 62 Full Size Patterns, \$1.00. Strathairn Pattern Service, Dept. DP-8, Box 128, Belington, W. Va.

FREE BOAT KIT CATALOG

12 ft. Runabout

- Assemble your own boat
- No experience necessary
- Save 1/2 to 2/3 "factory built" prices
- Prices include freight and paint

Models from 39.25 complete



Marine Hardware & complete accessories

Kit Division 3207 FREMONT AVE. SO. MINNEAPOLIS 8, MINN.

BUILD
your own **SMITH**
AIR COMPRESSOR

Operates spray guns, rock drills, tampers, paving breakers, sandblasting . . . Uses only 1 gallon of gas an hour! Famous the world over! Capacity 60 cu. ft.; pressure up to 100 lbs. per sq. inch. Just order the Smith Compressor Head and Accessories with complete instructions for assembling. All you need is a Ford Motor and shop facilities. Head equipped with high speed compressor valves; automatic unloading and idling.

Write for complete information!

GORDON SMITH & COMPANY, Inc.
410 College Street • Bowling Green, Ky.



Look what you can do with these ready-to-install **Curtis Cabinets**

You can have the most modern kitchen in town —because Curtis wood cabinets bring you the 53 kitchen features women want *most*. Curtis cabinets are easily fitted together for any size or shape of kitchen. They are available in beautiful natural birch—or can be painted, if you prefer.



You can have a storage wall —here's the answer to getting more storage space in bedroom or utility room.



1866 **CURTIS** WOODWORK

More room for playthings—they can easily be stored in easy-to-reach cabinets in basement or child's room. Sold through retail lumber dealers everywhere.

Curtis Companies
Service Bureau
200 Curtis Building
Clinton, Iowa

PM-5-54

Please send Curtis kitchen idea book. I enclose 10 cents.

Name.....

Address.....

City..... State.....

Take perfect pictures!

USE THE NEW



SKAN
Quick
Exposure Meter

Instant
reading!

No computing needed!

Correct camera settings at-a-glance for all color or black & white photography!

New color styling! In handsome "Sportsman-Gray" with bright metal trim and smart black and red accents. A full size meter, weighs only 4 oz.

Complete with neck cord in "jewel-clear" Gift Box...
\$17.50
Ever-ready Case... \$1.95

New, full size photoelectric exposure meter eliminates tricky computations and guesswork. Has changeable ASA Index Slides that correspond to all popular films—black & white, color, indoor, outdoor. By merely inserting proper slide in meter you read correct camera settings in f/stops from f/2.8 to f/22 and speeds from 1/25 to 1/200. Covers entire color film range in 1/5 f/stops and has special marks for movie settings.

Complete computer dial on back—for special films and light conditions other than normal. Calculates speeds from 1/1000 to full 16 seconds; f/stops from f/1 to f/64; ASA Indexes from .3 to 800.

AT LEADING PHOTO DEALERS EVERYWHERE

SKAN a product of **G-M LABORATORIES INC.**
4230 N. KNOX AVE., CHICAGO 41

FIND OUT ABOUT AMERICA'S NEWEST AND FINEST 8" AND 10" TILT/ARBOR SAWS!



ATLAS PRESS COMPANY
524 N. PITCHER ST.
KALAMAZOO,
MICHIGAN

**FREE
CATALOG**

Please send me complete information about THE GREAT NEW ATLAS SAWS with the TEN ALL-NEW FEATURES that make them the fastest, smoothest, most accurate ever offered. I want to see for myself why they are being acclaimed by commercial users and hobbyists alike.

Also send me the name of my nearest franchised ATLAS dealer.

NAME _____

ADDRESS _____

CITY _____ STATE _____

you can DO so much MORE so much BETTER with



NOW EASY TO APPLY YOURSELF ALUMINUM MOULDINGS

Twelve Foot Turns any home-coil for only \$2.50

Turns any home-made shelves, sink tops, false tops, etc. into a beautiful, lasting installation with professional finished edges and streamlined effect. Each kit contains twelve foot coil of heavy gauge chrome finish extruded aluminum counter-edge moulding with trim-aluster finish, guaranteed not to rub off black. Order by mail.

Fasteners enclosed. Easy to install. No experience needed. State number of coils wanted and choice of sizes 3/4", 1 1/2" or 1-1/16" underlip. Or 3/4" inside corner cove moulding, all \$2.50 per 12 foot Roll-Pack. Order now C.O.D. plus postage. Or save money; enclose payment with order and we pay postage.

ALBERT ALLAN INDUSTRIES
Matheson Bldg., Baltimore 2, Md.
Also write for Free Catalog of Decorative Genuine FORMICA for table tops, etc.

At Bottom: — Style A 126, 1/2" counter edge moulding with 3/8" plastic color insert, which covers fasteners. Twelve foot coil \$3.00. State color insert desired.

WELD BRAZE
SOLDER CUT

4WAY
ONLY \$14.75
f.o.b. factory

WELDER

Acclaimed by thousands of Homeowners, Mechanics and Hobbyists as the welder of 1001 uses. Easily operated from properly wired 110 volt AC or DC line. The ideal gift with a life-long use... Order today on 10 day money back guarantee.

FOUR-WAY WELDER CO., Dept. F2-E
1810 S. Federal St. • Chicago 16, Ill.

Complete with Twin Carbon Arc Torch and accessories... to handle all metal-craft work.

FREE CRAFT CATALOG

120 PAGES... Craft Supplies, Tools, Designs, Instruction Books from America's Largest, Most Complete Handcraft Stock.

Send for your free copy NOW!
GRIFFIN CRAFT SUPPLIES
5626-A Telegraph Ave • Oakland 9, Calif.

HAWAIIAN WIGGLER #1

WORLD-FAMOUS FISH-GETTER

Deep runner. No snag-up in pads and brush. Easy to cast. Rubber Mula Skirt acts alive. At your dealer 5/8 oz. or **FRED ARBOGAST CO. INC.** 1/4 oz., \$1.15 each. 2215 W. North St., Akron 3, Ohio

FREE WRITE TODAY FOR YOUR BIG FREE ARBOGAST COLOR CATALOG—FULL OF PICTURES OF CATCHES

Say You Saw It in Popular Mechanics

DON'T SETTLE FOR *Less!*

SEND FOR THE STORY OF THE WORLD'S MOST ADVANCED MOWER

GEORGE

SELF-PROPELLED
ROTARY MOWER 20"
ONLY \$15900 F.O.B.

ADD-TACHMENTS FOR USE WITH SAME POWER UNIT

- DUMP BARROW
- SNOW FLOW
- GARDEN TOOLS

WRITE FOR ILLUSTRATED BROCHURE
Dept. B GEORGE GARDEN TOOLS • SULLIVAN, ILL.

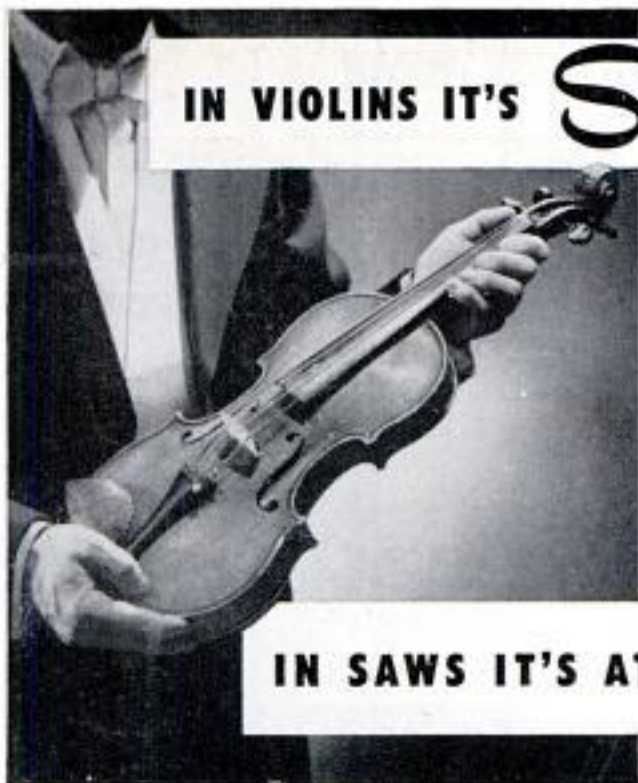

IN VIOLINS IT'S **Stradivarius**



IN SAWS IT'S ATKINS **Silver Steel**[®]



ATKINS

ATKINS SAW DIVISION
BORG-WARNER CORPORATION
INDIANAPOLIS 9, INDIANA



Treasure - Minerals - COINS
Easily located with new Light-weight M-Scope Detector. Superior performance, lowest price, monthly payment plan.
FREE LITERATURE
FISHER RESEARCH LAB., INC.
PALO ALTO CALIF.

BIG SAVINGS — ASSEMBLE YOUR OWN!



Beautiful upholstered chairs, sectionals, etc., at big savings! Kits come complete, with frame, springs, paddings, cover. Choice of 20 fabrics. Step-by-step instructions. No experience needed. 2 piece sectional only \$70.75 fob. Armchair \$20.75 fob. Use only ordinary hammer, screw driver, scissors to assemble. Your chance to save more than half on beautiful new furniture. Write for free details and fabric samples.
NEW TRENDS FURNITURE CO.
Dept. P-5, 737 Robertson, Wauwatosa 13, Wis.

Regular Price of a Slide Rule \$4 and up



Slide Rule **92c**
and this coupon Add 8c Postage

If you can use a pencil you can use a slide rule. For bookkeepers, accountants, salesmen (figuring commissions, cost, etc.), farmers, housewives, etc. For Armed Forces highly important. Men's most useful tool. Easy to calculate instantly. Multiplying, proportions, division, roots, etc. "High Vision" Clear View Slide. Full 10" Rule. A, B, C, D, C1 and K scales.
FREE 28-page instruction book on how to get correct answers instantly without pencil or paper.
Gene Loewy, 545 5th Ave., Dept. 43-R, N.Y. 17
Limit three rules to each coupon

NOW — build this practical **SWING-UP GARAGE DOOR**
at a major saving



MAKE it at home...
... with HOMASOTE

The construction plan for this door is adaptable to openings of many sizes. Light and easy to operate, the door swings up on standard overhead garage door hardware. *You build without blueprints!* Our Simplified Easi-Bild* Pattern No. 86 shows you how to cut each piece to exact size—specifies all materials required—shows how to assemble and install the finished door.

15/32" Homasote—the oldest and strongest insulating-building board on the market—is the major material used. *Weatherproof and permanently crackproof*, Homasote saws and nails easier than wood—provides the perfect surface for any paint or stain finish. Homasote is distributed by building materials dealers throughout the United States and in Canada. Send coupon today for pattern and Homasote literature. *T. M. Reg. Easi-Bild Pattern Company

HOMASOTE CO., Dept. 65, Trenton 3, N. J.
I enclose 50¢ for which send me Pattern #86.

NAME.....
ADDRESS.....
CITY.....STATE.....
My lumber dealer is.....



OWN YOUR BUSINESS

Start in Spare Time with a FOLEY SAW FILER

Here is a steady repeat CASH business you can start at home in your basement or garage, while you are working at your regular job. No experience is necessary to turn out perfect cutting saws—"the first saw I sharpened came out 100%. I think the Foley Saw Filer is a marvel of perfection," writes Clarence E. Parsons. Every saw you sharpen will bring you new customers. You will find you can make up to \$3 or \$4 an hour — \$20 to \$30 a week in your spare time as a starter.

With a Foley Saw Filer you can file all hand saws, also band and cross-cut circular saws. It is easy to operate—simple adjustments—no eye-strain. Patented jointing principle evens up all irregular teeth and makes an old saw cut just like new.

This Free Book Shows How to Start

"MONEY MAKING FACTS" shows you how to get plenty of saws to file without canvassing, and how you can develop into a general repair shop that will be your own business. This is a helpful, practical book that tells just what to do—send for your free copy today. No salesman will call.



Send for **FREE BOOK**

FOLEY MFG. CO., 516-4 Foley Bldg.
Minneapolis 18, Minn.

Send me free book "MONEY MAKING FACTS."

Name _____

Address _____

HARGRAVE

HAND SCREWS



Ideal for craftsmen in home shop or factory. Hargrave Hand Screws are strong and durable, have refinements of construction found in no other Hand Screw. Spindles are cold-drawn with longer wearing "Acme" thread. Jaws are of selected maple. Openings in a complete range of sizes down to 2 inches.

Ask for Hargrave at your Hardware Dealer

Write for Catalog of Complete Line

1987 Waverly Ave.
Cincinnati 12, Ohio

The CINCINNATI TOOL Co.



COMPLETE SET \$125
of 12 Post Paid Only

Vanadium steel drills, 3/32" shanks. Assorted No. 1 to 12 or all the same (state which). Easily worth more than double our low price. Send check or money order to Dept. M.

GENERAL AIRE CO.
3523 Cottman Avenue, Phila., Pa.

MAKE MORE MONEY!

Dealers or Representatives Needed for nationally advertised line of Spark Plugs — Oil Filters — Auto Specialties — Liberal Proposition — Full or Part Time — Experience Not Necessary — Write Today

ENGINE PRODUCTS MFG. CO.

5801 E. Beverly Blvd., Dept. 100 Los Angeles 22, Calif.



BRONZE FOUNDRY

Schools and Home Workshops

Make your own castings of aluminum, copper, bronze, silver. Foundry sets are available in three sizes including 2400 Deg. F. blast Furnaces. \$22.50; \$29.50; and \$42.00. f.o.b. Kansas City. Free Circular.

KANSAS CITY SPECIALTIES CO. P. O. Box 6022, Dept. P-5
KANSAS CITY, MO.

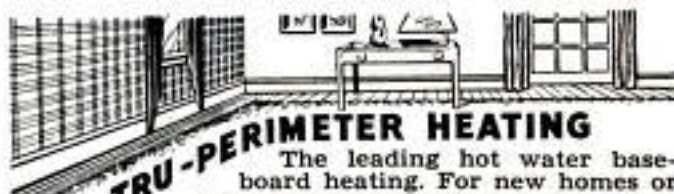

TRU-PERIMETER HEATING

The leading hot water baseboard heating. For new homes or old. Folder on request to Dept. PM5, Warren Webster and Company, Camden 5, N. J.

Webster
TRU-PERIMETER FORCED HOT WATER
BASEBOARD HEATING

41 NEW MODELS for 1954

Custom-Craft

THE ORIGINAL "PACKAGED"

BOAT KITS

RATED "TOPS" BY THE EXPERTS in DESIGN, STYLING, PERFORMANCE

See the World's finest, most complete line before you decide! 41 exciting new models.

SEND 25c for BIG, NEW 1954 KIT CATALOG

1954 Catalog PLUS booklet "Boat Selection, Operation & Maintenance" \$1.00. (Refundable)

DEALER INQUIRIES INVITED



Modern BOAT PLANS

World's Finest Designs

With FULL-SIZE PAPER PATTERNS EASIER TO BUILD, SAVES TIME, MONEY

Over 150 modern plans and patterns with material lists and building procedure. Racing classes, cruisers, inboards, outboards, sailboats, 6 to 36 ft. All materials, fittings, etc. available at "Package" prices. Big savings! Design Catalog tells all!

SEND 35¢ for 1954 DESIGN CATALOG

Design Catalog PLUS boat building handbook, \$1.00

CUSTOM-CRAFT • DEPT. 7 • BUFFALO 7, N. Y.

HOME AC VOLTAGE TESTER

Save needless service calls and wasted repairs.

An inexpensive, accurate voltage tester that will give you instantaneous readings right at the receptacle — no wires, no assembly. 90° swivel arrangement at the prongs makes reading easy from any position. Underwriter approved, \$4.50. If your dealer can not supply you send cash or money order to—

For Penna. Del. Add to Sales Tax
ELECTRO MECHANICAL INSTRUMENT CO.
Perkasie 22, Penna.



SHOPMASTER'S

NEWEST SENSATION

COMBINATION POWER TOOL



For Complete Information Write Dept. PM 5
224 S. 2nd St., Minneapolis, Minn.

SHOPMASTER, INC.

MACHINED PARTS READY TO ASSEMBLE

DO IT YOURSELF

MODEL 120 FAN KIT

DO IT YOURSELF

- FOR HOME - FARM - SHOP!
- 20" ALUMINUM BLADE WITH STEEL HUB
- 4840 CUBIC FT. OF AIR PER MINUTE
- RUBBER MOUNTED BEARINGS
- COMPLETE V BELT DRIVE
- STEEL FAN SHAFT & COLLARS
- ALL HARDWARE TO ASSEMBLE
- ALL YOU NEED IS ANY 1/4 TO 1/2 HP 1725 RPM MOTOR A SCREW DRIVER AND 20 MINUTES TIME TO ASSEMBLE THIS WONDERFUL HOME OR SHOP FAN KIT QUALITY AT LOW COST!



FAN KIT ONLY \$15.95

28x24x1 1/2 WINDOW KIT BOX \$5.95

JUST SAW & NAIL - FITS MOST WINDOWS (INSTRUCTION SHEET INCLUDED)

A. E. BOGG MACHINE & TOOL COMPANY
311 JEFFERSON ST. JEFFERSON CITY, MO

Dept. 554

Replace 'em for good



with NON-STAINING ALCOA SCREENING

When you repair screens, do a job that will last for years. Do it with screening made from Alcoa® Aluminum. It won't stain or streak your sills and siding. It won't rot, sag or burn.

Hardware stores and building supply yards carry Alcoa Aluminum Screening. Look for the Alcoa label. Write for Folder that tells easy ways to Replace Screening. ALUMINUM COMPANY OF AMERICA, 1931-E Alcoa Building, Pittsburgh 19, Penna.

ALCOA ALUMINUM

ALUMINUM COMPANY OF AMERICA

this tag means quality



Do 5 gardening jobs in one operation



**PLOW • DISC •
HARROW •
AERATE •
CULTIVATE**

**THE BOLENS
M-E MUSTANG**

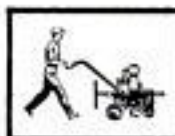

BOLENS M-E ROTARY TILLERS

do the work... You
have the fun

*Tines Guaranteed
against Breakage*

Till without toil! Completely prepare your garden for planting in one operation... then cultivate, weed and mulch. Plenty of power, and what a performer... turns on a dime. Budget priced for you to enjoy better crops and better soil.

A complete selection of work saving year 'round plug-in attachments available for BA Series.



3 H.P. BA 12C3



4 1/2 H.P. BA 16W4-1/2



6 H.P. BA 24W6



America's Finest Outdoor
Power Equipment

MAIL COUPON TODAY!

BOLENS PRODUCTS DIVISION
Food Machinery and Chemical Corporation
265-5 South Park St., Port Washington, Wisconsin

I am interested in literature on:

- TILLERS POWER MOWERS
 TRACTORS CHAIN SAWS

Name _____

Address _____

City _____ Zone _____ State _____

Protect your home against
power interruptions
with an...

ONAN Emergency ELECTRIC PLANT



Provides dependable stand-by electricity for heating system, pumps, freezer, lights, appliances. Keeps home safe, livable. Automatic start and stop. Find out how little it costs!

Write for Folder!

D. W. ONAN & SONS, INC.
8577 University Ave. S. E. • Minneapolis 14, Minnesota

A SIZE FOR EVERY NEED
1,000 to 50,000 watts.
Compact, quiet-running,
easy to install. Gasoline
engine powered.

SUPER DRILL GRINDER



Sharpens round shank drills from 3/32" to 1/2" in diameter, up to 6" long. Grinds old drills like new in 4 different point angles, using hand or power grinding wheels. Money-back guarantee... only \$2.95

At Dealers or Postpaid
A. D. McBURNEY Dept. A-41
5908 Hollywood Blvd. Hollywood 28, Calif.

KLEAN-STRIP

"Peels off Paint"

Heavy-Bodied Klean-Strip also available

The Klean-Strip Co., Inc., Memphis 6, Tenn.



SILVER SOLDER TORCH & KIT \$7.95

JOINS ALL METALS PERMANENTLY
Do your own repairing. KIT includes one tube silver solder, photo and 10 1/2-in. length silver solder alloy. Hottest ALCOHOL TORCH known. 2700° F. flame. Operates in any position, indoors or out. Pint of special fuel included. Complete outfit ready for use \$7.95 postpaid. TORCH alone with pint of special fuel \$6.85. KIT alone \$1.65. Instructions included.
AMERICAN PRODUCTS CORP., 422 S. Dearborn, Dept. 3-E, Chicago

3 CU. FT. MIXER 39⁷⁵

DIRECT FROM MFR.

Fills long felt need for small mixer for concrete, feed, fertilizer, seed and many other materials. Saves 3/4 cost of ready mixed concrete. Pays for itself on first job. Combination belt pulley and crank for hand operation. Also power mixers. Write for circular.

3 Cu. Ft. Drum—Mixes 2 Cu. Ft. Concrete \$39.75
5 Cu. Ft. Drum—Mixes 3 Cu. Ft. Concrete \$59.50

608 Pulaski, N. Y. Cash, Check or M. O. Money back guarantee
UNITED STATES FORGE AND FOUNDRY CO.
CONSTRUCTION EQUIPMENT DIV. PULASKI, NEW YORK



Do a Real Professional-Like Job
Yourself and SAVE

HOW to PAINT

With Brush and Spray

Covers All Painting Methods and
Materials

You can do professional-like painting and finishing jobs yourself and save about two-thirds of the cost. Sam Brown, noted craft authority, makes it so easy for you in his book, **HOW TO PAINT WITH BRUSH AND SPRAY**. Order your copy now and enjoy this tremendous saving. It covers exterior painting, wall and interior decorating, furniture finishing, concrete painting—every type of painting with brush, spray gun, roller and other methods. Tells what finish is best; what materials to use, etc. No previous experience needed. Fully illustrated. Order by mail. Only \$2.50. Money back if not pleased.

POPULAR MECHANICS PRESS, Dept. PM18
200 E. ONTARIO ST., CHICAGO 11, ILL.



New "PULL-GEAR" SPEED-REDUCING PULLEY



Provides Correct Speed and Power to Drill Up to 1 3/8" with 1/2 H.P. Motor

Amazing new internally geared speed reducer doubles drill press capacity. Greater power, greater efficiency, greater productivity.

Provides the correct speed and power for larger drilling, reaming, tapping and boring on light presses. Easily installed in five minutes. Adaptable to all type machines. Spindle speed range approx. 45 to 3000 RPM. Made in 3 motor shaft sizes: 1/2" — 5/8" — 3/4". Write for literature.

WRITE FOR LITERATURE

THE PULL-GEAR CO.

25427 Mound Road
Center Line, Mich.

x-acto

KNIVES • TOOLS
HANDICRAFT KITS



NO. 77
VIZI-DOME
WOODCARVING
SET \$3.60

X-ACTO, INC.
48-41 Van Dam St.
Long Island City, N. Y.

Send 20¢ for 28-page Catalog

BUILD YOUR OWN AIR CONDITIONERS

AND DEHUMIDIFIERS
FROM JUNKED REFRIGERATORS — FOR \$15
FOR HOME OR AUTOMOBILE

Don't let your family suffer from the heat. Live and ride in cool comfort. Send 50¢ for instruction booklet (specify whether for home or car).

SEELEY CO. 3718E BELMONT DEPT. 50, CHICAGO 18, ILL.

When you wash your
CAR...wash the MOTOR!



Just brush on Klantz and hose off... your motor shines like new!

ASK YOUR DEALER FOR
KLANZ
motor cleanser

CONTINENTAL LABORATORIES, INC., 4727 N.E. Prescott, Portland 13, Ore.

MAY 1954



If you can
drive a nail...



You can install Bruce Prefinished Oak Floors

No sanding or finishing! Beautiful, modern Bruce Oak Floors are completely finished—even waxed—at the factory. Just cover your old floor or new subfloor with felt paper and nail down this highest quality oak (or install in mastic over concrete).

There's no expensive sanding and finishing... your new floor is ready for use as soon as it's laid. You can choose Block (pictured above), Ranch Plank, or Strip design—approved by leading decorators for style and beauty.

It's economical! A new Bruce Oak Floor will cost you less than a good rug or carpet, and will last the life of your home. The famed Bruce "Scratch Test" Finish doesn't scratch, chip or mar... and is so easy to care for. Ask your lumber dealer for prices. Mail coupon below for colorful literature.

MAIL FOR FREE LITERATURE



E. L. Bruce Co.,
Box 397-P, Memphis 1, Tenn.

Send me complete information on
Bruce Prefinished Oak Floors.

Name _____

Address _____

Bruce PREFINISHED Oak Floors

Product world's largest hardwood flooring maker



Guard **NOW** against summer overheating

1. Drain out winter-worn anti-freeze and clean with **DU PONT COOLING SYSTEM CLEANSER**



Do it *before* the first summer day can cause overheating! Du Pont Cooling System Cleanser gets rid of rust, scale, grease . . . works as you drive. Thorough, safe, simple.

2. Put in **Du Pont Anti-Rust** Just pour it in and leave it in!

Just as you pour in anti-freeze for winter, pour in Anti-Rust for summer. Du Pont Anti-Rust protects against the most common causes of overheating. Its special rust-inhibiting action keeps water from rusting in the cooling system. And, at the same time, Anti-Rust keeps out acids and lubricates the water pump—helps prevent squeaking. Simple to use—just pour in liquid Du Pont Anti-Rust and forget it!



ASK ABOUT THE COMPLETE DU PONT SPRING DRAIN-OUT

Includes drain-out, clean-out, adding Du Pont Anti-Rust plus complete cooling system check-up. At garages, car dealers and service stations.

DU PONT No 7. PRODUCTS
From Chemical Research . . . For Easier Car Care



BETTER THINGS FOR BETTER LIVING . . . THROUGH CHEMISTRY

IDEAL LAWNMOWER SHARPENER



BOOST YOUR INCOME

You can earn extra cash with the Model 300 Ideal Lawnmower Sharpener. Used and recommended by leading manufacturers and service shops, the Ideal has everything you need, nothing else to buy. Grinds reel and bed knife, also reconditions. Get started now in this highly profitable business. Write for catalog today.

The Fate-Root-Heath Co.
Dept. PM-5, Plymouth, Ohio

AT ALL HARDWARE STORES

FULLER'S "SCREW HOLDER" SCREW DRIVERS

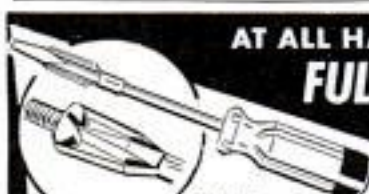

NOW! do the job at HALF THE COST!

- Spring Clip holds and sets screws tightly!
- Reaches those "out of the way" spots! In 3 1/2", 4 1/2", 6" and 8" lengths — only **30c** (3 1/2" x 1/8" blade)
- Hi Carbon Blades! • Unbreakable Amber Handles!

FULLER TOOL CO., Inc. 3522 Webster Ave., N. Y. 67
Export Sales Dept., John H. Graham Co., 105 Duane St. • New York, U. S. A.

RADIO CONTROL YOUR MODELS

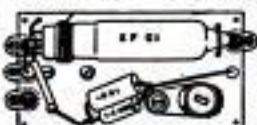

DELUXE MIDGET 1" Radio Control consists of license free TRANSMITTING & RECEIVING Radio plus a control ESCAPEMENT. Long range to operate Aircraft, Boat & Auto Models. Three units above easy assembly with our parts and plans \$9.98
DETAILED INFORMATION & RADIO CATALOGUE 25c
Special "SUPPLY DIRECTORY" plus a \$7.00 Supply Coupon . . . \$1.00
Book "RADIO CONTROL OF MODEL AIRCRAFT" \$2.98

"DELUXE MIDGET 1" RADIO CONTROL \$9.98
RADIOMODELS, BOX 36, DEPT. PM
BALTIMORE 6, MARYLAND

DEPENDABLE



You can count on the performance of a genuine Gerstner Chest. Free Catalog.

GERSTNER TOOL CHESTS
454 Columbia St.
Dayton 7, Ohio

BUILD YOUR OWN . . . MODERN FURNITURE!

POSTPAID SETS OF FOUR LEGS **FREE . . .**
6" 3/8" ROD \$4.25
9" 3/8" ROD \$4.50
16" 3/8" ROD \$6.25
28" 1/2" ROD \$8.00
Catalogue of modern furnishings you can build or assemble . . . LOW FACTORY PRICES.

PHILLIPS FURNITURE CO.
EAST PEORIA, ILLINOIS

\$1295
F.O.B. complete
WELD BRAZE, CUT SOLDER
PAYS FOR ITSELF!



Most practical time & money saving welding outfit. Genuine craftsman's unit—easy to operate, features new improved foot control switch. Ideal for auto repairs, farmers, tin-smiths, hobbyists, etc. Plugs into any properly wired 110 volt AC or DC line (available in 220 volt AC or DC at slightly higher cost). Simple instructions to weld Iron, Steel, Aluminum, Bronze, Brass, other metals. Order now! Send for **FREE** informative folder!

ALL-WAY ARC WELDER, Dept. PM-5
6 Short Street Mt. Vernon, N. Y.

10 DAY TRIAL
ORDER NOW

UNIQUE EUROPEAN DISCOVERY . . .

Cuts YOUR repair bills HELPS ENGINES Stay HEALTHY!

NOW BEING INTRODUCED TO THE U.S., SOLATONE has been tried, perfected and proven in Europe, where gasoline and repairs are really expensive. Solatone lets you drive further between repairs!

INCREASES ENGINE LIFE

By catalytic action on the gasoline before it enters your carburetor, SOLATONE prevents the forming of hard abrasive carbon in your engine. It also prevents the formation of varnish and gum. A major cause of engine wear is eliminated.

BETTER ENGINE PERFORMANCE

Because it is clean, and stays clean, your engine will perform better, give you all the power it is capable of delivering.



BETTER GAS MILEAGE

A clean, efficiently operating engine will give you more miles to every gallon of gasoline. Costly carbon and varnish are forming in your motor every time it fires. Clean it out with a SOLATONE. You'll save your car, you'll save money. Don't put it off, order your SOLATONE today! **SATISFACTION GUARANTEED.**

SEE DEALER OR
SEND CHECK OR M.O. **12⁹⁵**

SOLATONE

MANUFACTURED IN U.S.A. BY

A-B

**HYDROCARBON
SYSTEMS**

2808 MCKINNEY AVE.
DALLAS, TEXAS

DEALERS WRITE FOR FREE CATALOGUE

MAGNETS

ASSORTED MAGNETS with big list of handy uses. 5 for \$1
POWERFUL POCKET MAGNET ideal for testing metals. \$1
RETRIEVING MAGNET pulls tools, etc., from tank or lake. \$3
HOT PAD MAGNETS to insert in your own hot pads. 8 for \$1
BULLETIN BOARD MAGNETS to "pin-up" memos, etc. 8 for \$1
SLENDER MAGNETS remove chips from drill holes. 2 for \$1
WE REFUND EVERY PENNY IF NOT 100% PLEASSED . . . POSTPAID
RONALD EYRICH, 1091 N. 48th St., MILWAUKEE 8, WIS.

Find **HIDDEN TREASURES**

GEIGER COUNTERS (as shown) for Uranium Detection. **TREASURE DETECTORS** for gold, silver, etc. Light-weight, ultra sensitive. None finer. Also Mineralights for Tungsten.

• INFORMATION FREE •

Detectron co.
5420 Vineland, North Hollywood, Calif

**DO-IT-YOURSELF!
PAINT BRUSH KIT
A COMPLETE HOMEOWNERS KIT!**

Contains 3 brushes for all home painting purposes. All brushes pure black bristle, ideal for painting Walls, Floors, Trim, Ceilings, Furniture, etc.

All lacquer finished handles. Vulcanized in hard rubber, in bright tin metal ferrules preventing shedding.

HERE'S WHAT YOU GET.
1 - 4" Wall
1 - 2" Varnish
1 - 1 1/2" Flat Sash

\$2⁹⁸ P.P.

AARDVARK BRUSH SUPPLY CO. 242 E. 58 St., N. Y. 22, N. Y.

You get all three for practically as low as the cost of one brush. No C.O.D.'s.

DEALERS INQUIRIES INVITED
Dept. PM8

Use These 3 Simple Steps to Get Expert Paint Jobs!

Step 1. Prepare surface. Remove all chipped and peeling paint or varnish down to bare wood. Do this by "flowing on" deep-cutting Strypeeze . . . stays wet longer, clings to upright surfaces. Clean off with scraper or #3 steel wool. Won't sting hands. Contains no benzol.



Step 2. Rebuild broken corners, fill nicks and holes with Savogran Wood Putty, a powder-form real wood filler. You can form it, tool it . . . and it doesn't shrink. (For cracks in plaster, use Savogran Crack Filler. It's the original patented quick-hardening water putty.)

Step 3. Start job with clean brushes. Clean old brushes before painting. Clean all brushes after painting and whenever you change colors. Savogran Kwikkeeze, the Liquid Brush Cleaner, softens hard brushes in minutes . . . cleans out fresh paint instantly! An excellent deglosser. May be reused.



Whenever you're painting, you need
SAVOGRAN

REG. U. S. PAT. OFF.

PRODUCTS . . . at better paint & hardware stores
Write for free helpful literature

SAVOGRAN CO., Dept. 48, 25 Huntington Ave., Boston 16, Mass.

BOAT KIT BUILDERS!



Aerojet
INBOARD MARINE
ENGINE

4 cycle—26½ h. p. motor and Vee-drive. Weighs only 220 lbs. drives 12-20 ft. boats ½ m. p. h. to 30 m. p. h. Cuts fuel costs 50% compared to outboards of comparable H. P.

- Vee-drive reverse and reduction drive
- 9 to 1 compression
- 24¾" L x 17½" W x 19½" H.
- Overhead camshaft
- Overhead valves
- 4 hours to install

\$695.00
State and Federal Taxes extra

WRITE FOR FREE BOOKLET

AEROJET-GENERAL CORPORATION • Cincinnati 14, Ohio

Gentlemen: Send me information on new Aerojet Inboard marine motor, and name of your nearest dealer.

NAME _____

ADDRESS _____

CITY _____ STATE _____ 10 _____

AEROJET-GENERAL CORPORATION • Cincinnati 14, Ohio

send for FREE CATALOG

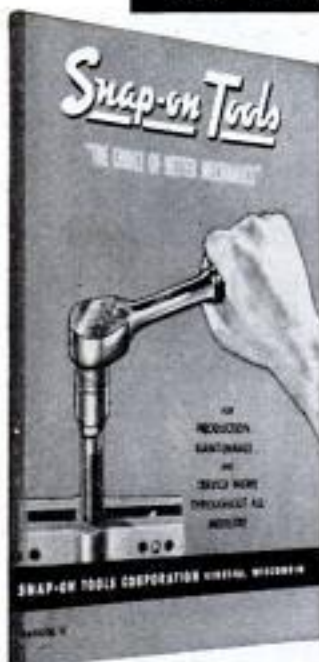

America's Foremost
money-making
MECHANICS' TOOLS

It's easy to own the same "pay-off" tools used and endorsed by America's top-earning mechanics throughout the automotive, aviation and industrial fields! Snap-on tools help you handle every repair job faster, easier, better. And they LAST . . . pay for themselves over and over again! Start building your own tool set now with basic Snap-on units—add others any time. Genuine Snap-on tools are never sold in stores—direct to users only. Mail coupon for free catalog.

Snap-on Tools
THE CHOICE OF BETTER MECHANICS

Snap-on Tools Corporation
8062-E 28th Ave., Kenosha, Wis.

Send me free catalog. Occupation _____

Name _____

Address _____

City _____ Zone _____ State _____

SPECIAL!



500x4 TIRE, TUBE and WHEEL with High Speed Bearing \$13.50
10¼x4 TIRE, TUBE and WHEEL with Roller Bearings \$9.00
Stub Axle . \$2.50 40" Axle . \$5.00
68" Axle . . . \$7.50

Write for 1954 catalog. Tires, Tubes, Wheels, Axles, and Complete Assemblies. A Wheel and Stub for every tire up to 56" high.
DEPT. P.M.

HARMO TIRE & RUBBER CORP.
804 Hammond Bldg. Detroit 26, Michigan

Enjoy the Fascinating Story of the Horseless Carriage in its thrilling, fascinating, informative. From the very first gasoline-propelled buggy to the cars of today and the atomic auto of the future. The first cars—the men who made them—the scrambled start and development of the fabulous auto industry—the story of auto racing. 166 thrilling action pictures—old-time cars—racing cars—early auto advertising—automotive oddities. Listing of 2000 U. S. autos included. Ideal gift book. Cloth bound, only \$1.00 by mail. Money back if not pleased. Paper covered edition \$1.00 at newsstands.



POPULAR MECHANICS PRESS, Dept. PM15, 20 E. Ontario St., Chicago 11

DO MORE PLANING JOBS WITH LOW COST BELSAW



Exclusive MONEY-MAKING Features: • Full 12½" x 6" capacity • Power feeds at 24" a minute • Provides for Grinding Knives in the Cutterhead • Attachments for Jointing, Rabbeting, Tongue, Groove, Matching. Convert low cost rough lumber into high priced cabinet finished stock . . . Easy to make flooring and popular patterns. Send today for free literature and prices.

Belsaw Machinery Co., 1011 Field Bldg., Kansas City 11, Mo

JITTERBUG • CATCHES MORE FISH

Noisy surface bait. World's best hooker—day or night. Gurgling, paddling action of the double-lobed lip makes fish strike hard. 5/8 oz. or 3/8 oz. or 1/4 oz. spinning size \$1.25. Musky size \$2.00.



FRED ARBOGAST CO. INC., 2245 W. North St., Akron 3, Ohio

FREE WRITE TODAY FOR YOUR BIG FREE ARBOGAST COLOR CATALOG—FULL OF PICTURES OF CATCHES



NEW TRIG-AID CALCULATOR SIMPLIFIES TRIGONOMETRY

- (1) By omitting (32) trig book formulas.
- (2) By omitting square root formulas.
- (3) By defining the three sides of R.T.
- (4) By using diagrams in two colors thus separating known & unknown dimensions in right triangle solutions. Made of durable white plastic, pocket size, price \$1.00 plus 5c stamp. No C.O.D. Send to TRIG-AID SALES, 4133 Marwick, Long Beach, Cal.

Motor coupling included DRAINS cellars, laundry tubs; FILLS tanks; CIRCULATES oil; IRRIGATES gardens, fields.



1,001 USES—HOUSE, GARDEN, FARM

Original "Type P" All-Purpose Pump has 2400 GPH capacity, 360 GPH 2' high, or 1500 GPH from 25' well. Use any 1/4 to 3/4 HP motor. RUSTPROOF! 1" inlet; 3/4" outlet. Oil-less bearing.

STAINLESS STEEL SHAFT. DOES NOT CLOG!

Postpaid if cash with order. (West of Miss. add 50c) **MONEY BACK GUARANTEE**

Also larger Centrifugal Pumps and Gear Pumps in all sizes.

LABAWCO PUMPS \$6.95
BELLE MEAD 2, N. J.

CARPENTERS, HOME CRAFTSMEN . . .

make nail pulling easy —



CAT'S PAW
NAIL PULLER
does the job
faster, better!

IF YOU USE A HAMMER YOU'LL
WANT A CAT'S PAW NAIL PULLER

The new CAT'S PAW Nail Puller is indispensable to Home Craftsmen, Carpenters, Builders. It removes nails easily and with a minimum of damage to wood. Spoon-shaped head gets under nailheads cleanly.

Also Available 2778

Large size 24" x 3/4"
Wrecking Bar with
exclusive CAT'S
PAW CLAW — \$2.50
Delivered in U.S.A.

\$3.00
SPECIAL OFFER

For set of both styles
277H, 15" long 277B,
10 1/2" long, 5/8" hex. Tem-
pered DREWALLOY Steel.
Delivered price \$3.00, any-
where in U.S.A. only.

Tough, rusty nails, up to
20-penny size, withdrawn
with ease . . . the CAT'S
PAW specially designed con-
tour head gives leverage where
it's needed. DREWALLOY — a
tough-treat process — gives
rugged strength. CAT'S PAW
Nail Puller is enthusiastically
endorsed by thousands of satisfied
customers!
Order your set today, at special
mail order price. SEE YOUR
DEALER OR ORDER DIRECT

Do it the Easy Way . . . the Cat's Paw Way!

Black,
with polished head.

C. DREW & CO. KINGSTON, MASS.

FREE Plan To Build Your Own Self-Propelled POWER MOWER



Now you can save money by building your own Power Mower. Pulls Itself—Steers Itself. We furnish you any part or parts you need plus building instructions. Write for FREE PLANS . . . No Obligation.

T & H Mfg. Co., Dept. P-5
811 E. 31 St., Kansas City, Mo.



STARRETT "Tools and Rules" BOOK

Describes and illustrates the precision methods skilled mechanics use. Only one dime. Write Dept. AP.

THE L. S. STARRETT CO., Athol, Mass., U. S. A.

INTRODUCTORY
OFFER

CARBIDE SAW SERVICE

REPAIRS AND SHARPENING FOR
SEARS, WARD & SIMILAR SAWS

NO. TIPS	SHARPEN	NO. TIPS	SHARPEN
6	\$2.50	10	\$3.10
8	2.80	12	3.40

Chipped and broken tips replaced -50c each. Correspondingly low prices for other saws. 24-hr. sharpening service. 48-hr. repair service. C. O. D. only. Expires 7-31-54.

C. R. S. CORPORATION

1705 A BERRY BLVD.

LOUISVILLE 15, KENTUCKY

MAY 1954

"Handy" SANDY says:



Here are some more
**GOOD
SHORT-CUTS**
for your file!

The fellow who leaned over the edge of his dock to get a drink, and caught the trout that bit his nose was doin' it the hard way! I recommend a hook and line — and a handy CARBORUNDUM® Silicon Carbide Hook Stone to keep the hook "catching" sharp. This grooved, tapered stone is designed especially for sharpening fish hooks. Comes in a handy leather case . . . costs less than a dollar at your favorite hardware store. Makes a fine gift.

Buzzing alone behind a boat on an aqua-board is fun — specially if your feet don't slip when you're in rough water. Glue two sheets of RED-I-CUT® Waterproof Paper where your feet are supposed to stay . . . and stay they will. Use waterproof glue to hold the paper. Of course, the conventional way to use CARBORUNDUM's RED-I-CUT® Paper . . . for fast, easy sanding of undercoats and finishes on everything from furniture to automobiles . . . isn't as glamorous, but it's mighty profitable. You'll find many uses for it around your workshop or home, so buy a good supply of various grit sizes. Be sure to look on the back for the distinctive red color, and the CARBORUNDUM Brand name.

Quickest way to fix a drawer that rides in too far: drive wood screws part way into the back of the drawer — one near each corner — to act as "stops" . . . adjust each as required.

My next door neighbor's latest hobby is making things with the new aluminum that you can saw, plane, chisel, etc. — just like wood. I loaned him my MX® Aluminum Oxide Cut-off Wheel a few weeks ago to let him see what a slick job it does in cutting and finishing. He tells me it's wonderful — but nary a word about returning it! If your neighbor doesn't have one, buy it at your favorite hardware store or lumber yard. It's inexpensive . . . fits your bench saw, grinder or portable saw . . . cuts steel, aluminum, brass, bronze, copper — as well as the new "do-it-yourself" metals. MX Aluminum Oxide Wheels are strong, safe . . . finish as they cut. You can use the sides of 'em to sharpen tools, too.

Get a pair while you're at it: The MX Aluminum Oxide Wheel (for metals) comes in a red envelope; the MX Silicon Carbide Wheel (for cutting non-metals such as plastics, fiberboard, hardboard, asbestos, etc.) in a green envelope.

Send for FREE PAMPHLET, "HOW TO SAND". Address a postcard to me—



"Handy" Sandy
CARBORUNDUM
Niagara Falls, New York

"CARBORUNDUM", "RED-I-CUT" and "MX" ARE REGISTERED TRADEMARKS OF THE CARBORUNDUM COMPANY, NIAGARA FALLS, NEW YORK

90-418

289

Now you can afford the best!

Porter-Cable
Quality Electric Tools

New

Electric One-Man
CHAIN SAW



Model 110
14" Cutter Bar

Only
\$115

NEW in every respect to provide the finest, lowest-priced chain saw you can buy—anywhere! . . .

New Quality Construction — Equipped with Oregon® Chipper Chain—finest made. Rust-resistant hard-chromed teeth stay sharp twice as long. Heavy-duty precision ball bearings throughout. Oversized worm gears. Special steel alloy chain sprocket.

New Advanced Design — Exclusive V-shape gives greater leverage—keeps chain off ground when saw is at rest.

New Sawing Ease — Exceptionally light (only 18 lbs.)—can be operated in any position on the ground or in a tree. Saw pulls itself into the wood. You can saw much longer—with less effort, less fatigue.

New Versatility — Cuts everything from saplings to 28" trees. Use it for undercutting, bucking, flush cutting, notching, felling, limbing topping.

New Safety — Specially designed log-gripping teeth grip firmly—prevent saw's bucking or jumping—eliminate pull to left or right.

New Power — Plenty of power for the toughest cutting. Husky 115 V. Universal motor operates on standard AC or DC outlet.

New Economy — Easy to start — inexpensive to run — nothing to get out of order. Never before a quality electric chain saw at a price so low!

See this remarkable new Chain Saw at your Porter-Cable dealer's. Or, mail coupon today for complete information.



Ideal for cutting cord and pulpwood. Zips through hard or soft, wet or dry wood.



Clearing lots made easy. Two portable generators—AC or DC—available for field work.



Light and compact—safe and easy to use in high places.

PORTER-CABLE MACHINE CO.
2445 N. Salina St., Syracuse 8, N. Y.

Send free descriptive folder on your new Model 110 Chain Saw . . . also name of nearest dealer.

Name

Occupation

Street

City..... Zone..... State.....

In Canada write: Strongridge, Ltd., London, Ont.

CUT COSTS with ALLEN Punch Press

1-Ton Power Bench Type
Powerful, Dependable, Economical



\$97.50
Less Motor

For light work—stamping, forming, riveting, etc.—Metal, fiber or other material.

Overall height 17 1/2" . . . Base size 8 1/2" x 8 1/2" . . . Die bed 8 1/2" x 8 1/2" . . . Ram face 1 1/2" x 3 1/2" . . . Ram stroke 3/4" . . . Positive 3/4" ram adjustment . . . Sturdy, single pin, non-repeat hand lever clutch. V-belt drive. Weight 105 lbs. Requires only 1/4 to 1/2 H.P. Motor.

The machine of a thousand uses! Adequate for many types of work now done on larger presses at greater expense.

30-Day Money-Back Guarantee

FREE CIRCULAR

Order TODAY. Price \$97.50 F.O.B., Clinton, Mo. (Includes Motor bracket, V-belt, motor pulley, less motor).

ALVA F. ALLEN, Dept. PM, CLINTON, MO.

MONEY for MEN ALL DATA FREE

THE PLASTEX Industry needs manufacturers on small scale and for big production of Lamp and Clock Stands, Art Goods and Novelties in Plastex and Marble Imitation. Experience unnecessary. Use material makes regular 10c store sellers. Rubber moulds furnished for speed production. Small investment brings good returns. We are now placing big Chain Store Orders with manufacturers. Ambitious men have chance for real prosperity. Our Free booklet will interest and benefit you.

PLASTEX INDUSTRIES, Dept. A
3400 Third Ave. New York 88, N. Y.

SURPLUS SALE



\$39.50 NEW TOOL POST GRINDERS
REGULAR PRICE \$125.00

1-6 H. P. MOTOR
GRINDS WHEELS UP TO 1 1/2" x 4"
EXTRA OUIL EXTRA \$8
INTERNAL \$9.50
MONEY BACK GUARANTEE

EDWARD J. NOLAN, PULASKI, NEW YORK

"SNOOPER" GEIGER COUNTER



Super-sensitive! Only 1 1/2 lbs! Fits pocket—uses flashlight battery Find a fortune in uranium Order Now! Send \$5.00, balance C.O.D. MONEY BACK GUARANTEE. FREE CATALOG—scintillator and larger uranium and metal detectors DEALERS WANTED.

2995 COMPLETE PRECISION RADIATION INSTRUMENTS
2235 PM S. LA BREA, LOS ANGELES 16, CALIF.

Wholesale! TOOLS! GUNS! CAMERAS!

BUY TOOLS, PHOTO EQUIPMENT, SPORTING GOODS, JEWELRY AND THOUSANDS OTHER NATIONALLY ADVERTISED PRODUCTS AT BIG DISCOUNTS. SAVE ON OWN PURCHASES. BIG PROFITS SELLING TO OTHERS. POSTCARD BRINGS FREE COPY "THE WHOLESALE PLAN".

Get up to
40% off

AMERICAN BUYERS SERVICE
629 Linden Ave., Dept. 15, Buffalo 16, N.Y.

TRIPLE ELECTRODE LUTHY AERO SPARK PLUGS

with ALUMINUM OXIDE INSULATORS

Longer Life More Economy SET \$5.34
High Speed Performance SET \$7.12
Postpaid



Packed In Engineered Sets
Luthy Aeronautical Sales Company
JACKSON, MICHIGAN (Canadian address, Box 294, Hamilton, Ontario)

Send me a set of ___ plugs. Enclosed is \$ ___ Check here if you want us to ship C.O.D.

Name _____ Address _____

Year of Car _____ Make and Model _____

A New Summer Business SHARPEN MOWERS



MAKE SUMMER MONEY SHARPENING LAWN MOWERS—AT A GOOD PROFIT

ROLAND JR. is designed to sharpen all reel type home lawn mowers. Uses well known lap grinding principle. Sharpens old mowers like new.

IT'S EASY—TAKES ONLY MINUTES FOR A GRASS-CUTTING EDGE

You can establish a regular service for sharpening mowers several times a summer. You make a good profit for easy work. Full instructions included.

COMPLETE KIT MONEY BACK GUARANTEE Only \$4.95

Send check or M. O. today

\$4.95 PREPAID

MARCUS MFG. CO.

10039 Marcus Ave., Detroit 13, Mich.

DINSMORE AUTO COMPASSES

Enjoy traveling with America's finest auto compass. Accurate—dependable—trouble-free. Quickly and conveniently mounted on any car. Always insist on a DINSMORE—It's the only compass approved by auto manufacturers. Send for free folder "Pants, Knives, Compasses" and name of nearest dealer.

Travelite Only \$5.49

Guide-Way \$4.49 Non-Illuminated

DINSMORE INSTRUMENT COMPANY
1802-29 Kelso St., Flint, Michigan

Our 723rd Advertisement

REAL DIESEL ENGINE

\$3.95

- for planes, boats, midget cars
- 7500 RPM; 1/7 HP; ht. 3 1/2"; wt. 5 oz.
- precision machined for smooth operation

You just can't beat this price for a precision diesel engine! Streamlined, compact, easy to install. Thousands of satisfied users all over the world. Fast delivery if you ORDER TODAY! Send \$3.95 plus 23c postage.

GOTHAM HOBBY CORP. Dept. P, 107 E. 126th St. New York 35, N. Y.

"Do-It-Yourself" Begins With How

"How to Work With Tools and Wood" makes the basic do-it-yourself skill easy for handyman or homeowner. Fully illustrated, only \$2.00 post-paid. Order from Stanley Tools, 354A Elm Street, New Britain, Conn. In Canada, write to Stanley Tool Co. of Canada 354A Stanley Street, Roxton Pond, Quebec.



THE TOOL BOX OF THE WORLD
Hardware • Electric Tools • Steel Strapping • Steel

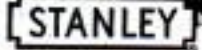

NOW! USE YOUR WILLYS OR DODGE AS BOTH A 2 and 4 WHEEL DRIVE



Give your 4-wheel drive Willys or Dodge 2-wheel pep, power, speed, extra mileage, passenger car performance—as well as 4-wheel power and traction! Change from 2-wheel to 4-wheel or back in seconds with fingertip control. Warn hubs reduce wear on front axle assembly and front tires, eliminate shimmy, increase gas mileage to 6 m.p.g. Money back guarantee. For Willys \$69.00, Dodge \$74.00 pr. pod. Warn Standard Hub for Willys \$20.00 pr., Dodge \$23.00 pr. and Warn Automatic Hub for Willys \$120.00 pr. At Dealers or direct.

WARN MFG. CO., RIVERTON Box 6064-A3, Seattle 88, Wash.

Shavings from the **WIZARD'S WORKSHOP** by the Weldwood Wizards with Wood



WHAT'S YOUR "SHAVING?" Want your short cut or shop trick printed? Send it to United States Plywood Corp., Box 109, N.Y. 36, N.Y. If used, we'll send you a one year subscription to this magazine. All entries become our property. None can be returned. Keep 'em short—35 words or less.

CAN'T GET AROUND? A handy large-radius compass is made with a strip of wire screen cloth. Use a glass headed push pin for the center; a pencil or awl for marking or scribing the circle.

A NATURAL FOR WOOD! Here's an easy way to get that costly hand rubbed look when you want a natural finish on wood. For a wizard job use Satinlac! Works fine on any wood—hard, soft, solid or ply. Protects and preserves the surface. Never looks "built-up"; never turns yellow or darkens with age.

PIN UP: Instead of plugging screw holes, try using brass countersink screws. Make countersink shallow, so that screw slot is above wood surface. Screw work tightly (best to glue it, too) then file off head of screw flush with wood. Looks like a decorative brass pin.

HOW TO GLUE JOINTS TO STAY: You need never worry about a joint glued up with Weldwood Plastic Resin Glue. It makes a bond stronger than the wood itself. And it gets stronger as it ages. Always in perfect condition when you want to use it, because you mix it yourself from the powder, in a few seconds. Stain free, rot-proof, highly water resistant, inexpensive. America's largest selling wood glue.

QUICK CLEAN HANDS. A dab of cotton soaked with ordinary finger-nail polish remover works fine to take paint, varnish, etc., off your skin.

PREFER BLONDES? You can get those rich "woody" blond or pickled effects by using White Firzite on any wood: hard, soft, ply or solid. Or for pastel tones, tint White Firzite with colors-in-oil. It gives an easy, amazingly beautiful finish!

PAINTER'S SECRET: Just brush Clear Firzite on plywood to prevent "wild" grain. It's also a wonderful undercoater on any paint or enamel jobs.

WELDWOOD® Plastic Resin Glue Makes a bond stronger than wood itself. Highly water resistant.	FIRZITE® White for pickled or blond effects. Clear tames wild grain on stain jobs.	SATINLAC® For exquisite natural wood finish. Enhances natural grain; preserves the surface.

At hardware, paint, lumber dealers.

United States Plywood Corporation
Dept. 109, 55 West 44th St., New York 36, N. Y.
Send me free leaflets on Weldwood Plastic Resin Glue, Firzite and Satinlac.

NAME _____
ADDRESS _____

Want a real finish?



Try WET SANDING

BETWEEN COATS OF VARNISH OR SHELLAC

in furniture finishing or primer coats in automobile refinishing, use fine grit TUFBAK® SPEED-WET® Paper, dipping it often in a pail of water. This lubricates the cut of the diamond-hard silicon carbide grains. Repeated immersion cannot harm BEHR-MANNING® TUFBAK, for the tough paper backing and the bond which holds the grit are both thoroughly waterproof. Ask for TUFBAK at your hardware or paint store.

ON DRY SANDING WOOD IN THE WHITE, get that beautiful "silky" finish with BEHR-MANNING GARNET Paper. On power sanders use ADALOX® Paper or Cloth — sizes for all popular machines. Excellent for sanding wood, metal or plastic.

TIPS ON SANDING in the 32-page, illustrated book, "Sandpaper — How to Choose and Use It." Send 10¢ for your copy to Behr-Manning Corp., Troy, N. Y., Dept. PM-5.



In Canada: Behr-Manning (Canada) Ltd., Brantford.
For Export: Norton Behr-Manning Overseas Inc.,
New Rochelle, N. Y., U. S. A.

C-10

® * Trade-marks

BEHR-MANNING
CORPORATION
division of NORTON Company

▲ COATED ABRASIVES ▲ SHARPENING STONES ▲ PRESSURE-SENSITIVE TAPES

DRILL SAW REAM CUT

INTERNATIONAL
HI-SPEED COPE SAW DRILL BIT



DRILL, SAW, REAM . . . metal, pipe, wood, plastic, Transite, etc. Use with any electric drill, slow drill press, lathe or milling machine. Drills own starting hole—upper part of bit is used to cut, saw or ream circles, ovals, squares or scrolls. Easy to operate. Ideal for carpenters, mechanics, electricians, plumbers, hobbyists, many others. Abrasive resistant, high speed steel. Flutes ground from solid. Will withstand severe continuous use without breaking. Resharp-ened at no charge. Takes place of up to \$30 in tools. 1/4" diameter, 2" cutting sections, total length 3 1/2". Available in three types—All Purpose, Wood, Heavy Metal. Specify type needed. Set of 3, \$11.50. Details on request. Shipped same day. Money-back guarantee. Dealer inquiries invited. **ORDER NOW! SEND CASH, CHECK OR MONEY ORDER.**

Manufactured and distributed by
INTERNATIONAL TWIST DRILL CORP.
618 Wyandotte, Rm. 636, Kansas City 5, Mo.

only
\$3.95
POST PAID

FREE—BIG CATALOG

HOBBY — PROFESSIONAL

MICROSCOPES

100 to 2000 POWER—\$6.95 to \$319. 40 pages of fascinating information on microscopes, micro-hobby materials, telescopes and binoculars **SEND POSTCARD.**



AKRON

89 Akron Bldg. 4379 Sunset Blvd.
Los Angeles 27, Calif.

SEND ONLY \$1 for next 6 issues of famous DELTA-GRAM, best home woodworking magazine you ever saw. Packed with shop-tested ideas—12 to 15 in each issue. Send \$1 (no stamps) to: Delta Power Tool Division, Rockwell Mfg. Co., 502E N. Lexington Ave., Pittsburgh 8, Pa.

WORLD'S BEST SMALL TRENCHERS

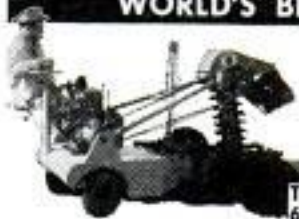

Portable DITCH-WITCH digs 2" to 6" deep, even ditches to 36" depth in all types of soil. Complete unit—self propelled—outdigs 8 men. Four rugged models.

Write for illustrated literature.
THE CHARLES MACHINE WORKS
620 B Street Perry, Oklahoma

Say You Saw It in Popular Mechanics

MAKE YOUR OWN FOLDING TABLES IN MINUTES . . . AND SAVE MONEY!

WITH TABLECRAFTERS' TUBULAR STEEL FOLDING TABLE LEGS

You simply screw leg assemblies to your table top. They're sturdy and rustproof. Won't collapse . . . yet fold easily for storage. For banquet, buffet, hobby, work and game tables.

COMPLETE KIT **\$9.95** FOR ONE TABLE

Send check or money order and we'll pay postage.

ATTENTION!

SHOW THIS AD TO THE COMMITTEE OF YOUR CHURCH, LODGE OR OTHER ORGANIZATION. THEY'RE ENTITLED TO SPECIAL DISCOUNTS.

TABLECRAFTERS Dept. A-4
6713 CASTOR AVE., PHILA., PA.

THE MOST EFFICIENT WRENCH ON THE MARKET

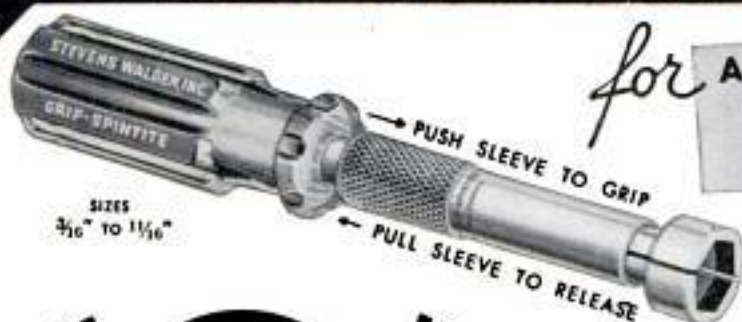

for **AUTOMOTIVE · TELEVISION
RADIO · INSTRUMENTS
and ASSEMBLY WORKERS**

- .. it **HOLDS** (NUT OR BOLT)
- .. it **STARTS** and **TIGHTENS**
- .. it **RELEASES!**

"GRIP SPINTITE" WRENCHES

PATENTS PENDING

FINEST QUALITY STEEL SHANK AND SLEEVE
BRIGHT PLATED FINISH
STRONG PLASTIC HANDLE
SPECIAL SIZES AND MATERIALS TO ORDER

... it's all a **ONE HAND OPERATION**

- **GRIPS** nuts or bolts of any material
- **HOLDS** firmly in any position
- **TIGHTENS** nut or bolt securely
- **RELEASES** at the pull of the fingers

Write for catalogue

MAKERS OF THE ORIGINAL
SPINTITE WRENCHES
OVER 150 STYLES AND SIZES

STEVENS WALDEN Inc.
480 SHREWSBURY STREET — WORCESTER, MASSACHUSETTS

WORLD-FAMOUS
HAND TOOLS
FOR OVER
50 YEARS

*Build, Repair, Re-model, Sand, Re-finish
and Polish with*

Speedway

**Do-it-yourself
POWER
TOOLS**



• Speedway tools are becoming part of every well equipped home because they do so many tedious jobs easily, quickly and professionally. Write today for catalog showing these inexpensive quality tools sold by the better tool stores everywhere.



SPEEDWAY MFG. CO.

Builders of Quality Power
Tools for Over 40 Years

1863 So. 52nd Ave. CICERO 50, ILL., U.S.A.

MAY 1954

I'VE TRIED THEM ALL—
THERE'S NOTHING THAT
DOES THE JOB LIKE
PLASTIC WOOD!



Plastic Wood is stronger—resists weather. Sands down to a smooth, hard finish. Professional craftsmen have preferred Plastic Wood for more than 50 years because it takes paint, varnish and other finishes best. Will not chip, crack or peel . . . won't pull away! In cans and tubes.

In natural, white and 8 wood colors.

"PLASTIC WOOD"

BE YOUR OWN BOSS! Make UP TO \$50.00 PER WEEK IN YOUR SPARE TIME

Mr. B. of California writes "The lawn mower grinding business, with my Universal Grinder, has been a gold mine these last two years." Mr. J.L.P. of Pennsylvania says "Thank you for getting me started in this wonderful business. . . I averaged \$100.00 per week for the month of May."

ONLY ON THE UNIVERSAL LAWN MOWER GRINDER

. . . can the inside face and edge of the stationary blade, as well as the reel blades, be ground to proper clearance

ALL IN ONE SET-UP

WITHOUT REMOVING ANY BLADE FROM THE MOWER

Users who have tried them all acclaim the UNIVERSAL far above any grinder on the market. Write today for full details of our Proved Success Plan. It's Free.



ROGERS MFG. CO., Dept. M-54, LINDSEY, OHIO

SEND THIS COUPON NOW

ROGERS MFG. CO., Dept. M-54, Lindsey, Ohio
Please send me full details about the profit possibilities of Lawn Mower Sharpening.

NAME _____
ADDRESS _____
CITY _____ STATE _____

NEW! Giant 1954 Catalog of AUTO PARTS AND Accessories



World's Largest Selection—50,000 Items at WHOLESALE PRICES!

YOU SAVE UP TO 50%

Ready now . . . complete automotive buying guide . . . everything for your car, truck, custom-styled car, or hot rod . . . all at rock-bottom wholesale prices! Hard-to-find equipment, parts for cars from 1920 to 1954 models! New HOLLYWOOD ACCESSORIES; HIGH-SPEED PARTS; CUSTOM-STYLING EQUIPMENT!

FREE . . . valuable Check Chart showing how you can know if your car is safe—sent free if you mail coupon for catalog TODAY with 25c to help pay postage and handling. We credit the 25c on your first \$5-or-more order, so Catalog will then be FREE TO YOU. Fill in and mail Coupon NOW!

J. C. WHITNEY & CO., 1917 P-5 Archer Ave., Chicago 16, Ill.

J. C. WHITNEY & CO.
1917 P-5 Archer Ave., Chicago 16, Ill.
Rush giant 1954 Catalog of auto parts and accessories at wholesale prices. I enclose 25c to cover part of cost, which will be credited to me on my first \$5.00-or-more order.

Name _____
Address _____
City _____ State _____

148 Pages packed with items like these . . . all at Wholesale Prices!
Auto radios — Mufflers, pipes — Engines, parts — Transmissions — Tires, tubes — Fuels — Springs, shocks — Ignites parts

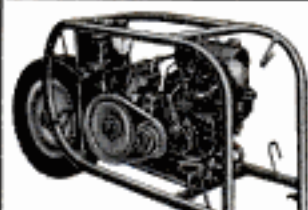

AIR COMPRESSOR

SURPLUS! NEW Release!
Original Gov. Cost \$375.00

The Finest 2-H.P. TWIN CYLINDER Industrial Unit **\$129.00** f.o.b. Fully Guaranteed

5.3 C.F.M.

200 lb. PRESSURE

Maintains 40 to 65 lb. pressure for CONTINUOUS spraying (no waiting till tank keeps building up)

- BENDIX-WESTINGHOUSE Twin-cylinder compressor
- HIGGS & STRATTON 2-HP, 4 cycle, "Kick" or rope start Engine
- TWO independent air outlets (one for high pressure to 200 lbs.—one controlled by regulator from 0 to max.)
- Large Face Gauge • Safety release Valve
- Automatic governor and unloader keeps pressure constant without stopping engine
- Hollow frame acts as air reservoir assuring large supply of OIL-FREE air with absolutely NO PULSATION!

A BUY for: Contractor, Farm, Garage, Service station, Factory, Shop!
UNEXCELLED FOR:
• Spraying • Greasing
• Tire inflation
• Blowing out heating & refrigeration lines
• Small pneumatic tool operation
• Flocking • Under-Coating • Insecticiding & Dusting

ALSO AVAILABLE! Same unit with 1-HP Electric Motor, 110-220 volts, 60 cy. **\$129.00** f.o.b.

ORDER DIRECT FROM THIS AD! Satisfaction Guaranteed!
Send for CATALOG of Motors and Electrical equipment
ROBERTS ELECTRIC CO., Dept. 175, 849 W. Grand, Chicago 22, Ill.



NEW HULL AUTO COMPASSES ARE EASIEST TO INSTALL

• Greater accuracy and a patented, more positive means of compensating against magnetic interference have long kept Hull Auto Compasses first with America's motorists. Now, choice of a new vacuum cup mounting bracket with special adhesive, or the original clamp type, gives greater-than-ever ease of installation.

Write for local dealer's name, free literature

HULL MFG. CO. P.O. Box 246 D-5 WARREN, OHIO



Assemble Your Own DIVING LUNG

We furnish the parts and instructions. Complete outfits \$39.95 and \$49.95. Write for descriptive literature.

COMPLETE PORTABLE OXYGEN RESUSCITATOR

Ideal for Ambulances, Home Therapy, Clinics, Fire Dept., Police, etc. \$49.95 and \$59.95. Write for literature.

• Air & Oxygen Tank. For Diving Lungs, etc. 205 cu. in. capacity, 1800 psi. Hydro. tested. current dating 10C-3A1800. Reconditioned. Wt. 12 3/4 lb. P.O.B. St. L. \$10.95
Ed. Aguado Trdg. Co., Dept. H, Box 4525 Plaza Stn., St. Louis, Mo.

PARTS FOR MILITARY TRUCKS

and JEEPS 4 & 6 WHEEL DRIVE. WRITE FOR PARTS CATALOG STATING MAKES

American AUTO PARTS CO. INC.
1830 LOCUST — DEPT. P.M.
KANSAS CITY, MISSOURI

8 in 1 WRENCH

Order by check, money order or C.O.D.



8 Different 12-Point Openings

Small Head; 7/16, 1/2, 9/16, 19/32"
Large Head; 5/8, 11/16, 3/4, 7/8"

ONLY **\$4.98** postpaid

IMMEDIATE DELIVERY

Grip hex nuts all 6 sides, no slip-no rounding of nut corners! Entire wrench is drop forged and heat-treated. Finished in zinc plate! Length 9".

DASTCO INDUSTRIES LTD. 4447-9 W. FULLERTON CHICAGO 39, ILL.

Enjoy New Driving Comfort with the Sensational

AIR LIFT

PNEUMATIC SPRING BOOSTER



Front AIR LIFTS are specifically designed to give you new driving comfort. They dampen the suspensions, cushion the bumps and eliminate costly repairs.

You'll appreciate the ease with which you can drive the roughest roads and the severest turns with AIR LIFTS to steady your car.

For comfort, stability and safety install AIR LIFTS in your FRONT coil springs. To assist your rear springs . . . if you are carrying overloads . . . use REAR AIR LIFTS. Installation is simple . . . nothing to dismantle . . . economical and guaranteed.

AIR LIFT

See Your Dealer Today or Write to:



AIR LIFT CO.
2330 W. Main Street
LANSING, MICHIGAN

MAKE UP TO \$5 AN HOUR WITH

EASISHARP



**MONEY
MAKING
SALES PLAN FREE**

—everybody uses scissors and all need sharpening two to four times a year. Don't let some one else get ahead of you. Write immediately to

SERR-EDGE MACHINE CO., 9731 Lorain Ave., Cleveland, Ohio

Big profits in your spare time sharpening scissors. We show you how to start making money immediately. This is your chance now to have your own business with Easisharp. Sharpens a pair of scissors in less than two minutes! A child can operate it. Weighs only 10 lbs. Every home, barber, tailor, dressmaker



**ALL-STEEL
DRILL PRESS VISE**
3 1/2" Hardened Jaws **\$9.95**
Free Circular Postpaid
B. M. SYPHER CO.
204 Cherry St. Toledo 4, Ohio

REGULEVER for REGULATORS

FOR WELDERS, PAINTERS,
DRUGSTORES, HOSPITALS

Replaces thumb screw. Turn in to pressure desired. Turn on or off with a flick of lever. In some cases, save up to 50% on gas and oxygen.

REGULEVER enables operator to turn gas on or off in one second, eliminating tiresome turning of knobs, screws, and handles. After pressure is selected it remains the same. If not at dealers, sent postpaid for \$3.45. No C.O.D.'s. Please give diameter and thread size of thumb screw, also effective screw length. Available sizes 3/8", 7/16", 1/2", 9/16", 5/8" in fine and coarse threads.

DEALERS WANTED all over U.S. — Very Attractive Discount. Supply is absolutely unlimited, but mail your order NOW to:

STRONG MANUFACTURING CO.

P.O. Box 6175

Albuquerque, N.M.



Pat. pending

Use good files on your

**DO-IT-YOURSELF
PROJECTS**



You really get the urge to make and repair things when the files you use are Nicholson or Black Diamond. There's a rare crispness in their bite, economy in their long-lasting sharpness, satisfaction in knowing that you have the world's finest.

The man in the picture is finishing off a pair of hardwood book ends, but even his modest assortment of these *good* files can take care of scores of jobs around the house, garage and workshop.

It's worth while going out of your way to get Nicholson or Black Diamond files, but most good hardware and tool-supply houses have them . . . because they know that "once a customer, you're *always* a customer."

FREE BOOK,
"File Philosophy,"

will help you on your Do-It-Yourself projects. It has 48 illustrated pages on kinds, use and care of files. Send for it.



**NICHOLSON
U.S.A.**

NICHOLSON FILE CO.

22 Acorn Street
Providence 1, R. I.

(In Canada: Nicholson File Company
of Canada Ltd., Port Hope, Ontario)

**BLACK DIAMOND
U.S.A.**

**NICHOLSON
FILES** FOR EVERY PURPOSE

**Lighten work
on outside jobs...**



Painters on painting exterior walls: Make sure surface is dry and temperature between 55° and 90°. Remove loose paint with scraper or wire brush. Fill cracks and holes. Dust thoroughly. Select brush 3" to 5" wide and always...

Use brushes with bristles of Du Pont **TYNEX** nylon

TRADE-MARK

YOU'LL find "Tynex" nylon bristles pick up a full load of paint every dip and brush it out easily in a uniform coat. Outside or in, brushes bristled with "Tynex" help you get work done fast. "Tynex" bristles simplify brush upkeep, too. They are quickly cleaned by any commercial cleaner and last up to five times longer than other bristles.

Send for free booklet on "How to Choose and Use a Paintbrush Bristled with 'Tynex' Nylon." Write: E. I. du Pont de Nemours & Co. (Inc.), Polychemicals Dept. PM-5, Wilmington, Del.

"Tynex" is the new trade-mark for genuine Du Pont nylon bristles.



LOOK FOR
"TYNEX"
WHEN YOU
BUY
BRUSHES



Better Things for Better Living
... through Chemistry

Make BIG SAVINGS With FACTORY-DIRECT PRICES!



HAND WINCHES AT FACTORY PRICES
3 to 1 ratio, 700 lb. pull. Drum has 1 1/2" spool, 9" flange. Takes 75 ft. of 3/16" cable. Stop locking pawl. \$16.85
24 to 1 ratio. Worm drive. 1000 lb. pull. Width 11", depth 7 1/2", height 7 3/4" \$28.00
10 to 1 ratio, Super-duty 4000 lb. pull. Double drum, with jaw type clutch. Wgt. 280 lbs. \$49.50

Electric Winches—Direct-to-You Prices
1/2 HP master gearhead driven winch with drum. Will lift 500 lbs. Pull 1100 lbs. \$98.00

1/2 HP Electric Ball Bearing. Compact gear box. 12 RPM drum speed. \$165.00
3/4 HP, same as above. More lifting power, greater speed. \$185.00
Super-duty 3/4 HP Ball Bearing. With 24 to 1 worm gear reducer. Length 36". Width 24". Height 17". Pull 3500 lbs. Complete with 100 ft. of aircraft cable, up-and-down buttons. \$245.00
(All electric motors Heavy-Duty. Repulsion-Induction. Instant Reverse. 110 V single phase. 3 phase available).
Complete Stock of Limit Switches, Magnetic Brakes, Magnetic Reversing Switches, Aircraft Cable
CABLE 3/4" pre-formed aircraft cable. 17c ft.
3/16" pre-formed aircraft cable. 12c ft.

HOT ROD SUPERCHARGER

Extra soup and go at a price you can't afford to miss! Mfr'd by Borg-Warner. Specifications: 7 1/2" deep, 7" high. Wgt. 17 lbs. Compact and sturdy. 4 base mounting holes, 3/4" outlet, 3/8" shaft with female Loveloy coupling. Priced today at \$85. SPECIAL NEW only \$31.00 USED \$18.95



Here are only a few big \$\$\$ savings! More in our catalog!

Air Compressor	Electric Motors	Hand Truck	Rubber Cable
Air Tank	Electric Switches	Hydraulic	Rubber Wheels
Block & Tackle	Elevator	Cylinder	Saw Tables
Blowers	Drawing	Hydraulic	Shower Sprays
Bomb Trailer	Elevator Incline	Stacker	Starters
Buzz Saw	Fans, Exhaust	1 Beam Trolley	Tools
Compressor	Fans, Heat	Lawn Mower	Transformers
Accessories	Booster	Sulky	Writing Hoist
Clutches	Gas Engines	Magnetic Starter	Wilton Vice
Conveyors	Generators	Mail Chain Saw	Winch, Electric
Delta Tools	Grinders	Mail Grinder	Winch, Hand
Drop Cords	1/2 Ton Wagon	Pumps	Fire Extinguisher
Electric Hoists	Male Fire Pump	Reduction Gear	4 Wheel Trailer

Get this catalog! 72 pages, packed with useful charts, information, plans for dummy & incline elevators, more than 1100 tool and equipment items at money-saving, factory-to-you prices. Send 25c (refund with first order) or write on company letterhead for free copy.

**C&H ELECTRIC
MACHINE Co. Inc.**

434 W. Juneau Ave., Milwaukee 3, Wisconsin

SAY YOU SAW IT IN POPULAR MECHANICS

Rely on **ROBERTON** Electric or Gas-Power Reel-Type or Rotary **MOWERS**

Quality
Since 1922



ROBERTON MFG. CO.
Chicago 14

Build Your Own Walks,
Driveway, Outdoor
Fireplace, Steps, Etc.

What to Make With **CONCRETE**



The terrific high costs of even little concrete jobs are mostly for labor. Get Popular Mechanics **WHAT TO MAKE WITH CONCRETE** and save all the labor costs while making your home or farm ship-shape. You can lay foundations, sidewalks and driveways; build steps, outdoor fireplaces, sandboxes, tennis courts, garden and swimming pools and other installations at very little cost. Book shows all — tells all — how to make the right mixture, plan, apply and gives 50 professional short cuts. Hundreds of pictures. Only \$2.00 postpaid. Order today. Money back if not pleased.

POPULAR MECHANICS
PRESS

Dept. PM17, 200 E. Ontario
Chicago 11, Ill.



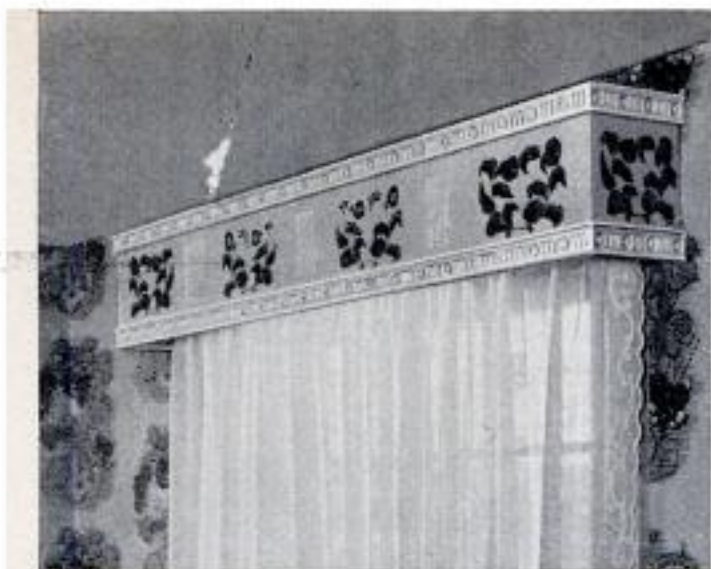

WINDOW VALANCE fashioned from Reynolds *Do-It-Yourself* Aluminum sheet and wood brings beauty to any window. Easi-Bild† Pattern #550, 35c with coupon.

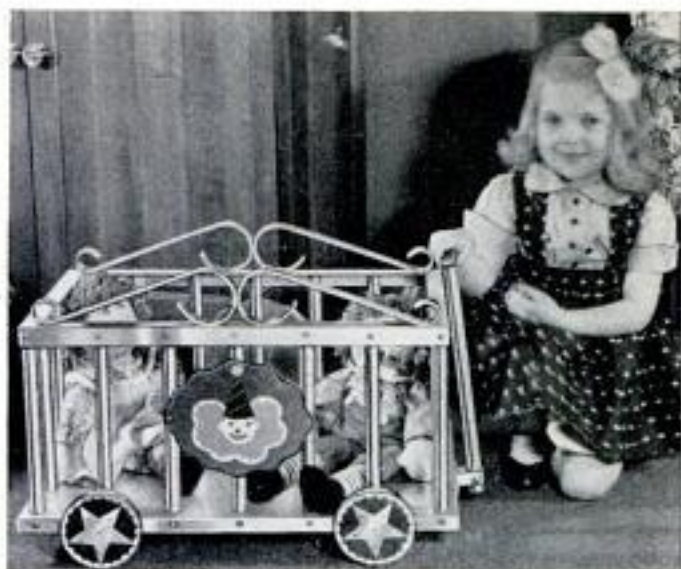

CIRCUS WAGON TOY HOPPER teaches tidiness to tots, is a real joy to Mother. Whip one out this weekend. Reynolds Plan #108, only 25c with coupon.

HOMEMADE MIRACLES IN METAL!

Make these and 101 other projects with amazing

REYNOLDS *DO-IT-YOURSELF** ALUMINUM



ALUMINUM SCREENS never rust or stain. Make them easily with Reynolds *Do-It-Yourself* Aluminum. Free Folder. See Coupon.



STUNNING PLANTER-LAMP is a simple, inexpensive project. Follow Easi-Bild Pattern #541, 50c with coupon.



DRAWER-IN-A-DRAWER Handy, sliding "Tray" Drawer. One of ten plans in Reynolds Plan #102, 25c with coupon.



LOOK FOR THIS RACK at your Hardware or Department Store, or Building Supply Dealer.

No special equipment needed . . . use standard hand or power tools

Who says the Age of Miracles is passed? Right in your own home you can now perform *miracles in metal* that will simply amaze you. The secret is Reynolds *Do-It-Yourself* Aluminum. You can saw it, drill it, plane it, joint it just like wood, yet it's far, far easier to use.

There's a form of Reynold's *Do-It-Yourself* Aluminum for almost every project. It comes in sheets, tubes, rods, bars, angles, storm sash and screen sections and handy fasteners. Use only Reynolds *Do-It-Yourself* Aluminum with the special Seal on every piece. Other types of aluminum may harm standard tools.

*T. M. Reynolds Metals Company
†T. M. Reg. Easi-Bild Pattern Company



REYNOLDS METALS COMPANY
2494 South Third Street, Louisville, Ky.

Please send me the following PLANS and free booklets (check as desired). I enclose \$..... in money order or coin (no stamps, please).

- Easi-Bild Pattern #550 for WINDOW VALANCE—35c
- Reynolds Plan #108 for TOY HOPPER—25c
- Reynolds Plan #102 for DRAWER-IN-A-DRAWER (includes plans for nine other projects)—25c
- Instruction Folder for SCREENS, STORM SASH—FREE
- How-To Booklet—FREE
- Easi-Bild Pattern #541 for PLANTER-LAMP—50c

Name.....

Address.....

City..... Zone..... State.....

Reynolds *Do-It-Yourself* Aluminum
is also available in Canada

The easy way to paint!

Speedy Sprayer

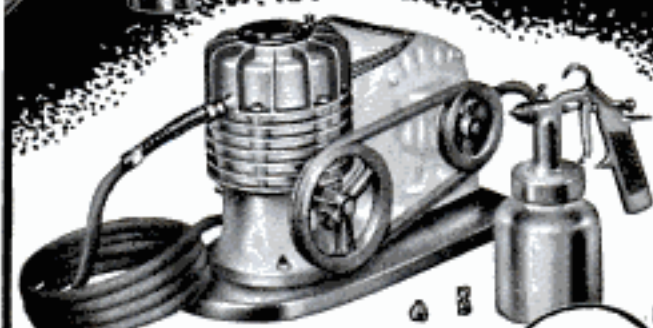

Favorite of home owners and craftsmen for 20 years! SPEEDY SPRAYER gives your work that professional paint finish everyone admires. Sprays paint, enamel, varnish, lacquer, etc. . . . 4 to 7 times faster than hand brushing! Lightweight, portable, uses any 1/4 H.P. motor. Improved diaphragm principle assures clean, oil-free air. You'll find dozens of time and money saving uses for SPEEDY SPRAYER, including spraying insecticides 2-4-D and DDT. Complete outfit, without motor, only \$36.50.

At leading hardware, lumber, and auto supply dealers. FREE—write for handy booklet "How to Spray."

W. R. BROWN CORPORATION
2635 N. Normandy • Chicago 35, Ill.

ONLY
\$36.50
LESS
MOTOR

New Big Barrel Micrometers Have 7 BIG Features

1. Easy-to-reach ratchet cap.
2. Big, sensitive direct-feel thimble.
3. Perfect balance in shorter length.
4. Non-glare satin-chrome finish.
5. Easy-to-read markings widely spaced on big barrel.
6. Rapid reading — big numbers mark every thousandth.
7. Slip-proof black crackle finish on frame.



Designed by
LUFKIN

for Faster, Easier,
More Accurate Measurements

Get full information on this and many other new Lufkin time and work-saving precision tools. Send the coupon today.

304 BUY **LUFKIN** TAPES • RULES • PRECISION TOOLS AT YOUR HARDWARE OR TOOL STORE

THE LUFKIN RULE CO., Dept. PM, Saginaw, Michigan
Please send me your Free "New Tools" booklet.

NAME _____
ADDRESS _____
CITY _____ STATE _____

NEW
TOOLS
BOOKLET
FREE

ROTO-HOE ^{TOOLS} _{GARDEN} Brings You the Easy NEW and PROVEN WAY to buy POWER EQUIPMENT



Years of experience in perfecting ROTO-HOE plus plenty of "garden testing" by thousands of users, insures your satisfaction. Send for our new free 16-page full color catalog which can save you hundreds of dollars. Look at these ROTO-HOE advantages:

1. Low first cost, complete ROTO-HOE only \$134.
2. Many thousands of satisfied customers.
3. Variety of low cost attachments to do extra jobs.
4. Minimum storage space needed—hang attachments from the garage wall.
5. Low cost replacement parts if ever needed.

You'll want to know more about just what ROTO-HOE and attachments can do to make gardening easier for you. Write today for free color catalog and name of nearby dealer.

START YOUR OWN BUSINESS. There may be an opportunity for you to start your own business selling and servicing ROTO-HOE in your community. Write for full details.

ROTO-HOE & SPRAYER COMPANY

BOX 19 NEWBURY, OHIO

PRECISION PLIERS



• For accurate, exacting work use the fine, small pliers jewelers and watchmakers use — Kraeuter's Precision Pliers. Matched in size and handle shape, drop forged from selected tool steel, machined and heat treated to exacting specifications. For hobby crafters, model builders, TV and radio technicians.

Buy wherever fine tools are sold in U. S. and Canada.

KRAEUTER

Save Hundreds of Dollars Yearly With
Guide to Home Repairs

Home Repairs, Modernizing Jobs Made Easy for Home Owners

Beat the high cost of home upkeep. Stop staggering labor costs. Save hundreds of dollars every year on carpentry, electrical, painting, plumbing and other jobs around the house with Popular Mechanics **GUIDE TO HOME REPAIRS**. Simplified how-to-do-it instructions and 646 pictures make all jobs, inside and out, easy. Covers construction, remodeling, modernizing, repairing that you can do yourself at small cost. Repair leaky faucets for pennies; save \$10 to \$15 on new electrical outlets; save hundreds of dollars on new floors, porch repairs, tuck pointing, gutter replacements and other improvements. 192 page cloth bound book only \$2.50 postpaid. Get **GUIDE TO HOME REPAIRS** today under our money back guarantee.

POPULAR MECHANICS PRESS, Dept. PM1, 200 E. Ontario St., Chicago 11



275 HOW-TO BOOKS—GIANT CATALOG FREE

How-to-do-it books on hunting, fishing, shop tools, concrete work, welding, plastics, carpentry, photography, boat building, gardening, auto repair, etc., in the new giant 40-page Popular Mechanics Book Catalog. Send postcard for your free copy! Write Dept. CT3.

Popular Mechanics Press, 200 E. Ontario, Chicago 11

Your most useful shop tool . . .
DESMOND-SIMPLEX VISE



Extra features . . . no extra cost

The Desmond-Simplex Utility Vise is the handyman's "third hand"—for easier, faster work—for sure results, smooth finish. At no extra price, Desmond has extra features: steel slide, enclosed screw, shoulder-fit jaw inserts, pipe jaws (replaceable on larger models), cut-off tool, anvil with horn, 360° swivel, non-pinching type handle. Ask your hardware retailer for a Desmond-Simplex Utility Vise. Write for folder showing vise applications in home, garage, or farm shop.

The Desmond-Stephan Mfg. Co.
 173 Walnut Street, Urbana, Ohio



Motor-Generator WELDER

No Separate Motor or Engine Required
 Just Plug it in! REG. VALUE \$350.00

• WELDS!
 • CUTS!
 • BRAZES!
140 AMPS. \$85.00 f.o.b.

For Heavy Work to Lightest Fine Job!
 On a PORTABLE roller stand . . . can quickly be taken to the job. BRAND NEW! General-Electric motor-generator produces DC welding current up to 140 amps. Will handle up to 5/32" rod. Operates on AC or DC, 110 or 220 volts, 25-60 cy. Single or 3-phase. Welds straight or reverse polarity. Heavy-duty Ball Bearing construction. Has 7 welding ranges from 0 to 140 amps. Motor becomes power unit to Grind, Sand, Buff and Polish (with attachments incl.)

ACCESSORIES AT A BUY! Two 15-ft. cables, Ground Clamps, 300 amp. electrode holder, Ass't. electrodes, Helmet, Simplified instructions, COMPLETE OUTFIT (shpg. wt. 85 lbs.) only. . . . **\$98.50** f.o.b. **FULLY GUARANTEED!** You can't go wrong. Send for our

10-DAY FREE TRIAL! ORDER FROM AD! LIMITED OFFER!
 Use it for 10 days. Be 100% satisfied or money back!

FREE Catalog of Motors and Electrical Equipment
 ROBERTS ELECTRIC CO., Dept 178, 849 W. Grand, Chicago 22, Ill.

NEW! Every Electric Drill
A Powerful PORTABLE
JIG SAW



"ARCO JIG-SAW"

HAS SAME CAPACITY,
 CUTS AS FAST AS SAWS
 COSTING \$50 & UP!

DOES WORK OF JIG,
 KEYHOLE, COPING,
 BAND, RIP, CROSSCUT,
 HACKSAW.

HAS EXCLUSIVE, BUILT-
 IN AIR BLOWER

Here for the first time is a Portable Jig Saw that attaches in ONE MINUTE to any 1/4" electric drill. It will handle any project from the smallest to the largest, cuts openings without a starting hole. Cuts intricate patterns, circles, etc., in wood, wallboard, plastics, metals.

"ARCO JIG SAW" is a powerful, lightweight tool that is easy to handle because of its Right Angle Drive. Strong Safety-Yoke & Worm Drive Clamp make it a vibration-free unit.

No. 505—Six extra blades for wood, metals, etc. . . . **\$1.95**
BUY THE BEST—see your hardware dealer now! If not available, try "ARCO JIG-SAW" on our **10-DAY MONEY BACK GUARANTEE.** Send us check or M.O. (Postpaid), C.O.D.'s—postage extra.

ARROW METAL PRODUCTS CO.

Dept. PM-5, 140 WEST BROADWAY, NEW YORK 13, N.Y.

Pine panel your kitchen!
DO-IT-YOURSELF
 it's easy with Gold Bond
 Fireproof Grainboard!



GIVE your kitchen that warm, cozy pine-paneled look with Gold Bond Gypsum Grainboard. It has all the expensive beauty of fine wood paneling, at a fraction of the cost. Sturdy, fireproof Grainboard is available in two convenient widths—4 ft. panels or handy 16-in. planks...in Knotty Pine, Bleached Walnut and Dark Walnut. It's ideal for finishing off old walls or adding a den or gameroom.



Lightweight and easy to work, Gold Bond Gypsum Grainboard goes up fast—covers large areas at a time. A hammer and knife are the only tools you need. Cuts easier than wood...just score and snap to fit.



In new construction, Gold Bond Gypsum Grainboard can be nailed to the studs. Or, in remodeling, you can nail it directly to old walls or over furring strips.

Get your FREE Do-It-Yourself instruction folder. Send for it today! National Gypsum Company—Buffalo 2, N. Y.



MAIL COUPON TODAY!

NATIONAL GYPSUM COMPANY
 Dept. PM-54, Buffalo 2, N. Y.

Please send me a free copy of your Do-It-Yourself Wallboard Application Folder.

Name.....

Address.....

City..... Zone..... State.....

GIGANTIC MAIL SALE

WAR SURPLUS
EXCESS INVENTORY
BANKRUPT STOCK

POWER PLANTS & GENERATORS

● Army's finest plant. 115-v 60-c, 3000-4000-w. Size 20"x 30"x48". Wt. 600 lbs. 4-cyl. water-cooled self-start engine. Gov't. cost over \$4800.00. Ppd. in U.S.A. \$349.50

AIR COMPRESSOR UNITS

Paint, clean, for tires, control termites, etc. Build your own.

● DeLuxe Kit. Tank, comprsr. gauge, valves, paint gun, regulator, fittings, etc. \$70 value. \$45

● Compressors. \$20 Tanks \$6.79. Pressure Switch \$4.95. Gauges (160 lbs.) \$1.89.

● Air Supply Unit. Fill at filling station. Holds air indefinitely. \$15.95



DC-AC GENERATOR

● Brand new ball brg. G.E. unit, suitable for D-C welder, electroplating, high current battery charging, home emergency plant for lights, etc.

● Generates 200 amps at 30-v. D-C. Also furnishes 115-v 800-c A-C at 2000 watts. Marvellous buy! 131 units available. Government cost over \$300. Ppd. to you. \$29.48



HYD. CYLINDER



● Leading make. Brand new. Standard unit. 3" bore, 8" stroke, one way, 1" rod, 1/4" inlet. Made for plow Co. that changed to different stroke. Will lift 7000 lbs. Guaranteed. Hundreds of uses on farm, industry. Lift plows, arbor press, wagon dumps, dozer, etc. Natl. Advd. \$24.50. SPECIAL. PPD. \$11.95

ORCHARD-ESTATE POWER SPRAYER

Genuine Hydro-Jet pressure pump. 1 1/2 h.p. Clinton engine. 50-gal. steel tank with agitator and 50' hose and hand spray boom. For truck farms, estates, factories, orchards, etc. List over \$200. \$114.50 Ppd.



ARMY PARTS CLEANER

● Air-solvent cleaner. Makes dirty, greasy parts shiny bright. Wonderful for garages, factories, farm, repair shops.

● Heavy galv. tank 25"x20"x20". with valve, hose, hydraulic lid riser. Cost \$100. Ppd. frt. \$29.95



SPECIAL OF THE MONTH! Airport or Advertising GIANT FLOOD LIGHT!

● Buy of the year! Air Force landing field flood light. Throws wide flat beam of concentrated light for long distance on runway.

● Ideal for private flying field, small airport, contractor, parking lot, estate.

● Makes marvelous flashing adv. lite for entrance or roof top of drive-in, motel, supermarket. Attention getter.

● Consists of giant concentrator Fresnel lens, 1250-w, 110-v, hi-intensity bulb, 3' to 12' collapsible steel tripod, expensive shipping trunk, 4 extra bulbs, anchors, etc. Trunk makes wonderful tool chest. Total wt. 140 lbs. Govt. Cost, \$280!

Special Ppd.

\$49.50



Hundreds other surplus items: pumps, optical, levels, phones, winches, etc. We pay shipping charges. Send for catalog.

BURDEN SALES COMPANY

819 "O" STREET

LINCOLN, NEBR.

100 BEST Woodworking Projects

SELECTED FOR YOU BY POPULAR MECHANICS EDITORS

Enjoy the fun — the pride — of making things. Get 100 BEST WOODWORKING PROJECTS, complete with simplified instruction, plans, diagrams and more than 400 how-to-do-it pictures. Make all kinds of furniture, baby carriages, clocks, lamps, book shelves, fireplaces and other useful articles at little or no cost. Send only \$2.00 with name and address. Money back if not pleased.

POPULAR MECHANICS PRESS, Dept. PM6, 200 E. Ontario St., Chicago 11

this ONE GOVERNOR



fits ALL popular farm & industrial gasoline engines

PIERCE LONG RANGE Universal Governor ONLY \$39.50

- Instant variable speed selection and accurate engine control at any speed setting within 1200 to 2200 RPM. Higher and lower ranges obtainable by simple change of pulley. Also "constant speed" operation.
- Accurate, dependable speed control for engines operating corn shellers, drag lines, hoists, arc welders, trucks and tractors with power take-offs, etc.

Pulley extra
Send Check or Money Order.
State Make, Model of engine.

Write for Complete Information.

DEALERSHIPS AVAILABLE

"World's Most Experienced Governor Manufacturer"

THE PIERCE GOVERNOR CO., Inc.
1652 Ohio Avenue, Box 1000
Anderson, Indiana, U. S. A.

Enjoy the Fascinating Story of the Horseless Carriage in

Popular Mechanics

AUTO ALBUM

166 Illustrations

The most intriguing book about the automobile ever printed. It's thrilling, fascinating and informative. From the very first gasoline-propelled buggy to the cars of today and the atomic auto of the future. The first cars — the men who made them — the scrambled start and the development of the fabulous auto industry — the story of auto racing — the growth of the Nation's highways, 166 thrilling action pictures — old-time cars — racing cars — early auto advertising — automotive oddities. Roll call of names of more than 2000 autos made in the U.S. included. Ideal gift book. Cloth bound, only \$3.00 by mail. Money back if not pleased. Paper covered edition \$1.00 at newsstands.

POPULAR MECHANICS PRESS, Dept. PM14
200 East Ontario Street Chicago 11, Illinois

PAGE Tractors

Do The Job Faster — Easier — At Less Cost!

DOES TILLING, PLOWING, DISKING, Dozens of other jobs

Rugged 1954 riding, walking models 2 to 6 HP. All gear drive with reverse. Over 60 attachments! No belts, no chains. Fully Guaranteed!

Over 25 years' experience Free Catalog — PAGE 1804 S. 81st St. Milwaukee, Wis.

Only HOLD-E-ZEE

The Original AUTOMATIC GRIP

SCREWDRIVERS

PROVIDE THESE FEATURES:

- LOK-BLOK that makes blade twist and impact proof.
- GRIPPER that snaps back — recedes deep into handle, giving full blade use.
- HAND GROUND BITS — chrome vanadium, chrome plated blades.

YET COST NO MORE THAN ORDINARY SCREWDRIVERS

At Leading Dealers Everywhere!

UPSON BROS., INC., ROCHESTER 14 N. Y.

BUILD YOUR OWN POWER TOOLS - GIL-BILT

Exclusive GIL-BILT Build-It-Yourself Features

- No machining—build easily with hand tools only
- No blueprint reading — step-by-step pictorial plans, full scale patterns, actual photographs
- Sturdy wood, aluminum and steel construction
- Capacity and performance of commercial saws selling for \$40 and up
- Proved performance. Nationally advertised and sold for 7 years. Satisfied customers around the world

PARTS KITS
PLANS
only
\$1.00 EACH
 POSTPAID

GIL-BILT 10-in. TILT/ARBOR SAW



- 27x28 in. table, 13 1/2 in. capacity in front of blade
 - 10 in. blade cuts 3 1/4 in. deep, tilts full 45 degrees
 - Floor model 34" high, table always stays level
 - New Departure ball bearing arbor, 3/4" precision shaft turned down for 3/8" bore blades, alum. housing, shipped ready to run
 - Jackscrew and 4 1/2 in. dia. handwheel lowers and raises blade
 - Cast aluminum miter gauge and self-aligning rip fence guide
- GIL-BILT Metal Parts Kit includes Plans, ball bearing arbor, miter gauge and bar, rip fence guide, dado insert, lock knobs, jackscrew mechanism and handwheel, and all other metal parts (less blade).....\$22.95
 Same Kit with 10" Combination Blade \$25.90
 Same Kit with 8" Combination Blade \$24.90

GIL-BILT 12-INCH BAND SAW



- Cuts to center of 24 inch circle
 - Handles stock up to 6 inches thick
 - 18x18 inch table tilts 45 degrees
 - Lower wheel and drive pulley runs on sealed New Departure Ball Bearings; Upper wheel runs on two 3/8" bore Oilite Bronze bearings
 - Upper wheel tension and tilt mechanism of cast aluminum, completely assembled
 - Upper and lower blade guides, Each has ball thrust bearing, self-lub bronze jaws
 - Rigid cast aluminum wheels fully machined ready-to-install. Heavy rubber tires
 - Uses standard 78 inch blades up to 3/4 in. wide
 - Fully enclosed mechanism for utmost safety
- GIL-BILT Metal Parts Kit includes Plans, rubber tires, aluminum wheels, 1/4 in. blade, ball bearing spindle, tilt mechanism, blade guides, table tilt segments, and all other metal parts.....\$23.95
 Return Kits in 10 days for refund if not satisfied.
 For shipments up to 600 miles, add 5%; over 600 add 10%
 Amount in excess of actual postage will be refunded.

ALSO AVAILABLE
 Plans & Parts
 Kits for 18-in.
 Band Saw, Belt
 Sander, Spindle
 Shaper, 8-in.
 Tilt/Table Saw

Order Kit now, or order Plans at \$1.00 each and Kit later less cost of plans. Write for FREE Catalog.
 P. O. Box 1-PE, Lambert Field
 St. Louis 21, Missouri

GILLIOM POWER TOOLS

YOU can improve... protect... beautify
 ... your home

with everlasting
Alumatic[®]

ALUMINUM WEATHER CONTROL PRODUCTS



Alumatic products never rust or rot—seldom need repair, always look beautiful. Once they're up—they're up for good—your good!

ALUMINUM COMBINATION WINDOWS

No changing or storing with 3 TRACK operation plus Velglidel Insulate—protect year 'round.

ALUMINUM COMBINATION DOORS

Storm door in Winter, Screen door in Summer
 Enduring beauty and protection for every home.

ALUMINUM AWNINGS and CANOPIES

Full ventilation, exclusive "Magic Light", modern horizontal lines and bright rainbow colors!

Alumatic products are easily and quickly installed.

write for folders and your dealer's name.

Alumatic Corporation of America
 Dept. C95D, Milwaukee 14, Wisconsin
 Alumatic of Canada, Ltd., Windsor, Ont.



Objections OVERRULED

Fish love the SILVERTROL, the Electric Trolling Motor. It's slow enough to give them a chance to catch your hook. No noise or exhaust to scare them away. The SILVERTROL is ideal on waters where gasoline outboards are prohibited. Operates on standard 6 or 12-volt automobile batteries.

LIGHT, EASY TO CARRY AND INSTALL.



\$74.50
 F. O. B.

1. Two Speed Switch
2. Tiller Grip
3. Transom Adjustment
4. Chrome-plated Steel Column
5. Fixed Steering Adjustment
6. 5-Adjustment Transom Bracket
7. 2-Conductor Rubber Cable with Speed Clips
8. Streamlined Aluminum and Steel Construction
9. Efficient Aluminum Propeller

PATENTED THROUGHOUT WORLD

SILVERTROL ELECTRIC TROLLING MOTOR



FREE Booklet

Silver Creek Precision Corp., Dept. PM
 Silver Creek, N. Y.

Please send me name of nearest dealer and a copy of your new illustrated booklet, "Your Guide to Good Fishing."

Name _____

Address _____

NOW! Meet the Amazing
turtle wax
family!



turtle wax
AUTO POLISH

TURTLE WAX, the World's Finest Auto Polish! Only TURTLE WAX Cleans, Polishes and PROTECTS your car with a brilliant HARD SHELL FINISH, all in one easy operation! Full year's supply, only \$2 (Fair Traded)

turtle wax
FURNITURE
POLISH

Now! Transform old furniture into NEW! In minutes, TURTLE WAX Cleans, Polishes and PROTECTS furniture with a rich, lustrous HARD SHELL FINISH. Full year's supply in the new NON-BREAKABLE Plastic Squeeze Bottle, only 98¢ (Fair Traded)



tommy turtle
BICYCLE
POLISH



Tommy Turtle Cleans, Polishes and PROTECTS bicycles with an amazing HARD SHELL FINISH. Removes rust...protects all chrome surfaces. Full year's supply, only 49¢ (Fair Traded)

Only Turtle Wax Products give you a

HARD SHELL FINISH

Available at leading stores everywhere.

© 4-1954 Plastone Co., Inc., Chicago 51, Ill.

ace
of
Aces

in
LOW
COST

transportation

Cushman is the top card in the transportation deck for speed, power—low cost operation. Ride it to work, for sport, school, on errands, deliveries. You're set to go! No traffic or parking worries either. And total operating cost LESS THAN A PENNY A MILE! See your nearest Cushman dealer for FREE demonstration.



Up to
75
miles
per
gallon

Write TODAY
for FREE
illustrated
literature

CUSHMAN MOTOR WORKS, INC.

919 No. 21st St., Lincoln, Nebraska

COMPRESSORS—PAINT SPRAY UNITS
CASH WITH ORDER WE PAY FREIGHT

PORTABLE COMPRESSOR UNIT
WITH 22 GALLON TANK

Hvy. duty, 1/2 h.p. capacitor AC motor, 125 lbs. capacity. Complete with rubber tired wheels, all valves, gauges, cord, plug, air hose, and tire chuck. NOTHING ELSE TO BUY. Ship. wt. 90 lbs.

UNASSEMBLED...\$92.95 ASSEMBLED.....\$109.50



PORTABLE PAINT SPRAY UNIT

Hvy. duty, 1/2 h.p. AC motor, 7 1/2 x 25" tank. Piston type compressor. Unit with all valves, int. atom. gun, quart cup, 20 ft. hose, carrying handle. Complete ready to use. NOTHING ELSE TO BUY. Ship. wt. 60 lbs.

UNASSEMBLED...\$52.95 ASSEMBLED...\$72.50



WELLWORTH COMPRESSORS

Model 800
As in above unit 2" bore, 1 3/4" stroke, 2.8 cfm up to 150 lbs. Use with 1/4 h.p. motor.

\$20.50

Ship. wt. 16 lbs.

Model W3
2 1/2" x 2", 2.55 to 4.80 cfm up to 150 lbs. Use with 1/2-1/2-3/4 HP motor.

\$29.95

Ship. wt. 20 lbs.



FLOCK GUN & DUST SPRAYER

For dusting plants, etc. Easy to use, works off compressor, 14" in length. Sprays insecticides, powders.

Also use for lub. gun, 2 lbs.\$2.95



V BELT CLUTCH

Takes starting load off engine or motor, "A" belt, 2.35 pitch diameter, 3/8" bore, ball bear. Price.....\$8.00
3/4" bore, \$9.00 Bushing for 1/2" shaft 20c

ALL PRODUCTS CARRY 1 YEAR MONEY BACK GUARANTEE
SEND FOR FREE CATALOG DEPT. D5

WELLWORTH TRADING COMPANY
1832 S. WABASH AVE. CHICAGO 16, ILL.

The NEWEST PLIERENCH
The EIFEL . . . 1000% . . .
GEARED-PIVOT Plierench!

It has the FIRST and Only Scientific 'OMNI-Grip' that Holds ANY Shape in Various Positions . . . gives Parallel and Near-Parallel grips in 7 Pivot-positions . . . has 'Nose-Vs' for End-on grips on Nuts, Balls, screws, etc . . . has Extra Deep Thread, 1 1/2"!



Sets of Toothed-Vs of Various widths and Angles give Universal grips with incomparably More Holding-power . . . Crossed-Vs serve to make SPRINGS, 1/32" to 1/4", of .008" 1/32" wire, and . . . for 1001 other jobs most other tools just Can't handle.



Work position Shift position
an Instant Flip of the Lever Does it!

With the First and only Perfect Parallel Grips, 0"-3" . . . 10X Power, Once to 1/2-Ton Grips, 7" & 8 1/2", 3-Jaw KITS . . . Plus 6 Jaws, etc. for the 8 1/2" Plierench!



The Only Scientific Pivot-System . . . has 4X-to-10X Power, Opngs. 0"-2 1/4". Double that of Most pliers up to 10"! . . . Price Includes 15 sec. Grip-Clamp . . . makes Hand & Pin Vise, Clamp, etc.!

MAIL this COUPON TODAY . . . Get FREE . . .

- 1) The 53-Picture GEARED-Pivot Manual,
- 2) The 175-Picture KIT Catalog-Manual . . . with Offer as marked—(Please print Addr.)

DISTRIBUTOR Pl. Tm. AGENT User
American Plierench Corp'n 4611 N. Ravenswood Ave.
Chicago 40, Ill. (Dept. 245)

*IF Ck. or M.O. with COUPON . . . Before July 31, '54 . . . Only \$3.15 Pstpd.

APPLIANCE & CIRCUIT TESTER
NEW SAFE TESTING with POWER OFF



KREST TESTER tests for shorts, grounded circuits, open circuits—safely with power off. Practical, safe, compact—ideal for home mechanic, hobby shop, workshop, home, garage.

SAVES YOU MONEY! Helps you "Do It Yourself"—repair your own home appliances, motors, generators, auto circuits, switches, etc.

HELPS PREVENT FIRES caused by faulty wiring—tests house wiring, lamps, fuses, etc.

Dealer and agent inquiries invited.
Satisfaction guaranteed or your money back.
Send check or money order today to —

KREST PRODUCTS CO. 1303 W. Jackson Blvd.
Chicago 7, Illinois

SENSATIONAL MOTOR VALUE

BRAND NEW — FACTORY INSPECTED — PERFECT CONDITION. Built for long life, rugged use for Buffing and Grinding, Pans, Small Lathes and other Machine Tools, Compressors, Sprayers, Mixers, Action Displays, and many other uses! Variable Speed AC-DC 1/16 HP at 9000 RPM. Complete Kit includes Motor, Speed Control Rheostat, mounting bracket, dual plug, pulley, and belt—for only . . . \$9.45 (Motor alone—\$8.00. Accessory set only, \$4.00). Send only \$1.00 with COD orders or send full amount, save COD charges. JOHN A. CHADWICK CORPORATION, Dept. PM-5, 827 Hinman Avenue, Evanston, Illinois.

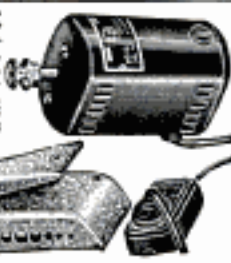

Say You Saw It in
POPULAR MECHANICS

**MEET WILSON'S INTERESTING
NEW KITS FOR '54**

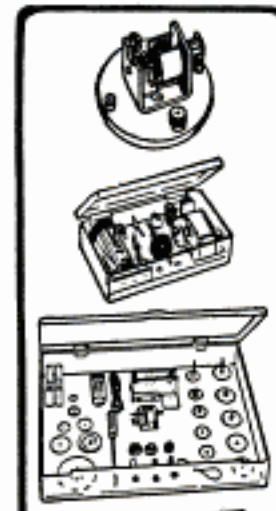

Wilson's aim is to provide motor devices to the scientifically minded boy and hobbyist—dependable dry-cell motors and parts for applying them to models, experiments and use by industry. Fully Guaranteed.

Model 96—Sturdy steel frame motor packaged with pinion, gear, worm, and pulley. Permanent Alnico V magnet—wound rotor—ball bearings—plenty of power. For 3 to 6 volts.
Price \$4.00

Model 3113—"Build it yourself" parts kit for "Tiny Atom" motor. Plastic case also contains shafts, brackets, connectors, worm gear, pulley, screws and educational instruction book.
Price \$3.00

Model 700—Wilson's Super Power Kit—contains "Tiny Atom" motor, variable speed power applicator, gears, pinions, pulleys, friction drive, connectors, shafts, brackets, belts. Leaves nothing more to buy. In plastic case.
Price \$10.00

Remit with order and we pay postage in U.S.A. No C.O.D. Add 2% Sales Tax for delivery in Ohio. Write Dept. PM.

For quick delivery see your local dealer — or order direct



WILSON'S OF CLEVELAND

425 Lakeside Ave., N.W. • Cleveland 13, Ohio



Low Cost "Husky Boy" Welds Anywhere! Earns BIG PROFITS!

Cash in on the profitable outside emergency repair jobs with the Transformer Type A.C. Welder. For in or out of shop welding you'll get years of dependable service at a low investment cost. Wheels and handles available at slight extra cost. "Build Your Own" AC welder, AC power. Operates away from power lines. Ask for details on generator only.

HOBART Brothers Co., Box M-54, Troy, Ohio Phone 21223

"One of the world's largest builders of arc welders."



Mail this Coupon!

Get started now in arc welding and increase your earnings. There's a big demand for welders. Simply check the items below for complete information.

- Hobart "Husky Boy" FREE Welder's Year Pocket Guide
- Transformer Type AC Welder
- Hobart Trade School

Hobart Bros. Co., Box M-54, Troy, Ohio

This amazing pump **SAVES** you plenty

GOULDS BALANCED-FLOW JET is a full-capacity, shallow-well water system—yet has no costly tank, fewer fittings to buy, costs dollars less to install. Exclusive self-adjusting capacity delivers exact flow of water wanted at all outlets at the same time, within capacity!

Costs less to buy . . . less to install

You save TWO ways—and enjoy performance found in no other pump at any price! Trouble-free, quiet, only one moving part—can't lose its prime.

Small and compact—install it most anywhere easily and quickly! Send for facts . . .

Mail this Coupon today

NO TANK
fewer fittings to buy

GOULDS

PUMPS, INC., SENECA FALLS, N.Y.

Enclosed find 10¢ for 20-page booklet on Balanced-Flow and other Goulds Pumps. Also distributor's name.

Name

Address

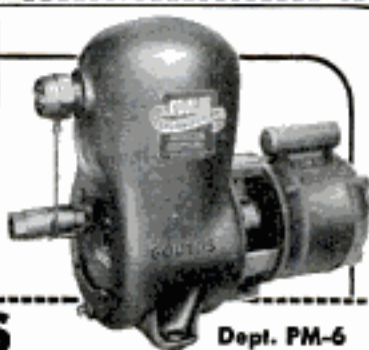

Dept. PM-6

Greatest Jig-Saw Value of All Time

Sensational NEW MOTO-JIG SAW



Cuts 1 1/2" wood . . . Has Built-in Rotary Motor!
(Not a Vibrator)



Pat. Appl. For

Only \$23.50

CREATED ESPECIALLY FOR THE DO-IT-YOURSELF FAMILY!

Here's the revolutionary new DREMEL Jig Saw the whole family can enjoy. Cuts 1 1/2" wood, 3/4" plywood fast as you can follow a line—also cuts metal, plastics, etc. New **ROCKER ACTION** principle maintains constant blade tension, cuts faster, lengthens blade life. Powered by a real **ROTARY** motor, it's rugged enough for production

work, cuts intricate scrolls impossible for other jig saws. 4-Way Blade Holder saws in any direction, takes any length stock. Has tilting table; foolproof blade guard makes it safe for women and children. A trial will convince you that dollar-for-dollar, the new DREMEL out-performs them all!

SEE YOUR DEALER. If he cannot supply, order direct on 5-day trial, money-back guarantee. Remit in full for postpaid shipment; or send \$2, pay postman balance plus postage and OOD.

DREMEL MFG. CO. Dept. 114-E, Racine, Wis.

THE BEST IN PLIERS? CHANNEL LOCK
CHAMPION DeARMENT TOOL CO., MEADVILLE, PA.

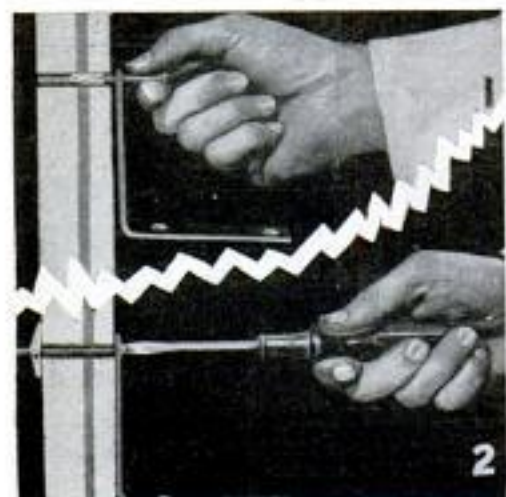

FASTEN FIXTURES QUICKLY EASILY!

U-S-E Golden "Loktite" Hollow Wall Fasteners are *easy to use* for fastening all types of fixtures to walls and ceilings. Drill hole, insert fastener with fixture attached (Fig. 1). Tighten with screwdriver (Fig. 2).

Assures a safe, secure mounting that will be sure to stay put.

For solid walls, ask for U-S-E Multi-Diameter Wood Screw Anchors.

Look for the U-S-E Display at your hardware store.



Send for FREE Booklet

U.S. EXPANSION BOLT CO. DEPT. P.M. YORK, PA.

JOINT AND SHARPEN ALL SAWS

SAVE TIME AND \$\$\$



Sensational new Super Filer No. 11 joints and sharpens both hand and circular saws 4" to 10" with all teeth the correct height, depth, pitch and bevel. Easy to use—when file hits hardened steel roller, teeth are finished. Saw runs true and smooth with no side pull. Complete with special 8" file \$9.95 ppd. **FREE FOLDER.**

"**TRU-CIRCLE**" saw set. Automatically sets teeth at 10° or more \$2.95. **FILE SAWS THE RIGHT WAY**

Guaranteed



SO EASY with this new filing jig and jointer anyone can now sharpen any handsaw like new! When file hits hardened steel rollers teeth are finished and **EXACTLY THE SAME HEIGHT**. All teeth cut and saw runs true and smooth. Jig and instructions \$2.95 postpaid. Free Folder. **A. D. McBURNEY, 5908 Hollywood Blvd., Hollywood 28, Calif., Dept. A-41**

VARIABLE SPEED HYDRAULIC POWER TRANSMISSION



It has Infinite Speeds 0 to 550. Reverse. Automatic Overload Protection. Adjustable Torque up to 180 inch pounds. 3/4" input and Output Shafts. It will handle 1/2 to 1 1/2 H.P. Motor. Case measures 7 1/2" long, 7" high, 6 1/2" wide. **VALUE OVER \$300.** Shipping Wt. 25#. On C.O.D. Orders we require a 10% only **\$54.50** Fob. Chicago Deposit.

DIRZIUS MACHINE SHOP "B" 1423-25 So. 52nd Ave., Cicero 50, Ill.

Also Esbelman SPORT CARS WORLD'S LOWEST PRICE

70 Miles Per Gal. Holds 1 Adult Free Literature



ESHELMAN ROTARY TILLER

Turns virgin ground into a garden bed in one operation. Replaces plowing, disking, and cultivating. Women can operate it. Also 1 to 8 H.P. POWER MOWERS & RIDING TRACTORS from \$69. Free Catalog. Write:

ESHELMAN CO., Dept. T-55
119 Light St., Balto. 2, Md.
333 N. Michigan Ave., Chicago-1, Ill.
7070 N. Wood Blvd., Los Angeles 28, Cal.

BUILD YOUR OWN ARC-WELDER

We show you how to build NEW powerful welder. No rewinding. Uses most any surplus aircraft generator. Easy to build, 75-300 amps. Complete **PLANS 25c.** Send today and we'll include **FREE** our Big War Surplus & Electrical Catalog.

LEJAY MFG. CO., 1247 LEJAY BLDG., MINNEAPOLIS 8, MINN.



NEW HOME FIRE DETECTOR

LIFE SAVER Thermostat



Prompt positive detection of any smoldering, slow-burning or violent flash fire. **Life Saver** operates the alarm promptly. Small (1 1/2"x5 1/2") inexpensive and efficient. Underwriters Labs approved. Write today for further information. Dealer inquiries invited.

FIRE ALARM THERMOSTAT CORP.
53 West 23rd Street, New York 10, N. Y.

General SALVAGE CO. SURPLUS Bargain-SALE! BUY DIRECT FROM THIS AD!

BUILD YOUR OWN ARC WELDER OR LIGHT PLANT

Give \$250 to \$500
\$15.50 used, good cond. Instr. incl. for Comb. welder & light plant. 200 amps. 28 Volts. Or Brand **\$21.50** New.....Price
PRICE F.O.B. K. C. MO.

CONVERTS TO ARC WELDER 100-250 AMP. OR LIGHT PLANT CAP. LOAD 5000 WATTS

Stock #711 D.C. Generator R-1 Jack & Heintz. Rated 300 Amp. 30 Volts. Gov't cost \$300.00. Instructions for converting to welder or light-plant incl. **\$27.50**

RHEOSTAT R-27 Heavy duty for regulating the voltage on the converted P-1, R-1, Welder, & A.C.-D.C. type **\$6.95** post paid

115 V. A. C. GENERATOR

Makes Ideal A.C. Light plant & DC Battery Charger. Stock #511 Mfg. by G.E. Rated 1250 Watts, 400 cy., 10.9 Amps. 115V. A.C. 200 Amps. 30V. D.C. Converts to dependable 115V. A.C. Light plant and D.C. Battery Charger. Gov't cost \$300.00. Instructions incl. Wt. 50 lbs. **\$22.50** NEW **\$32.50** Used, good cond.

HYDRAULIC SOLENOID CONTROL VALVE BENDIX #1560 For remote control & for hydraulic cylinders. For 24V. D.C. & Applicable for 110V. A.C. 800 to 1500 P.S.I. \$35.00 value. Instructions included. **\$3.95** ea. **\$7.50** pair

VALUABLE GEARS BARGAIN SPEED REDUCER 3:1 or 10:1 ratio 90 degree angle 1/2" spindled shaft 3 mm. holes **\$6.45** post paid

ELECTRIC MOTOR 1/2 H.P. 24V. D.C. & applicable for 110V. A.C. 2000 R.P.M. Instructions included. #4949 **\$4.95**

CUNO OIL FILTER Aircraft type. Filters oil without cartridge replacements. Just turn handle and cartridge is clean. Standard 3/8" inlet and outlet ports. STOP CHANGING OIL. Instructions included. **\$4.95** post paid

Send CHECK OR M. ORDER. PRICES F.O.B. KCMO EXCEPT when marked POSTPAID U.S.A.

BEAM ROTATOR MOTOR. Powerful, reversible Freewheel geared motor for TV aeriads, Ham, FM, etc. Light weight. Approx. 7 H.P.M. Incl. 3 mounting lugs. Applicable for 24V. D.C. and 110V. A.C. Instructions incl. Stock #572. O. Gov't cost over \$100.00. **\$12.95**

MAKES IDEAL WINCH HOIST

AIRCRAFT STARTING MOTOR operates on 12 to 32 Volts. Gives high torque, slow speed and tremendous power. Applicable for pulling or moving heavy loads. Makes ideal winch or heavy duty hoist. For belt or direct drive. Mfg. by Jack & Heintz. O. Cost over \$300.00. Ship. wt. 55 lbs. **\$9.95** f.o.b. Stock #310..... **\$9.95** KCMO.

PESCO FUEL PUMP & MOTOR Positive Displacement. Rated 350 G.P.H. at 2000 R.P.M. 15 P.S.I. Incl. motor 1/2 H.P. 24V. D.C. 7 Amp. 2000 R.P.M. & applicable for 110V. A.C. 1" pipe. **\$16.50**

ELECTRIC ACTUATOR Has a 1/2 H.P. 24V. D.C. 7500 R.P.M. reversible motor with push & pull actuator. Motor drives actuator in a 5" travel through a high reduction gear box. Ideal for remote control, lifting, lowering, etc. Complete with micro switches. Stationary load rating is 2800 lbs. & applicable for 110V. A.C. Stock #AA-LM. Instructions incl. **\$12.95**

THOMPSON MOTOR DRIVEN PUMP. Including built in motor. Applicable for 24V. D.C. & 110V. A.C. Ideal for pumping fuel, oil, hot water heating circulator, etc. Capacity 300 G.P.H. **\$8.95** Instructions incl. #1200.....

DILUTER DEMAND OXYGEN REGULATOR. "Build your own diving lung." 1800 P.S.I. O. Aeq. 885.00. **\$5.95** post paid

SOLENOID #804 Equipped with lever arm which gives a 1/2" or 1 1/2" travel. Compact, powerful as actuator & to operate locks, switches, toy applications, etc. For 24V D.C. & applicable for 110V. A.C. Instructions included. **\$2.95** Per **\$4.95** post paid. Ea.

STRATOPOWER CONSTANT DISPLACEMENT PUMPS. For Operating Hydraulic cylinders, motors on tractors, bulldozers, etc. Rated 400 G.P.H. at 3750 RPM. 1250-1400 P.S.I. Has built in relief. #37. \$150.00 value. **\$17.50** Instructions included.....

VICKERS CONSTANT DISPLACEMENT HYDRAULIC PUMP Brand New No. PF-713-20. 375 G.P.H., 3750 R.P.M. 1000 P.S.I. 410 cu. in. rev. Gov't. cost over \$100.00. Data incl. **\$17.50** post-paid

AIR OR OIL HYDRAULIC CYLINDERS Stock #11—Double action 1 1/2" Bore, 6" Stroke, 3/4" Dia. shaft. Clevis mounting base and shaft end. Capacity 1180 lbs. with 1000 P.S.I. **\$8.95** post-paid. \$80.00 value.....

Stock #17 Double Action 1 1/2" Bore 3 3/4" Stroke, 1/2" dia. shaft. Rated 1800 lbs. with 1000 P.S.I. **\$12.95** Price.....

Stock #12 Double action 4" Bore, 10 3/4" Stroke, 1/2" dia. shaft. Rated 12500 lbs. with 1000 P.S.I. Clevis mounting. O. Gov't. cost over \$300.00. **\$27.50**

FOUR WAY HYDRAULIC VALVE Poppet type Spring loaded pressure balanced Open Center in Neutral position. 1500 P.S.I. **\$7.95** post paid

No. 21 FOUR WAY HYDRAULIC VALVE Off at neutral with built in relief valve for limit of cylinder strokes. Control with 3 positions, raise, lower and hold. **\$9.95** post paid

PESCO EQUALIZER VALVE No. 397-D. New For 2 cylinders or 2 systems, will prevent uneven movement due to unbalanced **\$12.50** post load. Data incl. \$75.00 value.....

FUEL SHUT-OFF VALVE Electrically operated with built in limit switches to operate valve on and off. Port size 1/2" and 1/4" 1/8" thread. For 24V. D.C. & applicable for 110V. A.C. **\$14.50** Instructions incl.....

FOUR WAY SOLENOID VALVE Operates on 24V. D.C. & applicable for 115V. A.C. For operating hydraulic cylinder, for remote control operation, etc. 3/4" 1/8 thd. size ports. Brand New **\$9.95** \$50.00 value. #1213.....

GENERAL SALVAGE CO., 2922 E. 27 St., Dept. 754, Kansas City, Mo.

OVER 700% PROFIT!
 WITH THE **PDQ CHAMPION PHOTOMASTER**
 Makes finished pictures in 2 minutes.
 Takes and finishes 30 to 40 over-lasting, black and white or sepia photos an hour. No dark room. Guaranteed not to fade. Photos taken on "SUPER-SPEED" direct positive paper. Picture size 2 1/2 x 3 1/4 in. Complete, easy-to-operate portable photo studio. Size 4 1/2 x 8 1/2 in. Wt. 6 lbs. **700% PROFIT.** Write quick, get details about the great **PDQ CHAMPION PHOTOMASTER.**
P D Q CAMERA CO.
 1161 N. CLEVELAND AVE. Dept. PM-554 CHICAGO 10, ILL.

LAMINATED FINISH — FIGURES WILL NOT WEAR OFF

HANDY ACCURATE 6 1/2" POCKET SLIDE RULE
 At last, here's a pocket-sized, conveniently flat plastic slide rule for everyone! Easy to learn—easy to use. Not a cheap wooden slide rule but accurately made of top-quality milk white Vinylic plastic. Figures exceptionally easy to read and guaranteed not to wear off because of laminated finish. New design insures smooth movement of sliding rule—no binding. Ideal for students, technicians, businessmen, as well as engineers, architects and chemists. An unusually practical tool that can save you time and labor in making estimates or solving problems involving multiplying, dividing, proportions, roots, etc. Rule has A, B, C, C, D, T, L, S, decimal equivalent, and "equivalent-squares" scales. Comes complete with instructions. Shipped prepaid. Act now—send for yours today. **\$2.00** each
HOBEAU, 19 E. Cullerton, Chicago 16, Ill. or 3 for \$5.80

DO-IT-YOURSELF KIT SAVES YOU OVER 50%

on Aluminum Combination SCREEN & STORM WINDOW



Why bother fixing and painting old screens when it's easier to assemble a year 'round U-Fab-It-Urself Combination Window and end forever seasonal repairs? Only screw-driver and pliers needed.

Kit includes all hardware; all parts factory cut, drilled, mitered. Complete except for glass. Fab-It-Urself for year 'round economy.

U-FAB-IT-URSELF, INC.
 P.O. Box 209 (Dept. PM5) Worthington, O.

U-Fab-It-Urself, Inc.
 P. O. Box 209 (Dept. PM5)
 Worthington, Ohio
 Please send me FREE Measurement Chart and descriptive folder.

Name _____
 Address _____

UTICA[®]

UTILITY PLIERS



WITH THE
**WIDE
MOUTH**

How often have you been stumped with pliers that wouldn't open wide enough? Then here's the answer. And the rib joints on these are full forged to add strength exactly where required. Jaw surfaces extra-hardened by electronic induction for longer wear.

Look for the name "UTICA[®] No. 507." Your dealer has them or can get them for you. Size 10", only \$2.85.

U T I C A

DROP FORGE & TOOL CORP.

Utica 4, N. Y.

JOBS AVAILABLE FOR TECHNICALLY TRAINED PERSONNEL

SAVE UP TO 85% ON GOVT SURPLUS

NEW 7 to 1 HANDY HOIST

Small enough to hold in one hand, yet strong enough to lift 1000 pounds. Weighs only 1 lb. Consists of 2 pulley blocks with self lubricating bearings, 100 feet of NYLON cord, 2 NYLON slings and canvas carrying bag. Handy around the Farm, Home, Shop, as a Hunter's Game Hoist, etc. Carry one in your car for emergency.

FREE! EMERGENCY FLASHLIGHT... 12⁵⁰
With each order for a Hoist you receive a handy emergency light FREE!

NAVY SOUND-POWERED PHONE SET

An ideal emergency communication system because it requires no additional power supply. Originally used by NAVY for light deck and gunnery control. Can be used for office-to-shop, house-to-barn or garage, or any point-to-point within 1/2 mile radius. These sets are fully sound powered. A set includes 2 phones on a chest plate, 2 headsets, button switches, 35 ft. of cable. **995**

ORDER FROM THIS AD - Pay by Money Order or Check, P.O.'s accepted from D&B firms. 1/2 deposit with C.O.D.'s. Prices FOB Los Angeles.

WORLD'S MOST AMAZING BARGAIN CATALOG

320 PAGES FULLY ILLUSTRATED

Packed with SENSATIONAL VALUES in WAR SURPLUS, FACTORY CLOSE-OUTS and GENERAL MERCHANDISE!

Thousands of items for the HOBBYIST, GADGETEER, etc. Includes Hand & Power Tools, Microscopes, Binoculars, Precision Instruments, Outdoor & Sport Equipment, Photo Supplies & Cameras, Hardware, Foam Rubber, Industrial Tools, Aircraft Supplies such as - over 20,000 Hydraulic Cylinders in 61 sizes & types, also Hydraulic motors, pumps, fittings, tubing, valves, etc. Also hundreds of War Surplus Gadgets and parts.

SEND 50¢ TO COVER THE COST OF HANDLING & MAILING - REFUNDED WITH YOUR FIRST ORDER!

PALLEY SUPPLY CO. 2263 E. VERNON AVE., DEPT. PM-5
LOS ANGELES 58, CALIF.

THE ONLY WOOD GLUE THAT'S WATERPROOF



For home craftsmen who want the best, a resorcin resin is the only cold-setting glue that meets U.S. government specifications for marine laminating. Defies cold or boiling water, mould, fungus, solvents, mild acids and alkalis, extreme heat or cold and continuous outdoor exposure. Use for boats, toys, outdoor furniture - wherever strongest possible waterproof bond is desired. Write for folder.



ELMER'S

OT.B.C. Resorcin Resin
WATERPROOF GLUE

THE BORDEN COMPANY, CHEMICAL DIVISION, DEPT. PM-54, 350 MADISON AVENUE, NEW YORK 17, N. Y.



**Better
Than
Ever**

8" and 9"
Tilt Arbor
SAWS

More For Your Money!

Better in every way... larger work tables... sturdier frames... newest mechanical improvements. Darra-James engineering department is constantly working to give you more for your money.

WRITE FOR CATALOGS

TOOLKRAFT CORP., SPRINGFIELD 1, MASS.



CORBIN PADLOCK

withstands burglars' .45 cal. bullets!



Here's proof that CORBIN padlocks are the safest, strongest you can buy!

Mr. Robert M. Chesler, 10721 Tabor St., Los Angeles, Cal., writes:

"Burglars placed two .45 cal. bullets into my Corbin padlock at vital points to force it open—without success! My congratulations to you on the production of such high quality in a popular priced article."

INEXPENSIVE
—BUT WHAT
A BUY!

When YOU want to be sure . . . safe . . . really secure, insist on a **CORBIN** padlock.

55c up at better hardware stores everywhere.

CORBIN CABINET LOCK Division

The American Hardware Corporation
New Britain, Connecticut, U.S.A.

FREE! for every
**Household
Handy man!**

**101
ILLUSTRATIONS
AND INSTRUCTIONS**



Anything made of wood—and this folder illustrates 101 items—should have the water repellency, resistance against warping, swelling and shrinking—and immunity against termites and decay—made possible with Woodlife.

WOODLIFE is the original water repellent wood preservative that should be on every handyman's work shelf—along with this folder which shows how to apply Woodlife to 101 household wood-working projects.

Ask your lumber, paint or hardware dealer for Woodlife and for your copy of this informative "do it yourself" folder! or write,



Protection Products MANUFACTURING COMPANY
Dept. O Kalamazoo, Michigan
When you repair, remodel or build, ALWAYS ask for Woodlife treated lumber!

MAY 1954

Simplest, Lowest-Cost RADIANT HEAT REFLECTOR!



Shut out Summer Heat, Save Winter Fuel—with REYNOLDS ALUMINUM REFLECTIVE INSULATION

This low cost, readily installed aluminum foil bonded to tough kraft paper in walls or attic provides real insulation. Keeps winter heat in, summer heat out! Costs only about \$40 over ceilings of average 6-room house! Clean, odorless, pliable. Perfect vapor barrier, fire-retardant. Readily tacked or stapled over ceilings, under rafters, between wall studs, under ground floors. Rolls 250 sq. ft., 25", 33", 36" wide. Makes great reflectors for radiators, photolights, etc. Mail coupon for free samples.

ALUMINUM GUTTERS



Easy to install, slip joints—no soldering. Non-staining. Cost much less than other rustproof materials.

Aluminum Nails. Rustproof, never stain, stay tight.

REYNOLDS Do-It-Yourself ALUMINUM*



New kind of aluminum—easy to saw, drill, join, shape with ordinary woodworking tools. At hardware and lumber supply dealers.

*Reg. U. S. Pat. Off.

See your Building Supplies or Hardware Dealer

REYNOLDS *Lifetime* ALUMINUM BUILDING PRODUCTS

SEE "MISTER PEEPERS," starring Wally Cox, Sundays, NBC-TV.

MAIL THIS COUPON NOW!

Reynolds Metals Company
Building Products Division
2035 So. Ninth St., Louisville 1, Ky.

Send full information and FREE SAMPLES of Reflective Insulation. Also full details about

Gutters & Downspouts Nails Flashing

Name _____

Address _____

City _____ State _____



WAR SURPLUS AND OTHER BARGAINS **SAVE UP TO 90%**

PRECISION GROUND SQUARES

Production engineer's Squares. Accuracy guaranteed. Mfd. by Wright & Moore, Sheffield, Eng. Square blades hardened & tempered. Individually marked in wood box. Brand NEW. Fraction of original cost. 2"-\$2.25, 3"-\$2.50, 4"-\$2.75, 5"-\$3, 6"-\$3.25, 8"-\$4.25, 10"-\$6.25, 12"-\$8.25



1" MICROMETER Mfd. by famous European precision toolmakers. NEW. Reads in 1000's. Decimal equivalents engraved on frame. Complete with lock nut, ratchet, cut-away frame for close tolerance measuring and Spanner wrench for fine adjustments. A \$21 value. Only **\$6.95** incl. velvet lined case.

MICROMETERS Chrome plated, precision engineered, carefully tested to give long life. All new 0-1" cap. **\$2.25** ea., 1-2" cap. **\$3.50**



"HELIOS" ORIGINAL TOOLMAKERS VERNIER CALIPERS

ULTRAPRECISION - Imported. Used by machinists at Lockheed, Douglas, Boeing, GM, RCA, GE. Model 51/2E. Genuine Helios. Hardened lapped precision surfaces. 1/1000" and 1/128" graduations. Handy slide roll and thumb lock. Quick, accurate depth. A \$35 value. Satin finish. ALL NEW, just **\$6.50**. Leather carrying case, \$1 extra.

NEW P1 GENERATORS
Electric Auto-Lite. 200 Amps. 24 Volt, 2500 RPM. Dandy arc welder. Wt. 33 lbs. Approx. Govt. Cost \$450. NEW, **\$17.50** incl. easy to follow diagram.

SPECIAL CARBON PILE TYPE VOLTAGE REGULATOR Helps maintain constant current and prevents pulsation. Ideal for installation with above Generator for lighting plant. Wt. 23 1/2 lbs. NEW. Approx. Govt. cost \$90. NOW ONLY **\$4.95** POSTPAID!

SENSITIVE ALTIMETER in 10 Ft. Increments. NEW! Famous Pioneer! 0 to 35,000 ft. inches of Mercury. Tested and inspected in our own instrument lab. Guaranteed perfect. Approx. Govt. Cost \$150. NOW ONLY **\$12.95** PREPAID!

AIRESEARCH LINEAR ACTUATOR
Open and close garage doors, remote control of industrial machines, marine use, displays, etc. Motor drives actuator in a 6 1/2" travel through a reduction gear box. Wealth of gears. 24 Volt, 11 Amps, 1750 lb. lift. Wt. 8 1/2 lbs. Approx. GOVT. COST \$250. While they last - **\$5.95**.

Send 25¢ for big catalog. Bargains for everyone. Check, Money Order or Cash. 25¢ deposit on C.O.D. orders. Please P.O.B. Culver City, Calif., unless otherwise stated.

AIRBORNE SALES CO., INC. DEPT. PM554
8501 Stellar Drive, Culver City, Calif.

Also Eshelman SPORT CARS WORLD'S LOWEST PRICE 70 Miles Per Gal. Holds 1 Adult Free Literature

ESHELMAN FOR BETTER LAWNS AND GARDENS

1 1/2-3 1/2 H.P. and

Also Power Reverse. Women can operate it. Free Catalog. Writer: **ESHELMAN, Dept. 55**
119 Light St., Balto., Md.
333 N. Michigan Ave., Chicago-1, Ill.
7070 Hollywood Blvd., Los Angeles 28, Calif.

MAKES PLOWS CULTIVATES NARROWS HAULS SPRAYS SAWS DOZER MOWS CUTS ROLLS TILLS SNOW PLOW

Low as **\$69** Plus Tools

AUTOMATIC AIR COMPRESSOR

1 1/2 H.P. **\$79.00** FREE **\$12.00** QUART GUN

1/2 HP heavy duty R.I. or Cap. motor, 115-V, 60 Cy. AC. **\$23.50**
X2 Quincy 3 CFM, 100-150 lb. compressor **\$20.50**
Automatic adjustable pressure switch **\$6.50**
Tank 8x26, rubber tired wheels and handle **\$17.00**
Adjustable pressure regulator and gauge **\$6.00**
Moisture filter - **\$3.25** V-belt drive **\$2.75**
Hose and tire chuck **\$2.50** Safety valve **\$1.50**
Check valve & copper tubing **\$3.75**
Small parts shipped parcel post prepaid at above prices.

Complete 1/2 HP unit assembled, ready to use—Plus Special FREE \$12.00 value Quart External Atomizing Spray Gun with every unit **\$54.50** **\$89.00** FOB Chicago. Save **\$10.00** — 1/2 HP outfit knocked down, you assemble, free spray gun, **\$12.00** value. **\$54.50** **\$79.00** FOB Chicago **\$54.50** **\$89.00** **\$123.50** FOB Chicago. Same as above, Larger Motor, Larger Capacity. All accessories **K.D. \$199.50**

2SK-75 — 3/4 HP Motor 12x24 Stainless Steel Tank, wheels, all accessories, large 4 CFM compressor, free gun. **\$123.50** FOB
2SK-100 — 1 HP Motor 15x30 Tank Twin Cylinder 9 CFM Compressor, All Access. You assemble. Free Gun. **\$169.50** FOB
C. MARSHALL SALES, 3546 W. Fullerton Ave., Dept. P-5, Chicago 47

Every Fisherman Needs...

FAMOUS **Dayton** ORIGINAL

SNAP ON-SNAP OFF **Fishing FLOATS**

AT LEADING DEALERS in U.S.A. and CANADA!

BE READY FOR ANY FISHING OPPORTUNITY!

CARRY A **Handle-Rod**

ALONG AT ALL TIMES IN YOUR POCKET - IN YOUR TACKLE BOX GLOVE COMPARTMENT BRIEF CASE - SUITCASE PICNIC BASKET

A 5 foot precision made Casting Rod — Telescopes within its handle to just 11 inches. Will not rust. Weights only 6 oz.

\$13.50

CHAMPION PRODUCTS CO.
Muskegon, Michigan

Guide to **HOME REPAIRS**

Pays for Itself 100 Times Over

Beat the high cost of home upkeep. Save hundreds of dollars every year on carpentry, electrical, painting, plumbing and other jobs around the house with Popular Mechanics GUIDE TO HOME REPAIRS. Simplified how-to-do-it instruction and 646 pictures make all jobs, inside and out, easy. Covers construction, remodeling, modernizing, repairing that you can do yourself at small cost. 192 page cloth bound book only **\$2.50** postpaid. Order today under our money back guarantee.

POPULAR MECHANICS PRESS, Dept. PM16
200 EAST ONTARIO STREET CHICAGO 11, ILLINOIS

HELPFUL BOOKS

Send post card asking for FREE catalog

Popular Mechanics Press, 200 E. Ontario, Dept. 601, Chicago 11

ATOMIC POWER—NO! BUT WE HAVE HORSEPOWER in these ELECTRIC MOTOR BARGAINS

1/2 hp WESTINGHOUSE SUPER INDUCTION type rubber mounted — 1/2 in. shaft 1725 rpm ± 1 . . . only **\$12.50**
1/2 hp DAYTON SUPER INDUCTION type rubber mtd. shaft size 1/2 in. 3450 RPM ± 2 . . . only **\$18.50**
1/2 hp REPULSION INDUCTION type TOTALLY ENCLOSED — DUSTPROOF — switch 3/8 shaft 1725 rpm ± 3 . . . only **\$19.50**
3/4 hp Gen. Elec. capacitor type Ball brg double shafts 1/2 in. — 1725 rpm ± 4 . . . only **\$34.50**
ALL MOTORS FOB CHGO. • ALL ABOVE 110 v 60 cy AC

• **BEAT THE HEAT—WITH THESE FAN BARGAINS** •

10 INCH BLADE KITCHEN WALL FAN • WHITE GRILL • CHAIN OPERATED DOOR • GENERAL ELECTRIC POWERED • LIST PRICE \$42.50 special offer ± 5 postpaid **\$23.50**

BUILD YOUR OWN WINDOW FAN • ATTIC FAN • HOUSE FAN WITH THESE motor & blade combinations

12 inch BLADE • 110 v AC motor: set only . . . **\$7.50**
15 inch Aircraft blade 1/6 hp AC motor. . . . **\$10.00**
24 inch Paddle blade 1/2 hp AC motor. . . . **\$20.00**

Write for CIRCULAR: Listing Motors; ALL SIZES; Fans and Air Compressors—ALL SIZES.

5 BIG POWER TOOLS
in ONE

8" TILTING TABLE SAW

30" LATHE

HORIZONTAL DRILL PRESS

GRINDER

SANDER

RETAIL PRICE \$125.00
FACTORY TO YOU \$79.95

SUPERSHOP is a PRECISION-BUILT WORKSHOP. 100% ball bearing. All running parts precision ground. Big capacity. Extra rugged. Amazing value. Write for FREE catalog.

BUY ON EASY PAYMENTS

POWER TOOLS, INC. 159 YATES AVENUE
BELOIT, WISCONSIN

VERTICAL DRILL PRESS

AMAZING TOOL BARGAINS!

75 MOUNTED WHEELS AND MINIATURE CUTTERS \$4.50
Regular \$11.00 Post-Paid Value

For cutting and grinding on wood, metal or plastic. Includes 26 mtd. wheels and points on 3/32" shanks; 24 miniature cutters on 3/32" shanks; 25 short shank min. cutters. Will fit all electric drills and hand grinders.

FLEXIBLE SHAFT — ONLY \$4.95
Post-Paid Value

Fits all electric drills & hand power tools. 35 3/4" long. Oilite bearings. Core of specially wound, high carbon steel wire in flexible steel casing. Will accommodate tool shafts up to 1/8" dia. For lathes, electric drills, etc.

SCHUPACK SUPPLY CO. 7331 Cottage Grove, Dept. M-54
Chicago 19, Ill.
New Illustrated Catalog 10c

How to Build Your Own GARAGE

Save as Much as 50% of Usual Construction Costs

Get Popular Mechanics' brand new book *How to Build Your Own Garage* by Wayne Leckey, Assistant Shop Notes Editor, and find out how you can build your own garage at savings of 50% of usual cost. Leckey tells in famous step-by-step instructions and shows in big, clear photos, drawings and diagrams how to perform every building operation from laying the concrete to installing the final trim. There are 25 designs. Brick, frame, and concrete block fully covered. Send \$3.50 for your copy. 7-day money back guarantee.

POPULAR MECHANICS PRESS, 200 E. Ontario, Chicago 11, Ill.

NEW TAPERED REAMER
HUNDREDS OF USES AT HOME, WORK!

OPEN UNDERSIZE HOLES quickly, easily. Here's the tool you always need and never have. A "must" for every craftsman. Why risk breaking expensive drills opening undersize holes? A few turns with this new tapered reamer opens a 1/8" hole up to 1/4" in metal, wood, plastic, etc. Useful in aligning two holes to be bolted or screwed together. Reams undersize holes from 1/8" to 1/4"

ONLY \$1.25 POSTPAID

A TOOLBOX NECESSITY

Made of finest tool steel, correctly hardened and ground. Unbreakable plastic handle. Order yours today.

MASTER MFG. CO., Dept. PM, Buffalo 14, N. Y.

For radio, TV and sheet metal work

For quickly aligning holes!

Hundreds of home handyman uses!

Floor Surfacing Contractors NEEDED!



- ★ BIG PAY
 - ★ FULL or PART TIME
 - ★ AGE No Barrier
 - ★ Minimum Investment
- BE YOUR OWN BOSS**

Highly respected profession offers you unusual opportunity to *be your own boss!* Thousands of men from 18 to 80 have found financial security and happiness in this phase of building and remodeling. Pay scale is high—many earn \$50 a day and more. Men even with physical handicaps enjoy this pleasant year 'round work. No schooling or special skill required. Only small investment in sander gets you started. Send for booklet "Opportunities in Floor Surfacing", enclosing 25c in coin or stamps to cover handling.

SEND..

AMERICAN

FLOOR SURFACING MACHINE CO.
535 So. St. Clair St., Toledo 3, O.

Do-It-Yourself LUMBER CATALOG

FEATURING AMERICA'S FINEST FURNITURE AND CABINET LUMBER FOR THE HOME SHOP CRAFTSMAN

Now you can buy your "Do-It-Yourself" Lumber in small quantity orders of \$20 or more. Send for new 32-page, net price catalog which contains detailed information on 16 species of Furniture Lumber, Plywood, Dowels, Turning Squares, etc., as used by the home craftsman.

● For complete catalog, send 15c to cover handling and mailing costs. Mimeographed Price List sent free.

HARDWOOD CORPORATION OF AMERICA E. L. DIVISION
Box 1091, Dept. M Asheville, N. C.

I enclose 15c for "Do-It-Yourself" lumber catalog.

Name.....
Address.....
City..... Zone..... State.....

WISE-GRIP SERVES AS COMPLETE TOOL KIT FOR TEEN-AGE MOTOR SCOOTER OWNER!



"All my repairs—and there are lots of them—are done with my Wise-Grip. I've even filed the lever tip to use as a screwdriver! At high school I stow my Wise-Grip in my pocket, carry it with me all day for safe keeping. Without it, I couldn't keep my scooter running. What an all-around 'tool kit' it is!" — M. C.



WISE-GRIP WRENCH

DOES MORE JOBS EASIER THAN ANY OTHER TOOL!

True stories like this show why Wise-Grip is the **HANDIEST** tool of all! A squeeze of the hand **locks** these powerful jaws onto work with *Ton-Grip*. Pulls, bends, turns, twists, ratchets, cuts — **WON'T SLIP**. A whole tool kit in one trim tool! At your dealer.

7W, 7" \$2.25
10W, 10" 2.60

Made only by PETERSEN MFG. CO., DEPT. M-5 DE WITT, NEBR.

EASY MONEY FOR YOU!
Sell the Wheelhorse.
Dealerships open! Write today

Wheelhorse

Makes gardening easier — adds to your leisure!



FREE Catalog! Send Postcard today!

Only **\$149.50**
2 h.p. model

You'll buy a Wheelhorse when you compare price... construction... design and ease of handling! Easy to change attachments help you plow, cultivate, harrow, haul, spray, mow, saw, cut, roll, plow snow. Guaranteed! 2, 2½, 3 and 3½ h.p. models. Write!

POND COMPANY

2643-P5 Dixie Way North, South Bend 17, Ind.

This Can Save Your Life

THE FINEST SAFETY DEVICE EVER INTRODUCED TO THE AUTOMOTIVE INDUSTRY
TRACTION MASTER



- Eliminates Drive Line Snap
- Stops Your Car up to 40% Faster
- Prevents Sudden Forward Weight Transfer in Quick Stops
- Stabilizes Your Car if a Blowout Occurs
- Stabilizes Your Car on Rough Roads
- Gives More Stability on Turns
- Gives 50% More Traction on Wet Roads and Snow
- Increases Brake Lining Life Up To 50%
- Increases Tire Mileage up to 33 1/3%

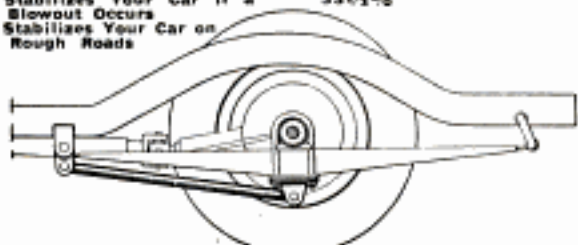

How Traction Master Works

The rear springs are the only things that hold the rear end under your car, and the flexible spring cannot cope with the torque surge coming down the drive line. When power is applied to move the car forward the rear end wants to rotate around its own axis. The spring actually bends in an arc in the forward half of the spring causing the right rear wheel to spin. Result: Loss of power and increased tire wear. **TRACTION MASTER PREVENTS THIS ACTION!** When the brake is applied, the opposite happens. The rear end is thrown downward around its own axis causing the rear half of the rear spring to bend in an upward arc. The rear wheels become unladen with weight, and most of the braking power is transferred to the front wheel brakes. Result: More rear wheel slippage and excessive tire wear. **TRACTION MASTER PREVENTS THIS ACTION!**

Miles Per Hour	Stopping Distance After Brakes Are Applied		No. of Feet Braking Improvement
	WITHOUT Traction Master	WITH Traction Master	
10	5.0	4.4	0.6
20	20.0	17.6	2.4
30	45.0	39.0	6.0
40	80.0	68.0	12.0
50	125.0	93.0	32.0
60	180.0	117.5	62.5

CAN BE SELF-INSTALLED WITHOUT SPECIAL TOOLS
WRITE FOR COMPLETE INFORMATION
AUTO-MASTER CORPORATION **\$34.95**
165 Eleventh Street (Dept. PM), San Francisco, California

Also Eshelman SPORT CARS WORLD'S LOWEST PRICE 70 Miles Per Gal. Holds 1 Adult Free Literature

ESHelman BOAT TRAILER

World's Lowest Price ONLY \$79
Easy Load & Easy Haul & Easy Launch
Write for Catalog
Top quality welded steel construction. Shipped complete with Hi-Speed wheels, tires, tubes, hitch, etc. Write **ESHelman CO., Dept. BT-105** 119 Light St., Baltimore 2, Md.; 333 N. Michigan Ave., Chicago 1, Ill.; 7070 Hollywood Blvd., Los Angeles 28, Cal.

STRATEX DRAFTING FURNITURE FITS TIGHT BUDGETS!

It costs less to buy the best when you buy direct! Guaranteed StrateX equipment fits any wallet, any space, any requirement — lovely to look at too! Free data.

STRATEX INSTRUMENT CO., INC.
1861F HILLHURST, LOS ANGELES 37, CALIF.

EQUIP YOUR CAR WITH AN AIR CONDITIONER

BUILT FROM COMPLETE KIT FOR \$164.70

Drive in cool comfort. Banish dust and noise. Easy-to-install kit includes 2-ton capacity compressor and all essential parts—FREE LITERATURE.
SEELEY CO. 3716 BELMONT DEPT. 100, CHICAGO 18, ILL.

MAKE YOUR OWN FOUNTAINS, LAKES, RIVERS, WINDOW DISPLAYS

With New Miniature Water Pump
Here's real action for window displays. Xmas tree layouts or the home job. Pump only 4 1/2" high—3 1/4" wide. Threaded for pipe, or uses 3/8" rubber tubing. Operates in 1" of water. 110 A.C. 60 Cycle. 1/250 H.P. 50 gals. per hr. Furnished complete—ready to work—your satisfaction absolutely guaranteed or your money back. **\$9.95**
MOORE MANUFACTURING COMPANY
Swedesboro 15, N. J.

Say You Saw It in Popular Mechanics

MAKE YOUR OWN POWER LAWN MOWER

With this DRIVE CUTTER ASSEMBLY

For those who desire to build their own power mower. Complete with 20" blade and double ball-bearing drive. Only \$13.95.
Send check or M.O. Add 50c to cover handling and shipping.

SEND FOR FREE Power Mower Catalog **ATLAS KEEN MOWER** ONLY \$13.95
229 Southwest Blvd., Kansas City 8, Mo.

PORTABLE LIGHT PLANTS



600-700 Watt PUSH BUTTON START
115 v. 60 cye. AC. Easy starting. 2 hp. easy-starting Briggs gas engine. No wiring necessary. Plenty of current for any oil burner, freezer, brooder, emergency lights, etc. which require up to 700 watts. Ideal for Civil Defense, Fire Dept., trailers and camps. Complete with Voltmeter and built-in winding to charge 6 v. auto batteries. Item 24. Wt. 73 lbs. Be prepared if war or storm knock out power lines. Reg. \$275. value **\$143.50**
700-800 Watt Plant (Item 44) same as Item 24 but larger engine. **\$169.95**
1000-1200 Watt Plant (Item 45) same as Item 24 but larger generator and engine with 50% greater output. **\$199.50**
1500-1700 Watt Plant (Item 20) similar to Item 24, but has three times more capacity. Wt. 173 lbs. Factory Price. **\$279.50**
LITTLE GIANT—350 WATT (Item 27) 115 v. DC 1 1/2 hp. Briggs engine. Perfect for lights, radios, small power tools. **\$99.75**
Wt. 65 lbs. Factory price.

BUY DIRECT FROM FACTORY SAVE MIDDLEMAN PROFITS

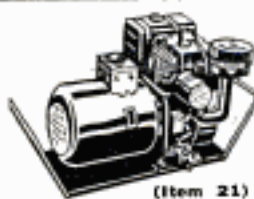

MASTER-LITE 2500 Watt Plant
110/120 v. 60 cye. AC. A powerful plant, ruggedly constructed and yet designed for easy portability. Can be started by rope or built-in 12 v. electric push button starter. Built-in winding to charge batteries. Powered by a big 5.10 HP Briggs engine, complete with all accessories. Includes control box, voltmeter, and handy plug-in power receptacle. An ideal plant for permanent or stand-by service. Wt. 225 lb. Reg. price \$645.00. **\$329.50** (Item 21) Factory Price.

DYNA-POWER 3500 WATT PLANT
Push Button Start 115 v. 60 cye. AC. Built-in battery for charging. Powered by a sturdy 8 hp. air-cooled Wisconsin engine. A powerful plant built for continuous duty, yet compact and portable. Integral positive drive — an exclusive Master Mechanic engineering feature. Includes control box, plug-in power receptacle and voltmeter. Wt. 270 lbs. **\$379.50** (Item 23) Factory special.

6000 WATT PLANT PUSH BUTTON START.
115-230 v. 60 cye. AC. A big, heavy duty plant powered by an air cooled V-type 4-cyl. Wisconsin engine direct drive connected. Plenty of current for ranges, water heaters, oil burners, stokers, pumps, refrigerators, freezers, lights, machinery, etc. Affords both 115 and 230 v. current simultaneously. 1800 rpm generator. Ideal for continuous duty. Ideal for continuous heavy winding assures years of trouble-free service. Quiet and smooth running. Complete with duplex power receptacle, power distribution box and voltmeter. Wt. 735 lb. Reg. \$1395. Factory price... **\$899.50**
Model MMSO, 5000 Watts, similar plant powered by 2 cyl. Wisconsin engine. **\$795.00**
We make fully automatic controls to operate any of the above light plants. Write for details. We make all sizes up to 25,000 Watts.

FROM FACTORY TO YOU

GIANT 2000-2500 WATT PLANT
110-120 v. 60 cye. AC. Absolutely the best made — exclusive dynamically balanced armature; heavy windings develop up to 5000 watt overload for motor starting. Skid mounted — portable. Powered by an easy starting Briggs or 6 HP Wisconsin engine—complete with all accessories; engine easily disconnected for other uses. Voltmeter, big outlet box, no wiring necessary. Ample current for all purposes. Factory warranty. (Item 31) Wt. 210 lb. Reg. price \$585. Special at... **\$299.50**
Same plant with electric self starter (Item 31a)..... **\$359.50**
Generator only and control box..... **\$169.50**



POWER-FLO 3000-3500 WATT
115-230 v. 60 cye. AC. A rugged power plant for heavy duty use. Duplex power distribution provides both 115 v. and 230 v. output at the same time if desired. Powered by a big 8 HP Wisconsin engine with triple belt drive. Has built-in overload protection. A dependable plant for either standby or regular service. Equipped with electric self-starter. (Can also be started by rope) and plug-in outlet box. (Item 198) Wt. 310 lbs. **\$399.50** Factory price. **\$239.50** GENERATOR ONLY belt driven.



CONDITION-AIRE EXHAUST FANS
Heavy welded frame, pre-drilled for easy mounting—just cut opening and bolt in place. Efficient propeller type blades move huge volume of air quietly and effortlessly. Continuous duty, slow speed motors. Ideal for barns, attics, chicken houses, restaurants, garages, etc. Can be operated manually or with thermostat. Compare our unbeatable factory prices!
Size HP CFM Wt. Item
10" 1/2 2925 19 lb. 365a **\$27.95**
18" 1/4 3600 27 lb. 365b **\$31.95**
20" 1/4 4100 30 lb. 365c **\$39.95**
SHUTTERS—open automatically. 16" wt. 10 lb. **\$9.00**; 18" wt. 12 lb. **\$10.25**; 20" wt. 14 lb. **\$11.25**. **THERMOSTATS**: BARN type (range 40°-60°) Wt. 2 lb. **\$6.95**; ATTIC type (50°-90°) Wt. 2 lb. **\$11.95**

MASTER GARDENER SELF-PROPELLED

It's a plow It's a rotary tiller
It's a power sickle It's a bulldozer
It's a cultivator It's a lawn mower
Where else can you get a power tool that does so many jobs? Works for you year 'round. Prepares mellowed, deep seeded beds without labor. Built-in power take-off to drive pumps, saws, generators, etc. Safety clutch — can't burn out. New gear tread tires assure non-slip drive. The Master Gardener performs better — does more than tractors costing twice as much. Converts in minutes to Tiller, Power Sickle, etc. Basic self-propelled tractor with Briggs **\$119.50**
and Stratton engine. Only
Rotary Lawn Mower..... **\$42.50**
Sickle Bar Mower..... **\$42.50**
Lawn Mower Hitch..... **\$4.50**
Furrowing Tool \$8.75 Rotary Tiller..... **\$15.75**
Cultivator..... \$8.75 Disc Harrow..... **\$15.00**
Snow Blow..... \$38.50 Plow..... **\$15.00**
Freight prepaid to most areas. Easy payment plan available.



52 pc. SOCKET SET
Highest quality, guaranteed non-breakable sockets made by Husky. Beautifully matched chrome finish. All wall alloy absolutely the best. Contains a complete set of 38 sockets in 1/2" drive, 3/4" drive and 1 1/4" drive, plus all necessary extensions, handles, speeders, reversible ratchets, etc.; all unroad. Guaranteed against breakage. A beautiful set of tools that will handle any job; in a big doghouse sized box. Wt. 17 lbs. (Item 205) List price \$62.90. Factory special... **\$27.50**
44 Pc. SOCKET SET
(Item 506) Same unconditionally guaranteed, non-breakable sockets as above. Complete range of 21 sockets from 3/8" thru 7/16" (1/2" drive) & 7/16" thru 1-1/16" (1/2" drive). Two extensions, reversible 1/2" ratchet, 3 drift punches, sliding "T" handle, all angle coupler, 1/2" speeder, 3/4" breaker, 5 pc. high chrome alloy combination wrench set and 8 pc. offset wrench set in big doghouse tool box with ample room for other tools. Reg. \$49.50. Wt. 16 lb. **\$21.95**
37 Pc. SOCKET SET
(Item 507) Contains a complete set of 17 sockets from 5/8" thru 1 1/2" (1/2" drive) and 7/16" thru 1-1/16" (1/2" drive), 1 extension, reversible 1/2" ratchet, adapter bit, sliding "T" handle, 1/2" handle, 1/2" speeder, 5 pc. alloy combination wrench set, 8 pc. Allen wrench set and a big doghouse tool box. We challenge anyone to match this value. **\$16.95** Easily worth \$41.95. Wt. 14 lbs.



HEAVY DUTY D-C ARC WELDER
Use as portable or shop welder. Up to 300 amps. Senior model. Made for years of trouble-free, continuous service. Will handle light or heavy jobs. Easily works up to 3/4" plate using 1/4" rods. Built-in air cooling system. Arc is easy to strike and hold, because of specially designed arc stabilizer. Hi-lo switch and dial control gives wide range of welding heats. Run welder at 2600 rpm, with tractor, jeep or 15 hp. gas engine, or 7 hp. elec. motor. Complete with instructions, guar. and triple V belt or flat pulley. You can't buy a better welder. Wt. 110 lbs. \$400 value at **\$99.75**
DUAL CONTROL MODEL, same as above but with built-in dual rheostat for low heat soldering, brazing. **\$119.50** Special.

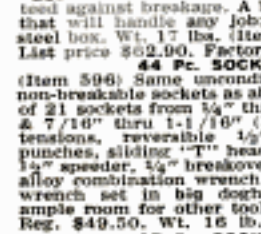

WELDING KIT Two 10 ft. leads, welding helmet, electrode holder, ground clamp, sold only with welder at **\$10.50**

EXTENSION CORD

(Item 16a) Heavy duty, made of Buna rubber insulated #14-2 conductor, stranded wire enclosed in a treated braid jacket. So tough that you can drive over it. Use indoors or out. Resists oil, grease or water. Extends electricity up to 400 ft. without voltage drop. Complete with heavy rubber plug and outlet. (Item 16c) **\$1.99**
(Item 16) 40 ft. 2 1/2 lbs. **\$1.99**
Combination 2-40 ft. and 1-20 ft. (total 100 ft.)..... (Item 16c) **\$4.95**
NEOPRENE CABLE #14-2 (Item 185) Heavy duty, very flexible, 20 year quality. Wt. 9 lbs. 100 ft. Complete with rubber plug and outlet. A terrific buy at only **\$8.95**
NO. 12-2 POWER CABLE. Very flexible rubber covered, special outside shield for grounding power tools, etc. 50 ft. (Item 199) wt. 8 lbs. **\$6.95**. 100 ft. (Item 200)..... **\$12.95**

MASTER AIR COMPRESSOR

COMPARE! This is the only compressor built with a NO RUST stainless steel tank. Safe up to 500 lbs. (Item 209) High pressure type for large volume of air for heavy duty service. For paint spraying, inflating truck & auto tires, greasing & the hundreds of other jobs done by compressed air. Piston type. 2" bore compressor with built-in air filter. Master built with high strength alloys and precision bearings. Tank, 12"x24", 2100 cu. in. cap. Equipped with automatic switch that starts and stops motor to maintain desired pressure (up to 150 lbs.) and check valve, safety valve, gauge, shut-off valve, 20 ft. air hose and tire chuck. Beautifully balanced on ball bearing wheels and rubber tires. Don't take chances with used or surplus equipment. Our compressors are factory new and are guaranteed SAFE. Low factory prices. With 1/2 HP., 110 v. AC motor. **\$109.50** Reg. \$175. (Item 209)



HEATING & VENTILATING FAN

(Item 10) Easily installed in furnace pipes. Forces even heat to all rooms. Over range removes kitchen smoke and odors. Powerful, continuous duty motor, 110-120v. AC. Mount in wall or ceiling to ventilate any area. Quiet, super-efficient fan moves huge volume of air. (400 to 600 CFM).
8" Fan, wt. 5 lb. **\$6.85**
10" Fan, wt. 6 lb. **\$7.85**
12" Fan, wt. 7 lb. **\$8.85**
14" Fan, wt. 8 lb. **\$9.85**
HEAVY DUTY FAN. Semi-enclosed motor, suitable for spray booths, restaurant exhausts, poultry houses, etc. 10" Fan, wt. 8 lbs. (Item 10E)..... **\$11.95**
12" Fan, wt. 10 lbs. (Item 10D)..... **\$12.95**

AIR COMPRESSOR ACCESSORIES
Pressure Gauge, range 0-160 lbs. 1/4" pipe thread connection 2" face... **\$1.50**
Check Valve, solid bronze, 200 lbs. pressure, works in all positions. 1/2" or 3/4" pipe threads, (specify)..... **\$3.35**
Pressure Regulator, solid brass, std. 1/4" pipe thread, reduces any pressure to a range of 0-50..... **\$3.75**
Pop (safety) Valve, adjustable from 0-200 lbs. 1/4" pipe thread..... **\$1.40**
SPECIAL... All four above..... **\$8.95**
Pressure Switch for pumps and compressors, 0-85 lbs., \$5.95; 0-150 lbs., with unloader (3 HP), \$10.95; 0-200 lbs. (5 HP), \$12.95
COMBINATION TYPE SPRAY GUN (Item 223) Precision made, converts in seconds from internal mix (for spraying heavy house or barn paints) to external mix (for spraying fast drying lacquers and synthetic enamels.) Conversion is made simply by changing nozzles and inserting an adaptor plug. Complete with 4 nozzles, including angle nozzle for spraying floors and ceilings. Wt. 4 lbs. **\$12.95**
Heavy Duty Spray Gun Internal mix type for spraying heavy paints. (Item 121) 3 Gal. Tank with 10' air & paint hoses **\$22.50**



Send check or M.O. Prices f.a.b. Factory. 10 day Money back guarantee. SEND 10c for... **1954 Catalog**

MASTER MECHANIC MFG. CO., DEPT. 100

Burlington, Wis.



SOUTH BEND

13" Precision Lathes

**for accurate,
low-cost machining**

These lathes are popular in the toolroom, production shop, or wherever varieties of precision parts are machined. Users prefer them for their simplicity and practically effortless handling. Job set-ups and tooling changes are made so quickly and easily that down-time is held to a minimum. A very complete line of attachments simplifies tooling. Send coupon for complete information.

SPECIFICATIONS

Swing — 13½" over bed and saddle wings, 8" over cross slide.

Distances Between Centers — 28¼", 40¼", 52¼" maximum.

Collet Capacity — 1" maximum (Collets interchangeable with South Bend 10"-1" Collet, 14½", 16" and 16-24" lathes).

Spindle Bore — 1½".

Spindle Speeds — Eight, 40 to 940 r.p.m., approximate.

Power Longitudinal Feeds — 48 R.H. or L.H., .0015" to .0841".

Power Cross Feeds — 48, .0006" to .0315".

Thread Cutting — 48 R.H. or L.H. pitches, 4 to 224 per inch.

Send For This Book!

Every machinist needs "How to Run a Lathe." This helpful handbook contains 128 pages and over 365 illustrations and diagrams on all phases of lathe operation and care. Price postpaid 50 cents.





**Can I get it?
When? How?**







Yes—you can get most any South Bend product immediately from our distributor's stocks in principal cities. Items not stocked, shipped promptly from factory.

Three ways to order:

1. See or telephone nearest distributor.
2. Order by mail from your distributor.
3. If no distributor is nearby, order direct from factory.

South Bend machine tools with accessories may be purchased on convenient terms up to 24 months.

SEND INFORMATION CHECKED:

<input type="checkbox"/>  9" and 10" BENCH LATHES	<input type="checkbox"/>  10" to 16-24" FLOOR LATHES	<input type="checkbox"/>  DRILL PRESSES	<input type="checkbox"/>  TOOL GRINDERS
<input type="checkbox"/>  ½" & 1" Collet TURRET LATHES	<input type="checkbox"/>  7" BENCH SHAPERS		

Name _____

Street _____ City & State _____

Building Better Tools Since 1906 • SOUTH BEND LATHE • South Bend 22, Indiana





...all's quiet ON THE WATER FRONT!

THERE goes the dawn fishing patrol! But *this time* not a soul was wakened to curse them on their way! The difference is *Whispering Power*, by Evinrude... and light-sleeping cottagers will tell you it's the greatest step forward in outboard design of our time. We'd like you to see, and hear, and *TRY* it—this new, quiet, vibrationless Fleetwin *Aquasonic*... for *the biggest thrill of all* is reserved for the man who holds the steering handle! There's no "wrist tingle"—no dancing tackle box—no hull quiver! And you find you can talk, at last, without letting the world in on your conversation! And there's so *much more*—*big-motor* features like Gearshift, and Cruis-a-Day Tank, and Auto-Lift Hood. And *big-motor* performance that planes your boat! 7.5* horsepower—only 49 pounds!

SEE YOUR EVINRUDE DEALER—he's listed under "Outboard Motors" in the yellow pages of your phone book. Let him show you the complete Evinrude line for '54. Four great motors—smoothest, quietest in each power class—3 to 25 H.P.—the right motor for every boat! For free catalog write EVINRUDE MOTORS, 4353 North 27th Street, Milwaukee 16, Wisconsin.

IN CANADA, Manufactured by Evinrude Motors, Peterborough



CATALOG FREE! Write for big full-color catalog of the complete Evinrude line. Send for it today!

Evinrude

quiet OUTBOARD MOTORS



7.5 O.B.C.
certified brake H.P.
at 4000 R.P.M.

Copyrighted material



"Yessir! the Ol' Redhead has changed
to **CAMELS**"
(choice of many of his friends
in the Major Leagues!)

I'VE TRIED
'EM ALL. I'VE CHANGED
TO **CAMELS** FOR MILDNESS AND
FLAVOR THAT AGREE WITH ME
BEST. YOU TRY CAMELS, YHEAR?

Red Barber

RED BARBER, Famous Sports Announcer



BOB LEMON, Cleveland Indian pitcher, says, "Camels are mild—the flavor's great!"



MICKEY MANTLE, Yankee slugger, tried Camels for 30 days. "I'm for Camels!"



HARVEY KUENN, Detroit Tigers' flashy shortstop, says: "I go for Camels' flavor!"



MEL PARNELL, Red Sox pitcher, is a long-time Camel fan. "I'll never change!"



RED SCHOENDIENST, Cards' second baseman, says, "I'll take Camels' mildness!"



TED KLUSZEWSKI, Cincinnati Reds' slugging infielder, says: "Camels are richer!"



WARREN SPAHN, Braves' hurler says, "I'm for Camels' cool mildness!"



GRANNY HAMNER, Philadelphia Phils, says Camels have the "best flavor"!



EDDIE LOPAT, Yankee hurler, has smoked Camels for years. "Can't beat 'em!"



MICKEY VERNON, Senators' 1st sacker, says, "Camels' flavor agrees with me!"

**CAMELS FIRST IN SALES —
NOW LEAD BY RECORD**

50⁸/₁₀%

Latest published figures* from the leading industry analyst, Harry M. Wootton, show Camels now 50⁸/₁₀% ahead of the second-place brand — biggest preference lead in history!

*Printers' Ink, 1964



R. J. Reynolds
Tobacco Co.
Winston-Salem, N. C.

For Mildness... for Flavor...

**Camels agree with more people
than any other cigarette!**

● Year after year, Camels increase their popularity—lead over the second-place brand! Listen to Major Leaguers — listen to smokers everywhere—and you'll know why more people get more pure pleasure from Camels' mild, flavorful blend of costly tobaccos! Try Camels for 30 days — and see!